



HAL
open science

Damage Identification and Estimation of Geometry Damage Properties using Vibration Based Structure Health Monitoring

Anurag Dubey

► **To cite this version:**

Anurag Dubey. Damage Identification and Estimation of Geometry Damage Properties using Vibration Based Structure Health Monitoring. Engineering Sciences [physics]. INSA Centre Val de Loire, 2021. English. NNT: . tel-04787717

HAL Id: tel-04787717

<https://hal.science/tel-04787717v1>

Submitted on 18 Nov 2024

HAL is a multi-disciplinary open access archive for the deposit and dissemination of scientific research documents, whether they are published or not. The documents may come from teaching and research institutions in France or abroad, or from public or private research centers.

L'archive ouverte pluridisciplinaire **HAL**, est destinée au dépôt et à la diffusion de documents scientifiques de niveau recherche, publiés ou non, émanant des établissements d'enseignement et de recherche français ou étrangers, des laboratoires publics ou privés.

ÉCOLE DOCTORALE
ÉNERGIE, MATÉRIAUX, SCIENCES DE LA TERRE ET DE L'UNIVERS

LABORATOIRE de Mécanique Gabriel Lamé

THÈSE présentée par :
Anurag DUBEY

soutenue le : **22 Avril 2021**

pour obtenir le grade de : **Docteur de l'INSA Centre Val de Loire**

Discipline/ Spécialité : **Génie Mécanique**

**Identification des Dommages et Estimation des
Propriétés des Dommages Géométriques par
Surveillance de l'État de la Structure Basée sur les
Vibrations**

THÈSE dirigée par :

Roger SERRA
Vivien DENIS

Maître de conférences, HDR, INSA Centre Val de Loire
Maître de conférences, INSA Centre Val de Loire

RAPPORTEURS :

Thien-Phu LE

Maître de conférences, HDR, Université d'Évry-Val
d'Essonne

Jean-Michel GENEVAUX

Professeur, Université du Maine

JURY :

François GUILLET

Professeur, Université Jean Monnet Saint-Étienne

Massimiliana CARELLO

Professeur, Politecnico di Torino

Jean-Michel GENEVAUX

Professeur, Université du Maine

Thien-Phu LE

Maître de conférences, HDR, Université d'Évry-
Val-d'Essonne

Vivien DENIS

Maître de conférences, INSA Centre Val de Loire

Roger SERRA

Maître de conférences, HDR, INSA Centre Val de Loire

L'Institut National des Sciences Appliquées (INSA) Centre Val de Loire

Doctoral School of Energy, Materials, Earth and Universe Sciences

Doctoral Thesis in Mechanical Engineering

**Damage Identification and Estimation of
Geometry Damage Properties using Vibration
Based Structure Health Monitoring**

Anurag DUBEY

Defended : 22 April, 2021

Prepared in the Laboratoire de Mécanique Gabriel Lamé EA 7494, Blois

Examination Committee :

President :	François GUILLET	Professor, Université Jean Monnet Saint-Étienne
Reviewers :	Thien-Phu LE	Associate Professor, HDR, Université d'Évry Val d'Essonne
	Jean-Michel GENEVAUX	Professor, Université du Maine
Examiner :	Massimiliana CARELLO	Professor, Politecnico di Torino
Supervisor :	Roger SERRA	Associate Professor, HDR, INSA Centre Val de Loire
Co-supervisor :	Vivien DENIS	Associate Professor, INSA Centre Val de Loire

I dedicate this thesis to my loving parents and my brother

“Hope is the thing with feathers
That perches in the soul
And sings the tune without the words
And never stops at all.”
— *Emily Dickinson*

Acknowledgements

First of all, I would like to thank my thesis supervisors, Dr. Roger SERRA, HDR and Dr. Vivien DENIS, MCF at INSA Center Val de Loire, Blois, France. I am very grateful to them for having supported me throughout the duration of my thesis, and for their valuable time, which have given to me for the progress of my research work.

I would like to thank the Conseil Région Centre Val de Loire, France and INSA Centre Val de Loire, France for having provided the funding, and doctoral contract for this thesis. I would also like to thank the Laboratoire de Mécanique Gabriel Lamé for all the resources provided. Meanwhile, I am thankful to my supervisors who gave me an opportunity to complete my doctoral study at INSA.

I would also express my sincere gratitude to Dr. Michel GRATTON, MCF and Mr. Frédéric MABILAT, at INSA Center Val de Loire, Blois, France having provided me the courses and support to teach at INSA Centre Val de Loire.

I would like to thank my supervisor Dr. Vivien DENIS, MCF and my friend Mr. Karl BOUCHER, having motivated me to learn and speak French language during my stay and the completion of this thesis.

I must also thank my colleagues Mr. Friday ARCHIBONG, Ms. Sonya REDJALA, Mr. Olawale Monsur SANUSI, Mr. Abdoulaye Haroun BOUKOUN, and Ms. Xiaolin LI and other candidates at the LaMé laboratory, who have helped me during the journey of this thesis.

I would also like to express my sincere gratitude to former Assoc. Prof. (Dr.) Varinder Kumar MITTAL at BITS Pilani, India and Amity University, Noida, India and Dr. Pradeep MISHRA at JNKVV, Hoshangabad, India for having encouraged me to pursue my career in research.

I obviously do not forget to thank my family, my mother Mrs. Aparna DUBEY, my father Mr. Rajendra Kumar DUBEY and my brother Mr. Anudeep DUBEY and my Aunt Mrs. Poonam TIWARI who have always supported me, and have always encouraged me to grow in life.

Résumé

Si des dommages ne sont pas détectés et atteignent une taille critique, des effondrements soudains et des pannes catastrophiques peuvent survenir. L'une des méthodes de surveillance les plus appropriées pour définir la présence de dommages et évaluer la structure est la surveillance de l'état de la structure basée sur les vibrations. Premièrement, la recherche se concentre sur une technique d'identification des dommages basée sur les changements de fréquence entre une structure de poutre saine et endommagée. Un algorithme basé sur le Coefficient de Décalage de Fréquence est proposé, et la sensibilité des fréquences naturelles est étudiée. L'effet de l'incertitude sur les fréquences propre (0.1%, 0.2% et 0.3%) dans le cas endommagé est testé, et des échantillons sont utilisés pour estimer la position et la sévérité moyennes des dommages. Deuxièmement, l'objectif de cette recherche est de corrélérer le type possible de dommages géométriques avec l'évaluation de la réduction de la rigidité en flexion à l'aide de la poutre encastré-libre d'Euler Bernoulli. Pour atteindre cet objectif, la corrélation numérique entre les simulations de modèles d'éléments finis 2D et 3D a été réalisée pour obtenir une bibliothèque de dommages comparant le pourcentage de réduction de la rigidité en flexion et les dommages géométriques tels que les rectangles et les trous. Enfin, différents cas endommagés sont examinés dans les différentes parties le long de la poutre avec les changements de positions d'endommagement, de type de géométrie d'endommagement, de valeurs d'endommagement et d'endommagement simple et double, etc. La poutre expérimentale avec des dommages géométriques réels est testée pour localiser, quantifier et classer les propriétés des dommages géométriques.

Keywords: analyse modale, recalage de modèle, évaluation des dommages, propriétés des dommages géométriques, coefficient de décalage de fréquence, incertitude sur la fréquence propre, surveillance de l'état de la structure basée sur les vibrations.

Abstract

If damages remain undetected and reach a critical size, sudden collapses and catastrophic failure can happen. One of the most suitable monitoring methods to define the presence of damage and assess the structure is the Vibration-Based Structure Health Monitoring (VBSHM). Firstly, the research is focused on a damage identification technique based on the frequency changes between healthy and damaged beam structure. An algorithm based on Frequency Shift Coefficient (FSC) is proposed, and the sensitivity of natural frequencies is studied. The effect of uncertainty on natural frequencies (0.1%, 0.2% and 0.3%) in damaged case is tested, and samples are used to estimate the average damage position and severity. Secondly, the objective of this research is to correlate the possible type of geometry damages with the bending stiffness reduction evaluation using Euler Bernoulli cantilever beam. To achieve this goal, the numerical correlation between 2D and 3D finite element models simulations were performed to obtain damage library comparing the percentage of bending stiffness reduction and geometry damages such as rectangular and hole. Finally, different damaged cases are examined in the different parts along the beam with the changes in damage positions, damage geometry type, damage values, and single and double damage, etc. The experimental beam with real geometry damage is tested to localize, quantify and classify the geometry damage properties.

Keywords: modal analysis, model updating, damage assessment, geometry damages properties, frequency shift coefficient, uncertainty on natural frequency, vibration-based structural health monitoring.

Structure du Mémoire de Thèse

Cette thèse est articulée en six Chapitres. Le chapitre 3 et Le Chapter 4 sont reproduits à partir de nos articles de recherche. Certains des principaux détails et stratégies spécifiques sont répétés dans différents chapitres, ce qui permet aux lecteurs de passer en revue un chapitre particulier sans avoir à manquer d'informations importantes. Les chapitres de thèse sont listés comme suit:

Le chapitre 1 fournit une brève introduction sur les dommages, la classification des dommages, la surveillance de la santé des structures, la détection des dommages concernant l'analyse des vibrations et les paramètres du modèle, et les niveaux de surveillance de la santé des structures basée sur les vibrations.

Le chapitre 2 donne une vue d'ensemble des méthodes d'identification des dommages basées sur les vibrations. Une revue de la littérature est illustrée sur la base d'un modèle de poutre analytique, numérique et expérimental. Différentes méthodes sont présentées, en considérant les fréquences naturelles, les formes de mode et la matrice de flexibilité qui sont utilisées pour les changements dynamiques structurels. De plus, une revue des différents algorithmes utilisant les optimisations par essaims de particules est également détaillée. Les modifications de la structure et l'apparition de dommages sont étudiées par l'application de méthodes d'identification des dommages. Ensuite, les types et les géométries de dommages sont présentés, ce qui est exploré plus en détail dans cette thèse. Enfin, la conclusion est donnée sur la base de l'application de différentes méthodes d'identification des dommages sur le VBSHM.

Le chapitre 3 illustre l'algorithme d'identification des dommages basé sur le coefficient de décalage de fréquence, et la stratégie de localisation et de quantification des dommages en utilisant uniquement les fréquences naturelles. L'algorithme utilise le coefficient de décalage de fréquence pour localiser et quantifier les dommages uniques et multiples. Le chapitre rend compte de la faisabilité numérique et expérimentale d'une méthode d'identification basée sur les vibrations pour identifier un défaut artificiel dans une structure de type poutre. En outre, les effets de l'incertitude de modélisation sur les fréquences naturelles sont examinés à travers l'étude de l'algorithme proposé.

Un essai au marteau d'impact est utilisé pour mesurer expérimentalement le comportement dynamique des poutres.

Le chapitre 4 se concentre sur le développement d'une nouvelle stratégie VBSHM pour estimer les propriétés des dommages géométriques. En outre, la stratégie proposée utilise un algorithme basé sur le coefficient de décalage de fréquence, développé dans Le chapitre 2, pour construire une bibliothèque de dommages. La disposition de la stratégie VBSHM proposée est illustrée à l'aide de modèles FE 2D et 3D. L'effet de la position du dommage sur le développement de la bibliothèque de dommages est également examiné en considérant deux dommages différents avec leur variation dans les positions des poutres. En conséquence, on constate que la bibliothèque de dommages ne dépend pas de la position des poutres. La technique est ensuite utilisée pour estimer les propriétés des dommages géométriques, c'est-à-dire l'emplacement, la taille et la magnitude. Différents cas de géométrie rectangulaire artificielle et réelle sont étudiés, leurs tailles sont estimées grâce à l'utilisation de la bibliothèque de dommages.

Le chapitre 5 concerne une étude plus approfondie de la nouvelle stratégie VBSHM proposée pour l'estimation des propriétés de dommages de la géométrie du trou. La bibliothèque d'endommagement des trous est construite en utilisant l'algorithme de minimisation avec coefficient de décalage de fréquence, où le diamètre du trou et la sévérité de l'endommagement du trou sont déterminés par la corrélation des modèles FE 2D et 3D. Les cas artificiels endommagés avec les géométries de trou sont quantifiés, et les tailles du trou sont obtenues à partir de la bibliothèque de dommages. Enfin, un trou réel est testé afin d'examiner la nouvelle technique.

Le chapitre 6 aborde les conclusions, les perspectives futures et les limites de la stratégie VBSHM. Le chapitre conclut sur la base des différents cas endommagés testés évalués et de l'efficacité de l'algorithme. Ce travail mèneront au développement d'un outil de conception numérique potentiel pour les ingénieurs de recherche afin d'intégrer davantage la technologie de surveillance de la santé structurelle basée sur les vibrations dans les structures sensibles à la sécurité.

Structure of the Thesis

This thesis is articulated into six Chapters. Chapter 3 and Chapter 4 are reproduced from our research articles. Some of the main specific details and strategies are repeated in different chapters, where readers would be able to review any particular chapter without having to miss out on any important information. The thesis chapters are listed as follows:

Chapter 1 provides a brief introduction on damage, damage classification, structure health monitoring, damage detection concerning vibration analysis and model parameters, and levels of vibration based structure health monitoring.

Chapter 2 gives an overview of the vibration-based identification of damage methods. A literature review is illustrated based on analytical, numerical and experimental beam model. Different methods are overviewed, considering natural frequencies, mode shapes and flexibility matrix which are used as for structural dynamic changes. Furthermore, review on different algorithms using particle swarm optimizations is also detailed. Structure modifications and the occurrence of damages is studied through the application of damage identification methods. Then, damage types and geometries are presented, which is further explored in this thesis. Finally, the conclusion is given on the basis of the application of various damage identification methods on VBSHM.

Chapter 3 illustrates frequency shift coefficient (FSC) based damage identification algorithm, and the strategy to localize and quantify the damages using only natural frequencies. The algorithm uses the FSC to locate and quantify single and multiple damages. The chapter accounts for the numerical and experimental feasibility of an identification method of vibration-based identification method to identify an artificial defect in the beam type structure. In addition, the effects of modeling uncertainty on natural frequencies are examined through the investigation of the proposed algorithm. The beam-hammer impact test, including the Siemens LMS Multi-analyzer, is used to measure the dynamic behavior of the beams experimentally.

Chapter 4 focuses on the development of a novel VBSHM strategy to estimate the geometry damage properties. Additionally, the proposed strategy uses an FSC-based algorithm, developed in Chapter 2, to build a damage library. The layout of the proposed VBSHM strategy is illustrated using 2D vs 3D FE models. The effect of the damage position on the development of the damage library is also examined by considering two different damages with their variation in the beam positions. Consequently, it is noted that the damage library does not depend on beam positions. The technique is then used to estimate the properties of geometry damages, i.e. location, size and magnitude. Different artificial and real rectangular geometry cases are investigated, their sizes are estimated through the use of the damage library.

Chapter 5 concerns a further investigation of the proposed novel VBSHM strategy for the estimation of hole geometry damage properties. Hole damage library is built using the FSC minimizing algorithm, where the hole diameter and the severity of the hole damage are determined by the correlation of 2D and 3D FE models. The artificial damaged cases with the hole geometries are quantified, while the sizes of the hole are obtained from the damage library. Finally, a real hole is being tested in order to examine the novel technique.

Chapter 6 addresses the conclusions, future perspectives and limitations of the VBSHM strategy. The chapter concludes on the basis of the tested different damaged cases evaluated and the efficiency of the algorithm. This work will lead to the development of a potential numerical design tool for research engineers to further incorporate vibration-based structural health monitoring technology in safety-sensitive structures.

Table of contents

Résumé	v
Abstract	vii
Structure du Mémoire de Thèse	ix
Structure of the Thesis	xi
List of figures	xvii
List of tables	xxi
Nomenclature	xxiii
1 Introduction	1
1.1 Introduction	2
1.2 Structural Damage and Their Categories	4
1.3 Structural Health Monitoring : Scientific Context	6
1.4 Vibration Based Structure Health Monitoring	9
1.4.1 Background	10
1.4.2 Levels of VBSHM	11
1.5 Effects of Damage on Modal Properties	13
1.6 Research Objectives and Summary	14
2 Overview of Vibration Based Techniques for Damage Identification	19
2.1 Introduction	21
2.2 Vibration Based Damage Detection, Localization and Quantification	21
2.3 Damage Identification Methods	24
2.3.1 Natural Frequency Based Methods	25
2.3.2 Mode Shape Based Methods	28
2.3.3 Flexibility Based Methods	32
2.4 Optimization Algorithms using Particle Swarm	34

Table of contents

2.5	Vibration Equation on Cantilever Beam Structure	36
2.6	Modal Parameters by Finite Elements	38
2.7	Conclusion	40
3	Frequency Shift Coefficient Based Damage Identification Algorithm in Beams	41
3.1	Introduction	43
3.2	Beam Vibration Theory	46
3.2.1	2D FE Model	47
3.2.2	Numerical Modeling of Damage	47
3.3	Proposed Damage Identification Strategy	49
3.3.1	Objective Function	49
3.3.2	Proposed Strategy and Minimization Problem	49
3.3.3	Steps for Damage Identification Procedure	50
3.3.4	Modeling Uncertainty on Natural Frequencies	51
3.4	Numerical Validation of Method	51
3.4.1	Numerical Beam Model	52
3.4.2	Localization and Quantification of Single Damage	53
3.4.3	Localization and Quantification of Double Damages	55
3.4.4	In the Case of Modeling Uncertainty on Natural Frequencies	59
3.5	Experimental Example for Damage Identification	62
3.5.1	Results	65
3.6	Conclusions	67
4	Geometry Damage Properties Identification in Beam Structures	69
4.1	Introduction	71
4.2	Beam Bending Vibration and FE Models	74
4.2.1	General Context	74
4.2.2	2D FE Model of Healthy and Damaged Beam	75
4.2.3	3D FE Model of Healthy and Damaged Beam	76
4.2.4	3D FE Frequency Convergence Test	77
4.3	Strategy and Objective Function for Damage Identification	78
4.3.1	Proposed Strategy	79
4.3.2	Initial Model Updating	80
4.3.3	Frequency Shift Coefficient (FSC)	81
4.4	Numerical Assessment of the Strategy Using 3D and 2D models	81
4.4.1	Material and Geometry	82
4.4.2	Damage Library Using 3D and 2D Model Correlation	83
4.4.3	Localization and Quantification of Single Damage	86
4.4.4	Localization and Quantification of Double Damage	88
4.4.5	In the Case of Rectangular Geometry Damage	91

4.5	Identification of Damage on an Experimental Beam	93
4.5.1	Experimental Setup	93
4.5.2	Results	95
4.6	Conclusions	97
5	Identification of Hole Geometry Damage Properties	99
5.1	Introduction	101
5.2	Numerical Assessment of hole damages using 2D and 3D FE models .	102
5.2.1	Development of Hole Damage Library	103
5.2.2	In the Case of Hole Geometry Damage	104
5.3	Experimental Test	105
5.3.1	Results	107
5.4	Conclusions	109
6	Conclusions and Perspectives	111
6.1	Conclusions	115
6.1.1	Limitations of the damage identification method	117
6.2	Future Perspectives	118
	References	119
	List of Publications	131

List of figures

1.1	Influence of damages	3
1.2	Numerical example of geometry damages (a) rectangular, and (b) hole type.	5
1.3	Principle and organization of a SHM system.	7
1.4	The multidisciplinary structural health monitoring process	7
1.5	Techniques for SHM.	8
1.6	Levels of structure damage identification	12
1.7	Influence of damages in modal parameters	14
2.1	Flowchart of damage identification method.	23
2.2	Flowchart of damage identification method using optimization.	35
2.3	Euler-Bernoulli beam and cross-section of the beam is at 90 degrees to the neutral axis, where w is a distance between before and after bending axis, M is the bending moment.	36
2.4	Modal parameters i.e. damping, frequency are obtained same at each measurement point, and mode shape is the imaginary part of FRF, obtained at same frequency from each measurement points.	38
3.1	(a) 2D FE damaged model of a cantilever beam and (b) cross-section area	48
3.2	Flowchart of proposed strategy for structure damage identification. . .	50
3.3	FSC as a function of position and severity (%) of the damage. The white circles denote real damage scenarios, where cross symbols and colorbar indicate the lowest minimized value (a) 0.15 m with 2%, (b) 0.40 m with 15%, (c) 0.70 m with 8% and (d) 0.80 m with 24%.	54
3.4	FSC as a function of positions and severities (%), where white circles represent real damaged parameters. Cross symbols and color bars indicate the lowest minimized value. (a) Damage positions are located at 0.24 m and 0.82 m, and (b) the severity of the localized damage is estimated at 3% and 5%, respectively.	56

List of figures

3.5	FSC as a function of positions and severities (%), where white circles represent real damaged parameters. Cross symbols and color bars indicate the lowest minimized value. (a) Damage positions are located at 0.60 m and 0.90 m, and (b) the severity of the localized damage is estimated at 30% and 17% , respectively.	57
3.6	FSC as a function of positions and severities (%), where white circles represent real damaged parameters. Cross symbols and color bars indicate the lowest minimized value. (a) Damage positions are located at 0.34 m and 0.44 m, and (b) the severity of the localized damage is estimated at 9% and 4%, respectively.	58
3.7	FSC as a function of positions and severities (%), where white circles represent real damaged parameters. Cross symbols and color bars indicate the lowest minimized value. (a) Damage positions are located at 0.10 m and 0.15 m, and (b) the severity of the localized damage is estimated at 60% and 70% , respectively.	58
3.8	FSC as a function of position and severity (%) of the damage. The red plus symbols indicate the position and severity of the artificial damaged case (a) (see Table 3.5). The white circles (obtained by FE updating strategy using FSC), green cross symbols (obtained by PSO using FSC) indicate the lowest minimized value, where damage positions and severities are identified (a) without perturbation, and (b) 0.1%, (c) 0.2% and (d) 0.3% with perturbation levels.	60
3.9	FSC as a function of position and severity (%), where white circles denote a real identified damaged case. The cross symbols and colorbars indicate the lowest minimized value. (a) The damage parameter (position and severity) are estimated at 0.50 m beam position with 0.50% severity, and (b) the red dot denotes the estimated damage parameter without perturbation, while green, (c) yellow and (d) cyan dots denote estimated damage parameters concerning for hundred samples with 0.1%, 0.2% and 0.3% perturbation, respectively.	61
3.10	Set up of beam hammer impact test using LMS multi-analyzer (Siemens LMS software)	63
3.11	Experimental setup of real cantilever damaged beam with accelerometers.	64
3.12	Frequency response functions (FRFs) curve of the healthy beam (blue curve) and damaged beam (orange curve), at mid position (0.5 m).	65

3.13	Experimentally tested damaged beam where FSC as a function of position and severity (%). The cross symbols and colorbars indicate the lowest minimized value. (a) The damage positions are identified at 0.244 m and 0.676 m, and (b) severities of these localized damage are estimated with 34.2% and 28.5%, respectively.	66
4.1	2D FE model of a cantilever beam and cross-section area.	75
4.3	Relative error on natural frequencies versus COMSOL Multiphysics standard mesh parameters for 3D FE model of damaged beam. Each line corresponds to the eigenfrequency in increasing order.	78
4.4	Flowchart of proposed strategy for geometry damage properties identification	79
4.5	Surface view of the damage library built at midposition (0.5 m) of a cantilever beam.	84
4.6	Contour view of the damage libraries which is built at position (a) 0.30 m and (b) 0.50 m. (c) Severity equivalent to a damage 1 mm × 1.5 mm (blue) and 1 mm × 2.5 mm (red) for varying position along the beam.	85
4.7	Single-damaged cases set in 2D beam, where positions and stiffness reduction are: (a) 0.15 m with 10% ; (b) and at 0.8 m with 4%.	86
4.8	Frequency Shift Coefficient (FSC) as a function of tested position and severity, where (a) the white circle indicates 10% severity and 0.15 m position identified by the algorithm (b) slice view of 10% estimated damage.	88
4.9	FSC as a function of tested position and severity, where (a) the white circle indicates 4% severity and 0.80 m position identified by the algorithm (b) slice view of 4% estimated damage.	88
4.10	Double damage cases set in a 2D beam (a) at 0.3 m and 0.7 m with 40% and 30% stiffness reduction, (b) at 0.10 m and 0.20 m with 7% and 2% stiffness reduction, respectively.	89
4.11	FSC as a function of tested multiple damage positions and severities (a) the white circle indicates that damage positions are 0.30 m and 0.70 m, (b) and severities of localized damage are 40% and 30%.	90
4.12	FSC as a function of tested multiple damage positions and severities (a) the white circle indicates that damage positions are 0.45 m and 0.55 m, (b) and severities of localized damages are 7% and 2%.	90
4.13	2-D clamped free beam plan with rectangular geometry damaged case (a) and case (b).	91

List of figures

4.14	(a) FSC as a function of damage position and severity for damage described in Figure 4.13a ; the white circle indicates that the damage position and severity are 0.20 m and 14.37%, respectively; (b) width and depth are extracted for 14.37% severity from the damage library (blue dots: raw extraction, red line: cubic fit, black cross: recovered geometry).	92
4.15	(a) FSC as a function of damage position and severity for damage described in Figure 4.13b ; the white circle indicates that the damage position and severity are 0.70 m and 25.35%, respectively; (b) width and depth are extracted for 25.35% severity from the damage library (blue dots: raw extraction, red line: cubic fit, black cross: recovered geometry).	93
4.16	Experimentally tested cantilever beam where A shows experimental set up and input/output measurement points with accelerometers; B displays acquisition card and software; C shows details on the rectangular geometry.	94
4.17	Experimentally tested rectangular geometry case where FSC is a function of position and severity (a) the white circle indicates 34.93% estimated damage severity at position 0.72 m; (b) width 1.3 mm and depth 1.62 mm for 34.93% severity extracted from the damage library (blue dots: raw extraction, red line: cubic fit, black cross: recovered parameters).	96
5.3	2-D plan view of clamped free beam with hole damage. (a) case (a) with 10 mm diameter at position 500 mm (b) and case (b) 6 mm diameter at 300 mm beam position.	104
5.4	FSC as a function of tested geometry damage (a) for hole case (see Figure 5.3a) white circle indicates 28% estimated severity at position 0.5 m, and for hole case (b) (see Figure 5.3b) identified hole properties is 11% severity at position 0.3 m.	105
5.6	Experimentally tested hole geometry case where FSC as a function of position and severity (a) the white circle indicates 74% estimated severity damage at position 1.8 m, (b) radius of hole damage are linked from damage library.	107

List of tables

3.1	Beam dimensions and properties.	52
3.2	Numerically and experimentally (see Section 3.5) measured natural frequencies of healthy cantilever beam.	53
3.3	Single damaged cases and numerically identified natural frequencies of damaged beams.	53
3.4	Two damaged cases and their numerically identified natural frequencies.	56
3.5	Damaged cases and numerically identified natural frequencies of damaged beams.	59
3.6	Experimentally identified natural frequencies of healthy and damaged beam.	65
4.1	Beam dimensions and steel properties.	82
4.2	Eigenfrequencies of healthy cantilever beam.	83
4.3	Numerically measured natural frequencies of single damaged cases (a) and (b) with parameters of position and severity.	87
4.4	Numerically computed natural frequencies of double damage cases (a) and (b) with parameters of position and severity.	89
4.5	Numerically measured natural frequencies of rectangular damaged case (a) and (b) with parameters of position and geometry size.	91
4.6	Experimentally identified natural frequencies of healthy and rectangular damaged beam.	94
5.1	Numerically obtained natural frequencies of 3D FE beam models with hole damage cases at different positions with dissimilar geometry dimensions	104
5.2	Experimentally identified natural frequencies of healthy and hole geometry damaged beam.	106
5.3	Hole geometry damage properties and their values, obtained from experimental and numerical correlation.	108
5.4	Experimental test (hole geometry)	108

Nomenclature

Acronyms

SHM	Structure Health Monitoring
VBSHM	Vibration Based Structure Health Monitoring
PHM	Prognosis Health Monitoring
NDT	Non-Destructive Testing
FEA	Finite Element Analysis
FEM	Finite Element Method
SSA	Singular Spectrum Analysis
MSC	Mode Shape Curvature
MSE	Modal Strain Energy
IPV	Inner Product Vector
3D	Three Dimensional
2D	Two Dimensional
PCA	Principal Component Analysis
IPV	Inner Product Vector
SA	Sensitivity Analysis
PSO	Particle Swarm Optimization
DLAC	Damage Location Assurance Criterion
MDLAC	Multiple Damage Location Assurance Criterion
LFCR	Local Frequency Change Ratio
FRFs	Frequency Response Functions
GA	Genetic Algorithm
MAC	Modal Assurance Criterion
COMAC	Coordinated Modal Assurance Criterion
DOFs	Degree of Freedoms
ULS	Uniform Load Surface
AWCD	Approximate Waveform Capability Dimension
KWFD	Katz Waveform Fractal Dimension
WT	Wavelet Transform
DI	Damage Index
FSC	Frequency Shift Coefficient

List of Symbols

$\{\Delta f\}$	Observed frequency change vector for unknown damage
$\{\delta f_j\}$	Hypothesis frequency change vector for the j^{th} location
$\{\delta D\}$	Defined pattern of the damage vector
(σ_f)	Standard deviation of beam natural frequency
f^h or ω^h	Healthy beam natural frequency (Hz)
f^d or ω^d	Damaged beam natural frequency (Hz)
$[M]$	Mass matrix
$[C]$	Damping matrix
$[K]$	Stiffness matrix
LF	Local natural frequency of an element
$\{\phi_j\}$	j^{th} mass normalized mode shape vector
N_m or n	Total number of modes
h	Length of two elements between $q - 1$ and $q + 1$
q	The number of current structural DOF
$\bar{\beta}$	Mean
σ	Standard deviation
$[FM]$	Flexibility Matrix
EI	Flexural rigidity
$M(x)$	Mass per unit length of beam
M	The bending moment
w	Distance between before and after bending axis
c	Damping
$f(x, t)$	External force
$\{\tilde{y}\}$	Amplitude for the mode shape
$w(x, t)$	Transverse deflection of the beam base axis
L	Length of the beam
$EI(x)$	Bending stiffness of the beam
$\phi_n(x)$	Function of the normal modes
$u(x)$	Assumed function
$\phi_n'(x)$ and $\phi_n''(x)$	Derivatives of the mode shape functions
V	vertical translation degree of freedom
θ_z	bending rotation degree of freedom
α_l or α_m	stiffness reduction coefficient at l or m beam element
X	Damaged case
A	2D updating beam model (reference)

E	Young's modulus
x_l or x_m	Position for the l or m beam element
ρ	Mass density (kg/m^3)
ν	Poisson's ratio
L	Length of the beam (mm)
T	Thickness of the beam (mm)
W	Width of the beam (mm)
(h, X)	A set of experimental healthy frequencies
(d, X)	A set of experimental unknown frequencies
(h, A)	A set of frequencies obtained with a healthy model
(d, A)	A set obtained with a damaged model
$(W_d), (D_d),$ and (H_d)	Width, depth and height of the damage
$(D), (P)$ and (H_d)	Diameter, position and height of hole damage
η	Presence of uncertainty (%) on natural frequency

Chapter 1

Introduction

Summary

1.1	Introduction	2
1.2	Structural Damage and Their Categories	4
1.3	Structural Health Monitoring : Scientific Context	6
1.4	Vibration Based Structure Health Monitoring	9
1.4.1	Background	10
1.4.2	Levels of VBSHM	11
1.5	Effects of Damage on Modal Properties	13
1.6	Research Objectives and Summary	14

Résumé

La surveillance de la santé des structures (SHM), y compris aussi l'identification des dommages et le diagnostic des structures, est souvent menée par des ingénieurs et des techniciens qui ont besoin d'une formation et d'une expertise particulières pour éviter toute défaillance et conséquences graves. Avec le temps, les structures peuvent vieillir et causer des dommages. L'apparition inattendue de dommages peut provoquer des défaillances catastrophiques ce qui peut entraîner l'arrêt non planifié de machines et de lignes de production. Ce chapitre fournit un aperçu complet sur les dommages et de leurs catégories, et aussi des possibilités de surveiller l'apparition de dommages dans une structure grâce à l'utilisation de la surveillance de la santé des structures basée sur les vibrations (VBSHM). Afin de surmonter ces problèmes, il est essentiel de détecter les défauts avant qu'ils n'atteignent leurs dimensions critiques. À cette fin, il est important d'utiliser des méthodes non destructives, rapides et peu coûteuses. L'utilisation des méthodes vibratoires est une perspective importante pour réduire les services manuels inefficaces en augmentant le fonctionnement automatique et l'application d'outils intelligents.

Abstract

Structural Health Monitoring (SHM), including damage identification and structure diagnosis, is often carried out by engineers and technicians that need special training and expertise to avoid any failures and serious consequences. Over time, structures can be aged and cause of damages. Unexpected occurrence of damages can cause catastrophic failures that can lead to the unplanned shutdown of machines and production lines. This chapter provides a comprehensive overview of the damages and their categories, possibilities to monitor the occurrence of damages in structure through the use of Vibration Based Structure Health Monitoring (VBSHM). In order to overcome these problems, it is essential to detect the defects before they reach their critical dimensions. Towards this end, it is important to use non-destructive, fast and inexpensive methods. The usage of vibration methodologies is a significant perspective in order to reduce inefficient manual services by increasing automatic operation and application of smart tools.

1.1 Introduction

Damages in structure can occur due to various reasons. The presence of damages varies from the physical parameters of the structure, which can be determined by

changes in the dynamic behavior of the structures. Although the formation of damages is almost impossible to prevent, they are known to propagate in the structure due to fluctuating stress or fatigue conditions. If damage remains undetected and exceeds a critical scale, it can cause catastrophic failure and reduction in load-carrying capacity. The problem of structural damages is a critical situation which causes changes in physical parameters and geometrical parameters. Specifically, changes in the dynamic characteristics of the structure. In engineering, structures are very essential for the transformation of loads. Therefore, it is important to monitor the prevention of structural and non-structural elements from the occurrence of any damage or to limit the damages that can reach at the critical levels by employing vibration methods.



Figure 1.1: Influence of damages

Damage problems can arise from various reasons, such as the alteration of the material properties, changes in boundary conditions or loss in the connectivity of the structure system. The most significant causes of damage in structural steel are classified due to corrosion, material degradation, joints and fasteners, layer separation, rupture structure system-induced during the manufacturing process, as well as in-service loadings such as fatigue and other object impacts. These issues have serious effects on the performance of the whole structure system, where damage can be either formed of the multiscale that relies on the dynamic formation process. **Figure 1.1** indicates the

effects of damage in the form of operational loss, stiffness loss, reduction in tensions and reduction in service life.

The research interests on damage detection using vibration analysis has started in the field of oil and aero industry since the early 1970s, and increased rapidly later in civil and mechanical industries over the last few decades (Doebbling et al., 1998). The concept behind was to develop structure diagnosis techniques using vibration analysis, those are automated, accurate, secure and effective with structure integrity-based conditions. Interestingly, vibration tests are needed to determine and estimate the damages. Advances and automated inspection techniques have been in process of standardization on the basis of the advancement of modal analysis thereby enabling modal identification.

The chapter is detailed as follows: In **Section 1.2**, the study of damage and their classifications are illustrated. In **Section 1.3**, a scientific background is detailed on the basis of available global SHM damage detection methods. In **Section 1.4**, a comprehensive review of VBSHM is provided. Here, five levels of VBSHM are discussed. These levels are continuously applying for the purpose of structural damage identification. In **Section 1.5**, consequences of damages on modal parameters are discussed. This section also addresses changes in dynamic parameters due to structural modifications. In **Section 1.6**, the objectives and research of this thesis, are detailed which will be further achieved in this thesis. A brief summary is given for the development of a novel damage identification strategy.

1.2 Structural Damage and Their Categories

In the structure, damages or defects can be considered as material imperfection which may lead to the failure of the system to perform the desired purpose. Structure defects (appears as crack, hole, void) or a group of similarly oriented shapes (difficult to detect) when loaded that causes imperfections. Defects can occur during changes in the physical parameters i.e. mass and stiffness followed by impacts. The damage reduces the load-carrying capacity of a structure. It can cause structural failures mostly accompanied by damage growth mechanisms. Moreover, damages may extend deep inside the structures, or even become larger that leads to the fracture. Ritchie (1986) presented problems of small cracks, and their solutions. The authors have illustrated the cracks, their behavior and life prediction.

The classification terms of the structure damages, and their categories depend on their formation, causes, geometries, types of defective structure and mechanisms to foreign body impact. These damages can be grouped based on scaling, spalling, curling and cracking. Damage can be caused by different mechanisms, and can be identified by using different strategies. Damage to structures can be induced by stress

1.2 Structural Damage and Their Categories

due to thermal gradients and the thick slab type supported in corners that do not allow free movement at the ends, which are classified as an additional causal factor leading to damage to environmental conditions. Structure damage can also occur from overloading, such as lack of quality control and inadequate construction and environmental corrosion. Depending on the type of damage, it differs from their geometries, which can be formed as rectangular, triangular and circular in shape and size. [Sobey \(1963\)](#) acknowledged the stress concentration factors for unreinforced rounded rectangular slots and square holes in infinite sheets subjected to tension or shear loading using the complex variable methods. These are the shapes or geometries of the defect that can be occurred during the foreign body impact. In geometries, the growth of the defects occurs on the surface of the structure. Size and location can differ, but estimation and treatment are at a macroscopic level focused on damaged quantification approaches. Geometries damaged can be tested in the laboratory environment, and hence most experimental work is focused on this type of crack breathing crack, and the type of tip is most influenced when structure goes under tension. Growth of damages can be broadly classified as follows:

(a) Transverse damage: These are defects that exist perpendicular to the axis of the structure body. They are the most frequent and serious, since they decrease the cross-section through the weakening the structure. They occurred due to loss of local flexibility in the stiffness of the structure, which can be caused due to the concentration of strain energy in the vicinity of the defect edge.

(b) Longitudinal damage: These are defects that exist parallel to the axis of the structure body. They are not so common, but they pose a risk when tension/load is applied to the crack growth path at the right angle, i.e. perpendicular to the structure body axis.

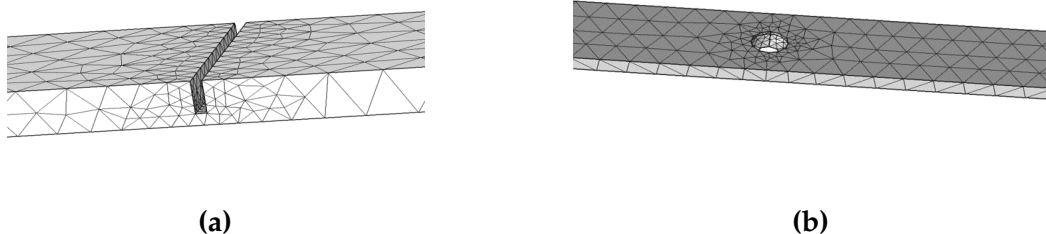

Figure 1.2: Numerical example of geometry damages (a) rectangular, and (b) hole type.

Open defects are often known more precisely as "notches" These cracks always remain open. In the laboratory environment, the majority of experimental investigations

focuses on this type of defect. Open cracks can be specified, when the section of the material is subject to tensile stress, and close when the stress is reversed. The structure can be most affected under tension.

Damage geometries can be classified in various types such as rectangular, triangular, or hole shapes. Here, two geometry types are numerically simulated, shown in **Figure 1.2**, which are going to further investigate in this thesis. The proposed strategy and damage properties estimation for the geometry types (rectangular, hole) are illustrated in later **Chapter 4** and **Chapter 5**.

1.3 Structural Health Monitoring : Scientific Context

The prior phase in health monitoring is to assess, the ability of the structure or framework to withstand loading using proactive approaches. It is known as Prognosis Health Management (PHM), addressed in [Pham et al. \(2012\)](#) and [Li et al. \(2020\)](#). The key aspects of PHM are to ensure the structural integrity and performance that has been inspected during the prior measurements and assessment of the structure before it reaches in a critical situation. This process manages the unexpected growth of damages, and ageing of the structure during the inspection. Furthermore, authors have mentioned, that PHM with periodic maintenance is important factor in order to manage the potential performance and functionality of structures, systems and components by periodic inspections.

[Balageas et al. \(2010\)](#) provided the basic theory and the design of a standard SHM system, as shown in **Figure 1.3**. The SHM scheme refers to the structural integrity monitoring mechanism, described in two ways. The first is the type of physical phenomenon that is closely related to the damage, and is typically controlled by the sensors. The second is the type of physical phenomenon used by the sensor to produce a signal, and send to the acquisition and storage subsystem. In fact, SHM consists of monitoring in real-time or at regular intervals for the damage detection. [Ooijevaar \(2014\)](#) proposed a SHM procedure, consisting of diagnosis and prognostic part, as shown in **Figure 1.4**. Diagnostic analyzes are used to estimate the structure's current state. The prognostic analysis measures the evolution of the damage and forecasts the remaining service life. The main objective of SHM is to recognize the presence of defects or cracks in the structure. Damages are difficult to avoid for safety purposes. SHM methodologies have great significance for the safety and reliability of space vehicles and their services ([Chang et al., 2005](#)). SHM is generally used for preventive maintenance purposes. SHM methods are based on Non-Destructive Testing (NDT) such as ultrasonic, acoustic and X-ray emissions, etc. Any structure can be monitored in first using two ways, global or local monitoring methods, as seen in **Figure 1.5**, it also depends on the complexity and size of the structures. Local

1.3 Structural Health Monitoring : Scientific Context

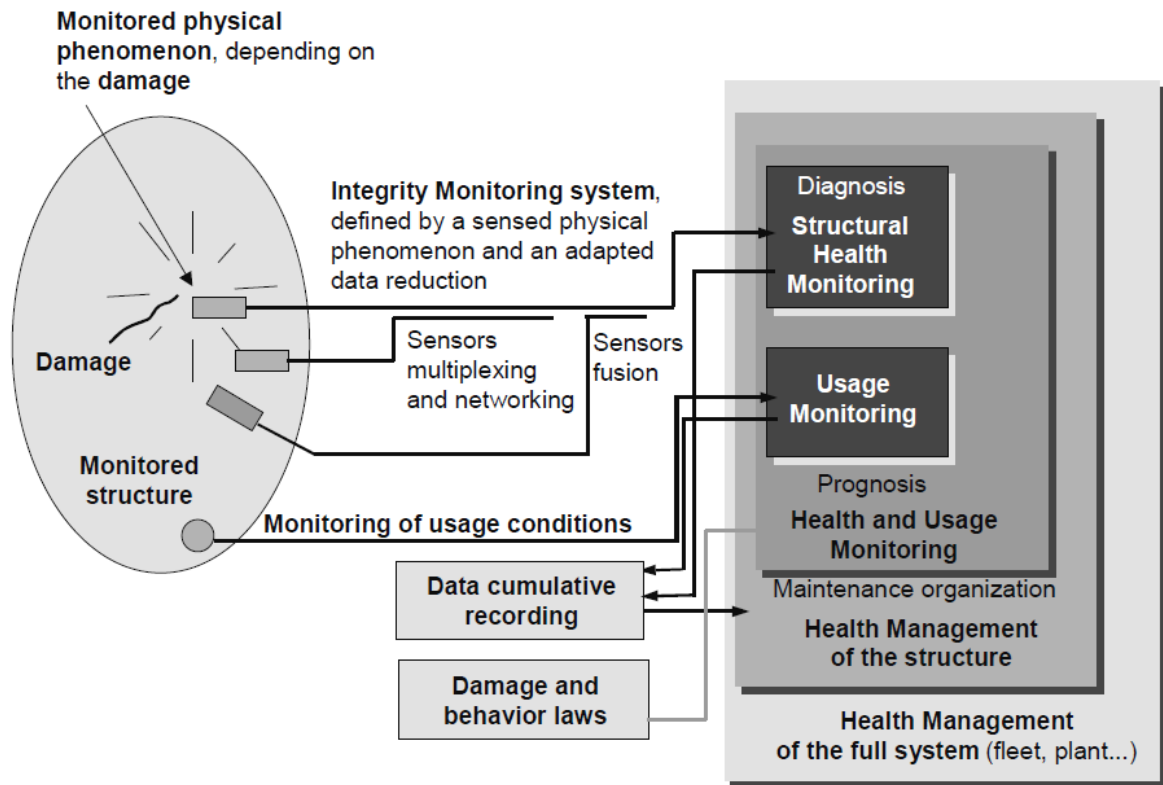

Figure 1.3: Principle and organization of a SHM system. (Balageas et al., 2010)

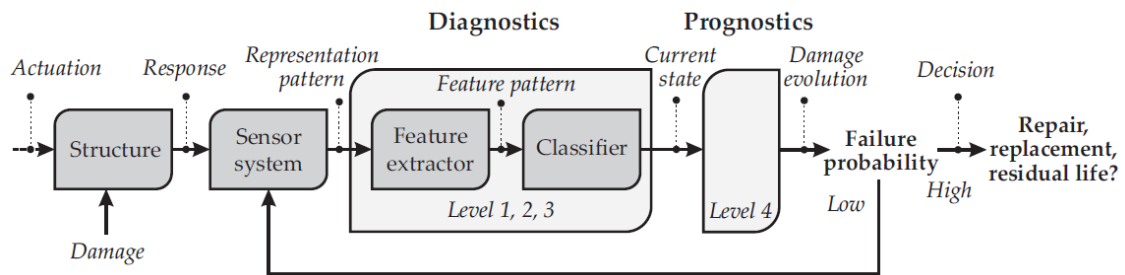

Figure 1.4: The multidisciplinary structural health monitoring process (Ooijevaar, 2014)

inspection can only spot defects at the surface of the structure. In addition, the monitoring of the entire structure by global methodologies is commonly recognized, and has contributed to SHM research. The use of NDT techniques to detect damage in structures has become a hotspot. NDT techniques are commonly used in industries such as aviation astronautics, spacecraft, power plant, machinery, structures and buildings, metallurgy and mechanical engineering etc.

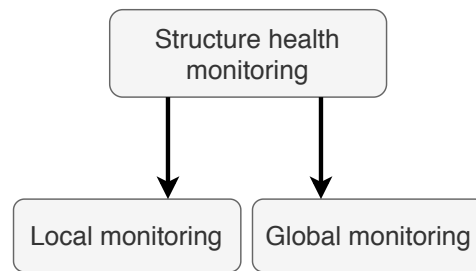

Figure 1.5: Techniques for SHM.

The future advantages of SHM include reliability, increased protection, reduction in the expense and operation of the lifecycle. [Worden and Duijvelde \(2004\)](#) described an overview of SHM strategies for the detection of faults, such as a definition based on a fault taxonomy, an operational evaluation using a hierarchical damage identification scheme, an approach to sensor prescription and optimization with data processing, and later they investigated quasi-static and fatigue loading with the application of thermo-elastic stress analysis and FE analysis. SHM depends on sensor-based devices that collect structural data, and then on dynamic parameters. For the past few decades, technology has been fast and cost-effective for large-scale monitoring, such as bridges, buildings and long-term health assessment of structures. In addition, SHM methods combine algorithms and sensor technologies to assess the health status of the structures. SHM piezoelectric wafer sensors were acknowledged in [Giurgiutiu et al. \(2002\)](#) to aged structures to monitor the growth of structural damage such as fatigue cracking and corrosion. [Yang and Qiao \(2005\)](#) presented pulse-echo method and piezoelectric sensors for damage detection in various materials. This method showed very effective results for damage detection in various engineering structures. The conceptual design of SHM, with active sensing technology, has also been developed through the use of the pulse electrical sensor for the identification of defects in metal and composite structures was presented in [Ihn and Chang \(2008\)](#), where the pitch-catch process, which uses a pair of sensor and piezoelectric actuator, generates the damage index. The automated damage detection technique was proposed by [Mal et al. \(2005\)](#) with the use of an array of actuators and sensors to stimulate and monitor dynamic response including vibration and wave propagation impact. A cyber-physical co-design approach to SHM focused on wireless sensor networks that integrate with flexibility-based damage localization methods, using the number of sensors and energy-efficient multi-level computing architecture. SHM for cyber-physical systems based on wireless sensor networks, were implemented in [Hackmann et al. \(2013\)](#).

These days, the concept of SHM using vibration analysis has gained the attention from many research communities. Various SHM methods using dynamic parameters are suggested, where [Karbhari and Lee \(2009\)](#) provided a general review of the SHM

1.4 Vibration Based Structure Health Monitoring

techniques, to use for dynamic testing and damage detection. Zhang et al. (2017) implemented frequency shifts as the input of three inverse algorithms, including graphics, surrogate-assisted optimization and artificial neural network, to predict the position, size and interface of the damage. These SHM techniques can be used with the application of modern or traditional methods. Modern type methods are known as online signal measurements from response based structures. The modern type of structure monitoring is less dependent on experiments, and only require the vibration responses during the servicing of the damaged structure. Moreover, the cost of modern style methodologies is much lower, and easy to operate as online, as production pauses are not necessary. This type of approaches makes it very easy to identify damages in a small structure with better dynamic response signals. Modern forms of damaged identification, including genetic algorithms, wavelet analysis and artificial neural network, are implementing for SHM. The modern techniques of damage detection also have numerous drawbacks, such as noise pollution in measured signals, and reliance on environmental excitation during SHM. On the other side, some earlier existing SHM techniques are incorporated with the basic features of damage detection, and are less reliable, high time consuming and not dependent throughout the optimization procedure.

1.4 Vibration Based Structure Health Monitoring

Over the years, Vibration Based Structure Health Monitoring (VBSHM) has been the main the topic of discussion among the different research communities. Usually, most structural defects are occurred due to material fatigue, foreign bodies impact and overloading. Therefore, VBSHM methods are essential to detect, locate and quantify the damages for the safety and integrity purpose. Vibration data and approaches that can be used now to monitor the structure, were first implemented by Lifshitz and Rotem (1969). A very detailed overview covering for VBSHM methods to identify damages, was presented in Doebling et al. (1996), and the latest developments on VBSHM were introduced in Montalvão et al. (2006) for damage detection with an emphasis on structures. An overview of the current status of VBSHM methods is detailed in Fritzen (2005). Wang and Chan (2009) provided a comprehensive review on damage detection methods to monitor bridge structures. In addition, Sinou (2009) gave a review on damage detection methods with the consideration of changes in linear and non-linear vibration measurements. Furthermore, VBSHM consists of five levels (detection, localisation and classification, assessment and prediction) to monitor the structure and manage structural integrity. The levels of VBSHM is discussed in Section 1.4.2. Jassim et al. (2013) presented a review on VBSHM to identify de-

fects and decision-making work, which focuses on the theoretical and experimental investigations on crack effects.

1.4.1 Background

VBSHM has long been used in the industry for the diagnosis of structures and machines. Various significant research is undergoing to explore damage identification methodologies for the monitoring of structures. Different methods based on vibration analysis has incorporated more sophisticated informations for monitoring of the structures. The vibration methods depend on structural changes because of damage which is more or less pronounced for changes in dynamic behaviour. Now, there is also demand for a fully automatic system for automatic remote monitoring applications based on the vibration signals and large arrays. For examples, a modern VBSHM method was published in [Garcia and Trendafilova \(2014\)](#) using principle components analysis known as Singular Spectrum Analysis (SSA). [Lakhdar et al. \(2013\)](#) exploited the dynamic response of a structure based on vibration analysis to detect the damage and the confirmation of experimental findings has been contrasted with the numerical models to check the effectiveness of VBSHM method.

In their book, [Fu and He \(2001\)](#) described a definition of the modal analysis, which is "a method of determining the intrinsic dynamic characteristics of a system in the form of natural frequencies, damping factors and modal shapes, and using them to formulate a mathematical model for its dynamic behaviour." They are characterized only by their physical properties and their geometry of the structure. Each model shall be considered for its modal parameters: natural frequency, modal damping factor and characteristic displacement pattern. The dynamic response of the structure to detect damage with the experimental results is compared by [Lakhdar et al. \(2013\)](#) to the prediction of the numerical models to confirm the process. A dynamic structural analysis of delaminated bi-layer beams with considerations of transverse shear and delamination tip deformations as well as effects of friction and contact in delaminated ([Qiao and Chen, 2012](#)), and it was found that design and optimisation of the dynamic behaviour can evaluate the vibration response of the structure. The analysis of the bending vibration response on laminated beams with ply damage using FE model, was studied by [Averill \(1994\)](#). The VBSHM method as a result of impact shocks on the structure, was evaluated by [Çam et al. \(2005\)](#) to obtain information on the position and depth of cracks in cracked beams, where the signals obtained in cracked and defect-free beams, were compared using the natural frequency. The impact echo method was used in [Abraham et al. \(2003\)](#) to detect the void type in tendon ducts using frequency profiles.

In this research, the implementation of the modal analysis focuses on having a dynamic mathematical model of a structure, whereas the model is derived from the FE analysis.

1.4.2 Levels of VBSHM

The identification of damages based on VBSHM depends on the principle, where changes in the physical properties of a structure, such as its mass, stiffness or damping, directly affects its vibratory response. We found that many researchers engaged in the continuous serviceability of the VBSHM. In dissertation, [Rytter \(1993\)](#) introduced damage identification methodologies and five classification levels (see [Figure 1.6](#)) for the monitoring of structures. It has been widely accepted by the communities dealing with the VBSHM. An extensive review introduced by [Sohn et al. \(2003\)](#), [Worden and Duijvelde \(2004\)](#), [Farrar and Worden \(2007\)](#) on structure monitoring with an investigation on damage identification, and including five levels for the monitoring of the structure are:

1. **Detection:** to verify the existence of damage in the structure;
2. **Localisation:** to identify the location of the damage in the structure;
3. **Classification:** to characterize the type of the damage;
4. **Assessment:** to quantify the severity of the damage;
5. **Prediction:** to evaluate the prognosis life of the structure.

The description of these five classification levels are presented as:

Level 1 - Detection

The level provides information about the detection of the damage, whether there is or does not occur any existing damage. This stage also includes many important features such as to detects damages, distinguish them from the modal parameters of the structure, and changes regarding their environment. In the identification procedure, the VBSHM approaches mostly used model-based parameters, and comparison in dynamic characteristics between the results obtained from damaged and undamaged structures. Examine the difference between them to detect structural damages.

Level 2 - Localization

This level gives the existence of damage. The step indicates the precise location of the damage, and even also the locations of multiple damages. The localization's accuracy and cost depend on many factors such as type of methods, operational and

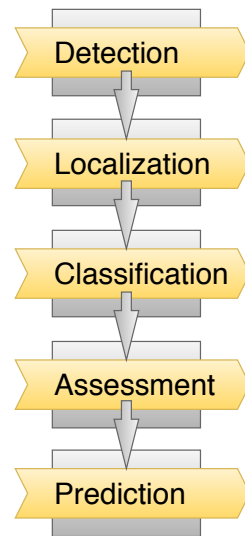

Figure 1.6: Levels of structure damage identification

environmental conditions. The hypothesis of localization is following similarly as for detection.

Level 3 - Classification

Damage classification is an important step in the monitoring of the structure. However, this level provides details on the type and size of the damage. This could be derived from the FE models and require a high level of computing operations. Damage classification can depend on many factors based on the size, nature and scale of the damage. In addition, this step relies on vibration analysis and response based function during algorithm optimization and damage quantification.

Level 4 - Assessment

This step evaluates the extent of the damage, and gives a further assessment of the structure if the structure is appropriate for service. Structural damage assessment is the ability to conduct the level of damages for safety evaluations in civil, aircraft and mechanical structures, which to perform structural inspections, and mitigation activities. Damage can be quantified by the use of several damage indices, specified as functions whose values may be related to specific structural damage states. It is also important to consider the spectrum of experiments and indices, which have the facility to run over a long period of time, preferably starting from fabrication, for effective operation conditions and damage assessment. Before fully knowing the structural assessment, load paths, critical load carrying capacities, and potential failure mechanisms are also important factors that should be included.

Level 5 - Prediction

This step estimates the remaining service life of the structure using a global model and a damaged model. It is also a step-by-step decision level. This step is included whereas to implement the objecting function, vibration analysis and optimization parameters to estimate the remaining service life of the structure, and to make the further decision for the next action.

There are several challenges for the identification of damage, and their damage properties with the use of fast and inexpensive non-destructive methods. For that, it is important aspect for the improvement of the VBSHM technologies. It is very crucial to ensure structural safety, where costs can be saved. Extensive use of lightweight materials as a conventional source that increases the sensitivity of structures from both fatigue and foreign induced damage as for their critical structural components during their service life. The effect of structural damage can alter their vibration properties, and their intensity in complex stability areas so that the diagnosis will make it easier, to distinguish areas at an early stage.

1.5 Effects of Damage on Modal Properties

Modal parameters consist of natural frequencies, mode shapes and damping ratios, which are functions of the physical properties of the structure, such as mass, density and stiffness. Thus, any modifications to the physical parameters will cause changes in the modal parameters. Damage is assessed by changes in dynamic characteristics or response of structures. Damage assessment approaches attempt to identify damage by solving an inverse problem, often involving the creation of computational models (Friswell et al., 2001). A robust damage identification will be able to determine whether the damage can be identified at a very early stage, locate the damage, and provide some estimation of the severity of the damage. The effects of damages on modal parameters are shown in **Figure 1.7**.

Damages cause, typically changes in the physical properties (i.e. boundary conditions, stiffness, mass and damping) with structural characteristics (i.e., resonant frequencies, modal damping and mode shapes) of the structure. Therefore, changes in properties, such as flexibility or stiffness matrices derived from measured modal properties, which changes in the eigenvalues, have also shown potential for the detection of structural damage. Thus, it is more difficult to correlate the physical parameters to the dynamic parameters, and even to understand how physical parameters influence the structure.

As previously mentioned, modal information are reflection of the system's global properties, whereas damage is an outcome with local elemental physical effects. The issue has prompted a number of scholars to question the suitability of modal data

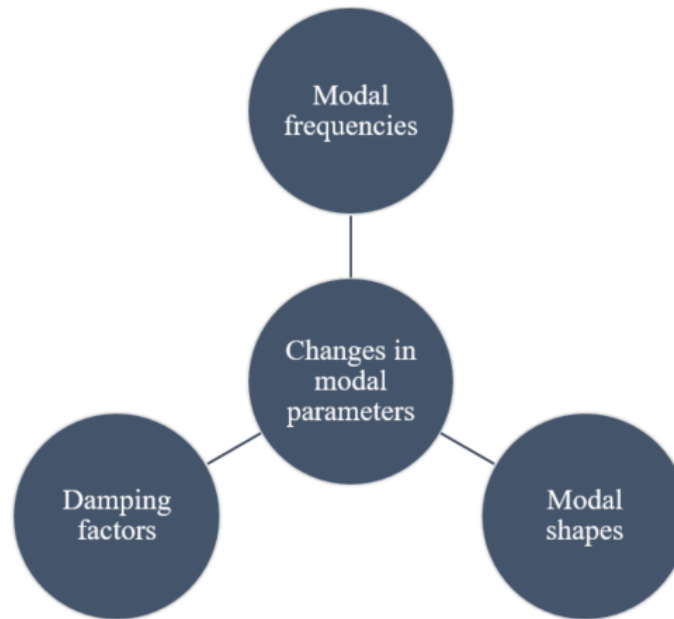

Figure 1.7: Influence of damages in modal parameters

for damage detection. However, the bulk of the literature on the damage detection are based on modal analysis, as the experimental practice has also relied on the experimental modal analysis.

From literature, many researchers presented overviews based on a modal analysis considering modal parameters for structure damage assessment, and can be found in [Geweth et al. \(2017\)](#); [Wei et al. \(2004\)](#). The study on approximate methods, kinematics, modal analysis, model updating based on dynamics of structures, were presented in [Génevaux \(2011\)](#). The method introduced by [Huang et al. \(2017\)](#) based on online model updating to identify the mass, stiffness and damping properties in order to establish the relation between structural energy and unknown structure parameters. It is critical known, that the dynamic response parameters are used to locate and estimate the severity of the damage, which can be determined by comparing the damaged to the undamaged state.

1.6 Research Objectives and Summary

Considering the elements incorporated and the motivations, the main objective of this research is to develop the VBSHM method for the identification of damages and their geometry damage properties estimation. The ability to identify damages as well as to distinguish geometry damage properties different diagnostics steps is implemented. Vibration analysis, based on experimental testing, and numerical analyzes, combined

with optimization method, are applied for the identification of damages. The proposed research is included with the comparative study of various vibration-based damage identification steps: local diagnostic process, model-based analysis, and experimental testings. The objective of this research is first to develop a VBSHM strategy for the identification of damages and then the estimation of the geometry damage properties i.e. position, severity and size. Here, the novel concept is used for building the geometry damage library, which is further going to use for estimation of geometry damage properties. Subsequently, the important contribution of this research is followed, where real experimental geometry damage is estimated from numerical models and damage library to validate the efficiency of the strategies. In order to accomplish the objectives of this thesis, the following issues will be investigated, as addressed separately:

- To develop FE models for the cantilever beam structure using their physical properties, and to provide the better dynamic characteristics of structure in the form of natural frequencies, mode shape and bending stiffness.
- To implement a frequency based method, and to evaluate the situation as to whether they are suitable for localization and quantification of damage. FE models, numerical and experimental vibration tests are used, where single and multiple damage cases are chosen to investigate the method.
- To improve the localization and quantification method using the frequency based algorithm with the application of global optimization function during the damage identification procedure. Furthermore, to investigate the sensitivity of eigenfrequencies, the effect of modeling uncertainty on eigenfrequencies is considered.
- To build geometry damage library by correlating bending stiffness reduction to the geometry damage size. Here also, to study the influence of the damage library to the damage position of the beam.
- To localize and quantify geometry damage on an experimental real beam, and to estimate their geometry properties by the implementation of the novel VBSHM strategy.
- To identify damages on numerical and experimental beam models, and discussion on the relative advantages, disadvantages and limitations of the novel damage identification strategy by considering different damage cases and other factors.

In summary, the main objective of the research proposed in this thesis is: "A development of novel VBSHM strategy in order to localize, quantify and es-

Introduction

estimate the geometry damage properties only using the natural frequencies and damage library". The research is considered by performing the number of vibration tests based on the prior overview of damage identification methods. We have established a novel strategy for the identification of geometry damage properties, *i.e.*, location, severity, and size from the use of frequency shift coefficient and extracted modal parameters. This research is developed by the relation between natural frequency changes with damage geometry for building a geometry damage library. The work goes beyond the damage identification indicator by estimating the geometry properties of single or multiple damages. To take all of these into account, a novel VBSHM technique is going to be built based solely with the use of frequency shifts and geometry damage library for the estimation of geometry damage properties.

1.6 Research Objectives and Summary

Chapter 2

Overview of Vibration Based Techniques for Damage Identification

Summary

2.1	Introduction	21
2.2	Vibration Based Damage Detection, Localization and Quantification	21
2.3	Damage Identification Methods	24
2.3.1	Natural Frequency Based Methods	25
2.3.2	Mode Shape Based Methods	28
2.3.3	Flexibility Based Methods	32
2.4	Optimization Algorithms using Particle Swarm	34
2.5	Vibration Equation on Cantilever Beam Structure	36
2.6	Modal Parameters by Finite Elements	38
2.7	Conclusion	40

Résumé

L'objectif de ce chapitre est de fournir un aperçu détaillé des différentes méthodes VBSHM. Depuis quelques décennies, de nombreuses techniques VBSHM ont été développées pour l'identification des dommages. Certaines d'entre elles se sont avérées avoir des avantages exceptionnels dans le domaine de la détection des dommages. De nombreuses méthodes sont également capables de surveiller globalement une structure, ce qui permet d'identifier les changements dans les caractéristiques vibratoires pour la détection précoce des dommages. Dans ce chapitre, une étude des avancées dans l'identification, la localisation et la quantification des dommages basés sur les vibrations qui ont eu lieu au cours des dernières décennies, est discutée. L'objectif est d'évaluer les dommages par les changements des paramètres modaux dans les systèmes structurels ou mécaniques. Des dommages peuvent être causés par des changements dans les propriétés matérielles et/ou géométriques des structures. Ils peuvent également être inclus par des changements dans les conditions aux limites et d'autres connectivités du système, qui affectent négativement la performance des structures. Différentes méthodes basées sur les changements de fréquence et de forme de mode sont détaillées, et abordent également les avancées récentes des méthodes d'identification des dommages basées sur l'optimisation.

Abstract

The objective of this chapter is to provide a detailed overview of different VBSHM methods. Since last few decades, many VBSHM techniques have been developed for the identification of damages. Some of them have been shown to have outstanding advantages in the field of damage detection. Many methods are also capable of monitoring a structural globally, which are used to identify changes in vibration characteristics for the early detection of damage. In this chapter, a study of the advances in vibration-based damage identification, localization and quantification that have taken place over the last few decades, are discussed. The aim is to assess the damages by changes in modal parameters in structural or mechanical systems. Damage can occur by changes in the material and/or geometric properties of structures. This can be also included by changes in boundary conditions and other system connectivity, which adversely affect the performance of the structures. Different methods based on frequency and mode shape changes are detailed, and also addressed recent advances in optimization based damage identification methods.

2.1 Introduction

The first step in VBSHM is to detect damages, and after detection the other steps (location, quantification....etc) can be performed, as previously detailed in Section 1.4.2. For that, many remarkable VBSHM tools for damage detection have been developed. Some researchers have used traditional VBSHM methods by the application of modal analysis to achieve an effective defective model. Especially, they concentrate on the complex parameters of the systems. The modal analysis is convenient and easier to operate in FE structures. Mode Shape Curvature (MSC) and Modal Strain Energy (MSE) are examples of modal dependent methods which are among the most common approaches. After all, over the last few years, some model-based features have become easier to monitor large and complex structures, and are not limited for damage identification due to changes in only modal parameters and their derivatives.

Vibration analysis is widely considered as a diagnostic tool for structural damage detection over the years, due to its ability to monitor and diagnose damage through global structural health monitoring. Various methods are available in the literature, which is particularly addressed damage localization and quantification problems in structures. The location of the damages can be directed using sensitive features towards the site of damages. The location can be usually determined by changes in the dynamic response parameters of the structure, such as mode shape, natural frequency and damping ratios. Some damage detection and localization methods focus on the physical and geometrical properties of the investigated structure without updating the FE models. Other methods depend on updating of the FE models in order to identify the damages.

The chapter is detailed as follows. In Section 2.2, a detailed analysis of vibration-based damage identification, position and quantification is presented. In Section 2.3, recent advancements in vibration-based approaches are demonstrated. This section focuses on the review of the frequency, mode shape, and flexibility method. In Section 2.4, the several studies of algorithms based on particle swarm optimization, are discussed. In Section 2.5, the vibration equations for the cantilever beam is derived, and the solutions of the eigenproblem are given. In Section 2.6, the evaluation of modal parameters by finite elements are addressed. In Section 2.7, the conclusion is drawn based on the application of vibration-based approaches for damage identification.

2.2 Vibration Based Damage Detection, Localization and Quantification

In the last few years, researchers have been introduced various methods in the field of damage identification. Yan et al. (2007) presented the state of the art and development

Overview of Vibration Based Techniques for Damage Identification

of vibration-based structural damage identification, where methods are classified on the basis of structural dynamic characteristics, damage diagnosis and new possibilities for structural damage detection as a result of advances in structural damage detection. [Kong et al. \(2017\)](#) reviewed the state of the art of vibration-based damage identification, considering different levels, as well as prediction of the remaining usable life of the systems and further decision-making. As also shown in **Figure 2.1**, the authors ([Kong et al., 2017](#)) presented the flowchart for identification procedure of damages, including different levels, and decision making. [Chesné and Deraemaeker \(2013\)](#) presented a critical review on transmissibility functions for damage detection and localization.

A damage detection algorithm ([Chen et al., 2015](#)) using optimum sensor placement based on eigenvector sensitivity analysis, was carried out with the advantage of the mode shape and natural frequency using the optimal sensor locations. Model-based and non-model-based damage detection approaches were reviewed, and a new concept was added in [Yang et al. \(2009\)](#), which relies on Inner Product Vector (IPV) using the cross-correlation function. The element of IPV is the inner product of time-domain vibration response, which corresponds to the measurement points, and the correlation function of the vibration response, and damage detection method correlated by IPV vector. Later, [Wang et al. \(2010\)](#) reviewed the IPV-based damage detection, where the damage is located by the abrupt changes from the damage index depend on the changes in IPV of the safe and damaged structure. The application of three-dimensional (3-D) spectral element method were used in [Peng et al. \(2009\)](#) using wave propagation problems in plate structures for damage detection. By applying this method, a 3-D spectral finite elements based model was used to simulate the wave propagation in plate structures. [Jeon et al. \(2017\)](#) proposed to use of wavenumber filtering for damage detection with a signal-frequency standing wave excitation to determine dominant wavenumber components of the measured wavefield, were used for indicating of the structural damage. Further, they used mapping process followed by wave number filtering to visualize the damaged area. [Whittingham et al. \(2006\)](#) performed experiments in order to detect damage, due to alterations in structural properties such as stiffness and damping on plate specimens and T-joint specimens, where the specimens had various degrees of damage in the form of delaminations. [Philipp et al. \(2016\)](#) proposed novel damage identification method using signal processing algorithms, including for damage initiation and propagation from the vibration measurements.

The dynamic method based on statistical analysis using time series analysis for the detection of damages, was proposed in [Trendafilova and Manoach \(2008\)](#). [Farrar et al. \(1999\)](#) acknowledged in his research that the process of VBSHM is fundamentally one of the statistical pattern recognition paradigm. Damage assessment technique published by [González and Fassois \(2013\)](#) on the basis of vibration-based statistical damage

2.2 Vibration Based Damage Detection, Localization and Quantification

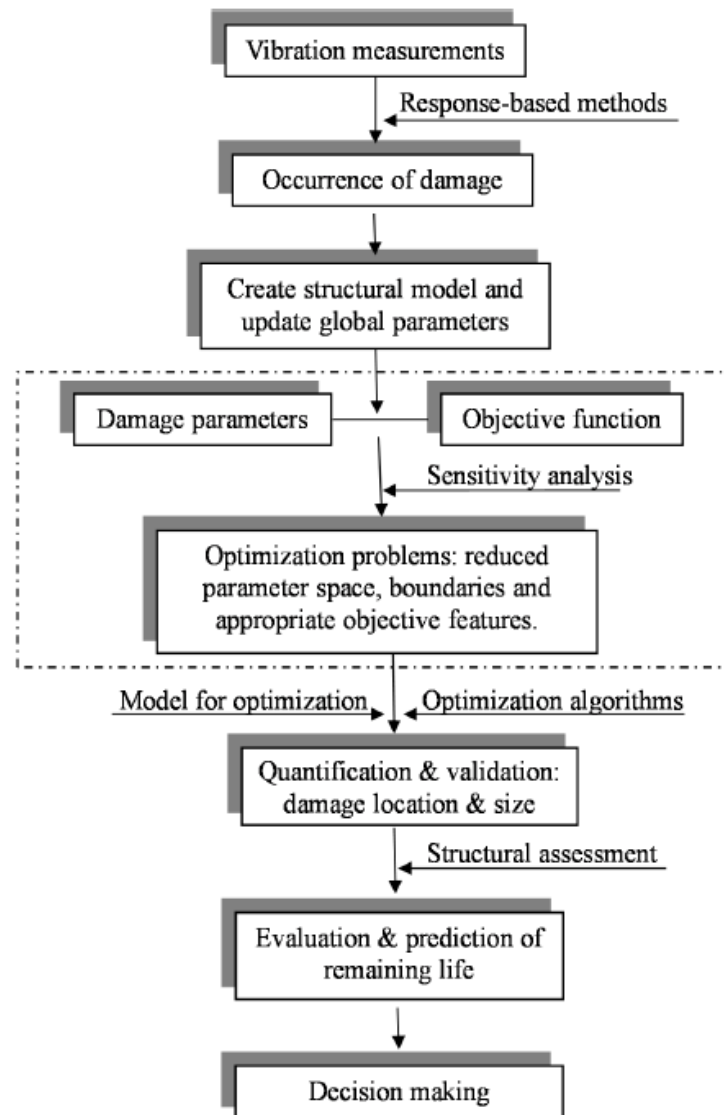

Figure 2.1: Flowchart of damage identification method.
(Kong et al., 2017)

detection, which used the Principal Component Analysis (PCA) of the two variants: the first is an output-only scheme based on the vibration response Power Spectral Density, and the second is an input-output scheme based on the input-output Frequency Response Function. Trendafilova et al. (2008) addressed vibration-dependent structural identification, and suggested a PCA-based approach and a simple pattern recognition process based on the structure vibration response analysis. The review acknowledged on the transmissibility based damage assessment techniques in Zhou et al. (2017) with vibration measurement with highlighting the recent advancements in

Overview of Vibration Based Techniques for Damage Identification

the damage might induce severe changes structures. [Das and Dey \(1994\)](#) studied the random vibration response of beams in order to localize the zones of damage under stochastic excitation using FE analysis. The authors considered the ratio of the stiffness elasticity of the damaged region to that of the undamaged beam for the measurement of the damage extent. [Chandrashekhar and Ganguli \(2009\)](#) used curvature damage factor for a tapered cantilever beam as a damage identification indicator, and Monte Carlo Simulation to study changes in the damage indicator due to uncertainty in the geometric properties of the beam.

In order to solve vibration problems for continuous systems with various dynamic parameters effects, including modal, transient, harmonic and spectrum response analyses, [Wang \(2009\)](#) provided complete analytical formulation where these four types of vibration analysis are applicable for continuous systems as well as engineering structures. [Ciambella and Vestroni \(2015\)](#) used the second derivative of mode shapes by exploiting a perturbative solution of the Euler Bernoulli equation based on stiffness variation in damaged beams to localize damages. Modal curvatures can be effectively used to localize structural damage, and the perturbative solutions were an effective solution to analysis the effective measurable to localize damages. The advantages of a FE model updating using model-based method for structural damage identification was implemented in [Keye \(2006\)](#).

In the last few decades, a large number of non-destructive tests for structural integrity evaluation are developed. They are known to reduce time and costs to perform structure damage monitoring and predictive maintenance. Various strategy was induced by the use statistical methods to identify structural damage, where sensitivity of eigenfrequencies shown the efficiency of methods. Data-driven and model-based methods can be used for the purpose of damage localisation and quantification. Data-driven values can be extracted from the FE model without updating the modal parameters for the reference and damaged states. Furthermore, localization and quantification can be done by flexibility and sensitivity based methods by the data information extracting from the FE models.

2.3 Damage Identification Methods

There are several damage identification methods that can be used to monitor and diagnose the structure using vibration analysis. The identification of structural damage can be categorized using following VBSHM methods:

- Natural frequency based methods
- Mode shape based methods
- Local flexibility based methods

Traditional damage detection methods rely on structural dynamics such as natural frequency, modal shapes, modal damping, and modal energy etc. These methods are mainly based on modal analysis and are convenient for the detection of damage. The efficiency of many approaches often rely on time-consumption, cost and experimental validation, and it is important to accomplish universal structural methodology so that the approach is suitable for damage identification. For example, huge advances in sensing technologies based on damage data from the sensor and automated system have held strong and cost-efficient structural integrity (Farrar and Worden, 2007).

Typically, dynamic methods are the application of the modal parameters such as natural frequencies, mode shapes and stiffness. Each methods based on modal parameters is using to diagnose the structures, as addressed.

2.3.1 Natural Frequency Based Methods

In several of the research studies included in the last few years, the natural frequency is found as the parameters for damage identification. In the literature review, Salawu (1997) noted that the natural frequencies are the sensitive parameter to detect the damage. Cawley and Adams (1979) proposed a method based on FE model updating using natural frequencies to identify damage in a plane structure. Furukawa and Kiyono (2004) introduced a technique to detect the damage in structures using the frequency response function, and data produced by the harmonic excitation force. The method works on the fact that structural damage typically results in a reduction in structural stiffness and an increase in structural damping resulting in changes to the vibration characteristics. Kim et al. (2003) developed algorithms to locate and quantify the damage, incurred from changes in the natural frequency. They presented the damage sizing algorithms to measure the size of damage from the natural frequency perturbation. Messina et al. (1996) presented Damage Location Assurance Criterion (DLAC), expressed as:

$$DLAC(j) = \frac{|\{\Delta f\}^T \cdot \{\delta f_j\}|^2}{\left(\{\Delta f\}^T \cdot \{\Delta f\} \right) \cdot \left(\{\delta f_j\}^T \cdot \{\delta f_j\} \right)}, \quad (2.1)$$

where $\{\Delta f\}$ is the vector of observed frequency change in the unknown size or position of the damage structure, and $\{\delta f_j\}$ is the hypothesis frequency changes vector in the known size at damage area j . DLAC values lie in the range of 0 and 1, with 0 indicates no correlation, and 1 indicates the perfect match of the frequency shift patterns. The j location with the maximum DLAC value specifies the estimated damage location, and later Messina et al. (1998) extended to Multiple Damage Location Assurance Criterion (MDLAC) based on natural frequency changes.

$$MDLAC(\{\delta D\}) = \frac{|\{\Delta f\}^T \cdot \{\delta f(\{\delta D\})\}|^2}{\left(\{\Delta f\}^T \cdot \{\Delta f\} \right) \cdot \left(\{\delta f(\{\delta D\})\}^T \cdot \{\delta f(\{\delta D\})\} \right)}, \quad (2.2)$$

where $\{\delta f(\{\delta D\})\}$ provides frequency changes, that resulting from defined pattern of damage vector $\{\delta D\}$.

The use of statistical analysis (Brincker et al., 1995) to detect damage with the consideration of changes in the measured vibration frequencies, is used as an indicator for the modal frequency. This indicator is written as:

$$(S_f)_i = \frac{f_i^h - f_i^d}{\sqrt{(\sigma_f^h)_i^2 + (\sigma_f^d)_i^2}}, \quad (2.3)$$

where $(\sigma_f)_i$ is the estimated standard deviation of the healthy and unknown beam natural frequency.

Another indicator is Local Frequency Change Ratio (LFCR) indicator, which has been proposed by Shi et al. (1997). This indicator is based on the study of natural frequencies. Local frequencies are calculated with:

$$LF_{ij} = \frac{\phi_i^T K_j \phi_i}{\phi_i^T M_j \phi_i}, \quad (2.4)$$

where M is the mass matrix and K is stiffness matrix, the local frequency (LF) of the (j^{th}) element to the (i^{th}) mode can be calculated before and after the occurrence of damage.

The difference between frequencies of healthy (h) and damaged (d) structure is calculated as:

$$LFCR_{ij} = \frac{|LF_{ij}^d - LF_{ij}^h|}{LF_{ij}^h}, \quad (2.5)$$

Yang and Oyadiji (2017) presented a frequency-based damage detection method using the model curve and square wavelet coefficient. A new damage indicator and damage estimator based on biorthogonal wavelet coefficient was designed to locate and evaluate the damage. Dahak et al. (2017) introduced a frequency-based damage identification method applying the classification of normalized frequencies to locate the damage zone in the cantilever beam. The authors tested a case, where the damage is symmetrical to the mode shape node. They used the unchanged natural frequency to obtain a more accurate location. This method is shown to be independent of the

beam dimension or material propriety and the severity of the damage. [Khiem and Toan \(2014\)](#) performed an investigation on eigenfrequency from the Rayleigh quotient, which is derived for a clamped beam with an arbitrary number of cracks. The authors compared natural frequencies, calculated by the Rayleigh quotient, and measured by an experiment. The results show that Rayleigh formula provides a simple and consistent tool for modal analysis of cracked structures. The Rayleigh quotient parameters were developed a new procedure for crack detection from the natural frequencies. [Yang and Oyadiji \(2016\)](#) investigated the effects of delamination on modal eigenfrequency on composite beams, and modal eigenfrequency variations that depend on the difference between the eigenfrequencies of the intact and the delaminated beam states. Based on the delamination due to mass loading of the modal frequency deviation depends on the longitudinal location and interlayer positions of the delamination. [Mohan et al. \(2013\)](#) used the Frequency Response Function (FRF) with the help of the Particle Swarm Optimization (PSO) technique to detect and quantify structural damage. The authors investigated the robustness and efficiency of the method by comparing the results between the two techniques, Genetic Algorithm, and Particle Swarm Optimization, considering natural frequencies as response quantities. [Zhang et al. \(2014\)](#) developed a damage detection method for cylindrical shell structures that depends on the frequency shift curve, and an auxiliary mass-induced curve contains both natural frequency and mode shape information. [Gelman \(2010\)](#) developed a new FRF technique focused on higher-order spectra for monitoring of structure non-linearity and signal non-gaussianity due to damage. [Gillich et al. \(2017\)](#) performed crack identification on multi-span beam based on natural frequency changes, and to accurately identify the characteristics of the crack to beam structure, they used a mathematical model to predict frequency changes for any boundary conditions. [Alamdari et al. \(2015\)](#) implemented a new scheme for damage detection and localization only using FRFs for damaged structure, and the damage sensitive shape generated from taking the derivatives of the operational mode shapes with the anti-symmetric extension and the shape signals with normalized at different frequencies. The investigation conducted in [Zhou et al. \(2017\)](#) using dynamic structural analysis to diagnose damage by applying a cosine-based indicator, and model assurance criteria in FRFs for eight degrees of freedom structure in order to perform well assessment of structural damage.

Using natural frequencies, the identification of damage can be accurate due to sensitivity of frequency shifts to the damage states. Different frequency-based methods offers very reliable identification that can be used to find damages in specific points, by the application of resonant frequencies and low mode shapes. In order to identify the damage, it is important to consider the number of vibration measurements, where

the procedure should be able to identify the existence of the damage, as well as the exact location and extent of the damage.

2.3.2 Mode Shape Based Methods

(i) Mode Shape Changes

The mode shape information was implemented in [West \(1984\)](#) for the location of damage without prior use of FEM. The author used Modal Assurance Criterion (MAC) to determine the level of correlation between mode shapes of healthy and damaged structure, and changes in MAC values by portioning techniques to determine the location of damages. Mode shape method described a pattern in which structure will naturally displace during excitation. The normal mode shape of the vibratory structure can be determined when all elements of the structure move sinusoidally at the same frequency level. Mode shape changes and mode shape slope parameters were examined in [Yuen \(1985\)](#), which can be computed as follows:

$$\{\phi^*\}_j = \frac{\{\phi^d\}_j}{\omega_j^d} - \frac{\{\phi^h\}_j}{\omega_j^h}, \quad (2.6)$$

$$\{\phi^*\}'_j = \frac{\{\phi^d\}'_j}{\omega_j^d} - \frac{\{\phi^h\}'_j}{\omega_j^h}, \quad (2.7)$$

where $\{\phi_j^h\}$ and $\{\phi_j^d\}$ are the j^{th} mass normalized mode shape vector of healthy and damaged beam. ω_j^h and ω_j^d are the j^{th} modal frequency of healthy and damaged beam.

From the application of mode shapes in structural damage detection, the changes between expected mode shapes and intact mode shapes are used to compare for the identification of the damage. [Katunin \(2015\)](#) introduced algorithm using modal analysis for damaged structure, and whereas mode shapes are allowed to provide the accurate location of the damage. [Baghiee et al. \(2009\)](#) proposed mode shape characteristics based on modal parameters of damaged reinforced concrete beam specimens using experimental test data. They introduced the methods on the basis of measured modal parameters, which included the Modal Assurance Criterion (MAC) and Coordinated Modal Assurance Criterion (COMAC).

In literature, [Wolff and Richardson \(1989\)](#) suggested the use of MAC to detect the damage. The MAC values can be calculated as follows:

$$MAC_{ij} = \frac{|\{\phi_j^h\}^T \{\phi_j^d\}|^2}{(\{\phi_j^h\}^T \{\phi_j^h\})(\{\phi_j^d\}^T \{\phi_j^d\})}, \quad (2.8)$$

where i is the number of the element and j is the mode. If consistency exists, the value of MAC is 1. Lower values are expected if the consistency is not perfect. The problem of the MAC damage indicator is that it is only useful to detect the damage, but not to locate it. It confirms that certain modes are more sensitive to damage than others. This could be due to the fact that the damaged elements may be close to node of mode shapes, causing the influence of damage over modal shapes very small. Overall, MAC has proven to be a successful damage detector.

[Chen et al. \(2014\)](#) examined the dynamics of the vibro-impact beam, how the vibro-impacts do affect the low and high-frequency modes in the global and local senses, the approach can calculate typical values of indicators such as MAC and COMAC. MAC provides a global aspect of damage occurrence, and COMAC could extract the locations of the damage (i.e., wherein the structural defects exist that yield low correlation values in specific modes). COMAC is conceptually similar to MAC but it tries to solve the problem of location of the damage. To do so, it gives local information analyzing results from different modes. COMAC criteria was first presented in [Lieven and Ewins \(1988\)](#), and can be calculated as follows:

$$COMAC_i = \frac{\sum_{j=1}^n (\phi_{ij}^h)(\phi_{ij}^d)}{|\sum_{j=1}^{N_m} (\phi_{ij}^h)|^2, |\sum_{j=1}^{N_m} (\phi_{ij}^d)|^2} \quad (2.9)$$

where n is the total number of modes calculated. ϕ^h represents vertical displacement modal shape of the healthy structure, and ϕ^d of the damaged structure.

[Altunışık et al. \(2017\)](#) investigated on modal parameter identification to extract the dynamic characteristics using enhanced frequency domain decomposition and stochastic subspace identification methods. The authors used MAC and COMAC criteria employing the two sets of mode shapes measurements to determine the correlation between measured and calculated values for damage detection and localization.

Over the years, several damage identification techniques have been developed on using mode shapes, which can be compared between two structural states to detect and localize the damage. [Esfandiari \(2017\)](#) introduced sensitivity equations to estimate stiffness parameters using mode shape datas. Some sensitivity-based model updating methods use changes of mode shapes. This method use a relation between the change of structural parameters and the mode shapes of the damaged structure.

Overview of Vibration Based Techniques for Damage Identification

The modal based method and improved differential evolution (IDE) algorithm (Vo-Duy et al., 2016) is used for damage identification in composite plates. The method is used to identify the location of the damage, and then the improved differential evolution algorithm is used to quantify the extent of the damages. The IDE algorithm is used to minimize a mode shape error with damage variables to indicate the extent of elements.

For damages in masonry structures and historical constructions, Ramos et al. (2006) performed modal identification analysis at each damage stage to find the adequate difference between dynamic behavior, internal crack growth and comparisons between different techniques based on vibrations measurements. Moore et al. (2012) approached model-shape based method on identifying a single crack in a thin clamped plate undergoing free vibration which performed experimentally.

The use of mode shapes changes has some disadvantages for damage identification. Damage is a local phenomenon, and cannot always influence the mode shapes of the lower modes, typically determined during vibration measurements of a large structure. There could be a significant effect on the efficiency of the damage detection using mode shapes from utilizing the number of sensors and the choice of sensor locations. Finally, extracted mode shapes may be affected by environmental noise from ambient loads.

(ii) Mode Shape Curvature (MSC)

In the last few decades, methods of structural damages identification have been focused on mode-shapes and their derivatives. Most of the existing methods require a numerical or measured baseline of mode shapes, which can be used as a reference for the identification of damage. Criteria using mode shape changes are greatly limited based on the practicability of methods. An alternative way is necessary to obtain the mode shapes using derivative with curvature.

Mode shape curvature can be used for FEM beam structures that demonstrate absolute changes, which are computed from displacement mode shape and central difference approximation.

$$\phi''_{q,j} = \frac{\phi_{q-1,j} - 2\phi_{q,j} + \phi_{q+1,j}}{h^2} \quad (2.10)$$

where h is the length of two elements between $q - 1$ and $q + 1$, q is the number of current structural DOF.

$$MSC_j = \sum_{j=1}^{N_m} |\phi''_{q,j}^d - \phi''_{q,j}^h| \quad (2.11)$$

Mode shape curvature method are used to compute the central difference approximation, as defined in equation 2.10. The method computes relative difference to the mode shape relative difference by the selecting the modes, which are used during analysis.

Xu et al. (2015) investigated vibration-based damage identification using mode shapes and their derivatives, among which the 2D curvature mode shape is called a damage identifier, the process of use of 2D curvature mode shape to depict damage is explained analytically in the form of the thin plate. Roy and Ray-Chaudhuri (2013) provided mathematical derivation to illustrate the correlation between structural damage and the change in the fundamental mode shape, and their derivatives from the expression of the damaged mode shape using the perturbation process. This approach reveals that the changes in the mode shape and their derivatives due to damage, is an excellent indicator for the localization of damage. Pandey et al. (1991) used an indicator called curvature mode shape using cantilever and simply supported analytical beam model. The authors used absolute changes in curvature mode shapes for localization of the region of structural damage. They also used the relationship between beam stiffness and mode shape curvature. The correlation between the model parameters between the damaged and the undamaged state provides the relative details required to find the location of the damage. Zhang and Aktan (1998) acknowledged that the change in Uniform Load Surface Curvature (ULS) could be used to locate damage due to their truncation effect and vulnerability to experimental errors according to authors. They observed that the approach had a lower truncation effect and less sensitive to experimental errors. Wu and Law (2004) represented the ULS Curvature-based method that involves requiring and mode shapes before and after structural damage. Qiao and Cao (2008) implemented improvements in curvature mode shapes with increasing damage size. The authors explored and implemented mode shapes for crack recognition through waveform fractal dimensions such as Katz Waveform Fractal Dimension (KWFD), and developed approximate waveform capability dimension (AWCD), and then further used AWCD-based modal abnormality algorithm.

Mode shape curvature method has also some drawbacks. The methods depend on the number of modes and sensors. Also, the mode curvature attains some error during approximation method because of displacement of mode shapes in structures.

(iii) Modal Strain Energy (MSE)

MSE has been widely used to locate and quantify damage in structural components. The method is considered based on changes in modal strain energy before and after the occurrence of damage. The method of strain energy is used as the extension of the deformation energy index. According to Cornwell et al. (1999), if the damage

Overview of Vibration Based Techniques for Damage Identification

is assumed to be primarily in a single sub-region, the fractional energy will remain relatively constant in healthy sub-regions. For a single damaged sub-area localization, the modal identification equations based on strain energy can be used to indicate a change in the flexural rigidity of the sub-region. The equation of MSE of a structure on the mode is written:

$$\frac{f_{ij}^*}{f_{ij}} = \frac{\int_a^b EI_j \left[\frac{\partial^2 \phi(x)_i^*}{\partial x^2} \right]^2 dx / \int_0^l EI_j \left[\frac{\partial^2 \phi(x)_i^*}{\partial x^2} \right]^2 dx}{\int_a^b EI_j \left[\frac{\partial^2 \phi(x)_i}{\partial x^2} \right]^2 dx / \int_0^l EI_j \left[\frac{\partial^2 \phi(x)_i}{\partial x^2} \right]^2 dx} \quad (2.12)$$

For all the measured modes, the MSE auxillary index is needed: $\beta_i = \frac{\sum_{j=1}^{N_m} f_{ij}^*}{\sum_{j=1}^{N_m} f_{ij}}$

Normalized damage index is calculated: $Z_i = \frac{\beta_i - \bar{\beta}_i}{\sigma_i}$. where $\bar{\beta}_i$ and σ_i = mean and standard deviation of damage index, respectively.

MSE is an accepted method to quantify the extent of damage, in particular, using the vibration modes. In some literature, the approach based on modal flexibility matrices, such as normalized uniform load surface curvature, was presented by [Sung et al. \(2013\)](#). [Tiachacht et al. \(2017\)](#) developed cornwell indicator, which is based on strain energy fraction, is used for the detection and quantification of damage in the composite beams. Moreover, modal strain energy-based method and improved differential evolution (IDE) algorithm was introduced in [Vo-Duy et al. \(2016\)](#) for the detection of damage in the plate structure. MSE is performed to locate damages, and improved differential evolution algorithm is employed to quantify the extent of damages. [Hu and Wu \(2009\)](#) implemented MSE method for the identification of damage using modes, where modal displacements are used to compute strain energy. They introduced damage index using modal strain energy ratio, where the indicator is sensitive to the small change of structural response parameters.

Several studies ([Osegueda et al., 1997](#); [Seyedpoor, 2012a](#)) are used to compare MSE from damaged to undamaged state condition of structures. The MSE indicator has several advantages for the identification of damages. [Seyedpoor \(2012a\)](#) developed a scheme for multiple damage cases depending on modal strain energy, to precisely locate the damage, performed by modal analysis data using FE modeling. [Tan et al. \(2017\)](#) introduced VBSHM technique using only the vibration mode for damage location and severity estimation, followed by the modal strain energy damage index that was capable of locating and quantifying single damage. Here, artificial neural network with a strain energy damage index was used for multiple damages.

2.3.3 Flexibility Based Methods

Flexibility-based methods are another essential group for the identification of structural damage. Flexibility Matrix $[FM]$ depends on the mode shape and reciprocal of natural

frequency, which can be measured only using low order modes and frequencies. The Flexibility Matrix is the opposite of the rigidity matrix, so can be expressed as:

$$[FM] = [K]^{-1} = \phi[\Lambda]^{-1}\{\phi\}^T = \sum_{j=1}^m \frac{1}{\omega_j^2} \phi_j \phi_j^T \quad (2.13)$$

where ω_j is the j^{th} natural frequency, ϕ_j the j^{th} mode shape. Changes in flexibility matrix is defined as the difference between damaged and undamaged state:

$$[\Delta F] = [FM_d] - [FM_h] \quad (2.14)$$

where $[FM_h]$ and $[FM_d]$ are the flexibility matrix for healthy and damaged beam, respectively.

Flexibility-based method have been used in different ways to detect structural damages. [Zhang et al. \(2013\)](#) has shown that flexibility indexes such as inter-story deflection and flexibility curvature are sensitive to structural damage. They also developed a flexibility based damage detection algorithm without considering the structural mass, and then damage indices are used for structural damage detection purpose. [Sung et al. \(2013\)](#) suggested a procedure using a normalized uniform load surface obtained by modal flexibility to detect damage in the cantilever beam structure.

Baseline modification is a newly introduced concept using the flexibility method to detect damage, which is employed by changing the baseline to the prior damage location. In some studies, the algorithms used flexibility-based damage detection, with the help of damage indexes, considering uniform load surface and curvature. [Reynders and De Roeck \(2010\)](#) suggested a method for damage localization and quantification by quasi-static flexibility matrix and local flexibility. The experimental identification performed from the flexibility matrix via local stiffness change value. [Reynders and De Roeck \(2010\)](#) suggested a method for damage localization and quantification by quasi-static flexibility matrix and local flexibility. Here, the experimental identification was performed from the flexibility matrix via local stiffness change value. [Perera et al. \(2007\)](#) contrasted analytic and experimental flexibility matrices. They performed procedure for the simulated beams, followed by experimental results from vibration tests of a beam. The method has demonstrated that it is very promising to locate and quantify damaged elements, and also greatly improves predictions based only on modal flexibility parameters.

[Dinh-Cong et al. \(2017\)](#) proposed a multi-stage optimization technique for structural damage detection. This strategy is accomplished by minimizing the objective function, provided by flexibility structural changes. They provided the vector design of the variables corresponding to the severity of damage in finite elements, discretized by the FEM. The approach effectively identifies the location and severity of various damages in the plate structure. [Hackmann et al. \(2013\)](#) suggested an SHM design

system with flexibility based structural method, and it can locate damage with a multi-level computing architecture and leverages the multi-resolution feature of flexibility method. A method developed by [Montazer and Seyedpoor \(2014\)](#) for the estimation of damage based on the concepts of flexibility and strain energy of the structure. [Shih et al. \(2009\)](#) proposed a method for damage estimation in beam structures using flexibility matrix and modal strain energy-based damage index. [Dawari and Vesmawala \(2013\)](#) used a method based on modal curvature and modal flexibility differences to identify and locate honeycomb damage in reinforced concrete beam models. The authors verified the applicability of algorithms by analyzing the eigenvalue and extracting the eigenvectors of the reinforced concrete beam FE models. [Sung et al. \(2013\)](#) introduced a new vibration-based damage detection method based on the normalized uniform load surface curvature obtained by modal flexibility. The method works with changes occurring in the curvature at damaged elements and not in safe elements due to internal forces, caused by damage only. The computational method works only for damaged elements at a normalized level.

Conventional flexibility-based methods have some limitations, such as the requirement for the intact FE model, a noise-sensitive feature, and no apparent correlation between other damage characteristics etc. In order to make the identification of damages more reliable, precise and appropriate, these limitations have to be overcome. Different environmental effects and the unavoidable assessment of noise will also have an effect on traditional flexibility methods

2.4 Optimization Algorithms using Particle Swarm

In the last few years, numerous optimization algorithms have been developed, as reliable and intelligent damage identification tools for various structural application. These algorithms have great advantages throughout the SHM processes. In some optimization methods, either few elements or various parts of elements are considered as for identification of the damaged region, but neither the total number of elements nor the overall structure. Particle Swarm optimization (PSO) has been used to design for the global optimization. PSO method has received considerable attention over the last few years due to advanced optimization tool, and provides accurate identification of the damage. PSO method is a part of non-destructive approaches, and it is widely used in many industries such as space vehicles, astronautics aviation, and architecture. Several algorithms are developed using modal parameters and PSO.

[Mohan et al. \(2013\)](#) developed an algorithm with FRF and PSO for the detection and quantification of damages. The authors tested the algorithm in beam and plane frame structures for chosen several damage scenarios using natural frequencies as response quantities. [Gökdağ \(2013\)](#) conducted a method for detection of damage in beam

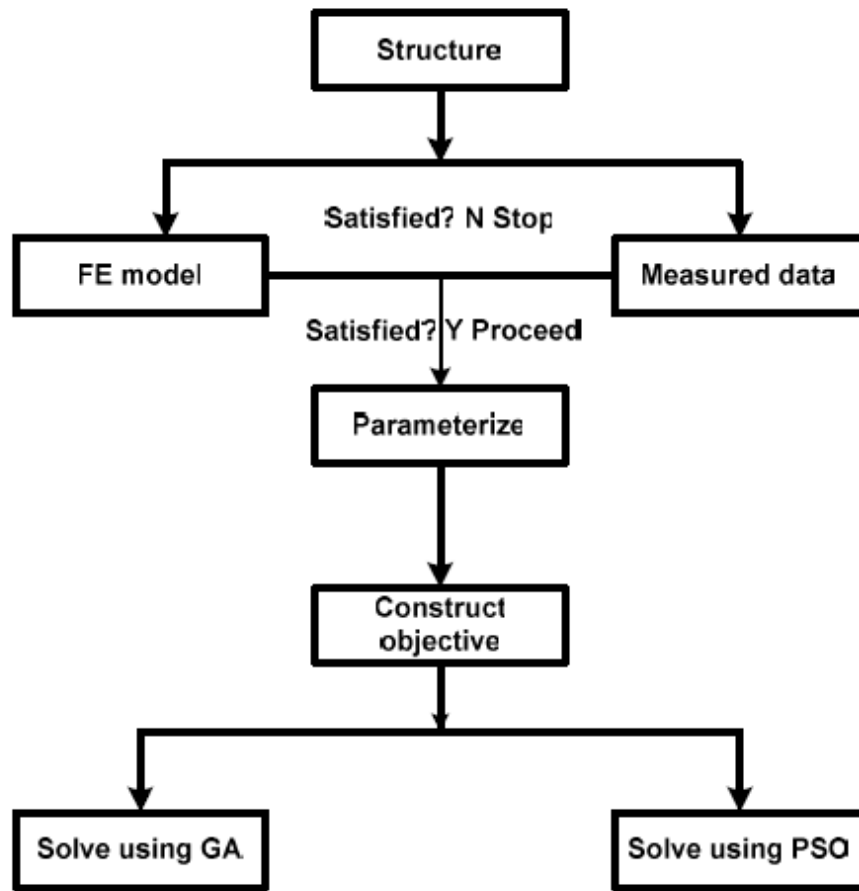

Figure 2.2: Flowchart of damage identification method using optimization. (Marwala, 2010)

structures subject to moving load. The method is formulated to solve an optimization problem for crack locations and depths using PSO with constriction factor. [Benaissa et al. \(2017\)](#) suggested an approach based on the model reduction to estimate the crack size. The method was integrated the proper orthogonal decomposition with radial base functions using the PSO algorithm. [Zhang et al. \(2016\)](#) presented an improved method through model-based quantitative crack identification by the use of FEM and PSO. [Seyedpoor \(2012b\)](#) showed that the combination of modal strain energy-dependent index and PSO are considered as a reliable strategy for detecting multiple structural damages. [Khatir et al. \(2018\)](#) proposed an optimization algorithm for crack detection and localization using experimentally determined natural frequencies and PSO process. The flowchart for optimization approach ([Marwala, 2010](#)) can be seen more precisely in the flow chart shown in **Figure 2.2**. [Wei et al. \(2018\)](#) also proposed an improved PSO using vibration data for three different structures (beam, truss and

plate). The authors mentioned that the damage identification method is effective during consideration of measurement noise. [Jebieshia et al. \(2020\)](#) presented an optimization method to detect and quantify damages in the laminated composite beam and plate-like structures using unified PSO technique. They considered few natural frequencies as the diagnostic parameter for noisy and noise-free environment. The unified PSO as an improved version of PSO was also expressed in [Parsopoulos and Vrahatis \(2005\)](#) for the identification of damages. [Xiang and Liang \(2012\)](#) presented a two-step method for localization and quantification of multiple damages in thin plates, where 2-D wavelet transform is used to identify damage locations in the first step, and PSO algorithm is used for the second step to obtain the relationships between natural frequencies and damage severities using a wavelet FEM.

In PSO, all swarm particles share the common information, which can be directed towards to search a best-fit global value. PSO also provides other advantages, feasibility to implementation, ease of operation and fast convergence.

2.5 Vibration Equation on Cantilever Beam Structure

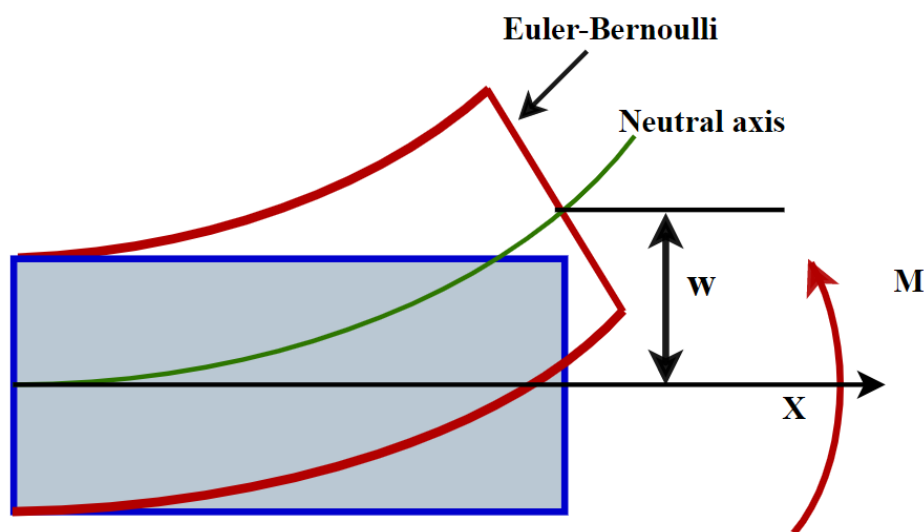

Figure 2.3: Euler-Bernoulli beam and cross-section of the beam is at 90 degrees to the neutral axis, where w is a distance between before and after bending axis, M is the bending moment.

The goals that we have chosen in this study are basically followed by the principles and practices of flexural vibration, considering the use of vibrational behavior of the Euler-Bernoulli cantilever beam ([Bauchau and Craig, 2009](#)). To explicit this, the model structure is going to consider a cantilever beam throughout this thesis, where the cases

2.5 Vibration Equation on Cantilever Beam Structure

are implemented in particular with the Euler-Bernoulli theory (see **Figure 2.3**). Euler-Bernoulli beam theory does not consider the influence of the transverse shear tension, and vibration model makes the cross-section of the beam, always perpendicular to the neutral axis.

The theoretical analysis, eigenvalue problem, and clamped-free boundary condition of the Euler's Bernoulli beam, follows as given:

(i) Equation of Motion

The equation of motion of the Euler-Bernoulli beam is

$$M(x)\frac{\partial^2 w(x,t)}{\partial t^2} + C(x)\frac{\partial w(x,t)}{\partial t} + EI\frac{\partial^4 w(x,t)}{\partial x^4} = f(x,t), \quad (2.15)$$

where $w(x,t)$ is the transverse deflection of the beam base axis, M is mass per unit length of beam. Considering $EI(x)$ and $M(x)$ are assumed to be constant, and if there is no damping and no external force so that $C(x) = 0$, $f(x,t) = 0$, **Equation 2.15** is written as:

$$\frac{\partial^2 w(x,t)}{\partial t^2} + \frac{EI}{M}\frac{\partial^4 w(x,t)}{\partial x^4} = 0, \quad (2.16)$$

Equation 2.16 describes free vibrations and is of order four spatial derivatives, and requires four boundary conditions. Here, the two-time derivatives require for two initial conditions, one for the velocity and one for the displacement.

(ii) Clamped-Free Boundary Condition

The boundary conditions for clamped-free case are given:

$$u(0) = 0, \quad \frac{dU(x)}{dx}\Big|_{x=0} = 0, \quad \frac{d^2U(x)}{dx^2}\Big|_{x=L} = 0, \quad \frac{d^3U(x)}{dx^3}\Big|_{x=L} = 0, \quad (2.17)$$

(iii) Eigenvalue Problem

For eigenvalue problem, and product solution is assumed as:

$$w(x,t) = U(x)F(t), \quad (2.18)$$

where $U(x)$, $F(t)$ depends on the spatial position and time domain. Substituting **Equation 2.18** into **Equation 2.16**, we can obtain the following equation:

$$\frac{d^4U(x)}{dx^4} - \beta^4U(x) = 0, \quad (2.19)$$

where $\beta = \frac{\omega^2 M}{EI}$, $0 < x < L$, and the characteristic equation is:

$$\cos \beta L \cosh \beta L = -1, \tag{2.20}$$

Then, the solution of Equation 2.19 is written as:

$$U(x) = C_1 \sin \beta x + C_2 \cos \beta x + C_3 \sinh \beta x + C_4 \cosh \beta x, \tag{2.21}$$

where ω is the natural frequency, and C_1, C_2, C_3, C_4 are constants. These constants are unique for a given set of boundary conditions.

2.6 Modal Parameters by Finite Elements

The vibration response of simple structures, such as beams, can be obtained by solving the differential equation of motion together with appropriate boundary conditions. In practical circumstances, the geometrical or material properties vary; in this situation, it may be impossible to obtain all analytical solutions to the equations of motion which satisfy boundary conditions. This difficulty can be overcome by seeking approximate solutions to the structure. A structure can be used as an assemblage of components of different types, for example, a beam structure can be analyzed as multi-beams elements.

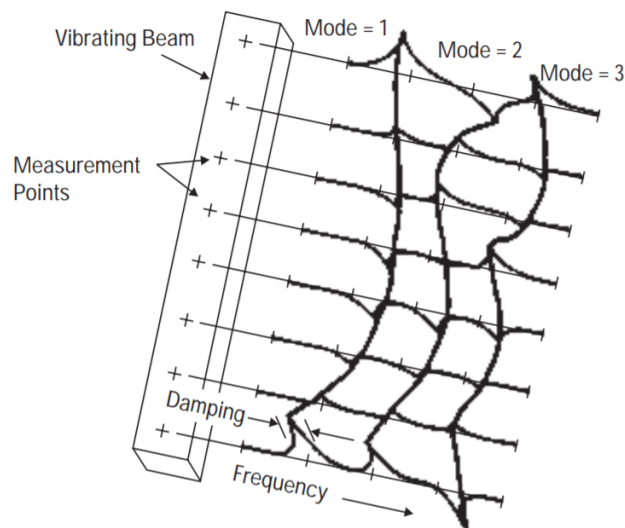

Figure 2.4: Modal parameters i.e. damping, frequency are obtained same at each measurement point, and mode shape is the imaginary part of FRF, obtained at same frequency from each measurement points.

(Notes, 1986)

FEM is widely used as a numerical technique to solve the differential equation (Gurunakala et al., 2012; Reddy, 2019). Here, if the length of Euler’s Bernoulli beam is

discretized into finite elements, each of which has at least two end nodes. The dynamic equation of motion for the system is given as:

$$[M]\{\ddot{X}\} + [C]\{\dot{X}\} + [K]\{X\} = 0, \quad (2.22)$$

where $[M]$ is the mass matrix, $[C]$ is the damping matrix and $[K]$ is stiffness matrix for the system. $\{\ddot{X}\}$, $\{\dot{X}\}$, $\{X\}$ are vectors containing acceleration, velocity and displacement in function of time. If free movement and negligible damping are taken into consideration, the following equation is expressed as:

$$[M]\{\ddot{X}\} + [K]\{X\} = 0, \quad (2.23)$$

If $\{\tilde{y}\}$ are the amplitudes for each mode shape, and ω_i are the natural frequencies of vibration for each mode shape. The following equation is obtained:

$$([K] - \omega_i^2[M])\{\tilde{y}\} = \{0\}, \quad (2.24)$$

This equation represents a set of linear homogeneous equations. The condition so that these equations should have no zero solution is:

$$\det ([K] - \omega_i^2[M]) = 0, \quad (2.25)$$

Equation 2.25 can be generalized in a polynomial form, where w_i^2 is the root of the polynomials. These roots are referred to as eigenvalues. Since $[M]$ and $[K]$ are positive, then the eigenvalues are real, which will be either positive or zero for a vibrating beam. Corresponding to each eigenvalue, there exists a unique solution, represented as $\{\tilde{y}\}$. These solutions are known as eigenvectors, and they define the mode shapes of vibration of the structure as for an approximate context.

The solution of the equation is known as an eigenproblem. Numerical methods to find the solutions for eigenproblems are carried out in this report. These solutions, as indicated above, give approximate solutions for the natural frequencies and modes of free vibration.

Conclusion

Ce chapitre donne un aperçu des dernières avancées en matière d'identification des dommages par analyse vibratoire, à l'aide de diverses méthodes conventionnelles. L'identification des dommages et l'étude des propriétés géométriques des dommages se concentrent généralement sur les structures mécaniques. Pour atteindre ces objectifs, une revue brève mais complète est rappelée sur les méthodes d'identification des dommages basées sur les changements des fréquences propres, des formes de mode avec

Overview of Vibration Based Techniques for Damage Identification

la prise en compte des outils d'optimisation, à la fois d'un point de vue expérimental et numérique. La revue de la littérature est détaillée à propos des dommages/fissures dans la structure des poutres qui conduisent à différentes méthodes basées sur les modes. En outre, une variété de travaux liés au renforcement des techniques, et des indicateurs pour l'identification des dommages sont également mis en évidence.

2.7 Conclusion

This chapter provides an overview of the latest advancement in vibration-based damage identification, using various conventional methods. The focus of the damage identification and investigation on geometry damage properties is typically concentrated on mechanical structures. To achieve these objectives, a brief but comprehensive review is recalled on damage identification methods based on changes on eigenfrequencies, mode shapes with consideration of optimization tools, both from an experimental and numerical point of view. The literature review is detailed on damage/crack in the beam structure leads to different modal based methods. In addition, a variety of works related to the strengthening the techniques, and indicators for damage identification are also highlighted.

Chapter 3

Frequency Shift Coefficient Based Damage Identification Algorithm in Beams

Summary

3.1	Introduction	43
3.2	Beam Vibration Theory	46
3.2.1	2D FE Model	47
3.2.2	Numerical Modeling of Damage	47
3.3	Proposed Damage Identification Strategy	49
3.3.1	Objective Function	49
3.3.2	Proposed Strategy and Minimization Problem	49
3.3.3	Steps for Damage Identification Procedure	50
3.3.4	Modeling Uncertainty on Natural Frequencies	51
3.4	Numerical Validation of Method	51
3.4.1	Numerical Beam Model	52
3.4.2	Localization and Quantification of Single Damage	53
3.4.3	Localization and Quantification of Double Damages	55
3.4.4	In the Case of Modeling Uncertainty on Natural Frequencies	59
3.5	Experimental Example for Damage Identification	62
3.5.1	Results	65
3.6	Conclusions	67

Résumé

La surveillance de la santé dans les industries est une perspective importante pour assurer la sécurité et prévenir les effondrements soudains. L'identification des dommages basée sur les vibrations est utilisée en permanence pour le diagnostic des structures et des machines dans l'industrie. Les changements de fréquences propres sont fréquemment utilisés comme paramètre d'entrée dans les mesures de vibrations. Dans cet article, le coefficient de décalage de fréquence (FSC) est utilisé pour l'évaluation de divers cas numériques de dommages. L'algorithme basé sur le FSC est employé afin d'estimer les positions et la sévérité des dommages en utilisant uniquement les fréquences naturelles de structures saines et inconnues, probablement endommagées. En considérant la minimisation du FSC, les emplacements et la gravité des dommages sont obtenus. Les cas de dommages artificiels sont évalués par des changements dans leurs emplacements, le nombre de dommages et la taille des dommages avec les différentes parties de la poutre encastré-libre. L'étude est approfondie en considérant l'effet de l'incertitude sur les fréquences naturelles (0.1%, 0.2% and 0.3%) dans les cas endommagés, et l'algorithme est utilisé pour estimer la position et la sévérité des dommages. Les résultats et l'efficacité de la méthode proposée basée sur le FSC sont évalués afin de localiser et de quantifier les dommages. Une poutre réelle endommagée est étudiée à l'aide de mesures expérimentales pour montrer l'efficacité de l'algorithme en identifiant deux dommages.

Abstract

Health surveillance in industries is an important prospect to ensure safety and prevent sudden collapses. Vibration Based Structure Health Monitoring (VBSHM) is being used continuously for structures and machine diagnostics in the industry. Changes in natural frequencies are frequently used as an input parameter for VBSHM. In this paper, Frequency Shift Coefficient (FSC) is used for the assessment of various numerical damaged cases. FSC-based algorithm is employed in order to estimate the positions and severities of damages using only the natural frequencies of healthy and unknown structures probably a damaged one. By considering the minimization of FSC, damage locations and severities are obtained. Artificial damaged cases are assessed by changes in its locations, the number of damages and size of damages along with the various parts of the cantilever beam. The study is further investigated by considering the effect of uncertainty on natural frequencies (0.1%, 0.2% and 0.3%) in damaged cases, and the algorithm is used to estimate the position and severity of the damage.

The outcomes and efficiency of the proposed FSC based method are evaluated in order to locate and quantify damages. A real damaged beam is investigated using measurements to show the efficiency of the algorithm by identifying double damages.

Note: The article has been written at the end of thesis using this chapter.

3.1 Introduction

Damage identification has drawn much interest in the sector of aerospace, civil and mechanical structures. The basic components of the structure make it very sensitive to damage which requires techniques for detecting damage using efficient methodologies. Damage can occur during manufacturing and in-service loadings, such as fatigue and other object impacts. There are many methods to detect and determine the extent of damage based on Structure Health Monitoring (SHM). Many SHM methods, such as ultrasonic (Dai and He, 2014), guided wave (Clarke et al., 2010), eddy current (Sodano, 2007) etc. have been developed to identify structural damage, which are using for various purposes. Although several vibration based structure health monitoring (VBSHM) methods have been also proposed, they rely on vibration characteristics such as natural frequencies, mode shapes etc. Some important VBSHM indicators are Damage Location Assurance Criterion (DLAC) (Messina et al., 1996), Multiple Damage Location Assurance Criterion (MDLAC) (Messina et al., 1998) mode shape curvature method (Pandey et al., 1991) and flexibility based method (Pandey and Biswas, 1994), which are effective and widely acceptable in order to identify damage and their characteristics. Doebling et al. (1996) presented a comprehensive review of different damage identification methods and health monitoring of structure from changes in vibration characteristics. The damage condition of system can be described in five steps as discussed in Rytter (1993). These steps are : 1) detection; 2) localization; 3) classification; 4) assessment; and 5) prediction. More recently, Toh and Park (2020) provided a review applying machine learning algorithms for damage monitoring using the vibration factors, and interpretation on deep neural networks to guide further applications for structural vibration analysis.

In recent decades, natural frequencies used as an identification parameter for detection, localization and quantification of damages. Salawu (1997) acknowledged that the natural frequency is a sensitive indicator to detect the damage in the structure. Cawley and Adams (1979) proposed a method based on the frequency shift that identifies the location of damage in a plane structure. Narkis (1994) analyzed the inverse problem for identification of crack location from frequency measurements. Silva and Araujo Gomes (1994) proposed a technique using Frequency Shift Coefficient (FSC) to detect the crack

size and position. [Brincker et al. \(1995\)](#) used statistical analysis indicator to detect damage by changes in the measured natural frequencies. [Kim et al. \(2003\)](#) developed algorithms to locate and quantify the damage by changes in natural frequency. They addressed the damage sizing algorithms to quantify the size of damage from the natural frequency perturbation. [Armon et al. \(1994\)](#) introduced the rank ordering of natural frequency shift for the location of the damage. The development of a damage detection method by [Zhang et al. \(2014\)](#) based on the frequency shift curve caused by auxiliary mass with both the natural frequency and mode shape information for cylindrical shell structures. [Gillich et al. \(2017\)](#) performed crack identification based on natural frequency change. They established a mathematical model and signal processing algorithm, which can predict frequency changes for any boundary conditions with the identification of cracks on multi-span beams. [Shukla and Harsha \(2016\)](#) presented a view that the change in natural frequency is an indication of cracks in the blade geometry. [Keye \(2006\)](#) investigated the advantages of Finite Element (FE) model updating in association with a model-based method for structural damage localization. [Dahak et al. \(2017\)](#) presented a normalized natural frequencies based method for a specific damage location to locate the damage in the cantilever beam. Therefore, the use of the unchanged frequency also gives more accuracy when the damage is symmetric to the mode shape node. However, this method is independent of the beam dimension or material propriety and the severity of the damage. [Khatir et al. \(2013\)](#) presented a local frequencies change ratio function based on vibration data for the detection and localization of defect in beam structures. The author used FE model for diagnostic purposes of the beams. The loss of rigidity of the element is supposed to represent a defect of the structure.

[Khiem and Toan \(2014\)](#) investigated natural frequency changes from the Rayleigh quotient that is derived for a clamped free beam with an arbitrary number of cracks. The authors compared natural frequencies calculated by using the Rayleigh quotient and measured by an experiment, and showed that Rayleigh formula is a simple and consistent tool for modal analysis of cracked structures. Moreover, crack detection procedure based on the natural frequencies was introduced using Rayleigh quotient parameters. [Le et al. \(2016\)](#) presented a method for the localization and quantification of simultaneous structural modifications based on the dynamic analysis in Euler Bernoulli beams with or without axial force. The method employs first-order estimation of frequency relative variation, which is derived from the continuous formulation. By this method, once the location is identified the damage can be quantified by the relative variations of axial force, density and bending stiffness with nonlinear coefficients depending on the location of density and bending stiffness modification. [Khatir et al. \(2015\)](#) presented an approach for damage identification based on model reduction where an optimization algorithm is used to minimize the normalized difference

between a frequency vector of the tested structure and its numerical model. [Yam et al. \(2002\)](#) investigated the occurrence of damage in plate-like structures using sensitivities of static and dynamic parameters. The authors suggested two damage indices for damage identification based on the curvature mode shape and the strain frequency response function.

[Serra et al. \(2016\)](#) proposed a strategy to detect and localize damage using various classical indicators by testing different damage cases. [Eraky et al. \(2015\)](#) focused on Damage Index Method (DIM) as a tool for determining elemental local damages occurred in beam and plate structures. However, the technique depends on the experiment based on comparing modal strain energies at different degradation stages. More recently, [Serra and Lopez \(2017\)](#) presented combined modal wavelet strategy. They compared it with the most frequently used indicators and wide-studied methods in order to identify the damages. The performance of each method is evaluated and the capacity to detect and localize damage are tested through different cases. [Hu et al. \(2015\)](#) used a statistical based damage-sensitive indicator for the health monitoring of a wind turbine system by considering environmental and operational influences on structural dynamic properties. [Karbhari and Lee \(2009\)](#) investigated on dynamic structural analysis to detect damages by applying cosine based indicator and model assurance criterion for eight degrees of freedom structure to perform well in identifying damages in the structure.

Showing the several studies of damage detection based on the use of Frequency Response Function (FRF). [Furukawa and Kiyono \(2004\)](#) introduced a technique for detection of damage in structures that use FRF data, generated from the harmonic excitation force. The method is based on the fact that structural damage usually causes a decrease in structural stiffness and an increase in structural damping thereby producing changes in vibration characteristics. [Mohan et al. \(2013\)](#) used FRFs with the help of Particle Swarm Optimization (PSO) technique for damage detection and quantification. The robustness and efficiency of the method, are acknowledged after comparing results between the two methods namely Genetic Algorithm (GA), and PSO. [Alamdari et al. \(2015\)](#) implemented FRFs in damaged structure and the damage sensitive shape is generated by taking the derivatives of operational mode shapes with the anti-symmetric extension and the shape signals with the normalized at different natural frequencies. Again, these research investigations focused on frequency-based damage detection strategies.

From this literature review, it is found that several VBSHM techniques using natural frequencies are considered for structure damage detection. A few techniques (wavelet transform, artificial neural network...) have proven reliable results with the consideration of measurement errors or uncertainties. As we know, uncertainty or noise is always present on natural frequencies and other modal parameters that can

lead to inadequate structural damage detection. FSC-based algorithm is introduced, and different cases are investigated with or without consideration of uncertainty or measurement errors on natural frequencies. The algorithm is employed by minimizing FSC using PSO, where damages are localized and quantified by updating the FE model from the FSC algorithm based on natural frequency shifts. The damage identification technique is performed based on bending stiffness reduction using the FE models. For that, 2D FE models are developed for the healthy and damaged beams, and numerical damage cases are built artificially to test the proposed algorithm. The difference between healthy and damaged models are weighted depending on the shift of natural frequencies. It means the damage localization and quantification can be accurate based on the sensitivity of frequencies shift to the damage states. The paper is intended to further investigate the efficiency of the FSC-based method by evaluating the identification capacity to uncertain damaged cases. The FSC-based method is demonstrated by testing a real beam with double damaged using an experimental test.

The chapter is organized as follows: **Section 3.2**, illustrates modeling of the beams and bending vibration theory; **Section 3.3**, presents proposed damaged identification strategy using FSC minimizing algorithm; **Section 3.4**, shows different numerical examples to verify the effectiveness of the method and discussion about the factors influencing, i.e. influence about the damage positions and severities. The artificial damaged cases are investigated to localize and estimate the severities along the cantilever beam. The effect of modeling uncertainty is considered and the test cases are examined by considering the different noise levels; **Section 3.5**, shows a simple laboratory experiment for the vibration measurements in order to find locations and severities of damages in a real beam structure.

3.2 Beam Vibration Theory

It is assumed that simplest damage detection problem can be explained by testing beams using a linear equation of motion with undamped free vibration. The equation of motion for free vibration analysis of an Euler-Bernoulli beam is given:

$$M(x) \frac{\partial^2 w(x, t)}{\partial t^2} + \frac{\partial^2}{\partial x^2} \left(EI(x) \frac{\partial^2 w(x, t)}{\partial x^2} \right) = 0, \quad (3.1)$$

where $w(x, t)$ is the transverse deflection of the beam base axis, $M(x)$ is the mass per unit length of the beam, $EI(x)$ is the bending stiffness of the beam. Here, a harmonic time dependency is assumed, and cantilever beam is taken into consideration that is clamped in $x = 0$ and free in $x = L$; then the solution would satisfy $u''(L) = u'''(L) = 0$ and $u'(0) = u(0) = 0$. We have considered as linear homogeneous equation

similar to **Equation 3.1**. Then, the differential equation of eigenvalue problem is written as:

$$(EI(x)\phi_n''(x))'' - \lambda_n M(x)\phi_n(x) = 0, \quad (3.2)$$

where $\sqrt{\lambda_n}$ and ϕ_n are the associated natural frequencies and the normal modes. In order to determine the Rayleigh quotient using normal mode shapes (ϕ_n) of the undamped problem, the normal modes (ϕ_n) are considered as the functions, represented by $\phi_n(x)$, which is the square integral on $[0, L]$ (i.e. $\phi_n(x) \in C^2(0, L)$, and C^2 denotes for a square-integrable function) as well as ϕ_n' and $\phi_n''(x)$. Multiplying **Equation 3.2** by any function $u(x)$ with $u \in C^2(0, L)$ and taking the partial integration, we get:

$$\int_0^L (EI(x)\phi_n''(x)u''(x))'' - \lambda_n M(x)\phi_n(x)u(x) dx + bc = 0 \quad (3.3)$$

Similarly, natural frequency (Hz) calculation for the beam is given by:

$$f_n = \frac{\sqrt{\lambda_n}}{2\pi}, \quad (3.4)$$

3.2.1 2D FE Model

The studied model here is considered to be an Euler-Bernoulli cantilever beam with a uniform cross-section area having 2D healthy and damaged FE beam models. The 2D FE beam models are discretized in N elements and $N + 1$ nodes. **Figure 3.1** shows a 2D FE damaged model of cantilever beam and cross-section area. Each node of the FE models has two degrees of freedom, a vertical translation V and a bending rotation θ_z .

Natural frequencies and mode shapes may be obtained by solving an eigenvalue problem from FE model as described by the following equation:

$$([K] - (\omega_i^2)[M])y_i = 0 \quad (3.5)$$

where $[M]$ is the $n \times n$ mass matrix of the system, and $[K]$ is the $n \times n$ stiffness matrix of the system, where ω_i are natural frequencies and y_i are modal shapes.

The damage is assumed at location x_l within node i to $i + 1$ of beam. If a defect is introduced in a beam structure, it reduces the stiffness of beam structure at a particular element of the beam.

3.2.2 Numerical Modeling of Damage

In 2D FE model, damage severity is represented by an elemental stiffness reduction coefficient α_i which is the ratio of the stiffness reduction to the base stiffness. The

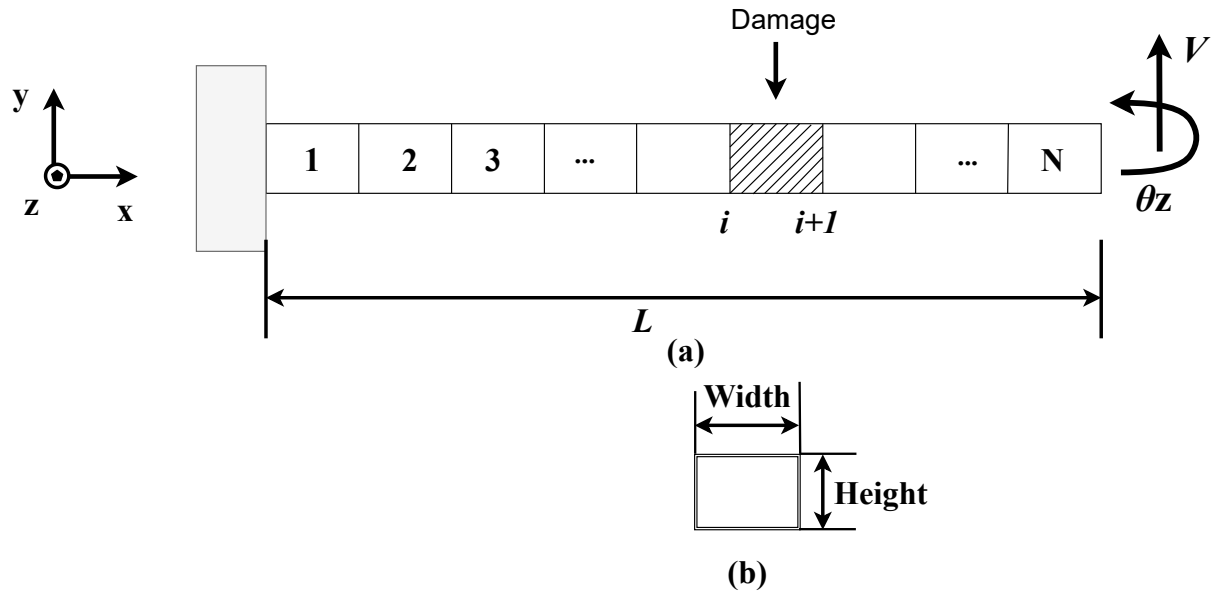

Figure 3.1: (a) 2D FE damaged model of a cantilever beam and (b) cross-section area

stiffness matrix of a numerical damaged FE model is defined as a sum of elemental matrices multiplied by reduction coefficient:

$$[K_d] = \sum_{i=1}^N (1 - \alpha_i) [K_e] \quad (3.6)$$

where K_d is the global stiffness matrix for damaged beam, K_e is the elemental stiffness matrix, N is number of elements, and α_i is a reduction coefficient, which varies from 0 to 1 for the damaged structure. The value of $\alpha_i = 0$ indicates a healthy element.

3.3 Proposed Damage Identification Strategy

3.3.1 Objective Function

Damage locations and severities are estimated using FSC based method. FSC is cited by Doebeling et al. (1996), and first presented by Silva and Araujo Gomes (1994) for damage identification problems. The indicator requires experimental measurements or numerical solutions for the frequency shifts as a function of position and size of damage. FSC indicator is written as:

$$\text{FSC} = \sqrt{\frac{1}{n} \left| \sum_{i=1}^n \left(\frac{\{\Gamma_i\}_X - \{\Gamma_i\}_A}{\{\Gamma_i\}_X} \right) \right|^2} \quad (3.7)$$

and $\Gamma_i = \frac{f_i^d}{f_i^h}$

where n is the total number of modes, X is the tested case, A is the updating model, f_i^d is the unknown beam natural frequencies, f_i^h is healthy beam natural frequencies and i denotes modes indices. Here, considering vectors of $l = [l_j, \dots, l_p]$ and $\alpha = [\alpha_0, \dots, \alpha_p]$ these vectors are the set of testing locations (measured from the clamped to end of the beam) and corresponding stiffness reduction in each location for unknown defect, respectively.

FSC value arrives zero or close to zero during identification of damage location and severity using natural frequencies of healthy and damage beams. For the noisy and real experimental cases, the values fall close to zero. FSC values are found for damaged cases, ranging from 1 to 90% stiffness reduction at all beam positions. Overall, the minimized value from FSC indicates corresponding damage positions and severities.

The coefficient is suitable for locating and quantifying damages at the beginning to the end of beam as it is further demonstrated in later sections. With small damages, the results are very precise; in other words, the FSC is capable for damage assessment as in the case with small to big damages.

3.3.2 Proposed Strategy and Minimization Problem

In this section, **Figure 3.2** shows the flowchart of the proposed damage identification strategy. FSC is used as a function of beam position and elemental stiffness reduction. The damage is compared between healthy and damaged FE models using frequency shift approach. Here, four beam models with the same beam properties are used for the FSC-minimization purpose. The damaged and healthy beam natural frequencies are measured, which is used to compare with other healthy and FE updat-

Frequency Shift Coefficient Based Damage Identification Algorithm in Beams

ing damaged model. The aim of FSC minimization to identify the best-fit values of positions and severities for tested damaged case.

The solutions of minimization problem are obtained using Particle Swarm Optimization (PSO) (Kennedy and Eberhart, 1995). Many other methods can be used, but the principal purpose behind this choice is to find global solutions and to evaluate or approximate the solution of the cost function, i.e. the FSC. PSO is implemented by the `particlewarm()` function in the MATLAB global optimization toolbox, and proves to be adequate for solving the minimizing problem. The application of FSC algorithm with PSO, reveals directly solutions as parameters for the damage assessment from the steps as if the initial damage is already detected.

There are several parameters in PSO, i.e., swarm size, number of iterations, inertia weight, learning factors, etc. We use default values for most PSO parameters, because it allows to obtain the correct results. In FSC minimization, only the swarm size and number of maximum iterations with values of 20 and 100 are explicitly specified.

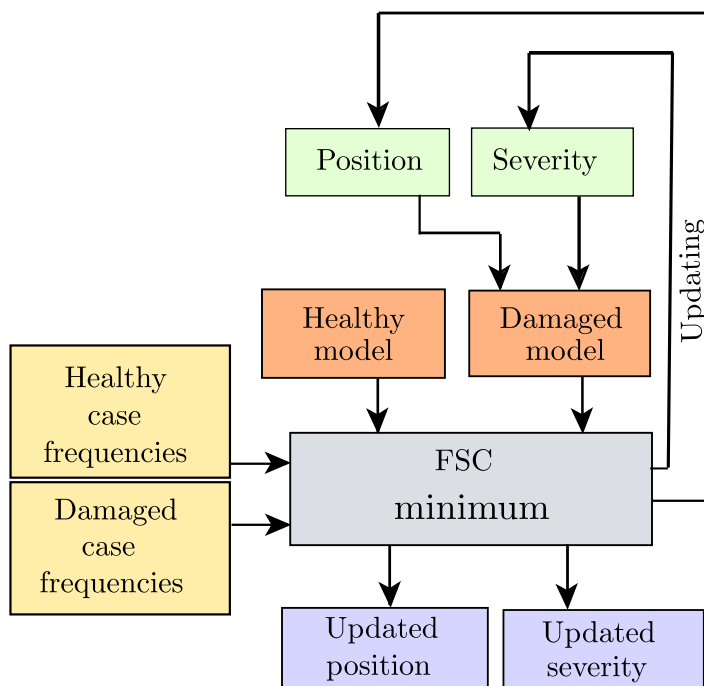

Figure 3.2: Flowchart of proposed strategy for structure damage identification.

3.3.3 Steps for Damage Identification Procedure

The proposed algorithm for damage assessment is detailed in the following steps:

1. Generate damaged case with the reduction in bending stiffness ranging from 0.01 to 0.99. This corresponds to an experimental real damaged case or unknown case.

2. Estimate the natural frequencies for the first n -bending vibration modes by developing FE models of healthy and damaged states. It leads to the vectors of healthy (H_f) and damaged beam natural frequencies (D_f) : $[f_1 \dots f_n]$. In order to simulate measurement imprecision, consider introducing a perturbation to the set of natural frequencies for the case being impaired.

3. Use the FSC function and the minimization strategy, for each set of tested natural frequencies, update the FE model for a generic damage.

4. Consider the updated parameters as the damage parameters. In the case of perturbations, find the mean and standard deviation of different identified damage parameters as the final results.

3.3.4 Modeling Uncertainty on Natural Frequencies

Measurement errors are always present in experimentally determined natural frequencies and other modal parameters. In this aspect, the proposed algorithm is tested for numerically generated uncertain cases, i.e. cases with incorrectly estimated natural frequencies. In the case of a damaged beam, uncertain or noisy conditions are introduced on the natural frequencies with the addition of percentage noise levels and considered Gaussian distributed random variables. To generate the uncertainty on natural frequencies the following equation is adopted:

$$\bar{\omega}_i^d = \omega_i^d(1 + \eta\gamma_i) \quad \text{and} \quad i = 1, 2, \dots, n \quad (3.8)$$

where $\bar{\omega}_i^d$ is i th damaged beam natural frequency after noise addition, η is the percentage of noise, and γ_i is a Gaussian random number between -1 to 1, different for each i .

Measurement errors and sensor noise can be cause of uncertainties in modal parameters. However, it is impossible to remove completely uncertainty from the measurement data. Therefore, uncertainty in the results can be expected to occur all the time during each measurement. We have assumed randomly distributed noise levels (0.1%, 0.2%, 0.3%) in natural frequencies of damaged beam.

3.4 Numerical Validation of Method

In this section, FSC minimizing algorithm is considered, and various numerical cases are evaluated to determine the efficiency of the proposed identification procedure. The FE models of the cantilever beam structure are developed to extract the dynamic characteristics. To examine the FSC method, various numerically introduced damaged cases are selected and simulated, where the position of damage and size are varied.

3.4.1 Numerical Beam Model

The Euler-Bernoulli cantilever beam is discretized using 100 elements, as described in **Section 3.2.1**, and its material and physical properties are given in **Table 3.1**. Modal parameters for healthy and damaged beams are generated using MATLAB.

Table 3.1 Beam dimensions and properties.

Beam Properties	Value
Length (L)	1000 mm
Width (W)	25 mm
Depth (D)	5.4 mm
Young's modulus (E)	210 GPa
Poisson's ratio (ν)	0.33
Mass density (ρ)	7850 kg/m ³

First, the issue consists in updating Young's modulus of 2D FE model in order to find closely match the natural frequencies of 2D FE healthy model to a healthy real experimental beam. To determine the updated Young's modulus, a maximization problem is formulated which uses the inverse of the statistical error on implementing the natural frequencies of 2D numerical and experimental healthy beam. The function of Young's modulus updating (E), as follows:

$$E = \operatorname{argmax} \left(\frac{1}{\sqrt{\frac{1}{m} \left| \sum_{i=1}^m (f_i^{2D} - f_i^h)^2 \right|}} \right) \quad (3.9)$$

The Young's modulus of primary 2D FE model ($E = 210$ GPa) must be minimized on the basis of the modeling errors between the natural frequencies of real structure and 2D FE healthy model. The updated Young's modulus will be then used for damage identification purpose.

For 2D FEM, Young's modulus is taken into account by considering it as an updating parameter. A set of vector parameter is generated, and Young's modulus value of steel beam is updated from an initial value of 210 GPa to 189.26 GPa using **Equation 3.9** with a maximum value of 0.863.

In addition, the first seven healthy beam natural frequencies (experimental and numerical) are listed in **Table 3.2**. Experimental beam test in order to obtain natural frequencies is detailed in **Section 3.5**. Here, relative errors between the natural frequencies of the real healthy beam, and the 2D FE healthy beam, have been reported in **Table 3.2**. The mean error value is 0.687 Hz between experimental and numerical updated natural frequencies.

Table 3.2 Numerically and experimentally (see Section 3.5) measured natural frequencies of healthy cantilever beam.

Healthy beam	Natural frequencies (Hz)						
	1	2	3	4	5	6	7
Experimental	4.27	26.33	73.26	142.34	240.12	355.66	499.66
2D FEM (updated E = 189.26 GPa)	4.20	26.35	73.77	144.56	238.96	356.97	498.57
Errors (%)	0.70	0.08	0.69	1.54	0.49	0.36	0.22

Moreover, the reduction in CPU time is an important factor in the identification of damages. For that, seven natural frequencies are considered to be appropriate for the identification of damages that may occur in the structure. During Young's modulus updating procedure, the seven lowest frequencies are assumed enough sensitive to classify the damage location and severity using FSC. Here, two significant digits after decimal in the natural frequencies proves sufficient for the algorithm to solve the minimization problem for determining damage parameters.

3.4.2 Localization and Quantification of Single Damage

Further identification of damage is considered to highlight the efficiency of the proposed FSC minimizing algorithm. In this part, FSC is used for localization and estimation of artificially introduced 2D damaged cases.

Four single, artificially damaged cases are developed in 2D FE cantilever beam model. For a given case, damages are introduced in different positions from the clamp to end sites of the cantilever beam. These cases are given (a) near the clamped site at 0.15 m, (b) before the mid-site at 0.25 m, (c) after the mid-site at 0.65 m, and (d) near end-site at 0.80 m with 2%, 15%, 8% and 24% along the beam, respectively. Single damages cases, and their first natural frequencies are reported in Table 3.3.

Table 3.3 Single damaged cases and numerically identified natural frequencies of damaged beams.

Damaged cases	Natural frequencies (Hz)						
	1	2	3	4	5	6	7
(a) $x_l = 0.15$ m, $\alpha_l = 2\%$	4.20	26.34	73.77	144.55	238.92	356.90	498.51
(b) $x_l = 0.25$ m, $\alpha_l = 15\%$	4.20	26.34	73.68	144.35	238.88	356.90	497.89
(c) $x_l = 0.65$ m, $\alpha_l = 8\%$	4.20	26.35	73.73	144.46	238.92	356.93	498.23
(d) $x_l = 0.80$ m, $\alpha_l = 24\%$	4.20	26.33	73.59	144.04	238.37	356.79	492.47

Frequency Shift Coefficient Based Damage Identification Algorithm in Beams

In damaged cases, single damages are assessed to demonstrate the efficiency of the approach as shown in **Figure 3.2**. The proposed technique (see **Section 3.3.2**) and algorithm (see **Section 3.3.3**) are implemented to classify the location and severity of the damage. The technique is evaluated using the FE updating strategy of bending stiffness within 2D vs 2D FE models. Based on FSC, 2D healthy and damaged case natural frequencies are extracted, performed with other 2D healthy and stiffness updating damaged model natural frequencies to minimize FSC.

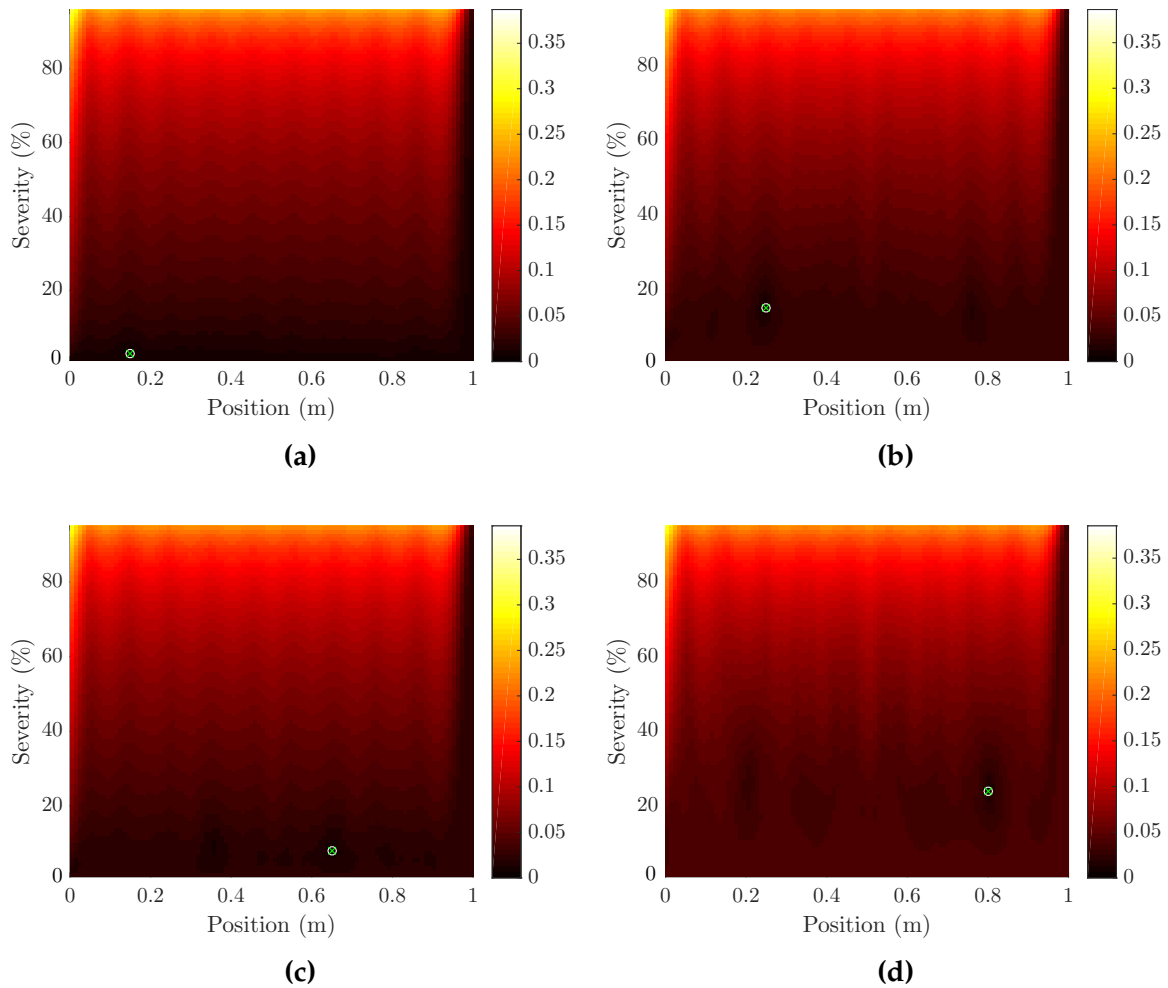

Figure 3.3: FSC as a function of position and severity (%) of the damage. The white circles denote real damage scenarios, where cross symbols and colorbar indicate the lowest minimized value (a) 0.15 m with 2%, (b) 0.40 m with 15%, (c) 0.70 m with 8% and (d) 0.80 m with 24%.

In the same time, PSO (as implemented by `Particleswarm()` from MATLAB global optimization toolbox) with FSC algorithm is then used to locate and estimate the severity of the damage using the FSC objective function as defined in **Equation 3.7**.

FSC value arrives zero or close to zero. Here, `Particleswarm()` function works as part of the algorithm to find an optimal global solutions (position and severity).

Figure 3.3 shows the identification of given single damaged cases (see **Table 3.3**). FSC is displayed as a function of the location and severity. The white circles denote real damaged parameters. Here, cross symbols are obtained by minimizing the FSC using PSO function, and colorbars signify the color value for FSC. As results, the damage location and severity values are obtained at 0.15 m, 0.40 m, 0.70 m and 0.80 m with 2%, 15%, 8% and 24%, respectively. A low value of FSC indicates that tried damaged case and unknown case are similar from the FSC point of view, when we present the FSC for a better understanding. The minimum value can indicate the damage parameters, especially if it is zero or close to zero. This means that the algorithm is well adapted for localizing and estimating the damage.

In **Figure 3.3a**, it is found that minor damage can be estimated when using more precise measurements. Indeed, FSC shows (see **Figure 3.3**) that the location and severity of the damage are correctly assessed, and does not give doubts about the actual position and severity of the damage. It is noted that the processing time is approximately 10s using the PSO function. To summarize, FSC has solid performance in these cases, at a low computational time. To verify the accuracy of FSC algorithm's, location and severity corresponding to the FSC minimum values are considered to be damage identification parameters which are precisely consistent with the actual location and severity values of the damaged cases.

3.4.3 Localization and Quantification of Double Damages

Specific numerical damaged cases, each with two damages will be assessed along the cantilever beam structure. Double damaged cases are generated numerically by the reduction of bending stiffness of two beam elements.

In the FE beam, the damage sites were selected close and far from each others, where the amount of damage ranges from lower to higher percentages. In terms of location and stiffness reductions, double-damaged cases are given (a) at 0.1 m and 0.2 m with 7% and 2%, (b) at 0.50 m and 0.90 m with 15% and 35%, (c) at 0.45 m and 0.55 m with 15% and (d) 0.10 m and 0.15 m with 60% and 68%, respectively. Different damaged sites with two damages are introduced and, for each, their natural frequencies are reported (see **Table 3.4**) solving the eigen problem using FE.

Frequency Shift Coefficient Based Damage Identification Algorithm in Beams

Table 3.4 Two damaged cases and their numerically identified natural frequencies.

Damaged cases	Natural frequencies (Hz)						
	1	2	3	4	5	6	7
(a) $x_l = 0.24$ m, $\alpha_l = 3\%$, $x_m = 0.82$ m, $\alpha_m = 5\%$	4.20	26.34	73.73	144.43	238.81	356.87	498.47
(b) $x_l = 0.60$ m, $\alpha_l = 30\%$, $x_m = 0.90$ m, $\alpha_m = 17\%$	4.20	26.24	73.59	144.30	237.70	356.27	495.61
(c) $x_l = 0.34$ m, $\alpha_l = 9\%$, $x_m = 0.44$ m, $\alpha_m = 4\%$	4.20	26.33	73.70	144.51	238.77	356.61	498.35
(d) $x_l = 0.55$ m, $\alpha_l = 1\%$, $x_m = 0.75$ m, $\alpha_m = 6\%$	4.20	26.34	73.72	144.46	238.93	356.90	498.25

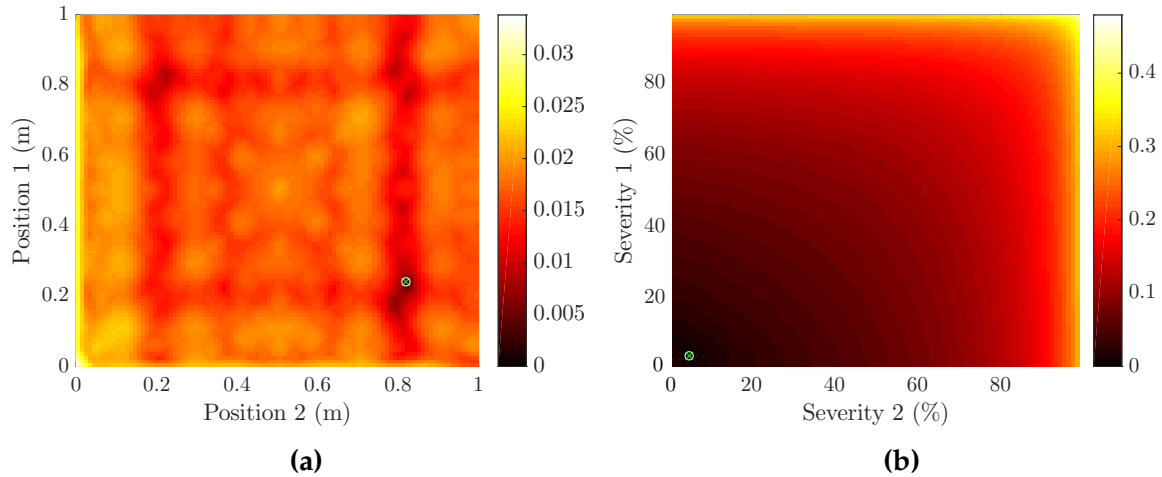

Figure 3.4: FSC as a function of positions and severities (%), where white circles represent real damaged parameters. Cross symbols and color bars indicate the lowest minimized value. (a) Damage positions are located at 0.24 m and 0.82 m, and (b) the severity of the localized damage is estimated at 3% and 5%, respectively.

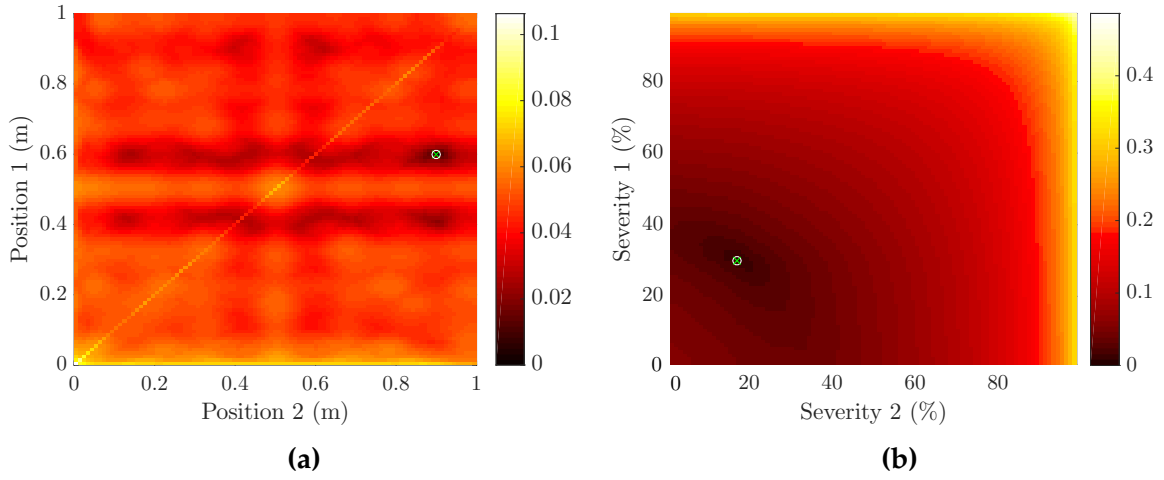

Figure 3.5: FSC as a function of positions and severities (%), where white circles represent real damaged parameters. Cross symbols and color bars indicate the lowest minimized value. (a) Damage positions are located at 0.60 m and 0.90 m, and (b) the severity of the localized damage is estimated at 30% and 17% , respectively.

In order to minimize FSC, the numerical seven natural frequencies of the damaged beam were used as inputs. Natural frequencies are extracted from the double-damaged beam (see **Table 3.4**) and are fed to the algorithm based on FSC. There are four parameters (position 1, position 2, severity 1 and severity 2) unknown to identify for two damage identification, and two stages are followed to represent identified damaged positions and severities and the variations of the FSC on **Figure 3.4, 3.5, 3.6** and **3.7**. For a better understanding and a comprehensive representation, we will split the parameters space in two. First: assuming a certain percentage of severities for two damages, FSC is represented as a function of beam positions. Second: assuming the positions of two-damages, FSC is displayed as a function of severities. Lastly, cross symbols and circles signify global minimized values. However, cross symbols are obtained using the PSO function with the global FSC minimization. In order to classify the damages in terms of parameters (positions and severities), vectors of four parameters are defined in the algorithm. Next, PSO was used to find the global minimum on the parameters space. Accordingly, there will be only one global minimum indicating the associate presence of impaired parameters, which is obtained by modal analysis using FSC between healthy and damaged states. Note that the two damages may happen to have the same position; in this case, we add the severities and apply the stiffness reduction to a single element.

Frequency Shift Coefficient Based Damage Identification Algorithm in Beams

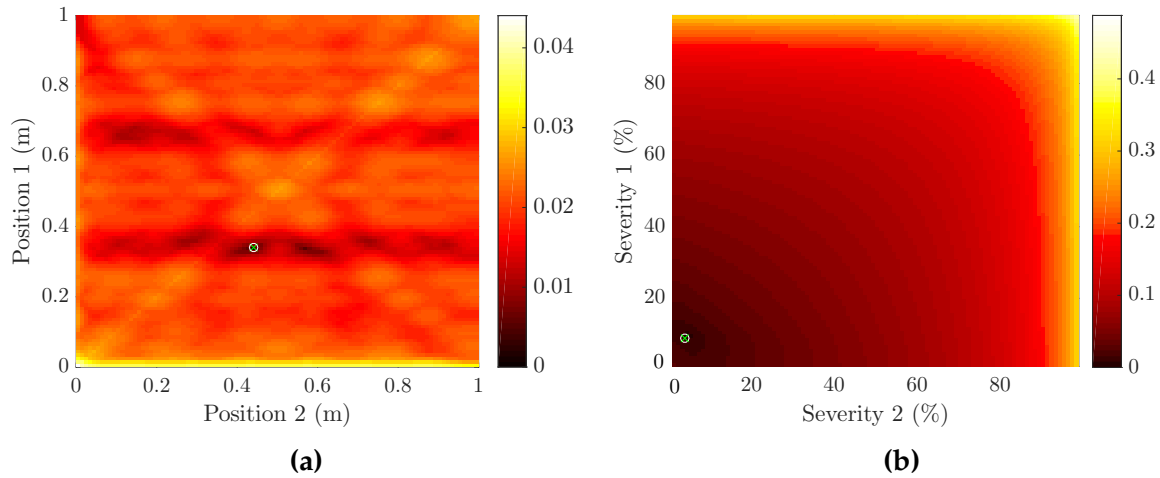

Figure 3.6: FSC as a function of positions and severities (%), where white circles represent real damaged parameters. Cross symbols and color bars indicate the lowest minimized value. (a) Damage positions are located at 0.34 m and 0.44 m, and (b) the severity of the localized damage is estimated at 9% and 4%, respectively.

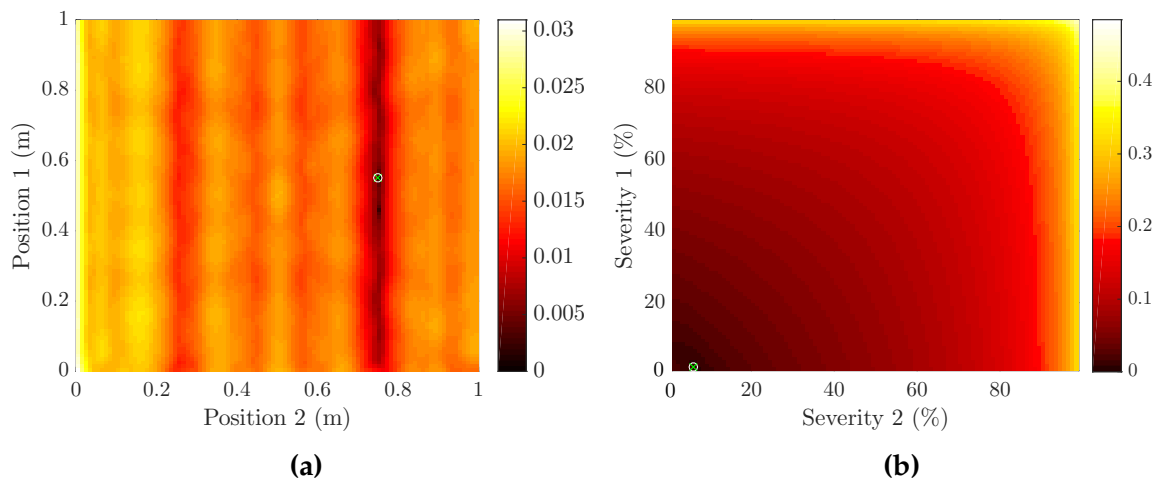

Figure 3.7: FSC as a function of positions and severities (%), where white circles represent real damaged parameters. Cross symbols and color bars indicate the lowest minimized value. (a) Damage positions are located at 0.10 m and 0.15 m, and (b) the severity of the localized damage is estimated at 60% and 70% , respectively.

Positions and severities of double damaged cases (a) and (b) are identified, and shown in the **Figures 3.4**, and **3.5**, where **Figures (a)** and **(b)** are two representation of the same 4+1D space. FSC is plotted as a function of positions and severities. These examples are localized at far distances from each other along the beam, while levels of severities are estimated from lower to higher percentages. Double-damaged case (a) is identified at positions 0.24 m and 0.82 m with 3% and 5% damage severities. Similarly,

double-damaged case (b) is found at the end side of the beam, where damages are localized at 0.60 m and 0.90 with 30% and 17% severities, respectively. The PSO solver is used to get an output of minimizing parameters which are denoted by cross symbols. However, these symbols are perfectly overlapping to circles as these circles are defined for real parameters of artificial damaged cases. Hence, damages are identified in the end sites of the beam since they are located well apart from each other. **Figure 3.4b** shows that the low levels of damage severities are quantified, where damages are located far from each other. It also indicates that the algorithm is well-suitable to identify the small double damages, and also if they are located in the longer distance from each other.

Other subsequent double damaged cases (c) and (d) are explored at various beam locations with dissimilar stiffness reduction using FSC-based minimizing algorithm. Similarly, the algorithm with the PSO function is used to get outputs of minimizing parameters. **Figures 3.6 and 3.7** show the identification of double damaged cases (c) and (d). These two instances are achieved as low (9% and 4%) and high (60% and 70%) levels of impaired severities at positions (0.34 m and 0.44 m) and (0.10 m and 0.15 m), respectively. These identifications also demonstrate that the algorithm is suitable to identify small damages, and also if the damages are close enough to each others. This reveals that the algorithm has a close correlation between artificially simulated damaged case and 2D updating FE reference model.

In order to localize and estimate more than two damages, the condition should be assessed by increasing the number of parameters to solve the minimization problem. It is important to note that there is a relationship between input and output parameters throughout the minimization problem.

3.4.4 In the Case of Modeling Uncertainty on Natural Frequencies

Numerical damaged cases and their identified natural frequencies are listed in **Table 3.5**. These cases will be tested by the proposed damage identification to investigate the sensitivity of FSC. Here, uncertainty on natural frequencies are generated from the **Equation 3.8** by adding the perturbation of 0.1%, 0.2% and 0.3%.

Table 3.5 Damaged cases and numerically identified natural frequencies of damaged beams.

Damaged cases	Natural frequencies (Hz)						
	1	2	3	4	5	6	7
(a) $x_l = 0.30$ m, $\alpha_l = 40\%$	4.18	26.31	73.35	144.21	238.86	354.98	496.20
(b) $x_l = 0.50$ m, $\alpha_l = 50\%$	4.19	26.08	73.77	143.16	238.94	353.60	498.51

Frequency Shift Coefficient Based Damage Identification Algorithm in Beams

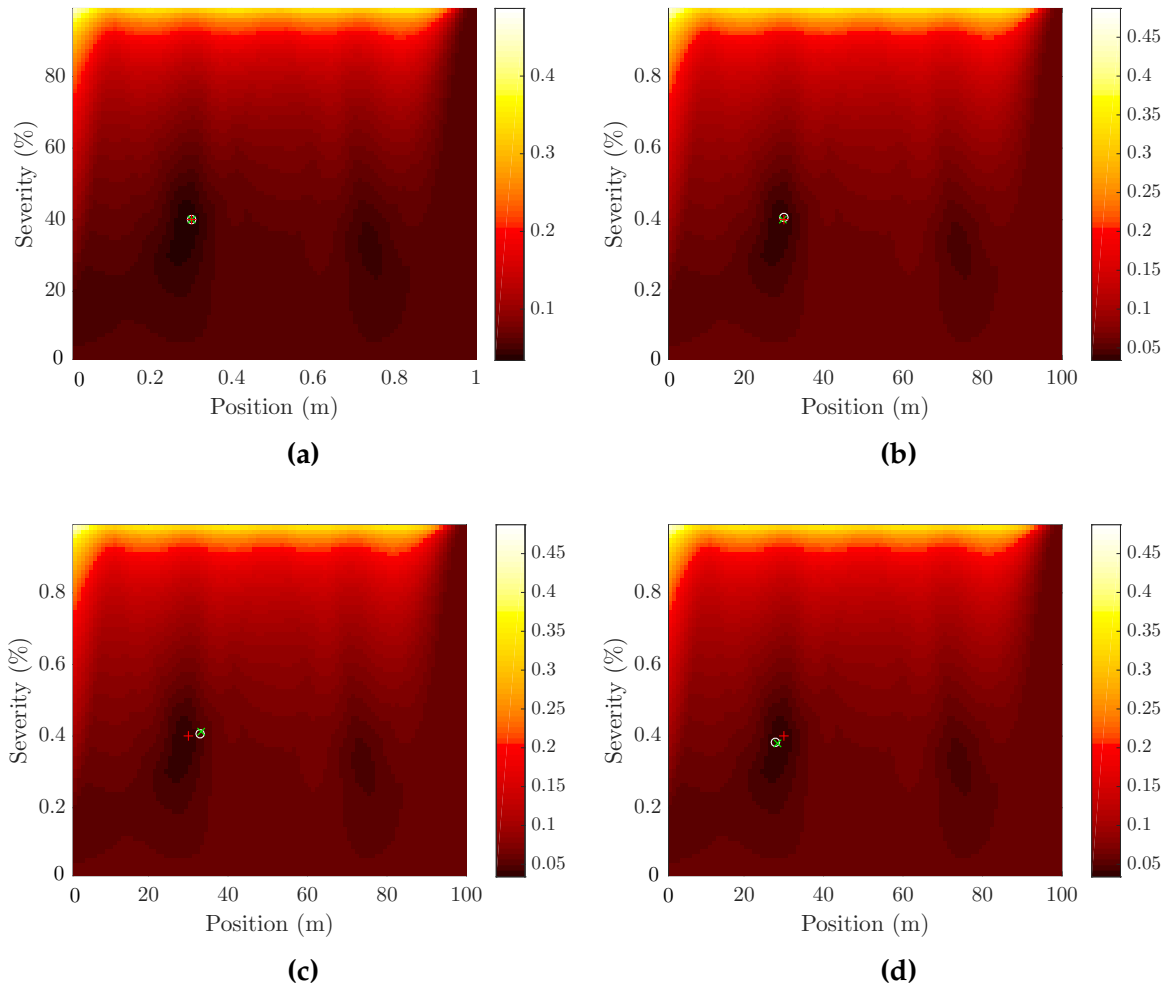

Figure 3.8: FSC as a function of position and severity (%) of the damage. The red plus symbols indicate the position and severity of the artificial damaged case (a) (see **Table 3.5**). The white circles (obtained by FE updating strategy using FSC), green cross symbols (obtained by PSO using FSC) indicate the lowest minimized value, where damage positions and severities are identified (a) without perturbation, and (b) 0.1%, (c) 0.2% and (d) 0.3% with perturbation levels.

Figure 3.8 indicates the identification of the damaged case (a) ($x_1=0.30$ m and $\alpha_1=40\%$) with and without consideration of the perturbation in natural frequencies, while the natural frequencies for the tested case (a), which is listed in **Table 3.5**. FSC is plotted as a function of positions and severity, and plus symbols indicate the actual damage location and severity depending on the impaired case. White circles (obtained by FE updating strategy using FSC), green cross symbols (obtained by PSO using FSC) and color bars represent the lowest minimized values. The damage is perfectly localized and quantified at a beam location of 0.30 m with 40% magnitude without consideration of perturbation using PSO. In comparison, damage locations

3.4 Numerical Validation of Method

and severities (see **Figure 3.8**) are reported with the values of 0.296 m and 40.12%, 0.312 m and 40.6%, and 0.284 m and 38.01% based on introduced perturbation levels of 0.1%, 0.2%, and 0.3% in damaged beam natural frequencies, respectively. The locus of the FSC minimum values (obtained from FE updating and PSO) for the estimated results, is found to be close to the actual damage parameters. Essentially, it shows that the FSC criterion is performed accurately.

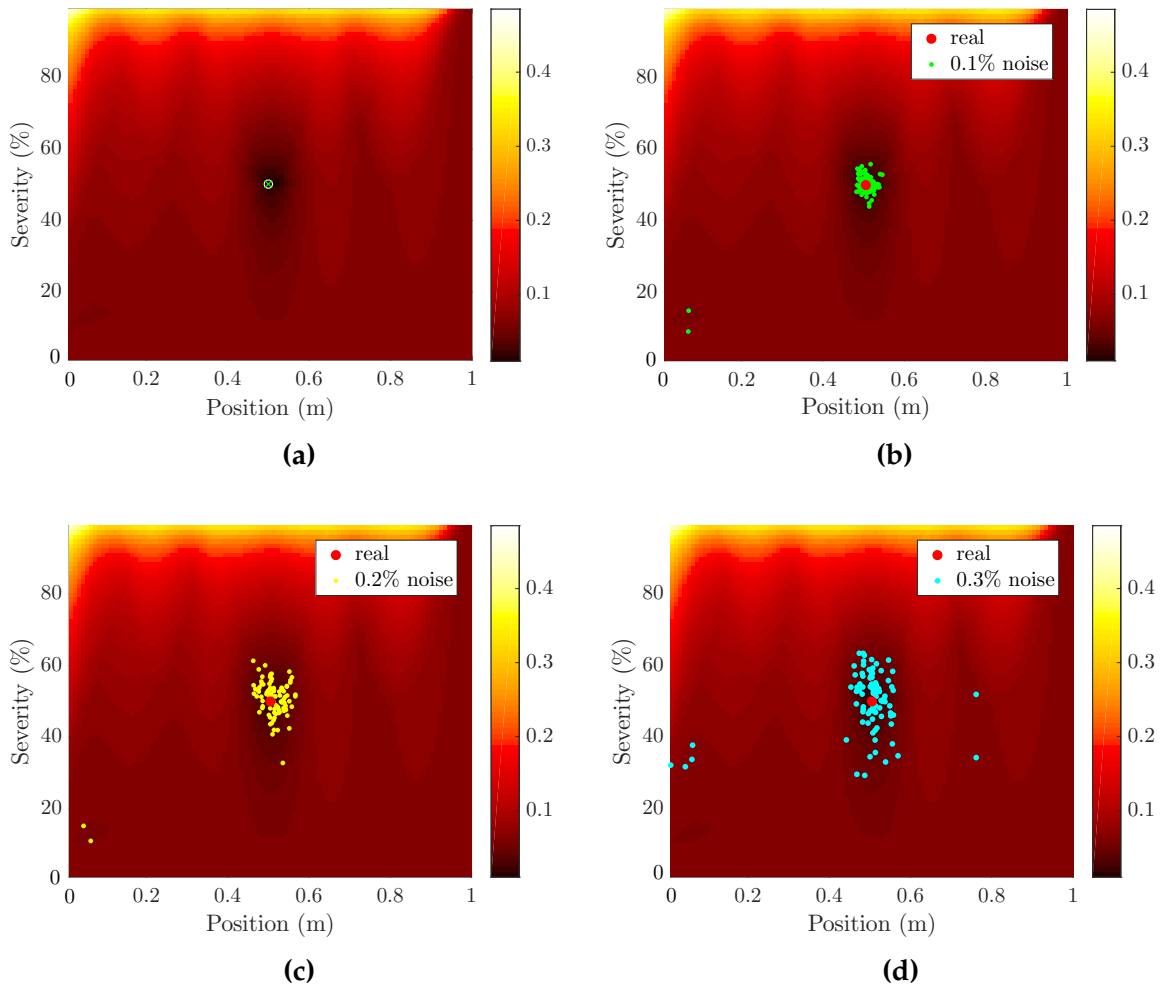

Figure 3.9: FSC as a function of position and severity (%), where white circles denote a real identified damaged case. The cross symbols and colorbars indicate the lowest minimized value. (a) The damage parameter (position and severity) are estimated at 0.50 m beam position with 0.50% severity, and (b) the red dot denotes the estimated damage parameter without perturbation, while green, (c) yellow and (d) cyan dots denote estimated damage parameters concerning for hundred samples with 0.1%, 0.2% and 0.3% perturbation, respectively.

Frequency Shift Coefficient Based Damage Identification Algorithm in Beams

In order to further analyze the strategy and evaluate the sensitivity of the FSC algorithm, damaged case (b) given in **Table 3.5** is tested by adding the perturbation on the natural frequencies as defined in **Equation 3.8**. Artificial damaged case (b) ($x_l = 0.5$ m, $\alpha_l = 50\%$) in the beam and its natural frequencies are mentioned in **Table 3.5**. Firstly, the damaged test case is localized and quantified (see **Figure 3.9a**) using FSC without consideration of perturbation on the natural frequencies. Here, the white circle denotes a real damaged case, while the green cross symbol is acquired by a minimization of the FSC with the PSO. The colorbar and cross symbol indicate damage position and severity. Here, damage parameters are accurately estimated at 0.5 m position with 50% severity. The minimum value refers to the estimated position as well as the severity which is as low as 0.0001. Secondly, the damaged case ($x_l = 0.5$ m, and $\alpha_l = 50\%$) is localized and quantified by the presence of perturbation ($\eta = 0.1, 0.2$ and 0.3%) on the natural frequencies. To note that the added noise levels do not affect the performance of the algorithm. Therefore, the algorithm works precisely localizing and estimating the damage with consideration of perturbation levels. **Equation 3.8** is used to generate 100 random samples using `randn` MATLAB function which generate the artificial measurement errors in the natural frequencies of tested damaged case. In the FSC minimization, each sample, i.e. each set of seven natural frequencies, is used to estimate the damage parameters.

Damage identification results with perturbations of 0.1%, 0.2% and 0.3%, are shown in **Figures 3.9b, 3.9c** and **3.9d**, where the red dot represents the real damage parameters without perturbation. Green, yellow and cyan color dots indicate estimated damage positions and severities with consideration of 0.1%, 0.2% and 0.3% perturbation levels, respectively. The average values of locations and severities are obtained at 0.499 m, 0.505 m, and 0.494 m with 49.90%, 50.21%, and 50.18%, respectively. The standard deviation values for the estimated damage locations and severities are 0.063 m, 0.069 m, 0.102 m and 5.81%, 6.93% and 8.09% respectively. Here, standard deviation values and estimated average damage parameters indicate the efficiency of the algorithm.

3.5 Experimental Example for Damage Identification

To estimate positions and severities of the damage in a real structure, steel beam has been examined with same material and geometrical properties (see **Section 3.4.1**) as those stated in the numerical FEMs. Healthy and damaged beams are used for the experimental test. On damaged beam, two damage (saw cut) are done. The damage 1 and damage 2 are placed at 0.25 m and 0.68 m beam locations from the clamped end. Damage (damage 1 and damage 2) sizes are also measured; where first (damage 1) was found with a depth of 1.3 mm and a width of 1.15 mm, and other (damage 2) was

3.5 Experimental Example for Damage Identification

obtained with a depth of 1.55 mm and a width of 1.40 mm, respectively. In this case, the height of both saw cuts is considered with a similar value of the beam's height.

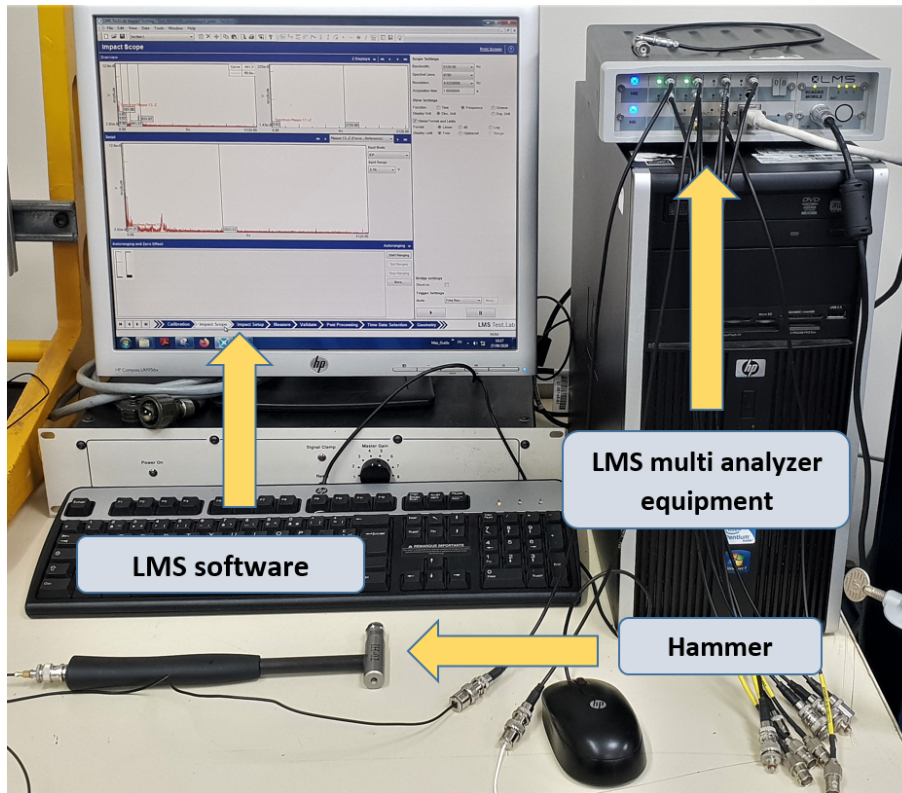

Figure 3.10: Set up of beam hammer impact test using LMS multi-analyzer (Siemens LMS software)

During experimental beam tests, two accelerometers are mounted at different beam positions (0.35 m and 0.75 m). Experimental beam configurations and setup are shown in **Figures 3.10** and **3.11**. Hammer impact test is conducted on mid-position (0.5 m) the beam, and signals with LMS multi-analyzer (Siemens LMS software) are used to record the vibration measurements. The input excitation is produced by the hammer and output data has been recorded by the monoaxial accelerometer (Brüel and Kjær-DeltaTron Type 4507). The beam is clamped on one side with a strong mechanical hinge, while the other side is free. The experimental setup (see **Figure 3.10**) is then designed in such a way as to extract natural frequencies from the beams (healthy and damaged). Frequency response functions (see **Figure 3.12**) of the healthy and damaged cantilever beam corresponds to sensor 1st near the clamped part, are used to acquire natural frequencies by implementing the circle fit method with EasyMod Module ([Kouroussis et al., 2012](#)) using MATLAB, and **Table 3.6** represents experimentally measured seven natural frequencies of the healthy and damaged real beam.

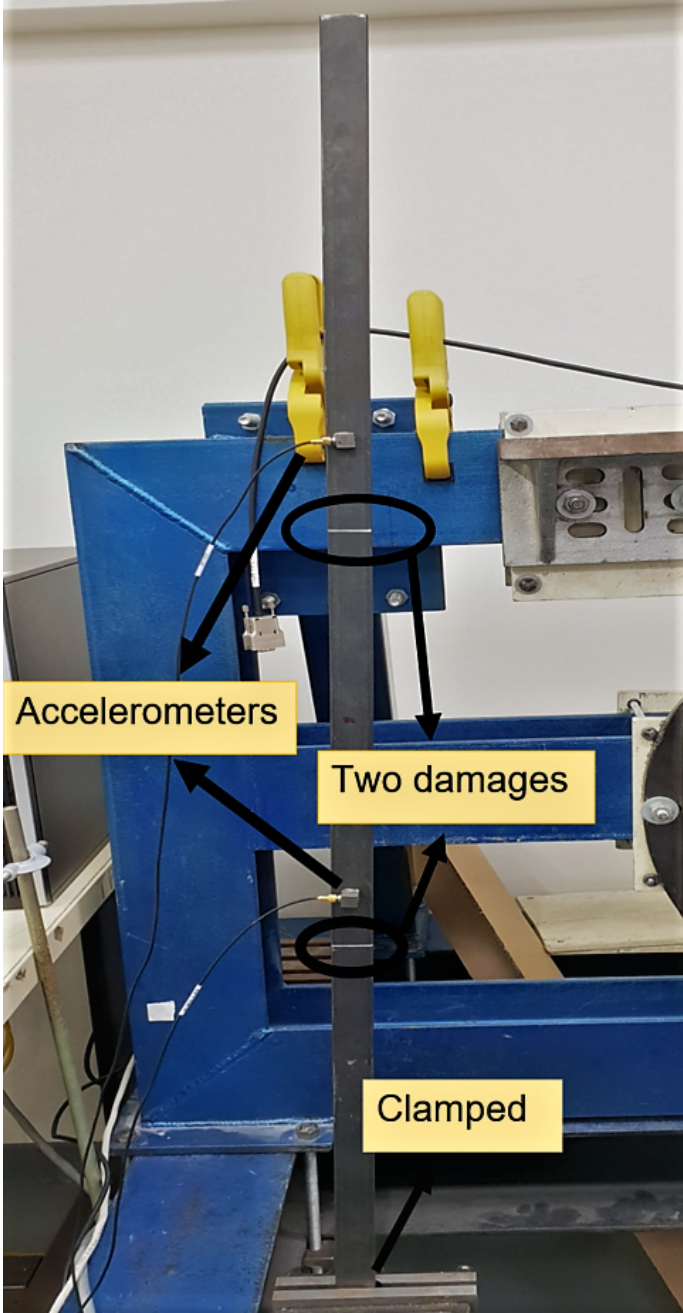

Figure 3.11: Experimental setup of real cantilever damaged beam with accelerometers.

3.5 Experimental Example for Damage Identification

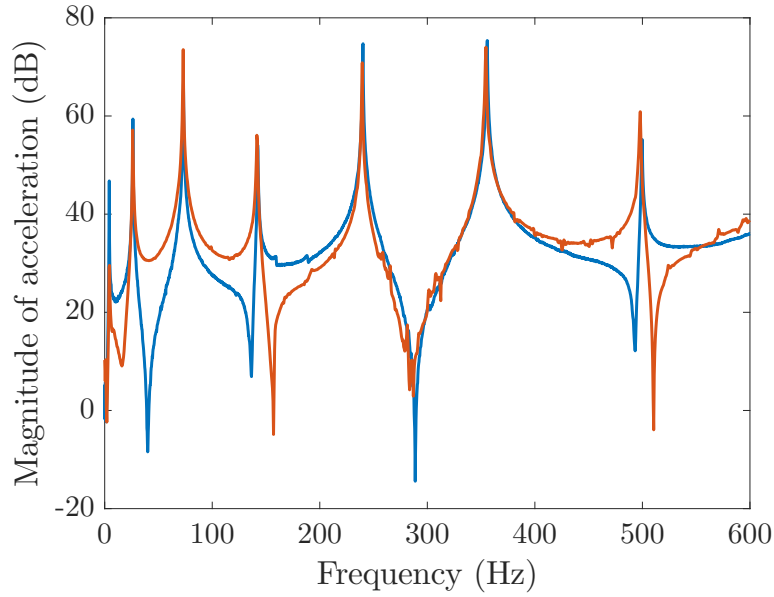

Figure 3.12: Frequency response functions (FRFs) curve of the healthy beam (blue curve) and damaged beam (orange curve), at mid position (0.5 m).

Table 3.6 Experimentally identified natural frequencies of healthy and damaged beam.

Experimental beam	Natural frequencies (Hz)						
	1	2	3	4	5	6	7
$f_{healthy}$	4.27	26.33	73.26	142.34	240.13	355.67	499.66
$f_{damaged}$	4.25	26.22	72.82	141.73	239.38	354.36	497.97

3.5.1 Results

To classify damage properties (positions and severities), the test is conducted on the basis of the frequencies shift between healthy and damaged real beams. A real damaged beam (see **Figure 3.11**) is evaluated and compared to numerical 2D FE healthy and damaged models using FSC. The beam model (see **Figure 3.1**) based on the 2D FE mesh (100 elements) is used for the purpose of FSC minimization. As similarly illustrated during double damaged identification, the representation of **Figures 3.13a** and **3.13b** is done after obtaining the positions and severities using FSC-based algorithm with `particleswarm()` solver.

Using FSC algorithm, damages are found at beam positions of 0.244 m and 0.676 m, and severities of these localized damages are estimated with 34.2% and 28.5%, respectively. Here, the error (%) between measured (experimental tools) and estimated (FSC algorithm) damage positions (1 and 2), are obtained with the values of 2.4% and

Frequency Shift Coefficient Based Damage Identification Algorithm in Beams

0.59%. If we obtain the positions and severities corresponding to the global minimum. Then, representations of **Figures 3.13a** and **3.13b** can be performed, to indicate the identified damage parameters. The representations are obtained by considering either positions or severities of respective two damages, which allows FSC to be a function of beam positions and damage severities. Thus, the results indicate that the FSC-based algorithm is well suited for localizing and quantifying damages in the real structure.

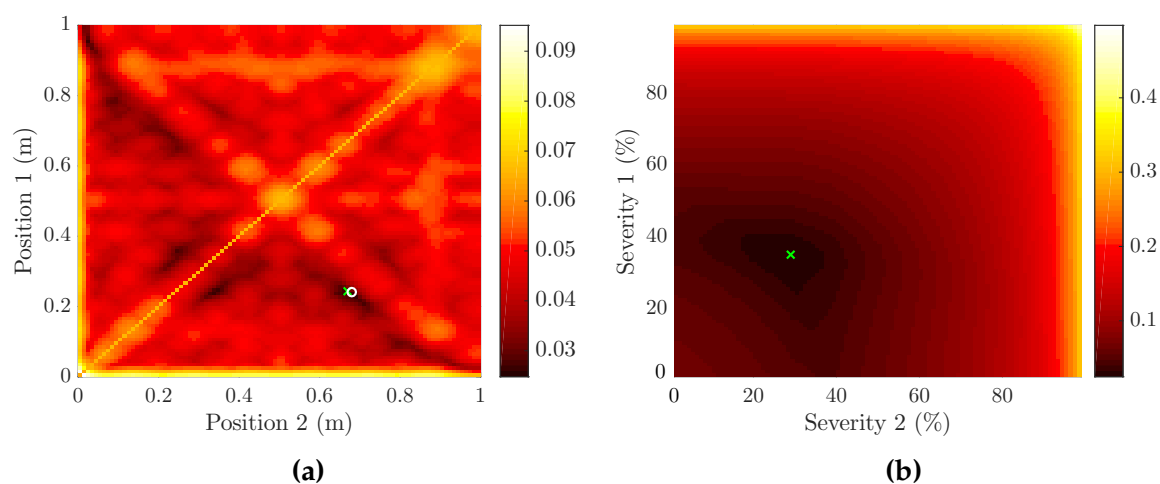

Figure 3.13: Experimentally tested damaged beam where FSC as a function of position and severity (%). The cross symbols and colorbars indicate the lowest minimized value. (a) The damage positions are identified at 0.244 m and 0.676 m, and (b) severities of these localized damage are estimated with 34.2% and 28.5%, respectively.

Conclusions

Le travail se concentre sur le développement d'un algorithme d'identification des dommages en utilisant les FEM et la minimisation du coefficient de décalage de fréquence. Différents cas d'endommagement sont localisés et quantifiés, et sur la base des résultats obtenus, il est démontré que l'algorithme est approprié pour identifier des dommages uniques et multiples, même dans une structure réelle. Des imprécisions de mesure existent toujours lors de l'estimation des fréquences naturelles, ces erreurs sont nuisibles à l'identification des dommages. Les cas endommagés numériques ont été localisés et quantifiés en considérant la perturbation sur les fréquences naturelles, pour vérifier la sensibilité de l'algorithme basé sur l'ensemble des paramètres de dommages obtenus à partir de la minimisation FSC. A partir de ces paramètres, en considérant les valeurs moyennes, il est déterminé que les valeurs moyennes sont proches des valeurs réelles ; l'écart type entre les échantillons indique la sensibilité de l'algorithme.

3.6 Conclusions

The work was focused on the development of damage identification algorithm using FEMs and minimization of the frequency shift coefficient. Different damaged cases are localized and quantified, and based on the obtained results, it shows the algorithm is suitable to identify single and multiple damages even also in a real structure. Measurement imprecisions are always present during the estimation of natural frequencies, these errors are detrimental for the identification of damages. Numerical damaged cases were localized and quantified by considering the perturbation on natural frequencies, in order to check the sensitivity of the algorithm based on the obtained set of damage parameters from FSC minimization. The sensitivity of FSC algorithm is also illustrated by considering the perturbation on natural frequencies. Based on the introduced perturbation, the efficiency of the algorithm is investigated by obtaining damage parameters (positions and severities) through FSC minimization. From these damage parameters, considering the average values, it is determined that the average values are close to the real ones; the standard deviation between samples indicates the sensitivity of the algorithm.

Chapter 4

Geometry Damage Properties Identification in Beam Structures

Summary

4.1	Introduction	71
4.2	Beam Bending Vibration and FE Models	74
4.2.1	General Context	74
4.2.2	2D FE Model of Healthy and Damaged Beam	75
4.2.3	3D FE Model of Healthy and Damaged Beam	76
4.2.4	3D FE Frequency Convergence Test	77
4.3	Strategy and Objective Function for Damage Identification	78
4.3.1	Proposed Strategy	79
4.3.2	Initial Model Updating	80
4.3.3	Frequency Shift Coefficient (FSC)	81
4.4	Numerical Assessment of the Strategy Using 3D and 2D models	81
4.4.1	Material and Geometry	82
4.4.2	Damage Library Using 3D and 2D Model Correlation	83
4.4.3	Localization and Quantification of Single Damage	86
4.4.4	Localization and Quantification of Double Damage	88
4.4.5	In the Case of Rectangular Geometry Damage	91
4.5	Identification of Damage on an Experimental Beam	93
4.5.1	Experimental Setup	93
4.5.2	Results	95
4.6	Conclusions	97

Résumé

Le VBSHM est un moyen efficace pour diagnostiquer les dommages et l'intégrité structurale au stade le plus précoce. Dans cet article, une nouvelle stratégie est développée pour la localisation et l'estimation des dommages, ainsi que l'identification des propriétés des dommages pour une forme rectangulaire en utilisant seulement les fréquences propres de la structure saine et endommagée. Cette stratégie est appliquée à une poutre encastree-libre. Dans ce cadre, une bibliothèque de dommages est construite en corrélant les modèle éléments finis 2D et 3D. La corrélation est effectuée en minimisant un coefficient dit de décalage de fréquence. La stratégie proposée utilise également le coefficient de décalage de fréquence pour corréler un modèle endommagé 2D avec un cas de poutre inconnue. Le dommage 2D, représenté par une réduction de la rigidité en flexion, est ensuite associé à un dommage 3D en utilisant la bibliothèque de dommages. Des cas numériques avec des dommages simples et doubles de position et de sévérité variables sont testés et utilisés pour valider l'approche. Enfin, les résultats expérimentaux qui sont proposés démontrent la pertinence de la stratégie.

Abstract

VBSHM is an efficient way to diagnose damage and structural integrity at the earliest stage. In this paper, a new strategy is developed for damage localization and estimation, as well as damage properties identification for a rectangular geometry damage using only eigenfrequencies of the healthy and damaged structure. This strategy is applied to a cantilever beam. In this framework, a damage library is built by correlating 2D and 3D finite element models. The correlation is done by minimizing a so-called frequency shift coefficient. The proposed strategy also uses the frequency shift coefficient to correlate a 2D damaged model with an unknown beam case. The 2D damage, represented by a bending stiffness reduction, is then associated to a 3D damage by employing the damage library. Numerical cases with single and double damage of varying position and severity are tested and used to validate the approach. Finally, experimental results are proposed that show the relevance of the strategy.

Attachment of the Article: Published in Applied Sciences (Switzerland)

Dubey, A., Denis, V., Serra, R. (2020). A Novel VBSHM Strategy to Identify Geometrical Damage Properties Using only Frequency Changes and Damage Library. *Applied Sciences (Switzerland)* (10) 8717.

4.1 Introduction

In recent decades, significant research has been conducted on Structural Health Monitoring (SHM) by using many techniques which are applied in various fields such as aerospace, civil and mechanical engineering. SHM aims to provide maintenance services throughout the life of the structure. Vibration based structure health monitoring (VBSHM) is widely used as a structure diagnostic technique over the years because of its ability to monitor and detect damage from global testing of the structure (Chimentin et al., 2019; Sinha et al., 2002). Worden and Dulieu-Barton (2004) gave an overview strategy for damage detection such as the definition based on a taxonomy of damage, operational evaluation with the use of a hierarchical damage identification scheme, an approach to sensor prescription and optimization and a data processing methodology. More recently, Kong et al. (2017) reviewed the state of the art on the framework of vibration-based damage identification in different levels including the prediction of the remaining useful life of structures and the decision making for proper actions. Toh and Park (2020) provided a summary of studies applying machine learning algorithms for health monitoring using vibration factors to categorize the studies.

The first step for damage identification using modal analysis relies on changes in the properties of the structure, mainly their eigenvalues. Salawu (1997) proposed a review on methods using eigenfrequencies only for the localization and identification of damage in structure. Several works are described more precisely here, and more recent research works are added. Cawley and Adams (1979) developed the first study for damage localization and estimation, using changes in natural frequencies for 1D and 2D structures and relying on a FE model of the structures. Messina et al. (1996) proposed Damage Location Assurance Criterion (DLAC) and after extended to the statistical correlation coefficient, which is called Multiple Damage Location Assurance Criterion (MDLAC) Messina et al. (1998). The two methods rely on changes in natural frequencies for estimating the position and size of defects in complex structures. Hassiotis and Jeong (1993) developed a method for the estimation of damage using measured changes in the natural frequencies. They presented eigenvalues variation to localize damage using

reductions in the stiffness by derived equations from the first-order perturbation. They have also introduced a criterion to solve these equations by minimizing the difference between eigenvalue problems for the undamaged and damaged structures. It was concluded that few frequencies allows the estimation and location of single or multiple defect in structures such as beams but that the results are sensitive to uncertainty on the natural frequencies. [Meneghetti and Maggiore \(1994\)](#) made a sensitivity analysis on a cracked beam and used a local modal crack sensitivity in order to localize damage using natural frequency measurement only. According to [Doebbling et al. \(1996\)](#), [Silva and Araujo Gomes \(1994\)](#) proposed a technique to detect the crack size and position using a so-called Frequency Shift Coefficient.

[Sinha et al. \(2002\)](#) use a model for stiffness reduction due to a crack and a minimization involving the sensitivity matrix from a Finite Element (FE) model and a set of five measured natural frequencies for finding crack depth and location on a cantilever beam. [Khiem and Toan \(2014\)](#) examined natural frequencies from the Rayleigh quotient for a clamped beam with an arbitrary number of cracks. The cracks are represented as spring stiffnesses. Through an iterative procedure, three experimentally measured frequencies of a beam with fixed ends are sufficient to locate cracks and estimate their severity using the explicit expression of the Rayleigh quotient. [Le et al. \(2016\)](#) introduced a method based on the first-order analytical estimation of the variation of natural frequencies due to structural modifications. It allows, with the help of a minimization procedure, to quantify and localize several structural modifications i.e., damage on a Euler–Bernoulli beam subject to axial constraint, using only modal shapes of the intact structure and natural frequencies of both intact and modified structures. [Dahak et al. \(2017\)](#) used normalized frequencies method for a specific damage location in the cantilever beam. The damaged zone is determined only by the classification of the normalized frequencies of the structure. The change in stiffness caused by the damage is reflected locally in the frequencies. [Yang and Oyadiji \(2017\)](#) have presented a theoretical and experimental study of a frequency-based damage detection method. The method uses the modal frequency curve of a beam with moving point mass and discrete wavelet transform in order to build a damage index. [Gillich et al. \(2017\)](#) used the link between natural frequency shift and modal curvature to localize and identify defects in a multispan beam. [Sha et al. \(2019\)](#) presented a study of relative natural frequency change curves for characterization of damage in a fixed-fixed beam. They detail the relationship between these curves and mode shapes. They introduced a novel probabilistic damage indicator for localizing single and multiple damages and severity factor to quantify the damage. [Serra and Lopez \(2017\)](#) proposed a new methodology based on combined modal wavelet transform strategy to cope with noisy signals, while at the same time, able to extract the relevant information from each mode shape. [Pan et al. \(2019\)](#) presented a noise response rate to evaluate

the sensitivity of each mode of the frequency shift to noise. The authors developed a novel method of mode selection for improving the accuracy of frequency-based damage detection.

In some experimental studies, [Niemann et al. \(2010\)](#) presented an optimization approach for damage localization based on the correlation of a local stiffness loss and the change in experimental modal parameters. They applied this approach to a composite laminate beam. [Masoumi and Ashory \(2014\)](#) proposed a method based on the flexibility matrix and the use of stationary wavelet transform to localize cracks in cantilever beams. [Gautier et al. \(2015\)](#) use a 4SID technique combined with a FE model updating procedure coupled and an iterative domain partitioning procedure to localize damages. [Altunışık et al. \(2017\)](#) considered multiple crack effects on a cantilever beam. In their work, Enhanced Frequency Domain Decomposition and Stochastic Subspace Identification were implemented to extract the dynamic characteristics; the Modal Assurance Criterion, the Coordinated Modal Assurance Criterion and the natural frequencies are used to update a FE model and the approach was validated by experiment.

From this literature overview, it can be concluded that for simple structures at least, natural frequencies may be sufficient for the localization and estimation of single or multiple damage. Several indicators exist and the use of modal shapes may provide more accuracy. Yet, few studies make the link between natural frequencies variation and the geometry of damage; this paper is going beyond a severity indicator by estimating the geometry of single or multiple damages. To achieve this goal, a novel VBSHM strategy is developed based only on frequency changes for the identification of geometrical damage properties, i.e., location, severity, and size. In this matter, the focus is made on the development of a damage library in order to estimate the geometry damage parameters. For the sake of simplicity, a cantilever beam is chosen. The proposed strategy uses the Frequency Shift Coefficient (FSC) as cost function to correlate position, element stiffness reduction and geometry of damage between different FE models of the structure, using a minimization algorithm. The correlation between 2D and 3D FE models allows us to build a numerical damage library for the beam. As the FSC only uses natural frequencies, it will also be used to update a 2D FE model using a small set of natural frequencies of a tested structure. We can thus solve the damage identification problem (single and multiple damages) as a function of damage position and severity. Rectangular geometry damage cases are tested, and their properties are identified based on obtained damage library. The proposed strategy is demonstrated on numerical cases. Finally, the experimental test is carried out by considering the geometry damage in a real beam in order to validate the efficiency of the strategy.

The rest of paper is organized as follows. In **Section 4.2**, the dynamics of the specific case of a cantilever beam in flexural vibration are recalled, and FE models (2D and 3D) are introduced to extract the dynamic parameters of a structure. In **Section 4.3**, the proposed strategy for damage identification is given, and an approach that involves minimizing the FSC as a function of position and severity is proposed. In **Section 4.4**, 2D and 3D FE models of beams are used to build a so called damage library. In addition, this section contains numerical examples that are used to validate FSC based approach. Different test cases are examined to localize and estimate the damages which concern (i) four numerical cases, consisting of 2D vs. 2D FE model correlation that contains single and multiple damages, and (ii) two numerical cases for rectangular geometry damage, consisting of 3D vs. 2D FE model correlation. Finally, in **Section 4.5**, an experimental beam is tested to identify damage properties.

4.2 Beam Bending Vibration and FE Models

4.2.1 General Context

The equation of motion for the flexural vibration of a cantilever Euler–Bernoulli beam can be written:

$$M(x)\frac{\partial^2 w(x,t)}{\partial t^2} + C(x)\frac{\partial w(x,t)}{\partial t} + \frac{\partial^2}{\partial x^2} \left(EI(x)\frac{\partial^2 w(x,t)}{\partial x^2} \right) = F(x,t), \quad (4.1)$$

where x is the coordinate along the main direction of the beam, t is the time, $w(x,t)$ is the transverse deflection, $M(x)$ is the mass per unit length, $C(x)$ is the viscous damping coefficient, $EI(x)$ is the bending stiffness and $F(x,t)$ is the external force per unit length of the beam. The solution of **Equation (4.1)** can be sought under the following form:

$$w(x,t) = X(t)u(x), \quad (4.2)$$

where $X(t)$ and $u(x)$ are time and displacement solution parts. Let us now consider a beam that is clamped in $x = 0$ and free in $x = L$ (cantilever beam); then the solution must satisfy $u''(L) = u'''(L) = 0$ and $u'(0) = u(0) = 0$.

When discretized, for example using the finite element method, the equation of motion may take the following matrix form:

$$[M]\{\ddot{X}\} + [C]\{\dot{X}\} + [K]\{X\} = \{F\}, \quad (4.3)$$

where $[M]$ is the mass matrix, $[C]$ is the damping matrix and $[K]$ is stiffness matrix for the system, $\{\ddot{X}\}$, $\{\dot{X}\}$, $\{X\}$ are vectors containing acceleration, velocity and displace-

4.2 Beam Bending Vibration and FE Models

ment respectively in all degrees of freedom of the model; and $\{F\}$ contains external forces actuating in the system.

If we neglect damping and assume free motion, the eigenvalue problem for a healthy structure is written as:

$$([K] - \omega_i^2[M])y_i = 0, \quad (4.4)$$

where ω_i and y_i are the i th natural frequency and modal shape of a healthy structure. Conversely, let us consider the case of a damaged structure. The associated eigenvalue problem can be written as:

$$([K_d] - \omega_i^{*2}[M_d])y_i^* = 0, \quad (4.5)$$

where $[M_d]$ and $[K_d]$ are the mass and stiffness matrix of a damaged structure (yet to be defined) while ω_i^* and y_i^* are the i th natural frequency and modal shape of a damaged structure.

4.2.2 2D FE Model of Healthy and Damaged Beam

Equation (4.1) is discretized using 2-nodes beam elements with 2 degrees of freedom (DOFs) per node, a vertical translation v and a bending rotation θ_z . As can be seen in Figure 4.1, the beam is divided into N elements of equal size and the model has $N + 1$ nodes. The damage is assumed to be placed within the beam elements of the FE model. Consider the damage at location x_l within node i and $i + 1$ of beam. It will be assumed that stiffness reduction falls within one or several elements.

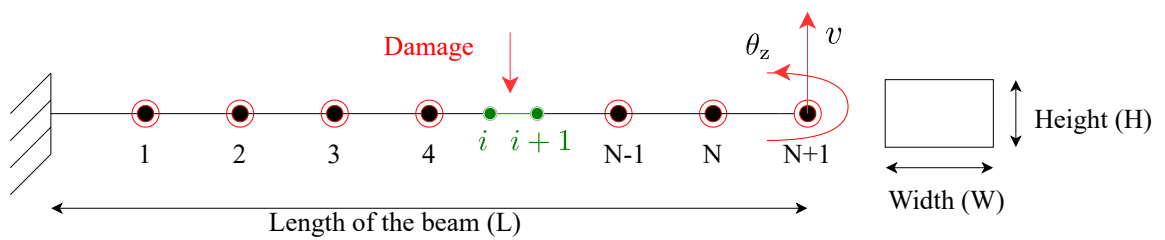

Figure 4.1: 2D FE model of a cantilever beam and cross-section area.

Natural frequencies of healthy and damaged 2D beam are obtained from solving the eigenvalue formulation using MATLAB $eig()$ function and their expression (in Hz) is $f_i = \frac{\omega_i}{2\pi}$.

In this 2D FE model, the damage is simulated by reducing the stiffness of selected element. Here, damage severity is represented by the reduction coefficient α_i , which is the ratio of the stiffness reduction to the initial stiffness. The stiffness matrix of a

damaged beam is defined as a sum of elemental matrices multiplied by coefficient by the following equation:

$$[K_d] = \sum_{i=1}^N (1 - \alpha_i) [k_e], \quad (4.6)$$

where $[K_d]$ is the global stiffness matrix for damaged beam, $[k_e]$ is elemental stiffness matrix and α_i is a bending stiffness reduction coefficient, which varies from 0 to 1 for the damaged structure. A value of $\alpha_i = 0$ indicates healthy element.

According to a convergence study, the beam is divided into 100 elements of equal size (10 mm). The 2D FE model has a total number of 202 DOFs.

4.2.3 3D FE Model of Healthy and Damaged Beam

In this section, a 3D FE model of healthy and damaged beam with clamped-free boundary condition is proposed. The models are implemented in COMSOL Multiphysics. In this context, we emphasize that a damage has a physical geometry.

The beams are meshed with tetrahedral elements (6 DOFs per node). The mesh density is *in fine* controlled by COMSOL. Typically, converged models with damage have 22,000 DOFs. A high mesh density is applied close to the damage area. **Figure 4.2a,b** represent 3D healthy and damaged FE models, respectively. A zoomed view of the rectangular geometry damage is shown on **Figure 4.2b**.

Natural frequencies of 3D healthy and damaged models are obtained using COMSOL Multiphysics' own solver.

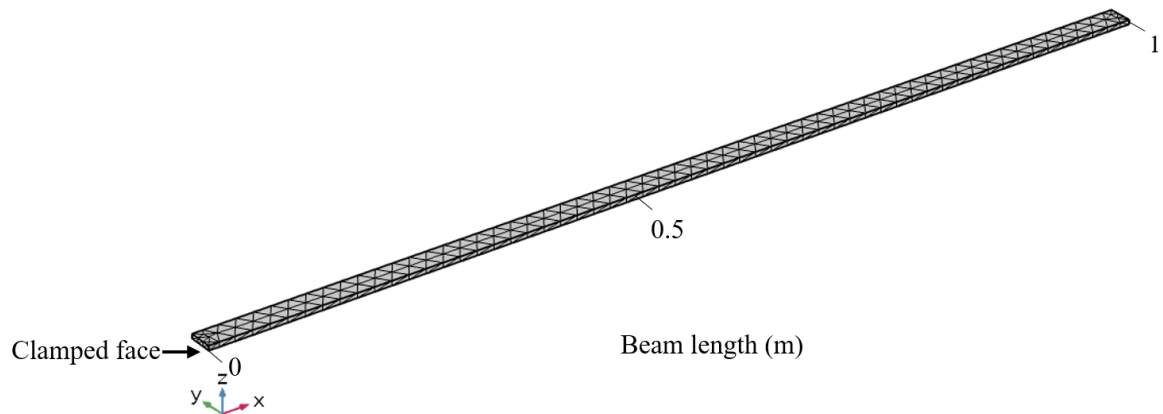

(a)

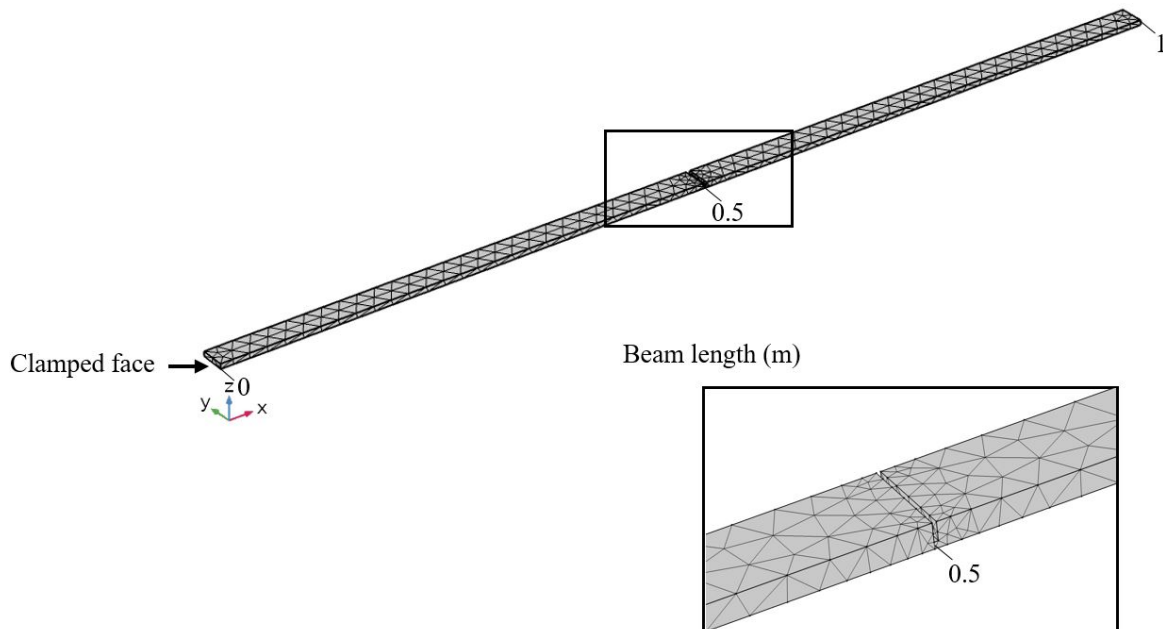

(b)

Figure 4.2: 3D FE mesh of the cantilever beam (a) healthy state (b) and example of damaged state with zoom in the damage area.

4.2.4 3D FE Frequency Convergence Test

A convergence test is performed to ensure that the 3D FE model is adequately meshed. It is here given for the damaged beam, with a damage at midposition with a width of 2 mm and a depth of 2.5 mm. The beam properties are given in [Table 4.1](#). The convergence test is carried out by changing the mesh densities. Using the five mesh standard

Geometry Damage Properties Identification in Beam Structures

parameters proposed in COMSOL Multiphysics: Finer, Fine, Normal, Coarse, Coarser, the first seven bending natural frequencies are computed. Note that these standard mesh parameters correspond to a number of DOFs varying from 22,000 to 2300 respectively, using tetrahedral elements, and that we rely on COMSOL Multiphysics to adequately mesh the damage area, as shown in **Figure 4.2b**. In a convergence study shown in **Figure 4.3**, the relative error on the natural frequency (with respect to the “Finer” mesh configuration) is determined. It is shown that the relative error for the “Fine” mesh is below 0.5%. Therefore, it can be concluded that the results are converged for both “Fine” and “Finer” mesh parameters and the frequencies are independent on the mesh size. For this reason, the “Finer” mesh is used in the rest of the study to build a damage library and to estimate geometry damage parameters.

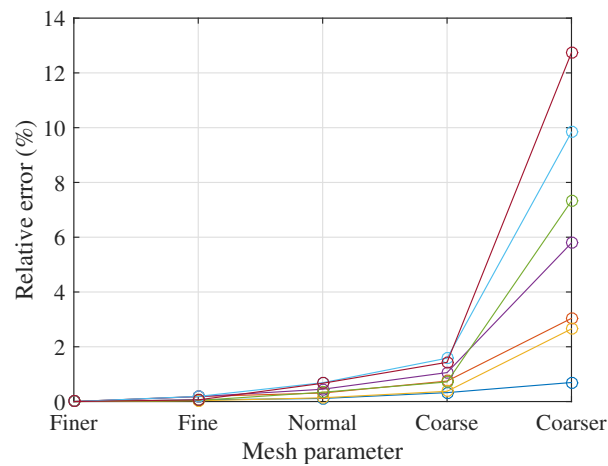

Figure 4.3: Relative error on natural frequencies versus COMSOL Multiphysics standard mesh parameters for 3D FE model of damaged beam. Each line corresponds to the eigenfrequency in increasing order.

4.3 Strategy and Objective Function for Damage Identification

It is well known that the presence of damages modifies dynamic parameters and behavior of the structure. In the proposed strategy, numerical cases and experimental validation are performed with only using frequencies changes between healthy and damaged structure. In this work, the novelty consists in using an existing severity indicator building a damage library for estimating properties of rectangular damage.

4.3.1 Proposed Strategy

In this section, a methodology for damage properties identification is described in three main steps. Figure 4.4 represents a complete flowchart of the proposed strategy for geometry damage properties identification.

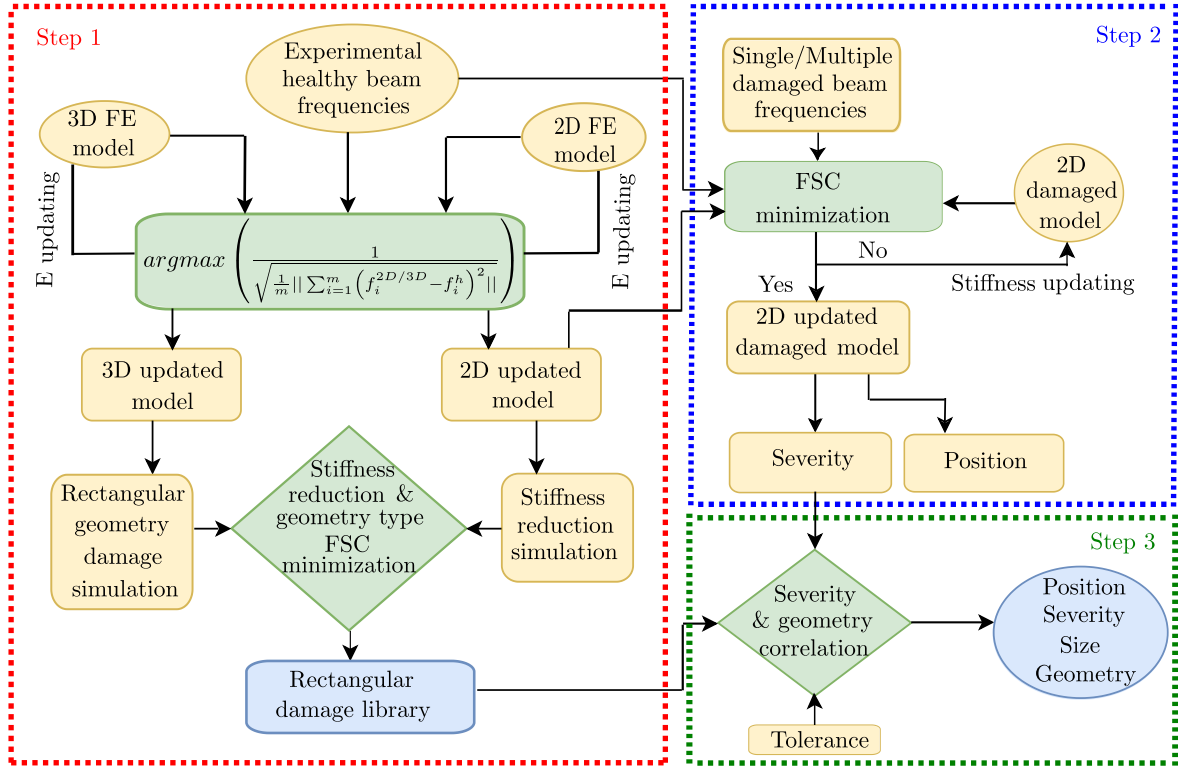

Figure 4.4: Flowchart of proposed strategy for geometry damage properties identification

Step 1: A set of healthy state frequencies are identified from the experimental beam. 2D and 3D FE healthy model are built, and Young’s modulus of FE models are updated to closely match the frequencies with the healthy beam (the cost function is described later on). Then, in the 3D FE model, the damage is materialized as a rectangular discontinuity considering the position, width and depth of the damage. At the same time, the damage is materialized as a local reduction of bending stiffness in one element in the 2D FE model. Numerical correlation using FSC minimization between 2D and 3D FE models is performed, that is, for each set of physical parameter, a bending stiffness reduction is sought in the 2D model. At the end of this step, damage library is obtained, where 3D rectangular damage provides the width and depth, and 2D model gives bending stiffness reduction in percentage value of severity at particular damage position. More precisely, the damage library is a relation between

physical parameters and bending stiffness reduction. Moreover, these parameters can be extracted in the form of one item from the damage library.

Step 2: An updating of the 2D FE model of damaged beam is performed using FSC to identify location and severity of single or multiple damage. Typically, the basis for the model update is a set of frequencies issued from a 2D model, a 3D model or an experimental measurement. For a given updating procedure, four beam models with the same characteristics (healthy beam case, damaged beam case, 2D healthy model and 2D stiffness updated damaged model) are used. The stiffness reduction coefficient (or severity) and the localization of the reduction are updated during this procedure. The minimum value of the FSC is sought during the updating process. The argument of the minimum yield wanted location and severity. Practically, the minimization is performed using Particle Swarm Optimization (PSO) (Kennedy and Eberhart, 1995) in MATLAB global optimization toolbox. If the damage is identified, then we can proceed to the next step for geometry investigation.

Step 3: In this step, based on the results of **Step 2** and **Step 3**, the identification of damage physical parameters can be done. The estimated damage severity from **Step 2** is searched in the damage library. It corresponds to a (potentially nonunique) set of width and depth for a rectangular geometry. Note that curve fitting may be necessary if the library is not precise enough and that a tolerance can be introduced. The nonuniqueness of the solution and the way to go beyond will be discussed later on.

Remark: The interest of using a damage library instead of directly correlating the tested structure to a 3D model is indeed to reduce the computational time.

4.3.2 Initial Model Updating

According to **Figure 4.4**, an initial updating of the numerical models (2D and 3D) with respect to an experimental healthy beam is done first. Only the Young's modulus is updated. A maximization problem is formulated which uses the inverse of the statistical error on the natural frequencies. The updated Young's modulus is then given by:

$$E = \operatorname{argmax} \left(\frac{1}{\sqrt{\frac{1}{m} \left| \sum_{i=1}^m \left(f_i^{2D/3D} - f_i^h \right)^2 \right|}} \right), \quad (4.7)$$

where $f_i^{2D/3D}$ is the i th frequency of 2D/3D FE model of the beam, f_i^h is the i th healthy beam frequency which is obtained from the experimental modal analysis.

4.3.3 Frequency Shift Coefficient (FSC)

The modal method for damage detection relies on changes in dynamic properties of the structure and particularly natural frequencies. Any changes in the structure, such as the reduction in stiffness, will cause changes in the natural frequencies. One of the important advantages of natural frequency is that it can be easily measured through vibration measurements. Classical measurements schemes can be used for the determination of experimental resonant frequencies. In this context, the Frequency Shift Coefficient is first presented by [Silva and Araujo Gomes \(1994\)](#) for damage identification problems. This coefficient uses four sets of natural frequencies. We consider on the one hand so called experimental frequencies denoted X (issues from a numerical model or an experiment) and on the other hand frequencies from a model, denoted A . In each category, there can be frequencies from a healthy or reference structure, denoted h and frequencies from an unknown, or damaged structure, denoted d . To be clear, there is a set of experimental healthy frequencies (h, X) , a set of experimental unknown frequencies (d, X) , a set of frequencies obtained with a healthy model (h, A) and a set obtained with a damaged model (d, A) . The frequency shift coefficient is defined as:

$$FSC = \sqrt{\frac{1}{m} \left| \sum_{i=1}^m \left(\frac{(\Gamma_i)_X - (\Gamma_i)_A}{(\Gamma_i)_X} \right) \right|} \quad \text{and} \quad \Gamma_i = \frac{f_i^d}{f_i^h}, \quad (4.8)$$

where m is number of modes taken into account, X is the damaged case, A is the 2D beam model (reference), f_i^d is the damaged beam frequencies, f_i^h is healthy beam frequencies and i denotes modes' indices.

The FSC is then used to qualify (d, X) by updating (d, A) using the shifts with respects to the sets (h, A) and (h, X) . Remember that (h, A) was first updated with respect to (h, X) . In other words, the location and severity of damage in (d, X) are given by minimizing the value of FSC.

4.4 Numerical Assessment of the Strategy Using 3D and 2D models

Following the methodology proposed in [Section 4.3](#), numerical assessments are performed using 3D and 2D models. In the beginning, beam properties and Young's modulus updating procedure are detailed. Complementing the 2D model made in MATLAB, a 3D model built with COMSOL is going to be used to be simulated as well as correlated using FSC minimization in order to build a damage library using **Step 1**. Cases with Single and multiple damage are tested to validate the bending

Geometry Damage Properties Identification in Beam Structures

stiffness based identification using **Step 2**. Furthermore, rectangular damage cases modeled with 3D FE are investigated; **Step 3** is used in order to distinguish the damage properties and size (width and depth) based on the obtained severity.

4.4.1 Material and Geometry

The numerical simulation test is performed to verify the efficiency of the proposed VB-SHM method. A cantilever steel beam was taken into consideration for the numerical test and beam properties are given below in **Table 4.1**.

Table 4.1 Beam dimensions and steel properties.

Beam Properties	Value
Length (L)	1000 mm
Width (W)	25 mm
Thickness (T)	5.3 mm
Young's modulus (E)	210 GPa
Mass density (ρ)	7850 kg/m ³
Poisson's ratio (ν)	0.33

The updating procedure is done for 2D and 3D healthy FE models with respect to an experimental beam presented in **Section 4.5**. Young's modulus is updated from an initial value of 210 GPa according to **Section 4.3.2** by obtaining the maximum value of the function expressed in **Equation (4.7)**. Seven bending frequencies are used in the procedure, which are indicated in **Table 4.2** for the healthy experimental beam. In the 3D model, a procedure is first applied to filter the results and consider only the frequencies corresponding to bending modes. The updated results of Young's modulus are found to be 189.26 GPa with 0.8635 maximized value for the 2D beam and 188.90 GPa with 0.8466 maximized value for the 3D beam. The frequencies of the updated 2D and 3D FE models of the beam structure are reported in **Table 4.2**. Note that the mean error values are 0.569% for 3D model and 0.584% for 2D model, respectively.

4.4 Numerical Assessment of the Strategy Using 3D and 2D models

Table 4.2 Eigenfrequencies of healthy cantilever beam.

Mode	$f_{experimental}$ (Hz)	3D FE updated $E = 188.90$ GPa		2D FE Updated $E = 189.26$ GPa	
		f_{3D} (Hz)	Error (%)	f_{2D} (Hz)	Error (%)
1	4.27	4.21	0.48	4.20	0.71
2	26.33	26.36	0.11	26.35	0.08
3	73.26	73.81	0.75	73.77	0.69
4	142.34	144.63	1.58	144.56	1.54
5	240.12	239.04	0.46	238.96	0.49
6	355.67	357.03	0.38	356.97	0.36
7	499.66	498.56	0.22	498.57	0.22
			Mean = 0.569	Mean = 0.584	

Note that, just as in the initial updating procedure, the seven lowest frequencies are assumed to be sensitive enough to find damage parameters with the help of FSC. Remember that Ref. [Pan et al. \(2019\)](#) suggests that the modes can be selected in a smarter way, which is not done here for the sake of simplicity. Finally, in this study, the bending frequencies with two digits after the decimal are considered, which proves necessary to correctly correlate the FE models.

4.4.2 Damage Library Using 3D and 2D Model Correlation

In this section, 2D and 3D FE models are correlated using FSC minimization in order to obtain a damage library. The damage library is built for rectangular geometry damage. First, the library is built in midposition (0.5 m) of a cantilever beam. The process detailed in **Step 1** (see **Figure 4.4**) is implemented. In order to build a damage library, a beam embedding a rectangular damage is simulated using 3D FE, while the correlation between the two FE models permits us to obtain the corresponding 2D bending stiffness reduction. The physical parameters of the rectangular geometry are then varied and the process is repeated. In the library, stiffness reduction is performed in a single element while the width and depth of the rectangular damage are varied from 0.01 mm to 10 mm and 0.01 mm to 4.0 mm, respectively. Each item from the damage library is a triplet: width and depth of the rectangular damage in the 3D model and bending stiffness reduction in the 2D model.

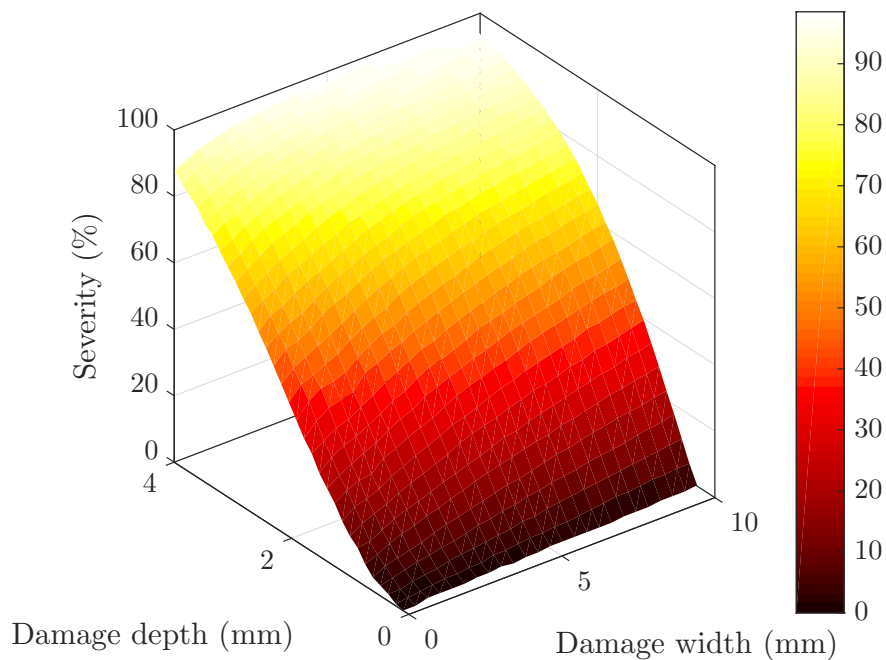
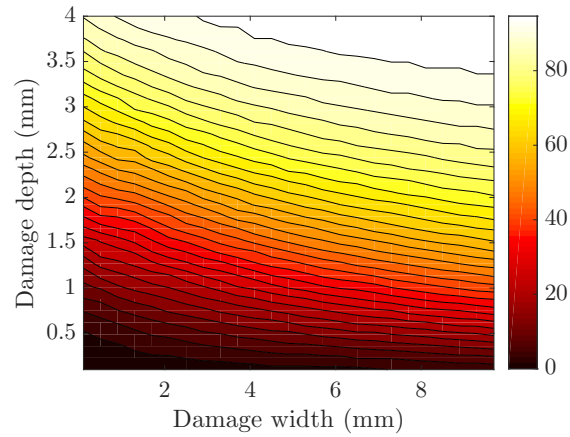

Figure 4.5: Surface view of the damage library built at midposition (0.5 m) of a cantilever beam.

Figure 4.5 shows the surface view of the damage library built at midposition on the beam. The colorbar represents severity associated to the size of damage. The result of the simulation is, as expected, a smooth surface. Here, the library also illustrates a monotonic response to the size of damages. Interestingly, the width of damage contributes to the decrement of severity to a larger extent compared to its depth.

Notice that the damage severity here ranges from 1 to 99%. It is not in the scope of this paper to assess whether or not it is relevant to model a deep damage with linear assumptions and an important stiffness reduction. In the rest of the study, the damage dimensions will be kept small and severity will be kept less than 50%.

4.4 Numerical Assessment of the Strategy Using 3D and 2D models



(a)

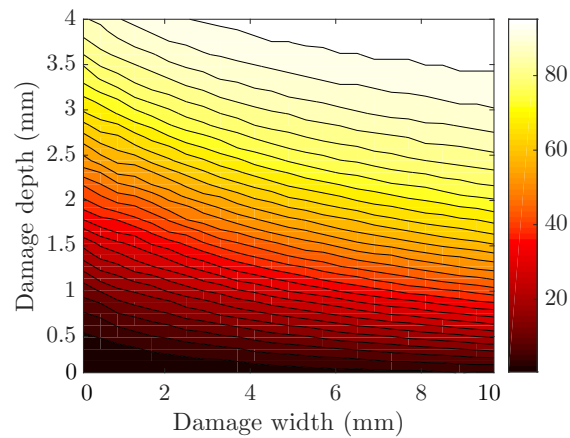

(b)

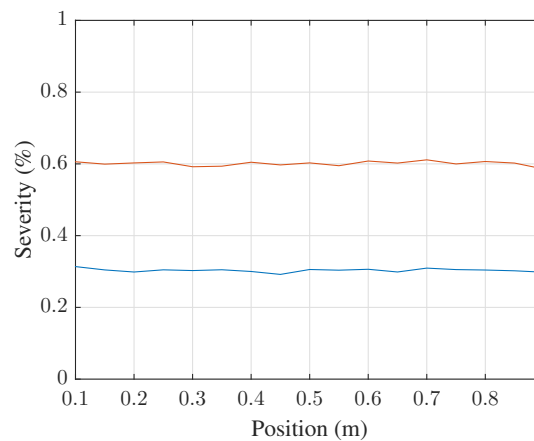

(c)

Figure 4.6: Contour view of the damage libraries which is built at position (a) 0.30 m and (b) 0.50 m. (c) Severity equivalent to a damage 1 mm × 1.5 mm (blue) and 1 mm × 2.5 mm (red) for varying position along the beam.

Geometry Damage Properties Identification in Beam Structures

The effect of beam position for building a library is investigated. A library is built by choosing a different beam position, with a damage positioned at 0.3 m. Again, a range of sizes for the rectangular damage is computed and the stiffness is reduced in a selected element during 2D and 3D correlation. **Figure 4.6a,b** shows contour view of two different damage libraries which are built at 0.30 m and 0.50 m beam positions, respectively. Note that **Figure 4.6b** is simply another view of the results seen in **Figure 4.5**. The colorbar represents the percentage of severity corresponding to the depth and width of the damage. The evolution of severity with the geometry of damage is similar for the two positions. In fact, the maximum difference of severity between the two position is 1.8% on the entire domain. Moreover, **Figure 4.6c** shows the severity equivalent to a given damage for a range of positions along the beam. Two geometries are shown here: the blue curve is associated to a 1 mm \times 1.5 mm damage, and the red curve to a 1 mm \times 2.5 mm damage. The results show that the severity corresponding to a given damage geometry has a very small dependence to the position on the range displayed. Thus, it means that the library does not depend on the beam position. Indeed, it is possible to build a library at any position of the beam. Finally, note that it takes approximately 1.5 h on a Intel Core i7 (2.6 GHz) to build an entire map such as the one in **Figure 4.5**.

4.4.3 Localization and Quantification of Single Damage

In this section, the proposed methodology (see **Figure 4.4**) is tested by considering numerical damaged cases (see **Figure 4.7**), i.e., a 2D damaged FE model is used to generate a set of frequencies, and **Step 2** is used to find position and severity based on this set. In given cases, the damage is introduced at different beam positions: (a) 0.15 m near the clamped end (b) and 0.80 m close to the free end of the beam with 10% and 5% stiffness reduction, respectively. The first seven frequencies for each case were used in the FSC computation. They are plotted in **Table 4.3**. Note that differences between the two cases are very small. The minimization of the FSC (see **Equation (4.8)**) is carried out to localize and estimate damage. The two parameters considered in the procedure are hence the position and severity of the stiffness reduction.

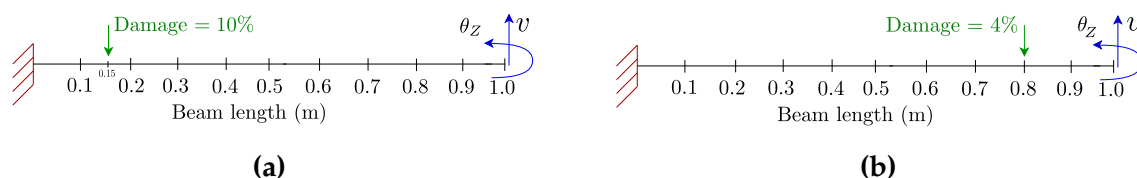

Figure 4.7: Single-damaged cases set in 2D beam, where positions and stiffness reduction are: (a) 0.15 m with 10% ; (b) and at 0.8 m with 4%.

4.4 Numerical Assessment of the Strategy Using 3D and 2D models

Table 4.3 Numerically measured natural frequencies of single damaged cases (a) and (b) with parameters of position and severity.

Damaged Cases	Natural Frequencies (Hz)						
	1	2	3	4	5	6	7
(a) 10% at position 0.15 m	4.20	26.34	73.77	144.50	238.76	356.62	498.23
(b) 4% at position 0.80 m	4.20	26.34	73.74	144.48	238.88	356.94	498.56

In **Figure 4.8a**, FSC is shown in color levels as a function of position and severity of the damage for case (a) schematized in **Figure 4.7a**. Note that this color map is only an illustration of the variation of FSC on the whole range of parameters, the definitive result being provided by the minimization algorithm. We notice several dark areas (low value of FSC) that correspond to frequency shifts between healthy and updated damaged model that, overall, are close to the actual frequency shifts. The dark area for positions close to the free end of the beam is especially interesting: it means that from the FSC point view, any stiffness reduction close to the free end is quite similar to the investigated case. The white circle indicates the set of parameters that minimized the FSC: location and severity values of damage are obtained at x abscissa 0.15 m with 10%, respectively. The zero value of FSC for this set of parameters indicates that the tried damaged case and the unknown case are similar from FSC point of view. The minimum value is likely to indicate the parameters of damaged case, especially if it is zero or close to zero. **Figure 4.8b** shows a slice view of the FSC as a function of severity only in the range [1, 90]% at abscissa 0.15 m. On this view, it is more clear that the FSC reaches zero for a severity of 10%. **Figure 4.9** also indicates results for another single damaged case (b) (see **Figure 4.7b**) where the minimum value of FSC is obtained with 4% estimated damage at x abscissa 0.80 m, respectively. Again, a slice view at abscissa 0.8 m is shown in **Figure 4.9b**, which represents estimated severity for single damaged case (b). Thus, minimization of FSC provides accurate values for location and estimated severity of the damage. In terms of CPU times, the algorithm takes 5–10 s on a Intel Core i7 (2.6 GHz) using MATLAB's *particleswarm* for a given case.

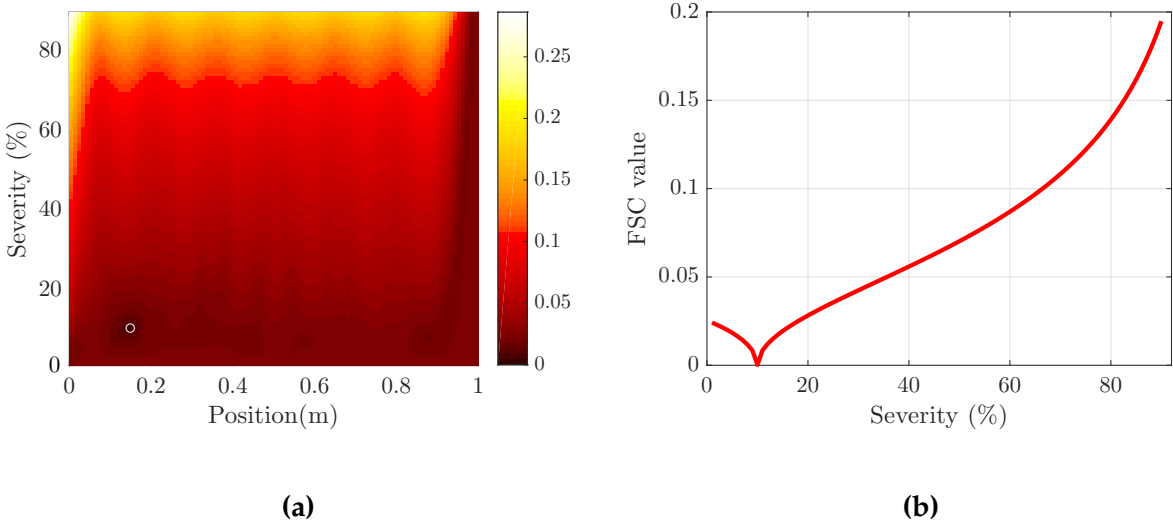

Figure 4.8: Frequency Shift Coefficient (FSC) as a function of tested position and severity, where (a) the white circle indicates 10% severity and 0.15 m position identified by the algorithm (b) slice view of 10% estimated damage.

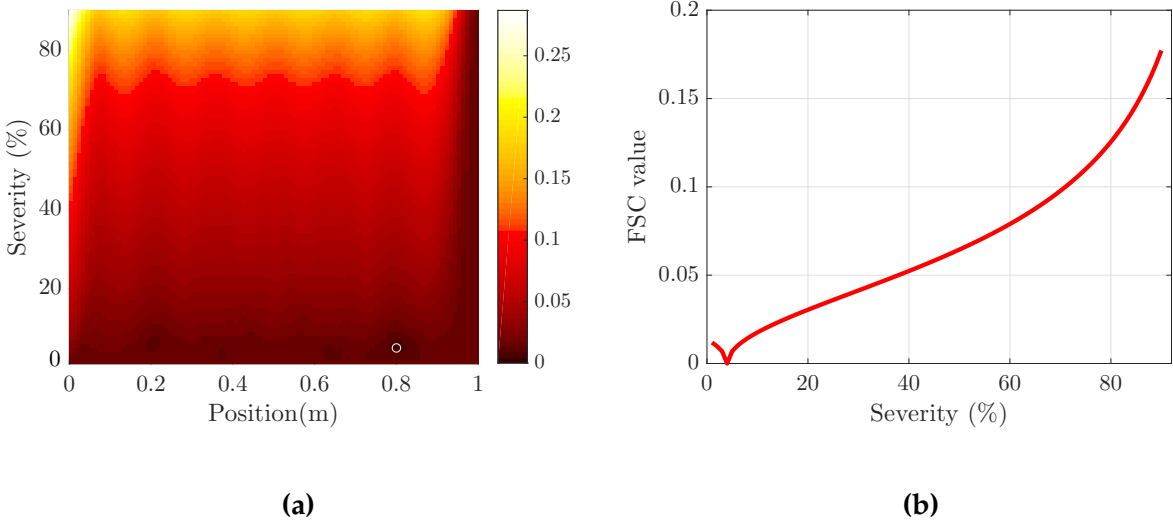

Figure 4.9: FSC as a function of tested position and severity, where (a) the white circle indicates 4% severity and 0.80 m position identified by the algorithm (b) slice view of 4% estimated damage.

4.4.4 Localization and Quantification of Double Damage

For highlighting the potential of the method, it is applied to localize and estimate double damage based on the given strategy (Step 2) from Figure 4.4. Numerical

4.4 Numerical Assessment of the Strategy Using 3D and 2D models

cases with two damaged areas are proposed in Figure 4.10. Two damaged cases are investigated: (a) at 0.3 m and 0.7 m beam positions with 40% and 30% stiffness reduction (see Figure 4.10a), (b) and near the clamped area of the beam at 0.10 m and 0.20 m with 7% and 2% stiffness reduction (see Figure 4.10b), respectively.

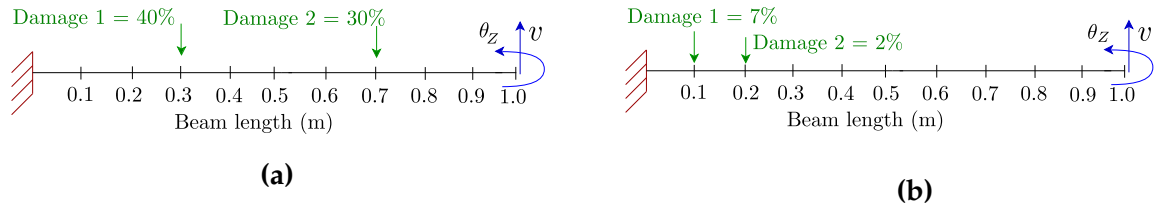

Figure 4.10: Double damage cases set in a 2D beam (a) at 0.3 m and 0.7 m with 40% and 30% stiffness reduction, (b) at 0.10 m and 0.20 m with 7% and 2% stiffness reduction, respectively.

Table 4.4 Numerically computed natural frequencies of double damage cases (a) and (b) with parameters of position and severity.

Damaged Cases	Natural Frequencies (Hz)						
	1	2	3	4	5	6	7
(a) 40% at 0.50 m and 30% at 0.70 m	4.18	26.25	73.00	144.01	238.72	353.61	495.02
(b) 7% at 0.10 m and 2% at 0.20 m	4.20	26.33	73.76	144.53	238.90	356.84	498.32

The test was initiated by obtaining a set of frequencies from each numerical case. The natural frequencies are given in Table 4.4 for damaged cases. Damage identification is done by updating a model embedding two damages, thanks to the FSC. As with single damage, the first seven natural frequencies of the damaged structure were used as an input for the FSC. In double damage identification, there are four parameters (position 1, position 2, severity 1 and severity 2) to identify. Evolution of FSC with parameters for the two studied cases is plotted on Figure 4.11 and 4.12. Because it is difficult to represent a variable of four parameters, the plot is split in two in these examples: First, in Figure 4.11a and 4.12a, for the actual severities for the two damages (40 and 30% in Figure 4.11a, 7 and 2% in Figure 4.12a), the FSC is represented as a function of positions only. Second, in Figure 4.11b and 4.12b, for the actual positions of the damages (0.30 and 0.70 m in Figure 4.11b, 0.45 and 0.55% in Figure 4.12b), the FSC is represented as a function of severities only. The minimization of FSC gives the following results (indicated as white circles in Figure 4.11 and 4.12): for case (a), the severities are 30% and 40% and positions are 0.30 m and 0.70 m. For case (b), the severities are 7% and 2% for two damage localized

Geometry Damage Properties Identification in Beam Structures

at 0.10 m and 0.20 m). In the two cases, the estimation correspond to the values given in **Figure 4.10**. In other words, the algorithm is employed satisfactorily to identify both locations and severities of double damage.

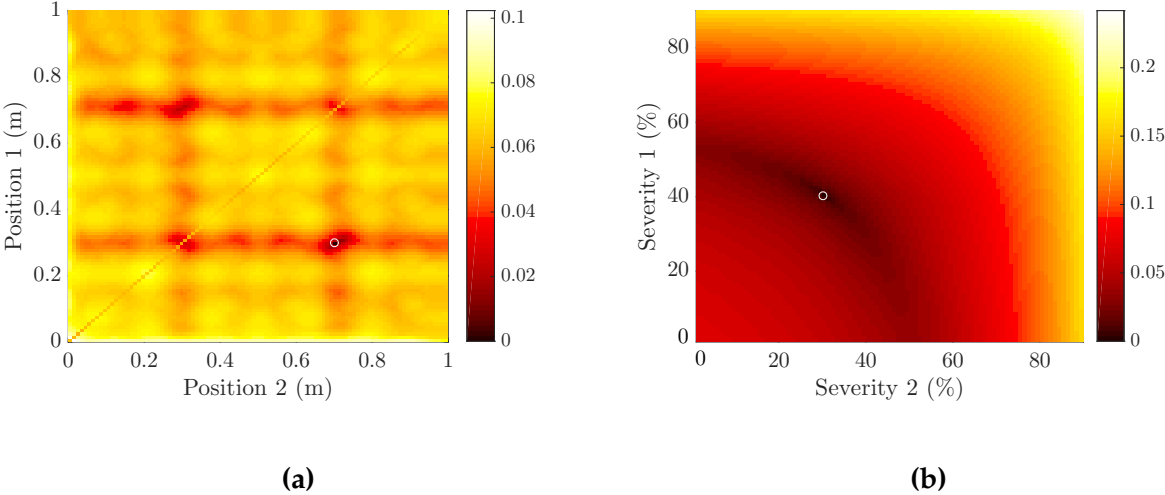

Figure 4.11: FSC as a function of tested multiple damage positions and severities (a) the white circle indicates that damage positions are 0.30 m and 0.70 m, (b) and severities of localized damage are 40% and 30%.

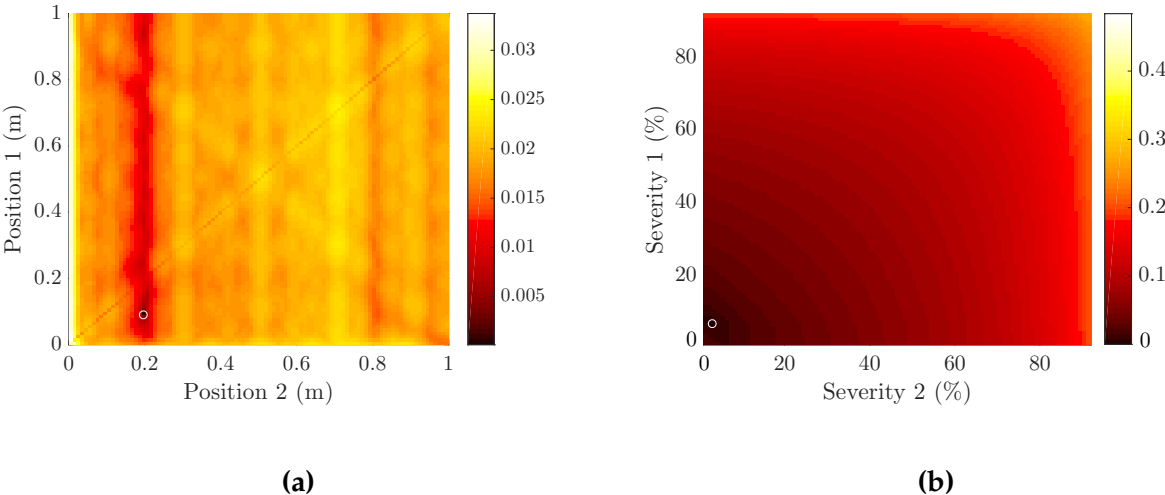

Figure 4.12: FSC as a function of tested multiple damage positions and severities (a) the white circle indicates that damage positions are 0.45 m and 0.55 m, (b) and severities of localized damages are 7% and 2%.

Note that the same number of frequencies has been used in the single and the double damage cases. The numerical study that is described here demonstrates that

4.4 Numerical Assessment of the Strategy Using 3D and 2D models

seven frequencies are sufficient. Further work needs to be done to study the effect of adding more natural frequencies.

4.4.5 In the Case of Rectangular Geometry Damage

In this section, the strategy is carried out in order to investigate the rectangular geometry damage using all **Steps**. **Figure 4.13a,b** show a detailed 2D view of rectangular geometry cases. Here, the width (W_d), depth (D_d) and height (H_d) are 2.5 mm, 0.75 mm and 25 mm for rectangular damaged case (a), while 0.9 mm, 1.34 mm and 25 mm dimensions for rectangular damaged case (b), respectively. The rectangular damaged case (a) and (b) are assumed at positions 200 mm and 700 mm on the beam. Numerical cases are meshed and computed in COMSOL Multiphysics in order to obtain the natural frequencies. These frequencies are tabulated in **Table 5.1** for the two rectangular damaged cases.

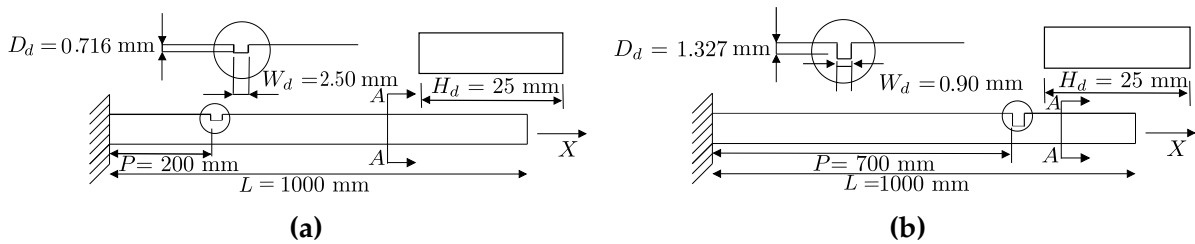

Figure 4.13: 2-D clamped free beam plan with rectangular geometry damaged case (a) and case (b).

Table 4.5 Numerically measured natural frequencies of rectangular damaged case (a) and (b) with parameters of position and geometry size.

Damaged Cases	Natural Frequencies (Hz)						
	1	2	3	4	5	6	7
(a) 3D rectangular ($D_d = 0.716$ mm, $W_d = 2.50$ mm)	4.20	26.37	73.79	144.43	238.76	356.91	498.50
(b) 3D rectangular ($D_d = 1.327$ mm, $W_d = 0.90$ mm)	4.21	26.31	73.53	144.44	238.97	355.96	497.47

The rectangular geometry damaged case (a) is investigated to find damage properties. Based on the set of frequencies of **Table 4.5**, minimizing the FSC yields estimation of position and equivalent severity. **Figure 4.14a** shows identified position and severity for rectangular damaged case (a) where the white circle represent 14.37% damage extent at position 0.20 m with a minimum value of 0.011 for the FSC. After obtaining the severity of the damage, it is possible to examine physical damage parameters (width

Geometry Damage Properties Identification in Beam Structures

and depth). **Figure 4.14b** represents the different possibilities of extracted geometry parameters for 14.37% severity from the damage library (according to **Section 4.4.2**). Specifically, the blue dots represent the raw extraction from the library with a 1% tolerance. The red curve is a cubic fit of the raw result. Remember that one value of severity corresponds to two parameters, hence the line. In this section, it is assumed that the width of damage is the actual value, while the depth is a parameter to identify. It is a good way to check the method because if the damage library is reliable, the obtained depth should be the actual depth. In a more general case, it is also possible to assume the *smallest detectable size* as a width. This makes sense in an experimental context, where a visual inspection would be limited by this smallest detectable size, let us say a hairline thickness. For the rectangular damaged case (a), the assumed width is 2.5 mm. Hence, the result of estimated depth is 0.716 mm, as shown in **Figure 4.14b** (black cross). A difference between estimated and actual depth would lie in the tolerance in the library extraction and the curve fitting that is applied.

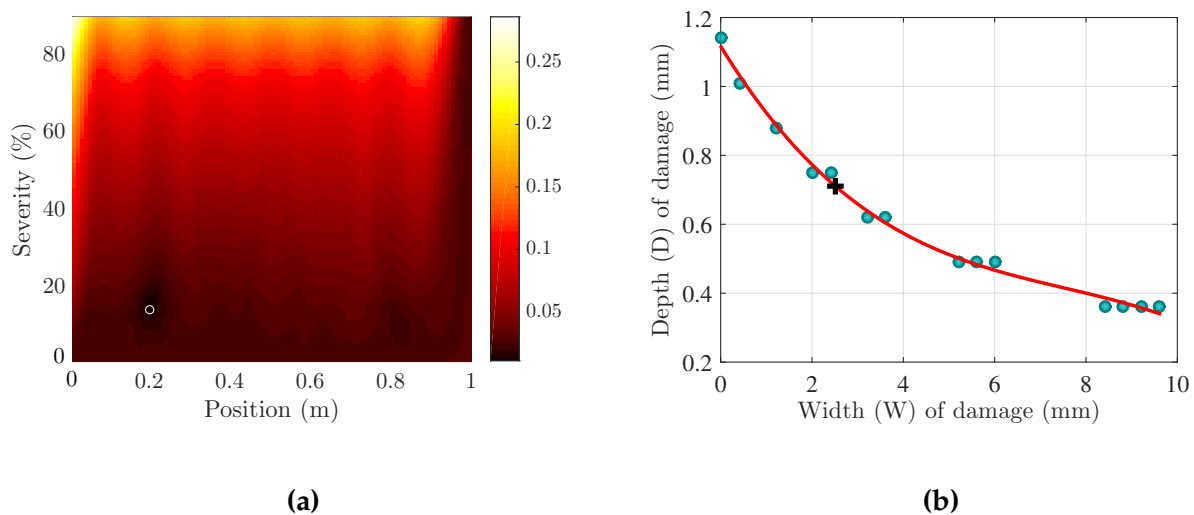

Figure 4.14: (a) FSC as a function of damage position and severity for damage described in **Figure 4.13a**; the white circle indicates that the damage position and severity are 0.20 m and 14.37%, respectively; (b) width and depth are extracted for 14.37% severity from the damage library (blue dots: raw extraction, red line: cubic fit, black cross: recovered geometry).

Similarly, the rectangular damaged case (b) is investigated to recover its physical properties. **Figure 4.15a** represents the identified position and severity using FSC algorithm. In this case, a 25.35% damage extent is obtained at 0.70 m beam position with 0.012 minimum value. The severity of 25.35% is searched in the damage library, as shown in **Figure 4.15b**. Hereafter, the width size is assumed based on the actual value, which is 0.9 mm for the geometry case (b). Based on width, the obtained depth

4.5 Identification of Damage on an Experimental Beam

is estimated 1.327 mm from the library. Based on these numerical investigations, the proposed strategy seems reliable to identify the physical geometry of damage.

Remark: Here, the number of element of the updated 2D beam is the same as for the model used in the damage library. Therefore, the elements have the same size and the bending stiffness reduction found in the updating process is employed to find the physical parameters in the damage library. Although it is not mandatory to use the same number of elements, this aspect has not yet been studied in detail.

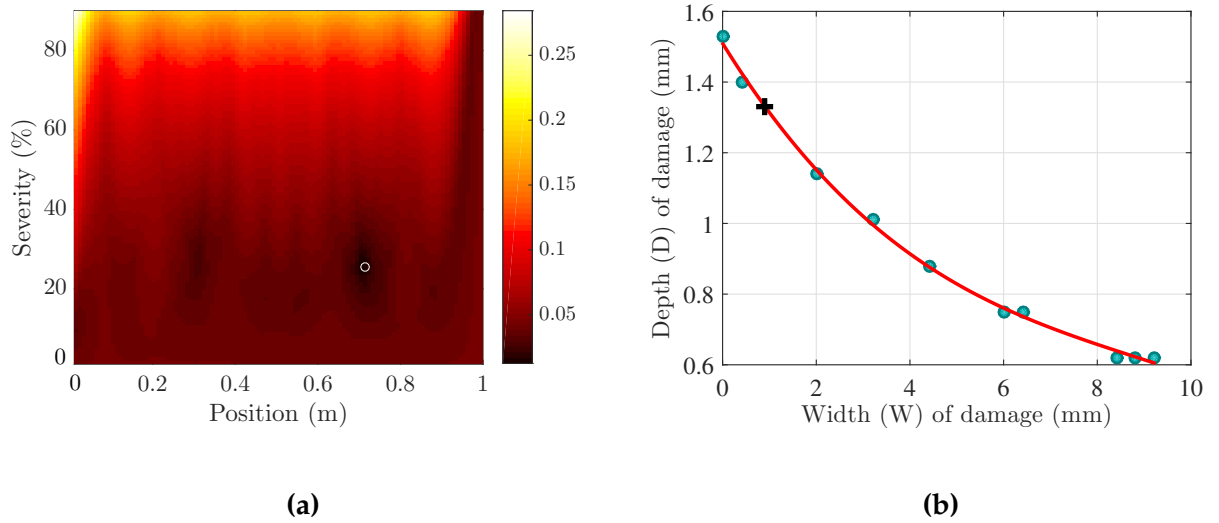

Figure 4.15: (a) FSC as a function of damage position and severity for damage described in **Figure 4.13b**; the white circle indicates that the damage position and severity are 0.70 m and 25.35%, respectively; (b) width and depth are extracted for 25.35% severity from the damage library (blue dots: raw extraction, red line: cubic fit, black cross: recovered geometry).

4.5 Identification of Damage on an Experimental Beam

4.5.1 Experimental Setup

An experimental cantilever beam is studied in order to investigate the accuracy of the proposed strategy using FE based FSC approach. As with the numerical studies, the study is done for a rectangular damage. A steel beam (length $L = 1$ m, width $W = 25$ mm and thickness $T = 5.3$ mm) is instrumented with 2 accelerometers, as displayed in **Figure 4.16**. Material properties (E , ρ , ν) of beams for the experiment are similar to those depicted in **Section 4.4.1**. Two experimental beams were measured and tested; the first is considered as healthy, and the second is a damaged beam. On damaged beam, a rectangular damage is done (saw cut) and measured with a depth of 1.55 mm

Geometry Damage Properties Identification in Beam Structures

and a width of 1.3 mm. It is placed at 710 mm from the clamped end. In order to extract the natural frequencies from the healthy and damaged beam, impact testing is chosen, and signals are recorded with a Siemens LMS multianalyser. The input excitation is produced through an impact hammer, while monoaxial accelerometers (Brüel et Kjær) record the output data. Two accelerometers are placed at 0.35 m and 0.75 m from the clamped end. Frequencies of a healthy and damaged structure are obtained from frequency response function by applying circle fit method using EasyMod package (Kouroussis et al., 2012). The first seven experimentally identified frequencies for each beam are listed in Table 4.6. Slight differences in natural frequencies are noticeable.

Table 4.6 Experimentally identified natural frequencies of healthy and rectangular damaged beam.

Experimental Beam Case	Natural Frequencies (Hz)						
	1	2	3	4	5	6	7
$f_{healthy}$	4.23	26.33	73.26	142.34	240.12	355.67	499.66
$f_{damaged}$ (rectangular)	4.24	26.21	72.82	141.73	239.38	354.36	498.00

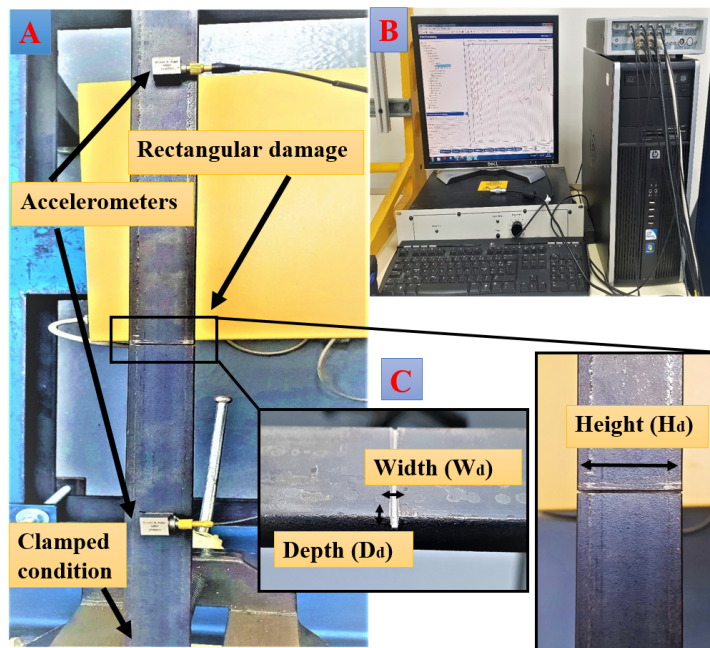

Figure 4.16: Experimentally tested cantilever beam where A shows experimental set up and input/output measurement points with accelerometers; B displays acquisition card and software; C shows details on the rectangular geometry.

4.5.2 Results

The measured natural frequencies are used to identify the damage properties. First, the 2D beam model based on the FE mesh (100 elements) depicted in **Figure 4.1** is correlated to the experiment. The bending stiffness updating technique is employed in a 2D damaged model to obtain the updated model. It should be pointed out that the mass of accelerometers is not taken into account in the FE model as localized mass; however, the model is updated based on the natural frequencies of the experimental beam with accelerometers.

In this experimental case, the damage is first localized and quantified. After, based on the severity, its geometry is recovered. The FSC is computed as a function of position and severity using **Step 2** and plotted as a color map on **Figure 4.17a**. As previously mentioned, the colorbar indicates FSC value and the white circle gives position and severity, according to the minimization. In this case, the damage severity is 34.93% at 0.72 m beam position, where the FSC minimum value is 0.039. Note that the estimation of localization (0.72 m) is very close to the real position (0.71 m). Again, it takes 5–10 s to solve the minimization problem.

The obtained severity (34.93%) is searched in the damage library in order to extract width and depth using **Step 3**. Again, several sizes of damage correspond to a single severity, as shown in **Figure 4.17b**. For the sake of the demonstration, we here assume the width to be the actual width (1.3 mm). It is found that the depth corresponding to 1.3 mm width is 1.62 mm (see **Figure 4.17b**). This estimation is close to the real value of depth (1.55 mm). It indicates that the physical parameters are correctly identified through the damage library. Hence, the proposed strategy constitutes an efficient identification tool for the estimation of geometry damage properties in an experimental context.

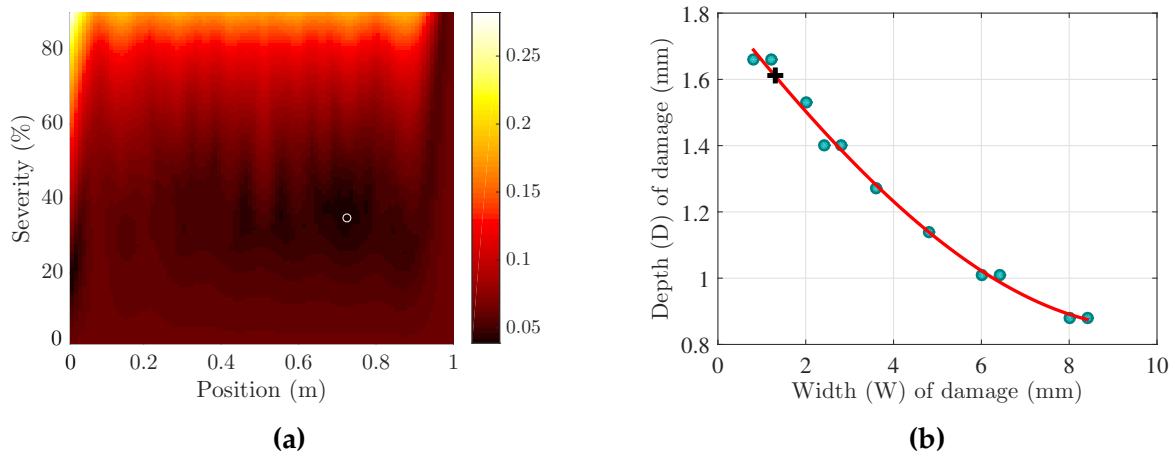

Figure 4.17: Experimentally tested rectangular geometry case where FSC is a function of position and severity (a) the white circle indicates 34.93% estimated damage severity at position 0.72 m; (b) width 1.3 mm and depth 1.62 mm for 34.93% severity extracted from the damage library (blue dots: raw extraction, red line: cubic fit, black cross: recovered parameters).

Conclusions

Dans ce travail, une stratégie a été développée pour l'identification des propriétés physiques des dommages (position, sévérité et taille) basée sur la réduction de la rigidité en flexion. La procédure utilise uniquement les fréquences naturelles et les modèles FE de la structure. Elle est appliquée sur une poutre encastree-libre. Dans ce contexte, la minimisation du coefficient de décalage en fréquence est utilisée de deux manières. Premièrement, nous sommes en mesure de construire une bibliothèque de dommages en corrélant les modèles 2D et 3D de la poutre endommagée. La bibliothèque a été construite pour un dommage rectangulaire et relie la profondeur et la largeur dans le modèle 3D avec une réduction de la rigidité en flexion dans le modèle 2D. La bibliothèque ne dépend pas de la position de la poutre. Ensuite, un modèle simple de la poutre endommagée est recalé afin d'identifier la position et la sévérité du dommage. La bibliothèque des dommages est alors utilisée pour obtenir plus d'informations sur la géométrie des dommages. La stratégie a été testée numériquement en récupérant des informations sur une poutre numérique endommagée modélisée en 2D ou 3D. Des dommages simples et doubles ont été étudiés. La sévérité la plus faible quantifiée dans cette étude numérique était de 2 %. La stratégie a également été testée avec succès sur une poutre encastre-libre expérimentale présentant des dommages causés par un trait de scie. Dans ce qui suit, cette méthodologie sera testée avec d'autres types de

structures, de comportements structurels et de géométries de dommages (trou, coupe oblique ou triangulaire) afin de valider son efficacité.

4.6 Conclusions

In this work, a strategy has been developed for physical damage properties (position, severity and size) identification based on bending stiffness reduction. The procedure makes use of natural frequencies only and of FE models of the structure. It is applied on a cantilever beam but nothing prevents its use with more complex structures. In this context, the minimization of the Frequency Shift Coefficient is used in two ways. First, we are able to build a damage library by correlating 2D and 3D model of damaged beam. The library was built for a rectangular damage and links depth and width in the 3D model with a bending stiffness reduction in the 2D model. The library does not depend on the beam position. Second, a simple model of the damaged beam is updated in order to identify position and severity of the damage. The damage library is then used to obtain more information about the geometry of the damage. The strategy has been tested numerically by recovering information about numerical damaged beam modeled in 2D or 3D. Single and double damage have been investigated. The lowest severity quantified in this numerical study was 2%. The strategy has also been successfully tested in an experimental cantilever beam embedding a saw-cut damage. In the future, this methodology will be tested with other types of structure, structural behavior and damage geometries (hole, oblique or triangular cut) in order to validate its efficiency.

Chapter 5

Identification of Hole Geometry Damage Properties

Summary

5.1	Introduction	101
5.2	Numerical Assessment of hole damages using 2D and 3D FE models .	102
5.2.1	Development of Hole Damage Library	103
5.2.2	In the Case of Hole Geometry Damage	104
5.3	Experimental Test	105
5.3.1	Results	107
5.4	Conclusions	109

Résumé

La propagation des dommages peut conduire à des défaillances structurelles et mécaniques catastrophiques, qui peuvent avoir des conséquences tragiques et entraîner des pertes matérielles. En raison de l'endommagement de la structure, une réduction de la rigidité en flexion et des modifications des paramètres de mode peuvent se produire. Dans ce chapitre, une stratégie similaire à celle développée précédemment est utilisée pour la localisation et l'estimation des dommages, ainsi que pour l'identification des propriétés géométriques des trous en utilisant les fréquences propres de la structure saine et endommagée. Ici, pour construire une bibliothèque d'endommagement des trous pour une poutre encastree-libre, la technique utilise une corrélation de minimisation numérique entre les modèles élément fini 2D et 3D. En outre, l'identification des dommages utilise le coefficient de décalage de fréquence (FSC) pour l'évaluation de différents scénarios numériques de trous à différents emplacements de la poutre. Les dommages quantifiés des trous sont liés à une réduction équivalente de la rigidité en flexion par l'utilisation de FSC. Enfin, la méthode est validée par l'identification des propriétés de dommages de la géométrie des trous dans la poutre numérique ainsi que dans une poutre expérimentale réelle avec des dommages à géométrie circulaire.

Abstract

The growth of damage can lead to catastrophic structure and mechanical failures, that can result in tragic consequences and material losses. Due to damage to the structure, reduction in bending rigidity and changes in mode parameters can occur. In this chapter, similar strategy as developed before, is used for the damage localization and estimation, as well as geometry damage properties identification of hole cases using eigenfrequencies of healthy and damaged structure. Here, to build a hole damage library for a cantilever beam, the technique uses a numerically minimizing correlation between 2D vs 3D finite element models. Furthermore, the damage identification uses Frequency Shift Coefficient (FSC) for the assessment of different numerical hole scenarios at different beam locations. The quantified hole damages are related to an equivalent bending stiffness reduction by the use of FSC. Finally, the method is validated through the identification of hole geometry damage properties in the numerical beam as well as a real experimental beam with hole geometry damages.

5.1 Introduction

Structural integrity evaluation based on vibration analysis is an important aspect for researchers and scientific committee. There are many critical mechanisms in a structure that can cause for damage. However, the presence of damage can causes changes in the physical parameters (mass, stiffness and damping) and geometry parameters (thickness, length, height, etc.). Therefore, changes in the natural frequencies and mode shapes of the structure. [Cawley and Adams \(1979\)](#) introduced sensitivity analysis using natural frequencies to detect, locate and quantify damage. [Salawu \(1997\)](#) mentioned that natural frequency is a sensitive parameter and measurements of frequencies can be quickly conducted and are reliable. [Silva and Araujo Gomes \(1994\)](#) introduced FSC to detect damage position and estimate crack length. [Dubey et al. \(2020\)](#) used a FSC based damage identification to locate and estimate the severity of the damage. The authors are also investigated uncertainties on eigenfrequencies. [Shukla and Harsha \(2016\)](#) acknowledged that the changes in natural frequency are an indication of cracks in the blade geometry. [Zhang et al. \(2017\)](#) presented techniques based on vibration methodologies by the frequency shifts from three inverse algorithms based on graphical technique, surrogate-assisted optimization and artificial neural network, to predict the location, size and interface of damages in the composite beam. [Le et al. \(2016\)](#) employed a method based on the first-order analytical estimation value of the relative variations of eigenfrequencies due to the change in mass and/or rigidity from the estimation of the modal parameters. [Serra et al. \(2016\)](#) examined numerical damage case using different indicators and a damage library was created from 3D and 2D FE models of a cantilever beam from considering bending frequencies. [Serra and Lopez \(2017\)](#) compared many classical indicators to evaluate their performance and capacity to detect and localize damage from different cases. More recently, [Dubey et al. \(2020\)](#) introduced a novel strategy using 2D and 3D FE models to identify geometry damage properties only using frequency changes.

The motivation behind the present chapter is to further investigate the proposed strategy (see [Section 4.3](#)) for the identification of damage properties (location, severity, and size) using the numerical correlation between element stiffness reduction to the size of hole damage. In this work, hole geometry damaged cases are investigated. At first, hole damage library is built using 2D vs 3D model correlation. To build a damage library, the proposed strategy given in [Chapter 4](#) are used to investigate the hole cases. Firstly, hole damaged cases are localized and quantified. Secondly, the estimated severity is linked to the hole damage library to find the size of the hole. The real experimental case is tested by considering the damage geometry dimension for hole (diameter) to validate the efficiency of strategy.

The rest of chapter is organised as follows. In [Section 5.2](#), the numerical correlation is performed to build a hole geometry damage library, and numerical hole damaged

Identification of Hole Geometry Damage Properties

cases are tested using 2D and 3D FE models to identify geometry damage properties. In **Section 5.3**, real damaged beam is tested, where hole damaged properties are identified using damage library. In **Section 5.4**, the conclusion has been drawn based on investigated proposed strategy and identified damage properties from hole damage.

5.2 Numerical Assessment of hole damages using 2D and 3D FE models

The study model focuses on a Euler's-Bernoulli cantilever beam structure, as shown in **Figure 4.1**. The beam is modeled with 100 elements, and each element size is 10 mm. The 2D FE model has a the total number of 202 DOFs, where each node has 2 DOFs: displacement along y-axis and rotation (θ_z) along the z-axis.

A damaged beam with the zoom area of the hole geometry is represented in **Figure 4.2a**. Here, *fine* FE mesh is used, and controlled by COMSOL Multiphysics. Here, the converged models with damage have 22,000 DOFs. A high mesh density is applied close to the damage area. **Figure 5.1** shows a 3D meshed beam with hole geometry damage. The issue here consists in the estimation of geometry damage with other damage parameters, i.e., width, depth for rectangular and radius for the hole.

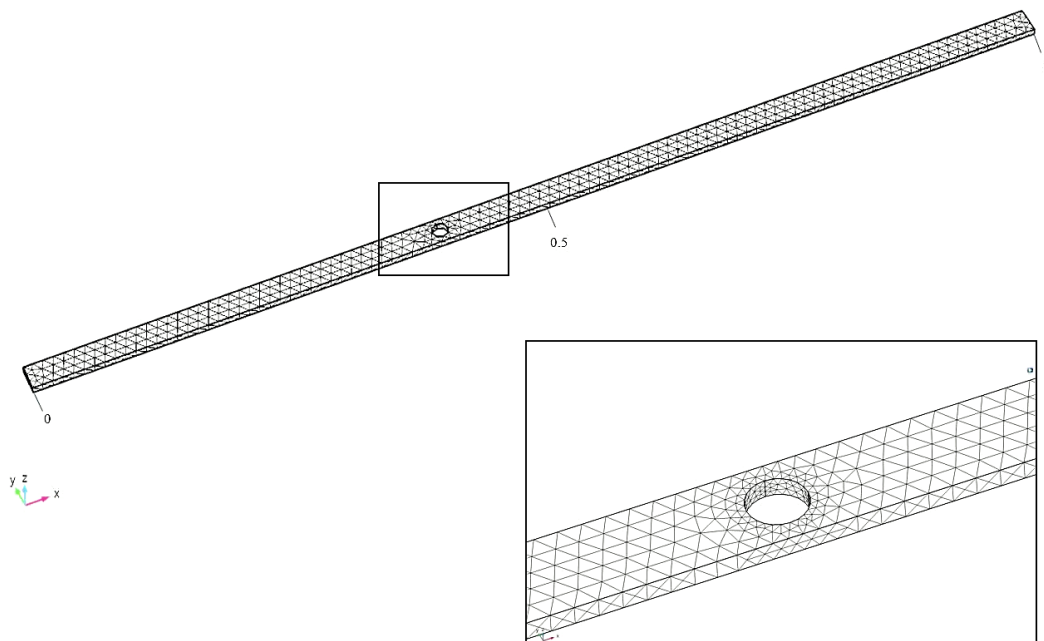

Figure 5.1: 3D FE mesh of the cantilever beam with an example of hole damaged state with zoom in the damage area.

5.2 Numerical Assessment of hole damages using 2D and 3D FE models

Note that steel beam properties and dimensions are given in **Table 4.1**. Frequencies of healthy beam are listed in **Table 4.2**, which are used for the purpose of building a hole damage library.

5.2.1 Development of Hole Damage Library

In this section, 2D and 3D FE models are correlated to obtain a damage library using FSC minimization. Model numerical simulation test for geometry investigation is performed to verify the efficiency of the proposed VBSHM strategy in **Figure 4.4**. In the methodology, **Step 1** provides a scheme to build a damage library. Hole damage geometry was simulated in 3D software and bending stiffness reduction is performed at the same time to correlate the FE models. Each item from the damage library is quantified in terms of stiffness reduction to the 2D FE model. In the library, the hole radius is varied from 1 mm to 12 mm. Here, the damage library is built for hole geometry damage as shown in **Figure 5.2**. The library is built in mid-position (0.5 m) of a beam to identify the geometry damage parameters. However, the library does not depend on the damage position. Similar geometry cases with same damage properties are tested in different positions to quantify severities using damage library. It was found (see **Figure 4.6**) that the severities are similar estimated for both cases.

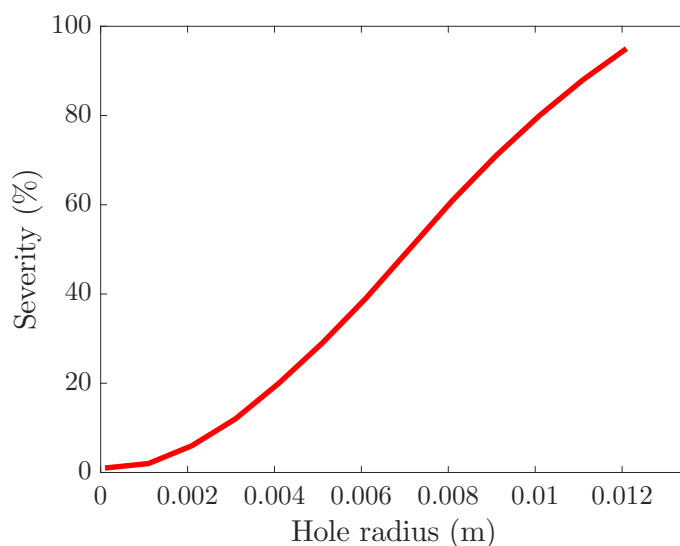

Figure 5.2: Hole geometry damage library is built at mid position of a cantilever beam structure.

Thus, it is possible to link a certain reduction in stiffness with a size of a hole damage by comparing from the library. Both 2D MATLAB and 3D COMSOL FE models will be used for this purpose. The library is suitable to identify the size of hole damage with 1% to 90% stiffness reduction.

5.2.2 In the Case of Hole Geometry Damage

Two hole damaged cases are given in **Figure 5.3a** and **Figure 5.3b**. In hole case (a), the hole is assumed at position 500 mm with the diameter 10 mm, and hole case (b) is assumed at position 300 mm with the diameter of 6 mm, respectively. Hole defects are simulated in a clamped free beam; both cases were performed after obtaining frequencies from damaged structure using COMSOL multiphysics. Natural frequencies for hole cases are listed in **Table 5.1**.

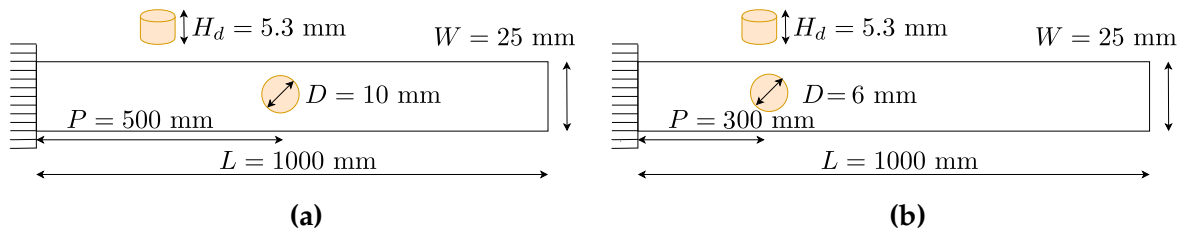

Figure 5.3: 2-D plan view of clamped free beam with hole damage. (a) case (a) with 10 mm diameter at position 500 mm (b) and case (b) 6 mm diameter at 300 mm beam position.

Table 5.1 Numerically obtained natural frequencies of 3D FE beam models with hole damage cases at different positions with dissimilar geometry dimensions

3D beam test	Natural frequencies (Hz)						
	1	2	3	4	5	6	7
f_h	4.21	26.36	73.81	144.63	239.04	357.03	498.56
Hole Case (a): f_d	4.19	26.18	73.58	143.62	238.22	354.46	496.58
Hole Case (b): f_d	4.12	25.72	72.47	141.15	234.62	348.43	489.06

The study cases are carried out similar to the rectangular damage properties identification. **Figure 5.2** represents a damage library for hole geometry. Hole case (a) and (b) are some examples that extracted from damage library. It is also possible to estimate the directly damage extent from the given library with geometry dimensions. At first, it should be localized, and then it can be estimated. For that, the diameter (D) and height (H_d) of hole damage are assumed, but position and severity are the parameters to identify. In the case, hole geometry works as a damaged case for FSC point of view. The algorithm based on the proposed strategy is applied to minimize the cost function — the stiffness updating damaged model and healthy model also taken into consideration to utilize in the algorithm.

The white circles (see **Figure 5.4**) indicate, highlighted FSC minimum values as a function of position and severity. In correspondence to minimized values for hole

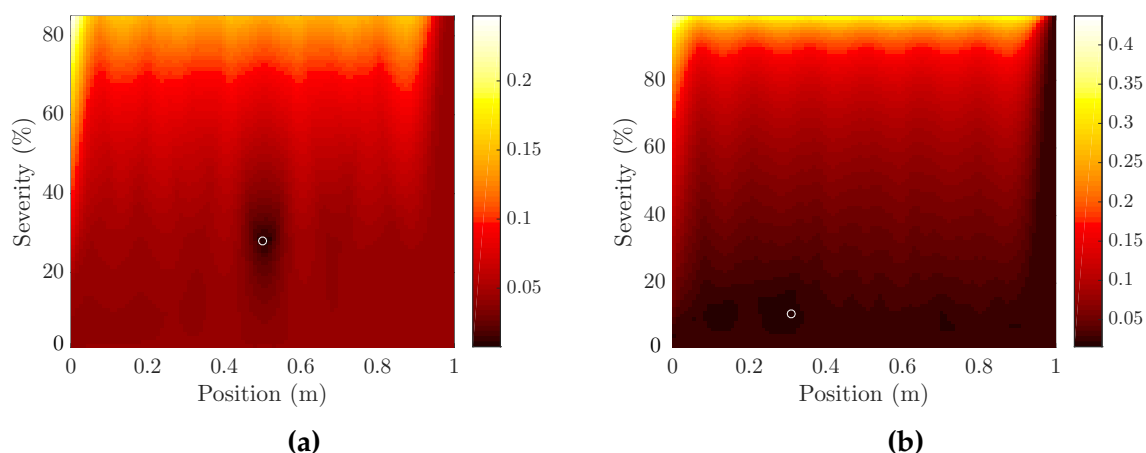

Figure 5.4: FSC as a function of tested geometry damage (a) for hole case (see **Figure 5.3a**) white circle indicates 28% estimated severity at position 0.5 m, and for hole case (b) (see **Figure 5.3b**) identified hole properties is 11% severity at position 0.3 m.

case (a) and (b), severities are estimated with 28%, and 11% at 500 mm and 800 mm beam positions, respectively. Hence, these obtained severities are linked to the hole library, whereas, hole sizes are obtained by 10 mm diameter with 0.0076 minimized value for 28%, and 6 mm diameter with 0.0156 minimized value for 11% damage, respectively.

5.3 Experimental Test

Application on real experimental cantilever beam is carried out to investigate the accuracy of the proposed damage properties identification strategy using FE based FSC approach. The experimental framework on cantilever has been designed with hole geometry test to verify the applicability of strategy in real structures. Each test is conducted with the real healthy and damaged beam with similar beam dimensions and properties. In test, a steel beam (length $L = 300$ mm, width $W = 25.0$ mm and height $H = 5.3$ mm) is instrumented with 2 accelerometers, as experimental set up showed in **Figure 5.5**. This experiment test is conducted for hole geometry. Here, it is also designed to investigate the approach in different length of the damaged beam. Material properties (E , ρ , ν) of beams during test are similar to numerical to those depicted in **Section 4.4.1**.

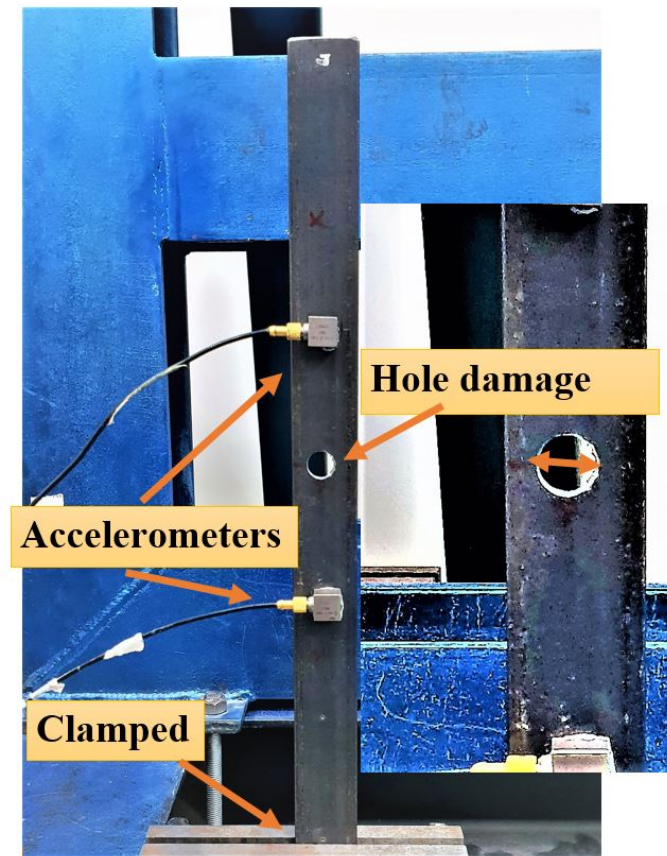

Figure 5.5: Experimental test for hole geometry damaged.

Table 5.2 Experimentally identified natural frequencies of healthy and hole geometry damaged beam.

Experimental beam test	Natural frequencies (Hz)						
	1	2	3	4	5	6	7
Healthy beam (f_h)	45.5	259.5	801.4	1629.5	2565.4	3806.2	5336.6
Hole damaged beam (f_d)	45.2	237.3	761.6	1520.6	2594.3	3754.1	5302.9

This experimental test is designed to extract the natural frequencies from the damaged and healthy beam. Similarly, the impact testing is chosen, and signals are recorded with a Siemens LMS multi-analyser. Accelerometers were placed near the clamped and free end of the beam. Here, natural frequencies of a healthy and hole damaged structure are obtained from FRF using EasyMod package (Kouroussis et al., 2012). Furthermore, circle fit method is applied to extract the natural frequencies. Experimentally identified seven frequencies for test, is recorded with and without prior hole damage, as depicted in **Table 5.2**.

5.3.1 Results

In experimental test (see **Figure 5.5**), a damaged beam is investigated to identify hole damage properties. The case is similarly conducted as rectangular geometry damage. At first, experimental and numerical correlation is performed by using the natural frequencies. FSC is minimized as a function of position and severity. In **Figure 5.6a**, the white circle and color bar indicates the localized position and severity. In the test, it is estimated 74% damage at 0.18 m of beam position. The obtained severity is linked from the library, as given in (see **Figure 5.6b**), Thus, it is found 20.20 mm diameter of the hole for 74% severity. In this study, damage severity is matched with the library in a localized position. The test is designed only for a real hole geometry damage in order to validate the approach to the small length of the beam. It also shows that the strategy is suitable for all kind of beams with different boundary condition.

The real hole diameter is also measured by the laboratory tool, and the diameter was 20.78 mm, which is quite near the value obtained from the library with 2% error value. **Table 5.4** is listed for results, illustrating damage properties for a real hole geometry damage. To summarize, the proposed strategy using FSC is validated by experimentally in order to find the geometry properties of damage with the percentage of severity, at a low computational cost.

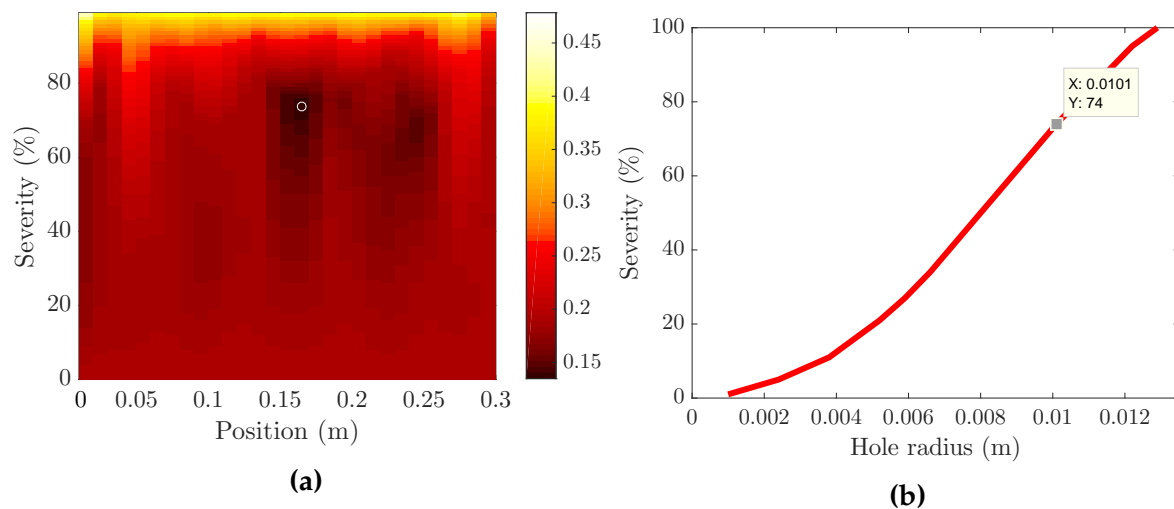

Figure 5.6: Experimentally tested hole geometry case where FSC as a function of position and severity (a) the white circle indicates 74% estimated severity damage at position 1.8 m, (b) radius of hole damage are linked from damage library.

Identification of Hole Geometry Damage Properties

Table 5.3 Hole geometry damage properties and their values, obtained from experimental and numerical correlation.

Table 5.4 Experimental test (hole geometry)

Type	Hole
Diameter (D)	20.2 mm
Height (H_d)	5.3 mm
Position (P)	180 mm
Severity	74 %

Conclusions

Dans ce travail, une nouvelle stratégie a été testée pour les dommages causés par la géométrie des trous, basée sur la réduction de la rigidité en flexion. La procédure utilise les fréquences naturelles de modèles FE 2D et 3D de structures de poutres saines et endommagées par des trous. L'application de la méthode est également basée sur la réduction de la rigidité en flexion et la corrélation des modèles d'éléments finis afin de construire une bibliothèque de dommages. L'un des avantages de la stratégie proposée est l'utilisation d'un algorithme de minimisation basé sur la fonction FSC pour traiter uniquement les changements de fréquences propres. Ici aussi, la fonction FSC requiert des fréquences de cas sains et endommagés avec un modèle de dommage sain et de mise à jour 2D en fonction de la position et de la sévérité. De plus, différents cas de trous endommagés ont été réalisés dans les différents modèles FE (3D vs 2D) en choisissant les poutres endommagées et saines. Pendant la corrélation numérique des modèles 3D et 2D, une bibliothèque de dommages pour la géométrie du trou a été construite. La bibliothèque fournit des informations sur les propriétés d'endommagement des trous avec leurs tailles de géométrie de rayon, obtenues en liant la taille de l'endommagement à la réduction de la rigidité. Elle a également été validée pour l'estimation de la sévérité de défauts circulaires dans des structures de type. La quantification des trous utilisant une comparaison avec la bibliothèque de dommages a réduit le coût du processeur. La stratégie a été testée avec succès dans une poutre expérimentale, et d'autres cas de trous ont été identifiés avec des propriétés d'endommagement. La stratégie convient à tous les types de longueur de la structure de poutre. Enfin, l'applicabilité de la stratégie est validée expérimentalement avec des modèles FE 2D et 3D suivis de VBSHM.

5.4 Conclusions

In this work, a novel strategy has been further tested for hole geometry damage based on bending stiffness reduction. The procedure makes use of natural frequencies of 2D and 3D FE models of healthy and hole damaged beam structures. The application of the method is similarly based on bending stiffness reduction and FE models correlation in order to build a damage library. One of the advantages of the proposed strategy is employed with consideration of FSC based minimizing algorithm to deal with only changes in eigenfrequencies. Here also, the FSC function requires healthy and damaged case frequencies with 2D healthy and 2D updating damage model as a function of position and severity. Moreover, different hole damage cases have been performed within the different (3D vs 2D) FE models by choosing the damaged and healthy beams. During the numerical correlation of 3D and 2D models, damage library for the hole geometry has been built. The library provides information about hole damage properties with their radius geometry sizes, which obtain by linking the size of damage to the reduction in stiffness. It has also been validated for the severity estimation of the hole damages in the beam-like structure. Hole quantification employing a comparison with the damage library was CPU cost lower. The strategy has been successfully tested in an experimental beam, and further hole cases have been identified with damage properties. The strategy is suitable for all kind of length of the beam structure. Finally, the applicability of the strategy is experimentally validated with 2D and 3D FE models followed by VBSHM.

Chapter 6

Conclusions and Perspectives

Summary

6.1	Conclusions	115
6.1.1	Limitations of the damage identification method	117
6.2	Future Perspectives	118

Conclusions and Perspectives

Structural health monitoring as a damage detection tool is widely considered in the engineering community, due to increased environmental factors, chemical processes infrastructural complexity and social expectations, among others. As demonstrated in the literature and shown in this dissertation, changes in the physical parameters of the structures, will influence the dynamic vibration characteristics of the structures. Consequently, various indicators for damage identification have been developed to take advantages of this phenomenon. Several different methods were reviewed that were categorized based on the use of the modal parameters. As a matter of fact, the development of an effective and reliable damage identification method has profound significance as it can have not only life-safety but also economic implications. The necessity to provide practicable and efficient strategies for the identification of damage and their properties, here concerning to address the following issues:

- The study investigated theoretical and numerical concepts, and their implementations on vibration-based damage identification. The review of the most common vibration-based damage identification methods from the latest publications is discussed and concluded.

- It concentrated on the use of the Frequency Shift Criterion by introducing in a minimizing algorithm. In the identification of damage, the use of frequency changes have become more popular because of its efficiency to classify the size and location of the damages through the minimizing algorithm.

- It studied the effect of severity as the principal parameter that may influence the final assessment of the algorithm.

- It implemented a methodology based on a combination of FSC minimizing function and a `particleswarm()` function in MATLAB Global Optimization Toolbox which proves to be adequate to solve the problem, and that takes advantage of PSO in order to find best-fit values in terms of damage locations and severities.

- It highlighted the efficiency of the algorithm by incorporating the modelling uncertainty on natural frequency. Depending on the changes in natural frequencies, the sensitivity of the algorithm was weighted.

- It compared the proposed method with the changes in position, severity and number of the damages. The FSC algorithm has shown better performance for the identification of single and double damages, particularly also in the case of uncertain measurements on natural frequencies.

- It used 2D vs 3D models, alongside FSC minimizing algorithm, to correlate the size of the damage to the bending stiffness reduction from the 3D vs 2D modeled structure

– It correlated 2D and 3D FE models to build a damage library. It also compared the 2D vs 3D models in order to estimate geometry damage (rectangular, hole) properties from linking the bending stiffness reduction to geometry sizes.

– It estimated the damage properties of real geometry by testing the experimental beams, where geometry sizes are linked to the percentage damage using after building damage library.

Conclusions

En raison des changements physiques dans les structures, les modèles EF de la structure dynamique peuvent être utilisés pour prévoir les changements dans ses paramètres modaux. L'identification des dommages est concernée par la méthode de recalage du modèle EF, suivie par les changements des fréquences propres. Le travail est conçu pour identifier les dommages ainsi que leurs paramètres de dommages, là où le changement physique est le plus approprié pour un changement de paramètre modal suggéré, tel que le décalage des fréquences propres. Les modifications structurelles consistent à explorer les changements dans les paramètres modaux dus à un changement physique choisi. Les essais de vibration sont particulièrement utiles pour l'étude d'un système dynamique lorsque ses paramètres physiques sont modifiés. Ensuite, la procédure d'identification des caractéristiques dynamiques est à bien définir, et la stratégie la plus efficace est à mettre en œuvre pour trouver ses changements.

Dans la première partie, le travail s'est concentré sur la localisation et la quantification des dommages avec un algorithme utilisant des modèles EF et la minimisation de la FSC. Cet algorithme d'identification des dommages FSC basé sur les EF est établi en utilisant la technique d'analyse modale pour les structures de type poutre. Deux états : l'état sain et l'état endommagé, ont été utilisés pour la mesure de la réponse vibratoire de la structure. Dans la première partie, le travail s'est concentré sur la localisation et la quantification des dommages avec un algorithme utilisant des modèles EF et la minimisation de la FSC. Cet algorithme d'identification des dommages FSC basé sur les EF est établi en utilisant la technique d'analyse modale pour les structures de type poutre. Deux états, l'état sain et l'état endommagé, ont été utilisés pour la mesure de la réponse vibratoire de la structure. En utilisant les différences de fréquences propres de ces deux états, la position et la quantification des dommages sont déterminées. L'algorithme est utilisé pour localiser et quantifier les défauts sur la base du décalage de la fréquence naturelle entre les structures saines et endommagées. Afin de valider l'algorithme d'identification des dommages proposé, un algorithme est d'abord testé entre les mêmes modèles EF (2D vs 2D) pour classer les dommages. L'algorithme est considéré pour l'identification des dommages doubles en considérant différents cas, où la sévérité de dommage la plus faible de 2% a été identifiée. La sensibilité du critère

Conclusions and Perspectives

aux fréquences propres de la poutre est étudiée en considérant la perturbation de ces fréquences à différents niveaux. Les niveaux de perturbation des fréquences naturelles (0.1 %, 0.2 % et 0.3 %) sont introduits numériquement en ajoutant un bruit aléatoire aux fréquences de la poutre endommagée. Dans chaque niveau de perturbation, on obtient un ensemble différent de paramètres de dommages. Ainsi, un total de cent échantillons sont utilisés dans les fréquences de la poutre endommagée pour estimer la position et la sévérité moyennes des dommages. En moyenne, ces paramètres montrent la sensibilité de l'algorithme, qui dépend du niveau de perturbation mais qui est proche des paramètres réels. Enfin, la sensibilité est donnée par l'écart type basé sur un certain nombre d'échantillons. Les résultats numériques ont démontré que les positions et les sévérités des dommages peuvent être correctement identifiées en minimisant le FSC avec ou sans perturbation, en un temps de calcul réduit. Les résultats sont validés pour plusieurs cas (différents niveaux et positions de dommages, nombre de dommages, et plusieurs niveaux de perturbation).

Dans la deuxième partie, une nouvelle stratégie est établie pour l'estimation des propriétés des dommages géométriques (positions, gravité et taille) en utilisant la corrélation numérique entre la réduction de la rigidité en flexion et la taille des dommages géométriques. Cela a suggéré une méthode de corrélation des modèles EF 2D et 3D en créant une bibliothèque numérique de dommages. En utilisant la technique de minimisation FSC, une bibliothèque est obtenue en comparant les dommages de la géométrie 3D à la réduction de la rigidité en flexion des modèles EF 2D. L'un des problèmes rencontrés est que de nombreux dommages géométriques, trouvés à différents endroits, ont un effet sur les paramètres modaux. Pour cela, deux dommages géométriques distincts (rectangulaire et trou) sont effectués, et leurs propriétés sont estimées sur la base de la bibliothèque de dommages développée. Afin de pouvoir distinguer la position, la sévérité et la taille des dommages géométriques, différentes étapes de diagnostic sont implémentées. La comparaison entre les géométries saines et endommagées est analysée en fonction des changements des fréquences naturelles correspondantes. Premièrement, la stratégie tire parti du FSC pour résoudre le problème d'identification des dommages pour des dommages uniques et multiples, en fonction de la position et de la sévérité. Ici, un algorithme de minimisation est utilisé, qui consiste à mettre à jour la rigidité en flexion de la poutre. Deuxièmement, la taille est utilisée pour estimer en liant, la sévérité obtenue (comme précédemment) à la bibliothèque de dommages.

Enfin, la procédure algorithmique permet de surmonter le problème de la réduction de la rigidité de tous les éléments individuellement avec la géométrie 3D des dommages. Dans la poutre expérimentale, des dommages de géométrie réelle ont été identifiés, et leurs tailles ont été estimées en considérant les dimensions de la

géométrie des dommages pour le rectangulaire (largeur, profondeur) et pour le trou (rayon) afin de valider l'efficacité de la stratégie.

6.1 Conclusions

Due to physical changes in structures, FE models of the dynamic structure can be used to forecast the changes in its modal parameters. The damage identification is concerned with the FE model updating method, followed by changes in natural frequencies. The work is designed through to identify the damages as well as their damage parameters, where physical change is most suited for a modal parameter change suggested, such as the shift of natural frequencies. Structural modifications are to explore changes in modal parameters due to a chosen physical change. The vibration tests are especially useful, for the investigation of a dynamic system when its physical parameters are changed. Then, the identification procedure of dynamic characteristics is well defined, and the most effective strategy is to implement to find its changes.

In the first part, the work focused on damage localization and quantification with an algorithm using FE models and the minimization of the FSC. This FE-based FSC damage identification algorithm is established using the modal analysis technique for beam-type structures. Two states: healthy and damaged state, were used to measure the vibratory response of the structure. Using natural frequency differences from these two states, the position and quantification of damages are determined. The algorithm is used to localize and quantify defects on the basis of the natural frequency shift between healthy and damaged structures. In order to validate the proposed damage identification algorithm, an algorithm is first tested between the same FE models (2D vs 2D) to classify damages. The algorithm is considered for the identification of double damages by considering different cases, where the lowest 2% damage severity was identified. The sensitivity of the criterion to the natural frequencies of the beam is investigated by considering the perturbation of these frequencies at different levels. The perturbation levels on natural frequencies (0.1%, 0.2% and 0.3%) are numerically introduced by adding random noise in damaged beam frequencies. In each perturbation level, it provides a different set of damage parameters. Thus, a total of hundred samples are used in damaged beam frequencies to estimate the average damage position and severity. On average, these parameters as outcome show the sensitivity of the algorithm, which depends on the perturbation level but are close to the real ones. Finally, sensitivity is given by the standard deviation on a number of samples. The numerical results demonstrated that damage positions and severities may be correctly identified by minimizing the FSC with or without perturbation,

Conclusions and Perspectives

within a small computational time. The results are validated for several cases (different damage levels and positions, number of damages, and several perturbation levels).

In the second part, a novel strategy is established for the estimation of geometry damage properties (location, severity, and size) using the numerical correlation between bending stiffness reduction to the size of the geometry damage. This suggested a 2D and 3D FE model correlation method by building a numerical damage library. Using FSC minimization technique, a library is obtained by comparing 3D geometry damage to 2D FE reduction of bending stiffness. One of the problems involved is that many geometry damages, found in various locations have an effect on modal parameters. For that, two separate geometry damages (rectangular and hole) are conducted, and their properties are estimated on the basis of the built damage library. The ability to distinguish position, severity and size of geometry damages, different diagnostics steps are implemented. The comparison between healthy and damaged ones are weighted depending on the changes in corresponding natural frequencies. First, the strategy takes advantage of FSC to solve the damage identification problem for single, multiple damages, as a function of the position and severity. Here, a minimizing algorithm is used, which consists of updating the bending stiffness of the beam. Second, the damage size is used to estimate by linking, the obtained severity (as previously) to the damage library.

Finally, the algorithm procedure overcomes the issue of stiffness reduction of all elements individually with the 3D damage geometry. In experimental beam, real geometry damages were identified, and their sizes were estimated by considering the damage geometry dimensions for rectangular (width, depth) and for the hole (radius) to validate the efficiency of the strategy.

Limites de la méthode d'identification des dommages

La présente recherche a réalisé une série de tests numériques et expérimentaux sur l'utilisation des paramètres modaux pour l'identification des propriétés des dommages sur des structures de type poutre. Des calculs numériques ont été effectués pour obtenir les paramètres modaux. Dans diverses études, les paramètres modaux numériques sont considérés de façon minimale par rapport au pourcentage d'erreur qui peut se produire dans les structures réelles. Non seulement le bruit, mais aussi les instruments ou les erreurs humaines peuvent influencer les mesures expérimentales. Afin d'améliorer l'applicabilité de la stratégie proposée à des fins expérimentales, la conduite de la méthodologie proposée doit être évaluée par le traitement des mesures expérimentales.

Afin d'identifier certaines tailles de géométrie, il est nécessaire d'avoir une hypothèse préalable de certains paramètres et dimensions. Par conséquent, la stratégie

dépend du type de géométrie et de leur bibliothèque de dommages. Enfin, les applications futures devraient viser à résoudre ces inconvénients.

6.1.1 Limitations of the damage identification method

The present research has carried out a series of numerical and experiments test on the use of modal parameters for damage properties identification to beam-like structures. Numerical calculations have been performed to achieve the modal parameters. In various study, numerical modal parameters are minimally considered to the error percentage that may occur in actual structures. Not only noise but also instruments or human errors can influence experimental measurements. In order to improve the applicability of the proposed strategy to experimental purposes, the conduct of the proposed methodology must be evaluated by the treatment of experimental measurements.

In order to identify some geometry sizes, it is necessary to have a prior assumption of some parameters and dimensions. Therefore, the strategy depends on the type of geometry and their damage library. Finally, future applications should be aimed to solve these drawbacks.

Perspectives futures

Dans la support de la présente recherche, il est nécessaire d'aborder dans un avenir proche d'autres points sur les sujets suivants. Ces aspects sont :

- La stratégie peut être testée avec d'autres types de structures, de caractéristiques structurelles et de géométries de dommages (étape, coupe oblique ou triangulaire) afin de valider son efficacité.
- Plus de recherches sont nécessaires sur les effets de divers changements dans les conditions environnementales et opérationnelles.
- D'autres algorithmes d'optimisation, des techniques programmables et des caractéristiques de dommages peuvent implémentés. Profiter d'approches de calcul de haute précision peut offrir des avantages dans l'identification des dommages géométriques, il est connu de combiner d'autres stratégies telles que l'utilisation de réseaux de neurones et la mise à jour du modèle.
- D'autres types de matériaux et de structures, tels que les composites, les cadres et les coques, devraient être étudiés pour le développement d'outils de détection des dommages. En termes de fourniture de structures critiques sûres, l'outil d'identification peut aider à la mise en œuvre des technologies VBSHM.

6.2 Future Perspectives

In the support of the current research, more viewpoints on the following topic are necessary to address in near future. These aspects are:

- The strategy can be tested with other types of structure, structural behavior and damage geometries (step, oblique or triangular cut) in order to validate its efficiency.
- Further research is needed on the effects of various changes in environmental and operational conditions.
- Further optimization algorithms, programmable techniques and damage features can be implemented. Taking advantage of high-precision computational approaches can provide advantages in geometry damage identification, it is known to combine other strategies such as using Neural Networks and Model Updating.
- Other types of materials and structures, such as composites, frame and shells, should be studied for the development of damage detection tools. In terms to provide safe-critical structures, the identification tool can help in the implementation of VBSHM technologies.

References

- Abraham, O., Le, T.-P., Cote, P., and Argoul, P. (2003). Two enhanced complementary impact echo approaches for the detection of voids in tendon ducts. *1st International Conference on Bridge Maintenance, Safety and Management, Barcelona, Spain* :151-152.
- Alamdari, M. M., Li, J., and Samali, B. (2015). Damage identification using 2-d discrete wavelet transform on extended operational mode shapes. *Archives of Civil and Mechanical Engineering*, 15(3):698–710.
- Altunışık, A. C., Okur, F. Y., and Kahya, V. (2017). Modal parameter identification and vibration based damage detection of a multiple cracked cantilever beam. *Engineering Failure Analysis*, 79:154–170.
- Armon, D., Ben-Haim, Y., and Braun, S. (1994). Crack detection in beams by rankordering of eigenfrequency shifts. *Mechanical Systems and Signal Processing*, 8(1):81–91.
- Averill, R. C. (1994). Static and dynamic response of moderately thick laminated beams with damage. *Composites Engineering*, 4(4):381–395.
- Baghiee, N., Esfahani, M. R., and Moslem, K. (2009). Studies on damage and frp strengthening of reinforced concrete beams by vibration monitoring. *Engineering Structures*, 31(4):875–893.
- Balageas, D., Fritzen, C.-P., and Güemes, A. (2010). Structural health monitoring. *John Wiley & Sons*, 90.
- Bauchau, O. A., and Craig J. I. (2009). Euler-Bernoulli beam theory. *Structural analysis. Springer, Dordrecht*, 173–221.
- Benaissa, B., Köppen, M., Abdel Wahab, M., and Khatir, S. (2017, 10-12 July). Application of proper orthogonal decomposition and radial basis functions for crack size estimation using particle swarm optimization. *12th International Conference on Damage Assessment of Structures (DAMAS), Kitakyushu, Japan*, 842.
- Brincker, R., Kirkegaard, P. H., Andersen, P., and Martinez, M. (1995, 13-16 February). Damage detection in an offshore structure. *13th International Modal Analysis Conference, Nashville, Tennessee, USA R9434(56)*.
- Çam, E., Orhan, S., and Lüy, M. (2005). An analysis of cracked beam structure using impact echo method. *Ndt & E International*, 38(5):368–373.

References

- Cawley, P. and Adams, R. D. (1979). The location of defects in structures from measurements of natural frequencies. *The Journal of Strain Analysis for Engineering Design*, 14(2):49–57.
- Chandrashekhara, M. and Ganguli, R. (2009). Damage assessment of structures with uncertainty by using mode-shape curvatures and fuzzy logic. *Journal of Sound and Vibration*, 326(3-5):939–957.
- Chesné, S., and Deraemaeker, A. (2013). Damage localization using transmissibility functions: a critical review. *Mechanical systems and signal processing*, 38(2):569-584.
- Chang, F.-K., Markmiller, J. F., Yang, J., and Kim, Y. (2005). Design of shm-embedded structures for space operation vehicles. *Proceedings of the first NASA Vehicle Engineering Health Management*.
- Chen, H., Kurt, M., Lee, Y. S., McFarland, D. M., Bergman, L. A., and Vakakis, A. F. (2014). Experimental system identification of the dynamics of a vibro-impact beam with a view towards structural health monitoring and damage detection. *Mechanical Systems and Signal Processing*, 46(1):91–113.
- Chen, W., Zhao, W., Yang, H., and Chen, X. (2015). Damage detection based on optimized incomplete mode shape and frequency. *Acta Mechanica Solida Sinica*, 28(1):74–82.
- Chiementin, X., Kouroussis, G., Murer, S., and Serra, R. (2019). Experimental modal analysis of hand–arm vibration in golf: Influence of grip strength. *Applied Sciences*, 9(10):2050.
- Ciambella, J. and Vestroni, F. (2015). The use of modal curvatures for damage localization in beam-type structures. *Journal of Sound and Vibration*, 340:126–137.
- Clarke, T., Simonetti, F., and Cawley, P. (2010). Guided wave health monitoring of complex structures by sparse array systems: Influence of temperature changes on performance. *Journal of Sound and Vibration*, 329(12):2306–2322.
- Cornwell, P., Doebling, S. W., and Farrar, C. R. (1999). Application of the strain energy damage detection method to plate-like structures. *Journal of Sound and Vibration*, 224(2):359–374.
- Dahak, M., Touat, N., and Benseddiq, N. (2017). On the classification of normalized natural frequencies for damage detection in cantilever beam. *Journal of Sound and Vibration*, 402:70–84.
- Dai, D. and He, Q. (2014). Structure damage localization with ultrasonic guided waves based on a time–frequency method. *Signal Processing*, 96:21–28.
- Das, A. and Dey, S. (1994). Random vibration of beams with localized region of damage. *Computers & Structures*, 51(1):33–38.
- Dawari, V. and Vesmawala, G. (2013). Modal curvature and modal flexibility methods for honeycomb damage identification in reinforced concrete beams. *Procedia Engineering*, 51:119–124.

- Dinh-Cong, D., Vo-Duy, T., Ho-Huu, V., Dang-Trung, H., and Nguyen-Thoi, T. (2017). An efficient multi-stage optimization approach for damage detection in plate structures. *Advances in Engineering Software*, 112:76–87.
- Doebling, S. W., Farrar, C. R., Prime, M. B., et al. (1998). A summary review of vibration-based damage identification methods. *Shock and Vibration Digest*, 30(2):91–105.
- Doebling, S. W., Farrar, C. R., Prime, M. B., and Shevitz, D. W. (1996). Damage identification and health monitoring of structural and mechanical systems from changes in their vibration characteristics: a literature review. *Technical Report, Los Alamos National Lab., NM (United States)*.
- Dubey, A., Denis, V., and Serra, R. (2020). A damage identification strategy in beams based on natural frequencies shift. *International Conference on Noise and Vibration Engineering, Leuven, Belgium* :2883–2890.
- Dubey, A., Denis, V., and Serra, R. (2020). A novel vbshm strategy to identify geometrical damage properties using only frequency changes and damage library. *Applied Sciences*, 10(23):8717.
- Eraky, A., Anwar, A. M., Saad, A., and Abdo, A. (2015). Damage detection of flexural structural systems using damage index method–experimental approach. *Alexandria Engineering Journal*, 54(3):497–507.
- Eraky, A., Anwar, A. M., Saad, A., and Abdo, A. (2015). Damage detection of flexural structural systems using damage index method–experimental approach. *Alexandria Engineering Journal*, 54(3):497–507.
- Esfandiari, A. (2017). An innovative sensitivity-based method for structural model updating using incomplete modal data. *Structural Control and Health Monitoring*, 24(4):e1905.
- Farrar, C. R., Duffey, T. A., Doebling, S. W., and Nix, D. A. (1999). A statistical pattern recognition paradigm for vibration-based structural health monitoring. *Structural Health Monitoring* :764–773.
- Farrar, C. R., and Worden, K. (2010) An introduction to structural health monitoring. *New Trends in Vibration Based Structural Health Monitoring* :1-17
- Farrar, C.R. and Lieven, N.A., (2007) Damage prognosis: the future of structural health monitoring. *Philosophical Transactions of the Royal Society A: Mathematical, Physical and Engineering Sciences* 365(1851):623-632
- Fritzen, C. P. (2005). Vibration-based structural health monitoring–concepts and applications. In *Key Engineering Materials*, volume 293, pages 3–20. Trans Tech Publ.
- Fu, Z.-F. and He, J. (2001). Modal analysis. *Butterworth-Heinemann, Boston, MA*.
- Furukawa, A. and Kiyono, J. (2004, 1-6 August). Identification of structural damage based on vibration responses. *Proceedings, 13th world conference on earthquake engineering, Vancouver, B.C., Canada*.

References

- Garcia, D. and Trendafilova, I. (2014). A multivariate data analysis approach towards vibration analysis and vibration-based damage assessment:: Application for delamination detection in a composite beam. *Journal of Sound and Vibration*, 333(25):7036–7050.
- Gautier, G., Mencik, J.-M., and Serra, R. (2015). A finite element-based subspace fitting approach for structure identification and damage localization. *Mechanical Systems and Signal Processing*, 58:143–159.
- Génevaux, J. (2011). Dynamique des structures : méthodes approchées, cinématiques ; Analyse Modale ; Recalage de Modèle, *Ensim*.
- Gelman, L. (2010). The new frequency response functions for structural health monitoring. *Engineering Structures*, 32(12):3994–3999.
- Geweth, C. A., Khosroshahi, F. S., Sepahvand, K., Kerkeling, C., and Marburg, S. (2017). Damage detection of fibre-reinforced composite structures using experimental modal analysis. *Procedia Engineering*, 199:1900–1905.
- Gillich, G., Ntakpe, J., Wahab, M. A., Praisach, Z., and Mimis, M. (2017). Damage detection in multi-span beams based on the analysis of frequency changes. In *Journal of Physics 2017: Conference Series*, 842.
- Giurgiutiu, V., Zagrai, A., and Jing Bao, J. (2002). Piezoelectric wafer embedded active sensors for aging aircraft structural health monitoring. *Structural Health Monitoring*, 1(1):41–61.
- Gökdağ, H. (2013). Structural damage detection for beams subject to moving load using pso algorithms. *International Journal of Engineering and Applied Sciences*, 5(1):1–17.
- González, A. G. and Fassois, S. D. (2013, 29-30 October). Vibration-based statistical damage detection for scale wind turbine blades under varying environmental conditions. *International Conference Surveillance, Chartres, France*, 7.
- Gunakala, S. R., Comissiong, D. M. G., Jordan, K., and Sankar, A. (2012). A finite element solution of the beam equation via MATLAB. *International Journal of Applied*, 2(8).
- Hackmann, G., Guo, W., Yan, G., Sun, Z., Lu, C., and Dyke, S. (2013). Cyber-physical codesign of distributed structural health monitoring with wireless sensor networks. *IEEE Transactions on Parallel and Distributed Systems*, 25(1):63–72.
- Hassiotis, S. and Jeong, G. (1993). Assessment of structural damage from natural frequency measurements. *Computers & Structures*, 49(4):679–691.
- Hu, H. and Wu, C. (2009). Development of scanning damage index for the damage detection of plate structures using modal strain energy method. *Mechanical Systems and Signal Processing*, 23(2):274–287.
- Hu, W.-H., Thöns, S., Rohrman, R. G., Said, S., and Rucker, W. (2015). Vibration-based structural health monitoring of a wind turbine system part ii: Environmental/operational effects on dynamic properties. *Engineering Structures*, 89:273–290.

- Huang, X.-H., Dyke, S., Sun, Z., and Xu, Z.-D. (2017). Simultaneous identification of stiffness, mass, and damping using an on-line model updating approach. *Structural Control and Health Monitoring*, 24(4):e1892.
- Friswell, M. I., and Mottershead, J. E. (2001). Inverse methods in structural health monitoring. *Key Engineering Materials*, 204, 201-210.
- Ihn, J.-B. and Chang, F.-K. (2008). Pitch-catch active sensing methods in structural health monitoring for aircraft structures. *Structural Health Monitoring*, 7(1):5-19.
- Jassim, Z., Ali, N., Mustapha, F., and Jalil, N. A. (2013). A review on the vibration analysis for a damage occurrence of a cantilever beam. *Engineering Failure Analysis*, 31:442-461.
- Jebieshia, T., Maiti, D., and Maity, D. (2020). Frequency-based damage assessment of composite members using unified particle swarm optimization. *International Journal of Aeronautical and Space Sciences*, 21(1):63-79.
- Jeon, J. Y., Gang, S., Park, G., Flynn, E., Kang, T., and Woo Han, S. (2017). Damage detection on composite structures with standing wave excitation and wavenumber analysis. *Advanced Composite Materials*, 26(sup1):53-65.
- Karbhari, V. M. and Lee, L. S.-W. (2009). Vibration-based damage detection techniques for structural health monitoring of civil infrastructure systems. *Structural Health Monitoring of Civil Infrastructure Systems* :177-212.
- Katunin, A. (2015). Stone impact damage identification in composite plates using modal data and quincunx wavelet analysis. *Archives of Civil and Mechanical Engineering*, 15(1):251-261.
- Kennedy, J. and Eberhart, R. (1995, 27 November-1 December). Particle swarm optimization. In *Proceedings of ICNN'95-International Conference on Neural Networks, Perth, Australia*, 4:1942-1948.
- Keye, S. (2006). Improving the performance of model-based damage detection methods through the use of an updated analytical model. *Aerospace science and technology*, 10(3):199-206.
- Khatir, S., Belaidi, I., Serra, R., Wahab, M. A., and Khatir, T. (2015). Damage detection and localization in composite beam structures based on vibration analysis. *Mechanics*, 21(6):472-479.
- Khatir, S., Dekemele, K., Loccufier, M., Khatir, T., and Wahab, M. A. (2018). Crack identification method in beam-like structures using changes in experimentally measured frequencies and particle swarm optimization. *Comptes Rendus Mécanique*, 346(2):110-120.
- Marwala, T. (2010). Finite element model updating using computational intelligence techniques: applications to structural dynamics. *Book Springer Science & Business Media*.

References

- Khatir, S., Serra, R., and Belaidi, I. (2013). Détection et localisation de défauts dans des structures poutres par analyse vibratoire. *Proceeding of 4ième Congrès Algérien de Mécanique, Mascara, Algérie*.
- Khiem, N. and Toan, L. (2014). A novel method for crack detection in beam-like structures by measurements of natural frequencies. *Journal of Sound and Vibration*, 333(18):4084–4103.
- Kim, J.-T., Ryu, Y.-S., Cho, H.-M., and Stubbs, N. (2003). Damage identification in beam-type structures: frequency-based method vs mode-shape-based method. *Engineering Structures*, 25(1):57–67.
- Kong, X., Cai, C.-S., and Hu, J. (2017). The state-of-the-art on framework of vibration-based structural damage identification for decision making. *Applied Sciences*, 7(5):497.
- Kouroussis, G., Fekih, L. B., Conti, C., and Verlinden, O. (2012, 8 -12 July). Easymod: A matlab/scilab toolbox for teaching modal analysis. *Proceedings of The International Congress on Sound and Vibration, Vilnius, Lithuania*
- Lakhdar, M., Mohammed, D., Boudjemâa, L., Rabiâ, A., and Bachir, M. (2013). Damages detection in a composite structure by vibration analysis. *Energy Procedia*, 36:888–897.
- Le, T.-T.-H., Point, N., Argoul, P., and Cumunel, G. (2016). Structural changes assessment in axial stressed beams through frequencies variation. *International Journal of Mechanical Sciences*, 110:41–52.
- Lieven, N. and Ewins, D. (1988, 1-4 February). Spatial correlation of mode shapes, the coordinate modal assurance criterion (comac). *Proceedings of the 6th International Modal Analysis Conference, Kissimmee, Florida, USA.*, 1, 690–695.
- Lifshitz, J. M. and Rotem, A. (1969). Determination of reinforcement unbonding of composites by a vibration technique. *Journal of Composite Materials*, 3(3):412–423.
- Mal, A., Ricci, F., Banerjee, S., and Shih, F. (2005). A conceptual structural health monitoring system based on vibration and wave propagation. *Structural Health Monitoring*, 4(3):283–293.
- Masoumi, M. and Ashory, M. (2014). Damage identification from uniform load surface using continuous and stationary wavelet transforms. *Latin American Journal of solids and structures*, 11(5):738–754.
- Meneghetti, U. and Maggiore, A. (1994). Crack detection by sensitivity analysis. *Proceedings of SPIE The International Society For Optical Engineering, Bellingham, WA, USA* :1292–1292.
- Messina, A., Jones, I., and Williams, E. (1996, 1 March). Damage detection and localization using natural frequency changes. *Proceedings of Conference on Identification in Engineering Systems, Cambridge, UK* :67–76.
- Messina, A., Williams, E., and Contursi, T. (1998). Structural damage detection by a sensitivity and statistical-based method. *Journal of sound and vibration*, 216(5):791–808.

- Mohan, S., Maiti, D. K., and Maity, D. (2013). Structural damage assessment using frf employing particle swarm optimization. *Applied Mathematics and Computation*, 219(20):10387–10400.
- Gelman, L. (2010). The new frequency response functions for structural health monitoring, *Engineering Structures*. *Engineering Structures*, 32(12):3994-3999.
- Montalvão, D., Maia, N. M. M., and Ribeiro, A. M. R. (2006). A review of vibration-based structural health monitoring with special emphasis on composite materials. *Shock and Vibration Digest*, 38(4):295–324.
- Montazer, M. and Seyedpoor, S. (2014). A new flexibility based damage index for damage detection of truss structures. *Shock and Vibration*, 2014.
- Moore, E. Z., Nichols, J. M., and Murphy, K. D. (2012). Model-based shm: Demonstration of identification of a crack in a thin plate using free vibration data. *Mechanical Systems and Signal Processing*, 29:284–295.
- Narkis, Y. (1994). Identification of crack location in vibrating simply supported beams. *Journal of Sound and Vibration*, 172(4):549–558.
- Niemann, H., Morlier, J., Shahdin, A., and Gourinat, Y. (2010). Damage localization using experimental modal parameters and topology optimization. *Mechanical Systems and Signal Processing*, 24(3):636–652.
- Notes, A. (1986). Hewlett packard application notes 243-3 - the fundamentals of modal testing. *Technical Report, HP Application, Agilent Technologies*.
- Ooijevaar, T. H. (2014). Vibration based structural health monitoring of composite skin-stiffener structures. *PhD Thesis, University of Twente*.
- Osegueda, R. A., Carrasco, C., and Meza, R. (1997). A modal strain energy distribution method to localize and quantify damage. *Proceedings-SPIE The International Society For Optical Engineering* :1298–1304.
- Pan, J., Zhang, Z., Wu, J., Ramakrishnan, K. R., and Singh, H. K. (2019). A novel method of vibration modes selection for improving accuracy of frequency-based damage detection. *Composites Part B: Engineering*, 159:437–446.
- Pandey, A. and Biswas, M. (1994). Damage detection in structures using changes in flexibility. *Journal of Sound and Vibration*, 169(1):3–17.
- Pandey, A., Biswas, M., and Samman, M. (1991). Damage detection from changes in curvature mode shapes. *Journal of Sound and Vibration*, 145(2):321–332.
- Parsopoulos, K. E. and Vrahatis, M. N. (2005). Unified particle swarm optimization for solving constrained engineering optimization problems. *International Conference on Natural Computation* :582–591.
- Peng, H., Meng, G., and Li, F. (2009). Modeling of wave propagation in plate structures using three-dimensional spectral element method for damage detection. *Journal of Sound and Vibration*, 320(4-5):942–954.

References

- Perera, R., Ruiz, A., and Manzano, C. (2007). An evolutionary multiobjective framework for structural damage localization and quantification. *Engineering Structures*, 29(10):2540–2550.
- Pham, B. T., Agarwal, V., Lybeck, N. J., and Tawfik, M. S. (2012). Prognostic health monitoring system: Component selection based on risk criteria and economic benefit assessment. *Technical report, Idaho National Laboratory*.
- Li, R., Verhagen, W. J., and Curran, R. (2020). A systematic methodology for Prognostic and Health Management system architecture definition. *Reliability Engineering and System Safety*, 193:106598.
- Philipp, K., Filippatos, A., Kuschmierz, R., Langkamp, A., Gude, M., Fischer, A., and Czarske, J. (2016). Multi-sensor system for in situ shape monitoring and damage identification of high-speed composite rotors. *Mechanical Systems and Signal Processing*, 76:187–200.
- Qiao, P. and Cao, M. (2008). Waveform fractal dimension for mode shape-based damage identification of beam-type structures. *International Journal of Solids and Structures*, 45(22-23):5946–5961.
- Qiao, P. and Chen, F. (2012). On the improved dynamic analysis of delaminated beams. *Journal of Sound and Vibration*, 331(5):1143–1163.
- Ramos, L. F., De Roeck, G., Lourenço, P. B., and Costa, A. C. (2006). Vibration based damage identification of masonry structures. *5th International Conference of Structural Analysis of Historical Constructions, New Delhi, India*
- Reynders, E. and De Roeck, G. (2010). A local flexibility method for vibration-based damage localization and quantification. *Journal of Sound and Vibration*, 329(12):2367–2383.
- Reddy, J. N. (2019) Introduction to the finite element method. *Book, McGraw-Hill Education*.
- Roy, K. and Ray-Chaudhuri, S. (2013). Fundamental mode shape and its derivatives in structural damage localization. *Journal of Sound and Vibration*, 332(21):5584–5593.
- Rytter, A. (1993). Vibrational based inspection of civil engineering structures. *PhD thesis, Dept. of Building Technology and Structural Engineering, Aalborg University*.
- Toh, G. and Park, J. (2020). Review of Vibration-Based Structural Health Monitoring Using Deep Learning. *Applied Applied Sciences*, 10(5):1680.
- Salawu, O. (1997). Detection of structural damage through changes in frequency: a review. *Engineering Structures*, 19(9):718–723.
- Serra, R. and Lopez, L. (2017). Damage detection methodology on beam-like structures based on combined modal wavelet transform strategy. *Mechanics & Industry*, 18(8):807.

- Serra, R., Lopez, L., and Gautier, G. (2016). Tentative of damage estimation for different damage scenarios on cantilever beam using numerical library. *Proceedings of the 23rd International Congress on Sound and Vibration, Athens, Greece* :10–14.
- Seyedpoor, S. (2012a). A two stage method for structural damage detection using a modal strain energy based index and particle swarm optimization. *International Journal of Non-Linear Mechanics*, 47(1):1–8.
- Seyedpoor, S. (2012b). A two stage method for structural damage detection using a modal strain energy based index and particle swarm optimization. *International Journal of Non-Linear Mechanics*, 47(1):1–8.
- Sha, G., Radzieński, M., Cao, M., and Ostachowicz, W. (2019). A novel method for single and multiple damage detection in beams using relative natural frequency changes. *Mechanical Systems and Signal Processing*, 132:335–352.
- Shi, Z., Law, S., and Zhang, L. (1997, Jan). Two stages damage detection in structure based on modal data. *Proceedings of the 15th International Modal Analysis Conference*, 3089.
- Shih, H. W., Thambiratnam, D. P., and Chan, T. H. (2009). Vibration based structural damage detection in flexural members using multi-criteria approach. *Journal of Sound and Vibration*, 323(3-5):645–661.
- Shukla, A. and Harsha, S. (2016). Vibration response analysis of last stage lp turbine blades for variable size of crack in root. *Procedia Technology*, 23:232–239.
- Silva, M. E. and Araujo Gomes, A. (1994, 31 January–3 February). Crack identification on simple structural elements through the use of natural frequency variations: The inverse problem. *Proceedings of the 12th International Modal Analysis 2251, Honolulu, HI, USA* :1728-1735
- Sinha, J. K., Friswell, M., and Edwards, S. (2002). Simplified models for the location of cracks in beam structures using measured vibration data. *Journal of Sound and vibration*, 251(1):13–38.
- Sinou, J.-J. (2009). A review of damage detection and health monitoring of mechanical systems from changes in the measurement of linear and non-linear vibrations. *Mechanical Vibrations: Measurement, Effects and Control* :643–702.
- Ritchie, R. O., and Lankford, J. (1986) Small fatigue cracks: a statement of the problem and potential solutions. *Materials Science and Engineering* 84:11-16.
- Sobey, A. (1963, November). Stress concentration factors for rounded rectangular holes in infinite sheets. *Reports and Memoranda No. 3407*.
- Sodano, H. A. (2007). Development of an automated eddy current structural health monitoring technique with an extended sensing region for corrosion detection. *Structural Health Monitoring*, 6(2):111–119.

References

- Sohn, H., Farrar, C. R., Hemez, F. M., Shunk, D. D., Stinemates, D. W., Nadler, B. R., and Czarnecki, J. J. (2003, February). A review of structural health monitoring literature: 1996–2001. *Los Alamos National Laboratory, USA*, 1.
- Sung, S.-H., Jung, H., and Jung, H. (2013). Damage detection for beam-like structures using the normalized curvature of a uniform load surface. *Journal of Sound and Vibration*, 332(6):1501–1519.
- Tan, Z. X., Thambiratnam, D., Chan, T., and Razak, H. A. (2017). Detecting damage in steel beams using modal strain energy based damage index and artificial neural network. *Engineering Failure Analysis*, 79:253–262.
- Tiachacht, S., Bouazzouni, A., Khatir, S., Zhou, Y.-L., Wahab, M.A. (2017, May). A proposal application based on strain energy for damage detection and quantification of beam composite structure using vibration data. *Journal of Physics: Conference Series*, 842(1), 012027.
- Toh, G. and Park, J. (2020). Review of vibration-based structural health monitoring using deep learning. *Applied Sciences*, 10(5):1680.
- Trendafilova, I., Cartmell, M. P., and Ostachowicz, W. (2008). Vibration-based damage detection in an aircraft wing scaled model using principal component analysis and pattern recognition. *Journal of Sound and Vibration*, 313(3-5):560–566.
- Trendafilova, I. and Manoach, E. (2008). Vibration-based damage detection in plates by using time series analysis. *Mechanical Systems and Signal Processing*, 22(5):1092–1106.
- Vo-Duy, T., Ho-Huu, V., Dang-Trung, H., and Nguyen-Thoi, T. (2016). A two-step approach for damage detection in laminated composite structures using modal strain energy method and an improved differential evolution algorithm. *Composite Structures*, 147:42–53.
- Wang, B.-T. (2009). Vibration analysis of a continuous system subject to generic forms of actuation forces and sensing devices. *Journal of Sound and Vibration*, 319(3-5):1222–1251.
- Wang, L. and Chan, T. H. (2009). Review of vibration-based damage detection and condition assessment of bridge structures using structural health monitoring. *Proceedings of The Second Infrastructure Theme Postgraduate Conference: Rethinking Sustainable Development-Planning, Infrastructure Engineering, Design and Managing Urban Infrastructure, Queensland University of Technology, Australia*.
- Wang, L., Yang, Z., and Waters, T. (2010). Structural damage detection using cross correlation functions of vibration response. *Journal of Sound and Vibration*, 329(24):5070–5086.
- Wei, Z., Liu, J., and Lu, Z. (2018). Structural damage detection using improved particle swarm optimization. *Inverse Problems in Science and Engineering*, 26(6):792–810.
- Wei, Z., Yam, L., and Cheng, L. (2004). Detection of internal delamination in multi-layer composites using wavelet packets combined with modal parameter analysis. *Composite Structures*, 64(3-4):377–387.

- West, W. M. (1984). Illustration of the use of modal assurance criterion to detect structural changes in an orbiter test specimen. *Proceedings of the Air Force Conference on Aircraft Structural Integrity* :1–6.
- Whittingham, B., Li, H. C., Herszberg, I., and Chiu, W. K. (2006). Disbond detection in adhesively bonded composite structures using vibration signatures. *Composite Structures*, 75(1-4):351–363.
- Wolff, T. and Richardson, M. (1989, 30 January-2 February). Fault detection in structures from changes in their modal parameters. *Proceedings of The 7th International Modal Analysis Conference, Las Vegas, Nevada, USA*, 1:87–94.
- Worden, K. and Dulieu-Barton, J. M. (2004). An overview of intelligent fault detection in systems and structures. *Structural Health Monitoring*, 3(1):85–98.
- Wu, D. and Law, S. (2004). Damage localization in plate structures from uniform load surface curvature. *Journal of Sound and Vibration*, 276(1-2):227–244.
- Xiang, J. and Liang, M. (2012). A two-step approach to multi-damage detection for plate structures. *Engineering Fracture Mechanics*, 91:73–86.
- Xu, W., Cao, M., Ostachowicz, W., Radziński, M., and Xia, N. (2015). Two-dimensional curvature mode shape method based on wavelets and teager energy for damage detection in plates. *Journal of Sound and Vibration*, 347:266–278.
- Yam, L., Li, Y., and Wong, W. (2002). Sensitivity studies of parameters for damage detection of plate-like structures using static and dynamic approaches. *Engineering Structures*, 24(11):1465–1475.
- Yan, Y., Cheng, L., Wu, Z., and Yam, L. (2007). Development in vibration-based structural damage detection technique. *Mechanical Systems and Signal Processing*, 21(5):2198–2211.
- Yang, C. and Oyadiji, S. O. (2016). Detection of delamination in composite beams using frequency deviations due to concentrated mass loading. *Composite Structures*, 146:1–13.
- Yang, C. and Oyadiji, S. O. (2017). Damage detection using modal frequency curve and squared residual wavelet coefficients-based damage indicator. *Mechanical Systems and Signal Processing*, 83:385–405.
- Yang, Z., Wang, L., Wang, H., Ding, Y., and Dang, X. (2009). Damage detection in composite structures using vibration response under stochastic excitation. *Journal of Sound and Vibration*, 325(4-5):755–768.
- Yang, M., and Qiao, P. (2005). Modeling and experimental detection of damage in various materials using the pulse-echo method and piezoelectric sensors/actuators. *Smart materials and structures*, 14(6):1083.
- Yuen, M. M. F. (1985). A numerical study of the eigenparameters of a damaged cantilever. *Journal of Sound and Vibration*, 103(3):301–310.

References

- Zhang, J., Xu, J., Guo, S., and Wu, Z. (2013). Flexibility-based structural damage detection with unknown mass for iasc-asce benchmark studies. *Engineering Structures*, 48:486–496.
- Zhang, X., Gao, R. X., Yan, R., Chen, X., Sun, C., and Yang, Z. (2016). Multivariable wavelet finite element-based vibration model for quantitative crack identification by using particle swarm optimization. *Journal of Sound and Vibration*, 375:200–216.
- Zhang, Y., Lie, S. T., Xiang, Z., and Lu, Q. (2014). A frequency shift curve based damage detection method for cylindrical shell structures. *Journal of Sound and Vibration*, 333(6):1671–1683.
- Zhang, Z. and Aktan, A. (1998). Application of modal flexibility and its derivatives in structural identification. *Journal of Research in Nondestructive Evaluation*, 10(1):43–61.
- Zhang, Z., Zhan, C., Shankar, K., Morozov, E. V., Singh, H. K., and Ray, T. (2017). Sensitivity analysis of inverse algorithms for damage detection in composites. *Composite Structures*, 176:844–859.
- Zhou, Y.-L., Hongyou, C., Zhen, N., and Wahab, M. A. (2017). Review on structural damage assessment via transmissibility with vibration based measurements. *Journal of Physics: Conference Series*, 842(1):012016.

List of Publications

Articles

- **Dubey, A., Denis, V., and Serra, R.** Sensitivity and efficiency of frequency shift coefficient based on damage identification algorithm : modeling uncertainty on natural frequencies, *Under Review*.
- **Dubey, A., Denis, V., and Serra, R.** (2020). A novel VBSHM strategy to identify geometrical damage properties using only frequency changes and damage library. *Applied Sciences*, 10(23):8717.

Conferences

- **Dubey, A., Denis, V., and Serra, R.** (2020). A damage identification strategy in beams based on natural frequencies shift. *International Conference on Noise and Vibration Engineering-ISMA, Leuven, Belgium* :2883–2889.
- **Dubey, A., Denis, V., and Serra, R.** (2019). Localization and quantification of damage by frequency based methods: numerical and experimental applications on bending vibration beams. *International Conference on Surveillance Vibration Shock and Noise (SURVISHNO), Lyon, France* :386-391.
- **Dubey, A., Denis, V., and Serra, R.** (2019). Damage localization and quantification in cantilever beam structure by using vibration-based criteria *Journée des Jeunes Chercheurs, Blois, France*.
- **Dubey, A., and Serra, R.** (2018). Comparison of geometric damages and their bending stiffness reduction based on flexural vibration structural health monitoring of cantilever beam. *3ème Édition des Doctoriales de La COFREND, Paris, France*.

Anurag DUBEY

Identification des Dommages et Estimation des Propriétés des Dommages Géométriques par Surveillance de l'État de la Structure Basée sur les Vibrations

Résumé :

Si des dommages ne sont pas détectés et atteignent une taille critique, des effondrements soudains et des pannes catastrophiques peuvent survenir. L'une des méthodes de surveillance les plus appropriées pour définir la présence de dommages et évaluer la structure est la surveillance de l'état de la structure basée sur les vibrations. Premièrement, la recherche se concentre sur une technique d'identification des dommages basée sur les changements de fréquence entre une structure de poutre saine et endommagée. Un algorithme basé sur le Coefficient de Décalage de Fréquence est proposé, et la sensibilité des fréquences naturelles est étudiée. L'effet de l'incertitude sur les fréquences propre (0.1%, 0.2% et 0.3%) dans le cas endommagé est testé, et des échantillons sont utilisés pour estimer la position et la sévérité moyennes des dommages. Deuxièmement, l'objectif de cette recherche est de corréler le type possible de dommages géométriques avec l'évaluation de la réduction de la rigidité en flexion à l'aide de la poutre encastré-libre d'Euler Bernoulli. Pour atteindre cet objectif, la corrélation numérique entre les simulations de modèles d'éléments finis 2D et 3D a été réalisée pour obtenir une bibliothèque de dommages comparant le pourcentage de réduction de la rigidité en flexion et les dommages géométriques tels que les rectangles et les trous. Enfin, différents cas endommagés sont examinés dans les différentes parties le long de la poutre avec les changements de positions d'endommagement, de type de géométrie d'endommagement, de valeurs d'endommagement et d'endommagement simple et double, etc. La poutre expérimentale avec des dommages géométriques réels est testée pour localiser, quantifier et classer les propriétés des dommages géométriques.

Mots clés : analyse modale, recalage de modèle, évaluation des dommages, propriétés des dommages géométriques, coefficient de décalage de fréquence, incertitude sur la fréquence propre, surveillance de l'état de la structure basée sur les vibrations.

Damage Identification and Estimation of Geometry Damage Properties using Vibration Based Structure Health Monitoring

Summary :

If damages remain undetected and reach a critical size, sudden collapses and catastrophic failure can happen. One of the most suitable monitoring methods to define the presence of damage and assess the structure is the Vibration-Based Structure Health Monitoring (VBSHM). Firstly, the research is focused on a damage identification technique based on the frequency changes between healthy and damaged beam structure. An algorithm based on Frequency Shift Coefficient (FSC) is proposed, and the sensitivity of natural frequencies is studied. The effect of uncertainty on natural frequencies (0.1%, 0.2% and 0.3%) in damaged case is tested, and samples are used to estimate the average damage position and severity. Secondly, the objective of this research is to correlate the possible type of geometry damages with the bending stiffness reduction evaluation using Euler Bernoulli cantilever beam. To achieve this goal, the numerical correlation between 2D and 3D finite element models simulations were performed to obtain damage library comparing the percentage of bending stiffness reduction and geometry damages such as rectangular and hole. Finally, different damaged cases are examined in the different parts along the beam with the changes in damage positions, damage geometry type, damage values, and single and double damage, etc. The experimental beam with real geometry damage is tested to localize, quantify and classify the geometry damage properties.

Keywords : modal analysis, model updating, damage assessment, geometry damages properties, frequency shift coefficient, uncertainty on natural frequency, vibration-based structural health monitoring.



INSTITUT NATIONAL
DES SCIENCES
APPLIQUÉES
CENTRE VAL DE LOIRE

**Laboratoire de Mécanique Gabriel
Lamé EA 7494, 3 Rue de la
Chocolaterie, 41000 Blois, France**