



HAL
open science

Une approche stoechiométrique intégrative des interactions entre producteurs primaires, herbivores et décomposeurs et de leur rôle dans les écosystèmes

Mehdi Cherif

► **To cite this version:**

Mehdi Cherif. Une approche stoechiométrique intégrative des interactions entre producteurs primaires, herbivores et décomposeurs et de leur rôle dans les écosystèmes. Biodiversité. Université Paris VI - Pierre et Marie Curie, 2007. Français. NNT : 2007PA066586 . tel-04766794

HAL Id: tel-04766794

<https://hal.science/tel-04766794v1>

Submitted on 5 Nov 2024

HAL is a multi-disciplinary open access archive for the deposit and dissemination of scientific research documents, whether they are published or not. The documents may come from teaching and research institutions in France or abroad, or from public or private research centers.

L'archive ouverte pluridisciplinaire **HAL**, est destinée au dépôt et à la diffusion de documents scientifiques de niveau recherche, publiés ou non, émanant des établissements d'enseignement et de recherche français ou étrangers, des laboratoires publics ou privés.

THÈSE DE DOCTORAT DE L'UNIVERSITÉ PARIS VI

École Doctorale : Diversité du Vivant

Spécialité: ÉCOLOGIE

Présentée par :

M. Mehdi CHERIF

Pour obtenir le grade de DOCTEUR DE L'UNIVERSITÉ PARIS 6

Une approche stœchiométrique intégrative des interactions entre producteurs primaires, herbivores et décomposeurs et de leur rôle dans les écosystèmes.

Soutenance le mardi 19 juin 2007,

devant le jury composé de :

M. Michel Loreau,

M. Val H. Smith,

M. Xavier Le Roux,

M. Robert Barbault,

Directeur de thèse.

Rapporteur.

Rapporteur.

Examineur.

Remerciements:

Je voudrais dédier cette thèse à mon fils Enis : Que la curiosité, l'amour de la nature, la soif de connaissance, l'espérance soient tes compagnes tout au long de ta vie !

Je voudrais exprimer ma gratitude à mon épouse Aurore, pour m'avoir accompagné tout au long de ces années de thèse : elles n'ont pas toujours été de tout repos et elles t'ont demandé de nombreux sacrifices, mais tu as toujours été là pour m'aider !

Je remercie Michel pour m'avoir offert l'opportunité de faire de la recherche en écologie et d'explorer cette vie si singulière qui peuple notre planète et qui m'intrigue et m'émerveille depuis mon enfance. Notre association a commencé bien avant ma thèse, au cours de mon année de DED et depuis, son soutien et ses conseils ne m'ont jamais fait défaut. Je le remercie également pour m'avoir encouragé et aidé à tenter l'aventure du Québec de ces deux dernières années.

Je remercie aussi Gérard Lacroix qui m'a, le premier, accueilli dans ce laboratoire du 46 rue d'Ulm où j'ai passé ensuite quatre années passionnantes. Les théories scientifiques un peu folles et les idées d'expériences audacieuses que nous avons imaginées ensemble y sont pour beaucoup, sans oublier les moments partagés à pagayer sur le Bandama à Lamto. Les discussions à refaire le monde avec Jacques Mériquet, Luc Abbadie et tous les adeptes de la pause-café dans le couloir du 6^{ème} étage font partie aussi des moments inoubliables du labo.

Je remercie MM Robert Barbault, Val Smith et Xavier Le Roux qui ont accepté sans hésiter d'examiner l'ensemble de ma thèse et de faire partie de mon jury. Je tiens à mentionner aussi l'aide précieuse que M. Robert Barbault m'a apporté en tant que directeur de l'Ecole Doctorale. Que ce soit pour des participations à des conférences ou des séjours à l'étranger, ses interventions ont permis d'ouvrir l'horizon scientifique de nombreux thésards.

Je remercie tous ceux qui m'ont donné un coup de main pour la partie expérimentale de mon travail de thèse et dont malheureusement seule une fraction se retrouve dans le compte-rendu final. L'expérimentation est une tâche souvent ingrate et l'aide des autres est d'une valeur inestimable. Je remercie donc Mathieu Buffet, Loïc Le Peintre, Michaël Danger, Michèle Huet, Danielle Benest, Catherine

Oumarou, Jim Cotner, Meghan Funke, Andrea Little, Andre Amado, Larry Wackett et Lisa Strong.

Ma pensée va aussi à tous les thésards, présents ou passés avec qui j'ai partagé une pièce, de l'amitié, de nombreuses conversations, quelques indignations communes ou des parties de foot : Cathy, Nirmala, Romain, Pierre, Colin, Blandine, Alexandra, Thomas, les Nicolas, Gaëlle, Yeo, Michel, Félix, Céline, Elisa, Sandie, Samuel, Mathilde, Delphine, Moïse, Sébastien, Virginie, Pascal, Tanguy, Shawn, Grygoris, Volker et encore tant d'autres.

J'adresse aussi un remerciement particulier à Paola, Christelle et Anne-Marie qui m'ont rendu tant de services et m'ont aidé à éviter les pièges de la jungle administrative où, laissé à moi-même, il me semble que je me perdrais bien plus facilement que dans une vraie jungle !

Un grand merci enfin à mes parents qui ont toujours encouragé ma passion pour la nature et les sciences. Merci de m'avoir laissé déployer mes ailes et quitter le foyer familial pour nous retrouver maintenant séparés par tout un océan, mais si proches par cette valeur partagée que vous m'avez transmise de ne jamais se satisfaire des idées reçues et de chercher soi-même la vérité envers et contre tout !

Résumé de la thèse :

La stœchiométrie écologique étudie l'effet de la composition chimique en éléments des organismes sur leurs interactions trophiques. Parce qu'elle lie éléments chimiques, tel le carbone, l'azote et le phosphore, et interactions écologiques, elle a un grand rôle à jouer dans une meilleure intégration de l'étude des cycles biogéochimiques et des interactions trophiques.

Après la production primaire, les processus d'herbivorie et de décomposition sont les plus importants dans un écosystème. Les différences de composition chimique entre producteurs primaires et herbivores et entre producteurs primaires et décomposeurs microbiens sont parmi les plus grandes qu'on puisse trouver entre une ressource et son consommateur. Jusqu'à présent, ces deux processus ont généralement été abordé séparément. Cette thèse, qui se base sur la stœchiométrie écologique, a donc pour but d'étudier simultanément les interactions entre producteurs primaires, herbivores et décomposeurs afin d'obtenir une vision plus intégrée du fonctionnement des réseaux trophiques et des écosystèmes.

Dans les deux premiers chapitres de la thèse, j'ai construit un modèle mathématique et réalisé une expérience pour étudier l'effet de la composition de la matière organique en éléments et en molécules sur l'utilisation simultanée par les décomposeurs microbiens de ressources organiques et inorganiques.

Dans les deux chapitres suivants, j'ai utilisé les résultats précédents pour étudier l'interaction entre producteurs primaires, herbivores et décomposeurs. J'ai donc construit deux modèles explicitement stœchiométriques à trois niveaux trophiques: producteurs primaires, décomposeurs et herbivores. Le premier modèle s'est intéressé aux effets des herbivores sur l'interaction entre les producteurs primaires et les décomposeurs, tandis que le deuxième modèle a étudié l'effet des décomposeurs sur l'interaction entre les herbivores et les producteurs primaires.

Les conclusions issues de ce travail de thèse sont nombreuses. Elles peuvent néanmoins être rassemblées en deux points principaux :

- L'hétérogénéité chimique des ressources organiques est un déterminant important de la minéralisation des éléments par les décomposeurs et de la structure de la communauté de ces derniers. Puisque les producteurs primaires sont une source principale de ressources organiques et les principaux consommateurs des éléments minéraux, cette hétérogénéité est donc essentielle à prendre en compte pour comprendre l'interaction entre producteurs primaires et décomposeurs. Les herbivores affectent cette interaction en modifiant la composition chimique élémentaire et moléculaire de la ressource organique.

- L'effet stœchiométrique d'un niveau trophique sur un autre doit prendre en compte tous les niveaux trophiques qui tirent une partie de leur ressource du premier niveau trophique. La complexité des liens entre herbivores, producteurs primaires et décomposeurs due au recyclage des éléments chimiques ne permet pas d'étudier l'herbivorie ou la décomposition de façon détachée du reste du réseau trophique.

J'ai espoir que les approches expérimentales et théoriques développées dans ce travail de thèse serviront de base à des études plus intégrées des interactions stœchiométriques à l'échelle des écosystèmes.

Mots-clés :

Bactéries ; C :N :P ; Compétition pour les ressources ; Décomposeurs microbiens ; Herbivores ; Homéostasie ; Interactions trophiques ; Modèles ; Producteurs primaires ; Stœchiométrie écologique.

Abstract :

Ecological stoichiometry studies the effects of the elemental composition of organisms on their trophic interactions. Because ecological stoichiometry links flows of elements such as carbon, nitrogen and phosphorus, and population dynamics, it has a huge potential to integrate biogeochemistry and the study of trophic interactions.

After primary production, herbivory and decomposition are the most important processes in ecosystems. The greatest differences between the chemical compositions of consumers and their resources are also between herbivores and primary producers and microbial decomposers and detritus. Usually, in ecological stoichiometry, these two processes are studied separately. This thesis investigates interactions between primary producers, herbivores and decomposers simultaneously, in order to reach a more comprehensive view of the functioning of ecosystems and food webs.

In the first two chapters of the thesis, I used a modeling approach and an experiment to study the effects of the elemental and molecular composition of organic matter on the simultaneous use by microbial decomposers of organic and inorganic resources.

The results from the first chapters were used in the next chapters to investigate the effects of herbivores on primary producer-decomposer interaction. I built two stoichiometrically-explicit models with three trophic levels: primary producers, herbivores and decomposers. The first model was meant to study the effects of herbivores on primary producer-decomposer interaction. In the second model, I focused on the effects of decomposers on the interaction between herbivores and primary producers.

The many results of this work can be summarized in two main conclusions:

- The chemical heterogeneity of organic matter is a main determinant of decomposer community structure and of their regeneration of inorganic elements. Primary producers are the main sources of organic matter and the main consumers of inorganic elements. Organic matter heterogeneity is thus an essential factor of primary producer-decomposer interaction. Herbivores can influence this interaction by modifying organic matter elemental and molecular composition.

- To assess the impact of one trophic level on another, it is necessary to include all trophic levels that derive some resource from the first trophic level. For example, the complexity of matter exchanges between primary producers, herbivores and decomposers through organic matter recycling makes it necessary to study herbivory and decomposition in the larger context of food webs.

I hope that the experimental and theoretical approaches that I developed in this thesis will be useful as a basis for more studies integrating stoichiometric interactions at the scale of ecosystems.

Keywords:

Bacteria; C:N:P; Ecological stoichiometry; Herbivores; Homeostasis; Microbial decomposers; Models; Primary producers; Resource competition; Trophic interactions.

Table des Matières :

1	Introduction- Contexte général.	10
1.1	L'étude des écosystèmes : Interactions trophiques et écologie des écosystèmes, approches divergentes ou complémentaires ?	10
1.1.1	L'étude des interactions trophiques.	12
1.1.2	Définition de l'écologie des écosystèmes.	16
1.1.3	L'importance du rapprochement de ces deux approches.	17
1.2	Présentation de la stœchiométrie écologique.	20
1.2.1	Définition.	20
1.2.2	Historique.	20
1.3	Objectif de la thèse.	30
1.4	Organisation de la thèse.	33
2	Résultats.	35
2.1	Chapitre 1 : utilisation simultanée d'une ressource organique et d'une ressource inorganique par les décomposeurs.	35
2.2	Chapitre 2 : Effets de la composition chimique des ressources organiques sur l'utilisation simultanée de substrats organiques et inorganiques par les bactéries.	40
2.3	Chapitre 3 : Les différents effets des herbivores dérivant de la régulation de leur stœchiométrie et de leur nutrition.	45
2.4	Chapitre 4 : le rôle des décomposeurs dans l'effet des herbivores sur la limitation des producteurs primaires.	52
3	Discussion :	58
3.1	L'hétérogénéité de la matière organique : quelles sources et quels effets sur les décomposeurs ?	58
3.2	Étudier les interactions trophiques dans le contexte de l'écosystème et du réseau trophique.	60
4	Conclusion.	66
	Références.	67
	Annexes.	82
1.	Stoichiometric constraints on resource use, competitive interactions and elemental cycling in microbial decomposers	83

2. Elemental and molecular compositions of organic substrates control nitrogen cycling by bacteria	130
3. Disentangling the effects of herbivore nutrition on autotroph-decomposer interactions: a theoretical approach	152
4. Microbial interference with the effects of herbivore stoichiometry on plant nutrient limitation	210

1 Introduction- Contexte général.

« Mais le concept le plus fondamental est, à ce qu'il me semble, le système en entier (dans le sens de la Physique), incluant non seulement le complexe des organismes, mais aussi le complexe total des facteurs physiques qui forment ce qu'on nomme l'environnement du biome-les facteurs de l'habitat dans son sens le plus large. Bien que les organismes représentent notre intérêt principal, lorsque nous y réfléchissons fondamentalement, nous ne pouvons les séparer de leur environnement spécifique, avec lequel ils forment un seul système physique. »¹

A. G. Tansley (1935), définissant pour la première fois la notion d'écosystème.

1.1 L'étude des écosystèmes : Interactions trophiques et écologie des écosystèmes, approches divergentes ou complémentaires ?

Pour celui qui observe et étudie la nature, celle-ci se révèle sous deux aspects différents, difficilement réconciliables en apparence.

À première vue, elle se caractérise par une hétérogénéité et une diversité, source d'émerveillement, mais aussi déroutante : une multitude d'espèces, radicalement différentes, ou parfois très semblables, qui se partagent une mosaïque de paysages et agissent les unes sur les autres chacune pour son propre bien, sans but commun apparent. C'est cette vision que personnifie la représentation courante de la jungle et de sa fameuse loi qui, à priori, n'engendrerait aucun ordre supérieur.

¹“But the more fundamental conception is, as it seems to me, the whole system (in the sense of physics), including not only the organism-complex, but also the whole complex of physical factors forming what we call the environment of the biome-the habitat factors in the widest sense. Though the organisms may claim our primary interest, when we are trying to think fundamentally we cannot separate them from their special environment, with which they form one physical system.”

Pourtant, pour qui prend du recul, l'ordre et la régularité sont des propriétés incontournables de la nature. Le cycle des saisons, la succession prévisible des espèces végétales qui repeuplent un lieu après une perturbation, la similarité entre les espèces qui appartiennent au même climat malgré des origines évolutives différentes, sont toutes des expressions concrètes de cette organisation qui a amené certains à parler d'« organisme complexe » pour décrire chaque ensemble cohérent d'êtres vivants (Phillips 1935). L'image donnée dans les documentaires animaliers de la savane africaine, au paysage si caractéristique, avec son alternance de saisons sèches et humides, d'incendies et de migration des grands herbivores est un bon exemple de ce que serait un organisme complexe.

Entre ces deux visions de la nature, la notion d'écosystème a été développée par Tansley comme une tentative de réconcilier ces deux aspects de la nature (Tansley 1935). C'est l'interaction non coordonnée de l'ensemble des êtres vivants entre eux et avec l'environnement physique qui crée l'entité de l'écosystème. Cette entité, en retour, impose des contraintes sur les espèces et les interactions permises dans l'écosystème. Ainsi, l'ensemble des êtres vivants forme un système ordonné et potentiellement prévisible, tout en reconnaissant le rôle parfois aléatoire des caractéristiques de chaque espèce.

En pratique, Cette notion d'écosystème n'a pas été aussi rassembleuse qu'elle ne le promettait. En effet, pour étudier le fonctionnement des écosystèmes, deux approches principales divergentes ont été suivies, selon qu'était prise en compte la diversité des espèces et des interactions (l'étude des interactions trophiques), ou l'existence à l'échelle de l'écosystème de réponses prédictibles aux grands facteurs environnementaux climatiques, géologiques et anthropiques (l'écologie des écosystèmes)².

² En dehors même de l'étude des écosystèmes, le champ de l'écologie de façon plus large est divisé de façon semblable selon deux approches : une première approche biodémographique basée sur l'individu, qu'on retrouve dans l'écologie des populations, l'épidémiologie et l'écologie des communautés ; et l'approche biogéochimique qui se retrouve dans les domaines de l'écologie des écosystèmes et de l'écophysiologie.

⇒ L'écosystème est une notion qui cherche à concilier la diversité et la complexité des interactions des espèces entre-elles et avec leur environnement physique, avec la régularité de certains phénomènes à une échelle plus large. Dans la pratique, cependant, cette notion a généré deux approches différentes : l'une qui se consacre à l'étude des interactions, l'autre à l'étude de processus à large échelle.

1.1.1 L'étude des interactions trophiques.

Une première approche se consacre à répertorier les espèces présentes dans un écosystème, à caractériser leurs interactions, à donner une structure à l'ensemble de ces interactions et à comprendre les propriétés de cette structure. Elle fait le pari que cette compréhension permettra d'expliquer, voir de prédire, le fonctionnement de l'écosystème. De fait, elle pense, comme Scheu (2002), que « L'objectif principal de l'écologie est de comprendre la dynamique des populations et des communautés »³.

L'objet d'étude de base de cette approche est « l'interaction trophique ». Cela représente simplement le transfert de matière qui s'opère entre le mangeur et le mangé, et le changement dans l'abondance du consommateur et de sa ressource qui résulte de cet acte d'alimentation⁴.

Les premières représentations de l'ensemble des interactions trophiques d'un écosystème se basèrent sur un classement simple et intuitif des organismes. C'est la représentation en chaîne trophique (Lindeman 1942, figure 1) :

³ "The major goal of ecology is to understand the dynamics of populations and communities".

⁴ Il existe d'autres types d'interactions entre espèces qui ne sont pas basées sur la consommation (mutualisme, modification de l'habitat, ou du comportement, etc). Bien qu'importantes, ces interactions ont été globalement moins étudiées que les interactions trophiques. Elles n'ont pas abouti en tout cas à l'élaboration d'une théorie qui relie ensemble la totalité des espèces de l'écosystème comme le fait l'étude des interactions trophiques.

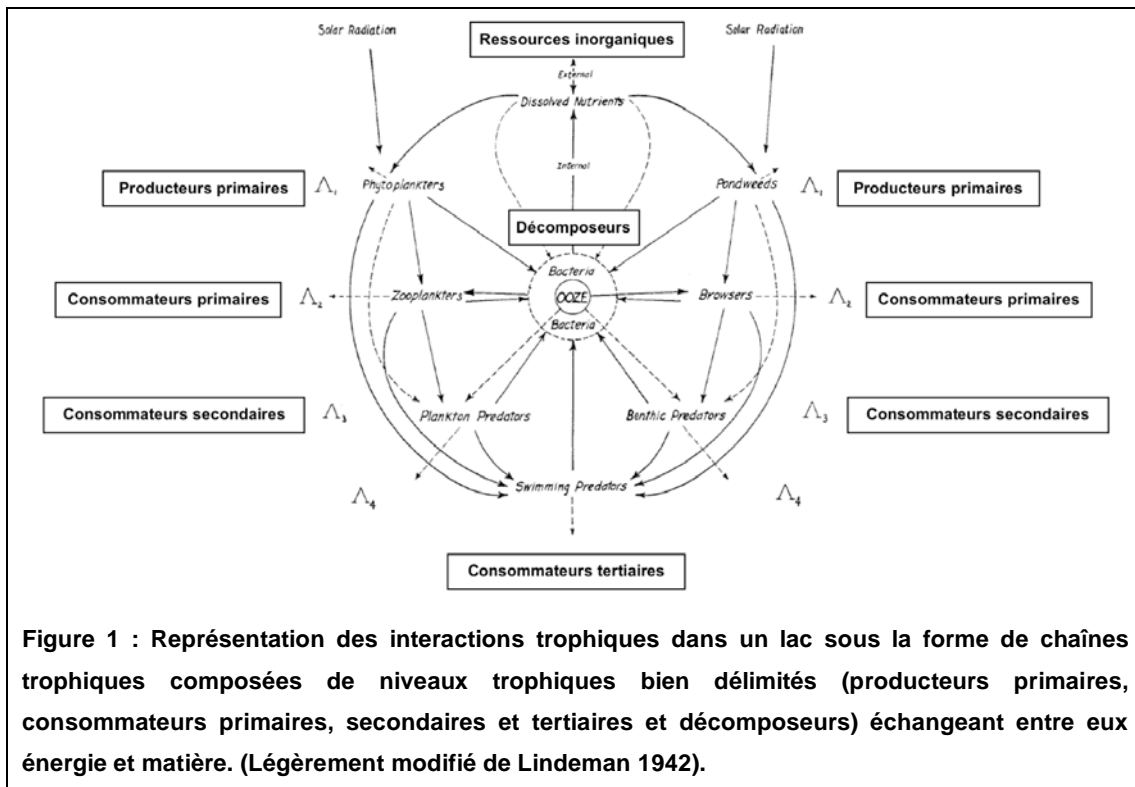
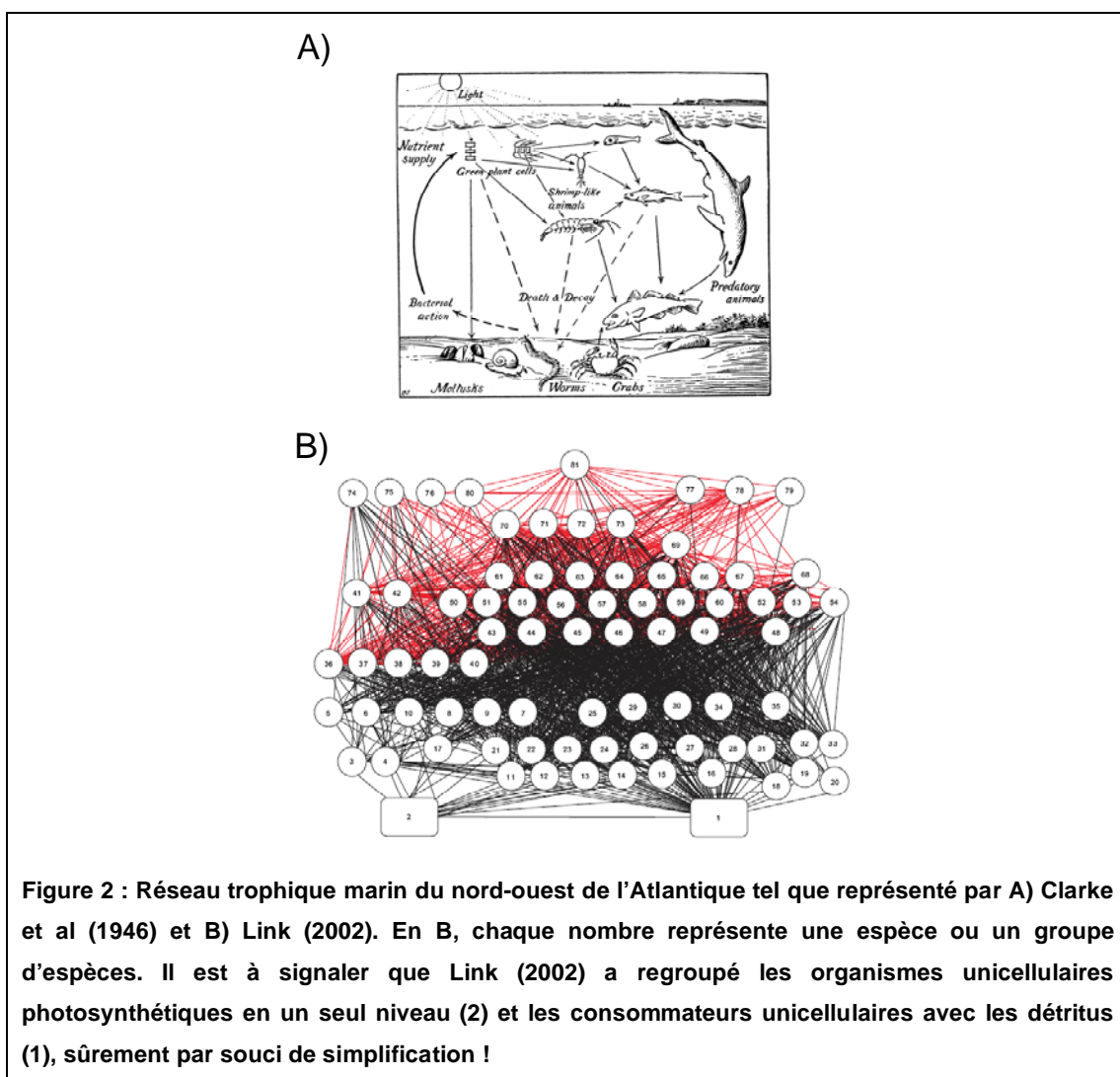

Figure 1 : Représentation des interactions trophiques dans un lac sous la forme de chaînes trophiques composées de niveaux trophiques bien délimités (producteurs primaires, consommateurs primaires, secondaires et tertiaires et décomposeurs) échangeant entre eux énergie et matière. (Légèrement modifié de Lindeman 1942).

Les producteurs primaires, généralement des plantes, transforment l'énergie et la matière minérale en matière organique dont une partie est consommée par des consommateurs primaires, ou herbivores. Les consommateurs sont eux-mêmes mangés par d'autres consommateurs qu'on appellera secondaires, tertiaires ou plus, selon leur position dans cette hiérarchie de consommation. Tous ces niveaux trophiques finissent par mourir et la matière organique ainsi perdue est retransformée en matière minérale par les décomposeurs, généralement des bactéries ou des champignons.

Un examen attentif de la figure 1 nous laisse soupçonner qu'il existait déjà, alors même qu'elle était élaborée, la conscience que cette représentation en chaîne de l'organisation des êtres vivants peignait une image trop simpliste de la réalité. En effet, on peut voir prise en compte sur ce schéma l'existence, avérée dans les lacs, de l'omnivorie : des consommateurs primaires se nourrissant aussi des décomposeurs et des consommateurs secondaires et tertiaires consommant un peu de tous les niveaux trophiques qui les précèdent. Par ailleurs, les décomposeurs consomment des ressources inorganiques aussi bien qu'ils en régénèrent, fournissant ainsi aux consommateurs une voie alternative aux producteurs pour s'approvisionner en nutriments.

La représentation des interactions trophiques d'un écosystème a donc rapidement mué d'un schéma de chaînes trophiques vers celui de réseaux trophiques avec l'espèce comme niveau fondamental et une multitude de liens entre ces espèces. Car comme l'expliquent Polis et Strong (1996), « La recherche en écologie a amplement démontré que les réseaux trophiques contiennent des centaines voir des milliers d'espèces, connectées de façon réticulée via de multiples liens de forces variées à d'autres espèces des voies autotrophes et saprophages du même habitat ou d'habitats différents ; Il est commun d'avoir des consommateurs omnivores, structurés selon l'âge »⁵ (figure 2).



⁵ “Ecological research has amply demonstrated that food webs in nature contain hundreds to thousands of species, reticulately connected via multiple links of various strength to species in the autotroph and saprophagous channels and in the same and different habitats; omnivorous, age-structured consumers are common”

Les réseaux trophiques tels que représentés dans la figure 2 sont des réseaux trophiques de connexion, c'est-à-dire qu'ils indiquent simplement l'existence d'un lien de consommation entre deux espèces, sans préciser l'importance de ce lien. Il se peut par exemple, qu'une espèce ne soit consommée qu'occasionnellement par un prédateur qui se nourrit préférentiellement d'une troisième espèce. Les deux proies seront cependant représentées d'égale façon dans de tels réseaux de connexion. Des réseaux prenant alors en compte les forces d'interaction ou l'intensité des flux d'énergie entre les espèces peuvent aussi être construits (Scheu 2002).

La complexité des réseaux trophiques, due au nombre et à la variété des interactions trophiques possibles est le principal défi que doit relever l'étude des interactions trophiques (Polis et Strong 1996). Elle pose en effet une importante question : comment un assemblage aussi large et dynamique peut-il se maintenir de façon stable dans le temps, sans perdre d'espèces au fur et à mesure ? R. M. May (1972) montre en effet que, pour une force d'interaction moyenne donnée, les réseaux ont d'autant moins de chances d'être stables que leur complexité augmente. La résolution de ce problème et de ses ramifications reste l'une des tâches principales de l'étude des réseaux trophiques. Les réponses apportées à cette problématique nécessitent de postuler des contraintes sur la structure des réseaux trophiques (DeAngelis 1975, Lawlor 1978, McCann et al 1998). De nombreuses études empiriques montrent que les réseaux trophiques étudiés présentent effectivement des caractéristiques favorisant leur stabilité (Neutel et al 2002). Il reste cependant à déterminer dans quelle mesure l'existence de ces propriétés stabilisantes est le résultat des propriétés physiologiques des organismes (Shurin et al 2006), de la dynamique interne des réseaux (Closs et al 1999, Fox et McGrady-Steed 2002), de la phylogénie (Cattin et al 2006), ou de facteurs de l'environnement physique (Woodward et Hildrew 2002).

⇒ L'étude des interactions des organismes entre eux se base principalement sur la notion d'interaction trophique et de réseau trophique, qui est une représentation de l'ensemble des interactions trophiques d'un écosystème. Elle est confrontée à la question de la complexité de la plupart des réseaux existants qui pose le problème de leur stabilité.

1.1.2 Définition de l'écologie des écosystèmes.

Si, pour utiliser une image, la théorie des réseaux trophiques fait le pari que le fonctionnement de la machine vivante peut être compris par l'étude de son organisation interne, l'écologie des écosystèmes pense qu'il peut être prédit par l'étude des réponses de cette machine aux variations extérieures.

Comme la définissent Groffman et al (2004), l'écologie des écosystèmes est principalement une « approche basée sur la conservation de la matière, analysant les entrées et sorties et les flux internes de l'eau et des éléments »⁶. Pour cela, elle définit donc des processus écosystémiques qui sont les produits de « tous les organismes qui fonctionnent ensemble dans une zone donnée en interagissant avec l'environnement physique de telle sorte qu'un flux d'énergie produise des structures biotiques bien définies et un cycle de la matière entre les parties vivantes et non-vivantes »⁷ (Odum 1983, figure 3).

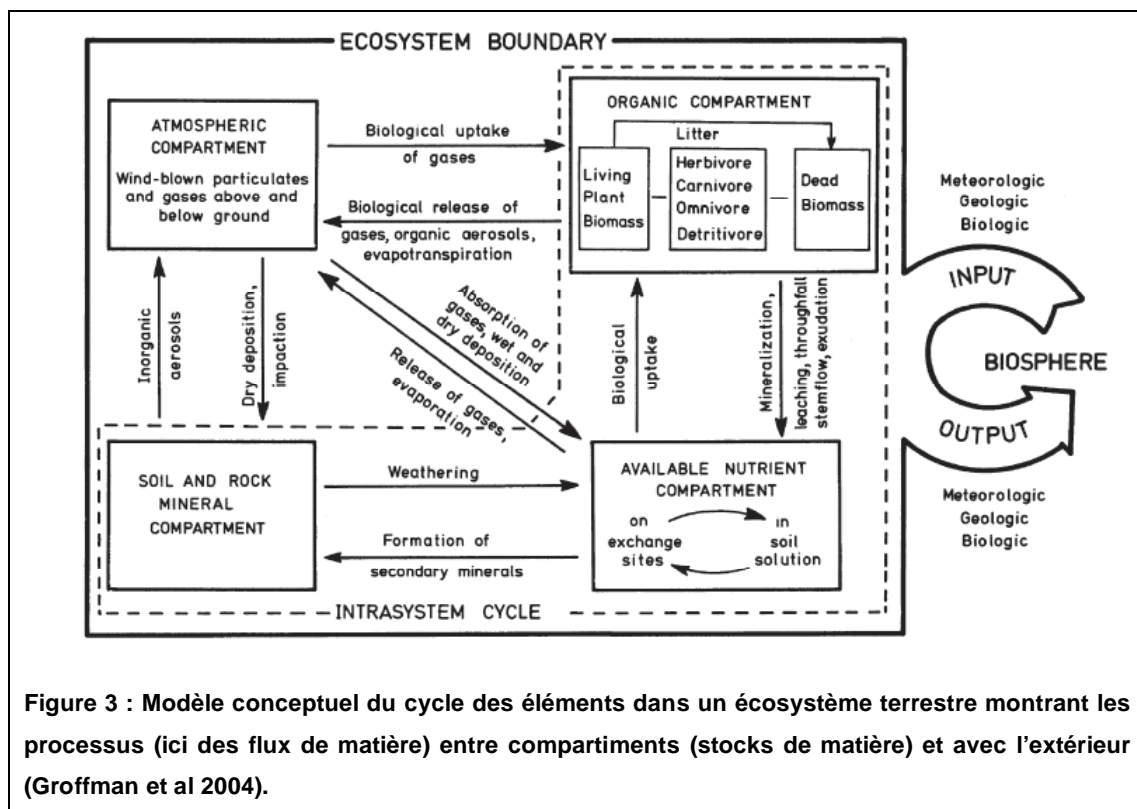

⁶ “Mass-balance approach analyzing inputs-outputs, internal fluxes of water and elements”

⁷ “all the organisms that function together in a given area interacting with the physical environment so that a flow of energy leads to clearly defined biotic structures and cycling of materials between living and nonliving parts”

La minéralisation de la matière organique, la fixation de l'azote atmosphérique ou la perte de minéraux par l'érosion du sol sont des exemples de processus écosystémiques.

Il s'agit alors d'étudier l'effet sur ces processus de facteurs ultimes tels que la topographie, la géologie, le climat, le temps, l'ensemble des espèces disponibles régionalement, et de perturbations aléatoires telles que coupes, tempêtes, pluies acides, eutrophisation, invasions, pertes d'espèces ou autres (Groffman et al 2004).

Dans le contexte de la crise de la biodiversité, et de l'impact grandissant des sociétés humaines sur la nature, l'écologie des écosystèmes s'est récemment intéressée aux services des écosystèmes (Carpenter et al 2006). Ce sont les processus et composants des écosystèmes qui ont une valeur pour les êtres humains : eau potable, fertilité des sols, zones récréatives, espèces emblématiques, etc. Les mécanismes maintenant ces services peuvent être vus comme de nouveaux processus de l'écosystème qui étendront l'attention de l'écologie des écosystèmes hors du cadre des flux de matière et d'énergie (Groffman et al 2004).

⇒ L'écologie des écosystèmes étudie les processus à l'intérieur des écosystèmes et cherche à comprendre leurs réponses aux facteurs physiques et aux perturbations environnementales. Les principaux processus étudiés sont les flux de matière et d'énergie entre les différentes composantes de l'écosystème, mais les services des écosystèmes aux sociétés humaines devraient occuper une part plus importante de ces travaux.

1.1.3 L'importance du rapprochement de ces deux approches.

Le réseau trophique faisant partie intégrante de l'écosystème, les deux approches que sont l'étude des réseaux trophiques et l'écologie des écosystèmes se recoupent forcément en de nombreux points. Pour autant, les connaissances accumulées sur les réseaux trophiques sont-elles utiles pour comprendre le fonctionnement des processus écosystémiques ? Inversement, les connaissances sur ces processus sont-elles nécessaires à l'étude de la structure et de la dynamique des

réseaux ? Est-il important de tenter de regrouper ces deux démarches et quelles seraient les retombées de ce rapprochement ?

Nous avons vu qu'une problématique importante des réseaux trophiques est d'expliquer la stabilité des réseaux présentant un grand nombre d'interactions trophiques. Il est rare que ces réseaux prennent en compte l'environnement physique explicitement. C'est ce qui distingue formellement cette approche de l'écologie des écosystèmes où il arrive parfois que les interactions trophiques soient introduites sous forme de chaînes ou de réseaux simplifiés. Or, l'introduction de certains éléments physiques, ne serait-ce que les ressources minérales des plantes et organiques des décomposeurs, et de leurs interactions avec les membres des réseaux trophiques modifie souvent les interactions trophiques elles-mêmes (Chase 1996) et suffit parfois à augmenter la stabilité des réseaux (DeAngelis et al 1989, Loreau 1996, Kesh et al 1997, Harding 1999, Moore et al 2004). Une autre influence des facteurs écosystémiques se fait à travers les contraintes qu'ils imposent sur certaines propriétés de la structure des réseaux trophiques qui sont importantes pour leur dynamique, comme la longueur des chaînes trophiques (Post et al 2000), la prévalence de l'omnivorie (Diehl 2003) ou les forces d'interaction (Emmerson et al 2004).

L'écologie des écosystèmes s'intéresse de plus en plus aux réponses des écosystèmes aux perturbations. Or, que ce soit les invasions ou extinctions d'espèces, la fragmentation des paysages ou les événements climatiques, ces perturbations touchent souvent directement des membres des réseaux trophiques. L'étude de leurs impacts sur l'écosystème passe alors forcément par une connaissance du fonctionnement de ce réseau (Van Peer et al 2001). De même, certains services des écosystèmes sont souvent directement reliés à quelques membres précis des réseaux trophiques, telle la pollinisation ou le contrôle biologique des ravageurs, et ne peuvent être étudiés en dehors du cadre des réseaux trophiques (Montoya et al 2003).

De ce bref aperçu des liens entre ces deux domaines de l'étude des écosystèmes, l'importance de chacune des deux approches l'une pour l'autre ressort de façon évidente. Il paraît donc de plus en plus essentiel de trouver une nouvelle démarche qui permettra de lier ces deux approches en une seule théorie. La stœchiométrie écologique, une approche assez récente dans l'étude des interactions trophiques est vue comme étant une voie prometteuse vers une telle réunion, voir vers la convergence, de plusieurs domaines de la biologie d'après Elser et al (2000b), car elle « [...] lie le flux d'énergie et la dynamique des populations pour produire une

approche plus intégrée à la compréhension des réseaux trophiques »⁸ (Woodward et Hildrew 2002).

⇒ Que ce soit pour expliquer la stabilité et la dynamique des réseaux trophiques, ou la réponse des processus écosystémiques et de certains composants des écosystèmes aux perturbations, l'étude des réseaux trophiques et l'écologie des écosystèmes ont besoin l'un de l'autre. La stœchiométrie écologique apparaît pour certains comme étant une voie prometteuse à la réunion de ces deux approches.

⁸ “[...] links energy flow and population dynamics to produce a more integrated approach to understanding food webs.”

1.2 *Présentation de la stœchiométrie écologique.*

1.2.1 *Définition.*

La stœchiométrie écologique est définie par ceux-là même qui ont été des acteurs majeurs de son développement comme étant l'étude « [de] l'équilibre des multiples substances chimiques dans les interactions et processus écologiques »⁹ (Sturner and Elser 2002). Les mots-clés dans cette définition sont les mots « multiples » et « interactions ». C'est ce qui distingue en fait cette approche de l'approche classique de l'écologie des écosystèmes. Les organismes vivants et la matière organique qui en dérive sont constitués d'un ensemble d'éléments essentiels à la vie comme le carbone, l'azote ou le fer. La stœchiométrie écologique postule que la composition chimique des organismes en ces éléments, c'est-à-dire leur stœchiométrie, détermine pour une large part leurs interactions trophiques. Par exemple, comme nous le verrons plus loin en détail, la différence entre la composition chimique des décomposeurs et de la matière organique qu'ils consomment détermine en grande partie le signe de leur effet, positif ou négatif, sur la croissance et la biomasse des producteurs primaires.

⇒ La stœchiométrie écologique étudie l'effet de la composition chimique des organismes sur leurs interactions trophiques.

1.2.2 *Historique.*

Pionnier dans beaucoup de domaines de l'écologie, A. J. Lotka aurait pu être de plus l'initiateur de l'apparition précoce d'une approche stœchiométrique de l'écologie. En effet, dans son œuvre « Elements of Physical Biology » (1925), il définit la stœchiométrie comme étant « cette branche des sciences qui s'occupe des transformations matérielles, des relations entre les quantités des composants »¹⁰. Il

⁹ “[of] The balance of multiple chemical substances in ecological interactions and processes”

¹⁰ “that branch of the science which concerns itself with material transformations, with the relations between the masses of the components.”

compare la composition en éléments de la matière vivante avec celle de l'environnement physique, afin de comprendre les effets mutuels de l'un sur l'autre. Il décrit les êtres vivants comme étant des « transformateurs d'énergie » qui « n'opèrent pas avec une seule substance de travail, mais avec une variété complexe de telles substances, un fait qui a certainement des conséquences importantes »¹¹. Il fut donc l'un des premiers à prôner l'importance de prendre en compte tous les composants de la matière. Malheureusement, l'étincelle ne prit pas et pendant longtemps, seule l'énergie fut considérée dans l'étude des interactions trophiques.

Seuls les chercheurs travaillant sur des processus écologiques pour lesquels le rôle de la teneur en certains éléments était flagrant, menèrent des recherches qu'on pourrait qualifier de premières recherches stœchiométriques.

Les écologistes étudiant la décomposition de la matière organique, étape cruciale s'il en est dans le cycle terrestre des éléments, ont naturellement et rapidement concentré leur attention sur l'action des microorganismes décomposeurs (bactéries et champignons). En 1917 déjà, Waksman apporte une explication stœchiométrique à l'inhibition de la production d'ammonium par ces microorganismes en présence de sucres (Waksman 1917). Un peu plus tard, Findlay (1934) puis Schmitz et Kaufert (1936) démontrèrent expérimentalement le rôle de la teneur en azote du bois dans sa faible décomposition par les champignons. L'extension de ces travaux ont abouti à un modèle de décomposition dans lequel la différence entre le ratio C/N (Teneur en carbone divisée par la teneur en azote) de la matière organique du sol ou de la litière et le ratio C/N des microorganismes détermine le taux de décomposition et la minéralisation de l'azote (Ågren and Bosatta 1996) :

On peut calculer ou estimer expérimentalement un ratio C/N critique, égal à la somme des besoins des microorganismes décomposeurs en carbone (carbone nécessaire à leur croissance et leur métabolisme) divisé par leurs besoins en azote. Si le ratio C/N de la matière organique est inférieur à ce seuil, cette dernière est alors trop riche en azote et pas assez en carbone par rapport aux besoins des décomposeurs. Ceux-ci minéralisent alors l'excès d'azote sous forme minérale. À l'opposé, si le ratio C/N de la matière organique est supérieur à ce seuil, l'azote est en déficit par rapport

¹¹ “does not operate with a single working substance, but with a complex variety of such substances, a fact which has certain important consequences.”

aux besoins des décomposeurs et ceux-ci compensent ce manque en consommant (immobilisant est le terme utilisé en science des sols) de l'azote minéral s'il est présent dans le milieu. Plus le C/N de la matière organique est grand, plus le déficit en N des décomposeurs s'accroît et plus le taux de décomposition baisse (Taylor et al 1989). Des travaux supplémentaires ont montré que ce modèle s'applique aussi ailleurs que dans le sol, et pour d'autres éléments que l'azote (Goldman 1987, Enríquez et al 1993, figure 4).

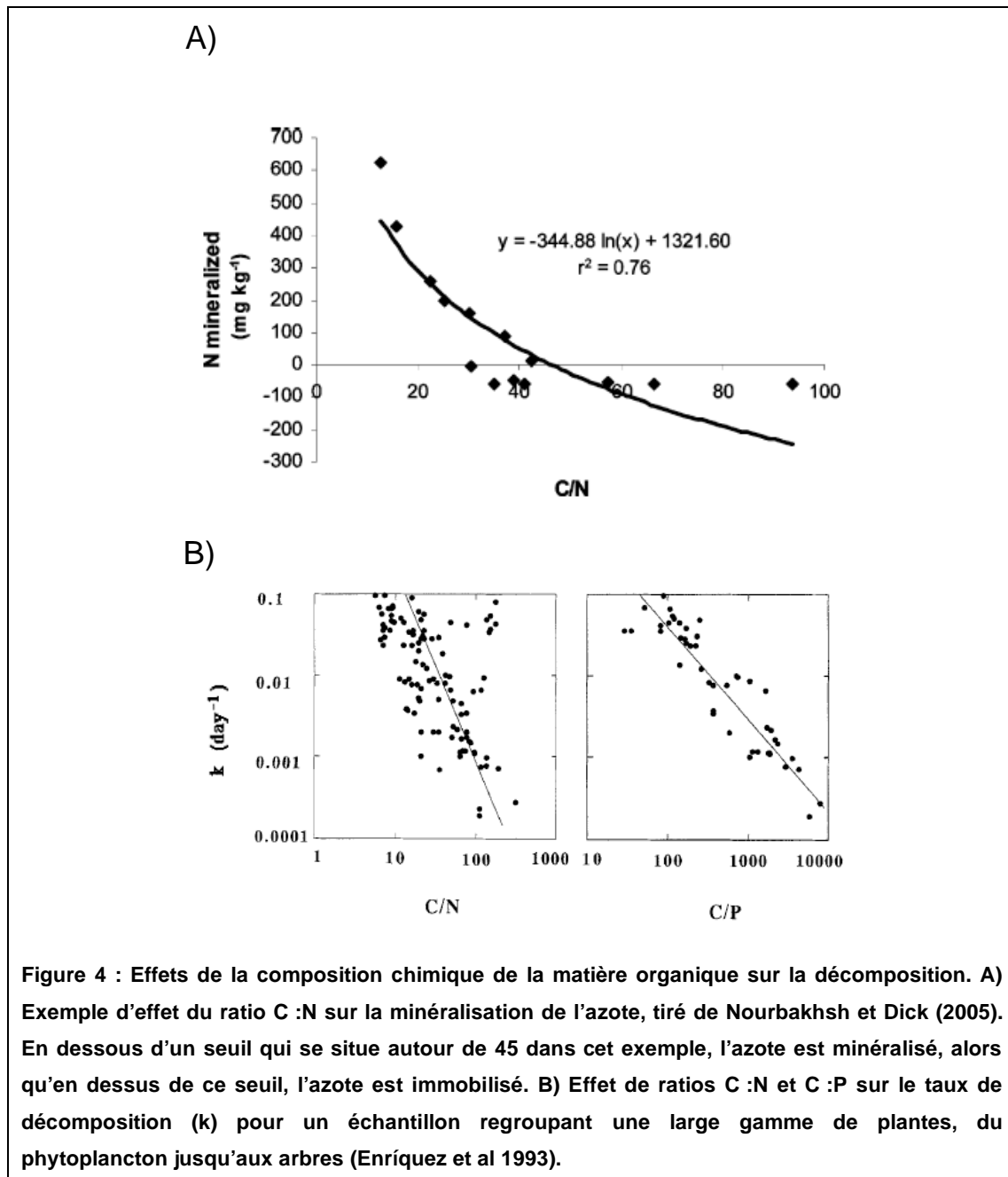

Figure 4 : Effets de la composition chimique de la matière organique sur la décomposition. A) Exemple d'effet du ratio C :N sur la minéralisation de l'azote, tiré de Nourbakhsh et Dick (2005). En dessous d'un seuil qui se situe autour de 45 dans cet exemple, l'azote est minéralisé, alors qu'en dessus de ce seuil, l'azote est immobilisé. B) Effet de ratios C :N et C :P sur le taux de décomposition (k) pour un échantillon regroupant une large gamme de plantes, du phytoplancton jusqu'aux arbres (Enríquez et al 1993).

Les processus de minéralisation et d'immobilisation ont une place essentielle, particulièrement dans les écosystèmes terrestres, où la source principale d'azote pour les plantes est souvent l'azote reminéralisé par les décomposeurs. La stœchiométrie joue donc un rôle primordial dans l'interaction entre plantes et décomposeurs puisqu'elle détermine s'il y a minéralisation ou pas, et l'intensité de cette minéralisation. Étonnement, peu de travaux en milieu terrestre abordèrent l'étude de cette interaction sous l'angle stœchiométrique. C'est en milieu aquatique principalement que les recherches s'intéressèrent à la possibilité d'une compétition entre plantes et décomposeurs (Mayfield et Inness 1978). Il s'ensuivit la prise de conscience de l'existence d'un « paradoxe » : Lorsque les décomposeurs immobilisent la ressource minérale, les plantes se retrouvent dans la position de fournir la matière organique nécessaire à leurs compétiteurs, et augmenter ainsi leur propre limitation par la ressource minérale immobilisée, voir provoquer leur propre exclusion si la pression de compétition par les décomposeurs est trop forte (Bratbak et Thingstad 1985). Ce paradoxe a été résolu lorsqu'il a été trouvé que les décomposeurs sont généralement meilleurs compétiteurs pour les ressources minérales que les plantes (Currie et Kalff 1984). Comme le démontrèrent Daufresne et Loreau (2001a) ceci est une condition suffisante, en l'absence d'apports extérieurs significatifs en matière organique, pour garantir que les décomposeurs seront limités par la disponibilité en ressource organique à l'équilibre et n'excluent pas ainsi les producteurs primaires limités par la ressource minérale.

⇒ Bien que Lotka (1925) ait préconisé son application globale à l'étude des écosystèmes, l'approche stœchiométrique ne fut d'abord utilisée que dans l'étude de quelques processus, dont celui de décomposition. Les premiers travaux ont ainsi rapidement montré le rôle du ratio C/N de la matière organique dans la détermination de son taux de décomposition et dans la minéralisation ou l'immobilisation de l'azote.

En 1958, A. C. Redfield compare le contenu en carbone, azote et phosphore du phytoplancton des zones de plein océan au contenu des nutriments dissous dans l'eau et régénérés dans la partie profonde de l'océan. La similitude entre ces différents ratios l'amène à faire l'hypothèse que c'est la composition chimique du plancton qui

détermine, sur des temps géologiques, la composition chimique de l'océan. Il propose en effet que le plancton équilibre sa consommation d'azote par rapport à celle du phosphore, pour que leur ratio devienne égal à celui de leur composition chimique (le fameux ratio N/P de Redfield égal à 16), en fixant l'azote atmosphérique dissous dans l'eau. Ceci revient donc à dire que c'est le phosphore qui, en dernière instance, limite la croissance du phytoplancton, alors que l'azote est simplement ajusté par l'activité biologique du phytoplancton lui-même.

Ce modèle de fonctionnement stœchiométrique de l'océan a suscité des travaux sur les apports en éléments dans les océans (Dugdale et al 1961, Berner 1977) et encouragé de nombreuses spéculations sur la genèse et le maintien des propriétés chimiques de l'océan, voire de l'atmosphère (Walker 1974, Griffith et al 1977, Lovelock et Watson 1982). Curieusement, cela n'amena pas de tentative sérieuse de généraliser ces résultats à d'autres écosystèmes, ni d'évaluer le rôle de la composition chimique des organismes dans les transferts trophiques.

Par contre, l'affirmation de la nécessaire limitation par le phosphore de la croissance du phytoplancton suscita de nombreuses recherches car elle contredisait les mesures expérimentales qui démontraient généralement une limitation par l'azote (Smith 1984). Commencèrent alors plusieurs décennies d'études sur la croissance du phytoplancton et sa composition chimique en présence de plusieurs éléments potentiellement limitant, en particulier l'azote et le phosphore (Droop 1974, Rhee 1978, Goldman et al 1979, Tett et al 1985). Ces expériences montrèrent qu'aussi bien la composition chimique que la nature de l'élément limitant varie d'une espèce à l'autre et que la constance du ratio de Redfield est probablement la résultante de plusieurs processus plutôt qu'une propriété fixe du phytoplancton (LeRouzic et Bertru 1997, Falkowski 2000, Geider et La Roche 2002, Klausmeier et al 2004).

Les connaissances qui commençaient à s'accumuler sur la diversité de besoins en éléments, de limitation et de composition chimique des différentes espèces de phytoplancton conduisirent à penser qu'il était possible d'apporter une réponse au « paradoxe de Hutchinson ». Hutchinson (1961) s'étonne en effet de la grande richesse en espèces du phytoplancton (de l'ordre de plusieurs dizaines d'espèces) dans l'environnement relativement homogène des eaux de surface, malgré le faible nombre de ressources partagées par ces espèces. Le principe d'exclusion compétitive prédit en effet qu'il ne peut y avoir plus d'espèces que de ressources limitantes à l'équilibre (Armstrong et McGehee 1980).

Développant des travaux précédents (MacArthur et Levins 1964, Rapport 1971, Leon et Tumpson 1975), D. Tilman élaborera une théorie de compétition pour les ressources qui permet de prédire l'issue de la compétition entre plusieurs espèces de phytoplancton en fonction de leurs besoins en éléments, de leur composition chimique et en particulier des apports en éléments (Tilman 1980). Plus tard, intégrant à son approche les fluctuations dans le temps et l'espace que connaissent les apports en ressources, il confirma que ces fluctuations permettent la coexistence de plus d'espèces que de ressources, apportant ainsi ce qu'il considéra comme une réponse finale au paradoxe du phytoplancton (Tilman et al 1982). Plus loin, en cherchant à expliquer concrètement par sa théorie les caractéristiques des communautés naturelles de phytoplancton, il fit l'hypothèse que « si quelques nutriments (par exemple le phosphore) sont régénérés plus rapidement que d'autres, le zooplancton pourrait significativement affecter la structure de la communauté du phytoplancton en modifiant à la fois les taux d'apports des nutriments et leurs ratios. »¹² (Tilman et al 1982). Il ne reste plus alors que quelques pas supplémentaires avant l'apparition de la première idée fondatrice de la stœchiométrie écologique.

En 1988, Elser et al observèrent un changement dans la nature de l'élément limitant le phytoplancton, lié au type de zooplancton présent. Lorsque la communauté de zooplancton était dominée par des copépodes, le phytoplancton était limité par l'azote, alors qu'il était limité par le phosphore lorsque dominé par des cladocères comme les daphnies (Elser et al 1988). Ils savaient déjà que le zooplancton recyclait avec une efficacité différente l'azote et le phosphore (Lehman 1984). Mais ils ne parvenaient pas à expliquer l'effet différent des copépodes et des cladocères, surtout que de nombreuses différences entre les deux sortes de zooplancton pouvaient intervenir : les copépodes sont principalement de petite taille et sélectionnent les espèces qu'ils consomment, alors que les cladocères sont généralement de plus grande taille (jusqu'à faire plusieurs millimètres) et consomment de façon très efficace toutes les espèces saisies dans leurs filtres. La réponse fut rapidement apportée lorsque R. W. Sterner (1990) démontra théoriquement que des espèces de zooplancton avec des compositions chimiques différentes pouvaient influencer de façon différentes la

¹² "If some nutrients (e.g. phosphorus) are regenerated more rapidly than others, zooplankton may significantly affect phytoplankton community structure by changing both nutrient supply rates and ratios."

limitation du phytoplancton, à condition que leur composition chimique soit maintenue constante au cours du temps. Andersen et Hessen (1991) trouvèrent ensuite que les copépodes et les cladocères se différenciaient par leur composition chimique, les copépodes étant riche en azote et les daphnies en phosphore et que cette composition variait très peu au cours du temps, quelle que soit la composition de leur ressource (figure 5).

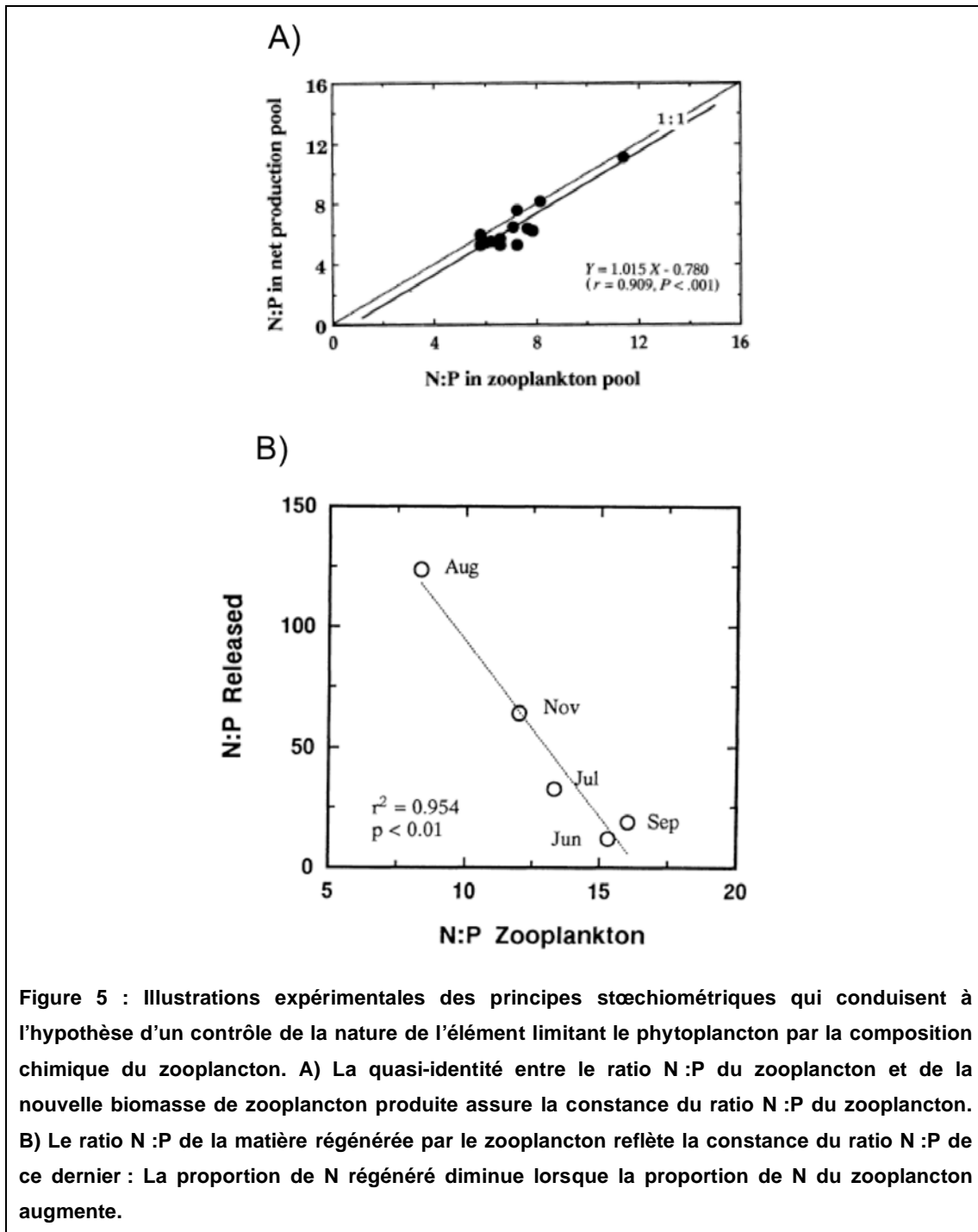

Tous ces éléments s'imbriquèrent pour donner alors la première description stœchiométrique d'une interaction trophique, celle du phytoplancton et du zooplancton : « Des espèces herbivores avec un fort ratio N/P dans leurs tissus devraient régénérer les nutriments dans un ratio N/P relativement faible comparé à des espèces herbivores avec de faibles N/P corporels »¹³ (Sterner et al 1992). L'augmentation de la disponibilité pour le phytoplancton de l'élément en excès pousse ceux-ci vers une limitation par le même élément qui limite la croissance des herbivores (N pour les herbivores avec un fort ratio N :P et P pour ceux avec un faible N :P) .

Les principales critiques de cette hypothèse portèrent étrangement sur un point qui n'est pas essentiel au mécanisme de l'hypothèse, mais découle des premiers travaux qui suivront sa formulation (Hessen 1992, Urabe et Watanabe 1992). La possibilité d'une limitation directe de la croissance du zooplancton par un élément minéral que ce soit N ou P suscita de nombreuses oppositions qui penchèrent plutôt pour une limitation par des substances biochimiques telles qu'acides aminés ou acides gras, dont la concentration dans le phytoplancton serait corrélée à celle de l'élément le limitant (Brett 1993, Müller-Navarra 1995). De nombreuses recherches se sont alors appliquées à tester et à prouver les effets négatifs d'un phytoplancton carencé en azote ou en phosphore sur la croissance du zooplancton (Sterner et al 1993, Anderson and Hessen 1995, Urabe et al 1997, Urabe et Sterner 2001).

La régénération de l'azote et du phosphore par le zooplancton en fonction de sa composition chimique et de celle de sa ressource fut un autre volet de l'hypothèse qui fut largement confirmé (Sterner et Smith 1993, Urabe 1993, Carillo et al 1996, Balseiro et al 1997, Elser et Urabe 1999). Par contre, l'effet en retour de cette régénération sur la limitation du phytoplancton fut, si ce n'est moins étudiée, peu souvent mise en évidence. Bien que certaines études montrèrent effectivement, un fort effet des herbivores et de leur composition chimique (Carpenter et al 1993, Rothhaupt 1997, MacKay et Elser 1998), d'autres résultats laissaient penser que l'effet de l'herbivorie sur la limitation du phytoplancton ne suit pas toujours le même schéma (Møgenburg et Vanni 1991, Urabe 1993). Daufresne et Loreau (2001b) apportèrent

¹³ Herbivore species with a high ratio of N:P in their tissues should resupply nutrients at a relatively low N:P ratio compared to herbivore species with low body N:P

une réponse à ce problème, en démontrant théoriquement que l'effet des herbivores sur la limitation des plantes dépend non seulement de leur composition chimique, mais aussi de la réponse des plantes à l'herbivorie. En effet, la diminution de biomasse des plantes qui résulte de l'herbivorie résulte en une augmentation de la disponibilité en élément par unité de biomasse et en une augmentation des besoins des plantes en éléments pour pallier les pertes subies. La nature de l'élément limitant promu par les herbivores est déterminée par la résultante de ces différents effets.

⇒ En milieu aquatique, les travaux de Redfield (1958) montrant une concordance troublante entre les proportions de carbone, d'azote et de phosphore dans la biomasse du phytoplancton et les nutriments dissous dans les océans, enclenchèrent une suite féconde d'hypothèses, de controverses et de travaux qui mena, en passant par l'étude de la compétition pour les ressources, à la formulation de la première théorie explicitement stœchiométrique. Cette hypothèse avance que la différence de composition chimique entre le phytoplancton et le zooplancton amène ceux-ci à modifier la disponibilité des nutriments pour le phytoplancton et à contrôler ainsi l'identité du nutriment limitant la croissance de ces derniers.

Une autre orientation donnée aux recherches en stœchiométrie écologique fut de tenter d'élargir son champ d'intérêt hors de la sphère de la limnologie et des relations d'herbivorie. Plusieurs travaux se sont donc tournés vers d'autres milieux : marins (Elser et Hassett 1994), arctiques (Dobberfuhl et Elser 2000), terrestres (Elser et al 2000), benthiques (Frost et al 2002), désertiques (Schade et al 2003) ou même paléontologiques (Elser et al 2006), d'autres organismes et interactions trophiques : bactéries (Chrzanowski et Kyle 1996, Makino et al 2003), protistes (Nakano 1994), vertébrés (Vanni et al 2002), insectes (Woods et al 2002, Watts et al 2006), voir même à d'autres niveaux d'organisations du vivant : molécules (Elser et al 2006), génomes (Bragg et Hyder 2004, Weider et al 2005). Cette extension de l'application du cadre stœchiométrique a permis l'émergence d'hypothèses, de processus et de questions fondamentales, dont une partie est bien résumée dans le livre « *Ecological Stoichiometry : The biology of elements from molecules to the biosphere* » publié en

2002 par Sterner et Elser, synthèse de tous les travaux et théories développées jusque-là.

Cependant, les travaux à l'échelle de l'écosystème furent moins nombreux. Peu tentèrent ou purent utiliser les progrès réalisés par l'étude stœchiométrique des interactions d'herbivorie et de décomposition pour comprendre et prédire des processus à une échelle plus large (Sterner et al 1997, Hall et al 2006).

⇒ Bien qu'elle eût pu apparaître bien plus tôt, la stœchiométrie écologique comme théorie n'a été formulée que récemment. Elle repose cependant sur des études précédentes qui furent, sans l'exprimer ouvertement, stœchiométriques. Ces études, principalement en milieu aquatique, ont énormément orienté les premières questions abordées par la stœchiométrie écologique qui cherche maintenant à élargir son champ d'exploration à d'autres organismes, écosystèmes et niveaux biologiques, au détriment peut-être d'une tentative de synthèse des premiers processus déjà bien étudiés.

1.3 Objectif de la thèse.

La production primaire est le processus majeur dans la plupart des écosystèmes : c'est le lieu de création de la matière organique qui est ensuite, soit distribuée entre les membres du réseau trophique, soit minéralisée, soit stockée dans un compartiment non vivant de l'écosystème, soit exportée vers d'autres écosystèmes (Cebrián 1999).

Toujours d'après Cebrián (1999), la décomposition et l'herbivorie sont les deux principales destinées de cette production primaire. Ce sont par ailleurs les deux processus qui déterminent l'importance des flux de matière et d'énergie en direction des autres membres du réseau trophique (carnivores, bactérivores...).

Or, comme je l'ai décrit dans ma présentation de la stœchiométrie écologique, les deux interactions trophiques les mieux étudiées du point de vue stœchiométrique sont celles entre les plantes et les décomposeurs et entre les plantes et les herbivores. Ces deux interactions ont mobilisé la plupart des efforts de recherche, aussi bien expérimentaux que théoriques. La concentration des efforts de la stœchiométrie écologique sur ces deux processus n'a rien à voir avec le hasard, car c'est entre les producteurs primaires et leurs consommateurs (herbivores et décomposeurs) que se trouve la plus grande différence entre la composition chimique du consommateur et de sa ressource.

En effet, la composition chimique en C, N et P est probablement assez semblable entre les différents organismes métazoaires, qu'ils soient herbivores, omnivores ou carnivores. La composition des décomposeurs microbiens (bactéries et champignons) n'est probablement pas très différente de celle de leurs consommateurs bactérivores et fongivores, bien que cela reste à prouver. Par contre, la différence de composition entre les organismes autotrophes et leurs consommateurs est un phénomène avéré et peut atteindre des valeurs très grandes. Il n'est pas rare de voir jusqu'à dix fois plus de phosphore ou d'azote chez les herbivores que chez les plantes dont la croissance est limitée par ces éléments. Pour les décomposeurs, la différence de composition est souvent encore plus marquée, la litière étant souvent appauvrie en éléments par rapport aux plantes dont elle provient. Il n'est donc pas étonnant que la stœchiométrie soit décisive pour ces deux interactions, au point peut être de déterminer le pourcentage de production primaire consommée par les herbivores ou les décomposeurs (Cebrián 1999, figure 6).

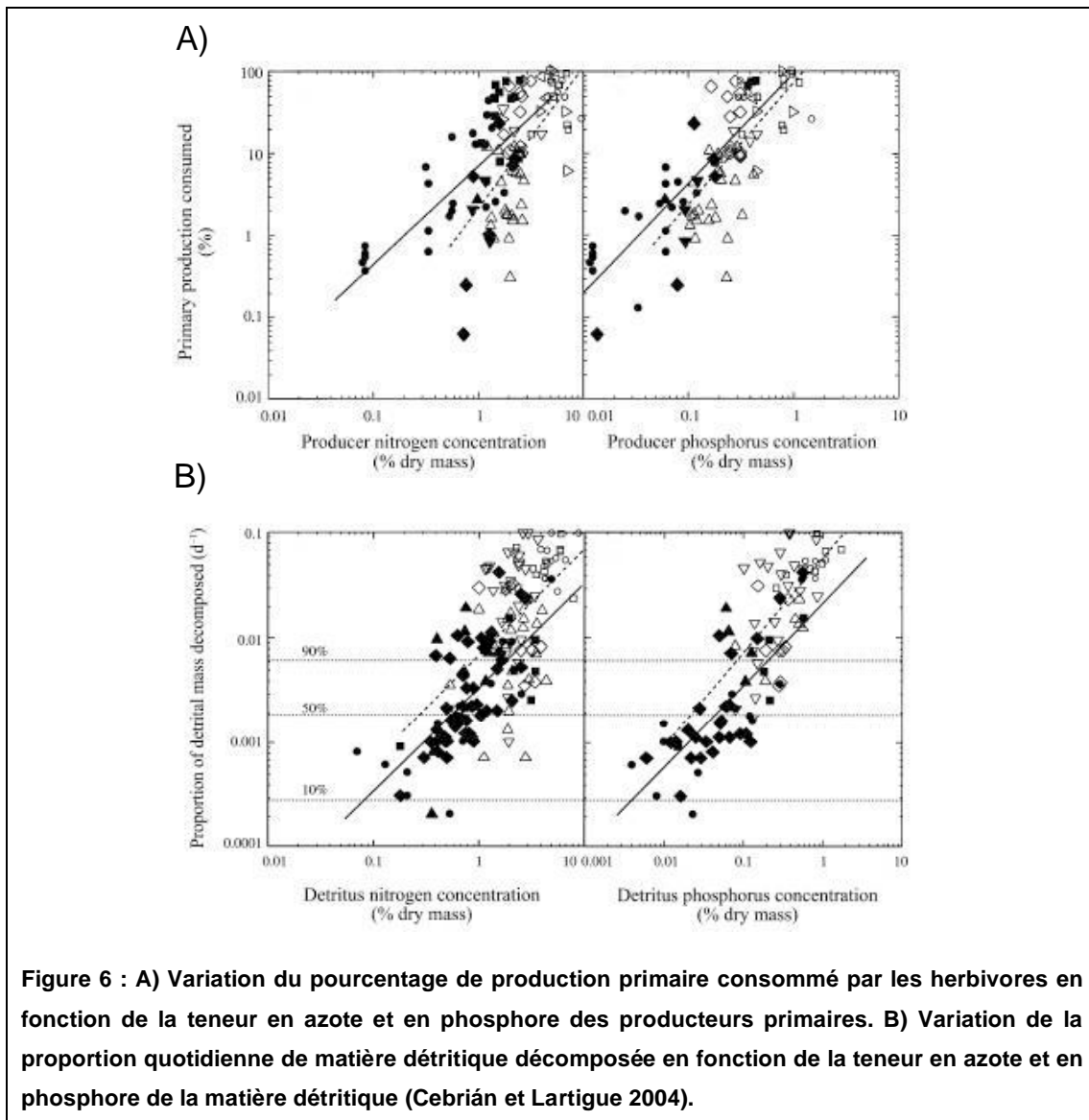

Il nous paraît donc qu'un modèle stœchiométrique réunissant ces deux interactions trophiques serait une bonne base pour avoir une vue, sûrement pas intégrale, mais, tout au moins, beaucoup plus complète du rôle de la stœchiométrie dans le fonctionnement de l'écosystème.

La stœchiométrie dans l'interaction entre plante et herbivore résulte pour les herbivores en une possible limitation de leur croissance par le contenu en un élément minéral plutôt que par la quantité de plantes présente. En retour, elle leur donne un certain contrôle sur la limitation des plantes par leur recyclage différentiel des éléments. Pour ce qui est de l'interaction entre plantes et décomposeurs, la stœchiométrie détermine si cette relation est plutôt de nature mutualiste ou compétitive, car elle contrôle la minéralisation ou l'immobilisation par les décomposeurs des éléments minéraux qui limitent la croissance des plantes.

Une question évidente et que j'ai cherché à résoudre dans cette thèse est alors de comprendre l'effet de chaque consommateur sur l'interaction entre le deuxième consommateur et le producteur primaire, c'est-à-dire de comprendre l'effet des herbivores sur l'interaction entre plantes et décomposeurs et inversement, de comprendre l'effet des décomposeurs sur l'interaction entre plantes et herbivores.

Une voie de passage évidente pour l'effet d'un consommateur sur l'autre se situe bien sûr au niveau des producteurs primaires. En effet, l'influence de chaque consommateur sur les producteurs primaires ne peut que se répercuter sur l'interaction des producteurs primaires avec l'autre consommateur. Cependant, si l'interaction entre les deux consommateurs ne se faisait que par l'intermédiaire des producteurs primaires, l'étude en serait facilitée. Un effet de l'un sur les plantes se répercuterait sur l'autre et l'effet des deux consommateurs sur les producteurs primaires ne serait que la conjugaison de chacun des effets.

Cependant, il existe de multiples possibilités pour une interaction entre les deux consommateurs, qui ne passe pas par les producteurs primaires. Dans beaucoup d'écosystèmes en effet, il arrive que les herbivores consomment des décomposeurs, souvent parce qu'ils sont mêlés de façon difficilement dissociable aux producteurs primaires. Cette consommation représente un lien direct entre les deux consommateurs. Aussi, les herbivores recyclent la matière non assimilée provenant de leur nourriture, sous forme minérale ou organique. Cette matière recyclée est souvent disponible pour les décomposeurs, ce qui représente donc un lien presque direct entre décomposeurs et herbivores, qui ne passe pas par l'intermédiaire des producteurs primaires. J'ai fait le pari dans ce travail de considérer que ces interactions entre décomposeurs et herbivores ne passant pas par les producteurs primaires étaient importantes aussi pour déterminer la résultante des deux processus d'herbivorie et de décomposition.

La matière minérale recyclée par les herbivores ne peut prendre que peu de formes différentes, peu influencée par les propriétés stœchiométriques des herbivores (ammonium pour l'azote, éventuellement transformée en nitrate, et phosphate pour le phosphore). La matière organique, elle, peut varier dans sa composition chimique ou sa susceptibilité à être décomposée. La réponse des décomposeurs à des ressources organiques ayant des propriétés différentes m'a donc semblé un des points clés permettant de prédire l'effet des herbivores sur les décomposeurs et leur effet sur les plantes par ricochet.

C'est pourquoi la première partie de cette thèse s'attarde à étudier la réponse des décomposeurs confrontés à des ressources qui diffèrent dans leur nature (minérale ou organique) et leurs propriétés (composition chimique, dégradabilité).

Les connaissances ainsi acquises sont utilisées pour construire des modèles réunissant plantes, herbivores et décomposeurs, se concentrant soit sur l'effet des herbivores sur l'interaction plantes-décomposeurs, soit sur l'effet des décomposeurs sur l'interaction plantes-herbivores.

⇒ Les processus d'herbivorie et de décomposition sont souvent les plus importants en quantité dans un écosystème. Ce sont aussi les plus étudiés par l'écologie stœchiométrique, car ce sont ceux où les différences de composition chimique entre la ressource et le consommateur sont les plus grandes. Jusque-là, ils ont généralement été abordés séparément. Mon travail a donc pour but d'étudier ces deux processus simultanément afin d'atteindre une vision plus globale du rôle de la composition chimique des organismes dans le fonctionnement des écosystèmes.

1.4 Organisation de la thèse.

La thèse s'articule en quatre chapitres :

Dans un premier chapitre de ma thèse, j'ai utilisé la théorie de la compétition pour les ressources, développée par Tilman, pour comprendre comment les contraintes stœchiométriques peuvent influencer l'utilisation par les décomposeurs microbiens de deux ressources, l'une organique et l'autre inorganique, contenant le même élément essentiel.

Le deuxième chapitre de la thèse est un compte-rendu d'une expérience en laboratoire qui avait pour but de tester certaines des hypothèses et résultats du précédent modèle, ainsi que de montrer que la minéralisation de l'azote par les bactéries dépend autant de la composition moléculaire de la ressource organique et de sa dégradabilité que de son ratio C/N.

J'ai utilisé les résultats des premiers chapitres comme base, dans le troisième chapitre, pour étudier l'interaction entre décomposeurs et producteurs primaires et comment la présence d'herbivores peut modifier cette interaction. J'ai donc construit

un modèle explicitement stœchiométrique à trois niveaux trophiques: autotrophes, décomposeurs et herbivores. Étant donné que les effets des herbivores sur les plantes et les décomposeurs sont multiples et parfois contraires, j'ai dû concevoir une approche originale qui permette de séparer les différents effets des herbivores liés à la régulation de leur nutrition et de leur stœchiométrie.

Enfin, le dernier chapitre de ma thèse est aussi un modèle d'herbivores, de plantes et de décomposeurs, mais il se concentre cette fois-ci sur l'hypothèse que les décomposeurs microbiens pourraient interférer avec le changement que les herbivores apportent à la limitation des plantes.

2 Résultats.

2.1 Chapitre 1 : utilisation simultanée d'une ressource organique et d'une ressource inorganique par les décomposeurs.

L'annexe 1 présente de façon détaillée l'étude de ce modèle sous la forme d'un manuscrit qui a été accepté pour publication :

Cherif, M. and M. Loreau. In press. Stoichiometric constraints on resource use, competitive interactions and elemental cycling in microbial decomposers. *The American Naturalist*.

Comme expliqué auparavant, les microorganismes décomposeurs comme les champignons et les bactéries immobilisent ou minéralisent les éléments inorganiques en fonction de la différence entre leur composition chimique et celle de leur ressource organique. Ce fait a des conséquences considérables sur leurs interactions avec les autres consommateurs des éléments inorganiques, que ce soit les producteurs primaires ou les autres espèces de décomposeurs. J'ai donc développé un modèle qui considère la croissance de microorganismes décomposeurs utilisant deux éléments différents, le carbone (C) et un autre élément que j'ai noté E. L'élément E pourrait être n'importe quel élément essentiel à la croissance, qui s'associe au carbone dans des molécules organiques et qui peut potentiellement limiter la croissance des décomposeurs, tel le phosphore, l'azote ou le fer. Ces deux éléments sont contenus dans deux ressources : une première ressource est minérale et contient seulement de l'élément E. La seconde ressource est organique et contient à la fois du C et du E. Le modèle que j'ai développé est basé sur la théorie de la compétition pour les ressources élaborée par MacArthur et Levins (1964), reprise par Léon et Tumpson (1975) et développée pour les plantes par Tilman (1980). Par rapport à la plupart des autres modèles utilisant cette théorie, mon modèle prend explicitement en compte la composition chimique de la ressource et des décomposeurs et leur impose un ratio C/E constant, en ligne avec le principe d'homéostasie de la composition chimique présent dans la théorie de la stœchiométrie écologique. Il s'agit donc d'une approche combinant la stœchiométrie écologique et la compétition pour les ressources.

En accord avec la théorie de la compétition pour les ressources, j'ai défini quelques paramètres qui m'ont permis de résoudre et d'analyser les propriétés du modèle à l'équilibre. Dans un milieu initialement riche en ressource, une population

en croissance consomme la ressource qui limite sa croissance jusqu'à la réduire à une quantité qui lui suffit juste à compenser les pertes qu'elle subit. Cette quantité appelée R^* par Tilman (1980) est donc à la fois la quantité à l'équilibre de cette ressource lorsqu'elle est limitante et le minimum requis par les décomposeurs pour assurer le renouvellement de leur biomasse. C'est aussi une mesure de la capacité compétitive des décomposeurs, puisque l'espèce avec le plus petit R^* sera capable de persister avec des quantités de ressources insuffisantes à assurer le minimum requis par les autres espèces avec un R^* plus grand (Tilman 1980).

Graphiquement, les R^* de la ressource organique et inorganique du modèle permettent de tracer dans le plan formé par ces deux ressources l'isocline de croissance nulle (ICN), qui n'est autre que l'ensemble des points combinant les quantités des deux ressources qui résultent en une croissance nulle des décomposeurs (figure 7). Pour trouver l'équilibre, il reste alors à reporter sur la figure le point d'apport, qui combine les apports extérieurs des deux ressources dans le milieu, et le vecteur de consommation, qui représente les quantités relatives des deux ressources que consomment les décomposeurs. Le point d'équilibre se trouve à l'intersection de l'ICN et de la droite passant par le point d'apport et le vecteur de consommation (figure 7).

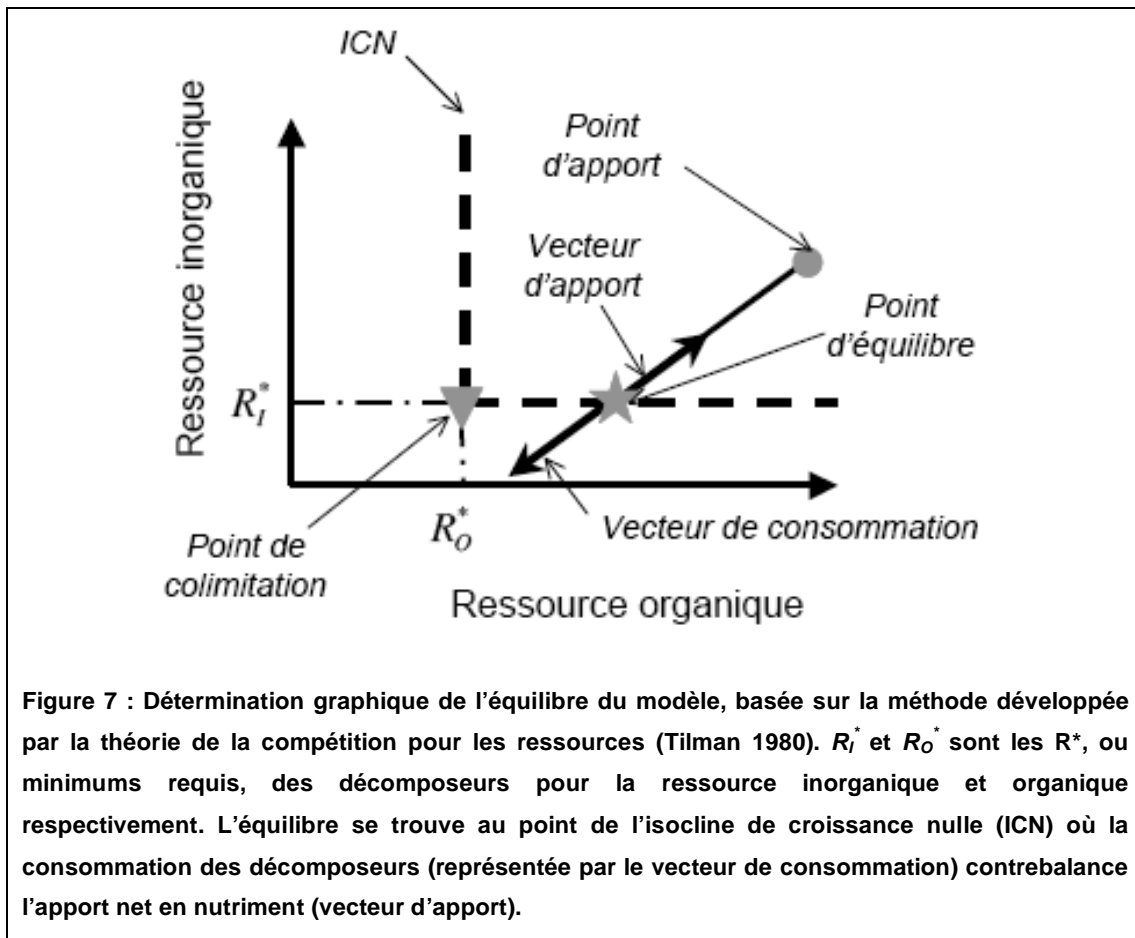

Les positions relatives du point d'apport et de l'ICN déterminent ensuite si l'équilibre est faisable ou pas, les décomposeurs allant vers l'extinction dans ce dernier cas, s'il y a minéralisation ou immobilisation et si la croissance est limitée par l'élément C ou E.

La suite de l'analyse a consisté à étudier la variation des différents paramètres (R^* , ICN, vecteur de consommation) en fonction des demandes relatives des décomposeurs en C et E. La demande représente la quantité de ressources qui est consommée pour assurer la croissance des décomposeurs plus les fonctions métaboliques telle la respiration. J'ai montré que la position de l'ICN dans le plan des ressources dépend du ratio C/E de la demande des décomposeurs : plus le C/E augmente, plus le R^* de la ressource organique augmente et le R^* de la ressource inorganique diminue et plus l'ICN se décale vers le bas et la droite du plan (figure 8).

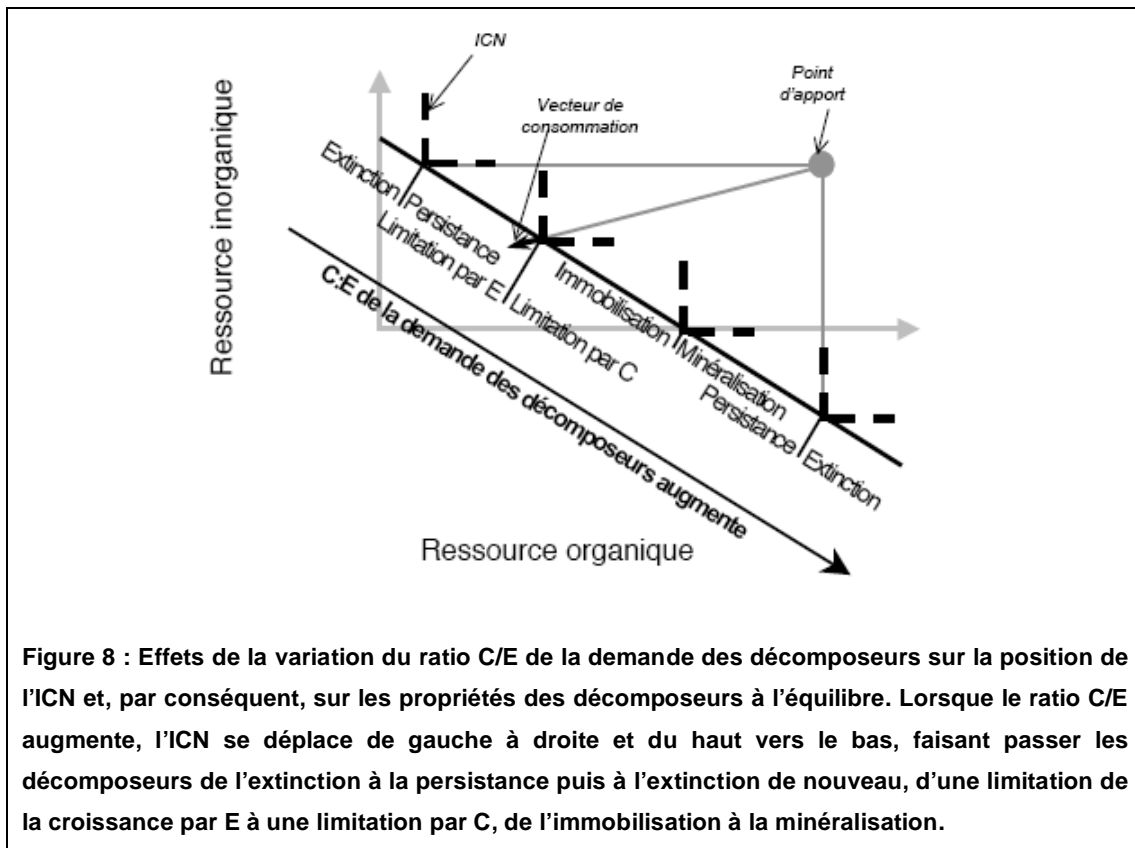

Le ratio C/E de la demande détermine donc les propriétés de l'équilibre du modèle : persistance ou extinction, limitation par C ou E, minéralisation ou immobilisation.

Plusieurs conclusions et prédictions intéressantes découlent de ces résultats :

Il existe un compromis, ou trade-off, entre les R^* des ressources organiques et inorganiques, généré par l'homéostasie de la stœchiométrie des décomposeurs. Les décomposeurs ne peuvent en effet présenter des R^* pour les deux ressources qui soient tous les deux petits ou tous les deux grands.

L'existence de ce compromis favorise la coexistence de décomposeurs possédant des ratios C/E différents à condition qu'ils soient limités par des éléments différents à l'équilibre.

Pour des durées de temps suffisamment longues par contre, la contrainte stœchiométrique conduit, par adaptation ou remplacement d'espèces, à la convergence des ratios C/E des décomposeurs vers la valeur assurant la colimitation par la ressource organique et inorganique.

⇒ L'étude de ce modèle nous a donc permis de mettre en évidence l'importance de la composition chimique des décomposeurs et de leur ressource organique, ainsi que de l'apport extérieur en ressources, sur les capacités compétitives des décomposeurs et sur leur utilisation de la ressource inorganique (minéralisation ou immobilisation). Les producteurs primaires étant pour les décomposeurs à la fois leur source de ressources organiques, leurs compétiteurs potentiels s'il y a immobilisation et leurs bénéficiaires s'il y a minéralisation, les résultats de ce modèle ne peuvent être qu'essentiels pour expliquer l'interaction entre ces deux niveaux trophiques.

2.2 Chapitre 2 : Effets de la composition chimique des ressources organiques sur l'utilisation simultanée de substrats organiques et inorganiques par les bactéries.

L'annexe 2 présente de façon détaillée les résultats de cette expérience sous la forme d'un manuscrit qui sera soumis à publication :

Cherif, M., J. B. Cotner and M. Loreau. Draft manuscript. Elemental and molecular compositions of organic substrates control nitrogen cycling by bacteria.

À l'heure de la soumission de ce rapport de thèse, une partie des données de l'expérience, issues d'analyses sous-traitées par un laboratoire de l'université du Nebraska, n'étaient pas à ma disposition. Ce chapitre, ainsi que l'annexe 2, ne présente donc que des résultats préliminaires qui seront étendus et révisés ultérieurement à l'arrivée des données manquantes.

Le couplage entre le ratio C/N de la matière organique et la régénération d'ammonium par les microorganismes décomposeurs est une constatation ancienne qui est à la base de beaucoup d'études sur la décomposition (Waksman 1917). L'explication généralement évoquée à ce phénomène repose sur l'idée que les décomposeurs, pour maintenir constante la proportion d'azote et de carbone dans leur biomasse, rejettent l'azote en excès sous forme d'ammonium lorsque le C/N de leur substrat est inférieur à leur propre C/N et prennent l'azote minéral du milieu lorsque le C/N du substrat est supérieur à leur propre C/N. Ce modèle conceptuel de couplage entre le ratio C/N de la matière organique et la régénération d'ammonium est à la base de nombreux modèles et travaux sur l'utilisation couplée de l'azote et du carbone par les bactéries (Parnas 1975, Lancelot et Billen 1985, Goldman et Dennett 1991, Daufresne et Loreau 2001a). Il a été résumé de la façon la plus simple possible par Goldman et al (1987) sous la forme d'une équation :

$$E_N = C_T [1/(C:N)_s - GGE_C / (C:N)_b]$$

où E_N est le taux de régénération de l'azote minéral (qui peut être positif ou négatif, signalant une minéralisation ou une immobilisation), C_T est le taux d'absorption du carbone, $(C:N)_s$ est le ratio C/N du substrat organique, GGE_C est le rendement de croissance brut des décomposeurs (quantité de carbone produite par la quantité de carbone absorbée) et $(C:N)_b$ est le ratio C/N des décomposeurs.

Cependant d'autres mécanismes pourraient expliquer en partie ou en totalité cette relation entre C/N du substrat et régénération de l'ammonium.

L'augmentation du C/N est souvent obtenue expérimentalement par l'ajout de substrats riches en carbone mais qui sont aussi facilement dégradables, tel le glucose. Or, ces substrats pourraient être utilisés comme source d'énergie de préférence aux acides aminés et protéines, empêchant l'oxydation catabolique de ces derniers et donc l'excrétion d'ammonium. De plus, ces substrats pourraient sélectionner des souches microbiennes dont les taux d'excrétions de l'azote sont plus faibles, diminuant ainsi de fait le taux d'excrétion de l'ammonium (Waksman 1917).

En milieu naturel, le ratio C/N de la matière organique est souvent corrélé positivement avec sa teneur en composés secondaires peu dégradables, telle la lignine, qui pourraient inhiber la décomposition et la minéralisation de l'azote (Murphy et al 2002).

La plupart des modèles théoriques de décomposition ont ignoré ces mécanismes potentiels. De même, la plupart des protocoles expérimentaux ce modèle conceptuel ne permettaient pas de séparer les facteurs confondants possibles que sont l'hétérogénéité des ressources organiques utilisées pour faire varier le C/N total du substrat, et le remplacement d'espèces. La plupart ont en effet utilisé des assemblages de différentes souches et ajouté des substrats très labiles (généralement du glucose) pour obtenir des substrats avec de forts ratios C/N (Goldman et Dennett 2000) en contradiction avec la relation observée entre ratio C/N et teneur en composés secondaires de la matière organique.

L'expérience que j'ai réalisée a pur but de séparer ces différents effets, et par contre coup, de mettre en évidence l'effet de l'hétérogénéité chimique de la ressource organique sur la régénération d'ammonium (figure 9).

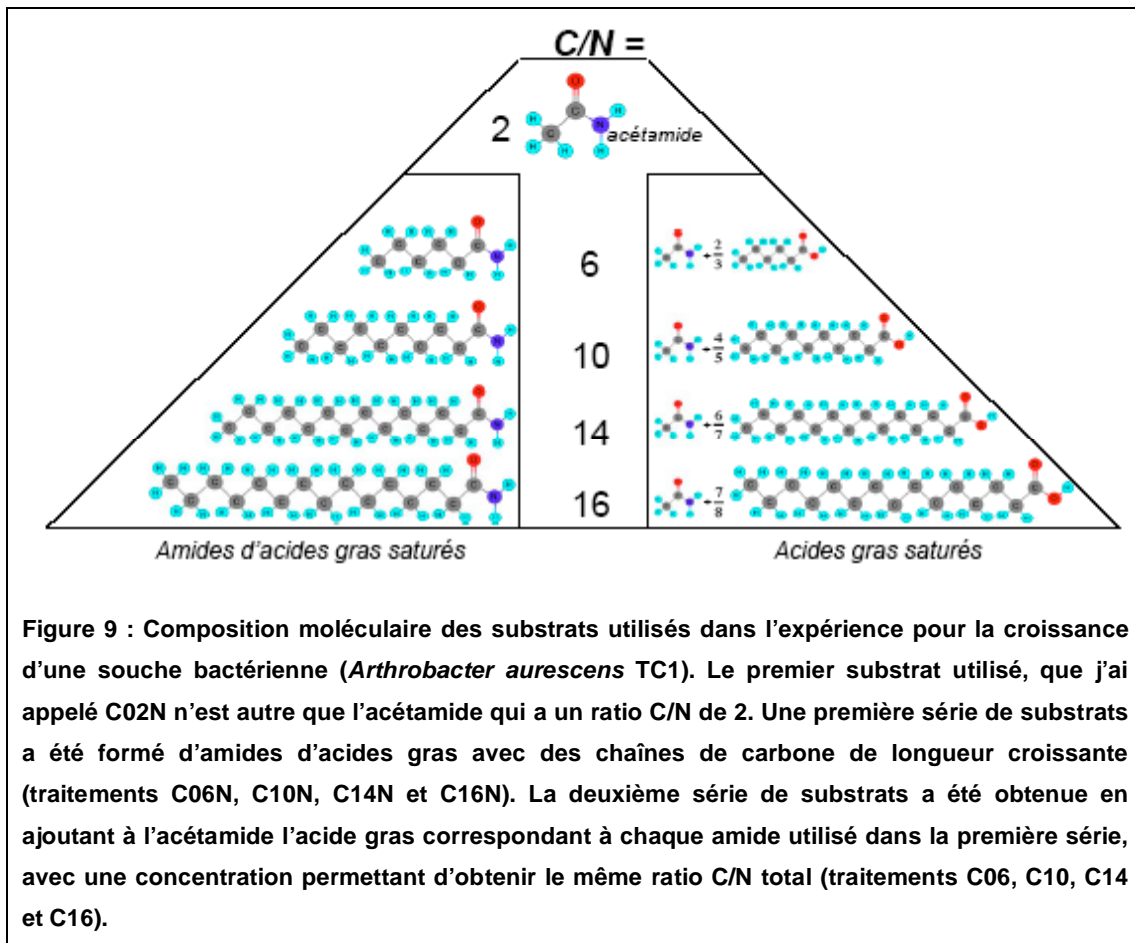

J'ai donc cultivé une souche unique bactérienne en présence de substrats organiques avec des ratios C/N différents. Pour changer le ratio C/N du substrat, j'ai utilisé deux méthodes différentes. Dans une première série de cultures, j'ai utilisé une famille de molécules aux propriétés proches, mais aux ratios C/N différents, ce qui m'a permis de faire varier le ratio C/N sans introduire d'hétérogénéité chimique dans le substrat organique, toute variation dans le taux de régénération ne pouvant alors qu'être le résultat direct du ratio C/N du substrat.

Dans la deuxième série de cultures, j'ai modifié le ratio C/N du substrat organique en rajoutant au substrat avec le C/N le plus faible des molécules organiques ne contenant que du carbone, introduisant ainsi de fait une hétérogénéité dans la composition moléculaire du substrat organique.

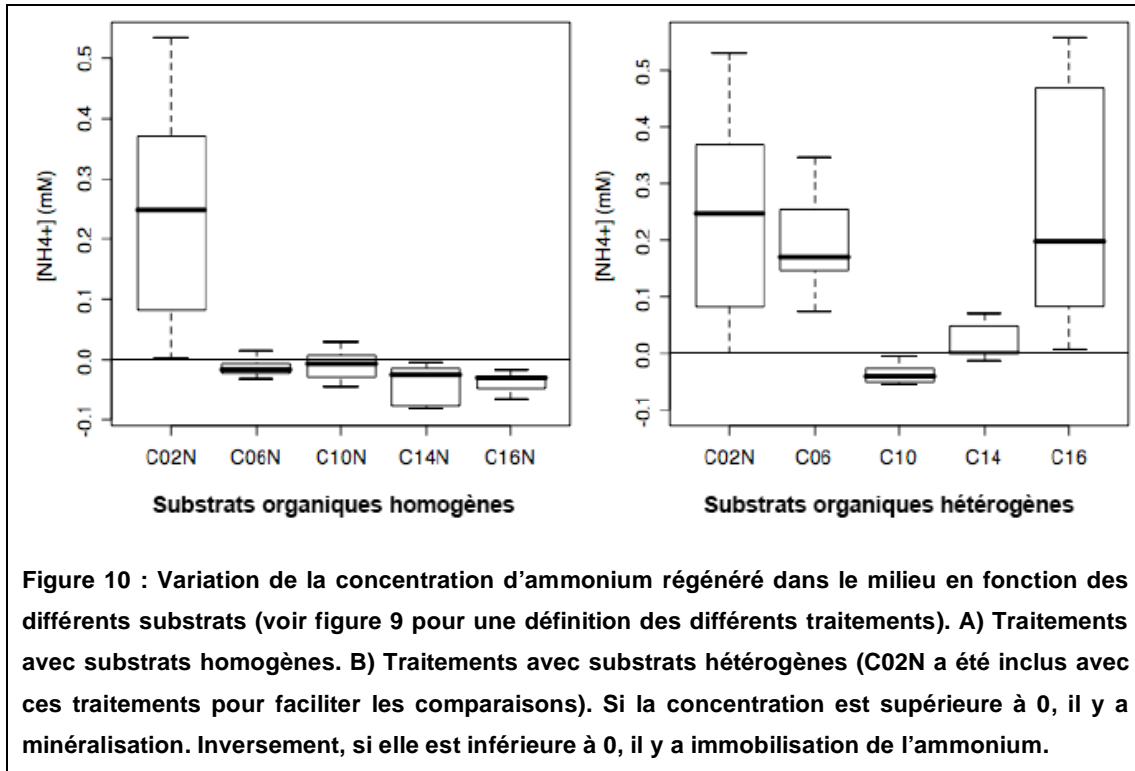

La comparaison entre les régénérations d'ammonium des substrats homogènes (figure 10), confirme largement le modèle conceptuel de couplage entre le ratio C/N de la ressource organique et la régénération d'ammonium. Il y a en effet passage de la minéralisation vers l'immobilisation lorsque que le ratio C/N augmente : les bactéries minéralisent l'azote dans le traitement C02N, ne régénèrent ni ne consomment d'ammonium pour C06N et C10N et immobilisent l'azote pour C14N et C16N.

Pour le substrat hétérogène, par contre, la variation de la régénération d'ammonium en fonction des traitements n'est plus fonction du ratio C/N. Il y a minéralisation dans les traitements C06 et C16. L'explication provient probablement du fait que les acides gras utilisés pour augmenter le ratio C/N de la ressource organique dans ces deux traitements sont beaucoup moins dégradables que l'acétamide. Celui-ci a donc été consommé de façon préférentielle par les bactéries, au détriment des acides gras, menant ainsi à la minéralisation de l'azote en excès dans l'acétamide. Dans le traitement C10 par contre, les bactéries immobilisent l'ammonium. On peut supposer que l'acide décanoïque, utilisé dans ce traitement, est plus labile que l'acétamide pour cette souche. L'acide myristique (C14), lui semble être toxique pour cette souche. Il n'y a eu que peu de croissance dans ce traitement et les bactéries n'ont consommé que peu de ressources organiques, malgré la présence d'acétamide.

Les premières analyses de cette expérience permettent de conclure que la régénération d'ammonium peut être prédite grâce au ratio C/N, lorsque le carbone et l'azote sont liés dans une seule molécule. Par contre, elle ne dépend plus de ce ratio lorsque carbone et azote sont partiellement séparés. La préférence, ou l'affinité, des bactéries pour les différentes molécules formant la ressource organique devrait être alors un facteur déterminant de la régénération de l'ammonium. L'analyse des données encore indisponibles permettra peut-être de confirmer numériquement l'importance des différences d'affinités entre molécules dans la régénération d'ammonium et de préciser les propriétés des molécules contrôlant cette affinité.

⇒ Cette expérience a permis de confirmer l'importance du ratio C/N de la ressource organique dans la régénération de l'ammonium par les bactéries. Elle a montré aussi que la composition moléculaire de la ressource organique et l'affinité des souches bactériennes pour les différentes molécules étaient aussi importantes que ce ratio.

2.3 Chapitre 3 : Les différents effets des herbivores dérivant de la régulation de leur stœchiométrie et de leur nutrition.

L'annexe 3 présente de façon détaillée l'étude de ce modèle sous la forme d'un manuscrit en préparation pour publication :

Cherif, M. and M. Loreau. Manuscript in preparation. Disentangling the effects of herbivore nutrition on autotroph-decomposer interactions: a theoretical approach.

J'ai entrepris, dans ce chapitre d'aborder la question de l'effet des herbivores sur l'interaction trophique entre les décomposeurs et les producteurs primaires, ou autotrophes. Pour cela, j'ai développé un modèle explicitement stœchiométrique des cycles du carbone (C) et d'un autre élément E, à travers un écosystème réunissant des herbivores, des décomposeurs et des autotrophes.

Le modèle sur l'utilisation de la ressource organique étudié au premier chapitre montrait l'influence, pour les décomposeurs, de la différence entre le ratio C/E de leur demande en éléments et celui de leur ressource organique sur leur capacité compétitive et leur minéralisation ou immobilisation de la ressource inorganique.

Me basant sur ces résultats, j'ai tout d'abord caractérisé l'interaction entre décomposeurs et autotrophes, ainsi que la variation de cette interaction en fonction du ratio C/E de la ressource organique produite par les autotrophes et consommée par les décomposeurs (figure 11).

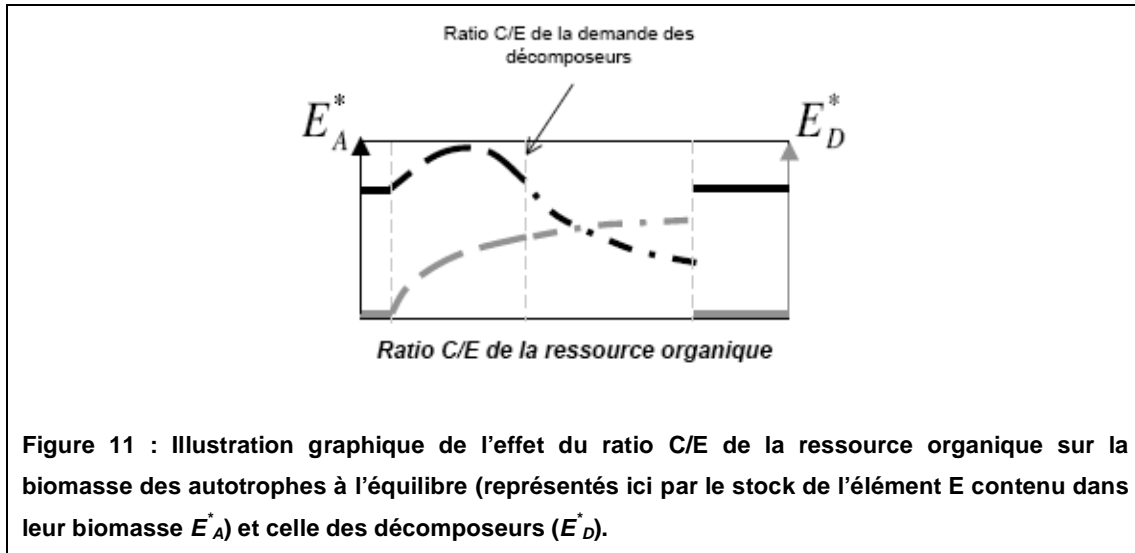

Lorsque le C/E de la ressource organique est extrêmement faible, la quantité absolue de carbone à disposition des décomposeurs est inférieure au minimum requis pour leur persistance et ceux-ci finissent par disparaître du milieu. Au dessus d'une certaine valeur cependant, le C/E de la ressource organique dépasse ce minimum requis et les décomposeurs utilisent le C en surplus pour accumuler de la biomasse, ce qui explique la relation positive entre le ratio C/E de la ressource organique et la biomasse des décomposeurs. La réponse des autotrophes dépend, elle, du ratio C/E de la demande des décomposeurs. Si le ratio C/E de la ressource organique est inférieur au ratio C/E de la demande des décomposeurs, la biomasse à l'équilibre des autotrophes est augmentée par la présence des décomposeurs car ceux-ci minéralisent une partie du E de la ressource organique. Dans le cas inverse, les décomposeurs entrent en compétition avec les autotrophes en immobilisant la ressource inorganique et diminuent la biomasse de ceux-ci à l'équilibre. Enfin, pour des ratios C/E de la ressource organique vraiment forts, les besoins en ressource inorganique des décomposeurs peuvent être tels, que le R^* de ceux-ci devient plus grand que le R^* des autotrophes. Les décomposeurs sont alors compétitivement exclus par ces derniers.

La deuxième partie du travail a alors consisté à étudier les répercussions de l'introduction des herbivores sur l'interaction entre décomposeurs et autotrophes.

J'ai trouvé dans un premier temps que l'herbivorie avait de multiples effets sur cette interaction, qui dépendaient des différentes manières possibles qu'avaient les herbivores de modifier la disponibilité et les propriétés de la ressource organique pour les décomposeurs. J'ai alors entrepris de diviser l'effet global de l'herbivorie en

différents effets dépendant chacun d'un processus nutritionnel spécifique des herbivores.

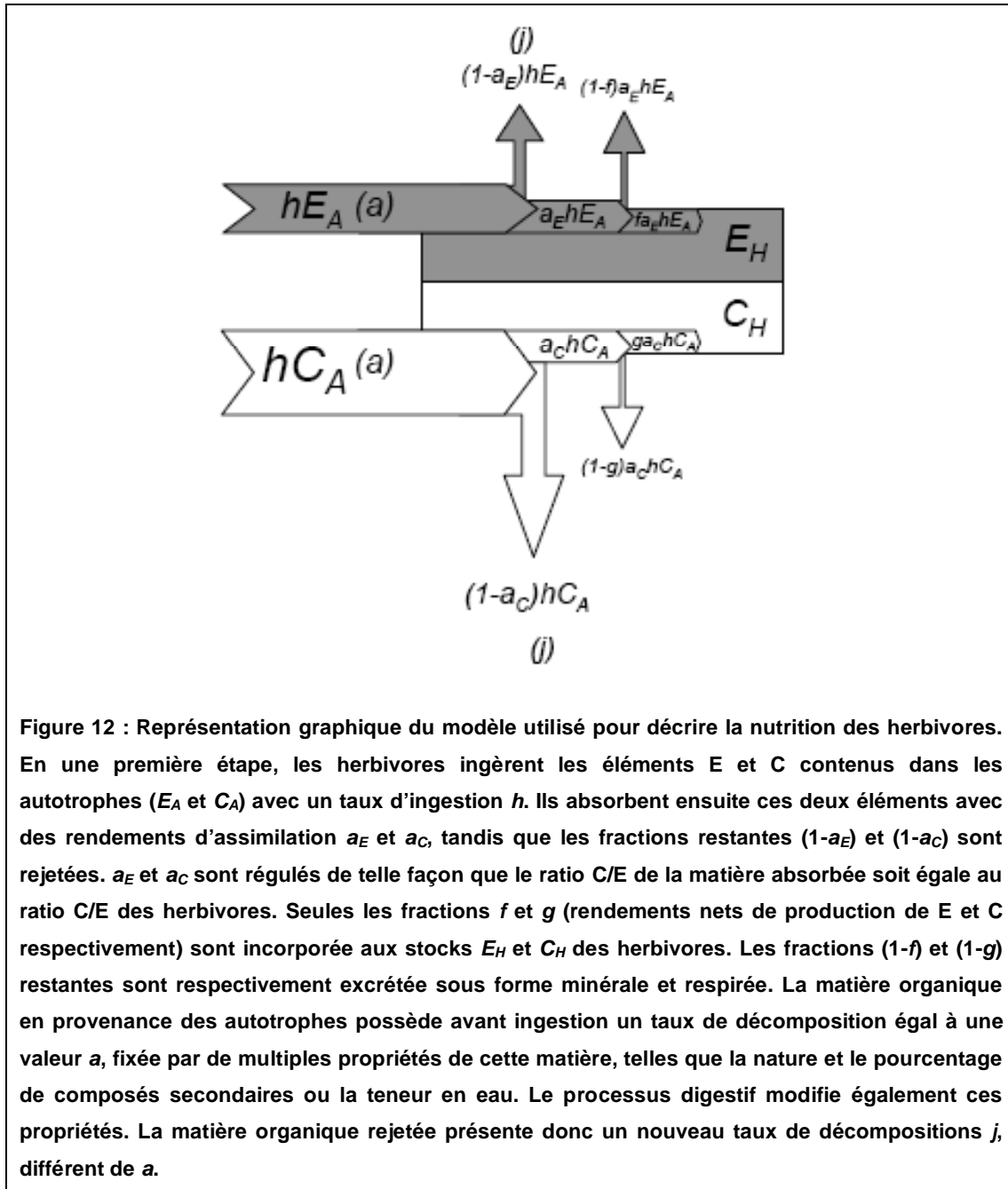

Le premier processus nutritionnel des herbivores est celui de l'ingestion des producteurs primaires (figure 12). Tous les changements dans les autotrophes, les décomposeurs et leur interaction découlant de ce processus sont regroupés sous le nom d'effet de l'ingestion. Il consiste principalement en une diminution de la

production primaire et donc de la disponibilité en ressource organique pour les décomposeurs. Cet effet est associé au taux d'ingestion h . Il suffit en effet de fixer ce taux à zéro pour faire disparaître ce processus et l'effet associé.

Le deuxième processus est le rejet d'une partie de la matière organique ingérée ou défécation. L'effet associé dépend des rendements d'assimilation a_E et a_C . Il disparaît en effet lorsque ces rendements sont fixés arbitrairement à 1. Cet effet se résume à la mise à disposition des décomposeurs d'une source supplémentaire de ressource organique, augmentant ainsi sa disponibilité globale.

Le troisième processus est celui de la régulation de la composition de la matière organique absorbée par les herbivores pour la rendre égale à la leur. Il est associé au ratio C/E de la demande des herbivores puisque l'effet associé peut être éliminé en forçant arbitrairement ce ratio C/E à être égal au ratio C/E des autotrophes. Ce processus modifie à la fois le ratio C/E de la matière organique rejetée par les herbivores et mise à disposition des décomposeurs, mais aussi la quantité absolue de carbone dans cette ressource.

Le quatrième processus, toujours associé à la matière organique déféquée, est le changement de dégradabilité que connaît la matière provenant des autotrophes lors de son passage dans le système digestif. Cet effet de la digestion est associé au taux de décomposition de la matière déféquée j . Cet effet disparaît en effet lorsque ce taux j est égal au taux de décomposition de la matière organique autotrophe non ingérée a . La dégradabilité de la matière fécale étant généralement supérieure à celle de la matière végétale, cet effet consiste principalement en une plus grande disponibilité relative de la matière fécale pour les décomposeurs.

Enfin, le dernier effet est lié à l'excrétion sous forme inorganique du E utilisé par les herbivores pour leur métabolisme. Il dépend de f , le rendement net de production de l'élément E, puisqu'il n'y a excrétion que si f est strictement inférieur à 1. L'excrétion de la ressource qui limite la croissance des autotrophes résulte en une augmentation de la production primaire à l'équilibre et donc de la disponibilité de la ressource organique des décomposeurs.

En me basant sur quelques études comparatives entre écosystèmes (Kimmins 1997, Cebrián 1999) et des hypothèses communément admises j'ai tenté comparer les valeurs des paramètres associés aux cinq différents effets de l'herbivorie dans un ensemble d'écosystèmes classés le long d'un gradient de « terrestrialité », qui correspond vraisemblablement à un gradient d'investissement des autotrophes dans

des structures de soutien aux dépens du renouvellement rapide de leurs tissus (Shurin et al 2006). Cela m'a permis de prédire l'importance comparative de ces différents effets le long de ce gradient (Tableau 1).

Écosystèmes	Pélagique aquatique	Benthique aquatique	Zones humides	Prairies	Forêts	Explications ou références
h (taux d'ingestion)						Kimmins 1997, Cebrián 1999
Effet de l'ingestion						Déduction
a_c (rendement brut d'assimilation de C)						Diminution de la digestibilité des plantes due aux composés secondaires
α (ratio C/E des autotrophes)						Cebrián 1999
η (ratio C/E de la demande des herbivores)	?					Pas assez de données
a (dégradabilité de la matière organique autotrophe)						Augmentation des composés secondaires des plantes
j (dégradabilité de la matière fécale)						Corrélation avec la dégradabilité de la matière organique autotrophe
$j-a$ (changement de dégradabilité)						Temps de passages dans le système digestif plus long dû aux composés secondaires
f (rendement net d'assimilation de E)						Augmentation de la taille moyenne des herbivores
μ (ratio C/E de la ressource organique des décomposeurs)						Cebrián 1999
δ (ratio C/E de la demande des décomposeurs)						Augmentation du pourcentage de champignons, qui ont des demandes avec des ratios C/E plus forts. Kirschbaum et Paul 2002
Effet de l'ingestion						Déduction
Effet de la défécation						Déduction
Effet de maintenance de la stœchiométrie	?					
Effet de la digestion						Déduction
Effet de l'excrétion						Déduction

Tableau 1 : Variation des différents effets liés à la nutrition des herbivores et des paramètres les contrôlant, entre différents écosystèmes ordonnés le long d'un gradient de « terresteité ».

D'après ce tableau, les effets de l'ingestion et de l'excrétion devraient être plus importants dans les milieux aquatiques pélagiques et diminuer au fur et à mesure de l'investissement des autotrophes dans des structures de soutien. Inversement, certains effets liés au recyclage de la matière organique par les herbivores (effets de la défécation et de la digestion) devraient être plus importants dans les milieux

terrestres. Il y a peu d'informations sur la variation des ratios C/E de la demande des herbivores entre écosystèmes, il est donc difficile d'en déduire la variation de l'effet de la maintenance de la stœchiométrie le long du gradient de terrestrialité. Cependant, si l'on fait l'hypothèse, en absence de données contradictoires, que ce ratio reste à peu près le même dans tous les écosystèmes, les herbivores devraient avoir un ratio supérieur, ou très proche, au ratio C/E des autotrophes dans les milieux aquatiques, et inférieur dans les milieux les plus terrestres. Le ratio C/E des autotrophes augmente en effet le long du gradient des écosystèmes. En se basant sur l'analyse que j'ai effectuée de l'effet de la maintenance de la stœchiométrie, on peut en conclure que les herbivores devraient alors avoir un effet positif sur la minéralisation et la biomasse des décomposeurs et des autotrophes dans les milieux aquatiques.

⇒ L'étude de ce modèle stœchiométrique plantes-herbivores-décomposeurs m'a permis de clarifier les différents mécanismes nutritionnels des herbivores pouvant affecter l'interaction entre autotrophes et décomposeurs. De façon générale, les processus liés au recyclage de la matière par les herbivores tendent à contrebalancer l'effet négatif de l'ingestion sur la production de ressource organique par les plantes pour les décomposeurs. Seul le processus de maintenance de la constance de la stœchiométrie des herbivores est plus ambigu, car il modifie à la fois la composition chimique de la ressource organique et la quantité absolue de carbone recyclé. L'effet global de ce processus dépend alors, sans surprise, de la différence entre la composition des autotrophes et celle de la demande des herbivores.

2.4 Chapitre 4 : le rôle des décomposeurs dans l'effet des herbivores sur la limitation des producteurs primaires.

L'annexe 4 présente de façon détaillée l'étude de ce modèle sous la forme d'un manuscrit qui a été soumis pour publication :

Cherif, M. and M. Loreau. Submitted. Microbial interference with the effect of herbivore stoichiometry on plant nutrient limitation. *Ecology Letters*.

Ce dernier chapitre étudie l'impact des décomposeurs sur l'interaction entre les producteurs primaires et les herbivores. J'ai déjà longuement présenté l'hypothèse, largement étayée, de l'effet du recyclage différentiel de l'azote (N) et du phosphore (P) par les herbivores sur l'identité de l'élément limitant la croissance des producteurs primaires ou autotrophes. La question posée est donc plus précisément celle de l'interférence des microorganismes décomposeurs dans ce mécanisme.

Basé sur quelques connaissances à priori, j'ai pu formuler quelques hypothèses sur la forme que pouvait revêtir cette interférence. J'ai testé ensuite la validité de ces hypothèses à l'aide d'un modèle explicitement stœchiométrique.

L'excrétion différentielle ne concerne pas que les seuls éléments potentiellement limitants pour les autotrophes, tel l'azote et le phosphore. Les herbivores doivent en effet aussi se débarrasser du carbone en excès dans leur nourriture. Or, en se basant sur le premier chapitre, on sait que les décomposeurs sont limités par la disponibilité en carbone (C) lorsqu'ils coexistent sur le long terme avec les autotrophes. Le carbone recyclé par les herbivores devrait donc stimuler la croissance des décomposeurs. Ces derniers étant riches en phosphore et très efficaces à l'obtenir devraient alors pousser les autotrophes vers une limitation par le phosphore. Les herbivores peuvent aussi influencer les décomposeurs en consommant une partie. Les décomposeurs sont en effet souvent intimement liés aux autotrophes. Les herbivores consomment alors les deux de façon indiscriminée. Ou bien ces « herbivores » peuvent tout simplement être en réalité des omnivores, même s'il est peu vraisemblable que les décomposeurs représentent une part significative du régime herbivore, l'herbivorie, la bactériovorie et la fongivorie demandant des adaptations différentes. Les décomposeurs étant riche en phosphore, leur ingestion comble une partie des besoins en phosphore des herbivores et peut donc augmenter l'excrétion relative du phosphore.

On voit donc ainsi qu'il y a potentiellement plusieurs façons pour les décomposeurs de moduler l'effet des herbivores sur la limitation des autotrophes.

Pour explorer ces différents mécanismes, j'ai donc modifié le modèle plantes-herbivores de Daufresne et Loreau (2001) pour y inclure les décomposeurs et décrire les échanges de trois éléments, C, N et P, entre ces trois niveaux trophiques.

En utilisant de nouveau le formalisme graphique développé dans la théorie de la compétition pour les ressources (Tilman 1980), j'ai étudié les propriétés du modèle à l'équilibre.

En traçant l'isocline de croissance nulle des autotrophes dans le plan des ressources en phosphore et en azote des autotrophes, puis en déterminant la position de l'équilibre grâce aux vecteurs de consommation et d'apport, on se rend compte que la limitation des autotrophes dépend du ratio N/P de l'impact de la communauté sur les ressources (figure 13).

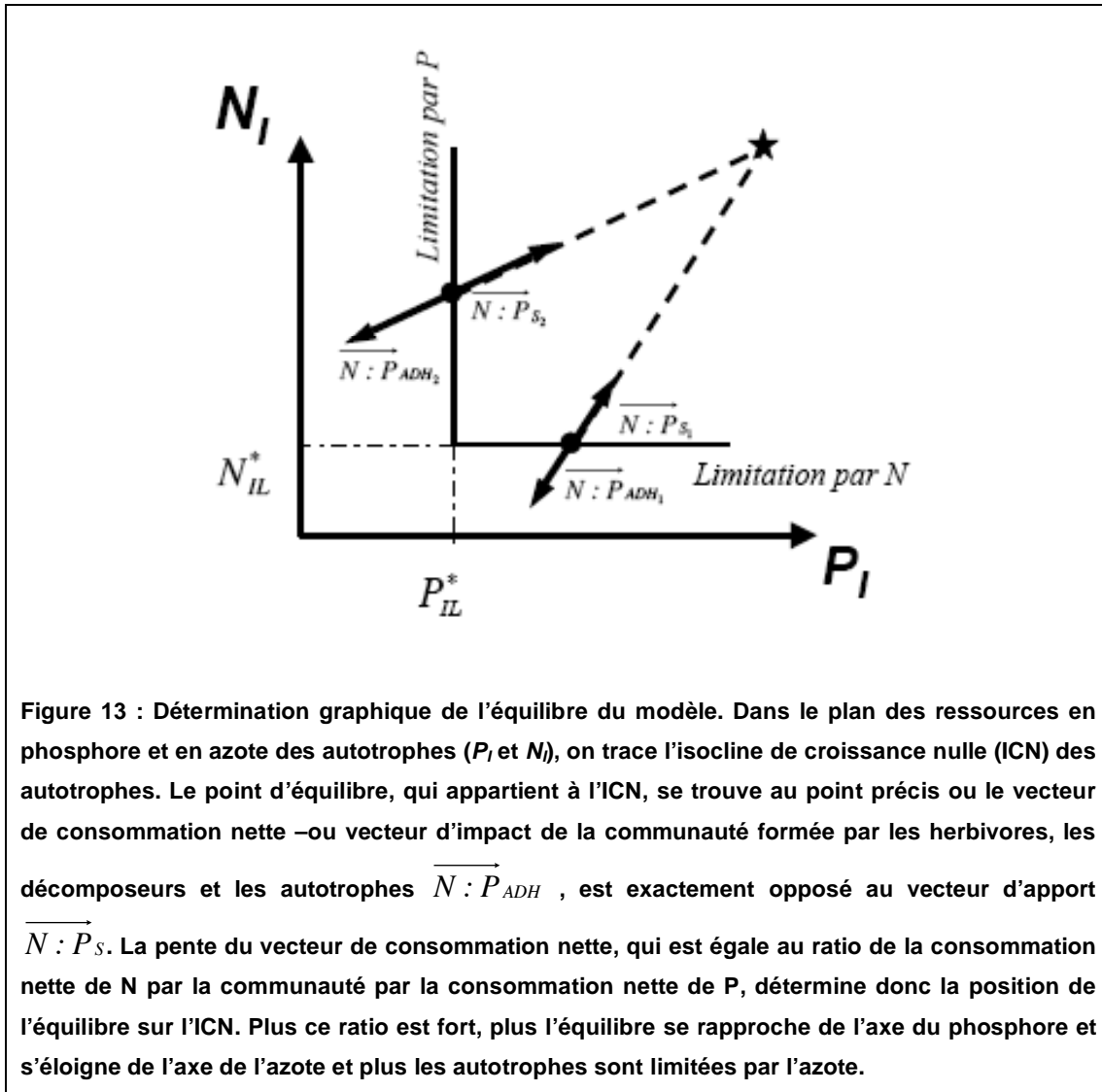

En effet, plus la consommation nette d'azote par la communauté, en proportion de sa consommation nette de phosphore, est grande, plus les autotrophes sont limitées par l'azote, ou plus elles se rapprochent d'une limitation par cet élément si elles restent limitées par le phosphore.

La suite de ce travail a donc consisté à analyser l'effet de l'inclusion des décomposeurs dans une communauté formée au départ uniquement d'autotrophes et d'herbivores sur le ratio N/P de la consommation nette de la communauté (figure 14).

En distinguant les portions de la consommation nette des herbivores qui proviennent respectivement des autotrophes et des décomposeurs, on peut diviser la consommation nette d'éléments de la communauté en deux parties. Une première partie additionne la consommation nette des autotrophes et la consommation nette des herbivores provenant de celles-ci. La deuxième partie est la somme de la

consommation nette des décomposeurs et de la consommation nette des herbivores provenant de ceux-ci (figure 14).

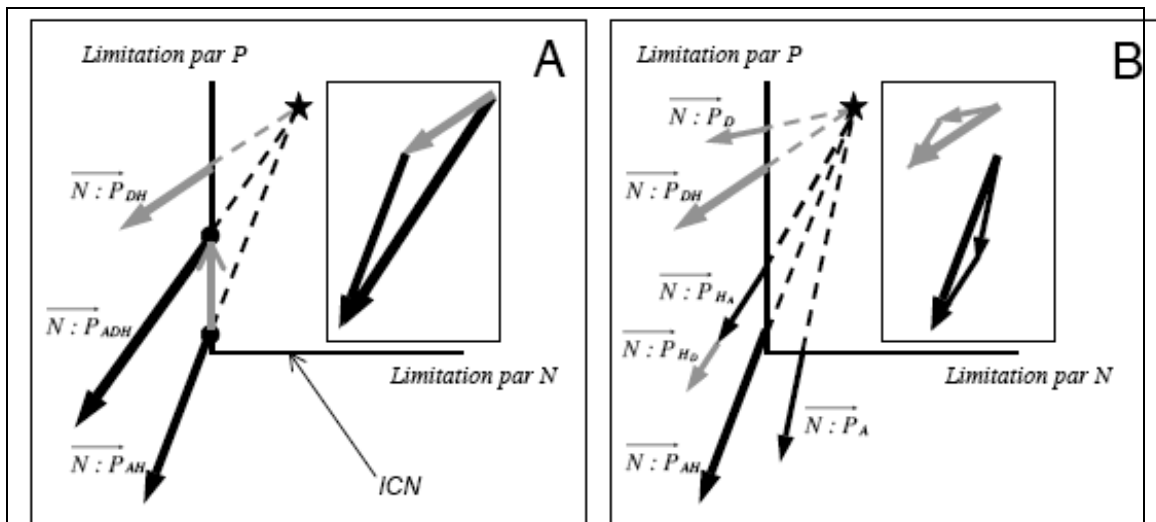

Figure 14 : Détermination graphique de l'effet de l'addition des décomposeurs sur la limitation des autotrophes. A) Cet effet peut être caractérisé en comparant les vecteurs de consommation nette de la communauté sans décomposeurs ($\overrightarrow{N : P_{AH}}$) et avec décomposeurs ($\overrightarrow{N : P_{ADH}}$). Le vecteur de consommation nette de la communauté totale (autotrophes, herbivores et décomposeurs) est la somme vectorielle du vecteur de consommation nette basée sur les autotrophes ($\overrightarrow{N : P_{AH}}$) et du vecteur de consommation nette basée sur les décomposeurs ($\overrightarrow{N : P_{DH}}$). B) Ces deux vecteurs sont eux-mêmes la somme respectivement du vecteur de consommation nette des autotrophes ($\overrightarrow{N : P_A}$) et de consommation nette des herbivores basée sur la consommation des autotrophes ($\overrightarrow{N : P_{HA}}$), et du vecteur de consommation nette des décomposeurs ($\overrightarrow{N : P_D}$) et de consommation nette des herbivores basée sur la consommation des décomposeurs ($\overrightarrow{N : P_{HD}}$).

La figure 14 nous montre que le vecteur de consommation nette de la communauté globale –et donc le ratio N/P de sa consommation nette– est une combinaison des différents ratios N/P de la consommation nette des membres de la communauté. Le rôle des décomposeurs dans la promotion de la limitation des autotrophes par N ou P dépend donc de ces différents ratios et de l'importance de la contribution des décomposeurs dans la consommation des herbivores, tel que le résume la figure 15.

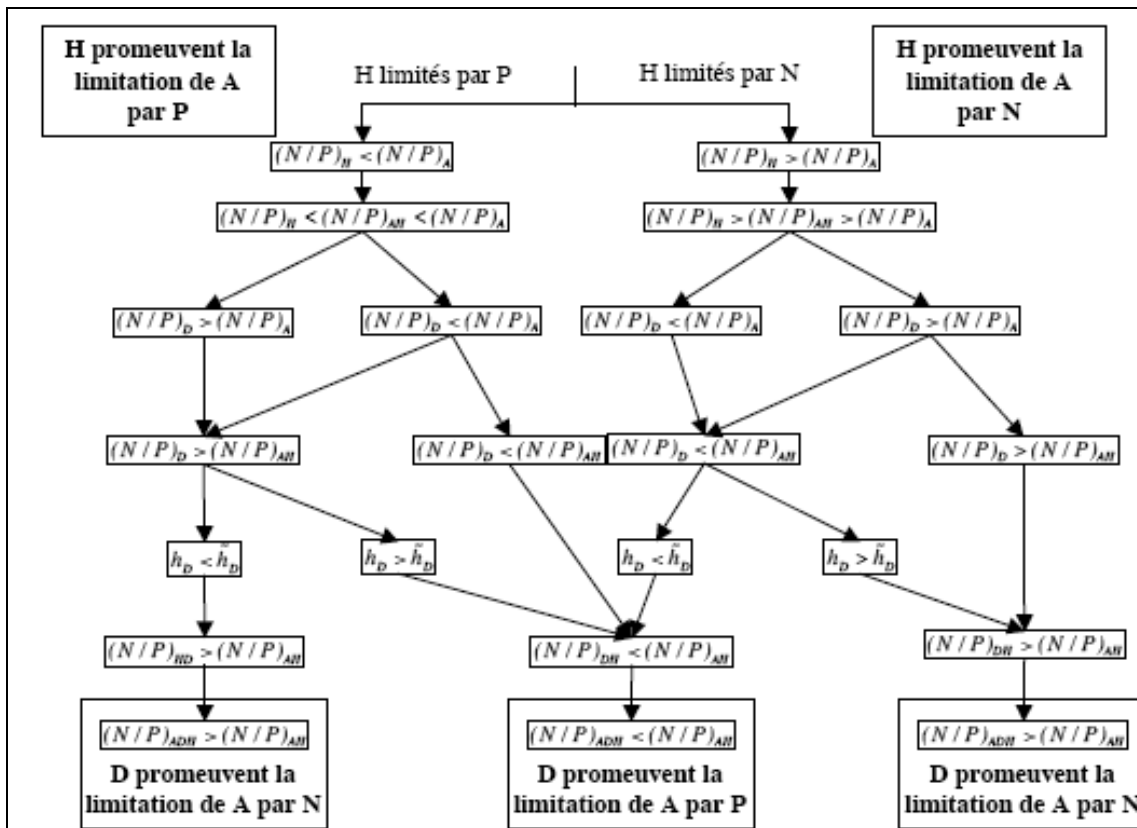

Figure 15 : Diagramme de la détermination par les ratios N/P (azote/phosphore) des membres de la communauté tritrophique (A=autotrophes, D=décomposeurs et H=herbivores) de l'influence des décomposeurs sur la limitation des autotrophes. Il est à noter que lorsque les ratios N/P des décomposeurs et des herbivores devraient avoir des effets opposés sur la limitation des autotrophes, $(N/P)_D < (N/P)_{AH} < (N/P)_H$ ou $(N/P)_D > (N/P)_{AH} > (N/P)_H$, un fort taux d'ingestion des décomposeurs par les herbivores ($h_D > \tilde{h}_D$) conduit les décomposeurs à promouvoir la même limitation que les herbivores.

En général, l'identité de l'élément que les décomposeurs promeuvent comme élément limitant dépend du ratio N/P de ceux-ci. Lorsque ce ratio est inférieur au ratio N/P des consommations nettes des herbivores et autotrophes combinées ($(N/P)_D < (N/P)_{AH}$), c'est le phosphore que les décomposeurs promeuvent comme élément limitant. À l'inverse, lorsque $(N/P)_D > (N/P)_{AH}$, c'est la limitation des autotrophes par l'azote que les décomposeurs promeuvent. Cependant, lorsque le taux d'ingestion des décomposeurs par les herbivores dépasse une certaine valeur seuil, ce n'est plus le ratio N/P des décomposeurs qui détermine l'élément que ceux-ci promeuvent, mais celui des herbivores. En effet, lorsque l'omnivorie devient importante, l'effet principal des décomposeurs est d'augmenter la biomasse des herbivores et renforcer ainsi l'effet de ces derniers sur la limitation des autotrophes.

Nous venons de voir que l'identité de l'élément que les décomposeurs promeuvent comme élément limitant pour la croissance des autotrophes ne dépend que des ratios N/P des différents membres de la communauté, ainsi que du taux d'ingestion des décomposeurs par les herbivores. Le recyclage par les herbivores du carbone en excès dans leur nourriture n'est cependant pas sans importance dans l'effet des décomposeurs sur la limitation des autotrophes. En effet, cet apport supplémentaire de carbone en provenance des herbivores augmente la biomasse des décomposeurs et renforce quantitativement l'effet de ces derniers sur la limitation des autotrophes.

⇒ L'effet des décomposeurs sur la limitation des producteurs primaires dépend de la comparaison entre les compositions chimiques de la production des décomposeurs et de la production de la communauté basée sur les autotrophes, ainsi que de l'importance de l'omnivorie. Si les décomposeurs représentent une part importante du régime des herbivores, les décomposeurs augmenteront l'effet des herbivores sur la limitation des producteurs primaires.

3 Discussion :

3.1 L'hétérogénéité de la matière organique : quelles sources et quels effets sur les décomposeurs ?

Dans la première partie de la thèse, regroupant les deux premiers chapitres, je me suis attaché à étudier, de façon théorique dans le premier chapitre et expérimentale dans le deuxième, l'effet des propriétés chimiques des ressources organiques sur la croissance des microorganismes décomposeurs et sur leur rôle dans le cycle des éléments essentiels à la vie.

J'ai montré dans le premier chapitre, l'importance de la différence entre les teneurs en éléments de la ressource organique et des décomposeurs sur le maintien à long terme de ces derniers dans leur milieu, sur la régénération des éléments inorganiques, sur l'identité de l'élément limitant leur croissance et sur leurs interactions compétitives avec les autres consommateurs des ressources organiques et inorganiques.

Le travail rapporté dans le deuxième chapitre a permis de confirmer expérimentalement ce rôle de la différence entre les teneurs en éléments de la ressource organique et des décomposeurs sur la régénération des éléments inorganiques dans le cas du carbone et de l'azote. Il a de plus démontré l'importance de la distribution du carbone et de l'azote entre des molécules pour lesquelles l'affinité des décomposeurs diffère. La notion d'affinité regroupe elle-même des propriétés différentes. L'affinité d'un organisme pour une molécule représente en effet son efficacité à capturer cette molécule puis à l'utiliser pour sa croissance. Il y a un lien évident entre cette notion et celle de R^* développée par la théorie de la compétition pour les ressources, la notion de R^* intégrant en plus les pertes de matière (voir premier chapitre).

Ainsi donc, de même que la réponse des producteurs primaires à la présence des herbivores et des autres niveaux trophiques de l'écosystème dépend de leur composition chimique et de leur affinité pour les ressources inorganiques régénérées (Daufresne et Loreau 2001b et chapitre 4 de cette thèse), la réponse des décomposeurs à la présence des producteurs de matière organique dépend aussi de leur propre composition chimique et de leurs affinités pour les différentes sortes de molécules organiques produites. Les ressources organiques sont beaucoup plus hétérogènes que

les ressources inorganiques car les différentes molécules organiques diffèrent en effet à la fois dans leurs compositions chimiques en éléments et leurs dégradabilités. J'entrevois alors ici une voie potentiellement prometteuse pour expliquer l'énorme richesse spécifique des communautés microbiennes, qui peut atteindre de l'ordre de plusieurs milliers d'espèces pour des volumes de quelques cm³ (Kassen et Rainey 2004). La différenciation des différentes souches de décomposeurs selon leurs compositions chimiques (comme étudié dans le chapitre 1) et selon leurs affinités pour les différentes molécules à leur disposition me paraît en effet un mécanisme important de création d'un grand nombre de niches qui permettrait la coexistence de nombreuses espèces.

Il est évident alors que plus l'offre de molécules à la disposition des décomposeurs sera grande, plus la possibilité d'une diversification des décomposeurs sera importante. Il me paraît donc important pour la suite d'étudier les facteurs contrôlant la richesse en types de molécules de la matière organique.

Les producteurs primaires, qui sont à l'origine d'une grande part de la matière organique, apparaissent comme la première source de diversité des molécules. Les décomposeurs eux-mêmes génèrent de nouvelles molécules grâce à l'excrétion d'enzymes extracellulaires et de métabolites secondaires (Helling et al 1987, Rosenzweig et al 1994) D'autres facteurs cependant sont à même de réguler la diversité des molécules. L'effet photochimique de la lumière est capable à la fois de détruire les molécules organiques les plus fragiles et de décomposer les molécules complexes en plusieurs types de molécules différentes, affectant ainsi de façon significative la croissance des décomposeurs (Geller 1986, Cole 1999).

Si tous les consommateurs recyclent une partie des molécules organiques qu'ils ingèrent, les herbivores devraient être parmi eux ceux qui ont le plus d'effet sur la diversité moléculaire. Tout d'abord, ils sont quantitativement les consommateurs les plus importants de la production primaire, après les décomposeurs (Cebrián 1999). Ensuite, en terme de composition biochimique, la différence entre herbivores et producteurs primaires est beaucoup plus grande qu'entre les autres consommateurs (Brown et al 1997). Les molécules recyclées par les carnivores par exemple ne sont probablement pas très différentes dans leurs propriétés de celles rejetées par les herbivores, alors que la différence entre les molécules organiques que produisent les herbivores et les producteurs primaires a de fortes chances d'être grande, bien que cela reste à vérifier.

Il nous paraît donc très important, en tout cas dans les milieux où les effets de digestion et de défécation des herbivores sont relativement importants (voir chapitre 3), d'étudier l'effet de l'herbivorie sur la diversité des molécules organiques à la disposition des décomposeurs, si l'on veut comprendre à la fois la régénération des ressources minérales par les décomposeurs et l'effet des herbivores sur ce processus. Un premier point à aborder serait de déterminer si les molécules organiques rejetées par les herbivores seraient plus facilement dégradables par les décomposeurs, comme je l'ai supposé dans le chapitre 3, ce qui favoriserait l'immobilisation, ou plutôt moins dégradables, ce qui diminuerait l'activité globale des décomposeurs, mais pourrait favoriser la minéralisation.

⇒ L'hétérogénéité chimique des ressources organiques des décomposeurs est un déterminant important de la structure de leur communauté et de leur régénération des éléments sous forme inorganique. Les herbivores sont probablement un des facteurs importants de régulation de la diversité chimique de la ressource organique, mais cela reste un domaine à étudier.

3.2 Étudier les interactions trophiques dans le contexte de l'écosystème et du réseau trophique.

Dans la deuxième partie de la thèse, je me suis intéressé aux relations entre les deux principaux consommateurs de la production primaire que sont les décomposeurs et les herbivores, à travers leurs interactions respectives avec les producteurs primaires et leurs interactions directes, grâce au recyclage de la matière organique par les herbivores et leur consommation des décomposeurs.

L'étude de l'effet de la présence des herbivores et de leurs propriétés nutritionnelles sur l'interaction entre décomposeurs et producteurs primaires a montré que celle-ci pouvait difficilement être étudiée en l'absence de toute prise en compte des herbivores. Ne serait-ce qu'à travers leur impact sur la capacité compétitive des producteurs primaires, les herbivores sont capables d'exercer une forte influence sur cette interaction. Le recyclage d'une partie importante de la matière qu'ils ingèrent peut représenter une ressource organique alternative non négligeable pour les décomposeurs, comme le laisse penser les résultats du quatrième chapitre qui estiment

une multiplication par 7 de la proportion de bactéries par rapport au phytoplancton due au recyclage du carbone organique par des Daphnies limitées par l'azote (basé sur les paramètres de la Table 1, annexe 4). À cela se rajoute l'effet des herbivores sur la dégradabilité et la composition chimique de la ressource organique des décomposeurs (chapitre 3).

De même, dans le quatrième chapitre, je montre que l'interaction entre les herbivores et les producteurs primaires ne peut être saisie entièrement sans la prise en compte de la présence des décomposeurs et probablement des autres membres du réseau trophique tels que les consommateurs des herbivores. En effet, les herbivores modifient directement la disponibilité des ressources des producteurs primaires à travers leur consommation nette, mais aussi indirectement en aidant à la croissance des niveaux trophiques auxquels ils fournissent des ressources.

Me basant sur ces conclusions, je me permets d'avancer l'hypothèse que l'approche de la stœchiométrie écologique a peut-être restreint la portée de ces prédictions et la pertinence de ces conclusions pour les systèmes naturels en étudiant les interactions trophiques majeures que sont l'herbivorie et la décomposition détachées du reste du réseau trophique (Gaedke et al 2002).

Il me semble de plus que ces conclusions, obtenues en étudiant les cas de l'herbivorie et de la décomposition, peuvent être généralisées à toutes les interactions au cours desquelles un niveau trophique modifie la disponibilité des ressources d'un autre niveau trophique. Il paraît alors nécessaire de prendre en compte, non seulement l'effet direct du premier niveau trophique, mais aussi tous les niveaux trophiques qui en dépendent. De même, si on s'intéresse à l'effet en retour du deuxième niveau trophique sur le premier, il faut considérer aussi les niveaux trophiques qui dépendent de ce deuxième niveau.

Il est indiscutable qu'élargir ainsi l'étude d'une interaction trophique pour y inclure de nombreuses autres interactions peut s'avérer rapidement très complexe et difficile à aborder. Il s'agit alors maintenant de développer des approches théoriques qui aideront à cette intégration.

La méthode développée par la théorie de la compétition pour les ressources s'est avérée une aide très utile dans ma tentative d'intégrer les interactions trophiques entre les trois niveaux trophiques des producteurs primaires, des décomposeurs et des herbivores. Elle possède certainement un grand potentiel pour étendre l'étude de la stœchiométrie à l'échelle de l'écosystème comme l'argumentent Schade et al (2005).

Son plus grand avantage réside dans sa capacité analytique. Elle permet en effet, connaissant quelques paramètres tels que la position du point d'apport, les vecteurs de consommation nette des différents niveaux trophiques et leurs R^* , de prédire le niveau des ressources à l'équilibre de l'écosystème. Cependant, cette méthode ne permet de représenter adéquatement que deux ressources et elle peut s'avérer rapidement limitée s'il s'agit de représenter les trois éléments carbone, azote et phosphore, et les différentes sortes de ressources organiques disponibles pour les décomposeurs.

Une autre approche, qui permet de représenter la stœchiométrie du réseau trophique, me paraît offrir de bonnes opportunités d'avoir une vue d'ensemble du fonctionnement stœchiométrique du réseau trophique. Cette approche développée par Sterner et al (1996) permet en effet de représenter sur un même diagramme la composition chimique des différents niveaux trophiques et les liens qui les unissent. En y incluant en plus les ressources organiques et inorganiques, cette représentation de l'écosystème permet de poser de nombreuses hypothèses a priori sur le fonctionnement d'un écosystème donné (figure 16).

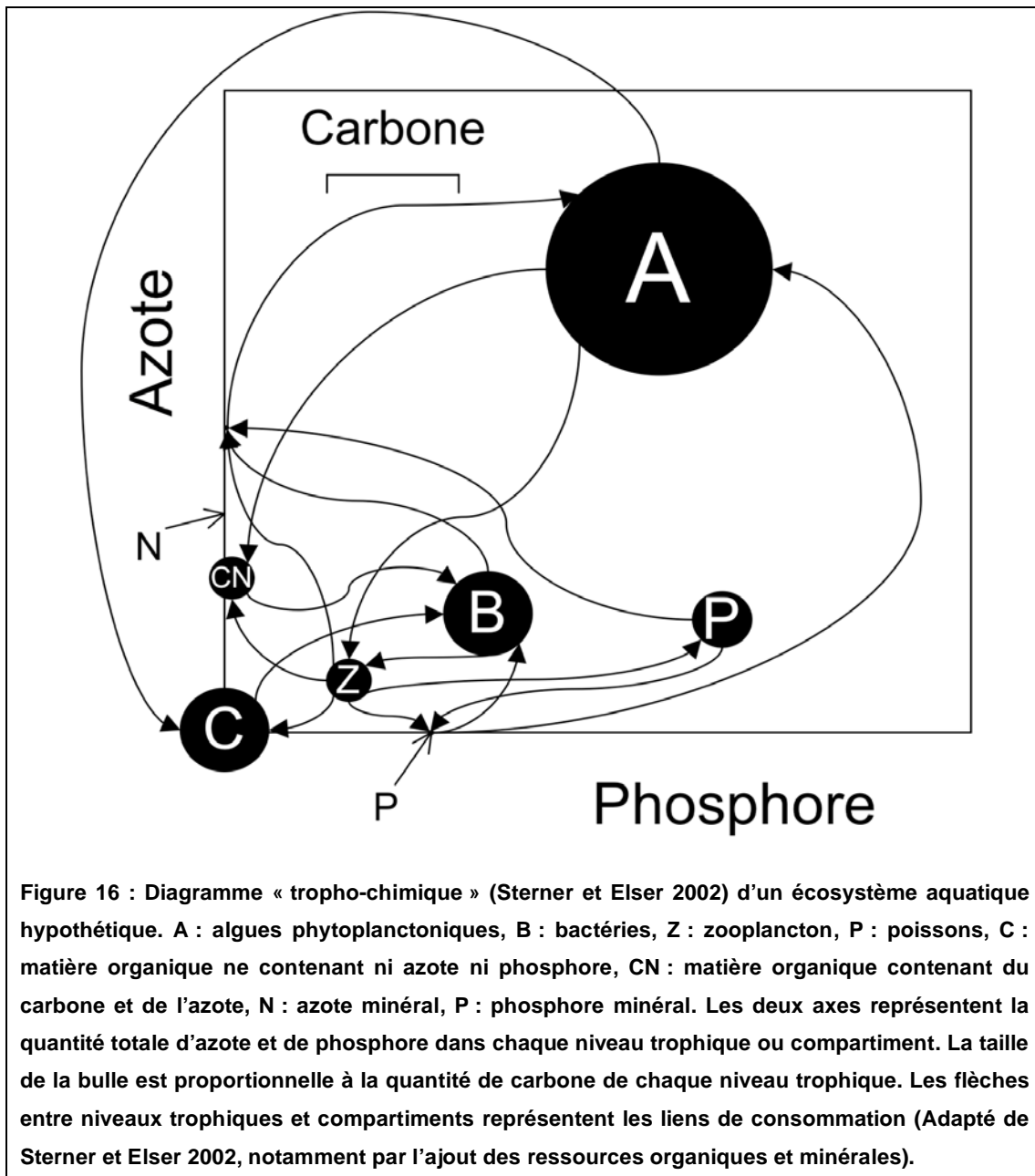

L'examen des caractéristiques du réseau trophique représenté sur la figure 16 permet en effet de faire quelques prédictions sur le fonctionnement de cet écosystème (hypothétique) :

- La forte concentration en azote inorganique en comparaison avec le phosphore inorganique et la richesse relative des algues en carbone et en azote indiquent que nous sommes dans un écosystème où les producteurs primaires sont limités par la disponibilité du phosphore.

- La richesse relative en phosphore des bactéries et du zooplancton par rapport au phytoplancton nous font supposer que ceux-ci participent à accentuer la limitation en phosphore de ce dernier.

- La richesse relative en phosphore des poissons par rapport au zooplancton nous laisse penser qu'ils sont limités soit par le phosphore, soit par le carbone. En tout cas, il est fort probable qu'ils régénèrent beaucoup plus d'azote que de phosphore, participant ainsi à leur tour à promouvoir la limitation des algues par le phosphore.

- Malgré la plus grande disponibilité des ressources organiques ne contenant que du carbone par rapport aux ressources organiques contenant carbone et azote, les bactéries minéralisent l'azote au lieu de l'immobiliser. Ceci indiquerait que les ressources ne contenant que du carbone ne sont que peu dégradables, en tout cas en comparaison des ressources contenant carbone et azote.

- Les algues étant, proportionnellement, plus riche en carbone et en azote et moins riche en phosphore que le zooplancton, celui-ci est probablement limité en phosphore. Il recycle donc une quantité importante de carbone en excès, ce qui pourrait expliquer la quantité importante des ressources organiques ne contenant que du carbone.

Il y aurait probablement encore d'autres prédictions à tirer de l'examen de ce diagramme. On peut cependant conclure de celles que j'ai déjà énoncées que ce diagramme permet, à partir de l'étude des différentes interactions dans le contexte du réseau trophique dans son entier, de brosser le portrait d'un écosystème où les producteurs primaires sont fortement dépendants pour leur approvisionnement en ressource du recyclage par les consommateurs. Or ceux-ci étant relativement riches en phosphore, les producteurs sont amenés vers une limitation par le phosphore. On peut alors se poser la question essentielle des mécanismes permettant le maintien de consommateurs riches en phosphore sur des producteurs primaires qui eux sont pauvres en phosphore, sans qu'il y ait sélection de zooplancton mieux adapté à la composition de leur ressource.

Il existe cependant de nombreuses faiblesses à cette approche basée sur les diagrammes tropho-chimiques. Contrairement à la démarche de la compétition pour les ressources, ces diagrammes ne permettent pas de prédire l'équilibre d'un système car seuls les stocks des éléments, et non leurs flux, sont représentés. La théorie de la compétition pour les ressources a montré l'importance des apports en éléments dans la détermination de la limitation des producteurs primaires à l'équilibre. Or, ces apports ne sont pas présents sur ces diagrammes. Il n'est pas évident, non plus, de trouver un moyen de faire apparaître la diversité des molécules qui composent la matière organique. Or, cette thèse a montré l'importance de cette diversité dans la régénération des éléments minéraux.

Cependant, la capacité de cette approche à décrire l'écosystème de façon à la fois globale et précise, ainsi qu'à relier interactions trophiques et échanges d'éléments, mériterait que l'on essaie résolument de la développer et d'en améliorer les faiblesses.

⇒ La complexité des liens entre herbivores, producteurs primaires et décomposeurs, et probablement avec les autres membres du réseau trophique aussi, ne permet pas d'étudier de façon stœchiométrique une interaction trophique de façon détachée du reste du réseau trophique. Des méthodes basées sur la démarche de la théorie de la compétition pour les ressources ou sur les diagrammes tropho-chimiques de Sterner et al (1996), seront probablement d'une grande aide pour aborder l'étude des interactions stœchiométriques à l'échelle des écosystèmes.

4 Conclusion.

Cette thèse avait pour but d'intégrer les connaissances acquise par la stœchiométrie écologique dans l'étude de l'interaction trophique entre producteurs primaires et décomposeurs d'une part et producteurs primaires et herbivores d'autre part, pour étudier, d'un point de vue principalement théorique, ces deux interactions ensemble.

Basée sur un travail théorique et expérimental, la première partie de la thèse a permis de montrer l'importance, pour le maintien de la richesse spécifique des décomposeurs et la détermination de leur régénération des ressources minérales, de la diversité des ressources organiques en ce qui concerne leur composition chimique et leur dégradabilité.

Les herbivores étant eux-mêmes à l'origine d'une part non négligeable de ces ressources, il paraît important de déterminer leur rôle dans la création et le maintien de l'hétérogénéité chimique des ressources organiques.

La deuxième partie de la thèse s'est attelée à étudier l'impact de chacun des deux consommateurs sur l'interaction de l'autre consommateur avec les producteurs primaires. Plus précisément, le troisième chapitre de la thèse a modélisé l'effet des herbivores sur le passage du mutualisme vers la compétition de la relation entre les décomposeurs et les producteurs primaires en fonction des propriétés chimiques de la ressource organique des décomposeurs.

Le quatrième chapitre a modélisé l'influence des décomposeurs sur la détermination de l'élément limitant la croissance des producteurs primaires par les herbivores.

Ces deux études ont pointé l'importance de prendre en compte l'ensemble du réseau trophique dans l'étude stœchiométrique d'une interaction trophique.

Cette thèse me permet donc d'avancer deux domaines qu'il me paraît important de développer : l'étude des sources et des effets de l'hétérogénéité chimique des ressources organiques des décomposeurs et le mise au point d'approches permettant d'étudier la stœchiométrie du réseau trophique dans son ensemble.

Références :

- Ågren, G. L. and E. Bosatta. 1996. Theoretical ecosystem ecology: understanding element cycles. Cambridge University Press, Cambridge.
- Andersen, T. and D. O. Hessen. 1991. Carbon, nitrogen and phosphorus-content of fresh-water zooplankton. *Limnology and Oceanography* 36:807-814.
- Anderson, T. R. and D. O. Hessen. 1995. Carbon or nitrogen limitation in marine copepods. *Journal of Plankton Research* 17:317-331.
- Armstrong, R. A. and R. McGehee. 1980. Competitive exclusion. *The American Naturalist* 115:151-170.
- Balseiro, E. G., B. E. Modenutti and C. P. Queimaliños. 1997. Nutrient recycling and shifts in N:P ratio by different zooplankton structures in a South Andes lake. *Journal of Plankton Research* 19:805-817.
- Berner, R. A. 1977. Stoichiometric models for nutrient regeneration in anoxic sediments. *Limnology and Oceanography* 22:781-786.
- Bragg, J. G. and C. L. Hyder. 2004. Nitrogen versus carbon use in prokaryotic genomes and proteomes. *Proceedings of the Royal Society of London Series B- Biological Sciences* 271:374-377 (Suppl. 5)
- Bratbak, G. and T. F. Thingstad. 1985. Phytoplankton-bacteria interactions: an apparent paradox? Analysis of a model system with both competition and commensalisms. *Marine Ecology Progress Series* 25:23-30.
- Brett, M. T. 1993. Comment on “Possibility of N or P limitation for planktonic cladocerans: An experimental test” (Urabe and Watanabe” and “Nutrient element limitation of zooplankton production” (Hessen). *Limnology and Oceanography* 38:1333-1340.

- Brown, M. R., S. W. Jeffrey, J. K. Volkman and G. A. Dunstan. 1997. Nutritional properties of microalgae for mariculture. *Aquaculture* 151:315-331.
- Carpenter, S. R., E. M. Bennett and G. D. Peterson. 2006. Scenarios for Ecosystem Services: An overview. *Ecology and Society* 11:29.
- Carpenter, S. R., J. A. Morrice, P. A. Soranno, J. J. Elser, N. A. MacKay and A. St Amand. 1993. Dynamics of primary production and nutrients. p. 225-251 in S. R. Carpenter and J. F. Kitchell, eds. *The trophic cascades in lakes*. Cambridge University Press, Cambridge, UK.
- Carrillo, P., I. Reche and L. Cruz-Pizarro. 1996. Intraspecific stoichiometric variability and the ratio of nitrogen to phosphorus resupplied by zooplankton. *Freshwater Biology* 36: 363-374.
- Cattin, M. F., L. F. Bersier, C. Banasek-Richter, R. Baltensperger and J. P. Gabriel. *Nature* 427: 835-839.
- Cebrián, J. 1999. Patterns in the fate of production in plant communities. *The American Naturalist* 154:449-468.
- Cebrián, J. and J. Lartigue. 2004. Patterns of herbivory and decomposition in aquatic and terrestrial ecosystems. *Ecological Monographs* 74:237-259.
- Chase, J. M. 1996. Abiotic controls of trophic cascades in a simple grassland food chain. *Oikos* 77:495-506.
- Chrzanowski, T. H. and M. Kyle. 1996. Ratios of carbon, nitrogen and phosphorus in *Pseudomonas fluorescens* as a model for bacterial element ratios and nutrient regeneration. *Aquatic Microbial Ecology* 10:115-122.
- Clarke, G. L., W. T. Edmondson and W. E. Ricker. 1946. Dynamics of production in a marine area. *Ecological Monographs* 16:321-337.

- Closs, G. P., S. R. Balcombe and M. J. Shirley. 1999. Generalist predators, interaction strength and food-web stability. *Advances in Ecological Research* 28:93-126.
- Cole, J. J. 1999. Aquatic Microbiology for ecosystem scientists: new and recycled paradigms in ecological microbiology. *Ecosystem* 2:215-225.
- Currie, D.J. and J. Kalff. 1984. A comparison of the abilities of freshwater algae and bacteria to acquire and retain phosphorus. *Limnology and Oceanography* 29:298-310.
- Daufresne, T. and M. Loreau. 2001a. Ecological stoichiometry, primary producer-decomposer interactions, and ecosystem persistence. *Ecology* 82:3069-3082.
- Daufresne, T. and M. Loreau. 2001b. Plant-herbivore interactions and ecological stoichiometry: when do herbivores determine plant nutrient limitation? *Ecology Letters* 4:196-206.
- DeAngelis, D. L. 1975. Stability and connectance in food web models. *Ecology* 56:238-243.
- DeAngelis, D. L., S. M. Bartell and A. L. Brenkert. 1989. Effects of nutrient recycling and food-chain length on resilience. *The American Naturalist* 134:778-805.
- Diehl, S. 2003. The evolution and maintenance of omnivory: Dynamic constraints and the role of food quality. *Ecology* 84:2557-2567.
- Dobberfuhl, D. R. and J. J. Elser. 2000. Elemental stoichiometry of lower food web components in arctic and temperate lakes. *Journal of Plankton Research* 22:1341-1354.

- Droop, M. R. 1974. The nutrient status of algal cells in continuous culture. *Journal of the Marine biological Association of the United Kingdom* 54:825-855.
- Dugdale, R. C., D. W. Menzel and J. H. Ryther. 1961. Nitrogen fixation in the Sargasso Sea. *Deep-Sea Research* 7:397-300.
- Elser, J. J., M. M. Elser, N. A. MacKay and S. R. Carpenter. 1988. Zooplankton-mediated transitions between N- and P-limited algal growth. *Limnology and Oceanography* 33:1-14.
- Elser, J. J., W. F. Fagan, R. F. Denno, D. R. Dobberfuhl, A. Folarin, A. Huberty, S. Interlandi, S. S. Kilham, E. McCauley, K. L. Schulz, E. H. Siemann and R. W. Sterner. 2000. Nutritional constraints in terrestrial and freshwater food webs. *Nature* 408:578-580.
- Elser, J. J., W. F. Fagan, S. Subramanian and S. Kumar. 2006. Signatures of ecological resource availability in the animal and plant proteomes. *Molecular Biology and Evolution* 23:1946-1951.
- Elser, J. J. and R. P. Hassett. 1994. A stoichiometric analysis of the zooplankton-phytoplankton interaction in marine and fresh-water ecosystems. *Nature* 370:211-213.
- Elser, J. J., R. W. Sterner, E. Gorokhova, W. F. Fagan, T. A. Markow, J. B. Cotner, J. F. Harrison, S. E. Hobbie, G. M. Odell and L. J. Weider. 2000. Biological stoichiometry from genes to ecosystems. *Ecology Letters* 3:540-550.
- Elser, J. J. and J. Urabe. 1999. The stoichiometry of consumer-driven nutrient recycling: Theory, observations and consequences. *Ecology* 80:735-751.

- Elser, J. J., J. Watts, J. H. Schampel and J. Farmer. 2006. Early Cambrian food webs on a trophic knife-edge? A hypothesis and preliminary data from a modern stromatolite-based ecosystem. *Ecology Letters* 9:292-300.
- Emmerson, M., T. M. Bezemer, M. D. Hunter, T. H. Jones, G. J. Masters and N. M. Van Dam. 2004. How does global change affect the strength of trophic interactions? *Basic and Applied Ecology* 5:505-514.
- Enríquez, S., C. M. Duarte and K. Sandjensen. 1993. Patterns in decomposition rates among photosynthetic organisms- The importance of detritus C-N-P content. *Ecologia* 94:457-471.
- Falkowski, P. G. 2000. Rationalizing elemental ratios in unicellular algae. *Journal of Phycology* 36: 3-6.
- Findlay, W. P. K. 1934. Studies in the physiology of wood-destroying fungi. I. The effect of nitrogen content upon the rate of decay of timber. *Annals of Botany* 48:109-117.
- Fox, J. W. and J. McGrady-Steed. 2002. Stability and complexity in microcosm communities. *Journal of Animal Ecology* 71:749-756.
- Frost, P. C., R. S. Stelzer, G. A. Lamberti and J. J. Elser. 2002. Ecological stoichiometry of trophic interactions in the benthos: Understanding the role of C:N:P ratios in lentic and lotic habitats. *Journal of the North American Benthological Society* 21:515-528.
- Gaedke, U., S. Hochstädter and D. Straile. 2002. Interplay between energy limitation and nutritional deficiency: empirical data and food web models. *Ecological Monographs* 72:251-270.

- Geider, R. J. and J. La Roche. 2002. Redfield revisited: variability of C:N:P in marine microalgae and its biochemical basis. *European Journal of Phycology* 37:1-17.
- Geller, A. 1986. Comparison of mechanisms enhancing biodegradability of refractory lake water constituents. *Limnology and Oceanography* 31:755-764.
- Goldman, J. C., D. A. Caron and M. R. Dennett. 1987. Regulation of Gross Growth Efficiency and ammonium regeneration in bacteria by substrate C:N ratio. *Limnology and Oceanography* 32:1239-1252.
- Goldman, J. C. and M. R. Dennett. 1991. Ammonium regeneration and carbon utilization by marine-bacteria grown on mixed substrates. *Marine Biology* 109:369-378.
- Goldman, J. C. and M. R. Dennett. 2000. Growth of marine bacteria in batch and continuous culture under carbon and nitrogen limitation. *Limnology And Oceanography* 45: 789-800.
- Goldman, J. C., J. J. McCarthy and D. G. Peavey. 1979. Growth-rate influence on the chemical composition of phytoplankton in oceanic waters. *Nature* 279:210-215.
- Griffith, E. J., C. Ponnampereuma and N. W. Gabel. 1977. Phosphorus, a key to life on primitive Earth. *Origins of Life and Evolution of the Biosphere* 8:71-85.
- Groffman, P. M., C. T. Driscoll, G. E. Likens, T. J. Fahey, R. T. Holmes, C. Eagar and J. D. Aber. 2004. No gloom of night: A new conceptual model for the Hubbard Brook ecosystem study. *BioScience* 54:139-148.

- Hall, S. R., M. A. Leibold, D. A. Lytle and V. H. Smith. 2006. Inedible producers in food webs: controls on stoichiometric food quality and composition of grazers. *The American Naturalist* 167:628-637.
- Harding, S. P. 1999. Food web complexity enhances community stability and climate regulation in a geophysical model. *Tellus* 51B:815-829.
- Helling, R. B., C. N. Vargas and J. Adams. 1987. Evolution of *Escherichia coli* during growth in a constant environment. *Genetics* 116:349-358.
- Hessen, D. O. 1992. Nutrient element limitation of zooplankton production. *The American Naturalist*. 140:799-814.
- Hutchinson, G. E. 1961. The paradox of the plankton. *The American Naturalist* 882:137-145.
- Kassen, R. and P. B. Rainey. 2004. The ecology and genetics of microbial diversity. *Annual Review of Microbiology* 58:207-231.
- Kesh, D., A. K. Sarkar and A. B. Roy. 1997. Qualitative analysis of two resource-based food-web models of three interacting species. *International Journal of Systems Science* 28:99-807.
- Kimmins, J. P. 1997. *Forest Ecology: A Foundation for Sustainable Management* (2nd ed.). MacMillan Publishing.
- Kirschbaum, M. U. F. and K. I. Paul. 2002. Modelling carbon and nitrogen dynamics in forest soils with a modified version of the CENTURY model. *Soil Biology and Biochemistry* 34:341-354.
- Klausmeier, C. A., E. Litchman, T. Daufresne and S. A. Levin. 2004. Optimal nitrogen-to-phosphorus stoichiometry of phytoplankton. *Nature* 429:171-174.

- Kondoh, M. 2006. Does foraging adaptation create the positive complexity-stability relationship in realistic food-web structure? *Journal of Theoretical Biology* 238:646-651.
- Lancelot, C. and G. Billen. 1985. Carbon-nitrogen relationships in nutrient metabolism of coastal marine ecosystems. *Advances in Aquatic Microbiology* 3:263-321.
- Lawlor, L. R. 1978. A comment on randomly constructed model ecosystems. *The American Naturalist* 112:445-447.
- Lehman, 1984. Grazing, nutrient release, and their impacts on the structure of phytoplankton communities. In *Trophic dynamics of aquatic ecosystems*, p 49-72. American Association for the Advancement of Science Selected Symposium.
- Leon, J. A. and D. B. Tumpson. 1975. Competition between 2 species for 2 complementary or substitutable resources. *Journal of Theoretical Biology* 50:185-201.
- LeRouzic, B. and G. Bertru. 1997. Phytoplankton community growth in enrichment bioassays: Possible role of the nutrient intracellular pools. *Acta Oecologica- International Journal of Ecology* 18:121-133.
- Lindeman, R. L. 1942. The trophic-dynamic aspect of ecology. *Ecology* 23:399-418.
- Link, J. 2002. Does food web theory work for marine ecosystems? *Marine Ecology-Progress Series* 230:1-9.
- Loreau, M. 1996. Coexistence of multiple food chains in a heterogeneous environment: Interactions among community structure, ecosystem functioning, and nutrient dynamics. *Mathematical Biosciences* 134:153-188.

- Lotka, A. J. 1925. Elements of physical biology. Williams and Wilkins, Baltimore.
- Lovelock, J. E. and A. J. Watson. 1982. The regulation of carbon-dioxide and climate- Gaia or geochemistry. *Planetary and Space Science* 30:795-802.
- MacArthur, R. and R. Levins. 1964. Competition, habitat selection, and character displacement in a patchy environment. *Proceedings of the National Academy of Sciences of the USA* 51:1207-1210.
- MacKay, N. A. and J. J. Elser. 1998. Differential nutrient recycling by *Daphnia* reduces N₂ fixation by cyanobacteria. *Limnology and Oceanography* 43:347-354.
- Makino, W., J. B. Cotner, R. W. Sterner and J. J. Elser. 2003. Are bacteria more like plants or animals? Growth rate and resource dependence of bacterial C:N:P stoichiometry. *Functional Ecology* 17:121-130.
- May, R. M. 1972. Will a large complex system be stable ? *Nature* 238:413-414.
- Mayfield, C. I. and W. E. Inniss. 1978. Interactions between freshwater bacteria and *Ankistrodesmus braunii* in batch and continuous culture. *Microbial Ecology* 4:331-344.
- McCann, K., A. Hastings and G. R. Huxel. 1998. Weak trophic interactions and the balance of nature. *Nature* 395:794-798.
- Møgenburg, S. M. and M. J. Vanni. 1991. Nutrient regeneration by zooplankton- Effects on nutrient limitation of phytoplankton in a eutrophic lake. *Journal of Plankton Research* 13:573-588.
- Montoya, J. M., M. A. Rodríguez and B. A. Hawkins. 2003. Food web complexity and higher-level ecosystem services. *Ecology Letters* 6:587-593.

- Moore, J. C., E. L. Berlow, D. C. Coleman, P. C. de Ruiter, Q. Dong, A. Hastings, N. C. Johnson, K. S. McCann, K. Melville, P. J. Morin, K. Nadelhoffer, A. D. Rosemond, D. M. Post, J. L. Sabo, K. M. Scow, M. J. Vanni and D. H. Wall. Detritus, trophic dynamics and biodiversity. *Ecology Letters* 7:584-600.
- Müller-Navarra, D. 1995. Biochemical versus mineral limitation in *Daphnia*. *Limnology and Oceanography* 40:1209-1214.
- Murphy, K. L., I. C. Burke, M. A. Vinton, W. K. Lauenroth, M. R. Aguiar, D. A. Wedin, R. A. Virginia and P. N. Lowe. 2002. Regional analysis of litter quality in the central grassland region of North America. *Journal of Vegetation Science* 13:395-402.
- Nakano, S. 1994. Carbon-nitrogen-phosphorus ratios and nutrient regeneration of a heterotrophic flagellate fed on bacteria with different elemental ratios. *Archiv Für Hydrobiologie* 129:257-271.
- Neutel, A.-M., J. A. P. Heesterbeek and P. C de Ruiter. 2002. Stability in real food webs: Weak links in long loops. *Science* 296:1120-1123.
- Nicolardot, B., S. Recous and B. Mary. 2001. Simulation of C and N mineralization during crop residue decomposition: A simple dynamic model based on the C:N ratio of the residues. *Plant and Soil* 228:83-103.
- Nourbakhsh, F. and R. P. Dick. 2005. Net nitrogen mineralization or immobilization potential in a residue-amended calcareous soil. *Arid Land Research and Management* 19:299-306.
- Odum, E. P. 1983. *Basic Ecology*. W. B. Saunders eds. Philadelphia, USA.
- Parnas, H. 1975. Model for decomposition of organic material by microorganisms. *Soil Biology and Biochemistry* 7:161-169.

- Phillips, J. 1934. Succession, development, the climax and the complex organism: an analysis of concepts. III. *Journal of Ecology* 23:488-508.
- Polis, G. A. and D. S. Strong. 1996. Food web complexity and community dynamics. *The American naturalist* 147:813-846.
- Post, D. M., M. L. Pace and N. G. Hairston. 2000. Ecosystem size determines food-chain length in lakes. *Nature* 405:1047-1049.
- Rapport, D. J. 1971. An optimization model of food selection. *The American Naturalist* 105:575-587.
- Redfield, A. C. 1958. The biological control of chemical factors in the environment. *American Scientist* 46:205-221.
- Rhee, G. Y. 1978. Effects of N-P atomic ratios and nitrate limitation on algal growth, cell composition, and nitrate uptake. *Limnology and Oceanography* 23:10-25.
- Rosenzweig, R. F., R. R. Sharp, D. S. Treves and J. Adams. 1994. Microbial evolution in a simple unstructured environment: genetic differentiation in *Escherichia coli*. *Genetics* 137:903-917.
- Rothhaupt, K. O. 1997. Grazing and nutrient influences of *Daphnia* and *Eudiaptomus* on phytoplankton in laboratory microcosms. *Journal of Plankton Research* 19:125-139.
- Schade, J. D., J. F. Espeleta, C. A. Klausmeier, M. E. McGroddy, S. A. Thomas and L. Zhang. 2005. A conceptual framework for ecosystem stoichiometry: balancing resource supply and demand. *Oikos* 109:40-51.
- Schade, J. D., M. Kyle, S. E. Hobbie, W. F. Fagan and J. J. Elser. 2003. Stoichiometric tracking of soil nutrients by a desert insect herbivore. *Ecology Letters* 6:96-101.

- Scheu, S. 2002. The soil food web: structure and perspectives. *European Journal of Soil Biology* 38:11-20.
- Schmitz, H. and F. Kaufert. 1936. The effect of certain nitrogenous compounds on the rate of decay of wood. *American Journal of Botany* 23:635-638.
- Shurin, J. B., D. S. Gruner and H. Hillebrand. 2006. All wet or dried up? Real differences between aquatic and terrestrial food webs. *Proceedings of the Royal Society B- Biological Sciences* 273:1-9.
- Smith, S. V. 1984. Phosphorus versus nitrogen limitation in the marine environment. *Limnology and Oceanography* 29:1149-1160.
- Sterner, R. W. 1990. The ratio of nitrogen to phosphorus resupplied by herbivores: Zooplankton and the algal competitive arena. *The American Naturalist* 136:209-229.
- Sterner, R.W. and J.J. Elser. 2002. *Ecological Stoichiometry: The Biology of Elements from Molecules to the Biosphere*. Princeton University Press, Princeton, NJ USA.
- Sterner, R. W., J. J. Elser, E. J. Fee, S. J. Guildford and T. H. Chrzanowski. 1997. The light:nutrient ratio in lakes: The balance of energy and materials affects ecosystem structure and process. *The American Naturalist* 150:663-684.
- Sterner, R. W., D. D. Hagemeyer, W. L. Smith and R. F. Smith. 1993. Phytoplankton nutrient limitation and food quality for *Daphnia*. *Limnology and Oceanography* 38:857-871.

- Sterner, R. W. and R. F. Smith. 1993. Clearance, ingestion and release of N and P by *Daphnia-obtusa* feeding on *Scenedesmus-acutus* of varying quality. *Bulletin of Marine Science* 53:228-239.
- Tansley, A. G. 1935. The use and abuse of vegetational concepts and terms. *Ecology* 16:284-307.
- Taylor, B. R., D. Parkinson and W. F. J. Parsons. 1989. Nitrogen and lignin content as predictors of litter decay rates: a microcosm test. *Ecology*: 70:97-104.
- Tett, P., S. I. Heaney and M. R. Droop. 1985. The Redfield ratio and phytoplankton growth-rate. *Journal of the Marine Biological Association of the United Kingdom* 65:487-504.
- Tilman, D. 1980. Resources- A graphical-mechanistic approach to competition and predation. *The American Naturalist* 116:362-393.
- Tilman, D., S. S. Kilham and P. Kilham. 1982. Phytoplankton community ecology: The role of limiting nutrients. *Annual Review of Ecology and Systematics* 13:349-372.
- Urabe, J. 1993. N and P cycling coupled by grazers' activities: Food quality and nutrient release by zooplankton. *Ecology* 74:2337-2350.
- Urabe, J., J. Clasen and R. W. Sterner. 1997. Phosphorus limitation of *Daphnia* growth: Is it real? *Limnology and Oceanography* 42:1436-1443.
- Urabe, J., M. Nakanishi and K. Kawabata. 1995. Contribution of metazoan plankton to the cycling of nitrogen and phosphorus in lake Biwa. *Limnology and Oceanography* 40:232-241.

- Urabe, J. and R. W. Sterner. 2001. Contrasting effects of different types of resource depletion on life-history traits in *Daphnia*. *Functional Ecology* 15:165-174.
- Urabe, J. and Y. Watanabe. 1992. Possibility of N or P limitation for planktonic cladocerans: An experimental test. *Limnology and Oceanography* 37:244-251.
- Van Peer, L., I. Nijs, J. Bogaert, I. Verelst and D. Reheul. 2001. Survival, gap formation, and recovery dynamics in grassland ecosystems exposed to heat extremes: The role of species richness. *Ecosystems* 4:797-806.
- Vanni, M. J., A. S. Flecker, J. M. hood and J. L. Headworth. 2002. Stoichiometry of nutrient recycling by vertebrates in a tropical stream: linking species identity and ecosystem processes. *Ecology Letters* 5:285-293.
- Waksman, S. A. 1917. The influence of available carbohydrates upon ammonia accumulation by microorganisms. *Journal of the American Chemical Society* 39:1503-1512.
- Walker, J. C. G. 1974. Stability of atmospheric oxygen. *American Journal of Science* 274:193-214.
- Watts, T., H. A. Woods, S. Hargand, J. J. Elser and T. A. Markow. Biological stoichiometry of growth in *Drosophila melanogaster*. *Journal of Insect Physiology* 52:187-193.
- Weider, L. J., J. J. Elser, T. J. Crease, M. Mateos, J. B. Cotner and T. A. Markow. 2005. The functional significance of ribosomal (r)DNA variation: Impacts on the evolutionary ecology of organisms. *Annual Review of Ecology, Evolution and Systematics* 36:219-242.

- Woods, H. A., M. C. Perkins, J. J. Elser and J. F. Harrison. 2002. Absorption and storage of phosphorus by larval *Manduca sexta*. *Journal of Insect Physiology* 48:555-564.
- Woodward, G. and A. G. Hildrew. 2002. Food web structure in riverine landscapes. *Freshwater Biology* 47:777-798.
- Yodzis, P. 1981. The stability of real ecosystems. *Nature* 289:674-676.

ANNEXES

Annexe 1 :

Submitted article:

Stoichiometric constraints on resource use, competitive interactions and elemental cycling in microbial decomposers

Mehdi Cherif¹ and Michel Loreau²

¹Author for correspondence:

Laboratoire d'Ecologie, BIOEMCO UMR 7618, Ecole Normale Supérieure, 46 rue d'Ulm, F-75230 Paris Cedex 05, France

Current address:

Department of Biology, McGill University, 1205 avenue Docteur Penfield, Montreal, Quebec H3A 1B1, Canada

Phone: 514-398-6815

FAX: 514-398-5069

E-mail: cherif@biologie.ens.fr

²Department of Biology, McGill University, 1205 avenue Docteur Penfield, Montreal, Quebec H3A 1B1, Canada

E-mail: michel.loreau@mcgill.ca

Keywords: Stoichiometry; Mineralization; Immobilization; Resource Ratio Theory; Competition;

Abstract:

Heterotrophic microbial decomposers such as bacteria and fungi immobilize or mineralize inorganic elements, depending on their elemental composition and that of their organic resource. This fact has major implications for their interactions with other consumers of inorganic elements. We combine the stoichiometric and resource-ratio approaches in a model describing the use by decomposers of an organic and an inorganic resource containing the same essential element, to study its consequences on decomposer interactions and their role in elemental cycling. Our model considers the elemental composition of organic matter and the principle of its homeostasis explicitly. New predictions emerge, in particular: (1) stoichiometric constraints generate a trade-off between the R^* values of decomposers for the two resources; (2) they create favorable conditions for the coexistence of decomposers limited by different resources and with different elemental demands; but, combined with conditions on species-specific equilibrium limitation, (3) they draw decomposers towards co-limitation by the organic and inorganic resources on an evolutionary timescale. Moreover, we derive the conditions under which decomposers switch from consumption to excretion of the inorganic resource. We expect our predictions to be useful in explaining decomposer community structure and their interactions with other consumers of inorganic resources, particularly with primary producers.

Introduction

Heterotrophic microbial decomposers such as bacteria and fungi are key components of ecosystems since they play a major role in the processing of plant detritus, which is the fate of the majority of primary production (Cebrian 1999). Despite their importance in elemental cycling, decomposers have long been studied as a black box for which little was known about its internal structure and dynamics (Tiedje et al 1999). The explanation of this state of affairs lies at least partly in the technical difficulties to separate microbial organisms from their surrounding environment because of their small size and their intricate link to their substrate, and to culture the most ecologically relevant strains *in vitro*. Because of these methodological handicaps, parameters and patterns relevant to modeling interactions among decomposers, or between decomposers and other trophic levels, are scarcely known. In recent years, however, technological advances have made it possible to open the black box and to start studying decomposers as a community shaped by the specific properties of its members and by their interactions with each other and their surroundings (Tiedje et al 1999, Leckie 2005). Somehow paradoxically, these new techniques are generating a wealth of data that are critically in need of a theoretical framework that would allow to understand the relationship between decomposer community structure and their role in ecosystem functioning (Andr n and Balandreau 1999).

A successful approach that has been used previously to understand and predict community attributes in other organisms is the resource-ratio theory (McArthur 1972, Tilman 1980). This theory offered a fruitful method to link the properties of phytoplankton species to processes among them and with other trophic levels (Tilman 1980, Daufresne et Loreau 2001a, Grover 2002). R^* , the minimum requirement of a phytoplankton species for a given resource at equilibrium, is a central parameter in this theory. Determining this parameter for the various resources and species involved allows one to predict which species will persist

under given resource supplies, and which species will replace others along a resource gradient (Tilman 1980). Microbial decomposers share with plants their ability to assimilate elements that are essential to their growth, such as nitrogen and phosphorus, in inorganic form. Simple species-specific parameters like R^* would therefore be useful in explaining competitive interactions of decomposers and ecosystem-level elemental fluxes. But decomposers differ from primary producers in their requirement of an organic source of carbon, because they cannot fix CO_2 , and in their ability to retain the essential elements other than carbon contained in this organic resource. Application of the resource-ratio theory to organisms that have this ability to use alternative resources that bind together essential elements in different ratios may bring interesting new insights and conclusions, even though the theory was developed mainly for the study of organisms that use separate essential resources.

Ecological stoichiometry provides another approach to understand the use of resources by decomposers. Ecological stoichiometry characterizes the relative growth requirements of decomposers for the various essential elements and compares them to the relative quantities of these elements in their resources. The assimilation of the various resources is constrained in such a way that both mass balance and homeostasis of elemental composition are satisfied (Goldman and Dennett 1991, Sterner and Elser 2002). Because of these homeostatic stoichiometric constraints, inorganic elements can be either taken up (immobilized) or excreted (mineralized) by decomposers depending on whether the quantity of these elements contained in the organic resources is deficient or exceeds the requirements of decomposers (Goldman and Dennett 2000, Daufresne and Loreau 2001b).

In this work, we combine the stoichiometric and resource-ratio approaches in a model that describes the growth of decomposers on dual inorganic and organic resources. Our model considers the elemental composition of resources and decomposers explicitly, and incorporates the principle of homeostasis of elemental composition. We use this model to

investigate the factors and constraints that influence the use of the two resources by decomposers, their consequences on decomposer interspecific competition, and the resulting role of decomposers in elemental cycling.

We use a graphical analysis to examine how the stoichiometry of a decomposer population controls the relative use of two resources that contain the same essential element, one of which is organic and the other inorganic. We highlight how this stoichiometry, in interaction with external resource supplies, determines the impact of the decomposer population on the cycling of the element considered. We then use the framework established in this analysis to study competitive interactions among decomposers. By expanding the graphical analysis to two decomposer populations and using resource-ratio theory, we show how stoichiometric constraints should play a positive role in the coexistence of decomposers with different elemental compositions but drive decomposers towards co-limitation by the organic and inorganic resources in the long run.

1. Model description

This model represents the growth of a decomposer population on two resources in a chemostat-like ecosystem (fig. 1). The first resource is made of an essential element, E, in inorganic form (E_I). The second resource contains the same essential element E (E_V), linked to organic carbon (C_V). All compartments experience some loss due to the constant renewal of a part of the medium, as in a chemostat. For simplicity, the loss rate is set to the same value l for all compartments. Again as in a chemostat, the turnover of the medium brings with it fresh resources with a concentration that is assumed to be constant (E_I^0 for the inorganic resource, C_V^0 for the organic carbon and E_V^0 for the organic element). Tables 1 and 2 summarize the symbols used and the differential equations of the model, respectively.

The flow of carbon through the system is rather simple: it is supplied as organic C with a concentration C_V^0 , is consumed by decomposers with a flux $\Phi_{v,C}$, and is lost through

respiration $((1-c) \Phi_{v,c})$ and turnover of the organic resource (lC_V) and decomposers (lC_D) . The element E is supplied in both an organic form with a concentration E_V^0 and an inorganic form with a concentration E_I^0 . It is lost through the turnover of decomposers (lE_D) and organic (lE_V) and inorganic (lE_I) resources. Decomposers consume organic E with a flux Φ_v . The flux between inorganic E and decomposers (Φ_i) can go in both directions, depending on the stoichiometric properties of the organic resource and of decomposers. More generally, the three fluxes Φ_i , Φ_v and $\Phi_{v,c}$ are determined by these stoichiometric properties, as we show next.

A first stoichiometric constraint affects the organic resource, which contains C and E in a fixed ratio:

$$C_V : E_V = \alpha \quad (1)$$

Decomposers are made of the same elements: carbon (C_D) and E (E_D). They have a fixed stoichiometric composition too:

$$C_D : E_D = \beta$$

During the process of growth, decomposers need C and E in a ratio equal to β to build their biomass, but they also need some C to produce, through respiration, the energy necessary to this growth process. Therefore we define a third C:E ratio, δ , which represents what we call the decomposer C:E demand ratio. δ integrates the C and E needed to form biomass and the C needed for energy production through the formula

$$\delta = \frac{\beta}{c} \quad (2)$$

where β is the C:E ratio of decomposer biomass, and c is decomposer gross growth efficiency for C, or the percentage of C ingested that is not respired.

Most models of organism growth include the consumption of energy and nutrients for what is called either basal metabolism or maintenance cost. This consumption is needed to

fuel the most basic processes essential to cellular life and replace the elements inescapably lost from all cells, and so, is totally independent from the growth process. We did not feel though, that it was an important process to include in our special case (see discussion).

Decomposers obtain their carbon solely from the organic resource (C_V) with a flux $\Phi_{v,C}$ (fig. 1). Concurrently, they obtain some of the needed E from E that is linked to the carbon (E_V) with a flux Φ_v . Since the two elements are absorbed together, and given equation (1), we have

$$\Phi_{v,C} = \alpha\Phi_v \quad (3).$$

Homeostasis of decomposer elemental composition requires that $\frac{dC_D}{dt} = \beta \frac{dE_D}{dt}$. From equations in Table 2, we see that this stoichiometric constraint translates into the following relation between fluxes:

$$\Phi_{v,C} = \delta(\Phi_v + \Phi_i)$$

where Φ_i is a flux of E_I adjusting for decomposer C:E composition: E_I is either taken up by the decomposers if their organic E uptake is not sufficient to meet their E demand (immobilization), or excreted if organic E comes in excess (mineralization).

After some algebraic manipulation using equations (2) and (3), we obtain the following stoichiometric relation between the regulating flux of E_I and the flux of ingested C:

$$\Phi_i = \left(\frac{1}{\delta} - \frac{1}{\alpha} \right) \Phi_{v,C} \quad (4).$$

From equation (4), we understand that the two fluxes are proportional and that the factor of proportionality is simply the difference between the N:C ratio of the organic resource and of decomposer demand. However, we cannot deduce from this equation which of the two fluxes controls the other. But looking at the resources that can potentially limit decomposer growth rate, we can distinguish two situations:

(1) E_I is insufficient to entirely complement the organic food available for uptake. In other words, decomposers are E limited and Φ_i is the growth-limiting flux. If we consider that E_I uptake in this case obeys the law of mass action, i.e.,

$$\Phi_i = iE_D E_I$$

where i is the uptake rate of the inorganic resource by E-limited decomposers. Then, considering equation (4), we have

$$\Phi_{v,C} = \left(\frac{1}{\delta} - \frac{1}{\alpha} \right)^{-1} i E_I E_D$$

(2) E_I availability is sufficient. Decomposers are then limited by the availability of C, and Φ_v is the growth limiting flux. In this case, applying again the mass-action law,

$$\Phi_{v,C} = v C_V E_D.$$

where v is the uptake rate of the organic resource by C-limited decomposers. Introducing this into equation (4) yields

$$\Phi_i = \left(\frac{1}{\delta} - \frac{1}{\alpha} \right) v C_V E_D$$

Note that for C limited decomposers, depending on the relative values of the C:E ratios of the organic resource and of decomposer demand (α and δ), Φ_i can be negative. Due to the stoichiometric constraints on the compositions of the organic resource and of the decomposers, the inorganic resource is an unusual resource, which is needed by decomposers only when their organic resource is deficient in E. The inorganic resource —when needed— cannot, in this model, be complemented by any other resource since decomposers are in absolute need for E_I to satisfy their E demand. Then inorganic and organic resources are essential resources (sensu Tilman 1980) for E-limited decomposers, and Liebig's law of the minimum can be applied, that is

$$\Phi_i = \text{Min} \left[i E_I E_D, \left(\frac{1}{\delta} - \frac{1}{\alpha} \right) v C_V E_D \right] \quad (5).$$

When $iE_I < (\frac{1}{\delta} - \frac{1}{\alpha})vC_V$, we are in the case of an E-limited growth where $\Phi_i = iE_D E_I$ and $\Phi_{v,C} = (\frac{1}{\delta} - \frac{1}{\alpha})^{-1} iE_I E_D$. Whereas when $iE_I > (\frac{1}{\delta} - \frac{1}{\alpha})vC_V$, we are in the case of a C-limited growth where $\Phi_{v,C} = vC_V E_D$ and $\Phi_i = \frac{\alpha - \delta}{\alpha \delta} vC_V E_D$. One can verify easily that $\Phi_{v,C} = \text{Min}[(\frac{1}{\delta} - \frac{1}{\alpha})^{-1} iE_I E_D, vC_V E_D]$ could have been used instead of equation (5) and lead to the same formulation for the two fluxes Φ_i and $\Phi_{v,C}$.

2. Graphical determination of the resource equilibrium

Our model describes the dynamics of a population consuming two potential resources and can be solved using the resource-ratio graphical approach developed in Tilman (1980).

Take the plane formed by all the combinations of values of the two potential resources (C_V in abscissa and E_I as an ordinate — E_V can be deduced from the former by dividing it by α). Draw on this plane the Zero Net Growth Isocline (ZNGI) for decomposer growth. The ZNGI corresponds to the set of combined values of resources that lead to a stop in net growth of decomposers. This is the case, when decomposers are C limited, for

$$C_V^* = R_V^* = \delta \frac{l}{v} \text{ and } E_I^* \geq \frac{\alpha - \delta}{\alpha} \frac{l}{i} \quad (6),$$

and when decomposers are E-limited, for

$$E_I^* = R_I^* = \frac{\alpha - \delta}{\alpha} \frac{l}{i} \text{ and } C_V^* \geq \delta \frac{l}{v} \quad (7).$$

(see Appendix 1). Expressions (6) and (7) are simply the equations for two half-lines, which union makes The ZNGI (fig. 2 A). The two half-lines are perpendicular and parallel to the axes, as is always the case for two essential resources (Tilman 1980). The point of junction of the two half ZNGI is a particular case where both resources are limiting. It is the co-limitation

point (fig. 2 A). The coordinates of this point (R_V^*, R_I^*) are the minimum requirements of decomposers for the two resources C_V and E_I respectively, their R^* values according to Tilman (1980).

Notice, though, that contrary to the usual acceptance of R^* , R_I^* can be negative (fig. 2 B). From equation (7), we deduce that it is the case when the decomposer C:E demand ratio, δ , is greater than the C:E ratio of the organic resource, α . It corresponds to the situation where the decomposers mineralize E_I , which in this case cannot be considered as a resource anymore. The ZNGI is then only the positive part of the half-line with equation

$$C_V^* = R_V^* = \delta \frac{l}{v}.$$

We know that the resource equilibrium point is situated on the ZNGI, but more information is needed to locate its exact position. At equilibrium, we have $l(C_V^0 - C_V^*) = \Phi_{v,C}^*$ and $l(E_I^0 - E_I^*) = \Phi_i^*$ (see corresponding equations in table 2) or, written in vectorial form,

$$\begin{bmatrix} E_I^0 - E_I^* \\ C_V^0 - C_V^* \end{bmatrix} = \begin{bmatrix} \Phi_i^* \\ \Phi_{v,C}^* \end{bmatrix}$$

The left-hand side vector is the net “supply vector”, while the right-hand side vector is the “consumption vector” (Tilman 1980, Daufresne and Loreau 2001a). The two vectors must be exactly opposite at equilibrium (fig. 2). But we know that, because of the stoichiometric

constraints, $\frac{\Phi_i^*}{\Phi_{v,C}^*} = \frac{1}{\delta} - \frac{1}{\alpha}$ (equation 4). Thus, we also have

$$\frac{E_I^0 - E_I^*}{C_V^0 - C_V^*} = \frac{1}{\delta} - \frac{1}{\alpha} \quad (8)$$

The resource equilibrium point (C_V^*, E_I^*) is then located at the intersection between the ZNGI

and the line with slope $\frac{1}{\delta} - \frac{1}{\alpha}$ passing through the supply point (C_V^0, E_I^0) (fig. 2).

The supply points located between the ZNGI and the axes (fig. 2 A region I) lead to equilibrium values of resources that would be greater than their supply values, a non-sustainable situation. They correspond to trivial equilibria, where decomposers are washed out and the resource equilibrium point coincides with the supply point (C_V^0, E_I^0) .

Supply points above the ZNGI lead to non-trivial equilibria. The line with slope $\frac{1}{\delta} - \frac{1}{\alpha}$ passing through the co-limitation point (the co-limitation line) divides this part of the resource plane into two regions (regions II and II' in fig. 2 A). We can see easily that supply points under this line (fig. 2 A, II) give equilibria that are E-limited, while supply points above it give C-limited equilibria (fig. 2 A, II'). In the case where decomposers are mineralizers (fig. 2 B), only C-limited equilibria are possible.

3. Stoichiometry-induced R* trade-off

In plants, for a given loss rate, the rules governing the relation between R* values of different essential elements are not well determined: a trade-off between the competitive abilities of a species for two essential elements is often hypothesized (Tilman 1980), but this assumption has seldom been tested and there are some counter-examples (Tilman 1981). In the case of decomposers, the simultaneous use of the organic and inorganic resources must satisfy the stoichiometric constraint of a constant composition, and this constraint results necessarily in a trade-off between the two R* values.

$R_V^* = \delta \frac{l}{v}$ is the R* for the organic resource (equation 6 and Appendix 1). We see

immediately that R_V^* is proportional to δ , decomposer C:E demand ratio. This positive relation between these two parameters is not surprising since both of them are a measure of the importance of the C demand of decomposers. The higher the percentage of C in

decomposer biomass, the higher is its C demand, and the higher is the minimum requirement of C at equilibrium (R_V^*).

$$R_I^* = \frac{\alpha - \delta}{\alpha} \frac{l}{i}, \text{ the } R^* \text{ for the inorganic resource, (equation 11 and Appendix 1), is also}$$

related to δ . But, here, it is negatively proportional to δ . Again, this is not surprising as δ measures the importance of E demand relatively to C demand. The lower the C:E demand ratio of decomposers, the higher their relative demand for E, and the higher the minimum equilibrium concentration of E_I (R_I^*) needed to complement E_V and meet the equilibrium E demand.

The trade-off between the two R^* values can be expressed analytically:

$$R_I^* = \frac{l}{i} - \frac{1}{\alpha} \frac{v}{i} R_V^* \quad (9)$$

Thus, the co-limitation point (R_V^*, R_I^*) is located on the R^* trade-off curve $E_I = \frac{l}{i} - \frac{1}{\alpha} \frac{v}{i} C_V$. Decomposers with different C:E demand ratios (all other parameters being kept constant) will have their ZNGIs positioned in different places on the resource plane but with all their co-limitation points placed on the trade-off line (fig. 3 A). The smaller the C:E demand ratio, the lower the minimum C requirement of decomposers at equilibrium (R_V^*) and the higher their minimum E_I requirement (R_I^*). Graphically, this translates into the fact that the smaller the δ ratio is, the closer the co-limitation point is to y-axis (fig. 3 A). In the limiting case where the C:E demand ratio tends to zero, R_V^* also tends to zero and R_I^* tends to a maximum value R_I^{\max} equal to $\frac{l}{i}$. In a first interpretation, R_I^{\max} can be understood as the R_I^* of decomposers with a C demand considerably less than its E demand. This may not look possible biologically, but an alternative approach may help to better grasp the biological

meaning of the parameter R_I^{\max} . From the analytical expression of $R_I^* = \frac{\alpha - \delta}{\alpha} \frac{l}{i}$, we can

notice that $R_I^{\max} = \frac{l}{i}$ can be reached when α , the C:E ratio of the organic resource, tends to

infinitely high values. Here the biological interpretation of R_I^{\max} is straightforward: it is simply the concentration to which E_I is driven by E-limited decomposers when these have an organic resource that only has traces of E.

4. Definition and graphical determination of δ threshold values

The identity of the limiting element at equilibrium as well as the persistence of decomposers at equilibrium depends on the relative positions of the ZNGI and the supply point (fig. 2). Since a change in the decomposer C:E demand ratio δ leads to a change in the position of the ZNGI, some values of δ will result in equilibria where C limits decomposer growth, while others will produce E-limited equilibria. Some will result in the extinction of decomposers, while others will allow for their persistence at equilibrium. Some will lead to mineralization, others to immobilization of E_I . These various contrasts lead to the definition of different threshold values of δ , which can be calculated analytically.

The first of these threshold values, δ_{Imm}^{Min} , separates the decomposer C:E demand ratios that lead to equilibria for which decomposers mineralize E from those that result in equilibria where they immobilize E. Decomposers with δ exactly equal to this threshold value do not immobilize or mineralize E and so, they do not have any requirement for E_I at equilibrium ($R_I^* = 0$). They have relative C and E demands that perfectly match the C:E ratio of their organic resource, which explains why δ_{Imm}^{Min} is equal to the organic resource C:E ratio. The position of their ZNGI can be determined easily since their co-limitation point (R_V^*, R_I^*) is at the intersection of R^* trade-off curve with the x-axis (fig. 3 B). Decomposers with other C:E

demand ratios immobilize for ratios less than δ_{Imm}^{Min} and mineralize for ratios greater than δ_{Imm}^{Min} .

The second threshold value, δ_{Clim}^{Elim} , is the decomposer C:E demand ratio that separates E-limited equilibria from C-limited equilibria. It is the unique value of δ where decomposers are co-limited by the two elements E and C. In this case, the E_I concentration at equilibrium needed by decomposers for a sustainable growth (E_I^*) is just enough to provide the complement of E needed by the decomposers to grow on the C_V concentration available at equilibrium. Graphically, it is the value of δ for which the supply point lies on the co-limitation line (fig. 3 B). When δ is greater than δ_{Clim}^{Elim} , a higher decomposer C demand leads to a C-limited equilibrium while when δ is less than δ_{Clim}^{Elim} , a higher E requirement leads to an E-limited equilibrium.

Two threshold values of δ separate equilibria where decomposers are persistent from equilibria where they are driven to extinction, one for each type of elemental limitation (E and C limitation). Among decomposer C:E demand ratios leading to C-limited equilibria, $\delta_{Clim}^{washout}$ is the value for which the supply of C, C_V^0 , matches precisely the minimum C_V decomposer requirement at equilibrium, R_V^* . Since the entire C supplied at equilibrium is required in the form of organic resource C_V , there is not any C left for building biomass and decomposers go extinct. But the slightest increase in the supply of C or decrease in the decomposer C:E demand ratio would lead to the appearance of a small viable decomposer population at equilibrium. Thus, $\delta_{Clim}^{washout}$ marks the transition between C:E demand ratios leading to sustainable decomposer populations at equilibrium (when δ is less than $\delta_{Clim}^{washout}$) and C:E demand ratios conducive to the extinction of decomposers (when δ is greater than

$\delta_{Clim}^{washout}$). Graphically, it is the value of δ for which the supply point lies on the half-ZNGI holding the C-limited equilibria (fig. 3 B).

The equivalent threshold value for E-limited equilibria, $\delta_{washout}^{Elim}$, is the decomposer C:E demand ratio for which the supply of E_I is hardly sufficient to sustain an E-limited decomposer population at equilibrium. When the decomposer C:E demand ratio is less than $\delta_{washout}^{Elim}$, the minimum equilibrium E requirement of decomposers cannot be met, and these go extinct. When the decomposer C:E demand ratio is greater than $\delta_{washout}^{Elim}$, their equilibrium E requirement is satisfied, and equilibria with a viable decomposer population are possible. Graphically, it is the value of δ for which the supply point lies on the half-ZNGI holding the E-limited equilibria (fig. 3 B).

5. Interaction between resource supplies, R* trade-off and decomposer elemental composition in determining the properties of the equilibrium

The four threshold values defined in the preceding section, δ_{Imm}^{Min} , δ_{Clim}^{Elim} , $\delta_{Clim}^{washout}$ and $\delta_{washout}^{Elim}$, can be calculated or found graphically for any supply point (C_V^0, E_I^0) . But, for one given supply point, some of these values may result in unfeasible equilibria. The most evident case is when the supply point is situated below the R* trade-off curve a case that is represented in fig. 4 A. In that situation, for all values of δ , at least one of the resource supplies C_V^0 and E_I^0 is below its corresponding equilibrium requirement. The medium is simply not rich enough for any kind of decomposers to persist, and these are always washed out given enough time (fig 4 A'). $\delta_{Clim}^{washout}$ and $\delta_{washout}^{Elim}$, which mark the transitions between persistent and non-persistent equilibria, are not feasible, and δ_{Imm}^{Min} and δ_{Clim}^{Elim} are not

meaningful since decomposers are extinct at equilibrium and no mineralization, immobilization or growth limitation occur.

For supply points located above R^* trade-off curve (fig. 4 B, C, D and E), there is always a range of decomposer C:E demand ratios where the supply point is above the ZNGI, producing persistent decomposer populations at equilibrium.

For supply points located as in fig. 4 B, we can see graphically that $0 < \delta_{washout}^{Elim} < \delta_{Clim}^{Elim} < \delta_{Imm}^{Min} < \delta_{Clim}^{washout}$. For E-limited decomposers to be persistent, their C:E demand ratio has, first, to be part of the values that result in E-limited equilibria, which is true for δ less than δ_{Clim}^{Elim} (limitation condition), and be part of the values that lead to persistent E-limited decomposers, i.e., with δ greater than $\delta_{washout}^{Elim}$ (persistence condition). E-limited persistent decomposers are thus possible only for $\delta_{washout}^{Elim} < \delta < \delta_{Clim}^{Elim}$. In the same way, C-limited persistent equilibria are reached for $\delta_{Clim}^{Elim} < \delta < \delta_{Clim}^{washout}$. The range of C:E demand ratios leading to persistent equilibria is then $\delta_{washout}^{Elim} < \delta < \delta_{Clim}^{washout}$ (fig. 4 B'). Mineralization only takes place with C-limited decomposers since E-limited decomposers consume E_I instead of mineralizing it. Also, the decomposer population must be persistent if there is to be a non-zero mineralization flow at equilibrium, i.e., δ is to be lower than $\delta_{Clim}^{washout}$ (persistence condition for mineralization). Since decomposers at equilibrium mineralize only for C:E demand ratios greater than δ_{Imm}^{Min} (stoichiometric condition for mineralization), mineralization occurs for $\delta_{Imm}^{Min} < \delta < \delta_{Clim}^{washout}$ (fig. 4 B').

In the case of fig 4 C, the supply concentration of E_I , E_I^0 , is greater than R_I^{\max} , the highest possible R_I^* value. Thus, E_I^0 is always greater than R_I^* , decomposer E_I minimum requirement, and all E-limited equilibria are persistent. Here, we have

$\delta_{washout}^{Elim} < 0 < \delta_{Clim}^{Elim} < \delta_{Imm}^{Min} < \delta_{Clim}^{washout}$, and decomposers are persistent for $0 < \delta < \delta_{Clim}^{washout}$ (fig. 4 C').

The case of fig 4 D is close to that of fig. 4 B with the lowest values of decomposer C:E demand ratios leading to the extinction of E-limited decomposers ($0 < \delta < \delta_{washout}^{Elim}$). But a difference lies in the fact that $\delta_{Clim}^{washout}$ is less than δ_{Imm}^{Min} . Mineralization is possible only for decomposer C:E demand ratios greater than δ_{Imm}^{Min} but all the values of δ that would lead to mineralization are also greater than $\delta_{Clim}^{washout}$ and correspond to non-persistent equilibria (fig 4 D'). This explains why, in this case, there cannot be mineralization for any value of the decomposer C:E demand ratio.

The last situation in fig 4 E and 4 E' shares with the case in fig. 4 C the fact that all E-limited equilibria are persistent and with the case of fig. 4 D the absence of δ values resulting in mineralization.

From the different cases illustrated in fig. 4, we can draw some conclusions on the links between resource supplies and the feasibility of the different equilibria: (1) when the supply of inorganic resource (E_I^0) is greater than R_I^{\max} (fig. 4 C and E), the minimum requirement of decomposers for E_I is always smaller than E_I^0 . Hence, the supply of E_I is always sufficient to sustain E-limited decomposer growth at equilibrium even for decomposers with high demands for E (small values of δ). (2) Mineralization is possible only when the supply of organic C (C_V^0) is sufficiently high (fig. 4 B and C). When C_V^0 is too low, as in fig. 4 D and E, decomposer C:E demand ratios that would result in mineralization do not allow the persistence of decomposers at equilibrium. Mineralization is thus possible only for ecosystems that are rich in organic resources and for decomposers with C:E demand ratios greater than the C:E ratio of their organic resource.

6. Competition between decomposers with different elemental compositions

The resource-ratio theory has been extended straightforwardly from the study of one plant population to the case of two or more different plant species competing for two resources (Tilman 1980). Our model can also be extended to study the competition between two decomposer species differing in their C:E demand ratio. We just have to introduce a new decomposer species and its associated material fluxes with its two resources. The introduced species differs from the first decomposer species only by its δ ratio; we assume that all the other parameters are equal.

There are two conditions to make coexistence between two species sharing two resources possible (Tilman 1980). First, because the equilibrium point lies necessarily at the intersection of the two ZNGIs, the two ZNGI must intersect at least in one point. Because of the stoichiometric constraints, the two decomposers have their co-limitation points located on the R^* trade-off curve; hence the two ZNGIs necessarily intersect (fig. 5).

At the equilibrium point, the two species are limited by different resources: the population species with the lowest C:E demand ratio, δ , (species 1 in fig. 5 A) is E limited while the other (species 2 in fig. 5 A) is C limited. The second condition for a possible coexistence is that each species consumes relatively more of the resource that limits its own growth rate (Tilman 1980). In our particular case, it means that species 1 should consume more E_I than does species 2 at equilibrium, and species 2 should consume more C_V than does species 1 at equilibrium. At equilibrium, each species has its own consumption vector:

$\vec{c}_1 = \begin{bmatrix} \Phi_{i,1}^* \\ \Phi_{v,C,1}^* \end{bmatrix}$ for species 1, and $\vec{c}_2 = \begin{bmatrix} \Phi_{i,2}^* \\ \Phi_{v,C,2}^* \end{bmatrix}$ for species 2. Because of the stoichiometric

constraints, \vec{c}_1 and \vec{c}_2 have slopes

$$p_1 = \frac{1}{\delta_1} - \frac{1}{\alpha} \text{ And } p_2 = \frac{1}{\delta_2} - \frac{1}{\alpha} \quad (10)$$

If we remember that $\delta_1 < \delta_2$, we deduce immediately from equation (10) that $p_1 > p_2$ (fig. 5). In terms of resource consumption, this translates simply into the fact that species 1 does consume more E_I than does species 2, and species 2 does consume more C_V than does species 1 at equilibrium, thus fulfilling the second condition.

Hence, the stoichiometric constraints on decomposer composition result automatically in the first two conditions necessary for the coexistence between decomposer species that differ in their δ ratio being satisfied.

The last, sufficient condition for coexistence depends on the position of the supply point, which has to be located in the region of the plane delimited by the extension of the two consumption vectors \bar{c}_1 and \bar{c}_2 (fig. 5 A).

As is shown graphically in fig. 5 A and can be justified straightforwardly with geometrical arguments, the last two conditions are fulfilled when the two single-species resource equilibrium points are located above the two-species resource equilibrium point. When at least one of the single-species equilibrium point is situated below the two-species equilibrium, as is the case for species 2 in fig. 5 B, the supply point cannot belong to the region delimited by the extension of the two consumption vectors, and the last condition for coexistence is not fulfilled. If one of the two single-species equilibrium points lies beneath the two-species equilibrium point ($R_{V,2}^*, R_{I,1}^*$), either $E_{I,2}^*$ is less than $R_{I,1}^*$ or $C_{V,1}^*$ is less than $R_{V,2}^*$ (as is the case in fig. 5 B). In the first case, species 2 is still able to grow for values of E_I slightly lower than $R_{I,1}^*$, the two-species equilibrium value, but species 1 cannot and hence is excluded competitively. In the second case, illustrated in fig. 5 B, it is species 1 that wins competition because it is able to grow for values of C_V slightly lower than $R_{V,2}^*$, contrary to species 2. When the two single-species equilibrium points lies beneath the two-species equilibrium point, the two consumption vectors are not in the appropriate arrangement to fulfill the second condition for coexistence (not shown in fig. 5).

A corollary of the last coexistence condition is that two decomposer species limited by the same element when alone cannot coexist (fig. 5 B): if the two species are C-limited, $C_{V,1}^*$ is equal $R_{V,1}^*$ which is less than $R_{V,2}^*$ because δ_1 is less than δ_2 . So, it is species 1 that wins the competition (as is the case in fig. 5 B); if the two species are E-limited, $E_{I,2}^*$ is equal to $R_{I,2}^*$, which is less than $R_{I,1}^*$ because δ_2 is greater than δ_1 . In that case, species 1 is competitively excluded. An ensuing consequence is that, given enough time for evolution of the decomposer C:E demand ratio δ , coexisting decomposers should converge towards co-limitation by C and E, because E-limited decomposers will be out-competed by E-limited decomposers with greater C:E demand ratios and C-limited decomposers will be out-competed by C-limited decomposers with lower C:E demand ratios.

In summary, there are three conditions for the coexistence of two species of decomposers competing for an inorganic resource and an organic resource. First, the two ZNGIs must intersect. Second, each species must consume relatively more of the resource that limits its own growth rate. And third, the supply point, has to be located in the region of the plane delimited by the extension of the two consumption vectors (Tilman 1980). Stoichiometric constraints on the relative consumption of the two resources ensure that the first two conditions are fulfilled. Fulfillment of the third condition is not made easier by stoichiometric constraints. However, we show that the second and third condition can be combined into a single condition: the two single-species resource equilibrium points must lie above the two-species resource equilibrium point. Because of stoichiometric constraints, this condition should result, by means of species replacement or adaptation, in the convergence of decomposer communities towards co-limitation by C and E.

Discussion

The model developed here applies the methodology elaborated mainly for plants in the resource-ratio theory to the growth of microbial decomposers on two elements, carbon (C) and another element (noted E), which could be phosphorus, nitrogen, iron, or any other potentially growth-limiting essential element. These two elements are contained into two resources available to decomposers. One resource contains only E in inorganic form. The second resource is organic and made of both C and E. The improvement brought by this model, compared with the usual models employed in resource-ratio theory, lies in the introduction of constraints on the elemental compositions of the organic resource and of decomposer demand by imposing a constant C:E ratio. The addition of these stoichiometric constraints leads to a set of new insights and predictions, in particular: (1) a trade-off between the R^* values of the two resources, (2) favorable conditions for the coexistence of decomposers that have demands with different elemental ratios, and (3) convergence of the decomposer community, through species replacement or evolution, towards co-limitation by the organic and inorganic resources. The homeostasis of decomposer stoichiometry and the difference between the elemental composition of the organic resource and of the demand of decomposers are the key factors responsible for these predictions.

To reach our predictions on the coexistence and evolution of competing decomposers, we examined the variation of a single parameter, i.e., the decomposer C:E demand ratio, while keeping all other parameters constant. We also performed an equilibrium analysis and assumed that environmental parameters such as resource supplies and loss rates were constant. Although these restrictions may limit the generality of our predictions, we feel that lifting them would be out of the scope of this article and would not affect our main point i.e., that stoichiometric constraints are the source of a trade-off between the R^* values of the two resources and a factor favoring the coexistence of decomposers that differ in their relative

demands of the two elements. We anticipate that letting decomposers vary in parameters other than their demand C:E ratio will not have a systematic impact on coexistence unless these parameters are correlated to the demand ratio. We also expect that environmental variability will generally prevent the competitive interaction to reach its conclusion and, hence facilitate coexistence and delay the long-term convergence of decomposers to co-limitation by the organic and inorganic resources. More detailed studies on these issues, however, would be useful.

Two important assumptions of our model require some discussion: the constancy of decomposer elemental composition and the constancy of their carbon gross growth efficiency, which together result in the constancy of the decomposer C:E demand ratio. The assumption that single-species decomposer elemental composition is constant is still open to debate. There are a number of studies on variation in the chemical composition of different organisms (i.e. Sterner and Elser 2002, Evans-White et al 2005) but few of them deal with variation in the chemical composition of microbial decomposers such as bacteria and fungi. There is a fundamental difference between autotrophs, which can experience large variations in their elemental composition, and metazoans, which have much more reduced variations (Sterner and Elser 2002). Bacteria seem to lean more towards the case of metazoans with much less variation than autotrophs (Makino et al 2003). But some variation does exist among individual strains of bacteria (Vrede et al 2002). Although a comprehensive review of the factors causing variations in microbial elemental composition is still lacking, it seems from current knowledge that the growth rate is the most important factor controlling the variation of the element that limits growth (Vrede et al 2002, Makino et al 2003), while both the growth rate and element supply control the variation of non-limiting elements (Vrede et al 2002, Zinn et al 2004). Since our analysis was performed at equilibrium, as long as the loss rate—which is equal to the growth rate at equilibrium—is constant there should not be any change in the

elemental composition of decomposers due to variation in their growth rate. For the non-limiting element, its supply is also important because it influences the amount of this element stored by decomposers at equilibrium (Herbert 1976, Zinn et al 2004). The storage capacity of decomposers generally decreases with their growth rate (Vrede et al 2004, Zinn et al 2004), and some elements, such as nitrogen, do not seem to be stored at all. Hence, our hypothesis of a constant composition is appropriate for high growth rates and for some elements such as nitrogen.

Carbon gross growth efficiencies measured in nature are highly variable (del Giorgio and Cole 1998). As for decomposer elemental composition, it seems that growth rate and resource supply are the main drivers of these variations (Cajal-Medrano and Maske 2005, Lennon and Pfaff 2005, Jansson et al 2006). Most of these studies, however, concern bacterial assemblages, and shifts in community composition might be a better explanation of these variations than is physiological plasticity of single species (Eiler et al 2003). Hence, it is still difficult, based on current knowledge, to conclude on the constancy or variation in the carbon gross growth efficiency of decomposers. This parameter is also important because it determines the intensity of the mismatch between the C:E ratios of decomposer demand and elemental composition. A poor estimation of carbon gross growth efficiency may lead to erroneously assume that decomposers mineralize or immobilize the inorganic resource and thus to miss their true function in the ecosystem. For all these reasons, we see the study of this physiological parameter and of the factors that govern its variations as a key target for future microbial ecological studies.

Contrary to many models of microbial growth, we also assumed that there was no consumption of C and E for basal metabolism. It is commonly assumed that losses of C and E for maintenance are small, constant fractions of decomposer biomass (Marr et al 1962). The introduction of a constant mass-specific basal metabolic rate in accordance with this

assumption should not bring qualitative changes to our predictions. This rate would simply add to the loss rate l . Because of these increased losses of C and E in decomposers, the model would deviate from the conditions of a chemostat, which would make the calculations of equilibrium values, threshold values, stability conditions and feasibility conditions a little more complicated but would not yield qualitatively different results. One qualitative difference would appear in the special case where the supply and loss rate of one resource are zero. Our model predicts the persistence of decomposers after they have exhausted the amount present in the ecosystem of the non-renewed resource, while the addition of a basal metabolic rate would predict that decomposers burn their own biomass until extinction. However, many microbial decomposers are known to have resistance forms such as spores or dormant stages that have negligible maintenance costs, and thus our model might be closer to reality even in this very special case of starvation in a closed ecosystem. Models such as those of Thingstad and Pengerud (1985) and Thingstad (1987) explicitly introduced variation in C:P composition and/or maintenance costs but these improvements did not bring conclusions that differ drastically from our conclusions on the common issues addressed by the various models, and they did not address the main topic of interest of the present paper, i.e., the use by decomposers of a resource that contains both carbon and another element, and its consequences on their species interactions and their role in elemental cycling.

In resource-ratio theory, the coexistence of two decomposer populations requires that each of them be limited by a different resource at equilibrium, and consume proportionately more of the resource that limits its own growth (Tilman 1980). Because they link the relative consumption of an element to its relative demand for growth, we predict that the stoichiometric constraints on the elemental compositions of the organic resource and decomposers should help fulfill these two conditions and make coexistence on the two resources possible, given adequate resource supplies. Resource competition between different

decomposer strains or species has rarely been addressed experimentally (e.g. Vadstein 1998, Basson 2000, Celar 2003, Diedhiou et al 2004), and certainly not using organic resources that combine two limiting elements or looking for differences in elemental composition between competitors. Therefore it is premature to draw conclusions on the validity of this result. Our model, however, seems a promising path to understand decomposer community structure. It is known, for example, that bacteria and fungi have different C:P and C:N ratios and that substrate C:N ratio can have an influence on fungal/bacterial biomass ratios (Eiland et al 2001). If we also consider the vast number of limiting resources created by the combination of the various essential elements (C, N, P, Fe...) in organic resources with different possible elemental ratios (parameter α in the present models) we see that this stoichiometry-enhanced mechanism of coexistence has a great potential in explaining the high diversity that is usually encountered in natural decomposer communities. A last necessary condition for coexistence concerns the location of the supply point, which must belong to the region delimited by the extension of the consumption vectors of the two competing species (Tilman 1980). We have shown graphically that the second and third conditions are fulfilled if and only if the two single-species equilibrium points are located above the two-species equilibrium point, which lies at the intersection of the ZNGIs of the two decomposer species. Although we derived this condition in the specific context of our model, it is general for all kinds of consumers. The condition that the two ZNGIs must intersect and the condition that the two single-species equilibrium points must lie above the two-species equilibrium point are necessary and sufficient to ensure the stable coexistence of any two species competing for two resources. The biological interpretation of these two conditions is straightforward: coexistence is stable if the two species exhibit a trade-off in their minimum resource requirement at equilibrium and if each species on its own requires less of the resource limiting the other species at equilibrium than the latter. Our reformulation of Tilman's (1980) three conditions for

coexistence into these two new conditions also has a practical advantage: it is generally more difficult to estimate the supply rate of resources in the field than to measure their concentrations and to determine which one is limiting. Therefore, we hope that our work will facilitate the use of resource-ratio theory in field studies, outside of the realm of experimental and theoretical studies (Miller et al 2005).

We showed that decomposers limited by the same resource when alone cannot coexist and that, by means of species replacement or evolution of their C:E demand ratio, decomposers should converge along the R^* trade-off curve towards co-limitation by the inorganic and organic resource. Hence, even though stoichiometry is a potent mechanism to explain diversity of consumers on an ecological timescale (Loladze et al 2004, Hall 2004), it might prove insufficient on the timescale of evolution because, in absence of other factors, co-limitation, which is the best strategy of resource use, will always dominate ultimately. Therefore, other mechanisms, such as environmental variability or trade-offs between the decomposer demand elemental ratio and other growth-related parameters might be needed to account for microbial decomposer diversity.

Other studies already extended resource-ratio theory to decomposer growth on two resources (see Smith 1993). In contrast to these earlier studies, however, we were able to derive an explicit trade-off between the R^* of the two resources that has far-reaching consequences for the coexistence of competing decomposers. In fact, in many of previous models, C and E were assumed to be totally separate resources for decomposers (Thingstad and Pengerud 1985, Thingstad 1987). As a result, the inorganic element E was always immobilized and never mineralized, the amount of inorganic E consumed at equilibrium when it was limiting was independent of the C:E ratios of decomposers and of the organic resource, and no trade-off between the R^* of the two resources could be deduced directly from their equilibrium values. A few models examined the use by decomposers of an organic resource

that contains both C and E and its relation to the use of inorganic E, but they were simulation models (Parnas 1975, Vallino et al 1996, Touratier et al 1999).

All our results about decomposer competition are valid for other kinds of consumers as long as there is a trade-off between the R^* 's of the two resources resulting from constraints on the demand ratio for the two resources. For situations in which C and E are physically separated, as is the case with plants consuming essential resources, such a trade-off was hypothesized based on optimal foraging theory (Tilman 1980, 1986). In our study, in which C and E are partially linked, this trade-off arises from stoichiometric constraints and facilitates the coexistence of two consumer species limited by different elements. A study of grazer competition by Loladze et al (2004), in which C and E were totally coupled, concluded that stoichiometric constraints could lead to the coexistence of consumers limited by the same element. Thus, in addition to the elemental ratios that are considered traditionally in stoichiometric studies, the way in which these elements are linked in resources seems to play an important role in determining the growth and competitive interactions of consumers. It would be interesting to study this factor in a more systematic way.

Decomposers compete for inorganic resources not only with each other, but also with primary producers. Many studies have addressed the issue of coexistence between primary producers and decomposers to resolve the apparent paradox of primary producers providing a much needed organic resource to decomposers, their main competitors for inorganic resources (Currie and Kalff 1984, Bratbak and Thingstad 1985, Daufresne and Loreau 2001b, Mindl et al 2005). Our present work is a useful basis for predicting when decomposer interactions with primary producers change from competition to mutualism and from coexistence to competitive exclusion because it identifies the conditions under which decomposers switch from immobilizing the inorganic resource to mineralizing it, and from carbon limitation to inorganic resource limitation (Cherif and Loreau, unpublished results).

Based on resource-ratio and ecological stoichiometry theories, our model yields interesting new predictions and perspectives on important aspects of community structure and ecosystem functioning related to microbial decomposers. Most of these new predictions result from the stoichiometric constraints that act on the elemental composition of decomposer demand and of their organic resources. First, stoichiometric constraints generate a trade-off between the abilities of decomposers to utilize an inorganic element and an organic resource containing this same element. As a consequence of this trade-off, coexistence is facilitated between decomposer types that have different elemental demand ratios, even though, in the long run, they should evolve towards the demand ratio that results in co-limitation of growth by the organic resource and the inorganic element. Because of the diversity of elemental compositions of inorganic resources, organic resources and decomposers, we expect this stoichiometry-related trade-off to be an important mechanism in explaining the diversity of decomposer communities. Second, we predict that decomposers will be mineralizers only in ecosystems that are rich enough to provide the quantity of organic resources needed by mineralizing decomposers, which are more demanding in carbon. Since other organisms provide these organic resources, we intend to use our model as a basis for studying the interactions between decomposers and the other major trophic levels in ecosystems.

Acknowledgments

We are most grateful to Claire de Mazancourt for her precious advice that led to substantial improvement of our manuscript. We are also thankful to our reviewers and editors. M. Cherif was supported by a grant from the French Ministry of Research and Education. M. Loreau acknowledges a Discovery grant of the Natural Sciences and Engineering Research Council of Canada. This work was supported by an ACI ECCO-PNBC grant from the Centre National de la Recherche Scientifique (France).

Online Appendix A: Equilibria and stability of the model

- Equilibrium values:

The following table presents the equilibrium values of the variables in the model with a single decomposer species. Two equilibria are possible for each kind of limitation (E or C limitation), one in which decomposers are “washed out” (trivial equilibrium) and the other in which decomposers persist (non-trivial equilibrium).

Equilibrium	C-limited growth	E-limited growth
Trivial	$C_V^* = C_V^0, E_D^* = 0, E_I^* = E_I^0$	$C_V^* = C_V^0, E_D^* = 0, E_I^* = E_I^0$
Non trivial	$C_V^* = \delta \frac{l}{v} = R_V^*, E_D^* = \frac{l(C_V^0 - C_V^*)}{vC_V^*},$ $E_I^* = \frac{C_V^0}{\alpha} + E_I^0 - \frac{C_V^*}{\alpha} - E_D^*$	$E_I^* = \frac{\alpha - \delta l}{\alpha i} = R_I^*, E_D^* = \frac{l(E_I^0 - E_I^*)}{iE_I^*},$ $C_V^* = \delta \left(\frac{C_V^0}{\alpha} + E_I^0 - E_I^* - E_D^* \right)$

- Local stability and feasibility:

An equilibrium is locally stable if the system returns to it after a small perturbation. Local stability is assessed by calculating the eigenvalues of the Jacobian matrix. An equilibrium is locally stable if and only if the real part of all these eigenvalues is negative. Below we provide the Jacobian matrix and its eigenvalues for each of the possible equilibria, and we derive the corresponding stability conditions. Although our dynamical system comprises five variables (C_V, E_V, C_D, E_D and E_I), it can be reduced to the three variables C_V, E_D and E_I for the stability analysis. Indeed, E_V and C_D are simply equal to C_V and E_D , respectively, multiplied by the positive constants $1/\alpha$ and δ . Therefore their response to a small perturbation is the same as that of C_V and E_D , and the study of the latter is sufficient to conclude on the stability and feasibility of an equilibrium.

- C-limited trivial equilibrium:

$$J = \begin{bmatrix} -l & -vC_V^0 & 0 \\ 0 & \frac{1}{\delta}vC_V^0 - l & 0 \\ 0 & -(\frac{1}{\delta} - \frac{1}{\alpha})vC_V^0 & -l \end{bmatrix}$$

Two eigenvalues are negative and equal to $-l$. The third eigenvalue is negative, and hence the equilibrium locally stable, for $C_V^0 < \delta \frac{l}{v} = R_V^*$.

- E-limited trivial equilibrium:

$$J = \begin{bmatrix} -l & \frac{-\alpha\delta}{\alpha - \delta}iE_I^0 & 0 \\ 0 & \frac{\alpha}{\alpha - \delta}iE_I^0 - l & 0 \\ 0 & -iE_I^0 & -l \end{bmatrix}$$

Two eigenvalues are negative and equal to $-l$. The third eigenvalue is negative, and the equilibrium locally stable for $E_I^0 < \frac{\alpha - \delta}{\alpha} \frac{l}{i} = R_I^*$.

- C-limited non-trivial equilibrium:

$$J = \begin{bmatrix} -(vE_D^* + l) & -vC_V^* & 0 \\ \frac{1}{\delta}vE_D^* & 0 & 0 \\ -(\frac{1}{\delta} - \frac{1}{\alpha})vE_D^* & -(\frac{1}{\delta} - \frac{1}{\alpha})vC_V^* & -l \end{bmatrix}$$

One eigenvalue is negative and equal to $-l$. The other two eigenvalues are solutions to the equation $a_0\lambda^2 + a_1\lambda + a_2 = \lambda^2 + (vE_D^* + l)\lambda + \frac{1}{\delta}vE_D^*vC_V^* = 0$. Using Routh-Hurwitz criteria, the solutions are negative if a_0 , a_1 and a_2 have the same sign. Since this is the case here, this equilibrium is always locally stable when feasible. This equilibrium is feasible when by C limits decomposers ($iE_I^* > \frac{\alpha - \delta}{\alpha\delta}vC_V^*$) and their biomass is greater than zero ($C_V^0 > R_V^*$).

- E-limited non-trivial equilibrium:

$$J = \begin{bmatrix} -l & -\frac{\alpha\delta}{\alpha-\delta}iE_I^* & -\frac{\alpha\delta}{\alpha-\delta}iE_D^* \\ 0 & 0 & \frac{\alpha}{\alpha-\delta}iE_D^* \\ 0 & -iE_I^* & -(l+iE_D^*) \end{bmatrix}$$

One eigenvalue is negative and equal to $-l$. The other two eigenvalues are solutions to the

equation $a_0\lambda^2 + a_1\lambda + a_2 = \lambda^2 + (l+iE_D^*)\lambda + \frac{\alpha}{\alpha-\delta}iE_I^*iE_D^* = 0$. a_0 , a_1 and a_2 are all positive

(since α must be greater than δ for decomposers to be E limited), hence this equilibrium is

always locally stable when feasible. This equilibrium is feasible when E limits decomposers

($iE_I^* < (\frac{1}{\delta} - \frac{1}{\alpha})\nu C_V^*$) and their biomass is greater than zero ($E_I^0 > R_I^*$).

Here is a summary of the conditions that result in the local stability of the various equilibria:

Equilibrium	C limitation	E limitation
Trivial	$iE_I^0 > (\frac{1}{\delta} - \frac{1}{\alpha})\nu C_V^0$ & $C_V^0 < R_V^*$	$iE_I^0 < (\frac{1}{\delta} - \frac{1}{\alpha})\nu C_V^0$ & $E_I^0 < R_I^*$
Non-trivial	$iE_I^* > (\frac{1}{\delta} - \frac{1}{\alpha})\nu C_V^*$ & $C_V^0 > R_V^*$	$iE_I^* < (\frac{1}{\delta} - \frac{1}{\alpha})\nu C_V^*$ & $E_I^0 > R_I^*$

- For the stability and feasibility analysis of the model with two competing decomposers, readers are referred to Tilman (1980).

Online Appendix B: Calculation of δ threshold values

This Appendix shows how we derived the analytical expressions of the four δ threshold values defined in the text:

- δ_{Imm}^{Min} is reached when $R_I^* = \frac{\alpha - \delta l}{\alpha i} = 0$, which gives $\delta_{Imm}^{Min} = \alpha$.

- δ_{Clim}^{Elim} is reached when decomposers are co-limited at equilibrium, that is, $iE_I^* = (\frac{1}{\delta} - \frac{1}{\alpha})vC_V^*$. Replacing the variables with their equilibrium values (Appendix A), we obtain δ_{Clim}^{Elim} as the positive root of the 2nd degree equation:

$$(1 - \frac{i}{v})l \frac{\delta^2}{\alpha} + \left[i(\frac{C_V^0}{\alpha} + E_I^0) - (1 - \frac{i}{v})l \right] \delta - iC_V^0 = 0,$$

$$\delta_{Clim}^{Elim} = \frac{1}{2} \left(- \left[i(\frac{C_V^0}{\alpha} + E_I^0) - (1 - \frac{i}{v})l \right] + \sqrt{\left[i(\frac{C_V^0}{\alpha} + E_I^0) - (1 - \frac{i}{v})l \right]^2 + 4i \frac{C_V^0}{\alpha} (1 - \frac{i}{v})l} \right)$$

- $\delta_{Clim}^{washout}$ is reached when $C_V^0 = R_V^* = \delta \frac{l}{v}$, which gives $\delta_{Clim}^{washout} = \frac{evC_V^0}{l}$.

- $\delta_{washout}^{Elim}$ is reached when $E_I^0 = R_I^* = \frac{\alpha - \delta l}{\alpha i}$ which gives $\delta_{washout}^{Elim} = \alpha(1 - \frac{iE_I^0}{l})$.

Literature Cited:

- Andr n, O. and J. Balandreau. 1999. Biodiversity and soil functioning—from black box to can of worms? *Applied Soil Ecology* 13:105-108.
- Basson, N.J. 2000. Competition for glucose between *Candida albicans* and oral bacteria grown in mixed culture in a chemostat. *Journal of Medical Microbiology* 49:969-975.
- Bratbak, G. and T. F. Thingstad. 1985. Phytoplankton-bacteria interactions: an apparent paradox? Analysis of a model system with both competition and commensalism. *Marine Ecology Progress Series* 25:23-30.
- Cajal-Medrano, R. and H. Maske. 2005. Growth efficiency and respiration at different growth rates in glucose-limited chemostats with natural marine bacteria populations. *Aquatic Microbial Ecology* 38:125-133.
- Cebrian, J. 1999. Patterns in the fate of production in plant communities. *The American Naturalist* 154:449-468.
- Celar, F. 2003. Competition for ammonium and nitrate forms of nitrogen between some phytopathogenic and antagonistic soil fungi. *Biological Control* 28:19-24.
- Currie, D.J. and J. Kalff. 1984. A comparison of the abilities of freshwater algae and bacteria to acquire and retain phosphorus. *Limnology and Oceanography* 29:298-310.
- Daufresne, T. and M. Loreau 2001a. Plant-herbivore interactions and ecological stoichiometry: when do herbivores determine plant nutrient limitation? *Ecology Letters* 4:196-206.
- Daufresne, T. and M. Loreau. 2001b. Ecological stoichiometry, primary producer-decomposer interactions and ecosystem persistence. *Ecology*, 82:3069–3082.
- Del Giorgio, P. A. and J. J. Cole. 1998. Bacterial growth efficiency in natural aquatic systems. *Annual Review of Ecology and Systematics* 29:503-541.
- Diedhiou, A.G., F. Verpillot, O. Gueye, B. Dreyfus, R. Duponnois and A.M. Ba. 2004. Do concentrations of glucose and fungal inoculum influence the competitiveness of two early-stage ectomycorrhizal fungi in *Afzelia africana* seedlings? *Forest Ecology and Management* 203:187–194.
- Eiland, F., M. Klamer, A.-M. Lind, M. Leth and E. B  ath. 2001. Influence of initial C/N Ratio on chemical and microbial composition during long term composting of straw. *Microbial Ecology* 41:272–280.
- Eiler, A., S. Langenheder, S. Bertilsson and L. J. Tranvik. 2003. Heterotrophic bacterial growth efficiency and community structure at different natural organic carbon concentrations. *Applied and Environmental Microbiology* 69:3701-3709.
- Evans-White, M. A., R. S. Stelzer and G. A. Lamberti. 2005. Taxonomic and regional patterns in benthic macroinvertebrate elemental composition in streams. *Freshwater Biology* 50: 1786-1799.
- Goldman, J. C. and M. R. Dennett (1991). Ammonium regeneration and carbon utilization by marine bacteria grown on mixed substrates. *Marine Biology* 109:369-378.
- Goldman, J. C. and M. R. Dennett (2000). Growth of marine bacteria in batch and continuous culture under carbon and nitrogen limitation. *Limnology and Oceanography* 45:789-800.
- Grover, J.P. 2002. Stoichiometry, herbivory and competition for nutrients: simple models based on planktonic ecosystems. *Journal of Theoretical Biology* 214:599-618.
- Hall, S. R. 2004. Stoichiometrically explicit competition between grazers: species coexistence, replacement, and priority effects along resource supply gradients. *The American Naturalist* 164:157-172.

- Herbert, D. 1976. Stoichiometric aspects of microbial growth. In: Continuous Culture 6: Application and New Fields Dean, ACR, Ellwood, DC, Evans, and J. Melling eds. Ellis Horwood, Chichester, United Kingdom.
- Jansson, M., A. K. Bergström, D. Lymer, K. Vrede, J. Karlsson. 2006. Bacterioplankton growth and nutrient use efficiencies under variable organic carbon and inorganic phosphorus ratios. *Microbial Ecology* 52:358-364.
- Leckie, S. E. 2005. Methods of microbial community profiling and their application to forest soils. *Forest Ecology and Management* 220:88-106.
- Lennon, J. T. and L. E. Pfaff. 2005. Source and supply of terrestrial organic matter affects aquatic microbial metabolism. *Aquatic Microbial Ecology* 39:107-119.
- Loladze, I., Y. Kuang, J. J. Elser and W. F. Fagan. 2004. Coexistence of two predators on one prey mediated by stoichiometry. *Theoretical Population Biology* 65:1-15.
- MacArthur, R. 1972. *Geographical Ecology*. Harper and Row, New York, New York, USA.
- Makino, W., J. B. Cotner, R. W. Sterner and J. J. Elser. 2003. Are bacteria more like animals than plants? Growth rate and resource dependence of bacterial C:N:P stoichiometry. *Functional Ecology* 17:121-130.
- Marr, A. G., E. H. Nilson and D. J. Clark. 1962. The maintenance requirement of *Escherichia coli*. *Annals of The New York Academy of Sciences* 102:536-548.
- Miller, T. E., J. H. Burns, P. Munguia, E. L. Walters, J. M. Kneitel, P. M. Richards, N. Mouquet and H. L. Buckley. 2005. A critical Review of twenty years' use of the resource-ratio theory. *The American Naturalist* 165:439-448.
- Mindl, B., B. Sonntag, J. Pernthaler, J. Vrba, R. Psenner and T. Posch. 2005. Effects of phosphorus loading on interactions of algae and bacteria: reinvestigation of the 'phytoplankton-bacteria paradox' in a continuous cultivation system. *Aquatic Microbial Ecology* 38:203-213.
- Parnas, H. 1975. Model for decomposition of organic material by microorganisms. *Soil Biology and Biochemistry* 7:161-169.
- Smith, V. H. 1993. Applicability of resource-ratio theory to microbial ecology. *Limnology and Oceanography* 38:239-249.
- Sterner, R. W. and J. J. Elser. 2002. *Ecological Stoichiometry: The Biology of Elements from Molecules to the Biosphere*. Princeton University Press, Princeton, NJ.
- Thingstad, T. F. 1987. Utilization of N, P, and organic C by heterotrophic bacteria. I. Outline of a chemostat theory with a consistent concept of 'maintenance' metabolism. *Marine Ecology Progress Series* 35:99-109.
- Thingstad, T. F. and B. Pengerud. 1985. Fate and effect of allochthonous organic material in aquatic microbial ecosystems. An analysis based on chemostat theory. *Marine Ecology Progress Series* 21:47-62.
- Tiedje, J. M., S. Asuming-Brempong, K. Nüsslein, T. L. Marsh and S. J. Flynn. 1999. Opening the black box of soil microbial diversity. *Applied Soil Ecology* 13:109-122.
- Tilman, D. 1980. Resources: a graphical mechanistic approach to competition and predation. *The American Naturalist* 116 : 362-393.
- Tilman, D. 1981. Tests of resource competition theory using four species of Lake Michigan algae. *Ecology* 62:802-815.
- Tilman, D. 1986. A consumer-resource approach to community structure. *American Zoologist* 26:5-22.
- Touratier, F., L. Legendre, and A. Vézina. 1999. Model of bacterial growth influenced by substrate C:N ratio and concentration. *Aquatic Microbial Ecology* 19:105-118.

- Vadstein, O. 1998. Evaluation of competitive ability of two heterotrophic planktonic bacteria under phosphorus limitation. *Aquatic Microbial Ecology* 14:119–127.
- Vallino, J., C. Hopkinson and J. Hobbie. Modeling bacterial utilization of dissolved organic matter: Optimization replaces Monod growth kinetics. *Limnology and Oceanography* 41:1591-1609.
- Vrede, K., M. Heldal, S. Norland and G. Bratbak. 2002. Elemental Composition (C, N, P) and Cell Volume of Exponentially Growing and Nutrient-Limited Bacterioplankton. *Applied and Environmental Microbiology* 68:2965-2971.
- Vrede, T., D. R. Dobberfuhl, S. A. L. M. Kooijman, and J. J. Elser. 2004. Fundamental connections among organism C : N : P stoichiometry, macromolecular composition, and growth. *Ecology* 85:1217-1229.
- Zinn, M., B. Witholt and T. Egli. Dual nutrient limited growth: models, experimental observations, and applications. *Journal of Biotechnology* 113:263-279.

Tables

Table 1: Summary of the symbols used in the model.

Symbols	Explanation	Dimension
Φ_v	Decomposer organic E uptake flux	Quantity of E * time ⁻¹
$\Phi_{v,C}$	Decomposer C uptake flux	Quantity of C * time ⁻¹
Φ_i	Decomposer E_I Stoichiometric adjustment flux	Q of E * time ⁻¹
E_D	E stock in decomposers	Q of E
C_D	Carbon stock in decomposers	Q of C
E_V	E stock in the organic resource	Q of E
C_V	Carbon stock in the organic resource	Q of C
E_I	Inorganic E stock	Q of E
E_I^0	Inorganic E supply to decomposers	Q of E
E_V^0	Organic E supply to decomposers	Q of E
C_V^0	C supply to decomposers	Q of C
α	Organic resource C:E ratio	Q of C * Q of E ⁻¹
β	Decomposer C:E biomass ratio	Q of C * Q of E ⁻¹
δ	Decomposer C:E demand ratio	Q of C * Q of E ⁻¹
δ_{lim}^{Min}	Value of δ that separates equilibria with mineralization from equilibria with immobilization	Q of C * Q of E ⁻¹
$\delta_{C\ lim}^{E\ lim}$	Value of δ that separates C-limited from E-limited equilibria	Q of C * Q of E ⁻¹
$\delta_{C\ lim}^{washout}$	Value of δ that separates C-limited equilibria with decomposers persistent from those with decomposers extinct	Q of C * Q of E ⁻¹
$\delta_{washout}^{E\ lim}$	Value of δ that separates E-limited equilibria with decomposers persistent from those with decomposers extinct	Q of C * Q of E ⁻¹
i	E_I uptake rate of E-limited decomposers	Q of E ⁻¹ * time ⁻¹
v	Organic resource uptake rate of C-limited decomposers	Q of E ⁻¹ * time ⁻¹
l	Ecosystem loss rate	time ⁻¹
c	Decomposer C gross growth efficiency	Q of C * Q of C ⁻¹
R_I^*	E_I minimum requirement of decomposers at equilibrium	Q of E
R_I^{max}	Maximal E_I minimum requirement of decomposers at equilibrium	Q of E
R_V^*	C minimum requirement of decomposers at equilibrium	Q of C

Table 2: Differential equations of the Model describing the growth of a decomposer population using an organic resource and an inorganic resource containing the same essential element (E_x).

	C-limited Growth	E-limited Growth
Decomposer Population:		
$\dot{E}_D = \Phi_v + \Phi_i - lE_D$	$\dot{E}_D = \frac{1}{\alpha}vC_V E_D + (\frac{1}{\delta} - \frac{1}{\alpha})vC_V E_D - lE_D$	$\dot{E}_D = \frac{\delta}{\alpha - \delta}iE_I E_D + iE_I E_D - lE_D$
$\dot{C}_D = c\Phi_{v,C} - lC_D$	$\dot{C}_D = cvC_V E_D - l\delta E_D$	$\dot{C}_D = (\frac{1}{\delta} - \frac{1}{\alpha})^{-1}iE_I E_D - l\delta E_D$
Organic Resource:		
$\dot{E}_V = lE_V^0 - \Phi_v - lE_V$	$\dot{E}_V = lE_V^0 - vE_V E_D - lE_V$	$\dot{E}_V = lE_V^0 - \frac{\delta}{\alpha - \delta}iE_I E_D - lE_V$
$\dot{C}_V = lC_V^0 - \Phi_{v,C} - lC_V$	$\dot{C}_V = lC_V^0 - vC_V E_D - lC_V$	$\dot{C}_V = lC_V^0 - (\frac{1}{\delta} - \frac{1}{\alpha})^{-1}iE_I E_D - lC_V$
Inorganic Resource:		
$\dot{E}_I = lE_I^0 - lE_I - \Phi_i$	$\dot{E}_I = lE_I^0 - lE_I - (\frac{1}{\delta} - \frac{1}{\alpha})vC_V E_D$	$\dot{E}_I = lE_I^0 - lE_I - iE_I E_D$

Legends of Figures:

Fig. 1: Diagram of our model representing the growth of a decomposer population on an inorganic resource and an organic resource containing two essential elements, carbon C and another element E, in a chemostat-like system. E_i : E content of the inorganic resource. E_V : E content of the organic resource. C_V : carbon content of the organic resource. E_D : E content of decomposer biomass. C_D : carbon content of decomposer biomass. Φ_x : flux of E. Φ_c : flux of C. α : constant $C_V:E_V$ ratio. β : constant $C_D:E_D$ ratio. l : dilution rate. c : C gross growth efficiency. E_i^0 : inorganic E supply concentration. E_V^0 : organic E supply concentration. C_V^0 : organic C supply concentration.

Fig. 2: Graphical determination of the resource equilibrium, based on the method developed by the resource-ratio theory (Tilman 1980). In the plane formed by the two resources C_V and E_i as coordinates, the decomposer Zero Net Growth Isocline (ZNGI: - - -) is the set of (C_V, E_i) values that result in zero net growth of the decomposer population. The supply point (●) is the point corresponding to the two resource supply concentrations (C_V^0, E_i^0) . For supply points in region I, the supply of resources is too low to maintain a viable decomposer population at equilibrium. Decomposers then go extinct, and the resource equilibrium point merges with the supply point. For supply points outside region I, decomposers persist at equilibrium. The resource equilibrium point (★) is the point of the ZNGI where the consumption vector is exactly opposite to the supply vector. As the consumption vector has a slope of $(1/\delta)-(1/\alpha)$ and the supply vector points towards the supply point then, the

resource equilibrium point lies at the intersection between the ZNGI and the line with slope $(1/\delta)-(1/\alpha)$ passing through the supply point. The co-limitation line (····) is the line with the same slope that passes through the co-limitation point (\blacktriangledown). It divides the region of supply points that allow decomposer persistence into a region that yield E-limited equilibria (region II) and a region that yield C-limited equilibria (region II'). In **A**, δ , the C:E demand ratio of decomposers, is less than α , the C:E ratio of the organic resource. Decomposers have a deficit in organic E and have to immobilize E_i to maintain the constancy of their composition. In **B**, δ is greater than α . Decomposers have an excess of organic E and have to mineralize E_i to keep their composition constant.

Fig. 3: A. Changes in the location of the decomposer ZNGI with δ , the C:E demand ratio of decomposer biomass. As δ varies, all other parameters being constant, the co-limitation point (\blacktriangledown) that lies at the corner of the ZNGI moves along the R^* trade-off curve (—). The smaller δ , the closer the ZNGI is to the y -axis and the co-limitation point to the point $(0, R_i^{max})$.

B. Graphical determination of the various δ threshold values that delimit equilibria with different properties. δ_{Imm}^{Min} separates δ values that result in immobilization by decomposers from those that result in mineralization. The decomposer co-limitation point (\blacktriangledown) lies at the intersection between the R^* trade-off curve and the x -axis. ZNGI (—) then has its E-limited half-part confounded with the x -axis. δ_{Clim}^{Elim} separates δ values that result in E-limited equilibria from those that result in C-limited equilibria. The co-limitation line (····) with slope $(1/\delta)-(1/\alpha)$ then passes through the supply point

(●), and the resource equilibrium point (★) is confounded with the co-limitation point.

$\delta_{Clim}^{washout}$ separates δ values that result in C-limited equilibria with a viable decomposer population from those that result in C-limited equilibria with an extinct decomposer population. The supply point then lies on the C-limited half of the decomposer ZNGI.

$\delta_{washout}^{Elim}$ separates δ values that result in E-limited equilibria with a viable decomposer population from those that result in E-limited equilibria with an extinct decomposer population. The supply point then lies on the E-limited half of the decomposer ZNGI.

Fig. 4: Effects of the location of the resource supply point (C_V^0, E_I^0) (●) on the feasibility of the various possible equilibria of a decomposer population growing on an inorganic (E) and an organic resource (C_V) according to Model 1 (A to E), and on the variation in equilibrium decomposer biomass (E_D^*) as a function of the decomposer C:E demand ratio δ (A' to E'). The feasibility of the equilibria can be deduced from the order of the δ threshold values (defined in fig. 4). In **A**, the supply point lies below the R^* trade-off curve (—), and decomposers go extinct. Equilibrium decomposer biomass is zero for all δ values as shown in **A'**. In **B**, $E_I^0 < R_I^{max}$, so decomposers with low values of δ go extinct. C_V^0 is sufficiently high for mineralization (—) to occur for decomposers with a δ ratio between δ_{Imm}^{Min} and $\delta_{Clim}^{washout}$ as shown in **B'**. In **C**, $E_I^0 > R_I^{max}$, and all E-limited decomposers are persistent at equilibrium (..... in **C'**). C_V^0 is still sufficient for mineralization. In **D**, $E_I^0 < R_I^{max}$ but now, C_V^0 is

too low and C-limited persistent decomposers (\rightarrow) immobilize E at equilibrium. In **E**,

$E_i^0 > R_i^{max}$ and C_V^0 is too low for mineralization.

Fig. 5: Graphical determination of the resource equilibrium point and its stability in the case of two competing decomposer populations that differ only in their δ values (δ_1 and δ_2). The resource equilibrium point (\star) is located at the intersection of the two ZNGIs. Because the two co-limitation points lie on the R^* trade-off curve, the two ZNGIs necessarily intersect and the equilibrium is feasible. At this equilibrium, decomposers with ratio δ_1 are E limited, while decomposers with ratio δ_2 are C limited. For the equilibrium to be stable, each decomposer must consume more of the resource that limits its own growth. In this model this condition is always fulfilled, as can be seen from the relative positions of the two consumption vectors \bar{c}_1 and \bar{c}_2 (see Tilman 1980). This is the case because the ratio of $E_i:C_V$ consumed at equilibrium, $(1/\delta)-(1/\alpha)$, is greater for decomposers with ratio δ_1 than for those with ratio δ_2 . The last condition for coexistence requires that the two single-species resource equilibrium points (\star) be above the two-species resource equilibrium point. Only when this condition is fulfilled does the supply point belong to the region of the plane delimited by the extension of the two consumption vectors. This last condition is met in A, but not in B.

Fig. 1:

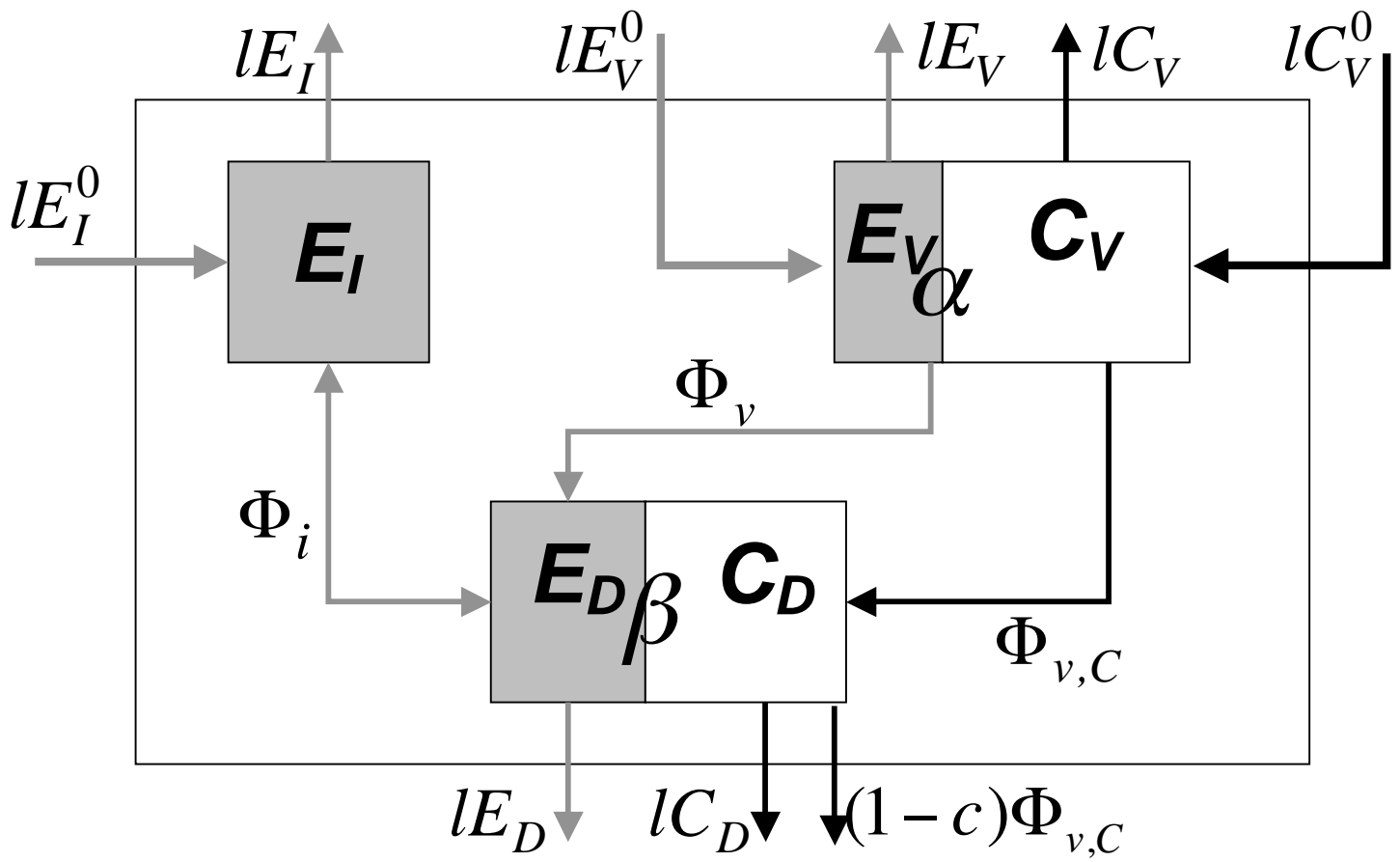

Fig. 2:

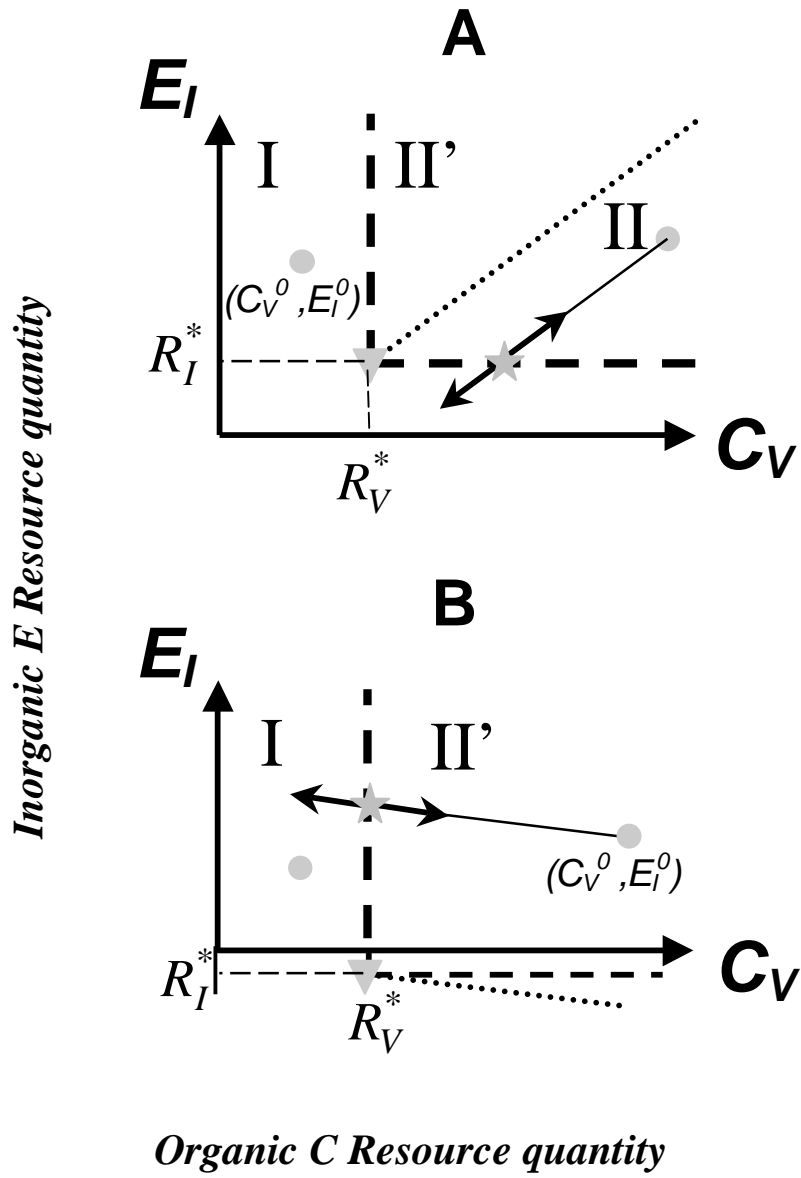

Fig. 3:

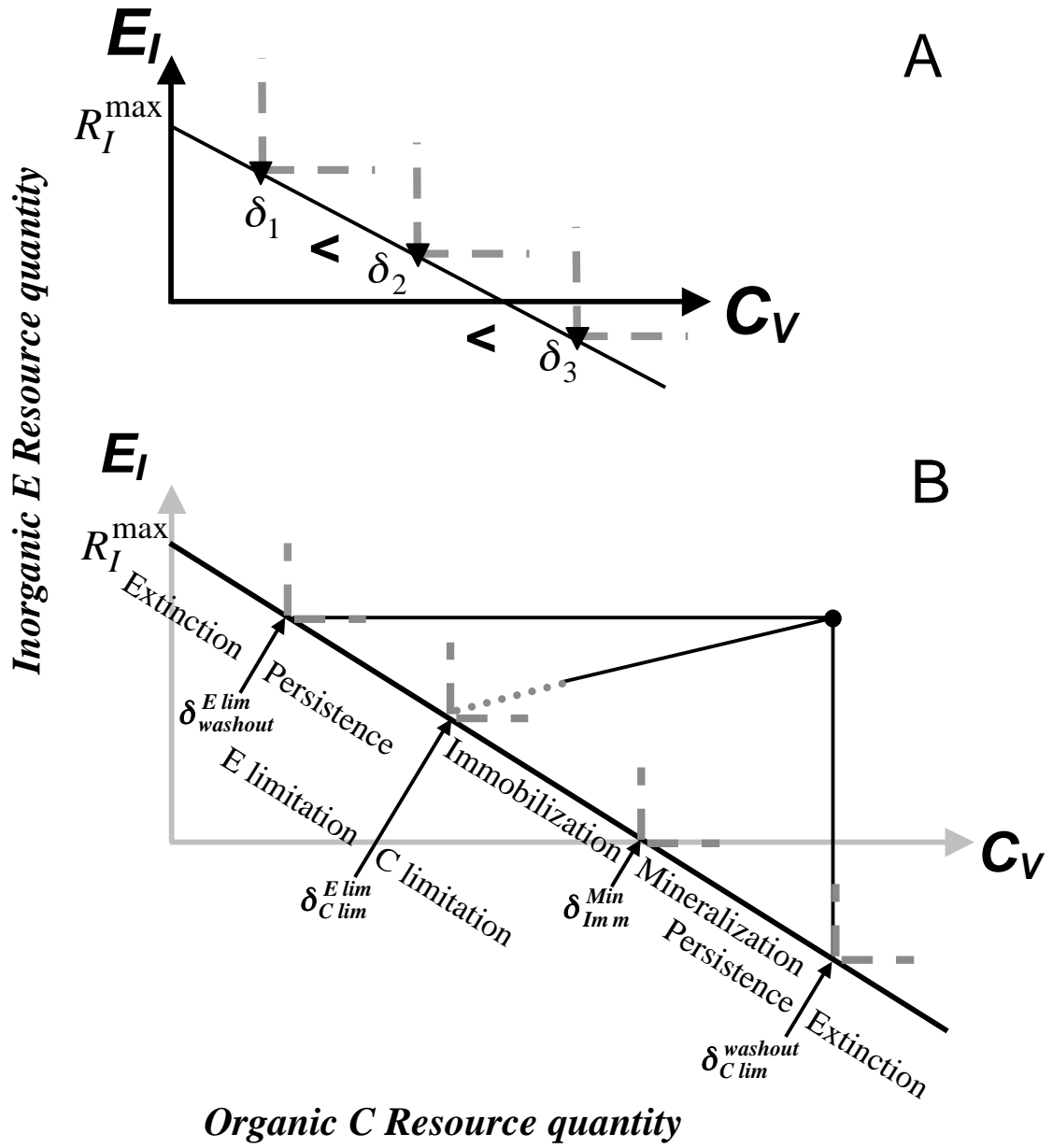

Fig. 4:

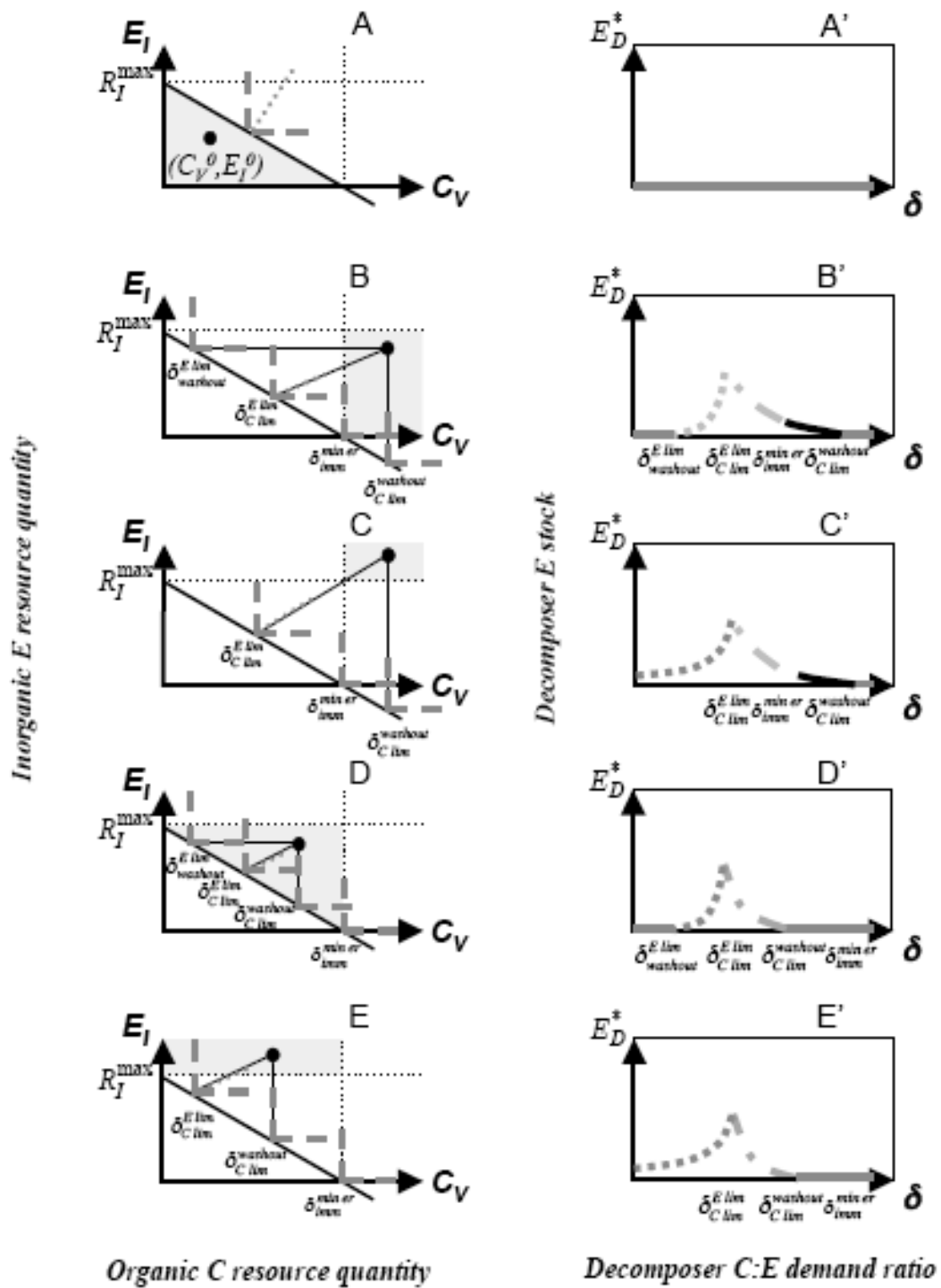
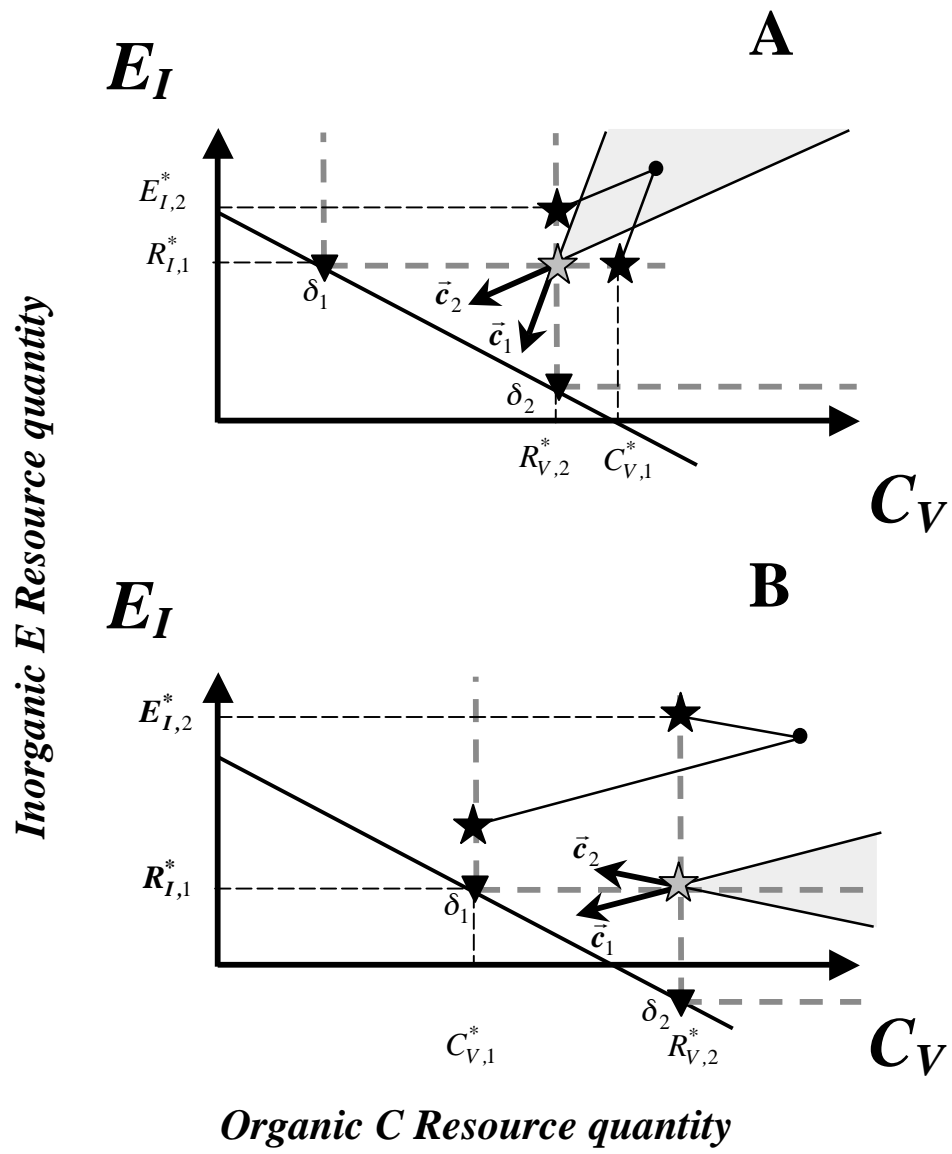

Fig. 5:



Annexe 2 :

Draft manuscript:

Elemental and molecular compositions of organic substrates control nitrogen cycling by
bacteria.

Mehdi Cherif¹, James B. Cotner² and Michel Loreau³

¹Author for correspondence:

Laboratoire d'Ecologie, BIOEMCO UMR 7618, Ecole Normale Supérieure, 46 rue d'Ulm, F-75230 Paris Cedex 05, France

Current address:

Department of Biology, McGill University, 1205 avenue Docteur Penfield, Montreal, Quebec H3A 1B1, Canada

Phone: 514-398-6815

FAX: 514-398-5069

E-mail: cherif@biologie.ens.fr

²Department of Ecology, Evolution and Behavior, University of Minnesota, 1987 Upper Buford Circle, Saint Paul, Minnesota 55108, USA

E-mail: cotne002@umn.edu

³Department of Biology, McGill University, 1205 avenue Docteur Penfield, Montreal, Quebec H3A 1B1, Canada

E-mail: michel.loreau@mcgill.ca

Keywords: *Arthrobacter aurescens*; C:N ratio; Fatty acid amides; immobilization; mineralization;

Abstract:

Microbial regeneration of ammonium is a key process that controls primary production in most ecosystems. It is generally accepted that the carbon:nitrogen ratio of the organic substrate of microbial decomposers is the most important determinant of ammonium regeneration, because it controls whether decomposers mineralize or immobilize ammonium and the intensity of this flux of ammonium. However, comparative studies show that the molecular composition of organic matter affects ammonium regeneration significantly. Because most previous studies ignored or confounded the molecular composition factor with the C:N ratio factor, we designed an experiment to separate the molecular composition effect from the elemental composition effect. We demonstrated that when homogeneous organic substrates were used to modify the organic C:N ratio of media, this ratio was indeed the main determinant of ammonium regeneration. However, when the organic C:N ratio was modified by the addition of different molecules as a source of carbon, ammonium regeneration was no longer correlated with the organic C:N ratio, and the chemical properties of the molecules gained importance. These results will help to unravel new important factors of ammonium regeneration, such as photochemical reactions and herbivore organic matter recycling. They also provide a new potential mechanism to explain microbial diversity.

Introduction:

Microbial decomposers and particularly bacteria play an important role of in the cycling of nutrients. Their role is essential for plants and for primary production. They can mineralise nutrients locked into dead biomass and make them available again for plants or algae or they can take up mineral nutrients to meet their own needs and hence compete with plants or algae, a process called immobilization in soil science (Wheeler and Kirchman 1986, Kaye and Hart 1997).

It is known from the very beginnings of soil microbiology that the chemical composition of the organic matter available to decomposers is a major determinant of their mineralization or immobilization of ammonium. Waksman (1917) for example showed that the addition of organic substrates containing no nitrogen inhibits the mineralization of ammonium. Schmitz and Kaufert (1936) demonstrated that the addition of nitrogen-rich organic compounds increased the decomposition rate and probably the rate of mineralization too.

Experimental and theoretical developments based on these earlier works have led to a consensual model where the carbon:nitrogen ratio (C:N ratio) of organic matter is the major factor controlling the regeneration of ammonium (Parnas 1975, Goldman et al 1987, Goldman and Dennett, 1991 and 2000, Daufresne and Loreau 2001, Cherif and Loreau in press). This relation between ammonium regeneration and organic matter derives from the maintenance by decomposers of a constant C:N ratio in their biomass. When the C:N ratio of organic matter is smaller than decomposer C:N ratio, decomposers release the excess of nitrogen in the shape of ammonium. In contrast, when the C:N ratio of organic matter is bigger than decomposer C:N ratio, decomposers take up ammonium from their environment. The C:N ratio control model of ammonium regeneration is expressed in a simple mathematical equation (Goldman et al 1987):

$$E_N = C_T(1/\{C : N\}_s - GGE_C / \{C : N\}_b),$$

in which E_N is the rate of nitrogen excretion, C_T is the rate of carbon uptake, GGE_C is carbon gross growth efficiency, $\{C:N\}_s$ is the C:N ratio of organic matter and $\{C:N\}_b$ is the C:N ratio of decomposer biomass.

This equation has been tested successfully in controlled experiments (Goldman et al 1987, Goldman and Dennett 1991 and 2000). In-situ measures, however, demonstrated that

other chemical properties of organic matter, besides its C:N ratio, were also important in explaining mineral nitrogen regeneration. Lignin, polyphenol and cellulose contents were all found to control ammonium regeneration to some extent (Oglesby and Fownes 1992, Entry and Backman 1995, Bending et al 1998). In some studies, the relation between the C:N ratio and ammonium regeneration was not even found (Tietema 1998, Dendooven et al 2000).

On a theoretical basis, it is evident that the factor controlling ammonium regeneration should be the C:N ratio of the organic matter consumed by decomposers, and not the total C:N ratio of the organic matter available to them. We think that the discrepancy between the C:N ratio control model and some measurements comes from the fact that this model is based on the assumption of a homogeneous organic matter, where carbon and nitrogen are equally consumed by microbial decomposers, as if they were linked in one molecule. However, organic matter is generally a heterogeneous assemblage of molecules that vary widely in their lability (Berendse et al 1987, Ågren and Bosatta 1996). Hence, there might be situations where the total C:N ratio of organic matter does not represent the C:N ratio of the organic matter consumed by decomposers.

We designed an experiment in order to test the hypothesis that organic matter heterogeneity might produce a difference between the C:N ratios of total and consumed organic matter, resulting in a departure of ammonium regeneration from the C:N ratio control model. A bacterial strain was grown in a set of cultures with organic C:N ratios ranging from two to sixteen. The C:N ratio of organic matter in the cultures was manipulated in two different ways. In a first set of cultures, the C:N ratio was modified by introducing organic C and N as a homogeneous substrate in the form of a molecule chosen from a family of molecules that contain one atom of nitrogen but differ in the number of atoms of their carbon chains (saturated fatty acid amides). Because carbon and nitrogen are linked in one molecule, we expect ammonium regeneration in homogeneous substrates to follow the pattern of the C:N ratio control model.

In a second set of cultures, acetamide, a fatty acid amide with a C:N ratio of 2, was used as the unique source of organic nitrogen. The C:N ratio was then modified by adding a saturated fatty acid as a second source of carbon. The concentrations of fatty acids added were calculated to obtain final organic C:N ratios similar to those of the homogeneous-substrate cultures. Fatty acids, particularly with long carbon chains, are bigger in size and less soluble in water than acetamide, so they should be less labile. Then, the C:N ratio of consumed organic matter should reflect a bigger contribution of acetamide than fatty acids and be smaller than the total C:N ratio. That is why we expect either less immobilization or more

mineralization in heterogeneous substrates than in homogeneous substrates with the same total organic C:N ratio.

Our results confirmed that when homogeneous organic substrates were used to modify the organic C:N ratio of media, the pattern of ammonium regeneration supported the model of a control of ammonium regeneration by the total organic C:N ratio. When the organic C:N ratio was changed by the addition of different fatty acids, ammonium regeneration was no longer a function of the organic C:N ratio, confirming that the chemical properties of the molecules became more important than the total organic C:N ratio.

Materials and Methods:

Strain, media and growth conditions:

The strain used in the experiment, *Arthrobacter aurescens* TC1 is a courtesy of Lawrence Wackett (University of Minnesota). It was chosen because it is metabolically diverse and is known to possess amidases (Wackett 2004).

Table 1: Mineral composition of the modified minimal R medium used in the experiment.

Compound	Concentration
(NH ₄) ₂ SO ₄	50 µM
KH ₂ PO ₄	67mM
MgSO ₄ , 7H ₂ O	0.4 g/L
FeSO ₄ , 7H ₂ O	10 mg/L
CaCl ₂ , 2H ₂ O	100 µM
(NH ₄) ₂ SO ₄	50 µM
ZnSO ₄ , 7H ₂ O	0.01 mg/L
CuSO ₄ , 5H ₂ O	0.001 mg/L
CoCl ₂ , 6 H ₂ O	0.02 mg/L
NiCl ₂ , 6 H ₂ O	0.002 mg/L
Na ₂ MoO ₄ , 2 H ₂ O	0.003 mg/L
H ₃ BO ₃	0.03 mg/L

Bacteria were grown on a modified minimal R medium (Strong et al 2002, Table 1). The cultures differed in the C:N ratio of their organic substrates. The C:N ratio was changed in two different ways. In a first set of cultures, the organic matter C:N ratio was changed by adding organic matter as a single molecule (a fatty acid amide) with different C:N ratios (homogeneous substrates in table 2). In a second set of cultures, the C:N ratio was varied by adding a saturated fatty acid, which contains only carbon, to acetamide that contains the organic nitrogen (heterogeneous substrates in table 2).

Table 2: Organic substrates used in the different culture types of the experiment. For each culture type, the molecules used, the total organic C:N ratio and the abbreviation (between parenthesis) are indicated.

C:N ratio	Homogeneous substrate	Heterogeneous substrate
2	Acetamide (C02N)	
6	Hexanamide (C06N)	Acetamide + hexanoic acid (C06)
10	Decanamide (C10N)	Acetamide + decanoic acid (C10)
14	Myristamide (C14N)	Acetamide + myristic acid (C14)
16	Hexadecanamide (C16N)	Acetamide + palmitic acid (C16)

In all the cultures, the final concentration of organic nitrogen was 0.5 mM. In order to obtain the same final organic carbon concentration in culture types with the same C:N ratio, the concentration of the fatty acid molecule added to a heterogeneous-substrate culture was equal to $(C:N-2)/C:N$ of the concentration of the amide molecule in the corresponding homogeneous-substrate culture type. For example, the concentration of hexanoic acid in C06 cultures was equal to $2/3 - (6-2)/6$ of the concentration of hexanamide in C06N cultures.

All cultures were grown in 250-ml flasks with porous cellulose stoppers in a final volume of 50 ml, at 30°C and shaken at 75 rpm. Cultures were run in triplicates for each type of organic substrate. Also, negative controls were set for each culture (media without inoculation of bacteria).

Sampling and sample Preparation:

On the sixth, ninth and twelfth day, 30 ml were sampled from each culture and replaced with fresh medium. 20 ml from each sample were centrifuged at 5000 rpm during 15 minutes. Supernatants were collected, acidified and stored at 4°C until analyses of ammonium, dissolved residual organic carbon and nitrogen were performed. Pellets were resuspended in organic substrate-free and ammonium-free R medium and filtered

immediately on pre-muffled GF/F filters (0.7 pore filters). Filters were then dried overnight at 80°C and folded in tin foils for CHN analyses.

Chemical analyses:

Ammonium concentration was measured using a fluorimetric method modified from (Holmes et al 1999) and courtesy of R. W. Sterner and S. Brovold (University of Minnesota). Residual organic carbon and nitrogen concentrations in cultures were measured on a TOC analyzer at the department of Ecology, Evolution and Behavior of the university of Minnesota. Carbon and nitrogen contents of filters from cultures were determined using a CHN analyzer (COSTECH Analytical ECS 4010) at the Ecosystems analysis lab of the university of Nebraska.

Data analysis:

Negative controls were used to correct any distortion in the measurements (fatty acids and amides with long carbon chains were hardly dissolvable in R media and were generally underestimated when measured by TOC analysers).

Unfortunately, at the time where data analyses were performed, data of bacterial carbon and nitrogen contents (CHN analyses) and of residual organic carbon concentrations (TOC analyses) were not available yet. Hence, data analyses were restricted to ammonium and organic nitrogen concentrations. But analyses of residual organic carbon concentrations and of bacterial carbon and nitrogen contents will be included as soon as they are available.

For ammonium concentrations, values from negative controls were subtracted from the values of the corresponding triplicates. The ammonium concentrations obtained are thus the amounts of regenerated ammonium. We interpreted positive concentrations of regenerated ammonium as mineralization and negative concentrations as immobilization of ammonium by bacteria.

To estimate the proportion of organic nitrogen recovered by our analytical method in negative controls, we divided the concentration measured by the expected concentration, which we supposed to be equal to the initial concentration (0.5 mM) in the media:

$$\textit{Proportion recovered in - control} = [\textit{Measured in - control}] / [\textit{expected in - control}]$$

The proportion of organic nitrogen recovered in inoculated samples was assumed to be equal to the proportion recovered in the corresponding negative control:

$$[\textit{Measured in sample}]/[\textit{Expected in sample}]=\textit{Proportion recovered in - control}$$

So, the corrected, equal to the expected, concentrations of organic nitrogen in samples was obtained by dividing the measured residual concentrations in samples by the proportion recovered in the corresponding negative control:

$$[\textit{Corrected in sample}]=[\textit{Measured in sample}]/([\textit{Measured in - control}]/[\textit{Expected in - control}])$$

For corrected ammonium and organic N concentrations, after considering culture type, date and replicate effects, Shapiro-Wilk tests of normality executed with R software showed that residual values did not follow a normal distribution. Hence, we used non-parametric Kruskal-Wallis tests to investigate sampling date, replicate and factor effects. Date and replicates had non-significant effects. They were thus not included in tests of culture type effects. When tests for differences in ammonium and organic N concentrations between culture types were found to be significant (p-value <0.05), we tested all combinations of culture types with non-parametric pairwise Mann-Whitney tests. Two types of substrates were deemed different when the p-value of the test was <0.005. We also tested with one-sided Wilcoxon sign rank tests if the regenerated ammonium concentrations were significantly (p<0.005) lower (when immobilized) or higher (when mineralized) than 0 mM, and if residual concentrations of organic N were significantly lower than 0.5 mM (the initial concentration in the media).

Table 3: Means (standard error in parenthesis) of regenerated ammonium concentrations and residual organic N concentrations in the different culture types of the experiment.

Culture type	C:N ratio	NH ₄ ⁺ (mM)	Organic N (mM)
Homogeneous substrates			
C02N	2	0.252* (0.065)	0.288† (0.047)
C06N	6	-0.008 (0.009)	0.468† (0.011)
C10N	10	-0.007 (0.008)	0.229† (0.01)
C14N	14	-0.037* (0.01)	0.156† (0.035)
C16N	16	-0.036* (0.009)	0.309† (0.033)
Heterogeneous substrates			
C06	6	0.196* (0.028)	0.255† (0.006)
C10	10	-0.041* (0.009)	0.463† (0.005)
C14	14	0.032 (0.019)	0.474 (0.055)
C16	16	0.244* (0.068)	0.251† (0.019)

* Regenerated ammonium concentration significantly (p-value < 0.005)

greater (or smaller) than 0 mM (One-sided Wilcoxon sign rank test).

† Residual organic N concentration significantly (p-value < 0.005)

smaller than 0.5 mM, the initial concentration of organic N in media

(One-sided Wilcoxon sign rank test).

Results:

Cultures with homogeneous organic substrates:

We compare here the cultures where the organic carbon and nitrogen substrates were introduced as single molecules with various C:N ratios to create (a fatty acid amide).

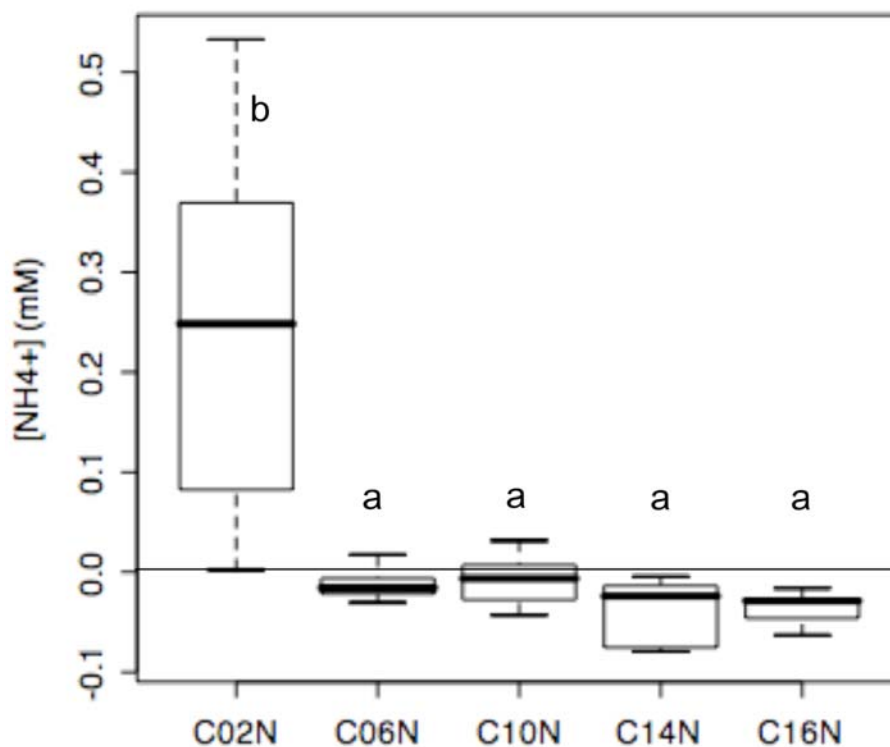

Fig. 1: Boxplot of the concentration of ammonium regenerated by bacteria in cultures with homogeneous organic substrates. Boxplots provide a graphical view of the median, quartiles, minimum and maximum values for each culture type. For one type of substrate, the concentration of regenerated NH_4^+ is the difference between the ammonium concentration measured in a culture with bacteria and a culture with no inoculation of bacteria. Thus, a positive concentration of regenerated NH_4^+ indicates mineralization (C02N cultures) while a negative concentration indicates immobilization (C06N, C10N, C14N and C16N cultures). Culture types with different letters have significantly different median regenerated ammonium concentrations (p-value <0.005, Mann-Whitney test).

The amount of ammonium regenerated varied significantly between the different cultures (Kruskal-Wallis test, p-value = 6.73e-05). Although pair-wise comparisons between culture types suggested that only C02N cultures differed from the others (Figure 1), comparisons of the medians of each culture type to zero demonstrated that ammonium regeneration variation was correlated with the total C:N ratio of the organic substrate (Table 3). Bacteria in cultures with an organic C:N ratio of 2 mineralized nitrogen; regenerated

concentrations of ammonium in C06N and C10N were not significantly different from 0; while bacteria in C14N and C16N cultures significantly immobilized ammonium (table 3).

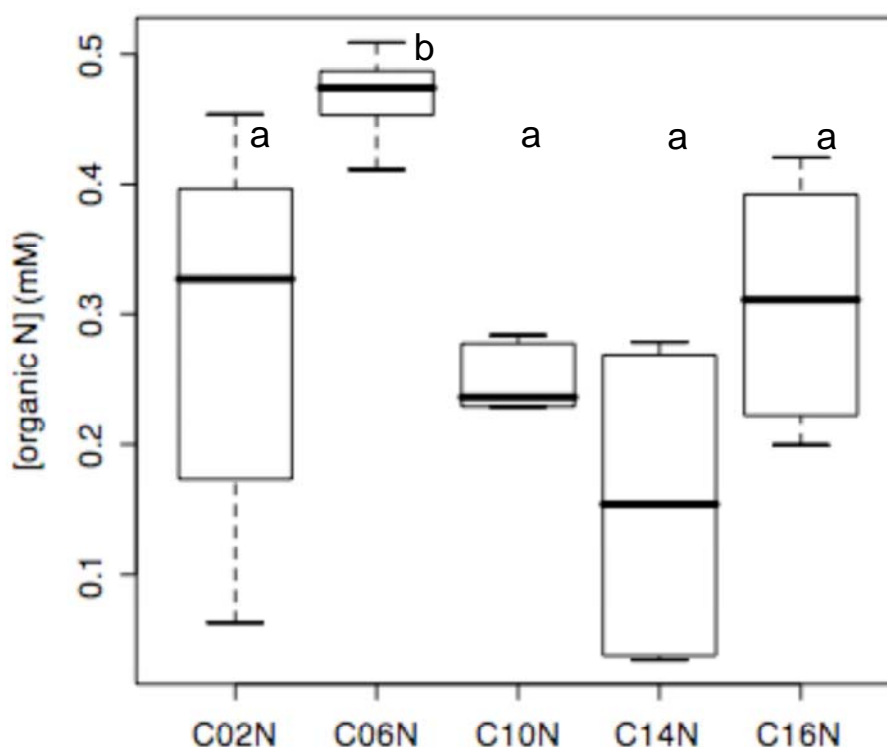

Fig. 2: Boxplot of the residual concentration of organic N left by bacteria in cultures with homogeneous organic substrates. The initial concentration of organic N in the media was equal to 0.5 mM. Culture types with different letters have significantly different median residual concentrations of organic N (p -value <0.005 , Mann-Whitney test).

A comparison of the residual concentrations of organic nitrogen in cultures demonstrates that differences between cultures in ammonium regeneration were not the result of differences in organic nitrogen consumption (figure 2). Apart from C06N cultures, bacteria in different culture types did not differ significantly in their consumption of organic nitrogen (figure 2 and table 3). Organic N residual concentration measured in C06N cultures were only slightly lower than the initial concentration in the media. This suggests that bacteria may not have grown properly on this organic substrate. This impaired growth of bacteria could be

invoked as an explanation for the lack of ammonium regeneration in C06N cultures. However, in the other culture types, organic N was consumed in significant and similar amounts (around half of the available organic N). Substrates with a C:N ratio of 2 lead to mineralization, while cultures with an organic C:N ratio bigger than 6 resulted in immobilization.

Hence, we conclude that the pattern of variation in the regeneration of ammonium as a function of the organic C:N ratio in this set of homogeneous-substrate cultures conforms to the C:N ratio control model, that is a model where ammonium regeneration derives from the maintenance by bacteria of the constancy of their elemental composition through the excretion of the elements in excess and the uptake of deficient elements from mineral stocks in the environment.

Cultures with heterogeneous organic substrates:

We compare cultures where organic carbon and nitrogen were brought in the form of acetamide and organic carbon was added as a fatty acid to modify the organic C:N ratio.

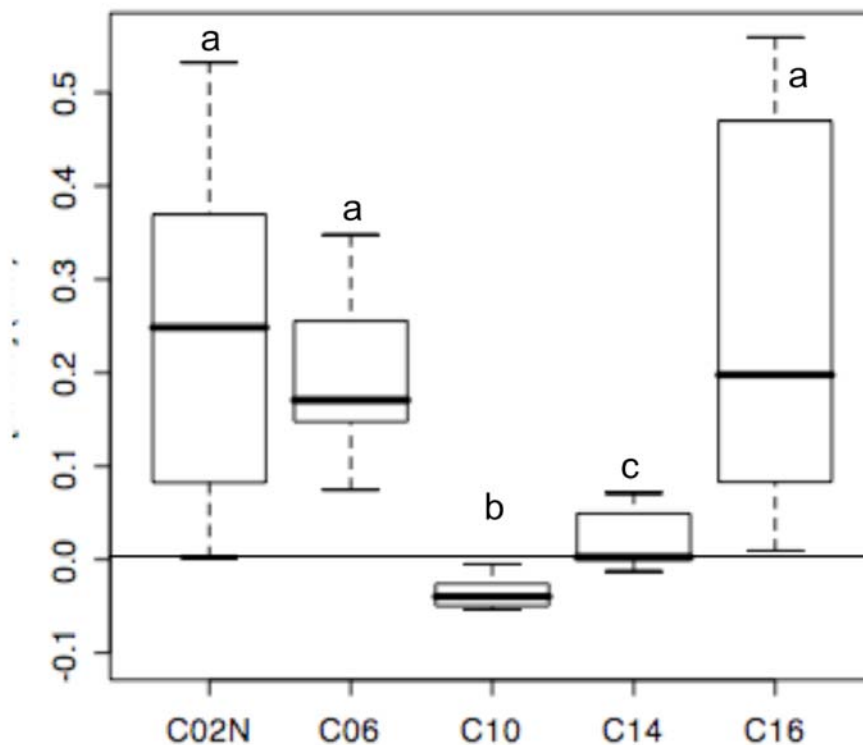

Fig. 3: Boxplot of the concentration of ammonium regenerated by bacteria in cultures with heterogeneous organic substrates. Culture types with different letters have significantly different median regenerated ammonium concentrations (p-value <0.005, Mann-Whitney test).

As for cultures with homogeneous organic substrates, ammonium regeneration was significantly different between culture types with heterogeneous organic substrates (Kruskal-Wallis chi-squared = 29.2654, df = 4, p-value = 6.905e-06). However, the variation was not correlated with the organic C:N ratio. Only C10 and C14 cultures were significantly different from the other cultures (figure 3). C10 was the only culture type where bacteria immobilized ammonium (table 3, one-sided Wilcoxon signed rank test, $H_0: \text{median} \geq 0$, $V = 0$, p-value = 0.001953). Median regenerated ammonium concentration in C14 was not significantly different from 0 (Wilcoxon signed rank test, $V=36$, p-value=0.1289).

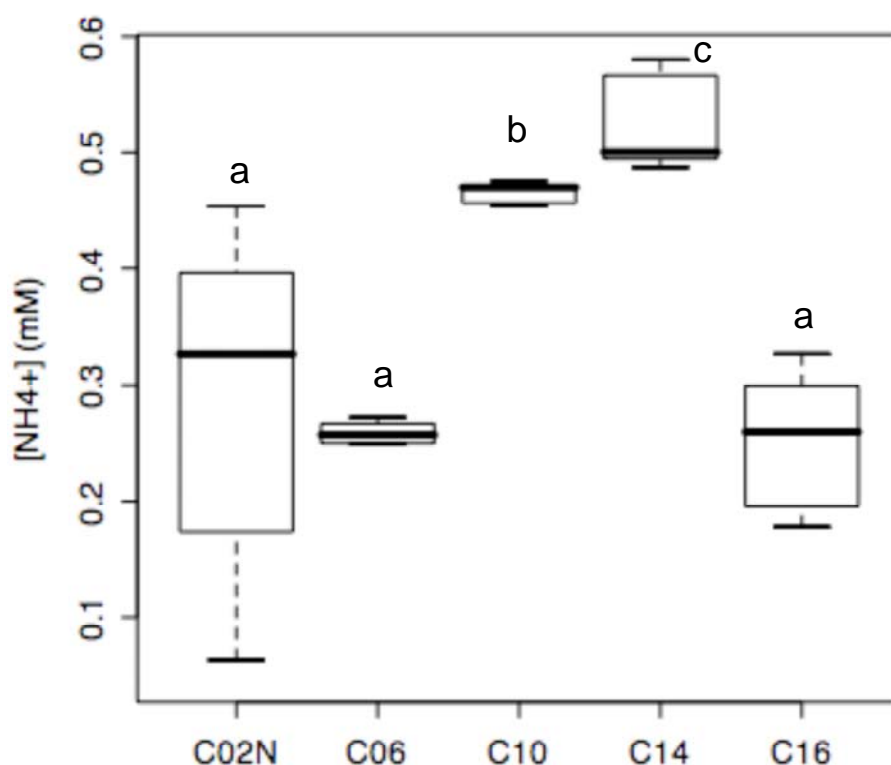

Fig. 4: Boxplot of the residual concentration of organic N left by bacteria in cultures with heterogeneous organic substrates. The initial concentration of organic N in the media was equal to 0.5 mM. Culture types with different letters have significantly different median residual concentrations of organic N (p-value <0.005, Mann-Whitney test).

Unlike homogeneous-substrate cultures (figure 2), ammonium regeneration differences between heterogeneous-substrate cultures are mirrored by the differences between residual organic N concentrations. C14 cultures, which do not regenerate ammonium, do not consume organic N either (table 3). This suggests that bacteria did not grow at all in C14 cultures. Significant and similar amounts of organic N were consumed in C02N, C06 and C16 cultures. But in contrast to homogeneous-substrate cultures (figure 1), organic N consumed in these cultures resulted in about the same amount of ammonium mineralised, independently from the organic C:N ratio (table 3 and figure 4). Bacteria in C10 cultures consumed some organic N (table 3), but immobilized ammonium instead of mineralizing it like bacteria in C02N, C06 and C16 cultures.

Comparison between homogeneous-substrate and heterogeneous-substrate cultures:

The comparison between C16N and C16 cultures best highlights the effect of the heterogeneity of organic substrates on ammonium regeneration. Both culture types have the same organic C:N ratio (C:N=16). About the same amounts of organic nitrogen were consumed in both culture types (Mann-Whitney test, $W = 21$, $p\text{-value} = 0.1672$). However, bacteria in C16N cultures immobilised ammonium, while bacteria in C16 cultures mineralized nitrogen (Table 3).

Consumption of organic N by bacteria was higher in C10N cultures than in C10 cultures (Table 3, Mann-Whitney test, $W = 0$, $p\text{-value} = 4.114e-05$). But, bacteria in C10 cultures immobilized ammonium significantly, while C10N bacteria did not (Table 3). This trade-off between organic N and ammonium consumptions among the two culture types indicates that heterogeneity of organic substrates in C10 cultures modified the C:N ratio of organic matter effectively available to bacteria in comparison with C10N cultures, although the two culture types have the same total organic C:N ratio.

Homogeneous organic substrate with a C:N ratio of 6 seems to be balanced for the bacterial strain used in this experiment, since there was neither immobilisation nor mineralization in C6N cultures, although they consumed some organic N (Table 3). However, the same C:N ratio with a heterogeneous organic substrate lead to significant mineralization in C06 cultures (Table 3). This suggests that organic N was more available than organic C in the heterogeneous-substrate C06 cultures than in the homogeneous-substrate C06N cultures.

Since bacteria did not grow on C14 cultures, it is not possible to conclude on the effect of heterogeneity of the organic substrate at the corresponding C:N ratio of 14. Given that bacteria in C14 had some acetamide at their disposal, which allowed for bacterial growth in C02N cultures, we can infer that the fatty acid (myristic acid) in this culture was probably toxic at the concentration provided. When compared to the high consumption by bacteria of the corresponding fatty acid amide (myristamide) in C14N cultures (Table 3), the toxicity of myristic acid highlights how small changes in the molecular structure of organic matter could greatly affect bacterial growth and ammonium regeneration.

Discussion:

It is generally accepted that the regeneration of ammonium by microbial decomposers is mainly determined by the C:N ratio of their organic substrate. However, theoretical works that produced this model of ammonium regeneration generally assumed a homogeneous organic substrate ((Parnas 1975, Daufresne and Loreau 2001). Experiments that tested this C:N control model of ammonium regeneration used heterogeneous substrates, but the molecules had similar, high labilities for decomposers (Goldman et al 1987, Goldman and Dennett 1991 and 2000). However, organic matter is generally made of many molecules that vary widely in their lability (Berendse et al 1987, Ågren and Bosatta 1996). These models cannot explain discrepancies with some in-situ data, nor the role of less labile chemical compounds such as lignin (Scott and Binkley 1997), polyphenols (Oglesby and Fownes 1992) and cellulose (Bending et al 1998) in ammonium regeneration.

We manipulated the C:N ratio of the organic substrate of a bacterial strain in two different ways. In a first set of cultures, we added organic matter as a unique molecule, drawn from a family of molecules that differ only in their C:N ratio. This first treatment was meant to test the effect of organic C:N ratio, when carbon and nitrogen are linked together in one molecule. We expected to find ammonium regeneration in these homogeneous-substrate cultures to follow the pattern predicted by the C:N control model, which we did. In a second set of cultures, the C:N ratio was modified by the addition of different saturated fatty acids, that do not contain nitrogen, to acetamide, a substrate with a C:N ratio of two. We supposed that fatty acids were less labile than acetamide. So, we expected more mineralization or less immobilization in these cultures, compared to their homogeneous-substrate counterparts. Indeed, we did find mineralization in heterogeneous cultures with total C:N ratios of 6 and 16, while homogeneous-substrate cultures with the same C:N ratios showed no mineralization. However, in the two other heterogeneous-substrate cultures, with C:N ratios of 10 and 14, mineralization did not increase. This is probably because in both culture types, bacterial growth was impaired. In fact, decanoic acid and myristic acid were sometimes found to be toxic for bacteria, although at higher concentrations than we used (Banchio and Gramajo 1997, Odongo et al 2007). The heterogeneous-substrate cultures with a C:N ratio of 10 still resulted in significant immobilization. This suggests that decanoic acid, despite its toxicity, was still consumed preferentially to acetamide, resulting in immobilisation, but no growth. However, these interpretations of ammonium regeneration based on bacterial growth have to

be taken with care until we analyze the data of bacterial carbon and nitrogen content and of residual carbon concentrations.

These results are a clear indication that the molecular composition of organic matter can be as important a determinant of ammonium regeneration, as the total organic C:N ratio. It is known that the molecular composition of organic matter varies as its total C:N ratio varies. For example, the lignin and cellulose contents increase with an increase in the C:N ratio of residues in soils (Murphy et al 2002, Morvan et al 2005). Still, in many comparative studies, the link between ammonium regeneration and total organic C:N ratio was strong (Booth et al 2005). Based on our results, we hypothesize that, in these studies, the molecular composition effect of organic matter on ammonium regeneration was positively correlated with the effect of the total organic C:N ratio.

But, there are many factors that can modify the molecular composition of organic matter without changing its C:N ratio and could lead to a departure of ammonium regeneration from the C:N control model. In aquatic systems, for example, sunlight is known to modify the biochemical composition of organic matter and increase the bioavailability of carbon to bacteria (Geller 1986, Bertilsson et al 1999, Cole 1999). At constant total C:N ratio, we expect more immobilization of nitrogen in aquatic ecosystems exposed to more sunlight, because of an increase in carbon availability. Because herbivores are major actors in the cycle of matter (Cebrián 1999) and they differ biochemically from plants, which are generally the main source of organic matter in ecosystems (Brown et al 1999), we also expect them to affect ammonium regeneration by decomposers through the modification of organic matter molecular composition (Richardot et al 2001). Decomposers themselves are major drivers of changes in organic matter molecular composition, creating a strong feedback mechanism on their regeneration of ammonium (Ågren and Bosatta 1996).

We showed recently that differences in ammonium regeneration and organic matter consumption between microbial decomposer strains favor coexistence in microbial communities (Cherif and Loreau in press). In this experiment, we found a great variation in ammonium regeneration and organic nitrogen consumption as soon as mixtures of organic molecules were used. Hence, the heterogeneity of organic matter molecular composition in ecosystems, through its effect on ammonium regeneration and organic matter consumption, can prove to be a potent explanation of the huge diversity of microbial decomposer communities (Kassen et Rainey 2004).

Fatty acids and fatty acid amides are not amongst the most common molecules encountered in natural organic matter. Nevertheless, we chose them as organic substrates in our experiment,

because they allow choosing molecules that vary in their C:N ratio and organic carbon content without varying too much in other chemical properties. They are also among the most commercially available families of molecules that present such a range in their C:N ratio and organic carbon content. We welcome all experiments that will repeat the same experimental design as our experiment with organic substrates that are more common in ecosystems, such as lignin, cellulose, amino acids and microbial glucosamines that are all common molecules in most ecosystems. We think that such experiments would be of the greatest importance in understanding the control of mineral nutrient regeneration in ecosystems, a key process of ecosystem functioning and food webs.

Literature cited:

- Ågren, G. L. and E. Bosatta. 1996. Theoretical ecosystem ecology: understanding element cycles. Cambridge University Press, Cambridge.
- Berendse, F., B. Berg and E. Bosatta. 1987. The effect of lignin and nitrogen on the decomposition of litter in nutrient-poor ecosystems: a theoretical approach. *Canadian Journal of Botany* 65:116-1120.
- Bertilsson, S., R. Stepanauskas, R. Cuadros-Hansson, W. Granéli, J. Wikner and L. Tranvik. Photochemically induced changes in bioavailable carbon and nitrogen pools in a boreal watershed. *Aquatic Microbial Ecology* 19:47-56.
- Bragg, J. G. and C. L. Hyder. 2004. Nitrogen versus carbon use in prokaryotic genomes and proteomes. *Proceedings of the Royal Society of London Series B-Biological Sciences* 271:374-377 (Suppl. 5)
- Booth, M. S., J. M. Stark and E. Rastetter. 2005. Controls on nitrogen cycling in terrestrial ecosystems: A synthetic analysis of literature data. *Ecological Monographs* 75:139-157.
- Brown, M. R., S. W. Jeffrey, J. K. Volkman and G. A. Dunstan. 1997. Nutritional properties of microalgae for mariculture. *Aquaculture* 151:315-331.
- Cebrián, J. 1999. Patterns in the fate of production in plant communities. *The American Naturalist* 154:449-468.
- Cherif, M. and M. Loreau. Stoichiometric constraints on resource use, competitive interactions and elemental cycling in microbial decomposers. *The American Naturalist* in press.
- Cole, J. J. 1999. Aquatic Microbiology for ecosystem scientists: new and recycled paradigms in ecological microbiology. *Ecosystem* 2:215-225.

- Daufresne, T. and M. Loreau. 2001. Ecological stoichiometry, primary producer-decomposer interactions, and ecosystem persistence. *Ecology* 82:3069-3082.
- Dendooven, L., E. Murphy and D. S. Powlson. 2000. Failure to simulate C and N mineralization in soil using biomass C-to-N ratios and measured by the fumigation extraction method? *Soil Biology and Biochemistry* 32:659-668.
- Entry, J. A. and C. B. Backman. 1995. Influence of carbon and nitrogen on cellulose and lignin degradation in forest soils. *Canadian Journal of Forest Research* 25:1231-1236.
- Findlay, W. P. K. 1934. Studies in the physiology of wood-destroying fungi. I. The effect of nitrogen content upon the rate of decay of timber. *Annals of Botany* 48:109-117.
- Geller, A. 1986. Comparison of mechanisms enhancing biodegradability of refractory lake water constituents. *Limnology and Oceanography* 31:755-764.
- Goldman, J. C., D. A. Caron and M. R. Dennett. 1987. Regulation of gross growth efficiency and ammonium regeneration in bacteria by substrate C:N ratio. *Limnology and Oceanography* 32:1239-1252.
- Goldman, J. C. and M. R. Dennett (1991). Ammonium regeneration and carbon utilization by marine bacteria grown on mixed substrates. *Marine Biology* 109:369-378.
- Goldman, J. C. and M. R. Dennett (2000). Growth of marine bacteria in batch and continuous culture under carbon and nitrogen limitation. *Limnology and Oceanography* 45:789-800.
- Holmes, R. M., A. Aminot, R. Kereuel, B. A. Hooker and B. J. Peterson. 1999. A simple and precise method for measuring ammonium in marine and freshwater ecosystems. *Canadian Journal of Fisheries and Aquatic Sciences* 56:1801-1808.

- Kassen, R. and P. B. Rainey. 2004. The ecology and genetics of microbial diversity. *Annual Review of Microbiology* 58:207-231.
- Kaye, J. P., and S. C. Hart. 1997. Competition for nitrogen between plants and soil microorganisms. *Trends in Ecology and Evolution* 12:139–142.
- Morvan, T., B. Nicolardot and L. Péan. 2005. Biochemical composition and kinetics of C and N mineralization of animal wastes: a typological approach. *Biology and fertility of Soils* 42:513-522.
- Murphy, K. L., I. C. Burke, M. A. Vinton, W. K. Lauenroth, M. R. Aguiar, D. A. Wedin, R. A. Virginia and P. N. Lowe. 2002. Regional analysis of litter quality in the central grassland region of North America. *Journal of Vegetation Science* 13:395-402.
- Odongo, N. E., M. M. Or-Rashid, E. Kebreab, J. France and B. W. McBride. 2007. Effect of supplementing myristic acid in dairy cow rations on ruminal methanogenesis and fatty acid profile in milk. *Journal of Dairy Science* 90:1851-1858.
- Oglesby, K. A. and J. H. Fownes. 1992. Effects of chemical composition on nitrogen mineralization from green manures of seven tropical leguminous trees. *Plant and Soil* 143:127-132.
- Parnas, H. 1975. Model for decomposition of organic material by microorganisms. *Soil Biology and Biochemistry* 7:161-169.
- Richardot, M., D. Debroas, A. Thouvenot, D. Sargos, J. L. Berthon, J. Devaux. 2001. Influence of cladoceran grazing activity on dissolved organic matter, enzymatic hydrolysis and bacterial growth. *Journal of Plankton Research* 23: 1249-1261.
- Schmitz, H. and F. Kaufert. 1936. The effect of certain nitrogenous compounds on the rate of decay of wood. *American Journal of Botany* 23:635-638.

- Scott, N. A. and D. Binkley. 1997. Foliage litter quality and annual net N mineralization: Comparison across North American forest sites. *Ecologia* 111:151-159.
- Strong, L. C., C. Rosendahl, G. Johnson, M. J. Sadowsky and L. P. Wackett. 2002. *Arthrobacter aurescens* TC1 metabolizes diverse s-triazine ring compounds. *Applied and Environmental Microbiology* 68:5973-5980.
- Wackett, L. P. 2004. Evolution of new enzymes and pathways: soil microbes adapt to s-triazine herbicides. *Pesticide Decontamination and Detoxification ACS Symposium Series* 863:37-48.
- Waksman, S. A. 1917. The influence of available carbohydrates upon ammonia accumulation by microorganisms. *Journal of the American Chemical Society* 39:1503-1512.
- Wheeler, P. A. and D. L. Kirchman. 1986. Utilization of inorganic and organic nitrogen by bacteria in marine systems. *Limnology and Oceanography* 31:998-1009.

Manuscript in preparation:

Disentangling the effects of herbivore nutrition on autotroph-decomposer interactions: a theoretical approach.

Mehdi Cherif¹ and Michel Loreau²

¹Author for correspondence:

Laboratoire d'Ecologie, BIOEMCO UMR 7618, Ecole Normale Supérieure, 46 rue d'Ulm, F-75230 Paris Cedex 05, France

Current address:

Department of Biology, McGill University, 1205 avenue Docteur Penfield, Montreal, Quebec H3A 1B1, Canada

Phone: 514-398-6815

FAX: 514-398-5069

E-mail: cherif@biologie.ens.fr

²Department of Biology, McGill University, 1205 avenue Docteur Penfield, Montreal, Quebec H3A 1B1, Canada

E-mail: michel.loreau@mcgill.ca

Keywords: *Competition; Egestion; Excretion; Herbivory; Mineralization; Model; Nutrient cycling; Stoichiometry;*

Abstract

Autotroph and decomposer interactions largely determine elemental cycles in ecosystems. Usually, herbivores are also present and should modify these interactions. In this study, we model the effects of herbivore nutritional regulation on heterotrophic microbial decomposers and autotroph interactions. We divided the effects of herbivory in five subsets: effects of ingestion, egestion, stoichiometry-maintenance, digestion and excretion, each depending on separate nutritional processes of herbivores. We investigated how the stepwise inclusion of these effects modifies autotroph and decomposer biomasses, and five key parameters that determine autotroph-decomposer trophic interactions. Ingestion has a negative effect on both autotrophs and decomposers, but weakens the competitive ability of autotrophs with a low elemental content. Herbivore egestion and digestion influences decomposers because these processes increase the availability of the decomposer organic resource. The effects of egestion and digestion on autotrophs are indirect and depend on whether decomposers immobilize or mineralize the inorganic resource. Excretion directly enhances autotroph biomass, which results in more organic resource for decomposers. Herbivores with high carbon demands favor mineralization and have a positive stoichiometry-maintenance effect on both autotrophs and decomposers because they increase the content of detritus in elements. Herbivores with low carbon demands are detrimental to autotrophs because they decrease mineralization, but they benefit decomposers because they also increase detritus carbon content. By comparing ecosystems roughly ordered along a gradient of autotroph adaptation to terrestrial life, one expects relatively stronger ingestion and excretion effects and weaker egestion effects in more aquatic ecosystems. Concerning the stoichiometry maintenance effect, herbivores should have lower element demand relative to autotrophs element content in aquatic ecosystems and should increase mineralization and autotroph and decomposer biomasses.

Introduction

Primary production is the major biotic flow of energy and matter into most trophic webs (Polis 1999). But in most ecosystems, the fate of the majority of primary production is eventually to be recycled as detritus (Cebrián 1999). Heterotrophic microbial decomposers (hereafter "decomposers") process a large part of this autotroph-produced detrital biomass. The chemical elements of the decomposed matter are then stored into decomposer biomass, transmitted to other trophic levels, wasted or returned to the inorganic reservoir of chemical elements in the ecosystem, ready to be re-used by autotrophs.

For a given element in detritus, its destination as a component of decomposer biomass or as an inorganic element available to autotrophs is highly dependant on the concentration of this element in autotroph and decomposer biomass. In fact, decomposers are rather homeostatic organisms regarding their chemical elemental composition (Sturner and Elser 2002). When faced with a resource that is deficient in an essential element, decomposers take up this essential element in mineral form from other sources in the ecosystem. We call this process immobilization. Conversely, when the element is overabundant, decomposers excrete the excess in mineral form into the environment. We call this process mineralization (Goldman et al 1987, Ågren and Bosatta 1996, Cherif and Loreau in press). When they immobilize inorganic elements that limit the growth of autotrophs, decomposers compete with the latter (Rhee 1972, Bratbak and Thingstad 1985, Kaye and Hart 1997). In contrast, when they mineralize these elements, they benefit autotroph growth (Cole 1982).

In the first case, autotrophs that compete with decomposers, are in a paradoxical situation because they provide their competitors with organic resources (Bratbak and Thingstad 1985) with a risk of driving themselves to extinction (Mayfield and Inniss 1978). The carbon limitation hypothesis has been proposed as a solution to this paradox (Currie and

Kalff 1984). This hypothesis states that coexistence is possible when decomposers are better competitors for the inorganic resource and external supplies of carbon are low, resulting in C-limited decomposers and inorganic resource-limited autotrophs (Currie and Kalff 1984).

In most ecosystems, autotroph ingestion by herbivores ranks among the most significant energy exchanges (Cebrián 1999). Consequently, herbivores may determine how much autotroph production is available to support decomposer growth. What's more, herbivores are also homeostatic organisms regarding their chemical elemental composition (Sturner and Elser 2002). Herbivores consuming imbalanced resources eliminate excess elements and retain deficient elements (Elser and Urabe 1999, Evans-White et al 2005). Excretion, egestion and shedding are different mechanisms that herbivores use to remove excess elements and contribute to the detritus pool. The elemental composition of the organic matter produced by herbivores should therefore reflect the homeostatic constraints on herbivore stoichiometry and differ from the elemental composition of autotroph production (Sturner 1990). The organic matter produced by herbivores can also differ from autotroph organic matter in its degradability. Finally, herbivory often initiates changes in autotroph physiological functions such as growth rate (McNaughton 1983), elemental composition (Choudhury 1988), resource allocation (Jaramillo and Detling 1988) and nutrient yields (Green and Detling 2000).

The mechanisms by which herbivores may affect autotroph-decomposer interactions are gaining growing research interest, however recent studies are often contradictory and difficult to compare: some reported negative effects of herbivores on decomposers, others reported positive effects: (Jumars et al 1989, Peduzzi and Herndl 1992, Carman 1994, Reche et al 1997, Strom et al 1997, Hygum et al 1997, Richardot et al 2001, Sankaran and Augustine 2004, Wardle and Bardgett 2004). In this study, we focus on the effects of herbivory resulting from herbivore nutritional regulation functions such as assimilation, stoichiometry maintenance, egestion and excretion. We present a stoichiometrically-explicit model of the

cycling of carbon (C) and another element (E), which could be any potentially limiting essential element such as N, P and Fe, in a simple ecosystem with autotrophs, decomposers and herbivores as the only living compartments. We demonstrate that the rate of ingestion is an important factor driving changes in coexistence conditions but stoichiometry maintenance, egestion and excretion are also important. The overall effect of herbivory is difficult to predict qualitatively, so we devised stepwise graphical and analytical approaches to gain some predictability. We finally use our approach to compare the different herbivory effects between different kinds of ecosystems.

Model description

The model is an ecosystem composed of three living compartments: autotrophs, microbial decomposers, and herbivores; plus two inert compartments: detritus (Detritic Organic Matter or DOM) and the element E in its inorganic form E_I . DOM is made of organic matter originating from autotrophs either through excretion or senescence and from the egestion of the herbivores when they are present. We assume that dead organic matter from herbivores and decomposers is negligible compared to the two other fluxes of DOM, therefore, we do not include it as a source of DOM. Each trophic level (E_I excluded) is composed of a combination of a C and E stocks (fig. 1). A strong homeostasis is assumed for all trophic levels, resulting in a fixed C:E ratio for all organic compartments. As we will explain, homeostasis has pronounced effects on the elemental fluxes between compartments.

E_I availability limits the fluxes of E and C primary production (Φ_n^E and Φ_n^C respectively). Parts of these fluxes are lost to the detritus pool (abbreviation: DOM), either through excretion (Φ_e^E and Φ_e^C) or through senescence and death ($\Phi_{d,A}^E$ and $\Phi_{d,A}^C$). Another part of the two primary production fluxes is consumed by herbivores (Φ_h^E and Φ_h^C). Herbivores assimilate a fraction of the ingested biomass and reject the remaining in the DOM pool (Φ_g^E and Φ_g^C). They also use a fraction of assimilated E and C for their metabolism and excrete it in a mineral form, E_I for E (Φ_f^E) and CO_2 for C (Φ_f^C). Decomposers consume the accumulated DOM to fulfill their energy and biomass building demands. If the DOM they consume is deficient in E, decomposers uptake some of the available E_I , while if the DOM is too rich in E, they mineralize the organic E in excess (Φ_i).

▪ Autotroph compartment

We assume that the availability of E_I determines the growth of autotrophs and their uptake of this element. Assuming the law of mass action, we obtain

$$\Phi_n^E = nE_I E_A \quad (1)$$

where Φ_n is the flux of inorganic E consumed by autotrophs, E_A is the E stock in autotrophs and n is the uptake rate of E by autotrophs (see Table 1 for the definition of all symbols used in this article).

The nutrients taken up are not totally assimilated and fluxes of excreted organic E and C (Φ_e and $\Phi_{e,C}$) leave autotrophs to the DOM compartment:

$$\Phi_e^E = (1-e)nE_I E_A \quad \text{and} \quad \Phi_e^C = (1-e)nE_I C_A = \alpha \Phi_e^E \quad (2)$$

where e is the net assimilation efficiency of E by autotrophs, C_A is the C stock in autotrophs and α is their C:E ratio.

We chose a donor-controlled function for autotroph ingestion by herbivores because it is often the case when the whole trophic level of herbivores is considered (Polis and Strong 1996):

$$\Phi_h^E = hE_A \quad \text{and} \quad \Phi_h^C = hC_A = \alpha \Phi_h^E \quad (3)$$

where Φ_h^E and Φ_h^C are the fluxes of E and C ingested by herbivores and h is herbivory rate.

Another losses from autotrophs to DOM occurs through death or senescence,

$$\Phi_{d,A}^E = l_A E_A \quad \text{and} \quad \Phi_{d,A}^C = l_A C_A \quad (4)$$

where l_A is autotroph death and senescence rate.

Since we assume strong homeostasis (i.e., constant α) we must insure that $\dot{C}_A = \alpha \dot{E}_A$ (see Table 2 for a summary of the equations of this model). Considering equations (1), (2), (3) and (4), we obtain,

$$\Phi_n^C = \alpha \Phi_n^E = nE_I C_A \quad (5).$$

▪ Herbivore compartment

As stated in equation (3), herbivores ingest E and C with fluxes Φ_h and $\Phi_{h,C}$. A part of these fluxes is not assimilated but egested:

$$\Phi_g^E = (1 - a_E)\Phi_h^E \text{ and } \Phi_g^C = (1 - a_C)\Phi_h^C \quad (6)$$

where Φ_g^E and Φ_g^C are the organic E and C egestion fluxes of herbivores, and a_E and a_C are the herbivore E and C gross assimilation efficiencies. Moreover, only fractions f and g of the absorbed E and C respectively are assimilated in the biomass as some of this E is excreted in a mineral form and some C is used for respiration.

Losses to herbivores occur through death or migration with fluxes

$$\Phi_{d,H} = l_H E_H \text{ and } \Phi_{d,H,C} = l_H C_H \quad (7)$$

Combining (3), (6) and (7) with the homeostatic constraint on herbivore stoichiometry, that is $\dot{C}_H = \gamma \dot{E}_H$ — γ being the C:E ratio in herbivore biomass— yields

$$a_C = \frac{f}{g} \gamma \frac{1}{\alpha} a_E.$$

We define a new parameter $\eta = \frac{f}{g} \gamma$ that represents the total C:E demand ratio of herbivores because it includes the C and E needed for biomass building and for metabolism and energy production. Now, the relation between the two gross assimilation efficiencies is

$$a_C = \frac{\eta}{\alpha} a_E \quad (8).$$

This equation shows that a_C and a_E are not independent parameters. By knowing one of the two assimilation rates, we can derive the other using equation (8). Assuming that herbivores assimilate more efficiently the element that limits their growth, we follow Sterner (1990) and set the assimilation efficiency of the deficient element at a maximum value L_C or L_E , for C and E respectively. The other assimilation efficiency is adjusted to meet the requirement of equation (8). We assume that $L_C < L_E$, which is reasonable for most essential

elements, particularly N and P, the elements more likely to limit autotroph growth in most ecosystems. Thus, when C_A limits herbivore growth ($\eta \geq \alpha \frac{L_C}{L_E}$), a_C is equal to L_C , while

$a_E = \frac{\alpha}{\eta} L_C$ (8a). In contrast, when herbivores are limited by E_A ($\eta \leq \alpha \frac{L_C}{L_E}$), a_E is equal to L_E ,

while $a_C = \frac{\eta}{\alpha} L_E$ (8b).

We define φ as the C:E ratio of the egested organic matter. Then, combining equations (3) and (6), we obtain

$$\varphi = \frac{\Phi_g^C}{\Phi_g^E} = \alpha \frac{1 - a_C}{1 - a_E} \quad (9).$$

By replacing a_C and a_E with their values in (8a) and (8b), we have

$$\text{either } \varphi = \alpha \frac{1 - L_C}{1 - \frac{\alpha}{\eta} L_C} \quad (\eta \geq \alpha \frac{L_C}{L_E}) \quad (9a) \text{ or } \varphi = \alpha \frac{1 - \frac{\eta}{\alpha} L_E}{1 - L_E} \quad (\eta \leq \alpha \frac{L_C}{L_E}) \quad (9b).$$

▪ Decomposer compartment

As for the herbivores, we can combine decomposer C:E ratio, β , with their C gross growth efficiency, c , to yield their C:E demand ratio

$$\delta = \frac{\beta}{c} \quad (10).$$

Decomposers consume organic E and C from DOM (fluxes Φ_m^E and Φ_m^C respectively). Moreover, some E_I is either taken up by decomposers if their organic E uptake is not sufficient to meet their E demand, or excreted if organic E is in excess. Let Φ_r^E be the flux of regenerated E_I that adjusts for decomposer C:E composition: Homeostasis requires that $\dot{C}_D = \beta \dot{E}_D$. If we define decomposer loss fluxes as

$$\Phi_{d,D}^E = l_D E_D \text{ and } \Phi_{d,D}^C = l_D C_D \quad (11)$$

where l_D is decomposer loss rate, and make the assumption that

$$\Phi_m^E = \frac{\Phi_m^C}{\mu} \quad (12),$$

where μ is the C:E ratio of DOM, this stoichiometry condition results in a simple relation between the regeneration flux of E_I and the flux of consumed organic C:

$$\Phi_r^E = \frac{1 - \delta/\mu}{\delta} \Phi_m^C \quad (13).$$

Equation (13) does not indicate which flux determines the other. Two cases are possible:

(i) E_I is insufficient to entirely complement the organic food available for uptake. In other words, decomposers are E-limited and Φ_r^E is the growth-limiting flux. If we consider, as for equation (1), that E_I uptake obeys the law of mass action

$$\Phi_r^E = rE_D E_I \quad (14),$$

where r is the uptake rate of E_I by E-limited decomposers, then, combining equation (13) with equations (14) yields

$$\Phi_m^C = \frac{\delta\mu}{\mu - \delta} rE_I E_D \quad (15).$$

(ii) E_I availability is sufficient. Then, organic C limits decomposers, and Φ_m^C is the growth limiting flux. In this case, applying again the mass-action law,

$$\Phi_m^C = mC_M E_D \quad (16)$$

where C_M is the C stock in DOM and m is its uptake rate by C-limited decomposers.

Combining equations (13) and (16) yields

$$\Phi_r^E = \frac{\mu - \delta}{\mu\delta} mC_M E_D \quad (17).$$

Depending on the relative values of μ and δ , Φ_r^E can be positive or negative and E_I a resource for decomposers or a waste product. The inorganic resource, when needed, is

necessary to decomposers to satisfy their E demand. In this case, E_I is an essential resource (sensu Tilman 1982), as is the organic resource. Hence, Liebig's law of the minimum can be applied, that is

$$\Phi_r^E = \text{Min}[rE_I E_D, \frac{\mu - \delta}{\mu \delta} mC_M E_D] \quad (18).$$

When $rE_I < \frac{\mu - \delta}{\mu \delta} mC_M$, we have the case of E-limited growth where equations (14) and (15) apply, whereas when $rE_I > \frac{\mu - \delta}{\mu \delta} mC_M$, we have the case of C-limited growth where equations (16) and (17) apply. $\Phi_m^C = \text{Min}[\frac{\mu \delta}{\mu - \delta} rE_I E_D, mC_M E_D]$ could have been used instead of equation (18) and lead to the same result.

▪ Detritic Organic Matter (DOM) compartment

DOM originates from two different sources: dead or excreted organic matter from autotrophs and non-assimilated organic matter egested by herbivores. Therefore, its properties will be a combination of the properties of these two types of organic matter and will reflect their relative proportions.

For example, it can be shown that μ , the C:E ratio of DOM, is equal to the mean of the C:E ratios of the excreted and egested organic matter, weighted by their proportion in the total organic matter:

$$\mu = \frac{l_A + (1 - e)nE_I}{l_A + (1 - e)nE_I + (1 - a_E)h} \alpha + \frac{(1 - a_E)h}{l_A + (1 - e)nE_I + (1 - a_E)h} \varphi \quad (19).$$

Decomposer DOM uptake rate, m , should also be a weighted mean of decomposer uptake rates of the organic matter excreted by autotrophs (a) and of the organic matter egested by herbivores (j):

$$m = \frac{l_A + (1-e)nE_I}{l_A + (1-e)nE_I + (1-a_C)h} a + \frac{(1-a_C)h}{l_A + (1-e)nE_I + (1-a_C)h} j \quad (20).$$

E and C components of DOM also experience some losses not due to decomposers,

$$\Phi_{d,M}^E = lE_M \quad \text{and} \quad \Phi_{d,M}^C = lC_M \quad (21)$$

where l is a passive loss rate of matter from the ecosystem, $\Phi_{d,M}^E$ and $\Phi_{d,M}^C$ are DOM E and C loss fluxes respectively.

▪ Inorganic resource compartment

Autotrophs consume the inorganic resource with a flux Φ_n^E . It is either consumed or produced by decomposers with a flux Φ_r^E . It is supplied by the excretion flux of E from herbivores, Φ_f^E , which is simply the fraction of E assimilated by herbivores that is used for metabolism,

$$\Phi_f^E = (1-f)(\Phi_h^E - \Phi_g^E) = (1-f)a_E h E_A \quad (21)$$

where f is E net growth efficiency of herbivores, Φ_h^E is the ingestion flux of autotrophs by herbivores and Φ_g^E is their egestion flux.

There is also an external input and an output of E_I , with a constant supply I_E , and a loss flux

$$\Phi_{d,I}^E = lE_I \quad (22)$$

Where the loss rate l is the same passive loss rate as for DOM.

Autotroph-decomposer interaction in absence of herbivory

In order to establish the modification of the autotroph-decomposer trophic interaction by herbivory, we must characterize this interaction in absence of herbivores and compare it to the situation where the latter are present. The removal of herbivores from our tri-trophic model, leaving only autotrophs and decomposers can be done by setting h to zero. The equilibrium of the simpler model hence obtained can be found with the graphical approach that we used in Cherif and Loreau (in press) and that is based on the resource-ratio theory developed in Tilman (1980).

On the plane formed by all the combinations of values of the two resources (C_M in abscissa and E_I as an ordinate — E_M can be deduced from the former by dividing it by α), draw the Zero Net Growth Isoclines (ZNGIs) of decomposers and autotrophs. The ZNGI corresponds to the set of combined values of resources that lead to a stop in the net growth of a compartment. Decomposer growth is stopped whenever $C_M^* = R_M^* = \delta \frac{l_D}{a}$ and $E_I^* \geq \frac{\alpha - \delta}{\alpha} \frac{l_D}{r}$ when decomposers are limited by C, and $E_I^* = R_I^* = \frac{\alpha - \delta}{\alpha} \frac{l_D}{r}$ and $C_M^* \geq \delta \frac{l_D}{a}$ when decomposers are limited by E (Appendix A). Decomposer ZNGI is then the union of these two half-lines (fig. 2). Notice, though, that part of the ZNGI can be out of the positive quadrant of the resource plane (fig. 3 A). This is the case when decomposer C:E demand ratio is greater than autotroph C:E ratio. It corresponds to the situation where the decomposers mineralize E_I , which in this case cannot be considered as a resource anymore. The ZNGI is then only the positive part of the half-line with equation $C_M^* = R_M^* = \delta \frac{l_D}{a}$.

The ZNGI of autotrophs is a half-line parallel to C_M -axis with equation $E_I^* = R_A^* = \frac{l_A}{en}$, reflecting the fact that they do not use organic C and are limited by E_I (Appendix A).

R_A^* , R_I^* , and R_M^* are the R^* values of autotrophs for E_I , and of decomposers for E_I and C_M respectively (Tilman 1980). R^* is the minimum amount of a resource that is needed by the organism to maintain a growth rate equal to its loss rate. When two species compete for a common resource, the winner of the competition is generally the species with the lowest R^* . These three parameters almost completely determine the feasibility and the stability of the equilibrium where both autotrophs and decomposers coexist.

The equilibrium resource point for coexistence lies at the intersection of the two ZNGIs. This equilibrium is persistent and feasible if the two ZNGIs intersect, reflecting the fact that decomposers are better competitors for E_I ($R_I^* < R_A^*$), and if the availability of organic C is sufficient to satisfy the minimum requirement of decomposers for C ($C_M^0 > R_M^*$, where C_M^0 is the equilibrium concentration of C_M in absence of decomposers).

Both R_I^* and C_M^0 are related to the parameter α , the C:E ratio of autotrophs—and of DOM, when herbivores are absent. Hence, the trophic interactions of decomposers with autotrophs is determined by α . Depending on the difference between the C:E demand ratio of decomposers δ , and α , decomposers can persist in the ecosystem or go extinct, and they can compete or cooperate with autotrophs by respectively immobilizing or mineralizing the inorganic resource. We progressively increase the parameter α from low to high values to find the threshold values of α marking the boundaries between these different outcomes of autotroph-decomposer interactions. During this process, we investigate the variations in decomposer ZNGI and in decomposer and autotroph biomasses (fig. 3).

For low values of α —much lower than δ —the organic resource does not contain enough C, in proportion to E, to fulfill decomposer needs. Here, C limits decomposer growth.

For very low values of α , C_M availability is even lower than decomposer minimum growth requirement for organic C ($C_M^0 < R_M^*$). Decomposers cannot persist in the long run, and their biomass is zero at equilibrium (fig. 3 D and H). By increasing α , one increases C_M availability, to the point where it is sufficient to sustain a viable decomposer population at equilibrium. α_{extin} is the value of α that marks the transition between the extinction and the persistence of C-limited decomposers at equilibrium (fig. 3 A and F). It is the value of α where C_M availability matches exactly the equilibrium growth requirement of decomposers for C_M ($C_M^0 = R_M^*$). Once this growth requirement fulfilled, the additional C can be diverted to the accumulation of biomass, explaining the positive relationship between decomposer biomass and α in this range of α values (fig. 3 D and H).

While α is still smaller than decomposer C:E demand ratio δ , organic E is in excess of decomposer E demand. The E in excess is then mineralized. However, for values of α greater than δ , the organic E taken up by decomposers is not sufficient to fulfill decomposer E demand. Decomposers are obliged to immobilize some E_I to use it as a complementary source of E. When δ is equal to α , decomposer E demand is equal to the organic E taken up and decomposers do not interfere with E_I concentration ($R_I^* = 0$). The value of α for which decomposers shift from immobilization to mineralization of E_I , here equal to δ , is named α_{miner} (fig. 3 B and E). The decomposer population must be persistent if there is to be a non-zero mineralization flow at equilibrium (i.e. $\alpha \geq \alpha_{extin}$). Since decomposers at equilibrium mineralize E only when $\alpha \leq \alpha_{miner}$, mineralization is possible only if $\alpha_{miner} \geq \alpha_{extin}$ (as in fig. 3 D). Since mineralization changes organic E into E_I , an available resource for autotrophs, autotroph biomass, for this range of α values, is enhanced above its value in absence of decomposers (fig. 3 D). When $\alpha_{miner} \leq \alpha_{extin}$, as in fig. 3 H, decomposers with $\alpha \leq \alpha_{miner}$ are not persistent and mineralization at equilibrium is not possible. Autotroph biomass is always

reduced in the presence of decomposers because of the competitive uptake of their limiting resource by decomposers (fig. 3 H).

As α becomes bigger than α_{miner} , the organic resource becomes relatively poorer in E and R_I^* increases towards an asymptotic maximum $R_I^{max} = \frac{l_D}{i}$. If R_I^{max} is lower than R_A^* , R_I^* is always lower than R_A^* , decomposers are the best competitors for E and coexistence is still maintained, even for DOM with very high α , that contains only C and virtually no E (fig. 3 G and H). On the other hand, if R_I^{max} is greater than R_A^* , there is a value of α , α_{exclu} , for which $R_I^* \geq R_A^*$ and above which decomposers are excluded (fig. 3 C and D).

With this analysis of the trophic interactions between autotrophs and decomposers, we have defined three threshold values for autotroph C:E ratios that mark the limit for decomposers between extinction, persistence, competitive exclusion, immobilization and mineralization (α_{extin} , α_{exclu} and α_{miner}) and two R^* values that define the actual and maximum competitive abilities for inorganic E of autotrophs and decomposers respectively (R_A^* and R_I^{max}). When ordered and compared to the actual α and R_I^* values of decomposers, these five parameters determine whether decomposers will persist in the long term, whether they will consume or regenerate the inorganic resource and compete or cooperate with autotrophs. To study the effect of herbivores on these trophic interactions we examine the effects of the presence of herbivores and of the intensity of herbivory on these key parameters.

Analysis of the effect of herbivory

Now that we have characterized the trophic interaction between autotrophs and decomposers in the absence of herbivores, we have to introduce the latter by relaxing the condition that $h=0$, in order to analyze their effect on this interaction.

There are several ways through which herbivores can affect autotroph-decomposer trophic interaction in our model: through their ingestion of primary production, through their recycling of the non-assimilated biomass by excretion or egestion, through their retention of the consumed elements in a ratio fitted to their own elemental composition or through the modification of the degradability of DOM. Combined with the many possible outcomes for autotroph-decomposer interactions presented above, the total effect of herbivores on this interaction is complex and highly contingent on the values of the parameters of herbivores but also of autotrophs and decomposers.

Fig. 4 is meant to illustrate the diversity of outcomes from the introduction of herbivores. It plots the variation of autotroph and decomposer E stocks as a function of h , the herbivory rate, for two sets of parameter values. The first set presents autotrophs with very low C:E ratios, while the C:E ratio of autotrophs is high in the second set. This results in decomposers that mineralize E and herbivores that are limited by C in the first case (fig. 4 A), while decomposers immobilize E and herbivores are limited by E in the second case (fig. 4 B). Hence, decomposers and autotrophs have a mutualistic interaction and autotroph biomass is increased by decomposer presence in the first example, while decomposers and autotrophs are competing for E_f in the second example. Autotrophs in the second set have a lower loss rate than in the first set, and are better competitors than decomposers in this case. As a result, in the absence of herbivory ($h=0$), decomposers coexist with autotrophs in the first case (fig.4 A), while they are competitively excluded in the second case (fig. 4 B). Our set of parameters

are not based on any published quantitative study, but could represent a potential pelagic system for the first set, and some alpine or arctic ecosystem for the second set (Stark et al 2006), with nitrogen as the element E.

In both cases, increasing the herbivory rate h , results in a decrease of autotroph biomass. At one point, autotrophs disappear because of overconsumption and the two ecosystems collapse (fig. 4 A and B). The effect of herbivory on decomposers however is different between the two cases. In the first case, herbivory decreases the biomass of the decomposers that are already present, until their extinction (fig. 4 A). In the second case, a low herbivory (h around 0.04) allows for the appearance of decomposers that are excluded for lower herbivory rates (fig. 4 B). However, decomposer biomass decreases for higher values of h , and they disappear eventually, just before autotroph extinction.

In order to gain some predictability of the effect of herbivory on autotroph-decomposer interactions, we developed an approach where we sequentially add each herbivory effect to the autotroph-decomposer model simply by assigning specific values to some parameters. After each added effect, we look at changes in autotroph and decomposer E stocks as well as in the five key parameters that define primary-autotroph-decomposer interactions (α_{extin} , α_{miner} , α_{exclu} , R_A^* and R_I^{max}). Since these five parameters determine trophic autotroph-decomposer interaction, the knowledge of their variation with herbivory effects helps to understand the impact of herbivores on this interaction.

1) Definition and ordering of the different effects:

In our model, the effects of herbivory on autotroph-decomposer trophic interactions all result from the changes in E and C stocks caused by the nutritional processes of herbivores.

We define a process effect as the sum of all the changes in autotroph-decomposer trophic interactions resulting solely from this process. Table 3 presents the five process effects that, when put together, constitute all the changes in autotroph-decomposer trophic interactions linked to the presence of herbivores. For each effect, Table 3 gives the conditions on the parameters that lead to the inclusion of this effect in our model of herbivory. Most effects cannot be obtained while excluding all the others, for example, all effects require some ingestion, since, without some matter being ingested, egestion, digestion, excretion or stoichiometry maintenance cannot occur. Consequently, we analyze the different effects by introducing first the ingestion effect, then the egestion, stoichiometry-maintenance, digestion and finally excretion effects. At each step, we compare the values of the five key parameters (α_{extin} , α_{miner} , α_{exclu} , R_A^* and R_I^{max}) and of autotroph and decomposer E stocks before and after the inclusion of the effect (Table 4).

2) Effects on the five key parameters (R_A^* , R_I^{max} , α_{exclu} , α_{miner} and α_{extin})

- Effects on R_A^* :

The first parameter R_A^* is both a measure of autotroph minimum equilibrium requirement for E_I and of their competitive ability compared to other consumers of E_I . The higher its value, the more autotrophs need E_I and the less competitive they are in comparison with decomposers.

Ingestion by herbivores increases R_A^* because autotrophs have to compensate for the E lost, and hence it decreases their competitive ability compared to decomposers.

The other herbivory effects do not affect losses of autotrophs at equilibrium and hence do not change R_A^* . The overall herbivory effect on this parameter is then the same as the ingestion effect and is an increase in R_A^* .

- Effects on R_I^{max} :

R_I^{max} is the maximum R^* of decomposers for inorganic E (R_I^*). It is reached in the case where their organic resource does not contain any E.

R_I^{max} is a property of decomposers and is not affected by herbivory. From its expression in this model ($R_I^{max} = \frac{l_D}{i}$), we see that it depends only on two parameters, the loss rate of decomposers l_D and their uptake rate of E_I i , that are specific to decomposers. Thus, it is not affected by herbivores and does not change with any of the five effects of herbivory.

- **Effects on α_{exclu} :**

α_{exclu} is the lowest C:E ratio leading to the competitive exclusion of decomposers because their growth becomes limited by E_I availability, as autotroph growth is. It is alternatively the C:E ratio for which the competitive abilities of decomposers and autotrophs are equal ($R_I^* = R_A^*$). An increase in α_{exclu} means that decomposers will coexist with autotrophs for C:E ratios that would have otherwise lead to their exclusion.

Because of its decrease of autotroph competitive ability and not of decomposers, herbivore ingestion increases α_{exclu} . Apart from the stoichiometry-maintenance effect, other effects do not modify any of the two competitive abilities and hence do not impact α_{exclu} . The difference between autotroph C:E ratio and herbivore C:E demand ratio results in a change in DOM C:E ratio, which in turn, modifies R_I^* , the minimum requirement of decomposers for E_I . A herbivore C:E demand ratio greater than autotroph C:E ratio results in a lower DOM C:E ratio (19) and consequently a higher competitive ability, reflected in an increase of α_{exclu} by stoichiometry maintenance. The inverse situation brings a decrease of α_{exclu} .

Hence, the total herbivory effect is an increase of α_{exclu} , when herbivore C:E demand ratio is greater than α_{exclu} , because both ingestion and stoichiometry effects force α_{exclu} in

the same direction. Otherwise, it is dependent on the relative strength of ingestion and stoichiometry effects.

- **Effects on α_{miner} :**

α_{miner} is the C:E ratio of autotrophs for which, the C:E ratio of DOM matches exactly the C:E demand ratio of decomposers. It is the critical value of the autotroph C:E ratio that separates C:E ratios that result in mineralization of E from C:E ratios that result in immobilization. An increase in this value means that C:E ratios of autotrophs that would have resulted in immobilization before, now lead to mineralization of E_I .

As long as a herbivory effect does not modify the C:E ratio of DOM, it has no impact on α_{miner} . This is why, ingestion, egestion, excretion and digestion effects do not change α_{miner} . Stoichiometry maintenance is the only nutritional process that can have an effect on α_{miner} . The addition of herbivores that have a C:E demand ratio different from α_{miner} decreases the C:E ratio of DOM (if $\eta > \alpha_{miner}$) and leads to a higher α_{miner} , or increases the C:E ratio of DOM (if $\eta < \alpha_{miner}$) and results in a lower α_{miner} .

Since only stoichiometry is effective in changing α_{miner} , overall herbivory effect is the same as stoichiometry-maintenance effect and is an increase in α_{miner} when $\eta > \delta$, and a decrease when $\eta < \delta$.

- **Effects on α_{extin} :**

α_{extin} is the lowest C:E ratio of autotrophs that can sustain a viable decomposer population. An increase in this parameter means that decomposers cannot persist for autotroph C:E ratios that were sufficient to provide for their requirement before the increase. It reflects a decrease, for low autotroph C:E ratios, in the availability of DOM C to decomposers. Inversely, a decrease in α_{extin} is the sign that the availability of DOM C has increased for low C:E ratios.

Herbivore ingestion decreases autotroph biomass and primary production at equilibrium. This causes a drop in DOM availability to decomposers. Hence, ingestion effect leads to an increase in α_{extin} (Table 4). The ingestion effect is stronger with increasing herbivory rates h , making low C:E ratios of autotrophs less and less likely to allow for the persistence of decomposers.

Egestion effect leads to a decrease in α_{extin} . This is evident because egestion adds a new source of DOM.

The excretion effect also leads to a decrease in α_{extin} , but through its augmentation of primary production, which in turn, results in more DOM production by autotrophs.

Stoichiometry-maintenance effect on α_{extin} is dependent on the difference between α_{extin} and herbivore C:E demand ratio. When the extinction threshold value α_{extin} is lower than herbivore C:E demand ratio ($\alpha_{extin} < \eta$), it is not modified. In the opposite case ($\alpha_{extin} > \eta$), it is either increased or kept constant. Stoichiometry maintenance can affect α_{extin} only through the change in C assimilation efficiency that it brings, which is reflected in the amount of organic C egested and the availability of DOM C to decomposers. In fact, herbivores limited by E have a lower C assimilation efficiency than C-limited herbivores. Herbivores are more likely to be limited by E the lower their C:E demand ratio is. An increase in η from the condition that $\alpha = \eta$ increases the C-limitation of herbivores and keeping a_C equal to its maximum value. Hence, α_{extin} is unchanged. A decrease in η decreases a_C (if herbivores change from a limitation by C to a limitation by E) or maintains it constant (if herbivores stay limited by C). Hence, α_{extin} will decrease in the first case or will stay the same in the second case.

The degradability of the egested organic matter is improved by digestion ($j > a$), so decomposers can achieve a better growth with the same DOM availability, and α_{extin} decreases.

Because the processes of herbivory affect the variation of α_{extin} differently, it is not possible to conclude on the overall effect of herbivory without knowing the magnitude of the associated parameters. However, it can be shown that at high herbivory rates, the ingestion effect becomes more influential. So, we conclude that at high herbivory rates, the whole effect of herbivory on α_{extin} is likely to be an increase, while at low herbivory rates, it will be more contingent on the different properties and parameters of the ecosystem.

3) Effects on autotroph and decomposer E stocks (E_A^* and E_D^*):

Any negative effect on autotroph biomass is also negative for decomposer biomass because of the role of autotrophs as suppliers of DOM. Any positive effect on decomposer biomass is negative for autotroph biomass when decomposers are immobilizing ($\alpha > \alpha_{miner}$) or positive when decomposers are mineralizing ($\alpha < \alpha_{miner}$).

The ingestion effect decreases autotroph biomass and also decomposer biomass. The egestion and digestion effects increase DOM availability to decomposers and consequently are positive for decomposer biomass. Their effect on autotrophs depends on whether decomposers mineralize or immobilize the inorganic resource.

The excretion effect provide autotrophs with more of their limiting resource and increases their biomass at equilibrium, in turn increasing decomposer biomass.

The stoichiometry effect is positive for both biomasses when herbivores have a C:E demand ratio higher than autotroph C:E ratios. When the herbivore C:E demand ratio is smaller than autotroph C:E ratio, the stoichiometry effect is negative for autotroph biomass.

For decomposers, it is generally negative, but can be positive when both herbivore C:E ratios and E maximum assimilation efficiencies are low. An increase in herbivore C:E demand ratio results in a decrease in DOM C:E ratio, μ (19). Because the difference between μ and decomposer C:E demand ratio controls the intensity of the flux of mineralized or immobilized $E_I(\Phi_r^E, (13))$, a decrease in μ , results in less immobilization or more mineralization. This, in turn, has a positive impact on autotroph and decomposer biomass. When $\eta < \alpha$, the availability of DOM C is increased when herbivores change to limitation by E, affecting decomposers positively. But DOM C:E ratio increases and autotroph biomass decreases. The two opposite effects more or less neutralize each other. Decomposer biomass might even increase in the case of highly E-limited herbivores that egest a lot of C.

As an illustration, we go back to the two sets of parameters used in fig. 4., and compare the effect of total herbivory to the effect of ingestion only on autotroph and decomposer E stocks (fig. 4 C and D). Herbivores in the second set are more efficient in retaining E and C than in the first set (i.e., they have higher maximum assimilation and net assimilation efficiencies L_C , L_E and f). Consequently, all the effects linked to the recycling of matter by herbivores (i.e., egestion, digestion, stoichiometry-maintenance and excretion effects) are weaker in the second case, as is illustrated by the smaller difference between the variations of autotroph and decomposer E stocks under ingestion-only and total herbivory (compare fig. 4 C and D). Because herbivore C:E demand ratio is higher than autotroph C:E ratio in the first set of parameters, all the recycling-linked effects (egestion, stoichiometry maintenance, digestion and excretion) increase decomposer E stock (Table 4 and fig. 4 C). Since decomposers benefit autotrophs through mineralization, autotroph E stocks also increase (fig. 4 C). As in the first set, egestion, digestion and excretion increase decomposer E stock in the second set of parameters (Table 4); however, because herbivore C:E demand ratio in this case is lower than autotroph C:E ratio, stoichiometry-maintenance effect results in a decrease in

decomposer E stock that is more important than the increase due to the three other effects. In total, this results in a small but negative impact of recycling-linked effects on decomposer E stock (fig. 4 D). The impact on autotroph E stock is positive because in this case, decomposers are competitors of autotrophs for their limiting resource (fig. 4 D).

4) Summary of the different effects:

Given the patterns of change in the key parameters and autotroph and decomposers E stocks, we can draw some general conclusions about each effect.

Ingestion has a negative effect on autotroph and decomposer biomasses by decreasing DOM availability, particularly for low C:E ratios of autotrophs. However, it also affects decomposers positively by decreasing the intensity of autotroph competition, particularly for high C:E ratios of autotrophs. The ingestion effect is amplified by an increase in the herbivory rate h .

The egestion effect is positive for decomposers through its increase in DOM availability. It does not interfere with their interaction with autotrophs and hence, its effect on autotrophs depends on whether this interaction is mutualistic or competitive. This effect is enhanced by a decrease in the maximum C assimilation efficiency, L_C .

The stoichiometry effect is contingent on the values of the parameters. However, we can conclude broadly, that herbivores with a high C:E demand ratio decrease competition between decomposers and autotrophs with a high C:E ratio, increase autotroph and decomposer biomasses and, , increase mineralization because of a smaller DOM C:E ratio. Herbivores with a low C:E demand ratio set in motion two opposite effects: they decrease mineralization or increase immobilization because of a bigger DOM C:E ratio, affecting autotroph and decomposer biomasses negatively; but they also have a positive effect on decomposer

biomass by increasing DOM C availability. The stoichiometry effect is intensified by a greater difference between autotroph C:E ratio and herbivore C:E demand ratio.

The digestion effect enhances the egestion effect, by making the egested DOM and by extension the whole bulk of DOM more available to decomposers. This effect is more important when the increase in egested organic matter degradability, j , is greater.

Finally, the excretion effect is positive for autotroph E stock and so for decomposers by increasing DOM availability. A lower net growth efficiency, f , results in a greater excretion effect.

Discussion

Few models investigate interactions between autotrophs, microbial decomposers and herbivores in a stoichiometric framework (but see Andersen 1997). Autotrophs and decomposers are important in biogeochemical cycles, therefore, we focused on investigating the effect of herbivores on autotroph and decomposer interactions. Previous studies of the influence of herbivores on decomposers have reported variable effects on microbial populations and on their interaction with autotrophs (Reche et al 1997, Richardot et al 2001, Sankaran and Augustine 2004). Several mechanisms, with mutually opposing or reinforcing effects and whose prevalence depends on environmental conditions, can be invoked as an explanation for the lack of a single consistent pattern (Stark et al 2000, Wardle and Bardgett 2004). Our study modeled the mechanisms that are linked to herbivore nutritional regulation and demonstrated the consequences of these mechanisms on decomposers and autotrophs. Although we did not include more indirect influences of herbivory such as changes in autotroph community composition, herbivores through autotroph ingestion and the physiological regulation of their assimilation already exert a complex influence on autotroph-decomposer trophic interactions. To disentangle this complexity, we divided the overall impact of herbivores into a hierarchy of partial effects, each one related to a simple measurable parameter of herbivore nutrition. The ingestion effect is dependent on the intensity of the herbivory rate parameter. The egestion effect sums all the consequences resulting from the egestion by herbivores of non-assimilated autotroph biomass. It is related to herbivore assimilation efficiencies of C and E. The stoichiometry-maintenance effect describes the consequences of the modification of E and C assimilation efficiencies of herbivores to maintain the constancy of the C:E ratio of herbivores. It is obviously related to herbivore C:E demand ratio. The digestion effect groups the results brought by the increase in

the degradability of the organic matter egested by herbivores brought by the digestion process. Finally, the excretion effect describes the changes brought by the metabolic excretion of inorganic E by herbivores. It is related to the net assimilation efficiency of herbivores for E. We hope that our results may help comparative studies of these parameters to better predict the impacts of different kinds of herbivores.

Contrary to Andersen (1997), our model was not designed to be applied to a specific ecosystem. We develop a general model because the goal of our work was not to provide quantitative predictions, but to investigate potential mechanisms through which herbivores can affect the interactions between decomposers and autotrophs. However, by noticing some differences in properties related to our model between well-studied ecosystems, we can begin to compare the effects of herbivores in these ecosystems. We order different ecosystems in along a gradient of increased terrestriality, where we define terrestriality as the extent of presence in autotrophs of structures and traits adapted to a fixed and open-air life (Table 5). There is a decrease in herbivory pressure on autotroph production when one follows this gradient, and hence also a decrease in the ingestion effect. Since the ingestion effect is strengthened by higher herbivory rates, we expect it to be more prevalent in aquatic systems, which means less competition between autotrophs and decomposers, but more severe carbon limitation of decomposers. C maximum assimilation efficiency depends on autotroph digestibility, which in turn depends on autotroph lignin content (Jung and Allen 1995). Since autotroph lignin content increases from aquatic, pelagic to terrestrial ecosystems, C maximum assimilation efficiency of herbivores also decreases. The egestion effect should be higher in more terrestrial ecosystems. So, DOM provided through egestion should be one of the main means of influence of herbivores in terrestrial ecosystems. There is a consistent increase in autotroph C:E ratios along the gradient. Then, if herbivore C:E demand ratios are reasonably similar between these ecosystems, we expect them to be lower than plant C:E ratios in more

terrestrial ecosystems, probably resulting in E limitation of herbivores and greater relative recycling of C. Similar to the second example in fig. 4, we expect a negative effect on mineralization and plant biomass. We expect also an increase of E net growth efficiency because of the presence of more large-bodied herbivores in terrestrial ecosystems. Since specific metabolic rates are negatively related to body mass, E excretion rates should be lower in larger terrestrial herbivores and E net growth efficiencies should be higher. If we add to this the process of volatilization of urines in terrestrial ecosystems, a higher excretion effect is expected in aquatic ecosystems. Although decomposers C:E demand ratios are higher in more terrestrial ecosystems, so is the C:E ratio of DOM. Since mineralization occurs when decomposers C:E demand ratio is lower than DOM C:E ratio and both ratios increase concurrently along the ecosystem gradient, we cannot conclude yet on the differences in mineralization between these ecosystems.

Our description of herbivory and of the nutritional regulation of herbivores may in many ways seem too simple. But we made, in our view, what were the most reasonable simplifications compatible with a maximum of analytical tractability. We chose a donor-controlled herbivory function to avoid having to care about the conditions necessary for the maintenance of herbivores and to be able to use a single parameter h , the herbivory rate, as a measure of herbivory pressure without having to consider herbivore biomass as well. In support of our choice, top-down control of the entire autotroph trophic level by herbivores occurs rather infrequently in nature, whether because herbivores in turn experience predation by carnivores or because some autotrophs are inedible (Polis and Strong 1997). We assumed the elemental composition of herbivores to be constant despite an imbalanced resource composition. This is a reasonable hypothesis for metazoans (Andersen and Hessen 1991, Elser et al 2000), even though their elemental composition can exhibit some variation (DeMott et al 1998, Woods et al 2002). To maintain a constant composition, herbivores have

to modify their gross production efficiencies for C and E according to their resource composition (Sturner 1990), so that their relative net production of C and E is maintained equal to their elemental composition. To reach this result, they have two non-exclusive methods. They can either modify the relative assimilation or the relative excretion of the two elements. In our model, the homeostasis of herbivore elemental composition takes place through the modification of their assimilation efficiencies. A review of the few cases where nutrition budgets have been studied simultaneously for carbon and another nutrient (Anderson et al 2005) shows that in the short term, homeostasis of composition in some herbivores is maintained mainly through the regulation of excretion and net production efficiency, while assimilation efficiency is only marginally modified. We still chose a regulation of stoichiometric balance through assimilation because in the long term, gross assimilation efficiency is generally slowly adapted to match food composition, either through physiological plasticity or natural selection (Hassett and Landry 1988, Anderson 1994, Arredondo et al 1997, van den Lingen 1998). In support of this hypothesis, herbivores, which often deal with C-rich resources, have a lower assimilation efficiency for C than for other major nutrients (Anderson 1994), while this is not the case for some secondary consumers that are more likely to be C limited (Lehman 1993). Thus, short-term regulation of homeostasis by excretion does not preclude an adaptation of assimilation efficiencies to food composition in the long term, which may even be a better adaptive method (Darchambeau 2005).

In our model, we have expounded many mechanisms by which herbivores act on autotroph-decomposer trophic interactions. Experiments support the positive effect of egestion on decomposers (Strom et al 1997, Vadstein et al 2003), the difference between the C:E ratios of autotrophs and egested organic matter (Pastor et al 1993, Anderson 1994, Eskelinen 2002), the importance of the degradability of the organic matter (Vallino et al 1996, Ågren and Bosatta 1996), and the difference in the degradability of organic matter from

autotrophs and from herbivores (Richardot et al 2001). However, our model did not consider other more indirect mechanisms by which herbivores were proven to alter autotroph-decomposer interactions. Herbivores can change autotroph communities and physiological characteristics by selectively choosing their food (Sirotnak and Huntly 2000, Wardle and Bardgett 2004). They induce changes in the C:E composition of autotrophs and of organic matter of autotroph origin (Choudhury 1988, McNeil and Cushman 2005). Herbivore ingestion can result in an increase in the excretion of dissolved organic carbon by autotrophs (Paterson and Sim 2000, Hamilton and Frank 2001). These mechanisms are not directly related to the nutritional regulation of herbivores, which explains why we did not include them. But we see their addition to our model as a natural and welcome extension.

Herbivores can affect autotroph-decomposer interactions through the regulation of their nutrition. Each of the nutritional processes can have a different effect. Thus, the resulting, total effect of herbivory is made harder to predict. But, by investigating the few key parameters that control these nutritional processes, we should be able to make a better idea of the effects that will predominate in specific situations.

Acknowledgments

We would like to thank G. Lacroix, T. Daufresne, and M. Danger for useful discussions. M. Cherif was supported by a grant from the French Ministry of Research and Education. This work received financial support from an ACI ECCO-PNBC grant from the Centre National de la Recherche Scientifique.

Appendix A: Equilibriums and their stability

The possible equilibriums for the model described in table 2 are as follows:

Equilibrium	C-limited growth	E-limited growth
Trivial	$E_A^* = 0, C_M^* = 0, E_H^* = 0, E_D^* = 0, E_I^* = \frac{I_E}{l}.$	Not feasible
Decomposer-excluded	$E_A^* = e \frac{I_E - l \frac{h+l_A}{en}}{h+l_A - e(1-f)a_E h},$ $C_M^* = C_M^0 = \frac{h+l_A - eha_C}{el} \alpha E_A^*, E_H^* = f \frac{a_E h}{l_H} E_A^*,$ $E_D^* = 0, E_I^* = \frac{l_A + h}{en} = R_A^*.$	$E_A^* = e \frac{I_E - l \frac{h+l_A}{en}}{h+l_A - e(1-f)a_E h},$ $C_M^* = C_M^0 = \frac{h+l_A - eha_C}{el} \alpha E_A^*,$ $E_H^* = f \frac{a_E h}{l_H} E_A^*, E_D^* = 0,$ $E_I^* = \frac{l_A + h}{en} = R_A^*.$
Decomposer-persistent	$E_A^* = e \frac{I_E - l \frac{h+l_A}{en} + l \frac{\mu - \delta}{\mu} \frac{l_D}{m}}{\frac{\mu - \delta}{\mu \delta} \alpha [h+l_A - eha_C] + h+l_A - e(1-f)a_E h},$ $C_M^* = \frac{l_D}{m} \delta, E_H^* = f \frac{a_E h}{l_H} E_A^*,$ $E_D^* = \frac{h+l_A - eha_C}{\delta e l_D} \alpha E_A^* - \frac{l}{m}, E_I^* = \frac{l_A + h}{en} = R_A^*.$	$E_A^* = e \frac{I_E - l \frac{h+l_A}{en} - r \frac{h+l_A}{en} E_D^*}{h+l_A - e(1-f)a_E h},$ $E_H^* = f \frac{a_E h}{l_H} E_A^*,$ $E_I^* = \frac{\mu - \delta}{\mu} \frac{l_D}{r} = R_I^*,$ $E_I^* = \frac{l_A + h}{en} = R_A^*.$

The local stability of these equilibriums and the persistence of the various ecosystem components are analyzed below. (The Jacobian matrix J has variables in the order E_A, C_M, E_H, E_D and E_I in what follows.)

- C-limited trivial equilibrium:

$$J = \begin{bmatrix} en \frac{I_E}{l} - (h + l_A) & 0 & 0 & 0 & 0 \\ \left[l_A + (1-e)n \frac{I_E}{l} + (1-a_C)h \right] \alpha & -l & 0 & 0 & 0 \\ a_E h \alpha & 0 & -l_H & 0 & 0 \\ 0 & 0 & 0 & -l_D & 0 \\ -n \frac{I_E}{l} & 0 & 0 & 0 & -l \end{bmatrix}$$

Four eigenvalues are equal to $-l$, $-l_H$, $-l_D$, and $-l$. The last eigenvalue is negative for

$$\frac{I_E}{l} < \frac{h + l_A}{en} = R_A^*.$$

This equilibrium is stable as long as the external supply of the inorganic resource is lower than the minimum growth requirement of autotrophs.

- E-limited trivial equilibrium:

This equilibrium is not feasible since rE_I^* cannot be smaller than $\frac{\mu - \delta}{\mu\delta} mC_M^*$ when $C_M^* = 0$

$$\text{and } E_I^* = \frac{I_E}{l}.$$

- C-limited decomposer-excluded equilibrium:

$$J = \begin{bmatrix} 0 & 0 & 0 & 0 & enE_A^* \\ \left[l_A + \frac{1-e}{e}(h + l_A) + (1-a_C)h \right] \alpha & -l & 0 & -mC_M^* & (1-e)n\alpha E_A^* \\ fa_E h \alpha & 0 & -l_H & 0 & 0 \\ 0 & 0 & 0 & \frac{mC_M^*}{\delta} - l_D & 0 \\ (1-f)a_E h - \frac{h + l_A}{e} & 0 & 0 & -\frac{\mu - \delta}{\mu\delta} mC_M^* & -l - nE_A^* \end{bmatrix}$$

This equilibrium is feasible if $\frac{I_E}{l} > \frac{h + l_A}{en} = R_A^*$. Two eigenvalues are equal respectively to $-l$

and $-l_H$. Two other eigenvalues are negative solutions of the equation

$\lambda^2 + (l + nE_A^*)\lambda + [h + l_A - h(1 - f)a_E]nE_A^* = 0$. The last eigenvalue is negative for

$\frac{mC_M^*}{\delta} - l_D < 0$. It can be shown that the last condition is equivalent to $\alpha < \alpha_{extin}$.

- E-limited decomposer-excluded equilibrium:

$$J = \begin{bmatrix} 0 & 0 & 0 & 0 & enE_A^* \\ \left[l_A + \frac{1-e}{e}(h + l_A) + (1 - a_C)h \right] \alpha & -l & 0 & -\frac{\mu\delta}{\mu - \delta} r \frac{h + l_A}{en} & (1 - e)n\alpha E_A^* \\ fa_E h \alpha & 0 & -l_H & 0 & 0 \\ 0 & 0 & 0 & \frac{\mu\delta}{\mu - \delta} r E_I^* - l_D & 0 \\ (1 - f)a_E h - \frac{h + l_A}{e} & 0 & 0 & -r \frac{h + l_A}{en} & -l - nE_A^* \end{bmatrix}$$

This equilibrium is feasible if $\frac{I_E}{l} > \frac{h + l_A}{en} = R_A^*$ and decomposers are limited by C. Two

eigenvalues are equal respectively to $-l$ and $-l_H$. Two other eigenvalues are negative solutions

of the equation $\lambda^2 + (l + nE_A^*)\lambda + [h + l_A - h(1 - f)a_E]nE_A^* = 0$. The last eigenvalue is

negative for $\frac{\mu\delta}{\mu - \delta} r E_I^* - l < 0$. It can be shown that the last condition is equivalent to

$$\alpha > \alpha_{washout}^{Elim}$$

- C-limited decomposer-persistent equilibrium:

The Jacobian matrix is too complex to give any insight into the local stability of this

equilibrium. But we can notice that the stability condition of the C-limited decomposer-

excluded equilibrium is equivalent to an invasibility condition for decomposers. That is, the

sole eigenvalue whose sign determines the stability of the equilibrium without decomposers is also the net growth rate of decomposers when rare, $\frac{mC_M^*}{\delta} - l_D$. Thus, when the C-limited decomposer-excluded equilibrium is feasible, decomposers should invade and persist in the system, not necessarily in a locally stable equilibrium, whenever the C-limited decomposer-excluded equilibrium is unstable ($\alpha > \alpha_{extin}$).

- E-limited decomposer-persistent equilibrium:

This equilibrium is feasible only for one specific value of α ($\alpha = \alpha_{exclu}$). At this α , the equilibrium values of the variable are not determined by the parameters only, because there are only four equations to determine five unknowns (two equations are used only to calculate E_I^*). Hence, the equilibrium values are dependant on the initial conditions and this equilibrium is structurally unstable.

N.B.: The equilibriums and their stability in the absence of herbivory can be obtained simply by setting h to zero.

Appendix B: Analysis of the changes in the key parameters and in autotrophs and decomposers' E stocks due to the herbivory effects

These changes are summarized in Table 3.

- Changes in R_A^* :

From its analytical expression ($R_A^* = \frac{l_A + h}{en}$), it is clear that the ingestion effect, that is when h changes from 0 to a positive value, brings an increase in R_A^* . It is also clear that this increase is higher with higher values of h , and that R_A^* is not dependant on the parameters controlling the other herbivory effects.

- Changes in R_I^{max} :

See text.

- Changes in α_{exclu} :

α_{exclu} is the α value for which $\frac{\mu}{\mu - \delta} r E_I^* = l_D$. By replacing variables by their equilibrium values (Appendix A) and applying on the parameters the conditions leading to the different herbivory effects, we can obtain the explicit analytical expression of this key parameter for the five herbivory effects:

$$\alpha_{exclu}^{inges} = \alpha_{exclu}^{egest} = \delta \frac{l_D}{l_D - r \frac{h + l_A}{en}};$$

$$\alpha_{exclu}^{stoic} = \alpha_{exclu}^{decom} = \alpha_{exclu}^{excre} = \delta \frac{l_D}{l_D - r \frac{h + l_A}{en}} \frac{(h + l_A)\eta}{(h + l_A - ehL_C)\eta + eL_C h \delta} \frac{l_D}{l_D - r \frac{h + l_A}{en}} \quad \text{for C-limited}$$

$$\text{herbivores } (\eta > \alpha_{exclu} \frac{L_C}{L_E}); \quad \alpha_{exclu}^{stoic} = \alpha_{exclu}^{decom} = \alpha_{exclu}^{excre} = \delta \frac{l_D}{l_D - r \frac{h + l_A}{en}} \frac{h + l_A - ehL_E}{h + l_A} + \frac{\eta L_E eh}{h + l_A} \quad \text{for}$$

$$\text{E-limited herbivores } (\eta < \alpha_{exclu} \frac{L_C}{L_E}).$$

It is immediately evident that the ingestion effect (when h changes from 0 to a positive value) results in an increase in α_{exclu} , and that egestion, digestion and excretion do not affect α_{exclu} . By calculating algebraically the difference between α_{exclu}^{egest} and α_{exclu}^{stoic} , one can show that $\alpha_{exclu}^{egest} < \alpha_{exclu}^{stoic}$ when $\eta > \alpha_{exclu} \frac{L_C}{L_E}$ (C-limited herbivores) and that $\alpha_{exclu}^{egest} > \alpha_{exclu}^{stoic}$ when $\eta < \alpha_{exclu} \frac{L_C}{L_E}$ (E-limited herbivores).

- Changes in $\alpha_{min er}$:

$\alpha_{min er}$ is the value of α for which $\frac{\mu - \delta}{\mu \delta} mC_M^* = 0$. We have $\alpha_{min er}^{consu} = \alpha_{min er}^{egest} = \delta$;

$$\alpha_{min er}^{stoic} = \alpha_{min er}^{decom} = \alpha_{min er}^{excre} = \frac{\delta(h + l_A)\eta}{(h + l_A)\eta + eL_C h(\delta - \eta)} \text{ for C-limited herbivores } (\eta > \alpha_{min er} \frac{L_C}{L_E});$$

$$\alpha_{min er}^{stoic} = \alpha_{min er}^{decom} = \alpha_{min er}^{excre} = \delta + \frac{L_E e h}{h + l_A} (\eta - \delta) \text{ for E-limited herbivores } (\eta < \alpha_{min er} \frac{L_C}{L_E}).$$

As for α_{exclu} , egestion, digestion and excretion do not affect $\alpha_{min er}$. However, ingestion also does not change it. From the analytical expression of $\alpha_{min er}^{stoic}$, it is straightforward to show that $\alpha_{min er}^{egest} < \alpha_{min er}^{stoic}$ when $\xi > \alpha_{min er}^{egest} = \delta$ and that $\alpha_{min er}^{egest} > \alpha_{min er}^{stoic}$ when $\eta < \alpha_{min er}^{egest} = \delta$.

- Changes in α_{extin} :

It is the α value for which $\frac{1}{\delta} mC_M^0 = l_D$. $\alpha_{extin}^{consu} = \frac{\delta l_D (h + l_A)}{(h + l_A - eh)a(\frac{I_E}{l} - \frac{h + l_A}{en})}$;

$$\alpha_{extin}^{egest} = \frac{\delta l_D (h + l_A)}{(h + l_A - ehL_C)a(\frac{I_E}{l} - \frac{h + l_A}{en})} ; \alpha_{extin}^{stoic} = \alpha_{extin}^{egest} = \frac{\delta l_D (h + l_A)}{(h + l_A - ehL_C)a(\frac{I_E}{l} - \frac{h + l_A}{en})} \text{ for C-}$$

limited herbivores ($\eta > \alpha_{extin} \frac{L_C}{L_E}$); $\alpha_{extin}^{stoic} = \frac{\delta l_D}{a(\frac{I_E}{l} - \frac{h+l_A}{en})} + \frac{\eta L_E eh}{h+l_A}$ for E-limited herbivores

($\eta < \alpha_{extin} \frac{L_C}{L_E}$); $\alpha_{extin}^{decom} = \frac{\delta l_D (h+l_A)}{[(h+l_A - eh)a + e(1-L_C)hj](\frac{I_E}{l} - \frac{h+l_A}{en})}$ (C-limited herbivores);

$\alpha_{extin}^{decom} = \frac{\delta l_D (h+l_A)}{[(h+l_A - eh)a + ehj](\frac{I_E}{l} - \frac{h+l_A}{en})} + \frac{\eta L_E ehj}{(h+l_A - eh)a + ehj}$ (E-limited herbivores);

$\alpha_{extin}^{excre} = \frac{\delta l_D (h+l_A)}{[(h+l_A - eh)a + e(1-L_C)hj](\frac{I_E}{l} - \frac{h+l_A}{en}) + \frac{\delta}{\eta} l_D e(1-f)hL_C}$ (C-limited herbivores);

$\alpha_{extin}^{excre} = \frac{\delta l_D (h+l_A - e(1-f)hL_E)}{[(h+l_A - eh)a + ehj](\frac{I_E}{l} - \frac{h+l_A}{en})} + \frac{\eta L_E ehj}{(h+l_A - eh)a + ehj}$ (E-limited herbivores).

The calculation of the derivative of α_{extin}^{consu} by h shows that the ingestion effect increases α_{extin} . Keeping in mind the different conditions on the parameters ($L_C < L_E$, $j > a$, $f < 1$,

$\eta > \alpha_{extin} \frac{L_C}{L_E}$ when C-limited and $\eta < \alpha_{extin} \frac{L_C}{L_E}$ when E-limited), the calculation of the

derivatives of α_{extin}^{egest} by L_C , of α_{extin}^{decom} by j , and of α_{extin}^{excre} by f demonstrate the decrease in α_{extin} due to egestion, digestion and excretion effects. We have $L_C < L_E$, so $\alpha_{extin} \frac{L_C}{L_E} < \alpha_{extin}$.

Then, when $\eta > \alpha_{extin}^{egest}$, we have also $\eta > \alpha_{extin} \frac{L_C}{L_E}$ and the addition of the stoichiometry effect

does not keep herbivores C-limited. Since $\alpha_{extin}^{stoic} = \alpha_{extin}^{egest}$ for herbivore C limitation,

stoichiometry has no impact on α_{extin} in this case. Only when $\eta < \alpha_{extin}^{egest}$ and $\eta < \alpha_{extin} \frac{L_C}{L_E}$, is

α_{extin}^{stoic} different from α_{extin}^{egest} . A simple calculation of the algebraic difference between the two

shows that α_{extin} increases because $\alpha_{extin}^{stoic} > \alpha_{extin}^{egest}$.

- Changes in E_D^* and E_A^* :

It is straightforward to show that under the ingestion effect conditions, E_D^* and E_A^* decrease with an increase in h . By inspecting closely the analytical expressions of E_D^* and E_A^* or by calculating their derivatives with respect to the parameters considered, one can demonstrate that E_D^* increases with the parameter j , and decreases with the parameters μ , a_C and f , and that E_A^* decreases with μ and f , and its answer to variations in a_C and j depends on whether $\alpha < \alpha_{miner}$ or $\alpha > \alpha_{miner}$. Egestion decreases a_C and hence increases E_D^* , and E_A^* if $\alpha < \alpha_{miner}$. Digestion increases j and so increases E_D^* , its effect on E_A^* again depending on the order between α and α_{miner} . Excretion decreases f , increasing both E_D^* and E_A^* . The effect of stoichiometry depends on whether $\eta > \alpha_{extin}^{egest}$, in which case μ is decreased, resulting in an increase in both E_D^* and E_A^* , or $\eta < \alpha_{extin}^{egest}$, in which case μ is increased and a_C decreased, resulting in a decrease in E_A^* , and an increase in E_D^* possible for very low values of η , where the effect through a_C becomes more important than the effect through μ .

Literature Cited

- Agren, G. I., and E. Bosatta. 1996. Theoretical ecosystem ecology, understanding element cycles. Cambridge University Press, Cambridge, UK.
- Andersen, T. 1997. Pelagic nutrient cycles, herbivores as sources and sinks. Ecological Studies 129. Springer-Verlag, Berlin, Germany.
- Andersen, T. and D. O. Hessen. 1991. Carbon, nitrogen, and phosphorus content of freshwater zooplankton. Limnology and Oceanography 36:807-814.
- Anderson, T. R. 1994. Relating C:N ratios in zooplankton food and faecal pellets using a biochemical model. Journal of Experimental Marine Biology and Ecology 184:183-199.
- Anderson, T. R., D. O. Hessen, J. J. Elser and J. Urabe. 2005. Metabolic Stoichiometry and the Fate of Excess Carbon and Nutrients in Consumers. The American Naturalist 165:1-15.
- Arredondo, M., A. Orellana, M. A. Garate and M. T. Nunez. 1997. Intracellular iron regulates iron absorption and IRP activity in intestinal epithelial (Caco-2) cells. American Journal of Physiology – Gastrointestinal and Liver Physiology 273:275-280.
- Bratbak, G. and T. F. Thingstad. 1985. Phytoplankton-bacteria interactions: an apparent paradox? Analysis of a model system with both competition and commensalisms. Marine Ecology Progress Series 25:23-30.
- Carman, K. R. 1994. Stimulation of marine free-living and epibiotic bacterial-activity by copepod excretions. FEMS Microbiology Ecology 14: 255-261.
- Cebrian, J. 1999. Patterns in the fate of production in plant communities. The American Naturalist 154:449-468.

- Cherif, M. and M. Loreau. Stoichiometric constraints on resource use, competitive interactions and elemental cycling in microbial decomposers. Unpublished manuscript.
- Choudhury, D. 1988. Herbivore induced changes in leaf-litter resource quality – a neglected aspect of herbivory in ecosystem nutrient dynamics. *Oikos* 51:389-393.
- Cole, J. J. 1982. Interactions between bacteria and algae in aquatic ecosystems. *Annual Review of Ecology and Systematics* 13:291-314.
- Currie, D.J. and J. Kalff. 1984. A comparison of the abilities of freshwater algae and bacteria to acquire and retain phosphorus. *Limnology and Oceanography* 29:298-310.
- Darchambeau, F. 2005. Filtration and digestion responses of an elementally homeostatic consumer to changes in food quality: a predictive model. *Oikos* 111:322-336.
- DeMott, W. R., R. D. Gulati and K. Siewertsen. 1998. Effects of phosphorus-deficient diets on the carbon and phosphorus balance of *Daphnia magna*. *Limnology and Oceanography* 43:1147-1161.
- Elser, J. J., W. F. Fagan, R. F. Denno, D. A. Dobberfuhl, A. Folarin, A. Huberty, S. Interlandi, S. S. Kilham, E. McCauley, K. L. Schulz, E. H. Siemann, and R. W. Sterner. 2000. Nutritional constraints in terrestrial and freshwater food webs. *Nature* 408:578-580.
- Elser, J. J. and J. Urabe. 1999. The stoichiometry of consumer-driven nutrient recycling: Theory, observations, and consequences. *Ecology* 80:735-751.
- Eskelinen, O. 2002. Diet of the wood lemming *Myopus schisticolor*. *Annales Zoologici Fennici* 39:49-57.

- Evans-White, M. A., R. S. Stelzer and G. A. Lamberti. 2005. Taxonomic and regional patterns in benthic macroinvertebrate elemental composition in streams. *Freshwater Biology* 50: 1786-1799.
- Goldman, J. C., D. A. Caron and M. R. Dennett. 1987. Regulation of gross growth efficiency and ammonium regeneration in bacteria by substrate C:N ratio. *Limnology and Oceanography* 32:1239-1252.
- Green, R. A. and J.K. Detling. 2000. Defoliation-induced enhancement of total aboveground nitrogen yield of grasses. *Oikos* 91:280-284.
- Grover, J.P. 2000. Resource competition and community structure in aquatic microorganisms: experimental studies of algae and bacteria along a gradient of organic carbon to inorganic phosphorus supply. *Journal of Plankton Research* 22:1591–1610.
- Hamilton, E. W. and D. A. Frank. 2001. Can plants stimulate soil microbes and their own nutrient supply? Evidence from a grazing tolerant grass. *Ecology* 82:2397-2402.
- Hassett R. P. and M.R. Landry. 1988. Short-term changes in feeding and digestion by the copepod *Calanus pacificus*. *Marine Biology* 99:63-74.
- Hygum, B. H., J. W. Petersen and M. Sondergaard. 1997. Dissolved organic carbon released by zooplankton grazing activity - A high-quality substrate pool for bacteria. *Journal of Plankton Research* 19:97-111.
- Jaramillo, V. J. and J. K. Detling. 1988. Grazing history, defoliation, and competition: effects on shortgrass production and nitrogen accumulation. *Ecology* 69:1599-1608.
- Jumars, P. A., D. L. Penry, J. A. Baross, M. J. Perry and B. W. Frost. 1989. Closing the microbial loop – dissolved carbon pathway to Heterotrophic bacteria from incomplete ingestion, digestion and absorption in animals. *Deep-Sea Research Part A-Oceanographic Research Papers* 36:483-495.

- Jung, H. G. and M. S. Allen. 1995. Characteristics of plant-cell walls affecting intake and digestibility of forages by ruminants. *Journal of Animal Science* 73:2774-2790.
- Kaye, J. P., and S. C. Hart. 1997. Competition for nitrogen between plants and soil microorganisms. *Trends in Ecology and Evolution* 12:139–142.
- Kimmins, J. P. 1997. *Forest Ecology: A Foundation for Sustainable Management* (2nd ed.). MacMillan Publishing.
- Kirschbaum, M. U. F. and K. I. Paul. 2002. Modelling carbon and nitrogen dynamics in forest soils with a modified version of the CENTURY model. *Soil Biology and Biochemistry* 34:341-354.
- Lehman, J. T. 1993. Efficiencies of ingestion and assimilation by an invertebrate predator using C-dual and P-dual isotope labeling. *Limnology and Oceanography* 38:1550-1554.
- Mayfield, C. I. and W. E. Inness. 1978. Interactions between freshwater bacteria and *Ankistrodesmus braunii* in batch and continuous culture. *Microbial Ecology* 4: 331-344.
- McNaughton, S. J. 1983. Compensatory plant-growth as a response to herbivory. *Oikos* 40:329-336.
- Pastor, J., B. Dewey, R. J. Naiman, P. F. McInnes and Y. Cohen. 1993. Moose Browsing and soil fertility in the boreal forests of Isle Royale national park. *Ecology* 74:467-480.
- Paterson, E. and A. Sim. 2000. Effect of nitrogen supply and defoliation on loss of organic compounds from roots of *Festuca rubra*. *Journal of Experimental Botany* 51:1449-1457.

- Peduzzi, P., G. J. Herndl. 1992. Zooplankton activity fueling the microbial loop – differential growth-response of bacteria from oligotrophic and eutrophic waters. *Limnology and Oceanography* 37:1087-1092.
- Polis, G. A. 1999. Why are parts of the world green? Multiple factors control productivity and the distribution of biomass. *Oikos* 86:3-15.
- Polis, G. A. and D. S. Strong. 1996. Food web complexity and community dynamics. *The American naturalist* 147:813-846.
- Reche, I., P. Carrillo, L. Cruz-Pizarro. 1997. Influence of metazooplankton on interactions of bacteria and phytoplankton in an oligotrophic lake. *Journal of Plankton Research* 19:631-646.
- Rhee, G.-Y. 1972. Competition between an alga and an aquatic bacterium for phosphate. *Limnology and Oceanography* 17:505-514.
- Richardot, M., D. Debroas, A. Thouvenot, D. Sargos, J. L. Berthon, J. Devaux. 2001. Influence of cladoceran grazing activity on dissolved organic matter, enzymatic hydrolysis and bacterial growth. *Journal of Plankton Research* 23: 1249-1261.
- Sankaran, M. and D. J. Augustine. 2004. Large herbivores suppress decomposer abundance in a semiarid grazing ecosystem. *Ecology* 85:1052-1061.
- Singer, F. J. and K. A. Schoenecker. 2003. Do ungulates accelerate or decelerate nitrogen cycling? *Forest Ecology and Management* 181:189-204.
- Sirotnak, J. M. and Huntly, N. J.. 2000. Direct and indirect effects of herbivores on nitrogen dynamics: voles in riparian areas. *Ecology* 81:78–87.
- Sterner, R. W. 1990. The ratio of nitrogen to phosphorus resupplied by herbivores – zooplankton and the algal competitive arena. *The American Naturalist* 136:209-229.
- Sterner, R. W. and J. J. Elser. 2002. *Ecological Stoichiometry: The Biology of Elements from Molecules to the Biosphere*. Princeton University Press, Princeton, NJ.

- Strom, S. L., R. Benner, S. Ziegler and M. J. Dagg. 1997. Planktonic grazers are a potentially important source of marine dissolved organic carbon. *Limnology and Oceanography* 42:1364-1374.
- Tilman, D. 1980. Resources: a graphical mechanistic approach to competition and predation. *The American Naturalist* 116 : 362-393.
- Vadstein, O., L. M. Olsen, A. Busch, T. Andersen and H. R. Reinertsen. 2003. Is phosphorus limitation of planktonic heterotrophic bacteria and accumulation of degradable DOC a normal phenomenon in phosphorus-limited systems? A microcosm study. *FEMS Microbiology Ecology* 46:307-316.
- Vallino, J., C. Hopkinson and J. Hobbie. 1996. Modeling bacterial utilization of dissolved organic matter: Optimization replaces Monod growth kinetics. *Limnology and Oceanography* 41:1591-1609.
- van der Lingen, C. D. 1998. Nitrogen excretion and absorption efficiencies of sardine *Sardinops sagax* fed phytoplankton and zooplankton diets. *Marine Ecology – Progress Series* 175:67-76.
- Wardle, D. A. and R. D. Bardgett. 2004. Human-induced changes in large herbivorous mammal density: the consequences for decomposers. *Frontiers in Ecology and Environment* 2:145-153.
- Woods, H. A., M. C. Perkins, J. J. Elser and J. F. Harrison. 2002. Absorption and storage of phosphorus by larval *Manduca sexta*. *Journal of Insect Physiology* 48:555–564.

Tables**Table 1: Summary of the symbols used in the Model.**

Symbols	Explanation	Dimension
Φ_n^E	Autotroph ingestion flux of inorganic E	Quantity of E * time ⁻¹
Φ_n^C	Autotroph fixation flux of inorganic C	Quantity of C * time ⁻¹
Φ_e^E	Autotroph production flux of organic E	Q of E * time ⁻¹
Φ_e^C	Autotroph production flux of organic C	Q of C * time ⁻¹
Φ_h^E	Herbivore ingestion flux of E	Q of E * time ⁻¹
Φ_h^C	Herbivore ingestion flux of C	Q of C * time ⁻¹
Φ_g^E	Herbivore egestion flux of E	Q of E * time ⁻¹
Φ_g^C	Herbivore egestion flux of C	Q of C * time ⁻¹
Φ_m^E	Decomposer assimilation flux of DOM E	Q of E * time ⁻¹
Φ_m^C	Decomposer assimilation flux of DOM C	Q of C * time ⁻¹
Φ_f^E	Herbivore excretion flux of E	Q of E * time ⁻¹
Φ_f^C	Herbivore respiration flux of C	Q of C * time ⁻¹
Φ_r^E	Decomposer regeneration flux of inorganic E	Q of E * time ⁻¹
E_A	E stock in autotrophs	Q of E
C_A	Carbon stock in autotrophs	Q of C
E_H	E stock in herbivores	Q of E
C_H	Carbon stock in herbivores	Q of C
E_D	E stock in decomposers	Q of E
C_D	Carbon stock in decomposers	Q of C
E_M	DOM E stock	Q of E
C_M	DOM C stock	Q of C
E_I	Inorganic E stock	Q of E
I_E	supply of Inorganic E	Q of E
α	C:E ratio of autotrophs	Q of C * Q of E ⁻¹
γ	Herbivore C:E ratio of herbivores	Q of C * Q of E ⁻¹
η	C:E ratio of Herbivore demand	Q of C * Q of E ⁻¹
β	C:E ratio of decomposers	Q of C * Q of E ⁻¹
δ	C:E ratio of decomposer demand	Q of C * Q of E ⁻¹
φ	C :E ratio of the Egested Organic Matter	Q of C * Q of E ⁻¹
μ	C:E ratio of DOM	Q of C * Q of E ⁻¹
n	Autotroph assimilation rate of Inorganic E	Q of E ⁻¹ * time ⁻¹
r	E limited-decomposer uptake rate of inorganic E	Q of E ⁻¹ * time ⁻¹
a	Decomposer uptake rate of autotroph-produced organic matter	Q of E ⁻¹ * time ⁻¹
j	Decomposer uptake rate of the egested organic matter	Q of E ⁻¹ * time ⁻¹
m	Decomposer uptake rate of DOM	Q of E ⁻¹ * time ⁻¹
h	Herbivory rate	time ⁻¹
e	Autotroph assimilation efficiency of E	time ⁻¹
l	Ecosystem loss rate	time ⁻¹
l_A	Autotroph loss rate	time ⁻¹
l_H	Herbivore loss rate	time ⁻¹
l_D	Decomposer loss rate	time ⁻¹
a_E	Herbivore gross assimilation efficiency of E	dimensionless
a_C	Herbivore gross assimilation efficiency of C	dimensionless
L_E	Maximum herbivore gross assimilation efficiency of E	dimensionless
L_C	Maximum herbivore gross assimilation efficiency of C	dimensionless
f	Herbivore net assimilation efficiency of E	dimensionless
g	Herbivore net assimilation efficiency of C	dimensionless
c	Decomposer net assimilation efficiency of C	dimensionless
R_A^*	Minimum equilibrium-requirement of autotrophs for inorganic E	Q of E
R_I^*	Minimum equilibrium-requirement of decomposers for inorganic E	Q of E
R_I^{\max}	Maximum value for R_I^*	Q of E

Table 2: Differential equations of our model describing the growth of autotrophs, decomposers and herbivores, made up of 2 elements: carbon (C) and another essential element (E).

Mass-balance differential equations :

Compartments	E	C
Autotrophs:	$\dot{E}_A = \Phi_n^E - \Phi_e^E - \Phi_h^E - \Phi_{d,A}^E$	$\dot{C}_A = \Phi_n^C - \Phi_e^C - \Phi_h^C - \Phi_{d,A}^C$
Herbivores:	$\dot{E}_H = \Phi_h^E - \Phi_g^E - \Phi_f^E - \Phi_{d,H}^E$	$\dot{C}_H = \Phi_h^C - \Phi_g^C - \Phi_f^C - \Phi_{d,H}^C$
Decomposers:	$\dot{E}_D = \Phi_m^E + \Phi_r^E - \Phi_{d,D}^E$	$\dot{C}_D = c\Phi_m^C - \Phi_{d,D}^C$
Detritic Organic Matter (DOM):	$\dot{E}_M = \Phi_{d,A}^E + \Phi_e^E + \Phi_g^E - \Phi_m^E - \Phi_{d,M}^E$	$\dot{C}_M = \Phi_{d,A}^C + \Phi_e^C + \Phi_g^C - \Phi_m^C - \Phi_{d,M}^C$
Inorganic resource:	$\dot{E}_I = I_E - \Phi_{d,I}^E - \Phi_n^E + \Phi_f^E - \Phi_r^E$	

Explicit differential equations when decomposer growth is limited by C:

Compartments	E	C
Autotrophs:	$\dot{E}_A = enE_A E_I - hE_A - l_A E_A$	$\dot{C}_A = en\alpha E_A E_I - h\alpha E_A - l_A \alpha E_A$
Herbivores:	$\dot{E}_H = f[hE_A - (1 - a_E)hE_A] - l_H E_H$	$\dot{C}_H = g[h\alpha E_A - (1 - a_c)h\alpha E_A] - l_H \gamma E_H$
Decomposers:	$\dot{E}_D = \frac{1}{\delta} m C_M E_D - l_D E_D$	$\dot{C}_D = cm C_M E_D - l_D \beta E_D$
Detritic Organic Matter (DOM):	$\dot{E}_M = l_A E_A + (1 - e)nE_I E_A + (1 - a_E)hE_A - m \frac{C_M}{\mu} E_D - l \frac{C_M}{\mu}$	$\dot{C}_M = l_A \alpha E_A + (1 - e)nE_I \alpha E_A + (1 - a_c)h\alpha E_A - m C_M E_D - l C_M$
Inorganic resource:	$\dot{E}_I = I_0 - lE_I - nE_I E_A + (1 - f)a_E hE_A - \frac{1}{\delta} \frac{\mu - \delta}{\mu} m C_M E_D$	

Explicit differential equations when decomposer growth is limited by E:

Compartments	E	C
Autotrophs:	$\dot{E}_A = enE_A E_I - hE_A - l_A E_A$	$\dot{C}_A = en\alpha E_A E_I - h\alpha E_A - l_A \alpha E_A$
Herbivores:	$\dot{E}_H = f[hE_A - (1 - a_E)hE_A] - l_H E_H$	$\dot{C}_H = g[h\alpha E_A - (1 - a_c)h\alpha E_A] - l_H \gamma E_H$
Decomposers:	$\dot{E}_D = \frac{\mu}{\mu - \delta} i E_I E_D - l_D E_D$	$\dot{C}_D = \beta \frac{\mu}{\mu - \delta} r E_I E_D - l_D \beta E_D$
Detritic Organic Matter (DOM):	$\dot{E}_M = l_A E_A + (1 - e)E_I E_A + (1 - a_E)hE_A - \frac{\delta}{\mu - \delta} r E_I E_D - l \frac{C_M}{\mu}$	$\dot{C}_M = l_A \alpha E_A + (1 - e)E_I \alpha E_A + (1 - a_c)h\alpha E_A - \frac{\mu \delta}{\mu - \delta} r E_I E_D - l C_M$
Inorganic resource:	$\dot{E}_I = I_0 - lE_I - nE_I E_A + (1 - f)a_E hE_A - r E_I E_D$	

Table 3: Presentation of the five nutritional processes that make herbivory: ingestion, egestion, stoichiometry maintenance, digestion and excretion; definition of their associated effects and of the conditions on the parameters that lead to their inclusion in our model of herbivory.

Process	Process effect	Conditions on parameters
Ingestion	All the changes in decomposers, autotrophs and their trophic interactions, resulting from the process of autotroph ingestion by herbivores.	$h > 0$
Egestion	All the changes in decomposers, autotrophs and their trophic interactions, resulting solely from the action of egestion by herbivores of the non-assimilated fraction of ingested autotrophs.	$h > 0, L_C \leq L_E < 1$
Stoichiometry-maintenance	All the changes in decomposers, autotrophs and their trophic interactions, resulting from the modification of E and C assimilation efficiencies of herbivores to maintain the constancy of their C:E ratio.	$h > 0, L_C \leq L_E < 1, \eta \neq \alpha$
Digestion	All the changes in decomposers, autotrophs and their trophic interactions, resulting from the increase in the degradability of the organic matter egested by herbivores brought by the digestion process.	$h > 0, L_C \leq L_E < 1, j > a$
Excretion	All the changes in decomposers, autotrophs and their trophic interactions, resulting from the process of excretion of inorganic E by herbivores.	$h > 0, f < 1$

Table 4: Variation in the key parameters and in autotroph and decomposer E stocks due to the herbivory effects

Effect added	+ Ingestion ($h>0, L_C=L_E=1, \eta = \alpha, j=a, f=1$)	+ Egestion ($h>0, L_C \leq L_E < 1, \eta = \alpha, j=a, f=1$)	+ Stoichiometry-maintenance ($h>0, L_C \leq L_E < 1, \eta \neq \alpha, j=a, f=1$)	+ Digestion ($h>0, L_C \leq L_E < 1, \eta \neq \alpha, j>a, f=1$)	+ Excretion ($h>0, L_C \leq L_E < 1, \eta \neq \alpha, j>a, f<1$)	Total herbivory
R_A^*	+	0	0	0	0	+
R_I^{max}	0	0	0	0	0	0
α_{exclu}	+	0	$\eta > \alpha_{exclu}^{stoic} : +$ $\eta < \alpha_{exclu}^{stoic} : -$	0	0	$\eta > \alpha_{exclu}^{stoic} : +$ $\eta < \alpha_{exclu}^{stoic} : ?$
$\alpha_{min\ er}$	0	0	$\eta > \alpha_{min\ er}^{egest} = \delta : +$ $\eta < \alpha_{min\ er}^{egest} = \delta : -$	0	0	$\eta > \alpha_{min\ er}^{egest} = \delta : +$ $\eta < \alpha_{min\ er}^{egest} = \delta : -$
α_{extin}	+	-	$\eta > \alpha_{extin}^{egest} : 0$ $\eta < \alpha_{extin}^{egest} : 0/+$	-	-	?
E_D^*	-	+	$\eta > \alpha : +$ $\eta < \alpha : -/+$ (if $L_E \approx L_C$ and $\eta \ll \alpha$)	+	+	?
E_A^*	-	$\alpha > \alpha_{min\ er}^{egest} = \delta : -$ $\alpha < \alpha_{min\ er}^{egest} = \delta : +$	$\eta > \alpha : +$ $\eta < \alpha : -$	$\alpha > \alpha_{min\ er}^{stoic} : -$ $\alpha < \alpha_{min\ er}^{stoic} : +$	+	?

+, - and 0 describe respectively an increase, a decrease or a constancy in the numerical value of the key parameter or variable at equilibrium considered. ? means that it can not be determined qualitatively if the total effect of herbivory will tend towards an increase or a decrease in a key parameter or variable at equilibrium. α_x^y is the value of the key parameter α_x after the inclusion of the effect y. The key parameters are defined in text.

Table 5: Variation of the parameters controlling the different herbivory effects, between a set of ecosystems that are ordered on a gradient of “terrestriality”.

Ecosystems	Aquatic pelagic	Aquatic benthic	Wetlands	Grasslands	Woodlands	Explanation or References
h (Herbivory pressure)						Kimmins 1997, Cebrian 1999
L_C (C maximum assimilation efficiency)						Decrease in the digestibility of autotroph detritus
η (Herbivore C:E demand)			?			Not enough data
a (degradability of autotroph organic matter)						Cebrian 1999
j (degradability of egested organic matter)						Correlation with the degradability of plant organic matter
$j-a$ (Change in lability)						Longer gut passage time
f (E net growth efficiency)						Increase in mean body mass of herbivores
μ (DOM C:E ratio)						Increase in the structural parts in plants
δ (Decomposer C:E demand)						Increase in the percentage of fungi which have higher C:E demand ratios. Kirschbaum and Paul 2002
α (autotroph C:E ratio)						Cebrian 1999
Ingestion effect						Deduction
Egestion effect						Deduction
Stoichiometry effect			?			
Digestion effect						Deduction
Excretion Effect						Deduction

means that a parameter increases along the gradient of ecosystems, that it decreases, and ? denotes an unknown relationship between a parameter and the gradient. In the third column are indications of references or known facts from which we deduced the variation in the parameter considered. The inferred variations in the herbivory effects are also given in the five last rows.

Legends of figures:

Fig. 1: Flow diagram of the model that couples the cycles of carbon (in white) and another limiting element E (in black). The model presents the combined growth of autotrophs (C_A and E_A), decomposers (C_D and E_D) and herbivores (C_H and E_H), with inorganic E (E_I) and Detritic Organic Matter, or DOM, (C_M and E_M) as resources. Carbon (black arrows) and E (dashed arrows) flow in and out of the ecosystem and between the different C and E stocks with intensities (Φ_x^C and Φ_x^E) that are defined in table 1.

Fig. 2: Graphical determination, based on the method developed by the resource-ratio theory (Tilman 1980), of the resource equilibrium of our model, when herbivory rate h is equal to zero. In the plane with the two resources C_M and E_I as coordinates, the decomposer Zero Net Growth Isocline (ZNGI: - - -) is the set of (C_M , E_I) values that result in zero net growth of the decomposer population. When autotrophs and decomposers coexist, the resource equilibrium point (★) lies at the intersection of this ZNGI with Autotroph ZNGI (- - -). The viability of decomposers depends on whether the resource availability point (★) is above the resource equilibrium point ($C_M^0 > R_M^*$) or not and whether the two ZNGIs intersect at all ($R_I^* < R_A^*$) or not.

Fig. 3: Variation in the interaction of autotrophs and decomposers when the C:E ratio of autotrophs, α , is changed. A to D and E to H illustrate the movement upward in the positions of decomposers ZNGI, resource equilibrium point and resource availability point (legend as in fig. 2) as α is increased. In A and F, the resource equilibrium point

and resource availability point are confounded. We define the corresponding α as α_{extin} . In B and E, part of decomposer ZNGI is confounded with x-axis ($R_I^*=0$). The corresponding α is defined as α_{miner} . In C, part of decomposer ZNGI is confounded with autotroph ZNGI ($R_I^{max} = R_A^*$) and both organisms are limited by E. the corresponding α is defined as α_{exclu} . In G, the two ZNGI's cannot coincide as in C, because R_I^* approaches asymptotically a maximum value R_I^{max} when α tends to infinity, and in this case, $R_I^{max} < R_A^*$. D and H present the variation in autotroph and decomposer E stocks (E_A^* and E_D^*) as a function of α , when respectively, $R_I^{max} > R_A^*$ and $\alpha_{extin} < \alpha_{miner}$, and $R_I^{max} < R_A^*$ and $\alpha_{extin} > \alpha_{miner}$. As a consequence, in D, decomposers are mineralizing for $\alpha_{extin} < \alpha < \alpha_{miner}$ and are competitively excluded for $\alpha > \alpha_{exclu}$, while in G, decomposers immobilizers for $\alpha > \alpha_{extin}$ and are never competitively excluded.

Fig. 4: Two examples of variations in autotroph and decomposer E stocks (E_A^* and E_D^*) as a function of the herbivory rate h . In A and C, the values for the parameters were $\alpha=16$, $\delta=10.5$, $\eta=22$, $L_C=0.4$, $L_E=0.9$, $f=0.7$, $a=3.8$, $j=5.3$, $i=0.3$, $n=1.5$, $e=0.4$, $l=0.1$, $l_A=0.3$, $l_D=1.1$, $l_0=0.2$. In B and D, the values for the parameters were $\alpha=8$, $\delta=12$, $\eta=18$, $L_C=0.4$, $L_E=0.9$, $f=0.5$, $a=4$, $j=5.3$, $i=0.3$, $n=1.5$, $e=0.2$, $l=0.1$, $l_A=0.3$, $l_D=0.9$, $l_0=0.4$. In A and B, E_A^* and E_D^* are plotted, as well as autotroph E stock if decomposers were absent ($E_D=0$). The comparison between the latter and real autotroph E stock highlights the positive effect of decomposers on autotrophs through mineralization or their negative effect through immobilization. In C and D, besides E_A^* and E_D^* , we plot the values of E_A^* and E_D if only the process of ingestion was

included in herbivory (ingestion). For each E stock, the comparison between the real and ingestion-only values highlights the effects of the remaining nutritional processes of herbivores, which are the egestion, stoichiometry-maintenance, digestion and excretion processes.

Fig. 1:

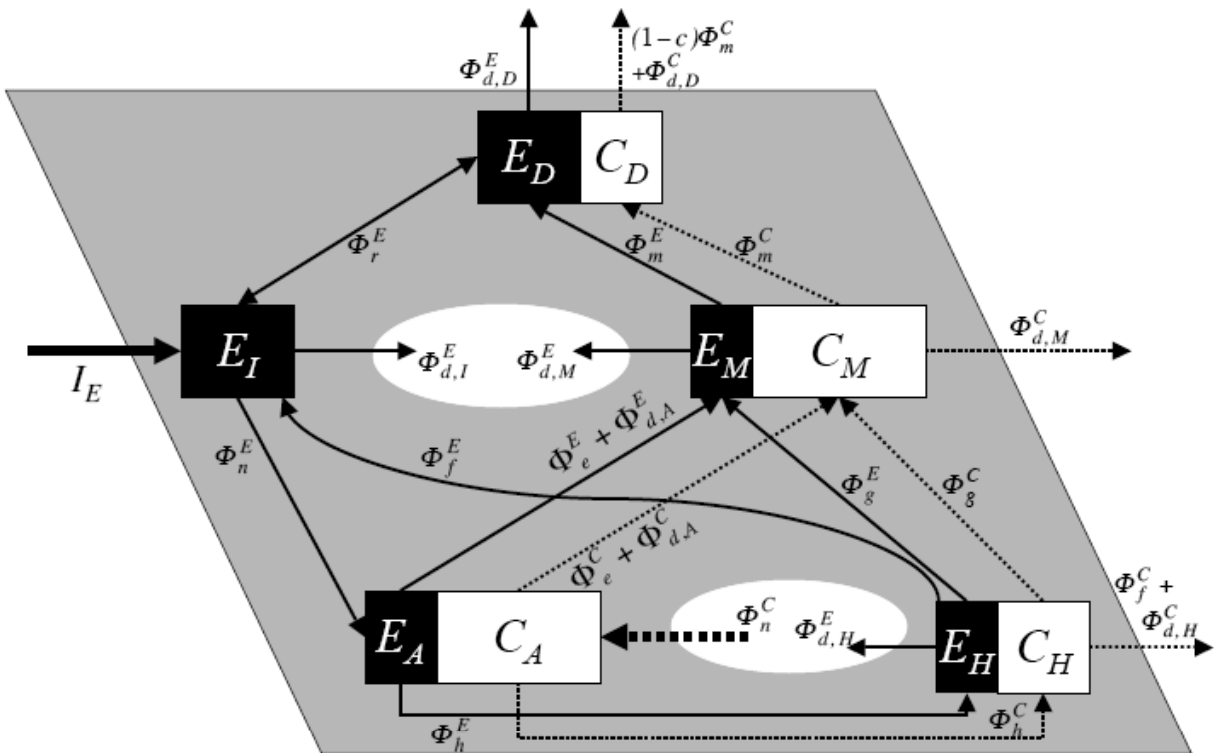

Fig. 2:

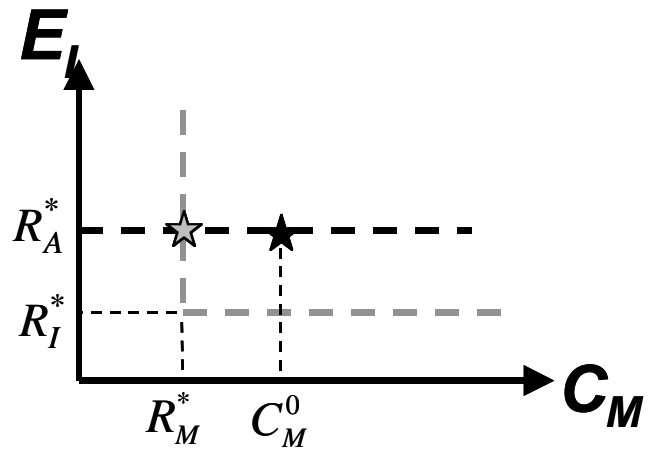

Fig. 3:

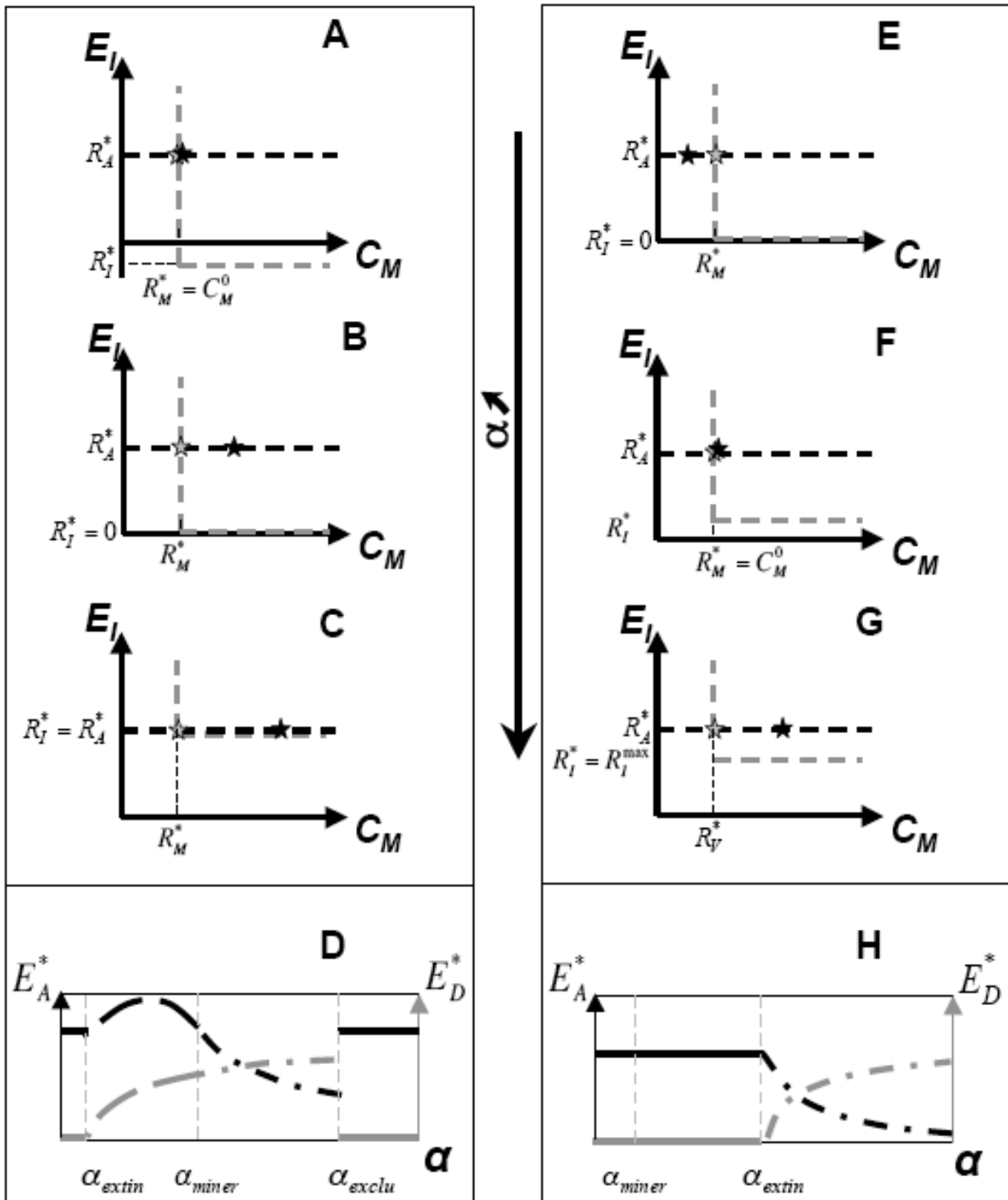
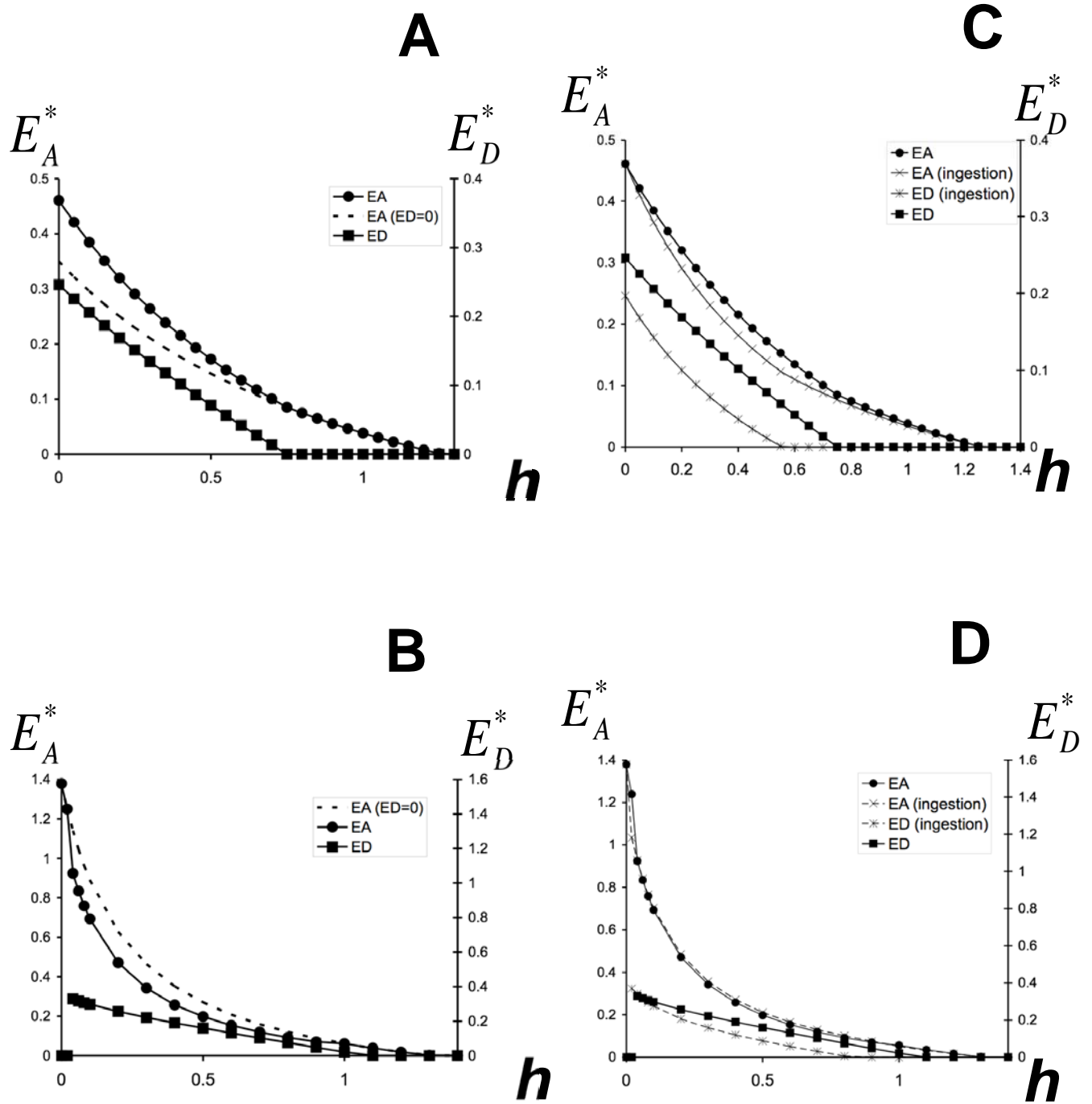

Fig. 4:



Annexe 4 :

Letter :

Microbial interference with the effects of herbivore stoichiometry on plant nutrient limitation.

Abbreviated title: Microbial and herbivore effects on plant limitation

Mehdi Cherif¹ and Michel Loreau²

¹Author for correspondence:

Laboratoire d'Ecologie, BIOEMCO UMR 7618, Ecole Normale Supérieure, 46 rue d'Ulm, F-75230 Paris Cedex 05, France

Current address:

Department of Biology, McGill University, 1205 avenue Docteur Penfield, Montreal, Quebec H3A 1B1, Canada

Phone: 514-398-6815

FAX: 514-398-5069

E-mail: cherif@biologie.ens.fr

²Department of Biology, McGill University, 1205 avenue Docteur Penfield, Montreal, Quebec H3A 1B1, Canada

E-Mail: michel.loreau@mcgill.ca

words in abstract: 149; # words in body text: 4839; # references: 45; # figures: 5; # tables:

1.

Keywords: *autotrophs; Brachionus; Daphnia; excess C recycling; herbivores; microbial decomposers; microbial loop; model; N:P ratio; omnivory;*

Abstract

Differential excretion of elements by herbivores faced with an imbalanced diet can shift the element that limits plant growth. However, herbivores excrete both potential plant-limiting elements and excess organic carbon. This carbon fuels the growth of microbial decomposers, which are generally rich in phosphorus, and could drive plants towards phosphorus limitation. To investigate the interference of decomposers with the effects of herbivores on plant nutrient limitation, we extend a model of plants and herbivores exchanging phosphorus and nitrogen to include carbon and decomposers. Our results show that the effect of a trophic level on the availability of nutrients cannot be understood without considering both the net consumption of this trophic level and of all the other levels that it supports, a fact rarely taken into account in stoichiometric theories. In our case, omnivory and detrital chains are important factors explaining the effect of herbivores on plant nutrient limitation.

Introduction

Few concepts in the history of ecology have witnessed such dramatic changes in perspective as our understanding of the impact of herbivores on plants. From a situation where herbivores were viewed merely as a special kind of predators (Fenton 1937), they were later regarded as accelerators of element cycling (Kitchell et al 1979, Loreau 1995), as potential optimizers of primary productivity (McNaughton 1979, de Mazancourt et al 1998), as modulators of the intensity and severity of fires and diseases (Liedloff et al 2001, Rostas et al 2003) and as controllers of plant quality (Chapman et al 2003).

One of the most recent of these developments, brought to light the idea that herbivores could determine the identity of the element that limits plant growth (Elser et al 1988, Sterner 1990). This hypothesis suggests that, because the needs of herbivores in elements usually differ widely from what they find in their food, their diet is highly imbalanced and they should excrete the elements that are in excess in their food. For example, *Daphnia* species, which are very rich in phosphorus (Andersen and Hessen 1991), tend to witness a deficiency in this element and an excess of nitrogen in their food. They thus retain in their biomass more phosphorus than nitrogen and excrete more nitrogen than phosphorus (Elser and Urabe 1999). By excreting more of one element than the other, they change the balance of these elements in the chemical environment. This, in turn, can influence plants, sometimes to the point of changing the identity of the element limiting plants to that of their own limiting element (phosphorus in the case of *Daphnia*). There are, however, a few conditions for this change in the limitation of plants to occur. First, the elements recycled by herbivores must represent a significant share of the elements available to plants. A theoretical study by Daufresne and Loreau (2001) highlights a second less evident condition. They show that the affinity of the

eaten plants for the different elements is also an important component in determining the change in limitation of plants brought by herbivores.

Although taking into account two elements (nitrogen and phosphorus) to understand the impact of herbivores on plant growth is a significant improvement, we feel that it is also important to consider a third, essential element, carbon. While regulating the assimilation of nitrogen and phosphorus, herbivores also regulate the assimilation of carbon by excreting the carbon in excess (Darchambeau et al 2003). But carbon has a fate different from the other elements. Nitrogen and phosphorus are rapidly available to both plants and microbial decomposers after they are recycled by herbivores. In contrast, organic carbon is generally consumed only by microbial decomposers (Thor et al 2003). It is known that microbial decomposers and in particular bacteria have high demands in phosphorus and are efficient competitors for phosphorus compared to plants (Currie and Kalff 1984). Hence, we hypothesize that the fuelling of microbial growth by the excretion of carbon in excess by herbivores might enhance phosphorus uptake by microbial decomposers, and draw plants towards a limitation by phosphorus, independently of the fact that herbivores are themselves limited by nitrogen or phosphorus.

The supply of organic carbon to decomposers is not the only way through which herbivores and decomposers interact. In many ecosystems, particularly in aquatic systems, herbivores also consume some decomposers, as those are intimately interlaced with plants in biofilms, as epibionts or because they are in the same size range as the phytoplankton (Brendelberger 1991, Arndt 1993). Because again, decomposers are a food resource rich in phosphorus, we hypothesize that omnivorous phosphorus-limited herbivores are less efficient in promoting phosphorus limitation of plants than strict herbivores. In contrast, omnivorous nitrogen-limited herbivores should be more efficient promoters of nitrogen limitation of plants.

To investigate how decomposers modify the effect of herbivores on the limitation of plants, we extended a model in Daufresne and Loreau (2001) that studies the interaction between plants and herbivores exchanging nitrogen and phosphorus to include a compartment of microbial decomposers and carbon as an additional element. First, we compare the relative net consumption of nitrogen and phosphorus by the whole community (plants and herbivores plus decomposers when present) in the cases where decomposers are not included to the cases where they are part of the community. In this first step, herbivores are feeding only on autotrophs. To study the effect of omnivory on plant limitation, we repeat the analysis of the model a second time with herbivores feeding on decomposers. We also use four sets of parameters extracted from the literature (two common freshwater zooplankton genera × nitrogen- or phosphorus-limited plants).

The analysis of the model shows that, more than the richness of decomposers in phosphorus, it is the nitrogen:phosphorus ratio of the decomposer-based community net consumption – decomposer net consumption plus decomposer-based herbivore net consumption – that determines the identity of the limiting element promoted by decomposers. If herbivores feed on decomposers significantly, this ratio reflects the nitrogen:phosphorus ratio of herbivores. Decomposers then promote the same limiting element as their consumers, even if they, themselves, consume preferentially the non-limiting element. These results advocate for the importance of considering the chain of consumers that a trophic level supports, when investigating its impact on the availability of nutrients. We also think that our model is suitable, with some changes, to be applied to the study of detritivores, whose diet consists of both plant-derived material and microbial decomposers.

Model description

The model is an extension of the model in Daufresne and Loreau (2001). Along the nitrogen (N) and phosphorus (P) stocks of inorganic nutrients (N_I and P_I), autotrophs – a term more generic than plants– (N_A and P_A) and herbivores (N_H and P_H), we introduced stocks representing the microbial decomposers (N_D and P_D). We also added carbon (C) stocks to the living compartments, C_A , C_H and C_D (see Fig. 1 for a presentation of the model).

The three elements P, N and C are bound in the biomass of the three living compartments in the ratios $(N:P)_A$, $(N:P)_H$ and $(N:P)_D$ for the N:P ratio of autotrophs, herbivores and decomposers respectively, and $(C:P)_A$, $(C:P)_H$ and $(C:P)_D$ for their C:P ratio. Because decomposers are generally richer in P than autotrophs, the only constraint that we impose on these stoichiometric ratios is that $(C:P)_D$ is inferior to $(C:P)_A$.

Because decomposers are generally more efficient than autotrophs in taking up P and N, we assume that C is the element that limits their growth (Bratbak and Thingstad 1985). In addition, decomposers are usually highly efficient at using the pool of labile carbon. So, we assume both that the organic C produced by autotrophs and herbivores is totally labile, and that decomposers use almost instantaneously and totally the entire C produced. In this work, we are interested in the role of decomposers in the stoichiometric interaction between herbivores and autotrophs. So, we think that introducing explicitly a compartment of refractory carbon is not of a great use because it is hardly a resource for decomposers. An instantaneous and total use of the produced carbon allows counting one less compartment in the model. We checked, however, that the inclusion of a compartment of labile carbon standing on its own does not change qualitatively the conclusions. In fact, it is already known theoretically that compartments that are part of a chain, as would be the labile and decomposer carbon compartments, can be safely merged without much qualitative change (Puccia and Levins 1986).

Herbivores in our model primarily feed on autotrophs, but they also feed on decomposers. We assume that the ingestion of herbivores is donor-controlled, that is, the amount of elements transferred from the resource compartments to herbivore compartment is not controlled by herbivores but is simply proportional to resource compartment stocks (the factor of proportionality or feeding rate is h_A for autotrophs and h_D for decomposers). For many reasons, most of them stated in Polis and Strong (1996), a donor control of herbivory is more likely than a recipient control when the whole trophic levels of herbivores and autotrophs are considered, and not single species.

Herbivores maintain the constancy of their stoichiometry by excreting the elements that are in excess of their need. Hence when their food is deficient in N, they reject the excess of P and C with fluxes W_P and W_C that are above zero, while, when P is deficient, they reject the excess of N and C with positive W_N and W_C fluxes. The N and P rejected are available to both plants and decomposers. In fact, we made the simplifying assumption that all the recycled N and P, whether organic or inorganic, is available to both autotrophs and decomposers. Phosphatases, whether from plant (Tarafdar and Claassen 1988) or microbial origin (Rodríguez and Fraga 1999), make organic phosphorus available to both compartments and there is growing evidence that organic nitrogen might also be available to autotrophs (Kaye and Hart 1997). The C rejected is organic and is immediately taken up by decomposers.

The excess of C rejected by herbivores is only one of the sources of C for decomposers. Two other sources are the C ingested by herbivores but not assimilated (fraction $1-e_H$ of ingested food) and the C excreted by autotrophs (fraction r_A of primary production). Herbivores also eliminate elements as a by-product of their metabolism, but the C produced therein is not available to decomposers, as it is respired in the form of CO_2 (specific respiration rate r_H).

Of all the C they take up, decomposers assimilate only a fraction e_D , the remaining fraction $1 - e_D$ is used for respiration. The N_I and P_I taken up by decomposers are totally assimilated because they are net uptakes.

Naturally, autotrophs also take up N_I and P_I . Their growth can be limited by either of the two elements and, applying Liebig's law to growth rate, it is the element that gives the lowest growth rate that is the actual limiting element (Blackman 1905).

All the different compartments have loss rates: a_A , a_H , a_D and a_I for autotrophs, herbivores, decomposers and both N_I and P_I respectively. They represent all the various losses from the different compartments that are not recycled and are lost from the system.

To counterbalance these losses from the ecosystem, N_I and P_I are supplied to the ecosystem in quantities S_N and S_P respectively, with a rate equal to their loss rate a_I , which is de facto the renewal rate of the inorganic resources.

RESULTS

1) The role of the community net consumption N:P ratio in plant nutrient limitation:

As explained in Daufresne and Loreau (2001), at equilibrium, the inorganic resource limiting autotroph growth is at its R^* value (Tilman 1980 and fig. 2). Also, the community net consumption vector $\overrightarrow{N:P_{ADH}}$ balances the supply vector $\overrightarrow{N:P_S}$ (Fig. 2). We define net consumption, or impact, of the community as the consumption minus recycling of inorganic nutrients (Daufresne and Loreau 2001). Because for all living compartments at equilibrium, net consumption is equal to loss, the community net consumption vector components are more simply expressed as the sum of the losses of N and P from the living compartments:

$$\underbrace{\begin{pmatrix} a_I(S_N - N_I^*) \\ a_I(S_P - P_I^*) \end{pmatrix}}_{N:P_S} = - \underbrace{\begin{pmatrix} a_A N_A^* + a_D N_D^* + a_H N_H^* \\ a_A P_A^* + a_D P_D^* + a_H P_H^* \end{pmatrix}}_{N:P_{ADH}}$$

where the star denotes equilibrium values.

The absolute value of the slope of the community net consumption vector, the community net consumption ratio $(N:P)_{ADH}$, is equal to the ratio of the N consumed by the community to the

$$\text{consumed P, } (N:P)_{ADH} = \frac{a_A N_A^* + a_D N_D^* + a_H N_H^*}{a_A P_A^* + a_D P_D^* + a_H P_H^*}.$$

For a given supply point, it is this ratio that will determine the element limiting autotroph growth and the intensity of the limitation. As illustrated in fig. 2, the smaller the ratio is –i.e. the smaller the net consumption of N by the community, in comparison to P net consumption– the more likely, or the more severe, the P limitation of autotrophs. Hence, in the rest of our analysis, we address the problem of the effect of decomposers on plant limitation by comparing the community net consumption ratio without decomposers $(N:P)_{AH}$ to the ratio $(N:P)_{ADH}$, when decomposers are included in the community. If the community net consumption ratio with decomposers is larger than without them, then decomposers promote N limitation of autotrophs. In contrast, if it is smaller, decomposers drive autotrophs towards P limitation.

We analyze in detail only the case where herbivores are limited by P when feeding on autotrophs $((N:P)_H < (N:P)_A)$. The results for N-limited herbivores $((N:P)_H > (N:P)_A)$ are symmetrical and can be found at the end of this section in Fig. 5.

In a first step we exclude the effects of omnivory by setting the feeding rate of herbivores on decomposers h_D to 0; and we proceed to analyze the influence of decomposer inclusion on plant limitation. Subsequently, we repeat this analysis with $h_D > 0$. We highlight the changes

brought by omnivory on the effect of decomposers by comparing the results of the two analyses.

In a last part, we assess the effect of recycling by herbivores of excess C on the influence of decomposers on autotroph limitation, by comparing a model with excess C recycling ($W_C > 0$) to a model without excess C-recycling ($W_C = 0$).

2) Effect of decomposer presence on autotroph limitation:

In order to find the influence of decomposers on autotroph limitation in absence of herbivore omnivory, we compare the community net consumption N:P ratios without,

$$(N : P)_{AH} = \frac{a_A N_A^* + a_H N_H^*}{a_A P_A^* + a_H P_H^*}, \text{ and with decomposers, } (N : P)_{AHD} = \frac{a_A N_A^* + a_H N_H^* + a_D N_D^*}{a_A P_A^* + a_H P_H^* + a_D P_D^*},$$

under the constraint $h_D = 0$.

We conduct this analysis for herbivores that are P-limited by autotrophs that is, for herbivores that are richer in P than their autotroph food ($(N : P)_H < (N : P)_A$). Results for N-limited herbivores are the same mutatis mutandis.

In absence of decomposers, the community net consumption vector $\overrightarrow{N : P}_{AH}$ is the vectorial sum of the net consumption vectors of autotrophs $\overrightarrow{N : P}_A$ and $\overrightarrow{N : P}_H$ of herbivores (Fig. 3 A):

$$\underbrace{- \begin{pmatrix} a_A N_A^* + a_H N_H^* \\ a_A P_A^* + a_H P_H^* \end{pmatrix}}_{\overrightarrow{N : P}_{AH}} = \underbrace{-a_A \begin{pmatrix} N_A^* \\ P_A^* \end{pmatrix}}_{\overrightarrow{N : P}_A} - \underbrace{a_H \begin{pmatrix} N_H^* \\ P_H^* \end{pmatrix}}_{\overrightarrow{N : P}_H}$$

From this vectorial representation of the community N and P net consumptions, it appears that the community ratio $(N : P)_{AH}$ is bounded by the two single-compartment ratios, i.e. $(N : P)_H < (N : P)_{AH} \leq (N : P)_A$. It is clear from this inequality that P-limited herbivores drive autotrophs towards P limitation since $(N : P)_{AH} \leq (N : P)_A$, a result already found in Daufresne and Loreau (2001). Increasing the feeding rate of herbivores on autotrophs h_A

amplifies the contribution of herbivore net consumption to the community net consumption at the expense of autotroph net consumption. From this fact and from the analytical expression of $(N:P)_{AH}$ in table 2 of the appendix, it appears that $(N:P)_{AH}$ moves from $(N:P)_A$ to $(N:P)_H$ as the feeding rate h_A increases from 0 to infinity (Fig. 3 A).

In a similar way, the net consumption vector of the community including decomposers $\overrightarrow{N:P}_{ADH}$ is also a vectorial sum of the net consumption vectors $\overrightarrow{N:P}_{AH}$ and $\overrightarrow{N:P}_D$:

$$\underbrace{\begin{pmatrix} a_A N_A^* + a_D N_D^* + a_H N_H^* \\ a_A P_A^* + a_D P_D^* + a_H P_H^* \end{pmatrix}}_{\overrightarrow{N:P}_{ADH}} = \underbrace{\begin{pmatrix} a_A N_A^* + a_H N_H^* \\ a_A P_A^* + a_H P_H^* \end{pmatrix}}_{\overrightarrow{N:P}_{AH}} - \underbrace{a_D}_{\overrightarrow{N:P}_D} \begin{pmatrix} N_D^* \\ P_D^* \end{pmatrix}$$

Therefore, the community net consumption N:P ratio, $(N:P)_{ADH}$, is bounded by the ratio of decomposers, $(N:P)_D$, and the ratio of the autotroph-based community net consumption, $(N:P)_{AH}$ (Fig. 3 B and C). The effect of decomposer inclusion on autotroph limitation depends on these two ratios:

- If $(N:P)_D$ is smaller than $(N:P)_{AH}$, decomposers promote P-limitation of autotrophs (Fig. 3 B).
- On the other hand, if $(N:P)_D$ is larger than $(N:P)_{AH}$, decomposer presence drives autotrophs towards N limitation (Fig. 3 C).

It is not always necessary to calculate $(N:P)_{AH}$ and compare it to $(N:P)_D$ in order to find the impact of decomposers on autotroph limitation. Because $(N:P)_{AH} < (N:P)_A$ (P-limitation of herbivores), $(N:P)_D$ is automatically larger than $(N:P)_{AH}$ if $(N:P)_D > (N:P)_A$, which corresponds to a promotion of N limitation by decomposers.

Fig. 5 A. presents in a chart the various conditions on the net consumption N:P ratios that result in decomposers that promote either the P or N limitation of autotrophs. N-rich decomposers added to P-limited herbivores or, conversely, P-rich decomposers added to N-limited herbivores –i.e. $(N:P)_D > (N:P)_A > (N:P)_H$ or $(N:P)_D < (N:P)_A < (N:P)_H$ –

drive autotrophs towards N or P limitation respectively. However, when both decomposers and herbivores are richer than autotrophs in P, i.e. $(N:P)_D < (N:P)_A$ and $(N:P)_H < (N:P)_A$, the resulting effect of decomposers depends on whether they consume respectively relatively more P ($(N:P)_D < (N:P)_{AH}$) or more N ($(N:P)_D > (N:P)_{AH}$) than autotrophs and herbivores together. The same applies when both decomposers and herbivores are richer than autotrophs in N ($(N:P)_D > (N:P)_A$ and $(N:P)_H > (N:P)_A$).

3) Effects of omnivory on autotroph limitation:

Including decomposers in the diet of herbivores ($h_D > 0$) means that at equilibrium, a fraction of herbivore N and P net consumption comes from decomposer ingestion, while another fraction comes from autotroph ingestion. The net consumption vector of herbivores is thus the sum of two parallel vectors (Fig. 4 A):

$$\overrightarrow{N:P}_H = - \underbrace{\frac{h_A}{h_A + h_D f} a_H}_{\overrightarrow{N:P}_{HA}} \begin{pmatrix} N_H^* \\ P_H^* \end{pmatrix} - \underbrace{\frac{h_D f}{h_A + h_D f} a_H}_{\overrightarrow{N:P}_{HD}} \begin{pmatrix} N_H^* \\ P_H^* \end{pmatrix}, \text{ where } h_A \text{ and } h_D \text{ are the feeding rates of}$$

herbivores on autotrophs and decomposers respectively and f is the ratio of decomposer to autotroph stocks of the element that limits herbivores. $\frac{h_A}{h_A + h_D f}$ and $\frac{h_D f}{h_A + h_D f}$ are the respective proportions of autotrophs and decomposers in herbivore diet.

By combining the herbivore autotroph-based net consumption vector $\overrightarrow{N:P}_{HA}$ and the autotroph net consumption vector ($\overrightarrow{N:P}_A$), we obtain the autotroph-based community net consumption vector ($\overrightarrow{N:P}_{AH}$). Similarly, we obtain a decomposer-based net consumption vector $\overrightarrow{N:P}_{DH}$ by combining the herbivore decomposer-based net consumption vector $\overrightarrow{N:P}_{HD}$ and the decomposer net consumption vector $\overrightarrow{N:P}_D$.

Because the community net consumption vector $\overrightarrow{N:P}_{ADH}$ is a combination of the autotroph-based and decomposer-based community net consumption vectors ($\overrightarrow{N:P}_{AH}$ and $\overrightarrow{N:P}_{DH}$ respectively), finding the change induced by decomposers on autotroph limitation is just a matter of comparing the slopes of the two vectors:

- if $(N:P)_{DH}$ is smaller than $(N:P)_{AH}$, the community net consumption N:P ratio $(N:P)_{ADH}$ is smaller than the autotroph-based community ratio $(N:P)_{AH}$, and hence decomposers promote autotroph P limitation (Fig. 4 B).
- On the other hand, if $(N:P)_{DH}$ is larger than $(N:P)_{AH}$, decomposers drive autotrophs towards N limitation (Fig. 4 C).

As is shown in Fig. 4 A, the exact position of the decomposer-based community net consumption vector $\overrightarrow{N:P}_{DH}$ between decomposer and herbivore net consumption vectors, $\overrightarrow{N:P}_D$ and $\overrightarrow{N:P}_H$, depends on the intensity of the feeding rate of herbivores on decomposers h_D : the larger h_D , the closer $\overrightarrow{N:P}_{DH}$ is to $\overrightarrow{N:P}_H$. Hence, the fact that, for specific $(N:P)_A$, $(N:P)_H$ and $(N:P)_D$ ratios, $(N:P)_{DH}$ is smaller or larger than $(N:P)_{AH}$ depends to some extent on h_D .

Similarly to Fig. 5 A, Fig. 5 B presents a summary chart of the various conditions on the net consumption N:P ratios that result in decomposers that promote either the P or N limitation of autotrophs, in the case of omnivorous herbivores.

To illustrate our main conclusions and see if they are relevant to natural systems, we have extracted from the literature four sets of parameters typical of two common genera of freshwater zooplankton (*Brachionus* and *Daphnia*) growing on P or N-limited phytoplankton *Scenedesmus acutus* and freshwater bacterioplankton (Table 1). Freshwater zooplanktonic herbivores present some of the most extended data sets and among them, *Daphnia* and *Brachionus* genera have been the most used to test the effect of herbivores on plant limitation.

We summarize the main results of this analysis as follows:

- If decomposers promote the same limiting element as herbivores in absence of omnivory (herbivores are P-limited and $(N:P)_D < (N:P)_{AH}$ or herbivores are N-limited and $(N:P)_D > (N:P)_{AH}$), then omnivory does not change the identity of the element that is promoted by decomposers. This is the case for both *Brachionus* and *Daphnia* when *Scenedesmus* are limited by P, where the bacterioplankton promotes autotroph P limitation with or without omnivory (Table 1 and figure 5 B).
- However, if decomposers promote a different limiting element than herbivores in absence of herbivory, the overall outcome of the presence of decomposer on autotroph limitation depends on the feeding rate h_D . Indeed, by increasing the net consumption of herbivores, decomposers increase the influence of the latter on autotroph limitation. If the omnivorous-feeding rate h_D is larger than a threshold value \tilde{h}_D , decomposers end up promoting the same limitation as herbivores, notwithstanding the fact that they do not consume relatively more of the limiting element. According to our calculations, N-limited *Daphnia* are an example where decomposers should promote the limitation of autotrophs by the same element as herbivores (N) because of a high omnivorous-feeding rate (Table 1 and figure 5 B). In contrast, decomposers growing with N-limited *Brachionus* should promote the limitation of autotrophs by P, because they consume relatively more P than N $-(N:P)_D < (N:P)_{AH}$ and the omnivorous-feeding rate is too low (Table 1 and figure 5 B).

4) The quantitative effect of the cycling of excess C by herbivores:

N- and P- limited herbivores recycle the excess of C from their food back to decomposers through the flux W_C (Fig. 1). To analyze the influence of this C in excess, we

compare the community net consumption ratio $(N:P)_{ADH}$ obtained by setting W_C to 0 with the ratio when $W_C > 0$.

$(N:P)_{ADH}$ can be expressed as a function of both autotroph-based and decomposer-based community net consumptions and a factor of proportionality f between the limiting-element stocks of decomposers and autotrophs, equal to $\frac{N_D^*}{N_A^*}$ for N-limited herbivores and to $\frac{P_D^*}{P_A^*}$ for P-limited herbivores (table A2 in the appendix). Setting W_C to zero does not change $(N:P)_{AH}$ nor $(N:P)_{DH}$, but it decreases the ratio of limiting-element stocks of decomposers and autotrophs, f (Table A3 in the appendix). Calculated for the set of parameters of Table 1, the recycling of C in excess by herbivores should cause at least a two-fold increase in decomposer biomass (up to a 7-fold increase for N-limited *Daphnia*).

Thus, the effect of excess-C recycling does not affect the identity of the autotroph-limiting element promoted by decomposers. This recycling, however, provides organic C to decomposers that are limited by C. This results in an increase of decomposer biomass in proportion to autotroph biomass, which intensifies the effect of decomposers on autotroph limitation (figure 4 B and C: $\overrightarrow{N : P_{ADH}}$ moves closer to $\overrightarrow{N : P_{DH}}$).

Discussion

We used an stoichiometrically explicit model that couples the cycles of three elements – C, N and P– between autotrophs, herbivores and decomposers, to investigate theoretically the changes brought by decomposers in the effect of herbivores on autotroph nutrient limitation.

Our vectorial, graphical analysis demonstrates that the promotion of P or N limitation of autotrophs by decomposers depends (1) on the difference between the N:P ratio of the net consumption of the part of the community that is based on decomposers and the N:P ratio of the autotroph-based community net consumption, and (2) on the degree to which decomposers are fed upon by omnivorous herbivores: if the feeding rate of herbivores on decomposers is sufficiently large, these latter promote the same limiting element as their consumer, even if they consume more of the non-limiting element. For example, P-rich decomposers should normally drive plants towards limitation by P, unless they are heavily fed upon by N-promoting herbivores, in which case they promote N-limitation too. This result highlights the importance of considering not only a trophic level's specific relative demands in elements, but also those of the trophic levels that it supports. For example, we anticipate that herbivores supporting a high production of carnivores may not have the same impact on nutrient availability as herbivores that are almost not consumed.

We show also that the identity of the element limiting autotrophs that decomposers promote, either P or N, does not depend on the recycling of excess C by herbivores. As we said, the identity of the promoted element is entirely determined by the N:P ratios of decomposer- and autotroph-based community net consumptions. However, this recycling increases decomposer biomass in proportion to autotroph biomass, which amplifies the influence of decomposers on autotroph limitation. According to many previous researches that already documented experimentally the positive effect of herbivore C cycling on

decomposers, this effect is likely to be important in aquatic planktonic systems (Jumars et al 1989, Strom et al 1997, Hygum et al 1997).

The hypothesis of a control of plant limitation by herbivore elemental recycling was first enunciated and subsequently tested in the case of pelagic ecosystems (Sterner et al 1992, Elser and Urabe 1999). To see how our model can contribute to the understanding of these ecosystems, we made a first modest attempt at the parameterization of our model for pelagic organisms. Hence, we extracted from the literature estimates for the model parameters, in order to evaluate the influence of freshwater bacterioplankton on the effect of two common genera of freshwater zooplankton (*Brachionus* and *Daphnia*) on the nutrient limitation of the phytoplankton *Scenedesmus acutus*. We recognize that this was somewhat of a crude attempt, in need of more work and more precise models in order to be accurately predictive. For instance, as is already detectable from our estimates, N and P contents of autotrophs and, to less extent, of decomposers can vary widely according to the growth rate, the supply ratio of nutrient, but also to other factors such as light and temperature (Elrifi and Turpin 1985, Vrede et al 2002, Leonardos and Geider 2004, Cotner et al 2006). These variations will have to be accounted for to reach more reliable predictions. However, this parameterization proved useful to show that the effects of decomposers and of omnivory predicted by our model can be found in natural systems.

Our calculations show that both herbivores, when limited by P, reinforce their promotion of autotroph P limitation by providing P-promoting decomposers with organic C. When limited by N however, the two herbivores differ in their relation with decomposers. By feeding heavily on decomposers, *Daphnia* increase their own biomass and promotion of autotroph N limitation, excluding any P promotion by decomposers that are nonetheless richer in P than N than the autotroph-herbivore complex. In contrast, the omnivorous feeding rate of

Brachionus is too low to thwart the P promotion by decomposers and so, *Brachionus* are indeed decreasing their promotion of N by supplying decomposers with organic C.

Daufresne and Loreau (2001) showed that herbivores also change autotroph nutrient limitation through their increase in autotroph mortality. The identity of the limiting element promoted this way depends on the relative affinity of autotrophs for phosphorus and nitrogen. This mechanism is still present in our model but is not influenced by decomposer presence since these latter modify neither autotroph mortality nor their affinity for phosphorus and nitrogen. So the analysis of this mechanism in our model is rigorously similar to the analysis in Daufresne and Loreau (2001) and we did not include it. Nevertheless, this mechanism must certainly be incorporated when the overall effect of herbivores on autotroph element limitation is to be estimated.

At the root of this work was the hypothesis that the contribution of herbivores, through the recycling of excess C, to the growth of decomposers with small C:P ratios should promote the P limitation of autotrophs. The results of the model show though that the N:P ratio of decomposers, rather than their C:P ratio, is the important factor in determining decomposer impact on autotroph limitation. The effects of omnivory aside, it is the relative magnitudes of N and P consumptions by decomposers that determine whether they promote N or P limitation, and not the intensity of P consumption only. But, because C:N ratios of decomposers are less variable, their C:P ratio is partially correlated to their N:P ratio. So, decomposers that have lower C:P ratios than autotrophs tend also to have lower N:P ratios.

We partitioned the net consumption of the community in an autotroph-based and a decomposer-based net consumption, in a way akin to the classical division of –mainly aquatic- food webs into the grazing chain and the microbial loop (Azam et al 1983, Polis and Strong 1996). The results of our model, hence, are another indication of the importance of this microbial loop in understanding material cycles in ecosystems. We show moreover that one

have to estimate the part of herbivore net consumption that is supported by this loop, in order to evaluate accurately the role of herbivores in controlling autotroph limitation.

Due to the overlap between the sizes of microbes and of autotrophs, omnivory of herbivores seems to be common in aquatic systems (Brendelberger 1991, Arndt 1993). It is probably less important in aboveground terrestrial herbivores, which should therefore more closely conform to the pattern drawn in Fig. 5 A of limitation promotion in absence of omnivory. Without omnivory, we estimate with our choice of parameters that the bacterioplankton would always promote the P limitation of autotrophs, for both P- and N-limited *Brachionus* and *Daphnia*, because decomposer N:P ratio is smaller than the N:P ratio of the autotroph-based community net consumption in all four cases of table 1.

But omnivory should be important for belowground terrestrial herbivores, because decomposers are generally associated or close to the roots of plants (Watt et al 2006). If one is willing to extend a bit the scope of our model, as we think that it is possible to do, our model should be applicable to detritivores that consume both plant biomass (although generally dead) and the microbial decomposers that are processing it.

In conclusion, we think that our model makes a strong case for the incorporation of omnivory and of the microbial loop/detrital chain in the characterization of the role of herbivores in food webs. It shows that indirect effects resulting from the stoichiometric constraints, such as herbivore stimulation of decomposers through their recycling of excess-C, are important and not necessarily intuitive. Finally, it strongly advocates for the importance of considering the whole food-web context when analyzing stoichiometric mechanisms even in the case of an interaction as close-knit as that of plants and herbivores.

Acknowledgments

We are thankful to Shawn Leroux and Pr. Noreen Bider for their corrections and suggestions on the first drafts of the manuscript. M. Cherif was supported by a grant from the French Ministry of Research and Education. M. Loreau acknowledges a Discovery grant of the Natural Sciences and Engineering Research Council of Canada. This work was supported by an ACI ECCO-PNBC grant from the Centre National de la Recherche Scientifique (France).

Appendix:

This appendix presents the formal analysis of the explicit-resource autotroph-herbivore-decomposer model presented in this paper.

Differential equations:

The differential equations of the model can be obtained from the diagram in figure 1 by setting the instantaneous variation of a compartment with time equal to the sum of the input fluxes to this compartment minus the output fluxes, which gives:

$$\frac{dC_A}{dt} = \frac{(C:P)_A}{(N:P)_A} F_A - (r_A \frac{(C:P)_A}{(N:P)_A} F_A + h_A C_A + a_A C_A)$$

$$\frac{dN_A}{dt} = F_A - (r_A F_A + h_A N_A + a_A N_A)$$

$$\frac{dP_A}{dt} = \frac{F_A}{(N:P)_A} - (r_A \frac{F_A}{(N:P)_A} + h_A P_A + a_A P_A)$$

$$\frac{dC_H}{dt} = (h_A C_A + h_D C_D) - ([1 - e_H][h_A C_A + h_D C_D] + W_C + r_H C_H + a_H C_H)$$

$$\frac{dN_H}{dt} = (h_A N_A + h_D N_D) - ([1 - e_H][h_A N_A + h_D N_D] + W_N + r_H N_H + a_H N_H)$$

$$\frac{dP_H}{dt} = (h_A P_A + h_D P_D) - ([1 - e_H][h_A P_A + h_D P_D] + W_P + r_H P_H + a_H P_H)$$

$$\begin{aligned} \frac{dC_D}{dt} &= (r_A \frac{(C:P)_A}{(N:P)_A} F_A + [1 - e_H][h_A C_A + h_D C_D] + W_C) \\ &\quad - (h_D C_D + e_D [r_A \frac{(C:P)_A}{(N:P)_A} F_A + [1 - e_H][h_A C_A + h_D C_D] + W_C) + a_D C_D \end{aligned}$$

$$\frac{dN_D}{dt} = F_D - (h_D N_D + a_D N_D)$$

$$\frac{dP_D}{dt} = F_D - (h_D P_D + a_D P_D)$$

$$\begin{aligned} \frac{dN_I}{dt} &= (a_I S_N + r_A F_A + [1 - e_H][h_A N_A + h_D N_D] + W_N + r_H N_H) \\ &\quad - (F_A + F_D + a_I N_I) \end{aligned}$$

$$\begin{aligned} \frac{dP_I}{dt} &= (a_I S_P + r_A \frac{F_A}{(N:P)_A} + [1 - e_H][h_A P_A + h_D P_D] + W_P + r_H P_H) \\ &\quad - (\frac{F_A}{(N:P)_A} + \frac{F_D}{(N:P)_D} + a_I P_I) \end{aligned}$$

F_A is controlled by the element limiting autotroph growth according to the Law of the Minimum, so $F_A = \text{Min}[n_N N_I N_A, c n_P P_I N_A]$, where n_N and n_P are the specific uptake rate of autotrophs for N and P respectively.

F_D is equal to the uptake fluxes of organic C from autotroph and herbivore origin divided by

decomposer C :N ratio, so $F_D = \frac{(N:P)_D}{(C:P)_D} e_D [r_A F_A \frac{(C:P)_A}{(N:P)_A} + (1-e_H)(h_A C_A + h_D C_A) + W_C]$.

W_C , W_N and W_P expressions have to insure that $\frac{dC_H}{dt} : \frac{dN_H}{dt} : \frac{dP_H}{dt} = C_H : N_H : P_H$. Thus, we

have $W_C = e_H \left(\frac{(C:P)_A}{(N:P)_A} - \frac{(C:P)_H}{(N:P)_H} \right) h_A N_A + e_H \left(\frac{(C:P)_D}{(N:P)_D} - \frac{(C:P)_H}{(N:P)_H} \right) h_D N_D$, when N limits herbivores,

and $W_C = e_H \left(\frac{(C:P)_A}{(N:P)_A} - \frac{(C:P)_H}{(N:P)_A} \right) h_A N_A + e_H \left(\frac{(C:P)_D}{(N:P)_D} - \frac{(C:P)_H}{(N:P)_D} \right) h_D N_D$ when P limits herbivores.

W_N is equal to 0 or $e_H \left(1 - \frac{(N:P)_H}{(N:P)_A} \right) h_A N_A + e_H \left(1 - \frac{(N:P)_H}{(N:P)_D} \right) h_D N_D$ when herbivores are N- or P-

limited respectively; and W_P is equal to

$e_H \left(\frac{1}{(N:P)_A} - \frac{1}{(N:P)_H} \right) h_A N_A + e_H \left(\frac{1}{(N:P)_D} - \frac{1}{(N:P)_H} \right) h_D N_D$ or 0 when herbivores are N- or P-

limited respectively.

Equilibrium values of the model variables:

We first present the equilibrium values of 5 variables of the model: N_A , N_H , N_D , N_I and P_I (the other variables P_A , P_H , P_D , C_A , C_H and C_D can be derived from the previous variables by multiplying them with the corresponding stoichiometric ratio), for the different possible cases (herbivores N or P limited × autotrophs N or P limited). For each limitation, two equilibria are possible: a trivial equilibrium, where all the living compartments are extinct and the inorganic resources equal to their concentration in the supply; a non-trivial equilibrium with all the living compartments present with their expression in Table A1.

Table A1: Non-trivial equilibrium values of the model for the different cases of autotroph and herbivore limitation:

		H e r b i v o r e s	
		N limitation	P limitation
A u t o t r o p h s	N limitation	$N_I^* = N_{IL}^* = \frac{h_A + a_A}{(1 - r_A)n_N}$ $* N_D^* = fN_A^*; N_H^* = e_H \frac{h_A + h_D f}{a_H + r_H} N_A^*$ $N_A^* = \frac{a_I(S_N - N_I^*)}{a_A + a_D f + \frac{a_H e_H (h_A + h_D f)}{a_H + r_H}}$ $P_I^* = S_P - \frac{1}{a_I} \left(\frac{a_A}{(N:P)_A} + \frac{a_D f}{(N:P)_D} + \frac{a_H + r_H}{(N:P)_H} \right) N_A^*$	$N_I^* = N_{IL}^* = \frac{h_A + a_A}{(1 - r_A)n_N}$ $N_D^* = \frac{(N:P)_D}{(N:P)_A} f N_A^*; N_H^* = \frac{(N:P)_H}{(N:P)_A}$ $N_A^* = \frac{a_I(S_N - N_I^*)}{a_A + a_D \frac{(N:P)_D}{(N:P)_A} f + \frac{(N:P)_H}{(N:P)_A}}$ $P_I^* = S_P - \frac{1}{a_I(N:P)_A} \left(a_A + a_D f + \frac{a_H e}{a_H + r_H} \right)$
	P limitation	$N_I^* = S_N - \frac{1}{a_I} \left(a_A + a_D f + \frac{a_H e_H (h_A + h_D f)}{a_H + r_H} \right) N_A^*$ $N_D^* = fN_A^*; N_H^* = e_H \frac{h_A + h_D f}{a_H + r_H} N_A^*$ $N_A^* = \frac{a_I(S_P - P_I^*)}{\frac{a_A}{(N:P)_A} + \frac{a_D f}{(N:P)_D} + \frac{a_H + r_H}{(N:P)_H}}$ $P_I^* = P_{IL}^* = \frac{h_A + a_A}{(1 - r_A)\alpha n_P}$	$N_I^* = S_N - \frac{1}{a_I} \left(a_A + a_D \frac{(N:P)_D}{(N:P)_A} f + \frac{(N:P)_H}{(N:P)_A} \right)$ $N_D^* = \frac{(N:P)_D}{(N:P)_A} f N_A^*; N_H^* = \frac{(N:P)_H}{(N:P)_A}$ $N_A^* = \frac{(N:P)_A a_I (S_P - P_I^*)}{a_A + a_D f + \frac{a_H e_H (h_A + h_D f)}{a_H + r_H}}$ $P_I^* = P_{IL}^* = \frac{h_A + a_A}{(1 - r_A)\alpha n_P}$

* f is the ratio of the decomposer and autotroph stocks of the element that limits herbivores (see Table A3 for its analytical expression):

- $f = \frac{N_D^*}{N_A^*}$ when herbivores are N-limited.
- $f = \frac{P_D^*}{P_A^*}$ when herbivores are P-limited.

N:P net consumption ratios:

From the equilibrium values of the variables, it is possible to calculate the net consumption N:P ratios of the autotroph-based, decomposer-based and total communities. These ratios for N- and P-limited herbivores are presented in TableA2.

Table A2: Analytical expressions for the N:P net consumption ratios of the autotroph-based, decomposer-based and total communities, in the cases of N- and P-limited herbivores:

	$(N:P)_{AH}$	$(N:P)_{DH}$
Herbivores N-limited	$\frac{\overbrace{a_A + a_H \frac{e_H}{a_H + r_H} h_A}^{H_A}}{\underbrace{\frac{a_A}{A} N : P_A + a_H \frac{e_H}{a_H + r_H} h_A}_{H_A} \frac{1}{N : P_H}}$	$\frac{\overbrace{a_D + a_H \frac{e_H}{a_H + r_H} h_D}^{H_D}}{\underbrace{\frac{a_D}{D} N : P_D + a_H \frac{e_H}{a_H + r_H} h_D}_{H_D} \frac{1}{N : P_H}}$
Herbivores P-limited	$\frac{\overbrace{a_A N : P_A + a_H \frac{e_H}{a_H + r_H} h_A}_{H_A} N : P_H}{\underbrace{\frac{a_A}{A} + a_H \frac{e_H}{a_H + r_H} h_A}_{H_A}}$	$\frac{\overbrace{a_D N : P_D + a_H \frac{e_H}{a_H + r_H} h_D}_{H_D} N : P_H}{\underbrace{\frac{a_D}{D} + a_H \frac{e_H}{a_H + r_H} h_D}_{H_D}}$
	$(N:P)_{ADH}$	
Herbivores N-limited	$\frac{\overbrace{a_A + a_H \frac{e_H}{a_H + r_H} h_A}^{AH} + \left(\overbrace{a_D + a_H \frac{e_H}{a_H + r_H} h_D}^{DH} \right) f}{\underbrace{\frac{a_A}{A} \frac{1}{N : P_A} + a_H \frac{e_H}{a_H + r_H} h_A}_{AH} \frac{1}{N : P_H} + \left(\underbrace{\frac{a_D}{D} \frac{1}{N : P_D} + a_H \frac{e_H}{a_H + r_H} h_D}_{DH} \frac{1}{N : P_H} \right) f}$	
Herbivores P-limited	$\frac{\overbrace{a_A N : P_A + a_H \frac{e_H}{a_H + r_H} h_A}_{AH} N : P_H + \left(\overbrace{a_D N : P_D + a_H \frac{e_H}{a_H + r_H} h_D}_{DH} N : P_H \right) f}{\underbrace{a_A + a_H \frac{e_H}{a_H + r_H} h_A}_{AH} + \left(\underbrace{a_D + a_H \frac{e_H}{a_H + r_H} h_D}_{DH} \right) f}$	

* f is the ratio of the decomposer to autotroph stocks of the element that limits herbivores ($f = \frac{N_D^*}{N_A^*}$ for N-

limited and $f = \frac{P_D^*}{P_A^*}$ for P-limited herbivores).

The braces illustrate how the ratios are combinations of autotroph- and decomposer-derived contributions to N and P net consumptions.

Effect of excess C recycling:

The recycling of excess C by herbivores modifies the value of f , the ratio of the decomposer to autotroph stocks of the element that limits herbivores, as presented in Table A3.

Table A3: Analytical expressions for f in absence ($W_C=0$) and presence ($W_C>0$) of excess C recycling by herbivores:

	$W_C=0$	$W_C>0$
Herbivores N-limited	$e_D \frac{N:P_D}{N:P_A} \frac{C:P_A}{C:P_D} \frac{r_A(h_A+a_A) + (1-e_H)h}{(h_D+a_D) - e_D(1-e_H)h}$	$e_D \frac{(N:P)_D}{(N:P)_A} \frac{(C:P)_A \frac{r_A(h_A+a_A)}{1-r_A} + \left((C:P)_A - e_H \frac{(N:P)_A}{(N:P)_H} (C:P)_H \right) h}{(C:P)_D (h_D+a_D) - e_D \left((C:P)_D - e_H \frac{(N:P)_D}{(N:P)_H} (C:P)_H \right) h}$
Herbivores P-limited	$e_D \frac{C:P_A}{C:P_D} \frac{r_A(h_A+a_A) + (1-e_H)h_A}{(h_D+a_D) - e_D(1-e_H)h_D}$	$e_D \frac{(C:P)_A \frac{r_A(h_A+a_A)}{1-r_A} + ((C:P)_A - e_H)(C:P)_H h_A}{(C:P)_D (h_D+a_D) - e_D((C:P)_D - e_H(C:P)_H) h_D}$

Feasibility of equilibria:

An equilibrium is feasible if the variable values are positive at equilibrium and if the conditions for the limitation of autotrophs and herbivores are met.

Table A4 presents the feasibility conditions for the non-trivial equilibria.

Table A4: Conditions on the parameters that ensure the feasibility of the non-trivial equilibrium, for the different cases of autotroph and herbivore limitation:

		H e r b i v o r e s	
		N limitation	P limitation
A u t o t r o p h s	N- li mi ta ti o n	$N_A^* > 0 \Leftrightarrow S_N > N_{IL}^* = \frac{h_A + a_A}{(1 - r_A)n_N}$ $W_P^* > 0 \Leftrightarrow (N : P)_H > \frac{h_A + h_D f}{\frac{h_A}{(N : P)_A} + \frac{h_D f}{(N : P)_D}}$ $W_C^* > 0 \Leftrightarrow \frac{(C : P)_H}{(N : P)_H} < \frac{\frac{(C : P)_A}{(N : P)_A} h_A + \frac{(C : P)_D}{(N : P)_D} h_D f}{h_A + h_D f}$ $* S_N < (N : P)_{ADH} S_P + (j(N : P)_A - (N : P)_{ADH}) P_{IL}^*$	$N_A^* > 0 \Leftrightarrow S_N > N_{IL}^* = \frac{h_A + a_A}{(1 - r_A)n_N}$ $W_N^* > 0 \Leftrightarrow (N : P)_H < \frac{(N : P)_A h_A + (N : P)_D h_D f}{h_A + h_B f}$ $W_C^* > 0 \Leftrightarrow (C : P)_H < \frac{(C : P)_A h_A + (C : P)_D h_B f}{h_A + h_B f}$ $S_N < (N : P)_{ADH} S_P + (j(N : P)_A - (N : P)_{ADH}) P_{IL}^*$
	P- li mi ta ti o n	$N_A^* > 0 \Leftrightarrow S_P > P_{IL}^* = \frac{h_A + a_A}{(1 - r_A)an_P}$ $W_P^* > 0 \Leftrightarrow (N : P)_H > \frac{h_A + h_D f}{\frac{h_A}{(N : P)_A} + \frac{h_D f}{(N : P)_D}}$ $W_C^* > 0 \Leftrightarrow \frac{(C : P)_H}{(N : P)_H} < \frac{\frac{(C : P)_A}{(N : P)_A} h_A + \frac{(C : P)_D}{(N : P)_D} h_D f}{h_A + h_D f}$ $S_N > (N : P)_{ADH} S_P + (j(N : P)_A - (N : P)_{ADH}) P_{IL}^*$	$N_A^* > 0 \Leftrightarrow S_P > P_{IL}^* = \frac{h_A + a_A}{(1 - r_A)an_P}$ $W_N^* > 0 \Leftrightarrow (N : P)_H < \frac{(N : P)_A h_A + (N : P)_D h_D f}{h_A + h_D f}$ $W_C^* > 0 \Leftrightarrow (C : P)_H < \frac{(C : P)_A h_A + (C : P)_D h_D f}{h_A + h_D f}$ $S_N > (N : P)_{ADH} S_P + (j(N : P)_A - (N : P)_{ADH}) P_{IL}^*$

* j is the ratio between the autotroph affinities for P and N (Daufresne and Loreau 2001): $j = \frac{n_P}{n_N}$.

* f is the ratio of the decomposer and autotroph stocks of the element that limits herbivores.

Local stability of equilibria:

The local stability of an equilibrium can be assessed by constructing the Jacobian matrix J of the system:

$$J = \begin{matrix} N_A \\ N_H \\ N_D \\ N_I \\ P_I \end{matrix} \begin{bmatrix} a_{AA} & a_{AH} & a_{AD} & a_{AN} & a_{AP} \\ a_{HA} & a_{HH} & a_{HD} & a_{HN} & a_{HP} \\ a_{DA} & a_{DH} & a_{DD} & a_{DN} & a_{DP} \\ a_{NA} & a_{NH} & a_{ND} & a_{NN} & a_{NP} \\ a_{PA} & a_{PH} & a_{PD} & a_{PN} & a_{PP} \end{bmatrix}$$

where $a_{XY} = \frac{\partial(dX/dt)}{\partial Y}$ at equilibrium.

The equilibrium is stable when all the eigenvalues of the matrix have negative real parts.

We analyze here only the case of herbivores and autotrophs that are both limited by N. The resolution and conclusions are similar for the other equilibria:

- In the trivial case ($N_A^* = N_H^* = N_D^* = 0$, $N_I^* = S_N$ and $P_I^* = S_P$), the Jacobian matrix is as follows:

$$J = \begin{bmatrix} a_{AA} & 0 & 0 & 0 & 0 \\ a_{HA} & a_{HH} < 0 & a_{HD} & 0 & 0 \\ a_{DA} & 0 & a_{DD} < 0 & 0 & 0 \\ a_{NA} & 0 & a_{ND} & a_{NN} < 0 & 0 \\ a_{PA} & 0 & a_{PD} & 0 & a_{PP} < 0 \end{bmatrix}$$

It is straightforward to find that the first four eigenvalues are equal to a_{HH} , a_{DD} , a_{NN} and a_{PP} ; and that the last eigenvalue, $a_{AA} = (1 - r_A)n_N S_N - (h_A + a_A)$, is negative when the supply is lower

than the R^* of the limiting element ($S_N < N_{il}^* = \frac{h_A + a_A}{(1 - r_A)n_N}$).

- In the non-trivial case, the Jacobian matrix becomes:

$$J = \begin{bmatrix} 0 & 0 & 0 & a_{AN} > 0 & 0 \\ a_{HA} > 0 & a_{HH} < 0 & a_{HD} > 0 & 0 & 0 \\ a_{DA} > 0 & 0 & a_{DD} < 0 & a_{DN} > 0 & 0 \\ a_{NA} & 0 & a_{ND} & a_{NN} < 0 & 0 \\ a_{PA} & 0 & a_{PD} > 0 & a_{PN} < 0 & a_{PP} < 0 \end{bmatrix}$$

Two obvious eigenvalues are a_{HH} and a_{PP} , which are negative. The three other eigenvalues are the roots λ of the characteristic equation of the simplified Jacobian matrix,

$$J' = \begin{vmatrix} 0 & 0 & a_{AN} > 0 \\ a_{DA} > 0 & a_{DD} < 0 & a_{DN} > 0 \\ a_{NA} & a_{ND} & a_{NN} < 0 \end{vmatrix},$$

which is $a_3\lambda^3 + a_2\lambda^2 + a_1\lambda + a_0 = 0$. According to Routh-Hurwitz criteria (Puccia and Levins 1986), the roots are negative –and the equilibrium stable– if a_3, a_2, a_1 and a_0 share the same sign.

- $a_3 = -1$ is < 0 .
- $a_2 = a_{DD} + a_{NN}$ is < 0 .
- $a_1 = a_{AN}a_{NA} + a_{DN}a_{ND} - a_{DD}a_{NN}$. Using a small trick, we have

$$a_1 = a_{AN}a_{NA} + a_{DN}a_{ND} - a_{DD}a_{NN} + (a_{AN}a_{DA} - a_{AN}a_{DA}) + (a_{DD}a_{DN} - a_{DD}a_{DN}).$$

Further transforming the expression yields

$$a_1 = a_{AN}(a_{NA} + a_{DA}) + a_{DN}(a_{ND} + a_{DD}) - a_{DD}(a_{NN} + a_{DN}) - a_{AN}a_{DA}.$$

$$a_{NA} + a_{DA} = -e_H h_A - a_A, \quad a_{ND} + a_{DD} = -e_H h_D - a_D \quad \text{and} \quad a_{NN} + a_{DN} = -e_H h_A - a_A \quad \text{are all } < 0,$$

which given the known signs of a_{AN}, a_{DN}, a_{DD} and a_{DA} , results in $a_1 < 0$.

- $a_0 = a_{AN}(a_{DA}a_{ND} - a_{DD}a_{NA})$, Its sign depends on the sign of $(a_{DA}a_{ND} - a_{DD}a_{NA})$, since $a_{AN} > 0$, we have $a_{DA}a_{ND} - a_{DD}a_{NA} = a_{DA}a_{ND} - a_{DD}a_{NA} + a_{DA}a_{DD} - a_{DA}a_{DD} = a_{DA}(a_{ND} + a_{DD}) - (a_{DA} + a_{NA})a_{DD}$. $a_{ND} + a_{DD} = -e_H h_D - a_D$ and $a_{DA} + a_{NA} = -e_H h_A - a_A$ are both < 0 , resulting in $a_0 < 0$.

Thus, the three remaining eigenvalues are also negative and the non-trivial equilibrium is always stable when feasible.

Literature Cited

- Andersen, T. and D. O. Hessen. 1991. Carbon, nitrogen, and phosphorus content of freshwater zooplankton. *Limnol. Oceanogr.* 36:807-814.
- Arndt, H. 1993. Rotifers as predators on components of the microbial food web (bacteria, heterotrophic flagellates, ciliates) – a review. *Hydrobiologia* 255/256:231-246.
- Azam, F., T. Fenchel, J. G. Field, J. S. Gray, L. A. Meyerreil and F. Thingstad. 1983. The ecological role of water-column microbes in the sea. *Mar. Ecol.- Prog. Ser.* 10:257-263.
- Baines, S. P. and M. L. Pace. 1991. The production of dissolved organic matter by the phytoplankton and its importance to bacteria: patterns across marine and freshwater systems. *Limnol. Oceanogr.* 36: 1078-1090.
- Blackman, F. F. 1905. Optima and limiting factors. *Ann. Bot.* 19:281-295.
- Bratbak, G. and T. F. Thingstad. 1985. Phytoplankton-bacteria interactions: an apparent paradox? Analysis of a model system with both competition and commensalisms. *Mar. Ecol.- Prog. Ser.* 25:23-30.
- Brendelberger, H. 1991. Filter mesh size of cladocerans predicts retention efficiency for bacteria. *Limnol. Oceanogr.* 36:884-894.
- Chapman, S. K., S. C. Hart, N. S. Cobbs, T. G. Whitham and G. W. Koch. 2003. Insect herbivory increases litter quality and decomposition: An extension of the acceleration hypothesis. *Ecology* 84:2867-2876.
- Cotner, J. B., W. Makino and B. A. Biddanda. 2006. Temperature affects stoichiometry and biochemical composition of *Escherichia coli*. *Microb. Ecol.* 52:26-33.

- Currie, D.J. and J. Kalff. 1984. A comparison of the abilities of freshwater algae and bacteria to acquire and retain phosphorus. *Limnol. Oceanogr.* 29:298-310.
- Darchambeau, F., P. J. Faerovig and D. O. Hessen. 2003. How *Daphnia* copes with excess carbon in its food. *Oecologia* 136:336-346.
- Daufresne, T. and M. Loreau. 2001. Plant-herbivore interactions and ecological stoichiometry: when do herbivores determine plant nutrient limitation? *Ecol. Lett.* 4:196-206.
- de Mazancourt, C., Loreau, M., and Abbadie, L. 1998. Grazing optimization and nutrient cycling: When do herbivores enhance primary production? *Ecology* 79: 2242-2252.
- Elser, J. J., M. M. Elser, N. A. Mackay and Carpenter S. R. 1988. Zooplankton-mediated transitions between N-limited and P-limited algal growth. *Limnol, Oceanogr.* 33:1-14.
- Elrifi, I. R. and D. H. Turpin. 1985. Steady-state luxury consumption and the concept of optimum nutrient ratios – a study with phosphate and nitrate limited *Selenastrum-minutum* (Chlorophyta). *J. Phycol.* 21:592-602.
- Elser, J. J. and J. Urabe. 1999. The stoichiometry of consumer-driven nutrient recycling: Theory, observations, and consequences. *Ecology* 80:735-751.
- Fenton, E. W. 1937. The influence of sheep on the vegetation of hill grazing in Scotland. *J. Ecol.* 25:424-430.
- He, X. J. and W. X. Wang. 2006. Relative importance of inefficient feeding and consumer excretion to organic carbon flux from *Daphnia*. *Freshwater Biol.* 51:1911-1923.

- Hygum, B. H., J. W. Petersen and M. Sondergaard. 1997. Dissolved organic carbon released by zooplankton grazing activity - A high-quality substrate pool for bacteria. *J. Plankton Res.* 19:97-111.
- Jensen, T. C., T. R. Anderson, M. Daufresne and D. O. Hessen. 2006. Does excess carbon affect respiration of the rotifer *Brachionus calyciflorus* Pallas? *Freshwater Biol.* 51:2320-2333.
- Jumars, P. A., D. L. Penry, J. A. Baross, M. J. Perry and B. W. Frost. 1989. Closing the microbial loop – dissolved carbon pathway to heterotrophic bacteria from incomplete ingestion, digestion and absorption in animals. *Deep-Sea Res.* 36:483-495.
- Kaye, J. P., and S. C. Hart. 1997. Competition for nitrogen between plants and soil microorganisms. *Trends Ecol. Evol.* 12:139–142.
- Kitchell, J. F., R. V. O’Neill, D. Webb, G. W. Gallepp, S. M. Bartell, J. F. Koonce and B. S. Ausmus. 1979. Consumer regulation of nutrient cycling. *BioScience* 29:28-34.
- Kristiansen, K., H. Nielsen, B. Rieman and J. A. Fuhrman. 1992. Growth efficiencies of freshwater bacterioplankton. *Microb. Ecol.* 24:145-160.
- Leonardos, N. and R. J. Geider. 2004. Responses of elemental and biochemical composition of *Chaetoceros muelleri* to growth under varying light and nitrate: phosphate supply ratios and their influence on critical N : P. *Limnol. Oceanogr.* 49:2105-2114.
- Liedloff, A. C., M. B. Coughenour, J. A. Ludwig and R. Dyer. 2001. Modelling the trade-off between fire and grazing in a tropical savanna landscape, northern Australia, *Environ. Int.* 27:173-180.
- Loreau, M. 1995. Consumers as maximizers of matter and energy flow in ecosystems. *Am. Nat.* 145:22-42.

- Makino, W. and J. B. Cotner. 2004. Elemental stoichiometry of a heterotrophic bacterial community in a freshwater lake: implication for growth- and resource-dependent variations. *Aquat. Microb. Ecol.* 34:33-41.
- McNaughton, S. J. 1979. Grazing as an optimization process: grass-ungulate relationships in the Serengeti. *Am. Nat.* 113:691-703.
- Polis, G. A. and D. R. Strong. 1996. Food web complexity and community dynamics. *Am. Nat.* 147:813-846.
- Puccia, C. J. and R. Levins. 1986. *Qualitative Modeling of Complex Systems: An Introduction to Loop Analysis and Time Averaging.* Harvard University Press, Cambridge, MA.
- Rodríguez, H. and R. Fraga. 1999. Phosphate solubilizing bacteria and their role in plant growth promotion. *Biotechnol. Adv.* 17:319-339.
- Rostas, M., M. Simon and M. Hilker. 2003. Ecological cross-effects of induced plant responses towards herbivores and phytopathogenic fungi. *Basic Appl. Ecol.* 4:43-62.
- Rothhaupt, K. O. 1995. Algal nutrient limitation affects rotifer growth rate but not ingestion rate. *Limnol. Oceanogr.* 40:1201-1208.
- Sterner, R. W. 1990. The ratio of nitrogen to phosphorus resupplied by herbivores – zooplankton and the algal competitive arena. *Am. Nat.* 136:209-229.
- Sterner, R. W., J. J. Elser and D. O. Hessen. 1992. Stoichiometric relationships among producers, consumers and nutrient cycling in pelagic ecosystems. *Biogeochemistry* 17:49-67.
- Sterner, R. W., D. D. Hagemeier, W. L. Smith and R. F. Smith. 1993. Phytoplankton nutrient limitation and food quality for *Daphnia*. *Limnol. Oceanogr.* 38:857-871.

- Strom, S. L., R. Benner, S. Ziegler and M. J. Dagg. 1997. Planktonic grazers are a potentially important source of marine dissolved organic carbon. *Limnol. Oceanogr.* 42:1364-1374.
- Tarafdar, J. C. and N. Claassen. 1988. Organic phosphorus compounds as a phosphorus source for higher plants through the activity of phosphatases produced by plant roots and microorganisms. *Biol. Fert. Soils* 5:308-312.
- Thor, P., H. G. Dam and D. R. Rogers. 2003. Fate of organic carbon released from decomposing copepod fecal pellets in relation to bacterial production and ectoenzymatic activity. *Aquat. Microb. Ecol.* 33:279-288.
- Tilman, D. 1980. Resources: a graphical mechanistic approach to competition and predation. *Am. Nat.* 116 : 362-393.
- Vadstein, O., G. Øie and Y. Olsen. 1993. Particle size dependent feeding by the rotifer *Brachionus plicatilis*. *Hydrobiologia* 255/256: 261-267.
- Vrede, K., M. Heldal, S. Norland and G. Bratbak. 2002. Elemental composition (C, N, P) and cell volume of exponentially growing and nutrient-limited bacterioplankton. *Appl. Environ. Microb.* 68:2965-2971.
- Watt, M., P. Hugenholtz, R. White and K. Vinall. 2006. Numbers and locations of native bacteria on field-grown wheat roots quantified by fluorescence in situ hybridization (FISH). *Environ. Microb.* 8:871-884.
- Yúfera, M., G. Parra and E. Pascual. 1997. Energy content of rotifers (*Brachionus plicatilis* and *Brachionus rotundiformis*) in relation to temperature. *Hydrobiologia* 358:83-87.

Table 1: Parameters of four hypothetical experiments where *Brachionus* and *Daphnia* would grow on P- or N-limited *Scenedesmus acutus* and freshwater bacteria in a chemostat with the same loss rate – equal to a dilution rate a of 0.4 day^{-1} – for all the compartments. h_A and h_D are in fact clearance rates calculated on a per C-content basis. They have to be multiplied by the total zooplankton molar C concentration to give the actual feeding rates of the zooplankton. Thus, the calculated values really correspond to the effect of one $\mu\text{mol C}$ of zooplankton. All the calculations were done according to the formulas that can be found in the appendix. f_N and f_P are the ratios of decomposer to autotroph equilibrium N stocks and decomposer to autotroph equilibrium P stocks respectively. Herb. Lim. is the element limiting herbivores. Ele. Prom. is the element whose limitation of plant growth is promoted by decomposers. All the other parameters are defined in Fig. 1 or in the analysis part of the text.

Parameters	Plants N limited		Plants P limited		Units	From
	<i>Brachionus</i>	<i>Daphnia</i>	<i>Brachionus</i>	<i>Daphnia</i>		
$(N:P)_A$	8		73		At:At	Rothhaupt 1995
$(C:P)_A$	123		874		At:At	Rothhaupt 1995
$(N:P)_H$	23	22	23	22	At:At	Rothhaupt 1995, Sterner et al 1993
$(C:P)_H$	92	124	92	124	At:At	Rothhaupt 1995, Sterner et al 1993
$(N:P)_D$	15				At:At	Makino and Cotner 2004
$(C:P)_D$	72				At:At	Makino and Cotner 2004
a	0.4				day^{-1}	Rothhaupt 1995
r_A	0.2				dim.	Baines and Pace 1993
h_A	9.6	52.9	9.6	44.4	$\text{ml} \cdot \mu\text{mol C}^{-1} \cdot \text{day}^{-1}$	Rothhaupt 1995, Yúfera et al 1997, Sterner et al 1993
h_D	1.9	29.1	1.9	24.4	$\text{ml} \cdot \mu\text{mol C}^{-1} \cdot \text{day}^{-1}$	Rothhaupt 1995, Vadstein et al 1993, Sterner et al 1993, Brandelberger 1991
r_H	0.18	0.25	0.18	0.25	day^{-1}	Jensen et al 2006, Darchambeau et al 2003,
e_H	0.7	0.86	0.7	0.86	dim.	Rothhaupt 1995, Arndt 1993, He and Wang 2006
e_D	0.3				dim.	Kristiansen et al 1992
$(N:P)_{AH}$	20.02	21.47	26.97	22.85	At:At	Calculated
$(N:P)_{DH}$	19.79	21.75	20.57	18.36	At:At	Calculated
$(N:P)_{ADH}$	19.89 (19.93)*	21.6 (21.5)*	21.67 (22.45)*	19.21 (22.22)*	At:At	Calculated
$f = \frac{N_D^*}{N_A^*}$	4.82 (2.43)*	1.61 (0.23)*			dim.	Calculated
$f = \frac{P_D^*}{P_A^*}$			18.52 (9.2)*	6.45 (2.66)*	dim.	Calculated
\tilde{h}_D	2.14	13.55	-2.5	-6.95	$\text{ml} \cdot \mu\text{g C}^{-1} \cdot \text{day}^{-1}$	Calculated
Herb. Lim.	N	N	P	P		Calculated
Ele. Prom.	P	N	P	P		Calculated

* The value in parenthesis is calculated with $W_C=0$ (no recycling of excess-C by herbivores).

Legends of figures:

Fig. 1: Representation of an explicit-resource autotroph-herbivore-decomposer model that couples three elements: carbon C, nitrogen N and phosphorus P.

A) Schematic diagram of matter transfers between the compartments of the model. Autotrophs provide decomposers with organic C and excrete some of the inorganic nutrients that they take up. Decomposers consume organic C recycled by both herbivores and autotrophs and take up inorganic nutrients. Herbivores feed upon both autotrophs and decomposers. They excrete inorganic nutrients and recycle organic carbon that is used by decomposers.

B) Flow diagram of the model. Carbon stocks are in black, nitrogen stocks in grey and phosphorus stocks in spotted grey. C_A , C_H and C_D are the stocks of C in autotrophs, herbivores and decomposers respectively. N_I , N_A , N_H and N_D are the inorganic stock and the stock of N in autotrophs, herbivores and decomposers respectively. P_I , P_A , P_H and P_D are the inorganic stock and the stock of P in autotrophs, herbivores and decomposers respectively. a_I is the renewal rate –i.e. both the loss and the supply rate– of the inorganic resources N_I and P_I . a_A , a_H and a_D are the loss rates of autotrophs, herbivores and decomposers respectively. F_A , $F_A/(N:P)_A$ and $F_A(C:P)_A/(N:P)_A$ are the uptake fluxes of N_I , P_I and CO_2 by autotrophs. r_A is the fraction of the uptake fluxes of autotrophs that is released, back to the inorganic pools for N and P and in an organic form for C. h_A and h_D are the feeding rate of herbivores on autotrophs and decomposers respectively. e_H is the assimilation efficiency of herbivores. r_H is their respiration rate. W_C , W_N and W_P are the fluxes of excess C, N and P respectively, that are excreted by herbivores to maintain their C:N:P ratio constant. F_D and $F_D/(N:P)_D$ are the uptake fluxes of N_I and P_I by decomposers.

Fig. 2: Graphical analysis of the explicit-resource autotroph-herbivore-decomposer model at equilibrium. The coordinates represent the inorganic N and P resources, N_I and P_I . At equilibrium, N_I is equal to the R^* value N_{IL}^* when autotrophs are N-limited or, when they are P-limited, P_I is equal to the R^* value P_{IL}^* . The Zero Net Growth Isocline or ZNGI –the set of (N_I, P_I) pairs that lead to equilibrium– is thus the joining of the horizontal solid line of resource points leading to N limitation and the vertical solid line of resource points resulting in P limitation. At equilibrium, the net consumption vector $\overrightarrow{N:P_{ADH}}$ entirely balances the supply vector $\overrightarrow{N:P_S}$. The supply vector always points towards the supply point (\star). Hence, the equilibrium resource point (\bullet) lies at the intersection between the ZNGI and the dashed line with the community net consumption N:P ratio $(N:P)_{ADH}$ as a slope and passing through the supply point. For N limitation, the closer to the colimitation point (P_{IL}^*, N_{IL}^*) the equilibrium point, the nearer to P limitation are autotrophs. In contrast, the farther from colimitation the P-limited equilibrium point, the more intense the P limitation of autotrophs. Hence, the closer to the top-left corner the equilibrium point, the more the P limitation of autotrophs is promoted. Inversely, the closer to the bottom-right corner the equilibrium point, the more the N-limitation of autotrophs is promoted. For a specific supply point, the position of the equilibrium point is set by the community net consumption N:P ratio $(N:P)_{ADH}$: as illustrated by the two equilibrium points associated to the vectors $\overrightarrow{N:P_{ADH_1}}$ and $\overrightarrow{N:P_{ADH_2}}$, the gentler the slope of the net consumption vector –the smaller $(N:P)_{ADH}$ – the more P limitation is promoted.

Fig. 3: Graphical analysis of the effect of decomposer presence on autotroph limitation in a context of pure herbivory (the feeding rate of herbivores on decomposers $h_D=0$).

- A) Graphical determination of $\overrightarrow{N:P_{AH}}$, the net consumption vector of a community made up of autotrophs and herbivores only, as the vectorial sum of autotroph and herbivore net consumption vectors $\overrightarrow{N:P_A}$ and $\overrightarrow{N:P_H}$. As herbivore feeding rate on autotrophs h_D increases, $\overrightarrow{N:P_{AH}}$ moves closer to $\overrightarrow{N:P_H}$.
- B) Promotion of autotroph P limitation by decomposers with an N:P ratio smaller than $(N:P)_{AH}$, the N:P net consumption ratio of the autotroph-based community, as highlighted by the gentler slope of the community net consumption vector $\overrightarrow{N:P_{ADH}}$, the vectorial sum of decomposer and autotroph-based community net consumption vectors $\overrightarrow{N:P_D}$ and $\overrightarrow{N:P_{AH}}$, in comparison to the slope of $\overrightarrow{N:P_{AH}}$.
- C) Promotion of autotroph N limitation by decomposers with an N:P ratio larger than $(N:P)_{AH}$, as highlighted by the steeper slope of the community net consumption vector $\overrightarrow{N:P_{ADH}}$ in comparison to the slope of $\overrightarrow{N:P_{AH}}$.

Fig. 4: Graphical analysis of the effect of decomposer presence on autotroph limitation in a context of omnivory (the feeding rate of herbivores on decomposers $h_D>0$).

- D) Graphical determination of $\overrightarrow{N:P_{DH}}$, the decomposer-based community net consumption vector, as the vectorial sum of decomposer and decomposer-

based herbivore net consumption vectors $\overrightarrow{N:P_D}$ and $\overrightarrow{N:P_{H_D}}$. As herbivore feeding rate on decomposers h_D increases, $\overrightarrow{N:P_{DH}}$ moves closer to $\overrightarrow{N:P_{H_D}}$.

- E) Promotion of autotroph P limitation by a decomposer-based community with an N:P ratio smaller than $(N:P)_{AH}$, the N:P net consumption ratio of the autotroph-based community, as highlighted by the gentler slope of the community net consumption vector $\overrightarrow{N:P_{ADH}}$, the vectorial sum of decomposer-based and autotroph-based community net consumption vectors $\overrightarrow{N:P_{DH}}$ and $\overrightarrow{N:P_{AH}}$, in comparison to the slope of $\overrightarrow{N:P_{AH}}$.
- F) Promotion of autotroph N limitation by a decomposer-based community with an N:P ratio larger than $(N:P)_{AH}$, as highlighted by the steeper slope of the community net consumption vector $\overrightarrow{N:P_{ADH}}$ in comparison to the slope of $\overrightarrow{N:P_{AH}}$.

Fig. 5: A) Summary chart of the effect of decomposers on autotroph limitation in a context of pure herbivory ($h_D=0$). The promotion of N or P limitation of autotrophs by decomposers depends on the relations between $(N:P)_A$, $(N:P)_H$, $(N:P)_D$ and $(N:P)_{AH}$, autotroph, herbivore, decomposer and autotroph-based-community net consumption ratios respectively.

B) Summary chart of the effect of decomposers on autotroph limitation in a context of omnivory ($h_D>0$). The promotion of N or P limitation of autotrophs by decomposers depends on the relations between $(N:P)_A$, $(N:P)_H$, $(N:P)_D$ and $(N:P)_{AH}$, autotroph, herbivore, decomposer and autotroph-based-community net consumption ratios respectively, but also on herbivore feeding rate on decomposers h_D in

comparison to a threshold value \tilde{h}_D . The dashed and dotted arrows represent the results obtained from a set of parameters for *Brachionus* (dashed) and *Daphnia* (dotted) that would grow in a chemostat on P-limited or N-limited *Scenedesmus acutus*. *Daphnia* and *Brachionus* growing on P-limited phytoplankton are also P-limited. Decomposers drive autotrophs to P limitation in the two species because they promote P limitation through both their N:P ratio, with $(N:P)_D < (N:P)_{AH}$, and the N:P ratio of the herbivores that they support since $(N:P)_H < (N:P)_A$. When growing on N-limited phytoplankton *Daphnia* and *Brachionus* are N-limited. Here, however, the N:P ratio of decomposers promotes P limitation because $(N:P)_D < (N:P)_{AH}$, while their consumption by herbivores promote the N limitation of autotrophs since $(N:P)_H < (N:P)_A$. These two opposite effects result in an overall P limitation promotion by decomposers in the case of *Brachionus*, because their feeding rate on decomposers is smaller than \tilde{h}_D . In the *Daphnia* case, decomposers overall promote the N limitation of decomposers because the feeding rate on decomposers is larger than \tilde{h}_D .

Fig. 1:

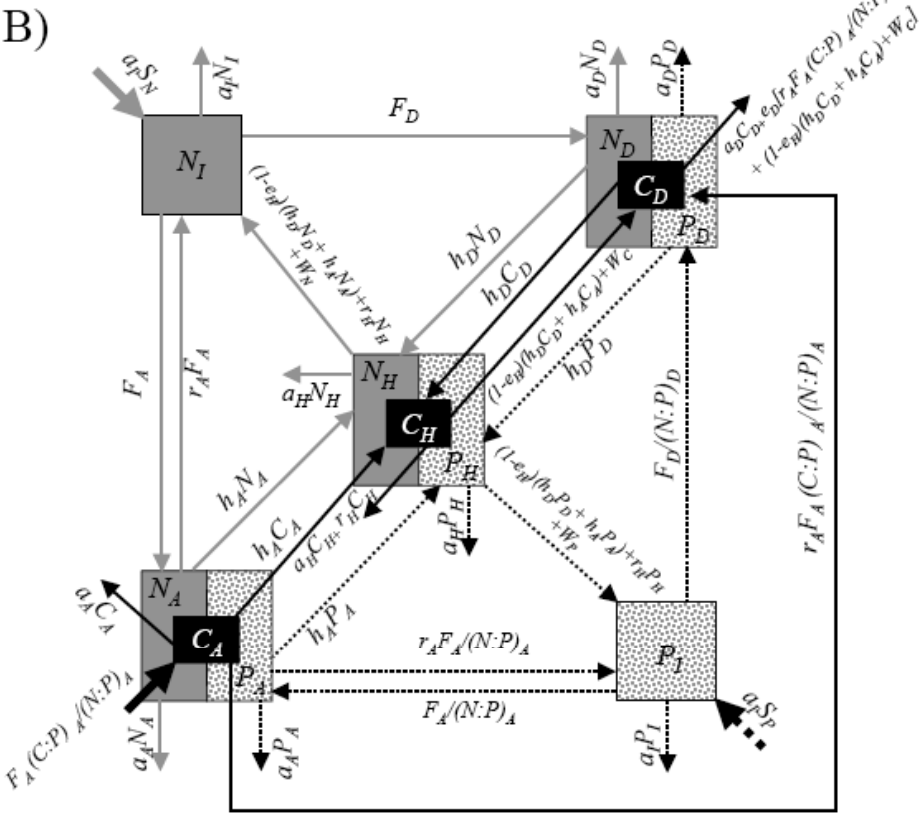
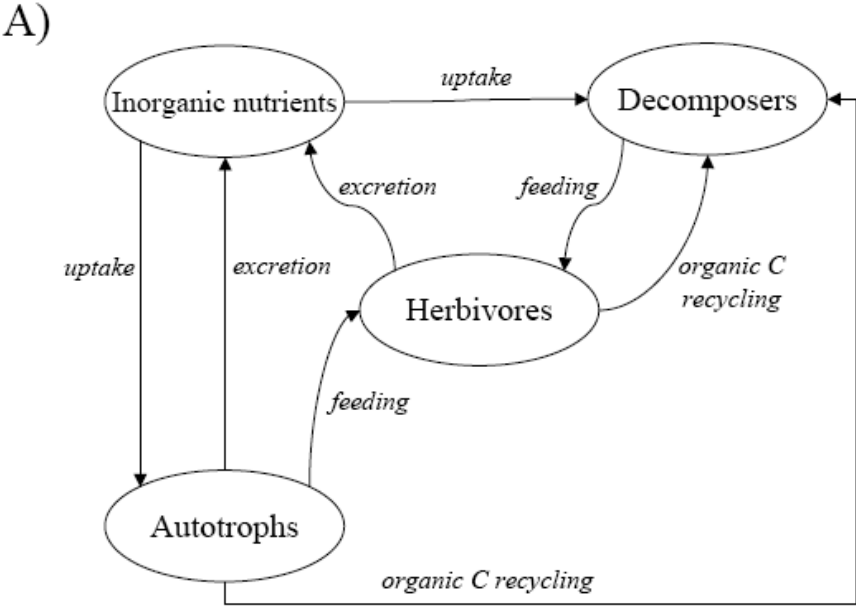

Fig. 2:

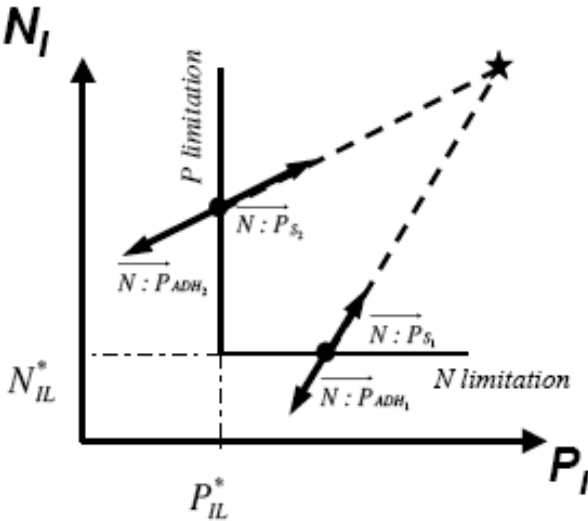

Fig. 3:

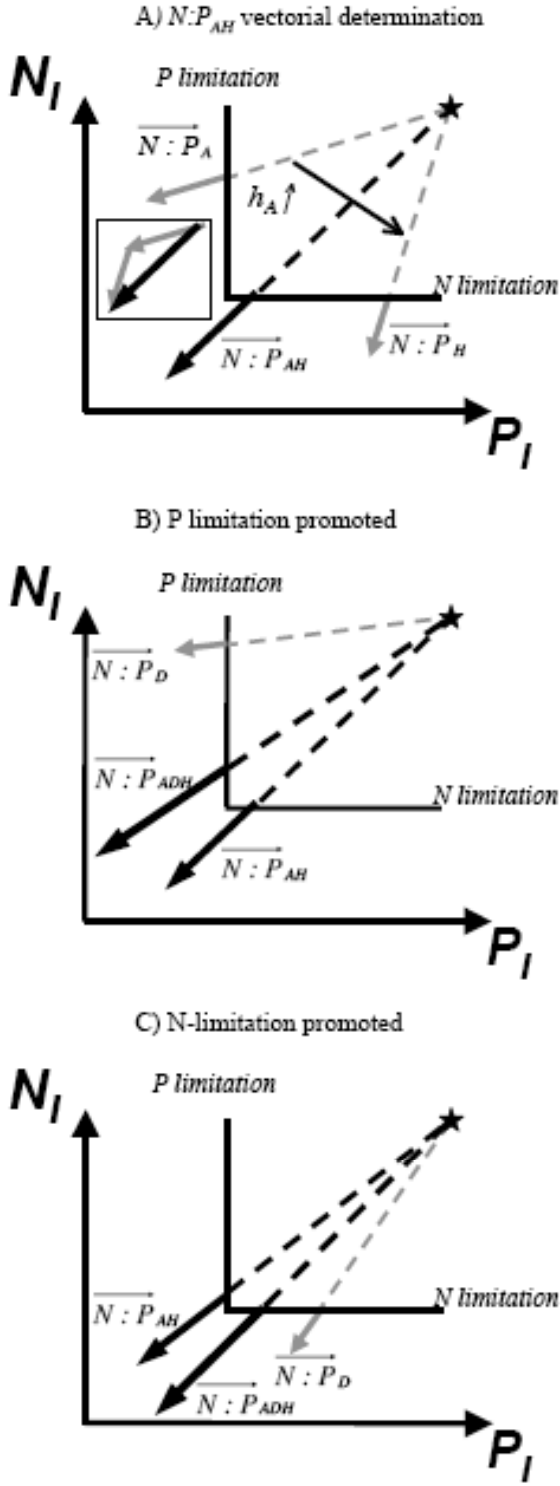

Fig. 4:

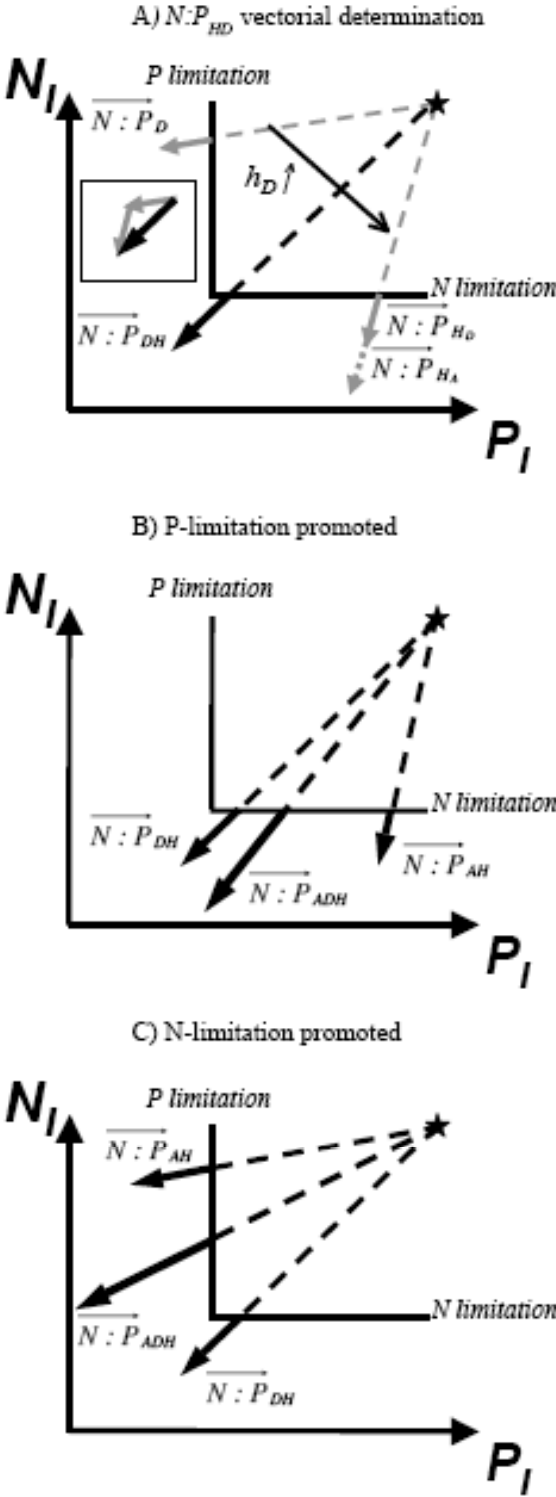

Fig. 5:

