



HAL
open science

Stratégies anti-infectieuses contre les pathogènes multirésistants aux antibiotiques

Caroline Giraud

► **To cite this version:**

Caroline Giraud. Stratégies anti-infectieuses contre les pathogènes multirésistants aux antibiotiques. Microbiology and Parasitology. Université de Caen (France), 2022. <tel-04705485>

HAL Id: tel-04705485

<https://hal.science/tel-04705485v1>

Submitted on 23 Sep 2024

HAL is a multi-disciplinary open access archive for the deposit and dissemination of scientific research documents, whether they are published or not. The documents may come from teaching and research institutions in France or abroad, or from public or private research centers.

L'archive ouverte pluridisciplinaire **HAL**, est destinée au dépôt et à la diffusion de documents scientifiques de niveau recherche, publiés ou non, émanant des établissements d'enseignement et de recherche français ou étrangers, des laboratoires publics ou privés.



HAL Authorization

DIPLÔME D'HABILITATION A DIRIGER DES RECHERCHES

Mémoire présenté par Caroline Giraud

Stratégies anti-infectieuses contre les pathogènes multirésistants aux antibiotiques

Soutenu le 24 octobre 2022 devant le jury composé de :

Sylvie Chevalier	<i>rapportrice</i>	<i>Professeur Université de Rouen</i>
Nathalie Leblond	<i>rapportrice</i>	<i>Professeur Université de Lorraine</i>
Séverine Zirah	<i>rapportrice</i>	<i>Maître de conférences Muséum National d'Histoire Naturelle</i>
Yanyan Li	<i>examinatrice</i>	<i>Chargée de recherche Muséum National d'Histoire Naturelle</i>
Christophe Bordi	<i>examineur</i>	<i>Professeur Université d'Aix Marseille</i>
Axel Hartke	<i>examineur</i>	<i>Professeur Université de Caen Normandie</i>

Avant-propos

Mon arrivée dans le monde de la recherche s'est faite en 2007 lors du mon stage de master 2 à l'Institut de Microbiologie de la Méditerranée à Marseille, que j'ai poursuivi par une thèse dans le même institut, puis un post-doctorat au Centre Médical Universitaire, à Genève, puis j'ai finalement enfin été recrutée en tant que maître de conférences à l'université de Caen-Normandie en janvier 2014. J'ai donc à présent 15 ans d'activités de recherche dont 8 en tant que titulaire. Le moment est ainsi venu de rédiger ce manuscrit dans le but d'obtenir le diplôme d'Habilitation à Diriger les Recherches.

J'y présenterai tout d'abord un *curriculum vitae* détaillé, avant de me concentrer sur l'exposé des activités de recherches que j'ai mené au cours de mon parcours scientifique, en mettant l'accent sur les recherches qui ont été associées à l'encadrement d'étudiants, et donc celles que j'ai pu mener depuis mon recrutement. Comme nous le verrons, mes sujets de recherche ont toujours été en relation avec les bactéries pathogènes. Dans les premières années de mon parcours je me suis intéressée à leur capacité de formation du biofilm et leurs facteurs de virulence, ainsi qu'à la régulation génétique associée. Ceci a été le cas du premier projet que j'ai mené en tant que maître de conférences qui s'intéressait aux gènes exprimés par *E. faecium* en condition d'infection et qui a permis de mettre en évidence quatre nouvelles protéines impliquées dans l'infection. Ce projet m'a permis de participer à l'encadrement d'une première doctorante, Margherita Cacaci. Par la suite, mes sujets de recherche se sont davantage tournés vers la résistance aux antibiotiques et la recherche de nouvelles molécules thérapeutiques. Je présenterai ainsi trois projets ayant cette thématique commune et en particulier le projet portant sur l'étude des peptides lasso de type 1. Ce sujet a constitué le cœur de mon travail ces dernières années, et impliqué à divers degrés quatre des cinq étudiants et étudiantes de master 2 et/ou thèse que j'ai eu la chance d'encadrer. Il s'agit d'un sujet confidentiel car un dépôt de brevet y est associé et ne permet pas pour le moment de publier notre travail. Néanmoins les deux doctorants qui sont associés à ce projet, Abdelhakim Boudrioua et Benjamin Baëtz, ont pu valoriser une partie de leur travail grâce à une revue et, dans le cas d'Abdelhakim, un article portant sur un sujet connexe. Je présenterai ensuite en perspectives les trois projets que j'ai initiés et que je souhaite poursuivre dans les prochaines années. J'achèverai enfin ce manuscrit par une conclusion personnelle sur l'évolution de mon parcours.

Table des matières

CV

1.1	Situation administrative	8
1.2	Parcours scientifique	8
1.3	Titres universitaires	8
1.4	Prix, contrats et financements	9
1.5	Responsabilités administratives.....	9
1.6	Encadrements d'étudiants	9
1.6.1	Thèse	9
1.6.2	Master 2	10
1.6.3	Master 1	10
1.7	Publications et brevet.....	10
1.8	Communications scientifiques	12
1.8.1	communications orales : 10	12
1.8.2	Communications affichées : 13	13

Synthèse des travaux de recherche

1	Travaux de thèse : Etude d'acteurs de la formation du biofilm chez <i>P.aeruginosa</i> et de leur régulation.	15
2	Travaux de post doctorat : Etude des hélicases à ARN chez <i>S. aureus</i>	16
3	Identification des gènes surexprimés par <i>E. faecium</i> en condition d'infection chez la souris et caractérisation de protéines impliquées dans la virulence.....	17
3.1	Contexte	17
3.2	Etude du transcriptome d' <i>E. faecium</i> en condition d'infection.	17
3.3	Implication des protéines contenant des domaines LysM dans la virulence.....	18
3.4	La protéine EFAU004_01209 pourrait être une cible prometteuse pour le traitement des infections urinaires.....	19
3.5	Conclusion, valorisation et perspectives.	20
4	Suppression de la virulence et de la résistance aux antibiotiques de pathogènes Gram-positifs majeurs par des peptides lasso (travail confidentiel).	21
4.1	Contexte	21
4.2	Les peptides lasso, des molécules prometteuses	22
4.3	Effets des PLT1 sur la croissance et la morphologie.	24
4.4	Les PLT1 inhibent la virulence.	25
4.5	Les PLT1 inhibent la résistance à la vancomycine.	26
4.6	Mode d'action de l'effet anti-résistance à la vancomycine des PLT1.	28

4.7	Conclusion, valorisation et perspectives.....	32
5	Blocage de la transition commensal/virulent comme outil de lutte contre <i>Pseudomonas aeruginosa</i>	33
5.1	Contexte	33
5.2	Les azetidomonamides sont des atténuateurs de virulence.....	33
5.3	La peptidase AzeA dégrade l'azetidomonamide A pour déclencher la virulence.....	34
5.4	Conclusion, valorisation et perspectives.....	35
6	Exploration du potentiel anti-microbien et d'ingénierie du microbiote d'un peptide dérivé d'une bactérie commensale	36
6.1	Contexte	36
6.2	Caractérisation du cluster <i>las</i> in silico	36
6.3	Obtention de l'expression du cluster <i>las</i>	39
6.4	Conclusion, valorisation et perspectives.....	40
	Perspectives	
1	Suppression de la virulence et de la résistance aux antibiotiques de pathogènes Gram-positifs majeurs par des peptides lasso (travail confidentiel).	41
2	Blocage de la transition commensal/virulent comme outil de lutte contre <i>Pseudomonas aeruginosa</i>	42
3	Exploration du potentiel anti-microbien et d'ingénierie du microbiote d'un peptide dérivé d'une bactérie commensale	44
	Conclusion personnelle	45
	Références bibliographiques	47
	Annexes	51

CV

1.1 Situation administrative

Nom : Giraud

Prénom : Caroline

Grade : Maître de Conférences classe Normale, 6ème échelon

Etablissement : Université de CAEN Normandie

Composante : UFR des sciences

Unité de Recherche : Unité de Recherche Risques Microbiens, Equipe stress-Virulence

Adresse professionnelle: Esplanade de la paix, CS1403, 14032 Caen cedex 5

Téléphone : 06 88 68 78 68

E-mail : caroline.giraud@unicaen.fr

Adresse personnelle : 2 rue d'Aubusson, 14000 Caen

Date et Lieu de Naissance : le 18 juillet 1985 à Draguignan (83)

Nationalité : Française

Fonction : Maître de Conférences, depuis le 15 janvier 2014.

Section CNU : 64ème Section

1.2 Parcours scientifique

- Depuis le 15 janvier 2014 : Maître de conférences à l'université de Caen-Normandie, dans l'unité de recherche « risques microbiens » dirigée par le Pr Axel Hartke, devenue le 1^{er} janvier 2022 l'unité de recherche « Communication Bactérienne et Stratégies Anti-infectieuses ».
- 2011-2014 : post doctorat au Centre Médical Universitaire, département de microbiologie et médecine moléculaire, Genève, dans l'équipe du Pr. Patrick Linder.
- 2007-2011 : Thèse, Faculté des sciences de Luminy, Université d'Aix-Marseille II, Laboratoire d'Ingénierie des Systèmes Macromoléculaires : « Le système CupE de la voie chaperonne - "usher" de *Pseudomonas aeruginosa* : assemblage, fonction et régulation. Identification du système à deux composants PprA-PprB et caractérisation de son régulon », sous l'encadrement de Sophie de Bentzmann. Mention très honorable.
- 2006-2007 : Master 2 recherche, Faculté des sciences de Luminy, Université d'Aix-Marseille II, Laboratoire d'Ingénierie des Systèmes Macromoléculaires : « Etude des clusters *cupE* and *cupD* chez *Pseudomonas aeruginosa* ». Mention très bien (rang 1/21).

1.3 Titres universitaires

- 2011 : Doctorat de Microbiologie.

Faculté des sciences de Luminy, Université d'Aix-Marseille II, Laboratoire d'Ingénierie des Systèmes Macromoléculaires

Sujet : « Le système CupE de la voie chaperonne - "usher" de *Pseudomonas aeruginosa* : assemblage, fonction et régulation. Identification du système à deux composants PprA-PprB et caractérisation de son régulon »

Soutenu le 13 juillet 2011 devant le jury composé de :

Madame le Professeur Chantal Tardif, Présidente du jury
Monsieur le Professeur Juan Luis Ramos, Rapporteur
Monsieur le Professeur Dieter Haas, Rapporteur
Monsieur le Professeur Alain Filloux, Examineur
Madame le Docteur Sophie de Bentzmann, Directrice de thèse

Mention très honorable.

- 2007 : Master 2 recherche microbiologie.

Faculté des sciences de Luminy, Université d'Aix-Marseille II, Laboratoire d'Ingénierie des Systèmes Macromoléculaires.

Sujet : « Etude des clusters *cupE* and *cupD* chez *Pseudomonas aeruginosa* ».

Mention très bien (rang 1/21).

1.4 Prix, contrats et financements

- 2019 : responsable scientifique du projet ANR LasSoCocci coordonné par Axel Hartke (ANR-19-CE18-0026-01 ; 2020-2023 ; 488,6 k€)
- 2016 : Obtention d'une allocation doctorale financée à 100% par la région Normandie pour la thèse d'Abdelhakim Boudrioua, d'octobre 2016 à octobre 2019.
- 2013 : Participation au projet fonds national pour la recherche scientifique Suisse « *Staphylococcus aureus* RNA helicases » coordonné par Patrick Linder.
- 2011 : Responsable du projet Novartis « *Staphylococcus aureus* degradosome ».
- 2010 : Obtention d'un contrat de demi ATER, faculté des sciences de Luminy, Marseille.
- 2007-2009 : Obtention d'une bourse MENRT et d'un contrat de monitrice.
- 2007 : Master 2 2006-2007 : prix major de promotion.

1.5 Responsabilités administratives

Responsable du champ thématique « stratégies anti-infectieuses » de l'unité CBSA (qui comporte cinq champs thématiques au total) : participation à la rédaction du rapport et la présentation orale de l'évaluation HCERES, membre du bureau de l'unité CBSA, collecte des informations relatives aux différents projets du champ thématique.

1.6 Encadrements d'étudiants

1.6.1 Thèse

Benjamin Baetz (1^{er} mars 2021 – fin de la thèse prévue le 28 février 2024) : Ingénierie des peptides lasso actifs contre les bactéries pathogènes à Gram positif et étude du mode d'action associé.

Abdelhakim Boudrioua (1^{er} octobre 2016 – 22 novembre 2019) : Mode d'action moléculaire des peptides lasso sur la virulence et la résistance aux antibiotiques des bactéries pathogènes à Gram positif. Thèse co-encadrée avec Axel Hartke. Situation actuelle : PostDoctorant à l'Université de Tübingen, Allemagne. Thèse confidentielle. Un processus de dépôt de brevet est en cours à la SATT Lutec de Paris. Cette procédure n'autorise pas à publier les résultats de la thèse avant le dépôt du brevet.

Margherita Cacaci (1^{er} octobre 2013 – 17 mars 2017) : Identification and characterisation of *in vivo* expressed genes in *Enterococcus faecalis* and *Enterococcus faecium*. Participation à l'encadrement avec Axel Harke ; thèse en co-tutelle avec Maurizio Sanguinetti de l'Université Catholique de Rome. Situation actuelle : poste permanent de chercheuse à l'Université Catholique de Rome.

1.6.2 Master 2

Solenn Desmadril (4 janvier 2021 – 18 juin 2021) : Exploration du potentiel antimicrobien et d'ingénierie du microbiote d'un peptide dérivé d'une bactérie commensale.

Benjamin Baetz (6 janvier 2020 – 12 juin 2020) : Validation de VanS en tant que cible de l'activité anti-résistance à la vancomycine des peptides lasso par approches biochimiques.

Yoann Quignon-Nègre (8 janvier 2018 – 8 juin 2018) : Etude de l'impact des peptides lasso sur la résistance à la vancomycine d'*Enterococcus faecalis*.

Abdelhakim Boudrioua (Janvier – juin 2016) : étude des effets des peptides lasso sur les entérocoques pathogènes.

1.6.3 Master 1

Benjamin Baetz (18 mars 2019 – 22 mai 2019) : Validation de VanS en tant que cible de l'activité anti-résistance à la vancomycine des peptides lasso par approches génétiques.

Pierre Labadie (Avril- juin 2015) : étude des effets des peptides lasso sur les entérocoques pathogènes.

1.7 Publications et brevet

Articles originaux : 13

- Dangla-Pélissier G, Roux N, Schmidt V, Chambonnier G, Ba M, Sebban-Kreuzer C, de Bentzmann S, **Giraud C**, Bordi C. "The horizontal transfer of *Pseudomonas aeruginosa* PA14 ICE PAPI-1 is controlled by a transcriptional triad between TprA, NdpA2 and MvaT". *Nucleic Acids Res.* 2021 Nov 8;49(19):10956-10974.
- Staerck C, Wasselin V, Budin-Verneuil A, Rincé I, Cacaci M, Weigel M, **Giraud C**, Hain T, Hartke A, Riboulet-Bisson E. "Analysis of glycerol and dihydroxyacetone metabolism in *Enterococcus faecium*". *FEMS Microbiol Lett.* 2021 May 6;368(8):fnab043.
- Grosjean M, Guénard S, **Giraud C**, Muller C, Plésiat P, Juarez P. "Targeted Genome Reduction of *Pseudomonas aeruginosa* Strain PAO1 Led to the Development of Hypovirulent and Hypersusceptible rDNA Hosts". *Frontiers in Bioengineering and Biotechnology*, 11 Mar 2021, 9:640450
- Khemici V, Prados J, Petrignani B, Di Nolfi B, Bergé E, Manzano C, **Giraud C**, Linder P. "The DEAD-box RNA helicase CshA is required for fatty acid homeostasis in *Staphylococcus aureus*." *PLoS Genet.* 2020 Jul 30;16(7):e1008779.
- Boudrioua A, Li Y, Hartke A, **Giraud C**. "Opposite effect of vancomycin and D-Cycloserine combination in both vancomycin resistant *Staphylococcus aureus* and enterococci." *FEMS Microbiol Lett.* 2020 Apr 1;367(8):fnaa062.
- Hong Z, Bolard A, **Giraud C**, Prévost S, Genta-Jouve G, Deregnaucourt C, Häussler S, Jeannot K, Li Y. "Azetidine-Containing Alkaloids Produced by a Quorum-Sensing- Regulated Nonribosomal

Peptide Synthetase Pathway in *Pseudomonas aeruginosa*.” *Angew Chem Int Ed Engl*. 2019 Mar 4;58(10):3178-3182.

- Cacaci M[#], **Giraud C**[#], Leger L, Torelli R, Martini C, Posteraro B, Palmieri V, Sanguinetti M, Bugli F, Hartke A. “Expression profiling in a mammalian host reveals the strong induction of genes encoding LysM domain-containing proteins in *Enterococcus faecium*”. *Sci Rep*. 2018 Aug 17;8(1):12412. [#]Contribution égale.
- Li Y, Ducasse R, Zirah S, Blond A, Goulard C, Lescop E, **Giraud C**, Hartke A, Guittet E, Pernodet JL, Rebuffat S.” Characterization of svuceucin from *Streptomyces* provides insights into enzyme exchangeability and disulfide bond formation in lasso peptides.” *ACS Chem Biol*. 2015; 10(11):2641-9.
- **Giraud C**, Hausmann S, Lemeille S, Prados J, Redder P, Linder P. “The C-terminal region of the RNA helicase CshA is required for the interaction with the degradosome and turnover of bulk RNA in the opportunistic pathogen *Staphylococcus aureus*”. *RNA Biol*. 2015; 12(6):658-74.
- Oun S, Redder P, Didier JP, François P, Corvaglia AR, Buttazzoni E, **Giraud C**, Girard M, Schrenzel J, Linder P. “The CshA DEAD-box RNA helicase is important for quorum sensing control in *Staphylococcus aureus*”. *RNA Biol*. 2013; 10(1):157-65.
- de Bentzmann S, **Giraud C**, Bernard C, Calderon V, Ewald F, Plésiat P, Nguyen C, Grunwald D, Attree I, Jeannot K, Fauvarque MO and Bordi C. “Unique biofilm signature, drug susceptibility and decreased virulence in *Drosophila* through the *Pseudomonas aeruginosa* two-component system PprAB”. *PLoS Pathogens*, 2012; 8(11):e1003052.
- **Giraud C**, Bernard CS, Calderon V, Yang L, Filloux A, Molin S, Fichant G, Bordi C and de Bentzmann S. “The PprA-PprB two-component system activates CupE, the first non archetypal *Pseudomonas aeruginosa* chaperone-usher pathway system assembling fimbriae”. *Environmental microbiology*, 2010 ; 13(3):666-83.
- Mikkelsen H, Ball G, **Giraud C**, Filloux A. “Expression of *Pseudomonas aeruginosa* CupD fimbrial genes is antagonistically controlled by RcsB and the EAL-containing PvrR response regulators. » *PLoS One*, 2009 Jun 23;4(6):e6018.

Articles de revue : 3

- Baëtz, B., Boudrioua, A., Hartke, A., **Giraud, C**. “Alternatives to fight Vancomycin-Resistant *Staphylococci* and *Enterococci*”. *Antibiotics* 2021, 10, 1116. <https://doi.org/10.3390/antibiotics10091116>.
- **Giraud C** and de Bentzmann S. "Inside the complex regulation of *Pseudomonas aeruginosa* chaperone usher systems." *Environmental Microbiology*. 2011; 14(8):1805-16.
- **Giraud C**, Bernard C, Ruer S and de Bentzmann S. “Biological “glue” and “Velcro”: Molecular tools of adhesion and biofilm formation in the hairy and gluey bug *Pseudomonas aeruginosa*. *Environmental Microbiology Reports*. 2010; 2(3):343-58.

Chapitre de livre : 1

- Bernard CS, **Giraud C**, Spagnolo J, de Bentzmann S. Biofilms: the secret story of microbial communities. In *Bacterial pathogenesis*; Horizon Press. 2011.

Brevet :1 + 1 en phase de maturation

- Projet LASSolution, en phase de maturation auprès de la SATT Lutech (références MA00354 – DFM – CI20180619). Coût du programme : 402835€. Inventeurs : Li Y, **Giraud C**, Boudrioua A, Hartke A.
- Brevet numéro BI2787-01 et INPI N° 1001324. ADH chips. Inventeurs : Bernard CS, **Giraud C**, Bordi C, et de Bentzmann S.

1.8 Communications scientifiques

1.8.1 communications orales : 10

Invitations : 2

- **Giraud C**, Hausmann S, Lemeille S, Linder P. “Regulation of RNA stability by the RNA helicase CshA in *Staphylococcus aureus*”. Séminaire IBPC, 10/04/15, Paris; FRANCE.
- **Giraud C**, de Bentzmann S. « The CupE system of the chaperone – usher pathway of *Pseudomonas aeruginosa* : assembly, function and regulation. Identification of the two component system PprA-PprB and regulon’s characterization ». Séminaire CEBUG ; 24/10/11 ; Genève; SUISSE.

Congrès internationaux : 4

- **Cacaci M.**, Torelli R., Hartke A., **Giraud C.**, Palmieri V., Martini C., Bugli F., Sanguinetti M. “Expression profiling in a mammalian host revealed strong induction of LysM domain-containing proteins.” 28th European Congress of Clinical Microbiology and Infectious Diseases 2018, Madrid, Espagne.
- **Giraud C**, de Bentzmann S. « A new atypical fimbrial assembly machinery of the chaperone-usher pathway accounts for *P. aeruginosa* community lifestyle ». Workshop « *Pseudomonas aeruginosa*: opportunistic pathogen and human infections » 08-10/11/2010, Baeza; ESPAGNE.
- **Giraud C**, de Bentzmann S. « A new atypical fimbrial assembly machinery of the chaperone-usher pathway accounts for *P. aeruginosa* community lifestyle ». 3rd European CF Young Investigator Meeting, 25-28/08/2009, Lille; FRANCE
- **Giraud C**, de Bentzmann S. « A new atypical fimbrial assembly machinery of the chaperone-usher pathway accounts for *P. aeruginosa* community lifestyle ». 2nd European CF Young Investigator Meeting, 27-29/08/2008, Lille; FRANCE.

Congrès nationaux : 4

- **Boudrioua A.**, Hartke A. and **Giraud C**. « Effect of genetic background of vancomycin resistant Gram positive pathogens in response to D-cycloserine and vancomycin combination. » 22^{èmes} Journées de l’Ecole Doctorale Normande de Biologie Intégrative, Santé et Environnement 2019, Caen, France.
- **Giraud C**, Bernard C, Bordi C, de Bentzmann S. « Biofilm et résistance chez *P. aeruginosa* : un lien fonctionnel joué par le système à deux composants PprA-PprB ». GDR *Pseudomonas*, 06-08/10/2010, Carry le Rouet, FRANCE.
- **Giraud C**, de Bentzmann S. « Etude du cluster de gènes *cupE* chez *Pseudomonas aeruginosa* » GDR *Pseudomonas* ; 06/10/2009; Obernai; FRANCE.
- **Giraud C**, de Bentzmann S. « Etude du cluster de gènes *cupE* chez *Pseudomonas aeruginosa* ». 10^{ème} congrès “Vaincre la Mucoviscidose” 16/03/2009 Paris; FRANCE.

1.8.2 Communications affichées : 13

Congrès internationaux : 10

- Boudrioua A., Hartke A. and **Giraud C.** Vancomycin and D-cycloserine combination in vancomycin resistant *Staphylococcus aureus* (VRSA) and enterococci (VRE): From Synergism to Antagonism. 8th congress of European Microbiologists (FEMS, Antimicrobial Resistance) 2019, Glasgow, Ecosse.
- Juarez P., Guénard S., **Giraud C.**, Plésiat P., Muller C. "Development of non-virulent non-resistant bacterial chassis derived from strain PAO1 of *Pseudomonas aeruginosa*". 8th congress of European Microbiologists (FEMS, Antimicrobial Resistance) 2019, Glasgow, Ecosse.
- Cacaci M., Torelli R., Bugli F., Palmieri V., Hartke A., **Giraud C.**, Posteraro B., Sanguinetti M.. An in vivo RNA-seq approach in *Enterococcus faecium* reveals the over-expression of LysM- domain containing proteins in vitro and in vivo characterization. 44rd Conference of the Italian Society of Microbiology (SIM) 2016, Pisa, Italie.
- Cacaci M., **Giraud C.**, Muller C, Torelli R, Bugli F, Sanguinetti M, Hartke A. "Genome wide identification of *in vivo* expressed genes in *Enterococcus faecium* by RNA sequencing ". 8th International Conference on Gram-Positive Microorganisms, 21-25/06/15, Montecatini Terme, ITALY. Prix du meilleur poster.
- **Giraud C.**, Lemeille S, Redder P, Linder P. "Regulation of RNA stability by the RNA helicase CshA in *Staphylococcus aureus*". Swiss Molecular Microbiology Meeting, 06-07/09/12, Villars-sur-Ollon; SUISSE.
- **Giraud C.**, de Bentzmann S. « A new atypical fimbrial assembly machinery of the chaperone-usher pathway accounts for *P. aeruginosa* community lifestyle ». Workshop « *Pseudomonas aeruginosa* : opportunistic pathogen and human infections » 08-10/11/2010, Baeza; ESPAGNE.
- **Giraud C.**, Lemeille S, Redder P, Linder P. "Regulation of RNA stability by the RNA helicase CshA in *Staphylococcus aureus*", 15th International Symposium on Staphylococci and Staphylococcal Infections, 26-30/08/12, Lyon; FRANCE.
- **Giraud C.**, de Bentzmann S. « A new atypical fimbrial assembly machinery of the chaperone-usher pathway accounts for *P. aeruginosa* community lifestyle ». 3rd European CF Young Investigator Meeting, 25-28/08/2009, Lille; FRANCE.
- **Giraud C.**, de Bentzmann S. « A new atypical fimbrial assembly machinery of the chaperone-usher pathway accounts for *P. aeruginosa* community lifestyle ». *Pseudomonas* 2009, 13-17/08/2009, Hannover; ALLEMAGNE.
- **Giraud C.**, de Bentzmann S. « A new atypical fimbrial assembly machinery of the chaperone-usher pathway accounts for *P. aeruginosa* community lifestyle ». 2nd European CF Young Investigator Meeting, 27-29/08/2008, Lille; FRANCE.

Congrès nationaux : 3

- **Giraud C.**, de Bentzmann S. « A new atypical fimbrial assembly machinery of the chaperone-usher pathway accounts for *P. aeruginosa* community lifestyle ». Jacques Monod Commemorative Minisymposium Molecular Microbiology, 31/06/2010, Paris, FRANCE
- **Giraud C.**, de Bentzmann S. « Etude du cluster de gènes *cupE* chez *Pseudomonas aeruginosa* ». Ecole thématique microbiologie et physico-chimie des biofilms, 19/10/2009; Vittel; FRANCE.
- **Giraud C.**, de Bentzmann S. « Etude du cluster de gènes *cupE* chez *Pseudomonas aeruginosa* ». 9^{ème} congrès "Vaincre la Mucoviscidose" 17/03/2008 Paris; FRANCE.

Synthèse des travaux de recherche

Parcours scientifique

J'ai effectué ma thèse en microbiologie à l'Institut de Microbiologie de la Méditerranée sous la direction du Dr. Sophie de Bentzmann grâce à un financement MENRT puis un contrat de demi ATER. J'ai alors étudié la formation du biofilm chez *Pseudomonas aeruginosa*, ainsi que la régulation génétique par les systèmes à deux composants. J'ai ensuite effectué mon stage de post doctorat en Suisse au Centre Médical Universitaire, à Genève, où j'ai rejoint l'équipe du Pr. Patrick Linder grâce à un financement du fonds national suisse pour la recherche et un financement Novartis. J'ai travaillé sur le métabolisme de l'ARN, et en particulier sur les hélicases à ARN de *Staphylococcus aureus*. J'ai enfin été recrutée en tant que maître de conférences à l'université de Caen-Normandie. J'ai tout d'abord mené mon activité de recherche dans l'équipe stress-virulence de l'unité de recherche risques microbiens (U2RM) et à présent dans l'unité de recherche Communication Bactérienne et Stratégies Anti-infectieuses (CBSA) qui a été créée au 1^{er} janvier 2022 et qui est issue de la fusion du LMSM et de l'équipe Stress-Virulence de l'U2RM. Lors de mon recrutement, j'ai débuté mon activité de recherche par l'analyse de l'expression génétique en contexte d'infection chez *Enterococcus faecium*, et la caractérisation de nouveaux facteurs de virulence mis à jour par cette analyse. Je me suis ensuite intéressée au potentiel thérapeutique d'un peptide capable d'annuler la virulence et la résistance à certains antibiotiques chez des bactéries pathogènes à Gram positif (*E. faecium* et *E. faecalis*, *S. aureus*). L'antibiorésistance constituant une menace majeure pour la santé mondiale, cette thématique de recherche de nouvelles molécules thérapeutiques, ainsi que la compréhension de leurs modes d'action, a peu à peu représenté la majorité de mes activités de recherche. J'ai ainsi étendu cette thématique à d'autres molécules au potentiel thérapeutique, et à d'autres bactéries, y compris mon « premier amour » *Pseudomonas aeruginosa*. Mon parcours m'a ainsi permis de concentrer mes recherches sur les bactéries pathogènes, leur capacité de formation du biofilm, leur virulence et leur résistance aux antibiotiques, ainsi que la régulation génétique des systèmes correspondants.

Dans ce manuscrit, je commencerai par présenter très brièvement mes travaux de thèse et de post-doctorat pour permettre au lecteur de situer mes « origines scientifiques » s'il le souhaite. Je me concentrerai ensuite sur les quatre projets de recherche que j'ai mené ou mène depuis mon recrutement à l'université de Caen-Normandie.

Contexte général des travaux

Pseudomonas aeruginosa, *Staphylococcus aureus*, *Enterococcus faecalis* et *Enterococcus faecium* sont toutes des pathogènes de l'Homme responsables d'infections nosocomiales (Boucher et al. 2009). Ces pathogènes sont capables de s'adapter à de nombreux environnements, notamment en formant un biofilm, qui confère aux bactéries une meilleure résistance aux défenses immunitaires et aux antibiotiques (Mohamed et Huang 2007). La formation de biofilm est généralement associée à des infections chroniques difficiles à éradiquer. Ces bactéries sont également capables de produire différentes toxines qui vont par exemple conduire à une activité hémolytique et être responsables de la virulence bactérienne, associée à des infections aiguës (Singh et Ray 2014). Il existe une balance entre le mode de vie en biofilm et le mode de vie planctonique associé à la production de toxines qui permet aux bactéries de coloniser différentes niches et développer différentes infections. Enfin, une

problématique majeure associée à ces bactéries est leur capacité à résister aux antibiotiques, ce qui rend les infections difficiles à traiter (Alanis 2005). Ces mécanismes de formation de biofilm, de virulence et de résistance aux antibiotiques résultent de la capacité des bactéries à s'adapter à leur environnement et au stress. Cette adaptation implique une régulation génétique fine qui peut intervenir à différents niveaux : initiation de la transcription, stabilité de l'ARN messager (ARNm) ou encore au niveau de l'initiation de la traduction. La compréhension de ces mécanismes de virulence et de résistance aux antibiotiques permet d'envisager le développement de molécules thérapeutiques alternatives aux antibiotiques.

1 Travaux de thèse : Etude d'acteurs de la formation du biofilm chez *P.aeruginosa* et de leur régulation.

Contexte

Parmi les systèmes permettant la formation du biofilm chez *P. aeruginosa*, on retrouve les fimbriae assemblés par la voie chaperonne – « usher » (Giraud et al. 2009). *P. aeruginosa* possède plusieurs de ces systèmes et les gènes correspondants sont finement régulés par des réseaux de régulation parfois complexes (Giraud et de Bentzmann 2012). Ces réseaux peuvent impliquer des systèmes à deux composants (TCS). Les TCS sont formés d'un senseur qui perçoit des signaux environnementaux, ce qui conduit à une autophosphorylation. Le phosphate est ensuite transmis à un régulateur de réponse, ce qui déclenche son activation et permet classiquement sa fixation à l'ADN pour réguler des gènes cibles.

Résumé des résultats

Mon travail de thèse a principalement porté sur l'étude du cluster de gènes *cupE*, codant pour un système chaperonne – « usher » putatif. Nous avons montré que le système CupE est fonctionnel et permet l'assemblage de fimbriae à la surface de la cellule qui jouent un rôle important dans la formation et la structuration du biofilm. Les gènes *cupE* sont spécifiquement exprimés en conditions de formation du biofilm et par une approche de mutagenèse aléatoire par transposition, le TCS PprA – PprB a été identifié comme un régulateur positif de ce cluster. Nous avons démontré que ce contrôle est direct et que PprB se lie sur des boîtes putatives en amont du +1 de transcription de *cupE*. (Giraud et al. 2011).

Ce TCS ayant été identifié au préalable comme un régulateur positif de pili de type IVB Flp, eux-mêmes acteurs du biofilm chez *P. aeruginosa*, nous avons caractérisé le régulon du régulateur de réponse PprB. Parmi les gènes régulés positivement par PprB, nous avons identifié un opéron de quatre gènes codant pour un transporteur ABC impliqué dans la résistance aux antibiotiques spécifiquement en conditions de biofilm et pour une protéine de haut poids moléculaire, substrat potentiel de ce transporteur ABC. Cette protéine est effectivement sécrétée par le transporteur ABC et correspond à nouvelle adhésine participant à la structuration du biofilm chez *P. aeruginosa*. L'activation de PprB conduit à une hyper-formation du biofilm et l'utilisation de la *Drosophila* comme modèle animal a montré que cette augmentation du biofilm est liée à une diminution de la virulence et de la dissémination de l'intestin vers l'hémolymphe. Cette étude a ainsi montré que PprB est un régulateur clef de la balance entre formation du biofilm et virulence (de Bentzmann et al. 2012).

2 Travaux de post doctorat : Etude des hélicases à ARN chez *S. aureus*.

Contexte

Les hélicases à ARN de la famille des « DEAD-box » jouent des rôles importants dans le contrôle du métabolisme de l'ARN (Linder et Jankowsky 2011). Elles fonctionnent en couplant la fixation et l'hydrolyse de l'ATP avec des changements d'affinité pour l'ARN. Beaucoup de ces protéines utilisent ce mécanisme pour avoir une activité hélicase qui leur permet de séparer des duplexes d'ARN selon un processus n'impliquant pas de translocation. Elles peuvent également fixer l'ARN pour devenir des centres de nucléation de complexes ARN-protéine. Chez les procaryotes, les hélicases à « DEAD-box » sont impliquées dans la biogenèse des ribosomes, la dégradation de l'ARN et l'initiation de la traduction, ce qui les place comme régulateurs importants de l'expression génétique. Chez *S. aureus* l'hélicase à « DEAD box » CshA fait partie du dégradosome, un complexe protéique responsable de la dégradation de l'ARN dans la bactérie (Roux et al. 2011).

Résumé des résultats

Nous avons montré que la mutation de *cshA* conduisait à un défaut de formation du biofilm, ainsi qu'à une augmentation de l'hémolyse. Ces phénotypes sont liés à une stabilisation de l'ARN messager *agr* dans le mutant *cshA*. Le système Agr est un système de quorum sensing permettant l'activation de la transcription de l'ARN III, un ARN régulateur permettant le contrôle de la virulence, de la résistance aux antibiotiques et de la formation du biofilm chez *S. aureus*. Dans le contexte du dégradosome, CshA pourrait être nécessaire pour dérouler certaines structures protectrices de l'ARNm *agr* et ainsi permettre aux RNAses du dégradosome de dégrader cet ARNm. Le mutant *cshA* est également sensible au froid, ce qui pourrait être dû au fait que l'abaissement de la température stabilise des structures rendant inaccessible le site de fixation du ribosome (RBS). L'activité hélicase de CshA serait ainsi nécessaire pour l'initiation de la traduction de ces ARNm. Ce travail qui a donné lieu à une publication (Oun et al. 2013) était en cours lorsque je suis arrivée dans l'équipe du professeur Linder et j'ai pu y participer.

Bien que le rôle important de CshA dans le contrôle de l'expression génétique chez *S. aureus* ait été démontré, nous ne connaissons pas les détails moléculaires de l'activité de CshA chez ce pathogène. Le projet qui m'a été confié dans le laboratoire du Pr. Linder consistait en l'identification des cibles ARN de CshA et à déterminer comment CshA reconnaît ces cibles. Pour définir les ARN dont la dégradation nécessite CshA nous avons utilisé une approche de transcriptomique permettant de comparer la stabilité des ARNm entre la souche de *S. aureus* SA564 sauvage et le mutant de délétion SA564 Δ *cshA*. Pour cette expérience, la transcription est bloquée à un temps donné grâce à l'ajout de rifampicine et les ARN messagers sont extraits à différents temps de culture après l'ajout de rifampicine. Ceci a permis de déterminer la demi-vie de chaque ARN messager dans la souche sauvage ainsi que dans le mutant SA564 Δ *cshA* et de montrer que CshA est requise pour la dégradation de la majorité des ARNm. La délétion de CshA conduit à une stabilisation encore plus importante d'un sous-ensemble de molécules d'ARNm qui codent notamment des protéines impliquées dans la virulence de la bactérie et dans la régulation génétique.

Outre un domaine cœur impliqué dans l'activité enzymatique, CshA possède une extension C-terminale. Il a été montré pour différentes hélicases à DEAD-box que des extensions de ce type sont responsables d'interactions avec le substrat ARN ou des protéines partenaires, et donc confèrent une

spécificité à ces hélicases. Pour savoir si ce domaine pouvait jouer un tel rôle, nous avons construit un mutant portant une délétion de la partie du gène codant ce domaine C-terminal. La délétion de ce domaine affecte le turnover des ARNm de la même manière que la délétion totale de CshA. Par une approche de purification par affinité en tandem, nous avons montré que ce domaine était nécessaire à l'interaction avec les composants du dégradosome de manière indépendante de l'ARN, ce qui explique le phénomène observé de stabilisation des ARNm dans la souche portant la délétion du domaine C-terminal. Ce travail qui a permis de mieux comprendre les mécanismes de dégradation de l'ARNm chez *S. aureus* a donné lieu à une publication (Giraud et al. 2015).

3 Identification des gènes surexprimés par *E. faecium* en condition d'infection chez la souris et caractérisation de protéines impliquées dans la virulence.

3.1 Contexte

Pour parvenir à coloniser son hôte et à établir une infection avec succès, les bactéries devront adapter leur expression génétique afin de mettre en place des facteurs adaptés spatialement et temporellement. L'expression des gènes est donc différente selon que la bactérie pousse en condition de laboratoire, dépourvue de stress, ou en condition d'infection, dans laquelle sa survie dépendra de l'expression de gènes spécifiques. Connaître ce programme génétique permet de savoir quels gènes sont nécessaires à l'infection, et donc susceptibles de coder pour des protéines pouvant devenir des cibles thérapeutiques. Or, à cause de contraintes techniques, la plupart des études transcriptomiques sont faites en conditions de laboratoire. Nous avons donc choisi d'étudier le transcriptome d'*E. faecium* en condition d'infection et de le comparer au transcriptome de la même bactérie cultivée en conditions de laboratoire.

3.2 Etude du transcriptome d'*E. faecium* en condition d'infection.

Nous avons utilisé un modèle de péritonite chez la souris. Brièvement, la bactérie a été injectée directement dans le péritoine de la souris puis, à différents temps après injection, les bactéries ont été récupérées par lavage du péritoine des souris sacrifiées. En parallèle, nous avons cultivé la même souche bactérienne en condition de laboratoire et nous avons pris des échantillons correspondant à différentes phases de croissance bactérienne. L'ARN bactérien a été isolé dans chacun des cas et séquencé en utilisant la technologie Illumina.

La comparaison du transcriptome des bactéries infectieuses avec celui des bactéries cultivées en condition de laboratoire a permis de mettre en évidence plusieurs groupes de gènes particulièrement surexprimés en condition d'infection. Tout d'abord, nous avons observé que la bactérie met en place de nouvelles voies métaboliques. En particulier, les gènes codant pour la voie de catabolisme du glycérol sont surexprimés, ce qui semble signifier que le glycérol est un important substrat pour la bactérie dans ces conditions. Il serait donc intéressant de développer des molécules interférant avec ces voies métaboliques pour combattre l'infection bactérienne. Ensuite, nous avons observé la surexpression des gènes codant pour les protéines constituant le dégradosome, une machinerie de dégradation de l'ARN qui joue un rôle important dans la régulation génétique (voir section ci-dessus). Ainsi, nous observons la surexpression des gènes codant l'hélicase à DEAD-box CshA, les RNases Y, J1 et J2, l'enolase et la PNPase qui sont les constituants du dégradosome des bactéries Gram-positives, ce qui confirme l'implication du dégradosome dans le contrôle de la

virulence bactérienne. Il est possible qu'une partie des modifications des niveaux d'ARNm observées soit attribuable à des changements de stabilité de ces messagers suite à des variations de l'activité du dégradosome. Nous avons également observé la surexpression de gènes codant des protéines connues pour leur implication dans la formation du biofilm, la sécrétion et la résistance au stress. Notre étude a donc pointé précisément quels étaient les facteurs impliqués dans l'infection.

3.3 Implication des protéines contenant des domaines LysM dans la virulence.

Outre ces facteurs de virulence connus, nous avons identifié des gènes fortement surexprimés en condition d'infection mais codant des protéines non caractérisées. Ces protéines pouvant constituer de nouveaux facteurs de virulence, nous avons étudié plus précisément leur fonction. Nous nous sommes intéressés à quatre protéines, toutes comportant un domaine LysM : EFAU004_00494, 01059, 01150 et 01209 (Figure 1). Ce domaine connu pour fixer le peptidoglycane de la paroi bactérienne est retrouvé chez les bactéries principalement dans des protéines impliquées dans le métabolisme de la paroi (Buist et al. 2008).

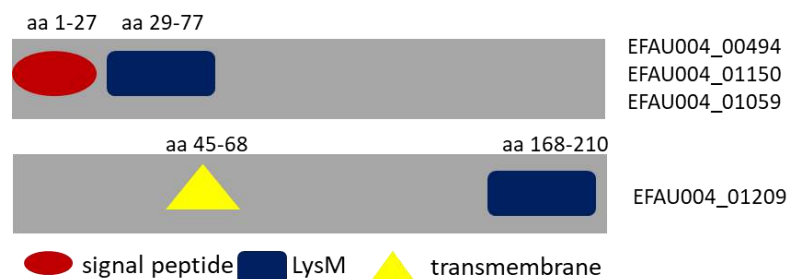
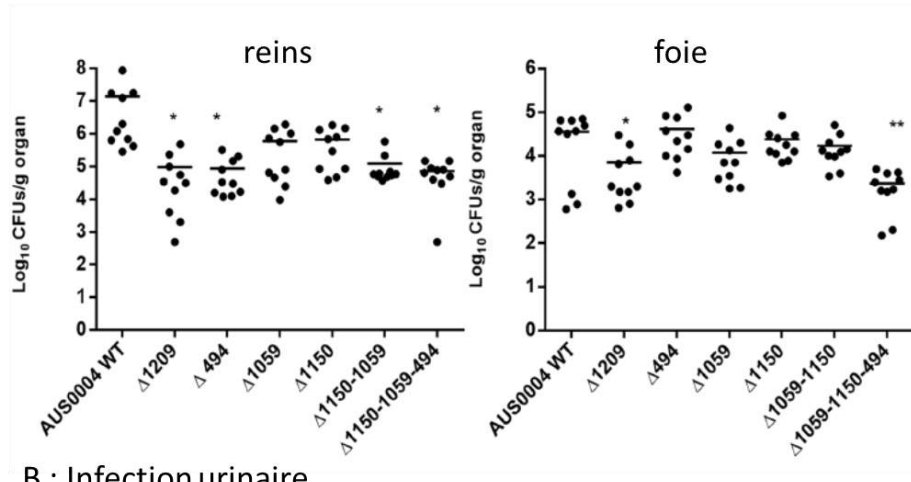

Figure 1 : organisation des domaines protéiques des protéines EFAU004_00494, EFAU004_01150, EFAU004_01059 et EFAU004_01209. Cercle rouge : peptide signal ; carré bleu : domaine LysM ; triangle jaune : domaine transmembranaire.

Les trois protéines EFAU004_00494, 01059 et 01150 sont hautement homologues et contiennent toutes une séquence signal à l'extrémité N-terminale, suivie du domaine LysM. Il n'y a pas d'homologie significative entre ces protéines et EFAU004_01209. Le domaine LysM de EFAU004_01209, situé en partie C-terminale, est plus éloigné de la séquence consensus de ce domaine que celui des protéines EFAU004_00494, 01059 et 01150. La séquence signal est absente dans EFAU004_01209, mais elle contient une hélice transmembranaire.

Nous avons construit des souches portant des mutations individuelles dans ces gènes, ainsi qu'un double mutant Δ EFAU004_01059-01150 et un triple mutant Δ EFAU004_00494-01059-01150, étant donné la forte homologie de ces protéines et donc leur rôle cellulaire possiblement redondant. Nous avons montré que ces bactéries étaient affectées à différents degrés dans leur capacité à coloniser les organes des souris dans un modèle d'infection systémique (Figure 2A), bien que leur croissance en condition de laboratoire soit similaire à celle de la souche parentale. Etant donné le fort tropisme d'*E. faecium* AUS0004 pour les reins dans ce modèle, nous avons également utilisé un modèle d'infection urinaire qui a permis de vérifier le phénotype détecté dans le modèle systémique (Figure 2B). Ceci confirme l'implication de ces protéines dans l'établissement de l'infection et les désigne comme de nouveaux facteurs de virulence.

A : Infection systémique



B : Infection urinaire

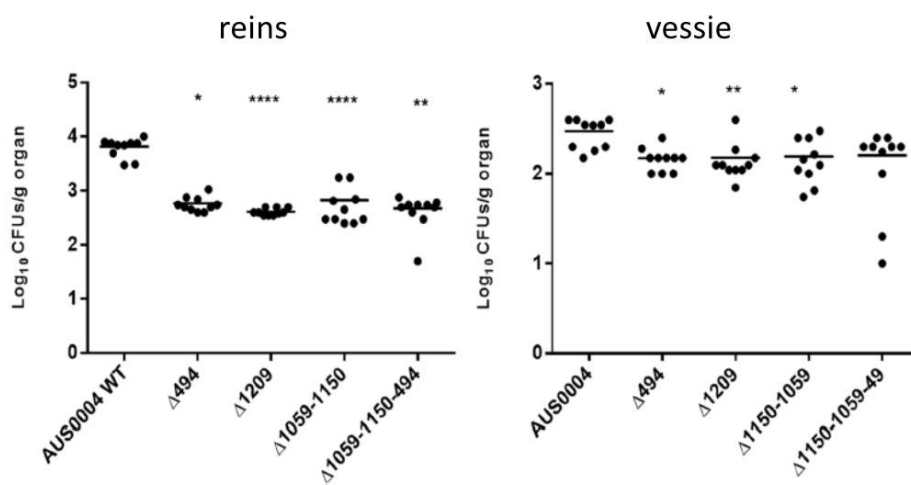

Figure 2 : Colonisation des organes de souris par *E. faecium* AUS0004 (souche sauvage) et les mutants de délétion en modèle d'infection systémique (panel A) et urinaire (panel B). Des groupes de 10 souris femelles BALB/c ont été infectées avec 10^8 bactéries par voie intraveineuse (A) ou transurétrale (B). Les données sont exprimées en tant que \log_{10} de CFU de bactéries récupérées par gramme d'homogénat d'organe sept (A) ou quatre (B) jours après l'infection. Les barres horizontales représentent la moyenne géométrique. Les comptages bactériens ont été comparés par ANOVA à deux facteurs. Les P values inférieures à 0.05 ont été considérées significatives. *<0.05 ; **<0.005 ; ***<0.001.

3.4 La protéine EFAU004_01209 pourrait être une cible prometteuse pour le traitement des infections urinaires.

Etant donné que les entérocoques sont des causes importantes d'infections urinaires, nous avons testé la croissance des différentes souches dans l'urine humaine et avons montré que la croissance du mutant ΔEFAU004_01209 était affectée dans ce milieu (Figure 3).

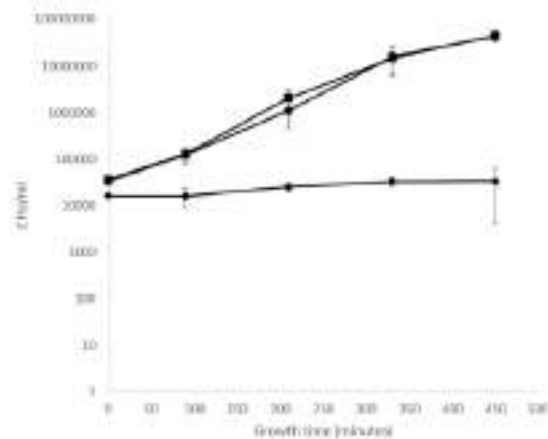

Figure 3 : Croissance de la souche sauvage de *E. faecium* AUS0004 (carrés), du mutant de délétion Δ EFAU004_01209 (losanges) et du mutant complété Δ EFAU004_01209 ::1209 (ronds) dans l'urine humaine. Les bactéries ont été inoculées dans l'urine filtrée, incubées à 37°C et dénombrées. L'expérience a été réalisée en duplicat et les barres d'erreurs représentent la déviation standard.

La protéine EFAU004_01209 présente un domaine transmembranaire et nous avons montré par microscopie à immunofluorescence sa localisation à la surface de la bactérie (Figure 4). Cet élément, ainsi que son implication dans la capacité d'*E. faecium* à croître dans l'urine humaine et à coloniser les reins et la vessie, en font une cible thérapeutique attractive pour le traitement des infections urinaires à *E. faecium* résistante aux antibiotiques.

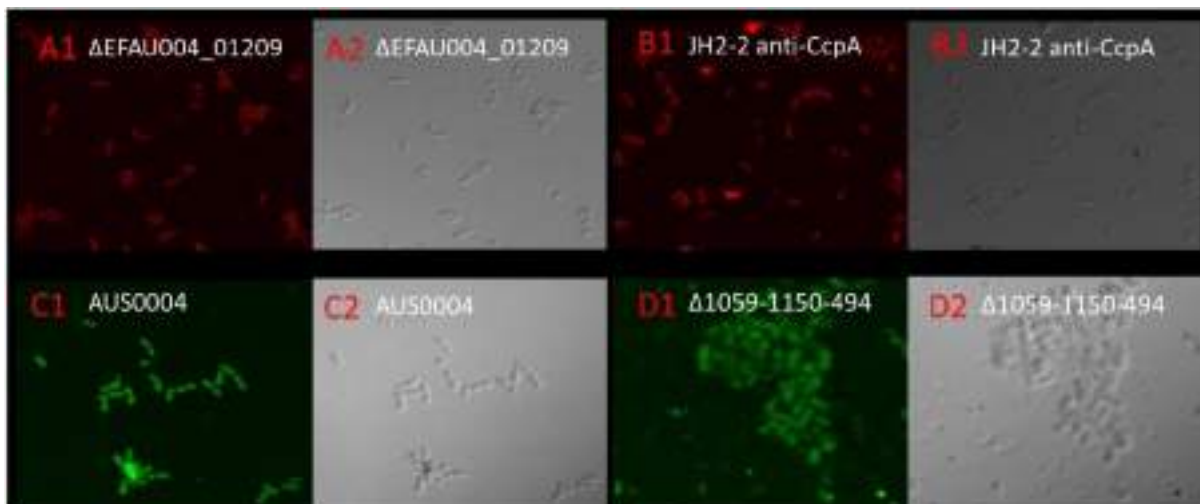

Figure 4 : Microscopie à immunofluorescence de souches d'entérocoques marquées avec un anticorps anti-1209 couplé au FITC. Les cellules sont colorées au bleu Evans. Panels 1 : microscopie à immunofluorescence ; panels 2 : phase relative. A : mutant Δ EFAU004_01209 ; aucun signal associé au FITC n'est détecté. B : *E. faecalis* JH2-2 marquées avec un anticorps anti-CcpA (protéine cytoplasmique) ; aucun signal n'est détecté. C : *E. faecium* AUS0004 ; on détecte de la fluorescence verte, associée à la localisation probable de EFAU004_01209 à la surface bactérienne. D : triple mutant Δ EFAU004_01059-1150-494 ; on détecte de la fluorescence verte, associée à la localisation probable de EFAU004_01209 à la surface bactérienne.

3.5 Conclusion, valorisation et perspectives.

Ce projet a été réalisé en collaboration avec l'équipe de Maurizio Sanguinetti à l'université catholique de Rome. Cela m'a notamment permis de participer à l'encadrement de Margherita Cacaci, qui est une étudiante qui a effectué sa thèse en cotutelle entre Rome et l'université de Caen-Normandie et l'a soutenue en mars 2017. La présentation de ce travail lors du 8^{ème} congrès sur les microorganismes

Gram-positif a été récompensée par le premier prix du meilleur poster et a donné lieu à une publication (Cacaci et al. 2018).

L'étude du transcriptome d'*E. faecium* nous a permis de détecter la présence de petits ARNs, grâce à la présence de reads de séquençage dans des régions intergéniques. Certains de ces petits ARNs ont été caractérisés dans une étude précédente (Siné et al. 2017) mais beaucoup d'autres n'ont pas été détectés dans cette étude. Ceci s'explique par le fait que les conditions de culture en laboratoire sont différentes entre nos deux études mais surtout car certains petits ARNs ne sont exprimés qu'en condition d'infection, qui est une condition propre à notre étude. De la même manière que ce qui a été fait pour les protéines contenant des domaines LysM, il serait intéressant de caractériser ces petits ARNs exprimés spécifiquement en condition d'infection et de comprendre leur implication probable dans la virulence. Pour cela, nous collaborons avec l'équipe du Dr Torsten Hain de l'université de Giessen en Allemagne pour définir plus précisément les coordonnées de ces petits ARNs, ainsi que leurs valeurs d'expression dans les différentes conditions expérimentales. Une fois ces données obtenues, nous sélectionnerons des petits ARNs candidats afin d'étudier leur rôle dans la physiologie bactérienne et l'infection.

4 Suppression de la virulence et de la résistance aux antibiotiques de pathogènes Gram-positifs majeurs par des peptides lasso (travail confidentiel).

4.1 Contexte

Les résistances à la vancomycine sont fréquentes chez *E. faecalis* et *E. faecium* (Courvalin 2006) et rapportées chez *Staphylococcus aureus* (Chambers et DeLeo 2009), ce qui rend le traitement des infections associées difficile car peu d'alternatives à la vancomycine sont disponibles (Baëtz et al. 2021). L'Organisation Mondiale de la Santé (OMS) a ainsi classé ces bactéries comme « hautement prioritaires » parmi celles contre lesquelles de nouveaux antibiotiques sont urgemment requis. La propagation rapide de la résistance aux antibiotiques ainsi que l'absence d'identification de nouveaux médicaments possédant de nouvelles structures et des mécanismes d'action hors du commun amène un regain d'intérêt dans l'étude des processus cellulaires comme cibles médicamenteuses alternatives pour le développement de prochaines générations d'antibiotiques. Idéalement, ces nouveaux médicaments interfèrent avec la virulence sans bloquer la croissance bactérienne, ce qui devrait réduire la probabilité d'apparition de résistance grâce à une réduction de la pression sélective. Il serait également intéressant d'obtenir des médicaments interférant avec les mécanismes de résistance, ce qui rendrait les bactéries plus sensibles à un antibiotique donné. En collaboration avec l'équipe du Dr Yanyan Li au Museum National d'Histoire Naturelle (MNHN) nous avons identifié des peptides lasso de type 1 (PLT1) comme molécules prometteuses (Figure 5 ; publication commune : (Li et al. 2015).

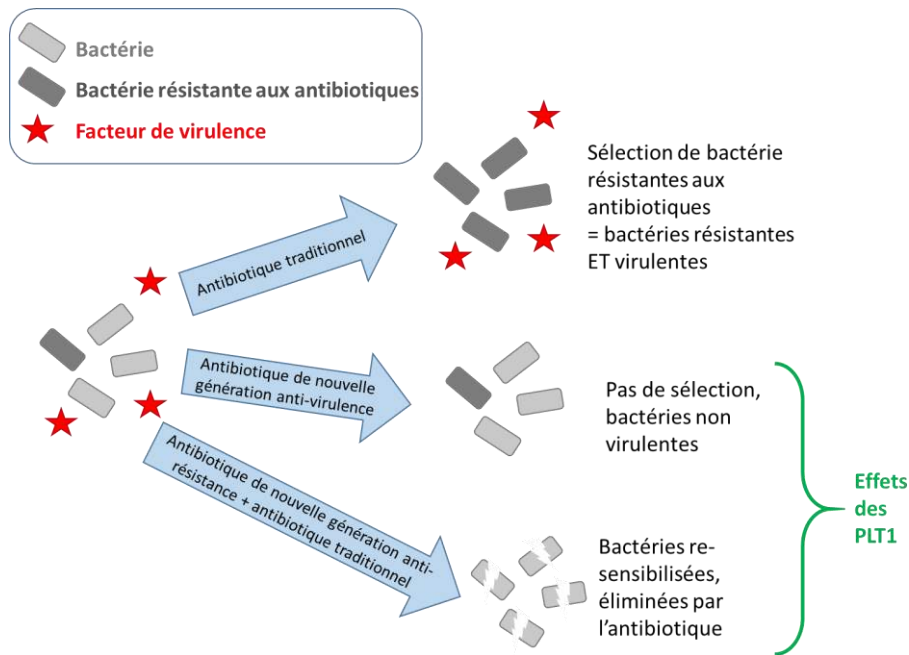

Figure 5 : Comparaison des effets des antibiotiques traditionnels et des antibiotiques de nouvelle génération aux propriétés anti-virulence ou anti-résistance.

4.2 Les peptides lasso, des molécules prometteuses

Les peptides lasso sont des peptides cycliques de 15 à 24 acides aminés dotés d'une topologie mécaniquement verrouillée de type 1-rotaxane, pouvant être produits par différentes bactéries. Leur structure est caractérisée par un cycle macrolactame en N-terminal et par une queue C-terminale qui passe au travers du cycle, à l'intérieur duquel elle est maintenue par des moyens stériques ou des ponts disulfure (Figure 6). Ce repliement compact confère aux peptides une forte stabilité, en particulier aux pH très acides, aux températures élevées ou à un grand nombre de protéases.

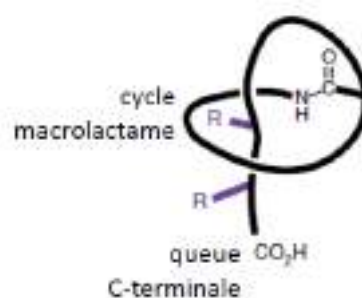

Figure 6 : Caractéristiques structurales des peptides lasso. En N-terminal du peptide se trouve un cycle macrolactame au travers duquel passe la queue C-terminale pouvant être maintenue dans le cycle au moyen de résidus arginine (en violet). Adapté d'après Tietz et al., 2017.

Les peptides lasso sont des peptides synthétisés par voie ribosomique et modifiés post-traductionnellement (RiPP pour « Ribosomally-synthesized and Postranslationally modified Peptides » ; (Arnison et al. 2013). Ils sont synthétisés sous forme de peptides précurseurs linéaires qui subissent une maturation impliquant des enzymes dédiées assurant une mise en forme topologique, une protéolyse et une cyclisation pour conduire à la structure finale en lasso (Figure 7a). Le fait que leur précurseur soit codé par un gène permet la génération de variants par bio-ingénierie. En effet, des études menées sur un peptide lasso modèle, la microcine J25 produite par *Escherichia*

coli, ont démontré que la plupart des positions du peptide sont tolérantes aux substitutions sans influence sur la topologie en lasso (Pavlova et al. 2008). Il est à noter que la structure en lasso ne peut pas encore être synthétisée par des méthodes chimiques et que seules les enzymes bactériennes y parviennent (Saito et Bode 2017; Wang et al. 2017). Les peptides lasso avec des activités antimicrobiennes connues montrent de nouveaux modes d'action, tels que l'inhibition de la protéase ClpC (Gavriš et al. 2014). Cependant, malgré leur fort potentiel thérapeutique les peptides lasso sont encore relativement peu étudiés.

La sviceucine et la siamycine appartiennent à la famille des peptides lasso de type I (PLT1) caractérisée par la présence de deux ponts disulfure. La siamycine a été précédemment identifiée à partir de différents cribles (Nakayama et al. 2007 ; Lin et al. 1996). La sviceucine a été découverte par l'équipe du Dr Yanyan Li à partir de *Streptomyces sviceus* par une approche d'exploration du génome (Li et al. 2015). Les deux molécules partagent des résidus conservés et présentent des structures tridimensionnelles similaires (Figure 7b). Cependant, leur composition en acides aminés est différente.

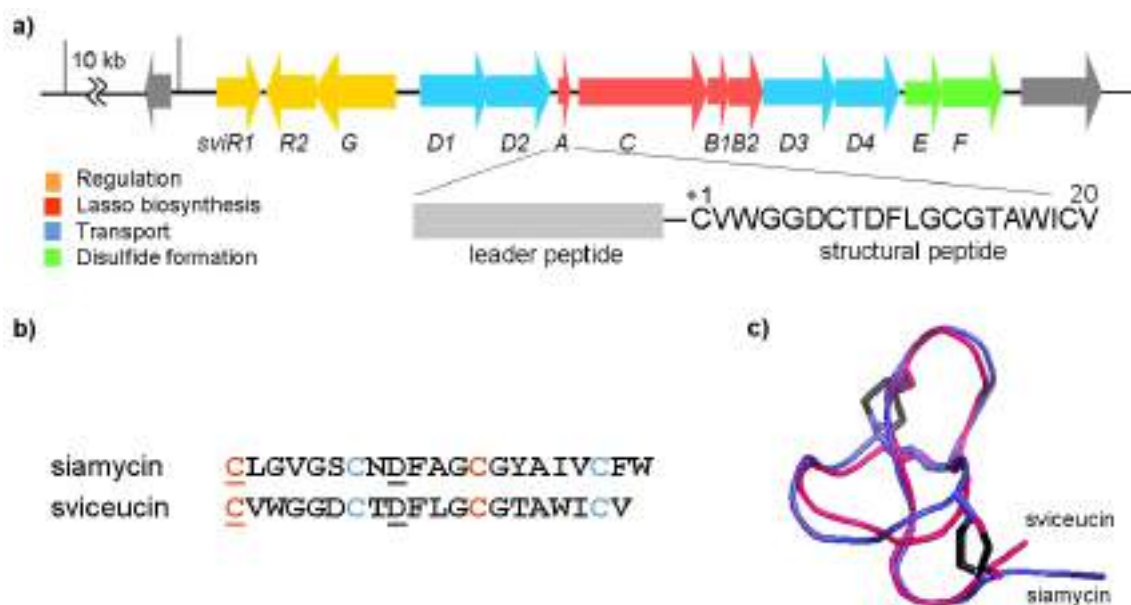

Figure 7 a) Cluster de gènes de biosynthèse de la sviceucine montrant l'origine ribosomique du peptide. b) Comparaison des séquences de la siamycine et de la sviceucine : les résidus impliqués dans la fermeture du cycle macrolactame sont soulignés ; les cystéines impliquées dans les appariements de liaisons disulfure sont surlignées en rouge et bleu. c) Superposition des structures 3D de la sviceucine (en magenta) et de la siamycine (en bleu) (PDB 2LS1 et 1RPC respectivement). D'après Li et al., 2015.

Les activités de la siamycine sur *E. faecalis* et *S. aureus* ont été partiellement étudiées dans des études antérieures (Nakayama et al. 2007 ; Ma et al. 2008). Il a été démontré que la siamycine inhibe la croissance d'*E. faecalis* et de *S. aureus* à 5 et 7 μ M respectivement. De plus, à des concentrations sous-inhibitrices, la siamycine inhibe le quorum sensing d'*E. faecalis* (Nakayama et al. 2001). Ce système de quorum sensing nommé Fsr comprend le système à deux composants FsrC-FsrA. Fsr contrôle l'expression du gène *gelE*, qui code pour l'enzyme gélatinase, une protéase clé dans la formation de biofilm (Figure 8). À l'échelle moléculaire, la siamycine inhibe l'autophosphorylation des

histidines kinases, dont FsrC, d'*E. faecalis* et d'autres ATPases (Ma et al. 2011). Motivés par ces données, nous avons commencé à examiner l'effet de la siamycine et de la sviceucine chez *E. faecalis*, *E. faecium* et *S. aureus*.

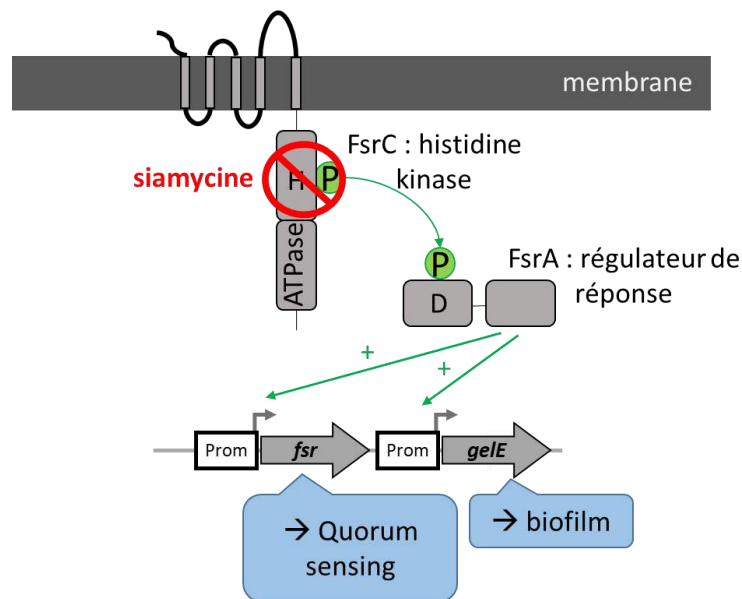

Figure 8 : Le système de quorum sensing Fsr d'*E. faecalis* active la transcription du gène *gelE*, dont le produit est responsable de la formation du biofilm. L'autophosphorylation de l'histidine kinase FsrC est inhibée par la siamycine. Prom : promoteur.

4.3 Effets des PLT1 sur la croissance et la morphologie.

Contrairement à la siamycine, la sviceucine n'est pas bactéricide à 10 μM . Elle ne réduit que légèrement le taux de croissance de *E. faecalis* (Figure 9), *E. faecium* et *S. aureus*. Dans le cadre du développement d'antibiotiques de nouvelle génération, cela représente un avantage puisque l'on s'attend à une pression sélective limitée pour l'apparition d'une résistance à ce peptide.

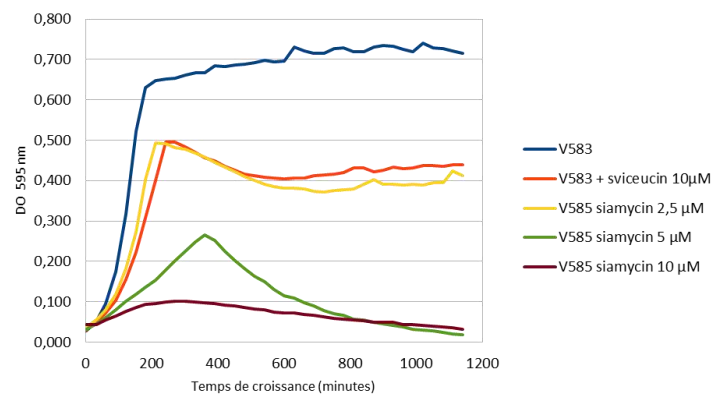

Figure 9 : Croissance d'*E. faecalis* V583 sans traitement et en présence de 10 μM de sviceucine, 2,5 μM , 5 μM et 10 μM de siamycine.

En utilisant la microscopie électronique à transmission, nous avons vu qu'une concentration sous-inhibitrice de siamycine (1 μM) affecte la morphologie d'*E. faecalis*, conduisant à des cellules avec des cloisons de division placées de manière aberrante, ce qui n'a pas été observé pour la sviceucine (Figure 10). De plus, il a été montré chez *S. aureus* par Tan et collaborateurs que la siamycine interagit avec le lipide II, le bloc de construction central du peptidoglycane, ce qui compromet la

biosynthèse de la paroi cellulaire (Tan et al. 2019). Cet effet de la siamycine sur la paroi bactérienne pourrait expliquer son action inhibitrice de la croissance chez *E. faecalis*.

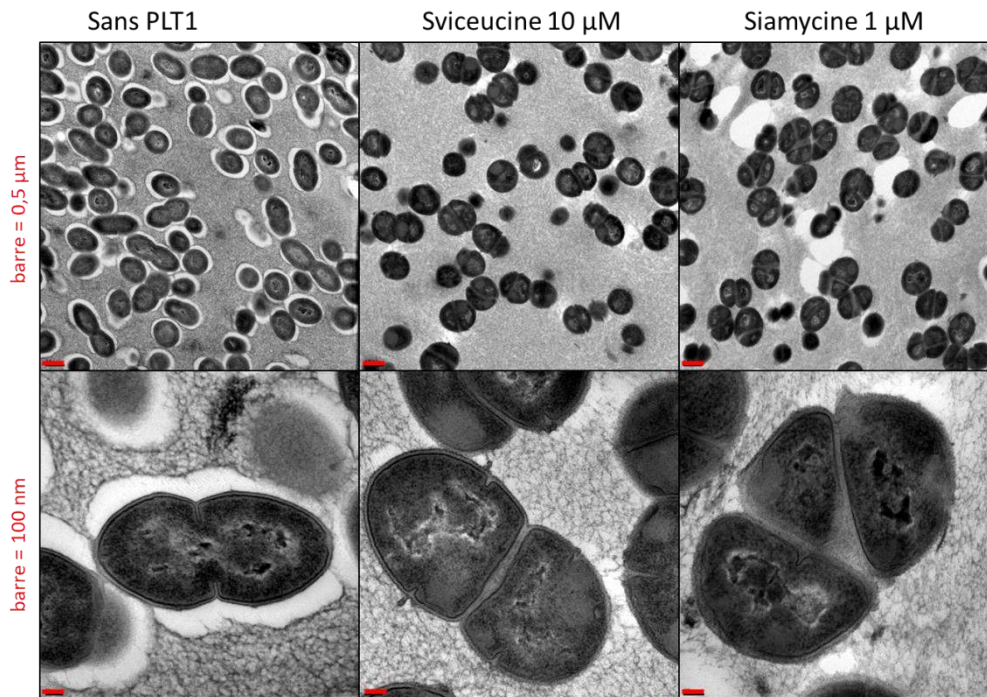

Figure 10 : Images en microscopie électronique à transmission d'*E. faecalis* avec, de gauche à droite, contrôle sans traitement, traité avec 10 µM de sviceucine et traité avec 1 µM de siamycine. L'échelle est indiquée à gauche.

4.4 Les PLT1 inhibent la virulence.

De manière similaire à ce qui a été démontré pour la siamycine (Nakayama et al. 2001), le traitement avec 10 µM de sviceucine entraîne une diminution de l'activité de la gélatinase et de la formation de biofilm chez *E. faecalis* (Li et al. 2015). La formation de biofilm contribue à la persistance des bactéries chez l'hôte, les rendant plus résistantes au système immunitaire, au traitement antibiotique et aux stress (Mohamed et Huang 2007). Ainsi, inhiber la formation de biofilm est une puissante stratégie anti-virulence. Par qRT-PCR, nous avons confirmé que l'expression de *gelE* est régulée négativement en présence de sviceucine (Figure 11). Comme la siamycine, la sviceucine pourrait cibler FsrC, ce qui expliquerait la diminution de l'activité de la gélatinase.

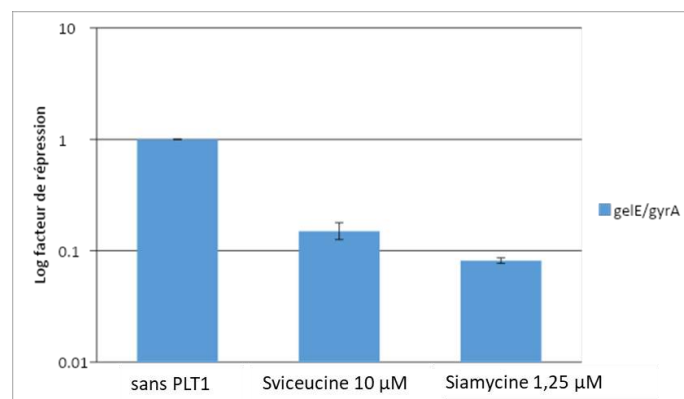

Figure 11 : Effet de 10 µM de sviceucine ou 1,25 µM de siamycine sur la transcription de *gelE* chez *E. faecalis* V583, standardisée sur l'expression de *gyrA* et en comparaison du contrôle sans traitement (sans PLT1).

Étant donné que la siamycine et la sviceucine diminuent la formation de biofilm, nous nous sommes demandé si les PLT1 pouvaient interférer avec la virulence. Nous avons utilisé comme premier modèle les larves de *G. mellonella*, car cet insecte est un hôte fiable pour étudier la virulence des pathogènes humains. Il peut être élevé à 37°C et son système immunitaire partage un degré élevé d'homologie structurelle et fonctionnelle avec le système immunitaire inné des mammifères (Bergin et al. 2005). L'infection par *E. faecalis* provoque la mort de 100 % des larves 24 heures après l'injection de la bactérie. Cependant, *E. faecalis* cultivée en présence de sviceucine ou de siamycine perd presque complètement sa capacité à tuer les larves (Figure 12).

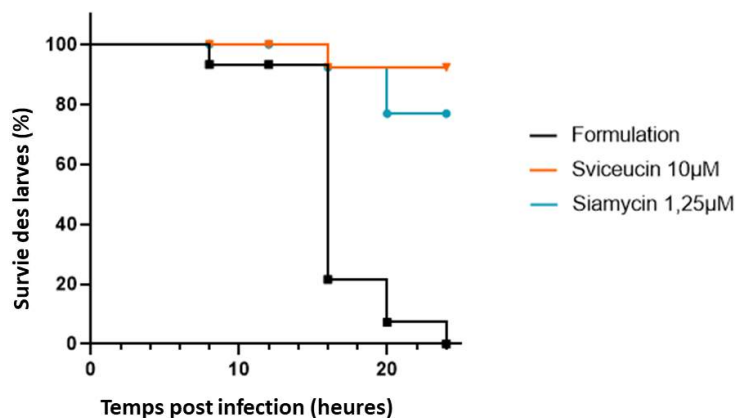

Figure 12 : Courbes de survie de Kaplan-Meier des larves de *G. mellonella* infectées par *E. faecalis* V583 traitée avec la formulation des PLT1 (noir) ou traitée avec 10 µM de sviceucine (orange) ou 1,25 µM de siamycine (bleu). Les résultats représentent les valeurs moyennes de trois expériences indépendantes pour lesquelles une différence significative a été montrée selon le test du logrank ($p < 0,0001$) entre le traitement par la formulation et le traitement avec chaque PLT1.

4.5 Les PLT1 inhibent la résistance à la vancomycine.

La résistance à la vancomycine est conférée par un opéron *van* dont il existe plusieurs types, les types *vanA* et *vanB* étant les plus répandus. Nous avons montré que le traitement de souches résistantes à la vancomycine d'entérocoques (*E. faecalis* et *E. faecium*) et de *S. aureus* avec de la vancomycine en présence de siamycine (à une concentration sub-inhibitrice comprise entre 1,25µM et 2,5µM) ou de sviceucine (à une concentration de 10µM) diminue la CMI de ces souches au niveau de celui de souches sensibles (Tableau 1). Les PLT1 font ainsi partie des rares molécules connues pour annuler la résistance à un antibiotique (Olsen 2015 ; Stone et al. 2016). Alors que la siamycine agit sur les souches porteuses d'opérons *vanA* ou *vanB*, la sviceucine n'agit que sur les souches porteuses d'opérons *vanB*, ce qui semble indiquer une spécificité de la sviceucine pour un élément de cet opéron.

Tableau 1 : CMI de la vancomycine en absence (Lasso-) ou en présence de 10 µM de sviceucine (Svic+) ou de 1,5 µM de siamycine (Sia+). Formulation : traitement avec la formulation des PLT1 (eau/méthanol 1:1) ; ND, Non déterminé. *CMI variable entre 2 et 8 selon l'expérience. Dans tous les cas, la CMI reste inchangée en présence de sviceucine ou de siamycine I. Extrait de la thèse d'A. Boudrioua.

Souche	Type de résistance	CMI (µg/ml)			
		Lasso-	Svic+	Sia+	Formulation
<i>E. faecalis</i> V583	VanB chromosomique	32	2-4	2-4	32
<i>E. faecalis</i> V583 Δ vanB	Sensible, vanB-	2	2	2	2
<i>E. faecalis</i> JH2-2 08048	VanB plasmidique	64	2	ND	ND
<i>E. faecium</i> BI22	VanA chromosomique	128	128	2	ND
<i>S. aureus</i> T-SAR12	Sensible, van-	0,5	0,5	ND	0,5
<i>S. aureus</i> T-SAR12 VRSA.A	VanA, van+	> 512	> 512	1	>512
<i>S. aureus</i> T-SAR12 VRSA.B	VanB, van+	64	2	2	64
<i>S. aureus</i> 16038*	Intermédiaire, van-	4	4	4	ND

Nous avons montré que la combinaison de la vancomycine et la siamycine permet de traiter une infection à *E. faecalis* V583 (résistante à la vancomycine) dans le modèle animal *G. mellonella* de la même manière que la vancomycine seule traite l'infection *E. faecalis* V583 Δ vanB (sensible à la vancomycine), ce qui confirme que la siamycine permet effectivement de restaurer l'activité de la vancomycine dans le cadre du traitement d'une infection (Figure 13). De manière intéressante, le traitement de l'infection à *E. faecalis* V583 par la siamycine seule permet également d'améliorer la survie des larves, soit grâce à l'effet inhibiteur de la croissance de la siamycine, soit grâce à son effet anti-virulence. Enfin, il convient de noter que l'injection de la siamycine dans les larves n'entraîne pas de mortalité de celles-ci, ce qui montre que la siamycine n'est pas toxique, au moins dans ce modèle animal.

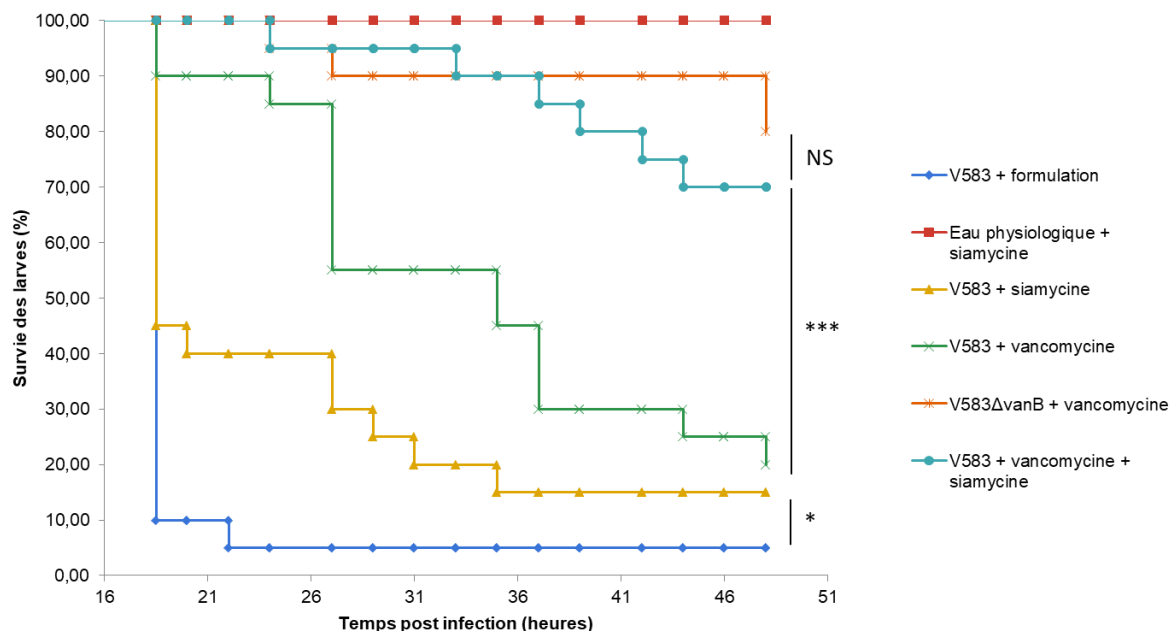

Figure 13 : Courbes de survie de Kaplan-Meier des larves de *G. mellonella* infectées par *E. faecalis* V583 (résistance à la vancomycine) ou V583 Δ vanB (sensible à la vancomycine) ou ayant subi une injection avec de l'eau physiologique. 1h30 et 24h post-infection, les larves sont traitées avec la formulation de la siamycine (nanoémulsion blanche) ou la nanoémulsion chargée avec la siamycine ou de la vancomycine, ou de la vancomycine et la nanoémulsion chargée avec la siamycine.

Chaque lot comprend 20 chenilles. Une différence très significative (***) a été montrée selon le test du logrank ($p = 0,000649$) entre la survie des chenilles dont le traitement de l'infection à V583 a été fait par la vancomycine seule (courbe verte) et celle des chenilles dont l'infection à V583 a été traitée avec la vancomycine et la siamycine (courbe bleu clair). La différence entre la survie des chenilles dont le traitement de l'infection à V583ΔvanB a été fait par la vancomycine seule (courbe orange) et celle des chenilles dont l'infection à V583 a été traitée avec la vancomycine et la siamycine (courbe bleu clair) est non significative ($p = 0.444$). Une différence significative (*) a été montrée selon le test du logrank ($p=0.0486$) entre la survie des chenilles dont le traitement de l'infection à V583 a été fait par la nanoémulsion blanche (courbe bleu foncé) et celle des chenilles dont l'infection à V583 a été traitée avec la siamycine (courbe jaune).

4.6 Mode d'action de l'effet anti-résistance à la vancomycine des PLT1.

La vancomycine inhibe la croissance des bactéries à Gram positif en se liant aux extrémités peptidyl-D-alanyl-D-alanine des précurseurs du peptidoglycane, bloquant leur incorporation dans la paroi cellulaire. Les opérons de gènes *van* qui confèrent la résistance à la vancomycine (exemple sur la Figure 14) codent pour une VanH déshydrogénase qui réduit le pyruvate en D-Lactate, une ligase VanA (VanB pour les opérons *vanB*) qui synthétise le depsipeptide alternatif D-Ala:D-Lac et une D,D-dipeptidase VanX qui hydrolyse le dipeptide D-Ala-D-Ala (Courvalin 2006). En présence de vancomycine, la transcription de ces gènes est activée par le système à deux composants VanS-VanR. Sans vancomycine, le senseur VanS se comporte comme une phosphatase de VanR et les gènes *van* ne sont pas transcrits (Arthur et al. 1997).

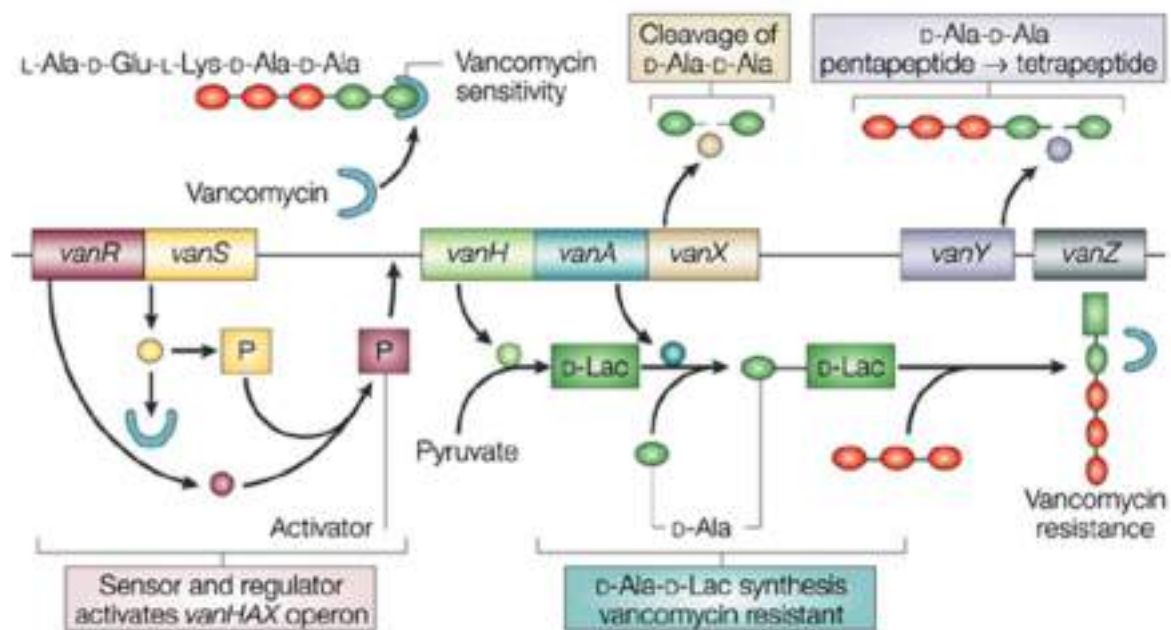

Figure 14 : Représentation du mécanisme de résistance à la vancomycine conféré par le groupe de gènes *vanA*. De Hugues 2003.

En nous basant sur l'observation que la siamycine inhibe l'autophosphorylation de différentes histidines kinases d'*E. faecalis* (Ma et al. 2011), nous avons émis l'hypothèse que les PLT1 bloquaient la résistance à la vancomycine en inhibant le senseur VanS (et/ou le senseur VanS_B dans le cas de l'opéron *vanB*). Cependant, 30 minutes après induction de l'expression de l'opéron *vanB* par la vancomycine, nous n'avons observé aucune répression de l'expression de *vanY_B* par les PLT1 chez *E. faecalis* V583 (Figure 15).

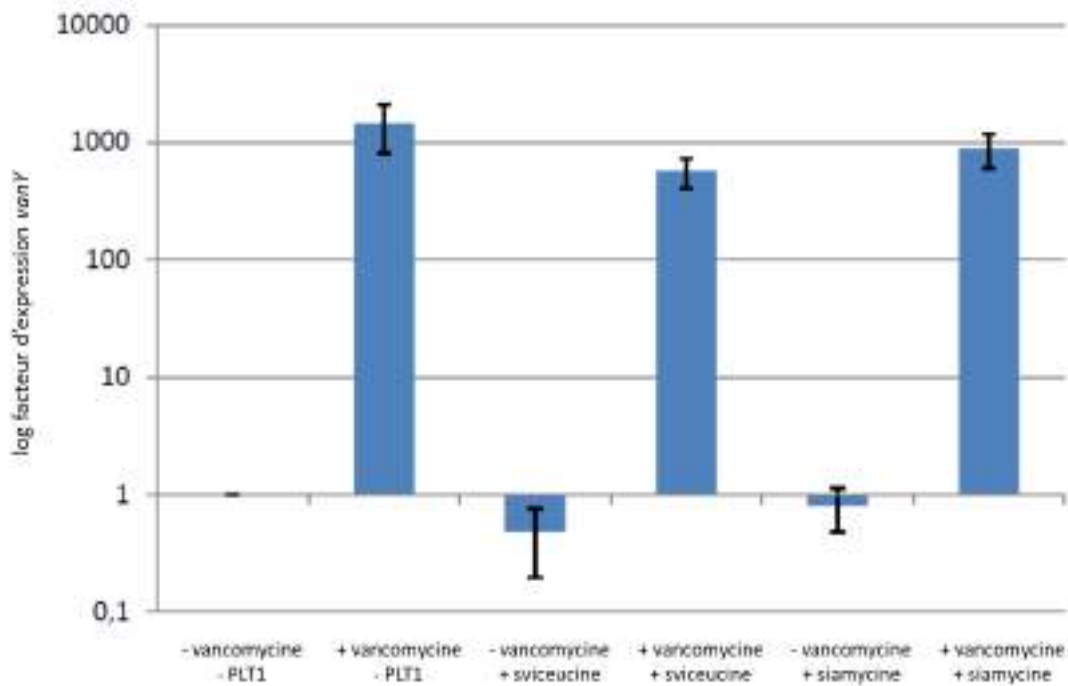

Figure 15 : Effet de 10 μ g/ml de vancomycine et/ou 10 μ M de sviceucine et/ou 2 μ M de siamycine sur la transcription de *vanY_B* chez *E. faecalis* V583, standardisée sur l'expression de *gyrA* et en comparaison du contrôle sans traitement (sans vancomycine, sans PLT1). Extrait de la thèse d'A. Boudrioua.

Néanmoins, des résultats préliminaires semblent indiquer que 10 heures après induction de l'expression de l'opéron *vanB* par la vancomycine, la sviceucine pourrait inhiber l'expression de *vanY_B*, ce qui impliquerait une cinétique lente d'inhibition de VanS_B par la sviceucine (Figure 16). Pour obtenir ce résultat nous devons nous placer dans des conditions sub-inhibitrices, ce qui implique que l'effet observé sera toujours moindre que celui obtenu dans les conditions permettant de resensibiliser totalement les bactéries à la vancomycine.

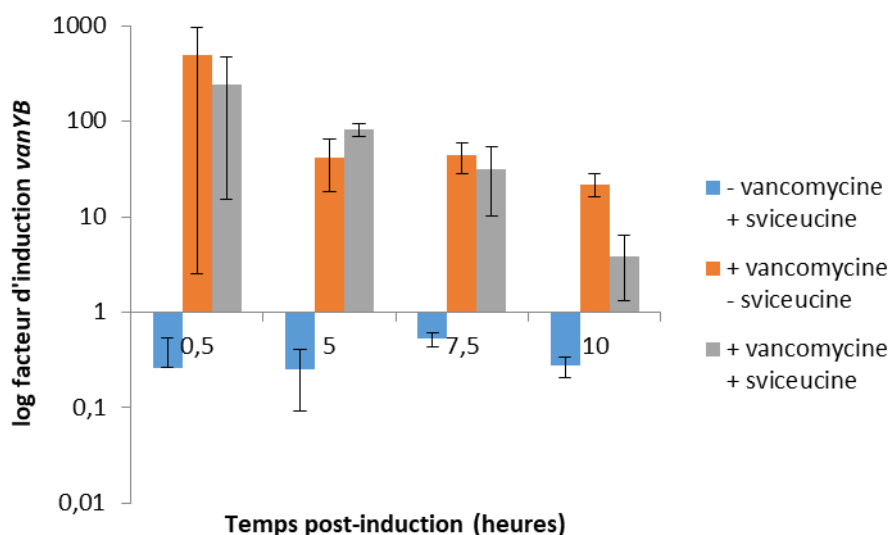

Figure 16 : Effet de 10 μ g/ml de vancomycine et/ou 8 μ M de svicucine sur la transcription de *vanY_B* chez *E. faecalis* V583 30 minutes, 5 heures, 7 heures 30 minutes et 10 heures après induction de l'expression de l'opéron *vanB* par la vancomycine (ou temps équivalents pour le contrôle sans vancomycine). L'expression de *vanY_B* est standardisée sur l'expression de *gyrA* et en comparaison du contrôle sans traitement (sans vancomycine, sans svicucine).

En parallèle de ces études transcriptomiques, nous avons également obtenu deux mutants spontanés d'*E. faecalis* résistants à la vancomycine qui sont insensibles à la sviceucine (mutant C1) et/ou la siamycine (mutant SiaA). Ces mutants ont été obtenus à une fréquence assez faible ($1/10^8$ pour C1 et une fréquence extrêmement faible pour SiaA). De plus, le mutant C1 résistant aux effets de la sviceucine est toujours sensible à l'action de la siamycine, et le mutant SiaA n'est que partiellement résistant à l'action de la siamycine. Ces données indiquent que les PLT1 ne devraient pas susciter d'inquiétudes quant à une apparition potentiellement élevée de résistance bactérienne. Le séquençage global du génome de ces mutants a mis en évidence dans les deux cas une unique mutation située dans la partie du gène *vanS_B* codant pour le domaine HATPase du senseur VanS_B (Figure 17). Ces mutations, S402I pour C1 et D398E pour SiaA, ont été réintroduites dans le génome d'*E. faecalis* V583 et le phénotype de résistance à la sviceucine et/ou la siamycine a pu être reproduit (Tableau 2), ce qui confirme que le senseur VanS_B est probablement la cible des PLT1.

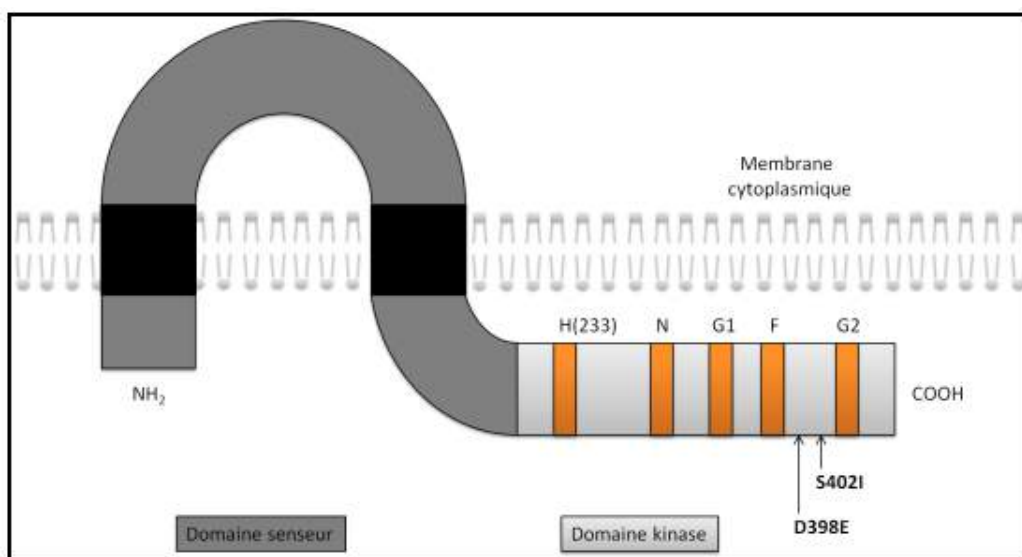

Figure 17 : Représentation schématique du senseur VanS_B d'*E. faecalis*. La localisation des substitutions S402I et D398E observées respectivement chez les mutants C1 et SiaA est indiquée. Noir : segment transmembranaire ; orange : motifs conservés. Adapté d'après Depardieu et al., 2003, extrait de la thèse d'A. Boudrioua.

Tableau 2 : CMI de la vancomycine en absence (Lasso-) ou en présence de 10 μ M de sviceucine (Svic+) ou de 1,5 μ M de siamycine. Extrait de la thèse d'A. Boudrioua.

Souche	CMI de la vancomycine (μ g/ml)		
	Lasso -	Svic +	Sia +
<i>E. faecalis</i> V583	32	4	2
<i>E. faecalis</i> V583 C1	128	128	2
<i>E. faecalis</i> V583 HS _B S402I	64-128	64-128	2
<i>E. faecalis</i> V583 SiaA	128	128	32
<i>E. faecalis</i> V583 HS _B D398E	64-128	64-128	16

Pour confirmer que les senseurs VanS et/ou VanS_B sont effectivement les cibles directes des PLT1 nous avons produit et purifié des protéines recombinantes correspondant aux parties

cytoplasmiques de ces senseurs. La partie cytoplasmique du senseur VanS_B s'est avérée insoluble mais la partie cytoplasmique du senseur VanS a pu être obtenue et l'interaction avec les PLT1 a été confirmée par une approche de « thermal shift assay » (Figure 18). Les constantes de dissociation (Kd) obtenues pour la sviceucine et la siamycine sont respectivement de 51,99µM et 38,01µM, ce qui est en accord avec l'observation que la sviceucine n'a que peu ou pas d'effet *in vivo* sur les souches possédant un opéron *vanA* (et donc un senseur VanS et non VanS_B), contrairement à la siamycine. Nous avons vérifié qu'aucune interaction n'est observée entre VanS et un peptide lasso de type II, la microcine J25, pour lequel aucune activité n'est observée *in vivo* chez *E. faecalis*.

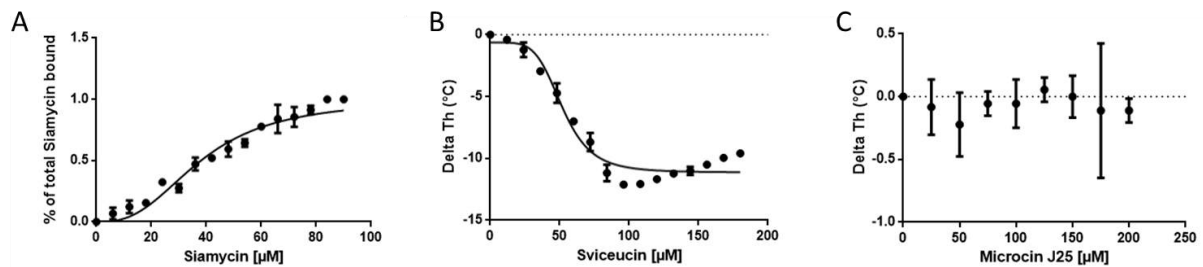

Figure 18 : Interactions de la siamycine (A), sviceucine (B) ou microcine J25 (C) avec la partie cytoplasmique du senseur VanS, évaluées par « thermal shift assay ». A : courbe de régression non linéaire du pourcentage de siamycine liée à VanS en fonction de la concentration de siamycine ; B, C : courbe de régression non linéaire du delta Th de VanS en fonction de la concentration de sviceucine (B) ou de microcine J25 (C).

Enfin, pour confirmer que l'inhibition du senseur VanS est bien responsable d'un défaut de modification du peptidoglycane, nous avons analysé les mucopeptides d'*E. faecalis* V583 et des mutants C1 et SiaA cultivés avec et sans vancomycine et/ou PLT1. En absence de vancomycine et/ou dans un mutant V583Δ*vanB*, uniquement des mucopeptides se terminant par D-Ala-D-Ala sont détectés. La présence de vancomycine entraîne la détection de mucopeptides se terminant par D-Ala-D-Lac de manière plus abondante que ceux se terminant par D-Ala-D-Ala. Chez V583, la présence de PLT1 diminue le ratio D-Ala-D-Lac / D-Ala-D-Ala, ce qui explique probablement la re-sensibilisation de la bactérie à la vancomycine par les PLT1. Cependant, les mucopeptides se terminant par D-Ala-D-Ala sont toujours détectés mais il faut garder en tête que cette expérience est réalisée dans des conditions sub-inhibitrices. Enfin, chez les mutants C1 et SiaA, le ratio D-Ala-D-Lac / D-Ala-D-Ala est augmenté et la présence de PLT1 ne modifie pas ce ratio, ce qui explique probablement la résistance de ces mutants aux PLT1 (exemples Figure 19).

Quantification relative des muropeptides	CMI de la vancomycine
<i>E. faecalis</i> V583 Δ vanB	
	2 µg/ml
<i>E. faecalis</i> V583 WT Van+	
	32 µg/ml
<i>E. faecalis</i> V583 WT Van+ Svic+	
	4 µg/ml
<i>E. faecalis</i> V583 C1 Van+ Svic+	
	128 µg/ml

Figure 19 : Détection et quantification relative des muropeptides extracellulaires d'*E. faecalis* V583 et des mutants V583 Δ vanB et C1, cultivés avec et sans vancomycine (Van) à 2µg/ml et/ou siamycine à 10µM (Svic). Bleu : muropeptides se terminant par D-Ala-D-Ala ; rouge : muropeptides se terminant par D-Ala-D-Lac.

4.7 Conclusion, valorisation et perspectives.

Ce travail a débuté en 2015 et est financé depuis janvier 2020 par le projet ANR LasSoCocci coordonné par Axel Hartke (ANR-19-CE18-0026-01 ; 2020-2024 ; 488,6 k€) dont je suis responsable scientifique. Les résultats obtenus sont le fruit d'une part de la fructueuse collaboration avec l'équipe du Dr Yanyan Li au Museum National d'Histoire Naturelle (publication commune : Li et al. 2015) et, d'autre part, de l'engagement de principalement trois étudiants que j'ai eu ou que j'ai la chance d'encadrer : Abdelhakim Boudrioua, Benjamin Baetz et Solenn Desmadril.

Abdelhakim Boudrioua a commencé à travailler sur ce sujet en 2016 en tant qu'étudiant de master 2 pendant son stage de six mois au laboratoire. J'ai effectué une demande de financement de contrat doctoral auprès de la région Normandie qui a été acceptée, permettant à cet étudiant de poursuivre ce travail durant une thèse qui a été soutenue en novembre 2019. J'ai co-encadré ce doctorat avec le

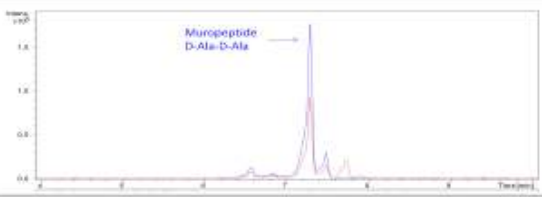
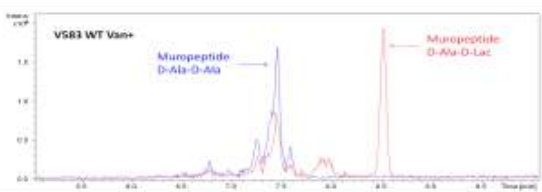
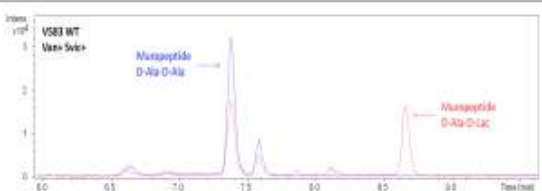
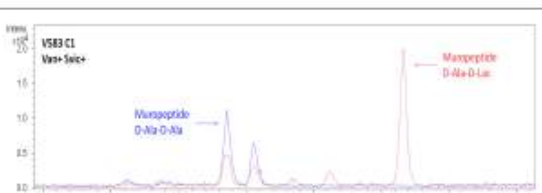
Pr Axel Hartke. Benjamin Baetz a poursuivi le travail d'Abdelhakim Boudrioua lors d'un stage de master 1 en 2019 puis de master 2 en 2020. A la suite de son stage de master 2, Benjamin Baetz a brillamment réussi le concours de l'Ecole doctorale Normande de Biologie intégrative, Santé, Environnement (EdNBISE classement 3/42), ce qui lui a permis de débiter en mars 2021 une thèse que je co-encadre avec Axel Hartke. Enfin, Solenn Desmadril a rejoint en septembre 2021 le projet en tant qu'ingénieure d'études financée par le projet ANR LasSoCocci.

Les potentielles applications des PLT1 comme traitement des infections à bactéries résistantes sont le sujet d'un dépôt de brevet, géré par la société d'accélération de transfert technologique (SATT) Lutech. Un expert a évalué positivement notre projet et la demande de dépôt de brevet est actuellement en cours d'écriture. Les résultats liés à ce projet sont confidentiels et seront publiés dès que le brevet aura été déposé.

Par la suite, nous aurons pour but de comparer les interactions entre différents PLT1 et différents senseurs afin d'établir des relations entre la structure et la séquence des peptides et leur fonction. Ceci nous permettra par « drug design » d'élaborer des peptides modifiés possédant des propriétés alternatives et pouvant cibler différents senseurs. Les systèmes à deux composants contrôlant chez les bactéries plusieurs comportements liés à la virulence, la formation de biofilm et la résistance aux stress et antibiotiques, ceci est une stratégie prometteuse de développement d'antibiotiques non-conventionnels.

5 Blocage de la transition commensal/virulent comme outil de lutte contre *Pseudomonas aeruginosa*.

5.1 Contexte

Sur la liste de l'OMS classant les bactéries pour lesquelles de nouveaux antibiotiques sont nécessaires de toute urgence, *Pseudomonas aeruginosa* résistant aux carbapénèmes est classée comme « critique », la catégorie la plus élevée de la liste. Cette bactérie opportuniste à Gram négatif est un important pathogène nosocomial humain associé aux infections chez les patients immunodéprimés ou souffrant de maladies chroniques comme la mucoviscidose. Elle est capable d'infecter différents sites du corps humain (yeux, plaies, vessie) mais est principalement connue pour être responsable d'infections pulmonaires aiguës. Comme mentionné précédemment, une solution serait l'utilisation de molécules bloquant la virulence sans inhiber la croissance bactérienne. L'identification de telles molécules est rare, bien que son impact soit important (Rasko et Sperandio 2010). En collaboration avec plusieurs équipes dont celle du Dr Yanyan Li au MNHN nous avons identifié des azétidomonamides comme molécules présentant ces propriétés (publication commune : Li et al. 2015).

5.2 Les azétidomonamides sont des atténuateurs de virulence

Nous avons identifié chez *P. aeruginosa* un cluster de gènes (le cluster *azeA-J* ; Figure 20) impliqué dans la biosynthèse de peptides non-ribosomaux appelés azétidomonamides.

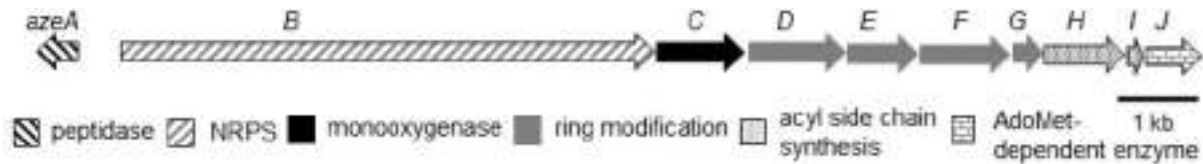

Figure 20 : Représentation du cluster de gènes aze de *P. aeruginosa*.

Une souche de *P. aeruginosa* (AB16.2) qui surexprime ce cluster a été identifiée. La vitesse de croissance de cette souche est réduite (Figure 21 A) et elle est fortement atténuée en virulence dans le modèle insecte *G. mellonella* par rapport à la souche sauvage (Figure 21 B). L'introduction de mutations (notamment la délétion de *azeB*, codant la NRPS) dans des gènes de biosynthèse des azétidomonamides dans cette souche a conduit à une croissance plus rapide (Figure 21 A) et à une restauration de la virulence dans le modèle *G. mellonella* (Figure 21 B). Un résultat similaire a également été obtenu par une autre équipe qui a montré que les souris infectées par un mutant *azel* avaient une charge bactérienne plus élevée dans le modèle d'infection pulmonaire que les souris infectées par la souche sauvage.

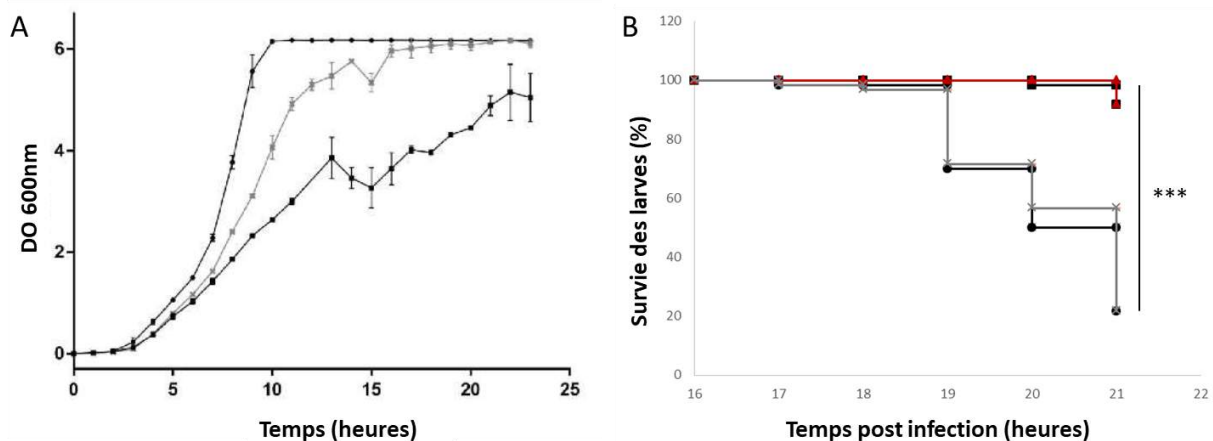

Figure 21 : Rôles fonctionnels des azétidomonamides sur la croissance et la virulence. A : courbe de croissance en LB à 37°C. B : Courbes de survie de Kaplan-Meier des larves de *G. mellonella* infectées par *P. aeruginosa*. Les résultats représentent les valeurs moyennes de trois expériences indépendantes pour lesquelles une différence significative a été montrée selon le test du logrank avec correction Bonferroni ($p < 0,001$). Cercles noirs : PAO1 ; carrés noirs : AB16.2 ; croix grises : AB16.2ΔazeB ; triangles rouges : AB16.2ΔazeA.

Ces données identifient clairement les azétidomonamides comme molécules impliquées dans l'atténuation de la virulence de *P. aeruginosa*, probablement via la modulation de la croissance. Ce mécanisme permettrait d'établir une relation stable à long terme avec l'hôte, comme dans les situations où *P. aeruginosa* se comporte comme un commensal inoffensif. Ces propriétés font des azétidomonamides des candidats parfaits pour le développement d'antibiotiques non conventionnels car cela rendrait les bactéries non virulentes sans pression sélective car les azétidomonamides ne présentent pas d'activités antibactériennes sur diverses bactéries Gram-positives ou Gram-négatives.

5.3 La peptidase AzeA dégrade l'azétidomonamide A pour déclencher la virulence

Nous avons pu identifier deux azétidomonamides, appelés azétidomonamide A (azA) et azétidomonamide B (azB) (Figure 22).

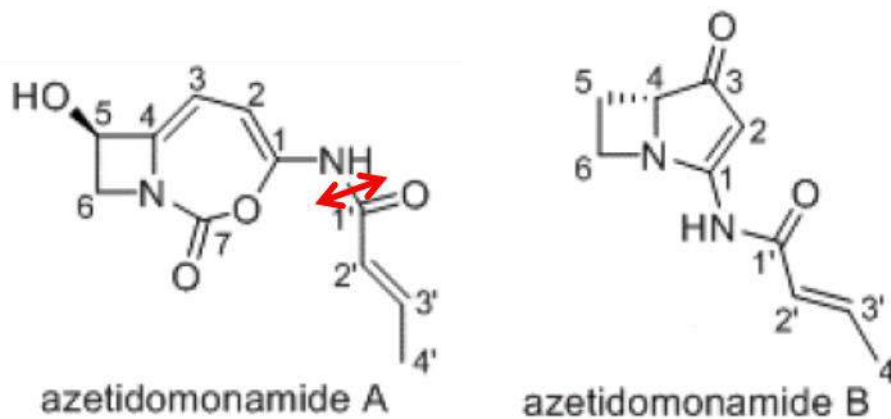

Figure 22 : Structures de azA et azB, respectivement. L'hydrolyse de azA par AzeA est indiquée par une flèche rouge.

Contrairement à azB, azA semble être le produit final du cluster biosynthétique, car sa synthèse implique toutes les enzymes Aze. Le cluster aze est organisé en deux unités transcriptionnelles divergentes, azeA et azeB-J (Figure 20). Alors que les enzymes AzeB-J sont nécessaires à la biosynthèse des azetidomonamides, AzeA est une peptidase capable de dégrader azA en hydrolysant la liaison amide de la chaîne latérale (Figure 22). Fait intéressant, nos résultats préliminaires montrent des profils de virulence opposés dans le modèle *G. mellonella* pour les mutants *azeA* et *azeB*. Le mutant *azeB*, qui ne peut pas synthétiser les azetidomonamides, est plus virulent, tandis que le mutant *azeA*, qui produit toujours des azetidomonamides mais ne peut pas dégrader azA, est moins virulent. Ces résultats indiquent donc vraisemblablement que azA est une molécule anti-virulence que *P. aeruginosa* synthétise au début de l'infection pour permettre la colonisation de l'hôte. Plus tard dans le processus de l'infection, la peptidase AzeA est produite pour dégrader azA et déclencher le processus de virulence. Une version non dégradabile d'azA a le potentiel d'être une nouvelle molécule thérapeutique anti-virulence agissant spécifiquement contre *P. aeruginosa*.

5.4 Conclusion, valorisation et perspectives.

Ce travail est issu principalement de la collaboration entre l'équipe du Dr Katy Jeannot au CHRU de Besançon qui a identifié le mutant AB16.2, celle du Dr Yanyan Li au Museum National d'Histoire Naturelle qui a caractérisé les azetidomonamides et notre équipe qui a réalisé les tests de virulence chez *G. mellonella* (publication commune : Hong et al. 2019). A cette occasion, Yoann Nègre, étudiant de master 2 que j'encadrais alors, a participé ponctuellement à ces expériences et figure dans les remerciements de la publication.

Les perspectives de ce projet résident en la caractérisation plus avancée de la production et des fonctions d'azA chez *P. aeruginosa*, ainsi que la compréhension de son mode d'action. Enfin, l'objectif final serait la synthèse d'une version non dégradabile d'azA, qui constituerait une première étape vers une application potentielle de ces composés comme traitement contre des infections par *P. aeruginosa* multirésistante aux antibiotiques. Ce projet a été présenté lors de l'appel à manifestation d'intérêt « antibiorésistance » organisée par l'agence nationale de la recherche en 2020 (voir la section « perspectives »).

6 Exploration du potentiel anti-microbien et d'ingénierie du microbiote d'un peptide dérivé d'une bactérie commensale

6.1 Contexte

L'intestin représente un réservoir pour la plupart des pathogènes pouvant causer des infections invasives (Tacconelli et al. 2017). On retrouve parmi ces pathogènes de nombreuses souches multirésistantes aux antibiotiques pour lesquelles de nouveaux traitements doivent être urgemment développés. Or, dans l'intestin la flore commensale va entrer en compétition avec ces pathogènes et limiter leur développement. Cette compétition peut être permise par la capacité de certaines bactéries à produire des peptides antimicrobiens et le microbiote peut donc être considéré comme un réservoir de molécules thérapeutiques potentielles.

Parmi les constituants de la flore commensale intestinale de l'homme et des mammifères se trouve *E. faecalis*. Cette bactérie présente de multiples facettes puisque certaines souches sont considérées comme probiotiques, tandis que d'autres vont être à l'origine d'infections telles que des endocardites, péritonites ou des infections urinaires. On retrouve chez cette bactérie une forte proportion d'isolats multi-résistants aux antibiotiques et en particulier à la vancomycine, un antibiotique utilisé classiquement en dernier recours, ce qui classe *E. faecalis* parmi les pathogènes nosocomiaux les plus problématiques.

Des études ont montré qu'*E. faecalis* présente un potentiel intéressant en termes de production de molécules permettant de lutter contre des pathogènes, y compris *E. faecalis* elle-même. Certaines souches produisent en effet des bactériocines (peptides antimicrobiens d'origine bactérienne) permettant de combattre la levure pathogène *Candida albicans*, et en particulier d'inhiber sa virulence (Graham et al. 2017), ou encore de favoriser sa compétition avec d'autres souches d'*E. faecalis* ne produisant pas de bactériocine (Kommineni et al. 2015).

En collaboration avec l'équipe du Dr Yanyan Li au MNHN et celle du Pr Nathalie Leblond à l'INRA, nous avons identifié un cluster de biosynthèse de peptide lasso dans le génome de plusieurs souches d'*E. faecalis*. Etant donné les caractéristiques intéressantes des peptides lasso et l'écologie d'*E. faecalis*, ce peptide présente un potentiel prometteur. Il pourrait en effet être utilisé pour lutter contre les entérocoques résistants, et en particulier pour décontaminer le tube digestif d'entérocoques résistants à la vancomycine de certains patients pour prévenir les risques d'infections par ces pathogènes problématiques.

6.2 Caractérisation du cluster *las* in silico

La recherche de clusters de gènes de biosynthèse de peptides lasso (BGC) par bioinformatique révèle la présence d'un cluster *lasACB1B2DEFG* dans le génome de 222 souches d'*E. faecalis*. Ce cluster est un élément génétique intégré car il est toujours borné par des séquences répétées DR *attL* et DR *attR*. Les éléments génétiques intégrés peuvent être de trois types :

1. ICE (integrative and conjugative element) : on retrouve dans cet élément un module de transfert (qui peut être un phage ou un système de conjugaison), un module de recombinaison (intégrase) et il est borné par des séquences répétées.
2. MGE (mobile genetic element) : cet élément ne possède pas de module de transfert (ou il est très dégénéré) mais il présente d'un module de recombinaison et il est borné par des séquences répétées.

3. CIME (*cis*-mobilizable element) : cet élément est borné par des séquences répétées mais on ne retrouve ni module de transfert, ni module de recombinaison.

La séquence DR *attL* bornant le cluster *las* est située aux alentours du gène *polC* et la séquence DR *attR* est située en 3' du gène *sufB* (Figure 23). La mesure de la distance entre *polC* et *sufB* montre des tailles variables dans ces souches, comprise entre 23,912 et 106,516 kb, et permet de mettre en évidence 9 contextes génétiques différents (Tableau 3). Pour la majorité de ces souches (173 souches sur 222), la distance entre *polC* et *sufB* est inférieure à 25kb et le cluster *las* est situé dans un CIME puisque on ne retrouve ni module de recombinaison, ni module de transfert (phage ou système de conjugaison) entre les séquences répétées. Ce CIME ne porte que le cluster *las*, à l'exception d'un gène codant une protéine de fixation de l'ATP et d'un pseudogène. Dans le reste des souches, le cluster *las* est également porté par le CIME, auquel est accolé un MGI (6 MGI différents dont un dans lequel un phage s'est intégré) ou un ICE (deux différents).

Tableau 3 : différents contextes génétiques portant le cluster *las* chez les 222 souches d'*E. faecalis* possédant ce cluster.

Contexte génétique	Nombre de souches concernées	Distance <i>sufB</i> - <i>polC</i>	Type d'élément génétique
1	173/222 (dont souche D6 et TX0470)	<25 kb	cluster <i>las</i> porté par un CIME
2	22/222 (dont souche TX2134)	35,458 kb	<i>sufB</i> – MGI1 (Tyr integrase) – CIME <i>las</i>
3	1/222	36,734 kb	<i>sufB</i> – MGI2 (Tyr integrase) – CIME <i>las</i>
4	12/222	38,284	<i>sufB</i> – MGI3 (Tyr integrase) – CIME <i>las</i>
5	1/222	42,673	<i>sufB</i> – MGI4 (Tyr integrase) – CIME <i>las</i>
6	4/222	54,439	<i>sufB</i> – MGI5 (Tyr integrase) – CIME <i>las</i>
7	1/222	54,921	<i>sufB</i> – ICE1 (système de conjugaison et Tyr integrase) – CIME <i>las</i>
8	6/222	60,761	<i>sufB</i> – ICE2 (système de conjugaison et Tyr integrase) – CIME <i>las</i>
9	1/222 (souche ATCC 4200)	106,515	<i>sufB</i> – MGI (Tyr integrase) dans lequel est intégré un phage - CIME <i>las</i>

Le cluster *las* est ainsi acquis par transfert horizontal et confère certainement un avantage sélectif aux souches correspondantes. L'organisation des gènes *las* peut être comparée à celle du cluster codant la biosynthèse de la nisine, un RiPP d'intérêt bien caractérisé produit par la bactérie à Gram positif *Lactococcus lactis* (Lubelski et al. 2008). Bien que la nisine ne soit pas un peptide lasso mais un lantipeptide, on retrouve une similarité fonctionnelle entre ces deux systèmes qui rend leur rapprochement pertinent (Arnison et al. 2013). On retrouve en effet dans chaque cas des gènes codant un précurseur, des enzymes de modifications post-traductionnelles, un transporteur, un système d'immunité et d'export (ABC transporteur) et un système de régulation à deux composants.

Au sein du cluster *las* (Figure 23), *lasA* code le précurseur du peptide lasso, *lasC* code la macrolactame synthase permettant de cycliser le peptide, *lasB1* code la protéine reconnaissant le peptide leader du précurseur (protéine à domaine RRE pour RiPP Recognition Element), tandis que *lasB2D* est vraisemblablement une fusion d'un gène codant la peptidase permettant de cliver le peptide leader du précurseur (*lasB2*) et d'un gène codant un ABC transporteur permettant l'export

du peptide (*lasD*). La fusion de la peptidase et de l'ABC transporteur suggère une maturation couplée à l'export du peptide, ce qui est inédit pour un peptide lasso. Les gènes *lasE*, *lasF* et *lasG* codent les sous-unités d'un autre ABC transporteur qui pourrait être impliqué dans l'immunité de la souche productrice au peptide. La présence d'un système de maturation conjointe à l'export ainsi que d'un système d'immunité suppose une toxicité du peptide pour la souche productrice, ce qui laisse présager d'une activité du peptide sur des souches d'entérocoques.

Un terminateur est présent entre le gène codant le précurseur et les gènes permettant la synthèse et l'export du peptide, sans que l'on détecte par bioinformatique un second promoteur entre ces gènes. Cette caractéristique est retrouvée dans d'autres opérons codant des peptides antimicrobiens, y compris la nisine, et donne lieu à des mécanismes de régulation jouant un rôle important dans la production du peptide.

Enfin, des gènes codant un système à deux composants (TCS) sont retrouvés à côté de l'opéron *las* et il est probable que ce système régule l'expression de cet opéron. Les TCS sont constitués d'un senseur (ici LskK) qui perçoit des signaux environnementaux, ce qui conduit à une autophosphorylation d'un résidu histidine conservé. Le phosphate est ensuite transmis à un régulateur de réponse (ici LasR) au niveau d'un résidu aspartate également conservé. Cette phosphorylation active le régulateur qui va classiquement se fixer à l'ADN pour réguler des gènes cibles.

La présence d'une protéine bifonctionnelle B2/D est caractéristique d'un sous-clade de clusters de BCG retrouvés principalement chez les Firmicutes et qui a été mis à jour lors d'une campagne de génome mining précédente (Tietz et al. 2017). Ces clusters sont souvent retrouvés chez des bactéries appartenant aux microbiotes humains ou animaux, et qui peuvent être des bactéries commensales ou pathogènes. Outre les protéines de biosynthèse du peptide lasso, on retrouve communément dans ces clusters à la fois les gènes codant le système de régulation et ceux codant le système d'immunité.

Parmi ces clusters, celui de *Streptococcus suis* LSS65 a été plus particulièrement caractérisé dans l'étude de Hegemann et collaborateurs (Hegemann et al. 2021). Ce cluster code deux précurseurs de peptides lasso et les auteurs ont réussi à produire l'un d'eux, la cochonodin I, par production hétérologue chez *E. coli* et à confirmer son architecture en lasso.

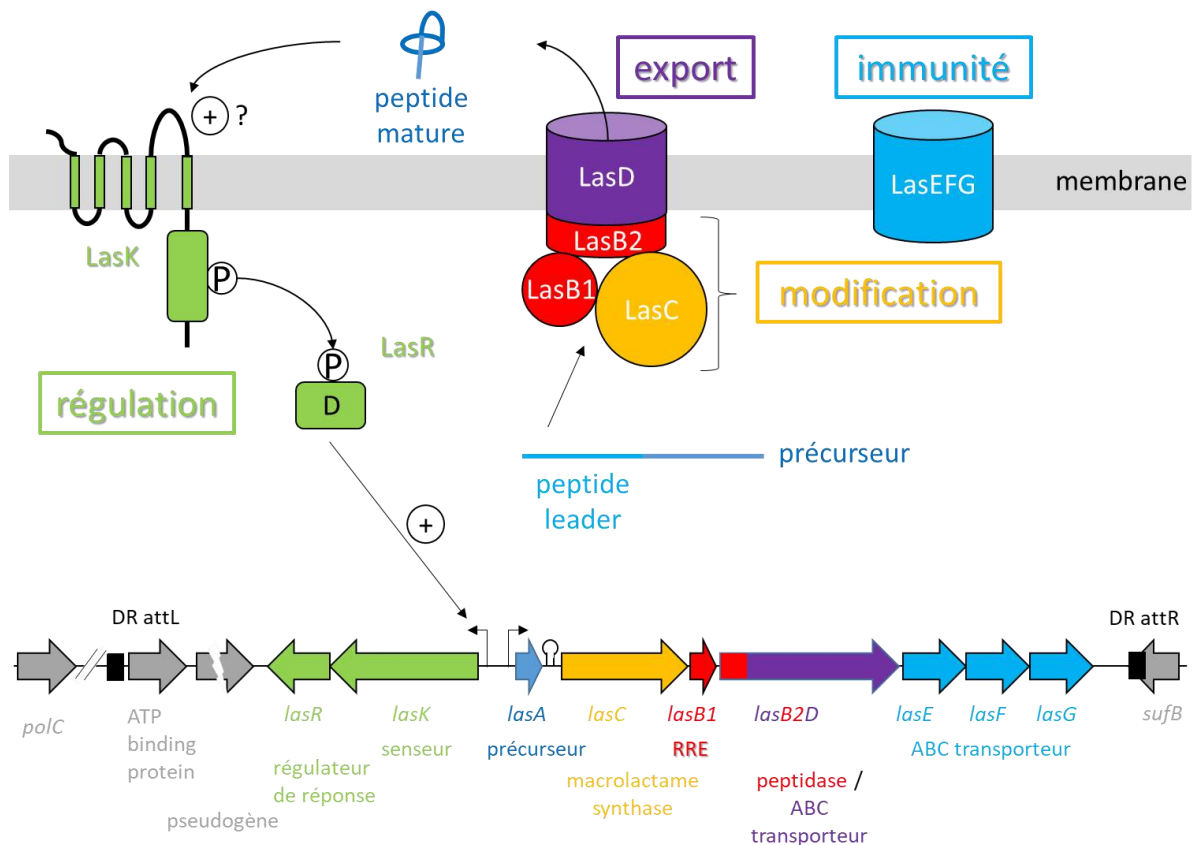

Figure 23 : Représentation schématique du cluster de gènes *las* et du système de biosynthèse correspondant. Les gènes sont représentés sous forme de flèches et les fonctions des protéines correspondantes sont indiquées en dessous. Au-dessus, modèle représentant les systèmes de régulation, de modifications post-traductionnelles, d'export et d'immunité du peptide lasso. Le peptide est synthétisé sous forme d'un précurseur codé par le gène *lasA*. Ce précurseur va être modifié par les enzymes *LasB* et *LasC* et exporté par l'ABC transporteur *LasD*. L'ABC transporteur *LasEFG* pourrait permettre l'immunité au peptide tandis que le TCS *LasKR* pourrait réguler l'expression des gènes *las*. Les séquences répétées ayant permis l'insertion du CIME sont indiquées (rectangles noirs).

6.3 Obtention de l'expression du cluster *las*.

Malgré le bon potentiel thérapeutique des peptides lasso, le principal défi dans le développement de ces molécules en tant que médicaments consiste à trouver les conditions permettant leur étude et leur production. Nos résultats préliminaires montrent que le cluster *las* est effectivement silencieux dans diverses conditions de laboratoire. L'expression hétérologue des gènes de biosynthèse des peptides lasso donne généralement lieu à des taux de production assez faibles (communication personnelle Yanyan Li), ce qui a notamment freiné l'investigation de l'activité biologique de la cochonodin I par Hegemann et collaborateurs (Hegemann et al. 2021).

Nous avons donc opté pour une approche fondée sur la compréhension de la biologie de l'organisme producteur. En effet, ces clusters de gènes de biosynthèse ne sont souvent exprimés que dans des conditions dans lesquelles la production de ce métabolite confèrera un avantage sélectif au producteur. Des analyses métatranscriptomiques ont effectivement montré l'expression de BCG comprenant un gène *lasB2D* chez *Ruminococcus albus* 8 dans le microbiote du rumen de moutons (Sabino et al. 2020). Le TCS à proximité du cluster *las* est probablement responsable de la détection de ces conditions et de l'activation subséquente de l'expression de l'opéron *las*. Il est particulièrement difficile d'identifier le signal exact perçu par le senseur et même dans le cas dans lequel ces conditions seraient connues, elles peuvent être difficiles à mettre en œuvre en laboratoire.

Nous avons donc choisi d'insérer dans le génome de souches cibles une version du gène *lasR* codant une version constitutivement active du régulateur LasR (que nous appellerons LasRDE). Ceci est obtenu en remplaçant l'aspartate conservé du régulateur par un glutamate, ce qui permet de mimer la phosphorylation. Ce gène *lasRDE* est placé sous le contrôle du promoteur *Ptuf*, un promoteur constitutif d'*E. faecalis*. Nous avons également construit des souches dans lesquelles le promoteur endogène de *lasA* est remplacé par le promoteur *Ptuf*, et des souches présentant les deux modifications, dans le cas où la biosynthèse du peptide nécessiterait à la fois l'expression du cluster *las* et celle de gènes du génome cœur de la bactérie qui seraient activés par LasR.

Nos résultats montrent que la présence du régulateur LasRDE permet effectivement l'expression du cluster *las*, et donc la levée du principal verrou scientifique et technique à l'étude de ce peptide lasso.

6.4 Conclusion, valorisation et perspectives.

Ce travail qui vient de débiter est issu de la découverte du cluster *las* par genome mining chez 48 souches d'*E. faecalis* par Yanyan Li du Museum National d'Histoire Naturelle. Un projet de recherche associé a été présenté lors de l'appel à manifestation d'intérêt « antibiorésistance » organisée par l'agence nationale de la recherche en 2020 (voir la section « perspectives ») et nous a permis de rencontrer Nathalie Leblond de l'INRA de Nancy qui a étendu la première analyse *in silico* et a défini le contexte génétique du cluster. J'ai pu encadrer Solenn Desmadril sur ce sujet de janvier à juin 2021.

L'objectif de ce projet est de réussir à produire et caractériser ce peptide lasso et d'explorer son potentiel en tant que peptide anti-microbien ayant une activité probable sur *E. faecalis*. Le but final serait d'utiliser ce peptide pour décoloniser l'intestin de patients des entérocoques résistants à la vancomycine.

Perspectives

L'explosion alarmante d'infections causées par des bactéries multirésistantes est une menace majeure pour la santé humaine dans le monde. L'OMS met en garde contre une «ère post-antibiotique», dans laquelle les bactéries deviendront résistantes à tous les antibiotiques existants et les infections courantes tueront à nouveau. Malgré ce besoin urgent de nouveaux antibiotiques, peu de molécules sont introduites, et la recherche tend à redécouvrir des molécules déjà connues. Dans ce contexte, je souhaite orienter mes recherches vers la découverte de nouvelles molécules alternatives aux antibiotiques, ainsi qu'à l'élucidation de leurs modes d'action, souvent différents des antibiotiques classiques. Pour cela, je souhaite mener à bien trois projets, qui sont déjà en cours au laboratoire CBSA et dont les premiers résultats sont décrits précédemment : il s'agit de l'étude des PLT1, des azétidomonamides et du peptide lasso d'*E. faecalis*. Pour les deux premiers projets, il s'agit de molécules bloquant la virulence des bactéries pathogènes sans action bactéricide, ce qui diminue les risques d'apparition de résistances. Dans le cas des PLT1, ces molécules peuvent également être associées à la vancomycine pour permettre l'action de cet antibiotique malgré les résistances bactériennes. Le troisième projet que je souhaite mener vient de débiter mais vise également à l'exploration du potentiel thérapeutique de ce nouveau peptide lasso.

1 Suppression de la virulence et de la résistance aux antibiotiques de pathogènes Gram-positifs majeurs par des peptides lasso (travail confidentiel).

Nous avons pu mettre en évidence les effets remarquables des PLT1 en tant qu'inhibiteurs de la virulence et de la résistance à la vancomycine sur les entérocoques et staphylocoques. A ce stade du projet, il nous reste deux objectifs à atteindre. Nous effectuons ce travail en collaboration avec l'équipe du Dr Yanyan Li du MNHN et nous sommes financés par l'ANR (488,6 k€) et la SATT Lutech (402,8k€).

Objectif 1 : compréhension du mode d'action des PLT1 : caractérisation des interactions peptide - cibles protéiques.

Nous souhaitons comprendre le mode d'action de ces peptides et caractériser en profondeur leurs interactions avec leurs cibles protéiques. Nous avons mis en évidence que les PLT1 ciblent les senseurs de différents TCS associés à la virulence et à la résistance à la vancomycine des entérocoques et staphylocoques. Nous avons purifié ces senseurs et nous allons caractériser leurs interactions avec les PLT1 par résonance plasmonique de surface et/ou titrage calorimétrique isotherme. Nous allons comparer les constantes de liaison des différents PLT1 dont nous disposons avec ces différents senseurs et relier ces données aux informations obtenues *in vivo*. Ceci nous informera sur la spécificité d'inhibition des PLT1 et nous guidera dans l'étude des relations structure-fonction que nous prévoyons dans notre second objectif.

Il est possible que les PLT1 aient d'autres cibles cellulaires que les senseurs des TCS. Pour connaître l'ensemble de ces cibles, nous allons utiliser une méthode de pull down et spectrométrie de masse. Les nouvelles cibles découvertes seront caractérisées par des approches *in vivo* (construction

mutants et analyse phénotypique) et *in vitro* (études d'interaction similaires à celles utilisées pour les senseurs).

Objectif 2 : création de peptides modifiés et définition du consensus de la séquence active.

Les PLT1 sont synthétisés à partir d'un précurseur codé par un gène qui est soumis à des modifications par des enzymes de maturation. Ceci permet une mutagenèse sur le gène précurseur qui conduira à la production de peptides variants. Nous allons générer une banque de mutants des PLT1 et tester leurs activités anti-virulence et anti-résistance sur les entérocoques et *S. aureus*. Ceci nous permettra de définir la séquence consensus responsable de l'activité des peptides qui sera protégée par un brevet.

Nous allons également créer des hybrides des différents PLT1 dans le but d'obtenir des peptides aux propriétés modulées. Les structures 3D des variants avec les activités les plus intéressantes seront déterminées par RMN et modélisation moléculaire. Nous établirons ainsi des relations entre la séquence des peptides, leur structure et leur fonction biologique. Cette étude ouvrira la perspective de peptides de lasso rationnellement conçus avec un intérêt thérapeutique.

2 Blocage de la transition commensal/virulent comme outil de lutte contre *Pseudomonas aeruginosa*.

Nos premiers résultats ont mis en évidence le potentiel thérapeutique des azétidomonamides en tant que molécules anti-virulence agissant spécifiquement contre *P. aeruginosa*. Nous avons pu identifier deux azétidomonamides, appelés azétidomonamide A (azA) et azétidomonamide B (azB). Contrairement à azB, azA semble être le produit final du cluster biosynthétique, car sa synthèse implique toutes les enzymes Aze. C'est donc sur cette molécule que nous concentrerons nos efforts. L'objectif principal sera d'explorer l'utilité potentielle d'azA en tant que nouvelle molécule thérapeutique anti-virulence contre *P. aeruginosa*. Pour cela, nous allons collaborer avec l'équipe du Dr Yanyan Li du MNHN et le Dr Sébastien Prévost de l'ENSTA/Ecole Polytechnique. Plus spécifiquement, notre programme de recherche sera le suivant :

- 1: Nous allons d'abord effectuer une analyse complète de la production et des fonctions d'azA chez *P. aeruginosa*.
- 2: Nous décrypterons le mode d'action d'azA, probablement différent de celui des antibiotiques conventionnels. Ces connaissances sont essentielles pour son développement en tant que médicament et ces études pourraient conduire à la découverte de nouvelles voies pouvant être ciblées pour la thérapie antibactérienne.
- 3: Nous synthétiserons une version non dégradable d'azA et rechercherons en parallèle un inhibiteur de la protéase AzeA. Nous testerons les propriétés anti-virulence de ces composés sur *P. aeruginosa*, ce constituera une première étape vers une application potentielle de ces composés comme traitement contre des infections par ces pathogènes multirésistants aux antibiotiques.

Objectif 1 : Analyse de la production et des fonctions d'azA chez *P. aeruginosa*.

Nous soupçonnons que azA est d'abord produit grâce à l'activité des enzymes AzeB-J, puis que la protéase AzeA est produite pour cliver azA. Le modèle d'expression des gènes *aze* correspondant

impliquerait un profil opposé pour les deux unités de transcription divergentes *azeA* et *azeB-J*, avec *azeB-J* étant d'abord exprimé au début de l'infection pour permettre la production d'azA. Ces gènes seraient alors réprimés, tandis que le gène *azeA* serait induit afin de permettre la dégradation d'azA lorsque la bactérie est prête à passer en mode de virulence. Ainsi, pour vérifier cette hypothèse, nous étudierons la cinétique de l'expression des gènes *azeA* et *azeB* par qRT-PCR dans des conditions de laboratoire et au cours de l'infection des larves de *G. mellonella*.

Comme azA et azB ont été identifiés comme des produits du cluster de biosynthèse aze, nous vérifierons que azA est bien la molécule porteuse des propriétés anti-virulence. Pour ce faire, nous allons construire un double mutant *azeA-azeB* qui n'est donc capable ni de synthétiser ni de dégrader les azétidomonamides. Nous testerons son profil de virulence dans le modèle *G. mellonella* et analyserons l'impact d'azA et azB purifiés, ainsi que d'azA traité par AzeA sur la virulence de *P. aeruginosa*. De plus, nous testerons les effets des deux azétidomonamides sur la croissance bactérienne car ils semblent également affecter ce paramètre. Les molécules testées seront produites par fermentation et purifiées par l'équipe du Dr Yanyan Li qui a déjà réalisé précédemment ces purifications. Ces expériences consolideront notre hypothèse basée sur l'interprétation des résultats obtenus avec des mutants *azeA* et *azeB* qui est qu'azA est en effet une molécule anti-virulence inactivée par la protéase AzeA.

Objectif 2 : Etude du mode d'action des azétidomonamides.

Les azétidomonamides sont susceptibles d'utiliser un mécanisme original pour atténuer la virulence. La compréhension du mode d'action correspondant peut révéler une nouvelle voie moléculaire qui peut être ciblée par une thérapie antibactérienne. Comme la virulence résulte d'une combinaison complexe de différents facteurs, nous analyserons l'effet d'azA sur l'expression globale des gènes de *P. aeruginosa* par séquençage d'ARN (RNAseq). De plus, pour identifier la cible directe d'azA, nous utiliserons une approche de pull-down couplée à l'identification des protéines par spectrométrie de masse. Certains alcaloïdes bicycliques ont été décrits comme des inhibiteurs de protéines, il est donc concevable que azA puisse interagir directement avec une protéine. L'équipe du Dr Yanyan Li produira et purifiera différentes versions d'azA contenant des groupes fonctionnels de photo cross-link (comme l'azide ou le diarizine) en nourrissant *P. aeruginosa* avec des acides aminés modifiés. Nous testerons l'activité de ces versions d'azA et les versions actives seront utilisées pour les expériences de pull-down. Les cibles protéiques identifiées par cette méthode seront ensuite validées par des approches *in vivo* (construction mutants et analyse phénotypique) et *in vitro* (études d'interaction protéine-azA).

Objectif 3 : Stratégies anti-virulence : versions non hydrolysables d'AzA et inhibiteurs de la protéase AzeA.

Afin d'exploiter le potentiel thérapeutique des azétidomonamides en tant que molécules anti-virulence agissant contre *P. aeruginosa* nous allons opter pour deux stratégies que nous mènerons en parallèle.

La première stratégie consistera à synthétiser différentes versions non hydrolysables d'azA dans lesquelles la liaison amide sera remplacée par synthèse chimique et/ou enzymatique par le Dr Prévost. Nous vérifierons que ces versions modifiées d'azA ont encore des propriétés anti-virulence sur un mutant *azeA-azeB* de *P. aeruginosa*. Ensuite, nous testerons leurs activités sur la virulence de

P. aeruginosa sauvage, en utilisant un modèle *G. mellonella* dans un premier temps. Un modèle souris sera envisagé par la suite si les premiers résultats s'avèrent prometteurs.

La seconde stratégie consistera à rechercher des inhibiteurs de la protéase AzeA. Comme suggéré par les travaux préliminaires, cette peptidase serait un acteur clé dans la transition de *P. aeruginosa* vers un état virulent. Il est par conséquent concevable que l'inhibition d'AzeA soit une stratégie d'anti-virulence prometteuse. La caractérisation biochimique d'AzeA sera effectuée *in vitro* en utilisant la protéine recombinante. Les paramètres cinétiques de la réaction seront déterminés. Afin de faciliter le criblage des inhibiteurs d'AzeA de manière haut débit, une sonde fluorescente mimant le substrat d'AzeA sera développée et synthétisée par le Dr Prévost comme décrit précédemment. Les chimiothèque et extratothèque hébergées dans l'unité du Dr Li seront criblées dans un premier temps. Le criblage sera étendu aux autres chimiothèques nationales. Les inhibiteurs ainsi identifiés seront testés pour leurs effets anti-virulence *in vitro* et *in vivo* dans le modèle *G. mellonella*.

3 Exploration du potentiel anti-microbien et d'ingénierie du microbiote d'un peptide dérivé d'une bactérie commensale

Bien que les entérocoques fassent partie de la microflore intestinale, deux espèces, *E. faecalis* et *E. faecium*, sont aussi des causes courantes d'infections nosocomiales. La prévention ou la limitation de la colonisation gastro-intestinale serait un moyen efficace pour prévenir l'infection par ces pathogènes problématiques. Nous avons récemment découvert par une approche de "genome mining" la présence d'un cluster de gènes de biosynthèse (nommé cluster *las*) d'un peptide lasso (PL) que nous nommerons ici PLEnt sur le génome de certaines souches d'*E. faecalis*. Aucune de ces souches n'est résistante à la vancomycine. Le cluster *las* code également pour un système d'immunité qui conférerait à ces souches productrices une protection contre le PLEnt. Il est donc fort probable que le PLEnt synthétisé par ces souches soit actif contre des entérocoques ne portant pas le système de biosynthèse de PL. Si cela s'avère le cas, le PLEnt aurait le potentiel d'une application très intéressante visant à décontaminer le tube digestif d'entérocoques résistants à la vancomycine (VRE) de certains patients pour prévenir les risques d'infections par ces pathogènes problématiques. Nous avons trois objectifs de travail et pour les atteindre, nous allons collaborer avec l'équipe du Dr Yanyan Li du MNHN.

Objectif 1 : Production, purification et caractérisation du PLEnt.

Le principal défi pour explorer les activités anti-microbiennes du PLEnt consiste à trouver des conditions permettant sa production. Nos résultats préliminaires montrent que le cluster *las* est effectivement silencieux dans diverses conditions de laboratoire. Nous avons cependant pu obtenir l'expression du cluster *las* en modifiant le gène codant le régulateur LasR retrouvé à côté de l'opéron *las* et qui s'avère le réguler. Grâce à cette souche modifiée, le Dr Li produira, purifiera et caractérisera la structure du LPEnt. Nous testerons ensuite l'activité du peptide sur différentes bactéries pathogènes et en particulier sur des VRE. En plus des tests classiques d'activité antibactérienne, nous testerons également la capacité du PLEnt à interférer avec la virulence, la formation de biofilms et la résistance aux antibiotiques.

Objectif 2 : Mode d'action du PLEnt.

Parmi les PL étudiés jusqu'à présent, beaucoup ont des modes d'action originaux. Pour identifier les protéines cibles du peptide, nous commencerons par une approche pull down couplée à une analyse

protéomique. Une fois les cibles identifiées, les interactions correspondantes seront étudiées *in vivo* et *in vitro*. Nous allons également générer des variants du PLEnt qui seront utilisés pour effectuer des études de relation structure-activité et concevoir un nouveau PL avec des activités modulées.

Objectif 3 : Effets du PLEnt sur le microbiote murin et test de décolonisation des entérocoques.

Nous analyserons en parallèle l'impact global du PLEnt sur le microbiote intestinal et sa capacité à décoloniser les VRE de l'intestin. Pour cela, des souris possédant un microbiote humanisé pourront être utilisées afin de nous rapprocher au plus près des conditions retrouvées chez l'Homme. Il est probable que le PLEnt ait une action restreinte aux entérocoques et si cela est le cas, le PLEnt pourra être utilisé pour décoloniser les VRE sans impact néfaste sur le microbiote. Si ces tests sont positifs, nous envisagerons rapidement la valorisation de ce peptide en tant que nouvelle molécule thérapeutique.

Conclusion personnelle

Mon intérêt scientifique principal s'est toujours porté sur les bactéries pathogènes. Je trouve fascinant la manière dont ces organismes unicellulaires qui pourraient être considérés comme simples peuvent élaborer des mécanismes moléculaires complexes pour coloniser et persister dans leur hôte. J'ai ainsi commencé mon parcours scientifique en étudiant la formation du biofilm, les systèmes de virulence, de persistance ou de résistance au stress et la régulation génétique associée. J'ai ainsi pu travailler sur différentes bactéries pathogènes, à Gram négatif et positif.

Mon arrivée au laboratoire U2RM, devenu depuis CBSA, m'a sensibilisée à la problématique de la résistance aux antibiotiques et j'ai connu une « révélation scientifique » en débutant le travail sur la sviveucine. Tandis que j'étais jusqu'alors dans le camp des bactéries, je suis devenue leur adversaire en étudiant un peptide qui bloque leur capacité à former un biofilm, être virulentes et résister aux antibiotiques.

Ceci est intervenu dans le contexte de la prise de conscience de la menace que représente l'antibiorésistance pour l'humanité, avec la parution de rapports de plus en plus alarmants par l'OMS. La nécessité de travailler à l'identification de nouvelles stratégies anti-bactériennes m'a semblé une évidence et j'ai commencé à orienter mes projets de recherche dans ce but, avec non seulement l'étude de la sviveucine et de la siamycine, mais aussi avec les azetidomonamides et le peptide lasso d'*E. faecalis*. Les bactéries sur lesquelles je souhaite travailler en priorité sont celles du groupe ESKAPE (*Enterococcus faecium*, *Staphylococcus aureus*, *Klebsiella pneumoniae*, *Acinetobacter baumannii*, *Pseudomonas aeruginosa*, and *Enterobacter spp.*), que l'OMS a identifié comme étant problématiques de par leur antibiorésistance et le peu de molécules thérapeutiques disponibles pour traiter les infections associées. Les trois projets que je voudrais mener à bien ont ainsi pour cible *E. faecalis*, *E. faecium*, *S. aureus* et *P. aeruginosa*. Les molécules étudiées sont différentes puisque les peptides lasso sont des RiPPs tandis que les azetidomonamides sont synthétisés par voie non-ribosomale mais la stratégie de lutte anti-bactérienne est similaire puisqu'il s'agit de bloquer la capacité des bactéries à mener à bien l'infection sans inhiber leur croissance et ainsi éviter la sélection de bactéries résistantes.

Un versant de cette thématique de recherche de nouvelles molécules thérapeutiques est la compréhension du mode d'action moléculaire associé. Ceci est important non seulement pour le développement de ces molécules en médicament, mais aussi car cela peut mener à l'identification de nouvelles voies pouvant être ciblées par d'autres molécules. La connaissance de la biologie de la bactérie cible et de ses mécanismes de virulence et de résistance est alors primordiale et ainsi, les connaissances que j'ai pu acquérir au début de mon parcours trouvent leur application pratique.

Un aspect important de mes activités de maître de conférences a été la rédaction de demandes de financements, que j'ai effectuées dans l'espoir d'obtenir les moyens de mener à bien ces projets et de participer au fonctionnement de l'unité de recherche. J'ai ainsi déposé quinze demandes entre 2015 et 2022, auprès de l'Agence Nationale de la Recherche (ANR), de la région Normandie, de l'université de Caen-Normandie et de la Fondation pour la Recherche Médicale (FRM, et ce, en tant que coordinatrice, responsable ou partenaire scientifique. Sur toutes ces demandes, deux ont été acceptées. La première est une demande d'allocation doctorale financée à 100% par la région

Normandie pour la thèse d'Abdelhakim Boudrioua, que j'ai encadré d'octobre 2016 à octobre 2019. La seconde demande est le projet ANR LasSoCocci coordonné par Axel Hartke (ANR-19-CE18-0026-01 ; 2020-2024 ; 488,6 k€) dont je suis responsable scientifique. La rédaction de ces demandes a été pour moi énormément consommatrice d'énergie et de temps et s'est faite forcément au détriment d'autres activités. Cependant je ne regrette pas ce choix et c'est une activité que je poursuivrai à l'avenir, en comptant sur l'expérience que j'ai acquise dans ce domaine. Le projet portant sur les PLT1 étant financé jusqu'en juin 2024, je vais à présent orienter plus particulièrement mes efforts vers le financement du projet s'intéressant au peptide lasso d'*E. faecalis*. Les évaluations des premières demandes que j'ai effectuées sur ce sujet ont montré que davantage de résultats préliminaires étaient nécessaires pour le rendre plus convaincant. Solenn Desmadril a travaillé sur ce projet durant son stage de Master 2 et j'espère pouvoir soumettre à nouveau ce projet avec de meilleures chances de réussite.

Enfin, un aspect crucial de notre métier est l'encadrement d'étudiants. Au cours des huit années qui se sont écoulées depuis mon recrutement, j'ai eu le bonheur d'encadrer cinq étudiant.e.s, dont trois que j'ai pu accompagner du master à la thèse ou au premier emploi. Les échanges avec ces personnes ont été ou sont particulièrement enrichissants, et ce, je l'espère de tout cœur, de manière réciproque. Je fais tout mon possible pour transmettre aux étudiants que j'encadre le maximum de savoir et d'expérience et en retour j'apprends et évolue continuellement à leur contact. J'espère que ceci se poursuivra à l'avenir et c'est justement le but de « l'habilitation à diriger des recherches ».

Références bibliographiques

- Alanis, Alfonso J. 2005. « Resistance to Antibiotics: Are We in the Post-Antibiotic Era? » *Archives of Medical Research* 36 (6): 697-705. <https://doi.org/10.1016/j.arcmed.2005.06.009>.
- Arnison, Paul G., Mervyn J. Bibb, Gabriele Bierbaum, Albert A. Bowers, Tim S. Bugni, Grzegorz Bulaj, Julio A. Camarero, et al. 2013. « Ribosomally Synthesized and Post-Translationally Modified Peptide Natural Products: Overview and Recommendations for a Universal Nomenclature ». *Nat. Prod. Rep.* 30 (1): 108-60. <https://doi.org/10.1039/C2NP20085F>.
- Arthur, Michel, Florence Depardieu, Guy Gerbaud, Marc Galimand, Roland Leclercq, et Patrice Courvalin. 1997. « The VanS sensor negatively controls VanR-mediated transcriptional activation of glycopeptide resistance genes of Tn1546 and related elements in the absence of induction. » *Journal of bacteriology* 179 (1): 97-106.
- Baëtz, Benjamin, Abdelhakim Boudrioua, Axel Hartke, et Caroline Giraud. 2021. « Alternatives to Fight Vancomycin-Resistant Staphylococci and Enterococci ». *Antibiotics (Basel, Switzerland)* 10 (9): 1116. <https://doi.org/10.3390/antibiotics10091116>.
- Bentzmann, Sophie de, Caroline Giraud, Christophe S. Bernard, Virginie Calderon, Friederike Ewald, Patrick Plésiat, Cathy Nguyen, et al. 2012. « Unique Biofilm Signature, Drug Susceptibility and Decreased Virulence in *Drosophila* through the *Pseudomonas Aeruginosa* Two-Component System PprAB ». Édité par David S. Schneider. *PLoS Pathogens* 8 (11): e1003052. <https://doi.org/10.1371/journal.ppat.1003052>.
- Bergin, D., E. P. Reeves, J. Renwick, F. B. Wientjes, et K. Kavanagh. 2005. « Superoxide Production in *Galleria Mellonella* Hemocytes: Identification of Proteins Homologous to the NADPH Oxidase Complex of Human Neutrophils ». *Infection and Immunity* 73 (7): 4161-70. <https://doi.org/10.1128/IAI.73.7.4161-4170.2005>.
- Boucher, Helen W., George H. Talbot, John S. Bradley, John E. Edwards, David Gilbert, Louis B. Rice, Michael Scheld, Brad Spellberg, et John Bartlett. 2009. « Bad Bugs, No Drugs: No ESKAPE! An Update from the Infectious Diseases Society of America ». *Clinical Infectious Diseases* 48 (1): 1-12. <https://doi.org/10.1086/595011>.
- Buist, Girbe, Anton Steen, Jan Kok, et Oscar P. Kuipers. 2008. « LysM, a Widely Distributed Protein Motif for Binding to (Peptido)Glycans ». *Molecular Microbiology* 68 (4): 838-47. <https://doi.org/10.1111/j.1365-2958.2008.06211.x>.
- Cacaci, Margherita, Caroline Giraud, Loic Leger, Riccardo Torelli, Cecilia Martini, Brunella Posteraro, Valentina Palmieri, Maurizio Sanguinetti, Francesca Bugli, et Axel Hartke. 2018. « Expression Profiling in a Mammalian Host Reveals the Strong Induction of Genes Encoding LysM Domain-Containing Proteins in *Enterococcus Faecium* ». *Scientific Reports* 8 (1): 12412. <https://doi.org/10.1038/s41598-018-30882-z>.
- Chambers, Henry F., et Frank R. DeLeo. 2009. « Waves of resistance: *Staphylococcus aureus* in the antibiotic era ». *Nature Reviews Microbiology* 7 (9): 629-41. <https://doi.org/10.1038/nrmicro2200>.
- Courvalin, Patrice. 2006. « Vancomycin resistance in gram-positive cocci ». *Clinical Infectious Diseases* 42 (Supplement 1): S25-34.
- Gavrish, Ekaterina, Clarissa S. Sit, Shugeng Cao, Olga Kandror, Amy Spoering, Aaron Peoples, Losee Ling, et al. 2014. « Lassomycin, a Ribosomally Synthesized Cyclic Peptide, Kills *Mycobacterium Tuberculosis* by Targeting the ATP-Dependent Protease ClpC1P1P2 ». *Chemistry & Biology*, mars. <https://doi.org/10.1016/j.chembiol.2014.01.014>.
- Giraud, Caroline, et Sophie de Bentzmann. 2012. « Inside the complex regulation of *Pseudomonas aeruginosa* chaperone usher systems ». *Environmental Microbiology* 14 (8): 1805-16. <https://doi.org/10.1111/j.1462-2920.2011.02673.x>.
- Giraud, Caroline, Christophe Bernard, Ségolène Ruer, et Sophie De Bentzmann. 2009. « Biological 'glue' and 'Velcro': molecular tools for adhesion and biofilm formation in the hairy and gluey

- bug *Pseudomonas aeruginosa* ». *Environmental Microbiology Reports* 2 (3): 343-58. <https://doi.org/10.1111/j.1758-2229.2009.00070.x>.
- Giraud, Caroline, Christophe S. Bernard, Virginie Calderon, Liang Yang, Alain Filloux, Søren Molin, Gwennaele Fichant, Christophe Bordi, et Sophie de Bentzmann. 2011. « The PprA-PprB two-component system activates CupE, the first non-archetypal *Pseudomonas aeruginosa* chaperone-usher pathway system assembling fimbriae ». *Environmental Microbiology* 13 (3): 666-83. <https://doi.org/10.1111/j.1462-2920.2010.02372.x>.
- Giraud, Caroline, Stéphane Hausmann, Sylvain Lemeille, Julien Prados, Peter Redder, et Patrick Linder. 2015. « The C-Terminal Region of the RNA Helicase CshA Is Required for the Interaction with the Degradosome and Turnover of Bulk RNA in the Opportunistic Pathogen *Staphylococcus Aureus* ». *RNA Biology* 12 (6): 658-74. <https://doi.org/10.1080/15476286.2015.1035505>.
- Graham, Carrie E., Melissa R. Cruz, Danielle A. Garsin, et Michael C. Lorenz. 2017. « Enterococcus Faecalis Bacteriocin EntV Inhibits Hyphal Morphogenesis, Biofilm Formation, and Virulence of *Candida Albicans* ». *Proceedings of the National Academy of Sciences of the United States of America* 114 (17): 4507-12. <https://doi.org/10.1073/pnas.1620432114>.
- Hegemann, Julian D., Kevin Jeanne Dit Fouque, Miguel Santos-Fernandez, et Francisco Fernandez-Lima. 2021. « A Bifunctional Leader Peptidase/ABC Transporter Protein Is Involved in the Maturation of the Lasso Peptide Cochonodin I from *Streptococcus Suis* ». *Journal of Natural Products* 84 (10): 2683-91. <https://doi.org/10.1021/acs.jnatprod.1c00514>.
- Hong, Zhilai, Arnaud Bolard, Caroline Giraud, Sébastien Prévost, Grégory Genta-Jouve, Christiane Deregnacourt, Susanne Häussler, Katy Jeannot, et Yanyan Li. 2019. « Azetidine-Containing Alkaloids Produced by a Quorum-Sensing Regulated Nonribosomal Peptide Synthetase Pathway in *Pseudomonas Aeruginosa* ». *Angewandte Chemie (International Ed. in English)* 58 (10): 3178-82. <https://doi.org/10.1002/anie.201809981>.
- Kommineni, Sushma, Daniel J. Bretl, Vy Lam, Rajrupa Chakraborty, Michael Hayward, Pippa Simpson, Yumei Cao, Pavlos Bousounis, Christopher J. Kristich, et Nita H. Salzman. 2015. « Bacteriocin production augments niche competition by enterococci in the mammalian gastrointestinal tract ». *Nature* 526 (7575): 719-22. <https://doi.org/10.1038/nature15524>.
- Li, Yanyan, Rémi Ducasse, Séverine Zirah, Alain Blond, Christophe Goulard, Ewen Lescop, Caroline Giraud, et al. 2015. « Characterization of Sviceucin from *Streptomyces* Provides Insights into Enzyme Exchangeability and Disulfide Bond Formation in Lasso Peptides. » *ACS Chemical Biology*, septembre, 150907011450007. <https://doi.org/10.1021/acscchembio.5b00584>.
- Lin, P. F., H. Samanta, C. M. Bechtold, C. A. Deminie, A. K. Patick, M. Alam, K. Riccardi, R. E. Rose, R. J. White, et R. J. Colonna. 1996. « Characterization of Siamycin I, a Human Immunodeficiency Virus Fusion Inhibitor ». *Antimicrobial Agents and Chemotherapy* 40 (1): 133-38. <https://doi.org/10.1128/AAC.40.1.133>.
- Linder, Patrick, et Eckhard Jankowsky. 2011. « From unwinding to clamping — the DEAD box RNA helicase family ». *Nature Reviews Molecular Cell Biology* 12 (8): 505-16. <https://doi.org/10.1038/nrm3154>.
- Lubelski, J., R. Rink, R. Khusainov, G. N. Moll, et O. P. Kuipers. 2008. « Biosynthesis, Immunity, Regulation, Mode of Action and Engineering of the Model Lantibiotic Nisin ». *Cellular and Molecular Life Sciences* 65 (3): 455-76. <https://doi.org/10.1007/s00018-007-7171-2>.
- Ma, Pikyee, Pikyee Ma, Hayley M. Yuille, Pikyee Ma, Hayley M. Yuille, Victor Blessie, Nadine Göhring, et al. 2008. « Expression, Purification and Activities of the Entire Family of Intact Membrane Sensor Kinases from *Enterococcus Faecalis* ». *Molecular Membrane Biology* 25 (6-7): 449-73. <https://doi.org/10.1080/09687680802359885>.
- Ma, Pikyee, Kenzo Nishiguchi, Hayley M. Yuille, Lianne M. Davis, Jiro Nakayama, et Mary K. Phillips-Jones. 2011. « Anti-HIV Siamycin I Directly Inhibits Autophosphorylation Activity of the Bacterial FsrC Quorum Sensor and Other ATP-Dependent Enzyme Activities ». *FEBS Letters* 585 (17): 2660-64. <https://doi.org/10.1016/j.febslet.2011.07.026>.

- Mohamed, J. A., et D. B. Huang. 2007. « Biofilm Formation by Enterococci ». *Journal of Medical Microbiology* 56 (12): 1581-88. <https://doi.org/10.1099/jmm.0.47331-0>.
- Nakayama, J., E. Tanaka, R. Kariyama, K. Nagata, K. Nishiguchi, R. Mitsuhata, Y. Uemura, M. Tanokura, H. Kumon, et K. Sonomoto. 2007. « Siamycin Attenuates Fsr Quorum Sensing Mediated by a Gelatinase Biosynthesis-Activating Pheromone in *Enterococcus Faecalis* ». *Journal of Bacteriology* 189 (4): 1358-65. <https://doi.org/10.1128/JB.00969-06>.
- Nakayama, Jiro, Yong Cao, Takaaki Horii, Shohei Sakuda, Antoon DL Akkermans, Willem M. De Vos, et Hiromichi Nagasawa. 2001. « Gelatinase biosynthesis-activating pheromone: a peptide lactone that mediates a quorum sensing in *Enterococcus faecalis* ». *Molecular microbiology* 41 (1): 145-54.
- Olsen, I. 2015. « New Promising β -Lactamase Inhibitors for Clinical Use ». *European Journal of Clinical Microbiology & Infectious Diseases* 34 (7): 1303-8. <https://doi.org/10.1007/s10096-015-2375-0>.
- Oun, Stella, Peter Redder, Jean-Philippe Didier, Patrice Francois, Anna-Rita Corvaglia, Elena Buttazzoni, Caroline Giraud, Myriam Girard, Jacques Schrenzel, et Patrick Linder. 2013. « The CshA DEAD-box RNA helicase is important for quorum sensing control in *Staphylococcus aureus* ». *RNA Biology* 10 (1): 157-65. <https://doi.org/10.4161/rna.22899>.
- Pavlova, O., J. Mukhopadhyay, E. Sineva, R. H. Ebright, et K. Severinov. 2008. « Systematic Structure-Activity Analysis of Microcin J25 ». *Journal of Biological Chemistry* 283 (37): 25589-95. <https://doi.org/10.1074/jbc.M803995200>.
- Rasko, David A., et Vanessa Sperandio. 2010. « Anti-virulence strategies to combat bacteria-mediated disease ». *Nature Reviews Drug Discovery* 9 (2): 117-28. <https://doi.org/10.1038/nrd3013>.
- Roux, Christelle M., Jonathon P. DeMuth, et Paul M. Dunman. 2011. « Characterization of Components of the *Staphylococcus Aureus* mRNA Degradosome Holoenzyme-like Complex ». *Journal of Bacteriology* 193 (19): 5520-26. <https://doi.org/10.1128/JB.05485-11>.
- Sabino, Yasmin Neves Vieira, Katialaine Corrêa de Araújo, Fábila Giovana do Val de Assis, Sofia Magalhães Moreira, Thaynara da Silva Lopes, Tiago Antônio de Oliveira Mendes, Sharon Ann Huws, et Hilário C. Mantovani. 2020. « In Silico Screening Unveil the Great Potential of Ruminant Bacteria Synthesizing Lasso Peptides ». *Frontiers in Microbiology* 11: 576738. <https://doi.org/10.3389/fmicb.2020.576738>.
- Saito, Fumito, et Jeffrey W. Bode. 2017. « Synthesis and Stabilities of Peptide-Based [1]Rotaxanes: Molecular Grafting onto Lasso Peptide Scaffolds ». *Chemical Science* 8 (4): 2878-84. <https://doi.org/10.1039/c7sc00021a>.
- Sinel, Clara, Yoann Augagneur, Mohamed Sassi, Julie Bronsard, Margherita Cacaci, François Guérin, Maurizio Sanguinetti, Pierrick Meignen, Vincent Cattoir, et Brice Felden. 2017. « Small RNAs in Vancomycin-Resistant *Enterococcus Faecium* Involved in Daptomycin Response and Resistance ». *Scientific Reports* 7 (1): 11067. <https://doi.org/10.1038/s41598-017-11265-2>.
- Singh, Rachna, et Pallab Ray. 2014. « Quorum Sensing-Mediated Regulation of Staphylococcal Virulence and Antibiotic Resistance ». *Future Microbiology* 9 (5): 669-81. <https://doi.org/10.2217/fmb.14.31>.
- Stone, Laura K, Michael Baym, Tami D Lieberman, Remy Chait, Jon Clardy, et Roy Kishony. 2016. « Compounds that select against the tetracycline-resistance efflux pump ». *Nature Chemical Biology* 12 (11): 902-4. <https://doi.org/10.1038/nchembio.2176>.
- Tacconelli, Evelina, Ingo B. Autenrieth, et Andreas Peschel. 2017. « Fighting the Enemy Within ». *Science (New York, N.Y.)* 355 (6326): 689-90. <https://doi.org/10.1126/science.aam6372>.
- Tan, Stephanie, Kevin C. Ludwig, Anna Müller, Tanja Schneider, et Justin R. Nodwell. 2019. « The Lasso Peptide Siamycin-I Targets Lipid II at the Gram-Positive Cell Surface ». *ACS Chemical Biology* 14 (5): 966-74. <https://doi.org/10.1021/acscchembio.9b00157>.
- Tietz, Jonathan I, Christopher J Schwalen, Parth S Patel, Tucker Maxson, Patricia M Blair, Hua-Chia Tai, Uzma I Zakai, et Douglas A Mitchell. 2017. « A new genome-mining tool redefines the lasso peptide biosynthetic landscape ». *Nature Chemical Biology*, février. <https://doi.org/10.1038/nchembio.2319>.

Wang, Yuping, Junling Sun, Zhichang Liu, Majed S. Nassar, Youssry Y. Botros, et J. Fraser Stoddart. 2017. « Radically Promoted Formation of a Molecular Lasso ». *Chemical Science* 8 (4): 2562-68. <https://doi.org/10.1039/c6sc05035b>.

Annexes

Les publications relatives au manuscrit seront présentées ici selon leur ordre de citation :

- Cacaci M[#], **Giraud C[#]**, Leger L, Torelli R, Martini C, Posteraro B, Palmieri V, Sanguinetti M, Bugli F, Hartke A. "Expression profiling in a mammalian host reveals the strong induction of genes encoding LysM domain-containing proteins in *Enterococcus faecium*". *Sci Rep.* 2018 Aug 17;8(1):12412. [#]Contribution égale.
- Li Y, Ducasse R, Zirah S, Blond A, Goulard C, Lescop E, **Giraud C**, Hartke A, Guittet E, Pernodet JL, Rebuffat S." Characterization of sviceucin from *Streptomyces* provides insights into enzyme exchangeability and disulfide bond formation in lasso peptides." *ACS Chem Biol.* 2015; 10(11):2641-9.
- Baëtz, B., Boudrioua, A., Hartke, A., **Giraud, C.** "Alternatives to fight Vancomycin-Resistant Staphylococci and Enterococci". *Antibiotics* 2021, 10, 1116. <https://doi.org/10.3390/antibiotics10091116>.
- Hong Z, Bolard A, **Giraud C**, Prévost S, Genta-Jouve G, Deregnacourt C, Häussler S, Jeannot K, Li Y. "Azetidine-Containing Alkaloids Produced by a Quorum-Sensing- Regulated Nonribosomal Peptide Synthetase Pathway in *Pseudomonas aeruginosa*". *Angew Chem Int Ed Engl.* 2019 Mar 4;58(10):3178-3182.

En complément des publications précédentes, la publication ci-dessous correspond à une partie du travail de thèse d'Abdelhakim Boudrioua :

- Boudrioua A, Li Y, Hartke A, **Giraud C.** "Opposite effect of vancomycin and D-Cycloserine combination in both vancomycin resistant *Staphylococcus aureus* and enterococci." *FEMS Microbiol Lett.* 2020 Apr 1;367(8):fnaa062.

Expression profiling in a mammalian host reveals the strong induction of genes encoding LysM domain-containing proteins in *Enterococcus faecium*

Cacaci M[#], **Giraud C[#]**, Leger L, Torelli R, Martini C, Posteraro B, Palmieri V, Sanguinetti M, Bugli F, Hartke A. [#]Contribution égale.

Sci Rep. 2018 Aug 17;8(1):12412.

SCIENTIFIC REPORTS



OPEN

Expression profiling in a mammalian host reveals the strong induction of genes encoding LysM domain-containing proteins in *Enterococcus faecium*

Margherita Cacaci^{1,2}, Caroline Giraud¹, Loic Leger¹, Riccardo Torelli², Cecilia Martini², Brunella Posteraro³, Valentina Palmieri⁴, Maurizio Sanguinetti^{1,2}, Francesca Bugli² & Axel Hartke¹

Enterococcus faecium is an important health care-associated pathogen that is difficult to treat due to the high level of antibiotic resistance of clinical isolates. The identification of new potential therapeutic targets or vaccination strategies is therefore urgently needed. In this regard, we carried out a transcriptomic analysis of the *E. faecium* vancomycin-resistant strain AUS0004, comparing the gene expression of bacteria grown under laboratory conditions and bacteria isolated from an infection site. This analysis highlighted more than 360 genes potentially induced under infection conditions. Owing to their expression profiles, four LysM domain-containing proteins were characterized in more detail. The EFAU004_01059, 1150 and 494 proteins are highly homologous, whereas EFAU004_01209 has a unique domain-architecture and sequence. The analysis of corresponding mutants showed that all LysM proteins played relevant roles in the infection process of *E. faecium* in mice. The EFAU004_01209 mutant also displayed profound morphological modifications, suggesting it has a role in cell wall synthesis or cell division. Furthermore, the adhesion to kidney cells and growth of the mutant was affected in human urine. All these phenotypes and the surface exposure of EFAU004_01209 identify this protein as an interesting new drug target in *E. faecium*.

Enterococci are Gram-positive bacteria that colonize several ecological niches, including the guts of mammals and numerous other animals¹. These bacteria have emerged as important nosocomial pathogens due to their multiple antibiotic resistances². *Enterococcus faecalis* and *Enterococcus faecium* are the third and fourth most commonly isolated nosocomial pathogens worldwide, causing up to 14% and 16% of hospital acquired infections in the US and Europe respectively^{3–5}. *E. faecium* infections, in particular, have become a major concern, since their resistance to vancomycin and ampicillin has increased up to almost 100% in some clinical institutions in the US, and a similar rise in resistances has recently been observed in Europe^{6–8}. The ability of *E. faecium* to survive under a range of adverse environmental conditions and the dramatic increase in the antibiotic resistance of clinical isolates highlight the need for the development of alternative treatments and prevention strategies^{9,10}. Well expressed and abundant proteins, located on the surface of bacteria during the infection process, could be potential targets for new drugs or vaccines^{11–13}. To identify these surface proteins in *E. faecium*, we conducted a comprehensive RNA sequencing (RNAseq) transcriptome analysis on the *E. faecium* vancomycin resistant strain Aus0004 isolated from a bloodstream infection¹⁴. Transcription profiles during the incubation

¹Normandie Univ, UNICAEN, U2RM-Stress and Virulence, 14000, Caen, France. ²Institute of Microbiology, Università Cattolica del Sacro Cuore, Fondazione Policlinico Universitario IRCCS Agostino Gemelli, 00168, Rome, Italy. ³Institute of Public Health (Section of Hygiene), Università Cattolica del Sacro Cuore, Fondazione Policlinico Universitario IRCCS Agostino Gemelli, 00168, Rome, Italy. ⁴Physics Institute, Università Cattolica del Sacro Cuore, Fondazione Policlinico Universitario IRCCS Agostino Gemelli, 00168, Rome, Italy. Margherita Cacaci, Caroline Giraud, Francesca Bugli and Axel Hartke contributed equally to this work. Correspondence and requests for materials should be addressed to M.S. (email: maurizio.sanguinetti@unicatt.it) or A.H. (email: axel.hartke@unicaen.fr)

of the bacteria inside the mice peritoneum were compared to the transcriptome of bacteria grown in standard laboratory conditions. Among the *in vivo* induced transcripts were four LysM domain-containing proteins, EFAU004_01209, EFAU004_01059, EFAU004_01150 and EFAU004_00494. In a recent study, we highlighted, among others, a LysM domain-containing protein as a promising vaccine candidate in *E. faecium*¹⁵. The LysM domain is a carbohydrate-binding module conserved across all kingdoms¹⁶. It is mostly present in bacterial extracellular proteins, including peptidoglycan (PG) hydrolases, adhesins and virulence factors¹⁷. Prokaryotic LysM modules bind non covalently to the N-acetylglucosamine moieties of PG, the main component of the bacterial cell wall¹⁸. This domain can be present in one or multiple copies and be located at the N- or C-terminal parts of the corresponding proteins¹⁸. On the basis of the induction of the corresponding genes, we decided to study the physiological *in vitro* and *in vivo* roles of the LysM domain-containing proteins in *E. faecium* AUS0004.

Results and Discussion

Interpretation of the infection transcriptome of *E. faecium*. To gain an understanding of the adaptation of *E. faecium* to the host environment and identify cell wall associated proteins expressed during infection, *E. faecium* strain Aus0004¹⁴ was inoculated into the mouse peritoneum, and bacteria were recovered 24 hours post-infection. In parallel, bacteria were grown *in vitro* in brain heart infusion broth (BHI) to the exponential mid log phase (O.D.₆₀₀ = 0.4) and stationary growth phase (24 hour culture). Total RNA from bacteria grown *in vivo* and *in vitro* was extracted, and RNAseq was performed to analyze the transcriptional activity under these different conditions. Considering a threshold fold change of 2 as significantly differentially expressed, we obtained 715 and 613 overexpressed genes in the analysis against the stationary phase and exponential phase cultures, respectively. Since the physiological state of the bacteria during the infection was unknown, we decided to consider only the overlapping genes between the two analyses, reducing our *in vivo* database to 362 genes. The list of genes identified as upregulated in both conditions is shown in Supplementary Table S4. A comparable study has been previously conducted on *E. faecalis*¹⁹. The main conclusions that can be drawn from the transcriptome data for both bacteria species is that the strategy *E. faecium* uses to adapt to host conditions is profoundly different from the strategy of *E. faecalis*. Only two orthologous, *in vivo* induced operons, overlap between the transcriptomes of the two species; two *E. faecium* paralogous genes, EFAU004_00919 and 01244, overlap with EF0202 of *E. faecalis*, and EFAU004_00560-64 of *E. faecium* overlaps with EF02390-94 of *E. faecalis*. The EFAU004_00919, EFAU004_01244, and EF0202 genes encode phosphopyrimidine kinases converting hydroxymethylpyrimidine monophosphate HMP~P with ATP as the co-factor to HMP~P~P. In *E. coli*, this reaction is part of the biosynthesis-pathway of Thiamine~P~P²⁰. The loci EFAU004_02390-02394/EF0560-0564 correspond to the sufCDSUB operon in both species, which is involved in the assembly of Fe-S clusters in corresponding proteins²¹. While *E. faecalis* induced numerous genes encoding stress defense proteins¹⁹, only four stress genes are induced in *E. faecium*. Two of them encode peptide methionine sulfoxide reductases (Msr) (EFAU004_00288, EFAU004_01188). Methionine (Met) is among the most sensitive amino acids to oxidative damage and is converted into methionine sulfoxide (MetSO). Msr are enzymes that reduce MetSO back to Met²². The genome of *E. faecium* AUS0004 strain harbors five genes encoding these activities, and the induction of two of them might indicate that the bacteria were submitted to mild oxidative stress. A further hint that the bacteria were stressed in the peritoneum is the strong induction of two genes encoding the substrate binding domain and transporter ATP binding subunit of a glycine betaine transport system. This system catalyzes the accumulation of glycine betaine, a compatible solute that alleviates the effects of osmotic stress²³. A further striking difference between the enterococcal species relates to the induction of ABC transporters. Considerably more of these transporters were induced in *E. faecium* (N° = 14) than *E. faecalis* (N° = 5). Several of these operons were annotated as amino acid or peptide ABC transporters, and some of them were very strongly induced (>120-fold). The latter observation may be related to the induction of numerous genes encoding peptidases (N° = 6) and seems to suggest the bacteria have an increased need for the supply of amino acids inside the mouse peritoneum. This is further supported by the strong induction (nearly 200 fold) of a gene annotated as amino acid permease (EFAU004_00626). The data also seem to reflect that *E. faecium* divides in the peritoneum, since genes encoding key cell division proteins (FtsA: EFAU004_00770, FtsZ: EFAU004_0771, DivIVA: EFAU004_00994, and FtsK: EFAU004_02286) were induced under the *in vivo* conditions. We tried to verify cell growth in the peritoneum. However, CFU counts did not change much over time at 24 h post infection as shown in Fig. S2. This may reflect a balance between cells phagocytized by polymorphonuclear cells, bacteria that translocate into organs and cells dividing in the peritoneum. To proliferate, the bacteria had to find nutrients, including an energy source, inside the peritoneum. The transcriptome database of *E. faecalis* highlighted several putative substrates, including glycerol and maltodextrines¹⁹. In *E. faecium*, glycerol-3-phosphate (glycerol-3-P) is a potential substrate, since a glycerophosphodiester phosphodiesterase (EFAU004_01774) was strongly induced in the peritoneum. This enzyme is implicated in glycerophospholipid metabolism and the hydrolysis of glycerophosphodiester liberates glycerol-3-P. The resulting catabolic enzyme, glycerol-3-P dehydrogenase, generates dihydroxyacetone phosphate, which enters the glycolytic pathway. Interestingly, a gene (EFAU004_02253) annotated to encode this final activity was also significantly induced during peritonitis. Another substrate for the growth of *E. faecium* inside the mouse peritoneum might be ascorbate, since the corresponding operon encoding enzymes implicated in the transport (EFAU004_01270-72, EFAU004_01296) and conversion (EFAU004_1267, 1269, 1273) of ascorbate to D-xylulose-5-phosphate were significantly induced. It has been recently shown that *E. faecalis* can grow on ascorbate as the sole energy source²⁴, and this might also be the case for *E. faecium*. The *E. faecium* strain AUS0004 is a vancomycin resistant clinical isolate that harbors a chromosomal *vanB* operon¹⁴ whose expression is induced by the presence of the glycopeptide²⁵. However, other stimuli seem to induce expression of the *van* genes, since the entire operon (EFAU004_02774-79) was highly induced (~16-fold) in bacteria present in the mouse peritoneum in the absence of the antibiotic. The significance of the induction of the *van* operon for the infection process of *E. faecium* remains unknown. A substantial number of the *in vivo* induced genes are implicated in peptidoglycan synthesis and modification. The most important differences in expression

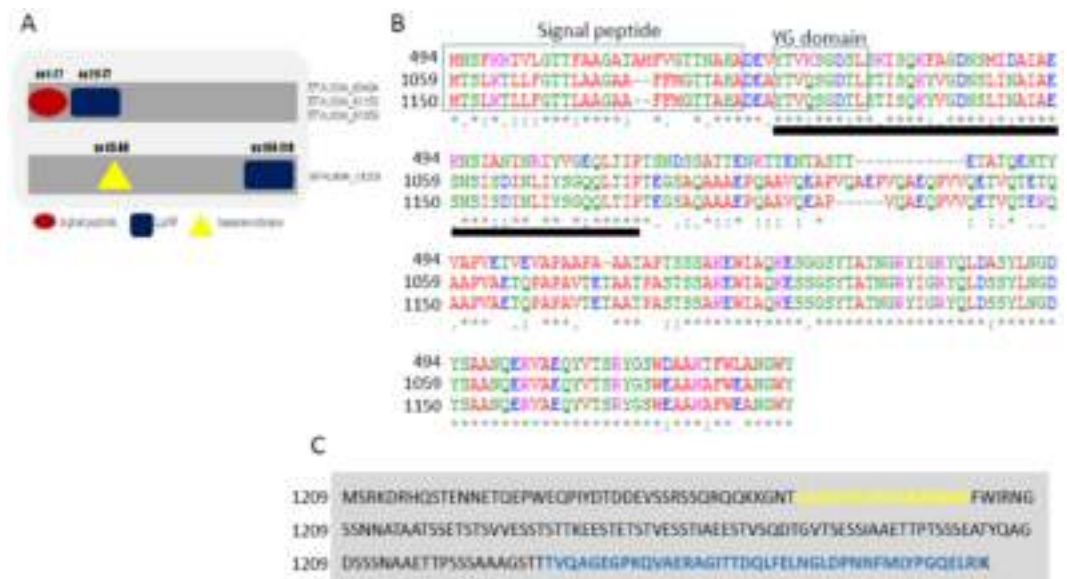

Figure 1. Domain organization and alignment of *E. faecium* LysM domain-containing proteins. **(A)** Domain organization of the LysM-containing proteins. EFAU004_00494, EFAU004_01150 and EFAU004_01059 have the same organization, whereas EFAU004_01209 is organized differently. Red circle: signal peptide; blue square: LysM domain; yellow triangle: transmembrane domain. **(B)** Clustal Omega alignment of proteins EFAU004_00494, EFAU004_01150 and EFAU004_01059. The signal peptide and the conserved YG domain are boxed. The LysM domain is indicated by the black line below the alignment. **(C)** Sequence of the EFAU004_01209 LysM protein. The transmembrane helix and the LysM motif are highlighted in yellow and blue, respectively.

concern four penicillin binding or penicillin binding domain protein encoding genes (EFAU004_00870, 00997, 01299, 02553) which were induced between 3 and 25 fold in the mouse peritoneum. The *dlt* operon (EFAU004_00725–28) was highly induced. It encodes proteins implicated in the addition of D-alanine to teichoic acids of the cell wall, which results in the reduction of the net anionic charge of the bacterial cell envelope²⁶. This D-alanylation of cell wall polymers increases the resistance of bacteria to antimicrobial peptides²⁶, which are potentially encountered in the peritoneum. Interestingly, among the most highly *in vivo* induced genes are four *E. faecium* genes encoding LysM domain proteins (EFAU004_00494, 01059, 01150, 01209), which show induction factors ranging from 4 fold to 600 fold (Table S4). This might indicate that the corresponding proteins, especially those that are highly induced, are important for the pathogenicity of *E. faecium*. Therefore, we decided to study their roles in the infection process in more detail.

General characteristics of the LysM domain-containing proteins of *E. faecium*. The genes encoding the four LysM domain-containing proteins are very likely organized in monocistronic operons. Compared to EFAU004_1209, which was significantly expressed under laboratory conditions and slightly induced *in vivo*, the genes encoding the three other LysM proteins were weakly expressed *in vitro* but highly induced *in vivo*. The count per million reads (cpm) of the corresponding genes are shown in Supplementary Table S5. To confirm the RNAseq data, we performed a real-time quantitative PCR on EFAU004_01209 gene in the three different conditions described before. The data, shown in Fig. S1, confirmed the RNAseq analysis. The LysM proteins are comparable in size and have isoelectric points ranging from 202 AA to 212 AA and 4.24 to 4.93. Three genes (EFAU004_00494, 01059 and 01150) were annotated as encoding the endopeptidase M23, although the characteristic HxH motif²⁷ is absent in these proteins. The three proteins are highly homologous, especially proteins EFAU004_01059 and EFAU004_01150, which differ only by an additional sequence (VQAEP) present nearly in the middle of protein EFAU004_01059 (Fig. 1B). All of the proteins contain a signal sequence at the N terminus followed by the LysM domain harboring the highly conserved YG motif (Fig. 1A). No significant homology exists between the abovementioned proteins and EFAU004_01209 (Fig. 1C). Its LysM domain, situated at the C-terminal part of the protein, is more distant from the consensus sequence, even in the well conserved YG motif. Furthermore, a signal sequence is absent in this protein, but it contains one transmembrane helix (Fig. 1A,C). A Blast analysis with the amino acid sequences of the LysM domain-containing proteins as the input revealed the presence of 97% and 100% conserved orthologues of EFAU004_01150 and EFAU004_01209 respectively, of unknown function in a particular *Clostridioides difficile* strain (strain Y384).

Construction and characterization of lysM deletion mutants. To evaluate the role of the LysM domain-containing proteins in the *E. faecium* infection process, deletion mutants of EFAU004_00494, EFAU004_01059, EFAU004_01150 and EFAU004_01209 were constructed. Due to the high similarity of EFAU004_01059, EFAU004_01150 and EFAU004_00494 and their therefore expected redundant cellular roles,

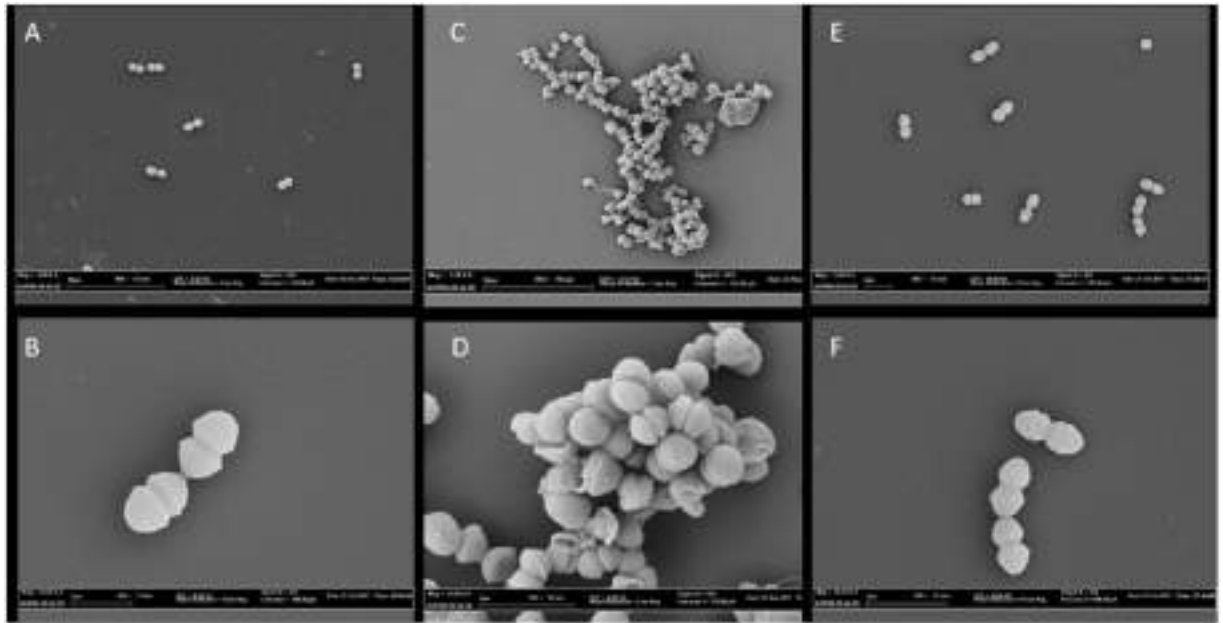

Figure 2. Scanning electron microscopy images of: (A,B) AUS0004. (C,D) Δ EFAU004_01209 deletion mutant. (E and F) Δ 1209:1209 complemented strain. (A,C) bar = 10 μ m. (B) bar = 1 μ m (D,E,F) bar = 2 μ m.

we also constructed the double mutant Δ EFAU004_01059-01150 and the triple mutant Δ EFAU004_01059-01150-494. The growth rates of all mutant strains in laboratory medium was comparable to that of the parent strain, as shown in supplementary Fig. S3. However, an initial slight decrease of OD was observed for the Δ EFAU004_01209 and we noticed that the mutant EFAU004_01209 had the tendency to sediment to the bottom of the test tube, while the wildtype, complemented and other mutant strains grew normally, resulting in uniform turbid medium with few sedimenting cells. (Fig. S4, supplemental materials). Subsequent cell morphology studies by scanning electron microscopy (SEM) showed that, compared to the wild type, the Δ 1209 mutant had an irregular morphology with unseparated daughter cells, suggesting a defect of cell separation (Fig. 2). Transmission electron microscopy (TEM) observations further supported the inhibition of cell separation in the mutant cells (Fig. 3). The mutant cells showed anarchic septa formations leading to emergence of mini compartments inside the cells. These alterations were restored in the complemented strain.

Implication of LysM domain-containing proteins in *E. faecium* virulence. Since the LysM encoding genes were overexpressed during the infection, we postulated that the corresponding proteins might play important roles during infection. We used two different animal model approaches, systemic and urinary tract infections, to detect a possible decrease in the colonization ability of the mutants compared to the wild type. The wild type and the isogenic mutant strains were injected intravenously in Balb/C mice. Seven days post infection, we examined the tissue burdens in the kidneys and livers of the infected mice. As shown in Fig. 4, the single mutants EFAU004_01059 and EFAU004_01150 did not exhibit tissue burden differences compared to the wild type. Conversely, the single mutants Δ EFAU004_00494 and Δ EFAU004_01209 and the double Δ EFAU004_01059-01150 and the Δ EFAU004_01059-01150-494 triple mutants showed a significantly decreased colonization in the kidneys. The AUS0004 wild type strain and the mutants displayed a low tropism for liver. The Δ EFAU004_01209 strain and the triple mutant Δ EFAU004_01059-01150-494 showed a decreased tissue burden. Since enterococci can cause urinary tract infections, and the *E. faecium* AUS0004 strain showed high tropism for kidneys in the systemic model, we used a mouse model of urinary tract infection to assess the effect of the deletions. Female Balb/C mice were infected via intra urethral catheterization, and, 4 days after infection, their bladders and kidneys were homogenized and serial dilution plated to enumerate the CFU per gram of organ. As shown in Fig. 5, the numbers of bacteria recovered from the single mutants Δ EFAU004_1209 and Δ EFAU004_00494, as well as from the double and the triple mutants, were significantly lower than those of the wild type and the other mutant strains, in accordance with the phenotype detected in the systemic model.

Cell adhesion assay. A possible contribution of the LysM domain-containing proteins in the *E. faecium* adherence process was tested on kidney epithelial cells, as previously described²⁸. VERO cells were infected with an MOI of 100:1 with the AUS0004 wild type, the triple mutant Δ EFAU004_01059-01150-494, the Δ EFAU004_01209 single mutant strains and the corresponding complemented strain Δ 1209:1209. Samples were collected at 2 and 24 hours post infection, and the numbers of adhered cells were enumerated. As shown in Fig. 6, the adherence of the triple mutant was comparable to that of the parent strain. In contrast, the adherence of the Δ EFAU004_01209 mutant was significantly reduced compared to that of the wild type. The decreased ability of the Δ EFAU004_01209 mutant to adhere to kidney epithelial cells could explain its decreased ability to colonize mice kidneys during infection, although we cannot exclude that the reduced adherence of the

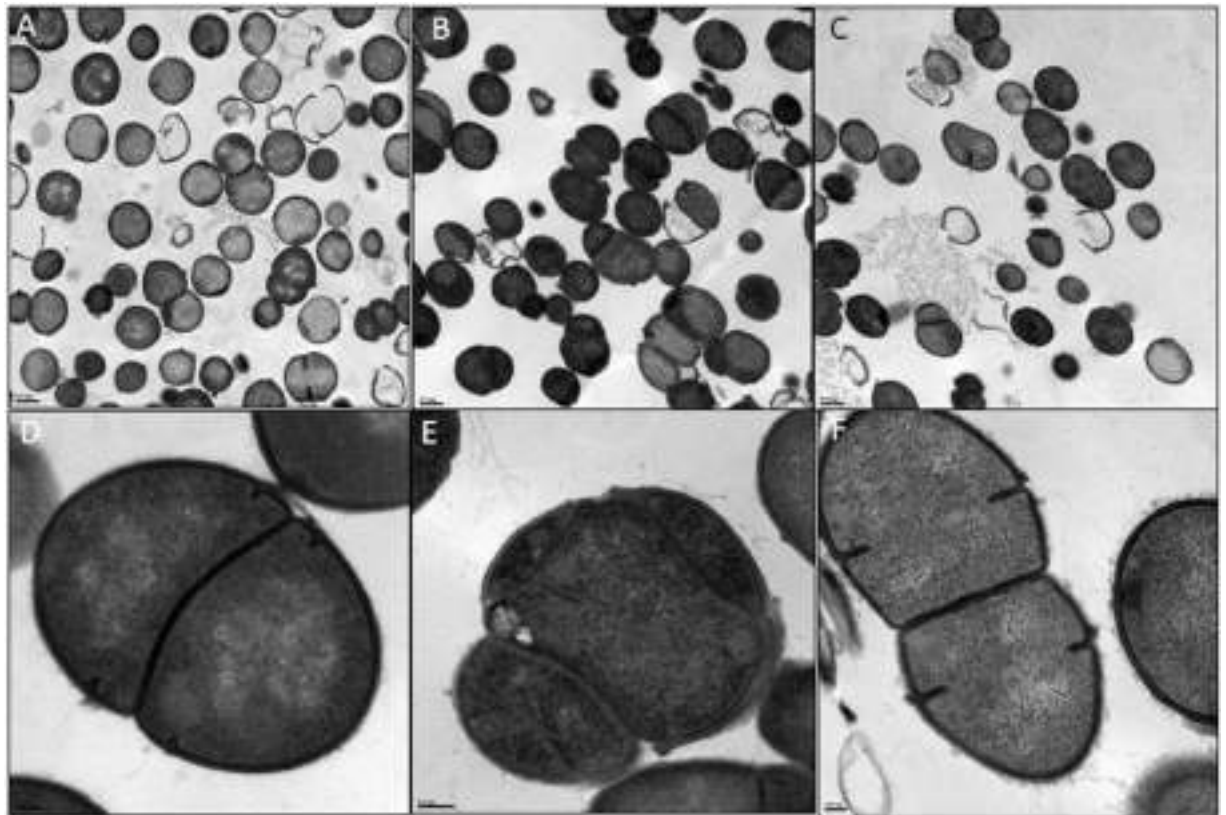

Figure 3. Transmission electron microscopy images of: (A,D) AUS0004; (B,E) Δ EFAU004_01209 deletion mutant, (C,F) Δ 1209:1209 complemented mutant. (A–C) bar = 0.5 μ m. (D,F) bar = 0.1 μ m. (E) bar = 0.2 nm.

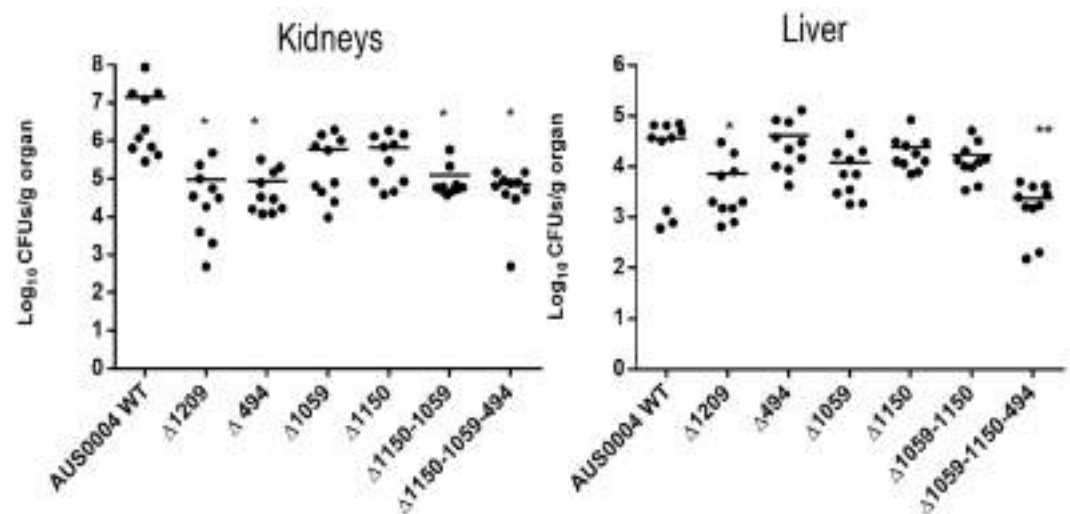

Figure 4. Effect of AUS0004 (wild-type strains) and the deletion mutants in a mouse model of systemic infection. Groups of 10 BALB/c female mice were injected intravenously with approximately 1×10^8 cells of the indicated strains. Data are expressed as the \log_{10} colony-forming units (CFUs)/g of bacteria recovered from kidney and liver homogenates seven days after the challenge. The \log_{10} CFUs of both kidneys were combined and averaged. A value of 0 was assigned to the uninfected organs. Horizontal bars represent geometric means. \log_{10} counts were compared for statistical significance by two-way ANOVA. P values < 0.05 were considered significant. * < 0.05, ** < 0.005, *** < 0.001.

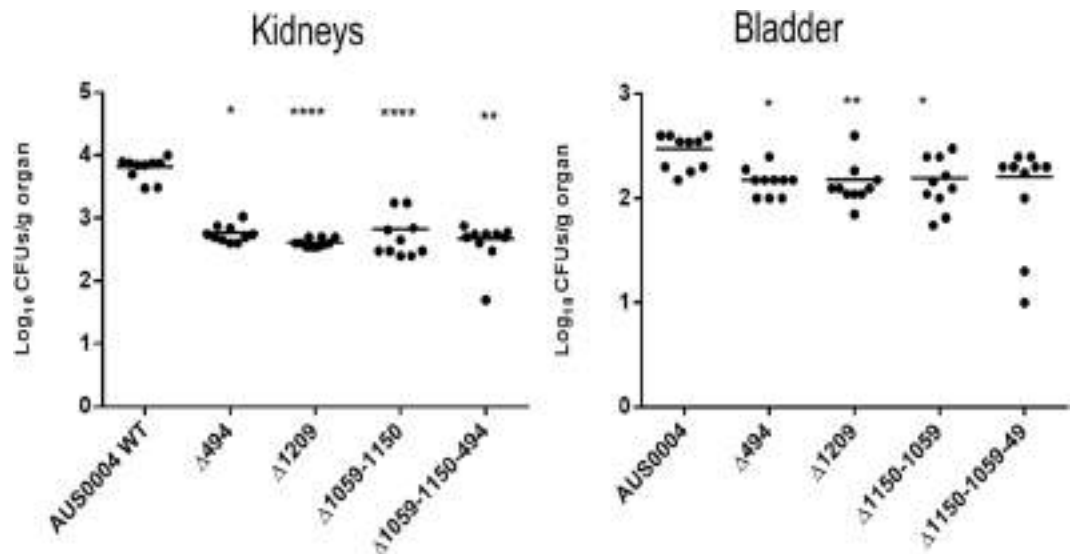

Figure 5. Effect of AUS0004 (wild-type strains) and the deletion mutants in a mouse model of urinary tract infection. Groups of 10 BALB/c female mice were transurethral challenged with approximately 1×10^8 cells of the indicated strains. Data are expressed as the \log_{10} colony-forming units (CFUs)/g of bacteria recovered from kidney and urinary bladder homogenates four days after the challenge. The \log_{10} CFUs of both kidneys were combined and averaged. A value of 0 was assigned to the uninfected organs. Horizontal bars represent geometric means. \log_{10} counts were compared for statistical significance by two-way ANOVA. P values < 0.05 were considered significant. * < 0.05 , ** < 0.005 , *** < 0.001 .

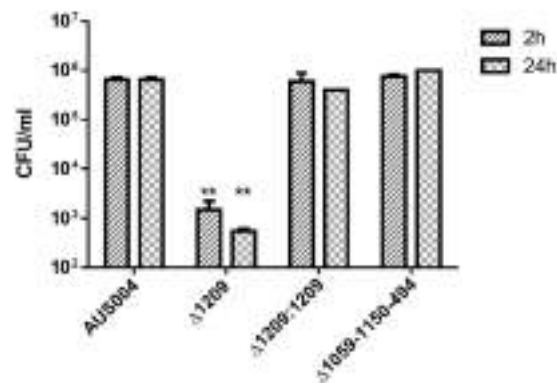

Figure 6. Adherence of *E. faecium* AUS0004 wild type and its isogenic mutant strains, the triple mutant Δ EFAU004_01059-01150-494 and the single Δ EFAU004_01209 mutant, and the complemented strain Δ 1209:1209 to kidney epithelial VERO cells after two and twenty-four hours. Cells were infected with an MOI of 100:1. Adherent bacteria were collected after 2 and 24 hours and enumerated by plating serial dilutions on BHI agar plates and counting CFU. The bars indicate standard deviations. The assay was performed in triplicate and repeated twice. The analysis was performed by two-way ANOVA. p values < 0.01 were considered significant. **p = 0.001.

Δ EFAU004_01209 mutant could be due to the defect of correct cell separation and tendency to aggregation. Both phenotypes observed in the Δ EFAU004_01209 mutant could in fact indirectly interfere with the adhesion to the cell monolayer.

LysM domain containing protein EFAU004_01209 is a surface exposed protein. Unlike the other three highly homologous LysM containing proteins, the *EFAU004_01209* protein has no conventional leader sequence required for protein export via the general secretory pathway, but it shows a transmembrane helix motive in its N-terminal part. Furthermore, the protein appears to have a role in septum formation during cell division. This set of elements has led us to hypothesize a probable localization of this protein on the surface of the bacterium. To demonstrate that the *EFAU004_01209* protein is a surface exposed protein, we overexpressed and purified recombinant rEFAU004_01209, and mice were subcutaneously immunized to obtain the corresponding polyclonal anti- EFAU004_01209 serum. The specificity of the serum is shown in Supplementary Fig. S5.

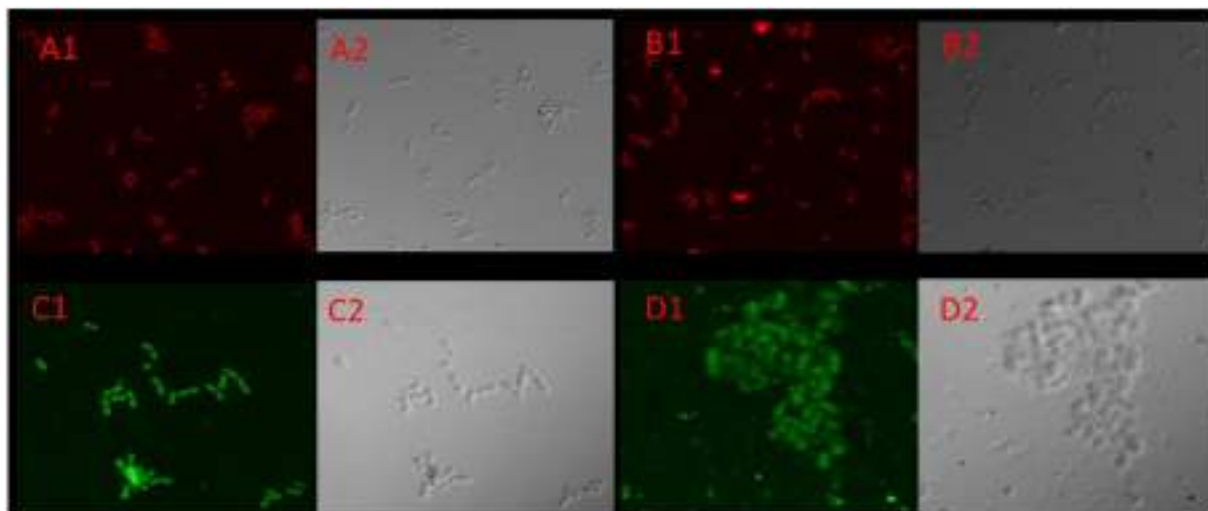

Figure 7. Immunofluorescence microscopy of the enterococcal strains labeled with anti-1209 serum coupled with fluorescein isothiocyanate (FITC) (green); cells are stained with Evans blue. (A) A1 Δ EFAU004_01209. No signal is detected. A2 relative phase channel (B) B1 Anti-CcpA serum on total protein extracts of the *E. faecalis* JH2-2 strain; no immunofluorescence signal is detected due to the cytoplasmic localization of the CcpA protein. B2 Relative phase channel (C) C1 AUS0004 wild-type strain shows green fluorescence, indicating a possible surface localization of the EFAU004_1209 protein. C2 relative phase channel (D) D1 Triple mutant Δ 1050-1150-494. D2 Relative phase channel.

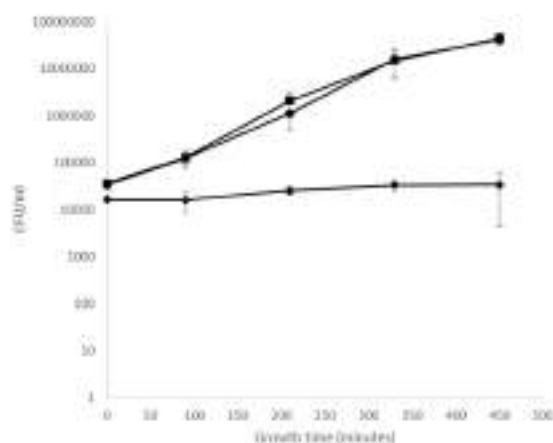

Figure 8. Growth in human urine. Bacteria were inoculated in filtered urine and incubated for 7.5 hours at 37°C, and CFU/ml counts determined for the wild-type strain (black square), the Δ 1209:1209 complemented strain (black circle) and Δ EFAU00_01209 mutant strain (black rhombus). The assay was performed in duplicate. Error bars represent the standard deviations.

The localization of EFAU004_01209 was determined by immunofluorescence experiments on whole cells of the wild-type strain AUS0004 and the triple mutant strain Δ EFAU004_01150-1059-494 using the specific mouse antiserum. A uniform fluorescence distribution around the bacterial cell surface was observed, indicating that the EFAU004_01209 protein was present on the cell surface of the *E. faecium* strain AUS0004 (Fig. 7C1,D1). We further tested an anti-CcpA serum that recognizes the cytoplasmic protein CcpA²⁹. No signal was detected (Fig. 7B1), demonstrating that, under our experimental conditions, cytoplasmic proteins were not detected. In addition, no fluorescence signal is detected in the Δ EFAU004_01209 strain, confirming the specificity of the signal (Fig. 7A1).

LysM domain containing protein EFAU004_01209 might be a promising target for treatment of UTI. Enterococci are leading causes of urinary tract infections-(UTI)³⁰. Treatment has increasingly been challenging because of their intrinsic and acquired resistances to recently introduced antibiotics³¹, and vancomycin resistant enterococci (VRE), along with multiply resistant enterococcus (MRE) strains, are now common in UTI³². We tested the wild type and mutant strains for growth in human urine and found that the growth of the Δ EFAU004_01209 mutant was strongly affected in this bio fluid, whereas its growth in laboratory medium is

comparable to that of the parental strain (Fig. 8). Wild type growth was restored in the complemented strain. This interesting finding may identify the peptidoglycan associated LysM domain-containing protein encoded by the EFAU004_01209 gene as an attractive new drug target for the treatment of UTI caused by multiple resistant *E. faecium* strains.

Conclusions

In conclusion, this work presents for the first time a global transcriptomic analysis of the adaptation of the health care associated pathogen *E. faecium* to an infection site. This allowed the establishment of a database of *in vivo* induced genes. We focused our efforts on the four genes encoding the LysM domain containing proteins of *E. faecium*, which were significantly induced under infection conditions. These proteins had unknown cellular functions. The most interesting phenotypes were obtained with the Δ EFAU004_01209 mutant. The corresponding gene was significantly expressed both *in vitro* during growth in brain hearth infusion broth and *in vivo* during the intra peritoneal infection, suggesting that it has an important cellular role. The corresponding protein is surface exposed and indispensable for proper cell division, suggesting its role in cell wall synthesis. The observed morphological modifications are very comparable to those observed for a *sle1* mutant of *Staphylococcus aureus*³³. These authors showed that the protein encoded by the *sle1* gene had *N*-acetylmuramyl-L-alanine amidase activity. Despite the fact that the EFAU004_01209 gene showed no homology with *sle1*, we conducted a zymographic analysis, as described in the work of Kajimura and collaborators³³. However, no lytic activity in the *Micrococcus luteus* gel was detected for the EFAU004_01209 recombinant protein. Work is in progress to define the exact role of the EFAU004_01209 protein in peptidoglycan synthesis. Altogether, the surface exposed protein EFAU004_01209 could correspond to a new interesting drug target since the absence of this protein reduces significantly the capacity of host colonization. Regarding the other three LysM domain-containing proteins, EFAU004_01059, EFAU004_01150 and EFAU004_00494 were found to be highly similar, especially EFAU004_01059 and EFAU004_01150. In the systemic and urinary tract infection models, only the infection with the double and the triple mutants resulted in a significantly decreased tissue burden compared to the wild type, while the only single mutant with a reduced organ colonization ability was EFAU004_00494. This led us to speculate that EFAU004_00494 may have a specific role unrelated to the other two enterococcal proteins, which seem to have redundant roles. Blast analysis revealed a 56% homology with the SS9 LysM domain protein of *Streptococcus suis*, characterized as involved in the virulence of the bacterium; experiments conducted on the SS9 deletion mutant demonstrated that the mutant was more sensitive to the antibacterial activity of host macrophages *ex vivo*. The concentration of free iron in the blood was lower in mice infected with the SS9 mutant compared to the wild type, suggesting that the SS9 protein contributes to virulence by releasing more free iron in the blood of the host³⁴. A similar role may be attributed to the three LysM domain-containing proteins, which are also supposed to be secreted outside the cell. Future experiments on survival inside the host will be conducted to verify this hypothesis.

Material and Methods

Bacterial strains and growth media. The *E. faecium* strains indicated in Supplementary Table S1 were grown at 37 °C in Brain Heart Infusion (BHI, Sigma Aldrich, Saint Louis, MO, USA). To grow the cells on solid media, BHI agar was used. When required, spectinomycin (Sigma Aldrich) at a final concentration of 500 µg/ml was added. The *Escherichia coli* strains (Supplementary Table S1) EC1000, Top10 and BL21 were grown in liquid and solid Luria Bertani (LB Sigma Aldrich) media. If necessary, kanamycin (50 µg/ml) (Sigma Aldrich) or spectinomycin (100 µg/ml) was added to the medium. Human urine was collected from a healthy volunteer who had no history of UTI or antibiotic use in the last 6 months. The urine was centrifuged at 12000 × g and sterilized by filtration (0.22 µm pore size). Since the composition of human urine may be variable, samples were collected on three separate days for three replicate experiments and used by the next day.

Transmission electron microscopy. The cells were rinsed in physiological water and fixed (2.5% glutaraldehyde in 0.1 M RR cacodylate buffer at pH 7.0 containing 0.04% ruthenium red) for 15 hours at 4 °C. The cells were then rinsed in RR cacodylate buffer, post fixed 1 hour with 1% osmium tetroxide in RR cacodylate buffer (at 4 °C protected from light), rinsed in RR cacodylate buffer, pelleted in 1.5% agar with a low melting point of 40 °C, dehydrated in progressive bath of ethanol (70–100%), embedded in resin (Embed 812) and polymerized for 24 h at 60 °C. Ultrathin sections were prepared and compared with uranyl acetate and lead citrate. The cells were observed with the JEOL 1011 transmission electron microscope and images were taken with the ORIUS 200 camera and digital micrograph software.

Scanning electron microscopy. The cells were rinsed in physiological water, fixed with 2.5% glutaraldehyde in 0.1 M cacodylate buffer at pH 7.0 for 15 hours at 4 °C, rinsed in 0.1 M cacodylate buffer at pH 7.0 and sedimented for one week on Thermanox[®] coverslip coated with poly-L-lysine. The cells were then dehydrated in a progressive bath of ethanol (70–100%) and critical point dried (CPD 030 LEICA Microsystem). The cells were sputtered with platinum and observed with the JEOL 6400F scanning electron microscope.

RNA purification. Total RNA was extracted from the *E. faecium* Aus0004 strain cultured in BHI (Brain Heart Infusion Medium) during the mid-exponential ($OD_{600\text{nm}} = 0.3$) or stationary growth phase (24 h of culture) and from bacteria recovered from mice peritoneum after infection. Pellets were resuspended in 200 µl of Max Bacterial Enhancement Reagent (Thermo Scientific, Breda, the Netherlands). This suspension was added to a 2:1 volume of acid phenol (Thermo Scientific) with glass beads and then agitated for 30 min at 30 Hz in the MM200 shaker (Retsch GmbH, Haan, Germany). After 20 minutes of centrifugation, the aqueous phase was taken and transferred to 1 volume of TRIzol (Thermo Scientific), mixed and incubated for 5 min at room temperature. One

volume of ethanol was then added. RNA was then purified using Direct Zol RNA Miniprep (Zymo Research, Irvine, USA CA) according to the manufacturer's instructions.

RNA sequencing. The RNA sequencing experiments were performed at the iGE3 genomics platform of the University of Geneva. A total of 1 µg of total RNA was ribo depleted using the Ribo Zero Magnetic Kit for bacteria from Epicentre (Illumina, Wisconsin, USA). Libraries were then prepared using the Illumina TruSeq stranded mRNA kit according to manufacturer's recommendations. Libraries were validated on the Bioanalyzer 2100 (Agilent Technologies, Santa Clara, USA) and the Qubit fluorimeter (Thermo Scientific). Samples were multiplexed by 8 and loaded at 8 pM on one lane of an Illumina HiSeq 2500 according to the single read, 50 cycle protocol.

Bioinformatic analysis. The sequencing quality control was done with FastQC³⁵. The reads were mapped with the TopHat v.2 software to the *Enterococcus faecium* Aus0004 reference^{14,36}. The table of counts with the number of reads mapping to each gene feature of the Aus0004 reference genome was prepared with HTSeq v0.6p1 (htseq count). The differential expression analysis was performed with the R/Bioconductor statistical analysis package EdgeR v. 3.4.23³⁷. The counts were normalized according to the library size and filtered. The genes with a count above 1 count per million reads (cpm) in at least 2 samples were kept for further analysis. The differentially expressed gene tests were statistically assessed with the exact test in EdgeR. The differentially expressed gene p-values were corrected for multiple testing error with a 5% FDR (false discovery rate). The correction used was Benjamini Hochberg (BH).

Mutants construction. To generate deletion mutants for the EFAU004_00494, EFAU004_01059, EFAU004_01150 and EFAU004_01209 genes, we used the thermosensitive PWS3 vector. The plasmids used in this study are listed in Supplementary Table S2³⁸. Regions 1 kb upstream and downstream of the genes of interest were amplified by the Kapa HiFi PCR mix (Kapa Biosystem, Wilmington, Massachusetts, USA) using the primers listed in Supplementary Table S3. The purified PCR products were used as a template for overlapping PCR (primers FW2 and RV5, Table S3). The samples were then digested with the restriction enzymes (New England Biolabs) indicated in Table S3 and ligated in PWS3. The resulting vectors were then inserted into the *E. faecium* Aus0004 genome by electrotransformation followed by homologous recombination and excision, as previously described^{38,39}. The effective deletion was confirmed by PCR and the sequencing of regions of interest. For complementation, the entire EFAU004_01209 gene with its promoter and the regions between 1597888–1598925 (genomic coordinates) and 1598926–1599972 were amplified using the Kapa HiFi PCR mix (Kapa Biosystem, Wilmington, Massachusetts, USA) using the primers listed in Table S3. The purified products were used for overlapping PCR (primers OCG119 and OCG124). The resulting products were digested with SacII and SpeI (NEB) and cloned into the vector pWS3³⁹. The vector was electroporated into the Δ1209 strain to obtain the single copy chromosomal *trans*-complemented strain, following the protocol described for the construction of the mutant.

Expression of recombinant EFAU004_01209. The EFAU004_01209 PCR purified product was cloned into the pETSumo vector (Thermo Scientific) according to the manufacturer's instructions. The expression and purification of the recombinant EFAU004_01209 (rEFAU004_01209) under native conditions was performed as described previously⁴⁰. The eluted rEFAU004_01209 protein was dialyzed against PBS (phosphate buffered saline).

Bacterial infection of mice. For *in vivo* RNA preparation, the enterococcal cells were grown overnight and then pelleted and resuspended in 5 ml of phosphate buffered saline (PBS) for injection. Mice were infected by intraperitoneal injection of 1000 µl, corresponding 10⁷ to 10⁸ cells. Twenty four hours after inoculation, the bacteria and eukaryotic cells were collected by peritoneal washing. The eukaryotic cells were then lysed in ice cold water for 45 minutes. The bacteria were resuspended in PBS, and serial dilutions were made on TSA medium to quantify recovery. For the intravenous infection model, overnight cultures of the strains were centrifuged, and pellets were resuspended in PBS at final concentrations of 10⁹ bacteria/ml. A total of 100 µl from each strain was injected into 10 female BALB/c mice (10 weeks old; Harlan Italy S.r.l., Udine, Italy) through the tail vein. Mice were euthanized by cervical dislocation 7 days after infection. Kidneys and livers were then removed, weighed, and homogenized using a stomacher (model 80; Pbi International, Milan, Italy). Serial homogenate dilutions were plated onto enterococcus selective agar (Fluka Analytical, Switzerland) for CFU determination. The CFU counts were analyzed by the unpaired *t*-test. Overnight grown strains were centrifuged, and pellets were resuspended in PBS to achieve final concentrations of 10⁹ C.F.U./ml. Ten six weeks old female mice were infected via intra-urethral catheterization (polyethylene catheter, 4 cm long; outside diameter, 0.61 mm; Becton Dickinson, Sparks, MD) with 100 µl of each strain suspension. Mice were sacrificed four days after transurethral challenge, and the bladders and kidneys were excised, weighed, and homogenized with a Stomacher 80 device (PBI International, Italy) for 120 s at a high speed. Serial homogenate dilutions were plated for CFU determination. The CFU counts were analyzed by the unpaired *t*-test.

Production of polyclonal antiserum. To obtain an anti EFAU004_1209 serum, two male BALB/c mice (6 to 8 weeks old; 25 to 30 g) were immunized with recombinant purified rEFAU004_1209. Animals were immunized subcutaneously with 25 µg of rEFAU004_1209 in Freund's complete adjuvant, and then two boosters containing the same amount of protein/adjuvant were given at 3 week intervals. Three weeks after the final inoculation, mice were injected intraperitoneally with 10 µg of rEFAU004_1209 mixed with uncomplete Freund's adjuvant. Animals were bled 2 weeks after each booster, and sera were tested for anti rEFAU004_1209 antibody titer by immunoblotting.

Real-time quantitative PCR. To test EFAU004_01209 expression levels in AUS0004, RNA was extracted from bacteria grown in BHI medium till exponential phase (O.D.: 0,4) and stationary phase culture (24 hours) and from bacteria recovered after intra-peritoneal infection, as described before, using RNeasy mini kit (Qiagen), which includes an RNase free DNase treatment step to eliminate DNA. Quantitative real-time reverse transcription PCR (RT-PCR) was performed in a CFX96 system (BIO Rad Laboratories), using *gyrA* as normalization gene¹⁹ using primers listed in supplementary Table S3. The relative messenger RNA (mRNA) expression level of the target gene in each sample was calculated using the comparative cycle threshold method.

Immunofluorescence. For the immunofluorescence staining, whole cells of the AUS004 wild type strain, Δ EFAU004_1209 and the triple mutant strains, grown overnight, were fixed with PBS containing 4% paraformaldehyde for 5 minutes and then incubated overnight with a polyclonal antiserum against rEFAU004_1209 that was generated in mouse. The bound antibodies were detected by incubation for 1 hour with fluorescein isothiocyanate (FITC) coupled anti mouse antibodies (Sigma). A total of 15 μ l of the sample was applied to a glass slide, air dried, and heat fixed. The analysis was performed with a confocal microscope (Eclipse Ti-E Nikon). Pre-immune antiserum from the same animal was used as a negative control. In the same experiments, the same strains were also considered without the incubation with the primary antibody.

Cell adhesion assay. Kidney epithelial cells from monkey (VERO cells) were cultured in Dulbecco's modified Eagle medium (DMEM) (Gibco, Invitrogen, United Kingdom) supplemented with 10% heat inactivated fetal calf serum (Integro B.V., Zaandam, The Netherlands), 1% nonessential amino acids (Gibco), and 1 mM glutamine (Gibco) and incubated in a 37 °C incubator with 5% CO₂. Differentiated VERO cells were prepared by seeding cells from passages 25 to 45 in 12 well tissue culture plates (Costar) at 1.6×10^5 cells/ml in DMEM, with all supplements. The culture medium was replaced every second day. Overnight grown cultures of AUS0004, Δ EFAU004_01209, the complemented strain and the triple mutant were diluted (1:100) and grown at 37 °C to an OD₆₆₀ of 0.4. Bacteria were harvested by centrifugation and resuspended in DMEM to a concentration of 1×10^7 CFU/ml. For each strain, 1 ml bacterial suspension was added to the wells (100 bacteria per cell). Plates were centrifuged and incubated for 1 h at 37 °C. After incubation, monolayers were rinsed three times with DMEM/EMEM, and cells were lysed with 1% Triton X 100 (Merck, Darmstadt, Germany) in PBS for 5 min at room temperature. The adherent bacteria were quantified by plating serial dilutions on BHI agar plates and counting CFU. The inoculum was plated to determine viable counts. The assay was performed in triplicate and repeated twice

Ethics statement. The mouse experiments were performed under a protocol approved by the Institutional Animal Use and Care Committee at the Università Cattolica del Sacro Cuore, Rome, Italy (Protocol N° 903/2017 PR) and authorized by the Italian Ministry of Health, according to Legislative Decree 116/92, which implemented the European Directive 86/609/EEC on laboratory animal protection in Italy. Animal welfare was routinely checked by veterinarians of the Service for Animal Welfare. We confirm that all experiments were performed in accordance with relevant guidelines and regulations. Urine collection was approved and the need for informed consent was waived by the Institutional Review Board of Università Cattolica del Sacro Cuore, Policlinico Universitario Agostino Gemelli, I.R.C.C.S. (protocol number 49/18). All methods were carried out in accordance with relevant guidelines and regulations.

References

- Nelson, I., Agudelo, H. & Huycke, M. M. Enterococcal Disease, Epidemiology, and Implications for Treatment in *Enterococci: From Commensals to Leading Causes of Drug Resistant Infection*. (eds Gilmore, M. S., Clewell, D. B., Ike, Y. & Shankar, N.) Boston: Massachusetts Eye and Ear Infirmary. (2014).
- Murray, B. E. Vancomycin-resistant enterococcal infections. *N Engl J Med.* **342**, 710–721 (2000).
- Zarb, P. *et al.* The European Centre for Disease Prevention and Control (ECDC) pilot point prevalence survey of health care associated infections and antimicrobial use. *Euro Surveill.* **17**, 46 (2012).
- Sievert, D. M. *et al.* Antimicrobial-resistant pathogens associated with healthcare-associated infections: summary of data reported to the National Healthcare Safety Network at the Centers for Disease Control and Prevention, 2009–2010. *Infect Control Hosp Epidemiol.* **34**, 1–14 (2013).
- Werner, G. *et al.* Emergence and spread of vancomycin resistance among enterococci in Europe. *Euro Surveill.* **13**, 47 (2008).
- Arias, C. A. & Murray, B. E. Antibiotic-resistant bugs in the 21st century—a clinical superchallenge. *N Engl J Med.* **360**, 439–443 (2009).
- Top, J., Willems, R., van der Velden, S., Asbroek, M. & Bonten, M. Emergence of clonal complex *Enterococcus faecium* in The Netherlands. *J Clin Microbiol.* **46**, 214–219 (2008).
- Treitman, A. & Yarnold, P. Emerging incidence of *Enterococcus faecium* among hospital isolates (1993 to 2002). *J Clin Microbiol.* **43**, 462–463 (2005).
- Fisher, K. & Phillips, C. The ecology, epidemiology and virulence of *Enterococcus*. *Microbiology* **155**, 1749–1757 (2009).
- Sava, I. G., Heikens, E. & Huebner, J. Pathogenesis and immunity in enterococcal infections. *Clin Microbiol Infect.* **16**, 533–540 (2010).
- Lin, J., Huang, S. & Zhang, Q. Outer membrane proteins: key players for bacterial adaptation in host niches. *Microbes Infect* **4**, 325–331 (2002).
- Olaya-Abril, A., Jiménez-Munigua, I., Gómez-Gascón, L., Obando, I. & Rodríguez-Ortega, M. J. Identification of potential new protein vaccine candidates through pan-surfomic analysis of pneumococcal clinical isolates from adults. *PLoS One* **8**, e70365 (2013).
- Barinov, A. *et al.* Prediction of surface exposed proteins in *Streptococcus pyogenes*, with a potential application to other Gram-positive bacteria. *Proteomics.* **9**, 61–73 (2009).
- Lam, M. M. *et al.* Comparative analysis of the first complete *Enterococcus faecium* genome. *J Bacteriol.* **194**(9), 2334–41 (2012).
- Romero-Saavedra, F. *et al.* Identification of peptidoglycan-associated proteins as vaccine candidates for enterococcal infections. *PLoS One.* **9**, 11 (2014).
- Buist, G., Steen, A., Kok, J. & Kuipers, O. P. LysM, a widely distributed protein motif for binding to (peptidoglycans). *Molecular Microbiology.* **68**(4), 838–847 (2008).

17. Visweswaran, G. R., Leenhouts, K., van Roosmalen, M., Kok, J. & Buist, G. Exploiting the peptidoglycan-binding motif, LysM, for medical and industrial applications. *Appl Microbiol Biotechnol.* **98**, 4331–4345 (2013).
18. Mesnage, S. *et al.* Molecular basis for bacterial peptidoglycan recognition by LysM domains. *Nature communication.* **5**, 4269 (2014).
19. Muller, C. *et al.* The Intraperitoneal Transcriptome of the Opportunistic Pathogen *Enterococcus faecalis* in Mice. *PLoS One.* **10**, 5 (2015).
20. Nakayama, H. & Hayashi, R. Biosynthetic pathway of thiamine pyrophosphate: a special reference to the thiamine monophosphate-requiring mutant and the thiamine pyrophosphate-requiring mutant of *Escherichia coli*. *J Bacteriol.* **12**, 1118–26 (1972).
21. Roche, B. *et al.* Iron/sulfur proteins biogenesis in prokaryotes: formation, regulation and diversity. *Biochim Biophys Acta* **1827**(3), 455–69 (2013).
22. Boschi-Muller, S., Olyry, A., Antoine, M. & Branlant, G. The enzymology and biochemistry of methionine sulfoxide reductases. *Biochim Biophys Acta.* **1703**(2), 231–8 (2005).
23. Mendum, M. L. & Smith, L. T. Characterization of glycine betaine porter I from *Listeria monocytogenes* and its roles in salt and chill tolerance. *Appl Environ Microbiol.* **68**(2), 813–9 (2002).
24. Mehmeti, I., Solheim, M., Nes, I. F. & Holo, H. *Enterococcus faecalis* grows on ascorbic acid. *Appl Environ Microbiol.* **79**(15), 4756–8 (2013).
25. Arthur, M. & Quintiliani, R. Regulation of VanA- and VanB-Type Glycopeptide Resistance in Enterococci. *Antimicrob Agents Chemother.* **45**(2), 375–81 (2001).
26. Peschel, A. & Sahl, H. G. The co-evolution of host cationic antimicrobial peptides and microbial resistance. *Nat Rev Microbiol.* **4**, 529–536 (2006).
27. Hooper, N. M. Families of zinc metalloproteases. *FEBS Lett.* **354**(1), 1–6 (1994).
28. Le Breton, F. *et al.* AsrR Is an Oxidative Stress Sensing Regulator Modulating *Enterococcus faecium* Opportunistic Traits, Antimicrobial Resistance, and Pathogenicity. *Plos Path* **8**(8), 1002834 (2012).
29. Küster, E., Luesink, E. J., de Vos, W. M. & Hillen, W. Immunological cross-reactivity to the catabolite control protein CcpA from *Bacillus megaterium* is found in many Gram-positive bacteria. *FEMS Microbiol. Lett.* **39**, 109–115 (1996).
30. Flores-Mirelesa, A. L. *et al.* Antibody-Based Therapy for Enterococcal Catheter-Associated Urinary Tract Infections. *Mbio.* **5**, 01653–16 (2016).
31. Miller, W. R., Munita, J. M. & Arias, C. A. Mechanisms of antibiotic resistance in enterococci. *Expert Rev Anti Infect Ther.* **12**(10), 1221–36 (2014).
32. Escaut, L. *et al.* Eradication of an outbreak of vancomycin-resistant *Enterococcus* (VRE): the cost of a failure in the systematic screening. *Antimicrob Resist Infect Control.* **7**(2), 189–192 (2013).
33. Kajimura, J. *et al.* Identification and molecular characterization of an N-acetyl-muramyl-L-alanine amidase Sle1 involved in cell separation in *Staphylococcus aureus*. *Molecular Microbiology* **58**(4), 1087–110 (2005).
34. Wu, Z. *et al.* A Streptococcus suis LysM domain surface protein contributes to bacterial virulence. *Vet Microbiol.* **1**(187), 64–69 (2016).
35. Wang, L., Wang, S. & Li, W. RSeQC: Quality Control of RNA-seq experiments. *Bioinformatics.* **28**(16), 2184–2185 (2012).
36. Trapnell, C., Pachter, L. & Salzberg, S. L. TopHat: discovering splice junctions with RNASeq. *Bioinformatics.* **25**(9), 11005–1111 (2009).
37. Robinson, M. D., McCarthy, D. J. & Smyth, G. K. edgeR: a Bioconductor package for differential expression analysis of digital gene expression data. *Bioinformatics.* **26**, 139–140 (2010).
38. Zhang, X., Vrijenhoek, J. E., Bonten, M. J., Willems, R. J. & Van Schaik, W. A genetic element present on megaplasmid allows *Enterococcus faecium* to use Raffinose as carbon source. *Apl. Environ. Microbiol.* **13**(2), 518–528 (2011).
39. Leenhouts, K. *et al.* MolA general system for generating unlabelled gene replacements in bacterial chromosomes. *Gen Genet.* **253**, 217–24 (1996).
40. Bugli, F. *et al.* Synthesis and characterization of different immunogenic viral nanoconstructs from rotavirus VP6 inner capsid protein. *Int J Nanomedicine.* **9**, 2727–39 (2014).

Acknowledgements

RNA sequencing experiments were performed at the iGE3 genomics platform of the University of Geneva (http://www.ige3.unige.ch/genomics_platform.php), and the TEM experiments were performed at the CMABio microscopy platform of the University of Caen-Normandy. We respectively thank Mylène Docquier and Didier Goux for their expertise. We thank Willem van Schaik for the generous gift of the pWS3 plasmid. The expert technical assistance of Anne-Cécile Appourchaut, University of Caen-Normandy, was greatly appreciated.

Author Contributions

Conceived and designed the experiments: M.C., C.G. and F.B. Performed the experiments: M.C., L.L., R.T., C.M. and V.P. Analyzed the data: M.C., C.G. and A.H. Contributed discussion/reagents/materials/analysis tools: M.S., A.H., B.P. and F.B. Wrote the paper: M.C., C.G., M.S., F.B. and A.H.

Additional Information

Supplementary information accompanies this paper at <https://doi.org/10.1038/s41598-018-30882-z>.

Competing Interests: The authors declare no competing interests.

Publisher's note: Springer Nature remains neutral with regard to jurisdictional claims in published maps and institutional affiliations.



Open Access This article is licensed under a Creative Commons Attribution 4.0 International License, which permits use, sharing, adaptation, distribution and reproduction in any medium or format, as long as you give appropriate credit to the original author(s) and the source, provide a link to the Creative Commons license, and indicate if changes were made. The images or other third party material in this article are included in the article's Creative Commons license, unless indicated otherwise in a credit line to the material. If material is not included in the article's Creative Commons license and your intended use is not permitted by statutory regulation or exceeds the permitted use, you will need to obtain permission directly from the copyright holder. To view a copy of this license, visit <http://creativecommons.org/licenses/by/4.0/>.

© The Author(s) 2018

Characterization of svuceucin from *Streptomyces* provides insights into enzyme exchangeability and disulfide bond formation in lasso peptides.

Li Y, Ducasse R, Zirah S, Blond A, Goulard C, Lescop E, **Giraud C**, Hartke A, Guittet E, Pernodet JL, Rebuffat S.

ACS Chem Biol. 2015; 10(11):2641-9.

Characterization of Svceucin from *Streptomyces* Provides Insight into Enzyme Exchangeability and Disulfide Bond Formation in Lasso Peptides

Yanyan Li,^{*,†} Rémi Ducasse,[†] Séverine Zirah,[†] Alain Blond,[†] Christophe Goulard,[†] Ewen Lescop,[‡] Caroline Giraud,[§] Axel Hartke,[§] Eric Guittet,[‡] Jean-Luc Pernodet,^{||} and Sylvie Rebuffat[†]

[†]Laboratory Molecules of Communication and Adaptation of Microorganisms (MCAM, UMR 7245 CNRS-MNHN), Sorbonne Universités, Muséum National d'Histoire Naturelle, Centre National de la Recherche Scientifique, CP 54, 57 rue Cuvier, F-75005, Paris, France

[‡]Institut de Chimie des Substances Naturelles, Centre de Recherche de Gif, UPR 2301 CNRS Université Paris-Sud, 1 avenue de la Terrasse, F-91198 Gif-sur-Yvette, France

[§]Unité de Recherche Risques Microbiens (U2RM)-Stress et Virulence (EA 4655), Université de Caen-Basse Normandie, F-14032 Caen, France

^{||}Institute for Integrative Biology of the Cell (I2BC), CEA, CNRS, Université Paris-Sud, Bât. 400, Université Paris-Sud, F-91405 Orsay, France

Supporting Information

ABSTRACT: Lasso peptides are bacterial ribosomally synthesized and post-translationally modified peptides. They have sparked increasing interest in peptide-based drug development because of their compact, interlocked structure, which offers superior stability and protein-binding capacity. Disulfide bond-containing lasso peptides are rare and exhibit highly sought-after activities. In an effort to expand the repertoire of such molecules, we heterologously expressed, in *Streptomyces coelicolor*, the gene cluster encoding svceucin, a type I lasso peptide with two disulfide bridges originating from *Streptomyces svceus*, which allowed it to be fully characterized. Svceucin and its reduced forms were characterized by mass spectrometry and peptidase digestion. The three-dimensional structure of svceucin was determined using NMR. Svceucin displayed antimicrobial activity selectively against Gram-positive bacteria and inhibition of *fsr* quorum sensing in *Enterococcus faecalis*. This study adds svceucin to the type I lasso peptide family as a new representative. Moreover, new clusters encoding disulfide-bond containing lasso peptides from Actinobacteria were identified by genome mining. Genetic and functional analyses revealed that the formation of disulfide bonds in svceucin does not require a pathway-encoded thiol–disulfide oxidoreductase. Most importantly, we demonstrated the functional exchangeability of the svceucin and microcin J25 (a non-disulfide-bridged lasso peptide) macrolactam synthetases *in vitro*, highlighting the potential of hybrid lasso synthetases in lasso peptide engineering.

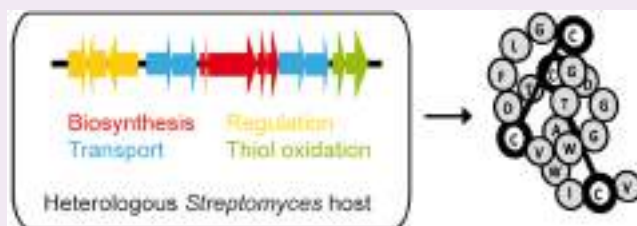

Cyclic peptide natural products with stable interlocked structures are advantageous frameworks for drug development.¹ Lasso peptides produced by bacteria, which have a [1]rotaxane mechanically interlocked topology, provide an example of such structures. The lasso scaffold features an N-terminal 7–9 amino acid macrocycle and a C-terminal tail that folds back and threads through the ring. The tail is prevented from unthreading by sterically demanding amino acid side chains or by disulfide bridges. This compact and constrained topology favors peptide–protein interactions and accounts for the diverse biological activities of lasso peptides, mainly as enzyme inhibitors and receptor antagonists.² Recent discoveries of lassomycin and streptomonicin as potent antibiotics with unusual modes of action against *Mycobacterium tuberculosis* and *Bacillus anthracis*, respectively, highlighted the pharmaceutical potential of lasso peptides.^{3,4} Moreover, the lasso scaffold is

highly valuable for epitope grafting, as demonstrated for microcin J25 (MccJ25).^{5,6} For the purpose of medicinal applications, it is necessary to unveil lasso peptides' chemical and structural diversity from bacteria. Because synthetic routes to these molecules have yet to be available, understanding the mechanism of biosynthesis is the key to applying their enzyme machineries to generate designer peptides.

Over the past 5 years, efforts have been made to discover novel lasso peptides from Proteobacteria using genomics-guided approaches.^{7–14} These studies required successful heterologous expression in *Escherichia coli* to circumvent the

Received: July 24, 2015

Accepted: September 5, 2015

Published: September 7, 2015

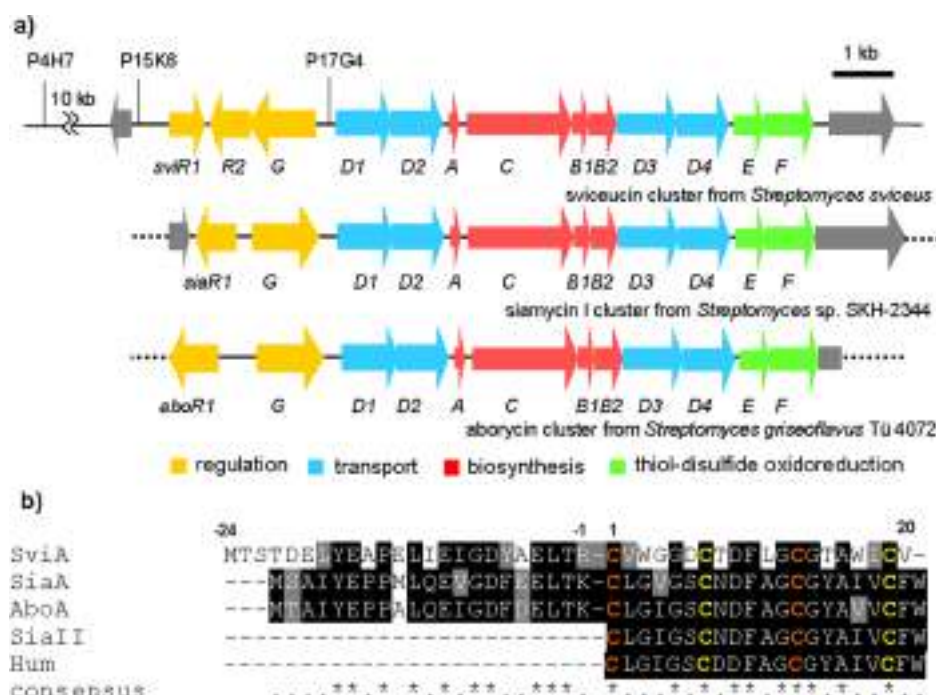

Figure 1. Gene clusters and sequences of type I lasso peptides. (a) Gene organization. Left limits of the *svi* cluster in cosmids P4H7, P15K6, and P17G4 are indicated. (b) Sequence alignment. SviA, SiaA and AboA are precursors of sviceucin, siamycin I and aborycin, respectively. SiaII and Hum are core peptides of siamycin II and humidimycin, respectively. Paired cysteines are indicated by the same color.

problems of low production in native hosts. In contrast, Actinobacteria have not been exploited yet by such efforts, although they are rich sources of bioactive lasso scaffolds.^{3,4,15} In particular, lasso peptides with two or one disulfide bonds, which define the type I and III subgroups, respectively, have been isolated uniquely from *Streptomyces*. These peptides are rare and particularly interesting. Indeed, disulfide bridges may confer further stability/rigidity into the lasso topology, which would be beneficial for biological activities. The four known type I lasso peptides, namely, siamycin I,¹⁶ II,¹⁷ RP-71955¹⁸ (also termed aborycin¹⁹), and humidimycin,²⁰ possess nearly identical sequences. They have been shown to display anti-HIV and antibacterial properties as well as to potentialize the antifungal activity of a clinically used antifungal drug. The only type III peptide, BI-32169, is a glucagon receptor antagonist.²¹ The mechanisms governing disulfide bond formation in these peptides remain unknown.

Lasso peptides are ribosomally synthesized and post-translationally modified peptides (RiPPs).²² The linear precursor peptide (A), composed of leader and core sequences, is transformed into the lasso topology by the concerted action of two maturation enzymes (B and C). Detailed characterization has been carried out for MccJ25 maturation enzymes McjB and McjC.^{23,24} The B protein is an ATP-dependent cysteine protease, whereas the C protein is a macrolactam synthetase. Both proteins are functionally interdependent and require the formation of a presumed complex (lasso synthetase). The full-length B enzyme comprises distinctive N- and C-terminal domains, with the former proposed to be involved in the prefolding of the precursor (a process driven by ATP hydrolysis) and the latter confirmed to catalyze cleavage of the leader peptide.²⁴ These two domains may be encoded in some lasso clusters as individual polypeptides (B1 and B2), as exemplified by the lariatin cluster in *Rhodococcus jostii*.²⁵ The

multipartner organization of lasso synthetases would be advantageous for peptide engineering.

A peptidogenomic study has previously demonstrated, by MS imaging analyses, the capacity of *S. svicensis* to produce a type I lasso peptide.²⁶ Here, we report the full characterization of this new representative that we termed sviceucin. This was made possible by heterologous expression of the lasso gene cluster in *Streptomyces coelicolor*. Genetic and functional analyses of sviceucin biosynthesis were performed to clarify the mechanism of thiol oxidation into disulfide bridges. Moreover, this study demonstrated, for the first time, the functional exchangeability of the macrolactam synthetase components between lasso synthetases *in vitro*, underlining the potential use of hybrid synthetases for lasso peptide engineering.

RESULTS AND DISCUSSION

Gene Cluster Analysis and Genome Mining. The sviceucin gene cluster (termed *svi* genes hereafter) originally identified by genome mining contained core genes coding for a precursor peptide (SviA), three maturation enzymes (the split B subunits [SviB1/B2] and SviC), and an ABC transporter system (SviD3/D4) (Figure 1a and Supporting Information Table S3), an organization similar to that found in the lariatin cluster.²⁵ *In silico* analysis of the SviA sequence and its comparison to known type I lasso peptides predicted that sviceucin would consist of 20 amino acids (aa) and contain a 9-residue macrolactam ring formed between Cys1 and Asp9 as well as two disulfide bond pairs, Cys1–Cys13 and Cys7–Cys19 (Figure 1b). The original encoded SviC was composed of 440 aa, which was smaller than the average size of C proteins (600 aa). Therefore, resequencing and manual annotation were performed. This led to a corrected version of *sviC*. Sequence analysis further revealed other genes that might be involved in the transport (*sviD1/D2*), regulation (*sviG/R1/R2*), and disulfide bond formation (*sviE/F*) in the flanking region of

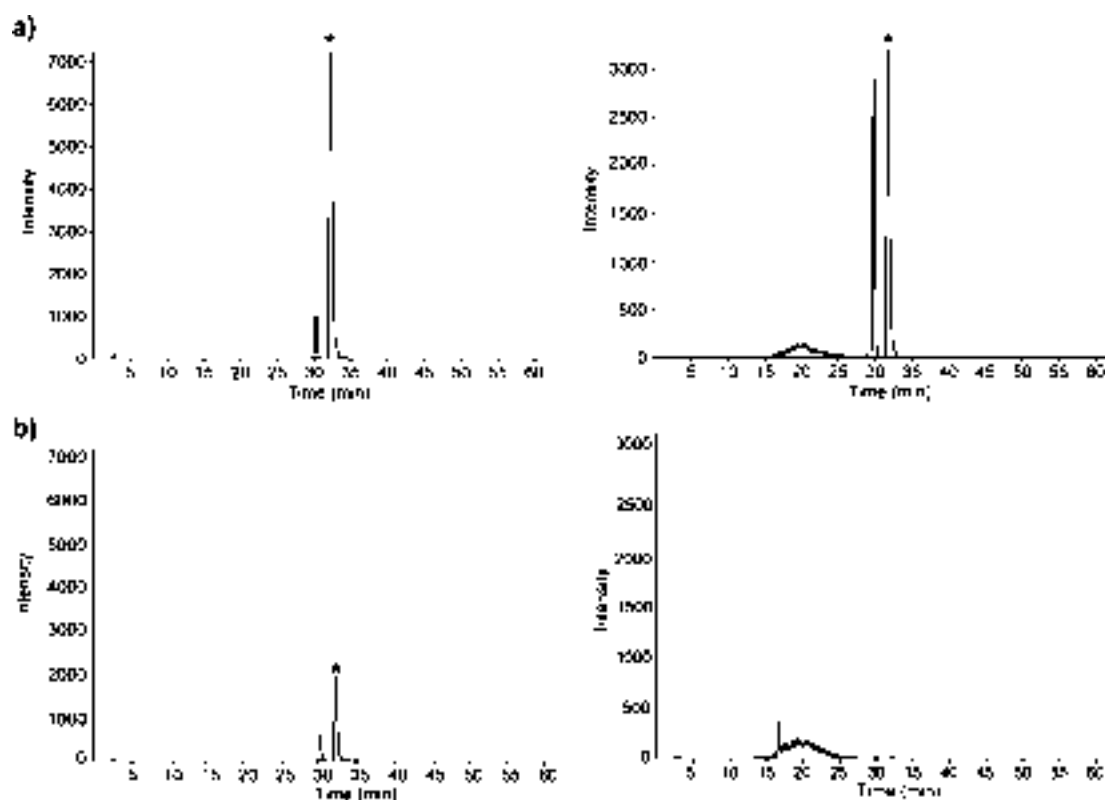

Figure 2. HPLC-MS analyses of extracts of *S. coelicolor* harboring the wild-type or $\Delta sviF$ cluster. Extracted ion chromatograms of the doubly charged ion at m/z 1042.4 are shown. (a) Wild-type cluster. (b) $\Delta sviF$ cluster. Left panels: mycelia extracts; right panels: supernatant extracts. Asterisk (*) depicts the sviveucin peak. The peak at t_R 29.8 min displayed an identical mass to that of sviveucin and was detected mainly in the supernatant. This compound was not stable along the purification procedure.

the core cluster. Genes *sviD1/D2* encode an additional ABC transporter. SviG is a two-component histidine kinase, whereas both SviR1 and R2 are similar to response regulators, despite the low sequence similarity between them. SviE belongs to the DoxX Pfam family whose members are of unknown function. SviF contains a thioredoxin domain with a conserved CXXC motif and is thus similar to thiol–disulfide oxidoreductases (TDORs). Structural prediction revealed that both SviE and SviF harbor transmembrane domains and are thus predicted to be membrane-anchored. This expanded *svi* cluster shares a conserved organization with known gene clusters of type I lasso peptides including siamycin I and aborycin,²⁷ except that the latter two lack a SviR2 homologue. Alignment of the three precursor peptides revealed consensus sequences both in the leader and core peptide regions (Figure 1b).

In an effort to identify new disulfide bond-containing lasso peptides, SviB2 was used to search available genomes by position-specific iterated (PSI)-BLAST. The putative precursor genes were annotated manually. A total of 19 genomes belonging to Actinobacteria were found to harbor putative type I or III lasso clusters (Supporting Information Table S4). This further reflects the rare occurrence of these molecules in nature compared to that of non-disulfide-bridged lasso peptides.

Heterologous Expression. *S. sviveucus* was first cultivated in different media including GYM, TSB, and MP5 at 28 °C, and both supernatants and methanolic extracts of mycelia were analyzed for the production of sviveucin by LC-MS. In all cases, only a small amount of a doubly charged ion at m/z 1042.4, which corresponds to the monoisotopic mass of 2082.8 Da

expected for the predicted peptide with two disulfide linkages, could be detected. This correlates with previous observations that lasso peptides were generally produced at low levels by the native strains under laboratory conditions. In order to obtain enough peptide for complete structural characterization, we set out to develop a heterologous expression system for the *svi* gene cluster in *S. coelicolor* M1146, an engineered strain for the production of secondary metabolites.²⁸ A cosmid library of *S. sviveucus* genomic DNA was generated using pWED4 vector that allows site-specific integration into the host chromosome. Using a *sviC* fragment as probe for hybridization, six out of 2324 clones were revealed to be positive. Among them, cosmids P4H7 and P15K6 contained the entire cluster with 10 and 0.4 kb between the vector sequence and *sviR1*, respectively, whereas cosmid P17G4 lacked *sviG/R1/R2* regulator genes (Figure 1a). *S. coelicolor* M1146 strains harboring the respective cosmids were grown in GYM medium at 28 °C for 5 days. Mycelia and culture supernatants were extracted and analyzed separately. LC-MS analysis revealed a major peak at retention time (t_R) 32 min with the expected molecular monoisotopic mass of 2082.8 Da (obs. $[M + 2H]^{2+}$ at m/z 1042.4) in extracts of strains with integrated P4H7 and P15K6 and not in those of strains without cosmids or with P17G4 (Figure 2a and Supporting Information Figure S1). These results indicate that *sviG/R1/R2*, encoding the two-component regulatory system, are part of the gene cluster and play an essential role in sviveucin production. Moreover, sviveucin accumulated more in the mycelia than in the culture supernatant by 2-fold. Sviveucin was thus extracted and purified from both the mycelia and

culture supernatants of *S. coelicolor* with P4H7 (Figure 3a). The total yield was, on average, 15 mg per liter of culture.

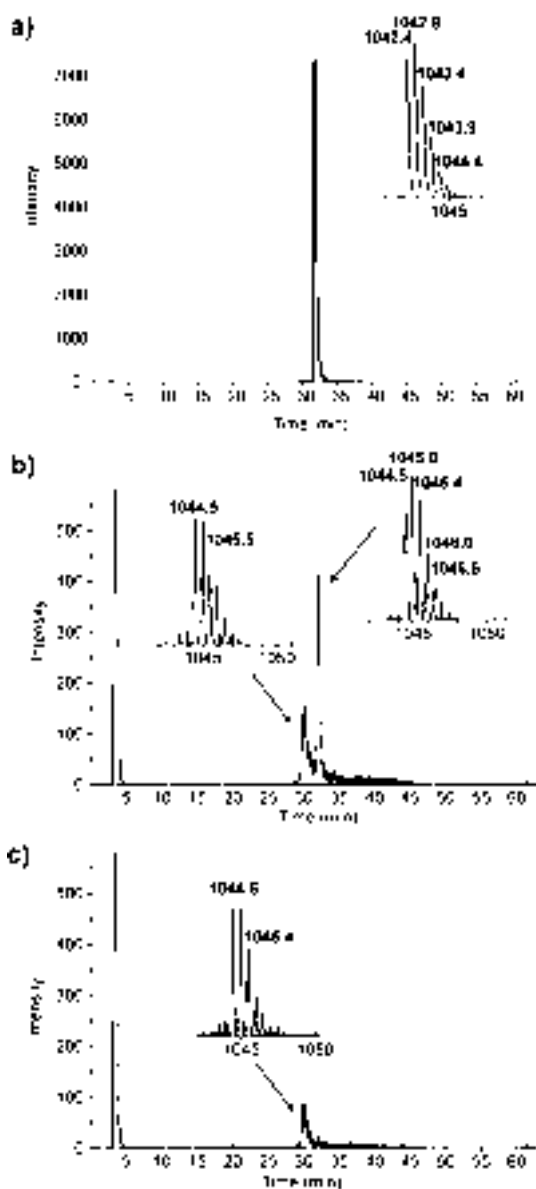

Figure 3. Reduction and enzymatic digestion of svuceucin. Extracted ion chromatograms and the corresponding mass spectra are shown. (a) Purified svuceucin. (b) Reduced svuceucin. (c) Reduced svuceucin after carboxypeptidase Y digestion.

Characterization of the Native and Reduced Peptides by MS and Peptidase Degradation. Tandem mass spectrometry has been shown to be a useful tool to characterize lasso peptides, as the lasso topology can result in noncovalently associated b- and y-type product ions.²⁹ The doubly charged species of svuceucin (m/z 1042.4) was subjected to collision-induced dissociation (CID), revealing an overall weak and complex fragmentation pattern (Supporting Information Figure S2). The spectrum revealed fragmentation mainly in the ring and tail regions, yielding numerous b and y product ions covalently linked by disulfide bonds (termed $M-\{X\}$, where X indicates the lost peptidic segment), related ions with H_2O and CO neutral losses, and complementary internal product ions as well as related amino acid immonium ions. A similar behavior

was observed for the lasso peptide BI-32169, which contains one disulfide bond.³⁰ The smallest observed b-series was b_9 (e.g., $[M-\{FLG\}]^{2+}$ at m/z 883.7), confirming that Asp9 establishes the macrolactam linkage with Cys1. The largest internal fragment was GTAWI, consistent with the assumption that Cys13 and Cys19 are each involved in a different disulfide bridge.

Enzymatic digestion by carboxypeptidase Y is a quick and robust method to determine whether a peptide is in the lasso topology because lasso peptides are totally or partially resistant to enzymatic degradation, whereas the corresponding branched-cyclic topoisomers are not.^{7,31} Svuceucin was incubated with carboxypeptidase Y at RT for 3 h, and no degradation occurred. Since this could be a consequence of the presence of disulfide bonds, we performed reduction under mild conditions (at RT in the presence of 10 mM DTT) before enzymatic digestion and LC-MS analysis. Reduced svuceucin yielded two distinct HPLC peaks having a $[M + 2H]^{2+}$ ion at m/z 1044.4, which corresponds to the complete reduction of two disulfide bonds (Figure 3b). The two peaks might correspond to the lasso and nonlasso topoisomers, respectively. The peptide eluted at t_R 32 min was degraded completely by carboxypeptidase Y, whereas the peptide eluted at t_R 30 min remained intact (Figure 3c). Therefore, reduced svuceucin is a mixture of the lassoed (t_R 30 min) and branched-cyclic (t_R 32 min) forms, which can arise only if the original structure is interlocked. Importantly, this also indicates that the lasso topology can be partly maintained in the absence of the disulfide linkages.

To further confirm these results, tandem MS analysis was performed on the reduced peptides (doubly charged species at m/z 1044.4; Supporting Information Figure S3). As expected, both peptides fragmented more extensively than the native peptide. The two topoisomers yielded mainly b- and y-series corresponding to cleavages within the C-terminal linear tail, but they showed differences in the extent of fragmentation and the relative intensities of the product ions. The peptide at t_R 32 min (assigned to the cyclic-branched topoisomer) was more fragmented and yielded mainly singly charged y- and b-type product ions, whereas the topoisomer at t_R 30 min (assigned to the lasso peptide) generated more abundant doubly charged b-type product ions corresponding to cleavages in the Ala16–Cys19 region.

Structure Determination by NMR. To unambiguously assign the svuceucin lasso topology, its three-dimensional structure was determined by NMR. Complete 1H signals assignment was obtained in CD_3OH (Supporting Information Table S5). Strong NOEs between the Cys1-NH and the Asp9- H_β were observed, confirming an internal linkage between these two residues through the macrolactam ring. The chemical shifts of the β carbons of the Cys residues ($C_{\beta-Cys1} = 44.52$ ppm, $C_{\beta-Cys7} = 43.90$ ppm, $C_{\beta-Cys19} = 42.43$ ppm) are characteristic of oxidized cysteines (>42 ppm) (Supporting Information Table S6),³² indicating the presence of two disulfide bonds. Strong NOE correlations between the H_β of Cys7 and Cys19 were observed in the NOESY spectrum recorded in H_2O , suggesting that the disulfide pairing is Cys1–Cys13 and Cys7–Cys19. Initial structure calculations were performed using experimental restraints without defining the topology of the disulfide bridge. The ensemble of structures showed the close proximity of the sulfur atoms of Cys1 and Cys13 and of Cys7 and Cys19, thus confirming the proposed topology. Subsequent structure calculations were carried out by imposing the disulfide bridges.

Numerous long-range NOEs between residues of the macrolactam ring and residues Thr15 or Ala16 were observed, such as the correlations $d_{\alpha N}(A16,V2)$, $d_{\beta N}(T15,G4)$, $d_{\beta N}(T15,G5)$, $d_{\alpha N}(T15,C7)$, $d_{\beta N}(T15,C7)$, and $d_{\alpha N}(T8,A16)$ (Supporting Information Table S8). These contacts provide strong evidence of the threading of the C-terminal tail through the ring and suggest that residues Thr15 and Ala16 are located next to the interlocked region. Residue Trp17 also showed long-range NOEs with the macrolactam ring (amino acids Val2–Gly5), suggesting that its side chain is in close contact with this region.

The solution structure of svuceucin calculated using the NMR-derived constraints adopts an interlocked topology (Figure 4 and Supporting Information Figure S4 and Table

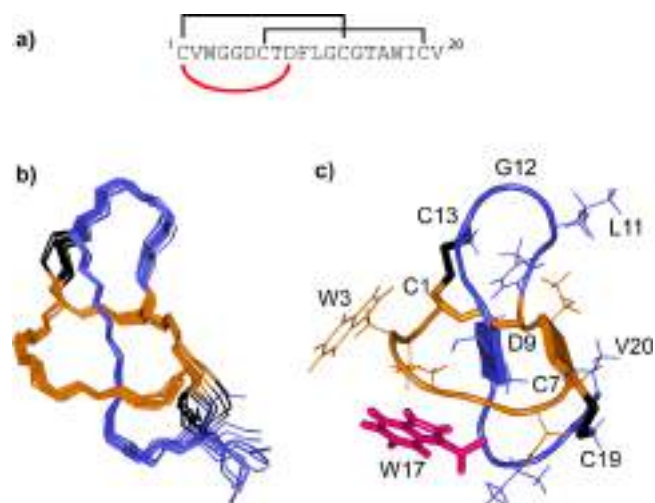

Figure 4. Primary and three-dimensional structures of svuceucin. (a) Primary structure showing the macrolactam ring (red line) and disulfide linkages (black lines). (b) Superposition of the 20 lowest energy structures. (c) Ribbon representation of a representative structure. The macrolactam ring, tail, and disulfide bonds are shown in orange, blue, and black, respectively.

S9). The C-terminal tail is threaded through the nine-membered macrolactam ring, forming a five-residue loop motif (Phe10–Thr15) and a threaded five-residue tail portion below the ring (Ala16–Val20). A small antiparallel β -sheet is present in the structure, consisting of strands Cys7–Thr8 and Thr15–Ala16. In addition to the disulfide linkage between Cys7 and Cys19, the bulky Trp17 below the ring very likely acts as a plug residue to prevent the tail from unthreading, which explains the threaded conformation upon complete reduction of the disulfide bridges. The 3D structure of svuceucin is similar to that of type I lasso peptides including siamycin I,³³ II,³⁴ and RP-71955.^{19,35} Superposition of the structures of svuceucin and the representative RP-71955 revealed that both structures fit closely and display amphipathic surface properties (Figure 5). The surface of the loop region is nearly identical, attributed to the highly conserved sequence in this area among type I lasso peptides (Figure 1b; F¹⁰XGCGX¹⁵, where X denotes any amino acid). Subtle differences appear in terms of the overall surface shape and distribution of the polar patch, reflecting the variation in the amino acids of the ring and threaded tail region. The amphipathic nature of RP-71955 was proposed to be important for its interaction with biological targets.³⁵ Taken together, these analyses suggest that svuceucin and other type I lasso peptides might share common targets that, however, have distinct features.

Antimicrobial Activities. The antimicrobial activity of svuceucin was assayed against a panel of Gram-negative and -positive bacteria as well as fungi (Supporting Information Table S10). Svuceucin showed moderate activity against Gram-positive bacteria and no activity against Gram-negative bacteria or fungi. The most sensitive strains tested were *Bacillus megaterium*, *Lactobacillus bulgaricus* 340, *Staphylococcus aureus* subsp. *aureus* ATCC 6538, *Lactobacillus sakei* subsp. *sakei* DSM 20017, and a closely related *Streptomyces* sp. 523 from our in-house collection, with minimal inhibitory concentrations (MICs) of 1.25–2.5 μ M. Similar antimicrobial activities were found for other type I lasso peptides.^{17,19} In addition, given that

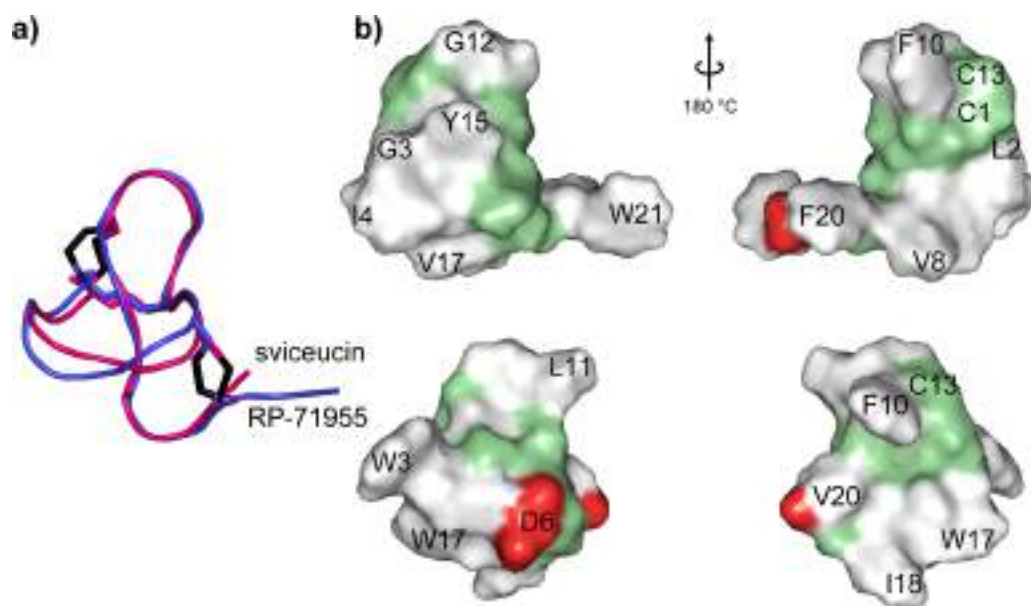

Figure 5. Structural comparison of svuceucin and RP-71955 (PDB 1RPC). (a) Superposition of the two backbone structures (svuceucin: magenta; RP-71955: blue). (b) Surface properties of RP-71955 (upper panel) and svuceucin (lower panel). Hydrophobic regions are shown in gray; acidic residues are shown in red and green, respectively.

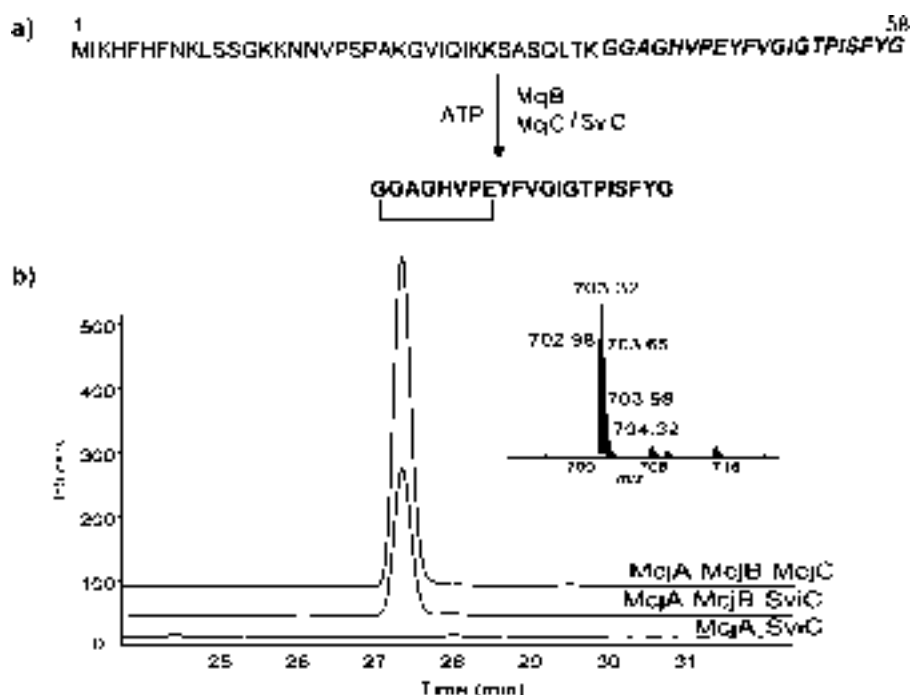

Figure 6. Exchangeability of SviC with McjC in MccJ25 maturation. (a) Maturation reactions of MccJ25. Core peptide is in bold and italic. The macrolactam ring formed by Gly1 and Glu8 is shown by a connecting line. (b) Extracted ion chromatograms and mass spectra ($[M + 3H]^{3+}$ at m/z 703) showing the production of MccJ25 *in vitro*.

siamycin I was able to reduce gelatinase production in *E. faecalis* via inhibition of the *fsr* quorum sensing (QS) system at sublethal concentrations,³⁶ this activity was examined for sviceucin. Similarly, sviceucin at 1 μ M inhibited 50–70% of gelatinase production in *E. faecalis* (strains OG1RF, V583, and 12030) after 6 h of growth (Supporting Information Figure S5), whereas the MIC for these strains was above 10 μ M. Our data suggest that sviceucin is likely to share a similar mode of action with that of siamycins. Siamycins have been shown to inhibit bacterial RNA polymerase³⁷ and, in the case of QS inhibition in *E. faecalis*, target the FsrC sensor kinase.^{38,39}

SviF Is Dispensable for the Disulfide Bond Formation in Sviceucin. How disulfide bonds are formed in lasso peptides remains a fundamental unanswered question. The *svi* gene cluster encodes a TDOR homologue (SviF) that is an obvious candidate to fulfill the function of disulfide bond formation in sviceucin. To test this hypothesis, *sviF* was replaced by an apramycin resistance cassette in P4H7, and heterologous expression of the resulting *sviF*-inactivated cluster was performed. LC-MS analysis revealed that a peak with identical mass and t_R to those of sviceucin was detected in the mycelia; however, it was absent in the culture supernatant (Figure 2b). Tandem mass analysis further confirmed its identity as being mature sviceucin. No reduced forms were observed. These results suggest that SviF is not essential for the formation of disulfide bonds in sviceucin but that it is required for the transporter activity. SviF would catalyze thiol oxidation or disulfide isomerization to ensure that the Cys pairing in the transporter is correct. To support this, the importance of intramolecular disulfide bridges has been previously shown for certain ABC transporters.⁴⁰ Precedent examples of TDORs involved in bacteriocin production are BdbB and BlpGst from sublancin 168 and thermophilin 9 biosyntheses,^{41,42} respectively. However, their direct implication in the formation of disulfide bonds in the related peptides has not been

demonstrated. Our present data raise a question as to what the exact roles of these TDORs are. In a SviF-independent manner, thiol oxidation in sviceucin is likely to occur in the active site of the lasso synthetase. It is worth noting that most of the identified gene clusters of disulfide-containing lasso peptides do not encode TDORs (Supporting Information Table S4).

Exchangeability of SviC with McjC in MccJ25 Production. Lasso maturation enzymes are difficult to study *in vitro* due to their low expression levels and insolubility issues. In an attempt to reconstitute sviceucin biosynthesis *in vitro*, SviC (65 kDa), but not SviA/B1/B2, could be produced with an N-terminal His₆-tag with reasonable yields (Supporting Information Figure S6). MccJ25 maturation reaction is currently the only available *in vitro* reconstitution system for lasso peptides. Although SviC shares little similarity to McjC in terms of their primary structures (12.2% sequence identity/25.7% similarity), both display conserved ATP binding sites found in asparagine synthetase B (Supporting Information Figure S7). These residues have been validated experimentally for McjC, namely, S199, D203, Gly298, and D302.²⁴ We then examined if SviC could functionally replace McjC in the maturation reaction of MccJ25 described previously.²⁴ Incubation of McjA with McjB and SviC in the presence of ATP led to MccJ25 production ($[M + 3H]^{3+}$ ion at m/z 703.2), as confirmed by LC-MS and tandem MS analysis (Figure 6). The yield was comparable with that obtained with McjC, demonstrating the similar efficiency of McjC and SviC for MccJ25 maturation. The ability of SviC to efficiently catalyze macrolactam ring formation between Gly1 and Glu8 in MccJ25, residues different from its cognate substrate (between Cys1 and Asp9 in sviceucin), is intriguing. This indicates that macrolactam synthetase activity is independent of the leader peptide, as McjA and SviA share limited sequence homology in the leader peptide region, which agrees with our previous *in vitro*

study of McjC.²⁴ In sharp contrast, McjC has been shown to display a strict requirement for the residues involved in the isopeptidic linkage, a feature shared by most lasso synthetases.^{8,10,11,13,43,44} Altogether, these data suggest that whether a macrolactam ring can be closed or not is likely determined by its intrinsic constraints and/or the C protein active site that accommodates it. Importantly, although more exchangeability assays are required to draw generalized conclusions, our findings strongly indicate that the B protein, i.e., the ATP-dependent protease, determines the overall specificity of the lasso synthetase. Interaction between the B protein and the leader peptide could be one possible mechanism driving this specificity. In accord with this, a very recent report established that the B1 protein, a PqqD homologue, is the RiPP precursor peptide recognition element conserved in many RiPP pathways. It was demonstrated that StmB1, involved in streptomycin biosynthesis, binds the corresponding leader peptide with high affinity ($K_d = 35$ nM).⁴⁵ Moreover, our study highlights the flexibility of the B/C molecular interaction in the synthetase complex since McjB can accommodate different C proteins. Intriguing questions thus arise, such as how strong and specific the interactions between the B and C proteins in a lasso synthetase are. Work is ongoing in our laboratory to answer these questions.

In conclusion, this study adds svuceucin as a second representative to the rare type I lasso peptide family. This is the first report of heterologous expression of a bioactive lasso peptide originating from Actinobacteria, an important source that has not yet been tapped by such efforts. The available heterologous expression system and three-dimensional structure set the stage for structure–activity relationship and mode of action studies. This study also clarified that the pathway-encoded TDOR is not required for thiol oxidation in svuceucin. Most importantly, the functional exchangeability of macrolactam synthetase McjC and SviC within MccJ25 synthetase demonstrated, for the first time, the feasibility of producing a hybrid lasso synthetase, which holds promise for lasso peptide bioengineering.

METHODS

Heterologous Production and Purification of Svuceucin. A genomic library of *S. svuceus* DSM 924 was constructed using cosmid pWED4.⁴⁶ Cosmids containing the *svi* gene cluster were introduced into *S. coelicolor* M1146²⁸ by conjugation with *E. coli* ET12567/pUZ8002 as the donor strain. Correct transconjugants were verified by PCR.

Two liters of *S. coelicolor* M1146 with P4H7 was grown in GYM medium at 28 °C for 5 days. The resulting mycelia were extracted with 500 mL of MeOH/acetone 50:50 (v/v) at RT for 3 h. The culture supernatant was passed through a pre-equilibrated 35 cc C8 Sep-Pak cartridge (Waters). The cartridge was washed with 20% MeCN, and svuceucin was eluted with 60% MeCN. This fraction and mycelia extracts were concentrated and further purified by HPLC on a Capcell C18 column (7 × 300 mm, 5 μm, Interchim). The following gradient was used at a flow-rate of 2 mL/min: linear increase from 35 to 60% B within 20 min followed by an increase to 100% B in 5 min (A: water with 0.1% formic acid; B: MeCN). The elution profile was monitored at 226 nm. Extracts or purified peptides were analyzed by LC-ESI-MS.

Structure Determination by NMR Spectroscopy. Spectra were recorded at 298 K on either a 600 MHz Avance II or 950 MHz Avance III spectrometer (Bruker Biospin). ¹H and ¹³C resonance assignments were carried out using a series of TOCSY, DQF-COSY, NOESY, HSQC, and HMBC experiments. Distance constraints for svuceucin structure calculation were derived from a NOESY spectrum recorded at 600 MHz and 298 K with a mixing time of 150 ms. NOE crosspeaks

were converted into distances by volume integration. Twelve restraints for dihedral angles Φ derived from the vicinal coupling constants ³ $J_{\text{HN-H}\alpha}$ (Supporting Information Table S7) were also included. Structure calculations were performed with X-PLOR⁴⁷ using two successive simulated annealing protocols, each followed by energy minimization. A set of 20 lowest energy structures with no systematic distance violations larger than 0.2 Å and no dihedral angle violations greater than 5° was selected to represent the solution structure of svuceucin. Structure analysis was carried out using PROCHECK-NMR.⁴⁸ The coordinates have been deposited in the Protein Data Bank (ID 2LS1), and ¹H and ¹³C chemical shift assignments have been deposited in the BioMagResBank (entry ID 18405).

Production of SviC and Enzymatic Assays. The *sviC* gene was cloned into pET28b(+) to generate the expression construct pET28-sviC. *E. coli* Rosetta(DE3)pLyS was transformed with pET28-sviC for protein production. Production and purification of N-terminal His₆-tagged SviC followed the same procedure as that previously reported for McjC.²⁴ Recombinant McjA, McjB, and McjC were produced as described.²⁴ A standard reaction in 200 μL contained 50 mM Tris-HCl (pH 8), 5 mM MgCl₂, 1 mM ATP, 2 mM DTT, 0.5 μM McjA, 0.1 μM McjB, and 0.1 μM SviC or McjC. The reaction was incubated at 30 °C for 3 h before being stopped by adding 20 μL of acetic acid. The cleared supernatant was subjected to LC-MS analysis.

ASSOCIATED CONTENT

Supporting Information

The Supporting Information is available free of charge on the ACS Publications website at DOI: 10.1021/acschembio.5b00584.

Additional methods; lists of plasmids and primers; list of genes present in the svuceucin cluster; list of disulfide-containing lasso peptide clusters identified by genome mining; HPLC and tandem MS spectra; NMR data, spectra and structure statistics; table of MICs and Figure of gelatinase assay; SDS-PAGE of recombinant proteins and sequence alignment of SviC and McjC (PDF).

Accession Codes

GenBank accession numbers for *sviC* and *sviG* are KT310072 and KT310073, respectively.

AUTHOR INFORMATION

Corresponding Author

*E-mail: yanyanli@mnhn.fr.

Notes

The authors declare no competing financial interest.

ACKNOWLEDGMENTS

We thank Prof. M. Bibb (John Innes Center, UK) for the kind gift of *S. coelicolor* M1146 and Drs. H. Boubakri and A. Raynal (Orsay, France) for advice on cosmid library construction. We thank the analytical platform at MNHN for access both to NMR spectrometers (which is funded by the MNHN, the CNRS, and the Région Ile-de-France) and to the mass spectrometer. Financial support from the TGIR-RMN-THC Fr3050 CNRS for conducting this research is gratefully acknowledged. This work was supported by ANR grant BLAN_NT09_692063.

REFERENCES

- (1) Craik, D. J., Swedberg, J. E., Mylne, J. S., and Cemazar, M. (2012) Cyclotides as a basis for drug design. *Expert Opin. Drug Discovery* 7, 179–194.

- (2) Maksimov, M. O., Pan, S. J., and Link, A. J. (2012) Lasso peptides: structure, function, biosynthesis, and engineering. *Nat. Prod. Rep.* 29, 996–1006.
- (3) Gavriš, E., Sit, C. S., Cao, S., Kandror, O., Spoering, A., Peoples, A., Ling, L., Fetterman, A., Hughes, D., Bissell, A., Torrey, H., Akopian, T., Mueller, A., Epstein, S., Goldberg, A., Clardy, J., and Lewis, K. (2014) Lassomycin, a ribosomally synthesized cyclic peptide, kills *Mycobacterium tuberculosis* by targeting the ATP-dependent protease ClpC1P1P2. *Chem. Biol.* 21, 509–518.
- (4) Metev, M., Tietz, J. I., Melby, J. O., Blair, P. M., Zhu, L., Livnat, I., Severinov, K., and Mitchell, D. A. (2015) Structure, bioactivity, and resistance mechanism of streptomycin, an unusual lasso peptide from an understudied halophilic actinomycete. *Chem. Biol.* 22, 241–250.
- (5) Knappe, T. A., Manzenrieder, F., Mas-Moruno, C., Linne, U., Sasse, F., Kessler, H., Xie, X., and Marahiel, M. A. (2011) Introducing lasso peptides as molecular scaffolds for drug design: engineering of an integrin antagonist. *Angew. Chem., Int. Ed.* 50, 8714–8717.
- (6) Hegemann, J. D., De Simone, M., Zimmermann, M., Knappe, T. A., Xie, X., Di Leva, F. S., Marinelli, L., Novellino, E., Zahler, S., Kessler, H., and Marahiel, M. A. (2014) Rational improvement of the affinity and selectivity of integrin binding of grafted lasso peptides. *J. Med. Chem.* 57, 5829–5834.
- (7) Knappe, T. A., Linne, U., Zirah, S., Rebuffat, S., Xie, X., and Marahiel, M. A. (2008) Isolation and structural characterization of capistruiin, a lasso peptide predicted from the genome sequence of *Burkholderia thailandensis* E264. *J. Am. Chem. Soc.* 130, 11446–11454.
- (8) Hegemann, J. D., Zimmermann, M., Xie, X., and Marahiel, M. A. (2013) Caulosegnins I–III: a highly diverse group of lasso peptides derived from a single biosynthetic gene cluster. *J. Am. Chem. Soc.* 135, 210–222.
- (9) Hegemann, J. D., Zimmermann, M., Zhu, S., Klug, D., and Marahiel, M. A. (2013) Lasso peptides from proteobacteria: Genome mining employing heterologous expression and mass spectrometry. *Biopolymers* 100, 527–542.
- (10) Hegemann, J. D., Zimmermann, M., Zhu, S., Steuber, H., Harms, K., Xie, X., and Marahiel, M. A. (2014) Xanthomonins I–III: a new class of lasso peptides with a seven-residue macrolactam ring. *Angew. Chem., Int. Ed.* 53, 2230–2234.
- (11) Zimmermann, M., Hegemann, J. D., Xie, X., and Marahiel, M. A. (2013) The astexin-1 lasso peptides: biosynthesis, stability, and structural studies. *Chem. Biol.* 20, 558–569.
- (12) Maksimov, M. O., Pelczar, I., and Link, A. J. (2012) Precursor-centric genome-mining approach for lasso peptide discovery. *Proc. Natl. Acad. Sci. U. S. A.* 109, 15223–15228.
- (13) Zimmermann, M., Hegemann, J. D., Xie, X., and Marahiel, M. A. (2014) Characterization of caulonodin lasso peptides revealed unprecedented N-terminal residues and a precursor motif essential for peptide maturation. *Chemical Science* 5, 4032–4043.
- (14) Maksimov, M. O., and Link, A. J. (2013) Discovery and characterization of an isopeptidase that linearizes lasso peptides. *J. Am. Chem. Soc.* 135, 12038–12047.
- (15) Iwatsuki, M., Uchida, R., Takakusagi, Y., Matsumoto, A., Jiang, C. L., Takahashi, Y., Arai, M., Kobayashi, S., Matsumoto, M., Inokoshi, J., Tomoda, H., and Omura, S. (2007) Lariatins, novel antimycobacterial peptides with a lasso structure, produced by *Rhodococcus jostii* K01-B0171. *J. Antibiot.* 60, 357–363.
- (16) Lin, P. F., Samanta, H., Bechtold, C. M., Deminie, C. A., Patick, A. K., Alam, M., Riccardi, K., Rose, R. E., White, R. J., and Colonno, R. J. (1996) Characterization of siamycin I, a human immunodeficiency virus fusion inhibitor. *Antimicrob. Agents Chemother.* 40, 133–138.
- (17) Tsunakawa, M., Hu, S. L., Hoshino, Y., Detlefsen, D. J., Hill, S. E., Furumai, T., White, R. J., Nishio, M., Kawano, K., Yamamoto, S., et al. (1995) Siamycins I and II, new anti-HIV peptides: I. Fermentation, isolation, biological activity and initial characterization. *J. Antibiot.* 48, 433–434.
- (18) Helynyck, G., Dubertret, C., Mayaux, J. F., and Leboul, J. (1993) Isolation of RP 71955, a new anti-HIV-1 peptide secondary metabolite. *J. Antibiot.* 46, 1756–1757.
- (19) Potterat, O., Stephan, H., Metzger, J. W., Gnau, V., Zähler, H., and Jung, G. (1994) Aborycin - a tricyclic 21-peptide antibiotic isolated from *Streptomyces griseoflavus*. *Liebigs Ann. Chem.* 1994, 741–743.
- (20) Valiante, V., Monteiro, M. C., Martin, J., Altwasser, R., El Aouad, N., Gonzalez, I., Kniemeyer, O., Mellado, E., Palomo, S., de Pedro, N., Perez-Victoria, I., Tormo, J. R., Vicente, F., Reyes, F., Genilloud, O., and Brakhage, A. A. (2015) Hitting the caspofungin salvage pathway of human-pathogenic fungi with the novel lasso peptide humidimycin (MDN-0010). *Antimicrob. Agents Chemother.* 59, 5145–5153.
- (21) Potterat, O., Wagner, K., Gemmecker, G., Mack, J., Puder, C., Vettermann, R., and Streicher, R. (2004) BI-32169, a bicyclic 19-peptide with strong glucagon receptor antagonist activity from *Streptomyces* sp. *J. Nat. Prod.* 67, 1528–1531.
- (22) Arnison, P. G., Bibb, M. J., Bierbaum, G., Bowers, A. A., Bugni, T. S., Bulaj, G., Camarero, J. A., Campopiano, D. J., Challis, G. L., Clardy, J., Cotter, P. D., Craik, D. J., Dawson, M., Dittmann, E., Donadio, S., Dorrestein, P. C., Entian, K. D., Fischbach, M. A., Garavelli, J. S., Goransson, U., Gruber, C. W., Haft, D. H., Hemscheidt, T. K., Hertweck, C., Hill, C., Horswill, A. R., Jaspars, M., Kelly, W. L., Klinman, J. P., Kuipers, O. P., Link, A. J., Liu, W., Marahiel, M. A., Mitchell, D. A., Moll, G. N., Moore, B. S., Muller, R., Nair, S. K., Nes, I. F., Norris, G. E., Olivera, B. M., Onaka, H., Patchett, M. L., Piel, J., Reaney, M. J., Rebuffat, S., Ross, R. P., Sahl, H. G., Schmidt, E. W., Selsted, M. E., Severinov, K., Shen, B., Sivonen, K., Smith, L., Stein, T., Sussmuth, R. D., Tagg, J. R., Tang, G. L., Truman, A. W., Vederas, J. C., Walsh, C. T., Walton, J. D., Wenzel, S. C., Willey, J. M., and van der Donk, W. A. (2013) Ribosomally synthesized and post-translationally modified peptide natural products: overview and recommendations for a universal nomenclature. *Nat. Prod. Rep.* 30, 108–160.
- (23) Duquesne, S., Destoumieux-Garçon, D., Zirah, S., Goulard, C., Peduzzi, J., and Rebuffat, S. (2007) Two enzymes catalyze the maturation of a lasso peptide in *Escherichia coli*. *Chem. Biol.* 14, 793–803.
- (24) Yan, K. P., Li, Y., Zirah, S., Goulard, C., Knappe, T. A., Marahiel, M. A., and Rebuffat, S. (2012) Dissecting the maturation steps of the lasso peptide microcin J25 *in vitro*. *ChemBioChem* 13, 1046–1052.
- (25) Inokoshi, J., Matsuhama, M., Miyake, M., Ikeda, H., and Tomoda, H. (2012) Molecular cloning of the gene cluster for lariat-in biosynthesis of *Rhodococcus jostii* K01-B0171. *Appl. Microbiol. Biotechnol.* 95, 451–460.
- (26) Kersten, R. D., Yang, Y. L., Xu, Y., Cimermanic, P., Nam, S. J., Fenical, W., Fischbach, M. A., Moore, B. S., and Dorrestein, P. C. (2011) A mass spectrometry-guided genome mining approach for natural product peptidogenomics. *Nat. Chem. Biol.* 7, 794–802.
- (27) Ebright, R. H., and Severinov, K. (2007) *Nucleic acid sequences for biosynthesis of non-MccJ25-related lariat peptides*, Patent US 8461314 B2.
- (28) Gomez-Escribano, J. P., and Bibb, M. J. (2011) Engineering *Streptomyces coelicolor* for heterologous expression of secondary metabolite gene clusters. *Microb. Biotechnol.* 4, 207–215.
- (29) Zirah, S., Afonso, C., Linne, U., Knappe, T. A., Marahiel, M. A., Rebuffat, S., and Tabet, J. C. (2011) Topoisomer differentiation of molecular knots by FTICR MS: Lessons from class II lasso peptides. *J. Am. Soc. Mass Spectrom.* 22, 467–479.
- (30) Knappe, T. A., Linne, U., Xie, X., and Marahiel, M. A. (2010) The glucagon receptor antagonist BI-32169 constitutes a new class of lasso peptides. *FEBS Lett.* 584, 785–789.
- (31) Ducasse, R., Yan, K.-P., Goulard, C., Blond, A., Li, Y., Lescop, E., Guittet, E., Rebuffat, S., and Zirah, S. (2012) Sequence determinants governing the topology and biological activity of a lasso peptide, microcin J25. *ChemBioChem* 13, 371–380.
- (32) Martin, O. A., Villegas, M. E., Vila, J. A., and Scheraga, H. A. (2010) Analysis of 13C α and 13C β chemical shifts of cysteine and cystine residues in proteins: a quantum chemical approach. *J. Biomol. NMR* 46, 217–225.
- (33) Detlefsen, D. J., Hill, S. E., Volk, K. J., Klotz, S. E., Tsunakawa, M., Furumai, T., Lin, P. F., Nishio, M., Kawano, K., Oki, T., et al. (1995) Siamycins I and II, new anti-HIV-1 peptides: II. Sequence

analysis and structure determination of siamycin I. *J. Antibiot.* 48, 1515–1517.

(34) Constantine, K. L., Friedrichs, M. S., Detlefsen, D., Nishio, M., Tsunakawa, M., Furumai, T., Ohkuma, H., Oki, T., Hill, S., Bruccoleri, R. E., et al. (1995) High-resolution solution structure of siamycin II: novel amphipathic character of a 21-residue peptide that inhibits HIV fusion. *J. Biomol. NMR* 5, 271–286.

(35) Frechet, D., Guitton, J. D., Herman, F., Faucher, D., Helynck, G., Monegier du Sorbier, B., Ridoux, J. P., James-Surcouf, E., and Vuilhorgne, M. (1994) Solution structure of RP 71955, a new 21 amino acid tricyclic peptide active against HIV-1 virus. *Biochemistry* 33, 42–50.

(36) Nakayama, J., Tanaka, E., Kariyama, R., Nagata, K., Nishiguchi, K., Mitsuhashi, R., Uemura, Y., Tanokura, M., Kumon, H., and Sonomoto, K. (2007) Siamycin attenuates *fsr* quorum sensing mediated by a gelatinase biosynthesis-activating pheromone in *Enterococcus faecalis*. *J. Bacteriol.* 189, 1358–1365.

(37) Ebright, R. H., Mukhopadhyay, J., Semenova, E., and Severinov, K. (2009) *Non-MccJ25-related lariat-peptide inhibitors of bacterial RNA polymerase*, Patent US 8354246 B2.

(38) Ma, P., Nishiguchi, K., Yuille, H. M., Davis, L. M., Nakayama, J., and Phillips-Jones, M. K. (2011) Anti-HIV siamycin I directly inhibits autophosphorylation activity of the bacterial FsrC quorum sensor and other ATP-dependent enzyme activities. *FEBS Lett.* 585, 2660–2664.

(39) Phillips-Jones, M. K., Patching, S. G., Edara, S., Nakayama, J., Hussain, R., and Siligardi, G. (2013) Interactions of the intact FsrC membrane histidine kinase with the tricyclic peptide inhibitor siamycin I revealed through synchrotron radiation circular dichroism. *Phys. Chem. Chem. Phys.* 15, 444–447.

(40) Wakabayashi, K., Nakagawa, H., Tamura, A., Koshiya, S., Hoshijima, K., Komada, M., and Ishikawa, T. (2007) Intramolecular disulfide bond is a critical check point determining degradative fates of ATP-binding cassette (ABC) transporter ABCG2 protein. *J. Biol. Chem.* 282, 27841–27846.

(41) Dorenbos, R., Stein, T., Kabel, J., Bruand, C., Bolhuis, A., Bron, S., Quax, W. J., and Van Dijk, J. M. (2002) Thiol-disulfide oxidoreductases are essential for the production of the lantibiotic sublancin 168. *J. Biol. Chem.* 277, 16682–16688.

(42) Fontaine, L., and Hols, P. (2008) The inhibitory spectrum of thermophilin 9 from *Streptococcus thermophilus* LMD-9 depends on the production of multiple peptides and the activity of BlpG(St), a thiol-disulfide oxidase. *Appl. Environ. Microbiol.* 74, 1102–1110.

(43) Pavlova, O., Mukhopadhyay, J., Sineva, E., Ebright, R. H., and Severinov, K. (2008) Systematic structure-activity analysis of microcin J25. *J. Biol. Chem.* 283, 25589–25595.

(44) Knappe, T. A., Linne, U., Robbel, L., and Marahiel, M. A. (2009) Insights into the biosynthesis and stability of the lasso peptide capistruiin. *Chem. Biol.* 16, 1290–1298.

(45) Burkhart, B. J., Hudson, G. A., Dunbar, K. L., and Mitchell, D. A. (2015) A prevalent peptide-binding domain guides ribosomal natural product biosynthesis. *Nat. Chem. Biol.* 11, 564–570.

(46) Karray, F., Darbon, E., Oestreicher, N., Dominguez, H., Tiphile, K., Gagnat, J., Blondelet-Rouault, M. H., Gerbaud, C., and Pernodet, J. L. (2007) Organization of the biosynthetic gene cluster for the macrolide antibiotic spiramycin in *Streptomyces ambofaciens*. *Microbiology* 153, 4111–4122.

(47) Brünger, A. T. (1992) *X-PLOR*, version 3.1, a System for X-ray crystallography and NMR, Yale University Press, London.

(48) Laskowski, R. A., Rullmann, J. A., MacArthur, M. W., Kaptein, R., and Thornton, J. M. (1996) AQUA and PROCHECK-NMR: programs for checking the quality of protein structures solved by NMR. *J. Biomol. NMR* 8, 477–486.

Alternatives to fight Vancomycin-Resistant Staphylococci and Enterococci.

Baëtz, B., Boudrioua, A., Hartke, A., **Giraud, C.**

Antibiotics 2021, 10, 1116. <https://doi.org/10.3390/antibiotics10091116>.

Review

Alternatives to Fight Vancomycin-Resistant *Staphylococci* and *Enterococci*

Benjamin Baëtz , Abdelhakim Boudrioua [†], Axel Hartke and Caroline Giraud ^{*} 

Normandie Univ., UNICAEN U2RM-Stress and Virulence, Esplanade de la paix, 14000 Caen, France; benjamin.baetz@unicaen.fr (B.B.); Abdelhakim.Boudrioua@med.uni-tuebingen.de (A.B.); axel.hartke@unicaen.fr (A.H.)

^{*} Correspondence: caroline.giraud@unicaen.fr

[†] Present address: Interfaculty Institute of Microbiology and Infection Medicine (IMIT), University of Tübingen, Elfriede-Aulhorn-Str. 6, 72076 Tübingen, Germany.

Abstract: Gram positive pathogens are a significant cause of healthcare-associated infections, with *Staphylococci* and *Enterococci* being the most prevalent ones. Vancomycin, a last resort glycopeptide, is used to fight these bacteria but the emergence of resistance against this drug leaves some patients with few therapeutic options. To counter this issue, new generations of antibiotics have been developed but resistance has already been reported. In this article, we review the strategies in place or in development to counter vancomycin-resistant pathogens. First, an overview of traditional antimicrobials already on the market or in the preclinical or clinical pipeline used individually or in combination is summarized. The second part focuses on the non-traditional antimicrobials, such as antimicrobial peptides, bacteriophages and nanoparticles. The conclusion is that there is hitherto no substitute equivalent to vancomycin. However, promising strategies based on drugs with multiple mechanisms of action and treatments based on bacteriophages possibly combined with conventional antibiotics are hoped to provide treatment options for vancomycin-resistant Gram-positive pathogens.

Keywords: Gram-positive; vancomycin; *Staphylococci*; *Enterococci*; antibiotics; antimicrobial peptides; bacteriophages; nanoparticles



Citation: Baëtz, B.; Boudrioua, A.; Hartke, A.; Giraud, C. Alternatives to Fight Vancomycin-Resistant *Staphylococci* and *Enterococci*. *Antibiotics* **2021**, *10*, 1116. <https://doi.org/10.3390/antibiotics10091116>

Academic Editor: Adelaide Almeida

Received: 22 July 2021

Accepted: 13 September 2021

Published: 16 September 2021

Publisher's Note: MDPI stays neutral with regard to jurisdictional claims in published maps and institutional affiliations.

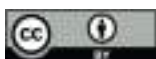

Copyright: © 2021 by the authors. Licensee MDPI, Basel, Switzerland. This article is an open access article distributed under the terms and conditions of the Creative Commons Attribution (CC BY) license (<https://creativecommons.org/licenses/by/4.0/>).

1. Introduction

The increasing spread of multidrug-resistant (MDR) bacteria is a global public health concern. Difficult-to-treat infections caused by MDR bacteria are responsible for an increase in morbidity, mortality, and healthcare costs [1–3]. Due to scientific and economic challenges, there are currently few novel drugs at the clinical stage with new mechanisms of action (MoA) [4]. The underlying economic issue regarding novel antibacterial drug development is mainly due to the early emergence of resistant strains that eventually limit new drugs' lifespans and compromise the treatment of MDR bacterial infections [5]. In addition, although active drugs against antibiotic resistant priority pathogens listed by the WHO are urgently needed due to their acute virulence and multidrug resistance pattern [6], this same list based on anticipated patient need does not necessarily match the current market need. The global burden of MDR bacterial infections is predicted to increase in the coming years especially in locations where prevention and control measures of infectious diseases and antibiotic-use stewardship are not fully implemented [1,7].

The difficulty of identifying and developing new small molecules with broad spectrum antibiotic activity has helped to promote other strategies. Diverse drugs in terms of chemistry and MoA have recently emerged as potent alternatives to traditional approaches. Agents that are either not small molecules, do not act by directly targeting bacterial components necessary for bacterial growth, or both, are considered non-traditional approaches [7].

In this review, we focus on current available treatments against vancomycin resistant Gram-positive pathogens, promising drugs in preclinical and clinical stages, and finally, research prospects focusing on long term and sustainable solutions to tackle antibiotic resistance.

Vancomycin is a cell wall-active antibiotic approved in 1958 which was quickly reserved as a last-line antibiotic and has long been used to treat ampicillin resistant enterococci, methicillin resistant *Staphylococcus aureus* (MRSA), and *Clostridioides difficile* infections [8–10]. Despite supervised use, resistance to vancomycin appeared in the 1980s with the emergence of vancomycin resistant *Enterococci* (VRE) and *Staphylococcus aureus* (VRSA) driven by the acquisition of *van* resistance genes through horizontal gene transfer [11–13].

Vancomycin is a glycopeptide antibiotic targeting the peptidoglycan. The aglycone part of the compound forms hydrogen bonds with the dipeptide D-Alanyl-D-Alanine (D-Ala-D-Ala) of the *N*-acetylglucosamine-*N*-acetylmuramic acid-Pentapeptide of the peptidoglycan [14]. This drug-target complex blocks transglycosylation and transpeptidation steps of peptidoglycan biosynthesis and is the reason for its antimicrobial activity [15,16].

Acquisition of *van* genes clusters allows the synthesis of modified pentapeptide precursors. Different types of inducible vancomycin resistance operons have been described but VanA and VanB types are the most widespread and concerning from a clinical point of view [10]. Both clusters code for enzymes which leads to the modification of the dipeptide D-Ala-D-Ala to D-Ala-D-Lactate for which vancomycin has less binding affinity.

Expression of the *van* cluster is under control of the VanR/VanS two component system in VanA type resistance and VanR_B/VanS_B in VanB type resistance. Autophosphorylation of the sensor kinase VanS occurs in the presence of both glycopeptides, vancomycin and teicoplanin, subsequently leading to the activation of the response regulator VanR which activates expression of *vanHAX* responsible for target modification. In contrast, VanS_B is activated only by vancomycin but not teicoplanin [13].

The continuous increase of vancomycin resistance in enterococci is of clinical concern. In 2014, vancomycin resistant *E. faecium* represented 10% of enterococcal clinical isolates in Europe. In 2019, vancomycin resistant *E. faecium* represented 18.3% of them (ECDC, EARS-Net, 2020) [17]. Compared to vancomycin susceptible isolates, the mortality of bacteremia caused by VRE is 2.5 times higher [18]. Therefore, efficient alternatives to vancomycin to treat VRE infections are urgently needed.

2. Alternatives to Vancomycin

2.1. Traditional Antimicrobials

2.1.1. Conventional Antibiotics

Several antibiotics have been tested or are recommended against microorganisms resistant to vancomycin and in particular VRE [19,20]. The first oxazolidinone recommended by the U.S. Food and Drug Administration (FDA) and then by the European Medicines Agency (EMA) was linezolid [20,21]. This bacteriostatic antibiotic binds to the 23S rRNA of the 50S ribosomal subunit thus preventing the formation of the 70S ribosomal complex and hence translation (Figure 1, Table 1) [22,23]. The G2576T mutation (from *Escherichia coli* strain K12) in the gene encoding 23S RNA, as well as its duplication, allows resistance (MIC > 4 mg/L) to linezolid [20]. Some plasmids carrying genes for resistance to linezolid such as a methyltransferase encoded by *cfr*, which allows the methylation of the adenine residue 2503 of 23S RNA and thus resistance to five classes of antibiotics including linezolid, can spread between different bacterial species and genera [24]. Plasmids containing *cfr* are at risk of spreading due to their low fitness cost and the benefit they provide [20,25]. The *optrA* gene, also carried by a plasmid, codes for an ABC-F protein which also allows resistance to oxazolidinones and phenicol by a target protection mechanism [20,26,27]. The plasmid seems to be lost in the absence of selection pressure, which would limit its dissemination [28]. Similar resistance mechanisms are also found in *S. aureus* including MRSA strains [29]. Despite the presence of the above-mentioned resistance mechanisms, linezolid-resistant enterococci represent less than 1% of enterococcal infections in Europe, and the resistant strains are still sensitive to tigecycline and daptomycin [20,30]. On the other hand,

several cases of enterococci resistant to both vancomycin and linezolid (LVRE) have been reported in recent years, which could ultimately prevent the use of this oxazolidinone against VRE [31,32]. These LVRE harbor the *van* operon and the G2576T mutation in most cases. Tedizolid may represent a viable alternative to linezolid in the treatment of skin and soft tissue infections [33]. The MIC of tedizolid is lower than that of linezolid in VRE and *S. aureus* [33]. Other antibiotics like nitrofurantoin or chloramphenicol have also been tested on urinary VRE isolates but were slightly less efficient than linezolid [34]. Quinupristin-dalfopristin have also been recommended for the treatment of VRE infections but later withdrawn because of the absence of bactericidal activity against *Enterococcus faecium* and their lack of activity against *Enterococcus faecalis* [35].

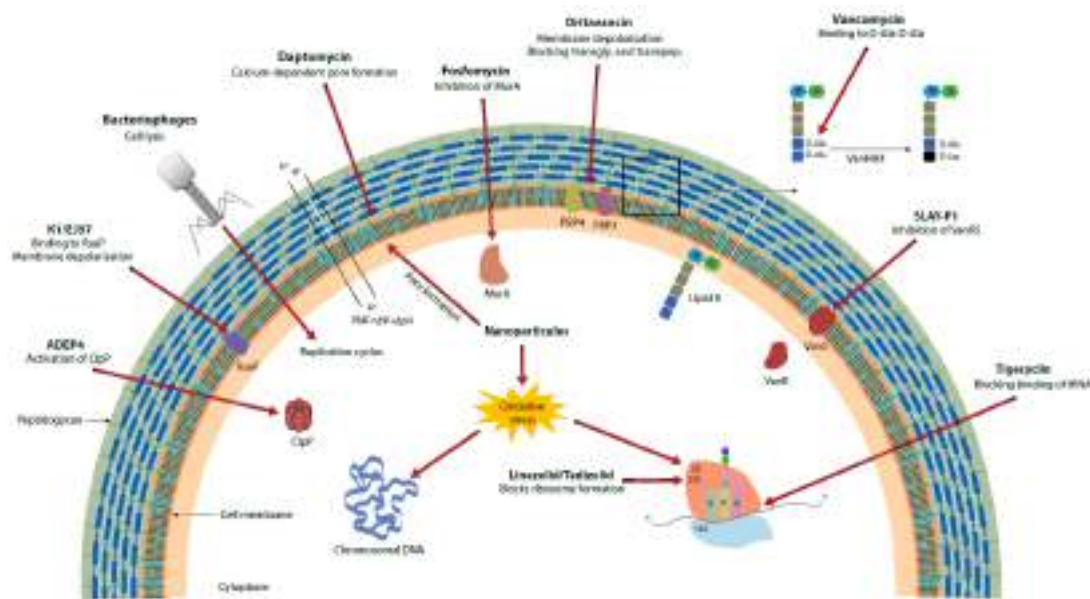

Figure 1. Mechanism of action of the different traditional and non-traditional strategies against vancomycin resistant Gram-positive pathogens. In bold, name of the molecule.

Table 1. Sum up of the antimicrobials presented in this review. Bold text means that all the antimicrobials of the same type are concerned.

Antimicrobial	Utilization	Target	Mechanism of Action	Pros	Cons	References
Available antibiotics						
linezolid	clinical use	23S ribosomal RNA	protein synthesis inhibition	- well known - industrial production	resistance	[20–26,28–32,36]
daptomycin	clinical use	calcium ions	membrane disruption			[20,22,29,35,37–43]
tigecycline	clinical use	30S ribosomal subunit	protein synthesis inhibition			[20,44–47]
tedizolid	clinical use	23S ribosomal RNA	protein synthesis inhibition	active against linezolid resistant bacteria (<i>cfr</i> gene)		[33,48]
Modified antibiotics						
vancomycin dimers	in vitro (in vivo on <i>S. pneumoniae</i>) [49]	Penicillin binding protein 2	cell wall synthesis inhibition	new mechanism of action	resistance is still possible	[50–53]
teicoplanin derivatives	in vitro	lipid II	cell wall synthesis inhibition	active on VanA phenotype		[54]
dalbavancin	clinical use	lipid II			- increasing MIC - resistance of VanA phenotype	[55–58]

Table 1. Cont.

Antimicrobial	Utilization	Target	Mechanism of Action	Pros	Cons	References
oritavancin	clinical use	lipid II—membrane	- cell wall synthesis inhibition (transglycosylation and transpeptidation) - membrane disruption	3 different mechanisms of action	resistance in vitro	[55,56,58–60]
vancomycin derivative	in vitro	lipid II (D-ala-D-ala and D-ala-D-lac)—membrane	- cell wall synthesis inhibition - membrane disruption	3 different mechanisms of action		[61]
Combination of antibiotics						
various types and classes	clinical use	DNA/RNA/protein metabolism—membrane	multiple	- multiple mechanisms of action - overcome resistance	wide spectrum	[22,43,62–74]
Antimicrobial peptides						
anti-vancomycin peptide	in vivo	vancomycin	vancomycin concentration decreasing	prevent the emergence of resistance		[75]
SLAY-P1	in vivo	VanRS	vancomycin resistance inhibition	- overcome resistance - stable in human serum	resistance is still possible	[76]
cationic peptides	in vivo	membrane	membrane disruption	- physical interactions - easy engineering	- stability in host - toxicity - production cost - resistance	[76]
peptides + antibiotics combination	in vivo	DNA/RNA/protein metabolism—membrane	multiple	- multiple mechanisms of action - overcome resistance - activity on biofilm	resistance is still possible	[76–79]
Bacteriocins						
bacterial transplantation	in vivo	intestinal VRE	VRE elimination	resistant pathogen elimination before infection	- resistance is still possible - sensitive to proteases	[80]
mersacidin	in vivo	lipid II	cell wall synthesis inhibition			[81,82]
lactacin 3147	in vivo	lipid II	membrane disruption	active against multiple pathogens of interest		[81,83]
pumilicin 4	(clinical use = <i>B. pumilus</i> probiotic)	unknown	membrane destabilization	heat resistant		[84]
K1 and EJ97	in vitro	RseP	membrane depolarization	attenuates bacteria's pathogenicity	narrow spectrum	[19,85]
EF478	in vitro	peptidoglycan	cell wall disruption	active against MDRE		[86]

Table 1. Cont.

Antimicrobial	Utilization	Target	Mechanism of Action	Pros	Cons	References
bacteriocins + antibiotics combination	in vitro	DNA/RNA/protein metabolism—membrane	multiple	<ul style="list-style-type: none"> - multiple mechanisms of action - overcome resistance - activity on biofilm - used in food for more than 50 years - generally stable - easy engineering - non toxic 		[87,88]
Lysins						
	in vivo	cell wall	peptidoglycan lysis	<ul style="list-style-type: none"> - act quickly = less resistance - heterologous production - easy engineering 	resistance	[89–92]
combination lysin bacteriocin	in vitro	cell wall	peptidoglycan lysis			[93]
Bacteriophages						
ENB6	in vivo	cell metabolism				[94]
EFDG1/EFLK1	in vivo	cell metabolism		<ul style="list-style-type: none"> - can act on biofilm - overcome resistance 		[95–97]
combination phages antibiotics	in vivo	<ul style="list-style-type: none"> - cell metabolism - DNA/RNA/protein metabolism—membrane 	hijack of the cell metabolism + other depending on the antibiotic	<ul style="list-style-type: none"> - overcome resistance - reduce antibiotics concentrations 	wide spectrum	[96,98]
all bacteriophages	clinical use	cell metabolism	hijack of the cell metabolism	<ul style="list-style-type: none"> - “smart therapy” - only one administration 	<ul style="list-style-type: none"> - host immune response - possible toxicity with toxins - narrow spectrum = isolation needed 	
Nanoparticles						
silver nanoparticles	in vivo	<ul style="list-style-type: none"> - membrane - cell metabolism 	<ul style="list-style-type: none"> - membrane disruption - inhibition of DNA replication - ROS production 	multiple mechanisms of action	possible toxicity	[99]
chitosan nanoparticles	in vitro	<ul style="list-style-type: none"> - membrane - cell metabolism 	<ul style="list-style-type: none"> - membrane disruption (<i>P. acnes</i>) - transcription inhibition - metal chelation 	multiple mechanisms of action		[100,101]
AgNPs@PCL-b-AMPs	in vivo	<ul style="list-style-type: none"> - membrane - cell metabolism 	<ul style="list-style-type: none"> - membrane disruption - ROS production 	<ul style="list-style-type: none"> - no toxicity to eukaryotic cells - no resistance in vitro 		[49]
DA95B5	in vivo	cell surface	biofilm inhibition	<ul style="list-style-type: none"> - no toxicity - limitation of biofilm 	need another treatment to kill bacteria	[102]
polypeptide-based nanoparticles	in vitro	membrane	membrane disruption	<ul style="list-style-type: none"> - no nanoparticles resistance observed - low toxicity 		[103]

Daptomycin, a bactericidal antibiotic approved by the FDA and EMA for the treatment of skin and soft tissue infections as well as for *S. aureus* bacteremia, is a lipopeptide that acts by oligomerizing in the plasma membrane of Gram-positive bacteria in a calcium-dependent manner leading to pore formation, ion leakage, and death (Figure 1, Table 1) [22,37]. Several trials of treatments using daptomycin against VRE infections have been carried out, but these treatments appear to be associated with higher mortality than with linezolid in the case of bacteremia [38]. Nevertheless, this antibiotic is still active against VRE and seems to be preferable in certain types of infections such as endocarditis [35]. Non-susceptibility to daptomycin has already been reported, but these clinical isolates represent less than 1% of enterococcal infections worldwide [20,39]. For *S. aureus*, daptomycin resistance has also been reported, mostly based on an increase of the positive charge of the cell surface causing a repulsive effect of the antibiotic [40]. In addition, genes involved in cell wall synthesis and homeostasis allow low level vancomycin and daptomycin resistance in vancomycin intermediate *S. aureus* (VISA) [29,41]. In enterococci, several resistance mechanisms come into play, and they are different in *E. faecalis* and *E. faecium*. In *E. faecalis*, the three-component LiaFSR system, which participates in the regulation of envelope stress, appears to play an important role in adaptation to daptomycin. A deletion of Ile177 in LiaF (*liaF*Δile177) triggers a change in the distribution of cardiolipin, which seems to influence the location of daptomycin binding away from the dividing septum of the bacteria [41]. It also appears that LiaR, the response regulator of the LiaFSR system, binds to other promoters allowing expression of *liaX*, *liaY*, and *liaZ* [41]. The functions of LiaY and LiaZ remain unknown, but LiaX has been characterized and its N-terminal and C-terminal domains appears to have distinct roles. The N-terminal domain binds to daptomycin in the extracellular environment, which leads to the activation of the envelope stress response via LiaFSR. The C-terminal domain inhibits the LiaFSR pathway and its truncation in daptomycin-resistant strains releases the inhibition, leading to cell-membrane remodeling [42]. Some mutations in *cls* coding for cardiolipin synthase, and *gdpD* coding for glycerol-phosphodiester phosphodiesterase, increase resistance of *E. faecalis* to daptomycin. The *gdpD* mutation has an effect on daptomycin resistance only if the *liaF*Δile177 mutation is present. Resistance to daptomycin in *E. faecium* is mainly due to antibiotic repellence and can be acquired if *liaS* and *liaR* each have a specific mutation (T120A for LiaS and W73C for LiaR) [41]. Certain mutations in *yycFG*, a two-component system involved in cell homeostasis [43], may increase resistance to daptomycin, but the underlying mechanism at the basis of resistance is still unknown. Mutations in *cls* also appear to play a role in daptomycin resistance in *E. faecium* [40].

Tigecycline is a bacteriostatic antibiotic of the glycylcycline class indicated for the treatment of skin and soft tissue infections and intra-abdominal infections. It acts on both Gram-positive and Gram-negative bacteria by preventing the binding of the aminoacyl-tRNA/EF-Tu-GTP complex to the 30S subunit of the ribosome, which inhibits protein synthesis (Figure 1, Table 1) [20,104]. Although most resistances (MIC > 0.5 mg/L) are reported for Gram-negative bacteria, enterococci have also developed resistance mechanisms to this antibiotic. The clinical strains already reported have either the *tet(M)*, *tet(L)*, or both gene(s), which encode ribosome protective proteins (RPPs) that confers tetracycline resistance [20]. According to Dönhöfer et al. [44], the MoA of Tet(M) would be to sterically block the binding site of the antibiotic on the ribosome. Mutations in *rpsJ*, which encodes ribosomal protein S10, also lead to resistance in enterococci [20,45]. Although these tigecycline-resistant enterococci are still rare in the clinic (<1%) [20], a recent article reported a cluster of enterococci resistant to both tigecycline and vancomycin in a hospital in northern Germany [46]. Tigecycline-resistant MRSA have also been reported in Malaysia [47].

2.1.2. Modified Antibiotics

One possible alternative could be the optimization of existing antibiotics to overcome bacterial defenses. Regarding VRE, the majority of research in this area focuses on the modification of glycopeptides.

Among these, the dimers of vancomycin were studied very early. The MoA of this antibiotic is thought to be related to the inhibition of the transglycosylase activity of penicillin binding protein 2 (PBP2) rather than by binding to the D-Ala-D-Lac precursors of monomers [50–52]. The advantage of this different MoA is inhibition of another step in peptidoglycan synthesis and therefore restoring the sensitivity of VRE. Despite numerous studies on this dimeric vancomycin, to our knowledge there seems hitherto to be no clinical study for this new drug.

Another solution consists of modifying certain sites of the glycopeptides in order to improve their effectiveness or to extend their spectrum which can sometimes allow the molecule to acquire a new MoA [105–107]. This is, for example, the case for teicoplanin derivatives which show activity on both VRE VanB and VanA while teicoplanin has activity only on VanB strains [54]. The most promising strategy in the development of next-generation glycopeptides would be to modify the binding pocket of lipid II so that the molecule can bind both the D-ala-D-ala as well as the D-ala-D-lac version of the precursor [108,109].

There are currently glycopeptide derivatives that have been approved by the various regulatory agencies, which are telavancin, dalbavancin (formerly BI 397 [55]), and oritavancin (formerly LY333328 [55]). These lipoglycopeptides are indicated to treat complicated skin and soft tissue infections and telavancin has also been approved for the treatment of patients with ventilator-associated pneumonia but has subsequently been withdrawn from the European market [110]. Dalbavancin and oritavancin have activity against VRE and *S. aureus*, including against MRSA and VISA [56]. While dalbavancin has no activity on VanA strains, oritavancin has activity on both VanA and VanB strains [57,59,60]. It also exhibits *in vitro* activity on *S. aureus* biofilms [56]. The advantage of oritavancin over the other two molecules is that it has three distinct MoAs, namely, depolarization of the membrane, inhibition of transglycosylation, and inhibition of transpeptidation, which limits the emergence of resistance (Figure 1) [59]. Resistance has been demonstrated in the laboratory but not in the clinic [56,58].

In order to avoid this potential resistance development, new glycopeptides combining several MoAs in the same molecule would be promising [61]. For example, a vancomycin analogue with a modification in the lipid II binding pocket combined with two peripheral modifications, one of which is also present in oritavancin binds both the D-ala-D-ala end and the D-ala-D-lac end of lipid II, inhibits transglycosylation, and permeabilizes the bacterial membrane. This vancomycin analogue has a very low MIC, and, due to its triple action, showed limited risk of resistance development. This strategy of combining the MoAs, especially if they act synergistically, seems to be the key to obtaining antibiotics with long-lasting antimicrobial activity. This would provide a viable alternative over time to vancomycin in the case of VRE, but this strategy should be adaptable to other antibiotics as well.

Finally, certain modifications on other classes of antibiotics such as aminoglycosides make it possible to obtain activity on VRE [111]. However, there are only few examples concerning the modification of previously ineffective antibiotic classes into effective drugs against enterococci.

The modification of antibiotics is a promising alternative in the fight against VRE provided that antibiotics with several MoAs are developed in order to limit rapid appearance of resistance in these multidrug-resistant bacteria.

2.1.3. Combinations of Antibiotics

Using multiple antibiotics simultaneously is another strategy used in the clinical settings. Combining the advantages of different molecules can give rise to synergistic

effects that make it possible to overcome certain resistances and limit their development and spread. This strategy is recommended in cases of infective endocarditis due to enterococci and other Gram-positive bacteria resistant to vancomycin [22].

There are only few examples of combinatorial treatments with vancomycin. In one of these studies the combination with daptomycin was tested, which had a synergistic bactericidal effect [62]. A combination of vancomycin with citrinin, a polyketide, reduced the MIC of vancomycin [63].

Linezolid has also been tested with many antibiotics. While rifampicin has an antagonistic effect in some studies [64], several antibiotics such as ceftriaxone, doxycycline, or fosfomycin act in synergy or have additive effects on bacteria resistant to vancomycin, at least in vitro [65]. Combinations of vancomycin with oritavancin have also been tested but have not shown better results than individual treatments with the antibiotics [66]. The combination of linezolid with fosfomycin is promising, as it has been shown that synergy is possible between these two molecules in the *G. mellonella* larvae model [67]. The authors supposed that fosfomycin, by acting on cell wall synthesis via MurA inhibition, promotes linezolid penetration, showing increased activity on both VRE [67] and MRSA (Figure 1) [68,69]. In addition, an activity on biofilms of vancomycin resistant *E. faecium* has been demonstrated with this combination [69].

Daptomycin is also the subject of many studies. As with the linezolid combination, rifampicin or oritavancin combined to daptomycin had either antagonistic activity or no synergistic effect, respectively [64,66]. Other antibiotics, especially β -lactams (ceftazidime, ertapenem, ampicillin, ceftriaxone, cefepime, and ceftazidime) act in synergy with daptomycin to re-sensitize some daptomycin resistant VRE strains [39,70]. A synergistic effect is also observed between daptomycin and gentamicin or fosfomycin, and the latter combination is recommended by some authors for the treatment of VRE [22,64].

Tigecycline is recommended in combination with gentamicin but only as a last resort because of its limited clinical efficacy and its adverse effect profile [22]. Significant activity of tigecycline on biofilms of vancomycin resistant *E. faecalis* and MRSA when combined with Fosfomycin has also been reported [68,69].

Oritavancin is also being studied in combination with other antibiotics, but like combinations with linezolid or daptomycin, little benefit has hitherto been demonstrated. Smith et al. [71] thus found that there is no gain in activity in the presence of β -lactams in VRE and Meyer et al. [66] showed that oritavancin alone was as effective as in combination with ceftriaxone, gentamicin, or rifampicin to treat VRE in the *G. mellonella* model. One study reported synergy between oritavancin with gentamicin but only on strains sensitive to gentamicin and was therefore not recommended in the treatment of VRE [72].

Other antibiotic combinations are being tested to counter bacteria resistant to vancomycin, such as quinupristin-dalfopristin in combination with doxycycline which was predicted to be synergistic, although this has not been clearly proven yet [22].

Fosfomycin, already presented in combination with linezolid, daptomycin, and tigecycline, is one of the antibiotics that improve activity against bacteria resistant to vancomycin. This antibiotic also acts in synergy with teicoplanin or rifampicin with strong activity not only on VRE but also on MRSA [68,69]. On the other hand, the authors do not recommend combining it with ampicillin due to absence of synergy.

A very potent class of antibiotics are activators of the Clp protease ClpP subunit. ADEP4 is one of them and has high activity on Gram-positive bacteria. This antibiotic induces the autodigestion of cells by activation of ClpP and allows elimination of the pathogen even in the presence of high cell density (Figure 1) [73]. The problem with this antibiotic is that its target is accessory in bacteria, so using it in combination with other drugs is essential to avoid the fast appearance of resistance. In general, glycopeptides have antagonistic activity with this antibiotic [73,74]. All the antibiotics tested, namely, linezolid, ampicillin, ciprofloxacin, daptomycin, rifampicin, and tigecycline allow a marked decrease in the bacterial load in vitro, while limiting the development of resistance [73]. Oritavancin

has an antagonistic effect in combination with ADEP4. Ampicillin appears to be the most effective antibiotic in combination with ADEP4 to treat VRE [73].

The use of several antibiotics simultaneously reduces the risk of treatment failures and the appearance of resistances in pathogens, but this strategy also has drawbacks. The antibiotic combinations used lack generally specificity and have a major impact on the microbiota. In addition, the majority of these data come from in vitro studies, and may differ from treatments of real-world infections in the clinic.

2.2. Non-Traditional Antimicrobials

2.2.1. Antimicrobial Peptides and Bacteriocins

Antimicrobial Peptides

Antimicrobial peptides (AMPs) are host defense peptides found in both eukaryotes and prokaryotes. This part will focus on eukaryotic AMPs. They are part of the innate immune system in humans and have several activities including bactericidal activity [112].

AMPs have a variety of different MoAs. Some cause depolarization of the membranes by pore formation, and others modify intracellular processes such as transcription and translation, degradation of the cell wall or modification of the composition of the membrane [37,112].

There are several strategies for using peptides against vancomycin resistance. These can, for example, be designed to prevent the emergence of resistance. Mull et al. [75] synthesized a vancomycin antagonist peptide that binds covalently to vancomycin. This peptide is capable of post-treatment lowering of the concentration of the antibiotic in the colon, and therefore decreases selection pressure and hence resistance development.

Many antimicrobial peptides currently under study are cationic peptides [113]. These peptides integrate into the negatively charged bacterial membrane with their hydrophobic regions. This MoA is fast and the risk of resistance development of these peptides is generally low [112]. Furthermore, numerous peptides active against VSE and VRE have been reported [76].

Another approach is to use the antimicrobial peptides in combination with conventional antibiotics to treat infections with Gram-positive pathogens. Thus, many peptides allow re-sensitization of resistant strains to vancomycin. The SLAY-P1 peptide, for example, has a synergistic effect with vancomycin on VRE. The peptide inhibits the transcription of *van* genes under vancomycin exposure. The exact mechanism is unknown but the authors suggested that the peptide blocks the VanS sensor (Figure 1, Table 1) [76]. An antimicrobial cationic peptide derivative based on chitosan and lysine residues, called CSM5-K5, allowed re-sensitization of several pathogens against antibiotics for which they are resistant by perturbation of the bacterial membrane [77]. This peptide thus allows the re-sensitization of VRE to vancomycin and of MRSA to oxacillin [77]. It also helps reduce biofilm formation in combination with these antibiotics [77]. Some derivatives of the human antimicrobial peptide LL-37, namely, LL-13 and LL-17, demonstrated activity on VISA and a reduction in vancomycin MIC on VRSA in combination with vancomycin and also demonstrated anti-biofilm activity on these pathogens [78]. Umstätter et al. [79] fused vancomycin with a cationic peptide and this conjugate showed greater efficacy on VanA, VanB, and VanC strains than the glycopeptide itself. This derivative is less concentrated in the kidneys than vancomycin and its MoA is not linked to binding the D-ala-D-ala ends of pentapeptides [79].

The use of antimicrobial peptides is still limited due to their high production costs and their sensitivity to proteolytic enzymes limiting their in-host stability. Some peptides also have hemolytic activity, which seems to be correlated with increased positive charges of the peptides [112]. Although resistance development to these compounds is rare, some bacteria have nevertheless developed an arsenal of defenses. For example, bacteria produce proteolytic enzymes in the presence of antimicrobial peptides [112]. The modification of surface charges and the trapping or active efflux of peptides are other mechanisms of bacteria to withstand their toxic activities [114]. A strategy to avoid instability might be by

sending the peptides directly to their targets with the help of nanocarriers that will protect the peptides until their delivery [112].

Bacteriocins

Bacteriocins are special types of AMPs ribosomally synthesized by bacteria, often targeting organisms phylogenetically close to the producing strain. Bacteriocin-producing strains have a selective advantage in their ecological niches by inhibiting the growth of competitors, and are produced by both Gram-positive and Gram-negative bacteria [19].

Bacteriocins are divided into three classes: class I contains bacteriocins with modified residues, called lanthipeptides or lantibiotics; class II, comprising small heat-stable non-modified molecules and which are subdivided into four categories; and class III, which are large and heat labile [115]. Members of the three classes have been used in the food industry for over 50 years against foodborne pathogens, but their use in the medical field is hitherto very limited [19]. Bacteriocins have different MoA that are similar to the antimicrobial peptides except that the membrane-targeting bacteriocins interact with proteins rather than purely physical interactions [19,81,86].

Several strategies have been tested to prevent or treat vancomycin resistant pathogen infections by bacteriocins. One example is the introduction of a consortium of bacteria by fecal transplantation to combat the presence of VRE in the colon of patients at risk [80]. One of the added strains, *Blautia producta* (BP_{SCSK}), secretes a lantibiotic that reduces the density of enterococci in the colon of infected mice, and could therefore decrease the risk of VRE infections in critically ill patients. Other lantibiotics demonstrate efficacy against Gram-positive pathogens such as mersacidin or epidermin and gallidermin which have an effect on MRSA [81]. Lacticin 3147, representative of the two-peptides lantibiotics, binds to lipid II and integrates into the bacterial membrane resulting in the formation of pores. This lantibiotic not only has activity on MRSA, but also on VRE and other bacteria of clinical interest [83]. Another two-component lantibiotic, roseocin, also has an effect on MRSA and VRE, but lacks a lipid II binding motif. The MoA of roseocin is still unknown [116].

The MoA of the other classes of bacteriocins are also very diverse. For example, pumilicin 4, which is active against MRSA and VRE, seems to destabilize the bacterial membrane [84]. The K1 and EJ97 class II bacteriocins target the membrane-bound protease RseP, which is upregulated at the start of an infection. The spectrum of action of these molecules is restricted to *E. faecium* and *E. faecalis* (VSE and VRE), respectively [19,85]. The binding of K1 and EJ97 bacteriocins to their receptor RseP leads to the formation of pores which ultimately causes a depolarization of the membrane (Figure 1, Table 1). Although RseP is an accessory, bacteria not expressing this protease will be more sensitive to stress since RseP is needed for the release of an alternative RNA polymerase sigma factor important for stress resistance. Therefore, these K1 and EJ97 resistant bacteria should have reduced fitness in an infected host. Other bacteriocins, like EF478, which is a serine protease that hydrolyses peptidoglycan, and BLIS, are active against VSE, VRE, and even certain pan-drug-resistant enterococci [86,117].

An interesting approach also consists of the use of bacteriocins in combination with antibiotics, especially if the two drugs are synergistic. Many bacteriocins are being studied, such as CSpK14, which allows the sensitization of VRE and VRSA to β -lactams [87] and AS-48 active against VRE (phenotypes VanA, B, and C) in combination with vancomycin, gentamicin, or amoxicillin/clavulanate [88]. AS-48 has the added advantage that it does not show cross-resistance with the tested antibiotics.

Bacteriocins offer several advantages in the treatment of resistant pathogens. They are generally stable over a wide pH range, withstand high temperatures (60 °C for 1 h for EF478), and are not toxic for humans. Their target is often different from those of traditional antibiotics. Their MoA can be either broad or narrow, which can be an advantage in treating an infection without disrupting the patient's microbiota. In addition, their protein nature allows easier modifications of the molecules than for antibiotics [19].

A disadvantage of using bacteriocin producing strains is the proximity of the producing and target strains which increase the risk of transfers of bacteriocins and associated resistances. This is particularly the case with the bacteriocins Bac32 and Bac43. The genes coding for these bacteriocins are on transferable plasmids allowing their biosynthesis and associated immunity that can be transferred by conjugation to other bacteria. Another problem linked to this conjugation is that these plasmids are generally co-transferred with a plasmid conferring gentamicin resistance for Bac32 and vancomycin resistance for Bac43 [118,119]. The recipient bacteria therefore acquired both bacteriocin and antibiotic resistances. Another disadvantage of bacteriocins is that, as antimicrobial peptides in general, their protein nature should make them susceptible to proteases inside an infected host. Some bacteriocins are highly stable to proteases, like pseudomycolidin, a lantibiotic, which is resistant to trypsin [120] or lasso peptides in general that are totally or partially resistant to enzymatic degradation [121,122].

2.2.2. Bacteriophages

Bacteriophages (or phages) are viruses that target one or more species of bacteria. The infection of a bacterium by a phage leads to its lysis, so they can be used as a treatment for certain pathogens. Their cycle can be lysogenic or lytic, but only lytic phages are used clinically [95]. The first therapies took place in the 1920s, but several limitations as well as the discovery of antibiotics, hampered the development of these therapies in Western countries [94]. These therapies continued to be developed in the Eastern Bloc during the cold war and are still in use today in these countries. Due to the emergence of antibiotic resistant bacteria these phago-therapies are currently experiencing a renaissance with several clinical trials underway around the world [123–125].

A strategy to prevent the spread of resistance to vancomycin is the use of a phage (vrep-5) to treat livestock compost to eliminate VRE. Since farm animals were formally treated with avoparcin, a vancomycin analogue, strains of VRE were found in the compost which, once scattered, contaminated neighboring soils and surrounding areas [126].

The application of phages seems to also be a promising strategy to prevent or fight infections due to vancomycin resistant pathogens. Phage treatments can be divided into two approaches. The first is based on the endolysins (or lysins) of the phages of interest. During the infection process of the bacteriophage, the lysins are exported from the bacterial cell. Their substrate is the peptidoglycan and its degradation causes lysis of the bacterium and release of the virions. Several recombinant lysins have been tested against VRE. For example, the lysins, Lys168 and Lys170, have an activity on most of the tested strains of *E. faecalis* and several strains of *E. faecium*, including vancomycin resistant strains [89]. Another lysin, ORF28, derived from phage ϕ Ef11, has muramidase, glucosaminidase, and endopeptidase activity and acts on vancomycin resistant *E. faecalis* but has limited effects on *E. faecium* [90]. Other lysins are under study, such as LysSAP26 from phage SAP-26, which has activity on VRE [91]. These lysins have many advantages over conventional antibiotics. First, their target is the peptidoglycan of bacteria, an essential component of bacterial cells, and they act quickly, reducing the risk of developing resistance. In addition, their target (peptidoglycan) is specific for bacteria, so they are not toxic to eukaryotes. As their spectrum of action is limited to a few species, they are also more specific than antibiotics [90]. They can be produced via heterologous expression in *E. coli*, which allows increased production [89]. However, resistance to phage endolysins might be due to the presence of prophages in the targeted bacteria encoding the lysins as reported for phage ϕ Ef11 [92]. Lysins from temperate phages may therefore be less useful.

Lysins could also be used in combination with bacteriocins, as the Tgl lysin of the MSA6 phage active against VISA, which, associated with nisin, decreases the survivability of *S. aureus* cells [93].

The second option is to treat infections with whole phages. Many phages are isolated and characterized, such as LM99, active against VRE, Φ EF24C, active against vancomycin resistant *E. faecalis*, or CoNSHP-3, active against coagulase negative Staphylococci [127–129].

The lysins of these phages have both endopeptidase and amidase activity and act on some VRSA and MRSA even when organized in biofilms [129]. Some phages have been tested on mice with VRE bacteremia such as ENB6, which allowed 100% survival of infected mice and rescued 50% of moribund animals [94]. The pair of phages, EFDG1/EFLK1, has been particularly studied. EFDG1 is active against VRE and their biofilms [95]. Resistance to EFDG1 phage was observed after treatment which led to the discovery of phage EFLK1, which showed an activity on strains resistant to EFDG1 [96]. These two phages were given as a cocktail to mice with peritonitis caused by VRE and a single dose resulted in 100% survival if the treatment was given within the first hour of infection, and 60% survival if it was given 6 h later [96].

Another treatment strategy consists of a combination of one or more phages with antibiotics. The addition of ampicillin to the phage cocktail reduced bacterial load in mouse organs greater than phage cocktail or ampicillin alone [96]. The combination of EFLK1 with vancomycin allows a synergy of treatment in planktonic VRE, and is more effective than each separate antimicrobial on biofilms. This also greatly reduced the required concentrations of vancomycin [98].

There are drawbacks to the use of phages. The narrow spectrum of action of phages requires isolating the pathogen in order to find an appropriate phage highly lytic for the isolate. This increases patient management time significantly [130]. It is also necessary to sequence the phage genome in order to verify the absence of genes for toxins or resistance to antibiotics. Horizontal gene transfer of antimicrobial resistance genes by phage transduction is also possible and could disseminate these genes among bacterial populations [131]. In addition, phage resistance can quickly appear in target bacteria [132,133]. The site of infection is also important, because phages should have access to the pathogen to be efficient. It has been shown that some phages and their bacterial target could coexist in the gut of mice [134]. Conversely, intravenous administration of phages seemed to result in better outcomes for patients in the case of sepsis caused by *S. aureus* [135].

Some phages can trigger an immune response in the host, which could still allow better elimination of the infection since the non-specific immune response will eliminate both phages and pathogens [94,96,99,136]. The use of phage cocktails or combinations with antibiotics increase selection pressures and therefore decrease the probability for appearance of bacteria resistant to any component of the treatment [96,97]. Phages are also considered as self-propagating antimicrobials [129], since their abundance is correlated to the target population and therefore a single injection of phage(s) should be enough to treat patients [95]. Another advantage of phages and their lysins is the ease to create variants by directed or non-directed mutagenesis (UV passages, chemical mutagens, etc.). A new platform technology has been developed to create on demand phages with custom genome, allowing the creation of libraries of phages [137]. Libraries of variants can then be screened for more efficient phages or lysins [97]. Many phages can also act on biofilms, which are often resistant to antibiotics [95]. The use of personalized phage cocktails would also limit the appearance of resistance before complete curing of the infection since all phages will be active on the corresponding pathogen. Although currently phages for Gram-negative pathogens seems easier to isolate, the increased interest in phage therapy should also accelerate the isolation of lytic phages infecting Gram-positive pathogens [132].

2.2.3. Nanoparticles

Numerous studies to evaluate the effectiveness of nanoparticle-based treatments are currently conducted on various pathogens. These treatments are promising due to the wide variety of nanoparticles (NPs) with different MoAs available (Figure 1, Table 1) [100]. Approaches based on NPs have been extensively reviewed previously [100] and therefore we will focus here on those effective on VRE or VRSA.

Several types of NPs exist. Metallic NPs can be composed of various metals, such as zinc, silver, gold, titanium, magnesium, or copper and others are composed of polymers [102,138]. There are also NPs loaded with traditional antibiotics.

Concerning metal NPs, they can have various MoAs. NPs containing silver elicit the generation of reactive oxygen species (ROS) inside bacteria leading to cell death. In addition, silver ions (Ag^+) can create pores in bacterial membranes, and inhibit DNA replication by binding to DNA [100,139,140]. In addition to ROS, some NPs can generate reactive nitrogen species which have many MoAs on the metabolism of bacteria [100]. Some zinc oxide (ZnO) NPs are active on VRE and *S. aureus* [141]. Other NPs act on VRE but some of them are only active at concentrations also toxic for eukaryotic cells [142].

Different polymer NPs have very diverse MoAs. For example, chitosan NPs can cause membrane disruption in *P. acnes* [101]. They can also bind to the DNA of the bacteria to inhibit transcription or act as a metal chelator [100,101]. Another NP, named DA95B5, is a non-bactericidal “block copolymer nanoparticle” capable of eradicating biofilms of Gram-positive bacteria, including VRE. It binds to the surface of the bacterial cells thereby preventing interaction with the matrix without causing damage to the bacteria. Such a treatment would be particularly interesting for skin infections [102].

NPs can also be used in combination with antibiotics or AMPs. These drugs can be given separately or loaded onto the NP. For example, zinc NPs used in combination with vancomycin delivered promising results on enterococci [143]. NPs loaded with silver ions and an antimicrobial peptide copolymer have a multimodal effect on VRE including membrane damage and ROS production resulting in killing of the bacteria in vitro and in a mouse model. These NPs were found to be of low toxicity for eukaryotic cells and no resistance was observed in the bacteria studied after 21 passages in the presence of the NPs [49]. Gold NPs associated with different antibiotics including vancomycin were active on VRE in vitro without being toxic for macrophages [144,145]. One of these vancomycin-loaded gold NPs have been shown to be more active on VRE than vancomycin alone and to have activity on *S. aureus* inside macrophages [144]. Furthermore, NPs made of self-assembled amphiphilic peptides have an antibacterial effect on *E. faecalis*, including VRE [103]. Furthermore, vancomycin-conjugated chitosan NPs seem to have an effect on VRSA [100,146].

Technical progress and the urgent need of alternatives to antibiotics has intensified the research on NPs as therapeutics against MDR pathogens. Many efforts are currently being undertaken to synthesize NPs in a single environmentally friendly step to facilitate their production [138,141]. The wide spectrum of NPs already synthesized allows having many different MoAs at our disposal, and NPs can be used to encapsulate antibiotics in order to improve their delivery [147]. Combinations with antibacterials increase the versatility of NPs. Although few studies reported toxic effects of NPs for eukaryotic organisms, so far this technology has not been approved for use in human medicine.

3. Conclusions

The awareness of the generalization of the antibiotic resistance acquisition by bacteria has stimulated the development of many antimicrobials and very diverse approaches, including in the fight against pathogens resistant to vancomycin.

In general, antibiotics constitute a short-term approach to counter this resistance because their development until introduction into the market is long and resistance appearance is generally fast. The solution of the combination of antibiotics makes it possible to diversify the MoA and thus limit the appearance of resistance, but this solution is far from being perfect due to the broad spectrum of action of such a treatment, leaving the patient with altered microbiota and possible increased of the risk of subsequent infections [148]. Some antibiotic molecules still have a chance to replace vancomycin as the last-line antibiotic, such as the vancomycin-derived molecule from Okano et al. which, due to its multiple synergistic MoA, can treat infections caused by pathogens resistant to vancomycin while preventing the development of resistance [61]. Without coordination between players in the antimicrobial sector, these types of molecules will however end up being overtaken by bacteria that have accumulated resistance to antibiotics sharing an MoA with these “super antibiotics”.

The development of research around unconventional antimicrobials has therefore logically increased with the aim of finding a viable solution to the problem of MDR bacteria. While bacteriocins may have the same problem as antibiotics if their use increases, some antimicrobials could play an important role in fighting antibiotic-resistant bacteria. Antimicrobial peptides and NPs, for example, have the advantage of being able to act physically on bacteria, without the need for a specific bacterial target, reducing the risk of resistance appearance. However, once in the host, a toxicity problem is possible [112,142]. Conversely, bacteriophages target only bacteria and are harmless to the host even if immune reactions have already been observed [94]. This technology is perhaps the most promising of those presented here, because one injection is enough to treat the pathogens, and even in the case of a resistance, a phage effective against the resistant bacteria will be able to emerge quickly. The use of phage cocktails also helps reduce the risk of resistance development. The problem with this technology is that identification of the pathogen and its sensitivity to a given phage is required, delaying the start of patients' treatment, and the treatment site conditions the efficacy of phages.

Some approaches reduce the emergence or spread of vancomycin resistant strains, as shown by the vancomycin antagonist peptide and phage vrep-5 [75,80,126]. Although these potential treatments come too late to prevent vancomycin resistance, the approach is interesting because it can still prevent the spread of it and it should be developed in conjunction with new antimicrobials. The development of anti-virulence treatments could also constitute a lasting alternative to current treatments because they would greatly decrease the selection pressure. Indeed, such treatment would not kill the pathogen but would prevent its virulence, reducing the selective pressure.

There are currently alternatives to vancomycin (linezolid, oritavancin, etc.), but the risk of resistance is to be expected. Therefore, the development of new antimicrobials and treatment strategies is important to pursue.

Author Contributions: Conceptualization, C.G., B.B., and A.B.; investigation, B.B. and A.B.; writing—original draft preparation, B.B. and A.B.; writing—review and editing, B.B., A.B., C.G., and A.H.; visualization, A.B., B.B., C.G., and A.H.; supervision, C.G. All authors have read and agreed to the published version of the manuscript.

Funding: This work was funded by the Agency of National Research (ANR-19-CE18-0026) and the French Ministry of Education and Science funded the doctoral fellowship of Benjamin Baëtz.

Informed Consent Statement: Not applicable.

Data Availability Statement: Data sharing not applicable.

Conflicts of Interest: The authors declare no conflict of interest.

References

1. O'Neill, J. *Tackling Drug-Resistant Infections Globally: Final Report and Recommendations*; Government of the United Kingdom: London, UK, 2016.
2. Touat, M.; Opatowski, M.; Brun-Buisson, C.; Cosker, K.; Guillemot, D.; Salomon, J.; Tuppin, P.; de Lagašnerie, G.; Watier, L. A Payer Perspective of the Hospital Inpatient Additional Care Costs of Antimicrobial Resistance in France: A Matched Case-Control Study. *Appl. Health Econ. Health Policy* **2019**, *17*, 381–389. [[CrossRef](#)] [[PubMed](#)]
3. Cassini, A.; Högberg, L.D.; Plachouras, D.; Quattrocchi, A.; Hoxha, A.; Simonsen, G.S.; Colomb-Cotinat, M.; Kretzschmar, M.E.; Devleeschauwer, B.; Cecchini, M.; et al. Attributable Deaths and Disability-Adjusted Life-Years Caused by Infections with Antibiotic-Resistant Bacteria in the EU and the European Economic Area in 2015: A Population-Level Modelling Analysis. *Lancet Infect. Dis.* **2019**, *19*, 56–66. [[CrossRef](#)]
4. Theuretzbacher, U.; Bush, K.; Harbarth, S.; Paul, M.; Rex, J.H.; Tacconelli, E.; Thwaites, G.E. Critical Analysis of Antibacterial Agents in Clinical Development. *Nat. Rev. Microbiol.* **2020**, *18*, 286–298. [[CrossRef](#)] [[PubMed](#)]
5. McKenna, M. The Antibiotic Paradox: Why Companies Can't Afford to Create Life-Saving Drugs. *Nature* **2020**, *584*, 338–341. [[CrossRef](#)] [[PubMed](#)]
6. Tacconelli, E.; Carrara, E.; Savoldi, A.; Harbarth, S.; Mendelson, M.; Monnet, D.L.; Pulcini, C.; Kahlmeter, G.; Kluytmans, J.; Carmeli, Y.; et al. Discovery, Research, and Development of New Antibiotics: The WHO Priority List of Antibiotic-Resistant Bacteria and Tuberculosis. *Lancet Infect. Dis.* **2018**, *18*, 318–327. [[CrossRef](#)]

7. Rex, J.H.; Lynch, H.F.; Cohen, I.G.; Darrow, J.J.; Outterson, K. Designing Development Programs for Non-Traditional Antibacterial Agents. *Nat. Commun.* **2019**, *10*, 3416. [[CrossRef](#)]
8. Levine, D.P. Vancomycin: A History. *Clin. Infect. Dis.* **2006**, *42* (Suppl. S1), S5–S12. [[CrossRef](#)]
9. Arias, C.A.; Murray, B.E. The Rise of the *Enterococcus*: Beyond Vancomycin Resistance. *Nat. Rev. Microbiol.* **2012**, *10*, 266–278. [[CrossRef](#)]
10. Kristich, C.J.; Rice, L.B.; Arias, C.A. Enterococcal Infection—Treatment and Antibiotic Resistance. In *Enterococci: From Commensals to Leading Causes of Drug Resistant Infection*; Gilmore, M.S., Clewell, D.B., Ike, Y., Shankar, N., Eds.; Massachusetts Eye and Ear Infirmary: Boston, MA, USA, 2014.
11. Kaplan, A.H.; Gilligan, P.H.; Facklam, R.R. Recovery of Resistant Enterococci during Vancomycin Prophylaxis. *J. Clin. Microbiol.* **1988**, *26*, 1216–1218. [[CrossRef](#)] [[PubMed](#)]
12. Leclercq, R.; Derlot, E.; Duval, J.; Courvalin, P. Plasmid-Mediated Resistance to Vancomycin and Teicoplanin in *Enterococcus faecium*. *N. Engl. J. Med.* **1988**, *319*, 157–161. [[CrossRef](#)]
13. Gholizadeh, Y.; Courvalin, P. Acquired and Intrinsic Glycopeptide Resistance in Enterococci. *Int. J. Antimicrob. Agents* **2000**, *16*, 11–17. [[CrossRef](#)]
14. Reynolds, P.E. Structure, Biochemistry and Mechanism of Action of Glycopeptide Antibiotics. *Eur. J. Clin. Microbiol. Infect. Dis.* **1989**, *8*, 943–950. [[CrossRef](#)] [[PubMed](#)]
15. Schaechter, M. *Desk Encyclopedia of Microbiology*, 2nd ed.; Elsevier/AP: Amsterdam, The Netherlands, 2009; ISBN 978-0-12-374980-2.
16. Nitanaï, Y.; Kikuchi, T.; Kakoi, K.; Hanamaki, S.; Fujisawa, I.; Aoki, K. Crystal Structures of the Complexes between Vancomycin and Cell-Wall Precursor Analogs. *J. Mol. Biol.* **2009**, *385*, 1422–1432. [[CrossRef](#)]
17. ECDC. Antimicrobial Resistance in the EU/EEA (EARS-Net)—Annual Epidemiological Report for 2019. Available online: ecdc.europa.eu/en/publications-data/surveillance-antimicrobial-resistance-europe-2019 (accessed on 1 January 2021).
18. DiazGranados, C.A.; Zimmer, S.M.; Mitchel, K.; Jernigan, J.A. Comparison of Mortality Associated with Vancomycin-Resistant and Vancomycin-Susceptible Enterococcal Bloodstream Infections: A Meta-Analysis. *Clin. Infect. Dis.* **2005**, *41*, 327–333. [[CrossRef](#)]
19. Reinseth, I.S.; Ovchinnikov, K.V.; Tønnesen, H.H.; Carlsen, H.; Diep, D.B. The Increasing Issue of Vancomycin-Resistant Enterococci and the Bacteriocin Solution. *Probiot. Antimicrob. Proteins* **2020**, *12*, 1203–1217. [[CrossRef](#)] [[PubMed](#)]
20. Bender, J.K.; Cattoir, V.; Hegstad, K.; Sadowy, E.; Coque, T.M.; Westh, H.; Hammerum, A.M.; Schaffer, K.; Burns, K.; Murchan, S.; et al. Update on Prevalence and Mechanisms of Resistance to Linezolid, Tigecycline and Daptomycin in Enterococci in Europe: Towards a Common Nomenclature. *Drug Resist. Updates* **2018**, *40*, 25–39. [[CrossRef](#)] [[PubMed](#)]
21. Contreras, G.A.; Munita, J.M.; Arias, C.A. Novel Strategies for the Management of Vancomycin-Resistant Enterococcal Infections. *Curr. Infect. Dis. Rep.* **2019**, *21*, 22. [[CrossRef](#)]
22. Yim, J.; Smith, J.R.; Rybak, M.J. Role of Combination Antimicrobial Therapy for Vancomycin-Resistant *Enterococcus faecium* Infections: Review of the Current Evidence. *Pharmacotherapy* **2017**, *37*, 579–592. [[CrossRef](#)]
23. Livermore, D.M. Linezolid in Vitro: Mechanism and Antibacterial Spectrum. *J. Antimicrob. Chemother.* **2003**, *51*, ii9–ii16. [[CrossRef](#)]
24. Long, K.S.; Poehlsgaard, J.; Kehrenberg, C.; Schwarz, S.; Vester, B. The Cfr RRNA Methyltransferase Confers Resistance to Phenicols, Lincosamides, Oxazolidinones, Pleuromutilins, and Streptogramin A Antibiotics. *Antimicrob. Agents Chemother.* **2006**, *50*, 2500–2505. [[CrossRef](#)]
25. Locke, J.B.; Zurenko, G.E.; Shaw, K.J.; Bartizal, K. Tedizolid for the Management of Human Infections: In Vitro Characteristics. *Clin. Infect. Dis.* **2014**, *58*, S35–S42. [[CrossRef](#)]
26. Brenciani, A.; Morroni, G.; Vincenzi, C.; Manso, E.; Mingoia, M.; Giovanetti, E.; Valardo, P.E. Detection in Italy of Two Clinical *Enterococcus faecium* Isolates Carrying Both the Oxazolidinone and Phenicol Resistance Gene *optrA* and a Silent Multiresistance Gene *cfr*: Table 1. *J. Antimicrob. Chemother.* **2016**, *71*, 1118–1119. [[CrossRef](#)]
27. Sharkey, L.K.R.; O'Neill, A.J. Antibiotic Resistance ABC-F Proteins: Bringing Target Protection into the Limelight. *ACS Infect. Dis.* **2018**, *4*, 239–246. [[CrossRef](#)] [[PubMed](#)]
28. Gawryszewska, I.; Żabicka, D.; Hryniewicz, W.; Sadowy, E. Linezolid-Resistant Enterococci in Polish Hospitals: Species, Clonality and Determinants of Linezolid Resistance. *Eur. J. Clin. Microbiol. Infect. Dis.* **2017**, *36*, 1279–1286. [[CrossRef](#)] [[PubMed](#)]
29. Nannini, E.; Murray, B.E.; Arias, C.A. Resistance or Decreased Susceptibility to Glycopeptides, Daptomycin, and Linezolid in Methicillin-Resistant *Staphylococcus aureus*. *Curr. Opin. Pharmacol.* **2010**, *10*, 516–521. [[CrossRef](#)]
30. Bi, R.; Qin, T.; Fan, W.; Ma, P.; Gu, B. The Emerging Problem of Linezolid-Resistant Enterococci. *J. Glob. Antimicrob. Resist.* **2018**, *13*, 11–19. [[CrossRef](#)]
31. Krull, M.; Klare, I.; Ross, B.; Trenchel, R.; Beelen, D.W.; Todt, D.; Steinmann, E.; Buer, J.; Rath, P.-M.; Steinmann, J. Emergence of Linezolid- and Vancomycin-Resistant *Enterococcus faecium* in a Department for Hematologic Stem Cell Transplantation. *Antimicrob. Resist. Infect. Control* **2016**, *5*, 31. [[CrossRef](#)]
32. Heininger, A.; Zimmermann, S.; Bootsveld, C.; Boutin, S.; Nurjadi, D. Low Prevalence of Combined Linezolid- and Vancomycin-Resistant *Enterococcus faecium* from Hospital Admission Screening in an Endemic Region in Germany. *J. Glob. Antimicrob. Resist.* **2020**, *22*, 646–650. [[CrossRef](#)] [[PubMed](#)]
33. Zhanel, G.G.; Love, R.; Adam, H.; Golden, A.; Zelenitsky, S.; Schweizer, F.; Gorityala, B.; Lagacé-Wiens, P.R.S.; Rubinstein, E.; Walkty, A.; et al. Tedizolid: A Novel Oxazolidinone with Potent Activity Against Multidrug-Resistant Gram-Positive Pathogens. *Drugs* **2015**, *75*, 253–270. [[CrossRef](#)] [[PubMed](#)]

34. Zhanel, G.G. Antibiotic Activity against Urinary Tract Infection (UTI) Isolates of Vancomycin-Resistant Enterococci (VRE): Results from the 2002 North American Vancomycin Resistant Enterococci Susceptibility Study (NAVRESS). *J. Antimicrob. Chemother.* **2003**, *52*, 382–388. [[CrossRef](#)] [[PubMed](#)]
35. O'Driscoll, T.; Crank, C.W. Vancomycin-Resistant Enterococcal Infections: Epidemiology, Clinical Manifestations, and Optimal Management. *Infect. Drug Resist.* **2015**, *8*, 217–230. [[CrossRef](#)]
36. Wang, Y.; Li, X.; Wang, Y.; Schwarz, S.; Shen, J.; Xia, X. Intracellular Accumulation of Linezolid and Florfenicol in OptrA-Producing *Enterococcus faecalis* and *Staphylococcus aureus*. *Molecules* **2018**, *23*, 3195. [[CrossRef](#)]
37. Straus, S.K.; Hancock, R.E.W. Mode of Action of the New Antibiotic for Gram-Positive Pathogens Daptomycin: Comparison with Cationic Antimicrobial Peptides and Lipopeptides. *Biochim. Biophys. Acta* **2006**, *1758*, 1215–1223. [[CrossRef](#)] [[PubMed](#)]
38. Chuang, Y.-C.; Wang, J.-T.; Lin, H.-Y.; Chang, S.-C. Daptomycin versus Linezolid for Treatment of Vancomycin-Resistant Enterococcal Bacteremia: Systematic Review and Meta-Analysis. *BMC Infect. Dis* **2014**, *14*, 687. [[CrossRef](#)]
39. Werth, B.J.; Barber, K.E.; Tran, K.-N.T.; Nonejuie, P.; Sakoulas, G.; Pogliano, J.; Rybak, M.J. Ceftobiprole and Ampicillin Increase Daptomycin Susceptibility of Daptomycin-Susceptible and -Resistant VRE. *J. Antimicrob. Chemother.* **2015**, *70*, 489–493. [[CrossRef](#)] [[PubMed](#)]
40. Miller, W.R.; Bayer, A.S.; Arias, C.A. Mechanism of Action and Resistance to Daptomycin in *Staphylococcus aureus* and Enterococci. *Cold Spring Harb. Perspect. Med.* **2016**, *6*, a026997. [[CrossRef](#)]
41. Tran, T.T.; Munita, J.M.; Arias, C.A. Mechanisms of Drug Resistance: Daptomycin Resistance. *Ann. N. Y. Acad. Sci.* **2015**, *1354*, 32–53. [[CrossRef](#)] [[PubMed](#)]
42. Khan, A.; Davlieva, M.; Panesso, D.; Rincon, S.; Miller, W.R.; Diaz, L.; Reyes, J.; Cruz, M.R.; Pemberton, O.; Nguyen, A.H.; et al. Antimicrobial Sensing Coupled with Cell Membrane Remodeling Mediates Antibiotic Resistance and Virulence in *Enterococcus faecalis*. *Proc. Natl. Acad. Sci. USA* **2019**, *116*, 26925–26932. [[CrossRef](#)]
43. Werth, B.J.; Steed, M.E.; Ireland, C.E.; Tran, T.T.; Nonejuie, P.; Murray, B.E.; Rose, W.E.; Sakoulas, G.; Pogliano, J.; Arias, C.A.; et al. Defining Daptomycin Resistance Prevention Exposures in Vancomycin-Resistant *Enterococcus faecium* and *E. faecalis*. *Antimicrob. Agents Chemother.* **2014**, *58*, 5253–5261. [[CrossRef](#)]
44. Dönhöfer, A.; Franckenberg, S.; Wickles, S.; Berninghausen, O.; Beckmann, R.; Wilson, D.N. Structural Basis for TetM-Mediated Tetracycline Resistance. *Proc. Natl. Acad. Sci. USA* **2012**, *109*, 16900–16905. [[CrossRef](#)]
45. Beabout, K.; Hammerstrom, T.G.; Perez, A.M.; Magalhães, B.F.; Prater, A.G.; Clements, T.P.; Arias, C.A.; Saxer, G.; Shamoo, Y. The Ribosomal S10 Protein Is a General Target for Decreased Tigecycline Susceptibility. *Antimicrob. Agents Chemother.* **2015**, *59*, 5561–5566. [[CrossRef](#)]
46. Bender, J.K.; Klare, I.; Fleige, C.; Werner, G. A Nosocomial Cluster of Tigecycline- and Vancomycin-Resistant *Enterococcus faecium* Isolates and the Impact of RpsJ and Tet(M) Mutations on Tigecycline Resistance. *Microb. Drug Resist.* **2020**, *26*, 576–582. [[CrossRef](#)]
47. Hamzah, A.M.C.; Yeo, C.C.; Pua, S.M.; Chua, K.H.; Rahman, N.I.A.; Abdullah, F.H.; Othman, N.; Chew, C.H. Tigecycline and Inducible Clindamycin Resistance in Clinical Isolates of Methicillin-Resistant *Staphylococcus aureus* from Terengganu, Malaysia. *J. Med. Microbiol.* **2019**, *68*, 1299–1305. [[CrossRef](#)]
48. Bensaci, M.; Sahm, D. Surveillance of Tedizolid Activity and Resistance: In Vitro Susceptibility of Gram-Positive Pathogens Collected over 5 Years from the United States and Europe. *Diagn. Microbiol. Infect. Dis.* **2017**, *87*, 133–138. [[CrossRef](#)]
49. Zhen, J.-B.; Kang, P.-W.; Zhao, M.-H.; Yang, K.-W. Silver Nanoparticle Conjugated Star PCL-b-AMPs Copolymer as Nanocomposite Exhibits Efficient Antibacterial Properties. *Bioconjug. Chem.* **2020**, *31*, 51–63. [[CrossRef](#)] [[PubMed](#)]
50. Jain, R.K.; Trias, J.; Ellman, J.A. D-Ala-D-Lac Binding Is Not Required for the High Activity of Vancomycin Dimers against Vancomycin Resistant Enterococci. *J. Am. Chem. Soc.* **2003**, *125*, 8740–8741. [[CrossRef](#)] [[PubMed](#)]
51. Yoshida, O.; Nakamura, J.; Yamashiro, H.; Miura, K.; Hayashi, S.; Umetsu, K.; Xu, S.; Maki, H.; Arimoto, H. New Insight into the Mode of Action of Vancomycin Dimers in Bacterial Cell Wall Synthesis. *Med. Chem. Commun.* **2011**, *2*, 278. [[CrossRef](#)]
52. Nakamura, J.; Yamashiro, H.; Hayashi, S.; Yamamoto, M.; Miura, K.; Xu, S.; Doi, T.; Maki, H.; Yoshida, O.; Arimoto, H. Elucidation of the Active Conformation of Vancomycin Dimers with Antibacterial Activity against Vancomycin-Resistant Bacteria. *Chem. Eur. J.* **2012**, *18*, 12681–12689. [[CrossRef](#)] [[PubMed](#)]
53. Lu, J.; Yoshida, O.; Hayashi, S.; Arimoto, H. Synthesis of Rigidly-Linked Vancomycin Dimers and Their in Vivo Efficacy against Resistant Bacteria. *Chem. Commun.* **2007**, *3*, 251–253. [[CrossRef](#)]
54. Szűcs, Z.; Ostorházi, E.; Kicsák, M.; Nagy, L.; Borbás, A.; Herczegh, P. New Semisynthetic Teicoplanin Derivatives Have Comparable in Vitro Activity to That of Oritavancin against Clinical Isolates of VRE. *J. Antibiot.* **2019**, *72*, 524–534. [[CrossRef](#)]
55. Malabarba, A.; Ciabatti, R. Glycopeptide Derivatives. *Curr. Med. Chem.* **2001**, *8*, 1759–1773. [[CrossRef](#)] [[PubMed](#)]
56. Zeng, D.; Debatov, D.; Hartsell, T.L.; Cano, R.J.; Adams, S.; Schuyler, J.A.; McMillan, R.; Pace, J.L. Approved Glycopeptide Antibacterial Drugs: Mechanism of Action and Resistance. *Cold Spring Harb. Perspect. Med.* **2016**, *6*, a026989. [[CrossRef](#)]
57. Jones, R.N.; Fritsche, T.R.; Sader, H.S.; Goldstein, B.P. Antimicrobial Spectrum and Potency of Dalbavancin Tested Against Clinical Isolates from Europe and North America (2003): Initial Results from an International Surveillance Protocol. *J. Chemother.* **2005**, *17*, 593–600. [[CrossRef](#)] [[PubMed](#)]
58. Lozano, C.; Torres, C. Actualización en la resistencia antibiótica en Gram positivos. *Enferm. Infecc. Microbiol. Clin.* **2017**, *35*, 2–8. [[CrossRef](#)]
59. Karaoui, L.R.; EL-Lababidi, R.; Chahine, E.B. Oritavancin: An Investigational Lipoglycopeptide Antibiotic. *Am. J. Health Syst. Pharm.* **2013**, *70*, 23–33. [[CrossRef](#)] [[PubMed](#)]

60. Rosenthal, S.; Decano, A.G.; Bandali, A.; Lai, D.; Malat, G.E.; Bias, T.E. Oritavancin (Orbactiv): A New-Generation Lipoglycopeptide for the Treatment of Acute Bacterial Skin and Skin Structure Infections. *Pharm. Ther.* **2018**, *43*, 143–179.
61. Okano, A.; Isley, N.A.; Boger, D.L. Peripheral Modifications of [Ψ [CH₂NH]Tpg⁴] Vancomycin with Added Synergistic Mechanisms of Action Provide Durable and Potent Antibiotics. *Proc. Natl. Acad. Sci. USA* **2017**, *114*, 201704125. [[CrossRef](#)]
62. Aktas, G. In Vitro Synergistic Effect of Vancomycin Combined with Daptomycin Against Vancomycin-Resistant Enterococci. *Microb. Drug Resist.* **2019**, *25*, 1484–1489. [[CrossRef](#)]
63. de Oliveira, K.S.; Queiroz, P.R.M.; Fensterseifer, I.C.M.; Migliolo, L.; Oliveira, A.L.; Franco, O.L. Purified Citritin in Combination with Vancomycin Inhibits VRE in Vitro and in Vivo. *Microbiology* **2017**, *163*, 1525–1531. [[CrossRef](#)] [[PubMed](#)]
64. Luther, M.K.; Arvanitis, M.; Mylonakis, E.; LaPlante, K.L. Activity of Daptomycin or Linezolid in Combination with Rifampin or Gentamicin against Biofilm-Forming *Enterococcus faecalis* or *E. faecium* in an In Vitro Pharmacodynamic Model Using Simulated Endocardial Vegetations and an In Vivo Survival Assay Using *Galleria mellonella* Larvae. *Antimicrob. Agents Chemother.* **2014**, *58*, 4612–4620. [[CrossRef](#)]
65. Chen, H.; Du, Y.; Xia, Q.; Li, Y.; Song, S.; Huang, X. Role of Linezolid Combination Therapy for Serious Infections: Review of the Current Evidence. *Eur. J. Clin. Microbiol. Infect. Dis.* **2020**, *39*, 1043–1052. [[CrossRef](#)]
66. Meyer, K.A.; Deraedt, M.F.; Harrington, A.T.; Danziger, L.H.; Wenzler, E. Efficacy of Oritavancin Alone and in Combination against Vancomycin-Susceptible and -Resistant Enterococci in an in-Vivo *Galleria mellonella* Survival Model. *Int. J. Antimicrob. Agents* **2019**, *54*, 197–201. [[CrossRef](#)]
67. Qi, C.; Xu, S.; Wu, M.; Zhu, S.; Liu, Y.; Huang, H.; Zhang, G.; Li, J.; Huang, X. Pharmacodynamics of Linezolid-Plus-Fosfomycin Against Vancomycin-Susceptible and -Resistant Enterococci In Vitro and In Vivo of A *Galleria mellonella* Larval Infection Model. *Infect. Drug Resist.* **2019**, *12*, 3497–3505. [[CrossRef](#)]
68. Tang, H.-J.; Chen, C.-C.; Zhang, C.-C.; Su, B.-A.; Li, C.-M.; Weng, T.-C.; Chiang, S.-R.; Ko, W.-C.; Chuang, Y.-C. In Vitro Efficacy of Fosfomycin-Based Combinations against Clinical Vancomycin-Resistant *Enterococcus* Isolates. *Diagn. Microbiol. Infect. Dis.* **2013**, *77*, 254–257. [[CrossRef](#)] [[PubMed](#)]
69. Tang, H.-J.; Chen, C.-C.; Cheng, K.-C.; Toh, H.-S.; Su, B.-A.; Chiang, S.-R.; Ko, W.-C.; Chuang, Y.-C. In Vitro Efficacy of Fosfomycin-Containing Regimens against Methicillin-Resistant *Staphylococcus aureus* in Biofilms. *J. Antimicrob. Chemother.* **2012**, *67*, 944–950. [[CrossRef](#)]
70. Smith, J.R.; Barber, K.E.; Raut, A.; Aboutaleb, M.; Sakoulas, G.; Rybak, M.J. β -Lactam Combinations with Daptomycin Provide Synergy against Vancomycin-Resistant *Enterococcus faecalis* and *Enterococcus faecium*. *J. Antimicrob. Chemother.* **2015**, *70*, 1738–1743. [[CrossRef](#)] [[PubMed](#)]
71. Smith, J.R.; Yim, J.; Raut, A.; Rybak, M.J. Oritavancin Combinations with β -Lactams against Multidrug-Resistant *Staphylococcus aureus* and Vancomycin-Resistant Enterococci. *Antimicrob. Agents Chemother.* **2016**, *60*, 2352–2358. [[CrossRef](#)] [[PubMed](#)]
72. Wu, T.; Meyer, K.; Harrington, A.T.; Danziger, L.H.; Wenzler, E. In Vitro Activity of Oritavancin Alone or in Combination against Vancomycin-Susceptible and -Resistant Enterococci. *J. Antimicrob. Chemother.* **2019**, *74*, 1300–1305. [[CrossRef](#)] [[PubMed](#)]
73. Mroue, N.; Arya, A.; Gandt, A.B.; Russell, C.; Han, A.; Gavriish, E.; LaFleur, M. Pharmacodynamics of ClpP-Activating Antibiotic Combinations against Gram-Positive Pathogens. *Antimicrob. Agents Chemother.* **2019**, *64*, e01554-19. [[CrossRef](#)] [[PubMed](#)]
74. Gandt, A.B.; Griffith, E.C.; Lister, I.M.; Billings, L.L.; Han, A.; Tangallapally, R.; Zhao, Y.; Singh, A.P.; Lee, R.E.; LaFleur, M.D. In Vivo and in Vitro Effects of a ClpP-Activating Antibiotic against Vancomycin-Resistant Enterococci. *Antimicrob. Agents Chemother.* **2018**, *62*, e00424-18. [[CrossRef](#)]
75. Mull, R.W.; Brennan, A.A.; Russ, B.R.; Tal-Gan, Y. Attenuating the Selection of Vancomycin Resistance Among Enterococci through the Development of Peptide-Based Vancomycin Antagonists. *ACS Infect. Dis.* **2020**, *6*, 2913–2925. [[CrossRef](#)]
76. Liu, Y.; Jia, Y.; Yang, K.; Li, R.; Xiao, X.; Wang, Z. Antagonizing Vancomycin Resistance in *Enterococcus* by Surface Localized Antimicrobial Display-Derived Peptides. *ACS Infect. Dis.* **2020**, *6*, 761–767. [[CrossRef](#)]
77. Thappeta, K.R.V.; Vikhe, Y.S.; Yong, A.M.H.; Chan-Park, M.B.; Kline, K.A. Combined Efficacy of an Antimicrobial Cationic Peptide Polymer with Conventional Antibiotics to Combat Multidrug-Resistant Pathogens. *ACS Infect. Dis.* **2020**, *6*, 1228–1237. [[CrossRef](#)] [[PubMed](#)]
78. Shurko, J.F. Evaluation of LL-37 Antimicrobial Peptide Derivatives Alone and in Combination with Vancomycin against *S. aureus*. *J. Antibiot.* **2018**, *71*, 971–974. [[CrossRef](#)] [[PubMed](#)]
79. Umstätter, F.; Domhan, C.; Hertlein, T.; Ohlsen, K.; Mühlberg, E.; Kleist, C.; Zimmermann, S.; Beijer, B.; Klika, K.D.; Haberkorn, U.; et al. Vancomycin Resistance Is Overcome by Conjugation of Polycationic Peptides. *Angew. Chem. Int. Ed.* **2020**, *59*, 8823–8827. [[CrossRef](#)]
80. Kim, S.G.; Becattini, S.; Moody, T.U.; Shliaha, P.V.; Littmann, E.R.; Seok, R.; Gjonbalaj, M.; Eaton, V.; Fontana, E.; Amoretti, L.; et al. Microbiota-Derived Lantibiotic Restores Resistance against Vancomycin-Resistant *Enterococcus*. *Nature* **2019**, *572*, 665–669. [[CrossRef](#)]
81. Lawton, E.; Ross, R.; Hill, C.; Cotter, P. Two-Peptide Lantibiotics: A Medical Perspective. *MRMC* **2007**, *7*, 1236–1247. [[CrossRef](#)] [[PubMed](#)]
82. Kruszewska, D.; Sahl, H.-G.; Bierbaum, G.; Pag, U.; Hynes, S.O. Mersacidin Eradicates Methicillin-Resistant *Staphylococcus aureus* (MRSA) in a Mouse Rhinitis Model. *J. Antimicrob. Chemother.* **2004**, *54*, 648–653. [[CrossRef](#)]
83. Piper, C.; Casey, P.G.; Hill, C.; Cotter, P.D.; Ross, R.P. The Lantibiotic Lactacin 3147 Prevents Systemic Spread of *Staphylococcus aureus* in a Murine Infection Model. *Int. J. Microbiol.* **2012**, *2012*, 806230. [[CrossRef](#)] [[PubMed](#)]

84. Aunpad, R.; Na-Bangchang, K. Pumilicin 4, A Novel Bacteriocin with Anti-MRSA and Anti-VRE Activity Produced by Newly Isolated Bacteria *Bacillus pumilus* Strain WAPB4. *Curr. Microbiol.* **2007**, *55*, 308–313. [[CrossRef](#)] [[PubMed](#)]
85. Ovchinnikov, K.V.; Kristiansen, P.E.; Straume, D.; Jensen, M.S.; Aleksandrak-Piekarczyk, T.; Nes, I.F.; Diep, D.B. The Leaderless Bacteriocin Enterocin K1 Is Highly Potent against *Enterococcus faecium*: A Study on Structure, Target Spectrum and Receptor. *Front. Microbiol.* **2017**, *8*, 774. [[CrossRef](#)]
86. Phumisantiphong, U.; Siripanichgon, K.; Reamtong, O.; Diraphat, P. A Novel Bacteriocin from *Enterococcus faecalis* 478 Exhibits a Potent Activity against Vancomycin-Resistant Enterococci. *PLoS ONE* **2017**, *12*, e0186415. [[CrossRef](#)]
87. Regmi, S.; Choi, Y.H.; Choi, Y.S.; Kim, M.R.; Yoo, J.C. Antimicrobial Peptide Isolated from *Bacillus amyloliquefaciens* K14 Revitalizes Its Use in Combinatorial Drug Therapy. *Folia Microbiol.* **2017**, *62*, 127–138. [[CrossRef](#)]
88. Montalbán-López, M.; Cebrián, R.; Galera, R.; Mingorance, L.; Martín-Platero, A.M.; Valdivia, E.; Martínez-Bueno, M.; Maqueda, M. Synergy of the Bacteriocin AS-48 and Antibiotics against Uropathogenic Enterococci. *Antibiotics* **2020**, *9*, 567. [[CrossRef](#)]
89. Proença, D.; Fernandes, S.; Leandro, C.; Silva, F.A.; Santos, S.; Lopes, F.; Mato, R.; Cavaco-Silva, P.; Pimentel, M.; São-José, C. Phage Endolysins with Broad Antimicrobial Activity against *Enterococcus faecalis* Clinical Strains. *Microb. Drug Resist.* **2012**, *18*, 322–332. [[CrossRef](#)]
90. Zhang, H.; Buttaro, B.A.; Fouts, D.E.; Sanjari, S.; Evans, B.S.; Stevens, R.H. Bacteriophage ΦEf11 ORF28 Endolysin, a Multifunctional Lytic Enzyme with Properties Distinct from All Other Identified *Enterococcus faecalis* Phage Endolysins. *Appl. Environ. Microbiol.* **2019**, *85*, e00555-19. [[CrossRef](#)] [[PubMed](#)]
91. Kim, S.; Jin, J.-S.; Choi, Y.-J.; Kim, J. LysSAP26, a New Recombinant Phage Endolysin with a Broad Spectrum Antibacterial Activity. *Viruses* **2020**, *12*, 1340. [[CrossRef](#)]
92. Zhang, H.; Stevens, R.H. Intrinsic Resistance of *Enterococcus faecalis* Strains to ΦEf11 Phage Endolysin Is Associated with the Presence of ΦEf11 Prophage. *Arch. Virol.* **2020**, *166*, 249–258. [[CrossRef](#)] [[PubMed](#)]
93. Głowacka-Rutkowska, A.; Ulatowska, M.; Empel, J.; Kowalczyk, M.; Boreczek, J.; Łobocka, M. A *Kayvirus* Distant Homolog of Staphylococcal Virulence Determinants and VISA Biomarker Is a Phage Lytic Enzyme. *Viruses* **2020**, *12*, 292. [[CrossRef](#)] [[PubMed](#)]
94. Biswas, B.; Adhya, S.; Washart, P.; Paul, B.; Trostel, A.N.; Powell, B.; Carlton, R.; Merrill, C.R. Bacteriophage Therapy Rescues Mice Bacteremic from a Clinical Isolate of Vancomycin-Resistant *Enterococcus faecium*. *Infect. Immun.* **2002**, *70*, 204–210. [[CrossRef](#)] [[PubMed](#)]
95. Khalifa, L.; Shlezinger, M.; Beyth, S.; Hourri-Haddad, Y.; Copenhagen-Glazer, S.; Beyth, N.; Hazan, R. Phage Therapy against *Enterococcus faecalis* in Dental Root Canals. *J. Oral Microbiol.* **2016**, *8*, 32157. [[CrossRef](#)]
96. Gelman, D.; Beyth, S.; Lerer, V.; Adler, K.; Poradosu-Cohen, R.; Copenhagen-Glazer, S.; Hazan, R. Combined Bacteriophages and Antibiotics as an Efficient Therapy against VRE *Enterococcus faecalis* in a Mouse Model. *Res. Microbiol.* **2018**, *169*, 531–539. [[CrossRef](#)] [[PubMed](#)]
97. Khalifa, L.; Gelman, D.; Shlezinger, M.; Dessal, A.L.; Copenhagen-Glazer, S.; Beyth, N.; Hazan, R. Defeating Antibiotic- and Phage-Resistant *Enterococcus faecalis* Using a Phage Cocktail in Vitro and in a Clot Model. *Front. Microbiol.* **2018**, *9*, 326. [[CrossRef](#)] [[PubMed](#)]
98. Shlezinger, M.; Copenhagen-Glazer, S.; Gelman, D.; Beyth, N.; Hazan, R. Eradication of Vancomycin-Resistant Enterococci by Combining Phage and Vancomycin. *Viruses* **2019**, *11*, 954. [[CrossRef](#)] [[PubMed](#)]
99. Górski, A.; Międzybrodzki, R.; Łobocka, M.; Głowacka-Rutkowska, A.; Bednarek, A.; Borysowski, J.; Jończyk-Matysiak, E.; Łusiak-Szelachowska, M.; Weber-Dąbrowska, B.; Bagińska, N.; et al. Phage Therapy: What Have We Learned? *Viruses* **2018**, *10*, 288. [[CrossRef](#)]
100. Pelgrift, R.Y.; Friedman, A.J. Nanotechnology as a Therapeutic Tool to Combat Microbial Resistance. *Adv. Drug Deliv. Rev.* **2013**, *65*, 1803–1815. [[CrossRef](#)]
101. Friedman, A.J.; Phan, J.; Schairer, D.O.; Champer, J.; Qin, M.; Pirouz, A.; Blecher-Paz, K.; Oren, A.; Liu, P.T.; Modlin, R.L.; et al. Antimicrobial and Anti-Inflammatory Activity of Chitosan-Alginate Nanoparticles: A Targeted Therapy for Cutaneous Pathogens. *J. Investig. Dermatol.* **2013**, *133*, 1231–1239. [[CrossRef](#)]
102. Li, J.; Zhang, K.; Ruan, L.; Chin, S.F.; Wickramasinghe, N.; Liu, H.; Ravikumar, V.; Ren, J.; Duan, H.; Yang, L.; et al. Block Copolymer Nanoparticles Remove Biofilms of Drug-Resistant Gram-Positive Bacteria by Nanoscale Bacterial Debridement. *Nano Lett.* **2018**, *18*, 4180–4187. [[CrossRef](#)]
103. Zhen, J.-B.; Zhao, M.-H.; Ge, Y.; Liu, Y.; Xu, L.-W.; Chen, C.; Gong, Y.-K.; Yang, K.-W. Construction, Mechanism, and Antibacterial Resistance Insight into Polypeptide-Based Nanoparticles. *Biomater. Sci.* **2019**, *7*, 4142–4152. [[CrossRef](#)]
104. Wilson, D.N. Ribosome-Targeting Antibiotics and Mechanisms of Bacterial Resistance. *Nat. Rev. Microbiol.* **2014**, *12*, 35–48. [[CrossRef](#)]
105. Mühlberg, E.; Umstätter, F.; Kleist, C.; Domhan, C.; Mier, W.; Uhl, P. Renaissance of Vancomycin: Approaches for Breaking Antibiotic Resistance in Multidrug-Resistant Bacteria. *Can. J. Microbiol.* **2020**, *66*, 11–16. [[CrossRef](#)]
106. Mishra, N.M.; Stolarzewicz, I.; Cannaearts, D.; Schuermans, J.; Lavigne, R.; Looz, Y.; Landuyt, B.; Schoofs, L.; Schols, D.; Paeshuyse, J.; et al. Iterative Chemical Engineering of Vancomycin Leads to Novel Vancomycin Analogs with a High in Vitro Therapeutic Index. *Front. Microbiol.* **2018**, *9*, 1175. [[CrossRef](#)]
107. Yoshida, O.; Yasukata, T.; Sumino, Y.; Munekage, T.; Narukawa, Y.; Nishitani, Y. Novel Semi-Synthetic Glycopeptide Antibiotics Active against Methicillin-Resistant *Staphylococcus aureus* (MRSA) and Vancomycin-Resistant Enterococci (VRE): Doubly-Modified Water-Soluble Derivatives of Chloroorienticin B. *Bioorg. Med. Chem. Lett.* **2002**, *12*, 3027–3031. [[CrossRef](#)]

108. James, R.C.; Pierce, J.G.; Okano, A.; Xie, J.; Boger, D.L. Redesign of Glycopeptide Antibiotics—Back to the Future. *ACS Chem. Biol.* **2012**, *7*, 797–804. [[CrossRef](#)]
109. Ma, N.; Jia, Y.; Liu, Z.; Gonzalez-Zamora, E.; Bois-Choussy, M.; Malabarba, A.; Brunati, C.; Zhu, J. Design and Synthesis of Macrocycles Active against Vancomycin-Resistant Enterococci (VRE): The Interplay between d-Ala-d-Lac Binding and Hydrophobic Effect. *Bioorg. Med. Chem. Lett.* **2005**, *15*, 743–746. [[CrossRef](#)] [[PubMed](#)]
110. Plotkin, P.; Patel, K.; Uminski, A.; Marzella, N. Telavancin (Vibativ), a New Option for the Treatment of Gram-Positive Infections. *Pharm. Ther.* **2011**, *36*, 127–138.
111. Zhang, J.; Keller, K.; Takemoto, J.Y.; Bensaci, M.; Litke, A.; Czyryca, P.G.; Chang, C.-W.T. Synthesis and Combinational Antibacterial Study of 5'-Modified Neomycin. *J. Antibiot.* **2009**, *62*, 539–544. [[CrossRef](#)] [[PubMed](#)]
112. Mwangi, J.; Hao, X.; Lai, R.; Zhang, Z.-Y. Antimicrobial Peptides: New Hope in the War against Multidrug Resistance. *Zool. Res.* **2019**, *40*, 488–505. [[CrossRef](#)] [[PubMed](#)]
113. Fedders, H.; Podschun, R.; Leippe, M. The Antimicrobial Peptide Ci-MAM-A24 Is Highly Active against Multidrug-Resistant and Anaerobic Bacteria Pathogenic for Humans. *Int. J. Antimicrob. Agents* **2010**, *36*, 264–266. [[CrossRef](#)]
114. Bechinger, B.; Gorr, S.-U. Antimicrobial Peptides. *J. Dent. Res.* **2017**, *96*, 254–260. [[CrossRef](#)]
115. Kumariya, R.; Garsa, A.K.; Rajput, Y.S.; Sood, S.K.; Akhtar, N.; Patel, S. Bacteriocins: Classification, Synthesis, Mechanism of Action and Resistance Development in Food Spoilage Causing Bacteria. *Microb. Pathog.* **2019**, *128*, 171–177. [[CrossRef](#)] [[PubMed](#)]
116. Singh, M.; Chaudhary, S.; Sareen, D. Roseocin, a Novel Two-component Lantibiotic from an Actinomycete. *Mol. Microbiol.* **2020**, *113*, 326–337. [[CrossRef](#)] [[PubMed](#)]
117. Shokri, D.; Zaghian, S.; Khodabakhsh, F.; Fazeli, H.; Mobasherizadeh, S.; Ataei, B. Antimicrobial Activity of a UV-Stable Bacteriocin-like Inhibitory Substance (BLIS) Produced by *Enterococcus faecium* Strain DSH20 against Vancomycin-Resistant *Enterococcus* (VRE) Strains. *J. Microbiol. Immunol. Infect.* **2014**, *47*, 371–376. [[CrossRef](#)] [[PubMed](#)]
118. Inoue, T.; Tomita, H.; Ike, Y. Bac 32, a Novel Bacteriocin Widely Disseminated among Clinical Isolates of *Enterococcus faecium*. *Antimicrob. Agents Chemother.* **2006**, *50*, 1202–1212. [[CrossRef](#)] [[PubMed](#)]
119. Todokoro, D.; Tomita, H.; Inoue, T.; Ike, Y. Genetic Analysis of Bacteriocin 43 of Vancomycin-Resistant *Enterococcus faecium*. *Appl. Environ. Microbiol.* **2006**, *72*, 6955–6964. [[CrossRef](#)] [[PubMed](#)]
120. Basi-Chipalu, S.; Dischinger, J.; Josten, M.; Szekat, C.; Zweynert, A.; Sahl, H.-G.; Bierbaum, G. Pseudomycoicidin, a Class II Lantibiotic from *Bacillus pseudomycooides*. *Appl. Environ. Microbiol.* **2015**, *81*, 3419–3429. [[CrossRef](#)]
121. Li, Y.; Ducasse, R.; Zirah, S.; Blond, A.; Goulard, C.; Lescop, E.; Giraud, C.; Hartke, A.; Guittet, E.; Pernodet, J.-L.; et al. Characterization of Sviceucin from *Streptomyces* Provides Insight into Enzyme Exchangeability and Disulfide Bond Formation in Lasso Peptides. *ACS Chem. Biol.* **2015**, *10*, 2641–2649. [[CrossRef](#)]
122. Hegemann, J.D.; Zimmermann, M.; Xie, X.; Marahiel, M.A. Lasso Peptides: An Intriguing Class of Bacterial Natural Products. *Acc. Chem. Res.* **2015**, *48*, 1909–1919. [[CrossRef](#)]
123. Nir-Paz, R.; Gelman, D.; Khouri, A.; Sisson, B.M.; Fackler, J.; Alkalay-Oren, S.; Khalifa, L.; Rimon, A.; Yerushalmy, O.; Bader, R.; et al. Successful Treatment of Antibiotic-Resistant, Poly-Microbial Bone Infection with Bacteriophages and Antibiotics Combination. *Clin. Infect. Dis.* **2019**, *69*, 2015–2018. [[CrossRef](#)]
124. Leitner, L.; Sybesma, W.; Chanishvili, N.; Goderdzishvili, M.; Chkhotua, A.; Ujmajuridze, A.; Schneider, M.P.; Sartori, A.; Mehnert, U.; Bachmann, L.M.; et al. Bacteriophages for Treating Urinary Tract Infections in Patients Undergoing Transurethral Resection of the Prostate: A Randomized, Placebo-Controlled, Double-Blind Clinical Trial. *BMC Urol.* **2017**, *17*, 90. [[CrossRef](#)]
125. Sarker, S.A.; Sultana, S.; Reuteler, G.; Moine, D.; Descombes, P.; Charton, F.; Bourdin, G.; McCallin, S.; Ngom-Bru, C.; Neville, T.; et al. Oral Phage Therapy of Acute Bacterial Diarrhea with Two Coliphage Preparations: A Randomized Trial in Children From Bangladesh. *EBioMedicine* **2016**, *4*, 124–137. [[CrossRef](#)]
126. Otawa, K.; Hirakata, Y.; Kaku, M.; Nakai, Y. Bacteriophage Control of Vancomycin-Resistant Enterococci in Cattle Compost. *J. Appl. Microbiol.* **2012**, *113*, 499–507. [[CrossRef](#)]
127. Barros, J.; Melo, L.D.R.; Poeta, P.; Igrejas, G.; Ferraz, M.P.; Azeredo, J.; Monteiro, F.J. Lytic Bacteriophages against Multidrug-Resistant *Staphylococcus aureus*, *Enterococcus faecalis* and *Escherichia coli* Isolates from Orthopaedic Implant-Associated Infections. *Int. J. Antimicrob. Agents* **2019**, *54*, 329–337. [[CrossRef](#)]
128. Uchiyama, J.; Rashel, M.; Maeda, Y.; Takemura, I.; Sugihara, S.; Akechi, K.; Muraoka, A.; Wakiguchi, H.; Matsuzaki, S. Isolation and Characterization of a Novel *Enterococcus faecalis* Bacteriophage ΦEF24C as a Therapeutic Candidate. *FEMS Microbiol. Lett.* **2008**, *278*, 200–206. [[CrossRef](#)]
129. Sofy, A.R.; Abd El Haliem, N.F.; Refaey, E.E.; Hmed, A.A. Polyvalent Phage CoNShP-3 as a Natural Antimicrobial Agent Showing Lytic and Antibiofilm Activities against Antibiotic-Resistant Coagulase-Negative Staphylococci Strains. *Foods* **2020**, *9*, 673. [[CrossRef](#)]
130. Altamirano, F.L.G.; Barr, J.J. Phage Therapy in the Postantibiotic Era. *Clin. Microbiol. Rev.* **2019**, *32*, e00066-18. [[CrossRef](#)]
131. Thierauf, A.; Perez, G.; Maloy, S. Generalized Transduction. In *Bacteriophages*; Clokie, M.R.J., Kropinski, A.M., Eds.; Methods in Molecular Biology; Humana Press: Totowa, NJ, USA, 2009; Volume 501, pp. 267–286, ISBN 978-1-58829-682-5.
132. Mattila, S.; Ruotsalainen, P.; Jalasvuori, M. On-Demand Isolation of Bacteriophages Against Drug-Resistant Bacteria for Personalized Phage Therapy. *Front. Microbiol.* **2015**, *6*, 1271. [[CrossRef](#)] [[PubMed](#)]
133. Kortright, K.E.; Chan, B.K.; Koff, J.L.; Turner, P.E. Phage Therapy: A Renewed Approach to Combat Antibiotic-Resistant Bacteria. *Cell Host Microbe* **2019**, *25*, 219–232. [[CrossRef](#)] [[PubMed](#)]

134. Lourenço, M.; Chaffringeon, L.; Lamy-Besnier, Q.; Pédrón, T.; Campagne, P.; Eberl, C.; Bérard, M.; Stecher, B.; Debarbieux, L.; De Sordi, L. The Spatial Heterogeneity of the Gut Limits Predation and Fosters Coexistence of Bacteria and Bacteriophages. *Cell Host Microbe* **2020**, *28*, 390–401.e5. [[CrossRef](#)] [[PubMed](#)]
135. Fabijan, A.P.; Lin, R.C.Y.; Ho, J.; Maddocks, S.; Zakour, N.L.B.; Iredell, J.R.; Westmead Bacteriophage Therapy Team; Khalid, A.; Venturini, C.; Chard, R.; et al. Safety of Bacteriophage Therapy in Severe *Staphylococcus aureus* Infection. *Nat. Microbiol.* **2020**, *5*, 465–472. [[CrossRef](#)]
136. Cisek, A.A.; Dąbrowska, I.; Gregorczyk, K.P.; Wyżewski, Z. Phage Therapy in Bacterial Infections Treatment: One Hundred Years After the Discovery of Bacteriophages. *Curr. Microbiol.* **2017**, *74*, 277–283. [[CrossRef](#)]
137. Kilcher, S.; Studer, P.; Muessner, C.; Klumpp, J.; Loessner, M.J. Cross-Genus Rebooting of Custom-Made, Synthetic Bacteriophage Genomes in L-Form Bacteria. *Proc. Natl. Acad. Sci. USA* **2018**, *115*, 567–572. [[CrossRef](#)] [[PubMed](#)]
138. Asghar, M.A.; Yousuf, R.I.; Shoaib, M.H.; Asghar, M.A. Antibacterial, Anticoagulant and Cytotoxic Evaluation of Biocompatible Nanocomposite of Chitosan Loaded Green Synthesized Bioinspired Silver Nanoparticles. *Int. J. Biol. Macromol.* **2020**, *160*, 934–943. [[CrossRef](#)] [[PubMed](#)]
139. Gordon, O.; Slenters, T.V.; Brunetto, P.S.; Villaruz, A.E.; Sturdevant, D.E.; Otto, M.; Landmann, R.; Fromm, K.M. Silver Coordination Polymers for Prevention of Implant Infection: Thiol Interaction, Impact on Respiratory Chain Enzymes, and Hydroxyl Radical Induction. *Antimicrob. Agents Chemother.* **2010**, *54*, 4208–4218. [[CrossRef](#)] [[PubMed](#)]
140. Lara, H.H.; Ayala-Núñez, N.V.; del Turrent, L.I.C.; Padilla, C.R. Bactericidal Effect of Silver Nanoparticles against Multidrug-Resistant Bacteria. *World J. Microbiol. Biotechnol.* **2010**, *26*, 615–621. [[CrossRef](#)]
141. AlSalhi, M.S.; Devanesan, S.; Atif, M.; AlQahtani, W.S.; Nicoletti, M.; Serrone, P.D. Therapeutic Potential Assessment of Green Synthesized Zinc Oxide Nanoparticles Derived from Fennel Seeds Extract. *Int. J. Nanomed.* **2020**, *15*, 8045–8057. [[CrossRef](#)]
142. Punjabi, K.; Mehta, S.; Chavan, R.; Chitalia, V.; Deogharkar, D.; Deshpande, S. Efficiency of Biosynthesized Silver and Zinc Nanoparticles Against Multi-Drug Resistant Pathogens. *Front. Microbiol.* **2018**, *9*, 2207. [[CrossRef](#)]
143. Iram, S.; Akbar Khan, J.; Aman, N.; Nadhman, A.; Zulfiqar, Z.; Yameen, M.A. Enhancing the Anti-Enterococci Activity of Different Antibiotics by Combining with Metal Oxide Nanoparticles. *Jundishapur J. Microbiol.* **2016**, *9*, e31302. [[CrossRef](#)] [[PubMed](#)]
144. Lai, H.-Z.; Chen, W.-Y.; Wu, C.-Y.; Chen, Y.-C. Potent Antibacterial Nanoparticles for Pathogenic Bacteria. *ACS Appl. Mater. Interfaces* **2015**, *7*, 2046–2054. [[CrossRef](#)] [[PubMed](#)]
145. Wang, S.-G.; Chen, Y.-C.; Chen, Y.-C. Antibacterial Gold Nanoparticle-Based Photothermal Killing of Vancomycin-Resistant Bacteria. *Nanomedicine* **2018**, *13*, 1405–1416. [[CrossRef](#)] [[PubMed](#)]
146. Chakraborty, S.P.; Sahu, S.K.; Mahapatra, S.K.; Santra, S.; Bal, M.; Roy, S.; Pramanik, P. Nanoconjugated Vancomycin: New Opportunities for the Development of Anti-VRSA Agents. *Nanotechnology* **2010**, *21*, 105103. [[CrossRef](#)] [[PubMed](#)]
147. Honary, S.; Ebrahimi, P.; Hadianamrei, R. Optimization of Particle Size and Encapsulation Efficiency of Vancomycin Nanoparticles by Response Surface Methodology. *Pharm. Dev. Technol.* **2014**, *19*, 987–998. [[CrossRef](#)] [[PubMed](#)]
148. Bäumlér, A.J.; Sperandio, V. Interactions between the Microbiota and Pathogenic Bacteria in the Gut. *Nature* **2016**, *535*, 85–93. [[CrossRef](#)] [[PubMed](#)]

Azetidine-Containing Alkaloids Produced by a Quorum-Sensing- Regulated Nonribosomal Peptide Synthetase Pathway in *Pseudomonas aeruginosa*.

Hong Z, Bolard A, **Giraud C**, Prévost S, Genta-Jouve G, Deregnacourt C, Häussler S, Jeannot K, Li Y.

Angew Chem Int Ed Engl. 2019 Mar 4;58(10):3178-3182.



A Journal of the Gesellschaft Deutscher Chemiker

Angewandte Chemie

GDCh

International Edition

www.angewandte.org

Accepted Article

Title: Azetidine-Containing Alkaloids Produced by a Quorum-Sensing-Regulated Nonribosomal Peptide Synthetase Pathway in *Pseudomonas aeruginosa*

Authors: Zhilai Hong, Arnaud Bolard, Caroline Giraud, Sébastien Prévost, Grégory Genta-Jouve, Christiane Deregnacourt, Susanne Häussler, Katy Jeannot, and Yanyan Li

This manuscript has been accepted after peer review and appears as an Accepted Article online prior to editing, proofing, and formal publication of the final Version of Record (VoR). This work is currently citable by using the Digital Object Identifier (DOI) given below. The VoR will be published online in Early View as soon as possible and may be different to this Accepted Article as a result of editing. Readers should obtain the VoR from the journal website shown below when it is published to ensure accuracy of information. The authors are responsible for the content of this Accepted Article.

To be cited as: *Angew. Chem. Int. Ed.* 10.1002/anie.201809981
Angew. Chem. 10.1002/ange.201809981

Link to VoR: <http://dx.doi.org/10.1002/anie.201809981>
<http://dx.doi.org/10.1002/ange.201809981>

COMMUNICATION

Azetidine-Containing Alkaloids Produced by a Quorum-Sensing-Regulated Nonribosomal Peptide Synthetase Pathway in *Pseudomonas aeruginosa*

Zhilai Hong,^[a] Arnaud Bolard,^[b] Caroline Giraud,^[c] Sébastien Prévost,^[d] Grégory Genta-Jouve,^[e] Christiane Deregnacourt,^[a] Susanne Häussler,^[f] Katy Jeannot,^{*[b]} and Yanyan Li^{*[a]}

Abstract: *Pseudomonas aeruginosa* displays an impressive metabolic versatility, which ensures its survival in diverse environments. Herein we report the identification of rare azetidine-containing alkaloids from *P. aeruginosa* PAO1, termed azetidomonamides, that are derived from a conserved, quorum-sensing regulated non-ribosomal peptide synthetase (NRPS) pathway. Biosynthesis of the azetidine motif has been elucidated by gene inactivation, feeding experiments and biochemical characterization *in vitro*, which involves a new *S*-adenosylmethionine-dependent enzyme to produce azetidine 2-carboxylic acid as an unusual building block of NRPS. The mutants of *P. aeruginosa* unable to produce azetidomonamides had an advantage in growth at high cell density *in vitro* and displayed rapid virulence in *Galleria mellonella* model, inferring functional roles of azetidomonamides in the host adaptation. This work opens the avenue to study the biological functions of azetidomonamides and related compounds in pathogenic and environmental bacteria.

Pseudomonas aeruginosa is a highly adaptable Gram-negative bacterium, which thrives in diverse environments including soil, water, plant and animal hosts. This microorganism is a prominent nosocomial human pathogen, which is associated with acute pulmonary infections in immunocompromised patients, particularly in intensive care units. It is also well-known in cystic

fibrosis patients for the deleterious impact on lung function. The ecological success of *P. aeruginosa* is largely attributed to its metabolic plasticity and versatility, frequently linked to quorum-sensing (QS) regulation. QS is a cell-cell communication mechanism allowing bacteria to sense cell density and to coordinate gene expression at the community level, in response to environmental conditions. *P. aeruginosa* has evolved complex QS systems to control critical processes including biofilm formation, virulence factor production and antimicrobial resistance. The knowledge of the chemical nature and biological function of QS-regulated specialized metabolites is thus of prime importance and would provide new biomarkers or therapeutic strategies to progress in combating *P. aeruginosa* infection^[1].

The core genome of *P. aeruginosa* encodes six non-ribosomal peptide synthetase (NRPS) biosynthetic gene clusters (BGCs) as major components of the specialized metabolism^[2]. Among them, three are involved in the production of siderophores such as pyoverdine and pyochelin as well as an antibacterial antimetabolite, *L*-2-amino-4-methoxy-*trans*-3-butenic acid^[3]. Although extensively studied, products of other NRPS pathways remain elusive. During the course of investigating new physiological functions associated with polymyxin resistance, we generated a spontaneous mutant from *P. aeruginosa* reference strain PAO1 on colistin (16 mg/L), named AB16.2, and performed the whole genome expression profile. Among genes that are most up-regulated in the mutant AB16.2 in comparison with the parental strain PAO1, we identified the operons *pmrAB* encoding a two-component system PmrA-PmrB involved in polymyxin resistance^[4], *pqsABCDE* coding the *Pseudomonas* Quinolone Signal (PQS) belonging to the QS system and one uncharacterized BGC for non-ribosomal peptide synthesis (Table S1). This BGC comprises 10 genes (PA3326-PA3335) encoding notably a bimodular NRPS (the product of PA3327) and modification enzymes (Figure 1a; Table S2). Worth to note, this BGC is strictly conserved in all sequenced *P. aeruginosa* genomes, with only few exceptions in other *Pseudomonas* species, in the *Pseudomonas* genome database^[5]. Moreover, some genes of this BGC including PA3326, 3327, 3329 and 3332, have been shown to be part of the core regulon of the *las/rhl* QS systems using acyl-homoserine lactone as signals^[6]. Given that *pqs* genes are overexpressed in the mutant AB16.2, we assessed if the cluster is also regulated by *pqs* QS. Quantitative real-time PCR with reverse transcription analysis showed that in-frame deletion of *pqsA* in the mutant AB16.2 resulted in a significant decrease of PA3327 transcription (Figure S1). Therefore, this BGC is under the control of three QS systems operating in *P. aeruginosa*. Taken together, this suggests that the metabolites derived from this pathway play an important role in the pathogen's physiology.

To facilitate compound identification, a PA3327 deficient mutant of AB16.2 was constructed. After media screening,

- [a] Z. Hong, Dr. C. Deregnacourt, Dr. Y. Li
Unité Molécule de Communication et Adaptation des
Microorganismes (MCAM)
Muséum National d'Histoire Naturelle (MNHN), Centre National de
la Recherche Scientifique (CNRS)
CP 54, 57 rue Cuvier, 75005 Paris, France.
E-mail: yanyanli@mnhn.fr
- [b] A. Bolard, Dr. K. Jeannot
Laboratoire de Bactériologie, Centre National de Référence (CNR)
de la Résistance aux Antibiotiques, Centre Hospitalier Régional
Universitaire (CHRU) de Besançon, UMR4269 "Chrono-
Environnement"
Boulevard Fleming, 25030 Besançon, France.
E-mail : katy.jeannot@univ-fcomte.fr
- [c] Dr. C. Giraud
U2RM Stress/Virulence, Normandy University, UNICAEN
14000 Caen, France.
- [d] Dr. S. Prévost
Laboratoire de Synthèse Organique, UMR 7652, CNRS, Ecole
Polytechnique, ENSTA ParisTech, Université Paris-Saclay
828 Bd des Maréchaux, 91128 Palaiseau, France.
- [e] Dr. G. Genta-Jouve
C-TAC, UMR 8638, CNRS, Faculté de Pharmacie de Paris,
Université Paris Descartes, Sorbonne Paris Cité
4 Avenue de l'Observatoire, 75006 Paris, France.
- [f] Prof. Dr. S. Häussler
Institute for Molecular Bacteriology, TWINCORE, Centre for
Experimental and Clinical Infection Research, Hannover, Germany.
Department of Molecular Bacteriology, Helmholtz Centre for
Infection Research, Braunschweig, Germany.

Supporting information for this article is given via a link at the end of the document. **(Please delete this text if not appropriate)**

COMMUNICATION

AB16.2 and AB16.2Δ27 were grown in selected E2 medium and their metabolic profiles were compared by liquid chromatography coupled to high resolution mass spectrometry (LC-HRMS). Two major peaks with $[M+H]^+$ ion at m/z 237.0868 (**1**) and 193.0969 (**2**), respectively, were present only in the extract of AB16.2 (Figure S2). The exact masses indicated molecular formulas of $C_{11}H_{12}N_2O_4$ for **1** and $C_{10}H_{12}N_2O_2$ for **2**, indicating a CO_2 loss in the latter. Fermentation and subsequent purification allowed the full elucidation of their structures by HR-MS/MS, UV and NMR

spectroscopy (Supplementary Information; Table S3; Figure S3-19). Compound **1**, named azetidomonamide A, features a [5.2.0]bicyclocarbamate ring system, whereas **2**, termed azetidomonamide B, has an azetidopyrrolidine scaffold (Figure 1b). Based on specific rotation and the comparison between the measured and theoretical electronic circular dichroism (ECD) spectra, the absolute configuration was determined to be 5*R* for azetidomonamide A (**1**) and 4*R* for azetidomonamide B (**2**), respectively (Figure S20-21).

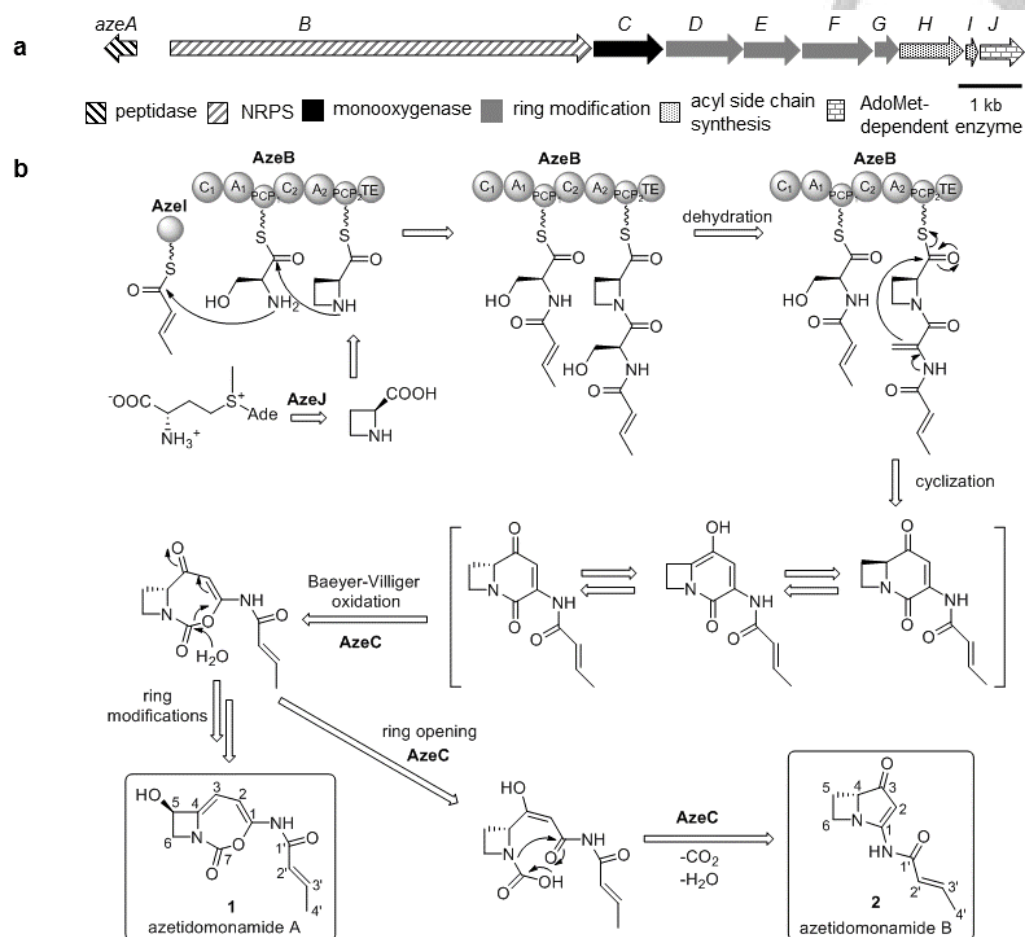

Figure 1. a) Gene organization of the *aze* cluster. b) Structure and proposed biosynthetic pathway of azetidomonamides.

The four-membered azetidine heterocycle presented in azetidomonamides is rare in natural products (Figure S22), which raised the question about its biosynthetic origin. Structurally, azetidomonamide A and B are related to bacterial lipocyclocarbamates^[7] and pyrrolizidine alkaloids^[8] (Figure S23). Biosynthesis of these compounds has been characterized to involve a bimodular NRPS that ligates a serine (Ser) or threonine (Thr) to a proline (Pro) residue, and a Baeyer-Villiger monooxygenase whose action leads to two bicyclic skeletons^[8-9]. Predicted functions of now designated *aze* genes (Table S2), suggested that azetidomonamide biogenesis would operate in a similar way, except the activation by NRPS of an azetidine 2-

carboxylic acid (AZC) or a derivative thereof instead of Pro. To prove this, *in vivo* isotope labelling experiments with *L*-Ser, *L*-methionine (Met) and *L*-AZC were performed using an inverse feeding approach^[10]. The rationale to feed Met was that Met-derived *S*-adenosylmethionine (AdoMet) could be a key precursor of AZC, similarly to the synthesis of plant nicotianamine^[11]. LC-HRMS and MS/MS analysis showed the incorporation of all three amino acids into azetidomonamide B (**2**) (Figure S24-25). As for azetidomonamide A (**1**), its labelling by *L*-Ser and *L*-Met was observed, but addition of *L*-AZC appeared to reduce significantly its production level which prevented the detection (Figure S26-27). Furthermore, *in silico* analysis of the adenylation (A) domains of

COMMUNICATION

AzeB was carried out. This predicted that AzeB_A1 activates Ser, whereas the specificity of AzeB_A2 could be Pro but without certainty (Table S4). To unambiguously establish the building blocks of AzeB, both A domains together with their cognate condensation (C) and peptidyl-carrier-protein (PCP) were produced and purified from *Escherichia coli*, respectively, for characterization *in vitro* (Figure S28). Twenty proteinogenic amino acids together with additional ones (*i. e.* L-AZC, D-Pro, AdoMet and homoserine) were tested as substrates. Using a hydroxylamine-trapping assay,^[12] it was shown that AzeB_A2 displayed the highest activity towards L-AZC and showed substrate promiscuity notably to the structural mimics of AZC such as L-Pro and L-Ala (Figure 2a). By a more specific ATP-release assay^[13], we could further confirm the substrate preference of AzeB_A1 and AzeB_A2 for L-Ser and L-AZC, respectively (Figure S29-30). Together, these data established that the azetidine motif comes from L-AZC, which is derived from the Met cycle and is subsequently incorporated into the NRPS assembly line.

AZC has been known as a non-proteinogenic amino acids in some plants since 60 years^[14]. However, its biosynthetic route still remains unknown, although feeding studies similarly showed a link of AZC and the Met metabolism^[15]. We envisioned that L-AZC can result from the intramolecular cyclisation of AdoMet, as in the plant nicotianamine biosynthesis^[11]. Inspection of the *aze* cluster identified *azeJ* encoding an AdoMet-dependent enzyme as a candidate for this reaction. Indeed, inactivation of *azeJ* in the mutant AB16.2 disrupted completely the production of both

azetidomonamides, while complementation of *azeJ* back to the mutant restored the production, albeit at a much lower level (Figure 2b). Interestingly, supply of L-AZC to the medium yielded only azetidomonamide B (2), which is consistent with the feeding experiments. It thus appeared that AZC availability regulates directly the product outcome. To provide direct evidence of the AzeJ function, recombinant AzeJ was purified from *E. coli* and characterized *in vitro* (Figure S28). Incubation of AdoMet with AzeJ led to the production of 5'-methylthioadenosine (MTA), as revealed by HPLC coupled to UV/Vis spectrophotometry (Figure S31). Detection of AZC was achieved by derivatization with benzyl chloroformate followed by LC-HRMS analysis. AZC was observed in the AzeJ reaction and absent in the control with the heat-inactivated enzyme (Figure 2d). Moreover, AZC was found only in the extract of *E. coli* expressing the *azeJ* gene, compared to that of control cells with an empty vector (Figure S32). These experiments showed unambiguously that AzeJ is an AZC synthase. Under our conditions, AzeJ displayed $K_m^{app}(\text{AdoMet})$ of 1.3 ± 0.1 mM and k_{cat}^{app} of 16.7 ± 0.7 min⁻¹, indicating a rather low catalytic efficiency (Figure S33). Worth to note, a similar enzyme (VioH) proposed to catalyze the same reaction as AzeJ, has been identified very recently by gene inactivation in the myxobacterial vioprolide pathway^[16]. Sequence analysis using profile hidden Markov models pointed out that AzeJ homologs can be found in disparate bacteria, and occasionally in eukaryotes (e.g. algae) or archaea (Table S5). The discovery of AZC synthases from bacteria adds a new reaction to AdoMet-dependent enzymes and may inform the biosynthetic origin of AZC in plants.

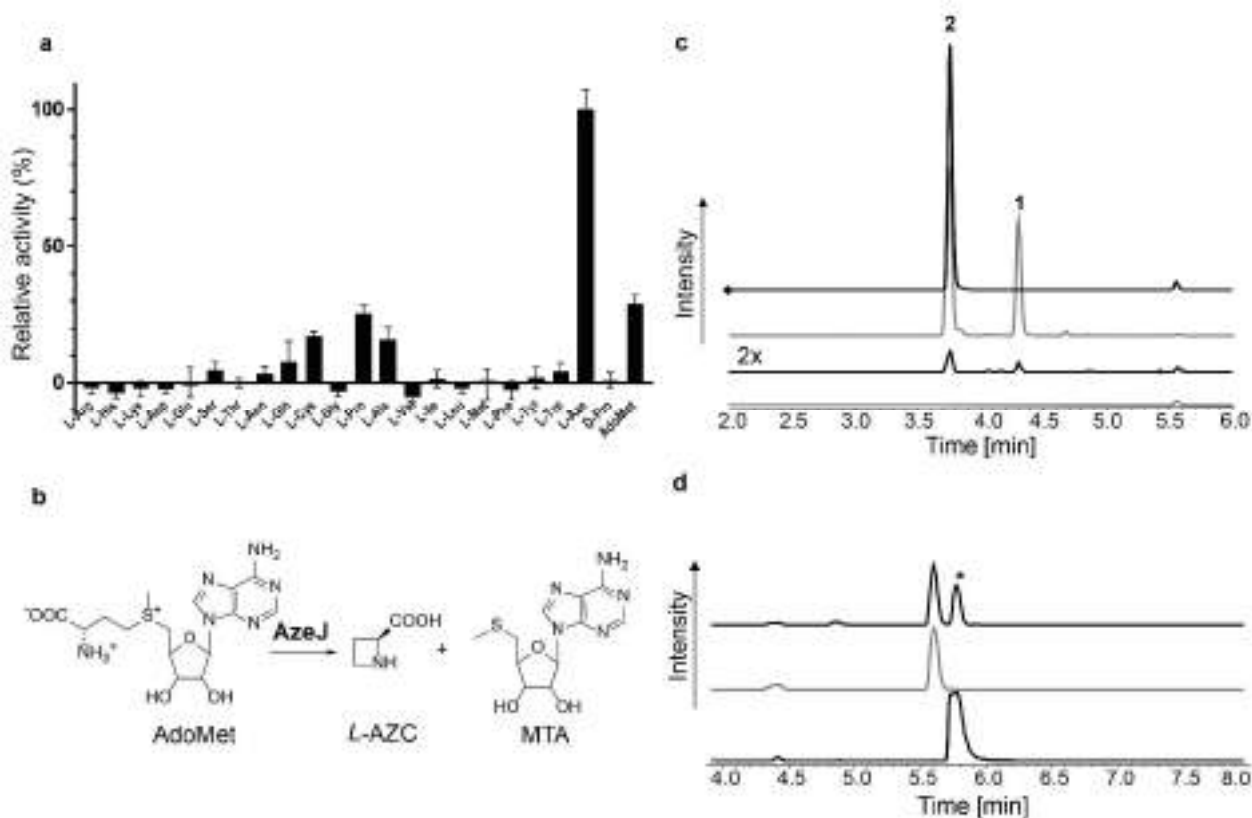

COMMUNICATION

Figure 2. Biosynthetic origin of the azetidine motif. a) The substrate specificity of AzeB_A2 domain determined *in vitro*. b) Reaction scheme of AzeJ. c) LC-MS analysis of azetidomonamide production in *P. aeruginosa* AB16.2 (grey), the *azeJ*-deficient strain AB16.2Δ35 (dotted line), AB16.2Δ35 supplemented with AZC (black) and the complementation strain AB16.2Δ35 *attB*:PA3335 (dashed line). Extracted ion chromatograms (EICs) of ions m/z 237.0867 ([M+H]⁺ of 1) and m/z 193.0968 ([M+H]⁺ of 2) were shown. For clarity, the trace of the complementation strain was enlarged 2 folds. Addition of AZC disrupted the production of 1. d) LC-MS analysis of AZC production in AzeJ assays *in vitro*. EICs of m/z 258.0729 ([M+Na]⁺ of the derivatized AZC product): AZC standard (dashed line), AzeJ reaction (black) and a control with boiled AzeJ (grey).

Overall, the ensemble of our data consolidates the proposed biosynthetic route to azetidomonamides (Figure 1), which is similar to that of related bacterial alkaloids (Figure S34).^[8-9] Our data also extends the current model. The crotonyl side chain in azetidomonamides is delivered to the NRPS on a dedicated ACP, contrary to other pathways that use CoA esters. On-line cyclisation would operate on a dipeptide intermediate containing a serine-derived dehydroalanine (Dha), a process likely assisted by the TE domain.^[8-9] A plausible cyclisation mechanism would involve nucleophilic attack of the Dha β-carbon to the carbonyl group, which is enabled by delocalization of the lone pair of electrons of the enamine nitrogen. Upon cyclisation, the azetidopyridin-2-one intermediate would undergo keto-enol tautomerization to generate a *R*-configured substrate for AzeC, which catalyzes Baeyer-Villiger oxidation in a stereospecific manner. This resembles the biosynthesis of brabantamide A.^[9b]

More minor products derived from the *aze* BGC could be identified by LC-HRMS. In particular, compound 3 ([M+H]⁺ at m/z 207.1124) and 4 ([M+H]⁺ at m/z 251.1024) are analogues of azetidomonamide B and A, respectively (Figure S35-36). The pyrrolizidine structure of 3 was confirmed by a synthetic reference (Supplementary Information). These molecules are generated by incorporating Pro instead of AZC during the assembly-line synthesis. Such diversity-oriented biosynthesis would imply distinct or/and synergetic functional roles of these metabolites in the physiology of *P. aeruginosa*.

Azetidomonamide A (1), B (2) and the synthetic pyrrolizidine 3 showed no antibacterial activities to tested Gram-negative and Gram-positive bacteria (*E. coli*, *Micrococcus luteus*, *Staphylococcus aureus*), no inhibition of human phospholipase A2, an activity reported for the related 5,5- or 5,7-lipocyclocarbamate^[7, 12], as well as no cytotoxicity to murine macrophages cell line J774A.1. This indicates that, at least, these metabolites are less likely to be involved in microbial competition or acute virulence. To gain insight into their biological function in *P. aeruginosa*, the mutants AB16.2 and AB16.2Δ27 were subject to phenotypic characterization. No significant difference between them could be observed with regard to biofilm formation, microcolony morphology and antibiotic resistance. However, the mutant AB16.2 displayed a reduced growth at high cell density as compared to AB16.2Δ27 *in vitro* (Figure 3a). The deviation typically started at the mid- or late logarithmic phase, corroborating with the growth phase-dependent QS-regulation of these *aze* genes^[6b]. To note, both strains showed a slower growth rate than the parental PAO1. When microinjected into a caterpillar host, *Galleria mellonella*, the mutant AB16.2 had a delayed killing phenotype, whereas AB16.2Δ27 killed as rapidly and efficiently as the wildtype PAO1 (Figure 3b). This attenuated virulence effect manifested by the presence of the *aze* BGC, likely via the growth modulation, is reminiscent of a QS-controlled virulence reduction in an insect endosymbiotic bacterium, following its infection of

insects^[18]. The direct implication for *P. aeruginosa* would be to establish a long-term stable relationship with the host, as under the chronic infection conditions^[19]. The underlining molecular mechanisms are being investigated.

Genome mining revealed that identical *aze* BGC is present in two strains of human pathogens, namely *Acinetobacter baumannii* AB32_M and *Enterobacter cloacae* e403 (Figure S37), indicating a horizontal gene transfer event from *P. aeruginosa*. Using the combined presence of *azeB*, *azeC* and *azeJ* as indication, related *aze* BGCs can be identified in a handful of bacteria, some of them are plant-associated (Figure S37). Consistently, phylogenetic analysis showed that, A2 domains of the AzeB-like NRPSs, which would activate AZC, form a distinct group from the Pro-utilizing ones involved in the biosynthesis of bacterial pyrrolizidine alkaloids and cyclocarbamates^[8] (Figure S38). Together, these analyses open the avenue to study the diversity and biological functions of azetidomonamide-like compounds in various ecological settings, particularly in human pathogens.

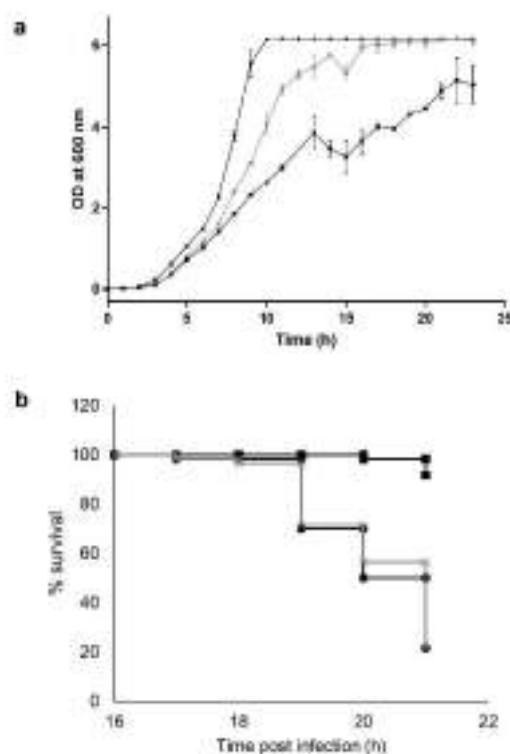

Figure 3. Characterization of the functional roles of azetidomonamides. a) Growth curve in LB medium at 37 °C. b) Kaplan-Meier survival curves of *Galleria mellonella* infected with *P. aeruginosa* strains with an inoculum of 25 (± 5) CFU per larvae. $p < 0.001$ (log-rank test with Bonferroni correction). PAO1 (black circles), AB16.2 (black squares) and AB16.2Δ27 (grey crosses).

COMMUNICATION

In conclusion, this work identifies a novel class of specialized metabolites in the major opportunist human pathogen *P. aeruginosa*, elucidates their biosynthesis which involves a new family of AdoMet-dependent enzymes, and provides first insight into their physiological functions. Further studies of exact roles of azetidomonamides in host-pathogen interaction with regard to QS regulation would warrant important mechanistic discoveries.

Experimental Section

Experimental details are given in the Supplementary Information.

Acknowledgements

The bioorganic analytical platform of MNHN and the bacteriology service in the MCAM unit are acknowledged for giving access to necessary instruments. We thank Yoann Negre for technical assistance in caterpillar killing assays, Dr. Gérard Lambeau (Université Côte d'Azur, France) for providing radioactive *E. coli* membranes for phospholipase tests, and Dr. Stéphane Mann (MNHN, France) for helpful discussions. Z. H. was supported by a China Scholarship Council PhD fellowship. This work was partially supported by the French Ministry of Health through the Santé publique France agency.

Keywords: biosynthesis • natural products • nonribosomal peptide synthetase • *Pseudomonas aeruginosa* • quorum sensing

- [1] J. Lee, L. Zhang, *Protein & cell* **2015**, *6*, 26-41.
- [2] B. Valot, C. Guyeux, J. Y. Rolland, K. Mazouzi, X. Bertrand, D. Hocquet, *PLoS ONE* **2015**, *10*, e0126468.
- [3] A. M. Gulick, *Nat. Prod. Rep.* **2017**, *34*, 981-1009.
- [4] S. M. Moskowitz, R. K. Ernst, S. I. Miller, *J. Bacteriol.* **2004**, *186*, 575-579.
- [5] G. L. Winsor, E. J. Griffiths, R. Lo, B. K. Dhillon, J. A. Shay, F. S. Brinkman, *Nucleic Acids Res.* **2016**, *44*, D646-653.
- [6] a) S. Chugani, B. S. Kim, S. Phattarasukol, M. J. Brittnacher, S. H. Choi, C. S. Harwood, E. P. Greenberg, *Proc. Natl. Acad. Sci. USA* **2012**, *109*, E2823-2831; b) V. E. Wagner, D. Bushnell, L. Passador, A. I. Brooks, B. H. Iglewski, *J. Bacteriol.* **2003**, *185*, 2080-2095; c) A. M. Firoved, V. Deretic, *J. Bacteriol.* **2003**, *185*, 1071-1081; d) P. Salunkhe, C. H. M. Smart, J. A. W. Morgan, S. Panagea, M. J. Walshaw, C. A. Hart, R. Geffers, B. Tuemmler, C. Winstanley, *J. Bacteriol.* **2005**, *187*, 4908-4920.
- [7] D. J. Busby, R. C. Copley, J. A. Hueso, S. A. Readshaw, A. Rivera, *J. Antibiot.* **2000**, *53*, 670-676.
- [8] a) S. Huang, J. Tabudravu, S. S. Elsayed, J. Travert, D. Peace, M. H. Tong, K. Kyeremeh, S. M. Kelly, L. Trembleau, R. Ebel, M. Jaspars, Y. Yu, H. Deng, *Angew. Chem. Int. Ed.* **2015**, *54*, 12697-12701; b) O. Schimming, V. L. Challinor, N. J. Tobias, H. Adihou, P. Grun, L. Poschel, C. Richter, H. Schwalbe, H. B. Bode, *Angew. Chem. Int. Ed.* **2015**, *54*, 12702-12705.
- [9] a) C. W. Johnston, R. Zvanych, N. Khyzha, N. A. Magarvey, *ChemBioChem* **2013**, *14*, 431-435; b) Y. Schmidt, M. van der Voort, M. Crusemann, J. Piel, M. Josten, H. G. Sahl, H. Miess, J. M. Raaijmakers, H. Gross, *ChemBioChem* **2014**, *15*, 259-266.
- [10] H. B. Bode, D. Reimer, S. W. Fuchs, F. Kirchner, C. Dauth, C. Kegler, W. Lorenzen, A. O. Brachmann, P. Grun, *Chemistry* **2012**, *18*, 2342-2348.
- [11] J. F. Ma, T. Shinada, C. Matsuda, K. Nomoto, *J. Biol. Chem.* **1995**, *270*, 16549-16554.
- [12] B. P. Duckworth, D. J. Wilson, C. C. Aldrich, *Methods Mol. Biol.* **2016**, *1401*, 53-61.
- [13] A. J. Lloyd, N. J. Potter, C. W. Fishwick, D. I. Roper, C. G. Dowson, *ACS Chem. Biol.* **2013**, *8*, 2157-2163.
- [14] L. Fowden, *Nature* **1955**, *176*, 347.
- [15] E. Leete, G. E. Davis, C. R. Hutchinson, K. W. Woo, M. R. Chedekel, *Phytochemistry* **1974**, *13*, 427-433.
- [16] F. Yan, D. Auerbach, Y. Chai, L. Keller, Q. Tu, S. Huttel, A. Glemser, H. A. Grab, T. Bach, Y. Zhang, R. Muller, *Angew. Chem. Int. Ed.* **2018**, *57*, 8754-8759.
- [17] J. Thirkettle, E. Alvarez, H. Boyd, M. Brown, E. Diez, J. Hueso, S. Elson, M. Fulston, C. Gershater, M. L. Morata, P. Perez, S. Ready, J. M. Sanchez-Puelles, R. Sheridan, A. Stefanska, S. Warr, *J. Antibiot.* **2000**, *53*, 664-669.
- [18] S. Enomoto, A. Chari, A. L. Clayton, C. Dale, *Cell host & microbe* **2017**, *21*, 629-636.
- [19] a) X. Qin, *Crit. Rev. Microbiol.* **2016**, *42*, 144-157; b) G. Jansen, L. L. Crummenerl, F. Gilbert, T. Mohr, R. Pfefferkorn, R. Thanert, P. Rosenstiel, H. Schulenburg, *Mol. Biol. Evol.* **2015**, *32*, 2883-2896.

COMMUNICATION

Entry for the Table of Contents (Please choose one layout)

Layout 1:

COMMUNICATION

Be more strained: The major opportunist human pathogen *Pseudomonas aeruginosa* produces azetidine 2-carboxylic acid, a proline mimic, to be incorporated into a quorum-sensing controlled nonribosomal peptide synthetase assembly line, yielding constrained bicyclic alkaloids. These compounds play important functions in the physiology of *P. aeruginosa*.

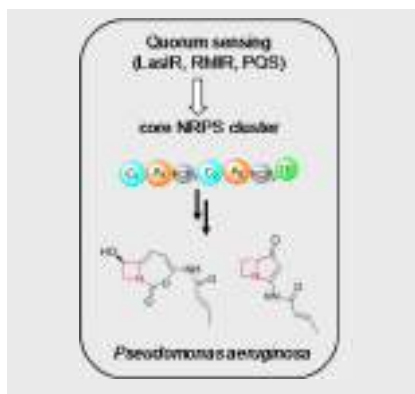

Zhilai Hong, Arnaud Bolard, Caroline Giraud, Sébastien Prévost, Grégory Genta-Jouve, Christiane Deregnacourt, Susanne Häussler, Katy Jeannot* and Yanyan Li*

Page No. – Page No.

Azetidine-Containing Alkaloids Produced by a Quorum-Sensing-Regulated Nonribosomal Peptide Synthetase Pathway in *Pseudomonas aeruginosa*

Accepted Manuscript

Opposite effect of vancomycin and D-Cycloserine combination in both vancomycin resistant *Staphylococcus aureus* and enterococci.

Boudrioua A, Li Y, Hartke A, **Giraud C.**

FEMS Microbiol Lett. 2020 Apr 1;367(8):fnaa062.



RESEARCH LETTER – Physiology & Biochemistry

Opposite effect of vancomycin and D-Cycloserine combination in both vancomycin resistant *Staphylococcus aureus* and enterococci

Abdelhakim Boudrioua^{1,†}, Yanyan Li², Axel Hartke¹ and Caroline Giraud^{1,*;‡}

¹Normandie Univ, UNICAEN, U2RM, 14000, Caen, France and ²Laboratory Molecules of Communication and Adaptation of Microorganisms (MCAM, UMR 7245 CNRS-MNHN), National Museum of Natural History (MNHN), CNRS, CP 54, 57 rue Cuvier 75005, Paris, France

*Corresponding author: U2RM, Université de Caen Normandie. Esplanade de la Paix CS 14032 CAEN cedex 5 FRANCE. Tel: (+33) 2 31 56 53 85; E-mail: caroline.giraud@unicaen.fr

One sentence summary: Vancomycin resistance genes cluster turns the outcome of vancomycin and D-cycloserine combination from synergism to antagonism.

Editor: Rustam Aminov

[†]Abdelhakim Boudrioua, <http://orcid.org/0000-0003-0001-7577>

[‡]Caroline Giraud, <http://orcid.org/0000-0002-8294-3218>

ABSTRACT

The increasing spread of antibiotic resistant bacteria is a major human health concern. The challenging development of new effective antibiotics has led to focus on seeking synergistic antibiotic combinations. Vancomycin (VAN) is a glycopeptide antibiotic used to treat *Staphylococcus aureus* and enterococci infections. It is targeting D-Alanyl-D-Alanine dimers during peptidoglycan biosynthesis. D-cycloserine (DCS) is a D-Alanine analogue that targets peptidoglycan biosynthesis by inhibiting D-Alanine:D-Alanine ligase (Ddl). The VAN-DCS combination was found to be synergistic in VAN resistant *S. aureus* strains lacking *van* genes cluster. We hypothesize that this combination leads to opposite effects in *S. aureus* and enterococci strains harboring *van* genes cluster where VAN resistance is conferred by the synthesis of modified peptidoglycan precursors ending in D-Alanyl-D-Lactate. The calculated Fractional Inhibitory Concentration of VAN-DCS combination in a *van*- vancomycin-intermediate, VanA type, and VanB type strains were 0.5, 5 and 3, respectively. As a result, VAN-DCS combination leads to synergism in *van*-lacking strains, and to antagonism in strains harboring *van* genes cluster. The VAN-DCS antagonism is due to a mechanism that we named *van*-mediated Ddl inhibition bypass. Our results show that antibiotic combinations can lead to opposite effects depending on the genetic backgrounds.

Keywords: antibiotic resistance; vancomycin; D-Cycloserine; antibiotic combination; VRSA; VRE

INTRODUCTION

Antibiotic resistant bacteria are the cause of 33 000 deaths per year in Europe (Cassini *et al.* 2018). The lack of identification of new drugs makes treatment of these infections increasingly difficult leading to increases in morbidity, mortality and health care costs. Therefore, Antibiotic combinations are increasingly seen

as attractive options to fight the inexorable spread of antibiotic resistance.

Enterococci and Staphylococci are Gram-positive opportunistic pathogens that are the leading causes of healthcare associated infections. Enterococci are mainly responsible for bacteremia, endocarditis and urinary tract infections (Arias and Murray 2012). These bacteria are resistant to clindamycine,

Received: 10 October 2019; Accepted: 8 April 2020

© The Author(s) 2019. Published by Oxford University Press on behalf of FEMS. All rights reserved. For permissions, please e-mail: journals.permissions@oup.com

Table 1. Bacterial strains used in this study. Met, methicillin; Van, vancomycin. ^R, resistant; ^S, sensitive.

Strains	Description	Reference
<i>Enterococcus faecalis</i>		
V583	Clinical isolate, Van ^R , VanB type	Sahm et al. 1989
JH2-2 0 8048	JH2-2 derivative containing <i>vanB</i> resistance genes from <i>E. faecium</i> 0 8048, Van ^R	National reference center, University Hospital of Caen
<i>Enterococcus faecium</i>		
Bi22	Clinical isolate, Van ^R , VanA type	Palmer et al. 2010
0 8048	Clinical isolate, Van ^R , VanB type	University Hospital of Caen
<i>Staphylococcus aureus</i>		
T-SAR12	Clinical isolate, Met ^R , Van ^S	University Hospital of Caen
T-SAR12.A	T-SAR12 derivative containing <i>vanA</i> resistance genes from <i>E. faecalis</i> Bi8 (HIP11704), Met ^R , Van ^R	This study
T-SAR12.B	T-SAR12 derivative containing <i>vanB</i> resistance genes from <i>E. faecium</i> 0 8048, Met ^R , Van ^R	This study
16 038	Clinical isolate, VISA, <i>van</i> -	University Hospital of Caen

Table 2. Minimum inhibitory concentrations (MIC) of vancomycin (VAN) and D-cycloserine (DCS) alone, and in combination in strains lacking (*van*-) and harboring *van* genes cluster. Fractional inhibitory concentration index (FIC) is calculated for each strain. ND, not determined.

Strains		MIC of VAN		MIC of DCS		FIC	Outcome
		Alone	With DCS	Alone	With VAN		
VRE, VanA-type	<i>E. faecium</i> Bi22	64	256	128	128	5	Antagonism
VRE, VanB-type	<i>E. faecium</i> 0 8048	32	64	128	128	3	Antagonism
VRE, VanB-type	<i>E. faecalis</i> JH2-2 0 8048	16	32	256	256	3	Antagonism
VRE, VanB-type	<i>E. faecalis</i> V583	32	64	256	256	3	Antagonism
VRSA, VanA-type	<i>S. aureus</i> T-SAR12.A	16	64	256	256	5	Antagonism
VRSA, VanB-type	<i>S. aureus</i> T-SAR12.B	256	512	256	256	3	Antagonism
VISA, <i>van</i> -	<i>S. aureus</i> 16 038	8	2	32	2	0.5	Synergism
VRSA, <i>van</i> -	<i>S. aureus</i> VR7	16 ¹	4 ¹	64 ¹	ND	ND	Synergism ¹

¹As stated by Tabuchi et al. (2017).

cephalosporins, carbapenems and aminoglycosides (Arias and Murray 2012). A large percentage of *Enterococcus* clinical isolates have acquired resistance to vancomycin through horizontal gene transfer leading to the emergence of vancomycin resistant enterococci (VRE) (Kaplan et al., 1988; Leclercq et al., 1988; Gholizadeh and Courvalin 2000) which contributed to the spread of vancomycin resistance genes (*van*). The first reported clinical isolate of *Staphylococcus aureus* highly resistant to vancomycin acquired vancomycin resistance genes from Enterococci (Chang et al. 2003; Weigel et al. 2003) and numerous vancomycin resistant *S. aureus* (VRSA) clinical strains have been described since the first report (Goswami et al. 2011; Rossi et al. 2014; Vellappally et al. 2017; ElSayed, Ashour and Amine 2018; Ghahremani, Hosseini Jazani and Sharifi 2018). *S. aureus* strains are considered VRSA when their MIC is above 16 µg/mL and considered vancomycin intermediate (VISA) when their VAN MIC is 4 to 8 µg/mL (Clinical and Laboratory Standards Institute, CLSI). VISA strains do not possess vancomycin resistance genes. The decreased sensitivity to VAN is rather due to point mutations in genes regulating peptidoglycan homeostasis. These modifications lead to reduced autolysis activity, reduced cross-linking and cell wall thickening thus increasing the amount of free D-Ala-D-Ala dimers allowing the sequestration of more VAN molecules and therefore reduced susceptibility of VISA strains to glycopeptides (Sieradzki et al. 2003; Hu, Peng and Rao 2016). To the best of our knowledge, *S. aureus* clinical isolates lacking vancomycin resistance genes (*van*-) with VAN MIC values above 16 µg/mL have not been reported hitherto, although *van*- VISA

strains with VAN MICs up to 100 µg/mL have been obtained under laboratory conditions by *in vitro* mutagenesis (Berscheid et al. 2014; Ishii et al. 2015). The prevalence of VRSA infections remains low (CDC 2013). However, VRSA and VRE are considered as high priority pathogens by the World Health Organization considering their acute virulence and multidrug resistance pattern.

Vancomycin has long been used as a last resort treatment against infections caused by ampicillin resistant enterococci and methicillin resistant *Staphylococcus aureus* (MRSA). It is also administered to patients allergic to β-lactams (Arias & Murray 2012).

Vancomycin is a cell wall-active glycopeptide antibiotic that targets the dipeptide D-Alanyl-D-Alanine (D-Ala-D-Ala) of the pentapeptide that links to N-acetylmuramic acid (Reynolds 1989). The interference with peptidoglycan biosynthesis is the source of its antimicrobial activity.

Vancomycin resistance in *E. faecalis* and *E. faecium* is due to the *van* genes cluster, which codes for enzymes that modify the dipeptide target. Numerous different types of inducible vancomycin resistance are found in enterococci but VanA and VanB types dominate among clinical isolates (Kristich, Rice and Arias 2014). VanA type strains are resistant to both glycopeptides vancomycin and teicoplanin while VanB type strains are susceptible to the latter (Gholizadeh and Courvalin 2000). In both types, resistance is conferred by the replacement of D-Ala-D-Ala by D-Ala-D-Lactate which leads to about 1000-fold decrease in vancomycin affinity (Arthur et al. 1993).

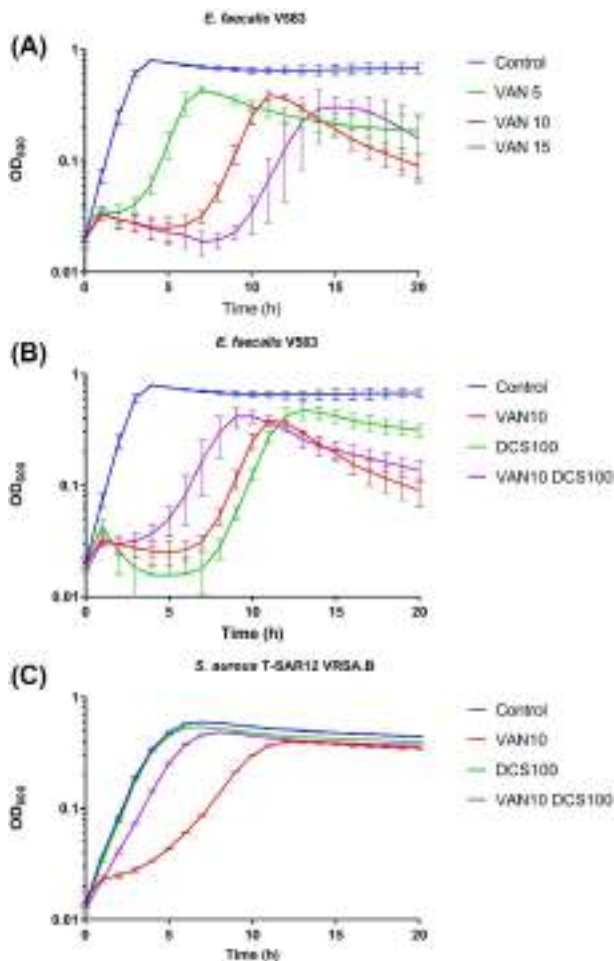

Figure 1. Growth curves of *E. faecalis* V583 and *S. aureus* T-SAR12 VRSA.B in rich growth medium supplemented with subinhibitory concentrations of either vancomycin at 10 $\mu\text{g}/\text{mL}$ (VAN10) or D-cycloserine at 100 $\mu\text{g}/\text{mL}$ (DCS100) alone, or in combination (Van10 DCS100). Curves are averages of results from three separate experiments (A and B) or from three technical replicates (C).

The *van* genes cluster expression is induced in presence of glycopeptides and is regulated by the VanR/VanS two component system in VanA type resistance and VanR_B/VanS_B in VanB type resistance. The number of genes varies between strains. Yet, the core cluster is composed of *vanR/vanS* and *vanHAX* encoding D-Ala-D-Ala modifying enzymes. VanH (VanH_B) is a D-Lactate dehydrogenase that converts pyruvate to D-Lactate. VanA (VanA_B) is a D-Ala:D-Lac ligase, and VanX (VanX_B) is a D-Ala-D-Ala dipeptidase that hydrolyses the endogenous D-Ala-D-Ala dimers (Hong et al. 2008).

The clinical relevance of *van* genes cluster goes beyond reduced susceptibility to vancomycin. VRE strains are more life threatening than vancomycin susceptible ones. VRE bacteremia is associated with a 2.5-fold increase in mortality as compared to vancomycin-susceptible enterococcal bacteremia (DiazGranados et al. 2005). As VRE infections are still increasing in Europe (EARS-Net, ECDC 2018) it becomes urgent to develop new therapeutic strategies. VRE infections can be treated by daptomycin and linezolid alone or in combination with tigecycline (van Harten et al. 2017). However, low susceptibility and resistance to these antibiotics have been reported (Miller et al. 2016).

D-Cycloserine (DCS) is a structural analog of D-Ala produced by *Streptomyces garyphalus* and *Streptomyces lavendulae*. DCS is

active against *E. faecalis* and D-Ala competitively reverses its inhibitory action (Shockman 1959). DCS targets the D-Ala:D-Ala ligase (Ddl) of *S. aureus* (Kurokawa et al. 2009) and the alanine racemase (Alr) of *E. coli* (Lambert and Neuhaus 1972). It has been shown through a metabolomic study that Ddl enzyme is predominantly targeted by DCS in *Mycobacterium tuberculosis* (Prosser and de Carvalho 2013).

A recent study (Tabuchi et al. 2017) described a synergistic effect of VAN and DCS combination against vancomycin highly resistant *S. aureus* strains lacking *van* genes cluster. However, the authors pointed out that the outcome could be different in VRSA clinical isolates harboring *van* genes cluster. Since both VAN and DCS target peptidoglycan biosynthesis of *S. aureus* and enterococci, it is not surprising that their combination leads to a synergism in *van*-lacking strains. Here we demonstrate that VAN-DCS combination leads to fundamentally opposite effects in VRSA and VRE strains that harbor *van* genes cluster.

MATERIALS AND METHODS

Strains and growth conditions

Bacterial strains used in this study are listed in Table 1. All strains were cultured at 37°C in M17 medium (Terzaghi and Sandine 1975) supplemented with 0.5% (wt/vol) glucose (GM17 medium). Overnight cultures are grown in GM17 broth and are used to inoculate the cultures for growth analysis that was assessed by measuring the optical density of the culture at 600 nm (OD₆₀₀). Growth analysis was performed in 96-well microplates (CytoOne) in a spectrophotometer (Tecan) with agitation for *S. aureus* strains and without agitation for *Enterococcus* strains.

Construction of VRSA strains

S. aureus strains harboring *van* genes cluster were constructed by conjugative transfer from VRE strains as previously described (de Niederhäusern et al. 2011). Tetracycline resistant *S. aureus* T-SAR12 strain acquired a VanA type cluster-containing plasmid from *E. faecalis* Bi8 leading to *S. aureus* T-SAR12.A strain, or acquired a VanB type cluster-containing plasmid from *E. faecium* 0 8048 leading to *S. aureus* T-SAR12.B strain. GM17 medium supplemented with tetracyclin (8 $\mu\text{g}/\text{mL}$) and VAN (8 $\mu\text{g}/\text{mL}$) was used for the selection of *S. aureus* strains resistant to VAN. The presence of VanA type genes cluster in *S. aureus* strains was confirmed by PCR using *vanS*_A-specific primers 5'-TTTGAGCCTGCTT GACGAGGC-3' (OHB7) and 5'-AGGCCCGCGGTAATGTCAATG-3' (OHB8). *vanS*_B specific primers 5'-AAATGACAACGCCGATCAAAG C-3' (OHB5) and 5'-TTTCGGAAATGGTTTTGCC-3' (OHB6) were used to confirm the presence of VanB type genes cluster.

Measurement of minimal inhibitory concentration

The MIC of VAN and DCS were determined by microdilution method in accordance with the guidelines of the Clinical and Laboratory Standards Institute (CLSI 2012) with the exception of growth medium. GM17 medium was used instead of BHI medium. Bacterial strains were added with an inoculum of 5.10⁵ CFU/mL. Subsequent 2-fold serial dilutions of VAN or DCS were performed to obtain concentrations ranging from 0.5 to 512 $\mu\text{g}/\text{mL}$. The MIC corresponds to the lowest concentration in the wells where no growth is observed.

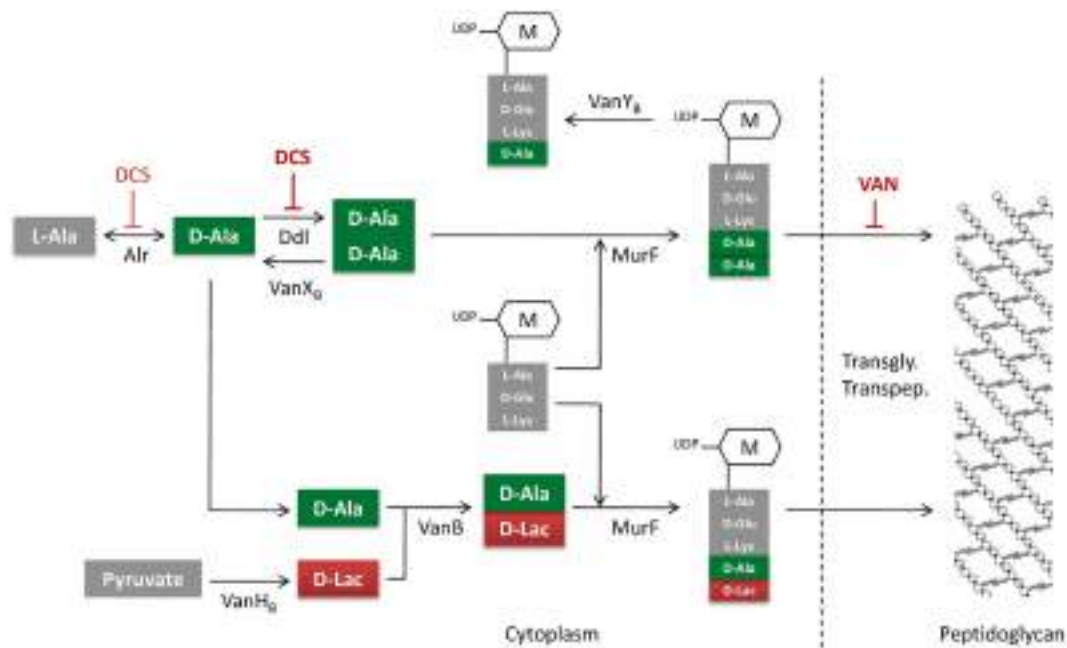

Figure 2. Proposed model of *van*-mediated Ddl inhibition bypass in *E. faecalis* V583. M, N-acetylmuramic acid; UDP, Uridine diphosphate; Transgly., transglycosylation; Transpep., transpeptidation. The cytoplasmic membrane is represented by a dashed line.

Calculation of fractional inhibitory concentration

The combination outcome of VAN and DCS was determined by the checkerboard method by varying both antibiotics concentrations in a 96-well microplate (CytoOne). Each row and column contained subsequent 2-fold serial dilutions of either VAN or DCS at concentrations ranging from 0.5 to 512 $\mu\text{g/mL}$. The FIC index was calculated according to the formula (MIC of VAN in combination/MIC of VAN alone) + (MIC of DCS in combination/MIC of DCS alone). The combination outcome is considered synergistic when FIC index is ≤ 0.5 (meaning that the combination leads to a greater antibiotic activity than predicted by adding the effects of the two antibiotics), additive when FIC index is between 0.5 and 2 (meaning that the combination effect is similar to the predicted by adding the effects of the two antibiotics), and antagonistic when > 2 (meaning that the two antibiotics negatively affect their respective antibiotic activities leading to an increase of their respective MICs) (Suzuki and Ohashi 2013).

RESULTS AND DISCUSSION

Evaluation of inhibitory activity of DCS against VanA and VanB ligases

To determine whether DCS interferes with pentapeptide precursors biosynthesis following VAN induction, we investigated the possibility that DCS inhibits ligation reaction of D-Ala and D-Lac by VanA or VanB ligases in addition to its known inhibitory activity against D-Ala-D-Ala ligase. If so, the combination of VAN and DCS should inhibit both pentapeptide and pentapeptide precursors biosynthesis pathways. This should result in a synergism in *van* + VRSA and VRE strains as well as in *van*- *S. aureus* and *Enterococcus* strains. The results presented in Table 2 show that the susceptibility of *van* + strains

to DCS alone is the same as that observed for DCS in combination with VAN. The MIC of DCS of the VanA strain *E. faecium* Bi22 is 128 $\mu\text{g/mL}$ independent of the presence or absence of VAN. The MIC of DCS of other tested VanA type (*S. aureus* T-SAT12.A) and VanB type strains (*E. faecalis* V583 and *S. aureus* T-SAT12.B) is 256 $\mu\text{g/mL}$ either alone or in combination with VAN. When DCS was tested alone and in combination with VAN on the *van*- VISA strain *S. aureus* 16 038, the MIC value decreased from 32 $\mu\text{g/mL}$ to 8 $\mu\text{g/mL}$, respectively. The identical MIC values of DCS alone and in combination with VAN in *van* + strains, and the reduced MIC values in *van*- strains show that DCS does not interfere with VanA or VanB ligases activity involved in pentapeptide precursors biosynthesis.

Effect of *van* genes cluster on VAN and DCS combination outcome

We tested the susceptibility of *van* + and *van*- strains to VAN and DCS in combination and calculated the FIC index. The VAN MIC in VanA-type and VanB-type strains of either *S. aureus* or *E. faecium* increased when combined with DCS by factors ranging from 2-fold increase for VanB-type strains to 4-fold increase for VanA-type strains. When combined with DCS, the VAN MIC decreased in *van*- strain *S. aureus* 16 038 by a factor of 4 which is similar to that reported by Tabuchi *et al.* (2017), for *van*- *S. aureus* VR7. The calculated FIC index of VAN-DCS combination in the *van*- *S. aureus* 16 038 was 0.5 meaning that the combination acts synergistically. This result is in accordance with the conclusion of Tabuchi and colleagues (2017) who first reported that DCS increases the effectiveness of VAN in *van*- VRSA strains. In the case of *van* + strains of either *S. aureus* or both *enterococci*, the calculated FIC index was 3 for VanB-type strains and 5 for VanA-type strains, meaning that VAN-DCS combination acts antagonistically. We concluded that VAN-DCS combination leads to a synergism in *van*- strains regardless of the MIC of VAN alone,

but leads to a strong antagonism in *van* + strains regardless of VAN resistance type.

Ddl inhibition bypass model as a mechanism of VAN-DCS antagonism

To gain more insight into the mechanism that leads to the strong VAN-DCS antagonism, we monitored the growth of *van* + strains *E. faecalis* V583 and *S. aureus* T-SAR12 VRSA.B at subinhibitory concentrations of VAN and DCS alone or in combination (Fig. 1). When *E. faecalis* V583 is grown in the presence of increasing subinhibitory concentrations of VAN (5, 10 and 15 µg/mL), the lag phase increased with increasing VAN concentrations (Fig. 1A). This lag phase likely corresponds to the time needed to eliminate pentapeptides ending in D-Ala-D-Ala by VanX (VanX_B) and the D,D-carboxypeptidase VanY (VanY_B) while synthesizing pentadepsipeptide precursors ending in D-Ala-D-Lac (Arthur et al. 1993; Händel et al. 2013). At subinhibitory concentrations of DCS, we also observed a delay of growth of *E. faecalis* V583 (Fig. 1B). The combination of VAN at 10 µg/mL and DCS at 100 µg/mL shortened the lag phase compared to the condition with VAN or DCS alone. Similar results were also obtained for *S. aureus* T-SAR12 VRSA.B (Fig. 1C). Growth of the strain starts immediately after inoculation when both antibiotics are added to the medium, whereas initiation of growth is delayed with VAN alone.

According to our results, we suggest that the strong VAN-DCS antagonism is due to a bypass of pentapeptide synthesis pathway inhibition by the synthesis of pentadepsipeptide precursors (Fig. 2). Inhibition of Ddl activity by DCS leads to a 4-fold decrease of D-Ala-D-Ala dimers and a 3000-fold increase of UDP-N-acetylmuramyl-tripeptide precursors (Vemula et al. 2017). As a result, these accumulated tripeptides precursors are processed through pentadepsipeptide precursors pathway, should speed up the exchange of peptidoglycan precursors ending in D-Ala-D-Ala by those ending in D-Ala-D-Lac. This allows *van* + strains to resist to higher concentrations of VAN and to shorten their lag phase when grown in presence of VAN and DCS compared to VAN alone.

Previous studies established a link between Ddl enzyme activity and pentadepsipeptide precursors synthesis where the inactivation of *ddl* gene in VRE leads to VAN dependence. In these strains, peptidoglycan precursors ending in D-Ala-D-Ala cannot be synthesized. The growth of the bacteria depends on the synthesis of peptidoglycan precursors ending in D-Ala-D-Lac which is only possible when the *van* cluster is induced (Gholizadeh and Courvalin 2000).

Despite DCS serious side effects due to its agonist activity on the human postsynaptic receptors N-methyl-D-aspartic acid (NMDA) (Schade and Paulus 2016), Ddl remains an interesting target for the screening of peptidoglycane biosynthesis inhibitors (Batson et al. 2017). However, VAN-DCS antagonism would be observed for all inhibitors that specifically target the Ddl enzyme. There is currently no reported molecule that inhibits the D-Ala:D-Lac ligases VanA and VanB. Nevertheless, D-Ala:D-Ala and D-Ala:D-Lac ligases remain attractive targets for the screening of novel antibiotic molecules that target both ligases. These would be promising candidates active against *van*- and *van* + *S. aureus* and enterococci.

CONCLUSION

In this study, we showed that VAN-DCS combination in *S. aureus* and enterococci leads to synergism in *van*- strains and to strong

antagonism in *van* + strains presumably through Ddl inhibition bypass. However, the bypass model needs experimental verification by the quantification of pentapeptide/pentadepsipeptide precursors ratios in presence of VAN alone and in combination with DCS.

FUNDING

We thank the Region of Normandy for the doctoral fellowship of A.B. This work was funded by the French Ministry of Higher Education, Research and Innovation.

Conflicts of interest. None declared.

REFERENCES

- Arias CA, Murray BE. The rise of the enterococcus: beyond vancomycin resistance. *Nat Rev Microbiol* 2012;10:266–78.
- Arthur M, Molinas C, Depardieu F et al. Characterization of Tn1546, a Tn3-related transposon conferring glycopeptide resistance by synthesis of depsipeptide peptidoglycan precursors in *Enterococcus faecium* BM4147. *J Bacteriol* 1993;175:117–27.
- Batson S, Chiara C de, Majce V et al. Inhibition of D-Ala:D-Ala ligase through a phosphorylated form of the antibiotic D-cycloserine. *Nat Commun* 2017;8:1–7.
- Berscheid A, François P, Strittmatter A et al. Generation of a vancomycin-intermediate *Staphylococcus aureus* (VISA) strain by two amino acid exchanges in *VraS*. *J Antimicrob Chemother* 2014;69:3190–8.
- Cassini A, Högberg LD, Plachouras D et al. Attributable deaths and disability-adjusted life-years caused by infections with antibiotic-resistant bacteria in the EU and the European Economic Area in 2015: a population-level modelling analysis. *Lancet Infect Dis* 2018;19:56–66.
- Centers for Disease Control and Prevention (CDC). Antibiotic resistance threats in the united States. 2013. <https://www.cdc.gov/drugresistance/pdf/ar-threats-2013-508.pdf> (10 October 2019, date last accessed).
- Chang S, Sievert DM, Hageman JC et al. Infection with vancomycin-resistant *Staphylococcus aureus* containing the *vanA* resistance gene. *N Engl J Med* 2003;348:1342–7.
- CLSI. *Methods for Dilution Antimicrobial Susceptibility Tests for Bacteria That Grow Aerobically; Approved Standard - Ninth Edition*. CLSI document M07-A9. Wayne, PA: Clinical and Laboratory Standards Institute; 2012.
- de Niederhäusern S, Bondi M, Messi P et al. Vancomycin-resistance transferability from *VanA* enterococci to *Staphylococcus aureus*. *Curr Microbiol* 2011;62:1363–7. <https://doi.org/10.1007/s00284-011-9868-6>
- DiazGranados CA, Zimmer SM, Klein M et al. Comparison of mortality associated with vancomycin-resistant and vancomycin-susceptible enterococcal bloodstream infections: a meta-analysis. *Clin Infect Dis* 2005;41:327–33.
- ElSayed N, Ashour M, Amine AEK. Vancomycin resistance among *Staphylococcus aureus* isolates in a rural setting, Egypt. *Germes* 2018;8:134–9.
- European Centre for Disease Prevention and Control. *Surveillance of Antimicrobial Resistance in Europe – Annual Report of the European Antimicrobial Resistance Surveillance Network (EARS-Net) 2017*. Stockholm: ECDC; 2018.
- Ghahremani M, Hosseini Jazani N, Sharifi Y. Emergence of vancomycin intermediate and resistant *Staphylococcus aureus* among methicillin resistant *S. aureus* isolated from clinical

- specimens in the northwest of Iran. *J Glob Antimicrob Resist* 2018;**14**:4–9.
- Gholizadeh Y, Courvalin P. Acquired and intrinsic glycopeptide resistance in enterococci. *Int J Antimicrob Agents* 2000;**16 Suppl 1**:S11–17.
- Goswami NN, Trivedi HR, Goswami APP et al. Antibiotic sensitivity profile of bacterial pathogens in postoperative wound infections at a tertiary care hospital in Gujarat, India. *J Pharmacol Pharmacother* 2011;**2**:158–64.
- Hong H-J, Hutchings MI, Buttner MJ et al. Vancomycin resistance VanS/VanR two-component systems. *Adv Exp Med Biol* 2008;**631**:200–13.
- Hu Q, Peng H, Rao X. Molecular events for promotion of vancomycin resistance in vancomycin intermediate *Staphylococcus aureus*. *Front Microbiol* 2016;**7**:1601.
- Händel N, Schuurmans JM, Brul S et al. Compensation of the metabolic costs of antibiotic resistance by physiological adaptation in *Escherichia coli*. *Antimicrob Agents Chemother* 2013;**57**:3752–62.
- Ishii K, Tabuchi F, Matsuo M et al. Phenotypic and genomic comparisons of highly vancomycin-resistant *Staphylococcus aureus* strains developed from multiple clinical MRSA strains by in vitro mutagenesis. *Sci Rep* 2015;**5**:17092.
- Kaplan AH, Gilligan PH, Facklam RR. Recovery of resistant enterococci during vancomycin prophylaxis. *J Clin Microbiol* 1988;**26**:1216–8.
- Kristich CJ, Rice LB, Arias CA. Enterococcal infection—treatment and antibiotic resistance. In: Gilmore MS, Clewell DB, Ike Y et al. (eds). *Enterococci: From Commensals to Leading Causes of Drug Resistant Infection*. Boston: Massachusetts Eye and Ear Infirmary; 2014.
- Kurokawa K, Hamamoto H, Matsuo M et al. Evaluation of target specificity of antibacterial agents using *Staphylococcus aureus* *ddlA* mutants and D-cycloserine in a silkworm infection model. *Antimicrob Agents Chemother* 2009;**53**:4025–7.
- Lambert MP, Neuhaus FC. Mechanism of D-cycloserine action: alanine racemase from *Escherichia coli* W. *J Bacteriol* 1972;**110**:978–87.
- Leclercq R, Derlot E, Duval J et al. Plasmid-mediated resistance to vancomycin and teicoplanin in *Enterococcus faecium*. *N Engl J Med* 1988;**319**:157–61.
- Miller WR, Murray BE, Rice LB et al. Vancomycin-resistant enterococci: therapeutic challenges in the 21st century. *Infect Dis Clin North Am* 2016;**30**:415–39.
- Palmer KL, Carniol K, Manson JM et al. High-quality draft genome sequences of 28 *Enterococcus* sp. isolates. *J Bacteriol* 2010;**192**:2469–70.
- Prosser GA, de Carvalho LPS. Metabolomics Reveal D-Alanine:D-Alanine Ligase As the Target of D-Cycloserine in *Mycobacterium tuberculosis*. *ACS Med Chem Lett* 2013;**4**:1233–7.
- Reynolds PE. Structure, biochemistry and mechanism of action of glycopeptide antibiotics. *Eur J Clin Microbiol Infect Dis* 1989;**8**:943–50.
- Rossi F, Diaz L, Wollam A et al. Transferable vancomycin resistance in a community-associated MRSA lineage. *N Engl J Med* 2014;**370**:1524–31.
- Sahm DF, Kissinger J, Gilmore MS et al. In vitro susceptibility studies of vancomycin-resistant *Enterococcus faecalis*. *Antimicrob Agents Chemother* 1989;**33**:1588–91.
- Schade S, Paulus W. D-cycloserine in neuropsychiatric diseases: a systematic review. *Int J Neuropsychopharmacol* 2016;**19**, DOI: 10.1093/ijnp/pyv102.
- Shockman GD. Reversal of cycloserine inhibition by D-alanine. *Proceedings of the Society for Experimental Biology and Medicine* 1959;**101**:693–5.
- Sieradzki K, Leski T, Dick J et al. Evolution of a vancomycin-intermediate *Staphylococcus aureus* strain in vivo: multiple changes in the antibiotic resistance phenotypes of a single lineage of methicillin-resistant *S. aureus* under the impact of antibiotics administered for chemotherapy. *J Clin Microbiol* 2003;**41**:1687–93.
- Suzuki T, Ohashi Y. Combination effect of antibiotics against bacteria isolated from keratitis using fractional inhibitory concentration index. *Cornea* 2013;**32**:e156–160.
- Tabuchi F, Matsumoto Y, Ishii M et al. D-cycloserine increases the effectiveness of vancomycin against vancomycin-highly resistant *Staphylococcus aureus*. *J Antibiot* 2017;**70**:907–10.
- Terzaghi BE, Sandine WE. Improved medium for lactic streptococci and their bacteriophages. *Appl Microbiol* 1975;**29**:807–13.
- van Harten RM, Willems RJL, Martin NI et al. Multidrug-resistant enterococcal infections: new compounds, novel antimicrobial therapies? *Trends Microbiol* 2017;**25**:467–79.
- Vellappally S, Divakar DD, Al Kheraif AA et al. Occurrence of vancomycin-resistant *Staphylococcus aureus* in the oral cavity of patients with dental caries. *Acta Microbiol Immunol Hung* 2017;**64**:343–51.
- Vemula H, Ayon NJ, Burton A et al. Antibiotic effects on methicillin-resistant *Staphylococcus aureus* cytoplasmic peptidoglycan intermediate levels and evidence for potential metabolite level regulatory loops. *Antimicrob Agents Chemother* 2017;**61**, DOI: 10.1128/AAC.02253-16.
- Weigel LM, Clewell DB, Gill SR et al. Genetic analysis of a high-level vancomycin-resistant isolate of *Staphylococcus aureus*. *Science* 2003;**302**:1569–71.