



HAL
open science

Characterization of Natural Killer Cells in Polycythemia verae and Acute Myeloid Leukemia

Céline Baier

► **To cite this version:**

Céline Baier. Characterization of Natural Killer Cells in Polycythemia verae and Acute Myeloid Leukemia. Life Sciences [q-bio]. Aix Marseille Université, 2014. English. NNT : 2014AIXM5052 . tel-04673801

HAL Id: tel-04673801

<https://hal.science/tel-04673801v1>

Submitted on 20 Aug 2024

HAL is a multi-disciplinary open access archive for the deposit and dissemination of scientific research documents, whether they are published or not. The documents may come from teaching and research institutions in France or abroad, or from public or private research centers.

L'archive ouverte pluridisciplinaire **HAL**, est destinée au dépôt et à la diffusion de documents scientifiques de niveau recherche, publiés ou non, émanant des établissements d'enseignement et de recherche français ou étrangers, des laboratoires publics ou privés.

UNIVERSITE D'AIX-MARSEILLE
Ecole Doctorale des Sciences de la Vie et de la Santé
-
Laboratoire Technological Advances for Genomics and Clinics
- Unité U1090 -

**Thèse présentée
pour obtenir le grade universitaire de docteur**

**Discipline : Pathologie Humaine
Spécialité : Oncologie**

Céline BAIER

**CARACTÉRISATION DES CELLULES NATURAL KILLER
DANS LA POLYGLOBULIE DE VAQUEZ
ET DANS LA LEUCÉMIE AIGÛE MYÉLOÏDE**

Soutenue le 01/12/2014 devant le jury :

Pr. Franck GALLAND _____	PRESIDENT
Pr. Régis T. COSTELLO _____	DIRECTEUR DE THESE
Dr. Massimo VITALE _____	RAPPORTEUR
Dr. Martin VILLALBA _____	RAPPORTEUR

UNIVERSITE D'AIX-MARSEILLE
Ecole Doctorale des Sciences de la Vie et de la Santé
-
Laboratoire Technological Advances for Genomics and Clinics
- Unité U1090 -

**Thèse présentée
pour obtenir le grade universitaire de docteur**

**Discipline : Pathologie Humaine
Spécialité : Oncologie**

Céline BAIER

**CHARACTERIZATION OF NATURAL KILLER CELLS
IN POLYCYTHEMIA VERA AND ACUTE MYELOID LEUKEMIA**

Soutenue le 01/12/2014 devant le jury :

Pr. Franck GALLAND _____	PRESIDENT
Pr. Régis T. COSTELLO _____	DIRECTEUR DE THESE
Dr. Massimo VITALE _____	RAPPORTEUR
Dr. Martin VILLALBA _____	RAPPORTEUR

ACKNOWLEDGEMENTS

First of all, I would like to thank Pr. Franck Galland who accepted becoming president of jury, Dr. Martin Villalba and Dr. Massimo Vitale who agreed to be reporters of thesis. I also extend thanks to my supervisor, Dr. Catherine Nguyen and Régis T. Costello who have recruited me and trust me to complete successfully this thesis project. Their great professional and their human qualities helped me to go through this work, I also learned to be autonomous and to get used to all situations.

Thanks to INSERM-Region for supporting financially this subject. I also thank blood donors of EFS Alpes-Méditerranée and all patients who agreed to give their blood samples or bone marrow.

I thank especially the current members of our laboratory. Genevieve and Brigitte, thank you for your welcome to the TAGC, your guidance and your advice. I would like to thank Carole Sanchez for guiding and advise me at the beginning of my PhD. Magali, thank you for your enthusiasm, your availability and your invaluable help for RT-qPCR. Thanks to Christine and Benoit for help in English. Benoit, Aurélien and Denis, thank you for taking your time to help me in bioinformatics. I want to thank Rabbie, Aurore and Yasmine for achieving the transcriptomic analyzes, and Sarwat for chromatin immunoprecipitation. Finally, I thank members of the Axe I meeting for guiding me throughout my thesis.

A great thank you to Laurence Borges for her good humor, her availability for our discussions throughout the three years.

I thank all those who are in the laboratory or not but who participated in any way close to my experimentations and my knowledge of human NK cells in cancer and cell therapies (Eve-lyne, Lydie, Amélie Cornillon, Marie-Laure Tibult, Cyril Faurat, Aude Leroy, Mark Barad...).

Audrey, Yasmine and Sabrina, huge thanks for your presence, your support, your humor and valuable help. I have had excellent moments with you: experimentations, congress, scientific discussions (or not), going out, running... It allowed me to hold on in times of stress and motivated me to achieve my task.

I also warmly thank Lydie and Nathalie who helped me to improve my manuscript. Nathalie, your advice and our scientific discussions helped me a lot.

Lastly, a special thanks to my family. Your support, your love and the good times have been very important for me and the smooth progress of my thesis. Nicolas, thank you for your humor and above infinite patience throughout my thesis and particularly in the last months.

Thank you all.

Celine BAIER

CONTENTS

List of figures and tables	6
Abbreviations	7
List of publications	10
Resume	12
Abstract	14
I. INTRODUCTION	19
A. Hematological malignancies	19
B. Myeloid haemopathies	19
C. Polycythemia vera	20
a) Pathophysiology and epidemiology	20
b) Symptoms	21
c) Diagnosis	21
d) Treatments	22
e) Tyrosine kinase JAK2 and JAK2V617F mutation	23
D. Acute myeloid leukemia	27
a) Pathophysiology and epidemiology of AML	27
b) Classification of AML	28
c) Biology and clinic	30
d) Diagnosis and prognostic factors	30
e) Description of therapeutic modalities	33
f) Role of NK cell alloreactivity in HSCT and cellular therapy	37
II. NATURAL KILLER CELLS	40
A. NK cell subpopulations	40
B. NK cells functions	42
a) Activation of NK cell cytotoxicity	42
b) NK cells cytotoxicity	44
c) Cytokines production and regulation of immune response	47

C. NK cells receptors	48
a) NK cells MHC-specific receptors	48
b) NK cells activating receptors	52
c) Activating co-receptors	57
D. NK cell in hematological malignancies	59
III. WHICH ROLE FOR NK CELLS IN HAEMOPATHIES DEVELOPMENT ?	93
IV. RESULTS	94
A. Result 1 : Natural Killer cells in patients with polycythemia vera	94
B. Result 2 : Regulation of natural cytotoxicity receptors expression in NK cells from patients with acute myeloid leukemia	116
V. CONCLUSION	152
VI. ANNEXES	154
A. Differential expressions of Natural Killer cell activating receptors in blood versus bone marrow in patients with monoclonal gammopathy	154
B. Expression of activating receptors on Natural Killer cells from AIDS-related lymphoma patients	159
VII. REFERENCES	178

LIST OF FIGURES AND TABLES

Figure 1 : Hematopoiesis and myeloid haemopathies	20
Figure 2 : Domain structure of JAK2 and mutation V617F / exon 14	26
Figure 3 : Mechanism of activation of JAK2 kinase activity by mutation in the JAK2 signaling pathway	27
Figure 4 : KIR mismatch in hematopoietic stem cell transplantation	40
Figure 5 : NK cells sub-population	43
Figure 6 : Regulation of NK cell effector activation	46
Figure 7 : Granzyme Pathways	47
Figure 8 : Death receptors signaling pathway	48
Figure 9 : NKG2D signaling pathways	55
Figure 10 : The molecular structure of NKp46	57
Table 1 : FAB classification	31
Table 2 : WHO classification	31
Table 3 : Prognostic value of AML according to the karyotype	34
Table 4 : KIR gene products and their HLA ligands	51

ABBREVIATIONS

- ADCC** : Antibody Dependant Cytotoxicity
- AML** : Acute Myeloid Leukemia
- ATRA** : All-Trans-Retinoic Acid
- CBC** : Complete Blood Count
- CML** : Chronic Myeloid Leukemia
- CD** : Cluster of Differentiation
- EPO** : Erythropoietine
- ET** : Essential Thrombocythemia
- FAB** : French American British
- FERM** : 4.1, Erzin, Radixin, Moesin
- FOXO** : Forkhead transcription factors
- GM-CSF** : Granulocyte Macrophage - Colony Stimulating Factor
- GHR** : Growth Hormone Receptor
- GVHD** : Graft versus Host Disease
- GVH** : Graft versus Host
- GVL** : Graft versus Leukemia
- HiDAC** : Histone Deacetylase inhibitor
- HM** : Hematological Malignancies
- HLA** : Human Leukocyte Antigen
- HSTC** : Hematopoietic Stem Cell Transplantation
- IFNs** : Interferons
- Ig** : Immunoglobuline
- ILs** : Interleukines
- ILT** : Immunoglobulin Like Transcripts
- ITAM** : Immunoreceptor Tyrosine-based Activating Motif

ITD : Internal Tandem Duplications

ITIM : Immunoreceptor Tyrosine-based Inhibitory Motif

JAK : JAnus Kinase

KIR : Killer cell Immunoglobulin-like Receptor

LIR : Leukocyte Immunoglobulin-like Receptors

LFA-1 : Leukocyte Function-associated Antigen-1

mTOR : mammalian target of rapamicyn

MAPK : MitogenActivatingProtein Kinase

MHC-I : Major Histocompatibility Complex class I

MICA / B : MHC class I Chain-related A/B

MPN : Myeloproliferative neoplasms

NCR : Natural Cytotoxicity Receptor

NCAM : Neural Cell Adhesion Molecule

NK : Natural Killer (cells)

NKG2 : Natural-Killer Group 2 receptor

PBMC : Peripheral Blood Mononuclear Cells

PCR : Polymerase Chain Reaction

Ph : Philadelphie chromosome

PMF : Primary Myelofibrosis

PV : Polycythemia Vera

RT : Reverse Transcription

SH : Src Homology region

SHP 1 / 2 : Src Homology (SH) 2-containing Phosphatase

SMP : Myeloproliferative Syndromes

SOCS : Suppressor of cytokine signalling

STAT proteins : Signal Transducers and Activators of Transcription proteins

TET2 : tetmethylcytosinedioxygenase 2

TNF α : Tumour Necrosis Factor α

TRAIL : TNF-related Apoptosis-Inducing Ligands

ULBP : UL16 - Binding Proteins

WHO : World Health Organisation

LIST OF PUBLICATIONS

- **Published papers** :

Baier C, Fino A, Sanchez C, et al. Natural killer cells modulation in hematological malignancies. *Frontiers in immunology* 2013.

C.J. Sanchez, **C. Baier**, R.T. Costello. Natural Killer cells and their abnormalities in hematological malignancies, and more particularly in polycythemia vera. *Immunanalyse et biologie spécialisée* 2012.

Farnault L, Sanchez C, **Baier C**, Le Treut T, Costello RT. Hematological malignancies escape from NK cell innate immune surveillance: mechanisms and therapeutic implications. *Clinical & developmental immunology* 2012.

Costello RT, Boehrer A, Sanchez C, **Baier C** et al. Differential expression of natural killer cell activating receptors in blood versus bone marrow in patients with monoclonal gammopathy. *Immunology* 2013.

- **Articles in submission** :

Baier C, Sanchez C, Chelbi R, et al. Natural killer cells in patients with polycythemia vera.

Mercier-Bataille D, Sanchez C, **Baier C**, et al. Expression of activating receptors on natural killer cells from AIDS-related lymphoma patients.

- Articles in preparation :

Céline Baier, Aurore Fino, Sarwat Afridi et al. NCR down regulation of NK cells patients with acute myeloid leukemia.

RESUME

En 2012, le nombre de nouveaux cas d'hémopathies malignes en France a été estimé à 35 000. Plus d'un tiers des cas sont des hémopathies myéloïdes. Aujourd'hui, les dernières avancées dans les traitements des hémopathies aboutissent à un meilleurs taux de rémission complète ainsi qu' à de meilleurs taux de survie après traitement. Cependant les risques de rechutes restent élevés. Les rechutes sont dues à la prolifération de cellules tumorales résiduelles qui ont résisté au traitement. Les cellules NK, qui participent à la surveillance immunitaire et qui sont capables de tuer naturellement les cellules tumorales, devraient tuer ces cellules résiduelles, or de nombreuses anomalies ont été observées dans la plupart des hémopathies malignes. Notre projet s'inscrit dans la compréhension du rôle des cellules NK dans l'évolution de ce type de pathologies.

Dans une première partie nous nous sommes intéressés à la polyglobulie de Vaquez (PV) pour plusieurs raisons : cette pathologie présente une évolution lente et progressive, elle peut évoluer en myélofibrose ou en leucémie myéloïde aiguë, et elle est caractérisée par une mutation de JAK2 (mutation V617F JAK2 touchant l'exon 14 ou plus rarement mutation impliquant l'exon 12) présente dans la lignée myéloïde chez plus de 95% des patients. Nous avons d'abord cherché à détecter la mutation dans les cellules NK de patients, puis, pour savoir si la mutation avait un effet sur les NK, nous avons exploré leurs fonctions *in vitro*. Nos résultats ont montré que, bien que la mutation soit présente dans les cellules NK, elle ne semble pas avoir d'impact sur les fonctions des cellules NK que nous avons pu tester. Nous en avons conclu que l'évolution de la polyglobulie de Vaquez en leucémie n'était peut-être pas due à une perte de fonction des NK mais plutôt à leur inhibition par l'environnement cellulaire.

Dans une deuxième partie nous avons étudié la régulation des natural cytotoxicity receptors (NCR) dans la leucémie aiguë myéloïde (LAM). Des travaux antérieurs ont

montré que les NCR sont faiblement exprimés chez les patients, et que cette faible expression est acquise au cours de l'évolution de la LAM et réversible lors de la rémission complète. De plus, la faible expression des NCR à la surface des NK est corrélée à un mauvais pronostic de survie. D'après ces résultats, nous avons émis l'hypothèse que l'expression des trois NCR aurait une régulation commune s'effectuant au niveau de transcription de leurs gènes. Nos recherches bio-informatiques ainsi que notre expérimentation d'immunoprécipitation de la chromatine (Chip) montrent que le facteur de transcription ETS-1 semble être impliqué dans la régulation commune aux trois NCR.

ABSTRACT

In 2012, new cases of hematological malignancies in France have been estimated at 35,000. More than one third of cases are myeloid haemopathies. To date, the latest advances in blood disorders treatments lead to a better complete remission rate and a better survival rate after treatment. However, the risk of relapse remains high. Relapses are due to the proliferation of residual tumor cells that have resisted to the treatment. NK cells, which are involved in immune surveillance and which are naturally capable of killing tumor cells, should kill these residual cells, but many anomalies have been observed in most malignancies. Our project is included in the understanding of NK cells role in the development of these diseases.

In a first part, we focused on polycythemia Vera (PV) for several reasons: the pathology has a slowly progressive disease, it can evolve into myelofibrosis or acute myelogenous leukemia, and it is characterized by the presence of JAK2 mutation (JAK2 V617F, exon 14, or, less frequently, involving exon 12) in myeloid lineage, for > 95% of PV patients. We wanted to know if this mutation was found in NK cells from PV patients and what effects the mutation had on NK cells functions. Our results have shown that although the mutation was found in NK cells, it appears to have no impact on NK cells functions. We conclude that the evolution of PV to leukemia is not due to a loss of NK cell functions but to their inhibition by cellular environment.

In a second part, we investigated the regulation of natural cytotoxicity receptors (NCR) in acute myeloid leukemia (AML) because previous works have shown that NCR are weakly expressed in AML patients, that this down-regulation is acquired during evolution of AML and reversible after complete remission, and that NCR weak expression is related to poor prognosis. We supposed that the expression of the three NCR has a common regulation at genes transcription level. Our bioinformatic researches and our experiment of chromatin immunoprecipitation (Chip) show that

ETS-1 transcription factor is a good candidate involved in the common regulation of the three NCR.

INTRODUCTION

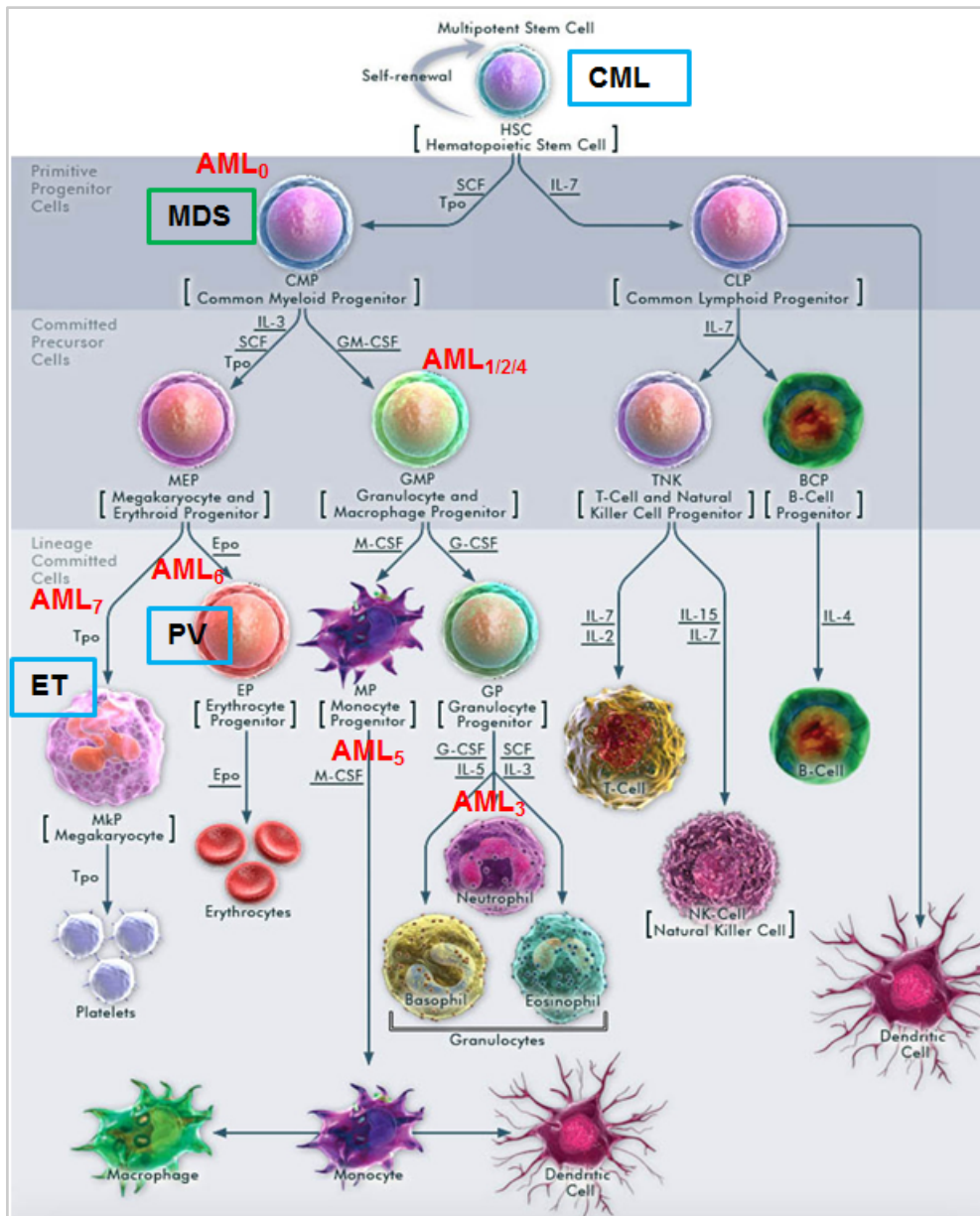

Abbreviations : Chronic lymphocytic leukemia (CLL). Acute myeloid leukemia in red (AML). Myeloproliferative disorder (blue) : chronic myeloid leukemia (CML), polycythemia Vera (PV), essential thrombocythemia (ET). Myelodysplasic disorder (green).

Figure 1: Hematopoiesis and myeloid haemopathies

(Adapted from www.biologend.com)

I. INTRODUCTION

A. HEMATOLOGICAL MALIGNANCIES

Hematological malignancies (HM) are blood cancers that affect the production and function of blood cells (**Figure 1**). Most of these cancers start in bone marrow or lymph node and then reach blood. HM are characterized by excessive proliferation of immature hematopoietic stem cells which are able or not to be differentiated, in bone marrow or lymphoid system.

The etiology of most hematological malignancies is not yet known. Ionising radiation, exposure to chemicals and dusts, industrial exposures including benzene, viral infections, and genetic predisposition are all associated with an increased risk of one or several of these diseases. Historically, hematological malignancies have been commonly divided by whether the malignancy is mainly located in the blood (leukemia) or in lymph nodes (lymphomas). World Health Organization (WHO) classification of 2001 exploits many different tumor characteristics and is based fundamentally on cell lineage, reinforcing the distinction between lymphoid and myeloid neoplasm. Several changes have been done in 2008, morphology based system incorporates clinical features, morphology, immunophenotyping, and cytogenetic/molecular genetic data leading to a single coherent diagnosis (Sabattini *et al.*, 2010). The aim was to separate and characterize distinct clinically and biologically relevant entities, especially to choose which therapy targeted.

B. MYELOID HAEMOPATHIES

Myeloid haemopathies are clonal diseases of hematopoietic progenitors or stem cells. They result from genetic and epigenetic alterations that perturb key processes such as

self-renewal, proliferation and differentiation. Myeloid malignancies are characterized by proliferation of hematopoietic precursors of cell line that normally produces granulocytes, erythrocytes, thrombocytes, macrophages and mast cells. The group of myeloid malignancies includes the following diseases: acute myeloid leukemia (AML), myelodysplastic syndrome (MDS) and myeloproliferative neoplasms (MPN). MPN comprises a variety of disorders such as chronic myeloid leukemia (CML), polycythemia Vera (PV), essential thrombocythemia (ET) and primary myelofibrosis (PMF). Chronic diseases are characterized by a proliferation and differentiation of cancer cells with a slow evolution which can transform in acute leukemia. Acute disorders, with blockade in cell differentiation, are associated with poor prognosis.

C. POLYCYTHEMIA VERA

a) Pathophysiology and epidemiology

PV is a clonal disorder arising in a multipotent hematopoietic progenitor cell that causes the accumulation of morphologically normal red cells with predominance on this lineage, white cells, and platelets in blood. PV is characterized by a mutation in the tyrosine kinase 2 (JAK2) that occurs in immature cells and acts in signaling pathways of the EPO-receptor (James *et al.*, 2005). The JAK2V617F mutation on exon 14 (or less frequently mutation in exon 12) leads to a constitutive activation of these receptors and renders cells hypersensitive to EPO, inducing erythroblast proliferation. Treatments and pressure of cellular environment lead to an accumulation of genetic mutations in immature cells. Then, clinical evolution of PV is characterized by thrombo-hemorrhagic complications and variable risk of transformation into myeloid metaplasia, myelofibrosis or acute myeloid leukemia / myelodysplastic syndromes which have a poor prognosis (Spivak, 2002). The incidence of AML/MDS ranges from 5% to 15% after 10 years of disease with progressive increase of risk over time. The use of myelosuppressive chemotherapy, with phosphorus P32 for example, is consistently

associated with increased risk for leukemic transformation (Finazzi *et al.*, 2005; Kiladjian *et al.*, 2003; Weinfeld *et al.*, 1994).

The incidence of PV increases with age, the median age at diagnosis to be 64 years. The overall incidence in the population was 10 cases per 100,000 by years, and the disease was more common in men than women (sex ratio M/W 1.2).

b) Symptoms

The symptoms of PV are: trouble breathing when lying down, dizziness, excess bleeding, full feeling in the left upper abdomen (due to enlarged spleen), headache, itchiness, especially after a warm bath, red skin coloring, especially of the face, shortness of breath, symptoms of blood clots in veins near the skin surface (phlebitis). Other symptoms that may occur with this disease are bluish skin color, fatigue, red skin spots and vision problems.

c) Diagnosis

In addition to a complete blood count (CBC), bone marrow aspiration and biopsy, cytogenetic analysis and a serum erythropoietin test are used to diagnose polycythemia vera. With the establishment of polymerase chain reaction (PCR)–based methods for detecting the *JAK2* mutation, this mutation is now the first molecular diagnostic marker for PV, similar to *BCR/ABL* for chronic myelogenous leukemia. Diagnostic criteria for PV according to the 2008 revised WHO guidelines (Tefferi & Vardiman, 2008). Diagnosis requires the presence of both major criteria and one minor criterion or the presence of the first major criterion with two minor criteria.

Major WHO criteria are:

- Hemoglobin > 18.5 g/dL in men and > 16.5 g/dL in women, or other evidence of increased red blood cell volume
- Detection of *JAK2* V617F or *JAK2* exon 12 mutation.

Minor WHO criteria are:

- Bone marrow biopsy showing hypercellularity with trilineage growth with prominent erythroid, granulocytic, and megakaryocytic proliferation
- Serum erythropoietin level below the reference range for normal
- Endogenous erythroid colony formation in vitro.

The major diagnostic issue related to PV is distinguishing it from other forms of erythrocytosis, which are more common than PV. JAK2 V617F mutation and erythropoietin level are keys in the diagnosis of erythrocytosis. If the JAK2 mutation is positive and EPO level is low, then the diagnosis of PV is confirmed.

If the JAK2 V6617F mutation is absent but the EPO level is low, then testing for JAK2 exon 12 and 13 mutations would be helpful in making a diagnosis of PV in the 2-3% of PV patients who are negative for JAK2 V617F mutation. Patients who are negative for JAK2 mutations and have a normal or high EPO level have secondary erythrocytosis.

d) Treatments

PV is a serious disease because of its possible evolution in fibrotic transformation and AML. Treatments are used to decrease the risk of arterial and venous thrombotic events (approximately 20%). The current treatment consists primarily of phlebotomy, used to decrease blood thickness and to keep the hematocrit below 45% or 47% in men and 42% or 45% in women. One unit of blood is removed each week until the number of red blood cells drops. The treatment is continued as needed. Patients are also treated with aspirin to reduce the risk of blood clots may be an option for some people. However, aspirin increases the risk of stomach bleeding and fails to prolong survival or prevent thrombotic events or progression to myelofibrosis in PV (Najean & Rain, 1997).

Other treatments may include chemotherapy (as the cytoreductive hydroxyurea) to reduce the number of red blood cells made by the bone marrow. This option may use when the numbers of other blood cell types are also high. In patients who are

refractory to or intolerant of hydroxyurea, interferon-alpha can be used as an alternative. Non-pegylated interferon has been shown to be effective in controlling erythrocytosis, thrombocytosis and thrombotic complications, but was found to have poor tolerability and excessive adverse effects. Recently, pegylated interferon alpha-2a (PegIFN2a) was introduced and found to be better tolerated and less toxic than standard interferon. In addition, pegylated interferon alpha-2a therapy was found to induce both hematologic and molecular remissions (Gowin *et al.*, 2012).

Myelosuppressive chemotherapy with busulfan is also an option for patients older than 65 years (Alvarez-Larran *et al.*, 2014). The risks for secondary leukemia depend on the type of therapy (phlebotomy, radioactive phosphorus-32 [³²P], chlorambucil) or the type of myelosuppressive agents (hydroxyurea, interferon alfa) and duration of therapy. The JAK1/JAK2 inhibitor ruxolitinib is the first US Food and Drug Administration (FDA)–approved drug for patients with intermediate- or high-risk myelofibrosis, including primary myelofibrosis, post-polycythemia vera myelofibrosis, and post-essential thrombocythemia myelofibrosis (Nussenzveig *et al.*, 2009; Quintas-Cardama *et al.*, 2011). Many other JAK inhibitors have been developed these last years, as SB1518, a JAK2/FLT3 inhibitor (Baffert *et al.*, 2010; Lasho *et al.*, 2010; Tyner *et al.*, 2010; Verstovsek, 2009).

e) Tyrosine kinase JAK2 and JAK2V617F mutation

JAK proteins are a family of four Janus kinases (JAK) 1, 2 and 3 and tyrosine kinase 2. They are coded by genes located on chromosome 9. In the cytoplasm, JAK proteins play a key role in signal transduction by its association with type I receptors such as growth hormone (GHR), prolactin (PRLR), leptin (LEPR), erythropoietin (EPOR), thrombopoietin (THPO); or type II receptors including IFN-alpha, IFN-beta, IFN-gamma and multiple interleukins (Imada & Leonard, 2000; Muller *et al.*, 1993). Many of those receptors transmit anti-apoptotic, proliferative and differentiation signals, and their expression and functions are critical for the formation of blood lineages. That's why

JAK2 is involved in these various processes and mediates essential signaling events in both innate and adaptive immunity.

JAK protein contains an active tyrosine kinase domain (JAK homology 1 (JH1)), a catalytically inactive pseudokinase domain (JAK homology 2 (JH2)) which seems to have an inhibitory role on JH1, a SRC homology 2 domain (SH2), and an amino terminal FERM (4.1, Erzin, Radixin, Moesin) homology domain (Smith & Fan, 2008). The FERM domain is responsible for attachment to the cytosolic domains of cytokine receptors type I (Vainchenker & Constantinescu, 2013) (**Figure 2**).

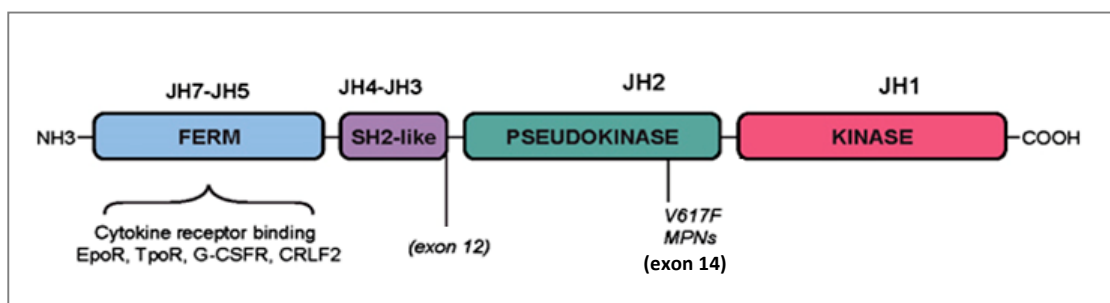

Figure 2 : Domain structure of JAK2 and mutation V617F / exon 14 (Smith *et al.*, 2008)

Under physiological conditions, cell stimulation with EPO during erythropoiesis leads to a conformational change of EPO-receptor (EPOR) and two cytoplasmic molecules JAK2 get closer for autophosphorylation and activation. The association of activated JAK2 with EPOR infers the phosphorylation of its cytoplasmic domain. Then, STAT molecules (Signal Transducer and Activator of Transcription) are recruited, phosphorylated and activated by JAK2. Once activated, STAT homodimerise and translocate into the nucleus and promotes the transcription of several essential genes involved in cell survival, apoptosis, proliferation and in the modulation of erythropoiesis (Levine *et al.*, 2007). JAK2 signaling is negatively regulated by SOCS1, a suppressor of cytokine signaling (SOCS) proteins (Puigdecanet *et al.*, 2008).

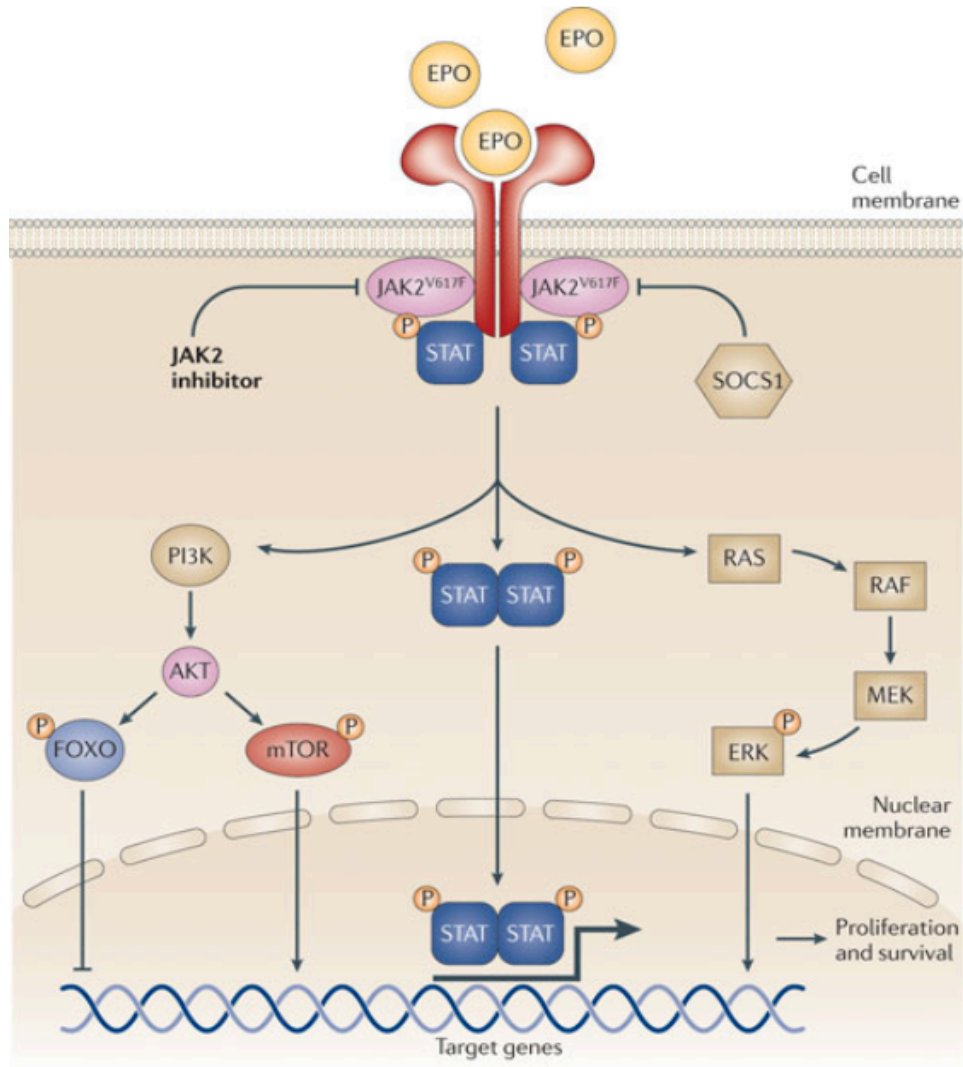

Figure 3 : Mechanism of activation of JAK2 kinase activity by mutation in the JAK2 signaling pathway (Quintas-Cardama *et al.*, 2011)

In early 2005, four different groups described an identical mutation in JAK2V617F in large numbers of patients with MPDs (Baxter *et al.*, 2005; James *et al.*, 2005; Kralovics *et al.*, 2005; Levine *et al.*, 2005). This somatic gain-of-function mutation is a guanine-to-thymidine substitution at nucleotide 1,849 of the JAK2 gene that results in a valine-to-phenylalanine substitution at codon 617 of JAK2 in exon 14 (James *et al.*, 2005; Kralovics *et al.*, 2005; Zhao *et al.*, 2005). JAK2V617F signaling pathway involves activation of STAT and ERK, extracellular signal-related kinase; MEK, MAPK/ERK kinase (David *et al.*, 1995; Goh *et al.*, 1999) (**figure 3**). The mutation also activates the phosphatidylinositol 3-kinase (PI3K)/AKT mammalian target of rapamycin (mTOR), forkhead transcription factors (FOXO) signaling proteins that transmit signals for survival and proliferation, thereby preventing apoptosis of hematopoietic progenitor cells (Cortot *et al.*, 2006; Levine *et al.*, 2005; Quintas-Cardama *et al.*, 2011; Smith *et al.*, 2008).

The presence of the JAK2V617F mutation has been reported with variable frequencies in myeloid haemopathies. JAK2V617F mutation is present in 50% of essential thrombocythemia (ET), 30% of primitive myelofibrosis (PM), also in patients with chronic myelomonocytic leukemia (5%), myelodysplastic syndromes (5%) or AML (less than 20%). Its presence has been described in > 95% of PV. Furthermore, JAK2V617F is found in granulocytes in 90% to 95% of patients with PV. In patients with myeloproliferative syndrome, the mutation is found in B and T lymphocytes (Delhommeau *et al.*, 2007; Larsen *et al.*, 2007).

Other mutations, including JAK2 exon 12, have been described for patients lacking the JAK2V617F mutation in PV, such as tet methyl cytosine dioxygenase 2 (TET2) mutation (Smith *et al.*, 2008; Tefferi, 2010; Tefferi *et al.*, 2009b). The nature of TET2 mutations undermines their specific pathogenetic contribution to MPN and did not

seem to affect survival, leukemic transformation, thrombosis risk or cytogenetic profile in either PV or primary myelofibrosis (Hussein *et al.*, 2010; Tefferi *et al.*, 2009a).

D. ACUTE MYELOID LEUKEMIA

Acute leukemias are malignant proliferation of the hematopoietic tissue characterized by an accumulation of immature cells in the blood and marrow which do not respond normally to differentiation and proliferation factors. There are two main types of acute leukemia according to the origin of hematopoietic precursor reached: lymphoblastic acute leukemia (LAL) and acute myeloid leukemia (AML). ALL is most common in childhood with a peak incidence at 2–5 years. AML are the most common acute leukemia affecting adults. There are primary leukemia or leukemia that develop from other types of pathologies such as myelodysplastic or myeloproliferative syndrome (secondary AML) (Sanz *et al.*, 1989).

a) Pathophysiology and epidemiology of AML

They are characterized by a blocking of the normal maturation of medullary myeloid lineages with progressive invasion of bone marrow, blood and hematopoietic organs by proliferation of abnormal immature elements called myeloblasts or blast. Without treatment, AML can quickly be fatal. The expected outcome for acute myeloid leukemia depends on certain factors: age, a history of blood disorders or cancers, gene mutations or chromosome changes, response to chemotherapy.

The incidence of AML is estimated between 5 and 8 per 100 000 cases. Rarely diagnosed before the age of 40 years, the median age at diagnosis is about 65 years. The incidence increases with age and men are more affected than women (sex ratio = 1.5).

Several leukemia risk factor have been identified (Deschler & Lubbert, 2006): smoking, exposure to certain chemicals such as benzene (a solvent used in oil refineries and

other industries and present in cigarette smoke), certain cleaning products, detergents, and paint strippers, treatment with certain chemotherapy drugs (alkylant agents) used to treat other cancers, especially when they are combined with radiation therapy, exposure to high doses of radiation; certain blood disorders, such as myeloproliferative disorders, and certain congenital syndromes: trisomy 21 is associated with a frequency of acute myeloid leukemia 20 times greater than the normal (Pedersen-Bjergaard *et al.*, 2008).

b) Classification of AML

Different subtypes of AML were previously described as M0 through M7 by the French-American-British (FAB) system which was established in 2001 according to the blasts morphology and their cell differentiation (Bennett *et al.*, 1976; Bennett *et al.*, 1985) (**Table 1**). In 2008, the WHO reclassified AML in an attempt to predict the prognosis and biologic properties more accurately and to enhance the clinical relevance of the system (Vardiman, 2010) (**Table 2**). This new classification reflected those entities with similar biologic and clinical features. It also takes into account the morphologic, genetic, and immunophenotypic features of the disease entities. The WHO classification system differs from the FAB system in that the previous blast cell threshold of 30% for the diagnosis of AML has been reduced to 20%, and patients with recurring cytogenetic abnormalities are now classified as having AML regardless of blast percentage.

French-American-British Classification	
M0	Myeloblastic undifferentiated
M1	Myeloblastic without maturation
M2	Myeloblastic with maturation
M3	Promyelocytic
M4	Myelomonocytic
M5	Monoblastic
M6	Erythroleukemia
M7	Megakaryoblastic

Table 1. FAB classification (Bennett *et al.*, 1985)

World Health Organization Classification
Acute myeloid leukemia with recurrent genetic abnormalities
➤ Acute myeloid leukemia with t(8;21)(q22;q22); RUNX1-RUNX1T1
➤ Acute myeloid leukemia with inv(16)(p13.1q22) or t(16;16)(p13.1;q22), CBFβ/MYH11
➤ Acute promyelocytic leukemia with t(15;17)(q22;q12); PML/RARA
➤ Acute myeloid leukemia with t(9;11)(p22;q23); MLLT3-MLL
➤ Acute myeloid leukemia with t(6;9)(p23;q34); DEK-NUP214
➤ Acute myeloid leukemia with inv(3)(q21q26.2) or t(3;3)(q21;q26.2), RPN1-EV11
➤ Acute myeloid leukemia (megakaryoblastic) with t(1;22)(p13;q13); RBM15-MKL1
➤ Acute myeloid leukemia with t(9;11)(p22;q23); MLLT3-MLL
➤ Provisional entity: Acute myeloid leukemia with mutated NPM1
➤ Provisional entity: Acute myeloid leukemia with mutated CEBPA

Table 2. WHO classification (Vardiman, 2010)

c) Biology and clinic

There is no specific evidence of acute leukemia. The diagnosis is suspected in a clinical complication of cytopenias (poor general condition, anemic syndrome, bleeding, and infection status) or on abnormalities on blood counts.

The symptoms of AML are caused by the blocking of mature cells production which result in pancytopenia and by the proliferation of leukemic cells. The lack of mature white blood cell makes the patient susceptible to infections and the leukemic cells that are derived from white blood cell precursors, have no infection-fighting capacity. The deficient production of red blood cells can lead to patient complaints of weakness, fatigue, or dyspnea on exertion. A lack of platelets can lead to easy bruising or bleeding with minor trauma.

The accumulation of blasts in the bone marrow, and in other organs can cause other disorders like bone pain, increased size lymph nodes (adenopathy), spleen (splenomegaly), liver (hepatomegaly), gums... In rare cases, the blasts pass through cerebrospinal fluid which is located around the brain and spinal cord, can cause damage to the nerves and meninges. Hyperleukocytosis, leukostasis, or both can cause impairment of blood flow, most often resulting in central nervous system or pulmonary symptoms.

d) Diagnosis and prognostic factors

Baseline evaluation involves routine blood work, including a complete blood count with differential, comprehensive metabolic profile, and coagulation studies. A bone marrow aspiration or biopsy (if aspirate is not possible, i.e presence of myelofibrosis) should be evaluated by cytochemistry, immunophenotyping, flow cytometry, and cytogenetic. Additional studies, including chest radiography and echocardiography are needed to determine a patient's ability to receive potentially cardiotoxic chemotherapy. A lumbar puncture may be needed if CNS symptoms are identified. Human leukocyte antigen

(HLA) typing is needed if bone marrow transplantation is being considered, and it should be performed prior to myeloablation.

First, questioning allows specifying the personal and family background, risk factors (especially previous cancer treatments and professional exposures) and comorbidities. It is important for the diagnosis to find a previous complete blood count suggesting the existence of a preleukemic syndrome. Clinical examination looks for tumor events, infectious signs, bleeding and anemia.

The diagnosis is confirmed with a complete blood count and will find: anemia and thrombocytopenia in 80-90% of cases; neutropenia, with or without leukocytosis (30%); the presence of circulating blasts (their absence in blood does not exclude the diagnosis of acute leukemia). A myelogram confirms the diagnosis and is also essential for the identification of acute leukemia. The diagnosis is considered if percentage of marrow blasts compared with nucleated cells is $\geq 20\%$ for LAM. The risk pattern in AML is determined not only by cytogenetic abnormalities, such as chromosomal deletions, duplications, or substitutions, but also by the elucidation of certain molecular mutations leading to over- or under-expressions of one of many proteins (Baldus *et al.*, 2007; Dohner *et al.*, 2010).

Cytogenetic studies performed on bone marrow in patients with AML play a crucial role in characterizing the leukemia, helping determine disease aggressiveness, response to treatment, and prognosis. The karyotype is the strongest predictor of response initial treatment and the risk of relapse. Some chromosomic or cytogenetic abnormalities can be in favor of a good or poor prognosis (Chen *et al.*, 2010; Grimwade *et al.*, 2010; Orozco & Appelbaum, 2012) (**Table 3**). For example, the finding of a translocation between chromosomes 15 and 17, or t(15;17) allowing the diagnosis of acute promyelocytic leukemia (M3) is associated with a favorable prognosis.

FAB leukemia type	Karyotype	Implicated genes	Prognostic value
AML – M2	t(8:21)(q22;q22)	RUNX1– RUNX1T1	Favorable
AML – M4	inv(16)(p13q22)/ t(16;16)(p13;q22)	CBFB–MYH11	
AML – M3	t(15;17)(q22;q21)	PML–RARA	Poor or intermediate
AML – M4/5	t(11q23)	MLL	
AML all types	t(9;22)(q34;q11)	BCR–ABL1	Poor
	-5/del(5q)	-	
	-7/del(7q)	-	

Table 3. Prognostic value of AML according to the karyotype

Several molecular abnormalities have been shown to have prognostic importance in patients with AML. FLT3 is the most commonly mutated gene in AML and appears to be activated in one third of AML cases. Internal tandem duplications (ITDs) in the juxta membrane domain of FLT3 are seen in 25% of AML cases, while others show mutations in the activation loop of FLT3. Patients with FLT3 -ITD tend to have a poor prognosis, and in a patient with normal cytogenetics (otherwise intermediate risk), the presence of FLT3 -ITD mutation changes the patient to poor risk (Thiede *et al.*, 2002). Mutation in NPM1 is generally favorable; patients with this mutation show increased response to chemotherapy and improved survival (changes otherwise intermediate-risk patients into better-risk). However, if present together with the FLT3 mutation, this survival benefit is negated (Brunet *et al.*, 2012; Gale *et al.*, 2008). Mutations in CEBPA are detected in 15% of patients with normal cytogenetics and are associated with a longer remission duration and longer overall survival (Frohling *et al.*, 2004). Of note, the presence of c-KIT mutations in patients with otherwise favorable cytogenetic markers (eg, t(8:21), inv(16)) confers a higher risk of relapse and would place an otherwise better-risk patient into the intermediate-risk category (Paschka *et al.*, 2006).

e) Description of therapeutic modalities

- **Chemotherapy**

Induction treatment

This first part of treatment is aimed at getting rid of all visible leukemia. How intense the treatment is may depend on a person's age and health. The most intensive chemo is given to people under the age of 60. Some older patients in good health may benefit from similar or slightly less intensive treatment.

Induction therapy aims to complete remission and to reduce the number of leukemic cells, as well as to return proper function to the bone marrow. This treatment has one or two courses of chemotherapy and includes 4 phases: the blast reduction; aplasia due to the treatment (<5% blasts); regeneration and remission.

People who are much older or are in poor health may not have intensive chemotherapy. Treatment of these patients is discussed. Age, health, and other factors clearly need to be taken into account when considering treatment options.

All FAB subtypes are usually given induction chemotherapy with cytarabine (ara-C) and an anthracycline. In younger patients, such as those under 60, induction often involves treatment with 2 chemo drugs. The 3+7 combination of the anthracycline / daunorubicin (45 mg/m² or 60 mg/m² intravenously for 3 days) and standard-dose cytarabine (100 mg/m² by continuous infusion over 7 days) results in complete remission rates between 65% and 75% in patients aged 18–60 years (Lowenberg *et al.*, 2003; Tallman *et al.*, 2005).

The M3 subtype of AML, known as acute promyelocytic leukemia, is almost universally treated with the drug all-trans-retinoic acid (ATRA) in addition to induction chemotherapy, usually an anthracycline (Fenaux *et al.*, 1999). Instead, ATRA (45

mg/m²/day divided into two doses), which promotes differentiation of leukemic promyelocytes into mature cells, has been shown to improve disease-free survival and overall survival compared with chemotherapy alone. A significant complication of APL treatment is APL differentiation syndrome which occurs 25% of the time when ATRA is used alone. The mechanism is the rapid differentiation of blasts into neutrophils. This syndrome is a cardiopulmonary syndrome characterized by fever, respiratory distress, pericardial effusion, hypotension, and acute renal failure. Remission induction usually does not destroy all the leukemia cells and a small number often persist. Without consolidation treatment, the leukemia is likely to return within several months, this is relapse.

Consolidation treatment (post-remission therapy)

Induction is considered successful if remission is achieved. Further treatment is then given to try to destroy any remaining leukemia cells and help prevent a relapse. This is called *consolidation*. It is at this point that may be offered an hematopoietic stem cell transplantation (HSCT), preceded by intensive chemotherapy. The specific type of post remission therapy is individualized based on a patient's prognostic factors and general health.

Post remission chemotherapy includes high-dose cytarabine (ara-c; HiDAC) for patients younger than 60 years, in whom a survival advantage has been demonstrated with this therapy, particularly in patients with good-risk, core binding factor cytogenetic abnormalities. In patients younger than 60 years, HiDAC yields a 4-year disease-free survival rate of 44%, but carries with it a 5% treatment-related mortality. In contrast, HiDAC failed to improve the outcome of patients older than 60 years (15% disease-free survival at 4 years). The HiDAC regimen is 1,000 to 3,000 mg/m² IV over 1 to 3 hours every 12 hours for 6 to 12 doses. High doses of cytarabine can be associated

with cerebellar, ophthalmologic, and gastrointestinal toxicity, particularly in patients over the age of 60 years.

The treatment of older AML patients is controversial. Older adults often cannot tolerate the toxicities of intensive remission induction chemotherapy. With the typical treatment plans, the treatment-related mortality is between 15% and 30%. Other less intensive regimens that may be used are oral agents (such as hydroxyurea), "low dose cytarabine" (20 mg/m² subcutaneous injection twice daily for 10 days), or one of the hypomethylating agents (azacitidine or decitabine). These are associated with less of a myelosuppressive effect, lower treatment-related mortality, and less time spent in the hospital.

- **Hematopoietic stem cell transplantation (HSCT)**

There are two main types of stem cell transplants: allogeneic and autologous. They differ with regard to the source of the blood-forming stem cells.

Allogeneic bone marrow transplantation is another option for post remission therapy in adults with AML. In this case, the stem cells come from an HLA-compatible donor, brother or sister if possible. The transplantation procedure includes a previous "conditioning" by a very intensive chemotherapy (which induces severe aplasia) with or without total body irradiation followed by injection of donor stem cells by intravenous way.

In an autologous transplant, a patient's own stem cells are removed from his or her bone marrow or peripheral blood. They are frozen and stored while the person gets treatment (high-dose chemotherapy and/or radiation). A process called purging may be used to try to remove any leukemia cells in the samples. The stem cells are then reinfused to the patient.

Some complications and side effects can persist for a long time or may not occur until months or years after the transplant. They include:

- Graft-versus-host disease (GVHD), which can occur in allogeneic (donor) transplants. This happens when the donor immune system cells attack tissues of the patient's skin, liver, and digestive tract. Symptoms can include weakness, fatigue, dry mouth, rashes, nausea, yellowing of the skin and eyes (jaundice), and muscle aches. In severe cases, GVHD can be life-threatening. GVHD is often described as either acute or chronic, based on how soon after the transplant it begins. Drugs that weaken the immune system are often given to try to keep GVHD under control.
- Damage to the lungs, causing shortness of breath
- Damage to the ovaries in women, causing infertility and loss of menstrual periods
- Damage to the thyroid gland that causes problems with metabolism
- Cataracts (damage to the lens of the eye that can affect vision)
- Bone damage called aseptic necrosis (where the bone dies because of poor blood supply).

Graft-versus-host disease (GVHD) is the most serious complication of allogeneic stem cell transplants. Sometimes the graft-versus-host disease becomes chronic and disabling and, if it is severe enough, can be life-threatening. In full haplotype-mismatched stem cell transplantation, in which donors and recipient are identical for one HLA haplotype and incompatible at the HLA class I and II, there are risks of T-cell-mediated alloreactions in the graft-versus-host (GvH) direction. These T-cell-mediated reactions can be eliminated by altering the immunosuppressive intensity of the conditioning to prevent the rejection of graft and GVHD. On the positive side, GVHD also leads to "graft-versus-leukemia" (GVL) activity, through T-cell-mediated alloreactions directed against host minor or major histocompatibility antigens on tumor cells. However, another level of alloreactivity is provided by mismatches between KIR receptors and HLA class I molecules. Indeed, in the full haplotype-mismatched setting, NK cells have been demonstrated to exert an important GVL effects (Ruggeri *et al.*,

1999). Then, any leukemia cells remaining after chemotherapy and radiation therapy should be killed by the immune reaction of the donor cells.

f) Role of NK cell alloreactivity in HSCT and cellular therapy

Cell-based therapies represent an area of exciting scientific and clinical development. Because of the relatively poor outcomes of patients treated only with chemotherapy, autologous HCT and more interestingly allo-HCT have been used as consolidation therapy for patients with AML. The cure of refractory leukemia and other hematologic malignancies following allogeneic stem cell transplantation has been largely attributable to the ability of donor immune cells in the graft to recognize and eliminate tumor cells that have escaped to high-dose of chemotherapy (Ruggeri *et al.*, 2002). A major barrier to the success of allo-HCT is the toxicity associated with the procedure. Many variables influence treatment related mortality, including host factors (age, prior treatment, and performance status) and transplantation characteristics (conditioning regimen, MHC disparity between donor and recipient, and stem-cell source).

It has been established that donor-alloreactive NK cells decreased graft rejection, enhanced engraftment, and mediated the GVL effect in the absence of GVHD after mismatched hematopoietic cell transplantation. The potential for NK alloreactivity in the GVH direction was determined by the KIR ligand incompatibility or “MHC mismatching” between donor and recipient. Then, the goal is to choose a donor in which NK cells will not recognize HLA molecules expressed by leukemia blasts. NK cells would not be inhibited in the recipient and will be able to mediate potent GVL (Ruggeri *et al.*, 2007).

For example, donor and recipient are HLA haplotype-mismatched and KIR-epitope mismatched at the HLA-C locus. If the recipient leukemic blasts express HLA-Cw3, a member of the group 1 HLA-C alleles, they are not recognized by the donor KIR2DL1 then donor NK cells are activated leading to leukemic cells lysis. In the case of leukemia cells express HLA-C alleles of the supertype group 2 (HLA-Cw2, 4, 5, and 6), they are recognized by KIR2DL1 and inhibit the activation of NK cells. KIR epitope mismatching exerts another level of graft alloreactivity and a potent GVL effect (Patil & Schwarzer, 2009) (Figure 4).

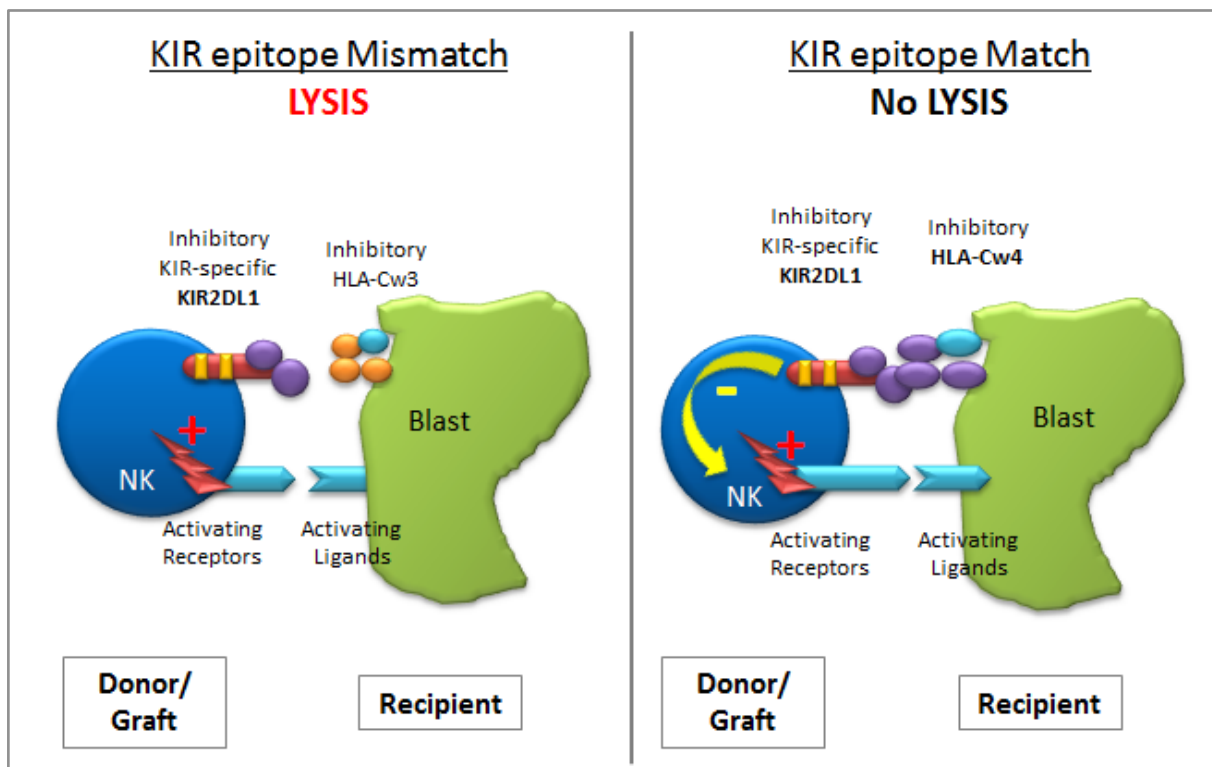

Figure 4 : KIR mismatch in hematopoietic stem cell transplantation

Additional studies have shown that activating KIRs may be involved in the GVL effect, as KIR2DS1 expressed on alloreactive NK that lyse targets cells expressing C2, and can override NKG2A-mediated inhibition (Foley *et al.*, 2008). Another study evaluated the role of donor and recipient KIR genes and found that transplantations from a KIR-B

haplotype donor (containing more activating KIR) resulted in lower relapse and improved survival (Cooley *et al.*, 2009).

Cytomegalovirus (CMV) may also be an important donor factor to potentiate donor NK cell function to eliminate malignant cells. A lower risk of relapse has been reported in umbilical cord blood transplantation and has been associated with CMV reactivation. In recipients of umbilical cord blood transplantation, CMV reactivation induces a rapid reconstitution of fully functional, educated NK cells with increased survival capacity and the ability to respond rapidly with cytokines. In the absence of CMV reactivation, NK cells remain hyporesponsive and recovery of NK cell effector function does not occur fully for 6 to 12 months (Brunstein *et al.*, 2010; Foley *et al.*, 2011; Foley *et al.*, 2012).

Finally, one strategy is to extend the collection of donors NK cells by *ex vivo* expansion with IL-2 and IL-15 and with lymphocytes or feeder before infusion in recipient and without concomitant HSCT (Denman *et al.*, 2012; Fujisaki *et al.*, 2009; Rubnitz *et al.*, 2010).

However, although these projects are promising, questions about NK cells expansion efficacy, cost, treatment toxicity and overall survival of patients remain to consider. Other strategies to exploit favorable donor immunogenetics or to expand NK cells *ex vivo* from blood, progenitors, or pluripotent progenitors may overcome immune barriers of adoptive transfer. Comparative clinical trials will be needed to test these approaches.

II. NATURAL KILLER CELLS

Identified 40 years ago, natural killer (NK) cells are cytotoxic lymphocytes that play a major role in the innate immune system particularly in host immune responses against tumors, viruses, intracellular bacteria and parasites (Herberman *et al.*, 1975; Kiessling *et al.*, 1975). NK cells population represents around 5 to 20% of lymphocytes in human blood and constitutes the third types of cells differentiated from the common lymphoid progenitor generating B and T lymphocytes (Bisset *et al.*, 2004; Galy *et al.*, 1995). In contrast cytotoxic T lymphocytes which are activated by ligation to class I MHC molecules with an appropriate specific peptide, one well defined function of NK cells is the lysis of target cells deficient in expression of class I MHC proteins (the well-known “missing self” hypothesis) (Ljunggren & Karre, 1990). In this manner NK cells carry out immune surveillance rather than direct detection of foreign antigens.

A. NK CELLS SUBPOPULATION

NK cells population is heterogeneous; at least 48 different subtypes have been described (Jonges *et al.*, 2001). NK cells are characterized by the expression of CD56, CD16 and lack expression of CD3 (Robertson & Ritz, 1990).

CD56 is an isoform of Neural Cell Adhesion Molecule (NCAM) implicated in cell–cell adhesion (Nitta *et al.*, 1989; Suzuki *et al.*, 1991). NK cells exert cell cytotoxicity by recognizing and inducing lysis of antibody-coated target cells (antibody-dependent cell cytotoxicity (ADCC)) through antibody binding to the receptor CD16 (Fc γ receptor III) (Mandelboim *et al.*, 1999).

NK cells are divided in two subpopulations upon their cell-surface density of CD56 and CD16 (Cooper *et al.*, 2001; Lanier *et al.*, 1986). The majority (90%) of circulating NK cells have low-density expression of CD56 (CD56^{dim}) and express high levels of CD16

(CD16^{high}), whereas 10% of NK cells are CD56^{bright} CD16^{dim} or CD56^{bright} CD16⁻ (Figure 5).

In the CD56^{dim}/CD16^{high} population, cells express high levels of immunoglobulin (Ig)-like NK receptors and contain 10-fold more perforin and granzyme A cytolytic molecules than the CD56^{bright}/CD16^{-/dim} NK cell population. Moreover, NK cell show weak proliferation abilities (Moretta, 2010).

In contrast, the CD56^{bright} /CD16^{-/dim} NK subset produces relatively large amounts of cytokines (e.g. IFN-g, TNF-a, IL-10, IL-5, IL-13) and chemokines (e.g. MIP-1a, MIP-1b, IL-8, RANTES) once activated, but has weak natural cytotoxic activity (Cooper *et al.*, 2001). This cytokines production confers immune-regulatory function to NK cells, enhance the innate immune response and help to shape the subsequent adaptive immune response (Strowig *et al.*, 2008; Yokoyama, 2008). NK cells also express homing molecules and chemokine receptors such as CD62L and CCR7 which enable them to home to secondary lymphoid organs through high endothelial venules (Campbell *et al.*, 2001; Jacobs *et al.*, 2001).

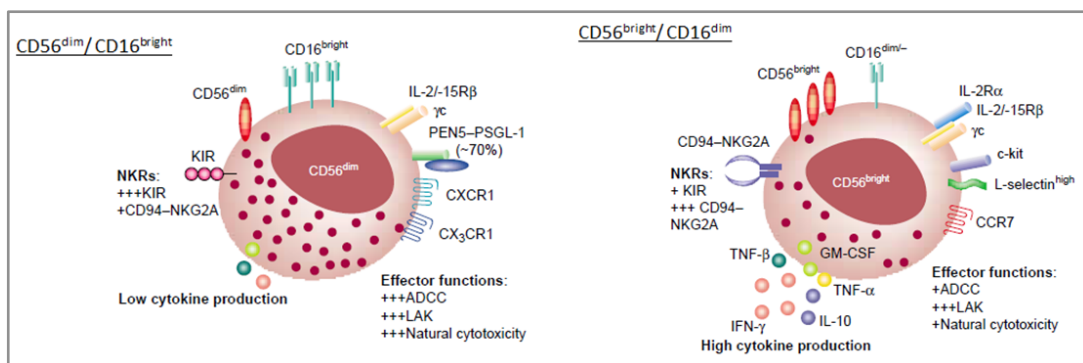

Figure 5 : NK cells sub-population (Cooper *et al.*, 2001)

B. NK CELLS FUNCTIONS

During formation of lytic NK cell immunological synapse via LFA-1/ICAM-1 adherence molecules, mechanisms of ADCC and/or recognition of lacking MHC class I molecule activate the NK cell cytotoxicity. Thus, activated NK cells release cytokines, perforin and granzyme inducing the death of target cell. Furthermore, NK cells contribute to the orientation of immune response recruiting T_H1 and T_H2 lymphocytes and activating antibody presenting cells (APC).

a) Activation of NK cell cytotoxicity

Antibody-dependent cell-mediated cytotoxicity

NK cell are able to kill an antibody-coated target cell. $CD56^{dim}$ NK cells subset expresses high amount of CD16 receptors (Fc γ RIII) which recognizes Fc fragment of immunoglobulins G (IgG). Two isoforms of CD16 have been identified, Fc γ RIII A and B. A isoform is a transmembrane receptor expressed by NK cells and a small population of T lymphocytes as well as monocytes and macrophages. Fc γ RIII A is involved in ADCC, phagocytosis, endocytosis and secretion of cytokines. Isoform B is anchored in the outer layer of the membrane plasma neutrophil.

Recognition of lack of CMH class I

The important feature of NK cells is their inability to kill normal cells, while they are highly cytotoxic for infected or transformed cells. Major histocompatibility complex class I (MHC-I) molecules are usually present on all nucleated human cells. There are two different classes of MHC molecules: MHC class I and II that differ in their structure, participation, and at times in their distribution among varied cells. These molecules share a few common attributes: spatial location on cell membranes and

presentation of antigens to immune competent cells. MHC class I molecules presents viral or tumor antigens to CD8⁺ T-cells, whereas the processed bacterial antigens are presented by MHC class II molecules to CD4⁺ T-cells. Thus, MHC molecules, through their presentation, make the immune competent cells alert and initiate a cascade of events to set up a designated and customized adaptive immunity.

If the target is an allogeneic cell, it certainly possesses compatible MHC antigens. But, if the target is a malignant cell, it is most commonly associated with the loss or down-regulation of MHC class I molecules (Elkins *et al.*, 1984; Urlacher *et al.*, 1987). Then, since there is no antigen presentation, CD8⁺ T-cells do not recognize and do not kill these potential target cells.

NK activation is controlled by the integration of signals from activation and inhibitory receptors. Inhibitory NK cell receptors recognize self MHC class I and restrain NK cell activation (**Figure 6 A**) (Cassidy *et al.*, 2014; Mocikat *et al.*, 2003). When inhibitory MHC class I molecules have a defect of presentation (lost or absence), inhibitory KIR receptors are not engaged, reducing the signal threshold for triggering. Thus, if there are activating ligands, activation of NK cells predominates (**Figure 6B**). In some circumstance, activating ligands are increased and this leads to activation of NK cells without loss of MHC class I (**Figure 6C**) (Ganal *et al.*, 2012; Lanier, 2003). Actually, these signals are combined and then NK cell decides to respond to the target cell or not. NK cell activation remains complex with influences from NK cell environment, cytokines and cytokines receptors signals, exposure to viruses and all receptors signals (Vivier *et al.*, 2011).

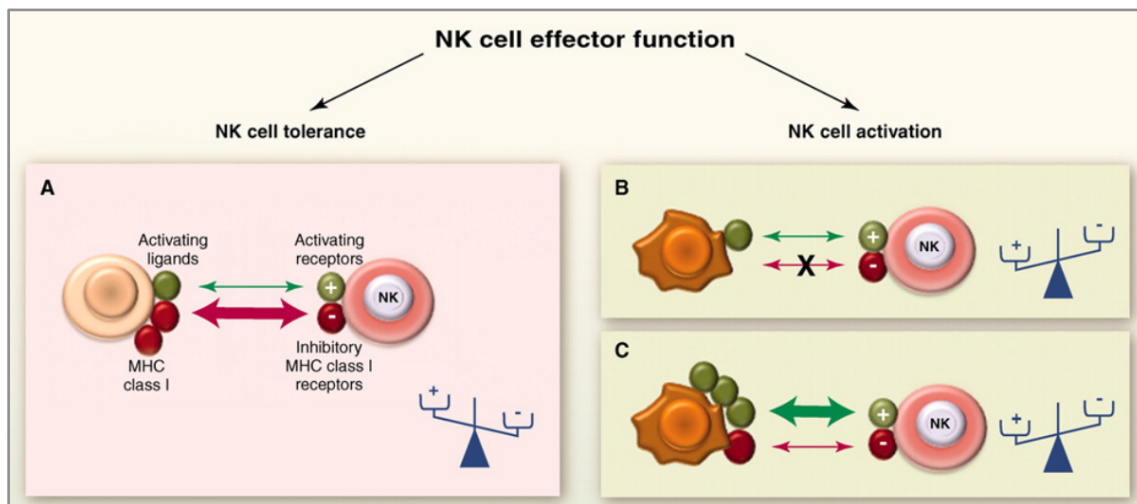

Figure 6 : Regulation of NK cell effector activation (Vivier *et al.*, 2011)

b) NK cytotoxicity

Granule exocytosis

NK cell uses two main mechanisms to kill tumor cells : granule exocytosis and death receptors (Smyth *et al.*, 2005). Cytotoxic granules contain perforin, granzymes, and other effector proteins of cytotoxicity. Granules are directed to the site of cell–cell-contact and fuse with the plasma membrane and secrete soluble effector molecules into the tight cytotoxic synapse. CD107a or LAMP-1 (Lysosomal-Associated Membrane Protein 1) is a marker of NK cell functional activity using multi-parameter flow cytometry. During degranulation, CD107a is significantly up-regulated to the surface of activated NK cells (Alter *et al.*, 2004; Uhrberg, 2005).

To destroy these targets NK cells mostly use the granule exocytosis pathway, which releases perforin and granzyme from cytolytic granules into the immunological synapse formed with the target (Trapani & Smyth, 2002). Granzyme-A and -B, the most abundant granzymes, are delivered to the target cell cytosol through perforin and independently induce cell death. Granzyme-B enters the target-cell cytosol and induces apoptosis through caspase-dependent and caspase-independent mechanisms.

Granzyme-B shares substrate specificity with many members of the caspase family of cysteine proteases. It cleaves and activates the apical caspases, caspase8, as well as caspase 3, caspase 6, and caspase 7. Granzyme-B can directly activate caspases3 and is capable of triggering apoptosis at multiple points of the caspase-dependent pathway and therefore is not absolutely dependent on caspase8 cleavage. Granzyme-B can also directly cleave BID (BH3 Interacting Death Domain) and CytoC (Cytochrome-C) release from mitochondria. Cells overexpressing natural inhibitors of caspases such as Bcl2 (B-Cell Leukemia-2), CRMA (Cytokine Response Modifier A) and SPI2 are sensitive to Granzyme-B mediated apoptosis. Granzyme-B promotes apoptosis by several mechanisms including cleaving ICAD (Inhibitor of CAD)/DFF45 (DNA Fragmentation Factor-45), the inhibitor of CAD (Caspase-Activated DNase)/DFF40 (DNA Fragmentation Factor-40). This pathway therefore provides an immune mechanism to eliminate tumors by DNA fragmentation (Smyth & Trapani, 1995; Trapani *et al.*, 1998) (**figure 7**). Although Granzyme-B is required for efficient apoptotic killing of cells, Granzyme-A is able to achieve the same effect, but not with the same efficiency or rapidity (Blink *et al.*, 1999).

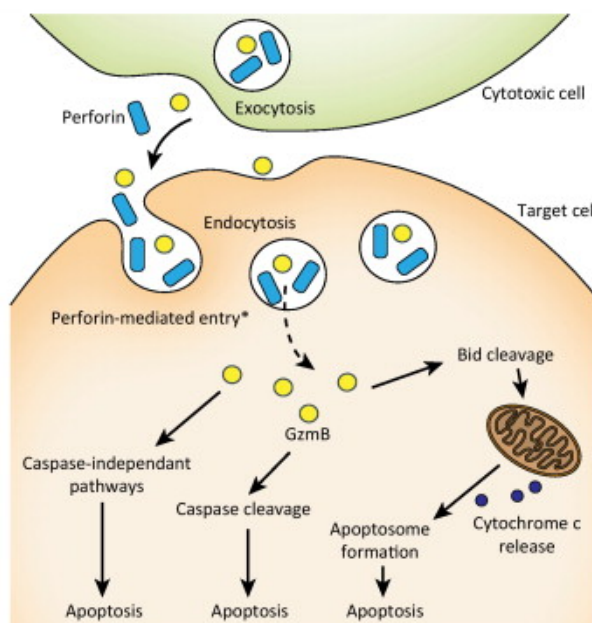
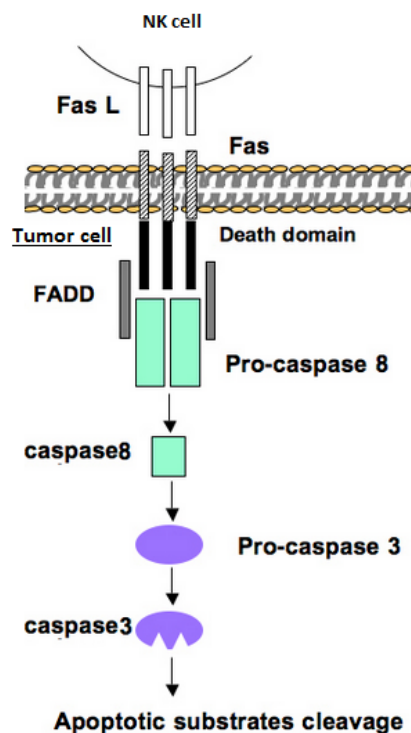

Figure 7 : Granzyme Pathways (Hiebert & Granville, 2012)

Death receptors

A second pathway involves death molecules produced by NK cells such as TNF α (Tumor Necrosis Factor), TRAIL (TNF-related apoptosis-inducing Ligand) and FASL (FAS Ligand). Death of tumor cell can be induced by the binding of ligands such as FASL to specific receptors FAS located at the cell surface. FAS contains a cytoplasmic death domain where FADD (Fas-associated death domain) can bind in presence of FasL, and recruit pro-caspase 8 for subsequent activation in caspase 8. This induces caspase 3 activation. Caspase 3 cleaves I-CAD, the inhibitor of CAD, which is released to enter the nucleus and cleaves DNA (Nagata & Golstein, 1995; Van Parijs & Abbas, 1996; Zamai *et al.*, 1998) (figure 8).



APOPTOSIS by DNA fragmentation

Figure 8 : Death receptors signaling pathway

(Adapted from <http://www.bioscience.org>)

c) Cytokines production and regulation of immune response

The cytokine microenvironment and interactions with other cells of the immune system, such as T cells, dendritic cells (DC) and macrophages define the intensity and the quality of NK cell cytotoxic and cytokine responses (Long, 2007). On the inflammatory site, sentinel immune cells that include dendritic cells, macrophages, and pathogen-infected tissue cells release interleukin-1 (IL-1), IL-10, IL-12, IL-15, and IL-18 (Cooper *et al.*, 2001). Rapidly, CD16^{bright} NK cells that constitutively express cytokine receptors to their surface produce a large variety of cytokines and chemokines. The main cytokines produced by NK cells are tumor necrosis factor- α (TNF- α) and interferon γ (IFN- γ). NK cells can also secrete several other factors, including immune regulatory cytokines such as IL-5, IL-10, IL-13, the growth factor GM-CSF, and the chemokines MIP-1 α , MIP-1 β , IL-8, and RANTES (Bluman *et al.*, 1996; Fehniger *et al.*, 1999; Maghazachi, 2010; Warren *et al.*, 1995). This production depends on the NK cell stimulation type and the time course after activation (Fauriat *et al.*, 2010; Vivier *et al.*, 2008). Through cytokines and chemokines, NK cells participate in a complex interaction network with other lymphocytes, dendritic cells, and macrophages.

It is also known that IL-2 promotes NK cell proliferation, cytotoxicity and, to some extent, cytokine secretion and that after activation of innate immune cells by pattern recognition receptors, NK cells can amplify cytokine signals (Trinchieri, 1989).

INF γ and TNF α influence both the innate immune response by activating macrophages and maturation of pro-inflammatory DC, and the adaptive immune response by promoting polarization of the CD4⁺ lymphocytes in T_H1 (Martin-Fontecha *et al.*, 2004). INF γ and TNF α have also been shown to be essential in viral and tumor clearance (Balkwill, 2009; Ikeda *et al.*, 2002).

GM-CSF is an important growth factor secreted by NK cells inducing tolerogenic DC maturation and may indirectly have an impact on the formation of regulatory LT (LTreg). It is also an essential factor for neutrophils growth (Levitt *et al.*, 1991).

Cytokines play critical roles in regulating all aspects of immune responses, including lymphoid development, homeostasis, differentiation, tolerance, and memory.

C. NK CELLS RECEPTORS

To recognize and respond to tumor cells, NK cells express many different inhibitory and activating receptors which maintain the balance of positive and negative signals leading to cell tolerance or NK cells activation respectively.

a) NK cells MHC-specific receptors

NK-cell cytotoxicity is downregulated by the engagement of MHC-specific inhibitory receptors. These receptors are represented by the killer cell immunoglobulin (Ig)-like receptors (KIRs) and Ig-like transcripts (ILT2) that belong to the Ig superfamily and CD94 (NKG2A/B and NKG2C/E) molecules that are included in the C-type lectin family. They recognise HLA-A, B, C, E, H and G molecules (Campbell & Purdy, 2011; Middleton *et al.*, 2002) (**Table 4**).

Gene name ¹	CD designation	Recognition motif on HLA ligands
<i>KIR2DL1</i>	CD158a	HLA-C Group 2
<i>KIR2DL2</i>	CD158b1	HLA-C Group 1, and some HLA-C Group 2 and HLA-B
<i>KIR2DL3</i>	CD158b2	HLA-C Group 1, and some HLA-C Group 2 and HLA-B (weaker affinity than 2DL2)
<i>KIR3DL1</i>	CD158e1	Bw4 epitopes among HLA-B allotypes and some HLA-A
<i>KIR3DL2</i>	CD158k	Certain HLA-A allotypes
<i>KIR3DL3</i>	CD158z	Unknown
<i>KIR2DL5A</i> ⁴	CD158f	Unknown
<i>KIR2DL5B</i> ⁴	CD158f	Unknown
<i>KIR2DL4</i>	CD158d	HLA-G
<i>KIR2DS1</i>	CD158h	HLA-C Group 2 ⁵
<i>KIR2DS2</i>	CD158j	HLA-C Group 1 ⁵
<i>KIR2DS3</i>	No CD assigned	HLA-C Group 1 ⁵
<i>KIR2DS4</i>	CD158i	HLA-C (some of both Group 1 and 2), A*11 ⁵
<i>KIR2DS5</i>	CD158g	Unknown
<i>KIR3DS1</i>	CD158e2	HLA-Bw4? ⁷

Table 4. KIR gene products and their HLA ligands (Campbell *et al.*, 2011)

Inhibitory receptors are highlighted in grey

KIR family receptors contains inhibitory receptors but some of them are activating. KIR appear to play a critical role in mediating self-tolerance as well as facilitating cytotoxicity against infected or transformed cells (Benson & Caligiuri, 2014). They regulate their responsiveness to signals received from their environment. The KIR receptors family is encoded by 15 genes located on chromosome 19 (19q13.4) on the Leukocyte Receptor Complex (LRC) (Trowsdale, 2001). Nomenclature of KIR is based on the number of C2-type immunoglobulin-like domains in the extracellular region, 2D for two domains, 3D for three domains and by the length of the cytoplasmic domain, L for long-tailed receptors and S for short ones (Marsh *et al.*, 2003).

All inhibitory KIR that have long cytoplasmic domains possessing immunoreceptor tyrosine-based inhibitory motifs (ITIMs) are critical for mediating inhibitory function (MacFarlane & Campbell, 2006). After receptor engagement and tyrosine phosphorylation, ITIMs recruit SH2-containing phosphatase 1/2 (SHP1/2) that can dephosphorylate and inactivate adaptators involved in NK-cell activation.

The receptors that have activating forms are characterized by a short intracellular tail and lack of ITIMs and are associated with a transmembrane signaling adaptor protein, DAP12 (also called KARAP) (Smyth *et al.*, 2005). The DAP12-dependent activation occurs through the recruitment of Syk/ZAP-70 tyrosine kinases (z-chain associated protein).

There is one exception, KIR2DL4, which has a short/long-tailed which is a unique long-tailed activating associated with ITAM-containing Fc ϵ RI- γ adaptor instead of DAP12 (Goodridge *et al.*, 2003; Kikuchi-Maki *et al.*, 2005; Rajagopalan *et al.*, 2001). Although it has a long cytoplasmic tail that is typical of inhibitory KIR, engagement of this receptor results in the activation of NK cells, not for cytotoxicity, but for cytokine and chemokine secretion. Unlike all other KIRs, which are expressed on the surface of NK cells, KIR2DL4 resides in endosomes but its surface levels can be up-regulated upon culture of these NK cells in interleukin 2 (IL-2) (Goodridge *et al.*, 2003; Kikuchi-Maki *et al.*, 2005). Endosomal KIR2DL4 can signal from there through a serine/threonine kinase cascade involving DNA-PKcs, Akt, and NF- κ B (Rajagopalan *et al.*, 2010). This endosomal signaling results in sustained signals for a pro-inflammatory / pro-angiogenic response. The only known ligand of KIR2DL4 is HLA-G (Rajagopalan & Long, 1999). In healthy individuals, while classical MHC-I molecules are widely expressed on most somatic cells, HLA-G expression is restricted to fetal trophoblast cells at the maternal-fetal interface improving pregnancy (Rizzo *et al.*, 2011). Currently this statement is questioned (Li *et al.*, 2009; van der Meer *et al.*, 2007; van der Meer *et al.*, 2004).

ILT receptors are also named LIR for leukocyte immunoglobulin-like receptor or MIR for macrophages Ig-like receptors. LIR receptors are expressed on subsets of NK cells and T cells, as well as on monocytes, B cells, and DC (Cosman *et al.*, 1997; Godal *et al.*, 2010; Samaridis & Colonna, 1997). They are encoded by genes located on chromosome 9. Most ILT receptors are transmembrane proteins containing two or four extracellular Ig domains. These receptors are divided in two groups according to the nature of their transmembrane and cytoplasmic regions.

One group, including ILT2, ILT3, ILT4, ILT5, and LIR8, possesses a longer cytoplasmic domain which contains several ITIM motifs. These ILT are inhibitory, and their co-ligation with certain stimulatory receptors prevents cell activation. The ILT2 (also named LIR1, CD85, MIR7) is an inhibitory receptor which is expressed at the surface of some NK cells. ILT2 contains cytoplasmic immunotyrosine-based inhibition motifs (ITIM) that, once phosphorylated, become docking sites for SHP-1 and SHP-2 phosphatases. ILT2 binds to HLA-G with a 3- to 4-fold higher affinity than to classical MHC class I, which suggests that ILT2/HLA-G recognition may play a dominant role in the regulation of NK-cell functions. It has been shown that ILT2/HLA-G interaction impairs NK-cell functions through the inhibition of the late events of the NK-cell activating synapse (Favier *et al.*, 2010; LeMaoult *et al.*, 2005).

A second group of ILT molecules including ILT1, ILT7, ILT8, and LIR6 have a much shorter cytoplasmic domain lacking obvious signaling motifs. These receptors, however, all possess a charged arginine residue within their transmembrane domain, similar to the charged amino acid seen in activating NK cell receptors which associate with a second signaling subunit.

CD94/NKG2 is a family of C-type lectin receptors. Because CD94 lacks cytoplasmic signaling motifs, the association of CD94 with NKG2 subunits via disulfide-link is critical for the biological activity of this family (Brostjan *et al.*, 2002). CD94/NKG2 family includes seven members: NKG2A, B (NKG2B is an alternative splice variant of

NKG2A), C, D, E and F (Carretero *et al.*, 1997). CD94/NKG2 (A/C/E) heterodimers recognise the non-classical MHC class I molecules HLA-E (Braud *et al.*, 1998; Brooks *et al.*, 1999; Sullivan *et al.*, 2007). These receptors are divided in activating and inhibitory receptors according to their function. Consequently, they stimulate or inhibit cytotoxic activity of NK cells. NKG2A/B contains cytoplasmic ITIM motifs that are typical of inhibitory receptors in other NK cell receptor families such as KIR (Houchins *et al.*, 1991). In contrast, NKG2E, 2F and NKG2C contain a positively charged residue in their transmembrane region that facilitates their association with the ITAM-containing adaptor protein DAP-12 and hence appear to function as activating receptors (Lanier *et al.*, 1998). Genes encoding these receptors are localized in the natural killer complex (NKC) on chromosome 12 (Chang *et al.*, 1995; Lazetic *et al.*, 1996).

b) NK cells activating receptors

NK cells require external positive signals to begin the process of cell activation. These signals are delivered by activating receptors including NKG2D, CD16, the “natural cytotoxicity receptors” (NCRs): NKp30, NKp44 and NKp46; and co-receptors such as 2B4 (CD244) or NTB-A.

NKG2-D was identified in 1991 and its function of activating receptor was first described in 1999. NKG2D is constitutively expressed on the surface of all human NK cells, and γ/δ and CD8⁺ T lymphocytes and is encoded by the highly conserved *KLRK1* (Killer cell lectin-like receptors subfamily K1) gene localized on chromosome 12p13.2 (Bauer *et al.*, 1999; Glienke *et al.*, 1998; Houchins *et al.*, 1991; Watzl, 2003).

As described above, this triggering receptor is a C-type lectin surface receptor, but contrary to other members of NKG2 family, NKG2D is a homodimer that binds to the MHC-class-I-related Chain A and B (MIC-A and MIC-B) and UL-16 protein (ULBPs) (Bauer *et al.*, 1999; Cosman *et al.*, 2001). Ligands for NKG2D are rarely detectable on

the surface of healthy cells and tissues, but are frequently expressed by tumor cell lines and in tumor tissues (Nausch & Cerwenka, 2008; Weiss-Steider *et al.*, 2011). NKG2D also plays a key role in antiviral infections and in autoimmune diseases (Hayakawa, 2012; Nakamura *et al.*, 2013; Zafirova *et al.*, 2011). Engagement of NKG2D/DAP10 by ULBPs or MICs expressed on a target cell can overcome an inhibitory signal generated by NK-cell recognition of MHC class I molecules and trigger NK cytotoxicity.

Upon recognition of its ligands, NKG2D recruits its adaptor proteins DNAX-activating protein 10 (DAP10) and DAP12 in the cell-cell contact site called NK cell immunological synapse (NK-IS). DAP10 is phosphorylated on a tyrosine residue within the cytoplasmic domain, which recruits phosphoinositide kinase-3 (PI3K) and growth factor receptor-bound protein 2 (Grb2). DAP10 molecules may induce the downstream activation of MAP kinases belonging to the signaling kinase cascades, using extracellular signal-regulated

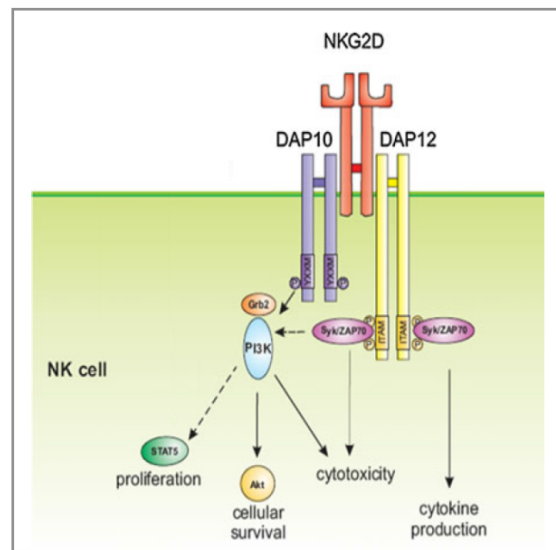

Figure 9 : NKG2D signaling pathways

(Zafirova *et al.*, 2011)

protein kinase ERK1/2, the mitogen-activated protein kinases (MAPKs), JAK2, and STAT factors (Watzl, 2003) (**Figure 9**). DAP12 mediates signaling via Syk/ZAP70. This provides a platform for intracellular signal transduction inducing the cytotoxic activity of NK cells and the lysis of their targets cells by perforin degranulation (Dustin & Long, 2010; Gilfillan *et al.*, 2002). NKG2D appears to play either a complementary or a synergistic role with NCRs.

CD16 (FcγRIIIa) has been described as a receptor expressed on NK cells that facilitates antibody dependent cellular cytotoxicity (ADCC) by binding to the Fc portion of various antibodies (Aramburu *et al.*, 1995; Cerwenka & Lanier, 2001). This is the best-characterized membrane receptor responsible for the NK cell mediated-lysis. CD16, the low-affinity receptor for the Fc portion of some IgG, is associated with FcγRI γ chain which participates in signal transduction by increasing intracellular Ca²⁺ levels and a cascade of bio-chemical events leading to the production of perforine, granzyme and cytokines such as IFN-γ (Lanier *et al.*, 1991; Vivier *et al.*, 1991).

NKp46, NKp44, and NKp30 are important mediators of NK cell cytotoxicity. They are also named NCR1, NCR2 and NCR3 respectively. The identification of NCRs was achieved in the 1990s and revealed that NKp46 and NKp30 are constitutively expressed by NK cells whereas NKp44 is induced upon NK cell activation or cultured in presence of interleukin 2 (Cantoni *et al.*, 2003; Pende *et al.*, 1999; Sivori *et al.*, 1997; Vitale *et al.*, 1998). The NCR family is composed by a heterogeneous group of molecules belonging to the Ig superfamily that are associated to different immune receptor tyrosine-based activating motif (ITAM). All of the NCRs comprise an extracellular ligand-binding domain, which binds to cellular and exogenously derived ligands, a transmembrane domain, and a short cytosolic domain (Biassoni, 2009). NCR transmembrane portions contain positively charged amino acids that are crucial for their association with distinct signal-transducing molecules bearing immune receptor tyrosine-based activating motifs.

NKp46/NCR1 is encoded by the NCR1 gene, which maps in the telomeric region of LRC on human chromosome 19q13.42 (Biassoni, 2008; Moretta *et al.*, 2001). This gene is located in the highly polymorphic telomeric end of the class III region of the human MHC locus.

NKp46 structure of 46-kDa is composed by extracellular Ig-like C2-type domains connected to the transmembrane domain by a short, 25-residue-long peptide. The amino terminal portion of the transmembrane region of NKp46 contains an arginine positively charged residue (green), which is involved in the formation of a salt bridge with an aspartic acid negatively charged residue (red). This residue is associated with CD3 ζ or Fc ϵ R γ adaptor proteins that contain ITAM motifs (blue) (Figure 10).

The recognition of haemagglutinin (HA) in influenza-infected cells, make a direct molecular interaction with NKp46 ligand (Mandelboim *et al.*, 2001). NKp46 recognizes also unknown ligands expressed on pancreatic b-cells and on stellate cells in the liver which triggers an NK cell response, leading to the development of type I diabetes and to protection from liver fibrosis (Gur *et al.*, 2012; Gur *et al.*, 2010).

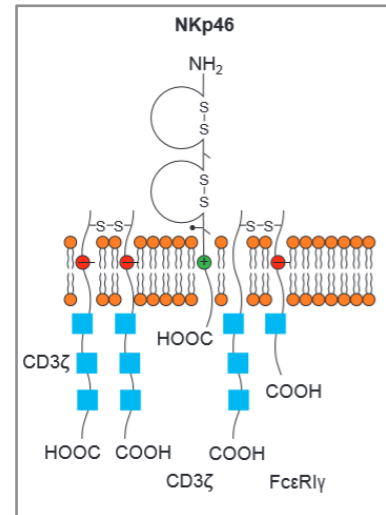

Figure 10 : The molecular structure of NKp46
(Moretta *et al.* 2000)

Binding of ligands to the extracellular immunoglobulin-like domain of NKp30 induces a slight conformational reorganisation of the ligand-binding interface. CD3 ζ and Fc ϵ R γ domains are phosphorylated by tyrosine kinases of the Src family, followed by the recruitment of Syk and ZAP70 tyrosine kinases. This signaling pathway triggers the NKp46-mediated cytotoxicity and cytokine release under crosslinking conditions (Sivori *et al.*, 1997). Indeed, NKp46 masked by specific mAbs inhibits lysis of the majority of human tumors cells, including lung, liver and breast carcinomas, melanoma, and Epstein–Barr virus (EBV)-transformed cell lines (Pessino *et al.*, 1998; Sivori *et al.*, 1999; Sivori *et al.*, 1997).

NKp44/NCR2 is encoded by similar gene to that coding for NKp30, *NCR2*, maps on human chromosome 6p21.1, position located to the human triggering receptor expressed on myeloid cells (TREM) gene cluster (Cantoni *et al.*, 1999).

The NKp44 receptor displays a single Ig-like type V domain and NKp44 molecule is approximately 44kDa. NKp44 glycoprotein is associated with the ITAM-bearing KARAP/DAP12 signal-transducing molecules that become tyrosine phosphorylated upon NKp44 cross-linking (Cantoni *et al.*, 1999; Vitale *et al.*, 1998).

The cellular ligand of NKp44 (NKp44L) is expressed on CD41+ T-cells during HIV infection and its expression is correlated with the decline of the CD41+ T-cell count, both

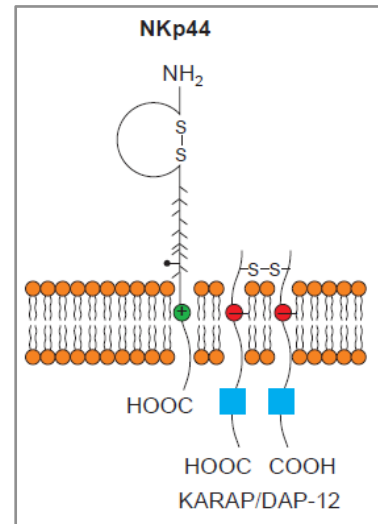

ex vivo in HIV-infected patients and in vivo in SHIV-infected macaques (Vieillard *et al.*, 2008; Vieillard *et al.*, 2005; Ward *et al.*, 2007). A novel NKp44 ligand has been detected in 2013, it is an isoform of mixed-lineage leukemia-5 (MLL5), located in the human chromosome band 7q22. NKp44L was not detectable at a steady state in the normal tissues but was present in a broad range of hematopoietic and non-hematopoietic tumor and transformed cells, where it could trigger autologous NK cells (Baychelier *et al.*, 2013).

The expression of NKp44 may play a role in the marked increase of cytolytic activity displayed by activated NK cells, whereas the lysis of some target cells is only marginally NKp44-dependent, as demonstrated by the lack of significant interference with cytotoxicity by antibody-mediated blocking of this molecule (Cantoni *et al.*, 1999; Vitale *et al.*, 1998).

NKp30/NCR3 is encoded by the *NCR3* gene is located on human chromosome 6p21.3, in the HLA class III region, close to the genes for lymphotoxin β and the allograft inflammatory factor (AIF) (Trowsdale, 2001; Trowsdale *et al.*, 2001).

NKp44 and NKp30 display Ig-V domains belonging to different subtypes, with NKp44 containing two disulfide bridges. NKp30 is associated with immune receptor tyrosine based activation motif (ITAM)-containing adaptor proteins, such as disulfide-linked homodimers of CD3 ζ and possibly heterodimers of CD3 ζ with the g-chain of the high-affinity Fc receptor for IgE (Fc ϵ R γ).

During immune surveillance of malignantly transformed cells, NKp30 recognizes the tumor antigens B7-H6 and BCL-2-associated gene 6 (BAG6, also known as BAT3) which leads to NK cell killing of the tumor cell and cytokine release (Kaifu *et al.*, 2011; Pogge von Strandmann *et al.*, 2007). B7-H6 is thought to be a tumor-specific ligand, because its expression has not been detected on healthy cells. NKp30 also binds several viral ligands, including the protein pp65 of HCMV and recognition of vaccinia virus haemagglutinin (HA) inhibits

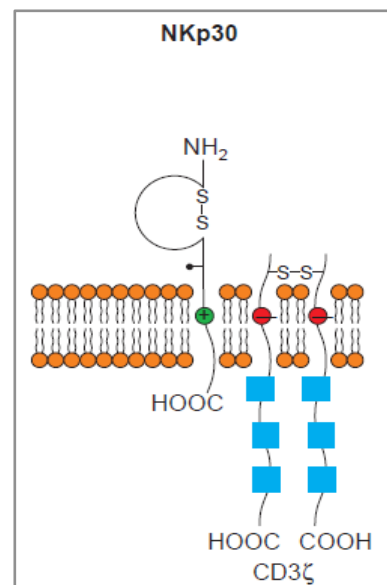

NKp30-mediated functions (Arnon *et al.*, 2005; Hartmann *et al.*, 2012; Jarahian *et al.*, 2011). NKp30 was found to cooperate with NKp46 and NKp44 in the induction of cytotoxicity against a variety of target cells. Moreover, NKp30 is the major receptor responsible for killing some tumor target cells, for which NKp46 or NKp44 do not appear to play a significant role (Pende *et al.*, 1999).

c) Activating co-receptors

Additional surface receptors are involved in triggering NK-mediated cytolytic activity. Among them, the major known co-receptors are DNAM-1, NKp80 and 2B4/NTB-A.

DNAM-1 is a 65-kDa surface glycoprotein, member of the Ig-superfamily, and contains two Ig-like domains of the V-type and encoded by a gene located on human chromosome 18q22.3. It has been implicated in cell adhesion and in triggering of T and NK cell-mediated cytotoxicity (Shibuya *et al.*, 1996). The DNAM-1 adhesion and signaling require the recruitment of tyrosine kinase Fyn and the phosphorylation of Ser329 by protein kinase C (PKC) and Tyr322 (Shibuya *et al.*, 1998). DNAM-1 interacts with adhesion molecule LFA-1 (Leukocyte function associated antigen-1), the poliovirus receptor PVR (CD112) and with Nectin-2 (PVRL2).

NKp80 is encoded by gene mapped on human chromosome 12p13.2-p12.3 in the NK cell. The signal transduction pathway of NKp80 is not dependent on associated ITAM-bearing signal transducing polypeptides. Its transmembrane region does not contain the charged amino acids that stabilize this interaction. The NKp80 cytoplasmic tail is characterized by two tyrosine-based motifs (not corresponding to typical ITAM sequences), which may play a role in NKp80-mediated signaling (Bianchi, 2008). NKp80 cooperates in the NK-mediated killing of phytohemagglutinin (PHA)-stimulated blast cells, but not of various tumor cells. The NKp80 has been shown to bind activation-induced C-type lectin (AICL), also known as CLEC2B. AICL is preferentially expressed on the surface of myeloid cells, and it is encoded in the NK cell. The NKp80/AICL interaction promotes myeloid cell killing and stimulates IFN- γ cytokine release from NK cells and TNF from myeloid cells (Welte *et al.*, 2006).

2B4 and NTB-A are members of the Ig-superfamily, and belong to the CD2 subfamily, which also includes CD48, CD58, CD84, CD150 (also termed SLAM), CS1, and Ly9 (Moretta *et al.*, 2001). All of the genes coding for those coreceptors map on chromosome 1 and can be divided in two clusters: one including CD2 and CD58 genes, which maps at 1p13.1, and the other including NTB-A, CD84, CD150, CD48, CS1, Ly9, and 2B4 genes, which is located at 1q23.2-3 (Morra *et al.*, 2001; Tangye *et al.*, 2000).

To induce activation of NK-mediated cytolytic activity, triggering function of 2B4 or NTB-A is dependent upon the simultaneous engagement of a main activating receptor NCR (Bottino *et al.*, 2001; Parolini *et al.*, 2000).

D. NK CELL IN HEMATOLOGICAL MALIGNANCIES

In the next three reviews, we resumed the mechanisms escape of hematological malignancies from the NK cells surveillance. We also described the different NK cells abnormalities observed in hematological malignancies and we listed novel agents used in current treatments with their impact on NK cells functions.

Revue 1 : Hematological Malignancies Escape from NK Cell Innate Immune Surveillance: Mechanisms and Therapeutic Implications

Revue 2 : Natural Killer Cells Modulation in Hematological Malignancies

Revue 3 : Les Cellules Natural Killer et leurs Anomalies dans les Hémopathies, et plus particulièrement la Maladie de Vaquez

Review Article

Hematological Malignancies Escape from NK Cell Innate Immune Surveillance: Mechanisms and Therapeutic Implications

Laure Farnault,^{1,2} Carole Sanchez,¹ Céline Baier,¹ Thérèse Le Treut,³ and Régis T. Costello^{1,2}

¹UMR1090, Aix-Marseille Université, TAGC, 13008 Marseille, France

²Service d'Hématologie, CHU La Conception, AP-HM, 13005 Marseille, France

³Laboratoire d'Hématologie, CHU Nord, AP-HM, 13015 Marseille, France

Correspondence should be addressed to Régis T. Costello, regis.costello@ap-hm.fr

Received 24 February 2012; Revised 1 June 2012; Accepted 3 June 2012

Academic Editor: Masoud H. Manjili

Copyright © 2012 Laure Farnault et al. This is an open access article distributed under the Creative Commons Attribution License, which permits unrestricted use, distribution, and reproduction in any medium, provided the original work is properly cited.

Hematological malignancies treatment improved over the last years resulting in increased achievement of complete or partial remission, but unfortunately high relapse rates are still observed. Therefore, sustainment of long-term remission is crucial. Immune system has a key role in tumor surveillance. Natural killer (NK) cells, at the frontier of innate and adaptive immune system, have a central role in tumor cells surveillance as demonstrated in the setting of allogenic stem cell transplantation. Nevertheless, tumor cells develop various mechanisms to escape from NK cells innate immune pressure. Abnormal NK cytolytic functions have been described in nearly all hematological malignancies. We present here various mechanisms involved in the escape of hematological malignancies from NK cells surveillance: NK cells quantitative deficiency and NK cell qualitative deficiency by increased inhibition signaling or decreased activating stimuli. A challenge of immunotherapy is to restore an efficient antitumor response. A combination of classical therapy plus immune modulation strategies will soon become a standard of care for hematological malignancies.

1. Introduction

Hematological malignancies are cancers that affect blood, bone marrow, and lymph nodes, thus maintaining a slight contact with immune system cells. Although complete remission (CR) rates have increased over the last years, the high incidence of relapse impairs long-term prognosis. While achievement of CR mainly relies on high-dose chemotherapy, long-term control involves maintenance protocols with daily, weekly, or monthly low dose of chemotherapy prolonged for some months or years, as well as the induction or restoration of immune pressure against minimal residual disease (MRD).

Natural killer (NK) cells play a key role in the immune antitumor response as demonstrated by the low relapse rate obtained in allogenic stem cell transplantation when there is a mismatch of NK inhibitory receptors between the host and the graft [1]. NK cells are lymphocytes that have cytotoxic properties and cytokine-production capacities.

They are innate immune-effector cells that recognize and kill transformed cells (i.e., tumor cells and virus-infected cells). NK cells also have immune regulatory functions thanks to cytokine and chemokine secretion, which favor the development of a T-helper cell (TH1) response [2].

The role of NK cells in immune monitoring of tumors is essential mainly due to their nonhuman leukocyte antigen (HLA) restricted effect, as the absence or abnormal expression of HLA molecules induces NK-cell cytotoxicity (the so-called “missing self” hypothesis of Karre [3]). Indeed, as a consequence of antigen-specific immune pressure by T-cells, tumor cells with downregulated HLA class I molecules are progressively selected and thus could become targets for NK cytotoxicity.

Phenotypically, NK cells are CD3—lymphocytes that express CD56 and/or CD16 at different levels. CD16 is the FcγRIIIa receptor that can mediate antibody-dependent cell-mediated cytotoxicity (ADCC). When a NK cell has recognized its target cell, it kills the target cell by secreting

cytotoxic granules (perforin, granzyme, and granulysin), *via* interaction with the tumor-necrosis factor family (Fas/FasL) or even by cytokine secretion.

NK cells express a large panel of cell-surface activating and inhibitory receptors that recognize ligands on potential target cells. The balance between the signals delivered by activating and inhibitory receptors determines whether or not NK cells kill a target cell and secrete cytokines [4, 5]. Thus, a “dynamic equilibrium concept” between these receptors controls NK cell activation.

Activating receptors are mainly represented by the natural cytotoxicity receptors (NCR) Nkp30/NCR3, Nkp44/NCR2, Nkp46/NCR1, and NKG2D, but also by coreceptors such as 2B4/CD244 or NTBA. Activating receptors have various ligands (see review [6]), such as the stress-induced molecules HLA class-I chain-related A (MICA) and MICB, which activates cytotoxicity in NK cells through their ligation to NKG2D, leading to the destruction of the target cell. Conversely, NK cell cytotoxicity is downregulated by the engagement of HLA-specific inhibitory receptors (killer immunoglobulin-like receptors (KIR) and CD94/NKG2A/B heterodimers), thus protecting normal cells. The recognition of normal HLA class I molecules on target cells downregulates NK cytotoxicity.

Defects in NK-cell cytotoxicity have been observed in all hematological malignancies [7–10]. The escape of hematological malignancies from NK cell immunity can be explained by general mechanisms that are common to all immune-effector cells (see review [4]), that is, saturation of the immune system by rapid growth of the tumor, inaccessibility of the tumor because of deficient vascularization, but also by dysfunction of the immune system that could be restored by immune modulatory intervention. In this paper, we focus on tumor escape from NK cells surveillance by evocating successively various mechanisms involved (summarized in Table 1): the quantitative deficiency of NK cells, their qualitative impairments caused by increased inhibition, or decreased activation signaling. We then examine the key role of cytokine environments in tumor immune escape from NK cells. Finally, we briefly evocate various therapeutic means to enhance NK cell control of hematological malignancies.

2. Tumor Escape from NK Cell Surveillance: Role of NK Cells Effectors' Quantitative Deficiency

Quantitative deficiency is the first mechanism in myelodysplastic syndrome (MDS) to explain how tumors escape from innate immune surveillance. MDS is a preleukemic syndrome characterized by clonal hematopoietic stem-cell disorders and peripheral cytopenia. In 1984, Kerndrup et al., noticed that the decreased NK activity seen in patients with MDS was caused by a decreased number of circulating NK cells [5]. In 1994, Yokose et al., correlated the decreased absolute number of CD3–CD16+ and CD3–CD56+ cells, in patients that had a high risk of MDS, with an increased plasmatic level of sIL-2R [11]. The authors hypothesized

that plasma sIL-2R is produced by malignant MDS cells in the bone marrow and could impair IL-2 stimulated growth of NK cells. Nonetheless, an increased absolute number of NK cells can be associated with impaired cytotoxicity (Sanchez et al., personal data). Thus, in most hematological malignancies, qualitative impairment of the capacity of NK cytotoxic seems more important for tumor escape than quantitative defects.

3. Tumor Escape from NK Cell Surveillance: Role of NK Cells Effectors' Qualitative Deficiency

3.1. NK Cell Qualitative Deficiency by Increased Inhibition of NK Cell Cytotoxicity. Decreased expression of HLA class I molecules is a way for tumor cells to escape specific T-cell surveillance [35, 36]. Interestingly, the downregulation of HLA class I may allow NK cell targeting of tumor cells. Nevertheless, some reports from acute myeloid leukemia (AML) show a normal expression of HLA class I that inhibits the potential action of NK cells and leads to NK cell anergy [12]. Upregulation of HLA-A, -C, and -E molecule surface expression was demonstrated in a drug-resistant leukemic cell line that was also resistant to NK cell cytotoxicity [13]. Demanet et al. showed, in leukemic cells from 24 patients with acute lymphoblastic leukemia (ALL) and chronic lymphocytic leukemia (CLL), selective downregulation of HLA-A and HLA-Bw6 associated with HLA-Bw4 preservation, which provided an escape mechanism not only from T-cells but also from NK cell surveillance [14].

Similarly, in CLL cells, Maki et al. have demonstrated and increased the expression of tolerogenic HLA-G1, a class I molecule that engages NK cell inhibitory molecules. Blockade of HLA-G1 with a specific antibody in CLL samples increased their susceptibility to NK-mediated killing, demonstrating that HLA-G1 participates in protecting CLL cells from NK-mediated killing [15]. Beside leukemia, upregulation of HLA class I has been also described in multiple myeloma and lymphoma [16, 17]. High expression of HLA-I molecules is observed in late-stage multiple myeloma (MM) plasma cells, and confers protection from NK lysis, even though NK cells efficiently kill early-stage tumoral plasma cells in a NCR- and NKG2D-dependent pathways [17].

3.2. NK Cell Qualitative Deficiency by Impaired Activation of NK Cells. In AML, the downregulation of NCRs Nkp30/NCR3 and Nkp46/NCR1 is associated with decreased NK cell cytotoxicity [8, 18]. In sharp contrast with healthy donors, in most patients with AML, the majority of NK cells display low NCR surface density (NCR^{dull}). This phenotype correlates with their weak cytolytic activity against autologous leukemic cells, which cannot be reversed by monoclonal antibody-mediated disruption of HLA class I/KIR-receptor interaction. This phenotype is partially or totally reversed when patients achieve CR, suggesting that this phenotype is probably acquired by direct contact between leukemia blasts and NK cells [19]. In addition, NK cell activity correlates positively with the relapse-free survival

TABLE 1: Mechanisms of escape, receptor, and ligand involved and type of hematological malignancy.

Mechanisms of escape	Receptor in NK cells	Ligand in tumor cells	Hematological malignancy type	References	
NK-cell quantitative deficiency			MDS	[5, 11]	
Increased expression of inhibitory receptors		Upregulation of HLA class I	AML	[12–14]	
			CLL	[14, 15]	
			LAL	[14]	
			MM	[16]	
			Lymphoma	[17]	
Decreased activation by decreased expression of activating receptor or their ligands	NKp30	NCR-ligand	AML	[8, 18–20]	
	NKp46NKG2D		CLL	[21]	
			AML		
			LGL	[8]	
			sMICA and sMICB	CLL	[22]
				CML	[23]
				MM	
				ALL	[24]
	DNAM1		NKG2D on tumor cells	CMML	[25]
					[26]
	CD94/NKG2C		AML	[27]	
	2B4/CD244		AML	[27]	
	CD16		AML		
			MM	[27]	
			MM	[28, 29]	
				[28, 29]	
Impaired NK cell differentiation signaling			CML	[30]	
			PV	Personal data	
Impaired cytokine production	Elevated TNF		MDS	[31]	
	Elevated PDGF		MPS	[32]	
	Elevated TGF β			[33]	
	Decreased IL1		AML	[34]	
	IL2 and IFN γ		ALL	[34]	

Abbreviations: MDS: myelodysplastic syndrome; MPS: myeloproliferative syndrome; ALL: acute lymphoid leukemia; AML: acute myeloid leukemia; CML: chronic myeloid leukemia; MM: multiple myeloma; CMML: myelomonocytic leukemia; LGL: large granular lymphoma; PV: polycythemia vera; sMICA: stress-induced molecule HLA class-I chain-related A; IL: interleukin; IFN γ : interferon-gamma.

of patients with AML [7]. In CLL, although no difference is observed regarding NCR expression between patients and age-matched healthy controls, decreased NCR expression correlates with a poor prognosis [21]. Another mechanism that is pivotal to the immune escape of AML blasts, is the downregulation of ligands relevant in NCR-mediated target-cell recognition [8]. Together, insufficient activation, caused by defects in NCR expression and deficient expression of their ligands on leukemic target cells, may represent a potent method for tumor immune evasion. These abnormalities, when present at the diagnosis of leukemia, may also be related to a worse outcome [19].

Another activating receptor, NKG2D, has a crucial role in NK cell activation. The NKG2D ligands, MICA, and MICB [37], are expressed on half of AML blasts [38]. Leukemia cells that express MICA are lysed *in vitro* by NK cells via NKG2D engagement with the sera of patients, but not of healthy donors as the latter contain elevated levels of seric soluble MICA (sMICA), which impairs NKG2D-mediated immune surveillance of leukemia by triggering internalization of surface NKG2D [39]. In large granular lymphocyte (LGL) leukemia, the impaired cytolytic function of NK cells is associated with reduced expression of NKG2D, which correlates with disease progression [22]. Abnormally high levels of sMICA and weak expression

of NKG2D on NK cells have also been reported in chronic myeloid leukemia (CML) [40]. Interestingly, these abnormalities are reversed by imatinib mesylate therapy. In this setting, the level of MICA expression is under the posttranscriptional control of BCR/ABL tyrosine-kinase activity [40]. Similarly, MM patients have high levels of sMICA whereas tumor cells express low levels of MICA [24]. In contrast, in monoclonal gammopathy of undetermined significance (MGUS), a common disorder of aging and a precursor lesion to MM, tumor cells express high levels of MICA whereas low levels of sMICA are detected in peripheral blood. These data suggest that alterations of the NKG2D pathway are associated with progression from MGUS to MM [24]. Alteration of the NKG2D pathway is also observed in CLL and could, in part, be responsible for the defective NK cytotoxicity observed [15]. CLL leukemic cells do not express MICA- or UL-16-binding proteins (ULBPs) (excepted a very low expression of ULB3) [23]. Similarly, NK-resistant B-ALLs cells do not express MICA, MICB [25], or ULBPs (or only at very low levels) [41].

Recently, Weiss-Steider et al. demonstrated that myelomonocytic leukemia cells produce and secrete MICA and MICB, but also express the receptor NKG2D, resulting in an *in situ* depletion of stress signals, thus avoiding activation of NK cells [26]. Moreover, MICA and MICB appeared to act as a tumor-growth factor resulting in strong tumor proliferation in dose-dependent induction [26].

In addition to the downregulation of NCRs and NKG2D, downregulation of the NK-cell activating receptors or the co-receptor DNAM-1, 2B4/CD244 and CD94/NKG2C have been described in AML [38]. Similar to the NKG2D pathway, chronic exposure of these activating molecules to their ligands may be responsible for their downregulation [27]. This has been demonstrated for DNAM-1 since an inverse correlation between DNAM-1-ligand expression on leukemic blasts and DNAM-1 expression on NK cells has been found. Furthermore, the culture of NK cells from healthy donors with leukemic blasts that express DNAM-1 ligands induce DNAM-1 downregulation at the NK cell surface [27]. NK cell costimulatory molecule 2B4/CD244 has a natural ligand that is CD48, a molecule that is highly expressed in hematological malignancy cells [42]. In MM, despite normal NCR and NKG2D expression [17, 28, 29], there is drastic downregulation of CD16 and 2B4/CD244, which leads to decreased ADCC in MM [28, 29]. The downregulation of CD16 can be explained by the continuous exposure to circulating monoclonal immunoglobulin.

3.3. NK Cell Qualitative Deficiency by Impaired Differentiation Signaling. Altered NK differentiation from CML CD34+ progenitors is linked to their constitutive production of bioactive IL-15, which does not lead to NK cell differentiation [43]. This has been directly attributed to the *BCR-ABL* mutation, because the addition of BCR-ABL-transfected stem cells suppresses the differentiation of autologous normal cord blood CD34+CD38- [30]. Impairment of the signaling pathway is also suspected in polycythemia vera

(PV), an MP disorder associated with an acquired activated mutation of the tyrosin kinase JAK2. Patients with PV have an increased percentage and absolute number of NK cells with impaired cytotoxic functions, not caused by variation in inhibitory or activating receptors (Sanchez et al., personal data). The NK cytotoxic defect may be related to the direct or indirect impairment of cytotoxicity signaling pathways, putatively linked to JAK2 mutation. We are currently testing this hypothesis via the transcriptomic study of NK cells taken from PV patients (Baier et al., personal data).

4. Tumor Escape from NK Cell Surveillance: The Pivotal Role of Cytokines

Several cytokines are known to inhibit NK cell activation. In 1992, Verhoef et al. suggested that elevated and circulating levels of tumor-necrosis factor (TNF) impairs NK cytotoxicity in MDS [31]. Similarly, the high levels of PDGF, detected in myeloproliferative syndrome (MPS) could impair NK cell cytotoxicity [32]. TGF- β has also been implied in the inhibition of NK cell function following chronic interaction with tumor cells [33]. Indeed TGF- β antagonizes IL-15, which induces proliferation and gene expression associated with NK cell activation, resulting in inhibition of both NK cell activating receptor molecules and components of the cytotoxic apparatus [33]. Impaired NK cell function as been also linked to a decrease production of NK cell activating cytokine such as IL-1, interferon-gamma and IL-2 in the peripheral blood mononuclear cells of AML and ALL patients [34].

5. Therapeutics Implications “from Bench to Bedside”

As chemotherapy can disrupt potentially competent immune-surveillance mechanisms, thus favoring a relapse via induced immune suppression, the necessity of developing immunotherapy that enhances immune surveillance after chemotherapy is discontinued is admitted [44]. Markasz et al. have characterized the effect of 28 frequently used chemotherapeutic agents on the capacity of NK cells to kill tumor cells [45]. Although most chemotherapy drugs quantitatively decrease NK cell counts, some inhibit NK-cell activity whereas others enhance NK cells ability to kill tumors cells [45].

The greatest revelation of NK cells role in tumor control has been shown in allogenic transplantation. In 2002, Ruggeri et al. demonstrated a favorable prognosis for AML patients who were recipients of a haploidentical allogenic transplant with a NK HLA-specific receptor mismatch [46]: this enhanced the antileukemic graft reactivity. Interestingly, NK cell mismatch provides a graft-versus-leukemia (GvL) effect that is devoid of the deleterious graft-versus-host (GvH) reaction. This is because host cells, apart from leukemia cells, do not express activating ligands for NK cell cytotoxicity [47, 48]. Conversely, the benefit of NK-cell alloreactivity after unrelated cord-blood stem-cell transplantation remains unclear and is controversial [49]. Miller

TABLE 2: Novel agents used in hematological malignancies and their impact on NK-cell activation.

Class of drugs	Therapeutic molecules	Main indications	Inhibitory receptor ligands	Activating receptors	Activating receptor ligands	References
IMiDs	Thalidomide	Multiple myeloma		NKp46		[67]
	Lenalidomide					
HDACi	Vorinostat	Lymphoma		NKp30 and NKp46	NKG2D and DNAM ligand	[68, 69]
	Panobinostat					
Demethylating agents	5-azacytidine	MDS	Up regulation	KIR	NKG2D ligand	[70, 71]
	5-aza-2'-deoxycytidine					
Proteasome inhibitors	Bortezomib	Multiple myeloma	Downregulation HLA molecules		NKG2D TRAIL and DNAM ligand upregulation	[72–75]
All-trans retinoic acid	Vesanoid	AML3		NKG2D	Upregulation	[76]
Tyrosine kinase inhibitors	Imatinib mesylate	CML		NKG2D	sMICA	[77]
				upregulation	downregulation	

Abbreviations: IMiDs: immunomodulatory drugs; HDACi: Histone deacetylase inhibitors; MDS: myelodysplastic syndrome; AML: acute myeloid leukemia; CML: chronic myeloid leukemia; NK: natural killer cell; sMICA: stress-induced molecule HLA class-I chain-related A.

et al. were the first to infuse NK cells from haploidentical origins into AML recipients in a nontransplant setting [50]. Haploidentical NK cells can persist and expand *in vivo* if patients receive intensive immunosuppression regimens before NK cell infusion [50]. Successful transfer of alloreactive haploidentical KIR ligand-mismatched NK cells was performed in 13 elderly patients after administration of a combined immunosuppressive therapy of fludarabine plus cyclophosphamide, followed by subcutaneous administration of IL-2 for 2 weeks. Donor *versus* recipient alloreactive NK cells were shown to kill recipient leukemia cells. This phase I study demonstrates that infusion of purified NK cells is feasible and safe [51]. A phase II study, using a greater dose of NK cells and multiple infusions is being currently conducted. Similarly, a pilot study on transfer of alloreactive haploidentical KIR ligand-mismatched NK cells has been performed in children with AML after achievement of CR. The study gave encouraging results, and has allowed commencement of a phase II trial as consolidation therapy in children with AML [52]. In MM myeloma, infusion of haploidentical KIR-ligand mismatched NK cells has been proposed in relapsed patients in the setting of autologous stem-cell transplantation [53].

Since allogeneic transplantation raises several problems regarding high morbidity and mortality rates, manipulation of autologous NK cells rises increasing interest. The IL-15 supports large-scale expansion of NK cells by preserving activating-receptor expression [54]. *In vivo*, the TGF- β blockade, by both anti-TGF antibodies and a small molecule inhibitor of TGF- β signaling, is an interesting way to suppress the NK-cytotoxicity inhibition caused by TGF- β release by tumors cells [33]. In addition, because interferon (IFN) α enhances IFN γ and IL-12 secretion, which in turn triggers NK cytotoxicity, Lion et al. proposed IFN α post-CR maintenance immunotherapy for AML patients [55].

Another therapeutic approach to enhance NK cell cytotoxicity is the use of cytokines, such as IL-2, IL12, and IL18 alone, or in association with histamine dihydrochloride, which enhance both NK- and T-lymphocyte proliferation and cytotoxicity [56, 57]. In AML, a postconsolidation regimen with an association between histamine dihydrochloride and IL-2 has resulted in improved progression-free survival (PFS) for patients (at 3 years PFS 40% *versus* 26% for controls) [58]. This association protected NK from the downregulation of activating-receptor expression (more particularly NKp46/NCR1) induced by leukemia cells; thus, it enhanced NK cytotoxicity and tumor immune control with significant improvement in leukemia-free survival [59].

Chemokine manipulation is also of interest as molecules may both attract NK to the tumor-cell microenvironment and stimulate their cytotoxic properties [60]. Specific chemokine inhibitors are currently under investigation, although redundancy and pleiotropy of the chemokine system are obstacles in drug development [61]. An alternative immunotherapy based on cytokine manipulation is NK stimulation via dendritic cells (DCs). Stimulation of DCs using TLR9 agonists converts tolerogenic DCs into immunogenic DCs, and allows DC activation and cytokine secretion, which enhances NK cytotoxicity [62].

Another attractive approach to enhance NK cytotoxicity is to use monoclonal antibodies (mAbs). IPH-2101, a fully human IgG4 anti-KIR mAb (developed by Innate Pharma) is currently being tested in phase I and II clinical trials in patients with AML and MM [63]. Its blockade of inhibition could allow NK-cell activation when activating ligands are present on target cells. Preliminary results show enhanced NK cell activity has a good safety profile [63]. Bispecific mAbs directed against both the target cells and cytotoxic effectors (NK cells) are also currently under investigation. Anti-CD20 mAbs that have enhanced affinity for CD16

have been also developed, and they are more effective at NK activation than rituximab [64, 65]. Similarly, bispecific mAbs, which targets the CD16 molecule on the NK cell surface and CD30 (the molecule expressed in Hodgkin's tumor and anaplastic T-cell lymphoma), are currently being evaluated [66].

Novel drugs with immunomodulatory properties are increasingly being used these days to treat hematological malignancies. Most have an impact on NK cell activity and/or target susceptibility to NK lysis. Table 2 briefly outlines the major mechanisms identified or suspected that could explain their impact on NK cell cytotoxicity (see [9]).

6. Conclusion

As the knowledge of NK cells' role in tumor surveillance increases, therapies to boost NK immunity have emerged. Because impairment of NK cell cytotoxicity is associated with almost all hematological malignancies, restoration of normal NK function is an attractive goal for immunotherapy. New approaches attempt to boost immune surveillance by enhancing NK cytotoxicity and tumor-cell susceptibility to NK lysis. Because the mechanisms that tumors use to escape NK surveillance are multiple, there are multiple potential ways to increase the NK cell lysis of tumor cells, that is, by increasing expression of activating receptors, diminishing or counteracting expression of inhibitory receptors, increasing NK cell cytotoxicity, and modulating target-cell sensibility to NK cell lysis via upregulation of ligand expression on the tumor-cell's surface. Combined strategies, including cytotoxic conventional chemotherapy with immunomodulatory agents, and NK cell manipulation, are becoming increasingly attractive.

References

- [1] L. Ruggeri, A. Mancusi, E. Burchielli, F. Aversa, M. F. Martelli, and A. Velardi, "Natural killer cell alloreactivity in allogeneic hematopoietic transplantation," *Current Opinion in Oncology*, vol. 19, no. 2, pp. 142–147, 2007.
- [2] A. A. Maghazachi, "Role of chemokines in the biology of natural killer cells," *Current Topics in Microbiology and Immunology*, vol. 341, pp. 37–58, 2010.
- [3] K. Karre, "Express yourself or die: peptides, MHC molecules, and NK cells," *Science*, vol. 267, no. 5200, pp. 978–979, 1995.
- [4] R. T. Costello, J. A. Gastaut, and D. Olive, "Tumor escape from immune surveillance," *Archivum Immunologiae et Therapiae Experimentalis*, vol. 47, no. 2, pp. 83–88, 1999.
- [5] G. Kerndrup, K. Meyer, J. Ellegaard, and P. Hokland, "Natural killer (NK)-cell activity and antibody-dependent cellular cytotoxicity (ADCC) in primary preleukemic syndrome," *Leukemia Research*, vol. 8, no. 2, pp. 239–247, 1984.
- [6] R. Biassoni, C. Cantoni, D. Pende et al., "Human natural killer cell receptors and co-receptors," *Immunological Reviews*, vol. 181, pp. 203–214, 2001.
- [7] R. T. Costello, C. Fauriat, S. Sivori, E. Marcenaro, and D. Olive, "NK cells: innate immunity against hematological malignancies?" *Trends in Immunology*, vol. 25, no. 6, pp. 328–333, 2004.
- [8] R. T. Costello, S. Sivori, E. Marcenaro et al., "Defective expression and function of natural killer cell-triggering receptors in patients with acute myeloid leukemia," *Blood*, vol. 99, no. 10, pp. 3661–3667, 2002.
- [9] C. J. Sanchez, T. Le Treut, A. Boehrer et al., "Natural killer cells and malignant haemopathies: a model for the interaction of cancer with innate immunity," *Cancer Immunology, Immunotherapy*, vol. 60, no. 1, pp. 1–13, 2011.
- [10] J. Rey, C. Veuillen, N. Vey, R. Bouabdallah, and D. Olive, "Natural killer and $\gamma\delta$ T cells in haematological malignancies: enhancing the immune effectors," *Trends in Molecular Medicine*, vol. 15, no. 6, pp. 275–284, 2009.
- [11] N. Yokose, K. Ogata, T. Ito et al., "Elevated plasma soluble interleukin 2 receptor level correlates with defective natural killer and CD8+ T-cells in myelodysplastic syndromes," *Leukemia Research*, vol. 18, no. 10, pp. 777–782, 1994.
- [12] M. Wetzler, M. R. Baer, S. J. Stewart et al., "HLA class I antigen cell surface expression is preserved on acute myeloid leukemia blasts at diagnosis and at relapse," *Leukemia*, vol. 15, no. 1, pp. 128–133, 2001.
- [13] C. F. Classen, C. S. Falk, C. Friesen, S. Fulda, I. Herr, and K. M. Debatin, "Natural killer resistance of a drug-resistant leukemia cell line, mediated by up-regulation of HLA class I expression," *Haematologica*, vol. 88, no. 5, pp. 509–521, 2003.
- [14] C. Demanet, A. Mulder, V. Deneys et al., "Down-regulation of HLA-A and HLA-Bw6, but not HLA-Bw4, allospecificities in leukemic cells: an escape mechanism from CTL and NK attack?" *Blood*, vol. 103, no. 8, pp. 3122–3130, 2004.
- [15] G. Maki, G. M. Hayes, A. Naji et al., "NK resistance of tumor cells from multiple myeloma and chronic lymphocytic leukemia patients: implication of HLA-G," *Leukemia*, vol. 22, no. 5, pp. 998–1006, 2008.
- [16] M. Challa-Malladi, Y. K. Lieu, O. Califano et al., "Combined genetic inactivation of β 2-microglobulin and CD58 reveals frequent escape from immune recognition in diffuse large B cell lymphoma," *Cancer Cell*, vol. 20, no. 6, pp. 728–740, 2011.
- [17] E. Carbone, P. Neri, M. Mesuraca et al., "HLA class I, NKG2D, and natural cytotoxicity receptors regulate multiple myeloma cell recognition by natural killer cells," *Blood*, vol. 105, no. 1, pp. 251–258, 2005.
- [18] S. Sivori, D. Pende, C. Bottino et al., "NKp46 is the major triggering receptor involved in the natural cytotoxicity of fresh or cultured human NK cells. Correlation between surface density of NKp46 and natural cytotoxicity against autologous, allogeneic or xenogeneic target cells," *European Journal of Immunology*, vol. 29, no. 5, pp. 1656–1666, 1999.
- [19] C. Fauriat, S. Just-Landi, F. Mallet et al., "Deficient expression of NCR in NK cells from acute myeloid leukemia: evolution during leukemia treatment and impact of leukemia cells in NCR dull phenotype induction," *Blood*, vol. 109, no. 1, pp. 323–330, 2007.
- [20] R. T. Costello, C. Fauriat, and D. Olive, "Natural killer cells and immunity against cancer," *Discovery Medicine*, vol. 4, no. 23, pp. 333–337, 2004.
- [21] R. T. Costello, B. Knoblauch, C. Sanchez, D. Mercier, T. Le Treut, and G. Sébahoun, "Expression of natural killer cell activating receptors in patients with chronic lymphocytic leukaemia," *Immunology*, vol. 135, no. 2, pp. 151–157, 2012.
- [22] P. K. Epling-Burnette and T. P. Loughran, "Survival signals in leukemic large granular lymphocytes," *Seminars in Hematology*, vol. 40, no. 3, pp. 213–220, 2003.
- [23] A. Poggi, C. Venturino, S. Catellani et al., "V δ 1 T lymphocytes from B-CLL patients recognize ULBP3 expressed on leukemic

- B cells and up-regulated by trans-retinoic acid," *Cancer Research*, vol. 64, no. 24, pp. 9172–9179, 2004.
- [24] M. Jinushi, M. Vanneman, N. C. Munshi et al., "MHC class I chain-related protein A antibodies and shedding are associated with the progression of multiple myeloma," *Proceedings of the National Academy of Sciences of the United States of America*, vol. 105, no. 4, pp. 1285–1290, 2008.
- [25] A. Romanski, G. Bug, S. Becker et al., "Mechanisms of resistance to natural killer cell-mediated cytotoxicity in acute lymphoblastic leukemia," *Experimental Hematology*, vol. 33, no. 3, pp. 344–352, 2005.
- [26] B. Weiss-Steider, I. Soto-Cruz, C. A. Martinez-Campos, and J. F. Mendoza-Rincon, "Expression of MICA, MICB and NKG2D in human leukemic myelomonocytic and cervical cancer cells," *Journal of Experimental and Clinical Cancer Research*, vol. 30, no. 1, article 37, 2011.
- [27] B. Sanchez-Correa, I. Gayoso, J. M. Bergua et al., "Decreased expression of DNAM-1 on NK cells from acute myeloid leukemia patients," *Immunology and Cell Biology*, vol. 90, pp. 109–115, 2011.
- [28] H. Matsuzaki, T. Kagimoto, T. Oda, F. Kawano, and K. Takatsuki, "Natural killer activity and antibody-dependent cell-mediated cytotoxicity in multiple myeloma," *Japanese Journal of Clinical Oncology*, vol. 15, no. 4, pp. 611–617, 1985.
- [29] C. Fauriat, F. Mallet, D. Olive, and R. T. Costello, "Impaired activating receptor expression pattern in natural killer cells from patients with multiple myeloma," *Leukemia*, vol. 20, no. 4, pp. 732–733, 2006.
- [30] H. Nakajima, R. Zhao, T. C. Lund et al., "The BCR/ABL transgene causes abnormal NK cell differentiation and can be found in circulating NK cells of advanced phase chronic myelogenous leukemia patients," *Journal of Immunology*, vol. 168, no. 2, pp. 643–650, 2002.
- [31] G. E. G. Verhoef, P. De Schouwer, J. L. Ceuppens, J. Van Damme, W. Goossens, and M. A. Boogaerts, "Measurement of serum cytokine levels in patients with myelodysplastic syndromes," *Leukemia*, vol. 6, no. 12, pp. 1268–1272, 1992.
- [32] G. M. Gersuk, R. Carmel, S. Pattamakom, P. M. Challita, A. P. Rabinowitz, and P. K. Pattengale, "Quantitative and functional studies of impaired natural killer (NK) cells in patients with myelofibrosis, essential thrombocythemia, and polycythemia vera-I: a potential role for platelet-derived growth factor in defective NK cytotoxicity," *Natural Immunity*, vol. 12, no. 3, pp. 136–151, 1993.
- [33] E. B. Wilson, J. J. El-Jawhari, A. L. Neilson et al., "Human tumour immune evasion via TGF- β blocks NK cell activation but not survival allowing therapeutic restoration of anti-tumour activity," *PLoS ONE*, vol. 6, no. 9, Article ID e22842, 2011.
- [34] F. Tajima, T. Kawatani, A. Endo, and H. Kawasaki, "Natural killer cell activity and cytokine production as prognostic factors in adult acute leukemia," *Leukemia*, vol. 10, no. 3, pp. 478–482, 1996.
- [35] M. Rowe, R. Khanna, C. A. Jacob et al., "Restoration of endogenous antigen processing in Burkitt's lymphoma cells by Epstein-Barr virus latent membrane protein-1: coordinate up-regulation of peptide transporters and HLA-class I antigen expression," *European Journal of Immunology*, vol. 25, no. 5, pp. 1374–1384, 1995.
- [36] A. Urlacher, A. Falkenrodt, M. M. Tongio, and S. Mayer, "HLA Class I antigens on normal and leukemic cells (quantitative analysis)," *Tissue Antigens*, vol. 29, no. 5, pp. 237–245, 1987.
- [37] R. Biassoni, C. Cantoni, D. Marras et al., "Human Natural Killer cell receptors: insights into their molecular function and structure," *Journal of Cellular and Molecular Medicine*, vol. 7, no. 4, pp. 376–387, 2003.
- [38] B. Sanchez-Correa, S. Morgado, I. Gayoso et al., "Human NK cells in acute myeloid leukaemia patients: analysis of NK cell-activating receptors and their ligands," *Cancer Immunology, Immunotherapy*, vol. 60, no. 8, pp. 1195–1205, 2011.
- [39] V. Groh, J. Wu, C. Yee, and T. Spies, "Tumour-derived soluble MIC ligands impair expression of NKG2D and T-cell activation," *Nature*, vol. 419, no. 6908, pp. 734–738, 2002.
- [40] N. Boissel, D. Rea, V. Tieng et al., "BCR/ABL oncogene directly controls MHC class I chain-related molecule A expression in chronic myelogenous leukemia," *Journal of Immunology*, vol. 176, no. 8, pp. 5108–5116, 2006.
- [41] D. Pende, R. Castriconi, P. Romagnani et al., "Expression of the DNAM-1 ligands, Nectin-2 (CD112) and poliovirus receptor (CD155), on dendritic cells: relevance for natural killer-dendritic cell interaction," *Blood*, vol. 107, no. 5, pp. 2030–2036, 2006.
- [42] S. Sivori, S. Parolini, M. Falco et al., "2B4 functions as a co-receptor in human NK cell activation," *European Journal of Immunology*, vol. 30, no. 3, pp. 787–793, 2000.
- [43] G. Carayol, J. Giron-Michel, B. Azzarone et al., "Altered natural killer cell differentiation in CD34+ progenitors from Chronic Myeloid Leukemia patients," *Oncogene*, vol. 19, no. 23, pp. 2758–2766, 2000.
- [44] A. J. Barrett and B. N. Savani, "Does chemotherapy modify the immune surveillance of hematological malignancies?" *Leukemia*, vol. 23, no. 1, pp. 53–58, 2009.
- [45] L. Markasz, G. Stuber, B. Vanherberghen et al., "Effect of frequently used chemotherapeutic drugs on the cytotoxic activity of human natural killer cells," *Molecular Cancer Therapeutics*, vol. 6, no. 2, pp. 644–654, 2007.
- [46] L. Ruggeri, A. Mancusi, M. Capanni et al., "Donor natural killer cell allorecognition of missing self in haploidentical hematopoietic transplantation for acute myeloid leukemia: challenging its predictive value," *Blood*, vol. 110, no. 1, pp. 433–440, 2007.
- [47] S. S. Farag, T. A. Fehniger, L. Ruggeri, A. Velardi, and M. A. Caligiuri, "Natural killer cell receptors: new biology and insights into the graft-versus-leukemia effect," *Blood*, vol. 100, no. 6, pp. 1935–1947, 2002.
- [48] L. Ruggeri, F. Aversa, M. F. Martelli, and A. Velardi, "Allogeneic hematopoietic transplantation and natural killer cell recognition of missing self," *Immunological Reviews*, vol. 214, no. 1, pp. 202–218, 2006.
- [49] R. Willemze, A. Ruggeri, D. Purtill, C. A. Rodrigues, E. Gluckman, and V. Rocha, "Is there an impact of killer cell immunoglobulin-like receptors and KIR-ligand incompatibilities on outcomes after unrelated cord blood stem cell transplantation?" *Best Practice and Research*, vol. 23, no. 2, pp. 283–290, 2010.
- [50] J. S. Miller, Y. Soignier, A. Panoskaltsis-Mortari et al., "Successful adoptive transfer and in vivo expansion of human haploidentical NK cells in patients with cancer," *Blood*, vol. 105, no. 8, pp. 3051–3057, 2005.
- [51] A. Curti, L. Ruggeri, A. D'Addio et al., "Successful transfer of alloreactive haploidentical KIR ligand-mismatched natural killer cells after infusion in elderly high risk acute myeloid leukemia patients," *Blood*, vol. 118, no. 12, pp. 3273–3279, 2011.
- [52] J. E. Rubnitz, H. Inaba, R. C. Ribeiro et al., "NKAML: a pilot study to determine the safety and feasibility of haploidentical natural killer cell transplantation in childhood acute myeloid

- leukemia," *Journal of Clinical Oncology*, vol. 28, no. 6, pp. 955–959, 2010.
- [53] J. Shi, G. Tricot, S. Szmania et al., "Infusion of haplo-identical killer immunoglobulin-like receptor ligand mismatched NK cells for relapsed myeloma in the setting of autologous stem cell transplantation," *British Journal of Haematology*, vol. 143, no. 5, pp. 641–653, 2008.
- [54] G. Suck, V. Y. S. Oei, Y. C. Linn et al., "Interleukin-15 supports generation of highly potent clinical-grade natural killer cells in long-term cultures for targeting hematological malignancies," *Experimental Hematology*, vol. 39, no. 9, pp. 904–914, 2011.
- [55] E. Lion, E. L. J. M. Smits, Z. N. Berneman, and V. F. I. Van Tendeloo, "Acute myeloid leukemic cell lines loaded with synthetic dsRNA trigger IFN- γ secretion by human NK cells," *Leukemia Research*, vol. 33, no. 4, pp. 539–546, 2009.
- [56] R. Åhlberg, B. MacNamara, M. Andersson et al., "Stimulation of T-cell cytokine production and NK-cell function by IL-2, IFN- α and histamine treatment during remission of non-Hodgkin's lymphoma," *Hematology Journal*, vol. 4, no. 5, pp. 336–341, 2003.
- [57] C. Lehmann, M. Zeis, and L. Uharek, "Activation of natural killer cells with interleukin 2 (IL-2) and IL-12 increases perforin binding and subsequent lysis of tumour cells," *British Journal of Haematology*, vol. 114, no. 3, pp. 660–665, 2001.
- [58] M. Brune, S. Castaigne, J. Catalano et al., "Improved leukemia-free survival after postconsolidation immunotherapy with histamine dihydrochloride and interleukin-2 in acute myeloid leukemia: results of a randomized phase 3 trial," *Blood*, vol. 108, no. 1, pp. 88–96, 2006.
- [59] A. I. Romero, F. B. Thorén, J. Aurelius, G. Askarieh, M. Brune, and K. Hellstrand, "Post-consolidation immunotherapy with histamine dihydrochloride and interleukin-2 in AML," *Scandinavian Journal of Immunology*, vol. 70, no. 3, pp. 194–205, 2009.
- [60] M. J. Robertson, "Role of chemokines in the biology of natural killer cells," *Journal of Leukocyte Biology*, vol. 71, no. 2, pp. 173–183, 2002.
- [61] A. O. Kittang, K. Hatfield, K. Sand, H. Reikvam, and Ø. Bruserud, "The chemokine network in acute myelogenous leukemia: molecular mechanisms involved in leukemogenesis and therapeutic implications," *Current Topics in Microbiology and Immunology*, vol. 341, pp. 149–172, 2010.
- [62] X. Zhang, M. A. Munegowda, J. Yuan, Y. Wei, and J. Xiang, "Optimal TLR9 signal converts tolerogenic CD4⁺ DCs into immunogenic ones capable of stimulating antitumor immunity via activating CD4⁺ Th1/Th17 and NK cell responses," *Journal of Leukocyte Biology*, vol. 88, no. 2, pp. 393–403, 2010.
- [63] E. Alici, "IPH-2101, a fully human anti-NK-cell inhibitory receptor mAb for the potential treatment of hematological cancers," *Current Opinion in Molecular Therapeutics*, vol. 12, no. 6, pp. 724–733, 2010.
- [64] C. De Romeuf, C. A. Dutertre, M. Le Garff-Tavernier et al., "Chronic lymphocytic leukaemia cells are efficiently killed by an anti-CD20 monoclonal antibody selected for improved engagement of Fc γ RIIIA/CD16," *British Journal of Haematology*, vol. 140, no. 6, pp. 635–643, 2008.
- [65] J. A. Bowles, S. Y. Wang, B. K. Link et al., "Anti-CD20 monoclonal antibody with enhanced affinity for CD16 activates NK cells at lower concentrations and more effectively than rituximab," *Blood*, vol. 108, no. 8, pp. 2648–2654, 2006.
- [66] C. Renner, I. Stehle, F. T. Lee et al., "Targeting properties of an anti-CD16/anti-CD30 bispecific antibody in an in vivo system," *Cancer Immunology, Immunotherapy*, vol. 50, no. 2, pp. 102–108, 2001.
- [67] S. L. Berg, M. S. Cairo, H. Russell et al., "Safety, pharmacokinetics, and immunomodulatory effects of lenalidomide in children and adolescents with relapsed/refractory solid tumors or myelodysplastic syndrome: a Children's Oncology Group phase I consortium report," *Journal of Clinical Oncology*, vol. 29, no. 3, pp. 316–323, 2011.
- [68] S. Diermayr, H. Himmelreich, B. Durovic et al., "NKG2D ligand expression in AML increases in response to HDAC inhibitor valproic acid and contributes to allorecognition by NK-cell lines with single KIR-HLA class I specificities," *Blood*, vol. 111, no. 3, pp. 1428–1436, 2008.
- [69] H. Ogbomo, M. Michaelis, J. Kreuter, H. W. Doerr, and J. Cinatl, "Histone deacetylase inhibitors suppress natural killer cell cytolytic activity," *FEBS Letters*, vol. 581, no. 7, pp. 1317–1322, 2007.
- [70] K. F. Tang, C. X. He, G. L. Zeng et al., "Induction of MHC class I-related chain B (MICB) by 5-aza-2'-deoxycytidine," *Biochemical and Biophysical Research Communications*, vol. 370, no. 4, pp. 578–583, 2008.
- [71] S. Santourlidis, H. I. Trompeter, S. Weinhold et al., "Crucial role of DNA methylation in determination of clonally distributed killer cell Ig-like receptor expression patterns in NK cells," *Journal of Immunology*, vol. 169, no. 8, pp. 4253–4261, 2002.
- [72] J. Shi, G. J. Tricot, T. K. Garg et al., "Bortezomib down-regulates the cell-surface expression of HLA class I and enhances natural killer cell-mediated lysis of myeloma," *Blood*, vol. 111, no. 3, pp. 1309–1317, 2008.
- [73] A. Soriani, A. Zingoni, C. Cerboni et al., "ATM-ATR-dependent up-regulation of DNAM-1 and NKG2D ligands on multiple myeloma cells by therapeutic agents results in enhanced NK-cell susceptibility and is associated with a senescent phenotype," *Blood*, vol. 113, no. 15, pp. 3503–3511, 2009.
- [74] M. Valés-Gómez, S. E. Chisholm, R. L. Cassidy-Cain, P. Roda-Navarro, and H. T. Reyburn, "Selective induction of expression of a ligand for the NKG2D receptor by proteasome inhibitors," *Cancer Research*, vol. 68, no. 5, pp. 1546–1554, 2008.
- [75] A. Lundqvist, S. I. Abrams, D. S. Schrupp et al., "Bortezomib and depsipeptide sensitize tumors to tumor necrosis factor-related apoptosis-inducing ligand: a novel method to potentiate natural killer cell tumor cytotoxicity," *Cancer Research*, vol. 66, no. 14, pp. 7317–7325, 2006.
- [76] A. Poggi, S. Catellani, A. Garuti, I. Pierri, M. Gobbi, and M. R. Zocchi, "Effective in vivo induction of NKG2D ligands in acute myeloid leukaemias by all-trans-retinoic acid or sodium valproate," *Leukemia*, vol. 23, no. 4, pp. 641–648, 2009.
- [77] B. A. Pierson and J. S. Miller, "CD56(+bright) and CD56(+dim) natural killer cells in patients with chronic myelogenous leukemia progressively decrease in number, respond less to stimuli that recruit clonogenic natural killer cells, and exhibit decreased proliferation on a per cell basis," *Blood*, vol. 88, no. 6, pp. 2279–2287, 1996.



Natural killer cells modulation in hematological malignancies

Céline Baier^{1,2}, Aurore Fino^{1,2}, Carole Sanchez¹, Laure Farnault^{1,3}, Pascal Rihet^{1,2}, Brigitte Kahn-Perlès^{1,2} and Régis T. Costello^{1,2,3*}

¹ UMR1090 TAGC, INSERM, Marseille, France

² UMR1090 TAGC, Aix-Marseille Université, Marseille, France

³ Service d'hématologie, APHM, Hôpital de la Conception, Marseille, France

Edited by:

Massimo Vitale, IRCCS A.O.U.
S.Martino-IST, Italy

Reviewed by:

Laurel L. Lenz, National Jewish
Health, USA

Jacques Zimmer, Centre de
Recherche Public de la Santé,
Luxembourg

Nicolas Dulphy, Université Paris
Diderot, France

Renato Zambello, Padova University
School of Medicine, Italy

*Correspondence:

Régis T. Costello, Service
d'hématologie, APHM, Hôpital de la
Conception, 147 Bd Baille, 13005
Marseille 13005, France
e-mail: regis.costello@free.fr

Hematological malignancies (HM) treatment improved over the last years resulting in increased achievement of complete or partial remission, but unfortunately high relapse rates are still observed, due to remaining minimal residual disease. Therefore, sustainment of long-term remission is crucial, using either drug maintenance treatment or by boosting or prolonging an immune response. Immune system has a key role in tumor surveillance. Nonetheless, tumor-cells evade the specific T-lymphocyte mediated immune surveillance using many mechanisms but especially by the down-regulation of the expression of HLA class I antigens. In theory, these tumor-cells lacking normal expression of HLA class I molecules should be destroyed by natural killer (NK) cells, according to the missing-self hypothesis. NK cells, at the frontier of innate and adaptive immune system, have a central role in tumor-cells surveillance as demonstrated in the setting of allogeneic stem cell transplantation. Nevertheless, tumors develop various mechanisms to escape from NK innate immune pressure. Abnormal NK cytolytic functions have been described in many HM. We present here various mechanisms involved in the escape of HM from NK-cell surveillance, i.e., NK-cells quantitative and qualitative abnormalities.

Keywords: hematological malignancies, natural killer cells, natural cytotoxicity receptors, immune escape, immunotherapy

INTRODUCTION

The natural killer (NK) cells are central players in innate immunity particularly regarding the surveillance against malignant tumors (1, 2). NK role in tumor-cells clearance is proved by allogeneic stem cells transplantation, since a better engraftment and a low relapse rate are observed when the graft NK inhibitory receptors mismatch with recipient HLA molecules (3) (Figure 1). The triggering event of NK-cells activation and killing of target cells results from a balance between activating and inhibitory signals sent by membrane receptors that either enhance or block the NK-mediated cytotoxicity (4). Inhibitory signals arise from interaction between HLA-specific inhibitory receptors, as the killer immunoglobulin-like receptors (KIR), NK group protein 2A (NKG2A), or Immunoglobulin-like transcript 2 (ILT-2) with HLA class I molecules, whereas the absence or abnormal expression of the later molecules induces NK-cells cytotoxicity (5). The down-regulation of HLA class I molecules is an immune escape mechanism frequently used by tumor cells (6) that, accordingly, should not be recognized by the T-lymphocyte receptor (TCR). The absence of normal HLA class I molecule on tumor cells should lead to NK-cells activation, more efficiently when co-stimulatory molecules and ligands for NK activating receptor are present at tumor cell surface. The natural cytotoxicity receptors (NCR) NKp46/NCR1, NKp30/NCR3, and NKp44/NCR2 (7), NKG2D, DNAM-1 and also co-receptors such as 2B4/CD244 and NTBA, play a central role in NK activation. Once activated, NK lymphocytes kill tumor cells via FcγRIIIA (CD16) which can trigger

antibody-dependent cellular cytotoxicity (ADCC) on encountering target cells opsonized with IgG, via the Fas/Fas-L pathway and via cytotoxic granules (perforin/granzyme) secretion (1, 8).

Defects in NK-cell cytotoxicity have been described in most hematological malignancies (HM) (9–12) (Table 1). Interestingly, tumor-cells develop various escape mechanisms to NK-cell surveillance and contribute to the dysfunction of NK-cell cytotoxicity (4).

NK-CELLS DYSFUNCTIONS IN HEMATOLOGICAL MALIGNANCIES

QUANTITATIVE ABNORMALITIES

The first mechanism explaining tumor escape is the quantitative abnormalities of NK cells. In myelodysplastic syndrome (MDS) patients, decreased NK-cell cytolytic functions correlate with a low number of circulating NK cells and a high level of sIL-2R (13, 14). In chronic myelogenous leukemia (CML), functional NK-cell deficiency can be reversed *in vitro* by IL-2 (15), but this effect is progressively lost while a progressive decrease in NK-cell number is observed (16). In Philadelphia (Ph1)-negative myeloproliferative syndrome (MPS), NK cytotoxic activity is decreased, mostly in idiopathic myelofibrosis (IMF) patients. The percentage of NK cells is decreased in IMF and increased in polycythemia vera (PV) (17). We have confirmed that the percentage and absolute number of NK cells are significantly increased in PV, but we failed to detect any abnormalities in the expression of activating NK-cell receptors or cytotoxic functions (personal data, C. Sanchez). An

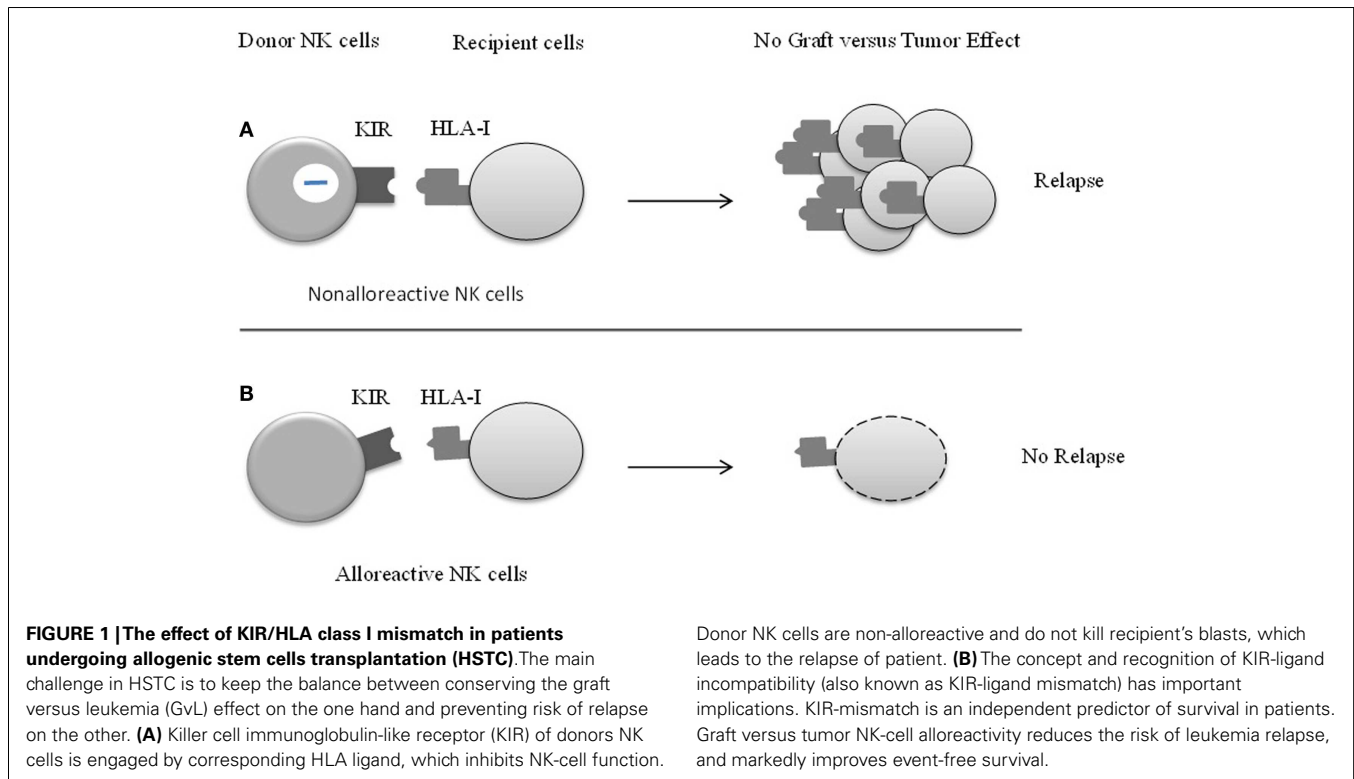

increase in the total number of NK cells in the peripheral blood has also been described in chronic lymphocytic leukemia (CLL) but still associated with defective cytolytic functions (18).

ALTERED ACTIVATING RECEPTORS PROFILES

In acute myeloid leukemia (AML) the down-regulation of activating receptors NKp30/NCR3 and NKp46/NCR1 correlates with defective NK-cell cytotoxicity and poor leukemia prognosis (9, 19). In patients attaining complete remission (CR) after chemotherapy, NKp46/NCR1 expression returns to normal levels while patients who do not achieve CR or who relapse maintain abnormal NCR expression (9, 19). The defect in NCRs expression could be potentiated by the low expression of NCR and NKG2D ligands by leukemic cells (20–22). Down-regulation of the NK activating receptors/co-receptor DNAM-1, 2B4/CD244, and CD94/NKG2C have also been reported in AML (23, 24). Leukemic blasts that express DNAM-1 ligands induce DNAM-1 down-regulation at the NK-cell surface (25), thus impeding NK-cell functions.

In acute lymphoblastic leukemia (ALL), expression of the NKG2D activating receptor ligands MICA/B was only observed in NK sensitive T-ALL cell line, while NK-resistant B-ALLs did not express detectable amounts of MICA/B (26). Deficient engagement of other activating receptors may also contribute to ALL resistance to NK lysis, since B-ALL cells lose or express low levels of several other NK activating ligands such as UL-16 binding proteins (ULBPs), PVR (polio virus receptor, CD155), Nectin-2 (CD112), or CD48 (27).

In MDS, a pre-leukemic stage, Epling-Brunette et al. (13) have shown that expression of NKp30/NCR3 and NKG2D was

decreased, in contrast with the data of Kiladjian et al. (28); this discrepancy could be related to the heterogeneity of MDS patients.

In CML patients, Boissel et al. (29) reported high serum sMICA levels and weak NKG2D expression on NK cells, that correlate with low NK-cell cytotoxicity capacities. Imatinib mesylate, the first inhibitor of tyrosine kinase used in CML, increases NKG2D expression and decreases MICA protein production and release, thus contributing to normal NK cytotoxicity through the restoration of a functional NKG2D signaling (29).

Monoclonal gammopathy of undetermined significance (MGUS) is a common disorder of aging and a precursor lesion to multiple myeloma (MM). In MGUS, tumor-cells express high levels of MICA, whereas low levels of sMICA are detected in peripheral blood (30). This explains the capacities of NK cells to kill MGUS tumor cells by interaction between MICA and NKG2D. Conversely, MM patients present high plasma level of sMICA while tumor-cells express low level of MICA, thus impeding NK stimulation via NKG2D (31). This reveals that the alterations in the NKG2D pathway signaling are associated with the progression from MGUS to MM (30, 32). In peripheral blood from patients with MM a normal expression of the NCRs and NKG2D is observed, while 2B4/CD244 and the low-affinity Ig-Fc receptor CD16 display significantly weaker expression in comparison with healthy donors (31). Nonetheless, when NK are studied at the site of tumor location, i.e., bone marrow, (33) a drastic down-regulation of three major activating NK receptors (NKp30/NCR3, NKG2D, and 2B4/CD244) is observed in comparison with bone marrow from healthy donors (34). This suggests that some NK abnormalities may be underestimated if only peripheral blood is studied.

Table 1 | Mechanisms of immune escape and drugs used with their effects on NK cells in hematological malignancies.

Hematological malignancies	Principal mechanisms of escape	References	Principal class of drugs used	Effects of drugs on NK activation	References
MDS	NK-cell quantitative deficiency Elevated TNF	(13, 14, 49)	Demethylating agents IMiDs	Up-regulation of KIR and NKG2D ligands NKp46 upregulation	(76, 81)
AML	Upregulation of HLA-I Decrease expression of NKp30, 2B4/CD244 Production of ROS	(9, 19, 39, 40, 54)	HDACIs Histamine dihydrochloride All-trans retinoic acid Monoclonal antibody (IPH2101)	Upregulation of MICA/B expression Suppress ROS production Promote NK-cells cytotoxicity	(65, 67, 72, 73, 84, 85)
CLL	Upregulation of HLA-I low level of MICA or ULBP	(18, 37)	Monoclonal antibody	Mediate NK-cells cytotoxicity	(88)
MM	Production of sMICA/sMICB Weak expression of CD16	(30, 31)	IMiDs Proteasome inhibitor IPH2101	NKp46 upregulation NKG2D ligand upregulation	(79, 82–84, 86)
CML	Production of sMICA and weak expression of NKG2D	(29)	Tyrosine kinase inhibitor	sMICA down-regulation and NKG2D upregulation	(29)
ALL	Low production of MICA/B and ULBP Down regulation of HLA-A and HLA-Bw6	(26, 27, 41)			

MDS, myelodysplastic syndrome; AML, acute myeloid leukemia; CLL, chronic lymphocytic leukemia; MM, multiple myeloma; CML, chronic myelogenous leukemia; ALL, acute lymphoblastic leukemia; s/MICA/B, soluble/stress-induced molecules human class I-like molecules A and B; ULBPs, UL-16 binding proteins; ROS, reactive oxygen species; KIR, killer immunoglobulin-like receptors; PDGF, platelet-derived growth factor; HDC, histamine dihydrochloride; IMiDs, immune-modulatory drugs; HDACIs, Histone deacetylase inhibitors.

In CLL, NK cells have weak cytotoxic functions which can be restored by stimulation with recombinant IFN- γ or IL-2 (35). We failed to detect a difference in NCR expression between patients and age-matched healthy donors (36), but we found a correlation with abnormal activating molecule expression and poor prognosis factors. In CLL decreased NK functions could be explained in part by absent or low level of MICA or ULBP (18, 37) at CLL lymphocyte cell surface, thus impeding NKG2D engagement.

ABNORMAL KIRs PHENOTYPE AND INHIBITORY MOLECULES

Killer immunoglobulin-like receptor-mismatch in allogenic stem cells transplantation improves the disease-free survival in AML (38). In fact, NK-cell cytotoxicity is down-regulated by the engagement of HLA-specific inhibitory receptors, including KIRs and CD94 and NKG2A/B heterodimers. The analysis of KIR phenotype in AML patients shows that the frequency of particular inhibitory KIRs in association with their putative HLA class I ligands is significantly increased compared to healthy donors (10, 39, 40). This supports the hypothesis that AML blasts escape from immune surveillance according to the dominance of inhibitory over activating KIR signals. In ALL, the resistance of B-cell precursors to cytotoxicity is explained by the interaction between HLA-G and KIR2DL4 (26). Demanet et al. (41) have observed in ALL and CLL a selective down-regulation of HLA-A and HLA-Bw6 associated with HLA-Bw4 preservation, which provided an escape mechanism from NK-cell immune surveillance. Maki et al. (18) reported

in CLL cells an increased expression of HLA-G1, a class I molecule that engages NK-cell inhibitory molecules and which has for ligand p49/KIR2DL4/CD158d (expressed on NK cells and a fraction of T cells), ILT-2 [expressed on NK, T, B cells, dendritic cells (DC), and monocytes], and ILT-4 [expressed on antigen-presenting cells (APC)] (42).

TUMOR ENVIRONMENT AND ROLE OF CYTOKINES

One of the strategies used by tumor cells having an effect on NK-cell function is the production of inhibitory molecules, which decrease NK-cells number and inhibit NK-cell activation. Increasing evidence supports the role of the tumor microenvironment in conferring drug resistance, a major cause of relapse and incurability of cancers. Tumor microenvironment includes tumor-cells contact and interaction, but also production of soluble factors, which provide signals for tumor growth and survival or inhibition of NK.

ROLE OF CYTOKINES AND CELLULAR LIGANDS

Several cytokines decrease NK-cell activation and cytotoxicity, such as the Transforming Growth Factor beta (TGF- β). High circulating TGF- β level correlates with poor prognosis in acute leukemia (43) and is linked to reduced NK-cell activity with reduced expression of NKp30/NCR3 and NKG2D (44). TGF- β antagonizes IL-15, a cytokine that induces NK-cell proliferation and activation. Thus, TGF- β inhibits the expression of both NK-cell activation

receptor molecules and components of the cytotoxic apparatus (45, 46). Several studies have also underlined that low INF- γ producing capacity of NK cells was correlated with loss of NK-cell cytotoxicity (47, 48).

A physiologic concentration of platelet-derived growth factor (PDGF) significantly inhibits human NK-cell cytotoxicity. Patients suffering from IMF and essential thrombocythemia have significantly elevated circulating levels of plasma PDGF. Pretreatment of normal NK cells with concentrated PDGF-containing platelet-poor plasma from patients with these diseases significantly inhibits NK cytotoxicity. This inhibitory effect is reversed by neutralization of plasma PDGF with anti-PDGF (17, 49). All these data suggest that PDGF is probably a key factor of NK functional deficiency in MPS.

Interaction between tumor cells and NK impairs NK-cell-mediated cytotoxicity and thus induces tolerance to tumor invasion. Up-regulation of the immunosuppressive cell surface glycoprotein CD200 and of soluble GITRL (glucocorticoid-induced TNFR related protein ligand) on AML cells specifically compromises NK-cell anti-tumor responses (50, 51) and is a poor prognosis factor. AML cells exert direct immunosuppressive effects on NK cells mediated by immunosuppressive ligands or soluble factors and induce regulatory T lymphocytes (Treg) that weaken NK-cell responses (52). NK cells can also interact with DC leading to activation of Treg and inhibition of NK cells (53). Recently, ligand of NKp44/NCR2 (NKp44L) was identified as an isoform of mixed-lineage leukemia-5 (MLL5) (54). This ligand is not detectable in the normal tissues but is present in hematopoietic, non-hematopoietic tumor and transformed cells. The expression of MLL5 is a good prognosis factor in AML (55). Thus we can speculate that the prognostic value of MLL5 expression is linked to its capacity to activate anti-leukemia NK cells.

REACTIVE OXYGEN SPECIES

Non-malignant phagocytic cells down-modulate lymphocyte functions by producing and releasing NADPH oxidase-derived reactive oxygen species (ROS) (56). Monocytic and myelomonocytic (French-American-British classification M4/M5 subtypes) AML cells, but not cells from myeloblastic (FAB class M2) or immature (FAB class M1) AML, produce ROS via the NADPH oxidase component gp91phox, and trigger extensive apoptosis of NK cells *via* a poly-[ADPribose] polymerase-1 dependent pathway, together with a down-regulation of NKp46/NCR1. This suggests a novel mechanism of immune evasion in myelo-monocytic and monocytic AML (57).

MATERIAL TRANSFER DURING CELL-CELL CONTACT

Tumor membrane-derived microvesicles (tMV) are important mediators of cell-to-cell communication. These circular membrane fragments are enriched in various bioactive molecules and directly stimulate cells as a kind of "signaling complex." An important mode of communication between carcinoma cells and immune cells involves tMV, also known as exosomes, ectosomes, or microparticles. These microvesicles carry lipids, proteins, mRNAs, and microRNAs and travel short or long distances to deliver undegraded and undiluted material to other cells (58). Microvesicles

present in AML patients' sera contain TGF- β that down-regulates the expression of NKG2D and thus interfere with NK-cell activation. Nonetheless, IL-15 protects NK cells from adverse effects of tMV and could thus contribute to maintain their anti-tumor response (59). Baj-Krzyworzeka et al. (60) have observed that tMV carry mRNA of tumor cells and transfer some of them to monocytes and modify their activity. This type of mRNA transfer could participate to NK inactivation and tumor escape to innate immunity.

IMMUNOTHERAPY APPROACHES

Modulation of NK-cell function by down-regulation of receptors and/or ligand corresponds to an immune escape mechanism for tumors. Restoring the expression of activating receptors on NK cells, or corresponding ligands on cancer cells, is an effective approach to cancer immunotherapy in order to improve disease-free survival after therapy. Currently, in most AML patients, the induction treatment leads to CR, defined as microscopic disappearance of leukemic disease along with the return of normal hematopoiesis. However, many patients in CR relapse with poor prospects of long-term survival. One of developing immunotherapy that enhances NK-cell ability to kill tumor cells is the allogeneic transplantation after chemotherapy. In AML, a recipient of haploidentical allogeneic transplant with a NK HLA-specific receptor-mismatch is associated with a favorable prognosis because this increases the anti-leukemic graft reactivity (61, 62). Rapid recovery of NK cells after hematopoietic stem cell transplantation has been associated with a reduction in the rates of relapse and acute graft-versus-host disease (GvHD) (63). The transfer of NK cell from haploidentical origins into AML recipients is a potent immunotherapy intervention that is, unfortunately, associated with a significant transplant-related morbidity and mortality that limit its use (64).

The use of cytokines is another therapeutic approach to enhance NK-cell cytotoxicity. IL-2, IL-12, IL-15 (65), and IL-18 have been used in culture to increase cell cytotoxic prior to the injection of NK cells in cancer patients (66). Another strategy consists in restoring normal NCR expression since these molecules are pivotal for the anti-leukemia response. A phase III study in 320 AML patients has demonstrated that immunotherapy with histamine dihydrochloride (HDC) and IL-2 decreases and delays relapses in AML (67). HDC suppresses or inhibits ROS formation in mononuclear and polymorphonuclear myeloid cells. This prevents from oxygen radical-induced NK apoptosis, restores NK-cell capacity to respond to IL-2, and improves NK proliferation and production of immuno-stimulatory cytokines (56, 68–71). Moreover, in presence of HDC, cytotoxic functions of NK cells remain intact due to the preserved expression of the activating receptors NKG2D and NKp46/NCR1.

DNA methylation also has a key role in the control of gene activity in cancer cells. Two agents are currently used in MDS treatment: 5-azacytidine (Vidaza) and 5-aza-20-deoxycytidine (Decitabine) (72). These two hypomethylating agents up-regulate NKG2D ligands MICA/B leading to enhanced NK-cell cytotoxicity (73, 74). Conversely we have observed the down-regulation of 2B4/CD244 in NK from AML patients treated with 5-azacytidine, that could

have an opposite effect, i.e., cytotoxicity down-regulation (Leclercq et al. personal data).

The immune-modulatory drugs (IMiDs) such as thalidomide and lenalidomide are used in MM and MDS treatment and have anti-angiogenic and anti-inflammatory properties. They also act as IMiDs by cytokine release and activating effector cells by enhancing ADCC and NK-cell cytotoxicity thanks to the up-regulation of Nkp46/NCR1 (75–77).

Bortezomib is a proteasome inhibitor used in MM treatment. Physiologically, proteasome is involved in protein degradation. Its inhibition by the drug interferes with tumor growth and with innate immunity. Bortezomib is involved in the down-regulation of HLA I molecules and in the up-regulation of NKG2D, TRAIL, and DNAM ligands, thus leading to increased NK-cell cytotoxicity against plasma cell (78, 79).

Another attractive therapeutic approach consists in blocking the NK inhibitory receptors. A phase I trial has tested the IPH2101, a fully humanized IgG4 anti-KIR monoclonal antibody, in patients with relapsed/refractory AML (clinical trial registration number NCT01256073) and MM (clinical trial registration number NCT00999830). IPH2101 promotes immune complex formation and NK-cell cytotoxicity specifically against MM cell targets but not normal cells. No evidence of autoimmunity was observed. These findings suggest that IPH2101 is safe and tolerable and that this approach warrants further development in MM and AML (80–82) as we are waiting for clinical results.

Several studies revealed ADCC as one major mode of action of antibody-based therapeutics and stimulated more interest in how to mobilize, expand, and activate NK cells in humans (83). In CLL, the ADCC pathway via the Fc receptor (FcγRIIIa) CD16 at surface of NK cells is pivotal in the clinical effect of mAbs such as rituximab or ofatumumab which mediate ADCC by NK cells (84). Second generation mAb are designed in order to maximize both direct apoptosis and ADCC. The role of ADCC is underlined by better clinical responses to rituximab when NK cells expressed the high-affinity form of the FcγRIII (85, 86).

Bi-specific NK-cell engagers (BiKE) simultaneously bind CD16α and c-Met (a receptor overexpressed in many tumors) and thus may increase NK-cell ADCC (87).

Another type of therapeutic strategy consists in taking advantage from anti-cancer drugs properties (Table 1). Chemotherapy drugs can be separated by their ability to inhibit (such as vinblastine, chlorambucil, docetaxel) or enhance (such as asparaginase, bleomycin, doxorubicin) NK-cell-mediated killing of target cells (88, 89). In cancer, epigenetic changes are also involved in dysregulating NK-cell ligand expression. Histone deacetylase inhibitors (HDACIs) such as trichostatin, are epigenetic anti-cancer agents that modulate innate immunity by the regulation of expression of NKG2D or DNAM-1 ligands. Indeed, HDACIs increase expression of ligands of these two activating receptors, MICA/B or PVR and Nectin-2 respectively, on acute leukemia cells (90, 91). This suggests that epigenetic drugs make tumor cells more sensitive to NK-cell-mediated lysis (92). However, it has also been demonstrated that HDACIs suppress NK-cell cytotoxic activity by down-regulation of Nkp30/NCR3, Nkp46/NCR1 (93). Thus, the same drug can have contradictory effects on NK cells.

CONCLUDING REMARKS

The more precise and exhaustive analysis of NK dysfunction in HM has opened the way to novel therapeutic strategies involving either specifically developed drugs/antibodies or innovative use of “old” drugs such as IMiDs. Due to the complexity of the immune response and the putative opposed effects of a drug on the various partners of the immune network, data obtained by *in vitro* experiments or *in vivo* in animal models have to be evaluated in clinically and biologically carefully monitored clinical trials.

ACKNOWLEDGMENTS

This work was supported by Grants from INSERM and Region Provence-Alpes-Côtes d’Azur “Bourse Doctorale Regionale 2011–2014.”

REFERENCES

- Vivier E, Tomasello E, Baratin M, Walzer T, Ugolini S. Functions of natural killer cells. *Nat Immunol* (2008) **9**:503–10. doi:10.1038/ni1582
- Vivier E, Raulet DH, Moretta A, Caligiuri MA, Zitvogel L, Lanier LL, et al. Innate or adaptive immunity? The example of natural killer cells. *Science* (2011) **331**:44–9. doi:10.1126/science.1198687
- Ruggeri L, Mancusi A, Burchielli E, Capanni M, Carotti A, Aloisi T, et al. NK cell alloreactivity and allogeneic hematopoietic stem cell transplantation. *Blood Cells Mol Dis* (2008) **40**:84–90. doi:10.1016/j.bcmd.2007.06.029
- Costello RT, Gastaut JA, Olive D. Tumor escape from immune surveillance. *Arch Immunol Ther Exp (Warsz)* (1999) **47**:83–8.
- Ljunggren HG, Karre K. In search of the ‘missing self’: MHC molecules and NK cell recognition. *Immunol Today* (1990) **11**:237–44. doi:10.1016/0167-5699(90)90097-5
- Garrido F, Cabrera T, Lopez-Nevot MA, Ruiz-Cabello F. HLA class I antigens in human tumors. *Adv Cancer Res* (1995) **67**:155–95.
- Moretta A, Biassoni R, Bottino C, Mingari MC, Moretta L. Natural cytotoxicity receptors that trigger human NK-cell-mediated cytotoxicity. *Immunol Today* (2000) **21**:228–34. doi:10.1016/S0167-5699(00)01596-6
- Campbell KS, Hasegawa J. Natural killer cell biology: an update and future directions. *J Allergy Clin Immunol* (2013) **132**:536–44. doi:10.1016/j.jaci.2013.07.006
- Costello RT, Sivori S, Marcenaro E, Lafage-Pochitaloff M, Mozziconacci MJ, Revivron D, et al. Defective expression and function of natural killer cell-triggering receptors in patients with acute myeloid leukemia. *Blood* (2002) **99**:3661–7. doi:10.1182/blood.V99.10.3661
- Sanchez CJ, Le Treut T, Boehrer A, Knoblauch B, Imbert J, Olive D, et al. Natural killer cells and malignant haemopathies: a model for the interaction of cancer with innate immunity. *Cancer Immunol Immunother* (2011) **60**:1–13. doi:10.1007/s00262-010-0898-x
- Costello RT, Fauriat C, Sivori S, Marcenaro E, Olive D. NK cells: innate immunity against hematological malignancies? *Trends Immunol* (2004) **25**:328–33. doi:10.1016/j.it.2004.04.005
- Rey J, Veuillen C, Vey N, Bouabdallah R, Olive D. Natural killer and gammadelta T cells in hematological malignancies: enhancing the immune effectors. *Trends Mol Med* (2009) **15**:275–84. doi:10.1016/j.molmed.2009.04.005
- Epling-Burnette PK, Bai F, Painter JS, Rollison DE, Salih HR, Krusch M, et al. Reduced natural killer (NK) function associated with high-risk myelodysplastic syndrome (MDS) and reduced expression of activating NK receptors. *Blood* (2007) **109**:4816–24. doi:10.1182/blood-2006-07-035519
- Yokose N, Ogata K, Ito T, An E, Tamura H, Dan K, et al. Elevated plasma soluble interleukin 2 receptor level correlates with defective natural killer and CD8+ T-cells in myelodysplastic syndromes. *Leuk Res* (1994) **18**:777–82. doi:10.1016/0145-2126(94)90060-4
- Chang WC, Fujimiyama Y, Casteel N, Pattengale P. Natural killer cell immunodeficiency in patients with chronic myelogenous leukemia. III. Defective interleukin-2 production by T-helper and natural killer cells. *Int J Cancer* (1989) **43**:591–7. doi:10.1002/ijc.2910430410
- Pierson BA, Miller JS. CD56+ bright and CD56+ dim natural killer cells in patients with chronic myelogenous leukemia progressively decrease in number,

- respond less to stimuli that recruit clonogenic natural killer cells, and exhibit decreased proliferation on a per cell basis. *Blood* (1996) **88**:2279–87.
17. Gersuk GM, Carmel R, Pattamakom S, Challita PM, Rabinowitz AP, Pattengale PK. Quantitative and functional studies of impaired natural killer (NK) cells in patients with myelofibrosis, essential thrombocythemia, and polycythemia vera. I. A potential role for platelet-derived growth factor in defective NK cytotoxicity. *Nat Immun* (1993) **12**:136–51.
 18. Maki G, Hayes GM, Naji A, Tyler T, Carosella ED, Rouas-Freiss N, et al. NK resistance of tumor cells from multiple myeloma and chronic lymphocytic leukemia patients: implication of HLA-G. *Leukemia* (2008) **22**:998–1006. doi:10.1038/leu.2008.15
 19. Fauriat C, Just-Landi S, Mallet F, Arnoulet C, Sainty D, Olive D, et al. Deficient expression of NCR in NK cells from acute myeloid leukemia: evolution during leukemia treatment and impact of leukemia cells in NCRdull phenotype induction. *Blood* (2007) **109**:323–30. doi:10.1182/blood-2005-08-027979
 20. Pende D, Cantoni C, Rivera P, Vitale M, Castriconi R, Marcenaro S, et al. Role of NKG2D in tumor cell lysis mediated by human NK cells: cooperation with natural cytotoxicity receptors and capability of recognizing tumors of nonepithelial origin. *Eur J Immunol* (2001) **31**:1076–86. doi:10.1002/1521-4141(200104)31:4<1076::AID-IMMU1076>3.0.CO;2-Y
 21. Biassoni R, Cantoni C, Marras D, Giron-Michel J, Falco M, Moretta L, et al. Human natural killer cell receptors: insights into their molecular function and structure. *J Cell Mol Med* (2003) **7**:376–87. doi:10.1111/j.1582-4934.2003.tb00240.x
 22. Hilpert J, Grosse-Hovest L, Grunebach F, Buechele C, Nuebling T, Raum T, et al. Comprehensive analysis of NKG2D ligand expression and release in leukemia: implications for NKG2D-mediated NK cell responses. *J Immunol* (2012) **189**:1360–71. doi:10.4049/jimmunol.1200796
 23. Sanchez-Correa B, Morgado S, Gayoso I, Bergua JM, Casado JG, Arcos MJ, et al. Human NK cells in acute myeloid leukaemia patients: analysis of NK cell-activating receptors and their ligands. *Cancer Immunol Immunother* (2011) **60**:1195–205. doi:10.1007/s00262-011-1050-2
 24. Lion E, Willemen Y, Berneman ZN, Van Tendeloo VF, Smits EL. Natural killer cell immune escape in acute myeloid leukemia. *Leukemia* (2012) **26**:2019–26. doi:10.1038/leu.2012.87
 25. Sanchez-Correa B, Gayoso I, Bergua JM, Casado JG, Morgado S, Solana R, et al. Decreased expression of DNAM-1 on NK cells from acute myeloid leukemia patients. *Immunol Cell Biol* (2012) **90**:109–15. doi:10.1038/icb.2011.15
 26. Romanski A, Bug G, Becker S, Kampfmann M, Seifried E, Hoelzer D, et al. Mechanisms of resistance to natural killer cell-mediated cytotoxicity in acute lymphoblastic leukemia. *Exp Hematol* (2005) **33**:344–52. doi:10.1016/j.exphem.2004.11.006
 27. Pende D, Castriconi R, Romagnani P, Spaggiari GM, Marcenaro S, Dondero A, et al. Expression of the DNAM-1 ligands, Nectin-2 (CD112) and poliovirus receptor (CD155), on dendritic cells: relevance for natural killer-dendritic cell interaction. *Blood* (2006) **107**:2030–6. doi:10.1182/blood-2005-07-2696
 28. Kiladjian JJ, Bourgeois E, Lobe I, Braun T, Visentin G, Bourhis JH, et al. Cytolytic function and survival of natural killer cells are severely altered in myelodysplastic syndromes. *Leukemia* (2006) **20**:463–70. doi:10.1038/sj.leu.2404080
 29. Boissel N, Rea D, Tieng V, Dulphy N, Brun M, Cayuela JM, et al. BCR/ABL oncogene directly controls MHC class I chain-related molecule A expression in chronic myelogenous leukemia. *J Immunol* (2006) **176**:5108–16.
 30. Jinushi M, Vanneman M, Munshi NC, Tai YT, Prabhala RH, Ritz J, et al. MHC class I chain-related protein A antibodies and shedding are associated with the progression of multiple myeloma. *Proc Natl Acad Sci U S A* (2008) **105**:1285–90. doi:10.1073/pnas.0711293105
 31. Carbone E, Neri P, Mesuraca M, Fulciniti MT, Otsuki T, Pende D, et al. HLA class I, NKG2D, and natural cytotoxicity receptors regulate multiple myeloma cell recognition by natural killer cells. *Blood* (2005) **105**:251–8. doi:10.1182/blood-2004-04-1422
 32. Fauriat C, Mallet F, Olive D, Costello RT. Impaired activating receptor expression pattern in natural killer cells from patients with multiple myeloma. *Leukemia* (2006) **20**:732–3. doi:10.1038/sj.leu.2404096
 33. Costello RT, Boehrer A, Sanchez C, Mercier D, Baier C, Le Treut T, et al. Differential expression of natural killer cell activating receptors in blood versus bone marrow in patients with monoclonal gammopathy. *Immunology* (2013) **139**:338–41. doi:10.1111/imm.12082
 34. Eissens DN, Spanholtz J, van der Meer A, van Cranenbroek B, Dolstra H, Kwekkeboom J, et al. Defining early human NK cell developmental stages in primary and secondary lymphoid tissues. *PLoS One* (2012) **7**:e30930. doi:10.1371/journal.pone.0030930
 35. Katrinakis G, Kyriakou D, Papadaki H, Kalokyri I, Markidou F, Eliopoulos GD. Defective natural killer cell activity in B-cell chronic lymphocytic leukaemia is associated with impaired release of natural killer cytotoxic factor(s) but not of tumour necrosis factor-alpha. *Acta Haematol* (1996) **96**:16–23. doi:10.1159/000203709
 36. Costello RT, Knoblauch B, Sanchez C, Mercier D, Le Treut T, Sebahoun G. Expression of natural killer cell activating receptors in patients with chronic lymphocytic leukaemia. *Immunology* (2012) **135**:151–7. doi:10.1111/j.1365-2567.2011.03521.x
 37. Pende D, Spaggiari GM, Marcenaro S, Martini S, Rivera P, Capobianco A, et al. Analysis of the receptor-ligand interactions in the natural killer-mediated lysis of freshly isolated myeloid or lymphoblastic leukemias: evidence for the involvement of the Poliovirus receptor (CD155) and Nectin-2 (CD112). *Blood* (2005) **105**:2066–73. doi:10.1182/blood-2004-09-3548
 38. Ruggeri L, Capanni M, Urbani E, Perruccio K, Shlomchik WD, Tosti A, et al. Effectiveness of donor natural killer cell alloreactivity in mismatched hematopoietic transplants. *Science* (2002) **295**:2097–100. doi:10.1126/science.1068440
 39. Wetzler M, Baer MR, Stewart SJ, Donohue K, Ford L, Stewart CC, et al. HLA class I antigen cell surface expression is preserved on acute myeloid leukemia blasts at diagnosis and at relapse. *Leukemia* (2001) **15**:128–33. doi:10.1038/sj.leu.2401982
 40. Verheyden S, Demanet C. Susceptibility to myeloid and lymphoid leukemia is mediated by distinct inhibitory KIR-HLA ligand interactions. *Leukemia* (2006) **20**:1437–8. doi:10.1038/sj.leu.2404279
 41. Demanet C, Mulder A, Deneys V, Worsham MJ, Maes P, Claas FH, et al. Down-regulation of HLA-A and HLA-Bw6, but not HLA-Bw4, allospecificities in leukemic cells: an escape mechanism from CTL and NK attack? *Blood* (2004) **103**:3122–30. doi:10.1182/blood-2003-07-2500
 42. Creput C, Durrbach A, Charpentier B, Carosella ED, Rouas-Freiss N. [HLA-G: immunoregulatory molecule involved in allograft acceptance]. *Nephrologie* (2003) **24**:451–6.
 43. Bergmann L, Schui DK, Brieger J, Weidmann E, Mitrou PS, Hoelzer D. The inhibition of lymphokine-activated killer cells in acute myeloblastic leukemia is mediated by transforming growth factor-beta 1. *Exp Hematol* (1995) **23**:1574–80.
 44. Lee JC, Lee KM, Kim DW, Heo DS. Elevated TGF-beta1 secretion and down-modulation of NKG2D underlies impaired NK cytotoxicity in cancer patients. *J Immunol* (2004) **172**:7335–40.
 45. Flavell RA, Sanjabi S, Wrzesinski SH, Licona-Limon P. The polarization of immune cells in the tumour environment by TGFbeta. *Nat Rev Immunol* (2010) **10**:554–67. doi:10.1038/nri2808
 46. Wilson EB, El-Jawhari JJ, Neilson AL, Hall GD, Melcher AA, Meade JL, et al. Human tumour immune evasion via TGF-beta blocks NK cell activation but not survival allowing therapeutic restoration of anti-tumour activity. *PLoS One* (2011) **6**:e22842. doi:10.1371/journal.pone.0022842
 47. Tajima F, Kawatani T, Endo A, Kawasaki H. Natural killer cell activity and cytokine production as prognostic factors in adult acute leukemia. *Leukemia* (1996) **10**:478–82.
 48. Castriconi R, Cantoni C, Della Chiesa M, Vitale M, Marcenaro E, Conte R, et al. Transforming growth factor beta 1 inhibits expression of NKp30 and NKG2D receptors: consequences for the NK-mediated killing of dendritic cells. *Proc Natl Acad Sci U S A* (2003) **100**:4120–5. doi:10.1073/pnas.0730640100
 49. Verhoeef GE, De Schouwer P, Ceuppens JL, Van Damme J, Goossens W, Boogaerts MA. Measurement of serum cytokine levels in patients with myelodysplastic syndromes. *Leukemia* (1992) **6**:1268–72.
 50. Coles SJ, Wang EC, Man S, Hills RK, Burnett AK, Tonks A, et al. CD200 expression suppresses natural killer cell function and directly inhibits patient anti-tumor response in acute myeloid leukemia. *Leukemia* (2011) **25**:792–9. doi:10.1038/leu.2011.1
 51. Baessler T, Krusch M, Schmiedel BJ, Kloss M, Baltz KM, Wacker A, et al. Glucocorticoid-induced tumor necrosis factor receptor-related protein ligand subverts immunosurveillance of acute myeloid leukemia in humans. *Cancer Res* (2009) **69**:1037–45. doi:10.1158/0008-5472.CAN-08-2650

52. Ustun C, Miller JS, Munn DH, Weisdorf DJ, Blazar BR. Regulatory T cells in acute myelogenous leukemia: is it time for immunomodulation? *Blood* (2011) **118**:5084–95. doi:10.1182/blood-2011-07-365817
53. Fauriat C, Moretta A, Olive D, Costello RT. Defective killing of dendritic cells by autologous natural killer cells from acute myeloid leukemia patients. *Blood* (2005) **106**:2186–8. doi:10.1182/blood-2005-03-1270
54. Baychelier F, Sennepin A, Ermonval M, Dorgham K, Debre P, Vieillard V. Identification of a cellular ligand for the natural cytotoxicity receptor NKp44. *Blood* (2013) **122**:2935–42. doi:10.1182/blood-2013-03-489054
55. Damm F, Oberacker T, Thol F, Surdzien E, Wagner K, Chaturvedi A, et al. Prognostic importance of histone methyltransferase MLL5 expression in acute myeloid leukemia. *J Clin Oncol* (2011) **29**:682–9. doi:10.1200/JCO.2010.31.1118
56. Thoren FB, Romero AI, Hellstrand K. Oxygen radicals induce poly(ADP-ribose) polymerase-dependent cell death in cytotoxic lymphocytes. *J Immunol* (2006) **176**:7301–7.
57. Aurelius J, Thoren FB, Akhiani AA, Brune M, Palmqvist L, Hansson M, et al. Monocytic AML cells inactivate antileukemic lymphocytes: role of NADPH oxidase/gp91(phox) expression and the PARP-1/PAR pathway of apoptosis. *Blood* (2012) **119**:5832–7. doi:10.1182/blood-2011-11-391722
58. Pucci F, Pittet MJ. Molecular pathways: tumor-derived microvesicles and their interactions with immune cells in vivo. *Clin Cancer Res* (2013) **19**:2598–604. doi:10.1158/1078-0432.CCR-12-0962
59. Szczepanski MJ, Szajnik M, Welsh A, Whiteside TL, Boyiadzis M. Blast-derived microvesicles in sera from patients with acute myeloid leukemia suppress natural killer cell function via membrane-associated transforming growth factor-beta1. *Haematologica* (2011) **96**:1302–9. doi:10.3324/haematol.2010.039743
60. Baj-Krzyworzeka M, Szatanek R, Weglarczyk K, Baran J, Zembala M. Tumour-derived microvesicles modulate biological activity of human monocytes. *Immunol Lett* (2007) **113**:76–82. doi:10.1016/j.imlet.2007.07.014
61. Ruggeri L, Mancusi A, Capanni M, Urbani E, Carotti A, Aloisi T, et al. Donor natural killer cell allorecognition of missing self in haploidentical hematopoietic transplantation for acute myeloid leukemia: challenging its predictive value. *Blood* (2007) **110**:433–40. doi:10.1182/blood-2006-07-038687
62. Ruggeri L, Aversa F, Martelli MF, Velardi A. Allogeneic hematopoietic transplantation and natural killer cell recognition of missing self. *Immunol Rev* (2006) **214**:202–18. doi:10.1111/j.1600-065X.2006.00455.x
63. Savani BN, Mielke S, Adams S, Uribe M, Rezvani K, Yong AS, et al. Rapid natural killer cell recovery determines outcome after T-cell-depleted HLA-identical stem cell transplantation in patients with myeloid leukemias but not with acute lymphoblastic leukemia. *Leukemia* (2007) **21**:2145–52. doi:10.1038/sj.leu.2404892
64. Miller JS, Soignier Y, Panoskalis-Mortari A, McNearney SA, Yun GH, Fautsch SK, et al. Successful adoptive transfer and in vivo expansion of human haploidentical NK cells in patients with cancer. *Blood* (2005) **105**:3051–7. doi:10.1182/blood-2004-07-2974
65. Suck G, Oei VY, Linn YC, Ho SH, Chu S, Choong A, et al. Interleukin-15 supports generation of highly potent clinical-grade natural killer cells in long-term cultures for targeting hematological malignancies. *Exp Hematol* (2011) **39**:904–14. doi:10.1016/j.exphem.2011.06.003
66. Chan CJ, Andrews DM, Smyth MJ. Can NK cells be a therapeutic target in human cancer? *Eur J Immunol* (2008) **38**:2964–8. doi:10.1002/eji.200838764
67. Brune M, Castaigne S, Catalano J, Gehlens K, Ho AD, Hofmann WK, et al. Improved leukemia-free survival after postconsolidation immunotherapy with histamine dihydrochloride and interleukin-2 in acute myeloid leukemia: results of a randomized phase 3 trial. *Blood* (2006) **108**:88–96. doi:10.1182/blood-2005-10-4073
68. Hansson M, Hermodsson S, Brune M, Mellqvist UH, Naredi P, Betten A, et al. Histamine protects T cells and natural killer cells against oxidative stress. *J Interferon Cytokine Res* (1999) **19**:1135–44. doi:10.1089/107999099313073
69. Hellstrand K, Asea A, Hermodsson S. Role of histamine in natural killer cell-mediated resistance against tumor cells. *J Immunol* (1990) **145**:4365–70.
70. Hellstrand K, Hermodsson S. Synergistic activation of human natural killer cell cytotoxicity by histamine and interleukin-2. *Int Arch Allergy Appl Immunol* (1990) **92**:379–89. doi:10.1159/000235169
71. Romero AI, Thoren FB, Brune M, Hellstrand K. NKp46 and NKG2D receptor expression in NK cells with CD56dim and CD56bright phenotype: regulation by histamine and reactive oxygen species. *Br J Haematol* (2006) **132**:91–8. doi:10.1111/j.1365-2141.2005.05842.x
72. Kopp LM, Ray A, Denman CJ, Senyukov VS, Somanchi SS, Zhu S, et al. Decitabine has a biphasic effect on natural killer cell viability, phenotype, and function under proliferative conditions. *Mol Immunol* (2013) **54**:296–301. doi:10.1016/j.molimm.2012.12.012
73. Tang KF, He CX, Zeng GL, Wu J, Song GB, Shi YS, et al. Induction of MHC class I-related chain B (MICB) by 5-aza-2'-deoxycytidine. *Biochem Biophys Res Commun* (2008) **370**:578–83. doi:10.1016/j.bbrc.2008.03.131
74. Santourlidis S, Trompeter HI, Weinhold S, Eisermann B, Meyer KL, Wernet P, et al. Crucial role of DNA methylation in determination of clonally distributed killer cell Ig-like receptor expression patterns in NK cells. *J Immunol* (2002) **169**:4253–61.
75. Davies FE, Raju N, Hideshima T, Lentzsch S, Young G, Tai YT, et al. Thalidomide and immunomodulatory derivatives augment natural killer cell cytotoxicity in multiple myeloma. *Blood* (2001) **98**:210–6. doi:10.1182/blood.V98.1.210
76. Reddy N, Hernandez-Ilizaliturri FJ, Deeb G, Roth M, Vaughn M, Knight J, et al. Immunomodulatory drugs stimulate natural killer-cell function, alter cytokine production by dendritic cells, and inhibit angiogenesis enhancing the anti-tumour activity of rituximab in vivo. *Br J Haematol* (2008) **140**:36–45.
77. Berg SL, Cairo MS, Russell H, Ayello J, Ingle AM, Lau H, et al. Safety, pharmacokinetics, and immunomodulatory effects of lenalidomide in children and adolescents with relapsed/refractory solid tumors or myelodysplastic syndrome: a Children's Oncology Group Phase I Consortium report. *J Clin Oncol* (2011) **29**:316–23. doi:10.1200/JCO.2010.30.8387
78. Shi J, Tricot GJ, Garg TK, Malaviarachchi PA, Szmania SM, Kellum RE, et al. Bortezomib down-regulates the cell-surface expression of HLA class I and enhances natural killer cell-mediated lysis of myeloma. *Blood* (2008) **111**:1309–17. doi:10.1182/blood-2007-03-078535
79. Soriani A, Zingoni A, Cerboni C, Iannitto ML, Ricciardi MR, Di Galleonardo V, et al. ATM-ATR-dependent up-regulation of DNAM-1 and NKG2D ligands on multiple myeloma cells by therapeutic agents results in enhanced NK-cell susceptibility and is associated with a senescent phenotype. *Blood* (2009) **113**:3503–11. doi:10.1182/blood-2008-08-173914
80. Alici E. IPH-2101, a fully human anti-NK-cell inhibitory receptor mAb for the potential treatment of hematological cancers. *Curr Opin Mol Ther* (2010) **12**:724–33.
81. Vey N, Bourhis JH, Boissel N, Bordessoule D, Prebet T, Charbonnier A, et al. A phase 1 trial of the anti-inhibitory KIR mAb IPH2101 for AML in complete remission. *Blood* (2012) **120**:4317–23. doi:10.1182/blood-2012-06-437558
82. Benson DM Jr, Hofmeister CC, Padmanabhan S, Suvannasankha A, Jagannath S, Abonour R, et al. A phase 1 trial of the anti-KIR antibody IPH2101 in patients with relapsed/refractory multiple myeloma. *Blood* (2012) **120**:4324–33. doi:10.1182/blood-2012-06-438028
83. Wallace ME, Smyth MJ. The role of natural killer cells in tumor control – effectors and regulators of adaptive immunity. *Springer Semin Immunopathol* (2005) **27**:49–64. doi:10.1007/s00281-004-0195-x
84. Weitzman J, Betancur M, Boissel L, Rabinowitz AP, Klein A, Klingemann H. Variable contribution of monoclonal antibodies to ADCC in patients with chronic lymphocytic leukemia. *Leuk Lymphoma* (2009) **50**:1361–8. doi:10.1080/10428190903026500
85. Cartron G, Dacheux L, Salles G, Solal-Celigny P, Bardos P, Colombat P, et al. Therapeutic activity of humanized anti-CD20 monoclonal antibody and polymorphism in IgG Fc receptor FcγRIIIa gene. *Blood* (2002) **99**:754–8. doi:10.1182/blood.V99.3.754
86. Treon SP, Hansen M, Branagan AR, Verselis S, Emmanouilides C, Kimby E, et al. Polymorphisms in FcγRIIIA (CD16) receptor expression are associated with clinical response to rituximab in Waldenström's macroglobulinemia. *J Clin Oncol* (2005) **23**:474–81. doi:10.1200/JCO.2005.06.059
87. Boltz A, Piater B, Toleikis L, Guenther R, Kolmar H, Hock B. Bi-specific aptamers mediating tumor cell lysis. *J Biol Chem* (2011) **286**:21896–905. doi:10.1074/jbc.M111.238261
88. Markasz L, Skribek H, Uhlin M, Otvos R, Flaberg E, Eksborg S, et al. Effect of frequently used chemotherapeutic drugs on cytotoxic activity of human cytotoxic T-lymphocytes. *J Immunother* (2008) **31**:283–93. doi:10.1097/CJI.0b013e3181628b76
89. Kittang AO, Hatfield K, Sand K, Reikvam H, Bruslerud O. The chemokine network in acute myelogenous leukemia: molecular mechanisms involved in

- leukemogenesis and therapeutic implications. *Curr Top Microbiol Immunol* (2010) **341**:149–72. doi:10.1007/82_2010_25
90. Kato N, Tanaka J, Sugita J, Toubai T, Miura Y, Ibata M, et al. Regulation of the expression of MHC class I-related chain A, B (MICA, MICB) via chromatin remodeling and its impact on the susceptibility of leukemic cells to the cytotoxicity of NKG2D-expressing cells. *Leukemia* (2007) **21**:2103–8. doi:10.1038/sj.leu.2404862
91. Schmutz M, Braun A, Pende D, Sonnemann J, Klier U, Beck JF, et al. Histone deacetylase inhibitors sensitize tumour cells for cytotoxic effects of natural killer cells. *Cancer Lett* (2008) **272**:110–21. doi:10.1016/j.canlet.2008.06.027
92. Diermayr S, Himmelreich H, Durovic B, Mathys-Schneeberger A, Siegler U, Langenkamp U, et al. NKG2D ligand expression in AML increases in response to HDAC inhibitor valproic acid and contributes to allorecognition by NK-cell lines with single KIR-HLA class I specificities. *Blood* (2008) **111**:1428–36. doi:10.1182/blood-2007-07-101311
93. Ogbomo H, Michaelis M, Kreuter J, Doerr HW, Cinatl J Jr. Histone deacetylase inhibitors suppress natural killer cell cytolytic activity. *FEBS Lett* (2007) **581**:1317–22. doi:10.1016/j.febslet.2007.02.045

Conflict of Interest Statement: The authors declare that the research was conducted in the absence of any commercial or financial relationships that could be construed as a potential conflict of interest.

Received: 20 September 2013; accepted: 02 December 2013; published online: 19 December 2013.

Citation: Baier C, Fino A, Sanchez C, Farnault L, Rihet P, Kahn-Perlès B and Costello RT (2013) Natural killer cells modulation in hematological malignancies. *Front. Immunol.* **4**:459. doi: 10.3389/fimmu.2013.00459

This article was submitted to *NK Cell Biology*, a section of the journal *Frontiers in Immunology*.

Copyright © 2013 Baier, Fino, Sanchez, Farnault, Rihet, Kahn-Perlès and Costello. This is an open-access article distributed under the terms of the Creative Commons Attribution License (CC BY). The use, distribution or reproduction in other forums is permitted, provided the original author(s) or licensor are credited and that the original publication in this journal is cited, in accordance with accepted academic practice. No use, distribution or reproduction is permitted which does not comply with these terms.



Disponible en ligne sur
SciVerse ScienceDirect
www.sciencedirect.com

Elsevier Masson France
EM|consulte
www.em-consulte.com



REVUES GÉNÉRALES ET ANALYSES PROSPECTIVES

Les cellules Natural Killer et leurs anomalies dans les hémopathies, et plus particulièrement la maladie de Vaquez

Natural Killer cells and their abnormalities in hematological malignancies, and more particularly in polycythemia vera

C.J. Sanchez^{a,*,b,c,d}, C. Baier^{b,c}, R.T. Costello^{a,b,c,e}

^a Laboratoire d'hématologie, hôpital Nord, AP–HM, chemin des Bourrelys, 13915 Marseille, France

^b U928 Inserm, TAGC, case 928, avenue de Luminy, 13009 Marseille, France

^c Université de la Méditerranée, 13000 Marseille, France

^d Centre hospitalier de Salon de Provence, 207, avenue Julien-Fabre, 13658 Salon de Provence, France

^e Service d'hématologie, hôpital de la Conception, AP–HM, boulevard Baille, 13005 Marseille, France

Reçu le 1^{er} octobre 2011 ; accepté le 7 juin 2012

KEYWORDS

NK cells;
Polycythemia vera;
Immune response;
JAK2

MOTS CLÉS

Cellules NK ;
Maladie de Vaquez ;
Réponse
immunitaire ;
JAK2

Summary Natural Killer (NK) cells have been so named because of their ability to lyse non-self cells. Many studies have been conducted to understand ontogeny and physiology of NK cells, allowing the identification of many activating and inhibitory receptors on their surface. These cells are also able to modulate the immune response by cytokine secretion or by helping dendritic cells' maturation. These properties have motivated the study of NK cells in malignant haemopathies, diseases for which few cures are available. NK cells' abnormalities have been described in all haemopathies. The major abnormality reported is the reduction in their cytotoxic activity. We have chosen to be of particular interest to polycythemia vera, an haemopathy characterized by the presence of a genetic defect, the *JAK2* mutation. We observed several abnormalities, including an altered distribution of lymphocyte subpopulations.

© 2012 Elsevier Masson SAS. All rights reserved.

Résumé Les cellules Natural Killer (NK) ont été nommées ainsi du fait de leur capacité à lyser des cellules du non soi. De nombreuses études ont été menées pour comprendre l'ontogénie et la physiologie des cellules NK, permettant la mise en évidence de nombreux récepteurs activateurs et inhibiteurs à leur surface. Ces cellules sont aussi capables de moduler la réponse immunitaire en sécrétant des cytokines ou en aidant à la maturation des cellules dendritiques. Ces propriétés ont motivé l'étude des cellules NK dans les hémopathies, pathologies pour lesquelles peu de traitements curatifs sont disponibles. Des anomalies des cellules NK ont été décrites dans toutes

* Auteur correspondant.

Adresse e-mail : carole.sanchez@ch-salon.fr (C.J. Sanchez).

les hémopathies, dont notamment la diminution de leur activité cytotoxique. Nous avons choisi de nous intéresser plus particulièrement à la maladie de Vaquez, une pathologie caractérisée par la présence d'une anomalie génétique, la mutation *JAK2*. Nous avons pu observer plusieurs anomalies dont une répartition modifiée des sous-populations lymphocytaires.

© 2012 Elsevier Masson SAS. Tous droits réservés.

Introduction

Les cellules Natural Killer (NK) sont de découverte relativement récente dans l'histoire de l'immunologie, mais leurs capacités à lyser des cellules tumorales ou infectées par un virus ont été rapidement remarquées. De ce fait, la connaissance de cette population lymphocytaire très particulière a rapidement progressé avec l'identification de nombreux récepteurs activateurs et inhibiteurs, la mise en évidence de leurs capacités sécrétoires ou l'élucidation de leur ontogénie.

Leurs propriétés antitumorales suscitent des espoirs en hématologie, et il est envisagé de les utiliser comme outil thérapeutique dans les hémopathies malignes, pathologies pour lesquelles les traitements curatifs sont peu nombreux. Une partie de l'article portera sur les anomalies des cellules NK dans ces pathologies. Peu de données récentes étant disponibles concernant les cellules NK dans la maladie de Vaquez, nous avons focalisé notre attention sur ce syndrome myéloprolifératif particulier caractérisé par l'existence constante d'une anomalie moléculaire bien définie (mutation du gène *JAK2*). Après quelques rappels sur la polyglobulie de Vaquez, nous ferons le point sur les données disponibles sur les cellules NK chez les patients atteints de polyglobulie primitive.

Physiologie des cellules Natural Killer

Les cellules NK furent décrites au début des années 1970 par les équipes de Kiessling, d'une part, et d'Herberman, d'autre part, qui avaient remarqué leur capacité spontanée à détruire d'autres cibles cellulaires [1,2]. Dès 1986, Kärre observa que des cellules de lymphomes n'exprimant pas de molécules *human leukocyte antigene* (HLA) de classe I sont lysées par les cellules NK, sans que les lymphocytes T n'interviennent [3]. Quelques années plus tard, Kärre et son étudiant, Ljunggren, formulèrent l'hypothèse du *missing self*, hypothèse controversée, car elle remettait en cause les mécanismes de discrimination du soi et du non soi par l'organisme [4]. Cette hypothèse postule que les cellules NK sont capables de lyser des cellules n'exprimant pas de molécules HLA de classe I, des molécules en nombre insuffisant ou altérées, même si ces cellules appartiennent au soi. Cela est illustré sur la Fig. 1.

Les cellules tumorales ou infectées par un virus n'expriment plus, ou de façon altérée, les molécules HLA de classe I, et sont ainsi reconnues et détruites par les cellules NK. Les cellules NK sont de grands lymphocytes granuleux représentant 5 à 15% des lymphocytes totaux. Elles contiennent des granules cytoplasmiques riches en perforine et granzyme, responsables de l'activité cytotoxique des NK. Les cellules NK sont des effecteurs de l'immunité innée,

ne possédant pas, à l'inverse des lymphocytes B et T, de récepteur dédié à la reconnaissance de l'antigène. Physiologiquement, elles interviennent essentiellement par leurs rôles antitumoral et anti-infectieux, notamment antiviral. Mais il a été montré récemment que ces cellules pourraient également avoir un rôle dans la greffe allogénique et dans les maladies auto-immunes [5]. Phénotypiquement, les cellules NK sont définies au sein des lymphocytes par l'absence d'expression des récepteurs CD3 et CD19 mais par l'expression du CD16 et du CD56. Le CD16 est le récepteur de type III pour le fragment constant des immunoglobulines de type IgG, permettant aux cellules NK de participer au phénomène de cytotoxicité dépendante des anticorps (*antibody dependent cell cytotoxicity* [ADCC]). Le CD56 est un isoforme de 140 kDa de la *neural cell adhesion molecule* (NCAM) dont le rôle est pour le moment mal défini. Les cellules NK sont phénotypiquement et fonctionnellement hétérogènes. Les niveaux d'expression membranaire du CD16 et du CD56 permettent l'identification de deux sous-populations de cellules NK :

- une sous-population CD16^{bright} CD56^{dim/neg} : ces cellules représentent la majorité des cellules NK circulantes mais aussi des cellules NK de la moelle osseuse et de la rate. Cette sous-population possède une faible capacité à produire des cytokines en réponse à une stimulation mais possède un fort potentiel cytotoxique ;
- une sous-population CD16^{dim/neg} CD56^{bright} : elle représente 5 à 10% des cellules NK circulantes mais presque la totalité des cellules NK présentes dans les organes lymphoïdes secondaires [6]. Ces cellules NK sont capables de produire d'importantes quantités de cytokines et de chémokines mais possèdent une faible capacité à lyser spontanément des cellules cibles [7]. Cette capacité de sécrétion d'IFN α et de TNF γ leur confère une fonction immunorégulatrice. Enfin, ces cellules possèdent un fort pouvoir prolifératif en présence d'IL-2.

Après activation, les cellules NK peuvent produire différentes cytokines (IFN γ , TNF α , IL-1 β , IL-10, IL-3, IL-5 et IL-13) et chimiokines (IL-8, MIP-1 α et RANTES) [8]. Ces différentes molécules confèrent leurs différentes propriétés aux cellules NK :

- l'IFN γ , produit précocement au cours d'une infection, est impliqué dans les défenses anti-infectieuses ;
- la production de cytokines et chimiokines permet aux cellules NK, d'une part, de participer à l'orientation Th1 ou Th2 de la réponse immunitaire, et, d'autre part, de recruter d'autres cellules participant à la réponse immunitaire ;

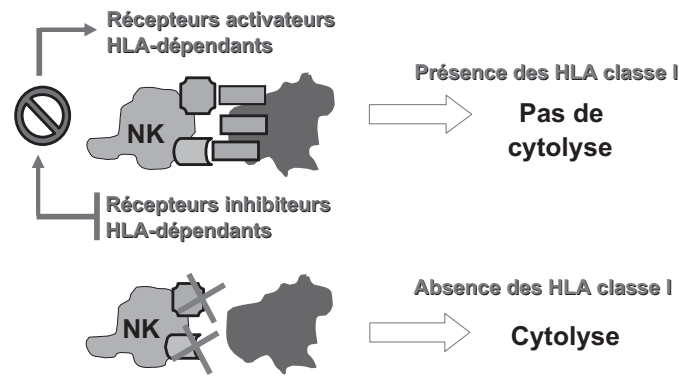

Figure 1 Théorie du *missing self*.

- enfin, les cellules NK peuvent aider à la maturation des cellules dendritiques et réciproquement [9].

Ainsi, les cellules NK interviennent précocement dans la réponse immunitaire acquise au site de l'inflammation ou au niveau des organes lymphoïdes secondaires par sélection des cellules dendritiques. Les deux sous-populations de cellules NK présentant des caractéristiques distinctes et des localisations différentes, ont des rôles distincts au cours de la réponse immunitaire et correspondent à des stades de maturation différents [10]. Freud et al. ont mis en évidence, dans les organes lymphoïdes secondaires, des cellules NK aux différentes étapes de leur différenciation, allant des cellules souches CD34⁺ CD45RA⁺ aux cellules CD3⁻ CD56^{bright} [11]. De plus, cette équipe a également montré que le développement des cellules NK est relativement similaire à celui des lymphocytes T, en termes de stades, d'activation des antigènes et de la migration des cellules dans les organes lymphoïdes au cours de leur maturation [12]. Les résultats de cette étude ainsi que d'autres études plus récentes confirment l'hypothèse de Lanier selon laquelle les cellules NK CD56^{dim} dériveraient directement des cellules NK CD56^{bright} [13]. En outre, l'équipe de Chan a pu mettre en évidence une implication du CD56 dans l'étape de maturation terminale : dans un modèle de coculture fibroblastes/cellules NK CD56^{bright} purifiés, l'utilisation d'un anticorps bloquant l'interaction entre le CD56 et le *fibroblast growth factor receptor-1* (FGFR-1) inhibe la génération des cellules NK CD56^{dim} [14]. Enfin, Ferlazzo et al. ont suggéré que l'activation des cellules NK CD56^{bright} a pour effet une augmentation de l'expression des KIRs, récepteurs caractéristiques de la sous-population CD56^{dim} [15]. Différentes cytokines, notamment l'IL-15, l'IL-21, le FLT3-ligand et le c-kit ligand, sont également impliquées dans la différenciation des cellules NK à partir d'un précurseur immature [6].

Les multiples études menées sur les cellules NK ont permis la mise en évidence de nombreux récepteurs activateurs et inhibiteurs, mais aussi de différentes molécules costimulatrices, qui régulent finement l'activité des cellules NK. Les cellules NK expriment à leur surface des récepteurs HLA-spécifiques et des récepteurs non HLA-spécifiques.

Parmi les récepteurs HLA-spécifiques, on retrouve les *killer cell immunoglobulin-like receptors* (KIRs), spécifiques des HLA-A, B, C et G [16]. Ces récepteurs peuvent être

activateurs ou inhibiteurs, selon que leur portion cytoplasmique est longue (L) et contient un motif inhibiteur *immunoreceptor tyrosine-based inhibitory motif* (ITIM) ou qu'elle est courte (S) et contient un motif activateur *Immunoreceptor Tyrosine-based Activating Motif* (ITAM). Leur dénomination repose également sur le nombre de domaines *immunoglobulin-like* : on distingue ainsi des récepteurs avec 2 (KIR2D) ou 3 (KIR3D) domaines *immunoglobulin-like*.

Les récepteurs de la famille *leukocyte immunoglobulin-like receptors* (LIR)/*immunoglobulin-like transcripts* (ILT) sont d'autres récepteurs spécifiques des molécules HLA de classe I. LIR1/ILT2 (CD85j) reconnaît plusieurs molécules HLA [17] alors que le LIR2/ILT4 ne reconnaît que HLA-F [18]. Ces deux récepteurs sont des récepteurs inhibiteurs. Enfin, le récepteur hétérodimérique CD94/NKG2A (CD159a), de type C-lectine, est également un récepteur inhibiteur et reconnaît la molécule HLA-E.

Les cellules NK, lysant préférentiellement les cellules n'exprimant pas de molécules HLA de classe I [15], expriment aussi à leur surface des récepteurs activateurs non spécifiques des molécules HLA de classe I.

Trois récepteurs présentant cette caractéristique ont été récemment identifiés : le NKp30/*natural cytotoxicity receptor* (NCR) 3, le NKp44/NCR2 et le NKp46/NCR1. Ces NCR sont des récepteurs activateurs et sont spécifiques des cellules NK [19]. Le NKp30 et le NKp46 sont exprimés constitutivement sur les cellules NK alors que le NKp44 n'est exprimé que par les cellules NK activées [20–22]. Ainsi, le NKp44 pourrait contribuer à l'augmentation d'efficacité des cellules NK activées à lyser les cellules cibles [23]. Les NCR jouent un rôle coopératif ou synergique dans la cytotoxicité médiée par les cellules NK. De plus, des analyses phénotypiques et fonctionnelles ont montré que la densité de NCR à la surface des cellules NK est variable d'un individu à l'autre et qu'il existe une corrélation entre la densité de surface des NCR et la capacité des cellules NK à lyser les cellules cibles [24]. Par ailleurs, des données récentes suggèrent l'existence d'un cross-talk entre les NCR : l'activation de l'un ou l'autre des NCR induirait un processus de phosphorylation de tyrosines qui n'est pas restreint aux molécules associées au NCR entrant en interaction avec un ligand mais qui implique également les molécules de signalisation associées aux autres NCR. Cela suggère que la cascade de signalisation activée par l'engagement d'un NCR peut être amplifiée par l'activation simultanée de molécules de

signalisation associées à d'autres membres de la même famille de récepteurs [25]. Les ligands des trois NCR sont pour l'instant mal connus mais il semblerait que les NCR soient capables de se lier à des molécules virales comme la protéine pp65 du cytomégalo virus pour le NKp30 ou des hémagglutinines de l'influenza virus pour le NKp46 [26,27]. Plus récemment, un nouveau ligand du NKp30 a été décrit : HLA-B *associated transcript*-3 ou BAT-3 [28], un facteur nucléaire relargué par la cellule tumorale en réponse à des signaux de stress. La molécule NKG2D fait aussi partie de la famille des récepteurs activateurs des cellules NK non HLA-restreints. NKG2D peut être exprimée par les lymphocytes T CD8⁺ et les lymphocytes TCR γ/δ . Ce récepteur appartient à la superfamille des récepteurs de type C-lectine. Ses ligands ont été identifiés récemment : MICA, MICB (*MHC class I chain-related A/B*) et les ULBP1-4 (*UL16-binding proteins*). Les gènes codant pour MICA et MICB se trouvent sur le chromosome 6, dans le complexe des gènes codant pour le HLA [29,30]. Ces molécules peuvent être induites en condition de stress et sont surexprimées dans des tumeurs épithéliales comme le sein, l'ovaire, le côlon, le rein et les poumons. Les ULBP sont des molécules *glycosyl phosphatidyl inositol*-ancrées (GPI) caractérisées par la capacité à induire l'activation des cellules NK médiée par le NKG2D. Leurs gènes sont également localisés sur le chromosome 6.

Enfin, les cellules NK portent à leur surface des corécepteurs, qui jouent un rôle dans l'activation des cellules NK. Leur fonction activatrice est dépendante de l'engagement simultané d'un récepteur activateur. De plus, la fonction activatrice ne serait pas uniquement dépendante de la densité de surface de certains des principaux récepteurs NK mais aussi de l'existence d'un nombre d'interactions suffisantes entre le récepteur et ses ligands sur les cellules cibles. La molécule 2B4/CD244 (ou p38) est une molécule de 70 kDa exprimée par les cellules NK, les lymphocytes T CD8⁺, les monocytes et les granulocytes [31]. Le 2B4 a pour ligand la molécule CD48 [32] et est capable de s'associer à une *Src homology (SH)-containing phosphatase* (SHP1). Le récepteur NKp80 a été identifié récemment. Comme 2B4, il permet préférentiellement l'activation des cellules NK présentant un phénotype NCR^{bright}. Cette protéine est quasiment spécifique des cellules NK : elle a été décrite sur une sous-population lymphocytaire T exprimant également le CD56. Le NKp80 est exprimé sous forme de dimère et appartient à la superfamille des récepteurs de type C-lectine.

Les principaux ligands des cellules NK, leur fonction et leur(s) ligand(s) sont rappelés dans le [Tableau 1](#).

La découverte de récepteurs activateurs et inhibiteurs à la surface des cellules NK a permis d'explicitier la théorie du *missing self*, le contrôle de l'activation des cellules NK résultant de la balance entre les signaux activateurs et inhibiteurs mettant en jeu ces différents récepteurs. Ainsi, plusieurs situations peuvent être décrites :

- la cellule cible normale exprime à sa surface des molécules HLA de classe I reconnues par un récepteur inhibiteur de la cellule NK. Dans ce cas, l'engagement des ligands de la cellule NK avec les molécules HLA de classe I présentes sur la cellule cible génère un signal inhibiteur, empêchant la lyse de la cible par la cellule NK [4] ;

- la cellule cible exprime des ligands pour les NCR mais n'exprime pas de molécules HLA de classe I (ou des molécules altérées), anomalie observée dans les cellules cancéreuses ou infectées par des virus. Dans ce cas, les récepteurs inhibiteurs ne peuvent s'engager avec leurs ligands et il n'y a pas d'inhibition du signal activateur. En conséquence, la cellule cible est lysée ;
- enfin, la cellule cible peut exprimer de façon anormale des ligands reconnus par les NCR ou le NKG2D, sans avoir perdu l'expression des molécules de HLA classe I. La génération d'un signal inhibiteur est donc possible avec pour conséquence le blocage de l'activation et de la cytotoxicité naturelle des cellules NK. Néanmoins, dans cette situation, le signal inhibiteur peut être dépassé si la densité en récepteurs activateurs ou si leur affinité pour leurs ligands est importante.

Cellules Natural Killer et hémopathies malignes

Les cellules NK, du fait de leurs propriétés antitumorales, ont été largement étudiées dans les hémopathies. Il est intéressant de noter que des anomalies de ces cellules ont été décrites dans presque toutes les hémopathies, myéloïdes ou lymphoïdes, chroniques ou aiguës.

Une anomalie a été décrite de façon constante dans toutes les hémopathies étudiées : la diminution de l'activité cytotoxique des cellules NK, qui pourrait permettre d'expliquer l'expansion des différents clones malins. Cette diminution de l'activité cytotoxique est mise en évidence par le test de cytotoxicité au chrome 51 qui permet d'étudier la lyse de cellule cibles, des cellules K562 (lignée cellulaire dérivant d'une érythroleucémie n'exprimant pas de molécules HLA de classe I à leur surface). Cette diminution d'activité cytotoxique pourrait être reliée à différentes anomalies des cellules NK : anomalie de nombre, anomalie de l'expression des récepteurs, anomalie de production des molécules cytolytiques. . .

La diminution de l'activité cytotoxique pourrait être reliée à la diminution globale du nombre de cellules NK, phénomène observé dans la myélofibrose primitive (MP) ou dans la leucémie myéloïde chronique (LMC) à un stade évolué. Un pourcentage de cellules NK diminué a également été rapporté dans les leucémies aiguës myéloblastiques (LAM).

Des anomalies de l'expression des récepteurs ou des ligands de ces récepteurs peuvent également être à l'origine de la diminution de l'activité cytotoxique des cellules NK. Au cours de l'évolution de la LMC, des cellules NK porteuses du transcrit *bcr/abl* apparaissent. Ces cellules présentent des capacités de prolifération diminuées et acquièrent l'expression de récepteurs inhibiteurs : les CD158i et CD158j, et dans une moindre mesure le CD158e, suggérant que l'oncogène *BCR/ABL* pourrait favoriser l'acquisition de ces récepteurs ou favoriser la survie des clones exprimant ces récepteurs [34]. Une anomalie d'expression des récepteurs activateurs pourrait également expliquer une diminution de l'activité cytotoxique des cellules NK. Chez les patients atteints de LAM, une proportion significativement augmentée de cellules NK présentant un phénotype NCR^{dull} [24] i.e. ayant une faible expression membranaire du NKp30 et du NKp46, a été rapportée [35]. De

Tableau 1 Principaux récepteurs impliqués dans les fonctions Natural Killer (NK) [33].

Gène	Récepteur	Fonction	Ligand(s)
<i>FCGR3A</i>	CD16	A; ADCC	IgG Fc
<i>Ncam1</i>	CD56		
<i>NKp30</i>	NKp30 (NCR3, CD337)	A; cytotoxicité, production de cytokines	BAT-3, pp65
<i>NKp44</i>	NKp44 (NCR2, CD336)	A; cytotoxicité	Hémagglutinines virales
<i>NKp46</i>	NKp46 (NCR1, CD335)	A; cytotoxicité, production de cytokines	Hémagglutinines virales
<i>NKp80</i>	NKp80 (KLF1)	A; cytotoxicité	CLEC2B (AICL)
<i>NKG2D</i>	NKG2D (CD314)	A; cytotoxicité	MICA/B, ULBP
<i>NKG2C</i>	NKG2C/CD94 (CD159c)	A; cytotoxicité	HLA-E
<i>KIR2DS1</i>	KIR2DS1 (CD158h, p50.1)	A; cytotoxicité, prolifération	HLA-Cw2, 4, 5, 6
<i>KIR2DS2</i>	KIR2DS2 (CD158j, p50.2)	A; cytotoxicité, prolifération	HLA-Cw1, 3, 7, 8
<i>KIR3DS1</i>	KIR3DS1 (CD158c2)	A; cytotoxicité	HLA-Bw4?
<i>KIR2DS4</i>	KIR2DS4 (CD158i, p50.3)	A	HLA-Cw4
<i>2B4</i>	2B4 (CD244)	A; cytotoxicité, production de cytokines	CD48
<i>Dna-m1</i>	DNAM-1 (CD266)	A; cytotoxicité	Nectin-2, PVR
<i>Lf-a1</i>	LFA-1 α (CD11a)	A; cytotoxicité	ICAM-1 (CD54)
<i>IL2ra</i>	IL-2R α (CD25)	A; prolifération	IL-2
<i>Ifngr1</i>	IFN- γ R α (CD119)	A; cytotoxicité, prolifération	IFN- γ
<i>IL12rb2</i>	IL-12R β (CD212)	A; production de cytokines	IL-12
<i>NKG2A</i>	NKG2A/CD94 (CD159a)	I	HLA-E
<i>LIR1/ILT2</i>	LIR1/ILT2 (CD85j)	I	HLA-A, B, C, E, F, G
<i>KIR3DL3</i>	KIR3DL3 (CD158z)	I	?
<i>KIR2DL3</i>	KIR2DL3 (CD158b2, p58.2)	I	HLA-Cw1, 3, 7, 8
<i>KIR2DL2</i>	KIR2DL2 (CD158b1, p58.2)	I	HLA-Cw1, 3, 7, 8
<i>KIR2DL1</i>	KIR2DL1 (CD158a, p58.1)	I	HLA-Cw2, 4, 5, 6
<i>KIR2DL4</i>	KIR2DL4 (CD158d, p49)	I?; production de cytokines	HLA-G, A3, B46
<i>KIR3DL1</i>	KIR3DL1 (CD158e1, p70)	I	HLA-Bw4 (par exemple B27)
<i>KIR2DL5A</i>	KIR2DL5A (CD158f)	I	?
<i>KIR2DL5B</i>	KIR2DL5B	I	?
<i>KIR3DL2</i>	KIR3DL2 (CD158k, p140)	I	HLA-A3, A11

A: activation; I: inhibition; BAT-3: *HLA-B associated transcript-3*; CLEC2B: *C-type lectin domain family 2, member B*; MICA/B: *MHC class I chain-related protein A/B*; ULBP: *UL16-binding proteins*; ICAM: *intercellular adhesion molecule 1*.

plus, chez les patients en rémission de leur LAM, il a été observé une augmentation de l'expression du NKp30 et du NKp46, associée à une restauration de l'activité cytotoxique des cellules NK [36], témoignant à la fois du caractère acquis mais aussi réversible de cette anomalie. Dans le myélome multiple (MM), au fil de l'évolution de la maladie, les plasmocytes deviennent résistants aux cellules NK du fait d'une expression augmentée des molécules HLA de classe I, l'utilisation d'anticorps masquant les molécules HLA de classe I permettant la restauration de la susceptibilité des plasmocytes aux cellules NK [37]. De plus, la présence de multiples transcrits du HLA-G dans les plasmocytes a aussi été rapportée [38]. Le HLA-G est capable d'inhiber les fonctions effectrices des lymphocytes T et des cellules NK, pouvant permettre l'échappement des cellules tumorales. De façon intéressante, il a également été observé la présence d'au moins un transcrit du HLA-G dans les cellules leucémiques de 89% des patients atteints de LLC. Le blocage du HLA-G par un anticorps permet d'augmenter la susceptibilité des cellules leucémiques aux cellules NK [38]. De plus, les cellules de LLC n'expriment ni MICA, ni ULBP, les ligands du récepteur activateur NKG2D. Dans les LAM, il a au contraire été montré une augmentation des concentrations des molécules MICA et MICB dans le plasma des patients [39].

Ces molécules solubles sont capables d'activer les processus d'internalisation du NKG2D, entraînant une diminution de l'activité cytotoxique des cellules NK [40]. De façon similaire, dans les syndromes myélodysplasiques (SMD), il a été noté une augmentation des taux plasmatiques de la forme soluble du récepteur de l'IL-2, aboutissant à une activation inappropriée des cellules NK [41]. Enfin, des anomalies de production de molécules participant à la cytotoxicité des cellules NK pourraient également être impliquées dans la diminution de leur activité cytotoxique. Ainsi, dans les SMD, il a été montré une diminution de la production d'interféron γ et de TNF α [42]. Chez les patients atteints de MP, il a été observé une augmentation des concentrations sériques de *platelet-derived growth factor* (PDGF), molécule capable d'inhiber les fonctions des cellules NK [43]. Les principales anomalies des cellules NK décrites dans les hémopathies sont regroupées dans le Tableau 2.

Les anomalies observées peuvent être à l'origine d'une baisse de l'activité cytotoxique des cellules NK, les empêchant de combattre la prolifération des cellules souches hématopoïétiques anormales. De ce fait, les cellules NK nous ont paru être intéressantes à étudier. Nous avons choisi de les étudier dans la maladie de Vaquez pour plusieurs raisons. Tout d'abord, cette pathologie a été peu étudiée

Tableau 2 Anomalie des cellules Natural Killer (NK) observées dans les différentes hémopathies [33].

Leucémies aiguës lymphoblastiques	Diminution de l'activité cytotoxique (augmentation possible par l'IFN ou l'IL-2) Diminution de la production de protéines cytolytiques (9,2% [P] vs 16,5% [T]) Expression du phénotype inhibiteur KIR AB (2DL1, 2DL2, 2DL3) chez 51,0% des patients vs 31,1% des témoins, liée surtout au 2DL2
Leucémies aiguës myéloïdes	Diminution de l'activité cytotoxique Pourcentage diminué de cellules NK Phénotype NCR ^{dull} (expression diminuée des NCRs) chez 16 P sur 18 Expression diminuée du NKG2D Expression du phénotype inhibiteur KIR AB (2DL1, 2DL2, 2DL3) chez 51,0% des patients vs 31,1% des témoins, liée surtout au 2DL2 Taux augmenté des MICA (335 [P] vs 64 [T] pg/mL) et des MICB (121 [P] vs 21 [T] pg/mL)
Myélome multiple	Diminution de l'activité cytotoxique Résistance acquise des plasmocytes aux cellules NK lors de la progression de la maladie (augmentation de l'expression des molécules HLA de classe I) Expression du HLA-G (100% des patients) Expression diminuée du NKG2D et du 2B4 Expression diminuée du MICA sur les plasmocytes
Leucémie lymphoïde chronique	Diminution de l'activité cytotoxique (augmentation possible par l'IFN ou l'IL-2) Nombre de cellules NK augmenté (45% des patients) Expression du HLA-G (89% des patients) Pas d'expression des ligands activateurs sur les cellules leucémiques Diminution de la production de protéines cytolytiques
Syndromes myélodysplasiques	Diminution de l'activité cytotoxique (augmentation possible par l'IFN ou l'IL-2) Augmentation des taux de sIL2R Diminution de la production d'IFN γ (62 [P] vs 232 [T] pg/mL) et TNF α (7,3 [P] vs 80 [T] pg/mL) Expression diminuée du NKp30 Expression diminuée du NKG2D Expression de MICA/B par 30% des cellules CD34+ Pas d'expansion des cellules NK in vitro après activation par IL-2 Augmentation de l'apoptose des progéniteurs myéloïdes
Syndromes myéloprolifératifs	Diminution de l'activité cytotoxique (sans augmentation par l'IFN ou l'IL-2) Apparition de l'oncogène <i>BCR/ABL</i> dans les cellules NK de la LMC évoluée Cellules NK : augmentées dans la PV (16,7 [P] vs 9,8 [T] %), diminuées dans la MP (5,8 [P] vs 9,8 [T] %) et la LMC évoluée Expression augmentée du PDGF dans la MP Expression diminuée du NKG2D dans la LMC Expression du MICA/B par les cellules CD34+ dans la LMC Concentration sérique élevée des MICA dans la LMC

P : patients ; T : témoins ; MICA/B : *MHC class I chain-related protein A/B* ; KIR : *killer cell immunoglobulin-like receptors* ; NCR : *natural cytotoxicity receptor* ; PDGF : *platelet-derived growth factor* ; LMC : leucémie myéloïde chronique.

contrairement aux hémopathies aiguës. Par ailleurs, cette pathologie présente quelques particularités :

- il s'agit d'une pathologie de développement lent, pouvant permettre la mise en place d'une réponse immune ;
- elle peut être contrôlée par des saignées thérapeutiques, sans qu'il y ait besoin d'induire une immunosuppression par l'utilisation de drogues cytotoxiques ;
- la présence quasiment constante d'une anomalie du gène *JAK2* (mutations *V617F* ou de l'exon 12) pose la question de la présence et du rôle de cette mutation en ce qui concerne les fonctions des cellules effectrices de l'immunité ;

- la polyglobulie primitive pourrait avoir une évolution naturelle vers la MP, pathologie avec une expression clinique et biologique bien distincte, pour laquelle il n'existe pas à l'heure actuelle de traitement efficace (en dehors peut être de l'allogreffe de cellules souches).

La maladie de Vaquez ou polyglobulie primitive

La polyglobulie (P) primitive, ou maladie de Vaquez (V), est une pathologie d'incidence faible (deux à trois cas pour 100 000 habitants par an). L'âge médian au diagnostic est

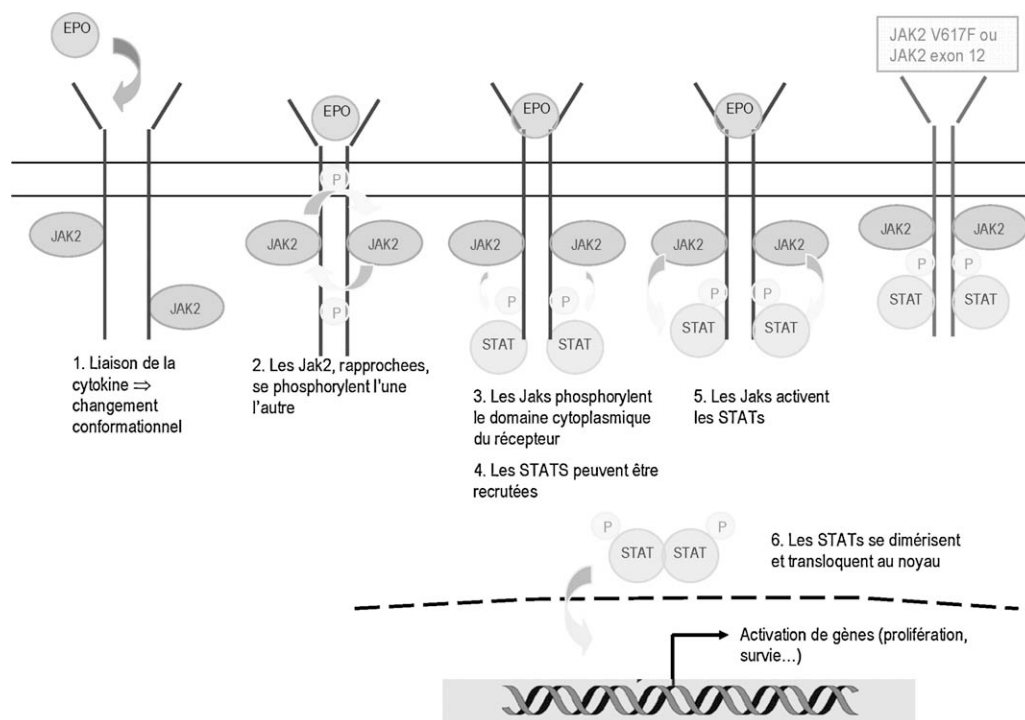

Figure 2 Voie de signalisation JAK/STAT.

de 60 ans (maladie rare avant 40 ans et exceptionnelle chez l'enfant) et le sex-ratio H/F est voisin de 1,2. Ce syndrome myéloprolifératif résulte de l'expansion clonale d'une cellule souche hématopoïétique pluripotente, prédominant sur la lignée érythroblastique. Cela est à l'origine de la plupart des signes observés : signes d'hyperviscosité (hypertension artérielle, céphalées), splénomégalie. Un prurit à l'eau chaude ou une érythrose tégumentaire peuvent également être observés. Parfois, la maladie peut être révélée par une complication thrombotique, veineuse le plus souvent (syndrome de Budd-Chiari par exemple). La PV peut s'acutiser en LAM ou évoluer en myélofibrose. Le diagnostic de cette pathologie fut longtemps un diagnostic d'exclusion mais la découverte en 2005 de la mutation JAK2 V617F a permis, d'une part, d'affiner le diagnostic de la PV et, d'autre part, d'élucider la physiopathologie de cette maladie [44,45]. La mutation JAK2 V617F est présente dans 95 % des PV mais aussi dans 50 % des thrombocythémies essentielles et 30 % des myélofibroses primitives. D'autres mutations ont été depuis décrites chez les patients ne possédant pas la mutation JAK2 V617F, notamment sur l'exon 12 du gène JAK2 [46]. La protéine mutée JAK2 joue également un rôle dans la physiopathologie de la maladie. Les protéines JAK sont des tyrosine kinases associées à différents récepteurs de cytokines. La protéine JAK2 se lie aux récepteurs de l'érythropoïétine (EPO), du *granulocyte macrophage-colony stimulating factor* (GM-CSF) et la thrombopoïétine (TPO) [47,48]. Cette protéine est constituée de plusieurs domaines dont les domaines JH1 et JH2 sont fonctionnellement importants : JH1 porte l'activité kinase alors que JH2 semblerait exercer un rôle inhibiteur sur JH1 [46]. Les mutations survenant principalement dans le domaine JH2, l'effet inhibiteur est annulé et la tyrosine kinase reste dans son état activé. L'activation constitutive de JAK2 a pour effet final

l'activation de la transcription de gènes impliqués dans la prolifération et la survie cellulaire notamment. Ce mécanisme est illustré sur la Fig. 2.

La maladie est le plus souvent découverte lors d'un bilan systématique, bien que quelques signes puissent être révélateurs. L'augmentation de l'hématocrite, du nombre de globules rouges ou du taux d'hémoglobine sont importantes à prendre en compte et sont les premiers signes évocateurs de la maladie, confirmés par la mise en évidence de la mutation JAK2. La polyglobulie est certaine pour des hématocrites supérieur à 56 % chez la femme et supérieur à 60 % chez l'homme ou si le volume globulaire total (VGT) est supérieur de plus de 25 % à la valeur théorique normale. Les anciens et les nouveaux critères diagnostiques sont présentés dans le Tableau 3, montrant toute l'importance accordée à la mutation JAK2 V617F.

Concernant le traitement de cette pathologie, les objectifs sont de maintenir l'hématocrite sous 45 % et les plaquettes sous 450 G/L. Les traitements symptomatiques peuvent être les saignées et l'aspirine. Les traitements myélofreinateurs les plus utilisés sont le pipobroman et l'hydroxyurée. Des inhibiteurs de tyrosine kinase, plus ou moins spécifiques de JAK2, sont en développement.

Les cellules Natural Killer dans la maladie de Vaquez

Dans cette dernière partie, nous allons nous intéresser plus spécifiquement aux cellules NK dans la polyglobulie primitive. Les équipes de Gersuk et Froom se sont intéressées plus globalement aux cellules NK dans les syndromes myéloprolifératifs [49,50]. Si Froom ne rapporte pas de différence de pourcentage de cellules CD16+ entre les patients atteints de

Tableau 3 Critères diagnostiques de la polyglobulie de Vaquez.

	Critères de l'OMS 2001	Critères de l'OMS 2008
Critères majeurs	A1 : VGT > 25% de la valeur théorique ou Hb > 18,5 g/dL (H) ou > 16,5 (F) g/dL A2 : pas de cause de polyglobulie secondaire A3 : splénomégalie A4 : anomalie cytogénétique clonale (sauf chromosome Philadelphie) A5 : pousse spontanée de colonies érythroblastiques en culture	A1 : Hb > 18,5 g/dL (H) ou > 16,5 (F) g/dL ou VGT > 25% de la valeur théorique A2 : mutation du gène <i>JAK2</i> (<i>JAK2 V617F</i> ou mutation de l'exon 12)
Critères mineurs	b1 : thrombocytose b2 : hyperleucocytose > 12 G/L b3 : panmyélose avec prolifération érythroïde et mégacaryocytaire à la BOM b4 : EPO sérique basse	b1 : myéloprolifération des 3 lignées à la BOM b2 : EPO sérique basse b3 : pousse spontanée de colonies érythroblastiques en culture
Diagnostic de PV si	A1 + A2 + 1 autre critère A ou A1 + A2 + 2 critères b	A1 + A2 + 1 critère b ou A1 + 2 critères b

VGT : volume globulaire total ; EPO : érythropoïétine.

SMP ($11 \pm 3\%$) et les témoins ($12 \pm 4\%$) [50], Gersuk et al. montrent un pourcentage de cellules NK augmenté chez les patients atteints de PV : $16,7 \pm 2,1\%$ vs $9,8 \pm 1,3\%$ [49]. Les patients présentent en valeur absolue un nombre de $0,46 \pm 0,18$ G/L cellules NK (en moyenne, 0,2 G/L de cellules NK). Pour étudier plus précisément les cellules NK, nous les avons définies selon leur phénotype classique $CD3^- CD16^+ CD56^+$. Nous avons pu montrer une augmentation significative des cellules NK en pourcentage et en valeur absolue. Froom et al. rapportent la diminution de l'activité cytotoxique des cellules chez dix patients sur 26 [50]. De même, Gersuk et al. montrent également une diminution de l'activité cytotoxique chez les patients atteints de PV : $76,9 \pm 5,4$ LU vs $173,9 \pm 6,3$ LU [49]. Cette unité LU est définie comme le nombre de cellules effectrices provoquant 30% du relargage spécifique du ^{51}Cr par 10^4 cellules cibles, exprimé pour 10^7 cellules effectrices [49]. Les deux équipes montrent que l'IFN α et l'IL-2 permettent d'augmenter mais pas de restaurer l'activité cytotoxique des cellules NK chez les patients. Nos études préliminaires sur les capacités d'activation des cellules NK chez les patients atteints de maladie de Vaquez suggèrent un déficit fonctionnel de ces cellules. De nombreuses anomalies de l'expression des récepteurs ayant été décrites, nous avons étudié l'expression de récepteurs activateurs (NCRs et NKG2D) et de récepteurs inhibiteurs (CD158a, CD158b, CD158e, CD158i, CD85j et CD159a). L'expression de ces récepteurs est normale, à l'exception du CD158a dont l'expression est augmentée chez les patients atteints de PV. Ces données suggèrent que le déficit cytotoxique des cellules NK pourrait être lié à une ou des anomalies de voies de signalisation malgré l'expression quasi normale des récepteurs à la surface des cellules NK.

Deux voies nous semblent intéressantes à investiguer dans ce contexte. D'une part se pose la question de la présence de la mutation *JAK2 V617F* dans les cellules NK des patients et de ses éventuels effets sur les cellules. La transfection de la lignée NK-92 avec le gène *JAK2* muté pourrait permettre d'étudier les effets de la

mutation sur les cellules NK. Des expériences similaires ont déjà été réalisées avec la transfection du transcrit de fusion *bcr/abl* dans cette lignée cellulaire. Il a été observé une diminution du nombre de cellules NK et l'expression de récepteurs inhibiteurs. Ce modèle permettrait également d'étudier les effets d'une molécule anti-*JAK2*. D'autre part, le clone malin pourrait se développer du fait d'une résistance des progéniteurs érythroblastiques aux cellules NK. Ainsi, il semble intéressant de rechercher l'expression du HLA-G mais aussi des autres molécules HLA de classe I à la surface des progéniteurs érythroblastiques des patients.

Conclusion

La découverte de récepteurs spécifiques des molécules HLA de classe I sur les cellules NK ainsi que l'étude de leurs fonctions, de leur régulation et de leurs propriétés moléculaires permettent d'envisager leur utilisation comme une immunothérapie innovante dans les hémopathies. En effet, des anomalies des cellules NK (nombre, expression des récepteurs, diminution de l'activité cytotoxique...) ont été décrites dans toutes les hémopathies. Nos premières études sur les cellules NK dans la polyglobulie de Vaquez nous ont permis de mettre en évidence des anomalies, notamment de la répartition des sous-populations lymphocytaires, nous engageant à poursuivre nos investigations dans cette pathologie.

Déclaration d'intérêts

Les auteurs déclarent ne pas avoir de conflits d'intérêts en relation avec cet article.

Références

- [1] Kiessling R, Klein E, Pross H, Wigzell H. "Natural" killer cells in the mouse. II. Cytotoxic cells with specificity for mouse

- Moloney leukemia cells. Characteristics of the killer cell. *Eur J Immunol* 1975;5:117–21.
- [2] Herberman RB, Nunn ME, Holden HT, Lavrin DH. Natural cytotoxic reactivity of mouse lymphoid cells against syngeneic and allogeneic tumors. II. Characterization of effector cells. *Int J Cancer* 1975;16:230–9.
- [3] Karre K, Ljunggren HG, Piontek G, Kiessling R. Selective rejection of H-2-deficient lymphoma variants suggests alternative immune defence strategy. *Nature* 1986;319:675–8.
- [4] Karre K. Natural killer cells and the MHC class I pathway of peptide presentation. *Semin Immunol* 1993;5:127–45.
- [5] Schleinitz N, Hamidou M, Vely F, Paul P, Figarella-Branger D, Kaplanski G, et al. NK cells: new insights on physiology and clinical implication in diseases. *Rev Med Interne* 2006;27:465–72.
- [6] Fehniger TA, Cooper MA, Nuovo GJ, Cella M, Facchetti F, Colonna M, et al. CD56 bright natural killer cells are present in human lymph nodes and are activated by T cell-derived IL-2: a potential new link between adaptive and innate immunity. *Blood* 2003;101:3052–7.
- [7] Cooper MA, Fehniger TA, Turner SC, Chen KS, Ghaheri BA, Ghayur T, et al. Human natural killer cells: a unique innate immunoregulatory role for the CD56 (bright) subset. *Blood* 2001;97:3146–51.
- [8] Cooper MA, Fehniger TA, Caligiuri MA. The biology of human natural killer cell subsets. *Trends Immunol* 2001;22:633–40.
- [9] Moretta A. Natural killer cells and dendritic cells: rendezvous in abused tissues. *Nat Rev Immunol* 2002;2:957–64.
- [10] Caligiuri MA. Human natural killer cells. *Blood* 2008;112:461–9.
- [11] Freud AG, Caligiuri MA. Human natural killer cell development. *Immunol Rev* 2006;214:56–72.
- [12] Freud AG, Yokohama A, Becknell B, Lee MT, Mao HC, Ferketich AK, et al. Evidence for discrete stages of human natural killer cell differentiation in vivo. *J Exp Med* 2006;203:1033–43.
- [13] Lanier LL, Phillips JH, Hackett Jr J, Tutt M, Kumar V. Natural killer cells: definition of a cell type rather than a function. *J Immunol* 1986;137:2735–9.
- [14] Chan A, Hong DL, Atzberger A, Kollnberger S, Filer AD, Buckley CD, et al. CD56 bright human NK cells differentiate into CD56 dim cells: role of contact with peripheral fibroblasts. *J Immunol* 2007;179:89–94.
- [15] Ferlazzo G, Thomas D, Lin SL, Goodman K, Morandi B, Muller WA, et al. The abundant NK cells in human secondary lymphoid tissues require activation to express killer cell Ig-like receptors and become cytolytic. *J Immunol* 2004;172:1455–62.
- [16] Moretta A, Biassoni R, Bottino C, Pende D, Vitale M, Poggi A, et al. Major histocompatibility complex class I-specific receptors on human natural killer and T lymphocytes. *Immunol Rev* 1997;155:105–17.
- [17] Borges L, Hsu ML, Fanger N, Kubin M, Cosman D. A family of human lymphoid and myeloid Ig-like receptors, some of which bind to MHC class I molecules. *J Immunol* 1997;159:5192–6.
- [18] Lepin EJ, Bastin JM, Allan DS, Roncador G, Braud VM, Mason DY, et al. Functional characterization of HLA-F and binding of HLA-F tetramers to ILT2 and ILT4 receptors. *Eur J Immunol* 2000;30:3552–61.
- [19] Bottino C, Biassoni R, Millo R, Moretta L, Moretta A. The human natural cytotoxicity receptors (NCR) that induce HLA class I-independent NK cell triggering. *Hum Immunol* 2000;61:1–6.
- [20] Pende D, Parolini S, Pessino A, Sivori S, Augugliaro R, Morelli L, et al. Identification and molecular characterization of NKP30, a novel triggering receptor involved in natural cytotoxicity mediated by human natural killer cells. *J Exp Med* 1999;190:1505–16.
- [21] Pessino A, Sivori S, Bottino C, Malaspina A, Morelli L, Moretta L, et al. Molecular cloning of NKP46: a novel member of the immunoglobulin superfamily involved in triggering of natural cytotoxicity. *J Exp Med* 1998;188:953–60.
- [22] Vitale M, Bottino C, Sivori S, Sanseverino L, Castriconi R, Marcenaro E, et al. NKP44, a novel triggering surface molecule specifically expressed by activated natural killer cells, is involved in non-major histocompatibility complex-restricted tumor cell lysis. *J Exp Med* 1998;187:2065–72.
- [23] Rosenberg SA, Lotze MT. Cancer immunotherapy using interleukin-2 and interleukin-2-activated lymphocytes. *Annu Rev Immunol* 1986;4:681–709.
- [24] Sivori S, Pende D, Bottino C, Marcenaro E, Pessino A, Biassoni R, et al. NKP46 is the major triggering receptor involved in the natural cytotoxicity of fresh or cultured human NK cells. Correlation between surface density of NKP46 and natural cytotoxicity against autologous, allogeneic or xenogeneic target cells. *Eur J Immunol* 1999;29:1656–66.
- [25] Augugliaro R, Parolini S, Castriconi R, Marcenaro E, Cantoni C, Nanni M, et al. Selective cross-talk among natural cytotoxicity receptors in human natural killer cells. *Eur J Immunol* 2003;33:1235–41.
- [26] Arnon TI, Achdout H, Levi O, Markel G, Saleh N, Katz G, et al. Inhibition of the NKP30 activating receptor by pp65 of human cytomegalovirus. *Nat Immunol* 2005;6:515–23.
- [27] Mandelboim O, Lieberman N, Lev M, Paul L, Arnon TI, Bushkin Y, et al. Recognition of haemagglutinins on virus-infected cells by NKP46 activates lysis by human NK cells. *Nature* 2001;409:1055–60.
- [28] Pogge von Strandmann E, Simhadri VR, von Tresckow B, Sasse S, Reiners KS, Hansen HP, et al. Human leukocyte antigen-B-associated transcript 3 is released from tumor cells and engages the NKP30 receptor on natural killer cells. *Immunity* 2007;27:965–74.
- [29] Bauer S, Groh V, Wu J, Steinle A, Phillips JH, Lanier LL, et al. Activation of NK cells and T cells by NKG2D, a receptor for stress-inducible MICA. *Science* 1999;285:727–9.
- [30] Groh V, Rhinehart R, Secrist H, Bauer S, Grabstein KH, Spies T. Broad tumor-associated expression and recognition by tumor-derived gamma delta T cells of MICA and MICB. *Proc Natl Acad Sci U S A* 1999;96:6879–84.
- [31] Sivori S, Parolini S, Falco M, Marcenaro E, Biassoni R, Bottino C, et al. 2B4 functions as a co-receptor in human NK cell activation. *Eur J Immunol* 2000;30:787–93.
- [32] Latchman Y, McKay PF, Reiser H. Identification of the 2B4 molecule as a counter-receptor for CD48. *J Immunol* 1998;161:5809–12.
- [33] Sanchez CJ, Le Treut T, Boehrer A, Knoblauch B, Imbert J, Olive D, et al. Natural killer cells and malignant haemopathies: a model for the interaction of cancer with innate immunity. *Cancer Immunol Immunother* 2011;60:1–13.
- [34] Chiorean EG, Dylla SJ, Olsen K, Lenvik T, Soignier Y, Miller JS. BCR/ABL alters the function of NK cells and the acquisition of killer immunoglobulin-like receptors (KIRs). *Blood* 2003;101:3527–33.
- [35] Costello RT, Sivori S, Marcenaro E, Lafage-Pochitaloff M, Mozziconacci MJ, Reviron D, et al. Defective expression and function of natural killer cell triggering receptors in patients with acute myeloid leukemia. *Blood* 2002;99:3661–7.
- [36] Fauriat C, Just-Landi S, Mallet F, Arnoulet C, Sainty D, Olive D, et al. Deficient expression of NCR in NK cells from acute myeloid leukemia: evolution during leukemia treatment and impact of leukemia cells in NCR dull phenotype induction. *Blood* 2007;109:323–30.
- [37] Carbone E, Neri P, Mesuraca M, Fulciniti MT, Otsuki T, Pende D, et al. HLA class I, NKG2D, and natural cytotoxicity receptors regulate multiple myeloma cell recognition by natural killer cells. *Blood* 2005;105:251–8.
- [38] Maki G, Hayes GM, Naji A, Tyler T, Carosella ED, Rouas-Freiss N, et al. NK resistance of tumor cells from multiple myeloma and chronic lymphocytic leukemia patients: implication of HLA-G. *Leukemia* 2008;22:998–1006.

- [39] Salih HR, Antropius H, Gieseke F, Lutz SZ, Kanz L, Rammensee HG, et al. Functional expression and release of ligands for the activating immunoreceptor NKG2D in leukemia. *Blood* 2003;102:1389–96.
- [40] Groh V, Wu J, Yee C, Spies T. Tumour-derived soluble MIC ligands impair expression of NKG2D and T cell activation. *Nature* 2002;419:734–8.
- [41] Yokose N, Ogata K, Ito T, An E, Tamura H, Dan K, et al. Elevated plasma soluble interleukin 2 receptor level correlates with defective natural killer and CD8+ T cells in myelodysplastic syndromes. *Leuk Res* 1994;18:777–82.
- [42] Kiladjian JJ, Bourgeois E, Lobe I, Braun T, Visentin G, Bourhis JH, et al. Cytolytic function and survival of natural killer cells are severely altered in myelodysplastic syndromes. *Leukemia* 2006;20:463–70.
- [43] Gersuk GM, Carmel R, Pattengale PK. Platelet-derived growth factor concentrations in platelet-poor plasma and urine from patients with myeloproliferative disorders. *Blood* 1989;74:2330–4.
- [44] Baxter EJ, Scott LM, Campbell PJ, East C, Fourouclas N, Swanton S, et al. Acquired mutation of the tyrosine kinase JAK2 in human myeloproliferative disorders. *Lancet* 2005;365:1054–61.
- [45] James C, Ugo V, Le Couedic JP, Staerk J, Delhommeau F, Lacout C, et al. A unique clonal JAK2 mutation leading to constitutive signalling causes polycythaemia vera. *Nature* 2005;434:1144–8.
- [46] Smith CA, Fan G. The saga of JAK2 mutations and translocations in hematologic disorders: pathogenesis, diagnostic and therapeutic prospects, and revised World Health Organization diagnostic criteria for myeloproliferative neoplasms. *Hum Pathol* 2008;39:795–810.
- [47] Parganas E, Wang D, Stravopodis D, Topham DJ, Marine JC, Teglund S, et al. Jak2 is essential for signaling through a variety of cytokine receptors. *Cell* 1998;93:385–95.
- [48] Witthuhn BA, Quelle FW, Silvennoinen O, Yi T, Tang B, Miura O, et al. JAK2 associates with the erythropoietin receptor and is tyrosine phosphorylated and activated following stimulation with erythropoietin. *Cell* 1993;74:227–36.
- [49] Gersuk GM, Carmel R, Pattamakom S, Challita PM, Rabinowitz AP, Pattengale PK. Quantitative and functional studies of impaired natural killer (NK) cells in patients with myelofibrosis, essential thrombocythemia and polycythemia vera. I. A potential role for platelet-derived growth factor in defective NK cytotoxicity. *Nat Immun* 1993;12:136–51.
- [50] Froom P, Aghai E, Kinarty A, Lahat N. Decreased natural killer (NK) activity in patients with myeloproliferative disorders. *Cancer* 1989;64:1038–40.

RESULTS

III. WHICH ROLE FOR NK CELLS IN HAEMOPATHIES DEVELOPMENT ?

The incidence of malignancies in France has been checked by the Health Surveillance Institute (HIS) between 1980 and 2012. HIS estimated that hematological malignancies, including leukemia or lymphoma, represent 10% of new cancer cases in France, or 35 000 per year. Prevalence is more important for individual aged 60 and older. Current treatments with chemotherapy prolong progression-free survival but the risk of relapse and transformation of some haemopathies in acute leukemia remains high. To date, allogenic transplantation is the only curative treatment.

There has been a substantial gain in our understanding of the role that natural killer cells play in mediating innate host immune responses against cancer. Although NK cells have long been known to be capable of killing cancer cells independently of antigen recognition, the full therapeutic potential of NK cell–based immunotherapy has yet to be realized.

This ten last years, defects in NK cells function, activation and phenotype have been described in almost all hematological malignancies (Sanchez *et al.*, 2011). These observations led us to continue investigating NK cells functions in these pathologies, and more particularly in polycythemia Vera and acute myeloid leukemia.

The monitoring of NK cell activity in patient with hematological malignancies is clearly topical as evidenced by the review of Sebastien Viel *et al.* published in 2013 (Viel *et al.*, 2013). In this context, our overall objective is to understand what the role of NK cells in PV and AML development.

IV. RESULTS

A. Result 1 : Natural killer cells in patients with polycythemia vera

In this first part, we investigated the peripheral NK cytotoxicity abilities and phenotype in patients with polycythemia Vera. PV is an interesting disease for several reasons:

- Few studies have been conducted on NK cells in this disease,
- PV has a slowly progressive disease, and can be controlled by therapeutic bleedings, without need of inducing immunosuppression by using cytotoxic drugs,
- It can evolve into myelofibrosis or acute myelogenous leukemia,
- Is characterized by almost constant presence of a molecular defect (JAK2 V617F) in myeloid lineage, and the JAK2V617 mutation is present 95% of PV patients(Larsen *et al.*, 2007).

Thus, the immune system seems to be able to control the development of the disease but not to eradicate it. This raises several questions:

- Is the mutation found in NK?
- What are the consequences of this mutation in NK cells: their number, their functions?

To answer these questions, we have first determined the percentage of JAK mutation in purified PV-NK cells, the number and percentage of NK and test NK cells cytotoxicity abilities in vitro before and after expansion with Il-2. Next we have investigated expression of inhibitory and activating receptors at NK cells surface and their gene level expression. We combined these experimentations by an original transcriptomic analysis comparing NK cells from PV and healthy donors which is the reflect of genes transcription in a cell for a given condition. This work leads to an article currently in submission.

Title:

Natural killer cells in patients with polycythemia vera

Running title:

Natural killer cells and polycythemia vera

Authors : Carole Sanchez^{1,2,3,4}, Céline Baier¹, Rabie Chelbi¹, Pascal Rihet¹, Thérèse Le Treut³, Jean Imbert¹, Gérard Sébahoun^{2,3}, Geoffroy Venton^{1,2} and Régis T. Costello^{1,2,3,4}

¹ Aix-Marseille Université, UMR 1090 TAGC, Marseille, France

² AP-HM, Hôpital de La Conception, Service d'Hématologie et Thérapie Cellulaire, Marseille, France

³ AP-HM, Laboratoire d'Hématologie, Hôpital Nord, Marseille, France

⁴ Laboratoire de Biologie Médicale, Centre Hospitalier, Salon de Provence, France

Current address for correspondence: Pr. Régis T. Costello, Service d'Hématologie et Thérapie Cellulaire, Centre Hospitalier Universitaire La Conception, 147 boulevard Baille, 13005 Marseille, France. Phone number: (33) 4 91 38 41 50, Fax number: (33) 4 91 36 41 54, E-mail address: regis.costello@ap-hm.fr

Word count: **Abstract:** 220 words, **main text:** 3 416 words, **figures:** 5

Keywords: Natural Killer, expansion, cytotoxicity, natural cytotoxicity receptors, transcriptome analysis.

Summary

Natural killer lymphocytes are pivotal cells of innate immunity that sense defective expression of human leukocyte antigen class I molecules and are complementary to specific cytotoxic T lymphocytes. Natural killer are potent antileukemic cytotoxic effectors. A defect in their cytotoxicity has been described in some hematopoietic malignancies such as acute myeloid leukemia, multiple myeloma and myelodysplastic syndromes. This defect is at least partially linked to a decreased or absent expression of some activating natural killer molecules, more particularly the so-called natural cytotoxicity receptors. In the present study, we more particularly focused our attention on natural killer cells of polycythemia vera, a myeloproliferative disease characterized by the presence of mutated JAK2 tyrosine kinase. The polymerase chain reaction analysis of natural killer from patients showed that they expressed the mutated form of JAK2. In polycythemia vera the proportion of natural killer was increased compared to healthy donors. The proliferative and cytotoxic capacities of natural killer cells from patients were similar to healthy donors. Expression of activating or inhibitory receptors was comparable in patients and donors, with nonetheless an imbalance for the inhibitory form of the CD158a,h couple of receptors in patients. Finally, the transcriptomic profile analysis clearly identified a discriminant signature between natural killer cells from patients and donors that could putatively be the consequence of abnormal continuous activation of mutated JAK2.

Introduction

Myeloproliferative disorders (MPD) are clonal pluripotent stem cell disorders characterized by a spontaneous growth of myeloid cells in bone marrow. Among the Philadelphia (Ph1) chromosome-negative MPD, polycythemia vera (PV) often has a favourable evolution limited to thrombotic events, although an increased incidence of secondary malignancies, development of myelofibrosis or acute leukaemia may impair life expectancy (Tefferi *et al.*, 2013). Moreover, in absence of allogenic hematopoietic stem cells transplantation, these diseases are incurable. PV is treated with phlebotomy and non specific cytotoxic drug such as hydroxyurea, or more recently, in the presence of myelofibrosis, by Janus kinase (JAK) inhibitors which do not stop the evolution of disease but improve symptoms and decrease splenomegaly.

Since malignant cells in haemopathies often have abnormal human leukocyte antigen (HLA) class I molecule expression, they should be natural targets for natural killer (NK) cells although they have developed some way to escape to innate immunity (Baier *et al.*, 2013; Sanchez *et al.*, 2011). Knowledge on NK cell functions in MPD relies on very few studies. Early studies have shown that MPD patients have decreased cytotoxic activity of NK cells despite an increase in the absolute count of CD16⁺. In vitro treatment with IFN- α or IL-2 restored normal NK cytotoxicity in the study of Gersuk *et al.* but not in the study of Froom *et al.* (Froom *et al.*, 1989; Gersuk *et al.*, 1993). Among MPD, PV is characterized by a constant acquired mutation of JAK2 affecting exon 14 and, less frequently, exon 12 (Baxter *et al.*, 2005; James *et al.*, 2005). This mutation leads to a gain of function with constitutive phosphorylation and downstream signaling via STAT3 and STAT5. JAK2 participates in the signaling of the interferon gamma receptor (IFN γ -R), which is expressed by NK cells and lead to STAT1 activation that increases the expression of interferon-stimulated genes (Schneider *et al.*, 2014). On the one hand, defect in NK cytotoxic functions have been described in many malignancies (Baier *et al.*, 2013; Sanchez *et al.*, 2011). On the other hand, a simple view could assess that the JAK2 gain of function could induce NK cell activation and augment cytotoxicity, thus providing an increased anti-tumoral and anti-infectious defense. Of note, since IFN- γ is also produced by NK cells, JAK2 gain of function could lead to a self-entertained autocrine loop with constitutive activation of STAT1, leading to auto-immunity and susceptibility to infections, a result that is counter-intuitive with the hypothesis of increased NK activation (O'Shea *et al.*, 2013). Moreover, it has been shown that the non-classical HLA molecule HLA-G is secreted by erythroblasts in all hematopoietic organs and that this molecules turns-off the erythropoietin receptor signaling through JAK2 and JAK2 V617F dephosphorylation in PV (Menier *et al.*, 2008). In addition, the HLA-G molecule can be transferred to activated NK cells by trogocytosis, leading to blockade of NK proliferation and

cytotoxicity owing to its interaction with the IL2 inhibitory receptor on other NK cells (Caumartin *et al.*, 2007). In chronic myeloid leukemia (CML), a MPD characterized by a gain of function due to constitutive tyrosine-kinase properties of the bcr-abl protein, decreases NK cytotoxicity is observed due to an abnormal expression of inhibitory killer immunoglobulin-like receptors (KIRs) (Chiorean *et al.*, 2003).

From these observations, we conclude that available data do not allow us to predict NK phenotype in PV, although the development of an immune response against PV clone could be of great interest in the attempt to eradicate the disease. In order to answer this question we analyzed NK from PV patients in comparison with HD regarding the expression of activating and inhibitory molecules, cytotoxic functions and gene expression patterns.

Methods

Cell preparation and cultures

Peripheral blood mononucleated cells (PBMC) were isolated from blood samples using lymphocyte separation medium density gradient centrifugation (Eurobio Technologies, France). Purified NK cells were obtained after depletion using EasySep kit (StemCell Technologies, Vancouver, Canada). Purity of the NK cell fraction (CD3⁻/CD16⁺/CD56⁺) obtained from PV patients was assessed by flow cytometry and varied from 64 to 86 %. NK were expanded for three weeks from total PBMC cultured at $0.75 \cdot 10^6$ cells/ml with feeder EBV cells at $0.75 \cdot 10^6$ cells/ml in RPMI 1640 medium GlutaMAX with 10% fetal calf serum (FCS) in the presence of recombinant human IL-2 (1000 UI/mL) (Sigma, St Louis, MO). The K562 cell line was grown in RPMI 1640 medium with 10 % FCS.

CD107a mobilization assay

NK cells were stimulated with K562 cells at ratio 1/1. The negative control was obtained with NK cells and medium. The positive control was obtained with NK cells stimulated with phorbol-12-myristate-13-acetate (PMA) (2.5 µg/mL) and ionomycin (0.5 µg/mL). The CD107a-FITC antibody was added directly to the wells at a concentration of 50 µL/mL and incubated overnight. After incubation, cells were labeled with CD56^{PC5} for 15 minutes at 4°C in the dark.

Immunophenotyping

Fluorescein isothiocyanate (FITC), phycoerythrin (PE), phycoerythrin-cyanin (PC5) coupled monoclonal antibodies (mAbs) were used to define the NK cells phenotype: CD3 (IgG1), CD16 (IgG1), CD56 (IgG1); activatory receptors and coreceptors: NCR3/NKp30 (IgG1), NCR2/NKp44 (IgG1), NCR1/NKp46 (IgG1), NKG2D (IgG1), CD244/2B4 (IgG1); inhibitory receptors: CD158a,h (IgG1), CD158b1,b2j (IgG1), CD158e1/e2 (IgG1), CD158i (IgG2a), CD85j/ILT2 (IgG1), CD159a/NKG2A (IgG2b). PBMC were stained with anti-CD3, anti-CD56, anti-CD158a,h (clone EB6) and anti-CD158a (clone 143211, IgG1, R&D Systems)-conjugated mAb. All antibodies were purchased from Beckman Coulter (Marseille, France). Total blood was incubated for 15 minutes at 4°C, washed with PBS and analyzed on a XL-Epics (Beckman Coulter, Marseille, France). Background levels were measured using isotypic controls.

Quantification of intracellular perforin and granzyme

NK cells ($5 \cdot 10^5$) were first incubated during 15 minutes at 4 °C with 10 µL anti-CD3^{FITC}/CD56^{PC5} and then fixed and permeabilized with Intraprep reagent (Beckman Coulter, Marseille, France). NK cells were incubated with anti-perforin^{PE} (eBiosciences, San Diego, USA) or anti-granzyme B^{PE} (R&D Systems) during 15 minutes at room temperature.

Transcriptome analysis

Sample amplification, labeling, and hybridization followed the Low Input Quick Amp Labeling, one-color protocol (version 6.5, May 2010) recommended by Agilent Technologies. 500 ng of each total RNA sample was reverse transcribed into cDNA using oligo dT-T7 promoter primer. Labeled cRNA was synthesized from the cDNA. The reaction was performed in a solution containing dNTP mix, cyanine 3-dCTP, and T7 RNA Polymerase, and incubated at 40 °C for 2 hours. Hybridization was performed into whole human genome microarray slides (4×44K G4112F, Agilent Technologies, Santa Clara, CA) containing 45,220 oligonucleotide probes at 65 °C for 17 hours. Hybridized microarray slides were then washed according to the manufacturer's instructions and scanned using an Agilent DNA Microarray Scanner, using the Agilent Feature Extraction Software (Agilent Technologies). Quantification files derived from the Agilent Feature Extraction Software were analyzed using the AgiND package (<http://tagc.univmrs.fr/AgiND>). We also used the AgiND R package for quality control and normalization. Quantile methods and a background correction were used for data normalization.

Results

Characteristics of patients and controls

After informed consent, blood samples were obtained from seventeen patients with PV and from fifteen aged-matched HD (66.3 years \pm 12.3 for PV patients vs 64.4 \pm 9.3 for HD). The patients were diagnosed according to the world health organization (WHO) criteria. Median haemoglobin, platelets and leucocytes counts at the time of blood sample collection were 18.7 g/dL (range : 16.0 - 22,6 g/dL), 438 G/L (range : 210 - 643 G/L) and 12,1 G/L (range : 3.3 - 26,4 G/L), respectively. The *JAK2* V617F mutation was found in 16 highly purified NK cells sample from patients and one patient had a mutation in exon 12 (F537-K539delinsL) (data not shown). PV patients were naive from any cytotoxic treatment at time of blood sampling.

Proportion and proliferation of NK cells in PV patients

Distribution of lymphoid populations in EDTA blood was compared between seventeen PV patients and fifteen HD and did not reveal significant difference regarding absolute number of lymphocytes (1.66 G/L \pm 0.67 vs 1.79 G/L \pm 0.49, not significant [NS]) (data not shown). We observed an increased percentage of NK cells (12.2 % \pm 7.3 vs 7.4 % \pm 5.3, $p < 0.05$) (Fig 1A) as well as an increased absolute number of NK cells (0.180 G/L \pm 0.088 vs 0.126 G/L \pm 0.082, $p < 0.05$) (Fig 1B). In line with the predominance of the CD56^{dim} subset in peripheral blood, this subset accounted for the increase of NK cells. In vitro stimulation with Il-2 induced a mean fold increase of 500 \pm 250 at 21 days of culture for HD and of 400 \pm 200 for PV-NK cells (Fig 1C). After 21 days of culture, proliferation capacities of PV and HD NK cells decreased (data not shown).

NK cells cytotoxicity

NK cells cytolytic granules membrane contains the lysosomal-associated membrane protein-1 (LAMP-1), corresponding to the CD107a cluster, which detection is considered to reflect degranulation and indirectly cytotoxic capacities (Alter *et al.*, 2004). The basal NK-mediated cytolytic activity against K562, assessed by evaluation of degranulation by CD107a surface expression, was not significantly different between PV patients and HD after short term (overnight) culture (11.4% \pm 5.93 vs 11.04% \pm 5.39, [NS]) (Fig 2A), or long term (17 days) culture with 1000U/ml Il-2rh (23.3% \pm 9.9 vs 29.2 \pm 13.2, [NS]) (Fig 2B). We next investigated the content in intracellular perforin and granzyme B of NK cells (Fig 2C). We did not find any difference between PV patients and HD, either in percentage of NK cells expressing perforin (74.4 % \pm 27.0 vs 70.6 % \pm 31.9) and granzyme B (66.6 % \pm 10.8 vs 58.7 % \pm 14.2) or in MFI : perforin (16.8 \pm 8.7 vs 19.6 \pm 9.6) and granzyme B (8.9 \pm 2.8 vs 7.4 \pm 2.2) (data not shown). So,

PV-NK cells did not present any deficit in content of important cytolytic molecules, perforin and granzyme B. We investigated gene expression of *TNF α* , *granzyme B* and *IFN γ* by RT-qPCR. In PV patients, the expression of *TNF α* gene tended to be increased (4.8 ± 1.60 vs 6.18 ± 0.91 in relative value) while gene expression of *granzyme B*, *IFN γ* tended to be decreased (1.8 ± 0.81 vs 0.73 ± 2.62 and 4.86 ± 2.14 vs 4.07 ± 1.76) (data not shown). We did not detect any difference in NK cytotoxicity between PV patient and HD.

Expression of activating receptors by peripheral PV NK cells

Flow cytometry analyses were investigated in EDTA blood on NK cells. We failed to detect any significant difference in percentage of NK cells expressing NKp30/NCR3 ($58.1 \% \pm 20.6$ vs $58.1 \pm 20.7\%$, $p > 0.05$, [NS]), NKp46/NCR1 ($68.9 \% \pm 20.9$ vs $74.9 \% \pm 16.0$, $p > 0.05$, [NS]), NKG2D ($95.8 \% \pm 1.7$ vs $94.8 \% \pm 2.5$, $p > 0.05$, [NS]), 2B4/CD244 ($97.6 \% \pm 1.7$ vs $97.4 \% \pm 1.1$, $p > 0.05$, [NS]), and CD158i ($0.7 \% \pm 17.7$ vs $1.8 \% \pm 20.7$, $p > 0.05$, [NS]) between PV patients and HD (Fig 3A). MFI for these four receptors and this co-receptor were also similar for NKp30/NCR3 (9.24 ± 8.8 vs 11.79 ± 6.74 , $p > 0.05$, [NS]), NKp46/NCR1 (16.55 ± 14.75 vs 22.14 ± 12.32 , $p > 0.05$, [NS]), NKG2D (29.82 ± 19.45 vs 38.63 ± 15.35 , $p > 0.05$, [NS]), 2B4/CD244 (65.81 ± 24.67 vs 67 ± 32.21 , $p > 0.05$, [NS]), and CD158i (3.55 ± 4.61 vs 2.65 ± 4.18 , $p > 0.05$, [NS]) between PV patients and HD (Fig 3B). NKp44/NCR2 is expressed only by activated NK cells. Three PV patients expressed this receptor (17.6 % of the patients) and only one HD expressed it (data not shown), although in both cases with very low MFI. In RT-qPCR, as expected, we were not able to detect RNA for *NKp44/NCR2* in resting NK cells. Gene expression of *2B4* and *NKp46/NCR1* was similar between PV patients and HD (6.4 ± 0.70 vs 6.2 ± 1.07 and 5.3 ± 0.48 vs 5.4 ± 2.34). In PV patients, gene expression of *NKp30/NCR3* and *NKG2D* tends to be decreased (5.9 ± 0.94 vs 4.6 ± 1.78 and 7.8 ± 0.66 vs 6.9 ± 0.76), but this difference was not significant (data not shown).

Expression of inhibitory receptors by peripheral PV-NK cells

In the series of fifteen HD, CD158b, CD158e, CD85j and CD159a were expressed by $25.8 \% \pm 16.5$, $12.2 \% \pm 8.0$, $36.3 \% \pm 25.8$ and $47.7 \% \pm 20$ of NK cells respectively. Fourteen PV patients exhibited same percentage of positive cells for these different receptors: $31.2 \% \pm 17.5$ [NS], $14.2 \% \pm 11.5$ [NS], $49.3 \% \pm 20.5$ [NS] and $45.5 \% \pm 16.7$ [NS] respectively (Fig 4A). Concerning the mean fluorescence intensity, we were not able to detect any statistical difference between PV-NK cells and HD-NK cells (Fig 4B).

The receptor CD158/KIR2DL1/DS1, exists in inhibitory and activating forms. We quantified the expression of both forms by using the CD158a,h antibody that recognizes both activating and

inhibitory form and the 143211 antibody that recognizes the inhibitory form only of CD158 (Cognet *et al.*, 2010). In a series of eight PV patients and eight HD, PV-NK cells expressed higher percentage of inhibitory form of CD158a,h receptor ($58.9\% \pm 33$ vs $48.4\% \pm 27.15$, $p > 0.05$, [NS]) although not reaching a statistical significant difference (Fig 4C).

Gene expression analysis of PV NK cells

By transcriptional approach, we looked for genes that were differentially expressed between NK cells from PV patients and HD. Thus, 10 RNA samples from 5 PV patients, 4 HD and NK-92 cell line were used to characterize the transcriptional signature of PV. Hierarchical clustering revealed seventeen differentially expressed genes and completely separated PV patients from HD (Fig 5). Several genes like *FAM27*, *XRRAR1*, *HDDC*, *ZNF282*, *TNFRSF 1B*, *GCG*, *NFIC*, *ALF1*, *SLC6A5*, *TOAP*, *SNX21*, *TRAV5* and the non-coding ARN *LOC100506845*, *LOC100508554* and *A_33_P3348151* were down regulated while *C7orf54* gene is the only gene that was over-expressed compared to HD.

Discussion

The possible role of the immune system in the control of PV, in its evolution to myelofibrosis or acute myeloid leukemia and in the increased incidence of secondary malignancies led us to thoroughly study NK cell phenotype. Although PV patients have a normal number of lymphocytes, they present an increased percentage and absolute number of NK cells in comparison with HD. This could suggest a proliferative advantage of PV-NK cells at least in vivo, since in vitro proliferation was not different from HD. We can hypothesize that under suboptimal in vivo conditions PV-NK cells have a proliferative advantage that disappears when NK are cultured under optimal conditions, i.e high concentrations of IL-2 and strong stimulation by feeder cells (EBV-infected B-cells) that express high level of NK stimulating molecules. In so far as the JAK2 mutation present in PV patients corresponds to a gain of function with increased activation of the JAK/STAT pathway, we hypothesize it could explain the increased number of NK cells in PV patients. To test this hypothesis, we performed RT-qPCR on highly purified PV-NK cells. The JAK2 mutation was detected at a significant level in all samples, we concluded to its presence in PV-NK cells, in accordance with the notion that this mutation occurs in very primitive cells explaining the multi-lineage abnormalities observed in JAK2-mutated MPD (Delhommeau *et al.*, 2007; Larsen *et al.*, 2007). We then tested the expression of both stimulating and inhibitory molecules on PV-NK in comparison with HD-NK, since the observation of increased KIRs expression in CML suggested that the JAK2 gain of function mutation, which has common point with the BCR/ABL gain of function, could lead to comparable results (Chiorean *et al.*, 2003). Regarding the activating and co-activating receptors expression (NCRs, NKG2D and 2B4) we failed to detect a significant difference in surface expression between PV-NK and HD-NK, although RT-qPCR showed a trend for decreased genes expression of NKp30/NCR3 and NKG2D in PV patients, but without impact on protein level, suggesting that post-transcriptional regulation plays a role in the level of expression of these molecules. We also failed to detect any expression difference for the inhibitory receptors CD158a, CD158b, CD158e, CD159a and CD85j. In addition, we evaluated the expression of CD158a,h a receptor that shares both an inhibitory and an activating form (Cognet *et al.*, 2010). We observed a trend for an increased expression of the inhibitory form of CD158a, h although the number of tested samples did not allow to attain a statistically relevant signification. The study of Chiorena et al. (Chiorean *et al.*, 2003) has showed that the BCR/ABL fusion protein induced decreased NK cytotoxicity. This prompted us to indirectly test this property by flow cytometry detection of NK degranulation. We observed a trend for short term decreased degranulation in PV-NK, which was restored during culture and even became higher than HD-

NK. Although we did not reach a statistically significant level, this data suggest that PV-NK have normal degranulation functions and probably cytotoxic functions, or that at least these functions are restored by optimal ex vivo culture conditions, allowing their use in an immunotherapeutic approach. Furthermore, the quantification by flow cytometry of perforin and granzyme B showed no differences between PV-NK and HD-NK, thus indicating a normal cytotoxic armamentarium. Detection of granzyme gene expression by RT-qPCR detected only moderately decreased levels, suggesting again a role for post-transcriptional regulation of protein levels (data not shown). On the contrary, increased RNA levels were detected for TNF α (data not shown), in line with the normal expression observed by Chiorean et al. in CML-NKs (Chiorean *et al.*, 2003). Human NK cells constitutively express membrane TNF α (mTNF α) that is responsible for cytotoxic activity of resting NK cells (assessed using paraformaldehyde fixed NK cells in order to avoid the participation of cytotoxic soluble mediators such as perforin, granzyme and TNF α) (Caron *et al.*, 1999). Normal or even increased TNF α levels could participate in immune surveillance by resting PV-NK, without any effect of a putative imbalance of negative vs positive signaling surface molecules. Finally, since PV-NK seems to mostly behave as normal HD-NK despite the JAK2 gain of function mutation, we compared the whole gene expression in the two NK populations by the transcriptomic microarray approach. We identified a pattern of gene expression that distinguished PV-NK from HD-NK, with seventeen genes differentially expressed between PV and HD NK cells. The only gene expression up-regulated in PV-NK was C7orf54 (Chromosome 7 open reading frame 54). This gene has no known function and has been identified in a genome-wide gene–environment interaction analysis for asbestos exposure in lung (Wei *et al.*, 2012). The other fifteen genes were all less expressed in PV-NK than in HD-NK. The functions of these fifteen genes are mostly unknown in NK, except for the tumor necrosis factor receptor superfamily member 1B (TNFRS1B = TNFR2 = CD120b = p75) which is the ligand for TNF α , a cytokine produced by NK themselves and monocytes/macrophages. The down-regulation of both TNFRS1B could have putative implication for NK cytotoxicity, since this receptor has a positive role in the regulation of cytotoxic function of NK cells that could not be detected under our investigational procedures. Nonetheless, the measure of TNFR2 expression at NK cell surface has to be performed since RNA levels do not preclude effective protein expression (Mason *et al.*, 1995). We lack of identified functions for some of the other fourteen differentially expressed genes. Nonetheless, we surprisingly observed that some genes more expressed in HD-NK than in PV-NK corresponded to genes associated to diseases and more particularly to cancer. AIF1 (allograft inflammatory factor 1) is associated with demyelinating polyneuropathy, XRRAR1 (X-ray radiation resistance associated 1) is suspected to be involved in neuroblastoma and colorectal

cancer, TROAP (trophinin associated protein) is associated with in human gallbladder cancer, while ZNF282 (zinc finger protein 282/ HUB-1) and LOH-12CR2 (loss of heterozygosity, 12, chromosomal region 2) expression are both associated with leukemia (Cave *et al.*, 1995; Chang *et al.*, 2009; Mesak *et al.*, 2003; Okumura *et al.*, 1997; Pawlik *et al.*, 2013). Although it is not possible to draw firm conclusion from this observation, we can nonetheless observe that JAK2 gain of function mutation, despite the constitutive activation of the JAK/STAT pathway, does not lead to over-expression (at least in NK) of oncogenes, in line with the observation that acute leukemia in PV patients rarely are JAK2-mutated, suggesting that the leukemic process is not under JAK2 control. We also failed to obtain a functional enrichment from our transcriptional study of PV-NK, a result that is counterintuitive in the context of a gain of function mutation.

We conclude that, in contrast with the study of Chiorean *et al.* (Chiorean *et al.*, 2003) in CML in which the significant modification of CML-NK phenotype is induced by BCR/ABL gain of function mutation, the JAK2 mutation did not drastically modify PV-NK phenotype at least for the parameter we tested. This could be in part due to the inhibition of receptor signaling through JAK2 (either normal or mutated) by HLA-G molecules secreted by the remaining normal erythroblasts (Menier *et al.*, 2008). This observation is important since it may give some clue for the relative good prognosis of PV that, despite its potent gain of function mutation, has a relatively low rate of leukemic transformation that could in part be explained by effective innate immune surveillance, in contrast with CML, leukemia, myeloma or even myelodysplastic syndromes (Costello *et al.*, 2013; Costello *et al.*, 2002; Kiladjian *et al.*, 2006). Moreover, the preserved functions of PV-NK predict the putative efficacy of immunotherapeutic strategies and could partly explain the efficiency of PV treatment by IFN α (Kiladjian *et al.*, 2011). In fact, part of the mechanisms of action of IFN α in PV relies on its immune properties; enhancement of NK cells cytotoxicity, production of IFN- γ , accumulation and survival of NK by IL-15 induction, together with the secretion of other cytokines via an autocrine IFN- γ loop (Hervas-Stubbs *et al.*, 2011). All these effects are likely to be more efficient on a population with normal or subnormal baseline properties, in sharp contrast with the drastic loss of function of NK observed in leukemia and that is hardly overcome by today available immune-restoration strategies.

Acknowledgments

The authors would like to thank INSERM and Region Provence-Alpes Côtés d'Azur for grants "bourse doctorale regionale 2011– 2014." We are grateful to Laurence Borge for assistance with the use of the cell culture platform facility (CRCM U1068, Marseille) and we thank Drs. Amelie Cornillon and Martin Villalba (UMR_S 1040, Montpellier) for training us in the NK cell expansion protocol.

Authorship

RTC was the principal investigator and takes primary responsibility for the paper. CS and CB contributed equally to this manuscript. CS, CB and RC have performed the laboratory work for this study: research design and data analysis. PR, TL and GS coordinated the research. GV and RTC have been implicated in revision of the manuscript.

Conflict of interest

The authors have no competing interests.

References

- Alter G, Malenfant JM, Altfeld M (2004). **CD107a as a functional marker for the identification of natural killer cell activity.** *Journal of immunological methods* **294**(1-2): 15-22.
- Baier C, Fino A, Sanchez C, Farnault L, Rihet P, Kahn-Perles B, *et al.* (2013). **Natural killer cells modulation in hematological malignancies.** *Frontiers in immunology* **4**: 459.
- Baxter EJ, Scott LM, Campbell PJ, East C, Fourouclas N, Swanton S, *et al.* (2005). **Acquired mutation of the tyrosine kinase JAK2 in human myeloproliferative disorders.** *Lancet* **365**(9464): 1054-1061.
- Caron G, Delneste Y, Aubry JP, Magistrelli G, Herbault N, Blaecke A, *et al.* (1999). **Human NK cells constitutively express membrane TNF-alpha (mTNFalpha) and present mTNFalpha-dependent cytotoxic activity.** *European journal of immunology* **29**(11): 3588-3595.
- Caumartin J, Favier B, Daouya M, Guillard C, Moreau P, Carosella ED, *et al.* (2007). **Trogocytosis-based generation of suppressive NK cells.** *The EMBO journal* **26**(5): 1423-1433.
- Cave H, Gerard B, Martin E, Guidal C, Devaux I, Weissenbach J, *et al.* (1995). **Loss of heterozygosity in the chromosomal region 12p12-13 is very common in childhood acute lymphoblastic leukemia and permits the precise localization of a tumor-suppressor gene distinct from p27KIP1.** *Blood* **86**(10): 3869-3875.
- Chang XZ, Yu J, Zhang XH, Yin J, Wang T, Cao XC (2009). **Enhanced expression of trophinin promotes invasive and metastatic potential of human gallbladder cancer cells.** *J Cancer Res Clin Oncol* **135**(4): 581-590.
- Chiorean EG, Dylla SJ, Olsen K, Lenvik T, Soignier Y, Miller JS (2003). **BCR/ABL alters the function of NK cells and the acquisition of killer immunoglobulin-like receptors (KIRs).** *Blood* **101**(9): 3527-3533.
- Cognet C, Farnarier C, Gauthier L, Frassati C, Andre P, Magerus-Chatinet A, *et al.* (2010). **Expression of the HLA-C2-specific activating killer-cell Ig-like receptor KIR2DS1 on NK and T cells.** *Clin Immunol* **135**(1): 26-32.
- Costello RT, Boehrer A, Sanchez C, Mercier D, Baier C, Le Treut T, *et al.* (2013). **Differential expression of natural killer cell activating receptors in blood versus bone marrow in patients with monoclonal gammopathy.** *Immunology* **139**(3): 338-341.
- Costello RT, Sivori S, Marcenaro E, Lafage-Pochitaloff M, Mozziconacci MJ, Reviron D, *et al.* (2002). **Defective expression and function of natural killer cell-triggering receptors in patients with acute myeloid leukemia.** *Blood* **99**(10): 3661-3667.
- Delhommeau F, Dupont S, Tonetti C, Masse A, Godin I, Le Couedic JP, *et al.* (2007). **Evidence that the JAK2 G1849T (V617F) mutation occurs in a lymphomyeloid progenitor in polycythemia vera and idiopathic myelofibrosis.** *Blood* **109**(1): 71-77.
- Froom P, Aghai E, Kinary A, Lahat N (1989). **Decreased natural killer (NK) activity in patients with myeloproliferative disorders.** *Cancer* **64**(5): 1038-1040.

Gersuk GM, Carmel R, Pattamakom S, Challita PM, Rabinowitz AP, Pattengale PK (1993). **Quantitative and functional studies of impaired natural killer (NK) cells in patients with myelofibrosis, essential thrombocythemia, and polycythemia vera. I. A potential role for platelet-derived growth factor in defective NK cytotoxicity.** *Natural immunity* **12**(3): 136-151.

Hervas-Stubbs S, Perez-Gracia JL, Rouzaut A, Sanmamed MF, Le Bon A, Melero I (2011). **Direct effects of type I interferons on cells of the immune system.** *Clinical cancer research : an official journal of the American Association for Cancer Research* **17**(9): 2619-2627.

James C, Ugo V, Le Couedic JP, Staerk J, Delhommeau F, Lacout C, *et al.* (2005). **A unique clonal JAK2 mutation leading to constitutive signalling causes polycythaemia vera.** *Nature* **434**(7037): 1144-1148.

Kiladjian JJ, Bourgeois E, Lobe I, Braun T, Visentin G, Bourhis JH, *et al.* (2006). **Cytolytic function and survival of natural killer cells are severely altered in myelodysplastic syndromes.** *Leukemia* **20**(3): 463-470.

Kiladjian JJ, Mesa RA, Hoffman R (2011). **The renaissance of interferon therapy for the treatment of myeloid malignancies.** *Blood* **117**(18): 4706-4715.

Larsen TS, Christensen JH, Hasselbalch HC, Pallisgaard N (2007). **The JAK2 V617F mutation involves B- and T-lymphocyte lineages in a subgroup of patients with Philadelphia-chromosome negative chronic myeloproliferative disorders.** *British journal of haematology* **136**(5): 745-751.

Mason AT, McVicar DW, Smith CA, Young HA, Ware CF, Ortaldo JR (1995). **Regulation of NK cells through the 80-kDa TNFR (CD120b).** *Journal of leukocyte biology* **58**(2): 249-255.

Menier C, Guillard C, Cassinat B, Carosella ED, Rouas-Freiss N (2008). **HLA-G turns off erythropoietin receptor signaling through JAK2 and JAK2 V617F dephosphorylation: clinical relevance in polycythemia vera.** *Leukemia* **22**(3): 578-584.

Mesak FM, Osada N, Hashimoto K, Liu QY, Ng CE (2003). **Molecular cloning, genomic characterization and over-expression of a novel gene, XRRA1, identified from human colorectal cancer cell HCT116Clone2_XRR and macaque testis.** *BMC Genomics* **4**(1): 32.

O'Shea JJ, Holland SM, Staudt LM (2013). **JAKs and STATs in immunity, immunodeficiency, and cancer.** *The New England journal of medicine* **368**(2): 161-170.

Okumura K, Sakaguchi G, Naito K, Tamura T, Igarashi H (1997). **HUB1, a novel Kruppel type zinc finger protein, represses the human T cell leukemia virus type I long terminal repeat-mediated expression.** *Nucleic acids research* **25**(24): 5025-5032.

Pawlik A, Herczynska MM, Dzieziejko V, Malinowski D, Kurzawski M, Drozdik M, *et al.* (2013). **Effect of allograft inflammatory factor-1 gene polymorphisms on rheumatoid arthritis treatment with methotrexate.** *Postepy Hig Med Dosw (Online)* **67**: 637-642.

Sanchez CJ, Le Treut T, Boehrer A, Knoblauch B, Imbert J, Olive D, *et al.* (2011). **Natural killer cells and malignant haemopathies: a model for the interaction of cancer with innate immunity.** *Cancer immunology, immunotherapy : CII* **60**(1): 1-13.

Schneider WM, Chevillotte MD, Rice CM (2014). **Interferon-stimulated genes: a complex web of host defenses.** *Annual review of immunology* **32**: 513-545.

Tefferi A, Rumi E, Finazzi G, Gisslinger H, Vannucchi AM, Rodeghiero F, *et al.* (2013). **Survival and prognosis among 1545 patients with contemporary polycythemia vera: an international study.** *Leukemia* **27**(9): 1874-1881.

Wei S, Wang LE, McHugh MK, Han Y, Xiong M, Amos CI, *et al.* (2012). **Genome-wide gene-environment interaction analysis for asbestos exposure in lung cancer susceptibility.** *Carcinogenesis* **33**(8): 1531-1537.

Figure Legends

Fig 1: Distribution of NK cells in PV and proliferation capacities of PV-NK cells in vitro, in response to recombinant human IL-2. Distribution of lymphoid populations in EDTA blood was compared between PV patients (n=17) and HD (n=15). The percentage (A) and the absolute number (B) of NK cells in PV patient (o) compared to HD (x). (C) NK cells from 10 PV patients and 9 HD are counted following 21 days of culture. The mean of fold increase is determined and reflects the proliferation capacities of NK cells.

Fig 2: Short and long term cytolytic function with content in perforin and granzyme of NK cells. (A) Cytolytic activity of resting NK cells against K562, for 19 PV patients (O) and 10 HD (X). (B) Cytolytic function of NK cells from 7 HD and 7 PV-patients is measured after seventeen days of culture. (C) The content in perforin and granzyme of NK cells was measured by flow cytometry. Results are expressed in percentage of NK cells containing perforin and granzyme in a series of 6 HD and 4 PV patients.

Fig 3: Expression of co-activating receptors in PV. Expression of activating receptors (NKp30, NKp46, NKG2D, and CD158i) and co-receptor 2B4 by resting NK cells in PV patients (O) and in HD (X): (A) percentage of expression, (B) MFI.

Fig 4: Expression of inhibitory receptors (CD158b, CD158e, CD159a and CD85j) by resting NK cells in PV patients (O) and in HD (X): (A) percentage of expression, (B) MFI. (C) This figure represents the percentage of inhibitory from of CD158 a, h in PV patient (8) and HD (8).

Fig 5: Hierarchical clustering of PV-NK cells genes. Differential gene expression obtained between resting NK cells from 5 PV-patients (UPN) and 4 HD with one NK cells line NK-92. Seventeen genes are differentially expressed; over-expressed genes are represented in red and down-regulated genes in green.

Figure 1.

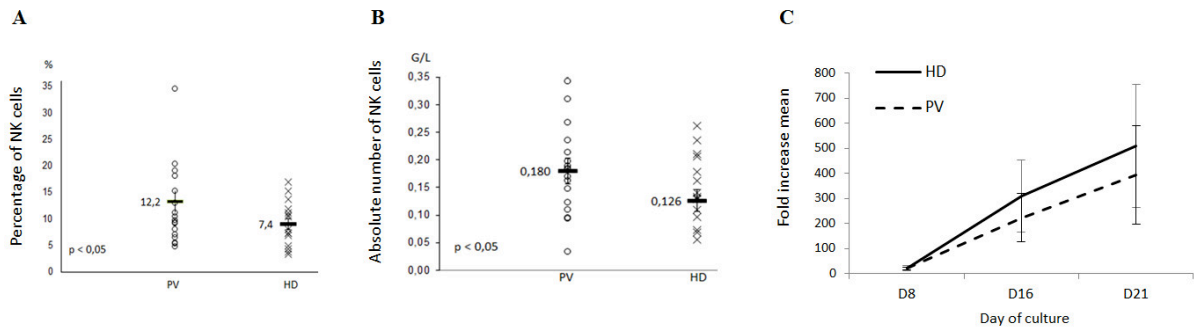

Figure 2.

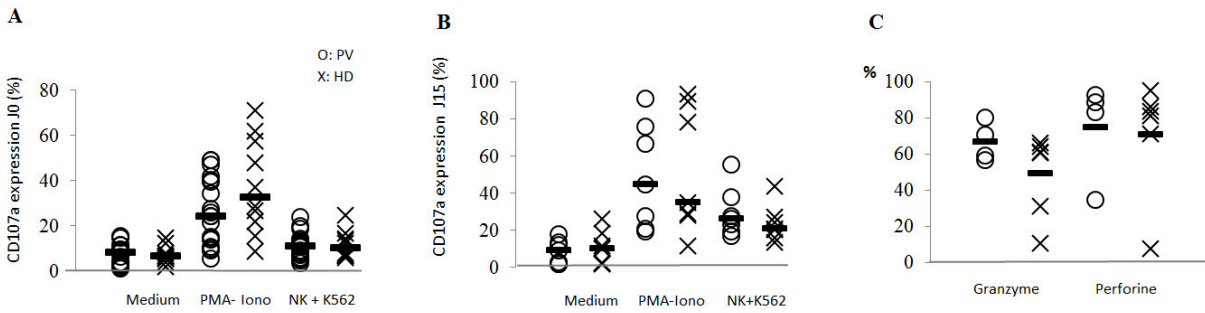

Figure 3.

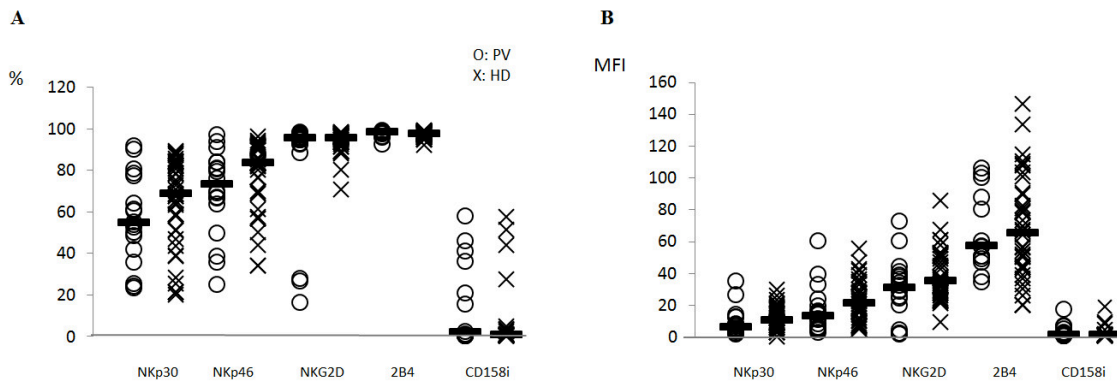
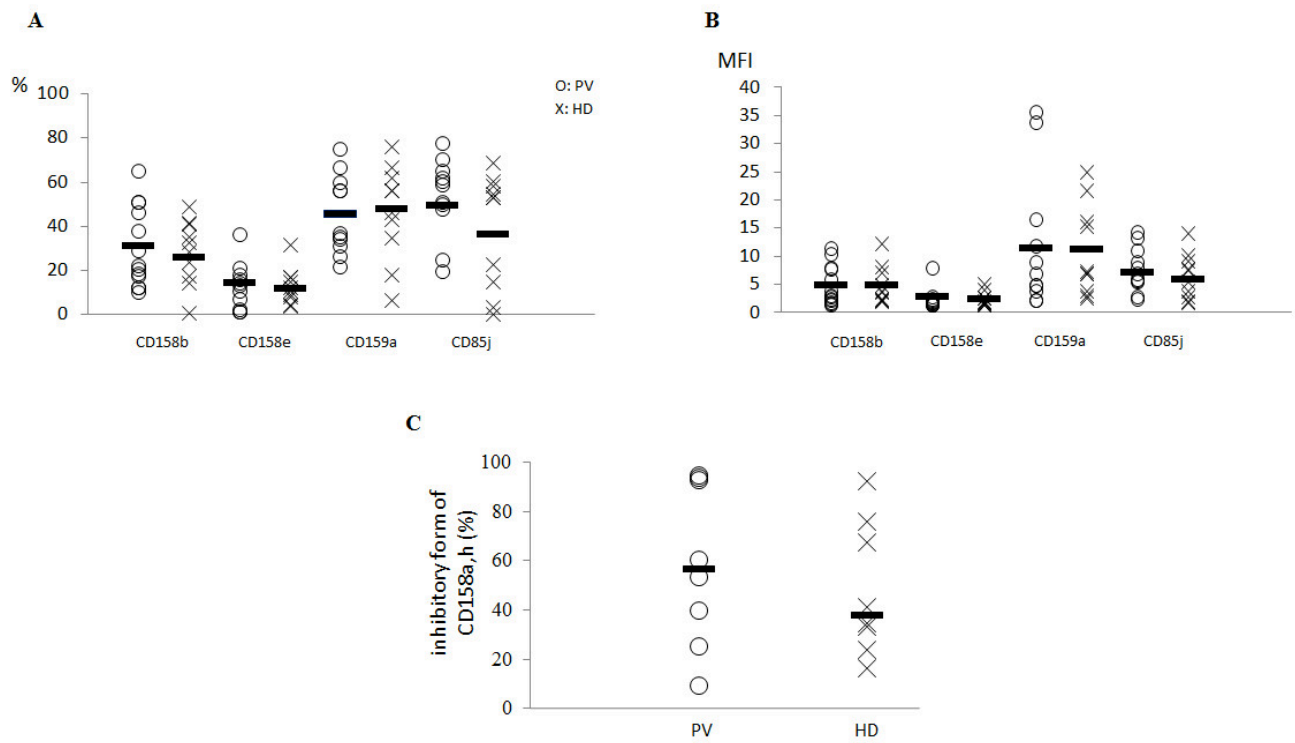

Figure 4.



Conclusion

In this study, the JAK2 mutation found in each purified samples of PV-NK cells. The mutation, characterized by a gain of function can be at the origin of the increasing of absolute number and the percentage of PN-NK cells. However, JAK2V617F seems to be silent since it does not induce modification of NK cells functions *in vitro*. Our results lead us to conclude that PV-NK cells behave as control cells. That is right that *in vivo*, this behavior can be inhibited in part by the production of HLA-G molecules secreted by PV-normal erythroblasts. It could be interesting to test *in vitro*, the effect of PV-cell environment on NK cells from HD. The release of HLA-G molecules by PV-erythroblasts, the NK cells functions and receptors phenotype could be tested after co-culture models with PV- erythroblasts or HLA-G molecules directly.

For this project, we hypothesized that JAK2V617in PV- NK cells could be at the origin of loss of function explaining the evolution of the pathology, but we failed to detect very significant abnormalities in PV-NK, at least regarding the parameters we tested.

B. Result 2: Regulation of natural cytotoxicity receptors expression in NK cells from patients with acute myeloid leukemia

In this second part, we focused on expression of NCR1/NKp46, NCR2/NKp44 and NCR3/NKp30 in patients with acute myeloid leukemia. Our previous works on AML have shown that:

- The three NCR are weakly expressed in AML patients (NCR^{dull} phenotype),
- This down-regulation is acquired during evolution of AML and reversible after complete remission,
- NCR^{dull} phenotype is related to poor prognosis (Costello *et al.*, 2002; Fauriat *et al.*, 2007).

- As the three NCR are located in two different chromosomes (NCR1/NKp46 on chromosome 19, and chromosome 6 for NCR2/NKp44 and NCD3/NKp30), we hypothesized that the expression of NCR has a common regulation at their genes transcription level.

Firstly, we have made a transcriptomic approach comparing NK cells from healthy donors with NK cells from AML patients (AML-NK cells) in order to obtain differentially expressed genes which can highlight different pathway involved in NCR regulation.

Then, to better understand the mechanisms of NCR regulation in AML-NK cells, we have:

- Verified the decrease of NCR expression on normal NK cells co-cultured with AML tumorous cells (AML blasts).
- Investigated common putative regulatory elements for the three NCR.

Currently this work is still in progress and need next experimentations to validate the hypothesis. To make reading easier and homogenize the writing of this work with the rest of the manuscript, this part is presented as an article draft.

INTRODUCTION

Acute myeloid leukemia (AML) is characterized by proliferation of immature and abnormal leukocytes that interfere with the normal production of normal blood cells. Several subtypes of AML have been described according to cytological characteristics and chromosomal abnormalities (Falini *et al.*, 2010). Disease progression and the high incidence of relapse after chemotherapy or after transplantation of allogeneic hematopoietic stem cells suggest that leukemic blasts escape to the immune system (Asai *et al.*, 1998; Jiang *et al.*, 1997; Lavigne & Acres, 1989).

Natural killer (NK) cells are lymphocytes of the innate immune system that recognize and kill various types of malignant cells. Under physiologic condition, cells are protected from NK cells mediated lysis through adequate amount of MHC-class I expression. A deficient MHC class I expression has been observed in leukemia cells, making them target of NK cells mediated lysis (Elkins *et al.*, 1984; Urlacher *et al.*, 1987). NK kill tumor cells by engagement of various activating receptors such as the natural cytotoxicity receptors (NCR): NCR1/NKp46, NCR2/NKp44 and NCR3/NKp30 that strongly enhance the cytolytic activity of NK cells. Defects of NK functions have been described in many hematological malignancies including AML (Costello *et al.*, 2012; Costello *et al.*, 2002; Fauriat *et al.*, 2007; Kiladjian *et al.*, 2006). The expression of the three NCR is high (NCR^{bright}) for most healthy persons and low (NCR^{dull}) in most patients with AML. The NCR expression is related to AML prognosis. The NCR^{dull} phenotype is acquired during leukemia development since a complete (for NCR1/NKp46) or partial (for NCR3/NKp30) reversibility is observed in patients achieving complete remission (CR) after “classical” chemotherapy. Moreover, the proposed action mechanism of treatment with IL-2 + Ceplene® (histamine dihydrochloride) for consolidation in AML is the restoration of normal NCR expression (Brune *et al.*, 1996; Costello *et al.*, 2002; Fauriat *et al.*, 2007; Thoren *et al.*, 2009). Reversibility of the NCR^{dull} phenotype after CR suggests that leukemia cells might be involved in down-regulation of NCR expression. The regulatory mechanisms of the NCR is are poorly understood, in particular how the

parallel expression of these receptors is coordinated since their genes are located on two different chromosomes, suggesting the existence of a common negative / positive regulatory factor to these receptors.

The NK cells from mice deficient in Ikaros, ETS1, MEF (myeloid ELF1 (E74-like factor 1)-like factor; also known as ELF4), IRF2 (interferon-regulatory factor 2) or RUNX3 have decreased cytotoxicity. The ETS-1 factor functions, at the earliest stages of NK cell development in mice, promote expression activating receptors such as NKp46 (Ramirez *et al.*, 2012). However, it is unclear whether these transcription factors have roles in NK cytotoxicity (Barton *et al.*, 1998; Lacorazza *et al.*, 2002; Lohoff *et al.*, 2000; Lotem *et al.*, 2013; Ramirez *et al.*, 2012; Townsend *et al.*, 2004; Wang *et al.*, 1996). A motif homologous to the ETS-binding site was identified in the mouse promoter that enhanced perforin, transcription in cytotoxic cells. This study also identified two DNA-binding proteins that interact with this element, which were postulated to be members of the ETS family of transcription factors (Glimcher *et al.*, 2004; Koizumi *et al.*, 1993).

Altogether, these data are in line with our hypothesis of a common regulation of NCR in patient with AML. We aim to highlight the mechanism of NCR down-regulation first by cultivating NK NCR^{bright} from healthy donors with leukemic cells or healthy hematopoietic cells, in order to observe the appearance of the NCR^{dull} phenotype, and second by analysis of *NCR* promoters region with observation of a common putative binding site of transcription factors. Interestingly, our preliminary results indicate that ETS-1 is a potential regulatory element of NCR expression in acute myeloid leukemia.

Ultimately, further insights into the biology of NK cells and particularly into the regulation of NCR expression, might also promote the development of novel strategies for stimulating their anticancer activity.

MATERIAL AND METHODS

Patients and controls

Peripheral blood samples were obtained from 8 LAM patients (UPN1 to 8) and 8 healthy donors (HD46, 49, 62, 197, 567,574, 662, 940) after informed consent. Median age of LAM patients was 78 years, and the half was women. The patients studied were classified according to the WHO classification (**Table 1**). Healthy patients samples came from the Etablissement Français du Sang Alpes-Méditerranée (EFS). All of them have NCR^{bright} phenotype except for donor number 940 which has NCR^{dull} phenotype. AML-patients have NCR^{dull} phenotype and we have excluded patients who presented CD45⁺/CD56⁺ leukemic cells phenotype.

NK Cells expansion and NK cells sorting

Peripheral blood mononuclear cells (PBMC) were isolated from blood using lymphocyte separation medium density gradient centrifugation (Eurobio Technologies). NK cells were expanded from 15 (for healthy NK cells) and to 31 days (for AML NK cells) from total PBMC cultured at $0.75 \cdot 10^6$ cells/ml with feeder EBV cells (from M.Villalba team, Montpellier) at $0,75 \cdot 10^6$ cells/ml in RPMI 1640 medium GlutaMAX with 10% fetal calf serum (FCS) in the presence of recombinant human IL-2 (1000 UI/mL) (Sigma) at 37°C in 5% CO₂. Expanded NK cells were purified by EasySep Human NK Cell Enrichment kit (EasySep) or by flow cytometry from expansion medium. Purity of obtained NK cell fractions (CD16⁺/CD56⁺) varied from 87 to 98%.

Co-culture

After expansion, healthy NK cells were co-cultured with AML blast coming from PBMC of AML patients with ratio NK/AML blast 1/5 and during five days in RPMI 1640 GlutaMax medium 10% FCS and IL-2rh (1000U/ml). Expanded AML NK cells were co-cultured with PBMC from donors in the same conditions and during 48 hours.

Malignant NK cell line NK-92 (ATCC, France) were co-cultured 48 hours with three AML lineages (ratio 1/5): MOLM-14, KG-1 and Kasumi-1 (ATCC, France), corresponding to AML5, AML6 and AML2 respectively. NK-92 (ATCC) was cultured in Alpha Minimum Essential medium without ribonucleosides and deoxyribonucleosides complemented with 2 mM L-glutamine, 1.5 g/L Sodium bicarbonate, 0.2 mM Inositol, 0.1 mM 2-mercaptoethanol, 0.02 mM folic acid, 200-400 U/ml recombinant human IL-2, 12.5% horse serum and 12.5% fetal bovine serum.

Immunophenotyping

Fluorescein isothiocyanate (FITC), phycoerythrin (PE), phycoerythrin-cyanin (PC5) coupled monoclonal antibodies (mAbs) were used to define the NK cells phenotype: CD3 (IgG1), CD56 (IgG1), activating receptors: NCR1/NKp46 (IgG1), NCR2/NKp44 (IgG1) and NCR3/NKp30 (IgG1). All antibodies were purchased from Beckman Coulter (Marseille, France). PBMC and expanded or co-cultured NK cells were incubated for 15 minutes at 4°C, washed with PBS and analyzed on a FACS Calibur cytometer (BD Biosciences). Background levels were measured using isotypic controls (IgG1 Mouse), and all mean fluorescence intensities (MFI) were expressed in ratio MFI antibody/ MFI isotypic control. Results are expressed in MFI \pm SEM (standard error of the mean). To know if modulation on NCR expression was significant, we have used Student paired T.Test.

RNA extraction and quantification

Total RNA was extracted using RNeasy Mini kit (Qiagen) according to manufacturer instructions. ARN were quantified with NanoDrop spectrophotometer (Thermo scientific) and the RNA integrity was assessed using Agilent 2100 Bioanalyser (Agilent).

Reverse transcriptase quantitative PCR (RT-qPCR)

A mixture containing optimized concentrations of dNTPs, random primers, oligo (dT) primer and qScript reverse transcriptase, was used for cDNA synthesis. Transcripts were quantified by real-time quantitative reverse transcription polymerase chain

reaction (RT-PCR) on an stratagene Mx3005P sequence detector (Agilent Technologies) with Applied Biosystems predesigned TaqMan Gene Expression Assays and TaqMan Universal PCR Master Mix. The following probes were used (Applied Biosystems): NCR1/NKp46 (Hs00183118_m1), NCR2/NKp44 (Hs00183113_m1), NCR3/NKp30 (Hs00394809_m1), NKG2D/KLRK1 (Hs00183683_m1), ETS1 (Hs00428293_m1). Housekeeping genes used were the gene GAPDH (Hs02758991_g1) and TBP (Hs00427620_m1). Results are expressed in relative mean expression \pm SD (standard deviation).

Transcriptome analysis

Sample amplification, labeling, and hybridization followed the Low Input Quick Amp Labeling, one-color protocol (version 6.5, May 2010) recommended by Agilent Technologies. 100 ng of each total RNA sample was reverse transcribed into cDNA using oligo dT-T7 promoter primer. Labeled cRNA was synthesized from the cDNA. The reaction was performed in a solution containing dNTP mix, cyanine 3-dCTP, and T7 RNA Polymerase, and incubated at 40 °C for 2 hours. Hybridization was performed at 65 °C for 17 hours into whole human genome microarray slides (Agilent[®] SurePrint G3 V2 8 x 60K, Agilent Technologies, Santa Clara, CA) containing 24 000 probes with 8 200 LincRNA (Long intergenic non-coding RNAs). Hybridized microarray slides were then washed according to the manufacturer's instructions and scanned using an Agilent DNAMicroarray Scanner, using the Agilent Feature Extraction Software (Agilent Technologies). Quantification files derived from the Agilent Feature Extraction Software were analyzed using the AgiND package (<http://tagc.univmrs.fr/AgiND>). We also used the AgiNDR package for quality control and normalization. Quantile methods and a background correction were used for data normalization.

Statistical analysis

For each comparison measurement of differential gene expression was obtained using the TigrMulti-experiment viewer (TMeV) program. Significant Analysis of Microarray (SAM) and Student's t-test were applied to determine fold changes (FC) and P-values

(P), respectively. The data were analyzed using a two-class unpaired response type, which compared control *versus* AML samples.

For each samples comparison, the functional annotation corresponding to the differentially expressed genes was identified using DAVID (Database for Annotation, Visualization, and Integrated Discovery; <http://david.abcc.ncifcrf.gov/>) with high classification stringency, FDR < 5% (False Discovery Rate). We also used ClueGo, a cytoscape plug-in to decipher functionally grouped gene ontology and pathway annotation networks (Bindea *et al.*, 2009).

Research of common putative transcription factors binding sites to NCR genes

The MAPPER₂ database (<http://genome.ufl.edu/mapperdb>) is a web-based platform for the analysis of transcription factor binding sites (TFBSS) in multiple genomes. The database contains predicted binding sites identified in the promoters of all human, mouse and *Drosophila* genes using 1017 probabilistic models representing over 600 different transcription factors. MAPPER₂ includes three large libraries of TFBSS models: TRANSFAC, MAPPER and JASPAR (Riva, 2012). We first performed this multiple search on the region -8Kb upstream transcription start site (TSS) of the human NCR1/NKp46, NCR2/NKp44 and NCR3/NKp30 genes. We extracted those sequences using BioMart (PMID 19144180) in GRCh37/hg19 coordinates from v76 (<http://grch37.ensembl.org/>) annotations (PMID 19906699). The ETS1 motif was retrieved from JASPAR core vertebrates database (version 5.0_alpha) and shortened to the core motif of 8bp.

The RSAT suite was then used to scan this modified ETS1 motif upstream of NCRs (NCR1/NKp46, NCR2/NKp44 and NCR3/NKp30). This in-silico search of ETS1 was performed with oligo-analysis (van Helden *et al.*, 1998) and matrixscan (Turatsinze *et al.*, 2008) from the RSAT (Regulatory Sequence Analysis Tools) (Thomas-Chollier *et al.*, 2011) suite with default settings and p-val < 10⁻⁴ (<http://tagc.univ-mrs.fr/ras-tools/>).

Chromatin Immunoprecipitation (ChIP)

Approximately 1×10^7 NK-92 cells were suspended in an ice-cold PBS. Proteins were cross-linked to the DNA using a final concentration of 1% formaldehyde for 10 min at room temperature. The formaldehyde was quenched with 0.125 mM glycine (final concentration). After centrifugation, the cell pellet was rinsed with an ice-cold PBS solution and then suspended in ChIP Lysis Buffer (Protease inhibitor (Roche applied sciences), 50 mM HEPES-KOH (pH 7.5), 140 mM NaCl, 1mM EDTA, 10% glycerol, 0.5% NP-40 and 0.25% Triton 10X). The sample was incubated on ice for 5 min and the pellet was rinsed with an ice-cold PBS solution again.

For sonication, the pellet was suspended in 300 μ l ChIP Lysis Buffer. Fragmentation of the DNA was performed on ice, first to isolate and break down the nuclei and then to fragment the DNA (size 200–500 nucleotides) with a CovarisTMS2 sonicator. The sheared chromatin was cleared by centrifugation at 4°C.

Magnetic Dynabeads protein A/G (Invitrogen) was added to the sample and the suspension was transferred and divided into two fractions (IP and input). We used 4 μ g of ETS-1 antibody (C-4), a mouse monoclonal IgG₁ antibody (sc-55581) (Santa Cruz biotechnology), the fraction without antibody (input) served as a positive control while, mouse nonspecific antibodies served as a negative control. All fractions were incubated for 1h at 4°C on a rotator device. The immune complexes were washed two times with 100 μ l of IP Buffer 1 and IP Buffer 2, respectively (Invitrogen). All washing steps were carried out at 4°C. To reverse crosslink, the Dynabeads protein A/G were suspended in reverse cross linking buffer (Invitrogen) and proteinase K and incubated in a thermal cycler for 15 min at 55°C. The DNA was isolated using the PCR Purification Kit (Invitrogen) following the manufacturer's instructions.

The DNA was amplified by quantitative PCR (Syber green 1, Light Cycler® 2, Roche applied science) using NCR-specific primers pair. All q-PCR results were replicated and normalized with input. Semi-quantitative results were obtained after 40 cycles PCR amplification. The primers used were:

	<u>Forward</u>	<u>Reverse</u>
NCR1/NKp46	5'-GGAGTTGTGAACGTTCTGATGA-3'	3'-TAGTGCTGAGCAGTGGGGACT-5'
NCR2/NKp44	5'-GGGAAGCAGTCCATAACTCG-3'	3'-TCCCAGGCCTCTGTAGAAA-5'
NCR3/NKp30	5'-AGGGTCTCTAGGAGGCCAAG-3'	3'-GTGCAGTGAGGCCAGATTC-5'

RESULTS

Comparison between NK cells from AML patients and from healthy donors

- *NK cells from AML patients exhibit weak proliferation abilities following in vitro stimulation*

Clinical characteristics of AML patients included in the present study were listed on **Table 1**. Since the percentage of AML-NK cells in total PBMC is very low, we have expanded NK cells beforehand. Indeed, percentage of NK cell in AML patients reached $2.42\% \pm 2.19$ versus $10.6\% \pm 3.18$ for HD (**figure 1a**). After 17 days of *in vitro* culture for HD-NK cells expansion, we obtained a proliferative index of 312 ± 93 and the percentage of NK cells ranged from $7.6\% \pm 2.9$ to $46.8\% \pm 21$. To reach the same percentage of AML-NK cells, the enrichment was carried on 31 days. Thus, we obtained $33.45\% \pm 18.88$ NK cells, with a proliferative index of 79 ± 19 . We observed that this NK cell expansion protocol induced an increase of NCR and NKG2D expression for all AML-NK (**figure 1b**). We compared NCR MFI ratio of HD-NK cells versus NCR MFI ratio of AML-NK cells. Mean MFI ratio for NCR1/NKp46 was 41% vs 58%, for NCR2/NKp44 683% vs 262%, for NCR3/NKp30 93% vs 54%, and for NKG2D 240% vs 40%.

We conclude that proliferation of AML-NK cell is slower and weaker than HD-NK cells and that increased of NCR expression was lower than it observed in HD-NK cells, except for NCR1/NKp46. NCR2/NKp44 that is only expressed on activated NK cells was not recovered at HD level. The proliferation of AML-NK cells was 4 times weaker than the proliferation of HD-NK cells, even after thirty days of stimulation with EBV feeder cells and high concentration of Il-2. EBV cell line was developed to select and activate specifically NK cells by NKG2D ligands expression (MHC class-I-chain-related protein A (MICA) and B (MICB) and UL16-binding protein 1 and 2 (ULBP1 and ULBP2)). Surprisingly, this cell line activates AML-NK cells by NKG2D without drastic increase of its receptor compared to HD-NK cells. This underlines that through *in vitro* stimulation, AML-NK cells exhibit low activation abilities by low expression of activating receptors,

except for NCR1/NKp46. Our results are in agreement with publication of Fauriat et al. (Fauriat *et al.*, 2007) that showed a complete recovery for NCR1/NKp46 and a partial recovery for NCR3/NKp30 in patients achieving complete remission.

- *Microarray analysis revealed an AML-NK cells transcriptional signature*

To characterize an AML transcriptional signature, we used 16 RNA samples obtained after NK cells expansion, 6 from expanded AML-NK cells and 8 from expanded HD-NK. High purity of HD and AML-NK cells was obtained: $92.83\% \pm 5.74$ for HD-NK cells and $95.16\% \pm 38.15$ for AML-NK cells. After conducting a significant analysis of microarray (SAM) analysis with a FDR = 5%, we visualized (cf. heatmap) that 90 transcripts differentially expressed between HD and AML patients. In the first cluster, 30 genes were up-regulated and in the second cluster 60 genes were down-regulated in NK cells from AML patients compared to HD (**figure 2**). Overexpressed genes in AML patients were related to cell death and apoptosis (FAIM2, CASP1 and SH3KBP1). Among the 60 underexpressed genes we found genes involved in cells functions for different pathologies: IGF2BP2, AIF1, FZD6, GAB2, RUNX2, SNCA and in NK cells functions: IL12RB2 and IRAK3.

Hierarchical clustering clearly distinguished AML-NK from HD-NK cells. We noted that differences in NCR expression observed *in vivo* in AML-NK cells NK and the possible pathways involved in down-regulation of NCR did not appear in the heatmap. These results are probably due to the NK cell enrichment protocol which has faded these differences. Several remaining down-regulated genes were related to NK cells functions and proliferation as for example interleukin-12 receptor beta 2 (IL12RB2) which promotes the proliferation and cytotoxicity of NK cells via JAK/STAT pathway (Galon et al., 1999; Lehtonen et al., 2003). Interleukin-1 receptor-associated kinase 3 (IRAK3) is an essential component of the IL-R immune signal transduction pathways and stimulates proliferation and interferon-gamma production by human NK cells (Cooper et al., 2001; del Fresno et al., 2005). Monocytes are the main source of secreted IL-1, which is also produced by activated macrophages and neutrophils.

Perturbations in IGF2BP2 expression are characteristic in B-acute lymphoblastic leukemia (Stoskus et al., 2011). Allograft inflammatory factor 1 (AIF1) plays a role in macrophage activation and T-lymphocytes proliferation (Zhao et al., 2013). It has been published that frizzled class receptor 6 (FZD6) triggers oncogenic transformation of B-cell in mouse model (Wu et al., 2009) and that runt-related transcription factor 2 (RUNX2) was transcription factor involved in leukemia transformation (Kuo et al., 2009). GRB2-associated binding protein 2 (GAB2) is involved in the regulation of cell proliferation and hematopoiesis and enhance oncogenic signaling (Zatkova et al., 2006). Under expression of synuclein alpha non A4 component of amyloid precursor, SNCA is characteristic of megakaryocytes of myeloproliferative neoplasm (Maitta et al., 2011; Nakai et al., 2007).

After thirty days of activating expansion, these under-expressed genes in AML-NK cells and their functions associated with other pathology explain the weak proliferation abilities of AML-NK cells that we observed. By this way, they highlight in part the cause of defect in NK cells function and then the proliferation of leukemic cells in AML patients. Other genes that with differential expression between AML-NK and HD-NK failed to give us more clues since their function is still unknown. Of course, expression level of differentially expressed genes will be verified by RT-qPCR, together, when possible, with direct quantification of the corresponding protein. Furthermore, another transcriptomic approach will be realized with resting NK without preliminary expansion in order to more extensively define the differentially expressed gene between AML-NK and HD-NK.

Monitoring of NCR down-expression in HD-NK cells in presence of AML blasts

- *NCR1/NKp46 and NCR3/NKp30 expression of HD-NK cells are down-regulated in presence of AML blasts*

To observe *in vitro* the NCR down-expression of expanded HD-NK during contact with AML blasts, expanded HD-NK were co-cultured with HD-PBMC or AML-blast from NCR^{dull} AML patients over 5 days (n=8). We then compared MFI ratio of NCR and

NKG2D in the AML co-culture with HD-PBMC co-culture. MFI for NCR1/NKp46 decreased of 28% (12.78 ± 1.70 vs 9.22 ± 0.99 , $p=0.0188$), NCR2/NKp44 MFI decreased of 21% (15.5 ± 4.65 vs 12.23 ± 3.01 , $p > 0.05$, [NS]), NCR3/NKp30 MFI decreased of 20% (10.19 ± 2.15 vs 8.15 ± 1.76 , $p=0.0173$). As control, no significant difference was observed in NKG2D expression (a decrease of 16% (16.12 ± 3.51 vs 13.53 ± 2.73 , $p > 0.05$, [NS])) (**Figure 3**).

Fauriat et al. (Fauriat *et al.*, 2007) have shown a similar decrease for NCR1/NKp46 (17%) and NCR3/NKp30 (28.3%) when HD-NK cells derived from progenitor cell (CD34+) were co-cultured 15 days with irradiated leukemic cells (ratio 1/20). However, when they co-cultured mature HD-NK cells 1 to 5 days with leukemic cells (ratio 1/20), they have observed a decrease of 67% for NCR3/NKp30 and no modification in NCR1/NKp46 expression. Our results demonstrated that co-culture of mature HD-NK cells with non-irradiated leukemic blast (ratio 1/5) during 5 days induced a decrease of these two NCR. Our data thus suggest that the process of NCR down-regulation takes place in mature NK cells, during cell-to-cell contact with AML blast.

- *NCR1/NKp46 and NCR3/NKp30 genes expression is decreased in presence of AML blasts*

Next, we wanted to analyze NCR messenger RNA level variation following AML blasts coculture by performing RT-qPCR. After normalization with TPB gene, we compared NCR genes expression level when HD-NK cells were co-cultured with AML-blast or with HD-PBMC which is the calibration condition (100%) (**Figure 4**). Mean expression for NCR1/NKp46 decreased of 42.2% (57.8 ± 24.5 vs 100%, $p > 0.05$, [NS]), NCR2/NKp44 mean expression increased of 4% (104.3 ± 44.8 , $p > 0.05$, [NS]), NCR3/NKp30 decreased of 43% (56.9 ± 48 , $p > 0.05$, [NS].9), and NKG2D decreased of 15.7% (84.2 ± 28.1 , $p > 0.05$, [NS]). These results indicated that NCR genes expression level tends to decrease as observed for NCR expression. The lack of significance of results could be explained by the dilution of ARN of expanded HD-NK cells with other AML PBMC we have added for the co-culture. Increasing number of experimentations and sorting of

NK cells after co-culture will probably lead to significant values that could underline that decrease of NCR at NK cells surface is correlated to their mRNA level.

Research of common transcription factor for *NCR* genes regulation

- *A common putative binding site ETS-1 in NCR promoters*

To characterize putative common regulatory elements we investigated the *NCR* promoters. Using Mapper2 database we obtained binding sites of common transcription factors (TF) upstream of the three *NCR* genes [-8Kb; TSS] (**Table 2**). Taking into account the involvement of ETS-1 TF in NK cell development and cytotoxicity in mice model, (Ramirez *et al.*, 2012) we decided to focus on ETS-1 TF. We next scanned the region [-8Kb; TSS] of *NCR* promoters with the matrix of ETS-1 motif from JASPAR database (**Figure 5**) using MatrixScan from the RSAT suite. Our approach identified several putative binding sites of ETS-1 upstream the three *NCR* (**Figure 6**). Among these binding sites we chose the three sites closest to the TSS but also found in conserved regions between seven different species (rhesus, chimp, mouse, chicken, dog, elephant, and zebrafish) defined from GERP elements in 37-way multiple genome alignments (Cite PMID 19906699). These predicted ETS-1 binding sites have for coordinates: for NCR1/NKp46: chr19: 54,906,112-54,906,119 (position -76; -69 from TSS with p-val= 3.4e-05) for NCR2/NKp44: chr6: 41,303,270-41,303,277 (position -345; -338 from TSS with p-val= 9.1e-04) and for NCR3/NKp30: chr6: 31,593,068-31,593,076 (position -7917; -7910 from TSS with p-val= 9.5e-04) (**Figure 7 a, b, c**).

- *NCR are down regulated in NK-92 co-cultured with Molm-14 AML cell line*

Since the investigation of gene regulation may be difficult to realize on primary NK cells, we decided to investigate effect of ETS-1 on NCR regulation mechanisms in cellular model. Our objective is to work with large amount of cellular material in order to easier decipher mechanism of NCR down-regulation. We co-cultured NK-92 with

three AML cell lines over 48 hours (n=10). The co-culture of NK-92 with AML cell line MOLM-14 significantly decreased the three NCR expressions at NK-92 surface. MOLM-14 corresponds to AML4 subtype a myelomonocytic leukemia, one of the most harmful of leukemia. Compared to internal control (NK-92 cultured without AML cell line), MFI for NCR1/NKp46 decreased of 40.8% (4.13 ± 0.36 vs 2.44 ± 0.33 , $p=0.001$), NCR2/NKp44 MFI decreased of 22.5% (2.16 ± 0.17 vs 1.67 ± 0.06 , $p=0.006$), and NCR3/NKp30 MFI decreased of 29% (3.36 ± 0.46 vs 2.39 ± 0.20 , $p=0.023$) (**Figure 8**). Co-culture of NK-92 with other AML cell lines KG-1 (AML6 subtype) and Kasumi (AML2 subtype) did not affect NCR expression. These results are different than those of Fauriat et al. (Fauriat *et al.*, 2007). In our experimentation, the fact that the two cell lines did not affect NCR expression at surface of NK-92 could be due to the loss of differential characteristics during cellular immortalization. In conclusion, co-culture of NK-92 with MOLM-14 will be a good model to investigate NCR down-regulation.

- *ETS-1 transcription factor bind in vivo the predicted region in NCR promoters, in NK-92*

Based on these results we designed pair of primers to perform site-specific chromatin immunoprecipitation (ChIP) assay and to test the recruitment in vivo of this ETS-1 candidate in NK-92 cell line. After crosslinking and sonication, the chromatin extract was immunoprecipitated by commercial ETS-1 mouse monoclonal antibody and its non-immune counterparts. The corresponding DNA fragments were then purified as previously described (Yeh *et al.*, 2001). The three regions of ETS-1 binding sites were amplified by PCR using specific primer pairs (see Material and Methods). We observed a strong recruitment of ETS-1 on targeted regions upstream the three *NCR* genes (**Figure 9**). This experimentation did not allow us to conclude if ETS-1 binds directly the targeted region. Indeed, in genes regulation, transcription factors do not act alone, some other TF can interact together to induce gene transcription. This Chip-qPCR will be repeated and EMSA (electrophoretic mobility shift assay) experimentation will confirm if ETS-1 binds directly the predicted region or if other TF interact with ETS-1.

- *ETS-1 gene expression is decreased in presence of AML blasts*

To know if ETS-1 mRNA level decreases in the same way than NCR expression, we then performed a preliminary study of ETS-1 gene expression level in expanded NK cells after co-culture with AML blasts. We compared the level expression of ETS-1 gene in HD-NK cells co-cultured with AML-blast or the co-culture with HD-PBMC (condition of calibration =100%) (**Figure 10**). ETS-1 gene expression level decreases of 34% (66.1 ± 19.4 vs 100% $p > 0.05$, [NS]). Even if data are not significant, the ETS-1 transcript level follows the same regulation than NCR1/NKp46 and NCR3/NKp30 mRNA. Then, ETS-1 could be a good candidate for a common regulation.

CONCLUSION

The role NK cells in evolution of AML and their *in vivo* or *ex vivo* manipulation for cellular immunotherapy led us to study NK cells in AML. We investigated the regulation of NCR expression in AML patients. Since AML patients present a low percentage of NK cells, these cells were firstly expanded *in vitro* with EBV feeder cells and high concentration of IL-2. Although these two components are used to activate specifically NK cells, expansion of AML-NK cells showed slow and low proliferation abilities with weak recovery of activating receptors expression. Interestingly, this expansion protocol could be usable in perspective of cellular therapy with NK cells activation *ex vivo* since it increases NCR1/NKp46 and NCR3/NKp30 expression as well as observed in AML patients when CR was attained. Furthermore, these data explain in part why AML patients possess a weak percentage of NK cells. In patients, proliferation of AML blast in blood certainly amplifies the weak proliferation abilities of AML-NK cells. The transcriptomic approach comparing expanded NK cells from patients and HD has confirmed that expansion protocol erases differences in NCR expression observed *in vivo* between AML and HD-NK cells. However, the down-expressed genes as IL12RB2 and IRAK3 may explain the defect in NK cells activation and proliferation observed during NK cells expansion.

In parallel, we have confirmed that NCR1/NKp46 and NCR3/NKp30 were down-expressed when HD-NK were co-cultured *in vitro* with leukemic blasts. Preliminary results of RT-qPCR suggest that *NCR1/NKp46* and *NCR3/NKp30* genes expression level paralleled the down-regulation of these two receptors at cell surface.

Next, we have identified a common putative binding site of ETS-1 transcription factors close to the transcription starting site (TSS) of the three *NCR* genes, in vertebrates conserved regions. *ETS-1* gene expression level tends to decrease in parallel to the decrease of mRNA level of NCR when HD-NK were cultured with leukemic blasts. The chromatin immunoprecipitation (ChIP) assays revealed the recruitment of ETS-1 to the

fragment predicted in the three *NCR* genes promoters. In conclusion, our preliminary results highlight the common regulation of NCR by a putative regulatory element during contact between HD-NK cell and leukemic blast.

To validate our hypothesis and according to our scheme, we will test the impact of ETS-1 on *NCR* transcription and NCR surface expression using ETS-1 silencing by short interfering RNA (siRNA) on NK-92 cell line. NCR expression at NK-92 surface will be measured by flow cytometry and *NCR* with *ETS-1* genes expression level will be measured by RT-qPCR. We will compare transfected NK-92 versus NK-92 control by transcriptomic approach. This approach will also be performed with NK-92 NK cell line co-cultured with leukemia MOLM-14 cell line. Finally, transcriptomic approaches of NK-92 and AML-NK cells will be confronted together and may reveal pathways, proteins, and regulatory elements similar or not between cellular model and primary AML-NK cells. Altogether, we hope these data will highlight mechanisms of the NCR down-expression in AML patients in order to base the NK cell immunotherapy on precise data.

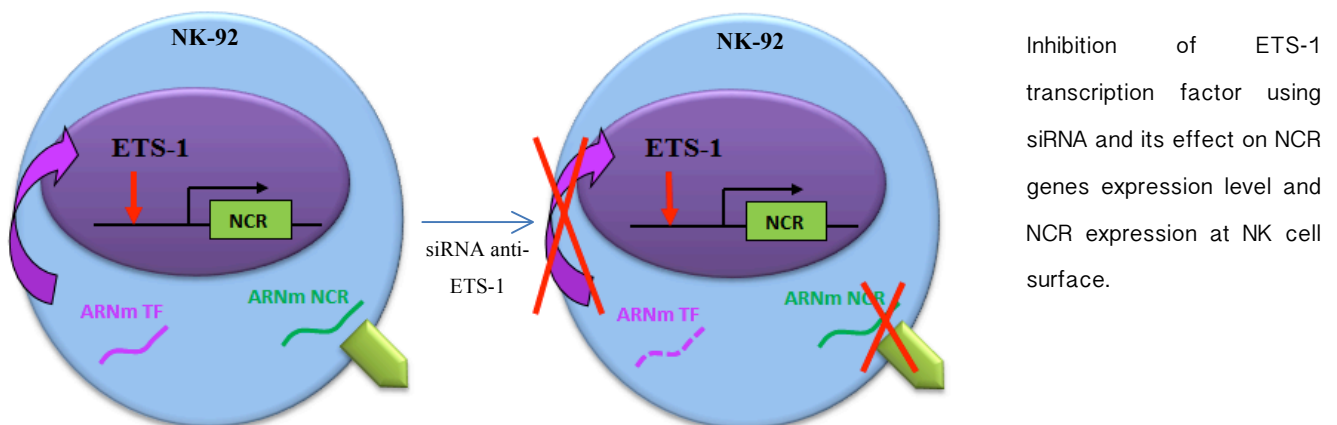

Ultimately, our goal is, once the mechanisms of decreased expression of NCR identified, to restore their expression by reversing the negative control mechanisms. Further insights into the biology of NK cells might also promote the development of novel strategies for stimulating their anticancer activity.

REFERENCES

- Asai O, Longo DL, Tian ZG, Hornung RL, Taub DD, Ruscetti FW, *et al.* (1998). **Suppression of graft-versus-host disease and amplification of graft-versus-tumor effects by activated natural killer cells after allogeneic bone marrow transplantation.** *The Journal of clinical investigation* **101**(9): 1835-1842.
- Barton K, Muthusamy N, Fischer C, Ting CN, Walunas TL, Lanier LL, *et al.* (1998). **The Ets-1 transcription factor is required for the development of natural killer cells in mice.** *Immunity* **9**(4): 555-563.
- Bindea G, Mlecnik B, Hackl H, Charoentong P, Tosolini M, Kirilovsky A, *et al.* (2009). **ClueGO: a Cytoscape plug-in to decipher functionally grouped gene ontology and pathway annotation networks.** *Bioinformatics* **25**(8): 1091-1093.
- Brune M, Hansson M, Mellqvist UH, Hermodsson S, Hellstrand K (1996). **NK cell-mediated killing of AML blasts: role of histamine, monocytes and reactive oxygen metabolites.** *European journal of haematology* **57**(4): 312-319.
- Cooper MA, Fehniger TA, Ponnappan A, Mehta V, Wewers MD, Caligiuri MA (2001). **Interleukin-1beta costimulates interferon-gamma production by human natural killer cells.** *European journal of immunology* **31**(3): 792-801.
- Costello RT, Knoblauch B, Sanchez C, Mercier D, Le Treut T, Sebahoun G (2012). **Expression of natural killer cell activating receptors in patients with chronic lymphocytic leukaemia.** *Immunology* **135**(2): 151-157.
- Costello RT, Sivori S, Marcenaro E, Lafage-Pochitaloff M, Mozziconacci MJ, Reviron D, *et al.* (2002). **Defective expression and function of natural killer cell-triggering receptors in patients with acute myeloid leukemia.** *Blood* **99**(10): 3661-3667.
- del Fresno C, Otero K, Gomez-Garcia L, Gonzalez-Leon MC, Soler-Ranger L, Fuentes-Prior P, *et al.* (2005). **Tumor cells deactivate human monocytes by up-regulating IL-1 receptor associated kinase-M expression via CD44 and TLR4.** *J Immunol* **174**(5): 3032-3040.
- Elkins WL, Pickard A, Pierson GR (1984). **Deficient expression of class-I HLA in some cases of acute leukemia.** *Cancer immunology, immunotherapy : CII* **18**(2): 91-100.
- Falini B, Tiacci E, Martelli MP, Ascani S, Pileri SA (2010). **New classification of acute myeloid leukemia and precursor-related neoplasms: changes and unsolved issues.** *Discovery medicine* **10**(53): 281-292.
- Fauriat C, Just-Landi S, Mallet F, Arnoulet C, Sainty D, Olive D, *et al.* (2007). **Deficient expression of NCR in NK cells from acute myeloid leukemia: Evolution during leukemia treatment and impact of leukemia cells in NCRdull phenotype induction.** *Blood* **109**(1): 323-330.
- Galon J, Sudarshan C, Ito S, Finbloom D, O'Shea JJ (1999). **IL-12 induces IFN regulating factor-1 (IRF-1) gene expression in human NK and T cells.** *J Immunol* **162**(12): 7256-7262.
- Glimcher LH, Townsend MJ, Sullivan BM, Lord GM (2004). **Recent developments in the transcriptional regulation of cytolytic effector cells.** *Nature reviews. Immunology* **4**(11): 900-911.
- Jiang YZ, Barrett AJ, Goldman JM, Mavroudis DA (1997). **Association of natural killer cell immune recovery with a graft-versus-leukemia effect independent of graft-versus-host disease following allogeneic bone marrow transplantation.** *Annals of hematology* **74**(1): 1-6.

- Kiladjian JJ, Bourgeois E, Lobe I, Braun T, Visentin G, Bourhis JH, *et al.* (2006). **Cytolytic function and survival of natural killer cells are severely altered in myelodysplastic syndromes.** *Leukemia* **20**(3): 463-470.
- Koizumi H, Horta MF, Youn BS, Fu KC, Kwon BS, Young JD, *et al.* (1993). **Identification of a killer cell-specific regulatory element of the mouse perforin gene: an Ets-binding site-homologous motif that interacts with Ets-related proteins.** *Molecular and cellular biology* **13**(11): 6690-6701.
- Kuo YH, Zaidi SK, Gornostaeva S, Komori T, Stein GS, Castilla LH (2009). **Runx2 induces acute myeloid leukemia in cooperation with Cbfbeta-SMMHC in mice.** *Blood* **113**(14): 3323-3332.
- Lacorazza HD, Miyazaki Y, Di Cristofano A, Deblasio A, Hedvat C, Zhang J, *et al.* (2002). **The ETS protein MEF plays a critical role in perforin gene expression and the development of natural killer and NK-T cells.** *Immunity* **17**(4): 437-449.
- Lavigne P, Acres S (1989). **Advisory Committee on Epidemiology. Resolutions.** *Canada diseases weekly report = Rapport hebdomadaire des maladies au Canada* **15**(25): 127-129.
- Lehtonen A, Lund R, Lahesmaa R, Julkunen I, Sareneva T, Matikainen S (2003). **IFN-alpha and IL-12 activate IFN regulatory factor 1 (IRF-1), IRF-4, and IRF-8 gene expression in human NK and T cells.** *Cytokine* **24**(3): 81-90.
- Lohoff M, Duncan GS, Ferrick D, Mittrucker HW, Bischof S, Prechtel S, *et al.* (2000). **Deficiency in the transcription factor interferon regulatory factor (IRF)-2 leads to severely compromised development of natural killer and T helper type 1 cells.** *The Journal of experimental medicine* **192**(3): 325-336.
- Lotem J, Levanon D, Negreanu V, Leshkowitz D, Friedlander G, Groner Y (2013). **Runx3-mediated transcriptional program in cytotoxic lymphocytes.** *PLoS one* **8**(11): e80467.
- Maitta RW, Wolgast LR, Wang Q, Zhang H, Bhattacharyya P, Gong JZ, *et al.* (2011). **Alpha- and beta-synucleins are new diagnostic tools for acute erythroid leukemia and acute megakaryoblastic leukemia.** *American journal of hematology* **86**(2): 230-234.
- Nakai M, Fujita M, Waragai M, Sugama S, Wei J, Akatsu H, *et al.* (2007). **Expression of alpha-synuclein, a presynaptic protein implicated in Parkinson's disease, in erythropoietic lineage.** *Biochemical and biophysical research communications* **358**(1): 104-110.
- Ramirez K, Chandler KJ, Spaulding C, Zandi S, Sigvardsson M, Graves BJ, *et al.* (2012). **Gene deregulation and chronic activation in natural killer cells deficient in the transcription factor ETS1.** *Immunity* **36**(6): 921-932.
- Riva A (2012). **The MAPPER2 Database: a multi-genome catalog of putative transcription factor binding sites.** *Nucleic acids research* **40**(Database issue): D155-161.
- Stoskus M, Gineikiene E, Valcekiene V, Valatkaite B, Pileckyte R, Giskevicius L (2011). **Identification of characteristic IGF2BP expression patterns in distinct B-ALL entities.** *Blood cells, molecules & diseases* **46**(4): 321-326.
- Thomas-Chollier M, Defrance M, Medina-Rivera A, Sand O, Herrmann C, Thieffry D, *et al.* (2011). **RSAT 2011: regulatory sequence analysis tools.** *Nucleic acids research* **39**(Web Server issue): W86-91.
- Thoren FB, Romero AI, Brune M, Hellstrand K (2009). **Histamine dihydrochloride and low-dose interleukin-2 as post-consolidation immunotherapy in acute myeloid leukemia.** *Expert opinion on biological therapy* **9**(9): 1217-1223.
- Townsend MJ, Weinmann AS, Matsuda JL, Salomon R, Farnham PJ, Biron CA, *et al.* (2004). **T-bet regulates the terminal maturation and homeostasis of NK and Valpha14i NKT cells.** *Immunity* **20**(4): 477-494.

- Turatsinze JV, Thomas-Chollier M, Defrance M, van Helden J (2008). **Using RSAT to scan genome sequences for transcription factor binding sites and cis-regulatory modules.** *Nature protocols* **3**(10): 1578-1588.
- Urlacher A, Falkenrodt A, Tongio MM, Mayer S (1987). **HLA class I antigens on normal and leukemic cells (quantitative analysis).** *Tissue antigens* **29**(5): 237-245.
- van Helden J, Andre B, Collado-Vides J (1998). **Extracting regulatory sites from the upstream region of yeast genes by computational analysis of oligonucleotide frequencies.** *Journal of molecular biology* **281**(5): 827-842.
- Wang JH, Nichogiannopoulou A, Wu L, Sun L, Sharpe AH, Bigby M, *et al.* (1996). **Selective defects in the development of the fetal and adult lymphoid system in mice with an Ikaros null mutation.** *Immunity* **5**(6): 537-549.
- Wu QL, Zierold C, Ranheim EA (2009). **Dysregulation of Frizzled 6 is a critical component of B-cell leukemogenesis in a mouse model of chronic lymphocytic leukemia.** *Blood* **113**(13): 3031-3039.
- Yeh JC, Hiraoka N, Petryniak B, Nakayama J, Ellies LG, Rabuka D, *et al.* (2001). **Novel sulfated lymphocyte homing receptors and their control by a Core1 extension beta 1,3-N-acetylglucosaminyltransferase.** *Cell* **105**(7): 957-969.
- Zatkova A, Schoch C, Speleman F, Poppe B, Mannhalter C, Fonatsch C, *et al.* (2006). **GAB2 is a novel target of 11q amplification in AML/MDS.** *Genes, chromosomes & cancer* **45**(9): 798-807.
- Zhao YY, Yan DJ, Chen ZW (2013). **Role of AIF-1 in the regulation of inflammatory activation and diverse disease processes.** *Cellular immunology* **284**(1-2): 75-83.

FIGURE LEGENDS

Table 1. AML patients and their clinical characteristics.

Table 2. List of common putative binding site of transcription factors upstream NCR genes, in [-8Kb, TSS] region.

Figure 1. AML-NK cells exhibit a weak proliferation ability compared to HD-NK cells. (a) Flow cytometry Dot Plot at day 0 and day 17 of NK cell expansion for healthy donors (HD) and AML patients. In ordinate: fluorescence intensity of antibody against CD56 specific marker of NK cells. In abscissa: fluorescence intensity of antibody against CD3 specific marker of T lymphocytes. Evolution of NK cell percentage is observed in Q1 quarter. (b) Evolution of activating receptors (NCR1, NCR2, NCR3 and NKG2D) expression expressed in mean fluorescence intensity (MFI) compared to isotypic control, before and after NK cell expansion.

Figure 2. Heatmap of gene expression changes in AML patients versus donors.(a) The hierarchical clustering represents overexpressed (red) and underexpressed (green) genes in sorted NK cells from 6 AML-patients (UPN) and 8 HD. Normalized signal intensities were treated with the SAM software to highlight the most differentially expressed genes with a FDR set at 5%.

Figure 3. Activating receptors expression in presence of leukemic blasts. Evolution of NCR1, NCR2, NCR3 and NKG2D expression in MFI ratio, after co-culture of HD-NK cells with leukemic blasts compared to the co-culture with HD-PBMC (peripheral blood mononuclear cells).

Figure 4. Genes expression level of activating receptors after co-culture with leukemic blasts. Histograms represent the relative mean expression in percentage of *NCR1*, *NCR2*, *NCR3* and *NKG2D* genes when HD-NK cells are co-cultured with PBMC from AML patients, compared to the same HD-NK cells co-cultured with PBMC from donors (corresponding to 100%).

Figure 5. ETS-1 motif. ETS1 motif was retrieved from JASPAR core vertebrates database.

Figure 6. ETS-1 binding regions upstream NCR genes. Each putative binding sites of ETS-1 were represented by blue bars in the [-8Kb ; TSS] region.

Figure 7. Coordinates of chosen ETS-1 binding sequences. Three binding sites for ETS-1 have been predicted *in silico*. **NCR1/NKp46:** Ch19: 54,906,112-54,906,119 **(a)** for **NCR2/NKp44:** Ch6: 41,303,270-41,303,277 **(b)** and for **NCR3/NKp30:** Ch6:31,593,068-31,593,076 **(c)**. Putative binding sites of ETS-1 were represented between blue bars, in vertebrates conserved regions (represented in violet, or with green or blue alignments).

Figure 8. Activating receptors expression in NK-92 co-cultured with leukemic blasts. Evolution of NCR1, NCR2 and NCR3 expression, in MFI ratio, after co-culture of NK-92 with Molm-14 AML cell line compared to NK-92 control.

Figure 9. In vivo recruitment of ETS-1 transcription factor on the human NCR genes promoter. **(a)** Semi-quantitative PCR results of electrophoresis on an agarose gel. **(b)** Results of the quantitative chromatin immunoprecipitation assays performed using antibodies specific for ETS-1 as described in Materials and Methods.

Figure 10. Genes expression level of ETS-1 after co-culture of HD-NK cells with leukemic blasts. Histograms represent the relative quantity of genes expression level of NCR1, NCR2, NCR3, NKG2D and ETS-1 when HD-NK cells are co-cultured with PBMC from AML patients, compared to the same HD-NK cells co-cultured with PBMC from donors (corresponding to 100%).

Table 1.

AML Patients	Sex	Age	Bone marrow blast	Blood blast	AML subtype (WHO)	Blood Lymphocytes
UPN 1	F	67	18%	48%	undeterm.	56%
UPN 2	F	56	100%	36%	M1	58%
UPN 3	F	84	80%	80%	undeterm.	51%
UPN 4	F	98	undeterm.	undeterm.	undeterm.	20%
UPN 5	M	85	20%	8%	M4	25%
UPN 6	M	86	40%	19%	M0	28%
UPN 7	F	53	77%	90%	M5	9%
UPN 8	M	63	9%	2%	ND	23%

AML: Acute Myeloid Leukemia; UPN: Unic Patient Number; WHO: World Health Organization; undeterm.: undetermined

Table 2.

Transcription Factors	NCR1	NCR2	NCR3
AML1	-171-166 -273-268	-84-79 -265-260	-90-95
br_Z1	-237-225	-26-14	-406-418
CP2	-179-169	-130-120	-134-144
dl_2	-307-298	-105-96	-91-100
Dof2	-76-71 -91-86	-334-329	-126-131
ETS1	-37-33 -360-356	-257-253	-231-235
Hand1_Tcfe2a	-243-235	-132-124	-232-240
HMG_1	-405-397	-407-399	-285-293
MZF1_5_13	-122-114	-61-53 -289-281	-19-27
NFKB1	-307-297	-106-96	-91-101
PacC	-19-14	-439-434	-160-165
RELA	-338-329	-105-96 -498-489	-91-100
RREB1	-71-52	-51-32 -134-115 -477-458	-16-35 -133-152 -212-231
Sp1	-16-7	-361-353	-22-30 -184-192
Su(H)	-282-268 -354-340	-93-79 -164-150	-89-103
TP53	-296-277 -302-283	-459-440	-130-149
znf143	-125-106 -218-199	-224-205	-263-282

Figure 1.

a.

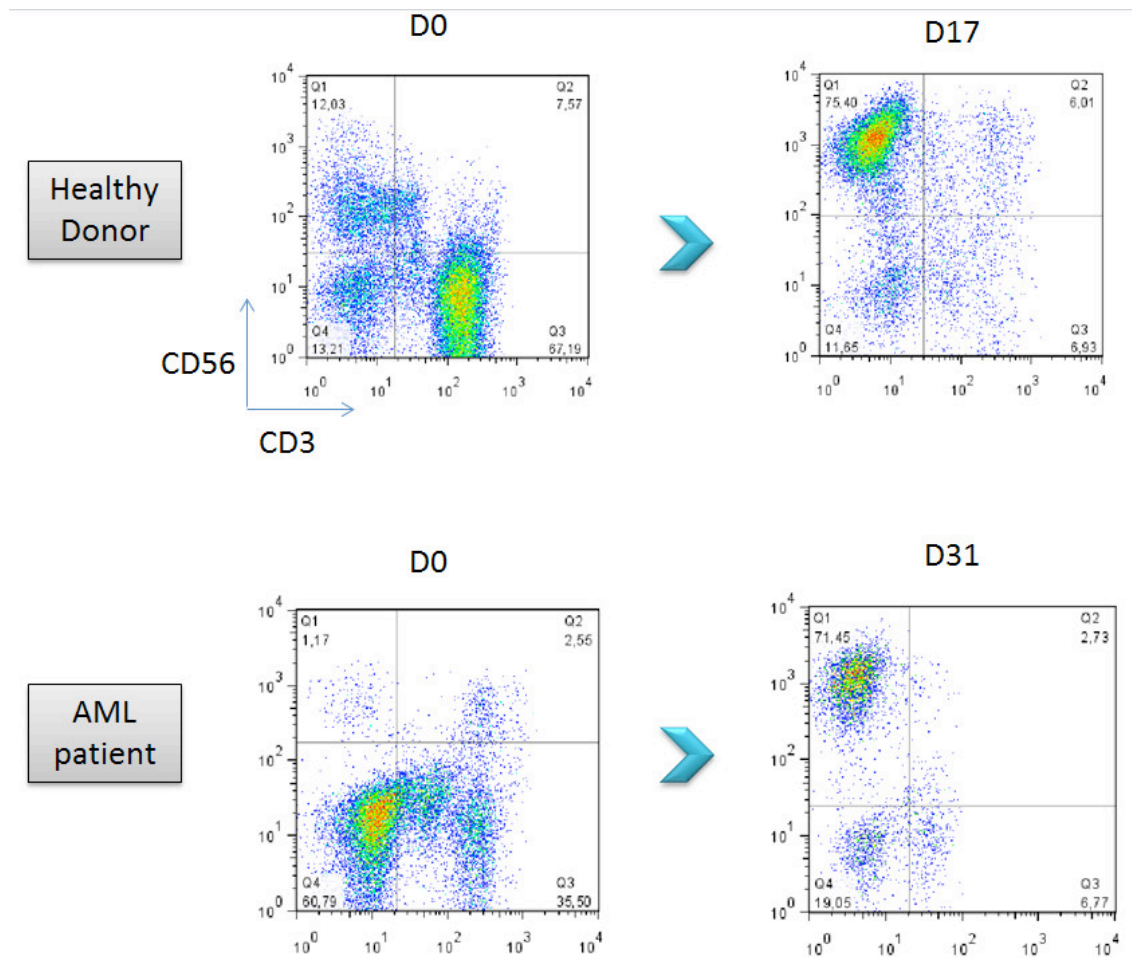

Figure1.

b.

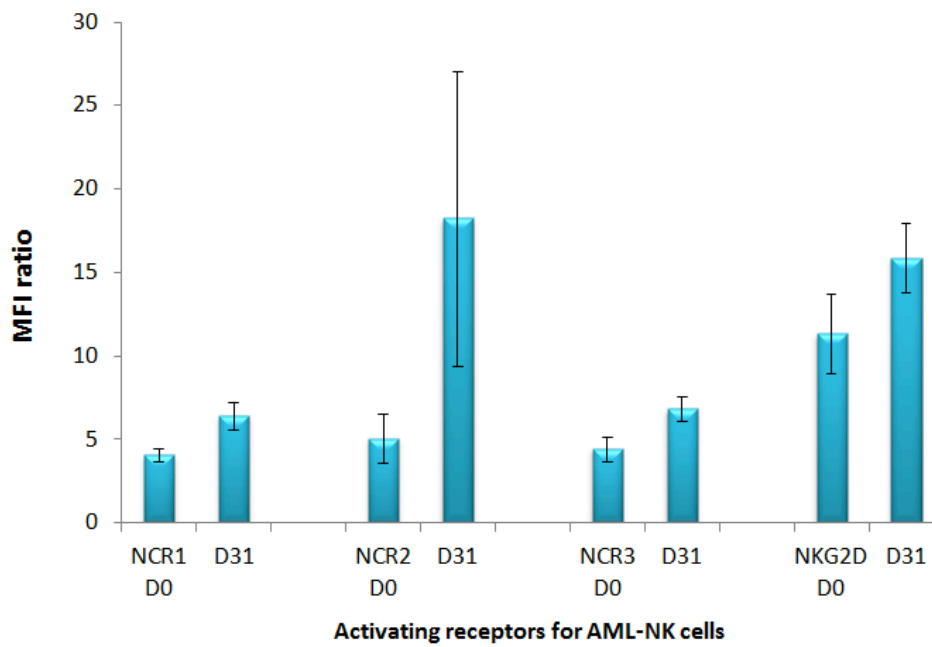
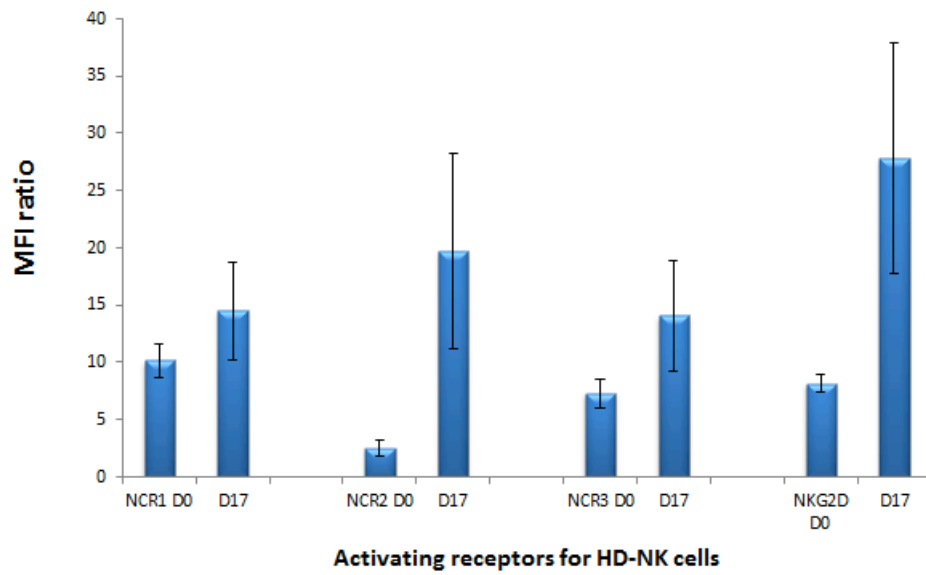

Figure 2.

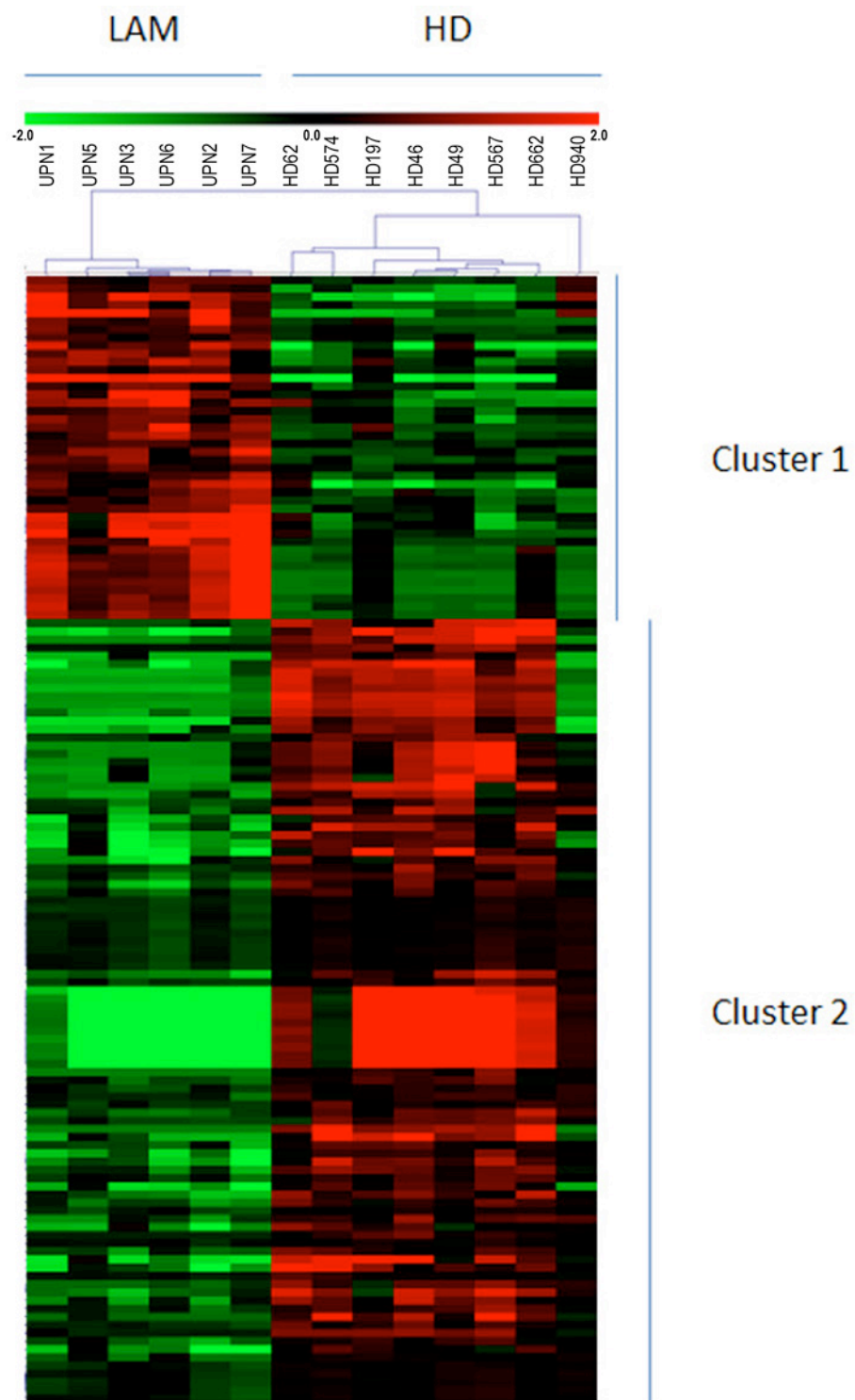

Figure 3.

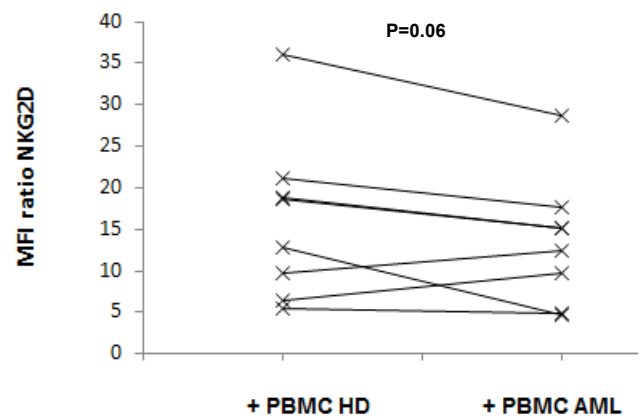
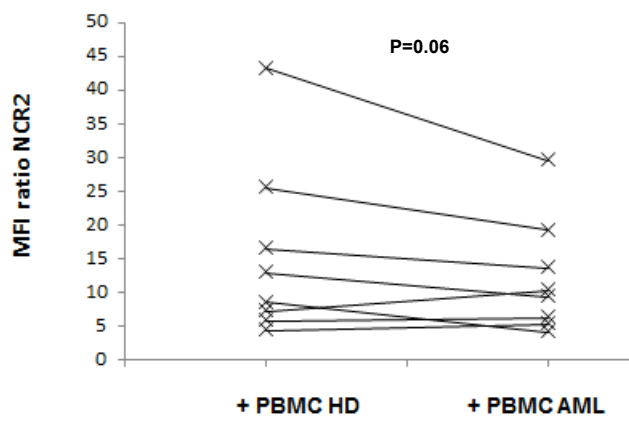
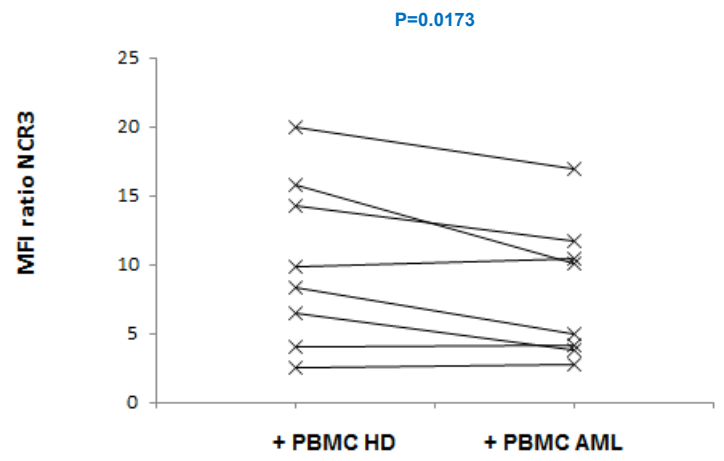
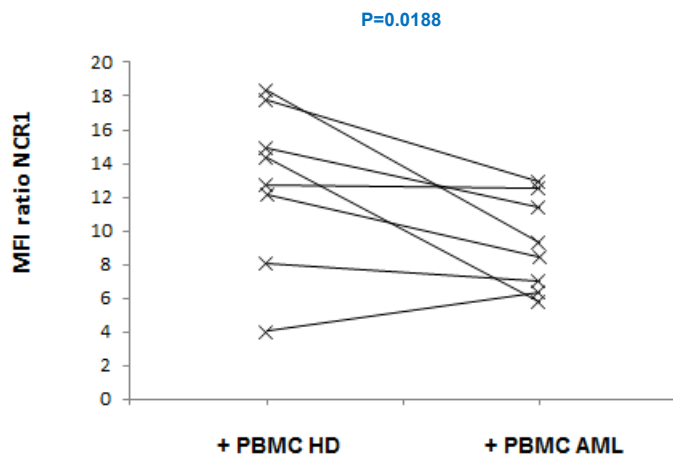

Figure 4.

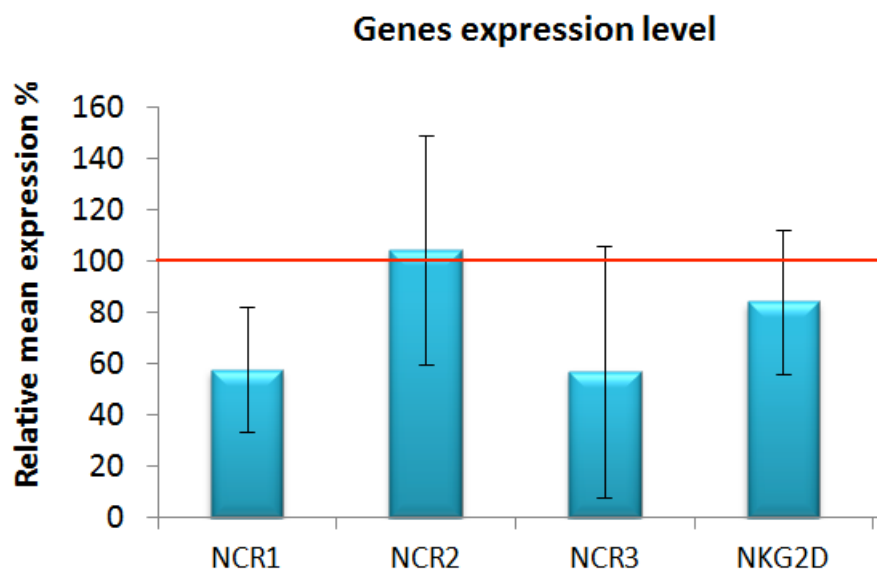

Figure 5.

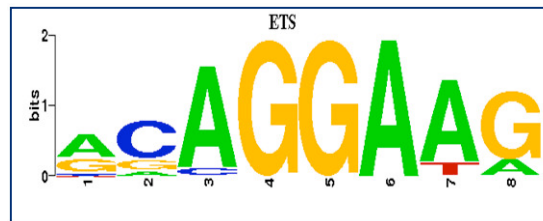

Figure 6.

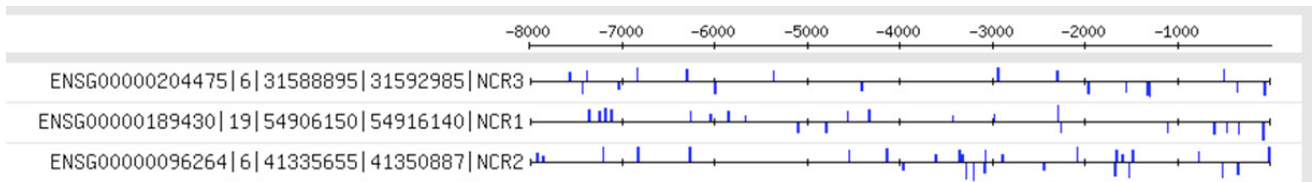

Figure 7 a.

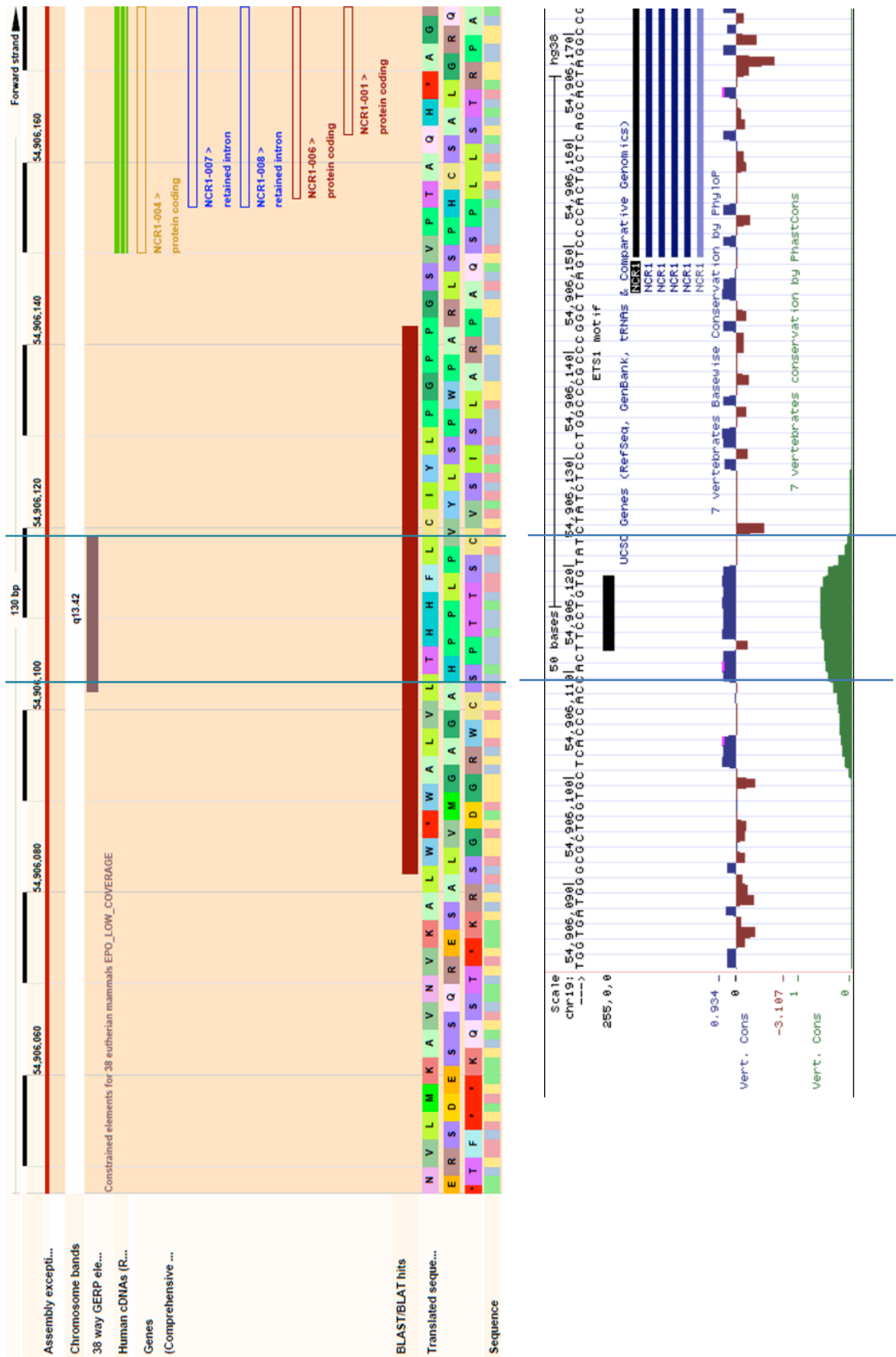

Figure7 b.

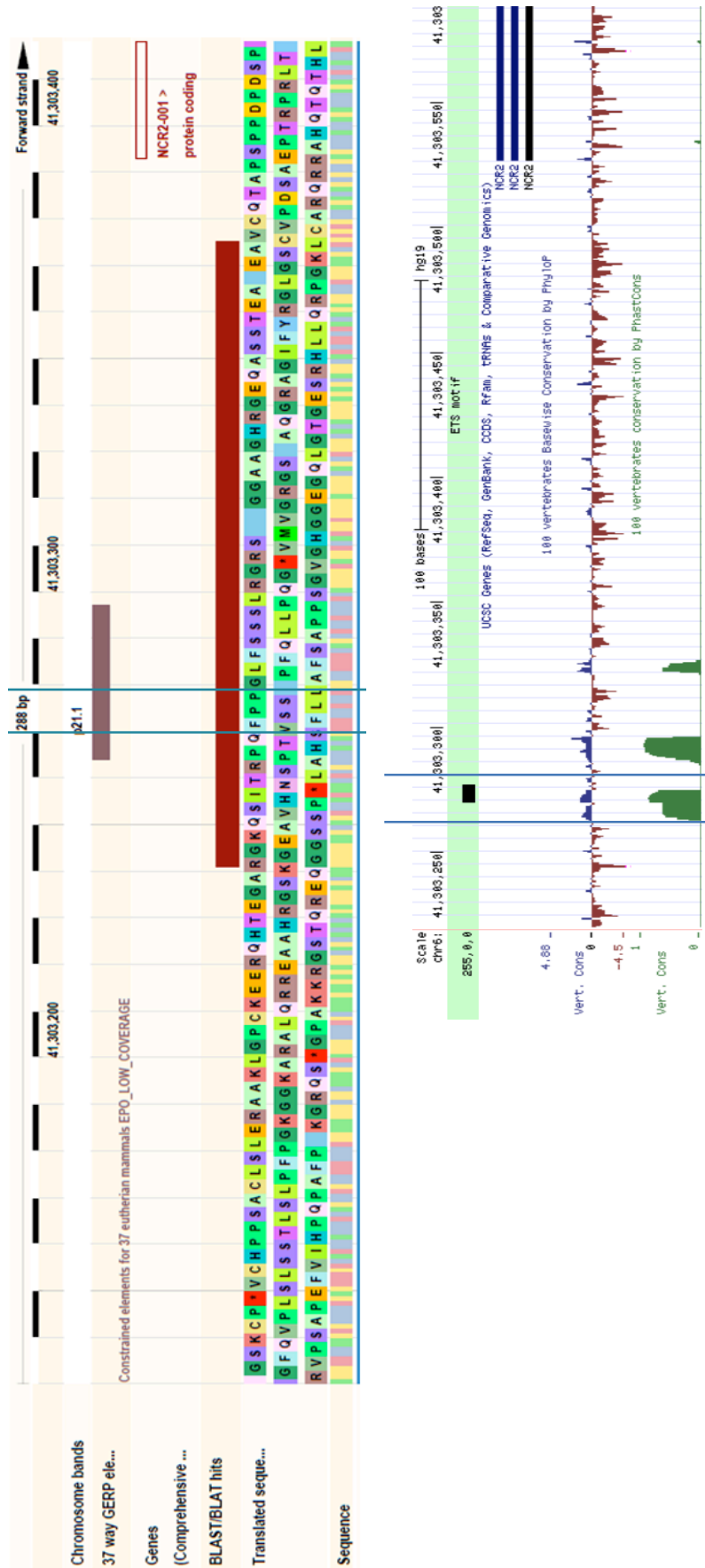

Figure 7 c.

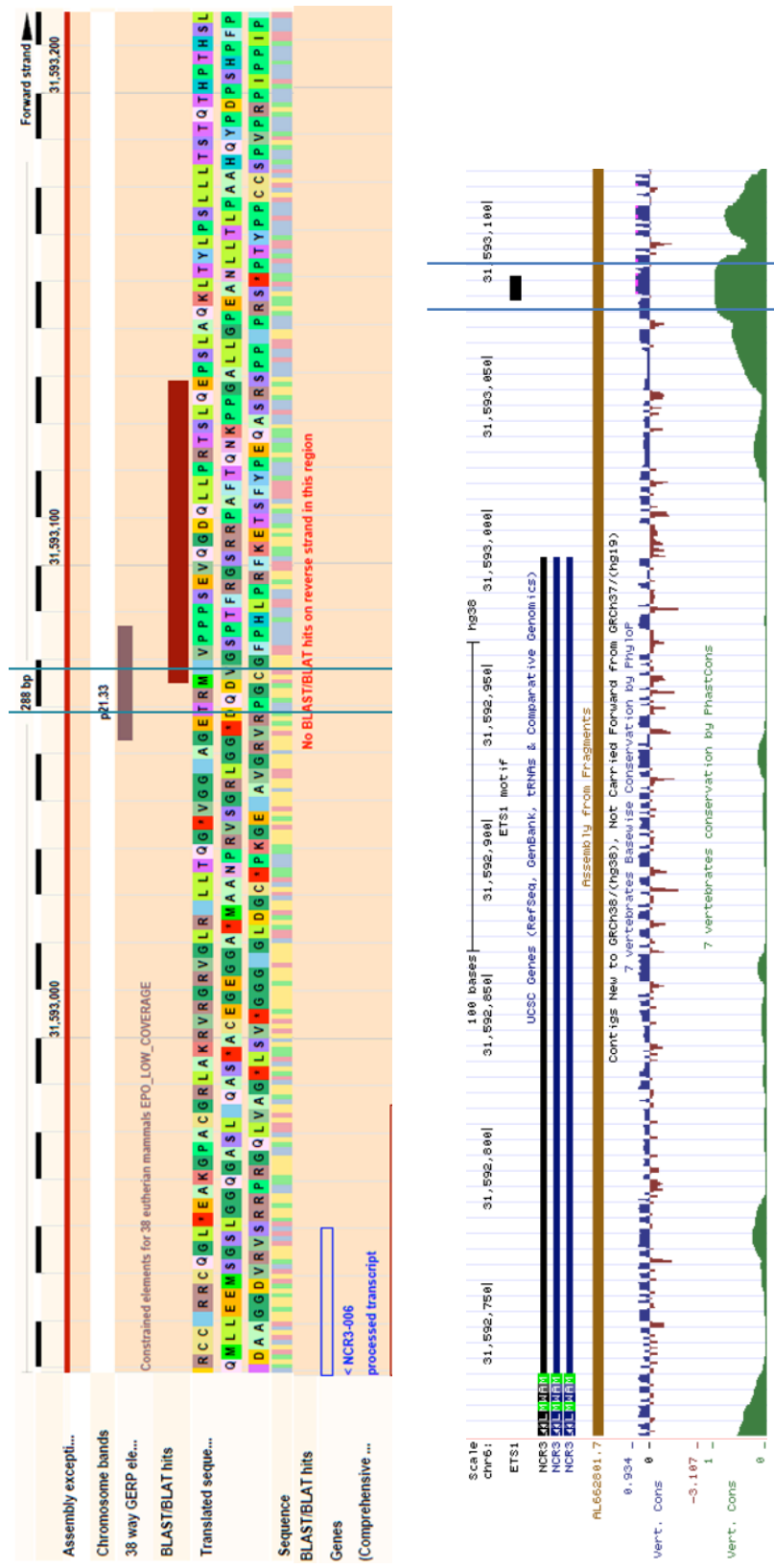

Figure 8.

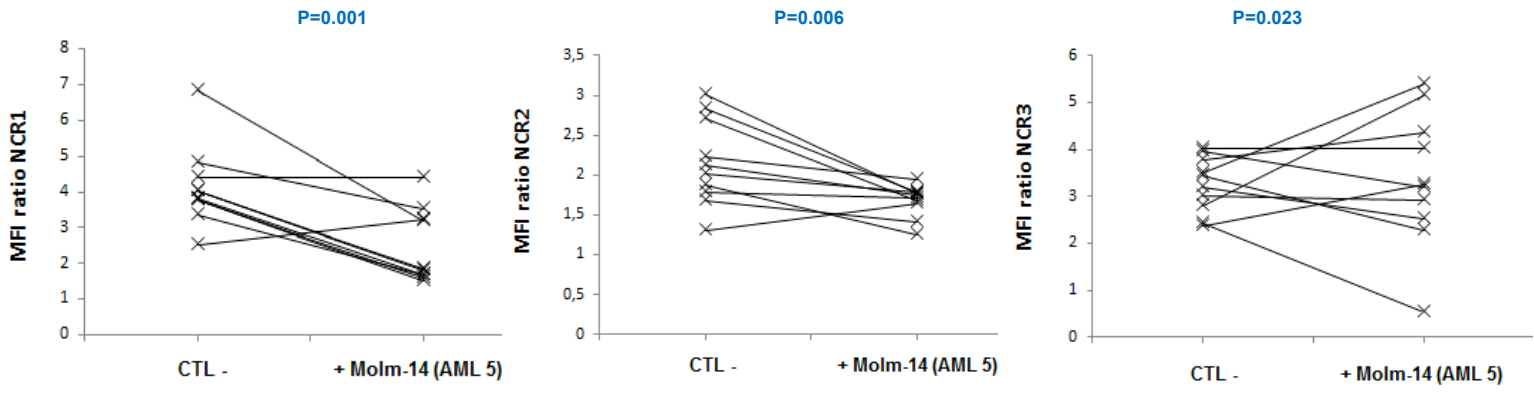

Figure 9.

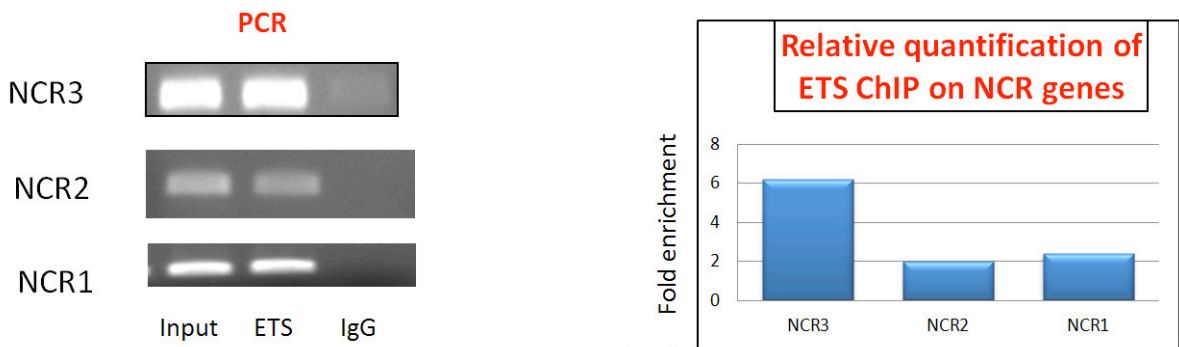
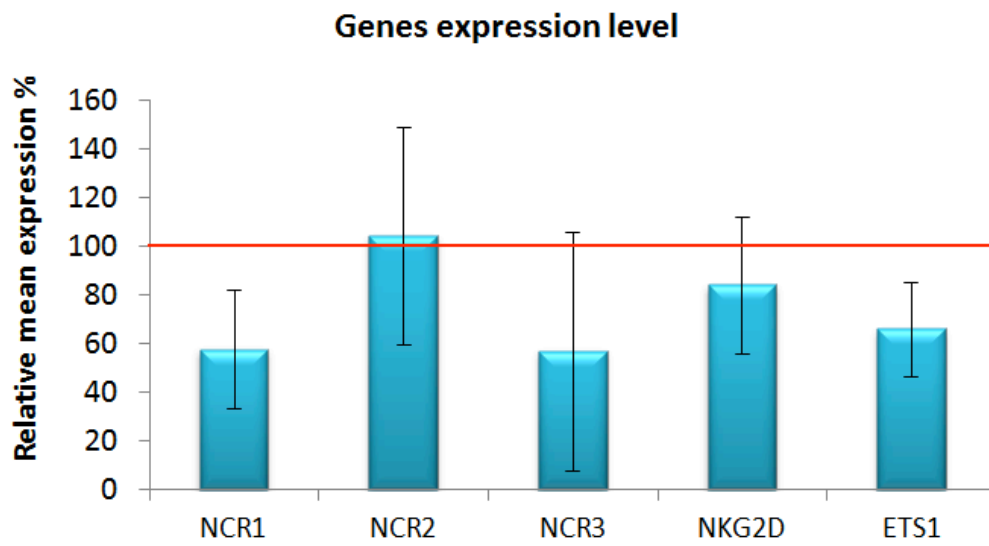

Figure 10.



CONCLUSION

V. CONCLUSION

During my thesis, I focused on NK cells in two different malignant haemopathies. Our first objective was to replace the role of NK in evolution of PV and our second objective was to highlight a possible mechanism of the three NCR co-regulation. We have concluded for the first part that NK cells from PV patients behaved like normal NK cells, at least for the functions tested, although transcriptional analysis clearly distinguished PV-NK from HD-NK. For the second project which is still in progress, our preliminary results have shown that among numerous transcription factors which can be involved in regulation of NCR expression, ETS-1 TF seems to be a good candidate for our researches.

The work I have performed and the scientific expertise I have acquired during my thesis have allowed me to contribute to the flow cytometry experiments, to the interpretation of data and to the revising of the manuscript for two other articles (Annexes 1 and 2). I have also written a review on NK cells modulation in hematological malignancies, and participated to the writing of two others. During the three years of my thesis, I also participated to the supervising of four students for driving experimentation in cellular biology / flow cytometry / RNA extraction.

Currently, for June month and with Dr. Geoffroy Venton (Hematologist to the Conception Hospital in Marseille), we work in collaboration with the company Advanced Biodesign (ABD). This company, member of Lyon biopôle, is a young biotechnology company founded in August 2010, working in the field of applied research and human health, in particular, the field of immuno-diagnostic. ABD aims to provide specific tools for research and diagnostics. Along with their service activities, ABD has an internal R & D activity very active in infectiology and oncology. Indeed, the company has

developed a molecule that targets and kill pre-leukemic stem cells. To the laboratory, our objectives are to test this molecule on stem cells from leukemic graft collected after treatment or leukemic PBMC and observe the effect on cellular viability. We also need to test the innocuousness of the molecule on graft from donors.

VI. ANNEXES

- A. Differential expression of natural killer cell activating receptors in blood versus bone marrow in patients with monoclonal gammopathy

Differential expression of natural killer cell activating receptors in blood versus bone marrow in patients with monoclonal gammopathy

Régis T. Costello,^{1,2,3,4} Anne Boehrer,^{1,2} Carole Sanchez,^{1,2,3} Delphine Mercier,^{1,2} Céline Baier,³ Thérèse Le Treut^{1,2} and Gérard Sébahoun^{1,2,4}

¹Laboratoire d'Hématologie, Hôpital Nord, Marseille, ²Université de la Méditerranée, Marseille, ³Technologies Avancées pour la Génomique et la Clinique (TAGC)/unité INSERM U1090, Marseille, and ⁴Service d'Hématologie, CHU La Conception, Marseille, France

doi:10.1111/imm.12082

Received 22 November 2012; revised 18

January 2013; accepted 23 January 2013.

Correspondence: Prof. Régis T. Costello, Service d'Hématologie, Centre Hospitalier Universitaire La Conception, 147 boulevard Baille, Marseille 13005, France. Email: regis.costello@free.fr

Senior author: Prof. Régis T. Costello

Introduction

Multiple myeloma (MM), despite initial response to conventional treatments and promising results with novel agents, is the paradigm of an incurable malignancy. Innate response and more specifically natural killer (NK) cells may participate in MM eradication or control (for review see ref. 1), as tumour plasmocytes are efficiently killed by normal NK cells.² Nonetheless (i) high HLA class I molecule (particularly HLA-G) and high MHC class I chain-related protein A (MICA) expression on bone marrow (BM) myeloma cells may protect tumour cells from NK lysis,^{2–4} (ii) decreased cytotoxicity of peripheral blood (PB) NK cells has been described in monoclonal gammopathies (MG) and MM. Phenotype and functions of PB NK cells have already been analysed in MG/MM. Expression of normal natural cytotoxicity receptors (NCR) (NCR1/NKp46, NCR2/NKp44, NCR3/NKp30) was shown, and a down-regulation of CD244/2B4/p38 was present⁵ that may prevent its binding to the CD48 molecule at the MM cell surface.⁶ Nonetheless,

Summary

In monoclonal gammopathies (MG) and multiple myeloma (MM), normal natural cytotoxicity receptors (NCR) expression (NCR1/NKp46, NCR2/NKp44, NCR3/NKp30) is observed in natural killer (NK) cells. Nonetheless, except in plasma cell leukemia, few tumor plasmocytes are present in PB, while NK studies have been performed on peripheral blood (PB). For this reason we focused our attention on NK from bone marrow (BM). Our study demonstrates that the down-regulation of NCR3/NKp30 is only detectable in NK from BM but not in PB, and shows a drastic decrease of both NKG2D and CD244/2B4/p38 expression in NK from BM in comparison with PB. In conclusion, our data more precisely describe the mechanism of immune escape of MG/MM from innate immunity since we show a drastic down regulation of 3 major activating NK receptors (NCR3/NKp30, NKG2D and CD244/2B4/p38) at the site of tumor, i.e BM, that was undetectable in PB. Further studies regarding immune regulatory drugs in MG/MM will imperiously require the assessment of immune cell status not only in PB but also in BM to obtain more relevant data regarding anti-tumor efficacy.

Keywords: anti-tumour immune response; CD244/2B4/p38; multiple myeloma; natural cytotoxicity receptors; natural killer cells; NKG2D.

except in plasma cell leukaemia, few tumour plasmocytes are present in PB, whereas NK studies have been performed on PB. As most MG/MM tumour cells are located in BM, we focused our attention on NK from BM.

Materials and methods

Blood samples were obtained from 13 patients before treatment: two MG of unknown significance (MGUS) and 11 MM. Healthy donors (HD, $n = 37$) were also analysed; 22 were selected as 'age-matched' (66.8 years \pm 14.6 for HD versus 68 years \pm 6 for patients). Regarding the International Myeloma Working Group prognosis index⁷, four patients were scored I, two patients scored II and five patients scored III, while regarding the MGUS one patient had a prognosis score⁸ of 1 and one had a score of 2. Median haemoglobin level was 114 g/l (80–148, $n = 130$ –170), median calcemia level was 2.31 mmol/l (2.02–2.65, $n = 2.23$ to $n = 2.58$), median creatinine level was 90 μ mol/l (63–464, $n = 60$ –120), median percentage of BM plasmocytes was 20% (8–75, $n < 5$). Bence Jones

proteinuria was detected at significant levels in four patients, MM-related bone lesions were detected in four patients. Cytogenetic analysis was performed in 11 patients and was abnormal in six patients. Data for each patient are detailed in Table 1. The analysis of PB was carried out less than 4 hr after blood sampling, on whole blood after red blood cell lysis (Q-Prep[®] lysing kit, Beckman-Coulter, Villepinte, France). The analysis of BM cells was performed after a Ficoll[®] gradient (Eurobio, Courtaboeuf, France) and depletion of plasmocytes (MACS[®] technology, using anti-CD138 monoclonal antibody, Miltenyi Biotec, Paris, France). The NK cell population was defined as CD3⁻ CD56⁺. The following monoclonal antibodies were all obtained from Beckman-Coulter: anti-CD3-FITC (UCHT1), anti-CD56-PC5 (N901-NKH1), anti-NCR1/NKp46-phycoerythrin (PE), anti-NCR2/NKp44-PE, anti-NCR3/NKp30-PE, anti-NKG2D-PE, anti-CD244(2B4,p38)-PE. Triple staining was performed using CD3-FITC/CD56-PC5 in addition with anti-NCR1/NKp46-PE, anti-NCR2/NKp44-PE and anti-NCR3/NKp30-PE. For cell surface staining, cells (5×10^5) were incubated for 20 min at 4° with 10 µl of the corresponding antibodies for 100 µl of cell preparation. Flow cytometry was performed on an Epics XL[®] flow cytometer (Beckman-Coulter). The results are expressed as follows; percentages correspond to (% positive cells – % isotype control), while the mean fluorescence intensities (MFI) correspond to the ratio (MFI positive cells : MFI isotype control). Statistical analysis was performed using the SPSS software (SPSS User's Guide. SPSS Inc., 1993; Chicago, IL). The Kolmogorov–Smirnov test was used to determine if the data fitted a normal distribution. As this test rejected the assumption of normality for all variables, comparisons were made using the non-parametric Wilcoxon matched-pairs (PB versus BM for each patient)

signed rank test or the Student's *t*-test (patients versus HD).

Results and discussion

First, we checked the percentage of NK cells in PB versus BM (data not shown), and failed to detect a significant difference both regarding the whole NK population (BM 11% ± 9 versus PB 9.5% ± 4, $P > 0.05$) and the CD56^{dim} subpopulation (BM 98% ± 2 versus PB 94% ± 8, $P > 0.05$), whereas we detected a difference regarding the CD56^{bright} subset (BM 2% ± 2 versus PB 6% ± 8, $P < 0.05$). We then compared the same parameters between PB from patients and HD (data not shown). We did not detect a difference regarding the whole NK population (10% ± 4 for HD versus 9.5 ± 4 for patients, $P > 0.05$), the CD56^{dim} (87% ± 13 for HD versus 91 ± 9 for patients, $P > 0.05$) or the CD56^{bright} subset (13% ± 13 for HD versus 9% ± 8 for patients, $P > 0.05$).

As defects in activating receptors have been described in NK cells from PB in many malignant haemopathies (see Sanchez *et al.*¹ for review), we checked their expression by flow cytometry (Fig. 1a,b; % and MFI, respectively) in PB from HD (black bars) versus PB from patients (white bars). Regarding the percentage of cells expressing each receptor, we failed to detect any significant difference in NKp30/NCR3 (HD 67% ± 21 versus patients 61% ± 25, $P > 0.05$), NKp44/NCR2 (HD 7% ± 6 versus patients 11% ± 7, $P > 0.05$) and NKp46/NCR1 (HD 79.5% ± 14 versus patients 75% ± 17, $P > 0.05$) and CD244/2B4/p38 (HD 98% ± 1 versus patients 96% ± 7, $P > 0.05$). In contrast, we detected a significant difference regarding NKG2D (HD 94% ± 6 versus patients 85% ± 10 versus, $P < 0.01$). Regarding the MFI of each receptor, we failed

Table 1. Patient's characteristics

	Age (years)	Type of MC	Type of gammopathy	IPI	Hb (g/l)	Calcemia (mmol/l)	Creatinine (µmol/l)	BJ proteinuria	Bone lesions	Cytogenetics	Marrow plasmocytes (%)
UPN1	74	IgA κ	MM	I	119	2.16	90	No	No	t(4;14), 9%	10
UPN2	67	IgG λ	MGUS	2	142	2.41	77	No	No	t(4;14), 86%	8
UPN3	67	IgG λ	MM	I	148	2.36	64	No	No	Normal	12
UPN4	74	IgG λ	MGUS	0	132	2.27	63	No	No	Not done	4
UPN5	55	IgG λ	MM	I	145	2.25	85	No	No	p53 deletion	11
UPN6	58	IgG λ	MM	II	108	2.36	138	No	No	Normal	18
UPN7	66	IgG λ	MM	III	106	2.02	119	> 1 g/day	No	Normal	20
UPN8	75	IgA λ	MM	I	114	2.40	90	No	No	t(4;14), 80%	20
UPN9	66	λ	MM	III	95	2.65	464	> 1 g/day	Yes	Not done	75
UPN10	71	IgG λ	MM	III	80	2.22	387	No	No	t(4;14), 85%	40
UPN11	71	λ	MM	III	108	2.25	66	> 1 g/day	Yes	MAF del.	50
UPN12	74	IgG λ	MM	III	95	2.4	124	No	Yes	Normal	53
UPN13	66	κ	MM	II	129	2.17	164	> 5 g/day	Yes	Normal	72

UPN, unique patient number; MC, monoclonal component; IPI, International Myeloma Working Group prognosis index; BJ, Bence Jones; MAF, musculo-aponeurotic fibrosarcoma oncogene homologue.

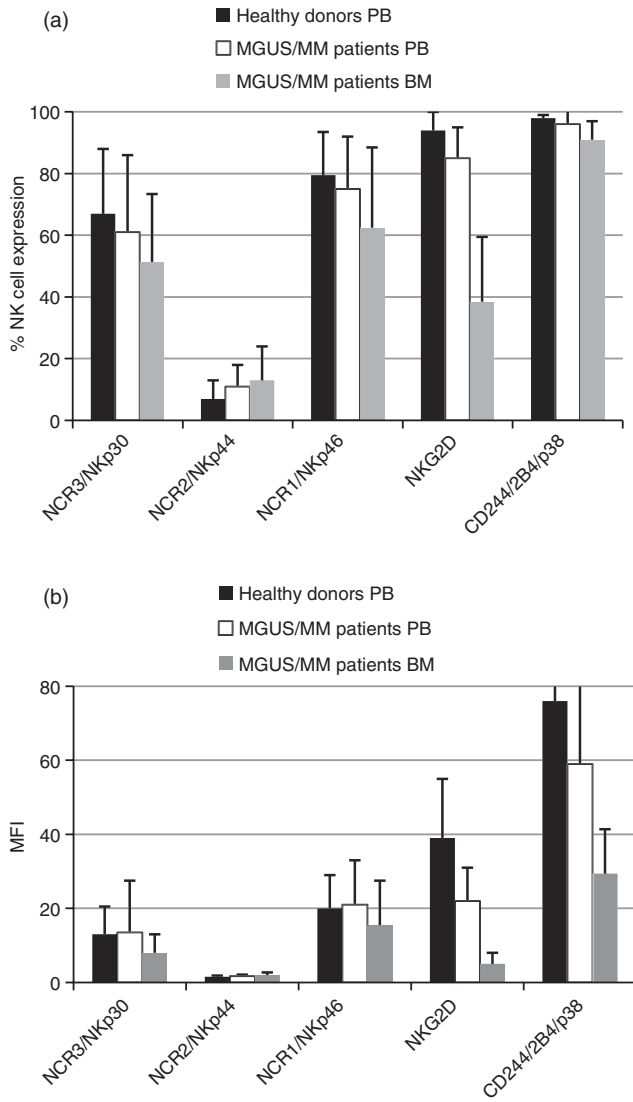

Figure 1. Comparison of the percentage (a) and mean fluorescent intensity (b) of natural killer (NK) cell expression of activating receptors in peripheral blood (PB) from healthy donors, PB of monoclonal gammopathies of unknown significance/multiple myeloma (MGUS/MM) patients, and bone marrow (BM) of MGUS/MM patients. The percentage (a) or mean fluorescence intensities (MFI) (b) of NK cell expression of the activating receptors in healthy donors' PB (black bars), MGUS/MM patients' PB (white bars) and MGUS/MM patients' BM (grey bars). Each plot corresponds to duplicate data from the 13 patients or 22 healthy donors, expressed as mean \pm standard deviation. Percentages are expressed after subtraction of control isotype, whereas MFI corresponds to the ratio between the molecule studied and the isotype control. These results are based upon gated NK cells ($CD3^+ CD56^+$).

to detect any significant difference in NKp30/NCR3 (HD 13 ± 7.5 versus patients 13.5 ± 14 , $P > 0.05$), NKp44/NCR2 (HD 1.5 ± 0.35 versus patients 1.7 ± 0.4 , $P > 0.05$) and NKp46/NCR1 (HD 20 ± 9 versus patients 21 ± 12 , $P > 0.05$). In contrast, we detected a significant difference regarding NKG2D (HD 39 ± 16 versus patients 22 ± 9 , $P < 0.01$) and CD244/2B4/p38 (HD 76 ± 36 versus 59 ± 30 , $P < 0.001$).

Finally, we compared the expression of the various activating receptors (Fig. 1a,b; % and MFI, respectively) between PB (white bars) and BM (grey bars) of patients. Regarding the percentage of cells expressing each receptor, we detected a significant difference in NKp30/NCR3 expression (PB $61\% \pm 25$ versus BM $51.4\% \pm 22$, $P < 0.05$) but not for NKp44/NCR2 (PB

$11\% \pm 7$ versus BM $13.7\% \pm 11$, $P > 0.05$) and NKp46/NCR1 (PB $75\% \pm 17$ versus BM $62.5\% \pm 26$, $P > 0.05$). We detected a significant difference for NKG2D expression (PB $85\% \pm 10$ versus BM $38.5\% \pm 21$, $P < 0.01$) and CD244/2B4/p38 expression (PB $96\% \pm 7$ versus BM $91\% \pm 6$, $P < 0.05$). Regarding the MFI of each receptor, we detected a significant difference in NKp30/NCR3 expression (PB 13.5 ± 14 versus BM 8 ± 5 , $P < 0.05$) but not for NKp44/NCR2 (PB 1.7 ± 0.4 versus BM 2 ± 0.7 , $P > 0.05$) or NKp46/NCR1 (PB 21 ± 12 versus BM 15.5 ± 12 , $P > 0.05$). In contrast, we detected a significant difference regarding NKG2D expression (PB 22 ± 9 versus BM 5 ± 3 , $P < 0.01$) and CD244/2B4/p38 (PB 59 ± 30 versus BM 29.4 ± 12 , $P < 0.01$).

Our study (i) confirms our previous results regarding the down-regulation of NK cell activating receptors in MGUS/MM; (ii) extends our observation with the down-regulation of NKG2D in PB; (iii) shows that the down-regulation of NCR3/NKp30 is only detectable in BM but not in PB; (iv) more precisely defines the innate immune defects in MG/MM by demonstrating a further drastic decrease of both NKG2D and CD244/2B4/p38 expression from PB to BM. A drawback in our report is the lack of corresponding data for normal BM NK cells. This could suggest that the differences observed are only related to the site of sampling and not to the disease. This hypothesis is unlikely as a recent report of Eissens *et al.*⁹ failed to detect significant differences between NK from BM or PB regarding the molecules we studied. In conclusion, our data more precisely describe the mechanism of immune escape of MG/MM from innate immunity because we show a drastic down-regulation of three major activating NK receptors (NCR3/NKp30, NKG2D and CD244/2B4/p38) at the site of tumour, i.e. BM, whereas a less profound or absent down-regulation was observed in PB. Further studies regarding immune regulatory drugs in MG/MM will inevitably require the assessment of immune cell status not only in PB but also in BM to obtain more relevant data regarding anti-tumour efficacy.

Acknowledgements

This work was funded in part by the Association pour le Développement de la REcherche Médicale (A.DE.RE.M).

Disclosure

The authors declare no conflict of interest.

References

- 1 Sanchez CJ, Le Treut T, Boehrer A, Knoblauch B, Imbert J, Olive D, Costello R. Natural killer cells and malignant haemopathies: a model for the interaction of cancer with innate immunity. *Cancer Immunol Immunother* 2011; **60**:1–13.
- 2 Carbone E, Neri P, Mesuraca M *et al.* HLA class I, NKG2D, and natural cytotoxicity receptors regulate multiple myeloma cell recognition by natural killer cells. *Blood* 2005; **105**:251–8.
- 3 Maki G, Hayes GM, Naji A, Tyler T, Carosella ED, Rouas-Freiss N, Gregory SA. NK resistance of tumor cells from multiple myeloma and chronic lymphocytic leukemia patients: implication of HLA-G. *Leukemia* 2008; **22**:998–1006.
- 4 von Lilienfeld-Toal M, Frank S, Leyendecker C *et al.* Reduced immune effector cell NKG2D expression and increased levels of soluble NKG2D ligands in multiple myeloma may not be causally linked. *Cancer Immunol Immunother* 2010; **59**:829–39.
- 5 Fauriat C, Mallet F, Olive D, Costello RT. Impaired activating receptor expression pattern in natural killer cells from patients with multiple myeloma. *Leukemia* 2006; **20**:732–3.
- 6 Hosen N, Ichihara H, Mugitani A *et al.* CD48 as a novel molecular target for antibody therapy in multiple myeloma. *Br J Haematol* 2012; **156**:213–24.
- 7 Greipp PR, San MJ, Durie BG *et al.* International staging system for multiple myeloma. *J Clin Oncol* 2005; **23**:3412–20.
- 8 Kyle RA, Durie BG, Rajkumar SV *et al.* Monoclonal gammopathy of undetermined significance (MGUS) and smoldering (asymptomatic) multiple myeloma: IMWG consensus perspectives risk factors for progression and guidelines for monitoring and management. *Leukemia* 2010; **24**:1121–7.
- 9 Eissens DN, Spanholtz J, van der Meer A, van Cranenbroek B, Dolstra H, Kwekkeboom J, Preijers FW, Joosten I. Defining early human NK cell developmental stages in primary and secondary lymphoid tissues. *PLoS ONE* 2012; **7**:e30930.

B. Expression of activating receptors on natural killer cells from AIDS-related lymphoma patients

Expression of activating receptors on natural killer cells from AIDS-related lymphoma patients

Delphine Mercier-Bataille¹, Carole Sanchez^{1,2}, Céline Baier², Thérèse Le Treut¹, Nicolas Mounier³, Saadia Mokhtari⁴, Daniel Olive⁵, Karine Baumstarck⁶, Gérard Sébahoun¹, Caroline Besson⁷ and Régis T Costello^{2,8}

¹ Université Aix-Marseille, Hôpital Nord, Laboratoire d'Hématologie, Chemin des Bourrely. 13915. Marseille Cedex 20, France.

² Technologies Avancées pour la Génomique et la Clinique (TAGC)/unité INSERM U1090, route de Luminy, 13008 Marseille, France

³ Service d'Oncologie-Hématologie, CHU de Nice, Hôpital Larchet, 151 Rte Saint Antoine Ginestiere BP 7906202 Nice Cedex 3, France.

⁴ Université Aix-Marseille, Hôpital Nord, Service des maladies infectieuses, Chemin des Bourrely. 13915. Marseille Cedex 20, France.

⁵ Laboratoire d'immunologie des tumeurs, Institut Paoli-Calmette, bd Leï Roure, 13008 Marseille, France.

⁶ Université Aix-Marseille, Faculté de La Timone, Unité d'Aide Méthodologique, 27 Boulevard Jean Moulin, 13005 Marseille, France.

⁷ Service d'hématologie et immunologie clinique, CHU Bicêtre, 78 rue du Gal Leclerc, 94275 Le Kremlin-Bicêtre, France.

⁸ Université Aix-Marseille, Hôpital La Conception, Service d'Hématologie et Thérapie Cellulaire, 147 Boulevard Baille, 13005 Marseille, France

Corresponding author: Pr Régis Costello, Université Aix-Marseille, Hôpital La Conception, Service d'Hématologie et Thérapie Cellulaire, 147 Boulevard Baille, 13005 Marseille, France. Phone number: (33) 4 91 38 41 50, Fax number: (33) 4 91 38 41 54, E-mail address: regis.costello@free.fr

Abstract:

Background: Abnormal NK phenotype and cytotoxic functions have been described in acute myeloid leukemia, chronic lymphocytic leukemia, myeloma and myelodysplastic syndromes. Defective NK cytotoxicity is due to decreased expression of the Natural Cytotoxicity Receptors (NCRs), 2B4/CD244/p38, or NKG2D. This prompted us to test the expression of these molecules on circulating NK cells from patients with AIDS-RL in comparison with HIV+ patients without lymphoma, healthy donors and HIV- patients with lymphoma.

Methods: Blood samples were analyzed by flow cytometry for NCRs, 2B4/CD244/p38 and NKG2D expression on NK cells defined as CD3-/CD56+ lymphocytes. We also analyzed by quantitative PCR specific RNA for NKp30/NCR3 and NKp46/NCR1.

Results: We could not detect any defect in NKp46/NCR1 expression between all groups. NKp44/NCR2, NKp30/NCR3 and NKG2D had lower expression in AIDS-RL in comparison with HIV+ patients without lymphoma when compared to patients with similar (>0.3 G/L) CD4+ lymphocyte levels. Expression of 2B4/CD244/p38 was lower in AIDS-RL than in HIV-negative lymphoma. Comparison of specific NKp30/NCR3 and NKp46/NCR1 RNA showed increased steady state levels, despite decreased surface expression for NKp30/NCR3, suggesting abnormal post-transcriptional regulatory mechanisms.

Conclusions: We show a more pronounced defect in NK activating molecule when HIV infection is associated with lymphoma than when only one condition (HIV positivity or lymphoma) is present. Defective NK function may be one of pathophysiological factors explaining the increased incidence of lymphoma in HIV patients in addition to CD4+ depletion and dysfunction.

Keywords:

Natural Killer Cells; Natural Cytotoxicity Receptors; HIV-1; Lymphoma; Antitumor Immune Response.

Background:

Advances in lymphoma treatment prolong progression-free survival. Nonetheless, many patients relapse. Deficient cytotoxic functions of natural killer (NK) cells [1], which can be infected by HIV [2], may participate in the failure to cure AIDS-related lymphomas (AIDS-RL). Engagement of inhibitory receptors by human leukocyte antigen (HLA)-class-I molecules inhibits NK cytotoxicity. Thus, according to the “missing self hypothesis”, absent or deficient expression of HLA-class-I molecule activates NK if an additional activating signal is delivered by the natural cytotoxicity receptors (NCR) NKp30/NCR3, NKp44/NCR2 or NKp46/NCR1, 2B4/CD244/p38 and NKG2D. Deficient NK functions interfere with the anti-tumor response: 1) during treatment, via decreased efficiency of anti-CD20 antibody-driven cell cytotoxicity (ADCC) [3, 4, 5] 2) during the complete remission phase by favoring residual HLA-class-I negative lymphoma cells to escape from NK-mediated immunity [6]. Abnormal NK functions have been described in hematological malignancies such as acute myeloid leukemia, chronic lymphocytic leukemia, myeloma and myelodysplastic syndromes [7, 8, 9, 10]. Of note, down-regulation of NCRs is associated with HIV infection [11]. We compared the NK cell surface activating molecules expression between patients with AIDS-RL, HIV-positive patients without lymphoma and lymphoma patients not infected by the HIV.

Results:

Population characteristics:

Among the 31 AIDS-RL (mean age: 43 ± 8 years) of the study, 20 had CD4+ lymphocytes $<300/\text{mm}^3$ (mean $133 \pm 70/\text{mm}^3$), 11 had CD4+ lymphocytes $>300/\text{mm}^3$ (mean $630 \pm 260/\text{mm}^3$). Only 2 patients (6.4%) were not treated by highly active antiretroviral therapy (HAART) at study inclusion. The control cohort included 56 HIV-positive patients without lymphoma (mean age: 44 ± 9 years) selected to be matched for the CD4+ lymphocyte count with the AIDS-RL: among this population, 9 patients [16%] were not treated by HAART. Two groups were designed: HIV patients with <300 CD4+ lymphocytes/ mm^3 ($n=12$; mean age 44 ± 8.4 years, 1 patient without HAART) and HIV patients with >300 CD4+ lymphocytes/ mm^3 ($n=44$; mean age 44 ± 9.8 years patients without HAART). Two other control cohorts of 33 HIV-negative lymphoma patients (mean age: 62 ± 14 years) and 19 healthy subjects (HS, mean age: 41 ± 16 years) were included.

Lymphoid cells repartition (Figure 1– Panel A):

There was no significant difference in total lymphocytes and T-lymphocytes count among the different groups ($p>0.05$). Lymphoma groups had more B lymphocytes ($1700 \pm 7000/\text{mm}^3$) than HIV ($200 \pm 200/\text{mm}^3$) and HS ($300 \pm 100/\text{mm}^3$) because of lymphoma circulating cells. Total NK cells counts in AIDS-RL with <300 CD4+ lymphocytes/ mm^3 and HIV+ patients without lymphoma but with <300 CD4+ lymphocytes/ mm^3 were lower than in the other groups (mean $41 \pm 35/\text{mm}^3$ for AIDS-RL <300 CD4+ lymphocytes/ mm^3 and $51 \pm 52/\text{mm}^3$ for HIV+ without lymphoma with <300 CD4+ lymphocytes/ mm^3 vs $137 \pm 257/\text{mm}^3$ for AIDS-RL with >300 CD4+ lymphocytes/ mm^3 , $131 \pm 148/\text{mm}^3$ for HIV+ with >300 CD4+ lymphocytes/ mm^3 , $276 \pm 510/\text{mm}^3$ for HIV-negative lymphoma patients and $150 \pm 70/\text{mm}^3$ for HS ($p=0.04$ and 0.02).

NK activating receptors expression (Figure 1-Panel B, C, D, E, F):

No difference in NKp46/NCR1 expression was observed (Figure 1, panel B, $p>0.05$, NS). The analysis of NKp44/NCR2 expression, an activating receptor only expressed on activated NKs (Figure 1, panel C) showed no difference between AIDS-RL and HIV-negative lymphoma patients ($p>0.05$, NS) and between AIDS-RL and HIV patients without lymphoma but with <300 CD4/ mm^3 patients ($p>0.05$, NS). However, AIDS-RL with >300 CD4+ lymphocytes/ mm^3 expressed lower NKp44/NCR2 than HIV+ patients without lymphoma with >300 CD4+ lymphocytes/ mm^3 (MFI median (M)=1.52; interquartile range (IQR)[1.24-1.850] vs M=1.80 IQR[1.540-2.110], $p=0.011$) and than HS (M=1.75 IQR[1.650-2.000], $p=0.006$). In spite of a very high NKp44/NCR2 expression by one HIV+ lymphoma with <300 CD4+ lymphocytes/ mm^3 (MFI = 6.21), this group tended to express lower

NKp44/NCR2 than HIV+ patients with >300 CD4+ lymphocytes/mm³ (M=1.42 IQR[1.320-1.765] vs 1.80[1.543-2.115], p=0.06). HIV-negative lymphoma patients expressed more NKp44/NCR2 than HIV+ patients without lymphoma and >300 CD4+ lymphocytes/mm³ (M= 1.48 IQR[1.330-1.690] vs 1.80[1.543-2.115], p=0.02) or HS (M=1.75[1.650-2.000], p=0.002). There was no difference in NKp30/NCR3 expression (Figure 1, panel D) between AIDS-RL and HIV-negative lymphoma patients (p>0.05, NS) or between AIDS-RL and HIV+ patients without lymphoma and <300 CD4+ lymphocytes/mm³ (p>0.05, NS). NKp30/NCR3 expression was lower in AIDS-RL with >300 CD4+ lymphocytes/mm³ than in HIV+ patients without lymphoma and >300 CD4+ lymphocytes/mm³ (M= 4.555 IQR[2.693-9.645] vs 7.525[4.853-16.19], p=0.014) or HS (M=8.86 IQR[4.630-14.56], p=0.041).

Regarding NKG2D (figure 1, panel E), AIDS-RL with <300 CD4+ lymphocytes/mm³ had a lower expression of NKG2D than HIV+ lymphoma patients with >300 CD4+ lymphocytes/mm³ (M=15.92 IQR[8.125-29.93] vs 29.18[18.18-41.32], p= 0.036), than HIV+ patients without lymphoma but >300 CD4+ lymphocytes/mm³ (M=24.92 IQR[18.68-35.45], p= 0.005), than HIV-negative lymphoma patients (M=31.89 IQR[25.71-42.17], p=0.001), or than HS (M=31.78 IQR[27.40-37.50], p=0.001). AIDS-RL with >300 CD4+ lymphocytes/mm³ had lower expression of NKG2D than HIV-negative lymphoma patients (M=23.65 IQR[15.45-28.19] vs 31.89[25.71-42.17], p=0.03), than HS (M=31.78 IQR[27.40-37.50], p=0.005) or HIV+ patients without lymphoma but >300 CD4+ lymphocytes/mm³ (M=24.92 IQR[18.68-35.45], p=0.005).

We failed to detect 2B4/CD244/P38 expression difference (Figure 1, panel F) between AIDS-RL and HIV+ patients without lymphoma (NS, p>0.05). 2B4/CD244/P38 expression was lower in AIDS-RL with <300 CD4+ lymphocytes/mm³ than in HIV-negative lymphoma patients (M=37.36 IQR[21.45-51.68] vs 63.43[45.16-86.86], p=0.002) and than in HS (M=51.64[38.93-78.76], p=0.023). 2B4/CD244/P38 expression was lower in AIDS-RL with >300 CD4+ lymphocytes/mm³ than in HIV-negative lymphoma patients (M=41.11 IQR[32.18-50.35] vs 63.43[45.16-86.86], p= 0.012).

Quantitative RT-PCR of NKp30/NCR3 and NKp46/NCR1 (Figure 2):

In line with cell surface expression, AIDS-RL had no modification of NKp46/NCR1 specific RNA level ($0.5 < \text{normalized ratio} < 2$ for the 6 of the 7 patients analyzed) compared with HIV+ population without lymphoma (Panel A). We did not find any correlation between NKp46/NCR1 expression and CD4+ lymphocyte count. On the contrary, NKp30/NCR3 RNA (Panel B) was overexpressed in AIDS-RL patients (normalized ratio > 2 for the 7 patients analyzed). No significant RNA level was detected for NKp44/NCR2, a results in line with normal physiology since this molecule is only expressed by stimulated NKs (data not shown).

Discussion:

The total NK cells count in patients with <300 CD4⁺ lymphocytes/mm³ was lower in AIDS-RL in comparison with the other groups, suggesting a poor prognosis as shown in low or high grade HIV-negative lymphomas [12, 13]. Low circulating counts concerned the NK CD56^{bright} and CD56^{low} subsets, while the CD56^{negative} subpopulation was elevated in AIDS-RL (data not shown). Since this NK cell subset has poor cytolytic and cytokine production abilities, AIDS-RL had both decreased total NK cell counts and expansion of an ineffective population. Regarding the NCR we found no difference in NKp46/NCR1 expression in the different groups but, in contrast, a significant decrease in both NKp44/NCR2 and NKp30/NCR3 was observed in AIDS-RL with >300 CD4/mm³ in comparison with HIV+ patients with comparable CD4⁺ lymphocytes. Thus in moderately immune-suppressed patients the development of lymphoma is associated with low expression of two activating molecules. Regarding NKp44/NCR2, low levels should be of good prognosis since NK cells in HIV-controller patients do not up-regulate NKp44/NCR2 thus protecting uninfected CD4⁺ lymphocytes from inadequate NK killing [14]. Regarding the mechanism of NCR regulation, quantitative RT-PCR measured comparable NKp46/NCR1 levels in AIDS-RL and controls, suggesting an identical regulation at both transcriptional and post-transcriptional levels. However elevated level of NKp30/NCR3 specific RNA was detected in AIDS-RL in comparison with HIV patients without lymphoma, despite identical surface expression of NKp30/NCR3. This suggests that a post-transcriptional mechanism negatively interferes with NKp30/NCR3 RNA translation or protein stability, leading to identical surface expression despite higher specific RNA levels. Regarding NKG2D, we observed a gradient of expression from lower level (AIDS-RL <300 CD4/mm³) to HS/HIV-negative lymphoma patients, with intermediary levels for AIDS-RL with >0.3 G/L CD4⁺ lymphocytes followed by HIV+ patients without lymphoma. The NKG2D ligands MICA/MICB/ULBP are stress molecules expressed on tumor cells, and secreted at high levels in HIV patients, leading to down-regulated NKG2D expression on NK and impaired anti-lymphoma cytotoxicity [15]. Expression of 2B4/CD244/p38 was lower in AIDS-RL (whatever CD4⁺ lymphocyte levels) than in HIV-negative lymphoma patients. The 2B4/CD244/p38 ligand is the CD48 molecule [16, 17] which is expressed on B normal and neoplastic lymphocyte and is drastically up-regulated by Epstein-Barr virus (EBV) infection. The down-regulation of 2B4/CD244/p38 could thus impair the cytotoxicity against EBV-positive B-cell lymphomas.

Conclusion:

In addition to the expansion of an ineffective CD56-negative NK population, AIDS-RL patients had decreased levels of 2 out of 3 NCRs, of NKG2D and of 2B4/CD244/p38. The most significant difference concerned NKG2D, which expression was significantly decreased regarding both HIV patients without lymphoma, non-HIV lymphoma patients and HS. This specific abnormality is of great interest since lymphoma cells express the stress ligands MICA/B and ULBP, but may escape to NK cytotoxicity due to impaired NKG2D expression. Of note, HAART was not sufficient to restore a normal phenotype since most of our patients were already treated at the time of NK phenotype analysis, with NK abnormalities also detected in patient with a satisfactory immune status (CD4+ lymphocytes >300/mm³). Since these defects in NK immune surveillance may also impair the anti-infectious immunity, they could also partly explain the susceptibility to infection of HIV patients during chemotherapy, even with high CD4+ T-lymphocytes levels. Altogether our data suggest that immune intervention aiming at NK cell function restoration could be of interest in AIDS-RL patients.

Material and methods:

Study design:

According to previous data [8], we hypothesized that $75\% \pm 10\%$ of AIDS-RL patients and $15\% \pm 10\%$ of HIV patients without lymphoma had low NCR expression (NCR^{dull}). In order to show a statistically significant difference between the 2 groups with a risk $\alpha = 5\%$ and $\beta = 75\%$, we included in our study 31 AIDS-RL patients and 56 HIV positive patients without lymphoma.

Patients:

From July 2006 to June 2011 patients from Marseille, Nice and Paris were included in first line of therapy. Inclusion criteria were the co-existence of HIV infection with biopsy-proven lymphoma. The 56 HIV positive patients without lymphoma were recruited from Service des Maladies Infectieuses (Hôpital Nord, Marseille). According to Helsinki declaration, patients were informed and signed a consent form. Biological samples were collected at diagnosis time, before lymphoma treatment. Additional comparison of our data was also performed with 33 non-HIV patients with lymphoma and 19 healthy subjects (HS).

Blood samples and cell separation:

Blood samples were collected on EDTA and analyzed by flow cytometry. Dry pellets of PBMC were frozen at -80°C for subsequent quantitative RT-PCR analysis.

qRT-PCR analysis:

qRT-PCR analysis concerned 7 AIDS-RL patients and 32 HIV-positive patients without lymphoma. qRT-PCR analysis was performed with the Applied Biosystems 7900HT Fast Real-Time PCR system using Taqman detection. Total RNA was isolated using TRIzol reagent (Invitrogen Life Technologies). Capture of fluorescence was recorded on the ABI Prism 7900HT scanner and the Ct (threshold cycle) was calculated for each assay (Sequence Detection System Software 2.3, Applied Biosystems). We used GAPDH as endogenous control ($\Delta\text{Ct} = \text{Ct target gene} - \text{Ct GAPDH}$). GAPDH TaqMan Gene Expression assays were from Applied Biosystems. Since the NCR expression is almost exclusively restricted to NK, the PCR was performed on the whole PBMC population, but the values were adjusted to the percentage of NK present in each sample. We compared ΔCt with the mean of VIH ΔCt using a ratio ($\Delta\text{Ct HIV+Lymphoma} / \Delta\text{Ct HIV}$), considering that a ratio >2 corresponded to RNA overexpression.

Phenotypic analysis :

Flow cytometry was performed on an Epics XL^R flow cytometer (Beckman Coulter). The NK cells were defined as CD3⁻/CD56⁺/CD16⁺. The following mAbs were used (Beckman-Coulter, Marseille, France): anti-CD3^{FITC} (UCHT1), anti-CD56^{PC5} (N901-NKH1), anti-NCR1/NKp46^{PE} (BAB281), anti-NCR2/^{NKp44}PE (Z231), anti-NCR3/NKp30^{PE} (Z25), anti-NKG2D-PE (ON72), anti-P38 (C1.7), anti-IgG1^{FITC}, anti-CD19^{PC5} (J4.119), CD4^{PE}/CD8^{ECD}/CD3^{PC5}, anti-CD3^{FITC}/CD16^{PE} (UCHT1/3G8). All our results were expressed as the mean fluorescent intensity ratio molecule of interest/isotypic control (MFIr).

Statistical analysis:

Data were compared between the 4 groups using a nonparametric Kruskal-Wallis test; post hoc tests for multiple comparisons were performed when the test was significant (macro Marta Garcia-Granero [07/2008] for SPSS). The statistical analyses were performed using the SPSS software package, version 17.0 (SPSS Inc., Chicago, IL, USA). All tests were two-sided. Statistical significance was defined as $p < 0.05$.

Abbreviations:

NK; natural killer, NCR; natural cytotoxicity receptors, AIDS-RL; AIDS-related lymphoma, HS; healthy subjects, MFI; mean fluorescent intensity, PBMC; peripheral blood mononucleated cells, PCR; polymerase chain reaction.

Competing interests:

No competing interests.

Author's contributions:

DMB, CS, TLT, CB, RC performed or contributed to the flow cytometry experiments, DMB performed the qPCR experiments, RC, DMB, CS, TLT, CB, DO, GS, CB, NM, SM, KB, GS participated to the interpretation of data and to the revising of the manuscript, RC, SM, NM contributed to subject recruitment, KB, RC contributed to the conception of the study and performed statistical analysis. All authors have given final approval of the version to be published, and are accountable for all aspects of the work.

Acknowledgements:

Special thanks to Bernadette Barbarat for kind help for qRT-PCR, and special thanks to Marta Garcia-Granero for additional help in statistical analysis. Special thanks to Jean Gabarre for helpful discussion.

References:

1. Altfeld M, Fadda L, Frleta D, Bhardwaj N. **DCs and NK cells: critical effectors in the immune response to HIV-1.** Nat Rev Immunol 2011, **11(3):**176-86.
2. Valentin A, Rosati M, Patenaude DJ, Hatzakis A, Kostrikis LG, Lazanas M, Wyvill KM, Yarchoan R, Pavlakis GN. **Persistent HIV-1 infection of natural killer cells in patients receiving highly active antiretroviral therapy.** Proc Natl Acad Sci U S A. 2002, **99(10):**7015-20.
3. Ahmad A, Yao XA, Tanner JE, Cohen E, Menezes J. **Surface expression of the HIV-1 envelope proteins in env gene-transfected CD4-positive human T cell clones: characterization and killing by an antibody-dependent cellular cytotoxic mechanism.** J Acquir Immune Defic Syndr 1994, **7(8):**789-98.
4. Forthal DN. **Cytotoxic T lymphocyte precursors in persons with repeated exposure to human immunodeficiency virus.** J Infect Dis 1999, **180(4):**1406-7.
5. Forthal DN, Landucci G, Daar ES. **Antibody from patients with acute human immunodeficiency virus (HIV) infection inhibits primary strains of HIV type 1 in the presence of natural-killer effector cells.** J Virol 2001, **75(15):** 6953-61.
6. Farnault L, Sanchez C, Baier C, Le Treut T, Costello RT. **Hematological malignancies escape from NK cell innate immune surveillance: mechanisms and therapeutic implications.** Clin Dev Immunol. 2012, **2012:**421702.
7. Costello RT, Sivori S, Marcenaro E, Lafage-Pochitaloff M, Mozziconacci MJ, Reviron D, Gastaut JA, Pende D, Olive D, Moretta A. **Defective expression and**

function of natural killer cell-triggering receptors in patients with acute myeloid leukemia. Blood 2002, **99(10)**:3661.

8. Fauriat C, Just-Landi S, Mallet F, Arnoulet C, Sainty D, Olive D, Costello RT. **Deficient expression of NCR in NK cells from acute myeloid leukemia: Evolution during leukemia treatment and impact of leukemia cells in NCRdull phenotype induction.** Blood 2007, **109(1)**:323-30.
9. Costello RT, Knoblauch B, Sanchez C, Mercier D, Le Treut T, Sébahoun G. **Expression of natural killer cell activating receptors in patients with chronic lymphocytic leukaemia.** Immunology 2012, **135(2)**:151-7.
10. Kiladjian JJ, Bourgeois E, Lobe I, Braun T, Visentin G, Bourhis JH, Fenaux P, Chouaib S, Caignard A. **Cytolytic function and survival of natural killer cells are severely altered in myelodysplastic syndromes.** Leukemia 2006, **20(3)**:463-70.
11. De Maria A, Fogli M, Costa P, Murdaca G, Puppo F, Mavilio D, Moretta A, Moretta L. **The impaired NK cell cytolytic function in viremic HIV-1 infection is associated with a reduced surface expression of natural cytotoxicity receptors (NKp46, NKp30 and NKp44).** Eur J Immunol 2003, **33(9)**:2410-8.
12. Shafer D, Smith MR, Borghaei H, Millenson MM, Li T, Litwin S, Anad R, Al-Saleem T. **Low NK cell counts in peripheral blood are associated with inferior overall survival in patients with follicular lymphoma.** Leuk Res 2013, **37(10)**:1213-5.
13. Plonquet A, Haioun C, Jais JP, Debard AL, Salles G, Bene MC, Feugier P, Rabian C, Casasnovas O, Labalette M, Kuhlein E, Farcet JP, Emile JF, Gisselbrecht C, Delfau-Larue MH; Groupe d'étude des lymphomes de l'adulte. **Peripheral blood natural killer cell count is associated with clinical outcome in patients with aaIPI 2-3 diffuse large B-cell lymphoma.** Ann Oncol 2007, **18(7)**:1209-15.

14. Marras F, Nicco E, Bozzano F, Di Biagio A, Dentone C, Pontali E, Boni S, Setti M, Orofino G, Mantia E, Bartolacci V, Bisio F, Riva A, Biassoni R, Moretta L, De Maria A. **Natural killer cells in HIV controller patients express an activated effector phenotype and do not up-regulate NKp44 on IL-2 stimulation.** Proc Natl Acad Sci U S A 2013, **110(29)**:11970-5.

15. Matusali G, Tchidjou HK, Pontrelli G, Bernardi S, D'Ettorre G, Vullo V, Buonomini AR, Andreoni M, Santoni A, Cerboni C, Doria M. **Soluble ligands for the NKG2D receptor are released during HIV-1 infection and impair NKG2D expression and cytotoxicity of NK cells.** FASEB J 2013, **27(6)**:2440-50.

16. Brown MH, Boles K, van der Merwe PA, Kumar V, Mathew PA, Barclay AN. **2B4, the natural killer and T cell immunoglobulin superfamily surface protein, is a ligand for CD48.** J Exp Med 1998, **188(11)**:2083-90.

17. Latchman Y, McKay PF, Reiser H. **Identification of the 2B4 molecule as a counter-receptor for CD48.** J Immunol 1998, **161(11)**:5809-12.

Figure legends:

Figure 1: Flow cytometry analysis of whole PBMC population (panel A) and of NK cells (panels B to F). Results are expressed as absolute number of cells per volume unit, *i.e.* Giga/Liter in panel A. Results are expressed as mean fluorescence intensity ratio (in comparison with isotype controls, *cf.* Material and Methods). When significant, statistical results are indicated with the corresponding p-value.

Figure 2: RT-qPCR analysis of NKp46/NCR1 (panel A) and NKp30/NCR3 (panel B). Values under 2 correspond to an RNA expression not statistically superior to the gene control, value above 2 correspond to over-expressed RNA.

Figure 1.

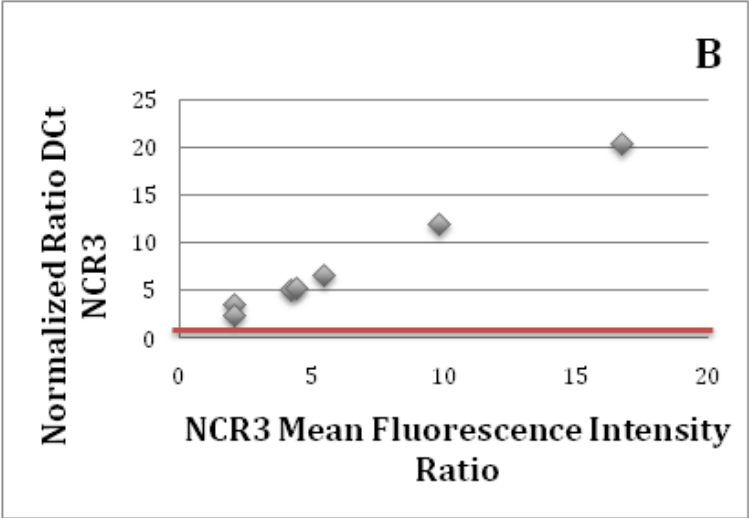
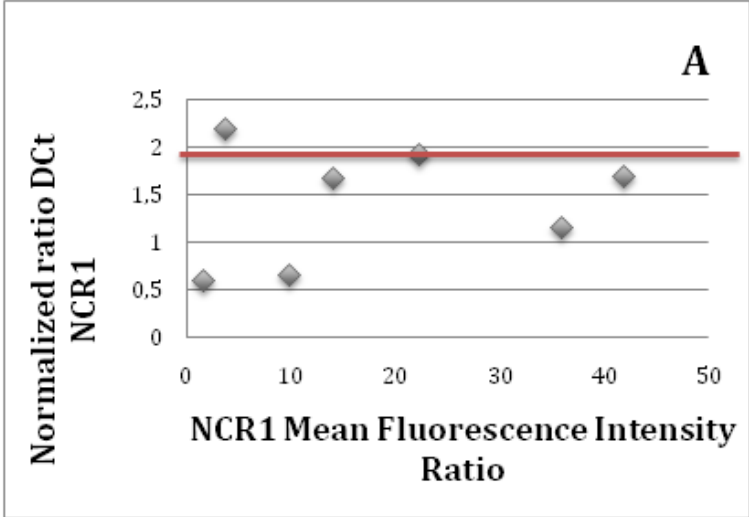
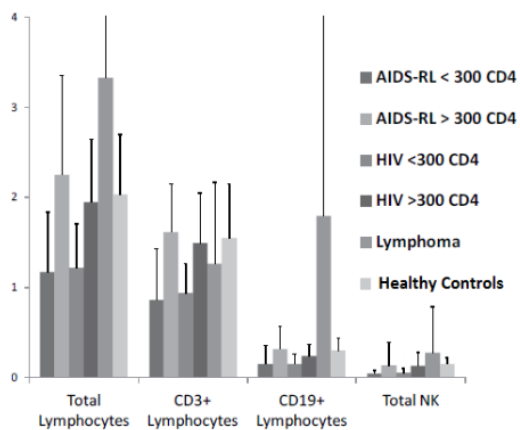
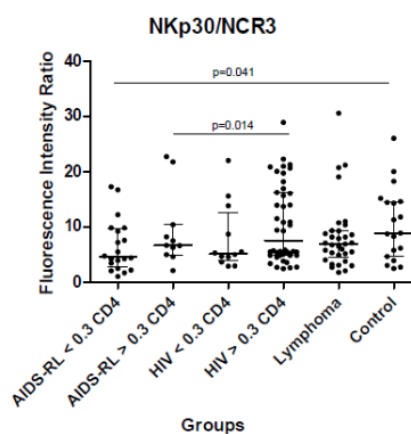

Figure 2.

A Lymphoid cells repartition



D



B

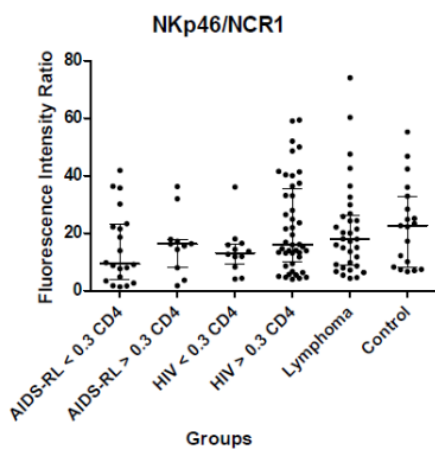

E

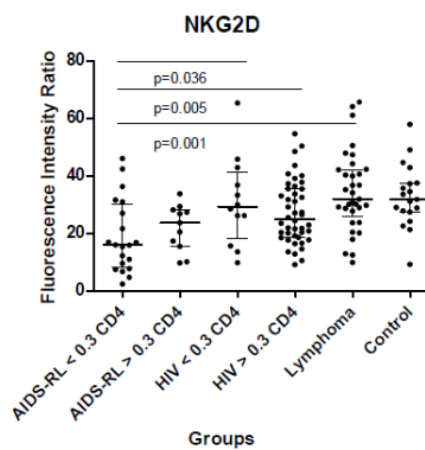

C

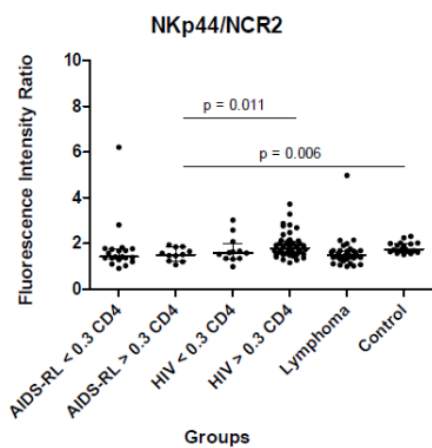

F

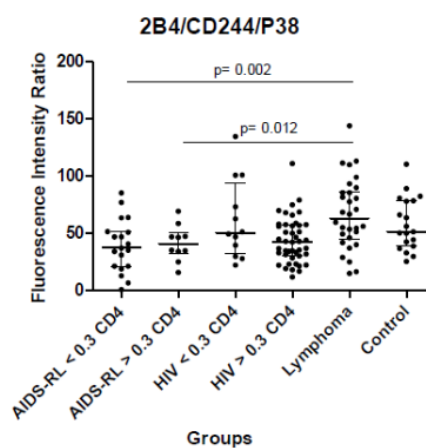

REFERENCES

VII. REFERENCES

- Alter G, Malenfant JM, Altfeld M (2004). **CD107a as a functional marker for the identification of natural killer cell activity.** *Journal of immunological methods* **294**(1-2): 15-22.
- Alvarez-Larran A, Martinez-Aviles L, Hernandez-Boluda JC, Ferrer-Marin F, Antelo ML, Burgaleta C, *et al.* (2014). **Busulfan in patients with polycythemia vera or essential thrombocythemia refractory or intolerant to hydroxyurea.** *Annals of hematology.*
- Aramburu J, Azzoni L, Rao A, Perussia B (1995). **Activation and expression of the nuclear factors of activated T cells, NFATp and NFATc, in human natural killer cells: regulation upon CD16 ligand binding.** *The Journal of experimental medicine* **182**(3): 801-810.
- Arnon TI, Achdout H, Levi O, Markel G, Saleh N, Katz G, *et al.* (2005). **Inhibition of the NKp30 activating receptor by pp65 of human cytomegalovirus.** *Nature immunology* **6**(5): 515-523.
- Baffert F, Regnier CH, De Pover A, Pissot-Soldermann C, Tavares GA, Blasco F, *et al.* (2010). **Potent and selective inhibition of polycythemia by the quinoxaline JAK2 inhibitor NVP-BSK805.** *Molecular cancer therapeutics* **9**(7): 1945-1955.
- Baldus CD, Mrozek K, Marcucci G, Bloomfield CD (2007). **Clinical outcome of de novo acute myeloid leukaemia patients with normal cytogenetics is affected by molecular genetic alterations: a concise review.** *British journal of haematology* **137**(5): 387-400.
- Balkwill F (2009). **Tumour necrosis factor and cancer.** *Nature reviews. Cancer* **9**(5): 361-371.
- Bauer S, Groh V, Wu J, Steinle A, Phillips JH, Lanier LL, *et al.* (1999). **Activation of NK cells and T cells by NKG2D, a receptor for stress-inducible MICA.** *Science* **285**(5428): 727-729.
- Baxter EJ, Scott LM, Campbell PJ, East C, Fourouclas N, Swanton S, *et al.* (2005). **Acquired mutation of the tyrosine kinase JAK2 in human myeloproliferative disorders.** *Lancet* **365**(9464): 1054-1061.
- Baychelier F, Sennepin A, Ermonval M, Dorgham K, Debre P, Vieillard V (2013). **Identification of a cellular ligand for the natural cytotoxicity receptor NKp44.** *Blood* **122**(17): 2935-2942.
- Bennett JM, Catovsky D, Daniel MT, Flandrin G, Galton DA, Gralnick HR, *et al.* (1976). **Proposals for the classification of the acute leukaemias. French-American-British (FAB) co-operative group.** *British journal of haematology* **33**(4): 451-458.
- Bennett JM, Catovsky D, Daniel MT, Flandrin G, Galton DA, Gralnick HR, *et al.* (1985). **Proposed revised criteria for the classification of acute myeloid leukemia. A report of the French-American-British Cooperative Group.** *Annals of internal medicine* **103**(4): 620-625.
- Benson DM, Jr., Caligiuri MA (2014). **Killer immunoglobulin-like receptors and tumor immunity.** *Cancer immunology research* **2**(2): 99-104.
- Biassoni R (2009). **Human natural killer receptors, co-receptors, and their ligands.** *Current protocols in immunology / edited by John E. Coligan ... [et al.] Chapter 14:* Unit 14 10.
- Biassoni R (2008). **Natural killer cell receptors.** *Advances in experimental medicine and biology* **640:** 35-52.

- Bisset LR, Lung TL, Kaelin M, Ludwig E, Dubs RW (2004). **Reference values for peripheral blood lymphocyte phenotypes applicable to the healthy adult population in Switzerland.** *European journal of haematology* **72**(3): 203-212.
- Blink EJ, Trapani JA, Jans DA (1999). **Perforin-dependent nuclear targeting of granzymes: A central role in the nuclear events of granule-exocytosis-mediated apoptosis?** *Immunology and cell biology* **77**(3): 206-215.
- Bluman EM, Bartynski KJ, Avalos BR, Caligiuri MA (1996). **Human natural killer cells produce abundant macrophage inflammatory protein-1 alpha in response to monocyte-derived cytokines.** *The Journal of clinical investigation* **97**(12): 2722-2727.
- Bottino C, Falco M, Parolini S, Marcenaro E, Augugliaro R, Sivori S, *et al.* (2001). **NTB-A [correction of GNTB-A], a novel SH2D1A-associated surface molecule contributing to the inability of natural killer cells to kill Epstein-Barr virus-infected B cells in X-linked lymphoproliferative disease.** *The Journal of experimental medicine* **194**(3): 235-246.
- Braud VM, Allan DS, O'Callaghan CA, Soderstrom K, D'Andrea A, Ogg GS, *et al.* (1998). **HLA-E binds to natural killer cell receptors CD94/NKG2A, B and C.** *Nature* **391**(6669): 795-799.
- Brooks AG, Borrego F, Posch PE, Patamawenu A, Scorzelli CJ, Ulbrecht M, *et al.* (1999). **Specific recognition of HLA-E, but not classical, HLA class I molecules by soluble CD94/NKG2A and NK cells.** *J Immunol* **162**(1): 305-313.
- Brostjan C, Bellon T, Sobanov Y, Lopez-Botet M, Hofer E (2002). **Differential expression of inhibitory and activating CD94/NKG2 receptors on NK cell clones.** *Journal of immunological methods* **264**(1-2): 109-119.
- Brunet S, Labopin M, Esteve J, Cornelissen J, Socie G, Iori AP, *et al.* (2012). **Impact of FLT3 internal tandem duplication on the outcome of related and unrelated hematopoietic transplantation for adult acute myeloid leukemia in first remission: a retrospective analysis.** *Journal of clinical oncology : official journal of the American Society of Clinical Oncology* **30**(7): 735-741.
- Brunstein CG, Gutman JA, Weisdorf DJ, Woolfrey AE, Defor TE, Gooley TA, *et al.* (2010). **Allogeneic hematopoietic cell transplantation for hematologic malignancy: relative risks and benefits of double umbilical cord blood.** *Blood* **116**(22): 4693-4699.
- Campbell JJ, Qin S, Unutmaz D, Soler D, Murphy KE, Hodge MR, *et al.* (2001). **Unique subpopulations of CD56+ NK and NK-T peripheral blood lymphocytes identified by chemokine receptor expression repertoire.** *J Immunol* **166**(11): 6477-6482.
- Campbell KS, Purdy AK (2011). **Structure/function of human killer cell immunoglobulin-like receptors: lessons from polymorphisms, evolution, crystal structures and mutations.** *Immunology* **132**(3): 315-325.
- Cantoni C, Bottino C, Vitale M, Pessino A, Augugliaro R, Malaspina A, *et al.* (1999). **NKp44, a triggering receptor involved in tumor cell lysis by activated human natural killer cells, is a novel member of the immunoglobulin superfamily.** *The Journal of experimental medicine* **189**(5): 787-796.
- Cantoni C, Ponassi M, Biassoni R, Conte R, Spallarossa A, Moretta A, *et al.* (2003). **The three-dimensional structure of the human NK cell receptor NKp44, a triggering partner in natural cytotoxicity.** *Structure* **11**(6): 725-734.
- Carretero M, Cantoni C, Bellon T, Bottino C, Biassoni R, Rodriguez A, *et al.* (1997). **The CD94 and NKG2-A C-type lectins covalently assemble to form a natural killer cell inhibitory receptor for HLA class I molecules.** *European journal of immunology* **27**(2): 563-567.

- Cassidy SA, Cheent KS, Khakoo SI (2014). **Effects of Peptide on NK cell-mediated MHC I recognition.** *Frontiers in immunology* **5**: 133.
- Cerwenka A, Lanier LL (2001). **Natural killer cells, viruses and cancer.** *Nature reviews. Immunology* **1**(1): 41-49.
- Chang C, Rodriguez A, Carretero M, Lopez-Botet M, Phillips JH, Lanier LL (1995). **Molecular characterization of human CD94: a type II membrane glycoprotein related to the C-type lectin superfamily.** *European journal of immunology* **25**(9): 2433-2437.
- Chen J, Odenike O, Rowley JD (2010). **Leukaemogenesis: more than mutant genes.** *Nature reviews. Cancer* **10**(1): 23-36.
- Cooley S, Trachtenberg E, Bergemann TL, Saeteurn K, Klein J, Le CT, *et al.* (2009). **Donors with group B KIR haplotypes improve relapse-free survival after unrelated hematopoietic cell transplantation for acute myelogenous leukemia.** *Blood* **113**(3): 726-732.
- Cooper MA, Fehniger TA, Caligiuri MA (2001). **The biology of human natural killer-cell subsets.** *Trends in immunology* **22**(11): 633-640.
- Cortot A, Armand JP, Soria JC (2006). **[PI3K-AKT-mTOR pathway inhibitors].** *Bulletin du cancer* **93**(1): 19-26.
- Cosman D, Fanger N, Borges L, Kubin M, Chin W, Peterson L, *et al.* (1997). **A novel immunoglobulin superfamily receptor for cellular and viral MHC class I molecules.** *Immunity* **7**(2): 273-282.
- Cosman D, Mullberg J, Sutherland CL, Chin W, Armitage R, Fanslow W, *et al.* (2001). **ULBPs, novel MHC class I-related molecules, bind to CMV glycoprotein UL16 and stimulate NK cytotoxicity through the NKG2D receptor.** *Immunity* **14**(2): 123-133.
- Costello RT, Sivori S, Marcenaro E, Lafage-Pochitaloff M, Mozziconacci MJ, Reviron D, *et al.* (2002). **Defective expression and function of natural killer cell-triggering receptors in patients with acute myeloid leukemia.** *Blood* **99**(10): 3661-3667.
- David M, Petricoin E, 3rd, Benjamin C, Pine R, Weber MJ, Lerner AC (1995). **Requirement for MAP kinase (ERK2) activity in interferon alpha- and interferon beta-stimulated gene expression through STAT proteins.** *Science* **269**(5231): 1721-1723.
- Delhommeau F, Dupont S, Tonetti C, Masse A, Godin I, Le Couedic JP, *et al.* (2007). **Evidence that the JAK2 G1849T (V617F) mutation occurs in a lymphomyeloid progenitor in polycythemia vera and idiopathic myelofibrosis.** *Blood* **109**(1): 71-77.
- Denman CJ, Senyukov VV, Somanchi SS, Phatarpekar PV, Kopp LM, Johnson JL, *et al.* (2012). **Membrane-bound IL-21 promotes sustained ex vivo proliferation of human natural killer cells.** *PloS one* **7**(1): e30264.
- Deschler B, Lubbert M (2006). **Acute myeloid leukemia: epidemiology and etiology.** *Cancer* **107**(9): 2099-2107.
- Dohner H, Estey EH, Amadori S, Appelbaum FR, Buchner T, Burnett AK, *et al.* (2010). **Diagnosis and management of acute myeloid leukemia in adults: recommendations from an international expert panel, on behalf of the European LeukemiaNet.** *Blood* **115**(3): 453-474.
- Dustin ML, Long EO (2010). **Cytotoxic immunological synapses.** *Immunological reviews* **235**(1): 24-34.

Elkins WL, Pickard A, Pierson GR (1984). **Deficient expression of class-I HLA in some cases of acute leukemia.** *Cancer immunology, immunotherapy : CII* **18**(2): 91-100.

Fauriat C, Just-Landi S, Mallet F, Arnoulet C, Sainty D, Olive D, *et al.* (2007). **Deficient expression of NCR in NK cells from acute myeloid leukemia: Evolution during leukemia treatment and impact of leukemia cells in NCRdull phenotype induction.** *Blood* **109**(1): 323-330.

Fauriat C, Long EO, Ljunggren HG, Bryceson YT (2010). **Regulation of human NK-cell cytokine and chemokine production by target cell recognition.** *Blood* **115**(11): 2167-2176.

Favier B, Lemaoult J, Lesport E, Carosella ED (2010). **ILT2/HLA-G interaction impairs NK-cell functions through the inhibition of the late but not the early events of the NK-cell activating synapse.** *FASEB journal : official publication of the Federation of American Societies for Experimental Biology* **24**(3): 689-699.

Fehniger TA, Shah MH, Turner MJ, VanDeusen JB, Whitman SP, Cooper MA, *et al.* (1999). **Differential cytokine and chemokine gene expression by human NK cells following activation with IL-18 or IL-15 in combination with IL-12: implications for the innate immune response.** *J Immunol* **162**(8): 4511-4520.

Fenaux P, Chastang C, Chevret S, Sanz M, Dombret H, Archimbaud E, *et al.* (1999). **A randomized comparison of all transretinoic acid (ATRA) followed by chemotherapy and ATRA plus chemotherapy and the role of maintenance therapy in newly diagnosed acute promyelocytic leukemia. The European APL Group.** *Blood* **94**(4): 1192-1200.

Finazzi G, Caruso V, Marchioli R, Capnist G, Chisesi T, Finelli C, *et al.* (2005). **Acute leukemia in polycythemia vera: an analysis of 1638 patients enrolled in a prospective observational study.** *Blood* **105**(7): 2664-2670.

Foley B, Cooley S, Verneris MR, Curtsinger J, Luo X, Waller EK, *et al.* (2011). **NK cell education after allogeneic transplantation: dissociation between recovery of cytokine-producing and cytotoxic functions.** *Blood* **118**(10): 2784-2792.

Foley B, Cooley S, Verneris MR, Pitt M, Curtsinger J, Luo X, *et al.* (2012). **Cytomegalovirus reactivation after allogeneic transplantation promotes a lasting increase in educated NKG2C+ natural killer cells with potent function.** *Blood* **119**(11): 2665-2674.

Foley B, De Santis D, Lathbury L, Christiansen F, Witt C (2008). **KIR2DS1-mediated activation overrides NKG2A-mediated inhibition in HLA-C C2-negative individuals.** *International immunology* **20**(4): 555-563.

Frohling S, Schlenk RF, Stolze I, Bihlmayr J, Benner A, Kreitmeier S, *et al.* (2004). **CEBPA mutations in younger adults with acute myeloid leukemia and normal cytogenetics: prognostic relevance and analysis of cooperating mutations.** *Journal of clinical oncology : official journal of the American Society of Clinical Oncology* **22**(4): 624-633.

Fujisaki H, Kakuda H, Shimasaki N, Imai C, Ma J, Lockey T, *et al.* (2009). **Expansion of highly cytotoxic human natural killer cells for cancer cell therapy.** *Cancer research* **69**(9): 4010-4017.

Gale RE, Green C, Allen C, Mead AJ, Burnett AK, Hills RK, *et al.* (2008). **The impact of FLT3 internal tandem duplication mutant level, number, size, and interaction with NPM1 mutations in a large cohort of young adult patients with acute myeloid leukemia.** *Blood* **111**(5): 2776-2784.

Galy A, Travis M, Cen D, Chen B (1995). **Human T, B, natural killer, and dendritic cells arise from a common bone marrow progenitor cell subset.** *Immunity* **3**(4): 459-473.

- Ganal SC, Sanos SL, Kalfass C, Oberle K, Johner C, Kirschning C, *et al.* (2012). **Priming of natural killer cells by nonmucosal mononuclear phagocytes requires instructive signals from commensal microbiota.** *Immunity* **37**(1): 171-186.
- Gilfillan S, Ho EL, Cella M, Yokoyama WM, Colonna M (2002). **NKG2D recruits two distinct adapters to trigger NK cell activation and costimulation.** *Nature immunology* **3**(12): 1150-1155.
- Glienke J, Sobanov Y, Brostjan C, Steffens C, Nguyen C, Lehrach H, *et al.* (1998). **The genomic organization of NKG2C, E, F, and D receptor genes in the human natural killer gene complex.** *Immunogenetics* **48**(3): 163-173.
- Godal R, Bachanova V, Gleason M, McCullar V, Yun GH, Cooley S, *et al.* (2010). **Natural killer cell killing of acute myelogenous leukemia and acute lymphoblastic leukemia blasts by killer cell immunoglobulin-like receptor-negative natural killer cells after NKG2A and LIR-1 blockade.** *Biology of blood and marrow transplantation : journal of the American Society for Blood and Marrow Transplantation* **16**(5): 612-621.
- Goh KC, Haque SJ, Williams BR (1999). **p38 MAP kinase is required for STAT1 serine phosphorylation and transcriptional activation induced by interferons.** *The EMBO journal* **18**(20): 5601-5608.
- Goodridge JP, Witt CS, Christiansen FT, Warren HS (2003). **KIR2DL4 (CD158d) genotype influences expression and function in NK cells.** *J Immunol* **171**(4): 1768-1774.
- Gowin K, Thapaliya P, Samuelson J, Harrison C, Radia D, Andreasson B, *et al.* (2012). **Experience with pegylated interferon alpha-2a in advanced myeloproliferative neoplasms in an international cohort of 118 patients.** *Haematologica* **97**(10): 1570-1573.
- Grimwade D, Hills RK, Moorman AV, Walker H, Chatters S, Goldstone AH, *et al.* (2010). **Refinement of cytogenetic classification in acute myeloid leukemia: determination of prognostic significance of rare recurring chromosomal abnormalities among 5876 younger adult patients treated in the United Kingdom Medical Research Council trials.** *Blood* **116**(3): 354-365.
- Gur C, Doron S, Kfir-Erenfeld S, Horwitz E, Abu-Tair L, Safadi R, *et al.* (2012). **NKp46-mediated killing of human and mouse hepatic stellate cells attenuates liver fibrosis.** *Gut* **61**(6): 885-893.
- Gur C, Porgador A, Elboim M, Gazit R, Mizrahi S, Stern-Ginossar N, *et al.* (2010). **The activating receptor NKp46 is essential for the development of type 1 diabetes.** *Nature immunology* **11**(2): 121-128.
- Hartmann J, Tran TV, Kaudeer J, Oberle K, Herrmann J, Quagliano I, *et al.* (2012). **The stalk domain and the glycosylation status of the activating natural killer cell receptor NKp30 are important for ligand binding.** *The Journal of biological chemistry* **287**(37): 31527-31539.
- Hayakawa Y (2012). **Targeting NKG2D in tumor surveillance.** *Expert opinion on therapeutic targets* **16**(6): 587-599.
- Herberman RB, Nunn ME, Holden HT, Lavrin DH (1975). **Natural cytotoxic reactivity of mouse lymphoid cells against syngeneic and allogeneic tumors. II. Characterization of effector cells.** *International journal of cancer. Journal international du cancer* **16**(2): 230-239.
- Hiebert PR, Granville DJ (2012). **Granzyme B in injury, inflammation, and repair.** *Trends in molecular medicine* **18**(12): 732-741.
- Houchins JP, Yabe T, McSherry C, Bach FH (1991). **DNA sequence analysis of NKG2, a family of related cDNA clones encoding type II integral membrane proteins on human natural killer cells.** *The Journal of experimental medicine* **173**(4): 1017-1020.

Hussein K, Abdel-Wahab O, Lasho TL, Van Dyke DL, Levine RL, Hanson CA, *et al.* (2010). **Cytogenetic correlates of TET2 mutations in 199 patients with myeloproliferative neoplasms.** *American journal of hematology* **85**(1): 81-83.

Ikeda H, Old LJ, Schreiber RD (2002). **The roles of IFN gamma in protection against tumor development and cancer immunoediting.** *Cytokine & growth factor reviews* **13**(2): 95-109.

Imada K, Leonard WJ (2000). **The Jak-STAT pathway.** *Molecular immunology* **37**(1-2): 1-11.

Jacobs R, Hintzen G, Kemper A, Beul K, Kempf S, Behrens G, *et al.* (2001). **CD56bright cells differ in their KIR repertoire and cytotoxic features from CD56dim NK cells.** *European journal of immunology* **31**(10): 3121-3127.

James C, Ugo V, Le Couedic JP, Staerk J, Delhommeau F, Lacout C, *et al.* (2005). **A unique clonal JAK2 mutation leading to constitutive signalling causes polycythaemia vera.** *Nature* **434**(7037): 1144-1148.

Jarahian M, Fiedler M, Cohnen A, Djandji D, Hammerling GJ, Gati C, *et al.* (2011). **Modulation of NKp30- and NKp46-mediated natural killer cell responses by poxviral hemagglutinin.** *PLoS pathogens* **7**(8): e1002195.

Jonges LE, Albertsson P, van Vlierberghe RL, Ensink NG, Johansson BR, van de Velde CJ, *et al.* (2001). **The phenotypic heterogeneity of human natural killer cells: presence of at least 48 different subsets in the peripheral blood.** *Scandinavian journal of immunology* **53**(2): 103-110.

Kaifu T, Escaliere B, Gastinel LN, Vivier E, Baratin M (2011). **B7-H6/NKp30 interaction: a mechanism of alerting NK cells against tumors.** *Cellular and molecular life sciences : CMLS* **68**(21): 3531-3539.

Kiessling R, Klein E, Wigzell H (1975). **"Natural" killer cells in the mouse. I. Cytotoxic cells with specificity for mouse Moloney leukemia cells. Specificity and distribution according to genotype.** *European journal of immunology* **5**(2): 112-117.

Kikuchi-Maki A, Catina TL, Campbell KS (2005). **Cutting edge: KIR2DL4 transduces signals into human NK cells through association with the Fc receptor gamma protein.** *J Immunol* **174**(7): 3859-3863.

Kiladjian JJ, Gardin C, Renoux M, Bruno F, Bernard JF (2003). **Long-term outcomes of polycythemia vera patients treated with pipobroman as initial therapy.** *The hematology journal : the official journal of the European Haematology Association / EHA* **4**(3): 198-207.

Kralovics R, Passamonti F, Buser AS, Teo SS, Tiedt R, Passweg JR, *et al.* (2005). **A gain-of-function mutation of JAK2 in myeloproliferative disorders.** *The New England journal of medicine* **352**(17): 1779-1790.

Lanier LL (2003). **Natural killer cell receptor signaling.** *Current opinion in immunology* **15**(3): 308-314.

Lanier LL, Corliss B, Wu J, Phillips JH (1998). **Association of DAP12 with activating CD94/NKG2C NK cell receptors.** *Immunity* **8**(6): 693-701.

Lanier LL, Le AM, Civin CI, Loken MR, Phillips JH (1986). **The relationship of CD16 (Leu-11) and Leu-19 (NKH-1) antigen expression on human peripheral blood NK cells and cytotoxic T lymphocytes.** *J Immunol* **136**(12): 4480-4486.

Lanier LL, Yu G, Phillips JH (1991). **Analysis of Fc gamma RIII (CD16) membrane expression and association with CD3 zeta and Fc epsilon RI-gamma by site-directed mutation.** *J Immunol* **146**(5): 1571-1576.

Larsen TS, Christensen JH, Hasselbalch HC, Pallisgaard N (2007). **The JAK2 V617F mutation involves B- and T-lymphocyte lineages in a subgroup of patients with Philadelphia-chromosome negative chronic myeloproliferative disorders.** *British journal of haematology* **136**(5): 745-751.

Lasho T, Tefferi A, Pardanani A (2010). **Inhibition of JAK-STAT signaling by TG101348: a novel mechanism for inhibition of KITD816V-dependent growth in mast cell leukemia cells.** *Leukemia* **24**(7): 1378-1380.

Lazetic S, Chang C, Houchins JP, Lanier LL, Phillips JH (1996). **Human natural killer cell receptors involved in MHC class I recognition are disulfide-linked heterodimers of CD94 and NKG2 subunits.** *J Immunol* **157**(11): 4741-4745.

LeMaout J, Zafaranloo K, Le Danff C, Carosella ED (2005). **HLA-G up-regulates ILT2, ILT3, ILT4, and KIR2DL4 in antigen presenting cells, NK cells, and T cells.** *FASEB journal : official publication of the Federation of American Societies for Experimental Biology* **19**(6): 662-664.

Levine RL, Pardanani A, Tefferi A, Gilliland DG (2007). **Role of JAK2 in the pathogenesis and therapy of myeloproliferative disorders.** *Nature reviews. Cancer* **7**(9): 673-683.

Levine RL, Wadleigh M, Cools J, Ebert BL, Wernig G, Huntly BJ, *et al.* (2005). **Activating mutation in the tyrosine kinase JAK2 in polycythemia vera, essential thrombocythemia, and myeloid metaplasia with myelofibrosis.** *Cancer cell* **7**(4): 387-397.

Levitt LJ, Nagler A, Lee F, Abrams J, Shatsky M, Thompson D (1991). **Production of granulocyte/macrophage-colony-stimulating factor by human natural killer cells. Modulation by the p75 subunit of the interleukin 2 receptor and by the CD2 receptor.** *The Journal of clinical investigation* **88**(1): 67-75.

Li C, Houser BL, Nicotra ML, Strominger JL (2009). **HLA-G homodimer-induced cytokine secretion through HLA-G receptors on human decidual macrophages and natural killer cells.** *Proceedings of the National Academy of Sciences of the United States of America* **106**(14): 5767-5772.

Ljunggren HG, Karre K (1990). **In search of the 'missing self': MHC molecules and NK cell recognition.** *Immunology today* **11**(7): 237-244.

Long EO (2007). **Ready for prime time: NK cell priming by dendritic cells.** *Immunity* **26**(4): 385-387.

Lowenberg B, Griffin JD, Tallman MS (2003). **Acute myeloid leukemia and acute promyelocytic leukemia.** *Hematology / the Education Program of the American Society of Hematology. American Society of Hematology. Education Program:* 82-101.

MacFarlane AWt, Campbell KS (2006). **Signal transduction in natural killer cells.** *Current topics in microbiology and immunology* **298**: 23-57.

Maghazachi AA (2010). **Role of chemokines in the biology of natural killer cells.** *Current topics in microbiology and immunology* **341**: 37-58.

Mandelboim O, Lieberman N, Lev M, Paul L, Arnon TI, Bushkin Y, *et al.* (2001). **Recognition of haemagglutinins on virus-infected cells by NKp46 activates lysis by human NK cells.** *Nature* **409**(6823): 1055-1060.

Mandelboim O, Malik P, Davis DM, Jo CH, Boyson JE, Strominger JL (1999). **Human CD16 as a lysis receptor mediating direct natural killer cell cytotoxicity.** *Proceedings of the National Academy of Sciences of the United States of America* **96**(10): 5640-5644.

- Marsh SG, Parham P, Dupont B, Geraghty DE, Trowsdale J, Middleton D, *et al.* (2003). **Killer-cell immunoglobulin-like receptor (KIR) nomenclature report, 2002.** *Tissue antigens* **62**(1): 79-86.
- Martin-Fontecha A, Thomsen LL, Brett S, Gerard C, Lipp M, Lanzavecchia A, *et al.* (2004). **Induced recruitment of NK cells to lymph nodes provides IFN-gamma for T(H)1 priming.** *Nature immunology* **5**(12): 1260-1265.
- Middleton D, Curran M, Maxwell L (2002). **Natural killer cells and their receptors.** *Transplant immunology* **10**(2-3): 147-164.
- Mocikat R, Braumuller H, Gumy A, Egeter O, Ziegler H, Reusch U, *et al.* (2003). **Natural killer cells activated by MHC class I(low) targets prime dendritic cells to induce protective CD8 T cell responses.** *Immunity* **19**(4): 561-569.
- Moretta A, Biassoni R, Bottino C, Mingari MC, Moretta L (2000). **Natural cytotoxicity receptors that trigger human NK-cell-mediated cytotoxicity.** *Immunology today* **21**(5): 228-234.
- Moretta A, Bottino C, Vitale M, Pende D, Cantoni C, Mingari MC, *et al.* (2001). **Activating receptors and coreceptors involved in human natural killer cell-mediated cytotoxicity.** *Annual review of immunology* **19**: 197-223.
- Moretta L (2010). **Dissecting CD56dim human NK cells.** *Blood* **116**(19): 3689-3691.
- Morra M, Howie D, Grande MS, Sayos J, Wang N, Wu C, *et al.* (2001). **X-linked lymphoproliferative disease: a progressive immunodeficiency.** *Annual review of immunology* **19**: 657-682.
- Muller M, Briscoe J, Laxton C, Guschin D, Ziemiecki A, Silvennoinen O, *et al.* (1993). **The protein tyrosine kinase JAK1 complements defects in interferon-alpha/beta and -gamma signal transduction.** *Nature* **366**(6451): 129-135.
- Nagata S, Golstein P (1995). **The Fas death factor.** *Science* **267**(5203): 1449-1456.
- Najean Y, Rain JD (1997). **Treatment of polycythemia vera: the use of hydroxyurea and pipobroman in 292 patients under the age of 65 years.** *Blood* **90**(9): 3370-3377.
- Nakamura K, Nakayama M, Kawano M, Amagai R, Ishii T, Harigae H, *et al.* (2013). **Fratricide of natural killer cells dressed with tumor-derived NKG2D ligand.** *Proceedings of the National Academy of Sciences of the United States of America* **110**(23): 9421-9426.
- Nausch N, Cerwenka A (2008). **NKG2D ligands in tumor immunity.** *Oncogene* **27**(45): 5944-5958.
- Nitta T, Yagita H, Sato K, Okumura K (1989). **Involvement of CD56 (NKH-1/Leu-19 antigen) as an adhesion molecule in natural killer-target cell interaction.** *The Journal of experimental medicine* **170**(5): 1757-1761.
- Nussenzweig RH, Cortes J, Sever M, Quintas-Cardama A, Ault P, Manshoury T, *et al.* (2009). **Imatinib mesylate therapy for polycythemia vera: final result of a phase II study initiated in 2001.** *International journal of hematology* **90**(1): 58-63.
- Orozco JJ, Appelbaum FR (2012). **Unfavorable, complex, and monosomal karyotypes: the most challenging forms of acute myeloid leukemia.** *Oncology (Williston Park)* **26**(8): 706-712.
- Parolini S, Bottino C, Falco M, Augugliaro R, Giliani S, Franceschini R, *et al.* (2000). **X-linked lymphoproliferative disease. 2B4 molecules displaying inhibitory rather than activating function are responsible for the inability of natural killer cells to kill Epstein-Barr virus-infected cells.** *The Journal of experimental medicine* **192**(3): 337-346.

Paschka P, Marcucci G, Ruppert AS, Mrozek K, Chen H, Kittles RA, *et al.* (2006). **Adverse prognostic significance of KIT mutations in adult acute myeloid leukemia with inv(16) and t(8;21): a Cancer and Leukemia Group B Study.** *Journal of clinical oncology : official journal of the American Society of Clinical Oncology* **24**(24): 3904-3911.

Patil S, Schwarzer T (2009). **Natural killer cells--new understanding of basic biology may lead to more effective allogeneic haematopoietic stem cell transplantation.** *Internal medicine journal* **39**(10): 639-647.

Pedersen-Bjergaard J, Andersen MK, Andersen MT, Christiansen DH (2008). **Genetics of therapy-related myelodysplasia and acute myeloid leukemia.** *Leukemia* **22**(2): 240-248.

Pende D, Parolini S, Pessino A, Sivori S, Augugliaro R, Morelli L, *et al.* (1999). **Identification and molecular characterization of NKp30, a novel triggering receptor involved in natural cytotoxicity mediated by human natural killer cells.** *The Journal of experimental medicine* **190**(10): 1505-1516.

Pessino A, Sivori S, Bottino C, Malaspina A, Morelli L, Moretta L, *et al.* (1998). **Molecular cloning of NKp46: a novel member of the immunoglobulin superfamily involved in triggering of natural cytotoxicity.** *The Journal of experimental medicine* **188**(5): 953-960.

Pogge von Strandmann E, Simhadri VR, von Tresckow B, Sasse S, Reiners KS, Hansen HP, *et al.* (2007). **Human leukocyte antigen-B-associated transcript 3 is released from tumor cells and engages the NKp30 receptor on natural killer cells.** *Immunity* **27**(6): 965-974.

Puigdecenet E, Espinet B, Lozano JJ, Sumoy L, Bellosillo B, Arenillas L, *et al.* (2008). **Gene expression profiling distinguishes JAK2V617F-negative from JAK2V617F-positive patients in essential thrombocythemia.** *Leukemia* **22**(7): 1368-1376.

Quintas-Cardama A, Kantarjian H, Cortes J, Verstovsek S (2011). **Janus kinase inhibitors for the treatment of myeloproliferative neoplasias and beyond.** *Nature reviews. Drug discovery* **10**(2): 127-140.

Rajagopalan S, Fu J, Long EO (2001). **Cutting edge: induction of IFN-gamma production but not cytotoxicity by the killer cell Ig-like receptor KIR2DL4 (CD158d) in resting NK cells.** *J Immunol* **167**(4): 1877-1881.

Rajagopalan S, Long EO (1999). **A human histocompatibility leukocyte antigen (HLA)-G-specific receptor expressed on all natural killer cells.** *The Journal of experimental medicine* **189**(7): 1093-1100.

Rajagopalan S, Moyle MW, Joosten I, Long EO (2010). **DNA-PKcs controls an endosomal signaling pathway for a proinflammatory response by natural killer cells.** *Science signaling* **3**(110): ra14.

Rizzo R, Vercammen M, van de Velde H, Horn PA, Rebmann V (2011). **The importance of HLA-G expression in embryos, trophoblast cells, and embryonic stem cells.** *Cellular and molecular life sciences : CMLS* **68**(3): 341-352.

Robertson MJ, Ritz J (1990). **Biology and clinical relevance of human natural killer cells.** *Blood* **76**(12): 2421-2438.

Rubnitz JE, Inaba H, Ribeiro RC, Pounds S, Rooney B, Bell T, *et al.* (2010). **NKAML: a pilot study to determine the safety and feasibility of haploidentical natural killer cell transplantation in childhood acute myeloid leukemia.** *Journal of clinical oncology : official journal of the American Society of Clinical Oncology* **28**(6): 955-959.

- Ruggeri L, Capanni M, Casucci M, Volpi I, Tosti A, Perruccio K, *et al.* (1999). **Role of natural killer cell alloreactivity in HLA-mismatched hematopoietic stem cell transplantation.** *Blood* **94**(1): 333-339.
- Ruggeri L, Capanni M, Urbani E, Perruccio K, Shlomchik WD, Tosti A, *et al.* (2002). **Effectiveness of donor natural killer cell alloreactivity in mismatched hematopoietic transplants.** *Science* **295**(5562): 2097-2100.
- Ruggeri L, Mancusi A, Capanni M, Urbani E, Carotti A, Aloisi T, *et al.* (2007). **Donor natural killer cell allorecognition of missing self in haploidentical hematopoietic transplantation for acute myeloid leukemia: challenging its predictive value.** *Blood* **110**(1): 433-440.
- Sabattini E, Bacci F, Sagrmoso C, Pileri SA (2010). **WHO classification of tumours of haematopoietic and lymphoid tissues in 2008: an overview.** *Pathologica* **102**(3): 83-87.
- Samaridis J, Colonna M (1997). **Cloning of novel immunoglobulin superfamily receptors expressed on human myeloid and lymphoid cells: structural evidence for new stimulatory and inhibitory pathways.** *European journal of immunology* **27**(3): 660-665.
- Sanchez CJ, Le Treut T, Boehrer A, Knoblauch B, Imbert J, Olive D, *et al.* (2011). **Natural killer cells and malignant haemopathies: a model for the interaction of cancer with innate immunity.** *Cancer immunology, immunotherapy : CII* **60**(1): 1-13.
- Sanz GF, Sanz MA, Vallespi T, Canizo MC, Torrabadella M, Garcia S, *et al.* (1989). **Two regression models and a scoring system for predicting survival and planning treatment in myelodysplastic syndromes: a multivariate analysis of prognostic factors in 370 patients.** *Blood* **74**(1): 395-408.
- Shibuya A, Campbell D, Hannum C, Yssel H, Franz-Bacon K, McClanahan T, *et al.* (1996). **DNAM-1, a novel adhesion molecule involved in the cytolytic function of T lymphocytes.** *Immunity* **4**(6): 573-581.
- Shibuya A, Lanier LL, Phillips JH (1998). **Protein kinase C is involved in the regulation of both signaling and adhesion mediated by DNAX accessory molecule-1 receptor.** *J Immunol* **161**(4): 1671-1676.
- Sivori S, Pende D, Bottino C, Marcenaro E, Pessino A, Biassoni R, *et al.* (1999). **NKp46 is the major triggering receptor involved in the natural cytotoxicity of fresh or cultured human NK cells. Correlation between surface target density of NKp46 and natural cytotoxicity against autologous, allogeneic or xenogeneic target cells.** *European journal of immunology* **29**(5): 1656-1666.
- Sivori S, Vitale M, Morelli L, Sanseverino L, Augugliaro R, Bottino C, *et al.* (1997). **p46, a novel natural killer cell-specific surface molecule that mediates cell activation.** *The Journal of experimental medicine* **186**(7): 1129-1136.
- Smith CA, Fan G (2008). **The saga of JAK2 mutations and translocations in hematologic disorders: pathogenesis, diagnostic and therapeutic prospects, and revised World Health Organization diagnostic criteria for myeloproliferative neoplasms.** *Human pathology* **39**(6): 795-810.
- Smyth MJ, Cretney E, Kelly JM, Westwood JA, Street SE, Yagita H, *et al.* (2005). **Activation of NK cell cytotoxicity.** *Molecular immunology* **42**(4): 501-510.
- Smyth MJ, Trapani JA (1995). **Granzymes: exogenous proteinases that induce target cell apoptosis.** *Immunology today* **16**(4): 202-206.
- Spivak JL (2002). **Polycythemia vera: myths, mechanisms, and management.** *Blood* **100**(13): 4272-4290.

- Strowig T, Brilot F, Munz C (2008). **Noncytotoxic functions of NK cells: direct pathogen restriction and assistance to adaptive immunity.** *J Immunol* **180**(12): 7785-7791.
- Sullivan LC, Clements CS, Beddoe T, Johnson D, Hoare HL, Lin J, *et al.* (2007). **The heterodimeric assembly of the CD94-NKG2 receptor family and implications for human leukocyte antigen-E recognition.** *Immunity* **27**(6): 900-911.
- Suzuki N, Suzuki T, Engleman EG (1991). **Evidence for the involvement of CD56 molecules in alloantigen-specific recognition by human natural killer cells.** *The Journal of experimental medicine* **173**(6): 1451-1461.
- Tallman MS, Gilliland DG, Rowe JM (2005). **Drug therapy for acute myeloid leukemia.** *Blood* **106**(4): 1154-1163.
- Tangye SG, Phillips JH, Lanier LL (2000). **The CD2-subset of the Ig superfamily of cell surface molecules: receptor-ligand pairs expressed by NK cells and other immune cells.** *Seminars in immunology* **12**(2): 149-157.
- Tefferi A (2010). **Novel mutations and their functional and clinical relevance in myeloproliferative neoplasms: JAK2, MPL, TET2, ASXL1, CBL, IDH and IKZF1.** *Leukemia* **24**(6): 1128-1138.
- Tefferi A, Lim KH, Levine R (2009a). **Mutation in TET2 in myeloid cancers.** *The New England journal of medicine* **361**(11): 1117; author reply 1117-1118.
- Tefferi A, Pardanani A, Lim KH, Abdel-Wahab O, Lasho TL, Patel J, *et al.* (2009b). **TET2 mutations and their clinical correlates in polycythemia vera, essential thrombocythemia and myelofibrosis.** *Leukemia* **23**(5): 905-911.
- Tefferi A, Vardiman JW (2008). **Classification and diagnosis of myeloproliferative neoplasms: the 2008 World Health Organization criteria and point-of-care diagnostic algorithms.** *Leukemia* **22**(1): 14-22.
- Thiede C, Steudel C, Mohr B, Schaich M, Schakel U, Platzbecker U, *et al.* (2002). **Analysis of FLT3-activating mutations in 979 patients with acute myelogenous leukemia: association with FAB subtypes and identification of subgroups with poor prognosis.** *Blood* **99**(12): 4326-4335.
- Trapani JA, Jans DA, Jans PJ, Smyth MJ, Browne KA, Sutton VR (1998). **Efficient nuclear targeting of granzyme B and the nuclear consequences of apoptosis induced by granzyme B and perforin are caspase-dependent, but cell death is caspase-independent.** *The Journal of biological chemistry* **273**(43): 27934-27938.
- Trapani JA, Smyth MJ (2002). **Functional significance of the perforin/granzyme cell death pathway.** *Nature reviews. Immunology* **2**(10): 735-747.
- Trinchieri G (1989). **Biology of natural killer cells.** *Advances in immunology* **47**: 187-376.
- Trowsdale J (2001). **Genetic and functional relationships between MHC and NK receptor genes.** *Immunity* **15**(3): 363-374.
- Trowsdale J, Barten R, Haude A, Stewart CA, Beck S, Wilson MJ (2001). **The genomic context of natural killer receptor extended gene families.** *Immunological reviews* **181**: 20-38.
- Tyner JW, Bumm TG, Deininger J, Wood L, Aichberger KJ, Loriaux MM, *et al.* (2010). **CYT387, a novel JAK2 inhibitor, induces hematologic responses and normalizes inflammatory cytokines in murine myeloproliferative neoplasms.** *Blood* **115**(25): 5232-5240.

- Uhrberg M (2005). **The CD107 mobilization assay: viable isolation and immunotherapeutic potential of tumor-cytolytic NK cells.** *Leukemia* **19**(5): 707-709.
- Urlacher A, Falkenrodt A, Tongio MM, Mayer S (1987). **HLA class I antigens on normal and leukemic cells (quantitative analysis).** *Tissue antigens* **29**(5): 237-245.
- Vainchenker W, Constantinescu SN (2013). **JAK/STAT signaling in hematological malignancies.** *Oncogene* **32**(21): 2601-2613.
- van der Meer A, Lukassen HG, van Cranenbroek B, Weiss EH, Braat DD, van Lierop MJ, *et al.* (2007). **Soluble HLA-G promotes Th1-type cytokine production by cytokine-activated uterine and peripheral natural killer cells.** *Molecular human reproduction* **13**(2): 123-133.
- van der Meer A, Lukassen HG, van Lierop MJ, Wijnands F, Mosselman S, Braat DD, *et al.* (2004). **Membrane-bound HLA-G activates proliferation and interferon-gamma production by uterine natural killer cells.** *Molecular human reproduction* **10**(3): 189-195.
- Van Parijs L, Abbas AK (1996). **Role of Fas-mediated cell death in the regulation of immune responses.** *Current opinion in immunology* **8**(3): 355-361.
- Vardiman JW (2010). **The World Health Organization (WHO) classification of tumors of the hematopoietic and lymphoid tissues: an overview with emphasis on the myeloid neoplasms.** *Chemico-biological interactions* **184**(1-2): 16-20.
- Verstovsek S (2009). **Therapeutic potential of JAK2 inhibitors.** *Hematology / the Education Program of the American Society of Hematology. American Society of Hematology. Education Program*: 636-642.
- Vieillard V, Le Grand R, Dausset J, Debre P (2008). **A vaccine strategy against AIDS: an HIV gp41 peptide immunization prevents NKp44L expression and CD4+ T cell depletion in SHIV-infected macaques.** *Proceedings of the National Academy of Sciences of the United States of America* **105**(6): 2100-2104.
- Vieillard V, Strominger JL, Debre P (2005). **NK cytotoxicity against CD4+ T cells during HIV-1 infection: a gp41 peptide induces the expression of an NKp44 ligand.** *Proceedings of the National Academy of Sciences of the United States of America* **102**(31): 10981-10986.
- Viel S, Charrier E, Marcais A, Rouzair P, Bienvenu J, Karlin L, *et al.* (2013). **Monitoring NK cell activity in patients with hematological malignancies.** *Oncoimmunology* **2**(9): e26011.
- Vitale M, Bottino C, Sivori S, Sanseverino L, Castriconi R, Marcenaro E, *et al.* (1998). **NKp44, a novel triggering surface molecule specifically expressed by activated natural killer cells, is involved in non-major histocompatibility complex-restricted tumor cell lysis.** *The Journal of experimental medicine* **187**(12): 2065-2072.
- Vivier E, Morin P, O'Brien C, Druker B, Schlossman SF, Anderson P (1991). **Tyrosine phosphorylation of the Fc gamma RIII(CD16): zeta complex in human natural killer cells. Induction by antibody-dependent cytotoxicity but not by natural killing.** *J Immunol* **146**(1): 206-210.
- Vivier E, Raulet DH, Moretta A, Caligiuri MA, Zitvogel L, Lanier LL, *et al.* (2011). **Innate or adaptive immunity? The example of natural killer cells.** *Science* **331**(6013): 44-49.
- Vivier E, Tomasello E, Baratin M, Walzer T, Ugolini S (2008). **Functions of natural killer cells.** *Nature immunology* **9**(5): 503-510.

- Ward J, Bonaparte M, Sacks J, Guterman J, Fogli M, Mavilio D, *et al.* (2007). **HIV modulates the expression of ligands important in triggering natural killer cell cytotoxic responses on infected primary T-cell blasts.** *Blood* **110**(4): 1207-1214.
- Warren HS, Kinnear BF, Phillips JH, Lanier LL (1995). **Production of IL-5 by human NK cells and regulation of IL-5 secretion by IL-4, IL-10, and IL-12.** *J Immunol* **154**(10): 5144-5152.
- Watzl C (2003). **The NKG2D receptor and its ligands-recognition beyond the "missing self"?** *Microbes and infection / Institut Pasteur* **5**(1): 31-37.
- Weinfeld A, Swolin B, Westin J (1994). **Acute leukaemia after hydroxyurea therapy in polycythaemia vera and allied disorders: prospective study of efficacy and leukaemogenicity with therapeutic implications.** *European journal of haematology* **52**(3): 134-139.
- Weiss-Steider B, Soto-Cruz I, Martinez-Campos CA, Mendoza-Rincon JF (2011). **Expression of MICA, MICB and NKG2D in human leukemic myelomonocytic and cervical cancer cells.** *Journal of experimental & clinical cancer research : CR* **30**: 37.
- Welte S, Kuttruff S, Waldhauer I, Steinle A (2006). **Mutual activation of natural killer cells and monocytes mediated by NKp80-AICL interaction.** *Nature immunology* **7**(12): 1334-1342.
- Yokoyama WM (2008). **Mistaken notions about natural killer cells.** *Nature immunology* **9**(5): 481-485.
- Zafirova B, Wensveen FM, Gulin M, Polic B (2011). **Regulation of immune cell function and differentiation by the NKG2D receptor.** *Cellular and molecular life sciences : CMLS* **68**(21): 3519-3529.
- Zamai L, Ahmad M, Bennett IM, Azzoni L, Alnemri ES, Perussia B (1998). **Natural killer (NK) cell-mediated cytotoxicity: differential use of TRAIL and Fas ligand by immature and mature primary human NK cells.** *The Journal of experimental medicine* **188**(12): 2375-2380.
- Zhao R, Xing S, Li Z, Fu X, Li Q, Krantz SB, *et al.* (2005). **Identification of an acquired JAK2 mutation in polycythemia vera.** *The Journal of biological chemistry* **280**(24): 22788-22792.

