



HAL
open science

Interphase formation and influence on adherence in bonded or painted systems

Maëlen Aufray

► **To cite this version:**

Maëlen Aufray. Interphase formation and influence on adherence in bonded or painted systems. Materials. Institut National Polytechnique de Toulouse, 2023. <tel-04561005>

HAL Id: tel-04561005

<https://hal.science/tel-04561005v1>

Submitted on 26 Apr 2024

HAL is a multi-disciplinary open access archive for the deposit and dissemination of scientific research documents, whether they are published or not. The documents may come from teaching and research institutions in France or abroad, or from public or private research centers.

L'archive ouverte pluridisciplinaire HAL, est destinée au dépôt et à la diffusion de documents scientifiques de niveau recherche, publiés ou non, émanant des établissements d'enseignement et de recherche français ou étrangers, des laboratoires publics ou privés.



Distributed under a Creative Commons CC BY-NC-ND 4.0 - Attribution - Non-commercial use - No Derivative Works - International License

Université Fédérale



Toulouse Midi-Pyrénées

Habilitation

Habilitation Thesis defended at Toulouse University

Delivered by: Toulouse Institute of Technology

Defended the 24 May 2023 by:

Maëlen Aufray

**Interphase formation and influence on adherence
in bonded or painted systems**

JURY

ÉRIC PAPON

Professor

Bordeaux University

VALÉRIE NASSIET

Professor

Tarbes ENI

VINCENT ROUCOULES

Professor

University of Upper Alsace

PASCAL CARRIÈRE

Associate professor

Toulon University

PAUL MONTSARRAT

Professor

Toulouse University

JULIEN JUMEL

Professor

Brittany ENSTA

CHRISTOPHE DROUET

Research Director

CNRS

DOMINIQUE POQUILLON

Professor

Toulouse INP

Research unit:

Interuniversity Center of Materials Research and Engineering

Habilitation director:

Dominique POQUILLON

Reviewers:

Valérie NASSIET, Vincent ROUCOULES and Pascal CARRIÈRE

President:

Éric PAPON

Acknowledgments

It is very difficult for me to give thanks in a way that will do justice to the gratitude I feel towards my colleagues, friends and family. Nevertheless, I will do my best.

I wish to start by mentioning the CIRIMAT laboratory to which I have been attached since 2008 and by thanking its director Christophe Laurent for his involvement in the life of the laboratory. Thank you to Dominique Poquillon, deputy director of CIRIMAT, for both managing the ENSI-ACET teams and, most importantly, for her daily support as my HDR (habilitation à diriger des recherches — accreditation to supervise research) correspondent ever since I asked her to take on this role. Dominique, your involvement in the lives of our teams is matched only by your energy! You provided valuable advice throughout my HDR and gave up your time during a very hectic period in the life of the INP. You were able to be there without putting pressure on me to finish writing my dissertation, which was never-ending.

Being as lucky as I am, I would also like to thank Christophe Drouet, who was my second correspondent, and who was just as involved, enthusiastic and positive as Dominique: I would not be as happy sharing this dissertation without the invaluable help you have both given to me.

I would next like to thank the members of the jury from outside the laboratory, who are all very busy people who did me the honour of coming to discuss the work being presented. I would like to extend my warmest thanks to Éric Papon, who did me the honour of presiding over the jury for this HDR: it is now nearly 8 years since I applied to take part in this defence. Despite such an inordinate period of time having passed, Éric, you showed no hesitation in agreeing once again to my request to take part.

On that very same day, I made a similar request to Valérie Nassiet. Valérie, seeing you that day and asking you to be an examiner for my work was an easy choice, given that we have attended nearly all JADH, EURADH and WCARP events together since 2003. We have had countless opportunities to talk about interphases, adhesion and 3-point bending, and I love hearing you talk about your first steps at the SFA alongside Alain Roche. Valérie, I thank you from the bottom of my heart for your support and your unfailing good sense of humour.

I also wish to extend my warmest thanks to Vincent Roucoules, with whom I had some fascinating discussions, throughout the HDR, of course, but also during JADH and visits to Mulhouse. Your knowledge of surfaces and their characterisation, your good sense of humour and zest for life are something to aspire to, and I was delighted that you agreed to be an examiner for this work.

Thank you also to Pascal Carrière, who was present at the defence of my thesis. Pascal, we saw each other regularly at the Journées de l'Adhésion and I always really enjoyed discussing your work on interphases and the innovative characterisation techniques you use: it was a real pleasure to have you agree to be an examiner for this work.

I would also like to thank Julien Jumel for travelling across France to take part in this jury. This part of the jury from the Société Française de l'Adhésion (French Adhesion Society) would not be complete without you, Julien. We may have crossed paths before, but the first discussion I remember having with you took place in 2014, at the World Congress on Adhesion and Related Phenomena. Since then, we have had long discussions on the vocabulary used by physical chemists and engineers. We have also met up again at every JADH, EURADH and WCARP, and regularly talk about the 3-point bend test and adhesion in France and abroad, from both an academic and industrial

perspective. We share these discussions with Valérie, and you are always brimming with enthusiasm and full of ideas that you share freely.

Finally, a huge thank you to Paul Montsarrat, who came to discuss this work, most of which is entirely unrelated to his day-to-day activities. Paul, it was a pleasure to meet you and to discuss potential future studies in the dental field.

I also thank my fellow researchers, technicians, engineers and research professors at CIRIMAT and other academic and industrial laboratories in France and abroad. All the work presented here is the fruit of our collective labours and would not have been possible without all of your help. In particular, I would like to thank Éric Paroissien, who I met while teaching and with whom I have worked continuously since the creation of TACCOS: Toulouse Adhésion Cohésion Collage Structural. Éric, you are always optimistic and full of ideas. Your hard work allows us to rise to any challenge and our discussions together are always a pleasure. Of course, thanks are also due to my non-permanent colleagues, PhD students, post-doctoral researchers and interns: many of the results discussed here are thanks to their work. I was particularly touched to see Sébastien Genty in attendance at the defence, and my thoughts go to Thiago Birro, who was unable to be there. As well as having produced some outstanding theses, you have given me some great moments in which we have shared our thoughts, exchanged ideas and even enjoyed a laugh or two together. The group would not be complete without the supporting departments CIRIMAT, ENSIACET and INP: I would therefore like to thank the staff of these departments. I would like to thank everyone in the workshop, at reception, in the shop, the media library, the IT department, the prevention department, the technical and logistics departments and the administrative and financial departments. Every single one of these people helps make work a good place to be, and each outsourced service is heart-breaking: I am thinking of the positions in the reprographics department and part of the logistics department which have not been renewed.

Finally, of course, I would like to mention my family and friends from Lyon and the surrounding region, some of whom have moved away, some far away and some not so far away, and my family and friends from the south-west.



Figure 1: A huge thank you to everyone.

Contents

| | |
|---|------------|
| Acknowledgments | iii |
| Contents | vii |
| List of acronyms | 1 |
| Definitions | 5 |
| Foreword | 7 |
| 1 History and current context of bonding | 11 |
| 1.1 From prehistory to the modern day | 12 |
| 1.2 National, European and international context | 14 |
| 1.3 Interdisciplinarity | 15 |
| 1.4 Adhesion and adherence: definitions | 17 |
| 1.5 Theories of adhesion | 18 |
| 1.6 Conclusion | 20 |
| 2 From adhesive function to elementary reactions | 21 |
| 2.1 Mechanics of bonded assemblies | 22 |
| 2.2 Chemistry of epoxide-amine systems | 37 |
| 2.3 Approaching interphase formation | 43 |
| 2.4 Conclusion | 53 |
| 3 Research project | 55 |
| 3.1 Themes in the continuity of the studies presented | 56 |
| 3.2 Towards new areas of application: biomaterials | 59 |
| 3.3 Conclusion | 63 |
| Conclusion | 65 |
| Bibliography | 82 |

Acronym list

2D Two Dimensions

3D Three Dimensions

ADEME French Agency for Ecological Transition, or *Agence De l'Environnement et de la Maîtrise de l'Énergie (fr)*

ANR French National Research Agency, or *Agence Nationale de la Recherche (fr)*

CC Coupled Criterion

CETIM French Technical Center for Mechanical Industries, or *CEntre Technique des Industries Mécaniques (fr)*

CIFRE Industrial agreements for PhD funding, or *Conventions Industrielles de Formation par la REcherche (fr)*

CIRIMAT Interuniversity Center of Materials Research and Engineering (Research laboratory), or *Centre Inter-universitaire de Recherche et d'Ingénierie des MATériaux (fr)*

CNRS French National Centre for Scientific Research, or *Centre National de la Recherche Scientifique (fr)*

CNU National Council of Universities, or *Conseil National des Universités (fr)*

DEA Master of Advanced Studies, or *Diplôme d'Études Approfondies (fr)*

DETA DiEthyleneTriAmine

DFT Density Functional Theory

DGEB A DiGlycidyl Ether of Bisphénol A

DSC Differential Scanning Calorimetry

EDA EthyleneDiAmine

EDX Energy-Dispersive X-ray spectroscopy

HTE High-temperature electrolysis

ENSIACET Toulouse Graduate School of Chemical, Materials, and Industrial Engineering (engineering school), or *École Nationale Supérieure des Ingénieurs en Arts Chimiques Et Technologiques (fr)*

EURADH EUROpean ADHesion conference

FIB Focused Ion Beam

FTIR Fourier Transform InfraRed spectroscopy

- HCERES** High Council for the Evaluation of Research and Higher Education, or *Haut Conseil de l'Évaluation de la Recherche et de l'Enseignement Supérieur (fr)*
- HDR** Habilitation Thesis, or *Habilitation à Diriger des Recherches (fr)*
- ICA** Clément Ader Institute (Research laboratory), or *Institut Clément Ader (fr)*
- ICGM** Institute Charles Gerhardt Montpellier (Research laboratory), or *Institut Charles Gerhardt Montpellier (fr)*
- ICP** Inductively Coupled Plasma spectroscopy
- INPT** Toulouse Institute of Technology (group of engineering schools), or *Institut National Polytechnique de Toulouse (fr)*
- IPDA** IsoPhorone DiAmine
- IRT M2P** Institute for Technological Research into Materials, Metallurgy and Processes, or *Institut de Recherche Technologique Matériaux Métallurgie et Procédés (fr)*
- ISAE** National Higher French Institute of Aeronautics and Space (engineering school), or *Institut Supérieur de l'Aéronautique et de l'Espace (fr)*
- JADH** Adhesion days, or *Journées d'étude sur l'ADHésion (fr)*
- LAAS** Laboratory for Analysis and Architecture of Systems (Research laboratory), or *Laboratoire d'Analyse et d'Architecture des Systèmes (fr)*
- L3** Third year of Licence (bachelor) degree
- M1** First year of Master degree
- M2** Second year of Master degree
- MESR** Minister of Higher Education and Research, or *Ministère de l'Enseignement Supérieur et de la Recherche (fr)*
- MESRI** Minister of Higher Education, Research and innovation, or *Ministère de l'Enseignement Supérieur, de la Recherche et de l'Innovation (fr)*
- NMR** Nuclear Magnetic Resonance
- PCA** Principal Component Analysis
- PEEK** PolyEtherEtherKetone
- PIA** French Future Investments Program, or *Programme d'Investissements d'Avenir (fr)*
- PPB** Phosphates, Pharmacotechnics, Biomaterials (CIRIMAT group)
- PTFE** PolyTetraFluoroEthylene
- PVD** Physical Vapor Deposition
- REACH** Registration, Evaluation, Authorization and restriction of CHemicals
- RTS** Coatings and surface treatments (CIRIMAT group), or *Revêtements et Traitements de Surface*
- SEC** Size Exclusion Chromatography
- SEM** Scanning Electron Microscope

- SFA** French adhesion society, or *Société Française de l'Adhésion (fr)*
- SFV** French vacuum society, or *Société Française du Vide (fr)*
- SOFC** Solid Oxide Fuel Cells
- SURF** SURFaces: reactivity, protection (CIRIMAT group)
- TACCOS** Toulouse Adhesion Cohesion. Structural Adhesive Bonding, or *Toulouse Adhésion Cohésion Collage Structural (fr)* is a collaboration between ICA and CIRIMAT laboratories
- TETA** TriEthyleneTetrAmine
- UMR** Administrative type of research laboratory that is partially supported by CNRS, or *Unité Mixte de Recherche (fr)*
- UV** UltraViolet
- WCARP** World Congress on Adhesion and Related Phenomena
- XPS** X-ray Photoelectron Spectroscopy
- XRD** X-Ray Diffraction

Definitions

This dissertation contains a number of definitions which are covered in this section. The sources and choice of terminology are explained throughout this document.

Adherence Difficulty in separating two bodies adhesively (*i.e.* with adhesive failure, see definition below). It should be noted that in the English-speaking world, the term “adherence” is not in widespread use: for example, articles dating from before 2000 tend to refer to “mechanical adhesion” or “practical adhesion”.

Adhesion Any phenomenon of attraction between two bodies involving only electronic or magnetic interactions.

Adhesion test Mechanical test involving adhesive failure.

Adhesive (noun) Product that forms a bond when pressure is applied (pressure-sensitive adhesive or PSA).

Adhesive failure Interfacial failure when the adhesive or paint residue present on the substrate is less than the roughness of said substrate following mechanical testing: in this dissertation, for industrial rolled sheet metal, the failure will be considered interfacial when the adhesive or paint residue on the substrate is less than 100 nm.

Cohesive failure A failure of one of the materials.

Epoxide Epoxide is basically a chemical group made up of 2 carbon atoms and one oxygen atom that form a three-atom ring: this group is also called “oxirane”. By extension, epoxide is a molecule containing one or more epoxide groups.

Epoxy The term epoxide is often shortened to “epoxy”. In this dissertation, “epoxy”, the shortened form of the term “epoxide”, will be reserved for the polymer, which will thus no longer have epoxide groups. This term will therefore be equivalent to the word “polyepoxy”.

Glue A substance capable of bonding two substrates. There is no distinction to be made between the terms “glue” and “adhesive” in terms of their function, but they are used in the context of different linguistic registers. The former is relatively less highbrow and intended for the general public, while the latter is a technical term preferred by scientists and formulators of high-tech adhesives to distinguish them from standard adhesives.

Initiation Appearance of the first critical (measurable) defect. Also referred to using the term “onset crack”.

Interface (Zero-thickness) surface between two media.

Interphase (Non-zero-thickness) volume between two media. The properties of the interphase are thus different to those of each medium. The interphase can also display a gradient of properties.

Mixed failure A failure of the adhesive and cohesive areas.

Polyepoxy Polymer made from monomers of which at least some have epoxide groups. After polymerisation, the polyepoxy no longer has epoxide groups.

Propagation Stage following initiation of a crack.

Resin Viscous substance containing prepolymers with reactive groups that, following chemical reaction, convert into a thermosetting polymer.

Structural adhesive Adhesive with a high level of cohesion and adhesion, used to help transfer forces in an assembly. The strength of the assembly is often noted as being greater than 20 MPa, although this value has no real meaning without an associated standard.

Foreword



I wish to begin this dissertation with a foreword that is intended to be a brief and informal curriculum vitae. I am not going to start this curriculum vitae at school. This was, however, where two dreams first began to coexist. The first was that of an airline pilot, someone who had the pleasure of getting to spend almost every day in the aeroplanes that gave us the means to travel and dream... The second was that of a researcher, as Pierre-Gilles de Gennes had just won the Nobel Prize for discovering “that methods developed for studying order phenomena in simple systems can be generalised to more complex forms of matter, in particular to liquid crystals and polymers”. He was often in the media at that time and his interest in education and the popularisation of science made him very popular with the general public. Pierre-Gilles de Gennes was a physicist who specialised in soft matter and one of the areas he worked on was wetting phenomena. The idea of studying why “water wets” seemed both ridiculous and exciting. Was finding out why water wets really a job? So, whether I was to become a pilot or researcher, and to keep all of these options open, following my baccalauréat scientifique I undertook two years of preparatory classes for the grandes écoles in Bourg en Bresse. My first dream, to become an airline pilot, had to be put to one side after sitting the ENAC (French National School of Aviation) entrance exam, but research was still an option and was even more important to me.

After sitting the entrance exams following my preparatory classes, I was able to study for a degree in physical sciences at Claude Bernard Lyon I University. To fulfil my dream of becoming a researcher, I continued along this path and completed my studies in Lyon with a master’s degree in physical chemistry, followed by a DEA (Diplôme d’études approfondies) in “polymers and composite materials”, and finally a PhD, which I defended at INSA Lyon (National Institute of Applied Sciences) in 2005. For this PhD, I specialised in materials, and examined the topic of bonding (adhesion), one of the theories of which is wetting. I really got to grips with research in 2001, when I was doing an internship at the company Allevard Rejna Autosuspensions as part of my degree. I completed this internship at a Joint Research Unit (UMR 5223) directed by Odile Tadjoa and **Alain Roche**, and worked on the development of a chip-resistant coating formula. Alain Roche was a great character and a defining figure of this turning point. Working in research was possible and I discovered the site of the first laboratory I would work at: the Institut des Matériaux Macromoléculaires (Institute of Macromolecular Materials). It was therefore only natural that I would remain at this great laboratory when Alain Roche suggested that I work on the “Chemistry of metal/epoxy-amine interphases” during my Master of Advanced Studies (2001-2002), with a view to applying for a research grant from the Ministry of Higher Education and Research.

I wrote a thesis entitled “Physico-chemical characterisation of epoxy-amine/metal oxide or hydroxide interphases and their constituents” between 2002 and 2005. It was during this thesis that I was able to become acquainted with the “adhesion community”, at the twelfth edition of Journées d’étude sur l’ADHésion (Figure 2¹). **Valérie Nassiet**, **Marie-Geneviève Barthés-Labrousse**, **Éric Papon**, **Robert Adams**, Costantino Creton, Jacques Schultz and all the active members of the French (and European) adhesion society, not to mention part of the French Vacuum Society, were in attendance. Alain Roche did warn me when he said, “this is a very friendly community... I’ll never leave”. During my thesis, I also had the opportunity to spend two months in Australia, at the laboratories of Professors Graeme Georges and Andrew Whittaker (Brisbane). The interdisciplinary nature of adhesion sciences and the interest of collaborations became clear. After defending my thesis in October 2005, a six-month study as a research engineer for DGTec (“Development of nanocomposite materials through the introduction of inorganic nanoparticles into a polymer matrix”) led to an 18-month post-doctorate in Germany. I had the opportunity to work with **Wulff Possart** (Lehrstuhl Adhäsion und Interphasen in Polymeren, Saarland University, Germany) on the topic “Epoxy matrix nanocomposite materials: a new approach based on dielectric spectroscopy”.

¹Personal photos and photos from the SFV.



Figure 2: JADH 2003 (french adhesion days), in Oléron: (a) General overview, (b) Pierre-Gilles de Gennes, (c) Bob Adams, (d) Valérie Nassiet, (e) Hamidou Haidara and Éric Papon, (f) Alain Roche.

During this post-doctorate, I met Jan Krüger, a specialist in Brillouin spectroscopy and a member of the Materials Science Research Laboratory at the Jean Lamour Institute in Nancy. Our collaborations were fruitful, and my passion for interdisciplinary scientific studies ever stronger, so I continued my research into polymer materials, working between the Materials Science Research Laboratory and the Structure and Reactivity of Complex Molecular Systems Laboratory, under the direction of Yves Fort and **Didier Rouxel**. This study on piezoelectric nanocomposites (synthesis, characterisation, applications) was relatively brief (5 months), as I passed the maître de conférences competitive examination that would allow me to carry out my research work at CIRIMAT (Interuniversity Material Research and Engineering Centre) and teach at ENSIACET (French National School of Chemical and Technological Engineers, a Toulouse INP school) in November 2007, on the subject of “surface properties of polymers and composites”.

And so I arrived in Toulouse on 1 February 2008, where I began working with **Alain Lamure**, among others, on issues such as surfaces, reactions at interfaces, interphase formation and measuring adhesion. These research topics can also be linked to the fields of bonding in a broad sense. Comprising three chapters followed by a conclusion, this document will review the research that I have undertaken since 2002, then outline proposals for my future research projects.

- History and current context of bonding;
- From adhesive function to elementary reactions;
- Research project.

Chapter 1

History and current context of bonding

Contents

| | |
|--|----|
| 1.1 From prehistory to the modern day | 12 |
| 1.2 National, European and international context | 14 |
| 1.3 Interdisciplinarity | 15 |
| 1.4 Adhesion and adherence: definitions | 17 |
| 1.5 Theories of adhesion | 18 |
| 1.6 Conclusion | 20 |

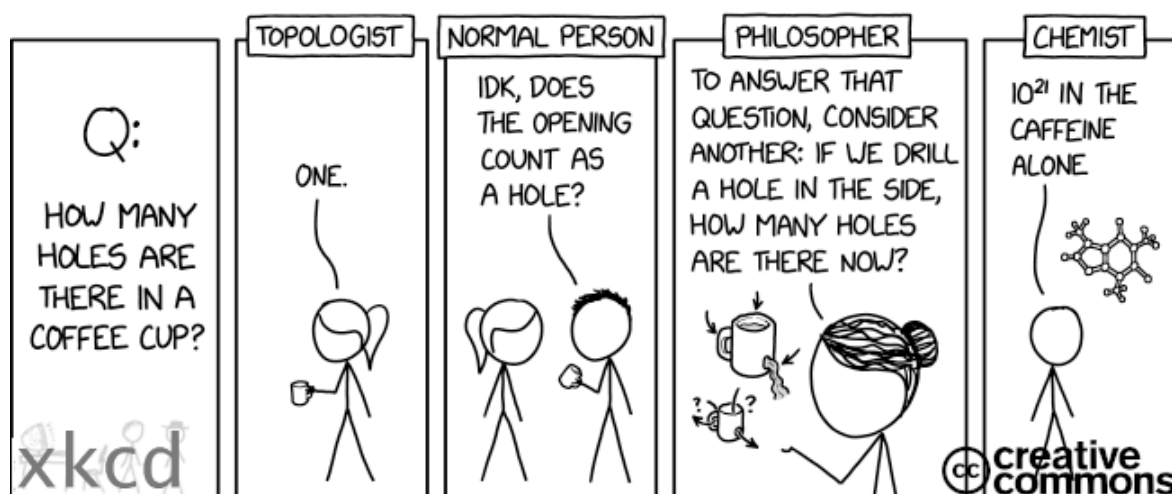

1.1 From prehistory to the modern day

This document focuses on the concept of “bonding”, a term which will cover two distinct configurations: bonded assemblies and coated substrates. These systems are in fact similar in the cases that will be discussed (chemistry of adhesives and paints, reactions at interfaces and interphase formation, adhesion). The only difference is the minimum number of interfaces: two in the case of bonded assemblies and just one for coated systems (Figure 1.1). An adhesive is thus a substance capable of bonding two substrates, while a coating is a substance covering a substrate. According to [Encyclopédie Universalis \[2021\]](#) an adhesive is a product that forms a bond when pressure is applied. I will endeavour to follow this terminology, but the words “glue” and “adhesive” commonly refer to the same thing: there is no distinction to be made between the terms “glue” and “adhesive” in terms of their function, but they are used in the context of different linguistic registers. The former is relatively less highbrow and intended for the general public, while the latter is a technical term preferred by formulators of high-tech adhesives to distinguish them from standard adhesives, and by scientists.



Figure 1.1: Similarity between a bonded assembly and a coated substrate.

Whilst not all adhesives are polymers (there are ceramic adhesives such as cement, plaster, etc.), the majority are: the history of adhesion is therefore directly linked to that of natural and subsequently synthetic polymers. In light of the discovery of tools made using plant gum (South Africa), it is generally accepted that natural materials were first used as glues 70-80,000 years ago. Following the discovery in Italy of tar used to fix stones in place (Figure 1.2) this estimate has recently been pushed back as far as 200,000 years ago. There are reports of natural glues (pine resin, animal gelatins, etc.) being used for other purposes throughout prehistory ([Fay \[2021\]](#)). The *Map-pae Clavicula*, a collection of recipes for making craft materials, including several glue recipes, was written in the Middle Ages. The modern adhesive era began with the industrial-scale manufacture of glue in Holland in 1690, followed by the first patent in England in 1754. The synthesis of artificial polymers led to a proliferation of adhesive formulations and applications, with epoxy resins and cyanoacrylate glues being patented and industrialised. The international adhesion research community formed in the second half of the 20th century, with the first journal in the field, *The Journal of Adhesion*, being published in 1969. In France, the first research day on the Contribution of Surface Studies to Adhesion Problems was held on 19 April 1983 in Paris: this gave rise to JADH (*Journées d'étude sur l'ADHésion*), which is now held every second year, alternating with the European Adhesion Conference (EURADH). The first ever international congress on adhesion (WCARP or “World Congress on Adhesion and Related Phenomena”) took place in Garmish-Partenkirchen (Germany) in 1998 and is now held every four years.

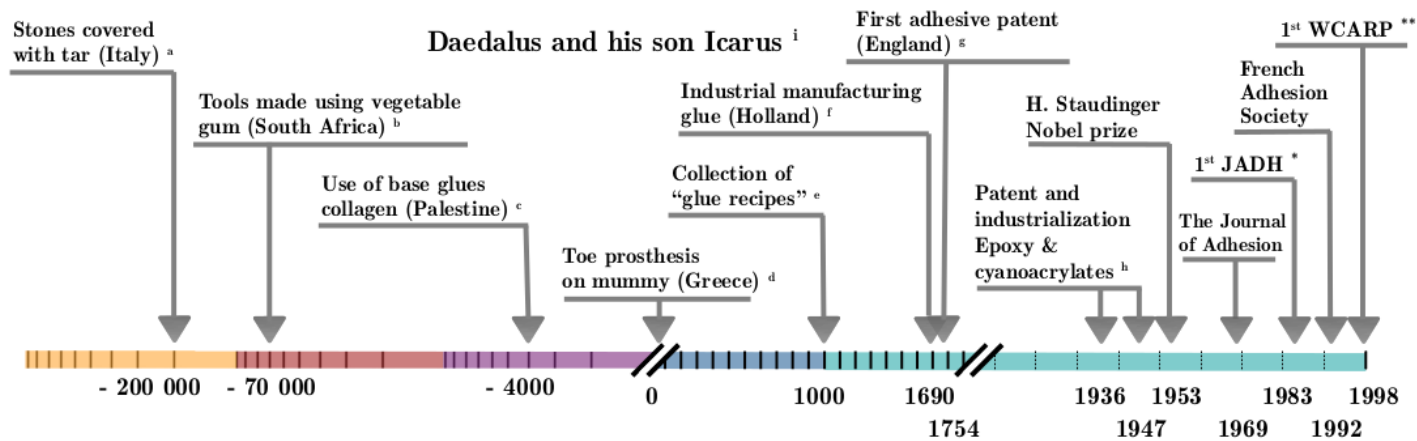

- (a) P. Mazza et al. *A new Palaeolithic discovery: tar-hafted stone tools in a European Mid-Pleistocene bone-bearing bed*. Journal of Archaeological Science. 2006, 33 (9): 1310.
 (b) L. Wadley *Compound-Adhesive Manufacture as a Behavioral Proxy for Complex Cognition in the Middle Stone Age*. Current Anthropology. 2010, 51 (s1): S111.
 (c) O. Bar-Yosef et al. *Early Neolithic organic remains from Nahal Hemar Cave*, National Geographic Research, 1989, 5 (2): 176.
 (d) S. Falder S et al. *Following in the footsteps of the pharaohs*, British Journal of Plastic Surgery, 2003, 56(2): 196.
 (e) C.S. Smith et al. *Mappae Clavicula: A little key to the world of medieval techniques*, Transactions of the American Philosophical Society, 1974, 64(4).
 (f) R.H. Bogue, *The Chemistry and Technology of Gelatin and Glue*, McGraw-Hill Book Company, Inc., New York. 1922, pp. 3.
 (g) **British Patent**, Number 691, to Peter Zomer, May 23, 1754.
 (h) S.R. Hartshorn, *Structural Adhesives: Chemistry and Technology*, Plenum, New York, 1986.
 (i) M.Dancourt, *Dédale et Icare : Métamorphoses d'un mythe* CNRS editions, 2002.

* JADH : Journées d'étude sur l'ADHésion, i.e. *French adhesion days*

** WCARP : World Congress on Adhesion and Related Phenomena

Figure 1.2: History of bonding and studies on adhesion.

1.2 National, European and international context

It is in this global context that research into adhesion has developed. There are currently three major journals that focus exclusively on adhesion, and three more minor ones (with no impact factor):

•❖ ***International Journal of Adhesion and Adhesives***

First publication: 1980

Editors in Chief in 2022: James Broughton, Steve Shaw

Publisher: Elsevier BV

Journal Metrics (2022): 3.4 (Impact Factor), 0.8 (SCImago Journal Rank)

•❖ ***The Journal of Adhesion***

First publication: 1969

Editors in Chief in 2022: Lucas F.M. da Silva

Publisher: Taylor & Francis

Journal Metrics (2022): 2.2 (Impact Factor), 0.5 (SCImago Journal Rank)

•❖ ***Journal of Adhesion Science and Technology***

First publication: 1987

Editors in Chief in 2022: J. M. Martín-Martínez

Publisher: Taylor & Francis

Journal Metrics (2022): 2.3 (Impact Factor), 0.4 (SCImago Journal Rank)

•❖ ***Reviews of Adhesion and Adhesives***

First publication: 2013

Editorial committee without editor-in-chief

Publisher: Scrivener Publishing

Journal Metrics (2022): 0.3 (SCImago Journal Rank)

•❖ ***Adhesion Adhesives + Sealants***

First publication: 2009

Editors in Chief in 2022: Hubert Pelc

Publisher: Springer Fachmedien Wiesbaden

No metrics: journal aimed more at the industrial than academic world

•❖ ***Applied Adhesion Science***

First publication: 2013

Editors in Chief in 2022: Silvio de Barros

Publisher: Springer International Publishing AG

Journal Metrics (2021): 0.3 (SCImago Journal Rank)

Open access journal associated with the Brazilian Society of Adhesion and Adhesives. No longer published since December 31, 2021.

These journals are inseparable from the conferences mentioned in the previous section and from the scientific societies associated with the field.

There are membership societies in several countries in Europe and throughout the rest of the world:

| | | |
|--------------------------|-----------|---|
| France | SFA (SFV) | Société Française de l'Adhésion |
| United Kingdom | SAA | Society for Adhesion and Adhesives |
| Germany | DECHEMA | DECHEMA Section Adhesive Technology |
| Spain | | Sociedad de Adhesión |
| Portugal | APAA | Portuguese Adhesion Society |
| Netherlands | BvM | De bond voor materialenkennis |
| United States of America | AS | Adhesion Society |
| Brazil | ABAA | Brazilian Society of Adhesion and Adhesives |
| Other States of America | | Grupo Iberoamericano de Adhesión |
| China | BAS | Bejing Adhesion Society |
| Japan | | Adhesion Society of Japan |
| South Korea | | Society of Adhesion & Interface Korea |

In France, the French Adhesion Society (*Société Française de l'Adhésion* [SFA]) is a division of the Société Française du Vide (French Vacuum Society) and was founded by Jacques Schultz in 1992. It is currently chaired by Julien Jumel and I have been its secretary since 2021.

1.3 Interdisciplinarity

The skills represented in adhesion science are manifold, reflecting the diversity of disciplines (Figure 1.3). Researchers in the field of adhesion often have a background in materials science.

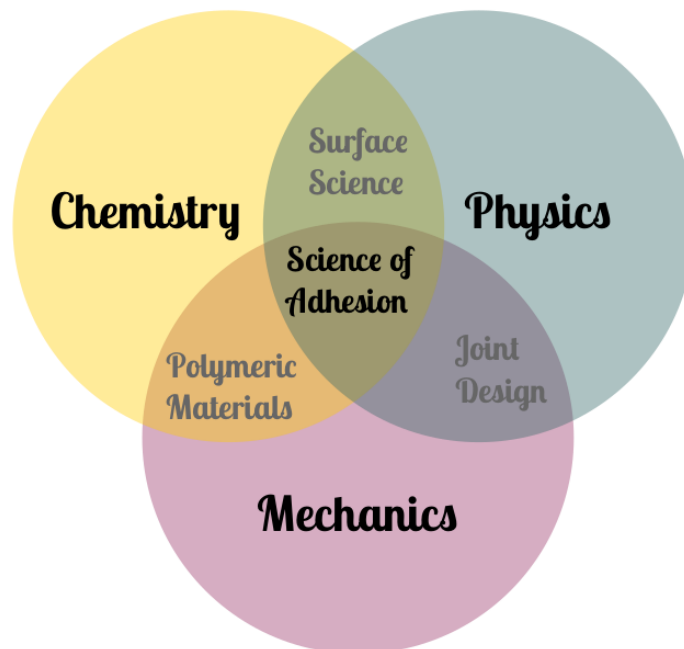

Figure 1.3: Adhesion, a multidisciplinary science, taken from Petrie [2007].

This multidisciplinary approach means that adhesion problematics can be tackled from different angles: chemical, physical and mechanical, as illustrated in the [Encyclopédie Universalis \[2021\]](#) mind map on bonding (Figure 1.4). For example, focusing on amine-metal bonds allows for different angles of approach. In the following chapter, I will present these bonds from the perspective of a polymerist, which I am myself, and I find nearly no common bibliographical references to the work of [Charlier \[2003\]](#), who entitled her HDR dissertation “La liaison organique-métal, pourquoi, comment?” (“The organic-metal bond, why, how?”). Her complementary understanding of the study of amine-metal bonds is that of a surface chemistry specialist and microscopist.

It is the juxtaposition of these different perspectives that reflects the complex phenomena discussed in this document. The science of adhesion thus coexists within these different disciplines, with there sometimes being some difficulty in choosing the vocabulary specific to each discipline.

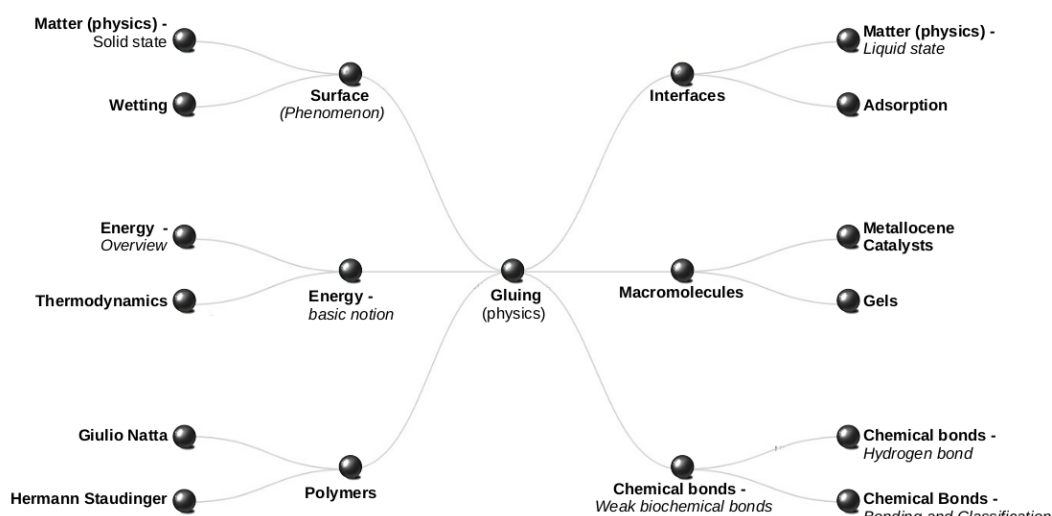

Figure 1.4: Bonding mind map, taken from [Encyclopédie Universalis \[2021\]](#).

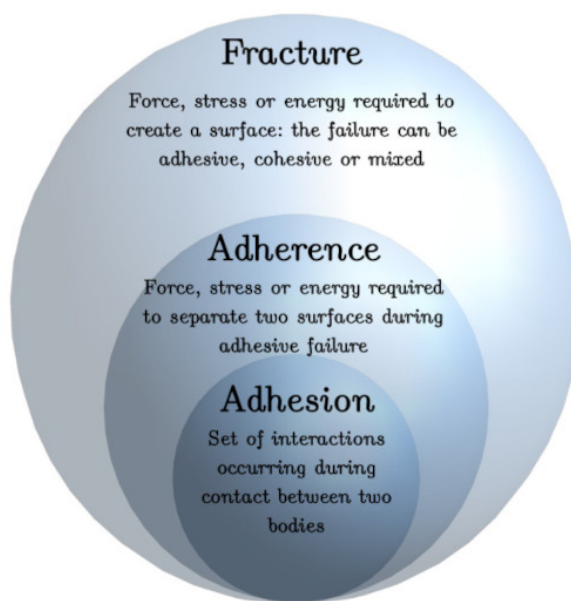

Figure 1.5: Adhesion, adherence and failure.

1.4 Adhesion and adherence: definitions

The basic definitions are more complex than they appear: [Petit, J. A. \[1992\]](#) and [Brown \[1995\]](#) were among the first researchers to distinguish between the terms adhesion and adherence. It should be noted that in the English-speaking world, the term “adherence” is not in widespread use: for example, articles dating from before 2000 tend to refer to “mechanical adhesion” or “practical adhesion” ([Good \[1976\]](#)). [Brown \[1995\]](#) highlights the confusion between these two terms and proposes that the term adherence include, but not be limited to, adhesion: an “adhesion failure” is reduced to a failure at the substrate/coating or adhesive interface, while an “adherence failure” includes both adhesive and cohesive failures.

The field of engineering differs from the field of research by not clearly differentiating between adhesion and adherence. In standard [NF-EN 923 \[2016\]](#) “Adhesives — Terms and definitions”, no distinction is necessarily made between the two terms. In the research field, according to [Darque-Ceretti and Felder \[2003\]](#), adhesion is defined as any phenomenon of attraction between two bodies involving only electromagnetic interactions. Attractions due to gravitational or nuclear forces are not included in this definition. Adherence, on the other hand, expresses the difficulty in separating two bodies.

In deviation from [Brown \[1995\]](#)’s definition, throughout the remainder of this document, we will only consider **adherence** to be the **difficulty in separating two adhesive bodies, leading to an adhesive failure**: this detail is not included in the definition offered by [Darque-Ceretti and Felder \[2003\]](#), nor that of [Cognard \[2000\]](#) (adhesion is the set of interactions occurring at the point of contact between the solid and the adhesive, and adherence is the result of an attempt to separate them), but it is widely accepted within the community of physical chemists working in the field of adhesion. Adherence can therefore be quantified by measuring force, stress or energy. Finally, in a test involving an assembly as a whole, failure force, failure stress or failure energy will be the broadest terms: they will refer to mechanical tests of assemblies or multi-materials involving adhesive or cohesive failure (Figure 1.5).

These definitions are particularly important during mechanical tests carried out on bonded assemblies, in order to identify exactly what is being measured (an interface property in the case of adherence, or an overall assembly property in the case of a structural test). While the definition of an interface (the surface separating two media) seems straightforward, the definition of interfacial failure is less straightforward in practice. [ISO 10365 \[2022\]](#) standard, which describes the main failure surfaces, states that “an adhesion failure is a rupture of an adhesive bond in which the separation appears visually to be at the adhesive/adherend interface” and on the following pages that “examination of the surface using a suitable instrument may enable the different types of failure pattern to be better distinguished”.

In this dissertation, the failure will be considered interfacial (and therefore “adhesive”) when the adhesive or paint residue present on the substrate following mechanical testing is less than 100 nm for the substrates studied with a roughness of this order of magnitude. This value is not arbitrary: it corresponds to the detection limits of current equipment (μ -FTIR, μ -Raman, mechanical profilometer, etc.). Of course, more advanced equipment such as XPS permits resolutions of less than 100 nm, but this value corresponds most crucially to the lower limit of the “classic” roughness of industrial surfaces.

The definitions of adhesion are in fact derived from the “fundamental relation of adhesion”, described by [Dupré and Dupré \[1869\]](#) which is defined by the (reversible) energy of adhesion [in $\text{J}\cdot\text{m}^{-2}$]:

$$W_{adhesion} = (\gamma_S + \gamma_L) - \gamma_{SL} \quad (1.1)$$

in the case of two elements S and L, with surface energies of γ_S and γ_L respectively, and possessing an interfacial energy γ_{SL} .

Furthermore, in the case of cohesive failure, $W = W_{cohesion} = 2\gamma_s$.

These definitions will give rise to one of the theories of adhesion: the thermodynamic theory. Adherence, however, will depend on adhesion, but also on many factors described in the other theories of adhesion.

1.5 Theories of adhesion

If we were to look only at the first definition of adhesion, as defined by Athanase and Paul Dupré (Eq. 1.1), adhesion would be governed solely by thermodynamics. This hypothesis is just one of the theories of adhesion. There are in fact eight theories, which are described briefly in Table 1.1. As with any form of classification, this is not the only one out there. Friedrich [2018] (pp. 14), for example, prefers to separate theories of adhesion into three families: physical, chemical and mechanical adhesion. It is to these families that the theories set out below belong (sometimes appearing in more than one family, such as the chemical theory found in the “chemistry category”, when the bonds formed are covalent and “physical” during acid-base interactions). It should be noted that while the first five theories of adhesion (white background in Table 1.1) do indeed concern adhesion (interactions that occur when two bodies come into contact with each other), the last three theories (grey background in Table 1.1) concern adhesive cohesion (which may have an impact on the measurement of adherence), not interfacial phenomena.

Table 1.1: Theories of adhesion.

| Theory | Authors | Year | Reference(s) | Application(s) |
|------------------------------|---------------------------------------|------|--|---|
| Chemical bonding | S. Buchan & W.D. Rae | 1946 | Buchan and Rae [1946] | initially presented in the case of an elastomer on bronze |
| Electrostatic | B.V. Deryagin & N.A. Krotova | 1948 | Deryagin and Krotova [1948] | proposed in the case of surface of oxide layers with ionic character) |
| Mechanical inter-lock | J.W. McBain & D.G. Hopkins | 1925 | McBain and Hopkins [1925] | in this theory, roughness has a preponderant role |
| Adsorption, wetting | L.H. Sharpe & H. Schonhorn | 1963 | Sharpe and Schonhorn [1963] | = thermodynamic theory: adhesion is attributed to Van der Waals type forces and hydrogen bonds |
| Diffusion | S.S. Voyutskii & V.L. Vakula | 1963 | Voyutskii and Vakula [1963] | theory initially intended for “self-adhesion” |
| Weak-boundary-layer | J.J. Bikerman | 1961 | Bikerman [1961] | the interfacial forces would always be stronger than the cohesive force of a of the numerous layers making up the assembly: the rupture will therefore always take place in the layer with the weakest cohesive force |
| Rheological | A.N. Gent, R.P. Petrich, & J. Schultz | 1969 | Gent et al. [1969] ; Gent and Schultz [1972] | taking into account energy dissipation phenomena during mechanical tests (case of elastomers) |
| Molecular dissipation | G.J. Lake & A.G. Thomas | 1967 | Lake et al. [1967] | taking into account the entropy variation linked to the orientation of chains during separation substrates |

These theories are described to some extent in reference works: [Cognard \[2005, 2006\]](#); [Comyn \[2006\]](#); [da Silva et al. \[2011\]](#); [Darque-Ceretti and Felder \[2003\]](#); [Ebnesajjad and Ebnesajjad \[2014\]](#); [Houwink and Salomon \[1965, 1967\]](#); [Lee \[1991\]](#); [Monternot et al. \[1978\]](#); [Petrie \[2007\]](#); [Skeist \[1990\]](#); [Villenave \[2005\]](#) : they may appear to be a juxtaposition of interpretations, useless in the case of applied sciences, yet they are directly linked to the different strategies for improving the strength of bonded assemblies in the world of industry (Figure 1.6).

For example, the primary function of sandblasting is to increase roughness in order to improve adherence: this treatment is therefore used when adhesion seems to be governed by mechanical theory, but also takes into account the weak boundary layer theory by removing weak or contaminated surface layers. Finally, it should be noted that theories of adhesion are sometimes contradictory, even if they often coincide. For example, Gutowski [1999] discussed the possible links between chemical theory, rheological theory and interdiffusion theory.

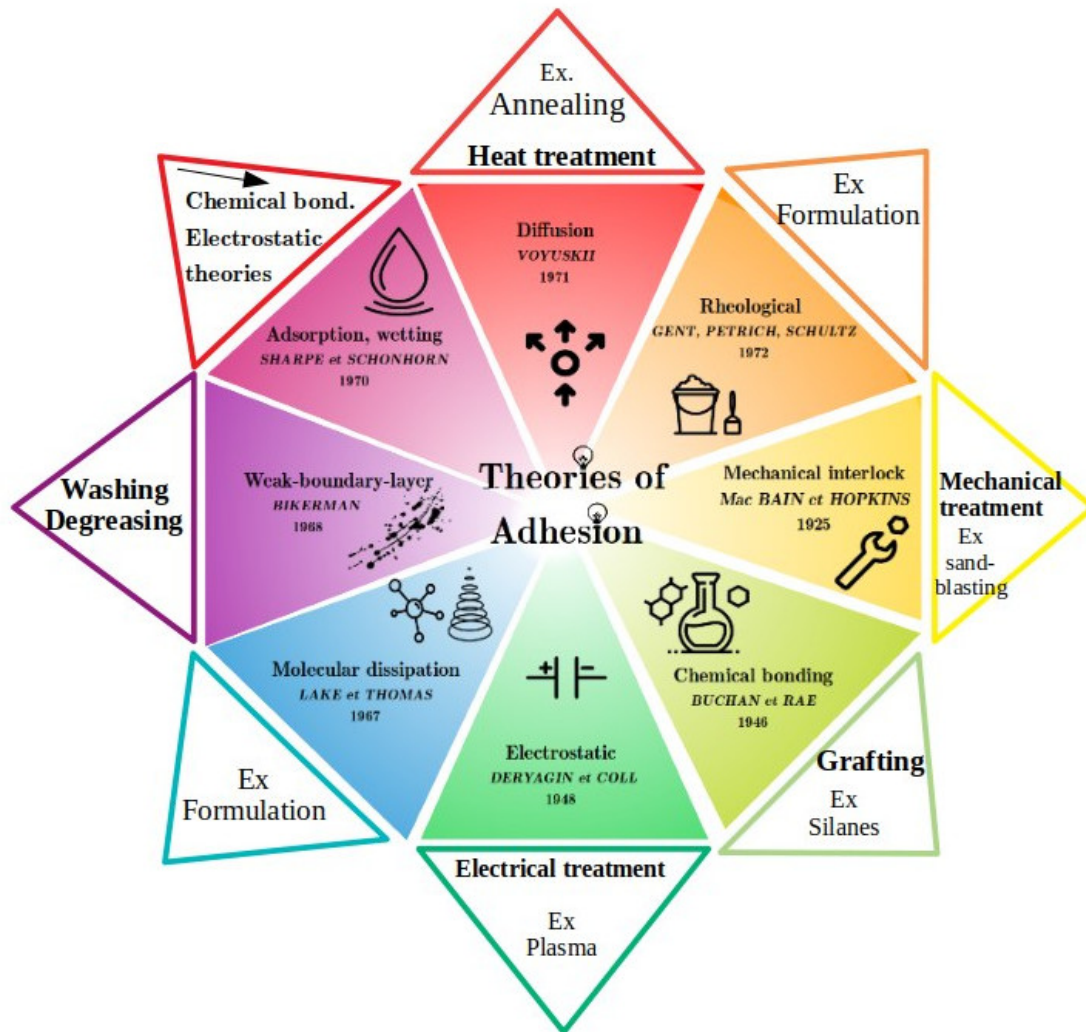

Figure 1.6: Theories of adhesion and improving the strength of bonded assemblies in relation to theories of adhesion.

Thus, as Cognard [2000] points out with a touch of irony, “beliefs around adhesion are based on 7 commandments (based on theories of adhesion)”. Each theory has its own area of validity and limitations, but it is always worth bearing all of them in mind when trying to understand a system as a whole. Subsequently, the theories used most frequently in my research, which is often linked to the formation of interphases, will be the chemical theory, the diffusion theory and the mechanical interlocking theory: in fact, interphases in epoxide-amine/metal systems form as the result of a reaction between amino monomers and metal surfaces whereby chelates are formed (chemical theory). These chelates then desorb and diffuse within the monomer mixture, until the mixture vitrifies, pulling metal ions several tens or even hundreds of microns from the surface (diffusion theory). The adherence measured following these reactions by studying the failure surface will then be directly linked to the roughness of the substrate (mechanical interlocking theory).

1.6 Conclusion

According to [Cognard \[2002\]](#) and [Carlac'h and Hemery \[2002\]](#), the French market for adhesives alone accounted for some 400,000 tonnes per year in the 2000s. This is just some of the 8.8 million tonnes produced worldwide in 2000, 3.7

According to [Petrie \[2005\]](#), epoxide-based adhesives are the second most widely used adhesives after polyurethane-based ones. It is this family of adhesives that will be specifically studied in the review set out in the next chapter.

Chapter 2

From adhesive function to elementary reactions

Contents

| | |
|--|-----------|
| 2.1 Mechanics of bonded assemblies | 22 |
| 2.1.1 Three-point bending test and measuring adherence | 22 |
| 2.1.2 Analytical assessment of adherence | 32 |
| 2.1.3 Modelling | 33 |
| 2.2 Chemistry of epoxide-amine systems | 37 |
| 2.2.1 Definitions, history and applications | 37 |
| 2.2.2 Polymerisation reaction | 37 |
| 2.2.3 On-demand polymerisation under infrared lamp | 41 |
| 2.3 Approaching interphase formation | 43 |
| 2.3.1 Reactions at the interfaces: interphase formation | 43 |
| 2.3.2 Influence of interphases on the properties of adhesive joints and coatings | 49 |
| 2.4 Conclusion | 53 |

CURVE-FITTING METHODS AND THE MESSAGES THEY SEND

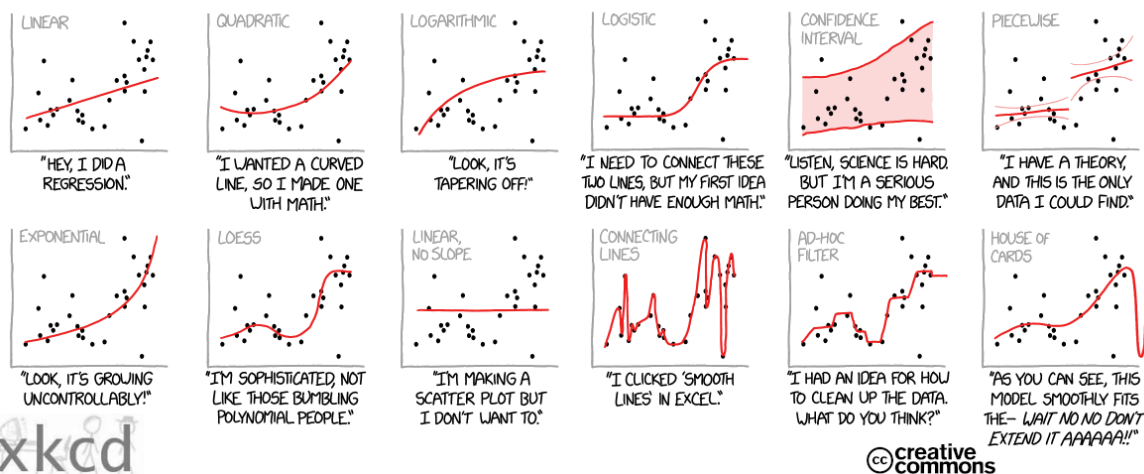

The central focus of my research is the substrate/coating or adhesive interface, and the primary function that we will seek to measure at this interface is adherence. In this chapter, I will therefore start with the desired property of the adhesive (*i.e.* adherence), discussing in particular adherence tests and the three-point bending test. The presented observations will then be compared with the modelling problematics developed in partnership with specialist researchers in the field. In the bonded assemblies studied, the material serving as the link between two substrates will be an epoxide-amine adhesive: the second section of this chapter will therefore be devoted to the chemistry of these very widely used adhesives. Finally, the last part of this chapter will be devoted to the formation of interphases (non-zero-thickness interfaces) and the changes in the epoxide-amine network described above when it forms in contact with a metal surface.

2.1 Mechanics of bonded assemblies

There are many mechanical tests designed to characterise the strength of bonded assemblies: most are standardised, and a search for the keyword “adhesive” on the ISO standards database returns more than 900 results. Fracture mechanics is the core of knowledge on which most tests of the mechanical properties of a bonded joint are based, resulting in the determination of fracture energy: this is the case, for example, with cleavage tests (DCB – double cantilever beam – or TDCB – tapered double cantilever beam –, ISO standard 25217, and the wedge test, ISO standard 15107), but also peel tests under certain conditions (ISO standards 8510 and 11339). As stated in Chapter 1, here I am working on the assumption that only tests which result in adhesive failure are adherence tests, as this can only be verified after studying the failure surface. By default, these tests are therefore fracture mechanics tests applied to bonded assemblies. It should also be noted that many of the tests are crack growth tests (*e.g.* peel, DCB – double cantilever beam).

2.1.1 Three-point bending test and measuring adherence

Tests designed to measure adherence are often “technological” (close to use): this is the case with the single-lap shear test (ISO standard 4587, NF EN 2243-1) and the pull-off test (ASTM standard D 4541, ISO standard 4624 & ISO standard 16276-1). These tests, which are widely used in industry, are crack initiation tests in the case of rigid adhesives (Figure 2.1).

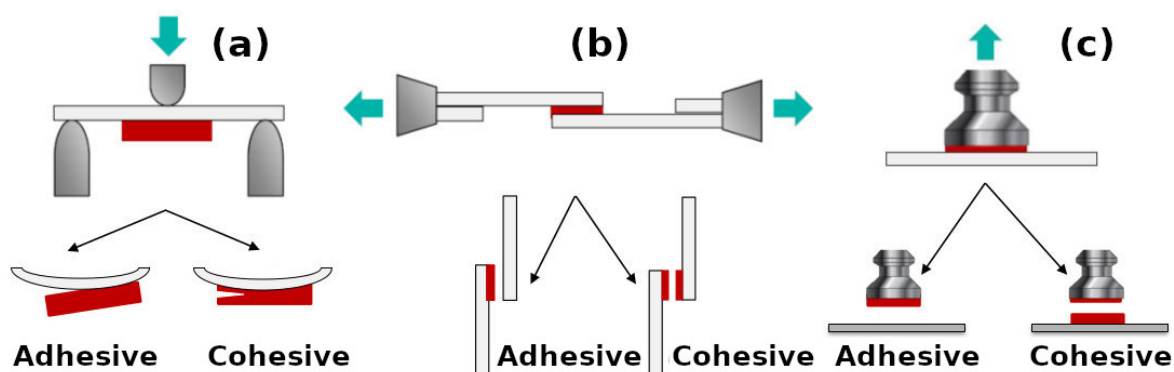

Figure 2.1: Diagrams of three-point bending (a), single-lap shear (b) and pull-off (c) tests, adapted from Genty et al. [2017].

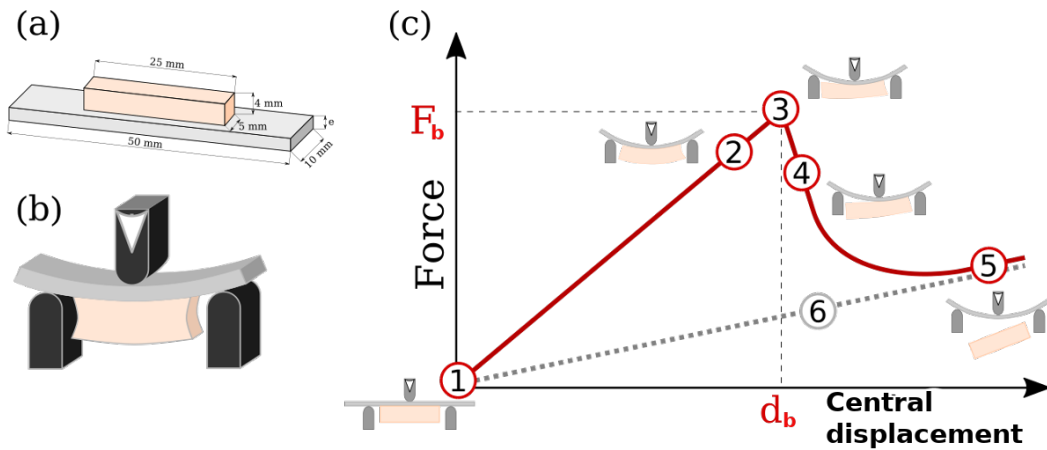

Figure 2.2: Principle of the three-point bending test: (a) diagram with dimensions of a three-point bending test sample (moulded adhesive block on substrate), (b) diagram of a test sample loaded in three-point bending, prior to failure initiation, (c) typical Force-Deflection curve of a test sample subjected to three-point bending.

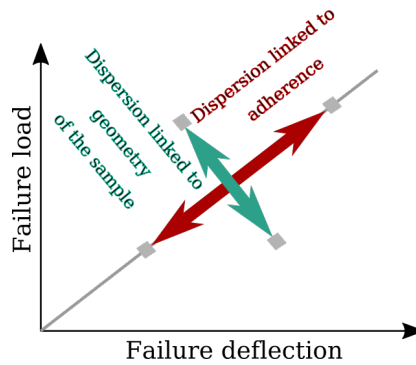

Figure 2.3: Scatter analysis of three-point bending results, taken from [Sauvage \[2016\]](#).

Although they are relatively easy to carry out, interpreting the results is a far less straightforward matter, but they have been studied extensively, notably in the case of single-lap joints ([da Silva et al. \[2009a,b\]](#)), particularly in order to qualify the interfaces. It was in this context that a specific three-point bending test configuration was proposed by [Roche et al. \[1982\]](#): the test was standardised from 1997 onwards ([ISO 14679 \[1997\]](#); [NF-EN 1966 \[2009\]](#)), and extensively described and discussed during this period ([de Gouvello \[1987\]](#); [Roche et al. \[1994, 1987, 1982\]](#)). It is currently used on a relatively limited basis outside of the work I undertake at CIRIMAT ([Belei et al. \[2022\]](#); [Cotton et al. \[2001\]](#); [Divin-Mariotti \[2019\]](#); [Jensen et al. \[2000\]](#); [Lapena and Lopes \[2023\]](#); [Tomasetti et al. \[2000\]](#)).

The principle is simple: load a single interface (substrate/adhesive or paint) and cause an adhesive failure by creating a concentration of stress by making a tensioning platform (Figure 2.2 (a and b)). A characteristic Force-Deflection curve resulting from the three-point bending test is shown in Figure 2.2 (c).

The first part of the curve (① to ③) shows a force proportional to the deflection: the entire test sample is loaded and characterised by its overall rigidity (equal to the gradient of this first part of the curve). The weak scatter of this gradient is therefore characteristic of the mastery of test sample manufacture. Jean-Baptiste Sauvage also showed this scatter in a schematic graph (Figure 2.3, [Sauvage \[2016\]](#)). In a batch of test samples, plotting the force at the point of failure as a function of deflection at the point of failure makes it possible to distinguish between the scatter linked to adherence and that linked to the geometry of the test samples (mainly variations in the dimensions of the blocks).

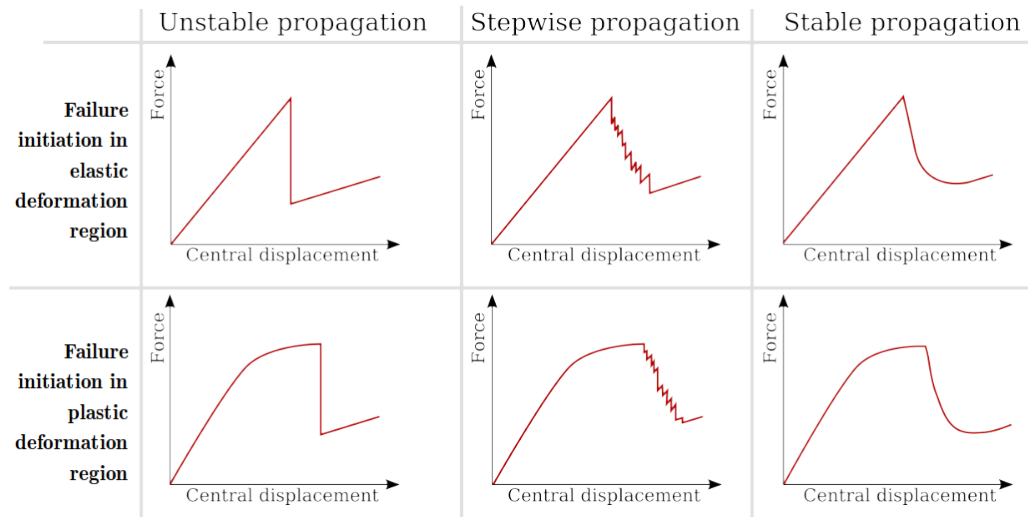

Figure 2.4: Initiation curves and possible failure propagation for test samples loaded in three-point bending.

The peak of the curve (Figure 2.2, ③ : F_R , d_R) corresponds to the appearance of the first defect of critical size, which can be described as the apparent initiation of failure: acoustic emission tests have also shown that “minor” defects appear before this critical point (Devos et al. [2001]; Rives [1999]). Nevertheless, it is the breaking force (F_R) that will be considered representative of adherence for a given substrate (thickness, Young’s modulus).

This test is therefore particularly sensitive to surface treatments and to phenomena present at the interfaces, such as the formation of interphases, which I will present further on in this dissertation. Failure initiation is followed by defect propagation (opening of the crack), which can be stable (Figure 2.2, ④), unstable, or may occur in jolts (Figure 2.4). Failure propagation by jolts can also be described as unstable semi-brittle. In the final section, the Force-Deflection curve of the complete sample ⑤ joins up with that of solely the substrate loaded in three-point bending ⑥: at this point, the block is completely detached or no longer acts as a support. Thus, in addition to the breaking force F_R characteristic of the failure initiation, it may be interesting to note the type of propagation, as shown in Figure 2.4: these three types of propagation can be observed during a failure in the elastic or plastic domains of the test sample. The study of crack propagation draws us one step closer to fracture mechanics and was part of Thiago Birro’s thesis project.

Failure initiation is characterised by the maximum force recorded on the Force-Deflection curve: it must then be checked to establish whether this can be linked to adherence by examining the failure surface and verifying that initiation occurred at the substrate/coating interface. This interface can theoretically be defined as a surface of physical or chemical bonds (strong or weak depending on the envisaged theory of adhesion) between the metal and coating. Figure 2.5 shows diagrams of samples after testing and examples of failure surfaces. This analysis applies to coated substrates (painted sheets onto which the supports are moulded) as well as to adhesives moulded directly onto their substrate: the failure surface clearly differentiates the zones of fracture initiation and propagation (Figure 2.5, diagrams (b) and (d) → micrograph (f)).

Failure initiation is deemed adhesive when it occurs at the substrate/coating or substrate/adhesive interface: on a metallic substrate, this interface can be easily identified with the naked eye by observing the metallic lustre. Figure 2.5 (g) shows a bright, almost circular characteristic initiation: it should therefore be checked to establish whether this metallic lustre actually corresponds to an adhesive failure. Figures 2.6 and 2.7 show scanning electron microscopy (SEM) images of crack initiation and propagation in coated bronze samples 3 after three-point bending testing. The images shown were taken by Claudie Josse at the Raimond Castaing microcharacterisation centre.

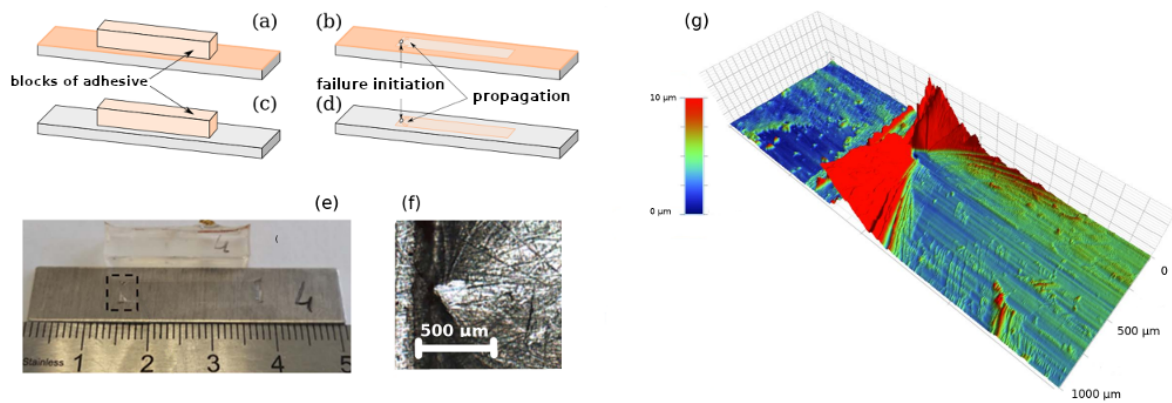

Figure 2.5: Three-point bending test samples and failure surfaces following adherence testing: coated substrate onto which a supporting block is moulded (a) → (c) after testing, adhesive directly moulded onto its substrate (b) → (d) after testing, and sample of DGEBA-TETA adhesive on 2024 aluminium alloy following three-point bending testing shown in a macroscopic photo (e), microscopic photo (f) and mechanical profilometer image (g), adapted from Genty [2018].

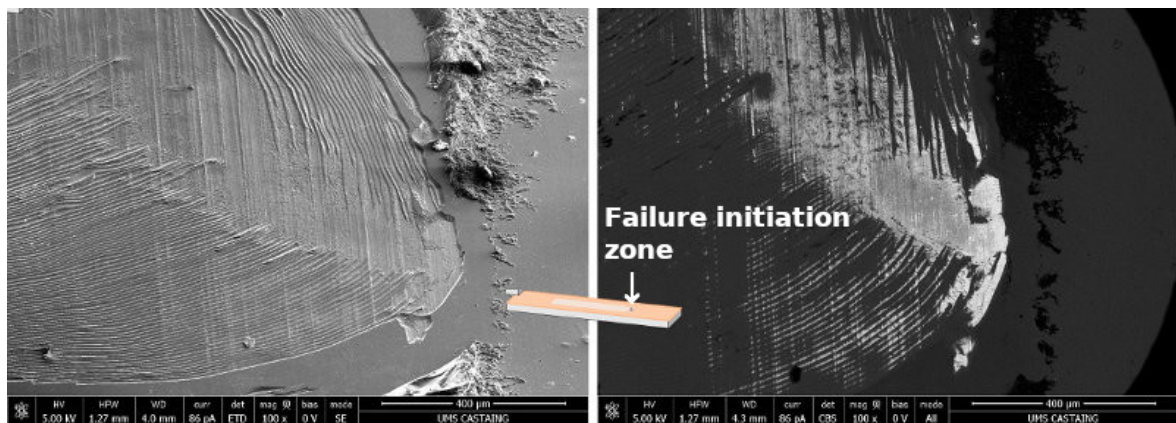

Figure 2.6: SEM images (secondary electrons on the left and backscattered electrons on the right) of silane-coated (or (3-mercaptopropyl)trimethoxysilane) Cu-6Sn bronze substrate (CW452K), unaged, following failure during the three-point bending test, adapted from Aufray et al. [2019].

The micrographs in Figure 2.6 clearly show an oblong failure initiation zone, followed by a wide failure propagation zone typical of an unstable stick-slip regime: this failure propagation surface can be linked to the propagation observed on the Force-Deflection curve during bending. It is typically observed in brittle polymers in volume (Zhang and Spinks [1997]). We would expect to see a jolting failure on the Force-Deflection curve, but this was not the case in this sample: the fracture was unstable (macroscopically, the jolts were likely present, but too fast to be detected).

It is interesting to see in this same figure that the backscattered electron mode image (chemical contrast) clearly shows a variation in contrast at the point of failure initiation, suggesting that this initiation occurs as close as possible to the metal/coating interface. Figure 2.7 confirms this hypothesis: a SEM analysis combined with a focused ion probe (FIB) was used in the failure initiation zone to observe a cross-section of the three-point bending sample following the test and in the failure initiation zone. The FIB cross-section clearly shows the bronze alloy grains, the 3.6 µm-thick Incralac® coating (dark layer to the right of the failure initiation zone), and the remains of the supporting block in the same area. In the failure initiation zone itself, a thin residual layer of Incralac coating can be seen: it was measured at several points and its thickness is around 50 nm.

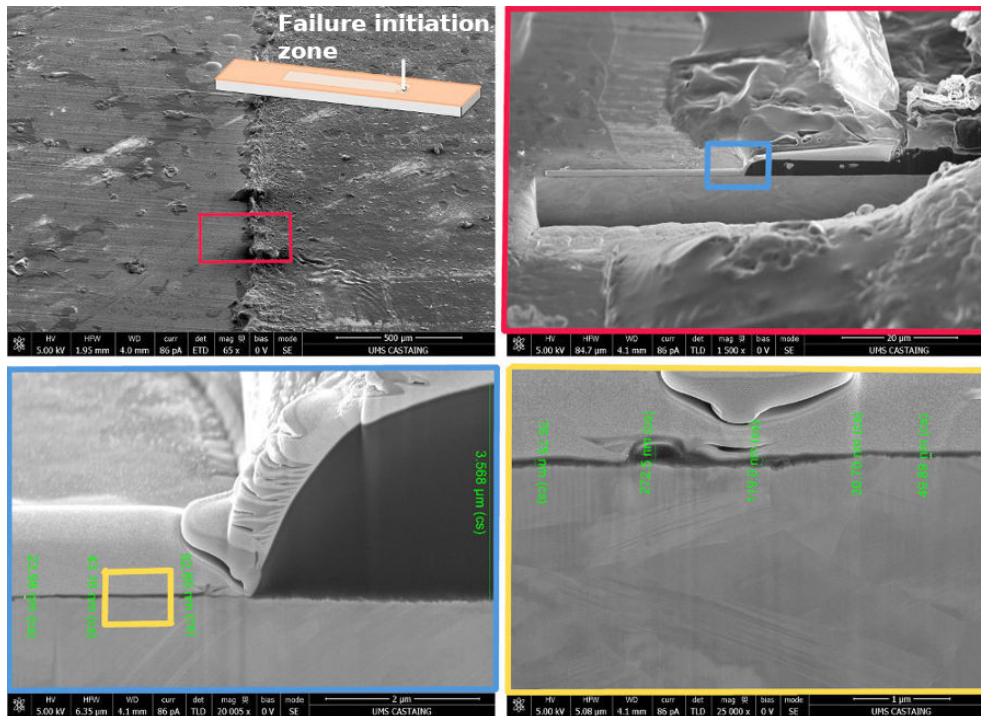

Figure 2.7: SEM images and localised FIB cross-section of a Cu-6Sn bronze substrate (CW452K) coated with Incralac® after 28 days of ageing by means of immersion in a synthetic acid rain solution, and after failure during the three-point bending test, adapted from [Aufroy et al. \[2019\]](#).

Failure initiation therefore does not always occur at the metal (or metal oxide)/coating bond as discussed in the previous chapter, but the thickness of this residual layer of coating is the same as the roughness of the substrate: the failure is therefore considered to be adhesive with an adhesive residue < 100 nm, in accordance with the definition given above. It also allows not only the chemical theory of adhesion, but also the mechanical theory, to be taken into account. Examination of macrographs of a large number of samples shows that the larger the failure initiation zone (round or oblong), the lower the breaking force ([Birro et al. \[2021\]](#); [Sauvage \[2016\]](#)).

The two borderline cases also seem logical: when adherence is very weak, the breaking force measured during three-point bending will be low and the initiation and propagation of the failure underneath the block will not be discernible. Conversely, if adherence is greater than the cohesion of the coating or adhesive, the failure initiation during the three-point bending test will not occur at the substrate/coating interface, but within the coating or adhesive. One can then study the intermediate cases by plotting the breaking forces of a large number of samples as a function of the failure initiation area (Figures [2.8](#) and [2.9](#)).

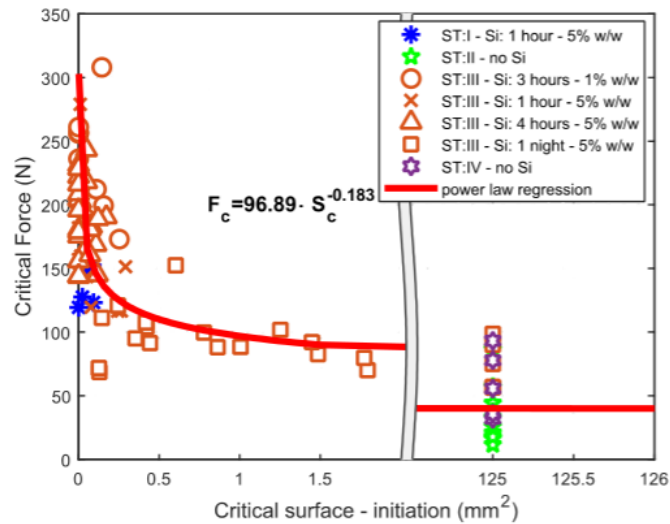

Figure 2.8: Breaking force of a DGEBA-DETA adhesive applied to aluminium alloy 2024 (thickness 1.08 mm) after various surface treatments, as a function of the failure initiation area, taken from Birro [2021]; Birro et al. [2021].

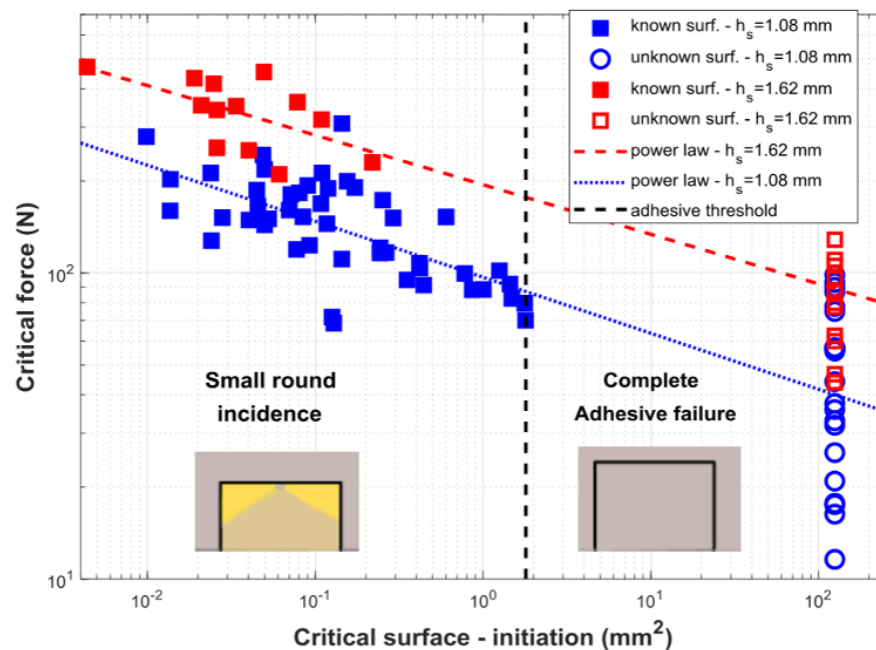

Figure 2.9: Breaking force of a DGEBA-DETA adhesive applied to aluminium alloy 2024 after various surface treatments, as a function of the failure initiation area, using a logarithmic scale, taken from Birro [2021]; Birro et al. [2021].

Simply observing the failure initiation could then allow adherence to be assessed without the use of other equipment. Experience has shown that when using metallic substrates, studying the failure surface by eye (or under a binocular magnifier), by observing the substrate's metallic lustre, is a very reliable way of identifying the initiation of an adhesive failure. EDX mapping, XPS, mechanical profilometers and infrared microscopes do not provide any more reliable information: these techniques are either too sensitive and "see" the few tens of nanometres of coating present in the roughness of the substrate, or they are not sensitive enough and cannot differentiate between failure initiation (and the circles or ovals associated with this initiation) and propagation. To go a step further, only FIB-SEM and some interferometric microscopes can be used to characterise the residual layers of coating following a three-point bending test.

The three-point bending test is a failure initiation and propagation test, but only the initiation has really been studied and explored thus far. This initiation can be located on the sample and is almost always adhesive: the reliability of the test and its effectiveness must now be assessed (Genty [2018]; Genty et al. [2017]). The three-point bending test was therefore compared with two other standardised adherence tests: the shear test in a single-lap joint (Standard NF-EN 2243-1 [2006]), and the pull-off or bonded stud test (Standard ASTM D 4541-17 [2017]). These three tests are shown in Figure 2.1. All three tests allow the forces or resistances specific to the failure initiation to be measured. Firstly, a DGEBA-TETA on 2024-T3 aluminium alloy model system was chosen: the model is representative of industrial adhesives (DGEBA and TETA are the main components of many epoxy adhesives) and allows for total control over the chemistry involved. A statistical study was then carried out on 108 samples per adhesion test, divided into 9 combinations of surface treatment and application of adhesion primer (Figures 2.10, 2.11 and 2.12). The three adherence tests show the same trends and classify the surface treatment and primer combinations in the same way. Nevertheless, the ratio of the breaking force of the best system to that of the worst varies significantly from one test to another: the pull-off test in particular is not very discriminating, as this ratio is around 2 to 5 for the three-point bending and shear tests. The experimental curves and failure surfaces show brittle failures. A Weibull analysis allowed the reliability of the adherence tests to be studied by comparing the Weibull moduli (Table 2.1), considering that the initiation of these failures is governed by the presence of a critical defect at the interface (Bergman [1984]). It can then be seen that three-point bending generally has the highest Weibull modulus. Furthermore, analysis of the values in this table shows that an effective surface treatment (e.g. $\text{HNO}_3 + \text{Sol} - \text{gel}$) not only increases the force at the point of failure (i.e. adherence), but also increases the Weibull modulus (i.e. reduces the scatter of the results, and therefore increases the reliability of the treatment). This result was confirmed during the series of tests set out in Table 2.2. In this study, the surface treatment (confidential) increased adherence by more than 25% (93 to 119 N), but also reduced the standard deviation of the series of measurements from 15 to 5%.

To explain the reliability of the three-point bending test with respect to the other adherence tests, a principal component analysis (PCA) was carried out on the 9 systems mentioned above (Genty et al. [2017]). The principal components calculated for each adherence test show, for this DGEBA-TETA on 2024 aluminium alloy system, a strong correlation between the single-lap shear and three-point bending tests, both of which are highly decorrelated from the pull-off test (bonded stud): a principal component would then be adherence (linked to the first two tests), while the pull-off test would mainly measure the cohesion of the adhesive. These statistical results and the associated conclusion are supported by the study of the failure surfaces: adhesive for the three-point bending and single-lap joint tests, and mixed (i.e. indeterminately adhesive or cohesive) for the pull-off test.

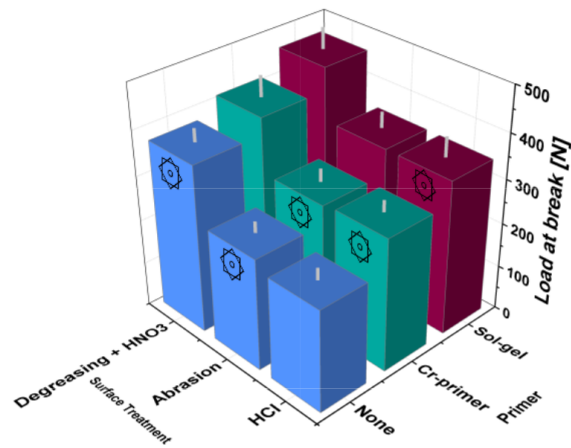

Figure 2.10: Adherence measured during the **pull-off test**: Al 2024 substrate, DGEBA-TETA adhesive, and a combination of 3 primers and 3 surface treatments. Most failures are mixed, adhesive or cohesive depending on the zone, taken from [Genty et al. \[2017\]](#).

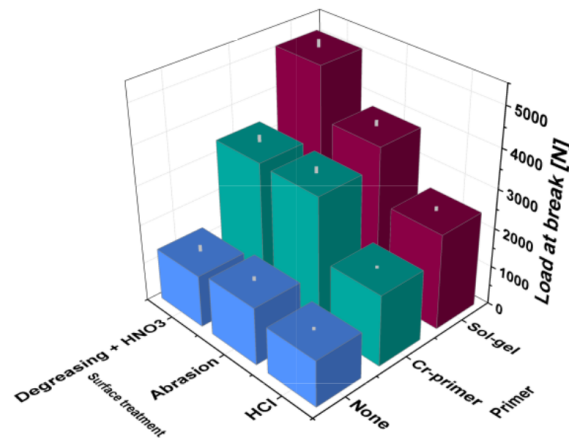

Figure 2.11: Adherence measured during the **single-lap joint test**: Al 2024 substrate, DGEBA-TETA adhesive, and a combination of 3 primers and 3 surface treatments. All failures are interfacial (adhesive), taken from [Genty et al. \[2017\]](#).

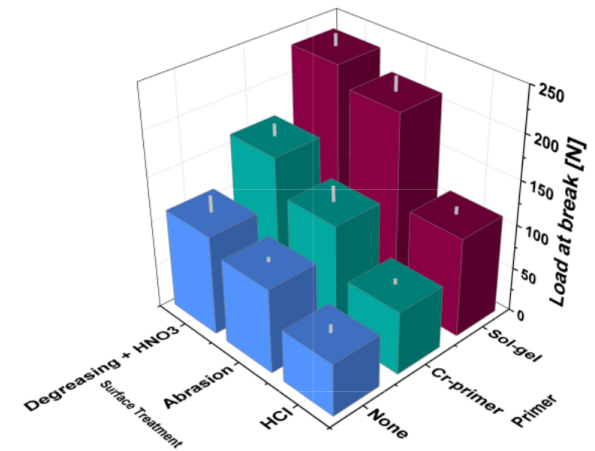

Figure 2.12: Adherence measured during the **three-point bending test**: Al 2024 substrate, DGEBA-TETA adhesive, and a combination of 3 primers and 3 surface treatments. All failures are interfacial (adhesive), taken from [Genty et al. \[2017\]](#).

Table 2.1: Weibull moduli for the 9 surface treatment and primer conditions, for the 3 adherence tests studied (Al 2024 substrate, DGEBA-TETA adhesive), taken from Genty et al. [2017].

| Surface treatment | HCl | | | Abrasion | | | Degreasing/HNO ₃ | | |
|---------------------|-----|-----------|---------|----------|-----------|---------|-----------------------------|-----------|---------|
| | ∅ | Cr-primer | sol-gel | ∅ | Cr-primer | sol-gel | ∅ | Cr-primer | sol-gel |
| Pull-off | 4.0 | 6.5 | 8.6 | 5.9 | 5.8 | 5.6 | 7.4 | 8.4 | 8.2 |
| SLJ | 4.4 | 5.5 | 8.8 | 6.0 | 5.9 | 6.9 | 2.3 | 4.9 | 8.0 |
| Three-Point Bending | 4.4 | 5.8 | 11.4 | 8.4 | 9.4 | 9.5 | 4.1 | 6.7 | 9.9 |

Table 2.2: Influence of surface treatment on adherence measured using the three-point bending test (averages over 8 samples, ISO standard 14679), confidential substrate/surface treatment, araldite adhesive.

| | Without surface treatment | Optimised surface treatment |
|------------------------|---------------------------|-----------------------------|
| Breaking Force [N] | 93 | 119 |
| Standard deviation [N] | 14 | 6 |

A final study of the reliability of the adherence tests was carried out using the same protocol and the same primer/surface treatment pairs, but replacing the DGEBA-TETA adhesive model with a commercial epoxy adhesive (Hysol EA 9334), which is known as a “structural” adhesive (*i.e.* an adhesive that aids the transfer of forces and helps to make the assembly stronger by providing a high level of cohesion and adherence, and therefore ensure an assembly strength generally greater than 20 MPa, although this value has no real meaning without an associated standard). Figures 2.13, 2.14 and 2.15 show the results obtained during the three adherence tests for a Hysol EA 9334 adhesive/Al 2024 alloy substrate system. Comparing these results with the previous breaking forces measured using a model system (Figures 2.10, 2.11 and 2.12), shows that they are much higher, in line with the “structural” nature of the commercial adhesive, as mentioned by the manufacturer. If one compares the three adherence tests, only the three-point bending test shows adhesive failure initiation. The pull-off test does not allow for any distinction to be made between the levels of effectiveness of the surface treatments and assesses the cohesion of the adhesive, with identical breaking forces regardless of the primer/surface treatment pair. Finally, the shear test is not very discriminating, despite all failure surfaces being cohesive. In conclusion, the pull-off test remains a method of choice for examining a large number of substrate/surface treatment/adhesive systems due to how simple it is to carry out, but it is not very discriminating. The shear test offers a good compromise and provides a relatively discriminating means of classifying adherence for non-critical systems. Its main advantage is that it is widely used and there is therefore a large database of results. Lastly, the three-point bending test is the most discriminating and reliable for measuring adherence, but this measurement is relative, as it depends in particular on the thickness and rigidity of the substrate used.

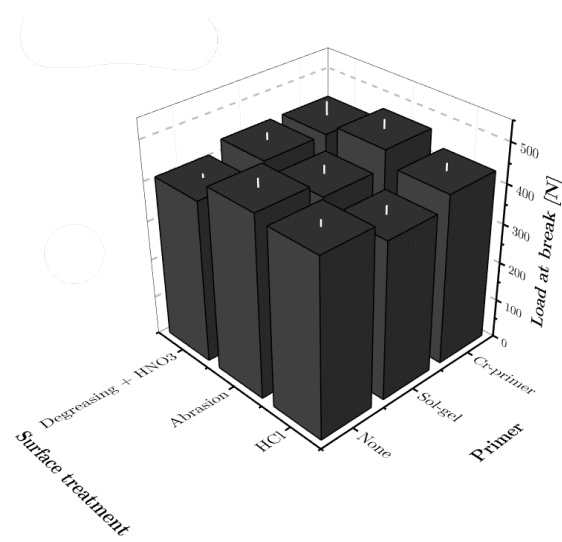

Figure 2.13: Adherence measured during the **pull-off test**: Al 2024 substrate, Hysol EA 9334 adhesive, and a combination of 3 primers and 3 surface treatments. All failures are cohesive (in the adhesive).

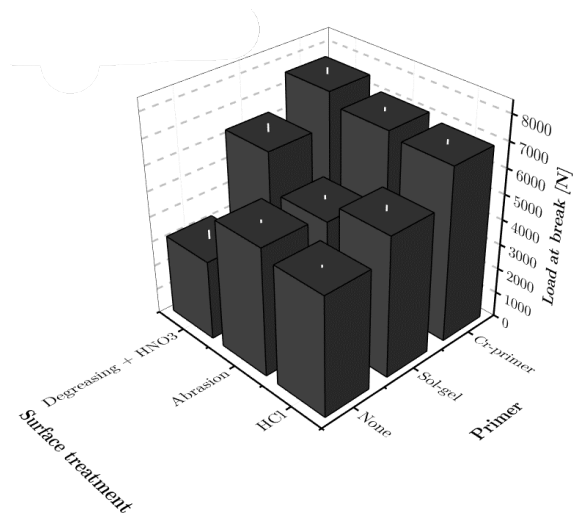

Figure 2.14: Adherence measured during the **single-lap joint test**: Al 2024 substrate, Hysol EA 9334 adhesive, and a combination of 3 primers and 3 surface treatments. All failures are cohesive (in the adhesive).

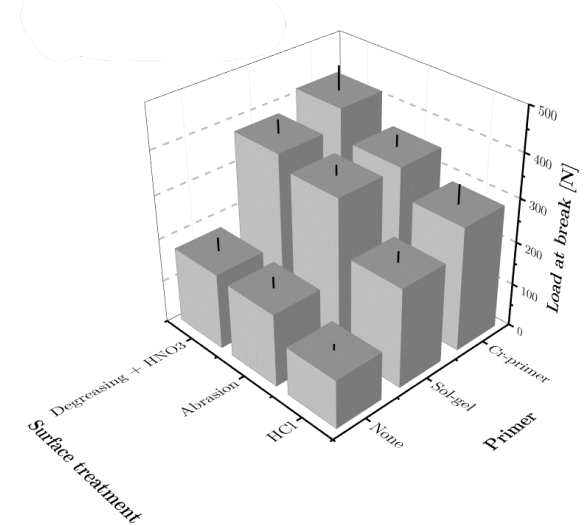

Figure 2.15: Adherence measured during the **three-point bending test**: Al 2024 substrate, Hysol EA 9334 adhesive, and a combination of 3 primers and 3 surface treatments. All failures are interfacial (adhesive).

2.1.2 Analytical assessment of adherence

Assessing “intrinsic” adherence, *i.e.* independent of the substrate’s thickness or modulus, is becoming a critical issue. In this section, the results of several macroscopic adhesive failure criteria will be presented using analytical resolution methods. In 1994, Roche et al. [1994] proposed calculating the area W below the Force-Deflection curve of the three-point bending sample according to ISO standard 14679 (Figure 2.16) and identifying this parameter W as the failure initiation energy. At this point, it should be noted that ISO standard 14679 three-point bending samples are multi-materials comprising two bending objects. In these studies, Roche et al. [1994] present the forces and deflections at break (F_b and d_b , Figure 2.16), the slope of the curve ($F/d \approx F_b/d_b$ in this case, as the failure occurs in the elastic deformation zone of the substrate), and the difference at failure between the area of the curve of the sample and that of the substrate alone (dotted line ⑥) using the following equation:

$$W = \frac{(F_b - F_s) \cdot d_b}{2} \quad (2.1)$$

The substrate thickness varies between 0.8 and 3.2 mm, the force and deflection at failure vary between 125 N $\pm 6\%$ and 1378 N $\pm 6\%$ and between 0.52 mm $\pm 10\%$ and 0.56 mm $\pm 12\%$ respectively. Finally, the W parameter varies between 26 mJ $\pm 15\%$ and 47 mJ $\pm 8\%$. It was expected that the breaking force would be highly dependent on the substrate thickness (as would the overall rigidity of the sample F/d). The article by Roche et al. [1994] indicates that the deflection at failure d_b and the parameter W are almost independent of the substrate thickness. It seems that this conclusion needs to be moderated, particularly for the parameter W , which almost doubles. Furthermore, the thickness of the block (as shown in Figure 2.2 (a)) was modulated from 2.4 mm to 5.6 mm, leading to non-monotonic breaking forces of 163 N $\pm 15\%$ to 140 N $\pm 15\%$ (passing through a maximum of 176 N $\pm 7\%$ and a minimum of 130 N $\pm 16\%$), breaking deflections of 1,87 mm $\pm 36\%$ to 0,43 mm $\pm 17\%$, and W parameters of 156 mJ $\pm 53\%$ to 29 mJ $\pm 29\%$. This second series of tests clearly shows that no failure parameter is truly independent of block thickness, even though the breaking force is the parameter that is least affected.

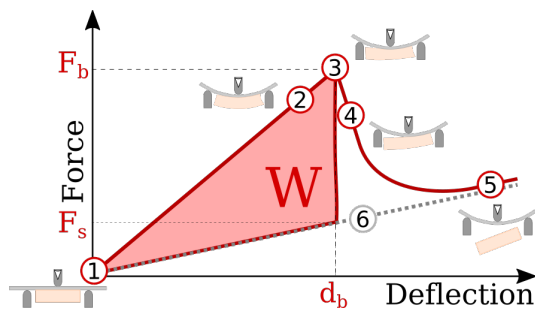

Figure 2.16: Assessment of adhesive failure energy according to the definition of Roche et al. [1994].

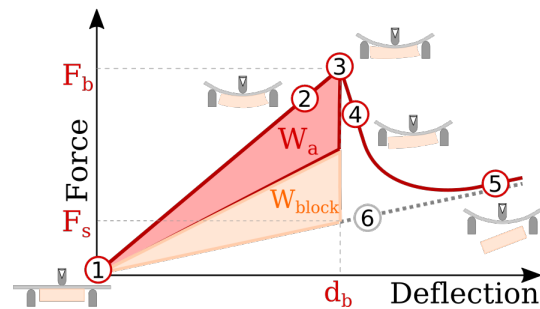

Figure 2.17: Assessment of adhesive failure energy according to the definition of Sauvage et al. [2017].

To take into account the bending of the two objects comprising the three-point bending sample (*i.e.* the substrate and the adhesive block), Sauvage et al. [2017] then proposed separating the objects and adding a component to the energy W presented in Figure 2.16: the elastic deformation energy of the block during the test W_{block} , shown in Figure 2.17.

It should be possible to write:

$$W = W_{adh} + W_{block} \quad (2.2)$$

$$W_{block} = \frac{1}{2} \cdot \frac{48 \cdot d^2 \cdot E_{block} \cdot a_{block} \cdot t_{block}^3}{12 \cdot L^3} = \frac{1}{2} \cdot \frac{48 \cdot d^2 \cdot E_{block} \cdot I_{block}}{L^3} \quad (2.3)$$

with d = breaking deflection, E_{block} = block modulus, a_{block} = block width, t_{block} = block thickness, L = span length, and I_{block} = block second moment of area.

In this study, the breaking force was significantly dependent on the thickness of the substrate, while the W_{adh} energy appeared to be independent of this parameter, subject to measurement errors. After considering these two approaches, neither seemed to meet the desired criterion: the determination of failure initiation energy independent of the substrate's thickness and modulus. The approach of Roche et al. [1994] seemed acceptable from a mechanical standpoint, but the experimental results show that the assumptions are probably incorrect: the area below the Force-Deflection curve (W) is not independent of the thickness of the substrate used. On the other hand, the approach of Sauvage et al. [2017] resulted in acceptable experimental outcomes, but the W_{block} energy is in fact the energy required to break the interface.

Even if the energetic approach developed in these studies seems unsatisfactory, the assessment favouring certain types of samples holds true. It was in fact noted that series of samples with a considerably thick substrate (3 mm for aluminium alloy 2024, for instance) showed a strong breaking force scatter. This can be easily explained by observing that the relative proportion of substrate deformation energy $W_{substrate}$ increases drastically as its thickness increases (the rigidity of the substrate alone F_s/d_b is close to the overall rigidity of the sample F_b/d_b). It is therefore recommended to use substrates that are as thin as possible while remaining within their elastic deformation range during the three-point bending test. It should be noted that there is currently no satisfactory analytical approach, probably because those mentioned correspond to global criteria (in terms of force, stress and energy), while the failure initiation studied during three-point bending is localised (area of 10^{-2} to 2 mm^2).

A local approach such as calculating the elastic energy restitution rate could remove this obstacle: this is the strategy adopted by Balladon [1993] in an internal IRSID report (formerly Arcelor-Mittal), which seems to show the possibility of overcoming sample parameters by calculating G_c to obtain an intrinsic measurement of adherence. Other authors have approached the problem by assessing G_c (Bosma and Oosterbroek [1994]; Bouchet [2000]; Bouchet et al. [2001b, 2002]). However, this calculation requires two prerequisites: larger samples that allow for the application of beam theory (among other things, the sample's radius of curvature at the point of initiation must be large in relation to its dimensions) and the use of digital resolution tools. Finally, an equivalent approach was taken by Bosma and Oosterbroek [1994], with the test in this case being called DCAT, which stands for "double cantilever adhesion test": here, beam theory was respected by using less rigid polymer substrates for samples with dimensions relatively close to those of ISO standard 14679.

2.1.3 Modelling

Using the three-point bending test to predict the failure of a bonded assembly would therefore require an analysis on a smaller scale than that typically used (F_{max} value). Figure 2.18 provides an overview of the mechanics applied to adherence problematics: it shows in particular the values measured at the different levels. As the digital work was at the limit of my capabilities, a strong partnership with the ICA's "Assembly" axis was initiated in 2017: this is the "TACCOS" initiative, presented in Figure 2.19. This initiative aims to investigate issues addressed by structural bonding technology, relying on Chemistry and Mechanics, and to promote academic and industrial partnerships. This collaboration allows adherence problematics to be studied in a comprehensive

manner: from the chemistry of adhesives to the modelling of bonded assemblies, to the physical chemistry of polymers and mechanics. Our complementary competencies in these interdisciplinary fields have allowed us to co-supervise two theses and offer ongoing training in structural assemblies (training at senior technician – engineer level).

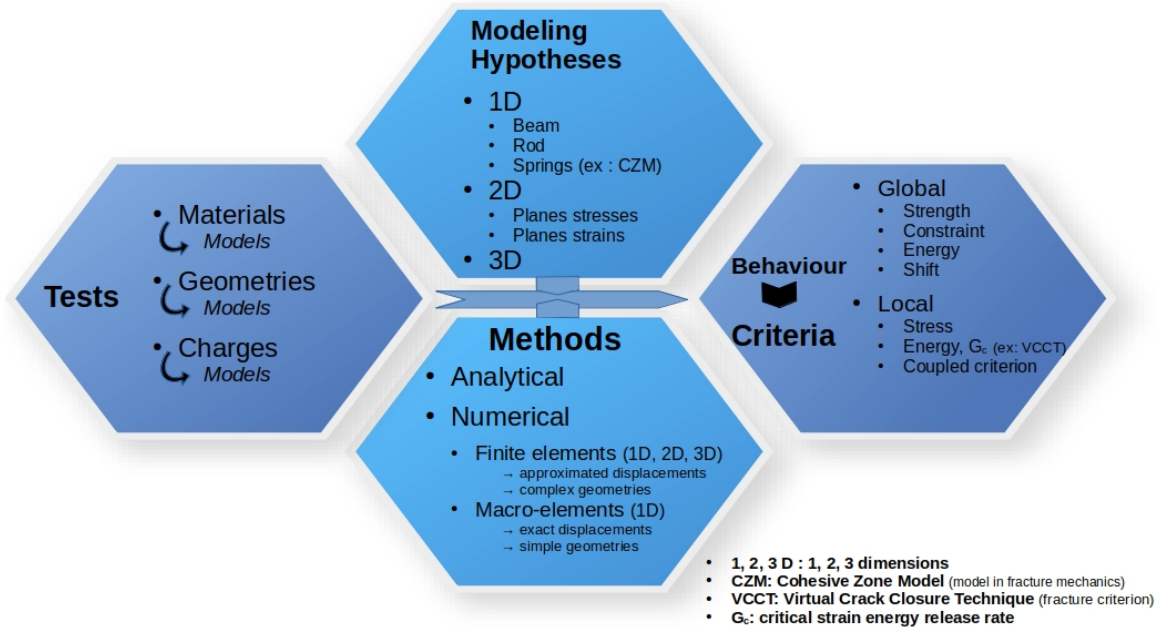

Figure 2.18: Overview of the mechanics applied to adherence problematics.

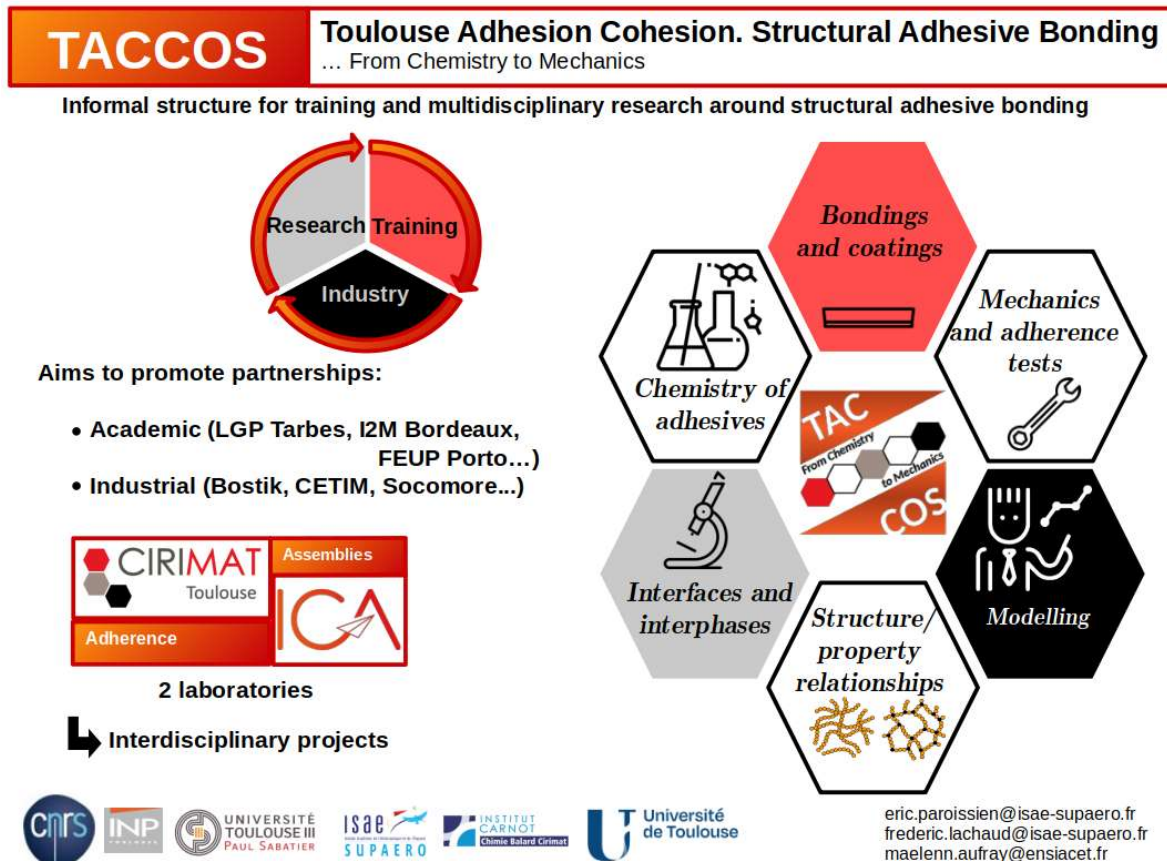

Figure 2.19: Initiative: Toulouse Adhesion Cohesion, Structural Adhesive Bonding.

Although the transition from analytical to digital resolution via semi-analytical methods is not fundamentally linked to the change of scale, there is an indirect link. Analytical equations can only be solved in simple cases corresponding to general criteria. Even more interestingly, it is possible to couple the criteria: Thiago Birro's thesis was centred around this approach (Birro et al. [2020] and Birro [2021]). During this project, the breaking force measured during the three-point bending test was used to determine a stress criterion, while the initiation surface was used to determine an energy criterion: this approach couples the energy and stress criteria to determine a more reliable failure criterion. The method used was developed based on macro-elements: it enabled failure stresses and energies that were independent of substrate thickness to be determined (Figure 2.20). It is therefore possible to transfer an experimental response from one system to another, which is the first step towards predicting the initiation of failure. However, these digital tools are still undergoing development, particularly due to the need to measure the “small circle” and therefore its appearance. Calculations that allow the energy release rate and critical stress to be plotted, which indicate the zone without distinguishing between failure initiation and propagation (and which lead to stable propagation), are therefore no more than an extrapolation of the coupled criterion calculation (Figure 2.20). These digital tools, which will eventually make it possible to model a bonded joint, have been described in greater detail in Éric Paroissien's Habilitation Thesis (Paroissien [2020]).

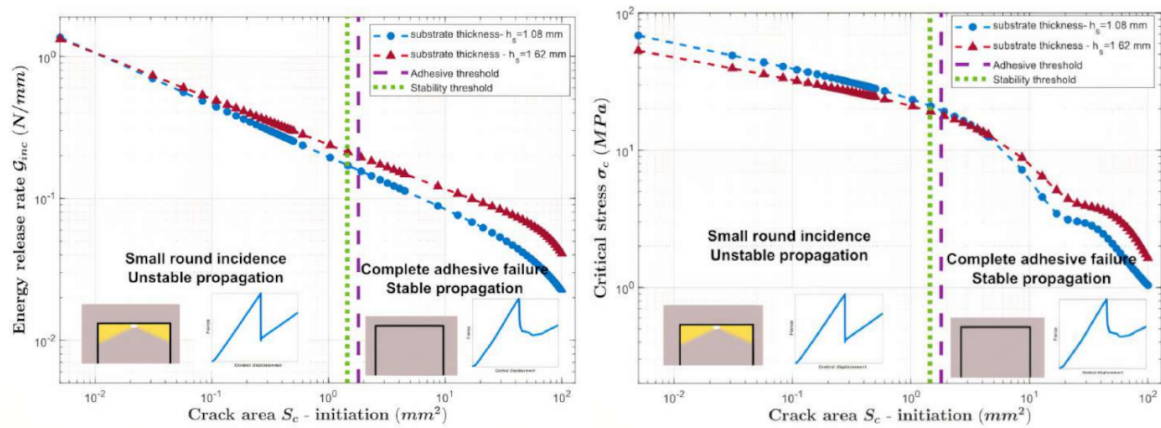

Figure 2.20: Variations in energy release rate (left) and critical stress (right) as a function of the critical zone at failure initiation – calculated using a coupled criterion, taken from Birro [2021].

As well as providing an answer to the issues of predicting the failure of bonded assemblies, these digital tools have also brought about a better experimental understanding of the three-point bending test and the development of increasingly reliable adherence tests. [Sauvage \[2016\]](#); [Sauvage et al. \[2019\]](#) did indeed study the different stress tensor components at the level of the supporting block. The normal stress at the interface was similar, regardless of the substrate thickness. The other stresses or stress compositions (such as the von Mises stress) were not concentrated in the initiation zone or had profiles that were dependent on the substrate thickness. Therefore, even if the loading mode is mixed, mode I is predominant. This confirms the conclusions of [Bouchet \[2000\]](#); [Bouchet et al. \[2001b\]](#) on the standard test ISO ISO 14679 [1997], as well as those of [Benson \[1967\]](#) who gives different examples of adherence tests in Figure 23.23 under the title “bending peel tests” or peel tests (mode I) during flexural loading. The three-point bending test is presented under the title “EMPA Versuch für Biegeschälfestigkeit”, or literally: “bending peel test” by Swiss laboratory EMPA. In this figure, the sample dimensions are very close to those used in standard ISO ISO 14679 [1997].

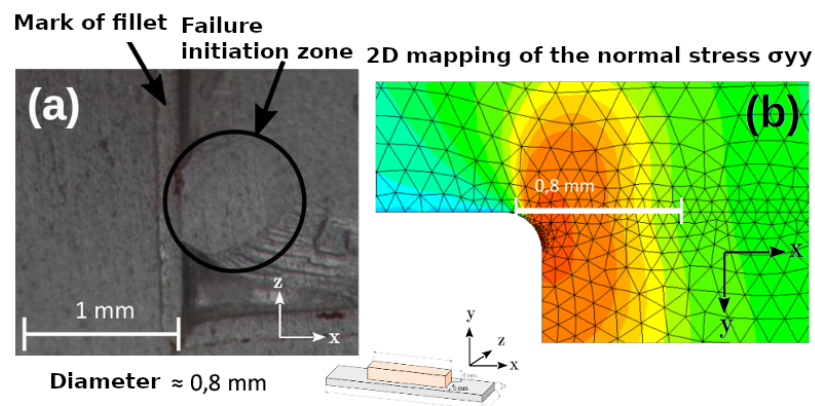

Figure 2.21: Optical microscopy image (a) and mapping of the normal stress σ_{yy} at the interface modelled by finite elements, 2D plane stresses (b), taken from [Sauvage \[2016\]](#) and [Sauvage et al. \[2019\]](#).

Furthermore, it was shown that the size of the experimentally measured crack initiation disc was the same as that of the normal stress concentration zone measured at the level of the supporting block following finite element analysis of the test for equivalent loads (Figure 2.21).

Finally, [Sauvage et al. \[2019\]](#) showed that the slight longitudinal uncertainty in the positioning of the sample (0.5 mm) had no significant impact on the distribution of stress at the interface. However, it is important to take into account the fillet of the supporting block in the modelling in order to guard against the effects linked to the geometric singularity at the level of the support, which artificially increase the stresses obtained at the singularity. This fillet was therefore measured using optical microscopy and SEM images and incorporated into the finite element models (Figure 2.21).

As mentioned in the introduction, measuring adherence requires knowledge of the interface between two materials. Before presenting the polymer/metal chemical interactions and reactions that can occur at interfaces, the following section will focus on the polymerisation reactions that will compete with the polymer/metal reaction.

2.2 Chemistry of epoxide-amine systems

2.2.1 Definitions, history and applications

Polyurethanes are used in the majority of structural adhesives and coatings, but polyepoxies are also widely used, with these coming in second place (Petrie [2005]; Sonnenschein [2015]).

Epoxide-amine systems are the most commonly used systems in the presented studies. The amines used in these studies all have a functionality strictly greater than two, meaning that the polymers formed are thermosetting.

The word *epoxide* is derived from the Greek prefix “*ep*” meaning “*on, above or around*” and “*oxy*”, a contracted form of “*oxygen*”. Epoxide is initially a chemical group comprising 2 carbon atoms and one oxygen atom, which form a ring of three atoms: this group is also called “*oxirane*”. The term epoxide is often shortened to “*epoxy*”. In this document, the term epoxide will be used to describe molecules with epoxide groups (monomers, oligomers also known as “*resins*”) while the terms epoxy and polyepoxy will refer to the thermoset polymer. It should also be noted that the term “*resin*” is defined by IUPAC [1997] as a viscous substance containing prepolymers with reactive groups that, following chemical reaction, form a thermoset polymer. One can then speak of “*epoxy resin*”, but the use of this term to refer to the final polymer is strongly discouraged by IUPAC [1997]; Pham and Marks [2004]. These definitions contradict the widespread definition of the term resin, which includes “*monomers that form a thermoplastic and a thermoset*”, but also “*thermoplastic and thermosetting polymer*”, as mentioned in standard NF-EN 923 [2016]: “*this term is used to refer to any polymer that is basic material for plastics*”. As this new definition leads to confusion, the IUPAC definition is widely preferred. Epoxides were first synthesised at the end of the 19th century, but it was in the 1930s that the first patent was filed by Farbenindustrie [1938] which described the preparation of epoxide monomers derived from bisphenol A and epichlorohydrin, which then react with amines (Mark [2003]).

These epoxide monomers were not commercialised until the 1940s, when US patents were filed (Ciba-Geigy [1943]; DeVoe & Reynolds [1948]). The global market grew rapidly in the 1970s and 1980s, accounting for more than one million tonnes in 2000, i.e. more than three million tonnes of formulated products (Lee and Neville [1982]). Epoxide monomers derived from renewable resources are still relatively seldom used, but can form part of a more sustainable approach, provided that the approach involves a life cycle analysis (Pascault and Williams [2010]). Finally, most polyepoxies are thermosets, which by definition cannot be mechanically recycled. However, chemical recycling systems are currently being developed: once again, these processes must involve life cycle analyses so that the appropriateness of these new recovery methods can be validated. Polyepoxies are a class of polymers with a wide range of applications: primers, paints and coatings, adhesives and composite matrices, in practically every area of application (electronics, packaging, energy, transport, construction, sport and leisure, etc.). This class of materials is still undergoing extensive development and promises a wide range of current and future applications (Shundo et al. [2022]). This diversity stems from the interesting properties of thermosets in general and polyepoxies in particular, as summarised in Table 2.3.

2.2.2 Polymerisation reaction

Polymerisation reactions are divided into several categories: in the course of his work at Du Pont (1929-1938), Wallace Carothers divided polymerisation reactions into polyaddition and polycondensation reactions (Coleman and Painter [2005]), while Paul Flory classified polymerisation into chain or step-growth reactions (Flory [1953]). Although epoxide monomers can react with many monomers (mainly amines, anhydrides and amides), the remainder of this document will focus on the use of amines as hardeners, which are mainly used in industry (Petrie [2005]). The polymerisation reaction between epoxide groups and amine groups is a polyaddition step-growth reaction, as described by Pascault et al. [2002] and shown in Figure 2.22.

Table 2.3: Main characteristics of thermosets in their rubbery and glassy states, from Pascault et al. [2002].

| Property | Glass | Rubber |
|---|---|---|
| Thermodynamic equilibrium | No | Yes |
| Molecular mobility | Local | Cooperative |
| Influence of crosslink density <small>on properties</small> | Low | High |
| Temperature effect <small>on properties</small> | Arrhenius law | WLF equation |
| Apparent activation energy | $\leq 150 \text{ kJ.mol}^{-1}$ | $\geq 500 \text{ kJ.mol}^{-1}$ |
| Expansion coefficient | $1.5 \cdot 10^{-4}$ to $3.5 \cdot 10^{-4} \text{ K}^{-1}$ | $4 \cdot 10^{-4}$ to $8 \cdot 10^{-4} \text{ K}^{-1}$ |
| Heat capacity | 1 to $1.6 \text{ kJ.kg}^{-1} \cdot \text{K}^{-1}$ | 1.6 to $2.2 \text{ kJ.kg}^{-1} \cdot \text{K}^{-1}$ |
| Young's modulus | 1 to 5 GPa | 10^{-3} to 10^{-1} GPa |
| Poisson's ratio | 0.30 to 0.46 | 0.49 to 0.50 |

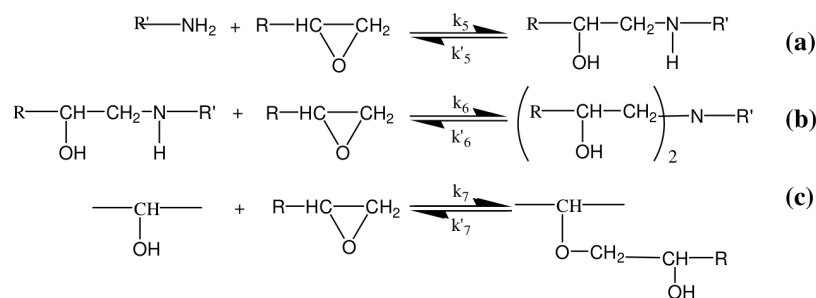

Figure 2.22: Reaction mechanisms of epoxide-amine reactions.

The nitrogen pair of the primary amine reacts by means of nucleophilic attack on the least hindered carbon of the epoxide ring, which will open up, resulting in the simultaneous formation of an amino alcohol (reaction (a)): the secondary amine can then react in turn with another epoxide group to form a tertiary amine (reaction (b)). The two reactions (a) and (b) have different rate constants (k_5 and k_6). Usually, they are complete in the forward direction (rate k), when the number of epoxide groups is less than or equal to the number of hydrogens in the amine groups. Finally, the reaction (c) between an alcohol and an epoxide group only occurs when there is an excess of epoxide or by means of catalysis *via* hydroxyl groups (present in water, alcohols, acids, etc.). The reactivity of amines increases as they become more nucleophilic in nature in the following order: aliphatic amines > cycloaliphatic amines > aromatic amines. In aliphatic amines, primary and secondary amines are equally (or almost equally) reactive. However, in aromatic amines, primary amines are generally two to five times more reactive than secondary amines (Pascault et al. [2002]).

In the polymerisation reaction, the stoichiometric ratio is determined using:

$$r = \frac{n_{\text{amino-hydrogen}}}{n_{\text{epoxide}}} \quad (2.4)$$

Using stoichiometry, the mass of amine added to 100 g of epoxide prepolymer (*phr* for Parts per Hundred Resin) will be calculated as follows:

$$phr = \frac{\text{AHEW} \times 100}{\text{EEW}}, \quad (2.5)$$

with AHEW (Amine Hydrogen Equivalent Weight) being the equivalent mass of one mole of amine hydrogen in *g/eq* and EEW (Epoxy Equivalent Weight) being the equivalent mass of one mole of epoxide group in *g/eq*, i.e.:

$$\text{EEW} = \frac{M_{\text{epoxide}}}{f_e}, \quad (2.6)$$

and

$$\text{AHEW} = \frac{M_{\text{amine}}}{f_a}, \quad (2.7)$$

with $M_{epoxide}$ and M_{amine} being the molar masses of the epoxide and amine monomers respectively, in $\text{g}\cdot\text{mol}^{-1}$ and f_e, f_a being the functionalities of the epoxide and amine monomers.

Some industrial epoxides are not composed solely of monomers, but of a mixture of monomers and dimers (or more): in the above formula, the $M_{epoxide}$ molar mass is then replaced by the average molar mass \overline{M}_n . Polymerisation can be monitored in several ways, classically by Fourier transform infrared spectroscopy (FTIR) or differential scanning calorimetry (DSC). Near- or mid-infrared spectroscopy can be used to monitor the conversion rate directly, by quantifying the epoxide ($\alpha_{\text{PIR or MIR, e}}$) or amine ($\alpha_{\text{PIR or MIR, a}}$) groups that remain in the medium using the generic equation:

$$\alpha_{\text{PIR ou MIR, e ou a}}(t) = 1 - \frac{\frac{A_{e \text{ ou } a}^t}{A_{ref}^t}}{\frac{A_{e \text{ ou } a}^0}{A_{ref}^0}}, \quad (2.8)$$

with A_e, A_a and A_{ref} , being the areas of the epoxide, amine and reference peaks at the start (A^0) and t (A^t) respectively.

As for DSC, according to standard [NF-EN-ISO 11357-5 \[2014\]](#), it allows the conversion rate α to be monitored indirectly in isothermal mode by integrating the heat flux between the reaction start time ($t = 0$) and time t based on the equation:

$$\alpha_{\text{DSC-isothermal}}(t) = \frac{1}{\Delta H_T} \int_0^t \left(\frac{dH}{dt} \right) dt, \quad (2.9)$$

with $\frac{dH}{dt}$ being the heat flux expressed in $[\text{W}\cdot\text{g}^{-1}]$ and ΔH_T being the total enthalpy of reaction in $[\text{J}\cdot\text{g}^{-1}]$.

In sweep mode (temperature gradient), the conversion rate can be determined using the equation:

$$\alpha_{\text{DSC-scan}}(t) = 1 - \frac{\Delta H_R}{\Delta H_T}, \quad (2.10)$$

with ΔH_R being the residual enthalpy of reaction at time t in $[\text{W}\cdot\text{g}^{-1}]$, measured as the area of the residual reaction peak, for the heat flux curve as a function of temperature.

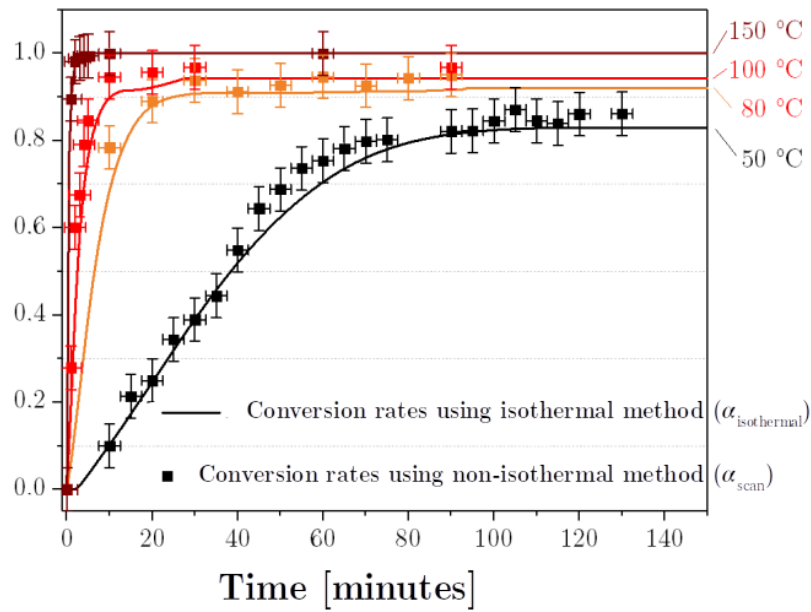

Figure 2.23: Comparison of conversion rates obtained during DSC using isothermal ($\alpha_{isothermal}$) and non-isothermal (α_{scan}), methods for the DGEBA-TETA system, adapted from Genty [2018]

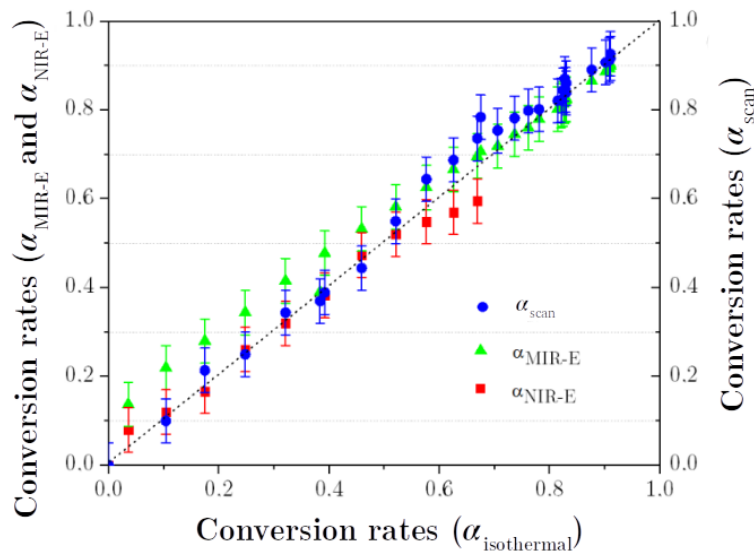

Figure 2.24: Comparison of conversion rates obtained during DSC using isothermal ($\alpha_{isothermal}$) and non-isothermal (α_{scan}), methods, and during infrared spectroscopy (epoxide peak monitoring): 915 cm^{-1} (α_{MIR-E}) and 4530 cm^{-1} (α_{NIR-E}), of the DGEBA-TETA system, adapted from Genty [2018].

Using a DGEBA-TETA model system (diglycidyl ether of bisphenol A - triethylene tetramine), based on molecules often used in industry, Figure 2.23 shows the conversion rates obtained during DSC using the isothermal method and by sweeping at different polymerisation temperatures: these conversion rates are identical, subject to measurement uncertainties. Figure 2.24 shows the conversion rates obtained by integrating the epoxide peaks using Fourier transform infrared spectroscopy (FTIR), in mid-infrared and near-infrared, and by integrating the residual polymerisation peak during DSC ($\alpha_{DSC-scan}$), as a function of the conversion rate measured continuously by integrating the DSC signal in isothermal mode ($\alpha_{DSC-isothermal}$).

Once again, the signals converge, subject to measurement uncertainties. As part of Sébastien Genty's thesis, we showed that these different polymerisation monitoring techniques were fully comparable in the case of the DGEBA-TETA reaction. It should be noted that there is nothing innovative about these techniques and reactive systems, but these results are still interesting and will enable monitoring of more complex systems, such as those discussed in the next section.

2.2.3 On-demand polymerisation under infrared lamp

While adhesive formulations enable polymerisation times to be reduced through the addition of accelerators, the aim of the CIFRE thesis project initiated in 2015 in collaboration with the company Socomore was to accelerate the epoxide-amine reaction, without modifying the formulation. The polymerisation kinetics of the DGEBA-TETA (diglycidyl ether of bisphenol A - triethylenetetramine) system were studied under an infrared lamp. The aim of the project was not only to quantify the effect of infrared radiation, but also to propose a mechanism by which the reaction involving this radiation and the material takes place. Figures 2.25 and 2.26 illustrate the first objective. Thermal polymerisation (in an oven) serves as the reference and the non-thermal effect (*i.e.* the effect of infrared radiation other than its thermal effect) is observed and shown to be greater the higher the radiative flux, for the same polymerisation temperature.

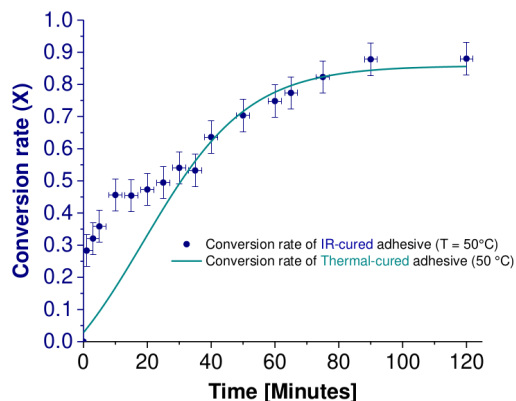

Figure 2.25: Conversion rate as a function of time for the DGEBA-TETA mixture, polymerised at 50°C in an oven and under an infrared lamp, adapted from Genty [2018].



Figure 2.26: Conversion rate as a function of time for the DGEBA-TETA mixture, polymerised at 50°C in an oven and under an infrared lamp by modulating the luminous flux (automatic $\approx 1500 \text{ W.m}^2$ or maximum $\approx 5000 \text{ W.m}^2$), adapted from Genty [2018].

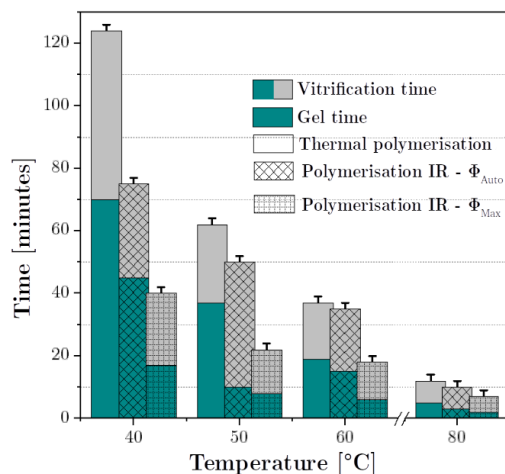

Figure 2.27: Gel and vitrification times of the DGEBA-TETA system at different polymerisation temperatures, in an oven and under an infrared lamp by modulating the luminous flux (automatic $\approx 1500 \text{ W.m}^2$ or maximum $\approx 5000 \text{ W.m}^2$), adapted from Genty et al. [2018].

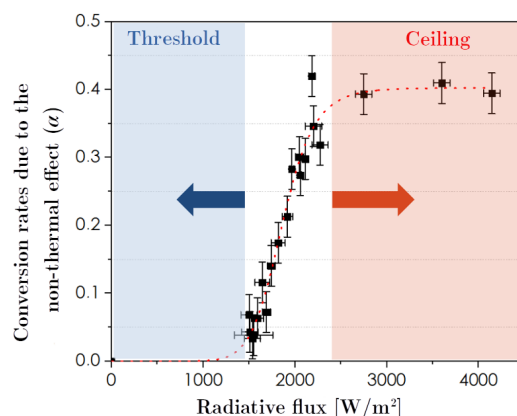

Figure 2.28: Correlation between the conversion rate due to the non-thermal effect and the radiative flux, adapted from Genty et al. [2018].

The acceleration of the polymerisation reaction was therefore quantified by measuring the gel and vitrification points at different polymerisation temperatures (Figure 2.27). The combination of thermal (heating) and non-thermal effects (the effect of infrared radiation other than its thermal effect) could thus be observed and quantified, showing the predominance of non-thermal effects at low temperatures, with thermal effects being most intense at high temperatures. This was verified by measuring the conversion rate due to the non-thermal effect as a function of the radiant flux of the infrared lamp (Figure 2.28). There is a threshold effect below which the non-thermal effect can no longer be observed and a ceiling effect which limits it. Between these two extremes, the non-thermal effect is directly proportional to the radiant flux. Finally, the use of band-pass filters enabled the project's second objective to be met and for a mechanism by which light and matter interact during the polymerisation of epoxide-amine systems under infrared to be proposed. Based on our findings, it seems that the non-thermal effect is induced by the absorption of IR radiation by the epoxide groups, leading to localised excitation of the reactive group and a decrease in the activation energy of the primary epoxide-amine reaction (reaction (a) in Figure 2.22). It was thus shown that for a epoxide-amine model system (DGEBA-TETA), the polymerisation reaction could be accelerated without the addition of a catalyst. This acceleration occurs through a combination of two effects: a thermal effect (increase in temperature due to infrared radiation) and a non-thermal effect, governed by the absorption of infrared radiation by the epoxide groups, thus reducing the activation energy of the primary epoxide-amine reactions. Finally, in an indirect way, polymerisation under an infrared lamp reduced the effect of reactions at the interfaces, favouring the polymerisation reaction (Genty et al. [2022]).

2.3 Approaching interphase formation

2.3.1 Reactions at the interfaces: interphase formation

Interphases have been known about and studied for many years, but the mechanisms by which they form were not described until much more recently (Crompton [1989]). They are present and widely studied in composite systems, which will not be discussed here, or will only be briefly touched upon. In the bonded or painted systems that are the focus of our studies, epoxide-amine mixtures are applied to metal surfaces and the epoxide-amine reaction described in Figure 2.22 takes place: this polymerisation reaction produces a polyepoxy thermosetting polymer. At this stage, it must be specified that, unless an exception is made and a precise description of the mechanisms offered, the following terms will be used somewhat loosely: “metal” or “metal surface” will refer to either a metal or one of its oxides or hydroxides. Furthermore, to my knowledge, very few studies have been carried out on several metals, and none have explored the influence of metal surface properties on the formation of epoxide-amine/metal interphases. However, the rest of this dissertation will show that the conclusions of the projects carried out on different metal substrates are in agreement. Metals or metal surfaces may therefore be pure (Cu, Sn, Cr, Ag, Fe, Al, Ni, Ti, Zn, Mg), or alloyed (Al1050, Al5182, Al2024, TA6V, SAE 1008/1010 steel, etc.) and covered with their native oxide/hydroxide layer.

Other reactions can take therefore place in the vicinity of the metal surface:

- The epoxide-(hydr)oxide metal reaction;
- The amine-(hydr)oxide metal reaction.

A few articles discuss interactions between epoxides or amines and metal surfaces in digital simulations (Bahlakeh et al. [2016]; Knaup et al. [2006]; Yamamoto and Tanaka [2021]). The results presented are not always consistent with each other: for example, Bahlakeh et al. [2016] observed interactions between amine groups and iron oxide/hydroxide surfaces as well as between epoxide groups and iron oxide/hydroxide surfaces, while Knaup et al. [2006] concluded that the amine-aluminium oxide reaction (DETA- γ -Al₂O₃) is extremely unfavourable. Yamamoto and Tanaka [2021] attributed the greater reactivity of the amine or epoxide to the size of the molecule: therefore, when the epoxide is smaller than the amine, it is the epoxide monomer that is predominantly found at the copper/monomer mixture interface. Conversely, when the amine is smaller than the epoxide, it is the amine monomer that is predominantly found at the copper/monomer mixture interface. These studies are therefore particularly interesting, but must be held up against experimental studies, as they certainly do not allow the entire complexity of these systems, such as internal stresses and shrinkage during polymerisation, to be taken into account. There has been little study of the epoxide-metal reaction, both in modelling (Krüger et al. [2005]; Lee et al. [2017]) and experimental studies (De Bruyne [1956]; Kollek et al. [1985]; Nakazawa [1994]; Schmidt and Bell [1986]) and its consequences appear to be minor. Brockmann [1987], discussed monomer-metal reactions, stating that the interactions of hydroxyl or amine groups on metal oxides are very favourable. Finally, De Bruyne [1956] studied the epoxide-metal reaction in the absence of amine and explained that in its presence, this equilibrium can be modified. Here, the epoxide-metal reaction is directly linked to the number of hydroxyl groups in the epoxide molecule (DGEBA) capable of creating interactions with the polar surface groups.

Conversely, the amine (or sometimes amide)-metal reaction has been extensively studied, as for example:

- in the Polymer Materials Engineering laboratory (*laboratoire d'Ingénierie des Matériaux Polymères* - IMP, Lyon, France), by A.A. Roche and his co-authors (Aufroy [2005]; Aufroy and Roche [2006a,b, 2007, 2008]; Benabdi [1998]; Bentadjine [2000]; Bentadjine et al. [2001]; Bouchet [2000]; Bouchet and Roche [2002]; Bouchet et al. [1999, 2001a,b, 2002]; Coulaud [2007]; Roche et al. [2006, 2002]; Roche and Guillemenet [1999]), mainly on titanium and aluminum alloys, but also on several pure metals (Cu, Sn, Cr, Ag, Fe, Al, Ni, Ti, Zn, Mg);

- in the Production Engineering Laboratory (*Laboratoire Génie de Production* - LGP, Tarbes, France), by V. Nassiet and her co-authors (Montois [2003]; Montois et al. [2007, 2006]), on titanium alloy TA6V ;
- in the Institute of Molecular Chemistry and Materials of Orsay (*Institut de Chimie Moléculaire et des Matériaux d'Orsay* - ICMMO, Paris, France), by M.G. Barthés-Labrousse and her co-authors (Ballerini et al. [2007]; Barthés-Labrousse [2002, 2012]; Debontridder [2001]; Fauquet et al. [1994]; Marsh et al. [1996, 1998]; Mercier [2006]; Mercier and Barthés-Labrousse [2009]; Mercier et al. [2010, 2008]), on titanium, copper, and aluminum alloys;
- in the Laboratory of Polymer Materials Marine Environment Interfaces (*Laboratoire des Matériaux Polymères Interfaces Environnement Marin* - MAPIEM, Toulon, France), by P. Carrière and his co-authors (Carrière et al. [2009]; Onard et al. [2011]; Phan et al. [2016]), on BaTiO₃ fillers and silicon wafers without or with surface treatments;
- in the Chair of Adhesion and Interphases in Polymers (*Lehrstuhl Adhäsion und Interphasen in Polymeren* - LAIP, Saarbrücken, Germany), par W. Possart and his co-authors (Bockenheimer et al. [2002a,b]; Meiser [2010]; Meiser et al. [2010]; Meiser and Possart [2011]; Meiser et al. [2008]; Passlack et al. [2009]; Possart et al. [2009]; Possart [1988]; Possart et al. [1996, 2006]; Wehlack and Possart [2004]; Wehlack et al. [2007]), on several pure metals (Cu, Al, Au) deposited by PVD on silicon wafers. In this group, Kanzow et al. [2005] also studied epoxy-amine/metal reactions, but in a symmetrical configuration, i.e. by PVD depositing metals in vapor phase on a polyepoxy after complete crosslinking;
- in the European Research Laboratory of Sarre and Lorraine (*Laboratoire Européen de Recherches Universitaires de Sarre et Lorraine* - LERUSL, between Saarbrücken, Nancy and Luxembourg, Germany, Luxembourg, France) by J. Krüger and his co-authors (Philipp et al. [2011]; Sanctuary et al. [2009]), on Al₂O₃ particles;
- in the Corrosion and Protection Centre, Department of Materials (Manchester, United Kingdom), by S. Lyon, S. Gibbon, S. Morsch and their co-authors (Morsch et al. [2021, 2019, 2020, 2022, 2023]; Wand et al. [2022]), on iron oxides and hydroxides, iron alloys;
- in the School of Chemistry, (Leicester Polytechnic, United Kingdom), by J. Comyn and his co-authors (Comyn et al. [1983, 1985]), on aluminum alloys;
- in the Department of Materials Science and Engineering (Cincinnati, Ohio, United States of America), by B.J. Boerio and his co-authors (Dillingham and Boerio [1987]; Hong et al. [1992]), on aluminum alloys, iron, zinc and aluminum oxides;
- in the Federal Institute for Materials Research and Testing (BAM, Berlin, Germany), by J. Chung, M. Munz and their co-authors (Chung [2006]; Chung et al. [2005, 2007]; Munz et al. [2005]), on copper;
- in the Research Institute in Civil and Mechanical Engineering (*Institut de Recherche en Génie Civil et Mécanique* - GeM, Saint Nazaire, France), by M. Girard and her co-authors (Grangeat [2019]; Grangeat et al. [2023, 2022, 2019]), on various steels;
- in the Institute of Polymeric Materials and Testing (Linz, Austria), by G. Wallner and his co-authors (Marchfelder et al. [2022]; Säckl et al. [2022]) on various steels;
- in the Center for Polymer Interface and Molecular Adhesion Science (Fukuoka, Japan), by K. Tanaka and his co-authors (Aoki et al. [2019]; Yamamoto et al. [2020, 2022]; Yamamoto and Tanaka [2021]), for the study of interphases of the order of a nanometer by linking molecular dynamics with some experimental results on copper;

- in our laboratory, the Interuniversity Center of Materials Research and Engineering (CIRI-MAT, Toulouse, France), in the various studies that I carried out (Drouet et al. [2021]; Fritah et al. [2020]; Pomes-Hadda [2015]; Pomes-Hadda et al. [2015]), on copper, aluminum and aluminum alloys;
- and by various groups more occasionally (Abrahami et al. [2016]; Bolouri et al. [1983]; De'Nève et al. [1998]; Geiss and Schumann [2012]; Goyanes et al. [2005]; Gutowski [1999]; Kelber and Brow [1992]; Knorr et al. [2012]; Krüger et al. [2005]; Langeloth et al. [2014]; Nazarov et al. [2011]; Safavi-Ardebili et al. [1997]; Salgin et al. [2013]; Semoto et al. [2011]; Sperandio [2009]; Sperandio et al. [2010a,b]; Valega Mackenzie and Thijsse [2015]; Wapner et al. [2006]; Wielant et al. [2007]; Zanni-deffarges and Shanahan [1994]).

Lastly, there are a few reviews summarising current knowledge about these polymer/metal interphases, and specifically epoxide-amine/metal interphases (Borges et al. [2021]; Cognard [1991]; Friedrich [2018]; Grundmeier and Stratmann [2005]).

There has been a consensus on how to describe the amine-metal reaction and the formation of epoxide-amine/metal interphases for a number of years now: this process can be divided into six stages (Aufroy [2005]).

1. Amine chemisorption:

Amines exhibit two types of interaction with metal surfaces (oxidised/hydroxidised), which have been extensively studied by XPS (Arita et al. [2002]; Barthés-Labrousse [2002, 2012]; Debontridder [2001]; Kishi [1988]; Kishi and Ikeda [1980]; Marsh et al. [1996]; Mercier [2006]; Mercier et al. [2008]):

- The lone pair of the amine nitrogen atoms is a Lewis base, which reacts with the empty orbital of metal atoms. This Lewis acid-base reaction is the source of the complexation of amines with metal atoms/ions;
- Amino hydrogens can act as Brønsted acids on hydroxides bonded to metal atoms.

These interactions have also been studied by grazing-angle reflectance FTIR (Aufroy [2005]; Bentadjine [2000]), FTIR emission (Aufroy [2005]) and UV spectroscopy (Bentadjine [2000]).

2. Formation of an amine-metal surface complex with release of water:

Most epoxide-amine systems involve multifunctional amines (diamines, triamines, etc.) with three or more amino hydrogens. Liquid-state NMR has been used to show that in the case of diamines, the two lone pairs of the two nitrogens complex the metal atoms, resulting in the formation of a surface complex (Bentadjine et al. [2001]). More recently, we have been able to extend this outcome to triamines by working on chelates (*i.e.* after desorption). By using theoretical calculations and applying DFT (density functional theory), it was suggested that DETA complexing with aluminium became a tridentate complex (the three amines being bonded to aluminium), as shown in Figure 2.29 (Drouet et al. [2021]). This was also confirmed by comparing theoretical and experimental Raman spectra.

3. Desorption and diffusion of amine-metal chelates:

The complexes that form desorb and diffuse in the liquid medium when permitted by its low viscosity or diffusion. This has been demonstrated by measuring metal ions in IPDA following contact with titanium (Bentadjine [2000]; Bentadjine et al. [2001]; Roche et al. [2002]) and then generalised for other amines and metals (Aufroy [2005]; Aufroy and Roche [2008]). In addition, steric exclusion chromatography confirmed the presence of new entities in the amine IPDA (isophorone diamine) following contact with titanium (Bentadjine [2000]; Roche et al. [2002]), and transmission FTIR spectroscopy demonstrated the presence of new chemical bonds in various amines following contact with metal surfaces (Aufroy [2005]; Aufroy and Roche [2006b]; Bentadjine [2000]; Roche et al. [2002]).

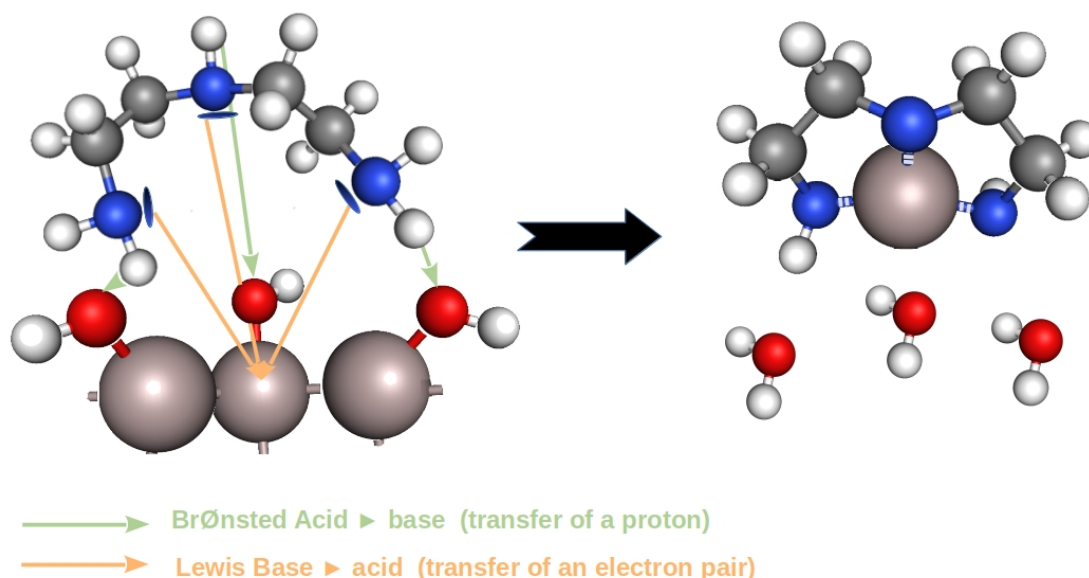

Figure 2.29: DETA reaction on a hydroxidised aluminium surface and creation of a tridentate chelate.

4. Dissolution of hydroxide, metal oxide or even metal layers:

Following amine-metal chelate desorption and diffusion, new amine molecules can therefore chemisorb on the surface to create new surface complexes that are ready to desorb. It is thanks to this continuous process that metal ion concentrations could be measured in modified amines (i.e. left in contact with a metal surface for three hours) using inductively coupled plasma (ICP) spectrometry, as they become non-negligible.

5. Crystallisation in the case of certain amines:

Of the large number of amines tested, only IPDA was found to crystallise following the formation of amine-metal complexes (Aufroy [2005]; Aufroy and Roche [2007, 2008]; Bentadjine [2000]; Roche et al. [2006, 2002]). These crystals were analysed by X-ray diffraction (XRD), leading to the finding that water and carbon dioxide were present in the crystal structure (Aufroy [2005]; Aufroy and Roche [2007]). These will play a crucial role in modifying the mechanical properties of the adhesive in the vicinity of the interface, as will be explained in section 2.3.2.

6. Competition with polymerisation results in the formation of two distinct networks:

The five stages described above have been clarified during analyses carried out when amines alone come in contact with a metal surface; they also take place, of course, when a mixture of epoxide and amine monomers comes into contact with a metal surface. In this second case, the epoxide-amine polymerisation reaction also takes place and competes with the amine-metal interaction, as the amine molecules can react with both the metal surface and the epoxide monomers. This competition limits diffusion of the complexes from the point at which the epoxide-amine mixture becomes viscous. This means that a low temperature (ambient temperature, a few degrees above the initial temperature of the polymerisation peak observed during DSC) will favour the amine-metal reaction until the epoxide-amine system vitrifies, while a high polymerisation temperature will result in almost immediate vitrification of the system, limiting the thickness of the interphase, as has been demonstrated (Aufroy [2005]; Aufroy and Roche [2007]; Montois [2003]; Montois et al. [2007, 2006]).

This amine-metal reaction has been observed on many pure metals covered with their native oxide/hydroxide layer (Cu, Sn, Cr, Ag, Fe, Al, Ni, Ti, Zn, Mg - Aufroy [2005]; Aufroy and Roche [2008]) and alloys covered with their native oxide/hydroxide layer (Al 1050, Al5182, Al 2024, TA6V, SAE 1008/1010 steel, etc.). It should be noted that it has also been observed on pure metallic gold (Aufroy [2005]; Aufroy and Roche [2008]).

Finally, these reactions have been observed when using numerous amines, including IPDA, DETA, TETA, EDA, propanediamine, butanediamine, pentanediamine, etc.

Although amine-metal reactions have been the subject of discussion for more than 30 years and extensively studied over the last 20, they have been studied indirectly. With the exception of certain infrared analyses (grazing-angle, emission), the experiments conducted prior to 2018 are all post-mortem experiments: amines, with or without epoxide monomers, are brought into contact with metal surfaces. These “modified” surfaces or amines are then analysed. Since 2018, micro-calorimetry, in our case combined with mixing cells, has allowed us to monitor and quantify amine-metal interactions *in situ*. It should be noted that while mixing micro-calorimetry is relatively well known in the field of characterisation of inorganic materials, it is less well known in the field of characterisation of polymers. Figure 2.30 shows, for example, that only 60 publications since 1974 include the term “mixing calorimetry”, with none of these explicitly relating to the field of polymer materials, whilst more than 160,000 publications use the term “calorimetry”, with nearly 20

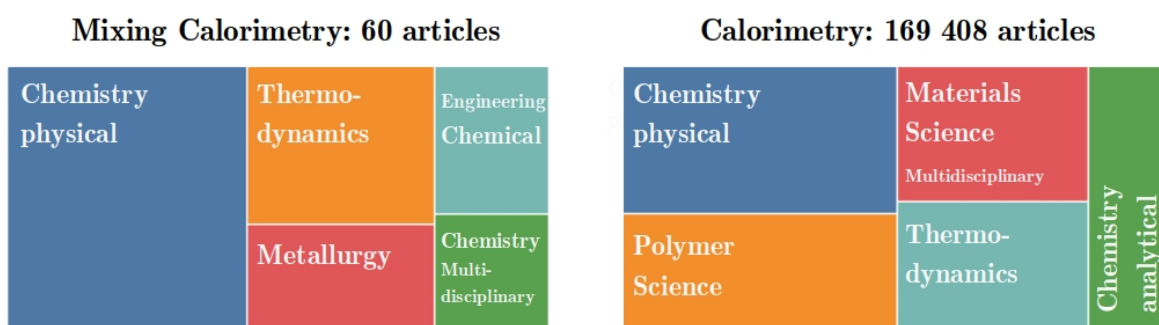

Figure 2.30: Breakdown of publications between 1975 and 2023 that include the terms “mixing calorimetry” and “calorimetry” by scientific field, according to the *Web of Science*TM website.

Micro-calorimetry can be compared to the well-known DSC: like DSC, the micro-calorimeter has two cells, a reference cell, which is often empty, and a measurement cell. As with DSC, micro-calorimetry is used to quantify the variation in enthalpy between the two cells over time, during temperature sweeps or isothermal experiments: micro-calorimetry is more commonly used during isothermal experiments, whereas DSC is very commonly used during temperature sweeps. The biggest difference lies in the measurement of heat flux: while DSC has only one (or two) thermocouples per cell, each micro-calorimeter cell is surrounded by numerous thermocouples: in the case of the C80 (Setaram), 9 thermo-elements, each comprising 38 thermocouples, encircle each measurement well. This allows the smallest heat flux to be quantified (< 100 mJ), but we will consider our enthalpy measurements as significantly quantifiable for energies of ≥ 1 J): this type of sensor is often called a “Calvet-type 3D sensor”, and the micro-calorimeter a “3D calorimeter”. In our studies, we used two-compartment cells allowing *in situ* monitoring of mixtures, which represents a major advance in the study of epoxide-amine/metal interphases. The compartments of the sample cell could hold various metal powders in the lower compartment of the cell and each of the epoxide (DGEBA) and amine (DETA) monomers in the upper compartment. The reactions observed corresponded to all of steps ① to ④ described above, *i.e.*:

1. Chemisorption of the amine;
2. Formation of an amine-metal surface complex;
3. Desorption and diffusion of amine-metal chelates;
4. Dissolution of hydroxide, metal oxide or even metal layers.

The measured enthalpy of the reaction between 1.5 mL of DGEBA and 300 mg of pure boehmite aluminium powder is $+2360 \pm 1000$ mJ. An interaction can therefore be quantified, but it is not thermodynamically favourable because it is endothermic. Figure 2.31 shows the enthalpies of the reactions of different masses of oxidised ($Al-ox$) or hydroxidised ($Al-boeh$) aluminium with the amine DETA. Hydroxidation was achieved by immersing aluminium powder in boiling water for one hour, resulting in the formation of boehmite.

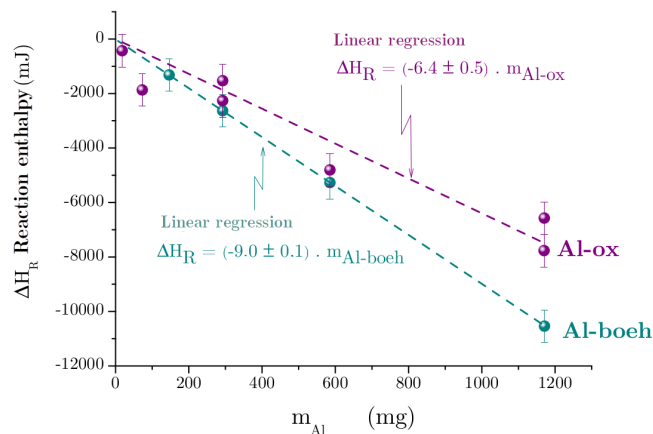

Figure 2.31: Enthalpies of the reactions of different masses of pure, oxidised or hydroxidised (boehmite) aluminium with 1.5 mL of the amine DETA, at 40°C, adapted from [Fritah et al. \[2020\]](#).

The linearity of the experimental points validates our protocol (diffusion of the species is not linked to any limitation of the reaction) as well as the hypothesis regarding DETA in excess with respect to the aluminium powders. It is also clear that, unlike the DGEBA – $Al_{boehmite}$ reaction which was endothermic, the DETA - *oxidised or hydroxidised Al* reactions are significantly exothermic ($\Delta H_{R,Al} \approx -6.4 \pm 0.5$ kJ.g⁻¹, equivalent to -0.21 ± 0.2 kJ.m⁻² and $\Delta H_{R,Al} \approx -9.0 \pm 0.1$ kJ.g⁻¹, *i.e.* equivalent to -0.3 ± 0.01 kJ.m⁻² for oxidised and hydroxidised aluminium powders respectively): it is therefore these reactions that we will mainly study hereafter ([Fritah et al. \[2020\]](#)). These initial results highlight the importance of the surface hydroxide content, which favours amine-metal reactions, and are consistent with [Barthés-Labrousse \[2012\]](#), but contradict [Wielant et al. \[2007\]](#), who concluded that the number of amine or amide molecules absorbed is independent of the hydroxylation rate, without any explanation, as the techniques used are similar (XPS); only the amines differ.

We have therefore confirmed that when an epoxide-amine mixture is deposited on a metal surface, it is indeed the amine that mainly reacts with the metal surface, which is consistent with the experimental observations of the authors cited above as well as with the DFT calculations of [Knaup et al. \[2006\]](#) showing that the amine-metal reaction was exothermic and the epoxide-metal reaction was endothermic. Nevertheless, even if the DGEBA- Al reaction is not favourable from an enthalpy point of view, it does exist and its enthalpy can be quantified using mixing calorimetry. Other metal powders are currently being analysed, but these values can already be compared with oxidised copper and gold: $\Delta H_{R,Cu} \approx -37.8 \pm 6.7$ kJ.m⁻² ([Fritah et al. \[2020\]](#)) and $\Delta H_{R,Au} \approx -11.2 \pm 0.5$ J.m⁻². It can therefore be seen that copper is particularly reactive towards amines, which was expected, as we know about the strong complexing power of copper-containing ions, but also that gold is significantly reactive, which is not consistent with the inert power usually attributed to it, but which confirms indirect observations of the DETA-gold reaction ([Aufroy and Roche \[2008\]](#)). Finally, one should bear in mind that the energies measured correspond to the first four stages of the process described, which include the dissolution of the first hydroxide or metal oxide layers, thus multiplying the “surface” metal atoms. Whatever their nature, these reactions are not insignificant and result in fundamental changes to the polymer networks discussed in the previous section.

2.3.2 Influence of interphases on the properties of adhesive joints and coatings

Section 2.3.1 described the interactions between amines and metal surfaces, which lead to the formation of surface complexes and subsequently chelates, which diffuse within the monomer mixture. The amine groups that have reacted with the metal surfaces and remain in interaction with the metal atoms in the chelates are no longer available to polymerise with the epoxide groups: the functionality of the amine molecules therefore decreases. Figure 2.32 shows the glass transition temperature (T_g) of DGEBA-DETA and DGEBA-*modified* DETA (or DGEBA-DETA*) systems as a function of the stoichiometric ratio used in the mixture (*i.e.* $a/e = n_{\text{amino-hydrogen}}/n_{\text{epoxide}}$). Note here that *modified DETA* is DETA that has been sandwiched between two metal surfaces for 3h and then recovered using a PTFE spatula. While the glass transition temperature curve for DGEBA-(pure) DETA volumes as a function of the a/e ratio shows an expected maximum for $a/e = 1$, this maximum shifts to $a/e = 1.2$ for the DGEBA-*modified* DETA system: the reduced functionality of the amine molecules that have reacted with a metal surface is therefore confirmed. Additionally, for a/e ratios of < 1.2 , the glass transition temperatures of the DGEBA-DETA systems are higher than those of the DGEBA-*modified* DETA systems, indicating the formation of new, less cross-linked networks when the amine comes into contact with a metal surface.

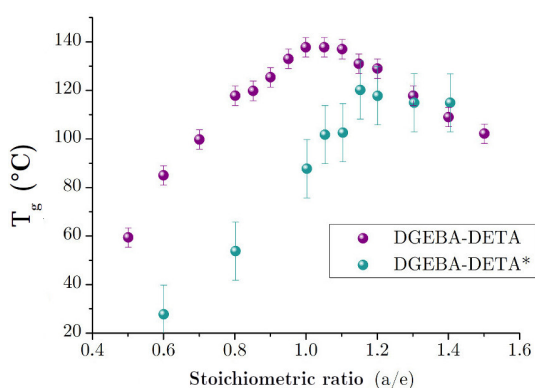

Figure 2.32: Variation in glass transition temperatures of DGEBA/pure or modified DETA systems on Al 1050 alloy substrates (*) as a function of the a/e stoichiometric ratio, adapted from [Aufray \[2005\]](#).

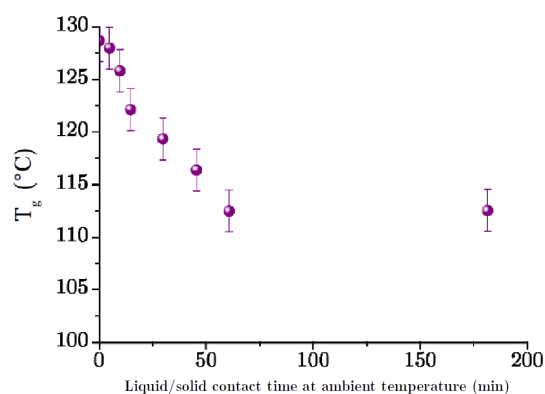

Figure 2.33: Variation in the glass transition temperature of 100 μm films as a function of liquid/solid contact time at ambient temperature prior to polymerisation of DGEBA-DETA coatings on Al 1050 alloy substrates, adapted from [Aufray \[2005\]](#).

There is therefore competition between the epoxide-amine polymerisation reaction and the amine-metal reaction resulting in the formation of the interphase. To monitor this competition, the glass transition temperature of a 100 μm film was measured as a function of liquid/solid contact time at ambient temperature prior to being placed in the oven at the maximum polymerisation temperature, resulting in very rapid vitrification of the epoxide-amine system, thus impeding the formation of the interphase (Figure 2.33). A decrease in the glass transition temperature can be observed as the liquid/solid contact time at ambient temperature before being placed in the oven increases, indicating an increase in the quantity of amino hydrogens involved in the amine-metal reaction and not available for the polymerisation reaction. Based on the two detailed examples, one can conclude that the glass transition temperature becomes the marker of interphase formation: the lower the glass transition temperature compared with that of a volume, the greater the interphase. To define the scale of the interphase, we must examine its “intensity” (*i.e.* the percentage of amino hydrogens not available for polymerisation in a given volume) and its “extent” (*i.e.* the variation in amino hydrogens not available in the thickness of a coating). To do this, the glass transition temperature was measured as a function of the thickness of DGEBA-DETA coatings on an Al 1050 alloy substrate (Figure 2.34).

The glass transition temperature increases with the thickness of DGEBA-DETA coatings until it reaches that of a volume for films of 300 μm or more in thickness: this is the thickness of the interphase. This thickness was also verified by monitoring the amine and epoxide groups using near-infrared spectroscopy (Aufroy and Roche [2006a, 2007]; Bentadjine et al. [2001]). Finally, we were able to track the formation of the interphase over time by measuring the thickness of this interphase using near-infrared spectroscopy as a function of liquid/solid contact time at ambient temperature prior to polymerisation of DGEBA-DETA coatings on an Al 1050 alloy substrate (Figure 2.35). Determining this thickness remains a complex task, and there is a certain degree of variability, but an increase in the thickness of the interphase can be observed when liquid/solid contact time at ambient temperature prior to polymerisation increases, thus allowing one to conclude that the increase in the “scale of the interphase” resulted in an increase in its extent and intensity: this contradicts the research of Goyanes et al. [2005], which will be discussed in the following section.

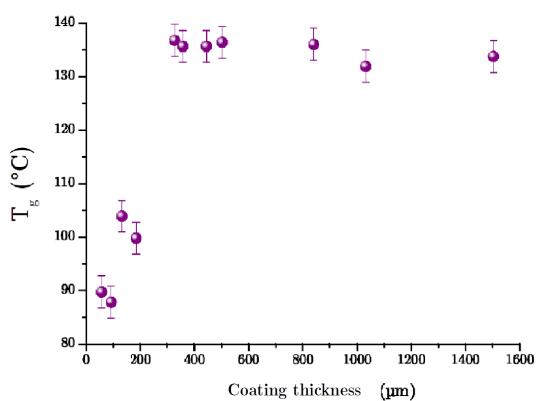

Figure 2.34: Variation in the glass transition temperature as a function of the thickness of DGEBA-DETA coatings on an Al 1050 alloy substrate, adapted from Aufroy [2005].

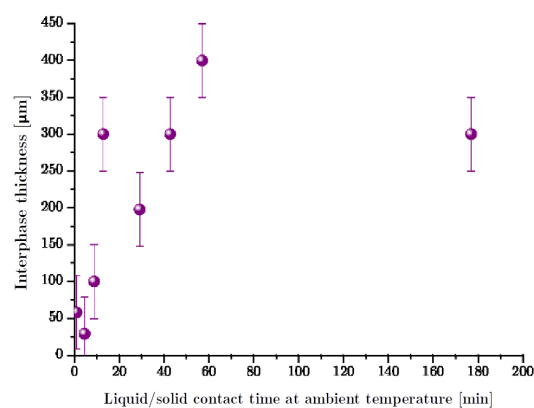

Figure 2.35: Variation in the thickness of the interphase as a function of liquid/solid contact time at ambient temperature prior to polymerisation of DGEBA-DETA coatings on Al 1050 alloy substrates, adapted from Aufroy [2005].

This variation in polymer cross-linking, reflected by the change in glass transition temperature, will also influence the Young’s modulus of the polymer network and of course the adherence of this polymer to its metal substrate (Figures 2.36 and 2.37 respectively). For example, it can be seen that the Young’s modulus of DGEBA-DETA coatings on Al 1050 alloy substrates decreases during the formation of the interphase: as the interphase changes the stoichiometry, the distance between cross-linking nodes increases during the formation of the interphase, causing the Young’s modulus of the network to fall. Conversely, the Young’s modulus of DGEBA-IPDA coatings on Al 1050 alloy substrates increases during interphase formation: this is due to the formation of IPDA($\text{CO}_2, \text{H}_2\text{O}$)-Al crystals. These crystals then act as mechanical reinforcements, leading to an increase in the Young’s modulus of the coatings to which they belong: these results were confirmed by Goyanes et al. [2005] who worked on the same system and obtained identical raw results by measuring the glass transition and relaxation temperatures α , as well as the real part of the dynamic modulus under traction, as a function of the thickness of the coatings. However, another explanation for these variabilities in the modulus and glass transition temperature is offered in the article written by Goyanes et al. [2005]: they are due to the internal stresses created during the amine-metal interaction. These authors compared the moduli and relaxations α of films of different thicknesses and of thinned films: the result being that the superimposable curves are those of films with the same initial thickness and not the same final thickness, which contradicts the previously presented conclusions regarding the gradient of properties in the interphase. The internal stress hypothesis mentioned above makes sense and is consistent with the residual stresses also measured by Roche et al. [2006].

However, it contradicts the infrared spectroscopy and microscopy measurements previously reported (Aufroy and Roche [2006a, 2007]). I believe that both of these phenomena occur and that they occur in conjunction with each other: the amine-metal interaction at the monomer/metal interface followed by diffusion of the amine-metal complexes AND the creation of residual stresses linked to reactions at the interfaces. The results of Goyanes et al. [2005] could be reproduced to monitor the amine and epoxide groups using infrared spectroscopy and the differences in the measurement of glass transitions, which are not discussed in the article, but described as identical to the relaxations α , could be explained by the different use of the films. Goyanes et al. [2005] mixed the monomers for 30 minutes before they were deposited on the metal surface, resulting in a significant advancement of the epoxide-amine reaction prior to coming into contact with the metal surface, followed by a polymerisation cycle that favours polymerisation to the detriment of interphase formation. We can therefore assume that the system discussed by Goyanes et al. [2005] is equivalent to only 10 minutes of contact for the systems described in our studies (Figures 2.33 and 2.35), which in our case corresponds to an overall glass transition temperature for a 100 μm film of less than 5°C below the reference glass transition temperature of the volume and an interphase thickness of around 50 μm .

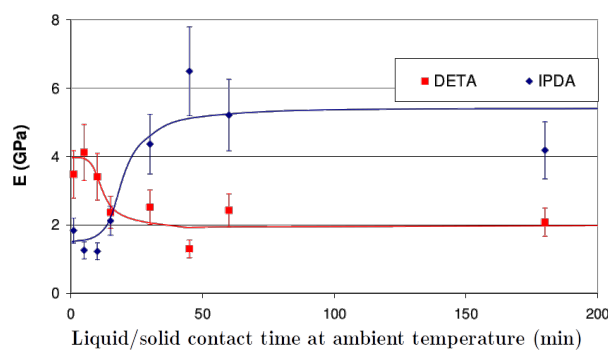

Figure 2.36: Variation in Young's modulus as a function of liquid/solid contact time at ambient temperature prior to polymerisation of DGEBA-DETA and DGEBA-IPDA coatings on Al 1050 alloy substrate, adapted from Aufroy [2005].

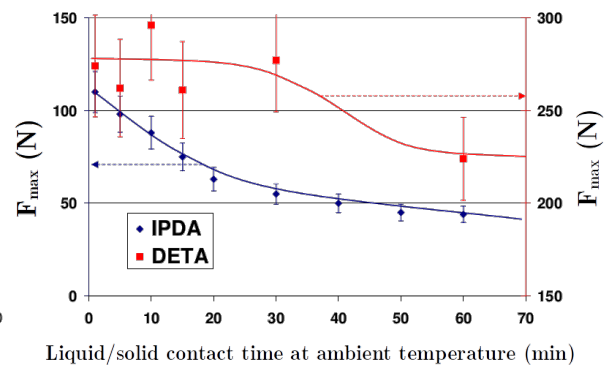

Figure 2.37: Variation in adherence as a function of liquid/solid contact time at ambient temperature prior to polymerisation of DGEBA-DETA and DGEBA-IPDA coatings on Al 1050 alloy substrate, adapted from Aufroy [2005].

Adherence decreases during interphase formation for both the DGEBA-DETA and DGEBA-IPDA systems (Figure 2.37: this may also be linked to residual stresses, as shown by Roche et al. [2006]). The formation of interphases in the fields of adhesion or painting might therefore appear unfavourable, but initial performances are rarely significant in such applications: conducting a follow-up during ageing thus becomes a matter of interest. This is shown in Figures 2.38 and 2.39. The ageing that the samples underwent was not severe (6°C, 85% relative humidity). However, in the two figures showing two epoxide-amine systems, the adherence of the films without an interphase decreased significantly from the first days of ageing, while that of the systems with an interphase remained constant: after 10-20 days for the DGEBA-DETA system and 50-60 days for the DGEBA-IPDA system, the adherence of the films with an interphase became better than that of the films without an interphase.

Although the decrease in adherence with ageing of epoxide-amine/metal systems has been widely reported in the literature for aluminium alloy substrates and different grades of steel (Bordes et al. [2009]; Calvez et al. [2012]; González Garcia et al. [2011]; Hartshorn [1986]; Kinloch et al. [2000]; Legghe et al. [2009]; Popineau and Shanahan [2006]; Prolongo et al. [2010]; Wu et al. [2014]), and in particular in the literature review by Borges et al. [2021], very few articles refer to the metal-polymer interphase. In these articles about hygrothermal ageing, the interphase is generally referred to as the water penetration zone only (Kinloch et al. [2000]).

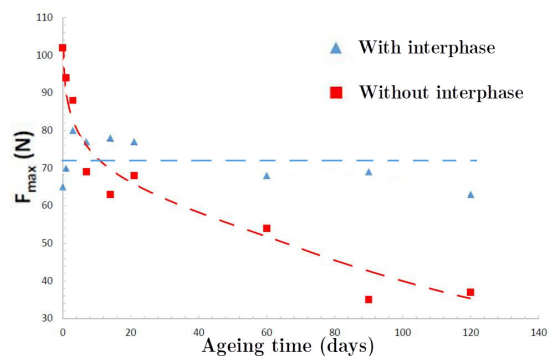

Figure 2.38: Variation in adherence of a DGEBA-DETA coating on an Al 1050 alloy substrate as a function of hygrothermal ageing time (6°C, 85% relative humidity), adapted from Pomes-Hadda [2015].

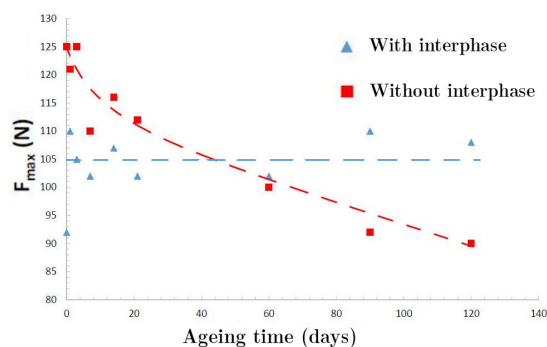

Figure 2.39: Variation in adherence of DGEBA-IPDA coating on an Al 1050 alloy substrate as a function of hygrothermal ageing time (6°C, 85% relative humidity), adapted from Pomes-Hadda [2015].

Others mention a polymer-metal interphase, but are unable to compare ageing with and without interphase formation and therefore unable to highlight its role in ageing mechanisms (Calvez et al. [2012]; Popineau and Shanahan [2006]). In conclusion, this difference in behaviour for systems that are initially identical, but whose interphase has been encouraged or impeded, could be explained in two ways:

- Internal stresses can vary, as discussed in a general sense by Sharpe [1972] and specifically in relation to epoxide-amine/metal systems by Roche et al. [2006] and Goyanes et al. [2005]. Other stresses associated with differential swelling during ageing are mentioned. Interphases are less cross-linked than the same adhesives by volume: this results in greater potential water absorption during ageing, but for an initially more deformable adhesive. The consequences of this differential swelling may therefore be less significant for systems with interphases. Stresses are particularly difficult to evaluate and decorrelate, but Wu et al. [2014] suggest differentiating between stresses under tension (due to the difference in the coefficient of thermal expansion between the polymer and the substrate) and internal stresses under compression (due to water swelling). In this article, which only studied samples with interphases as determined by the systems' stoichiometry, excess epoxides favoured adherence, which seems to contradict the findings presented, but further analyses would be required to confirm or refute these hypotheses.
- Amines can act as corrosion inhibitors, as already discussed by Duprat and Dabosi [1981]. More recent research often refers to "film-forming amines", which have been widely studied in the field of corrosion, but whose adhesion mechanisms appear to be poorly understood (Genxian et al. [2022]; Pensini et al. [2018]).

2.4 Conclusion

Understanding interphases is still a relatively limited subject, yet it is essential if we are to develop a good understanding of the properties of multi-materials: coated substrates, bonded assemblies and composite materials. The structure-property relationship of interphases has been the focus of my research activities, with epoxide-amine/metal systems being used as model systems. Having trained as a polymerist, most of my investigations have been based around the influence of epoxide or amine monomers and the polymerisation cycle, but there is still research to be done to study the influence of metal substrates. In the literature, only [Hong and Tsai \[2001\]](#) have compared several metal surfaces (oxidised aluminium, zinc and iron), but did not explain their difference in reactivity. At the CIRIMAT laboratory, we have begun to explore the influence of roughness and crystallinity. These will be studied further, in particular thanks to the new *in situ* analyses set up at CIRIMAT and in collaboration with other laboratories. The aim will be to define the respective influences of surface parameters on amines: crystallographic structure, electronic structure, energy and thermodynamic parameters. These issues will be addressed in particular by the ANR AMETIST project, which is due to start at the end of 2022.

Chapter 3

Research project

Contents

| | |
|--|-----------|
| 3.1 Themes in the continuity of the studies presented | 56 |
| 3.1.1 Advances in the mechanics of bonded assemblies | 56 |
| 3.1.2 Fatigue in the mechanics of bonded assemblies | 57 |
| 3.1.3 Advances in the characterisation of interphases | 58 |
| 3.2 Towards new areas of application: biomaterials | 59 |
| 3.2.1 Coatings on thermoplastic materials | 60 |
| 3.2.2 Adherence in odontology | 61 |
| 3.3 Conclusion | 63 |



THE AUTHOR OF THE WINDOWS FILE COPY DIALOG VISITS SOME FRIENDS.



My research project is divided into two parts: the first part is a continuation of the research discussed in this dissertation, while the second part will mark a turning point with regard to subject area, linked to my change of team in 2021. The second part will therefore cover medium-term and long-term projects, while the first part will mainly describe short-term and medium-term projects.

3.1 Themes in the continuity of the studies presented

As described in the first chapter, the science of adhesion is multi-disciplinary: collaboration is therefore essential for addressing issues of adhesion. CIRIMAT's interdisciplinary adhesion/adherence axis (HCERES five-year period 2016-2020) has helped to get the ball rolling and continuing this progress is key. In particular, the TACCOS initiative, which was developed in partnership with the ICA laboratory, is still active, especially in the MIAM project. Finally, close ties with the ICGM laboratory as part of the Institut Carnot Chimie Balard Cirimat has enabled us to co-supervise a thesis. This trio of laboratories also serves as the academic basis for the ANR AMETIST project, which will begin at the end of 2022.

3.1.1 Advances in the mechanics of bonded assemblies

Since arriving at CIRIMAT in 2008, I have set up the three-point bend test in accordance with ISO standard 14679. Its application to bonded assemblies is under development, as explained in *Chapter 2* of this dissertation. However, this test has a number of limitations. The stress distribution is determined by the dimensions of the samples, the distance between supports and therefore the associated standard. It would be interesting to be able to vary these stress distributions in order to map adherence as a function of the loading mode. We must remember that according to ISO [ISO 14679 \[1997\]](#) standard, the preferred loading mode for the interface is mode I, as explained in the previous chapter. My research project will therefore include the development of a flexural adherence test. Modifying the stress distribution by switching to four-point bending, for instance, is an initial idea. Among other things, this new configuration would allow us to obtain a constant moment between the central supports and to load the substrate/block interface in shear. This first element could be accompanied by modelling to determine the main loading mode in collaboration with the ICA as part of the TACCOS initiative. This configuration, shown in Figures [3.1](#) and [3.2](#), is used to some extent in the studies by [McAdams and Pearson \[2005\]](#) and [Maxwell \[2001\]](#): however, to my knowledge, the associated modelling work has not yet been carried out, nor has the adherence measured during three-point bending been compared with that measured during four-point bending.

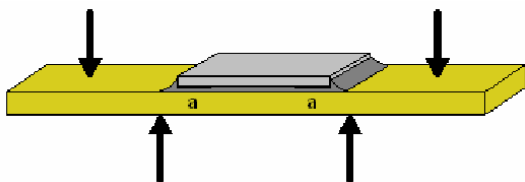

Figure 3.1: In the semiconductor field, a flip chip loaded in 4-point bending, taken from [McAdams and Pearson \[2005\]](#).

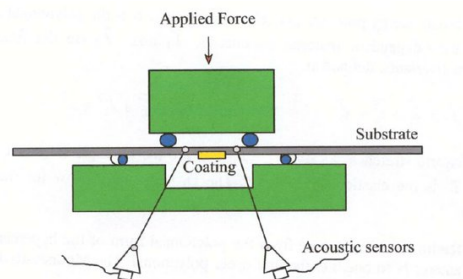

Figure 3.2: Measurement of coating adherence by 4-point bending and acoustic emission, taken from [Maxwell \[2001\]](#).

Modification of the test could go further, as shown in Figure 3.3: this configuration could also be the answer to the problems of CIRIMAT's Surface Coatings and Treatments (Revêtements et Traitements de Surfaces – RTS) team in our joint projects, particularly in the context of Laura Parvaix's thesis ("Development of new-generation SOFC stacks and high-temperature electrolysis (HTE) of water vapour to simultaneously optimise electrochemical performance and durability: prototype testing on the hydrogen platform").

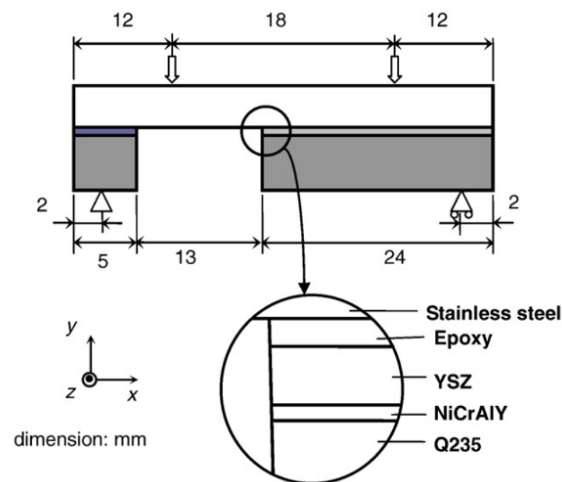

Figure 3.3: Modified 4-point bend test for measuring the adherence of thermal barriers, taken from [Zhao et al. \[2010\]](#).

Finally, the shift towards the field of biomaterials should result in the introduction of new sample geometries (adapted to ceramic materials, for example) and in situ mechanical tests (for example, in wet conditions mimicking a biological environment). These points will be expanded on in the second part of this chapter.

3.1.2 Fatigue in the mechanics of bonded assemblies

The second line of research concerns the fatigue strength of interfaces: this is a recurring question when I present my research to an industrial audience. The three-point bend test comes with the disadvantages set out in the previous chapter, but its ability to characterise the interface and therefore adherence is a major advantage. The question is whether this ability, and the possibility to locate failure initiation, is still possible during fatigue loading. In the latter case, the mechanical tests can be qualified using the same terminology as that used for static loading: depending on the definition of adhesion given, a fatigue adhesion test is not possible, but there could be adhesion tests and fatigue failure tests. There are few existing bibliographies on this subject, nevertheless, [Jeandrou et al. \[2015\]](#) and [Wahab \[2012\]](#) have written reviews on the fatigue of bonded joints. These two articles offer an overview of uses in this field and here we find mention of the classic single-lap joint tests, TAST (thick adherend shear test), Arcan, DCB tests, etc. The stresses applied are fluctuating tensile stresses with a stress ratio R often between 0.1 and 0.5 ($R = \frac{\sigma_{min}}{\sigma_{max}}$).

As previously stated, all of these tests have their benefits and allow the loading mode and the stage of failure studied (initiation or propagation) to be varied. However, they do not primarily load the interface and the study of failure surfaces is rarely associated with mechanical results. They are therefore tests of assemblies in their entirety. [Shenoy et al. \[2010a,b\]](#) go further in their analysis of fatigue testing of single-lap joints by studying the stress profile using finite elements and the failure surface. The failure path is thus clearly cohesive. These studies are essential for predicting the service life of bonded joints and allow the adhesive (in the case of the Arcan test, for instance) or the structure to be precisely characterised. However, there are no studies on the influence of reactions at the interfaces on adherence during fatigue tests.

The development of a test for characterising an interface under fatigue will address this challenge. It would then complement the studies carried out in parallel with the ICA, enabling the extraction of quantitative data to help predict interface service life.

3.1.3 Advances in the characterisation of interphases

In the short term, the physico-chemical characterisation of interphases and reactions at interfaces will continue as the mechanical testing of interfaces develops. This general characterisation and the associated links with partners are shown in Figure 3.4. Two major projects in particular have just begun. These are the ANR AMETIST project and the COCA project, which demonstrate the interest in the subject shown by both the academic and industrial communities.

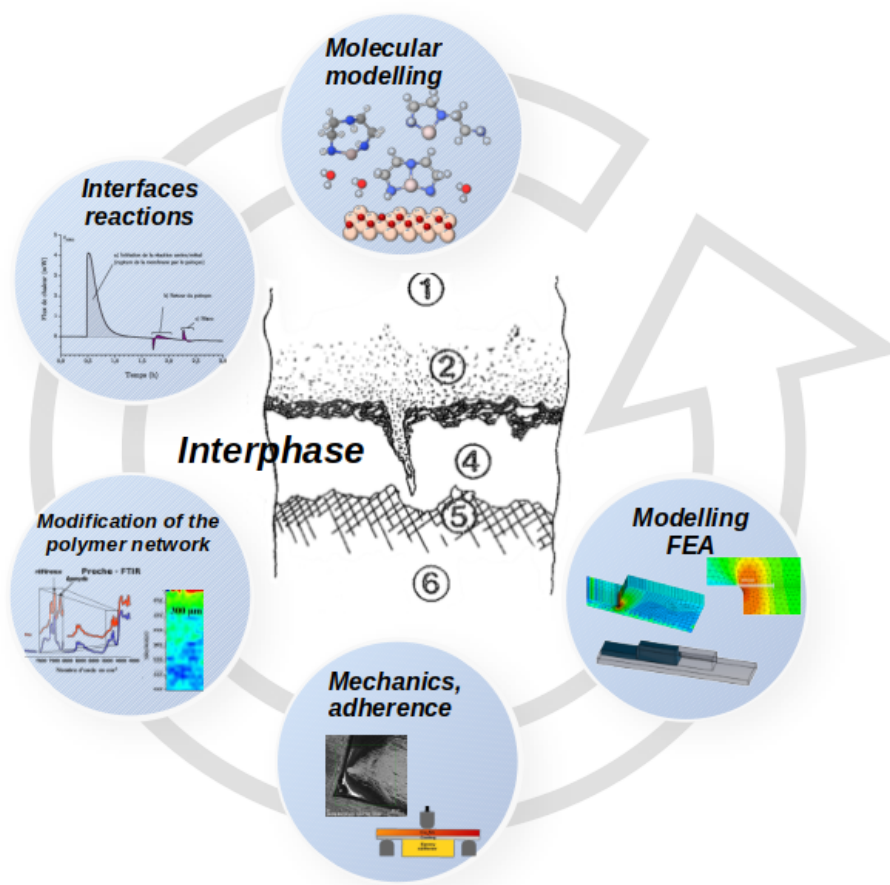

Figure 3.4: Interphase characterisation.

The ANR-PRCE AMETIST project is based on the premise that there is still virtually no available thermodynamic or mechanistic information on the formation of these interphases. It is therefore crucial to develop the approaches we have set out to explore the interactions that lead to the formation of interphases *in situ*, and thus gain a better understanding of the mechanisms involved at the molecular level and even predict the behaviour of the final materials.

The *in situ* analyses will include continuing to work with the mixing calorimeter, but also Mössbauer spectrometry (to study the local environment in the case of iron-based substrates) and X-ray absorption spectrometry to observe the geometry and electronic conformation of the amine-metal complexes. In the coming years, I will therefore continue to analyse the microscopic structuring of the interphase formed by the epoxide, amine and metals.

The aim is to understand and ultimately improve the thermal/mechanical properties (adherence) of the final multi-material parts in collaboration with the ICGM (Institut Charles Gerhardt Montpellier) and in particular Fabrice Salles, a simulation specialist, as a follow-up to the studies already published and those currently in progress. This will enable the study of these matters at both the microscopic and macroscopic levels, as shown in Figure 3.4.

This future research will pursue a number of different objectives: the first will be to propose a realistic model of the interphase by combining different experimental and theoretical techniques and to acquire a better understanding the interactions between the different system components based on the nature and degree of (hydr)oxidation of the metal and the nature of the amine. Few research teams are working on multiple metal substrates and none have explained the influences of crystallographic structures, electronic structures or energy and thermodynamic parameters. As part of the AMETIST project, several pure metals (Fe, Al, Cu, Ti) and several alloys (mainly titanium-based TA6V and steel-based AISI321) will be characterised and their reactivity towards one or more amines will be evaluated. Of course, external parameters such as atmospheric temperature and relative humidity will also be taken into account. Finally, I would like to link macroscopic properties (and in particular adherence) to the interactions and structuring of the interphase. This will eventually allow us to evaluate the importance of modifying adhesive formulations by reducing the number of qualification tests: these adherence, fatigue or ageing tests would then only be carried out on the most promising formulations. The influence of interphase formation will also be taken into account throughout the assembly's service life: the previous chapter described results showing the positive impact of interphase formation on adherence after several months of hygrothermal ageing (6°C, 85% relative humidity), while the presence of an interphase initially reduced adherence compared to an identical epoxide-amine/aluminium alloy system without an interphase. At this stage, these results can then be linked to mechanical modelling in connection with the collaborative work being carried out in partnership with the ICA. The IRT-M2P COCA project aims to study and understand the mechanisms of interphase formation in systems involving anodised, impregnated and sealed aluminium alloys and paints. In this project, the initial substrates (and therefore their electronic structure) will vary little: they will be 2000-series (copper-rich) and 7000-series (containing mainly zinc as an alloying element, but also magnesium and copper) aluminium alloys. It is the influence of surface treatments, particularly anodising followed by impregnation and sealing stages, that will be studied. These surface treatments will have an influence on the crystallographic structures, as well as the energy and thermodynamic parameters: this project will therefore aim to determine the surface parameters which have the greatest influence on the adherence of paints to these aluminium alloy substrates. These two projects are highly complementary and should provide a better understanding of the influence of surface parameters on adherence.

3.2 Towards new areas of application: biomaterials

After twelve years of research as a member of the *SURF* (surface: reactivity, protection) team, I joined the PPB (phosphates, pharmaceuticals, biomaterials) team in 2021: I wanted to get better acquainted with these research topics and the transition is underway. The idea is to use my expertise in the physical chemistry of polymers, the characterisation of interphases and the measurement of adherence for biomedical applications. I have already been able to take part in a number of “materials for health” projects from time to time, while continuing my “historical” activities. The 1986 and 1991 Chester conferences defined a biomaterial as “a material intended to interface with biological systems to evaluate, treat, augment, or replace any tissue, organ, or function of the body” (Williams and European Society for Biomaterials [1991]). Amédée Vilamitjana and Fricain [2017] have shown that this definition implies in particular that biomaterials are materials, whether synthetic or living, that can be used for medical purposes to replace a part of or function of an organ or tissue.

They must meet a number of requirements:

- they must be well tolerated by the recipient;
- they must not contain toxic substances;
- they must respond to mechanical stresses to adapt to the pressures exerted by the environment.

In particular, the PPB team has been working on the synthesis, characterisation and modelling of calcium phosphates such as hydroxyapatite $\text{Ca}_{10}(\text{PO}_4)_6(\text{OH})_2$ and biomimetic apatites for a number of years. Most of the research focuses described below will therefore combine hydroxyapatite with another material, and I wish to study the potential interactions between hydroxyapatite and polymers (see next section and ANR Ca-PEEK project) or metals (particularly titanium-based alloys such as TA6V), the formation of any interphases and measure the strength of the interfaces that form, *i.e.* adherence.

3.2.1 Coatings on thermoplastic materials

To get to grips with this new area of research, in 2021 I submitted the proposal for the ANR Ca-PEEK project (Adherent biomimetic apatite coating on medical devices based on inert polyetheretherketone polymers: an integrated approach). The project was not accepted in 2021, but was reworked within the team, re-submitted by Ghislaine Bertrand, as I was busy overseeing another project (ANR AMETIST), and accepted in 2022. PEEK (Polyetheretherketone) is a semi-crystalline homopolymer. Its degree of crystallinity falls somewhere around 30% when injection moulded. Its elastic modulus ranges from 3 to 4 GPa when unreinforced. Although PEEK polymers are increasingly used in maxillofacial surgery (low density and cost, ease of moulding, radiotransparency), their chemical inertness limits their osseointegration (Kurtz [2019]). In order to expand the use of PEEK in implants (spinal fusion cages, cranial surgery), provide immuno-modularity, anti-bacterial properties and propose the next generation of bioactive PEEK implants, the surface will be coated with biomimetic apatite. To ensure the durability of the multi-material, the cohesion of the hydroxyapatite coating and its adherence to the PEEK substrate will have to be sufficiently high in view of the target applications: minimal cohesion and adherence must not trigger any production of pro-inflammatory debris that could accumulate locally or circulate in the human body. The Carnot Interdisciplinary Laboratory in Burgundy (laboratoire Interdisciplinaire Carnot de Bourgogne – ICB) will be in charge of surface treatments and the application of coatings. For example, sandblasting will be used to promote mechanical anchoring, as discussed in the presentation of theories of adhesion in the first chapter of this dissertation.

The coating will then be applied by cold gas dynamic spraying. Commercial hydroxyapatite powders will be used initially, with CIRIMAT synthesising custom biomimetic nanocrystalline powders further down the line. These have already been deposited on TA6V alloy substrates at high speed and near-ambient temperature (Kergourlay et al. [2016]).

A key element of the project is therefore the adherence of the coating to the PEEK substrate. During the first part of the project, I will be responsible for quantifying this adherence as a function of the surface treatment parameters in order to evaluate their effectiveness. Developing an understanding of the structure/property relationship will also require the physico-chemical characterisation of failure surfaces to allow the phenomena at play at the PEEK/apatite interface to be understood and to help optimise PEEK treatments and coatings.

3.2.2 Adherence in odontology

PEEK is also used in dentistry, particularly for attaching implants, but I think this field is interesting to explore particularly due to the multitude of interface, adherence and bonding-related issues. In addition to generalist journals on biomaterials used in dentistry, there is a very specific journal covering this field of adhesion in odontology:

❖ ***The Journal of Adhesive Dentistry***

First published: 2001

Editors in 2023: Roland Frankenberger and Bart Van Meerbeek

Publisher: Quintessence Publishing

Impact factor in 2022: 3.3

Of course, there are already some literature reviews on adherence in dentistry (Marshall et al. [2010]; Özcan et al. [2012]; von Fraunhofer and Anthony [2012]; Zhao et al. [2021]) and measuring adhesion (Kelly et al. [1989]; Mourad and Aminah [2018]; Rasmussen [1978]; Rekow et al. [2009]; Salz and Bock [2010]; Söderholm [2009]; Triani et al. [2022]), with the same differences in approach between mechanical and physical-chemical researchers, and the same adhesion test limitations. Noudeau [1993]'s thesis offers an interesting overview of the state of the art of the subject, from adhesion mechanisms to adherence on various substrates (enamel, dentine, ceramics), covering families of adhesives, biocompatibility and cytotoxicity issues and bonding protocols. Reconstruction work in dentistry is multi-faceted and wide-ranging, as are the materials and interfaces potentially involved: ceramics, reconstruction composites, teeth, adhesives, etc. The adherence issues associated with this diversity of materials provide interesting study opportunities. From the outermost to the innermost layer, teeth are made up of enamel, dentin and pulp. Enamel and dentine are essentially hydroxyapatite and collagen composites, which means that these studies on adherence and reactions at interfaces are perfectly in line with the PPB team's research topics. However, the stoichiometry and crystallinity of the hydroxyapatites in enamel and dentine differ greatly, thus increasing the number of interfaces.

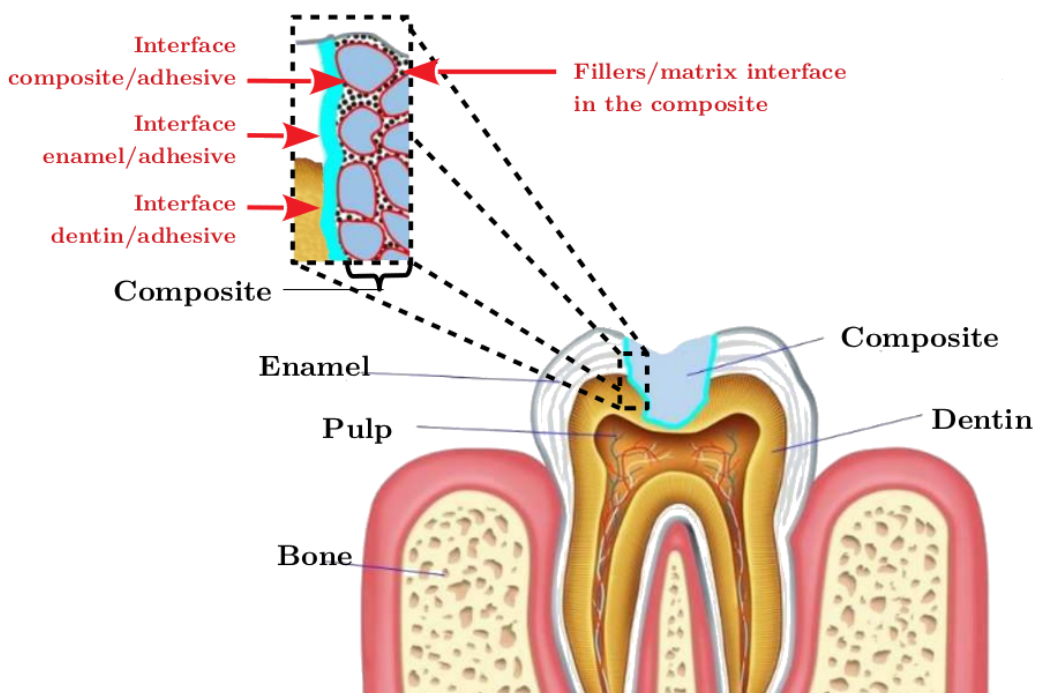

Figure 3.5: Diagram of a tooth restoration and highlighting of interfaces, adapted from Chaput and Faure [2019].

Taking into account the multitude of materials involved, many interfaces have been highlighted in a diagram of a tooth restoration (Figure 3.5) :

- filling material/matrix in the composite;
- composite/adhesive;
- enamel/adhesive;
- dentine/adhesive.

Composites used in dental restorations are generally mixtures of polymer and filling materials (Ferracane [2011]). The filling materials are often ceramic, but may also come in the form of glass, carbon, polyamid or polyethylene fibres (Khan et al. [2015]). There are also composites with a ceramic matrix, whose dimensions vary less over time (Canceill et al. [2017]). Polymer matrices are commonly derived from methacrylate monomers that undergo radical polymerisation via a chain polymerisation process: the monomers used in dentistry have a functionality strictly greater than two which, following the polymerisation reaction, produces a thermosetting polymer (Chaput and Faure [2019]; Delrieu et al. [2020]). The definition of the word “resin” used in the case of epoxides therefore applies here: resin is indeed the mixture of viscous monomers set to become a thermoset. There are already numerous filling material/matrix interfaces in composites, which are ideal for adherence studies into how to optimise filling material transfer and thus the composite’s mechanical properties. However, I would like to focus in particular on the bond between this restoration composite and the tooth: this bond is achieved using an adhesive, which is applied to the tooth following a surface treatment. The adhesive/composite interface rarely poses a problem, as the monomers involved in organic matrix adhesives and composites generally belong to the same family and are therefore highly chemically compatible. The critical interfaces are therefore the adhesive/dentine and adhesive/enamel interfaces.

There are histories of the adhesives and filling composites used in dentistry, such as those written by Van Meerbeek et al. [2020] and Mayou et al. [2018] which discuss the latest generation of adhesives commonly referred to as “universal adhesive systems”. Bayne [2013] presents this history in the case of filling composites, whose bonding technology is closely linked to that of adhesives, as a summarised timeline (Figure 3.6). Other interfaces are also of interest, such as those associated with the bonding of ceramic prostheses to TA6V titanium alloy implants. In this case, there are two interfaces involved: TA6V/adhesive and adhesive/ceramic. Once again, the adhesives used are based on methacrylate monomers. Whatever the applications in dentistry, the potential interactions between adhesives and enamel, dentine, TA6V or synthetic hydroxyapatite-type ceramics depending on pH could then be studied, in particular using mixing calorimetry. The presence of any interphases is indeed critical, as set out in the review by Geckeler et al. [1997].

I therefore believe that combining the skills of the TACCOS initiative team and the PPB team will allow us to deepen our understanding of phenomena at interfaces, measuring adherence and predicting the service life of tooth restorations. The three-point bend test in particular seems suitable for measuring adherence: it was already being used as far back as the 90s and has been standardised in the field of dentistry (ISO 9693 [2019]; Lenz and Kessel [1998]; Lenz et al. [1995]; Pröbster et al. [1996]). This could be coupled with the other approaches presented in this chapter, particularly measurements of performance under fatigue. In the case of dental applications, measuring fluctuating compressive stresses would be preferable, as these are more akin to the process of chewing. Finally, it would be interesting to conduct tests in an environment similar to saliva, so as to take into account chemical and bacterial influences. Once again, mixing calorimetry seems like it would be the tool of choice for characterising interactions.

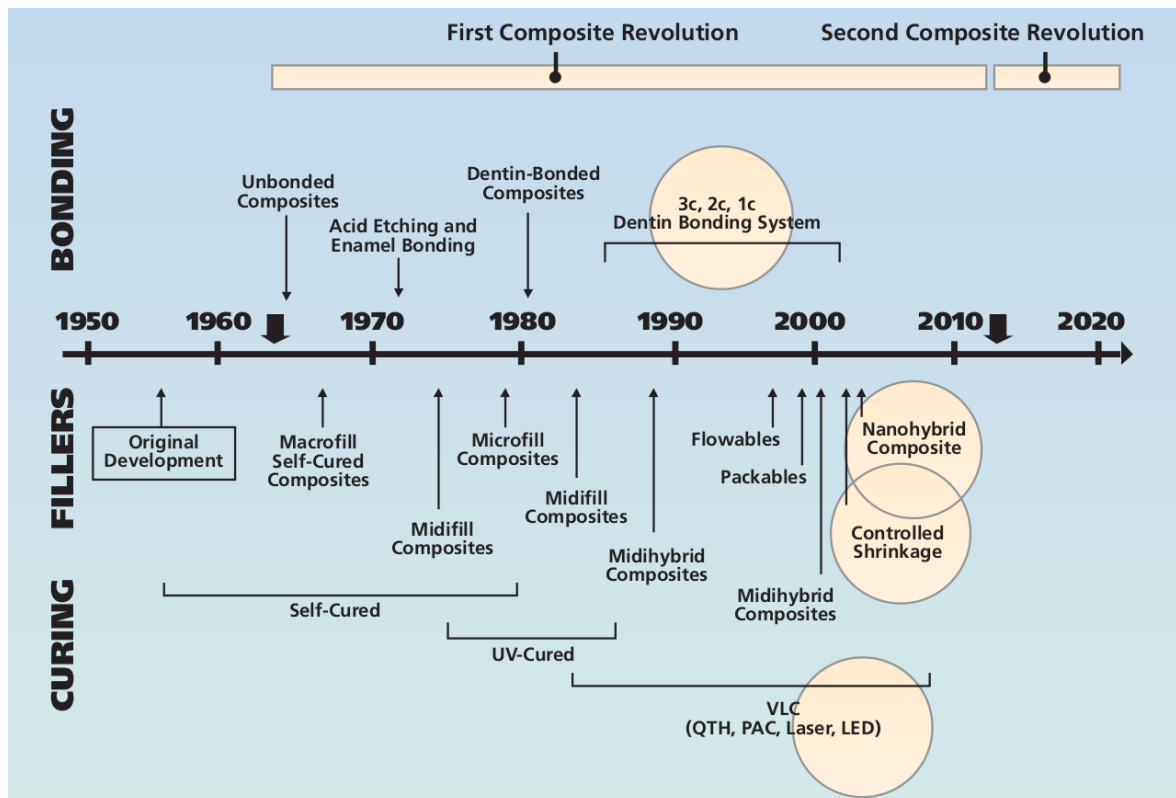

Figure 3.6: Schematic summary of the evolution of dental composite over more than 50 years. 3c: Three-component system (etch, prime, bond). 2c: Two-component system (etch, prime/bond or etch/prime, bond). 1c: One-component system (etch/prime/bond). LED: Light-emitting diode. PAC: Plasma arc light. QTH: Quartz-tungsten-halogen. UV: Ultraviolet. VLC: Visible light cured, taken from [Bayne \[2013\]](#).

3.3 Conclusion

The skills acquired and study methodologies developed by studying epoxide-amine/metal interfaces and interphases will be very useful for studying new systems in the field of biomaterials. In particular, reactions at interfaces will be studied using several in situ analyses at CIRIMAT or in collaboration with other laboratories. The ANRs selected in 2022 reflect this transition: the first, AMETIST, continues to focus on polymer-metal systems for aeronautical applications, but it will allow us to make progress in terms of in situ characterisations and gain a better understanding of the influence of metallic substrates' properties. The second Ca-PEEK project will allow me to apply the presented skills and characterisation methods to new systems intended for the biomedical field. In particular, PEEK-(hydroxy)apatite interactions will be characterised and linked to the adherence of apatitic coatings deposited on polymer substrates. This second ANR will be the link to the planned studies in the biomedical field and the application of these findings to bonding in dentistry, for instance.

Conclusion



The *Société Française de l'Adhésion* (French Adhesion Society), collaborations with its members and discussion during scientific days formed the basis of the studies carried out and presented in this dissertation. I wanted to provide a timeline of adhesion and bonding, from both a technological and scientific perspective. Here, this history is limited to the field of polymers used as adhesives. In particular, the class of adhesives derived from mixtures of epoxide and amine monomers has been studied, but the concepts are of course applicable to other classes of materials: this interdisciplinarity has been the common thread running through both the work already presented and that which is still to come, collaborations with other CIRIMAT teams, particularly as part of the interdisciplinary adhesion/adherence axis that I led between 2016 and 2020, and academic collaborations, as part of the TACCOS initiative, for example, which I co-created in 2017 and co-led with Frédéric Lachaud and Éric Paroissien (ICA).

Bonded assemblies are comprised of several materials, and the focus of this work is the study of interfaces. Interfaces have been described as a (zero-thickness) plane between two media, a macroscopic concept and an idealised view of observed phenomena. In reality, and from a microscopic perspective, the boundary between two materials extends to a non-zero thickness: the interphase. In this manuscript, the description of interphases focuses on epoxide-amine/metal systems in the case of many metal alloys or pure metals, covered by their oxide and hydroxide layer. To study these interphases, analyses, initially *post-mortem* analyses, were supplemented by new *in situ* analyses, such as mixing calorimetry. Collaboration with the ICGM and Fabrice Salles in particular allowed the interactions between amines and metal ions to be modelled. These characterisations were compared with the adherence of various polyepoxies to metal surfaces in order to assess the overall behaviour of an assembly when in use. To do this, close collaboration with the ICA and Éric Paroissien in particular enabled the development of semi-analytical and digital methods. I have chosen to present research that follows this common theme of epoxide-amine/metal systems and continue to study these or related systems, particularly as part of a collaboration with the University of Linz (Austria), where Gernot Wallner works. At the same time, various projects have allowed for work on other multi-materials to be carried out: the adherence of ice on coated aluminium alloy substrates, polyester-melamine paints and flexible adhesives on galvanised steel and aluminium alloy substrates respectively, polyurethane paints on PEEK-carbon fibre composites, and the adherence of hydroxyapatite coatings on titanium-based alloys. Finally, the ADEME BOPA (Omega Biosourced Sandwich Panel for Aeronautics) project has enabled interphase analysis techniques to be applied to particularly complex systems involving natural fibres (flax fibres) in partnership with the LCA (agro-industrial chemistry laboratory) and Antoine Rouilly in particular. This project is the link that will enable these techniques to be applied to systems containing natural materials. It is primarily in the field of biomaterials that I see my future in research, in carrying over the knowledge and skills acquired in the process of working on specific epoxide-amine/aluminium systems, among others. The expertise of the PPB team and particularly Christophe Drouet in the field of synthesis and characterisation of (hydroxy)apatites allows me to envision new projects in response to odontological problematics. In this context, the interfaces are numerous and their study complex. Pooling the skills acquired throughout the work presented here, those of the PPB team in the field of materials and those of CIRIMAT in the field of materials characterisation, should allow us to deepen our understanding of bonding mechanisms in dentistry and even orthopaedics, and perhaps improve the reliability of products and processes.

I would also like to expand the use of certain analysis techniques in the study of interphases, such as Raman spectroscopy/microscopy together with Olivier Marsan (CIRIMAT) and SEM-FIB together with Claudie Josse (Raimond Castaing Microanalysis Centre). To progress even further in analysing spectra from vibrational spectroscopy techniques, among others, I would like to work on modelling algorithms. Collaborations with Adrien Brochier (Université Paris Cité), followed by Louise Travé-Massuyès (LAAS – Laboratory for Analysis and Architecture of Systems) have opened up an exciting field of possibilities with interval analysis techniques, which I have found to be particularly well suited to the field of materials analysis and behaviour prediction. As I am particularly passionate about open science, I would also like to get involved by sharing ideas and communicating information about research tools and the ethical issues that arise when drafting a proposal: in particular, I would like to share research that is as open as possible by promoting open-source tools and taking the time to build ever more links between scientific fields by encouraging “slow science”¹.

¹Isabelle Stengers, *Une autre science est possible ! Manifeste pour un ralentissement des sciences*, Paris, La Découverte, series: “Les Empêcheurs de penser en rond”, 2013, 216 p.

Bibliography

- Abrahami, S. T., Hauffman, T., de Kok, J. M. M., Mol, J. M. C., and Terryn, H. (2016). Effect of anodic aluminum oxide chemistry on adhesive bonding of epoxy. *The Journal of Physical Chemistry C*, 120(35):19670–19677. [45](#)
- Amédée Vilamitjana, J. and Fricain, J.-C. (2017). *Biomatériaux : L'ingénierie tissulaire au secours du corps humain*. Technical report, INSERM. [59](#)
- Aoki, M., Shundo, A., Okamoto, K., Ganbe, T., and Tanaka, K. (2019). Segregation of an amine component in a model epoxy resin at a copper interface. *Polymer Journal*, 51(3):359–363. [44](#)
- Arita, H., Arita, A., and Kishi, K. (2002). Reaction of ethylenediamine with ultra-thin titanium oxides on Cu(100) modified by sodium oxide. *Surface Science*, 516(1):191–202. [45](#)
- ASTMD 4541-17 (2017). Standard Test Method for Pull-Off Strength of Coatings Using Portable Adhesion Testers. [28](#)
- Aufray, M. (2005). *Caractérisation physico-chimique des interphases époxyde-amine/oxycide ou hydroxyde métallique, et de leurs constituants*. PhD thesis, presented in the Institut National des Sciences Appliquées de Lyon. [43](#), [45](#), [46](#), [49](#), [50](#), [51](#)
- Aufray, M., Josse, C., Balbo, A., Monticelli, C., Švara Fabjan, E., Škrlep, L., Kosec, T., Gartner, N., Martini, C., Masi, G., Chiavari, C., Bernardi, E., Bignozzi, M. C., Robbiola, L., Babnik, M., Koršič, T., and Kete, M. (2019). Practical adhesion measurements of protective coatings on bronze by three-point bending test. *Journal of Coatings Technology and Research*, 16:146–1477. [25](#), [26](#)
- Aufray, M. and Roche, A. A. (2006a). *Adhesion - Current Research and Application*, chapter Properties of the interphase epoxy-amine / metal : Influences from the nature of the amine and the metal, page 89–102. Wiley-VCH, Weinheim (Germany). [43](#), [50](#), [51](#)
- Aufray, M. and Roche, A. A. (2006b). Residual stresses and practical adhesion: Effect of organo-metallic complex formation and crystallization. *Journal of Adhesion Science and Technology*, 20(16):1889–1903. [43](#), [45](#)
- Aufray, M. and Roche, A. A. (2007). Epoxy-amine/metal interphases: Influences from sharp needle-like crystal formation. *International Journal of Adhesion and Adhesives*, 27(5):387–393. [43](#), [46](#), [50](#), [51](#)
- Aufray, M. and Roche, A. A. (2008). Is gold always chemically passive: Study and comparison of the epoxy-amine/metals interphases. *Applied Surface Science*, 254(7):1936–1941. [43](#), [45](#), [46](#), [48](#)
- Bahlakeh, G., Ghaffari, M., Saeb, M. R., Ramezanzadeh, B., Proft, F. D., and Terryn, H. (2016). A close-up of the effect of iron oxide type on the interfacial interaction between epoxy and carbon steel: Combined molecular dynamics simulations and quantum mechanics. *Journal of Physical Chemistry C*, 120:11014–11026. [43](#)
- Balladon, P. (1993). Analyse mécanique simplifiée du test d'adhérence en flexion 3 points. Technical report N M 93/24, Institut de recherche de la sidérurgie (old name of ArcelorMittal). [33](#)
- Ballerini, G., Ogle, K., and Barthés-Labrousse, M.-G. (2007). The acid-base properties of the surface of native zinc oxide layers: An xps study of adsorption of 1,2-diaminoethane. *Applied Surface Science*, 253(16):6860–6867. [44](#)
- Barthés-Labrousse, M.-G. (2002). Acid-base characterisation of flat oxide-covered metal surfaces. *Vacuum*, 67(3-4):385–392. [44](#), [45](#)
- Barthés-Labrousse, M.-G. (2012). Mechanisms of formation of the interphase in epoxy-amine/aluminium joints. *The Journal of Adhesion*, 88(8):699–719. [44](#), [45](#), [48](#)

- Bayne, S. C. (2013). Beginnings of the dental composite revolution. *The Journal of the American Dental Association*, 144:42S–46S. [62](#), [63](#)
- Belei, C., Pommer, R., and Amancio-Filho, S. (2022). Optimization of additive manufacturing for the production of short carbon fiber-reinforced polyamide/Ti-6Al-4V hybrid parts. *Materials & Design*, 219:110776. [23](#)
- Benabdi, M. (1998). *Étude des Propriétés mécaniques de l'interphase polymère/métal*. PhD thesis, University Lyon 1. [43](#)
- Benson, N. K. (1967). *Adhesion and adhesives, volume 2: applications*, chapter Mechanical testing of bonded joints. Elsevier publishing company: Amsterdam, London, New York, second edition. [36](#)
- Bentadjine, S. (2000). *Mécanismes de formation et propriétés physico-chimiques et mécaniques des interphases époxy-diamine / métal*. PhD thesis, Institut National de Sciences Appliquées de Lyon. [43](#), [45](#), [46](#)
- Bentadjine, S., Petiaud, R., Roche, A. A., and Massardier, V. (2001). Organo-metallic complex characterization formed when liquid epoxy-diamine mixtures are applied onto metallic substrates. *Polymer*, 42(14):6271–6282. [43](#), [45](#), [50](#)
- Bergman, B. (1984). On the estimation of the weibull modulus. *Journal of Materials Science Letters*, 3(8):689–692. [28](#)
- Bikerman, J. (1961). *The Science of Adhesive Joints*. Academic Press, New York et London. [18](#)
- Birro, T. V. (2021). *Prédiction de la rupture adhésive des assemblages collés de substrats métalliques*. PhD thesis, University of Toulouse issued by the Institut Supérieur de l'Aéronautique et de l'Espace. [27](#), [35](#)
- Birro, T. V., Aufray, M., Paroissien, E., and Lachaud, F. (2021). Assessment of interface failure behaviour for brittle adhesive using the three-point bending test. *International Journal of Adhesion and Adhesives*, 110:10289. [26](#), [27](#)
- Birro, T. V., Paroissien, E., Aufray, M., and Lachaud, F. (2020). A methodology based on the coupled criterion for the assessment of adhesive-to-adherend interface crack initiation. *International Journal of Adhesion and Adhesives*, 102:102664. [35](#)
- Bockenheimer, C., Fata, D., Possart, W., Rothenfusser, M., Netzelmann, U., and Schaefer, H. (2002a). The method of non-linear ultrasound as a tool for the non-destructive inspection of structural epoxy-metal bonds—a résumé. *International Journal of Adhesion and Adhesives*, 22(3):227–233. [44](#)
- Bockenheimer, C., Valeske, B., and Possart, W. (2002b). Network structure in epoxy aluminium bonds after mechanical treatment. *International Journal of Adhesion and Adhesives*, 22(5):349–356. [44](#)
- Bolouri, H., Pethrick, R., and Affrossman, S. (1983). Bonding of a simulated epoxy resin to aluminium surfaces studied by XPS. *Applications of Surface Science*, 17(2):231. [45](#)
- Bordes, M., Davies, P., Cognard, J.-Y., Sohier, L., Sauvant-Moynot, V., and Galy, J. (2009). Prediction of long term strength of adhesively bonded steel/epoxy joints in sea water. *International Journal of Adhesion and Adhesives*, 29(6):595–608. [51](#)
- Borges, C., Marques, E., Carbas, R., Ueffing, C., Weißgraeber, P., and da Silva, L. (2021). Review on the effect of moisture and contamination on the interfacial properties of adhesive joints. *Proceedings of the Institution of Mechanical Engineers, Part C: Journal of Mechanical Engineering Science*, 235(3):527–549. [45](#), [51](#)

- Bosma, M. and Oosterbroek, M. (1994). A quantitative adhesion test for coated plastics. *International Journal of Adhesion and Adhesives*, 14(2):93–102. [33](#)
- Bouchet, J. (2000). *Influence des propriétés d'interphase sur les comportements d'éléments structuraux de multi-matériaux carbone-époxy/aluminium : cas des absorbeurs d'énergie*. PhD thesis, University Claude Bernard Lyon I. [33](#), [36](#), [43](#)
- Bouchet, J. and Roche, A.-A. (2002). The formation of epoxy/metal interphases: Mechanisms and their role in practical adhesion. *The Journal of Adhesion*, 78(9):799–830. [43](#)
- Bouchet, J., Roche, A. A., and Hamelin, P. (1999). Internal stresses, Young's modulus and practical adhesion of organic coatings applied onto 5754 aluminium alloy. *Thin Solid Films*, 355-356:270–276. [43](#)
- Bouchet, J., Roche, A. A., and Jacquelin, E. (2001a). Determination of residual stresses in coated metallic substrates. *Journal of Adhesion Science and Technology*, 15(3):321–343. [43](#)
- Bouchet, J., Roche, A. A., and Jacquelin, E. (2001b). The role of the polymer/metal interphase and its residual stresses in the critical strain energy release rate (gc) determined using a three-point flexure test. *Journal of Adhesion Science and Technology*, 15(3):345–369. [33](#), [36](#), [43](#)
- Bouchet, J., Roche, A. A., and Jacquelin, E. (2002). How do residual stresses and interphase mechanical properties affect practical adhesion of epoxy diamine/metallic substrate systems? *Journal of Adhesion Science and Technology*, 16(12):1603–1623. [33](#), [43](#)
- Brockmann, H. (1987). Chemical aspects of adhesion between metals and polymers. *The Journal of Adhesion*, 22(2):71–76. [43](#)
- Brown, S. (1995). *Adhesion measurement of thin films and coatings*, chapter Adherence failure and measurement : some troubling questions, pages 15–39. VSP BV, Utrecht (The Netherlands). [17](#)
- Buchan, S. and Rae, W. D. (1946). Chemical nature of the rubber-to-brass bond. *Rubber Chemistry and Technology*, 19(4):968–986. [18](#)
- Calvez, P., Bistac, S., Brogly, M., Richard, J., and Verchère, D. (2012). Mechanisms of interfacial degradation of epoxy adhesive/galvanized steel assemblies: Relevance to durability. *The Journal of Adhesion*, 88(2):145–170. [51](#), [52](#)
- Canceill, T., Garnier, S., Monsarrat, P., Nasr, K., and Joniot, S. (2017). Qu'est-ce qu'un ormocer ? *Biomatériaux Cliniques*, 2(2):14–17. [62](#)
- Carlac'h, D. and Hemery, Y. (2002). Étude prospective sur le collage en france : La voie de la productivité pour l'assemblage industriel. Technical report, DIGITIP / SIMAP. [20](#)
- Carrière, P., Onard, S., and Mallarino, S. (2009). Influence of substrate chemistry and the network homogeneity of ultra-thin cross-linked polymer films cured at their surface on the main relaxations temperatures probing by microthermal analysis. *Surface and Interface Analysis*, 41(11):858–864. [44](#)
- Chaput, F. and Faure, A.-C. (2019). Composites dentaires. *Techniques de l'ingénieur*, MED7500 V1:30. [61](#), [62](#)
- Charlier, J. (2003). *La liaison organique-métal, pourquoi, comment ?* Habilitation à diriger des recherches from the University Pierre et Marie Curie - Paris VI. [16](#)
- Chung, J. (2006). *Nanoscale Characterization of Epoxy Interphase on Copper Microstructures*. PhD thesis, Technische Universität Berlin : Fakultät III. [44](#)

- Chung, J., Munz, M., and Sturm, H. (2005). Amine-cured epoxy surface morphology and interphase with copper: An approach employing electron beam lithography and scanning force microscopy. *Journal of Adhesion Science and Technology*, 19(13-14):1263–1276. [44](#)
- Chung, J., Munz, M., and Sturm, H. (2007). Stiffness variation in the interphase of amine-cured epoxy adjacent to copper microstructures. *Surface and Interface Analysis*, 39(7):624–633. [44](#)
- Ciba-Geigy (1943). Patent 2,324,483 (U.S.). [37](#)
- Cognard, J. (1991). The metal/polymer interphase in adhesive joints. *International Journal of Adhesion and Adhesives*, 11(2):114–116. [45](#)
- Cognard, J. (2000). *Science et Technologie du collage*. Presses Polytechniques et Universitaires Romandes, EPFL. Lausanne, Suisse. [17](#), [19](#)
- Cognard, P. (2002). Collage des matériaux : Mécanismes, classification des colles. *Techniques de l'ingénieur*, BM 7 615:20. [20](#)
- Cognard, P. (2005). *Handbook of Adhesives and Sealants: Basic Concepts and High Tech Bonding*, volume 1. Elsevier. [18](#)
- Cognard, P. (2006). *Handbook of Adhesives and Sealants: General Knowledge, Application Techniques, New Curing Techniques*, volume 2. Elsevier. [18](#)
- Coleman, M. and Painter, P. (2005). History of polymers. In Bassani, F., Liedl, G. L., and Wyder, P., editors, *Encyclopedia of Condensed Matter Physics*, pages 386–391. Elsevier, Oxford. [37](#)
- Comyn, J. (2006). *Handbook of Adhesives and Sealants*, volume 2, chapter 1. Theories of Adhesion, pages 1–50. Elsevier. [18](#)
- Comyn, J., Horley, C. C., Oxley, D. P., Pritchard, R. G., and Tegg, J. L. (1983). The examination of some thermosetting polymers by inelastic electron tunnelling spectroscopy. *British Polymer Journal*, 15(1):50–55. [44](#)
- Comyn, J., Kinloch, A., Horley, C., Mallik, R., Oxley, D., Pritchard, R., Reynolds, S., and Werrett, C. (1985). The application of inelastic electron tunnelling spectroscopy to adhesive bonding. *International Journal of Adhesion and Adhesives*, 5(2):59–65. [44](#)
- Cotton, J., Grant, J., Jensen, M., and Love, B. (2001). Analytical solutions to the shear strength of interfaces failing under flexure loading conditions. *International Journal of Adhesion and Adhesives*, 21(1):65–70. [23](#)
- Coulaud, M. (2007). *Rôle des interfaces et interphases dans les assemblages collés*. PhD thesis, Institut National des Sciences Appliquées de Lyon. [43](#)
- Crompton, J. S. (1989). Interfacial properties and stability in bonded aluminium. *Journal of Materials Science*, 24(5):1575–1581. [43](#)
- da Silva, L. F., das Neves, P. J., Adams, R., and Spelt, J. (2009a). Analytical models of adhesively bonded joints - Part I: Literature survey. *International Journal of Adhesion and Adhesives*, 29(3):319–330. [23](#)
- da Silva, L. F., das Neves, P. J., Adams, R., Wang, A., and Spelt, J. (2009b). Analytical models of adhesively bonded joints - Part II: Comparative study. *International Journal of Adhesion and Adhesives*, 29(3):331–341. [23](#)
- da Silva, L. F., Öchsner, A., and Adams, R. D. (2011). *Handbook of adhesion Technology*, volume 1 & 2. Springer-Verlag Berlin Heidelberg. [18](#)

- Darque-Ceretti, E. and Felder, E. (2003). *Adhésion et Adhérence*. CNRS éditions, Paris. 17, 18
- De Bruyne, N. A. (1956). The adhesive properties of epoxy resins. *Journal of Applied Chemistry*, 6:303–310. 43
- de Gouvello, F. (1987). Application du test de flexion trois points à l'étude des phénomènes d'adhérence d'un polymère sur un métal. *Cahiers d'Informations Techniques - Revue de Métallurgie*, 84(2):127–134. 23
- Debontridder, F. (2001). *Influence de l'acidité de surface sur les mécanismes précurseurs de formation d'une interphase dans les assemblages époxy-aluminium*. PhD thesis, University Paris XI Orsay. 44, 45
- Delrieu, J., Meredith, C., Canceill, T., and Joniot, S. (2020). Les adhésifs universels, le point en 2020. *Clinic*, 41:328–333. 62
- De'Nève, B., Delamar, M., Nguyen, T., and Shanahan, M. (1998). Failure mode and ageing of steel/epoxy joints. *Applied Surface Science*, 134(1):202–212. 45
- Deryagin, B. and Krotova, N. (1948). Electric theory of adhesion of films to solid surfaces (translated by O.W. Bauer). *Doklady Akad Nauk SSSR*, 61:849–852. 18
- DeVoe & Reynolds (1948). Patent 2,456,408 (U.S.). 37
- Devos, P., Baziard, Y., Rives, B., and Michelin, P. (2001). Adherence evaluation of paint coatings using a three-point flexure test and acoustic emission. *Journal of Applied Polymer Science*, 81(8):1848–1857. 24
- Dillingham, R. G. and Boerio, F. J. (1987). Interphase composition in aluminum/epoxy adhesive joints. *The Journal of Adhesion*, 24(2-4):315–335. 44
- Divin-Mariotti, S. (2019). *Texturation micrométrique de surface par procédé mécanique de moulage pour optimiser la tenue des assemblages*. PhD thesis, University of Lyon, presented in the École centrale de Lyon. 23
- Drouet, C., Salles, F., Fritah, Z., Marsan, O., Thouron, C., and Aufray, M. (2021). Further insight on amine-metal reaction in epoxy systems. *Surfaces and Interfaces*, 23:100959. 45
- Duprat, M. and Dabosi, F. (1981). Corrosion inhibition of a carbon steel in 3% NaCl solutions by aliphatic amino-alcohol and diamine type compounds. *Corrosion*, 37(2):89–92. 52
- Dupré, A. and Dupré, P. (1869). *Théorie mécanique de la chaleur*. Gauthier-Villars, imprimeur-libraire, Paris. 17
- Ebnesajjad, S. and Ebnesajjad, C. F. (2014). *Surface Treatment of Materials for Adhesive Bonding*. Elsevier. 18
- Encyclopédie Universalis (consultée le 20 mai 2021). <https://www.universalis.fr/carte-mentale/collage-physique/>. 12, 16
- Farbenindustrie (1938). Patent 676,117 (German) and 2,136,928 (U.S.). 37
- Fauquet, C., Dubot, P., Minel, L., Barthés-Labrousse, M. G., Vilar, M. R., and Villatte, M. (1994). Adsorption of monoethanolamine on clean, oxidized and hydroxylated aluminium surfaces: a model for amine-cured epoxy/aluminium interfaces. *Applied Surface Science*, 81(4):435–441. 44
- Fay, P. A. (2021). 1 - a history of adhesive bonding. In Adams, R. D., editor, *Adhesive Bonding*, pages 3–40. Woodhead Publishing, second edition. 12
- Ferracane, J. L. (2011). Resin composite - state of the art. *Dental Materials*, 27(1):29–38. 62

- Flory, P. J. (1953). *Principles of polymer chemistry*. Cornell University Press, Ithaca, N.Y. 37
- Friedrich, J. (2018). *Metal–Polymer Systems: Interface Design and Chemical Bonding*. Wiley-VCH Verlag GmbH & Co. 18, 45
- Fritah, Z., Drouet, C., Thouron, C., and Aufray, M. (2020). Direct evidence of amine-metal reaction in epoxy systems: An in situ calorimetry study of the interphase formation. *Progress in Organic Coatings*, 148:105769. 45, 48
- Geckeler, K. E., Rupp, F., and Geis-Gerstorfer, J. (1997). Interfaces and interphases of (bio)materials: Definitions, structures, and dynamics. *Advanced Materials*, 9(6):513–518. 62
- Geiss, P. L. and Schumann, M. (2012). Investigation of the mechanical properties of interphases in adhesively bonded epoxy-aluminum joints by localized micro extensometry. *The Journal of Adhesion*, 88(11-12):941–955. 45
- Gent, A., Petrich, R., and Tabor, D. (1969). Adhesion of viscoelastic materials to rigid substrates. *Proceedings of the Royal Society of London. A. Mathematical and Physical Sciences*, 310(1502):433–448. 18
- Gent, A. and Schultz, J. (1972). Effect of wetting liquids on the strength of adhesion of viscoelastic material. *The Journal of Adhesion*, 3(4):281–294. 18
- Genty, S. (2018). *Physico-chimie d'adhésifs polymérisés par voie non conventionnelle et adhérence sur alliage base aluminium*. PhD thesis, University of Toulouse, issued by the Institut National Polytechnique de Toulouse. 25, 28, 40, 41
- Genty, S., Sauvage, J.-B., Tingaut, P., and Aufray, M. (2017). Experimental and statistical study of three adherence tests for an epoxy-amine/aluminum alloy system: Pull-off, single lap joint and three-point bending tests. *International Journal of Adhesion and Adhesives*, 79:50–58. 22, 28, 29, 30
- Genty, S., Tingaut, P., and Aufray, M. (2018). Fast polymerization at low temperature of an infrared radiation cured epoxy-amine adhesive. *Thermochimica Acta*, 666:27–35. 42
- Genty, S., Tingaut, P., Tendero, C., and Aufray, M. (2022). Effects of infrared radiation on the mechanical properties of an epoxy-amine adhesive using a central composite design method. *International Journal of Adhesion and Adhesives*, 112. 42
- Genxian, L., Yun, S., Canshuai, L., Jun, F., Lijun, S., and Bin, L. (2022). Adsorption behaviour of film-forming amine on pre-oxidized carbon steel surface. *Nuclear Engineering and Technology*, 54(4):1185–1194. 52
- González Garcia, F., Leyva, M. E., de Queiroz, A. A. A., and Simões, A. Z. (2011). Durability of adhesives based on different epoxy/aliphatic amine networks. *International Journal of Adhesion and Adhesives*, 31(4):177–181. 51
- Good, R. J. (1976). On the definition of adhesion. *The Journal of Adhesion*, 8(1):1–9. 17
- Goyanes, S. N., Saavedra, F., Roncaglia, A. J., and Rubiolo, G. H. (2005). Variation in physical and mechanical properties with coating thickness in epoxy–diamine–aluminum system. *Journal of Applied Polymer Science*, 98(2):891–895. 45, 50, 51, 52
- Grangeat, R. (2019). *Durabilité des assemblages collés en environnement humide – Instrumentation par capteurs à fibre optique*. PhD thesis, University of Nantes, à Saint-Nazaire. 44
- Grangeat, R., Girard, M., de Barros, S., and Jacquemin, F. (2023). An overview of interphase's formation and participation on water diffusion in epoxy/metal bonded assemblies. *The Journal of Adhesion*, in press(0):21. 44

- Grangeat, R., Girard, M., Jacquemin, F., and Lupi, C. (2022). Method of characterizing the interphase's mean water diffusion properties of a bonded assembly in immersion. *The Journal of Adhesion*, 98(3):207–226. [44](#)
- Grangeat, R., Girard, M., Lupi, C., Leduc, D., and Jacquemin, F. (2019). Revealing of interphases in bonded joints with a fiber optic sensor based on fresnel reflection. *International Journal of Adhesion and Adhesives*, 91:12–18. [44](#)
- Grundmeier, G. and Stratmann, M. (2005). Adhesion and de-adhesion mechanisms at polymer/metal interfaces: Mechanistic understanding based on in situ studies of buried interfaces. *Annual Review of Materials Research*, 35(1):571–615. [45](#)
- Gutowski, W. S. (1999). Physical model of interface and interphase performance in composite materials and bonded polymers. *Die Angewandte Makromolekulare Chemie*, 272(1):51–56. [19](#), [45](#)
- Hartshorn, S. (1986). *Structural Adhesives: Chemistry and Technology*, chapter The Durability of Structural Adhesive Joints, pages 347–406. Plenum Press, New York and London. [51](#)
- Hong, S. G., Cave, N. G., and Boerio, F. J. (1992). The modification of epoxy/metal interphases by adsorbed contaminants. *The Journal of Adhesion*, 36(4):265–279. [44](#)
- Hong, S.-G. and Tsai, J.-S. (2001). The adsorption and curing behaviors of the epoxy/amidoamine system in the presence of metal oxides. *Journal of Thermal Analysis and Calorimetry*, 63(1):31–46. [53](#)
- Houwink, R. and Salomon, G. (1965). *Adhesion and adhesives, volume 1: adhesives*. Elsevier publishing company: Amsterdam, London, New York, second edition. [18](#)
- Houwink, R. and Salomon, G. (1967). *Adhesion and adhesives, volume 2: applications*. Elsevier publishing company: Amsterdam, London, New York, second edition. [18](#)
- ISO 10365 (2022). Adhesives - Designation of main failure patterns. [17](#)
- ISO 14679 (1997). Adhesives: Measurement of adhesion characteristics by a three-point bending method. [23](#), [36](#), [56](#)
- ISO 9693 (2019). Dentistry - Compatibility testing for metal-ceramic and ceramic-ceramic systems [62](#)
- IUPAC (1997). *Compendium of Chemical Terminology, 2nd ed. (the "Gold Book")*. Blackwell Scientific Publications, Oxford. Online version (2019-) created by S. J. Chalk. [37](#)
- Jeandrau, J.-P., Peyrac, C., Lefebvre, F., Renard, J., Gantchenko, V., Patamaprohm, B., and Guinault, C. (2015). Fatigue behaviour of adhesive joints. *Procedia Engineering*, 133:508–517. Fatigue Design 2015, International Conference Proceedings, 6th Edition. [57](#)
- Jensen, M., Love, B., Grant, J., Cotton, J., Keiser, J., and Wilson, D. (2000). Comparison study of dicyandiamide-cured epoxy bonded steel joints and polyamidoamine-cured epoxy bonded steel joints. *International Journal of Adhesion and Adhesives*, 20(6):437–444. [23](#)
- Kanzow, J., Horn, P. S., Kirschmann, M., Zaporojtchenko, V., Dolgner, K., Faupel, F., Wehlack, C., and Possart, W. (2005). Formation of a metal/epoxy resin interface. *Applied Surface Science*, 239(2):227–236. [44](#)
- Kelber, J. and Brow, R. (1992). Model epoxy/metal-oxide chemical interactions: diethanolamine on oxidized copper and aluminum. *Applied Surface Science*, 59(3):273–280. [45](#)

- Kelly, J. R., Campbell, S. D., and Bowen, H. K. (1989). Fracture-surface analysis of dental ceramics. *The Journal of Prosthetic Dentistry*, 62(5):536–541. [61](#)
- Kergourlay, E., Grossin, D., Cinca, N., Josse, C., Dosta, S., Bertrand, G., Garcia, I., Guilemany, J. M., and Rey, C. (2016). First cold spraying of carbonated biomimetic nanocrystalline apatite on ti6al4v: Physical-chemical, microstructural, and preliminary mechanical characterizations. *Advanced Engineering Materials*, 18(4):496–500. [60](#)
- Khan, A. S., Azam, M. T., Khan, M., Mian, S. A., and Rehman, I. U. (2015). An update on glass fiber dental restorative composites: A systematic review. *Materials Science and Engineering: C*, 47:26–39. [62](#)
- Kinloch, A., Little, M., and Watts, J. (2000). The role of the interphase in the environmental failure of adhesive joints. *Acta Materialia*, 48(18):4543–4553. [51](#)
- Kishi, K. (1988). Adsorption of ethylenediamine on clean and oxygen covered Fe/Ni(100) surfaces studied by XPS. *Journal of Electron Spectroscopy and Related Phenomena*, 46(1):237–247. [45](#)
- Kishi, K. and Ikeda, S. (1980). X-ray photoelectron spectroscopic study for the adsorption of acetic acid and ethylenediamine on iron and nickel. *Applications of Surface Science*, 5(1):7–20. [45](#)
- Knaup, J. M., Köhler, C., Frauenheim, T., Blumenau, A. T., Amkreutz, M., Schiffels, P., Schneider, B., and Hennemann, O. D. (2006). Computational studies on polymer adhesion at the surface of γ -Al₂O₃. I. the adsorption of adhesive component molecules from the gas phase. *Journal of Physical Chemistry B*, 110:20460–20468. [43](#), [48](#)
- Knorr, D. B., Jaye, C., Fischer, D. A., Shoch, A. B., and Lenhart, J. L. (2012). Manipulation of interfacial amine density in epoxy-amine systems as studied by near-edge X-ray absorption fine structure (NEXAFS). *Langmuir*, 28(43):15294–15304. [45](#)
- Kollek, H., Brockmann, W., and Hennemann, O. D. (1985). Some aspects of chemistry in adhesion of aluminium joints. *Materials Science Monographs*, 29(2):83–94. [43](#)
- Krüger, T., Amkreutz, M., Schiffels, P., Schneider, B., Hennemann, O. D., and Frauenheim, T. (2005). Theoretical study of the interaction between selected adhesives and oxide surfaces. *Journal of Physical Chemistry B*, 109:5060–5066. [43](#), [45](#)
- Kurtz, S. M. (2019). *PEEK Biomaterials Handbook*. Elsevier, United Kingdom, United States, second edition. [60](#)
- Lake, G. J., Thomas, A. G., and Tabor, D. (1967). The strength of highly elastic materials. *Proceedings of the Royal Society of London. Series A. Mathematical and Physical Sciences*, 300(1460):108–119. [18](#)
- Langeloth, M., Sugii, T., Böhm, M. C., and Müller-Plathe, F. (2014). Formation of the interphase of a cured epoxy resin near a metal surface: Reactive coarse-grained molecular dynamics simulations. *Soft Materials*, 12:S71–S79. [45](#)
- Lapena, M. H. and Lopes, C. M. A. (2023). Improvement of aerospace thermoplastic composite adhesion to coating with dielectric barrier discharge atmospheric pressure plasma surface treatment. *Plasma Processes and Polymers*, 20(1):2200081. [23](#)
- Lee, H. and Neville, K. (1967, reprinted 1982.). *Handbook of Epoxy Resins*. McGraw-Hill, Inc., New York. [37](#)
- Lee, J. H., Choe, Y., and Lee, S. G. (2017). Adhesion mechanism of bisphenol a diglycidyl ether (BADGE) on an α -Fe₂O₃ (0001) surface. *Journal of Industrial and Engineering Chemistry*, 53:62–67. [43](#)

- Lee, L.-H. (1991). *Fundamentals of Adhesion*. Springer Science, New York. 18
- Legghe, E., Aragon, E., Bélec, L., Margailan, A., and Melot, D. (2009). Correlation between water diffusion and adhesion loss: Study of an epoxy primer on steel. *Progress in Organic Coatings*, 66(3):276–280. 51
- Lenz, J. and Kessel, S. (1998). Thermal stresses in metal–ceramic specimens for the iso crack initiation test (three-point flexure bond test). *Dental Materials*, 14(4):277–280. 62
- Lenz, J., Schwarz, S., Schwickerath, H., Sperner, F., and Schäfer, A. (1995). Bond strength of metal–ceramic systems in three-point flexure bond test. *Journal of Applied Biomaterials*, 6(1):55–64. 62
- Marchfelder, C., Pugstaller, R., Wallner, G. G., Brüggemann, O., and Aufray, M. (2022). Effect of epoxy structure on properties of waterborne coatings and electrical steel laminates. *Polymers*, 14. 44
- Mark, H. F., editor (2003). *Encyclopedia of Polymer Science and Technology*. Wiley-Interscience, 3rd edition. 37
- Marsh, J., Minel, L., Barthés-Labrousse, M. G., and Gorse, D. (1996). The nature of the surface acidity of anodised titanium: an XPS study using 1,2-diaminoethane. *Applied Surface Science*, 99(4):335–343. 44, 45
- Marsh, J., Minel, L., Barthés-Labrousse, M. G., and Gorse, D. (1998). Interaction of epoxy model molecules with aluminium, anodised titanium and copper surfaces: An XPS study. *Applied Surface Science*, 133(4):270–286. 44
- Marshall, S. J., Bayne, S. C., Baier, R., Tomsia, A. P., and Marshall, G. W. (2010). A review of adhesion science. *Dental Materials*, 26(2):e11–e16. 61
- Maxwell, A. S. (2001). Review of test methods for coating adhesion. Technical Report NPL Report MATC(A)49, National Physical Laboratory. 56
- Mayou, R., Karami, M., and Jabri, M. (2018). Systèmes adhésifs : évolution et efficacité. *Revue Odonto Stomatologique*, 47:77–85. 62
- McAdams, B. J. and Pearson, R. A. (2005). Studies on the disbonding initiation of interfacial cracks. Technical Report SAND2005-4749, Sandia National Laboratories. 56
- McBain, J. W. and Hopkins, D. G. (1925). On adhesives and adhesive action. *The Journal of Physical Chemistry*, 29(2):188–204. 18
- Meiser, A. (2010). *Vernetzung und Alterung eines Epoxidklebstoffs im Kontakt mit Atmosphären und Metallen*. PhD thesis, Universität des Saarlandes (Allemagne). 44
- Meiser, A., Kübel, C., Schäfer, H., and Possart, W. (2010). Electron microscopic studies on the diffusion of metal ions in epoxy-metal interphases. *International Journal of Adhesion and Adhesives*, 30(3):170–177. 44
- Meiser, A. and Possart, W. (2011). Epoxy-metal interphases: Chemical and mechanical aging. *The Journal of Adhesion*, 87(4):313–330. 44
- Meiser, A., Willstrand, K., Fehling, P., and Possart, W. (2008). Chemical aging in epoxies: A local study of the interphases to air and to metals. *The Journal of Adhesion*, 84(4):299–321. 44
- Mercier, D. (2006). *Étude des mécanismes de formation de l'interphase dans les systèmes époxy-amine / aluminium*. PhD thesis, University Paris Val de Marne. 44, 45

- Mercier, D. and Barthés-Labrousse, M.-G. (2009). The role of chelating agents on the corrosion mechanisms of aluminium in alkaline aqueous solutions. *Corrosion Science*, 51(2):339–348. [44](#)
- Mercier, D., Herinx, M., and Barthés-Labrousse, M.-G. (2010). Influence of 1,2-diaminoethane on the mechanism of aluminium corrosion in sulphuric acid solutions. *Corrosion Science*, 52(10):3405–3412. [44](#)
- Mercier, D., Rouchaud, J.-C., and Barthés-Labrousse, M.-G. (2008). Interaction of amines with native aluminium oxide layers in non-aqueous environment: Application to the understanding of the formation of epoxy-amine/metal interphases. *Applied Surface Science*, 254(20):6495–6503. [44](#), [45](#)
- Monternot, H., Bénazet, D., and Ancenay, H. (1978). *Guide du collage*. CETIM. [18](#)
- Montois, P. (2003). *Durabilité d'assemblages collés structuraux époxyde/alliage de titane ? Application à l'étude d'une interphase modèle*. PhD thesis, University of Toulouse, issued by the Institut National Polytechnique de Toulouse. [44](#), [46](#)
- Montois, P., Nassiet, V., Petit, J. A., and Adrian, D. (2007). Viscosity effect on epoxy-diamine/metal interphases. Part II: Mechanical resistance and durability. *International Journal of Adhesion and Adhesives*, 27(2):145–155. [44](#), [46](#)
- Montois, P., Nassiet, V., Petit, J. A., and Baziard, Y. (2006). Viscosity effect on epoxy-diamine/metal interphases. Part I: Thermal and thermomechanical behaviour. *International Journal of Adhesion and Adhesives*, 26(6):391–399. [44](#), [46](#)
- Morsch, S., Emad, S., Liu, Y., Lyon, S., and Gibbon, S. (2021). Local oxidation of the buried epoxy-amine/iron oxide interphase. *Progress in Organic Coatings*, 160:106516. [44](#)
- Morsch, S., Liu, Y., Malanin, M., Formanek, P., and Eichhorn, K.-J. (2019). Exploring whether a buried nanoscale interphase exists within epoxy-amine coatings: Implications for adhesion, fracture toughness, and corrosion resistance. *ACS Applied Nano Materials*, 2(4):2494–2502. [44](#)
- Morsch, S., Lyon, S., and Gibbon, S. (2020). Spectroscopic insights into adhesion failure at the buried epoxy-metal interphase using AFM-IR. *Surface and Interface Analysis*, 52(6):1139–1144. [44](#)
- Morsch, S., Wand, C. R., Emad, S., Lyon, S., Siperstein, F., Malanin, M., Muche, J., Caspari, A., Drechsler, A., Eichhorn, K. J., and Gibbon, S. (2022). Molecular origins of epoxy-amine/iron oxide interphase formation. *Journal of Colloid and Interface Science*, 613:415–425. [44](#)
- Morsch, S., Wand, C. R., Gibbon, S., Irwin, M., Siperstein, F., and Lyon, S. (2023). The effect of cross-linker structure on interfacial interactions, polymer dynamics and network composition in an epoxy-amine resin. *Applied Surface Science*, 609:155380. [44](#)
- Mourad, E. and Aminah, M. (2018). Assessment of bonding effectiveness of adhesive materials to tooth structure using bond strength test methods: A review of literature. *The open dentistry journal*, 12:664–678. [61](#)
- Munz, M., Chung, J., and Kalinka, G. (2005). *Adhesion - Current Research and Application*, chapter Mapping Epoxy Interphases, pages 103–123. Wiley-VCH, Weinheim (Germany). [44](#)
- Nakazawa, M. (1994). Mechanism of adhesion of epoxy resin to steel surface. technical report n.63, Nikkon Steel. [43](#)
- Nazarov, A., Thierry, D., Volovitch, P., and Ogle, K. (2011). An skp and eis investigation of amine adsorption on zinc oxide surfaces. *Surface and Interface Analysis*, 43(10):1286–1298. [45](#)

- NF-EN 1966 (2009). Adhésifs structuraux : Caractérisation d'une surface par mesure de l'adhérence au moyen de la méthode de la flexion en trois points. [23](#)
- NF-EN 2243-1 (2006). Essais de cisaillement d'un joint à recouvrement simple : Série aérospatiale, Matériaux non-métalliques, Système d'adhésifs structuraux, Méthodes d'essai : Partie 1. [28](#)
- NF-EN 923 (2016). Adhésifs : Termes et définitions. [17](#), [37](#)
- NF-EN-ISO 11357-5 (2014). Plastics — Differential scanning calorimetry (DSC) — Part 5: Determination of characteristic reaction-curve temperatures and times, enthalpy of reaction and degree of conversion. [39](#)
- Nouveau, P. (1993). *L'utilisation des adhésifs universels dans l'omnipratique*. PhD thesis, Faculté d'Odontologie de Marseille, issued by the University of Aix-Marseille. [61](#)
- Onard, S., Martin, I., Chailan, J.-F., Crespy, A., and Carrière, P. (2011). Nanostructuring in thin epoxy-amine films inducing controlled specific phase etherification: Effect on the glass transition temperatures. *Macromolecules*, 44(9):3485–3493. [44](#)
- Özcan, M., Dündar, M., and Çömlekoğlu, M. E. (2012). Adhesion concepts in dentistry: tooth and material aspects. *Journal of Adhesion Science and Technology*, 26(24):2661–2681. [61](#)
- Paroissien, E. (2020). *Modélisation simplifiée des transferts d'effort dans les assemblages boulonnés et/ou collés*. Habilitation à Diriger des Recherches from the University of Toulouse, issued by the Institut Supérieur de l'Aéronautique et de l'Espace. [35](#)
- Pascualt, J., Sautereau, H., Verdu, J., and Williams, R. (2002). *Thermosetting polymers*. Marcel Dekker (New York), 1st edn edition. [37](#), [38](#)
- Pascualt, J.-P. and Williams, R. J. J. (2010). *Epoxy Polymers: New materials and innovations*. Number 387 p. Wiley-VCH. [37](#)
- Passlack, S., Brodyanski, A., Bock, W., Kopnarski, M., Presser, M., Geiß, P. L., Possart, G., and Steinmann, P. (2009). Chemical and structural characterisation of dgeba-based epoxies by time of flight secondary ion mass spectrometry (ToF-SIMS) as a preliminary to polymer interphase characterisation. *Anal Bioanal Chem*, 393:1879–1888. [44](#)
- Pensini, E., van Lier, R., Cuoq, F., Hater, W., and Halthur, T. (2018). Enhanced corrosion resistance of metal surfaces by film forming amines: A comparative study between cyclohexanamine and 2-(diethylamino)ethanolbased formulations. *Water Resources and Industry*, 20:93–106. [52](#)
- Petit, J. A. (1992). Bases scientifiques de l'assemblage par collage. *Matériaux et techniques*, 80(4-5):3–10. [17](#)
- Petrie, E. (2005). *Epoxy Adhesive Formulations*. McGraw-Hill Chemical Engineering. McGraw-Hill (New York), first edition. [20](#), [37](#)
- Petrie, E. M. (2007). *Handbook of adhesives and sealants, Second Edition*. Mc Graw-Hill, New York, second edition. [15](#), [18](#)
- Pham, H. and Marks, M. (2004). *The Encyclopedia of Polymer Science and Technology*, volume 9, chapter Epoxy resins, pages 678–804. John Wiley & Sons, Inc., New York. [37](#)
- Phan, T. T. M., Chu, N. C., Luu, V. B., Nguyen Xuan, H., Martin, I., and Carrière, P. (2016). The role of epoxy matrix occlusions within BaTiO₃ nanoparticles on the dielectric properties of functionalized BaTiO₃/epoxy nanocomposites. *Composites Part A: Applied Science and Manufacturing*, 90:528–535. [44](#)

- Philipp, M., Müller, U., Sanctuary, R., Gaukler, J. C., Wehlack, C., Possart, W., and Krüger, J.-K. (2011). Heterogeneous transport processes and unexpected structure formation in layered epoxy and epoxy-alumina nanocomposite systems. *The Journal of Adhesion*, 87(11):1073–1098. [44](#)
- Pomes-Hadda, M. (2015). *Caractérisations et performances des assemblages collés époxyde-amine/aluminium*. PhD thesis, University of Toulouse, issued by the Institut National Polytechnique de Toulouse. [45](#), [52](#)
- Pomes-Hadda, M., Aufray, M., and Diahham, S. (2015). Interval analysis: A new tool for the characterization of an epoxy-amine/aluminum system. *Polymers*, 7(4):644–654. [45](#)
- Popineau, S. and Shanahan, M. E. (2006). Simple model to estimate adhesion of structural bonding during humid ageing. *International Journal of Adhesion and Adhesives*, 26(5):363–370. [51](#), [52](#)
- Possart, G., Presser, M., Passlack, S., Kopnarski, M., Brodyanski, A., and Steinmann, P. (2009). Micro-macro characterisation of DGEBA-based epoxies as a preliminary to polymer interphase modelling. *International Journal of Adhesion and Adhesives*, 29:478–487. [44](#)
- Possart, W. (1988). Experimental and theoretical description of the electrostatic component of adhesion at polymer/metal contacts. *International Journal of Adhesion and Adhesives*, 8(2):77–83. [44](#)
- Possart, W., Fanter, D., Dieckhoff, S., Gesang, T., Hartwig, A., Höper, R., Schlett, V., and Henneemann, O. D. (1996). Studies on the interphase of a model adhesive joint. *The Journal of Adhesion*, 57(1-4):227–244. [44](#)
- Possart, W., Krüger, J. K., Wehlack, C., Müller, U., Petersen, C., Bactavatchalou, R., and Meiser, A. (2006). Formation and structure of epoxy network interphases at the contact to native metal surfaces. *Comptes Rendus Chimie*, 9(1):60–79. [44](#)
- Prolongo, S. G., Horcajo, K. F., Rosario, G. D., and Ureña, A. (2010). Strength and durability of epoxy-aluminum joints. *The Journal of Adhesion*, 86(4):409–429. [51](#)
- Pröbster, L., Maiwald, U., and Weber, H. (1996). Three-point bending strength of ceramics fused to cast titanium. *European Journal of Oral Sciences*, 104(3):313–319. [62](#)
- Rasmussen, S. T. (1978). Fracture studies of adhesion. *Journal of Dental Research*, 57(1):11–20. [61](#)
- Rekow, E. D., Zhang, G., Thompson, V., Kim, J.-W., Coehlo, P., and Zhang, Y. (2009). Effects of geometry on fracture initiation and propagation in all-ceramic crowns. *Journal of biomedical materials research. Part B, Applied biomaterials*, 88:436–46. [61](#)
- Rives, B. (1999). *Adhérence de primaires aéronautiques sur oxydes d'aluminium*. PhD thesis, University Toulouse 3. [24](#)
- Roche, A., Dole, P., and Bouzziri, M. (1994). Measurement of the practical adhesion of paint coatings to metallic sheets by the pull-off and three-point flexure tests. *Journal of Adhesion Science and Technology*, 8(6):587–609. [23](#), [32](#), [33](#)
- Roche, A., Gaillard, E., Romand, M., and Von Fahnstock, M. (1987). Metal-adhesive bonded systems: Adhesion measurement using a three point flexure test. *Journal of Adhesion Science & Technology*, 1(2):145–157. [23](#)
- Roche, A. A., Aufray, M., and Jérôme, B. (2006). The role of the residual stresses of the epoxy-aluminum interphase on the interfacial fracture toughness. *The Journal of Adhesion*, 82(9):867–886. [43](#), [46](#), [50](#), [51](#), [52](#)

- Roche, A. A., Behme, A. K., and Solomon, J. S. (1982). A three-point flexure test configuration for improved sensitivity to metal/ adhesive interfacial phenomena. *International Journal of Adhesion and Adhesives*, 2(4):249–254. [23](#)
- Roche, A. A., Bouchet, J., and Bentadjine, S. (2002). Formation of epoxy-diamine/metal interphases. *International Journal of Adhesion and Adhesives*, 22(6):431–441. [43](#), [45](#), [46](#)
- Roche, A. A. and Guillemenet, J. (1999). Mechanical and chemical properties of organic coatings applied to metallic sheet substrates. *Thin Solid Films*, 342(1-2):52–60. [43](#)
- Safavi-Ardebili, V., Sinclair, A. N., and Spelt, J. K. (1997). Experimental investigation of the interphase in an epoxy-aluminum system. *The Journal of Adhesion*, 62(1-4):93–111. [45](#)
- Salgin, B., Özkanat, O., Mol, J. M. C., Terryn, H., and Rohwerder, M. (2013). Role of surface oxide properties on the aluminum/epoxy interfacial bonding. *The Journal of Physical Chemistry C*, 117(9):4480–4487. [45](#)
- Salz, U. and Bock, T. (2010). Testing adhesion of direct restoratives to dental hard tissue - a review. *The journal of adhesive dentistry*, 12:343–71. [61](#)
- Sanctuary, R., Baller, J., Zielinski, B., Becker, N., Krueger, J. K., Philipp, M., Mueller, U., and Ziehmer, M. (2009). Influence of Al_2O_3 nanoparticles on the isothermal cure of an epoxy resin. *Journal of Physics-condensed Matter*, 21(3):035118. [44](#)
- Sauvage, J.-B. (2016). *Caractérisation et modélisation de l'adhérence dans les assemblages collés*. PhD thesis, University of Haute Alsace. [23](#), [26](#), [36](#)
- Sauvage, J.-B., Aufray, M., Jeandrou, J.-P., Chalandon, P., Poquillon, D., and Nardin, M. (2017). Using the 3-point bending method to study failure initiation in epoxide-aluminum joints. *International Journal of Adhesion and Adhesives*, 75:181–189. [32](#), [33](#)
- Sauvage, J.-b., Chalandon, P., Poquillon, D., Nardin, M., and Aufray, M. (2019). Using the finite element analysis method to study the 3-point bending test for the characterization of the adherence. *Journal of Applied and Computational Mechanics*, 6(3):505–516. [36](#)
- Schmidt, R. G. and Bell, J. P. (1986). Epoxy adhesion to metals. *Advances in Polymer Science*, 75:33–71. [43](#)
- Semoto, T., Tsuji, Y., and Yoshizawa, K. (2011). Molecular understanding of the adhesive force between a metal oxide surface and an epoxy resin. *Journal of Physical Chemistry C*, 115:11701–11708. [45](#)
- Sharpe, L. and Schonhorn, H. (1963). Thermodynamic adhesion. *Chem. Eng. News.*, 41(15):67–88. [18](#)
- Sharpe, L. H. (1972). The interphase in adhesion. *The Journal of Adhesion*, 4(1):51–64. [52](#)
- Shenoy, V., Ashcroft, I., Critchlow, G., and Crocombe, A. (2010a). Fracture mechanics and damage mechanics based fatigue lifetime prediction of adhesively bonded joints subjected to variable amplitude fatigue. *Engineering Fracture Mechanics*, 77(7):1073–1090. [57](#)
- Shenoy, V., Ashcroft, I., Critchlow, G., and Crocombe, A. (2010b). Unified methodology for the prediction of the fatigue behaviour of adhesively bonded joints. *International Journal of Fatigue*, 32(8):1278–1288. [57](#)
- Shundo, A., Yamamoto, S., and Tanaka, K. (2022). Network formation and physical properties of epoxy resins for future practical applications. *JACS Au*, 2(7):1522–1542. [37](#)
- Skeist, I. (1990). *Handbook of adhesives*. Chapman & Hall, New York, 3rd edition. [18](#)

- Sonnenschein, M. F. (2015). *Polyurethanes: Science, thechnology, Markets and trends*. John Wiley & Sons, Inc., Hoboken (New Jersey, USA). 37
- Sperandio, C. (2009). *Étude et amélioration de la tenue mécanique des assemblages collés aluminium/résine époxyde/aluminium par greffage de nanoparticules et traitement de surface des substrats*. PhD thesis, University of Lorraine. 45
- Sperandio, C., Arnoult, C., Laachachi, A., Di Martino, J., and Ruch, D. (2010a). Characterization of the interphase in an aluminium/epoxy joint by using controlled pressure scanning electron microscopy coupled with an energy dispersive x-ray spectrometer. *Micron*, 41(2):105–111. 45
- Sperandio, C., Bardon, J., Laachachi, A., Aubriet, H., and Ruch, D. (2010b). Influence of plasma surface treatment on bond strength behaviour of an adhesively bonded aluminium-epoxy system. *International Journal of Adhesion and Adhesives*, 30(8):720–728. 45
- Säckl, G., Duchoslav, J., Pugstaller, R., Marchfelder, C., Haselgrübler, K., Aufray, M., Stifter, D., and Wallner, G. M. (2022). The interaction of waterborne epoxy/dicyandiamide varnishes with metal oxides. *Polymers*, 14:2226. 44
- Söderholm, K.-J. M. (2009). Critical evaluation of adhesive test methods used in dentistry. *Journal of Adhesion Science and Technology*, 23(7-8):973–990. 61
- Tomasetti, E., Legras, R., Henri-Mazeaud, B., and Nysten, B. (2000). Plastic deformation in polypropylene/(ethylene–propylene) copolymer blend during paint debonding. *Polymer*, 41(17):6597–6602. 23
- Triani, F., Pereira da Silva, L., Ferreira Lemos, B., Domingues, J., Teixeira, L., and Manarte-Monteiro, P. (2022). Universal adhesives: Evaluation of the relationship between bond strength and application strategies—a systematic review and meta-analyses. *Coatings*, 12:1501. 61
- Valega Mackenzie, F. O. and Thijsse, B. J. (2015). Study of metal/epoxy interfaces between epoxy precursors and metal surfaces using a newly developed reactive force field for alumina–amine adhesion. *The Journal of Physical Chemistry C*, 119(9):4796–4804. 45
- Van Meerbeek, B., Yoshihara, K., Van Landuyt, K., Yoshida, Y., and Peumans, M. (2020). From buonocore's pioneering acid-etch technique to self-adhering restoratives. a status perspective of rapidly advancing dental adhesive technology. *The Journal of Adhesive Dentistry*, 22(1):7–34. 62
- Villenave, J.-J. (2005). *Assemblage par collage*. Dunod. 18
- von Fraunhofer and Anthony, J. (2012). Adhesion and cohesion. *International Journal of Dentistry*, 2012:951324. 61
- Voyutskii, S. S. and Vakula, V. L. (1963). The role of diffusion phenomena in polymer-to-polymer adhesion. *Journal of Applied Polymer Science*, 7(2):475–491. 18
- Wahab, A. M. M. (2012). Fatigue in adhesively bonded joints: A review. *ISRN Materials Science*, 2012:25. 57
- Wand, C. R., Gibbon, S., Visser, P., and Siperstein, F. R. (2022). Water-mediated epoxy/surface adhesion: Understanding the interphase region. *Chemistry—A European Journal*, 28(68):e202202483. 44
- Wapner, K., Stratmann, M., and Grundmeier, G. (2006). In situ infrared spectroscopic and scanning kelvin probe measurements of water and ion transport at polymer/metal interfaces. *Electrochimica Acta*, 51:3303–3315. 45

- Wehlack, C. and Possart, W. (2004). Characterization of the epoxy-metal interphase: FTIR-ERAS and spectra calculation for ultra-thin films. *Macromolecular Symposia*, 205:251–262. [44](#)
- Wehlack, C., Possart, W., Krger, J. K., and Mller, U. (2007). Epoxy and polyurethane networks in thin films on metals - formation, structure, properties. *Soft Materials*, 5(2-3):87–134. [44](#)
- Wielant, J., Hauffman, T., Blajiev, O., Hausbrand, R., and Terryn, H. (2007). Influence of the iron oxide acid-base properties on the chemisorption of model epoxy compounds studied by XPS. *Journal of Physical Chemistry C*, 111:13177–13184. [45](#), [48](#)
- Williams, D. F. and European Society for Biomaterials, editors (1986 et 1991). *Definitions in biomaterials : proceedings of a consensus conference of the European Society for Biomaterials*, Chester (UK). Elsevier, Amsterdam. [59](#)
- Wu, T., Foyet, A., Kodentsov, A., van der Ven, L., van Benthem, R., and de With, G. (2014). Wet adhesion of epoxy-amine coatings on 2024-T3 aluminum alloy. *Materials Chemistry and Physics*, 145(3):342–349. [51](#), [52](#)
- Yamamoto, S., Kuwahara, R., Aoki, M., Shundo, A., and Tanaka, K. (2020). Molecular events for an epoxy-amine system at a copper interface. *ACS Applied Polymer Materials*, 2(4):1474–1481. [44](#)
- Yamamoto, S., Kuwahara, R., and Tanaka, K. (2022). Effects of chemistry of silicon surfaces on the curing process and adhesive strength for epoxy resin. *ACS Applied Polymer Materials*, 4(8):6038–6046. [44](#)
- Yamamoto, S. and Tanaka, K. (2021). Entropy-driven segregation in epoxy-amine systems at a copper interface. *Soft Matter*, 17:1359–1367. [43](#), [44](#)
- Zanni-deffarges, M. P. and Shanahan, M. E. R. (1994). Bulk and interphase effects in aged structural joints. *The Journal of Adhesion*, 45(1-4):245–257. [45](#)
- Zhang, Y. and Spinks, G. (1997). An atomic force microscopy study of the effect of surface roughness on the fracture energy of adhesively bonded aluminium. *Journal of Adhesion Science and Technology*, 11(2):207–223. [25](#)
- Zhao, P. F., Sun, C. A., Zhu, X. Y., Shang, F. L., and Li, C. J. (2010). Fracture toughness measurements of plasma-sprayed thermal barrier coatings using a modified four-point bending method. *Surface and Coatings Technology*, 204(24):4066–4074. [57](#)
- Zhao, Z., Wang, Q., Zhao, J., Zhao, B., Ma, Z., and Zhang, C. (2021). Adhesion of teeth. *Frontiers in Materials*, 7:615225. [61](#)