



HAL
open science

Hybridization of vehicular communication technologies for a resilient high-performance network

Badreddine Yacine Yacheur

► **To cite this version:**

Badreddine Yacine Yacheur. Hybridization of vehicular communication technologies for a resilient high-performance network. Computer Science [cs]. Université de Bordeaux, 2023. English. NNT : 2023BORD0454 . tel-04529733v2

HAL Id: tel-04529733

<https://hal.science/tel-04529733v2>

Submitted on 22 Oct 2024

HAL is a multi-disciplinary open access archive for the deposit and dissemination of scientific research documents, whether they are published or not. The documents may come from teaching and research institutions in France or abroad, or from public or private research centers.

L'archive ouverte pluridisciplinaire **HAL**, est destinée au dépôt et à la diffusion de documents scientifiques de niveau recherche, publiés ou non, émanant des établissements d'enseignement et de recherche français ou étrangers, des laboratoires publics ou privés.

THÈSE PRÉSENTÉE
POUR OBTENIR LE GRADE DE

**DOCTEUR DE
L'UNIVERSITÉ DE BORDEAUX**

ÉCOLE DOCTORALE MATHÉMATIQUES ET INFORMATIQUE
SPÉCIALITÉ : INFORMATIQUE

Opéré à l'Institut National Polytechnique de Bordeaux (INP Bordeaux)

Par Badreddine Yacine YACHEUR

**Hybridation des technologies de communication véhiculaire
pour un réseau résilient et performant**

**Hybridization of vehicular communication technologies for a
resilient high-performance network**

**Sous la direction de : Toufik AHMED
Co-directeur : Mohamed MOSBAH**

Soutenue le : 18/12/2023

Membres du jury :

M. PHAM, Congduc
M. FOUCHAL, Hacene
M. AIT SAADI, Nadjib
M. AHMED, Toufik
M. MOSBAH, Mohamed

Professeur UPPA, Pau
Professeur URCA, Reims
Professeur UVSQ Paris-Saclay, Versailles
Professeur UB, Bordeaux INP, Talence
Professeur UB, Bordeaux INP, Talence

Examineur
Rapporteur
Rapporteur
Directeur de thèse
Co-directeur de thèse

Président du jury : Pr. PHAM, Congduc

Title: Hybridization of vehicular communication technologies for a resilient, high-performance network

Abstract

In the modern landscape of transportation and communication, vehicular communications have emerged as a critical pillar for enabling Cooperative Intelligent Transport Systems (C-ITS). These communications facilitate seamless and real-time data exchange between vehicles, infrastructure, and even pedestrians, giving rise to a dynamic ecosystem known as Vehicular Ad-Hoc Networks (VANETs) and Vehicular-to-Everything (V2X) communication. Vehicular communications have an eminence potential to improve road safety and traffic management. It allows vehicles to exchange awareness messages with their surroundings to prevent road accidents that can be mitigated using C-ITS. These messages must be sent in a reliable, fast and high throughput medium to promise a better safety service, thus help reaching the European commission's target, which envisions reducing road accidents by half. Nowadays, vehicular communication technologies are globally based on IEEE (i.e. IEEE 802.11) standards like IEEE 802.11p and IEEE 802.11bd standards and 3GPP standards like LTE-V2X and 5G NR V2X. IEEE standards are used in the access layer of the ITS-G5 vehicular communication technology and the 3GPP standards are used to define Cellular V2X (C-V2X) technologies. Emerging standards, such as IEEE 802.11bd technology, are intended to work alongside (resp. potentially replace) LTE-V2X (resp. IEEE 802.11p) to better facilitate advanced use cases and higher levels of automation in transportation systems. Emerging new V2X applications, like Advanced Driver Assistance Systems (ADASs) and Connected Autonomous Driving (CAD) depend on a significant amount of shared data and require Ultra-Reliable Low Latency Communications (URLLC). Unfortunately, none of the existing V2X communication technologies can satisfy these requirements independently.

In this thesis, we study the importance and the feasibility of adopting a hybrid vehicular communication architecture to enhance the performance of the V2X communications. A hybrid vehicular communication architecture refers to a system that combines multiple communication technologies to facilitate resilient and reliable communication. The hybrid nature of this architecture involves integrating both ITS-G5 communication technology and C-V2X technologies. This approach leverages the strengths of both technologies to create a versatile and reliable communication framework for the vehicles of today and the future.

Our contribution in this thesis is threefold, focusing on C-ITS and hybrid communications. First, we initiate our inquiry by assessing the potential of new generation technologies to meet the demands of emerging V2X applications. In this context, we proceed with the implementation and

comprehensive evaluation of the IEEE 802.11bd standard, with a specific focus on its capacity to enhance reliability, increase throughput, and mitigate the number of vehicular accidents. Second, our main contribution introduced a novel scalable hybrid vehicular communication architecture that accommodates various combinations of existing vehicular communication technologies. This is done by integrating a new hybrid communication management layer in the protocol stack of the ITS station that maintains the transparency between the access layer and the application layer. In parallel, since the primary hurdle in hybrid communication is Radio Access Technology (RAT) selection, we investigate a decentralized RAT selection strategy that uses Deep Reinforcement Learning (DRL). Furthermore, Numerical results reveal that the hybrid vehicular communication architecture has the potential to enhance the Packet Reception Rate (PRR) by up to 30% compared to a legacy vehicular communication architecture. Additionally, the selection strategy exhibits about 20% improvement in throughput and a 10% reduction in channel busy ratio. The third contribution is presented as a Proof of Concept (PoC) on hybrid communication and the vMEC (vehicular Multiaccess edge computing) to enhance the orientation of approaching vehicles in a toll station.

Keywords: Hybrid vehicular network, ITS-G5, C-V2X, RAT selection, Reinforcement learning, URLLC (Ultra-Reliable Low Latency Communications).

Titre : Hybridation des technologies de communication véhiculaire pour un réseau résilient et performant

Résumé

Dans le domaine des transports intelligents, les réseaux de communication véhiculaire jouent un rôle crucial dans les Systèmes de Transport Intelligents Coopératifs (C-ITS). Ils facilitent l'échange de données en temps réel entre les véhicules, les infrastructures, et les piétons, réalisant ainsi une communication du véhicule vers Tout (V2X). Ces communications donnent naissance à un réseaux Ad-Hoc Véhiculaires (VANETs) qui a le potentiel d'améliorer la sécurité routière et la gestion du trafic en permettant aux véhicules d'échanger des messages de sensibilisation pour prévenir les accidents de la route, contribuant ainsi à l'objectif de la Commission européenne de réduire de moitié les accidents. Ces messages doivent être transmis de manière fiable, et à haut débit pour garantir un meilleur service de sécurité routière. Actuellement, les technologies de communication véhiculaire reposent sur les normes IEEE802.11 telles que 802.11p et 802.11bd ainsi que sur les normes 3GPP telles que LTE-V2X et 5G NR V2X. Les normes IEEE sont utilisées dans la couche d'accès de la technologie ITS-G5, tandis que les normes 3GPP définissent les technologies de communication véhiculaire cellulaires C-V2X. De nouvelles normes émergentes, telles que IEEE802.11bd et 5G NR V2X, sont conçues pour répondre aux besoins des applications V2X avancées et de l'automatisation élevée dans les systèmes de transport. Ces applications V2X, telles que les Systèmes Avancés d'Aide à la Conduite (ADAS) et la Conduite Autonome Connectée (CAD), dépendent d'une quantité significative de données partagées et nécessitent des Communications Ultra-Fiables et à Faible Latence (URLLC). Cependant, aucune des technologies de communication V2X existantes ne peut répondre aux exigences des nouvelles application V2X de manière indépendante.

Dans cette thèse, nous explorons la faisabilité de l'adoption d'une architecture hybride de communication véhiculaire pour améliorer les performances des communications et répondre aux besoins des nouvelles applications V2X. Une architecture hybride de communication véhiculaire désigne un système qui combine plusieurs technologies de communication pour développer une communication résiliente et fiable. La nature de cette architecture implique l'intégration à la fois de la technologie de communication ITS-G5 et des technologies C-V2X pour exploiter les avantages des deux familles de technologies pour créer un cadre de communication polyvalent et résilient.

Cette thèse propose trois contributions distinctes dans le contexte des C-ITS et des communications hybrides. Premièrement, nous commençons notre quête en évaluant la capacité des technologies de nouvelle génération à répondre aux exigences des applications V2X. Dans ce

contexte, nous procédons à l'implémentation et à l'évaluation de la norme IEEE 802.11bd, en mettant l'accent sur sa capacité à améliorer la fiabilité, et à réduire le nombre d'accidents de la route. La deuxième contribution est une nouvelle architecture de communication véhiculaire hybride évolutive qui prend en charge diverses combinaisons de technologies de communication véhiculaire. Cela est réalisé en intégrant une nouvelle couche de gestion de communication hybride qui maintient la transparence entre la couche d'accès et la couche d'application. Parallèlement, nous étudions une stratégie décentralisée de sélection de technologie d'accès qui utilise l'apprentissage profond par renforcement (DRL). De plus, les résultats numériques révèlent que notre architecture hybride améliore le taux de réception des paquets (PRR) jusqu'à 30 % par rapport à une communication ITS-G5 traditionnelle. De plus, la stratégie de sélection présente une amélioration d'environ 20 % du débit et une réduction de 10 % du taux d'occupation du canal. La troisième contribution est présentée sous forme de preuve de concept (PoC) sur la communication hybride et le vMEC pour améliorer l'orientation des véhicules approchants dans une station de péage.

Mots clés : Réseau véhiculaire hybride, ITS-G5, C-V2X, Sélection de technologie d'accès radio, Apprentissage par renforcement, URLLC (Communications à Faible Latence Ultra-Fiables).

Research unit

LaBRI (Laboratoire Bordelais de Recherche en Informatique) UMR 5800 - 351 Cours de
la Libération, 33405 Talence

Acknowledgment

I would like to express my sincere gratitude and appreciation to all individuals and institutions who have played a crucial role in this journey. Without their support and contributions, the success of this thesis would not have been possible. When I initially embarked on this remarkable PhD experience, I was drawn to its innovative and intriguing subject matter. Little did I know the depth of knowledge and experience I would acquire during these three years.

I am profoundly thankful for the guidance, support, and expertise provided by Prof Toufik AHMED. I appreciate his patience and assistance throughout my journey. I also wish to thank Prof Mohamed MOSBAH for his encouragement, support, and valuable introductions to various networking opportunities. Both Toufik and Mohamed are exceptional scientists and professors, making them a top-notch outstanding research team known for their excellent mentorship and research works.

To my family, whose unwavering love, encouragement, and inspiration have been a constant presence, even as we remain separated by distance. I'd like to extend a special thanks to my wife, who recently joined me on this journey, providing both emotional support and company in my daily life.

My sincere appreciation goes to my thesis committee members, Prof Hacene FOUCHAL, Prof Nadjib AIT SAADI, and Prof Congduc PHAM, for their insightful feedback and critical evaluation of my work.

I extend my gratitude to my colleagues and fellow peers who generously shared their insights and experiences with me. Working within a team that focused on a common subject, we collectively possessed a wealth of knowledge that we could openly discuss, exchange, and refine.

Résumé étendu en français

En 2010, l'Union européenne a établi un objectif (Commission européenne, 2010) visant à réduire de 50 % le nombre de décès sur les routes par rapport aux chiffres de 2010, d'ici à 2020 [1]. Les statistiques récentes de l'Union européenne (UE) indiquent que les décès sur les routes et les blessures graves ont déjà diminué de 30 % au cours de la dernière décennie, après avoir atteint un pic de 19 000 décès en 2020. Ce chiffre continue de baisser, et un nouvel objectif a été fixé, visant à réduire de 50 % le nombre de décès enregistrés en 2019 d'ici à 2030. Cet objectif ambitieux ne peut être atteint sans une gestion efficace de la circulation et un système de communication entre véhicules performant.

Les Systèmes de Transport Intelligents (ITS) se concrétisent par l'intégration des technologies de communication et de l'information dans le domaine des transports, visant ainsi à améliorer la commodité de la circulation et sa sécurité. Ceci est réalisé grâce à l'utilisation d'équipements de perception tels que les radars, les caméras et les lidars. De plus, les ITS optimisent l'efficacité des infrastructures de transport et fournissent des informations utiles aux usagers en collectant, en traitant et en diffusant des données sur la circulation. Cependant, dans un système ITS, les véhicules et les infrastructures sont séparés car les ITS ne maintiennent pas de partage constant et en temps réel des données entre le véhicule et son environnement. L'adoption des Systèmes de Transport Intelligents Coopératifs (C-ITS) se présente comme la solution pour réduire le nombre alarmant d'accidents de la circulation. Ces systèmes favorisent la collaboration entre divers composants ITS, notamment les piétons, les véhicules, les éléments routiers et les systèmes centraux. Les C-ITS permettent la fourniture de services ITS de meilleure qualité et respectant des normes de service plus élevées. Contrairement aux ITS traditionnels, les C-ITS établissent une connexion bidirectionnelle entre le véhicule et son environnement. Cette connectivité est réalisée à travers divers modes de communication, englobant les communications de véhicule à véhicule (V2V), de véhicule à infrastructure (V2I), de véhicule à piéton (V2P) et de véhicule à réseau (V2N), collectivement désignées sous le terme de communications de véhicule à tout (V2X). Dans ce contexte, le véhicule ne se contente pas de recevoir des informations en temps réel concernant les conditions de circulation, les fermetures de routes, les mises à jour météorologiques et la présence de véhicules à proximité, mais il est également capable d'évaluer ces données en temps réel et d'identifier les dangers potentiels. Par conséquent, il contribue activement à la prévention des accidents en transmettant des messages d'avertissement à d'autres véhicules et à l'infrastructure.

Les Systèmes de Transport Intelligents Coopératifs (C-ITS) reposent sur un ensemble de services de sécurité, de services de gestion de trafic, et de services d'info divertissement. Ces services exigent un réseau de communication véhiculaire fiable qui assure une communication à faible latence, une grande fiabilité et un débit élevé. Le tout étant soigneusement défini pour garantir une Qualité de Service (QoS) robuste et une Qualité de l'Expérience (QoE) élevée. Chaque service est assorti d'exigences spécifiques et utilise soit la communication de véhicule à véhicule (V2V) soit la communication de véhicule à infrastructure (V2I), en fonction de la nature et du

contenu des messages du service. Les services de sécurité jouent un rôle essentiel dans la diffusion de messages en temps réel critiques pour la sécurité afin de prévenir activement les accidents de la route potentiels. Ces services imposent des exigences strictes pour assurer la sécurité routière. En revanche, les services non sécuritaires visent à optimiser la circulation, à réduire le temps de trajet et à améliorer l'expérience globale des usagers de la route. Bien que ces services n'imposent pas de contraintes strictes en matière de latence et de fiabilité, ils nécessitent généralement un débit élevé et une précision de positionnement pour offrir les avantages prévus. De plus, les services V2X sont catégorisés en phases de déploiement, Day 1, Day 2, et Day 3. Les services Day 1 visent principalement à sensibiliser aux scénarios de conduite, nécessitant une latence inférieure à 100 millisecondes et des tailles de message généralement inférieures à 1200 octets. Les services du Day 2 abordent les aspects sensoriels de la conduite et facilitent l'obtention de réponses plus automatisées pour renforcer les systèmes de sensibilisation coopérative. Les services Day 3 aspirent à permettre une conduite coopérative et entièrement automatisée, aboutissant finalement à des expériences de conduite sans accident.

Les communications coopératives entre véhicules utilisent des technologies à courte portée telles que l'ITS-G5, le LTE-V2X PC5 et le 5G NR-V2X, en association avec des technologies de communication cellulaire à longue portée, telles que la 3G, la 4G et la 5G. Ces technologies présentent des variations dans leurs couches physiques et MAC, où l'une peut surpasser l'autre dans des cas d'utilisation spécifiques, et vice versa. Une technologie seule peut suffire à répondre aux exigences Day 1. Cependant, en raison de la nature dynamique des conditions du canal et de la grande mobilité des nœuds dans les réseaux de véhicules, se fier uniquement à une technologie pourrait ne pas être suffisant pour garantir une connectivité fluide et des débits élevés avec une fiabilité de 99,99 % pour les services de Day 2 et Day 3. En 2019, de grands constructeurs automobiles européens ont entamé le déploiement substantiel de services Day 1. Comme ces services ne nécessitent pas un réseau performant, ils reposent sur la technologie de communication coopérative V2X Adhoc sans fil ITS-G5 de l'ETSI. En revanche, les services de conduite de détection et de conduite coopérative visent un troisième niveau d'autonomie des véhicules et des conditions routières sans accident. Les véhicules de niveau 3 d'autonomie sont équipés de services avancés comme les systèmes avancés d'aide à la conduite (ADAS) et de fonctions d'automatisation qui leur permettent d'effectuer des tâches de conduite spécifiques dans des conditions prédéfinies. Toutefois, une intervention humaine est encore requise dans certaines situations. Ces services exigent une évolution des performances actuelles de la technologie de communication véhiculaire pour répondre aux exigences d'ultra-fiabilité et de faible latence. Ces exigences ne peuvent pas être satisfaites par une seule technologie de communication, mais plutôt par un réseau diversifié intégrant plusieurs technologies de manière complémentaire.

Les forces et faiblesses inhérentes à chaque technologie, influencées par des facteurs tels que la mobilité, la densité de la circulation et les prérequis du service, nous conduisent à concevoir des systèmes basés sur plusieurs technologies. Ce système de communication hybride entre véhicules combine ces technologies pour permettre leur utilisation simultanée et complémentaire. La mise en œuvre d'un tel système soulève cependant de nombreux défis techniques tels que la coexistence et l'interopérabilité de différentes technologies d'accès radio, garantir des transitions

fluides entre les modes pour maintenir un service ininterrompu, mettre en œuvre des mécanismes de sélection de la technologie d'accès radio, et une série d'autres problèmes complexes.

Dans le cadre de nos recherches, nous commençons par réaliser une évaluation initiale des nouvelles normes de communication véhiculaire émergentes, telles que IEEE 802.11bd et 5G NR-V2X. Ensuite, nous explorons le concept de réseaux de communication hybrides pour les véhicules, qui est déjà supporté au sein des groupes de normalisation de l'Institut européen des normes des télécommunications (ETSI) et du 3rd Generation Partnership Project (3GPP) [25]. Dans ce contexte, l'architecture de station ETSI ITS est déjà équipée pour intégrer une gamme de technologies d'accès, notamment ITS-G5, LTE-V2X, 5G NR, 4G et les réseaux cellulaires 5G. Cependant, il convient de noter qu'actuellement, il n'existe pas de mécanismes et de protocoles bien établis pour coordonner efficacement ces technologies ou pour gérer de manière optimale leur utilisation simultanée de manière collaborative afin d'améliorer les performances de la communication entre véhicules.

Notre première contribution est une évaluation complète des technologies de communication véhiculaire IEEE 802.11p, IEEE 802.11bd et LTE-V2X dans le contexte de la sécurité routière. Nous initiions ce processus en évaluant les performances des technologies IEEE 802.11 et LTE-V2X. Ensuite, mettons en place une version de base d'IEEE 802.11bd à l'aide d'OMNeT++/Artery et effectué une analyse comparative, en mettant l'accent sur le taux de réception des paquets (PRR), par rapport à 802.11p et LTE-V2X (mode 3). Nos observations ont régulièrement révélé que LTE-V2X (mode 3) présentait une fiabilité supérieure dans la transmission de messages d'alerte par rapport aux technologies basées sur IEEE 802.11 dans la majorité des scénarios. Après cette étude comparative, on a évalué l'impact de la fiabilité de chaque technologie sur la sécurité routière. Tout au long de notre évaluation, nous avons pris en compte les taux de pénétration estimés et neutres pour illustrer l'impact des contraintes de déploiement sur la prévention des accidents. Dans des scénarios de déploiement agressif, nous avons noté une amélioration significative de la sécurité routière de 16,98 % avec l'IEEE 802.11bd et de 19,20 % avec LTE-V2X, mode 3 par rapport à IEEE 802.11p. En revanche, dans des situations de taux de pénétration neutre, à la fois LTE-V2X et IEEE 802.11bd ont démontré la capacité de réduire simultanément des blessures plus graves par rapport à IEEE 802.11p. Il est essentiel de reconnaître que les performances d'une technologie sont étroitement liées à son adoption et à son utilisation par les constructeurs de véhicules, les taux de pénétration plus élevés entraînant une couverture réseau et une fiabilité améliorée. Comprendre cette relation est essentiel lors de l'évaluation de l'efficacité et du potentiel d'une technologie dans un contexte donné. Cependant, en cas de taux de pénétration faible, l'intégration d'une architecture de communication véhiculaire hybride présente une solution viable pour résoudre les insuffisances de performance.

Dans notre deuxième contribution, nous avons introduit une architecture de communication véhiculaire hybride innovante, complétée par une stratégie de sélection de la technologie d'accès radio (RAT) basée sur l'apprentissage profond par renforcement (DRL). Cette architecture a un double objectif : d'abord, répondre aux critères de performance exigeants des applications V2X émergentes, puis exploiter les synergies entre les technologies de communication véhiculaire, en particulier ITS-G5 et C-V2X, pour atténuer les limites des

technologies individuelles. Nous avons réalisé une comparaison des performances de notre algorithme de sélection par rapport à deux autres algorithmes de sélection conçus pour les architectures hybrides, et cette évaluation a été menée dans deux scénarios de congestion distincts. Les résultats obtenus dans des scénarios de faible congestion ont clairement mis en évidence la supériorité de notre stratégie de sélection DRL par rapport aux approches alternatives. De plus, ces résultats mettent en évidence l'utilisation efficace des modes de communication redondants, réduisant ainsi la fréquence des réceptions redondantes. Les résultats numériques révèlent que l'architecture hybride de communication véhiculaire a le potentiel d'améliorer le taux de réception des paquets (PRR) jusqu'à 30 % par rapport à la stratégie de sélection de la technologie d'accès radio (RAT) statique et à l'algorithme de sélection basé sur la prise de décision multicritère (MCDM). De plus, la stratégie de sélection présente une amélioration d'environ 20 % du débit et une réduction de 10 % du taux d'occupation du canal (CBR). Il est à noter que notre recherche reconnaît le rôle essentiel de la communication hybride dans la satisfaction des exigences de performance strictes des applications Day 2 et Day 3, en particulier en ce qui concerne la fiabilité et le débit, même en cas de congestion du réseau élevée.

Notre troisième contribution s'est concentrée sur un cas d'utilisation spécifique lié à l'optimisation de l'orientation des véhicules approchant d'une station de péage. Notre enquête s'est concentrée sur les avantages de l'utilisation de vMEC (Edge Computing Multiaccès pour véhicules) et de la communication véhiculaire hybride pour rationaliser l'orientation des véhicules vers la barrière de péage optimale. Dans cette expérience de communication hybride, nous avons intégré à la fois les technologies ITS-G5 et C-V2X UU. Selon nos scénarios définis, il devient évident que l'approche vMEC et l'approche du serveur distant ont chacune des avantages et des considérations uniques. L'approche vMEC se distingue par ses capacités de traitement en temps réel et à bord, ce qui permet de réduire au minimum les préoccupations liées à la sécurité et au réseau. En revanche, l'approche du serveur distant offre l'avantage de décharger les tâches de calcul et de potentiellement exploiter des ressources matérielles plus puissantes. Dans nos tests de communication hybride, nous avons observé que les réseaux cellulaires offrent une fiabilité supérieure et une couverture plus large, augmentant ainsi la probabilité de recevoir un message d'information embarqué (IVIM). Cependant, un inconvénient potentiel de l'utilisation de cette technologie dans ce cas d'utilisation particulier pourrait être une utilisation moins efficace des ressources radio dans le réseau cellulaire en raison de l'utilisation de transmissions en mode unicast. Des tests approfondis en conditions réelles sont essentiels pour valider l'efficacité de la communication hybride dans des environnements véhiculaires divers et dynamiques. Bien que les architectures hybrides de communication véhiculaires présentent un potentiel considérable, il est d'une importance primordiale de relever les défis inhérents à ce paradigme. Les travaux futurs peuvent se concentrer sur le développement de protocoles et d'algorithmes normalisés pour assurer une interopérabilité transparente entre différentes technologies de communication au sein des architectures hybrides. Il est très important aussi d'adopter des essais sur le terrain à grande échelle et des simulations pour évaluer comment la communication hybride se comporte dans diverses conditions, notamment dans des situations de trafic dense, de mauvais temps, et dans des environnements urbains et ruraux. Ces tests peuvent fournir des informations précieuses sur les avantages pratiques et les limites des réseaux de communication hybrides pour les véhicules.

Table of contents

Abstract	iii
Résumé.....	v
Acknowledgment	viii
Résumé étendu en français.....	ix
Publications.....	xxiv
1 Chapter 1.....	1
1.1 Motivations.....	3
1.2 Thesis contributions	4
1.3 Structure of the manuscript	5
2 Chapter 2.....	7
2.1 Generalities on vehicular communication systems	7
2.1.1 C-ITS services categorization.....	7
2.1.2 ITS station reference architecture	11
2.1.3 Vehicular communication technologies.....	14
2.2 Background and related works	24
2.2.1 Comparison study between ITS-G5 and C-V2X	24
2.2.2 Related works on hybrid vehicular communication architectures.....	30
2.2.3 Related works on RAT selection on hybrid vehicular networks	35
2.3 Conclusion.....	39
3 Chapter 3.....	40
3.1 IEEE 802.11bd implementation on OMNeT ++	40
3.1.1 In the INET Framework.....	41
3.1.2 In the Artery Framework	43
3.1.3 Model Validation	45
3.2 Packet Error Ratio performance evaluation	48
3.3 Road safety assessment	50
3.3.1 Model specifications	50

3.3.2	Road Safety improvements	51
3.4	Conclusion.....	53
4	Chapter 4.....	55
4.1	Hybrid network architecture definition and protocol stack design	55
4.1.1	Protocol stack.....	56
4.2	Communication modes and data flow control.....	58
4.3	Deep Reinforcement Learning for Communication Mode Selection.....	60
4.3.1	Reinforcement Learning	60
4.3.2	Mapping to Key Elements of RL.....	61
4.3.3	Double deep Q-learning algorithm	63
4.4	Performance evaluation.....	66
4.4.1	Simulation framework and scenario	66
4.4.2	DDQN algorithm parameters.....	68
4.4.3	Simulation results.....	69
4.5	Conclusion.....	76
5	Chapter 5.....	77
5.1	Introduction and overview on toll management systems	77
5.2	PoC specifications and architecture	78
5.2.1	Architecture adaptation for the vMEC experiment.....	80
5.2.2	Architecture adaptation for the hybrid communication experiment.....	81
5.3	Experimentation process	82
5.4	PoC results.....	85
5.4.1	Group one results	85
5.4.2	Group two results	88
5.5	Conclusion.....	91
6	Chapter 6.....	92
6.1	Future works.....	94
6.1.1	Road Safety Enhancement with 5G NR-V2X	94

6.1.2	Hybrid Vehicular Communication Challenges	94
6.1.3	Testing Hybrid Communication in Real-Life Scenarios	95

List of figures

Figure 2.1. ETSI ITS station architecture	13
Figure 2.2. Frame format of IEEE 802.11p (PPDU) [14].....	15
Figure 2.3. LTE-V2X architecture and communication interfaces.....	18
Figure 2.4. LTE-V2X Frame Structure.....	19
Figure 2.5. Functional architecture for hybrid vehicular architecture	31
Figure 2.6. Protocol stack design for the CellCar system [50]	34
Figure 2.7. Illustration of the HetVNET framework [26].....	35
Figure 3.1. Concerned modules with the modifications	42
Figure 3.2. Artery's ITS architecture [70]	43
Figure 3.3. Throughput comparison of IEEE 802.11bd and IEEE 802.11p	47
Figure 3.4. Latency comparison of IEEE 802.11bd and IEEE 802.11p	47
Figure 3.5. PRR variations according to the CQI and the distance	49
Figure 3.6. PRR variations according to the distance (packet of 300 bytes).....	49
Figure 3.7. Number of Avoided serious injuries in low penetration rates	52
Figure 3.8. Number of Avoided serious injuries in high penetration rates.....	53
Figure 3.9. Number of Avoided serious injuries in neutral penetration rates.....	53
Figure 4.1. Proposed Hybrid vehicular communication architecture	56
Figure 4.2. The hybrid communication layer in the ITS-S protocol stack	57
Figure 4.3. Different state representations of the environment	61
Figure 4.4. Reception evaluation vector	62
Figure 4.5. DDQN-based Communication mode selection system	65
Figure 4.6. Simulation environment	67
Figure 4.7. Expected reward of the Q-learning algorithm for slow-learning agents	71
Figure 4.8. Number of sent messages to reach the target for slow-learning agents	71
Figure 4.9. Expected reward of the Q-learning algorithm for fast-learning agents.....	71
Figure 4.10. Number of sent messages to reach the target for fast-learning agents	72
Figure 4.11. Expected reward of the Q-learning algorithm in a high congested scenario.....	72
Figure 4.12. The number of sent messages to reach the target in a high congested scenario.....	72
Figure 4.13. Percentage of use of each communication mode	73
Figure 4.14. Comparison between RAT selection approaches.....	74
Figure 4.15. Percentage of duplicated messages	74
Figure 4.16. Time complexity of static and DRL-based Hybrid communication	74
Figure 4.17. Hybrid architecture throughput enhancement compared to ITS-G5 throughput.....	75
Figure 4.18. The CBR value according to learning iterations	76

Figure 5.1. The location of the FLEURY-EN-BIERE secondary toll station	79
Figure 5.2. Open lane for testing	80
Figure 5.3. Toll management architecture	80
Figure 5.4. Data collecting and processing scheme for vehicles orientation.....	81
Figure 5.5. Modified architecture for hybrid vehicular communication	82
Figure 5.6. Used equipment.....	83
Figure 5.7. Algorithm processing time using the remote server.....	86
Figure 5.8. Algorithm processing time using the vMEC.....	87
Figure 5.9. Comparison between the total time of each approach.....	87
Figure 5.10. OBU's PRBs utilization per IVI message	88
Figure 5.11. Percentage of cell's PRB utilization.....	89
Figure 5.12. The reception range of the IVIM using ITS-G5 and C-V2X	89

List of tables

TABLE. 2-1. Safety and non-safety use cases [2]	9
TABLE. 2-2. Examples of V2X services from each deployment phase	11
TABLE. 2-3. User priorities, access categories association in EDCA method and AIFS values	16
TABLE. 2-4. Transfer rates, coding rates in 802.11p and IEEE 802.11bd [19].....	17
TABLE. 2-5. Advantages and challenges of using ITS-G5 and LTE-V2X for V2V and V2I communications [2]	28
TABLE. 3-1. Obtained simulation results compared to theoretical ones	46
TABLE. 3-2. Main simulation parameter set.....	48
TABLE. 4-1. Standards configuration	68
TABLE. 5-1. PoC scenarios.....	83
TABLE. 5-2. Number of PRBS per IVI message.....	85
TABLE. 5-3. Packet reception ratio	90

List of Acronyms

3GPP	3 rd Generation Partnership Project
5GAA	5G Automotive Alliance
ABC	Artificial Bee Colony
ACO	Ant Colony Optimization
ADAS	Advanced Driver Assistance Systems
AIFS	Arbitration Interframe Space
ANN	Artificial Neural Networks
BCC	Binary Convolutional Codes
BSS	Basic Service Set
BTP	Basic Transport Protocol
C2C-CC	CAR 2 CAR Communication Consortium
CACC	Cooperative Adaptive Cruise Control
CAD	Connected Autonomous Driving
CAD	Connected Autonomous Driving
CAM	Cooperative Awareness Message
CBR	Channel Busy Ratio
CC	Control Channel
CG	Configured Grant
C-ITS	Cooperative Intelligent Transport Systems
CN	Core Network
CP	Communication Profile
CPM	Collective Perception Messages
CQI	Channel Quality Indicator
CR	Channel occupancy Ratio
CRAD	Community Road Accident Database
CSMA/CA	Carrier Sense Multiple Access with Collision Avoidance
C-V2X	Cellular V2X
CWT	Channel Waiting Time
D2D	Device-to-Device
DCC	Decentralized Congestion Control

DCI	Downlink Control Information
DCM	Dual-Carrier Modulation
DCM	Dynamic Communication Management
DDQN	Double Deep Q-learning
DENM	Decentralized environmental notification Message
DG	Dynamic Grant
DICART	DIstributed Context-Aware Radio access Technology
DLL	Data Link Layer
DM	Decision Maker
DMRS	De-Modulation Reference Signal
DNN	Deep Neural Networks
DRL	Deep Reinforcement Learning
D-SPS	Distributed Semi-Persistent Scheduling
DSRC	Dedicated Short-Range Communication
EDCA	Enhanced Distributed Coordination Access
eMBB	enhanced Mobile Broadband
eNodeB	evolved Node B
FDM	Frequency Division Multiplexing
FS	Frame Simulator
GEMV²	Geometry-based Efficient propagation Model
GeoNeT	GeoNetworkig
GLOSA	Green Light Optimal Speed Advisory
gnNodeB	Next-Generation Node B
HARQ	Hybrid Automatic Repeat Request
HCM	Hybrid Communications Management
HLL	Heterogeneous Link Layer
HOP	Hybrid Overlay Protocol
IBSS	Independent Basic Service Set
iCAP	Intelligent Campus Automobile
IRT	Inter Reception Time
ITS	Intelligent transport systems

ITS-S	ITS Station
IVIM	Infrastructure-to-Vehicle Information Message
LBT	Listen Before Talk
LDM	Local Dynamic Map
LDPC	Low-Density Parity-Check
MARL	Multi-Agent Reinforcement Learning
MCDM	Multiple-Criteria Decision Making
MCS	Modulation and Coding Schemes
MDP	Markov Decision Process
MIH	Media Independent Handover
MIMO	Multiple Input Multiple-Output
mmWave	millimetric Wave
MNO	Mobile Network Operator
NLOS	Non-Line-Of-Sight
OBU	On-Board Units
OFDM	Orthogonal Frequency Division Multiplexing
PAR	Project Authorization Report
PDCCH	Physical Downlink Control CHannel
PDU	Packet Data Unit
PER	Packet Error Rate
PKI	Performance Key Indicator
PoC	Proof of Concept
PoI	Point of interest
PRB	Physical Resource Blocks
ProSe	Proximity Services
PRR	Packet Reception Rate
PSCCH	Physical Sidelink Control Channel
PSFCH	Physical Sidelink Feedback CHannel
PSO	Particle Swarm Optimization
PSSCH	Physical Sidelink Shared Channel
PUCCH	Physical Uplink Control CHannel

QF	Quality Function
QoE	Quality of Experience
QoS	Quality of Service
QPSK	Quadrature Phase Shift Keying
RAN	Radio Access Network
RAT	Radio Access Technology
RB	Resource Block
RE	Resource Elements
RL	Reinforcement Learning
RMH	Received Messages Hits
ROS	Robot Operating System
RRM	Radio Resource Management
RSRP	Reference Signal Received Power
RSRQ	Reference Signal Received Quality
RSSI	Received Signal Strength Indicator
RSU	Road Side Unit
SAM	Service Advertisement Message
SC-FMDA	Single-Carrier Frequency Division Multiple Access
SCI	Sidelink Control Information
SDVN	Software-Defined Vehicular Network
SGD	Stochastic Gradient Descent
SI	Swarm Intelligence
SL	Supervised Learning
SNR	Signal-to-Noise Ratio
SPS	Semi-Persistent Scheduling
SR	Success Reception
TB	Transport Block
TDC	Transmit Data rate Control
TDM	Time-Division Multiplexing
TMS	Toll Management system Server
TPC	Transmit Power Control

TRC	Transmit Rate Control
TTI	Transmission Time Interval
UE	User Equipment
UL	Unsupervised Learning
URLLC	Ultra-Reliable Low Latency Communications
V2I	Vehicle-to-Infrastructure
V2N	Vehicle-to-Network
V2P	Vehicle-to-Pedestrian
V2V	Vehicle-to-Vehicle
V2X	Vehicle-to-Everything
VANeT	Vehicular Ad-Hoc Networks
VHT	Very High Throughput
vMEC	vehicular Multi-access Edge Computing
YOLO	You Only Look Once

Publications

The findings and contributions of this thesis have been disseminated through publication in an international journal article and presentation at several peer-reviewed conferences on a global scale.

Book chapters and workshop papers

- **International Workshop on Communication Technologies for Vehicles** [92]: B. Y. Yacheur, T. Ahmed, and M. Mosbah, "Analysis and Comparison of IEEE 802.11p and IEEE 802.11bd," *Lecture Notes in Computer Science*, pp. 55–65, 2020, doi: https://doi.org/10.1007/978-3-030-66030-7_5

International journal paper

- **IEEE Transactions on Network and Service Management** [96]: B. Y. Yacheur, T. Ahmed and M. Mosbah, "Efficient DRL-Based Selection Strategy in Hybrid Vehicular Networks," in *IEEE Transactions on Network and Service Management*, doi: 10.1109/TNSM.2023.3300653

International conference papers

- **IEEE 18th Annual Consumer Communications & Networking Conference** [94]: B. Y. Yacheur, T. Ahmed and M. Mosbah, "Implementation and Assessment of IEEE 802.11BD for Improved Road Safety," 2021 IEEE 18th Annual Consumer Communications & Networking Conference (CCNC), Las Vegas, NV, USA, 2021, pp. 1-6, doi: 10.1109/CCNC49032.2021.9369649[93]
- **IEEE 97th Vehicular Technology Conference (VTC2023-Spring)** [94]: B. Y. Yacheur, T. Ahmed and M. Mosbah, "DRL-Based RAT Selection in a Hybrid Vehicular Communication Network," *2023 IEEE 97th Vehicular Technology Conference (VTC2023-Spring)*, Florence, Italy, 2023, pp. 1-5, doi: 10.1109/VTC2023-Spring57618.2023.10199400.
- **IEEE 28th Symposium on Computers and Communications (ISCC)** [95]: B. Y. Yacheur, T. Ahmed and M. Mosbah, "Throughput Enhancement in Hybrid Vehicular Networks Using Deep Reinforcement Learning," *2023 IEEE Symposium on Computers and Communications (ISCC)*, Gammarth, Tunisia, 2023, pp. 938-943, doi: 10.1109/ISCC58397.2023.10218018.

Chapter 1

Introduction

In 2010, the European Union established an objective (European Commission, 2010) to achieve a 50% reduction in road fatalities by 2020 [1], as compared to the 2010 figures. Recent European Union (EU) statistics indicate that road fatalities and severe injuries have already been reduced by 30% over the past decade, following a peak of 19,000 fatalities in 2020. This number continues to decrease, and a new target has been set, aiming to achieve a 50% reduction in the number of fatalities reported in 2019 by the year 2030. This ambitious goal cannot be realized without effective traffic management and a high-performing vehicular communication system.

Intelligent Transport System (ITS) are the integration of communication and information technology in the transport domain to improve the convenience of traffic and its safety. This is done by using perception equipment like radars, cameras, and lidars. It also maximizes the efficiency of transportation facilities and provides useful information to people by collecting, processing, and providing traffic information. However, in an ITS vehicles and the facilities are separated because ITS doesn't keep a constant and ongoing data sharing between the vehicle and its environment. Thus, without leveraging advanced information and communication technologies, vehicles cannot access real time information about the road state and the European target cannot be reached. On the other hand, adopting Cooperative Intelligent Transport Systems (C-ITS) is promoted to be the solution to reduce the dramatic number of traffic accidents. These systems involve the cooperation between two or more ITS (pedestrian, vehicle, roadside and central). It enables and provides an ITS service that offers better quality and an enhanced service level. C-ITS is a two-way system where the vehicle is on a continuous connection with its environment. This connectivity is facilitated through diverse communication modalities, encompassing Vehicle-to-Vehicle (V2V), Vehicle-to-Infrastructure (V2I), Vehicle-to-Pedestrian (V2P), and Vehicle-to-Network (V2N), collectively referred to as Vehicle-to-Everything (V2X) communications. On the one hand, the vehicle receives real-time information on traffic conditions, road closures, weather updates, and the presence of other vehicles nearby. Conversely, it has the capability to evaluate the real-time data it receives and identify potential hazards, thereby actively playing a role in accident prevention by sending warning messages to other vehicles and to the infrastructure.

C-ITS are funded upon a set of safety and non-safety services that require a resilient vehicular communication network. These requirements, including low-latency communication,

high reliability, and high throughput, have been established to guarantee a robust Quality of Service (QoS) and an elevated Quality of Experience (QoE). Each service comes with its specific requirements and utilizes either V2V communication or V2I communication, depending on the content of the service's messages. Safety services disseminate real-time safety-related messages, e.g., various warning messages including abrupt brake warning messages, to prevent car accidents. These services have strict reliability and latency requirements. Non-safety services aim to enhance traffic flow, reduce travel time, and provide a better experience for road users. These services do not have strict demands for latency and reliability but typically require high throughput and precise positioning accuracy. More details on C-ITS services are exposed in section 2.1.1. V2X services are also categorized according to their deployment phases. Day 1 services aim to achieve awareness driving and require a latency below 100 milliseconds and usually have a message size smaller than 1200 bytes. Day 2 services are designed to enhance the cooperative awareness system, addressing sensing driving and more automated reactions. Meanwhile, Day 3 services aim to provide cooperative driving and fully automated driving, ultimately leading to accident-free driving.

Cooperative vehicular communications employ short-range technologies such as ITS-G5, LTE-V2X PC5, and 5G NR-V2X, alongside long-range cellular communication technologies like 3G, 4G, and 5G. These technologies showcase variations in their physical and MAC layers, with one technology surpassing the other in specific use cases and vice versa. Thus, one technology may satisfy the requirements of Day 1 services. However, due to the frequently changing channel states and high node mobility in vehicular networks, one technology may not be sufficient to have seamless connectivity and high data rates with a reliability of 99.99% for Day 2 and Day 3 services. The fact that each technology has its advantages and disadvantages which vary based on factors such as mobility, traffic density, and service requirements, leads us towards designing systems built on multiple technologies. Such hybrid vehicular communication system combines these technologies for simultaneous and complementary use. This system's implementation results in choosing the best communication mode to satisfy the requirement of a given service. Nevertheless, the implementation of such a system gives rise to a multitude of technical challenges. Because, leveraging the benefits of distinct technologies appeals us to address: the coexistence and interoperability of diverse Radio Access Technologies, the facilitation of seamless handovers during mode transitions to ensure uninterrupted service, implementing RAT selection mechanisms, and a range of other complex issues.

After examining the ability of new generation technologies, mainly IEEE 802.11bd and C-V2X, to satisfy the requirements of Day 2 and Day 3 services. We present a hybrid vehicular communication architecture as a viable solution to address these service requirements. This architecture enhances the ETSI ITS station architecture and includes a novel RAT selection

strategy based on deep reinforcement learning. The motivation of our research is presented in section 1.1. Later in section 1.2, we enumerate our contributions. And finally, section 1.3 summarizes this manuscript's structure.

1.1 Motivations

In 2019, prominent European vehicle manufacturers initiated substantial deployment of Day 1 C-ITS services. These services support awareness driving and rely on the ETSI ITS-G5 cooperative V2X wireless ad-hoc communication technology. Awareness driving doesn't require a performant network and can be realized using ITS-G5 that delivers a reliable network and low latency short-range communications. Otherwise, sensing driving services and cooperative driving services targets a free accident road and the third level of vehicle autonomy. Level 3 autonomy vehicles are equipped with Advanced Driver Assistance Systems (ADAS) and automation features that allow them to perform certain driving tasks under specific conditions, such as accelerating past a slow-moving vehicle. But they still require human override. These services require the evolution of current vehicular communication technology's performances towards ultra-reliability and low latency requirements. These later call for not just a single communication technology but rather a diverse network that accommodates multiple technologies in a complementary manner. This is why, in our research, we initially evaluated emerging vehicular communication standards like IEEE 802.11bd and 5G NR-V2X.

The concept of hybrid vehicular communication networks is already under consideration within the ETSI standardization working groups and the 3rd Generation Partnership Project (3GPP) [25]. In this context, the ETSI ITS station architecture is already equipped to embrace a range of access technologies, including ITS-G5, LTE-V2X, 5G NR, 4G, and 5G cellular networks. Nonetheless, there are currently no established mechanisms and protocols for coordinating between these technologies or effectively managing their simultaneous utilization in a collaborative manner to improve vehicular communication performance. Furthermore, the ETSI ITS-S lacks adequate coexistence and interoperability mechanisms.

Based on the description of each ITS communication technology, hybrid vehicular communication networks are motivated by the fact that every technology not only offers its unique benefits, but also has its own drawbacks, especially in dense traffic areas and heavy load environments. However, many technical challenges are present to assure efficient hybrid communications. Aspects such as radio access management, resource allocation, interoperability between technologies, coexistence within the 5.9 GHz band, and more need to be examined and resolved to ensure the fulfillment of service Quality of Service (QoS). Because a hybrid

architecture should consistently deliver the user the most optimal network experience among those available.

Furthermore, the necessity for ubiquitous vehicular connectivity and the inclusion of both short-range and long-range communication technologies in new vehicles significantly promotes the adoption of hybrid vehicular communication networks.

1.2 Thesis contributions

This thesis presents three key contributions within the field of vehicular communication networks and intelligent transport systems. We start by assessing new V2X communication technologies, such as IEEE 802.11bd and NR V2X. Then, we explore hybrid communication networks to gauge their ability to improve vehicular communication network performance. Lastly, we demonstrate a real-world implementation of a V2X use case based on a hybrid vehicular communication architecture. Our contributions are organized as follows:

- **The IEEE 802.11bd assessment:** To well introduce and define the hybrid vehicular communication architecture, we study the ability of new V2X communication technologies to satisfy the requirements of Day 2 and Day 3 V2X services. Furthermore, we explore the complementarity of V2X communication technologies and the possibility to combine them by comparing the performance of IEEE 802.11bd with IEEE 802.11p and C-V2X. This contribution includes:
 - The implementation of IEEE 802.11bd within the OMNeT++ network simulation framework. We have also integrated the IEEE 802.11bd standard into the Artery framework, which simulates the ITS-5G ad-hoc vehicular communication networks.
 - Comparative analysis between IEEE 802.11p and IEEE 802.11bd, focusing on metrics such as throughput and reliability.
 - Comparative evaluation between IEEE 802.11bd and LTE-V2X, emphasizing metrics such as throughput and reliability.
 - Assessment of the relative performance of IEEE 802.11p, IEEE 802.11bd, and LTE-V2X technologies with regards to improving road safety in the European Union roads.
- **A hybrid vehicular communication architecture:** The second contribution concerns the definition and implementation of the hybrid vehicular communication architecture. We propose a scalable hybrid vehicular communication architecture that leverages the performance of multiple RATs. In pursuit of this objective, we introduce a novel hybrid communication management layer within the ITS-S

protocol stack. This layer establishes a transparent conduit for transmitting messages from any application across the hybrid communication system. It performs RAT selection, message control and preparation, communication modes definition, and verifies the availability of each employed RAT within the access layer through a cross-layer communication mechanism that is done by the management layer. In order to deploy a functionally efficient hybrid vehicular communication architecture, we introduce a decentralized RAT selection strategy that uses Deep Reinforcement Learning (DRL). Finally, we evaluate our architecture in comparison to other state-of-the-art approaches in the context of two Day 3 services: the platooning service and the see-through vision service.

- **A practical demonstration of hybrid vehicular communications:** Our third contribution comes as a Proof of Concept (PoC) study that aims to evaluate the impact of using hybrid communications on the performance of the vehicular communication network while operating a deployed V2X service. This PoC specifically examines the application of hybrid vehicular communications and vehicular multi-access edge computing to enhance the efficiency of the toll station approaching vehicles' orientation use case. We exclusively combine LTE-V2X UU and ITS-G5 in this experiment and with a focal point on enhancing reliability, minimizing latency, and extending coverage to augment the guidance provided to vehicles as they approach the toll station. This PoC was conducted in collaboration with "**Autoroutes Paris-Rhin-Rhône**" (APRR), "**Université Polytechnique Hauts-de-France**" (UPHF), and "**École nationale supérieure Mines-Télécom Atlantique**" (IMT Atlantique).

1.3 Structure of the manuscript

The manuscript is organized into six chapters. Starting with the abstract that provides a brief summary of this thesis study and key findings, accompanied by a list of relevant keywords. In Chapter 1, we introduce the scope of our research and delve into the challenges surrounding the fulfillment of service requirements in the absence of a unified communication system. These introductory discussions lay the groundwork for us to outline the reasoning behind our initiative to develop a hybrid vehicular communication network and delve into the distinctive contributions of this thesis.

The literature review in Chapter 2, examines fundamental concepts related to C-ITS, encompassing C-ITS services, ITS station architecture, and C-ITS technologies. In this chapter, we not only delve into the current state of the art but also undertake a comprehensive comparative

analysis of various V2X communication technologies, elucidating their respective advantages and shortcomings. Additionally, we examine the state of the art on hybrid vehicular communication architectures and RAT selection strategies.

The rest of this document is organized into three chapters dedicated to our contributions, followed by a concluding chapter. In the third chapter, we delve into our first contribution, which involves implementing IEEE 802.11bd within the OMNeT++ framework and conducting a road safety assessment.

Our main contribution is presented in Chapter 4, we introduce the hybrid architecture components, the novel protocol stack, and the deep reinforcement learning based RAT selection strategy.

Chapter 5 presents a practical experiment in the form of a Proof of Concept. This experiment is centered around hybrid vehicular networks and vehicular multi-access computing, with the primary goal of enhancing vehicle's orientation as they approach a toll station.

Chapter 6 concludes this thesis, where we provide a brief recap of our contributions and assessments, as well as a glimpse into possible future research directions.

Chapter 2

State-of-the-art

This chapter explores recent research in the field of C-ITS communication technologies and hybrid vehicular communication networks. Section 1 provides an overview of C-ITS and vehicular communications, encompassing subjects ranging from the classification of C-ITS services, the architecture of the ITS station, and its protocol stack, to an in-depth presentation of each V2X communication technology.

In the first part of section 2.2, we explore research endeavors that revolve around the comparative analysis of ITS-G5 and C-V2X technologies. Within this context, we specifically examine studies assessing the reliability and throughput of emerging V2X technologies, namely IEEE 802.11bd and NR V2X. These assessments serve the purpose of discerning the individual strengths and limitations inherent in ITS-G5 and C-V2X technologies. Because there is not a definitive standard for V2V communications, but it depends on the V2X service and on the penetration rates of the technology that is related to the car manufacturers' strategy. Furthermore, in subsection 2.2.2, our focus extends to a comprehensive review of research works proposing innovative hybrid architectures, which are based on the previously presented ITS station architecture. In subsection 2.2.3, we survey ongoing research efforts concerning RAT selection for hybrid architectures, with a particular emphasis on strategies rooted in reinforcement learning.

In conclusion, we present a summary of the covered topics, shedding light on the distinctive motivation underpinning the adoption of our hybrid architecture and RAT selection strategy in our primary contribution.

2.1 Generalities on vehicular communication systems

2.1.1 C-ITS services categorization

The objective of this section is to present safety and non-safety services. Safety services such as collision avoidance, pre-crash sense or platooning are aimed to minimize road accidents by using traffic monitoring and management applications. Non-safety services are classified in two categories, traffic efficiency services and infotainment services. Traffic efficiency services offer enhanced route guidance and navigation. We cite as an example the Green Light Optimal Speed Advisory (GLOSA) service that recommends optimal speed to catch the green light and

enable fluid traffic circulation. Infotainment services enable passengers to access various services like interactive communication, internet access, payment services, online games and Point of Interest (POI) notifications updates when vehicles are on the move.

2.1.1.1 Safety services

Safety services include vehicle status warning, vehicle type warning, traffic hazard warning, and dynamic vehicle warning. These services have strict requirements due to their characteristic of being vital and important to the driver's safety. The minimum frequency of periodic messages of a safety service varies from 1 to 10 Hz [2], and the reaction time of most drivers ranges from 0.6 to 1.4 s [3]. Thus, it is reasonable to restrict the maximum latency time to no more than 100 ms [2]. For example, the maximum latency of pre-crash warning is 50 ms. Safety services mainly use two message types. The Cooperative Awareness Message (CAM), this message usually includes the information on a vehicle's status, type, positions, speed, and other vehicle's state information. The second message type is the Decentralized environmental notification Message (DENM). These messages are usually triggered by special events, such as roadwork warning, and stationary vehicle warning. The purpose of DENM is to notify vehicles in areas of interest of potential hazards.

2.1.1.2 Non-Safety services

These services are used primarily for traffic management, improvement of traffic fluidity, and infotainment. The main objective of these services is to improve the QoE of the driver. These services do not necessitate an extremely high level of reliability or exceptionally low latency. Nevertheless, certain high-definition mapping services and infotainment services may require significant throughput to operate optimally. The benefits of traffic management services can impact indirectly the travel time and reduce fuel consumption. The minimum frequency of periodic messages, for these services is set to 1Hz, while the maximum latency is set to 500 ms [2]. On the other hand, traffic management services can require a high accuracy positioning of less than 5 meters or a high security transmission if dealing with monetary transactions.

As presented in [2], the following table presents a summary of safety and non-safety services' categorization along with their requirements.

TABLE. 2-1. Safety and non-safety use cases [2]

Safety Services						
Categories	User Cases	Communication Mode	Reliability	Usage	Frequency	Latency
Category I: Vehicle status warning	Emergency electronic brake lights	Time limited periodic broadcast on event	High	Warn a sudden slowdown of the following vehicle	10 Hz	100 ms
	Abnormal condition warning	Time limited periodic broadcast on event	High	Warn the abnormal vehicle State	1 Hz	100 ms
Category II: Vehicle type warning	Emergency vehicle warning	Periodic triggered by vehicle mode	High	Reduce emergency vehicle's intervention time	10 Hz	100 ms
	Slow vehicle warning	Periodic triggered by vehicle mode	High	Improve the traffic fluidity	2 Hz	100 ms
	Motorcycle warning	V2X cooperative awareness	High	Collision avoidance	2 Hz	100 ms
	Vulnerable road user Warning	V2X cooperative awareness	High	Collision avoidance	1 Hz	100 ms
Category III: Traffic hazard warning	Wrong way driving warning	Time limited periodic broadcasting on event	High	Wrong way driving warning	10 Hz	100 ms
	Stationary vehicle warning	Time limited periodic broadcasting on event	High	Avoid succession of collisions	10 Hz	100 ms
	Traffic condition warning	Time limited periodic messages broadcasting/ authoritative message triggered	High	Reduce the risk of longitudinal collision on traffic jam forming	1 Hz	100 ms
	Signal violation warning	Temporary messages broadcasting on event	High	Reduce the risk of a stop/traffic violation	10 Hz	100 ms
	Roadwork warning	Temporary messages broadcasting on event	High	Reduce the risk of accident at the level of roadwork	2 Hz	100 ms
	Decentralized floating car data	Time limited periodic broadcasting on event	High	Improve safety and traffic fluidity	10 Hz	100 ms
Category IV: Dynamic vehicle warning	Overtaking vehicle warning	V2X cooperative awareness	High	Reduce the risk of accident	10 Hz	100 ms
	Lane change assistance	V2X cooperative awareness	High	Active road safety	10 Hz	100 ms
	Pre-crash sensing warning	Broadcast of pre-crash State	High	Accident impact mitigation	10 Hz	50 ms
	Cooperative glare reduction	V2X cooperative awareness	Medium	Avoid the frontal collision	2 Hz	100 ms
Non-Safety Services						
Category I: Traffic management	Regulatory/contextual speed limits	Authoritative message triggered by traffic management entity	High	Enhance the traffic efficiency/reduce the vehicles' pollution	1 Hz	N/A
	Traffic light optimal speed advisory	Periodic, permanent messages broadcasting	High	Traffic regulation at an inter- section	2 Hz	100 ms
	Intersection management	Periodic, permanent messages broadcasting	High	Road safety and traffic regulation at an intersection	1 Hz	100 ms

	Co-operative flexible lane change	Periodic broadcasting messages	High	Enhancement of mobility efficiency	1 Hz	500 ms
	Electronic toll collection	12V broadcasting and unicast full duplex session	High	Traffic fluidity at the toll collect	1 Hz	500 ms
Category II: Infotainment	Point of interest notification	Periodic, permanent messages broadcasting	Medium	Driver and passengers' comfort	1 Hz	500 ms
	Local electronic commerce	Duplex communication between RSU and Vehicles	High	Vehicle driver/passenger comfort	1 Hz	500 ms
	Media download	User access to Internet for multimedia download	Medium	Passenger entertainment	1 Hz	500 ms
	Map download and update	Access to Internet for map download and update	Medium	Efficiency and comfort	1 Hz	500 ms

2.1.1.3 C-ITS services' deployment phases

In accordance with the CAR 2 CAR Communication Consortium (C2C-CC) [4], C-ITS services have three deployment phases, aligning with their specific requirements and complexity. These phases are known as Day 1, Day 2, and Day 3 phases. Day 1 services concentrate on information exchange to enhance proactive and awareness driving. Day 2 services aim to enhance service quality and share perception and awareness information. Day 3 and beyond introduce more sophisticated services, including the sharing of intentions, support for negotiation, and cooperation, which collectively pave the way for cooperative accident-free automated driving.

The first deployment phase includes services that provide information and warnings only, and that are based on a set of standardized messages developed by the ETSI. They support low penetration rates of C-ITS-enabled road users and are already available in cooperative V2X vehicles on European roads. Day 1 services are not linked to specific communication technologies. However, the use of ETSI ITS-G5 technology communicating within the 5,9 GHz band (such as R-ITS-S) is recommended and sufficient for Day 1 services.

Phase two encompasses sensing driving services, and within this category, some services, like long-term road works warning and extended intersection collision warning, represent an evolution of Day 1 services. Day 2 services require backward compatibility with their predecessors and the development of new standards to ensure service reliability and low latency.

The third deployment phase encompasses cooperative driving services that are founded upon the anticipation of the expected behaviors of all road users. This aspect holds significance in realizing highly automated and autonomous driving in the long term. Services related to phases of Day 2 and Day 3 are investigated in R&D projects. This is driven by their Ultra-Reliable Low Latency Communication (URLLC) demands, which cannot be met by a single technology,

particularly in congested traffic zones and high-load conditions. In addition to this, provisioning Day 1 services alone is unlikely to meet the requirements of self-driving autonomous cars. For instance, while current applications like left turn assistance and emergency electronic brake lights enhance vehicle safety, autonomous vehicles will need the ability to transmit messages signaling maneuvers, trajectory adjustments, platoon coordination, and exchange sensor data. Besides, even for human-driven vehicles the utilization of data received from sensors on nearby vehicles, such as one vehicle sharing its live camera feed with a trailing vehicle (i.e., providing a see-through service), is anticipated to significantly enhance safety benefits beyond what basic safety applications can achieve. These services have stringent requirements, with a maximum acceptable latency of less than 3 ms, reliability demands exceeding 99%, and communication ranges spanning from 200 meters to 500 meters. The following table presents some C-ITS services of each deployment phase:

TABLE. 2-2. Examples of V2X services from each deployment phase

Day 1	Day 2	Day 3 and beyond
Emergency electronic brake light	Extended Intersection Collision Warning	Platooning
Emergency vehicle approaching	Vulnerable Road User Warning	Cooperative merging assistance
Slow or stationary vehicle(s)	Cooperative Adaptive Cruise Control (CACC)	Cooperative lane change
Green Light Optimal Speed Advisory	Support for Semi-automated functions	Automated GLOSA with negotiation
Park & Ride information	Long-term Road Works Warning	Cooperative Overtaking
Traffic jam warning and smart routing	Electronic Toll Collection	Cooperative maneuver
Hazardous location notification	Real-Time Traffic Information	See-through
Road works warning	Lane change assistance	Remote driving
In-vehicle speed limits	Decentralized floating car data	Extended sensors
Cooperative collision risk warning	Pre-crash sensing warning	Automated Lane Keeping

2.1.2 ITS station reference architecture

In this section, we present the ISO/ETSI reference architecture for ITS stations, which forms the core framework for our contributions. The ITS station architecture is essentially based on the global TCP/IP protocol stack, with some modifications to accommodate vehicular communication and mobility requirements. As shown in Figure 2.1, mainly composed of four

horizontal layers, namely access, networking & transport, facilities, application, and two cross layers called management and security [5].

- **The Application layer** hosts different ITS services from safety to infotainment. Every message issued from this layer shall have a priority according to the functional and operational requirements of the ITS service.
- **The Facilities layer** offers the support of various applications. It is responsible for encoding and decoding, encryption (Presentation layer in OSI) and inter-host communication (Session layer in OSI). The Facilities layer is the core intelligence of the architecture as it provides support to the upper (i.e. application support) and lower layers (i.e. communication and information support) and manages storage of information in several data elements. Furthermore, this layer offers a digital map, specifically referred to as the Local Dynamic Map (LDM). It houses essential information related to objects affecting or being affected by road traffic, and this data can be provided to authorized applications upon their request.
- **The Networking & Transport layer** has the same functionalities as the Network and Transport layers of the TCP/IP reference architecture. It hosts functionalities such as packet routing, path establishment, end-to-end packet transport, multiplexing/demultiplexing with the facilities layer, and IP mobility. It contains one or several networking protocols such as the GeoNetworking protocol [6], IPv6 networking with mobility support, IPv6 over GeoNetworking [7], CALM FAST protocol [8], and other ways of IPv6 networking. It operates one or several transport protocols such as Basic Transport Protocol (BTP), UDP, and TCP.
 - **GeoNetworking (GN)** is a new ad-hoc location-based addressing, geographical forwarding, and geographical routing protocol. It uses geographic positions to share information and transmit data packets. It enables communication between individual ITS stations and packet distribution in specific geographic areas. GN protocol mainly supports the following forwarding schemes: Geo-Unicast, Geo-Broadcast, and Topologically scoped broadcast.
 - **Basic Transport Protocol (BTP)** offers connectionless, unreliable end-to-end packet transport like UDP. BTP's main goal is the multiplexing/demultiplexing of facility layer messages based on the port's concept.
- **The Access layer** is composed of a Physical layer and Data Link layer (DLL). The whole layer is already designed to support different interfaces such as vehicular ad-hoc technologies (i.e. ITS-G5 in Europe, DSRC in the USA), cellular short-range technologies (LTE-V2X PC5, and 5G NR), cellular (4G and 5G), and urban Wi-Fi (e.g. 802.11 g/n/ac).

- **Frequency allocation plan for C-ITS:** The 5.9 GHz band has been dedicated to vehicular communications in both the European union and the US. This band goes from 5855 MHz to 5925 MHz. In Europe, 50 MHz were allocated [9], whereas in the US, the FCC allocated 75 MHz of dedicated spectrum [10]. Both ITS-G5 and Cellular V2X are using this band to deliver safety-related services. Thus, the co-existence problem between these distinct technologies presents one of the current C-ITS challenges among industrial and academic communities.
- **The Security and Management layers** are cross-layers that offer support to the horizontal stack of layers. The security layer offers security and privacy procedures. It is responsible of secure message transmissions (e.g. cryptography, authentication management, firewall, and intrusion management). The management layer is responsible of cross interface management, general congestion control management, and ITS service advertisement. In our work, we will be interested in the communication interface to ITS-S service mapping management functionality.

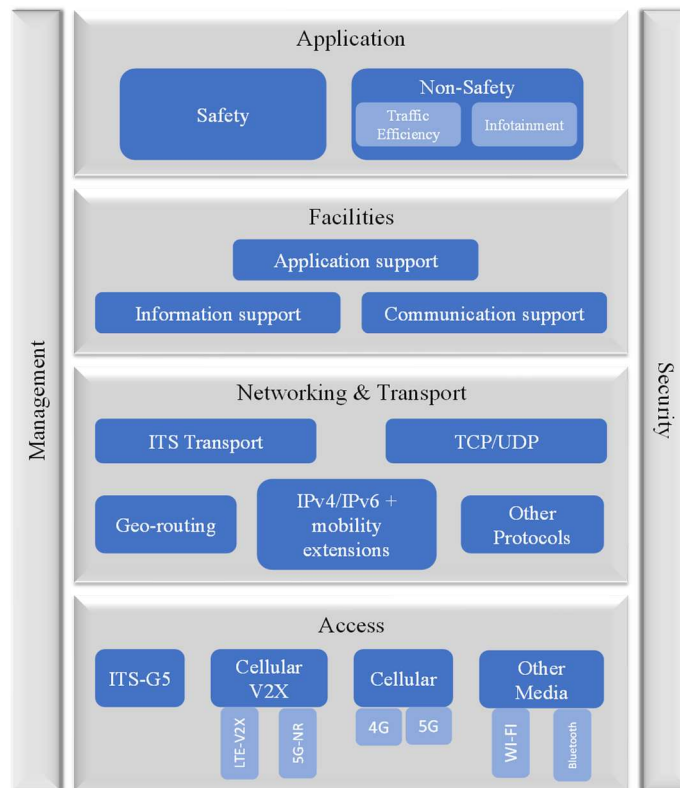

Figure 2.1. ETSI ITS station architecture

The functional components of the ITS-S architecture vary from one sub-system to another, so it depends on the context of use of the ITS Station. The ITS subsystems are:

- Personal ITS sub-system; in hand-held devices.
- Central ITS sub-system; part of an ITS central system.
- Vehicle ITS sub-system (On-Board Units); in cars, trucks, etc., in motion or parked.
- Roadside ITS sub-system; on gantries, poles, etc...

2.1.3 Vehicular communication technologies

In this section, we explore the various attributes of vehicular communication technologies, with a specific focus on ITS-G5 and LTE-V2X. We provide an overview of the features of both IEEE 802.11p and IEEE 802.11bd, followed by an overview of cellular V2X technologies.

2.1.3.1 ITS-G5

ITS-G5 is an access layer technology standardized by ETSI. The data link layer is divided into two sublayers; medium access control and logical link control. The physical layer and the medium access control layer are covered in IEEE 802.11 [11]. Furthermore, as safety services have high requirements on the reliability and the latency a Decentralized Congestion Control (DCC) method is employed in order to control the channel load and avoid unstable behavior of the system.

As the IEEE 802.11 standards for vehicular communications have evolved, two standards are developed to represent the access layer of the ITS-G5 technology. Specifically, IEEE 802.11p and its subsequent amendment, IEEE 802.11bd.

2.1.3.1.1 IEEE 802.11p

The IEEE 802.11pTM standard was introduced to define a set of requirements with the objective of enabling short-range communications among ITS stations within an ad-hoc vehicular communication network, particularly in environments characterized by high mobility and dynamic communication conditions. The IEEE 802.11pTM standard is based on the IEEE 802.11a Wi-Fi version. To enhance the efficiency of channel access for vehicular communication and to address the specific challenges associated with vehicle mobility and latency constraints, this standard offers vehicles the ability to communicate outside of the context of a Basic Service Set (OCB) [12], without the requirement for association and authentication to a Basic Service Set (BSS). Be careful not to confuse the Independent Basic Service Set (IBSS) mode (i.e. Ad Hoc mode) with the OCB mode.

As mentioned earlier, the 5.9GHz licensed band is exclusively allocated for ITS communications. In Europe, this frequency spectrum spans 70 MHz, while in the US, it covers 75

MHz. Within this band, there are seven channels, each with a 10MHz bandwidth and 156.25 kHz sub-carrier spacing. The modulation employed is Orthogonal Frequency Division Multiplexing (OFDM) based, utilizing 52 sub-carriers, of which 48 are designated for data transmission, and the remaining four sub-carriers serve as pilot signals [13]. The OFDM PHY layer supports eight distinct transmission rates, achieved through various modulation schemes and coding rates as shown in TABLE. 2-4. The duration of an OFDM symbol is 8 μ s, which incorporates a cyclic prefix (guard interval) lasting 1.6 μ s. Ideally, the maximum allowable delay spread should not exceed 1.6 μ s. This corresponds to a distance of approximately 480 meters, with a maximum communication range of less than 1 km.

The physical Packet Data Unit (PPDU) is composed of three fields as shown in Figure 2.2. A preamble that is used to synchronize the receiver. The signal field contains information about the packet length and the data rate. The signal field is always transmitted using BPSK with a coding rate of 1/2.

The MAC layer employs identical mechanisms as specified in IEEE 802.11-2012. It utilizes Enhanced Distributed Coordination Access (EDCA) to manage channel access, which is based on the Hybrid Coordination Function (HCF), a Carrier Sense Multiple Access with Collision Avoidance (CSMA/CA) algorithm with Quality of Service (QoS) features. CSMA/CA is a protocol that listens before transmitting, and in EDCA, the predefined listening period is referred to as the Arbitration Interframe Space (AIFS). The EDCA algorithm introduces priority classes known as access categories, which are determined based on User priorities (refer to TABLE. 2-3) outlined in the IEEE 802.1d [15] standard. The purpose behind establishing AIFSs and access categories is to provide data traffic with higher priority and enhanced likelihood of accessing the channel before data traffic with lower priority.

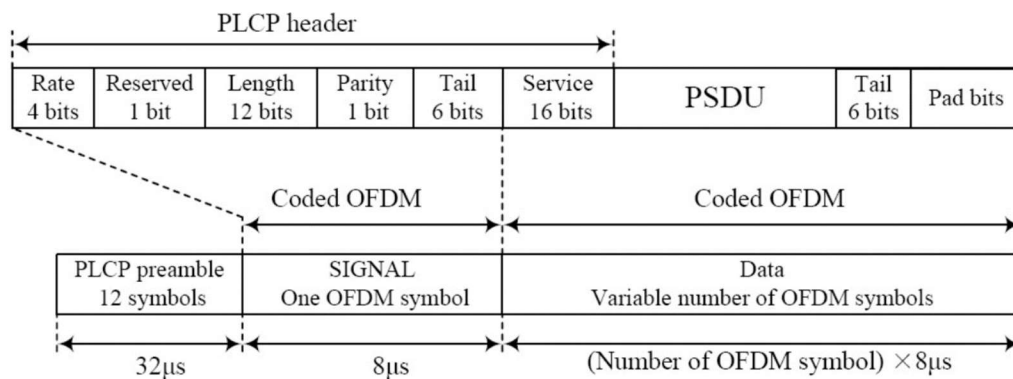

Figure 2.2. Frame format of IEEE 802.11p (PPDU) [14]

TABLE. 2-3. User priorities, access categories association in EDCA method and AIFS values

User Priority in 802.1D	Data traffic type in 802.1D	AC in 802.11	Data traffic type in 802.11	AIFSN
1	Background (BK)	AC BK	Background	9
2	Spare (-)	AC BK	Background	
0	Best effort (BE)	AC BE	Best effort	6
3	Excellent effort (EE)	AC BE	Best effort	
4	Controlled load	AC VO	Video	2
5	Video (VI)	AC VO	Video	
6	Video (VO)	AC VI	Voice	3
7	Network control (NC)	AC VI	Voice	

2.1.3.1.2 IEEE 802.11bd

As the IEEE 802.11 standards have undergone enhancements, progressing from IEEE 802.11a™-2009 to IEEE 802.11n™-2009, and further evolving with IEEE Std 802.11ac™-2013 and the ongoing IEEE 802.11ax™ amendment, a similar progression has occurred for IEEE 802.11p™, which has advanced to become IEEE 802.11bd™. While the IEEE 802.11ac PHY layer exhibits reduced performance in high-mobility scenarios, primarily due to interferences and channel fluctuations occurring within the frame duration [16], IEEE 802.11bd builds upon IEEE 802.11ac by incorporating support for mobility and vehicular communication. In January 2019, a new task group known as the IEEE 802.11bd Task Group was established to formulate the IEEE 802.11bd standard. As outlined in the Project Authorization Report (PAR) [17] for this group, the IEEE 802.11bd specifications are delineated as follows:

- At least one mode that achieves twice the MAC throughput of 802.11p with relative velocities up to 500 km/hr.
- At least one mode that achieves twice the communication range of 802.11p.
- At least one form of vehicle positioning in affiliation with V2X communications.

IEEE 802.11bd uses the same mechanisms as present in IEEE 802.11ac. To enhance message reliability and integrity, it incorporates Low-Density Parity-Check (LDPC) codes. Additionally, to reduce end-to-end transmission latency and enhance throughput, it utilizes Multiple Input Multiple-Output (MIMO) transmissions and employs higher Modulation and Coding Schemes (MCS). Furthermore, the channel bandwidth is expanded from 10 MHz to 20 MHz.

IEEE 802.11ac PHY layer performs lower than IEEE 802.11p in a high mobility environment, due to interferences and channel variations within the frame duration [16]. Furthermore, to prevent low performance and to provide an enhanced standard for the VANET environment, the IEEE 802.11bd introduces a new PHY layer level mechanism called midambles.

These midambles are similar in form to a preamble but used in-between OFDM data symbols to estimate the channel variation. The use of midambles was inspired using the De-Modulation Reference Signal (DMRS) symbols which are used for channel estimation in C-V2X (Cellular V2X such as LTE V2X and 5G NR-V2X) [19]. As a final point, millimetric Wave (mmWave) frequency bands (i.e., 60 GHz and above) that allow very high throughput can also be used in the IEEE 802.11bd standard. The PHY layer specifications can be resumed as followed:

- Subcarrier spacing: 156.25 kHz and 78.125 kHz.
- Channel coding: LDPC.
- Highest rate: MCS9 (5/6 256-QAM).
- Target speed: 250 km/h.
- Doppler recovery method: high-density midambles.

TABLE. 2-4. Transfer rates, coding rates in 802.11p and IEEE 802.11bd [19]

IEEE 802.11p			IEEE 802.11bd		
Transfer rate (Mbps)	Modulation scheme	Coding rate	Transfer rate (Mbps)	Modulation scheme	Coding rate
3	BPSK	1/2	7.2	BPSK	1/2
4.5	BPSK	3/4	14.4	QPSK	1/2
6	QPSK	1/2	21.66	QPSK	3/4
9	QPSK	3/4	28.88	16-QAM	1/2
12	16-QAM	1/2	43.33	16-QAM	3/4
18	16-QAM	3/4	57.78	64-QAM	2/3
24	64-QAM	2/3	65	64-QAM	3/4
27	64-QAM	3/4	72	64-QAM	5/6
			86.66	256-QAM	3/4

Another version of the 802.11bd standard is currently under discussion, namely the *IEEE 802.11bd^{DC}*, it is based on the IEEE 802.11ax standard and offers features such as Dual-Carrier Modulation (DCM) to have an extended range.

2.1.3.1.3 Decentralized Congestion Control (DCC) cross layer mechanism

DCC is an essential cross-layer mechanism for IEEE 802.11p based inter-vehicular communications. DCC approaches have been developed to mitigate the congestion by limiting the transmit parameters, mainly transmit rate and power based on channel condition. The DCC architecture is distributed across multiple layers, including the facilities layer, the networking and transport layer, the management layer, and the access layer, each having corresponding components [20]: DCC_FAC, DCC_NET, DCC_CROSS, and DCC_ACC, respectively. DCC uses CBR measurements to fairly allocate resources between different C-ITS stations. CBR is

calculated as the proportion of time the channel is sensed busy. DCC is a cross-layer mechanism. DCC's operational requirement is to keep the actual channel load below predefined limits. Different techniques exist for controlling the network load: Transmit power control (TPC), Transmit rate control (TRC), and Transmit data rate control (TDC). In TPC, the output power is altered to adjust the current channel load. TRC regulates the time between two consecutive packets from an ITS-S. TDC is a mechanism that can be used by wireless systems offering several transfer rate options.

2.1.3.2 LTE-V2X (Uu and PC5)

LTE-V2X, introduced by the 3GPP in 2017 as part of release 14 [21], is built upon Proximity Services (ProSe) technology (release 12), that is known as LTE direct Device-to-Device (D2D) communications. It was developed to address the performance demands of emerging V2X services. This type of communication is enabled by the Sidelink channel which was standardized by the 3GPP in 2016 under the umbrella of LTE release 14. In LTE-V2X, two communication radio interfaces are available, as depicted in Figure 2.3. The LTE-PC5, also known as LTE Sidelink, enables a User Equipment (UE) to directly communicate with another UE over the Sidelink channel. The LTE-Uu interface is the radio interface between the evolved Node B (eNodeB) and the UE. Network-based communication that uses the LTE-Uu interface is supported only when UEs are inside network coverage where UEs can receive V2X messages via downlink unicast or uplink broadcast.

The PC5 interface has enhancements to accommodate high speeds/high Doppler, high vehicle density, improved synchronization, and decreased message transfer latency. This interface has two communication modes, "Mode 3" and "Mode 4".

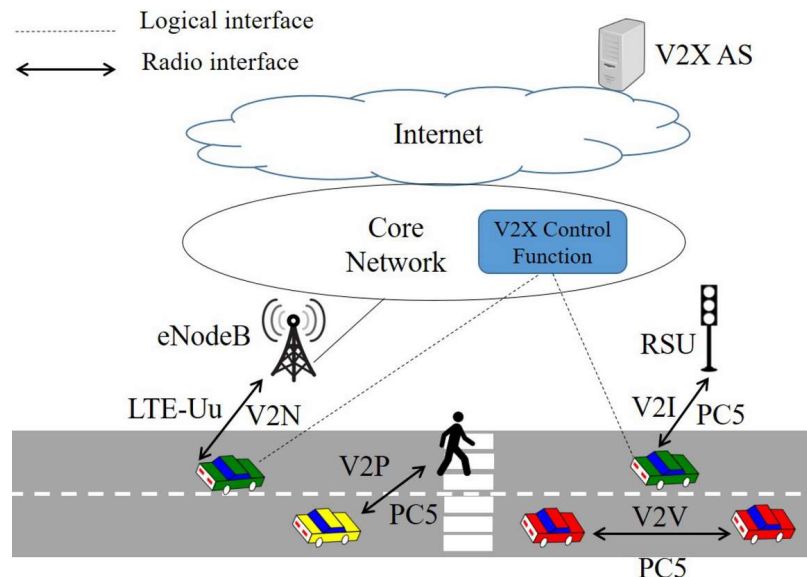

Figure 2.3. LTE-V2X architecture and communication interfaces

LTE-V2X Sidelink adopts as ITS-G5 OFDM at the physical layer and the Single-Carrier Frequency Division Multiple Access (SC-FDMA) at the MAC layer. The channel is subdivided in time and frequency domains into several orthogonal resources. LTE-V2X supports a 10MHz and a 20MHz channel bandwidth. In the time domain, the signal is organized into frames of 10 milliseconds. The frame is subdivided into 1-millisecond sub-frames. In the frequency domain, the signal is formed by Resource Blocks (RBs) which are of 180kHz each. A resource block is defined by 12 sub-carriers, spaced by 15 kHz and carrying 14 OFDM symbols. A sub-channel is defined as a group of RBs, and each vehicle can use one or multiple sub-channels to transmit its data [22]. Data is a two-part information; the first part is the Sidelink Control Information (SCI) and the second one is the Transport Block (TB). TBs are carried by the Physical Sidelink Shared Channel (PSSCH) while the Physical Sidelink Control Channel (PSCCH) carries the SCI. The SCI provides the critical information to decode the message at the receiver's side, such as the MCS information, the RBs occupied by the associated TB, the priority of the message and the resource reservation interval. In C-V2X, Quadrature Phase Shift Keying (QPSK) and 16QAM modulations are used to transmit the TB, whereas the SCI is always transmitted using QPSK. PSCCH and PSSCH are transmitted in the same sub-frame but using different frequency resources. There are two configuration schemes for the PSSCH and PSCCH. The first one is the adjacent configuration, where the PSCCH occupies the first two RBs of the allocated sub-channel, and it is directly followed by the PSSCH. The second configuration is a non-adjacent configuration, where the PSSCH and the PSCCH do not occupy successive RBs in the same sub-frame. In LTE-V2X, the number of RBs per sub-channel can vary depending on the packet size and the utilized MCS [22]. Figure 2.4 provides a summary of all the frame structure details. To better estimate the channel in high mobility environments, 4 DMRS symbols were inserted in the OFDM sub-frame.

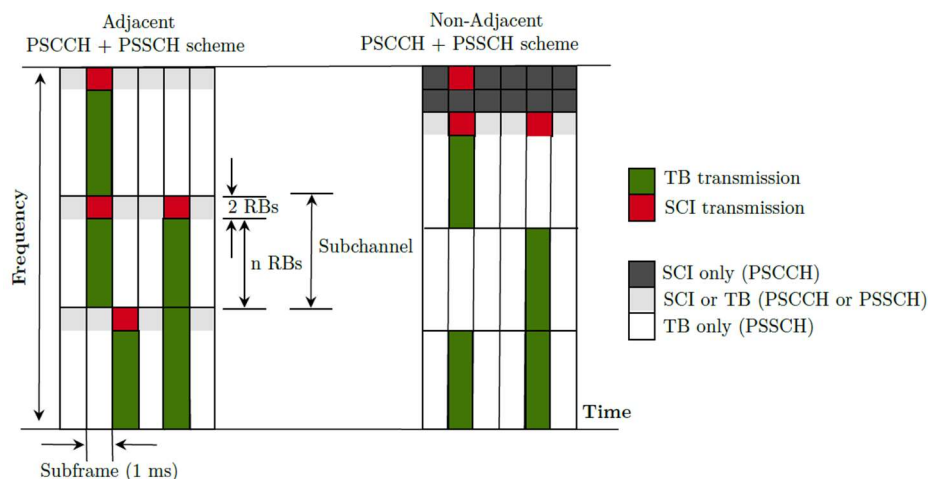

Figure 2.4. LTE-V2X Frame Structure

LTE-V2X employs turbo coding and the normal cyclic prefix, both recognized for their effectiveness in error correction and enhancing data quality. Turbo coding addresses error correction efficiently, while the normal cyclic prefix helps mitigate the impact of multipath propagation and Inter-Symbol Interference (ISI) by providing a guard interval.

2.1.3.2.1 "Mode 3" (In-coverage)

In this mode, radio resources allocation and management are done by the cellular network via control signaling over the Uu interface. Thus, vehicles need to be in the base station's coverage zone. In "mode 3", each vehicle reports its location and coordinates to assist the eNodeB in resource scheduling. However, 3GPP specifications do not define a resource management algorithm for "mode 3". Each operator can develop and implement its solution that can be one of two categories: Dynamic Scheduling or Semi-Persistent Scheduling algorithms.

In dynamic scheduling vehicles request subchannels for every packet transmission. For each Transmission Time Interval (TTI), the MAC layer checks the UEs to be scheduled, the data to be scheduled, and the UE feedback on the channel conditions. On the other hand, using semi-persistent scheduling the base station reserves sub-channels for the periodic transmission of a vehicle. Each vehicle sends to the eNodeB the necessary information such as packet size, transmission frequency, and priority of packets. This information is referred to as the assistance information, which is used by the eNodeB to semi-persistently reserve the appropriate resources for each vehicle.

2.1.3.2.2 "Mode 4" (Out-of-coverage)

Also known as "pure Adhoc V2V", Mode 4 is the mode standardized by 3GPP for the autonomous radio resource selection. In this mode, vehicles autonomously select their radio resources using the Distributed Semi-Persistent Scheduling (SPS) algorithm, which is more detailed in [23]. Thus, vehicles do not need to be in the base station's coverage zone. 3GPP Release 14 supports congestion control in mode 4 [24]. The standard does not specify a particular congestion control mechanism, but it defines some metrics and considerations to consider while developing congestion control mechanisms. For every transmission or a retransmission of a packet, vehicle estimates Channel Busy Ratio (CBR) and Channel occupancy Ratio (CR). The CBR indicates the level of channel congestion and is defined as the number of subchannels in the previous 100 sub-frames that experience an average RSSI higher than a pre-configured threshold. The CR quantifies the channel occupancy generated by the transmitting vehicle; the CR shouldn't exceed a CR threshold that is defined according to the CBR.

The Distributed SPS is based on the sensing before choosing a resource from a list of candidate resources. When a vehicle reserves one resource, this resource is used to transmit a random number of consecutive messages. This random number, also called the re-selection counter, depends on the periodicity of the CAM messages. The re-selection counter is chosen between [5 - 15] for a periodicity of 10 Hz, [10 - 30] for a periodicity of 20 Hz, and [25-75] for a periodicity of 50 Hz. The periodicity of the CAM messages and the value of the re-selection counter are included in the SCI field. Thus, based on this information, the vehicle can know which resources are free and which ones are occupied by other vehicles. After each transmission of a CAM message, the value of the re-selection counter is decremented by 1. When the re-selection counter reaches zero, a new resource must be selected with a probability of $(1 - P)$, where P is the probability of keeping the same resource for the next transmissions. The Distributed SPS can be divided into three steps:

- The vehicle listens to the channel during the sensing window for a period of 1 second. The sensing window corresponds to the last 1.000 sub-frames. Then, based on the listening information, the vehicle reserves candidate resources within a Selection Window (SW). This window is defined by $[T + T_1, T + T_2]$ where T is the trigger for the transmission, T_1 is the processing time required by a vehicle to identify and select candidate resources for transmission with $1\text{ms} \leq T_1 \leq 4\text{ms}$, and T_2 is also selected by the vehicle and must be included within the range $20 \leq T_2 \leq 100$ due to latency requirement of the traffic.
- In the second step, the vehicle creates a first list “ L_1 ” containing the resources selected during the selection window, except those presenting a level of Reference Signal Received Power (RSRP) higher than a fixed power threshold. Also, “ L_1 ” excludes the resources occupied by other vehicles for their next transmissions according to the received SCI information during the sensing window. This list must contain at least 20% of the total resources selected in the first step. Otherwise, this step is iteratively repeated by increasing the power threshold each time by 3 dB.
- In the third step, the vehicle creates a list of resources L_2 presenting the minimum Received Signal Strength Indicator (RSSI) values. The number of these resources must be equal to 20% of the total resources selected in the first step. Thus, the vehicle chooses randomly a final resource from the L_2 list and reserves this resource according to its re-selection counter for its next transmissions. Random selection avoids collision problems in case two vehicles select the same resource presenting the lowest RSSI value.

2.1.3.3 5G New Radio V2X

The 3GPP has standardized NR-V2X [25] to facilitate advanced V2X services like vehicle platooning, extended sensors, and advanced remote driving. NR-V2X is not a replacement for

LTE-V2X but rather complements it by enhancing support for these new services. In case a vehicle is equipped with the two Radio Access Technology (RAT), it can use the LTE-V2X for basic safety applications and NR-V2X for these new services.

NR-V2X supports the unicast and groupcast modes besides the broadcast mode, already supported in LTE-V2X. Like IEEE 802.11bd, NR V2X also considers the use of mmWave bands for V2X applications, particularly for applications that require a short range and high to very high throughputs. The key enhancements that are introduced in NR V2X are:

Support for new numerologies: unlike LTE-V2X, where the spacing between sub-carriers is fixed on 15 kHz, in NR-V2X it can take other values multiple of 15 kHz, i.e. 30, 60 and 120 kHz. As the sub-carrier spacing is variable, the time slot is also variable and decreases with the increase of the sub-carrier spacing, which reduces the latency and therefore favors critical applications in terms of latency.

Multiplexing of PSCCH and PSSCH in time domain: in LTE-VEX PSCCH and PSSCH are multiplexed in frequency. Due to tight latency constraints, and to avoid that the receiver buffers the message for the entire sub-frame to decode the message. 3GPP defines the multiplexing of PSCCH and PSSCH in time in NR V2X.

Slot, mini-slot and multi-slot scheduling: NR V2X supports mini-slot scheduling, where UEs that have latency-critical messages to send can start their transmissions at any of the 14 OFDM symbols and can occupy any number of OFDM symbols within the slot. Multi-slot is supported in NR V2X to cater to use-cases that require exchange of large-sized packets.

Physical Sidelink Feedback Channel (PSFCH): this new channel has been defined in NR-V2X to ensure the reliability for unicast and groupcast modes.

Physical layer enhancements: LDPC coding, higher order MCS including 64-QAM, and a flexible number of DMRS symbols per slot.

Like LTE-V2X, 5G NR-V2X [68] also defines two types of Sidelink communication modes: Mode1 and Mode2. The NR-V2X Mode 1 defines the mechanisms that allow direct vehicular communications within the Next-Generation Node B (gNodeB) coverage, while the cellular network base station allocates radio resources to the vehicle by the Uu interface. Mode 2 supports direct vehicular communications via PC5 interface under the out-of-coverage of the cellular network.

Similar to LTE-V2X a radio frame has a size of 10 milliseconds divided in 1 millisecond sub-frame or in mini-slots which is defined by 1 OFDM symbols that can be aggregated to a multi-slot. Following the introduced numerology, in the frequency domain, the signal is divided into Resource Elements (REs). A Resource Element is defined by 1 sub-carrier of 15 kHz in frequency domain for 1 OFDM symbol duration in time domain.

2.1.3.3.1 "Mode 1" (In-coverage)

In mode 1, the gNodeB schedules and allocates resources to vehicles. NR-V2X mode 1 uses the Dynamic Grant (DG) scheduling and uses the Configured Grant (CG) Scheduling instead of the SPS [69]. In the DG, the vehicle must request resources to the gNodeB for the transmission of every message using the Physical Uplink Control CHannel (PUCCH). Then, the gNodeB responds with the Downlink Control Information (DCI) over the Physical Downlink Control CHannel (PDCCH). The DCI indicates the sub-channels and slot allocated to the vehicle for the transmission of its message. Then, the vehicle informs other vehicles about the scheduled resources using the SCI. The main drawback of the DG is the increase in the delay and the signaling overhead. For that, mode 1 includes the Configured Grant Scheduling as a second option. In the Configured Grant scheduling, the gNodeB can assign a set of resources, referred to as a CG, to a vehicle to transmit several messages. To this aim, the vehicle sends a message to the gNodeB indicating information about periodicity of the message and its maximum size. Also, it indicates the QoS information such as the latency and reliability required by the transmitted message. Thus, based on this information, the gNodeB creates, configures and allocates a CG to the vehicle that satisfies the requirements of the Sidelink traffic.

2.1.3.3.2 "Mode 2" (Out-of-coverage)

In Mode 2 vehicles choose autonomously their appropriate resources. Resources are chosen from the Sidelink resources configured by the gNB or pre-configured in the vehicles. For advanced safety service, NR-V2X supports the transmission of periodic and non-periodic traffic with variable packet sizes. The 3GPP offers, in NR-V2X, a new channel sensing method, called short-term sensing, similar to the Listen Before Talk (LBT) mechanism [69]. For mode 2, the proposed resource allocation algorithm is the sensing-based SPS algorithm, already standardized for LTE-V2X mode 4, but the 3GPP proposals suggest modifying the sensing and the resource selection procedures in order to adapt to the periodic and the non-periodic traffic. Two channel sensing mechanisms are proposed in Mode 2, long-term sensing and short-term sensing. Long-term-sensing is similar to one used in LTE-V2X mode 4. Short-term-sensing is based on listening to the medium before the transmission. Short-term-sensing is more beneficial in case of non-periodic traffic, and it can be used as a complementary solution for the long-term-sensing to avoid collision problems.

In this subsection, we provide a comprehensive overview of ITS standardization efforts spanning different radio access technologies. These technologies may experience performance issues in high-density situations, creating difficulties for the effectiveness of C-ITS services. We also noticed that new generation technologies are standardized to support existing V2X

technologies and not to replace them. Because every technology possesses advantages and limitations, which will be discussed in the subsequent chapter. This discussion will underscore the necessity and rationale behind a hybrid architecture, combining the aforementioned technologies to deliver V2X services with the most suitable communication mode that meets their specific requirements.

2.2 Background and related works

2.2.1 Comparison study between ITS-G5 and C-V2X

Our state-of-the-art investigation commences with an in-depth review of prominent research papers centered around vehicular communication standards. This review places particular emphasis on the characteristics of these standards and the concurrent challenges they present. Additionally, these studies present a performance comparison by analyzing the MAC and PHY layers of these technologies.

Paper [26] presented an overview of IEEE 802.11p, with a brief comparison between some features of IEEE 802.11p and LTE-V2X. They presented relevant preliminary materials concerning MAC and PHY features of IEEE 802.11p under the umbrella of the Dedicated Short-Range Communication (DSRC). Like ITS-G5, DSRC enables vehicles to communicate with each other and with roadside infrastructure over short distances in an ad-hoc vehicular communication networks. Next, this paper discusses a comparison of IEEE 802.11p with LTE-V2X. These comparisons are made in identical external conditions.

In comparison with LTE-V2X, this paper reveals that IEEE 802.11p is as widespread as the LTE-V2V. However, in a low data traffic network, the LTE-V2V can deliver a 10% improvement in the packet reception ratio and a ten times lower update delay compared to the IEEE 802.11p. On the other hand, on a high data traffic condition is observed, LTE-V2V keeps the lead with 26% better reliability, but the IEEE 802.11p guarantees a lower update delay. The coverage analysis shows that utilizing IEEE 802.11p results in excellent performance within a range of a few hundred meters, providing awareness coverage of up to 250-300 meters. Nevertheless, as the distance increases beyond this range, the reliability of communication in various services diminishes due to a higher collision rate. Under similar conditions, it can be confirmed that the LTE-V2V standard exhibits diminished performance in short-distance communications but becomes more reliable as the distance increases, extending up to nearly 500 meters [27]. In conclusion, this paper asserts that the optimal technology choice depends on the specific usage conditions and the precise requirements of the service.

Another comparison study between IEEE 802.11p and $LTE - V2X_{Mode 4}$ in terms of Packet Error Rate (PER) versus SNR or range is presented in [28]. It also presents an evaluation of the performance of the MAC layers of both systems in their resource selection process and observing their impact on performance in terms of PER, range, latency and network load. The study shows that $LTE - V2X_{Mode 4}$ depends on the MCS and number of RBs. When largest number of RBs (larger bandwidth) $LTE - V2X_{Mode 4}$ outperforms other configurations (i.e. ITS-G5 and narrowband) in PER and throughput, thanks to the possibility to exploit frequency diversity and to use a lower coding rate (lower MCS) compared to narrowband allocations. The retransmission mechanism that is present in $LTE - V2X_{Mode 4}$ allows much greater ranges at lower data throughput levels. Based on the network congestion level, the results of this study indicate that C-V2X exhibits a greater loss in range compared to ITS-G5. However, C-V2X demonstrates superior performance in terms of range when user densities are low, primarily due to the variance in data rates (4.76 Mbps for 802.11p and 2.4 Mbps for C-V2X). Conversely, for high user densities (exceeding 150 users per square kilometer), 802.11p surpasses C-V2X due to its more effective resource scheduling.

In reference to paper [29], an assessment of the reliability of both IEEE 802.11bd and NR-V2X is conducted. These experiments involve an analysis of the physical layer performance of these technologies across various V2V scenarios, employing Monte Carlo simulations. The findings from this study indicate that NR-V2X is likely to exhibit superior reliability compared to IEEE 802.11bd, primarily due to its more effective handling of Doppler shifts. In the case of IEEE 802.11bd, elevated Doppler shifts lead to packet errors even under conditions of high Signal-to-Noise Ratio (SNR). This is caused by outdated channel estimations in combination with deep fades. To improve the channel estimation midambles are utilized to prevent saturation effects. With that done IEEE 802.11bd still needs at least 10 dB SNR to achieve a PER of 10^{-3} whereas NR-V2X can achieve the same target with a SNR of less than 0 db. The study reveals the necessity of adjusting the midamble periodicity based on the vehicle's speed. Additionally, to enhance the performance of IEEE 802.11bd in regions with low signal-to-noise ratio (SNR), the paper recommends the incorporation of features defined in IEEE 802.11ax, such as an extended range preamble and DCM. Enabling these options results in approximately a 5dB improvement in the performance of 802.11bd. After enabling DCM, the spectral efficiency of 802.11bd decreases by a factor of two, aligning it with NR-V2X MCS0.

Another study of same authors [30] presents an evaluation and comparison between IEEE 802.11bd and NR-V2X for V2V communications. LTE-V2X and IEEE 802.11p are also involved in this study. It is expected that NR-V2X outperforms all other standards in terms of reliability, range, latency and data rates. And as IEEE 802.11bd is the amendment of the IEEE 802.11p, it is expected to be more reliable with improved range and throughput compared to IEEE 802.11p. in

these evaluation two services' requirements are targeted, URLLC and enhanced Mobile Broadband (eMBB). To achieve the simulations, the complete PHY features of each technology are modeled in a MATLAB based simulation framework. This study doesn't consider packet re-transmissions nor Hybrid Automatic Repeat Request (HARQ) techniques. PER results show that in case of a low MCS IEEE 802.11p has the worst performance, followed by LTE-V2X. The IEEE 802.11bd has a better performance compared to both LTE-V2X and 11p, but NR-V2X is better than IEEE 802.11bd. However, with this MCS the *IEEE 802.11bd_{DC}* with DCM outperforms all other technologies because of its extended range option. When using an MCS of 2/3 64QAM both LTE-V2X and NR-V2X perform better for large packet sizes due to the increased error correction capability of both Turbo and LDPC decoders. The throughput findings clearly indicate that NR-V2X surpasses all other technologies, with LTE-V2X following closely. The performance of 802.11-based technologies is notably impacted by their substantial preamble overhead, particularly when handling short packet transmissions. Following this paper's results, NR-V2X is also superior to IEEE 802.11bd in terms of packet inter-arrival time due to more reliable MCS options with lower code rates.

Findings in paper [31] present a survey of recent advancements in the standardization of IEEE 802.11bd and NR V2X. This survey encompasses a comparative analysis of these two evolutionary RATs in comparison to their predecessors. These comparisons are represented in resuming tables of key differences between features and mechanisms. These new technologies are dedicated to use-cases that require the end-to-end latency to be as low as 3 milliseconds with a reliability of 99.999%. according to this survey and studies in [32] and [33], IEEE 802.11p, and LTE-V2X can support a basic set of vehicular safety services, known as Day 1 services, that are based on issuing driver-alerts to indicate potentially dangerous situations. Most of these applications require the delivery of periodic messages and have requirements ranging from 1-10 Hz periodicity and 50-100 milliseconds end-to-end latency. However, IEEE 802.11bd and NR-V2X are supposed to support advanced V2X services that have more stringent latency and reliability requirements. A Max latency of 3-50 milliseconds and a reliability of 99.999%. This paper presents also interoperability and coexistence challenges between the two evolutionary RATs and their respective predecessors. Additional existing research indicates that C-V2X exhibits performance advantages over ITS-G5, characterized by its enhanced link budget, increased resistance to interference, and improved Non-Line-Of-Sight (NLOS) capabilities [34]. Furthermore, studies suggest that both ITS-G5 and C-V2X can reliably support safety applications with latency requirements of approximately 100 milliseconds, as long as vehicular density remains relatively low [35]. However, as V2X use-cases evolve and demand more stringent QoS standards, particularly in advanced V2X applications [36], the current V2X RATs prove insufficient in delivering the desired performance.

In Paper [37], analyze IEEE 802.11p and LTE-V2V and evaluate their performance for the cooperative awareness service through simulations in a realistic highway scenario. Both in-coverage and out-of-coverage conditions are considered for LTE-V2V. This study shows that LTE-V2V in-coverage can achieve 10% (resp. 26%) better results in the packet reception ratio than IEEE 802.11p when small (resp. large) packets are transmitted. Authors affirm that there is not an optimal technology for every condition and that the adoption of a given technology depends on the specific application requirements, especially in terms of communication range and packet size. Additionally, studies in [2] demonstrate that ITS-G5 is well-suited for V2V communications due to its low overhead of Service Advertisement Messages (SAMs), which is less than 20 bytes. LTE-V2X PC5 technology excels in V2I communications, providing enhanced reliability for long-range awareness requirements [14]. TABLE. 2-5 summarizes the advantages and challenges of using ITS-G5 and LTE-V2X with both V2V and V2I communications. However, it loses its performance in dense and high-mobility vehicular environments.

Paper [38] evaluates the performance of ITS-G5 and C-V2X for safety message application through simulation in a realistic highway scenario. The findings show that IEEE 802.11p is better suited for networks with lower density, especially when operating at a lower beacon frequency of 10 Hz. On the other hand, LTE-V2X exhibits superior mean PRR and Inter Reception Time (IRT) in extremely dense highway scenarios, albeit causing a slight delay in CAM transmission, typically a few seconds. For end-to-end delay, this paper's results show that LTE-V2X experiences more delay than IEEE 802.11p for respective vehicle density and beacon frequency. The research outlined in the paper [39] indicates that the improvement achieved by LTE-V2X PC5 over 802.11p is minimal when dealing with a small platoon, such as up to 5 vehicles. Nevertheless, with long platoons, LTE-V2X PC5 is more performant due to a better link budget. Based on their findings, they concluded that LTE-V2X PC5 outperforms IEEE 802.11p for the platooning use case despite platooning being a V2V application. Therefore, these technologies complement each other, and the communication technology selection is closely tied to the specific requirements of the application and the characteristics of the vehicular environment.

In paper [40], the authors provided an in-depth exploration of cellular technologies applied to V2X applications. They outlined the 3GPP requirements for accommodating V2X scenarios across various automation levels. Their examination commenced by contrasting LTE-V2X with IEEE 802.11p standards in terms of re-transmission mechanisms, resource selection, and resource multiplexing among vehicles. Additionally, they conducted a comparative analysis between LTE-V2X and 802.11p with respect to modulation schemes, media access control, operating frequency ranges, and synchronization. The paper also furnished an overview of LTE-Uu and PC5 V2X communications, both with and without MBMS. The authors delved into the realm of security and

privacy concerns within V2X scenarios and delineated 3GPP's novel scenarios for V2X [41], encompassing advanced driving, extended sensors, and remote driving applications.

In summary, the conclusions drawn from the findings in these papers highlight that a technology's performance can vary depending on factors such as the MCS, distance, packet size, vehicle speed, and traffic congestion. This underscores the need to explore the potential of integrating multiple technologies within a hybrid vehicular communication network to leverage their respective strengths under varying conditions.

TABLE. 2-5. Advantages and challenges of using ITS-G5 and LTE-V2X for V2V and V2I communications [2]

Communications mode	LTE/LTE-V2X	DSRC/ITS-G5
V2I Communications	<p>Advantages:</p> <ul style="list-style-type: none"> – Large coverage – Robust mechanism for mobility management – High downlink and uplink capacity – Centralized and flat architecture – High-efficiency eMBMS <p>Challenges:</p> <ul style="list-style-type: none"> – Lack of efficient scheduling schemes for ITS services – Users in the idle state cause high delay in disseminating messages – Easily overloaded in high density environments 	<p>Advantages:</p> <ul style="list-style-type: none"> – Easy deployment and low costs – Suitable for local message dissemination i.e., traffic signal, parking information <p>Challenges:</p> <ul style="list-style-type: none"> – Sparse pilot design – Serious channel congestion with a large number of vehicles – Unbalanced link – Prioritization and service selection – Broadcast storm and hidden node problems
V2V Communications	<p>Advantages:</p> <ul style="list-style-type: none"> – High spectrum efficiency – High energy efficiency – Efficient scheduling on D2D resources <p>Challenges:</p> <ul style="list-style-type: none"> – Interference between D2D pair and other users – Peer and service discovery is time-consuming – High speed of vehicles seriously degrades the performance 	<p>Advantages:</p> <ul style="list-style-type: none"> – Easy deployment and low costs – Ad-hoc mode – The overhead of WSM message is low <p>Challenges:</p> <ul style="list-style-type: none"> – Sparse pilot design – Serious channel congestion with large number of vehicles – Adjacent band leakage in multi-channel operation – Broadcast storm and hidden node problems

2.2.1.1 Standardization challenges between V2X communication technologies

Given that emerging technologies will operate within the same frequency band and are likely to be integrated for simultaneous use in a hybrid vehicular communication architecture, it becomes essential to tackle interoperability and coexistence challenges.

2.2.1.1.1 Challenges between IEEE 802.11p and IEEE 802.11bd

With IEEE 802.11p-equipped vehicles already in operation on our roads [42], it's imperative that IEEE 802.11bd ensures interoperability, backward compatibility, and coexistence. In the absence of interoperability, 802.11bd (resp. 802.11p) devices would be restricted to communication exclusively with other 802.11bd (resp. 802.11p) devices. Therefore, by ensuring interoperability and backward compatibility, IEEE 802.11bd can successfully decode IEEE 802.11p packets, and vice versa. Coexistence is needed to avoid interferences between both IEEE 802.11 technologies when the same channel is used. Both technologies need to detect each other's transmissions as valid 802.11 frames and defer channel access.

Coexistence specification between IEEE 802.11bd and IEEE 802.11p are defined in the TGbd issued use cases document [43] of the 802.11bd technology as followed:

- **Interoperability:** IEEE802.11p devices have to be able to decode at least one mode transmission of 802.11bd device, and 802.11bd devices to be able to decode IEEE802.11p transmissions
- **Coexistence:** IEEE802.11p devices to be able to detect 802.11bd transmissions (and hence defer from transmissions during 802.11bd transmissions causing collisions) and vice versa
- **Backward compatibility:** the ability of NGV devices to operate in a mode in which they can interoperate with IEEE802.11p devices

2.2.1.1.2 Challenges between LTE-V2X and NR V2X

NR V2X is not backward compatible with LTE V2X [31] due to the use of different numerologies (i.e. channel specifications like sub-channel spacing). To realize a backward compatibility scenario, vehicles will be equipped with both LTE and NR V2X technologies, and to perform coexistence and avoid spectrum sharing issues, these technologies will operate in different channels using Frequency Division Multiplexing (FDM) coexistence approach or Time-Division Multiplexing (TDM) coexistence approach. In FDM approach, the two radio devices will operate in deferent frequencies in overlapping times.

2.2.1.1.3 Challenges between IEEE 802.11 technologies and C-V2X

IEEE 802.11 and C-V2X technologies are operating in the 5875-5905 MHz band, this band is reserved for safety-related applications in the European Union. These technologies employ distinct PHY and MAC protocols, yet they must coexist within the same geographical area. Managing this without a clearly defined strategy could compromise the speed and integrity of information transmission, potentially endangering lives. So, to coexist 3 scenarios are proposed in [44] [45].

In Scenario 1, specific frequency bands are designated for C-V2X and IEEE 802.11 technologies, with each of the 5875-5885 MHz and 5895-5905 MHz channels paired either with C-V2X or ITS-G5. The remaining 10 MHz bandwidth (5885-5895 MHz) is allocated to both technologies, and a "listen before talk" mechanism is implemented to prevent interference.

Scenario 2 extends the principles of Scenario 1 to optimize resource utilization. In this scenario, both technologies have access to the shared middle channel and can also utilize the preferred channel of the other technology. This is achieved through an extended "listen before talk" mechanism, which helps prevent interference and minimizes resource wastage.

Scenario 3 involves a straightforward approach to channel sharing between C-V2X and IEEE 802.11-based technologies, utilizing a channel access solution. The "ETSI TR 103 766" document [45] presents 6 methods that are based on sharing in the time domain. This implies that the available time is divided into time slots, where one technology occupies the whole bandwidth for a certain period (i.e., time slot).

2.2.2 Related works on hybrid vehicular communication architectures

In this section, we present various research efforts on hybrid vehicular communications. These include the standardization initiatives undertaken by 3GPP and ETSI to accommodate hybrid communications, as well as the hybrid architectural proposals documented in the literature. All this research believes that it is not expected that a single technology can support such a variety of expected V2X services for a large number of vehicles.

The discussed functional architecture of the hybrid vehicular network is shown Figure 2.5. Where a vehicle is connected directly with other vehicles via C-V2X PC5 and ITS-G5 interfaces. Vehicles can be connected to the base stations via the C-V2X Uu interface. A cellular 5G core network is depicted in this architecture, but we can be replaced with any cellular technology core network.

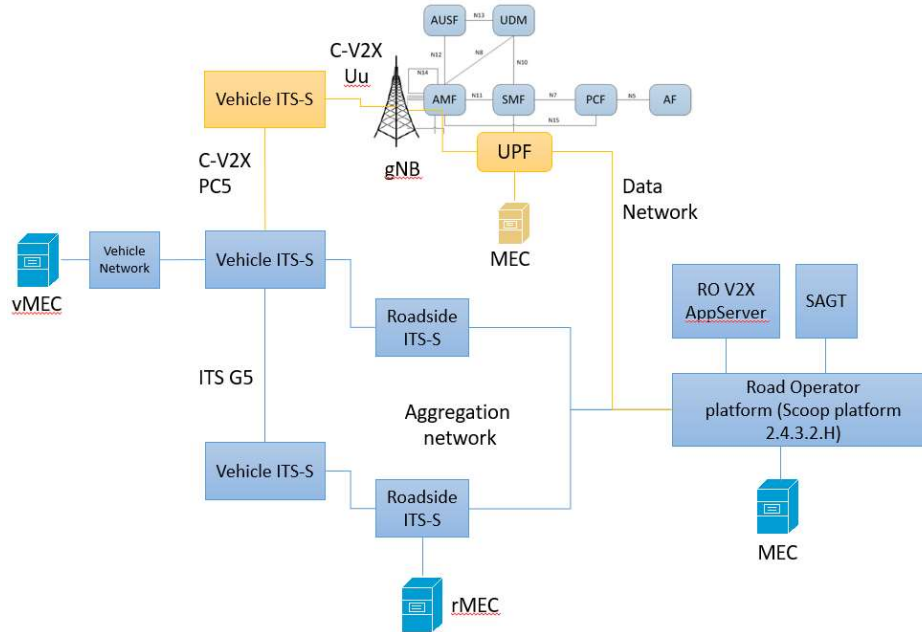

Figure 2.5. Functional architecture for hybrid vehicular architecture

Hybrid vehicular networks are also known in the literature as heterogeneous vehicular networks. Hybrid architecture may in some cases reference inter-road communications combining V2V and V2I communications. Moreover, the term "heterogeneous" architecture refers to a multi-RAT communication network. However, in our work, we use "hybrid" instead of "heterogeneous". The ETSI C-ITS reference architecture presents an access layer that supports many radio access technologies, which allows and prepares for implementing the hybrid vehicular architecture. However, this is not enough to use these technologies together. Thus, many research works have tried to draw an abstraction between the application and access layers to enable hybrid vehicular communication. This abstraction can be implemented in two ways. The first is done by adding a new layer (a.k.a. Heterogeneous Vehicular Network Abstraction Layer). The second implementation modifies the management and facilities layers by incorporating modules responsible for handling application profiles, RAT selection, seamless connectivity, and resource allocation.

In paper [46], the authors provide an overview of the possibilities, hurdles, and key design facets of hybrid V2X communications, considering the most recent technological advancements. This paper mentions that hybrid approaches are currently being investigated in various projects, e.g., 5GNetMobil, 5GCAR, CONVERGE and CODECS. This study clarifies the concept of hybrid V2X communications and studied its potential, technical challenges, and essential design aspects in the context of connected autonomous driving. Authors also provide a basic overview of Connected Autonomous Driving (CAV) services and highlight their unique challenges. They presented safety CAV services as two main categories: passive services, such as cooperative

perception services, and active services, like cooperative maneuvering services. Authors studied both single-technology and multi-technology profiles to increase the reliability (using a redundant strategy) or the communication system's throughput (using an aggregation strategy). As outlined in this paper, the key challenge for hybrid communication is to select appropriate communication profiles for each application considering the profiles' performance characteristics. This work also introduced a concrete system architecture based on four main components: the access interfaces, the C-ITS & TCP/IP stack, the applications layer and additionally a new Hybrid Communications Management (HCM) layer. This layer acts as a control function taking care of selecting, configuring and supervising of the Communication Profiles (CP). However, this paper did not conduct a specific evaluation of this architecture, leaving it without tangible results regarding its impact on improving vehicular communication performance.

Paper [47] presents an interworking study between DSRC (equivalent to ITS-G5 in the US) and cellular network technologies for efficient V2X communications. Authors compared DSRC standards and cellular communications to highlight the limitations of each technology in supporting V2X services. Following that, they introduced a solution for the interworking of these two technologies and identified key challenges arising from vehicle mobility, including vertical handover and network selection concerns. Their rationale for advocating a hybrid architecture stemmed from the recognition that the allocated DSRC radio spectrum alone is not expected to meet the substantial data traffic requirements for in-vehicle Internet access. Additionally, the centralized nature of cellular networks limits their capacity to support low-latency V2V communications. The authors gave a classification of hybrid communication according to network topology, either hierarchical or flat. In the hierarchical architecture, the use of cellular/DSRC technology for V2X communications is restricted to network nodes belonging to specific hierarchical levels. And in a flat architecture, the use of cellular or DSRC technology is not restricted to a certain group of nodes. Alternatively, it depends on the requirements of the service and on the network quality. Following this research, we also adopt a flat hybrid communication architecture. They also described the vehicle's mobility management as a critical issue to be considered one of the important criteria in heterogeneous architecture design. To solve this, they studied both vertical and horizontal handover strategies and network selection schemes.

In paper [48], a hybrid communication approach is suggested for V2X communication schemes. This approach relies on both Wi-Fi and 4G connections to ensure the continuous availability of vehicular communications, considering factors such as network availability, signal strength, and network security in real-time scenarios. They implemented hybrid communications for platforms based on Robot Operating System (ROS) architectures using Qtnetwork and network manager on Ubuntu. Hybrid communication algorithms were implemented on an electric golf cart as an Intelligent Campus Automobile (iCab). The results illustrate the process of transitioning

between these two technologies. The RAT selection approach utilizes the Wi-Fi connection when its quality meets the required threshold, and seamlessly switches to the 4G connection to guarantee a minimum acceptable overall quality.

Paper [49] proposes a hybrid vehicular communication architecture based on the ITS station reference architecture with a service-oriented radio access technology (RAT) selection algorithm. This algorithm allows for a mixed LTE/DSRC solution, where LTE and/or DSRC are chosen based on specific services. In this framework, it's assumed that each vehicle is equipped with both LTE and DSRC technologies. Within this architecture, authors introduce new services at the facilities layer to take care of network performance monitoring and RAT selection. The outcomes of this paper's experiments indicate that the suggested mixed LTE/DSRC approach surpasses the exclusive DSRC approach regarding PRR and average packet latency for safety-related messages and other services. Additionally, it meets the video streaming needs for the see-through use case.

Authors in paper [50] propose another hybrid vehicular network architecture approach. It combines the IEEE 802.11p DSRC technology ad-hoc network and an infrastructure-based LTE network. The protocol stack of this architecture is a generic framework called CellCar (see Figure 2.6). The CellCar is implemented in a vehicle that supports DSRC and LTE. This framework defines a dynamic RAT selection, an effective VHO mechanism, and a dynamic communication management mechanism. To assess network quality and select the appropriate RAT, the authors suggest a two-tiered Radio Resource Management (RRM) strategy. At the upper-tier, there's a distributed Central RRM module responsible for managing the Primary RRM for DSRC and coordinating radio resource allocation at the lower-tier, which is the Secondary RRM for C-V2X. The RAT selection used QoS metrics such as channel occupancy level in the Primary RAT and network load in the Secondary RAT. The evaluation of this architecture shows that employing a hybrid approach results in a fewer number of VHOs, higher reliability, and lower delays. However, this work does not include the defined LTE-V2X PC5, nor does it consider simultaneous multi-technology selection.

Paper [49] surveys and reviews some related studies in the literature that deals with VANET hybrid wireless networks communications in term of vertical handover, data dissemination and collection, gateway selection and other issues. While digging on hybrid communications and the possibility to combine C-V2X and ITS-G5, authors mention that the cellular network emerges as a superior alternative to IEEE 802.11p for accommodating vehicular services. This paper also discusses vertical handover approaches and algorithms to tackle an important challenge in hybrid communications that needs seamless handover with no delay and no packet lost. Data dissemination is studied in terms of transmission delay, throughput, and communication overhead.

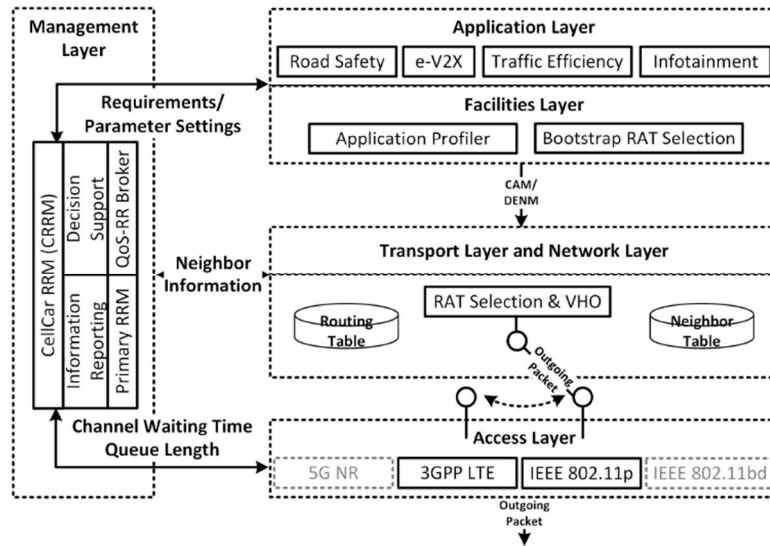

Figure 2.6. Protocol stack design for the CellCar system [50]

This paper also discussed routing algorithms in hybrid vehicular communication in terms of routing delay, gateway selection, throughput, channel capacity, and packet loss. This work highlights the recent development in autonomous cars, considering the integration of VANET heterogeneous wireless networks as an important step towards the success of driverless vehicles projects. On the other hand, this work will help future researchers to obtain ideas about vehicular heterogeneous networks collaboration in developing VANETs and enhancing the drivers' safety.

The study in [2] by Zheng et al. provides another survey on recent wireless networks techniques applied to HetVNETs. They present the requirements and use cases of safety and non-safety services and the HetVNET framework that utilizes a variety of wireless networking techniques. Similar to our study, this research also noted that delivering adequate ITS services solely through a single wireless network is challenging due to the high vehicle mobility and dynamic VANET topology changes. As shown in Figure 2.7, HetVNET is composed of three principal constituents: A Radio Access Network (RAN), a Core Network (CN), and a Service Center (SC). In alignment with what is presented in [23], a Heterogeneous Link Layer (HLL) is added to support a dynamic and instant composition of different networks, and to allow operators to utilize radio resources in an efficient and flexible way. This study also pointed out advantages and challenges of using LTE/LTE-V2X for V2I communications and ITS-G5/DSRC for V2V communications. MAC and networking design challenges in HetVNET, Multi-channel access, broadcast protocols, and resource allocation are discussed in different communication protocols and for vehicular networks. This research work concluded that the heterogeneous vehicular networking with LTE for V2I communications and DSRC for V2V communications is one of the best solutions for supporting vehicular services.

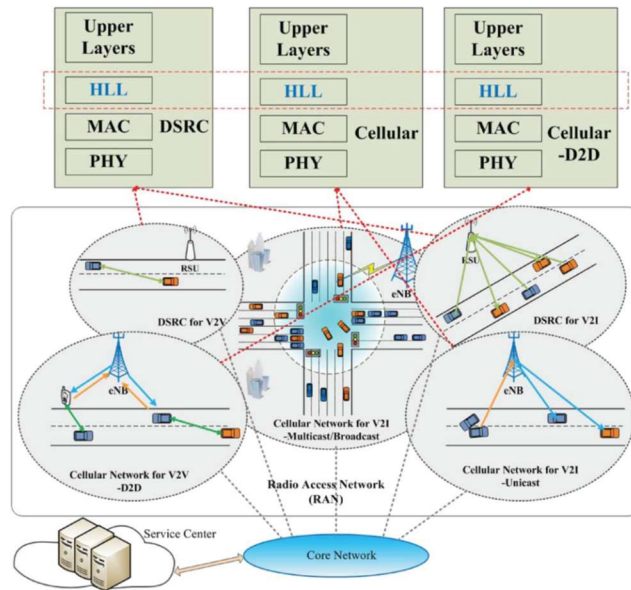

Figure 2.7. Illustration of the HetVNET framework [26]

2.2.3 Related works on RAT selection on hybrid vehicular networks

RAT selection strategies can be categorized into two primary classes: static selection and dynamic selection. In static selection, profiles are chosen based on predefined mappings between message types, their requirements, and the available profiles. These mappings can be determined by communication type (V2V or V2I), service category (safety or non-safety), or technology availability. If one technology is unavailable, the other is selected by default. Dynamic selection considers the real-time observations of radio and road traffic conditions to optimize communication performance. It aims to adapt to performance fluctuations, which can be particularly pronounced in vehicular communication environments due to the rapid movement of nodes and the constantly changing network topologies. This selection depends on Radio Access Parameters like RSRP or the derived Reference Signal Received Quality (RSRQ) in LTE and CBR and Radio Resource Utilization for direct communications like ITS-G5. It also depends on C-ITS Parameters like the number of surrounding nodes, average distance to neighbors, and heading-/speed differences. Vehicle Control Parameters also are considered by the dynamic selection like the vehicle's speed, and planned trajectories.

As a simple and basic RAT selection strategy, we cite the dynamic service aware RAT selection algorithm that is proposed in [86]. It depends on three types of services, which are safety-related Safety Service, bandwidth-greedy Bandwidth Service and Other Service. For safety purposes, the Safety Service messages are transmitted through DSRC radio. LTE networks are dedicated to Bandwidth Service messages. And finally, the RAT selection for Other Service is mainly based on the PRR of both interfaces. Another dynamic RAT strategy is presented in [50].

This latter is more advanced as it includes a Dynamic Communication Management module (DCM) that implements beaconing rate adaptation and admission control in both technologies radio resource management entities. By doing this they avoid unnecessary vertical handovers. Thus, switching RAT intelligently, when necessary, resulted in a lower communication delay. In other works, like in [51], a static multi-RAT redundancy protocol is proposed, which assigns sequence numbers to packets and sends multiple copies through different RATs. Results show improved PRR, PIRT, and communication distance. The authors in [52] present Software-Defined Vehicular Network (SDVN) as an optimum solution for managing and controlling the RAT diversity.

In the dynamic selection category, many papers classified the network decision process based on the Decision Maker's (DM) location: Network-centric (centralized), User-centric (distributed), and collaborative (semi-centralized).

In the network-centric approach, decisions are formulated primarily at the network level, either independently or with minimal input from user terminals. Within this category, the predominant focus revolves around optimizing bandwidth allocation, rendering it a pivotal concern. An inherent drawback of this network-centric paradigm is its potential to strain network resources, as it necessitates a persistent connection between user terminals and the network infrastructure. In accordance with this approach, the selection of RAT often employs linear and non-linear programming models. The primary goal is to maximize throughput or, conversely, minimize latency, as previously mentioned. While these centralized methodologies offer a comprehensible means of addressing RAT selection, the demanding requirements and real-world practicality pose significant challenges to their implementation.

Decisions in the user-centric approach are driven solely by the user terminal, prioritizing the user's individual benefit without considering the impact on other users. However, there is ongoing debate surrounding this approach because new users tend to focus solely on their own advantages, often overlooking the importance of network load balancing. Consequently, this approach can lead to rapid network congestion, potentially degrading the quality of service for existing users. This approach can easily manage access to heterogeneous networks. Once the mobile terminal can connect to multiple access technologies, the decision-maker can use the available access networks independently of the network operator.

In the collaborative approach, both the network and the user terminal play roles in the decision-making process. An example of this approach is illustrated by the IEEE 802.21 standard [53], which enables mobile devices and specific network entities to exchange data, streamlining the handover process between diverse networks. To ensure uninterrupted connectivity during a transition from one network to another, the IEEE 802.21 standard defines this transition as a "Media Independent Handover" (MIH). In this context, the network infrastructure can supply

information regarding the performance of various access technologies, while the mobile terminal can account for application requirements and make informed decisions. However, the effectiveness of this collaborative approach may be limited if either the user or the network infrastructure cannot provide the expected information to support decision-making.

2.2.3.1 Deterministic decision-making methods

Multiple-criteria decision making (MCDM) algorithms are one of the deterministic decision-making methods widely used in RAT selection. Typical MCDM algorithms are AHP, TOPSIS, GRA, and VIKOR [54]. When dealing with inaccurate data, fuzzy logic is applied with MCDM methods. The question related to choosing an MCDM algorithm instead of another is among the toughest questions to answer while using MCDM for the RAT selection problem. Each algorithm has its strengths and weaknesses, and none of them can ideally solve RAT selection. Function-based decision algorithms are also included in the deterministic category and are widely used in literature. These techniques are based on defining a utility function whose goal is to select the best network that maximizes the objective function, a weighted sum of QoS, cost, trust, compatibility, preference, and capacity parameters.

In paper [55], a centralized approach that applies the TOPSIS method on network attributes and user preferences such as velocity to rank network association alternatives WiMAX, LTE, or WLAN is proposed. Simulation results indicate that the proposed algorithm reduced handovers failure probabilities compared to a network decision algorithm based on Received Signal Strength (RSS).

In paper [56], authors propose a Distributed Context-Aware Radio access Technology (DICART) to provide road users with an Always Best Connected (ABC) facility, good quality of service, and high bandwidth. DICART was deployed under an architecture composed of IEEE 802.11p and LTE-V2X networks which are the key network technologies adopted in the C-ROADS project. They consider network nodes equipped with a set of service profiles and a range of access technologies. Each application profile generates data, and a functional module known as the "Decider" determines the appropriate transmission interface based on local statistics, employing the TOPSIS method for decision-making. The DICART selection framework ensures an end-to-end delay of approximately 0.5 ms in low-density scenarios and around 1 ms in medium traffic density, whereas random selection results in a 1.5 ms delay. In terms of application throughput, DICART achieves speeds of about 2.5 Mbps in medium traffic density, outperforming random selection, which achieves approximately 1.8 Mbps.

Paper [57] proposed an intelligent network selection scheme for audio and video streaming applications in vehicular networks. The authors used three metrics: faded Signal-to-Noise ratio,

residual channel capacity, and connection lifetime to develop a maximization scoring function that collects data from each network candidate during the selection process.

In [58], the authors introduce a RAT selection mechanism based on a utility function, taking into consideration user preferences, channel state information, network loads, and service costs. This mechanism involves central modules that regularly gather and disseminate network load information, which is incorporated into a normalized user utility function that accounts for the quality-of-service requirements for each service. Subsequently, the network with the highest utility function is chosen for access.

In paper [59], the authors presented a Hybrid Overlay Protocol (HOP). Their proposed layer is located between the transport and application layers. As a simulation tool, they used OMNeT++, INET framework, and SimuLTE to implement this solution. The decision to network candidate selection is based on status information received via the lower (ad hoc/cellular) communication layers and in-vehicle sensors. Authors choose the number of neighbors observed in one and two-hop ranges, the Packet Error Rate (PER), average uplink/downlink data, the availability of cellular data connection, and current vehicle speed. Moreover, this protocol takes into consideration the service requirement in terms of delay and priority. They evaluated the delay for the communication mode against the distance between the originator and the receiver. The authors' findings showed the developed layer's potential performance gain, showing the advantage of heterogeneous architecture usage.

2.2.3.2 Artificial Intelligence-based decision-making methods

ML-based solutions are divided into three main subcategories: Supervised learning (SL), Unsupervised learning (UL), and Reinforcement Learning (RL). SL and UL are offline algorithms where the prediction model has to be built before use. At the same time, RL approaches are generally classified as online algorithms. Swarm Intelligence (SI) algorithms are biologically inspired by the behavior of social insects like ants and bees.

Within the SL subcategories, there is the utilization of Artificial Neural Networks (ANN), drawing inspiration from the biological neural networks found in the human brain. Several papers have employed ANN to forecast the ideal network based on multiple input criteria, all with the aim of ensuring continuous connectivity while taking various factors into account [60], [61].

Decision problems are also solved using RL algorithms. In this context, authors in [62] propose a RL framework based on slow fading parameters and statistical information to perform V2V communication mode selection and power adaptation in 5G communication networks. Other papers adopted the game theory to analyze the network selection problem, and they used a Multi-Agent Reinforcement Learning (MARL) algorithm. Like in paper [63], the algorithm is based on

observing the selected network's performance and deciding whether the rewards or the punishments are to be given.

Authors in paper [64] formulated context-aware network selection as a Markov Decision Process (MDP) model. They used a centralized heterogeneous network architecture formed by LTE, Wlan, and Visible Light Communication (VLC). To resolve the radio access technologies selection game in 5G HetNets, authors in paper [65] proposed an ML-based framework where the throughput is the main objective function. They studied the problem of determining which RAT standard and spectrum to utilize and which Base stations or users to associate within the context of 5G HetNets.

Both [66] and [67] proposed SI-based solutions for network selection based on Artificial Bee Colony (ABC), Particle Swarm Optimization (PSO), and Ant Colony Optimization (ACO) algorithms. Authors in paper [66] proposed a hybrid intelligent handover decision algorithm primarily founded on two main heuristic algorithms: Artificial Bee Colony (ABC) and PSO named ABC-PSO to select the best wireless network during the vertical handover process. ACO based handover decision method is proposed in [67] to select the most suitable network in terms of QoS for mobile users. Ant colony's behavior fascinates in different ways because of its capabilities to accomplish complex tasks.

2.3 Conclusion

In this chapter, we have provided an overview of the current state of the art relevant to our work. To establish a strong foundation and rationale for hybrid communications, we conducted a comparative study and examined key research that highlights the advantages and challenges associated with both Ad-hoc short-range vehicular communication technologies (ITS-G5/DSRC) and C-V2X technologies. Additionally, we explored existing research on hybrid communication network architectures. Finally, we reviewed diverse works related to RAT selection strategies. In our research, we will be employing a flat hybrid vehicular network architecture with the inclusion of an additional layer, the hybrid communication management layer. Furthermore, our RAT selection strategy will be based on deep reinforcement learning principles.

Chapter 3

Implementation and Assessment of IEEE802.11bd for Improved Road Safety

Cooperative Intelligent Transport Systems are built based on vehicular communication technologies with real-time information exchange to improve overall traffic management such as road safety, efficiency, and comfort. Road safety depends on various factors, some of which are manageable and quantifiable, while others are influenced by different road conditions and human behavior. Therefore, analyzing these factors can provide deeper insights into the causes of road fatalities, with the aim of reducing or preventing them. C-ITS has been recognized by many stakeholders as a promising tool to advance the societal goal of enhancing road safety. This is achieved by enhancing both vehicle and road infrastructure to enable the exchange of safety and awareness messages, facilitating services like warnings about hazardous locations, in-vehicle speed limit displays, and intersection safety alerts. In the context of C-ITS communication, the reliability of delivering these alerts is crucial. Therefore, improving the delivery rate of alert and warning messages can contribute significantly to reducing road accidents and enhancing road safety. Therefore, communication technologies are rapidly evolving, and New Radio Access Technologies (i.e. IEEE 802.11bd and C-V2X technologies such as LTE-V2X and NR V2X) are emerging to provide enhanced performances in terms of reliability, coverage, and throughput. C-ITS can benefit from these new RATs enhancements to allow new use cases and applications and then prevent additional road accidents. This advance is fundamentally reshaping the C-ITS landscape as both technologies (IEEE 802.11bd and LTE-V2X) are competing. In this Chapter, we present the implementation of the IEEE 802.11bd on OMNeT++, and we compare its performance with LTE-V2X in terms of packet reception ratio. Finally, we will forecast the number of avoided serious injuries on the European roads.

3.1 IEEE 802.11bd implementation on OMNeT ++

To assess the performance of IEEE 802.11bd and determine its ability to meet the expected benchmarks, we implemented its important building blocks over the INET framework. Subsequently, we integrated this implementation into the Artery framework, leveraging its

advanced capabilities in our VANET simulation scenarios. Here are the most important modifications on the INET and Artery frameworks that we did in our implementation:

- Adding a new IEEE 802.11 mode-set representing the IEEE 802.11bd standard
- Adding a new 5.9 GHz band namely the “5.9GHz&20MHz”
- Changing the default behavior of the Artery to support the IEEE 802.11bd mode
- Adding the “5.9GHz&20MHz” band to Artery
- Adding parameters to the services.xml file to support services that transmit on a band with 20 MHz bandwidth
- The implementation does not contain the LDPC coding

The initial phase of this implementation involves examining and testing the components that were previously implemented according to IEEE 802.11ac and Very High Throughput (VHT) specifications in the physical layer models within the INET framework. Next, we adopt these specifications to build a new “bd” operating mode. Furthermore, we use this implementation in the Artery framework to benefit from an enhanced throughput in our VANET simulation scenarios. In the subsequent two subsections, we elaborate on the implementation of IEEE 802.11bd into both the INET framework and the Artery framework.

3.1.1 In the INET Framework

When we examine the INET framework composition, we notice that INET modules are organized into a directory structure that roughly follows OSI layers. IEEE 802.11 standards are enabled by adding a “Ieee80211Interface” module to the INET nodes. This interface defines the physical and MAC layers of the wireless nodes. Our implementation focuses on the physical layer, because the physical layer modules deal with modelling transmission and reception of frames. The two physical micro-layers being modified are the IEEE 802.11 “mode” modules and the “packet-level” modules. The “mode” modules are the “IEEE 802.11 mode” module and the “IEEE 802.11 band” module. The “mode” module defines the MCS, the number of streams, and the preamble format used to achieve the wanted data rate values. The “IEEE 802.11 band” module defines the frequency band and its respective channel bandwidth.

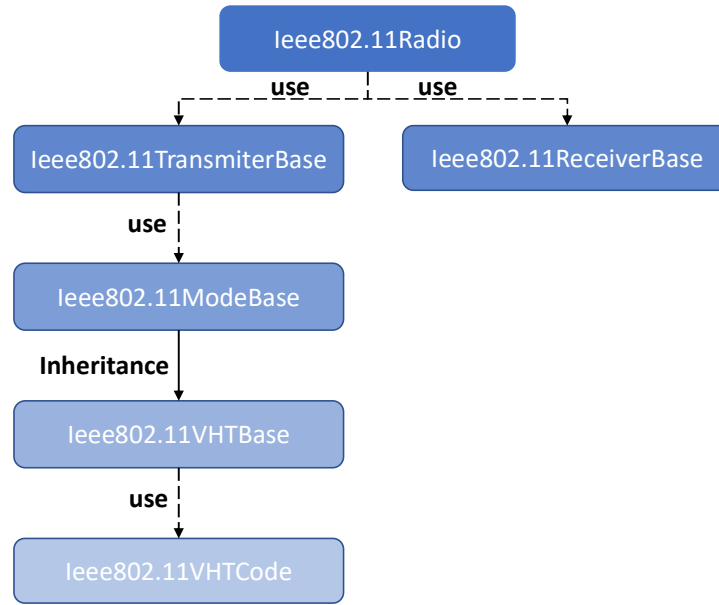

Figure 3.1. Concerned modules with the modifications

The IEEE 802.11bd requires the use of “VHT Mode” to support modulation schemes up to 256-QAM. And as the IEEE 802.11bd operates on a channel bandwidth of 20MHz in the 5.9 GHz band, we had to add the definition of these channel parameters to the “band” module. In Figure 3.1, we illustrate the modules concerned in the process of adding the “bd” operation mode. This operation mode had to be added in each of these modules to have a complete PHY layer that can support the “bd” mode.

To enable message transmission and reception within a 20MHz channel bandwidth, we established a 5.9 GHz band accommodating two 20 MHz bandwidth channels. Specifically, the 5.9 GHz band can support up to two 20 MHz channels, with central frequencies set at 5.875 GHz and 5.905 GHz. We designated this band using an "Ieee80211EnumeratedBand" structure, which requires parameters such as the band name and the central frequency of each channel. This configuration is illustrated in the "Ieee80211Band.cc" source code:

```

Const Ieee80211EnumeratedBand
Ieee80211CompliantBands::band5_9GHz20MHz("5.9 GHz&20 MHz",
{
    GHz(5.875),
    GHz(5.905),
});
    
```

With these modifications done we could modify the OMNeT++ Network Description Files (NEDs) to add the operation mode “bd” and the band name 5 GHz&20 MHz as depicted in the following extract of the “Ieee80211TransmitterBase.ned” source file.

```

module Ieee80211TransmitterBase extends NarrowbandTransmitterBase {

    parameters:

        string opMode @enum("a", "b", "g(erp)", "g(mixed)", "n(mixed-2.4Ghz)", "p", "ac", "bd");

        string bandName @enum("2.4 GHz", "5.9 GHz", "5.9 GHz&20 MHz", "5 GHz", "5 GHz&20 MHz", "5 GHz&40 MHz", "5 GHz&80 MHz", "5 GHz&160 MHz");

        int channelNumber;

        modulation = default("BPSK");

}
    
```

3.1.2 In the Artery Framework

Artery modules are responsible for the Application and the Facilities layers in the ITS station architecture (see Figure 3.2). The component that manages the message forwarding between these layers and the lower ones is the Artery middleware, which acts also as an abstraction and data provisioning layer for VANET applications (i.e. services). Artery offers the possibility of creating many services in a VANET node and each service can operate on a channel using a multi-channel communication policy [70]. These services are created according to an external definition as an XML configuration file (services.xml file).

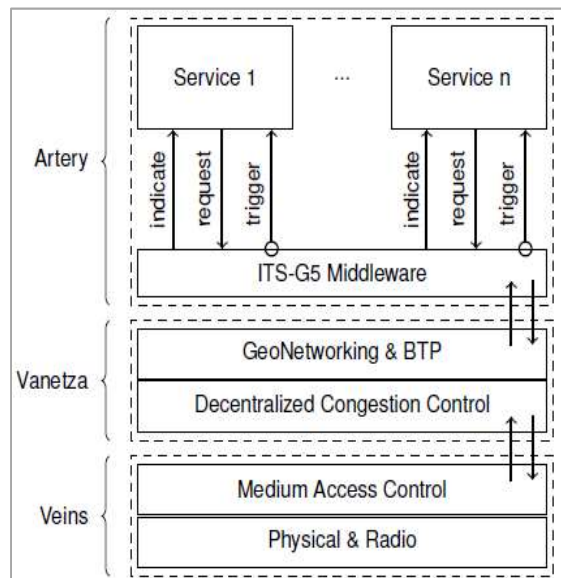

Figure 3.2. Artery's ITS architecture [70]

This XML file lists the services for a group of vehicles, with their respective port and operating channel numbers. By default, the channel number is set to the Control Channel (i.e. CCH: central frequency = 5.9 GHz) as defined in the ITS-G5 standard.

To incorporate the IEEE 802.11bd standard operating mode into the INET framework, we adjusted the “application”, “inet”, and “utility” packages within the Artery Framework. The “application” package represents the application layer related modules. The “inet” package represents the modules that are related to the INET framework. The “utility” package represents the definition of some basic elements that are essential for the operation of other Artery modules. For message transmission, the Artery middleware needs to find a network interface that operates on the appropriate service’s channel. Conversely, for message reception, it needs to find which service this message should be delivered to. In cases where these parameters are not explicitly defined in both the “omnet.ini” and “services.xml” files within the simulation scenario, the middleware defaults to using IEEE 802.11p network interfaces for sending and receiving messages. So, to be able to send and receive messages in the newly defined “5.9 GHz&20 MHz” channel, we added its definition in the “utility/channel” module under the name of SCH0_BD and SCH1_BD as listed in the following extract of the “channel.h” source file.

```
constexpr ChannelNumber SCH0_BD = 0;
constexpr ChannelNumber SCH1_BD = 1;
```

To differentiate between a service that will use the IEEE 802.11p PHY layer and a service that will use the IEEE 802.11bd PHY layer in Artery. We added the “channel-bd” parameter to the service in the “services.xml” configurations file as listed in the following extract of the source file.

```
<?xml version="1.0" encoding="UTF-8"?>
<services>
  <service type="artery.application.CaService">
    <listener port="2001" channel="180" channel-bd="0" />
  </service>
  <service type="artery.application.ExampleService">
    <listener port="4711" channel="180" channel-bd="0"/>
    <listener port="4712" channel="176" channel-bd="1"/>
    <filters>
      <penetration rate="0.5" />
    </filters>
  </service>
</services>
```

After the modification of both the INET and Artery frameworks to implement the basic specifications of the IEEE 802.11bd standard. The network interface configuration under the “bd” mode is listed in the following extract of the “VanetNic.ned” source file. In this latter, the “opMode” parameter indicates the IEEE 802.11 standard. Both “bandName” and “bandwidth” parameters define the band used to transmit and receive messages.

```
module VanetNic extends Ieee80211Nic
{
  parameters:
    macType = "Ieee80211Mac";
    mgmtType = "Ieee80211MgmtAdhoc";
    opMode = "bd";
    bitrate = default(52 Mbps);
    **.opMode = opMode;
    mac.modeSet = opMode;
    mac.qosStation = true;
    mac.rx.typename = default("ChannelLoadRx");
    radioType = default("VanetRadio");
    radio.bandName = "5.9 GHz&20 MHz";
    radio.bandwidth = 20 MHz;
    radio.channelNumber = default(0);
    radio.antenna.numAntennas = 8;
    radio.receiverType = default("VanetReceiver");
    ...}
}
```

3.1.3 Model Validation

Our implementation was validated by a comparison between the theoretical specifications and the obtained simulation outputs. We also intend to make a simulation-based comparison between IEEE 802.11-based C-ITS technologies (IEEE 802.11p and IEEE 802.11bd). This comparison has to be aligned with what was studied in the theoretical and analytical comparisons such as in [30]. In this context, we first compare the IEEE 802.11bd theoretical performances with the obtained simulated results in terms of data bitrate (i.e. net bitrate). Next, we compare the performance of this new generation standard with its predecessor IEEE 802.11p in terms of bitrate, latency while varying the modulation and coding schemes. Furthermore, to avoid interoperability

and fairness issues, we consider evaluating these technologies in an isolated simulation environment. Simulation parameters are Summarized in TABLE. 3-2. Our evaluation scenario is based on the Manhattan urban grid road type, where V2V communication is considered according to these characteristics:

- Max vehicle speed: 40 km/h
- Between vehicles Gap: 0.5 m (meter)
- Vehicle acceleration: 0.8 m/s²
- CAM message and alert/warning messages: 10 messages per second (10 Hz)

The throughput depends on the number of data subcarriers, and this latter is tightly related to the bandwidth [30]. So, with a 20 MHz channel bandwidth, we will have 52 data subcarriers out of 64 OFDM subcarriers. With these resources, the IEEE 802.11bd realizes the presented theoretical net bitrate in TABLE. 3-1.

TABLE. 3-1. Obtained simulation results compared to theoretical ones

Modulation	Coding	Net bit rate (Mbps)	Simulation Net bit rate (Mbps)
BPSK	1/2	7.2	6.5
QPSK	1/2	14.4	13
QPSK	3/4	21.66	19.5
16-QAM	1/2	28.88	26
16-QAM	3/4	43.33	39
64-QAM	2/3	57.78	52
64-QAM	3/4	65	58.5
64-QAM	5/6	72.22	65
256-QAM	3/4	86.66	78

To calculate the net bitrate (R_{data}), we used the same equation used in the IEEE 802.11ac standard as presented in [71].

$$R_{data} = \frac{N_{DPBS}}{T_{Symbol}} \quad (\text{Eq. 1})$$

The N_{DPBS} is the number of data bits per OFDM symbol and T_{Symbol} is the symbol duration. The N_{DPBS} is determined by the number of data subcarriers and the MCS, while T_{symbol} is determined by the employed bandwidth and the guard interval (GI) [71]. When we implemented the IEEE 802.11bd standard, we defined a set of modes. Each mode represents a combination of an MCS, a guard interval duration, and spatial streams. Each mode is associated with a specific data rate. After retrieving these simulation data rates and comparing them with the calculated theoretical ones, we found that the simulated bitrate confidently approaches the theoretical bit rate (see TABLE. 3-1).

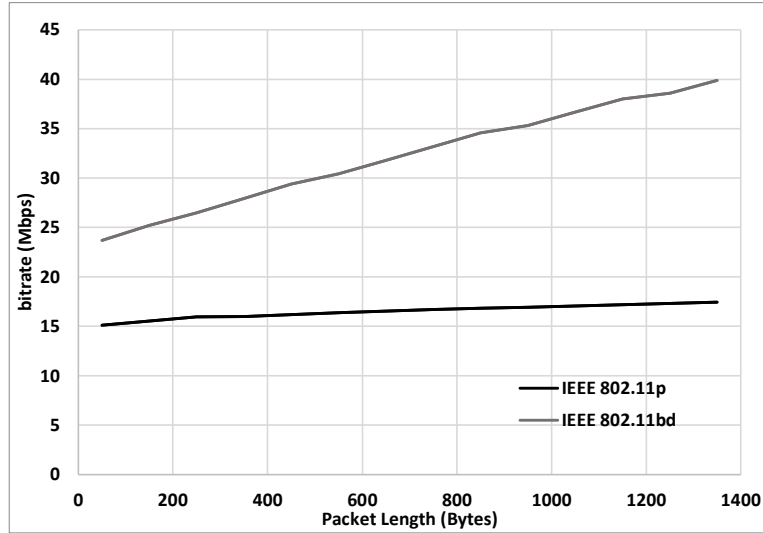

Figure 3.3. Throughput comparison of IEEE 802.11bd and IEEE 802.11p

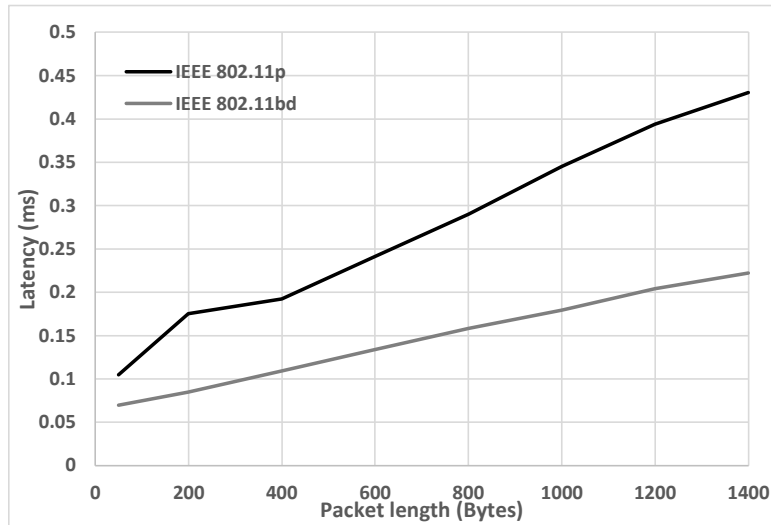

Figure 3.4. Latency comparison of IEEE 802.11bd and IEEE 802.11p

After comparing the calculated net-bitrate and the simulated one, we analyze this metric against the IEEE 802.11p. To do so, we launched two separate simulation runs, one using the IEEE 802.11bd standard (256-QAM), and the other using IEEE 802.11p (64-QAM). In this simulation runs, we vary the packet length from 50 bytes to 1300 bytes, and we fix the distance between two vehicles to 50 meters.

From Figure 3.3, we can see that the IEEE 802.11bd outperforms IEEE 802.11p in all cases. These results are aligned with the MATLAB ones presented in [72]. In Figure 3.4, we recorded a transmission latency of 0.4 ms for IEEE 802.11p and 0.2 ms for IEEE 802.11bd (for a 1200 packet length). Thus, we notice a remarkable transmission latency drop of 50% between the two technologies. Now that our implementation is validated, we compare the PRR between the

IEEE 802.11-based C-ITS technologies (i.e. IEEE 802.11p and IEEE 802.11bd) and C-V2X to make some baselines for the road safety comparison that will follow this work.

3.2 Packet Error Ratio performance evaluation

The Packet Reception Ratio is commonly used by the vehicular community to evaluate the maximum range of technology over the distance and to find out how reliable a technology is in terms of packet delivery. Thus, to assess road safety performance, PRR performance evaluation is needed. To get this PRR data, we defined a simple evaluation scenario that is based on the Manhattan urban grid road type, where V2V communication is considered between vehicles with the same simulation parameters as used in the validation process. To have accurate and free interoperability results while evaluating the PRR performance, we launched separate and isolated simulation runs for each technology. We run three distinct simulation instances, one with the IEEE 802.11bd standard with a 256-QAM MCS, another with the IEEE 802.11p standard with a 64-QAM MCS (bitrate of 24 Mbps), and the last one with the LTE-V2X standard 64-QAM MCS.

TABLE. 3-2. Main simulation parameter set

	IEEE 802.11p	IEEE 802.11bd	LTE-V2X
Simulation time	120s		
Message length	From 200 Bytes to 1400 Bytes.		
Channel bandwidth	10 MHz	20 MHz	20 MHz
MCS	Up to 64-QAM with $\frac{3}{4}$ coding	Up to 256-QAM with $\frac{3}{4}$ coding	Up to 64-QAM
Num. NSS	1		
Receiver sensitivity	-85 dBm	-85 dBm	-85 dBm
Noise	-110 dBm	-110 dBm	-110 dBm
Receiver energy detection	-85 dBm	-85 dBm	-85 dBm
Transmit power	23 dBm	23 dBm	15 dBm

Using the OMNeT++ discrete event simulation environment, the IEEE 802.11p and IEEE 802.11bd standards were simulated using the Artery framework, while the LTE-V2X technology was simulated using the SimuLTE framework. The parameters of our simulation runs are the same as presented in TABLE. 3-2.

LTE-V2X determines the MCS according to the channel state through the Channel Quality Indicator (CQI). The better the CQI (between 1 and 15) the higher is the MCS profile. To study the impact of CQI reports on the reliability of message delivery, we run our simulation scenario with $LTE - V2X_{mode\ 3}$ technology, adjusting the distance between vehicles as a variable. Figure 3.5 illustrates the impact of varying CQI values on PRR while increasing the distance between vehicles. At low CQI (i.e. equal to 1 or 2), we obtain a very weak PRR, typically not exceeding

20% in all scenarios. In low distances, we can notice that PRR is tightly related to the CQI (i.e. the higher is the CQI, the higher is the PRR). However, when we extend the distance, we observe an inverse relationship between CQI and PRR due to the employed MCS. Because augmenting the MCS means encoding more bits into a single OFDM symbol, which makes the signal more vulnerable and susceptible to interference.

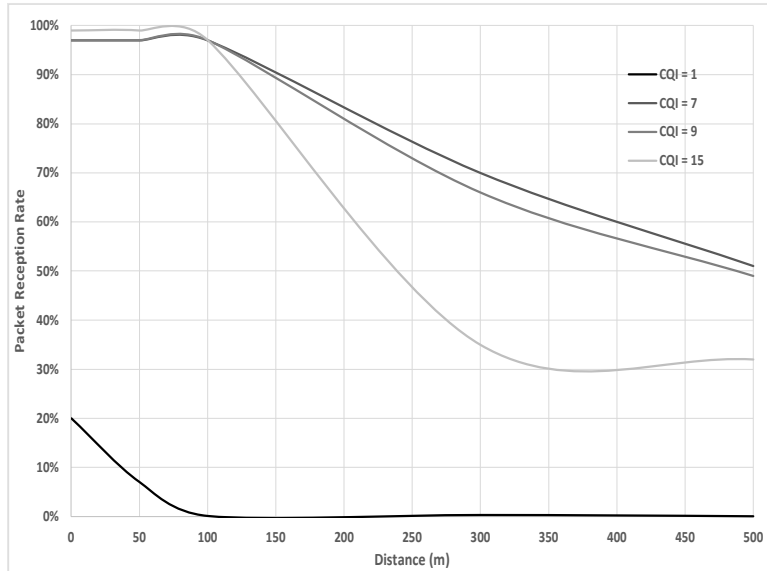

Figure 3.5. PRR variations according to the CQI and the distance

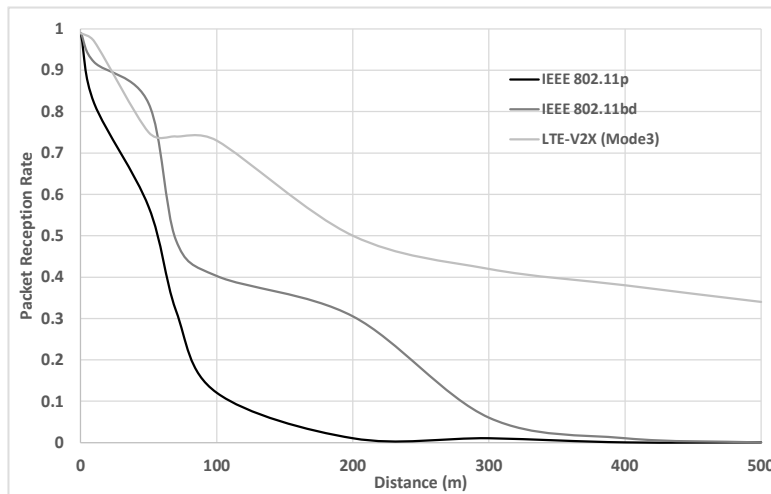

Figure 3.6. PRR variations according to the distance (packet of 300 bytes)

Figure 3.6 illustrates a comparison graph of the PRR between IEEE 802.11p, IEEE 802.11bd, and $LTE - V2X_{mode 3}$. At this stage, it is worth noting that our implementation of the 802.11bd standard in OMNeT++ does not include LDPC coding. So, to make a fair comparative study of PRR between IEEE 802.11-related technologies and LTE-V2X, we have integrated with

our simulation results from the finding in [72] that affirms that LDPC offers a gain of 1~4 dB gain over the Binary Convolutional Codes (BCC), which is translated into a 20% PRR gain over BCC.

Based on the plotted data, we can see that $LTE - V2X_{mode 3}$ performs better than Wi-Fi-related technologies at greater distances. However, we notice that IEEE 802.11bd is giving better PRR than $LTE - V2X_{mode 3}$ in distances between 50 and 100 meters. This difference in performance can be attributed to the utilization of LDPC and midambles, which mitigate the effects of interference on signal integrity, along with the influence of CQI estimation on the PRR, as previously demonstrated. And finally, among the IEEE 802.11-related technologies, we clearly notice that "bd" surpasses "p" and offers a better PRR in all scenarios.

3.3 Road safety assessment

In this section, we present the methodology used for comparing the relative performance of the IEEE 802.11 standard and C-V2X standard in regard to improving road safety in the EU roads. Towards this end, we will present and adapt an assessment model developed by the 5G Automotive Alliance (5GAA) [73]. This model utilizes the PRR results from the previous section to assess how the IEEE 802.11p, IEEE 802.11bd, and $LTE - V2X_{mode 3}$ technologies contribute to enhancing road safety on EU roads.

3.3.1 Model specifications

To realize the assessment of road safety using the 5GAA model, we need the PRR records of the three studied standards and the penetration rate of each standard. To have a realistic penetration rate of the IEEE 802.11bd technology in vehicles, we assume that the IEEE 802.11bd standard will be published by the end of 2021 [74]. For the simulation environment, we consider the same urban road scenario of the validation process. We consider the three technologies in isolation, to avoid any interoperability and fairness issues in all methodology parameters and inputs.

With that fixed, the number of fatalities and serious injuries that can be avoided can be modeled as followed:

$$N_{Avoid}(t) = N_{Base}(t) P_{C-ITS}(t) F_{avoided} D_{C-ITS} E \quad (\text{Eq. 2})$$

With: $N_{Avoid}(t)$ as the number of avoided serious injuries in year t. $N_{Base}(t)$ as the number of serious injuries in year t. $P_{C-ITS}(t)$ as the High and low penetration rate of the two RATs among vehicles in the EU roads over time. D_{C-ITS} as the likelihood performance in successfully delivering actionable warning messages between vehicles. $F_{avoided}$ as the likelihood of fatalities and serious

injuries that can be avoided using C-ITS technologies. E as the effectiveness of a received warning message on a vehicle's driver.

As presented in the 5GAA Study [73], we use a baseline number of serious injuries extrapolated from the Community Road Accident Database (CARE data) [75] released by the European Commission. This figure serves as an initial input, reflecting the count of fatalities and serious injuries in the absence of C-ITS technologies. As another input to our model, we consider the penetration rates of these technologies in vehicles. We consider both high and low penetration rates, like the approach employed in the 5GAA model. Additionally, we introduce a scenario with neutral penetration rates where the rates for each technology are equivalent. High penetration rates represent an ideal scenario where these technologies are widely adopted in vehicles, while low penetration rates align with the anticipated deployment density of these technologies in new vehicles by car manufacturers [76]. To project penetration rates over time for IEEE 802.11bd, we simply shift up the penetration rate data for IEEE 802.11p by one year. This approach is justified by the similarity in technology type, as both IEEE 802.11bd and IEEE 802.11p are short-range technologies, with IEEE 802.11bd expected to become available in 2021. The probability that an accident can be avoided with C-ITS technology is fixed to 0.82 by excluding accidents caused by drivers that are under the influence of drugs or alcohol. The effectiveness of a warning message is fixed to 67% based on the DRIVE C2X Study [77].

All these parameters are extracted from the EU statistical [78] study and assumptions, except the alert delivery reliability (i.e., PRR) that is extracted from the obtained simulation outputs in the PRR performance evaluation sub-section. Each run is defined by a specific bitrate (i.e. specific MCS) and a fixed distance that does not go beyond the limits of the urban grid simulation scenario.

3.3.2 Road Safety improvements

Now that our model is defined and that the PRR of the different technologies is obtained from our simulation study, we have deduced an average alert delivery reliability of 75% for the IEEE 802.11p, 88% for the IEEE 802.11bd, and 90% for LTE – V2X_{Mode 3}. In this sub-section, we analyze the ability of C-ITS to reduce the number of fatalities and serious injuries caused by road accidents in the EU. Towards this end, we calculate the number of avoided serious injuries caused by road accidents according to the previously presented mathematical modeling above.

We conducted two experiments to investigate road safety. Following the approach in the 5GAA study, we assessed the impact of high and low penetration rates on the number of avoided serious injuries for each technology. These penetration rates are calculated as the squared probability, representing the likelihood of the technology being present in both vehicles involved

in an accident. In a third experiment, we explored the safety performance of each technology under neutral penetration rates, where all technologies have comparable adoption levels.

We notice in Figure 3.7 and Figure 3.8 that in both 5GAA scenarios (i.e. low and high penetration rates), LTE-V2X is performing better than the IEEE 802.11-related technologies. LTE-V2X outperforms other technologies due to its superior radio link level for ad hoc/direct communications. It excels in dense urban settings with many competing vehicles, making it a strong choice for such environments. Additionally, LTE-V2X has a higher projected penetration in vehicles, leveraging its foundation on an already deployed cellular network. We can see that the “bd” allows us to avoid 17,533 more serious injuries by 2040 in high penetration rates which is too close to the number of avoided serious injuries by LTE-V2X. Nevertheless, according to the way each plot is growing over time, we can deduce that the IEEE 802.11bd will catch up with LTE-V2X’s performances, thus outperforming the “p” by far. We also notice that the effectiveness of the three technologies remains low in the first years of deployment due to a small penetration rate in vehicles.

By analyzing the neutral experiment results plotted in Figure 3.9, we can see that, if all technologies were deployed concurrently by car vendors, we expect that IEEE 802.11bd and LTE-V2X will avoid approximately the same number of road accidents. For example, in 2030, IEEE 802.11bd will allow avoiding 10496 extra serious injuries compared to 802.11p, and the $LTE - V2X_{mode 3}$ will help avoiding 11867 extra serious injuries compared to 802.11p. This is because both technologies offer very high throughput and powerful coding mechanisms, thus comparable reliability. However, we notice that even in this optimistic case the IEEE 802.11p performance remains low.

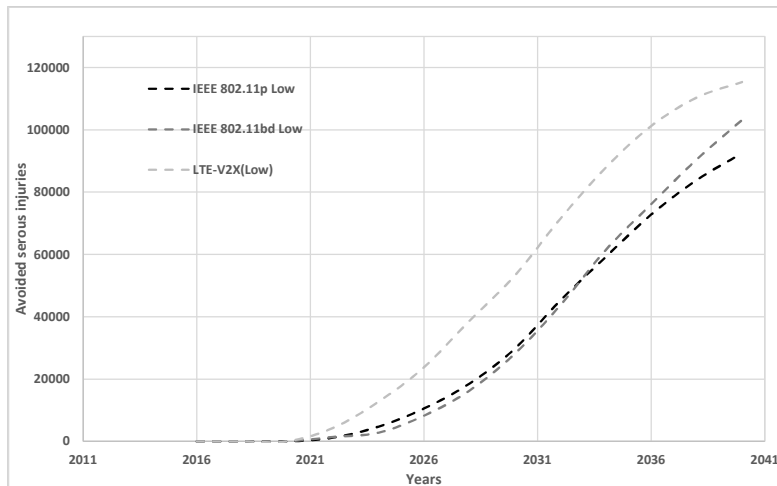

Figure 3.7. Number of Avoided serious injuries in low penetration rates

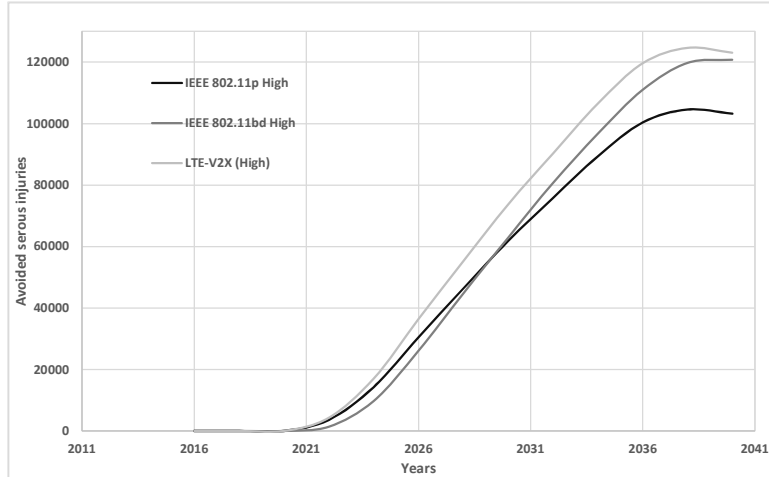

Figure 3.8. Number of Avoided serious injuries in high penetration rates

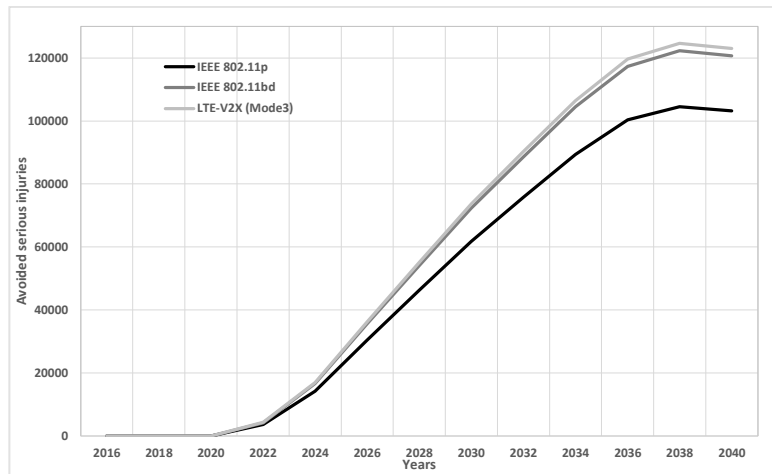

Figure 3.9. Number of Avoided serious injuries in neutral penetration rates

3.4 Conclusion

In this Chapter, we presented our first contribution, where we investigated the assessment of the IEEE 802.11p, IEEE 802.11bd, and LTE-V2X in the context of road safety. We first analyzed the performances of the IEEE 802.11 technologies and the LTE-V2X. Then, we used our basic IEEE 802.11bd implementation in OMNeT++/Artery to compare its performance with the 802.11p and $LTE - V2X_{mode\ 3}$ in terms of PRR. We found that $LTE - V2X_{mode\ 3}$ offers better alert delivery reliability than IEEE 802.11-related technologies in most cases. These findings assist us in assessing how IEEE 802.11bd enhances the dependable transmission of alert and warning messages to prevent accidents on urban roads compared to IEEE 802.11p. In this assessment, estimated and neutral penetration rates were considered to show the effect of deployment constraints in preventing accidents. In a highly aggressive deployment scenario, we could have a

16,98% (resp. 19.20%) road safety improvement with IEEE 802.11bd (resp. $LTE - V2X_{mode 3}$) over IEEE 802.11p. On the other hand, in similar penetration rates, we observed that LTE-V2X and IEEE 802.11bd are both, concurrently, avoiding more serious injuries than IEEE 802.11p. For future work, we envision continuing this work to compare our results with other C-ITS technologies such as 5G NR-V2X to complete the overall picture.

Chapter 4

Efficient DRL-based Selection Strategy in Hybrid Vehicular Networks

Emerging V2X services, like Advanced Driver Assistance Systems (ADASs) and Connected Autonomous Driving require Ultra-Reliable Low Latency Communications. Unfortunately, none of the existing V2X communication technologies, such as ETSI ITS-G5 or C-V2X (Cellular V2X including 5G NR), can satisfy these requirements independently. In this chapter, we study the proposal of a scalable hybrid vehicular communication architecture that leverages the performance of multiple Radio Access Technologies. Within this architecture, we propose a novel ITS station protocol stack and a decentralized RAT selection strategy that uses Deep Reinforcement Learning. This strategy employs a Double Deep Q-learning (DDQN) algorithm that allows each vehicle to determine the optimal RAT combination to meet the specific needs of the V2X application while limiting resource consumption and channel load. Furthermore, we assess the ability of our architecture to offer reliable and high throughput communication in two different scenarios with varying traffic flow densities.

This chapter sections are organized as follows: Section one discusses the proposed hybrid vehicular architecture and the new protocolary stack of the ITS station. In Section two, we bring some details about our DRL control approach. Later in Section three, we present the simulation environment and our implementation of the hybrid vehicular architecture. Finally, in section four, we present the performance results between single legacy vehicular communication architectures and our hybrid architecture regarding PRR, throughput, CBR, and hybrid communication efficiency.

4.1 Hybrid network architecture definition and protocol stack design

A hybrid vehicular communication network's efficiency depends on the communication technologies' availability in an ITS-S (i.e., a vehicle or a Road Side Unit (RSU)). In other words, the penetration rate of every RAT must be close to 100% to enable hybrid vehicular communication ultimately. Otherwise, we should use a hierarchical hybrid architecture [47], which means that only vehicles that belong to the top level of the hierarchy are responsible for bridging

messages from one technology to the other. In our work, we use two short-range communication technologies: the ETSI ITS-G5 and the LTE-V2X PC5. Additionally, we suppose that these two technologies are available in all vehicles and that the architecture is scalable to other technologies.

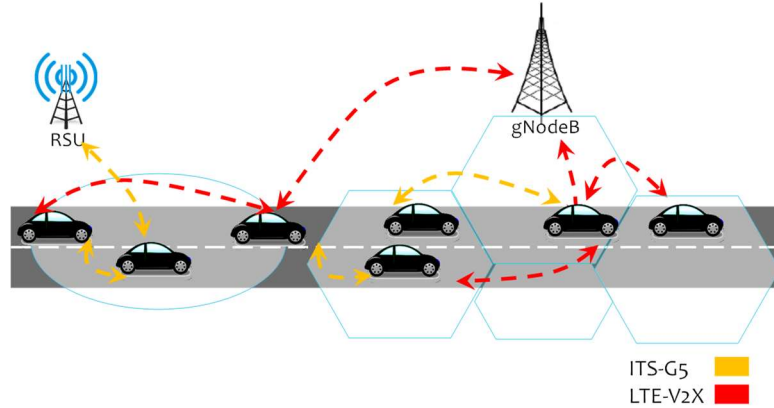

Figure 4.1. Proposed Hybrid vehicular communication architecture

As depicted in Figure 4.1, each vehicle can communicate with all vehicles in its communication range using both technologies. It is done by combining multiple RATs. These combinations are referred to as “communication modes.” The communication modes are detailed later.

4.1.1 Protocol stack

Safety and non-safety applications are found in the application layer. Each application has specific requirements that need to be satisfied for a higher QoS. In the ETSI specifications, the facilities layer provides three facilities classes, the application support facilities, the information support facilities, and the communication support facilities. Each application’s requirements are saved in the facilities layer as a communication facility called the application profile.

The Network and Transport Layers use the position-based forwarding strategy (i.e., GeoNetworking) and Basic Transport Protocol to support short-range vehicular communication technologies. Furthermore, using long-range communication technologies like LTE-V2X Uu implicates the integration of IPv4 as a networking protocol and UDP as a transport protocol. Therefore, the network and transport layer must be scalable to other RATs.

Each technology has a dedicated Radio Resource Management entity in the management layer to monitor the channel. The Access Layer comprises the Physical and Data Link Layers of each communication interface (ITS-G5, LTE-V2X). It is in charge of the channel access procedure of each technology.

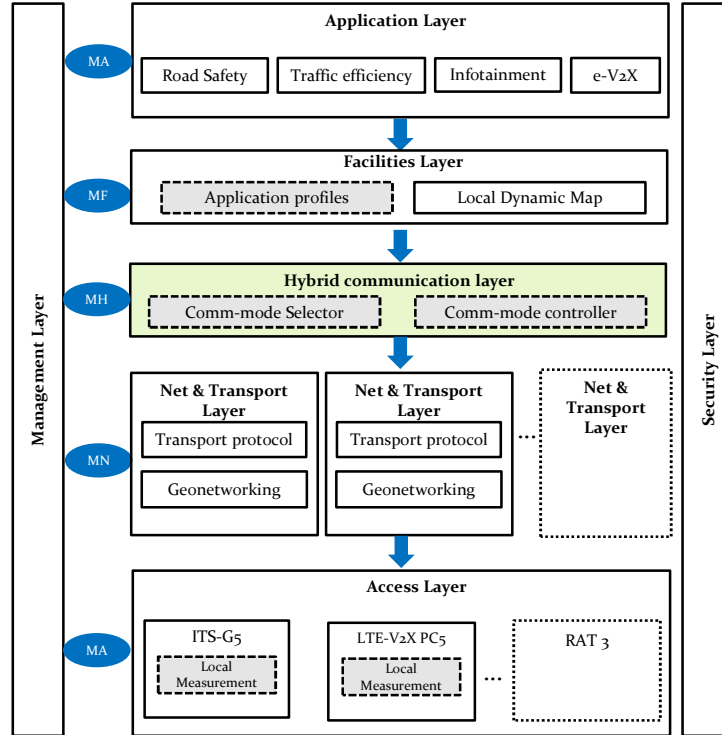

Figure 4.2. The hybrid communication layer in the ITS-S protocol stack

It also monitors the communication interface and provides information on the network state to the RRM, such as frame transmission statistics, SNIR, and other channel load indicators. Moreover, the access layer can also manipulate the parameters of the communication interface such as the bandwidth, the MCS profile, and the operating channel. ITS-G5 and LTE-V2X Sidelink operate on the 5.9 GHz band. However, they do not access the channel the same way, and each technology has its view of the channel. Therefore, a coexistence solution is needed to enable simultaneous channel access for both technologies. In our work, we use a priority-based spectrum sharing where each technology has priority in a 10 MHz channel [79]. Thus, no coexistence issues will be encountered.

The Hybrid communication layer, as depicted in Figure 4.2, covers all control functions, including the communication mode selection, communication technology configuration, and the appropriate processing before sending (resp. receiving) a message to (resp. from) the network and transport layer. The management layer assures the cross-layer communication to help the hybrid communication layer get the application requirements and the channel state from the facilities layer and the Access layer, respectively. This is done via interfaces between the management layer and other layers. The communication mode selector tracks the availability of each RATs and selects the optimal technology combination that satisfies the requirements of the V2X application. Then the communication mode controller prepares the message depending on the chosen communication

mode. Once this operation is done, the message is marked and multiplexed to the appropriate technology stack.

4.2 Communication modes and data flow control

By combining ITS-G5 and C-V2X PC5, we can compose three communication modes. The first is a single communication mode, where the message is transmitted over one RAT, as is usually done in a legacy vehicular communication network. The second communication mode is the redundant mode; in this mode, the same message is sent over two RATs to enhance the reliability of the transmission. This redundancy concept is called “Profile Diversity” in [46]. As an example of a V2X application that requires high reliability, we have the emergency brakes service in a platoon. With the redundant communication mode comes a light complexity on the receiver side; if one copy of the message is successfully received, the second copy must be discarded. The third communication mode is a division mode (aka. Profile Aggregation [46]); which can be employed in two different ways. The first method involves dividing the message into two independent transmissions and sending them through both RATs simultaneously. The second method involves using the division mode to balance the transmission flow across available RATs. In this mode, complexity is added on both sides. On the one hand, the transmitter has to divide the data according to the performance of each technology. On the other hand, the receiver has to reassemble the two parts to maintain the integrity of the message.

Algorithm 1 Duplication management algorithm for the redundancy communication mode

```
1:      Input
2:      Received message
3:      Output
4:      None
5:      Strat
6:      // L is the list of received messages
7:      if (message is in L) {
8:          Remove message from L
9:          RMH ++
10:     } else {
11:         Add message to L
12:         Save the receiving interface
13:     }
14:     End
15:
```

Algorithm 1 and Algorithm 2 are two potential algorithms to prepare the message according to each communication mode. The first algorithm explains how the hybrid communication module will check and eliminate duplicated messages. During this procedure, we introduce and calculate a Performance Key Indicator (PKI) called Received Messages Hits (RMH).

This indicator helps us evaluate the efficiency of the redundant communication mode in our hybrid strategy. When a message is received, the hybrid communication module verifies if it has already been received in the list. If so, it increments the RMH counter and deletes the message from the list. If the message was not received, we add it to the list and save the receiving interface for statistical needs.

Algorithm 2 Sequencing algorithm for the division communication mode

```

1: Input
2:  $NSNIR_{LTE}, NSNIR_{ITS-G5}, PRR_{LTE}, PRR_{ITS-G5}, success\_threshold = 0.98$  in our experiment
3: Output
4: Percentage of data for each technology
5: Strat
6: // Calculate the probability of success
7:  $success\_probability = PRR_{LTE} * PRR_{ITS-G5}$ 
8:
9: //Calculate the percentage of data
10: if ( $success\_probability \leq success\_threshold$ ) {
11:      $DATA_{LTE} = \frac{NSNIR_{LTE}}{NSNIR_{LTE} + NSNIR_{ITS-G5}}$ 
12:      $DATA_{ITS-G5} = \frac{NSNIR_{ITS-G5}}{NSNIR_{LTE} + NSNIR_{ITS-G5}}$ 
13: } else {
14:     Load-balance( $DATA_{LTE}, DATA_{ITS-G5}$ )
15: }
16: return  $DATA_{LTE}$  and  $DATA_{ITS-G5}$ 
17:

```

The second algorithm is specific to the division communication mode. The data flow division depends on link quality represented by the PRR and the SNIR. Each of the $NSNIR_{LTE}$ and the $NSNIR_{ITS-G5}$ refers to the normalized value of the SNIR during the simulation, and each of $DATA_{LTE}$ and $DATA_{ITS-G}$ refers to the percentage of data transmitted via LTE-PC5 and ITS-G5, respectively. Before dividing the data flow, the probability of a message being delivered successfully is calculated to ensure that the message will not be lost. This probability is calculated using both the PRR_{LTE} and the PRR_{ITS-G5} , it must also be superior to a success threshold that assures that both technologies have a PRR superior or equal to 0.99. If the success probability condition is not satisfied, we do not divide the data flow, and the message is sent only with one technology to load-balance the traffic. LTE-V2X has a probability to get a bigger part of data on behalf of ITS-G5 due to its error correction code, the turbo code. Which has a BER performance of 0.7dB from Shannon's limit [80]. These algorithms have a low-computational complexity. They only serve to format data for transmission and present received data while collecting some statistical information. Those algorithms don't require significant processing power or time, which can be especially useful in high-speed environments and vehicular networks.

4.3 Deep Reinforcement Learning for Communication Mode Selection

The simplest solution to benefit from two short-range technologies' performance is always transmitting the message using both technologies. Indeed, this solution improves the performance of the vehicular network. However, it can potentially incur additional resources and energy consumption when a message can be successfully delivered using a single technology. To avoid this, at the best complexity cost, we introduce in this section a dynamic communication mode selection based on DRL. We present the mapping of the key elements of reinforcement learning with our problem. Furthermore, we detail and explain our deep Q-learning-based solution.

4.3.1 Reinforcement Learning

Reinforcement learning designs a computational approach to real-time learning with the help of continuous feedback from an environment. RL consists of five elements, the agent, the environment, the state, the action, and the reward. The agent learns the most beneficial action by constantly interacting with the environment. The agent chooses an action based on the state of the environment in conjunction with his historical code of conduct (generally called a decision policy π). The decision policy π is a mapping between the state space \mathcal{S} and the action space \mathcal{A} . It can be determined by the state-action function, also called the Quality function (Q-function), $Q(s_t, a_t)$, which can be approximated by deep learning. Once the action is chosen, it causes specific changes in the environment. These changes generate a new observation of the environment, called the new state, and an action evaluation (a.k.a. reward). After all of the above steps, the agent repeats by choosing a new action. The Markov Decision Process (MDP) provides a mathematical foundation to represent the decision-making process of RL agents, and it is generally used as a formal means for RL. However, we cannot solve our problem by using an MDP because the vehicular communication network does not have a finite number of states due to the high mobility of vehicles. To this end, we explore the use of DRL instead of using other high computational complexity approaches. Moreover, DRL algorithms essentially leverage powerful function approximation properties of Deep Neural Networks (DNNs) to efficiently remove the curse of high dimensionality and complexity of problems.

In our DRL representation, we use s_t for the current state of the environment, a_t for the action taken according to the current state at time t , r_t to represent the immediate reward that the agent receives from the environment when action a_t is completed, and s'_t as the new state of the environment after the execution of action a_t .

4.3.2 Mapping to Key Elements of RL

Each vehicle equipped with ITS-G5 and C-V2X technologies is considered an agent. Agents in this vehicular communication network offer V2X services, and each service generates messages with a fixed frequency. A vehicle uses one of the previously presented communication modes to send messages over the vehicular network. To make this decision, a vehicle needs input information about the environment. This information represents the environment state. By trying and learning from its actions and the environment, the agent can obtain experience and adjust his strategy to reach the optimal policy.

As we mentioned previously, we have an infinite state space \mathcal{S} . And a local state is composed of six elements and is as follow: $s_t = [SNIR_{ITS-G5}, SNIR_{LTE}, PRR_{ITS-G}, PRR_{LTE}, L, R]$. Where $SNIR_{ITS-G}$ and $SNIR_{LTE}$ are the measured SNIR of each RAT network. PRR_{ITS-G} and PRR_{LTE} are the calculated packet reception ratio of each RAT. Each of L and R represents the service's latency and reliability requirements, respectively. These parameters cannot be obtained before sending a message via the transmitter. The only way to get the value of these parameters is to calculate them at the reception of a message. To this end, we consider three local environment states to have accurate state representations. First, s_t is the actual environment state. Second, s'_t represents the state of the environment after the vehicle receives the first message from another vehicle in the environment. Finally, we define s_{t+1} as the next state, which is the state of the environment after the vehicle receives the latest message before it sends a new one. The agent chooses an action based on s_t , then it measures the link quality every time it receives a message. The agent needs to receive an evaluation of its decision based on the earliest link quality measurement, which is s'_t , and then it updates the current state with the value of s_{t+1} . The relation between each state is depicted in Figure 4.3.

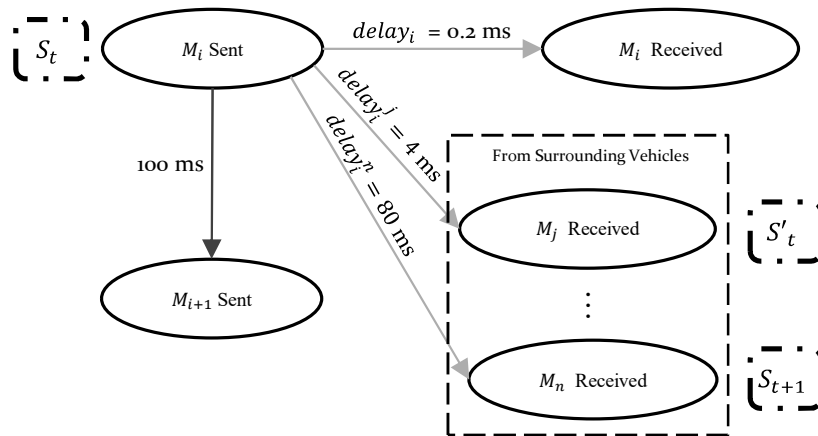

Figure 4.3. Different state representations of the environment

The action in our problem is to send a message with a communication mode. We are considering two instances of the single communication mode, one for ITS-G5 and the other for LTE-V2X PC5. Hence, our discrete action space is:

$$\mathcal{A} = \begin{cases} 0, & \text{Single}_{ITS-G5} \\ 1, & \text{Single}_{LTE} \\ 2, & \text{Hybrid}_{Redandant} \\ 3, & \text{Hybrid}_{Division} \end{cases} \quad (\text{Eq. 3})$$

The reward is composed of two parts. The determination of the reward is based on factors such as the reliability of the transmission, the Channel Waiting Time (CWT), and the CBR. The first part pertains to the satisfaction of reliability, which verifies whether the message has been successfully received by all nearby vehicles. It reports on the integrity of a message and whether it was received twice in case of using a redundant communication mode.

The second part is about the throughput performance satisfaction, and we use the CWT and the CBR to evaluate it. The reward equation is as follows, where α and β are set between 0 and 1 depending on the application requirements (i.e. if it needs high reliability, throughput, or both) with $\alpha + \beta = 1$. We play on the value of α and β according to the application requirements.

$$R_{V_i} = \begin{cases} \alpha \sum_{j=0}^n \text{ReceptionState}[V_i][V_j], & i \neq j \\ + \\ \frac{\beta}{2} (\text{CWT}_{S_i} - \text{CWT}_{S_{i+1}}) \\ + \\ \frac{\beta}{2} (\text{CBR}_{S_i} - \text{CBR}_{S_{i+1}}) \end{cases} \quad (\text{Eq. 4})$$

Acknowledging messages in a vehicular communication network are inhibited to avoid channel congestion. As a result, a vehicle cannot tell if its neighbors correctly received his message. However, using the multi-channel communication of ITS-G5, preselected vehicles can send an acknowledgment-like message and avoid creating perturbations with safety messages. Moreover, every 100 milliseconds, an agent sends a message. And knowing that the $delay_i$ (End-to-End latency), represented in Figure 4.3, is always less than 100 milliseconds. Each agent can receive a message's acknowledgment from the preselected vehicles from its surrounding vehicles before sending another message.

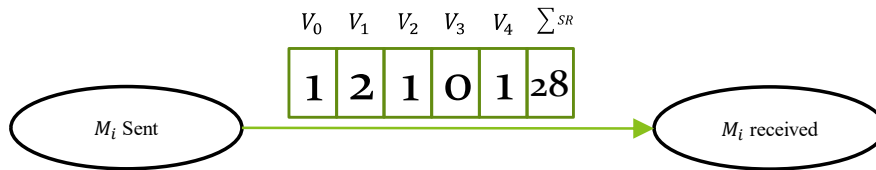

Figure 4.4. Reception evaluation vector

These acknowledgments are represented in a vector called the reception evaluation vector.

Figure 4.4 illustrates how the reception of a message M_i is reported with an example of five surrounding vehicles. The reception evaluation vector is updated every time a message is received. It contains reception reports and a Success Reception (SR) counter. If a message is received twice, a value of “2” is reported in the vector, and if it was not received, a value of “0” is reported. Otherwise, the message is considered perfectly received, and a value of “1” is reported. The SR counter represents the number of perfectly received messages, it is incremented if all reception reports are equal to “1”. The reception reports are cleared every time a message is sent, and the counter is reinitialized when it reaches “n” perfectly received messages. The value of “n” will be defined in the scenario description.

4.3.3 Double deep Q-learning algorithm

Double deep Q-learning algorithm combines Q-learning and deep learning. It uses a neural network called the behavior network to make a nonlinear approximation of the Q-values $Q(s_t, a_t)$ for each given state-action pair (s_t, a_t) . This Q-value is defined as the expected accumulated discounted rewards when taking an action a_t . Thus, an action is chosen by comparing the Q-values. The Q-learning algorithm gets an optimal policy to maximize the long-term expected accumulated discounted rewards by using the following equation.

$$\pi(s) = \operatorname{argmax}_a Q(s, a) \quad (\text{Eq. 5})$$

DDQN also introduces a second neural network (a.k.a., target network) with the same structure and initial parameters ω' as the approximation neural network. In the learning process (as explained in Algorithm 3), DDQN randomly samples a minibatch of tuples and updates the neural network parameters according to a variant of the Stochastic Gradient Descent (SGD) method, named mini-batch SGD. The behavior network parameters are constantly adjusted to match the optimal policy π^* by learning from uncorrelated experiences data. To do so, DDQN introduces a replay buffer (aka., experience replay) that collects and stores $\langle s_t, a_t, r_t, s_{t+1} \rangle$ tuple in every iteration.

It has been shown in [81] that in the MDP, the Q-values will converge to the optimal Q^* if each action in the action space is executed under each state for an infinite number of times on an infinite run and the learning rate decays appropriately. Then when $Q^*(s, a)$ is reached the optimal policy π^* is found.

As we are using Double Deep Q-learning, the Q-value $Q(s_t, a_t, \omega)$ is calculated using the Bellman optimality equation (Eq. 6) [81].

$$Q_{\pi}(s_t, a_t, \omega) = E[r_t + \gamma \max_{a'} Q_{\pi}(s'_t, a'_t, \omega) | s_t, a_t] \quad (\text{Eq. 6})$$

The optimal Q-value is reached by updating the parameters of the behavior network ω using the output of the target network and minimizing the loss function (Eq. 7), where M is the size of the sampled mini-batch.

$$\text{Loss}(\omega) = [r_t + \gamma \max_{a'} Q(s_t, a', \omega') - Q(s_t, a_t, \omega)]^2 / M \quad (\text{Eq. 7})$$

Algorithm 3 DDQN Algorithm for communication mode selection in a hybrid vehicular communication network

```

1:   Input
2:   Initialized behavior network and target network parameters ( $\omega, \omega'$ )
3:   Initialized replay buffer of size L, and a batch size of 64.
4:    $\epsilon = 1$ , and  $\epsilon_{decrement} = 10^{-5}$ 
5:    $\gamma = 0.99$ , target = n
6:   Output
7:   Learned agents
8:   Strat
9:   for episode = 1 to 5000 do {
10:    // Initialize the environment and get initial state observations
11:     $o_t = [SNIR_{ITS-G5}, SNIR_{LTE}, PRR_{ITS-G5}, PRR_{LTE}, L, R]$ 
12:    while ( $reception_{vector}[SR] < target$ ) do {
13:      //According to  $\epsilon$  choose the action and decrement  $\epsilon$ 
14:       $a_t = \left\{ \begin{array}{l} \text{random action} \\ a_t = \text{argmax}_{a_t} Q(s_t, a, \omega) \end{array} \right\}$ 
15:       $\epsilon = \epsilon - \epsilon_{decrement}$ 
16:      // Perform action  $a_t$ , and get the immediate  $s'_t, r_t$ 
17:      If (all reported values in  $reception_{vector} = 1$ )
18:         $reception\_vector [SR]++$ 
19:       $clean(reception\_vector)$ 

20:      // Get the observation of the next state  $s_{t+1}$ 
21:       $O_t = O_{t+1}$ 
22:       $store\_transition (< s_t, a_t, r_t, s_{t+1} >)$ 
23:      // Train the model
24:      If (buffer size is  $> 64$ ) {
25:        Sample a random mini-batch of  $\{s_t, a_t, r_t, s_{t+1}\}$ 
26:        // Calculate prediction using the mini-batch
27:         $Q_{target} \rightarrow \left\{ r_t + \gamma \max_{a'} Q(s_t, a', \omega') \right\}$ 
28:         $Q_{behavior} \rightarrow Q(s_t, a_t, \omega)$ 
29:        Perform mini-batch SGD using the loss function
30:        Update behavior network parameter
31:        Update target network parameters every 100 step
32:      } end if
33:    } end while //end of a game
34:     $reception_{vector}[SR] = 0$ 
35:  } end for

```

RL uses the feature of exploration and exploitation. Exploration consists of randomly choosing the action to see how the environment will react and discover new policies. This operation assists the model in avoiding a local maximum. In the exploitation, the agent uses equation (Eq. 5) to choose the action, which means it uses the result of the behavior neural network to choose the action. Exploration and exploitation are implemented in the learning algorithm using a parameter ϵ , which is decremented in each step to reduce the exploration rate.

The DQN algorithm introduces a fixed Q target mechanism and uses two DNNs with the same structure. Thus, it has a fixed computational complexity in each game. This latter depends on the number of layers it uses. If we assume that S is the number of neurons in the input layer, “ n ” is the number of hidden layers, L_i is the number of neurons in each hidden layer’s output, and A is the number of actions. Thus, the complexity of the input layer is $O(S * L_i)$, the complexity of the hidden layers is $O(n * L_i * L_i)$, and the complexity of the output layer is $O(L_i * A)$. Hence, the overall complexity of the DRL is the product of each layer’s complexity. The complexity of a TOPSIS decision-making algorithm in all its stages, which is $O(n^2) + O(n) + O(n)$ when having a decision matrix of $n \times n$.

If we compare the time complexity of a DQN in the operation phase after the Q network is trained and the TOPSIS time complexity. We find that the DQN time complexity is low, which meets the requirements of the real-time network conditions for online decision-making time. An illustration of the DDQN-based communication mode selection algorithm is depicted in Figure 4.5.

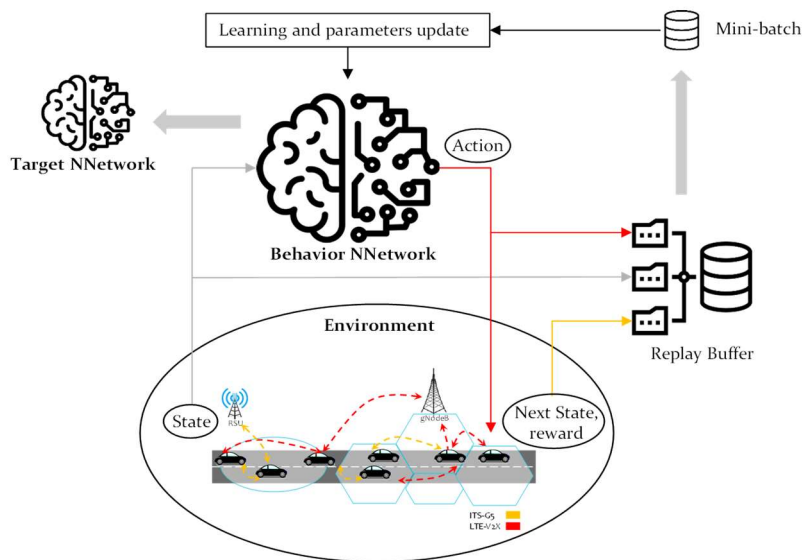

Figure 4.5. DDQN-based Communication mode selection system

4.4 Performance evaluation

To evaluate our hybrid communication architecture, we use OMNeT++ framework, Artery Framework [70], and SimuLTE [82] to simulate the ITS-G5 and LTE-V2X PC5 technologies, respectively. We also use the SUMO traffic simulator to design our simulation scenario and generate the respective traffic flow. In this section, we evaluate the performance of our hybrid vehicular communication architecture in satisfying the requirements of a V2X application that needs very high reliability and high throughput. For the reliability satisfaction evaluation, we use the platooning service [83], and for the throughput satisfaction evaluation, we use the see-through service. As a part of these evaluations, we compare our DRL-based selection approach to a simple legacy approach (i.e., a single RAT vehicular network, ITS-G5, or LTE-V2X) and to a MCDM mode selection strategy that leverages TOPSIS as described in [56]. We also consider a high-density and a low-density scenario in the platooning use case to show the absolute need for a hybrid vehicular communication network.

4.4.1 Simulation framework and scenario

This sub-section explains how we implemented the hybrid communication architecture on top of the ETSI ITS station architecture. In [84], authors proposed a stack-based simulation framework based on OMNeT++ with the module VeinsLTE. At the bottom layer of the VeinsLTE stack, there are two adjacent stacks, one for IEEE 802.11p and the second for LTE. Above this layer, there is a decision-making layer responsible for overseeing the hybrid aspect's transparency.

4.4.1.1 Hybrid architecture implementation

In contrast to VeinsLTE, our architecture enables the simultaneous utilization of ITS-G5 and LTE-V2X Sidelink. Consequently, it becomes necessary to implement a novel hybrid architecture that accommodates these short-range technologies within the OMNeT++ environment. To this end, we implemented the hybrid communication layer using simple OMNeT++ modules. Both ITS-G5 and LTE-V2X protocol stacks are linked to the hybrid communication layer using a sub-application module. When the main application generates a message, it is multiplexed to the appropriate sub-application according to the selected communication mode. The simulation environment and the hybrid communication layer implementation are depicted in Figure 4.6.

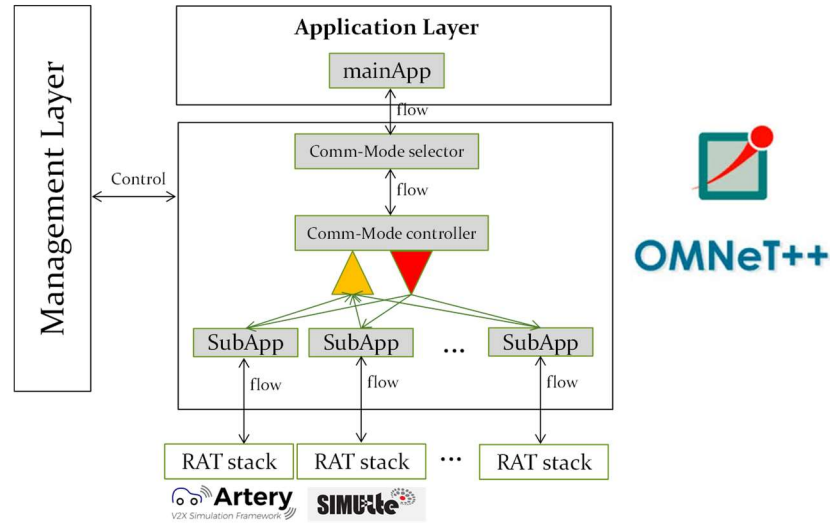

Figure 4.6. Simulation environment

4.4.1.2 Platooning service

In this service every vehicle in the platoon is equipped with both short-range technologies and considered as a DRL agent. The maximum size of the platoon is set to six vehicles. Thus, every vehicle in the platoon is in the coverage of a transmitter vehicle, and every vehicle can receive the reception evaluation acknowledgment that we use in the reward function. Moreover, this can be confirmed using the GPS position of each vehicle. To have multiple traffic flows, each ITS-S generates three types of messages. A periodic CAM message, Geonetworking messages, and if a vehicle is in the platoon, it generates a platooning message. This message is generated according to the vehicle's state in the platoon. If the vehicle wants to join the platoon, it generates a Join request. If it is in the platoon, it generates a periodic beacon to inform its neighbor in the platoon about its state. If the vehicle is the platoon leader, it generates control messages to organize and lead the platoon. Messages are exchanged with an average size of 128 bytes and a frequency of 10 Hz. Initially, the platoon is empty. It only contains the platoon leader. The distance between each vehicle in the platoon is 10 meters, and every platoon member follows the Cooperative Adaptive Cruise Control (CACC) car following model as defined in the SUMO simulator. The maximum speed limit for a vehicle in the platoon is set to 10 m/s and 20 m/s for the other vehicles.

4.4.1.3 See-through service

Similar assumptions on vehicles are adopted and all vehicles send periodic CAM message, and Geonetworking messages. When the service is needed and activated, vehicles use Collective Perception Messages (CPM) with a size of 1500 bytes to send service-related information. The see-through service doesn't have a specific message transmission frequency.

4.4.1.4 Scenario definition

We define a two-directional highway with two lanes in each direction, spanning a length of 2 km. And with a medium density of 100 vehicles per lane per kilometer. As infrastructure, two base stations are deployed to assist the LTE-V2X PC5 (mode 3) standard. No obstacles as buildings are present near the highway. To evaluate the need for hybrid communications, we vary the number of vehicles on the highway to simulate two traffic congestion levels. In the first one, a low traffic flow that does not exceed 40 vehicles is generated, and in the second one, a high traffic flow of 300 vehicles is generated with a throughput of 60 vehicles per lane per kilometer.

4.4.1.5 Coexistence between ITS-G5 and C-V2X

To solve the coexistence issue, each technology operates on a dedicated 10 MHz channel (i.e., ITS-G5 on the [5875 MHz – 5885 MHz] channel and LTE-V2X on the [5895MHz – 5905 MHz] channel). For the ITS-G5 technology, the transmitter power is set to 23 dBm, the receiver sensitivity and energy detection are set to -85 dBm, and the SNIR threshold is set to 4 dB. For LTE-V2X, the transmitter power is set to 15 dBm, and the same value as ITS-G5 is set for the receiver sensitivity and energy detection. The background noise is set to -90dBm for ITS-G5 and -110 for LTE-V2X. We use the Geometry-based Efficient propagation Model (GEMV²) [85] as a radio medium pathloss model for V2V and vehicle-to-infrastructure (V2I) communication. As a propagation model, we use the Jakes propagation model in LTE-V2X and the Constant Speed Propagation model for ITS-G5. These parameters are summarized in TABLE. 4-1.

TABLE. 4-1. Standards configuration

Parameter	ITS-G5	LTE-V2X
Access mechanism	EDCA	SPS (mode 3)
Access channel	5875 MHz – 5885 MHz	5895MHz – 5905 MHz
Transmitter power	23 dBm	23 dBm
Receiver sensitivity	-85 dBm	-85 dBm
Energy detection	-85 dBm	-85 dBm
Background noise	-90dBm	-110dBm
Propagation model	Constant Speed Propagation	Jakes

4.4.2 DDQN algorithm parameters

The OMNeT++ simulator is coded in C++. Therefore, to facilitate the interaction between the DRL model and the simulation of vehicular communications, we utilized the libtorch library to implement the DDQN algorithm. Libtorch is the C++ interpretation of the well-known Python machine learning framework Pytorch. Each vehicle has its own local DRL model. In this latter,

both the behavior and the target networks consist of four layers, six neurons input layer, two hidden layers of 256 neurons, and an output layer of three neurons. The activation function in each layer is a ReLu function. The ADAM optimizer and the MSE loss function are used to update the neural network parameters. The learning rate of our DDQN algorithm is set to 0.0005, γ is set to 0.99, and the epsilon decay is set to 10^{-5} . The maximum size of the replay buffer is set to 10^6 , and the mini-batch size is set to 64.

In our experiments, a game ends when 100 messages are received with the optimal configuration (i.e., the message is received by neighboring vehicles without any redundancy), and one step in a game is equivalent to sending a V2V message. The target network is updated every 100 learning steps. Once a game is finished, we evaluate and improve the communication's reliability and calculate the PRR using (Eq. 8). Where the $N_{sent\ messages}$ is the number of sent messages to reach the target which is 100 received messages with the optimal configuration.

$$PRR_{game} = \frac{target}{N_{sent\ messages}} \quad (Eq. 8)$$

The throughput is calculated based on the number of sent messages in a period, as shown in equation (Eq. 9). Where the N_{hits} is the number of times the vehicle sends two different messages via two different technologies simultaneously. N_{ITS-G5} is the number of messages sent with ITS-G5 without using the division mode. N_{LTE} is the number of messages sent with LTE-V2X PC5 without using the division mode.

$$Throughput_{game} = \frac{((N_{hits}*2)+N_{ITS-G5}+N_{LTE}) * Message_{size}}{Time_{Ga}} \quad (Eq. 9)$$

4.4.3 Simulation results

We use the following performance metrics to evaluate the performance of our hybrid vehicular communication network and the DRL-based communication mode selection algorithm.

- The average PRR during each game.
- The number of duplicated messages when the redundant mode is used. This provides an assessment of the effective utilization of the hybrid redundant communication mode.
- The percentage of usage for each communication mode.
- The average CBR during the simulation to track the enhancement of channel load.
- The throughput of the hybrid vehicular communication network compared to that of a regular ITS-G5 network.
- The expected average reward per game to evaluate the convergence performance of our proposed DDQN algorithm.

First, we study the results of our DRL-based selection strategy. Then, we evaluate our hybrid communication network in comparison to two baselines (I.e., a single ETSI ITS-G5 communication network and a single LTE-V2X communication network). Moreover, we compare our selection strategy with two RAT selection strategies from the state of the art. The first one is a static RAT selection strategy that selects a communication mode based only on the application's requirements as presented in [86]. The second one is a TOPSIS-based MCDM RAT selection strategy [56].

4.4.3.1 Reliability evaluation results

To assess the reliability of hybrid vehicular communication, we investigate low and high traffic congestion levels. In a low congestion level scenario, we notice two types of agents in the platoon: slow-learning agents and fast-learning agents. This phenomenon is due to the stochastic nature of vehicular communication networks and the mini-batch SGD method. Slow learning agents have long games and slow reward convergence, as shown in Figure 4.7. We also notice fluctuations due to the mobility-induced channel fading in the V2V communication network. As depicted in Figure 4.8, the slow convergence is followed by an impact on the communication's reliability. However, despite these fluctuations and slow convergence, we can reach 90% reliability after many training games, nearly 1200 games. On the other hand, Figure 4.9 illustrates that fast-learning agents achieve reward convergence around game number 600. This convergence is followed by an excellent reliability improvement, as depicted in Figure 4.10. We notice that in the first 400 games, the reliability of the transmission goes from 59% to nearly 80%. Then it reaches 99% by the end of the simulation.

In a high congestion level, we notice a prolonged convergence rate due to high traffic flow and mobility variations, which adds more states and makes the learning longer. Unlike the low congested scenario, the convergence starts slightly in game 600, as shown in Figure 4.11. We notice that messages are more commonly lost because of an important interference probability. Thus, the agent takes more time to learn which communication mode is better to maximize reliability. We observe a reliability of 90% at game 800, as depicted in Figure 4.12. Then, it continues nearly to 97% at the end of the learning.

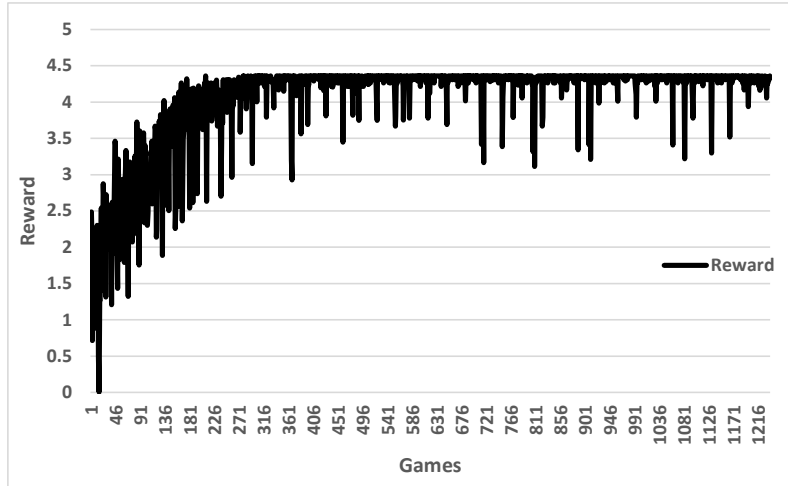

Figure 4.7. Expected reward of the Q-learning algorithm for slow-learning agents

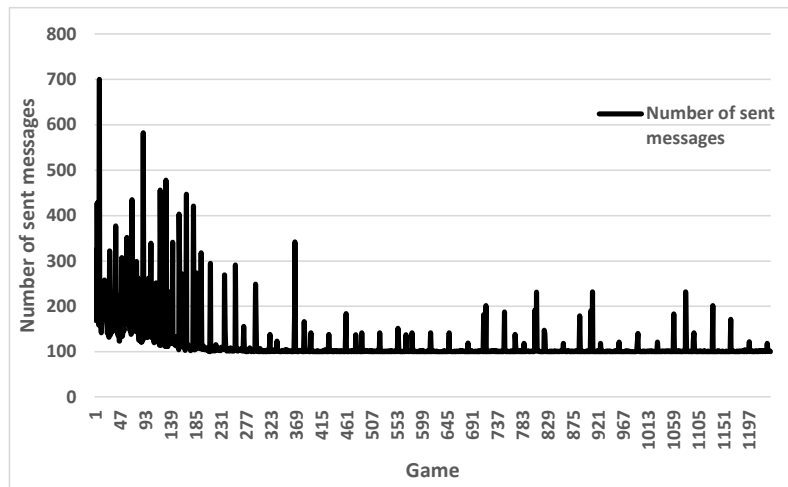

Figure 4.8. Number of sent messages to reach the target for slow-learning agents

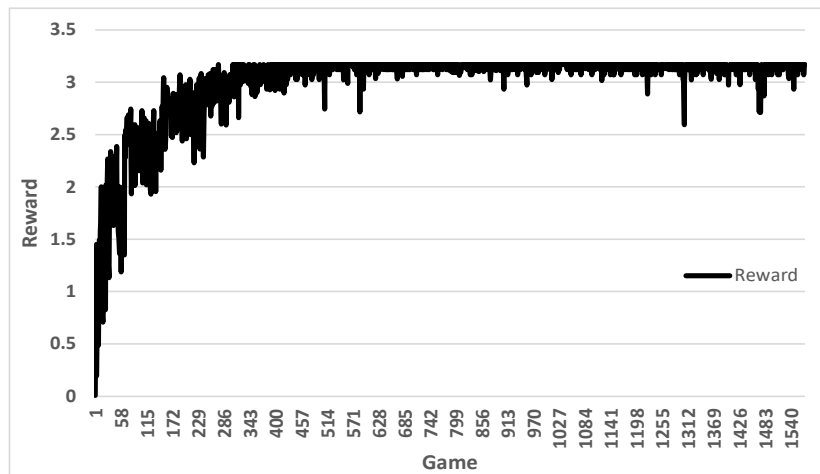

Figure 4.9. Expected reward of the Q-learning algorithm for fast-learning agents

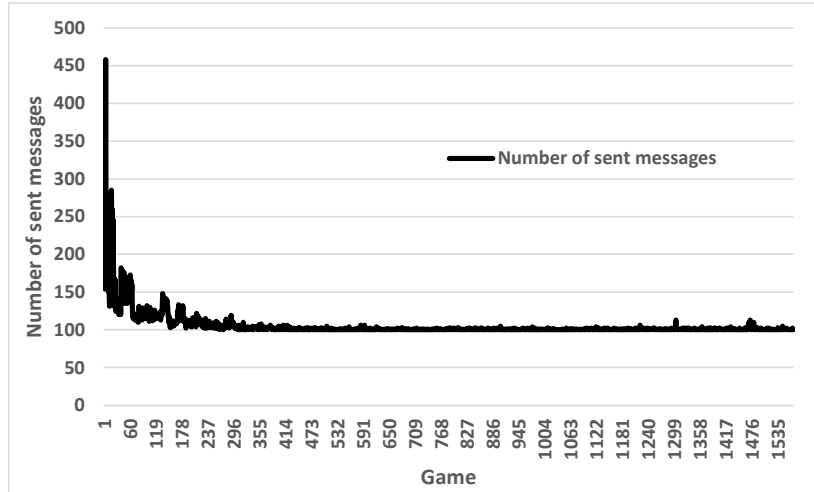

Figure 4.10. Number of sent messages to reach the target for fast-learning agents

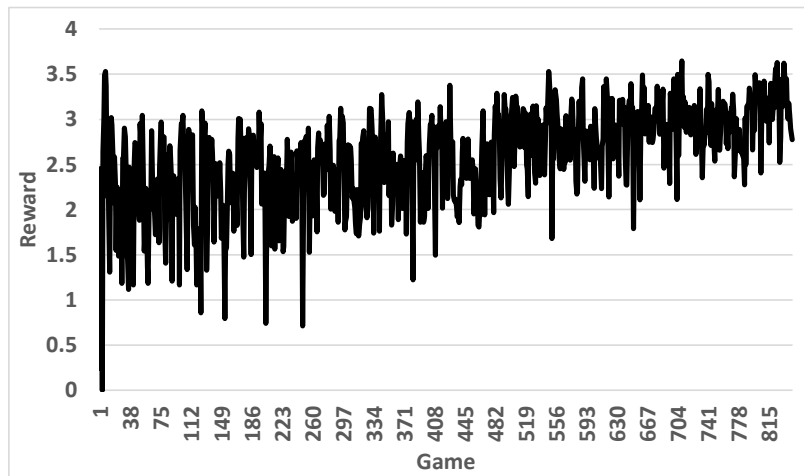

Figure 4.11. Expected reward of the Q-learning algorithm in a high congested scenario

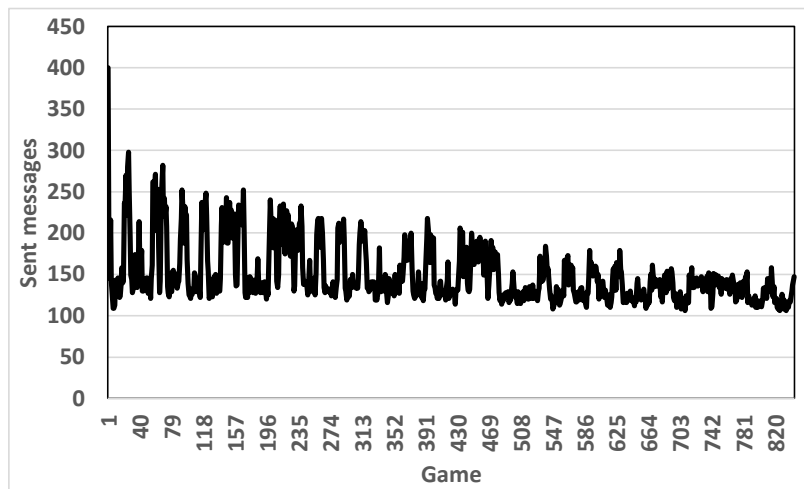

Figure 4.12. The number of sent messages to reach the target in a high congested scenario

Experiments using a high-congested scenario help us see the interest in using the redundant communication mode to reach very high reliability. In Figure 4.13, we can see that the redundant communication mode is used more often on a high congested highway than when a vehicle is on a low-congested highway. On a low congested highway, the agent tends to use the redundant mode with a probability of 0.03. On the other hand, in a high congested highway, the redundant mode is used with a probability of 0.3.

Figure 4.14 presents a comparison between the single-RAT legacy vehicular network, hybrid vehicular network with a static selection strategy, TOPSIS-based MCDM RAT selection strategy, and our DRL-based selection strategy in terms of reliability. We can see that hybrid communication, with both DRL and a static RAT selection, enhances the PRR in both traffic flow densities compared to the baseline performances with ETSI ITS-G5 and LTE-V2X. The most valuable performance that the hybrid communication adds is noticed in Figure 4.14 by examining the high traffic density results. We can see that the PRR goes from 66% (using only ITS-G5) to more than 97% (using hybrid communications). The static selection strategy uses the hybrid redundant communication mode when the safety service requires reliability that is higher than 99%. However, in our simulation results, we noticed that in some cases, we do not need to use the redundant communication mode to ensure that the message will be received successfully. Because if both technologies can ensure the transmission of the message, this latter will be received twice. With the hybrid static strategy, we report up to 7119 redundant messages out of 10718 sent messages (during the 250s of simulation time), which means 66% of redundant transmissions were inefficient and considered resource waste.

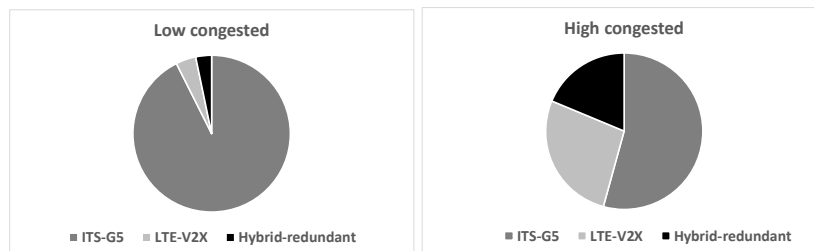

Figure 4.13. Percentage of use of each communication mode

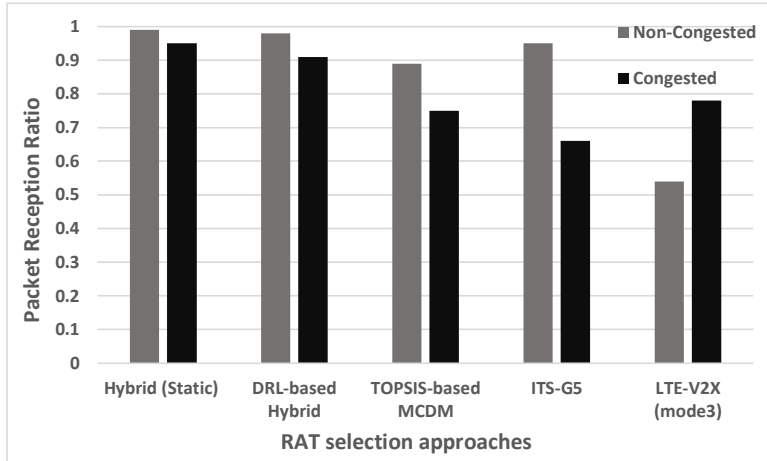

Figure 4.14. Comparison between RAT selection approaches

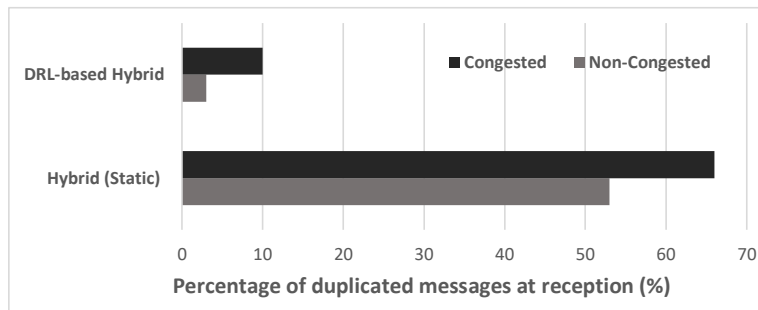

Figure 4.15. Percentage of duplicated messages

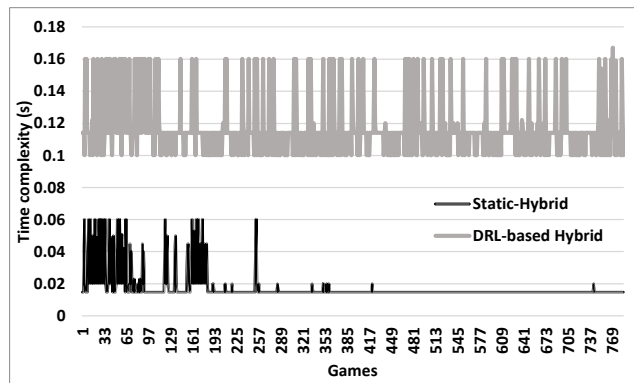

Figure 4.16. Time complexity of static and DRL-based Hybrid communication

By employing a communication mode selection strategy based on DRL, we achieve comparable performances to those obtained with the static hybrid RAT selection algorithm. Furthermore, according to our duplicated messages statistics in Figure 4.15, we notice that the rate of duplicated messages at reception goes from 60% to nearly 7% with the use of DRL. Which is an 80% reduction. This significant improvement in network resource consumption and spectral efficiency outweighs the computational complexity introduced by using neural networks (DRL),

which remains fixed in every game throughout the learning and exploiting phases [87]. Figure 4.16, shows that employing DRL introduces a marginal increase in average computational time, approximately 0.09 seconds. However, this trade-off is justifiable considering the significant reduction in redundant messages achieved by the DRL-based RAT selection algorithm.

To finish this reliability improvement study, we notice that similar findings to those reported in [56] are observed with the TOPSIS-based MCDM RAT selection strategy. This strategy demonstrates superior PRR performance in low traffic density (respectively, high traffic density) scenarios compared to LTE-V2X (respectively, ETSI ITS-G5). These results show that LTE-V2X and ITS-G5 are complementary technologies that achieve better performance when used together. However, hybrid communication is better than the TOPSIS-based MCDM RAT selection strategy in both scenarios.

4.4.3.2 Throughput evaluation results

To study the throughput enhancement in a high-congested network, we compare it to the throughput of a single RAT vehicular communication network that uses ITS-G5.

Figure 4.17 shows that the reward's convergence is accompanied by nearly a 20% enhancement in the throughput compared to the ITS-G5 throughput. By utilizing a hybrid communication mode, we were able to decrease the channel load and channel waiting time, resulting in more efficient usage of the ITS-G5 technology and higher communication throughput. The channel load enhancement can be observed by comparing the ITS-G5 CBR record of a legacy vehicular communication network that exclusively utilizes ITS-G5 with the ITS-G5 CBR record of the hybrid communication network.

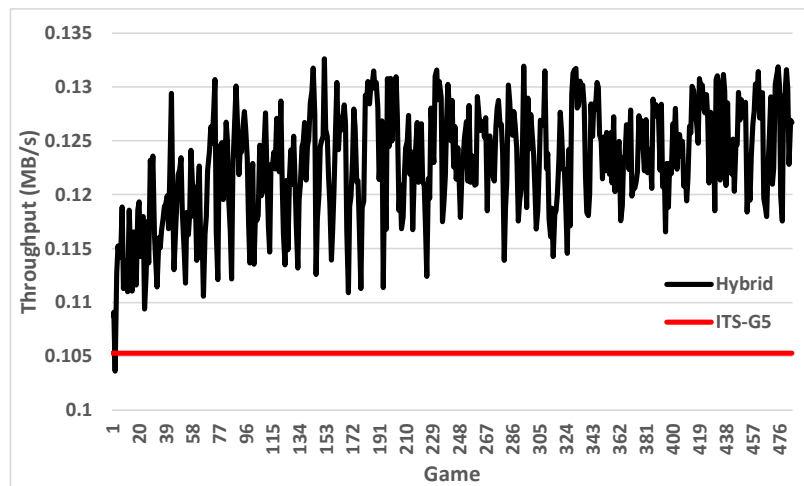

Figure 4.17. Hybrid architecture throughput enhancement compared to ITS-G5 throughput

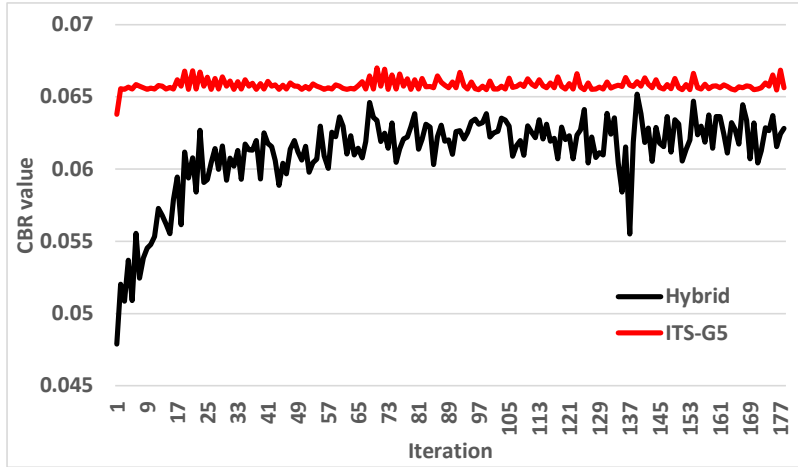

Figure 4.18. The CBR value according to learning iterations

Figure 4.18 depicts the average CBR value evolution according to learning iterations. We observe that the average CBR initially increases as the agent gradually starts to utilize ITS-G5 and then stabilizes at game 70. However, it is worth noting that some fluctuations were observed during the learning process due to the variation in the chosen communication mode. Despite these fluctuations, the CBR values in a hybrid architecture remained consistently lower than those in a legacy vehicular communication network. This also shows an improvement in the channel waiting time of ITS-G5.

4.5 Conclusion

In this chapter, we proposed and implemented a hybrid vehicular communication architecture with a DRL-based RAT selection strategy. The goal of this architecture is, on the one hand, to satisfy the performance needs of emerging V2X applications and, on the other hand, to benefit from the complementary aspect of vehicular communication technologies, namely ITS-G5 and C-V2X. By doing so, we aim to overcome the limitations and weaknesses associated with each technology. We compare the performance of our selection algorithm with the performances of two other reflective selection algorithms for hybrid architectures. We assess our work following two congestion levels. The results obtained under low congestion levels demonstrate the superiority of the DRL selection strategy over other strategies. Moreover, they highlight the efficient utilization of the redundant communication mode, leading to fewer redundant receptions. Notably, we observe the necessity of hybrid communication to meet the performance requirements of Day 2 and Day 3 applications in terms of reliability and throughput in the presence of high levels of network congestion. In future works, we will assess the performance of hybrid communications using a real-life scenario to validate our findings and further refine the implementation of these technologies for practical applications.

Chapter 5

Enhancing Vehicle Orientation in Toll Stations Using vMEC and Hybrid Vehicular Communications

Toll management systems have a vital role in facilitating smooth and effective traffic flow at toll stations. To this end, numerous use cases have been explored to guide and detect vehicles at toll stations. These activities rely on infrastructure for vehicular communications and the presence of adequate computational capacity either within the vehicle itself or at an edge computing unit located close to the toll station. In this chapter, we explore the use of hybrid communications and vehicular Multi-access Edge Computing (vMEC) to enhance the performance of toll management V2X services. To this aim, we present the outcomes and implications of a PoC study conducted to evaluate the use of hybrid vehicular communications and vehicular multi-access edge computing to enhance the efficiency of the toll station approaching vehicles' orientation use case. We used the deep learning algorithm, named You Only Look Once (YOLOv7), to detect the approaching zone of the toll station and the vehicles. And for hybrid communications, we used LTE-V2X Uu and ITS-G5. Our study focused on improving reliability, reducing latency, and extending coverage to enhance the guidance of vehicles as they approach the toll station. Additionally, we closely monitored the downlink resource block consumption of the base station located near the roadside unit while employing hybrid communication. This PoC was conducted in collaboration with "Autoroutes Paris-Rhin-Rhône" (APRR), "Université Polytechnique Hauts-de-France" (UPHF), and "École nationale supérieure Mines-Télécom Atlantique" (IMT Atlantique).

5.1 Introduction and overview on toll management systems

Given the escalating volume of traffic, a well-maintained transportation infrastructure becomes essential. Connected and cooperative intelligent transportation systems represent a promising solution that leverages advanced communication technologies to enhance traffic management and optimize transportation networks. Traffic management relies mainly on V2I and I2V communications. Toll station management systems are automated systems used to collect tolls or fees from vehicles passing through toll booths or stations on highways and roads. These systems

help streamline the toll collection process, reduce traffic congestion, and improve overall efficiency in managing toll facilities. These systems are a critical component of transportation networks. They are currently enhanced with a C-ITS infrastructure to optimize traffic flow, orient and detect vehicles that are crossing the toll barriers, and manage tolling transactions. Toll stations are strategically located at specific points along highways and expressways. Basically, in a toll management system, a single Roadside Unit can operate the entire toll station, executing the payment transaction and communicating with the C-ITS-enabled vehicles passing the tolling area [88]. Utilizing C-ITS for road tolling extends its applicability to various payment scenarios, encompassing parking space management, energy charging, and regulating access to city centers or ferries. The implementation of toll management systems has become increasingly sophisticated over the years, enabling faster and more efficient transactions while minimizing congestion at toll stations. To this end, works like [89] aim to reduce toll queues while improving the level of payment services, by developing an electronic toll management payment scheme based on vehicular ad-hoc networks. Vehicle identification and classification in toll stations have been enhanced and investigated too by leveraging AI-based techniques such as machine learning, and deep learning [90].

This evolution of toll management systems requires the integration of new technologies and robust vehicular communication networks. A relevant use case, relying on such implementation, is detecting and orienting connected vehicles as they approach the toll station. This operation must be performed within a constrained timeframe that allows the driver to react to the system's recommendation. Orienting vehicles to the optimal lane demands computational power, a low latency transmission, and a reliable network. To get these performances, we study the possibility of using a hybrid vehicular communication network and a vMEC in the toll management system. This chapter's next sections provide further details on the PoC specifications, architecture, implementation, and test outcomes.

5.2 PoC specifications and architecture

In this PoC, we deal with a well-defined use case in the InDiD European project "Toll station approaching: orientation of drivers". The objective of this use case is to inform the driver of a connected vehicle on the state of open toll lanes when approaching the toll gate and on the supported payment methods. However, no concrete experiments were done regarding the use of hybrid communications and vMEC for toll station management systems. This PoC investigates the use of these technologies by slightly modifying the previously mentioned use case. This work is realized at an operational toll station with an experimental implementation of the toll station approaching use case. The host toll station is the FLEURY-EN-BIERE secondary toll station

(Péage de Fleury-en-Bière - A6 - Sortie N°14), which is open only in case of high traffic density. The tollgate approaching zone and entrance zone are the only areas of interest in this experiment, as depicted in Figure 5.1.

For this Proof of Concept, the toll gate was specifically prepared, designating one open lane for testing purposes as depicted in Figure 5.2. With the availability of this open lane, we had the freedom to exit and re-enter the toll station, enabling us to conduct experiments in both directions without hindrance.

Toll station approaching service is deployed using an ITS-G5 vehicular communication network. The complete architecture of the toll station is composed of a toll station management server, a Road Side Unit (RSU), the toll gates, and vehicles. A Toll Management system Server (ToMS) is a centralized computer system that oversees and manages the operations of toll stations. It typically performs various tasks such as collecting toll payments, monitoring traffic, processing transactions, generating reports, and ensuring the smooth functioning of toll equipment and infrastructure. The ToMS is directly connected to the RSU to send the toll station configuration. Each station is connected to the ToMS via an RSU. Once the configuration is received, the RSU broadcasts the received lane configuration from the ToMS to the Onboard Unit (OBU) of the vehicle using Infrastructure-to-Vehicle Information (IVI) messages through ITS-G5 communication. The entire architecture is illustrated in Figure 5.3.

Subsequently, the architecture is modified to incorporate the vMEC and hybrid vehicular communication. The details of these modifications and new architectures are provided below.

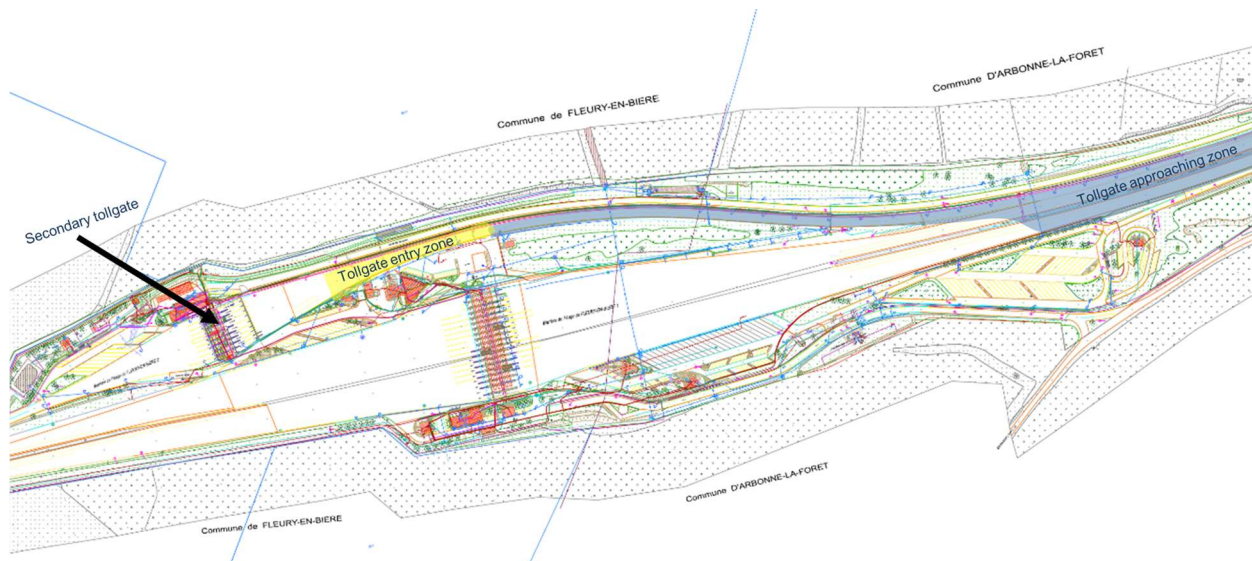

Figure 5.1. The location of the FLEURY-EN-BIERE secondary toll station



Figure 5.2. Open lane for testing

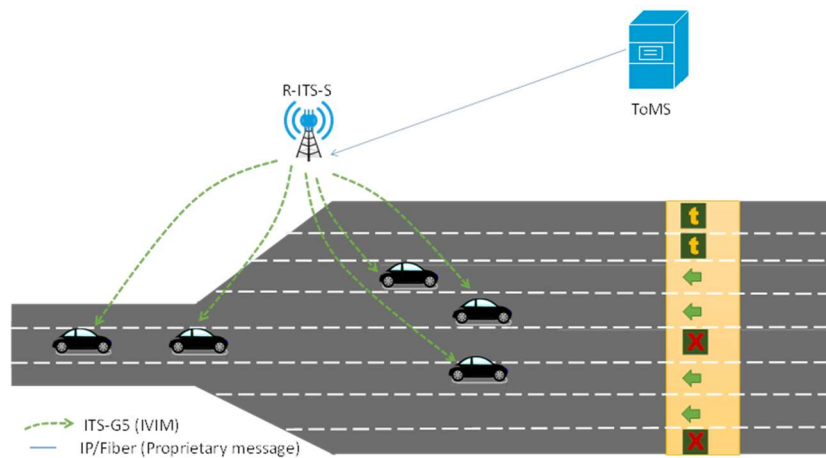

Figure 5.3. Toll management architecture

5.2.1 Architecture adaptation for the vMEC experiment

Running object detection in real-world computer vision services like the detection of approaching vehicles in a toll station is hard considering the mobility of the vehicles. It needs a system robustness, scalability, efficiency, and low-latency. In addition, when ML computer vision is used, it requires IoT communication for data streaming with images as input and detections as output. To overcome those challenges, the concept of Edge AI has been introduced, which leverages Edge Computing with Machine Learning. AI equipped Edges makes processing closer to the data source.

In our case, use a vMEC equipped with AI. To show the interest of the vMEC, we assume that the vehicle is equipped with an embedded camera and needs to process the data it collects. Additionally, we assume that the vehicle is connected to both an in-vehicle vMEC and a remote server in the cloud. The vehicle shall process the collected information and recommend a lane to the driver as shown in Figure 5.4. At this level, two cases could occur: The OBU does not have enough computing power. So, it sends the data, over cellular communications, to a remote server

to be processed, and the result is sent back to the vehicle. The OBU has enough computing power thanks to an embedded vMEC. In this case, the V-ITS-S processes the data locally and directly exploits the results.

For both cases, the YOLOv7 algorithm is used to detect the toll entry zone and identify vehicles in each lane. YOLO, which stands for "You Only Look Once," is a popular and widely used object detection algorithm in the field of computer vision and deep learning.

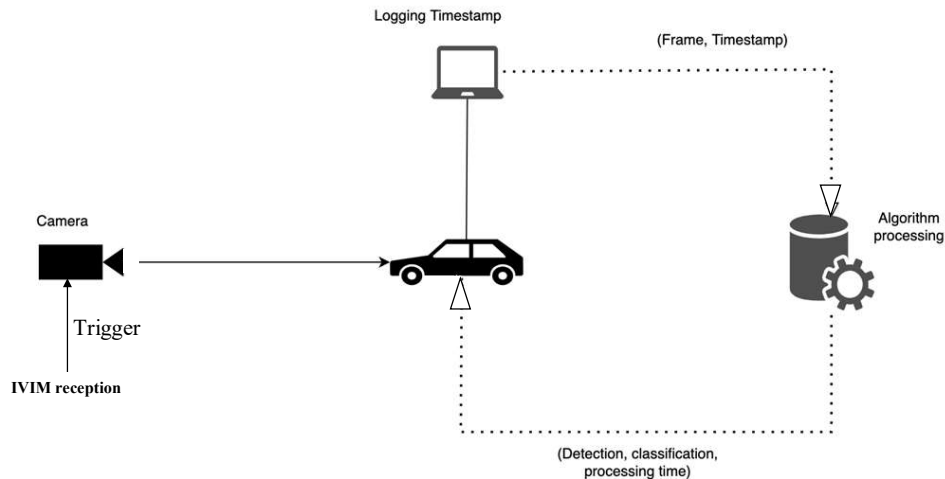

Figure 5.4. Data collecting and processing scheme for vehicles orientation

YOLO is known for its real-time object detection capabilities, allowing it to identify and locate multiple objects within an image or video frame in a single pass. YOLOv7 [91] is the latest official YOLO version created by the original authors of the YOLO architecture, released in July 2022. The training of the detection algorithm is performed using a dataset of videos captured on a vehicle entering a toll station. For faster processing of the test videos, the frames were saved at a certain interval and then the saved frames were passed through the algorithm.

5.2.2 Architecture adaptation for the hybrid communication experiment

This PoC also aims to evaluate the effectiveness of the toll management architecture by leveraging hybrid vehicular communications to improve communication reliability. Additionally, hybridization offers services to vehicles that are not equipped with ITS-G5 and on roads that are not covered by ITS-G5. Thus, it extends and maintains the availability of the V2X service.

Figure 5.5 shows the proposed hybrid communication adaptation of the PoC architecture. In this architecture, the OBU sends and receives messages through ITS-G5 and cellular links. And the RSU transmits IVIMs using ITS-G5 technology, while simultaneously, a remote server, that represents the ToMS, transmits IVIMs to subscribed users via the cellular network.

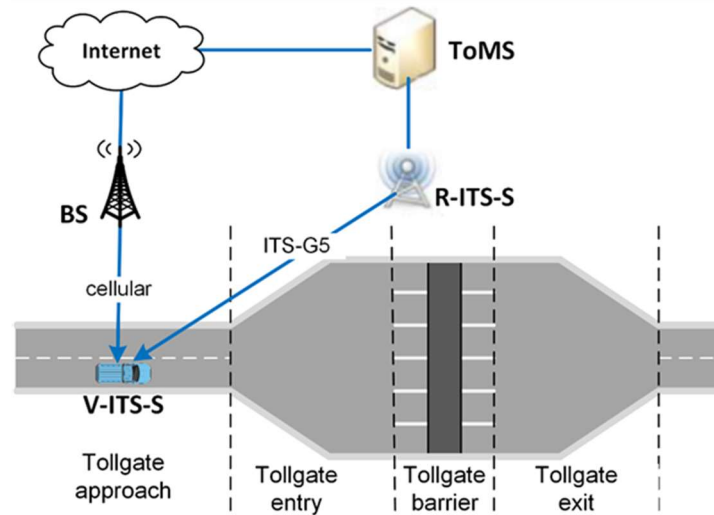

Figure 5.5. Modified architecture for hybrid vehicular communication

5.3 Experimentation process

In this section, we present the used equipment and the experimentation process for both defined adaptations of the “Toll station approaching: orientation of drivers” use case. In our experiments, we used the following set of equipment as shown in Figure 5.6. We used one RSU (NeoGLS RSU), two OBUs (NeoGLS and YoGoKo OBUs) a personal computer as a vMEC, an on-board camera, and one Frame Simulator (FS) to send the IVIM to the RSU.

The frame simulator emulates the TOMS and mimics the transmission of IVIM to the RSU. The RSU was installed on the roof of the toll gate supervision building. Despite its suboptimal height of 4 meters, it effectively provided a coverage range of one kilometer around the toll gate station area.

Both onboard units were securely mounted inside the vehicle. Their magnetic antenna is easily attached to the vehicle's roof, ensuring good maintenance and stability. Furthermore, the OBU has the capability to connect to the RSU via ITS-G5 and to the cellular network through an integrated SIM card. The camera was also mounted inside the vehicle to enable the capture of the necessary set of images for lane selection. The frame simulator was installed on the terminal in the server room. The terminal is linked to the RSU via an RJ45 Ethernet connection.

We define in this section two groups of scenarios, the first group is related to the vMEC experiment and the second one is for the hybrid communication experiment. The nomenclature of the scenarios is S_x_y where “S” means scenario, “x” is the group of the scenario, and “y” is the respective ID of the scenario. For example, S_1_1 is related to the first scenario of Group 1 (vMEC experiment N°1). These scenarios are detailed in TABLE. 5-1.

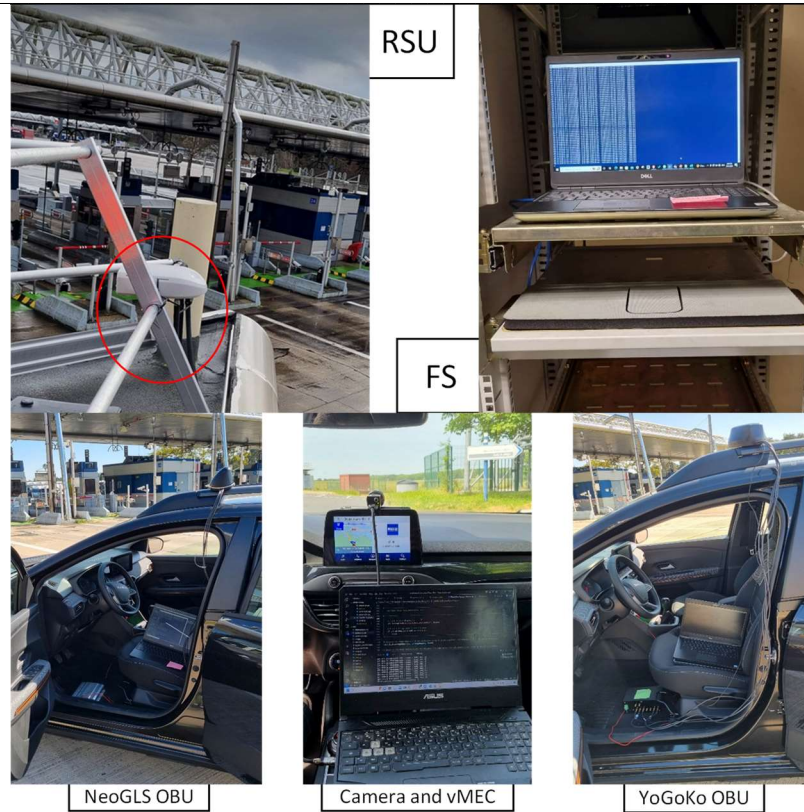

Figure 5.6. Used equipment

TABLE. 5-1. PoC scenarios

Scenario	Description
S_1_1	<p>Toll approaching vehicle orientation without the use of vMEC server</p> <p>Scenario:</p> <ul style="list-style-type: none"> – The vehicle approaches the toll station – The RSU sends the information received from the ToMS to the vehicle in an IVIM – The vehicle receives IVIM and activates the camera – The vehicle collects images from the cameras at the beginning of the tollgate entry zone – The vehicle sends the collected data to the cloud to select the suitable lane – The vehicle receives the results from the cloud
S_1_2	<p>Toll approaching vehicle orientation with the use of a vMEC server</p> <p>Scenario:</p> <ul style="list-style-type: none"> – The vehicle approaches the toll station – The RSU sends the information received from the ToMS to the vehicle in an IVIM – The vehicle receives IVIM and activates the camera – The vehicle collects images from the cameras at the beginning of the tollgate entry zone – The vehicle uses the vMEC to select the suitable lane
S_2_1	<p>Toll approaching vehicle orientation with hybrid communication where less ITS-G5 coverage</p> <p>Scenario:</p> <ul style="list-style-type: none"> – The vehicle approaches the toll station

	<ul style="list-style-type: none"> – The ToMS sends the toll station state to the RSU and directly to the OBU via the cellular link – The RSU sends the information received from the ToMS to the vehicle in an IVIM – The vehicle receives the state of the toll station via the cellular link when ITS-G5 is absent or out of coverage
S_2_2	<p>Toll approaching vehicle orientation without hybrid communication</p> <p>Scenario:</p> <ul style="list-style-type: none"> – The vehicle approaches the toll station – The RSU sends the information received from the ToMS to the vehicle in an IVIM – The vehicle receives IVIM
S_2_3	<p>Toll approaching vehicle orientation with hybrid communication</p> <p>Scenario:</p> <ul style="list-style-type: none"> – The vehicle approaches the toll station – The ToMS sends the toll station state to the RSU and directly to the OBU via the cellular link – The RSU sends the information received from the ToMS to the vehicle in an IVIM – The vehicle receives the state of the toll station lanes from the RSU and the ToMS

For first-group scenarios, the primary goal is to detect vehicles queuing at the toll station and determine the lanes that are relatively less congested. Throughout this experiment, the transmission times and the algorithm's processing times were logged for analysis. For the second group scenarios, we aim to enhance the reliability and coverage of the IVIM transmission. In this experiment, the IVIM is transmitted every 100 milliseconds by both the TOMS and the RSU. The following information was recorded during the experiment: the sending and reception timestamps using both networks, PCAP captures to calculate the packet reception ratio. The OBU receives and stocks all cellular and ITS-G5 messages. Then, through post-processing, only the messages of interest are filtered, namely, IVIMs received via ITS-G5 and the cellular network.

Furthermore, experiments on hybrid communication were also investigated by implementing a test bed to ascertain the maximum number of vehicles that can receive IVIMs using C-V2X communications. To this aim, we study the number of Physical Resource Blocks (PRBs) used by an IVIM transmission. We observe that the Mobile Network Operator (MNO) only uses the 800 MHz band with a bandwidth of 10 MHz at that base station, which corresponds to 50 PRBs per sub-frame. Knowing that the IVIM has a size of 3464 bits, the number of PRBs used for its transmission depends on the channel quality, thus on the MCS as detailed in TABLE. 5-2. Number of PRBS per IVI message. In the best-case scenario, when the OBU is very close to the base station an IVIM uses 5 PRBs. It should be noted that cellular links are unicast, and for each IVIM transmitted in the downlink, the OBU responds with an acknowledgment in the uplink. Hence, we monitor the number of PRBs used in the downlink and uplink for IVI message transmission.

TABLE. 5-2. Number of PRBS per IVI message

MCS index	Number of PRBs
4	49
10	22
16	12
22	8
28	5

5.4 PoC results

In this section, various results of this PoC are presented. First, we compare the outcomes of using a vMEC with those of processing data in a remote server. Next, we examine the results of monitoring the cellular link to determine the optimal number of vehicles capable of receiving IVIMs without packet loss. Finally, we proceed with an analysis of the hybrid vehicular communication results, considering reliability and coverage of the vehicular communication. We should note that for the S_1_1 scenario, the image frames were sent to the remote server (Cloud) using a simple Transmission Control Protocol (TCP) socket connection. All scenarios were executed on the highway A6 and the FLEURY-EN-BIERE secondary toll station with a speed ranging from 90km/h to 130km/h.

5.4.1 Group one results

For the first group of scenarios, we precise that the model loading time takes 2 seconds. The algorithm's average processing time per frame differs depending on whether the vMEC or the remote server is used. For these experiments, the vMEC is an Asus portable computer with an Intel i7 CPU, a GTX1650 GPU, and 16GB de RAM. And the remote server characteristics are as follows: an Alienware server with an Intel i9 CPU, a 3090RTX GPU, and 64 GB RAM.

5.4.1.1 Scenario S_1_1

For a transparent comparison, this scenario is carried out across three distinct cellular network operators. In this scenario, we notice that the processing time, on the remote server, has an average of 0.14 seconds as shown in Figure 5.7. Using the first operator's cellular network, we reported an average total time of 0.8 seconds for packet transmission and reception. Using the second operator's cellular network, we reported an average total time of 0.75 seconds for packet transmission and reception. The third operator's cellular network has a 5G radio access network.

Using this operator's cellular network, we had an average packet transmission and reception time of 0.6 seconds.

5.4.1.2 Scenario S_1_2

With the vMEC approach, we notice that the average algorithm processing time is 1.3 seconds per frame, as shown in Figure 5.8. The difference between the vMEC processing time and the cloud processing time is caused by the varying computational capabilities between the server and the local machine. Since the processing is performed locally, there are no transmission times involved.

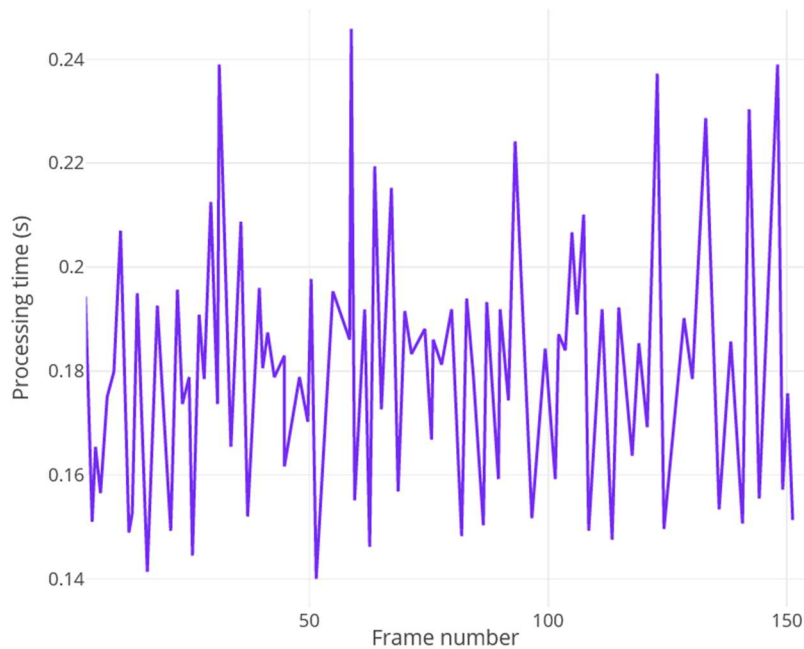

Figure 5.7. Algorithm processing time using the remote server

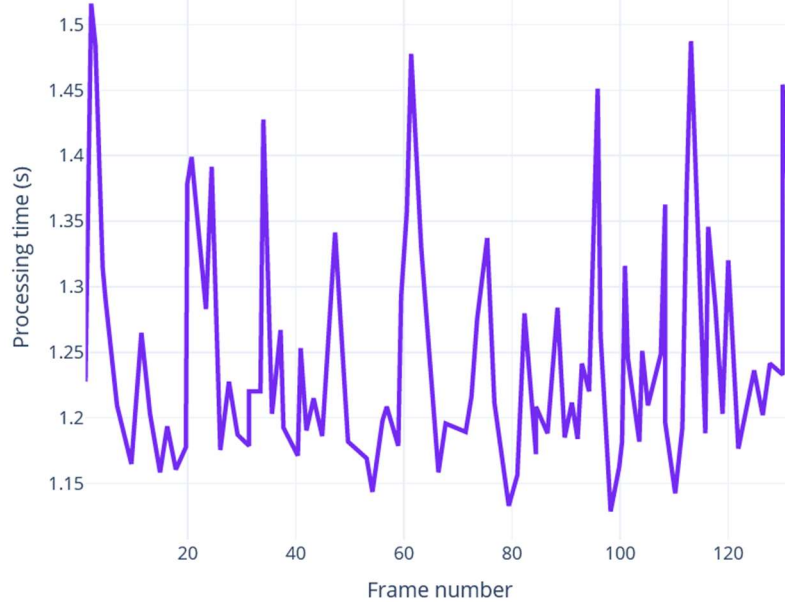

Figure 5.8. Algorithm processing time using the vMEC

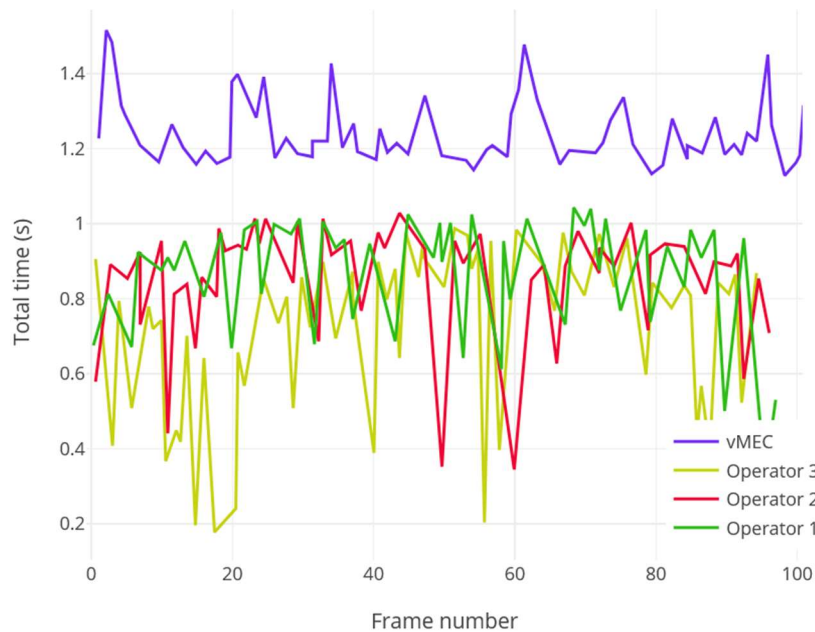

Figure 5.9. Comparison between the total time of each approach

After studying both group one scenarios, Figure 5.9 shows a comparison between the vMEC approach and the remote server approach. The presented times represent the overall duration taken by each approach (transmission time, processing time, and reception time), starting from the transmission of information to obtaining the processed result, which is the selected lane. We notice that the distant server approach significantly outperforms the vMEC approach. This is primarily due to the higher computational capacity of the distant server. Nevertheless, it is worth

noting that an average processing time of 1.3 seconds at the toll station entrance zone is sufficient for the conductor to be informed of the selected lane. Therefore, using a vMEC can still be considered a viable option to avoid potential issues associated with transmitting processed information from the OBU to a distant server and vice versa. When comparing the three operators, it appears that the 5G operator shows slightly better performance than the others.

5.4.2 Group two results

This subsection presents a detailed analysis of the obtained results from group two scenarios. At first, as preparation for our experiments, we monitored the downlink and uplink cellular resources. Figure 5.10 illustrates the percentage of PRBs used for one IVIM transmission. We monitored exchanges between the OBU and the base station, for about 4 minutes. On average, we observe that 0.115% and 0.041% of the cellular resources are used in the downlink (DL) and uplink (UL), respectively. Therefore, in the best-case scenario, there could be up to 870 vehicles in the cell receiving IVIMs simultaneously. However, this estimate assumes that all PRBs in the cell are dedicated to IVIMs transmission and that the vehicles are in very close proximity to the base station. In a real-world scenario, this becomes impractical due to the presence of other traffic demands and the varying distances of vehicles from the base station.

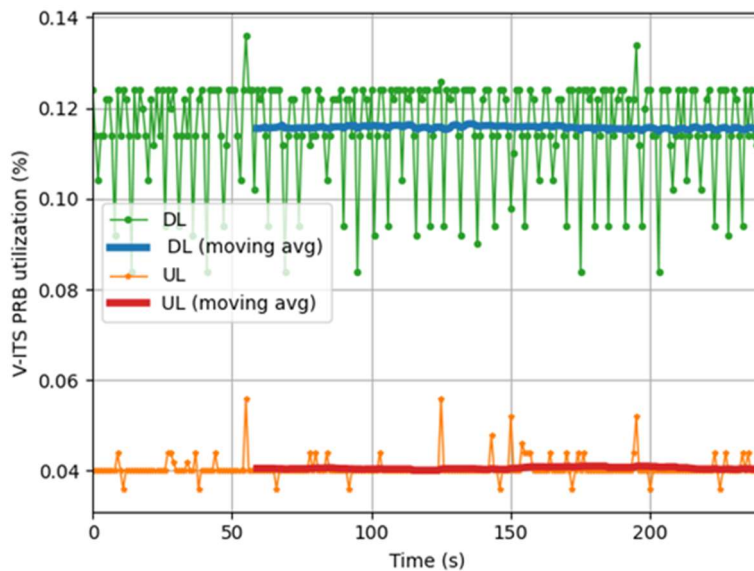

Figure 5.10. OBU's PRBs utilization per IVI message

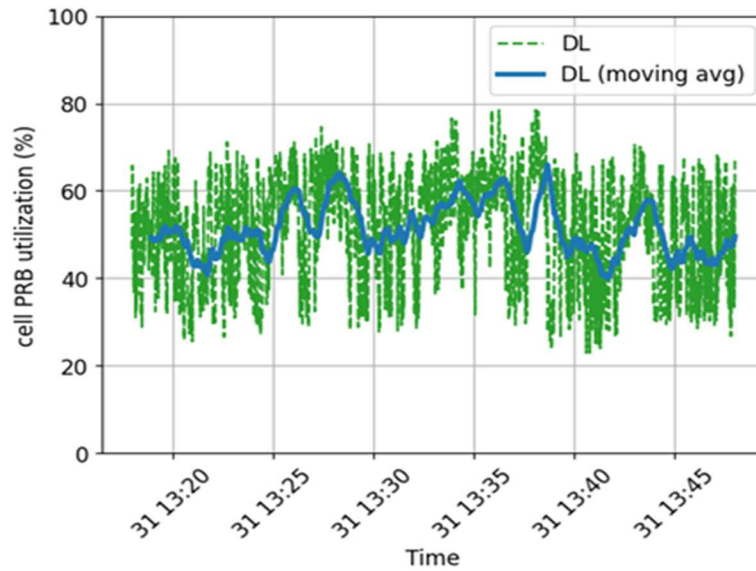

Figure 5.11. Percentage of cell's PRB utilization

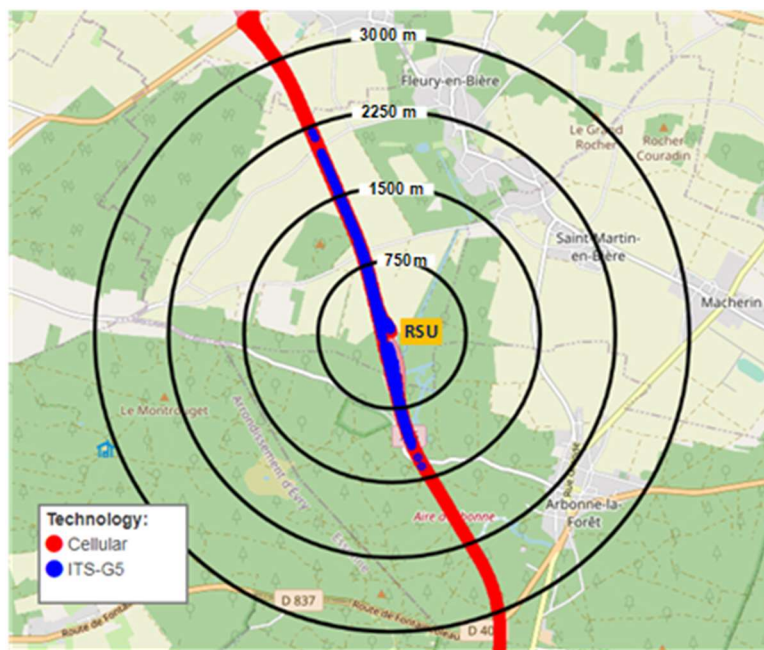

Figure 5.12. The reception range of the IVIM using ITS-G5 and C-V2X

After using a sniffer, we observed that approximately 50% of the available resources are used by the terminals connecting to this cell (Figure 5.11), including the OBU used in this experiment. Therefore, considering the absence of network overload and the good coverage, we can expect minimal loss of IVIMs transmitted over cellular links during the experimentation.

5.4.2.1 Scenario S_2_1

Figure 5.12 displays IVIMs received via cellular links (red) and ITS-G5 (blue). Each point on the figure represents the vehicle's location at the moment of receiving an IVIM. It can be observed that the OBU receives messages via the cellular network during the entire round trip, whereas the coverage from the RSU via ITS-G5 is shorter and asymmetric. This could be explained by the presence of a line of sight (LOS) on the road towards the north of the RSU. On the other hand, in the opposite direction, there is a dense vegetation area, resulting in a NLOS condition. We conclude that C-V2X guarantees the availability of the service in the absence of ITS-G5.

5.4.2.2 Scenario S_2_2 and S_2_3

By examining the Packet Capture (PCAP) files captured by the OBU, we conducted an analysis of the PRR for both technologies. The PRR analysis was performed for four distance ranges between the vehicle and the R-ITS-S: (0, 750], (750, 1500], (1500, 2250], and (2250, 3000] meters. Additionally, we analyzed two directions: from Paris to Lyon and from Lyon to Paris. Results are shown in TABLE. 5-3.

TABLE. 5-3. Packet reception ratio

Range (m) RAT	Paris → Lyon		Lyon → Paris	
	ITS-G5 (%)	Cellular (%)	ITS-G5 (%)	Cellular (%)
(0, 750]	92.6	99.4	74.5	100
(750, 1500]	75.3	100	32.4	99.6
(1500, 2250]	4.2	99	0	100
(2250, 3000]	0	99.3	0	100

We notice that the packet loss rate increases as the vehicle moves farther away from the RSU. For distances below 750 meters, the ITS-G5 communication experiences packet loss of 7.4% and 25.5% in the directions from Paris to Lyon and from Lyon to Paris, respectively. Regarding the cellular links, in all cases, we noticed that the packet loss rate is below 1%. In this experiment, only our vehicle was receiving IVIMs via the cellular network, which is insignificant compared to the number of available resources. Nevertheless, in a situation where numerous vehicles receive IVIMs via the cellular network, the utilization of resources may become more significant, resulting in a slightly higher packet loss ratio. Finally, hybrid communications facilitate the distribution of toll information to all vehicles arriving at the toll station, including those without ITS-G5 technology implemented.

5.5 Conclusion

Toll management systems are the subject of many improvements and are studied in many use cases in different European projects and by different entities. In this chapter, we studied one use case that is related to the orientation of vehicles that are approaching the toll station. In our study, we investigated the benefits of utilizing vMEC to optimize vehicle orientation towards less congested lanes. Additionally, we explored the advantages of employing hybrid vehicular communications, using ITS-G5 and C-V2X UU, to enhance the reliability and availability of services at the toll station. Based on the defined scenarios, it can be concluded that the vMEC approach and the distant server approach have distinct advantages and considerations. The vMEC offers the advantage of real-time processing and on-board processing, which minimizes security and network issues. On the other hand, the distant server approach provides the benefits of offloading computation and potentially leveraging more powerful hardware. Concerning hybrid communication tests, we notice that cellular networks provide higher reliability and better coverage and, therefore, a higher probability of receiving an IVIM. However, one of the drawbacks of using this technology in this particular use case may be the inefficient use of radio resources in the cellular network due to the use of unicast transmissions. In future work, we aim to explore additional services at the toll station and investigate the application of hybrid vehicular communications to enhance these services.

The contents of this research work are the sole responsibility of InDiD Consortium and do not necessarily reflect any opinion of the European Union. We would like to express our gratitude to the European project InDiD for providing financial support to conduct the research presented in this chapter. Their funding has been instrumental in making this study possible, contributing significantly to the advancement of our knowledge in this field.

Chapter 6

Conclusion and perspectives

Enhancing road safety and optimizing the mobility of road users have emerged as paramount priorities for stakeholders and automotive manufacturers. Consequently, promoting ubiquitous C-ITS service deployments is now a central focus of research efforts. The existing standards, such as IEEE 802.11p and 3GPP LTE-V2X, have been instrumental in laying the foundation for vehicular communications. However, emerging applications, like Advanced Driver Assistance Systems and Connected Autonomous Driving, demand Ultra-Reliable Low Latency Communications, a requirement that current technologies struggle to fulfill. In response to this challenge, this thesis explores the concept of a hybrid vehicular communication architecture, which combines the strengths of both ITS-G5 and C-V2X technologies. This architecture aims to provide a reliable communication framework for current and future vehicles, addressing new generation V2X communication technologies.

The contributions of this thesis are threefold. Firstly, it evaluates the potential of next-generation technologies, with a specific focus on the IEEE 802.11bd standard, to fulfill the requirements of emerging V2X applications and contribute to the reduction of road accidents. Secondly, it introduces a scalable hybrid vehicular communication architecture that can accommodate various combinations of existing technologies. In addition, it explores a decentralized radio access technology selection strategy that leverages deep reinforcement learning to improve communication management. Numerical results demonstrate notable improvements in packet reception rate, throughput, and channel efficiency. In the last contribution, a proof of concept is presented, showcasing the practical application of hybrid communication and vMEC to enhance vehicle orientation within a toll station. Collectively, these contributions underscore the potential of hybrid vehicular communication to revolutionize road safety, traffic management, and the future of transportation.

Our first contribution involved a comprehensive assessment of IEEE 802.11p, IEEE 802.11bd, and LTE-V2X technologies in the context of road safety. We began by evaluating the performance of IEEE 802.11 technologies and LTE-V2X. Subsequently, we implemented a basic version of IEEE 802.11bd in OMNeT++/Artery and compared its performance, particularly in terms of Packet Reception Rate (PRR), with that of 802.11p and LTE-V2X (mode 3). Our findings indicated that LTE-V2X (mode 3) consistently exhibited superior reliability in delivering alert

messages when compared to IEEE 802.11-based technologies in most scenarios. These insights helped us measure how IEEE 802.11bd contributes to accident prevention on urban roads. Throughout our assessment, we considered estimated and neutral penetration rates to illustrate the impact of deployment constraints on accident prevention. In scenarios with aggressive deployment, we observed a significant 16.98% (IEEE 802.11bd) and 19.20% (LTE-V2X, mode 3) improvement in road safety over IEEE 802.11p. Conversely, under neutral penetration rates, both LTE-V2X and IEEE 802.11bd demonstrated a capacity to prevent more serious injuries simultaneously compared to IEEE 802.11p. The performance of one technology is tightly dependable on how widely and extensively it is adopted and utilized by the vehicle's manufacturers. A higher penetration rate generally results in better network coverage and reliability. Understanding this relationship is crucial when assessing the effectiveness and potential of a technology within a given context. However, in situations of low penetration rates, the adoption of a hybrid vehicular communication architecture presents a viable solution to address the issue of inadequate performance.

In our second contribution, we introduced a novel hybrid vehicular communication architecture complemented by a DRL-based RAT (Radio Access Technology) selection strategy. The primary objective of this architecture is twofold: firstly, to fulfill the demanding performance requirements of emerging V2X applications, and secondly, to exploit the synergies between vehicular communication technologies, specifically ITS-G5 and C-V2X. This approach is aimed at mitigating the limitations of each individual technology. We conducted a performance comparison of our selection algorithm against two other selection algorithms designed for hybrid architectures. Our assessment was carried out under two different congestion scenarios. The results obtained under low congestion levels clearly demonstrate the superiority of our DRL selection strategy over the alternative approaches. Furthermore, these results underscore the effective utilization of the redundant communication mode, leading to a reduction in redundant receptions. Notably, we also recognize the essential role of hybrid communication in meeting the stringent performance requirements of Day 2 and Day 3 applications, particularly in terms of reliability and throughput, even in the presence of high network congestion.

The third contribution was focused on a specific use case related to optimizing the orientation of vehicles approaching a toll station. Our investigation centered around the advantages of leveraging vMEC and hybrid vehicular communications to streamline vehicle orientation toward the optimal toll station gate. Hybrid communication in this experiment encompasses ITS-G5 and C-V2X UU. Based on our defined scenarios, it becomes evident that the vMEC approach and the distant server approach each have unique advantages and considerations. The vMEC approach stands out for its real-time and on-board processing capabilities, which minimize security and network-related concerns. Conversely, the distant server approach offers the advantage of

offloading computation tasks and potentially harnessing more powerful hardware resources. In our hybrid communication tests, we observed that cellular networks provide superior reliability and broader coverage, thus increasing the likelihood of receiving an IVIM (In-Vehicle Information Message). However, one potential drawback of utilizing this technology in this particular use case could be the less efficient utilization of radio resources within the cellular network due to the use of unicast transmissions.

6.1 Future works

The contributions presented in this thesis offer opportunities for expansion into several areas of inquiry. In the subsequent discussion, we enumerate some future directions of our contributions.

6.1.1 Road Safety Enhancement with 5G NR-V2X

The continued development and implementation of 5G NR-V2X technology presents exciting opportunities for further improving road safety. However, as 5G NR-V2X adopts a new numerology, future research can delve into developing mechanisms for the interoperability between 5G NR-V2X and existing vehicular communication technologies like IEEE 802.11p (ITS-G5) and LTE-V2X.

Furthermore, evaluating the hybrid vehicular communication framework by incorporating both NR-V2X and LTE-V2X as a combined communication mode represents a significant research avenue due to its complementary nature with LTE-V2X technology.

In conclusion, to augment the comprehensive road safety analysis presented in our first contribution, it would be of significant interest to compare the findings of our contributions with the prospective accident mitigation achievable through the deployment of 5G NR-V2X.

6.1.2 Hybrid Vehicular Communication Challenges

While hybrid vehicular communication architectures exhibit considerable potential, it is of paramount importance to address the challenges inherent in this paradigm. Future work can focus on developing standardized protocols and algorithms for seamless interoperability between different communication technologies within hybrid architectures. Additionally, exploring methods to effectively utilize both technologies and facilitate their coexistence within the same communication channel would greatly enhance the efficient use of available bandwidth.

For efficient radio resource management in a hybrid vehicular communication network, particularly when multiple technologies coexist within the same frequency band, ensuring

interoperability is imperative. Future research endeavors can delve into strategies for optimizing frequency band utilization by efficiently reallocating resources from one technology to another when not in use. This reallocation process is challenging when interoperability is hard to reach.

To evaluate the performance of a specific technology, we used the PRR and the SNIR metrics. However, these metrics can't be obtained before sending a message and are rather obtained and updated at the reception of any message. One enhancement that can be made to our architecture is to use unicast communications and have an acknowledgment that helps to measure the performance of a communication link. However, this solution is not possible with all V2X communication technologies.

6.1.3 Testing Hybrid Communication in Real-Life Scenarios

Extensive real-world testing is essential to validate the effectiveness of hybrid communication in diverse and dynamic vehicular environments. Future research efforts can involve large-scale field trials and simulations to assess how hybrid communication performs under various conditions, including high-density traffic, adverse weather, and urban and rural settings. These tests can provide valuable insights into the practical advantages and limitations of hybrid vehicular communication networks.

A crucial phase of these experiments involves evaluating the hybrid architecture in diverse environments, considering services with uncorrelated characteristics and varying levels of requirements.

Bibliography

- [1] “European Road Safety Observatory Road safety targets Monitoring report,” 2022. Accessed: Sep. 06, 2023. [Online]. Available: https://road-safety.transport.ec.europa.eu/system/files/2022-07/erso_road_safety_targets_monitoring_20220706.pdf
- [2] K. Zheng, Q. Zheng, P. Chatzimisios, W. Xiang and Y. Zhou, "Heterogeneous Vehicular Networking: A Survey on Architecture, Challenges, and Solutions," in *IEEE Communications Surveys & Tutorials*, vol. 17, no. 4, pp. 2377-2396, Fourth quarter 2015, doi: 10.1109/COMST.2015.2440103
- [3] Z. Ding and K. Leung, “Cross-layer routing using cooperative transmission in vehicular ad-hoc networks,” *IEEE J. Sel. Areas Communication.*, vol. 29, no. 3, pp. 571–581, Mar. 2011
- [4] “Roadmap for service implementation beyond initial deployment -Version 2021 Deliverable 7 of sub-activity 4.4 (Cooperative ITS Services Deployment Support),” 2021. Accessed: Sep. 08, 2023. [Online]. Available: <https://www.its-platform.eu/wp-content/uploads/ITS-Platform/AchievementsDocuments/IntegratingC-ITS/EU%20EIP-44-D7-C-ITS%20Roadmap-v1.0%20211223.pdf>
- [5] E. E. 3. 6. V1.1.1, "Intelligent Transport Systems (ITS); Communications Architecture," 2010-09
- [6] ETSI, "Intelligent Transport Systems (ITS); Vehicular Communications; GeoNetworking".
- [7] ETSI, "ETSI TS 102 636-6-1"
- [8] I. 29281, "Intelligent Transport Systems - Communications access for land mobiles (CALM) - Non-IP networking"
- [9] Intelligent Transport Systems (ITS); European profile standard for the physical and medium access control layer of Intelligent Transport Systems operating in the 5 GHz frequency band, ETSI. 2009
- [10] Federal Communications Commission. FCC 99-305. FCC Report and order. Tech rep. 1999.
- [11] IEEE 802.11-2012: "IEEE Standard for Information technology - Telecommunications and information exchange between systems - Local and metropolitan area networks-

- Specific requirements - Part 11: Wireless LAN Medium Access Control (MAC) and Physical Layer (PHY) Specifications"
- [12] A. Festag, "Cooperative intelligent transport systems standards in Europe," in *IEEE Communications Magazine*, vol. 52, no. 12, pp. 166-172, December 2014, doi: 10.1109/MCOM.2014.6979970
- [13] E. G. Strom, "On Medium Access and Physical Layer Standards for Cooperative Intelligent Transport Systems in Europe," in *Proceedings of the IEEE*, vol. 99, no. 7, pp. 1183-1188, July 2011, doi: 10.1109/JPROC.2011.2136310
- [14] H. Wen, P. -H. Ho and G. Gong, "A Novel Framework for Message Authentication in Vehicular Communication Networks," *GLOBECOM 2009 - 2009 IEEE Global Telecommunications Conference*, Honolulu, HI, USA, 2009, pp. 1-6, doi: 10.1109/GLOCOM.2009.5425519.
- [15] ETSI TS 102 687. (V1.2.1), " Intelligent Transport Systems (ITS); Access layer specification for Intelligent Transport Systems operating in the 5 GHz frequency band" ETSI TS 102 687 (V1.2.1)
- [16] H. L. V. a. T. S. M. I. Hassan, "Performance analysis of the IEEE 802.11 MAC protocol for DSRC safety applications," *IEEE Trans. Veh. Technol*, vol. vol 60, pp. 3882-3896, OCT 2011.
- [17] B. S. a. H. Zhang, "802.11 NGV proposed PAR," IEEE 802.11-18/0861r8, 09/2018
- [18] G. Naik, B. Choudhury, and J.-M. Park, "IEEE 802.11bd & 5G NR V2X: Evolution of Radio Access Technologies for V2X Communications," *IEEE Access*, vol. 7, pp. 70169–70184, 2019, doi: <https://doi.org/10.1109/access.2019.2919489>
- [19] ETSI. ETSI TS 102 724 V1.1.1 (2012-10) Intelligent Transport Systems (ITS); Harmonized Channel Specifications for Intelligent Transport Systems operating in the 5 GHz frequency band. 2012. url: https://www.etsi.org/deliver/etsi_ts/102700_102799/102724/01.01.01_60/ts_102724v010101p.pdf
- [20] "Intelligent Transport Systems (ITS); Decentralized Congestion Control Mechanisms for Intelligent Transport Systems operating in the 5 GHz range; Access layer part." Accessed: Sep. 14, 2023. [Online]. Available: https://www.etsi.org/deliver/etsi_ts/102600_102699/102687/01.02.01_60/ts_102687v010201p.pdf
- [21] 3GPP, "TS 36.300 Evolved Universal Terrestrial Radio Access (E-UTRA) and Evolved Universal Terrestrial Radio Access Network (E-UTRAN); Overall description; Stage 2 (v14.3.0, Release 14)," *Tech. Rep*, Jun 2017

- [22] 3GPP, "LTE; evolved Universal Terrestrial Radio Access (E-UTRA), Radio Resource Control (RRC), protocol specification," Tech. Rep. TS 36.331 V16.2.1 Release 16, November 2020
- [23] A. Bazzi, G. Cecchini, A. Zanella, and B. M. Masini, "Study of The Impact of PHY and MAC Parameters in 3GPP C-V2V Mode 4," *IEEE Access*, pp. 71685–71698, 2018
- [24] TS 36.300 Evolved Universal Terrestrial Radio Access (E-UTRA) 3GPP and Evolved Universal Terrestrial Radio Access Network (E-UTRAN); Overall description; Stage 2 (v14.3.0) Release 14) (Tech. Rep.) 2017-06
- [25] 3GPP TR 22.886 V16.1.1; Technical Specification Group Services and System Aspects; Study on enhancement of 3GPP Support for 5G V2X Services (Release 16). September 2018
- [26] F. Arena, G. Pau, and A. Severino, "A Review on IEEE 802.11p for Intelligent Transportation Systems," *Journal of Sensor and Actuator Networks*, vol. 9, no. 2, p. 22, Apr. 2020, doi: <https://doi.org/10.3390/jsan9020022>
- [27] A. Bazzi, B. M. Masini, A. Zanella and I. Thibault, "On the Performance of IEEE 802.11p and LTE-V2V for the Cooperative Awareness of Connected Vehicles," in *IEEE Transactions on Vehicular Technology*, vol. 66, no. 11, pp. 10419-10432, Nov. 2017, doi: 10.1109/TVT.2017.2750803
- [28] V. Mannoni, V. Berg, S. Sesia and E. Perraud, "A Comparison of the V2X Communication Systems: ITS-G5 and C-V2X," 2019 IEEE 89th Vehicular Technology Conference (VTC2019-Spring), Kuala Lumpur, Malaysia, 2019, pp. 1-5, doi: 10.1109/VTCSpring.2019.8746562
- [29] W. Anwar, A. Traßl, N. Franchi and G. Fettweis, "On the Reliability of NR-V2X and IEEE 802.11bd," 2019 IEEE 30th Annual International Symposium on Personal, Indoor and Mobile Radio Communications (PIMRC), Istanbul, Turkey, 2019, pp. 1-7, doi: 10.1109/PIMRC.2019.8904104
- [30] W. Anwar, N. Franchi and G. Fettweis, "Physical Layer Evaluation of V2X Communications Technologies: 5G NR-V2X, LTE-V2X, IEEE 802.11bd, and IEEE 802.11p," 2019 IEEE 90th Vehicular Technology Conference (VTC2019-Fall), Honolulu, HI, USA, 2019, pp. 1-7, doi: 10.1109/VTCFall.2019.8891313
- [31] G. Naik, B. Choudhury and J. -M. Park, "IEEE 802.11bd & 5G NR V2X: Evolution of Radio Access Technologies for V2X Communications," in *IEEE Access*, vol. 7, pp. 70169-70184, 2019, doi: 10.1109/ACCESS.2019.2919489
- [32] R. Molina-Masegosa and J. Gozalvez, "LTE-V for sidelink 5G V2X vehicular communications: A new 5G technology for short-range vehicle to everything communications," *IEEE Veh. Technol. Mag.*, vol. 12, no. 4, pp. 30-39, Dec. 2017

- [33] K. A. Hafeez, L. Zhao, B. Ma, and J.W. Mark, "Performance analysis and enhancement of the DSRC for VANET's safety applications," *IEEE Trans. Veh. Technol.*, vol. 62, no. 7, pp. 3069-3083, Sep. 2013
- [34] 5GAA, "V2X Technology Benchmark Testing." <https://www.fcc.gov/ecfs/filing/109271050222769>, Sept. 2018
- [35] R. Molina-Masegosa and J. Gozalvez, "LTE-V for Sidelink 5G V2X Vehicular Communications: A New 5G Technology for Short-Range Vehicle-to-Everything Communications," *IEEE Vehicular Technology Magazine*, vol. 12, no. 4, pp. 30–39, 2017
- [36] 3GPP, "3GPP TR 22.886: Study on enhancement of 3GPP Support for 5G V2X Services (v16.2.0, Release 16)," Dec. 2018
- [37] G. Cecchini, A. Bazzi, B. M. Masini and A. Zanella, "Performance comparison between IEEE 802.11p and LTE-V2V in-coverage and out-of-coverage for cooperative awareness," 2017 IEEE Vehicular Networking Conference (VNC), Turin, Italy, 2017, pp. 109-114, doi: 10.1109/VNC.2017.8275637
- [38] B. Lonc and P. Cincilla, "Cooperative ITS security framework: Standards and implementations progress in Europe," 2016 IEEE 17th International Symposium on A World of Wireless, Mobile and Multimedia Networks (WoWMoM), 2016, pp. 1-6, DOI: 10.1109/WoWMoM.2016.7523576
- [39] A. K. Gulia, A Simulation Study on the Performance Comparison of the V2X Communication Systems: ITS-G5 and C-V2X. 2020. Accessed: Sep. 26, 2023. [Online]. Available: <http://urn.kb.se/resolve?urn=urn:nbn:se:kth:diva-271882>
- [40] V. Vukadinovic, K. Bakowski, P. Marsch, I. D. Garcia, H. Xu, M. Sybis, P. Sroka, K. Wesolowski, D. Lister, and I. Thibault, "3GPP C-V2X and IEEE 802.11 p for Vehicle-to-Vehicle communications in highway platooning scenarios," *Ad Hoc Networks*, vol. 74, pp. 17–29, 2018
- [41] X. Wang, S. Mao, M. X. Gong, "An overview of 3GPP cellular vehicle-to-everything standards", *GetMobile: Mobile Computing and Communications*, 21(3), pp. 19–25, 2017, doi:10.1145/3161587.3161593
- [42] A. Filippi, K. Moerman, V. Martinez, and A. Turley. (2017). White Paper: IEEE802.11p Ahead of LTE-V2V for Safety Applications. [Online]. Available: <https://www.nxp.com/docs/en/white-paper/ROADLINKTECH-WP.pdf>
- [43] B. Sadeghi, B. Sun, "11bd TG Use Cases," *IEEE 802.11-19-1342/r1*, 2019-07-18
- [44] A. Costandoiu, M. Leba, "Convergence of V2X communication systems and next generation networks," *IOP Conference Series: Materials Science and Engineering*, vol. 477, p. 012052, Feb. 2019, doi: <https://doi.org/10.1088/1757-899x/477/1/012052>

- [45] "Intelligent Transport Systems (ITS); Pre-standardization study on co-channel co-existence between IEEE-and 3GPP-based ITS technologies in the 5 855 MHz -5 925 MHz frequency band." Available: https://www.etsi.org/deliver/etsi_tr/103700_103799/103766/01.01.01_60/tr_103766v010101p.pdf
- [46] R. Jacob, N. Franchi, and G. Fettweis, "Hybrid V2X Communications: Multi-RAT as Enabler for Connected Autonomous Driving," 2018 IEEE 29th Annual International Symposium on Personal, Indoor and Mobile Radio Communications (PIMRC), 2018, pp. 1370-1376, DOI: 10.1109/PIMRC.2018.8580953
- [47] K. Abboud, H. A. Omar and W. Zhuang, "Interworking of DSRC and Cellular Network Technologies for V2X Communications: A Survey," in IEEE Transactions on Vehicular Technology, vol. 65, no. 12, pp. 9457-9470, Dec. 2016, DOI: 10.1109/TVT.2016.2591558
- [48] B. Abidi, F. M. Moreno, M. E. Haziti, A. Hussein, A. A. Kaff and D. M. Gomez, "Hybrid V2X Communication Approach using Wi-Fi and 4G Connections," 2018 IEEE International Conference on Vehicular Electronics and Safety (ICVES), Madrid, Spain, 2018, pp. 1-5, doi: 10.1109/ICVES.2018.8519489
- [49] A. Zekri and W. Jia, "Heterogeneous vehicular communications: A comprehensive study," Ad Hoc Networks, vol. 75–76, pp. 52–79, Jun. 2018, doi: <https://doi.org/10.1016/j.adhoc.2018.03.010>
- [50] Z. H. Mir, J. Toutouh, F. Filali and Y. -B. Ko, "Enabling DSRC and C-V2X Integrated Hybrid Vehicular Networks: Architecture and Protocol," in IEEE Access, vol. 8, pp. 180909-180927, 2020, DOI: 10.1109/ACCESS.2020.3027074
- [51] R. Jacob, W. Anwar, G. Fettweis, and J. Pohlmann, "Exploiting multi-RAT diversity in vehicular ad-hoc networks to improve reliability of cooperative automated driving applications," in Proc. IEEE 90th Veh. Technol. Conf. (VTC-Fall), Sep. 2019, pp. 1–7
- [52] M. A. Altahrawi, N. F. Abdullah, R. Nordin and M. Ismail, "Multi-Radio Access Software-Defined Vehicular Network," in IEEE Transactions on Intelligent Transportation Systems, vol. 23, no. 8, pp. 10030-10048, Aug. 2022, doi: 10.1109/TITS.2021.3115155
- [53] A. De La Oliva, A. Banchs, I. Soto, T. Melia and A. Vidal, "An overview of IEEE 802.21: media-independent handover services," in IEEE Wireless Communications, vol. 15, no. 4, pp. 96-103, Aug. 2008, doi: 10.1109/MWC.2008.4599227
- [54] R. Trestian, O. Ormond, and G.-M. Muntean, "Performance evaluation of MADM-based methods for network selection in a multimedia wireless environment," Wireless

- Networks, vol. 21, no. 5, pp. 1745–1763, Dec. 2014, doi: <https://doi.org/10.1007/s11276-014-0882-z>
- [55] R. M. Abdullah, A. Z. Abualkishik, and A. A. Alwan, “Improved Handover Decision Algorithm Using Multiple Criteria,” *Procedia Computer Science*, vol. 141, pp. 32–39, 2018, doi: <https://doi.org/10.1016/j.procs.2018.10.146>
- [56] M. Karoui, A. M. Mamadou and G. Chalhoub, "A Novel Distributed Context-Aware Radio Access Technology Selection Scheme For C-ITS Networks," 2022 International Wireless Communications and Mobile Computing (IWCMC), 2022, pp. 725-730, DOI: 10.1109/IWCMC55113.2022.9824955
- [57] A. S. Sadiq, K. A. Bakar, K. Z. Ghafoor, J. Lloret, and R. Khokhar, “An Intelligent Vertical Handover Scheme for Audio and Video Streaming in Heterogeneous Vehicular Networks,” *Mobile Networks and Applications*, vol. 18, no. 6, pp. 879–895, Oct. 2013, doi: <https://doi.org/10.1007/s11036-013-0465-8>
- [58] X. Wu and Q. Du, “Utility-function-based radio-access-technology selection for heterogeneous wireless networks,” *Computers & Electrical Engineering*, vol. 52, pp. 171–182, May 2016, doi: <https://doi.org/10.1016/j.compeleceng.2015.06.010>
- [59] S. Gopinath, L. Wischhof, C. Ponikvar and H. -J. Hof, "Hybrid solutions for data dissemination in vehicular networks," 2016 Wireless Days (WD), Toulouse, France, 2016, pp. 1-4, doi: 10.1109/WD.2016.7461519
- [60] N. M. Alotaibi and S. S. Alwakeel, "A Neural Network Based Handover Management Strategy for Heterogeneous Networks," 2015 IEEE 14th International Conference on Machine Learning and Applications (ICMLA), Miami, FL, USA, 2015, pp. 1210-1214, doi: 10.1109/ICMLA.2015.65
- [61] S. Kunarak, R. Sulesathira. “Vertical handover decision management on the basis of several criteria for LVQNN with ubiquitous wireless networks”. In: *International Journal of GEOMATE* 12.34 (2017), p. 123
- [62] D. Zhao, H. Qin, B. Song, Y. Zhang, X. Du, and M. Guizani, "A Reinforcement Learning Method for Joint Mode Selection and Power Adaptation in the V2V Communication Network in 5G," in *IEEE Transactions on Cognitive Communications and Networking*, vol. 6, no. 2, pp. 452-463, June 2020, DOI: 10.1109/TCCN.2020.2983170
- [63] V. Mannoni, V. Berg, S. Sesia, E. Perraud, and V. Mannoni, “A Comparison of the V2X Communication Systems: ITS-G5 and C-V2X A Comparison of the V2X Communication Systems: ITS-G5 and C-V2X,” 2019
- [64] Z. Du, B. Jiang, Q. Wu, Y. Xu, and K. Xu, “Learning the Optimal Network with Context Awareness: Transfer RL Based Network Selection,” *Springer eBooks*, pp. 65–78, Nov. 2019, doi: https://doi.org/10.1007/978-981-15-1120-2_5

- [65] P. Naghavi, S. H. Rastegar, V. Shah-Mansouri, and H. Kebriaei, "Learning RAT Selection Game in 5G Heterogeneous Networks," *IEEE Wireless Communications Letters*, vol. 5, no. 1, pp. 52–55, Feb. 2016, doi: <https://doi.org/10.1109/LWC.2015.2495123>
- [66] S. Goudarzi et al., "ABC-PSO for vertical handover in heterogeneous wireless networks," *Neurocomputing*, vol. 256, pp. 63–81, Sep. 2017, doi: <https://doi.org/10.1016/j.neucom.2016.08.136>
- [67] I. El Fachtali, R. Saadane, and M. ElKoutbi, "Vertical Handover Decision Algorithm Using Ants' Colonies for 4G Heterogeneous Wireless Networks," *Journal of Computer Networks and Communications*, vol. 2016, pp. 1–15, 2016, doi: <https://doi.org/10.1155/2016/6259802>
- [68] S. Khabaz, "Radio Resource Allocation in C-V2X: From LTE-V2X to 5G -V2X Sehla Khabaz. Radio Resource Allocation in C-V2X: From LTE-V2X to 5G -V2X. Networking and." Accessed: Sep. 17, 2023
- [69] I. Corporation, "Resource allocation schemes for NR V2X Communications, 3GPP TSG RAN WG1 Meeting 96 Document R1-1902484," tech. rep., February 25th - March 1st, 2019, Athens, Greece
- [70] R. Riebl, H.-J. Günther, C. Facchi, and L. Wolf, "Artery: Extending Veins for VANET applications," *IEEE Xplore*, Jun. 01, 2015. <https://ieeexplore.ieee.org/abstract/document/7223293> (accessed Apr. 06, 2023)
- [71] R. Liao, B. Bellalta, J. Barcelo, V. Valls, and M. Oliver, "Performance analysis of IEEE 802.11ac wireless backhaul networks in saturated conditions," *EURASIP Journal on Wireless Communications and Networking*, vol. 2013, no. 1, Sep. 2013, doi: <https://doi.org/10.1186/1687-1499-2013-226>
- [72] P. Sharama, R. Cao, H. Zhang, "LDPC Investigation for 11bd," Marvell, 2019-03-14
- [73] 5GAA, "An assessment of LTE-V2X (PC5) and 802.11p direct communications technologies for improved road safety in the EU," 5GAA Automotive Association, 5 December 2017
- [74] K. Moerman, "Next generation vehicular networks IEEE 80211bd". NXP, 6 March 2019 (2019).
- [75] "CARE database," road-safety.transport.ec.europa.eu. https://road-safety.transport.ec.europa.eu/statistics-and-analysis/methodology-and-research/care-database_en (accessed Sep. 20, 2023)
- [76] Visiongain, "Automotive Vehicle to Everything (V2X) Communications Market 2016-2026," 2016

- [77] TNO, "Drive C2X - Impact Assessment and User Perception of Cooperative Systems.," 2014
- [78] European Commission, "Road Safety: Encouraging results in 2016 call for continued efforts to save lives on EU roads," *Press release*, 2017
- [79] "Intelligent Transport Systems (ITS); Pre-standardization study on co-channel co-existence between IEEE-and 3GPP-based ITS technologies in the 5 855 MHz -5 925 MHz frequency band." Accessed: Jun. 19, 2023. [Online]. Available: https://www.etsi.org/deliver/etsi_tr/103700_103799/103766/01.01.01_60/tr_103766v01_0101p.pdf
- [80] C. Berrou, A. Glavieux and P. Thitimajshima, "Near Shannon limit error-correcting coding and decoding: Turbo-codes. 1," Proceedings of ICC '93 - IEEE International Conference on Communications, 1993, pp. 1064-1070 vol.2, DOI: 10.1109/ICC.1993.397441.
- [81] R. S. Sutton and A. Barto, Reinforcement learning: an introduction. Cambridge, Ma; Lodon: The Mit Press, 2018
- [82] A. Viridis, G. Stea, and G. Nardini, "SimuLTE - A modular system-level simulator for LTE/LTE-A networks based on OMNeT++," IEEE Xplore, Aug. 01, 2014. <https://ieeexplore.ieee.org/abstract/document/7095000> (accessed May 06, 2023)
- [83] P. Kavathekar and Y. Chen, "Vehicle Platooning: A Brief Survey and Categorization," Volume 3: 2011 ASME/IEEE International Conference on Mechatronic and Embedded Systems and Applications, Parts A and B, Jan. 2011, doi: <https://doi.org/10.1115/detc2011-47861>
- [84] Z. Hameed Mir and F. Filali, "LTE and IEEE 802.11p for vehicular networking: a performance evaluation," EURASIP Journal on Wireless Communications and Networking, vol. 2014, no. 1, May 2014, doi: <https://doi.org/10.1186/1687-1499-2014-89>
- [85] M. Boban, J. Barros, and O. K. Tonguz, "Geometry-Based Vehicle-to-Vehicle Channel Modeling for Large-Scale Simulation," IEEE Transactions on Vehicular Technology, vol. 63, no. 9, pp. 4146–4164, Nov. 2014, doi: <https://doi.org/10.1109/tvt.2014.2317803>
- [86] X. Shen, J. Li, L. X. Chen, J. Chen, and S. He, "Heterogeneous LTE/DSRC Approach to Support Real-time Vehicular Communications," Aug. 2018, doi: 10.1109/icait.2018.8686612
- [87] A. Altahrawi, N. F. Abdullah, R. Nordin and M. Ismail, "Multi-Radio Access Software-Defined Vehicular Network," in IEEE Transactions on Intelligent Transportation Systems, vol. 23, no. 8, pp. 10030-10048, Aug. 2022, doi: 10.1109/TITS.2021.3115155

- [88] ETSI, "Intelligent Transport Systems (ITS); Pre-Standardization Study on payment applications in Cooperative ITS using V2I communication." Accessed: Jul. 19, 2023. [Online]. Available: https://www.etsi.org/deliver/etsi_tr/103500_103599/103579/01.01.01_60/tr_103579v010101p.pdf
- [89] N. Michou, I. Panagiotopoulos and G. Dimitrakopoulos, "Electronic Toll Management Payment Scheme based on Vehicular Ad-hoc Networks and Cardano's Blockchain Platform," 2022 MTTW, Riga, Latvia, 2022, pp. 150-154, doi: 10.1109/MTTW56973.2022.9942659S
- [90] K. Rajput et al., "Automatic Vehicle Identification and Classification Model Using the YOLOv3 Algorithm for a Toll Management System," Sustainability, vol. 14, no. 15, p. 9163, Jan. 2022, doi: <https://doi.org/10.3390/su14159163>
- [91] Wang, C.-Y., Bochkovski, A. and Liao, H.-Y.M. (2023) 'Yolov7: Trainable bag-of-freebies sets new state-of-the-art for real-time object detectors', 2023 IEEE/CVF Conference on Computer Vision and Pattern Recognition (CVPR) [Preprint]. doi:10.1109/cvpr52729.2023.00721
- [92] B. Y. Yacheur, T. Ahmed, and M. Mosbah, "Analysis and Comparison of IEEE 802.11p and IEEE 802.11bd," Lecture Notes in Computer Science, pp. 55–65, 2020, doi: https://doi.org/10.1007/978-3-030-66030-7_5
- [93] B. Y. Yacheur, T. Ahmed and M. Mosbah, "Implementation and Assessment of IEEE 802.11BD for Improved Road Safety," 2021 IEEE 18th Annual Consumer Communications & Networking Conference (CCNC), Las Vegas, NV, USA, 2021, pp. 1-6, doi: 10.1109/CCNC49032.2021.9369649
- [94] B. Y. Yacheur, T. Ahmed and M. Mosbah, "DRL-Based RAT Selection in a Hybrid Vehicular Communication Network," 2023 IEEE 97th Vehicular Technology Conference (VTC2023-Spring), Florence, Italy, 2023, pp. 1-5, doi: 10.1109/VTC2023-Spring57618.2023.10199400
- [95] B. Y. Yacheur, T. Ahmed and M. Mosbah, "Throughput Enhancement in Hybrid Vehicular Networks Using Deep Reinforcement Learning," 2023 IEEE Symposium on Computers and Communications (ISCC), Gammarth, Tunisia, 2023, pp. 938-943, doi: 10.1109/ISCC58397.2023.10218018
- [96] B. Y. Yacheur, T. Ahmed and M. Mosbah, "Efficient DRL-Based Selection Strategy in Hybrid Vehicular Networks," in *IEEE Transactions on Network and Service Management*, vol. 20, no. 3, pp. 2400-2411, Sept. 2023, doi: 10.1109/TNSM.2023.3300653