



HAL
open science

Influence of the ethylene on the grape berry development and related-gene expression

Arak Tira-Umphon

► **To cite this version:**

Arak Tira-Umphon. Influence of the ethylene on the grape berry development and related-gene expression. Vegetal Biology. Institut National Polytechnique (Toulouse), 2008. English. NNT : 2008INPT002A . tel-04529577

HAL Id: tel-04529577

<https://hal.science/tel-04529577>

Submitted on 2 Apr 2024

HAL is a multi-disciplinary open access archive for the deposit and dissemination of scientific research documents, whether they are published or not. The documents may come from teaching and research institutions in France or abroad, or from public or private research centers.

L'archive ouverte pluridisciplinaire **HAL**, est destinée au dépôt et à la diffusion de documents scientifiques de niveau recherche, publiés ou non, émanant des établissements d'enseignement et de recherche français ou étrangers, des laboratoires publics ou privés.

N° d'ordre : 2598

Thèse

présentée

pour obtenir

LE TITRE DE DOCTEUR DE L'INSTITUT NATIONAL POLYTECHNIQUE DE TOULOUSE

École doctorale : **BIOLOGIE-SANTE- BIOTECHNOLOGIES**

Spécialité : **BIOSCIENCES VEGETALES**

Par **M. Arak TIRA-UMPHON**

**INFLUENCE DE L'ETHYLENE SUR LE DEVELOPPEMENT DES
BAIES DE RAISIN ET EXPESSION DES GENES APPARENTES**

**INFLUENCE OF THE ETHYLENE ON THE GRAPE BERRY
DEVELOPMENT AND RELATED-GENE EXPRESSION**

Soutenue le **11 Mars 2008** devant le jury composé de :

M. Mondher BOUZAYEN	Président
M. Christian CHERVIN	Directeur de thèse
Mme Catherine TESNIERE	Rapporteur
M. Jean-Michel MERILLON	Rapporteur

Acknowledgments

I would like, here, to thank all people who helped me during of this study:

I thank the French and the Thai governments for my study grants.

I wish to thank my three supervisors: Prof. Jean-Paul Roustan, Prof. Christian Chervin and Dr. Nancy Terrier, who welcomed me, and contributed to my formation.

My acknowledgments to Profs. Mondher Bouzayen, Jean-Claude Pech and Dr. Alain Latché that received me in their laboratory and advised me.

I also thank Dr. Philippe Chatelet of UMR BEPC of the ENSAM-INRA and Dr. Alain Jauneau of the pole of Plant Biotechnology of Toulouse (IFR40) that permitted me to use the techniques of biolistic and microscopy, respectively.

My thanks also go to all my colleagues of the laboratory of Génomique et Biotechnologie des Fruits for their support and their good mood.

I would like to thank my family (my wife's Mrs TIRA –UMPHON Wandee, and our children Yada and Wasaphon) in particular for their patience, their support and their love.

Thesis publication releases:

Tira-umphon A, Roustan JP, Chervin C (2007) The stimulation by ethylene of the UDP glucose-flavonoid 3-O-glucosyltransferase (UFGT) in grape tissues is independent from the MybA transcription factors. *Vitis* 46(4): 210-211.

Chervin C, **Tira-umphon A**, El-Kereamy A, Roustan JP, Lamon J, Latche A, Kanellis A., Bouzayen M (2005) Ethylene is required for the ripening of grape. *Acta Horticulturae* (689): 251-256.

Chervin C, **Tira-umphon A**, Terrier N, Zouine M, Severac D, Roustan JP (2008) Stimulation of the grape berry expansion by ethylene and effects on related gene transcripts, over the ripening phase. In preparation.

Posters:

Tira-umphon A, Chervin C, Terrier N, Roustan JP. The ethylene effect on the berry diameter and related gene expression in grape. *In* Europe-Asia symposium on Quality Management in Postharvest Systems 3rd – 6th December 2007, Bangkok, Thailand.

Tira-umphon A, Chervin C, Boss PK, Chatelet P, Jauneau A, Tesniere C, El-Kereamy A, Torregrosa L, Thomas MR, Roustan JP, Bouzayen M. Roles for ethylene in the expression of the UDP glucose-flavonoid 3-O-glucosyltransferase in grape tissues. *In* XIII^{ème} Forum des Jeunes Chercheurs 5th – 8th September 2006, Clermont-Ferrand, France.

Table of Contents

ACKNOWLEDGMENTS	1
THESIS PUBLICATION RELEASES:.....	2
TABLE OF CONTENTS	3
ABBREVIATION	6
RESUME	7
ABSTRACT.....	8
GENERAL INTRODUCTION AND THESIS OBJECTIVES	9
BIBLIOGRAPHIC REVIEW.....	11
1 – Fruit maturation	11
1.1 - Climacteric and non-climacteric ripening.....	11
1.2 - Common genetic regulatory mechanisms.....	11
1.3 - Ripening of fleshy fruits	12
2 - Berry development in grape.....	12
3 - Maturation- related genes and biochemical changes	13
3.1 - Berry expansion and softening.....	13
3.1.1 - Xyloglucan endotransglycosylase (<i>XET</i>)	15
3.1.2 - Polygalacturonase (<i>PG</i>)	15
3.1.3 - Pectin methylesterase (<i>PME</i>).....	16
3.1.4 - Cellulose synthase (<i>CS</i>).....	17
3.1.5 - Expansins (<i>EX</i>).....	19
3.1.6 - Aquaporin (<i>AQUA</i>).....	19
3.2 - Ethylene and fruit maturation.....	21
3.2.1 - Ethylene and plant physiology	21
3.2.2 - Ethylene and non- climacteric fruit.....	22
3.3 - The anthocyanin biosynthesis and related genes: <i>UFGT</i> and <i>Myb</i>	23
3.3.1 - Anthocyanins in grape berry	23
3.3.2 - Anthocyanins and the ethylene effect	25
4 - Microarray technique, case studies in grape and non-climacteric fruits.....	26
4.1 - Expressed sequence tags: tools for gene discovery and expression analysis	26
4.2 - Gene expression profiling	28
4.3 - Microarray types.....	29
4.4 - Microarray technology in grape and the other non climacteric fruits	31

MATERIALS AND METHODS	33
1 - Plant material.....	33
1.1 - Grapevines	33
1.2 - Grapevine cell cultures	33
2 - Treatment of grapevines with 1-MCP and ethylene.....	33
2.1 - Treatment of cluster grapevine with 1-MCP	33
2.2 - Treatment of grapevine clusters with ethylene	34
2.3 - Diameter and deformability measurement of berries after ethylene treatment	35
3 - Biolistic experiment	35
4 - RNA extractions and Northern blots	36
5 - Protein extractions and Western blots	37
6 - <i>ufgt</i> promoter cloning, plasmid construction and expression of pVvufgt::gfp in <i>planta</i>	37
7 - RNA extraction for microarray and qRT-PCR	38
8 - qPCR experiments	39
9 - Microarrays experiments.....	40
10 - Statistical analyses and similarity search	41
CHAPTER I: ROLES FOR ETHYLENE IN THE EXPRESSION OF THE UDP GLUCOSE-FLAVONOID 3-O-GLUCOSYLTRANSFERASE IN GRAPE TISSUES ...	42
1. Introduction.....	42
2. Results and Discussion	43
2-1 The color development and related characteristics of Cabernet Sauvignon berries.....	43
2-2 MCP application can reduce <i>ufgt</i> mRNA levels.....	43
2-3 A 1647 bp region upstream of the <i>ufgt</i> coding region directs reporter gene expression to berry skins post-véraison	48
2-4 The grapevine <i>ufgt</i> promoter.....	50
2-5 Does the ethylene signal stimulate mybA gene expression in grape tissues?	55
3. Conclusion	58
CHAPTER II: EFFECT OF ETHYLENE ON THE GENES EXPRESSED DURING THE BERRY DEVELOPMENT: THE CLASSIFICATION OF GENES WHICH ARE EXPRESSED ON BERRY DEVELOPMENT AT VÉRAISON	59
1- Introduction	59
2. Results.....	59
2.1- Genes for which expression is modulated by ethylene 24h after treatment.....	59
2.2- Genes for which expression is modulated by ethylene 1h after treatment in berries at two development stages: prévéraison (hard berry) and véraison (soft berry).....	65
3 -Discussion	91

CHAPTER III: EFFECT OF ETHYLENE ON THE EXPRESSION OF GENES RELATED TO CELL EXPANSION	94
1- Introduction	94
2 - Results	94
2.1- Influence of ethylene on grape berry development	94
2.2- Genes involved in expanding and softening of grape berries and whose expression is modulated by ethylene	96
2.3 - Time course evolution of the expression of <i>XET</i> , <i>PG</i> , <i>PME</i> , <i>CS</i> , <i>EX</i> , <i>AQUA</i> genes during the grape berry growth	96
2.4 - Effect of ethylene on the expression of <i>XET</i> , <i>PG</i> , <i>PME</i> , <i>CS</i> , <i>EX</i> and <i>AQUA</i> genes in pulp, skin and seeds tissues of grape berry	99
3 - Discussion	104
GENERAL CONCLUSIONS.....	106
PERSPECTIVES	108
BIBLIOGRAPHIC REFERENCES	109
ANNEX.....	126

Abbreviation

ABRE	abscisic acid responsive element (cis-element in a promoter)
ANOVA	analysis of variance
AQUA	aquaporin
BLAST	basic local alignment search tool
2-CEPA	2-chloroethylphosphonicacid
CS	cellulose synthase
EF1-a	elongation factor 1-a
ERE	ethylene responsive element (cis-element in a promoter)
EST	expressed sequence tag
EX	expansin
LRE	light responsive element (cis-element in a promoter)
1-MCP	1-methylcyclopropene
MIP	major integral protein (aquaporin)
NCBI	National Center for Biotechnology Information
PG	polygalacturonase
PIP	plasma membrane intrinsic protein (aquaporin)
PME	pectin methylesterase
RT-PCR	real time PCR
SGN	the Solanaceae Genomics Network
SIGnAL	the Salk Institute Genomic Analysis Laboratory
SURE	sugar responsive element (cis-element in a promoter)
TAI	transcript accumulation index
TAIR	The Arabidopsis Information Resource
TC	tentative contig
TIP	tonoplast intrinsic protein (aquaporin)
UFGT	UDP glucose-flavonoid 3-O-glucosyltransferase
XET	xyloglucan endotransglycosylase

Influence de l'éthylène sur le développement des baies de raisin et expression des gènes apparentés

Résumé

Le raisin est considéré comme un fruit non climactérique dont la maturation ne nécessite pas l'utilisation de l'éthylène. Cependant, les travaux antérieurs ont montré que l'éthylène était capable d'influencer les processus physiologiques pendant maturation de baies du raisin mais d'autres fonctions apparentées et d'autres gènes restent encore à découvrir. Un des effets de l'éthylène est principalement l'augmentation d'accumulation des anthocyanes, les pigments de baies du raisin rouges. Nous avons choisi de travailler avec le cépage Cabernet Sauvignon. Dans la première partie de cette étude, il est confirmé que cette accumulation est en relation avec une accumulation de l'UDP glucose-flavonoid 3-O-glucosyltransferase (UFGT), l'enzyme clé dans la biosynthèse et dans la stabilité d'anthocyanins. Cette étude a montré qu'un inhibiteur spécifique de récepteurs de l'éthylène (1-méthylcyclopropène) inhibe l'accumulation du mRNA de *ufgt* dans les baies du raisin. Une région du promoteur de *ufgt* a été clonée et il a été trouvé sept *cis*-éléments éthylène-dépendants. D'autres *cis*-éléments apparentés à trois signaux majeurs (lumière, sucre, et acide absicique) connus pour stimuler l'accumulation des anthocyanes chez les plantes, ont été trouvés dans le promoteur de *ufgt*. De plus, cette étude a montré la stimulation d'expression de *ufgt* par l'éthylène n'est pas dépendant de MybA, des régulateurs clé de la transcription de *ufgt*.

Des expériences ont alors été conçues alors pour étudier l'ensemble des gènes affecté par éthylène au commencement de la maturation de la baie de raisin. Les résultats ont montré que seuls 80 des 15,135 gènes des lames de microarray ont été significativement modulés par un traitement de 24 heures par l'éthylène (4 $\mu\text{l.l}^{-1}$), 8 semaines après avoir fleuri. Parmi ces 80 gènes, quelques uns ont aussi montré une induction rapide dans une expérience préliminaire avec traitement à l'éthylène d'une heure seulement. Dans la dernière partie de ce travail, l'étude s'est concentrée sur la variation d'accumulation de plusieurs mRNAs affectée par l'éthylène au début de la maturation. En particulier par rapport au diamètre de la baie, qui un des caractères importants dans la production du raisin. Son augmentation pendant la phase de la maturation est principalement due à l'import de sève élaborée et à des modifications de la paroi des cellules, ce qui permet un allongement cellulaire. Nous avons observé que l'application de l'éthylène à la véraison a entraîné une augmentation de la dimension des baies. Cela était corrélé avec les changements dans l'expression de plusieurs gènes, classés deux groupes: i) gènes de « circulation de l'eau »: plusieurs aquaporines (*AQUA*), et ii) gènes de structure de la "paroi cellulaire": polygalacturonases (*PG*), xyloglucan endotransglycosylases (*XET*), pectine méthylesterase (*PME*), cellulose synthase (*CS*) et expansines (*EX*). Leurs profils d'expression ont été suivis au cours du développement de la baie, ou dans trois tissus de la baie (pellicule, pulpe et pépin) au début de la véraison. L'éthylène stimule l'accumulation de la plupart de leurs transcrits en une heure, voire 24 heures. Ce travail de doctorat apporte de nouveaux éléments au sujet de la participation d'éthylène dans le développement et de la maturation de baies du raisin.

Mots-clé: UDP Glucose-flavonoid 3-O-glucosyltransferase (*UFGT*), raisin, anthocyanes, éthylène, récepteurs de l'éthylène, *mybA*, polygalacturonase (*PG*), xyloglucan endotransglycosylase (*XET*), pectin méthylesterase (*PME*), cellulose synthase (*CS*), expansine (*EX*), aquaporine (*AQU*), microarray, dimension de la baie, expansion et ramollissement de la baie

Influence of the ethylene on the grape berry development and related-gene expression

Abstract

Grape is considered as a non climacteric fruit which maturation is independent of the ethylene. However, previous works had shown that the ethylene was capable to affect the physiological processes during maturation of grape berries but many related functions and genes remain to discover. One of the main ethylene effect was the increase of anthocyanin accumulation, the pigments of red grape berries. We chose to work with the cv Cabernet Sauvignon. In the first part of this study, it was showed to be related to the accumulation of the UDP glucose-flavonoid 3-O-glucosyltransferase (UFGT) that it is a key enzyme in the biosynthesis and stability of anthocyanins. This study has shown that a specific inhibitor of ethylene receptors (1-methylcyclopropene) inhibits *ufgt* mRNA accumulation in grape berries. A promoter region of *ufgt* was cloned and found to possess seven putative ethylene-responsive *cis*-elements. Other *cis*-elements related to three major signals (light, sugar, and abscisic acid) known to induce anthocyanin accumulation in plant tissues were found in the *ufgt* promoter. Moreover, this study showed the stimulation of *ufgt* expression by ethylene signals is not mediated by MybA, key regulators of the *ufgt* transcription.

Experiments were then designed to screen the gene pool affected by ethylene at the inception of grape berry ripening. The results showed that 80 out of 15,135 genes of micro array slides were significantly modulated by a 24 hour ethylene treatment ($4 \mu\text{l.l}^{-1}$), performed 8 weeks after flowering. Some of these 80 genes were also showed to be rapidly induced by ethylene in a preliminary experiment (one hour ethylene treatment). In the last part of this work, the study focused on the variation of accumulation of several mRNAs affected by ethylene at the inception of ripening. In particular in relation to the berry size, that it is one of the important characters in the grape production. Its increase over the ripening phase is mainly due to water intake and modifications of cell wall, enabling cell elongation. We observed that the ethylene application at véraison led to an increase of the berry size. This was related to changes in the expression pattern of many genes, classified two groups: i) "water circulation" genes: various aquaporins (*AQUA*), and ii) "cell wall structure" genes: polygalacturonases (*PG*), xyloglucan endotransglycosylases (*XET*), pectin methylesterase (*PME*), cellulose synthase (*CS*) and expansins (*EX*). The expression patterns were followed either along berry development, or in three berry tissues (peel, pulp and seeds). The ethylene stimulates the accumulation of most of these gene transcripts in one hour; an in several parts of the berry, this stimulation may last for 24 hours in some cases. This thesis work brings more clues about the involvement of ethylene in the development and maturation of grape berries.

33ywords: UDP glucose-flavonoid 3-O-glucosyltransferase (*UFGT*), grape, anthocyanins, ethylene, ethylene receptors, *mybA*, polygalacturonase (*PG*), pectin methylesterase (*PME*), xyloglucan endotransglycosylase (*XET*), cellulose synthase (*CS*), expansin (*EX*), aquaporin (*AQU*), microarray, berry size, berry expansion and softening

❖ GENERAL INTRODUCTION AND THESIS OBJECTIVES

General introduction and thesis objectives

Grape (*Vitis vinifera* L.) is one of the most economically important fruit crops in the world, has been classified as non-climacteric (Coombe and Hale 1973), but evidence suggests that climacteric and non-climacteric fruit may in fact share similar pathways of ripening (White 2002). And recent studies have shown that grape berry tissues have a fully functional pathway for ethylene synthesis, and that this pathway is activated just before veraison (Chervin *et al.* 2004), when berries start to accumulate sugars and, in red cultivars, accumulate anthocyanins. Furthermore this study showed that ethylene perception is critical for some berry changes associated with ripening, including anthocyanin accumulation and berry expansion (Chervin *et al.* 2004).

Besides, Tesniere *et al.* (2004) reported the involvement of ethylene signaling in the regulation of ADH expression in grapevine. And there were similar reports about ethylene roles in other non-climacteric fruit such as strawberries (Tian *et al.* 2000), and citrus (Katz *et al.* 2004).

These reports lead us to check more globally the effects of ethylene on gene expression during berry ripening in grape, and many new tools and technologies for dissecting the gene expression profiling were available, e.g. microarray technology. Recent experiments using this technology showed the variation of expression of many genes during grape berry development (Terrier *et al.* 2005, Waters *et al.* 2005, and Waters *et al.* 2006).

In most fruit, an important part of the ripening process is berry expansion and berry softening and it is widely recognized that changes in cell walls accompany fruit ripening. Gross changes in wall composition may not always occur, and indeed more subtle structural modifications of constituent polysaccharides are often observed during softening (Brady 1987, Fischer and Bennett 1991).

The softening process is complicated by the fact that breakdown or modifications of different components are usually accompanied by the incorporation of newly synthesized components into the wall (Gibeaut and Carpita 1994, Seymour and Gross 1996). The synthesis of cell wall polymers is probably continuous throughout ripening, and a change in the turnover rate of particular component will affect the overall wall composition (Lackey *et al.* 1980) Modifications of wall components might also be expected in ripening grape berries, and indeed several researchers investigated the modification of cell wall

components and the expression of the gene for cell wall degradation-related enzymes during softening of the grape berries (Nunan *et al.* 2001, Terrier *et al.* 2005, Waters *et al.* 2005, Ishimaru and Kobayashi 2002), but about the relations between cell wall composition and the mechanism of softening are not fully understood.

This study will focus on: (i) the ethylene role about the regulation of anthocyanin glycosylation, completing a study that just initiated in a previous PhD thesis (El-Kereamy, 2003), (ii) then a global approach of the ethylene role in modulating gene transcript accumulation using a microarray chip and (iii) lastly particular roles of ethylene on berry expansion (enzymes involved in cell wall modifications and water transport).

❖ BIBLIOGRAPHIC REVIEW

Bibliographic review

1 – Fruit maturation

The climacteric and non-climacteric ripening in fruit, common genetic regulatory mechanisms and ripening of fleshy fruits, were reviewed a few years ago by Giovannoni (2001).

1.1 - Climacteric and non-climacteric ripening

Adams-Philips *et al.* (2004) has classified two major groups of ripening fruit: climacteric and non-climacteric, which have been utilized to distinguish fruit on the basis of respiration and ethylene biosynthesis rates. It's explained by Giovannoni (2001) that climacteric fruit, such as tomato, cucurbits, avocado, banana, peaches, plums, and apples, increased respiration and ethylene biosynthesis rates during ripening more than non-climacteric fruits, such as strawberry, grape, and citrus. In the climacteric fruits shows that the ethylene is necessary for the coordination and completion of ripening in climacteric fruit by analysis of inhibitors of ethylene biosynthesis and perception, in transgenic plants blocked in ethylene biosynthesis, and through examination of the *Never-ripe (Nr)* ethylene receptor mutant of tomato. In contrast, found a little change of the respiration and ethylene biosynthesis rates in non-climacteric fruits during ripening, although there are different mechanisms in fruits of two groups but White (2002) suggests that climacteric and non-climacteric fruit may in fact share similar molecule pathway of ripening and recent studies have shown that grape berry tissues have a fully functional pathway for ethylene synthesis that this pathway is activated just before véraison (Chervin *et al.* 2004).

1.2 - Common genetic regulatory mechanisms

A clarification of the common genetic regulatory elements that are shared among climacteric and non-climacteric species is central to a full understanding of fruit ripening. Such primary regulators of fruit maturation might be shared by, or at least related to, those that regulate maturation of dehiscent fruit. Although such common regulatory elements remain elusive, *Arabidopsis* silique development genes, such as those from the MADS-box family of transcription factors (Ferrandiz *et al.* 1999), may represent starting points in a search for common control mechanisms. Indeed, although antisense repression had no obvious effect on fruit ripening (Pnueli *et al.* 1994), ectopic expression of the tomato *AGAMOUS* gene (*TAG1*) results in fleshy expansion, ripening-like cell wall metabolism, and carotenoid accumulation in the sepals of transgenic tomatoes (Ishida *et al.* 1998). Though not conclusive, these results are consistent with a hypothesis in which *TAG1* represents a redundant ripening control function. Alternatively, *TAG1* may not regulate *in vivo* ripening, but it may be related to, and thus mimic, a

similar regulatory gene when over-expressed in sepals. In addition to a further pursuit of candidate genes or gene families, investigators have identified a number of climacteric ripening mutants that fail to ripen in response to ethylene and represent an additional track toward identification of common ripening regulators (Gray *et al.* 1994).

1.3 - Ripening of fleshy fruits

The increment of respiration and ethylene biosynthesis rates during ripening were used to classification of climacteric and non-climacteric fruits (Lelievre *et al.* 1997). Tucker and Brady (1987) showed that the ethylene is necessary for climacteric fruits ripening by using the tomato system. Ethylene-inducible analysis and ripening-related-gene expression in tomato, was a first observation of the critical ethylene role in coordinating climacteric ripening at the molecular level (Lincoln *et al.* 1987). Ripening of freshy climacteric fruits such as tomato was investigated and related genes were isolated using differential gene expression patterns and biochemical function in the late 1980s and early 1990s, with more recent screens focused on gene isolation strategies that are likely to detect less abundant mRNAs (Zegzouti *et al.* 1999). The *in vivo* functions of fruit development and ripening-related genes, including polygalacturonase (*PG*), *ACC* synthase, *ACC* oxidase, and the *NR* ethylene receptor, have been tested via antisense gene repression and/or mutant complementation in tomato (Gray *et al.* 1994). This is supported by the following examples: *PG* is necessary for ripening-related pectin depolymerization and pathogen susceptibility, and it has little effect on fruit softening (Giovannoni *et al.* 1989). Results of ethylene reduction in ripening inhibition of *ACC* synthase and *ACC* oxidase antisense lines (Hamilton *et al.* 1990), whereas a dominant mutant allele of the *NR* ethylene receptor results in tomato plants that are inhibited virtually in every measurable ethylene response in fruit ripening (Wilkinson *et al.* 1995).

2 - Berry development in grape

The growth of a grape berry consists of two successive sigmoid cycles, each with distinctive characteristics (Coombe 1992). The first cycle of berry formation begins with a spate of cell division in pericarp tissue the amount and direction of which largely determines a berry's final size and shape. The rate of these divisions is positively correlated with the growth rates of developing seeds in each berry. Pericarp cell division changes gradually to cell enlargement, which later slows as the first sigmoid cycle end. At this stage the berry is hard, green and slow growing; the pericarp organic compound accumulating is malic acid. The second cycle begins with the onset of sugar accumulation, berry softening, berry coloring, and renewed size increase; taken collectively these four last events constitute véraison, denoting the beginning of ripening process. Ripening is characterized by the accumulation in flesh and skin of hexose

sugars and in skin of potassium and phenolics (including anthocyanins in black grapes) (Coombe and Iland 1987). Flavor compounds accumulate late in ripening, a stage that has been termed “engustment” by Coombe and McCarthy (1997).

Coombe and McCarthy (2000) showed results from two experiments on development of grape berries (figure 1). The first set of results showed measurements of Muscat Gordo Blanco berries from inflorescences to harvest and it showed typical double-sigmoid volume/time curves. °Brix curves after véraison were almost coincident because, in each case, the rate of increase in solutes per berry was proportional to that of berry volume. These results indicate that sugar and water increments after véraison are linked and depend on the same source, namely, the phloem sap. In a second experiment, an irrigation experiment on cv. Shiraz showed divergent berry weight curves between treatments and years but with the difference that all berries shrank after a maximum berry weight was attained at 91 days after flowering (at about 20 °Brix). At this point, the curves of solutes per berry showed then plateaued; indicating that inflow of phloem sap had become impeded. Prior to shrinkage these berries accumulated primary metabolites (mainly phloem sugar) but, during shrinkage, when berries were apparently isolated from vascular transport, non-anthocyanin glycosides accumulated. These results have implications for the study of berry flavor build up and berry composition, and also for the understanding of sink competition within the vine, flesh and dried yield, and juice °Brix level.

3 - Maturation- related genes and biochemical changes

3.1 - Berry expansion and softening

At the inception of berry ripening, called véraison, the berries start to soften in all grape cultivars and it was first expressed as an increase in berry deformability (Coombe 1992). This softening is thought to be primarily linked to changes in expression of a set of cell wall modifying enzymes (Nunan *et al.* 2001) that we will develop below.

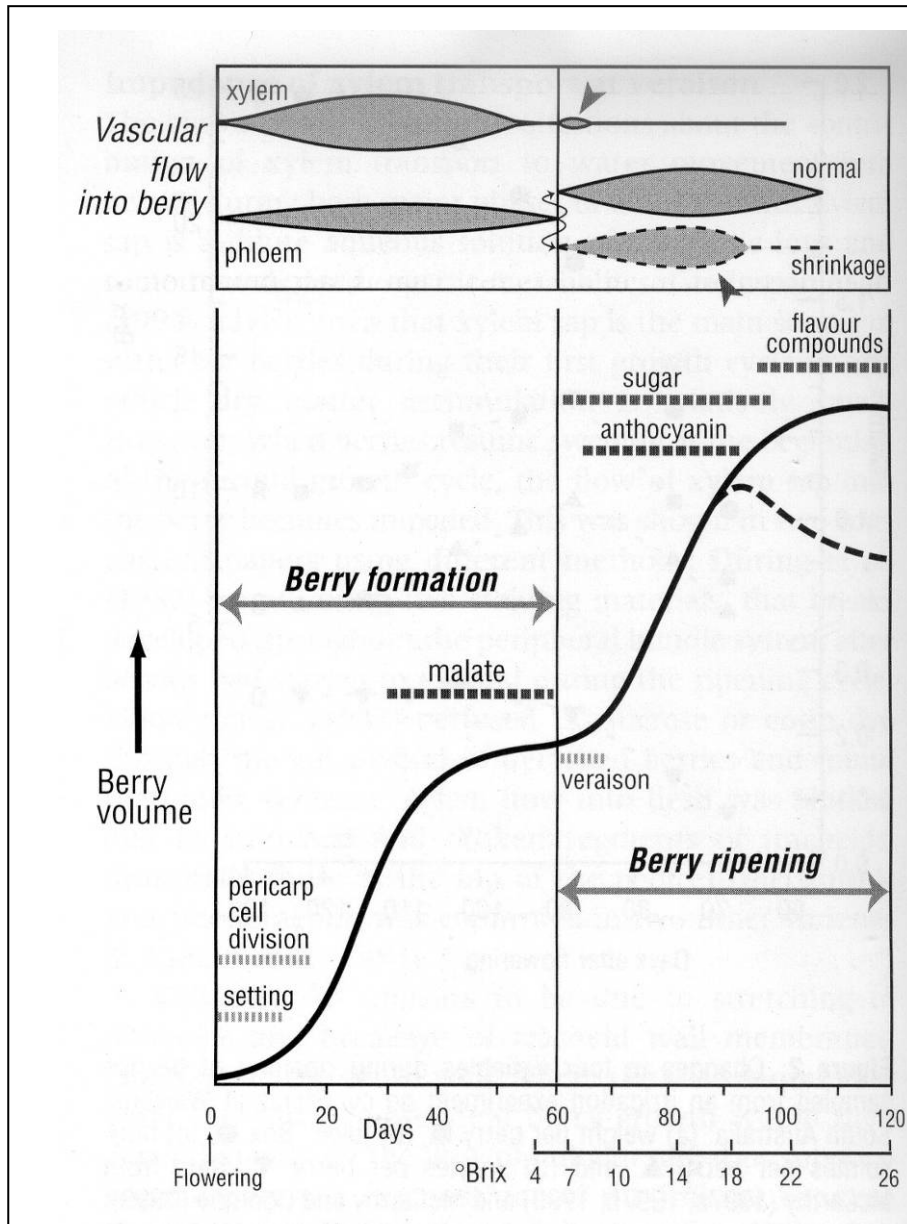

Figure 1. Diagrams showing, at top, estimates of rates of vascular flow into berries, partitioned between xylem and phloem, their sum matching the rates of water input as shown by the berry volume growth curves below of Muscat (solid lines) and Shiraz (dashed lines). The berry volume is an idealised curve against days after flowering and juice °Brix and shows the berry shrinkage and phloem blockage of Shiraz starting at about 18-20°Brix; the arrow-heads at top signify the timing of the proposed impedance of xylem flow (in all varieties) and of phloem flow in berries that shrink. Three successive but overlapping phases of solute accumulation are indicated-malate, sugar and flavour compounds-each sequence occurring in both varieties (extracted from Coombe and McCarthy 2000, reprinted with agreement of Dr. McCarthy).

3.1.1 - Xyloglucan endotransglycosylase (XET)

Xyloglucan endotransglycosylase (XET; EC 2.4.1.207) is an enzyme mediating the reversible formation of xyloglucan cross-link and catalyzing molecular grafting of newly arriving xyloglucan molecules into the cell wall structure. During cell expansion and elongation, the cell wall continually undergoes temporary loosening followed by rapid reinforcement of wall structure (Lu *et al.* 2006). XETs are unique enzymes in plants that are capable of modulating the chemistry of the matrix and therefore performing both of these functions (Eckardt 2004). XETs were first proposed to function in wall loosening to enable turgor-driven expansion. Indeed, there is a good correlation between high levels of XET activity and cell expansion. As the rate of expansion decreases XET activity decreases; however, activity is still readily detected in regions that have completed growth (Campbell and Braam 1999)

During Kyoho grape berry development, XET gene expression was closely related to berry softening; XET gene expression was detected slightly before véraison and was markedly increased at véraison. These observations suggest that XET plays an important role in grape berry softening. In Kyoho grape berries, the changes in cell wall components and in their molecular weights during berry softening. The results that neutral and acidic sugar contents of the pectin fraction decreased only after the véraison stage, While the neutral sugar content of the hemicellulose fraction decreased before and through the véraison stage. The cellulose content constantly decreased during berry softening, but a large decrease was observed before and through the véraison stage. The molecular masses of pectic and hemicellulosic polysaccharides began to decrease before véraison and up to the véraison stage; in particular, hemicellulosic xyloglucan was markedly depolymerized from before véraison to véraison stage (Ishimaru and Kobayashi 2002).

3.1.2 - Polygalacturonase (PG)

Polygalacturonases (PGs, poly (1→4- α -D-galacturonide) glycanohydrolases) are enzymes that catalyze the hydrolytic cleavage of galacturonide linkages, and can be of the exo- or endo-acting types. The exo type (EC 3.2.1.67) removes single galacturonic acid units from the non-reducing end of polygalacturonic acid, whereas the endo type (EC 3.2.1.15) cleaves such polymers at random. The fruit ripening-specific enzyme usually referred to as PG is of the endo-acting type; however, both endo and exo types of these enzymes are found in fruit. The substrate for PG in the cell wall is mainly homogalacturonans, which are secreted to the cell wall in a highly methyl-esterified form which must be deesterified before they can become a substrate for PG.

An increase in the activity of PG has long been associated with fruit ripening, although the amount detected varies widely with species (Brummell and Harpster 2001). Ripening avocado, tomato and peach possess relatively high levels of PG activity, although activity in peach is about 50 times less than in tomato. PG activity has been reported to be absent in other species including strawberry, apple and melon, but PG activity and/or mRNA have subsequently been detected and it seems that in some species PG activity is present at low levels but is either very labile or needs to be assayed under particular conditions. In tomato, PG activity is not detectable in pre-ripe fruit, but *PG* mRNA appears at the onset of ripening or breaker stage, and activity increases from early in ripening (Smith *et al.* 1988; Biggs and Handa 1989) PG activity and immunologically detectable PG protein accumulate rapidly with ripening, and activity continues to increase as fruit become over ripe. PGs are present in plants in very large gene families, with over 50 genes in *Arabidopsis*. Overall, PG activity is responsible for polyuronide depolymerization and solubilization during ripening but this makes only a small contribution to fruit softening. However, the integrity of stored fruit and the textural properties of paste were improved by suppression of PG. The role of PG in fruit ripening may thus be mainly concerned with fruit textural changes and quality properties, and ultimately in fruit deterioration to allow seed dispersal (Brummell and Harpster 2001).

3.1.3 - Pectin methylesterase (*PME*)

Pectin methylesterase was reviewed by Brummell and Harpster (2001). During ripening in tomato, the degree of methyl-esterification of cell wall pectin declines from 90% in mature green fruit to 35% in red ripe fruit. This is accomplished by pectin methylesterase (*PME*; EC 3.1.1.11), which de-esterifies polyuronides by removing methyl groups from the C6 position of galacturonic acid residues of high-molecular-weight pectin. Demethylation of pectin to their free carboxyl groups changes the pH and charge in the cell wall, allows the aggregation of polyuronides into a calcium-linked gel structure, and makes the polyuronides susceptible to degradation by PG. In tomato, *PME* protein is found in most tissues of the plant and exists in multiple isoforms. The abundance of *PME* mRNA shows a different pattern of accumulation, increasing to a maximum in mature green fruit and declining rapidly as ripening progresses. *PME* protein and activity reach a maximum after *PME* mRNA abundance has declined substantially. In the *Nr* and *nor* ripening mutants, levels of *PME* activity, protein and mRNA are similar to wild type, but in *rin* all three decline rapidly at a time equivalent to when ripening begins in wild-type fruit (Harriman *et al.* 1991). The *rin* mutation thus strongly affects *PME* expression (Brummell and Harpster 2001).

In the grape experiment of Nunan *et al.* (2001) found the level of *PME* activity was measured in the protein extracts at five stages of berry development, was generally low and decreased after

véraison while the PME transcripts was detected and minor differences in the patterns of mRNA accumulation during Gordo and Shiraz berries ripening.

The degree of pectin methylesterification in transgenic antisensed PME fruit was higher than controls by 15–40% throughout ripening, but the fruit otherwise ripened normally as judged by ethylene and lycopene production. Increased pectin methylesterification resulted in reduced polyuronide depolymerization in red ripe fruit, and decreased the amount of chelator-soluble pectin during ripening by 20–30% (Tieman *et al.* 1992). Presumably the former is due to the resistance of methyl-esterified pectin to PG mediated hydrolysis, and the latter to reduced amounts of pectin bound ionically to the wall and were instead attached by linkages not affected by removal of calcium.

Suppression of PME activity and consequent changes in pectin metabolism, including reduced pectin depolymerization, did not affect fruit softening during normal ripening, but in over-ripe fruit caused an almost complete loss of tissue integrity (Tieman and Handa 1994). This was correlated with an increase in soluble calcium and reductions in bound calcium, soluble sodium and bound and soluble magnesium, suggesting that a lowered ability of cell walls to bind divalent cations has deleterious effects on tissue integrity, probably in part due to reduced interpectate calcium cross-bridges. The changed ionic and physical conditions in the wall may also have affected the activity of other cell wall modifying enzymes, including PG.

Suppression of PME activity thus has a negative effect on fruit integrity during senescence in prolonged storage, but opposite to the improved fruit integrity and shelf life observed after suppression of PG. However, large improvements in several fruit processing attributes were observed. Raw juice prepared from antisense PME fruit showed an almost 20% increase in soluble solids content. Processed juice showed significantly higher total and soluble solids, serum viscosity, paste viscosity and reduced serum separation. This was associated with a large increase in polyuronide molecular weight relative to controls, larger than the difference in ripening fruit, presumably due to the high degree of pectin methyl-esterification protecting pectin from PG-mediated hydrolysis during fruit homogenization. PME activity thus plays little role in fruit softening during ripening, but substantially affects tissue integrity during senescence and fruit processing characteristics (Brummell and Harpster 2001).

3.1.4 - Cellulose synthase (CS)

Cellulose, an aggregate of unbranched polymers of β -1,4-linked glucose residues, is the major component of wood and thus paper, and is synthesized by plants, most algae, some bacteria and fungi, and even some animals. The genes that synthesize cellulose in higher plants differ

greatly from the well-characterized genes found in *Acetobacter* and *Agrobacterium* sp. More correctly designated as 'cellulose synthase catalytic subunits', plant cellulose synthase (*CesA*) proteins are integral membrane proteins, approximately 1,000 amino acids in length. The sequences for more than 20 full-length *CesA* genes are available, and they show high similarity to one another across the entire length of the encoded protein, except for two small regions of variability. There are a number of highly conserved residues, including several motifs shown to be necessary for processive glycosyltransferase activity. No crystal structure is known for cellulose synthase proteins, and the exact enzymatic mechanism is unknown. There are a number of mutations in cellulose synthase genes in the model organism *Arabidopsis thaliana*. Some of these mutants show altered morphology due to the lack of a properly developed primary or secondary cell wall. Others show resistance to well-characterized cellulose biosynthesis inhibitors (Richmond 2000).

To date, the cellulose synthase superfamily includes over 500 putative members, including cellulose synthase, chitin synthase, hyaluronan synthase, β -1,3-glucan synthase, and a number of uncharacterized genes from many organisms. The function of the various *Cs/* families is not known, but speculation is that they are responsible for producing some of the other polysaccharides found in plant cell walls and in secretions such as root cap or stylar mucilage. With six families of *Cs/* genes and six major non-cellulosic polysaccharides in *Arabidopsis* (i.e. callose, xyloglucan, glucuronoarabinoxylan, homogalacturonan, rhamnogalacturonan I, and rhamnogalacturonan II), it is tempting to speculate that each family is responsible for the biosynthesis of one of the principal polysaccharides of the cell wall. The relationship between enzyme structure and function, showing that as few as four amino acid changes can alter the catalytic outcome of an enzymatic reaction from desaturation to hydroxylation, emphasize the need for caution in using sequence similarity to infer function based on sequence. At present, there are more than 1250 *CesA* and *Cs/* sequences, from 29 different plant species in GenBank. Although the most extensive information available is for *Arabidopsis* where there are more than 330 partial or complete gene sequences, there is also a significant amount of information available for several other species, especially rice, maize, soybean, and tomato. A crude estimate of the relative abundance mRNA for the various family members can be calculated from the frequency with which each gene family is represented by EST sequences in the public databases (Richmond and Somerville 2000). Identification of the biosynthetic enzymes involved in cell wall biosynthesis remains one of the major unsolved problems of plant biology. Of the major polysaccharides of the plant cell wall, pectins and hemicelluloses are synthesized in the Golgi, and callose and cellulose are synthesized at the plasma membrane. The evidence is now quite extensive that the catalytic subunits of cellulose synthase are encoded by members of the large *CesA* gene family. Nothing is currently known about the

genes encoding the enzymes that catalyze the synthesis of the hemicellulose backbones (Hazen *et al.* 2002). The primary cell walls of all higher plants contain large amounts of cellulose in their walls, and, consistent with this, *CesA* genes are found throughout the plant kingdom (Richmond 2000; Richmond and Somerville 2000).

3.1.5 - Expansins (EX)

Expansins are cell wall proteins without any hydrolytic activity. The proposed mechanism of expansin action involves the disruption of hydrogen bonds between cellulose microfibrils and cross linking wall glycosides. They belong to a multi-gene family and have broadly been divided in two groups: α -expansins and β -expansins based on sequence homology. The expression of α -expansins during various stages of fruit softening indifferent fruit such as tomato, peach, pear, strawberry and banana, suggest that these proteins play a major role in cell wall disassembly even in non-growing tissues such as those of ripening fruit (Sane *et al.* 2005).

A tomato α -expansin gene, *LeEXP1*, was first found to be expressed in a ripening-specific manner and up-regulated by endogenous and exogenous ethylene. Subsequent studies with transgenic tomatoes demonstrated the *in vivo* role of *LeEXP1* in fruit softening (Rose *et al.* (1997). The fruits from antisense lines were slightly firmer throughout fruit development, whereas in sense lines the softening time was advanced, even to the green fruit stages, and softness also increased. These changes of physical characteristics in the transgenic fruits were also accompanied by changes in the status of wall polymers, suggesting that expansins soften tomato fruit primarily through a relaxation of the wall by direct action and through controlling the access of pectinases to the pectins in the wall. In contrast to expansin genes from climacteric tomatoes, an α -expansin gene (*FaEXP2*) from non-climacteric strawberries was insensitive to ethylene, although its pattern of gene expression was correlated with fruit ripening (Harrison *et al.* 2001). Thus, the expression of certain α -expansin genes suggests a role in fruit softening and this is supported by the results with sense and antisense transformed tomato lines. The effects noted in the latter experiments were significant, but relatively subtle. Thus, expansins are not the sole catalysts of fruit softening (Cho and Cosgrove 2004).

3.1.6 - Aquaporin (AQUA)

Aquaporins are channel-forming membrane proteins with the extra-ordinary ability to combine a high flux with a high specificity for water (Johanson *et al.* 2000). The first aquaporin gene from plants was cloned and functionally expressed in 1993, there has been a growing interest in the molecular biology of MIPs (membrane intrinsic proteins) and their bearing on the biophysics of water flow across plant membranes (Huang *et al.* 2002). Aquaporins from a large family of proteins present in the plasma membrane (PIPs) and tonoplast (TIPs) that increase the

hydraulic conductivity of the plasma membrane when expressed in *Xenopus laevis* oocytes. They are 25- to 29-kD membrane proteins with primary sequences similar to those of the MIP family. MIPs have six transmembrane domains with cytosolic amino and carboxy termini and short, conserved amino acid motifs, including the signature sequence SGxHxNPA, which is repeated in the second half of the protein as NPA. One of these proteins transport small solutes, others transport only water (Chaumont *et al.* 1998).

The expression patterns of specific plant aquaporins are tissue- and cell-type specific. The aquaporin α -TIP from common bean accumulates during seed maturation and the aquaporin γ -TIP and α -TIP from *Arabidopsis* are preferentially expressed in elongating root cells and in the parenchyma cells of vascular tissues, respectively. The plasma membrane aquaporin RD28 from *Arabidopsis* is found in all plant organs, but is absent from seeds (Daniels *et al.* 1994). Several other studies have revealed the organ- and cell-type-specific expression patterns of TIP and PIP aquaporins. The variety of the expression patterns suggests that aquaporins may function in long-distance transport (xylem and phloem loading and unloading), in short-distance transcellular water flow and in intracellular osmotic adjustment (Chaumont *et al.* 1998). γ -TIP message, in general, is a marker of expanding tissue. However, γ -TIP message is a qualitative marker of expanding or elongating tissue, it is not a quantitative marker for cell expansion (Ozga *et al.* 2002).

The discovery of water-channel proteins in the membranes of plant cells allows the formulation of new mechanism that may be used by plants to control water transport and osmotic adjustment. Rapid elongation of plant cells is based on an extensive uptake of solutes coupled with the uptake of water, resulting in the formation of a prominent vacuolar compartment. This mechanism maintains the turgor pressure that drives cell expansion. Rapid cell expansion may require a high hydraulic permeability of the tonoplast to support water entry into the vacuole (Chaumont *et al.* 1998). The high water permeability of the plant tonoplast was recently demonstrated directly with tonoplast vesicles of cultured tobacco cells and wheat roots. Tonoplast vesicles have channels that transport water with a low energy of activation and that are inhibited by mercuric chloride, whereas plasma membrane vesicles either do not have such channels or the channels are inactive. Together these experiments support the interpretation that TIPs permit the rapid influx of water into the vacuole of elongating cells. The much lower permeability of plasma membrane vesicles observed in the same studies may indicate that cells regulate the influx of water at the plasma membrane (Chaumont *et al.* 1998). The tonoplast is highly permeable to water and that this high permeability is caused by the presence of mercuric-chloride-inhibitable water channels that permit the rapid passage of water with a low energy of activation. Such observations are consistent with the presence of aquaporins in the tonoplast

(Chaumont *et al.* 1998). A couple of papers have been published about aquaporin expression in grape berries (Picaud *et al.* 2003; Reid *et al.* 2006). Both found aquaporins that were expressed at véraison and in the following weeks, when the berries underwent the second growth phase, known to involve cell expansion.

3.2 - Ethylene and fruit maturation

3.2.1 - Ethylene and plant physiology

Ethylene regulates a multitude of plant processes, ranging from seed germination to organ senescence. Of particular economic importance is the role of ethylene as an inducer of fruit ripening. The ethylene biosynthesis is regulated at the post-translational level by controlling turnover of several members of the ACC synthase (ACS) family, which converts Sadenosylmethionine to 1-aminocyclopropane-1-carboxylic acid (ACC), before further conversion to ethylene (Yang and Hoffman 1984). Environmental and endogenous signals regulate ethylene biosynthesis primarily through differential expression of ACC synthase genes. Components of the ethylene signal transduction pathway have been identified by characterization of ethylene-response mutants in *Arabidopsis thaliana* (Bleecker and Kende, 2000). Ethylene is perceived by a family of receptors related to bacterial histidine kinases (O'Malley *et al.* 2005) that modulate the activity of the Raf-like kinase *CTR1*, a negative regulator of the pathway. Functioning downstream of *CTR1* is *EIN2*, a protein with similarities to Nramp metal-ion transporters, followed by members of the EIN3/EIN3-like (*EIL*) family of transcription factors, which regulate the transcription of primary ethylene-response genes. Additional components of the signal transduction pathway have been proposed, but their contribution to signaling is not yet resolved. Due to the similarity of *CTR1* to Raf, a mitogen-activated protein kinase kinase kinase (MAPKKK), a MAP-kinase (MAPK) cascade has been proposed to act downstream of *CTR1*. In 2003, a putative MAPK module was implicated in ethylene signal transduction (Ouaked *et al.* 2003), but additional research indicates that the primary role of the MAPK in question (MPK6 in *A. thaliana*) is in the regulation of ethylene biosynthesis, not signaling (Ecker 2004). Because the ethylene receptors are related to histidine kinases, researchers have also wondered if the receptors might participate in phosphorelays involving other two-component signaling elements. Consistent with this possibility, the response regulator *ARR2* was proposed to transduce the ethylene signal as part of a *CTR1*-independent pathway (Hass *et al.* 2004). However, additional research suggests a primary role for *ARR2* in signaling by cytokinin, rather than ethylene (Mason *et al.* 2005). Biotechnological modifications of ethylene synthesis and of sensitivity to ethylene are promising methods to prevent spoilage of agricultural products such as fruits, whose ripening is induced by ethylene (Bleecker and Kende 2000).

3.2.2 - Ethylene and non-climacteric fruit

Since non-climacteric fruits are also able to synthesize ethylene, and in some cases it has been seen that ethylene can hasten the post-harvest deterioration, the possible involvement of this hormone in the ripening of the non-climacteric fruits has been studied in different laboratories (Armitage 1989; Ferrarese *et al.* 1995; Harpster *et al.* 1997; Katz *et al.* 2004; Mullins *et al.* 1999; Bower *et al.* 2003; Tian *et al.* 2000; Trainotti *et al.* 2005; Tesniere *et al.* 2004; Chervin *et al.* 2004). However, in spite of the many efforts, no results have been obtained that can demonstrate a clear relation between ethylene and the ripening of these fruits.

In pepper fruits, some cultivars seem to be ethylene insensitive, while in other cases continuous treatments with exogenous ethylene have been shown to accelerate ripening (Armitage 1989) and to up-regulate the expression of ripening-specific genes (Ferrarese *et al.* 1995; Harpster *et al.* 1997).

The citrus are non-climacteric fruit, that produce the ethylene in small quantity in normal conditions, but under stress condition, they produce big quantities of the ethylene (Yu and Yang 1980) The treatment of green peels of Paradise Citrus with the AVG (aminoethoxyvinyl glycine), an inhibitor of the ethylene action, increases the ACS activity during 24H to 36H after the treatment. However, the exogenous ethylene treatment or the ACC inhibits the induction of ACS activity by the AVG. It resembles that, the ethylene synthesis in non-climacteric fruits can be adjusted by auto-inhibition to the level of the prevent expression (Mullins *et al.* 1999). Recently, it has been shown that young citrus fruitlets attached to the tree produce high levels of ethylene, which decrease dramatically towards maturation (Katz *et al.*, 2004). Upon harvest, fruitlets exhibited a climacteric-like rise in ethylene production, preceded by the induction of transcription of 1-aminocyclopropane-1-carboxylate (ACC) synthase 1 (*CsACS1*), ACC oxidase 1 (*CsACO1*) and the ethylene receptor *CsERS1*. This induction was advanced and augmented by exogenous ethylene or propylene, indicating an autocatalytic system II-like ethylene biosynthesis. In mature, detached fruit, very low rates of ethylene production were associated with constitutive expression of the ACC synthase 2 (*CsACS2*) and ethylene receptor *CsETR1* genes (system I). *CsACS1* gene expression was undetectable at this stage, even following ethylene or propylene treatment, and *CsERS1* gene expression remained constant, indicating that no autocatalytic response had occurred. The transition from system II-like behavior of young fruitlets to system I behavior appears to be under developmental control (Katz *et al.* 2004).

An even more complex situation appears to be present in strawberry with regard to the relationship between ethylene and the ripening of fruit. Data have been published by different

laboratories that apparently contradict each other and so analysis of those data does not show any well-defined effects of ethylene on strawberry fruits (Bower *et al.* 2003). Moreover, in order to explain the variability of results obtained by treating strawberry with ethylene and/or 1-methylcyclopropene (1-MCP), Tian *et al.* (2000) proposed the hypothesis that strawberries might have ethylene receptors different from those present in climacteric fruits, and/or that ethylene receptors might carry out different functions in non-climacteric fruits. In Trainotti *et al.* (2005) experiment, two cDNAs coding for enzymes of the ethylene biosynthetic pathway (i.e. *FaACO1* and *FaACO2*), and three cDNAs encoding different ethylene receptors have been isolated (*FaETR1*, *FaERS1* and *FaETR2*). The expression of both the *ACO* and the receptor-encoding genes has been studied in fruits at different stages of development and in fruits treated with hormones (i.e. ethylene and the auxin analogue NAA). All the data thus obtained have been correlated to the known data about ethylene production by strawberry fruits. Interestingly, a good correlation has resulted between the expression of the genes described in this work and the data of ethylene production. In particular, similarly to what occurs during climacteric fruit ripening, there is an increased synthesis of receptors concomitant with the increased synthesis of ethylene in strawberries as well. Moreover, the receptors mostly expressed in ripening strawberries are those with a degenerate histidine-kinase domain. Since the latter domain is thought to establish a weaker link to the CTR1 proteins, even the little ethylene produced by ripening strawberries might be sufficient to trigger ripening-related physiological responses.

In grape berries, treatments with exogenous ethylene were able to stimulate the expression of genes related to anthocyanin biosynthesis that is described above (El-Kereamy *et al.* 2003). Also an involvement of this hormone in the expression of an alcohol dehydrogenase gene has been demonstrated in grape (Tesniere *et al.* 2004) On the other hand, Chervin *et al.* (2004) showed the increased *ACO* expression of the ethylene biosynthesis occurs just before véraison (i.e. inception of ripening) and they observed that ethylene perception, at this time, is required for at least the increase of berry diameter, the decrease of berry acidity and anthocyanin accumulation in the ripening berries; these latter experiments were performed with 1-methylcyclopropene, a specific inhibitor of ethylene receptors.

3.3 - The anthocyanin biosynthesis and related genes: *UFGT* and *Myb*

3.3.1 - Anthocyanins in grape berry

The colour of red and black grapes results from the accumulation of anthocyanins that are usually located in the skin of the berry. It has been demonstrated that the quantity and the quality of anthocyanins in grape berries greatly affect the quality of red wines. Grapevines usually produce 3-monoglucoside, 3-acetylglucoside and 3-p-coumarylglucoside derivatives of

the aglycones delphinidin, cyanidin, peonidin, petunidin and malvidin (Mazza and Miniati 1993). The pathway leading to the production of anthocyanins in grapevine is shown Figure 1bis and has been described and cDNAs for genes from the flavonoid pathway including chalcone synthase (*CHS*), chalcone isomerase (*CHI*), flavonone-3-hydroxylase (*F3H*), dihydroflavonol 4-reductase (*DFR*), leucoanthocyanidin dioxygenase (*LDOX*) and UDP glucose-flavonoid 3-O-glucosyl transferase (*UFGT*) have been isolated from grapes (Sparvoli *et al.* 1994). Expression

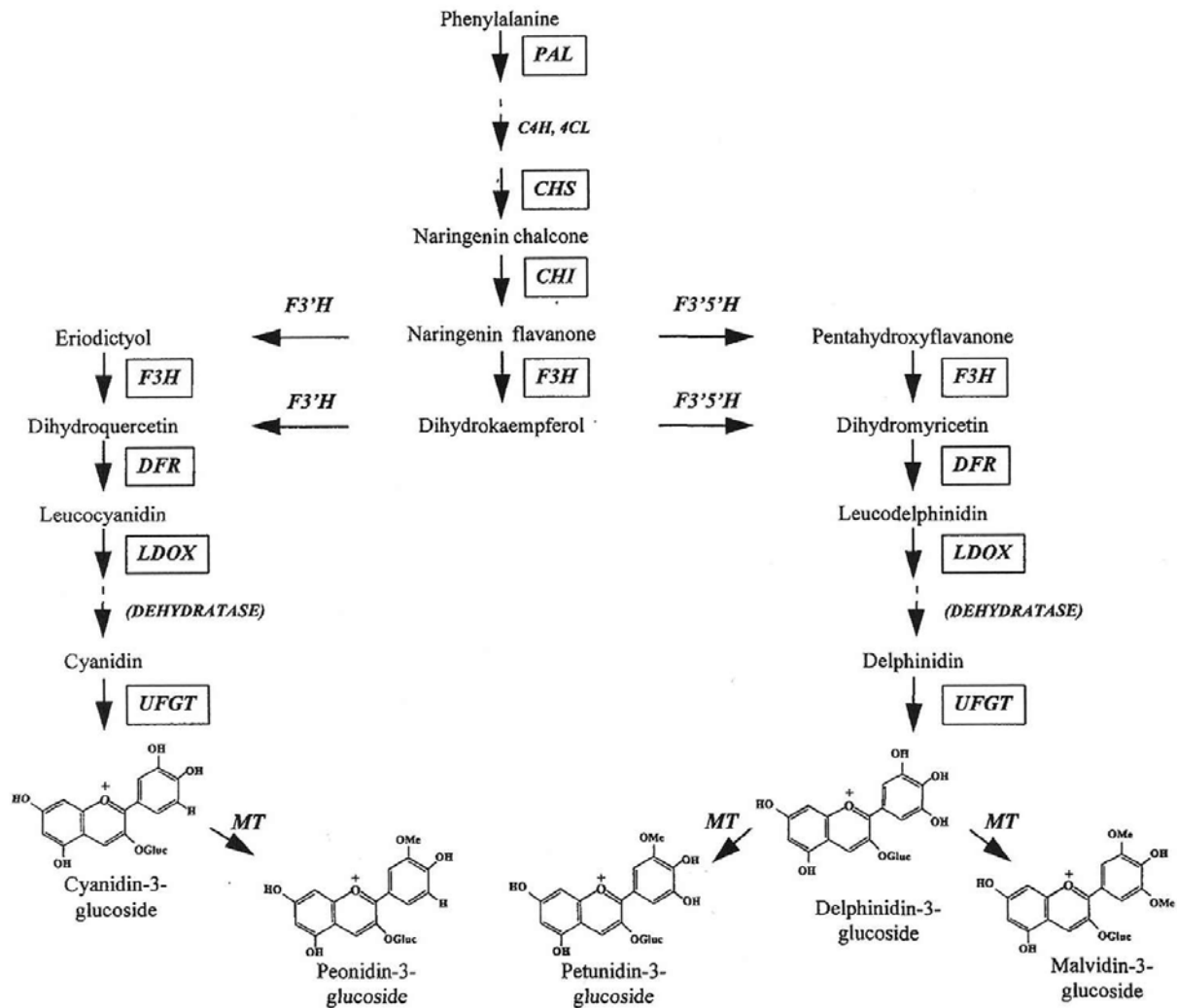

Figure 1bis. Simplified schematic of the anthocyanin biosynthetic pathway, modified to account for the major products found in grapes. The genes examined in this study are boxed. The dehydratase is putative and is thus written in brackets, and the substrates for flavonoid 3'-hydroxylase (*F3'H*) and flavonoid 3'5'-hydroxylase (*F3'5'H*) have not been determined for grapes. C4H, Cinnamate 4-hydroxylase; 4CL, 4-coumarate COA ligase; MT, methyltransferase (extracted from Boss *et al.* 1996a, reprinted with agreement of Dr. Boss).

of these genes has been detected in a number of grapevine tissues (Boss *et al.* 1996a). The mRNA of these genes except *Ufgt* accumulated in the early developing stage and decreased until véraison, and then the mRNA levels of all genes including *Ufgt* increased in the coloring

stage of red cultivars after véraison (Boss *et al.* 1996a; Kobayashi *et al.* 2001). The mRNA of *Ufgt* was detected only in the berry skins of red cultivars (Kobayashi *et al.* 2001; Boss *et al.* 1996b; Boss *et al.* 1996c). Thus, the expression of *Ufgt* was critical for anthocyanin biosynthesis in grape berry skins.

Since there were no differences in either the coding or the promoter sequences of *Ufgts* between white cultivars and their red-skin sports, the phenotypic change from white to red was presumed to be the result of a mutation in a regulatory gene controlling the expression of *Ufgt* (Kobayashi *et al.* 2001). Recently, Kobayashi *et al.* (2002) reported that *VlmybAs*, putative regulatory genes isolated from Kyoho (*Vitis labruscana*: *Vitis labrusca* × *Vitis vinifera*), were involved in the regulation of anthocyanin biosynthesis and expression of *Ufgt*. Kobayashi *et al.* (2004) also reported that a retrotransposon-induced mutation in a homologue of *VlmybAs*, *VvmybA1*, is associated with loss of pigmentation in white cultivars of *V. vinifera*. Thus, it would be interesting to determine whether plant hormones (i.e. auxin, ethylene) also affect the mRNA accumulation of *VvmybA1*.

3.3.2 - Anthocyanins and the ethylene effect

Recent studies have shown that low doses of ethanol stimulate the maturation of some fruits. The present work showed that spraying Cabernet Sauvignon grapes, with 5% ethanol at véraison enhances the anthocyanin accumulation. Véraison is the time when the berries turn from green to purple. HPLC analysis showed a marked increase in the total concentrations of the derivatives of delphinidin, cyanidin, petunidin, peonidin and malvidin from the fourth day after the ethanol treatment until harvest. This was not linked to a difference in berry weight in comparison to controls. Two distinct expression patterns were found for anthocyanin biosynthesis genes in the treated and untreated berries. For one group, consisting of chalcone synthase, flavanone-3-hydroxylase, dihydroxyflavonol-4-reductase and leucoanthocyanidin dioxygenase, the expression was inhibited or unchanged by the ethanol treatment, whereas for UDP glucose-flavonoid 3-O-glucosyltransferase (*UFGT*) there was a marked increase in expression from 1 to 20 days after ethanol treatment. These results suggest that the *UFGT* gene is a key factor in the observed anthocyanin accumulation following ethanol treatment (El-Kereamy *et al.* 2002).

The treatment of grape berries (*Vitis vinifera* L. cv. Cabernet Sauvignon) with the ethylene-releasing compound, 2-chloroethylphosphonic acid (2-CEPA), at véraison is a method known to enhance grape skin colour. They observed that it produced a 6-fold increase, up to 30 pmol g⁻¹ FW, of the cluster internal ethylene compared to untreated controls within the 24 h following treatment. This ethylene upsurge was associated with increased levels of chalcone synthase

(*CHS*) and flavanone 3-hydroxylase (*F3H*) transcripts, which persisted over the following 20 days. Transcript levels of leucoanthocyanidin dioxygenase (*LDOX*) and UDP glucose-flavonoid 3-O-glucosyl transferase (*UFGT*) were similarly enhanced by 2-CEPA, although to a lesser extent. The effect on *UFGT* was confirmed at the protein level by an immunoblot analysis. The transcript accumulation of dihydroflavonol4-reductase (*DFR*) was unaffected by 2-CEPA treatment. Examination of the levels of *CHS*, *F3H* and *UFGT* mRNAs in berries during bunch exposure to ethylene, revealed elevated levels of each transcript within the first 6 h of treatment when compared to non ethylene-treated controls. HPLC analyses of berry skin extracts showed that levels of each of the anthocyanins analysed (delphinidin, cyanidin, petunidin, peonidin and malvidin) increased over the 10 days following the ethylene burst, and decreased thereafter. However, anthocyanin levels at harvest were still higher in ethylene treated grapes than in controls (El-Kereamy 2003).

4 - Microarray technique, case studies in grape and non-climacteric fruits

Typical approaches to gene identification and functional characterization have and continue to involve protein characterization, peptide sequence determination, and identification of the corresponding DNA sequence. More recently, expressed sequence tags (ESTs), microarrays, large-scale gene expression (transcriptome) profiling, and associated informatics technologies are rapidly becoming common place in the plant sciences, and these investigations were reviewed by Alba *et al.* (2004).

4.1 - Expressed sequence tags: tools for gene discovery and expression analysis

An expressed sequence tag or EST is a short sub-sequence of a transcribed spliced nucleotide sequence (either protein-coding or not). They may be used to identify gene transcripts, and are instrumental in gene discovery and gene sequence determination (Adams *et al.* 1991). They produced by one-shot sequencing of a cloned mRNA (i.e. sequencing several hundred base pairs from an end of a cDNA clone taken from a cDNA library). The resulting sequence is a relatively low quality fragment whose length is limited by current technology to approximately 500 to 800 nucleotides. Because these clones consist of DNA that is complementary to mRNA, the ESTs represent portions of expressed genes. They may be present in the database as either cDNA/mRNA sequence or as the reverse complement of the mRNA, the template strand. EST collections are a relatively quick and inexpensive route for discovering new genes (Bourdon *et al.* 2002), confirm coding regions in genomic sequence (Adams *et al.* 1991), facilitate the construction of genome maps (Paterson *et al.* 2000), create opportunities to elucidate phylogenetic relationships (Nishiyama *et al.* 2003), can sometimes be interpreted directly for transcriptome activity (Ewing *et al.* 1999; Ogihara *et al.* 2003; Ronning *et al.* 2003),

and provide the basis for development of expression arrays also known as DNA chips (Chen *et al.* 1998), can result in identification of significant portions of an organism's gene content and thus can serve as a foundation for initiating genome sequencing projects (van der Hoeven *et al.* 2002). In addition, ESTs contain enough information to permit the design of precise probes for DNA microarrays that then can be used to determine the gene expression. The identification of ESTs has proceeded rapidly, with approximately 46 million ESTs now available in public databases (e.g. GenBank 9/2007, all species), more than 5 million of which derive from plants (<http://www.ncbi.nlm.nih.gov/dbEST/>) and 191616 ESTs of *Vitis* (<http://compbio.dfci.harvard.edu/tgi/cgi-bin/tgi/gimain.pl?gudb=grape>). With many large-scale EST sequencing projects in progress and new projects being initiated, the number of ESTs in the public domain will continue to increase in the coming years. As sequence and annotation data continue to accumulate, public databases for genomic analysis will become increasingly valuable to the plant science community. The Arabidopsis Information Resource (TAIR; <http://www.arabidopsis.org/home.html>), the Salk Institute Genomic Analysis Laboratory (SIGnAL; <http://signal.salk.edu/>), the Solanaceae Genomics Network (SGN; <http://sgn.cornell.edu/>), and GRAMENE (<http://www.gramene.org/>) serve well as examples of these on-line resources. With databases such as these, and advances in computational molecular biology and biostatistics, it is possible to mine and analyze large EST datasets efficiently and exhaustively (i.e. digital expression profiling; Ewing *et al.* 1999; Ogiwara *et al.* 2003; Ronning *et al.* 2003). Particularly important is the fact that this type of data mining can be used to corroborate and extend upon expression data obtained from microarray experiments. Expressed sequence tag collections also have limitations when being used for genomic analysis from the perspectives of accurate representation of genome content, gene sequence, and as windows into transcriptome activity. The fact that ESTs reflect actively transcribed genes makes it difficult to use EST sequencing alone as a means of capturing the majority of an organism's gene content. Additionally, and of great importance, is the fact that a fraction of this sequence data is erroneous. Some of these sequence errors derive from the imperfect nature of the enzymes used to generate cDNA libraries and sequence data (Echols and Goodman 1991). At present these sequence errors cannot be completely avoided, but multiple sequence reads through the same gene makes it possible to minimize this type of artifact. EST collections, even when not normalized or subtracted, are not perfectly representative of the mRNA populations they originate from. For example, low-abundance transcripts are unlikely to be represented fully in all EST collections. Misrepresentation can also originate from transcripts with atypical sequence features (e.g. extremely long transcripts, RNA secondary structures) that impair reverse transcription and/or subsequent cDNA cloning. A third source of error in EST collections can originate during processing of sequence data. This type of sequence error derives from the imperfect technology and algorithms used for base calling, sequence annotation, and contig

assembly. Finally, EST sequence data are also prone to human errors during storage, handling, replication, and management of EST collections. Consequently, re-sequencing ESTs of interest is an important means of validation prior to further characterization. Despite these limitations, it has been shown that EST databases can be a valid and reliable source of gene expression data (Ewing *et al.* 1999; Ogihara *et al.* 2003; Ronning *et al.* 2003).

4.2 - Gene expression profiling

Gene expression profiling holds tremendous promise for dissecting the regulatory mechanisms and transcriptional networks that underlie biological processes, Gene expression is the process by which the inheritable information which comprises a gene, such as the DNA sequence, is made manifest as a physical and biologically functional gene product, such as protein or RNA. Several steps in the gene expression process may be modulated, including the transcription step and the post-translational modification of a protein. Gene regulation gives the cell control over structure and function, and is the basis for cellular differentiation, morphogenesis and the versatility and adaptability of any organism. Gene regulation may also serve as a substrate for evolutionary change, since control of the timing, location, and amount of gene expression can have a profound effect on the functions (actions) the gene in the organism. A variety of methods have been developed for quantifying mRNA abundance in plant tissues. Although the established and reliable method of RNA gel-blot analysis can be quite sensitive and allows for the accurate quantification of specific transcripts (Hauser *et al.* 1997), this method is not readily adapted to genome-scale analysis. Differential display (Liang and Pardee 1992) uses low stringency PCR, a combinatorial primer set, and gel electrophoresis to amplify and visualize larger populations of cDNAs representing mRNA populations of interest. This technique suffers from output that is not quantitative and positives are often difficult to clone and confirm (Ding and Cantor 2004). Sequencing of cDNA libraries is a more direct and comprehensive approach to gene expression profiling (Adams *et al.* 1991; Okubo *et al.* 1992), but this method requires substantial resources for cloning and sequencing, and is less sensitive to low-abundance transcripts. cDNA - AFLP (Bachem *et al.* 1996, 1998) , this technique approach has been used to identify differentially expressed genes involved in a variety of plant processes (Bachem *et al.* 2001). This technique offers several advantages over more traditional approaches. The stringency of cDNA-AFLP PCR reactions is quite high (which is not the case with differential display) the fidelity of the cDNA-AFLP system allows much greater confidence in acquired data and differences in the intensities of amplified products can be informative (Bachem *et al.* 1996). And this technique allows a wide variety of tissue types, developmental stages, or time points to be compared concurrently. As with the other profiling methods described here, the sensitivity of cDNA-AFLP is only limited by the ability of cDNA libraries to capture low-abundance transcripts. Serial analysis of gene expression (i.e. SAGE; Velculescu *et al.* 1995) is an elegant technique

that combines differential display and cDNA sequencing approaches, and it has the advantage of being quantitative. Unfortunately, SAGE is laborious, requires an extensive foundation of sequence information, and suffers from some of the same concerns regarding low-abundance transcripts.

Microarrays take advantage of existing EST collections and genome sequence data (and are thus limited by the availability of the same), robotic instrumentation for miniaturization, and fluorescent dyes for simultaneously detecting nucleic acid abundance in RNA populations derived from multiple samples. Populations of fluorescent cDNA targets representing the mRNA populations of interest are queried via hybridization with a large number of probes that have been immobilized on a suitable substrate (Chen *et al.* 1998; DeRisi *et al.* 1996). DNA Microarrays are small, solid supports onto which the sequences from thousands of different genes are immobilized, or attached, at fixed locations. The supports themselves are usually glass microscope slides, the size of two side-by-side pinky fingers, but can also be silicon chips or nylon membranes. The DNA is printed, spotted, or actually synthesized directly onto the support. The American Heritage Dictionary defines "array" as "to place in an orderly arrangement". It is important that the gene sequences in a microarray are attached to their support in an orderly or fixed way, because a researcher uses the location of each spot in the array to identify a particular gene sequence. The spots themselves can be DNA, cDNA, or oligonucleotides. Why are microarrays important? Most importantly, it can be used to examine the expression of tens-or-thousands of different mRNA transcripts at once, it is semi-quantitative, and it is sensitive to low-abundance transcripts that are represented on a given array. This last point is worth emphasizing in that microarrays are inherently limited to their contained sequences, while so-called 'open architecture' systems such as differential display and SAGE can capture information for any sequence that is expressed at a level sufficiently above the level of detection. In those instances where complete genome sequence is available, microarrays make it possible to monitor the expression of an entire genome in a single experiment (Wang *et al.* 2003).

4.3 - Microarray types

Microarrays have two different types: cDNA microarrays and oligonucleotide microarrays, cDNA microarrays, known single-stranded DNA clones are robotically spotted out and fixed onto a glass slide. At the same time, two mRNA samples from cell populations to be compared are reversed transcribed into cDNA and separately labeled with dyes, usually red (Cy5) and green (Cy3). The two labeled probes are then mixed together and applied to the microarray. During hybridization, single strands in the probe solution competitively combine with their complementary base-pair nucleotide sequences spotted on the slide. The motivation behind the

technique is that the mRNA in the original cell sample reflects which genes are being used by the cell, and the intensity ratio at a spot is thus a measure of the relative abundance of the gene in the two samples. These arrays can be prepared directly from existing cDNA libraries, a large number of which are in the public domain. Thus, fabrication of cDNA arrays is only dependent upon availability of ordered clone collections, and appropriate arraying and scanning instrumentation (Clark *et al.* 1999). Once a set of corresponding PCR products has been generated, arrays can be created in multiple versions containing the entire set of available sequences or subsets of sequences resulting in smaller 'boutique' arrays suitable for specific research applications (e.g. regulatory-, pathway-, stage- or response-specific arrays; Jiao *et al.* 2003). Smaller 'boutique' arrays are also useful for reducing a statistical problem of scale (i.e. large numbers of features and low number of replications common in microarray experiments). Here, a large array might be used to identify differentially expressed genes of interest, which could then be re-arrayed as a smaller array and used in subsequent experiments. One benefit of this approach is that it can free up resources that can be used to increase experimental replication and thereby increase precision. Like cDNA arrays, oligonucleotides can be printed using robotic instrumentation and (once appropriate oligonucleotides have been synthesized) sub-arrays for specific research applications can be fabricated easily. The main limitations in development of oligonucleotide arrays are the costs associated with sequence selection and oligonucleotide synthesis. As these costs continue to decline oligo-based arrays are likely to become more predominant in the near future because they offer a number of important advantages over cDNA arrays. One such advantage is the fact that oligo-based arrays can be fabricated using microfluidic technology, which utilizes light to direct the synthesis of short oligonucleotides onto a suitable matrix i.e. photolithography (Fodor *et al.* 1991, 1993; Pease *et al.* 1994), Oligonucleotide Arrays can be either produced by piezoelectric deposition with full length oligonucleotides or in-situ synthesis and the major advantage of the oligo arrays is especially as they permit to dissociate profiles of expression of each isogene of a multigene family. Long Oligonucleotide Arrays are composed of 70-mers or 50-mers and are produced by ink-jet printing on a silica substrate. Short Oligonucleotide Arrays are composed of 25-mer or 30-mer and are produced by photolithographic synthesis (Affymetrix) on a silica substrate or piezoelectric deposition (GE Healthcare) on an acrylamide matrix. More recently, Maskless Array Synthesis from NimbleGen Systems has combined flexibility with large numbers of probes. Arrays can contain up to 390,000 spots, from a custom array design. New array formats are being developed to study specific pathways or disease states for a systems biology approach. Oligonucleotide microarrays often contain control probes designed to hybridize with RNA spike-ins. The degree of hybridization between the spike-ins and the control probes is used to normalize the hybridization measurements for the target probes (Lipshutz *et al.* 1999). Another important advantage is that the probes in an oligonucleotide array are designed to

represent unique gene sequences such that cross-hybridization between related gene sequences (e.g. genes belonging to a gene family or genes with common functional domains) is minimized to a degree dependent upon the completeness of available sequence information. Cross-hybridization between homologous sequences continues to be problematic when using cDNA arrays. Furthermore, the array elements in an oligonucleotide array are typically designed to have uniform length, uniform melting temperatures, and to be of uniform concentrations, which can significantly reduce experimental variation and thereby increase statistical power and precision. Thus, oligonucleotide arrays should be considered seriously when initiating new microarray projects. The primary disadvantage of oligo-based arrays is that oligonucleotide set can be very expensive because of the extensive sequence data and computational input required for designing gene-specific oligonucleotide probes. Currently, a single oligonucleotide chip is often three to five times more expensive than the cost of a single cDNA chip. A common limitation of all array approaches is their requirement of significant RNA for the preparation of fluorescently labeled targets. For this and other reasons, methods for generating sufficient signal from extremely small RNA populations (e.g. single cells) have and will continue to be investigated (Brandt *et al.* 2002; Feldmann *et al.* 2002; Nakazono *et al.* 2003).

4.4 - Microarray technology in grape and the other non climacteric fruits

Microarray technology is currently being used to investigate a variety of different physiological and developmental processes in plant species include grape, via a variety of different profiling techniques. Some examples in grape include response to various berry development process (Waters *et al.* 2005; Terrier *et al.* 2005), tissues and/or organs specific (Waters *et al.* 2005), cultivar specific (Waters *et al.* 2006), identify to the berry morphogenesis (Fernandez *et al.* 2007). While there were several investigations in the other non-climacteric fruits such as strawberry and citrus (see all details on table 1)

Table1. Micro-array technology history that was used to experiments in grape and the other non climacteric fruits.

Molecular function	μ-array technological	Reference
<u>Grape</u>		
response to various berry development process	DuPont, Wilmington, Del., USA	<i>Waters et al. Funct Integr Genomics 5, 40-58, (2005).</i>
response to various berry development process tissues and/or organs specific	MWG-Biotech, Ebersberg, Germany	<i>Terrier et al. Planta 222, 832-847, (2005).</i>
cultivar specific	DuPont, Wilmington, Del., USA	<i>Waters et al. Funct Integr Genomics 5, 40-58, (2005).</i>
identify to the berry morphogenesis	DuPont, Wilmington, Del., USA	<i>Waters et al. Plant Science 171, 132-138, (2006).</i>
pathogens and symbionts	MWG-Biotech, Ebersberg, Germany	<i>Fernandez et al. Plant Mol Biol 63, 307-323, (2007).</i>
responses to different stresses	GeneChip, Affymetrix, Memphis TN38105, USA	<i>Espinoza et al. Funct Integr Genomics 7, 95-110, (2007).</i>
	GeneChip, Affymetrix, Memphis TN38105, USA	<i>Cramer et al, Funct Integr Genomics 7, 111-134, (2007).</i>
<u>Strawberry</u>		
vascular development, oxidation stress and auxin response		<i>Aharoni et al, Plant Physiology 129, 1019-1013, (2002).</i>
tissues and/or organs specific		<i>Aharoni and O'Connell, J Exp Botany 53, 2073-2087, (2002).</i>
response to fruit flavor compound produced		<i>Aharori et al, Plant Cell 12, 647-661, (2000).</i>
<u>Citrus</u>		
tissues and/or organs specific		<i>Forment et al. Plant Mol Biol 57, 375-391, (2005).</i>
response to various plant and fruit development process		<i>Cercos et al. Plant Mol Biol 62, 513-527, (2006).</i>

❖ MATERIALS AND METHODS

Materials and methods

1 - Plant material

1.1 - Grapevines

Grapevines (*Vitis vinifera* L.) cv. Cabernet Sauvignon, grafted on 110 Richter rootstock, are grown in Toulouse, South-West of France (Domaine de Candie), in a non-irrigated vineyard. For the three seasons during which the experimentations have been performed - 2004, 2005 and 2006 full bloom occurred around mid-June and véraison occurred on week 8 or on week 9 after full bloom. The cluster harvest has been recorded 14 or 15 weeks after full bloom.

1.2 - Grapevine cell cultures

Cell suspension cultures of *Vitis vivifera* cv. Gamay, originating from the skin of grape berries, were grown in liquid medium as described previously by Ambid *et al.* (1983). The grapevine cultures were maintained at 25°C, under rotary agitation (120 rpm) and a 16-h light / 8 h dark cycle with a photon flux of 100 $\mu\text{molm}^{-2}\text{s}^{-1}$ (Osram L36W/36 Nature tubes). Cells were subcultured every 10 days by adding 8 ml of suspension to 80 ml of fresh medium in a 250 ml Erlenmeyer flask. Cell suspensions of 6-day-old cultures (exponential growth phase) were used in all experiments.

2 - Treatment of grapevines with 1-MCP and ethylene

2.1 - Treatment of cluster grapevine with 1-MCP

The 1-MCP (1-methylcyclopropane) was applied for 24 h, once a week, at various times following full bloom. The compound was applied using a polyethylene bag wrapped around the cluster, at an initial 1-MCP concentration of 4 $\mu\text{l.l}^{-1}$. Control clusters were wrapped in plastic bags for 24 h. For these experiments, clusters growing in a shaded area of the vines were chosen to avoid direct exposure to sunlight and overheating associated with such a treatment. After treatments, the clusters were sampled and stored at -80°C pending further analyses. In addition to, the grape cluster after flowering at all study weeks were sampled and took photos. These photos were used to calculate the berry colour percentage (Figure 2).

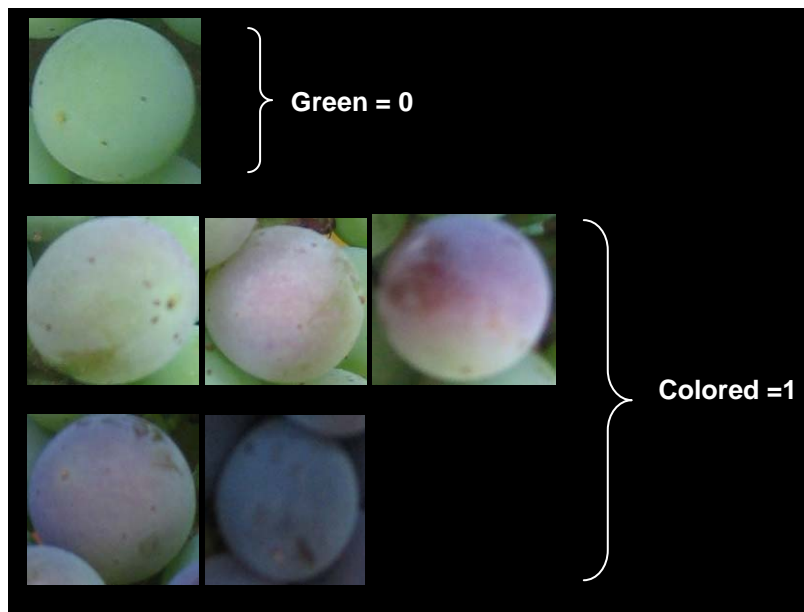

Figure 2. Images of Cabernet Sauvignon berry colour were indicated for calculating of the berry colour percentage.

2.2 - Treatment of grapevine clusters with ethylene

Clusters were sampled for two experiments, by wrapping in a polyethylene bag and exposing to ethylene gas at an initial concentration of $4 \mu\text{l.l}^{-1}$ for 1h or 24 h. This application was performed weekly, starting at week 2 post-flowering up to week 12 in 2004 and 2005. Control clusters were wrapped in plastic bags as each experiment but no ethylene treating. For all samples in all experiments, clusters growing in a shaded area as for MCP (see previous section). Three replicates were performed using three clusters (each one from a different vine) at a similar stage of development. After 1 hour treatments, for the second experiment, hard and soft berries were sampled separately, differences were determined by deformability value more than 0.3 cm and less than for hard and soft berries, respectively. After sampling berries were sampled and frozen at -80°C pending further analyses.

For the *ufgt-myb* experiment (end of chapter I), the ethylene was applied at a $40 \mu\text{l.l}^{-1}$ concentration.

2.3 - Diameter and deformability measurement of berries after ethylene treatment

At week 2 after grape flowering up to week 15 in 2006, 50 berries from vines treated by ethylene for 1 h as previously described and untreated (control) were harvested and diameter and deformability were measured by using harpenden skin fold calipers (British Indicators, UK) according to the method described on figure 3 by Coombe and Bishop (1980).



Figure 3. Calipers, tool for the diameter and deformability.

3 - Biolistic experiment

Suspensions of purple grape cells, cv. Gamay, have been used in the study of the effect of various effectors on the *UFGT* expression. Biolistic experiments were performed using a helium-driven gun with an initial propelling He pressure of 3.1 bars and a 30-mbar vacuum in the chamber at shooting time. The protocol described in Torregrosa *et al.* (2002) was used with slight modifications. Briefly, cells were vacuum-filtered onto Whatman n°1 filter paper and set upon MS-based cell culture medium containing 60 mM sucrose and solidified with 3 g.l⁻¹ Phytigel in small Petri dishes. Gold microprojectiles (1.0 µm, Biorad) were coated with the pVvufgt::gfp plasmid to achieve 1 µg DNA delivery per shot. Experiments were performed twice (two different dates), each date with three Petri dishes of 55 mm diameter (one dish per shot) for each treatment or treatment combination in each instance. After shooting, cells were sprayed with sterile water (control) or one ml sterile solutions of either 7 mM 2-chloroethylphosphonic acid (2-CEPA), a precursor of ethylene, or 150 mM sucrose or 500 µM abscisic acid (ABA), each compound added alone or in all combinations. To test the influence of darkness, the Petri dishes were wrapped in aluminium foil. The incubation time to get optimal GFP signal was around 40 h in a growth chamber with a 16:8 L:D light cycle. The observations were made in the morning of the second day after shooting, 2 h after light resumption.

Image acquisition and analysis were performed according to Cormeau *et al.* (2002), with the following modifications. The samples were examined with an epifluorescence microscope (DMIRB-E, Leica, Germany) equipped with suitable excitation and emission filters (i.e., blue range excitation BP 450-490 nm, DM 510 nm, LP 515 nm). Images were acquired using a Color CoolView 3-chip on chip CCD camera (Photonic Science, Millham, UK). The camera settings

were identical for all the experiments. For each image, the fluorescence intensity within the cell and the background were both measured from the green channel, using Image Pro-Plus 4.5 (Media Cybernetics, Silver Spring, MD, USA). The fluorescing cells were spotted by examining the Petri dishes with 10X magnification. The images of all observable cells per Petri dish were captured. A total of six Petri dishes were observed per treatment (three replicates x two bombardment series). There was no indication about the number of plasmids inserted per cell, but this is likely to vary similarly between treatments, as these were performed after the bombardment. The quantification was performed using SigmaScan (SPSS Inc., Chicago, IL). The signal intensities were normalised so the mean of controls under light is equal to 100. The LSD value was calculated at the 5% level using a one way ANOVA (SigmaStat, SPSS, Chicago, IL), which is sufficiently powerful to characterise the main differences.

4 - RNA extractions and Northern blots

Extraction of RNAs and Northern blots were performed from whole berries according to Boss *et al.* (1996a). Aliquots of 15 mg RNA were denatured and run on a 1.2% agarose gel (containing 3% formaldehyde and 10% MOPS). After electrophoresis, gels were stained with ethidium bromide (1.3 mg/l) and viewed under UV to confirm that RNA loadings were approximately equal. RNA was transferred to a Gene Screen Plus hybridization transfer membrane (NEN™ Life Science Products, Boston, USA) with a vacuum blotter (Type TDNA, Appligene) for 3.5 h at 45–50 mbar. Membranes were pre-hybridized for 4 h at 42°C in 5x SSPE, 50% (w/v) deionized formamide, 1% (w/v) SDS, 10% (w/v) Dextran sulphate-Na salt, MW 500,000 and 10 µg/ml denatured salmon sperm. Probes were derived from the cDNA clones of grape anthocyanin biosynthetic genes isolated by Sparvoli *et al.* (1994). The probes were labeled with ³²P by random primer labelling (Ready-To-Go DNA Labelling Beads, -dCTP Amersham Pharmacia Biotech, Uppsala, Sweden). Membranes were hybridized to denatured probe DNAs for 15 h at 42 ° C. The membranes were washed twice for 10 min at 42°C in 2x SSC (150 mM NaCl and 15 mM tri-sodium citrate, pH7.0) and 0.1% (w/v) SDS and then for 15 min in 0.1x SSC and 0.1% (w/v) SDS, again at 42°C, before exposure to autoradiography film (Hyper film, Amersham Pharmacia Biotech). The membranes were also hybridized with an 18S ribosomal RNA probe. Hybridization signal intensity was assessed with SigmaScan software (SPSS Inc, Chicago, IL, USA). To enable comparisons of individual transcript levels, calculations were performed as follows: for a probe λ , the hybridization signal of track Y was multiplied by [the mean value of the 18S signals of all tracks / the 18S value of track Y], as a way of taking into account loading variability, and then the resulting values were expressed as percentages of the means of the

day 0 signal (100%). Blots were performed in triplicate using RNA samples extracted from berries of different vines from within each treatment.

5 - Protein extractions and Western blots

The protein extraction from the grape berry has been achieved according to the protocol of Ford and Høj (1998) with sensitive modifications. The frozen powder (5 g) of berry tissues was thawed in 20 ml of extraction buffer (Tris-HCl 200 mM, pH 8.8, EDTA 1 mM, DETC 5 mM, glycerol 10% (v/v), PVPP 10% (w/v), DTT 2 mM), Overnight mixture at 4°C. The excerpts are centrifuged then on fiberglass (240 g, 15 min, 4° C) and the filtrate is centrifuged (30000 g, 1 h, 4°C). Aliquot 300 µl of pellet is precipitate in 1.2 ml of ammonium acetate 0.1M/MeOH during 3 h at -20°C. The pellet is collected by centrifugation (16000 g, 15 min., 4°C), stocked at -20°C.

The proteins dosage is achieved by method of Smith *et al.* (1985) while using the acidic bicinchoninique (BCA kit, Pierce). The proteins concentration is determined from a curve stallion achieved from increasing concentrations of BSA.

The proteins separated by SD-PAGE electrophoresis, then transferred on a membrane (Schleicher Schuell and-Protan BA 85-Celluloseenitrat) and the reactions of immunodetection are achieved in accordance with the protocol of Ford *et al.* (1998) Electrophoresis, 30 µg of proteins are deposited in all wells. The controlled antibodies of rabbit specifically against the UFGT are provided by Ford *et al.* (1998) that had experimented them with success on excerpts of grapevine. To detect these antibodies, we used secondary antibodies anti IgG of rabbit coupled to the peroxydase whose activity has been revealed by the reactive ECL (Amersham LifeScience).

6 - *ufgt* promoter cloning, plasmid construction and expression of pVvufgt::*gfp* in *planta*

A subclone obtained from the 5'-end of a grapevine *ufgt* cDNA (Ford *et al.* 1998) was used to probe a 400,000 plaque aliquot of a genomic library made from the cultivar Shiraz. Two positive plaques were obtained and one was used to isolate a genomic fragment consisting of 736 bp of *ufgt* coding sequence and 1647 bp of promoter sequence immediately upstream of the ATG start codon. For expression analysis, the grapevine *ufgt* promoter region was amplified using the primers UTPPF (5'-TCCCCCGGGCTTTTCGGTATCATGCGTCC-3') and UTPP2 (5'-

TCCCCCGGGTTGGAATGGGGGATGTT-3') and cloned into a promoterless-gfp shuttle vector (pART7napx+GFP) developed from pART7 (Gleave 1992) and pBINm-gfp5-ER (Haseloff *et al.* 1997). The entire expression cassette was then cloned into the binary vector pART27 (Gleave 1992) and the final construct was called pVvufgt::gfp.

The cis-elements were estimated by homology search using PLACE database, <http://www.dna.affrc.go.jp/PLACE/signalscan.html> (Higo *et al.* 1998) or PlantCARE database, <http://intra.psb.ugent.be:8080/PlantCARE/> (Lescot *et al.* 2002). Comparisons were made between the results obtained before and after the randomisation of the promoter sequence using the same databases. When the number of repetitions of one cis-element was equal or higher in the randomised sequence than in the original one, we kept it in the figure, but showed its name in italics.

The promoter-gfp fusion construct pVvufgt::gfp was stably inserted into the grapevine cultivar Shiraz using transformation and regeneration methods that have been described previously (Iocco *et al.* 2001). Berry sections of 0.5 to 1 mm thickness were taken with a fine double edged razor and were immersed in water on a glass slide for GFP detection. Berry sections were visualised and imaged for GFP immediately after slicing. Images of gfp expression in postvéraison berry sections were taken using a SPOT digital (Model # 2.3.0) attached to the Zeiss Axiolplan microscope at 40X magnification through a fluorescence filter (450-490nm) /520nm excitation/emission wavelengths under dark field or low light field. Corresponding bright light field images were also taken.

7 - RNA extraction for microarray and qRT-PCR

Total RNA extraction was performed as previously described (Boss *et al.*, 1996) with some modifications for microarray and qPCR. For the microarray the RNAs were extracted from whole berries, whereas for qPCR they were extracted from isolated skin, pulp or seed tissues. To obtain pure RNA without DNA contamination we used RNeasy mini kit (Qiagen), and apply 10 µl of RNase-Free DNase I (Qiagen) onto the Rneasy column before elution, all other steps were performed according to Rneasy kit instructions. The absence of DNA was checked using UFGT intron primers (*UFGTi-F* 5' CTGCAGGGCCTAACTCACTC 3' and *UFGTi-R* 5' TAGGTAGCACTTGGCCCATC 3'). DNase-treated RNA (4 µg) was reverse transcribed using Omniscript Reverse Transcription Kit (Qiagen). Checking the quality of cDNA was performed by PCR with *EF1-α* primers (Table 2).

Table 2. Primers were designed to the Real Time quantitative RT-PCR experiment.

Putative function	Gene code	Primers (F = forward, R = reverse)	Accession number	Expected size (bp)
Myb-related transcription factor	<i>mybA</i>	F- GCAAGCCTCAGGACAGAA R- AAGCCCACATCAAATGGAAAA	AB073010	107
UDP glucose-flavonoid 3-O-glucosyltransferase	<i>ufgt</i>	F- GGCTTTTGTACACATTGCG R- AAAAAGGGCCTGCAAATCAA	AF000372	81
Xyloglucan endotransglucosylase	<i>XET</i>	F- AGCTCCCTTCACTGCCTCCTATA R- AGATCAAAGAGGAAGAACTGAGCTG	CB346454	98
Polygalacturonase	<i>PG</i>	F- GCACCAACGGCCTTAACCT R- GGTGAGACCCGAAGCTTGAA	TC47375	126
Pectin methylesterase	<i>PME</i>	F- TCCAGTGGCCGGGTTTT R- TGAATTCGGTCACCGTGAAG	TC38735	69
Cellulose synthase	<i>CS</i>	F- ACTGCAAACCCATTATTGAACC R- GACATGACCCACCATCATCG	CB978247	121
Expansin	<i>EX1</i>	F- ACCTAGTCCTCATCACAAACGTTG R- TTTTGGCCCCAGTTCCTG	TC38813	106
	<i>EX2</i>	F- GAGTACCGCGCCGGAATT R- CTCCACTCTTTCGGCAGGATA	TC39737	61
Aquaporin	<i>AQUA1</i>	F- TCAACCCGATGCGCTCA R- CTCCGGCGAACACAAAAATT	TC38576	68
	<i>AQUA2</i>	F- TGCCGATTCCCCTCTTCTG R- CAAACAACACCACAAACGCATAG	TC39811	81
	<i>AQUA3</i>	F- GAAACGCCAGAGACTCTCACGT R- TGAACCAAGAACACTGCAAACC	TC38191	70
	<i>AQUA4</i>	F- GTTCACTTGGCCACTATTCTATCA R- TAACAGCAGCCCCAAACTC	TC38121	70
EF1 alpha (control gene)	<i>EF1- α</i>	F- GAATGGGTGCTTGATAGGC R- AACCAAAATATCCGGAGTAAAAGA	GT181C12	150

8 - qPCR experiments

The quantitative PCR was performed using 100 ng of total RNA in a 10 μ l reaction volume using SYBR GREEN PCR Master Mix (AppliedBiosystems) on an ABI PRISM 7900HT sequence-detection system. The primer used are described in Table 1. All qPCR experiments were run using three biological replicates, in addition to three technical replicates in 384-well plates.

Relative fold differences were calculated based on the comparative Ct method using the *EF1- α* as an internal standard. To demonstrate that the efficiencies of the different gene primers were approximately equal, the absolute value of the slope of log input amount versus Δ Ct was

calculated for all the study gene and the referent gene (*EF1- α*) as previously described (Terrier et al. 2005). To determine relative fold differences for each sample in each experiment, the Ct value for all the genes was normalised to the Ct value for *EF1- α* and was calculated relative to a calibrator using the formula $2^{-\Delta\Delta Ct}$.

9 - Microarrays experiments

The microarray experiment reported here, was performed with three biological replications, and two treatments: applying ethylene at 4 $\mu\text{l.l}^{-1}$ or nothing (controls) and leaving the polyethylene bags for 24 h around the clusters, before sampling, freezing the berries in liquid nitrogen and storing them at -80°C until further analysis. This was performed 8 weeks after full bloom in triplicate (three separate clusters, each one on a different vine). Then 3 berries of each sample were regrouped in a 9 berry biological replicate to extract RNAs. We processed three separate RNA extractions for each treatment as show in Figure 4.

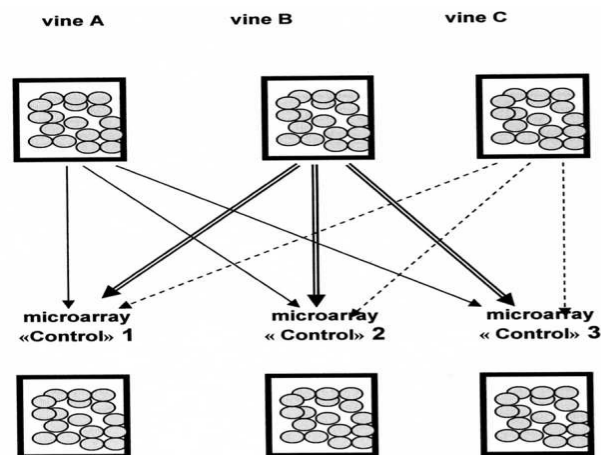

Figure 4. Diagram of three microarray replications sampling which showed each microarray replication was sampled from three biological replications in grapevine. The same diagram was applied to «Treatment» with ethylene.

We used the Array-Ready Oligo Set™ for the Grape (*Vitis vinifera*) Genome Version 1.0 containing 14,562 70mer probes representing 14,562 transcripts from The Institute for Genomic Research (TIGR) Grape Gene Index (VvGI), release 3. Oligonucleotides were spotted on mirror slides and the probes were labeled with Cy3- and Cy5 dyes as described in Terrier et al. (2005). The experimental was designed performed with 6 slides (3 biological replicates and a dye-swap, as show in Figure 5A). Hybridised microarrays were scanned simultaneously for Cy3- and Cy5- labelled probes with an Axon Genepix 4000B scanner.

A small experiment was run with RNA samples extracted from hard and soft berries (as show in Figure 5B) after 1 hour incubation in presence of ethylene, with concentrations as in the 24 h experiment. There was no dye swap for this experiment.

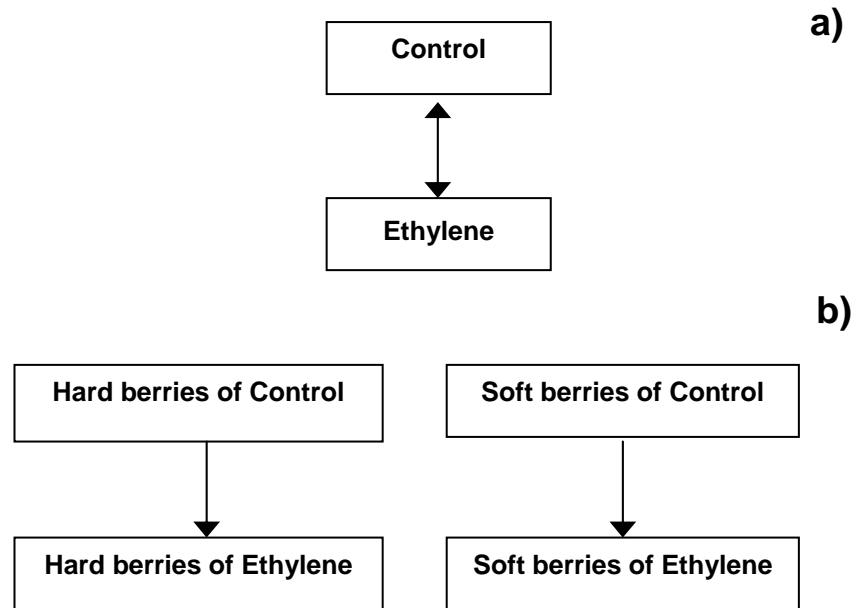

Figure 5. Experimental design for microarray experiments a) the first experiment, two treatments and b) the second experiment, four treatments. Each double array means that a dye swap experiment was effected. In each box the sample used for RNA extraction is described as treatment.

10 - Statistical analyses and similarity search

For berry diameter and deformability the means of the control and ethylene treatments were compared using t-tests.

Regarding the microarray experiment, for each slide, data from both channels corresponding to Cy3 and Cy5 labeled probes were normalised using the LOWESS algorithm in TIGR Microarray Data Analysis System (MIDAS). Data from all the slides were log transformed, and normalised (centered on 0, variance equalised to 1), those data are available in supplementary material (chervinsupptab). The significance was calculated at the 0.01 level by paired t-test in Multiexperiment Viewer (MeV) from TIGR.

All genes that were affected by ethylene were tentatively identified by BLASTn similarity search with mRNA sequences from the whole genome sequencing project (http://www.genoscope.cns.fr/externe/English/Projets/Projet_ML/projet.htm). The complete mRNA sequences corresponding to these genes were used to identify the corresponding *Arabidopsis thaliana* proteins homologs (<http://www.arabidopsis.org/>) using Blastx tool and an e-value <math><1e-5</math>. These grape genes were then assigned the functions corresponding to the *Arabidopsis* homologs according to gene ontology annotations for (GOSLIM) in TAIR.

**❖ CHAPTER – I. ROLES FOR ETHYLENE IN THE
EXPRESSION OF THE UDP GLUCOSE-FLAVONOID 3-O-
GLUCOSYLTRANSFERASE IN GRAPE TISSUES**

CHAPTER I: Roles for ethylene in the expression of the UDP glucose-flavonoid 3-O-glucosyltransferase in grape tissues

1. Introduction

Ripening is an essential step of fruit development that conditions the qualities of both whole fruit and transformed products. There are two classes of fruit regarding their ripening behaviour: the climacteric fruit for which ripening steps are controlled by a relatively strong ethylene evolution, and the non-climacteric fruit in which the ethylene evolution is very low and for which the ripening process seems to occur independently of the ethylene production (Giovannoni 2001). Grapes are regarded as non-climacteric fruit (Coombe and Hale 1973). However a recent study has shown that grape berry tissues have a fully functional pathway for ethylene synthesis, and that this pathway is activated just before véraison (Chervin *et al.* 2004), when berries start to accumulate sugars and, in red cultivars, accumulate anthocyanins. Furthermore this study showed that ethylene perception is critical for some berry changes associated with ripening, including anthocyanin accumulation (Chervin *et al.* 2004). This conclusion was supported by the fact that anthocyanin biosynthesis in the berry skins was inhibited when a specific inhibitor of ethylene receptors (1-methylcyclopropene or 1-MCP; Blankenship and Dole 2003) was applied to berries just before véraison, at the same time as ethylene was produced in the berry (Chervin *et al.* 2004).

The control of anthocyanin accumulation during the ripening phase in red grape berries and is thought to be greatly dependent on UFGT activity (Kobayashi *et al.* 2004; Kobayashi *et al.* 2002; Boss *et al.* 1996a). This enzyme plays a key role in stabilising the aglycone moiety of the anthocyanins (Piffaut *et al.* 1994) and may be essential for their transport to the vacuole. We have shown previously that exogenous ethylene could induce grape *ufgt* expression (El-Kereamy *et al.* 2003), confirming observations about the use of ethylene precursor to boost grape skin colour (Weaver and Montgomery 1974). However, we did not test whether the signal was acting on grape *ufgt* expression directly via ethylene receptors or indirectly through alternate pathways. To our knowledge there is no data about the induction of UFGT by ethylene in other plants; but there has been a recent report about induction by ethylene of another UDP-glycosyltransferase (Poppenberger *et al.* 2003). To further investigate the means by which ethylene induces grape *ufgt* expression, we cloned and sequenced the grape *ufgt* promoter and found ethylene cis-element motifs (ERE, ethylene responsive elements). The promoter region isolated was tested in planta to confirm that correct spatial and temporal signals were present in

the upstream region we cloned (data not shown). The *ufgt* promoter was fused to the *gfp* reporter gene and various transient expression studies in grape cell suspensions were conducted in order to test the importance of ethylene signals and other stimuli in the control of transcription from this promoter. The anthocyanin biosynthesis in model plants for the anthocyanin pathway such as petunia and maize is controlled by *Myc* and *Myb* transcription factors, and indeed, one transcription factor of this family, MybA1, was shown to be critical for the regulation of *ufgt* expression (Yakushiji *et al.* 2006 and refs therein) and anthocyanin accumulation in grape tissues. The question remains whether the ethylene signal is acting on grape *ufgt* expression through the activation of *mybA1* expression or via other “ethylene transcription factors”.

2. Results and Discussion

2-1 The color development and related characteristics of Cabernet Sauvignon berries

All images of berry development (Figure 6) were taken by camera during 2 to 15 weeks after flowering. We found that berry size increased rapidly at the beginning stage after the berry set (Figure 7a). But the berry color was unchanged until the beginning of véraison (7 weeks, Figure 7b). During the véraison, berries size was stable between 7 to 9 weeks, and increased again between 9 to 11 weeks after flowering, while berry skins lost chlorophyll and began to synthesise and accumulate anthocyanins that are responsible of the purple color (Boss *et al.* 1996c). As the berries approach full maturity, berry size reached a maximum.

2-2 MCP application can reduce *ufgt* mRNA levels

The application of 1-MCP significantly inhibited the accumulation of *ufgt* mRNA in Cabernet Sauvignon berries when applied 10 weeks after full bloom (Figure 8a). Western blot analysis was run only for the times at which *ufgt* mRNAs were detected but no significant difference between control and 1-MCP treatment was seen for UFGT protein levels, however the 1-MCP limited the UFGT protein accumulation over the three sampling times (Figure 8b). The fact that the 1-MCP effect was significant only on mRNA and not on proteins may be due to the higher stability of UFGT protein compared to mRNAs. To see changes in protein levels we may need to sample berries later than 24h after treatment to allow for the reduction in steady state *ufgt* mRNA levels to be reflected in reduced UFGT protein. Nevertheless, the difference seen in *ufgt* mRNA levels upon 1-MCP application in the 10 weeks post flowering.

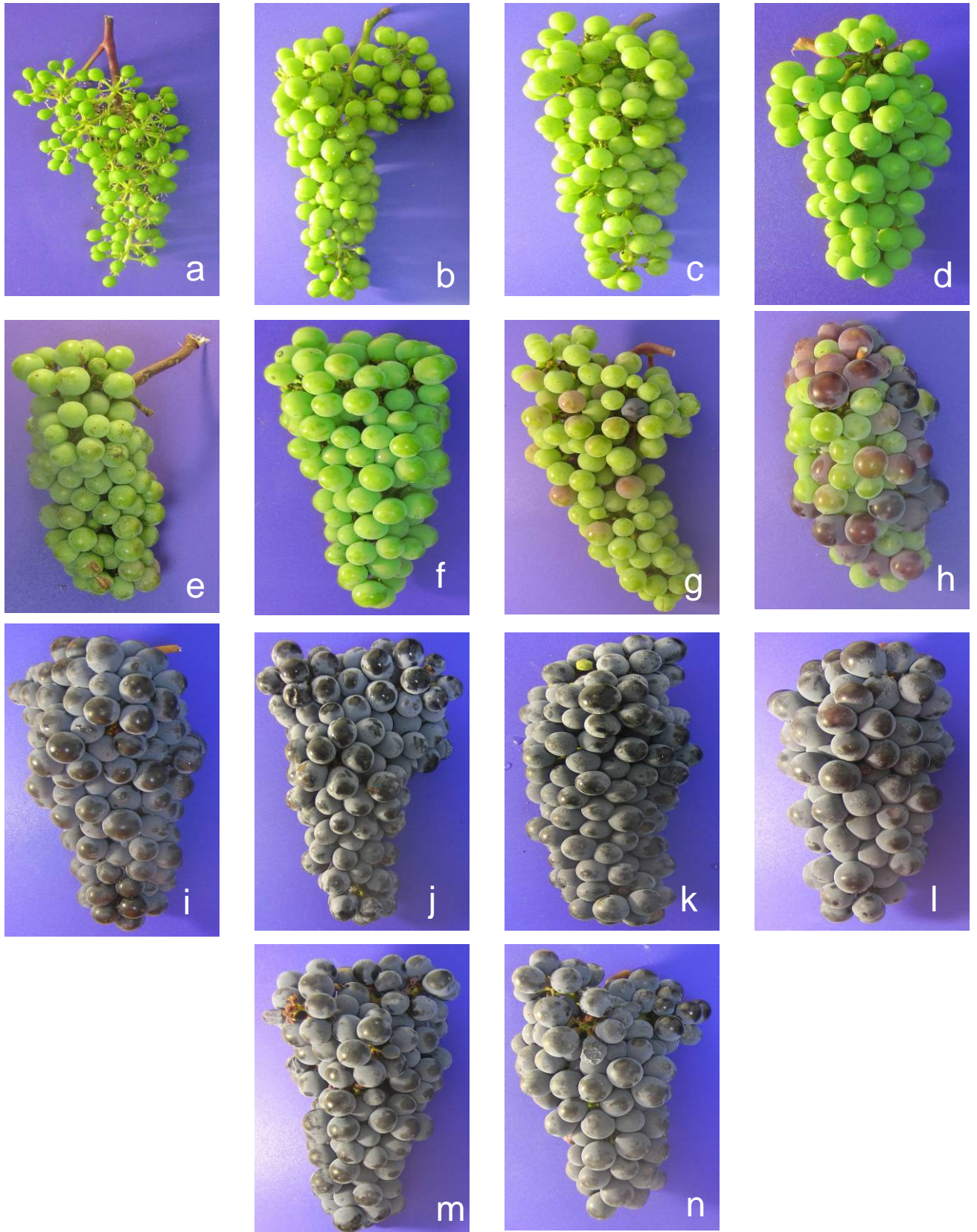

Figure 6. Images of Cabernet Sauvignon clusters at various stages after flowering: 2 weeks(a), 3weeks(b), 4 weeks(c), 5 weeks (d), 6 weeks(e), 7 weeks(f), 8 weeks(g), 9 weeks(h), 10 weeks(i), 11 weeks(j), 12 weeks(k), 13weeks(l), 14 weeks(m) and 15 weeks(n).

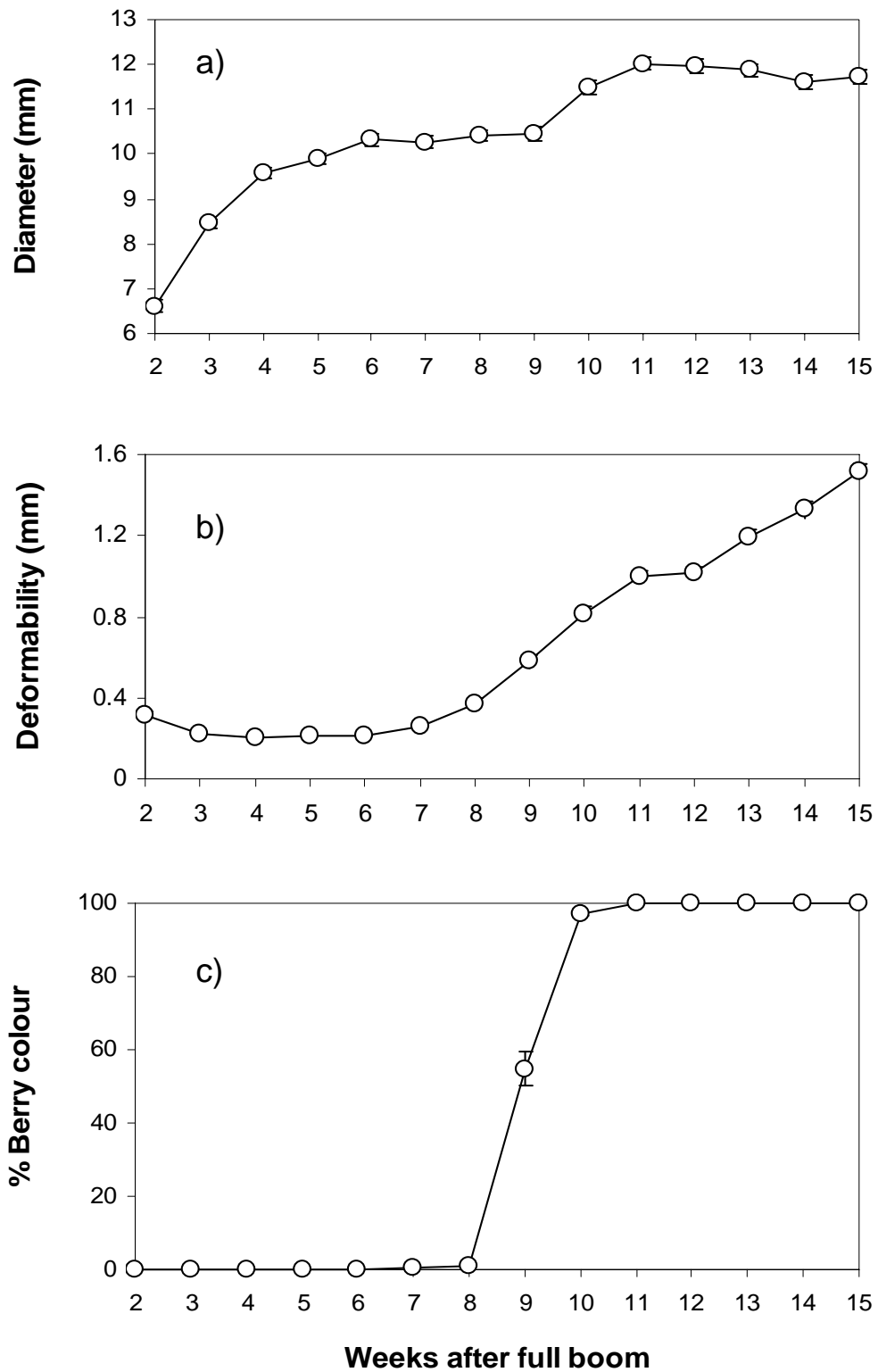

Figure 7. Diameter (a), deformability (b) and color percentage (c) of Cabernet Sauvignon berry after flowering at various time. The symbols represent means of 50 berries measurements, error bars are SE, and omitted when smaller than symbol size.

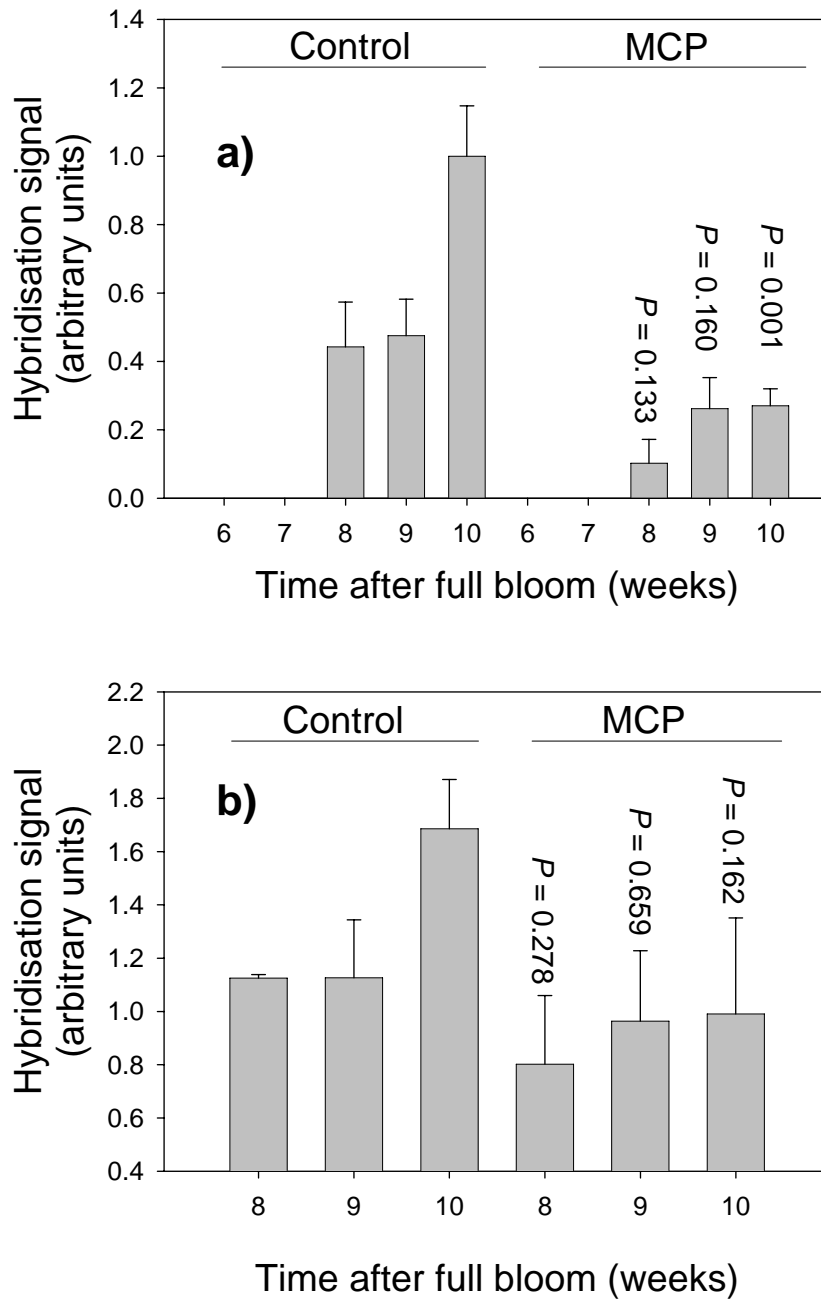

Figure 8. Effects of 1-MCP (methylcyclopropene), inhibitor of ethylene receptors, on the expression of the *ufgt* gene in grape berries (levels of mRNA accumulation), cv. Cabernet Sauvignon, as a function of the time of application after full bloom; a) Northern blots, results normalised with the 18S signals, the picture shows one of the three blots, b) Western blots, results normalised with the red Ponceau signals, the picture represents one of the three blots; n = 3 biological replicates, error bars represent SE, *P* is the probability that there was no difference between the control and the MCP means at the same sampling time (t-tests).

Sample confirms the previous observation that the induction of UFGT by exogenous ethylene is probably due to ethylene signal transduction and not to indirect stimulation via other metabolisms activated by ethylene or side-effects of the relatively high dose of the ethylene precursor that was sprayed onto the grapes (El-Kereamy *et al.* 2003). The inhibition of the UFGT protein accumulation by MCP (Figure 8b), without being significant by Western analysis, may lead to the significant decrease of anthocyanin accumulation previously observed (Chervin *et al.* 2004), as for week 10 there was a drop by 50 % of the protein accumulation after treatment with MCP (Figure 8b).

To allow the comparison of the different treatments and check that ethylene stimulation is dependent of active state of ethylene receptors, we regrouped a set of treatments at week 9 post-flowering (Figure 9). The application of exogenous ethylene led to a strong increase of *ufgt* mRNAs which was not occurring when MCP was applied first.

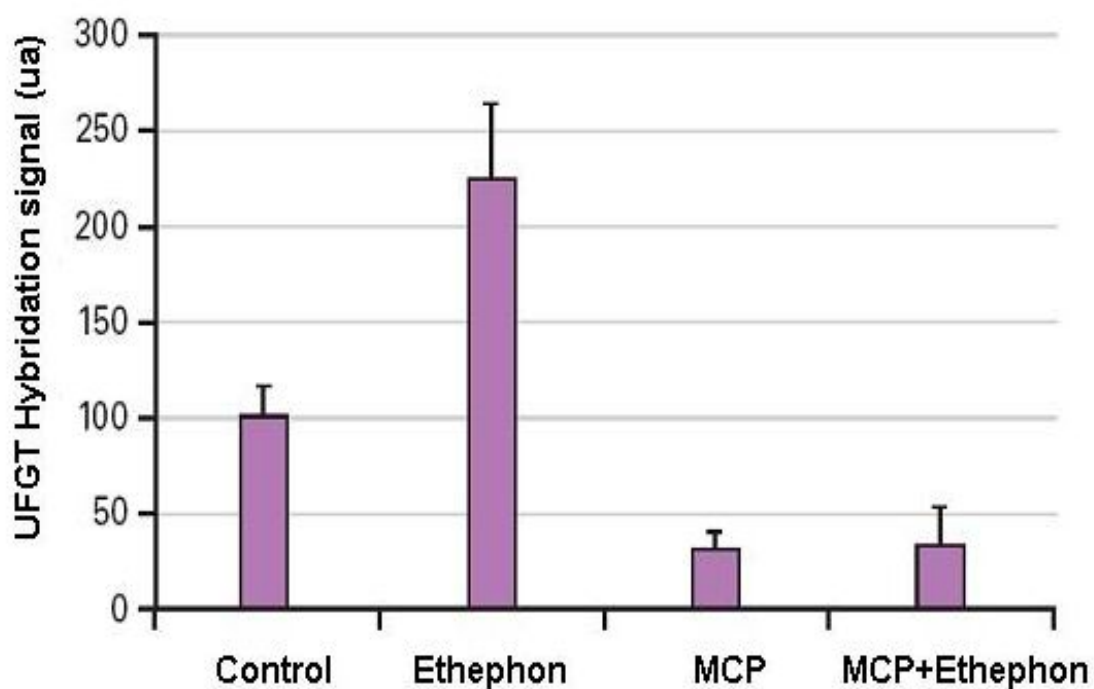

Figure 9. Influence of the ethephon and 1-methylcyclopropene (MCP) on the *ufgt* mRNA accumulation after a 6 h treatment, in Cabernet Sauvignon berries, 9 weeks after flowering. The bars are means of 3 biological replicates, error bars represent SE.

2-3 A 1647 bp region upstream of the *ufgt* coding region directs reporter gene expression to berry skins post-véraison

The control of the anthocyanin biosynthesis pathway in plants has been shown to occur at the level of gene transcription (Martin and Gerats 1993). Studies of the promoters of anthocyanin biosynthesis genes in both *Antirrhinum* (Sablowski *et al.* 1994) and maize (Roth *et al.* 1991) have identified transcriptional controlling elements. In grapevine, *ufgt* expression correlates with anthocyanin biosynthesis, which suggests that important promoter elements upstream of this gene control anthocyanin production in this plant species (Boss *et al.* 1996a). The results of the 1-MCP treatments above and experiments from previous work (El-Kereamy *et al.* 2003) suggest that the *ufgt* promoter can respond to ethylene signalling. In order to investigate the effects of ethylene and other possible stimuli on *ufgt* expression, a genomic clone encoding the promoter of grapevine *ufgt* was isolated and a 1647 bp region upstream of the putative ATG translational start codon cloned. To ensure that the region we had cloned possessed regulatory sites that direct the correct temporal and spatial expression patterns *in vivo*, we fused the promoter to *gfp* and transformed the fusion construct back into grapevines. We observed it was expressed only in berry skin tissues (data not shown). GFP was detectable in postvéraison berries in skin tissue but was undetectable in the berry flesh tissue of Shiraz pVvufgt::gfp transgenic plants (Figure 10a and 10b). GFP was undetectable in prévéraison berries, and leaves (data not shown). The *gfp* gene in pVvufgt::gfp codes for GFP which localises to the endoplasmic reticulum (Haseloff *et al.* 1997) and so is only present in the cytoplasm of the cells in which it is expressed. No GFP is detectable in the centre of cells which are taken up by large vacuoles. However, expression in the skin was not uniform and some cells that contained anthocyanins did not show GFP fluorescence (Figure 10a and 10b). This could be because those cells have already produced all the anthocyanin they are destined to produce and so the pathway is no longer active. Alternatively, the cells have been damaged during sampling and sectioning.

Nevertheless, the observation that GFP was only found in the skin of postvéraison berries in the transgenic plants suggests that the region of the promoter that was isolated possesses the controlling elements necessary to direct normal *ufgt* expression patterns.

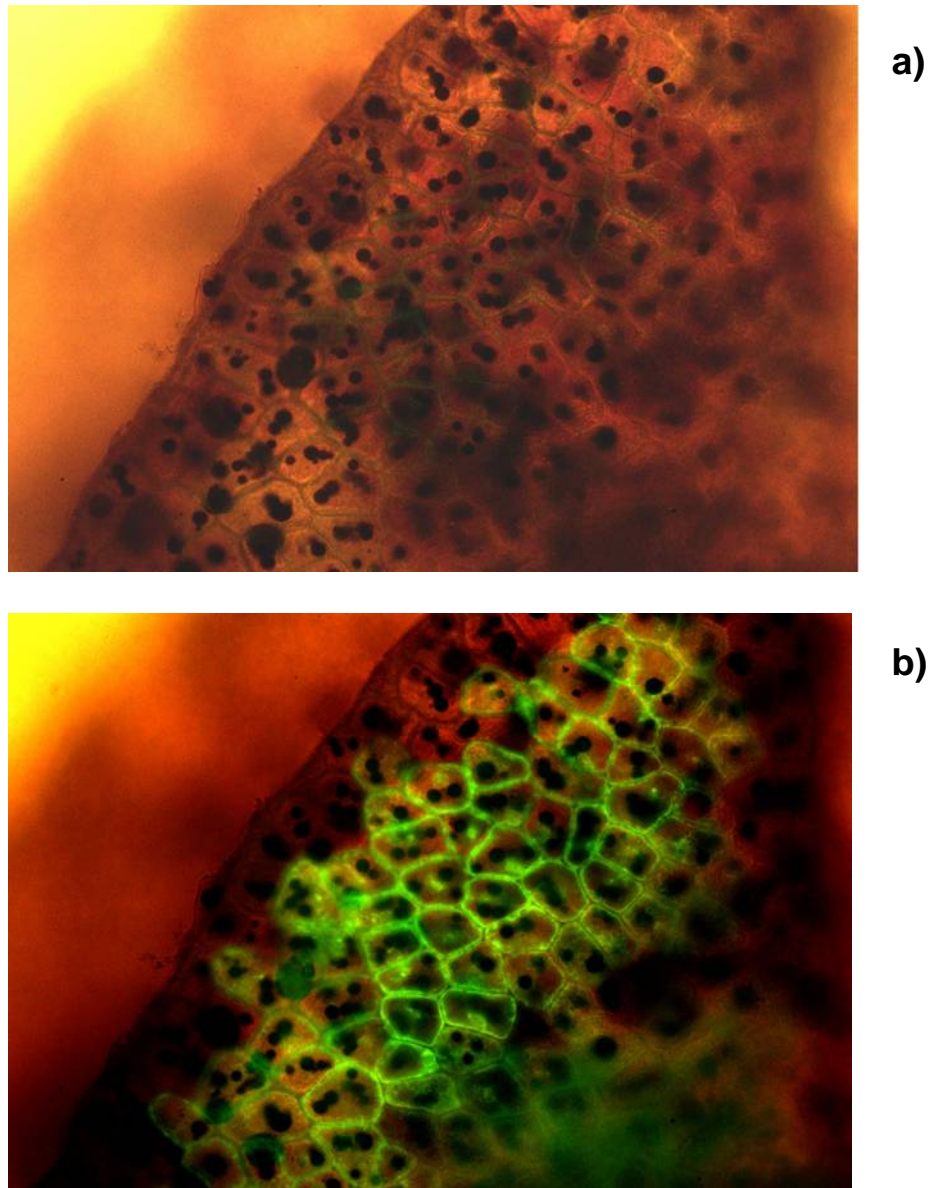

Figure 10. Images of transgenic Shiraz pVvufgt::gfp: a) postvéraison berry outer skin section under bright field showing anthocyanins in all cells, b) the same tissue section as in a) but taken under low light and fluorescence showing GFP fluorescence in the majority of cells a cross section of postvéraison berry outer skin.

2-4 The grapevine *ufgt* promoter

In Figures 11 and 12, we show the Shiraz *ufgt* promoter sequence isolated in this study (GenBank AY955269). It has 97 to 99 % homology to the grapevine *ufgt* promoter sequences isolated from the Kyoho, Italia, Ruby Oku, Muscat of Alexandria and Flame Muscat cultivars (Kobayashi *et al.* 2001), and 95 % to Cabernet Sauvignon (GenBank AY919624). The alignment of various *ufgt* promoter sequences has already been showed by Kobayashi *et al.* (2001).

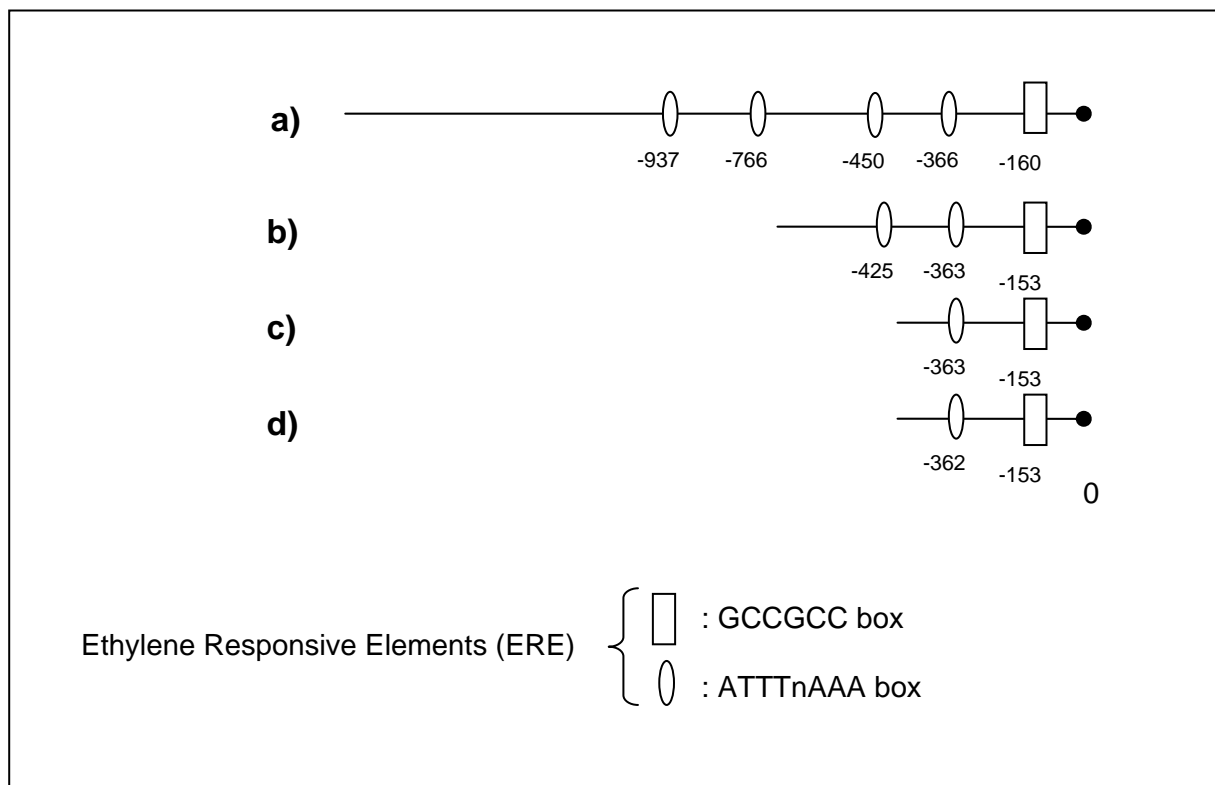

Figure 11. Locations of ethylene responsive elements (cis-acting) on the *ufgt* promoter of a) *Vitis vinifera* cv Shiraz (AY955269), b) Cabernet Sauvignon (AY919624), c) *Vitis labrusca* x *Vitis vinifera* KyUFGT2 (AB047091), and d) FIUFGT2 (AB047099) or AIUFGT2 (AB047097) or RuUFGT2 (AB047095) or ItUFGT2 (AB07093) that the b), c) and d) were homologed by a) 94.5%, 97.4% and 98.8% respectively. The nucleotide numbering is relative to the start codon (0). Cis-elements were estimated by homology search using PLACE and PlantCARE databases.

We sought to identify potential controlling motifs by looking for transcription factor binding sites on the sequence of this promoter (Figure 12). One ethylene cis-element, initially reported by Itzhaki *et al.* (1994), attracted our attention. This ERE sequence, ATTTCAA is located at -365 bp (Figure 12). This element was also present with a sequence differing by a single nucleotide, ATTTTAAA, at three other sites that could also be potential EREs. Indeed, this latter sequence is recognised as a potential ethylene cis-element using the online-database, PlantCARE (Lescot *et al.* 2002). Furthermore we found a promoter region with sequence homology to another class of ethylene cis-elements at -160 bp (sequence GCCGCC) previously described by Fujimoto *et al.* (2000). The presence of several putative ethylene cis-elements in the grapevine *ufgt* promoter supports our observations about the potential role for ethylene in inducing *ufgt* expression in berry skins after véraison. The EREs mentioned above are also present in the Cabernet Sauvignon *ufgt* promoter.

Submitting this promoter to PLACE analysis (Higo *et al.* 1998), we found many sequence matches to other known cis-elements (Figure 12), with several corresponding to three other stimuli known to affect plant development or metabolism: light, sugar and abscisic acid. These are also signals known to induce anthocyanin accumulation in grapes and other plant tissues (Mol *et al.* 1996). Using the Shiraz *ufgt* promoter transcriptionally fused to the *gfp* gene, we carried out transient expression experiments using purple grape cell suspension cultures established from the grape cultivar Gamay. These cells have been shown to produce glycosylated anthocyanins (Afifi *et al.* 2003), thus we expected that all the components necessary to activate the glycosylation of anthocyanins via the *ufgt* gene were present in these cells. These purple cells also present the advantage of having very low auto fluorescence at the wavelength used to track GFP activity. The aim of this transient expression study was to check the importance of ethylene signalling in inducing *ufgt* expression along with the three other potential regulators of *ufgt* expression mentioned above. We tested the effects of darkness or light alone on reporter gene expression, the addition of single effectors (ABA, ethylene or sucrose) on GFP fluorescence, and then the influence of all double and triple combinations of the stimuli on GFP expression.

Figure 13 and Figure 14 show that ethylene stimulates GFP production in the transient assays in darkness (a significant increase of the GFP signal by 25 % compared to the dark control alone), but ethylene does not stimulate GFP expression from the *ufgt* promoter in light (a non-significant increase by 5 %). This absence of stimulation in light could be due to overlapping or proximal cis-elements (one LRE and one ERE) like those at -366 bp or - 420 bp or -766 bp or - 936 bp (Figure 12). This is the case of nearly 60 % of the EREs located on this promoter. This

type of inhibition may be due to steric hindrance of transcription factors as discussed by Hahn *et al.* (2003). It is also possible that the timing of the initiation of each stimulus, leading to presence of transcription factors in a set order, may also lead to either synergistic or inhibitory effects regarding transcription. In the dark, there is no additive effect due to ethylene in combination to other effectors (Figure 14). The signal intensity reached a maximum as soon as one effector was present. In the light, ethylene and ABA may present some additive effect, as the signal intensity was significantly increased by + 11% in comparison to control = light alone, when none of the single effectors (ethylene or ABA) led to an increased signal.

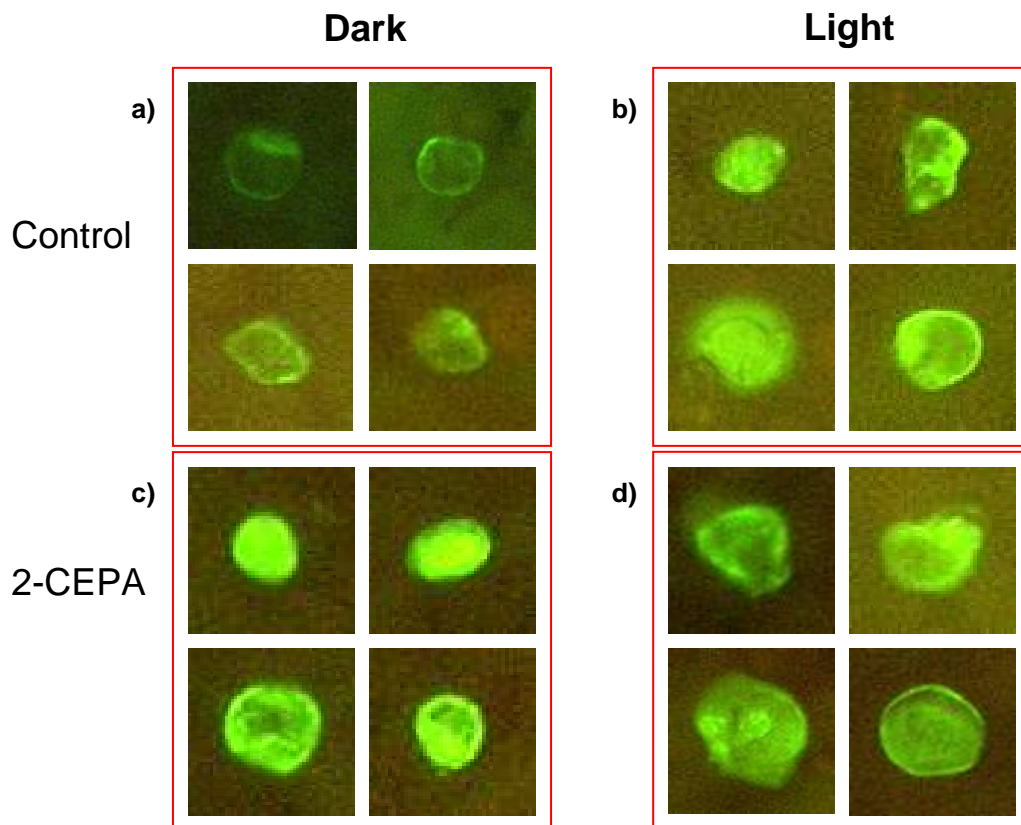

Figure 13. Images of Gamay cells experiment with GFP after 2-CEPA treating and maintained at the dark and light condition, 48 h.

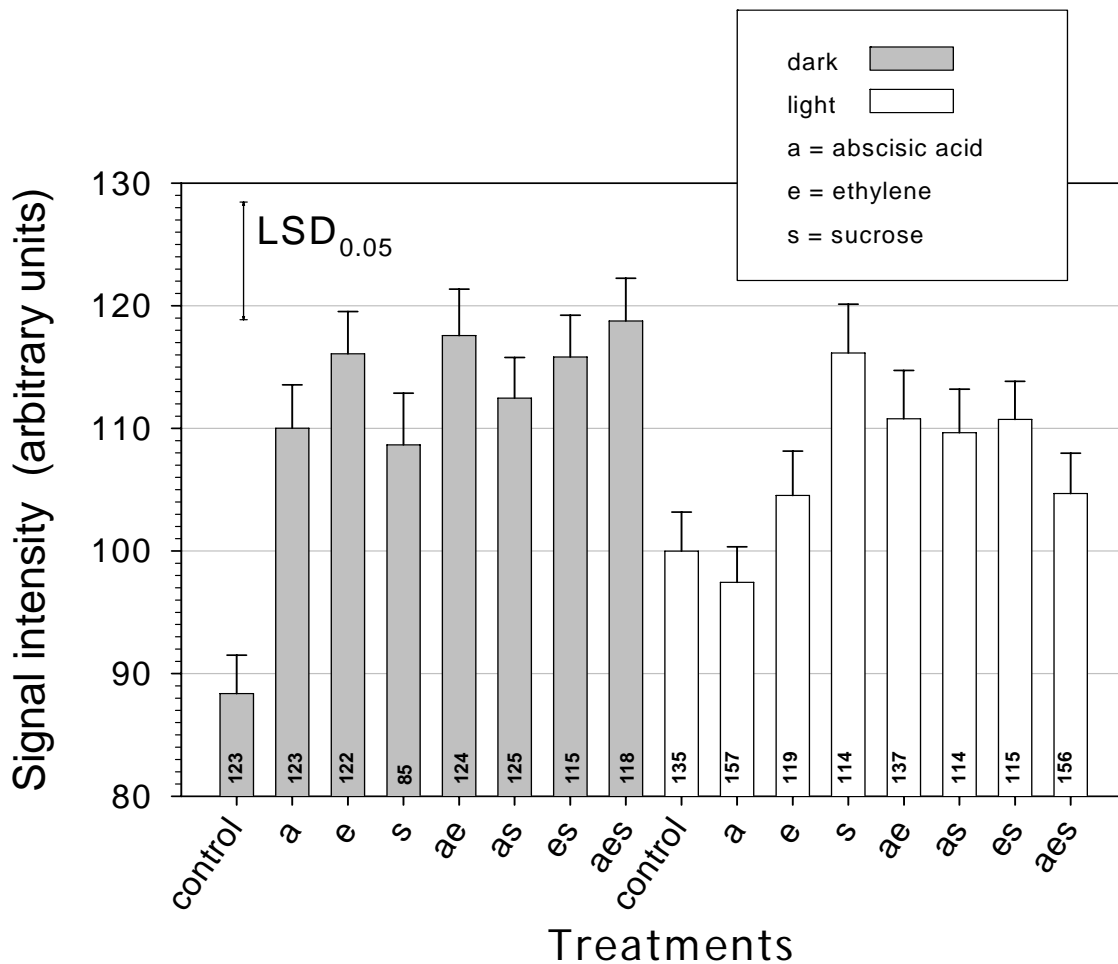

Figure 14. Activity of the *ufgt* promoter as a function of various stimuli. Fluorescence of the GFP, driven by an *ufgt* promoter, after bombardment of grape cells cv. Gamay and spraying with water (control), or solutions of abscisic acid, or chloroethylphosphonic acid, an ethylene precursor, or sucrose, and combinations of these stimuli. The cells were incubated in dark or light conditions. The bars represent the means values of “x” individual fluorescing cells, “x” is given at the bottom of each bars. These means are the results of six cell batches (3 replicates x 2 dates). The normalisation was performed by giving the “100” value to the mean value of “light controls”. The error bars represent SE, and the LSD bar was calculated at the 5% level.

As in other experiments of transient expression published in various plant systems, one can question their biological significance. In answer to this question, we can propose this set of results as a first description of the ethylene role in a complex combination of stimuli, controlling the expression of one key protein (UFGT) involved in the production of the anthocyanins.

ABA also had a stimulatory effect on GFP expression in the transient assays carried out in the dark, but no significant change was seen when the callus was maintained in the light (Figure 14). Sucrose treatments increased the levels of GFP fluorescence in both dark and light grown callus (Figure 14). In the context of berry ripening, these results are most interesting. The *ufgt* expression is induced at véraison and continues throughout the rest of berry ripening (Boss *et al.* 1996c). The induction of UFGT coincides with the initiation of an influx of sugars into berries and a peak of ABA levels in the berries (Boss *et al.* 1996c; Davies *et al.* 1997). Thus, these stimuli probably promote the *ufgt* expression in vivo.

Light was also found to stimulate GFP expression of the Shiraz *ufgt* promoter in the transient assays (Figure 14). This matches results obtained with Cabernet Sauvignon, in which shading of bunches has been shown to reduce the accumulation of anthocyanins (Jeong *et al.* 2004).

Future possible experiments could involve mutation/deletion of the promoter boxes meant to be under ethylene control. To be exhaustive, this would be quite a big task as there are many combinations of mutation/deletion to be tested with seven cis-elements.

2-5 Does the ethylene signal stimulate mybA gene expression in grape tissues?

The application of gaseous ethylene significantly stimulated the accumulation of *ufgt* mRNA in berries when applied 8 and 9 weeks after full bloom (Figure 15a). These observations made in Cabernet Sauvignon berry tissues were confirmed in another cultivar, under different experimental conditions, the Gamay cell suspension sprayed with the 2-CEPA, an ethylene precursor (Figure 15c). These results confirmed previous observations, either the enhancement of anthocyanin accumulation after spraying 2-CEPA onto the grape clusters (El-Keramy *et al.* 2003), or the inhibition of anthocyanin accumulation following a treatment of the clusters with the ethylene inhibitor, 1-methylcyclopropene (Chervin *et al.* 2004).

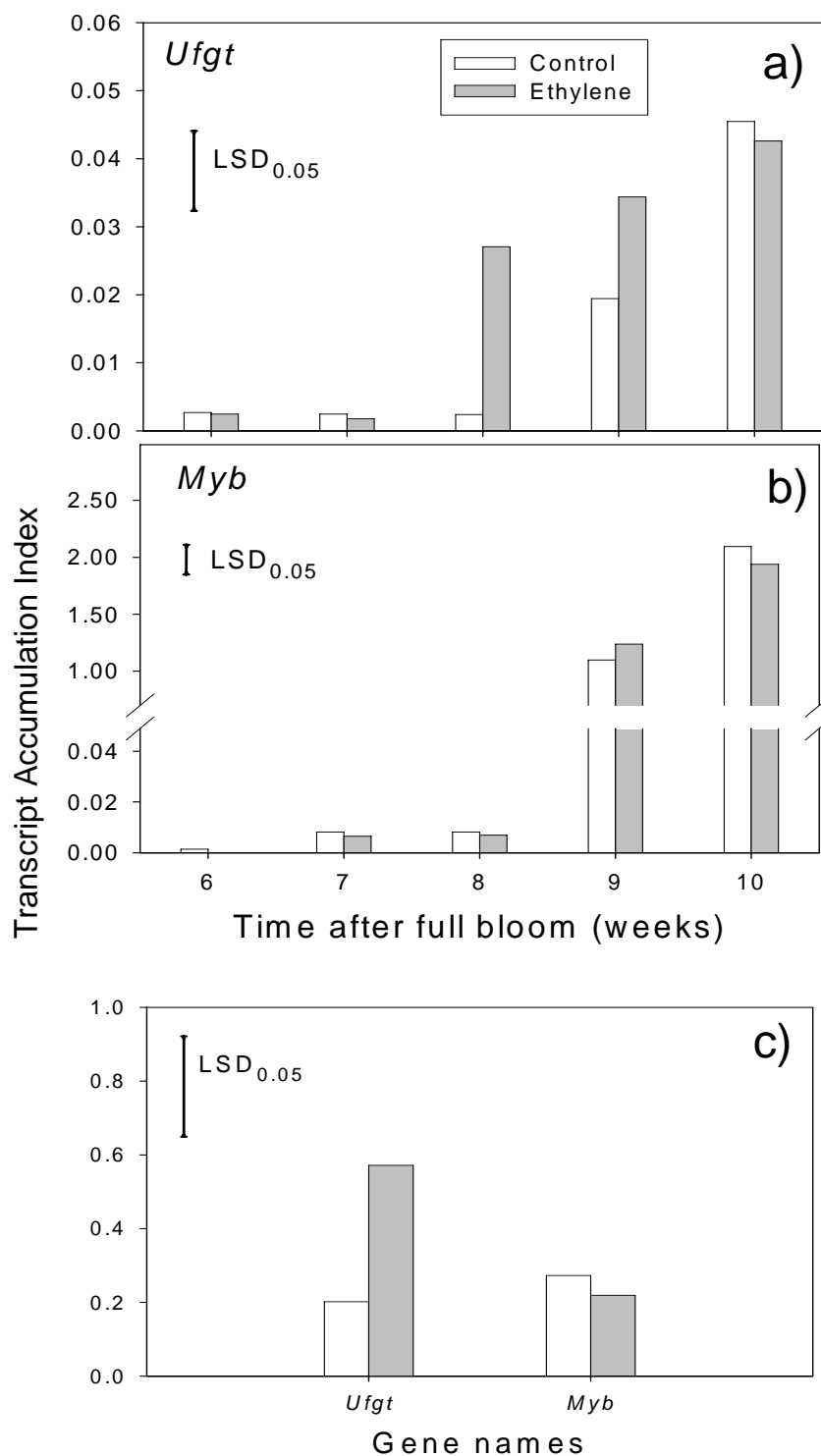

Figure 15. Effects of exogenous ethylene to a) the *ufgt* mRNA levels, to b) the *mybA* mRNA levels in grape berries, cv. Cabernet Sauvignon according to time after full bloom, and to c) mRNAs of both genes in grape cell suspensions, cv. Gamay. The mRNA levels were determined by qRT-PCR analyses and are expressed as the transcript accumulation index relative to *ef1- α* . Each bar represents the mean of three biological replicates, and LSD bars were calculated at the 0.05 level for differences between treatments (control or ethylene).

However no significant difference was seen for the accumulation *mybA* mRNAs in the same experimental conditions (Figure 15b and 15c). Our primers amplified both *mybA1* and *mybA2* cDNAs, as *mybA2* had not been described in detail by Walker *et al.* (2007) at the time we performed this experiment. This absence of responsiveness to an ethylene signal was further confirmed by the analysis of the *mybA1* promoter, GenBank AB242302 (the sequence of the *VvmybA2* promoter was not available when we performed this experiment), which did not show many ethylene cis-elements (ethylene response elements, ERE) in the -2 kb upstream region (Figure 16a). The closest GCCGCC box, one of the most potent EREs (Fujimoto *et al.* 2000), locates around -2100 bp. The closest ATTTnAAA box, the other common ERE, locates at -850 bp from *mybA1* start codon (Figure 16a). In comparison there are a lot more EREs in the *ufgt* promoter, GenBank AY955269, (Figure 16b). The GCCGCC sequence was found at -160 bp from the *ufgt* start codon, a good place to be active (Dr Ohme-Takagi, pers. comm.). Two other ERE sequences, ATTTnAAA are reasonably close to the gene start codon, located between -450 and -375 bp. Here we used the sequence of the Shiraz *ufgt* promoter, which has 97 to 99 % homology to the grapevine *ufgt* promoter sequences isolated from the Kyoho, Italia, Ruby Oku, Muscat of Alexandria and Flame Muscat cultivars (Kobayashi *et al.* 2001), and 95 % to Cabernet Sauvignon (GenBank AY919624). The alignment of various *ufgt* promoter sequences has already been showed (Kobayashi *et al.* 2001).

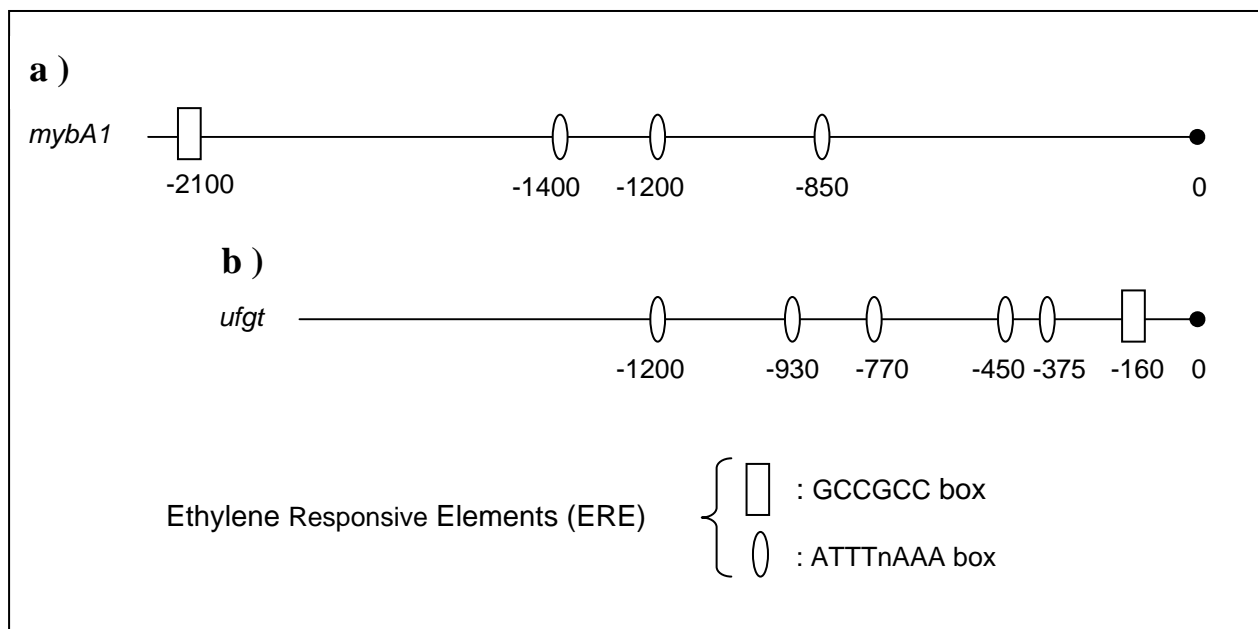

Figure 16. Locations of ethylene responsive elements (cis-acting) on the promoter of a) *mybA1* (AB242302) and b) *ufgt* (AY955269) of *Vitis vinifera*. The nucleotide numbering is relative to the start codon (0). Cis-elements were estimated by homology search using PLACE and PlantCARE databases.

3. Conclusion

We show that the ethylene inhibition by MCP reduces the *ufgt* mRNA and UFGT protein accumulation. These results confirm the data previously that the contribution of induced exogenous ethylene the UFGT expression and increase anthocyanins accumulation in Cabernet Sauvignon berries. These data clearly demonstrate that the ethylene is involved in the UFGT expression of grapevine. A 1647 bp upstream region of the Shiraz grapevine *ufgt* promoter has been shown to contain cis-elements that respond to the correct stimuli required for UFGT and thus anthocyanin production in berry skins. Transient expression analyses show that light, ABA, sugar and ethylene can all stimulate expression from the *ufgt* promoter under certain conditions (Figure 14). This is consistent with known changes in berry composition during berry development and in experiments designed to alter these variables (Boss *et al.* 1996c; Davies *et al.* 1997; Downey *et al.* 2004; Jeong *et al.* 2004). The trend observed here, that ethylene better boost the *ufgt* expression in the dark than in the light matches well the trend observed in the vineyards that spraying ethylene precursors has a more perceptible effect on clusters growing in shaded areas or during years with a low total sunlight hours over the ripening period (unpublished results). From this work and previous studies (Weaver and Montgomery 1974; El-Kereamy *et al.* 2003; Chervin *et al.* 2004) and including the μ -array result which was describe in chapter-2, it is quite clear that ethylene is involved in the signal mix leading to the *ufgt* expression in grape cells, and particularly in berry skin tissues that accumulate high concentrations of anthocyanins. We also showed that the stimulation of *ufgt* expression by ethylene is independent from MybA factors. But it does not preclude the importance of MybA in controlling the *ufgt* expression. Indeed, Dr Goto-Yamamoto found that the MybA protein binds to a region of the *ufgt* promoter around -428 to -303 bp from the start codon (pers. comm.) and their recent work confirms the role of MybA in stimulating anthocyanin accumulation (Yakushiji *et al.* 2006). Moreover, we found in a micro-array experiment (chapter 2, Table 5), after one-hour induction by ethylene, that *mybA2* mRNA accumulation was stimulated. But we tested only 6 and 24-hour inductions in the above experiments. To our knowledge this is one of the first, if not the first report addressing the potential responsiveness of *myb* expression to an ethylene signal.

**❖ CHAPTER - II. EFFECT OF ETHYLENE ON THE GRAPE
EXPRESSED DURING THE BERRY DEVELOPMENT:
THE CLASSIFICATION OF GENES WHICH ARE
EXPRESSED ON BERRY DEVELOPMENT AT VERAISON**

CHAPTER II: Effect of ethylene on the genes expressed during the berry development: The classification of genes which are expressed on berry development at véraison

1- Introduction

To better understand the role of ethylene in the process of ripening of grape berries, we have studied the effect of ethylene on the expression of more than 15000 genes from grape berries by using a microarray approach. The DNA microarray techniques that permit the simultaneous analysis of a large number of genes are now contributing to understanding the physiology of fruit ripening.

These experimentations have been performed in order to identify genes for which expressions are modulated by ethylene after a short time ethylene treatment (1 h after ethylene application) or a long time ethylene treatment (24h after ethylene application). The treatments have been performed at week 8, on clusters reaching the véraison stage (50 % of colored berries).

In this study, we have used the recently developed *Vitis vinifera* Gene Chip microarray that contains 14000 *V. vinifera* transcripts and 1700 transcripts from other *Vitis* species. The percent of probe set that showed hybridisation on the chips (percent call rate) ranged from 58 to 72 % across all arrays, indicating that about 9000 - 11300 genes were expressed at detectable level in leaf tissues.

Changes in gene expression in grape berries untreated (control) and treated by ethylene were monitored in the cultivar Cabernet Sauvignon. In each case, three independent biological replicates were performed and all hybridisations showed a similar distribution of expression values. After data normalisation, medians distribution was uniform, reflecting that expression values were corrected for technical variances.

2. Results

2.1- Genes for which expression is modulated by ethylene 24h after treatment

Results presented in Figure 17 show that 80 genes out of 15135 genes analysed by microarray, have an expression significantly modulated by ethylene ($P < 0.01$). Most affected genes could

be classified according to their molecular function, biological process, cellular component using the NCBI *Arabidopsis thaliana* database. The molecular function affected by ethylene concerned DNA or RNA binding 5%, hydrolase activity 13%, kinase activity 1%, molecular function unknown 18%, nucleic acid binding 6%, other binding 9%, other enzyme activity 11%, other molecular functions 4%, protein binding 4%, structure molecular activity 1%, transcription factor activity 3%, transferase activity 3%, transporter activity 9%, unknown 13%.

The obtained data showed that ethylene can affect several biological process such as developmental process 4%, electron transport or energy pathways 5%, other biological processes 20%, other cellular processes 13%, other metabolic processes 4%, other physiological processes 1%, protein metabolism 5%, response to abiotic or biotic stimulus 4%, response to stress 9%, transcription 5%, transport 9%, unknown 20%.

Furthermore, several cellular components are found to be affected by ethylene including cell wall 1%, cellular component unknown 20%, chloroplast 18%, ER 1%, extracellular 1%, golgi apparatus 1%, mitochondria 9%, nucleus 6%, other cellular components 1%, other cytoplasmic components 3%, other intercellular components 1%, other membranes 23%, plastid 4%, unknown 11%.

The results presented in Table 3 show that ethylene stimulates (ratio > 1) the expression of 46 genes whereas it reduces (ratio < 1) the expression of 34 genes according to the putative function. Beside the encoded genes, a great number of the 80 genes were not assigned to a known function and the remaining sequences showed similarity only with unannotated genome sequences and no match in the nucleotide database, suggesting that there are several new genes responsive to ethylene induction in grape berry.

The fact that some genes showed significant repression or induction by ethylene despite a ratio very close to 1 (more than 0.75 or less than 1.25), means that there was very small variations in the hybridization signals of the three replicates, but the results have to be considered with care.

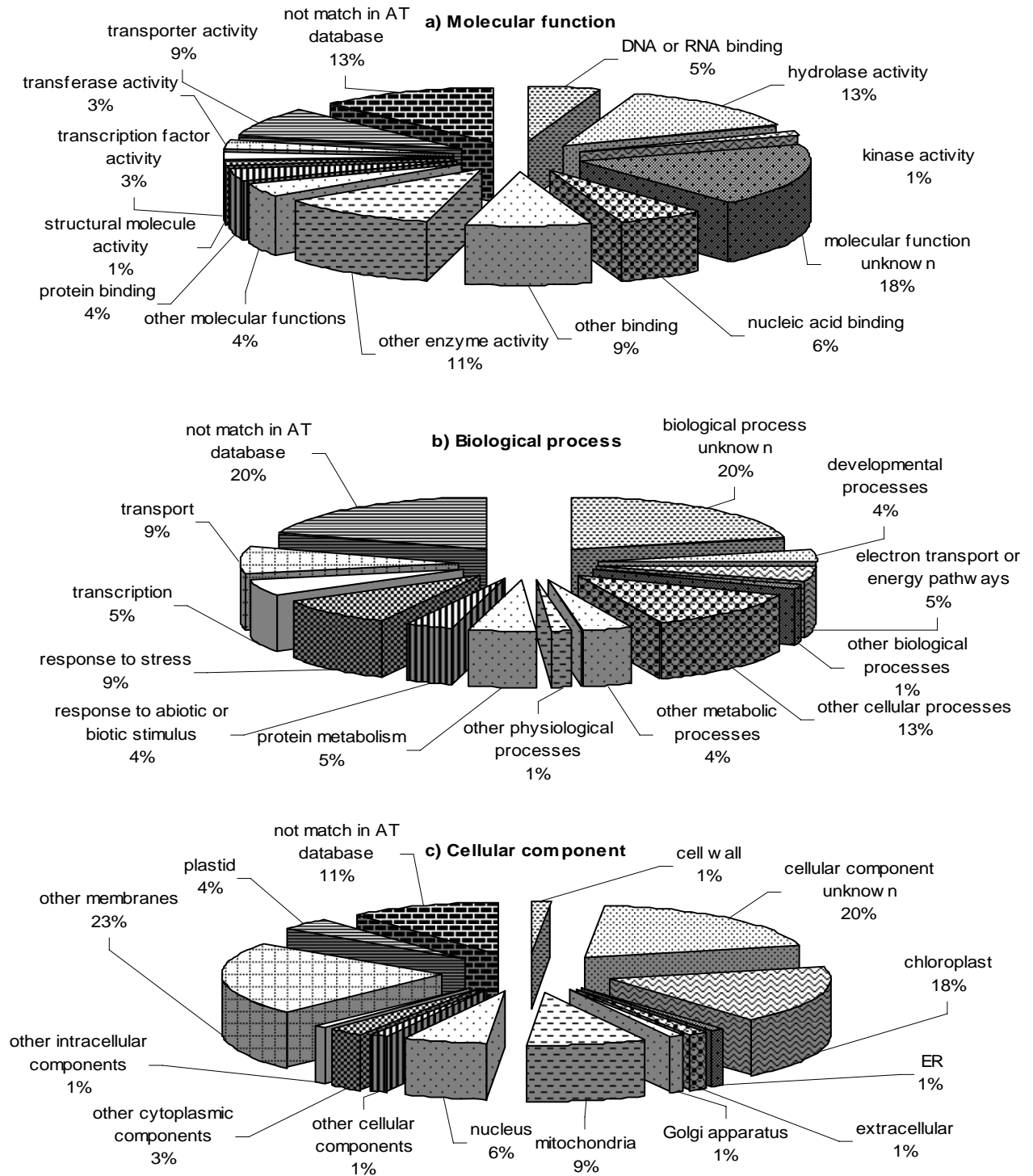

Figure 17. The lists of molecular function (a), biological process (b) and cellular component (c) in the parenthesis of 80 selected genes percentage from all genes (15135 genes) as determined by the micro array results which were modulated by the ethylene after 24H treat, at week 8 after flowering.

Table 3. The eighty genes showed with old TC numbers (TC = Tentative Contig), were selected significantly by T-test, $P = 0.01$, $n = 6$, these genes were redone to update to new TC numbers for determining by nearest *Arabidopsis thaliana* (AT) BlastX match and the ethylene/control ratio of array features which display differential levels of expression after 24 h ethylene treating, at week 8, Cabernet Sauvignon berry.

New TC number	Original TC number	AT Accession number	Description of nearest NCBI BlastX match of <i>Arabidopsis thaliana</i>	Ratio
			<u>Function:transport</u>	
TC64551	TC39811	AT1G17810	major intrinsic family protein / aquaporin	1.86
CA32EN0002_IVaF_B01	CB342010	AT5G49630	amino acid transporter capable of transporting aspartate and tryptophan	1.50
TC54859	TC46113	AT3G51860	Cation exchanger, putative	1.19
TC66900	TC45594	AT2G38410	VHS domain-containing protein / GAT domain-containing protein	1.10
TC62379		AT4G13420	potassium transporter	0.86
TC62760	TC46382	AT4G12520	protease inhibitor/seed storage/lipid transfer protein family protein	0.63
TC55300	TC38576	AT2G36830	major intrinsic family protein / aquaporin	0.56
			<u>Function:transcription</u>	
CA12E1202IIIbF_D05	CA814996	AT2G36990	RNA polymerase sigma subunit SigF / sigma-like factor	1.38
CAB20001_IVa_Fa_G11	CF207430	AT5G37020	Encodes a member of the auxin response factor family	1.19
EST_14983_CN546995	TC48301	AT2G03500	myb family transcription factor	0.89
TC55315	TC46494	AT4G35550	homeobox-leucine zipper protein / HD-ZIP protein	0.81
			<u>Function:response to stress</u>	
TC68149	TC38823	AT1G48130	peroxiredoxin / rehydrin, putative	2.08
CAB2SG0005_IlaF_H04		AT3G12500	basic endochitinase	1.61
EST_7912	TC45813	AT1G52560	26.5 kDa class I small heat shock protein-like	1.57
TC59001	TC38917	AT4G34710	encodes a arginine decarboxylase	1.24
TC62793	TC40499	AT1G71695	peroxidase 12	1.15
TC54762	TC45686	AT1G70000	DNA-binding family protein	0.85
TC53549	TC46791	AT5G54770	thiazole biosynthetic enzyme, chloroplast	0.69
			<u>Function:response to abiotic or biotic stimulus</u>	
TC63873	TC38716	AT1G75030	pathogenesis-related thaumatin family protein	1.34
TC69704		AT4G37990	mannitol dehydrogenase	0.88
TC61079	TC45213	AT1G75780	Tubulin beta-1 chain	0.86
			<u>Function:protein metabolism</u>	
TC63588	TC46224	AT5G45800	leucine-rich repeat transmembrane protein kinase, putative	1.50
TC59112	CA808079	AT5G53350	ATP-dependent Clp protease ATP-binding subunit ClpX1	1.30
TC51927	TC46117	AT3G60240	MIF4G domain-containing protein / MA3 domain-containing protein	1.19
TC59101		AT2G16920	ubiquitin-conjugating enzyme family protein	0.76
			<u>Function:other physiological processes</u>	
TC65677	TC45105	AT3G27690	chlorophyll A-B binding protein	0.64
			<u>Function:other metabolic processes</u>	
TC58450	TC47126	AT3G48000	putative (NAD+) aldehyde dehydrogenase) mRNA	1.79
TC52034	TC47375	AT2G41850	endo-polygalacturonase, putative	1.70
TC68043	TC45560	AT3G23920	beta-amylase, putative / 1,4-alpha-D-glucan maltohydrolase, putative	1.56
TC53508	TC38792	AT5G13870	xyloglucan endotransglycosylase / endo-xyloglucan transferase	1.37
			<u>Function:other cellular processes</u>	
CAB40005_IVa_Fa_C09	CB978247	AT1G55850	cellulose synthase family protein	1.73
TC67690	CB971426	AT5G51460	trehalose-6-phosphate phosphatase	1.43
CAB20007_IVa_Fa_C12	CF211195	AT2G41220	glutamate synthase, chloroplast / ferredoxin-dependent glutamate synthase	1.38

Table 3. (continued)

New TC number	Original TC number	AT Accession number	Description of nearest NCBI BlastX match of <i>Arabidopsis thaliana</i>	Ratio
TC58650	CB978533	AT4G16130	similar to galactokinase.	1.29
TC55828	TC48518	AT3G48780	Serine C-palmitoyltransferase, putative	1.18
TC69217	TC43706	AT2G27170	similar to SMC2-like condensin, putative	1.14
TC59181		AT1G71100	Ribose 5-phosphate isomerase-related	0.91
TC64563	TC47573	AT3G54420	class IV chitinase	0.80
TC54968	TC38641	AT3G23600	dienelactone hydrolase family protein	0.72
			<u>Function:other biological processes</u>	
TC60790	TC41864	AT3G12955	auxin-responsive protein-related	0.71
			<u>Function:electron transport or energy pathways</u>	
VVD133D11_373089	TC50492	AT1G66540	cytochrome P450, putative	0.81
CA12E1302IR_B07	TC40732	AT2G45560	cytochrome P450 family protein	0.80
TC59116	TC40369	AT5G66190	Encodes a leaf-type ferredoxin:NADP(H) oxidoreductase	0.75
TC65998	TC45453	AT1G20340	Plastocyanin	0.71
			<u>Function:developmental processes</u>	
TC62965	TC38812	AT2G03090	expansin, putative	variable
TC70668	TC42481	AT3G15670	late embryogenesis abundant protein, putative / LEA protein, putative	2.12
TC60322	TC39120	AT4G27410	no apical meristem (NAM) family protein	1.47
			<u>Function:biological process unknown</u>	
TC53967	TC45406	AT1G07750	cupin family protein	2.26
TC66930	TC41685	AT2G18540	cupin family protein	1.90
TC57394	TC40198	AT1G05510	expressed protein	1.86
TC66916	TC40153	AT2G23110	expressed protein	1.71
TC54946	TC47641	AT1G14860	MutT/nudix family protein	1.62
TC54941	TC45153	AT3G57520	alkaline alpha galactosidase, putative	1.52
TC56506	TC40622	AT5G59080	expressed protein	1.32
TC59024	TC46501	AT4G09150	T-complex protein 11	1.23
TC52464	TC40274	AT5G11680	expressed protein, predicted proteins	1.20
TC52231	TC46375	AT3G03790	ankyrin repeat family protein n	1.19
TC60367		AT2G40110	yippee family protein	0.95
TC54502	TC39190	AT3G15840	expressed protein	0.90
TC53685	TC46651	AT5G25270	expressed protein	0.82
TC68244	TC41770	AT1G75560	zinc knuckle (CCHC-type) family protein	0.80
TC56589	TC46181	AT4G34290	SWIB complex BAF60b domain-containing protein	0.75
TC57514	TC43170	AT4G39900	expressed protein	0.69
TC65275		AT1G70830	Bet v I allergen family protein	0.64
			<u>Function:no match in functional categories</u>	
TC51691	TC38507		not assigned	1.61
TC66717	TC47941	AT3G44735	Phytosulfokine 3 precursor	1.40
TC65763	TC45599	AT4G20780	calcium-binding protein	1.25
TC66717	TC47942	AT3G44735	Phytosulfokine 3 precursor	1.19
TC56003	TC38398		not assigned	1.17
TC62175	TC45300		not assigned	1.15
TC66161	TC41070		not assigned	1.1
TC63108	TC39823	AT2G31820	ankyrin repeat family protein	1.09
TC70937	TC50144	AT1G12760	zinc finger (C3HC4-type RING finger) family protein	0.92
TC61651	TC49329		not assigned	0.89

Table 3. (continued)

New TC number	Original TC number	AT Accession number	Description of nearest NCBI BlastX match of <i>Arabidopsis thaliana</i>	Ratio
TC54277	TC39486	AT4G16660	heat shock protein 70, putative	0.86
TC54715	TC47369	AT1G55255	zinc finger (C3HC4-type RING finger) family protein	0.77
TC64579	TC44665	AT1G65410	ABC transporter family protein	0.75
TC51920	TC45555	AT3G12120	omega-6 fatty acid desaturase, endoplasmic reticulum / delta-12 desaturase	0.75
VVD103G02_369365	CB915852	AT5G26940	exonuclease family protein	0.74
TC60444	TC49976	AT1G27070	5'-AMP-activated protein kinase-related	0.72

Among the genes for which the expression is inhibited by ethylene, we can find major MIP family protein (ratio 0.56), lipid transfer protein family protein (ratio 0.63), chlorophyll A-B, binding protein (ratio 0.64), auxin-responsive protein-related (ratio 0.71), calcium-binding protein (ratio 0.75), chitinase (ratio 0.80), cytochrome P450 (ratio 0.80), zipper protein (ratio 0.81).

In the grape berries, ethylene induces the expression of genes for which functions could be related to important characters in the berry development such as a cupin family protein (ratio 2.28), late embryogenesis abundant (LEA) protein (ratio 2.12) likely located in the seeds, cellulose synthase family protein (ratio 1.73), endo-polygalacturonase (ratio 1.70), endochitinase (ratio 1.61), endoxyloglucan transferase (ratio 1.40), pathogenesis-related thaumain family protein (ratio 1.34).

Ethylene seems to induce the expression of genes involved in the response to the stress and particularly arginine decarboxylase which is involved in the biosynthesis of polyamines and share common precursors with the biosynthesis of ethylene.

Another gene family is highly expressed by ethylene: the cupin superfamily. This family corresponds to a functionally diverse family of proteins that share a β -barrel structural core domain to which the term cupin was given (Dunwell *et al.* 2000). In spite of having very low levels of sequence identity, members of the cupin superfamily have highly conserved structures and include enzymes as well as proteins that bind different sugars. The cupin superfamily also comprises the major globulin storage proteins mainly from nuts and legumes from which the three-dimensional structures have been solved (Ko *et al.* 1993, Lawrence *et al.* 1994, Maruyama *et al.* 2001). The members of this family can be organized into a single domain (monocupin) or a two-domain cupin (bicupin) structure (Dunwell *et al.*, 2000). To our

knowledge, this is the first report about cupin expression depending on ethylene in grapevine tissues. Their function is not yet clearly identified in grapes, but could be related to protein storage.

In addition, ethylene regulates the expression of genes involved in the grape berry cellular expansion or softening such as xyloglucan endotransglucosylase (ratio 1.37), endopolygalacturonase (ratio 1.70), cellulose synthase (ratio 1.73), expansin (ratio 0.70) or aquaporins (ratio 0.56 or 1.86).

Furthermore, these results (24 h induction) show that the genes involved in ethylene biosynthesis are not strongly regulated by ethylene. Similarly, candidate regulatory genes for fruit development identified in climacteric fruits could not be found in these experimentations, but a shorter induction time (Tables 4 and 5) show more transcription regulators responding to the ethylene treatment.

These observed data - characterisation of 80 genes for which expression was modulated by ethylene out of 15135 genes - seems to show that the number of genes controlled by ethylene in grape berries at véraison was low. This result could be likely attributed to the fact that many genes are expressed before 24 h following an ethylene treatment, so we decided to test the response to ethylene just 1 h after treatment.

2.2- Genes for which expression is modulated by ethylene 1h after treatment in berries at two development stages: prévéraison (hard berry) and véraison (soft berry)

In order to characterise the genes for which the expression was affected by ethylene after a short time period (1 h), the berries were harvested from the cluster 1 hour after the ethylene treatment and classed in two categories: hard berries and soft berries before the véraison associated colour change, because in a cluster grape berries were at different stages of development. The berries were sorted according to softness as described in Terrier *et al.* (2005).

The high number of responses showed in the Tables 4 and 5 may be related to the fact there was no replication of this short induction experiment.

The results presented in the Figure 18, Figure 19 and Table 4, Table 5 and Table 6 show that in the grape berries of cultivar Cabernet Sauvignon treated by ethylene at week 8 after full bloom, the expression of 255 genes are found to be affected 1 h after the ethylene treatment in hard

berries and expression of 395 genes in soft berries. The list of affected genes were presented in Table 4 (hard berries) and Table 5 (soft berries) and each gene was characterised by the ethylene/control ratio of array features which display differential levels of expression. In Table 4, the genes were classified according to their functions determined by the nearest NCBI BlastX match.

The genes affected by ethylene in the hard berries have been classified into molecular function, biological process and cellular component according to the NCBI *Arabidopsis thaliana* database (Figure 18). The molecular function affected by ethylene concerned transporter activity 12%, transcription factor activity 9%, protein binding 7%, DNA or RNA binding 2%, hydrolase activity 2%, kinase activity 2%, nucleic acid binding 2%. Ethylene affects also other molecular functions which are unknown in this analysis 31%, other enzyme activity 13%, other binding 7%. Par contre, ethylene does not fail to affect the expression of genes involved in structural molecule activity.

The obtained data indicated that ethylene can affect several biological processes such as transcription 9%, transport 9%, protein metabolism 5%, response to stress 4%, developmental process 2% and signal transduction 2%. Ethylene affected gene expression in other cellular, biological or physiological processes 26 % which could not be identified in this analysis. But, ethylene fails to affect the expression of genes involved in electron transport or energy pathways or in response to abiotic or biotic stimulus.

Furthermore, several cellular components are found to be affected by ethylene including plast and chloroplast 22%, nucleus 7%, mitochondria 4%. It affects also a great percentage of genes involved in membranes 24% or other cellular components 18% and a great number of gene are a cellular component unknown.

Figure 19 presents the percentages of genes for which expression is affected by ethylene in soft berries at véraison stage development. The data can be compared to the hard berry results (Figure 18).

The molecular functions affected by ethylene concerned among others the hydrolase activity that greatly increased in comparison to the hard berries. This increase in the hydrolase function seems related to softening, which would then be partly under ethylene regulation. Other molecular functions are affected such as transporter activity 9%, nucleic acid binding 6%, DNA or RNA binding 5%, protein binding 4%, transcription factor activity 3% and transferase activity.

Ethylene also modulates other molecular functions which are unknown in this analysis 18%, other enzyme activity 11%, other binding 9%.

The data presented in Figure 19 indicated that ethylene can affect several biological processes such as protein metabolism 10%, transport 8%, response to stress 6%, transcription 3% at a level closed to that observed in hard berries at the prévéraison stage. But a great number of biological processes affected by ethylene remains unknown.

In addition, several cellular components were found to be affected by ethylene but in hard berries plastid and chloroplast were the most important (22%), then mitochondria 9% and nucleus 6%. The phytohormone affected also a great percentage of genes involved in membranes 23% and a great number of genes were unknown cellular components.

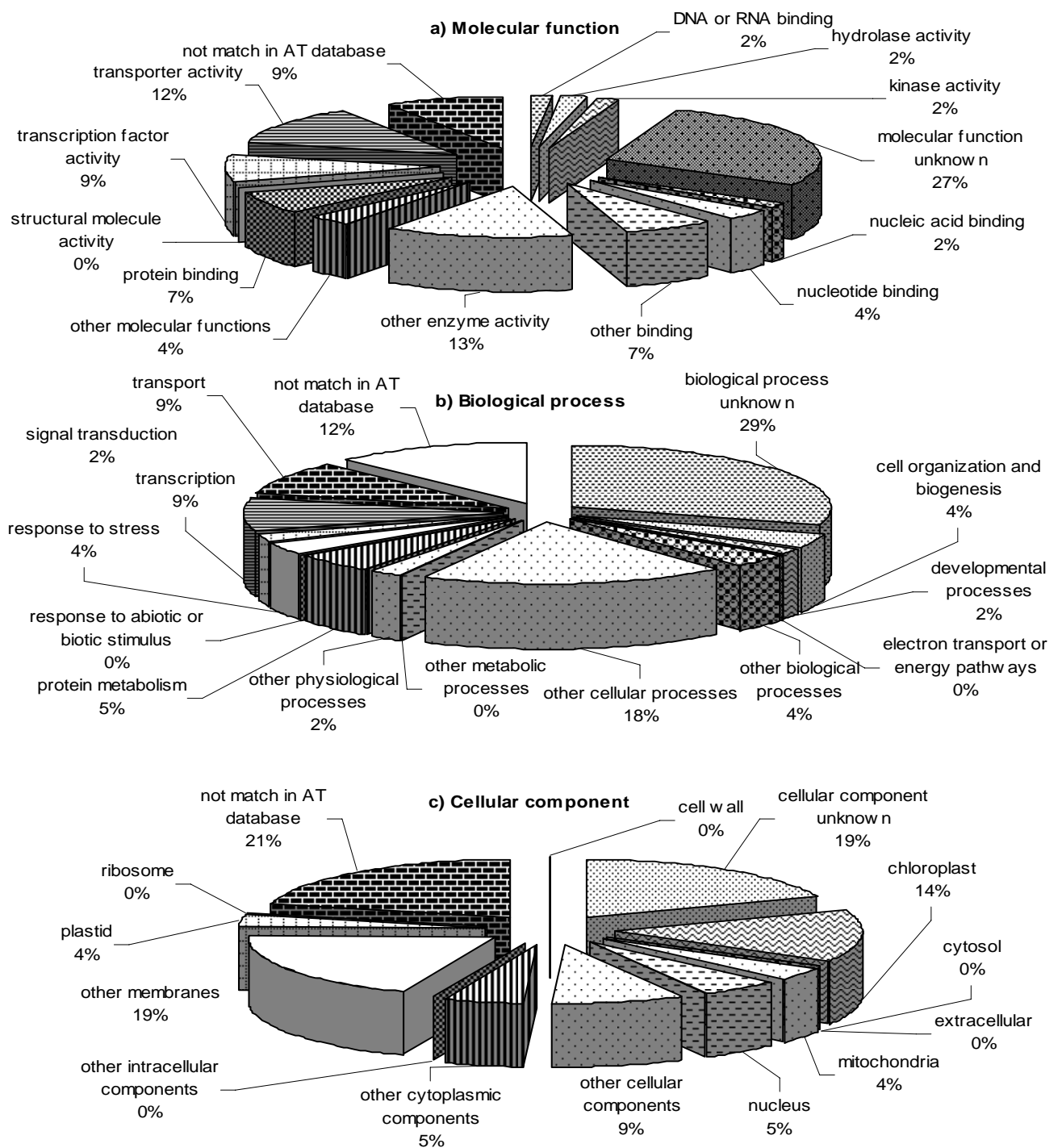

Figure 18. The lists of molecular function (a), biological process (b) and cellular component (c) in the parenthesis of 57 selected genes percentage from all genes (15135 genes) in hard berries (prevéraison stage development) as determined by the micro array results which were modulated by the ethylene after treat 1 H, at week 8 after flowering.

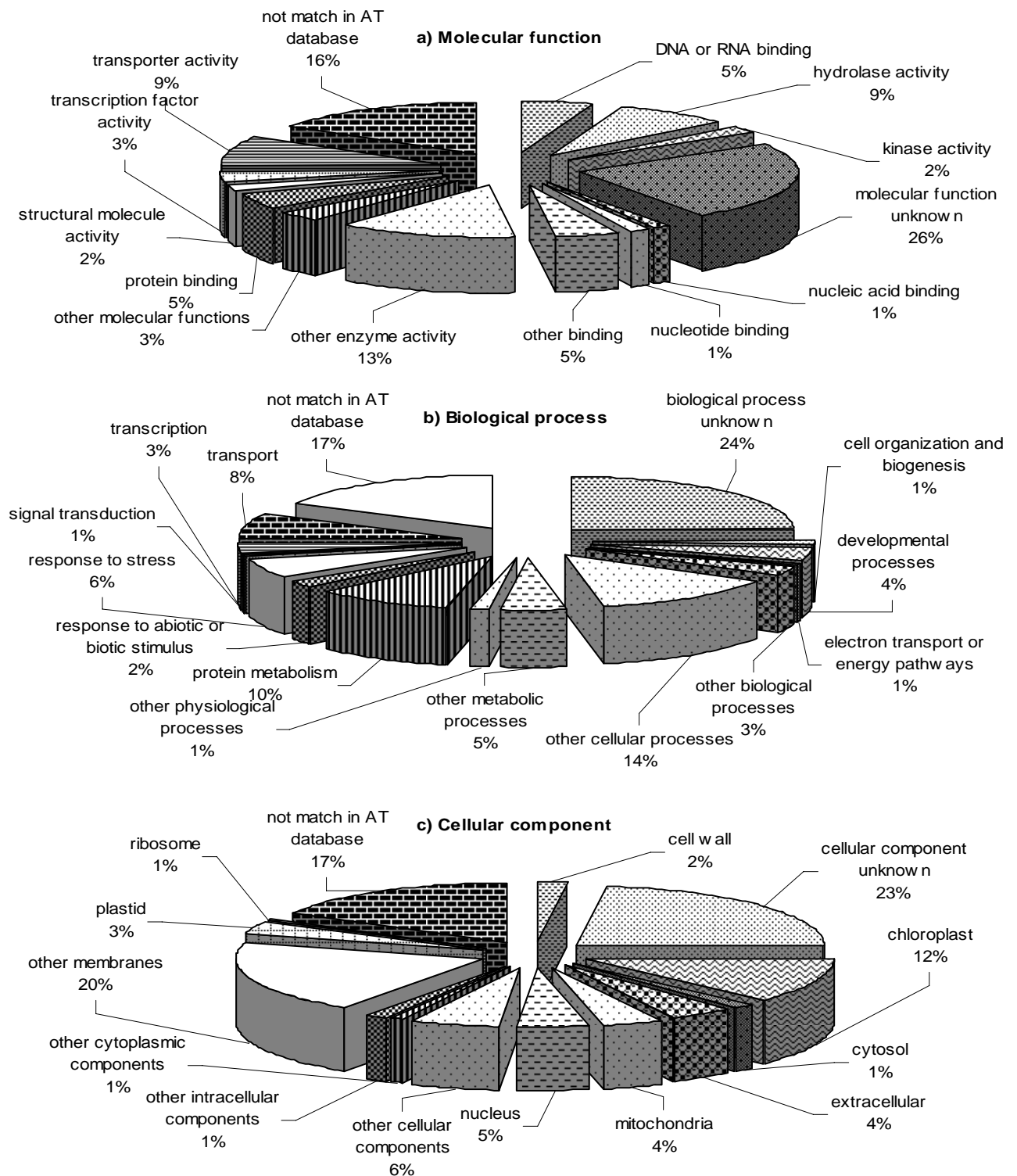

Figure 19. The lists of molecular function (a), biological process (b) and cellular component (c) in the parenthesis of 150 selected genes percentage from all genes (15135 genes) in soft berries (véraison stage development) (véraison stage (as determined by the micro array results which were modulated by the ethylene treat after 1H, at week 8 after flowering).

Table 4 shows the 255 genes for which the expression was strongly affected by ethylene in HARD berries corresponding to the prévéraison stage development: 58 genes were inhibited (ratio < 0.55) and 197 stimulated by ethylene (ratio > 1.75). In these berries, ethylene stimulated the genes involved in the perception of ethylene including ethylene receptor CS-*ETR2* (ratio 5.67), which is a good candidate for analysing the feed-back at the receptor level; an ethylene responsive element factor was also stimulated (ratio 1.88) as well as an ethylene receptor homolog (ratio 1.77).

Ethylene induced expression of genes involved in the biosynthesis of phenolic compounds such as caffeic acid 3-*O*-methyltransferase (ratio 3.19), cinnamyl-alcohol dehydrogenase (ratio 2.80) and flavonols 3-*O*-glucosyltransferase (ratio 2.24). Ethylene stimulated significantly the expression of genes involved in the softening and berry expansion such as polygalacturonase (ratio 1.81), pectin methylesterase (ratio 1.89), xyloglucan endotransglycosylase (ratio 1.90). Ethylene affected also the gene involved in the sugar metabolism such as sucrose synthase (ratio 1.98) and in ripening such as abscisic stress ripening protein homolog (ratio 1.82).

Table 5 shows the list of 395 genes which expression was affected by ethylene in SOFT berries: 129 genes are highly inhibited by ethylene (ratio < 0.55) and 266 genes were greatly stimulated by ethylene (ratio > 1.75) in the soft berries corresponding to the véraison stage development. In these berries, ethylene induced the expression of genes involved in the ethylene perception like in the hard berry.

Ethylene stimulated the expression of genes involved in the softening and berry expansion such as expansin (ratio 4.35, ratio 2.22, and ratio 2.03), aquaporin (ratio 3.69 and ratio 2.85), osmotin (ratio 2.16), polygalacturonase (ratio 2.16), pectin methylesterase (ratio 1.99), xyloglucan endo-transglycosylase (ratio 1.90 and 1.87) or glycine-rich cell wall protein (ratio 1.79). Ethylene also stimulated in the biosynthesis of phenolic compounds such as isoflavone reductase (ratio 1.82), leucoanthocyanidin dioxygenase (ratio 1.96), chalcone synthase (ratio 3.33), in sugar metabolism such as sugar transporter (ratio 2.36), in organic acid metabolism such as malate deshydrogenase (ratio 3.33) and ripening (ratio 2.30, 2.19, 1.86). The data show also that ethylene highly stimulated the expression of genes coding pathogenesis related proteins (ratio 4.1, 3.52, 3.01) or LEA protein (ratio 1.92). Ethylene also stimulated one gene coding for an alcohol deshydrogenase (ratio 2.85), which matches the previously published set of data by Tesniere *et al.* (2004).

Table 4. Genes of hard berries (Cabernet Sauvignon) at week 8 after flowering, related to the berry development which were determined by the nearest NCBI BlastX match and the ethylene/control ratio of array features which displayed differential levels of expression after 1 h ethylene treating, that ratio values showed more than 1.75 and less than 0.55.

TC number	Description of nearest NCBI BlastX match	Ratio
TC45225	T50802 serine	0.23
TC40001	Vitamin-B12-independent methionine synthase isozyme { <i>Catharanthus roseus</i> }	0.32
TC51583	F8K7.10 protein - <i>Arabidopsis thaliana</i>	0.33
TC45150	not assigns	0.33
TC45700,CB915820	not assigns	0.35
TC49547	AT4g12080	0.35
TC45402	fatty acid oxidation tetrafunctional protein, glyoxysomal - cucumber	0.35
TC45700,CB915820	40S ribosomal protein S10 { <i>Oryza sativa</i> }	0.37
TC42939	expressed protein { <i>Arabidopsis thaliana</i> }	0.38
TC45225	not assigns	0.38
TC43319	not assigns	0.39
TC38539	Rubisco subunit binding-protein beta subunit [imported] - <i>Arabidopsis thaliana</i>	0.39
TC45805	potassium transporter KUP3p { <i>Arabidopsis thaliana</i> }	0.42
TC47445	GcpE { <i>Lycopersicon esculentum</i> }	0.42
TC50818	F26F24.7 { <i>Arabidopsis thaliana</i> }	0.42
TC42939	not assigns	0.44
TC44550	not assigns	0.44
TC47489	P0638D12.11 { <i>Oryza sativa</i> (japonica cultivar-group)}	0.45
TC38194	chloroplast precursor { <i>Lycopersicon esculentum</i> }	0.45
TC39782	not assigns	0.46
TC49318	sucrose export defective 1 { <i>Arabidopsis thaliana</i> }	0.46
TC45584	ATFP3--gene_id:MLE2.16 { <i>Arabidopsis thaliana</i> }	0.47
TC43811	glutathione transferase- papaya	0.47
TC48437	GrpE protein { <i>Arabidopsis thaliana</i> }	0.47
Vv_10012898	not assigns	0.47
TC45176	not assigns	0.47
TC46274	Profilin 1 { <i>Lilium longiflorum</i> }	0.49
TC43235	lipoxygenaseloxC, chloroplast - tomato	0.49
TC38727	not assigns	0.49
TC43441	At2g44200	0.50
TC39287	not assigns	0.50
Vv_10008783	NADH glutamate dehydrogenase { <i>Vitis vinifera</i> }	0.50
NP596481	resistance gene analog [<i>Vitis vinifera</i>]	0.50
CB345339	ribulose-1,5-bisphosphate carboxylase	0.51
TC51335	At5g22890 { <i>Arabidopsis thaliana</i> }	0.51
TC47539	not assigns	0.51
TC44267	TMV resistance protein N - tobacco (<i>Nicotiana glutinosa</i>)	0.52
TC41881	3-deoxy-D-arabino-heptulosonate 7-phosphate synthase { <i>Morinda citrifolia</i> }	0.53
TC44944	lipoxygenase { <i>Lycopersicon esculentum</i> }	0.53
TC48898	not assigns	0.53
TC51569	splicing factor 3a { <i>Arabidopsis thaliana</i> }	0.53
TC43658	nodulin-like protein { <i>Arabidopsis thaliana</i> }	0.54
TC38449	PREG-like protein [imported] - <i>Picea mariana</i> (fragment)	0.54
TC45851	ABC transporter-like protein - <i>Arabidopsis thaliana</i>	0.54
TC47623	not assigns	0.54
TC44827	integral membrane protein - <i>Synechocystis</i> sp. (strain PCC 6803)	0.54
Vv_10000044	unspecific monooxygenase- common tobacco	0.54
TC47680	male fertility protein { <i>Zea mays</i> }	0.54
TC46568	50S ribosomal protein L15, chloroplast precursor (CL15) (Fragment) { <i>Pisum sativum</i> }	0.54

Table 4. HARD grape berries (continued)

TC number	Description of nearest NCBI BlastX match	Ratio
TC49220	glycine-rich structural cell wall protein {synthetic construct}	0.54
TC40774	not assigns	0.55
TC46152	cytochrome P450 F10N7.250 - <i>Arabidopsis thaliana</i>	0.55
Vv_10003752	vicilin-like protein { <i>Anacardium occidentale</i> }	0.55
TC47193	callus-associated protein - common tobacco (fragment)	0.55
TC38715	F8K4.12 { <i>Arabidopsis thaliana</i> }	0.55
TC48789	PHAP2B protein { <i>Petunia x hybrida</i> }	0.55
TC38941	progesterone-binding protein-like { <i>Arabidopsis thaliana</i> }	0.55
Vv_10000107	catalase { <i>Vitis vinifera</i> }	0.55
CF214712	F-box containing protein TIR1 { <i>Populus tremula x Populus tremuloides</i> }	1.75
TC43078	metallo-exopeptidase; leucyl aminopeptidase; LAP { <i>Lycopersicon esculentum</i> }	1.75
TC38217	late-embryogenesis protein lea5 - common tobacco	1.75
TC48227	phosphate permease-like protein { <i>Arabidopsis thaliana</i> }	1.75
TC39122	At5g17860	1.75
TC38889	heat-shock protein 80 { <i>Euphorbia esula</i> }	1.75
CF208610	RE01016p { <i>Drosophila melanogaster</i> }	1.76
TC47126	aldehyde dehydrogenase 1 precursor { <i>Lotus corniculatus</i> }	1.76
TC47127	hydroxyproline-rich glycoprotein GAS28 precursor - <i>Chlamydomonas reinhardtii</i>	1.76
TC39418	receptor-like protein kinase[<i>Oryza sativa</i> (japonica cultivar-group)]	1.76
CD005432	At1g10560	1.76
Vv_10007895	initiation factor 3g { <i>Arabidopsis thaliana</i> }	1.76
TC46333	expressed protein { <i>Arabidopsis thaliana</i> }	1.77
CD800882,CF405875	25.7 kDa protein { <i>Cicer arietinum</i> }	1.77
CB348066	dermal glycoprotein precursor, extracellular - carrot (fragment)	1.77
TC50911	ethylene receptor homolog { <i>Lycopersicon esculentum</i> }	1.77
TC50125	AT4g34410	1.77
CB910654	protein F14J16.6 [imported] - <i>Arabidopsis thaliana</i>	1.77
CB343548	Protein At5g10860, mitochondrial precursor { <i>Arabidopsis thaliana</i> }	1.77
TC44776	not assigns	1.77
CB921249	AT4g24800	1.77
CB914017	leucine-rich repeat transmembrane protein kinase 1 - maize (fragment)	1.77
CF216188	APS reductase { <i>Brassica juncea</i> }	1.78
CD801026	RE12147p { <i>Drosophila melanogaster</i> }	1.78
CB982789	UDP-glucose pyrophosphorylase { <i>Amorpha fruticosa</i> }	1.78
TC51637	UDP-glucose glucosyltransferase { <i>Arabidopsis thaliana</i> }	1.78
TC38818	G protein-coupled receptor-like protein { <i>Arabidopsis thaliana</i> }	1.78
Vv_10006952	VVTL1 { <i>Vitis vinifera</i> }	1.78
TC48660	DNA binding zinc finger protein (Pspzf) { <i>Pisum sativum</i> }	1.78
TC38393	sucrose synthase { <i>Citrus unshiu</i> }	1.78
TC39921	F2E2.7 { <i>Arabidopsis thaliana</i> }	1.79
Vv_10013406	not assigns	1.79
TC47126	aldehyde dehydrogenase (NAD)2A precursor, mitochondrial - common tobacco	1.79
CB969743	expressed protein { <i>Arabidopsis thaliana</i> }	1.79
TC44996	lipoygenaseloxC, chloroplast - tomato	1.79
CB972868	Eukaryotic translation initiation factor 3 subunit 8 { <i>Medicago truncatula</i> }	1.79
CB007475	ER6 protein { <i>Lycopersicon esculentum</i> }	1.80
TC46984	molybdopterin-converting factor homolog YKL027w - yeast (<i>Saccharomyces cerevisiae</i>)	1.80
TC41084	glucosyltransferase-10 { <i>Vigna angularis</i> }	1.80
CB916281	At3g19895 { <i>Arabidopsis thaliana</i> }	1.80
Vv_10001268	F22O13.25 { <i>Arabidopsis thaliana</i> }	1.81

Table 4. HARD grape berries (continued)

TC number	Description of nearest NCBI BlastX match	Ratio
CD799293	26S proteasome regulatory particle non-ATPase subunit8 (<i>Oryza sativa</i> (japonica cultivar-group))	1.81
TC47375	polygalacturonase PG1 (<i>Vitis vinifera</i>)	1.81
TC40018	PEP carboxylase (<i>Vitis vinifera</i>)	1.81
TC45756	RNA helicase (<i>Vigna radiata</i>)	1.82
TC40863	Clk4 associating SR-related protein L (<i>Mus musculus</i>)	1.82
TC40530	sulfate transport protein [imported] - <i>Arabidopsis thaliana</i>	1.82
TC38138	mipC protein - common ice plant	1.82
CB339234	P0435B05.20 (<i>Oryza sativa</i> (japonica cultivar-group))	1.82
Vv_10005713	UDP-glucosyltransferase (<i>Stevia rebaudiana</i>)	1.82
Vv_10011271	abscisic stress ripening protein homolog (<i>Prunus armeniaca</i>)	1.82
TC44288	not assigns	1.82
BM436439	AT5g24690	1.82
TC46017	Tubulin alpha chain. [Almond, <i>Prunus amygdalus</i>] (<i>Prunus dulcis</i>)	1.83
TC49524	cold-regulated LTCOR12 (<i>Lavatera thuringiaca</i>)	1.83
CD721199	AT5g16210	1.83
TC44549	At1g74680	1.83
CB922813	lamin B3 (<i>Carassius auratus</i>)	1.84
Vv_10011998	not assigns	1.84
TC42527	B1045F02.20 (<i>Oryza sativa</i> (japonica cultivar-group))	1.84
CD801525	28 kDa coat protein {Rupestris stem pitting associated virus-1}	1.85
TC41363	F22G5.9 (<i>Arabidopsis thaliana</i>)	1.85
Vv_10005710	At1g29640 (<i>Arabidopsis thaliana</i>)	1.85
TC49038	CTV.22 (<i>Poncirus trifoliata</i>)	1.85
TC43834	nitrate transporter NRT1-2 (<i>Glycine max</i>)	1.85
TC46074	ZPT2-14 (<i>Petunia x hybrida</i>)	1.85
TC44048	not assigns	1.85
TC38879	mitochondrial protein-like (<i>Arabidopsis thaliana</i>)	1.85
TC38164	ribulose 1,5-bisphosphate carboxylase-oxygenase large subunit (<i>Baphia massaiensis</i>)	1.86
TC46484	phi-1 (<i>Nicotiana tabacum</i>)	1.86
TC45592	phi-1 (<i>Nicotiana tabacum</i>)	1.86
Vv_10005391	alcohol dehydrogenase 7 (<i>Vitis vinifera</i>)	1.86
Vv_10005464	ADP-ribosylation factor (<i>Vigna unguiculata</i>)	1.87
CB006954	Ankyrin repeat and SOCS box containing protein 7 (<i>Mus musculus</i>)	1.87
CB980903	protein kinase-like (<i>Arabidopsis thaliana</i>)	1.88
TC39120	AT4g27410	1.88
TC44607	translation elongation factor EF-G (<i>Glycine max</i>)	1.88
TC42656	alpha-amylase - fission yeast (<i>Schizosaccharomyces pombe</i>)	1.88
TC45259	contains similarity to ethylene responsive element binding factor (<i>Arabidopsis thaliana</i>)	1.88
CF209728	AT3g23410	1.88
TC43740	AY208992 GIA	1.88
CD004586	nitrate transporter NRT1-5 (<i>Glycine max</i>)	1.89
TC47054	pectin methylesterase-like protein - <i>Arabidopsis thaliana</i>	1.89
TC45044	ribosomal protein L2 (<i>Atropa belladonna</i>)	1.89
TC47080	Systemin receptor SR160 precursor (Brassinosteroid LRR receptor kinase) (<i>Lycopersicon peruvianum</i>)	1.89
CB975438	protein F14N23.17 [imported] - <i>Arabidopsis thaliana</i>	1.90
TC45535	CCR4-associated factor 1-like protein - <i>Arabidopsis thaliana</i>	1.90
Vv_10007830	dynamin homolog (<i>Astragalus sinicus</i>)	1.90
CB007442	RNA polymerase II second largest subunit (<i>Nymphaea odorata</i>)	1.90
TC49524	not assigns	1.90

Table 4. HARD grape berries (continued)

TC number	Description of nearest NCBI BlastX match	Ratio
TC40411	xyloglucan endotransglycosylase 1 { <i>Fagus sylvatica</i> }	1.90
CF208244	sugar transporter-like protein - <i>Arabidopsis thaliana</i>	1.91
CB342817	40s ribosomal protein S23 { <i>Euphorbia esula</i> }	1.91
TC45814	AY054510 serine	1.91
TC38541	pectate lyase { <i>Fragaria x ananassa</i> }	1.91
CB348180	Sulfite Reductase { <i>Nicotiana tabacum</i> }	1.91
TC48783	OJ9990_A01.12 { <i>Oryza sativa</i> (japonica cultivar-group)}	1.91
TC39032	not assigns	1.91
TC49029	HMG-CoA reductase { <i>Camptotheca acuminata</i> }	1.92
TC43806	not assigns	1.92
CF214165	F3F9.21 { <i>Arabidopsis thaliana</i> }	1.92
TC40387, TC40388	AT4g38060	1.92
TC38987	P0414E03.8 { <i>Oryza sativa</i> (japonica cultivar-group)}	1.93
CB910721	Ca2+-transporting ATPase homolog F27B13.140 - <i>Arabidopsis thaliana</i>	1.94
TC40785	glucosidase II alpha subunit { <i>Arabidopsis thaliana</i> }	1.94
Vv_10014466	not assigns	1.94
TC47826	cytokinin oxidase { <i>Arabidopsis thaliana</i> }	1.94
CF214546	expressed protein { <i>Arabidopsis thaliana</i> }	1.95
TC40694	retroelement pol polyprotein-like { <i>Arabidopsis thaliana</i> }	1.96
TC45618	SOS2-like protein kinase { <i>Glycine max</i> }	1.96
TC43190	not assigns	1.96
TC38987	P0414E03.8 { <i>Oryza sativa</i> (japonica cultivar-group)}	1.96
TC45140	ATP-dependent Clp protease proteolytic subunit(Endopeptidase Clp) { <i>Nicotiana tabacum</i> }	1.97
CD720811	sucrose synthase- <i>Arabidopsis thaliana</i>	1.98
CB976445	Syntaxin 71 (AtSYP71) { <i>Arabidopsis thaliana</i> }	1.98
TC42203	protein T4O12.3 [imported] - <i>Arabidopsis thaliana</i>	1.98
TC39452	porin I, 36K - potato	1.98
TC48959	cinnamoyl-CoA reductase { <i>Prunus persica</i> }	1.98
CD797261	Mitogen-activated protein kinase homolog 1(PMEK1) { <i>Petunia hybrida</i> }	1.98
CB973276	At2g32700	1.99
CB347824	immunophilin - fava bean	2.00
TC38324	48-kDa glycoprotein precursor { <i>Corylus avellana</i> }	2.01
TC38917	arginine decarboxylase { <i>Vitis vinifera</i> }	2.01
TC38347	glutathione transferase- papaya	2.01
TC49025	SD07532p { <i>Drosophila melanogaster</i> }	2.01
TC41344	not assigns	2.02
TC40113	pSbaNS5 protein { <i>Sorghum bicolor</i> }	2.03
TC45831	26S proteasome regulatory subunit S2 (RPN1) { <i>Arabidopsis thaliana</i> }	2.03
TC45254	DNA binding protein EREBP-4 - common tobacco	2.04
CF213680	AT5g60920	2.04
TC38838	Mitochondrial 60S ribosomal protein L2 { <i>Oryza sativa</i> }	2.04
BQ797732	RING finger protein Pzf - soybean (fragment)	2.06
TC45755	At1g32920	2.06
TC48468	mutator-like transposase-like protein { <i>Arabidopsis thaliana</i> }	2.07
TC42054	not assigns	2.07
TC45736	not assigns	2.07
TC47227	cig3 { <i>Nicotiana tabacum</i> }	2.07
TC39576	DNA binding protein EREBP-4 - common tobacco	2.07
TC47531	AT5g12890	2.08

Table 4. HARD grape berries (continued)

TC number	Description of nearest NCBI BlastX match	Ratio
TC38720	dynein light chain 1 { <i>Schistosoma japonicum</i> }	2.08
TC47104	bZIP transcription factor ATB2 { <i>Glycine max</i> }	2.09
TC45044	not assigns	2.10
TC45468	Heat shock protein 81-2 (HSP81-2) { <i>Arabidopsis thaliana</i> }	2.11
TC45329	Elongation factor 2 (EF-2) { <i>Beta vulgaris</i> }	2.12
TC41184	GAL83 protein { <i>Solanum tuberosum</i> }	2.12
TC49053	protein T5E21.11 [imported] - <i>Arabidopsis thaliana</i>	2.13
CF207368	D-3-phosphoglycerate dehydrogenase, chloroplast precursor(3-PGDH) { <i>Arabidopsis thaliana</i> }	2.13
CB004461	NBS-LRR-like protein[<i>Hordeum vulgare</i> subsp. vulgare]	2.14
BQ792980	jasmonic acid 3 { <i>Lycopersicon esculentum</i> }	2.14
TC42419	CTV.15 { <i>Poncirus trifoliata</i> }	2.15
CB977557	Peptidase-like protein - <i>Arabidopsis thaliana</i>	2.16
TC44950	ubiquitin conjugating enzyme { <i>Metarhizium anisopliae</i> }	2.16
TC51624	SEUSS transcriptional co-regulator { <i>Arabidopsis thaliana</i> }	2.17
TC39129	AT5g20250	2.17
TC49610	not assigns	2.18
TC49919	not assigns	2.18
TC45394	not assigns	2.20
Vv_10011766	not assigns	2.21
TC41330	not assigns	2.21
CB921173	potassium transporter HAK3p { <i>Mesembryanthemum crystallinum</i> }	2.21
TC41330	desaturase	2.22
TC47525	protein F1N19.23 [imported] - <i>Arabidopsis thaliana</i>	2.22
CB343202	squamosa-promoter binding protein-like 3 [imported] - <i>Arabidopsis thaliana</i> (fragment)	2.22
TC48468	not assigns	2.23
TC41363	not assigns	2.23
TC41040	UDP-glucose flavonoid 3-O-glucosyltransferase 6 (Fragment) { <i>Manihot esculenta</i> }	2.24
TC46311	AT5g12010	2.25
CB970631	pleiotropic drug resistance like protein { <i>Nicotiana tabacum</i> }	2.25
TC44459	not assigns	2.25
CD719207	UDP-glucosyltransferase { <i>Stevia rebaudiana</i> }	2.26
TC42079, TC40411	syringolide-induced protein 19-1-5 { <i>Glycine max</i> }	2.31
CB349071	acetoacetyl-CoA thiolase { <i>Arabidopsis thaliana</i> }	2.33
CB342061	NADH dehydrogenase ND4 subunit { <i>Atropa belladonna</i> }	2.33
TC46464	glucosyltransferase-like protein { <i>Arabidopsis thaliana</i> }	2.34
TC45709	zinc-finger protein 1 { <i>Datisca glomerata</i> }	2.34
CB916297	peroxisomal targeting signal-1 receptor { <i>Citrullus lanatus</i> }	2.35
TC38440	polygalacturonase inhibitor-like protein { <i>Arabidopsis thaliana</i> }	2.38
TC51128	Peptidase-like protein - <i>Arabidopsis thaliana</i>	2.42
TC51620	P0431H09.21 { <i>Oryza sativa</i> (japonica cultivar-group)}	2.44
TC44459	Ku70-like protein { <i>Arabidopsis thaliana</i> }	2.47
TC48895	IAA16 protein { <i>Gossypium hirsutum</i> }	2.53
TC39388, TC39389	Pathogen-related protein. [Barley] { <i>Hordeum vulgare</i> }	2.53
TC49473	not assigns	2.57
TC48153	B1099D03.18 { <i>Oryza sativa</i> (japonica cultivar-group)}	2.60
TC38440	polygalacturonase inhibitor-like protein { <i>Arabidopsis thaliana</i> }	2.38
TC45394	4-alpha-glucanotransferase { <i>Arabidopsis thaliana</i> }	2.62
TC47524	protein F1N19.23 [imported] - <i>Arabidopsis thaliana</i>	2.66
TC38709	BEL1-related homeotic protein 29 { <i>Solanum tuberosum</i> }	2.69

Table 4. HARD grape berries (continued)

TC number	Description of nearest NCBI BlastX match	Ratio
TC46710	apetala2 domain-containing protein { <i>Atriplex hortensis</i> }	2.71
TC48377	neoxanthin cleavage enzyme { <i>Lycopersicon esculentum</i> }	2.72
TC45394	cinnamyl-alcohol dehydrogenase- cider tree	2.80
TC39864	cyclophylin-like protein - <i>Arabidopsis thaliana</i>	2.95
TC50438	caffeic acid O-3-methyltransferase { <i>Populus tomentosa</i> }	3.19
TC39880	grr1 { <i>Glycine max</i> }	3.65
TC45394	not assigns	3.82
TC45080	atpAse subunit III { <i>Atropa belladonna</i> }	4.04
TC40660, TC40661	ethylene receptor <i>CS-ETR2</i> { <i>Cucumis sativus</i> }	5.67

Table 5. SOFT grape berries (continued)

TC number	Description of nearest NCBI BlastX match	Ratio
TC46635	not assigns	0.51
TC40138	RING finger protein RMA1 [validated] - <i>Arabidopsis thaliana</i>	0.51
TC49220	glycine-rich structural cell wall protein {synthetic construct}	0.52
NP596481	resistance gene analog [<i>Vitis vinifera</i>]	0.52
Vv_10008947	OJ1714_H10.10 { <i>Oryza sativa</i> (japonica cultivar-group)}	0.52
TC41950	AT3g19120	0.52
TC45851	ABC transporter-like protein - <i>Arabidopsis thaliana</i>	0.52
TC46772	F2K11.19 { <i>Arabidopsis thaliana</i> }	0.52
CB005982	Presently translation qualifiers on V_region features are illegal { <i>Equus caballus</i> }	0.52
TC39498	not assigns	0.52
TC45052	not assigns	0.52
TC39232	ABC transporter { <i>Oryza sativa</i> (japonica cultivar-group)}	0.52
TC41207	laccase (diphenol oxidase) { <i>Arabidopsis thaliana</i> }	0.52
TC40474	ovarian fibroin-like substance-1 { <i>Cyprinus carpio</i> }	0.53
TC38370	Auxin-repressed 12.5 kDa protein { <i>Fragaria ananassa</i> }	0.53
TC42890	not assigns	0.53
CD712583	RGA-B protein { <i>Cicer arietinum</i> }, partial (16%)	0.53
TC40532	alpha galactosyltransferase-like protein - <i>Arabidopsis thaliana</i>	0.53
TC42339	B1064G04.14 { <i>Oryza sativa</i> (japonica cultivar-group)}	0.53
TC39338	phosphatidylinositol transfer-like protein III { <i>Lotus japonicus</i> }	0.53
CF209363	expressed protein { <i>Arabidopsis thaliana</i> }	0.53
TC39276	beta-1,3-glucanase-like protein { <i>Olea europaea</i> }	0.53
TC47520	H37217 come from this gene. { <i>Arabidopsis thaliana</i> }	0.53
TC38907	Shaggy-related protein kinase iota(ASK-iota) { <i>Arabidopsis thaliana</i> }	0.53
TC41579	Methanobacterium thermoautotrophicum transcriptional regulator { <i>Arabidopsis thaliana</i> }	0.53
TC45975	vacuolar sorting receptor protein homolog PV72 - cucurbit	0.53
TC50655	P0678F11.22 { <i>Oryza sativa</i> (japonica cultivar-group)}	0.53
TC48913	potassium transporter HAK2p { <i>Mesembryanthemum crystallinum</i> }	0.53
TC50150	not assigns	0.53
TC41977	not assigns	0.53
TC39591	orf100f { <i>Beta vulgaris</i> }	0.53
TC44550	human RAN binding protein 16-like { <i>Arabidopsis thaliana</i> }	0.53
TC42879	AT3g47850	0.53
TC47589	translation initiation factor eIF-4A.15 - common tobacco	0.54
TC47280	Succinate dehydrogenase [ubiquinone] flavoprotein subunit, mitochondrial(FP) (<i>Arabidopsis thaliana</i>)	0.54
TC42187	calcium-dependent protein kinase1 - common tobacco	0.54
TC47984	14-3-3 protein { <i>Populus x canescens</i> }	0.54
TC46871	globulin-like protein { <i>Daucus carota</i> }	0.54
TC38608	not assigns	0.54
TC39870	remorin { <i>Arabidopsis thaliana</i> }	0.54
TC45042	11S globulin beta subunit precursor { <i>Cucurbita maxima</i> }	0.54
TC43888	autophagy 3 { <i>Arabidopsis thaliana</i> }	0.54
TC50296	not assigns	0.54
TC48487	not assigns	0.54
TC39036	At4g22300 { <i>Arabidopsis thaliana</i> }	0.54
TC49959	not assigns	0.54
TC39170	ubiquinol-cytochrome-c reductasecytochrome c1 precursor (clone pC(1)3II) - potato	0.54
TC41785	asparaginyl endopeptidase { <i>Sesamum indicum</i> }	0.54
TC46979	NADH-ubiquinone oxidoreductase subunit 4 { <i>Globodera pallida</i> }	0.54
TC40270	not assigns	0.54

Table 5. SOFT grape berries (continued)

TC number	Description of nearest NCBI BlastX match	Ratio
TC50754	not assigns	0.54
TC47388	embryogenic callus protein 181 - carrot (fragment)	0.54
TC46945	CG31496-PA { <i>Drosophila melanogaster</i> }	0.54
TC40764	NADH2 dehydrogenase (ubiquinone)chain 6 - <i>Florometra serratissima</i> mitochondrion	0.54
TC49815	extensin - <i>Volvox carteri</i> (fragment)	0.54
TC47703	not assigns	0.54
TC39998	hsr201 protein, hypersensitivity-related - common tobacco	0.54
TC41694	not assigns	0.54
TC44694	CG14307-PB { <i>Drosophila melanogaster</i> }	0.54
TC44175	not assigns	0.55
CB916502	serine protease-like protein { <i>Arabidopsis thaliana</i> }	0.55
TC38451	phosphoenolpyruvate carboxykinase { <i>Flaveria trinervia</i> }	0.55
TC46274	not assigns	0.55
TC47506	blI0480 { <i>Bradyrhizobium japonicum</i> USDA 110}	0.55
TC49234	not assigns	0.55
TC46194	yolk sac permease-like molecule 2 { <i>Sus scrofa</i> }	0.55
TC44368	reverse transcriptase { <i>Picea glauca</i> }	0.55
TC38342	glutathione transferase- papaya	0.55
TC47493	AT5g16650	0.55
TC46261	Glutamate decarboxylase(GAD) (ERT D1) { <i>Lycopersicon esculentum</i> }	0.55
TC45303,TC45300	P0529H11.11 { <i>Oryza sativa</i> (japonica cultivar-group)}	0.55
TC38764	Heat stress transcription factor { <i>Lycopersicon peruvianum</i> }	0.55
TC39394	Kunitz trypsin inhibitor protein { <i>Phaseolus coccineus</i> }	0.55
TC45804	potassium transporter KUP3p { <i>Arabidopsis thaliana</i> }	0.55
Vv_10009755	nuclear matrix constituent protein 1 - carrot	0.55
CB920747	resolvase related protein PAB2076 - <i>Pyrococcus abyssi</i> (strain Orsay)	0.55
TC42175	pre-rRNA processing protein RRP5 { <i>Arabidopsis thaliana</i> }	0.55
TC45572	lipid transfer protein { <i>Arabidopsis thaliana</i> }	0.55
TC49690	H84824 En	0.55
TC44768	P0710E05.11 { <i>Oryza sativa</i> (japonica cultivar-group)}	1.75
TC38946	Peptide Met(O) reductase (Fruit- ripening protein E4) (Fragment) { <i>Lycopersicon esculentum</i> }	1.75
BQ798834	NAC domain protein NAC2 { <i>Arabidopsis thaliana</i> }	1.75
TC44459	not assigns	1.75
TC48630	osmotic stress-activated protein kinase { <i>Nicotiana tabacum</i> }	1.75
TC40990	expressed protein { <i>Arabidopsis thaliana</i> }	1.76
TC46377	protein F5O8.11 [imported] - <i>Arabidopsis thaliana</i>	1.76
TC46049	not assigns	1.76
TC39139	At2g31940	1.76
TC43906	mevalonate kinase { <i>Hevea brasiliensis</i> }	1.76
TC41184	GAL83 protein { <i>Solanum tuberosum</i> }	1.76
TC49031	fructokinase { <i>Lycopersicon esculentum</i> }	1.77
TC49189	D23244p { <i>Drosophila melanogaster</i> }	1.77
CB975076	Ras-related protein Rab2BV { <i>Beta vulgaris</i> }	1.77
CF215873	ARF GAP-like zinc finger-containing protein ZIGA3 { <i>Arabidopsis thaliana</i> }	1.77
CB971258	At2g37790 { <i>Arabidopsis thaliana</i> }	1.77
CF214546	expressed protein { <i>Arabidopsis thaliana</i> }	1.78
TC38541	pectate lyase { <i>Fragaria x ananassa</i> }	1.78
TC46304	PDI-like protein { <i>Oryza sativa</i> (japonica cultivar-group)}	1.78
CB923223	At1g05170	1.78

Table 5. SOFT grape berries (continued)

TC number	Description of nearest NCBI BlastX match	Ratio
TC48227	phosphate permease-like protein (<i>Arabidopsis thaliana</i>)	1.78
CB006527	F20P5.5 gene product (<i>Arabidopsis thaliana</i>)	1.78
Vv_10010935	Glycine-rich cell wall structural protein precursor (<i>Hordeum vulgare</i>)	1.79
TC38863	dicyanin (<i>Lycopersicon esculentu</i>)	1.79
BQ795835	leaf-senescence-related protein (<i>Arabidopsis thaliana</i>)	1.79
TC48442	not assigns	1.79
Vv_10010935	60S ribosomal protein L10 (QM protein homolog). [Frost grape, <i>Vitis vulpina</i>] (<i>Vitis riparia</i>)	1.79
TC43347	not assigns	1.79
TC42477	AT5g59210	1.79
CB982789	UDP-glucose pyrophosphorylase (<i>Amorpha fruticosa</i>)	1.79
Vv_10014466	not assigns	1.80
BM437958	fructose-bisphosphatase-like protein (<i>Arabidopsis thaliana</i>)	1.80
BQ794007	Apoptotic chromatin condensation inducer in the nucleus (Acinus) (<i>Homo sapiens</i>)	1.80
TC45012	P0510C12.9 (<i>Oryza sativa</i> (japonica cultivar-group))	1.80
TC49995	steroid sulfotransferase-like protein (<i>Arabidopsis thaliana</i>)	1.80
TC38901	ankyrin-like protein (<i>Arabidopsis thaliana</i>)	1.80
CB976514	atfp6-like protein (<i>Arabidopsis thaliana</i>)	1.80
CF211553	B1189A09.32 (<i>Oryza sativa</i> (japonica cultivar-group))	1.81
TC50661	Cysteine desulfurase, mitochondrial precursor (<i>Arabidopsis thaliana</i>)	1.81
TC40702	class IV endochitinase (<i>Vitis vinifera</i>)	1.81
CB913950	P0498E12.9 (<i>Oryza sativa</i> (japonica cultivar-group))	1.81
TC51154	AJ306825 aux	1.81
TC38981	Cell division cycle protein 48 homolog (Valosin containing protein homolog) (VCP) (<i>Glycine max</i>)	1.81
TC38188	band83 (<i>Rattus norvegicus</i>)	1.82
TC44940	isoflavone reductase related protein (<i>Pyrus communis</i>)	1.82
TC46571	T5E21.8 (<i>Arabidopsis thaliana</i>)	1.82
TC46571	not assigns	1.82
TC44854	RNA-binding protein AKIP1 (<i>Vicia faba</i>)	1.82
TC42663	pollen-specific protein - like (<i>Arabidopsis thaliana</i>)	1.82
CA808215	12-oxophytodienoate reductase (OPR1) (<i>Arabidopsis thaliana</i>)	1.83
CF208753	At1g47330	1.83
TC46245	major facilitator superfamily antiporter (<i>Oryza sativa</i> (japonica cultivar-group))	1.84
TC39032	not assigns	1.84
TC48895	IAA16 protein (<i>Gossypium hirsutum</i>)	1.84
TC38733	protein phosphatase 2C (<i>Mesembryanthemum crystallinum</i>)	1.85
CF209220	Yer006wp (<i>Saccharomyces cerevisiae</i>)	1.85
TC51091	not assigns	1.85
TC49051	branched-chain amino acid aminotransferase (<i>Solanum tuberosum</i>)	1.85
TC38414	Heat shock cognate protein 80 (<i>Lycopersicon esculentum</i>)	1.85
TC44400	phosphoprotein phosphatase, catalytic beta chain - alfalfa	1.85
TC45450	not assigns	1.85
TC41034	Neurofilament triplet M protein (160 kDa neurofilament protein) (<i>Homo sapiens</i>)	1.85
TC38450	lectin (<i>Glycine max</i>)	1.85
TC45249	F22G5.31 (<i>Arabidopsis thaliana</i>)	1.85
TC39406	P0688A04.5 (<i>Oryza sativa</i> (japonica cultivar-group))	1.86
CB912650	IAA-Ala hydrolase (IAR3) [imported] - <i>Arabidopsis thaliana</i>	1.86
TC39065	not assigns	1.86
CB009571	P0034A04.18 (<i>Oryza sativa</i> (japonica cultivar-group))	1.86
CD010713	bZIP transcriptional activator RSG (<i>Nicotiana tabacum</i>)	1.86

Table 5. Genes of soft berries (Cabernet Sauvignon) at week 8 after flowering, related to the berry development which were determined by the nearest NCBI BlastX match and the ethylene/control ratio of array features which displayed differential levels of expression after 1 h ethylene treating, that ratio values showed more than 1.75 and less than 0.55.

TC number	Description of nearest NCBI BlastX match	Ratio
TC45700,CB915820	not assigns	0.26
TC49547	AT4g12080	0.26
TC45150	not assigns	0.31
TC43853	not assigns	0.37
TC45700,CB915820	40S ribosomal protein S10. [Rice] { <i>Oryza sativa</i> }	0.38
CA808851	Cat {Promoter probe vector pPR9TT}	0.38
TC44267	TMV resistance protein N - tobacco (<i>Nicotiana glutinosa</i>)	0.40
TC50820	not assigns	0.41
TC45176	not assigns	0.42
TC40435	apospory-associated protein C { <i>Arabidopsis thaliana</i> }	0.42
TC46972	Flavonol synthase (FLS) (CitFLS). [Satsuma orange] { <i>Citrus unshiu</i> }	0.43
TC43319	not assigns	0.43
TC39042	synthase { <i>Nicotiana plumbaginifolia</i> }	0.44
TC41899	AT4g35920	0.44
TC46173	cinnamoyl CoA reductase-like protein - <i>Arabidopsis thaliana</i>	0.44
TC39386	At2g04160	0.45
TC49642	not assigns	0.45
TC40621	fructokinase- <i>Arabidopsis thaliana</i>	0.45
TC47193	callus-associated protein - common tobacco (fragment)	0.45
TC38201	basic 2S albumin { <i>Helianthus annuus</i> }	0.46
TC39845	At1g26850	0.47
Vv_10011280	snakin2 { <i>Solanum tuberosum</i> }	0.47
TC49560	fructose-1,6-bisphosphatase { <i>Pisum sativum</i> }	0.47
TC38248	proline-rich protein GPP1 - potato	0.47
TC40985	not assigns	0.47
TC41003	Stem-specific protein TSJT1. [Common tobacco] { <i>Nicotiana tabacum</i> }	0.48
TC46152	cytochrome P450 F10N7.250 - <i>Arabidopsis thaliana</i>	0.48
TC41861	not assigns	0.48
CA812048	myosin IC heavy chain { <i>Acanthamoeba castellanii</i> }	0.49
TC47498	At2g32240	0.49
TC49574	not assigns	0.49
TC50919	proline-rich protein APG { <i>Arabidopsis thaliana</i> }	0.49
TC44402	not assigns	0.49
CB917527	AT4g14220	0.49
TC38316	systemic acquired resistance-related protein SRE1a - potato	0.50
TC41976	myosin-like protein my5 - common sunflower	0.50
TC51055	not assigns	0.50
TC50854	tryptophan synthasealpha chain T10P11.11 - <i>Arabidopsis thaliana</i>	0.50
CA808990	P0479C08.11 { <i>Oryza sativa</i> (japonica cultivar-group)}	0.50
TC47817	phosphatidic acid phosphatase alpha { <i>Vigna unguiculata</i> }	0.50
TC46211	not assigns	0.50
TC38514	protein cytochrome P-450 F2P9.2 [imported] - <i>Arabidopsis thaliana</i>	0.50
TC38910,CF607854	not assigns	0.51
TC50635	photosystem I P700 chlorophyll A apoprotein A2 { <i>Oryza sativa</i> (japonica cultivar-group)}	0.51
TC49342	Thylakoid lumenal 15 kDa protein, chloroplast precursor (p15) { <i>Arabidopsis thaliana</i> }	0.51
TC39782	not assigns	0.51
TC47339	SET-domain-containing protein { <i>Nicotiana tabacum</i> }	0.51
TC46229	cytochrome P450 { <i>Arabidopsis thaliana</i> }	0.51
TC42390	contains similarity to protein kinase domains and leucien rich repeats { <i>Arabidopsis thaliana</i> }	0.51

Table 5. SOFT grape berries (continued)

TC number	Description of nearest NCBI BlastX match	Ratio
TC45121,TC45650	ripening-induced protein <i>{Fragaria vesca}</i>	1.86
TC46710	apetala2 domain-containing protein <i>{Atriplex hortensis}</i>	1.87
TC51128	Peptidase-like protein - <i>Arabidopsis thaliana</i>	1.87
TC45132	xyloglucan endo-transglycosylase <i>{Vitis labrusca x Vitis vinifera}</i>	1.87
CF210894	G protein beta subunit <i>{Pisum sativum}</i>	1.87
TC45090	protein F3F19.15 [imported] - <i>Arabidopsis thaliana</i>	1.87
TC47843	S-receptor kinase homolog 2 precursor - <i>Arabidopsis thaliana</i>	1.87
TC49029	3-hydroxy-3-methylglutaryl-coenzyme A reductase(HMG-CoA reductase). <i>{Camptotheca acuminata}</i>	1.88
TC44443	F7H2.9 protein - <i>Arabidopsis thaliana</i>	1.89
TC46153	not assigns	1.90
TC45088	OSJNBb0011N17.7 <i>{Oryza sativa (japonica cultivar-group)}</i>	1.90
TC38792	xyloglucan endotransglycosylase precursor <i>{Actinidia deliciosa}</i>	1.90
TC45204	not assigns	1.91
CF214479	30S ribosomal protein S11 <i>{Xanthomonas campestris pv}</i>	1.91
TC43874	permease 1 <i>{Arabidopsis thaliana}</i>	1.91
CB343548	Protein At5g10860, mitochondrial precursor <i>{Arabidopsis thaliana}</i>	1.91
CB972961	F5J5.4 <i>{Arabidopsis thaliana}</i>	1.91
TC49289	Late embryogenesis abundant protein Lea14-A <i>{Gossypium hirsutum}</i>	1.92
TC41852	not assigns	1.92
Vv_10009489	AY057407 Serine	1.92
TC45263	protein T10O22.19 [imported] - <i>Arabidopsis thaliana</i>	1.92
TC49665	protein kinase ADK1-like protein <i>{Arabidopsis thaliana}</i>	1.92
CB343319	high mobility group protein HMG-beta2 [validated] - <i>Arabidopsis thaliana</i>	1.92
TC40291	not assigns	1.92
CB981401,TC44989	glycosyl transferase homolog F3I6.10 - <i>Arabidopsis thaliana</i>	1.93
CB976445	Syntaxin 71 (AtSYP71) <i>{Arabidopsis thaliana}</i>	1.93
TC45260	not assigns	1.93
Vv_10007759	expressed protein <i>{Arabidopsis thaliana}</i>	1.93
TC45618	SOS2-like protein kinase <i>{Glycine max}</i>	1.93
TC50213	B1111E11.23 <i>{Oryza sativa (japonica cultivar-group)}</i>	1.93
Vv_10005464	ADP-ribosylation factor <i>{Vigna unguiculata}</i>	1.94
TC49113	P0694A04.2 <i>{Oryza sativa (japonica cultivar-group)}</i>	1.94
TC47104	bZIP transcription factor ATB2 <i>{Glycine max}</i>	1.94
TC48783	OJ9990_A01.12 <i>{Oryza sativa (japonica cultivar-group)}</i>	1.94
CF208954	AT4g31410	1.95
CB913018	AF264697 NDR1	1.95
TC47905	cytochrome P450 <i>{Arabidopsis thaliana}</i>	1.95
TC41363	not assigns	1.95
CB342753	Mitogen-activated protein kinase phosphatase 4 <i>{Homo sapiens}</i>	1.95
TC45401	glycine hydroxymethyltransferase- <i>Arabidopsis thaliana</i>	1.96
Vv_10004834	AF049937 PGPS	1.96
TC40209	leucoanthocyanidin dioxygenase-like protein <i>{Arabidopsis thaliana}</i>	1.96
TC45866	At1g18460	1.96
TC39687	OJ1714_H10.10 <i>{Oryza sativa (japonica cultivar-group)}</i>	1.97
CB343832	Transformation upregulated nuclear protein <i>{Rattus norvegicus}</i>	1.97
CB970173	beta-cyanoalanine synthase like protein <i>{Solanum tuberosum}</i>	1.97
TC47616	At2g42650	1.97
TC46953	protein F3M18.8 [imported] - <i>Arabidopsis thaliana</i>	1.97
CB342061	NADH dehydrogenase ND4 subunit <i>{Atropa belladonna}</i>	1.98

Table 5. SOFT grape berries (continued)

TC number	Description of nearest NCBI BlastX match	Ratio
Vv_10003671	metallothionein-like protein { <i>Arachis hypogaea</i> }	1.98
CB918270	pectin methylesterase { <i>Pisum sativum</i> }	1.99
TC46227	eukaryotic initiation factor 3E subunit { <i>Arabidopsis thaliana</i> }	1.99
CB004754	protein F22G5.28 [imported] - <i>Arabidopsis thaliana</i>	1.99
TC39704	GATA transcription factor 1 (AtGATA-1) { <i>Arabidopsis thaliana</i> }	1.99
TC46511	contains similarity to protein kinase-gene_id:MUA2.19 { <i>Arabidopsis thaliana</i> }	2.00
TC48252	not assigns	2.00
TC51646	POTASSIUM CHANNEL REGULATORY FACTOR { <i>Dictyostelium discoideum</i> }	2.01
TC48889	RING finger protein - <i>Arabidopsis thaliana</i>	2.01
Vv_10011032	ORF64c { <i>Pinus koraiensis</i> }	2.01
CB350248	At1g09430	2.02
CA817829	(NADH-plastoquinone oxidoreductase subunit J). { <i>Nicotiana tabacum</i> }	2.02
TC47227	cig3 { <i>Nicotiana tabacum</i> }	2.03
TC39737	alpha-expansin precursor { <i>Gossypium hirsutum</i> }	2.03
TC40650	F20B17.20 { <i>Arabidopsis thaliana</i> }	2.03
TC46280	DnaJ-like protein { <i>Arabidopsis thaliana</i> }	2.03
TC47686	latex-abundant protein { <i>Hevea brasiliensis</i> }	2.03
TC50408	monodehydroascorbate reductase { <i>Mesembryanthemum crystallinum</i> }	2.04
CB349071	acetoacetyl-CoA thiolase { <i>Arabidopsis thaliana</i> }	2.05
TC45660	AT3g16570	2.05
TC41867	not assigns	2.06
TC39450,CF605850	syringomycin biosynthesis enzyme-like protein { <i>Arabidopsis thaliana</i> }	2.06
TC51620	P0431H09.21 { <i>Oryza sativa</i> (japonica cultivar-group)}	2.06
TC46524	Thioredoxin F-type, chloroplast precursor (TRX-F) { <i>Pisum sativum</i> }	2.06
TC38262	early light-inducible protein-like { <i>Arabidopsis thaliana</i> }	2.07
TC46846	D-3-phosphoglycerate dehydrogenase, chloroplast precursor(3-PGDH) { <i>Arabidopsis thaliana</i> }	2.07
TC42029	AT3g07360	2.07
TC39626	At2g25350	2.08
TC38987	P0414E03.8 { <i>Oryza sativa</i> (japonica cultivar-group)}	2.08
TC48468	mutator-like transposase-like protein { <i>Arabidopsis thaliana</i> }	2.08
TC48129	AT4g13250	2.09
TC49160	26S proteasome p55 protein-like { <i>Arabidopsis thaliana</i> }	2.09
TC39933	embryo-abundant protein EMB { <i>Pisum sativum</i> }	2.09
BQ795867	Citrate synthase, glyoxysomal precursor(GCS) { <i>Cucurbita maxima</i> }	2.10
CB978121	endosomal protein-like { <i>Arabidopsis thaliana</i> }	2.11
TC44555	not assigns	2.11
TC46805	nam-like protein 3 { <i>Petunia x hybrida</i> }	2.11
TC46993	not assigns	2.12
TC39129	AT5g20250	2.12
TC40622	AT5g02020	2.13
TC40345	cytochrome-c oxidasechain II - garden petunia mitochondrion	2.13
CF212758	P0046E05.21 { <i>Oryza sativa</i> (japonica cultivar-group)}	2.13
TC42326	Heat shock 70 kDa protein { <i>Daucus carota</i> }	2.14
TC48745	poly(A)-binding protein { <i>Cucumis sativus</i> }	2.14
CB921249	AT4g24800	2.15
CB923248	Red protein (RER protein) (IK factor) (Cytokine IK) { <i>Homo sapiens</i> }	2.15
TC45134,CF603240	VVTL1 { <i>Vitis vinifera</i> }	2.15
TC45585	contains similarity to ATPF3-gene_id:MLE2.16 { <i>Arabidopsis thaliana</i> }	2.15

Table 5. SOFT grape berries (continued)

TC number	Description of nearest NCBI BlastX match	Ratio
CB005780	senescence-associated cysteine protease (<i>Brassica oleracea</i>)	2.15
TC39016	At1g53500	2.15
TC49189	not assigns	2.16
TC47375	polygalacturonase PG1 (<i>Vitis vinifera</i>)	2.16
TC41754	Pyrophosphate--fructose 6-phosphate 1-phosphotransferase alpha subunit (<i>Ricinus communis</i>)	2.16
TC39447	osmotin-like protein (<i>Vitis vinifera</i>)	2.16
BM437980	AT4g11680	2.17
CB918449	HSP associated protein like (<i>Arabidopsis thaliana</i>)	2.18
TC39388,TC39389	Pathogen-related protein. [Barley] (<i>Hordeum vulgare</i>)	2.19
TC38425,TC43087	Fruit protein PKIWI501 (<i>Actinidia chinensis</i>)	2.19
TC45171	L-ascorbate peroxidase, cytosolic isozyme - maize	2.20
TC45153	alkaline alpha galactosidase II (<i>Cucumis melo</i>)	2.20
TC49079	Gry-rbp (<i>Homo sapiens</i>)	2.21
TC45115	AT4g25260	2.22
TC41643	DnaJ protein homolog - kidney bean (fragment)	2.22
TC44909	At2g03440 (<i>Arabidopsis thaliana</i>)	2.22
Vv_10010999	prohibitin - common tobacco	2.22
TC38403	expansin (<i>Glycine max</i>)	2.22
TC45623	specific tissue protein 2 (<i>Cicer arietinum</i>)	2.24
TC44002	not assigns	2.24
TC39880	grr1 (<i>Glycine max</i>)	2.25
CB922253	At2g35260	2.25
BM437113	Beta secretase 2 precursor (EC 3.4.23.-) (Beta-site APP-cleaving enzyme 2) (Aspartyl protease 1)	2.25
TC38210	integral membrane transporter protein (<i>Homo sapiens</i>)	2.26
TC48981	cobalamine-dependent methionine synthase I (methyltransferase and cobalamine-binding domain)	2.26
TC40213	contains similarity to protein kinase~gene_id:MUA2.19 (<i>Arabidopsis thaliana</i>)	2.27
TC38720	dynein light chain 1 (<i>Schistosoma japonicum</i>)	2.27
TC41685	preproMP73 (<i>Cucurbita maxima</i>)	2.28
TC49919	3-ketoacyl-acyl carrier protein reductase (<i>Cuphea lanceolata</i>)	2.28
TC45545	A-agglutinin attachment subunit precursor. [Bakers yeast] (<i>Saccharomyces cerevisiae</i>)	2.28
TC45831	26S proteasome regulatory subunit S2 (RPN1) (<i>Arabidopsis thaliana</i>)	2.28
TC47939	cyclin C-like protein (<i>Arabidopsis thaliana</i>)	2.29
TC48153	B1099D03.18 (<i>Oryza sativa</i> (japonica cultivar-group))	2.29
CA809844	HSP90-like protein (<i>Oryza sativa</i>)	2.29
TC38914	OJ1559_F09.21 (<i>Oryza sativa</i> (japonica cultivar-group))	2.30
Vv_10011271	abscisic stress ripening protein homolog (<i>Prunus armeniaca</i>)	2.30
TC45814	AY054510 serine	2.30
TC39516	uncoupling protein homolog F22K18.230 - <i>Arabidopsis thaliana</i>	2.30
TC46464	glucosyltransferase-like protein (<i>Arabidopsis thaliana</i>)	2.30
TC47126	aldehyde dehydrogenase (NAD)2A precursor, mitochondrial - common tobacco	2.30
TC45639	RPT2 (<i>Arabidopsis thaliana</i>)	2.31
TC49025	SD07532p (<i>Drosophila melanogaster</i>)	2.32
TC41084	glucosyltransferase-10 (<i>Vigna angularis</i>)	2.32
TC51610	attractin (<i>Bos taurus</i>)	2.33
TC38228	proline-rich cell wall protein - carrot	2.36
CB921173	potassium transporter HAK3p (<i>Mesembryanthemum crystallinum</i>)	2.36
CA808171	polyubiquitin (<i>Pinus sylvestris</i>)	2.36
CB913482	sugar transporter (<i>Citrus unshiu</i>)	2.36
TC44459	Ku70-like protein (<i>Arabidopsis thaliana</i>)	2.37
TC38136	(Phospholipid transfer protein) (PLTP) (<i>Ricinus communis</i>)	2.37

Table 5. SOFT grape berries (continued)

TC number	Description of nearest NCBI BlastX match	Ratio
TC45756	RNA helicase { <i>Vigna radiata</i> }	2.39
TC43973	beta-1,3-glucanase-like protein { <i>Arabidopsis thaliana</i> }	2.40
TC48468	not assigns	2.41
TC45030,TC45073	40S ribosomal S4 protein { <i>Glycine max</i> }	2.44
TC38214,TC38197	aquaporin, plasma intrinsic protein 2,2 { <i>Juglans regia</i> }	2.45
TC41344	unknown [<i>Vitis vinifera</i>]	2.45
TC40088	expressed protein { <i>Arabidopsis thaliana</i> }	2.45
TC42048	At1g12050	2.45
TC44002	chalcone reductase { <i>Sesbania rostrata</i> }	2.47
TC40083	not assigns	2.48
TC38917	arginine decarboxylase { <i>Vitis vinifera</i> }	2.49
TC45645	pathogenesis-related protein 3 - kidney bean	2.50
TC45135	ATP-dependent Clp protease proteolytic subunit(Endopeptidase Clp) { <i>Nicotiana tabacum</i> }	2.51
TC39957	not assigns	2.51
TC39829	protein - soybean	2.52
TC45336,TC45338	GPI-anchored protein { <i>Arabidopsis thaliana</i> }	2.54
TC43740	AY208992 GIA	2.55
TC50477	predicted by genscan and genefinder { <i>Arabidopsis thaliana</i> }	2.55
TC39120	AT4g27410	2.55
TC49919	not assigns	2.60
TC42419	CTV.15 { <i>Poncirus trifoliata</i> }	2.61
CB972868	Eukaryotic translation initiation factor 3 subunit 8 (eIF3 p110) (eIF3c) { <i>Medicago truncatula</i> }	2.61
TC39957	Esterase D { <i>Homo sapiens</i> }	2.62
TC38202	late-embryogenesis protein lea5 - common tobacco	2.64
CF213967	alpha-tubulin 4 { <i>Gossypium hirsutum</i> }	2.64
Vv_10003938	dehydration-responsive protein RD22 { <i>Prunus persica</i> }	2.73
TC48377	neoxanthin cleavage enzyme { <i>Lycopersicon esculentum</i> }	2.73
TC38285	beta-cyanoalanine synthase { <i>Solanum tuberosum</i> }	2.74
TC40039	GDP-D-mannose-4,6-dehydratase { <i>Arabidopsis thaliana</i> }	2.74
TC44312	lipase SIL1 { <i>Brassica rapa</i> subsp. <i>pekinensis</i> }	2.76
TC45329	Elongation factor 2 (EF-2). [Sugar beet] { <i>Beta vulgaris</i> }	2.76
TC38476	Magnesium And Inhibitor Ipoha (N-Hydroxy-N- Isopropylxamate)	2.76
TC41344	not assigns	2.80
TC38440	polygalacturonase inhibitor-like protein { <i>Arabidopsis thaliana</i> }	2.81
TC38191	plasma membrane aquaporin { <i>Vitis vinifera</i> }	2.84
TC45293	alcohol dehydrogenase 2 { <i>Vitis vinifera</i> }	2.85
CF216188	APS reductase { <i>Brassica juncea</i> }	2.88
TC47525	protein F1N19.23 [imported] - <i>Arabidopsis thaliana</i>	2.90
TC38210,TC38192	allyl alcohol dehydrogenase-like protein { <i>Arabidopsis thaliana</i> }	2.92
Vv_10000758	pathogenesis related protein isoform b1 { <i>Solanum phureja</i> }	3.01
TC38210,TC38192	not assigns	3.10
TC45218	cytosolic malate dehydrogenase { <i>Cicer arietinum</i> }	3.16
TC44973	Chalcone synthase (Naringenin-chalcone synthase) { <i>Vitis vinifera</i> }	3.33
TC45394	not assigns	3.45
TC47119	Basic form of pathogenesis-related protein 1 precursor (PRP 1) { <i>Nicotiana tabacum</i> }	3.52
TC47524	protein F1N19.23 [imported] - <i>Arabidopsis thaliana</i>	3.66
TC38121	aquaporin 2 { <i>Samanea saman</i> }	3.69
TC48485,TC42341	myb-related transcription factor VIMYBA2 { <i>Vitis labrusca</i> x <i>Vitis vinifera</i> }	4.07
NP833510	putative pathogenesis related protein 1 precursor [<i>Vitis vinifera</i>]	4.17

Table 5. SOFT grape berries (continued)

TC number	Description of nearest NCBI BlastX match	Ratio
TC45113	expansin { <i>Vitis labrusca</i> x <i>Vitis vinifera</i> }	4.35
TC40660,TC40661	ethylene receptor CS-ETR2 { <i>Cucumis sativus</i> }	4.51

In the table 6, we present a comparison between gene changes in hard berries (prévéraison) and soft berries (véraison). The data indicate that a great number of genes (67 genes) present a same profile of expression in hard berries and soft berries. It is the case for example for the genes involved in the perception of ethylene.

Terrier *et al.* (2005) have also put in evidence the differences between genes that were not expressed in hard berries, but expressed in the soft berries to show the changes occurring during the véraison and the maturation.

In the contrary, the expressions of genes involved in the softening and expansion of the berries are more dependent upon ethylene in soft than hard berries. In hard berries, only the pectine methyl esterase (ratio 1.89) and the xyloglucan endo transglycosidase (ratio 1.90) have been increased by ethylene. In the soft berry, these two genes were also increased by ethylene at the same level, but we found also that polygalacturonase (ratio 2.16), expansin (ratio 4.35) and aquaporin (3.69) were highly expressed in these fruits.

Similarly, the expression levels of genes involved in the biochemical metabolic changes occurring during the ripening (sugar metabolism, organic acids, phenolic compounds) are more expressed in soft berries than in hard berries.

These data indicated deep changes during berry development from prévéraison stage development to véraison stage development.

Table 6. Induction of genes from hard and soft berries (Cabernet Sauvignon) at week 8 after flowering, related to the berry development which were determined by the nearest NCBI BlastX match and the ethylene/control ratio of array features which displayed differential levels of expression after 1 h ethylene treating.

TC number	Description of nearest NCBI BlastX match	Ratio	
		Hard berry	Soft berry
	<u>Function:transport</u>		
TC38121	major intrinsic family protein / MIP family protein	ND	3.69
TC41344	potassium transporter (KUP3)	2.02	2.80
TC39829	major intrinsic family protein / MIP family protein	ND	2.52
TC41344	potassium transporter (KUP3)	ND	2.45
TC38214,TC38197	Aquaporin	2.61	2.45
TC38136	similar to lipid transfer protein 3 (LTP3)	ND	2.37
CB913482	hexose transporter	ND	2.36
CB921173	potassium transporter	2.21	2.36
TC39516	mitochondrial substrate carrier family protein	ND	2.30
CB978121	endomembrane protein 70	ND	2.11
CA817829	chloroplast-encoded gene for beta subunit of ATP synthase	ND	2.02
TC45176	protease inhibitor/seed storage/lipid transfer protein (LTP) family protein	0.47	0.42
TC45805	potassium transporter (KUP3)	0.42	ND
	<u>Function:transcription</u>		
TC48485,TC42341	myb family transcription factor (MYB114)	ND	4.07
TC45394	zinc finger (CCCH-type) family protein	3.82	3.45
TC44459	WRKY family transcription factor	2.47	2.37
TC49025	trihelix DNA-binding protein	2.01	2.32
TC42939	zinc finger (B-box type) family protein	0.44	ND
TC42939	zinc finger (B-box type) family protein	0.38	ND
	<u>Function:signal transduction</u>		
TC40660,TC40661	ethylene receptor(ETR2)	5.67	4.51
	<u>Function:response to stress</u>	ND	ND
TC45293	Catalyzes the reduction of acetaldehyde using NADH as reductant	ND	2.85
TC38191	aquaporin PIP1;3	ND	2.84
TC45329	elongation factor 2	2.12	2.76
	dehydration-responsive protein (RD22)	ND	2.73
TC38917	encodes a arginine decarboxylase (ADC)	2.01	2.49
TC45171	Encodes a cytosolic ascorbate peroxidase	ND	2.20
CB005780	cysteine proteinase (RD21A) / thiol protease	ND	2.15
TC38262	chlorophyll A-B binding family protein / early light-induced protein (ELIP)	ND	2.07
TC48889	Encodes a small protein with an N-terminal trans-membrane domain.	ND	2.01
	<u>Function:response to abiotic or biotic stimulus</u>		
TC44312	GDSL-motif lipase/hydrolase family protein	ND	2.76
TC39447	osmotin-like protein (OSM34)	ND	2.16
TC45134,CF603240	osmotin-like protein (OSM34)	ND	2.15
	<u>Function:protein metabolism</u>	ND	ND
CB972868	eukaryotic translation initiation factor 3 subunit 8 / eIF3 p110 / eIF3c / p105 (TIF3C1)	ND	2.61
TC45135	Encodes the only ClpP (caseinolytic protease) encoded within the plastid genome	ND	2.51
TC40083	AALP protein mRNA	ND	2.48
TC45030,TC45073	40S ribosomal protein S4 (RPS4D)	ND	2.44
CA808171	polyubiquitin (UBQ3)	ND	2.36

Table 6. (continued)

TC number	Description of nearest NCBI BlastX match	Ratio	
		Hard berry	Soft berry
TC38228	40S ribosomal protein S25 (RPS25B)	ND	2.36
TC45814	protein kinase	ND	2.30
CA809844	heat shock protein 81-2 (HSP81-2)	ND	2.29
BM437113	aspartyl protease family protein	ND	2.25
TC39880	F-box family protein (FBL6)	3.65	2.25
TC41643	DNAJ heat shock protein	ND	2.22
TC49160	26S proteasome regulatory subunit	ND	2.09
TC42029	armadillo/beta-catenin repeat family protein / U-box domain-containing protein	ND	2.07
TC46280	DNAJ heat shock N-terminal domain-containing protein	ND	2.03
TC51646	protein phosphatase 2C family protein / PP2C family protein	ND	2.01
TC48437	co-chaperone grpE family protein	0.47	ND
TC38194	ATP-dependent Clp protease ATP-binding subunit / ClpC	0.45	ND
	<u>Function:other physiological processes</u>		
TC49919	mRNA level of the photosynthetic LHCB gene	2.18	2.60
TC49919	mRNA level of the photosynthetic LHCB gene	ND	2.28
	<u>Function:other metabolic processes</u>		
TC45218	malate dehydrogenase, cytosolic, putative	ND	3.16
TC43740	gibberellin response modulator (GAI) (RGA2)	ND	2.55
TC43973	glycosyl hydrolase family 17 protein	ND	2.40
TC41084	UDP-glucuronosyl/UDP-glucosyl transferase family protein	ND	2.32
TC47126	(NAD+) aldehyde dehydrogenase	ND	2.30
TC47375	endo-polygalacturonase, putative	ND	2.16
TC48129	short-chain dehydrogenase/reductase (SDR) family protein	ND	2.09
	<u>Function:other cellular processes</u>		
TC47524	Cys/Met metabolism pyridoxal-phosphate-dependent enzyme family protein	2.66	3.66
TC47525	Cys/Met metabolism pyridoxal-phosphate-dependent enzyme family protein	2.22	2.90
CF216188	Encodes a protein disulfide isomerase-like (PDIL) protein	ND	2.88
TC38476	ketol-acid reductoisomerase	ND	2.76
TC40039	GDP-D-mannose 4,6-dehydratase	ND	2.74
TC38285	encodes a cysteine synthase isomer	ND	2.74
TC48377	9-cis-epoxycarotenoid dioxygenase	2.72	2.73
TC39957	ribonuclease III family protein	ND	2.62
TC39957	ribonuclease III family protein	ND	2.51
TC42048	fumarylacetoacetase, putative	ND	2.45
TC45756	DEAD box RNA helicase (PRH75)	ND	2.39
TC47939	sarcosine oxidase family protein	ND	2.29
TC45831	encoding the RPN subunits of the 26S proteasome	2.03	2.28
TC41754	pyrophosphate--fructose-6-phosphate 1-phosphotransferase alpha subunit	ND	2.16
TC39016	Encodes a UDP-L-Rhamnose synthase involved in the biosynthesis of rhamnose	ND	2.15
TC45585	copper chaperone (CCH)-related	ND	2.15
BQ795867	Encodes a peroxisomal citrate synthase	ND	2.10
TC46846	D-3-phosphoglycerate dehydrogenase / 3-PGDH	ND	2.07
TC45660	rapid alkalization factor (RALF) family protein	ND	2.05
TC47686	Caspase family protein. Arginine/lysine-specific cysteine protease activity	ND	2.03
CB350248	Encodes subunit A of the heteromeric enzyme ATP citrate lyase (ACL)	ND	2.02

Table 6. (continued)

TC number	Description of nearest NCBI BlastX match	Ratio	
		Hard berry	Soft berry
TC43811	glutathione S-transferase	0.47	ND
TC45584	copper chaperone (CCH)-related	0.47	ND
TC47445	1-hydroxy-2-methyl-2-(E)-butenyl 4-diphosphate synthase	0.42	ND
TC45225	A member of Arabidopsis BAG (Bcl-2-associated athanogene) proteins	0.38	ND
TC45402	fatty acid multifunctional protein (MFP2)	0.35	ND
TC40001	fatty acid multifunctional protein (MFP2)	0.32	ND
TC45225	A member of Arabidopsis BAG (Bcl-2-associated athanogene) proteins <u>Function:other biological processes</u>	0.23	ND
NP833510	pathogenesis-related protein 1 (PR-1)	ND	4.17
Vv_10000758	pathogenesis-related protein 1 (PR-1)	ND	3.01
TC38440	leucine-rich repeat family protein	2.38	2.81
TC45639	signal transducer of phototropic response (RPT2)	ND	2.31
TC43235	Lipoxygenase <u>Function:electron transport or energy pathways</u>	0.49	ND
TC50408	Encodes a peroxisomal monodehydroascorbate reductase <u>Function:developmental processes</u>	ND	2.04
TC45113	expansin (EXP8)	ND	4.35
TC38202	late embryogenesis abundant 3 family protein / LEA3 family protein	ND	2.64
TC38403	expansin (EXP11)	ND	2.22
TC39129	alkaline alpha galactosidase	2.17	2.12
TC46805	no apical meristem (NAM) family protein	ND	2.11
TC39737	expansin (EXP6) <u>Function:cell organization and biogenesis</u>	ND	2.03
CF213967	tubulin alpha-2/alpha-4 chain (TUA2)	ND	2.64
TC38720	dynein light chain type 1 family protein	2.08	2.27
TC50818	dynein light chain <u>Function:biological process unknown</u>	0.42	ND
TC47119	pathogenesis-related protein	ND	3.52
TC42419	serine-rich protein-related	2.15	2.61
TC50477	expressed protein	ND	2.55
TC45336,TC45338	glycosyl hydrolase family protein 17	ND	2.54
TC45645	zinc finger (AN1-like) family protein	ND	2.50
TC44002	expressed protein	ND	2.47
TC40088	zinc finger (AN1-like) family protein	ND	2.45
TC48468	expressed protein	2.23	2.41
TC46464	glycosyl transferase family 2 protein	2.34	2.30
TC38914	remorin family protein	ND	2.30
TC45545	expressed protein	ND	2.28
TC41685	cupin family protein	ND	2.28
TC40213	octicosapeptide/Phox/Bem1p (PB1) domain-containing protein	ND	2.27
CB922253	expressed protein	ND	2.25
TC44002	expressed protein	ND	2.24
TC44909	nodulin-related	ND	2.22
TC49079	expressed protein	ND	2.21
TC45153	alkaline alpha galactosidase	ND	2.20

Table 6. (continued)

TC number	Description of nearest NCBI BlastX match	Ratio	
		Hard berry	Soft berry
TC39388,TC39389	pathogenesis-related family protein	2.53	2.19
TC49189	Encodes a gibberellin (GA) receptor ortholog of the rice GA receptor gene (OsGID1)	ND	2.16
CB921249	MA3 domain-containing protein	ND	2.15
TC40345	expressed protein	ND	2.13
TC40622	expressed protein	ND	2.13
TC46993	expressed protein	ND	2.12
TC48468	expressed protein	2.07	2.08
TC38987	expressed protein	ND	2.08
TC39626	exonuclease-related	ND	2.08
TC51620	expressed protein	2.44	2.06
TC39450,CF605850	expressed protein	ND	2.06
TC41867	phosphatidic acid phosphatase-related / PAP2-related	ND	2.06
CB349071	acetyl-CoA C-acyltransferase, putative / 3-ketoacyl-CoA thiolase	2.33	2.05
TC40650	expressed protein	ND	2.03
TC47227	expressed protein	2.07	2.03
TC48252	chaperone protein dnaJ-related	ND	2.00
TC39782	expressed protein	0.46	0.51
TC45700,CB915820	expressed protein	0.37	0.38
TC45700,CB915820	expressed protein	0.35	0.26
TC43441	expressed protein	0.50	ND
TC38727	expressed protein	0.49	ND
Vv_10012898	expressed protein, contains Pfam profile PF04720: Protein of unknown function (DUF506)	0.47	ND
TC49318	stigma-specific Stig1 family protein	0.46	ND
TC47489	expressed protein	0.45	ND
TC51583	expressed protein	0.33	ND
	<u>Function:no match in functional categorie</u>		
TC44973	not assigns	ND	3.33
TC38210,TC38192	not assigns	ND	3.10
TC38210,TC38192	not assigns	ND	2.92
TC39120	not assigns	ND	2.55
TC51610	not assigns	ND	2.33
Vv_10011271	not assigns	ND	2.30
TC48153	not assigns	2.60	2.29
TC48981	not assigns	ND	2.26
TC38210	not assigns	ND	2.26
TC45623	not assigns	ND	2.24
Vv_10010999	not assigns	ND	2.22
TC45115	invertase/pectin methylesterase inhibitor family protein	ND	2.22
TC38425,TC43087	not assigns	ND	2.19
CB918449	tetratricopeptide repeat (TPR)-containing protein	ND	2.18
BM437980	zinc finger (C3HC4-type RING finger) family protein	ND	2.17
CB923248	not assigns	ND	2.15
TC48745	polyadenylate-binding protein	ND	2.14
TC42326	not assigns	ND	2.14
CF212758	expressed protein	ND	2.13

Table 6. (continued)

TC number	Description of nearest NCBI BlastX match	Ratio	
		Hard berry	Soft berry
TC44555	not assigns	ND	2.11
TC39933	embryo-abundant protein-related	ND	2.09
TC46524	thioredoxin, putative	ND	2.06
Vv_10011032	not assigns	ND	2.01
TC43319	not assigns	0.39	0.43
TC45150	not assigns	0.33	0.31
TC49547	DNA-binding family protein	0.35	0.26
TC46274	not assigns	0.49	ND
TC44550	not assigns	0.44	ND
TC38539	Physically interacts with CIPK1.	0.39	ND

3 -Discussion

Grape berries are regarded as non-climacteric fruit. However, our results show clearly that at the inception of ripening, a stage called *véraison*, low doses of ethylene can modulate the expression of some genes having functions known to change the ripening process.

This study confirms at a crucial development stage that a wide spectrum of grape biological functions was affected by ethylene in grape berries. This is shown by application of exogenous ethylene, but the “natural” endogenous ethylene is probably important for these changes, as the use of an inhibitor of ethylene receptors (1-MCP) induced critical changes in the berry ripening (Chervin *et al.* 2004).

The results presented in the above tables show that the number of genes for which the expression was stimulated by ethylene is often higher than the number of genes for which the expression was depressed. The results also show that ethylene modulates the expression of several genes either on a short term (1h) or a long term (24h).

This long term effect due to an ethylene treatment has already been shown in grape berries by El Kereamy *et al.* (2003) and in chapter 1, where it was observed that anthocyanin accumulation was increased up to harvest after an ethylene treatment at *véraison*.

This rise was due in particular to the UFGT protein accumulation, which activity stabilises the anthocyanin by addition of a sugar moiety (Piffaut *et al.* 1994). The accumulation of *ufgt* transcripts had also been observed after an ethylene treatment by Northern blot, peaking 24 h post-treatment, then going down in 8 days (El Kereamy *et al.* 2003).

In our experimental conditions it has not been possible to observe transcript accumulation of glycosyltransferases after a 24 h ethylene treatment, but several glycosyltransferases were stimulated by a one hour ethylene treatment (Tables 4 and 5), one of which being described as a UFGT (ratio 2.24, TC41040).

Another hypothesis is related to the strong ethylene dose delivered in the El-Kereamy *et al.* (2003) series of experiments, in which the CEPA was sprayed at 1.8 g.l^{-1} , representing roughly $1,000 \text{ }\mu\text{l.l}^{-1}$ of ethylene, whereas in the 1h and 24h induction series for micro-array analysis we used $4 \text{ }\mu\text{l.l}^{-1}$, a much smaller dose that is probably more physiological.

These experimentations showed that grape berry cells, at the véraison stage of development, have probably a sensitive perception system of the ethylene signal. Thus ethylene can cause effects in grape berry cell physiology. We have also observed that ethylene can stimulate its own perception system, as shown after 1 hour in soft berries, with the strong stimulation of an ethylene receptor homolog to *ETR2* of *Cucumis sativus*, with a ratio of 4.51 (Table 5).

But we did not observed stimulation of gene expression of the ethylene biosynthesis pathway, as usual in climacteric fruit. This matches with the classification of grape as a non-climacteric fruit.

It is important to note that the short ethylene treatment (1h) stimulated strongly a critical Myb factor for anthocyanin accumulation, MybA2 (ratio 3.69 in Table 5), described recently by Walker *et al.* (2007), and we missed this stimulation in our study reported in chapter I. This may be because we sampled only 24 h hours after ethylene treatment in berries and 6 hours after ethylene treatment in cell suspensions.

Recent studies have allowed the comparison between the gene expression in tomato and grape (Fei *et al.* 2004). In order to gain insight into common regulatory mechanisms among diverse fruit species and ripening physiologies, these authors compared EST collection from ripening grape and tomato fruits. By comparing ESTs from green stage versus véraison fruit, 95 grape ripening-induced genes were identified. Nine of the 95 genes are homologous to genes involved in cell wall metabolism and five represent previously characterised ripening-related genes. Furthermore, none ethylene synthesis or signaling genes was revealed by analysis of grape ESTs. Comparison of the cDNA sequences of all 95 grape and 333 tomato ripening-induced genes shows that 33 tomato ripening-induced genes had homologues in the set of grape-induced genes. Interestingly, three transcription factors, including members of the MADS box, zinc finger, and bZIP transcription factors families, had been identified in both species. Furthermore, a number of genes associated with ripening process were identified in both species such as xyloglucan endo-1, 4- β -D-glucanase which is associated with fruit softening, alcohol dehydrogenase involved in changes of flavor metabolites, or putative PR protein in relation with the susceptibility to pathogen attack. Other genes putatively involved in signal transduction, stress response and transport were found to be induced over both tomato and grape ripening. These results suggest that the ripening processes of both tomato and grape share several features.

However, differentially expressed genes identified via digital expression analysis are biased

toward moderate or highly expressed genes to a degree dependent upon the total number of ESTs generated by tissue/treatment. In addition, genes that are induced by both tomato and grape fruit ripening and expressed at low levels or in specific tissue or cell types not emphasized in EST sequencing efforts may be missed.

It is notorious that the unknown biological processes constitute an important group of affected genes. The low similarity of some *Vitis* gene sequences to *Arabidopsis* and other known species could explain in part the abundance of genes that belong to this category.

Interestingly, several genes involved in berry expansion and softening were stimulated by ethylene, this data is summarised in Table 7 below. This was created from the data shown in Tables 3, 4 and 5. We will further get insight in the expression of these genes in the following chapter by studying their modulation by ethylene using a quantitative PCR technique.

Table 7. Summary showing, the genes involved in the cellular expansion and the softening for which expression is affected by C₂H₄ during the experiences presented in the above tables.

TC number	Description of nearest NCBI BlastX match	Ratio
	<u>24 h after the ethylene induction</u>	
TC38576	aquaporin, major intrinsic family protein { <i>Arabidopsis thaliana</i> }	0.56
TC38812	expansin { <i>Arabidopsis thaliana</i> }	0.70
TC38792	xyloglucan endotransglycosylase { <i>Arabidopsis thaliana</i> }	1.37
TC47375	endo-polygalacturonase { <i>Arabidopsis thaliana</i> }	1.70
CB978247	cellulose synthase family protein { <i>Arabidopsis thaliana</i> }	1.73
TC39811	aquaporin, major intrinsic family protein { <i>Arabidopsis thaliana</i> }	1.86
	<u>1 h after the ethylene induction in hard berries</u>	
TC47375	polygalacturonase PG1 { <i>Vitis vinifera</i> }	1.81
TC47054	pectin methylesterase-like protein { <i>Arabidopsis thaliana</i> }	1.89
TC40411	xyloglucan endotransglycosylase 1 { <i>Fagus sylvatica</i> }	1.90
	<u>1 h after the ethylene induction in soft berries</u>	
TC45132	Xyloglucan endo-transglycosylase { <i>Vitis labrusca</i> x <i>Vitis vinifera</i> }	1.87
TC38792	xyloglucan endotransglycosylase precursor { <i>Actinidia deliciosa</i> }	1.90
CB918270	pectin methylesterase { <i>Pisum sativum</i> }	1.99
TC39737	alpha-expansin precursor { <i>Gossypium hirsutum</i> }	2.03
TC47375	polygalacturonase PG1 { <i>Vitis vinifera</i> }	2.16
TC38403	expansin { <i>Glycine max</i> }	2.22
TC38214, TC38197	aquaporin, plasma intrinsic protein 2,2 { <i>Juglans regia</i> }	2.45
TC38191	aquaporin, plasma membrane aquaporin { <i>Vitis vinifera</i> }	2.84
TC38121	aquaporin 2 { <i>Samanea saman</i> }	3.69
TC45113	expansin { <i>Vitis labrusca</i> x <i>Vitis vinifera</i> }	4.35

**❖ CHAPTER - III. EFFECT OF ETHYLENE ON THE
EXPRESSION OF GENES RELATED TO CELL
EXPANSION**

CHAPTER III: Effect of ethylene on the expression of genes related to cell expansion

1- Introduction

The grape berry is a fruit for which the volume increase shows a characteristic double-sigmoidal curve as described by Coombe (1992). During the first phase, after anthesis, the increase of the fruit size can be attributed to both cell division and cell expansion. At the end of the first phase, the growth should be due solely to cell expansion. Then, the grape berry goes through a phase of little or no growth. The second phase of growth begins at véraison. The increase in berry size is due only to cell expansion and is accompanied by an accumulation of water and sugar (Coombe 1992).

It is admitted that the fruit softening during ripening is attributed to textural and compositional changes in the cell wall. In grapevine, Nunan *et al.* (1998) have demonstrated that cell wall structure can influence berry texture. These authors have shown that certain enzymes can participate in cell wall modification throughout berry development (Nunan *et al.* 2001). They found that galactosidase, pectin methylesterase, cellulose, xyloglucanase and galactanase are present in grape berry. In contrast, polygalacturonase activity could not be detected in grape berry although transcripts analysed by Northern hybridization techniques were detected during ripening.

In the precedent chapter, we have observed that a great number of genes coding enzymes involved in cell wall changes and water transport were affected by ethylene at the beginning of the ripening phase. Our objective has been to study the evolution of the transcript accumulation of these genes during grape berry development by qRT-PCR. In a first part, we have studied the influence of ethylene on berry volume and deformability over the ripening period, and in a second part, we show the effect of ethylene on the several genes known to modify cell wall structure and to modulate water transport.

2 - Results

2.1- Influence of ethylene on grape berry development

We have studied the influence of ethylene on the time course evolution on the diameter and

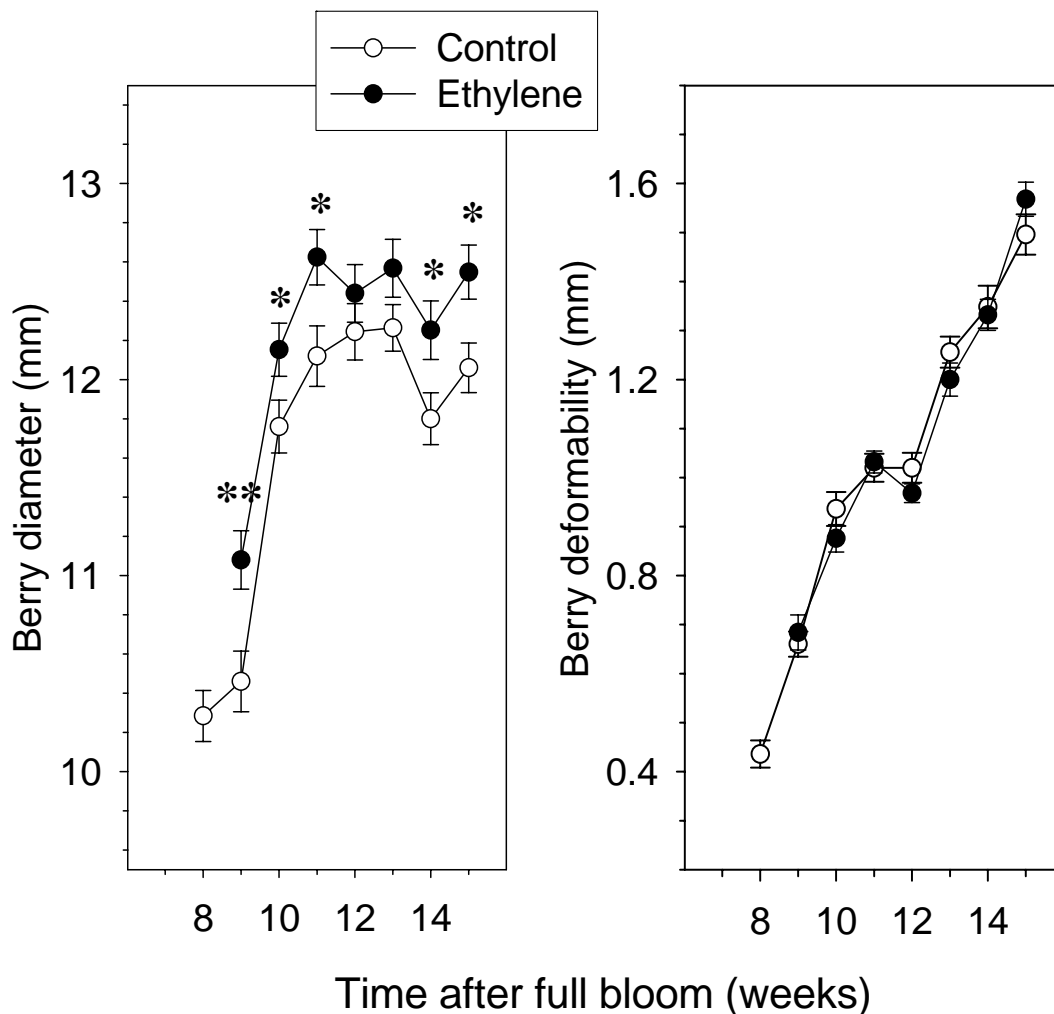

Figure 20. Variations of diameter (a) and deformability (b) of Cabernet Sauvignon berries affected by an ethylene treatment ($4 \mu\text{l.l}^{-1}$ for 24h) at week 8, as a function of the time after full bloom. The first assessments in the “ethylene” samples were made 1 week after the treatment; $n = 50$, error bars represent S.E; the stars *, ** show significant differences at 5 and 1%, respectively.

deformability of the grape berries of Cabernet Sauvignon cultivar. The determination of the berry diameter accounts for the evolution of the growth of the grape berries due to the increase in the number of cells and the increase in cellular volume in various tissues of the berries. The deformability was measured using skin-fold calipers and can be directly related to the berry softening. The ethylene treatments were applied each week after full bloom as described in material and methods. The véraison occurred at week 8 to 9 after full bloom (figure 8).

When the ethylene treatment was performed on grape berry at week 2 to week 7 after full bloom, before véraison, the diameter and the deformability of grape berries were not affected by ethylene (data not shown). The Figure 20 shows that after véraison, the diameter of berries rapidly increased, going from 10.2 mm to 12.2 mm into 3 weeks. Then, the diameter of the berries reached a maximum value and decreased slightly, probably because of a dry weather.

The treatment with ethylene at week 8 induced a significant increase in the berry diameter compared to control berries, measured one week later: 10.5 mm for the control against 11.1 mm for treated berries. This significant difference in berry diameter due to an ethylene treatment at week 8 was maintained throughout the second berry growth phase.

The deformability of grape berries follows a continuous evolution during the berry growth, with however a stop at week 12 (Figure 20). When the grape berries are treated by ethylene at week 8, the deformability of the berries was not significantly affected, over the second growth phase.

These results indicated that ethylene affected mainly the grape berry expansion, but not the deformability, when applied at the véraison stage.

2.2- Genes involved in expanding and softening of grape berries and whose expression is modulated by ethylene

The genes for which we decided to follow the transcript accumulation by qRT-PCR are presented in the Table 8. They arose from a choice made with the results of micro-array experiments reported in the precedent chapter. These genes can be classified in two groups: cell wall structure genes and water transporter genes. In the first group, there are the xyloglucan endotransglucosydase (*XET*), polygalacturonase (*PG*), pectin methylesterase (*PME*), cellulose synthase (*CS*), expansin (*EX*). The second group (water transport) includes several members of the aquaporin gene family (*AQUA*). Most genes were known to be expressed in fruit during ripening, in tomato (Cho and Cosgrove, 2004), mango (Sane *et al.* 2005), peach (Hayama *et al.* 2006), banana (Trivedi and Nath 2004; Wang *et al.* 2006) and strawberry (Tian *et al.* 2000).

2.3 - Time course evolution of the expression of *XET*, *PG*, *PME*, *CS*, *EX*, *AQUA* genes during the grape berry growth

In the micro-array experiments, we observed that *XET*, *PG*, *PME*, *CS*, *EX*, *AQUA* gene expression is ethylene-dependent. Using qRT-PCR, we first checked the expression of these genes during the development of grape berries. In the Figure 21, we show some potential correlation between the variation of the berry diameter and the related genes expression pattern during the development of berry, between week 2 and week 11 after full bloom.

The time course expansion of grape berries is characterized by two phases of growth, very characteristic in grape: a first phase (phase 1) of growth between week 2 and week 9 which is

stopped at the end of véraison and a second phase (phase 2) of growth from week 9 to week 14. The first phase of berry growth is in relation to the increase in the number of cells and the second phase of the increase in the diameter is mainly due to the increase in cellular volume. The second phase of berry growth is also characterised by an increase in the softening of berry (Figure 20).

Table 8. The seven genes selected over the complete micro-array experiment by t-test, $P = 0.01$, $n = 6$. These genes were identified with new TC numbers and their function was estimated by the nearest *Arabidopsis thaliana* (AT) BlastX match. The column named “ratio” indicates the ethylene/control ratio obtained in the micro-array performed for a 24 h ethylene treatment at week 8 in Cabernet Sauvignon berries.

New TC Number	Old TC number	AT Accession number	Description of nearest NCBI of a <i>Arabidopsis thaliana</i>	Gene code	Ratio
	CB346454		xyloglucan endotransglycosylase	<i>XET</i>	1.70
TC52034	TC47375	AT2G41850	endo-polygalacturonase	<i>PG</i>	1.70
	TC38735		pectin methylesterase	<i>PME</i>	1.28
CAB40005_IVa_Fa_C09	CB978247	AT1G55850	cellulose synthase family protein	<i>CS</i>	1.73
TC62965	TC38813		expansin	<i>EX1</i>	1.29
TC55300	TC38576	AT2G36830	major intrinsic family protein (aquaporin)	<i>AQUA1</i>	0.56
TC64551	TC39811	AT1G17810	major intrinsic family protein (aquaporin)	<i>AQUA2</i>	1.86

Transcript Accumulation Index —○—

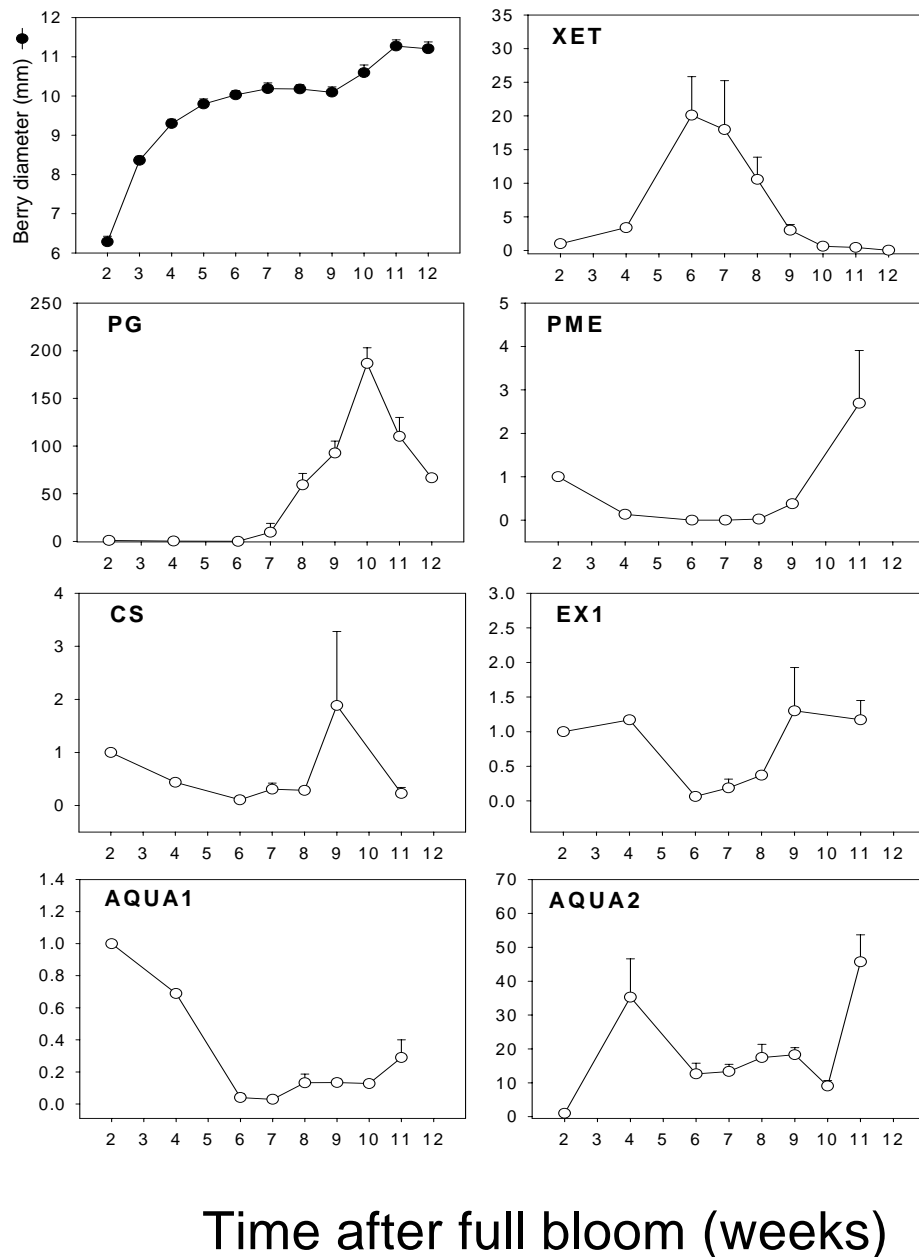

Figure 21: Comparison of the diameter changes and variations of gene transcript accumulation in Cabernet Sauvignon berries at various times after full bloom. “XET” is for Xyloglucan EndoTransglucosylase, “PG” is for PolyGalacturonase, “PME” is for Pectin MethylEsterase, “CS” is for Cellulose Synthase, “EX” is for Expansin, “AQUA” is for Aquaporin, n = 50 x 5 replications = 250 berries, for diameter assessment; n = 6 replications in qPCR experiments, error bars represent SE.

The analysis of the transcript accumulation allowed classifying these genes into three categories. In the first category, for which the transcript accumulation occurred during the first phase (phase 1) of diameter growth: it is the case for *AQUA1*. In the second category, the accumulation of transcripts was maximum at the beginning of the second phase (phase 2) of diameter growth: it is the case of *XET*, *PG*, *PME*, *CS*. The third category gathers the genes which expression was high over both expansion phases of the berries: it is the case of *EX1* and *AQUA2*.

These results suggest that some cell wall modifying enzymes and proteins involved in water transport (aquaporins) could be involved in both expansion phases of grape berries, as their transcripts accumulation show a good correlation with berry expansion phases. This is in agreement with previously published results (Nunan *et al.* 2001). The occurrence of aquaporin transcripts is a more original result.

2.4 - Effect of ethylene on the expression of *XET*, *PG*, *PME*, *CS*, *EX* and *AQUA* genes in pulp, skin and seeds tissues of grape berry

We have studied the expression of *XET*, *PG*, *PME*, *CS*, *EX* and *AQUA* genes in different tissues of grape berries treated at week 8 by ethylene over two durations: 1h for the short time ethylene effect (Figure 22) or 24h for the long time ethylene effect (Figure 23). These experimentations were performed to determine if these genes are expressed similarly in all grape berry tissues or if their expression are tissue specific. RNAs have been extracted from pulp, skin and seeds of grape berries untreated or treated by ethylene. qRT-PCR were performed by using the primers described in the Table 2

For each tissue, we have chosen to give the relative value of “1” for the transcript accumulation index (TAI=1) of controls (untreated). In other words, the transcript accumulation index (TAI) of each gene after ethylene treatment was determined relatively to this referent value (TAI=1).

The results presented in the Figure 22 show that ethylene has induced rapidly (1 h), a strong accumulation of transcripts of most of the selected genes in the skin, except *PME* gene which expression is not affected by ethylene. In the skin tissue, the transcript accumulation index (TAI) is strongly increased for *AQUA2* (TAI: 300), *EX2* (TAI: 100) or *PG* (TAI: 30) genes one hour after the ethylene treatment. Similarly, in the seeds, ethylene provokes a significant increase in the TAI for *PME* (TAI: 5) and *AQUA1* (TAI: 5) genes but these bursts were less important than in skin. In pulp, only the *XET* gene expression seems to be clearly increased by ethylene (TAI: 12) whereas the expression of the other studied genes is not affected by ethylene. The

strongest impact being observed in the peripheral tissues like skin is also logical with the fact, that in the case of this exogenous supply of ethylene, skin is the first tissue in contact with the plant hormone.

Indeed, after a 24h-induction, no transcript accumulation was boosted by ethylene in skin tissues any more (Figure 23). Only *AQUA2* gene (TAI: 3) was still highly expressed in the pulp of berries treated by ethylene. In the seeds, only *PG* gene was strongly induced by ethylene (TAI: 50); the stimulation of the other genes by ethylene, *XET* (TAI: 3.5), *CS* (TAI: 2.5), *AQUA2* (TAI: 2.5), *PME* (TAI: 2.5) and *EX1* (TAI: 4.5) was less marked.

These results show that the expression of these genes involved in the softening of grape berries is strongly tissue specific. In the skin, the gene expression is rapidly stimulated then comes back too a value similar to the control 24 h after the ethylene treatment. In contrary, in the seeds, a great number of genes were induced 24 h after ethylene treatment. In the pulp, ethylene does not seem to have marked effects on the gene expression 1 h or 24 h excepted for *XET* and *AQUA2* at various times. And these could be of great importance in the stimulation of berry expansion by ethylene observed in Figure 20. In the expansin family, the *EX2* and *EX1* gene expression was strongly stimulated in skin 1 h after ethylene treatment, but is not prolonged over 24 h.

In order to compare the relative level of gene expression in each tissue, we showed in the Figure 24 the transcript accumulation index for each gene in pulp, skin and seeds of grape berries untreated by ethylene. For each gene, the relative values of the transcript accumulation index for pulp, skin and seeds have been determined by choosing the pulp TAI value equal to one.

Some genes showed a higher accumulation of transcripts in pulp than in skin: *PG*, *EX1*, *EX2* and *AQUA2*. These are probably important proteins in relation to the stimulation of berry expansion by ethylene. The expression of these four genes is suggested to be highly responsive to ethylene (Figure 22).

Some other genes showed a higher accumulation of transcripts in seeds than in both of pulp or skin: *XET*, *PME*, *AQUA1*, *AQUA2* and *AQUA3*. These are probably critical for seed maturation. But this remains to be demonstrated.

Transcript Accumulation Index

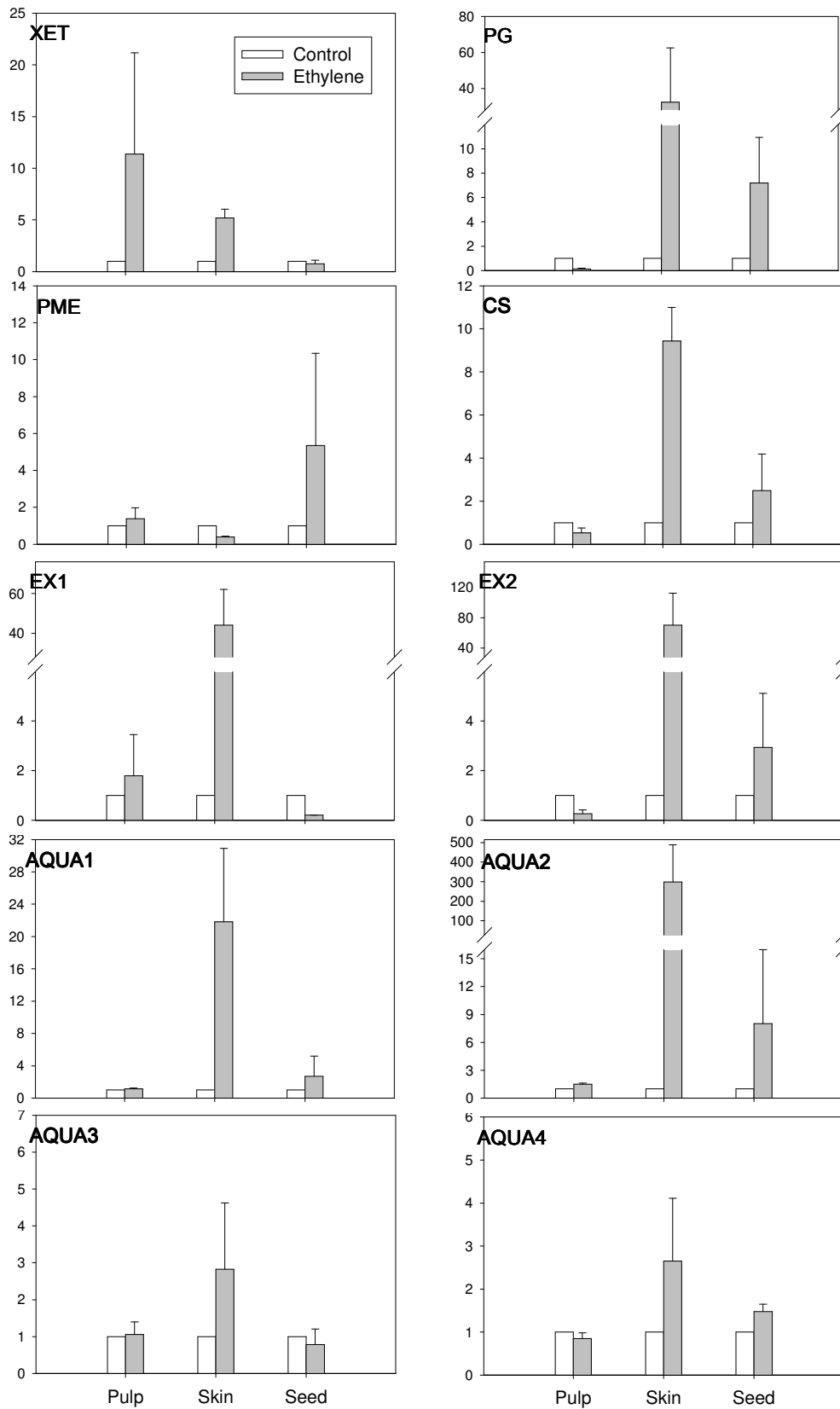

Grape berry tissues

Figure 22. The mRNA level of various genes in three tissue types after 1 h of ethylene treatment in Cabernet Sauvignon berries at week 8 after full bloom, was expressed relatively to controls (valued at 1), reference gene *EF1-alpha*. “XET” is for Xyloglucan EndoTransglucosylase, “PG” is for PolyGalacturonase, “PME” is for Pectin MethylEsterase, “CS” is for Cellulose Synthase, “EX” is for Expansin, “AQUA” is for Aquaporin ; n = 3 replications, error bars show SE.

Transcript Accumulation Index

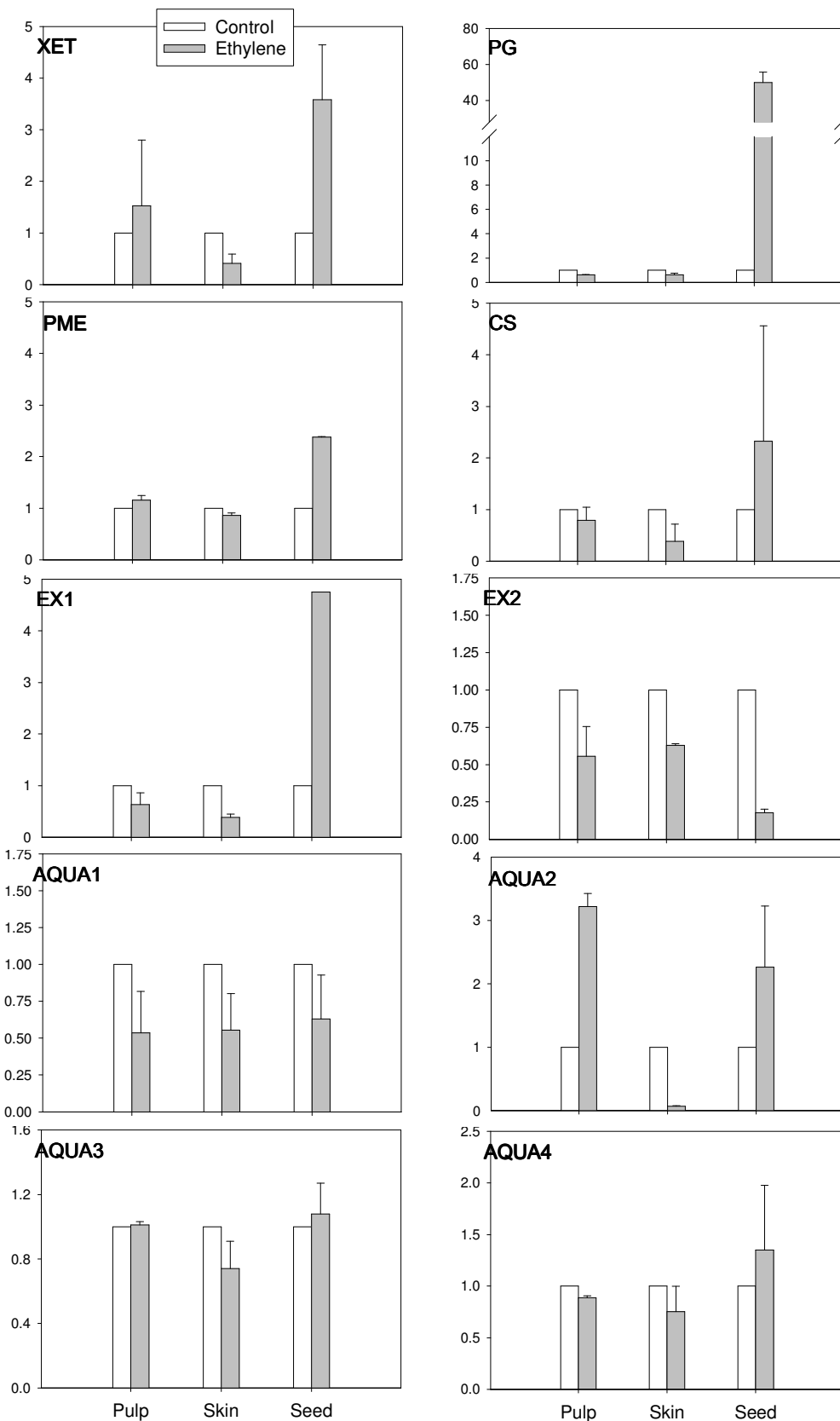

Grape berry tissues

Figure 23. The mRNA level of various genes in three tissue types after 24 h of ethylene treatment in Cabernet Sauvignon berries at week 8 after full bloom, was expressed relatively to controls (valued at 1), reference gene *EF1-alpha*. “XET” is for Xyloglucan EndoTransglucosylase, “PG” is for PolyGalacturonase, “PME” is for Pectin MethylEsterase, “CS” is for Cellulose Synthase, “EX” is for Expansin, “AQUA” is for Aquaporin ; n = 3 replications, error bars show SE.

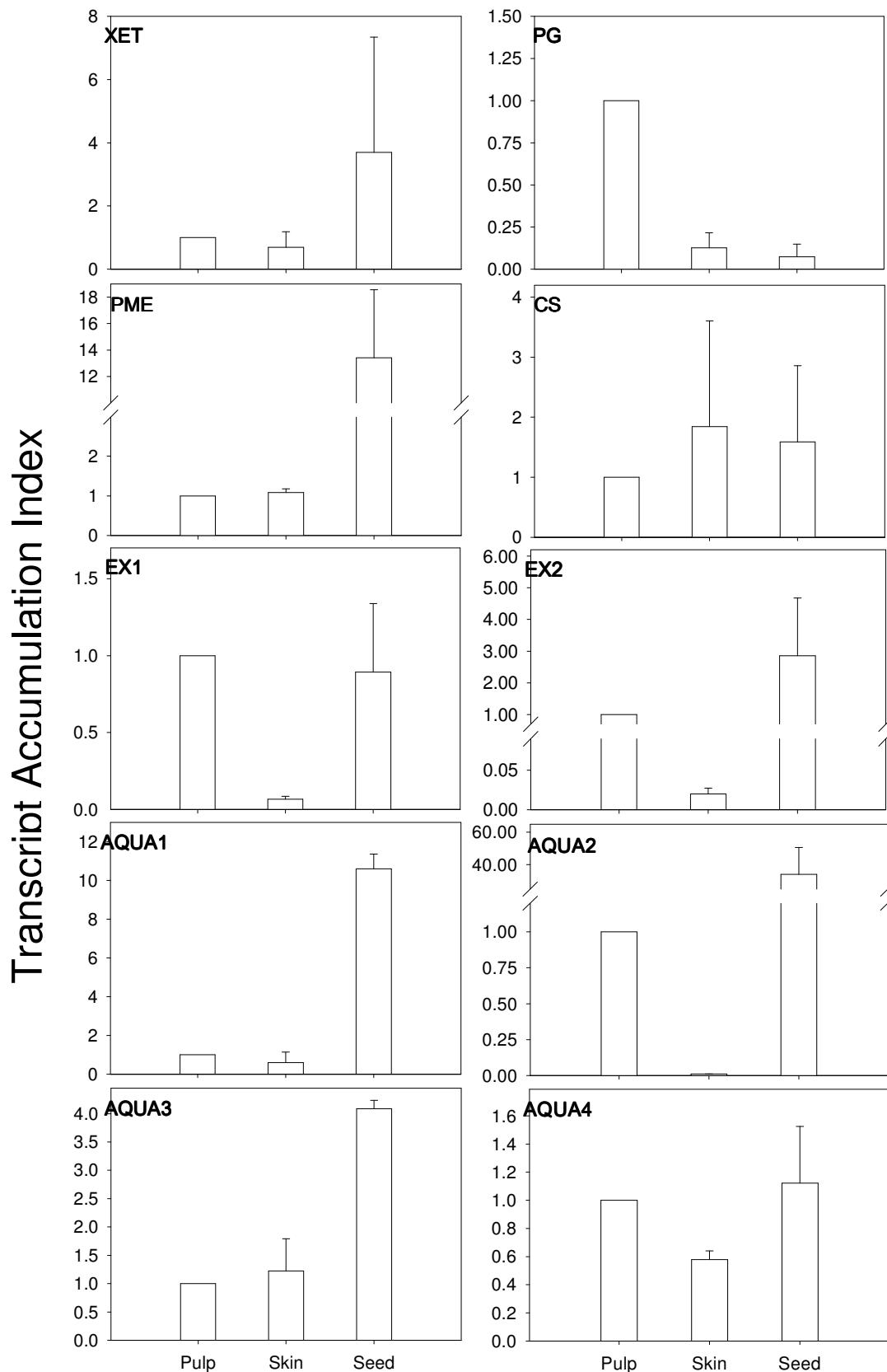

Grape berry tissues

Figure 24. The mRNA level of various genes in three tissue types in control Cabernet Sauvignon berries at week 8 after full bloom, was expressed relatively to pulp (valued at 1), reference gene *EF1*-alpha. “XET” is for Xyloglucan EndoTransglucosylase, “PG” is for PolyGalacturonase, “PME” is for Pectin MethylEsterase, “CS” is for Cellulose Synthase, “EX” is for Expansin, “AQUA” is for Aquaporin ; n = 3 replications, error bars show SE.

3 - Discussion

According to our knowledge, this is the most extensive set of data targeting the role of ethylene in the grape berry expansion and softening processes.

Fruit softening in grapes is clearly a complex process that involves subtle changes in different components of cell wall and in many cases would require only small amounts of enzyme activity indicating that a low change in gene expressions related to the control of cell wall composition could allow the beginning of softening.

The fact that low doses of ethylene stimulated the grape berry expansion (Figure 20) are in accordance with the fact that low doses of 1-MCP, an ethylene inhibitor, limited the berry expansion (Chervin *et al.* 2004). A role for ethylene in increase of fruit diameter is not well documented, we found one article showing that low doses of ethylene were able to enhance peach diameter (Byers *et al.* 1969).

PME and *PG* might contribute to increase the solubility of pectic polysaccharides of cell walls observed during ripening of grape berries (Nunan *et al.* 1998). *PG* transcript accumulations increase at véraison when berry expansion resumes (Figure 21). Ethylene stimulates the accumulation of the *PG* transcripts, indicating that ethylene could be one of the signal triggering the berry expansion. *PME* transcripts also increased after véraison, but later than *PG* (Figure 21), and in a previous study the authors did observe a *PME* transcript accumulation but no related increase in *PME* activity over the second phase of ripening of grape berries, cv. Muscat Gordo Blanco (Nunan *et al.* 2001). In addition the stimulation of *PME* by ethylene was less marked, and only in seeds (Figures 22, 23). Thus *PME* seems less critical than *PG* to the berry expansion in response to an ethylene stimulus.

Cellulose synthase was marginally induced as the berry expansion resumed (Figure 21) and was also stimulated by ethylene in the skin tissues (Figure 22). This enzyme is known to be critical in cell wall expansion, as a sustained cellulose synthesis is then necessary. There is not a lot of data regarding ethylene and cellulose synthesis. Luo *et al.* (2007) reported recently that inhibition of ethylene perception by 1-MCP retarded the cellulose accumulation in bamboo shoots.

XET mRNAs are present mainly in the skin and ethylene increases its accumulation. Nunan *et al.* (2001) have also found observed the presence of *XET* mRNAs in ripening grape berries and

suggested a possible role for this enzyme in wall modification.

Nunan *et al.* (1998) have shown that the first major change of the cell wall composition during grape berry ripening was a decrease in galactose/galactan content. This decrease was related to β -galactosidase activities, which increased dramatically as the berry began to soften. Nunan *et al.* (2001) showed that accumulation of β -galactosidase mRNA was detected in prévéraison and early post-véraison grapes. Similarly, Barnavon *et al.* (2000) showed that the pattern of a β -*gal* transcript accumulation was only detectable in the early stages of development. In our microarray experiment, no transcript of β -galactosidase was detected among the strong changes induced by ethylene (Tables 3 and 5), but we found an α -galactosidase in this category. This was not further developed.

Our results confirm that gene expression is time and tissue specific. In the skin, the ethylene treatment rapidly stimulates the expression of many genes, and then the levels come back to normal after 24h. On the contrary, in the seeds the expression burst is observed around 24 hour after the ethylene treatment.

In the pulp, the changes induced by ethylene are not great, except for *XET* and *AQUA2* that may be part of the expansion response to ethylene. Indeed the expansion of pulp tissues is probably critical in berry expansion phase, as they represent the major berry tissue. *AQUA2* is probably a good candidate to further study the role of aquaporin in expansion and turgor of grape berries. Aquaporin expression has already been observed in grape berries following véraison (Picaud *et al.* 2003).

Similarly, in the expansin family, the accumulation of *EX1* transcripts was high in each expansion phase of the berry diameter (Figure 21). The accumulation of *EX1* and *EX2* transcripts was strongly stimulated by ethylene in the skin one hour after treatment (Figure 22). The expansin involvement in berry expansion may be linked to depolymerisation of structural hemicelluloses and polyuronides (Brummell *et al.* 1999). In the seeds, *EX2* was inhibited by ethylene, but the expression of *EX1* was strongly increased. Whether the expansins produced in the seeds can migrate to the pulp remains undetermined.

❖ **GENERAL CONCLUSIONS AND PERSPECTIVES**

General conclusions

While Coombe and Hale (1973) found that grape is not producing enough ethylene over the ripening phase to be classified as a climacteric fruit (Giovannoni 2001), recent studies have shown that grape berry tissues have a fully functional pathway for ethylene synthesis including El-kereamy *et al.* (2003), and that ethylene seems required for the berry development and ripening in grapes (Chervin *et al.* 2004). There was also a report about the involvement of ethylene signaling for the regulation of *ADH* expression in grapevine that may be related to processes affected by the aldehyde/alcohol ratio (Tesniere *et al.* 2004).

Roles for ethylene in the expression of the UDP glucose-flavonoid 3-O-glucosyltransferase in grape tissues

UDP glucose-flavonoid 3-O-glucosyltransferase (UFGT) is a key enzyme in the biosynthesis and stability of anthocyanins, the pigments of red grape berries. Here we show that a specific inhibitor of ethylene receptors (1-methylcyclopropene) inhibits *ufgt* mRNA accumulation in grape berries. This confirms that ethylene is a key regulator of grape UFGT expression in berries and may regulate anthocyanin biosynthesis (El-Kereamy *et al.* 2003). A 1640 bp promoter region upstream of the putative *ufgt* translation start site was cloned and found to possess seven putative ethylene-responsive cis-elements. Other cis-elements related to three major signals known to induce anthocyanin accumulation in plant tissues, light, sugar, and abscisic acid, were also found. The *ufgt* promoter was shown to be active in berry skin tissues by stable expression *in planta* of an *ufgt::gfp* transcriptional fusion construct. In order to evaluate the ability of ethylene and other signals to drive expression from the *ufgt* promoter we ran transient expression experiments using an anthocyanin-rich grape cell culture, which showed that ethylene better stimulates expression of the *ufgt* promoter in the dark than with light, and that there may be a positive interaction between ethylene and abscisic acid. We also showed that the stimulation of *ufgt* expression by ethylene is independent from *mybA* expression. But it does not preclude the importance of *MybA* in controlling the *ufgt* expression. This result is the first report addressing the potential responsiveness of *myb* expression to an ethylene signal.

The ethylene effect the genes which are expressed at véraison (ripening inception)

Using a microarray technique to study the effect of ethylene on the expression of more than 15 000 genes from Cabernet Sauvignon berries, we found 80 genes whose expression is modulated by ethylene after the long time treatment (24 h application). While in a smaller experiment on the effect of a short ethylene treatment (1h application), some similar genes were found to respond rapidly to ethylene, and new genes were also uncovered by this preliminary study (more than 200 in hard berries, and nearly 400 in soft berries, then 70 in both berry types). Most genes were classified regarding their molecular function, their involvement in a biological process, or to a cellular component according to the NCBI *Arabidopsis thaliana* database. Among the genes some were related to cellular expansion or softening of the grape berries such as xyloglucan endotransglucosylase, endo-polygalacturonase, cellulose synthase, expansin or aquaporins. Among the genes that were affected by ethylene only in the short induction (1 h), there were genes related to the perception of ethylene including ethylene receptor *CS-ETR2*, in the biosynthesis of phenolic compounds such as caffeic acid 3-O-methyltransferase, cinnamyl-alcohol dehydrogenase and flavonols 3-O-glucosyltransferase. There were also genes related to the sugar and acid metabolisms such as sucrose synthase, sugar transporters and malate dehydrogenase, to ripening such as abscisic-stress-ripening protein homolog, one gene coding for alcohol dehydrogenase, and finally to the biosynthesis of phenolic compounds such as isoflavone reductase, leucoanthocyanidin dioxygenase, chalcone synthase.

Effect of ethylene on the expression of genes related to cell expansion

The grape berry size and softening are important characters in the grape production. In the first part of chapter 3, we observed the effect of ethylene on berry volume and deformability between the ripening stages: Before véraison, the diameter and the deformability of grape berries are not affected by ethylene but after véraison, the diameter of berries rapidly increases in 3 weeks and this was significantly affected by ethylene. Then, the berries diameter reaches a maximum value and after this period, at the end of the berry development and ethylene can still have minor effects. While the grape deformability is not strongly affected by ethylene. Thus it seems that ethylene affects mostly the berry expansion.

In a second part, we studied the expression pattern of some genes related to berry expansion in grapes from week 2 to week 11 after flowering. These genes were classified in two groups: i) “cell wall structure” genes: xyloglucan endotransglycosylase (*XET*), polygalacturonase (*PG*), pectin methyl esterase (*PME*), cellulose synthase (*CS*), expansin (*EX*) and ii) water transport genes: various aquaporins (*AQUA*). Over berry development time, we found good relationships

between the first increase of the berry diameter and *AQUA1* and *EX2*, and between the second increase of berry diameter and *PG*, *EX1 & 2*, *AQUA2*, and *PME*.

Further more, we have studied the expression of these genes in different tissues of grape berries treated at week 8 by ethylene and analysed the RNA accumulation after one hour incubation with ethylene (short time effect) or after 24h (long time effect).

After one hour ethylene treatment, all studied genes showed an increase transcript accumulation, mostly in peel tissues. In addition, for *XET* and *AQUA2*, the mRNA accumulation was also stimulated by ethylene in pulp tissues. After 24h, only *AQUA2* mRNAs were still high in pulp tissues due to an ethylene stimulation. This may be related to a protein having an important role in the berry expansion over the ripening phase.

Perspectives

The following studies may be of interest:

- Regarding the ethylene stimulation of the *ufgt* expression via Myb factors, we found in the 1-h-ethylene microarray in soft berries that *mybA2* was induced by ethylene. In our work we look at *mybA* mRNA accumulation (*mybA1* and *A2* confounded) after 6 and 24 h ethylene treatments. We might have missed a rapid induction of this *mybA2* gene by ethylene and we had no access to the sequence of *mybA2* promoter to check if there is ethylene cis-element.
- In the microarray experiment, we should add two biological replications to confirm the ethylene effect after a one-hour-treatment. We could also study the MCP effect on expression of the berry genes, to check whether the effect is opposite to ethylene or similar, as it has been observed in some cases.
- To get the promoter sequences of genes that have been shown to respond to ethylene (*PG*, *XET*, *PME*, *CS*, *EX*, *AQUA*) in order to further study the transcription regulation that is ethylene-dependent
- To transform a *Vitis vinifera* plant with a dominant mutant of ethylene receptor genes (eventually driven by a fruit-specific promoter) in order to validate the importance of ethylene signals in grape berry ripening.

❖ **BIBLIOGRAPHIC REFERENCES**

Bibliographic References

Adams M, Kelley J, Gocayne J (1991) Complementary DNA sequencing: expressed sequence tags and human genome project. *Science* 252: 1651-1656.

Adams-Phillips L, Barry C, Giovannoni J (2004) Signal transduction systems in regulating fruit ripening. *Trends in Plant Science* 9: 331-338.

Affi M, El-Kereamy A, Legrand V, Chervin C, Monje MC, Nepveu F, Roustan JP (2003) Control of anthocyanin biosynthesis pathways by eutipin, a toxin from *Eutypa lata*, in grape cell tissue cultures. *Journal of Plant Physiology* 160: 971-975.

Aharoni A, Keizer LCP, Bouwmeester HJ, Sun ZK, Alvarez-Huerta M, Verhoeven HA, Blaas J, van Houwelingen A, De Vos RCH, van der Voet H et al. (2000) Identification of the SAAT gene involved in strawberry flavor biogenesis by use of DNA microarrays. *Plant Cell* 12: 647 -661.

Aharoni A, Keizer LCP, Hetty C, Broeck Van Den, Blanco-Portales R, Munoz-Blanco J, Bois G, Smit P, De Vos RCH, O'Connell AP (2002) Novel insight into vascular, stress, and auxin-dependent and -independent gene expression programs in strawberry, a non-climacteric fruit. *Plant Physiology* 129: 1019-1031.

Aharoni A, O'Connell AP (2002) Gene expression analysis of strawberry achene and receptacle maturation using DNA microarrays. *Journal of Experimental Botany* 53: 2073-2087.

Alba R, Fei Z, Payton P, Liu Y, Moore SL, Debbie P, Cohn J, D'Ascenzo M, Gordon JS, Rose JKC, Martin G, Tanksley SD, Bouzayen M, Jahn MM, Giovannoni J. (2004) ESTs, cDNAs microarrays, and gene expression profiling: tools for dissecting plant physiology and development. *The Plant Journal* 39: 697-714.

Armitage AM (1989) Promotion of fruit ripening of ornamental peppers by ethephon. *HortScience* 24: 962-964.

Ambid C, Moisseeff M, Fallot J (1983) Interconversion des aldehydes et des alcools monoterpéniques par des cellules de raisin Muscat cultivées in vitro. *Physiologie Végétale* 21: 87-92.

Bachem C, Horvath B, Trindade L, Claassens M, Davelaar E, Jordi W, Visser R (2001) A potato tuber-expressed mRNA with homology to steroid dehydrogenases affects gibberellin levels and plant development. *The Plant Journal* 25: 595-604.

Bachem C, Oomen R, Visser R (1998) Transcript imaging with cDNA-AFLP: a step-by-step protocol. *Plant Molecular Biology Reporter* 16: 157-173.

Bachem C, van der Hoeven R, de Bruijn S, Vreugdenhil D, Zabeau M, Visser R (1996) Visualisation of differential gene expression using a novel method of RNA finger-printing based on AFLP: analysis of gene expression during potato tuber development. *The Plant Journal* 9: 745-753.

Baugh LR, Hill AA, Brown EL, Hunter CP (2001) Quantitative analysis of mRNA amplification by in vitro transcription. *Nucleic Acids Research* 5: e29.

Biggs MS, Handa AK (1989) Temporal regulation of polygalacturonase gene expression in fruits of normal, mutant, and heterozygous tomato genotypes. *Plant Physiology* 89: 117-125.

Blankenship SM, Dole JM (2003) 1-Methylcyclopropene: a review. *Postharvest Biology and Technology* 28: 1-25.

Bleecker AB, Kende H (2000) Ethylene: a gaseous signal molecule in plants. *Annual Review of Cell Developmental Biology* 16: 1-18.

Boss PK, Davies C, Robinson SP (1996a) Analysis of the expression of anthocyanin pathway genes in developing *Vitis vinifera* cv. Shiraz grape berries and the implications for pathway regulation. *Plant Physiology* 111: 1059-1066.

Boss PK, Davies C, Robinson SP (1996b) Anthocyanin composition and anthocyanin pathway gene expression in grapevine sports differing in berry skin colour. *Australian Journal of Grape and Wine Research* 2: 163-170.

Boss PK, Davies C, Robinson SP (1996c) Expression of anthocyanin biosynthesis pathway genes in red and white grapes. *Plant Molecular Biology* 32: 565-569.

Bourdon V, Naef F, Rao P, Reuter V, Mok S, Bosl G, Koul S, Murty V, Kucherlapati R, Chaganti R (2002) Genomic and expression analysis of the 12p11-p12 amplicon using EST arrays identifies two novel amplified and over expressed genes. *Cancer Research* 62: 6218-6223.

Bower JH, Biasi WV, Mitcham EJ (2003) Effects of ethylene and 1-MCP on the quality and storage life of strawberries. *Postharvest Biology and Technology* 28: 417-423.

Brady CJ (1987) Fruit ripening. *Annual Review of Plant Physiology* 38: 155-178.

Brandt S, Kloska S, Altmann T, Kehr J (2002) Using array hybridization to monitor gene expression at the single cell level. *Journal of Experimental Botany* 53: 2315-2323.

Brummell DA, Harpster MH (2001) Cell wall metabolism in fruit softening and quality and its manipulation in transgenic plants. *Plant Molecular Biology* 47: 311-340.

Brummell DA, Harpster MH, Civello PM, Palys JM, Bennett AB (1999) Modification of expansin protein abundance in tomato fruit alters softening and cell wall polymer metabolism during ripening. *The Plant Cell* 11: 2203-2216.

Byers RE, Dostal HC, Emeson FH (1969). Regulation of fruit growth with 2-chloroethylphosphonic acid. *BioScience*, 19: 903-904.

Campbell P and Braam J (1999) Xyloglucan endotransglycosylases: diversity of genes, enzymes and potential wall-modifying functions. *Trends in Plant Science* 4: 361-366.

Cercos M, Soler G, Iglesias D J, Gadea J, Forment J, Talon M (2006) Global analysis of gene expression during development and ripening of citrus fruit flesh. A proposed mechanism for citric acid utilization. *Plant Molecular Biology* 62:513-527.

Chaumont F, Barrieu F, Herman EM, Chrispeels MJ (1998) Characterization of a Maize Tonoplast Aquaporin Expressed in Zones of Cell Division and Elongation. *Plant Physiology* 117: 1143-1152.

Chen J, Wu R, Yang PC (1998) Profiling expression patterns and isolating differentially expressed genes by cDNA microarray system with colorimetry detection. *Genomics* 51: 313-324.

Chervin C, El-Kereamy A, Roustan JP (2006) Comment l'éthylène stimule l'accumulation des anthocyanes dans les baies de raisin. *Revue des Oenologues* 118: 1-2.

Chervin C, El-Kereamy A, Roustan JP, Latché A, Lamon J, Bouzayen M (2004) Ethylene seems required for the berry development and ripening in grape, a non-climacteric fruit. *Plant Science* 167: 1301-1305.

Cho H-T, Cosgrove DJ (2004) Expansins as Agents in Hormone Action in Plant Hormone; Biosynthesis, Signal Transduction, Action, ed. by Davies PJ. pp 262-281.

Clark M, Panopoulou G, Cahill D, Bussow K, Lehrach H (1999) Construction and analysis of arrayed cDNA libraries. *Methods in Enzymology* 303: 205-233.

Coombe BG (1992) Research on development and ripening of the grape berry. *American Journal of Enology and Viticulture* 43: 101-110.

Coombe BG, Bishop GR (1980) Development of the grape berry II. Changes in diameter and deformability during veraison. *Australian Journal of Agricultural Research* 31: 499-509.

Coombe BG, Hale CR (1973) The hormone content of ripening grape berries and the effect of growth substance treatments. *Plant Physiology* 51: 629-634.

Coombe BG, Iland PG (1987) Grape berry development Proceedings of the sixth Australian Wine Industry Technical Conference, ed Lee TH (Wintitles: Adelaide), pp 50-54.

Coombe BG, McCarthy MG (1997) Identification and naming of aroma development in ripening grape berries. *Australian Journal of Grape and Wine Research* 8: 18-20.

Coombe BG, McCarthy MG (2000) Dynamics of grape berry growth and physiology of ripening. *Australian Journal of Grape and Wine Research* 6: 131-135.

Cormeau J, Barthou H, Jauneau A, Petitprez M, Pont-Lezica R, Galaud JP (2002) Cellular import of synthetic peptide using a cell-permeable sequence in plant protoplasts. *Plant Physiology and Biochemistry* 40: 1081-1086.

Cramer GR, Ergul A, Grimplet J, Tillett RL, Tattersall EAR, Bohlman MC, Vincent D, Sonderegger J, Evans J, Osborne C, Quilici D, Schlauch KA, Schlauch KA, Schooley DA, Cushman JC (2007) Water and salinity stress in grapevines: early and late changes in transcript and metabolite profiles. *Functional & Integrative Genomics* 7: 111-134.

Daniels MJ, Mirkov TE, Schroeder JI, Chrispeels MJ (1994) The plasma membrane of *Arabidopsis thaliana* contains a mercuryinsensitive aquaporin that is a homolog of the tonoplast water channel protein TIP. *Plant Physiology* 106: 1325 -1333.

Davies C, Boss PK, Robinson SP (1997) Treatment of grape berries, a non-climacteric fruit with a synthetic auxin, retards ripening and alters the expression of developmentally regulated genes. *Plant Physiology* 115: 1155-1161.

DeRisi J, Penland L, Brown P, Bittner M, Meltzer P, Ray M, Chen Y, Su Y, Trent J (1996) Use of a cDNA microarray to analyze gene expression patterns in human cancer. *Nature Genetics* 14: 457-460.

Ding C, Cantor C (2004) Quantitative analysis of nucleic acids – the last few years of progress. *Journal of Biochemistry and Molecular Biology* 37: 1-10.

Downey MO, Harvey JS and Robinson SP (2004) The effect of bunch shading on berry development and flavonoid accumulation in Shiraz grapes. *Australian Journal of Grape and Wine Research* 10: 55-73.

Dunwell JM, Khuri S, Gane PJ (2000) Microbial relatives of the seed storage proteins of higher plants: conservation of structure and diversification of function during evolution of the cupin superfamily. *Microbiology and Molecular Biology Reviews* 64: 153-179.

Eberwise J, Yeh H, Miyashirao K, Cao Y, Nair S, Finnell R, Zettel M, Coleman P (1992) Analysis of gene expression in single live neurons. *Proceedings of the National Academy of Sciences USA* 89: 3010-3014.

Echols H, Goodman M (1991) Fidelity mechanisms in DNA replication. *Annual Review of Biochemistry* 60: 477-511.

Eckardt NA (2004) Inside the Matrix: Crystal Structure of a Xyloglucan endotransglycosylase. *The Plant Cell* 16: 792-793.

Ecker JR (2004) Reentry of the ethylene MPK6 module. *The Plant Cell* 16: 3169-3173.

EI Kereamy A, Chervin C, Souquet JM, Moutounet M, Monje MC, Nepveu F, Helene M, Ford CM, van Heeswijck R, Roustan JP (2002) Ethanol triggers grape gene expression leading to anthocyanin accumulation during berry ripening. *Plant Science* 163: 449-454.

EI-Kereamy A (2003) La maturation du raisin : rôle de l'éthanol et de l'éthylène sur l'accumulation d'anthocyanes. Thèse de l'ENSA Toulouse 75 pages.

EI-Kereamy A, Chervin C, Roustan JP, Cheynier V, Souquet JM, Moutounet M, Raynal J, Ford CM, Latché A, Pech JC, Bouzayen M (2003) Exogenous ethylene stimulates the long-term expression of genes related to anthocyanin biosynthesis in grape berries. *Physiologia Plantarum* 119: 175-182.

EI-Sharkawy I, Manríquez D, Flores BF, Regad F, Bouzayen M, Latché A, Pech JP (2005) Functional characterization of a melon alcohol acyl-transferase gene family involved in the biosynthesis of ester volatiles. Identification of the crucial role of a threonine residue for enzyme activity. *Plant Molecular Biology* 59: 345-362.

Espinoza C, Vega A, Medina C, Schlauch K, Cramer G, Arce-Johnson P (2007) Gene expression associated with compatible viral diseases in grapevine cultivars. *Functional & Integrative Genomics* 7: 95-110.

Ewing R, Kahla A, Poirot O, Lopez F, Audic S, Claverie J (1999) Large-scale statistical analyses of rice ESTs reveal correlated patterns of gene expression. *Genome Research* 9: 950-959.

Fei Z, Tang X, Alba RM, White JA, Ronning CM, Martin GB, Tanksley SD, Giovannoni JJ (2004) Comprehensive EST analysis of tomato and comparative genomics of fruit ripening. *The Plant Journal* 40: 47-59.

Feldmann A, Costouros N, Wang E, Qian M, Marincola F, Alexander H, Libutti S (2002) Advantages of mRNA amplification for microarray analysis. *Biotechniques* 33: 906-914.

Fernandez L, Torregrosa L, Terrier N, Sreekantan L, Grimplet J, Davies C, Thomas MR, Romieu C, Ageorges A (2007) Identification of genes associated with flesh morphogenesis during grapevine fruit development. *Plant Molecular Biology* 63: 307-323.

Ferrandiz C, Pelaz S, Yanofsky MF (1999) Control of carpel and fruit development in *Arabidopsis*. *Annual Review of Biochemistry* 68: 321- 354.

Ferrarese L, Trainotti L, Moretto P, Polverino de Laureto P, Rascio N, Casadoro G (1995) Differential ethylene-inducible expression of cellulase in pepper plants. *Plant Molecular Biology* 29: 735-747.

Fischer RL, Bennett AB (1991) Role of cell wall hydrolases in fruit ripening. *Annual Review of Plant Physiology and Plant Molecular Biology* 42: 675-703.

Fodor S, Rava R, Huang X, Pease A, Holmes C, Adams C (1993) Multiplexed biochemical assays with biological chips. *Science* 364: 555-556.

Fodor S, Read J, Pirrung M, Stryer L, Lu A, Solas D (1991) Light-directed, spatially addressable parallel chemical synthesis. *Science* 251: 767-773.

Ford CM, Boss PK, Høj PB (1998) Cloning and characterization of *Vitis vinifera* UDP-glucose: flavonoid 3-O-glycosyltransferase, a homologue of the enzyme encoded by the maize bronze-1 locus which may primarily serve to glucosylate anthocyanidins *in vivo*. *Journal of Biological Chemistry* 273: 9224-9233.

Ford CM, Høj PB (1998) Multiple glucosyltransferase activities in the grapevine *Vitis vinifera* L. *Australian Journal of Grape and Wine Research* 4: 48-58.

Forment J, Gadea J, Huerta L, Abizanda L, Agusti J, Alamar S, Alos E, Andre´s F, Arribas R, Beltran JP, Berbell A, Bla´zquez MA, Brumo´s J, Canas LA, Cercos M, Colmenero- Flores JM, Conesa A, Estables B, Gandia M, Garcia- Martinez JL, Gimeno J, Gisbert A, Gomez G, Gonzalez- Candelas L, Granell A, Guerri J, Lafuente MT, Madueno F, Marcos JF, Marques MC, Martinez F, Martinez-Godoy MA, Miralles S, Moreno P, Navarro L, Pallas V, Perez-Amador MA,

Perez-Valle J, Pons C, Rodrigo I, Rodriguez PL, Royo C, Serrano R, Soler G, Tadeo F, Talon M, Terol J, Trenor M, Vaello L, Vicente O, Vidal C, Zacarias L, Conejero V (2005) Development of a citrus genome-wide EST collection and cDNA microarray as resources for genomic studies. *Plant Molecular Biology* 57: 375-391.

Fujimoto SY, Ohta M, Usui A, Shinshi H, Ohme-Takagi, M (2000) Arabidopsis ethylene-responsive element binding factors act as transcriptional activators or repressors of GCC box-mediated gene expression. *The Plant Cell* 12: 393-404.

Gibeaut DM, Carpita NC (1994) Biosynthesis of plant cell wall polysaccharides. *The FASEB Journal* 8: 904-915.

Giovannoni J (2001) Molecular biology of fruit maturation and ripening. *Annual Review of Plant Physiology and Plant Molecular Biology* 52: 725–749.

Giovannoni JJ, DellaPenna D, Bennett AB, Fischer RL (1989) Expression of a chimeric polygalacturonase gene in transgenic rin (ripening inhibitor) tomato fruit results in polyuronide degradation but not fruit softening. *The Plant Cell* 1: 53-63.

Gleave AP (1992) A versatile binary vector system with a T-DNA organisational structure conducive to efficient integration of cloned DNA into the plant genome. *Plant Molecular Biology* 20: 1203-1207.

Gray JE, Picton S, Giovannoni JJ, Grierson D (1994) The use of transgenic and naturally occurring mutants to understand and manipulate tomato fruit ripening. *The Plant Cell and Environment* 17: 557-571.

Hahn MW, Stajich JE, Wray GA (2003) The effects of selection against spurious transcription factor binding sites. *Molecular Biology and Evolution* 20: 901-906.

Hamilton A, Lycett G, Grierson D (1990) Antisense gene that inhibits synthesis of the hormone ethylene in transgenic plants. *Nature* 346: 284-287.

Harpster MH, Lee KY, Dunsmuir P (1997) Isolation and characterization of a gene encoding endo- β -1, 4-glucanase from pepper (*Capsicum annuum* L.). *Plant Molecular Biology* 33: 47-59.

Harriman RW, Tieman DM, Handa AK (1991) Molecular cloning of tomato pectin methylesterase gene and its expression in Rutgers, ripening inhibitor, nonripening, and Never Ripe tomato fruits. *Plant Physiology* 97: 80-87.

Harrison EP, McQueen-Mason SJ, Manning K (2001) Expression of six expansin genes in relation to extension activity in developing strawberry fruit. *Journal of Experimental Botany* 52: 1437-1446.

Haseloff J, Siemering KR, Prasher D, Hodge S (1997) Removal of a cryptic intron and subcellular localisation of green fluorescent protein are required to mark transgenic Arabidopsis plants brightly. *Proceedings of the National Academy of Sciences USA* 94: 2122-2127.

Hass C, Lohrmann J, Albrecht V, Sweere U, Hummel F, Yoo SD, Hwang I, Zhu T, Schafer E, Kudla J, Harter K (2004) The response regulator 2 mediates ethylene signalling and hormone signal integration in *Arabidopsis*. *The EMBO Journal* 23: 3290-3302.

Hauser B, Pratt L, Cordonnier-Prat M (1997) Absolute quantification of five phytochrome transcripts in seedlings and mature plants of tomato (*Solanum lycopersicum* L.). *Planta*: 201: 379-387.

Hayama H, Shimada T, Fujii H, Ito A, Kashimura Y (2006) Ethylene-regulation of fruit softening and softening-related genes in peach. *Journal of Experimental Botany* 57: 4071-4077.

Hazen SP, Scott-Craig JS, Walton JD (2002) Cellulose Synthase-Like Genes of Rice. *Plant Physiology* 128: 336-340.

Higo K, Ugawa Y, Iwamoto M, Higo H (1998) PLACE: a database of plant cis-acting regulatory DNA elements. *Nucleic Acids Research* 26: 1358-1359.

Huang RF, Zhu MJ, Kang Y, Chen J, Wang XC (2002) Identification of plasma membrane aquaporin in guard cells of *Vicia faba* and its role in stomatal movement. *Acta Botanica Sinica* 44: 42-48.

Iocco P, Franks T, Thomas MR (2001) Genetic transformation of major wine grape cultivars of *Vitis vinifera* L. *Transgenic Research* 10: 105-112.

Ishida BK, Jenkins SM, Say B (1998) Induction of AGAMOUS gene expression plays a key role in ripening of tomato sepals *in vitro*. *Plant Molecular Biology* 36: 733-739.

Ishimaru M, Kobayashi S (2002) Expression of a xyloglucan endo-transglycosylase gene is closely related to grape berry softening. *Plant Science* 162: 621-628.

Itzhaki H, Maxson JM, Woodson WR (1994) An ethylene-responsive enhancer element is involved in the senescence-related expression of the carnation glutathione-S-transferase (*GST1*) gene. *Proceedings of the National Academy of Sciences USA* 91: 8925-8929.

Jeong ST, Goto-Yamamoto N, Kobayashi S, Esaka M (2004) Effects of plant hormones and shading on the accumulation of anthocyanins and the expression of anthocyanin biosynthetic genes in grape berry skins. *Plant Science* 167: 247-252.

Jiao Y, Yang H, Ma L (2003) A genome-wide analysis of bluelight regulation of *Arabidopsis* transcription factor gene expression during seedling development. *Plant Physiology* 133: 1480-1493.

Johanson J, Karlsson M, Johanson U, Larsson C, Kjellbom P (2000) The role of aquaporins in cellular and whole plant water balance. *Biochimica and Biophysica Acta* 1465: 324-342.

Katz E, Lagunes PM, Riov J, Weiss D, Goldschmidt EE (2004) Molecular and physiological evidence suggests the existence of a system II-like pathway of ethylene production in non-climacteric Citrus fruit. *Planta* 219: 243-252.

Ko TP, Ng JD, McPherson A (1993) The three-dimensional structure of canavalin from jack bean (*Canavalia ensiformis*). *Plant Physiology* 101: 729-744.

Kobayashi S, Goto-Yamamoto N, Hirochika H (2004) Retrotransposon-induced mutations in grape skin color. *Science* 304: 982.

Kobayashi S, Ishimaru M, Ding CK, Yakushiji H, Goto N (2001) Comparison of UDP-glucose:flavonoid 3-O-glucosyltransferase (*ufgt*) gene sequences between white grapes (*Vitis vinifera*) and their sports with red skin. *Plant Science* 160: 543-550.

Kobayashi S, Ishimaru M, Hiraoka K, Honda C (2002) *Myb*-related genes of the Kyoho grape (*Vitis labruscana*) regulate anthocyanin biosynthesis. *Planta* 215: 924-933.

Lackey GD, Gross KC, Wallner SJ (1980) Loss of tomato cell wall galactan may involve reduced rate of synthesis. *Plant Physiology* 66: 532-533.

Lawrence MC, Izard T, Beuchat M, Blagrove RJ, Colman PM (1994) Structure of phaseolin at 2.2Å resolution. Implications for a common vicilin/legumin structure and the genetic engineering of seed storage proteins. *Journal of Molecular Biology* 238: 748-776.

Lelievre JM, Latche A, Jones B, Bouzayen M, Pech JC (1997) Ethylene and fruit ripening. *Physiologia Plantarum* 101: 727-739.

Lescot M, Déhais P, Thijs G, Marchal K, Moreau Y, Van de Peer Y, Rouzé P, Rombauts S (2002) PlantCARE, a database of plant cis-acting regulatory elements and a portal to tools for in silico analysis of promoter sequences. *Nucleic Acids Research* 30: 325-327.

Liang P, Pardee A (1992) Differential display of eukaryotic messenger RNA by means of the polymerase chain reaction. *Science* 257: 967-971.

Lincoln JE, Cordes S, Read E, Fischer RL (1987) Regulation of gene expression by ethylene during *Lycopersicon esculentum* (tomato) fruit development. *Proceedings of the National Academy of Sciences USA* 84: 2793-2797.

Lipshutz R, Fodor S, Gingeras T, Lockhart D (1999) High density synthetic oligonucleotide arrays. *Nature Genetics* 21: 20-24.

Lu W, Wang Y, Jiang Y, Li J, Liu H, Duan X, Song L (2006) Differential expression of Litchi XET genes in relation to fruit growth. *Plant Physiology and Biochemistry* 44: 707-713.

Luo ZS, Xu XL, Cai ZZ, Yan M (2007) Effects of ethylene and 1-methylcyclopropene (1-MCP) on lignification of postharvest bamboo shoot. *Food Chemistry* 105 (2): 521-527.

Martin C, Gerats T (1993) Control of pigment biosynthesis genes during petal development. *The Plant Cell* 5: 1253-1264.

Mason MG, Mathews DE, Argyros DA, Maxwell BB, Kieber JJ, Alonso JM, Ecker JR, Schaller GE (2005) Multiple type-B response regulators mediate cytokinin signal transduction in *Arabidopsis*. *The Plant Cell* 17:3007-3018.

Maruyama N, Adachi M, Takahashi K, Yagasaki K, Kohno M, Takenaka Y, Okuda E, Nakagawa S, Mikami B, Utsumi S (2001) Crystal structures of recombinant and native soybean beta-conglycinin beta homotrimers. *European Journal of Biochemistry* 268: 3595-3604.

Mazza G, Miniati E (1993) Anthocyanins in Fruits, Vegetables, and Grains. CRC Press, Boca Raton, FL.

Mol J, Jenkins G, Schaefer E, Weiss D (1996) Signal perception, transduction, and gene expression involved in anthocyanin biosynthesis. *Critical Reviews in Plant Science* 15: 525-558.

Mullins ED, McCollum TG, McDonald RE (1999) Ethylene: a regulator of stress induced ACC synthase activity in non-climacteric fruit. *Physiologia Plantarum* 107: 1-7.

Nakazono M, Qiu F, Borsuk L, Schnable P (2003) Laser-capture microdissection, a tool for the global analysis of gene expression in specific plant cell types: identification of genes expressed differentially in epidermal cells or vascular tissues of maize. *The Plant Cell* 15: 583-596.

Nishiyama T, Fujita T, Shin-I T (2003) Comparative genomics of *Physcomitrella patens* gametophytic transcriptome and *Arabidopsis thaliana*: implication for land plant evolution. *Proceedings of the National Academy of Sciences USA* 100: 8007-8012.

Nunan KJ, Davies C, Robinson SP, Fincher GB (2001) Expression patterns of cell wall-modifying enzymes during grape berry development. *Planta* 214: 257-264.

Nunan KJ, Sims LM, Bacic A, Robinson SP, Fincher GB (1998) Changes in cell wall composition during ripening of grape berries. *Plant Physiology* 118: 783-792.

O'Malley RC, Rodriguez FI, Esch JJ, Binder BM, O'Donnell P, Klee HJ, Bleecker AB (2005) Ethylene-binding activity, gene expression levels, and receptor system output for ethylene receptor family members from *Arabidopsis* and tomato. *The Plant Journal* 41: 651-659.

Ogihara Y, Mochida K, Nemoto Y, Murai K, Yamazaki Y, Shin-I T, Kohara Y (2003) Correlated clustering and virtual display of gene expression patterns in the wheat life cycle by large-scale statistical analyses of expressed sequence tags. *The Plant Journal* 33: 1001-1011.

Okubo K, Hori N, Matoba R, Niyam T, Fukushima A, Kojima Y, Matsubara K (1992) Large scale cDNA sequencing for analysis of quantitative and qualitative aspects of gene expression. *Nature Genetics* 2: 173-179.

Ouaked F, Rozhon W, Lecourieux D, Hirt H (2003) A MAPK pathway mediates ethylene signaling in plants. *The EMBO Journal* 22: 1282-1288.

Ozga JA, Van Huizen R, Reinecke DM (2002) Hormone and Seed-Specific Regulation of Pea Fruit Growth. *Plant Physiology* 128: 1379-1389.

Paterson A, Bowers J, Burow M (2000) Comparative genomics of plant chromosomes. *The Plant Cell* 12: 1523-1540.

Pease A, Solas D, Sullivan E, Cronin M, Holmes C, Fodor S (1994) Light-directed oligonucleotide arrays for rapid DNA sequence analysis. *Proceedings of the National Academy of Sciences USA* 91: 5022-5026.

Picaud S, Becq F, Dédaldé champ F, Ageorges A, Delrot S (2003) Cloning and expression of two plasma membrane aquaporins expressed during the ripening of grape berry. *Functional Plant Biology* 30: 621-630.

Piffaut B, Kader F, Girardin M, Metche M (1994) Comparative degradation pathways of malvidin 3,5-diglucoside after enzymatic and thermal treatments . *Food Chemistry* 50: 115-120.

Pnueli L, Hareven D, Rounsley SD, Yanofsky MF, Lifschitz E (1994) Isolation of the tomato AGAMOUS gene TAG1 and analysis of its homeotic role in transgenic plants. *The Plant Cell* 6: 163-173.

Poppenberger B, Berthiller F, Lucyshyn D, Sieberer T, Schuhmacher R, Krska R, Kuchler K, Glossl J, Luschnig C, Adam G (2003) Detoxification of the Fusarium mycotoxin deoxynivalenol by a UDP-glucosyltransferase from *Arabidopsis thaliana*. *Journal of Biological Chemistry* 278: 47905-47914.

Reid KE, Olsson N, Schlosser J, Peng F, Lund ST (2006) An optimized grapevine RNA isolation procedure and statistical determination of reference genes for real-time RT-PCR during berry development, *BMC Plant Biology* 6: 27.

Richmond TA (2000) Higher plant cellulose synthases. *Genome Biology* 1(4): reviews 3001.1-3001.6.

Richmond TA, Somerville CR (2000) The Cellulose Synthase Superfamily. *Plant Physiology* 124: 495-498.

Ronning C, Stegalkina S, Ascenzi R (2003) Comparative analyses of potato expressed sequence tag libraries. *Plant Physiology* 131: 419-429.

Rose JKC, Lee HH, Bennett AB (1997) Expression of a divergent expansin gene is fruit-specific and ripening-regulated. *Plant Biology* 94: 5955-5960.

Roth BA, Goff SA, Klein TM, Fromm ME (1991) C1 and R-dependent expression of the maize *Bz1* gene requires sequences with homology to mammalian myb and myc binding sites. *The Plant Cell* 3: 317-325.

Sablowski RWM, Moyano E., Culianez-Macia A, Schuch W, Martin C, Bevan M (1994) A flower specific Myb protein activates transcription of phenylpropanoid biosynthesis genes. *The EMBO Journal* 13: 128-137.

Sane VA, Chourasia A, Nath P (2005) Softening in mango (*Mangifera indica* cv. Dashehari) is correlated with the expression of an early ethylene responsive, ripening related expansin gene, *MiExpA1*. *Postharvest Biology and Technology* 38: 223-230.

Seymour GB, Gross KC (1996) Cell wall disassembly and fruit softening. *Postharvest News and Information* 7: 45N-52N.

Smith CJS, Watson CF, Ray J, Bird CR, Morris PC, Schuch W, Grierson D (1988) Antisense RNA inhibition of polygalacturonase gene expression in transgenic tomatoes. *Nature* 334: 724-726.

Smith PK, Krohn RI, Hermanson GT, Mallia AK, Gartner FH, Provenzano MD, Fujimoto EK, Goeke NM, Olson BJ, Klenk DC (1985) Measurement of protein using bicinchoninic acid, *Analytical Biochemistry* 150: 76-85.

Sparvoli F, Martin C, Scienza A, Gavazzi G, Tonelli C (1994) Cloning and molecular analysis of structural genes involved in flavonoid and stilbene biosynthesis in grape (*Vitis Vinifera* L.). *Plant Molecular Biology* 24: 743-755.

Terrier N, Glissant D, Grimplet J, Barrieu F, Abbal P, Couture C, Ageorges A, Atanassova R, Léon C, Renaudin J-P, Dédaldéchamp F, Romieu C, Delrot S, Hamdi S (2005) Isogene specific oligo arrays reveal multifaceted changes in gene expression during grape berry (*Vitis vinifera* L.) development. *Planta* 222: 832-847.

Tesniere C, Pradal M, El-Kereamy A, Torregrosa L, Chatelet P, Roustan J-P, Chervin C (2004) Involvement of ethylene signaling in a non-climacteric fruit: new elements regarding the regulation of ADH expression in grapevine. *Journal of Experimental Botany* 55: 2235-2240.

Tian MS, Prakash S, ElgarHJ, Young H, Burmeister DM, Ross GS (2000) Responses of strawberry fruit to 1-methylcyclopropene (1-MCP) and ethylene. *Plant Growth Regulation* 32: 83-90.

Tieman DM, Handa AK (1994) Reduction in pectin methylesterase activity modifies tissue integrity and cation levels in ripening tomato (*Lycopersicon esculentum* Mill.) fruits. *Plant Physiology* 106: 429-436.

Tieman DM, Harriman RW, Ramamohan G, Handa AK (1992) An antisense pectin methylesterase gene alters pectin chemistry and soluble solids in tomato fruit. *The Plant Cell* 4: 667-679.

Torregrosa L, Verries C, Tesniere C (2002) Grapevine (*Vitis vinifera* L.) promoter analysis by biolistic-mediated transient transformation of cell suspensions. *Vitis* 41: 27-32.

Trainotti L, Pavanello A, Casadoro G (2005) Different ethylene receptors show an increased expression during the ripening of strawberries: does such an increment imply a role for ethylene in the ripening of these non-climacteric fruits?. *Journal of Experimental Botany* 56: 2037-2046.

Triantaphylidès C, Nespoulous L, Chervin C (1993) Ammonium requirement for radiation-induced accumulation of polyamines in suspension cultured grape cells. *Physiologia Plantarum* 87: 389-395.

Trivedi PK, Nath P (2004) MaExp1, an ethylene-induced expansin from ripening banana fruit. *Plant Science* 167: 1351-1358.

Tucker GA, Brady CJ (1987) Silver ions interrupt tomato fruit ripening. *Journal of Plant Physiology* 127: 165-169.

Van der Hoeven R, Ronning C, Giovannoni J, Martin G, Tanksley S (2002) Deductions about the number, organization and evolution of genes in the tomato genome based on analysis of a large EST collection and selective genomic sequencing. *The Plant Cell* 14: 1441-1456.

Velculescu V, Zhang L, Vogelstein B, Kinzler K (1995) Serial analysis of gene expression. *Science* 270: 484-487.

Walker AR, Lee E, Bogs J, McDavid AJ, Thomas MR, Robinson SP (2007) White grapes arose through the mutation of two similar and adjacent regulatory genes. *The Plant Journal* 49: 772-785.

Wang R, Okamoto M, Xing X, Crawford N (2003) Microarray analysis of the nitrate response in *Arabidopsis* roots and shoots reveals over 1,000 rapidly responding genes and new linkages to glucose, trehalose-6-phosphate, iron, and sulfate metabolism. *Plant Physiology* 132: 556-567.

Wang Y, Lu W, Jiang Y, Luo Y, Jiang W, Joyce D (2006) Expression of ethylene-related expansin genes in cool-stored ripening banana fruit. *Plant Science* 170: 962-967.

Waters DLE, Holton TA, Ablett EM, Lee LS, Henry RJ (2005) cDNAs microarray analysis of developing grape (*Vitis vinifera* cv. Shiraz) berry skin. *Functional & Integrative Genomics* 5: 40-58.

Waters DLE, Holton TA, Ablett EM, Lee LS, Henry RJ (2006) The ripening wine grape berry skin transcriptome. *Plant Science* 171: 132-138.

Weaver RJ, Montgomery R (1974) Effect of ethephon on coloration and maturation of wine grapes. *American Journal of Enology and Viticulture* 25: 39-41.

Wilkinson JQ, Lanahan MB, Conner TW, Klee HJ (1995) Identification of mRNAs with enhanced expression in ripening strawberry fruit using polymerase chain reaction differential display. *Plant Molecular Biology* 27: 1097-1108.

White PJ (2002) Recent advances in fruit development and ripening: an overview. *Journal of Experimental Botany* 53: 1995-2000.

Yakushiji H, Kobayashi S, Goto-Yamamoto N, Tae Jeong S, Sueta T, Mitani N, Azuma A (2006) A skin color mutation of grapevine, from black-skinned Pinot Noir to white-skinned Pinot Blanc, is caused by deletion of the functional *VvmybA1* allele. *Bioscience, Biotechnology, and Biochemistry* 70: 1506-1508.

Yang SF, Hoffman NE (1984) Ethylene biosynthesis and its regulation in higher plants. *Annual Review of Plant Physiology* 35: 155-89.

Yu YB, Yang SF (1980) Biosynthesis of wound ethylene. *Plant Physiology* 66: 281-285.

Zegzouti H, Jones B, Frasse P, Marty C, Maitre B, Latche A, Pech JC, Bouzayen M (1999) Ethylene-regulated gene expression in tomato fruit: characterization of novel ethylene-responsive and ripening-related genes isolated by differential display. *The Plant Journal* 18: 589-600.

❖ ANNEXES

Annex

Table annex 1. Genes show with old TC numbers (TC = tentative contig), were selected significantly by T-test, $P = 0.01$, $n = 6$, these genes were redone to update to new TC numbers for determining by nearest *Arabidopsis thaliana* (AT) BlastX match and these genes were classified by (i) molecular function, (ii) biological process and (iii) cellular component in the parenthesis of 80 selected genes percentage from all genes (15,135 genes) as determined by the micro array results which were modulated by the ethylene after 24H treat, at week 8 after flowering, Cabernet Sauvignon berry.

New TC number	Old TC number	AT Accession number	Description of nearest NCBI BlastX match of <i>Arabidopsis thaliana</i>	Molecular function	Biological process	Cellular component
TC55300	TC38576	AT2G36830	major intrinsic family protein / MIP family protein	transporter activity	transport	other membranes
TC62760	TC46382	AT4G12520	protease inhibitor/seed storage/lipid transfer protein family protein	other binding	other physiological processes	plastid
TC65677	TC45105	AT3G27690	chlorophyll A-B binding protein	other binding	transport	other membranes
TC65275		AT1G70830	Bet v I allergen family protein	molecular function unknown	biological process unknown	cellular component unknown
TC57514	TC43170	AT4G39900	expressed protein	molecular function unknown	developmental processes	extracellular
TC53549	TC46791	AT5G54770	thiazole biosynthetic enzyme, chloroplast	molecular function unknown	biological process unknown	cellular component unknown
TC60790	TC41864	AT3G12955	auxin-responsive protein-related	not match	response to stress	chloroplast
TC65998	TC45453	AT1G20340	plastocyanin	not match	not match	not match
TC54968	TC38641	AT3G23600	dienelactone hydrolase family protein	hydrolase activity	other cellular processes	other cytoplasmic components
TC51691	TC38507		not assigned	other binding	electron transport or energy pathways	plastid
TC66717	TC47941	AT3G44735	Phytosulfokine 3 precursor	molecular function unknown	other biological processes	mitochondria
TC65763	TC45599	AT4G20780	calcium-binding protein	not match	not match	other membranes
TC59116	TC40369	AT5G66190	Encodes a leaf-type ferredoxin:NADP(H) oxidoreductase	other binding	not match	cellular component unknown
TC56589	TC46181	AT4G34290	SWIB complex BAF60b domain-containing protein	not match	not match	other membranes
TC66717	TC47942	AT3G44735	Phytosulfokine 3 precursor	other enzyme activity	electron transport or energy pathways	plastid
TC59101		AT2G16920	ubiquitin-conjugating enzyme family protein	other enzyme activity	protein metabolism	cellular component unknown
TC56003	TC38398		not assigned	molecular function unknown	biological process unknown	chloroplast
TC64563	TC47573	AT3G54420	class IV chitinase	not match	not match	not match
CA12EI302IR_B07	TC40732	AT2G45560	cytochrome P450 family protein	hydrolase activity	other cellular processes	other membranes
TC68244	TC41770	AT1G75560	zinc knuckle (CCHC-type) family protein	other binding	electron transport or energy pathways	other membranes
TC55315	TC46494	AT4G35550	homeobox-leucine zipper protein / HD-ZIP protein	nucleic acid binding	biological process unknown	chloroplast
VVD133D11_373089	TC50492	AT1G66540	cytochrome P450, putative	DNA or RNA binding	transcription	nucleus
TC53685	TC46651	AT5G25270	expressed protein	other binding	electron transport or energy pathways	mitochondria
TC54762	TC45686	AT1G70000	DNA-binding family protein	molecular function unknown	biological process unknown	cellular component unknown

Table annex 1. (Continued)

New TC number	Old TC number	AT Accession number	Description of nearest NCBI BlastX match of <i>Arabidopsis thaliana</i>	Molecular function	Biological process	Cellular component
TC62379		AT4G13420	potassium transporter	transporter activity	transport	other membranes
TC61079	TC45213	AT1G75780	tubulin beta-1 chain	nucleic acid binding	response to stress	nucleus
TC62175	TC45300		not assigned	structural molecule activity	response to abiotic or biotic stimulus	other cellular components
TC69704		AT4G37990	mannitol dehydrogenase	not match	not match	not match
TC66161	TC41070		not assigned	DNA or RNA binding	transcription	nucleus
EST_14983_CN546995	TC48301	AT2G03500	myb family transcription factor	other enzyme activity	response to abiotic or biotic stimulus	cellular component unknown
TC54502	TC39190	AT3G15840	expressed protein	molecular function unknown	biological process unknown	chloroplast
TC59181		AT1G71100	ribose 5-phosphate isomerase-related	not match	not match	not match
TC63108	TC39823	AT2G31820	ankyrin repeat family protein	other enzyme activity	other cellular processes	cellular component unknown
TC60367		AT2G40110	yippee family protein	molecular function unknown	biological process unknown	cellular component unknown
TC70937	TC50144	AT1G12760	zinc finger (C3HC4-type RING finger) family protein	protein binding	not match	not match
TC61651	TC49329		not assigned	protein binding	not match	chloroplast
TC66900	TC45594	AT2G38410	VHS domain-containing protein / GAT domain-containing protein	transporter activity	transport	Golgi apparatus
TC69217	TC43706	AT2G27170	similar to SMC2-like condensin, putative	not match	not match	not match
TC62793	TC40499	AT1G71695	peroxidase 12	nucleotide binding	not match	other membranes
TC54277	TC39486	AT4G16660	heat shock protein 70, putative	nucleotide binding	other cellular processes	nucleus
TC54715	TC47369	AT1G55255	zinc finger (C3HC4-type RING finger) family protein	other enzyme activity	response to stress	cell wall
TC55828	TC48518	AT3G48780	serine C-palmitoyltransferase, putative	transporter activity	not match	chloroplast
TC54859	TC46113	AT3G51860	cation exchanger, putative	protein binding	not match	not match
CAB20001_IVa_Fa_G11	CF207430	AT5G37020	Encodes a member of the auxin response factor family	transferase activity	other cellular processes	other membranes
TC52231	TC46375	AT3G03790	ankyrin repeat family protein n	transcription factor activity	transcription	not match
TC51927	TC46117	AT3G60240	MIF4G domain-containing protein / MA3 domain-containing protein	other binding	biological process unknown	chloroplast
TC64579	TC44665	AT1G65410	ABC transporter family protein	transporter activity	transport	other membranes
TC52464	TC40274	AT5G11680	expressed protein, predicted proteins	DNA or RNA binding	protein metabolism	mitochondria
TC59024	TC46501	AT4G09150	T-complex protein 11	molecular function unknown	biological process unknown	cellular component unknown
TC59001	TC38917	AT4G34710	encodes a arginine decarboxylase	other enzyme activity	response to stress	cellular component unknown
TC51920	TC45555	AT3G12120	omega-6 fatty acid desaturase, endoplasmic reticulum / delta-12 desaturase	not match	biological process unknown	not match
TC58650	CB978533	AT4G16130	Similar to galactokinase.	other enzyme activity	not match	ER

Table annex 1. (Continued)

New TC number	Old TC number	AT Accession number	Description of nearest NCBI BlastX match of <i>Arabidopsis thaliana</i>	Molecular function	Biological process	Cellular component
TC51920	TC45555	AT3G12120	omega-6 fatty acid desaturase, endoplasmic reticulum / delta-12 desaturase	not match	biological process unknown	not match
TC58650	CB978533	AT4G16130	Similar to galactokinase.	other enzyme activity	not match	ER
TC59112	CA808079	AT5G53350	ATP-dependent Clp protease ATP-binding subunit ClpX1	kinase activity	other cellular processes	other cytoplasmic components
TC56506	TC40622	AT5G59080	expressed protein	hydrolase activity	protein metabolism	mitochondria
TC63873	TC38716	AT1G75030	pathogenesis-related thaumatin family protein	molecular function unknown	biological process unknown	chloroplast
TC53508	TC38792	AT5G13870	xyloglucan endotransglycosylase / endo-xyloglucan transferase	DNA or RNA binding	transcription	chloroplast
CAB20007_IVa_Fa_C12	CF211195	AT2G41220	glutamate synthase, chloroplast / ferredoxin-dependent glutamate synthase	other enzyme activity	other cellular processes	chloroplast
CA12EI202IIIbF_D05	CA814996	AT2G36990	RNA polymerase sigma subunit SigF / sigma-like factor	molecular function unknown	response to abiotic or biotic stimulus	other membranes
VVD103G02_369365	CB915852	AT5G26940	exonuclease family protein	hydrolase activity	other metabolic processes	other membranes
TC67690	CB971426	AT5G51460	trehalose-6-phosphate phosphatase	hydrolase activity	not match	other intracellular components
TC60322	TC39120	AT4G27410	no apical meristem (NAM) family protein	hydrolase activity	other cellular processes	chloroplast
TC63588	TC46224	AT5G45800	leucine-rich repeat transmembrane protein kinase, putative	not match	not match	chloroplast
CA32EN0002_IVaF_B01	CB342010	AT5G49630	high affinity amino acid transporter capable of transporting aspartate and tryptophan	transcription factor activity	developmental processes	nucleus
TC54941	TC45153	AT3G57520	alkaline alpha galactosidase, putative	transporter activity	transport	other membranes
TC68043	TC45560	AT3G23920	beta-amylase, putative / 1,4-alpha-D-glucan maltohydrolase, putative	nucleotide binding	protein metabolism	chloroplast
EST_7912	TC45813	AT1G52560	26.5 kDa class I small heat shock protein-like	hydrolase activity	biological process unknown	mitochondria
CAB2SG0005_IIaF_H04		AT3G12500	basic endochitinase	hydrolase activity	biological process unknown	cellular component unknown
TC60444	TC49976	AT1G27070	5'-AMP-activated protein kinase-related	molecular function unknown	response to stress	mitochondria
TC54946	TC47641	AT1G14860	MutT/nudix family protein	hydrolase activity	other metabolic processes	chloroplast
TC52034	TC47375	AT2G41850	endo-polygalacturonase, putative	hydrolase activity	response to stress	other membranes
TC66916	TC40153	AT2G23110	expressed protein	transferase activity	other cellular processes	other membranes
CAB40005_IVa_Fa_C09	CB978247	AT1G55850	cellulose synthase family protein	hydrolase activity	other metabolic processes	other membranes
TC58450	TC47126	AT3G48000	putative (NAD+) aldehyde dehydrogenase) mRNA	molecular function unknown	biological process unknown	cellular component unknown
TC57394	TC40198	AT1G05510	expressed protein	other enzyme activity	other metabolic processes	mitochondria
TC64551	TC39811	AT1G17810	major intrinsic family protein / MIP family protein	transporter activity	transport	other membranes
TC66930	TC41685	AT2G18540	cupin family protein	molecular function unknown	biological process unknown	cellular component unknown
TC68149	TC38823	AT1G48130	peroxiredoxin / rehydrin, putative	other molecular functions	biological process unknown	other membranes
TC70668	TC42481	AT3G15670	late embryogenesis abundant protein, putative / LEA protein, putative	other molecular functions	response to stress	cellular component unknown
TC53967	TC45406	AT1G07750	cupin family protein	molecular function unknown	developmental processes	cellular component unknown
TC62965	TC38812	AT2G03090	expansin, putative	other molecular functions	biological process unknown	cellular component unknown

Research Note

The stimulation by ethylene of the UDP glucose-flavonoid 3-O-glucosyltransferase (UFGT) in grape tissues is independent from the MybA transcription factors

A. TIRA-UMPHON, J. P. ROUSTAN and C. CHERVIN

UMR 990, Génomique et Biotechnologie des Fruits, INP, ENSAT, INRA, Université de Toulouse, Castanet Tolosan, France

Key words: C₂H₄, glucosyltransferase, grapevine, anthocyanin.

Introduction: Grapes are regarded as non-climacteric fruit (CHERVIN *et al.* 2004 and references herein), in which ethylene evolution is very low and for which the ripening process seems to occur independently of ethylene production. However, a recent study has shown that grape berry tissues have a fully functional pathway for ethylene synthesis, that this pathway is activated just before veraison when red berries start to accumulate anthocyanins, and that ethylene perception is critical for some berry changes associated with ripening, including anthocyanin accumulation (CHERVIN *et al.* 2004). This last conclusion was supported by the fact that anthocyanin accumulation in the berry skins was inhibited when a specific inhibitor of ethylene receptors, 1-methylcyclopropene was applied to berries just before veraison, at the same time as ethylene production was activated in the berry.

The control of anthocyanin accumulation during the ripening phase in red grape berries is thought to be greatly dependent on UFGT activity (KOBAYASHI *et al.* 2001, YAKUSHIJI *et al.* 2006). This enzyme plays a key role in stabilising the aglycone moiety of the anthocyanins (PIFFAUT *et al.* 1994) and may be essential for their transport to the vacuole. We have shown previously that exogenous ethylene could induce grape *ufgt* expression (EL-KEREAMY *et al.* 2003), confirming observations about the commercial use of ethylene precursor to boost grape skin colour.

The anthocyanin biosynthesis in model plants for the anthocyanin pathway such as petunia and maize is controlled by Myc and Myb transcription factors, and indeed, one transcription factor of this family, MybA1, was shown to be critical for the regulation of *ufgt* expression (YAKUSHIJI *et al.* 2006 and refs therein) and anthocyanin accumulation in grape tissues. WALKER *et al.* (2007) showed that two isoforms of this transcription factor, MybA1 and MybA2 are involved in anthocyanin accumulation in grapevine.

The question remains whether the ethylene signal is acting on grape *ufgt* expression through the activation of

mybA expression or via ethylene responsive transcription factors.

Materials and Methods: 'Cabernet Sauvignon' grapevines used for the ethylene experiments are grafted on '110 Richter' rootstocks and grown in Toulouse, South-West of France, in a non-irrigated vineyard. Full bloom occurred around mid-June. The ethylene was applied for 24 h at different times after full bloom, at an initial concentration of 40 µl·l⁻¹, three biological replicates were then collected and stored at -80 °C. All other sampling processes and the RNA extractions were performed as described in EL-KEREAMY *et al.* (2003). Suspensions of purple grape cells of 'Gamay' were grown as described previously (TRIANTAPHYLIDES *et al.* 1993). Cells were vacuum-filtered onto Whatman n°1 filter paper and set upon 5 ml fresh MS-based cell culture medium in small Petri dishes. Cells were then sprayed with one ml of a sterile solution of 7 mM 2-chloroethylphosphonic acid (2-CEPA), a precursor of ethylene, the controls were sprayed with sterile water. Incubation time was 6 h before freezing samples for RNA extraction, performed as described above.

The qRT-PCR analyses were performed according to EL-SHARKAWY *et al.* (2005), with the following modifications. Oligonucleotide sequences of *mybA* primers were *VvmybA1c*(F), 5'-GCAAGCCTCAGGACAGAA-3' and *VvmybA1c*(R), 5'-AAGCCACATCAAATGGAAAA-3'. They would amplify both *VvmybA1* (AB097923) and *VvmybA2* (AB097924) isoforms. Oligonucleotide sequences for the *ufgt* primers were *Vvufgt*(F) 5'-GGCTTTT-GTCACACATTGCG-3' and *Vvufgt*(R) 5'-AAAAAG-GCCTGCAAATCAA-3'. The *myb* et *ufgt* mRNA levels were expressed as transcript accumulation indexes relative to a control gene *ef1a*, as previously shown (TERRIER *et al.* 2005). The LSD value between treatments was calculated at the 5 % level using a one way ANOVA (SigmaStat, Systat Software Inc., San Jose, CA).

The ethylene cis-elements were estimated by homology search using PLACE database, <http://www.dna.affrc.go.jp/PLACE/signalscan.html> or PlantCARE database, <http://bioinformatics.psb.ugent.be/webtools/plantcare/html/>

Results and Discussion: The application of gaseous ethylene significantly stimulated the accumulation of *ufgt* mRNA in berries when applied 8 and 9 weeks after full bloom (Fig. 1 a). These observations made in 'Cabernet Sauvignon' berry tissues were confirmed in another cultivar, under different experimental conditions, the 'Gamay' cell suspension sprayed with the 2-CEPA, an ethylene precursor (Fig. 1c). These results confirmed previous observations, either the enhancement of anthocyanin accumulation after spraying 2-CEPA onto the grape clusters (EL-KEREAMY *et al.* 2003), or the inhibition of anthocyanin accumulation following a treatment of the clusters with the ethylene inhibitor, 1-methylcyclopropene (CHERVIN *et al.* 2004).

However no significant difference was seen for the accumulation *mybA* mRNAs in the same experimental conditions (Fig. 1 b and c). This absence of responsiveness to an ethylene signal was further confirmed by the analysis

Correspondence to: Dr C. CHERVIN, UMR 990, Génomique et Biotechnologie des Fruits, INP, ENSAT, INRA, Université de Toulouse, F-31320 Castanet Tolosan, France. Fax: +33-5-6219-3573. E-mail: chervin@ensat.fr

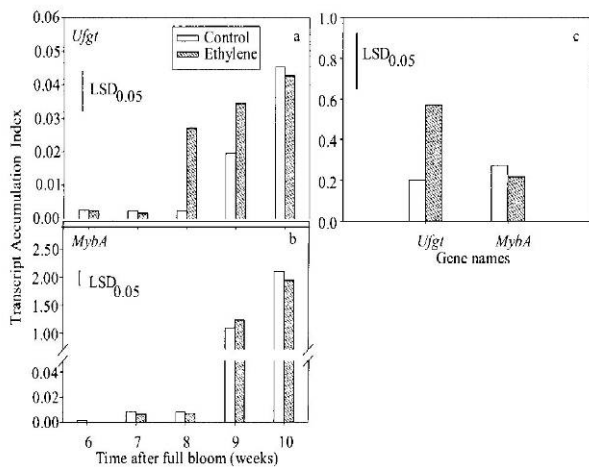

Fig. 1: Effects of exogenous ethylene to a) the *ufgt* mRNA levels, to b) the *mybA1* mRNA levels in 'Cabernet Sauvignon' berries according to time after full bloom, and to c) mRNAs of both genes in 'Gamay' cell suspensions. The mRNA levels were determined by qRT-PCR analyses and are expressed as the transcript accumulation index relative to *efl-a*. Each bar represents the mean of three biological replicates, and LSD bars were calculated at the 0.05 level for differences between the treatments (control or ethylene).

of the *VvmybA1* promoter, GenBank AB242302 (the sequence of the *VvmybA2* promoter was not available when we wrote this article), which showed three ethylene cis-elements (ethylene response elements, ERE) in the -2 kb upstream region (Fig. 2 a). The closest GCCGCC box, one of the most potent EREs (FUJIMOTO *et al.* 2000), locates around -2100 bp. The closest ATTTnAAA box, the other common ERE, locates at -850 bp from *mybA1* start codon (Fig. 2). In comparison there are seven EREs in the *ufgt* promoter, GenBank AY955269, (Fig. 2). The GCCGCC sequence was found at -160 bp from the *ufgt* start codon, a good place to be active (Dr Ohme-Takagi, pers. comm. and analyses of ethylene responsive promoters, data not shown). Two other ERE sequences, ATTTnAAA are reasonably close to the gene start codon, located between -450 and -350 bp. In another ethylene responsive promoter, they were shown to be active when placed at -500 bp (ITZHIKI *et al.* 1994). Here we used the sequence of the Shiraz *ufgt* promoter, which has 97 to 99 % homology to the grapevine *ufgt* promoter sequences isolated from the 'Kyoho', 'Italia', 'Ruby Oku', 'Muscat of Alexandria' and 'Flame Muscat' cultivars (KOBAYASHI *et al.* 2001), and 95 % to 'Cabernet Sauvignon' (GenBank AY919624). The alignment of various *ufgt* promoter sequences has already been shown (KOBAYASHI *et al.* 2001).

So we conclude that the stimulation of *ufgt* expression by ethylene is independent from *mybA* expression. But it does not preclude the importance of MybA in controlling the *ufgt* expression. Indeed, Dr. GOTO-YAMAMOTO found that the MybA protein binds to a region of the *ufgt* promoter around -428 to -303 bp from the start codon (pers. comm.) and recent works confirm the role of MybA in stimulating anthocyanin accumulation (YAKUSHIJI *et al.* 2006, WALKER *et al.* 2007). To our knowledge this is the

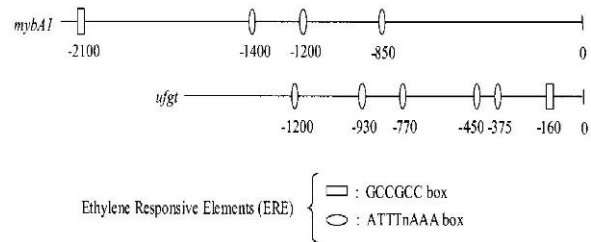

Fig. 2: Locations of ethylene responsive elements (cis-acting) on the promoter of *mybA1* (AB242302) and on the promoter of *ufgt* (AY955269) of *Vitis vinifera*. The nucleotide numbering is relative to the start codon (0). Cis-elements were estimated by homology search using PLACE and PlantCARE databases.

first report addressing the responsiveness of *myb* expression to an ethylene signal.

The authors wish to acknowledge the INRA-INP/ENSAT and the Midi-Pyrénées regional council for a partial funding of this collaborative work, the Domaine de Candie (Régie Agricole de la Ville de Toulouse) for the grapes and the team of CRGS platform of Genopole Toulouse where the qRT-PCR analyses were performed.

- CHERVIN, C.; EL-KEREAMY, A.; ROUSTAN, J. P.; LATCHE, A.; LAMON, J.; BOUZAYEN, M.; 2004: Ethylene seems required for the ripening of grape, a non-climacteric fruit. *Plant Sci.* **167**, 1301-1305.
- EL-KEREAMY, A.; CHERVIN, C.; ROUSTAN, J. P.; CHEYNIER, V.; SOUQUET, J. M.; MOUTOUNET, M.; RAYNAL, J.; FORD, C. M.; LATCHE, A.; PECH, J. C.; BOUZAYEN, M.; 2003: Exogenous ethylene stimulates the long-term expression of genes related to anthocyanin biosynthesis in grape berries. *Physiol. Plant.* **119**, 175-182.
- EL-SHARKAWY, I.; MANRIQUEZ, D.; FLORES, B. F.; REGAD, F.; BOUZAYEN, M.; LATCHE, A.; PECH, J. P.; 2005: Functional characterization of a melon alcohol acyl-transferase gene family involved in the biosynthesis of ester volatiles. Identification of the crucial role of a threonine residue for enzyme activity. *Plant Mol. Biol.* **59**, 345-362.
- FUJIMOTO, S. Y.; OHTA, M.; USUI, A.; SHINSHI, H.; OHME-TAKAGI, M.; 2000: Arabidopsis ethylene-responsive element binding factors act as transcriptional activators or repressors of GCC box-mediated gene expression. *Plant Cell* **12**, 393-404.
- KOBAYASHI, S.; ISHIMARU, M.; DING, C. K.; YAKUSHIJI, H.; GOTO, N.; 2001: Comparison of UDP-glucose:flavonoid 3-O-glucosyltransferase (*ufgt*) gene sequences between white grapes (*Vitis vinifera*) and their sports with red skin. *Plant Sci.* **160**, 543-550.
- PIFFAUT, B.; KADER, F.; GIRARDIN, M.; METCHE, M.; 1994: Comparative degradation pathways of malvidin 3,5-diglucoside after enzymatic and thermal treatments. *Food Chem.* **50**, 115-120.
- TERRIER, N.; GLISSANT, D.; GRIMPLET, J.; BARRIEU, F.; ABBAL, P.; COULTURE, C.; AGEORGES, A.; ATANASSOVA, R.; LEON, C.; RENAUDIN, J. P.; DÉDALDÉCHAMP, F.; ROMIEU, C.; DELROT, S.; HAMDI, S.; 2005: Iso-gene specific oligo arrays reveal multifaceted changes in gene expression during grape berry (*Vitis vinifera*, L.) development. *Planta* **222**, 832-847.
- TRIANTAPHYLIDIS, C.; NESPOULOUS, L.; CHERVIN, C.; 1993: Ammonium requirement for radiation-induced accumulation of polyamines in suspension cultured grape cells. *Physiol. Plant.* **87**, 389-395.
- WALKER, A. R.; LEE, E.; BOGS, J.; MCDAVID, D. A. J.; THOMAS, M. R.; ROBINSON, S. P.; 2007: White grapes arose through the mutation of two similar and adjacent regulatory genes. *Plant J.* **49**, 772-785.
- YAKUSHIJI, H.; KOBAYASHI, S.; GOTO-YAMAMOTO, N.; TAE JEONG, S.; SUETA, T.; MITANI, N.; AZUMA, A.; 2006: A skin color mutation of grapevine, from black-skinned Pinot Noir to white-skinned Pinot Blanc is caused by deletion of the functional *VvmybA1* allele. *Biosci. Biotech. Biochem.* **70**, 1506-1508.

Received March 9, 2007

Ethylene is Required for the Ripening of Grape

Christian Chervin, Arak Tira-Umphon,
Jean-Paul Roustan, Julien Lamon,
Alain Latche and Mondher Bouzayen
UMR 990, INRA/INP-ENSAT
BP 107, 31326 Castanet
France

Ashraf El-Kereamy
Dept. of Horticulture
Faculty of Agriculture
Ain Shams University
P.O. Box: 68, Hadayek Shoubra
11241 Cairo
Egypt

Angelos Kanellis
Dept. of Pharmaceutical Sciences
Aristotle University of Thessaloniki
GR-541 24 Thessaloniki
Greece

Keywords: *Vitis vinifera* L., ethylene, berry growth, non-climacteric fruit

Abstract

While grapes have been classified as a non-climacteric fruit, we show here that endogenous ethylene production just before veraison is required for an increase in berry size and possibly for anthocyanin accumulation in the ripening berry. Our data also show that the peak of ethylene production just prior to veraison is associated with increased accumulation of ACC oxidase mRNAs, enhanced ACC oxidase activity and higher concentrations of malonyl-ACC. Exposure of clusters to 1-MCP at various times before and after veraison inhibited ripening only in fruit treated at the time of the ethylene peak. Lastly, we observed some feed-back at the ethylene perception level and this response is discussed in relationship to the behaviour of non-climacteric plant tissues.

INTRODUCTION

Ethylene was thought to have had a very limited role, if any, in the ripening process of non-climacteric fruit (Coombe and Hale, 1973; Abeles et al., 1992). More recent work has indicated that some aspects of non-climacteric ripening may be associated with ethylene responses (Giovannoni, 2001). The classification of grapes as non-climacteric fruit was mainly due to a set of data showing only weak changes in endogenous ethylene levels around veraison (Coombe and Hale, 1973), a development stage often considered the beginning of ripening in grape berries (sugar accumulation increases, acid decreases, the berry softens and pigmentation occurs). Indeed, Coombe and Hale (1973) and Alleweldt and Koch (1977) found that the amounts of endogenous ethylene produced by grapes were quite small when expressed as a concentration per volume of internal gas (less than $0.5 \mu\text{l L}^{-1}$), but when expressed as a concentration per weight of tissue, then an ethylene burst was clearly observable around veraison (Alleweldt and Koch, 1977). However, the peak in the latter study represented one point (one date on which ethylene production rose) and the fruit was incubated for one hour under partial vacuum. This was an excessive period of time over which some of the ethylene collected could have been due to a plant response to the vacuum.

MATERIALS AND METHODS

'Cabernet Sauvignon' grapevines grafted onto '110 Richter' were grown in Toulouse, France, in a non-irrigated vineyard. Measurements were made over two consecutive years with anthesis occurring in mid-June. The 1-MCP at an initial concentration of $4 \mu\text{l L}^{-1}$ was applied at various times following anthesis, for a 24 h period, in a polyethylene bag wrapped around the cluster. Control clusters were wrapped with plastic bags for 24 h. Clusters located in a shaded area of the vines were chosen to

avoid direct exposure to sunlight. After 24 h, the clusters were sampled and immediately assayed for ACO activity and juice acidity or stored at -80°C . Berry diameter was measured using calipers as described by Coombe (1992). Titratable acidity of the juice was measured with 0.1 N NaOH up to pH 7. The total anthocyanin content was assayed according to Boss et al. (1996) and converted to malvidin-3-glucoside equivalents using a ϵ of $28,000\text{ mol}^{-1}\text{ cm}^{-1}$ at 520 nm (Souquet, J.M., pers. comm.).

The internal ethylene was assessed according to Coombe and Hale (1973). Briefly, control whole clusters that had not been incubated in plastic bags, weighing a total of $\sim 150\text{ g}$, were placed in a bowl filled with a NaCl solution at saturation, under an inverted funnel with an exhaust blocked by a rubber septum. The air remaining in the funnel exhaust was taken out with a syringe. Then the bowl was incubated under a partial vacuum of -700 mm Hg for 5 min using a freeze-dryer chamber. After returning to atmospheric pressure one ml of the internal atmosphere within the funnel directly under the septum was sampled with a syringe and injected in a gas chromatograph.

The *in vivo* ACO activity was assayed using 1 g fresh weight of berry tissue per 1.2 ml of *in vivo* buffer described by Pretel et al. (1995), with the following modifications: Tris-HCl 0.5M, pH 7 and mannitol 0.35 M. The berry content of 1-aminocyclopropane-1-carboxylic acid (ACC) was assayed according to Mansour et al. (1986).

Northern blots were performed according Boss et al. (1996). The ACO cDNA probe was obtained from genomic grape DNA using sequences with GenBank accession number AY211549. The probe matched a 255 bp sequence of the coding region at the 3' end.

A full-length cDNA from *Vitis vinifera* encoding *ETR1* was isolated by screening a lambda ZAP-XR cDNA library constructed from grapevine cell suspension culture mRNA (Loulalakis et al., 1996), using ^{32}P -labelled Arabidopsis *ETR1* C5 as the probe (Chang et al., 1993). DNA in plaque lifts was denatured and fixed according to Sambrook et al. (1989). Filters (Hybond N+, Amersham) were pre-hybridised for 2 h at 50°C in 0.5 M sodium phosphate pH 7.2, containing 7% SDS, 1mM EDTA and 1% BSA and hybridised with cDNA probe for 24 h. Filters were washed under low stringency conditions with 1% SSC and 0.1% SDS at 50°C , and then exposed to X-ray film using intensifying screens, at -70°C for almost 72 h. According to *in vivo* excision properties of lambda ZAP-XR vector, the positive clone was excised as described above. DNA sequencing was performed using a Sequenase DNA sequencing Kit (USB). Sequences were analysed and compared with the GeneBank and EMPL nucleic acid database, using BLAST, BESTFIT and TFASTA programs. The GeneBank accession number is AF243474.

RESULTS AND DISCUSSION

We confirmed the occurrence of an ethylene peak in 'Cabernet Sauvignon' grapes over a three-week period (weeks 6, 7 and 8). This peak represented a concentration of $0.2\text{ }\mu\text{l L}^{-1}$, which is above the physiological threshold in most plant tissues (Abeles et al., 1992). In addition, *in vivo* activity and transcript accumulation of 1-aminocyclopropane-1-carboxylic acid oxidase (ACO), the last enzyme in the ethylene production pathway, coincided with the occurrence of the ethylene peak (Table 1). The pre-veraison ethylene peak was observed two consecutive years, in irrigated and non-irrigated 'Cabernet Sauvignon' vineyards, and two using different rootstocks ('110R' and '3309C'). It should be pointed out that the timing of the ethylene peak depended on the climatic conditions of the month preceding the peak each year (data not shown).

The total content of ACC, the immediate precursor of ethylene including both conjugated and free forms, reached levels that were 20 times higher than those of the free form alone (Table 1). Therefore, most of the ACC was malonylated and indicates that in grape berries the competition for ACC between ACO and ACC malonyl transferase described previously (Mansour et al., 1986) favours the latter. The levels of total ACC reached approximately 5 nmoles g^{-1} fresh weight at veraison, 1000 times greater than the levels of ethylene production, suggesting that the production of ACC was not limiting.

This high ACC content in grapes had been noted previously (Mizutani et al., 1988). The slight delay between the ethylene peak (week 7) and the ACC peak (week 8) can be explained by the time necessary for the berry tissues to accumulate high levels of ACC. The decrease in ACC levels g^{-1} fresh weight at weeks 9 and 10 can be explained by the resumption of berry growth after veraison (Coombe and McCarthy, 2000).

In order to determine whether this temporary increase in ethylene production has physiological significance in grape ripening, ethylene receptors were blocked with 1-MCP at different times around the expected ethylene peak (i.e. 5 to 9 weeks after anthesis). This molecule has been described as an irreversible inhibitor of ethylene receptors, with an affinity for the receptors 10 times greater than that of ethylene (Blankenship and Dole, 2003). The application of 1-MCP delayed the increase of berry diameter. This delay was correlated to the application of 1-MCP at the time of the ethylene peak. According to Coombe and McCarthy (2000) the beginning of the second growth phase is mainly linked to fluxes within phloem. The roles of ethylene on these fluxes are not well described in the literature. However, ethylene seems to have a role in cell enlargement (Sanchez-Calle et al., 1989; Camp et al., 1981) and this could explain the limitation of diameter increase due to the blockage of ethylene receptors by 1-MCP.

The results also indicate that ethylene may affect the decrease in acid that occurs post-veraison. Grapes treated with 1-MCP at 6, 7 and 8 weeks after anthesis had higher acid levels than the untreated controls when harvested at 13 weeks post-anthesis. The greatest effect of MCP was evident when the treatments coincided with the timing of the endogenous ethylene peak. The decrease in juice acidity at this time is explained mainly by the decrease in malic acid concentration (Ollat et al., 2002). This decrease may be induced by ethylene as an increase in respiration is triggered by this phytohormone even in non-climacteric tissues (Abeles et al., 1992). Indeed, Saulnier-Blache and Bruzeau (1967) showed that several grape cultivars underwent an increase in CO_2 evolution at veraison that could be part of a respiratory burst. It was associated to a lesser extent with a rise in O_2 uptake. This respiratory rise lasted a fortnight following veraison (after which the measurements were stopped) and it seems to match the time in which acidity decreases in the berry. Others have suggested that malic enzyme could also be activated at veraison and be part of malate catabolism (Ollat et al., 2002), and this enzyme has also been shown to be induced by ethylene in ripening fruit (Mamedov et al., 1997). Moreover, the transport of organic acids within cell compartments is obviously involved in acid metabolism (Terrier and Romieu, 2001) and this transport may be modulated by ethylene signals (Schmidt et al., 2003). However, it cannot be ruled out that the sustained acidity could simply result from the inhibition of fruit expansion.

Finally, 1-MCP was shown to transiently inhibit anthocyanin accumulation in berry skins (Table 2). Again this inhibition was greater when 1-MCP was applied at the time of the ethylene peak. This is not surprising as the expression of several enzymes of the anthocyanin pathway (Robinson and Davies, 2000) can be induced by ethylene (El-Kereamy et al., 2003). It is also possible that reduced fruit expansion may have an effect on other signals leading to anthocyanin synthesis and accumulation, i.e. sugar levels (Vitrac et al., 2000). Indeed, it is known that rapid sugar accumulation in berries starts around veraison and is linked to phloem unloading (Coombe and McCarthy, 2000).

Such 1-MCP experiments have been conducted over two consecutive years and similar results have been observed. The results presented here are the data set of a single year, because the time at which the sensitivity to 1-MCP is maximal depends on the climate in the month following bloom, which also impacts the ethylene peak. In these experiments (Table 2), the berries were picked a few weeks before harvest as we noticed in preliminary trials that treated grapes can overcome the 1-MCP inhibition of ripening as time goes by, may be via *de novo* synthesis of ethylene receptors.

Our observations regarding the role of internal ethylene in modulating several metabolic pathways associated with berry development and ripening, confirm observations of other researchers. Hale et al. (1970) and others (Weaver and Montgomery, 1974; Shulman et al., 1985) observed that these ethylene applications

decreased acidity and enhanced the accumulation of red pigments. This suggests that berry tissues are able to sense ethylene but during the 1970s nothing was known about ethylene signal transduction. Since then, commercial treatments with ethylene precursors have been developed but these precursors are applied at rates that would give rise to an internal concentration of ethylene more than $500 \mu\text{l L}^{-1}$ presuming every mole of the precursor penetrates the plant tissue and is transformed to ethylene. It has been suggested that such treatments result in too high a concentration to have any physiological meaning to the plant in response to this treatment. However, it has been shown such treatments give rise to internal concentrations of ethylene that are 100 times smaller than expected (El-Kereamy et al., 2003).

One could argue that the delay in ripening induced by 1-MCP was due to a toxic effect. However, two arguments against this are: (i) the changes induced by 1-MCP are opposite to those induced by exogenous ethylene application (Weaver and Montgomery, 1974; Shulman et al., 1985); and (ii) the same 1-MCP dose had no effect on berry physiology (i.e. no toxic effect) if applied before or after the ethylene peak.

We found that *VvETR1* transcripts were present during the whole period of berry development up to veraison in Cabernet Sauvignon (data not given). However, there was a slight increase in transcript accumulation over the weeks preceding colour change in most berries. To our knowledge, this is the first expression study of ethylene receptor genes in grapes. It is possible that our cDNA probe picked transcripts related to *ETR1*, as a BLASTN survey (NCBI) with the probe sequence returned homologies with some *ETR2* and *ETR3*, members of the ethylene receptor family, but scores above 100 bits were only for homologies with *ETR1*.

To check whether the transcript changes mentioned above were dependent on the state of the ethylene receptors, we blocked the latter with 1-MCP. We found that the *VvETR1* transcript levels were reduced by the 1-MCP treatment. The mean hybridisation signal in control berries over the period from 6 to 10 weeks after full bloom was 88 (arbitrary units), when it was only 55 for the MCP treated berries. This reduction was significant ($P < 0.001$) and that the difference in the mean values among the different levels of treatment (control or 1-MCP) was greater than would be expected by chance after allowing for effects of differences in date (6, 7, 8, 9 and 10 weeks after full bloom). There was no significant effect of the date ($P = 0.239$). These results indicate that mRNA accumulation of the *VvETR1* gene is dependent on the signalling state of existing receptors (i.e. blocked or not by 1-MCP). To our knowledge this is the first negative feedback ever demonstrated in the ethylene signal perception pathway in grapes and one of the first in plants.

CONCLUSION

It appears that grapes contain a functional network of ethylene signalling at the onset of ripening and part of this complex is necessary to the ripening processes. Our data do not imply that grape should be considered as a climacteric fruit but that new techniques and tools may change the way of categorizing fruit ripening. Further interesting studies are planned, particularly with the development of grape micro-arrays. These studies will bring new insights into the triggering events of ripening in non-climacteric fruit.

ACKNOWLEDGEMENTS

We wish to thank George Papadakis, Institute of Viticulture and Vegetable Crops, Heraklion, Greece, for cloning the *VvETR1* gene.

Literature Cited

- Abeles, F.B., Morgan P.W. and Saltveit, Jr., M.E. 1992. Ethylene in Plant Biology. Second Edition. Academic Press, Inc., 581 p.
- Alleweldt, G. and Koch, R. 1977. Der Äthylengehalt reifender Weinbeeren. *Vitis* 16:263-271.

- Blankenship, S.M. and Dole, J.M. 2003. 1-Methylcyclopropene: a review. *Postharv. Biol. Technol.* 28:1-25.
- Boss, P.K., Davies, C. and Robinson, S.P. 1996. Analysis of the expression of anthocyanin pathway genes in developing *Vitis vinifera* L. cv. Shiraz grape berries and the implication for pathway regulation. *Plant Physiol.* 111:1059-1066.
- Camp, P.J. and Wickliff, J.L. 1981. Light or ethylene treatments induce transverse cell enlargement in etiolated maize mesocotyls. *Plant Physiol.* 67:125-128.
- Chang, C., Kwok, S.F., Bleecker, A.B. and Meyerowitz, E.M. 1993. Arabidopsis ethylene-response gene ETR1: similarity of product to two-component regulators. *Science* 262:539-544.
- Coombe, B.G. and Hale, C.R. 1973. The hormone content of ripening grape berries and the effect of growth substance treatments. *Plant Physiol.* 51:629-634.
- Coombe, B.G. 1992. Research on development and ripening of the grape berry. *Amer. J. Enol. Vitic.* 43:101-110.
- Coombe, B.G. and McCarthy, M.G. 2000. Dynamics of grape berry growth and physiology of ripening. *Austral. J. Grape Wine Res.* 6:131-135.
- El-Kereamy, A., Chervin, C., Roustan, J.P., Cheynier, V., Souquet, J.M., Moutounet, M., Raynal, J., Ford, C.M., Latche, A., Pech, J.C. and Bouzayen, M. 2003. Exogenous ethylene stimulates the long-term expression of genes related to anthocyanin biosynthesis in grape berries. *Physiol. Plant.* 119:175-182.
- Giovannoni, J. 2001. Molecular biology of fruit maturation and ripening. *Ann. Rev. Plant Physiol. Plant Mol. Biol.* 52:725-749.
- Hale, C.R., Coombe, B.G. and Hawker, J.S. 1970. Effects of ethylene and 2-chloroethylphosphonic acid on the ripening of grapes. *Plant Physiol.* 45:620-623.
- Loulakakis, K.A., Roubelakis-Angelakis, K.A. and Kanellis, A.K. 1996. Isolation of functional RNA from grapevine tissues poor in RNA content. *Amer. J. Enol. Vitic.* 47:181-185.
- Mamedov, Z.M., Gyulakhmedov, S.G., Kuliev, A.A., Bulantseva, E.A. and Salkova, E.G. 1997. Activity of NADPH-forming enzymes during growth and ripening of apples. *Appl. Bioch. Microbiol.* 33:297-301.
- Mansour, R., Latché, A., Vaillant, V., Pech, J.C. and Reid, M.S. 1986. Metabolism of 1-aminocyclopropane-1-carboxylic acid in ripening apple fruits. *Physiol. Plant.* 66:495-502.
- Mizutani, F., Sakita, Y., Hino, A. and Kadoya, K. 1988. Cyanide metabolism linked with ethylene biosynthesis in ripening processes of climacteric and non-climacteric fruits. *Sci. Hort.* 35:199-205.
- Ollat, N., Diakou-Verdin, P., Carde, J.P., Barrieu, F., Gaudillere, J.P. and Moing, A. 2002. Grape berry development: a review. *J. Int. Sci. Vigne Vin* 36:109-131.
- Pretel, M.T., Serrano, M., Amoros, A., Riquelme, F. and Romojaro, F. 1995. Non-involvement of ACC and ACC oxidase activity in pepper fruit ripening. *Postharvest Biol. Technol.* 5:295-302.
- Robinson, S.P. and Davies, C. 2000. Molecular biology of grape ripening. *Austral. J. Grape Wine Res.* 6:175-188.
- Schmidt, W., Michalke, W. and Schikora, A. 2003. Proton pumping by tomato roots. Effect of Fe deficiency and hormones on the activity and distribution of plasma membrane H⁺-ATPase in rhizodermal cells. *Plant Cell Environ.* 26:361-370.
- Shulman, Y., Cohen, S. and Loinger, C. 1985. Improved maturation and wine quality of Carignane grapes by ethephon treatment. *Amer. J. Enol. Vitic.* 36:264-267.
- Sambrook, J., Fritsch, E.F. and Maniatis, T. 1989. *Molecular Cloning: A Laboratory Manual*, 2nd ed., Cold Spring Harbor Laboratory, Cold Spring Harbor, NY.
- Sanchez-Calle, I.M., Delgado, M.M., Bueno, M., Diaz-Miguel, M. and Matilla, A. 1989. The relationships between ethylene production and cell elongation during the initial growth period of chick-pea seeds (*Cicer arietinum*). *Physiol. Plant.* 76:569-574.
- Saulnier-Blache, P. and Bruzeau, F. 1967. Développement du raisin III. *Ann. Physiol. Vég.* 9:179-196.

- Terrier, N. and Romieu, C. 2001. Grape berry acidity. Pages 35-58. In: Roubelakis-Angelakis K.A. (ed.). *Molecular Biology and Biotechnology of the Grapevine*. Kluwer Academic Pubs.
- Vitrac, X., Larronde, F., Krisa, S., Descendit, A., Deffieux, G. and Merillon, J.M. 2000. Sugar sensing and Ca²⁺-calmodulin requirement in *Vitis vinifera* cells producing anthocyanins. *Phytochem.* 53:659-665.
- Weaver, R.J. and Montgomery, R. 1974. Effect of ethephon on coloration and maturation of wine grapes. *Amer. J. Enol. Vitic.* 25:39-41.

Tables

Table 1. The variation in several parameters related to ethylene production in 'Cabernet Sauvignon' grapes, in comparison to baseline levels, 5 to 10 weeks after anthesis (time is given in weeks after anthesis). ACC = 1-aminocyclopropane-1-carboxylic acid; ACO = ACC oxidase.

	Percent Change	Time at which max levels were measured
Internal ethylene	+ 110%	week 7
ACO RNA accumulation	+ 400%	week 7
ACO activity	+ 100%	week 7
Total ACC	+ 130%	week 8
Free ACC	no change	-

Table 2. Variation in three grape maturity parameters of 'Cabernet Sauvignon' berries harvested 13 weeks after full bloom. The fruit had been gassed for 24 hours with 4 ppm MCP at various times (5 to 9 weeks) after full bloom. All variations were significant at the 5% level.

	Maximum variation in comparison to the control levels*	Application time at which the MCP treatment gave rise to maximum variation
Berry diameter	- 15%	week 7
Total acidity	+ 20%	week 7
Total anthocyanins	- 60%	week 8

Analyses of variance were performed with SigmaStat (SPSS Inc., Chicago, IL) and LSDs at the 0.05 level determined.

Influence de l'éthylène sur le développement des baies de raisin et expression des gènes apparentés

Résumé

Le raisin est un fruit non climactérique dont la maturation semble ne pas nécessiter l'éthylène. Ici, il est confirmé que l'accumulation d'anthocyanes est liée à l'accumulation d'une glucosyltransferase (UFGT), dont le promoteur a été cloné. Il a été trouvé 7 *cis* -éléments éthylène-dépendants. Cette étude a montré la stimulation d'expression de l'*ufgt* par l'éthylène n'est pas dépendant de MybA, un des régulateurs de la transcription de l'*ufgt*. Des expériences ont été conçues pour étudier l'ensemble des gènes affecté par éthylène au début de la maturation du raisin. Parmi eux certains sont en relation avec les variations de diamètre de la baie. Ces gènes sont impliqués dans la circulation de l'eau : plusieurs aquaporines, et dans la structure de la paroi cellulaire : polygalacturonases, xyloglucan endotransglucosylases, pectine méthylesterase, cellulose synthase et expansines. L'éthylène stimule l'accumulation de la plupart de leurs transcrits entre 1 heure et 24 heures d'incubation.

Mots-clé: UDP Glucose-flavonoïde 3-O-glucosyltransferase (*UFGT*), raisin, anthocyanes, éthylène, récepteurs de l'éthylène, *mybA*, polygalacturonase (*PG*), xyloglucan endotransglycosylase (*XET*), pectine méthylesterase (*PME*), cellulose synthase (*CS*), expansine (*EX*), aquaporine (*AQU*), microarray, dimension de la baie, expansion et ramollissement de la baie

Influence of the ethylene on the grape berry development and related-gene expression

Abstract

The grape is a non-climacteric fruit which maturation apparently does not require ethylene. Here, it is confirmed that the accumulation of anthocyanins is linked to the accumulation of a glucosyltransferase (UFGT), whose promoter was cloned. We found 7 *cis*-elements ethylene-dependent. This study showed the stimulation of *ufgt* expression by ethylene is not dependent to MybA, transcription regulators of the *ufgt*. Experiments were designed to investigate all genes affected by ethylene in early ripening grapes. Among them some are in relation to variations in berry diameter. These genes are involved in the movement of water: several aquaporins, and the structure of the cell wall: polygalacturonases, xyloglucan endotransglucosylases, pectin methyltransferase, cellulose synthase and expansins. Ethylene stimulates the accumulation of most of their transcripts between 1 hour and 24 hours of incubation.

Keywords: UDP glucose-flavonoid 3-O-glucosyltransferase (*UFGT*), grape, anthocyanins, ethylene, ethylene receptors, *mybA*, polygalacturonase (*PG*), pectin methyltransferase (*PME*), xyloglucan endotransglycosylase (*XET*), cellulose synthase (*CS*), expansin (*EX*), aquaporin (*AQU*), microarray, berry size, berry expansion and softening