



HAL
open science

Engineering Dispersion Properties of Periodic Materials: Numerical and Analytical Models for the Design of Guided-Wave and Radiating Devices

Guido Valerio

► **To cite this version:**

Guido Valerio. Engineering Dispersion Properties of Periodic Materials: Numerical and Analytical Models for the Design of Guided-Wave and Radiating Devices. Electromagnetism. Sorbonne Université, 2018. tel-04527770

HAL Id: tel-04527770

<https://hal.science/tel-04527770>

Submitted on 2 Apr 2024

HAL is a multi-disciplinary open access archive for the deposit and dissemination of scientific research documents, whether they are published or not. The documents may come from teaching and research institutions in France or abroad, or from public or private research centers.

L'archive ouverte pluridisciplinaire **HAL**, est destinée au dépôt et à la diffusion de documents scientifiques de niveau recherche, publiés ou non, émanant des établissements d'enseignement et de recherche français ou étrangers, des laboratoires publics ou privés.

Mémoire pour l'obtention de l'Habilitation à Diriger des Recherches

Sorbonne Université

Spécialité

Sciences pour l'Ingénieur

Présentée par

Guido VALERIO

Maître de Conférences

Laboratoire d'Electronique et Electromagnétisme, Sorbonne Université

Engineering Dispersion Properties of Periodic Materials: Numerical and Analytical Models for the Design of Guided-Wave and Radiating Devices

soutenue le 5 Juillet 2018

devant le jury composé de :

M Raphaël Gillard	Professeur à l'INSA de Rennes	Rapporteur
M Jean-Marc Laheurte	Professeur à l'Université Paris-Est Marne-La-Vallée	Rapporteur
M Francisco Medina	Full Professor à l'Universidad de Sevilla	Rapporteur
Mme Hélène Roussel	Professeure à Sorbonne Université	Examinatrice
M Shah Nawaz Burokur	Maître de Conférences à l'Université Paris Ouest Nanterre	Examineur
M Geoffroy Lerosey	CR1 CNRS, en détachement société Greenerwave	Examineur
M Lionel Pichon	Directeur de recherche CNRS, GeePs	Examineur

ἄνδρῖ σοφῶ πᾶσα γῆ βατή· ψυχῆς γὰρ ἀγαθῆς
πατρὶς ὁ ξύμπας κόσμος.

Democritus, D111

Felix qui potuit rerum cognoscere causas
Atque metus omnis et inexorabile fatum
Subiecit pedibus strepitumque Acherontis avari

Virgil, *Georgica*. 2, 490-492

Ciascuno di noi parte nella vita con una sola idea e
non fa altro che sviluppare quella.

Umberto Eco remembering a remark by Luigi Pareyson.

N'oubliez pas d'inventer votre vie.

Michel Foucault, *Le courage de la vérité*, 2009.

Marty. You're not thinking fourth dimensionally!

Robert Zemeckis and Bob Gale,
Back to the Future Part III, 1990.

Table of Contents

Introduction	7
Résumé en français	9
Career Description of Guido VALERIO	11
Working experiences	11
Visits abroad	11
Scientific publications	12
Contribution to software development	12
Invited seminars abroad (personal invitations)	12
Awards	13
Research grants (2014 - 2018)	13
Accepted grants	14
Proposals under evaluation	15
Recent international collaborations	16
Recent national collaborations	17
Participation to thesis committees	17
Organization of international conferences and special sessions	17
Participations to activities serving the scientific community	18
List of supervised students and postdocs	19
Supervision strategy	19
Teaching activities at Sorbonne Université	27
1 - Numerical methods for the dispersive analysis of periodic layered structures	29
1.1 Computation of multilayered periodic Green's functions	30
1.1.1 Lattice-sum formulation	32
1.1.2 Acceleration of planar potentials	33
1.1.3 Acceleration of dyadic multilayered potentials	34
1.2.4 Dispersion analyses of microstrip periodic lines: EIGER	35
1.2 Bloch analyses by simulating truncated cells	36
Selected references	38
2 - Exciting localized waves with frequency-dispersive radiating systems	41
2.1 RLSA for near-field synthesis	42
2.2 Hybrid mode-matching/MoM code for stacked SIW	44
2.3 Leaky-wave resonances exciting Bessel beams	46
2.4 Rotating beams	48
2.5 Frequency-dispersive excitation of X waves	50
The case of nondispersive excitation: constant θ	51
The case of dispersive excitation	52
A dispersive excitation carrying orbital angular momentum	54
Selected references	54
3 - Degeneracies in periodic structures: higher symmetries and modal couplings	57
Collaborations related to the project	57
Supervisions related to the project	57
Grants related to the project	58

Realization of prototypes	58
3.1 Motivation and impact of the research project	59
3.2 Beyond periodicity: creating degeneracies with higher symmetries	59
3.2.1 Modelling of higher symmetries: Floquet expansions	60
3.2.2 Modelling of higher symmetries: Bloch analysis	63
3.2.3 Higher-symmetric holey-surface for beam scanning	64
3.2.4 Transformation optics for higher-symmetric holey surfaces	65
3.3 Breaking symmetry: mechanical strains in graphene-based transistors	66
3.4 Degeneracies for the excitation of “giant resonances”	67
3.5 Study of dispersive effects related to higher-order mode coupling	68
Selected references	68
Publication list	71

Introduction

In this manuscript, I summarize the main research activities I have conducted as a PhD student (2005-2009, under the direction of Alessandro Galli) and as a post-doc (2009-2011) at Sapienza University in Rome, Italy, as post-doc at IETR in Rennes, France (2011-2014, in the group of Ronan Sauleau and Mauro Ettore) and since 2014 as a Maître de Conférences at L2E, Sorbonne Université (SU), formerly Université Pierre et Marie Curie (UPMC)¹ in Paris, France, in the team MINA, organized by Zhuoxiang Ren.

The first part of the manuscript is devoted to a *presentation of my career* starting with my thesis. More details are given starting from 2013. Tables and lists are preferred rather than simple text to describe grants, responsibilities, supervised students, courses taught, in order to give a more effective summary of the activities. As few exceptions, some general remarks are discussed concerning the grants obtained (p. 11), the supervision of PhD students and post-doc (p. 17), and some teaching duties (p. 25). These comments aim not only at describing the past activities, but also at explaining the direction of future choices.

In the second part of the manuscript, the research activities are presented in more detail. **Chapter 1** is devoted to the numerical study of dispersion in complex media, namely periodic multilayered structures (whose periodicity is orthogonal to the stratification direction). These structures are typically formed by a periodic array of scatterers embedded in a layered medium. **During my PhD and postdoc at Sapienza** (and a 6-month visit at University of Houston followed by a continuing collaboration), I have contributed to develop several methods to characterize the dispersion of periodic and/or multilayered media. The *accelerated computation of Green's functions* in multilayered and/or periodic media is required to perform dispersive analyses by means of the method of moments. A method is discussed to enhance *dispersive analyses with the characterization of a single cell* (Bloch analysis) taking into account the mutual coupling among several cells.

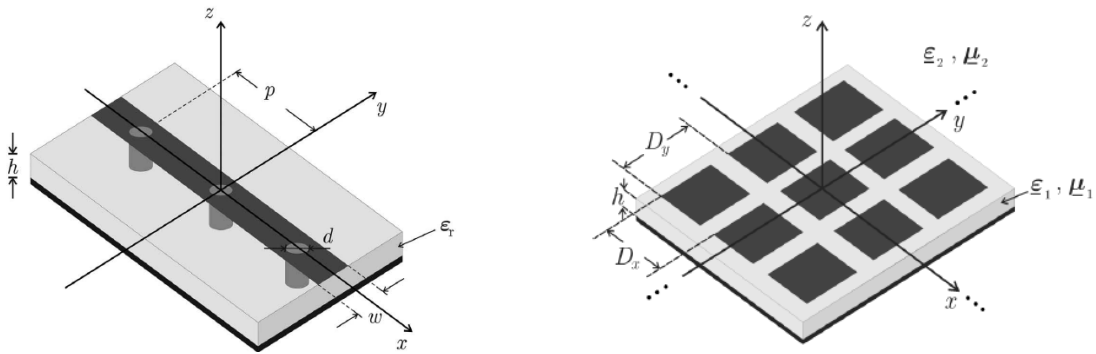

Chapter 2 mainly focuses on my work as a **postdoc at IETR** (Rennes, France). I have used my expertise in dispersive analyses of layered structures for the design of metasurface-based radial waveguides exciting in the near field monochromatic Bessel beam and X waves (i.e., localized pulses). I have contributed to the study of the impact of dispersion on near-field focalization properties thanks to my previous experience in leaky waves. The slot-based design of radial antennas are optimized with an *ad-hoc* numerical code developed during the postdoc, capable to describe general fields in multilayered substrate-integrated waveguides.

¹ The acronym UPMC will be preferred for activities performed before January 2018 (the birth of the new University “Sorbonne University”), while SU will be preferred for current or future activities.

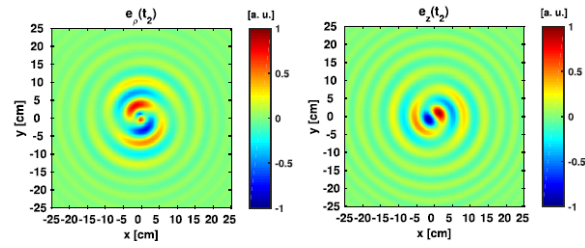
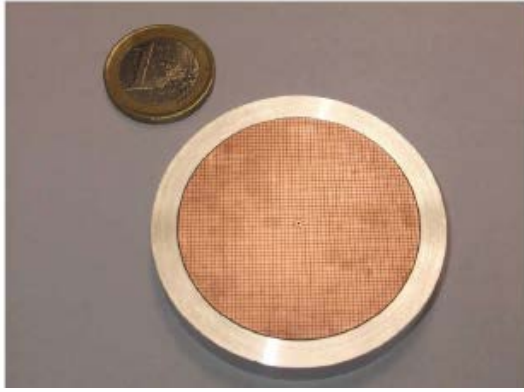

In **Chapter 3**, I describe my current and future activities at **Sorbonne Université**. I plan to work on the impact of higher-symmetries on the dispersive properties of a periodic material. Higher-symmetric metamaterials are not only periodic: each cell is also invariant under a certain geometrical transformation (translation of half a period and a mirror reflection in the glide-symmetric waveguides of the figure below). Recent research on periodic artificial materials shows that higher degrees of geometrical symmetries within a single periodic cell can introduce degeneracies in their Brillouin diagram. This can be useful for the design of ultra-large bandwidth responses and bandgap materials. On the contrary, a suitably introduced asymmetry such as holes in a perfect graphene sheet or an asymmetric coupling between transmission lines, can open an energy gap to realize a nanotransistor or create strong resonant behaviors in waveguides for the design of compact filters.

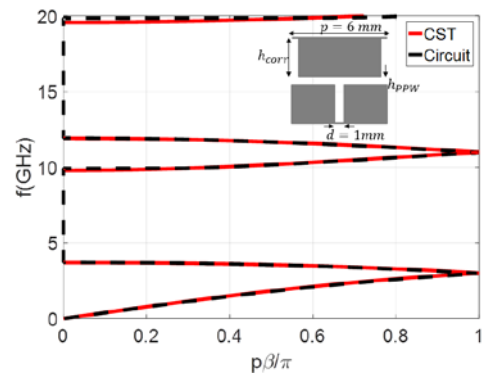
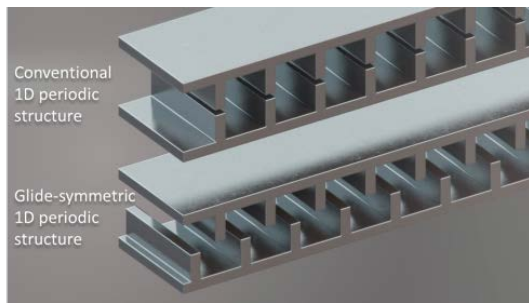

Each chapter is provided with a list of selected references (not including my own works) without the aim of completeness. References to my own works (journal papers only) are in the form [PXX] and refer to the list of publications at the end of the manuscript. All the figures are taken by published, accepted or submitted papers I have co-authored, unless explicitly written in the caption. The beginning of each chapter is an introduction to the more specific results presented later. This is done with the aim of re-using some of the text as teaching materials for courses in an international Master I would like to co-organize with colleagues at L2E (the choice of the English language is coherent with this aim).

Note relative aux modalités de rédaction du mémoire d'habilitation à diriger des recherches à Sorbonne Université : selon les UFR, votre mémoire d'habilitation, synthèse et perspectives de vos travaux d'environ 50 pages (hors les articles joints), en français ou en anglais, peut être ou pas déjà rédigé lorsque vous soumettez votre pré-dossier à la CTH. <http://www.sciences.sorbonne-universite.fr/fr/recherche/hdr.html>

Résumé en français

Dans ce mémoire pour l'obtention de l'Habilitation à Diriger des Recherches, je présente une synthèse de mes activités de recherche tout au long de ma carrière : mon doctorat (2005-2009 sous la direction d'Alessandro Galli) et post-doc (2009-2011) à Sapienza, Rome, Italie, mon post-doc à l'IETR, Rennes, France (2011-2014, dans le groupe de Ronan Sauleau et Mauro Ettore), et mes activités en tant que Maître de Conférences au Laboratoire d'Electronique, Sorbonne Université (ancienne Université Pierre et Marie Curie), Paris, France, depuis 2014, dans l'équipe MINA animée par Zhuoxiang Ren.

Les activités de recherches relatives à chacune des trois périodes sont décrites dans trois chapitres, après une description de mon parcours professionnel en termes de publications, prix, projets de recherches obtenus, principales collaborations internationales et nationales, activités dans la communauté scientifique, encadrements et co-encadrements, activités d'enseignement. La présentation est faite à l'aide de tables et listes d'activités pour donner un résumé plus efficace et synthétique. Font exception des paragraphes sur les projets de recherche (page 11), sur mes encadrements (page 17), et sur mes activités d'enseignement en lien avec mes recherches (page 25). Ces paragraphes servent à commenter mes activités passées mais aussi à expliquer ma stratégie pour les activités prévues pour les prochaines années.

Le premier chapitre porte sur la **modélisation des propriétés dispersives des structures périodiques en milieux stratifiés**. Deux stratégies y sont décrites. D'un côté, *le calcul accéléré des fonctions de Green périodiques dans des milieux stratifiés* permet de formuler des équations intégrales qui sont résolues avec la méthode des moments. Cela minimise le nombre d'inconnues, puisque la seule surface des objets périodiques doit être discrétisée, au lieu de l'entière cellule unitaire. D'un autre côté, *une analyse dispersive* peut être aussi effectuée *à l'aide de la caractérisation d'une seule cellule* dans un environnement non-périodique. Cette approche néglige les interactions entre cellules adjacents. Une méthode est discutée pour améliorer cette approche en prenant en compte le couplage mutuel parmi cellules adjacentes à partir de la simulation d'une structure tronquée.

Le deuxième chapitre porte sur la **focalisation de faisceaux de Bessel monochromatiques et de X-waves (impulsions à bande large)** dans le champ proche d'une antenne, aux ondes millimétriques. Des structures réalistes, de taille finie et à bande finie, sont considérées pour l'excitation de telles ondes. Le champ d'illumination nécessaire est synthétisé avec une distribution de fentes sur un plan de masse optimisée avec un code dédié. Les structures choisies présentent toujours une *dispersion en fréquence*, qui introduit un comportement non-idéale du champ d'illumination sur la bande de fréquence choisie. Grâce à mes connaissances sur les propriétés dispersives des structures stratifiées, l'impact de cette dispersion en fréquence est étudié sur la focalisation de X-waves à symétrie azimutale et sur des X-waves avec moment cinétique orbitale (rotating pulses).

Le troisième chapitre porte sur le projet de recherche que j'envisage pour les prochaines années, avec la description de résultats préliminaires récemment obtenus. Je propose d'étudier **l'effet des symétries spécifiques de réseaux périodiques sur leurs propriétés dispersives**. Notamment, la symétrie de type « glide » (symétrie de « réflexion glissée ») est une symétrie supplémentaire qui s'ajoute à la périodicité d'une metasurface. Dans une structure glide, chaque cellule du réseau périodique est invariante après une translation d'une demi-période et une réflexion par rapport à un plan. Un exemple est donné par deux metasurfaces périodiques en regard, déplacées d'une demi-période dans les deux directions de périodicité. La périodicité modifie l'indice de réfraction équivalent

vu par une onde qui se propage entre les metasurfaces. La symétrie glide permet d'obtenir un comportement non dispersif sur une large bande de fréquences, ce qui permet la réalisation de lentilles pouvant balayer le faisceau rayonné dans une bande ultra large sans dégradations significatives. Des effets dispersifs de type opposés (résonances à bande très étroite, « résonances géantes ») peuvent être également obtenus en introduisant des asymétries entre deux lignes de transmission couplées. Cela peut permettre la conception de résonateurs à facteur de qualité très élevé. Plus généralement, en modifiant le couplage périodique entre lignes, des comportements dispersifs intéressants pourraient être obtenus avec plusieurs applications pour la conception de structures sélectives en fréquence.

Career Description of Guido VALERIO born 29/05/1982 (35 year old)

**Maître de Conférences at the UFR 919 d'ingénierie,
Sorbonne Université,
Laboratoire d'Electronique et Electromagnétisme (L2E)**

Campus Pierre et Marie Curie
4 place Jussieu
75252 Paris Cedex 05, France
telephone : +33 (1) 44 27 42 36
guido.valerio@sorbonne-universite.fr

Working experiences

- Since Sep. 2014**
(4 years) **Maître de Conférences (Associate Professor), Section 63**
Sorbonne Université (former Université Pierre et Marie Curie)
- 2011 – 2014**
(3 years) **Post-doc researcher**
IETR, Université de Rennes 1, Rennes, France
Responsible: Ronan Sauleau
- April – Sept. 2011**
(6 months) **Adjoint Professor** (Electromagnetic Theory course)
Sapienza Università di Roma, Rieti section, Rieti, Italy
- 2009 – 2011**
(1 month) **Post-doctoral researcher**
Dipartimento di Ingegneria dell'Informazione, Elettronica e Telecomunicazioni,
Sapienza Università di Roma, Rome, Italy
Responsible: Alessandro Galli
- 2008**
(6 months) **Visiting Scholar**
Department of Electrical and Computer Engineering, University of Houston, TX,
USA
Responsible: David R. Jackson and Donald R. Wilton
- 2005 – 2009**
(3,5 years) **PhD thesis in Electromagnetics** (*defended April 14th 2009*)
Dipartimento di Ingegneria Elettronica, Sapienza Università di Roma, Italy
Thesis director: Alessandro Galli
Thesis title: Efficient Integral-Equation Methods for Periodic Electromagnetic Problems in Layered Media

Visits abroad

- July 2017**
(1 week) **Visiting Scholar**
University of Michigan, Radiation Laboratory, EECS Dept., Ann Arbor, USA
Contact: Prof. Anthony Grbic
Research: Metasurfaces for lens antennas
Funded by: Swedish project STINT
- June 2016**
(1 month)
- June 2015**
(1 month)

Visiting Scholar
Royal Institute of Technology, KTH, Dept. of Electromagnetic Engineering, Stockholm, Sweden
17 -28 Apr 2018 (2 weeks)
Contact: Prof. Oscar Quevedo-Teruel
Research: Higher-symmetric metasurfaces
14 -20 Dec 2015 (1 week)
Teaching: 2018 - 8 hours on numerical methods for the Antenna Master course
Dec. 2015 - 10 hours for the PhD course “Metasurfaces”
Apr. 2015 - 4 hours on numerical methods for the Antenna course
20 Apr. - 1 May 2015 (2 weeks)
Funded by: Apr. 2018 Swedish project **STINT**, and **Erasmus** contract KTH/SU
Dec. 2015 European project **COST VISTA**
Apr. 2015 European project **ESF NEWFOCUS**

Scientific Publications

See p. 71 for a full list of publications

	2006-2018	2013-2018	Comments (2013-2018)
Peer-Reviewed International Journals	42	23	+ 4 under revision
Peer-Reviewed International Conferences	124	68	9 personal invitations 11 invitations as a co-author
Peer-Reviewed National Conferences	20	5	
Invited International Book Chapters	3	1	

699 citations, h-index 14 (source : Google Scholar, 14/5/2018)

Contribution to software development

The numerical methods developed for the computation of periodic Green’s functions have been implemented in EIGER, during my visit at University of Houston and my following postdoc at Rome. EIGER is a MoM solving static and dynamic problems, in uniform and periodic structures, homogeneous and multilayered. It was developed by Sandia Labs, NASA, University of Houston, Livermore Labs.

Invited seminars abroad (personal invitations)

Invited seminar **Feb. 3rd 2017** at Universidad de Seville, for the thesis defense of M Carlos Molero (I had been invited as a committee member).

G. Valerio, “Computation of periodic Green’s functions for artificial media in layered structures using asymptotic extractions,” XM³, Exeter, United Kingdom, 7-8 Dec. **2015 (2 day workshop about metamaterials organized by University of Exeter)**.

G. Valerio “Analytical and numerical techniques for artificial structures embedded in multilayered media,” invited seminar at EECS department, University of Michigan, Ann Arbor, USA, 9 July **2015**.

G. Valerio “Computational aspects for the accurate and efficient analysis of periodic planar leaky-wave antennas,” invited seminar at the Department of Electromagnetic Engineering, KTH, Stockholm, Sweden, 22 April **2015**.

G. Valerio, M. Casaletti, J. Seljan, M. Ettore R. Sauleau, and M. Albani, “Numerical-asymptotic synergic approach for speeding up the filling time in a MoM/mode matching code for large SIW structures,” at the workshop *INTELECT’2013*, Dubrovnik, Croatia, 14-15 Oct. **2013 (workshop on integral methods in electromagnetics)**.

1

Numerical Methods for the Dispersive Analysis of Periodic Layered Structures

In this Chapter, I describe my research activities concerning the modeling of dispersion phenomena in periodic layered structures, *including both real and complex waves*. Periodic structures embedded in multilayered media (such as periodic microstrips, strip gratings, frequency-selective structures, etc.; Fig. 1) have been widely used in recent years to realize a great variety of electromagnetic structures: frequency-selective components [1],[2], leaky-wave antennas [3]–[5], artificial materials [6], [7], cloaking devices [8], and so forth. A versatile and accurate characterization of these structures requires flexible approaches to model arbitrary geometries and efficient algorithms to reduce computation time. These computational methods can involve either full-wave or simplified/hybrid approaches. Among full-wave methods, FDTD [9],[10] and finite-element implementations [11],[12] have been proposed. Well known advantages of these methods are the flexibility to treat generally-shaped and inhomogeneous structures. However, the treatment of multilayered structures is particularly suitable for boundary-integral formulations, solved with the method of moments (MoM) [13]–[15]. This choice leads to minimize the number of unknowns (only the surface of a scatterer needs to be discretized), since the stratification is described by the kernel of the integral equation (i.e., the multilayered periodic Green's function). Furthermore, MoM can be implemented in hybrid FEM/MoM approaches benefitting from the advantages of both methods [16].

Unfortunately, Green's functions (GF), both in free-space [17]–[19] and in multilayered media [20]–[22], are usually expressed through slowly converging expressions and require efficient computational methods. In Section 1.1.1, I describe the lattice-sum formulation for the efficient calculation of free-space periodic GF. In Section 1.1.2, the specific case of planar potential is treated, where a higher-order extraction is possible to regularize the potentials before interpolation. In Section 1.1.3, I describe an acceleration of the full dyadic multilayered mixed-potential periodic GF. In Section 1.1.4, some results concerning a periodic microstrip line are shown.

An alternative simplified method to study periodic structures is based on the simulation/measurement of a finite section of a periodic line in a nonperiodic environment. The formulation in [23] will be used here since it is the most adapted to study guided-wave (and specifically leaky-wave) problems. Note that different formulations [24] deal with similar problems

even when different configurations of scatterers and waves are considered. This topic is treated in Section 1.2, where its limitations for leaky-wave regimes are described and possible solutions to model the interaction among adjacent cells are discussed.

These activities have been mainly developed during my 2-year postdoc at Sapienza University, in continuity with my PhD research topics. The only exception is the lattice-sum formulation described in Section 1.1.1, recently developed in collaboration with Roma Tre University and the University of Duisburg-Essen. The activities of this chapter have been mainly developed by me as the principal investigator without involving the supervision of PhD students or post-docs. Thanks to these studies, I could acquire knowledge of dispersive phenomena and of their modelling methods. I have applied this knowledge in the following Chapter 2 and in the research project in Chapter 3.

1.1 Computation of Multilayered Periodic Green's Functions

In a periodic multi-layered environment, a metallic structure is periodic along one or two directions on the xy plane, while the stratification direction is taken along z , as shown in Figs. 1. The electric-field integral equation (EFIE) in the absence of impressed sources assumes the following form in a mixed-potential formulation [25]:

$$\hat{\mathbf{n}} \times \left[-j\omega \int_S \underline{\mathbf{G}}_A^p(\mathbf{r}, \mathbf{r}') \cdot \mathbf{J}(\mathbf{r}') ds' - \nabla \int_S K_\Phi^p(\mathbf{r}, \mathbf{r}') \nabla' \cdot \mathbf{J}(\mathbf{r}') ds' - \nabla \int_S P_z^p(\mathbf{r}, \mathbf{r}') \hat{\mathbf{z}} \cdot \mathbf{J}(\mathbf{r}') ds' \right] = \mathbf{0}, \quad \mathbf{r} \in S \quad (1)$$

S being the surface of the conductors within one unit cell only, \mathbf{n}_0 the unit vector normal to the conductors, and $\mathbf{r} = x\hat{\mathbf{x}} + y\hat{\mathbf{y}} + z\hat{\mathbf{z}}$ and $\mathbf{r}' = x'\hat{\mathbf{x}} + y'\hat{\mathbf{y}} + z'\hat{\mathbf{z}}$ the observation and source vectors, respectively. \mathbf{J} is the unknown *modal* current induced on the metallisation. The main difficulty in the evaluation of the integral equation (1) is the availability of computationally efficient expressions for the periodic layered-medium dyadic GF $\underline{\mathbf{G}}_A^p$ and scalar GF K_Φ^p P_z^p (magnetic currents are dealt with the duals of these potentials, and magnetic-field integral equations require their curls and gradients as discussed in [P32]). Note that the presence of non-diagonal dyadic potentials is due to the intrinsic anisotropic nature of the background medium, layered along one direction. Similar developments are possible in layered media with other geometric stratifications or inhomogeneities, in periodic or non-periodic problems [26]-[28].

The methods described in these sections have been applied to different configurations of sources (point/line sources) in different periodic arrangements (1-D and 2-D periodic). To fix the idea, a 1-D periodicity of line sources will be considered in the following [Fig. 1(a)]. By virtue of the linearity of

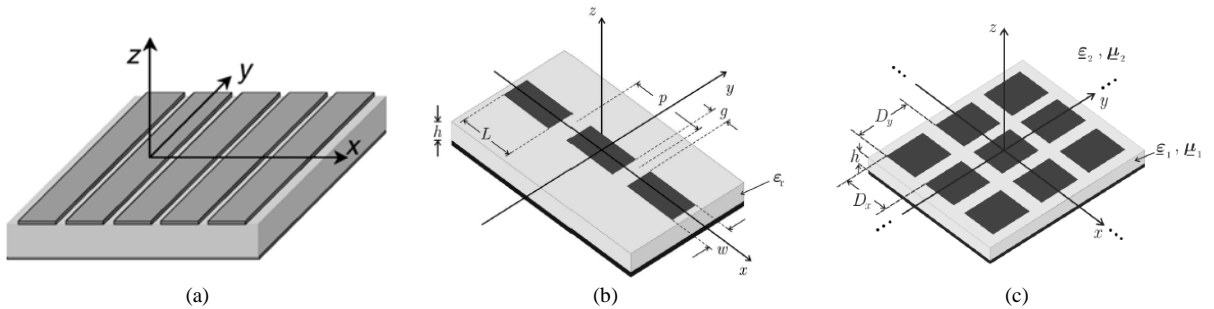

Fig. 1 - 3-D view of periodic structures embedded in layered media with relevant coordinate systems (the stratification is along the z direction) and physical and geometrical parameters. (a) 1-D periodic 2-D structure (from Burghignoli *et al.*, *IEEE T-AP*, Sep. 2006), (b) 1-D periodic 3-D structure; (c) 2-D periodic 3-D structure case. The structures in (a) and (c) are *planar*, since the equivalent currents are orthogonal to the stratification axis.

Maxwell equations and of the constitutive relations of the media, all the components of the potentials in (1) can be expressed through a *spatial series*. It is a phased superposition over all the periodic sources having spatial period p along x , with a phasing due to the wavenumber of the mode k_{x0} :

$$G^p(\mathbf{r}, \mathbf{r}') = \sum_{n=-\infty}^{+\infty} e^{-jn k_{x0} p} G(\mathbf{r}, \mathbf{r}' - np\hat{\mathbf{x}}) \quad (2)$$

Two important issues severely limit the practical utility of this series. Its convergence is usually very slow and not compatible to MoM applications, since in a lossless medium G has an algebraic decay as $n \rightarrow \infty$. Furthermore, if a leaky mode is considered, $k_{x0} = \beta_{x0} - j\alpha_x$ will be a complex constant (the attenuation constant α describes the attenuation due to the leakage occurring during the propagation). In this case, the series does not converge at all, since if $\alpha > 0$ ($\alpha < 0$) the exponential factor $e^{-jn k_{x0} p}$ will exponentially increase as $n \rightarrow -\infty$ ($n \rightarrow +\infty$).

An alternative representation (2) is possible by rewriting the function G^p as a Fourier series thus obtaining a *spectral series* (this is usually done by applying the so-called Poisson formula [13]). This is possible since, apart from a linear phasing related to k_{x0} which can be factored out, the periodic GF is periodic in the x direction:

$$G^p(\mathbf{r}, \mathbf{r}') = \frac{1}{p} \sum_{n=-\infty}^{+\infty} e^{-jk_{xn}\Delta x} \tilde{G}(k_{xn}; z, z') \quad (3)$$

where $\Delta x = x - x'$, the n th term of the summation (the n th “harmonic”) is a plane wave propagating along x with the wavenumber $k_{xn} = k_{x0} + \frac{2\pi}{p}n = \beta_{xn} - j\alpha_x$, and \tilde{G} is the spectral transform of the spatial-domain potential G with respect to x . This representation mitigates the convergence issues of the spatial series. The series is faster converging for $z \neq z'$ since in this case (the *off-plane* case) \tilde{G} is converging exponentially as $n \rightarrow \infty$. Furthermore, the presence of a complex phase shift does not prevent the convergence of this series. The spectral series (3) can then be regarded as the analytic continuation of the spatial series (2) in the k_{x0} complex plane, and then can be used to perform dispersive analyses of leaky-wave problems. Unfortunately, if $z \rightarrow z'$ the convergence of (3) gets worse and in the *on-plane* case $z = z'$ at an interface between media the spectral series (3) converges algebraically as the spatial series (2).

The GF (or potentials) in (1) can be divided into *planar* and *vertical* potentials. The planar potentials (the diagonal elements of the dyad \mathbf{G}_A^p and the scalar potential K_Φ^p) are the only necessary potentials to treat problems where metal patches lie on the plane orthogonal to the stratification direction [see Fig. 1(a)]. For these potentials, an accelerated expression can be obtained through the asymptotic extraction of a quasistatic image \tilde{G}_∞ consisting in free-space spectral GF (This extraction is usually referred to as Kummer’s extraction [20]). The extracted terms are summed back, and can be transformed back into spatial series. It turns out that this series is a periodic *free-space* GF $G_{\text{free-space}}^p$:

$$G^p = \frac{1}{p} \sum_{n=-\infty}^{+\infty} (\tilde{G} - \tilde{G}_\infty) e^{-jk_{xn}\Delta x} + \frac{1}{p} \sum_{n=-\infty}^{+\infty} \tilde{G}_\infty e^{-jk_{xn}\Delta x} = \frac{1}{p} \sum_{n=-\infty}^{+\infty} (\tilde{G} - \tilde{G}_\infty) e^{-jk_{xn}\Delta x} + G_{\text{free-space}}^p \quad (4)$$

The first series in the last term of (4) has the terms $\tilde{G} - \tilde{G}_\infty$ (the ‘‘regularized GF’’) and therefore is converging faster than the spectral series (3), since \tilde{G}_∞ is chosen to cancel \tilde{G} as $n \rightarrow \infty$.

The free-space periodic GF $G_{\text{free-space}}^p$ in (4) is a sum of images of phased line sources in free space, and this spatial series suffer of the same convergence issues as the multilayered potential in (2). Luckily, it can be computed with effective techniques [17] valid in the general case of complex wavenumber. The Ewald method [17],[29] is among the most efficient ones, leading to the following decomposition:

$$G_{\text{free-space}}^p(x, z) = \frac{1}{4j} \sum_{n=-\infty}^{+\infty} H_0^{(2)}(k_0 \rho_n) e^{-jn k_{x0} p} = G_E^{\text{spatial}}(x, z) + G_E^{\text{spectral}}(x, z) \quad (5)$$

with

$$G_E^{\text{spatial}}(x, y) = \frac{1}{2\pi} \sum_{n=-\infty}^{+\infty} e^{-jn k_{x0} p} \int_E^\infty \frac{e^{-\frac{\rho_n^2 \eta^2 + k_0^2 p^2}{p^2 + 4\eta^2}}}{\eta} d\eta, \quad G_E^{\text{spectral}}(x, y) = \frac{1}{2\pi} \sum_{n=-\infty}^\infty e^{-jn k_{x0} p} \int_0^E \frac{e^{-\frac{\rho_n^2 \eta^2 + k_0^2 p^2}{p^2 + 4\eta^2}}}{\eta} d\eta, \quad (6)$$

The integrals in each term of G_E^{spatial} can be solved in closed form, leading to a Gaussian-converging series easy to calculate. The series in G_E^{spectral} can be transformed with the Poisson rule into a spectral series whose terms can be easily computed and whose convergence is also Gaussian. The value of the number E can be arbitrarily chosen, but specific values have been derived [17],[29] in order to minimize the computation time by balancing the convergence of the two series, and to avoid cancellation errors between the two series that can occur at high frequencies (high-frequency breakdown).

In the next Section 1.1.1, I will describe recent results obtained for the computation of the free-space GF (5), necessary to perform the extraction (4). In Section 1.1.2, I will show how to improve the extraction (4) of the planar potentials. In Section 1.1.3, I will show how to extend the extraction (4) to the vertical potentials (off-diagonal elements of the dyad $\underline{\mathbf{G}}_A^p$ and P_z^p). In Section 1.1.4, I will show a dispersion analysis performed with the methods described so far.

1.1.1 Lattice-Sum Formulation

(current collaboration with Roma Tre University and the University of Duisburg-Essen)

A computation of $G_{\text{free-space}}^p$ in (4) alternative to the decomposition (5) is obtained by recurring to a formulation in terms of Lattice Sums (LSs) [19]. LSs are complex coefficients occurring in a Fourier-series development of $G_{\text{free-space}}^p$ with respect to the azimuthal variable φ :

$$G(x, z) = \frac{1}{4j} H_0^{(2)}(k_0 \rho) + \sum_{m=0}^{+\infty} L_m(k_{x0} p, k_0 p) J_m(k_0 \rho) \cos(m\theta) \quad (7)$$

The LSs are the complex coefficients $L_m(k_{x0} p, k_0 p)$. Since they are independent of the observation points, they can be computed only once and the series in (7) can be computed afterwards for each sample point. This approach is similar to other expansions proposed for different problems, such as in [30]. Unfortunately, the evaluation of LSs is also difficult, due to the occurrence of slowly convergent series. Considerable efforts have been devoted to develop methods for the evaluation of LSs [19]. However, a purely real phase shift among adjacent cells has always been considered so far.

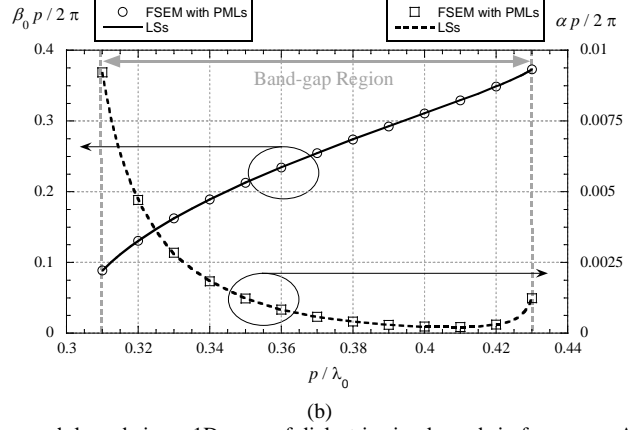
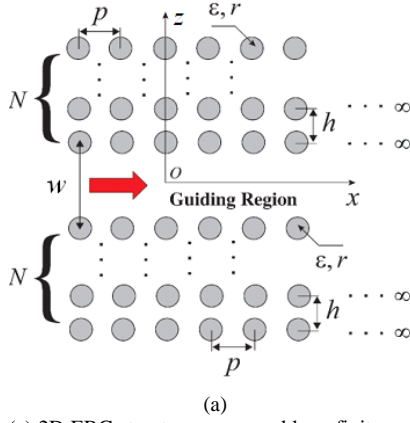

Fig. 2 - (a) 2D EBG structure composed by a finite number of layers, each layer being a 1D array of dielectric circular rods in free space. A typical guiding region is formed by removing one row of the dielectric rods from the original EBG structure. (b) Dispersion diagrams of the normalized phase $\beta_0 p / 2\pi$ and attenuation $\alpha h / 2\pi$ constants for the lowest order TE leaky mode of the 2-layered W1 type EBG waveguide shown in Fig. 2(a), obtained with the LSs technique (solid and dashed line, respectively) and an independent full-wave method (black circles and squares).

In the framework of an ongoing collaboration with Roma Tre University and the University of Duisburg-Essen, we have proposed an Ewald-based representation of LSs to **extend the use of LS to complex wavenumbers**. Each LS is expressed as the sum of an Ewald spatial series and an Ewald spectral series, both Gaussian converging also in the case of complex wavenumbers. Furthermore, the presence of a spectral series allows for simply choosing the proper/improper determination of each harmonic by changing the sign of the transverse wavenumber k_{zm} .

The LS technique has been used in order to perform a full-wave modal analysis of EBG structures formed by a periodic array of circular cylinders. This full-wave method develops the field in the periodic waveguide as a series of cylindrical waves, each one centred at the centre of each post (see Section 2.2 for a similar non-periodic problem). In Fig. 2 a sketch of a typical structure is shown with the complex wavenumbers supported, computed with the present method and with an independent validation approach (the paper has been recently submitted for publication).

1.1.2 Acceleration of Planar Potentials

(results obtained during my PhD thesis at Sapienza University, Italy [P5])

A remarkable improvement in the acceleration (4) for the two transverse potentials G_A^{xx} and K_Φ is obtained through a higher-order extractions granted by a careful choice of \tilde{G}_∞ . In fact, the extracted terms \tilde{G}_∞ are free-space GF in a medium with arbitrary wavenumber k : no value of k prevents the cancellation between \tilde{G} and \tilde{G}_∞ and then the acceleration of the sum. However, **a particular value of k has been found for each potential, leading to an improved cancellation between \tilde{G} and \tilde{G}_∞** . This means that series of the terms $\tilde{G} - \tilde{G}_\infty$ will present an improved convergence. These values are referred to as wavenumbers of *effective media* [P5]:

$$k_A = k_0 \sqrt{(\varepsilon_1 + \varepsilon_2) \frac{\mu_1 \mu_2}{\mu_1 + \mu_2}} \quad k_\Phi = k_0 \sqrt{2(\varepsilon_1 + \varepsilon_2) \frac{\mu_1 \mu_2}{\mu_1 + \mu_2} \frac{\varepsilon_1^2 \mu_1 + \varepsilon_2^2 \mu_2}{\varepsilon_1 + \varepsilon_2}} \quad (8)$$

when both the observation and source points are at the same interface between two layers with relative permittivities and permeabilities ε_1 , ε_2 , μ_1 , and μ_2 .

This extraction is of extreme importance for interpolation purposes. In fact, a faster convergence of the series of the terms $\tilde{G} - \tilde{G}_\infty$ affects the smoothness of its sum, accordingly to Fourier theory. **The extraction of images with arbitrary media leads to C^0 regularized sums** [i.e., continuous with discontinuous derivatives, Fig. 3(a)], **while the effective-media (8) lead to C^2 regularized Green's functions** [i.e., continuous with their derivatives up to the second order, see Fig. 4(b)]. **Fig. 4 shows the remarkable enhancement of accuracy obtained interpolating the smoother C^2 GFs (black)** with respect to the usual C^0 GFs (gray). The same grid of pre-computed points $N_{\text{int}} \times N_{\text{int}}$ is used.

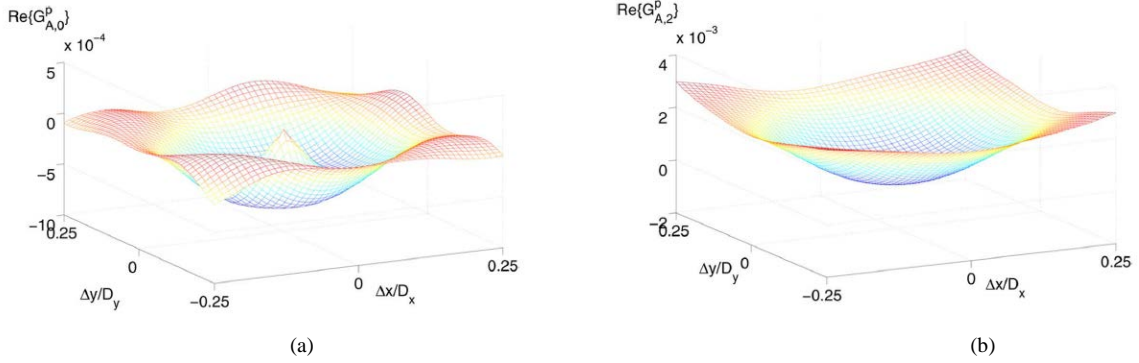

Fig. 3 – Real parts of G_A^{xx} at an interface. (a) Usual C^0 regularization and (b) C^2 regularization with new effective-media extraction.

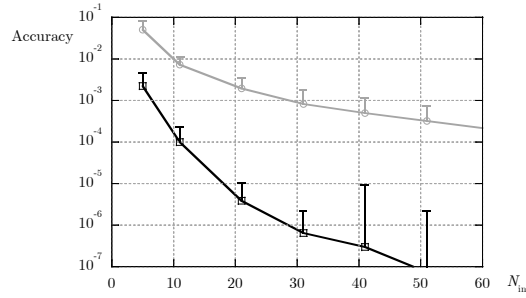

Fig. 4 – Mean of the accuracy reached interpolating C^0 GFs through first-order B-splines (gray solid line) and C^2 GFs through third-order B-splines (black solid line). The interpolation grid is made of $N_{\text{int}} \times N_{\text{int}}$ equispaced points in the unit cell at a dielectric-air interface. The vertical lines show the intervals $[\varepsilon, \varepsilon + \sigma]$, where ε is the average accuracy and σ is the Standard Deviation from the average value.

1.1.3 Acceleration of Dyadic Multilayered Potentials

(postdoc at Sapienza University, Italy, collaboration with University of Houston [P15], [P16], [P30],[P32])

In this Section, I address the computation of vertical mixed potentials (the off-diagonal elements of the dyad $\underline{\mathbf{G}}_A^p$ and P_z^p). Also for these potentials, a Kummer extractions as in (4) is possible. However, in this case, the extracted terms \tilde{G}_∞ do not give rise to any known free-space GF. Their form is of the kind \tilde{g} / k_{ν} , where \tilde{g} is a spectral-domain free-space GF and k_{ν} is the xy spectral wavenumber. The extra factor k_{ν} prevents the transformation of these terms into a free-space GF due to an array of line sources. An acceleration of these terms through higher-order Kummer extractions was proposed in [20]. Here, due to the asymptotic relation $k_{\nu} \cong -jk_{\nu}$ for large n , we have proposed to extract the

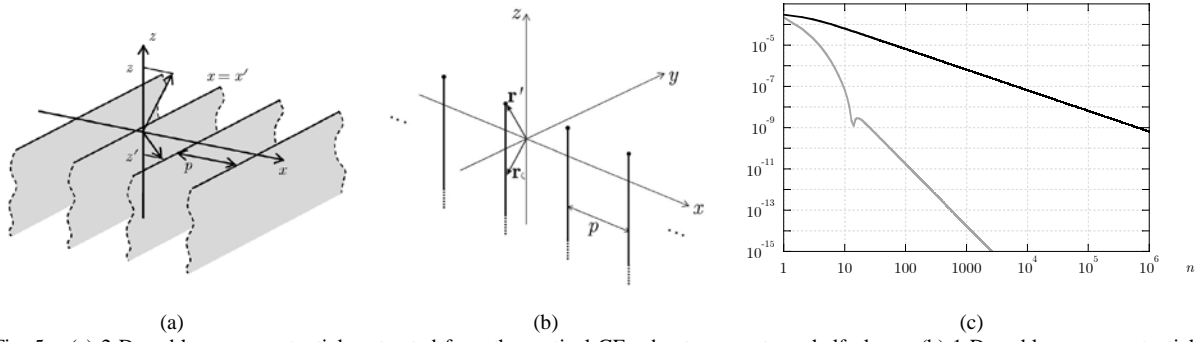

Fig. 5 – (a) 2-D problem: new potentials extracted from the vertical GFs, due to currents on half planes. (b) 1-D problem: new potentials extracted from the vertical GFs, due to currents on half lines. (c). Decay of the magnitude of terms in the nonaccelerated series for G_A^{zx} (black line) and in the accelerated series with extraction of half-plane images (gray line).

terms \tilde{g} / k_{zn} instead of \tilde{g} / k_{zn} . The division by k_z in the spectral domain is equivalent to an integration along z in the spatial domain, the images (named here g^z), are then integrals along z of the standard free-space periodic GF g . If the integral is regarded as a continuous superposition, g^z is the potential due to an array of currents on half planes [superposition of line sources, see Fig. 5(a)] or on half lines [superposition of point sources, see Fig. 5(b)]. **This relation allows for a simple evaluation through a modified Ewald method, developed for this purpose:**

$$g^z = \int_{|\Delta z|}^{+\infty} g dz = \int_{|\Delta z|}^{+\infty} g_E^{\text{spectral}} dz + \int_{|\Delta z|}^{+\infty} g_E^{\text{spatial}} dz = g_E^{z,\text{spectral}} + g_E^{z,\text{spatial}} \quad (9)$$

The GF g^z is expressed as the sum of the two Ewald series; they are separately integrated along the z axis, yielding modified Ewald series, both again with Gaussian convergence rate. The spectral series can be integrated term by term in closed form; the integration of the spatial series requires numerical quadrature rules *ad-hoc* developed, demanding a reduced number of points to reach a satisfactory accuracy. The integral representation (9) converges only if proper waves are considered (improper waves diverge at infinity). Nevertheless, the final Ewald expressions are valid in the most relevant case of complex waves, possibly improper, where the expressions are meant as an analytic continuation. In Fig. 5(c), the decay of terms of the original and of the regularized GFs is shown, for the off-diagonal entry G_A^{zx} .

1.1.4 Dispersion Analyses of Microstrip Periodic Lines: EIGER

(postdoc at Sapienza University, Italy, collaboration with University of Houston [P30])

The computational methods for mixed-potentials presented so far have been implemented in the **EIGER** software (Electromagnetic Interactions GENEralized). This is a general-purpose, 3D frequency-domain code suite, solving integral-equations for both electrodynamics and electrostatics, either in free-space or in layered media, developed by Lawrence Livermore National Laboratory, Sandia National Laboratory, University of Houston, SPAWAR (Navy), NASA, and ANT-S. Complex wavenumbers are allowed, in order to study stop-bands and space- or surface-waves leakage regimes.

In the simplest case of metallic objects, a source-free electric-field integral equation is enforced on the surface of the scatterers, discretized with triangular linear or quadratic basis functions, and tested with a Galerking approach (i.e., the same functions are chosen as test and basis functions). The matrix elements are evaluated in the spatial domain; the numerical integration of self-reactions is performed

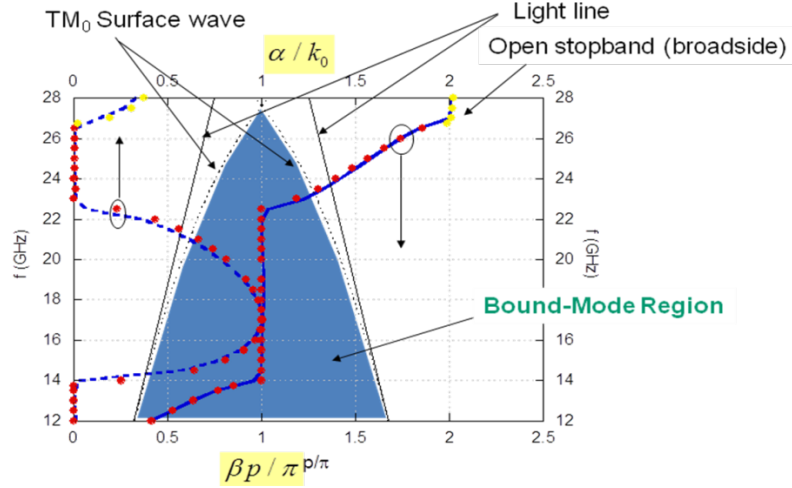

Fig. 6 – Dispersive analysis performed with the full-wave periodic code described in the text. Brillouin diagram for phase (*solid line*) and attenuation constant (*dashed line*) of the fundamental Bloch mode, for the periodic line in Fig. 1(b) (a microstrip with vertical vias). The lines are obtained through the full-wave code, the dots with the approach described in the following Section 2.1.

with singularity-cancellation quadrature rules, for their versatility when applied to different surface meshes and different GF. The unknown wavenumbers of Bloch modes are recovered as the zeroes of the determinant of the MoM matrix with zero-finding techniques for regular complex functions. Fig. 6 shows a Brillouin diagram of a microstrip line with periodic vertical vias. Different kinds of regimes can be treated, and the results agree with the simplified method described in next section.

2.1 Bloch Analyses by Simulating Truncated Cells

(postdoc at Sapienza University, Italy [P11])

An alternative approach for the study of periodic lines does not require the development of an *ad-hoc* periodic code. It is based on the characterization of a single unit cell through a two-port network (see Fig. 7) [23]. Equivalent voltages and currents at the ports are associated with propagation of the fundamental mode of an unperturbed background transmission line. A Floquet-periodicity relation

between the quantities at the two ports of a cell is enforced: $\mathbf{T} \cdot \begin{pmatrix} V_n \\ I_n \end{pmatrix} = \begin{pmatrix} V_{n+1} \\ I_{n+1} \end{pmatrix} = e^{-jk_{x0}p} \begin{pmatrix} V_n \\ I_n \end{pmatrix}$, where \mathbf{T} is the transmission matrix of a single cell. This means that the quantity $e^{-jk_{x0}p}$ is an eigenvalue of \mathbf{T} .

Unfortunately the characterization of a single cell as a two-port network (obtained, e.g., through a numerical simulation) necessarily neglects mutual coupling between adjacent cells. This could lead to inaccurate results for the wavenumber of the Bloch mode. This issue is particularly challenging when studying the dispersion of leaky-wave antennas in specific regimes such as the open stop band, where coupling among different harmonics generates a sudden variation in the attenuation constant of the Bloch mode which cannot be recovered from the simulation of a single unit cell.

In order to overcome this limitation of this method, a new “macro-cell” can be defined, composed by a number of unit cells of the structure. Obviously the same 1-D periodic structure is described by an infinite cascade of macro-cells, and each macro-cell will retain the coupling among different unit cells. The accuracy of the model is therefore improved in [P11] by computing the eigenvalues of this macro-cell $e^{-jk_{x0}Np}$ rather than the eigenvalues of a single unit cell $e^{-jk_{x0}p}$. Nevertheless, computing k_{x0} from $e^{-jk_{x0}Np}$ introduces $N-1$ spurious solutions in addition to the correct one, since a complex N th root of $e^{-jk_{x0}Np}$ should be computed to obtain $e^{-jk_{x0}p}$ and the correct root determination needs to be chosen among N choices. This ambiguity is due to the fact that we measure now the phase between planes separated by N cells. From this information, the phase between planes separated by only one cell is not uniquely defined, as well as the wavenumber k_{x0} .

A careful post-processing is usually required to recover the correct solution. This is usually possible by using a preliminary knowledge of the expected behavior of the structure under analysis. In order to avoid this issue, I have proposed a **simple automatic method to both recover the correct solution and check the convergence of the results with respect to the number of cells retained in the macro-cell**. The simulation of two different macro-cells, composed by N and M unit cell respectively, is performed. If N and M are mutually prime, the sets of solutions coming from the two macro-cells will have only one common element, which is the correct solution. In Fig. 8, the dispersive diagram of a leaky-wave microstrip antenna in the open stop-band regime ($\beta \cong 0$) is shown. The attenuation constant is plotted in the diagram, where several macro-cells are considered. As the number of cells retained in the simulation increases, the result converges toward the constant computed with the code described in Section 1.1.4. It is apparent that a large number of cells is necessary to obtain an accurate result.

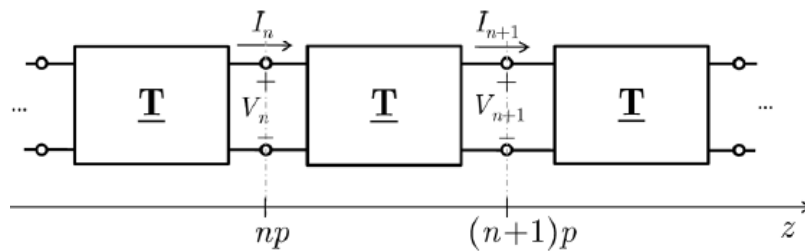

Fig. 7 - Equivalent network of a 1-D periodic line with minimal period p . Each unit cell is characterized by the transmission matrix \underline{T} .

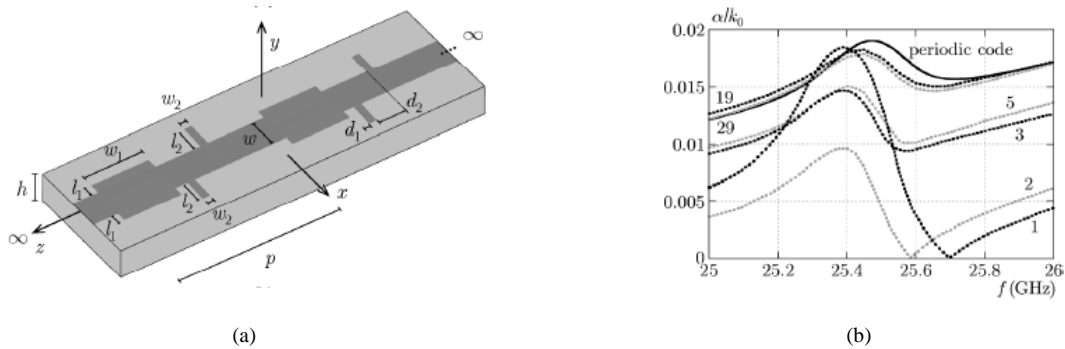

Fig. 8 – (a) Planar periodic leaky-wave antenna. (b) Normalized attenuation constant α/k_0 versus frequency for the structure as in Fig. 3(a), obtained with different numbers of simulated cells (black and gray dotted lines, the number of cells retained is near each curve) and with the periodic MoM code of Section 1.1.4.

It should be mentioned that, more recently, a macro-cell Bloch analysis has also been proposed in [31]. This more recent technique is again based on the characterization of two different macro-cells, composed by N and $N+1$ unit cells. Since N and $N+1$ are mutually prime, the information obtained is equivalent to that one obtained with the previous approach. However, instead of a comparison among the sets of solutions of each macro-cell, spurious solutions are suppressed with a simpler approach. Since $\mathbf{T}_N = \underbrace{\mathbf{T}_1 \cdot \dots \cdot \mathbf{T}_1}_N$ and $\mathbf{T}_{N+1} = \underbrace{\mathbf{T}_1 \cdot \dots \cdot \mathbf{T}_1}_{N+1}$, it follows that $\mathbf{T}_1 = \mathbf{T}_{N+1} \cdot \mathbf{T}_N^{-1}$, where \mathbf{T}_N (\mathbf{T}_{N+1}) is the transmission matrix of a N ($N+1$) macro-cell and \mathbf{T}_1 is the matrix of a single cell taking into account the coupling among N adjacent cells.

Currently, in the framework of the supervision of the thesis of Mr. Mohammad Bagheriasl, a more efficient method is under test in order to extract the accurate Bloch wavenumber from the simulation of a single unit cell. This avoids issues due to any ambiguity of solutions, and also minimizes the computational domain to a single cell. In this method we replace the commonly used 2×2 transmission matrix, where one mode is retained on each port, with a generalized $2N \times 2N$ transmission matrix, where N modes are instead retained on each port of the cell. Higher-order attenuated modes are expected to lead to an accurate description of the inter-cell coupling in a more rigorous way than the simulation of a macro-cell. It should be noted that an approach based on a multimodal T matrix has already been used in [32] with the aim of studying complex waves in metamaterial-based transmission lines, and in [31] to study giant resonances in periodic lines. These topics will be further discussed in Chapter 3.

SELECTED REFERENCES

- [1] B. A. Munk, *Frequency Selective Surfaces: Theory and Design*. New York: Wiley, 2000.
- [2] P. Burghignoli, P. Baccarelli, F. Frezza, A. Galli, P. Lampariello, G. Lovat, and S. Paulotto, "Modal properties of surface and leaky waves propagating at arbitrary angles along a metal strip grating on a grounded slab," *IEEE Trans. Antennas Propag.*, vol. 53, no. 1, pp. 36–46, Jan. 2005.
- [3] *Antenna Theory*, R. E. Collin and F. J. Zucker, Eds. New York: Mc-Graw-Hill, 1969, ch. 19 and 20.
- [4] A.A.Oliner and D.R. Jackson, "Leaky-wave antennas," in *Antenna Engineering Handbook*, J.Volakis, Ed. New York: McGraw-Hill, 2007.
- [5] D. R. Jackson and A. A. Oliner, "Leaky-Wave antennas," in *Modern Antenna Handbook*, C. Balanis, Ed. New York: Wiley, 2008.
- [6] *Handbook of Artificial Material. Theory and Phenomena of Metamaterials*, F. Capolino, Ed. Boca Raton, FL: CRC Press, 2009.
- [7] C. Caloz and T. Itoh, *Electromagnetic Metamaterials: Transmission Line Theory and Microwave Applications*. Hoboken, NJ: Wiley, 2006.
- [8] P. S. Kildal, "Artificially soft and hard surfaces in electromagnetics," in *IEEE Transactions on Antennas and Propagation*, vol. 38, no. 10, pp. 1537-1544, Oct 1990.
- [9] B. Le Lepvrier, R. Loison, R. Gillard, P. Pouliguen, P. Potier and L. Patier, "A new hybrid method for the analysis of surrounded antennas mounted on large platforms," in *IEEE Trans. Antennas Propag.*, vol. 62, no. 5, pp. 2388-2397, May 2014.
- [10] R. Qiang, J. Chen, F. Capolino, D. R. Jackson and D. R. Wilton, "ASM-FDTD: A technique for calculating the field of a finite source in the presence of an infinite periodic artificial material," in *IEEE Microw. Wireless Comp.s Lett.*, vol. 17, no. 4, pp. 271-273, April 2007.
- [11] S. D. Gedney and R. Mittra, "Analysis of the electromagnetic scattering by thick gratings using a combined FEM/MM solution," *IEEE Trans. Antennas Propag.*, 1991, 39, pp. 1605–1614.
- [12] A. Nicolet, S. Guenneau, C. Geuzaine, F. Zolla, "Modelling of electromagnetic waves in periodic media with finite elements," *Journal of Computational and Applied Mathematics*, vol. 168, no. 1–2, pp. 321-329, 2004.
- [13] A. F. Peterson, S. L. Ray, and R. Mittra, *Computational Methods for Electromagnetics*. New York: IEEE Press, 1998.
- [14] P. Baccarelli, C. Di Nallo, S. Paulotto, and D. R. Jackson, "A full-wave numerical approach for modal analysis of 1D periodic microstrip structures," *IEEE Trans. Microw. Theory Tech.*, vol. 54, pp. 1350–1362, Apr. 2006.

- [15] R. Florencio, R. R. Boix, J. A. Encinar and G. Toso, "Optimized periodic MoM for the analysis and design of dual polarization multilayered reflectarray antennas made of dipoles," in *IEEE Trans. Antennas Propag.*, vol. 65, no. 7, pp. 3623-3637, July 2017.
- [16] T. F. Eibert, J. L. Volakis, D. R. Wilton and D. R. Jackson, "Hybrid FE/BI modeling of 3-D doubly periodic structures utilizing triangular prismatic elements and an MPIE formulation accelerated by the Ewald transformation," in *IEEE Trans. Antennas Propag.*, vol. 47, no. 5, pp. 843-850, May 1999.
- [17] G. Valerio, P. Baccarelli, P. Burghignoli, and A. Galli, "Comparative analysis of acceleration techniques for 2-D and 3-D Green's functions in periodic structures along one and two directions," *IEEE Trans. Antennas Propag.*, vol. 55, n. 6, pp. 1630-1643, 2007.
- [18] A. L. Fructos, R. R. Boix, F. Mesa, and F. Medina, "An efficient approach for the computation of 2-D Green's functions with 1-D and 2-D periodicities in homogeneous media," *IEEE Trans. Antennas Propag.*, vol. 56, pp. 3733-3742, Dec. 2008.
- [19] A. M. Linton, "Lattice sums for the Helmholtz equation," *SIAM Rev.*, vol. 52, no. 4, pp. 630-674, 2010.
- [20] L. Fructos, R. R. Boix and F. Mesa, "Efficient computation of the off-diagonal elements of the vector-potential multilayered periodic dyadic Green's function," in *IEEE Trans. Antennas Propag.*, vol. 59, no. 7, pp. 2557-2564, July 2011.
- [21] F. T. Celepcikay, D. R. Wilton, D. R. Jackson and W. A. Johnson, "Interpolation of Ewald-accelerated periodic Green's function representations for homogeneous or layered media," in *IEEE Trans. Antennas Propag.*, vol. 65, no. 5, pp. 2517-2525, May 2017.
- [22] M. H. B. Cardoso, S. Mostarshedi, G. Baudoin, and J. M. Laheurte, "Analytical expressions of critical distances for near-ground propagation," in *Trans. Antennas Propag.*, in press.
- [23] D. M. Pozar, *Microwave Engineering*. John Wiley and Sons, Inc., 2011. Ch. 8: Microwave Filters.
- [24] Yann, R. Loison, R. Gillard, M. Labeyrie, and J. P. Martinaud, "A new approach combining surrounded-element and compression methods for analyzing reconfigurable reflectarray antennas," in *IEEE Trans. Antennas Propag.*, vol. 60, no. 7, pp. 3215-3221, July 2012.
- [25] K. A. Michalski and D. Zheng, "Electromagnetic scattering by sources of arbitrary shape in layered media, Part I: Theory," *IEEE Trans. Antennas Propag.*, vol. 38, no. 3, pp. 335-344, Mar. 1990.
- [26] R. Gillard, J. H. Corre, M. Drissi and J. Citerne, "A general treatment of matched terminations using integral equations modeling and applications," in *IEEE Transactions on Microwave Theory and Techniques*, vol. 42, no. 12, pp. 2545-2553, Dec 1994.
- [27] S. Mostarshedi, E. Richalot, J. M. Laheurte, M. F. Wong, J. Wiat and O. Picon, "Fast and accurate calculation of scattered electromagnetic fields from building faces using Green's functions of semi-infinite medium," in *IET Microwaves, Antennas & Propagation*, vol. 4, no. 1, pp. 72-82, January 2010.
- [28] D. P. Chrissoulidis and J. M. Laheurte, "Dyadic Green's function of a nonspherical model of the human torso," in *IEEE Transactions on Microwave Theory and Techniques*, vol. 62, no. 6, pp. 1265-1274, June 2014.
- [29] F. T. Celepcikay, D. R. Wilton, D. R. Jackson and F. Capolino, "Choosing splitting parameters and summation limits in the numerical evaluation of 1-D and 2-D periodic Green's functions using the Ewald method," in *Radio Science*, vol. 43, no. 06, pp. 1-11, Dec. 2008.
- [30] J. M. Laheurte, M. Roustia and S. Marchetti, "Improved frequency domain analysis of microstrip circuits by the method of moments," in *IEE Proceedings - Microwaves, Antennas and Propagation*, vol. 142, no. 6, pp. 421-428, Dec 1995.
- [31] N. Apaydin, L. Zhang, K. Sertel and J. L. Volakis, "Experimental validation of frozen modes guided on printed coupled transmission lines," in *IEEE Trans. Microw. Theory Tech.*, vol. 60, no. 6, pp. 1513-1519, June 2012.
- [32] J. Naqui, M. Duran-Sindreu, A. Fernandez-Prieto, F. Mesa, F. Medina and F. Martin, "Multimode propagation and complex waves in CSRR-based transmission-line metamaterials," in *IEEE Antennas Wireless Propag. Lett.*, vol. 11, pp. 1024-1027, 2012.

2

Exciting Localized Waves with Frequency-Dispersive Radiating Systems

In this chapter, I discuss the effect of frequency dispersion for the excitation of Bessel beams [1] and localized waves (i.e., pulses) [2]. They are solutions of the wave equation, and can be excited in the near field of a finite-size antenna. Near-field shaping is an interesting technique having a great number of applications, such as medical imaging, diagnostic, power wireless transfer, near field communications. At optical frequencies the electrical size of devices is such that diffraction and polarization phenomena can be neglected under certain hypotheses. Different kinds of lenses and gratings have been proposed for near-field shaping at those frequencies [3]-[5]. Tackling the problem at microwave and millimeter waves is much more difficult, since, as geometrical optics is not a valid tool, a full-wave vector treatment of Maxwell's equations is necessary. Focusing the electromagnetic field in a limited region of space has only recently been done by means of low-profile and low-cost layered structures [6],[7].

Bessel beams are monochromatic solutions of the wave equation which propagate along a direction (e.g., the z direction) in free-space without experiencing diffraction. This means that their cross section on the xy plane is invariant as the wave propagates. A TM^z Bessel beam (dual expressions hold for TE^z Bessel beams) is defined by the electric field components in polar coordinates:

$$E_z(\rho, \phi, z) = E_0 J_n(k_\rho \rho) e^{-jn\phi} e^{-jk_z z} \quad (1)$$

$$E_\rho(\rho, \phi, z) = -j \frac{k_z}{k_\rho} E_0 J'_n(k_\rho \rho) e^{-jn\phi} e^{-jk_z z} \quad (2)$$

$$E_\phi(\rho, \phi, z) = -\frac{nk_z}{k_\rho^2} E_0 \frac{J_n(k_\rho \rho)}{\rho} e^{-jn\phi} e^{-jk_z z} \quad (3)$$

with $k_z = \sqrt{k_0^2 - k_\rho^2}$. The integer n is the order of the beam and describes the possible presence of an angular momentum in the beam. The most common case is $n = 0$, where $E_\phi(\rho, \phi, z) = 0$ and an azimuthal symmetry is present. A polychromatic superposition of Bessel beams yields a wave focused both on the xy plane and on the z longitudinal direction (i.e., a **localized pulse**).

The beam in (1)-(3) can be excited by enforcing on the entire plane $z = 0$ a transverse field distribution of the kind (2)-(3):

$$\mathbf{E}(\rho, \phi) = -j \frac{k_z}{k_\rho} E_0 J'_n(k_\rho \rho) e^{-jn\phi} e^{-jk_z z} \hat{\boldsymbol{\rho}} - \frac{nk_z}{k_\rho^2} E_0 \frac{J_n(k_\rho \rho)}{\rho} e^{-jn\phi} \hat{\boldsymbol{\phi}}. \quad (4)$$

This is a vector cylindrical standing wave whose radial dependence is described by the Bessel function J_n . The necessary truncation of the aperture to a certain radius ρ_{ap} eventually introduce diffraction after a certain plane (non-diffractive range)

$$z = z_{\text{ndr}} = \rho_{\text{ap}} \sqrt{\left(\frac{k_0}{\beta_\rho}\right)^2 - 1} \quad (5)$$

where β_ρ is the real part of k_ρ (whose imaginary part is assumed much smaller than β_ρ). For $z > z_{\text{ndr}}$, the beam is no more focalized on the xy planes.

The cylindrical standing-wave nature of the Bessel function J_n in (4) requires a resonant structure, and it is not compatible with the excitation of a pulse (a wideband Bessel beam). Fortunately, an inward cylindrical travelling wave $H_n^{(1)}$ can replace the J_n standing wave in (4), and excite a Bessel beam in a suitable region within the non-diffractive range [19],[P35]:

$$\mathbf{E}(\rho, \phi) = -j \frac{k_z}{k_\rho} E_0 H_n^{(1)'}(k_\rho \rho) e^{-jn\phi} e^{-jk_z z} \hat{\boldsymbol{\rho}} - \frac{nk_z}{k_\rho^2} E_0 \frac{H_n^{(1)}(k_\rho \rho)}{\rho} e^{-jn\phi} \hat{\boldsymbol{\phi}} \quad (6)$$

The travelling wave nature of (6) is more interesting for large-band applications. However in a real radiating system, even the illumination field (6) presents a form of frequency dispersion [i.e., $k_\rho = k_\rho(\omega)$ and $k_z = k_z(\omega)$ are nonlinear functions]. The impact of this dispersion on the excitation of localized pulses will be the final conclusion of this chapter.

The topics discussed in this chapter are a part of my activities during my postdoc at IETR. However, the last results have been obtained when I was already at Sorbonne, and have recently been presented at the 2018 *EuCAP* conference, receiving the best paper award in Electromagnetic Theory. In Section 2.1, I introduce radial line slot array (RLSA) antennas and an optimization method to enforce a desired field (not necessarily a Bessel beam) in a certain region of space at a single frequency. The optimization of these structures is made possible by mean of a full-wave code described in Section 2.2. In Section 2.3, I describe a cavity resonating at millimeter waves for the excitation of a Bessel beam by using the illumination (4). In the rest of the chapter, the RLSA optimization is used in order to excite wide-bandwidth Bessel beams with the illumination (6). As a conclusion of the previous works, the impact of the field-aperture dispersion on the excitation of localized pulses is studied for the first time in Section 2.5 for zeroth order pulses and for pulses carrying angular momentum.

2.1 RLSA for Near-Field Synthesis

Collaboration with University of Siena, Italy [P27]

The design techniques used for focusing and shaping the electromagnetic field in the near-field or Fresnel zone of an antenna stem from the seminal works in [8]–[10]. In these works, large (in terms of wavelength) and linearly-polarized apertures are considered and an equivalence between their near and far fields is derived. The considered near fields are either transversal or longitudinal to the axis of a defined focal plane parallel to the focusing aperture. In brief, it is shown that the fields in the Fresnel and far-field zones exhibit the same properties if a quadratic phase taper is imposed to the tangential

field distribution of the focusing aperture. Therefore, the optimization/shaping of the fields in the Fresnel zone is generally done by using classical far-field techniques. This is strictly valid as long as the focal plane is placed at distance larger than one aperture size and generally beyond the near-field or reactive zone of an antenna. In addition, there is no control or design flexibility on the aperture and spillover efficiency, polarization, and size of the system. Besides, complicated and lossy beam forming networks are used to practically implement the required aperture field distribution introducing inevitable distortions [11]–[12].

A method for the automatic design of radial-line slot array (RLSA) antenna [see Fig. 1(a)] is here used to design, build, and measure a prototype focusing the normal component of the electric field in the near field with reduced side lobe levels and defined beamwidth. The design methodology is divided in two main steps. In the first step, the required near-field pattern is defined over a certain plane parallel to the RLSA aperture. The aperture field distribution generating such near-field pattern is then derived based on a set theoretic approach and alternate projection method [Fig. 1(b)]. In the second step, the derived aperture distribution is synthesized on the RLSA aperture by properly tuning the positions and sizes of the slots of the RLSA [see Fig. 1(a)]. The automatic design procedure optimizes a great number of variables by simulating the linked to-the-house Method of Moment (MoM) described in next section. The use of the full-wave code correctly takes into account mutual coupling among slots and keeps the computation time of each optimization step sufficiently short so that a full optimization is feasible in a few hour span. The same procedure could not be possible by simulating the intermediate structures with usual commercial software.

The normalized component of the electric field radiated by the optimized RLSA along the x - and y -axis on the focusing plane is shown in Fig. 2. The field radiated by the derived ideal aperture field distribution is also shown for comparison. A small difference can be noticed in the lobes lower than 20 dB but in all cases the patterns are within the imposed mask. Besides, the field radiated by the RLSA antenna has a good azimuthal invariance.

A prototype of the RLSA has been manufactured and tested at IETR [Fig. 3(a)]. The slots of the RLSA are etched by laser ablation on the upper face of a double grounded Neltec NY9217 substrate with permittivity $\epsilon_r = 2.17$ and thickness $h = 3.175$ mm.

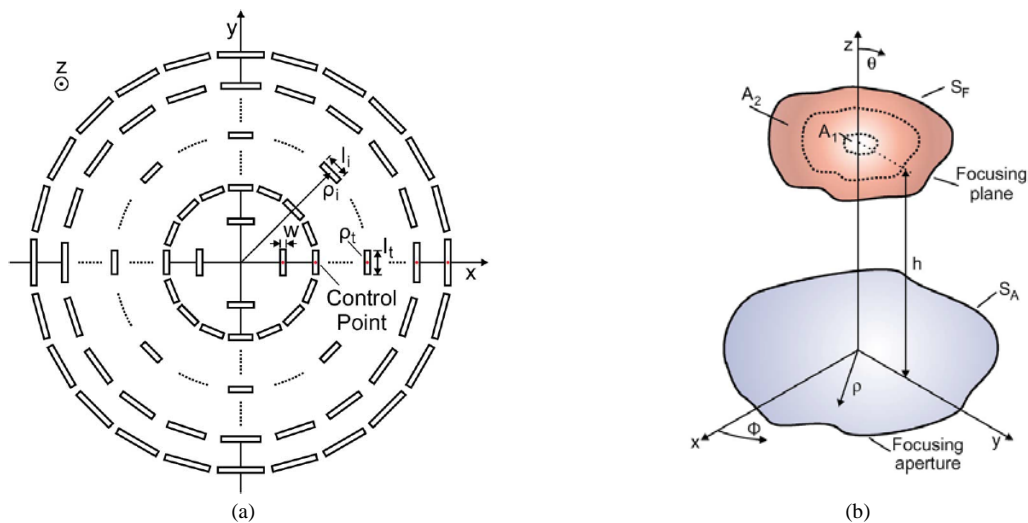

Fig. 1 – (a) Geometry of the RLSA (top view). The slots on each ring have the same length l . The width of the slots w is constant. The slots are uniformly distributed over the rings along ϕ . (b) Geometry of the problem with two generic surfaces defined on two parallel planes orthogonal to the z -axis. The aperture (i.e., the RLSA antenna) is located at $z = 0$. The focusing plane is at $z = h$.

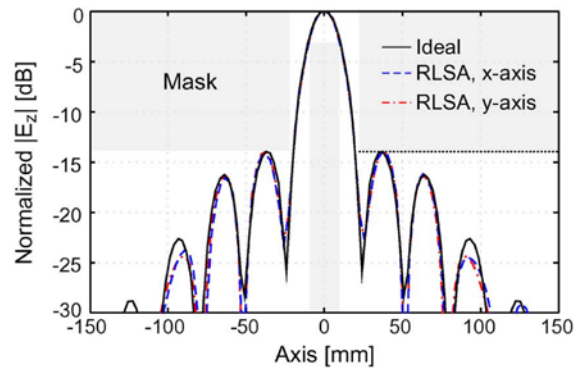

Fig. 2 - Normalized component of the electric field in the focusing plane ($z = 150$ mm, the antenna being at $z = 0$) radiated at 12.5 GHz by: ideal aperture field distribution (solid line); synthesized RLSA (blue dashed line along the x-axis, red dashed-dotted line along the y-axis). The reference mask is also provided for comparison. The antenna diameter is 300 mm.

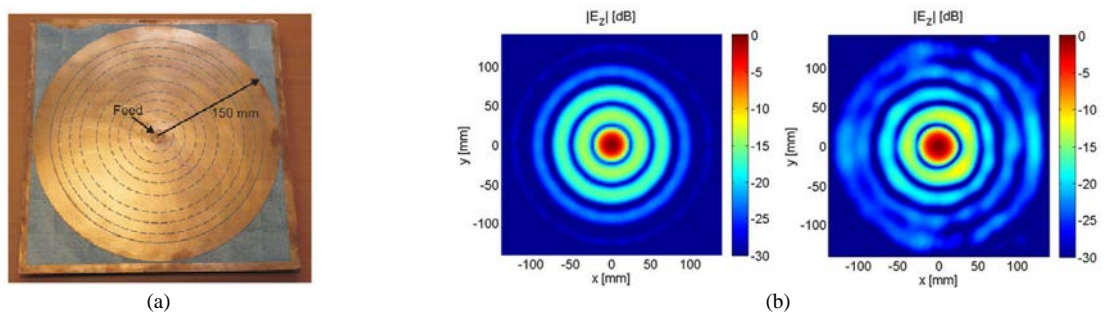

Fig. 3 – (a) Final prototype. The slots have been etched by laser ablation. (b) Normalized E_z component of the electric field at on the focusing plane.: 2-D MoM electric field plot (left) and 2-D measured electric field plot (right).

Good agreement is achieved between the measured and simulated results. This is evident in the 2-D plots of the fields in Fig. 3(b). A good circular symmetry of the pattern can be appreciated. Very small discrepancies between measured and simulated results can be noticed for side lobes lower than 15 dB at the edge of the measured space. Such discrepancies may be attributed to the fabrication tolerances related to the etching process used for the slots of the RLSA structure.

2.2 Hybrid Mode-Matching/MoM Code for Stacked SIW

Co-supervision of Josip Seljan (PhD student at IETR), and of Matthieu Bertrand (currently postdoc at Sorbonne) [P24],[P25],[P34]

A fast and accurate analysis tool is needed for designing and optimizing the RLSA antennas described in this chapter. To this aim, Dr. Massimiliano Casaletti and I have developed a code for the study of slotted stacked substrate-integrated waveguides (SIWs) (see Fig. 4). This kind of structure can be used to implement several device, ranging from relatively simple filters [13], to complex radiating slot arrays [14]. Existing numerical methods either are applicable to large structures but do not take into account specific features of the structures [15],[16], or overly simplify the problems by assuming restrictive symmetries or simplified field variations (e.g., periodicity or absence of vertical or azimuthal variation of the post currents) [17]. Rather, **our full-wave code takes advantage of specific SIW features to accurately analyze complex and electrically large structures through a realistic detail of all the relevant components.** Specifically, azimuthal variations around the posts are required to model posts with moderate diameter, while vertical PPW modes are required to model the breaking of vertical uniformity due to slot coupling and coaxial excitation. Our approach exploits the

advantages of method of moments (MoM) and mode matching (MM), as well as convenient representations of electromagnetic fields.

Radiating or coupling slots are accounted for by introducing equivalent magnetic currents. Boundary conditions on slots are enforced and a method of moments is formulated and solved. The MoM matrix entries are computed as usual as the reaction integral of the magnetic field radiated by a basis function defined on a slot on a testing function defined on another (or the same) slot. The magnetic field is expressed as the sum of a direct coupling (in the absence of vertical posts) plus a post-scattering contribution.

In order to calculate the direct PPW contribution, we use an analytical expression for the PPW Green's function, available thanks to the absence of posts. We use a radial transmission-line representation which converges much faster than the alternative z transmission-line representation for large radial distances. In fact, since only one cylindrical wave is usually propagating inside each PPW, the summation over cylindrical waves can be truncated by retaining a small number of radial terms. This enhanced convergence for large radial distances is particularly useful to model structures as in Fig. 4, since many slots are electrically far and their coupling is computed by sampling the Green's function for large values of $|\boldsymbol{\rho} - \boldsymbol{\rho}'|$.

The post-scattering contribution to the MoM matrix cannot be computed with an analytic Green's function, since the presence of post is here taken into account. Its expression is ($\mathbf{H}^{\text{Post},f}$ is the magnetic field scattered by all the posts when the f th basis function on a slot radiated):

$$Y_{k,f}^{\text{Posts}} = \int_S \mathbf{b}_k(\mathbf{r}) \cdot \mathbf{H}^{\text{Posts},f}(\mathbf{r}) d\mathbf{r} = \sum_{p=1}^{N_{\text{post}}} \sum_{n=-\infty}^{+\infty} \left[A_{0,n,p}^{\text{TM},f} I_{0,n,p}^{\text{TM},k} + \sum_{m=1}^{+\infty} \left(A_{m,n,p}^{\text{TM},f} I_{m,n,p}^{\text{TM},k} + A_{m,n,p}^{\text{TE},f} I_{m,n,p}^{\text{TE},k} \right) \right] \quad (7)$$

The I coefficients are the interaction integrals between a cylindrical wave and a test function. They are computed on a steepest-descent path requiring very few quadrature points [P25]. The coefficients A , arranged in vectors \mathbf{A}_m^{TM} and \mathbf{A}_m^{TE} (one per each PPW m -mode) are the solution of mode-matching linear problems:

$$\underline{\mathbf{T}}_m^{\text{TM}} \cdot \mathbf{A}_m^{\text{TM}} = \Omega_m^{\text{TM},f}, \quad \underline{\mathbf{T}}_m^{\text{TE}} \cdot \mathbf{A}_m^{\text{TE}} = \Omega_m^{\text{TE},f} \quad (8)$$

where $\underline{\mathbf{T}}$ are the post-post interaction matrices for each PPW mode. Once solved, these coefficients are re-used for the computation of all the MoM matrix entries.

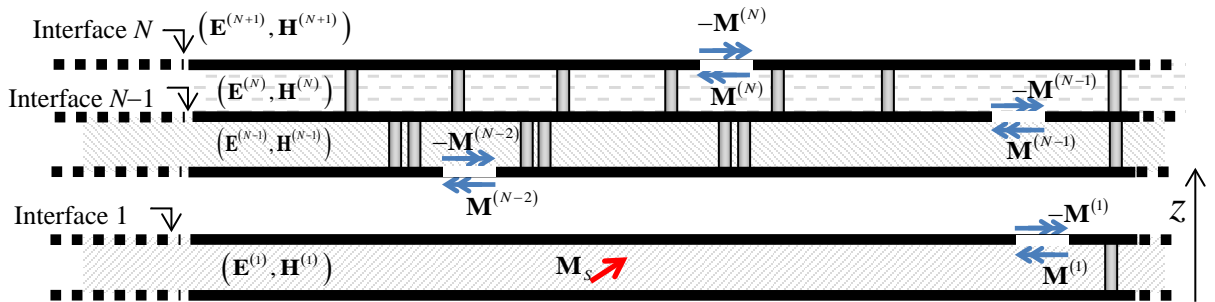

Fig. 4 - Stacked-PPW geometry analyzed in Section 2.2.

The present global implementation: *i*) accurately models dielectric posts; *ii*) includes an arbitrary number of aperture-coupled stacked PPWs; *iii*) considerably reduces the computation effort due to MM problems for radially attenuated modes by restricting the analyses to a limited number of posts selected through a simple rule-of-thumb; *iv*) simplifies the computation of MoM matrix entries and forcing terms due to post scattering, by means of simple formulas requiring no numerical integration. Moreover, we have suggested acceleration strategies based on common symmetries of slot arrays. These are possible since we can isolate the physical contributions of different wave species (PPW modes, free-space interactions, post scattering, guided waves) in the complete expressions of the MoM matrix entries. This would not hold for a MoM discretizing all the vertical posts or for a finite-element approach.

2.3 Leaky-wave Resonances Exciting Bessel Beams

Co-supervision of Walter Fuscaldo (PhD student co-directed at Sapienza and IETR) [P31]

The excitation of a Bessel beam with the resonant illumination (4) (the azimuthally symmetric case $n=0$ is here considered) can be done by placing an artificial surface on the top of a dielectric slab short-circuited at its end with a circular metallic rim [6] in order to obtain a stationary wave in the resulting cavity [see Fig. 5(a)]. The stationary wave, launched by a central coaxial cable, has a Bessel profile on the aperture, which is a sufficient condition to excite a Bessel beam. The single mode operation of the launcher proposed in [6] working at around 10 GHz restricts the separation between the impedance sheet and ground plane of the radial waveguide to thicknesses much smaller than the operating wavelength. Scaling the structure to the millimeter-wave range would require extremely thin waveguides (e.g., a thickness of the dielectric substrate equal to $37.6 \mu\text{m}$ at $f = 40 \text{ GHz}$) leading to restrictively high ohmic losses and practical mechanical problems. For this reason, **we have proposed a Bessel-beam launcher at millimeter waves using higher-order TM leaky modes**. While the structure is basically the same as in Fig. 5(a), a completely novel design approach is thus proposed based on dispersion analysis, valid for this new operation mode.

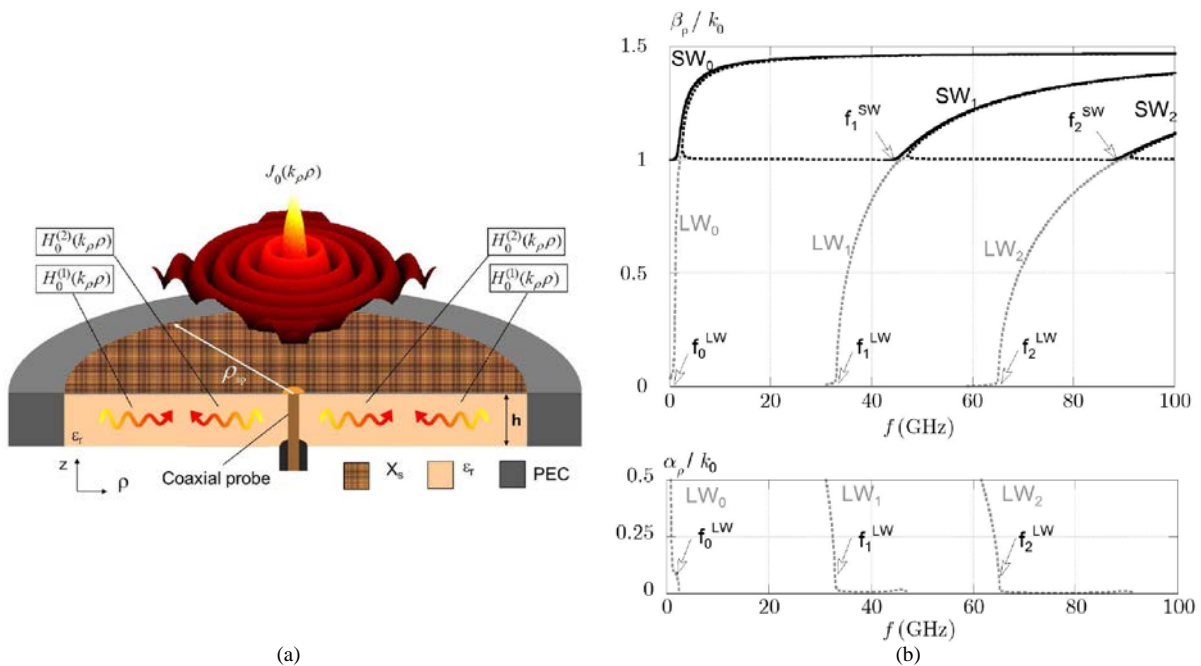

Fig. 5 – (a) Illustration of the leaky-mode Bessel-beam launcher under consideration. The red arrows show the outward and inward cylindrical waves launched within the structure by a central coaxial probe. The interference of these cylindrical waves creates a Bessel beam. (b) Normalized phase and attenuation constants versus frequency f from dc to 100 GHz for the first TM modes of the layered structure as in Fig. 5(a). SW modes are shown by black solid lines, whereas the LW modes are shown by gray dashed lines

In Fig. 5(b), a dispersive analysis of the layered structure (transversely unbounded, in the absence of the circular metallic rim) is shown. Since $\beta_p < k_0$ is required in order to have a propagating Bessel beam, only leaky waves are of interest in this design. Instead of working with the fundamental leaky wave (LW_0), the higher-order LW_1 is used to work at higher frequencies without reducing the resonator thickness. Suitable closed-form equations are derived to establish the annular spectrum needed for the generation of propagating Bessel beams. By following these formulas, the artificial surface on the top of the resonator is synthesized with a glide-symmetric (see Section 3.2) array of patches [Fig. 6(a)]. The final fabricated prototype is shown in Fig. 6(b) and the vertical measured field at different reference planes is shown in Figs. 7.

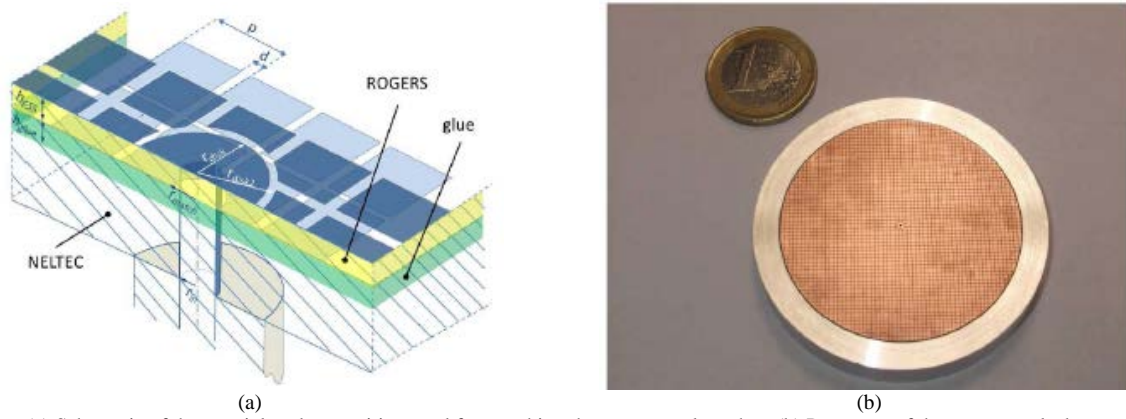

Fig. 6 – (a) Schematic of the coaxial probe transition used for matching the mm-wave launcher. (b) Prototype of the mm-wave leaky-mode Bessel-beam launcher. The feeding probe can be recognized at the center of the structure.

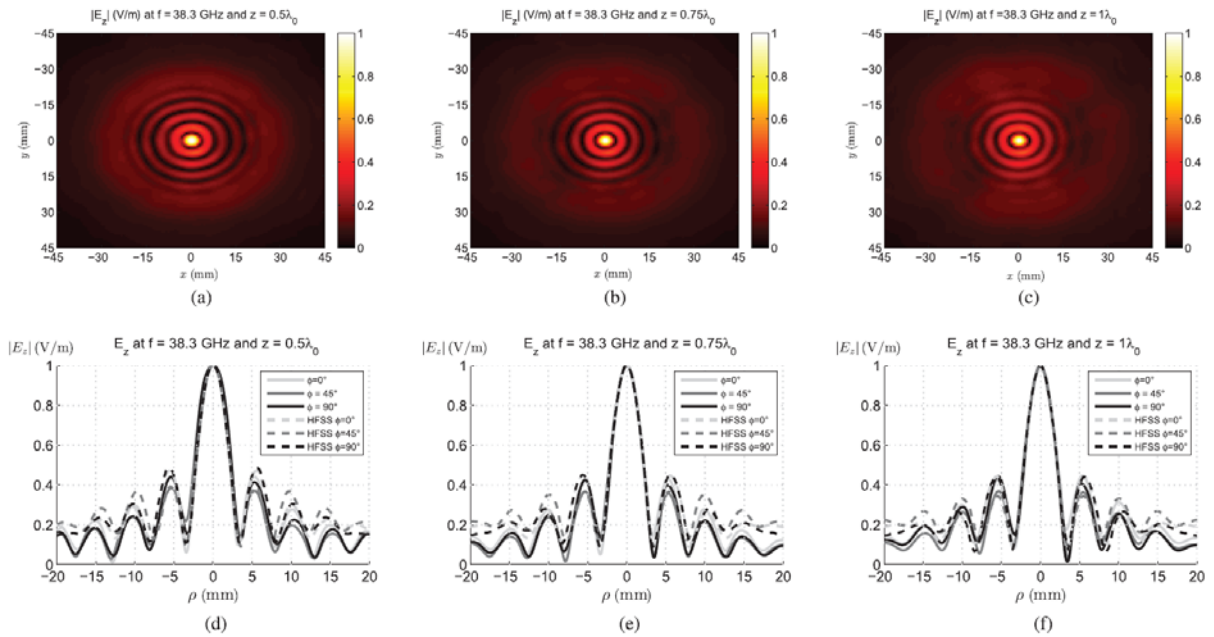

Fig. 7 – Measured patterns of the normalized E_z component of the electric field at $f = 38.3$ GHz at three different distances $z = 0.5\lambda_0, 0.75\lambda_0, 1\lambda_0$ from the impedance surface, where λ_0 equal to 7.5 mm. (a)–(c) Contour plots of the measured field. (d)–(f) A comparison between measurements and simulations along different azimuthal ϕ planes.

2.4 Rotating Beams

Co-supervision of Davide Comite (PhD student at Sapienza visiting IETR) [P36]

The structure presented in the previous section is based on the excitation of a resonant mode, which limits its operational bandwidth. As said in the introduction of this chapter, recent works have shown the possibility to generate nondiffractive Bessel beams by using only inward cylindrical traveling waves. This solution avoids resonant radiating apertures and allows for a wider band operation of the launcher. In this framework, the adoption of RLSA antennas allow for the implementation of low cost, compact, and highly efficient antenna centrally fed by a coaxial probe (as in Section 2.1), which have also a wider operational bandwidth.

While this possibility has been proved in [19] only for zeroth order Bessel beams, **we prove the possibility to excite also a higher-order Bessel beam with a traveling-wave illumination.** This beam carries on an orbital angular momentum (OAM) in the near field of the radiating structure. We propose here a RLSA device for its ease of fabrication and feeding system. To this aim, the near-field optimization procedure in Section 2.1 has suitably been modified and extended to take into account the phase profile of the considered aperture field distribution. Besides, the in-house method of moments (Section 2.2) is used during the optimization process to carefully consider the mutual coupling amongst the slots and maximize the radiation efficiency.

We consider here as an example the generation of a Bessel beam with $n = 1$ and $k_\rho \rho_{\text{ap}} = 0.4k_0$, at the operating frequency $f = 12.5$ GHz. However, the results can be easily reproduced at different frequencies and for different orders n . The field radiated in free space by each aperture distribution is evaluated numerically by means of Green's function integrals by defining equivalent magnetic currents for the field profile over the aperture [29]. In Fig. 8, the magnitudes and phases of the z -component of the electric field excited by an *infinite aperture* (i.e., an aperture with radius ρ_a much larger than $\lambda = 2.4$ cm) are presented. A standing wave excitation is considered in Fig. 8(a) and (b), while an inward wave is considered in Fig. 8(c) and (d). As expected, the standing wave excites a Bessel beam in the whole space. The inward wave excites the beam in a limited region of space, extending the results in [19] which were limited to azimuthally symmetric (i.e., 0th-order) beams. In both cases, it is possible to recognize the null of the magnitude on the z -axis, the magnitude oscillations of the J_1 functions, and a rotation of the phase typical of the vortex beam. In Fig. 9, the electric fields excited by a *finite circular aperture* with $\rho_{\text{ap}} = 25$ cm are shown. The same qualitative features of Fig. 8 can be remarked, but the finite aperture limits the NDR up to a distance $z_{\text{ndr}} = 57.3$ cm along z in both cases.

We extend the optimization procedure proposed in Section 2.1 for RLSAs to take into account the phase variation of the aperture field profile. The optimization procedure will provide the final slot layout for the RLSA. To give a practical example, Fig. 10 shows the holographic pattern for the RLSA to synthesize an aperture field having an azimuthal phase variation of order $n = 1$. The spiral arrangement of the slots constituting the RLSA profile is clearly visible.

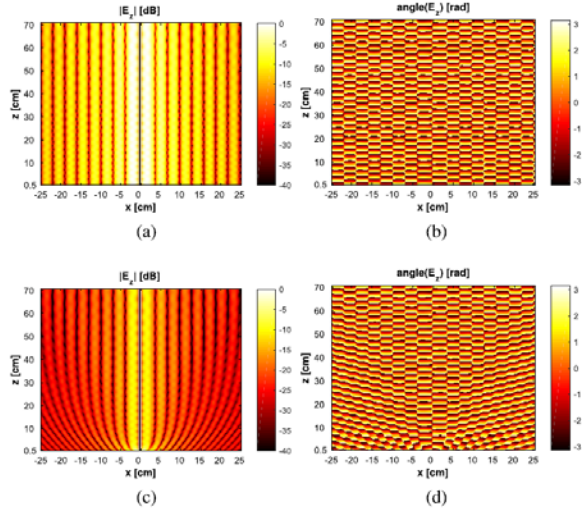

Fig. 8 - Normalized normal component of the electric field ($|E_z|$) radiated by an infinite ($\rho_{ap} \gg \lambda$) aperture. The field is plotted on a longitudinal plane (xz , i.e., orthogonal to the radiating aperture). Standing-wave distribution (a) amplitude and (b) phase. Inward-wave distribution (c) amplitude and (d) phase.

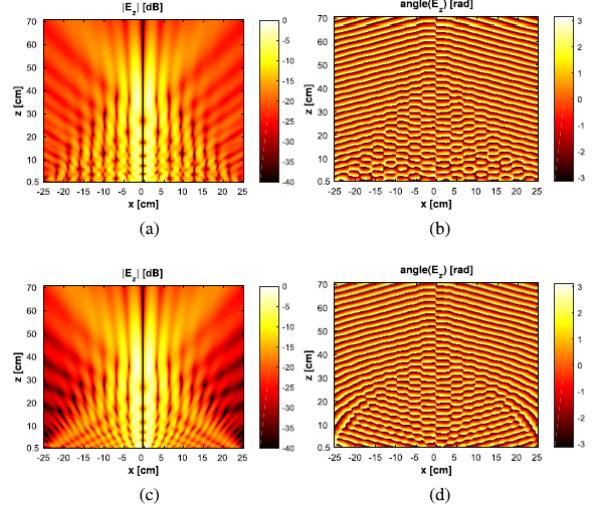

Fig. 9 - Normalized normal component of the electric field ($|E_z|$) radiated by a finite ($\rho_{ap} = 25$ cm) aperture with an ideal illumination and $n = 1$. The field is plotted on a longitudinal plane (xz , i.e., orthogonal to the radiating aperture). Standing-wave distribution (a) amplitude and (b) phase. Inward-wave distribution (c) amplitude and (d) phase.

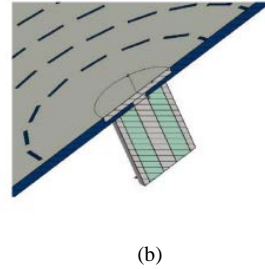
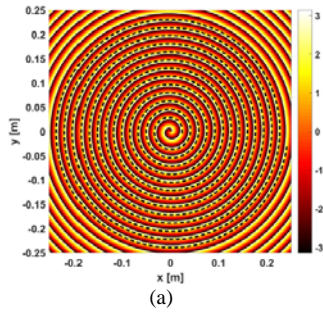

Fig. 10 – (a) Phase pattern obtained through interference. The slots follow a spiral arrangement. (b) Feeding system for the designed prototype.

In Figs. 11, 2-D plots of the normalized electric field E_z radiated by the optimized RLSA are provided on the longitudinal plane (i.e., xz plane) and transverse plane (i.e., xy plane) at different frequencies. Once again, the null in the origin associated with the first-order Bessel function is well defined inside the nondiffracting region. As expected, the focusing effect is maximum at about half of the nondiffracting range z_{ndr} . The phase pattern along the z -direction is coherent with the relevant rotation on the xy plane. Besides, the nondiffractive behavior is conserved within the considered band both in phase and in amplitude. The traveling-wave nature of the synthesized aperture distribution thus guarantees a wideband operation. As shown in Fig. 11(b) and (c) on the xy plane, the launcher still generates well-defined phase patterns for the Bessel beam with the expected azimuthal phase variation at different frequencies. Such large bandwidth behavior may pave the way for the generation of twisted X-waves (i.e., pulses). This will be described in next Section 2.5.

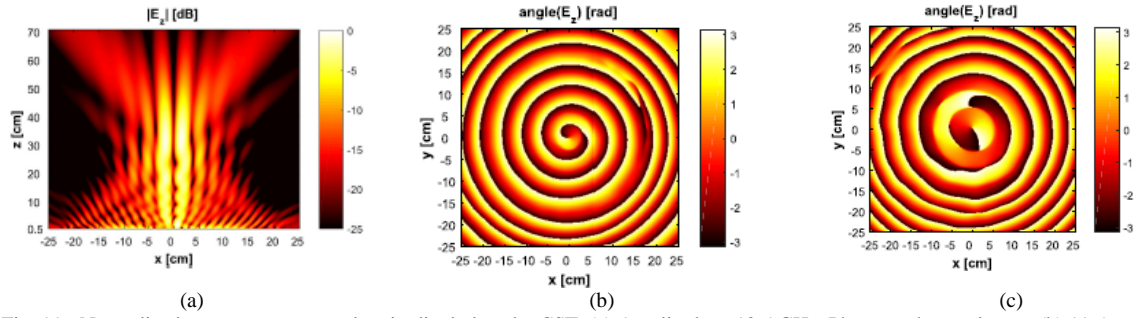

Fig. 11 - Normalized E_z component on a longitudinal plane by CST. (a) Amplitude at 12.5 GHz. Phase on the xy plane at (b) 11.5 and (c) 13.5 GHz.

2.5 Frequency-Dispersive Excitation of X waves

Co-supervisions of Walter Fuscaldo and Davide Comite (PhD students at Sapienza and IETR) [P33],[P35]

Although spatial and temporal confinements of an electromagnetic wave are closely related to each other, nondiffractive beams (monochromatic solutions) and pulses (polychromatic solutions) have been developed almost independently.

Nondispersive electromagnetic pulses were discovered during the 1980s [22]. As for ideal Bessel beams, these solutions were endowed by infinite energy [23] and thus nonphysical. Nonetheless, a particular class of these nondispersive, nondiffracting solutions, known as X-waves, has been studied in different branches of physics, especially in acoustics and optics, [24],[25] where pulses have been generated using finite apertures. Despite the large amount of works on X-waves (see [1] and references therein), most of them study the generation of X-waves under specific hypotheses, not always verified at millimeter waves. In particular, X-waves are frequently assumed to be nondispersive [26] and only few works have taken into account both the finiteness of the aperture and the wavenumber dispersion with frequency due to propagation in a dispersive medium [27]. Therefore, there is still a lack of a comprehensive study providing a detailed and suitable description of the focusing properties of such X-waves. In most practical applications, especially at millimeter waves, the radiating aperture is finite and the wavenumber is expected to vary nonlinearly with frequency (consider the case of the antennas in Sections 2.1 and 2.5). Neglecting dispersion in such polychromatic solutions is thus not possible for an accurate analysis. We aim to provide an analytical description of band-limited, dispersive, electromagnetic X-waves generated by finite apertures analyzing such effects at millimeter wavelengths.

We aim here to define the properties of localized pulses excited by apertures presenting a non-negligible frequency dispersion. Our discussion starts from the original formulation of an ideal X-wave, generated by an infinite aperture in the absence of frequency dispersion. By progressively removing all the simplifying hypotheses, it is still possible to generate an electromagnetic pulse with very interesting limited-diffraction and limited-dispersion properties. In the case of a zeroth order azimuthally symmetric pulse, the vertical electric field is

$$e_z(\rho, z, t) = \int_{-\infty}^{+\infty} F(\omega) J_0[k_\rho(\omega)\rho] e^{-jk_z(\omega)z} e^{j\omega t} d\omega \quad (9)$$

where J_0 is the zeroth-order Bessel function of the first kind, $F(\omega)$ is the frequency spectrum, ω is the angular frequency, z is the axis of propagation, and k_ρ , k_z are the transverse and longitudinal

wavenumbers, respectively, related by the separation relation $k^2 = k_z^2 + k_\rho^2$, with $k = \omega / c$ the free-space wavenumber and c is the velocity of light in vacuum. In particular, ideal X-waves can be thought as a superposition of ideal Bessel beams of infinite cross-section and sharing the same *axicon angle* θ

$$\theta = \arctan(k_\rho / k_z) \quad (10)$$

The Case of Nondispersive Excitation: Constant θ

Even under the hypotheses of constant θ and infinite aperture it is readily shown in the following that is not always possible to efficiently confine a pulse along both the transverse and the longitudinal axis, due to a finite operational bandwidth. To this aim, a “metric” has to be defined in order to intuitively characterize the spatial confinement efficiency of the pulse. It is known that a practical realization of X-waves requires a finite radiating aperture of radius ρ_{ap} , which limits the nondiffracting behavior of the constituent Bessel beams within a certain “non-diffractive range” z_{ndr} along the z -axis, given in (5).

Therefore, the spatial features of an ideal X-wave are well defined only within a certain ρz -plane limited by ρ_{ap} and z_{ndr} along the ρ - and z -axis, respectively. As a consequence, the energy of the pulse is efficiently confined along the ρ -axis if and only if the “spot width” along ρ (S_ρ) is much smaller than the aperture size (ρ_{ap}). Similarly, the confinement along the z -axis is effective if and only if the spot width along z (S_z) is smaller than the depth of field z_{ndr} . However, since we are also interested in solutions that are not efficiently confined in one direction but “extremely” confined along the other one, these constraints can be slightly relaxed and jointly enforced by requiring the product of the ratios $C_\rho = S_\rho / \rho_{\text{ap}}$ and $C_z = S_z / z_{\text{ndr}}$ be less than 1,

$$C_{z,\rho} = C_z C_\rho < 1 \quad (11)$$

where $C_{z,\rho}$ gives a measure of the spatial and temporal confinement for a practical realization of a generic X-wave. The smaller is $C_{z,\rho}$ the more confined is the X-wave. Obviously, for $C_{z,\rho} > 1$ there is no efficient confinement, since the transverse or the longitudinal spot widths exceed the aperture size or the depth of field, respectively. In the following, both the transverse and the longitudinal profiles of the ideal X-wave are calculated in closed forms assuming uniform frequency spectra. The analysis allows for the evaluation in close-form of C_ρ and C_z , thus of the spatiotemporal confinement properties of ideal X-waves:

$$C_{z,\rho} = \underbrace{\frac{j_{0.1}}{2\pi\hat{\rho}_{\text{ap}} \sin \theta}}_{C_z} \underbrace{\frac{2 \sin \theta}{\hat{\rho}_{\text{ap}} \overline{\Delta\omega} \cos^2 \theta}}_{C_\rho} = \frac{j_{0.1}}{\pi\hat{\rho}_{\text{ap}}^2 \cos^2 \theta} < 1 \quad (12)$$

where $\hat{\rho}_{\text{ap}} = \rho_{\text{ap}} / k_0$ is the aperture radius in the number of wavelengths and $\overline{\Delta\omega} = \Delta\omega / \omega_0$ is the fractional bandwidth. Finally, it is worth mentioning that the previous discussion on the confinement capabilities of X-waves is not related to any assumption on the chosen frequency spectrum.

In Fig. 12, the green hyperbola delimits a region of θ ; $\hat{\rho}_{\text{ap}}$ values for which (12) is satisfied, for two different values of the fractional bandwidth: $\overline{\Delta\omega} = 0.01$ [Fig. 12(a)] and $\overline{\Delta\omega} = 0.2$ [Fig. 12(b)]. As clearly shown, the region of efficient confinement increases as the fractional bandwidth increases up to $\overline{\Delta\omega} = 0.2$. Note that for higher values of $\overline{\Delta\omega}$ there are no significant changes with respect to Fig.

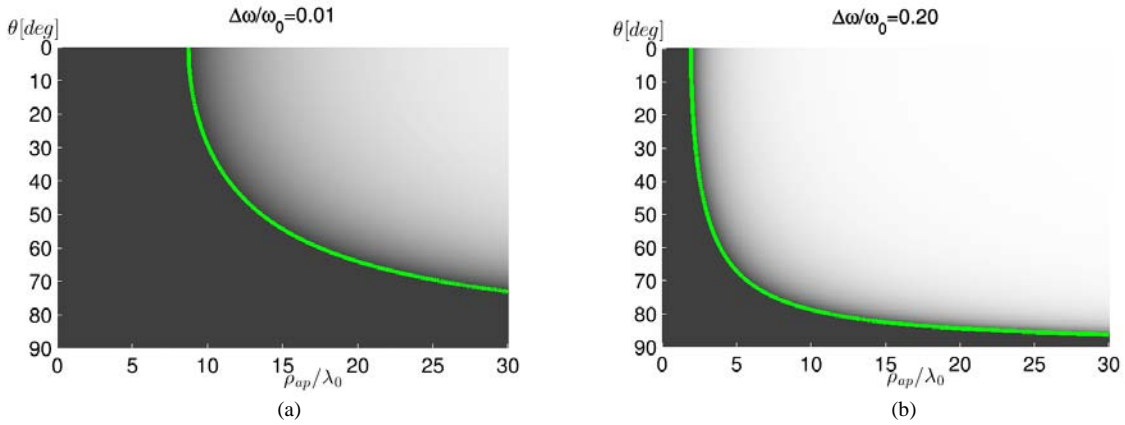

Fig. 12 - The green hyperbola represents the boundary between the region of efficient (in white) and non-efficient confinement (in grey) for ideal UXWs, when fractional bandwidths of (a) $\Delta\omega = 0.01$ and (b) $\Delta\omega = 0.2$ are considered.

12(b). However, from Fig. 12 it is easy to infer that electrically large apertures (high $\hat{\rho}_{ap}$) and low axicon angles θ are required to efficiently confine a pulse, even for an ideal X-waves. Furthermore, it is clear from (12) that the fractional bandwidth $\overline{\Delta\omega}$ controls the pulse confinement along the z -axis (C_z) without affecting the confinement along the ρ -axis (C_ρ). Conversely, θ affects both C_ρ and C_z . In particular, as θ increases, the pulse is more confined along ρ but spreads along z , and vice versa.

The Case of Dispersive Excitation

Until now, we assumed that the axicon angle is the same for each frequency within the considered band. However, in most electromagnetic devices, especially for those with considerable fractional bandwidths, a non-linear relationship between k_z , k_ρ , and ω is usually assumed, thus dispersion cannot be neglected. Generally, the dependence of both longitudinal and transverse wavenumbers on ω is not known in closed-form, but, for most cases (especially for narrow-band signals), it can be accurately described by the first terms of a Taylor series expansion.

In this case, the transport of the pulse is no longer rigid, hence both the transverse and longitudinal profiles depend on time. Moreover, the transverse profile as a function of time can only be calculated numerically. Nevertheless, the confinement factor is still well approximated by (12) provided that θ is now calculated at ω_0 .

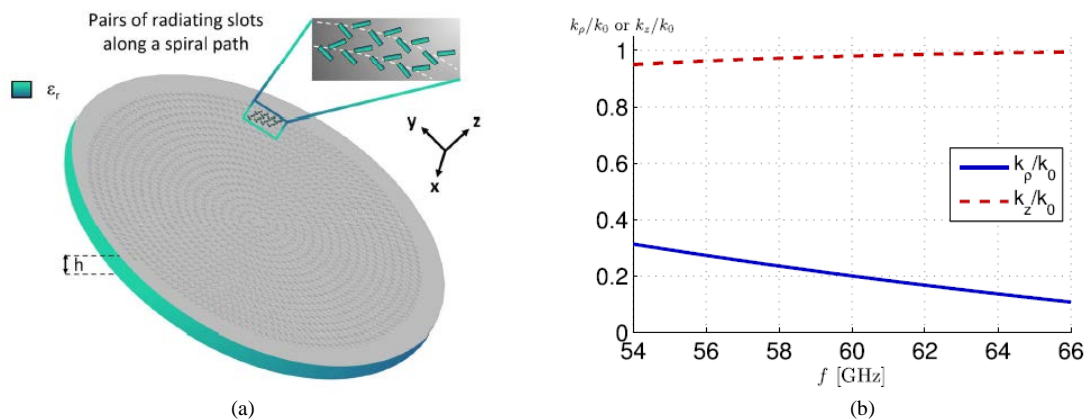

Fig. 13 - (a) Axonometric representation of the dielectric filled radial waveguide loaded with radiating slots. The device is centrally fed by a coaxial probe. (b) Dispersion of the longitudinal (red dashed line) and transverse normalized wavenumbers (blue solid line) with respect to the frequency in a fractional bandwidth $\overline{\Delta\omega} = 0.2$ around the carrier frequency $f = 60$ GHz.

If a RLSA is chosen to synthesize the required illumination, the aperture field distribution has an approximate dispersion behavior described by the expansion,

$$k_\rho(\omega) = k_\rho(\omega_0) - \frac{\sqrt{\epsilon_r}}{c}(\omega - \omega_0) \quad (13)$$

In Fig. 13(a), a RLSA is shown operating at $f_0 = 60$ GHz and with a finite radius of $\rho_{\text{ap}} = 15\lambda_0 = 75$ mm, where $\epsilon_r = 1.04$ is the relative permittivity of the dielectric material filling the radial waveguide. In Fig. 13(b) the dispersion relation of the RLSA is shown, following from the spiral alignment of the radiating slots that is needed to synthesize the desired aperture distribution. It is worth noting here that such wavenumber dispersion defines a space harmonic of backward type as required to radiate well-collimated waves.

Figs. 14(a)–(d) clearly show the impact of the bandwidth in the z -confinement of the pulse: the greater is the fractional bandwidth, the narrower is the spot size along the z axis. This behavior is also observable in Figs. 14(e)–(h) and 14(i)–(l), where the longitudinal spot size S_z of the pulse decreases as the bandwidth increases. However, in these last two cases the pulse no longer retains its shape as it propagates; hence, both the transverse and the longitudinal profiles of the pulse are different at each time frame. In particular, for both dispersive and dispersive-finite cases, the spot size over both ρ and z directions increases with time.

Further works have been conducted independently by the group at Sapienza University regarding the excitation of Bessel beams and X waves with leaky-wave antennas having the same kind of dispersion as (13) [28]. The features of the beams and waves have been explained there through the dispersive properties of the leaky wave supported by the structure.

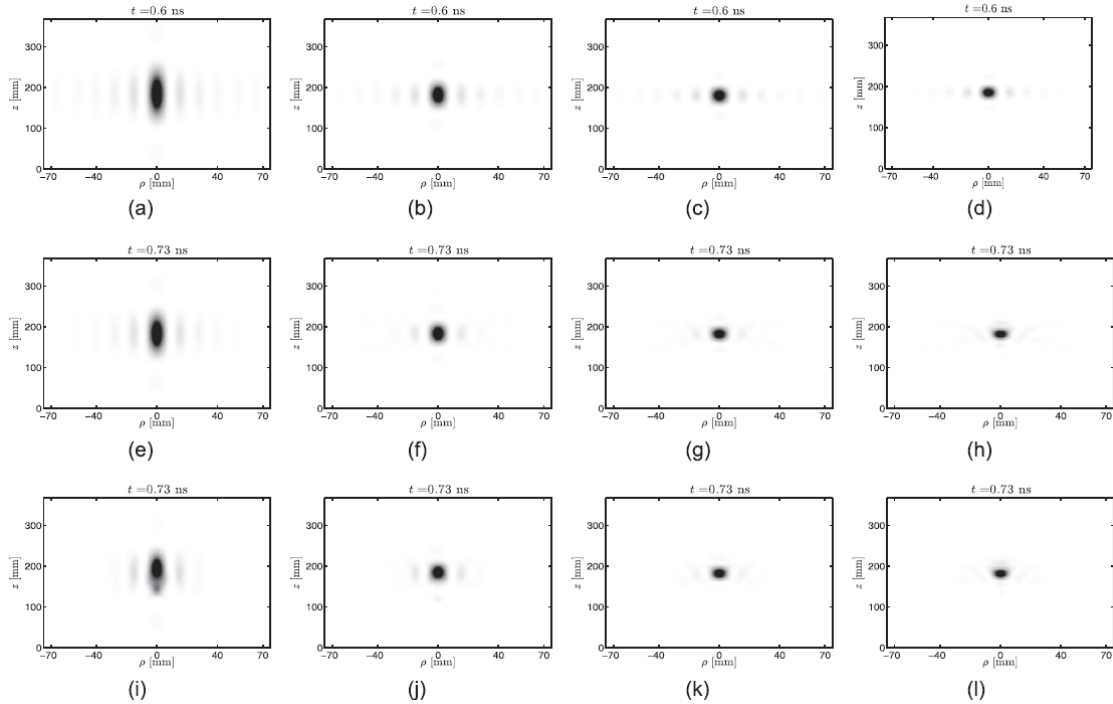

Fig. 14 - 2-D normalized intensities for ideal (first row: (a)–(d)), dispersive (second row: (e)–(h)), and dispersive-finite (third row: (i)–(l)) XWs, when the pulse has reached half the propagating distance of z_{ndr} . The numerical results are shown for $\overline{\Delta\omega} = 0.05$ (first column: (a), (e), and (i)), $\overline{\Delta\omega} = 0.1$ (second column: (b), (f), and (j)), $\overline{\Delta\omega} = 0.15$ (third column: (c), (g), and (k)), and $\overline{\Delta\omega} = 0.2$ (fourth column: (d), (h), and (l)).

A Dispersive Excitation Carrying Orbital Angular Momentum

In the same way as in the azimuthally symmetric X-wave presented in the previous section, a twisted X-wave can also be obtained by superposing continuously monochromatic Bessel beams over a certain frequency range. We prove this by numerically evaluating the inverse Fourier transform of the radiated beams E_z^{rad} as follows:

$$e_z^{\text{rad}}(\rho, \varphi, z; t) = \int_{-\infty}^{+\infty} F(\omega) E_z^{\text{rad}}(\rho, \varphi, z; \omega) d\omega \quad (14)$$

where E_z^{rad} is the frequency-domain beam in (1) and $F(\omega)$ is a spectral weighting function. To assess also in this case the effect of the wavenumber dispersion and the diffraction limit, in Fig. 15 the normalized amplitude of the electric field intensity of the pulse $|e_z^{\text{rad}}(\rho, \varphi, z; t)|$ has been reported at two time instants t_1 and t_2 (see the caption for the relevant details) in both the nondispersive [see Figs. 15(a) and 15(b)] and dispersive case [see Figs. 15(c) and 15(d)]. As is clearly visible when the dispersion is taken into account, the group velocity is reduced (the distance covered by the pulse is shorter). In addition, the spot size is slightly widened along the transverse direction [see Figs. 15(c) and 15(d)] without compromising the spatio-temporal localization of the pulse as long as it has not reached the nondiffractive distance ($z_{\text{ndr}} = 57.3$ cm). Conversely, when the pulse is propagating beyond the nondiffractive distance, the twisted pulse is gradually spreading either if the dispersion is [see Fig. 15(d)], or is not taken into account [see Fig. 15(b)].

Numerical results for the electric field components of the pulse on a transverse plane are reported in Fig. 16, where their spatial distributions have been evaluated at the reference plane $z = z_{\text{ndr}}/2 = 28.65$ cm, again for two distinct time instants. The peculiar twisted (i.e., rotating) behavior, as well as its nondiffractive nature, are visible. The pulse crosses the reference plane at around $t_0 = 1$ ns and gradually disappears: it is not yet practically visible at $t_1 = 0.8$ ns, whereas it is still crossing the reference plane at $t_2 = 1.2$ ns, after that, it will no longer be visible.

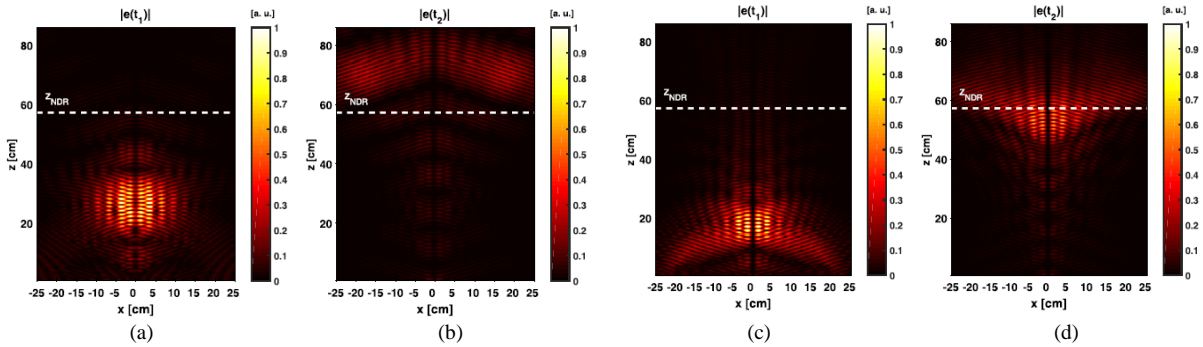

Fig. 15 - Field amplitude in the azimuthal xz ($\phi = 0$) plane. Comparison between (a) and (b) nondispersive and (c) and (d) dispersive case. The intensity of the vectorial electric field $|e|$ has been reported for two time instants: (a), (c) $t_1 = 0.8$ ns and (b), (d) $t_2 = 2.4$ ns.

SELECTED REFERENCES

- [1] H. E. Hernández-Figueroa, M. Zamboni-Rached, and E. Recami, *Nondiffracting Waves*. John Wiley & Sons, 2013.
- [2] H. E. Hernández-Figueroa, M. Zamboni-Rached, and E. Recami, *Localized Waves*. John Wiley & Sons, 2007, vol. 194.
- [3] R. Herman and T. Wiggins, "Production and uses of diffractionless beams," *J. Opt. Soc. Am. A*, vol. 8, p. 932, 1991.
- [4] W. Williams and J. Pendry, *J. Opt. Soc. Am. A*, vol. 22, p. 992, 2005.
- [5] G. Milne, G. D. Jeffries, and D. T. Chiu, *Appl. Phys. Lett.* vol. 92; no. 26, p. 261101, 1991.

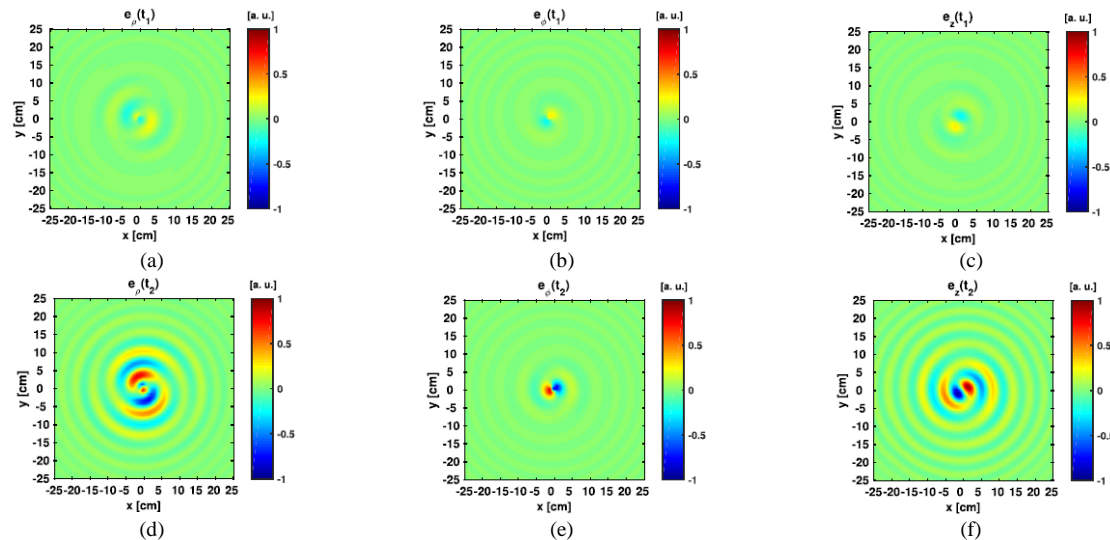

Fig. 16 – X wave with $n = 1$ angular momentum. Cylindrical electric-field components at $t_1 = 0.8$ ns (a), (c), (e), and at $t_2 = 1.2$ ns (d), (e), (f). The transverse plane $z_0 = z_{\text{ndf}}/2 = 28.65$ cm is fixed and time evolution is observed.

- [6] M. Ettore, S. M. Rudolph and A. Grbic, "Generation of propagating Bessel beams using leaky-wave modes: experimental validation," in *IEEE Transactions on Antennas and Propagation*, vol. 60, no. 6, pp. 2645-2653, June 2012.
- [7] P. Lemaitre-Auger, S. Abielmona, and C. Caloz, *IEEE Trans. Antennas Propag.* vol. 61, p. 1838, 2013.
- [8] J. W. Sherman, "Properties of focused apertures in the Fresnel region," *IRE Trans. Antennas Propag.*, vol. 10, no. 4, pp. 399–408, Jul. 1962.
- [9] W. J. Graham, "Analysis and synthesis of axial field pattern of focused apertures," *IEEE Trans. Antennas Propag.*, vol. AP-31, no. 4, pp. 665–668, Jul. 1983.
- [10] R. C. Hansen, "Focal region characteristics of focused array antennas," *IEEE Trans. Antennas Propag.*, vol. AP-33, no. 12, pp. 1328–1337, Dec. 1985.
- [11] A. Buffi, P. Nepa, and G. Manara, "Design criteria for near-field-focused planar arrays," *IEEE Trans. Antennas Propag.*, vol. 14, no. 1, pp. 40–50, Feb. 2012.
- [12] K. D. Stephan, J. B. Mead, D. M. Pozar, L. Wang, and J. A. Pearce, "A near field focused microstrip array for a radiometric temperature sensor," *IEEE Trans. Antennas Propag.*, vol. 55, no. 4, pp. 1199–1203, Apr. 2007.
- [13] Z. Hao, W. Hong, H. Li, H. Zhang, and K. Wu, "A broadband substrate integrated (SIW) filter," *Proc. Antennas Propag. Soc. Int. Symp.*, Jul. 3–8, 2005, pp. 598–601.
- [14] K. Tekkouk, M. Ettore, L. Le Coq and R. Sauleau, "Multibeam SIW slotted waveguide antenna system fed by a compact dual-layer Rotman lens," in *IEEE Transactions on Antennas and Propagation*, vol. 64, no. 2, pp. 504-514, Feb. 2016.
- [15] V. V. S. Prakash and R. Mitra, "Characteristic basis function method: A new technique for efficient solution of method of moments matrix equation," *Microw. Opt. Technol. Lett.*, vol. 36, no. 2, pp. 95–100, Jan. 20, 2003.
- [16] B. D. Braaten, R. M. Nelson, and M. A. Mohammed, "Electric field integral equations for electromagnetic scattering problems with electrically small and electrically large regions," *IEEE Trans. Antennas Propag.*, vol. 56, no. 1, pp. 142–150, Jan. 2008.
- [17] B. Tomasic and A. Hessel, "Linear array of coaxially fed monopole elements in a parallel plate waveguide—Part I: Theory," *IEEE Trans. Antennas Propag.*, vol. 36, no. 4, pp. 449–462, Apr. 1988.
- [18] M. Casaletti, R. Sauleau, M. Ettore, and S. Maci, "Efficient analysis of metallic and dielectric posts in parallel-plate waveguide structures," *IEEE Trans. Microw. Theory Tech.*, vol. 60, no. 10, pp. 2979–2989, Oct. 2012.
- [19] M. Albani, S. C. Pavone, M. Casaletti, and M. Ettore, "Generation of non-diffractive Bessel beams by inward cylindrical traveling wave aperture distributions," *Opt. Exp.*, vol. 22, no. 15, pp. 18354–18364, Jul. 2014.
- [20] M. Ornigotti, C. Conti, and A. Szameit, "Effect of orbital angular momentum on nondiffracting ultrashort optical pulses," *Phys. Rev. Lett.*, vol. 115, p. 100401-5, Sep. 2015.
- [21] J. Salo, J. Fagerholm, A. T. Friberg, and M. M. Salomaa, "Unified description of nondiffracting X and Y waves," *Phys. Rev. E, Stat. Phys. Plasmas Fluids Relat. Interdiscip. Top.*, vol. 62, p. 4261, Sep. 2000.
- [22] J. N. Brittingham, "Focus waves modes in homogeneous Maxwell's equations: Transverse electric mode," *Journal of Applied Physics*, vol. 54, no. 3, pp. 1179-1189, 1983.
- [23] R. W. Ziolkowski, "Exact solutions of the wave equation with complex source locations," *Journal of Mathematical Physics*, vol. 26, no. 4, pp. 861-863, 1985.
- [24] M. Dubois, M. Farhat, E. Bossy, S. Enoch, S. Guenneau, P. Sebbah, "Flat lens for pulse focusing of elastic waves in thin plates," *Applied Physics Letters*, vol. 103, no. 7, p. 071915, Aug. 2013.
- [25] P. Saari and K. Reivelt, "Evidence of X-shaped propagation-invariant localized light waves," *Phys. Rev. Lett.*, vol. 79, no. 21, pp. 4135, 1997.
- [26] E. Recami, "On localized 'X-shaped' superluminal solutions to Maxwell equations," *Statistical Mechanics and its Applications*, vol. 252, no. 3–4, pp. 586-610, 1998.
- [27] M. A. Porras, G. Valiulis, and P. Di Trapani, "Unified description of Bessel X waves with cone dispersion and tilted pulses," *Phys. Rev. E.*, vol. 68, no.1, pp. 016613, 2003.
- [28] W. Fuscaldò, D. Comite, A. Boesso, P. Baccarelli, P. Burghignoli and A. Galli, "Focusing leaky waves: a class of electromagnetic localized waves with complex spectra," *Physical Review Applied*, vol. 9, no. 5, pp. 054005, May 2018.

Invited International Book Chapters

- [B-3] N. Chahat, A. Tang, A. Guraliuc, M. Zhadobov, R. Sauleau, and **G. Valerio**, “Antennas, phantoms, and body-centric propagation at millimeter waves” in *Electromagnetics of Body-Area Networks: Antennas, Propagation, and RF Systems*, D. H. Werner and Z. H. Jiang, Eds., Wiley-IEEE Press, **2016**, cap. 7, pp. 205-260, ISBN: 978-1-119-02946-5. **(Invited as co-author)**
- [B-2] P. Baccarelli, P. Burghignoli, F. Frezza, A. Galli, P. Lampariello, S. Paulotto, and **G. Valerio**, “Techniques for harmonic tuning in microstrip active integrated antennas” in *Advanced Techniques for Microwave Systems*, G. Schettini, Ed., Kerala Ed., Trivandrum, India, **2011**, cap. 13, pp. 337-353, ISBN: 978-81-308-0453-82011. **(Invited as co-author)**
- [B-1] P. Baccarelli, P. Burghignoli, A. Galli, P. Lampariello, G. Lovat, S. Paulotto, and **G. Valerio**, “Modal properties in layered metamaterials” in *Theory and Phenomena of Metamaterials*, F. Capolino, Ed., CRC Press, Boca Raton, FL, **2009** (19 pp.), ISBN: 978-1-4200-5425-5. **(Invited as co-author)**

Under Revision: Peer-Reviewed International Journals

- [1] V. Jandieri, P. Baccarelli, **G. Valerio**, and G. Schettini, “1-D periodic lattice sums for complex and leaky waves in 2-D structures using higher-order Ewald formulation,” submitted to *IEEE Trans. Antennas Propag.* – **IF: 2.053**
- [2] O. Quevedo-Teruel, O. Dahlberg, and **G. Valerio**, “Propagation in waveguides with transversal twist-symmetric holey metallic plates,” submitted to *IEEE Microwave Wireless Comp. Lett.*, **IF: 1.887**
- [3] Q. Chen, F. Ghasemifard, **G. Valerio**, and O. Quevedo-Teruel, “Modeling and Dispersion Analysis of Coaxial Lines with Higher Symmetries,” submitted to *IEEE Trans. Microw. Theory. Tech.*, **IF: 2.284**
- [4] T. Zhang, J. Sarrazin, **G. Valerio**, and D. Istrate, “Estimation of human body vital signs based on 60 GHz Doppler radar using a bound constrained optimization algorithm,” submitted to *Sensors*. **IF: 2.677**

Peer-Reviewed International Journals

- [P42] **G. Valerio**, F. Ghasemifard, Z. Sipus, and O. Quevedo-Teruel, “Glide-symmetric all-metal holey metasurfaces for low-dispersive artificial materials: modelling and properties,” accepted on *IEEE Trans. Microw. Theory. Tech.*, **IF: 2.284**
- [P41] S. Razafimahatratra, J. Sarrazin, **G. Valerio**, F. Sarrazin, M. Casaletti, A. Benlarbi-Delai, and P. De Doncker “Input impedance of an aperture over a lossy half-space: applications to on-body antenna performance at 60 GHz,” *Progr. Electromagn. Res. C*, vol. 83, pp. 161-178, **2018**, ISSN 1937-8718. – **IF: 0.85**
- [P40] Y. Zheng, F. Zanella, **G. Valerio**, C. A. Dartora, and Z. Ren, “Study of strain effects on carbon-based transistors with semi-analytic and ab-initio models,” *IEEE Trans. Magnetics*, vol. 54, no. 3, pp. 1-4, **Mar. 2018**, doi: 10.1109/dab/TMAG.2017.2765705, ISSN 0018-9464. – **IF: 1.277**
- [P39] **G. Valerio**, Z. Sipus, A. Grbic, and O. Quevedo-Teruel, “Nonresonant modes in plasmonic holey metasurfaces for the design of artificial flat lenses,” *Optics Lett.*, vol. 42, no. 10, pp. 2026–2029, May **2017**, ISSN: 0146-9592 – **IF: 3.04**
- [P38] **G. Valerio**, Z. Sipus, A. Grbic, and O. Quevedo-Teruel, “Accurate equivalent-circuit descriptions of thin glide-symmetric corrugated metasurfaces,” *IEEE Trans. Antennas and Propag.*, vol. 65, no. 5, pp. 2695–2700, May **2017**, ISSN: 0018-926X – **IF: 2.053**
- [P37] Y. Zheng, **G. Valerio**, and Z. Ren, “Effect of mechanical stresses on graphene-based devices,” *Int. J. Num. Model: Elec. Networks, Dev. Fields*, **2017**;e2233, ISSN 1099-1204. – **IF: 2.053**

- [P36] D. Comite, **G. Valerio**, and A. Galli, M. Casaletti, and M. Ettore, "Exciting vorticity through higher-order Bessel beams with a radial-line slot-array antenna," *IEEE Trans. Antennas Propag.*, vol. 65, no. 4, pp. 2123-2128, Apr. 2017, doi: 10.1109/TAP.2017.2670503, ISSN: 0018-926X. – **IF: 2.053**
- [P35] D. Comite, W. Fuscaldo, S. C. Pavone, **G. Valerio** M. Ettore, M. Albani, and A. Galli, "Propagation of nondiffracting pulses carrying orbital angular momentum at microwave frequencies," *Appl. Phys. Lett.*, vol. 110, 114102, Mar. 2017, doi: 10.1063/1.4978601, E-ISSN 1077-3118 – **IF: 3.142**
- [P34] M. Casaletti, **G. Valerio**, R. Sauleau, and M. Albani, "Mode-Matching analysis of lossy SIW devices," *IEEE Trans. Microw. Theory, Tech.*, vol. 64, no. 12, pp. 4126 - 4137, Dec. 2016, doi: 10.1109/TMTT.2016.2605667, ISSN: 0018-9480. – **IF: 2.284**
- [P33] W. Fuscaldo, S. C. Pavone, **G. Valerio**, A. Galli, M. Albani, and M. Ettore, "Analysis of limited-diffractive and limited-dispersive X-waves generated by finite radial waveguides," *J. Appl. Phys.*, vol. 119, no. 19, 2016, doi: 10.1063/1.4949507, ISSN 0021-8979. – **IF: 2.04**
- [P32] **G. Valerio**, S. Paulotto, P. Baccarelli, D. R. Jackson, D. R. Wilton, W. A. Johnson, and A. Galli, "Convergent expressions for periodic potentials in stratified media using asymptotic extractions," *IEEE Trans. Magnetics.*, vol. 52, no. 3, Mar. 2016, doi: 10.1109/TMAG.2015.2499087, ISSN 0018-9464. – **IF: 1.277**
- [P31] W. Fuscaldo, **G. Valerio**, A. Galli, R. Sauleau, A. Grbic, and M. Ettore, "Higher-order leaky-mode Bessel-beam launcher," *IEEE Trans. Antennas Propag.*, vol. 64, no. 3, pp. 904-913, Mar. 2016, doi: 10.1109/TAP.2015.2513076, ISSN: 0018-926X. – **IF: 2.053**
- [P30] **G. Valerio**, S. Paulotto, P. Baccarelli, D. R. Jackson, D. R. Wilton, W. A. Johnson, and A. Galli, "Efficient computation of 1-D periodic layered mixed potentials for the analysis of leaky-wave antennas with vertical elements," *IEEE Trans. Antennas Propag.*, vol. 63, no. 6, pp. 2396-2411, Jun. 2015, doi: 10.1109/TAP.2015.2412959, ISSN: 0018-926X. – **IF: 2.053**
- [P29] M. Martinis, K. Mahdjoubi, R. Sauleau, S. Collardey, L. Bernard, and **G. Valerio**, "On maximum bandwidth of rectangular cavity antennas," *IEEE Antennas Wireless Propag. Lett.*, pp. 1709-1712, 2014, doi:10.1109/LAWP.2014.2352274, ISSN: 1536-1225. – **IF: 1.751**
- [P28] A. Gurialuc, M. Zhadobov, **G. Valerio**, and R. Sauleau, "Enhancement of on-body propagation at 60 GHz using electro textiles," *IEEE Antennas Wireless Propag. Lett.*, vol. 13, pp. 603-606, 2014, doi:10.1109/LAWP.2014.2313019, ISSN: 1536-1225. – **IF: 1.751**
- [P27] M. Ettore, M. Casaletti, **G. Valerio**, R. Sauleau, L. Le Coq, S. C. Pavone, and M. Albani, "On the near-field shaping and focusing capability of a radial line slot array," *IEEE Trans. Antennas Propag.*, vol. 62, no. 4, pp. 1991-1999, Apr. 2014, doi:10.1109/TAP.2014.2301994, ISSN: 0018-926X. – **IF: 2.053**
- [P26] A. Gurialuc, M. Zhadobov, **G. Valerio**, N. Chahat, and R. Sauleau, "Effect of textile on the propagation along the body at 60 GHz," *IEEE Trans. Antennas Propag.*, vol. 62, no. 3, pp. 1489-1494, Mar. 2014, doi:10.1109/TAP.2013.2295425, ISSN: 0018-926X. – **IF: 2.053**
- [P25] **G. Valerio**, M. Casaletti, J. Seljan, R. Sauleau, and M. Albani, "Efficient computation of the coupling between a vertical line source and a slot," *IEEE Trans. Antennas Propag.*, vol. 61 no. 12, pp. 6084-6093, Dec. 2013, doi:10.1109/TAP.2013.2282522, ISSN: 0018-926X. – **IF: 2.053**
- [P24] M. Casaletti, **G. Valerio**, J. Seljan, M. Ettore, and R. Sauleau, "A full-wave hybrid method for the analysis of multilayered SIW-based antennas," *IEEE Trans. Antennas Propag.*, vol. 61 no. 11, pp. 5575-5588, Nov. 2013, doi:10.1109/TAP.2013.2279795, ISSN: 0018-926X. – **IF: 2.053**
- [P23] S. E. Lauro, E. Mattei, P. M. Barone, E. Pettinelli, G. Vannaroni, **G. Valerio**, D. Comite, and A. Galli, "Estimation of subsurface dielectric target depth for GPR planetary exploration: Laboratory measurements and modeling," *J. Appl. Geophysics.*, vol. 93, pp. 93-100, Jun. 2013, doi:10.1016/j.jappgeo.2013.04.001 ISSN: 0926-9851. – **IF: 1.355**
- [P22] F. Soldovieri, I. Catapano, P. M. Barone, S. E. Lauro, E. Mattei, E. Pettinelli, **G. Valerio**, D. Comite, and A. Galli, "GPR estimation of the geometrical features of buried metallic targets in testing conditions," *Progr. Electromagn. Res. B*, vol. 49, pp. 339-362, Mar. 2013, doi:10.2528/PIERB1212050, ISSN: 1937-6472.
- [P21] M. Zucca, M. Ciattaglia, R. Pintauro, **G. Valerio**, and A. Galli, "Versatile and efficient hybrid-ring architecture for advanced radar functionalities," *Microw. Optic. Tech. Lett.*, vol. 55, no. 7, pp. 1663-1670, Mar. 2013, doi:10.1002/mop.27647, ISSN: 1098-2760. – **IF: 0.545.**
- [P20] N. Chahat, **G. Valerio**, M. Zhadobov, and R. Sauleau, "On-body propagation at 60 GHz," *IEEE Trans. Antennas Propag.*, vol. 61, no. 4, pp. 1876-1888, Apr. 2013, doi:10.1109/TAP.2013.2242034, ISSN: 0018-926X. – **IF: 2.053**

- [P19] N. T. Nguyen, A. Rolland, A. V. Boriskin, **G. Valerio**, L. Le Coq, and R. Sauleau "Size and weight reduction of integrated lens antennas using a cylindrical air cavity," *IEEE Trans. Antennas Propag.*, vol. 60, no. 12, pp. 5993-5998, Dec. **2012**, doi:10.1109/TAP.2012.2208931, ISSN: 0018-926X.
- [P18] S. A. Muhammad, R. Sauleau, **G. Valerio**, L. Le Coq, and H. Legay, "Self-polarizing Fabry-Perot antennas based on polarization twisting element," *IEEE Trans. Antennas Propag.* vol. 61, no. 4, pp. 1032-1040, Nov. **2012**, doi:10.1109/TAP.2012.2227443, ISSN: 0018-926X.
- [P17] **G. Valerio**, S. Mazzocchi, A. Galli, M. Ciattaglia, and M. Zucca, "New configurations of low-cost dual-polarized printed antennas for UWB arrays," *Int. J. Antennas Propag.*, (10 pp.) **2012**, doi:10.1155/2012/786791, ISSN: 1687-5877. **(Personally invited)**
- [P16] **G. Valerio**, D. R. Wilton, D. R. Jackson, and A. Galli, "Acceleration of mixed potentials from vertical currents in layered media for 2-D structures with 1-D periodicity," *IEEE Trans. Antennas Propag.*, vol. 60, no. 8, pp. 3782-3793, Aug. **2012**, doi:10.1109/TAP.2012.2201100, ISSN: 0018-926X.
- [P15] **G. Valerio**, A. Galli, D. R. Wilton, and D. R. Jackson, "An enhanced integral-equation formulation for accurate analysis of frequency-selective structures," *Int. J. Microw. Wirel. Tech.*, vol. 4, no. 3, pp. 365-372, Jun. **2012**, doi:10.1017/S1759078712000402, ISSN: 1759-0787. **(Personally invited)**
- [P14] F. Mastrangeli, A. De Luca, **G. Valerio**, and A. Galli, "A low-cost dual-polarized printed antenna for multifunction phased array radar," *Microw. Optic. Tech. Lett.*, vol. 53, no. 3, pp. 697-702, Mar. **2012**, doi:10.1002/mop.26665, ISSN: 1098-2760.
- [P13] **G. Valerio**, A. Galli, P. M. Barone, S. E. Lauro, E. Mattei, and E. Pettinelli, "GPR detectability of rocks in a Martian-like shallow subsoil: A numerical approach," *Planetary and Space Science*, vol. 62, no. 1, pp. 31-40, Mar. **2012**, doi:10.1016/j.jps.2011.12.003, ISSN: 0032-0633.
- [P12] P. Baccarelli, P. Burghignoli, F. Frezza, A. Galli, P. Lampariello, S. Paulotto, and **G. Valerio**, "Compact wide-band electromagnetic-band-gap-based filters for microstrip antenna design in harmonic-tuned transmitters," *IET Microwaves Antennas Propag.*, vol. 5, no. 11, pp. 1343-1350, Aug. **2011**, doi:10.1049/iet-map.2011.0073, ISSN: 1751-8725.
- [P11] **G. Valerio**, S. Paulotto, P. Baccarelli, P. Burghignoli, and A. Galli, "Accurate Bloch analysis of 1-D periodic lines through the simulation of truncated structures," *IEEE Trans. Antennas Propag.*, vol. 59, no. 6, pp. 2188-2195, Jun. **2011**, doi:10.1109/TAP.2011.2143667, ISSN: 0018-9480.
- [P10] **G. Valerio**, P. Baccarelli, P. Burghignoli, S. Paulotto, A. Galli, and P. Lampariello, "Dispersive analysis of 1D-periodic leaky-wave antennas through full-wave simulations of truncated structures," *Atti della Fondazione Giorgio Ronchi*, vol. LXV, no. 3, pp. 361-366, May-Jun. **2010**, ISSN: 0391-2051.
- [P9] **G. Valerio**, P. Burghignoli, P. Baccarelli, and A. Galli, "Input impedance of nonperiodic sources exciting 1-D periodic shielded microstrip structures," *IEEE Trans. Microwave Theory, Tech.*, vol. 58, no. 7, pp. 1796-1806, Jul. **2010**, doi:10.1109/TMTT.2010.2049919, ISSN: 0018-9480.
- [P8] **G. Valerio**, D. R. Jackson, and A. Galli, "Formulas for the number of surface waves on layered structures," *IEEE Trans. Microwave Theory Tech.*, vol. 58, no. 7, pp. 1786-1795, Jul. **2010**, doi:10.1109/TMTT.2010.2050028, ISSN: 0018-9480.
- [P7] **G. Valerio**, D. R. Jackson, and A. Galli, "Fundamental properties of surface waves in lossless stratified structures," *Proc. R. Soc. A*, vol. 466, pp. 2447-2469, **2010**, doi:10.1098/RSPA.2009.0664, ISSN: 1364-5021.
- [P6] **G. Valerio**, P. Baccarelli, S. Paulotto, F. Frezza, and A. Galli, "Efficient near-field interpolation of mixed-potential Green's functions in layered media," *IEEE Antennas Wireless Propag. Lett.*, vol. 8, pp. 674-677, **2009**, doi:10.1109/LAWP.2009.2021169, ISSN: 1536-1225.
- [P5] **G. Valerio**, P. Baccarelli, S. Paulotto, F. Frezza, and A. Galli, "Regularization of mixed-potential layered-media Green's functions for efficient interpolation procedures in planar periodic structures," *IEEE Trans. Antennas Propag.*, vol. 57, no. 1, pp. 122-134, Jan. **2009**, doi:10.1109/TAP.2008.2009695, ISSN: 0018-926X.
- [P4] P. Colantonio, F. Giannini, R. Giofrè, M. C. Montieri, P. Baccarelli, P. Burghignoli, F. Frezza, A. Galli, P. Lampariello, S. Paulotto, **G. Valerio**, R. Vescovo, V. Camarchia, G. Ghione, C. Naldi, M. Pirola, A. Santarelli, R. Cignani, F. Fantini, C. Florian, G. Manara, P. Nepa, G. Pelosi, and S. Selleri, "Antenne integrate attive per terminali mobili ad alta efficienza," *Atti della Fondazione Giorgio Ronchi*, vol. LXIII, no. 1-2, pp. 163-164, Jan.-Apr. **2008**, ISSN: 0391-2051.
- [P3] **G. Valerio**, P. Baccarelli, P. Burghignoli, A. Galli, R. R-Berral, and F. Mesa, "Analysis of periodic shielded microstrip lines excited by nonperiodic sources through the array scanning method," *Radio Sci.*, 43, RS1009, (15 pp.) **2008**, doi:10.1029/2007RS003697, ISSN: 0048-6604X.
- [P2] **G. Valerio**, P. Baccarelli, P. Burghignoli, and A. Galli, "Reply to: 'Comments on «Comparative analysis of acceleration techniques for 2-D and 3-D Green's functions in periodic structures along

one and two directions»' ,” *IEEE Trans. Antennas Propag.*, vol. 55 no. 12, p. 3747, Dec. 2007, doi:10.1109/TAP.2007.910525, ISSN: 0018-926X.

- [P1] **G. Valerio**, P. Baccarelli, P. Burghignoli, and A. Galli, “Comparative analysis of acceleration techniques for 2-D and 3-D Green's functions in periodic structures along one and two directions,” *IEEE Trans. Antennas Propag.*, vol. 55 no. 6, pp. 1630-1643, Jun. 2007, doi:10.1109/TAP.2007.897340, ISSN: 0018-926X.

Peer-Reviewed National Journals

M. Zucca, M. Ciattaglia, A. De Luca, S. Mazzocchi, **G. Valerio**, and A. Galli, “New multifunctional UWB planar antenna based on printed dipoles in rhombic configuration,” *Polaris Innovation J.*, no. 6, pp. 87-92, Apr. 2011 (Finalist at “Premio Innovazione 2010”, Selex S. I., Finmeccanica).

Peer-Reviewed International Conferences

- [IC - 126] Y. Zheng, F. Zanella, J. Njeim, C. A. Dartora, D. Brunel, **G. Valerio**, and Z. Ren, “Numerical and experimental study of graphene nanomesh based field effect transistor,” submitted at **17th Biennial Conf. Electromag. Field Comput. (CEFC 2018)**, Hangzhou, China, 28-31 Oct. 2018.
- [IC - 125] T. Zheng, H. Mohamad, M. Casaletti, A. F. Abdelshafy, F. Capolino, **G. Valerio**, and Z. Ren, “Achieving a degenerate band edge resonance in substrate integrated waveguides,” submitted at **17th Biennial Conf. Electromag. Field Comput. (CEFC 2018)**, Hangzhou, China, 28-31 Oct. 2018.
- [IC - 124] M. Fall, O. Quevedo-Teruel, and **G. Valerio**, “Bloch Analysis of Periodic Structures with Higher Symmetries,” accepted for presentation to **Int. Antennas Propag. Symp. (APS-URSI)**, Boston, MA, USA, 8 – 13 Jul. 2018.
- [IC - 123] H. Mohamad, T. Zheng, , M. Casaletti, Z. Ren, A. F. Abdelshafy, F. Capolino, and **G. Valerio**, “Degenerate Band Edge Condition in Substrate-Integrated Waveguides,” accepted for presentation to **Int. Antennas Propag. Symp. (APS-URSI)**, Boston, MA, USA, 8 – 13 Jul. 2018.
- [IC - 122] O. Quevedo-Teruel, and **G. Valerio**, and Z. Sipus “Implications of higher symmetries in periodic structures,” accepted for presentation at **URSI Atlantic Radio Science Meeting (AT-RASC)**, Gran Canaria, Spain, 28 May - 1 Jun. 2018. (Invited as co-author)
- [IC - 121] O. Quevedo-Teruel, and **G. Valerio**, “Electromagnetic structures with higher symmetries,” accepted for presentation at **Int. Workshop on Antenna Technology (iWAT)**, Nanjing, China, 4-7 Mar., 2018. (Invited as co-author)
- [IC - 120] F. Ghasemifard, **G. Valerio**, M. Norgren and O. Quevedo-Teruel, “Analysis of wave propagation in plasmonic holey metasurfaces with cylindrical holes,” accepted for presentation at **Eur. Conf. Antennas Propag. (EuCAP)**, London, UK, 9-13 Apr. 2018.
- [IC - 119] **G. Valerio**, F. Ghasemifard, Z. Sipus, and O. Quevedo-Teruel, “Floquet-expansion approach for the study of glide-symmetric metasurfaces,” accepted for presentation at **Eur. Conf. Antennas Propag. (EuCAP)**, London, UK, 9-13 Apr. 2018. (Special Session Organizer)
- [IC - 118] Qiao Chen, **G. Valerio**, and O. Quevedo-Teruel, “Dispersion analysis of polar glide symmetry with coaxial rings,” accepted for presentation at **Eur. Conf. Antennas Propag. (EuCAP)**, London, UK, 9-13 Apr. 2018.
- [IC - 117] W. Fuscaldo, S. C. Pavone, D. Comite, **G. Valerio**, M. Albani, M. Ettore, and A. Galli, “Design criteria of X-wave launchers for millimeter-wave applications,” accepted for presentation at **Eur. Conf. Antennas Propag. (EuCAP)**, London, UK, 9-13 Apr. 2018. (Best paper in Electromagnetic Theory)
- [IC - 116] F. Zanella, C. Augusto Dartora, Y. Zheng, **G. Valerio**, and Z. Ren, “Numerical technique to describe memory phenomena in nano devices,” in **Proc. Eur. Conf. Num. Methods Electrtomag (NUMELEC)**, Paris, France, 15 – 17 Nov. 2017.

- [IC - 115] M. Casaletti, G. Valerio, and M. Albani, Numerical analysis of multilayered lossy guiding and radiating structures,” in *Proc. Eur. Conf. Num. Methods Electrtomag (NUMELEC)*, Paris, France, 15 – 17 Nov. **2017**.
- [IC - 114] O. Quevedo-Teruel, and **G. Valerio**, “Higher symmetries for the design of periodic structures,” in *proc. ESA Antenna Workshop on Innovative Antenna Systems and Technologies for Future Space Missions*, Noordwijk, Netherland, 3-6 Oct. **2017**.
- [IC - 113] **G. Valerio**, and O. Quevedo-Teruel, “Suppressing and enhancing band gaps with glide-symmetric surfaces,” in *Proc. Int. Conf. Electromagn. Adv. Appl. (ICEAA)*, Turin, Italy, 11-15 Sep. **2017. (Personally invited)**
- [IC - 112] V. Jandieri, P. Baccarelli, **G. Valerio**, S. Ceccuzzi, C. Ponti, G. Schettini, “Efficient and rigorous analysis of leaky modes in 2-D EBG guiding structures,” in *Proc. Int. Conf. Electromagn. Adv. Appl. (ICEAA)*, Turin, Italy, 11-15 Sep. **2017. (Invited as co-author)**
- [IC - 111] Y. Zheng, **G. Valerio**, and Z. Ren, “Study of deformation on novel 2D semiconductor material,” in *Proc. Int. Electron Devices & Materials Symp. (IEDMS)*, Hsinchu, Taiwan 6–8 Sep. **2017**.
- [IC - 110] B. Majumder, **G. Valerio**, and O. Quevedo-Teruel, “Rectangular holey glide-symmetric metasurfaces for ultra-wideband anisotropy,” Incheon, South Korea, 25 – 28 Jul., **2017**.
- [IC - 109] O. Quevedo-Teruel and **G. Valerio**, “Higher Symmetries: A new degree of freedom for the design of periodic structures,” Marseille, France, 28 Aug. – 2 Sep., **2017**.
- [IC - 108] W. Fuscaldo, S. C. Pavone, D. Comite, **G. Valerio**, M. Albani, M. Ettore, and A. Galli, “Nondiffracting waves: criteria for dimensioning X-wave launchers,” in *Proc. Int. Antennas Propag. Symp. (APS-URSI)*, San Diego, CA, USA, 9 – 14 Jul. 2017.
- [IC - 107] P. Baccarelli, V. Jandieri, **G. Valerio**, and G. Schettini, “Green’s function computation using lattice sums for leaky-wave analyses,” in *Proc. Int. Antennas Propag. Symp. (APS-URSI)*, San Diego, CA, USA, 9 – 14 Jul. 2017.
- [IC - 106] **G. Valerio**, and O. Quevedo-Teruel, “Higher symmetries in periodic surfaces for graded-index and band-gap components,” in *Proc. Int. Antennas Propag. Symp. (APS-URSI)*, San Diego, CA, USA, 9 – 14 Jul. **2017. (Special Session Organizer)**
- [IC - 105] F. Ghasemifard, **G. Valerio**, and O. Quevedo-Teruel, “Analysis of wave propagation in glide-symmetric metasurfaces using mode-matching technique,” in *Proc. Int. Antennas Propag. Symp. (APS-URSI)*, San Diego, CA, USA, 9 – 14 Jul. **2017**.
- [IC - 104] Y. Zheng, F. Zanella, **G. Valerio**, C. A. Dartora, and Z. Ren “Study of Carbon-Based Transistors with Semi-Analytic and Full-Band Models,” in *Proc. Compumag 2017*, Daejeon, South Korea, June 18 – 22 **2017**.
- [IC - 103] P. Baccarelli, V. Jandieri, **G. Valerio**, and G. Schettini, “Efficient computation of the lattice sums for leaky waves using the Ewald method,” in *Proc. Eur. Conf. Antennas Propag. (EuCAP)*, Paris, France, 19-24 Mar. **2017**.
- [IC - 102] S. C. Pavone, D. Comite, W. Fuscaldo, **G. Valerio**, A. Galli, M. Ettore, and M. Albani, “Generation of limited-diffractive twisted pulses at millimeter waves,” in *Proc. Eur. Conf. Antennas Propag. (EuCAP)*, Paris, France, 19-24 Mar. **2017. (Best-paper finalist)**
- [IC - 101] T. Zhang, **G. Valerio**, J. Sarrazin, and D. Istrate, “Wavelet-based analysis of 60 GHz Doppler radar for non-stationary vital sign monitoring,” in *Proc. Eur. Conf. Antennas Propag. (EuCAP)*, Paris, France, 19-24 Mar. **2017**.
- [IC - 100] Z. Sipus, **G. Valerio**, and A. Grbic, “Floquet-mode analysis of glide-symmetric metasurfaces,” in *Proc. Eur. Conf. Antennas Propag. (EuCAP)*, Paris, France, 19-24 Mar. **2017. (Personally invited)**
- [IC - 99] O. Quevedo-Teruel, M. Ebrahimpouri, F. Ghasemifard, M. Ng Mou Kehn, R. Mitchell-Thomas, A. Grbic, Z. Sipus, E. Rajo-Iglesias, and **G. Valerio**, “Glide-symmetric metasurfaces: theory, simulation and practice,” in *Proc. Eur. Conf. Antennas Propag. (EuCAP)*, Paris, France, 19-24 Mar. **2017. (Invited as co-author)**
- [IC - 98] J. Sarrazin, **G. Valerio**, S. Razafimahatratra, M. Casaletti, F. Sarrazin, L. Petrillo, P. De Doncker, and A. Benlarbi-Delai, “Antenna radiation efficiency considerations in body area networks,” in *Proc. 11th Int. Conf. Body Area Networks (BodyNets 2016)*, Turin, Italy, 15 – 16 Dec. **2016**
- [IC - 97] T. Zhang, **G. Valerio**, J. Sarrazin, and D. Istrate, “Impact of random body movements on 60-GHz Doppler radar for real-time monitoring of vital signs,” in *Proc. 11th Int. Conf. Body Area Networks (BodyNets 2016)*, Turin, Italy, 15 – 16 Dec. **2016**

- [IC - 96] W Y. Zheng, **G. Valerio**, and Z. Ren, "Effect of deformations on carbon-based transistors in ballistic and partially ballistic regimes," in *Proc. 17th Biennial Conf. Electromag. Field Comput. (CEFC 2016)*, Miami, Florida, USA, 13-16 Nov. 2016.
- [IC - 95] M. Smierzchalski, M. Ettorre, R. Sauleau, **G. Valerio**, T. Makdissy, E. Girard, H. Legay "Imaging system fed by a quasi-optical beam-forming network for Ka-band satellite applications," in *Proc. 2016 IEEE Intern. Symp. Phased Array Systems and Techn.*, Waltham, Massachusetts, USA, 18-21 Oct. 2016.
- [IC - 94] T. Zhang, **G. Valerio**, J. Sarrazin, and D. Istrate "Non-contact estimation at 60 GHz for human vital signs monitoring using a robust optimization algorithm," in *Proc. Int. Antennas Propag. Symp. (APS-URSI)*, Fajardo, Puerto Rico, 26 Jun. – 1 Jul. 2016.
- [IC - 93] W. Fuscaldo, **G. Valerio**, R. Sauleau, M. Ettorre, A. Grbic, and A. Galli, "Design and experimental validation of leaky-wave Bessel-beam launchers at millimeter-wave frequencies," in *Proc. Int. Antennas Propag. Symp. (APS-URSI)*, Fajardo, Puerto Rico, 26 Jun. – 1 Jul. 2016.
- [IC - 92] W. Fuscaldo, S. C. Pavone, **G. Valerio**, A. Galli, M. Albani, and M. Ettorre, "Parameterization of the nondiffractive features of electromagnetic localized pulses," in *Int. Antennas Propag. Symp. (APS-URSI)*, Fajardo, Puerto Rico, 26 Jun. – 1 Jul. 2016.
- [IC - 91] **G. Valerio**, Z. Sipus, A. Grbic, and O. Quevedo-Teruel, "Modeling thin glide-symmetric corrugated metasurfaces with analytical methods," in *Proc. Int. Antennas Propag. Symp. (APS-URSI)*, Fajardo, Puerto Rico, 26 Jun. – 1 Jul. 2016.
- [IC - 90] Y. Zheng, **G. Valerio**, and Z. Ren, "Effects of mechanical stresses on graphene-based devices," in *Proc. 10th Int. Symp. Electric Magnetic Fields*, Lyon, France, 12-14 April 2016.
- [IC - 89] W. Fuscaldo, S. C. Pavone, **G. Valerio**, A. Galli, M. Albani, and M. Ettorre, "Generation of limited-diffraction electromagnetic pulses at millimeter waves," in *Proc. Eur. Conf. Antennas Propag. (EuCAP)*, Davos, Switzerland, 10-15 Apr. 2016.
- [IC - 88] **G. Valerio**, F. T. Celepcikay, D. R. Wilton, D. R. Jackson, and A. Galli, "Modeling artificial structures through accelerated multilayered periodic potentials," in *Proc. of META15 the 6th Int. Conference on Metamaterials, Photonic Crystals and Plasmonics*, New York City, NY, USA, 4 – 7 Aug. 2015. **(Personally invited)**
- [IC - 87] **G. Valerio**, M. Ettorre, T. Makdissy, and R. Sauleau, "Physical optics modeling of a pillbox as a beam forming network for a large imaging system in satellite communications," in *Proc Int. Antennas Propag. Symp. (APS-URSI)*, Vancouver, British Columbia, Canada, 7 – 12 Jul. 2015.
- [IC - 86] **G. Valerio**, S. Paulotto, P. Baccarelli, D. R. Jackson, D. R. Wilton, W. A. Johnson, and A. Galli, "Efficient computation of Green's functions for one-dimensional periodic structures in layered media," in *Proc. Int. Antennas Propag. Symp. (APS-URSI)*, Vancouver, British Columbia, Canada, 7 – 12 Jul. 2015. **(Personally invited)**
- [IC - 85] **G. Valerio**, S. Paulotto, P. Baccarelli, D. R. Jackson, D. R. Wilton, W. A. Johnson, and A. Galli "Enhanced convergence of periodic potentials in stratified media through asymptotic extractions," in *Proc. Compumag 2015*, Montreal, Quebec, Canada, Jun. 28 – Jul. 2 2015.
- [IC - 84] C. D. Diallo, O. Quevedo-Teruel, **G. Valerio**, H. Legay, R. Sauleau, "Parallel-plate-waveguide luneburg lens through a holey plate metasurface," in *Proc. IX Eur. Conf. Antennas Propag. (EuCAP)*, Lisbon, Portugal, 13-17 Apr. 2015.
- [IC - 83] M. Casaletti, **G. Valerio**, R. Sauleau, M. Albani, "Rigorous losses evaluation in the numerical analysis of SIW structures," in *Proc. Eur. Conf. Antennas Propag. (EuCAP)*, Lisbon, Portugal, 13-17 Apr. 2015. **(Personally invited)**
- [IC - 82] H. Legay, E. Girard, **G. Valerio**, M. Ettorre, A. Ali, and R. Sauleau, "Physical-optics analysis and design of a beam-forming network coupled to an imaging-system configuration for Ka-band satellite applications," in *Proc. Eur. Conf. Antennas Propag. (EuCAP)*, Lisbon, Portugal, 13-17 Apr. 2015. **(Invited as co-author)**
- [IC - 81] H. Legay, E. Girard, **G. Valerio**, M. Ettorre, A. Ali, and R. Sauleau, "Large imaging array in Ka band with a substrate integrated waveguide pillbox beamformer," in *Proc. IEEE Conference on Antenna Measurements & Applications (CAMA)*, Antibes Juan-les-Pins, France, 16 - 19 Nov. 2014. **(Invited as co-author)**
- [IC - 80] P. Lampariello, F. Frezza, A. Galli, P. Baccarelli, P. Burghignoli, G. Lovat, S. Paulotto, **G. Valerio**, and D. R. Jackson, "Advances in leaky-wave periodic structures after Oliner's pioneering investigations," in *Proc. Eur. Microwave Conf. (EuMC)*, Rome, Italy, 6 - 9 Oct. 2014. **(Invited as co-author)**

- [IC - 79] M. Ettorre, **G. Valerio**, R. Sauleau, W. Fuscaldo, A. Galli, and A. Grbic, "Generation of non-diffractive Bessel beams using leaky-wave modes," in *Proc. Eur. Microwave Conf. (EuMC)*, Rome, Italy, 6 - 9 Oct. **2014**. **(Personally invited)**
- [IC - 78] W. Fuscaldo, **G. Valerio**, A. Galli, R. Sauleau, and M. Ettorre, "Bessel beam launchers at millimeter waves using higher-order leaky-wave modes," in *Proc. Int. Antennas Propag. Symp. (APS-URSI)*, Memphis, TN, USA, 6 - 12 Jul. **2014**.
- [IC - 77] M. Casaletti, **G. Valerio**, J. Seljan, R. Sauleau and M. Albani, "Efficient analysis of lossy substrate integrated waveguide structures," in *Proc. Int. Antennas Propag. Symp. (APS-URSI)*, Memphis, TN, USA, 6 - 12 Jul. **2014**.
- [IC - 76] M. Ettorre, M. Casaletti, **G. Valerio**, R. Sauleau, L. Le Coq, S. C. Pavone, and M. Albani, "Automatically optimized near-field focusing radial line slot array," in *Proc. Int. Antennas Propag. Symp. (APS-URSI)*, Memphis, TN, USA, 6 - 12 Jul. **2014** pp. 1049-1050.
- [IC - 75] A. R. Guraliuc, M. Zhadobov, **G. Valerio**, N. Chahat, and R. Sauleau "On-body propagation at 60 GHz: impact of a textile presence," in *Proc. Int. Antennas Propag. Symp. (APS-URSI)*, Memphis, TN, USA, 6 - 12 Jul. **2014**, pp. 715-716.
- [IC - 74] **G. Valerio**, M. Casaletti, J. Seljan, R. Sauleau, and M. Albani, "Efficient computation of post-slot interactions in complex layered media with vertical interconnects," in *Proc. Int. Antennas Propag. Symp. (APS-URSI)*, Memphis, TN, USA, 6 - 12 Jul. **2014**, pp. 2108-2109.
- [IC - 73] J. Seljan, **G. Valerio**, M. Casaletti, K. Tekkouk, M. Ettorre, and R. Sauleau, "Hybrid MoM/mode-matching method for SIW devices housing layered dielectric substrates," *IEEE Conf. Electromagn. Field Comput. (CEFC2014)*, Annecy, France, 25-28 May **2014**.
- [IC - 72] A. R. Guraliuc, M. Zhadobov, **G. Valerio**, N. Chahat, and R. Sauleau, "Characterization of the body-centric propagation channel at 60 GHz in the presence of textiles," in *Proc. Eur. Conf. Antennas Propag. (EuCAP)*, The Hague, The Netherlands, 6-11 Apr. **2014**, pp. 4364-4366, ISBN: 978-88-907018-4-9.
- [IC - 71] M. Ettorre, M. Casaletti, **G. Valerio**, L. Le Coq, R. Sauleau, S. C. Pavone, and M. Albani, "A radial line slot array focusing in the near field: analysis and design," in *Proc. Eur. Conf. Antennas Propag. (EuCAP)*, The Hague, The Netherlands, 6-11 Apr. **2014**, pp. 1587-1591, ISBN: 978-88-907018-4-9.
- [IC - 70] **G. Valerio**, M. Casaletti, J. Seljan, M. Ettorre, R. Sauleau, and M. Albani, "Numerical-asymptotic synergic approach for speeding up the filling time in a MoM/mode matching code for large SIW structures," in *Proc. Eur. Conf. Antennas Propag. (EuCAP)*, The Hague, The Netherlands, 6-11 Apr. **2014**, pp. 828-829, ISBN: 978-88-907018-4-9. **(Personally invited)**
- [IC - 69] J. Seljan, **G. Valerio**, M. Casaletti, K. Tekkouk, M. Ettorre, and R. Sauleau, "Hybrid MoM/mode-matching method for SIW devices housing layered dielectric substrates," in *Proc. Eur. Conf. Antennas Propag. (EuCAP)*, The Hague, The Netherlands, 6-11 Apr. **2014**, pp. 4222-4225, ISBN: 978-88-907018-4-9.
- [IC - 68] D. Comite, A. Galli, E. Pettinelli, and **G. Valerio**, "Numerical analysis of the detection performance of ground coupled radars for different antenna systems and signal features," in *Proc. Eur. Conf. Antennas Propag. (EuCAP)*, The Hague, The Netherlands, 6-11 Apr. **2014**, pp. 4373-4375, ISBN: 978-88-907018-4-9. **(Personally invited)**
- [IC - 67] W. Fuscaldo, **G. Valerio**, A. Galli, R. Sauleau, and M. Ettorre, "A millimeter-wave Bessel beam launcher through the excitation of higher-order leaky modes," in *Proc. Eur. Conf. Antennas Propag. (EuCAP)*, The Hague, The Netherlands, 6-11 Apr. **2014**, pp. 1759-1761, ISBN: 978-88-907018-4-9.
- [IC - 66] **G. Valerio**, M. Casaletti, J. Seljan, M. Ettorre, and R. Sauleau, "Optimized analysis of slotted substrate integrated waveguides by a method-of-moments mode-matching hybrid approach," in *Proc. Int. Conf. Electromagn. Adv. Appl. (ICEAA)*, Turin, Italy, 9-13 Sep. **2013**, pp. 616-619, ISBN: 978-1-4673-5687-9. **(Personally invited)**
- [IC - 65] **G. Valerio**, R. Sauleau, N. Chahat, A. Guraliuc, and M. Zhadobov, "Characterization of on-body communications at millimeter waves," in *Proc. Int. Conf. Electromagn. Advanced Appl. (ICEAA)*, Turin, Italy, 9-13 Sep. **2013**, pp 42-44, ISBN: 978-1-4673-5687-9. **(Invited as co-author)**
- [IC - 64] M. Albani, M. Casaletti, M. Ettorre, **G. Valerio**, J. Seljan, and R. Sauleau, "A new synthesis technique for near-field focusing systems," in *Proc. Int. Antennas Propag. Symp. (APS-URSI)*, Lake Buena Vista, Florida, USA, 7 - 12 Jul. **2013**.

- [IC - 63] **G. Valerio**, A. Galli, D. Comite, and E. Pettinelli, "Analysis on the GPR detection of dielectric scatterers in shallow subsurface," in *Proc. Int. Antennas Propag. Symp. (APS-URSI)*, Lake Buena Vista, Florida, USA, 7 – 12 Jul. **2013**.
- [IC - 62] M. Casaletti, **G. Valerio**, J. Seljan, M. Ettorre, and R. Sauleau, "Efficient analysis of SIW-based antenna geometries through a rigorous MoM mode-matching approach," in *Proc. Int. Antennas Propag. Symp. (APS-URSI)*, Lake Buena Vista, Florida, USA, 7 – 12 Jul. **2013**, pp. 734-735.
- [IC - 61] **G. Valerio**, N. Chahat, M. Zhadobov, and R. Sauleau, "Study of propagation along the body at 60 GHz with analytical models and skin-equivalent phantoms," in *Proc. Int. Antennas Propag. Symp. (APS-URSI)*, Lake Buena Vista, Florida, USA, 7 – 12 Jul. **2013**, pp. 2097-2098.
- [IC - 60] **G. Valerio**, N. Chahat, M. Zhadobov, and R. Sauleau, "Theoretical and experimental characterization of on-body propagation at 60 GHz," in *Proc. Eur. Conf. Antennas Propag. (EuCAP)*, Gothenburg, Sweden, 8-12 Apr. **2013**, pp. 583-585, ISBN: 978-88-907018-1-8. **(Invited as co-author)**
- [IC - 59] A. Galli, D. Comite, **G. Valerio**, E. Pettinelli, "Numerical study on the critical detection of subsurface dielectric scatterers with GPR systems," in *Proc. Eur. Conf. Antennas Propag. (EuCAP)*, Gothenburg, Sweden, 8-12 Apr. **2013**, pp. 3361-3364, ISBN: 978-88-907018-1-8.
- [IC - 58] **G. Valerio**, S. Paulotto, P. Baccarelli, A. Galli, D. R. Jackson, D. R. Wilton, and W.A. Johnson, "Computation of layered mixed potentials for the accurate and efficient analysis of periodic printed structures," in *Proc. Eur. Conf. Antennas Propag. (EuCAP)*, Gothenburg, Sweden, 8-12 Apr. **2013**, pp. 616-617, ISBN: 978-88-907018-1-8. **(Invited as co-author)**
- [IC - 57] M. Casaletti, **G. Valerio**, J. Seljan, M. Ettorre, and R. Sauleau, "A full-wave hybrid method for the fast analysis of SIW-based antennas," in *Proc. Eur. Conf. Antennas Propag. (EuCAP)*, Gothenburg, Sweden, 8-12 Apr. **2013**, pp. 583-585, ISBN: 978-88-907018-1-8. **(Invited as co-author)**
- [IC - 56] **G. Valerio**, S. Paulotto, P. Baccarelli, A. Galli, D. R. Jackson, D. R. Wilton, and W.A. Johnson, "Computation of layered mixed potentials for the accurate and efficient analysis of 1-D periodic printed leaky-wave antennas," at *INTELECT'2012*, Seville, Spain, 19 Oct. **2012**. **(Invited as co-author)**
- [IC - 55] M. Zucca, M. Ciattaglia, R. Pintauro, **G. Valerio**, and A. Galli "Compact and low-loss printed circuit based on hybrid rings for radar applications," in *Proc. Eur. Microw. Conf. (EuMC)*, Amsterdam, Netherlands, 31 Oct – 2 Nov. **2012**, pp. 487-490, ISBN: 978-2-87487-026-2.
- [IC - 54] A. Galli, D. Comite, **G. Valerio**, P. M. Barone, S. E. Lauro, E. Mattei, E. Pettinelli, and G. Vannaroni, "Theoretical and experimental investigations on the performance of ground penetrating radars in challenging operational conditions," in *Proc. Eur. Radar Conf. (EuRad)*, Amsterdam, Netherlands, 31 Oct – 2 Nov. **2012**, pp. 79-83, ISBN: 978-1-4673-2471-7.
- [IC - 53] E. Gandini, K. Tekkouk, J. Seljan, M. Casaletti, **G. Valerio**, M. Ettorre, R. Sauleau, "Substrate integrated waveguide structures: analysis and design of multiple beam antennas," in *Proc. 7th Working Group and 9th Management Committee*, Istanbul, Turkey, 8 - 9 Oct. **2012**.
- [IC - 52] F. Soldovieri, D. Comite, A. Galli, **G. Valerio**, P. M. Barone, S. E. Lauro, E. Mattei, E. Pettinelli, "Retrieval of shape characteristics for buried objects with GPR monitoring" in *Proc. European Geosciences Union (EGU) General Assembly*, Vienna, Austria, 22 – 27 April **2012**, p. 11265. **(Invited as co-author)**
- [IC - 51] J. Seljan, M. Casaletti, **G. Valerio**, M. Ettorre, R. Sauleau, and S. Maci, "Novel mode-matching technique for the efficient analysis of complex multi-layer SIW and SISW-based structures," in *Proc. Nat. Radio Sci. meeting*, Chicago, Illinois, USA, 8 – 14 Jul. **2012**.
- [IC - 50] **G. Valerio**, D. R. Jackson, and A. Galli, "Integral representations of the 1D periodic layered-media Green's function for periodic printed leaky-wave antennas," in *Proc. Nat. Radio Sci. meeting*, Chicago, Illinois, USA, 8 – 14 Jul. **2012**.
- [IC - 49] D. R. Wilton, D. R. Jackson, **G. Valerio**, and M. A. Francavilla, "An overview of techniques for the efficient solution of multilayered media problems using the MPIE," in *Proc. Nat. Radio Sci. meeting*, Chicago, Illinois, USA, 8 – 14 Jul. **2012**. **(Invited as co-author)**
- [IC - 48] A. Galli, S. Mazzocchi, **G. Valerio**, M. Ciattaglia, and M. Zucca, "Novel printed UWB array based on a versatile and low-cost antenna configuration," in *Proc. VI Eur. Conf. Antennas Propag. (EuCAP)*, Prague, Czech Republic, 26-30 Mar. **2012**, pp. 626-628, ISBN: 978-1-4577-0918-0, . **(Invited as co-author)**
- [IC - 47] **G. Valerio**, S. Paulotto, D. R. Jackson, D. R. Wilton, P. Baccarelli, and A. Galli, "Computational aspects for the accurate and efficient analysis of periodic planar leaky-wave antennas," in *Proc.*

- VI Eur. Conf. Antennas Propag. (EuCAP)*, Prague, Czech Republic, 26-30 Mar. **2012**, pp. 260-262, ISBN: 978-1-4577-0918-0, . **(Personally invited)**
- [IC - 46] **G. Valerio**, F. Soldovieri, P. M. Barone, S. E. Lauro, E. Mattei, E. Pettinelli, D. Comite, and A. Galli, "Shape reconstruction of scatterers by suitable inverse processing of GPR data," in *Proc. VI Eur. Conf. Antennas Propag. (EuCAP)*, Prague, Czech Republic, 26-30 Mar. **2012**, pp. 2209-2211, ISBN: 978-1-4577-0918-0, doi: 10.1109/EuCAP.2012.6206268.
- [IC - 45] **G. Valerio**, A. Galli, D. R. Wilton, and D. R. Jackson, "An enhanced integral-equation formulation for accurate analysis of frequency-selective structures," in *Proc. Eur. Microwave Conf. (EuMC)*, Manchester, Great Britain, 10 - 13 Oct. **2011**, pp. 179-182, ISBN: 978-1-61284-235-6.
- [IC - 44] **G. Valerio**, S. Mazzocchi, A. Galli, M. Ciattaglia, and M. Zucca, "A versatile printed antenna configuration for multifunction UWB array applications," in *Proc. Eur. Microwave Conf. (EuMC)*, Manchester, Great Britain, 10 - 13 Oct. **2011**, pp. 1051-1054, ISBN: 978-1-61284-235-6.
- [IC - 43] W. A. Johnson, S. Paulotto, D.R. Jackson, D. R. Wilton, W. L. Langston, L. I. Basilio, P. Baccarelli, **G. Valerio**, and F. T. Celepcikay, "Modeling of 1-D periodic leaky-wave antennas in layered media with EIGER," at *INTELECT'2011*, Florence, Italy, 9 Sep. **2011 (Invited as co-author)**
- [IC - 42] **G. Valerio**, E. Pettinelli, P. M. Barone, S. E. Lauro, E. Mattei, and A. Galli, "Development of an efficient numerical set-up to predict the performance of ground-penetrating-radar systems for on-site Earth and planetary applications," in *Proc. URSI Gen. Ass. Sci. Symp. (URSI GASS)*, Istanbul, Turkey, 13 - 20 Aug. **2011**, (4 pp.) ISBN 978-1-4244-5117-3, doi: 10.1109/URSIGASS.2011.6050386.
- [IC - 41] **G. Valerio**, D. R. Jackson, D. R. Wilton, and A. Galli "An efficient numerical approach to the accurate analysis of propagation and radiation phenomena in metamaterial structures," in *Proc. URSI Gen. Ass. Sci. Symp. (URSI GASS)*, Istanbul, Turkey, 13 - 20 Aug. **2011**.(4 pp.), ISBN 978-1-4244-5117-3, doi: 10.1109/URSIGASS.2011.6050386 **(Invited as co-author)**
- [IC - 40] D. R. Jackson, **G. Valerio**, J. Chen, N. Zhou, F. Capolino, D. R. Wilton, and A. Galli, "Efficient full-wave analyses of bound and leaky modes in multilayered periodic structures," in *Proc. Nat. Radio Sci. meeting*, Spokane, Washington, USA, 3-8 Jul. **2011** (1 p.), ISBN: 978-1-4244-4967-5. **(Invited as co-author)**
- [IC - 39] **G. Valerio**, P. M. Barone, S. E. Lauro, E. Mattei, E. Pettinelli, and A. Galli, "GPR reconstruction of the features of martian subsoil in the frame of the ExoMars mission," in *Proc. V Eur. Conf. Antennas Propag. (EuCAP)*, Rome Italy, 11-15 Apr. **2011**, pp. 2615 - 2617, ISBN 978-88-8202-074-3.
- [IC - 38] **G. Valerio**, D. R. Jackson, and A. Galli, "Rigorous determination of the modal spectrum for multilayered structures through a simple closed-form approach," in *Proc. V Eur. Conf. Antennas Propag. (EuCAP)*, Rome Italy, 11-15 Apr. **2011**, pp. 673-675, ISBN 978-88-8202-074-3.
- [IC - 37] **G. Valerio**, D. R. Wilton, D. R. Jackson, and A. Galli, "Analysis of 2D metamaterial structures using accelerated computation of mixed-potential Green's functions," in *Proc. V Eur. Conf. Antennas Propag. (EuCAP)*, Rome Italy, 11-15 Apr. **2011**, pp. 2403-2405, ISBN 978-88-8202-074-3. **(Invited as co-author)**
- [IC - 36] D. F. Mastrangeli, **G. Valerio**, A. Galli, A. De Luca, and M. Teglia, "An attractive S-band dual-pol printed antenna for multifunction phased array radars," in *Proc. V Eur. Conf. Antennas Propag. (EuCAP)*, Rome Italy, 11-17 Apr. **2011**, pp. 514-516, ISBN 978-88-8202-074-3.
- [IC - 35] D. R. Wilton, D. R. Jackson, S. Paulotto, **G. Valerio**, W. A. Johnson, L. I. Basilio, W. L. Langston, F. T. Celepcikay, and A. Francavilla, "Efficient strategies for the MPIE solution of periodic structures in layered media," in *Proc. URSI Nat. Radio Sci. Meeting*, Boulder, Colorado, USA, Jan 5-11 **2011**.
- [IC - 34] **G. Valerio**, D. R. Jackson, and A. Galli, "Closed-form analysis of dispersive properties for multilayered waveguiding structures," in *Proc. Eur. Microwave Conf. (EuMC)*, Paris, France, 26 Sep.-1 Oct. **2010**, pp. 144-147, ISBN: 978-1-4244-7232-1.
- [IC - 33] **G. Valerio**, D. R. Wilton, D. R. Jackson, and A. Galli, "Investigation of bound and leaky modes on periodic bidimensional structures using mixed-potential integral equations," in *Proc. Int. Conf. Electromagn. Advanced Appl. (ICEAA)*, Sydney, Australia, 20-24 Sep. **2010**, pp. 156-159, doi: 10.1109/ICEAA.2010.5652132, ISBN: 978-1-4244-7366-3. **(Personally invited)**
- [IC - 32] W. A. Johnson, S. Paulotto, D. R. Jackson, D. R. Wilton, W. L. Langston, L. I. Basilio, P. Baccarelli, **G. Valerio**, and F. T. Celepcikay, "Modeling of general 1-D periodic leaky-wave antennas in layered media using EIGER™," in *Proc. Int. Conf. Electromagn. Advanced Appl. (ICEAA)*, Sydney, Australia, 20-24 Sep. **2010**, pp. 205-208, doi:10.1109/ICEAA.2010.5652952, ISBN: 978-1-4244-7366-3.

- [IC - 31] S. Paulotto, **G. Valerio**, D. R. Jackson, D. R. Wilton, P. Baccarelli, F. T. Celepcikay, and A. Galli, "Efficient calculation of 1-D periodic Green's functions for leaky-wave applications," in *Proc. Int. Symp. Electr. Theory (EMTS)*, Berlin, Germany, 16-19 Aug. **2010**, pp. 204-207, doi: 10.1109/URSI-EMTS.2010.5637089, ISBN: 978-1-4244-5154-8.
- [IC - 30] **G. Valerio**, A. Galli, P. M. Barone, S. E. Lauro, E. Mattei, and E. Pettinelli, "Characterization of scattering effects for GPR signals from rover on martian soil: measured and simulated data," in *Proc. URSI Nat. Radio Sci. meeting*, Toronto, Canada, 11-17 Jul. **2010** (1 p.), ISBN: 978-1-4244-4967-5.
- [IC - 29] **G. Valerio**, D. R. Jackson, and A. Galli, "The array scanning method for the computation of 1D-periodic 3D Green's functions in stratified media," in *Proc. Antennas Propag. Symp. (APS)*, Toronto, Canada, 11-17 Jul. **2010** (4 pp.), doi: 10.1109/APS.2010.5561087, ISBN: 978-1-4244-4967-5.
- [IC - 28] **G. Valerio**, P. Baccarelli, P. Burghignoli, and A. Galli, "Efficient computation of the impedance of a single vertical current in a periodic line," in *Proc. Antennas Propag. Symp. (APS)*, Toronto, Canada, 11-17 Jul. **2010** (4 pp.), doi: 10.1109/APS.2010.5561129, ISBN: 978-1-4244-4967-5.
- [IC - 27] **G. Valerio**, S. Paulotto, P. Baccarelli, P. Burghignoli, and A. Galli, "Improving modal analysis of 1D-periodic lines based on the simulation of finite structures," in *Proc. Antennas Propag. Symp. (APS)*, Toronto, Canada, 11-17 Jul. **2010** (4 pp.), doi: 10.1109/APS.2010.5561119, ISBN: 978-1-4244-4967-5.
- [IC - 26] **G. Valerio**, D. R. Wilton, D. R. Jackson, and A. Galli, "Accelerated solution of periodic problems involving arbitrarily-shaped cylindrical inclusions in stratified media," in *Proc. Antennas Propag. Symp. (APS)*, Toronto, Canada, 11-17 Jul. **2010** (4 pp.), doi: 10.1109/APS.2010.5561123, ISBN: 978-1-4244-4967-5.
- [IC - 25] **G. Valerio**, A. Galli, P. M. Barone, S. E. Lauro, E. Mattei, and E. Pettinelli, "GPR characterization of rocks buried in the martian subsoil," in *Proc. XII Int. Conf Ground Penetr. Radar*, Lecce, Italy, 21-25 Jun. **2010** (4 pp.), doi: 10.1109/ICGPR.2010.5550180, ISBN: 978-1-4244-4604-9.
- [IC - 24] S. Mazzocchi, **G. Valerio**, M. Zucca, M. Ciattaglia, A. De Luca, and A. Galli, "A new multifunctional UWB planar antenna based on printed dipoles in rhombic configuration," in *Proc. Eur. Conf. Antennas Propag. (EuCAP)*, Barcelona, Spain, 12-16 Apr. **2010** (3 pp.), ISBN: 978-84-7653-472-4. **(Invited as co-author)**
- [IC - 23] **G. Valerio**, A. Galli, P. M. Barone, S. E. Lauro, E. Mattei, and E. Pettinelli, "GPR investigation on buried rocks in Martian subsoil for "WISDOM" project: numerical and measurement set-up results," in *Proc. Eur. Conf. Antennas Propag. (EuCAP)*, Barcelona, Spain, 12-16 Apr. **2010** (3 pp.), ISBN: 978-84-7653-472-4.
- [IC - 22] **G. Valerio**, P. Baccarelli, P. Burghignoli, and A. Galli, "Excitation of a periodic microstrip line through a nonperiodic vertical current," in *Proc. Eur. Microwave Conf. (EuMC)*, Rome, Italy, 28 Sep. - 2 Oct. **2009**, pp. 806-809, doi: 10.1109/EUMC.2009.5295988, ISBN: 978-2-87487-001-9. **(Finalist at the "EuMC Young Engineering Prize")**
- [IC - 21] **G. Valerio**, D. R. Wilton, D. R. Jackson, and A. Galli, "Efficient computation of mixed potential dyadic Green's functions for a 1D periodic array of line sources in layered media," in *Proc. Int. Conf. Electromagn. Advanced Appl. (ICEAA)*, Turin, Italy, 14-18 Sep. **2009**, pp. 152-155, doi: 10.1109/ICEAA.2009.5297555, ISBN: 978-1-4244-3385-8. **(Personally invited)**
- [IC - 20] **G. Valerio**, A. Galli and D. R. Jackson, "Properties of surface waves in general stratified structures," in *Proc. URSI Nat. Radio Sci. meeting*, Charleston, South Carolina, USA, 1-5 Jun. **2009** (1 p.).
- [IC - 19] A. Galli, **G. Valerio**, A. De Luca, and D. Tallini, "Optimization of multifunctional UWB planar phased arrays," in *Proc. Eur. Conf. Antennas Propag. (EuCAP)*, Berlin, Germany, 23-27 Mar. **2009**, pp. 571-574, ISBN: 978-1-4244-4753-4. **(Invited as co-author)**
- [IC - 18] **G. Valerio**, S. Paulotto, P. Baccarelli, P. Burghignoli, F. Frezza, A. Galli and P. Lampariello, "Improving approximate 1D Bloch analysis through simulation of truncated periodic structures," in *Proc. Eur. Conf. Antennas Propag. (EuCAP)*, Berlin, Germany, 23-27 Mar. **2009**, pp. 3453-3456, ISBN: 978-1-4244-4753-4.
- [IC - 17] P. Baccarelli, P. Burghignoli, F. Frezza, A. Galli, P. Lampariello, S. Paulotto, and **G. Valerio**, "Efficient design of a compact wideband EBG filter for active integrated antennas," in *Proc. Eur. Microwave Conf. (EuMC)*, Amsterdam, Netherlands, Oct. **2008**, pp. 769-772, doi: 10.1109/EUMC.2008.4751566, ISBN: 978-2-87487-001-9.

- [IC - 16] **G. Valerio**, P. Baccarelli, S. Paulotto, F. Frezza, and A. Galli, "Improved acceleration of mixed-potential periodic Green's functions through the effective-medium concept," in *Proc. URSI GA*, Chicago, Illinois, USA, 7-16 Aug. **2008** (4 pp.).
- [IC - 15] P. Baccarelli, P. Burghignoli, F. Frezza, A. Galli, P. Lampariello, S. Paulotto, and **G. Valerio**, "A compact tapered microstrip EBG filter for harmonic-tuned active integrated antennas," in *Proc. URSI Nat. Radio Sci. meeting*, San Diego, California, USA, 5-11 Jul. **2008** (1 p.), ISBN: 978-1-4244-2041-4.
- [IC - 14] **G. Valerio** and A. Galli, "Analysis and design of notched dielectric resonator antennas for improving band performance," in *Proc. URSI Nat. Radio Sci. meeting*, San Diego, California, USA, 5-11 Jul. **2008** (1 p.), ISBN: 978-1-4244-2041-4.
- [IC - 13] **G. Valerio**, P. Baccarelli, S. Paulotto, F. Frezza, and A. Galli, "Efficient interpolation of mixed-potential periodic Green's functions in layered media," in *Proc. Antennas Propag. Symp. (APS)*, San Diego, California, USA, 5-11 Jul. **2008** (4 pp.), doi: 10.1109/APS.2008.4620022, ISBN: 978-1-4244-2041-4.
- [IC - 12] P. Baccarelli, P. Burghignoli, F. Frezza, A. Galli, P. Lampariello, S. Paulotto, and **G. Valerio**, "Dispersive Analysis of wide-bandstop compact EBG microstrip lines for filter applications," in *Proc. Int. Symp. Microwave Opt. Tech. (ISMOT)*, Monte Porzio Catone, Italy, 17-21 Dec. **2007**, pp. 57-60, ISBN: 978-88-548-1476-9. **(Invited as co-author)**
- [IC - 11] P. Colantonio, F. Giannini, R. Giofrè, M. C. Montieri, P. Baccarelli, P. Burghignoli, F. Frezza, A. Galli, P. Lampariello, S. Paulotto, **G. Valerio**, R. Vescovo, V. Camarchia, G. Ghione, C. Naldi, M. Pirola, A. Santarelli, R. Cignani, F. Fantini, C. Florian, G. Manara, P. Nepa, G. Pelosi, and S. Selleri, "Active integrated antennas for efficient mobile terminals," in *Proc. Int. Symp. Microwave Opt. Tech. (ISMOT)*, Monte Porzio Catone, Italy, 17-21 Dec. **2007**, pp. 625-628, ISBN: 978-88-548-1476-9. **(Invited as co-author)**
- [IC - 10] **G. Valerio**, P. Baccarelli, P. Burghignoli, A. Galli, R. R-Berral, and F. Mesa, "An efficient implementation for the analysis of periodic microstrip lines excited by nonperiodic sources," in *Proc. Eur. Conf. Antennas Prop. (EuCAP)*, Edinburgh, Great Britain, 11-16 Nov. **2007** (5 pp.), ISBN: 978-0-86341-842-6.
- [IC - 9] P. Baccarelli, P. Burghignoli, F. Frezza, A. Galli, P. Lampariello, S. Paulotto, and **G. Valerio**, "Harmonic tuned patch active integrated antenna for a high-efficiency Ku-band transmitter," in *Proc. Eur. Conf. Antennas Prop. (EuCAP)*, Edinburgh, Great Britain, 11-16 Nov. **2007** (4 pp.), ISBN: 978-0-86341-842-6.
- [IC - 8] V. Volski, G. A. E. Vandenbosch, P. Baccarelli, F. Frezza, A. Galli, S. Paulotto, and **G. Valerio**, "Interpolation of Green's functions with 2D periodicity in layered media," in *Proc. Eur. Conf. Antennas Prop. (EuCAP)*, Edinburgh, Great Britain, 11-16 Nov. **2007** (7 pp.), ISBN: 978-0-86341-842-6. **(Invited as co-author)**
- [IC - 7] **G. Valerio** and A. Galli, "Design of notched dielectric resonators for harmonic tuning in active antennas," in *Proc. Eur. Conf. Antennas Prop. (EuCAP)*, Edinburgh, Great Britain, 11-16 Nov. **2007** (5 pp.), ISBN: 978-0-86341-842-6.
- [IC - 6] P. Baccarelli, P. Burghignoli, F. Frezza, A. Galli, P. Lampariello, S. Paulotto, and **G. Valerio**, "Analysis and design of a microstrip patch antenna for harmonic tuning in a high-efficiency integrated microwave transmitter," in *Proc. Eur. Microwave Conf. (EuMC)*, Munich, Germany, 9-12 Oct. **2007**, pp. 364-367, doi: 10.1109/EUMC.2007.4405202, ISBN: 978-2-87487-001-9.
- [IC - 5] **G. Valerio**, P. Baccarelli, P. Burghignoli, and A. Galli, "Accelerated full-wave analysis of a 2D periodic array of rectangular patches excited by a 1D array of sources," in *Proc. Antennas Propag. Symp. (APS)*, Honolulu, Hawaii, USA, 10-15 Jun. **2007**, pp. 5011-5014, doi: 10.1109/APS.2007.4396671, ISBN: 978-1-4244-0877-1.
- [IC - 4] R. R-Berral, **G. Valerio**, F. Mesa, P. Baccarelli, P. Burghignoli, and A. Galli, "Full-wave analysis of periodic microstrip lines excited by an aperiodic delta-gap source," in *Proc. Int. Microwave Symp. (IMS)*, Honolulu, Hawaii, USA, 3-8 Jun. **2007**, pp. 1667-1670, doi: 10.1109/MWSYM.2007.380026, ISSN: 0149-645X, ISBN: 1-4244-0688-9.
- [IC - 3] **G. Valerio**, P. Baccarelli, P. Burghignoli, and A. Galli, "Nonperiodic excitation of a shielded periodic array of patches," in *Proc. Mediterr. Microwave Symp. (MMS)*, Budapest, Hungary, 14-16 May **2007**, pp. 57-60, ISBN: 978-963-87244-4-1.
- [IC - 2] P. Baccarelli, A. Galli, S. Paulotto, **G. Valerio**, V. Volski, and G. A. E. Vandenbosch, "Methods for the accelerated computation of Green's functions with 2-D periodicity in layered media," in *Proc.*

Eur. Conf. Antennas Propag. (EuCAP), Nice, France, 6-10 Nov. **2006**, CD# 350152 (6 pp.), doi: 10.1109/EUCAP.2006.4584499, ISBN: 978-92-9092-937-6. **(Invited as co-author)**

- [IC - 1] **G. Valerio**, P. Baccarelli, P. Burghignoli, and A. Galli, "3-D Green's functions in 1-D periodic structures: a comparative analysis of the acceleration techniques," in *Proc. Eur. Conf. Antennas Propag. (EuCAP)*, Nice, France, 6-10 Nov. **2006**, CD# 350213 (6 pp.), doi: 10.1109/EUCAP.2006.4584480, ISBN: 978-92-9092-937-6.

Peer-Reviewed National Conferences

- [NatC - 20] O. Quevedo-Teruel **G. Valerio**, and Z. Sipus "Higher Symmetries: A new degree of freedom for periodic structures," accepted for presentation at *XII Iberian Meeting on Computational Electromagnetics (EIEC)*, Coimbra, Portugal, May 16 – 18 **2018**.
- [NatC - 19] O. Quevedo-Teruel, and **G. Valerio** "Simetrías superiores para el diseño de estructuras periódicas," in *Proc. XXXII Simposium Nacional de la Unión Científica Internacional de Radio*, Cartagena, Spain, Sep. 6 – 8 **2017**.
- [NatC - 18] **G. Valerio**, Z. Sipus, A. Grbic, and O. Quevedo-Teruel, "Metasurfaces à symétries supplémentaires pour lentilles à bande ultra large," in *Proc. XIX Journées Nationales Microondes*, Saint Malo, France, 16-19 May **2017**.
- [NatC - 17] W. Fuscaldo, **G. Valerio**, A. Galli, R. Sauleau, and M. Ettorre, "A novel Bessel beam launcher based on higher-order leaky modes," in *Atti della XX RiNEM*, Padua, Italy, 15-18 Sep. **2014**.
- [NatC - 16] M. Casaletti, **G. Valerio**, J. Seljan, M. Ettorre, and R. Sauleau, "Méthode de raccordement modal pour l'analyse rapide d'antennes SIW," in *Proc. XVIII Journées Nationales Microondes*, Paris, France, 15-17 May **2013**.
- [NatC - 15] A. Galli, S. Mazzocchi, **G. Valerio**, M. Ciattaglia, and M. Zucca, "UWB multifunctional arrays based on versatile printed rhombic antenna configurations," in *Atti della XIX RiNEM*, Rome, Italy, 6-10 Sep. **2012**, pp. 559-562.
- [NatC - 14] D. Comite, A. Galli, F. Soldovieri, **G. Valerio**, P. M. Barone, S. E. Lauro, E. Mattei, and E. Pettinelli, "Estimation of the geometrical features of buried objects from GPR analysis," in *Atti della XIX RiNEM*, Rome, Italy, 6-10 Sep. **2012**, pp. 203-206.
- [NatC - 13] **G. Valerio**, S. Paulotto, P. Baccarelli, A. Galli, D. R. Jackson, and D. R. Wilton, "Efficient computation of periodic Green's functions for printed structures with vertical elements," in *Atti della XIX RiNEM*, Rome, Italy, 6-10 Sep. **2012**, pp. 142-145.
- [NatC - 12] **G. Valerio**, D. R. Wilton, D. R. Jackson, and A. Galli, "Accelerated numerical analysis of arbitrarily shaped bidimensional periodic structures in layered media with mixed-potential integral equations," in *Atti della XVIII RiNEM*, Benevento, Italy, 6-10 Sep. **2010**, pp. 336-338.
- [NatC - 11] P. Baccarelli, P. Burghignoli, A. Galli, P. Lampariello, S. Paulotto, and **G. Valerio**, "Analisi di Bloch di strutture periodiche monodimensionali mediante la simulazione di un numero finito di celle," in *Atti della XVIII RiNEM*, Benevento, Italy, 6-10 Sep. **2010**, pp. 339-341.
- [NatC - 10] S. Mazzocchi, **G. Valerio**, M. Zucca, M. Ciattaglia, A. De Luca, and A. Galli, "Analisi di un nuovo elemento radiante planare basato su dipoli stampati in configurazione rombica per antenne ultra-wide-band multifunzionali," in *Atti della XVIII RiNEM*, Benevento, Italy, 6-10 Sep. **2010**, pp. 637-639.
- [NatC - 9] **G. Valerio**, "Espressioni in forma chiusa per il calcolo rigoroso delle onde superficiali di una struttura multistrato arbitraria," in *Atti della XVIII RiNEM*, Benevento, Italy, 6-10 Sep. **2010**, pp. 45-50. **(Barzilai Prize for the best author younger than 35)**
- [NatC - 8] **G. Valerio**, V. Sozio, A. Galli, E. Pettinelli, E. Mattei, P. M. Barone, and S. Lauro, "Modelli elettromagnetici e simulazioni numeriche per la caratterizzazione GPR di rocce sepolte nel sottosuolo marziano nell'ambito del progetto 'WISDOM'," in *Atti del IX Congr. Naz. Planetologia*, Amalfi, Italy, 28 Sep.-2 Oct. **2009**.
- [NatC - 7] E. Pettinelli, E. Mattei, P. M. Barone, S. E. Lauro, **G. Valerio**, and A. Galli, "Misure sperimentali per la stima dell'attenuazione dei segnali radar di 'WISDOM' su simulanti del suolo marziano," in *Atti del IX Congr. Naz. Planetologia*, Amalfi, Italy, 28 Sep. – 2 Oct. **2009**.
- [NatC - 6] P. Baccarelli, P. Burghignoli, F. Frezza, A. Galli, P. Lampariello, S. Paulotto, and **G. Valerio**, "Trasmettitori ad alta efficienza in banda Ku basati su configurazioni 'harmonic tuned' e

- antenne integrate attive stampate,” in *Atti della XVII RiNEM*, Lecce, Italy, 15-19 Sep. **2008** (4 pp.).
- [NatC - 5] **G. Valerio**, P. Baccarelli, S. Paulotto, F. Frezza, and A. Galli, “Regolarizzazione e interpolazione delle funzioni di Green ai potenziali misti per l’analisi efficiente di strutture periodiche stampate su substrati dielettrici,” in *Atti della XVII RiNEM*, Lecce, Italy, 15-19 Sep. **2008** (4 pp.).
- [NatC - 4] **G. Valerio**, P. Baccarelli, P. Burghignoli, and A. Galli, “Il metodo dell’Array Scanning per l’analisi efficiente di microstrisce periodiche eccitate da sorgenti aperiodiche,” in *Atti della XVII RiNEM*, Lecce, Italy, 15-19 Sep. **2008** (4 pp.).
- [NatC - 3] P. Colantonio, F. Giannini, R. Giofrè, M. C. Montieri, P. Baccarelli, P. Burghignoli, F. Frezza, A. Galli, P. Lampariello, S. Paulotto, **G. Valerio**, R. Vescovo, V. Camarchia, G. Ghigne, C. Naldi, M. Pirola, A. Santarelli, R. Cignani, F. Fantini, C. Florian, G. Manara, P. Nepa, G. Pelosi, and S. Selleri, “Antenne Integrate Attive per Terminali Mobili ad Alta Efficienza,” *XIII Giornata di Studio sull’Ingegneria delle Microonde*, Fisciano, Italy, 14-15 May **2007**, pp. 85-88.
- [NatC - 2] P. Baccarelli, P. Burghignoli, F. Frezza, A. Galli, P. Lampariello, G. Lovat, S. Paulotto, and **G. Valerio**, “Proprietà modali di guide d’onda NRD metamateriali,” in *Atti della XVI RiNEM*, Genova, 18-22 Sep. **2006**, pp. 468-471.
- [NatC - 1] **G. Valerio**, P. Baccarelli, P. Burghignoli, and A. Galli, “Tecniche di accelerazione per funzioni di Green 3-D in strutture periodiche lungo una o due direzioni,” in *Atti della XVI RiNEM*, Genova, 18-22 Sep. **2006**, pp. 378-381.

Other Seminars and Workshops

T. Zhang, G. Valerio, J. Sarrazin, and D. Istrate, “Optimization algorithm for 60-GHz non-contact human-vital-sign monitoring,” *Journée annuelle de l’AREMIF 2016*, Paris, France, 2 June **2016**.