



HAL
open science

Molecular and physiological characterization of tomato (*Solanum lycopersicon*) ethylene response factor (ERF)

Julien Pirello

► **To cite this version:**

Julien Pirello. Molecular and physiological characterization of tomato (*Solanum lycopersicon*) ethylene response factor (ERF). *Vegetal Biology*. Institut National Polytechnique (Toulouse), 2008. English. NNT : 2008INPT010A . tel-04526448

HAL Id: tel-04526448

<https://hal.science/tel-04526448>

Submitted on 29 Mar 2024

HAL is a multi-disciplinary open access archive for the deposit and dissemination of scientific research documents, whether they are published or not. The documents may come from teaching and research institutions in France or abroad, or from public or private research centers.

L'archive ouverte pluridisciplinaire **HAL**, est destinée au dépôt et à la diffusion de documents scientifiques de niveau recherche, publiés ou non, émanant des établissements d'enseignement et de recherche français ou étrangers, des laboratoires publics ou privés.



THÈSE

En vue de l'obtention du

DOCTORAT DE L'UNIVERSITÉ DE TOULOUSE

Délivré par *l'Institut National Polytechnique de Toulouse*
Discipline ou spécialité : *Biosciences Végétales*

Présentée et soutenue par *Julien PIRRELLO*
Le 5 septembre 2008

Titre :
*Caractérisation moléculaire et physiologique des
Facteurs de Réponse à l'Ethylène (ERF) chez la tomate (Solanum lycopersicon)*

JURY

Mr. Jean-Claude PECH	Président (INP-ENSAT)
Mr. Christophe ROTHAN	Rapporteur (INRA Bordeaux)
Mr. Guy ALBAGNAC	Rapporteur (INRA Montpellier)
Mme. Mathilde CAUSSE	Examinatrice (INRA Avignon)
Mr. Masaru OHME-TAKAGI	Examineur (AIST Tsukuba)
Mr. Farid REGAD	Examineur (INP-ENSAT)
Mr. Mondher BOUZAYEN	Directeur de thèse (INP-ENSAT)
Mr. Xavier BERTHET	Membre invité (NINSAR Barcelone)

Ecole doctorale : *Biologie Santé et Biotechnologie*
Unité de recherche : *UMR990 INP-ENSAT/INRA Génomique et Biotechnologie des Fruits*
Directeur de Thèse : *Pr. Mondher BOUZAYEN*

Remerciements

Je remercie **Mondher BOUZAYEN** et **Masaru OHME-TAKAGI** pour m'avoir accueilli, encadré et fait confiance pendant ce travail de thèse.

Je remercie **Farid REGAD** pour les discussions scientifiques ainsi que son soutien jusqu'à très tard dans la nuit.

Je remercie **Jean-Claude PECH** et **Alain LATCHE** pour avoir échangé scientifiquement avec moi.

Un merci tout spéciale à **Corinne, Isabelle, Simone, Marie, Salma** et **Benoît** pour tous les moments de sciences (ou pas) partagés.

Merci à **Prasad, Ravi, Wangshu** et **Lanlan** d'avoir participé à cette aventure.

Un grand merci à **Hélène, Carole, Lydie, Olivier** et **Dominique** pour la transformation et le suivi des plantes transgéniques (et ce n'est pas peu dire).

Un grand merci à l'ensemble des membres du laboratoire pour tous les moments partagés, de sciences, et de convivialité : **Christian, Anne, Simo, Sophie, Paloma, Fabiola, Christina, Pierre, Murielle, Brice, Hua, Brigitte, Nadine...**

Je tiens également à remercier tous les membres du Research Institute of Genome-based Biofactory **Miho Ikeda, Akira Iwase, Yoshimi Umemura, Tomotsugu Koyama, Masahito Shikata, Kyoko Matsui, Nobut aka Mitsuda, Naoko Kaneta**, sans qui cette thèse n'aurait pas eu le même parfum. ありがとう. Merci aussi à **Toshi** et **Hiroshi Ezura** de m'avoir accueilli.

Merci à mes proches qui m'ont soutenu pendant ces années, **mes parents** et **mon frère**.

Enfin, je tiens à remercier tout particulièrement **Laëtitia** qui m'a suivi au bout du monde (au sens propre et au sens figuré), pour son soutien permanent et sans qui ce travail aurait été un peu différent.

Communications

Articles dans revues à comité de lecture

Julien Pirrello, Fabiola Jaimes-Miranda, Maria Teresa Sanchez-Ballesta, Barthélémy Tournier, Qaiser Khalil-Ahmad, Farid Regad, Alain Latché, Jean Claude Pech and Mondher Bouzayen (2006): Sl-ERF2, a Tomato Ethylene Response Factor Involved in Ethylene Response and Seed Germination Plant Cell Physiol. 47 (9): 1195–1205.

Chloé Marchive, Rim Mzid, Laurent Deluc, François Barrieu, **Julien Pirrello**, Adrien Gauthier, Marie-France Corio-Costet, Farid Regad, Bernard Cailleateau, Saïd Hamdi and Virginie Lauvergeat (2007): Isolation and characterization of a Vitis vinifera transcription factor, VvWRKY1, and its effect on responses to fungal pathogens in transgenic tobacco plants J Exp Bot.;58 (8):1999-2010

Communication Orale

Koyama T., **Pirrello J.**, Narukawa M., Bouzayen M., Ohme-Takagi M.: Identification of transcription factors that are involved in the ethylene-signaling pathway using the chimeric repressor gene silencing system 7th International Symposium on the Plant Hormone Ethylene, Pisa (2006)

Posters

Julien Pirrello, Farid Regad, Mondher Bouzayen: Molecular characterisation of tomato ERF trans-factors and GCC containing cis-elements, Xth France Japan Workshop on Plant Sciences, Toulouse (2005)

Pirrello J., Jaimes-Miranda F., Sanchez-Ballesta M.T., Tournier B., Qaiser A.K., Latche A., Pech J.C., Regad F., Bouzayen M: LeERF2, a tomato Ethylene Response Factor involved in ethylene response and seed germination 7th International Symposium on the Plant Hormone Ethylene, Pisa (2006)

B.C. Narasimha Prasad, **Pirrello J.**, Mila I, Zhang W., Zhang L, Zouine M., Regad F. and Bouzayen M.: Structural and Functional Characterization of Ethylene Response Factor Gene Family in Tomato Solanaceae Genome Workshop, Korea (2007)

Résumé

La phytohormone éthylène, contrôle de nombreux processus physiologique durant le développement des plantes, ainsi que la réponse aux stress biotiques et abiotiques. Les ERF (Facteurs de Réponse à l'Éthylène) sont les derniers facteurs de transcription de la voie de transduction de cette hormone. Ils sont par leur nombre, de bons candidats pour expliquer la diversité de réponse à l'éthylène. Dans cette étude 28 ERF de tomates ont été isolés, caractérisés et renommés. Des études d'interaction ADN/protéine montrent que l'environnement du *cis*-élément est déterminant pour l'interaction GCC/ERF. Des expériences d'expression transitoire des ERF ont permis de démontrer que leur activité transcriptionnelle est indépendante de leur classe d'appartenance. Leur profil d'expression suggère une spécificité de réponse au cours du développement végétatif ou de la maturation, ainsi qu'un rôle prépondérant dans l'initiation du fruit. L'analyse fonctionnelle est illustrée par deux exemples. D'une part, la surexpression de *SlERF2* dans la tomate induit une germination précoce des graines où il a été montré que la *MANNANASE2*, un marqueur de la germination, est fortement induit dans les graines transgéniques. D'autre part, la surexpression d'*ATERF13* fusionné à un domaine répresseur dominant induit une insensibilité partielle à l'éthylène et une hypersensibilité au stress salin.

Abstract

The phytohormone ethylene controls many physiological aspects of the plant development and stress response. ERFs (Ethylene Response Factors) are the last transcription factors of the ethylene transduction pathway. By their number, they are good candidates to explain the diversity of ethylene response. In this work 28 tomato ERFs have been isolated, characterized and renamed. DNA/protein interaction studies indicate that flanking regions of the *cis*-element are decisive for the GCC/ERF binding. Transient expression studies of ERFs demonstrated that the transcriptional activity is independent of the class they belong to. The study of their expression pattern revealed a specific response for some ERFs during the vegetative growth whereas others are preferentially expressed in fruit, from fruit set to ripening. The physiological significance of the ERFs is addressed through two examples. First, over-expression of the *SlERF2* gene in the tomato resulted in premature seed germination in which *MANNANASE2*, a germination marker, is dramatically enhanced in the transgenic seeds. Second, over-expression of *AtERF13* fused to a dominant repressor domain induces a partial insensitivity to ethylene and hypersensitivity to salt stress.

Sommaire

Communications	i
Résumé	ii
Abstract	iii
Abréviations	vii
Organisation générale de la thèse	1
Introduction au sujet de thèse	3
Problématique générale	3
Une espèce modèle : la tomate	4
La voie de transduction de l'éthylène.....	4
Les ERF, une famille multigénique importante pouvant expliquer la diversité de réponse à l'éthylène	5
Bibliographic review	7
1. Ethylene transduction pathway	8
1.1 Ethylene perception.....	9
1.2 A Raf like kinase as negative regulator of the pathway.....	10
1.3 A transcription factor cascade induce gene expression.....	11
2. Ethylene's functions	13
2.1 Senescence and abscission	13
2.2 Stress response	15
2.3 Fruit ripening.....	17
3. Ethylene Response Factor (ERF): a huge plant specific family.....	26
3.1 Dehydration Responsive Element Binding (DREB) proteins.....	27
3.2 Ethylene Response Factor (ERF)	27
Chapitre 1	34
Article 1	35
Introduction à l'article 1.	36
Specific features among members of the tomato Ethylene Response Factor family revealed by structural and functional studies	38
Abstract.....	38
Introduction	39
Results	42
Isolation of tomato ERF genes and generation of over-expression and repressor constructs.	42
Phylogenetic analysis of tomato ERFs	42
ERF activity	50
ERF expression pattern.....	52
ERF are regulated during fruit set initiation	54
Ethylene and auxin regulation of ERF genes.....	56
Discussion.....	58
Materials and Method.....	63
Plants growing	63
Cloning of over expressing and repressing ERF constructs.	63
Ethylene treatment	64
Auxin treatment	65
Hormonal treatment on emasculated flowers	65
RNA Extraction and quantitative Real Time PCR	65
Sequences Phylogenetic analysis.....	66
Mapping of ERFs.....	66

Cloning of promoters fused with GFP	66
Transient Expression Using a Single Cell System.....	67
Supplemental data.....	68
Article 2.....	75
Introduction à l'article 2.	76
The transcriptional regulation of the ethylene response genes: molecular characterization of Ethylene Response Factor and GCC box cis-element.	77
Abstract.....	77
Introduction	78
Results	80
Analysis of the GCC box flanking region in <i>Arabidopsis</i>	80
Flanking regions of the GCC box are involved in the affinity of interaction.....	82
The 6 th amino acid of the AP2/ERF domain influences the affinity of the binding	83
Discussion	Erreur ! Signet non défini.
Materials and Methods	87
Plant material	87
SI-ERF Cloning.....	87
Mutation of SI-ERF.B.3	87
Proteins production	88
Electro Mobility Shift Assay:	88
Chapitre 2.....	91
Article 3.....	91
Introduction à l'article 3.	93
<i>SI-ERF2</i>, a tomato Ethylene Response Factor involved in ethylene response and seed germination.....	95
Abstract	95
Introduction	95
Results	96
Structure of the <i>SI-ERF2</i> gene.....	96
Features of the <i>SI-ERF2</i> promoter.....	96
Tomato <i>SI-ERF2</i> gene undergoes alternative splicing	96
<i>SI-ERF2</i> is mainly expressed in ripening fruit.	97
Over-expression of <i>SI-ERF2</i> results in enhanced ethylene sensitivity and premature seed germination.....	98
<i>SI-ERF2</i> is involved in seed germination.....	99
The mannanase2 gene is up-regulated in the <i>SI-ERF2</i> over-expressing lines.....	101
Discussion	101
Materials and Methods	103
Plant material.....	103
Plant transformation	103
Germination assay	103
Apical curvature test.....	103
Isolation of the genomic clone	103
Isolation of the <i>SI-ERF2</i> promoter	103
RNA extraction and Quantitative PCR	103
References	104
Article 4.....	106
Introduction à l'article 4.	107
<i>AtERF13</i>, a member of the Ethylene Response Factor gene family is involved in ethylene response and salt stress.....	108

Abstract.....	108
Introduction	109
Results	111
Ethylene insensitivity screening	111
<i>PDF1.2</i> gene expression is altered in CR005 lines.....	112
Promoter sequence of <i>AtERF13</i> contains stress related <i>cis</i> -elements.....	113
Expression data-mining shows a root and stress related expression.....	113
AtERF13 is involved in salt stress	114
Discussion.....	116
Material and methods	118
Construction of plasmids and transformation	118
Screening for ethylene insensitivity	118
Salt treatment assay.....	119
Bioanalysis.....	119
Conclusions et perspectives	120
Bibliographie.....	125

Abréviations

1-MCP : 1-Methyl Cyclopropane

ABA : Abscissic Acid

ACC : Acide 1-AminoCyclopropane-1-Carboxilique

ACO : Acide 1-AminoCyclopropane-1-Carboxilique Oxydase

ACS : Acide 1-AminoCyclopropane-1-Carboxilique Synthase

AP2: Apetala2

ARC: Age-Related Changes

ARR: Age Related Resistance

CBF: C-repeat Binding Factor

CNR: Colorless Non Ripening

CTR: Constitutive Triple Response

CRES-T: Chimeric Repressor Silencing Technology

DAB: Delayed Floral Organ Abscission

DPA: Day Post Anthese

EAR: ERF Anphiphilic Repression domain

EBF: E3-Binding F-box protein

EBS: Ethylene Binding Site

EIN: Ethylene insensitive

ER: Ethylene Regulated

EREBP: Ethylene Response Element Binding Protein

ERF: Ethylene Response Factor

ERN: ERF Required for Nodulation

ERS: Ethylene Response Sensor

EST: Express Sequence Tag

ETR: Ethylene Triple Response

GA: Gibberellic Acid

GR: Green Ripe

GUS: β -glucuronidase

HR: Hypersensitive Response

HEG: Homing Endonuclease Genes

ISR: Induced systemic Resistance

JA: Jasmonic Acid
JERF: Jasmonate Ethylene Response Factor
KO: Knock Out
LOX: Lipoxigenase
MAP: Mitogen-Activated Protein
MAPK: Mitogen-Activated Kinase
MAPKKK: Mitogen-Activated Kinase Kinase Kinase
1-MCP: 1-methyl cyclo propane
NOR: Non-Ripening
NPA: Naphthylphthalamic Acid
NR: Never Ripe
IAA: Indol Acetic Acid
OLD: Onset of Leaf Death
PAG: Photosynthesis Associated Genes
PERE: Primary Ethylene Response
PG: Polygalacturonase
PR: Pathogenesis Related
RIN: Ripening Inhibitor
QTL: Quantitative Trait Loci
SA: Salicylic Acid
SAG: Senescence Associated Genes
SAR: Systemic acquired Resistance
SCF: Skp1-Cullin-F-box
SRDX: SUPERMAN Repression Domain X (#10)
TERF: Tomato Ethylene Response Factor
VOC: Volatile Organic Compounds
VWRE: Vascular system specific and Wound Responsive *cis*-Element
WT: Wild Type

Organisation générale de la thèse

Cette thèse s'inscrit dans le cadre de l'étude du comportement de la plante en réponse à la phytohormone éthylène, acteur clé des processus de développement, de maturation du fruit et de réponse aux stress. Sa voie de transduction, décrite comme étant linéaire, se termine en une étape appelée « réponse secondaire à l'éthylène » grâce à l'intervention de facteur de transcriptions de type ERF (Ethylene Response Factor). Le travail présenté sera axé sur l'étude de cette famille multigénique, chez la tomate (*Solanum lycopersicon*), où seront abordés sa structure et sa fonction. En **introduction** est présentée une revue bibliographique décrivant la voie de transduction de l'éthylène, de la perception jusqu'à la régulation des gènes cibles, ainsi que l'état de l'art sur les ERF.

Le chapitre 1 présente, sous forme d'articles en préparation, la famille des ERF de tomate ainsi que leur mode d'action et de régulation. Dans un premier temps, l'**article 1** est consacré à la caractérisation de 28 ERF dont 16 nouveaux, isolés au cours de ce travail. Les ERF de tomate ont été rangés en 8 sous-classes grâce à une analyse phylogénétique permettant d'établir une nouvelle nomenclature pour les membres de cette famille. L'étude de l'activité transcriptionnelle des ERF montre que leur activité ne dépend pas de leur classe d'appartenance, à l'exception de la classe F dont tous les ERF sont répresseurs. De plus, il est montré que les ERF se groupent selon leur profil d'expression spatio-temporel. Les résultats présentés dans l'**article 1** révèlent aussi une implication de certains ERF dans la phase d'initiation du fruit. Enfin nous montrons que les ERF étudiés peuvent être régulés par l'éthylène et/ou l'auxine suggérant qu'ils peuvent intervenir dans ces deux voies de signalisation hormonale.

Afin de savoir si l'activité transcriptionnelle est liée à l'affinité d'interaction des ERF au *cis*-élément GCCGCC des études de gel retard ont été réalisées dont les résultats sont présentés dans le projet d'**article 2**. Dans cette étude, menée d'une part sur le *cis*-élément et d'autre part sur le *trans*-activateur, il est mis en évidence que les régions flanquant la boîte GCC jouent un rôle primordial dans l'affinité de l'interaction GCC/ERF et que les acides aminés n'intervenant pas directement dans l'interaction ADN/protéine, peuvent néanmoins intervenir dans le degré d'affinité de l'interaction.

Le **chapitre 2** est consacré à l'étude fonctionnelle de deux ERF par l'utilisation de stratégies de génétique inverse. Par exemple, dans l'**article 3** il est démontré que des plantes sur-exprimant *Sl-ERF2* germent précocement en comparaison aux graines sauvages. L'activation importante de la *mannanase2* dans ces lignées est probablement à l'origine de ce phénotype. Ces résultats démontrent le rôle des ERF dans les processus fondamentaux de développement comme la germination dont le contrôle présente des intérêts du point de vue agronomique. Une application de la stratégie dénommée « CRES-T » pour Chimeric Repressor Silencing Technology est présentée dans l'**article 4**. *At-ERF13*, un nouvel ERF d'*Arabidopsis* intervenant dans la voie de transduction de l'éthylène est décrit. De façon remarquable, les lignées transgéniques sur-exprimant la protéine chimère AtERF13::SRDX sont partiellement insensibles à l'éthylène. En effet, ces lignées présentent une triple réponse partielle, puisque seules les racines sont plus courtes, comme chez le sauvage. Nous avons également pu démontrer que cet ERF est impliqué dans la réponse au stress salin.

Introduction au sujet de thèse

Problématique générale

Le processus de développement des plantes est sous le contrôle de nombreuses molécules « signal », qui peuvent être endogènes ou exogènes à la plante. Parmi tous les signaux endogènes, les phytohormones sont considérées comme les chefs d'orchestre du développement. Produites par certaines cellules, les phytohormones sont généralement transportées à quelque distance de leur lieu de formation et règlent, à dose oligodynamique, un processus physiologique spécifique. Parmi ces phytohormones, on peut citer l'acide abscissique (abscission), l'auxine (grandissement cellulaire, phototropisme, rhizogénèse et dominance apicale), les gibbérellines (stimulent la division cellulaire, l'élongation et la levée de dormance), les cytokinines (levée de dormance, multiplication cellulaire) et l'éthylène (maturation du fruit, abscission, sénescence). En plus de leur rôle dans le développement normal de la plante, ces hormones interviennent également en réponse aux stress abiotiques (froid, blessure, sécheresse, asphyxie racinaire) et biotiques (attaque de pathogène). L'éthylène est connu pour intervenir dans la maturation des fruits climactériques, dans la sénescence et l'abscission mais également dans la réponse aux stress biotiques comme l'attaque du pathogène *Pseudomonas syringae* ou dans la réponse aux stress abiotiques. Même si les liens de cause à effet ont été clairement établis entre cette phytohormone et les processus cités précédemment il reste cependant à élucider les mécanismes par lesquels l'éthylène peut entraîner des réponses aussi diverses sur la même plante. Le projet de thèse s'inscrit dans ce contexte et vise à identifier les acteurs expliquant la diversité de réponse de la plante à l'éthylène, et ainsi attribuer un rôle précis à chacun de ces acteurs dans les processus de développement et de réponse aux stress. Le second objectif est de comprendre les bases moléculaires de la spécificité de réponse à l'éthylène. En effet, alors même que les hormones exercent des effets pléiotropiques, les mécanismes qui conduisent à une réponse spécifique demeurent peu connus.

Une espèce modèle : la tomate

La tomate (*Solanum lycopersicon*) est considérée par l'ensemble de la communauté scientifique comme l'espèce modèle pour l'étude des fruits charnus. Cette espèce est également utilisée dans l'étude de nombreuses interactions plante pathogène. L'avantage de cette espèce en tant que modèle expérimental réside également dans sa facilité de culture (3 à 4 générations par an) et que sa transformation génétique est très bien maîtrisée. Le choix de ce modèle est particulièrement justifié par le fait qu'il existe de nombreux mutants naturels, notamment de la maturation (*nor*, *nr*, *rin*) qui sont autant de ressources pour l'étude du processus de mûrissement. De nombreuses ressources moléculaires et bioinformatiques ont été développées (tiling, séquençage d'EST, microarray, QTL) auxquelles va s'ajouter très prochainement la séquence annotée des parties riches en gènes du génome issu du programme de séquençage en cours. Bien que la plante modèle *Arabidopsis thaliana* possède également de nombreux avantages elle ne permettrait pas l'étude de certains processus comme la maturation du fruit qui est un des processus majeur régulé par l'éthylène.

La voie de transduction de l'éthylène.

La voie de transduction de l'éthylène et ses différents acteurs ont été étudiés de façon extensive chez *Arabidopsis*. Cependant pour chacun de ces acteurs un orthologue a été retrouvé chez la tomate. La fixation de l'éthylène à ses récepteurs entraîne l'inactivation de CTR1, régulateur négatif de la voie de transduction, et débloque ainsi la cascade de phosphorylation, mettant en jeu de nombreuses MAP kinase, pour finalement activer EIN2. EIN2 active à son tour EIN3, premier acteur d'une cascade transcriptionnelle qui vient ensuite activer les ERF (Ethylene Response Factor). Les ERF peuvent ensuite activer ou réprimer les gènes cibles de l'éthylène contenant dans leur promoteur des boîtes GCC (GCCGCC), *cis*-éléments auxquels se fixent les ERF. Bien que seul ERF1 d'*Arabidopsis* a été directement lié à EIN3, il est fort probable que d'autres ERF soit induit par EIN3, puisque de nombreuses études ont mis en évidence plusieurs ERF impliqués dans la réponse à l'éthylène. La voie de transduction de l'éthylène apparaît comme très linéaire et très simple relativement à la diversité de réponse engendrée. L'objectif de la thèse était donc de comprendre au niveau physiologique mais aussi au niveau moléculaire la contradiction apparente entre la simplicité de la voie de transduction et la diversité de réponses.

Les ERF, une famille multigénique importante pouvant expliquer la diversité de réponse à l'éthylène

Chez *Arabidopsis*, dont le génome est entièrement séquencé on dénombre 122 ERF ce qui en fait la 2^{ième} plus grande famille de facteurs de transcription. Selon des études récentes ils peuvent être classés en 10 sous-groupes. Il paraît donc raisonnable d'émettre l'hypothèse que cette famille de *trans*-régulateur est à l'origine de la diversité et de l'amplitude de la réponse de la plante à l'éthylène. Considérant le fait que chez la tomate seulement 12 ERF avaient été caractérisés avant le commencement de cette thèse, il est vite paru indispensable de cloner et de caractériser d'autres membres de cette famille. Le projet de recherche réalisé au cours de cette thèse est focalisé sur le clonage ainsi que la caractérisation d'un nombre exhaustif d'ERF de tomates, pour mettre en évidence les particularités structurales de chacun et essayer de les corrélérer à leurs fonctions spécifiques. Des résultats préliminaires ont permis de mettre en évidence que l'affinité de fixation à la boîte GCC n'était pas la même pour chaque ERF et qu'elle dépendait à la fois de l'ERF lui-même, mais aussi des régions adjacentes la boîte GCC. Ceci suggère que chaque ERF n'agit pas sur les mêmes gènes cibles.

Le travail de thèse a permis l'isolement de 16 nouveaux ERF de tomates, portant leur nombre à 28. L'analyse phylogénétique des séquences protéiques a permis de classer ces ERF dans les différents sous-groupes précédemment définis chez *Arabidopsis*. Ceci nous a naturellement conduit à clarifier la nomenclature utilisée et à renommer tous les ERF déjà connus en fonction de leur classe d'appartenance. L'expression transitoire des ERF de tomates dans les protoplastes de tabac co-transformés avec des promoteurs contenant ou non la boîte GCC a révélé des liens entre la sous-classe d'appartenance des ERF et leur activité sur ces promoteurs, mais a également mis en évidence qu'il pouvait y avoir des différences d'activité entre 2 ERF d'une même classe. L'analyse des profils d'expression a montré que les ERF s'expriment différemment au cours de la maturation du fruit ainsi que dans les tissus végétatifs. Enfin, l'étude a permis de montrer pour la première fois que les ERF peuvent répondre à une double régulation par l'auxine et par l'éthylène. Le traitement des plantules à l'éthylène et à l'auxine a révélé que certains ERF pouvaient être induits, d'autres réprimés alors que quelques uns sont insensibles à ces hormones. Les travaux de recherche se sont ensuite focalisés sur 2 ERF particuliers, *Sl-ERF.E.1* (anciennement appelé *Sl-ERF2*) et *At-ERF13*. Des lignées transgéniques sur-exprimant le gène *Sl-ERF.E.1* sous le contrôle d'un promoteur 35S montrent un phénotype de germination précoce et une réponse altérée à

l'éthylène. J'ai pu démontrer pendant ma thèse que SI-ERF.E.1 stimule la germination à travers l'activation du gène codant pour la *mannanase2*.

Parce que les ERF appartiennent à une grande famille multigénique dans laquelle il existe de la redondance fonctionnelle, les méthodes classiques d'étude fonctionnelle (stratégie anti-sens, RNAi, mutant KO) s'avèrent souvent inefficaces. C'est pourquoi une nouvelle stratégie a été mise en place en collaboration avec le laboratoire dirigé par Masaru Ohme-Takagi (Tsukuba, Japon), consistant à fusionner un domaine répresseur dominant (SRDX) à la partie C-terminale de la protéine. La surexpression de cette protéine chimère dans la plante permet de contrecarrer la redondance fonctionnelle. Le criblage de lignées transgéniques d'*Arabidopsis* transformées avec ce type de construits et basé sur le phénotype de la triple réponse à l'éthylène a permis d'isoler un mutant partiellement insensible à l'éthylène. La caractérisation de l'un de ces mutants transgéniques sur-exprimant *At-ERF13* fusionné au domaine répresseur SRDX a révélé son implication dans la résistance au stress salin. Des plantes transgéniques surexprimant ce type de construit ont été générées pour chacun des 28 ERF de tomates et leur caractérisation est en cours. Ces 2 exemples, l'un chez la tomate, l'autre chez *Arabidopsis*, illustrent concrètement la spécificité d'action des ERF dans la réponse à l'éthylène. Afin de mieux comprendre la spécificité de réponse au niveau moléculaire des expériences de gel retard ont été réalisées. Il en ressort que la présence de certaines bases dans l'environnement de la boîte GCC empêche toute fixation des ERF à cet élément *cis*-régulateur. Ces travaux de recherche proposent donc une vue d'ensemble sur différents niveaux (famille multigénique, gène, interaction moléculaire) du rôle prépondérant des ERF dans la diversité et la spécificité de la réponse à l'éthylène. Il apparaît que la réponse à l'éthylène met en jeu différents acteurs, selon le tissu ou le stress subit, qui agiront sur des gènes cibles en fonction de leur classe d'appartenance, mais aussi de l'environnement du *cis*-élément. La combinatoire de ces différents facteurs mène à une réponse adaptée des plantes aux signaux endogènes et exogènes.

Bibliographic review

Plant development is a very complex process and many molecules play an important role. Because ethylene is involved in lot of different important process such as senescence, abscission, fruit ripening but also in stress, like wounding and pathogenesis attack (Fig.1), lot of study has been done on this phytohormone (Abeles et al., 1992).

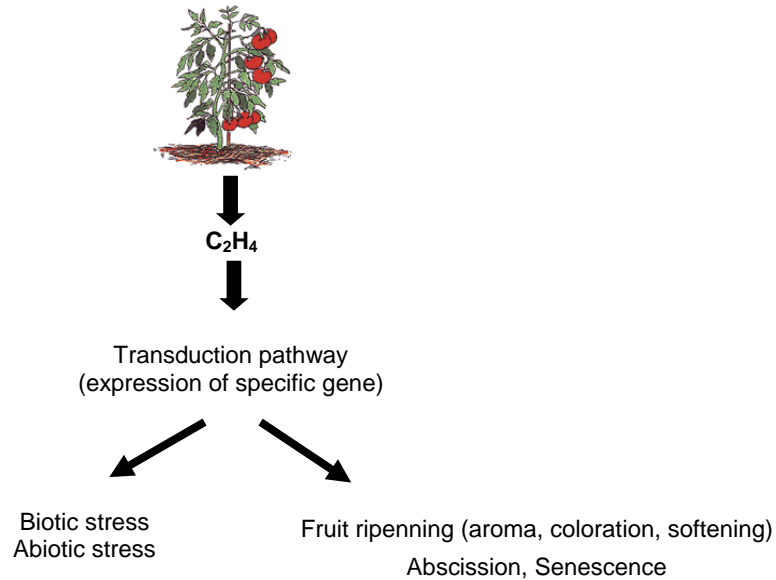

Figure 1: Effect of ethylene on plant. Ethylene is involved in many different plant development stages such as fruit ripening, abscission, senescence but also stress.

1. Ethylene transduction pathway

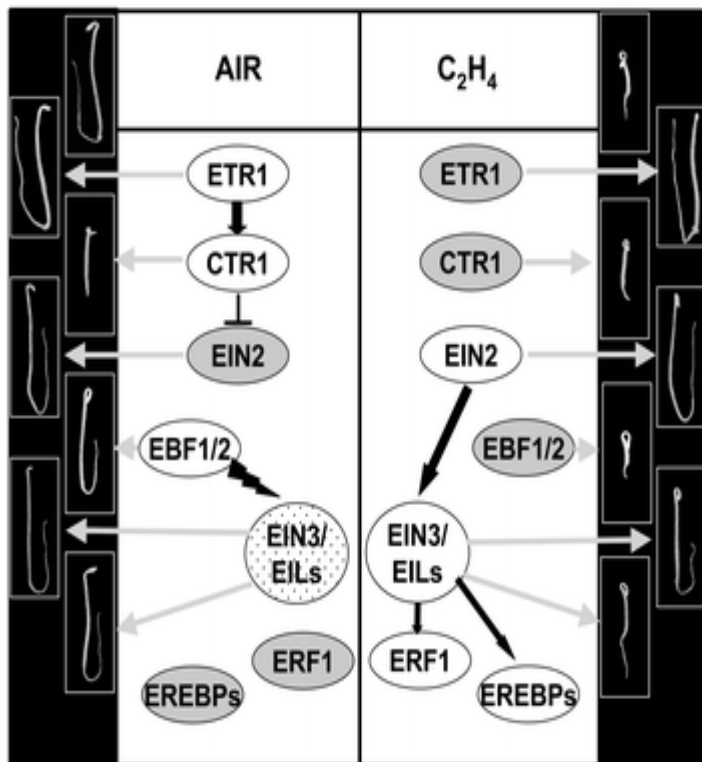

Figure 2: The ethylene signaling pathway and its genetically characterized components. The signaling pathway components are shown in their sequential order of action. Components drawn in white represent active forms, whereas grey ovals represent their inactive versions. Binding of ethylene to the receptors, represented by ETR1, leads to activation of ethylene responses. Dotted oval represents EIN3 degradation by the 26S proteasome pathway due to action of EBF1 and EBF2. Arrows indicate activation steps, whereas a blocked arrow depicts repression of downstream elements by CTR1. Illustrations of the classical ethylene mutants and their respective phenotypes both in “air” and “ethylene” (as observed in the triple response assay) are also provided. *etr1* is a dominant ethylene insensitive Gain Of Function allele; all other mutants shown are Loss Of Function. Images on the top correspond to wild-type Columbia responses and are shown for comparison (Benavente and Alonso, 2006).

The ethylene transduction pathway has been well deciphered in *Arabidopsis* using a combination of genetic, biochemical and molecular approaches (Fig.2) (Bleecker et al., 1988; Guzman and Ecker, 1990; Chang et al., 1993; Roman et al., 1995; Chao et al., 1997; Sakai et al., 1998; Alonso et al., 1999).

Details of this transduction pathway will be described in the next part.

1.1 Ethylene perception

Perception of ethylene in plants is achieved by several related membrane-bound histidine kinases. *Arabidopsis* has 5 receptors: ETR1, ETR2, EIN4, ERS1 and ERS2 (Fig.3) (Chang et al., 1993; Hua et al., 1998; Sakai et al., 1998). ETR1, ETR2, and EIN4 were characterized thanks to *etr1*, *etr2* and *ein4* mutants who show insensitivity to ethylene. Ethylene was found to bind receptor through a transition metal copper co-factor. Ethylene binding results to a modification of the coordination chemistry of the copper in the N-terminal region. This modification is transmitted to the C-terminal region (Rodriguez et al., 1999) and initiates the ethylene response. According to their sequence similarity and 3-dimensional structure, ethylene receptor can be classified in 2 subgroups. The first one (ETR1 and ERS1) have 3 hydrophobic transmembrane domains in the N-terminal region and a conserved histidine kinase domain in C-terminal region. The second one (ETR2, ERS2 and EIN4) have 4 hydrophobic domains in the N-terminal region and a less conserved kinase in the C-terminal region that lacks many important feature required for the kinase activity (Hua et al., 1998). Moreover, ETR1, ETR2 and EIN4 possess a C-terminal receiver.

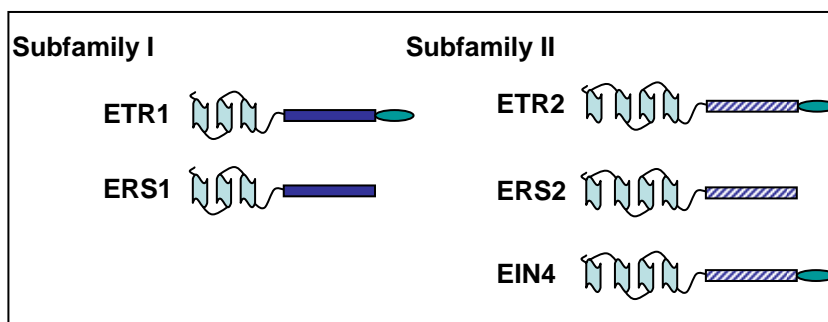

Figure 3 : Schematic representation of ethylene receptor. The N-terminal ethylene-binding hydrophobic transmembrane domains are shown in light blue. Horizontal dark blue box represents the conserved histidine kinase domain in subfamily I. The dashed blue box represents the degenerate histidine kinase domain of the subfamily II. The green oval is the C-terminal receiver domain (Benavente and Alonso, 2006).

Ethylene receptors show high similarity with the bacterial two component system. These systems are generally constituted of a sensor molecule containing an histidine kinase domain which autophosphorylates itself in reaction to a stimuli, and a response regulator containing a receiver domain which accept, the residue phosphate from the histidine sensor (Pirrung,

1999). Transformation of the triple mutant *etr1, etr2, ein4* with a truncated version of ETR1 which lacks histidine-kinase and the receiver domain failed to restore ethylene sensitivity. Whereas, the transformation of the same triple mutant with a truncated version of ETR1 deleted for the receiver domain partially restores the ethylene sensitivity. Moreover, transgenic plants over-expressing this construct show hypersensitivity phenotype (Qu and Schaller, 2004). These results demonstrate that the kinase domain is necessary for signal transmission by the receptor and that the receiver domain was not essential for restoring ethylene responsiveness (Benavente and Alonso, 2006). New results suggest that ETR2 can be a target for the proteasome (Chen et al., 2007) To resume the operation of perception, in the absence of the hormone, the receptor inhibit downstream component of the pathway. When ethylene binds to the receptor, there is inactivation of the receptor and activation of the transduction pathway. Although still discuss, receptor kinase activity possibly plays an important role in signaling (Benavente and Alonso, 2006).

1.2 A Raf like kinase as negative regulator of the pathway

The binding of ethylene to the receptor inactivates a Raf-like kinase CTR1 (Kieber et al., 1993; Huang et al., 2003). Yeast two-hybrid assay showed a physical interaction between ETR1 and CTR1 (Clark et al., 1998). Many results suggest a sublocalization in the Endoplasmic Reticulum (ER) of the 2 partners (Gao et al., 2003; Huang et al., 2003); as mammalian Raf kinase CTR1 acting as a mitogen-activated kinase kinase kinase (MAPKKK). It has been demonstrated that the ethylene binding to the receptor affects neither the interaction with CTR1 neither the localization (Gao et al., 2003). The current model suggest that the binding of ethylene to the receptor turns off CTR1 probably due to a structure modification, which is a negative regulator, and by this way activates the downstream signaling pathway (Fig.4) (Gao et al., 2003).

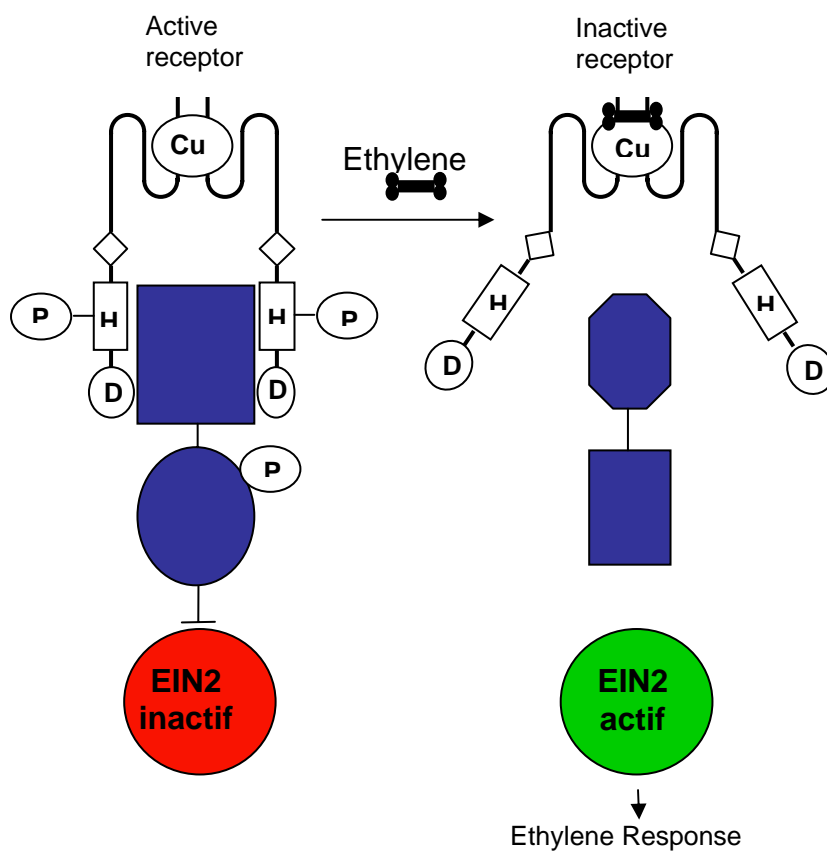

Figure 4 : *Model for the initiation of the ethylene response by ETR1-CTR1 interaction.* ETR1 is active in absence of ethylene and activates the repressor CTR1 (blue) which binds ETR1 by histidine kinase domain. When there is ethylene binding mediated by a single copper ion (Cu), CTR1 changes its conformational structure and becomes inactive that reduces its kinase activity, thereby relieving repression of the ethylene response pathway (Bleecker and Schaller, 1996; Gao et al., 2003).

In spite of the kinase activity of CTR1 and its similarity to MAPKKK, there is no evidence of the presence of a phosphorylation cascade in the ethylene transduction pathway (Ouaked et al., 2003; Liu and Zhang, 2004). The inactivation of CTR1 leads to the activation of a positive regulator EIN2. In spite of the unknown function of this protein, EIN2 shows homology to animal ion transporters Nramp (Alonso et al., 1999).

1.3 A transcription factor cascade induces gene expression

Ethylene transduction pathway finishes by transcriptional cascade, in which, the first actors are EIN3 and EIN3 like proteins (Chao et al., 1997). EIN3 is a transcription factor which binds PERE *cis*-elements (Primary Ethylene Regulator Element) present in some ERF (Ethylene Response Factor) promoters (Solano et al., 1998). ERFs are the last known actors of ethylene transduction pathway (Fig.5). They bind to GCC box *cis*-element in the promoter of target genes (Ohme-Takagi and Shinshi, 1995).

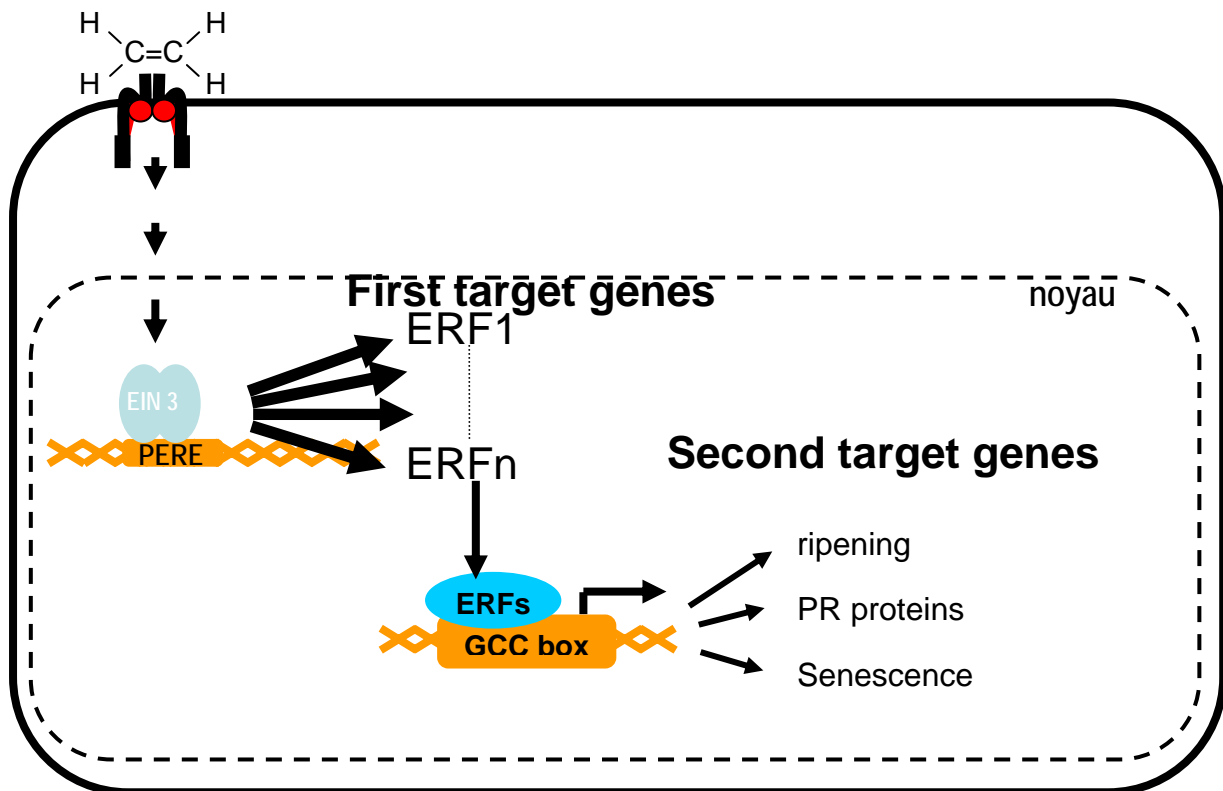

Figure 5: *Ethylene transduction pathway finishes by activation of a cascade of transcriptional regulator.* EIN3 binds Primary Ethylene Response Element and by this way there is transcription of ERF which bind GCC box localized in promoters of second target genes involved in ripening, senescence and biotic stress (Solano et al., 1998).

Recent results demonstrate the involvement of the SCF/26S proteasome to regulate the level of EIN3. Two F-box proteins (EBF1 and EBF2) were shown to act as a part of E3-ligase to bind and to target EIN3 in absence of ethylene, whereas in presence of ethylene EIN3 protein level increases (Guo and Ecker, 2003; Potuschak et al., 2003).

In spite of linearity and the apparent simplicity of its transduction pathway, ethylene has lot of different functions in normal growth and development, as well as in response to biotic and abiotic stress. Regulation of growth, seed germination, leaf abscission, senescence and fruit ripening (Abeles et al., 1992) are among essential process regulated by ethylene during normal development of plant. Ethylene biosynthesis increases by stimuli as wounding, pathogen attack, mechanical stimulation and drought (Abeles et al., 1992).

Different ways of regulation, at the transcriptional level have been found. In the next chapter we will review the ethylene-regulated genes involved in these different process. We will also focus on the different molecular mechanisms of ethylene regulation of gene transcription.

2. Ethylene's functions

2.1 Senescence and abscission

Arabidopsis has been the focus of intense genetic, biochemical and physiological study for over 40 years because of several traits that make it very desirable for laboratory study. As a photosynthetic organism, *Arabidopsis* requires only light, air, water and a few minerals to complete its life cycle. It has a fast life cycle, produces numerous self progeny, has very limited space requirements, and is easily grown in a greenhouse or indoor growth chamber. It possesses a relatively small, genetically tractable genome which has been fully sequenced and that can be manipulated through genetic engineering more easily and rapidly than any other plant genome. For all these reasons *Arabidopsis* is the plant model to study development of plant. Somatic tissues of any plant have a limited life span. The senescence of leaves is characterized by a progressive yellowing, beginning at the leaf margins and spreading to the interior (Bleecker and Patterson, 1997). Abscission is the developmental process regulating detachment of organs from the main body of the plant (Patterson and Bleecker, 2004); it is the mechanism for the removal of senescing or damaged organs but also for the release of the fruit when this one is ripened (Bleecker and Patterson, 1997). The pollination induces a burst of ethylene production in different floral organs. This production of ethylene is responsible for coordinating pollination associated events such as ovary growth (Zhang and O'Neill, 1993). Floral organs abscission may be used as a model system to study abscission (Bleecker and Patterson, 1997). For a long time, ethylene has been suspected to play an important role in abscission. In their study Jackson and Osborne (1970) concluded that ethylene is involved in the acceleration of abscission process but is, also, an essential regulator of this process.

Abscission process is characterized by separation of cells along the lamella (Esau, 1977). In 1995, Grbic and Bleecker (1995) demonstrated that *etr1-1* mutant shows a delay in leaf senescence. Lifespan of *etr1-1* leaves is 30% longer than wild type (Grbic and Bleecker, 1995). This delay is accompanied by a delayed induction of senescence associated genes (SAGs) which are used as molecular markers of leaf senescence (Hensel et al., 1993) and higher expression of photosynthesis-associated genes (PAGs) (Grbic and Bleecker, 1995). The onset of leaf death 2 (*old2*) mutants showed an earlier senescence syndrome upon ethylene treatment (Jing et al., 2002). Analysis of chlorophyll degradation, SAG accumulation and ion leakage indicate that leaf senescence was advanced in ethylene-treated *old1*, *old2* and *old3* (Jing et al., 2002). Before senescence can be initiated, some age-related changes (ARCs) must have taken place in the leaf (Jing et al., 2005). Age-related resistance (ARR) is an

example of ARC in *Arabidopsis* (Kus et al., 2002). Indeed, authors demonstrated that old plants are more resistant to *Pseudomonas syringae* (Kus et al., 2002). Ethylene can induce senescence only when developmental changes controlled by leaf age are present (Hensel et al., 1993; Grbic and Bleecker, 1995; Jing et al., 2002). For example, the oldest leaves showed the greatest increase in SAG transcripts after ethylene treatment, and little or no effect of ethylene was observed in the youngest leaves (Grbic and Bleecker, 1995). These results strongly suggest that ethylene can induce leaf senescence only within specific age window (Fig.6). In *Arabidopsis* flowers, immediately after the detachment of organ, the cells proximal to the abscission zone begin to enlarge. In wild-type this process takes between 2 and 3 days after anthesis, but in *etr1-1* mutant, this process is delayed and cells are never totally enlarged (Bleecker and Patterson, 1997).

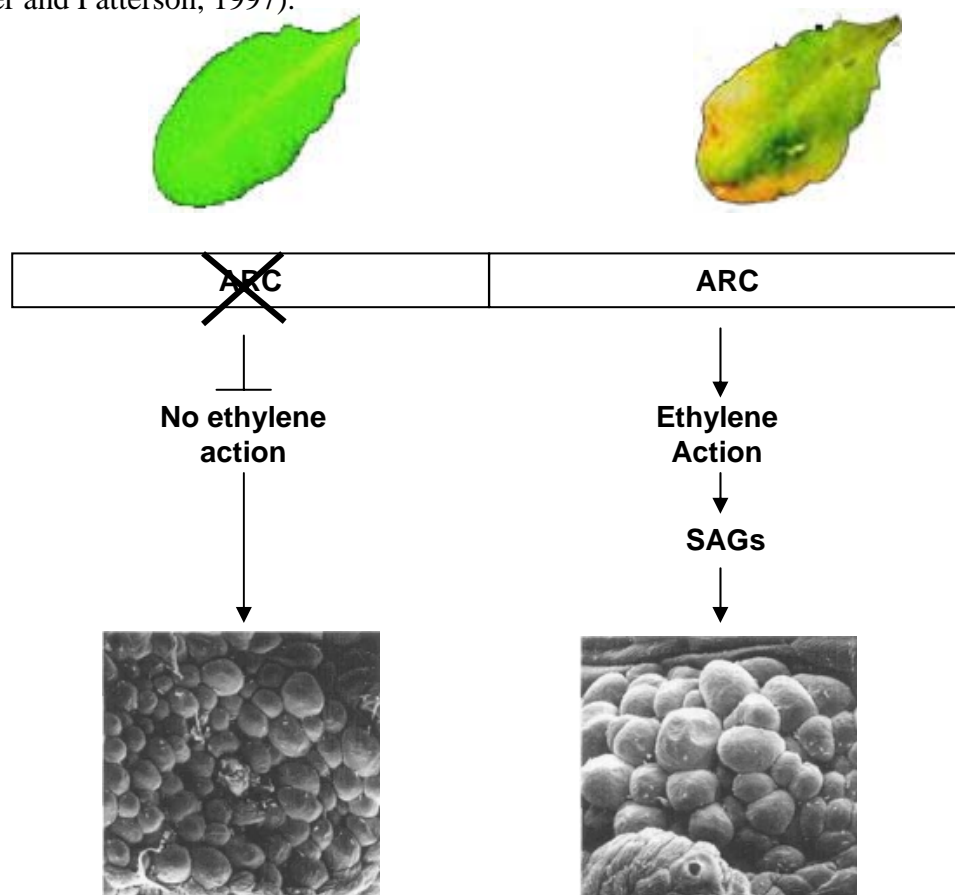

Figure 6: Role of ethylene in abscission. When Age Related Change (ARC) occurred in the organ, ethylene can induce Senescence Associated Genes (SAGs). In the abscission zone the proximal cells enlarge.

Patterson and Bleecker (2004) isolated five delayed floral organ abscission (*dab*) mutants. Abscission is delayed in these mutants. Break strength is a quantitative measure of the necessary force to detach the organ from plants body. Usually the break strength decreases after flowers position 3 and becomes immeasurable after position 5. In the *etr1-1* and *ein2-1* mutants the break strength does not begin to decrease before position 5 or 6. In *dab2-1*, *dab3-*

1, *dab3-2* and *dab3-3* the decrease of break strength is observable only from position 8 or 10 (Patterson and Bleecker, 2004). The *dab* mutants are fully sensitive to ethylene, this mean that ethylene transduction pathway is functional in this mutant. These results demonstrate that even if ethylene accelerates the abscission process, the perception of ethylene is not the unique process (Patterson and Bleecker, 2004).

In petunia, ethylene participates to the pollen tube growth (Holden et al., 2003). There is a burst of ethylene from the stigma within 2 to 4 hours after pollination (Hoekstra and Weges, 1986). This burst is followed by a constant autocatalytic ethylene production beginning around 12 hours after pollination and reaching a top, 24 hours after pollination (Jones, 2003). Using transgenic ethylene mutant of *Petunia Corollas* (35S::*etr1-1*) and Mitchell Diploid petunias Underwood et al. (2005) demonstrated that different components of emission of volatile organic compounds (VOCs) are ethylene regulated.

2.2 Stress response

2.2.1 Biotic stress

Ethylene is involved in biotic stress, such as virus and bacteria (van Loon et al., 2006). When plants perceive a pathogen attack, an increase of transcription ethylene genes response is generally observed. This over-production of ethylene is generally associated with induction of defence reaction (Boller, 1991). Some particular cases show the limit of this hypothesis. Indeed, *Pseudomonas syringae* pv. *Glycinea* cannot proliferate in mutant which cannot produce ethylene (Weingart et al., 2001). According to the work of Thomma and co-worker (2001) and Ton et al. (2002), ethylene contributes to resistance against necrotrophic but not biotrophic pathogens. Three main defence reactions can be distinguished. The systemic acquired resistance (SAR) refers to a resistance of the whole plant acquired after the formation of a local necrotic lesion against a broad spectrum (Ryals et al., 1996) this response needs an integrate salicylic acid transduction pathway, while the induced systemic resistance involves the jasmonic acid and the ethylene. The hypersensitive response (HR) is characterized by a rapid cell death around an infection point after the recognition of the pathogen. By this way the plant avoids the spreading of the pathogen (Pontier et al., 1998).

Responsiveness to ethylene, at the site of resistance induction, appears to be an important step for the starting of the induced systemic resistance (Knoester et al., 1999). Indeed, many ethylene response mutants *etr1-1*, *ein2-1*, *ein7* and *axr1-12* do not express Induced Systemic Resistance (ISR) (Knoester et al., 1999). In incompatible plant-pathogen interactions, the

hyper-sensitive reaction (HR) is associated with a burst of ethylene production around the time of necrotic lesion formation (van Loon et al., 2006). The ethylene insensitive mutant *nr* shows a higher tolerance to *Xanthomonas campestris* pv. *vesicatoria* which is manifested by reduction of chlorosis and necrosis. Infection of tomato by this strain induces the expression of the ethylene receptor genes *Nr* and *SlETR4* (Ciardi et al., 2000).

Tobacco plants were transformed with the mutant *ETR1-1* gene from *Arabidopsis*, conferring dominant ethylene insensitivity (transformant *tetr*) (Knoester et al., 1998). *Tetr* plants show a substantially reduced SAR response. Three days after inoculation of leaves with Tobacco mosaic virus (TMV) there is an induction of PR-1a and PR-2a in both WT and *tetr*, indicating that local expression of PR (Pathogenesis Related) protein is ethylene independent. Contrary to WT tobacco PR genes which are induced also in non infected leaves; there is no PR mRNA in systemic leaves of *Tetr* (Verberne et al., 2003). These observations indicate that the ethylene insensitive *Tetr* plants are defective, at least in part, in SAR signaling.

These results suggest that the burst of ethylene production is involved in HR and also enable to propagate SAR during an infection.

Because pathogenesis infection is a big problem for the culture of crop plants, lot of have been done to determine the *cis*-elements involved in the regulation of ethylene-inducible defence genes.

In tobacco acidic PR proteins accumulate extracellularly while basic PR proteins accumulate inside the vacuole (Linthorst et al., 1990). For example some PR proteins are known to have chitinase or glucanase activities (Kauffmann et al., 1987). PR-1b which encodes for basic PR1 type protein of tobacco is induced by ethylene (Eyal et al., 1992). A minimal sequence of promoter has been determined as responsible of ethylene response, by deletion analysis (Eyal et al., 1993). The sequence from -213 to -67 is sufficient to enhance a 20-fold increase of reporter gene β -glucuronidase expression in transgenic tobacco leaves exposed to 20 μL^{-1} of ethylene (Eyal et al., 1993). Study of Meller et al. (1993) revealed that the deletion of a fragment of 71 bp between position -213 and -142, failed ethylene-inducibility of GUS reporter gene. This region (-213 to -142) is sufficient to confer higher ethylene inducibility (25-fold) to GUS reporter gene (Sessa et al., 1995). This 73 bp fragment contains a GCC box TAAGAGCCGCC, in reverse orientation, at position -196 (Eyal et al., 1993). Other ethylene inducible genes contain this *cis*-element (Broglie et al., 1989; Gheysen et al., 1990; Ohme-Takagi and Shinshi, 1990; Eyal et al., 1992). Mutations of the GCC box in PR-1b promoter disrupt ethylene inducibility of the reporter gene (Sessa et al., 1995). Analysis of tobacco class I chitinase by Shinshi and co-worker (1995) determined a region of 146 bp (from -503 to -358) which is responsible of ethylene responsiveness, this region contains 2 GCC box.

Deletion of this region abrogates ethephon responsiveness. This result demonstrates that the GCC box plays an essential role in ethylene responsiveness.

2.2.2 *Abiotic stress*

Plants are sessile organisms which are fixed to the soil. They are submitted to number of environmental stimuli and stress like cold, drought, heat, wind and wounding. They need to adapt themselves to these different stressful situations. Plants develop different way to stay in life during these periods. In agriculture stressful situation can widely affect harvesting rate and fruit quality or vegetable. Because of the importance of economic, diet and social damage link to these stressful situations, lot of research has been done to better understand adaptive process that the plant use to resist. It is more and more evident that stress response of plant is the result of multiple signaling pathways. It was demonstrated that ethylene is involved in the induction of defence genes in response to wounding (O'Donnell et al., 1996; Leon et al., 2001). In *Arabidopsis* plant, it was demonstrated that in the wounding localization, ethylene control the expression of the gene by repressing a jasmonate-dependent pathway (Rojo et al., 1999). Because there is many results demonstrating that ERFs are involved in abiotic stress it is interesting to notice that *TERF1* and *JERF3* are involved in salt response (Huang et al., 2004; Wang et al., 2004; Zhang et al., 2005b).

2.3 Fruit ripening

Due to this social and economic interest fruit ripening is extensively studied at physiologic, biochemical and genetic levels. Fruit ripening is a very complex process which involves many changes. There is a dramatic change in colour, texture, flavour and aroma of the fruit flesh (Fig.7). There are different ripening mechanisms in which fruits can be divided into two broad groups, known as climacteric and non climacteric (Biale, 1964). Climacteric fruits present a peak in respiration and a concomitant burst of ethylene during maturation. This category includes tomato, banana, pears, and apple. Climacteric fruits need ethylene burst for normal fruit ripening, indeed in ethylene-suppressed transgenic plants there is no or very slow ripening (Oeller et al., 1991; Theologis et al., 1993; Ayub et al., 1996). Two systems of ethylene biosynthesis have been proposed by Lelièvre et al., 1997. The system 1 allows the ethylene production by the expression of *LEACSIA* and *LEACS6* (Barry et al., 2000), it is responsible for producing basal ethylene levels that are detected in all tissues including those of non-climacteric fruit. During climacteric burst there is an autocatalytic production of

ethylene which is the manifestation of the system 2 which is initiated and maintained by ethylene independent *LEACS2* (Barry et al., 2000). At the opposite, some fruits like pineapple, lemon, and cherry do not present any peak in respiration nor burst of ethylene. These non-climacteric fruits are generally considered to belong to an ethylene-independent process although some recent results suggest a role of ethylene in the ripening (Chervin et al., 2004; Trainotti et al., 2005).

Tomato has been chosen as model to study the role of ethylene in the ripening climacteric fruit. It is a good model system due to its relatively small genome which sequencing is in progress, there are well-characterized mutants, genetic transformation is easy, it exist a small variety *microtom* which is very convenient by its size and its short life cycle, and moreover it has an economic importance. Several natural ripening mutants have been isolated such as *rin* (ripening inhibitor) which is affected in MADS-box (Vrebalov et al., 2002), *nor* (non ripening mutant) which is affected in a transcription factor (Giovannoni, 2001) and *nr* (never ripe) which is affected in an ethylene receptor (Wilkinson et al., 1995), *cnr* (colourless non ripening), *gr* (green ripe) which is affected in ethylene transduction pathway (Barry and Giovannoni, 2006).

Analysis of ripening-related gene expression in natural mutant or in transgenic plant reveals two types of gene regulation, ethylene-dependant and ethylene-independent way (Dellapenna et al., 1989; Oeller et al., 1991; Theologis et al., 1993).

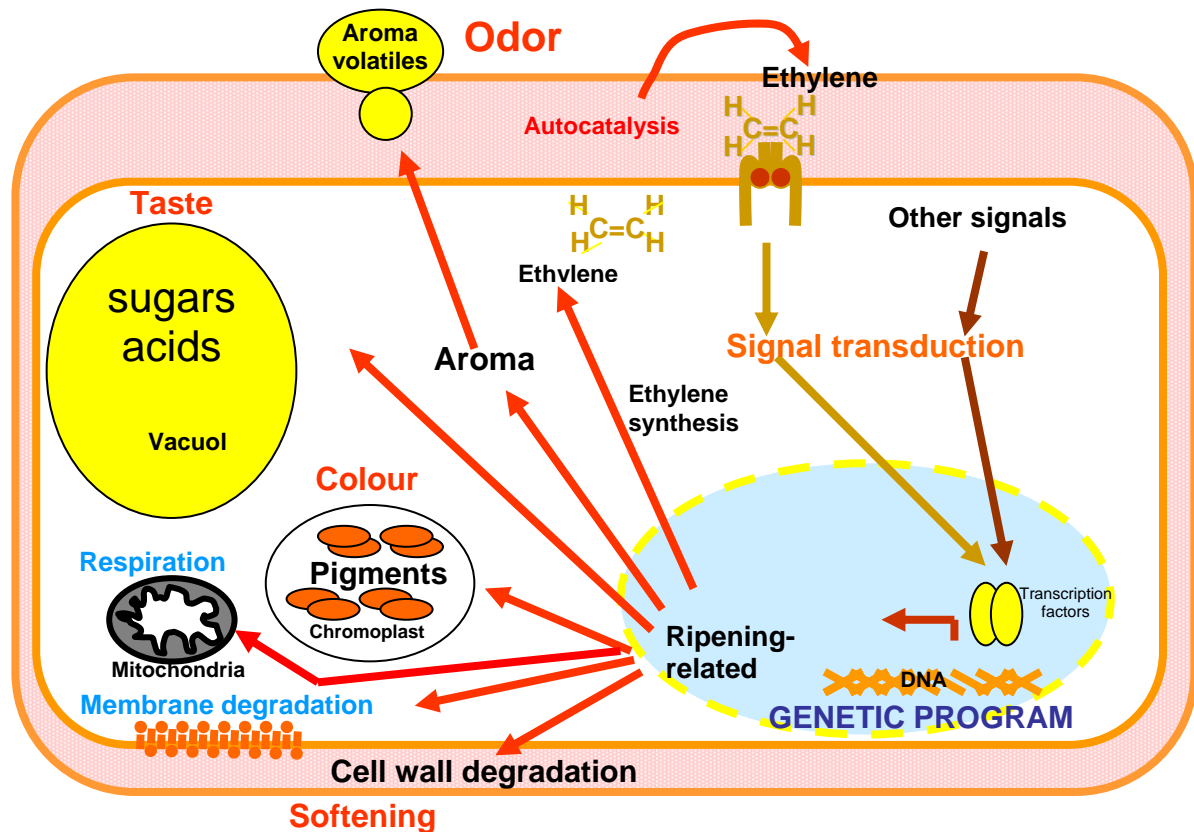

Figure 7: Tomato fruit ripening process at the cell level. Ethylene is involved in the colour, the aroma and the softening. Climacteric fruits are characterized by an autocatalytic production of ethylene and by a respiratory crisis. Other signal molecules are also involved fruit this process.

The enzyme ACC oxidase catalyses the last step of ethylene biosynthesis, it converts ACC (1-aminocyclopropane-1-carboxylic acid) into ethylene (Yang and Hoffman, 1984). It has been shown that ACC oxidase transcripts accumulate during ripening of climacteric fruits (Holdsworth et al., 1987; Ross et al., 1992; Balague et al., 1993). In tomato, ACC oxidase is encoded by a small multi gene family comprising four members *LEACO1*, *LEACO2*, *LEACO3* and *LEACO4* (Holdsworth et al., 1987; Kock et al., 1991; Nakatsuka et al., 1998). *LEACO1* is the more abundantly expressed one during fruit ripening (Barry et al., 1996). The fusion of the promoter of *LEACO1* to the *GUS* reporter gene has shown that the higher expression level of the reporter gene is 3 days after breaker stage (Blume and Grierson, 1997). Reporter gene expression driven by the -396 and -1825 *LEACO1* promoter fragment was induced 2.5 to 5 fold after exposing young leaves and immature fruit to $10 \mu\text{l.l}^{-1}$ ethylene for 6 hours (Blume and Grierson, 1997).

Recent studies demonstrated that receptor level, during fruit development, determines the timing of ripening (Kevany et al., 2007b). Moreover, the suppression of the ethylene receptor LeETR4 led to an early ripening of tomato fruits (Kevany et al., 2007a).

In 1999, Zegzouti et al., used differential display to isolate early ethylene regulated genes from late immature green tomato fruits. This study permitted to isolate 19 ethylene responsive genes (*ER*). Accordingly to their responsiveness to ethylene, these genes can be divided in to three classes: ethylene up-regulated, ethylene down-regulated and transiently induced genes. Transcript accumulation of ethylene dependant genes occurs rapidly, within 15 minutes, for most of the *ER* clones.

ER50 shows typical feature of the Raf protein kinase family, it is the first CTR1 of tomato (Leclercq et al., 2002). Although, SI-CTR1 is a negative regulator of ethylene transduction pathway, its transcript is up-regulated during fruit ripening when ethylene production should increase. The augmentation of SI-CTR1 transcript during fruit ripening can avoid an overproduction of ethylene to prevent ripening and subsequent senescence from proceeding too rapidly (Leclercq et al., 2002). The SI-CTR family is constituted of 4 genes in tomato (Adams-Phillips et al., 2004) which are differently regulated during ripening and differently regulated by ethylene treatment. *SI-CTR1* is the most induced one during fruit ripening and ethylene treatment (Adams-Phillips et al., 2004).

The work of Alba et al., 2005 demonstrated the importance of ethylene control during tomato fruit development. *Nr* mutant, who has a reduced ethylene sensitivity and shows inhibition ripening, present an alteration of 37% of 869 genes, represented in TOM1, that are differentially expressed during tomato pericarp development (Alba et al., 2005). Moreover, strawberry microarray analysis comparing akene and receptacle tissue show a high level of *ERF* and *ER* genes in akene tissue. These results suggest a role for ethylene in the maturation of the akene (Aharoni and O'Connell, 2002).

Taken together, all this data demonstrate an important role of ethylene in fruit ripening in both climacteric and non climacteric fruit.

2.3.1 Colour development

The characteristic colour of red ripe tomato fruit is associated with the change from green to red due to an accumulation of lycopene and β -carotene and a decrease of chlorophyll. Fraser et al., 1994, demonstrated that, at the breaker stage of tomato ripening, lycopene begins to accumulate and its concentration increases 500-fold in ripe fruit. In 1984, Jeffery et al., showed that the exposure of tomato fruit at ambient atmosphere containing $27\mu\text{l.l}^{-1}$ of ethylene accelerate and increase the accumulation of lycopene, and in the same time the level

of chlorophyll decrease more rapidly than in air. The work of Alba et al., 2000 confirmed the role of phytochrome in ethylene-independent lycopene accumulation. There is more and more evidence that there is a cross-talk between ethylene and phytochrome signaling (Genoud and Metraux, 1999; Pierik et al., 2004; Foo et al., 2006).

2.3.2 Cell wall softening

Ripening fruit is characterized by cell wall softening due to disassembly of cell wall which is hydrated. The middle lamella of the cell wall, rich in pectin, is modified and partially hydrolysed. The change in structure of the gel of pectin is responsible of the lost of cohesion between cells and the consequence is a softening texture of the ripened fruit.

Polygalacturonase (PG) catalyzes the hydrolytic cleavage of α -(1-4) galacturonan linkages and is responsible of the change in pectin structure that accompanies the ripening of many fruits (Fischer and Bennett, 1991). PG transcripts accumulate in the wild-type tomato fruit to reach the highest accumulation 55 days after flowering. In ripening mutants *rin* and *nor* the transcription level of PG is less than 3 % of the corresponding wild-type transcription rates. In *nr*, a tomato mutant affected in ethylene receptor (Wilkinson et al., 1995; Payton et al., 1996), the fruit shows a delay in accumulation of PG transcript and its transcription rate reach 20% of the maximal wild-type rate by 67 days (Dellapenna et al., 1989). Montgomery et al. (1993) analyzed the expression of a reporter gene fused to the PG promoter. These experiments determined that there are 3 main regulatory regions. A positive regulatory region from -231 to -134 that promotes gene transcription in the outer pericarp of ripped tomato fruit. A second positive regulatory region from -806 to -443 extends gene activity to the inner pericarp. There is a negative regulatory region from -1411 to -1150 which inhibits gene transcription in the inner pericarp (Montgomery et al., 1993). Sitrit and Bennett (1998) demonstrated that PG transcription is induced at very low concentration of ethylene ($0.1-1\mu\text{l.l}^{-1}$). In ACC synthase antisense fruits there is an accumulation of PG mRNA, but not PG protein (Sitrit and Bennett, 1998). These results suggest that ethylene plays a role also in post-transcriptional regulation (Theologis et al., 1993). Antisense lines where PG activity is reduced to 1% is only slightly firmer which prove that PG is not the major actor of tomato fruit softening (Grierson and Schuch, 1993).

In 1999, Zegzouti et al., isolated an ethylene-regulated gene encoding for a protein highly homologous to a rab/ypt-related small GTP-binding protein (Roehl et al., 1995). This means that ethylene can regulate trafficking factor between different cellular compartments. Moreover, transgenic tomato plants under expressing a Rab11 gene show reduced level of PG

and reduced fruit softening, suggesting that this GTPase plays a role in trafficking of cell-wall modifying enzymes (Lu et al., 2001).

At the beginning of ripening, polymeric galactose starts to be broken down into free molecules of galactose. β -galactosidase is the enzyme which catalyses this reaction (Smith and Gross, 2000). *TBG4*, a β -galactosidase, may be regulated by ethylene and the reduction of the activity of β -galactosidase can reduce fruit ripening by up to 40% (Smith et al., 2002). *TBG4* is up-regulated during fruit ripening to reach the maximum rate at turning stage, when the colour of the fruit is between yellow and orange. *TBG4* transcripts are not detected in ripening mutant *nor*, *rin* and *nr* (Smith and Gross, 2000). Expansin is a cell wall enzyme responsible of the disruption of the hydrogen bonds between cellulose microfibrils and matrix polysaccharides (Cosgrove, 2000). One of these enzymes EXP1 is ethylene-regulated; its transcripts accumulate specifically in the fruit and reach a peak just before or at breaker stage (Rose et al., 1997).

2.3.3 Volatile production

The fruit taste depends on the concentration of sugar and organic acid. The flavour of ripened tomato fruits results of the production of volatile aroma. Volatile precursors include lipids, amino acids, carotenoids and terpenoids (Buttery and Ling, 1993). Volatiles are formed from lipids oxidation when cells are disrupted. The most important compounds are hexanal, cis-3-hexenal, 1-penten-3-one, 3-methylbutanal, trans-2-hexenal, 6-methyl-5-hepten-2-one, methyl salicylate, 2-isobutylthiazole, β -ionone and furaneole (Buttery, 1993). Each compound is the result of a specific pathway. Hexanal and hexenal production involved lipoxygenase (LOX). These enzymes catalyse the hydroperoxidation of polyunsaturated fatty acids containing a *cis,cis*-pentadiene structure (Hatanaka, 1993). In tomato fruits, the main substrates of LOX are linoleic and linolenic acid. Tomato LOX constitute a family of at least 5 genes TomloxA and TomloxB (Ferrie et al., 1994), TomloxC and TomloxD (Heitz et al., 1997), and TomloxE (NCBI Accession AY008278). TomloxA transcript decreases during ripening. Analysis of *nr*, *rin* mutant and *ACO1* anti-sens transgenic line, indicate that TomloxA is regulated by both ethylene and other developmental factors (Griffiths et al., 1999). There is accumulation of tomloxB during ripening process and its expression is regulated by ethylene. TomloxC transcripts increase in response to ethylene, but ethylene treatment at mature green stage does not induce expression. This result suggest that the ethylene component enhance mRNA level after that the developmental pathway has initiated transcription (Griffiths et al., 1999). TomloxC and TomloxD are particular LOX because they

are chloroplast targeted (Heitz et al., 1997). Probably, TomloxC utilizes the polyunsaturated fatty acids from the thylakoid structures as a substrate to produce hexanal and hexanol. Transgenic plants which deplete TomloxC show a reduced level of flavour volatiles, including hexanal, hexenal, and hexenol, to as little as 1.5% of those of wild-type controls. Addition of linoleic or linolenic acid to under-express TomloxC fruit homogenates does not strongly increase flavour volatile, whereas in the WT there is a significant increase of the level. Fusion of TomloxC to the GFP confirmed a chloroplast localization of the protein. Together, these results suggest that TomloxC is a chloroplast-targeted lipoxygenase isoform that can use both linoleic and linolenic acids as substrates to generate volatile C6 flavour compounds (Chen et al., 2004).

Fruit ripening and the role of ethylene in this process are complex. Ethylene is involved in different parts of this process by the induction of specific genes. A better understanding of the first target genes of ethylene will probably give some key to better understand the different roles of ethylene during fruit ripening. There is more and more evidence that other phytohormones like auxin play, also an important role in fruit ripening. Analysis of crosstalk between ethylene transduction pathway and other phytohormone transduction pathway will help us to clarify the ripening process. Even if the study of climacteric fruits is more complete than the study of non-climacteric fruits there are some similarities between the two types of fruits and the study of ripening in climacteric fruits can help to understand ripening in non-climacteric fruits. While many ripening-related processes are inhibited in fruit with reduced ethylene, some other aspects remain unaffected. In transgenic tomato plants which over-express ACC deaminase enzyme or antisense line of EFE (Ethylene Forming Enzyme) there is a dramatic reduction of ethylene production and the level of this phytohormone is only 3 to 10% compared to the WT, however rate of tomato fruit softening are still the same than the WT (Klee, 1993; Murray et al., 1993). However, in ACO antisense melons retaining only 0.5% of ethylene production (Ayub et al., 1996), fruit softening was completely blocked (Guis et al., 1997). Colour change can be ethylene-dependent or independent regarding pigments. In transgenic tomato which have a decrease of ethylene production, lycopene biosynthesis is strongly delayed (Oeller et al., 1991; Klee, 1993; Murray et al., 1993). *Nr* tomato mutants also fail to accumulate lycopene (Tigchelaar et al., 1978). In the opposite, carotenoid accumulation in melon flesh is similar in transgenic and wild type fruit (Ayub et al., 1996; Guis et al., 1997). *E4* and *E8* require ethylene for induction (Lincoln et al., 1987) but *E8* transcripts are also present in ACS-antisense tomato fruit (Theologis et al., 1993) which demonstrates that *E8*

transcription is controlled by both ethylene and by a separate developmental factor. Although, PG is up-regulated by ethylene treatment (Sitrit and Bennett, 1998), transcript accumulation is unaffected in both *ACS*-antisense (Oeller et al., 1991) even if it is delayed. Application of exogenous ethylene on *rin* fruit does not restore the mRNA level of PG (Knapp et al., 1989). These results strongly suggest that both ethylene-dependant and ethylene-independent way is involved in the fruit ripening (Lelievre et al., 1997).

2.3.4 Fruit ripening-related gene transcription

I have previously described regulation of stress related genes by ethylene which is dependent of GCC box *cis*-element. Because GCC box has not been found in the promoter of fruit ripening related genes Ohme-Takagi and Shinshi (1995) hypothesized that regulation of fruit ripening related genes is different from the regulation of pathogenesis related genes (Ohme-Takagi and Shinshi, 1995).

E4 expression seems to be regulated only by ethylene, whereas *E8* seems to be regulated by ethylene but also by other fruit ripening signals (Deikman et al., 1998). Montgomery et al., (1993) determined that the region from -161 to -85 in the promoter of *E4* is necessary of the ethylene regulation. Experiments of Xu and co-worker (1996) demonstrated that the sequences from -150 to -121 were the most important for the level of expression. DNaseI footprint experiments demonstrate that a nuclear factor expressed in unripe fruits interacts specifically with a sequence in the region from -142 to -110 which is required for ethylene response (Montgomery et al., 1993). By linker scan mutation, Xu and collaborator (1996) demonstrated that the sequence which is responsible for the binding is localized between -140 and -131. The sequence of binding is GTTTTTGTTTTT, but does not match with the sequence found in the 5'-flanking region of other genes that are regulated by ethylene (Xu et al., 1996). *E4*-UpEREBP (*E4* upstream ethylene response element-binding protein), the protein which binds to this sequence, is still not well described, yet.

Deletion experiments of the promoter *E8* allowed Deikman and co-worker (1992) to isolate 3 5' regions controlling the expression during fruit ripening. The deletion from -2181 to -1088 of the *E8* promoter abolishes the ethylene responsiveness in unripe fruit (Deikman et al., 1992). When this region is removed, the reporter gene was still expressed during fruit ripening, but not in response to ethylene (Deikman et al., 1992). Later, Deikman and co-workers (1998) demonstrated that the region from -1528 to -1100 is sufficient to confer ethylene responsiveness when fused to a minimal 35S promoter. The region between -1088 and -863 and the region from -409 to -263 are unable to confer ethylene responsiveness but

are sufficient for the expression of *E8* during fruit ripening (Deikman et al., 1992). These results correlate the fact that *E8* expression is regulated by both ethylene and another fruit ripening signal. Using the ethylene-responsiveness region of *E8* promoter (from -1528 to -1100) as competitor took down the complex formed by the binding of E4-UpERE BP and *E4* region (-193 to -85) (Deikman et al., 1998). This result indicates that E4-UpERE BP interact with the ethylene-responsive region of *E8*.

By gel shift experiments, Cordes and co-workers (1989) put in evidence that a protein called E4/E8BP binds in *E4* and *E8* promoter. The binding region of *E4* spans the TATA box, but the binding region concerning *E8* promoter is located between -936 and -920. Strikingly, the binding activity of this protein is correlated with the expression of *E4* and *E8*. In order to test whether this protein is involved in the ethylene response of *E4*, site directed mutagenesis have been done in the binding region (Xu et al., 1996). These mutations have reduced the expression of a reporter gene in every stages of fruit ripening and was decreased 7.6-fold in ethylene treated fruit (Xu et al., 1996). Fusion of the 35S minimal promoter to *E4* region which is bound by E4/E8BP (-85 to +65) did no result in an ethylene responsive promoter. These results indicate that the E4/E8BP-binding site is not sufficient to confer ethylene responsiveness (Xu et al., 1996). These results suggest that ethylene responsiveness during fruit ripening of *E4* required 2 *cis*-elements, one between -150 and -121 and the other between -40 and +65. Indeed the regions from -150 to -121 are required for ethylene response but not sufficient, in addition mutation in the region where E4/E8BP binds *E4* dramatically decreases ethylene response but this region is not sufficient to confer ethylene response (Xu et al., 1996) (Fig.8). E4/E8BP-1 is related to 3AF1, a DNA binding protein from tobacco (Coupe and Deikman, 1997), which interacts with the promoter of the pea *rbcS-3A* gene (Lam et al., 1990). The structure of this protein suggests zinc binding, moreover, the requirement of metal binding was demonstrated for E4/E8BP-1. The transcript level of this protein increases during fruit ripening consistently with its putative role in the fruit ripening (Coupe and Deikman, 1997). Experiments of co-transformation of *E4* promoter fused to the luciferase reporter gene and E4/E8BP demonstrate that E4/E8BP enhances transcription level of E4-LUC in both air and ethylene treated mature green and breaker stage fruits (Coupe and Deikman, 1997).

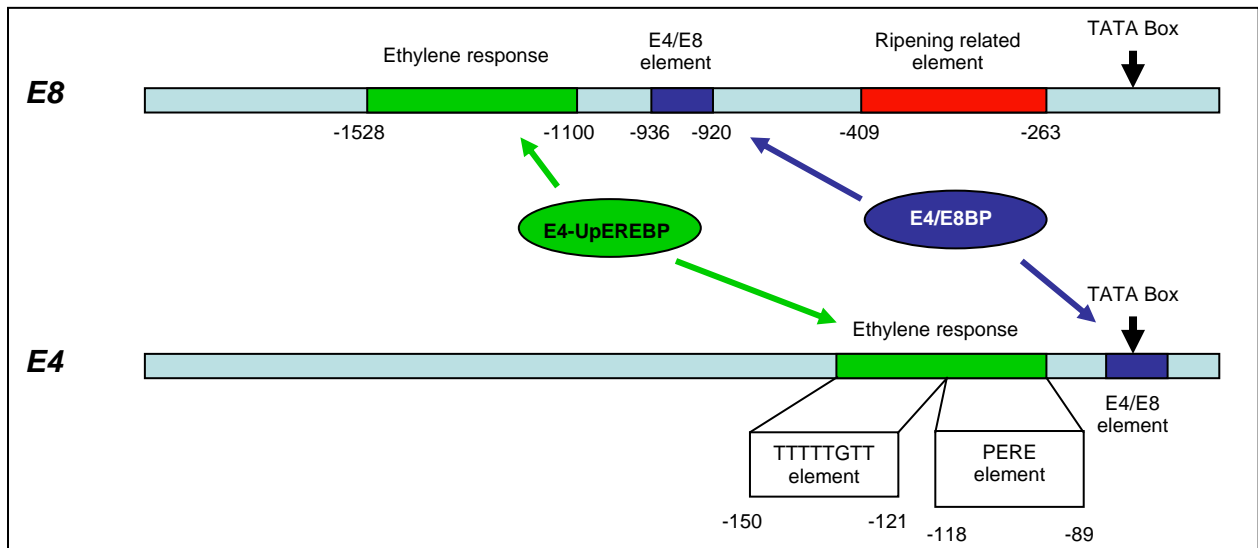

Figure 8: Schematic representation of *E4* and *E8* gene promoters. *E4* and *E8* are two strongly expressed genes during tomato fruit ripening. *Cis*-elements involved in ethylene and fruit ripening response are mentioned

3. Ethylene Response Factor (ERF): a huge plant specific family

The ethylene transduction pathway finishes by the transcription of EIN3 transcription factor. This transcription factor binds primary ethylene response element (PERE) which are present in ERF1 transcription factor (Solano et al., 1998). ERF1 belongs to Ethylene Response Family (ERF). ERFs are plant specific transcription factors, belonging to a large multigene family of 124 members in *Arabidopsis* (Riechmann et al., 2000). They are characterized by the presence of a conserved 58-59 amino acids DNA binding domain. This domain was first characterized in the *Arabidopsis* homeotic gene *APETALA2* (Jofuku et al., 1994), but it has been demonstrated that the amino acid involved in the DNA binding are not conserved (Allen et al., 1998; Nole-Wilson and Krizek, 2000). According to Nakano classification (2006) *Arabidopsis* ERFs can be classified in 10 subclasses. These sub-classes are characterized by several relatively conserved domains. Members of sub-class I, II, III, IV are characterized by the presence of a valine at position 14 of the AP2 domain and a glutamic acid at position 19. These members are categorized as DREB (Dehydration Response Element Binding) factors. Members of class V, VI, VII, VIII, IX and X are characterized by an alanine and an aspartic acid respectively at the position 14 and 19 of the AP2 domain (Sakuma et al., 2002). These last ones are called ERFs.

3.1 Dehydration Responsive Element Binding (DREB) proteins

DREB factors belong to two subfamilies DREB1/CBF and DREB2 which are induced respectively by cold and dehydration (Agarwal et al., 2006). By gel shift experiments it was demonstrated that these transcription factors can binds A/GCCGAC which is so-called Dehydration Response Element (DRE) (Yamaguchi-Shinozaki and Shinozaki, 1994; Liu et al., 1998; Dubouzet et al., 2003). When fused to a reporter gene, this *cis*-element is sufficient to drive the expression in response to dehydration, low temperature, high salt and ABA (Yamaguchi-Shinozaki and Shinozaki, 1994). During drought stress ABA is produced and plays an important protection role against this kind of stress. Many drought related genes are induced by ABA (Shinozaki and Yamaguchi-Shinozaki, 1997, 2000). Surprisingly, *DREB1/CBF* and *DREB2* are ABA independent except *CBF4*. These results suggest that there are two ways of response to drought and cold stress, one is ABA-independent which requires *DREB1/CBF* and *DREB2* (Gilmour et al., 1998; Shinwari et al., 1998; Medina et al., 1999; Nakashima et al., 2000), and another one which is ABA-dependant which requires *CBF4*.

3.2 Ethylene Response Factor (ERF)

3.2.1 Origin of AP2 DNA binding domain

Although it was widely accepted that AP2 domain is plant specific, different group identified AP2-like domains containing proteins in other organisms (Magnani et al., 2004; Wuitschick et al., 2004; Balaji et al., 2005; Lee et al., 2007). Three proteins have been found in the ciliate *Tetrahymena thermophila* (Wuitschick et al., 2004), it was also found in the cyanobacterium *Trichodesmium erythraeum* and in the viruses *Enterbacteria phage RB49* and *Bacteriophage Felix 01* (Magnani et al., 2004). More recently AP2-like domain proteins have been isolated in *Xanthomonas oryzae* bacteriophages (Lee et al., 2007) and in the apicomplexan as *Plasmodium falciparum* (Balaji et al., 2005). In cyanobacterium AP2 domain binds preferentially to poly(G)/poly(C) region. In the non plant species AP2 domain are associated to homing endonuclease genes (HEGs) (Wessler, 2005). Homing endonucleases promote lateral transfer of the intervening sequence from the allele with intron to an allele without intron (Wessler, 2005). They recognize a long sequence (between 15 and 30 bp) that is present only in allele without intron, they make a double strand cut and recombine with the intron allele (Fig.9).

Because AP2 domain proteins are mainly found in the plants kingdom but sporadically in other species, and because the composition of the AP2 domain of *T. thermophila* looks like ciliate (AT content, unusual codon), the most probable hypothesis raised by scientists is that plant AP2 domain moved laterally from bacteria or ciliate to plant (Wessler, 2005). In its work Wessler (2005) supposed that the AP2 domain binds the target allele, thus positioning the catalytic domain near its cleavage site.

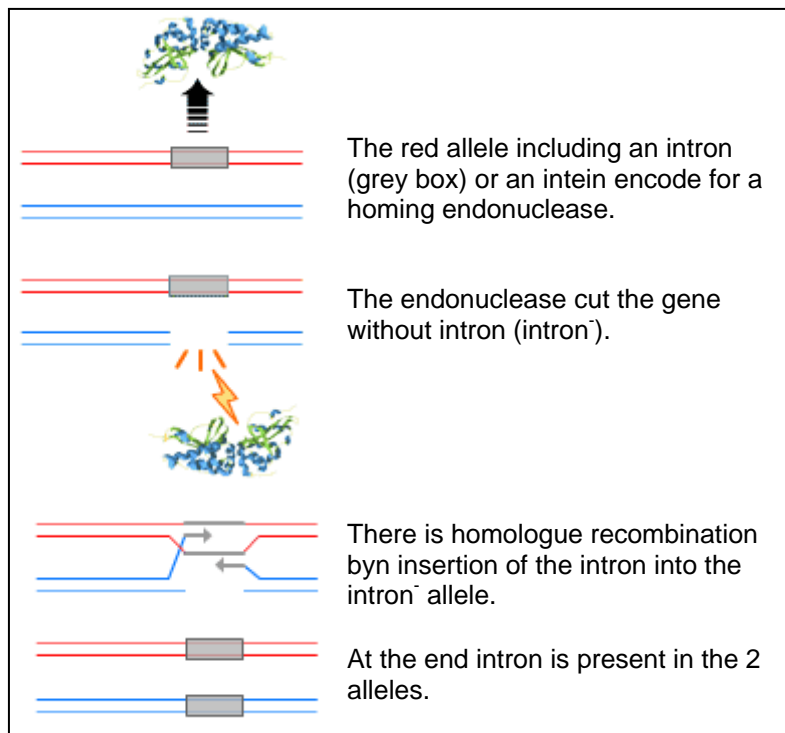

Figure 9: Homing endonuclease propagation.

3.2.2 ERF classification

The AP2/ERF domain is highly conserved, but flanking regions surrounding this domain are very divergent, it is the reason why Nakano et al., (2006) used the AP2/ERF domain to classify the ERF family. It is the first study which establishes a link between this kind of classification and the different conserved domains present outside the DNA binding domain. Usually, conserved regions outside of the DNA binding domain are functionally important, they can be involved in the activity, the protein-protein interaction or in sub-cellular localization (Liu et al., 1999). Most of the subgroup is characterized by the presence of conserved domain enriched in acidic amino acids, such as, glutamine, and proline (Nakano et al., 2006). These domains are putative activators (Liu et al., 1999) but their function is not clearly demonstrated. These results suggest that most of ERF transcription factors identified so far are activators (Zhou et al., 1997; Fujimoto et al., 2000; Ohta et al., 2000; Onate-Sanchez and Singh, 2002; Wu et al., 2007). However members of some other sub-class act as transcriptional repressors (Fujimoto et al., 2000; Ohta et al., 2000; Ohta et al., 2001). Indeed,

members of the class VIII are characterized by the presence of a highly conserved repressor domain so-called, ERF-associated amphiphilic repression (EAR) (Ohta et al., 2001; Nakano et al., 2006). This motif, which the consensus sequence is (L/F)DLN(L/F)xP, is located in the C-terminal region of the repressor ERF (Ohta et al., 2001). It was reported that a similar motif is also present in other repressor transcription factor family as AUX/IAA (Tiwari et al., 2004) and in SUPERMAN (Hiratsu et al., 2003).

3.2.3 ERF functions

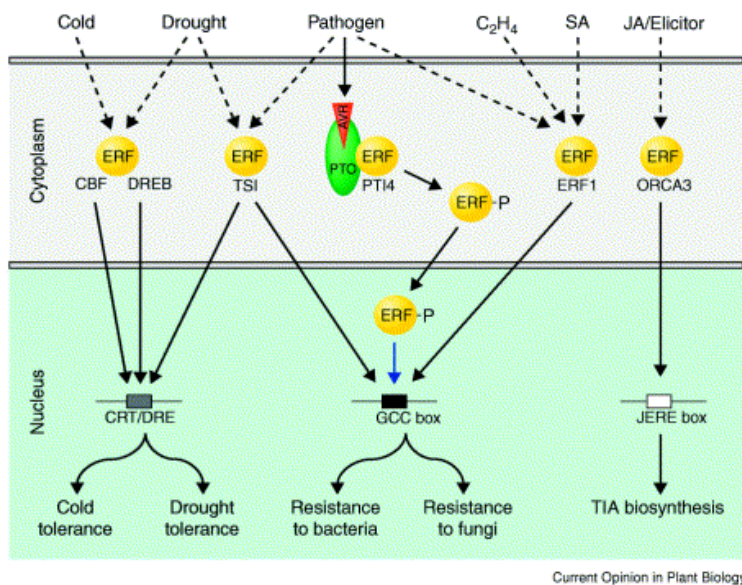

Figure 10: Outline of some of the stress responses and/or signals linked to ERF transcription factors. Also shown are the promoter elements that they bind to and the effects of their over expression in plants. Most of the pathway components between the reception of the stimuli and the activation of specific ERFs remain to be discovered (as indicated by dashed lines). The blue arrow for tomato PTI4 indicates an increase in DNA-binding upon phosphorylation by the PTO kinase. (Singh et al., 2002)

The regulation of ERFs by hormones like ethylene, jasmonic acid and salicylic acid or by pathogens attacks has been shown for several ERFs (Fujimoto et al., 2000; Gu et al., 2002; Chen et al., 2002; Onate-Sanchez and Singh, 2002; Brown et al., 2003; Cheong et al., 2003; Lorenzo et al., 2003). It has also been demonstrated that ERFs can be induced by wounding and abiotic stress (Fujimoto et al., 2000; Park et al., 2001; Chen et al., 2002). *ERF1* was the first one isolated as induced by ethylene in *Arabidopsis* (Solano et al., 1998). In 2003, a study demonstrated that *ERF1* is induced by both ethylene and jasmonic acid and the integrity of the 2 transductions pathway is necessary for the induction of *ERF1* by one of these hormones. This result suggest that *ERF1* is an integration node of the 2 pathways (Lorenzo et al., 2003). *ERF1* is a transcription factor involved in the induction of numerous defence genes that prevent disease progression. *ERF1* mRNA starts to be induced by jasmonate 30 min, after treatment (50 μ M) and return to its basal level after 10 hours of treatment (Lorenzo et al., 2003). By contrast, induction of *ERF1* transcript by ethylene is longer (Solano et al., 1998). A synergistic effect of both ethylene and jasmonate is observed in *PDF1.2* induction (Penninckx

et al., 1998). *PDF1.2* is known to encode for an antifungal peptide belonging to the family of plant defensins (Broekaert et al., 1995; Penninckx et al., 1998). β -chitinase, which is a pathogenesis-related (PR) protein, is induced by ethylene and jasmonate independently, but also when the plant is treated by both in the same time (Lorenzo et al., 2003). Transgenic plant which over express *ERF1* shows induction of many defence related genes, as *PDF1.2*, *PR1* or *osmotin* precursor (Lorenzo et al., 2003).

In tomato plant, which is useful to study interaction plant pathogenesis with *pseudomonas syringae* as pathogen, the first ERFs which have been isolated are *Pti4,5* and *Pti6* (Zhou et al., 1997). These ERFs have the capacity to bind GCC box *in vitro* but only *Pti4* is induced by ethylene (Gu et al., 2000). Expressions of the *Pti4*, *Pti5* and *Pti6* are induced by *pseudomonas syringae* (Thara et al., 1999; Gu et al., 2000). However, it is interesting that the ethylene action inhibitor norbornadiene did not inhibit the induction of *Pti4* and *Pti5* either in the compatible or incompatible interactions. These results suggest that the *Pseudomonas* bacterium induces *Pti4* and *Pti5* expression through a ethylene independent pathway (Thara et al., 1999).

Recent study demonstrated that ERFs can also be involved in resistance to fungi. Actually, McGrath et al., (2005) demonstrate that *AtERF4*, a repressor ERF (Yang et al., 2005), and *AtERF2* have opposite effect on the resistance to the necrotrophic pathogen *Fusarium oxysporum*. As describe above many ERFs are involved in plant pathogen interaction, but some ERFs are also involved in plant nodulation. Symbiotic interaction responsible of the nodulation needs expression of target gene by Nod factors. Recently, an ERF has been identified as a *trans*-activator for Nod factors, elicited genes (Middleton et al., 2007). Andriankaja et al. (2007) demonstrated that *ERN1* and *ERN2* mediate expression of *MtENOD11*, a marker gene for both the early preinfection and subsequent infection stages of the symbiotic association (Journet et al., 2001).

In spite of the main studied ERFs are involved in pathogenesis stress, there are more and more evidences that ERFs are also involved in developmental process. Transgenic plant overexpressing *Sl-ERF2* shows an early germinating phenotype, probably due to an over expression of *mannanase* genes involved in the radicle protrusion (Pirrello et al., 2006). Recent studies demonstrate that *MtSERF1* is required for somatic embryogenesis (Mantiri et al., 2008). Result of Wang et al. (2007) suggest that two ERFs are involved in the apple fruit ripening, whereas antisense *Sl-ERF1* fruits have longer shelf life (Li et al., 2007).

There are many publications demonstrating the importance of ERFs in the response to abiotic stress (Park et al., 2001; Huang et al., 2004; Lee et al., 2004). *TERF1* transcripts are induced under salt stress very rapidly, 10 min after the beginning of treatment (Huang et al., 2004).

TERF1 is also induced by drought (induction after 30min); cold (induction after 3h) and ABA (reach a top after 2H). *TERF1* activated GCC- and DRE-driven reporter gene (Zhang et al., 2005b). This result strongly suggests that *TERF1* induces genes which contain GCC box or DRE/CRT box. These results were confirmed by stable transformation in tobacco. Transgenic tobaccos overexpressing tomato *TERF1* exhibit constitutive triple response, enhanced salt tolerance and show a greater tolerance to drought (Huang et al., 2004; Zhang et al., 2005b). Overexpression of *TERF1* induces constitutive expression of PR genes like *Prb-1b*, *GLA*, *osmotin* or *CHN50* (Huang et al., 2004) and induces genes involved in ABA/osmotic stress (*NtLTP1*, *TobLTP1*, tomato *TSW12*) which belong to the lipid transfer protein, known to be involved in response to ABA, cold-, drought-, salt-stress (Dunn et al., 1991; Torres-Schumann et al., 1992; Ouvrard et al., 1996; Trevino and O'Connell, 1998). The addition of an inhibitor of ethylene action (AgNO₃) does not affect expression level of *NtLTP1* and *TSW12* but affects the expression of *TobLTP1* and *SAMI* (Zhang et al., 2005b). This result demonstrates that the hypersensitivity of overexpressing lines to ABA is in part ethylene dependant. *TERF1* makes the link between ethylene and salt response and it integrates different signaling pathway. It has been shown that salicylic acid (SA), jasmonic acid (JA) abscisic acid (ABA) and ethylene are involved in stress response (Dong, 1998). *JERF3* (Jasmonate and Ethylene Responsive Factor 3) makes the link between jasmonate and ethylene signal (Wang et al., 2004). *JERF3* transcripts are mainly induced by ethylene (after 2 hours), jasmonic acid (after 10min), by cold (after 10min) and by NaCl (after 10min). Constitutive expression of *JERF3* in tobacco plant activates significantly PR genes which contain GCC box like *osmotin*, *Prb-1b*, *CHN50*. Tobacco plants which overexpress *JERF3* are also more resistant to high salt concentration (Wang et al., 2004). Many researches demonstrate that ERF known to bind GCC box are also able to bind dehydration-responsive element (DRE) which is a *cis*-element involved in dehydration, high salt and low temperature (Park et al., 2001; Hao et al., 2002). For example, *JERF3* has been shown to interact *in vitro* with DRE (Wang et al., 2004).

The *AtERF* genes respond not only to ethylene but also to abiotic stress like cold, wounding, salt stress or drought (Fujimoto et al., 2000). But the induction of *AtERF* by wounding cold and drought seems to be ethylene independent because the response to this abiotic stress occurs even in the ethylene insensitive mutant plant *ein2* (Fujimoto et al., 2000).

3.2.4 Post translational regulation of ERFs

ERFs can interact with other proteins (Buttner and Singh, 1997; Zhou et al., 1997) and can also undergo post-translational modification. In tomato, resistance of plants carrying the Pto kinase locus to *Pseudomonas syringae* pv. *tomato* strains expressing the avirulence gene *avrPto* is a model system to study signal transduction pathway involved in plant resistance. The first tomato ERFs *Pti4*, 5 and 6 have been isolated using *Pto* as bait by yeast two-hybrid system (Zhou et al., 1997). Gu et al. (2000) demonstrated that Pto specifically phosphorylates *Pti4*. This phosphorylation increases the binding on the GCC box (Gu et al., 2000). Cheong et al. (2003) reported that *BWMK1*, a MAPK from rice, is able to phosphorylate *OsEREBP1* that binds the GCC box. The DNA binding of *OsEREBP1* is also improved by phosphorylation. These results were confirmed *in vivo*. Indeed, the transient co-expression of *BWMK1* and *OsEREBP1*, in *Arabidopsis* protoplasts, increases the expression level of a GUS reporter gene fused to a minimal promoter containing GCC boxes (Cheong et al., 2003).

3.2.5 The AP2/ERF domain allows binding with different cis-elements

The 3-dimensional structure of the AP2 domain was elucidated by X-ray crystallography. The DNA binding domain contains three β -sheets and one α -helix (Allen et al., 1998). The arginine and tryptophan residues in the β -sheet are identified to interact with eight of the nine consecutive base pairs of the *cis*-element.

Ohme-Takagi and Shinshi (1995) definitively demonstrated that the GCC box is sufficient for ethylene induction. The fusion of a synthetic promoter containing 2 GCC boxes to the GUS reporter gene confers ethylene responsiveness. A mutated version of the GCC box in which Gs are replaced by Ts prevents induction of the reporter gene by ethephon (Ohme-Takagi and Shinshi, 1995). Electro-mobility shift assay proved that tobacco proteins from a nuclear extract can specifically bind to the GCC box. Mutations of the GCC box abolish this binding. Moreover, mutated GCC box cannot compete for binding to nuclear factor (Ohme-Takagi and Shinshi, 1995). By yeast simple-hybrid system, using GCC boxes as probe, Ohme-Takagi and Shinshi (1995) isolated 4 tobacco cDNAs encoding ERFs. ERFs show low level of homology except in the binding domain which is a 59 amino acids domain (Ohme-Takagi et al., 2000). More and more studies suggest that ERFs can recognize other *cis*-elements. *Pti4* induces defence genes in response to biotic stress but, most of the genes regulated by this ERF does not contain a GCC box (Chakravarthy et al., 2003). More recently, new *cis*-elements have been isolated. Legumes as *Medicago* have the unique capacity to fix soil nitrogen in a

symbiosis relation with rhizobia. This symbiotic interaction induces the formation of a new roots organ, known as nodule. In the nodule, bacteria reduce atmospheric nitrogen (Gage, 2004). To establish this symbiotic interaction bacteria produce Nod factors (D'Haese and Holsters, 2002). Andrankaja et al., (2007) demonstrate by deletion experiment of *MtENOD11* promoter, within Nod Factor-Responsive Element, a GCC like motif (GCAGGCC) different from the GCC box, and/or its flanking region CAAT box and HD-ZIP-like motif are important for Nod factor elicited gene activation. Using yeast one-hybrid system they demonstrated that ERN (ERF Required for Nodulation) binds to this *cis*-element (Andriankaja et al., 2007).

The vascular system-specific and wound-responsive *cis*-element (VWRE) has been identified as a novel *cis*-element for wound-induced and vascular system-specific expression of the tobacco peroxidase gene, *tpoxN1*. *WRAF1* and *WRAF2* are ERFs of the subfamily X which bind the VWRE *cis*-element (Sasaki et al., 2007).

Chapitre 1

Article 1: *en préparation*

Structural and functional studies reveal specific features among members of the tomato Ethylene Response Factor family.

Introduction à l'article 1.

La voie de transduction de l'éthylène se termine par une cascade transcriptionnelle, dont les premiers acteurs sont les protéines de type EIN3-like et dont les derniers acteurs connus sont les ERF. Considérant la simplicité de la voie de transduction de l'éthylène qui s'oppose à la complexité et à la diversité de réponse de la plante à cette hormone, il est raisonnable d'émettre l'hypothèse que les ERF sont à l'origine de cette diversité. Chez *Arabidopsis* on dénombre 122 membres (Nakano et al., 2006) ce qui en fait la 2^{ième} plus grande famille de facteur de transcription après les facteurs MYB (Riechmann et al., 2000). Ils peuvent être classés en 10 sous-groupes. Cinquante sept de ces ERF peuvent être classés dans la sous-classe des DREB alors que 65 sont classés dans la sous-classe des AP2/ERF (Nakano et al., 2006). Parce que les ERF présentent peu de similitude de séquence en dehors du domaine AP2/ERF, de nombreuses études ont utilisé le domaine de fixation à l'ADN comme base pour la classification des ERF (Sakuma et al., 2002; Nakano et al., 2006). Cette classification est validée par le fait qu'en dehors du domaine AP2/ERF on retrouve des domaines conservés caractéristiques de chaque sous-groupe (Nakano et al., 2006). Chez la tomate seulement 12 ERF ont été isolés jusqu'à présent (Zhou et al., 1997; Tournier et al., 2003; Huang et al., 2004; Wang et al., 2004; Zhang et al., 2004b; Zhang et al., 2004a; Hongxing et al., 2005). En utilisant le BLAST (Altschul et al., 1990) comme outil informatique avec comme séquence modèle le domaine AP2/ERF nous avons pu isoler 59 unigènes de tomate. Nous avons décidé de nous focaliser sur le sous-groupe des ERF. Nous avons ainsi cloné 28 cDNA pleine taille (ATG-STOP) dont 16 nouveaux ERF jamais décrits à ce jour. L'analyse phylogénétique de ces 28 gènes en utilisant la séquence protéique complète ou la séquence du domaine de fixation à l'ADN nous a conduit au même résultat de classification des ERF de tomate dans les mêmes sous-groupes tels que définis précédemment par Nakano et al., 2006. Cette analyse nous a conduits à renommer les ERF de tomate connus en fonction de leur sous-groupe. Tous les ERF n'ayant pas la même activité régulatrice, certains étant activateurs alors que d'autres sont répresseurs (Fujimoto et al., 2000; Ohta et al., 2000), nous avons décidé d'étudier l'activité transcriptionnelle des membres de chaque sous-groupe. Des expériences d'expression transitoire dans des protoplastes de tabac BY2 co-transformés avec un ERF surexprimé et un promoteur minimum contenant ou pas la boîte GCC fusionnée au gène rapporteur de la GFP, ont permis de mettre en évidence que tous les ERF testés à l'exception de ERF.E.2 se fixent à la boîte GCC et que les ERF d'une même sous-classe présentent des activités distinctes.

La fonction biologique d'un gène ne dépendant pas seulement de son activité mais aussi de son expression dans les différents tissus, nous avons utilisé la technique de la qRT-PCR pour déterminer le profil d'expression de ces 28 gènes. Les ERF se distinguent par leur profil d'expression en 2 groupes, ceux qui sont principalement induits dans les tissus végétatif et ceux qui sont plutôt exprimés dans les fruits. Près de la moitié des ERF sont régulés au cours du développement ou de la maturation du fruit alors que l'autre moitié est essentiellement exprimée dans les fleurs au stade anthèse. Ces résultats sont à mettre en parallèle avec l'inductibilité des gènes par l'éthylène. La maturation du fruit de tomate est caractérisée par la production auto-catalytique de l'éthylène, ce qui correspond à la crise climactérique (Rowan et al., 1958). Cette surproduction d'éthylène est aussi observée dans la fleur (Peiser, 1989). Treize ERF sont induits par l'éthylène, 5 sont réprimés, alors que 6 ne semblent pas régulés par l'éthylène. Il est surprenant de constater que certains ERF surexprimés dans le fruit ou dans la fleur sont réprimés ou encore insensibles à l'éthylène. De manière surprenante, parmi ces derniers certains sont induits par l'auxine alors que d'autres y sont insensibles. Il est fort probable que parmi les ERF qui ne sont ni induits par l'éthylène ni par l'auxine certains soient régulés par d'autres phytohormones au cours du développement du fruit ou dans la fleur. De façon remarquable l'analyse en composante principale des données de transcriptomique a révélé que le niveau des transcripts dans les tissus fleur et vert immature avaient un comportement différent de tous les autres, suggérant ainsi un rôle clé des ERF pendant l'initiation de la fructification. Ce rôle a été confirmé par des études d'expression des ERF dans des fleurs émasculées traitées par différentes hormones connues pour être impliqués dans l'initiation de la fructification (Auxine, GA, ABA).

Il est nécessaire maintenant de connaître les fonctions de chaque ERF et ainsi déterminer les processus dans lesquels ils interviennent. Pour cela 3 types de constructions ont été réalisés. Les deux premières sont des constructions sens sous le contrôle d'un promoteur 35S ainsi que des lignées RNAi. Les ERF constituent une famille multigénique, c'est pourquoi nous nous attendons à ce que la majorité des lignées RNAi ne présentent pas de phénotype à cause de la redondance fonctionnelle. Pour cette raison nous avons également construits des protéines chimères en fusionnant en C-terminal le domaine répresseur dominant SRDX (Hiratsu et al., 2003) pour le troisième type. Ces constructions doivent nous permettre de contrecarrer la redondance fonctionnelle, en éteignant les gènes cibles du facteur de transcription étudié, contrairement aux stratégies knock-out classiques comme le RNAi dont l'objectif est d'éteindre spécifiquement le gène étudié.

Specific features among members of the tomato Ethylene Response Factor family revealed by structural and functional studies.

Authors: Julien Pirrello^{a*}, B. C. Narasimha Prasad^{a*}, Wangshu Zhang^a, Lanlan Zhang, Isabelle Mila^a, Stephane Muñoz^b, Mathilde Causse^b, Masaru Ohme-Takagi^{c,d}, Alain Latché^a, Jean Claude Pech^a, Farid Regad^a, Mondher Bouzayen^{a1}.

(a) *Génomique et Biotechnologie des Fruits, ENSAT, Pôle de Biotechnologie Végétale, BP 107 Auzeville Tolosane, 31326 Castanet Tolosan cedex, France.* (b) *INRA, UR1052, Unité de génétique et amélioration des fruits et légumes, Domaine St Maurice BP94, 84143 Montfavet* (c) *Gene Function Research Center, National Institute of Advanced Industrial Science and Technology (AIST), Central 4, Tsukuba 305-8562, Japan;* (d) *Core Research for Evolutional Science and Technology Agency, Kawaguchi 332-0012, Japan;*

*These authors contributed equally to the work

Abstract

The phytohormone ethylene is involved in a wide range of developmental processes and plays an important role in mediating plant responses to biotic and abiotic stresses. Ethylene signaling is a linear transduction pathway leading to the activation of Ethylene Response Factor (ERF) genes which form one of the largest gene families of plant transcription factors. Because ERFs lie in the last step of ethylene signaling, they are well suited to be the main components driving ethylene responses towards specificity and diversity. To gain better insight on the specific role played by members of the ERF family, we isolated 28 ERFs cDNA clones in tomato (*Solanum lycopersicon*) and performed their structural and functional characterization. Phylogenetic analyses revealed that tomato ERFs fall into eight sub-class that are also found in *Arabidopsis*. Transient expression assays in a single cell system failed to reveal any obvious correlation between protein structure, the class to which it belongs and the capacity of an ERF member to activate or repress transcriptional activity of ethylene-responsive promoters. Expression studies indicated that ERFs genes cluster in two main clades depending on whether they display preferential expression in fruit or in vegetative tissue. Moreover, principle component analysis revealed that ERFs expressed in flower and early immature green fruit group together and separately from those expressed in vegetative tissues and in ripening fruit. A number of ERFs genes show weak expression upon treatment with hormones known to induce fruit set such as auxin and gibberellins suggesting that down-regulation of these ERFs might be integral the process of fruit set. Noteworthy, while half of the tomato ERFs genes are regulated by ethylene treatment, transcript accumulation of some ERFs proved to be auxin-responsive suggesting that they may represent a point of convergence between ethylene and auxin signaling.

Introduction

Ethylene, a gaseous plant hormone is reported to have numerous effects on developmental processes, including germination, flower and leaf senescence, fruit ripening, leaf abscission, root nodulation, programmed cell death, and responses to abiotic stresses and pathogen attacks (Johnson and Ecker, 1998; Bleecker and Kende, 2000; Pirrello et al., 2006). Components of ethylene signaling have been extensively studied in *Arabidopsis* (Benavente and Alonso, 2006) revealing a linear transduction pathway that leads to the activation of transcriptional regulators from the Ethylene Response Factor (ERF) type. These last components of the ethylene signaling pathway are responsible for modulating the transcription of ethylene-regulated genes. However, the apparent simplicity of the ethylene transduction pathway cannot account for the tremendous diversity of plant responses to ethylene. Because ERF proteins are encoded by one of the largest family of plant transcription factors, it is likely that diversity and specificity of ethylene responses may take place at the level of this last step of ethylene signaling. ERFs are *trans*-acting factors unique to plants shown to bind specifically to the GCC box *cis*-acting element found in the promoter regions of ethylene-responsive genes (Ohme-Takagi and Shinshi, 1995; Solano et al., 1998). The ERF family is part of the AP2/ERF superfamily which also contains the AP2 and RAV families (Riechmann. JL et al., 2000). The ERF type family is further divided into two major subfamilies, the ERF and the CBF/DREB families of transcription factors (Sakuma et al., 2002). DREB family is characterized by the presence of a valine and glutamic acid respectively at position 14 and 19 in the AP2 domain, whereas alanine and aspartic acid are conserved in the corresponding positions in the ERF proteins (Sakuma et al., 2002). In the model plant, *Arabidopsis*, 65 ERFs have been identified, which accounts for up to 44% of the total proteins encoding AP2/ERF domain. Structural and functional analyses performed *in silico* for *Arabidopsis* and rice ERFs used either the entire protein sequence for phylogenetic analysis (Fujimoto et al., 2000; Tournier et al., 2003), or the conserved AP2 domain (Sakuma et al., 2002; Nakano et al., 2006) to infer relationships between ERFs. Recent phylogenetic analysis of *Arabidopsis* ERFs suggested a link between these two methods (Nakano et al., 2006). In *Arabidopsis* the ERF subfamily contains 65 members and is further divided into 5 classes on the basis of the conservation of the AP2 domain (Nakano et al., 2006). The ERF domain was first identified as a conserved motif of 59 amino acids in four DNA-binding proteins from *Nicotiana tabacum* (Ohme-Takagi and Shinshi, 1995). This motif, characterized by 3 β -sheets and 1 α -helix, allows binding of the ERFs to the GCC-box (Ohme-Takagi and

Shinshi, 1995; Allen et al., 1998). Binding affinity also depends on the flanking region of the GCC box and of the ERF itself (Tournier et al., 2003). Recent studies demonstrated that, beside the GCC box, ERFs can also bind different *cis*-elements such as VWRE (Vascular Wounding Responsive Element) (Sasaki et al., 2007). This is in line with the data reporting that *Pti4*, an ERF type transcription factor, is able to bind promoter lacking a GCC box *cis*-element (Chakravarthy et al., 2003).

ERFs were first identified in tobacco and subsequently isolated from several plant species indicating that they are ubiquitous in plant kingdom. Their functional implications have been studied in various plant species and in a wide range of processes such as hormonal signal transduction (Ohme-Takagi and Shinshi, 1995), response to biotic (Yamamoto et al., 1999; Gu et al., 2000) and abiotic stresses (Stockinger et al., 1997; Liu et al., 1998; Dubouzet et al., 2003), regulation of metabolic pathways (van der Fits and Memelink, 2000; Aharoni et al., 2004; Broun et al., 2004; Zhang et al., 2005a) and developmental processes (van der Graaff et al., 2000; Banno et al., 2001; Chuck et al., 2002). A number of studies demonstrated that ERFs can regulate the expression of ethylene-responsive genes harbouring the so-called GCC-box motif in their promoter but also genes that are responsive to jasmonic acid and salicylic acid (Gu et al., 2000; Brown et al., 2003; Lorenzo et al., 2003). It was also reported that some ERFs are regulated by abiotic stress such as wounding and salt stress (Park et al., 2001; Chen et al., 2002; Tournier et al., 2003). Recent studies demonstrated that ERFs are also involved, in germination (Pirrello et al., 2006). The large size of the ERF gene family suggests that different members of this family may have varied functionality and diverse binding activities. Hence, it is reasonable to hypothesize that each ERF or group of ERFs may target specific set of genes, thus conferring diversity and specificity of ethylene responses depending on the tissue, developmental stage or environmental conditions. On the other hand, the cross-talk between ethylene and other hormonal transduction pathways may also actively contribute to the complexity of ethylene responses (Stepanova et al., 2007, Rosado et al., 2006).

In this study, we describe 28 tomato ERFs genes among which 16 were newly isolated. Based on structural and phylogenetic analyses performed with both the entire protein and the AP2/ERF domain, to show that the ERF gene family is organised into 8 and 10 subclasses in tomato and *Arabidopsis*, respectively, allowing us to re-name the tomato ERFs. Using a single cell system, we characterized the binding affinity of tomato ERFs to both a synthetic GCC box promoter and native complex promoters harbouring or not the canonical GCC box. Our data indicate that no link could be found between the classification of the ERFs and their

regulated function. Expression studies indicated that ERFs display preferential spatio-temporal pattern of expression, differential responsiveness to ethylene and that the expression of some members is clearly regulated by auxin.

Results

Isolation of tomato ERFs genes and generation of over-expression and repressor constructs.

To isolate full-length cDNA clones for all available tomato ERFs, BLAST search (Altschul et al., 1990) of the tomato unigene database was performed on the SGN website using a consensus sequence of the AP2/ERF domain (59 amino acids) as a query sequence. Forty nine unigene sequences have been found and after removal of those corresponding to AP2, RAV and DREB sequences 28 unigenes remained. Among these, 25 have at least a complete CDS and for the 3 remaining genes (*Sl-ERF.D.3*, *Sl-ERF.G.1*, *Sl-ERF.F.3*) a RACE PCR was performed to obtain the corresponding full length cDNAs. The complete CDS was obtained for *Sl-ERF.D.3*, *Sl-ERF.G.1* and *Sl-ERF.F.3* by extending the 5' and 3' end of the coding sequence.

Phylogenetic analysis of tomato ERFs

The first classification of ERF genes was made using the *Arabidopsis* full length proteins (Fujimoto et al., 2000) and subsequently Tournier et al., 2003 further characterized the tomato ERFs according to the conservation of the amino acid residues within and surrounding the AP2 domain. Because the homology among ERF proteins outside the AP2/ERF domain is weak, Sakuma et al., (2002) used only AP2/ERF domain to classify the *Arabidopsis* ERF family. This classification revealed that ERF subfamily is characterized by the presence of an alanine and an aspartic acid residue at positions 14 and 19, respectively, in the AP2/ERF domain whereas valine and alanine are conserved in the corresponding position in DREB proteins (Sakuma et al., 2002). We used these features as guideline criteria to exclude DREB proteins and restrict our study to the ERF subfamily members. We thereafter compared the ERF phylogenetic tree constructed using either the whole protein sequences or solely the AP2/ERF domain (Fig.1). We obtained identical classification pattern independently of the method used for the clustering (*i.e.*: whole protein *vs.* AP2 domain). Moreover, most of the ERF subclasses that have been defined previously by Nakano et al. (2006) were conserved in the tomato (Fig. 1, Table 1). The different tomato ERF subclasses were then renamed as subclass A to H, in order to avoid any confusion with previous classifications (Table 1). Phylogenetic analyses clustered tomato ERFs in 8 subclasses whereas up to 10 subclasses were defined for *Arabidopsis*. The correspondence between the classification made in the present study and previous ones made by Tournier (2003) for tomato ERFs and Sakuma

(2002) and Nakano (2006) for *Arabidopsis* ERFs are given in Table 1 which also shows that, so far, no tomato ERF representatives were found for classes I and J present in *Arabidopsis*. In the tomato, subclass A, B and C, the AP2/ERF domain is composed of 59 amino acids whereas in subclass D to H, it only contains 58 amino acid residues.

Table 1: Correspondence between the new classification of tomato ERF subclasses and previous ERF classifications in tomato and *Arabidopsis*. The number of ERFs per subclass is indicated between brackets.

Present Study	Tournier et al. (2003) Tomato	Nakano et al. (2006) <i>Arabidopsis</i>	Sakuma et al. (2002) <i>Arabidopsis</i>
A (3)	I	IXa	B3
B (3)	III	IXb	B3
C (6)	-	IXc	B3
D (4)	-	X	B4
E (4)	IV	VII	B2
F (5)	II	VIII	B1
G (2)	-	VI	B5
H (1)	-	V	B6
I (-)	-	Xb-L	B6
J (-)	-	VI-L	B6

Sub-class A corresponds to the class I on Tournier's classification and class IXa on Nakano's classification (Tab.1). This class gathers three tomato ERFs (ERF.A.1-3) characterized by the presence of the highly conserved basic region common to all members of this class and composed of the consensus sequence SSSENGSPKRRKKGEQ that could serve as putative nuclear localization signal (Fig.2). With the exception of SI-ERF.A.1, members of class A also possess a conserved acidic domain in the N-terminal region of the protein (Tournier et al., 2003). This domain is known to be a putative activation domain and corresponds to the CM-IX-3 nomenclature (Nakano et al., 2006). Another distinguishing feature of this class is related to the AP2/ERF domain that is characterized by the presence of the AKN motif at position 21 (Fig.3).

Figure 1 : Phylogenetic tree of Arabidopsis and Tomato ERF proteins. Each color represent a different subclass, the name of the different subclass is given in the outside part. (A) Amino acid sequence of the whole protein was used. (B) Amino acid sequence of the AP2/ERF domain was used.

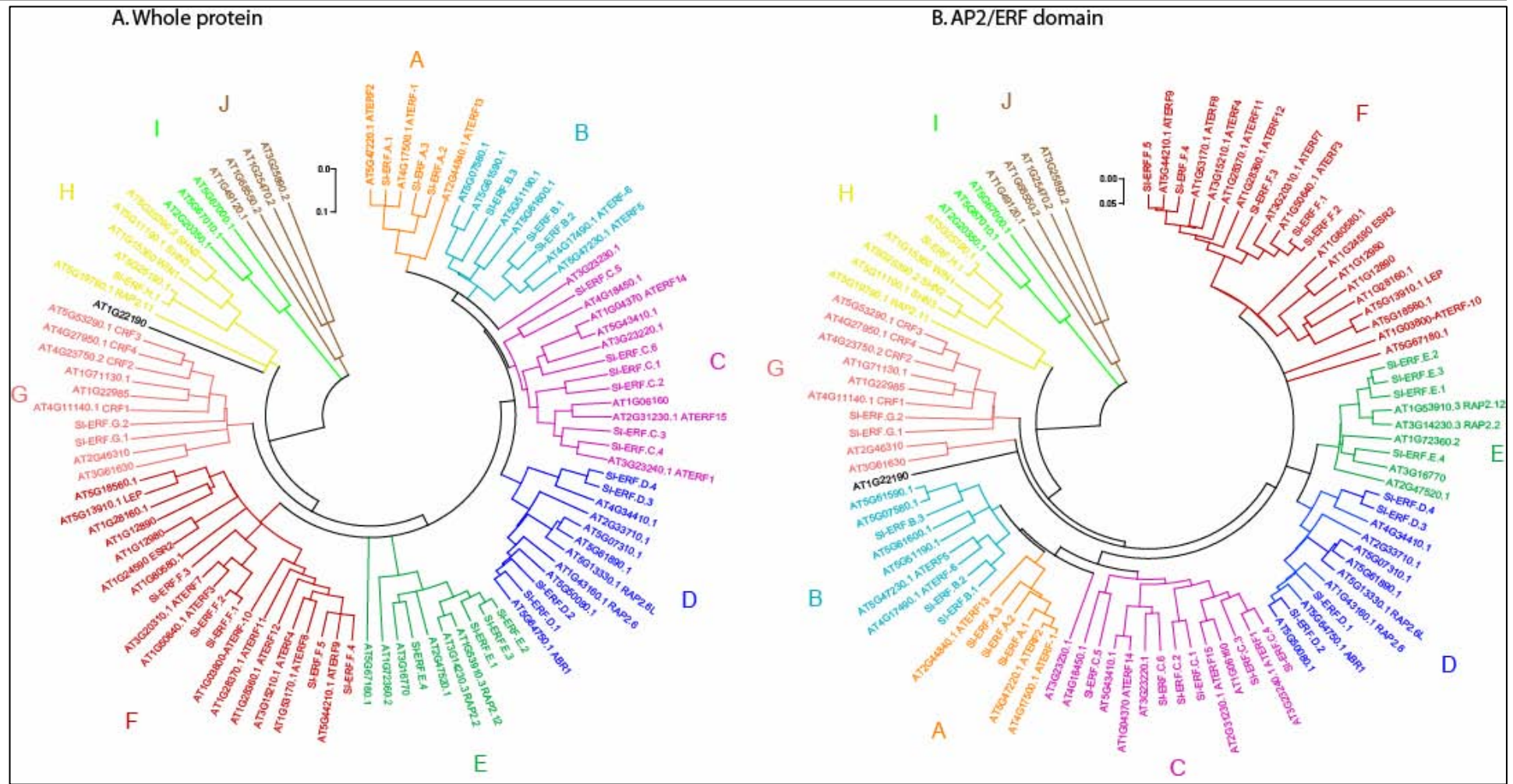

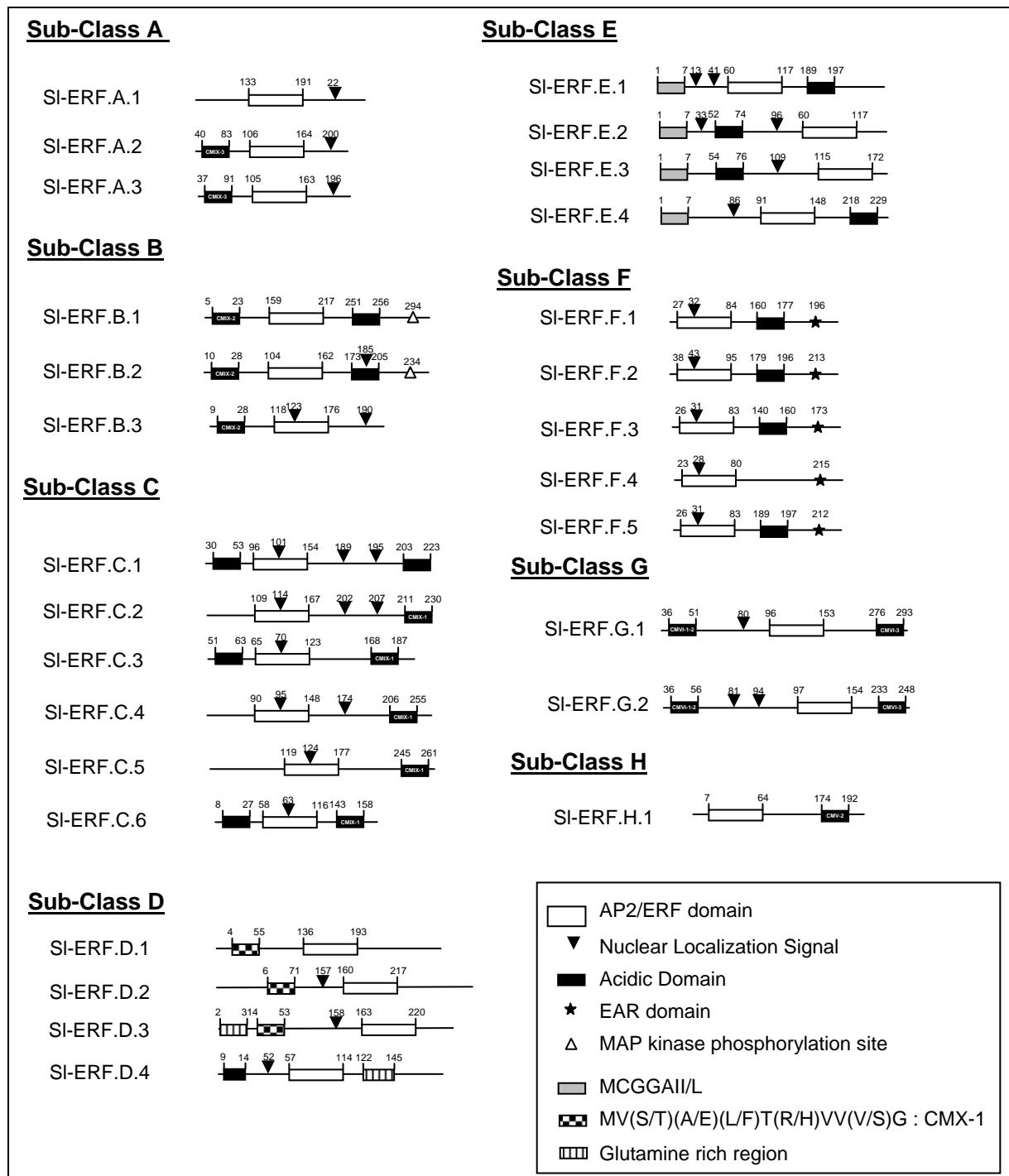

Figure 2: Schematic diagram depicting main structural features of tomato ERF proteins in each subclass. Each coloured box represents the AP2/ERF domain and conserved motifs, as indicated below the diagram. The position of the motif is indicating by the number on the top of the diagram. The name of motif by Nakano is given inside the box (Nakano et al., 2006).

Sub-class B is characterized by the presence of a conserved acidic domain at the N-terminal region (CMIX-2, (Nakano et al., 2006)). However, contrary to the description made by Fujimoto et al. (2000), the presence of the acidic domain in the C-terminal region is optional and 2 members (SI-ERF.B.1 and SI-ERF.B.2) out of 3 in the tomato this acidic domain lies in C-terminal region. Furthermore, SI-ERF.B.1 and SI-ERF.B.2 are characterized by the

presence of a putative mitogen-activated protein (MAP) kinase phosphorylation site (Fig.2) corresponding to the PXXSPXSP motif in which X represents any amino acid (Pearson and Kemp, 1991). This motif is also found in *Arabidopsis* ERFs of the same class and was called CMIX-5 motif (Nakano et al., 2006). This is consistent with reports indicating that ERF proteins can undergo post-translational modifications including phosphorylation (Gu et al., 2000; Cheong et al., 2003; Song et al., 2005). In all described cases this post-translational modification enhances binding to the GCC box (Gu et al., 2000) and the transcriptional activity of the ERF protein (Cheong et al., 2003; Song et al., 2005). However, so far, none of the subclass B members have been shown to be phosphorylated. Another specific feature of tomato members of subclass B is the presence of the (X)₁₉P(X)₁₆D(X)₁₇I motif in the AP2/ERF domain (Fig.3).

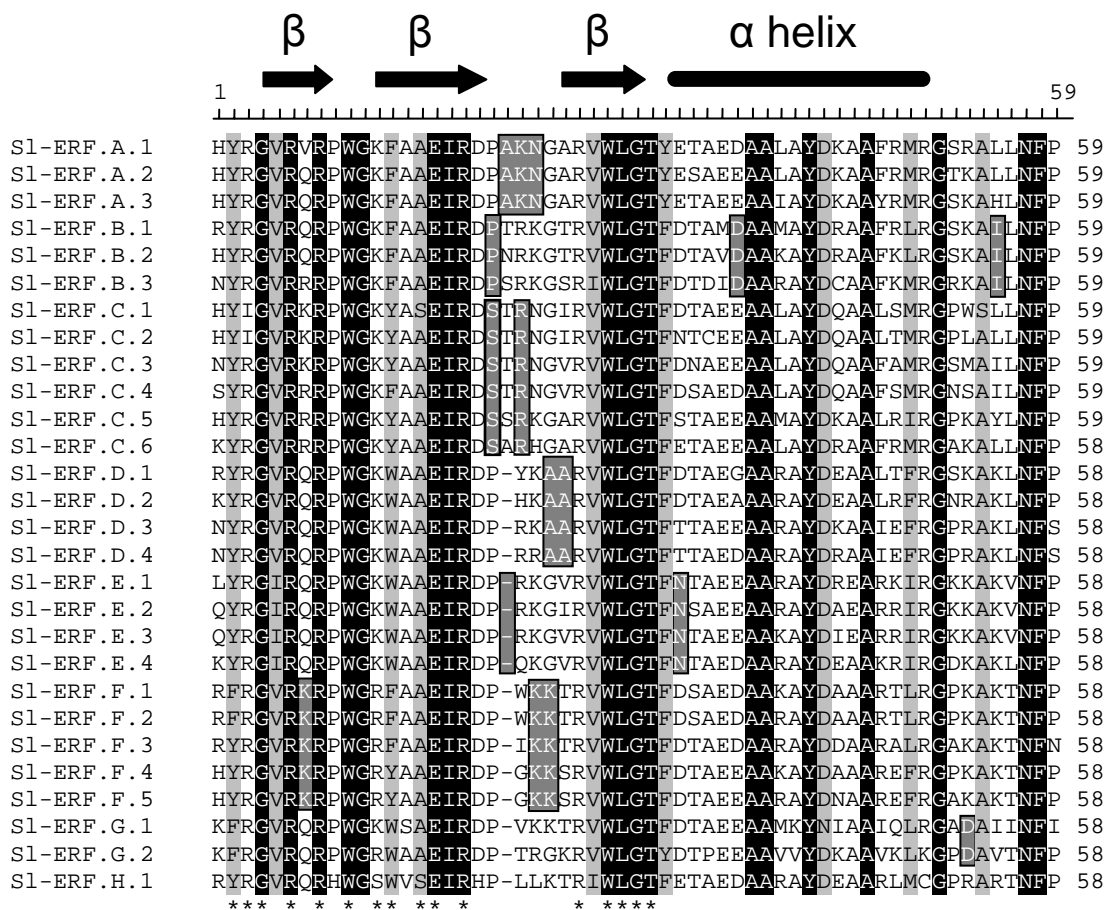

Figure 3: Alignment of the AP2/ERF domains from Tomato ERF proteins. Black and light grey shading indicate identical and conserved amino acid residues, respectively. Dark grey shading indicates conserved amino acid residues in different group. The black bar and arrows represent predicted α helix and β sheets, respectively. Asterisks represent amino acid residues that directly make contact with DNA (Allen et al., 1998)

Sub-Class C is the largest class containing 6 members in tomato and 8 members in *Arabidopsis*. This class is characterized by a conserved amino acid sequence at the C-terminal region that is conserved between both tomato and *Arabidopsis* ERFs, in this latter species it is called CMIX-1 (Nakano et al., 2006). In tomato, all the members of this class have a conserved R(K/R)RP nuclear localization signal (Raikhel, 1992) located in the AP2 domain. DNA binding domain in class C contains 59 conserved amino acids characterized by the presence of a serine at the position 20 (Fig.3).

Sub-Class D gathers 4 tomato ERF members and corresponds to group X in *Arabidopsis* according to Nakano et al. (2006) classification. This sub-class is characterized by the presence of a conserved amino acid motif of unknown function (Fig.2) corresponding to the CMX-1 motif previously described by Nakano et al., (2006). Though, SI-ERF.D.4 and AT2G33710 do not contain this motif, they have been included in subclass D based on their global sequence similarity with other members of this sub-class. The presence of alanine at position 24 in the AP2/ERF domain is another specific feature of tomato subclass D (Fig.3).

Sub-Class E was first described by Tournier et al. (2003) and contains 4 tomato members characterized by the presence of a highly conserved motif in N-terminal region (MCGGAIL/L). Though recent studies suggested that this domain is involved in the interaction with a MAP Kinases (Xu et al., 2007), direct evidence for this putative function is still lacking. Sub-class E members harbour a single conserved acidic domain located at the N-terminal region in SI-ERF.E.2 and SI-ERF.E.3 and at the C-terminal part of the protein in SI-ERF.E.1 and SI-ERF.E.4 (Fig.2). Tomato members of sub-class E contain an asparagine in position 32 of the DNA binding domain (Fig.3).

Sub-Class F is characterized by an AP2/ERF domain lying close to the N-terminal region (Fig.2) and by the presence of a conserved acidic domain at the C-terminal region. Moreover, this class is characterized by the presence of an EAR domain (ERF Amphiphilic Repression) first described by Ohme-Takagi in *Arabidopsis* ERFs and mentioned for the tomato ERFs by Tournier et al. (2003). Interestingly all five tomato ERF members of this class possess the EAR motif. Even though some *Arabidopsis* ERFs from subclass F lack this motif we included them in this subclass because they show the same primary structure according to Fujimoto et al., (2000) classification. Another striking feature of all members of class F is the presence of a fully conserved nuclear localization signal located within the AP2/ERF domain. Also, tomato members of class F are characterized by the presence of a lysine at position 7, 22 and 23 of the AP2/ERF domain (Fig.3).

Table2: The new names given to the tomato *ERF* genes in this study and the corresponding previous names when available. Reference of the first paper concerning the ERF genes is given in the last column.

New name	Previous name	Reference
<i>Sl-ERF.A.1</i>	-	
<i>Sl-ERF.A.2</i>	<i>Sl-ERF1</i>	(Tournier et al., 2003)
<i>Sl-ERF.A.3</i>	<i>Pti4</i>	(Zhou et al., 1997)
<i>Sl-ERF.B.1</i>	-	
<i>Sl-ERF.B.2</i>	-	
<i>Sl-ERF.B.3</i>	<i>Sl-ERF4</i>	(Tournier et al., 2003)
<i>Sl-ERF.C.1</i>	<i>JERF2/TERF1</i>	(Huang et al., 2004)
<i>Sl-ERF.C.2</i>	-	
<i>Sl-ERF.C.3</i>	-	
<i>Sl-ERF.C.4</i>	<i>TSRF1</i>	Zhang et al., 2004a)
<i>Sl-ERF.C.5</i>	-	
<i>Sl-ERF.C.6</i>	<i>Pti5</i>	(Zhou et al., 1997)
<i>Sl-ERF.D.1</i>	-	
<i>Sl-ERF.D.2</i>	-	
<i>Sl-ERF.D.3</i>	-	
<i>Sl-ERF.D.4</i>	-	
<i>Sl-ERF.E.1</i>	<i>Sl-ERF2</i>	(Tournier et al., 2003)
<i>Sl-ERF.E.2</i>	<i>JERF1</i>	(Zhang et al., 2004b)
<i>Sl-ERF.E.3</i>	<i>JERF3</i>	(Wang et al., 2004)
<i>Sl-ERF.E.4</i>	-	
<i>Sl-ERF.F.1</i>	-	
<i>Sl-ERF.F.2</i>	-	
<i>Sl-ERF.F.3</i>	-	
<i>Sl-ERF.F.4</i>	-	
<i>Sl-ERF.F.5</i>	<i>Sl-ERF3</i>	(Tournier et al., 2003)
<i>Sl-ERF.G.1</i>	-	
<i>Sl-ERF.G.2</i>	<i>Pti6</i>	(Zhou et al., 1997)
<i>Sl-ERF.H.1</i>	<i>Sl-ERF1</i>	(Hongxing et al., 2005)

Sub-Class G, which corresponds to class VI in Nakano et al. classification, contains two *Sl-ERFs* (Fig. 2). Members of this class are characterized by 2 conserved domains in the N-terminal region called CMVI-1 and CMVI-2 (Nakano et al., 2006) and share in C-terminal region a CMVI-3 motif observed in 6 *Arabidopsis* members (Fig.1). The two tomato members of subclass G possess an aspartic acid at position 52 within the DNA binding domain (Fig.3).

Sub-Class H contains only one tomato ERF (Fig. 2) and corresponds to class V in Nakano study. This class is characterized by the presence of a conserved CMV-2 acidic domain and a conserved CMV-1 domain (Nakano et al., 2006). However, these two domains are not conserved in all members of class H, and *Sl-ERF.H.1* does not contain domain CMV-1.

Our clustering identified two additional classes for *Arabidopsis*, named here sub-class I and sub-class J and corresponding to group Xb-L and VI-L, respectively in Nakano's classification, for which no tomato ERF representatives were found. (Fig.1).

Mapping of ERF genes on the tomato genetic map

In order to know the chromosomal distribution of the tomato ERF genes we used a PCR strategy to screen the multi-species introgression line population (ILs) obtained by crossing and successive back-crossing of cultivated *Solanum lycopersicum* with *Lycopersicon pennelli* (Eshed and Zamir, 1995). Using this mapping population figure 4 shows that 23 ERFs genes are distributed among ten different chromosomes, with chromosomes 11 and 12 being devoted of ERFs genes. Moreover, 4 genes (*Sl-ERF.B.1*, *Sl-ERF.C.1*, *Sl-ERF.B.3* and *Sl-ERF.A.3*) are clusterized in the same bin on chromosome 5 (5-E). Two genes (*Sl-ERF.D.1* and *Sl-ERF.B.2*) are localized on BAC clones assigned to chromosomes 4 and 8 and one share similarity with an EST marker from chromosome 5 (*Sl-ERF.B.1*). However, 5 ERFs genes (*Sl-ERF.D.2*, *Sl-ERF.E.4*, *Sl-ERF.F.2*, *Sl-ERF.F.4* and *Sl-ERF.E.3*) could not be localized using this mapping strategy.

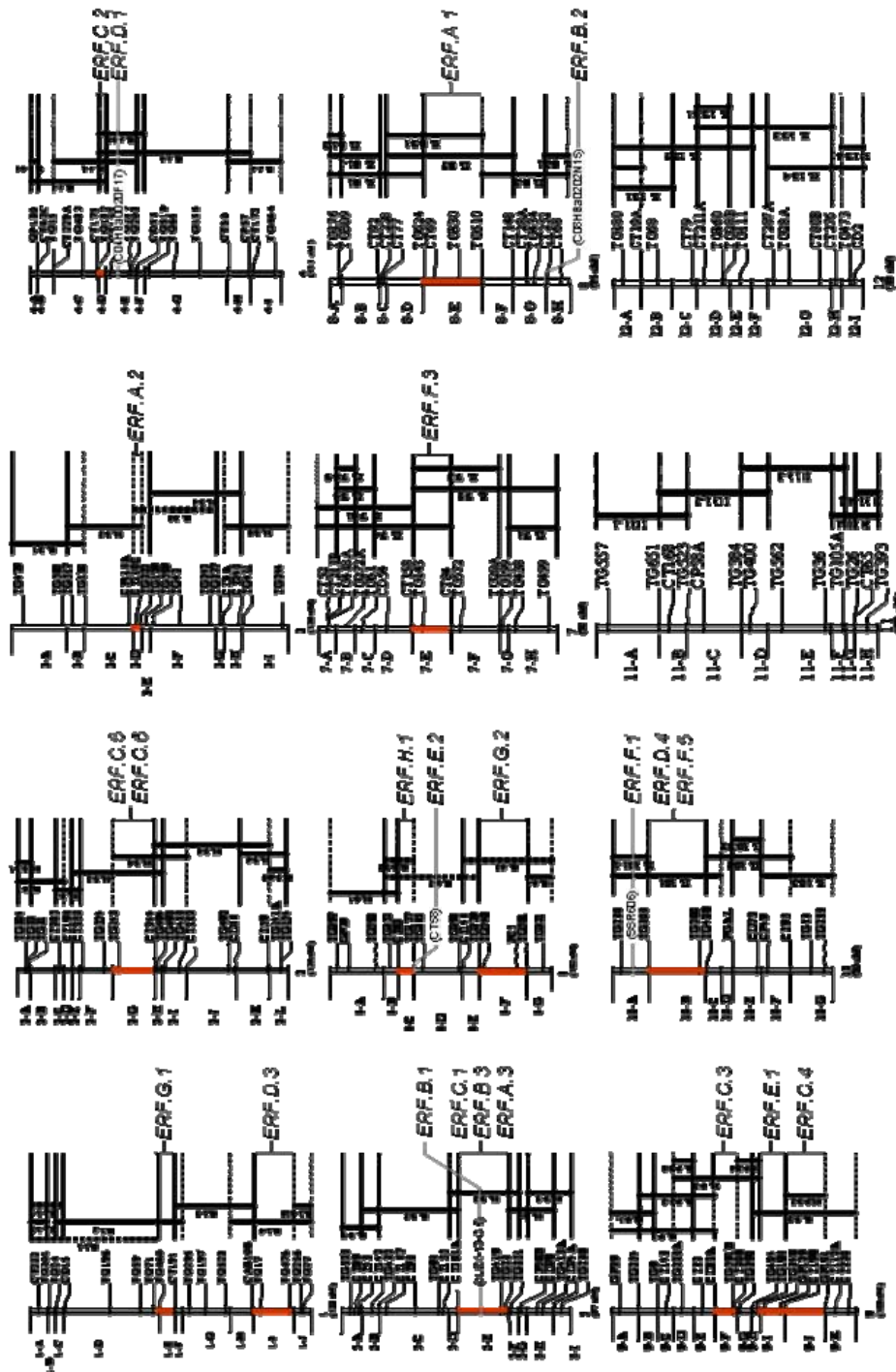

Figure 4: *ERF* mapping. Map location each ERF is indicated with red lines highlighting the IL bin they belong to.

ERF activity

It is well known that ERFs can bind the GCC box and modulate the transcriptional activity of the promoter harbouring this *cis*-acting element (Fujimoto et al., 2000; Gu et al., 2002). In

order to explore potential relationship between structural classification and functional activity of the ERFs, we tested whether members grouping on the same subclass share similar transcriptional activity.

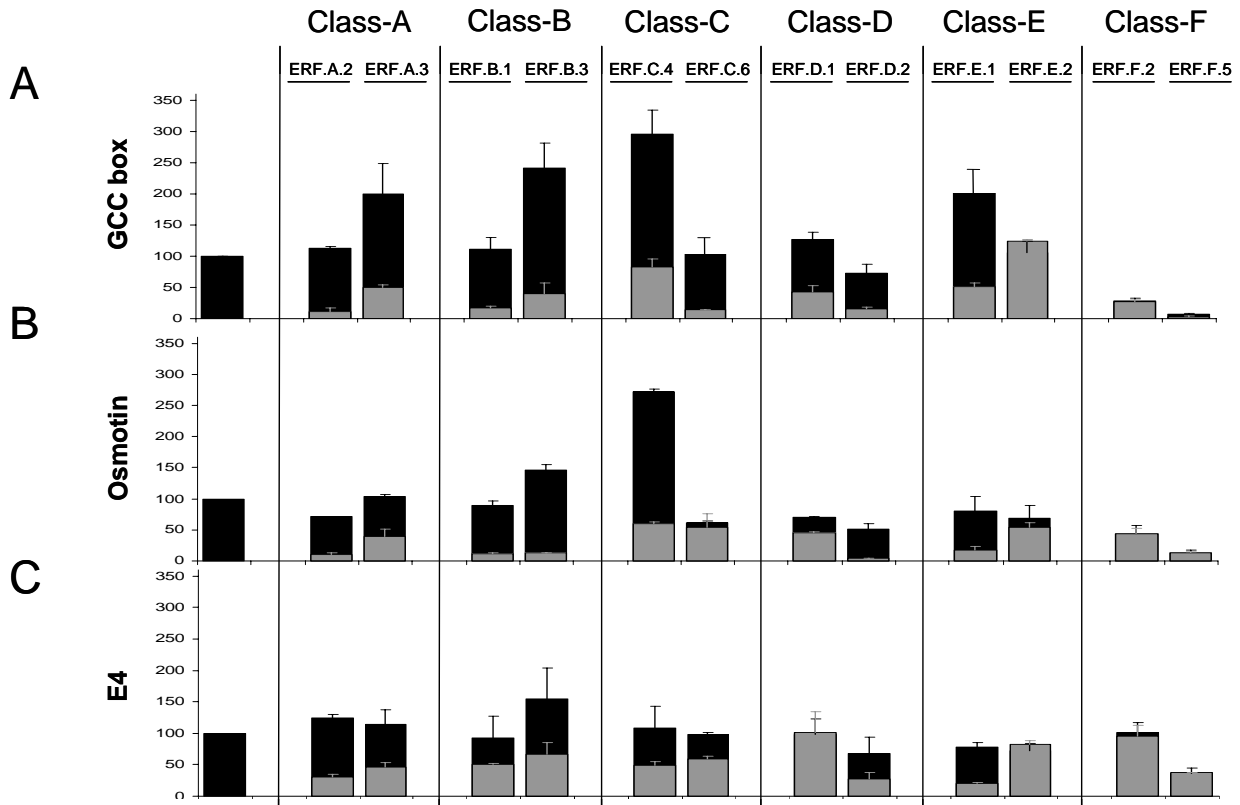

Figure 5: ERFs differentially regulate the expression of reporter genes driven by synthetic and native ethylene-responsive promoters. ERFs were challenged with a GCC-repeat synthetic promoter (A), tomato osmotin promoter containing a GCC box (C08HBa0235H18.1) (B) and tomato E4 promoter lacking the canonical GCC box (S44898) (C). A transient expression using a single cell system was performed to measure the reporter gene activity. The fluorescence was measured by flux cytometry. Two genes per class were tested for each promoter. The basal fluorescence obtained by co-transformation with the promoter fused to the reporter gene and with the empty vector is considered as reference. The results shown are the average of 3 independent biological repetitions for the native ERFs (black boxes) and the chimerical ERF-SRDXs (grey boxes).

The capacity of ERF proteins to drive transcription from either synthetic or native ethylene-responsive promoters was tested using a “single cell system” by transient expression assays. Tobacco BY2 protoplasts were co-transformed with the ERF genes driven by the 35S constitutive promoter as effector constructs, and the GFP gene driven either by GCC-rich synthetic promoter or a native ethylene-responsive complex promoter as reporter constructs.

Two tomato complex native promoters, osmotin and E4 previously shown to be ethylene-responsive, were isolated and fused to the GFP coding sequence. The osmotin promoter contains a typical GCC box while the ethylene-responsive tomato E4 promoter is lacking the canonical GCC motif. In order to discriminate between ERFs that are inactive because they cannot bind the target promoter from those who bind but remain inactive, we set up transient co-transfection assays using chimerical ERF constructs fused to the SRDX repressor motif as effectors (Hiratsu et al., 2003). Since the repression activity is a dominant feature of the chimerical construct, the absence of repression with any of these ERF-SRDX constructs can be interpreted as a result of the non-capacity of the ERF to bind the target promoter. Figure 5A shows that ERF proteins can activate, repress or remain inactive on the ethylene-responsive promoters. Members of the same subclass can display either similar or differential activities suggesting that there is no strict relationship between structural feature and the type of activity. ERF.A.3, B.3 and C.4 clearly activate the synthetic GCC-containing promoter while members of the same subclasses ERF.A.2, B.1 and C.6 are neither activator nor repressors. However, some discrepancy was found between the synthetic and native GCC-containing promoters suggesting more complex regulation in the case of the osmotin promoter since only ERF.C.4 displayed the same behaviour with the two types of promoters (Fig.5B). As expected, all ERF members from class-F acted as repressors of both synthetic and native GCC-containing promoters. We then challenged the ERFs with the E4 promoter lacking a canonical GCC motif to test their capacity to regulate this type of ethylene-responsive promoters. Noteworthy, none of the ERFs tested in this study was able to alter the expression of the reporter gene driven by the E4 promoter (Fig. 5C) even though the ERFs seem to be able to bind this target promoter as shown by the capacity of the ERF-SRDX construct to repress the activity of the E4 promoter. These results suggest that ERFs may interact directly or indirectly with the ethylene-responsive promoter lacking the GCC box.

ERF expression pattern

To gain better insight on the spatio-temporal pattern of expression of the tomato ERFs the accumulation of their transcript was assessed in different plant organs. The Treeview in Figure 6 shows the results of qRT-PCR studies on 25 ERFs using RNA samples corresponding to 9 different plant tissues. The clustering of the expression data revealed two main clades, clade 1 and 2, corresponding to genes preferentially expressed in reproductive tissues and in vegetative tissues, respectively. Moreover, clade 1 contains three distinct subclades, subclade 1a containing ERFs mainly expressed in ripening fruit, subclade 1b

gathering ERFs whose expression is highest in developing fruit and subclade 1c containing ERFs expressed in flowers. ERFs from clade 2 group into four subclades depending on whether they are expressed in vegetative tissues and transiently in early ripening fruit (subclade 2a), in vegetative tissues and in breaker fruit (subclade 2b), in vegetative tissues only (subclade 2c) and finally those expressed in vegetative tissues, flowers and early fruit development (subclade 2d).

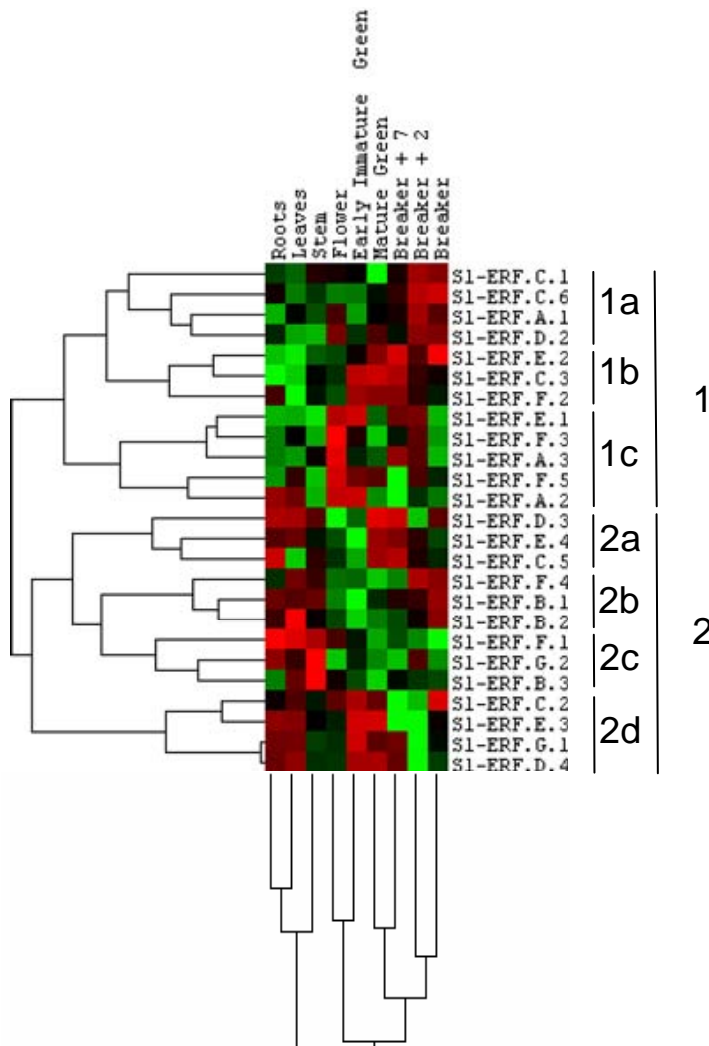

Figure 6 : *Heatmap showing ERF gene expressions in different tissues.* Quantitative RT-PCR of ERF transcript in total RNA samples extracted from Roots, Leaves, Stem, Flower, Early Immature Green, Mature Green, Breaker, Breaker + 2 days, Breaker + 7 days. Values represent the best experiment among 3 independent biological repetitions. Genes highly or weakly expressed in the tissues are colored red and green respectively. Heat map was generated using cluster 3.0 software.

In order to investigate the contribution of each tissue and genes to the clustering we performed a Principal Component Analysis. The results shown in Figure 7 indicate that vegetative tissues are reversely correlated to ripening tissues in the first axis. Strikingly, early immature green and flower tissues are correlated and are in opposition to vegetative and ripening tissues. These data reveal a specific gene expression regulation during the fruit set, suggesting a role of ERF during this developmental process also known to be under auxin regulation.

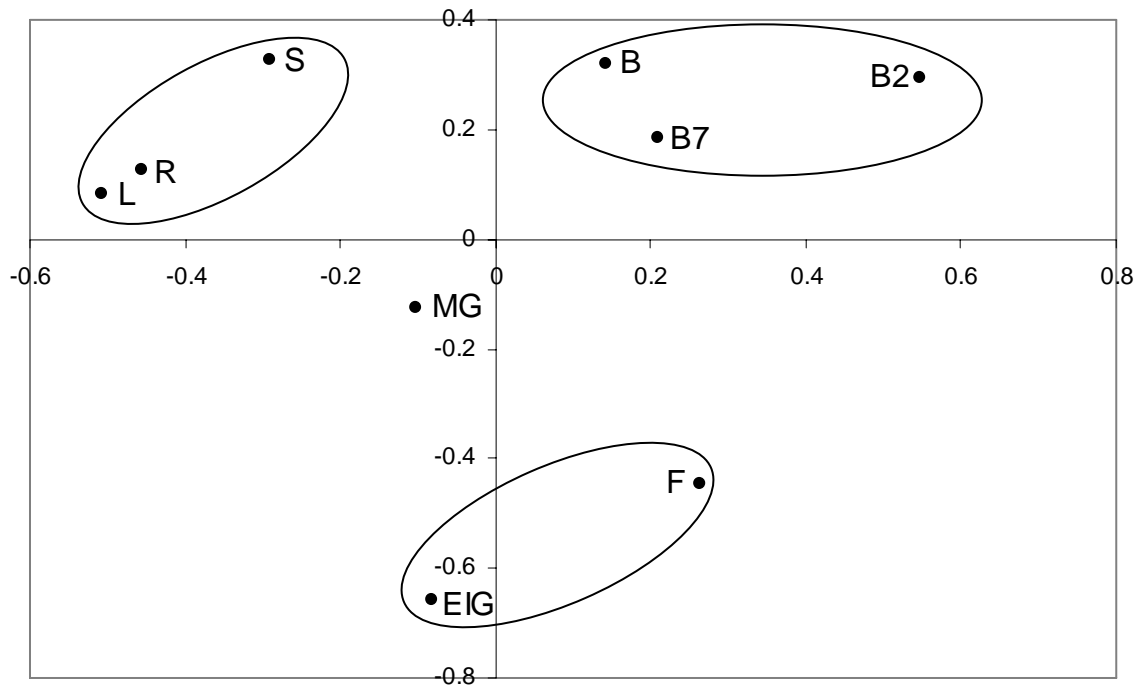

Figure 7: Tissue contribution determined by Principal Component Analysis. PCA was performed using Cluster 3.0. In the plot, Roots (R), Leaves (L), Stem (S), Flower (F), Early Immature Green (EIG), Mature Green (MG), Breaker (B), Breaker + 2 days (B2), Breaker + 7 days (B7) are represented on the two main axis.

***ERFs* are regulated during fruit set initiation**

Fruit set initiation is under the control of a specific hormonal balance of auxin and gibberellic acid. In order to study the potential involvement of *ERFs* during fruit set initiation we emasculated mature unpollinated flower and treated them either with IAA, GA3 or NPA known to be fruit set stimulators or with ABA and Paclobutrazol (PACLO) that inhibit fruit set. Heatmap (fig.8) shows that most *ERFs* (*Sl-ERF.E.1*, *Sl-ERF.C.1*, *Sl-ERF.F.4*, *Sl-ERF.B.1*, *Sl-ERF.B.2*, *Sl-ERF.A.3.*, *Sl-ERF.E.2*, *Sl-ERF.F.2*, *Sl-ERF.F.5*, *Sl-ERF.F.1*, *Sl-ERF.A.2* and *Sl-ERF.E.3*) are down-regulated by GA3, NPA and IAA but are not responsive to PACLO and ABA treatment. Two *ERFs* (*Sl-ERF.A.1* and *Sl-ERF.C.2*) are down-regulated by GA3 treatment but are not responsive to PACLO, ABA, NPA and IAA.

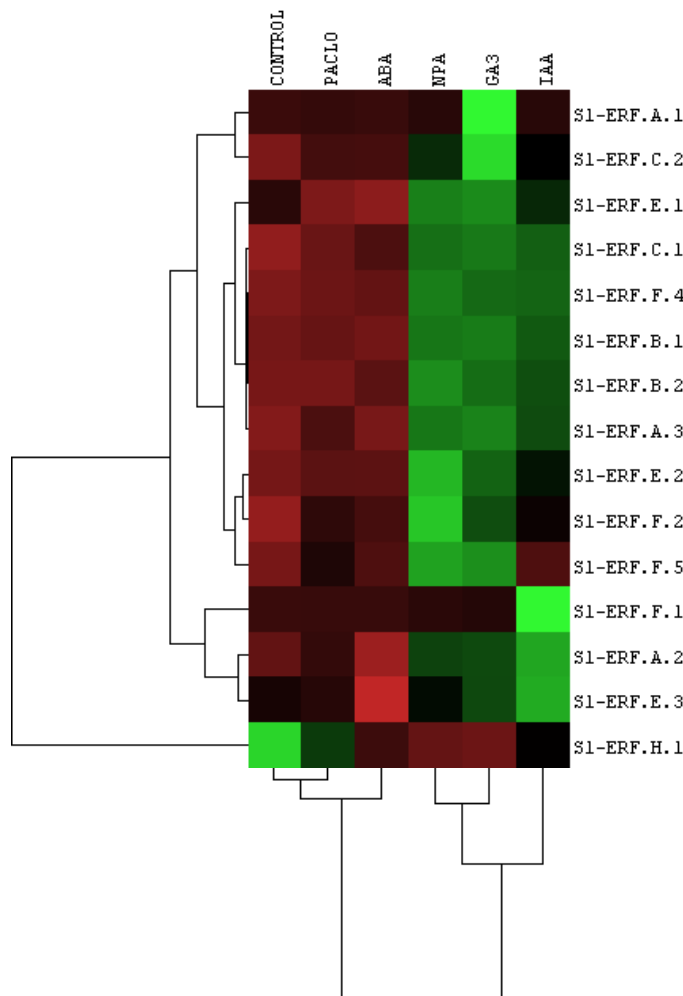

Figure 8: Heatmap showing *ERF* gene expressions in emasculated flowers treated by different hormones. Quantitative RT-PCR of *ERF* transcript in total RNA samples extracted from Emasculated flower (Control), Emasculated flower treated by gibberelins (GA3), naphthylphthalamic acid (NPA), indole acetic acid (IAA), paclobutrazol (paclo), abscissic acid (ABA). Values represent the best experiment among 3 independent biological repetitions. Genes highly or weakly expressed in the tissues are colored red and green respectively. Heat map was generated using cluster 3.0 software.

Strikingly, only *Sl-ERF.H.1* is strongly up-regulated by NPA and GA3 and to a lesser extent by PACLO, IAA and ABA. The differential regulation of *ERF* genes during fruit set showed here strongly suggests an active role for these transcriptional regulators in this important developmental process.

Ethylene and auxin regulation of *ERF* genes

Many studies demonstrate that beside ethylene, *ERFs* can also be induced by other hormones among which auxin (Gutterson and Reuber, 2004). To test the responsiveness of tomato *ERF* genes to ethylene and auxin, the levels of their transcript accumulation have assessed by qRT-PCR in seedling treated or untreated with ethylene (30 min or 5 h) and auxin for 3 h. The *E4* and *SAUR* genes were used as control for validating the ethylene and auxin treatments, respectively. Table 3 indicates that five *ERF* genes (*Sl-ERF.D.3*, *Sl-ERF.B.2*, *Sl-ERF.G.1*, *Sl-ERF.F.5* and *Sl-ERF.C.6*) displayed steady repression by ethylene treatment (30 min and 5 h) while one gene (*Sl-ERF.C.2*) is transiently repressed after 30 min of ethylene treatment. Fourteen *ERF* genes (*Sl-ERF.A.3*, *Sl-ERF.E.2*, *Sl-ERF.F.4*, *Sl-ERF.C.3*, *Sl-ERF.B.3*, *Sl-ERF.A.2*, *Sl-ERF.B.1*, *Sl-ERF.E.3*, *Sl-ERF.C.1*, *Sl-ERF.C.5*, *Sl-ERF.E.4*, *Sl-ERF.H.1*, *Sl-ERF.E.1* and *Sl-ERF.D.2*) are induced by ethylene treatment. Up to 10 *ERF* genes are responsive to auxin among which 9 are up-regulated and one down-regulated. Interestingly, some *ERF* genes undergo opposite regulation by the two hormones among which *Sl-ERF.F.5* and *Sl-ERF.C.6* are up-regulated by auxin and down-regulated by ethylene. Three *ERFs* genes (*Sl-ERF.F.4*, *Sl-ERF.E.3* and *Sl-ERF.H.1*) are up-regulated by both hormones auxin and one *ERF* (*Sl-ERF.C.5*) is down-regulated by auxin and up-regulated by ethylene. Moreover, four *ERFs* genes are only up-regulated by auxin treatment. Most interestingly, four *ERF* genes (*ERF.A.1*, *ERF.F.1*, *ERF.D.4* and *ERF.C.4*) are up-regulated by auxin but are not responsive to ethylene.

Table 3 : Expression level of ERFs in response to ethylene and auxin treatments. Quantitative RT-PCR of *ERF* transcripts in total RNA samples extracted from 5-days dark growing seedlings treated for 30 minutes (Eth 30min) or 5 hours (Eth 5h) with ethylene or with IAA for 3 hours (Aux 3h). $\Delta\Delta\text{Ct}$ refers to the fold of difference in *ERF* expression relative to the untreated seedlings. Genes pasted in green and red are down-regulated and up-regulated, respectively, upon hormone treatment.

	Eth_30min		Eth_5h		Aux_3h	
	$\Delta\Delta\text{Ct}$	<i>SD</i>	$\Delta\Delta\text{Ct}$	<i>SD</i>	$\Delta\Delta\text{Ct}$	<i>SD</i>
<i>SI-ERF.D.3</i>	0.080	0.004	0.057	0.009	1.149	0.239
<i>SI-ERF.B.2</i>	0.322	0.012	0.088	0.000	0.867	0.029
<i>SI-ERF.G.1</i>	0.707	0.164	0.282	0.073	1.282	0.241
<i>SI-ERF.F.5</i>	0.572	0.061	0.378	0.063	2.303	0.264
<i>SI-ERF.C.6</i>	0.760	0.210	0.631	0.034	2.039	0.074
<i>SI-ERF.G.2</i>	1.192	0.015	0.977	0.142	1.307	0.146
<i>SI-ERF.A.1</i>	0.775	0.155	1.023	0.250	4.540	0.476
<i>SI-ERF.F.1</i>	0.901	0.158	1.045	0.165	4.668	0.528
<i>SI-ERF.F.3</i>	1.225	0.150	1.150	0.046	0.969	0.027
<i>SI-ERF.F.2</i>	1.101	0.143	1.364	0.082	1.287	0.552
<i>SI-ERF.C.2</i>	0.496	0.023	1.392	0.058	1.160	0.177
<i>SI-ERF.A.3</i>	2.201	0.115	1.467	0.043	1.257	0.180
<i>SI-ERF.E.2</i>	1.265	0.226	1.687	0.054	0.972	0.064
<i>SI-ERF.F.4</i>	1.335	0.249	1.726	0.065	2.365	0.235
<i>SI-ERF.C.3</i>	1.718	0.256	1.889	0.320	ND	ND
<i>SI-ERF.B.3</i>	1.940	0.274	1.931	0.059	0.981	0.027
<i>SI-ERF.A.2</i>	1.412	0.073	1.950	0.263	1.015	0.180
<i>SI-ERF.B.1</i>	1.340	0.086	2.059	0.063	1.161	0.023
<i>SI-ERF.E.3</i>	1.083	0.690	2.912	0.112	5.853	0.217
<i>SI-ERF.C.1</i>	1.656	0.365	2.995	0.098	0.886	0.014
<i>SI-ERF.C.5</i>	1.706	0.307	3.144	0.183	0.464	0.090
<i>SI-ERF.E.4</i>	1.392	0.648	3.204	1.294	ND	ND
<i>SI-ERF.H.1</i>	2.356	0.101	3.311	0.135	7.494	0.362
<i>SI-ERF.E.1</i>	2.061	0.184	3.383	0.854	1.302	0.014
<i>SI-ERF.D.2</i>	0.621	0.066	4.932	0.558	0.994	0.081
<i>SI-ERF.D.4</i>	ND	ND	ND	ND	7.231	0.528
<i>SI-ERF.C.4</i>	ND	ND	ND	ND	4.256	0.165
<i>E4</i>	1.100	0.027	8.730	0.621	ND	ND
<i>SAUR</i>	ND	ND	ND	ND	2.641	0.397

Discussion

Tomato is the plant model for studying ripening of climacteric fruit (Rowan et al., 1958), known to be under strong regulation of the phytohormone ethylene. Considering that ethylene is involved in a wide range of developmental processes, and because its transduction pathway is so linear and simple, the diversity of ethylene responses may largely arise from fine tuning of ERF activities. ERFs belong to one of the largest transcription factor family in *Arabidopsis* (Riechmann. JL et al., 2000). Before starting this study, only 12 tomato ERFs have been described and classified into 4 sub-classes (Zhou et al., 1997; Tournier et al., 2003; Huang et al., 2004; Wang et al., 2004; Zhang et al., 2004b; Zhang et al., 2004a). Using sequence similarity and BLAST search on tomato EST databases (www.sgn.cornell.edu), we identified 16 new ERF candidates and isolated their corresponding full coding sequence. In total, 28 ERF cDNAs were cloned and the corresponding genes clustered into 8 subclasses according to Nakano's classification (Table 1). Remarkably, independently of the method used to generate this classification (*i.e.*: ERF whole sequence or AP2/ERF domain alignment) the same clustering was obtained (Fig. 1). Within the conserved AP2/ERF domain we found common motifs that are sufficient to distinguish each class (Fig. 3). These data suggest that the structural features of the AP2/ERF domain are prevalent in the classification of the ERF proteins.

To explore the correlation between the genetic divergence within the ERF family and gene duplication in tomato, the chromosomal location of each ERF gene was determined using ILs mapping population (Fig. 4). Among the mapped ERF genes *ERF.C.5* and *ERF.C.6* co-localize in the bin 2-G on chromosome 2. *ERF.B.1* and *ERF.B.3* co-localize in the same bin (5-E) on chromosome 5 suggesting that these genes may results from a recent duplication event. A recent genome analysis suggests that the expansion of ERF family in plant may have been due to a chromosomal/segmental duplication and tandem duplication (Nakano et al., 2006). The sequencing of the tomato genome will help greatly to reinforce the observation in *Arabidopsis* and rice genomes.

Recent studies suggest a link between the structural classification of ERF and their physiological function (Nakano et al., 2006; Sakuma et al., 2002), yet this hypothesis has never been experimentally tested. By transient expression assay using a single cell system we demonstrate that in most of the cases members of the same class can have different regulator activities on the GCC box, except for class-F whose members with no exception are negative regulators. We also demonstrated that in most cases that the absence of transcriptional activity

is not due to the absence of recognition of the *cis*-element by the ERF. Indeed, the fusion of ERF to the SRDX domain reduces dramatically the activity of the reporter gene. In order to study the activity of ERF on natural promoter environment, we have chosen two ethylene regulated promoters one containing a GCC box (osmotin) and the other one lacking this *cis*-element (*E4*). The data obtained with the osmotin promoter indicate that ERFs display a weaker activity in comparison to the synthetic promoter even though ERFs seem to bind similarly to both promoters. The strong basal expression of the osmotin promoter in the absence of effectors may also minimize the induction effect observed in the presence of ERFs (supplemental figure 1). Therefore, the activity of the ERFs on the target GCC box may be impacted by the environment of this *cis*-acting element within a native complex promoter. In the same line, we previously showed using gel shift assay that the GCC box flanking regions are involved in the binding activity (Tournier et al., 2003). Surprisingly, the results from the *E4* promoter suggest that ERF can interact with an ethylene-responsive promoter lacking a canonical GCC motif. This result is very interesting because recent studies demonstrated that in addition to the GCC box, ERFs can bind other *cis*-acting elements such as VWRE and GCC-like (Andriankaja et al., 2007; Sasaki et al., 2007; Wu et al., 2007). It is also possible that ERFs may induce indirectly the *E4* promoter through the activation of primary target genes encoding transcriptional proteins capable to bind the *E4* promoter. Some studies demonstrated that ERF can interact with a kinase protein partner that phosphorylates the ERF partner which leads to a higher activity of the ERF (Buttner et al., 1997; Cheong et al., 2003; Gu et al., 2000). Moreover, variation in amino acid composition of the binding domain may impact the binding affinity the ERFs to target promoter. It was reported that conserved amino acid residues within the DNA binding domain are at the origin of the differential affinity displayed by the ERF proteins for the GCC box (Tournier et al., 2003). Furthermore, the conserved motifs lying outside the DNA binding domain are probably involved in modulating the activity among ERFs. Recent studies demonstrates that the trans-activating activity of some ERFs was localized to the acidic domain (Jung et al., 2007). ERF.D.1 and ERF.D.2, members of class D, do not have a known activator domain and accordingly are unable to activate the synthetic GCC box promoter. On the other hand, the ERF members of subclass A, B, C and E harbour one or more acidic domains, however, not all of these display transcriptional activation of the synthetic promoter. Members of class F have a strong repressor domain in C-terminal region and they are all repressors of the activity of the GCC box-containing promoters.

Physiological effects of a transcription factors depend on their nature, activator or repressor, but also on their specific pattern of expression. Data describing the expression of *ERF* genes in the tomato are scarce and disparate (Chen et al., 2008; Tournier et al., 2003). In order to give a gene expression snap-shot of all the tomato *ERF* genes described in this study we have undertaken a quantitative RT-PCR analysis on several vegetative and reproductive tissues. We show that 2 different groups can be distinguished according to their expression pattern. One group is strongly expressed in vegetative tissue and the other one is more expressed during fruit development and ripening (Fig. 6). These data are consistent with previous description concerning *Pti4* (Chen et al., 2008) and *ERF1-4* (Tournier et al., 2003). However, the process of tomato fruit development from flower throughout ripe fruit, involve ERF members belonging to all classes, indicating that all ERF classes contribute to reproductive tissues development. The principle component analysis confirmed that based on their expression patterns, ERFs associated with vegetative tissues cluster separately from those expressed in ripening fruit and those ERFs associated with flower and early fruit development cluster together and separately from the two other groups. These data suggest a specific expression pattern of ERFs during the fruit set (Fig. 7). The fruit set correspond to a shift from the ovary to the growing fruit. This process is naturally induced upon successful fertilisation of the egg cell in the ovule (Gillaspy et al., 1993). Various experiments demonstrated that external application of auxin (Gustafson, 1936; Gustafson, 1937) and GA induces parthenocarpic fruit development independently of fertilisation (Alabadi et al., 1996; Fos et al., 2000) and that ABA inhibits parthenocarpic fruit growth (Rodrigo et al., 1998). In a previous global analysis of gene expression during the fruit set, it was shown that *Pti4* (*Sl-ERF.A.3*), *ERF1* (*Sl-ERF.A.2*) and *ERF3* (*Sl-ERF.F.5*) are down-regulated by GA on emasculated flowers (Vrizen et al., 2007). Our results are consistent with these data and extend the observation to other *ERFs*. Accordingly, ABA which is considered as inhibitor of fruit set has no effect on *ERF* gene expression. Our data show that most *ERFs* are not expressed in conditions mimicking the fruit set, as revealed by treatment of emasculated flowers by NPA and GA. This suggests that the majority of *ERFs* might act as negative regulators of the fruit set process. During fruit set the increase in GA and IAA concentrations could repress *ERF* expression and thus lead to ovary development into fruit.

To further investigate the hormonal control of ERFs on plant development we have studied the effect of ethylene and auxin. Up to 14 *ERFs* are up-regulated by ethylene and only five *ERFs* are down-regulated. For those previously characterized (*ERF1*, *ERF4*, *JERF1*, *JERF3*, *TERF1*) our study confirmed the pattern of their ethylene regulation (Huang et al., 2004;

Tournier et al., 2003; Wang et al., 2004; Zhang et al., 2004). Surprisingly, among the ethylene-regulated *ERFs* we found that five are up-regulated by auxin and one is down-regulated (Table 3). In addition 4 *ERFs* were found to be up-regulated by auxin treatment but not by ethylene. Genes which are not regulated by these hormones are probably regulated by other signaling molecules such as salicylic acid or jasmonic acid, as it was reported that *ERFs* can be regulated by these compounds (Gu et al., 2000; Lorenzo et al., 2003; Hirota et al., 2007).

It is well documented that ethylene and auxin regulate common physiological aspects such as hook formation (Lehman et al., 1996; Raz and Ecker, 1999), root hair differentiation (Masucci et al., 1994), root elongation (Pitts et al., 1998), root growth (Rahman et al., 2001) and hypocotyl phototropism (Harper et al., 2000). Numerous *Arabidopsis* auxin and ethylene mutants show respectively ethylene and auxin signaling defects suggesting a tight interaction between these two hormones signaling pathway (Harper et al., 2000; Luschign et al., 1998; Muller et al., 1998; Tian et al., 1999; Watahiki et al., 1997). Furthermore, auxin and ethylene have been reported to interact at the level of ethylene biosynthesis (Abel et al., 1995). Indeed, auxin induces the expression of ACC synthase in *Arabidopsis* (Abel et al., 1995; Abel and Theologis, 1996). One of the best examples of auxin-ethylene crosstalk in plant is the formation of the apical hook (Lehman, 1996; Raz and Ecker, 1999). However, information about interaction at the transcriptional level is scarce (*MtSERF1*). For the first time in this study we show that a panel of *ERF* genes is regulated by both auxin and ethylene. Moreover, *ERF.H.1* remains up-regulated by auxin in presence of 1-MCP strongly suggesting that this gene is regulated by both hormones independently (supplemental figure 4). To our knowledge this is the first evidence that an ERF is directly linked to ethylene-auxin crosstalk.

The present study considered only 28 ERFs, while the ERF family in *Arabidopsis* contains up to 65 members. Based on what is known from *Arabidopsis* and rice many tomato *ERFs* are still missing and the tomato sequencing project currently in progress will allow to increase the size of the family till completion in this species and will provide access to their promoters.

Considering the diversity of their transcriptional activity and expression patterns, *ERFs* are likely to be key regulators of plant developmental processes and response to environmental stresses. The advances and resources generated in the present study open new prospects towards addressing the specific role of each ERF or subset of ERFs in controlling target processes. By assigning a specific role to each ERF and identifying direct target genes for

each member of this important family of transcriptional regulators, we open new leads for agronomical applications either through biotechnology strategies or through marked assisted selection exploiting the natural allelic polymorphism within the ERF genes.

Materials and Method

Plants growing

Tomato (*Solanum lycopersicum* cv MicroTom) plants were grown in chamber room. The conditions are the following: 14-h-day/10-h-night cycle, 25/20 °C day/night temperature, 80 % hygrometry, 250 $\mu\text{mol.m}^{-2}.\text{s}^{-1}$ intense luminosity.

Cloning of over expressing and repressing ERF constructs.

The full CDS was found for most ERFs in SGN (<http://www.sgn.cornell.edu>) website. However, we performed Rapid Amplification of cDNA ends (RACE) for the incomplete ones using BD SMARTTM RACE cDNA Amplification kit (Cat. no. 634914, Clontech) according to user's recommendation. *Sl-ERF.D.3* was obtained by 5'RACE. Concerning *Sl-ERF.G.1* and *Sl-ERF.F.3* a 3' RACE was performed using the following primers:

SI-ERF.D.3_NGSP1	aacattcgtggtgtggtggcag
SI-ERF.D.3_GSP1	cccatggcctctgtctcactcctctgt
SI-ERF.G.1_GSP2	gaagaaaatggctgctgcagatgtgagg
SI-ERF.G.1_NGSP2	aaaagtttcgcggtgtcagacagaggcc
SI-ERF.F.3_GSP2	cctcgttatcgagggttcgtaaaccggc
SI-ERF.F.3_NGSP2	gccgcacgcgcttacgacgatgc

Specific primers were designed in order to amplify the sequence from ATG to STOP (Supplementary table 1) codons. After sequencing validation, ERF were cloned in over-expression vector, and in SRDX construct. We amplified the corresponding full length cDNA from a mix of cDNA of different tissue (stem, roots, leaves, flower, Early Immature green, Mature Green, Breaker, Breaker+2 and Breaker+7).

To generate over expressing constructs, the gene specific primers were designed spanning the ORF with AAAAAGCAGGCTTC and CAAGAAAGCTGGGTC adapters at 5' and 3'end respectively (supplementary table1) and primary amplicon was PCR amplified using ISIS *Taq* polymerase. For the addition of the *attB* sites, primary amplicons were used as templates and amplified by *attB* primers (*attB1*: 5'-ACAAGTTTGTACAAAAAAGCAGGCT-3' and *attB2*: 5'-ACCACTTTGTACAAGAAAGCTGGGT-3'). The PCR product was used for BP reaction to clone in the entry vector, pDONR207 (Invitrogen). Cloning of the amplicon (Gateway BP reaction) was carried out by adding a 150 ng of pDONR207 vector, 2 μL of BP clonase II mix (Invitrogen Cat. Number: 11789100) to 1 μL of the amplicon in 10 μL reaction

mixture made up to volume by TE buffer. The reaction was left overnight at 25°C, then stopped by the addition of 1 µL of proteinase K and incubated for 10 min at 37°C. One to 10 µL of the reaction mix was used to transform 50 µL of competent DH-5α cells. The cells were incubated with the DNA for 30 min on ice, heat-shocked for 30 sec at 42°C in a water bath, incubated for 5 min on ice, diluted with 250 µL of SOC medium, and shaken for 1 h at 37°C and plated on gentamycin (10µg/ml). The PCR with vector specific primers was carried out to check the inserts at 5 min at 95°C, followed by 35 cycles of 60 sec at 95°C, 60 sec at 55°C, 90 sec at 72°C, and terminated by 10 min at 72°C. Further, subcloning of GSTs from an entry clone (pDONR207) into the destination vector pEarleygate201 (Gateway LR reaction) was carried out by adding a 4-µL mix containing 150 ng of pEarleygate201 (Earley et al., 2006), 1 µL of LR clonase mix II (Invitrogen Cat. Number:11791020) to 1 µL (150ng) of the *attL1*-GST-*attL2* cassette DNA. The LR reaction followed by transformation and screening (plating on kanamycin LB agar plates) and sequencing of positive colonies were performed as the BP cloning explained above.

To generate repressor constructs, 5' phosphorylated primers was designed to amplify the protein coding regions of ERFs but without the native stop codon. The amplicon was ligated to entry vector digested with *smal* fused with SRDX (LDLDLELRGFA) (Hiratsu et al., 2003) . The transformation was performed as above and plating was done on ampicillin LB plates. The positive colonies were PCR checked and confirmed by sequencing. Further, through LR reaction (as explained above), the ERF fused to repressor motif was transferred to binary vector, pBCKH driven by 35S CaMV promoter and with *Nos* terminator. The transformation and plating (on Kanamycin LB plates) were performed as above and positive colonies were PCR checked and confirmed by sequencing.

Ethylene treatment

Four hundred seeds were sown in recipient Magenta vessels containing 50 mL Murashige and Skoog (MS) culture medium and were immediately put it in dark green house at 25 °C. One hundred 5 days old seedling was treated with air or ethylene gas (50 µL/L) for 30 min, 5H. After treatment seedlings were frozen in liquid nitrogen. RNA was extracted with RNeasy plant min kit (Qiagen, Cat. No. 74904) according to the manufacturer. Experiment was repeated 3 biological times.

Auxin treatment

Forty seeds were sown in recipient Magenta vessels containing 50 mL Murashige and Skoog (MS) culture medium and were immediately put in light green house at 25 °C. Seven days old seedlings were treated 3 hours with a solution of Auxin (20µM) under shaking. Auxin solution is in MS buffer (MS/2 pH6, Triton-X100 0.04%) Mock treatment is the MS buffer without auxin. Experiment was repeated 3 biological times.

Hormonal treatment on emasculated flowers

Flowers emasculation was performed according Wang et al., (2005) protocol, on 8 weeks old plants. Five different hormones were used for treatment Gibberellic acid (GA) (121.24 ng), Paclo (308.5 ng), Indole Acetic Acid (IAA) (122.65ng) Abscisic acid (ABA) (92.5 ng) naphthylphthalamic acid (NPA) (101.95 ng). Hormones were diluted in MS buffer (MS/2 pH6, Triton-X100 0.04%) and were deposit on each stigmata of each emasculated flower. Hormonal treatment started the day of emasculation once per day for 5 consecutive days. Mock treatments have been done with MS buffer alone. Experiment was repeated 3 biological times

RNA Extraction and quantitative Real Time PCR

Fifteen fruits for each repetition from different plants were harvested at different stage: Early Immature Green (17 days post anthesis), immature green (1 day before Breaker), Breaker + 2 days and Breaker + 7 days. The second leaf of 30 days old plant, Flowers at anthesis stage was harvested for RNA extraction. Roots' RNA was extracted from 3 weeks old plants grown under light and in hydroponics solution (50 mL Floramicro® + 50 mL Floragro® + 60 mL Florabloom®, General Hydroponics Europe, pH adjusted between 5.5 and 6.5 wit HNO₃). Stem of 30 days-old plant were used for RNA extraction. RNA was extracted by phenol-chloroform method according to Zegzouti et al. (1999). DNase-treated RNA (2 µg) was then reverse-transcribed in a total volume of 20 µl using Omniscript Reverse Transcription Kit (Qiagen, Valencia, CA, USA). Real-time quantitative PCR was performed using cDNAs corresponding to 4 ng of total RNA in a 10 µl reaction volume using SYBR GREEN PCR Master Mix (PE-Applied Biosystems, Foster City, CA, USA) on an ABI PRISM 7900HT sequence-detection system. PRIMER EXPRESS software (PE-Applied Biosystems) was used to design gene-specific primers (Supplementary table 2). Real-time-PCR conditions were as follow: 50 °C for 2 min, 95 °C for 10 min, then 40 cycles of 95 °C for 15 s and 60 °C for 1 min, and finally one cycle 95°C for 15s and 60°C for 15 s. For all Real-time-PCR experiments

two or three biological replicates were made and each reaction was run in triplicate. For each sample, a Ct (threshold constant) value was calculated from the amplification curves by selecting the optimal ΔRn (emission of reporter dye over starting background fluorescence) in the exponential portion of the amplification plot. Relative fold differences were calculated based on the comparative Ct method using the Sl-Actin-51 (accession number [Q96483](#)) as an internal standard. To determine relative fold differences for each sample in each experiment, the Ct value of genes was normalized to the Ct value for Sl-Actin-51 and was calculated relative to a calibrator using the formula $2^{-\Delta\Delta Ct}$.

Heat map representation was performed using centring and normalized ΔCt value, with Cluster 3.0 software and JavaTreeview to visualize dendogramme.

Sequences Phylogenetic analysis

The evolutionary history was inferred using the Neighbour-Joining method (Saitou and Nei, 1987). The optimal tree with the sum of branch length = 13.53632771 is shown. The phylogenetic tree was linearized assuming equal evolutionary rates in all lineages (Takezaki et al., 2004). The tree is drawn to scale, with branch lengths in the same units as those of the evolutionary distances used to infer the phylogenetic tree. The evolutionary distances were computed using the Poisson correction method (Zuckerandl and Pauling, 1965) and are in the units of the number of amino acid substitutions per site. All positions containing gaps and missing data were eliminated from the dataset (Complete deletion option). There were a total of 63 positions in the final dataset. Phylogenetic analyses were conducted in MEGA4 (Tamura et al., 2007). Conserved motif were determined using MEME version 3.5.5 (Bailey and Elkan, 1994).

Mapping of ERFs

Specific PCR primers were designed, PCR amplifications were carried out on the parent lines (*S. lycopersicum* and *S. pennellii*), products were sequenced to check that the desired gene had been amplified, and single nucleotide polymorphisms were identified and used to generate cleavage amplified polymorphism markers for use on the entire IL population.

Cloning of promoters fused with GFP

The synthetic reporter construct (4XGCC-GFP) contains 4 GCC box repeats that were placed upstream of the minimal -42 to +8 TATA box from the 35S promoter of *Cauliflower mosaic virus* and joined as a transcriptional fusion to the coding region of the Green Fluorescent

Protein (GFP). We selected two native promoters for the study; the promoters of *E4* and *Sl-Osmotine*. We amplified 1509 bp of *E4* promoter and 1039bp of *Sl-Osmotine* promoter from the genomic tomato DNA with attB adopters and cloned in pDONR207 using BP clonase mix II as explained above. Subsequently, we transferred the *E4* and *Sl-Osmotine* promoter to pMDC-107 (Curtis and Grossniklaus, 2003) (Plasmid fused with GFP) through LR reaction.

Transient Expression Using a Single Cell System

Protoplasts for transfection were obtained from suspension-cultured tobacco (*Nicotiana tabacum*) BY-2 cells according to the method described previously (Leclercq et al., 2005). Protoplasts were transfected by a modified polyethylene glycol method as described by Abel and Theologis (1994).

For co-transfection assays, aliquots of protoplasts (0.5×10^6) were transformed either with 10 μ g of the reporter vector alone containing the promoter fused to the GFP reporter gene or in combination with 10 μ g of ERF construct as the effector plasmid. Transformation assays were performed in three independent replicates. After 16 h, GFP expression was analyzed and quantified by flow cytometry (FACS Calibur II instrument, BD Biosciences, San Jose, CA) on the flow cytometry platform, IFR31, Inserm, Toulouse. For each sample, 100 to 1000 protoplasts were gated on forward light scatter and the GFP fluorescence per population of cells corresponds to the average fluorescence intensity of the population of cells above the background threshold (set arbitrarily based on a zero DNA transformed control, so that all control cells fall below this threshold). Data were analyzed using Cell Quest software. All transient expression assays were repeated at least three times with similar results.

Supplemental data

Supplemental Figure 1: *Comparison of the activity of the 3 tested promoters on the reporter gene expression.*

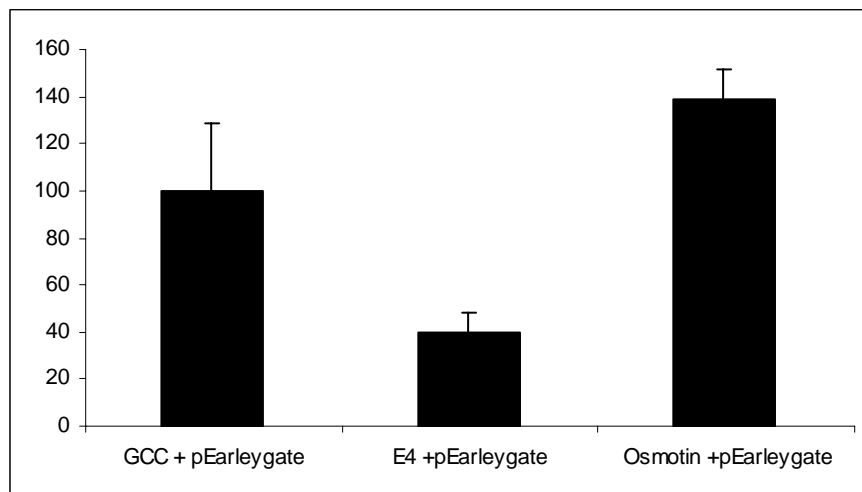

Supplemental Figure 2 : Expression pattern of ERFs in different tissues. Quantitative RT-PCR of ERF transcripts in total RNA samples extracted from Stem (St), Roots (R), Leaves (L), Flower (F), Early Immature Green (EIMG), Mature Green (MG), Breaker (B), Breaker + 2 days (B+2), Breaker + 7 days (B+7). $\Delta\Delta CT$ on the y axis refers to the fold difference in SI-ERF transcript levels relative to the lowest expression. Values represent the best experiment among 3 independent biological repetitions. Error bar represent technical standard deviation.

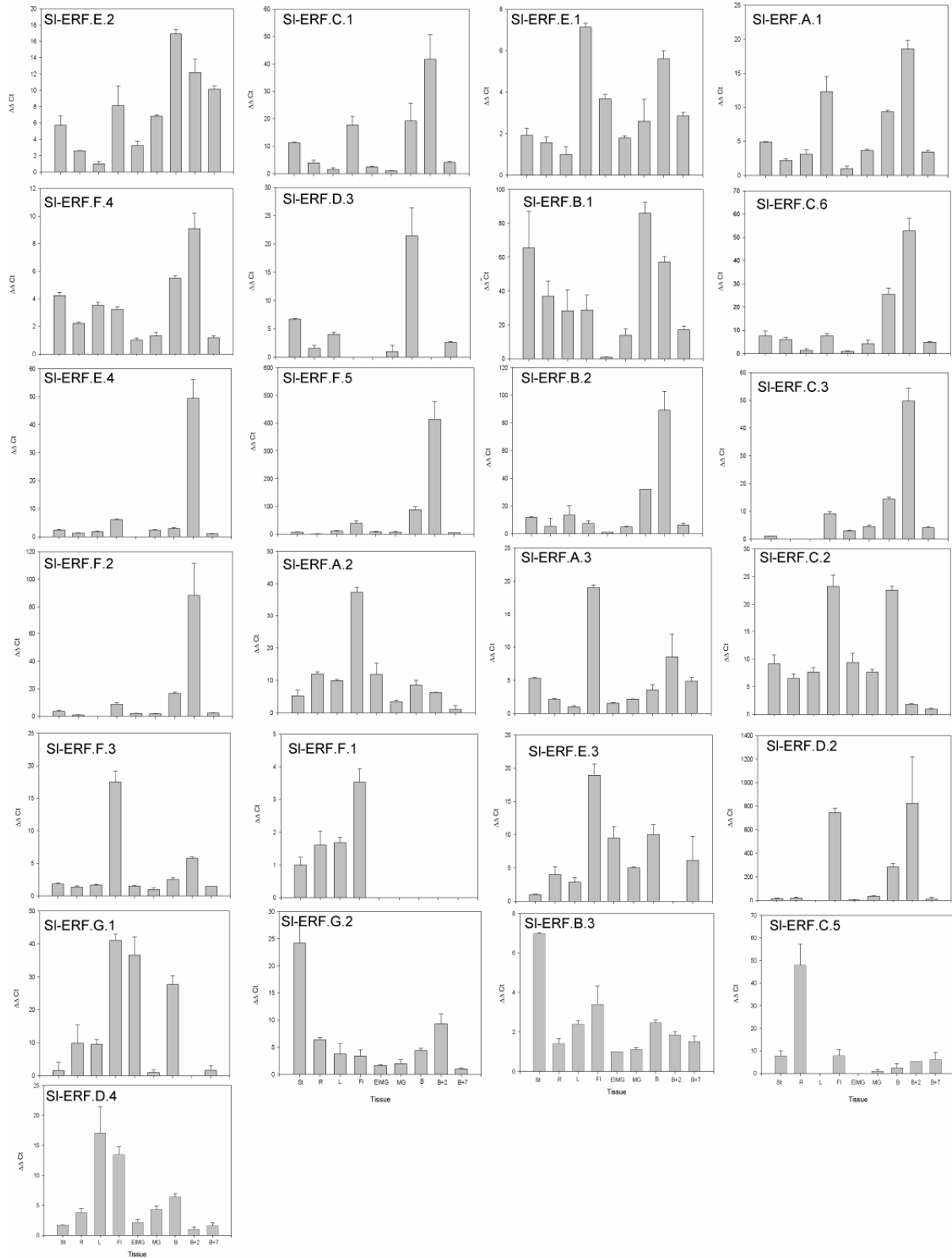

Supplemental figure 3: Expression pattern of ERF on emasculated flowers treated with different hormone: IAA, GA3, ABA and inhibitor of auxin transporters (NPA), or GA synthesis (paclo). $\Delta\Delta$ CT on the y axis refers to the fold difference in SI-ERF transcript levels relative to the non-treated plantlets.

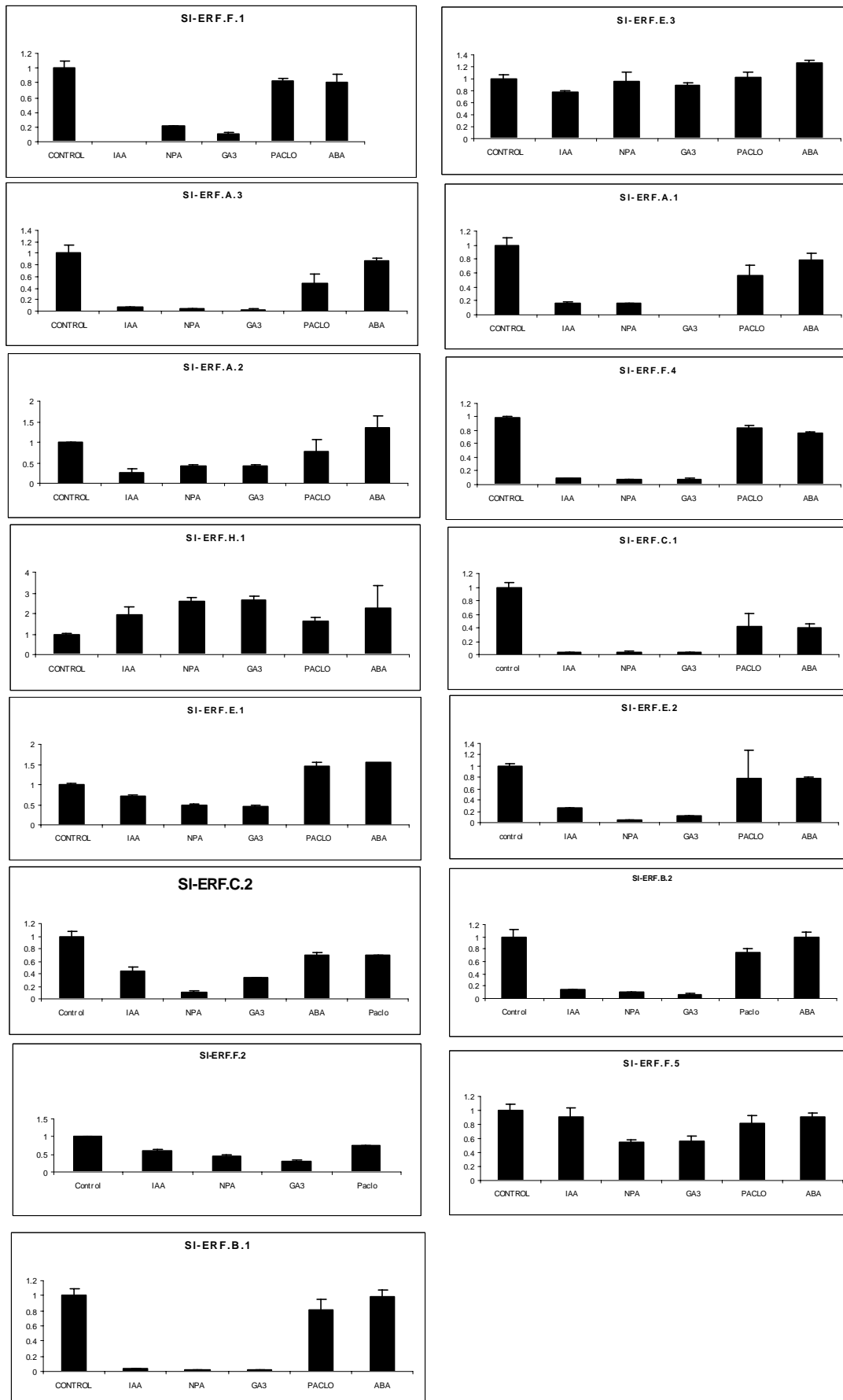

Supplemental figure 4: RT-PCR analysis of *Sl-ERF.H.1* transcript levels in RNA samples extracted from three week-old light-grown control and auxin treated (20 μ M IAA for two hours) seedlings in presence or absence of 1-MCP, the ethylene perception inhibitor (1 μ L L⁻¹ 1-MCP applied 16h prior to auxin treatment). $\Delta\Delta$ CT on the y axis refers to the fold difference in *Sl-ERF.H.1* transcript levels relative to the non-treated plantlets.

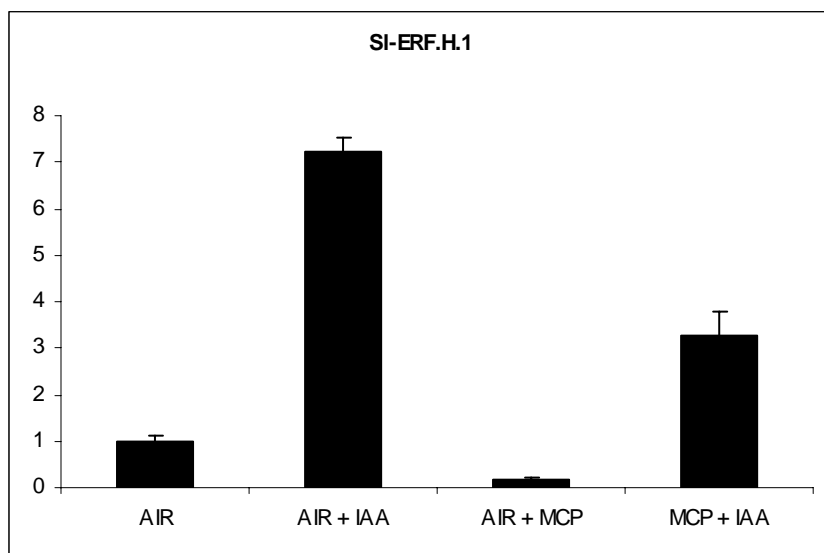

Supplemental table 1: *Primer sequences of ERFs* containing adaptors sequence 5'-AAAAAGCAGGCTTC-3' on forward primers and 5'-CAAGAAAGCTGGGT-3' on reverse primers used for the cloning of the full-length CDS by gateway strategy.

Name	Sequences
SI-ERF.A.1_F	AAAAAGCAGGCTTCATGTATTCAAATTGTGAACTAGAAAATG
SI-ERF.A.1_R	CAAGAAAGCTGGGTCTTATTGCTTTGTTCCACGAGC
SI-ERF.A.2_F	AAAAAGCAGGCTTCATGTATCAACTTCCCCTTCT
SI-ERF.A.2_R	CAAGAAAGCTGGGTGTTAGCTCCATATTTAACTAA
SI-ERF.A.3_F	AAAAAGCAGGCTTCATGGATCAACAGTTACCACCGACG
SI-ERF.A.3_R	CAAGAAAGCTGGGTCTTAAATGACCAATAGTTGATGG
SI-ERF.B.1_F	AAAAAGCAGGCTTCATGGATTCTTCTTACTAGAAATG
SI-ERF.B.1_R	CAAGAAAGCTGGGTCTCAGTGGATCGTGATGGCAG
SI-ERF.B.2_F	AAAAAGCAGGCTTCATGGTTCTCCACAAGAGACTTG
SI-ERF.B.2_R	CAAGAAAGCTGGGTCTTATATCATAACAAGCTGAGAT
SI-ERF.B.3_F	AAAAAGCAGGCTTCATGACGAAACAAGATGAAGGA
SI-ERF.B.3_R	CAAGAAAAGCTGGGTGCTACACCAACTCCATCTTGT
SI-ERF.C.1_F	AAAAAGCAGGCTTCATGTCAAGCCCACTAGAGATAG
SI-ERF.C.1_R	CAAGAAAGCTGGGTCTATGATGAAGTCATTAAGAGC
SI-ERF.C.2_F	AAAAAGCAGGCTTCATGGAATCTTATCCCTAAAAC
SI-ERF.C.2_R	CAAGAAAGCTGGGTCTAATTAGAGGAAGTACTCG
SI-ERF.C.3_F	AAAAAGCAGGCTTCATGGATTATTCATCTCGGG
SI-ERF.C.3_R	CAAGAAAGCTGGGTCTACCAATTTGTGATACTTTCTG
SI-ERF.C.4_F	AAAAAGCAGGCTTCATGGATTCTTCTTCTTCTTCTC
SI-ERF.C.4_R	CAAGAAAGCTGGGTCTTACCATGGACTAAAATAAGTTGC
SI-ERF.C.5_F	AAAAAGCAGGCTTCATGACTACTCATCATGTGG
SI-ERF.C.5_R	CAAGAAAGCTGGGTCTTACAAAGAGGATAATAAACTATCC
SI-ERF.C.6_F	AAAAAGCAGGCTTCATGGTTCCAACCTCAAAGTGATTTACC
SI-ERF.C.6_R	CAAGAAAGCTGGGTCTTAACATCTTGATTCAAATACATC
SI-ERF.D.1_F	AAAAAGCAGGCTTCTAGTGAATATTGTTCACTAC
SI-ERF.D.1_R	CAAGAAAGCTGGGTCTTATCCAGATGAAGAAGAAGGG
SI-ERF.D.2_F	AAAAAGCAGGCTTCATGTGCTTTTTAAAGGTGGCG
SI-ERF.D.2_R	CAAGAAAGCTGGGTCTTAACTAGAAGATGGAGGATATTGG
SI-ERF.D.3_F	AAAAAGCAGGCTTCATGCATTGGTTAAATAAAAAG
SI-ERF.D.3_R	CAAGAAAGCTGGGTCTTAAAAGCTGTGAACATTCCCG
SI-ERF.D.4_F	AAAAAGCAGGCTTCATGTCGCCGCCCTTGTTCGCGTACCG
SI-ERF.D.4_R	CAAGAAAGCTGGGTCTTAGAAGCTATGAGCAATATAGCC
SI-ERF.E.1_F	AAAAAGCAGGCTTCATGTGTGGTGGTGCAATTCTTGCTG
SI-ERF.E.1_R	CAAGAAAGCTGGGTCTTAACTACATTATAACTTGGTTG
SI-ERF.E.2_F	AAAAAGCAGGCTTCATGTGTGGTGGTGCAATTATCTCCG

(suite)

SI-ERF.E.2_R CAAGAAAGCTGGGTCTTAGTAGGCACCTCCATTAAGAAGG
SI-ERF.E.3_F AAAAAAGCAGGCTTCATGTGTGGTGGTTCTATAATCTCCG
SI-ERF.E.3_R CAAGAAAGCTGGGTCTCAGGTACCATAGTAACGGGGGTTCC
SI-ERF.E.4_F AAAAAAGCAGGCTTCATGTGTGGAGGTGCCATAATC
SI-ERF.E.4_R CAAGAAAGCTGGGTCTCAGTAGAACTGATGATGAG
SI-ERF.F.1_F AAAAAAGCAGGCTTCATGAGAAGAGGCAGAGCAACTCC
SI-ERF.F.1_R CAAGAAAGCTGGGTCTCAAAGACATAGTGCTGTGC
SI-ERF.F.2_F AAAAAAGCAGGCTTCATGCGGAGAAGCAGAGCAGCC
SI-ERF.F.2_R CAAGAAAGCTGGGTCTCAAATGACAGGTGGGTAC
SI-ERF.F.3_F AAAAAAGCAGGCTTCATGCGCCACCGAAGTCGTCCG
SI-ERF.F.3_R CAAGAAAGCTGGGTCTTAGAGGCATAAAGCGGTGACG
SI-ERF.F.4_F AAAAAAGCAGGCTTCATGGCTGTGAAAGATAAGGCTG
SI-ERF.F.4_R CAAGAAAGCTGGGTCTTAAACTCCATAGGTGGCGCAAG
SI-ERF.F.5_F AAAAAAGCAGGCTTCATGGCGCCTAAGGAAAAAATT
SI-ERF.F.5_R CAAGAAAGCTGGGTGTCACATGTTTTCCGGTGGAGG
SI-ERF.G.1_F AAAAAAGCAGGCTTCATGGAATCACAAAAAATCAAAAAG
SI-ERF.G.1_R CAAGAAAGCTGGGTCTCAACAAACATCTTGGAAGAAATC
SI-ERF.G.2_F AAAAAAGCAGGCTTCATGACGGAAAATTTCAGTTCCGG
SI-ERF.G.2_R CAAGAAAGCTGGGTCTATCGAGCTTCAAGGGCAAAATCG
SI-ERF.H.1_F AAAAAAGCAGGCTTCTAGGCTAGGGCACAAACAAGAT
SI-ERF.H.1_R CAAGAAAGCTGGGTCTCACTGGATTGGTGAGAAGG

Supplemental table 2: Primer sequences and concentration for expression pattern study

Name	Sequences	Concentration (nm)
SI-Actin-51F	TGTCCCTATTTACGAGGGTTATGC	300
SI-Actin-51R	CAGTTAAATCACGACCAGCAAGAT	300
SI-ERF.A.1_F	ACCGGATCCTGTTAGAGTTGGA	300
SI-ERF.A.1_R	CGACGCCGATGAACAATG	300
SI-ERF.A.2_F	CGGTATCATCAGCTTCGGAAA	300
SI-ERF.A.2_R	TCTCAACTTCTAATTCGGCTTGCT	300
SI-ERF.A.3_F	GCGAAATGGATCAACAGTTACCA	300
SI-ERF.A.3_R	ATTAGACGACTGAAGCTTGAATTCC	300
SI-ERF.B.1_F	GAATGATGACGGAATTGTAATGAAGA	900
SI-ERF.B.1_R	TTCCACAATCCCAAATTGAAGA	900
SI-ERF.B.2_F	AGTTTGCAGCGGAGATTCTGT	300
SI-ERF.B.2_R	TGCCCTGTCTATATGCCTTTG	300
SI-ERF.B.3_F	CGGAGATAAGAGATCCAAGTCGAA	300
SI-ERF.B.3_R	CTTAAACGCTGCACAATCATAAGC	300
SI-ERF.C.1_F	TTCTTCGTGTCGAAAATACTAAGTTCAGT	300
SI-ERF.C.1_R	ACTCTAAATTTCTCAAGAAATCCAGAACA	300
SI-ERF.C.2_F	ATCATTACCATGGAATGATCAACATT	300
SI-ERF.C.2_R	CCGTCTATAACTTTCTTCGAGGTTAA	300
SI-ERF.C.3_F	CAAGAAGTTTCTCAATCTCTCATGTAT	300
SI-ERF.C.3_R	CCGAGATGAATAATCCATTTGATTT	300
SI-ERF.C.5_F	CAACGTTGACAACATCTTTGCA	50
SI-ERF.C.5_R	AACTTGGAAGATATTCTCAATGGAA	50
SI-ERF.C.6_F	GGGAAATACGCTGCGGAAA	300
SI-ERF.C.6_R	TTTCGAACGTACCTAGCCATACTCT	300
SI-ERF.D.1_F	GGCAGCTGAAATAAGAGATCCATATAA	900
SI-ERF.D.1_R	CTAGCAGCCCCCTTCAGCAGTAT	900
SI-ERF.D.2_F	ACACAAGTAGCACCAGCACCACTA	300
SI-ERF.D.2_R	ACCCCAAAAAAGCAAGAAAATT	300
SI-ERF.D.3_F	ATTCATTTTCGGGTTGTGCAGTA	50
SI-ERF.D.3_R	CGACTATAATGATTTCTGCCGAAC	50
SI-ERF.D.4_F	GTTGCTGCTTTAACCAATGTGATTAT	50
SI-ERF.D.4_R	CTTCCGGTACGCGAAACAAG	50
SI-ERF.E.1_F	GTTCTCTCAACCCCAAACG	300
SI-ERF.E.1_R	TTCATCTGCTCACCACCTGTAGA	300
SI-ERF.E.2_F	ACTTCGTGAGGAAACCCTGAAC	300
SI-ERF.E.2_R	GTTACTAATATAAGTCATGTTGGGCTGAA	300
SI-ERF.E.3_F	GCATTTGCGATCTGAAGTTGTT	50
SI-ERF.E.3_R	CAAATGGCTTGACATCGACTTG	50
SI-ERF.E.4_F	AGGCCAAGGAAGAACAAGTACAGA	900
SI-ERF.E.4_R	CCAAGCCAAACGCGTACAC	900
SI-ERF.F.1_F	ACGAGCTTTCTTTCTTTCTCTCTAAA	300
SI-ERF.F.1_R	GAAACTCGATATCCTTCTGTAAAATCTTC	300
SI-ERF.F.2_F	TTGATACCACTGCTTACCTAGTTTTTCT	300
SI-ERF.F.2_R	TATCTTCTATGGCTCCTTCTCTTCT	300
SI-ERF.F.3_F	AGTAGTAAGGTGACCCGGATGAAG	300
SI-ERF.F.3_R	CACCGATCATCCACCACAGA	300
SI-ERF.F.4_F	GAGCTAATGGCTGATTTTTGTATATAAGTTC	300
SI-ERF.F.4_R	AAATGGTAGAAACAGCACGAGAAAAG	300
SI-ERF.F.5_F	TGGAGCGAAAGCGAAAATAA	300
SI-ERF.F.5_R	GTCTGACTCGGACTCCGATTG	300
SI-ERF.G.1_F	GAAGAAAGCGATCGATTTGAAGA	50
SI-ERF.G.1_R	TTTTCCCATGGCCTCTGT	50
SI-ERF.G.2_F	CGGTGGAGATAAAAGCGAAAAC	300
SI-ERF.G.2_R	CCACTTCGCAGAACCCTAGATT	300
SI-ERF.H.1_F	AGATGCAGCAAGAGCATATGATG	900
SI-ERF.H.1_R	TTGGGTTGTATGGGAAATTAGTTCT	900

Article 2: *en préparation*

The transcriptional regulation of the ethylene response genes: molecular characterization of Ethylene Response Factor and GCC box *cis*-element.

Introduction à l'article 2.

L'éthylène est une phytohormone dont la voie de transduction est maintenant bien connue. Cette voie de transduction se termine par une cascade transcriptionnelle dont les derniers acteurs sont les ERF. Il a été postulé que cette large famille de facteurs de transcription participe à l'amplification du signal et à la diversification des réponses à l'éthylène. Quatre ERF de tomate (*LeERF1* à 4, renommé respectivement *Sl-ERF.A.2*, *Sl-ERF.E.1*, *Sl-ERF.F.5* et *Sl-ERF.B.3*) appartenant à des classes différentes ont été isolés et partiellement caractérisés au laboratoire (Tournier et al., 2003). Ces ERF sont capables de fixer la boîte GCC mais avec des affinités différentes. De plus, il semble que l'environnement de ces boîtes GCC est responsable des différences d'affinité observées par Tournier et al (2003). Nous démontrons ici par des expériences de gel retard que la nature de la base suivant directement le motif GCC intervient de façon significative dans l'affinité de l'interaction de *Sl-ERF.E.1* et *Sl-ERF.B.3* avec la boîte GCC. Plus précisément, ces résultats montrent que la présence d'un T, 2 bases avant la boîte GCC favorise la fixation de *Sl-ERF.B.3* alors qu'elle ne modifie pas la fixation de *Sl-ERF.E.1*. Ceci suggère que la présence de certaines bases dans l'environnement des boîtes GCC peut favoriser la fixation d'un ERF spécifique.

Il a été également montré que les 4 ERF présentent une affinité différentielle pour une même boîte GCC, suggérant que la variabilité de certains résidus d'acides aminés au sein du domaine AP2/ERF peut également influencer l'affinité à leur *cis*-élément cible. Grâce à une stratégie de mutagenèse dirigée nous démontrons que la variabilité du 6^{ième} acide aminé (Arg) du domaine AP2/ERF qui se présentait comme le meilleur candidat n'est pas du tout responsable de la différence d'affinité observée. Cependant, la mutation de cette Arg en Lys ou en Gln augmente l'affinité de *Sl-ERF.B.3* pour la boîte GCC de l'osmotine, démontrant ainsi que les acides aminés n'interagissant pas avec la boîte GCC peuvent influencer grandement l'affinité des ERF pour une boîte GCC.

Les résultats présentés ici suggèrent que l'environnement des boîtes GCC intervient en combinaison avec les acides aminés du domaine AP2/ERF dans la détermination de l'affinité d'un ERF particulier pour une boîte GCC donnée. Ceci peut donc en parti expliquer la sélection par les ERF de leurs gènes cibles ainsi que leur capacité d'activation ou de répression. Ces données pourraient expliquer les mécanismes de régulation différentielle des gènes répondant à l'éthylène et fournir les premiers éléments des mécanismes moléculaires à la base de la mobilisation sélective des gènes au cours des processus de développement.

The transcriptional regulation of the ethylene response genes: molecular characterization of Ethylene Response Factors and GCC box *cis*-element.

Julien Pirrello, Farid Regad, Mondher Bouzayen

*Génomique et Biotechnologie des Fruits, ENSAT, Pôle de Biotechnologie Végétale, BP 107
Auzeville Tolosane, 31326 Castanet Tolosan cedex, France.*

Abstract

The transduction pathway of the plant hormone ethylene is among the best known. This transduction pathway ends to the activation of a transcription cascade where ERFs are the last protagonists. The members of the large family of ethylene transcription factors, the so-called Ethylene Response Factors (ERFs), are likely to be the mediators by which the ethylene signal is amplified and diversified into specific responses.

Four tomato ERFs, isolated in the laboratory, specifically bind to the ethylene response element containing the canonical GCCGCC motif so-called GCC-box. Sl-ERF.A.2, B.3, E.1 and F.5 displayed diverse binding affinity to the GCC box. In the present study we show by *in silico* analysis of promoter regions of ethylene responsive genes, that nucleotide environment of the GCC box is highly diverse which might impact the interaction affinity. Using electro mobility shift assays (EMSA) we demonstrate here that variation of the bases that directly flank the GCC box greatly influences the affinity of Sl-ERF.B.3 and E.1 to the GCC box.

On the other hand variability of amino acid environment within the AP2/ERF domain may also affect the binding affinity between ERFs and the GCC box. Directed mutagenesis approach was used to address the importance of a targeted amino acid residue.

Key word: ERF, GCC box, DNA-protein interaction, *cis*-element, affinity

Introduction

Phytohormones are key regulators of plant development. Five main hormones can be distinguished; ethylene, auxin, gibberellins, cytokinins and abscisic acid, and we can add brassinosteroids, methyljasmonic acid and salicylic acid as growth regulator. All these molecules act by the intermediary of a specific transduction pathway which finishes by the expression of specific target genes. Considering hormonal balance these molecules can control all developmental stages. Each molecule signal is involved in many developmental processes, and reciprocally each developmental process is under the control of many molecules. The ethylene transduction pathway is one of the best described. Ethylene binds a transmembrane receptor via an ion copper cofactor. Five ethylene receptors are known in *Arabidopsis thaliana*: ETR1, ERS1, ETR2, EIN4 and ERS2 (Chang et al., 1993; Hua et al., 1995; Schaller et al., 1995; Hua et al., 1998; Sakai et al., 1998). ETR1 is similar to histidine kinase two components of bacteria (Chang et al., 1993; Stock et al., 2000). However Serine/Threonine kinase receptor has been found in tobacco (Xie et al., 2003). Once ethylene bound receptor there is inactivation of CTR1. This protein is homologous to Raf like kinase (Kieber et al., 1993; Huang et al., 2003), which suggest that a phosphorylation cascade is involved in the ethylene transduction pathway. This cascade finishes by the activation of a putative membrane protein, EIN2. The primary response involved transcription factor of the EIN3 family which bind EBS (Ethylene Binding Site) present in the promoter of ERF1. ERF1 belongs to a huge transcription factors family initially described as inducer of the secondary response to this hormone. These ERFs can activate or repress target genes. EIN3 seems to be an important regulator node, indeed recent studies demonstrate that glucose and F-box EBF1 and EBF2 are involved in the degradation of EIN3 in *Arabidopsis* by the intermediary of the proteasome (Guo and Ecker, 2003; Potuschak et al., 2003; Yanagisawa et al., 2003). However mechanisms of interaction with other transduction pathways are not well understood. Existence of a unique transduction pathway cannot explain the diversity of ethylene responses observed in different tissues and during developmental stages. For example in climacteric fruit, ethylene induces ripening associated genes after breaker stage whereas during earlier stage ethylene has no effects.

ERFs are the last elements of the ethylene transduction pathway and are responsible of the installation of the secondary response. Moreover they are in the cross-talk of different hormonal pathways (Gu et al., 2000; Soderman et al., 2000; van der Fits and Memelink, 2000;

Brown et al., 2003). ERFs specifically bind the GCC box which was identified as necessary and sufficient for the induction of many basic PR proteins (Ohme-Takagi and Shinshi, 1995; Solano et al., 1998).

Four tomato ERFs (*ERF1-4*) have been isolated in tomato fruit (Tournier et al., 2003). These genes have been renamed *Sl-ERFA.2*, *Sl-ERF.E.1*, *Sl-ERF.F.5* and *Sl-ERF.B.3* respectively according to their class. Affinity studies by gel shift assay demonstrate a weaker binding on the endochitinase GCC box compared to the osmotin GCC box. These results suggest that flanking regions of GCC box are also important to determine ERF affinity for a given *cis*-element (Tournier et al., 2003). Moreover, these 4 ERFs do not show the same binding affinity for a given GCC box. *Sl-ERF.F.5* and *Sl-ERF.B.3* show a strong affinity for all tested GCC boxes whereas *Sl-ERF.A.2* and *Sl-ERF.E.1* show a weak affinity (Tournier et al., 2003). *In silico* studies based on the 3-dimensional modelling of the ERF/AP2 domain suggested that the lateral chain of the 6th amino acid of the DNA binding domain can influence the binding (Tournier et al., 2003). Indeed, *Sl-ERF.B.3* which presents the highest affinity has a basic charged amino acid at the position 6 (Arg). In this work we explore the hypothesis that a basic charged amino acid with a lateral chain more accessible improves the binding and that the presence of a non charged amino acid does not change the specificity of interaction but modifies the affinity (Tournier et al., 2003).

In this study, we analysed, at the molecular level, interaction between the GCC box and *Sl-ERF.E.1* which has the weakest binding affinity and *Sl-ERF.B.3* which has the strongest one. First we analyzed *in silico* the flanking region of *Arabidopsis* GCC box. Then we mutated flanking regions of the GCC box in order to study by Electro Mobility Shift Assay interactions between ERFs and GCC box. Finally we experimentally check the hypothesis concerning the role of the 6th amino acid in the interaction.

Results

Analysis of the GCC box flanking region in *Arabidopsis*

Up to now there is no exhaustive study concerning the influence of the flanking region on the function of the GCC box, except that a mutation of the A to T at position N4 induces a decrease of 70 % of affinity of AtERF1-4 (Fujimoto et al., 2000).

Using findpattern we looked for the presence of the GCC motif in the 1000 bp upstream the genes in the whole *Arabidopsis* genome. Thus, we have identified 2 826 GCC boxes and we further analysed the sequences flanking of these motifs. We focus our analysis on the 4 bp upstream and downstream the GCC box and these nucleotides are indexed as mention subsequently ($N_1N_2N_3N_4GCCGCCN_{11}N_{12}N_{13}N_{14}$).

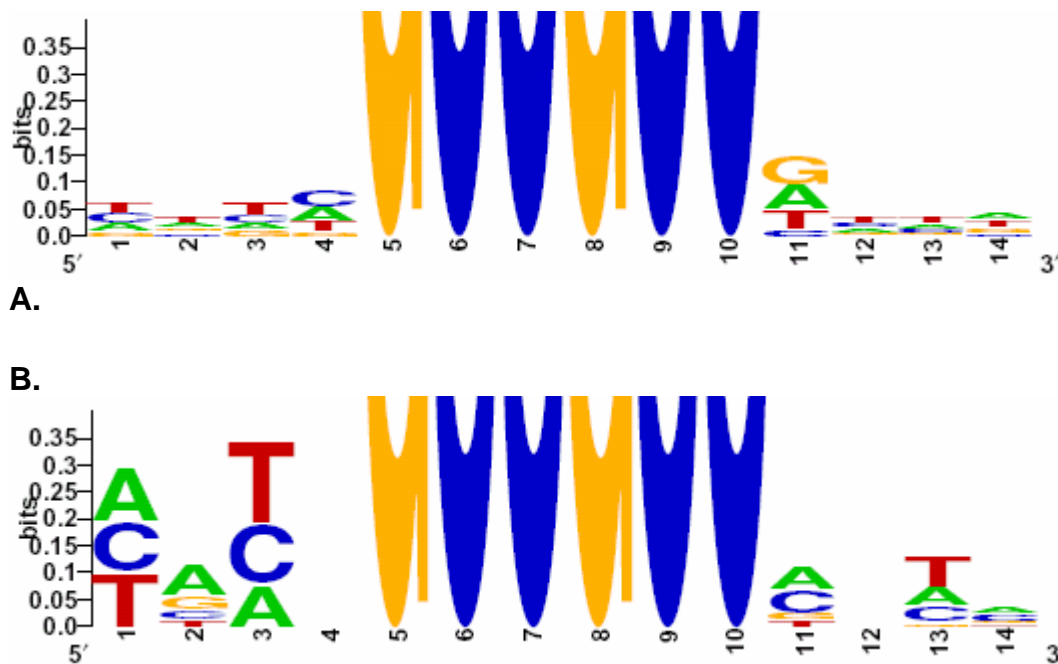

Figure 1: *In silico* analysis of nucleotide composition within the closest environment of the GCC box. **A**, base composition within the environment of the GCC motifs found in all *Arabidopsis* genes using weblogo (weblogo.berkeley.edu). **B**, base composition within the environment of the GCC motifs found in the promoters of ethylene-regulated genes in *Arabidopsis*.

“LOGO sequence” software (<http://weblogo.berkeley.edu/logo.cgi>) (Schneider and Stephens, 1990) gives a graphical result showing motifs in a set of sequences. The software pile up bases at each position by importance order representing the most abundant base at the top of the column. The size of the letter is proportional to the frequency of a base at this position.

Whereas, the size of the column indicates the information given by the position to determine the base. Figure 1A shows that when the analysis is performed with all GCC boxes no base seems to prevail significantly. Considering the fact that all *Arabidopsis* GCC boxes are probably not functional we analysed expression data from Schenk et al. (2000), to find GCC boxes present in the promoter of ethylene regulated genes. Eighteen GCC boxes have been found the T in position N₃ is predominant (Fig. 1B). However, with these data we cannot definitively conclude any relation between these bases and the functionality of GCC box. We can observe that the 4 bases are not equally distributed in the flanking region of the GCC box. (Tab. 1A)

A.

Position	N ₁	N ₂	N ₃	N ₄	N ₅	N ₆	N ₇	N ₈	N ₉	N ₁₀	N ₁₁	N ₁₂	N ₁₃	N ₁₄
A	27	28	22	30	0	0	0	0	0	0	31	26	28	31
T	31	33	38	23	0	0	0	0	0	0	23	30	32	28
G	13	21	17	12	100	0	0	100	0	0	37	16	17	26
C	29	18	22	34	0	100	100	0	100	100	9	28	23	15

B

Position	N ₁	N ₂	N ₃	N ₄	N ₅	N ₆	N ₇	N ₈	N ₉	N ₁₀	N ₁₁	N ₁₂	N ₁₃	N ₁₄
A	33	50	22	22	0	0	0	0	0	0	39	22	28	39
T	33	11	44	22	0	0	0	0	0	0	11	33	44	11
G	0	22	0	17	100	0	0	100	0	0	11	17	6	17
C	33	17	33	39	0	100	100	0	100	100	39	28	22	33

Table 1: Frequency of each base at each position

(A) GCC box located 1000 bp upstream of all *Arabidopsis* genes have been considered

(B) GCC box located 1000 bp upstream of all *Arabidopsis* ethylene regulated genes have been considered according microarrays results (Schenk et al., 2000).

At each position, one base is under represented. At position N₃ G represents only 17 % of base and only 12% at position N₄, whereas A, T and C represent 22, 38 and 22 % respectively in position N₃ and 30, 23 and 34 % respectively in position N₄. In opposite, in position N₁₁ the C is under represented (9%) whereas A, T and G represent respectively, 31, 23 and 37% of bases (Tab. 1A). In the case of GCC box located upstream ethylene regulated genes, G is the base the less represented because there is no G in position N₃ and only 17 % in position N₄, whereas A, T and C are respectively present in 22, 44 and 33 % in N₃ and 22, 22 and 39 % in N₄. In position N₁₁ G and T are under represented and in position N₁₂ the G is the less represented.

There is a big difference of nucleotide composition between GCC boxes which are putatively functional in ethylene induced genes and GCC boxes found in all gene upstream sequences. In particular, in most of the cases the guanine is less represented.

Thus, a consensus sequence can be defined for the putative functional GCC box: (T/A/C)ATCGCCGCC(A/C)TTA. In order to confirm this model we did a set of mutation of the flanking region of the GCC box and tested them *in vitro* by gel retardation assay.

Flanking regions of the GCC box are involved in the affinity of interaction

We mutated bases N₃, N₄, N₁₁ and N₁₂ in the flanking region of Nt-Chitinase GCC box and compared by EMSA the consequence of these modifications to the binding affinity for two ERFs (SI-ERF.E.1 and SI-ERF.B.3).

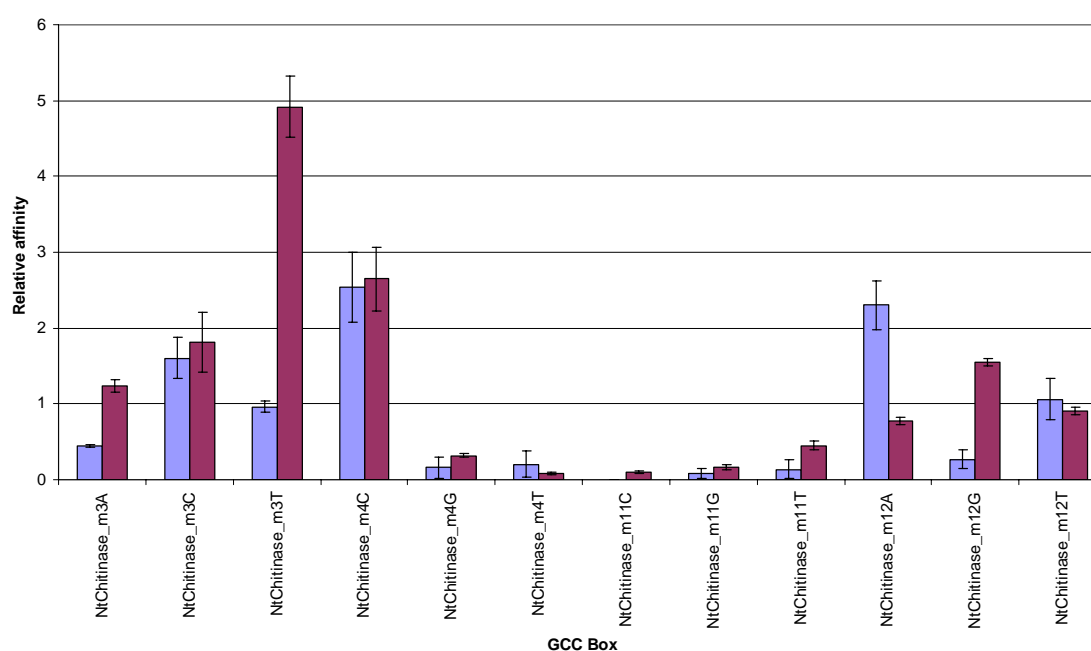

Figure 2: Analysis of binding affinity of mutated Nt-Chitinase GCC-boxes by Gel retardation assays. The signal corresponding to the gel shift was quantified using “Image Gauge” software. This value was divided by the signal of the free probe. The relative affinity is calculated using the value obtained with the non mutated Nt-Chitinase as reference. SI-ERF.E.1 is represented by blue bar and SI-ERF.B.3 is represented by red bar.

When A₄ is mutated to T or G the affinity of SI-ERF.E.1 and SI-ERF.B.3 dramatically decrease (Fig 2). The mutation of the same base to a C induces a better affinity for both ERFs. Moreover, any mutation of the 11th base, the first base just after the GCC box, induces a loss of affinity of the ERF for the GCC box. These results suggest that the base just before and just after the GCC box have the same effect on ERF affinity whatever the ERF used. Some bases at this position dramatically decrease the binding affinity, and by this way GCC box become inactive. In opposite, the presence of a T in position 3 increases up to 5 folds the affinity of SI-ERF.B.3. But this mutation has no effect on SI-ERF.E.1. In position 12, the presence of an

A increases the affinity of SI-ERF.E.1 and slightly decreases the affinity of SI-ERF.B.3, whereas a G will support the binding of SI-ERF.B.3 and not SI-ERF.E.1. These results demonstrate that the bases in position N_3 and N_{12} have different effects on different ERFs which suggest that these bases can discriminate the binding of specific ERFs.

Statistical analysis using the R package reveal that the flanking region of the GCC box is significantly involved in the affinity of the binding ($p < 0.05$). Here we can conclude that the base in position 11 is critical for the 2 ERFs tested.

The 6th amino acid of the AP2/ERF domain influences the affinity of the binding

The DNA binding domain AP2/ERF contains 58-59 amino acids, but only 16 amino acids directly interact with the GCC box. It has been suggested that the affinity binding depends of the sequence of the *cis*-element but also of the DNA binding domain sequence. The 6th amino acid is variable in the AP2/ERF domain is a potential candidate to explain the difference of affinity of ERFs for a GCC box (Tournier et al., 2003).

To confirm this hypothesis we have mutated the Arg₆ to Lys (SI-ERF.B.3/R6K) or Gln (SI-ERF.B.3/R6Q) in SI-ERF.B.3 which is the ERF with the highest affinity. Gln is the amino acid present at the same position in SI-ERF.E.1 which shows the weakest affinity, whereas lys is the amino acid which is present in SI-ERF.F.5. This last one shows an intermediary affinity between SI-ERF.E.1 and SI-ERF.B.3. These mutated proteins were tested for binding affinity against a tobacco chitinase GCC box and a tomato osmotin GCC box.

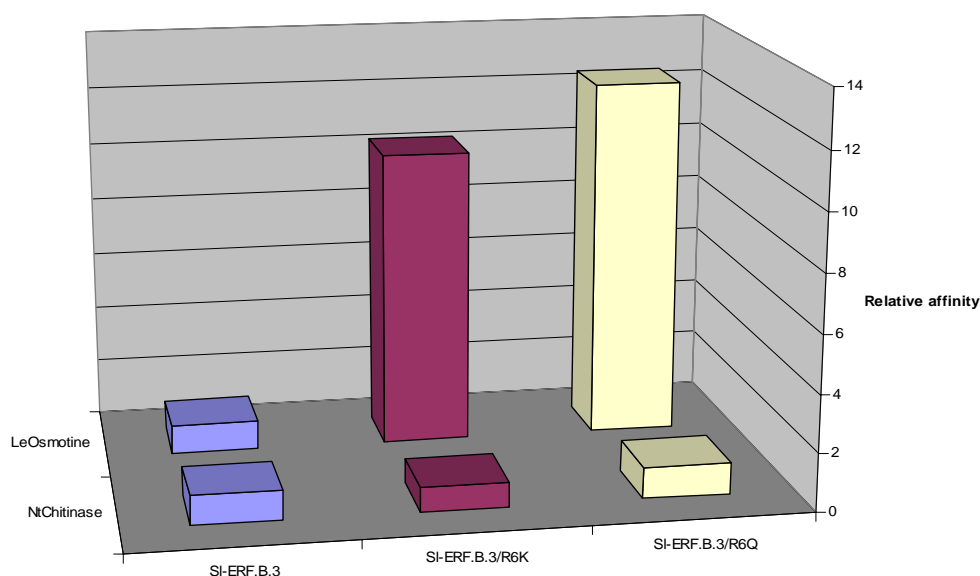

Figure 3. Binding affinity of mutated AP2/ERF domain tested by Gel retardation assays. Binding assay was performed with both SI-Osmotin and Nt-Chitinase GCC-boxes. Relative affinity is calculated with non mutated SI-ERF.B.3 as reference.

The figure 3 shows that the mutation of the 6th amino acid does not change the affinity of SI-ERF.B.3 for the Nt-Chitinase whereas the affinity dramatically increases for the SI-Osmotin. Indeed, in this last case the affinity is stimulated by 12 fold and 10 fold for SI-ERF.B.3/R6Q and SI-ERF.B.3/R6K, respectively. These results suggest that there is no positive correlation between the charge of the 6th residue and the binding affinity.

Discussion

The presence of the minimal GCC box (GCCGCC) in a promoter is not sufficient to explain different affinities observed for ERFs. In 1998, Hao et al demonstrated that ERFs are able to bind a minimal GCC box of 11 bp (NNGCCGCCNNN). Previously Büttner et al. (1997) demonstrated, by footprint experiment, that the protected region by the AtEBP is constituted of 13 bp (TAAGAGCCGCCAT).

An exhaustive study of all GCC box found 1000 bp upstream of *Arabidopsis* gene does not show any consensus sequence. Concerning GCC box present upstream of ethylene regulated genes we can notice the absence of a G in position N₁ and N₃.

Mutation of the G to T in position N₃ in the GCC box of the Nt-Chitinase, increases by 5 fold the binding with SI-ERF.B.3. The same mutation does not change the affinity of SI-ERF.E.1. Mutations of the bases in N₄ and N₁₁ have the same effect on SI-ERF.E.1 and SI-ERF.B.3 whereas mutations on position N₃ and N₁₂ have not same effect on the 2 tested ERFs. These results strongly suggest that some bases have a common effect on the affinity for each ERF (base N₄ and N₁₁). But N₃ and N₁₂ have a specific effect on the affinity. Interestingly the most common base according to *in silico* analysis in position N₃ is the T and it corresponds to the best affinity observed. It becomes evident that a given ERF will not bind with the same affinity all GCC boxes. It strongly suggests that the environment of a GCC box can drive the selection of the target genes by ERFs. Some environment can support binding of a specific class. Thus, flanking region could have an important physiological role.

All ERFs do not show the same binding affinity for the same GCC box. Indeed SI-ERF.B.3 strongly binds GCC box of Nt-Chitinase whereas SI-ERF.E.1 weakly binds the same GCC box (Tournier et al., 2003). SI-ERF.A.3, SI-ERF.C.6 and SI-ERF.G.2 (anciently named Pti4/5/6 respectively) are transactivator, however SI-ERF.A.3 shows a better affinity for the GCC box of *PDF1.2* than SI-ERF.C.6 and SI-ERF.G.2 (Gu et al., 2002). Three dimensional modelling analyse suggests that the 6th amino acid of the DNA binding domain is at the origin of this difference. That is, SI-ERF.B.3, which shows the highest binding affinity, also harbours an Arg basic residue at this position, deploying the most accessible side chain bearing a highly polar guanidinium group. To check this hypothesis we decided to mutate the Arg residue in SI-ERF.B.3 into a Lys or Gln. Arg mutation to either a non-charged Gln or a charged Lys increases the affinity of SI-ERF.B.3 for SI-Osmotin GCC-boxes indicating that there is no direct correlation between the charge of the 6th amino acid and the affinity of binding. Nevertheless, independently of its charge, this residue plays an important role in the

affinity since a mutation from Arg to Gln in the SI-ERF.B.3 background induces up to 12 fold the binding affinity.

While the conservation of the core GCC-box is essential for the binding of ERFs, it is not sufficient to explain the differential affinities displayed by a particular ERF to different GCC-box-containing *cis*-elements. Our data indicate that the nature of the bases surrounding the GCC-box can also play an important role in the binding. Moreover, all the flanking bases have not the same importance. Furthermore, the nature of some bases allows the discrimination between the two tested ERFs. On the other hand, some amino acid residues in the AP2/ERF domain, supposed to not directly be involved in the interaction with the DNA, play an important role in the affinity. These results give some clues to explain the differential regulation of ethylene regulated genes and give the first molecular mechanistic elements of the target gene during specific developmental process.

Materials and Methods

Plant material

Tomato (*Solanum lycopersicum* cv MicroTom) plants were grown under standard greenhouse conditions. For growth in chamber room the conditions are the following: 14-h-day/10-h-night cycle, 25/20°C day/night temperature, 80 % hygrometry, 250 $\mu\text{mol.m}^{-2}.\text{s}^{-1}$ intense luminosity.

SI-ERF Cloning

RNA was extracted from leaves, stems and red fruit. RNA was extracted by phenol-chloroform method according to Zegzouti et al. (1999).

Reverse transcription have been done independently with each RNA according to Zegzouti protocols (Zegzouti et al., 1999).

SI-ERF.B.3 has been amplified from leaves cDNA with the following primers:

SI-ERF.B.3_ATG_F: ATGACGAAACAAGATGAAGGATTAAC

SI-ERF.B.3_TAG_R: CTACACCAACTCCATCTTGTCTCT

SI-ERF.E.1 has been amplified from red fruit cDNA with the following primers:

SI-ERF.E.1_ATG_F : ATGTGTGGTGGTGCAATTCTTG

SI-ERF.E.1_TAA_R : ATAAAAACTCAATTCTTCCTA

The 2 ERFs were cloned by blunt end ligation into pGEX-6p-2 (Amersham).

Mutation of SI-ERF.B.3

Arginine in position 6 of the AP2/ERF domain of SI-ERF.B.3 has been mutated in lysine and in glutamine. These mutated proteins have been named SI-ERF.B.3/R6K and SI-ERF.B.3/R6Q. Mutations have been done with the “Quick Change Site-directed Mutagenesis Kit” (Stratagene Cat. #200518) according to manufacturer recommendations. Primers used for these mutations are the following:

ERF.B.3_R6Q_1 : GAATTACAGAGGGGTAAGGCAAAGGCCATGGGGGAAATT

ERF.B.3_R6Q_2: AATTTCCCCCATGGCCTTTGCCTTACCCCTCTGTAATTC

ERF.B.3_R6K_1: GAATTACAGAGGGGTAAGGAAGAGGCCATGGGGGAAATT

ERF.B.3_R6K_2: AATTTCCCCCATGGCCTCTTCCTTACCCCTCTGTAATTC

Proteins production

Proteins used in gel shift assay were produced *in vitro* using a “TNT®T7 Quick kit for PCR DNA” (Promega Cat. # L5540) according to manufacturer recommendations. Primers use to amplify ERF coding sequences were made compatible for the use of the kit by adding a T7 promoter, a spacer, and a Kozak consensus sequence (Kozak, 1987) on the forward primer. Thus, primers on 5' have the following structure: PromoterT7-spacer-Kozak-ATG(N)₁₇₋₂₂. Moreover, a poly “T” tail was added on the reverse primer.

Concerning non mutated protein, PCR product was obtain from previous construct in PJG vector. In this case the primers used are the following:

TNT PJG 5':

GGATCCTAATACGACTCACCTATAGGGAGCACCATGTTCCAGCTGCACGTCG

TNT PJG 3'

TTTTTTTTTTTTTTTTTTTTTTTTTTTTTTTTTTTTTCGACAACCTTGATTGGAGACTTG

Mutated proteins were produced in pGEX-6p-2 (Amersham) vector. In this case *in vitro* translations have been done with the following primers:

TNT_SI-ERF.B.3_ATG :

GGATCCTAATACGACTCACTATAGGGAGCCACCATGACGAAACAAGATGAG

GATTAAC

TNT_SI-ERF.B.3_TAG_R :

TTTTTTTTTTTTTTTTTTTTTTTTTTTTTTTTTTTTCTACACCAACTCCATCTTGTTCTCT

Electro Mobility Shift Assay:

All the primers used to generate the probes are described below:

SI-Osmotin: F : TCTAGAAAAAGCCGCCACACAC

R : ACTAGTGTGTGGCGGCTTTTTTC

Nt-Chitinase: F : TCTAGAAAGAGCCGCCACTAAC

R : ACTAGTTAGTGGCGGCTCTTTC

Nt-Chitinase_m3A: F : TCTAGAAAAAGCCGCCACTAAC

R : ACTAGTTAGTGGCGGCTTTTTTC

Nt-Chitinase_m3C: F: TCTAGAAACAGCCGCCACTAAC
R: ACTAGTTAGTGGCGGCTGTTTC

NtChitinase_m3T: F: TCTAGAAATAGCCGCCACTAAC
R: ACTAGTTAGTGGCGGCTATTTTC

NtChitinase_m4C: F: TCTAGAAAGCGCCGCCACTAAC
R: ACTAGTTAGTGGCGGCGCTTTC

NtChitinase_m4G: F: TCTAGAAAGGGCCGCCACTAAC
R: ACTAGTTAGTGGCGGCCCTTTC

NtChitinase_m4T: F: TCTAGAAAGTGCCGCCACTAAC
R: ACTAGTTAGTGGCGGCACTTTC

NtChitinase_m11C: F: TCTAGAAAGAGCCGCCCTAAC
R: ACTAGTTAGGGGCGGCTCTTTC

NtChitinase_m11G: F: TCTAGAAAGAGCCGCCGCTAAC
R: ACTAGTTAGCGGCGGCTCTTTC

NtChitinase_m11T: F: TCTAGAAAGAGCCGCCTCTAAC
R: ACTAGTTAGAGGCGGCTCTTTC

NtChitinase_m12A: F: TCTAGA AAGAGCCGCCAATAAC
R: ACTAGTTATTGGCGGCTCTTTC

NtChitinase_m12T: F: TCTAGAAAGAGCCGCCATTAAC
R: ACTAGTTAATGGCGGCTCTTTC

NtChitinase_m12G: F: TCTAGAAAGAGCCGCCAGTAAC
R: ACTAGTTACTGGCGGCTCTTTC

For annealing, forward and reverse primers were mixed in 7.5M NaCl, heated at 100°C for 2 minutes then progressively cooled to 4°C. Probes were labelled with klenow polymerase (Promega Cat. #M220) according following step:

- 15 minutes at room temperature

- 60 minutes at 37°C

Probes were labelled with ^{33}P -dATP and purified on acrylamide gel. The binding reaction was performed as follow: 2 μl of probes (corresponding to 80 fmoles), 4 μl of binding buffer 5X (100 mM TrisHCl pH8, 250 mM NaCl, 35 mM β -Mercaptoethanol, 50% glycerol) and 4 μl of proteins in a final volume of 20 μl , 20 minutes at room temperature. The binding specificity was done using as control an excess (X100) of unlabelled probe or a sample of reticulocyte extract used to produce ERF *in vitro*.

After separation on a polyacrylamide gel 6% in TBE 0.5X at 150V for 2 hours the gel was fixed with 10% acetic acid for 10 minutes then dried for 30 minutes and exposed to an autoradiographic film overnight at -80°C. Scanning and radioactivity quantification was done using a “Phosphoimageur Fujifilm Bas 5000” and the software “Image Gauge” (Fuji Film).

Chapitre 2

Article 3: *Plant Cell Physiology*. 47, 1195-1205.

**ERF2 (Sl-ERF.E.1) is involved in ethylene
response and seed germination**

Introduction à l'article 3.

La classe E (anciennement IV selon Tournier (Tournier et al., 2003) et VII selon Nakano (Nakano et al., 2006)) est caractérisée par la présence d'un motif très conservé dans la région N-terminal dont la séquence est MCGGAI(I/L) (Tournier et al., 2003). La fonction de ce motif est encore inconnue même si des résultats récents suggèrent un rôle dans l'interaction avec une protéine kinase (Jung et al., 2007). *Sl-ERF2* isolé pour la première fois par Tournier et al., 2003 appartenant à cette classe, a été renommé *Sl-ERF.E.1* conformément aux travaux précédemment décrits. L'analyse du clone génomique a mis en évidence l'existence d'un intron dans la séquence de ce gène. L'analyse de séquences d'EST disponibles dans les bases de données suggère l'existence d'un épissage alternatif. A l'aide d'oligonucléotides choisis pour discriminer les 2 formes d'ARN messager (épissé ou pas) nous avons prouvé l'existence des 2 formes de transcrits, cependant la forme épissée produisant la protéine la plus longue est majoritaire. De plus, cette forme épissée présente le domaine AP2/ERF de fixation à l'ADN ce qui suggère que ce transcrit produit une protéine fonctionnelle. L'analyse du promoteur de *Sl-ERF.E.1* a mis en évidence la présence de nombreux *cis*-éléments régulateurs incluant des Eléments de Réponse à l'Acide Abscisique (ABRE), des Eléments de Réponse à l'Ethylène (ERE) mais aussi un élément régulateur putatif RY trouvé dans les promoteurs de gènes spécifiquement régulés dans la graine (Reidt et al., 2000). Les études d'expression réalisées par PCR quantitative en temps réel ont montré que le transcript de *Sl-ERF.E.1* s'accumule principalement dans les graines. Des lignées transgéniques de tomate sur-exprimant ou sous-exprimant ce gène ont été générées. Les lignées surexprimeur montrent une cinétique de germination plus rapide que celle observée chez les lignées sauvages alors que les lignées antisense ne montrent aucun phénotype. L'absence de phénotypes chez ces lignées est probablement due à la redondance fonctionnelle pouvant exister dans cette famille multigénique. Ces lignées transgéniques montrent également une moindre sensibilité à l'ABA que les plantes sauvages. Ce phénotype de germination plus rapide peut être associé à la surexpression dans les lignées transgéniques de la *mannanase 2* considérée comme un marqueur de la germination (Nonogaki et al., 2000) et intervenant dans la dégradation des mannanes composés essentiels de l'endosperme (Dahal et al., 1997). Ce mécanisme de dégradation a été associé à la germination dans de nombreuses espèces (Watkins et al., 1985; Dutta et al., 1994; Downie et al., 1997; Sánchez and Miguel, 1997). L'acide abscisique qui est une hormone régulant négativement la germination (Toorop et al., 2000) semble réguler négativement *Sl-ERF.E.1* et la *mannanase2*. De plus, ces lignées montrent également une plus

grande sensibilité à l'éthylène. En effet, sans aucune adjonction d'éthylène les plantules de ces lignées transgéniques forment un crochet au niveau de l'hypocotyle caractéristique de la triple réponse observée chez le WT traité à l'éthylène. Cependant lorsque les récepteurs d'éthylène sont bloqués par du 1-MCP la surexpression de *Sl-ERF.E.1* ne suffit plus pour induire la formation du crochet. Ce qui signifie que la production endogène d'éthylène est nécessaire et suffisante aux lignées transgéniques à la formation du crochet. Ceci suggère que ce processus requiert d'autres composants éthylène dépendant. Pendant la germination *Sl-ERF.E.1* joue le rôle d'intégrateur du signal éthylène et du signal ABA conduisant à une régulation fine de ce processus. Pour confirmer le mécanisme proposé il serait pertinent d'effectuer des essais enzymatiques de la mannanase produite par les lignées transgéniques pour vérifier que l'activité de cette enzyme est plus importante que dans les plantes sauvages.

SI-ERF2, a Tomato Ethylene Response Factor Involved in Ethylene Response and Seed Germination

Julien Pirrello¹, Fabiola Jaimes-Miranda¹, Maria Teresa Sanchez-Ballesta, Barthélémy Tournier, Kaisar Khalil-Ahmad, Farid Regad, Alain Latché, Jean Claude Pech and Mondher Bouzayen *

UMR990 INRA/INP-ENSA Toulouse 'Génomique et Biotechnologie des Fruits' Avenue de l'Agrobiopole, BP 32607, 31326 Castanet-Tolosan cedex, France

Ethylene response factors (ERFs) are plant transcriptional regulators mediating ethylene-dependent gene expression via binding to the GCC motif found in the promoter region of ethylene-regulated genes. We report here on the structural and functional characterization of the tomato *SI-ERF2* gene that belongs to a distinct class of the large ERF gene family. Both spliced and unspliced versions of *SI-ERF2* transcripts were amplified from RNA samples and the search in the public tomato expressed sequence tag (EST) database confirmed the existence of the two transcript species in a number of cDNA libraries. The unspliced transcript contains two open reading frames yielding two hypothetical proteins, a small highly truncated version lacking the APETALA2 domain and a bigger protein lacking the N-terminal MCGGAAI¹/_L consensus peptide specific to ERF members from subfamily IV. Nevertheless, functional *SI-ERF2* protein may only derive from spliced transcripts since, depending on the tissue, the level of the spliced transcript is much higher than that of the unspliced transcript. *SI-ERF2* is expressed in all plant tissues tested, though its transcript accumulates preferentially in germinating seeds and ripening fruit. Overexpression of the *SI-ERF2* gene in transgenic tomato lines results in premature seed germination and enhanced hook formation of dark-grown seedlings, which is indicative of increased ethylene sensitivity. The expression of the *mannanase2* gene is upregulated in *SI-ERF2*-overexpressing seeds, suggesting that *SI-ERF2* stimulates seed germination through the induction of the *mannanase2* gene. It is noteworthy that the exaggerated hook phenotype is abolished when ethylene perception is blocked, strongly suggesting that *SI-ERF2* requires other ethylene-dependent components to impact the hook formation process.

Keywords: ABA — ERF — Ethylene — Germination — MAN2 — Tomato.

Abbreviations: ABRE, ABA-responsive element; AP2, APETALA2; CaMV35S, cauliflower mosaic virus 35S; Ct, threshold cycle; ERE, ethylene-responsive element; ERF, ethylene response factor; EST, expressed sequence tag; 1-MCP, 1-methylcyclopropene; MAN2, mannanase 2; ORF, open

reading frame; RT-PCR, reverse transcription-PCR; UTR, untranslated region.

Introduction

Ethylene is an important phytohormone involved in many plant developmental processes. Notably, this plant hormone is involved in germination, fruit ripening, abscission and senescence (Abeles et al. 1992). Ethylene response factors (ERFs) are known to act at the last step of the ethylene signaling pathway (Ohme-Takagi and Shinshi 1995). ERF-type transcription factors are specific to plants and belong to the large AP2/ERF family which accounts for >70 genes in *Arabidopsis thaliana* (Riechmann et al. 2000). Proteins encoded by this family have a highly conserved DNA-binding domain known as the AP2 domain made up of 58–59 amino acids involved in the high affinity binding to the target DNA sequences (Allen et al. 1998). The ERF proteins specifically bind the so-called GCC box with a strictly conserved GCCGCC core domain to modulate transcription of genes such as *PDF1.2* or *NtChitinase* harboring this type of *cis*-element on their promoter (Ohme-Takagi and Shinshi 1995, Gu et al. 2002). It is known that *ERF* genes are not only induced by ethylene but can also respond to jasmonate, ABA, NaCl (Finkelstein et al. 1998, Zhang et al. 2004), salicylic acid (Gu et al. 2000), wounding (Tournier et al. 2003) and biotic stress (Fujimoto et al. 2000, Onate-Sanchez and Singh 2002, Brown et al. 2003, Lorenzo et al. 2003).

It was reported recently that tomato ERFs belong to four distinct classes, and expression analyses revealed that representatives from each class display a differential pattern of expression in a tissue- and developmental-specific manner (Tournier et al. 2003). The tomato *SI-ERF2* (AY192368) gene belongs to class IV characterized by the presence of a conserved short N-terminal domain (MCGGAAI¹/_L) of unknown function. *SI-ERF2* was capable of binding the GCC box found in the promoter of ethylene-responsive genes and shows a distinctive

¹These authors contributed equally to this work.

* Corresponding author: E-mail, bouzayen@ensat.fr; Fax, +33-5-62-19-35-73.

ripening- and wound-associated expression, yet its transcript accumulation was unaffected by ethylene treatment in tomato leaves (Tournier et al. 2003).

ERFs have been shown to be involved in normal and abnormal plant developmental processes such as plant defense (Zhou et al. 1997, Thara et al., 1999, Brown et al. 2003, Chakravarthy et al. 2003, Cheong et al. 2003), osmotic stress tolerance (Park et al. 2001, Zhang et al. 2004) and seed germination (Finkelstein et al. 1998; Song et al. 2005). Seed germination is one of the earliest and most important steps of the plant life cycle as it allows embryos to develop into seedlings. In many plant species, germination is preceded by dormancy which is known to be maintained by ABA (Hilhorst et al. 1995) while gibberellin is required for breaking dormancy and inducing germination (Karssen et al. 1989, Debeaujon and Koorneef 2000). Germination is characterized by radicle protrusion as a result of weakening of the endosperm region enclosing the radicle tip, termed the endosperm cap (Groot and Karsen 1987). The ABA-insensitive Arabidopsis mutant *abi4* affected in seed germination displays altered expression of seed-specific genes (Finkelstein et al. 1998) and the *abi4* mutation is caused by a single pair deletion within an *APETALA2* gene (Finkelstein et al. 1998). While it has been known for a long time that ethylene impacts seed germination, it was demonstrated only recently that ERFs are involved in ethylene-dependent regulation of seed germination (Song et al. 2005). It was reported that AtERF7 acts as a transcriptional repressor of the ABA response and that transgenic Arabidopsis lines expressing an RNAi construct targeted to down-regulate the AtERF7 gene are more sensitive to ABA and germinate later than the wild-type seeds.

While direct evidence for the involvement of ERFs in the seed germination process is still scarce, we report in the present study that overexpression of the *Sl-ERF2* gene in transgenic tomato lines results in premature seed germination and causes altered ethylene response as assessed by the triple response. Moreover, our data suggest that Sl-ERF2 may stimulate seed germination through the activation of the *Sl-Man2* gene encoding mannanase.

Results

Structure of the Sl-ERF2 gene

In order to gain more information on the structure of the tomato *Sl-ERF2* gene, a 2,517 bp genomic fragment was isolated and fully sequenced, allowing delineation of the promoter region (1,367 bp) and the transcribed region (1,150 bp). The isolated gene is composed of two exons and one intron and contains an open reading frame (ORF) of 783 bp. As shown in Fig. 1A, the first exon starts at nucleotide 151 and ends at nucleotide 292, and the second

exon encompasses the region from nucleotide 368 to 1,150. Upstream of the first exon there is a 5'-untranslated region (5'UTR) of 150 bp and downstream of the second exon a 3'UTR of 141 bp. The *Sl-ERF2* gene contains a single, small intron of 75 bp (Fig. 1A). The closest Arabidopsis homolog of *Sl-ERF2* is *AtEBP* (AT3G16770.1) which also contains a single intron though of a larger size (237 bp). Sl-ERF2- and AtEBP-encoded proteins display 52% identity and 64% similarity at the amino acid level.

Features of the Sl-ERF2 promoter

The tomato *Sl-ERF2* genomic clone contains a 1,367 bp fragment upstream of the transcription site corresponding to the promoter region that is likely to harbor most regulatory elements necessary for driving the regulated transcription of the gene. In silico analysis of the promoter performed by PlantCare software (<http://bioinformatics.psb.ugent.be/webtools/plantcare/html/>) identified three putative ABA-responsive elements (ABREs) containing the consensus sequence GTACGTGGCGC lying at positions -929, -1,183 and -1,194 (Fig. 1A). A putative regulatory element, known as an RY-element, found in the promoter region of seed-specific regulated genes, was also identified at position -605. Finally, at least five putative ethylene-responsive elements (EREs) were found at positions -747, -631, -431, -322 and -32 (Fig. 1A).

Tomato Sl-ERF2 gene undergoes alternative splicing

Two Sl-ERF2 transcripts were detected and the corresponding cDNAs cloned and sequenced. The presence of the intronic region in one of these mRNA species raises the possibility that Sl-ERF2 undergoes alternative splicing (Fig. 1B). The search in the tomato expressed sequence tag (EST) database (sgn.cornell.edu) identified a number of contigs (SGN-E375112, SGN-E378950, SGN-E377694, SGN-E258222, SGN-E233294 and SGN-E231194) that contain an intronic region, confirming the co-existence of spliced and unspliced versions of Sl-ERF2 transcripts and suggesting that alternative splicing may play a role in controlling the expression of the *Sl-ERF2* gene. Sequence analysis of the unspliced Sl-ERF2 transcript revealed two putative 'Stop codons', the first being located in the intron region at position 153 from the 'Start codon' and the second at position 858. Two proteins can therefore be derived from this transcript: (i) a low molecular weight predicted peptide (5.5 kDa) of 50 amino acids; and (ii) a higher molecular weight protein of 209 amino acids (24 kDa). Compared with the protein derived from the spliced version of the Sl-ERF2 transcript, the short putative protein corresponds to the N-terminal part lacking the AP2 domain, while the larger one corresponds to the C-terminal moiety containing the AP2 domain but lacking the

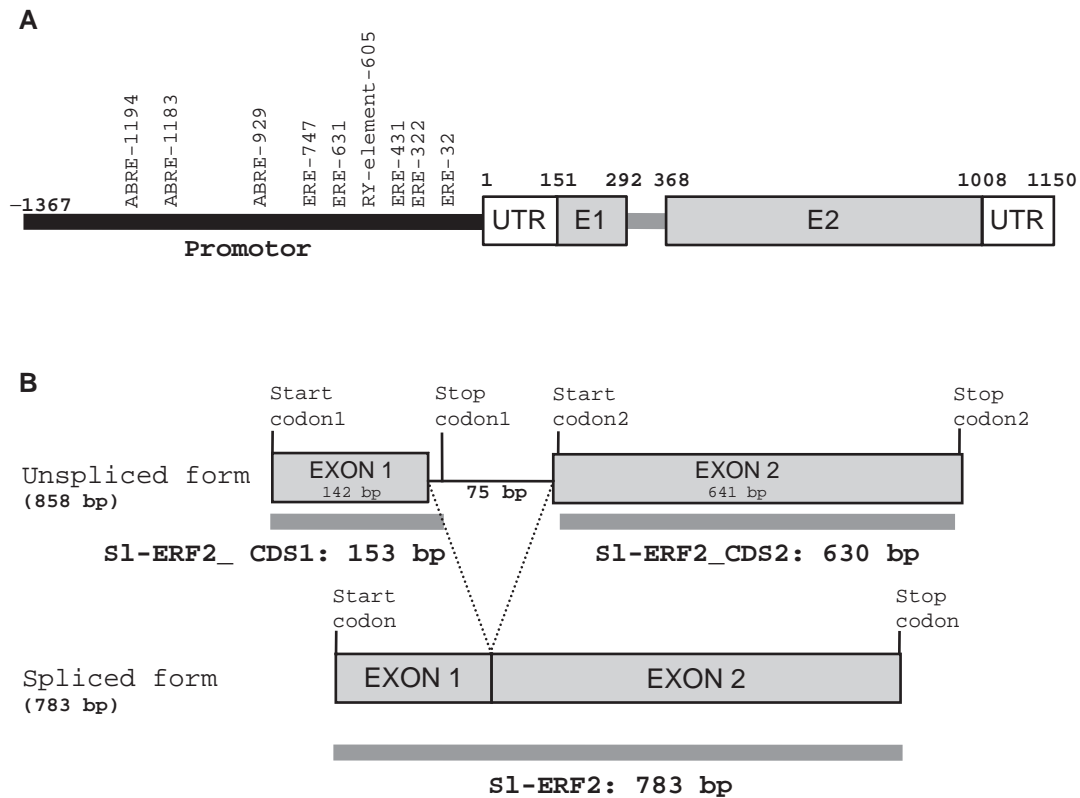

Fig. 1 Structure of the *Sl-ERF2* gene. (A) Genomic structure of the tomato *Sl-ERF2* (AAO34704) gene. The black line represents the promoter region, the gray line the intron, the gray boxes the exons, and white boxes the untranslated region. (B) Structure of *Sl-ERF2* unspliced and spliced forms. Gray boxes represent the exons, the black line the intron, and the gray lines represent complete open reading frames.

N-terminal MCGGAAI^I/_L consensus peptide specific to members of subfamily IV of the ERF gene family (Fig. 1B).

In order to assess the relative abundance of each version of the *Sl-ERF2* transcripts, we performed a comparative analysis of the accumulation of the spliced and unspliced *Sl-ERF2* transcripts. Specific primers allowing discrimination between the two mRNA species were used in a quantitative reverse transcription-PCR (RT-PCR) experiment with RNA samples extracted from different plant tissues. Table 1 shows that accumulation of the spliced transcript is 82–70,000 times higher than that of the unspliced version, suggesting that the spliced version accounts for most of the *Sl-ERF2* transcripts in all tissues tested. Hence, because it is more likely that functional *Sl-ERF2* protein only derives from the spliced transcript, we decided to target subsequent expression studies to this type of transcript.

Sl-ERF2 is mainly expressed in ripening fruit

To uncover the expression pattern of the *Sl-ERF2* gene at the transcriptional level, quantitative RT-PCR analyses were performed using different tomato plant tissues.

Table 1 Abundance of the unspliced and spliced forms of the *Sl-ERF2* transcript in different tissues of tomato plants

	Spliced/unspliced	±SD
Red fruit	72,744	2,395
Flower	10,026	3,113
Root	5,451	6,22
Seed	82	13
Stem	10,822	1,523

Transcript accumulation was monitored using specific primers, allowing complete discrimination between the spliced and unspliced forms. The expression level of both forms was assessed by real-time PCR, and the data are expressed in fold differences in the abundance of the *Sl-ERF2* spliced transcript relative to the unspliced transcript.

The data presented in Fig. 2A reveal a ubiquitous expression of *Sl-ERF2* in various plant tissues even though transcripts appear to accumulate preferentially in germinating seeds and ripening fruit. Pre-germinating seeds display the highest level of transcript accumulation, whereas the lowest expression is found in roots where *Sl-ERF2* transcript accumulation is 10 times lower than that in fruit.

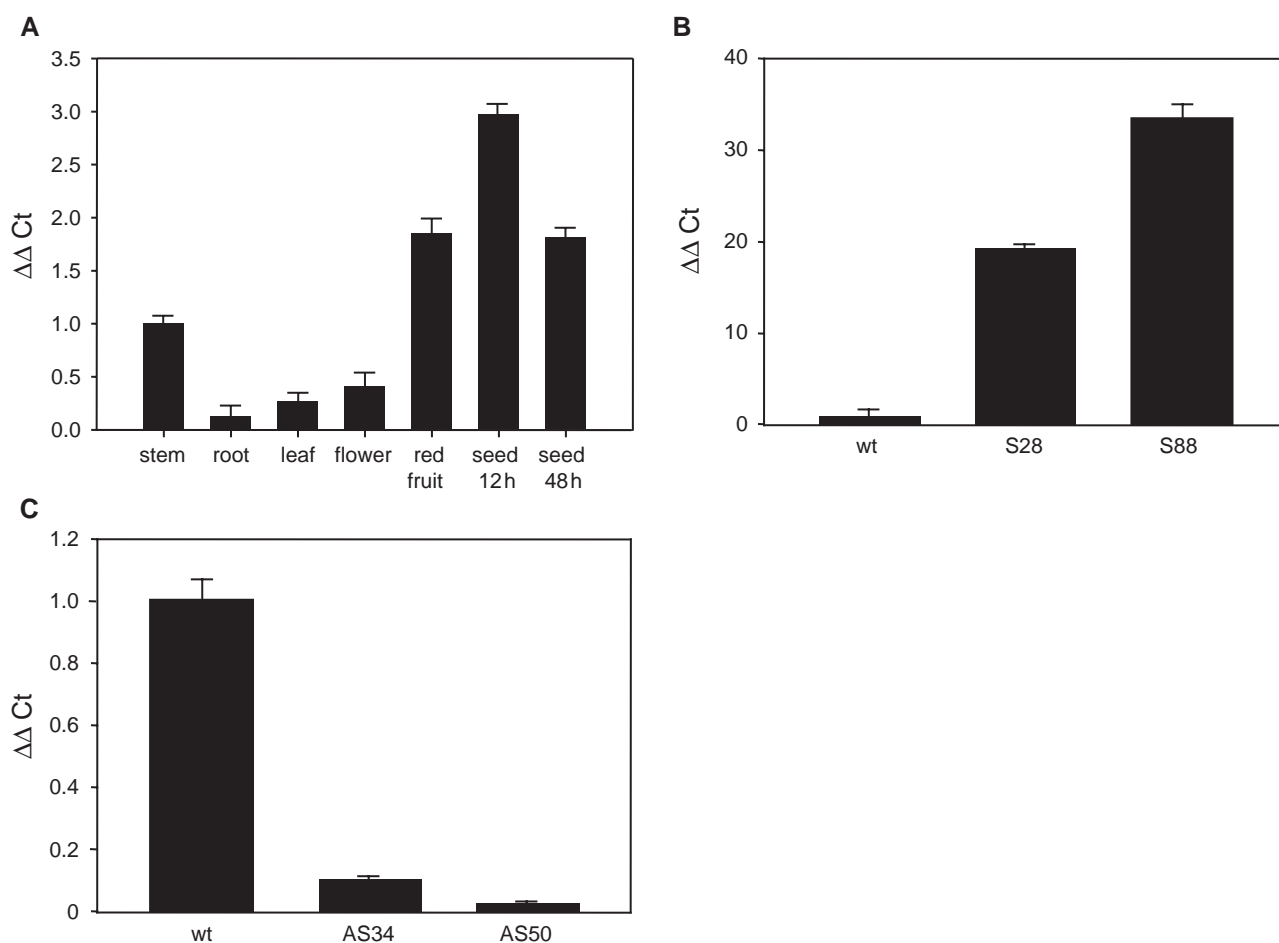

Fig. 2 Expression pattern of *SI-ERF2*. (A) Tissue-specific expression of *SI-ERF2* in tomato. The levels of *SI-ERF2* transcripts were assessed by real-time quantitative PCR and the data are mean values of three independent experiments. Accumulation of spliced *SI-ERF2* transcript was monitored in stem, root, leaf, flower, red fruit (69 d post-anthesis) and seeds after 12 and 48 h of imbibition in water. $\Delta\Delta Ct$ refers to the fold difference in *SI-ERF2* abundance relative to stem taken as a reference tissue. (B) Overexpression of the *SI-ERF2* gene in transgenic tomato seeds. The levels of *SI-ERF2* transcripts in transgenic sense lines (S28 and S88) were assessed by real-time quantitative PCR, and $\Delta\Delta Ct$ refers to the fold difference in *SI-ERF2* transcript accumulation relative to wild type (WT). The data are mean values corresponding to three independent experiments. (C) Down-regulation of the *SI-ERF2* transcript in transgenic tomato plants expressing an antisense construct of the *SI-ERF2* gene. The level of *SI-ERF2* transcripts in transgenic antisense lines (AS34 and AS50) was assessed by real-time quantitative PCR, and $\Delta\Delta Ct$ refers to the fold difference in *SI-ERF2* transcript accumulation relative to wild type (WT). The data are mean values corresponding to two independent experiments.

Overexpression of SI-ERF2 results in enhanced ethylene sensitivity and premature seed germination

In an attempt to unveil the physiological significance of *SI-ERF2* and to better explore its role in seed germination, we generated tomato lines under- and overexpressing this gene by stably transforming tomato plants with either sense or antisense constructs under the control of the constitutive 35S promoter. A number of homozygous transgenic lines corresponding to independent transformation events were obtained and analyzed. It is noteworthy that no visible phenotypes could be detected in any of the *SI-ERF2*-suppressed lines (Fig. 2C), which may be due to functional redundancy among *ERF* genes. In contrast,

SI-ERF2-expressing lines showed visible phenotypes associated with seed germination and ethylene response. Two transgenic lines S28 and S88 showing 19 and 33 times higher accumulation of *SI-ERF2* transcript, respectively, were selected for subsequent studies (Fig. 2B).

Hook formation in the seedlings is one component of the typical triple response displayed by dark-grown seedlings in response to the plant hormone ethylene. Compared with the wild type, dark-grown overexpressing lines exhibited exaggerated apical hook formation in the absence of exogenous ethylene treatment (Fig. 3A). Table 2 shows that when grown in the dark, 1% of wild-type seedlings exhibit complete hook formation, whereas this

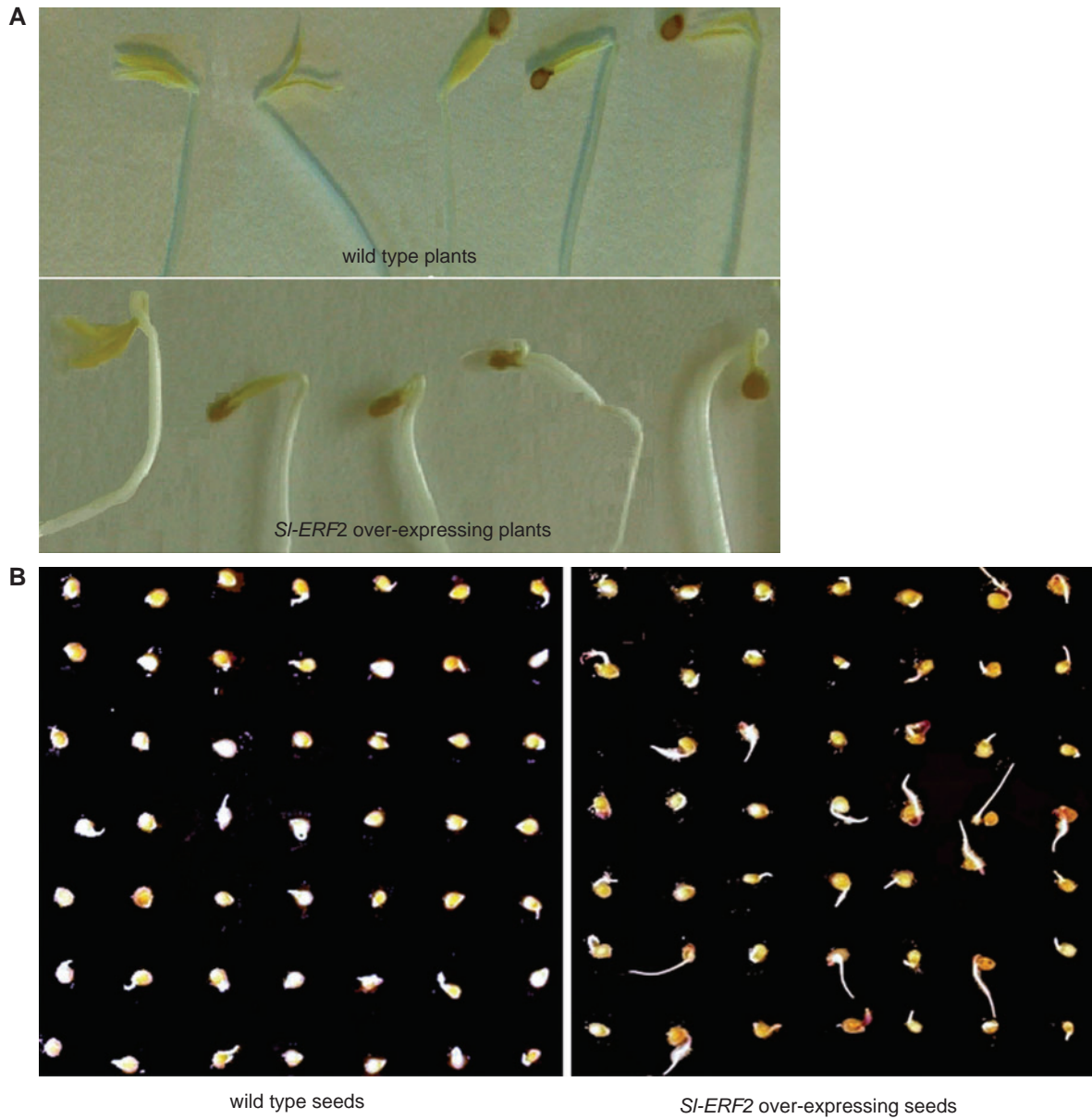

Fig. 3 Phenotypes of the transgenic *SI-ERF2*-overexpressing lines. (A) Exaggerated hook curvature displayed by overexpressing lines compared with the wild type. Hook curvature was monitored on 4-day-old etiolated seedlings. (B) Early germination phenotype displayed by *SI-ERF2*-overexpressing tomato lines. Seeds were imbibed on water-prepared 1% agar, and germination was scored at root protrusion.

proportion increased up to 16 and 18% for S28 and S88 overexpressing lines, respectively. Furthermore, treatment with 1-methylcyclopropene (1-MCP), a potent inhibitor of ethylene perception, abolished formation of a complete hook in the sense lines (Table 2).

SI-ERF2 is involved in seed germination

Considering the presence of the RY-element, a motif present in seed-specific promoters, and the ABREs in the

SI-ERF2 promoter, we sought to assess the effect of the overexpression of the *SI-ERF2* gene on seed germination. Figs. 3B and 4A show that both S28 and S88 lines displayed early germination compared with the wild type. Indeed, after 78 h imbibition in water, up to 72 and 66% of S28 and S88 overexpressing seeds germinated, respectively, whereas <25% of wild-type seeds initiated the germination process. Fig. 4A also indicates that both wild-type and transgenic seeds display full germination potential (100% germinated seeds) after 142 h. Because these data suggest that *SI-ERF2*

might be involved in triggering the seed germination process, we tested whether *Sl-ERF2* overexpression is capable of overcoming the typical ABA inhibition of seed germination. We therefore assessed the effect of this

Table 2 Apical hook formation in etiolated wild-type and *Sl-ERF2*-overexpressing tomato lines

	Air		1-MCP	
	%	±SD	%	±SD
Wild type	1	0.08	0	0
S88	16	2.9	1.5	0.21
S28	18	1.1	0	0

Complete hook formation (exceeding 270°) in wild-type and *Sl-ERF2*-overexpressing seedlings in the dark in air or in air + 1-MCP was scored. The data correspond to the mean value of three biological replicates corresponding to the seedlings.%, percentage of seedlings with complete hook formation. $P < 0.05$.

hormone on the germination of transgenic seeds. Fig. 4B shows that in the presence of 3 μM ABA, 85% of wild-type seeds failed to germinate, while in the same condition, inhibition of seed germination was reduced to 45 and 68% for S88 and S28 transgenic seeds, respectively. However, higher ABA concentrations resulted in almost complete inhibition of germination of both wild-type and *Sl-ERF2*-expressing seeds. We addressed the impact of ABA treatment on the expression of *Sl-ERF2* in germinating seeds. Fig. 4C shows that the seed-associated expression of *Sl-ERF2* is reduced when seed germination is inhibited by exogenous ABA treatment. However, ABA inhibition of *Sl-ERF2* gene expression in wild-type germinating seeds occurs only after 48 h imbibition but not at earlier stages (Fig. 4C).

In order to gain better insight into the mechanism by which *Sl-ERF2* impacts seed germination, we assessed its transcript accumulation during this process. Taking into

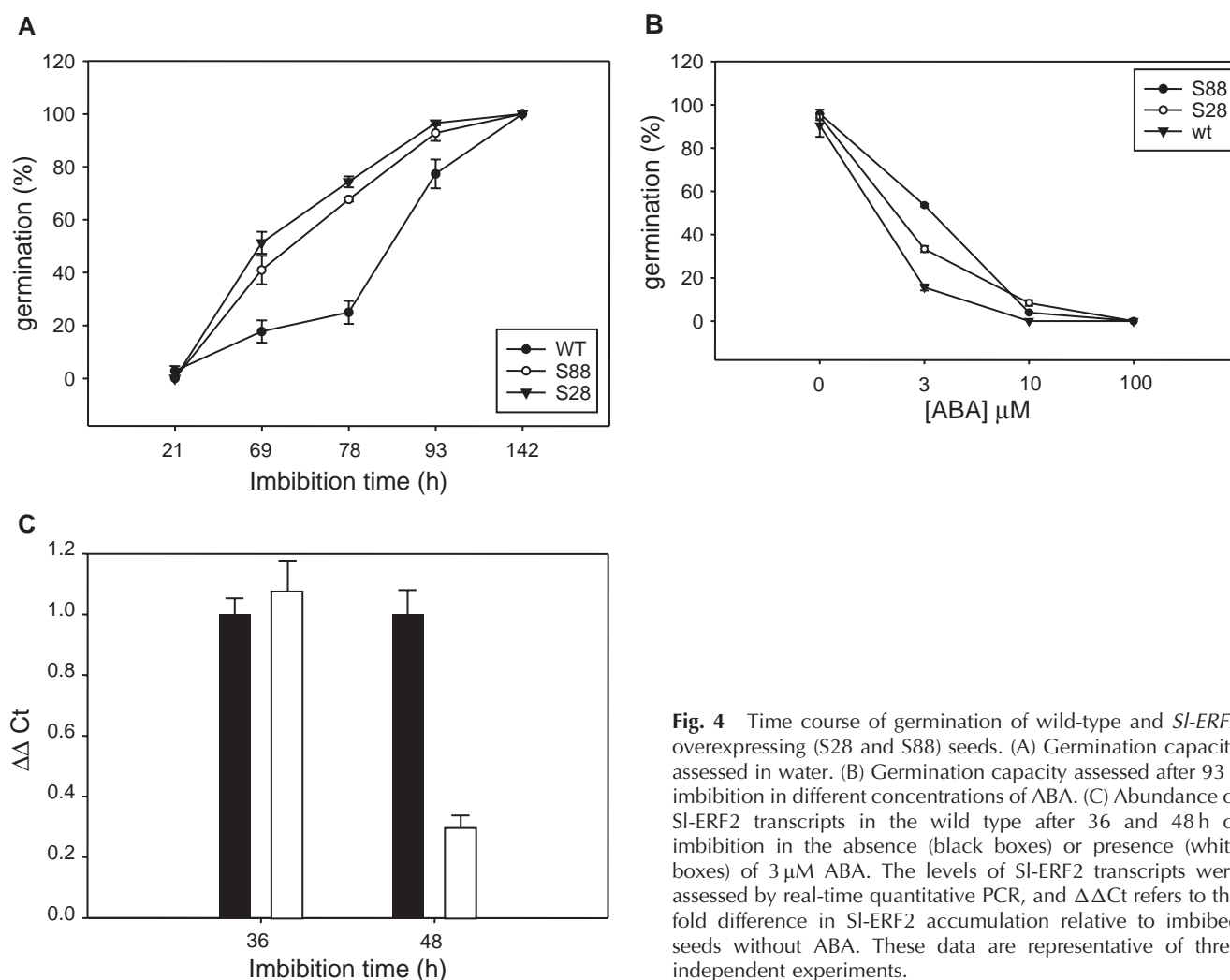

Fig. 4 Time course of germination of wild-type and *Sl-ERF2* overexpressing (S28 and S88) seeds. (A) Germination capacity assessed in water. (B) Germination capacity assessed after 93 h imbibition in different concentrations of ABA. (C) Abundance of *Sl-ERF2* transcripts in the wild type after 36 and 48 h of imbibition in the absence (black boxes) or presence (white boxes) of 3 μM ABA. The levels of *Sl-ERF2* transcripts were assessed by real-time quantitative PCR, and $\Delta\Delta\text{Ct}$ refers to the fold difference in *Sl-ERF2* accumulation relative to imbibed seeds without ABA. These data are representative of three independent experiments.

account that *Sl-ERF2* can give rise to two types of transcripts, specific primers were designed to target exclusively the spliced mRNA in all quantitative RT-PCR experiments. Fig. 5A shows that *Sl-ERF2* transcript accumulation in germinating wild-type seeds decreases after 24 h imbibition and then increases at 48 h, coincident with the start of the germination process (see Fig. 4A).

The mannanase2 gene is up-regulated in the Sl-ERF2 overexpressing lines

Because the *mannanase2* gene (AF184238) is considered as a marker of seed germination (Nonogaki et al. 2000), we assessed the accumulation of the tomato *mannanase2* transcript (*Sl-MAN2*) in germinating seeds. In wild-type seeds, the level of *Sl-MAN2* transcript decreases slightly after 6 h of imbibition in water and then undergoes a dramatic increase, reaching 15 times its initial level after 48 h imbibition (Fig. 5B). In order to uncover whether the overexpression of *Sl-ERF2* impacts the accumulation of *Sl-MAN2* transcripts during the germination process, we assessed the level of *Sl-MAN2* transcripts in the transgenic lines. Quantitative RT-PCR data (Fig. 6) reveal that after 12 h imbibition, accumulation of *Sl-MAN2* transcripts is substantially higher in *Sl-ERF2*-expressing seeds than in the wild type. The level of *Sl-MAN2* transcripts in S28 and S88 is three and six times higher than in the wild type, respectively, clearly indicating that the *Sl-MAN2* gene is up-regulated in the overexpressing lines (Fig. 6).

To explore further whether the *Sl-MAN2* gene is under direct regulation by *Sl-ERF2* and in order to address whether seed germination is dependent on the expression of the *mannanase2* gene, we assessed its expression in wild-type and transgenic seeds upon ABA treatment. Fig. 7 indicates that accumulation of *Sl-MAN2* transcripts completely collapses in the presence of 3 μ M ABA in both wild-type and *Sl-ERF2*-overexpressing lines. However, the ABA-induced inhibition of *mannanase2* expression is higher in wild type (39 times) than in transgenic S28 and S88 lines where it reaches 11 times and six times, respectively, (Fig. 7). As a result, the level of *Sl-MAN2* transcripts in transgenic seeds remains significantly higher than that in the wild type, which correlates with the higher germination capacity exhibited by S88 and S28 lines (see Fig. 4B).

Discussion

ERF proteins are defined as a large family of transcription factors involved in ethylene-mediated regulation of gene expression (Ohme-Takagi and Shinshi 1995). We have described previously four new members of the ERF gene family in tomato and showed that, among these, *Sl-ERF2* exhibits a ripening-associated pattern of

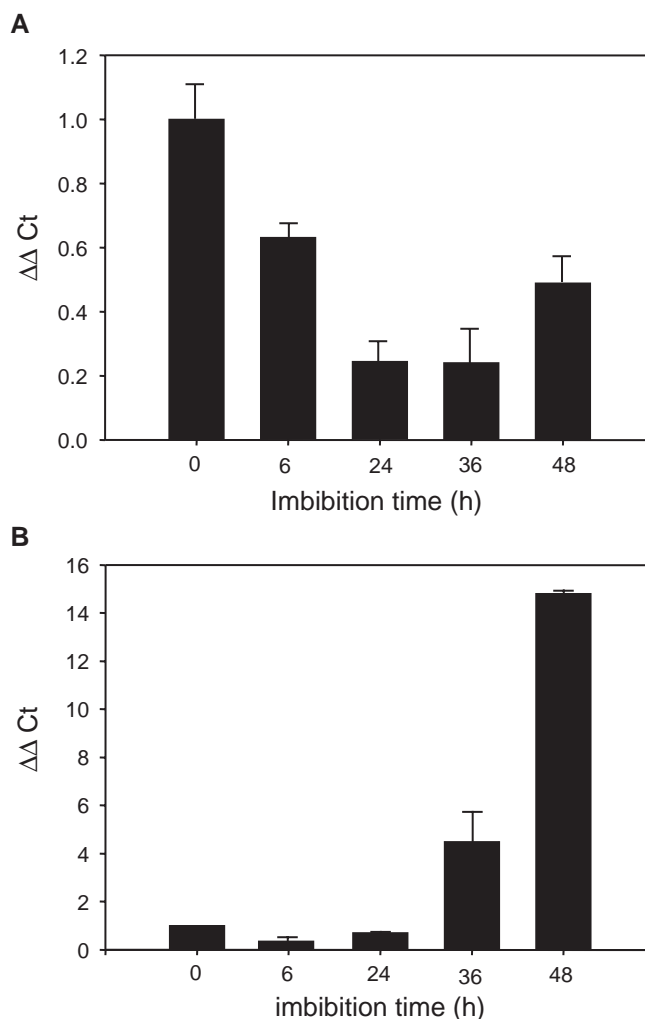

Fig. 5 Time course of accumulation of *Sl-ERF2* and *Sl-MAN2* transcripts during seed imbibition. Transcript accumulation of *Sl-ERF2* (A) and *Sl-MAN2* (B) assessed by real-time quantitative PCR. The experiment was carried out in triplicate, and $\Delta\Delta Ct$ refers to the fold difference in *Sl-ERF2* and *Sl-MAN2* expression relative to time 0 h.

expression (Tournier et al. 2003). We report here that *Sl-ERF2* is also involved in other ethylene-dependent developmental processes such as apical hook formation and seed germination. Comparative analyses show that the tomato *Sl-ERF2* gene shares a similar structure with *AtEBP*, its putative Arabidopsis ortholog. Both genes are composed of two exons and a single small intron. However, while the regulation through alternative splicing has not been described so far for any member of the ERF family, an important feature of the *Sl-ERF2* gene is the presence of two different transcripts corresponding to spliced and unspliced versions. The search in the tomato EST database (sgn.cornell.edu) confirmed the existence of the two mRNA species, opening up the possibility that alternative splicing

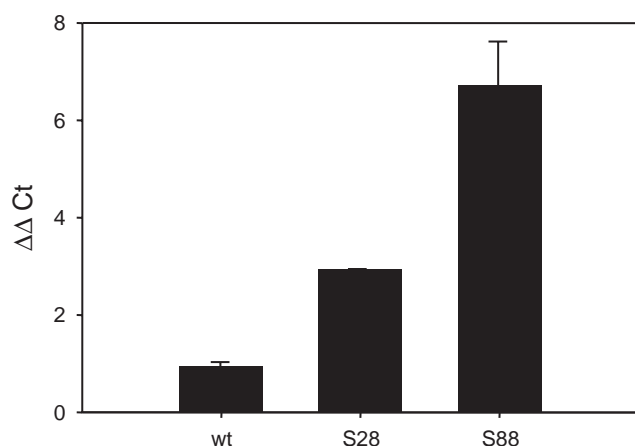

Fig. 6 Quantitative RT-PCR analysis of *SI-MAN2* transcript accumulation in *SI-ERF2*-overexpressing tomato seeds. $\Delta\Delta\text{Ct}$ refers to the fold difference in *SI-MAN2* expression relative to the wild type.

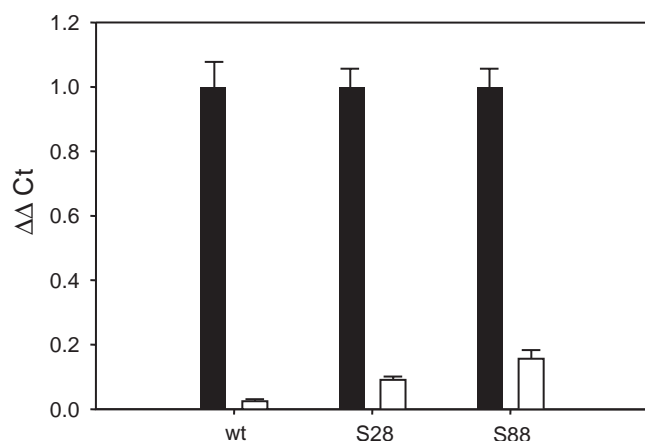

Fig. 7 ABA responsiveness of *SI-MAN2* in imbibed seeds. RNAs were extracted from wild-type (WT) or *SI-ERF2*-overexpressing (S28 and S88) seeds after 48 h of imbibition in either the absence (black boxes) or presence (white boxes) of 3 μM ABA. The levels of *SI-MAN2* transcripts were assessed by real-time quantitative PCR in triplicate, and $\Delta\Delta\text{Ct}$ refers to the fold difference in *SI-MAN2* expression relative to imbibed seeds without ABA.

might play a role in the regulation of the *SI-ERF2* gene in this species. Yet it appears that the unspliced *SI-ERF2* transcript is unlikely to give rise to functional protein since two truncated proteins can be derived from the two ORFs, one corresponding to the N-terminal part lacking the AP2 domain and the other corresponding to the C-terminal part which lacks the N-terminal MCGGAAI¹/_L consensus peptide specific to ERF members of subfamily IV (Tournier et al. 2003). Moreover, in all tomato tissues considered, the abundance of the spliced *SI-ERF2* transcripts is several thousand times higher than that of the unspliced form and therefore accounts for most of *SI-ERF2*-derived transcripts.

Taking into account that the abundance of the unspliced transcript is several thousand fold lower than that of the spliced form, and that the putative proteins derived from the unspliced form are truncated proteins, it can be speculated that functional proteins may only derive from the spliced transcript.

The *SI-ERF2* promoter harbors a number of putative *cis*-regulatory elements, among which are three ABREs, an RY-element found in seed-specific regulated genes (Fujiwara and Beachy 1994, Reidt et al. 2000) and five putative EREs. The presence of these regulatory elements suggests a role for *SI-ERF2* in the associated developmental processes. The physiological significance of the *SI-ERF2* gene was therefore addressed here by the analysis of up- or down-regulated transgenic tomato lines. However, none of the *SI-ERF2*-suppressed lines showed any visible phenotype which may result from functional redundancy among members of the ERF gene family. In contrast, consistent with the presence of the RY and ERE *cis*-elements in the promoter region of the *SI-ERF2* gene, overexpressing lines showed altered phenotypes associated with seed germination and ethylene response. The enhanced ethylene response in *SI-ERF2*-expressing lines is revealed by exaggerated hook formation in the absence of ethylene treatment. While these data strongly suggest that *SI-ERF2* is actively involved in hook formation, they also indicate that in the absence of ethylene perception, *SI-ERF2* alone is unable to induce hook formation. Therefore, *SI-ERF2* protein seems to require some other ethylene-dependent components to impact this developmental process.

Up-regulation of *SI-ERF2* also results in premature seed germination concomitant with enhancement of *mannanase2* gene expression. A number of studies showed that mannanase activity correlates with the germination process (Dahal et al. 1997, Dutta et al. 1997). It was reported that the endosperm cell walls contain approximately 60% mannan (Groot et al. 1988, Dahal et al. 1997) probably in the form of galactomannan or galactoglucomannan polymers which constitute the major carbohydrate reserves of the endosperm and contribute to its rigidity. Endo-(1,4)- β -mannanase, which hydrolyzes internal bonds within mannan polymers, has been associated with the mechanism of seed germination in many plant species (Watkins et al. 1985, Dutta et al. 1994, Downie et al. 1997, Dutta et al. 1997, Sanchez and De Miguel 1997). Mannanase activity was found to be high in the endosperm tissue and, among the tomato mannanase genes expressed in this tissue, *SI-Man2* was shown to be preferentially expressed in the endosperm cap of seeds prior to radicle emergence. In contrast, *SI-Man1* is expressed at the post-germinative phases (Nonogaki et al. 2000). Therefore, the expression of the *SI-Man2* gene can be considered as a good marker of seed germination and the *SI-Man2* protein as a

germination-specific protein. Mannanase gene expression seems to be required for seed germination, and in the *Sl-ERF2*-expressing lines the premature seed germination correlates with an enhanced expression of the *Sl-Man2* gene, suggesting that SI-ERF2 impacts seed germination through the positive regulation of the *Sl-Man2* gene. While we confirm in this study that ABA plays a role in the inhibition of seed germination (Toorop et al. 2000), we show for the first time that ABA exerts a negative regulation on both *Sl-ERF2* and *Sl-Man2* genes. Our data indicate therefore that ABA and SI-ERF2 have opposite effects on the expression of the mannanase gene and hence on seed germination. During the process of seed germination, SI-ERF2 may allow functional integration of ethylene and ABA signals, leading to a fine coordination of this crucial developmental process. The role of ERF-like proteins in integrating ABA and ethylene responses has been recently demonstrated for AtERF7, an Arabidopsis ERF, expressed during drought stress responses of plants (Song et al. 2005).

Materials and Methods

Plant material

Tomato (*Solanum lycopersicum* cv MicroTom) plants were grown under standard greenhouse conditions. For growth in chamber rooms, the conditions are as follow: 14 h day/10 h night cycle, 25/20°C day/night temperature, 80% hygrometry, 250 $\mu\text{mol m}^{-2} \text{s}^{-1}$ intense luminosity.

Plant transformation

A sense construct consisting of the full-length coding sequence of *Sl-ERF2* (from ATG to the Stop codon) under the transcriptional control of the cauliflower mosaic virus 35S (CaMV 35S) promoter and the nopaline synthase (NOS) terminator was introduced into tomato plants using the pGA643 binary vector. *Agrobacterium tumefaciens*-mediated transformation of tomato plants was carried out according to Jones et al. (2002), and transformed lines were selected as in Wang et al. (2005). All experiments were carried out using homozygous lines from F₃ or later generations.

Germination assay

After fruits were harvested, seeds were collected and stored at 20°C until use. For germination experiments, 100 tomato seeds were placed in Petri dishes on one layer of filter paper moistened with 10 ml of water, and incubated at 25°C in the dark. For ABA treatment, seeds were imbibed in the presence 3, 10 and 100 μM ABA.

Apical curvature test

Sterilized seeds were put on Murashige and Skoog agar medium plates and placed in the dark for 2 d at 4°C. Hook formation was assessed on 3-day-old dark-grown seedlings with or without MCP, and the apical curvature was estimated visually. Fifty seedlings were used for each experiment and three biological replicates were performed.

Isolation of the genomic clone

Genomic DNA was extracted from 1 g of ground tomato (*S. lycopersicum*) leaf tissue. The resulting powder was mixed with 5 ml of extraction buffer [2% (w/v) hexadecyl-trimethylammonium bromide, 1.4 M NaCl, 20 mM EDTA and 100 mM Tris-HCl, pH 8] and warmed at 65°C for 10 min. After a phenol/chloroform/isoamylalcohol and chloroform extraction, DNA was precipitated with 1 vol. of isopropanol for 20 min on ice. After centrifugation (5 min at 2,000 \times g), the pellet was re-suspended in 10 ml of washing buffer [76% (v/v) ethanol and 10 mM ammonium acetate]. After centrifugation (10 min at 2,000 \times g), the DNA was re-suspended in 200 μl of sterile water. An RNase treatment was done at 37°C for 10 min. A pair of primers was chosen based on the cDNA sequence, and PCRs were performed on the genomic DNA. The amplified fragments were cloned and fully sequenced. Comparative analysis between the genomic clone and cDNA sequences allowed the delimitation of introns and exons.

Isolation of the *Sl-ERF2* promoter

The Universal Genome Walker Kit (Clontech Laboratories, Inc., Palo Alto, CA, USA) was used to isolate the *Sl-ERF2* gene promoter region. Each tomato genomic DNA aliquot was digested with four 6bp-recognizing and blunt end-forming restriction enzymes *Dra*I, *Eco*RV, *Pvu*II and *Stu*I. Adaptor DNA which harbored two primer-binding sites for AP1 and AP2 primers provided by the Genome Walker Kit was linked to both ends of the restricted tomato DNA fragment at 16°C. AP1 (5'-GTAATACGACTCACTATAGGGC-3') and AP2 (5'-ACTATAGGGCAGCGTGGT-3') primers were used for PCR amplification, and were paired with two *Sl-ERF2* gene-specific antisense primers. The tomato genomic DNA fragment with adaptors at both ends was used as a template for the amplification of the promoter region. The generated PCR product was cloned into pGEMT-easy vector (Promega) and fully sequenced. DNA sequences were analyzed with BLAST network services at the National Center for Biotechnology Information (Altschul et al. 1997), and by PlantCARE, (Lescot et al. 2002).

RNA extraction and quantitative PCR

RNA was extracted by the phenol-chloroform method according to Zegzouti et al. (1999). Extractions from seed tissue were performed at different times of imbibition: 0, 6, 24, 36 and 48 h before root protrusion. The same protocol was used for RNA extraction from stem, leaf, root, flower and fruit tissues. DNase-treated RNA (2 μg) was then reverse-transcribed in a total volume of 20 μl using the Omniscript Reverse Transcription Kit (Qiagen, Valencia, CA, USA). Real-time quantitative PCR was performed using cDNAs corresponding to 2.5 ng of total RNA in a 10 μl reaction volume using the SYBR Green PCR Master Mix (PE-Applied Biosystems, Foster City, CA, USA) on an ABI PRISM 7900HT sequence detection system. PRIMER EXPRESS software (PE-Applied Biosystems) was used to design gene-specific primers for SI-ERF2 and SI-MAN2 transcripts. To assess the relative abundance of the SI-ERF2 spliced and unspliced transcripts, we designed specific primers capable of discriminating between the two mRNA species. *Actin* was used as a reference gene with constitutive expression in various tissues. The following gene-specific primers were used: SI-ERF2F spliced, GTTCCTCTCAACCCCAAACG; SI-ERF2R spliced, TTCATCTGCTCACCCTGTAGA; SI-ERF2F_unspliced, TCGACCCTCTACAGGTACTAGTTAATCATATATA; SI-ERF2R_unspliced, TTCCTCGCTCACCACCTGTTT;

SI-MAN2F, GAATTGGGAAAAAATCCATCCA; SI-MAN2R, TCATGGCATGAGACTGACTTGTAAT; SI-Actin-51F, TGTC CCTATTTACGAGGGTTATGC; SI-Actin-51R, AGTTAAATC ACGACCAGCAAGAT.

For *Sl-ERF2* and *Sl-MAN2*, the optimal primer concentration was 300 nM and for SI-Actin the primers were used at 50 nM concentration. Real-time PCR conditions were as follow: 50°C for 2 min, 95°C for 10 min, then 40 cycles of 95°C for 15 s and 60°C for 1 min, and finally one cycle at 95°C for 15 s and 60°C for 15 s. For all real-time PCR experiments, two biological replicates were made and each reaction was run in triplicate. For each sample, a Ct (threshold constant) value was calculated from the amplification curves by selecting the optimal ΔR_n (emission of reporter dye over starting background fluorescence) in the exponential portion of the amplification plot. Relative fold differences were calculated based on the comparative Ct method using the SI-Actin-51 (accession No. Q96483) as an internal standard. To determine relative fold differences for each sample in each experiment, the Ct value for *Sl-ERF2* and *Sl-MAN2* genes was normalized to the Ct value for SI-Actin-51 and was calculated relative to a calibrator using the formula $2^{-\Delta\Delta Ct}$.

Acknowledgments

We are grateful to Lydie Tessarotto, Hélène Mondières and Dominique Saint-Martin for tomato genetic transformation and plant growth. This work was supported by the Midi-Pyrénées Regional Council (Grants 01008920 and 03001146) and forms part of the requirement for the degree of PhD for J.P. and F.J.M. F.J.M. was supported by a doctoral scholarship from Consejo Nacional de Ciencia y Tecnología (CONACyT, Mexico).

References

- Abeles, F.B., Morgan, P.W. and Saltveit, M.E.Jr (1992) Ethylene in Plant Biology 2nd edn. Academic Press, San Diego.
- Allen, M.D., Yamasaki, K., Ohme-Takagi, M., Tateno, M. and Suzuki, M. (1998) A novel mode of DNA recognition by a beta-sheet revealed by the solution structure of the GCC-box binding domain in complex with DNA. *EMBO J* 17: 5484–5496.
- Altschul, S.F., Madden, T.L., Schaffer, A.A., Zhang, J., Zhang, Z., Miller, W. and Lipman, D.J. (1997) Gapped BLAST and PSI-BLAST: a new generation of protein database search programs. *Nucleic Acids Res.* 25: 3389–3402.
- Brown, R.L., Kazan, K., McGrath, K.C., Maclean, D.J. and Manners, J.M. (2003) A role for the GCC-box in jasmonate-mediated activation of the *PDF1.2* gene of Arabidopsis. *Plant Physiol.* 132: 1020–1032.
- Chakravarthy, S., Tuori, R.P., D'Ascenzo, M.D., Fobert, P.R., Despres, C. and Martin, G.B. (2003) The tomato transcription factor Pti4 regulates defense-related gene expression via GCC box and non-GCC box cis elements. *Plant Cell* 15: 3033–3050.
- Cheong, Y.H., Moon, B.C., Kim, J.K., Kim, C.Y., Kim, M.C., et al. (2003) BWMK1, a rice mitogen-activated protein kinase, locates in the nucleus and mediates pathogenesis-related gene expression by activation of a transcription factor. *Plant Physiol.* 132: 1961–1972.
- Dahal, P., Nevins, D.J. and Bradford, K.J. (1997) Relationship of endo-[beta]-D-mannanase activity and cell wall hydrolysis in tomato endosperm to germination rates. *Plant Physiol.* 113: 1243–1252.
- Debeaujon, I. and Koornneef, M. (2000) Gibberellin requirement for Arabidopsis seed germination is determined both by testa characteristics and embryonic abscisic acid. *Plant Physiol.* 122: 415–424.
- Downie, B., Hilhorst, H.W.M. and Bewley, J.D. (1997) Endo- β -mannanase activity during dormancy alleviation and germination of white spruce (*Picea glauca*) seeds. *Physiol. Plant.* 101: 405–415.
- Dutta, S., Bradford, K.J. and Nevins, D.J. (1994) Cell-wall autohydrolysis in isolated endosperms of lettuce (*Lactuca sativa* L.). *Plant Physiol.* 104: 623–628.
- Dutta, S., Bradford, K.J. and Nevins, D.J. (1997) Endo-[beta]-mannanase activity present in cell wall extracts of lettuce endosperm prior to radicle emergence. *Plant Physiol.* 113: 155–161.
- Finkelstein, R.R., Wang, M.L., Lynch, T.J., Rao, S. and Goodman, H.M. (1998) The Arabidopsis abscisic acid response locus *ABI4* encodes an APETALA 2 domain protein. *Plant Cell* 10: 1043–1054.
- Fujimoto, S.Y., Ohta, M., Usui, A., Shinshi, H. and Ohme-Takagi, M. (2000) Arabidopsis ethylene-responsive element binding factors act as transcriptional activators or repressors of GCC box-mediated gene expression. *Plant Cell* 12: 393–404.
- Fujiwara, T. and Beachy, R.N. (1994) Tissue-specific and temporal regulation of a beta-conglycinin gene: roles of the RY repeat and other cis-acting elements. *Plant Mol. Biol.* 24: 261–272.
- Groot, S.P.C. and Karssen, C.M. (1987) Gibberellins regulate seed germination in tomato by endosperm weakening: a study with gibberellin-deficient mutants. *Planta* 171: 525–531.
- Groot, S.P.C., Kieliszewska-Rokicka, B., Vermeer, E. and Karssen, C.M. (1988) Gibberellin-induced hydrolysis of endosperm cell walls in gibberellin-deficient tomato seeds prior to radicle protrusion. *Planta* 174: 500–504.
- Gu, Y.Q., Wildermuth, M.C., Chakravarthy, S., Loh, Y.T., Yang, C., He, X., Han, Y. and Martin, G.B. (2002) Tomato transcription factors Pti4, Pti5, and Pti6 activate defense responses when expressed in Arabidopsis. *Plant Cell* 14: 817–831.
- Gu, Y.Q., Yang, C., Thara, V.K., Zhou, J. and Martin, G.B. (2000) *Pti4* is induced by ethylene and salicylic acid, and its product is phosphorylated by the Pto kinase. *Plant Cell* 12: 771–786.
- Hilhorst, H.W.M. (1995) A critical update on seed dormancy. I. Primary dormancy. *Seed Sci. Res.* 5: 61–73.
- Jones, B., Frasse, P., Olmos, E., Zegzouti, H., Li, Z.G., Latche, A., Pech, J.C. and Bouzayen, M. (2002) Down-regulation of DR12, an auxin-response-factor homolog, in the tomato results in a pleiotropic phenotype including dark green and blotchy ripening fruit. *Plant J.* 32: 603–613.
- Karssen, C.M., Zagorski, S., Kepczynski, J. and Groot, S.P.C. (1989) Key role for endogenous gibberellins in the control of seed germination. *Ann. Bot.* 63: 71–80.
- Lescot, M., Déhais, P., Thijs, G., Marchal, K., Moreau, Y., Van de Peer, Y., Rouze, P. and Rombauts, S. (2002) PlantCARE, a database of plant cis-acting regulatory elements and a portal to tools for *in silico* analysis of promoter sequences. *Nucleic Acids Res.* 30: 325–327.
- Lorenzo, O., Piqueras, R., Sanchez-Serrano, J.J. and Solano, R. (2003) ETHYLENE RESPONSE FACTOR1 integrates signals from ethylene and jasmonate pathways in plant defense. *Plant Cell* 15: 165–178.
- Nonogaki, H., Gee, O.H. and Bradford, K.J. (2000) A germination-specific endo-beta-mannanase gene is expressed in the micropylar endosperm cap of tomato seeds. *Plant Physiol.* 123: 1235–1246.
- Ohme-Takagi, M. and Shinshi, H. (1995) Ethylene-inducible DNA binding proteins that interact with an ethylene-responsive element. *Plant Cell* 7: 173–182.
- Onate-Sanchez, L. and Singh, K.B. (2002) Identification of Arabidopsis ethylene-responsive element binding factors with distinct induction kinetics after pathogen infection. *Plant Physiol.* 128: 1313–1322.
- Park, J.M., Park, C.J., Lee, S.B., Ham, B.K., Shin, R. and Paek, K.H. (2001) Overexpression of the tobacco *Tsil* gene encoding an EREBP/AP2-type transcription factor enhances resistance against pathogen attack and osmotic stress in tobacco. *Plant Cell* 13: 1035–1046.
- Reidt, W., Wohlfarth, T., Ellerstrom, M., Czihal, A., Tewes, A., Ezcurrea, I., Rask, L. and Baumlein, H. (2000) Gene regulation during late embryogenesis: the RY motif of maturation-specific gene promoters is a direct target of the FUS3 gene product. *Plant J.* 21: 401–408.
- Riechmann, J.L., Heard, J., Martin, G., Reuber, L., Jiang, C., et al. (2000) Arabidopsis transcription factors: genome-wide comparative analysis among eukaryotes. *Science* 290: 2105–2110.
- Sánchez, R.A. and de Miguel, L. (1997) Phytochrome promotion of mannan-degrading enzyme activities in the micropylar endosperm of *Datura ferox* seeds requires the presence of embryo and gibberellin synthesis. *Seed Sci. Res.* 7: 27–33.

- Song, C.P., Agarwal, M., Ohta, M., Guo, Y., Halfter, U., Wang, P. and Zhu, J.K. (2005) Role of an Arabidopsis AP2/EREBP-type transcriptional repressor in abscisic acid and drought stress responses. *Plant Cell* 17: 2384–2396.
- Thara, V.K., Tang, X., Gu, Y.Q., Martin, G.B. and Zhou, J.M. (1999) *Pseudomonas syringae* pv tomato induces the expression of tomato EREBP-like genes Pti4 and Pti5 independent of ethylene, salicylate and jasmonate. *Plant J.* 20: 475–483.
- Toorop, P.E., van Aelst, A.C. and Hilhorst, H.W. (2000) The second step of the biphasic endosperm cap weakening that mediates tomato (*Lycopersicon esculentum*) seed germination is under control of ABA. *J. Exp. Bot.* 51: 1371–1379.
- Tournier, B., Sanchez-Ballesta, M.T., Jones, B., Pesquet, E., Regad, F., Latche, A., Pech, J.C. and Bouzayen, M. (2003) New members of the tomato ERF family show specific expression pattern and diverse DNA-binding capacity to the GCC box element. *FEBS Lett.* 550: 149–154.
- Wang, H., Jones, B., Li, Z., Frasse, P., Delalande, C., Regad, F., Chaabouni, S., Latché, A., Pech, J.C. and Bouzayen, M. (2005) The tomato Aux/IAA transcription factor IAA9 is involved in fruit development and leaf morphogenesis. *Plant Cell* 10: 2676–2692.
- Watkins, J.T., Cantliffe, D.J., Huber, D.J. and Nell, T.A. (1985) Gibberellic acid stimulated degradation of endosperm in pepper. *J. Am. Soc. Hortic. Sci.* 110: 61–65.
- Zegzouti, H., Jones, B., Frasse, P., Marty, C., Maitre, B., Latché, A., Pech, J.C. and Bouzayen, M. (1999) Ethylene-regulated gene expression in tomato fruit: characterization of novel ethylene-responsive and ripening-related genes isolated by differential display. *Plant J.* 18: 589–600.
- Zhang, H., Huang, Z., Xie, B., Chen, Q., Tian, X., Zhang, X., Zhang, H., Lu, X., Huang, D. and Huang, R. (2004) The ethylene-, jasmonate-, abscisic acid- and NaCl-responsive tomato transcription factor JERF1 modulates expression of GCC box-containing genes and salt tolerance in tobacco. *Planta* 220: 262–270.
- Zhou, J., Tang, X. and Martin, G.B. (1997) The Pto kinase conferring resistance to tomato bacterial speck disease interacts with proteins that bind a cis-element of pathogenesis related genes. *EMBO J.* 16: 3207–3218.

(Received April 26, 2006; Accepted June 29, 2006)

Article 4: *en préparation*

***AtERF13*, a member of the Ethylene Response Factor gene family is involved in ethylene response and salt stress.**

Introduction à l'article 4.

L'éthylène est impliqué dans de nombreux stress biotiques ou abiotiques (Abeles et al., 1992). La maîtrise biotechnologique de cette hormone et notamment de sa voie de transduction constitue donc un enjeu agronomique majeur. Le décryptage de la signalisation éthylène a été favorisé par l'isolement de nombreux mutants affectés dans la réponse à cette phytohormone, sur la base du phénotype de la triple réponse (Benavente and Alonso, 2006). L'analyse de ces mutants a permis la modélisation linéaire de cette voie de signalisation, partant d'un récepteur membranaire jusqu'à l'induction de facteurs de transcription nucléaires.

Dans le cadre d'une étude fonctionnelle globale des facteurs de transcription, une équipe japonaise a développé la technologie CRES-T (Chimeric Repressor Silencing Technologie). Cette technologie consiste à fusionner le domaine répresseur SRDX (SUPERMAN Repression Domain X) à la partie C-terminal de facteur de transcription pour le rendre répresseur dominant. Chaque facteur de transcription d'*Arabidopsis* a été fusionné avec ce domaine répresseur et des plantes transgéniques exprimant cette protéine chimérique ont été générées. Dans le but d'étudier le comportement de ces chimères en réponse à l'éthylène une collaboration avec cette équipe a été établie. Lors d'un séjour d'une année j'ai entrepris de cribler la population de mutants disponibles. Un criblage basé sur le phénotype de la triple réponse a permis d'identifier un nouvel ERF intervenant dans la voie de signalisation de l'éthylène. La fusion d'AtERF13 avec le domaine répresseur engendre une insensibilité partielle à l'éthylène. Les parties aériennes de ces plantes transgéniques ne présentent pas de sensibilité à l'éthylène (absence de crochet, hypocotyle de taille normale), par contre les racines sont très petites, comme dans le cas du sauvage. Ceci suggère qu'AtERF13 a un spectre d'action limité à certains gènes de la réponse secondaire permettant alors une régulation fine de la réponse à l'éthylène.

Les résultats de cette étude sont présentés sous forme de projet d'article centré sur la caractérisation préliminaire de cette lignée transgénique (CR005). L'analyse des séquences promotrices de ce gène et des profils d'expression disponibles dans les bases de données du transcriptome d'*Arabidopsis* (<http://www.arabidopsis.org>) nous a conduits à étudier plus particulièrement l'effet du stress salin. Les lignées surexprimant la construction *AtERF13::SRDX* sont plus sensibles à ce stress. A 100 mM NaCl les lignées transgéniques ne se développent pas, les cotylédons ainsi que les premières feuilles blanchissent et la plantule meurt alors que dans les mêmes conditions les plantules sauvages sont viables. Ces résultats suggèrent qu'AtERF13 est impliqué dans la résistance au stress salin.

***AtERF13*, a member of the Ethylene Response Factor gene family is involved in ethylene response and salt stress**

Pirrello J.³, Koyama T.^{1,2}, Narukawa M.¹, Regad F.³, Bouzayen M.³, Ohme-Takagi M.^{1,2}

(1) Gene Function Research Center, National Institute of Advanced Industrial Science and Technology (AIST), Central 4, Tsukuba 305-8562, Japan; (2) Core Research for Evolutional Science and Technology Agency, Kawaguchi 332-0012, Japan; (3) Génomique et Biotechnologie des Fruits, ENSAT, Pôle de Biotechnologie Végétale, BP 107 Auzeville Tolosane, 31326 Castanet Tolosan cedex, France.

Abstract

Ethylene is involved in many biotic and abiotic stresses. The control of its transduction pathway constitutes an important agronomical challenge. Chimeric Repressor Silencing Technology (CRES-T), in which each *Arabidopsis* transcription factor has been fused to a dominant repressor domain has been developed. Triple response screening revealed that *AtERF13* is involved in the developmental response to ethylene. Transgenic plants over-expressing the chimeric construct displayed partial sensitivity to ethylene as revealed by altered triple response including root shortening without affecting hook curvature and hypocotyl length. Molecular analyses demonstrated that *HOOKLESS1* transcript accumulation is not affected in transgenic lines suggesting a control of hook formation by *AtERF13* independent of *HOOKLESS1*. These data provide clear evidence that developmental responses to ethylene can be finely modulated through controlling the expression of specific ERFs. Expression analyses demonstrated that *PDF1.2*, a stress responsive gene, is regulated by *AtERF13* suggesting a role in biotic stress of this specific ERF. Furthermore, data-mining of *Arabidopsis* expression database showed an induction of *AtERF13* by salt stress. The implication of *ATERF13* in response to salt stress was further confirmed by the ectopic expression of *AtERF13::SRDX* transgenic lines which resulted in higher sensitivity to salt than wild type plants.

Introduction

Plants are sessile organisms which are submitted to many different biotic and abiotic stresses. Agronomical plants have to cope to unfavourable growth conditions, such as cold, dry and saline environments. When plants are exposed to these stimuli they set up an adaptive response such as cell wall enforcements, induction of programmed cell death (Jenks et al., 1994; Glazebrook, 2001; Xiong et al., 2002). In response to abiotic stress the plant accumulates abscisic acid (ABA) which is the main phytohormone involved in this kind of stress. Accumulation of ABA induces many stress responsive genes like *COR* genes (Leung and Giraudat, 1998). Ethylene is one of the main phytohormone involved in stress. Ethylene accumulation during biotic stress induces expression of specific defence gene as pathogenesis related genes (PR). Analysis of PR gene promoters reveal the presence of a common *cis*-element called GCC box which is necessary and sufficient to confer ethylene inducibility (Ohme-Takagi and Shinshi, 1995). This same study demonstrates that Ethylene Response Factor (ERF) are *trans*-activator able to bind GCC box and activate genes containing GCC box in their promoter (Ohme-Takagi and Shinshi, 1995; Fujimoto et al., 2000; Gu et al., 2002; Brown et al., 2003; Chakravarthy et al., 2003; Gutterson and Reuber, 2004). In *Arabidopsis*, the ERF family constitute the second largest family with 122 members (Nakano et al., 2006). This family is a subclass of ERF/DREB family which contains 10 subgroups. DREBs are classified in 4 subgroups (I to IV) and ERFs are classified in 6 subgroups according to sequence conservations within the ERF/AP2 domain. Usually DREBs are mainly involved in abiotic stress and bind the DRE/CRT sequence (Agarwal et al., 2006), whereas ERFs are mainly involved in biotic stress and bind the GCC box (Gutterson and Reuber, 2004). ERFs can integrate different signal such as ethylene, salicylic acid (Gu et al., 2000), jasmonic acid (van der Fits and Memelink, 2000; Brown et al., 2003) or ABA (Soderman et al., 2000). For example, *Arabidopsis ERF1* is induced by ethylene and by jasmonic acid, its expression needs an operational ethylene transduction pathway and jasmonic acid transduction pathway (Solano et al., 1998). Moreover some ERFs are involved in different stress responses. For example, over-expression of tobacco *Tsi1* improves salt tolerance and resistance to different pathogens. These results suggest that *Tsi1* can be involved in 2 separates signal transduction pathways under biotic and abiotic stress (Park et al., 2001). Usually ERFs which are involved in both resistances to biotic and abiotic stress are able to bind GCC box and DRE/CRT sequence (Park et al., 2001; Huang et al., 2004).

In this study, using an original strategy involving fusion of transcription factors to chimeric repressor we have characterized *AtERF13*. Over-expression of *AtERF13::SRDX* confers partial ethylene insensitivity and a high sensitivity to salt stress.

Results

Ethylene insensitivity screening

A novel gene silencing system has been previously developed that uses a chimeric repressor known as CRES-T (Hiratsu et al., 2003). A transcription factor (TF) to which the SRDX domain was fused (TF::SRDX) acts as a strong repressor and suppresses the expression of the target genes dominant over the activity of endogenous and functionally redundant transcription factors resulting in phenotypes similar to loss-of-function alleles of the factor. The same group previously showed, for example, that the chimeric EIN3 repressor effectively induced ethylene insensitivity in *Arabidopsis* (Hiratsu et al., 2003). To study the ethylene dependent gene expression in more details, we attempted to identify transcription factors that are involved in ethylene signaling pathway using CRES-T system. We prepared seed pool of the T2 lines of the transgenic *Arabidopsis* that express the chimeric repressor for independent transcription factors and screened seedlings that show altered triple response in the presence of ethylene.

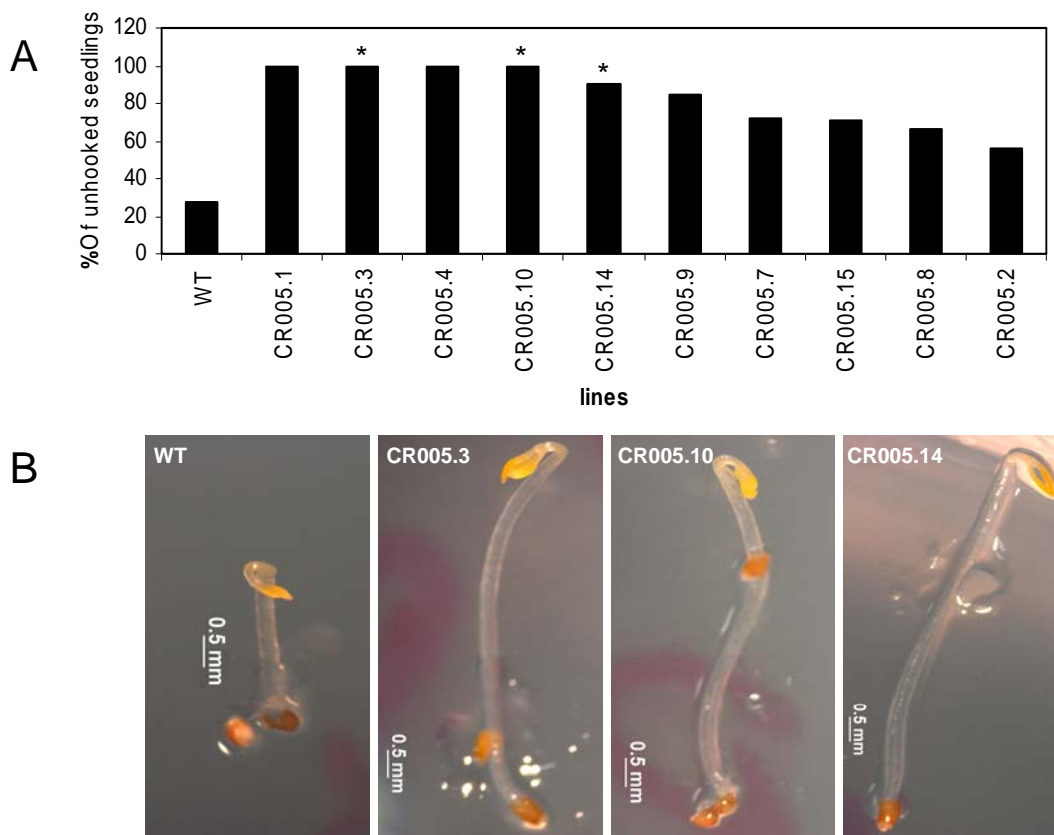

Figure 1: Ethylene sensitivity test of CR005 lines. (A) Percentage of unhooked seedlings after 3 days of ethylene gas treatment (100ppm) scored on 10 independent transgenic lines over-expressing AtERF13::SRDX and wt. Stars indicate lines used for further characterization in this paper. (B) Phenotype of dark grown seedlings of wt and transgenic lines mentioned above (CR005.3, CR005.10 and CR005.14) exposed 3 days to ethylene treatment.

Among all the chimeric TF::SRDX lines generated, using an ethylene treatment screening we have isolated CR005 (35S:AtERF13::SRDX) which shows partial triple response (Fig. 1). The observed phenotype was confirmed using 10 independent CR005 lines (Fig. 1A). For further studies we have randomly chosen 3 lines as indicated in figure 1 A. These lines show a partial ethylene insensitivity phenotype characterized by an absence of hook, a long and thin hypocotyl, but unexpectedly roots are very short as the WT (Fig.1B). These results suggest that this transcription factor control genes which are involved in the formation of the hook, the length of hypocotyl but not in the length of roots under ethylene treatment.

PDF1.2 gene expression is altered in CR005 lines

In the CR005 transgenic lines over-expression of *AtERF13::SRDX* was verified by semi-quantitative RT-PCR (Fig. 2). *PDF* and *HLS* were used as marker of ethylene response and hook formation, respectively. *PDF1.2* is down-regulated in the three CR005 lines tested in absence of ethylene in comparison to the WT. In seedlings exposed during 6 hours to ethylene, *PDF1.2* transcript accumulation is partially induced in 2 lines (CR005.10 and CR005.14) and equally induced in one line (CR005.3) in comparison to the WT level. The transcript accumulation of *HOOKLESS* is not affected in the transgenic line and behaves as in the WT (Fig.2).

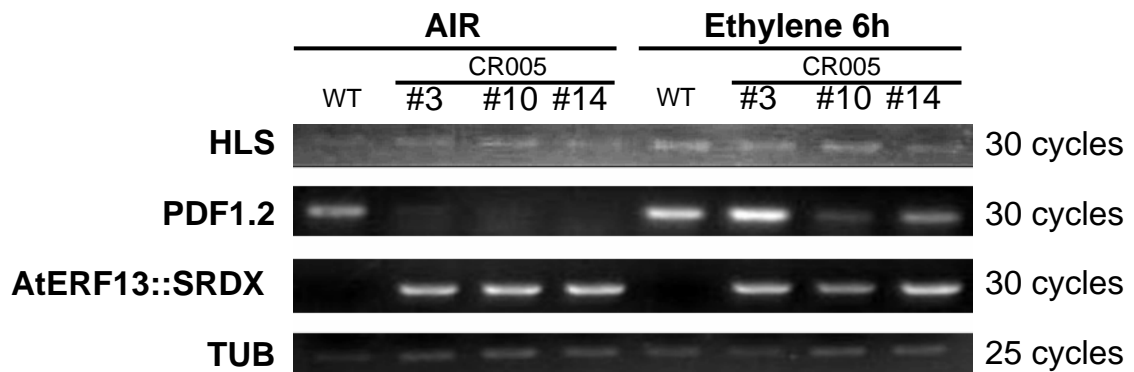

Figure 2: Expression of HLS and PDF1.2 in response to ethylene in three transgenic lines over-expressing AtERF13::SRDX. Gene expression was evaluated by semi-quantitative RT-PCR using as control β -TUB and AtERF13::SRDX. Number of cycles performed to detect the target expressed gene is mentioned in the right side.

Promoter sequence of AtERF13 contains stress related *cis*-elements

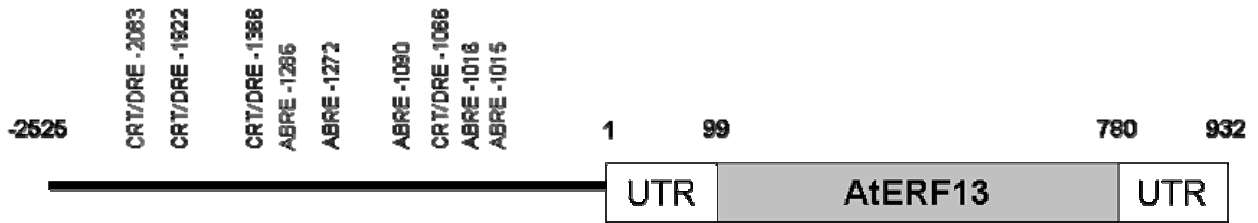

Figure 3: Genomic structure of AtERF13 (At2g44840). Black line represents the promoter region above which putative *cis*-elements are indicated. Grey box represents the coding sequence surrounded by untranslated regions (white boxes)

The *Arabidopsis ERF13* genomic sequence contains a 2525 bp fragment upstream of the initiation transcription site corresponding to the promoter region accordingly to the location of the previous genes (At2g44830). *In silico* analysis of the promoter performed using place database (Higo et al., 1999) identified 4 putative C-repeat/dehydration-responsive elements (CRT/DRE) at positions -2083, -1922, -1366 and -1066. Moreover, 5 putative ABA response elements (ABRE) are located at positions -1286, -1272, -1090, -1016 and -1015 as mentioned in figure 3. The CDS encodes a 226aa protein which belongs to group IX in Nakano's classification. ERFs within this group are characterized by the presence of a motif CMIX-3.

Expression data-mining shows a root and stress related expression.

There is no detailed study concerning *AtERF13*, but many microarray data are available on different databases. We used the electronic Fluorescent Pictograph (eFP) for exploring microarray data for hypothesis generation (Winter et al., 2007). Figure 4 shows that *AtERF13* is strongly express in the end of the root and more specifically in the endodermis and cortex layer (Fig.4A). Moreover, expression data mining suggest that *AtERF13* is transiently induced in the root in response to salt stress (150 mM) starting after 1 hour of treatment and reaching the highest absolute value (1972.22) after 6 hours of treatment (Fig.4B). Considering this result and the promoter analysis we studied the response of CR005 transgenic lines to salt stress.

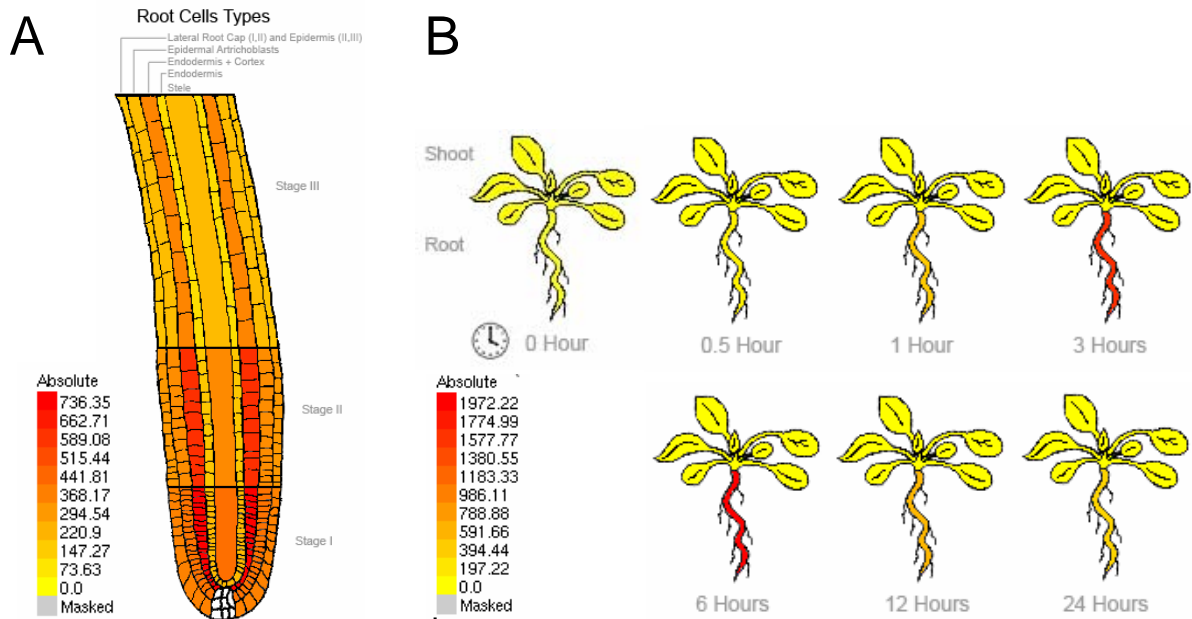

Figure 4: Electronic Fluorescent Pictograph of *AtERF13* expression. (A) Expression pattern of *AtERF13* in the different cell layers of the roots. (B) Time course of the *AtERF13* expression in response to salt stress (150 mM), in different part of the plant. Data are represented in absolute expression mode

AtERF13 is involved in salt stress

Osmotic stress is one of the major environmental stresses for plants. Usually osmotic stress correspond to salt stress, it is the reason why there is an agronomical interest to study this kind of stress. To examine the function of *AtERF13* in salt stress response the CR005 lines and control plants were grown on MS medium containing 100 mM NaCl during 21 days. The control plant grew slowly with green leaves; whereas CR005 transgenic withered and leaves whitened (Fig.5A and B). Around 75 % of WT plants stay viable (Fig.5C), while, the most resistant line CR005.10 presents only 20% of living plants (Fig.5C). These results indicate that the target genes of *AtERF13* are involved in salt stress response.

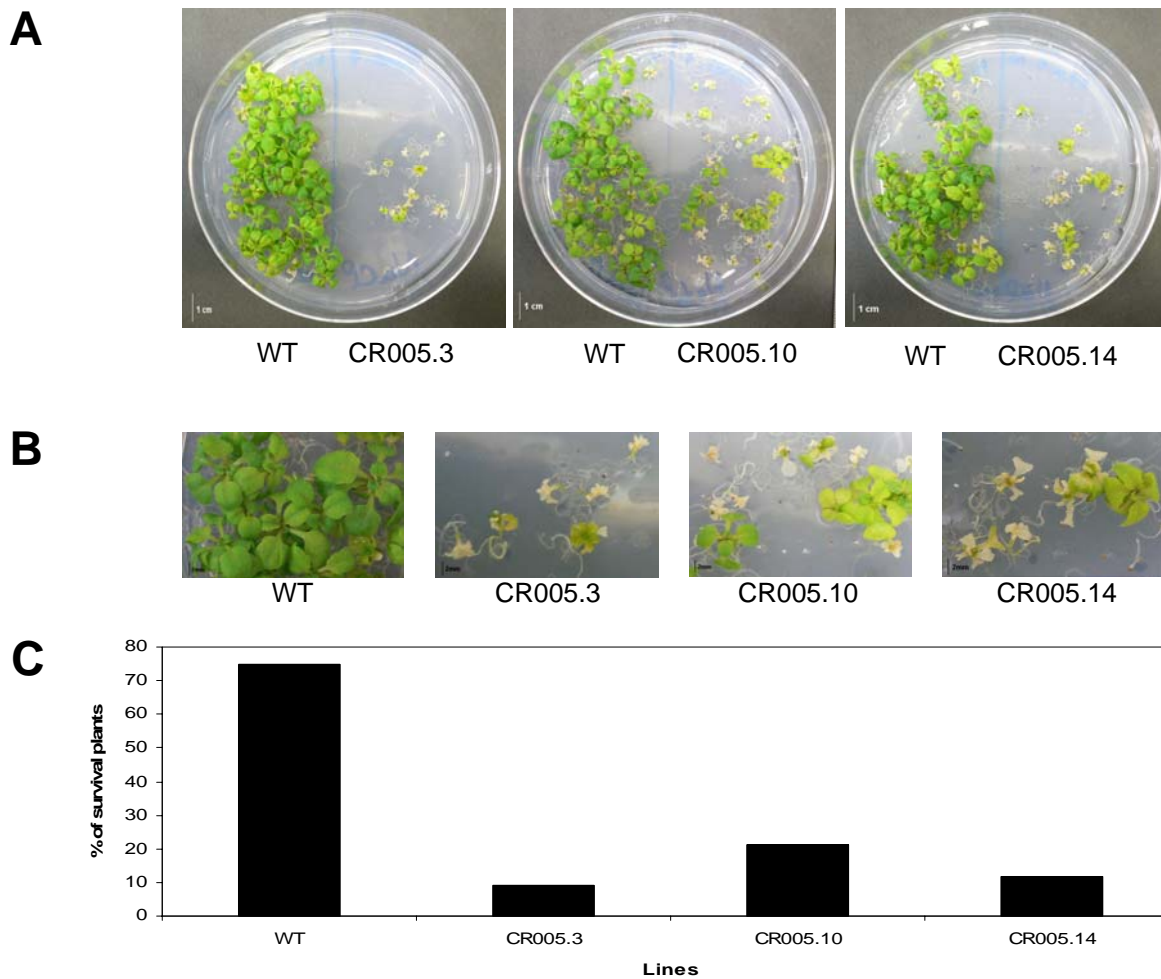

Figure 5: Salt stress sensitivity of CR005 lines. (A) Twenty one days-old seedling grown on medium containing 100 mM NaCl. (B) Detailed pictures of 21 days-old seedling grown on medium containing 100 mM NaCl. (C) Proportion of survival plants after 21 days of treatment on WT and on 3 independent transgenic lines.

Discussion

Triple response is the typical response of seedling to ethylene. This response is characterized by shorter and larger hypocotyls, formation of a hook and shorter roots. Triple response initially used to decipher the ethylene transduction pathway is commonly utilized to test ethylene transduction pathway integrity. To study *Arabidopsis* transcription factor, Takagi's group fused every transcription factor to the strong repressor domain SRDX and transform *Arabidopsis* plant with this chimeric construct (Mitsuda et al., 2008). On the basis of triple response screening using a bulk of several transgenic lines, we isolated one line displaying altered ethylene response. Interestingly, this transgenic line, transformed with *AtERF13* fused to the SRDX domain (CR005), shows partial ethylene insensitivity. Indeed, in presence of 100 ppm of ethylene for 3 days, CR005 does not display hook nor shortening of hypocotyls, nevertheless roots are very shorter, compared to WT (Fig.1). In 1996, Lehman et al., demonstrated that *HOOKLESS1* is responsible for the hook formation during triple response. In this study we demonstrate that *HOOKLESS1* gene expression is not altered in the transgenic lines, suggesting that *AtERF13* is involved in the hook formation independently of *HOOKLESS1* (Fig.3). Usually ethylene transduction pathway mutants show a total abolished triple response phenotype as observed in *etr1* or *ein3* which show an ethylene insensitivity characterized by an absence of hook, long hypocotyls and long roots (Bleecker et al., 1988; Chao et al., 1997). According to our knowledge *ERF13* is the first isolated component of the ethylene transduction pathway which alters only one component of the triple response. These data suggest that *ERF13* is involved in the control of a subset of ethylene-responsive genes. Phylogenetic analysis of *Arabidopsis* ERFs show that *AtERF13* belong to subgroup IXa (Nakano et al., 2006). Genes of this group have often been linked to expression of pathogenesis related genes. For example, *Arabidopsis* ERF1 and tomato Pti4 enhance resistance to necrotic and bacteria and biotrophic fungi (Berrocal-Lobo et al., 2002; Gu et al., 2002) respectively. Additionally, It has been demonstrated that ERFs are involved in biotic stress through the induction of PR genes as *PDF1.2* by the intermediary of the GCC box (Berrocal-Lobo et al., 2002; Brown et al., 2003; Gu et al., 2002; Gutterson and Reuber, 2004 ; Ohme-Takagi et al., 2000). Interestingly, *PDF1.2* is down regulated in CR005, suggesting an involvement of *AtERF13* in the induction of this gene. This result is in accordance with microarray data mining which suggest a concomitant induction of *AtERF13* and *PDF1.2* when plants are infected by *pseudomonas syringae* pv. Tomato. More surprisingly, according the same microarray data, *AtERF13* is not induced by phytophthora, in contrast to *PDF1.2*

(<http://www.weigelworld.org/resources/microarray/AtGenExpress/>). These data suggest a specificity of induction of *PDF1.2* by *AtERF13* related to the pathogen and demonstrate the interest to investigate the effect of biotic stress on CR005 lines.

Expression data mining indicates an induction of *AtERF13* during salt stress. We tested the sensitivity of transgenic lines to salt stress. CR005 lines show high sensitivity to salt. Indeed, at 100 mM NaCl all transgenic seedlings died whereas WT seedlings are not affected. Because repressor construct should silence target gene of *AtERF13* in CR005 transgenic lines, this result suggests that *AtERF13* is involved in the regulation of genes whose expression is associated and required for the tolerance to salt stress. Promoter sequence analysis revealed the presence of several abiotic stress-related *cis*-elements such as CRT/DRE or ABRE (Yamaguchi-Shinozaki and Shinozaki, 2005) (Fig.2) suggesting a role of *AtERF13* in different abiotic stress via these *cis*-element. To confirm these results, it would be interesting to analyse *AtERF13* over-expressing lines to check if they show enhanced tolerance to salt stress.

Material and methods

Construction of plasmids and transformation

To construct the transgene for the chimeric repressor, the coding sequence of the transcription factor, the coding sequence except the STOP codon, were amplified from an *Arabidopsis* tissue complementary DNA library. This coding region was cloned into the SmaI site of p35SSRDYG in frame to the region that encodes the SRDY repression domain (LDLDLELRGFA) from SUPERMAN (Hiratsu et al., 2003). p35SSRDYG contains a CaMV 35S promoter followed by an Ω translation enhancer sequence, the SRDY repression domain sequence, Nos terminator and the attL1 and attL2 Gateway recombination sites (Invitrogen Corp., Carlsbad, CA, USA) outside the region of the 35S promoter and the Nos terminator in the pUC119 vector. The transgene cassette was transferred into the destination vector pBCKH, which was derived from the plant transformation vector pBIG-HYG (Becker, 1990) using the gateway LRclonase reaction (Invitrogen Corp.) Each chimeric gene was used to transform *Arabidopsis thaliana* Col-0 by *Agrobacterium*-mediated transformation, as described previously (Hiratsu et al., 2003). Transgenic plants were selected on hygromycin plate.

Screening for ethylene insensitivity

Bulk of T2 seeds from 10 independent lines for 10 transgenic plants (10 genes) has been prepared. Seeds have been sowed on Murashig and Skoog medium. Plates were place in the dark at 4°C during 3 days. After 3 days of cold, plates have been put in dark at 23°C in contact with a mix gas containing 100 ppm ethylene and air. Influx of ethylene was around 15cc/min. After 3 days of treatment analysis have been done.

50 seeds for each line have been used to confirm the result of screening. Same number of WT seeds has been sowed in the same plate.

Salt treatment assay

45 seeds from transgenic lines and from WT were sowed for NaCl treatment assay. Seeds were sowed on MS containing 100 mM of NaCl. Seeds were stratified 3 days at 4°C and then grown at 23 °C under classic condition of light.

Bioanalysis

Schematic representation of ATERF13 (At2g44840) was done using data available from tair database (Arabidopsis.org). *In silico* analysis of the promoter was performed using PLACE database (Higo et al., 1999). Microarray data were recovered from eFP database (Winter et al., 2007).

Conclusions
et
Perspectives

Les plantes sont des organismes sessiles devant se développer sous l'influence de nombreuses contraintes environnementales. Le développement de la plante passe par 2 grandes phases, le développement végétatif, qui consiste à la mise en place d'organes servant, notamment à la production d'énergie, et le développement sexuel qui correspond à la phase reproductive. Lors de cette dernière il y a mise en place des organes reproducteurs, des fleurs, puis du fruit. Ces différentes phases de développement sont orchestrées par de nombreuses molécules « signals ».

L'éthylène est une phytohormone gazeuse dont les fonctions sont multiples. Cette phytohormone est associée à la maturation du fruit chez les espèces climactériques. Il est communément accepté que l'éthylène intervienne fortement dans la sénescence et l'abscission des organes. En plus d'être responsable de nombreux processus de développement, elle est liée à la réponse aux stress qu'ils soient biotiques (attaque de pathogène) ou abiotiques (déshydratation, stress salin). La voie de signalisation de l'éthylène a été initialement décrite comme étant linéaire. Toutefois il est maintenant établi que cette voie de signalisation comporte plusieurs nœuds de régulation. En effet, il a été démontré que le récepteur ETR et le facteur de transcription EIN3 étaient des cibles du complexe protéasome 26S. Ces points de régulations expliquent comment la voie de l'éthylène peut « s'allumer » ou « s'éteindre », mais en aucun cas ils suffisent à expliquer la diversité de réponses de la plante pour cette hormone.

Notre étude s'est focalisée sur les derniers acteurs de la voie de signalisation de l'éthylène que sont les ERF (Ethylene Response Factors), en effet leur grand nombre, chez *Arabidopsis*, laisse supposer qu'ils sont à l'origine de la diversité des réponses à l'éthylène. Jusqu'à présent, chez la tomate, seulement 12 ERF avaient été isolés et partiellement caractérisés, dans l'étude décrite dans l'**article 1** nous avons pu isoler et cloner 16 nouveaux ERF de tomate. L'analyse phylogénétique de ces ERF nous a permis de les ranger dans 8 sous-classes qui avaient été d'abord définies chez *Arabidopsis*. Suite à cette classification et pour faciliter l'étude des ERF, nous avons décidé de renommer l'ensemble des membres de la famille en fonction de leur classe d'appartenance. L'étude de l'activité des ERF par expression transitoire dans des protoplastes de tabac prouve que tous les ERF testés à l'exception de SI-ERF.E.2 se fixent à la boîte GCC. Bien que certaines classes semblent avoir une activité bien définie, comme la sous-classe F dont tous les ERF testés sont répresseurs, l'activité des autres ERF ne dépend pas de leur classe d'appartenance.

Les études des profils d'expression par PCR quantitative en temps réel montrent que la majorité des ERF s'expriment préférentiellement dans un tissu spécifique. Nous avons

également pu démontrer que bien que la plupart des ERF de tomate soit induits par l'éthylène d'autres peuvent être insensibles à cette hormone ou même être réprimés. Parmi les ERF régulés par l'éthylène 6 gènes sont également régulés par l'auxine, suggérant que les ERF peuvent intervenir dans ces deux voies de signalisation hormonale. Il a été démontré dans de nombreuses études que les ERF pouvaient être régulés par d'autres phytohormones comme l'acide abscissique, l'acide salicylique ou encore l'acide jasmonique. Nous avons donc pu démontrer sur un ensemble représentatif de gènes qu'il existe une diversité d'action, d'expression spatio-temporelle et de régulation des ERF. L'ensemble des combinaisons de ces facteurs suppose une variété de gènes induits par les ERF, pouvant expliquer les différentes réponses à l'éthylène. Ces résultats suggèrent que tous les ERF ont des gènes cibles privilégiés. Les résultats présentés dans l'**article 1** révèlent une implication de certains ERF dans la phase d'initiation du fruit. Il serait donc pertinent d'évaluer l'impact de l'altération de la fonction de ces gènes sur l'initiation et le développement du fruit.

La régulation transcriptionnelle est dépendante de l'affinité de l'interaction entre les ERF et leur *cis*-élément. Dans l'**article 2** les analyses par gel retard de l'interaction de SI-ERF.B.3 et SI-ERF.E.1 ont mis en évidence que les régions flanquantes la boîte GCC jouent un rôle primordial dans l'affinité de l'interaction ERF/GCC. En effet, il semble que la base située juste après le cœur de la séquence (GCCGCC) soit critique pour la fixation des 2 ERF testés, alors que les bases situées 2 nucléotides en amont et 2 nucléotides en aval de la boîte GCC jouent un rôle discriminant entre les ERF. La mutation de l'arginine en lysine ou en glutamine à la position 6 du domaine AP2/ERF de SI-ERF.B.3 conduit à une augmentation de l'affinité de cet ERF pour la boîte GCC. Ces résultats démontrent que les acides aminés n'intervenant pas directement dans l'interaction ADN/protéine, peuvent néanmoins intervenir dans le degré d'affinité de l'interaction. La différence d'activité observée lors de l'expression transitoire des ERF trouve ici une explication moléculaire. En effet, en fonction de la combinaison des régions flanquantes et de la nature des acides aminés du domaine AP2/ERF il y aura une activation plus ou moins forte des gènes cibles. Ceci suggère que les gènes cibles régulés par les ERF dépendent à la fois de l'environnement des boîtes GCC situées dans les promoteurs mais aussi de la nature des acides aminés présents dans le domaine AP2/ERF. Il serait intéressant de corréler les activités régulatrices observées en expression transitoire dans les protoplastes de tabac en utilisant le promoteur synthétique avec les capacités de fixation de ces ERF sur ce même *cis*-élément par des expériences de gel retard. En croisant nos données d'activation dans les protoplastes de trois ERF (ERF.A.2, ERF.E.1 et ERF.B.3) avec les

données d'interaction décrites par Tournier et al. (2003) (ERF1, ERF2 et ERF4), nous avons constaté une relation entre l'intensité d'activation et l'affinité de fixation.

Ces résultats expliquent, au moins partiellement, la spécificité d'action des ERF. Une illustration de cette spécificité est présentée dans l'**article 3** où il est démontré que des plantes sur-exprimant *Sl-ERF2* germent plus rapidement que les plantes sauvages. Ceci, est probablement la conséquence d'une activation importante de la *mannanase2* qui est une enzyme intervenant dans la dégradation des mannanes, constituant majeur de la paroi des graines. Ces résultats démontrent le rôle des ERF dans les processus fondamentaux de développement comme la germination dont le contrôle présente des intérêts du point de vue agronomique.

Pour l'étude fonctionnelle de gènes appartenant à des familles multigéniques les stratégies de type « knock-out » sont souvent mises en défaut à cause de la redondance fonctionnelle forte qui peut exister au sein de ces familles. Le laboratoire de Masaru Ohme-Takagi a développé une stratégie pouvant, par la fusion d'un domaine répresseur dominant aux facteurs de transcription étudiés, contourner cette redondance fonctionnelle. Une application de cette stratégie dénommée « CRES-T » pour Chimeric Repressor Silencing Technology, présentée dans l'**article 4**, a permis d'identifier un nouvel ERF d'*Arabidopsis* (*At-ERF13*) intervenant dans la voie de transduction de l'éthylène. De façon remarquable, les lignées transgéniques sur-exprimant la protéine chimère *AtERF13::SRDX* sont partiellement insensibles à l'éthylène. En effet, ces lignées présentent une triple réponse partielle, puisque seules les racines sont plus courtes, comme chez le sauvage. Ce résultat ouvre la porte à un contrôle très fin et ciblé de la réponse à l'éthylène, par la modification du facteur de transcription approprié. Dans le cas d'*AtERF13* la perspective d'une maîtrise fine de sa régulation est particulièrement intéressante puisque nous avons pu démontrer que cet ERF intervient dans la réponse au stress salin. Il est évident que des analyses complémentaires sont nécessaires afin de compléter cette étude. Ainsi, il serait intéressant, de déterminer le seuil limite de tolérance à ce stress. De plus, des lignées sur-expresses ont été générées, leur étude devrait permettre de valider le rôle d'*AtERF13* dans la résistance au stress salin.

Pour chaque ERF de tomate isolés, la production en cours de lignées transgéniques de surexpression, de lignées de type « CRES-T », ainsi que de lignées RNAi, constituera une source de matériel unique, dont la caractérisation permettra une meilleure compréhension de leur fonction. De plus, le séquençage du génome de la tomate va nous permettre d'identifier

l'ensemble des membres de cette famille. L'analyse des promoteurs et leur utilisation nous permettront de mieux connaître leurs modes de régulation.

La maîtrise de la régulation des ERF et de leurs gènes cibles constitue un véritable enjeu biotechnologique et agronomique. En effet, ces connaissances ouvrent les portes à une amélioration ciblée des plantes pouvant conduire à une bonification de la qualité des fruits et à une agriculture plus raisonnée grâce à une meilleure résistance des plantes aux stress.

Bibliographie

- Abel, S., and Theologis, A.** (1994). Transient transformation of Arabidopsis leaf protoplasts: a versatile experimental system to study gene expression. *Plant J.* **5**, 421-427.
- Abel, S., Nguyen, M.D., Chow, W., and Theologis, A.** (1995). ACS4, a primary indoleacetic acid-responsive gene encoding 1-aminocyclopropane-1-carboxylate synthase in Arabidopsis thaliana. Structural characterization, expression in Escherichia coli, and expression characteristics in response to auxin [corrected]. *J. Biol. Chem.* **270**, 19093-19099.
- Abel, S., and Theologis, A.** (1996). Early genes and auxin action. *Plant Physiol* **111**, 9-17.
- Abeles, F.B., Morgan, P.W., and Saltveit Jr., M.E.** (1992). Ethylene in Plant Biology, 2nd edn., Academic Press, San Diego, CA.
- Adams-Phillips, L., Barry, C., Kan nan, P., Leclercq, J., Bouzayen, M., and Giovannoni, J.** (2004). Evidence that CTR1-mediated ethylene signal transduction in tomato is encoded by a multigene family whose members display distinct regulatory features. *Plant Mol. Biol.* **54**, 387-404.
- Agarwal, P.K., Agarwal, P., Red dy, M.K., and Sopory, S.K.** (2006). Role of DREB transcription factors in abiotic and biotic stress tolerance in plants. *Plant Cell Rep.* **25**, 1263-1274.
- Aharoni, A., and O'Connell, A.P.** (2002). Gene expression analysis of strawberry achene and receptacle maturation using DNA microarrays. *J. Exp. Bot.* **53**, 2073-2087.
- Aharoni, A., Dixit, S., Jetter, R., Thoenes, E., van Arkel, G., and Pereira, A.** (2004). The SHINE clade of AP2 domain transcription factors activates wax biosynthesis, alters cuticle properties, and confers drought tolerance when overexpressed in Arabidopsis. *Plant Cell* **16**, 2463-2480.
- Alabadi, D., Aguero, M.S., Perez-Amador, M.A., and Carbonell, J.** (1996). Arginase, Arginine Decarboxylase, Ornithine Decarboxylase, and Polyamines in Tomato Ovaries (Changes in Unpollinated Ovaries and Parthenocarpic Fruits Induced by Auxin or Gibberellin). *Plant Physiol.* **112**, 1237-1244.
- Alba, R., Cordonnier-Pratt, M.M., and Pratt, L.H.** (2000). Fruit-localized phytochromes regulate lycopene accumulation independently of ethylene production in tomato. *Plant Physiol.* **123**, 363-370.
- Alba, R., Payton, P., Fei, Z., McQuinn, R., Debbie, P., Martin, G.B., Tanksley, S.D., and Giovannoni, J.J.** (2005). Transcriptome and selected metabolite analyses reveal multiple points of ethylene control during tomato fruit development. *Plant Cell* **17**, 2954-2965.
- Alejar, A.A., de Visser, R., and Spencer, M. S.** (1988). Ethylene Production by Attached Leaves or Intact Shoots of Tobacco Cultivars Differing in Their Speed of Yellowing during Curing. *Plant Physiol.* **88**, 329-332.
- Allen, M.D., Yamasaki, K., Ohme-Takagi, M., Tateno, M., and Suzuki, M.** (1998). A novel mode of DNA recognition by a beta-sheet revealed by the solution structure of the GCC-box binding domain in complex with DNA. *EMBO J.* **15**, 5484-5496.
- Alonso, J.M., Hirayama, T., Roman, G., Nourizadeh, S., and Ecker, J.R.** (1999). EIN2, a bifunctional transducer of ethylene and stress responses in Arabidopsis. *Science* **284**, 2148-2152.
- Altschul, S.F., Gish, W., Miller, W., Myers, E.W., and Lipman, D.J.** (1990). Basic local alignment search tool. *J. Mol. Biol.* **215**, 403-410.
- Andriankaja, A., Boisson-Dernier, A., Frances, L., Sauviac, L., Jau neu, A., Barker, D.G., and de Carvalho-Niebel, F.** (2007). AP2-ERF transcription factors mediate Nod factor dependent Mt ENOD11 activation in root hairs via a novel cis-regulatory motif. *Plant Cell* **19**, 2866-2885.

- Ayub, R., Guis, M., Ben Amor, M., Gillo t, L., Roustan, J.P., Latc he, A., Bouz ayen, M., and Pech, J.C.** (1996). Expression of ACC oxidase antisense gene inhibits ripening of cantaloupe melon fruits. *Nat. Biotechnol.* **14**, 862-866.
- Bailey, T.L., and Elkan, C.** (1994). Fitting a mixture model by expectation maximization to discover motifs in biopolymers. In *Second International Conference on Intelligent Systems for Molecular Biology* (Menlo Park, California: AAAI Press).
- Balague, C., Watson, C.F., Turner, A.J., Rouge, P., Picton, S., Pech, J.C., and Grierson, D.** (1993). Isolation of a ripening and wound-induced cDNA from *Cucumis melo* L. encoding a protein with homology to the ethylene-forming enzyme. *Eur. J. Biochem.* **212**, 27-34.
- Balaji, S., Babu, M.M ., Iyer, L.M., and Ar avind, L.** (2005). Discovery of the principal specific transcription factors of Apicomplexa and their implication for the evolution of the AP2-integrase DNA binding domains. *Nucleic Acids Res.* **33**, 3994-4006.
- Banno, H., Ikeda, Y., Ni u, Q.W., and Chua, N.H.** (2001). Overexpression of Arabidopsis ESR1 induces initiation of shoot regeneration. *Plant Cell* **13**, 2609-2618.
- Barry, C.S., Blume, B., Bouz ayen, M., C ooper, W., Hamilton, A.J., and Grierson, D.** (1996). Differential expression of the 1-aminocyclopropane-1-carboxylate oxidase gene family of tomato. *Plant J.* **9**, 525-535.
- Barry, C.S., Llop-Tous, M.I., and Grierson, D.** (2000). The regulation of 1-aminocyclopropane-1-carboxylic acid synthase gene expression during the transition from system-1 to system-2 ethylene synthesis in tomato. *Plant Physiol.* **123**, 979-986.
- Barry, C.S., and Giovannoni, J.J.** (2006). Ripening in the tomato Green-ripe mutant is inhibited by ectopic expression of a protein that disrupts ethylene signaling. *Proc. Natl. Acad. Sci. U.S.A.* **103**, 7923-7928.
- Becker, D.** (1990). Binary vectors which allow the exchange of plant selectable markers and reporter genes. *Nucleic Acids Res.* **18**, 203.
- Benavente, L.M., and Alonso, J.M.** (2006). Molecular mechanisms of ethylene signaling in Arabidopsis. *Mol. Biosyst.* **2**, 165-173.
- Berrocal-Lobo, M., Molina, A., and Solano, R.** (2002). Constitutive expression of ETHYLENE-RESPONSE-FACTOR1 in Arabidopsis confers resistance to several necrotrophic fungi. *Plant J.* **29**, 23-32.
- Biale, J.B.** (1964). Growth, Maturation, and Senescence in Fruits: Recent knowledge on growth regulation and on biological oxidations has been applied to studies with fruits. *Science* **146**, 880-888.
- Bleecker, A.B., Estelle, M.A., Somerville, C., and Kende, H.** (1988). Insensitivity to Ethylene Conferred by a Dominant Mutation in Arabidopsis thaliana. *Science* **241**, 1086-1089.
- Bleecker, A.B., and Schaller, G.E.** (1996). The Mechanism of Ethylene Perception. *Plant Physiol.* **111**, 653-660.
- Bleecker, A.B., and Patterson, S.E.** (1997). Last exit: senescence, abscission, and meristem arrest in Arabidopsis. *Plant Cell* **9**, 1169-1179.
- Bleecker, A., and Kende, H.** (2000). Ethylene: a gaseous signal molecule in plants. *Annu. Rev. Cell Dev. Biol.* **16**, 1-18.
- Blume, B., and Grierson, D.** (1997). Expression of ACC oxidase promoter-GUS fusions in tomato and *Nicotiana glauca* regulated by developmental and environmental stimuli. *Plant J.* **12**, 731-746.
- Boller, T.** (1991). Ethylene in pathogenesis and disease resistance In *The Plant Hormone Ethylene*, A.K.M.a.J.C. Suttle, ed (CRC Press), pp. 293-314.

- Broekaert, W.F., Terras, F.R., Cammue, B.P., and Osborn, R.W.** (1995). Plant defensins: novel antimicrobial peptides as components of the host defense system. *Plant Physiol.* **108**, 1353-1358.
- Broglie, K.E., Biddle, P., Cressman, R., and Broglie, R.** (1989). Functional analysis of DNA sequences responsible for ethylene regulation of a bean chitinase gene in transgenic tobacco. *Plant Cell* **1**, 599-607.
- Broun, P., Poindexter, P., Osborne, E., Jiang, C.Z., Riechmann, J.L.** (2004). WIN1, a transcriptional activator of epidermal wax accumulation in Arabidopsis. *Proc. Natl. Acad. Sci. U.S.A.* **101**, 4706-4711.
- Brown, R.L., Kazan, K., McGrath, K.C., Maclean, D.J., and Manners, J.M.** (2003). A role for the GCC-box in jasmonate-mediated activation of the PDF1.2 gene of Arabidopsis. *Plant Physiol.* **132**, 1020-1032.
- Buttery, R.G.** (1993). Quantitative and sensory aspects of flavor of tomato and other vegetables and fruits. In *Flavor Science: Sensible principles and techniques*, T.E. Acree and R. Teranishi, eds (Washington, D.C.: American Chemistry Society), pp. 259-286.
- Buttery, R.G., and Ling, L.C.** (1993). Volatiles of tomato fruit and plant parts: relationship and biogenesis. In *Bioactive volatile compounds from plants*, R. Teranishi, R. Buttery, and H. Sugisawa, eds (Washington, D.C.: ACS Books), pp. 23-34.
- Buttner, M., and Singh, K.B.** (1997). Arabidopsis thaliana ethylene-responsive element binding protein (AtEBP), an ethylene-inducible, GCC box DNA-binding protein interacts with an ocs element binding protein. *Proc. Natl. Acad. Sci. U.S.A.* **94**, 5961-5966.
- Chakravarthy, S., Tuori, R.P., D'Ascenzo, M.D., Fobert, P.R., Despres, C., and Martin, G.B.** (2003). The tomato transcription factor Pti4 regulates defense-related gene expression via GCC box and non-GCC box cis elements. *Plant Cell* **15**, 3033-3050.
- Chang, C., Kwok, S.F., Bleeker, A.B., and Meyerowitz, E.M.** (1993). Arabidopsis ethylene-response gene ETR1: similarity of product to two-component regulators. *Science* **262**, 539-544.
- Chao, Q., Rothenberg, M., Solano, R., Roman, G., Terzaghi, W., and Ecker, J.R.** (1997). Activation of the ethylene gas response pathway in Arabidopsis by the nuclear protein ETHYLENE-INSENSITIVE3 and related proteins. *Cell* **89**, 1133-1144.
- Chen, W., Provart, N.J., Glazebrook, J., Katagiri, F., Chang, H.S., Eulgem, T., Mauch, F., Luan, S., Zhou, G., and Whitham, S.A.** (2002). Expression profile matrix of Arabidopsis transcription factor genes suggests their putative functions in response to environmental stresses. *Plant Cell* **14**, 559-574.
- Chen, G., Hackett, R., Walker, D., Taylor, A., Lin, Z., and Grierson, D.** (2004). Identification of a specific isoform of tomato lipoxygenase (TomloxC) involved in the generation of fatty acid-derived flavor compounds. *Plant Physiol.* **136**, 2641-2651.
- Chen, Y.F., Shakeel, S.N., Bowers, J., Zhao, X.C., Etheridge, N., and Schaller, G.E.** (2007). Ligand-induced degradation of the ethylene receptor ETR2 through a proteasome-dependent pathway in Arabidopsis. *J. Biol. Chem.* **282**, 24752-24758.
- Chen, G., Hu, Z., and Grierson, D.** (2008). Differential regulation of tomato ethylene responsive factor LeERF3b, a putative repressor, and the activator Pti4 in ripening mutants and in response to environmental stresses. *J. Plant Physiol.* **165**, 662-670.
- Cheong, Y.H., Moon, B.C., Kim, J.K., Kim, C.Y., Kim, M.C., Kim, I.H., Park, C.Y., Kim, J.C., Park, B.O., Koo, S.C., Yoon, H.W., Chung, W.S., Lim, C.O., Lee, S.Y., and Cho, M.J.** (2003). BWMK1, a rice mitogen-activated protein kinase, locates in the nucleus and mediates pathogenesis-related gene expression by activation of a transcription factor. *Plant Physiol.* **132**, 1961-1972.

- Chervin, C., El-Kereamy, A., Roustan, J.P., Latché, A., Lamon, J., and Bouzayen, M.** (2004). Ethylene seems required for the berry development and ripening in grape, a non-climacteric fruit. *Plant Sci.* **167**, 1301-1305.
- Chinnusamy, V., Jagendorf, A., and Zhu, J.-K.** (2005). Understanding and Improving Salt Tolerance in Plants. *Crop Sci.* **45**, 437-448.
- Chuck, G., Muszynski, M., Kellogg, E., Hake, S., and Schmidt, R.J.** (2002). The control of spikelet meristem identity by the branched silkless1 gene in maize. *Science* **298**, 1238-1241.
- Ciardi, J.A., Tieman, D.M., Lund, S.T., Jones, J.B., Stall, R.E., and Klee, H.J.** (2000). Response to *Xanthomonas campestris* pv. *vesicatoria* in tomato involves regulation of ethylene receptor gene expression. *Plant Physiol.* **123**, 81-92.
- Clark, K.L., Larsen, P.B., Wang, X., and Chang, C.** (1998). Association of the Arabidopsis CTR1 Raf-like kinase with the ETR1 and ERS ethylene receptors. *Proc. Natl. Acad. Sci. U.S.A.* **95**, 5401-5406.
- Cordes, S., Deikman, J., Margosian, L.J., and Fischer, R.L.** (1989). Interaction of a developmentally regulated DNA-binding factor with sites flanking two different fruit-ripening genes from tomato. *Plant Cell* **1**, 1025-1034.
- Cosgrove, D.J.** (2000). New genes and new biological roles for expansins. *Curr. Opin. Plant Biol.* **3**, 73-78.
- Coupe, S.A., and Deikman, J.** (1997). Characterization of a DNA-binding protein that interacts with 5' flanking regions of two fruit-ripening genes. *Plant J.* **11**, 1207-1218.
- Curtis, M.D., and Grossniklaus, U.** (2003). A gateway cloning vector set for high-throughput functional analysis of genes in planta. *Plant Physiol.* **133**, 462-469.
- Dahal, P., Nevins, D.J., and Bradford, K.J.** (1997). Relationship of Endo-[beta]-D-Mannanase Activity and Cell Wall Hydrolysis in Tomato Endosperm to Germination Rates. *Plant Physiol.* **113**, 1243-1252.
- Deikman, J., Kline, R., and Fischer, R.L.** (1992). Organization of Ripening and Ethylene Regulatory Regions in a Fruit-Specific Promoter from Tomato (*Lycopersicon esculentum*). *Plant Physiol.* **100**, 2013-2017.
- Deikman, J., Xu, R., Kneissl, M.L., Ciardi, J.A., Kim, K.N., and Pelah, D.** (1998). Separation of cis elements responsive to ethylene, fruit development, and ripening in the 5'-flanking region of the ripening-related E8 gene. *Plant Mol. Biol.* **37**, 1001-1011.
- Dellapenna, D., Lincoln, J.E., Fischer, R.L., and Bennett, A.B.** (1989). Transcriptional Analysis of Polygalacturonase and Other Ripening Associated Genes in Rutgers, rin, nor, and Nr Tomato Fruit. *Plant Physiol.* **90**, 1372-1377.
- D'Haese, W., and Holsters, M.** (2002). Nod factor structures, responses, and perception during initiation of nodule development. *Glycobiology* **12**, 79R-105R.
- Dong, X.** (1998). SA, JA, ethylene, and disease resistance in plants. *Curr. Opin. Plant Biol.* **1**, 316-323.
- Downie, B., Hilhorst, H.W.M., and Bewley, J.D.** (1997). Endo- β -mannanase activity during dormancy alleviation and germination of white spruce (*Picea glauca*) seeds. *Physiol Plant* **101**, 405-415.
- Dubouzet, J.G., Sakuma, Y., Ito, Y., Kasuga, M., Dubouzet, E.G., Miura, S., Seki, M., Shinozaki, K., and Yamaguchi-Shinozaki, K.** (2003). OsDREB genes in rice, *Oryza sativa* L., encode transcription activators that function in drought-high-salt- and cold-responsive gene expression. *Plant J.* **33**, 751-763.
- Dunn, M.A., Hughes, M.A., Zhang, L., Pearce, R.S., Quigley, A.S., and Jack, P.L.** (1991). Nucleotide sequence and molecular analysis of the low temperature induced cereal gene, BLT4. *Mol. Gen. Genet.* **229**, 389-394.

- Dutta, S., Bradford, K.J., and Nevins, D.J.** (1994). Cell-Wall Autohydrolysis in Isolated Endosperms of Lettuce (*Lactuca sativa* L.). *Plant Physiol.* **104**, 623-628.
- Earley, K.W., Haag, J.R., Pontes, O., Opper, K., Juehne, T., Song, K., and Pikaard, C.S.** (2006). Gateway-compatible vectors for plant functional genomics and proteomics. *Plant J.* **45**, 616-629.
- Esau, K.** (1977). Cell wall. In *Anatomy of Seed Plants*, J.W.a. Sons, ed (New York), pp. 43-59.
- Eshed Y., and Zamir D.** (1995) An Introgression Line Population of *Lycopersicon pennellii* in the Cultivated Tomato Enables the Identification and Fine Mapping of Yield-Associated QTL. *Genetics* **141**, 1147-1162.
- Eyal, Y., Sagee, O., and Fluhr, R.** (1992). Dark-induced accumulation of a basic pathogenesis-related (PR-1) transcript and a light requirement for its induction by ethylene. *Plant Mol. Biol.* **19**, 589-599.
- Eyal, Y., Meller, Y., Lev-Yadun, S., and Fluhr, R.** (1993). A basic-type PR-1 promoter directs ethylene responsiveness, vascular and abscission zone-specific expression. *Plant J.* **4**, 225-234.
- Ferrie, B.J., Beaudoin, N., Burkhart, W., Bowsher, C.G., and Rothstein, S.J.** (1994). The cloning of two tomato lipoxygenase genes and their differential expression during fruit ripening. *Plant Physiol.* **106**, 109-118.
- Fischer, R.L., and Bennett, A.B.** (1991). Role of cell wall hydrolases in fruit ripening. *Annu. Rev. Plant Physiol. Plant Mol. Biol.* **42**, 675-703.
- Foo, E., Ross, J.J., Davies, N.W., Reid, J.B., and Weller, J.L.** (2006). A role for ethylene in the phytochrome-mediated control of vegetative development. *Plant J.* **46**, 911-921.
- Fos, M., Nuez, F., and Garcia-Martinez, J.L.** (2000). The gene *pat-2*, which induces natural parthenocarpy, alters the gibberellin content in unpollinated tomato ovaries. *Plant Physiol.* **122**, 471-480.
- Fraser, P.D., Truesdale, M.R., Bird, C.R., Schuch, W., and Bramley, P.M.** (1994). Carotenoid Biosynthesis during Tomato Fruit Development (Evidence for Tissue-Specific Gene Expression). *Plant physiology* **105**, 405-413.
- Fujimoto, S.Y., Ohta, M., Usui, A., Shinshi, H., and Ohme-Takagi, M.** (2000). Arabidopsis ethylene-responsive element binding factors act as transcriptional activators or repressors of GCC box-mediated gene expression. *Plant Cell* **12**, 393-404.
- Gage, D.J.** (2004). Infection and invasion of roots by symbiotic, nitrogen-fixing rhizobia during nodulation of temperate legumes. *Microbiol. Mol. Biol. Rev.* **68**, 280-300.
- Gao, Z., Chen, Y.F., Randlett, M.D., Zhao, X.C., Findell, J.L., Kieber, J.J., and Schaller, G.E.** (2003). Localization of the Raf-like kinase CTR1 to the endoplasmic reticulum of Arabidopsis through participation in ethylene receptor signaling complexes. *J. Biol. Chem.* **278**, 34725-34732.
- Genoud, T., and Metraux, J.P.** (1999). Crosstalk in plant cell signaling: structure and function of the genetic network. *Trends Plant Sci.* **4**, 503-507.
- Gheysen, G., Inze, D., Soetaert, P., Van Montagu, M., and Castresana, C.** (1990). Sequence of a *Nicotiana plumbaginifolia* beta(1,3)-glucanase gene encoding a vacuolar isoform. *Nucleic Acids Res.* **18**, 6685.
- Gillaspay, G., Ben-David, H., and Gruissem, W.** (1993). Fruits: A Developmental Perspective. *Plant Cell* **5**, 1439-1451.
- Gilmour, S.J., Zarka, D.G., Stockinger, E.J., Salazar, M.P., Houghton, J.M., and Thomashow, M.F.** (1998). Low temperature regulation of the Arabidopsis CBF family of AP2 transcriptional activators as an early step in cold-induced COR gene expression. *Plant J.* **16**, 433-442.

- Giovannoni, J.** (2001). Molecular biology of fruit maturation and ripening. *Annu. Rev. Plant Physiol.* **52**, 725–749.
- Glazebrook, J.** (2001). Genes controlling expression of defense responses in Arabidopsis--2001 status. *Curr. Opin. Plant Biol.* **4**, 301-308.
- Grbic, V., and Bleeker, A.B.** (1995). Ethylene regulates the timing of leaf senescence in Arabidopsis. *Plant J.* **8**, 595-602.
- Griffiths, A., Prestage, S., Linforth, R., Zhang, J., Taylor, A., and Grierson, D.** (1999). Fruit-specific lipoxygenase suppression in antisense-transgenic tomatoes. *Postharvest Biol. Technol.* **17**, 163-173.
- Grierson, D., and Schuch, W.** (1993). Control of ripening. *Philos. Trans. R. Soc. Lond., B, Biol. Sci.* **342**, 241-250.
- Gu, Y.Q., Yang, C., Thara, V. K., Zhou, J., and Martin, G.B.** (2000). Pti4 is induced by ethylene and salicylic acid, and its product is phosphorylated by the Pto kinase. *Plant Cell* **12**, 771–786.
- Gu, Y.Q., Wildermuth, M.C., Chakravarthy, S., Loh, Y.T., Yang, C., He, X., Han, Y., and Martin, G.B.** (2002). Tomato transcription factors pti4, pti5, and pti6 activate defense responses when expressed in Arabidopsis. *Plant Cell* **14**, 817-831.
- Guis, M., Botondi, R., Ben-Amor, M., Ayub, R., Bouzayen, M., Pech, J.-C., and Latché, A.** (1997). Ripening-associated Biochemical Traits of Cantaloupe Charentais Melons Expressing an Antisense ACC Oxidase Transgene. *J. Am. Soc. Hortic. Sci.* **122**, 740-896.
- Guo, H., and Ecker, J.R.** (2003). Plant responses to ethylene gas are mediated by SCF(EBF1/EBF2)-dependent proteolysis of EIN3 transcription factor. *Cell* **115**, 667-677.
- Gustafson, F.G.** (1936). Inducement of Fruit Development by Growth-Promoting Chemicals. *Proc. Natl. Acad. Sci. U.S.A.* **22**, 628-636.
- Gustafson, F.G.** (1937). Parthenocarpy induced by pollen extracts. *Am. J. Bot.* **24**, 102-107.
- Gutterson, N., and Reuber, T.L.** (2004). Regulation of disease resistance pathways by AP2/ERF transcription factors. *Curr. Opin. Plant Biol.* **7**, 465-471.
- Guzman, P., and Ecker, J.R.** (1990). Exploiting the triple response of Arabidopsis to identify ethylene-related mutants. *Plant Cell* **2**, 513-523.
- Halevy, A.** (1986). Pollination-induced corolla senescence. *Acta Hort.* **181**, 25-32.
- Hao, D., Yamasaki, K., Sara, i, A., and Ohme-Takagi, M.** (2002). Determinants in the sequence specific binding of two plant transcription factors, CBF1 and NtERF2, to the DRE and GCC motifs. *Biochemistry* **41**, 4202-4208.
- Harper, R.M., Stow e-Evans, E.L., Luesse, D.R., Muto, H., Tatematsu, K., Watahiki, M.K., Yamamoto, K., and Liscum, E.** (2000). The NPH4 locus encodes the auxin response factor ARF7, a conditional regulator of differential growth in aerial Arabidopsis tissue. *Plant Cell* **12**, 757-770.
- Hasenstein, K.H., and Evans, M.L.** (1986). Calcium ion dependency of ethylene production in segments of primary roots of *Zea mays*. *Physiol Plant* **67**, 570-575.
- Hatanaka, A.** (1993). The biogenesis of green odour by green leaves. *Phytochemistry* **34**, 1201-1218.
- Heitz, T., Bergey, D.R., and Ryan, C.A.** (1997). A gene encoding a chloroplast-targeted lipoxygenase in tomato leaves is transiently induced by wounding, systemin, and methyl jasmonate. *Plant Physiol.* **114**, 1085-1093.
- Hensel, L.L., Grbic, V., Baumga rten, D.A., and Bleeker, A.B.** (1993). Developmental and age-related processes that influence the longevity and senescence of photosynthetic tissues in Arabidopsis. *Plant Cell* **5**, 553-564.

- Higo, K., Ugawa, Y., Iwamoto, M., and Korenaga, T.** (1999). Plant cis-acting regulatory DNA elements (PLACE) database: 1999. *Nucleic Acids Res.* **27**, 297-300.
- Hiratsu, K., Matsui, K., Koyama, T., and Ohme-Takagi, M.** (2003). Dominant repression of target genes by chimeric repressors that include EAR motif, a repression domain, in *Arabidopsis*. *Plant J.* **34**, 733-739.
- Hirota, A., Kato, T., Fukaki, H., Aida, M., and Tasaka, M.** (2007). The auxin-regulated AP2/EREBP gene PUCHI is required for morphogenesis in the early lateral root primordium of *Arabidopsis*. *Plant Cell* **19**, 2156-2168.
- Hoekstra, F.A., and Weges, R.** (1986). Lack of Control by Early Pistillate Ethylene of the Accelerated Wilting of *Petunia hybrida* Flowers. *Plant Physiol.* **80**, 403-408.
- Holden M.J., Marty J.A., Singh-Cundy A.** (2003) Pollination-induced ethylene promotes the early phase of pollen tube growth in *Petunia inflata*. *J. Plant. Physiol.* **160**, 261-269.
- Holdsworth, M.J., Bird, C.R., Ray, J., Schuch, W., and Grierson, D.** (1987). Structure and expression of an ethylene-related mRNA from tomato. *Nucleic Acids Res.* **15**, 731-739.
- Hongxing, Z., Benzhong, Z., Bianyun, Y., Yanling, H., Daqi, F., Wentao, X., and Yunbo, L.** (2005). Cloning and DNA-binding properties of ethylene response factor, LeERF1 and LeERF2, in tomato. *Biotechnol. Lett.* **27**, 423-428.
- Hua, J., Chang, C., Sun, Q., and Meyerowitz, E.M.** (1995). Ethylene insensitivity conferred by *Arabidopsis* ERS gene. *Science* **269**, 1712-1714.
- Hua, J., Sakai, H., Nourizadeh, S., Chen, Q.G., Bleeker, A.B., Ecker, J.R., and Meyerowitz, E.M.** (1998). EIN4 and ERS2 are members of the putative ethylene receptor gene family in *Arabidopsis*. *Plant Cell* **10**, 1321-1332.
- Huang, Y., Li, H., Hutchison, C. E., Laskey, J., and Kieber, J.J.** (2003). Biochemical and functional analysis of CTR1, a protein kinase that negatively regulates ethylene signaling in *Arabidopsis*. *Plant J.* **33**, 221-233.
- Huang, Z., Zhang, Z., Zhang, X., Zhang, H., Huang, D., and Huang, R.** (2004). Tomato TERF1 modulates ethylene response and enhances osmotic stress tolerance by activating expression of downstream genes. *FEBS Lett.* **573**, 110-116.
- Jackson, M.B., and Osborne, D.J.** (1970). Ethylene, the natural regulator of leaf abscission. *Nature* **225**, 1019-1022.
- Jeffery, D., Smith, C., Goodenough, P., Prosser, I., and Grierson, D.** (1984). Ethylene-Independent and Ethylene-Dependent Biochemical Changes in Ripening Tomatoes. *Plant Physiol.* **74**, 32-38.
- Jenks, M.A., Joly, R.J., Peters, P.J., Rich, P.J., Axtell, J.D., and Ashworth, E.N.** (1994). Chemically Induced Cuticle Mutation Affecting Epidermal Conductance to Water Vapor and Disease Susceptibility in *Sorghum bicolor* (L.) Moench. *Plant Physiol.* **105**, 1239-1245.
- Jing, H.C., Sturre, M. J., Hille, J., and Dijkwel, P.P.** (2002). *Arabidopsis* onset of leaf death mutants identify a regulatory pathway controlling leaf senescence. *Plant J.* **32**, 51-63.
- Jing, H.C., Schippers, J.H., Hille, J., and Dijkwel, P.P.** (2005). Ethylene-induced leaf senescence depends on age-related changes and OLD genes in *Arabidopsis*. *Journal of experimental botany* **56**, 2915-2923.
- Jofuku, K.D., den Boer, B.G., Van Montagu, M., and Okamoto, J.K.** (1994). Control of *Arabidopsis* flower and seed development by the homeotic gene APETALA2. *Plant Cell* **6**, 1211-1225.
- Johnson, P.R., and Ecker, J.R.** (1998). The ethylene gas signal transduction pathway: a molecular perspective. *Annu. Rev. Genet.* **32**, 227-254.

- Jones, M.L., and Woodson, W.R.** (1997). Pollination-Induced Ethylene in Carnation (Role of Stylar Ethylene in Corolla Senescence). *Plant Physiol.* **115**, 205-212.
- Jones, M.L.** (2003). Ethylene biosynthetic genes are differentially regulated by ethylene and ACC in carnation styles. *Plant Growth Regul.* **40**, 129-138.
- Journet, E.P., El-Gachtouli, N., Vernoud, V., de Billy, F., Pichon, M., Dedieu, A., Arnould, C., Morandi, D., Barker, D.G., and Gianinazzi-Pearson, V.** (2001). *Medicago truncatula* ENOD11: a novel RPRP-encoding early nodulin gene expressed during mycorrhization in arbuscule-containing cells. *Mol. Plant Microbe Interact.* **14**, 737-748.
- Jung, J., Won, S.Y., Suh, S.C., Kim, H., Wing, R., Jeong, Y., Hwang, I., and Kim, M.** (2007). The barley ERF-type transcription factor HvRAF confers enhanced pathogen resistance and salt tolerance in *Arabidopsis*. *Planta* **225**, 575-588.
- Kauffmann, S., Legrand, M., Geoffroy, P., and Fritig, B.** (1987). Biological function of 'pathogenesis-related' proteins: four PR proteins of tobacco have 1,3-beta-glucanase activity. *EMBO J.* **6**, 3209-3212.
- Kevany, B.M., Taylor, M.G., and Klee, H.J.** (2008). Fruit-specific suppression of the ethylene receptor LeETR4 results in early-ripening tomato fruit. *Plant Biotechnol. J.* **6**, 295-300.
- Kevany, B.M., Tieman, D.M., Taylor, M.G., Cin, V.D., and Klee, H.J.** (2007). Ethylene receptor degradation controls the timing of ripening in tomato fruit. *Plant J.* **51**, 458-467.
- Kieber, J.J., Rothenberg, M., Roman, G., Feldmann, K.A., and Ecker, J.R.** (1993). CTR1, a negative regulator of the ethylene response pathway in *Arabidopsis*, encodes a member of the raf family of protein kinases. *Cell* **72**, 427-441.
- Klee, H.J.** (1993). Ripening Physiology of Fruit from Transgenic Tomato (*Lycopersicon esculentum*) Plants with Reduced Ethylene Synthesis. *Plant Physiol* **102**, 911-916.
- Knapp, J., Moureaux, P., Schuch, W., and Grierson, D.** (1989). Organisation and expression of polygalacturonase and other ripening genes in Ailsa Craig 'Neverripe' and 'ripening inhibitor' tomato mutants. *Plant Mol. Biol.* **12**, 105-116.
- Kneissl, M., and Deikman, J.** (1996). The Tomato E8 Gene Influences Ethylene Biosynthesis in Fruit but Not in Flowers. *Plant Physiol* **112**, 537-547.
- Knoester, M., van Loon, L.C., van den Heuvel, J., Hennig, J., Bol, J.F., and Linthorst, H.J.** (1998). Ethylene-insensitive tobacco lacks nonhost resistance against soil-borne fungi. *Proc. Natl. Acad. Sci. U.S.A.* **95**, 1933-1937.
- Knoester, M., Pieterse, C.M., Bol, J.F., and Van Loon, L.C.** (1999). Systemic resistance in *Arabidopsis* induced by rhizobacteria requires ethylene-dependent signaling at the site of application. *Mol. Plant Microbe Interact.* **12**, 720-727.
- Kock, M., Hamilton, A., and Grierson, D.** (1991). eth1, a gene involved in ethylene synthesis in tomato. *Plant Mol. Biol.* **17**, 141-142.
- Kozak, M.** (1987). At least six nucleotides preceding the AUG initiator codon enhance translation in mammalian cells. *J. Mol. Biol.* **196**, 947-950.
- Kus, J.V., Zaton, K., Sarkar, R., and Cameron, R.K.** (2002). Age-related resistance in *Arabidopsis* is a developmentally regulated defense response to *Pseudomonas syringae*. *Plant Cell* **14**, 479-490.
- Lam, E., Kano-Murakami, Y., Gilmarin, P., Niner, B., and Chua, N.H.** (1990). A metal-dependent DNA-binding protein interacts with a constitutive element of a light-responsive promoter. *Plant Cell* **2**, 857-866.
- Leclercq, J., Adams-Phillips, L.C., Zegzouti, H., Jones, B., Latche, A., Giovannoni, J.J., Pech, J.C., and Bouzayen, M.** (2002). LeCTR1, a Tomato CTR1-Like Gene,

- Demonstrates Ethylene Signaling Ability in Arabidopsis and Novel Expression Patterns in Tomato. *Plant Physiol.* **130**, 1132-1142.
- Leclercq, J., Ranty, B., Sanchez-Ballesta, M.T., Li, Z., Jones, B., Jauneau, A., Pech, J.C., Latche, A., Ranjeva, R., and Bouzayen, M.** (2005). Molecular and biochemical characterization of LeCRK1, a ripening-associated tomato CDPK-related kinase. *J. Exp. Bot.* **56**, 25-35.
- Lee, J.H., Hong, J.P., Oh, S.K., Lee, S., Choi, D., and Kim, W.T.** (2004). The ethylene-responsive factor like protein 1 (CaERFLP1) of hot pepper (*Capsicum annuum* L.) interacts in vitro with both GCC and DRE/CRT sequences with different binding affinities: possible biological roles of CaERFLP1 in response to pathogen infection and high salinity conditions in transgenic tobacco plants. *Plant Mol. Biol.* **55**, 61-81.
- Lee, C.N., Hu, R.M., Chow, T.Y., Lin, J.W., Chen, H.Y., Tseng, Y.H., and Weingartner, S.F.** (2007). Comparison of Genomes of Three *Xanthomonas oryzae* Bacteriophages. *BMC Genomics* **8**, 442.
- Lehman, A., Black, R., and Ecker, J.R.** (1996). HOOKLESS1, an ethylene response gene, is required for differential cell elongation in the Arabidopsis hypocotyl. *Cell* **85**, 183-194.
- Lelievre, J.M., Latche, A., Jones, B., Bouzayen, M., and Pech, J.C.** (1997). Ethylene and fruit ripening. *Physiol Plant* **102**, 336-360.
- Leon, J., Rojo, E., and Sanchez-Serrano, J.J.** (2001). Wound signaling in plants. *J. Exp. Bot.* **52**, 1-9.
- Leung, J., and Giraudat, J.** (1998). Abscisic Acid Signal Transduction. *Annu. Rev. Plant Physiol. Plant Mol. Biol.* **49**, 199-222.
- Li, Y., Zhu, B., Xu, W., Zhu, H., Chen, A., Xie, Y., Shao, Y., and Luo, Y.** (2007). LeERF1 positively modulated ethylene triple response on etiolated seedling, plant development and fruit ripening and softening in tomato. *Plant Cell Rep.* **26**, 1999-2008.
- Lincoln, J.E., Cordes, S., Read, E., and Fischer, R.L.** (1987). Regulation of Gene Expression by Ethylene during *Lycopersicon esculentum* (Tomato) Fruit Development. *Proc. Natl. Acad. Sci. U.S.A.* **84**, 2793-2797.
- Linthorst, H.J.M., Melchers, L.S., Mayer, A., Roekel, J.S.C.v., Cornelissen, B.J.C., and Bol, J.F.** (1990). Analysis of Gene Families Encoding Acidic and Basic β -1,3-Glucanase of Tobacco. *Proc. Natl. Acad. Sci.* **87**, 8756-8760.
- Liu, Q., Kasuga, M., Sakuma, Y., Abe, H., Miura, S., Yamaguchi-Shinozaki, K., and Shinozaki, K.** (1998). Two transcription factors, DREB1 and DREB2, with an EREBP/AP2 DNA binding domain separate two cellular signal transduction pathways in drought- and low-temperature-responsive gene expression, respectively, in Arabidopsis. *Plant Cell* **10**, 1391-1406.
- Liu, L., White, M.J., and MacRae, T.H.** (1999). Transcription factors and their genes in higher plants functional domains, evolution and regulation. *Eur. J. Biochem.* **262**, 247-257.
- Liu, Y., and Zhang, S.** (2004). Phosphorylation of 1-aminocyclopropane-1-carboxylic acid synthase by MPK6, a stress-responsive mitogen-activated protein kinase, induces ethylene biosynthesis in Arabidopsis. *Plant Cell* **16**, 3386-3399.
- Lorenzo, O., Piqueras, R., Sanchez-Serrano, J.J., and Solano, R.** (2003). ETHYLENE RESPONSE FACTOR1 integrates signals from ethylene and jasmonate pathways in plant defense. *Plant Cell* **15**, 165-178.
- Lu, C., Zainal, Z., Tucker, G.A., and Lycett, G.W.** (2001). Developmental abnormalities and reduced fruit softening in tomato plants expressing an antisense Rab11 GTPase gene. *Plant Cell* **13**, 1819-1833.

- Luschnig, C., Gaxiola, R.A., Grisafi, P., and Fink, G.R.** (1998). EIR1, a root-specific protein involved in auxin transport, is required for gravitropism in *Arabidopsis thaliana*. *Genes Dev.* **12**, 2175-2187.
- Magnani, E., Sjolander, K., and Hake, S.** (2004). From endonucleases to transcription factors: evolution of the AP2 DNA binding domain in plants. *Plant Cell* **16**, 2265-2277.
- Mantiri, F.R., Kurdyukov, S., Lohar, D. P., Sharopova, N., Saeed, N.A., Wang, X.D., Vandenbosch, K.A., and Rose, R.J.** (2008). The transcription factor MtSERF1 of the ERF subfamily identified by transcriptional profiling is required for somatic embryogenesis induced by auxin plus cytokinin in *Medicago truncatula*. *Plant Physiol.* **146**, 1622-36
- Masucci, J.D., and Sc hiefelbein, J.W.** (1994). The *rhd6* Mutation of *Arabidopsis thaliana* Alters Root-Hair Initiation through an Auxin- and Ethylene-Associated Process. *Plant Physiol.* **106**, 1335-1346.
- McGrath, K.C., Dombrecht, B., Manners, J .M., Schenk, P.M., Edgar, C.I., Maclean, D.J., Scheible, W.R., Udvardi , M.K., and Kaz an, K.** (2005). Repressor- and activator-type ethylene response factors functioning in jasmonate signaling and disease resistance identified via a genome-wide screen of *Arabidopsis* transcription factor gene expression. *Plant Physiol.* **139**, 949-959.
- Medina, J., BARGUES, M., Terol, J., Pere z-Alonso, M., and Salinas, J.** (1999). The *Arabidopsis* CBF gene family is composed of three genes encoding AP2 domain-containing proteins whose expression is regulated by low temperature but not by abscisic acid or dehydration. *Plant Physiol* **119**, 463-470.
- Meller, Y., Sessa, G., Eyal, Y., and Fluhr, R.** (1993). DNA-protein interactions on a cis-DNA element essential for ethylene regulation. *Plant Mol. Biol.* **23**, 453-463.
- Middleton, P.H., Jakab, J., Penmetsa, R.V., Starker, C.G., Doll, J., Kalo, P., Prabhu, R., Marsh, J.F., Mitra, R.M., Keresz t, A., Dudas, B., VandenBosch, K., Long, S.R., Cook, D.R., Kiss, G.B., and Oldroyd, G.E.** (2007). An ERF transcription factor in *Medicago truncatula* that is essential for Nod factor signal transduction. *Plant Cell* **19**, 1221-1234.
- Mitsuda N, Umemura Y, Ikeda M, Shikata M, Koyama T, Matsui K, Narumi T, Aida R, Sasaki K, Hiyama T, Higuchi Y, Ono M, Isuzugawa K, Saito K, Endo R, Ikeda K, Nak atsuka T, Nishihara M, Yamamura S, Yamamura T, Terak awa T , Ohtsubo N and Ohme-Takagi M** (2008). FioreDB: a database of phenotypic information induced by the chimeric repressor silencing technology (CRES-T) in *Arabidopsis* and floricultural plants. *Plant Biotechnol.* **25**: 37-43.
- Montgomery, J., Gold man, S., Deikman, J., Margossian , L., and Fischer, R.L.** (1993). Identification of an ethylene-responsive region in the promoter of a fruit ripening gene. *Proc. Natl. Acad. Sci. U.S.A.* **90**, 5939-5943.
- Muller, A., Guan, C., Galw eiler, L., Tanzler, P., Huijser, P., Marchant, A., Parry, G., Bennett, M., Wisman, E., and Palme, K.** (1998). AtPIN2 defines a locus of *Arabidopsis* for root gravitropism control. *EMBO J.* **17**, 6903-6911.
- Murray, A.J., Hobson , G.E., Sch uch, W., and Bird, C.R.** (1993). Reduced ethylene synthesis in EFE antisense tomatoes has differential effects on fruit ripening processes. *Postharvest Biol. Technol.* **2**, 301-313.
- Nakano, T., Suzuki, K., Fujimura, T., and Shi nshi, H.** (2006). Genome-Wide Analysis of the ERF Gene Family in *Arabidopsis* and Rice. *Plant Physiol.* **140**, 411-432.
- Nakashima, K., Shinwari, Z .K., Sakuma, Y. , Seki, M., Miura, S ., Shinoz aki, K., and Yamaguchi-Shinozaki, K.** (2000). Organization and expression of two *Arabidopsis*

- DREB2 genes encoding DRE-binding proteins involved in dehydration- and high-salinity-responsive gene expression. *Plant Mol. Biol.* **42**, 657-665.
- Nakatsuka, A., Murachi, S., Okunishi, H., Shiomi, S., Nakano, R., Kubo, Y., and Inaba, A.** (1998). Differential expression and internal feedback regulation of 1-aminocyclopropane-1-carboxylate synthase, 1-aminocyclopropane-1-carboxylate oxidase, and ethylene receptor genes in tomato fruit during development and ripening. *Plant Physiol.* **118**, 1295-1305.
- Nole-Wilson, S., and Krizek, B.A.** (2000). DNA binding properties of the Arabidopsis floral development protein AINTEGUMENTA. *Nucleic Acids Res.* **28**, 4076-4082.
- Nonogaki, H., Gee, O.H., and Bradford, K.J.** (2000). A germination-specific endo-beta-mannanase gene is expressed in the micropylar endosperm cap of tomato seeds. *Plant Physiol.* **123**, 1235-1246.
- O'Donnell, P.J., Calvert, C., Atzorn, R., Wasternack, C., Leyser, H.M.O., and Bowles, D.J.** (1996). Ethylene as a Signal Mediating the Wound Response of Tomato Plants. *Science* **274**, 1914-1917.
- Oeller, P.W., Lu, M.W., Taylor, L.P., Pike, D.A., and Theologis, A.** (1991). Reversible inhibition of tomato fruit senescence by antisense RNA. *Science* **254**, 437-439.
- Ohme-Takagi, M., and Shinshi, H.** (1990). Structure and expression of a tobacco beta-1,3-glucanase gene. *Plant Mol. Biol.* **15**, 941-946.
- Ohme-Takagi, M., and Shinshi, H.** (1995). Ethylene-inducible DNA binding proteins that interact with an ethylene-responsive element. *Plant Cell* **7**, 173-182.
- Ohme-Takagi, M., Suzuki, K., and Shinshi, H.** (2000). Regulation of ethylene-induced transcription of defense genes. *Plant Cell Physiol.* **41**, 1187-1192.
- Ohta, M., Ohme-Takagi, M., and Shinshi, H.** (2000). Three ethylene-responsive transcription factors in tobacco with distinct transactivation functions. *Plant J.* **22**, 29-38.
- Ohta, M., Matsui, K., Hiratsu, K., Shinshi, H., and Ohme-Takagi, M.** (2001). Repression domains of class II ERF transcriptional repressors share an essential motif for active repression. *Plant Cell* **13**, 1959-1968.
- Onate-Sanchez, L., and Singh, K.B.** (2002). Identification of Arabidopsis ethylene-responsive element binding factors with distinct induction kinetics after pathogen infection. *Plant Physiol.* **128**, 1313-1322.
- Ortega-Martinez, O., Pernas, M., Carol, R.J., and Dolan, L.** (2007). Ethylene modulates stem cell division in the Arabidopsis thaliana root. *Science* **317**, 507-510.
- Ouaked, F., Rozhon, W., Lecourieux, D., and Hirt, H.** (2003). A MAPK pathway mediates ethylene signaling in plants. *EMBO J.* **22**, 1282-1288.
- Ouvrard, O., Cellier, F., Ferrare, K., Tschuch, D., Lamaze, T., Dupuis, J.M., and Casse-Delbart, F.** (1996). Identification and expression of water stress- and abscisic acid-regulated genes in a drought-tolerant sunflower genotype. *Plant Mol. Biol.* **31**, 819-829.
- Park, J.M., Park, C.J., Lee, S.B., Ham, B.K., Shin, R., and Paek, K.H.** (2001). Overexpression of the tobacco Tsi1 gene encoding an EREBP/AP2-type transcription factor enhances resistance against pathogen attack and osmotic stress in tobacco. *Plant Cell* **13**, 1035-1046.
- Patterson, S.E., and Bleeker, A.B.** (2004). Ethylene-dependent and -independent processes associated with floral organ abscission in Arabidopsis. *Plant Physiol.* **134**, 194-203.
- Payton, S., Fray, R.G., Brown, S., and Grierson, D.** (1996). Ethylene receptor expression is regulated during fruit ripening, flower senescence and abscission. *Plant Mol. Biol.* **31**, 1227-1231.

- Pearson, R.B., and Kemp, B.E.** (1991). Protein kinase phosphorylation site sequences and consensus specificity motifs: tabulations. *Meth. Enzymol.* **200**, 62-81.
- Peiser, G.** (1989). Effect of 2,5-Norbornadiene upon Ethylene Biosynthesis in Midclimacteric Carnation Flowers. *Plant Physiol.* **90**, 21-24.
- Penarrubia, L., Aguilar, M., Margossian, L., and Fisher, R.L.** (1992). An Antisense Gene Stimulates Ethylene Hormone Production during Tomato Fruit Ripening. *Plant Cell* **4**, 681-687.
- Penninckx, I.A., Thomma, B.P., Buchala, A., Metraux, J.P., and Broekaert, W.F.** (1998). Concomitant activation of jasmonate and ethylene response pathways is required for induction of a plant defensin gene in Arabidopsis. *Plant Cell* **10**, 2103-2113.
- Pierik, R., Cuppens, M.L., Voeseek, L.A., and Visser, E.J.** (2004). Interactions between ethylene and gibberellins in phytochrome-mediated shade avoidance responses in tobacco. *Plant Physiol.* **136**, 2928-2936.
- Pirrello, J., Jaimes-Miranda, F., Sanchez-Ballesta, M.T., Tournier, B., Khalil-Ahmad, Q., Regad, F., Latche, A., Pech, J.C., and Bouzaïen, M.** (2006). Sl-ERF2, a Tomato Ethylene Response Factor Involved in Ethylene Response and Seed Germination. *Plant Cell Physiol.* **47**, 1195-1205.
- Pirrung, M.C.** (1999). Histidine kinases and two-component signal transduction systems. *Chem. Biol.* **6**, R167-175.
- Pitts, R.J., Cernac, A., and Estelle, M.** (1998). Auxin and ethylene promote root hair elongation in Arabidopsis. *Plant J.* **16**, 553-560.
- Pontier, D., Balague, C., and Roby, D.** (1998). The hypersensitive response. A programmed cell death associated with plant resistance. *Comptes rendus de l'Academie des sciences* **321**, 721-734.
- Potuschak, T., Lechner, E., Parmentier, Y., Yanagisawa, S., Grava, S., Koncz, C., and Genschik, P.** (2003). EIN3-dependent regulation of plant ethylene hormone signaling by two Arabidopsis F box proteins: EBF1 and EBF2. *Cell* **115**, 679-689.
- Qu, X., and Schaller, G.E.** (2004). Requirement of the histidine kinase domain for signal transduction by the ethylene receptor ETR1. *Plant Physiol.* **136**, 2961-2970.
- Rahman, A., Amakawa, T., Goto, N., and Tsurumi, S.** (2001). Auxin is a positive regulator for ethylene-mediated response in the growth of Arabidopsis roots. *Plant Cell Physiol.* **42**, 301-307.
- Raikhel, N.** (1992). Nuclear Targeting in Plants. *Plant Physiol.* **100**, 1627-1632.
- Raz, V., and Ecker, J.R.** (1999). Regulation of differential growth in the apical hook of Arabidopsis. *Development* **126**, 3661-3668.
- Reidt, W., Wohlfarth, T., Ellstrom, M., Czihal, A., Teves, A., Ezcurra, I., Rask, L., and Baumlein, H.** (2000). Gene regulation during late embryogenesis: the RY motif of maturation-specific gene promoters is a direct target of the FUS3 gene product. *Plant J.* **21**, 401-408.
- Riechmann, J.L., Heard, J., Martin, G., Reuber, L., Jiang, C., Keddie, J., Adam, L., Pineda, O., Ratcliffe, O.J., and Samaha, R.R.** (2000). Arabidopsis transcription factors: genome-wide comparative analysis among eukaryotes. *Science* **290**, 2105-2110.
- Rodrigo, M.J., and Garcia-Martinez, J.L.** (1998). Hormonal Control of Parthenocarpic Ovary Growth by the Apical Shoot in Pea. *Plant Physiol.* **116**, 511-518.
- Rodriguez, F.I., Esch, J.J., Hall, A.E., Binder, B.M., Schaller, G.E., and Bleecker, A.B.** (1999). A copper cofactor for the ethylene receptor ETR1 from Arabidopsis. *Science* **283**, 996-998.
- Roehl, T., Caliebe, A., Seedorf, M., and Soll, J.** (1995). Characterization of four cDNAs encoding small GTP-binding proteins from pea (Accession Nos. Z49899-Z49902)(PGR 95-079). *Plant Physiol.* **109**, 1125.

- Rojo, E., Leon, J., and Sanche z-Serrano, J.J.** (1999). Cross-talk between wound signaling pathways determines local versus systemic gene expression in *Arabidopsis thaliana*. *Plant J.* **20**, 135-142.
- Roman, G., Lubarsky, B., Kieber, J.J., Rothenberg, M., and Ecker, J.R.** (1995). Genetic analysis of ethylene signal transduction in *Arabidopsis thaliana*: five novel mutant loci integrated into a stress response pathway. *Genetics* **139**, 1393-1409.
- Rosado, A., Amaya, I., Valpuesta, V., Cuartero, J., Botella, M.A., and Borsani, O.** (2006). ABA- and ethylene-mediated responses in osmotically stressed tomato are regulated by the TSS2 and TOS1 loci. *J. Exp. Bot.* **57**, 3327-3335.
- Rose, J.K., Lee, H.H., and Bennett, A.B.** (1997). Expression of a divergent expansin gene is fruit-specific and ripening-regulated. *Proc. Natl. Acad. Sci. U.S.A.* **94**, 5955-5960.
- Ross, G.S., Knighton, M.L., and Lay-Yee, M.** (1992). An ethylene-related cDNA from ripening apples. *Plant Mol. Biol.* **19**, 231-238.
- Rowan, K., Pratt, H., and Robert son, R.** (1958). Relationship of high-energy phosphate content, protein synthesis, and the climacteric rise in the respiration of ripening avocado and tomato fruits. *Aust. J. Biol. Sci.* **2**, 329-335.
- Ryals, J.A., Neuenschwander, U.H., Willits, M.G., Molina, A., Steiner, H.Y., and Hunt, M.D.** (1996). Systemic Acquired Resistance. *Plant Cell* **8**, 1809-1819.
- Saitou, N., and Nei, M.** (1987). The neighbor-joining method: a new method for reconstructing phylogenetic trees. *Mol. Biol. Evol.* **4**, 406-425.
- Sakai, H., Hua, J., Chen, Q.G., Chang, C., Medrano, L.J., Bleecker, A.B., and Meyerowitz, E.M.** (1998). ETR2 is an ETR1-like gene involved in ethylene signaling in *Arabidopsis*. *Proc. Natl. Acad. Sci. U.S.A.* **95**, 5812-5817.
- Sakuma, Y., Liu, Q., Dubouzet, J.G., Abe, H., Shinozaki, K., and Yamaguchi-Shinozaki, K.** (2002). DNA-binding specificity of the ERF/AP2 domain of *Arabidopsis* DREBs, transcription factors involved in dehydration and cold-inducible gene expression. *Biochem. Biophys. Res. Commun.* **290**, 998-1009.
- Sánchez, R.A., and Miguel, L.d.** (1997). Phytochome promotion of mannan-degrading enzyme activities in the micropylar endosperm of *Datura ferox* seeds requires the presence of embryo and gibberellin synthesis. *Seed Sci. Res.* **7**, 27-33.
- Sasaki, K., Mitsuhashi, I., Seo, S., Ito, H., Matsui, H., and Ohashi, Y.** (2007). Two novel AP2/ERF domain proteins interact with cis-element VWRE for wound-induced expression of the Tobacco *tpoxN1* gene. *Plant J.* **50**, 1079-1092.
- Satler, S.O., and Kende, H.** (1985). Ethylene and the Growth of Rice Seedlings. *Plant Physiol.* **79**, 194-198.
- Schaller, G.E., Ladd, A.N., Lanahan, M.B., Spanbauer, J.M., and Bleecker, A.B.** (1995). The ethylene response mediator ETR1 from *Arabidopsis* forms a disulfide-linked dimer. *J. Biol. Chem.* **270**, 12526-12530.
- Schenk, P.M., Kazan, K., Wilson, I., Anderson, J.P., Richmond, T., Somerville, S.C., and Manners, J.M.** (2000). Coordinated plant defense responses in *Arabidopsis* revealed by microarray analysis. *Proc. Natl. Acad. Sci. U.S.A.* **97**, 11655-11660.
- Schneider, T.D., and Stephens, R.M.** (1990). Sequence logos: a new way to display consensus sequences. *Nucleic Acids Res.* **18**, 6097-6100.
- Sessa, G., Meller, Y., and Fluhr, R.** (1995). A GCC element and a G-box motif participate in ethylene-induced expression of the PRB-1b gene. *Plant Mol. Biol.* **28**, 145-153.
- Shinozaki, K., and Yamaguchi-Shinozaki, K.** (1997). Gene Expression and Signal Transduction in Water-Stress Response. *Plant Physiol.* **115**, 327-334.
- Shinozaki, K., and Yamaguchi-Shinozaki, K.** (2000). Molecular responses to dehydration and low temperature: differences and cross-talk between two stress signaling pathways. *Curr. Opin. Plant Biol.* **3**, 217-223.

- Shinshi, H., Usami, S., and Ohme-Takagi, M.** (1995). Identification of an ethylene-responsive region in the promoter of a tobacco class I chitinase gene. *Plant Mol. Biol.* **27**, 923-932.
- Shinwari, Z.K., Nakashima, K., Miura, S., Kasuga, M., Seki, M., Yamaguchi-Shinozaki, K., and Shinozaki, K.** (1998). An Arabidopsis gene family encoding DRE/CRT binding proteins involved in low-temperature-responsive gene expression. *Biochem. Biophys. Res. Commun.* **250**, 161-170.
- Singh, K., Foley, R.C., and Onate-Sanchez, L.** (2002). Transcription factors in plant defense and stress responses. *Curr. Opin. Plant Biol.* **5**, 430-436.
- Sitrit, Y., and Bennett, A.B.** (1998). Regulation of tomato fruit polygalacturonase mRNA accumulation by ethylene: A Re-examination. *Plant Physiol.* **116**, 1145-1150.
- Smith, D.L., and Gross, K.C.** (2000). A family of at least seven beta-galactosidase genes is expressed during tomato fruit development. *Plant Physiol.* **123**, 1173-1183.
- Smith, D.L., Abbott, J.A., and Gross, K.C.** (2002). Down-regulation of tomato beta-galactosidase 4 results in decreased fruit softening. *Plant Physiol.* **129**, 1755-1762.
- Soderman, E.M., Brocard, I.M., Lynch, T.J., and Finkelstein, R.R.** (2000). Regulation and function of the Arabidopsis ABA-insensitive4 gene in seed and abscisic acid response signaling networks. *Plant Physiol.* **124**, 1752-1765.
- Solano, R., Stepanova, A., Chao, Q., and Ecker, J.R.** (1998). Nuclear events in ethylene signaling: a transcriptional cascade mediated by ETHYLENE-INSENSITIVE3 and ETHYLENE-RESPONSE-FACTOR1. *Genes Dev.* **12**, 3703-3714.
- Song, C.P., Agarwal, M., Ohta, M., Guo, Y., Halfter, U., Wang, P., and Zhu, J.K.** (2005). Role of an Arabidopsis AP2/EREBP-type transcriptional repressor in abscisic acid and drought stress responses. *Plant Cell* **17**, 2384-2396.
- Stepanova, A.N., Yun, J., Likhacheva, A.V., and Alonso, J.M.** (2007). Multilevel Interactions between Ethylene and Auxin in Arabidopsis Roots. *Plant Cell* **19**, 2169-85.
- Stock, A.M., Robinson, V.L., and Goudreau, P.N.** (2000). Two-component signal transduction. *Annu. Rev. Biochem.* **69**, 183-215.
- Stockinger, E.J., Gilmour, S.J., and Thomashow, M.F.** (1997). *Arabidopsis thaliana* CBF1 encodes an AP2 domain-containing transcriptional activator that binds to the C-repeat/DRE, a cis-acting DNA regulatory element that stimulates transcription in response to low temperature and water deficit. *Proc Natl Acad Sci U.S.A.* **94**, 1035-1040.
- Takezaki, N., Figueroa, F., Zaleska-Rutczynska, Z., Takahata, N., and Klein, J.** (2004). The phylogenetic relationship of tetrapod, coelacanth, and lungfish revealed by the sequences of forty-four nuclear genes. *Mol. Biol. Evol.* **21**, 1512-1524.
- Tamura, K., Dudley, J., Nei, M., and Kumar, S.** (2007). MEGA4: Molecular Evolutionary Genetics Analysis (MEGA) software version 4.0. *Mol. Biol. Evol.* **24**, 1596-1599.
- Thara, V.K., Tang, X., Gu, Y.Q., Martin, G.B., and Zhou, J.M.** (1999). *Pseudomonas syringae* pv tomato induces the expression of tomato EREBP-like genes *pti4* and *pti5* independent of ethylene, salicylate and jasmonate. *Plant J.* **20**, 475-483.
- Theologis, A., Oeller, P.W., Wong, L.M., Rottmann, W. H., and Gantz, D.M.** (1993). Use of a tomato mutant constructed with reverse genetics to study fruit ripening, a complex developmental process. *Dev. Genet.* **14**, 282-295.
- Thomma, B.P., Penninckx, I.A., Broekaert, W.F., and Cammue, B.P.** (2001). The complexity of disease signaling in Arabidopsis. *Curr. Opin. Immunol.* **13**, 63-68.
- Tian, Q., and Reed, J.W.** (1999). Control of auxin-regulated root development by the Arabidopsis thaliana SHY2/IAA3 gene. *Development* **126**, 711-721.

- Tigchelaar, E.C., McGlasson, W.B., and Buescher, R.W.** (1978). Genetic regulation of tomato fruit ripening. *HortScience* **13**, 508-513.
- Tiwari, S.B., Hagen, G., and Guilfoyle, T.J.** (2004). Aux/IAA proteins contain a potent transcriptional repression domain. *Plant Cell* **16**, 533-543.
- Ton, J., Van Pelt, J.A., Van Loon, L.C., and Pieterse, C.M.** (2002). Differential effectiveness of salicylate-dependent and jasmonate/ethylene-dependent induced resistance in *Arabidopsis*. *Mol. Plant Microbe Interact.* **15**, 27-34.
- Toorop, P.E., van Aelst, A.C., and Hilhorst, H.W.** (2000). The second step of the biphasic endosperm cap weakening that mediates tomato (*Lycopersicon esculentum*) seed germination is under control of ABA. *J. Exp. Bot.* **51**, 1371-1379.
- Torres-Schumann, S., Godoy, J.A., and Piñtor-Toro, J.A.** (1992). A probable lipid transfer protein gene is induced by NaCl in stems of tomato plants. *Plant Mol. Biol.* **18**, 749-757.
- Tournier, B., Sanchez-Ballesta, M.T., Jones, B., Pesquet, E., Regad, F., Latche, A., Pech, J.C., and Bouzaïen, M.** (2003). New members of the tomato ERF family show specific expression pattern and diverse DNA-binding capacity to the GCC box element. *FEBS Lett.* **550**, 149-154.
- Trainotti, L., Pavanello, A., and Casadoro, G.** (2005). Different ethylene receptors show an increased expression during the ripening of strawberries: does such an increment imply a role for ethylene in the ripening of these non-climacteric fruits? *J. Exp. Bot.* **56**, 2037-2046.
- Trevino, M.B., and O'Connell M.A.** (1998). Three drought-responsive members of the nonspecific lipid-transfer protein gene family in *Lycopersicon pennellii* show different developmental patterns of expression. *Plant Physiol.* **116**, 1461-1468.
- Underwood, B.A., Tieman, D.M., Shibuya, K., Dexter, R.J., Loucas, H.M., Simkin, A.J., Sims, C.A., Schmelz, E.A., Klee, H.J., and Clark, D.G.** (2005). Ethylene-regulated floral volatile synthesis in petunia corollas. *Plant Physiol.* **138**, 255-266.
- van der Fits, L., and Memelink, J.** (2000). ORCA3, a jasmonate-responsive transcriptional regulator of plant primary and secondary metabolism. *Science* **289**, 295-297.
- van der Graaff, E., Dulk-Ras, A.D., Hooykaas, P.J., and Keller, B.** (2000). Activation tagging of the LEAFY PETIOLE gene affects leaf petiole development in *Arabidopsis thaliana*. *Development* **127**, 4971-4980.
- van Loon, L.C., Geraats, B.P., and Linthorst, H.J.** (2006). Ethylene as a modulator of disease resistance in plants. *Trends Plant Sci.* **11**, 184-191.
- Verberne, M.C., Hoekstra, J., Bol, J.F., and Linthorst, H.J.** (2003). Signaling of systemic acquired resistance in tobacco depends on ethylene perception. *Plant J.* **35**, 27-32.
- Vrebalov, J., Ruzinsky, D., Padmanabhan, V., White, R., Medrano, D., Drake, R., Schuch, W., and Giovannoni, J.** (2002). A MADS-box gene necessary for fruit ripening at the tomato ripening-inhibitor (*rin*) locus. *Science* **296**, 343-346.
- Vriezen, W.H., Feron, R., Maretto, F., Keijman, J., and Mariani, C.** (2008). Changes in tomato ovary transcriptome demonstrate complex hormonal regulation of fruit set. *New Phytol.* **177**, 60-76.
- Wang A., Tan D., Takahashi A., Li T. Z., Harada T.** (2007) MdERFs, two ethylene-response factors involved in apple fruit ripening. *J. Exp. Bot.* **58**, 3743-8.
- Wang, H., Huang, Z., Chen, Q., Zhang, Z., Zhang, H., Wu, Y., Huang, D., and Huang, R.** (2004). Ectopic overexpression of tomato JERF3 in tobacco activates downstream gene expression and enhances salt tolerance. *Plant Mol. Biol.* **55**, 183-192.
- Wang, H., Jones, B., Li, Z., Frasse, P., Delalande, C., Regad, F., Chaabouni, S., Latche, A., Pech, J.C., and Bouzaïen, M.** (2005). The tomato Aux/IAA transcription factor

- IAA9 is involved in fruit development and leaf morphogenesis. *Plant Cell* **17**, 2676-2692.
- Watahiki, M.K., and Yamamoto, K.T.** (1997). The massugul mutation of *Arabidopsis* identified with failure of auxin-induced growth curvature of hypocotyl confers auxin insensitivity to hypocotyl and leaf. *Plant Physiol* **115**, 419-426.
- Watkins, J.T., Cantliffe, D.J., Huber, D.J., and Nell, T.A.** (1985). Gibberellic acid stimulated degradation of endosperm in pepper. *J. Am. Soc. Hortic. Sci.* **110**, 61-65.
- Weingart, H., Ullrich, H., Geider, K., and Völksch, B.** (2001). The role of ethylene production in virulence of *Pseudomonas syringae* pvs. *glycinea* and *phaseolicola*. *Phytopathology* **91**, 511-518.
- Wessler, S.R.** (2005). Homing into the origin of the AP2 DNA binding domain. *Trends Plant Sci.* **10**, 54-56.
- Wilkinson, J.Q., Lanahan, M.B., Yen, H.C., Giovannoni, J.J., and Klee, H.J.** (1995). An ethylene-inducible component of signal transduction encoded by never-ripe. *Science* **270**, 1807-1809.
- Winter, D., Vinegar, B., Nahal, H., Ammar, R., Wilson, G.V., and Provart, N.J.** (2007). An "electronic fluorescent pictograph" browser for exploring and analyzing large-scale biological data sets. *PLoS ONE* **2**, e718.
- Wu, L., Chen, X., Ren, H., Zhang, Z., Zhang, H., Wang, J., Wang, X.C., and Huang, R.** (2007). ERF protein JERF1 that transcriptionally modulates the expression of abscisic acid biosynthesis-related gene enhances the tolerance under salinity and cold in tobacco. *Planta* **226**, 815-825.
- Wuitschick, J.D., Lindstrom, P.R., Meyer, A.E., and Karrer, K.M.** (2004). Homing endonucleases encoded by germ line-limited genes in *Tetrahymena thermophila* have APETELA2 DNA binding domains. *Eukaryotic cell* **3**, 685-694.
- Xie, C., Zhang, J.S., Zhou, H.L., Li, J., Zhang, Z.G., Wang, D.W., and Chen, S.Y.** (2003). Serine/threonine kinase activity in the putative histidine kinase-like ethylene receptor NTHK1 from tobacco. *Plant J.* **33**, 385-393.
- Xiong, L., Schumaker, K.S., and Zhu, J.K.** (2002). Cell signaling during cold, drought, and salt stress. *Plant Cell* **14 Suppl**, S165-183.
- Xu, R., Goldman, S., Coupe, S., and Deikman, J.** (1996). Ethylene control of E4 transcription during tomato fruit ripening involves two cooperative cis elements. *Plant Mol. Biol.* **31**, 1117-1127.
- Xu, Z.S., Xia, L.Q., Chen, M., Cheng, X.G., Zhang, R.Y., Li, L.C., Zhao, Y.X., Lu, Y., Ni, Z.Y., Liu, L., Qiu, Z.G., and Ma, Y.Z.** (2007). Isolation and molecular characterization of the *Triticum aestivum* L. ethylene-responsive factor 1 (TaERF1) that increases multiple stress tolerance. *Plant Mol Biol.* **65**, 719-32.
- Yamaguchi-Shinozaki, K., and Shinozaki, K.** (1994). A novel cis-acting element in an *Arabidopsis* gene is involved in responsiveness to drought, low-temperature, or high-salt stress. *Plant Cell* **6**, 251-264.
- Yamaguchi-Shinozaki, K., and Shinozaki, K.** (2005). Organization of cis-acting regulatory elements in osmotic- and cold-stress-responsive promoters. *Trends Plant Sci.* **10**, 88-94.
- Yamamoto, S., Suzuki, K., and Shinshi, H.** (1999). Elicitor-responsive, ethylene-independent activation of GCC box-mediated transcription that is regulated by both protein phosphorylation and dephosphorylation in cultured tobacco cells. *Plant J.* **20**, 571-579.
- Yanagisawa, S., Yoo, S.D., and Sheen, J.** (2003). Differential regulation of EIN3 stability by glucose and ethylene signaling in plants. *Nature* **425**, 521-525.

- Yang, S.F., and Hoffman, N.E.** (1984). Ethylene Biosynthesis and its Regulation in Higher Plants. *Annu Rev Plant Physiol* **35**, 155-189.
- Yang, Z., Tian, L., Latoszek-Green, M., Brown, D., and Wu, K.** (2005). Arabidopsis ERF4 is a transcriptional repressor capable of modulating ethylene and abscisic acid responses. *Plant Mol. Biol.* **58**, 585-596.
- Zegzouti, H., Jones, B., Frasse, P., Marty, C., Maitre, B., Latch, A., Pech, J.C., and Bouzayen, M.** (1999). Ethylene-regulated gene expression in tomato fruit: characterization of novel ethylene-responsive and ripening-related genes isolated by differential display. *Plant J.* **18**, 589-600.
- Zhang, X.S., and O'Neill, S.D.** (1993). Ovary and Gametophyte Development Are Coordinately Regulated by Auxin and Ethylene following Pollination. *Plant Cell* **5**, 403-418.
- Zhang, B., Foley, R.C., and Singh, K.B.** (1993). Isolation and characterization of two related Arabidopsis ocs-element bZIP binding proteins. *Plant J.* **4**, 711-716.
- Zhang, H., Zhang, D., Chen, J., Yang, Y., Huang, Z., Huang, D., Wang, X.C., and Huang, R.** (2004). Tomato stress-responsive factor TSRF1 interacts with ethylene responsive element GCC box and regulates pathogen resistance to *Ralstonia solanacearum*. *Plant Mol. Biol.* **55**, 825-834.
- Zhang, H., Huang, Z., Xie, B., Chen, Q., Tian, X., Zhang, X., Zhang, H., Lu, X., Huang, D., and Huang, R.** (2004). The ethylene-, jasmonate-, abscisic acid- and NaCl-responsive tomato transcription factor JERF1 modulates expression of GCC box-containing genes and salt tolerance in tobacco. *Planta* **220**, 262-270.
- Zhang, J.Y., Broeckling, C.D., Blancaflor, E.B., Sledge, M.K., Sumner, L.W., and Wang, Z.Y.** (2005a). Overexpression of WXP1, a putative *Medicago truncatula* AP2 domain-containing transcription factor gene, increases cuticular wax accumulation and enhances drought tolerance in transgenic alfalfa (*Medicago sativa*). *Plant J.* **42**, 689-707.
- Zhang, X., Zhang, Z., Chen, J., Chen, Q., Wang, X.C., and Huang, R.** (2005b). Expressing TERF1 in tobacco enhances drought tolerance and abscisic acid sensitivity during seedling development. *Planta* **222**, 494-501.
- Zhou, J., Tang, X., and Martin, G.B.** (1997). The Pto kinase conferring resistance to tomato bacterial speck disease interacts with proteins that bind a cis-element of pathogenesis-related genes. *EMBO J.* **16**, 3207-3218.
- Zuckerkindl, E., and Pauling, L.** (1965). Evolutionary divergence and convergence in proteins. In *Evolving Genes and Proteins* (New York: Academic Press), pp. 97-166.

Titre : Caractérisation moléculaire et physiologique des facteurs de réponse à l'éthylène (ERF) chez la tomate (*Solanum lycopersicon*)

Résumé :

La phytohormone éthylène, contrôle de nombreux processus physiologique durant le développement des plantes, ainsi que la réponse aux stress biotiques et abiotiques. Les ERF (Facteurs de Réponse à l'Éthylène) sont les derniers facteurs de transcription de la voie de transduction de cette hormone. Ils sont par leur nombre, de bons candidats pour expliquer la diversité de réponse à l'éthylène. Dans cette étude 28 ERF de tomates ont été isolés, caractérisés et renommés. Des études d'interaction ADN/protéine montrent que l'environnement du cis-élément est déterminant pour l'interaction GCC/ERF. Des expériences d'expression transitoire des ERF ont permis de démontrer que leur activité transcriptionnelle est indépendante de leur classe d'appartenance. Leur profil d'expression suggère une spécificité de réponse au cours du développement végétatif ou de la maturation, ainsi qu'un rôle prépondérant dans l'initiation du fruit. L'analyse fonctionnelle est illustrée par deux exemples. D'une part, la surexpression de *SIERF2* dans la tomate induit une germination précoce des graines où il a été montré que la *MANNANASE2*, un marqueur de la germination, est fortement induit dans les graines transgéniques. D'autre part, la surexpression d'*ATERF13* fusionné à un domaine répresseur dominant induit une insensibilité partielle à l'éthylène et une hypersensibilité au stress salin.

Mots Clés : Ethylène, Tomate, Ethylene Response Factor (ERF), germination, régulation transcriptionnelle.

Title: Molecular and physiological characterization of tomato (*Solanum lycopersicon*) ethylene response factor (ERF)

Abstract:

The phytohormone ethylene controls many physiological aspects of the plant development and stress response. ERFs (Ethylene Response Factors) are the last transcription factors of the ethylene transduction pathway. By their number, they are good candidates to explain the diversity of ethylene response. In this work 28 tomato ERFs have been isolated, characterized and renamed. DNA/protein interaction studies indicate that flanking regions of the cis-element are decisive for the GCC/ERF binding. Transient expression studies of ERFs demonstrated that the transcriptional activity is independent of the class they belong to. The study of their expression pattern revealed a specific response for some ERFs during the vegetative growth whereas others are preferentially expressed in fruit, from fruit set to ripening. The physiological significance of the ERFs is addressed through two examples. First, over-expression of the *SIERF2* gene in the tomato resulted in premature seed germination in which *MANNANASE2*, a germination marker, is dramatically enhanced in the transgenic seeds. Second, over-expression of *AtERF13* fused to a dominant repressor domain induces a partial insensitivity to ethylene and hypersensitivity to salt stress.

Key words: Ethylene, Tomato, Ethylene Response Factor (ERF), germination, transcriptional regulation