



HAL
open science

Affichages à retour haptique avec Friction Programmable : Interactions et Perception de Textures

Farzan Kalantari

► **To cite this version:**

Farzan Kalantari. Affichages à retour haptique avec Friction Programmable : Interactions et Perception de Textures. Interface homme-machine [cs.HC]. Université de Lille, 2018. Français. NNT : . tel-04453239

HAL Id: tel-04453239

<https://hal.science/tel-04453239>

Submitted on 12 Feb 2024

HAL is a multi-disciplinary open access archive for the deposit and dissemination of scientific research documents, whether they are published or not. The documents may come from teaching and research institutions in France or abroad, or from public or private research centers.

L'archive ouverte pluridisciplinaire **HAL**, est destinée au dépôt et à la diffusion de documents scientifiques de niveau recherche, publiés ou non, émanant des établissements d'enseignement et de recherche français ou étrangers, des laboratoires publics ou privés.

UNIVERSITÉ LILLE - SCIENCES ET TECHNOLOGIES

CENTRE DE RECHERCHE EN INFORMATIQUE, SIGNAL ET
AUTOMATIQUE DE LILLE (UMR CNRS 9189)

ÉCOLE DOCTORALE SCIENCE POUR L'INGENIEUR LILLE NORD-DE-FRANCE

Année 2018

Thèse

Pour l'obtention du grade de

Docteur de l'Université Lille - Sciences et Technologies

Discipline : Informatique

présentée par:

Farzan KALANTARI

Haptic Feedback Displays with Programmable Friction: Interaction and Texture Perception

Soutenue publiquement le 5 Juillet 2018 devant le jury composé de

Marcelo WANDERLEY	Professor, McGill University	Rapporteur
Maud MARCHAL	Maître de conférences, INSA Rennes	Rapporteuse
Edward LANK	Professor, University of Waterloo	Examinateur
Laurence DUCHIEN	Professeure, Université Lille	Examinatrice
Michael WIERTLEWSKI	Chargé de recherche, CNRS	Examinateur
Laurent GRISONI	Professeur, Université Lille	Directeur
Frédéric GIRAUD	Maître de conférences, Université Lille	Co-directeur

Abstract

Touch interactions with tactile displays such as smart-phones, tablets, and ultra portable computers have become more and more ubiquitous in our daily life. These commercial touchscreen devices rarely provide a compelling haptic feedback to human fingers despite the use of touch as primary input; haptic feedback is typically limited to vibration. As investigated in 1985 by Buxton et al. [1], flat touchscreens may need haptic feedback in order to ease end users' common interaction tasks, to enhance the efficiency of interfaces, and to increase the realism of visual environments. Therefore, different technologies have been explored to generate dynamic haptic feedback to enhance input on touchscreen devices. In this dissertation, we are particularly interested in a category of haptic feedback which leverages ultrasonic vibrations to create an air-gap between a user's finger and the display to reduce friction when activated, a phenomenon called the *squeeze film effect*. Indeed, user's tactile perception plays a crucial role for interacting with haptic displays. In this thesis, we first explore user's fingers limitation of tactile perception on ultrasonic haptic displays for both one-finger and multi-finger touch explorations by means of psychophysical experiments. We then propose a novel concept, called *tazel* concerning user's perception of tactile elements on ultrasonic haptic touchscreens. Furthermore, we describe how to optimize user's interaction performances in common interaction tasks by leveraging ultrasonic lubrication. Finally, we study how tactile signal can be combined with auditory signals to enhance user's perception in musical interactions on ultrasonic haptic displays.

Keywords: Haptic display; Ultrasonic vibration; Friction modulation; Squeeze film effect; Texture perception; Finger sensitivity; Interaction performance optimization; Haptic musical interface; User experience

Resumé

Les interactions tactiles avec les écrans tactiles tels que les smartphones, les tablettes et les ordinateurs ultra-portables sont devenues de plus en plus omniprésentes dans notre vie quotidienne. Ces dispositifs tactiles commerciaux fournissent rarement un retour haptique convaincant aux doigts humains malgré l'utilisation du toucher comme entrée principale; le retour haptique est généralement limité à la vibration. Comme il a été étudié en 1985 par Buxton et al. [1], les écrans tactiles plats ont besoin d'un retour haptique afin de faciliter les tâches d'interaction communes des utilisateurs finaux, d'améliorer l'efficacité des interfaces et d'augmenter le réalisme des environnements visuels. Par conséquent, différentes technologies ont été explorées pour générer un retour haptique dynamique afin d'améliorer la saisie sur les appareils à écran tactile. Dans cette thèse, nous nous intéressons plus particulièrement à une catégorie de retour haptique qui exploite les vibrations ultrasoniques pour créer un film d'air (air-gap) entre le doigt d'un utilisateur et l'écran pour réduire la friction lorsqu'il est activé, ce phénomène est appelé effet squeeze film. En effet, la perception tactile de l'utilisateur joue un rôle crucial dans l'interaction avec les dispositifs haptiques. Dans cette thèse, nous explorons d'abord la limitation de la perception tactile des doigts de l'utilisateur sur les écrans tactiles haptiques ultrasoniques pour des explorations tactiles à un doigt et à plusieurs doigts au moyen d'expériences psychophysiques. Nous proposons ensuite un nouveau concept, appelé taxel, concernant la perception par l'utilisateur des éléments tactiles sur les écrans tactiles haptiques à ultrasons. En outre, nous décrivons comment optimiser les performances d'interaction de l'utilisateur dans des tâches d'interaction communes en utilisant les vibrations ultrasoniques. Enfin, nous étudions comment le signal tactile peut être combiné avec des signaux auditifs pour améliorer la perception de l'utilisateur dans les interactions musicales sur les écrans haptiques ultrasoniques.

Mots clés: Écran haptique; Vibration ultrasonique; Modulation de friction; Effet squeeze film; Perception de texture; Sensibilité de doigt; Optimisation des performances d'interaction; Interface musicale haptique; Expérience utilisateur

Acknowledgements

I would like to express my great appreciation to all the people who have helped me in various ways to fulfill this dissertation throughout the three years of my life as a PhD student in Lille.

First, I would like to kindly thank my advisor, Prof. Laurent Grisoni, for his guidance, patience, kind supports and supervising me during my thesis. I have to thank also my co-supervisor, Dr. Frédéric Giraud, for providing me some useful help, advice and the different discussions we had during my thesis.

Secondly, I would like to express my deepest gratitude to Prof. Edward Lank for his great help, very insightful guidance and the time he sacrificed for me during the two research projects that we have done together. Ed, you are amazingly a great professor with a wonderful personality and I do owe you a lot to accomplish my dissertation. It was really a great opportunity for me to be able to work with you.

I would like to appreciate my committee members, Prof. Ed Lank, Prof. Marcelo Wanderley, Dr. Maud Marchal, Dr. Michael Wiertlewski and the president of the jury, Prof. Laurence Duchien for reviewing my dissertation and all their insightful comments and suggestions to improve the manuscript.

I also acknowledge all my colleagues at Mint team and L2EP lab at CNRS/IRCICA and University of Lille as well as Région Hauts de France for partially funded my research. My special thanks go to all my great friends in Lille for all their supports and invaluable times we spent together which I never forget. I won't mention the individual names in order not to forget anyone!

And last but not least, I'm truly grateful to my beloved family for all their love, strong supports and encouragements in my life. *Thank you all !*

Contents

Acknowledgements	v
List of Figures	xi
List of Tables	xvii
1 General Introduction	1
1.1 Thesis Context	1
1.2 Thesis Structure	3
1.3 Publications	5
2 Literature Review:	
Haptic Devices, Technologies and Applications	7
2.1 Introduction	9
2.2 Human Sense of Touch	9
2.3 Haptic Feedback Devices	11
2.4 Shape and Texture Rendering on Kinesthetic Haptic Devices	12
2.5 Haptic feedback technologies on tactile displays	17
2.5.1 Local Stimulation Techniques	18
2.5.2 Global Stimulation Techniques	19
2.5.2.1 Vibrotactile Actuation	20
2.5.2.2 Surface Acoustic Wave (SAW)	22
2.5.2.3 Electrostatic Vibrations	23
2.5.2.4 Ultrasonic Vibrations	29
2.5.3 Merging Electro vibration and Ultrasonic Vibration Technologies	38
2.6 Conclusion	40
3 Texture Perception on Ultrasonic Haptic Displays	43
3.1 Haptic Texture	45
3.1.1 Duplex Theory of Texture Perception	45
3.1.2 Texture Perception on Tactile Surfaces	46
3.2 Experiment 1	47
3.2.1 Participants	48
3.2.2 Experimental Apparatus: The E-ViT _a Haptic Display	48

3.2.3	General Procedure	50
3.3	Results of The Experiment 1	52
3.3.1	One-finger Exploration	52
3.3.2	Multi-finger Exploration	55
3.3.3	Discussion & Perspectives	57
3.4	Concept of Taxel	58
3.5	Experiment 2	59
3.5.1	Design of the Experiment 2	60
3.5.2	Procedure of the Experiment 2	60
3.5.3	Results of the Experiment 2	61
3.6	Experiment 3	62
3.6.1	General Procedure of the Experiment 3	62
3.6.2	Results of the Experiment 3	64
3.6.3	Discussion	66
3.7	Application Examples	67
3.7.1	Designing the Visual Interface for E-ViT _a	67
3.7.2	Gaming	68
3.7.3	Haptic Painting	69
4	Understanding Interaction Performances on Haptic Feedback Displays	71
4.1	Introduction	73
4.2	Optimizing the Targeting Performance on Ultrasonic Haptic Displays	76
4.3	Experiment 1	77
4.3.1	Apparatus	77
4.3.2	Participants	77
4.3.3	Experimental Design and Variables	77
4.3.4	Procedure and Task	78
4.4	Results of The Experiment 1	79
4.4.1	Error Rate	80
4.4.2	Number of Failed Attempts	81
4.4.3	Number of Overshoots	81
4.4.4	Trial Time	81
4.4.5	Qualitative Ranking	82
4.4.6	Discussion	83
4.5	Effect of Variable Friction for Interaction with Electrostatic Display on Different Age Group	85
4.6	Experiment 2	85
4.6.1	Apparatus	86
4.6.2	Participants	86
4.6.3	Procedure and Task	87
4.7	Results of The Experiment 2	89
4.7.1	Acquisition Time	89
4.7.2	Trial Time	90
4.7.3	Error Rate Analysis	91
4.7.4	Overshoots Analysis	91

4.7.5	Subjective Results	91
4.8	Conclusion	93
5	Musical Interaction with Programmable Friction Haptic Displays	95
5.1	Introduction	97
5.2	Exploring Gesture-sound Mappings and Haptics	99
5.3	Experiment	101
5.3.1	Design	101
5.3.2	Task and Procedure	103
5.4	Results and Discussion	104
5.5	Conclusion & Perspective	111
6	Conclusions and Perspectives	113
A	Structure of the Mappings used in our Haptic Musical Interface	117
B	Other Scientific Activities	121

List of Figures

1.1	Estimation of market size of touchscreen devices with different haptic feedback technologies from 2012 to 2025 by LuxResearch [2])	3
2.1	Mechanoreceptors of glabrous skin (adapted from [3])	10
2.2	Examples of haptic kinesthetic devices (From left to right: Novint Falcon® [4], Phantom Omni [5] and Omega® [6])	12
2.3	Examples of shape rendering on kinesthetic haptic devices a) inFORM [7], b) Sublimate [8], c) PneuUI [9]	13
2.4	The ClaytricSurface interactive surface for shape rendering by dynamic flexibility control [10]. a) Surface in a soft state (left) and hard state (right), b) System hardware	14
2.5	A self-deformable haptic strip for shape rendering of digital surfaces [11]	15
2.6	Five high-fidelity 3D haptic device prototypes for shape rendering including three NormalTouch and two TextureTouch [12]	15
2.7	a) Force cues overcome surface geometry for shape perception of bumps or holes during an active touch using a force-feedback device [13]. b) A haptic surface for shape rendering by using Lateral force fields(LFFs) [14]	16
2.8	a) The Pantograph haptic device for shape rendering by using lateral force, b) Rolling fingertip deformation as a method for haptic shape rendering [15]	16
2.9	A 3-DOF haptic interface for spatial texture and shape rendering a) tactile plate, b) force sensor, c) two falcon kinesthetic device, d) control PC [16]	17
2.10	A few examples of haptic feedback devices based on local stimulation technique. a) Electro-tactile device [17], b) STReSS tactile device [18], c) Pin arrays haptic device using RC servomotors [19], d) The FEELEX device for adding haptic to computer graphics [20] e) Thermal and vibrotactile feedback device [21]	19
2.11	Examples of vibrotactile haptic displays a) Haptic interface for small touchscreens [22], b) MudPad haptic display for generating localized tactile feedback [23], c) TouchMover 2.0 haptic display with force feedback and haptic texture rendering, d) TouchMover 2.0 system schematic [24]	22
2.12	Implementation of surface acoustic wave (SAW) principle for haptic displays. a) Basic structure of SAW for tactile feedback display, b) Friction shift by switching the SAW [25]	23
2.13	The general principle of the electrovibration effect	25

2.14	a) The TeslaTouch haptic display for various texture rendering , b) The principle of the TeslaTouch based on the electrovibration effect. By applying a periodic electrical signal $V(t)$ with sufficient amplitude, an attractive force f_e develops between a sliding finger and the surface which eventually increase the dynamic friction f_r [26].	26
2.15	The results of Normal Force and Friction Force for 10 kHz sine wave (up) and 10 kHz square wave (down) with 140 Volts applied voltage. The gray area demonstrates when the electrovibration effect is turned on. [27]	28
2.16	a) The principle of the squeeze film effect between two plates in which the one in above vibrates at ultrasonic frequencies. b) Ultrasonic vibration creates an air gap which reduces the friction and gives a slippery feeling on the user's finger.	30
2.17	Approximate profile of a finger pad ridges concerning to the Reynold's equation for ultrasonic vibrations on a tactile plate. h_r is the surface roughness, h_{vib} is the amplitude of vibration, L is the period of the fingerprints ridges and ω_0 is the vibrating frequency of the plate [28].	31
2.18	The evolution of the STIMTAC tactile plate design at L2EP lab. From left to right: 1D prefiguration (2004) with the free stator of a USR60 ultrasonic motor and a ring shaped resonator, 2D feedback (2007) with a tactile plate on top and piezoelectric ceramics at the bottom, 2D input and tactile feedback (2008) and compact standalone USB opaque prototype (2010) [29].	32
2.19	a) The transparent tactile stimulator based on the squeeze film effect , b) The LCD screen (in blue) and the force sensors (in green) to calculate the finger position on the transparent tactile stimulator [30], c) Using resistive touchscreen for enhancement of finger positioning measurement of Stimtac device, and d) capacitive haptic touchscreen	33
2.20	a) An example application of square wave grating shown on the PC screen and the appropriate chosen vibration amplitude in function of x position of a user's finger. b) An example of a textured surface (such as sand) shown on the PC screen. The provided texture is perceived while users slide a finger on the capacitive sensor of the device.	34
2.21	a) A 3D model of a vase with the collaboration of Musée des Beaux Arts de Lille. b) Normal mapping of the vase used for texture rendering	35
2.22	Haptic surface devices developed at Northwestern University a) Tactile Pattern Display (T-PAD) and its touchscreen principle [31], b) ActivePad [32] , c) ShiverPaD [33] , d) LateralPaD [34]	37
2.23	A summary of haptic feedback technologies on tactile interfaces and their interaction modes. (adapted from [35])	38
2.24	Evaluation of coupling of electrovibration and ultrasonic vibrations in phase (a), and in quadrature (b). In the first graph, the presence of the electrovibration effect (blue) and ultrasonic vibrations (red) are represented. In the second graph the recorded lateral force (blue color) is shown. In the third graph the measured normal force (red color) is illustrated [36].	39

2.25	Friction modulation for different finger speeds related to the measured plate vibration or voltage envelope reported in the figure. The shadowed area represents the measure standard deviation. (a), descending friction for ultrasonic devices, (b) increasing friction for ultrasonic devices, (c) decreasing friction for electrovibration effect and (d) increasing friction for electrovibration effect. [36].	40
3.1	a) The detailed structure of <i>E-ViT</i> a haptic feedback display based on ultrasonic vibrations. b) The equivalent electrical scheme of E-ViT display, the PWM signal drives the inverter which supplies the transformer powering the vibrating plate. For each resonant mode m of vibration there are series of RLC circuit illustrated at the right side of the scheme [37].	49
3.2	a) The cartography of the ultrasonic vibrating plate. b) Bode diagram of the vibration frequency response of the plate. The dashed line at -3 dB shows the bandwidth of the plate up to 400 Hz [37].	50
3.3	Sample of data collected from a single participant using 1-up 1-down staircase procedure. Turnover points (reversals) are marked with red color. The sensory threshold was calculated by averaging the correct detected texture over the last five turnover points.	51
3.4	The setup of our experiment in two tactile exploration conditions	52
3.5	The psychophysical threshold, computed as the 50% just noticeable difference between the comparison and reference stimuli of all finger types of both hands. The experiment was performed for a) sinusoidal gratings and b) square gratings. The finger types are as follow: (1) thumb, (2) index, (3)middle, (4) ring, (5) little. The boxplots show the median value and the error bars show the interquartile range.	53
3.6	a) The psychophysical threshold, computed as the 50% just noticeable difference for comparing the sensory thresholds (median±IQR) of <i>thumb,index</i> and <i>middle</i> fingers for both gratings. b) 50 % psychophysical thresholds for all finger types across both types of gratings were averaged for each participants. The resulting thresholds (median±IQR) were compared between the right and left hand. c) The same procedure was performed to compare the psychophysical thresholds (median±IQR) between both types of gratings.	55
3.7	Left: the 50 % psychophysical thresholds (median±IQR) when exploration was simultaneously performed with four fingers on a sinusoidal grating were compared between the right and left hand. Right: The same comparison was made for the exploration of the square grating. . .	56
3.8	Comparison of the 50 % psychophysical thresholds (median±IQR)	57
3.9	The setup of the experiment 2	60
3.10	Sample of data collected from a single participant using 1-up 1-down staircase procedure. Turnover points (reversals) are marked with red color. The sensory threshold was calculated by averaging the correct detected texture over the last five turnover points.	63
3.11	The setup of the experiment 3. The represented squares are considered to be the <i>taxel</i>	63

3.12	Minimum taxel size for a square texture. For the aim of better visibility of the data in order to find the minimum size of taxels, the data are sorted in an ascendant manner. The minimum size of taxel is 6.5 mm for 90% of participants.	64
3.13	Minimum taxel size for a sinusoidal texture. As for the square texture the data are sorted in an ascendant manner. The minimum size of taxel is 13.5 mm for all participants.	65
3.14	Minimum taxel size for a dirac texture. As for the two previous textures, the data are sorted in an ascendant manner. The minimum size of taxel is 13 mm for 90% of participants.	65
3.15	The detailed results of each participant for the minimum dimension of the tactile element for the 3 given textures	66
3.16	a) The setup of the “maze game” which is most suitable for visually impaired users. The virtual blue box with a haptic feedback has to be successfully controlled and dragged from entrance to exit. b) For any error in the game i.e. when there is a collision between the blue box with the maze edges, the texture perception is changed and the background color of E-Vita turns to red.	68
3.17	The setup of the pong game which enables visually impaired users to play. Two different kinds of textures can be perceived for each correct or wrong direction of sliding the blue paddle to get the red bouncing ball.	69
3.18	The setup of the paint application. Each color is associated to a specific texture which allows users to <i>feel</i> and <i>draw</i> at the same time. The white color is served as an eraser tool.	69
4.1	Two examples of daily life user interaction tasks enriched with variable friction haptic feedback [38]	74
4.2	a) SlickFeel setup to provide both sliding and tapping interactions techniques to users. TPAD piezos are activated at 30 kHz to produce squeeze film effect for sliding feedback. Keyclick piezos are activated with 3 cycles of a 500 Hz raised sinusoidal signal to generate tapping feedback. b) Button-click interface [39].	75
4.3	Four haptic feedback and <i>No Feedback</i> designs in our experiment	78
4.4	An example setup of the trials in our experiment	79
4.5	Average error rate cross feedback conditions. Error bars are standard error across participants (95% CI).	80
4.6	Average trial time cross feedback conditions. Error bars are standard error across participants (95% CI).	82
4.7	An example setup of the trials in east direction for a pointing task . . .	88
4.8	The acquisition time of different interfaces (LF,HF,VF) for both adults and children	89
4.9	The target time of different interfaces (LF,HF,VF) for both adults and children	90

4.10	Mean and standard deviation (SD) of questionnaire responses with 1 = strongly disagree (Failure of performance), and 5 = strongly agree (Perfect for performance). Results of Friedman test are reported to evaluate the effect of each interface on adults and children. Results of Wilcoxon-Signed-Rank test are also reported to study the effect of age group. The significant effects ($p < 0.05$) revealed from the tests are highlighted with green.	92
5.1	The structure of FM sound synthesis technique with two operators [40]. The modulator and the carrier are both periodic oscillators with specific frequency, amplitude and waveform (sinusoidal in our case).	102
5.2	a) The general structure of mapping between sound control parameters and gestures in our interactive musical system. b) E-ViTa haptic display used in our experiment for tactile feedback perception while sliding their finger to perform different gesture. No visual feedback was shown to participants during the experiment.	103
5.3	The setup of our experimental procedure using <i>Pure Data</i>	104
5.4	The tactile exploration of gesture trajectory of mapping 1 for the <u>first</u> pre-recorded sound where the tactile signal is associated to the resonance of the generated sound.	106
5.5	The tactile exploration of gesture trajectory of mapping 1 for the <u>second</u> pre-recorded sound where the tactile signal is associated to the resonance of the generated sound.	107
5.6	The tactile exploration of gesture trajectory for mapping 2 for the <u>first</u> pre-recorded sound where the tactile signal is associated to the roughness of the generated sound.	108
5.7	The tactile exploration of gesture trajectory of mapping 2 for the <u>second</u> pre-recorded sound where the tactile signal is associated to the roughness of the generated sound.	109
5.8	The tactile exploration of gesture trajectory of mapping 3 for the <u>first</u> pre-recorded sound where the tactile signal is associated to the gesture speed and thus the volume of the generated sound.	110
5.9	The tactile exploration of gesture trajectory of mapping 3 for the <u>second</u> pre-recorded sound where the tactile signal is associated to the gesture speed and thus the volume of the generated sound.	111
A.1	A detailed structure of mapping 1 in our audio/haptic musical interface using <i>Pure Data</i>	117
A.2	A detailed structure of mapping 2 in our audio/haptic musical interface using <i>Pure Data</i>	118
A.3	A detailed structure of mapping 3 in our audio/haptic musical interface using <i>Pure Data</i>	119

List of Tables

2.1	Summarized characteristics of human finger mechanoreceptors from [41–44]	11
3.1	The results of the chosen textures from experiment 2. The common chosen textures of participants are square, sinusoidal and dirac with the spatial period of 500, 1000 and 1000 μm respectively.	61
5.1	Classification of tactile feedback with programmable friction	100

To my beloved family ...

Chapter 1

General Introduction

Contents

1.1 Thesis Context	1
1.2 Thesis Structure	3
1.3 Publications	5

1.1 Thesis Context

The human tactile sense is capable to perceive daily life objects' various properties including textures via skin contact. Our touch sensing and object manipulations are related to a branch of science called *haptics*, at the edge of fields such as Computer Science, Electrical Engineering and Robotics. Haptic rendering is able to provide us a more intuitive and rich information of different surroundings physical stimuli that induce tactile sensation; such as haptic feedback reproduction on touchscreens.

Modern devices such as smartphones, tablets, and ultra portable computers frequently leverage touch as a primary input modality. Touch is an attractive input modality because the dexterity and sensitivity of our fingers makes possible a wide range of fine-grained manipulations and subtle variations of force. While touchscreen devices originally sensed touch as a binary state – touching or not-touching – recently we see ever-finer capture of characteristics of touch. For example, Android devices sometimes examine touch contact area to provide an estimate of pressure and recent Apple

touch sensors have incorporated force sensors to accurately capture force applied during input. On the other hand, while consumer devices have begun to use additional information for touch input, these devices still rarely provide fine-grained haptic output despite established research that demonstrates the need for haptic output, i.e. haptic feedback, to enhance efficiency and realism during common interaction tasks [1]. Therefore, in the recent years numerous studies have investigated how to generate a compelling and realistic haptic feedback on tactile displays and the effective ways of interactions.

Researchers exploring fine-grained haptic output typically explore various forms of dynamic haptic feedback to enhance input on touchscreen devices. Within this space of dynamic haptic feedback, four main technologies are used. First, vibrotactile actuators such as solenoids, vibrotactile coils, and ERM motors can be utilized for tactile rendering on touchscreens [45, 46]. These actuators are used presently on smartwatches, mobile phones and tablets, but typically provide for a device, on-or-off sensation. Alongside vibrotactile actuation, two techniques, electrostatic-vibration [26] and electroadhesion [47] use electrostatic force generated, respectively, by applying a voltage to the screen surface or by applying DC excitation of the tactile display. Both of these techniques increase the friction between the finger and the interaction surface when activated, thus varying the perceived stickiness of the surface. Finally, a fourth type of haptic feedback leverages ultrasonic vibrations typically by means of piezoelectric actuators to generate an air-gap between a user's finger and the display to reduce friction when activated, a phenomenon called the "*squeeze film effect*". These technologies will be completely discussed in the next chapter.

According to a recent investigation by LuxResearch [2] there will be a great growth of consuming electronic touchscreen devices, notably cellphones and tablet computers, with haptic effects via different technologies by 2025 as shown in figure 1.1.

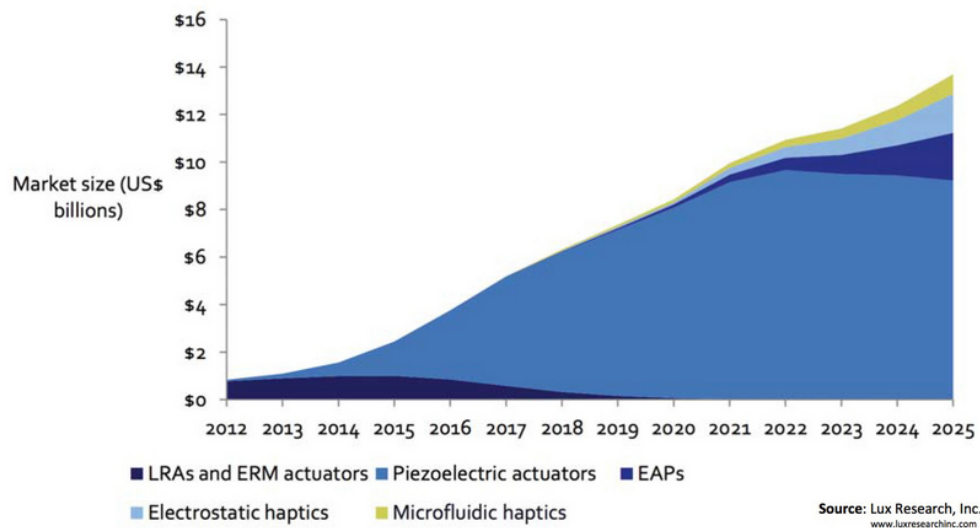

FIGURE 1.1: Estimation of market size of touchscreen devices with different haptic feedback technologies from 2012 to 2025 by LuxResearch [2])

As illustrated in figure 1.1, the consumer of market for haptic feedback touchscreens, which in 2012 comprised nearly all of the \$842 million, will be grow up to \$13.8 billion in 2025 and will be dominated by piezoelectric actuators used in ultrasonic based haptic displays. This is a very important reason that I'm motivated in this thesis to investigate user's perceptions and improve their interaction performances with haptic feedback displays; in particular with ultrasonic based haptic touchscreens in which piezoelectric actuators are commonly used.

This thesis has been carried out with a collaboration between the MINT team and L2EP lab in CNRS/IRCICA campus at University of Lille 1 - Sciences and Technologies. The L2EP lab has worked on designing haptic feedback surfaces along the STIMTAC project [29] with a primary interest in ultrasonic based devices for over ten years now.

1.2 Thesis Structure

This dissertation focuses on haptic feedback touchscreens with programmable friction and more particularly, ultrasonic based tactile devices. The study of user's texture perception and how to enhance their effective interactions on this category of devices

might be essential in order to take advantage of haptic touchscreens in future market. Hence, the structure of this thesis is as follows:

Chapter 2 reviews the principles of the human sense of touch and haptic devices (both tactile and kinesthetic) for tactile rendering and its applications. The two general techniques of local stimulation and global stimulation for haptic rendering on tactile surfaces as well as the common technologies for generating haptic effects on touchscreens are discussed. The three following chapters (chapter 3, 4 and 5) are the main contributions of the provided dissertation.

Chapter 3 describes a novel concept called *taxel* as a new tactile element to measure the minimum size on which tactile information can be retrieved by users while interacting with an ultrasonic based haptic display. Furthermore, the limitations of different human finger for tactile perception as well as multiple finger sensation thresholds of physical stimuli have been presented by using psychophysical investigations. The results of this chapter are essentials to give us a clear and definite idea of how users perceive different textures in order to improve performances of their common interaction tasks (such as drag and drop interaction technique) while sliding a finger on ultrasonic based haptic touchscreens.

Chapter 4 investigates how to optimize interaction performances on tactile feedback touchscreens with programmable friction. It replies to the main question of how to create haptic effects on displays through alternative technologies i.e. when and where to provide haptic feedback. The user's interaction performances by means of a targeting task (as a basic interaction technique while touching a touchscreen) of the two main technologies of haptic feedback; ultrasonic vibrations and electrovibrations have been also analyzed and compared. It is also shown that different haptic technologies produce different physical sensations for the end user and thus these differences must be taken into account to produce effective interaction techniques for different haptic displays.

Chapter 5 studies of how haptic feedback by means of programmable friction on tactile interfaces might influence and enrich musical interaction especially for musicians. Different mappings between sound synthesis parameters and haptic feedback and evaluation of the impact of these mappings on user experience when performing a given musical task, has been also discussed. The results of this chapter suggest

that friction-based tactile feedback is a useful tool to enrich musical interactions and learning.

Chapter 6 concludes the dissertation with a review of its main findings and explains potential future works.

1.3 Publications

- **Farzan Kalantari**, Laurent Grisoni, Frédéric Giraud, and Yosra Rekik, “Finding the Minimum Perceivable Size of a Tactile Element on an Ultrasonic Based Haptic Tablet”, In Proceedings of ISS '16, 11th ACM International Conference on Interactive Surfaces and Spaces, Niagara Falls, ON, Canada, pages 379-384, ACM, 2016 (related to **Chapter 3**)
- **Farzan Kalantari**, Florent Berthaut, and Laurent Grisoni, “Enriching Musical Interaction on Tactile Feedback Surfaces with Programmable Friction”, In Proceedings of 13th International Symposium on Computer Music Multidisciplinary Research (CMMR 2017), Porto, Portugal, pages 261-271, 2017 (related to **Chapter 5**)
- **Farzan Kalantari**, Edward Lank, Yosra Rekik, Laurent Grisoni, and Frédéric Giraud, “Determining the Haptic Feedback Position for Optimizing the Targeting Performance on Ultrasonic Tactile Displays”, In Proceedings of IEEE Haptics Symposium (HAPTICS), San Fransisco, USA, pages 204-209, IEEE, 2018 (related to **Chapter 4**)
- **Farzan Kalantari**, David Gueorguiev, Edward Lank, Nicolas Bremard, and Laurent Grisoni. “Exploring Fingers’ Limitation of Texture Density Perception on Ultrasonic Haptic Displays”, In Proceedings of EuroHaptics 2018, Pisa, Italy, pages 354-365, Springer, 2018 (related to **Chapter 3**)
- **Farzan Kalantari**, Florent Berthaut, and Laurent Grisoni, “Enriching Musical Interaction on Tactile Feedback Surfaces with Programmable Friction”, Lecture Notes in Computer Science (LNCS), Springer, In preparation (related to **Chapter 5**)

Chapter 2

Literature Review: Haptic Devices, Technologies and Applications

Contents

2.1	Introduction	9
2.2	Human Sense of Touch	9
2.3	Haptic Feedback Devices	11
2.4	Shape and Texture Rendering on Kinesthetic Haptic Devices	12
2.5	Haptic feedback technologies on tactile displays	17
2.5.1	Local Stimulation Techniques	18
2.5.2	Global Stimulation Techniques	19
2.5.3	Merging Electro vibration and Ultrasonic Vibration Technologies	38
2.6	Conclusion	40

2.1 Introduction

The term *haptic* is not so well-known in comparison to *vision* or *audition* to the majority of people, however they touch and interact with different physical objects during their daily life. The word *haptic* comes from a Greek verb *hapto* (to touch) and so it refers to everything concerning the sense of touch and all the sciences concerning to our tactile senses in order to manipulate and touch an object. “Haptics” describe pure mechanical interaction as well as thermal and pain perception. The sense of touch makes it possible for humans to accurately perceive the *borders of their physical being*, i.e. to identify where their own body begins and where it ends. With regard to this aspect, the sense of touch is much more efficient than the sense of vision as described in [48, 49].

In fact the idea of using haptic as means of communication and transferring information was proposed by Craig and Rollman [50] and Sherrick [51] as follows: “ *Our understanding of how simple patterns combine to yield the complexity needed to increase channel capacity for continuous information streams is still primitive.*”

In haptic interaction there is always a bidirectional nature which transfers information between the body and its kinesthetic senses and the world around. According to definition, a haptic device is a human-machine interface device that allows a mechanical interaction with objects through a system for transmitting and processing information. Hence it allows users to touch and feel the simulated objects with which they interact by means of virtual coupling which enables exchange of energy between the user and the virtual environment [52] . The application of haptic can be in the domain of: engineering, force-feedback devices for use with GUI, games, arts and creation such as rendering sound and images, manufacturing, scientific discovery and etc as discussed completely in [53].

2.2 Human Sense of Touch

Among the five important recognized senses of human; i.e. sight (or vision), hearing (or audition), taste (or gustation), smell (or olfaction) and touch (or haptic), the latter is probably less studied and understood. Taking into account that the human sense of

touch is such a crucial organism of our everyday life while few of us really notice it, compared to visual or auditory senses. These senses are our physical means by which we communicate with the world around us for taking information. The sense of touch enables us to actively manipulate and explore the world, while our other senses are not able to do so. As David Katz [54] realized, our immediate experience of the world concerns the act of touching. Our skin is our primary tactile sensory organ which utilize the tactile receptors. The touch receptors in our body are embedded on outer layer (epidermis) and underlying layer (dermis) of skin. These tactile receptors are called mechanoreceptors because they respond to mechanical stimulation such as: pressure, vibration or movement. There are four main types of mechanoreceptors in glabrous (hairless) skin: *Meissner's corpuscles*, *Merkel nerve endings*, *Pacinian corpuscles* and *Ruffini endings* as described in [3]. The different parts of mechanoreceptors of glabrous skin is illustrated in the figure 2.1.

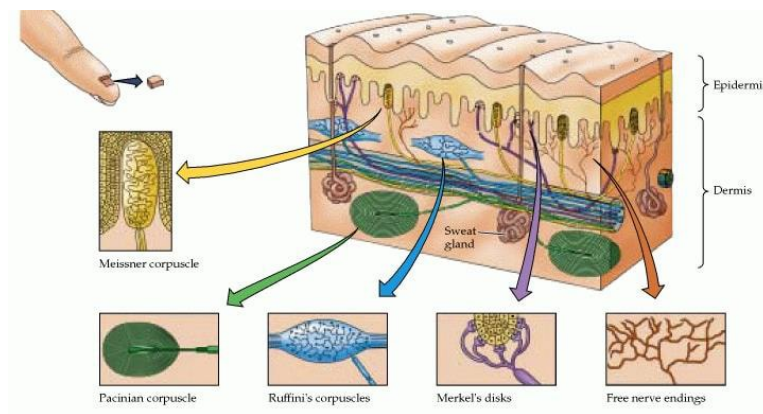

FIGURE 2.1: Mechanoreceptors of glabrous skin (adapted from [3])

Each of these have a different range of responsiveness and so they can be divided to four categories by the rate of adaptation and the sensation they can perceive [41, 55].

- The Slowly Adapting type 1 (SA1) with the Merkel cell endings, used for spatial information and perceive the form and roughness on the skin. They respond to stimulation and therefore enable us to sense some kind of low frequency signals, coarse textures and pressures. They are the most sensitive types of human finger mechanoreceptors which permit to perceive vibrations at very low frequencies. In humans, Merkel cells (along with Meissner's corpuscles) are the most commonly found types of mechanoreceptors in the superficial skin layers. They make the

	Merkel cells	Ruffini endings	Meissner's corpuscles	Pacinian corpuscles
Property	SA Type 1	SA Type 2	RA Type 1	RA Type 2
Adaption	Slow	Slow	Fast	Very Fast
Area (cm^2)	70	9	140	21
Distribution	Superficial Skin	Deeper Tissue	Superficial Skin	Deeper Tissue
Frequency (Hz)	0.4-100	15-400	10-100	40-1000
Sensation	Pressure,Texture	Skin stretch	Tap flutter	Vibration

TABLE 2.1: Summarized characteristics of human finger mechanoreceptors from [41–44]

ridges of the fingertips which leads eventually to generate specific fingerprints of human finger.

- The Slowly Adapting type 2 (SA2) with the Ruffini endings, respond to skin stretch and contributes to the kinesthetic sense and control of finger position and movements. They also respond to stimulation like SA1, but have large receptive fields. They exist only in the glabrous dermis and subcutaneous tissue of humans.
- The Fast Adapting type 1 (FA1) with Meissner's corpuscles end-organs, perceive low frequency vibration and slip on the skin. They have small receptive fields to provide some temporal information and transient stimulation such as: tactile events, grip control, tingling vibration and limited fine textures. They are located between the dermis and the epidermis and near the surface of the skin.
- The Fast Adapting type 2 (FA2) with Pacinian corpuscles, have the biggest dimensions along all the mechanoreceptors which perceive high frequency vibration. They are onion-like capsule surrounding a nerve fiber, located deep in the dermis and in the subcutaneous fat. This will permit the largest bandwidth of various frequencies in the range of 40Hz to 1kHz.

The summarized characteristics of each type based on the previous studies described in [41–44] is shown in table 2.1.

2.3 Haptic Feedback Devices

Generally, the haptic sensations are divided into two types: force feed-back (kinesthetic) and tactile feedback and so accordingly the haptic devices have two categories:

kinesthetic devices and tactile devices [56]. Kinesthetic devices illustrate forces and motions through a tool with different degrees of freedom (DOF) and they are usually grounded. While tactile devices stimulate the user's finger mechanoreceptors; mostly through vibrations by applying two different technologies i.e. local stimulation and global stimulation of the fingertip. These two technologies and their applications will be completely discussed in the following sections. In the figure 2.2 some of the more common examples of kinesthetic devices are illustrated.



FIGURE 2.2: Examples of haptic kinesthetic devices
(From left to right: Novint Falcon® [4], Phantom Omni [5] and Omega® [6])

Furthermore, a class of wearable fingertip haptic devices with various applications (such as Virtual Reality) have been recently developed and can be found in literature. Some examples are described in [57–62]. However, we are not interested in wearable haptic devices in this dissertation.

2.4 Shape and Texture Rendering on Kinesthetic Haptic Devices

Force feedback (kinesthetic) devices have been used in different studies for shape feedback and texture rendering. We can mostly refer to the performed studies at tangible media group of MIT Media Lab for shape rendering force-feedback devices. We mention some examples in literature of these devices as follows:

Follmer et al. [7] proposed to use shape rendering devices in three different ways for shape-changing UIs. interaction: to facilitate it by providing dynamic physical affordances through shape-changing, to restrict it by guiding users with dynamic physical constraints, and to manipulate it by actuating various forms of physical objects. They studied the potential interaction techniques and introduce Dynamic Physical Affordances and Constraints with the inFORM shape-changing device. Leithinger et al. [8]

described how 3D user interfaces can be utilized for spacial graphics and actuated shape displays. They have pointed out the potential in computational transitions between 3D spatial graphics and physical shape for mid-air interactions. Yao et al. [9] presented a shape-changing interface called PneUI through pneumatically-actuated soft composite materials. They showed that the integrated composite materials are able of both input sensing and active shape output and can be programmed structures as well, in order to design and control the direction, location and angle of shape deformation. These three kinesthetic haptic devices are illustrated in figure 2.3.

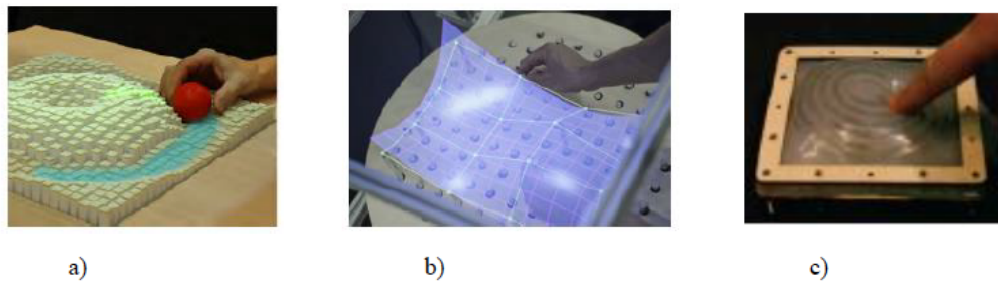

FIGURE 2.3: Examples of shape rendering on kinesthetic haptic devices
a) inFORM [7] , b) Sublimate [8] , c) PneUI [9]

Matoba et al. [10] presented a novel interactive surface with the capability of dynamic flexibility control for 2.5D shape rendering. This device can be used by users as both a traditional rigid/planar display and also a flexible/non-planar display. It is also able to present the gradual dynamic translation of its properties from soft to hard and vice versa and the users are capable of manipulating the surface softness state at any time for various types of shape rendering. The ClaytricSurface can be used for augmented pen-based interactions as well in which the user's pen input is detected by electromagnetic fields produced from under the device surface. This will enable users to dynamically render the shape of the surface and haptic sensation. Aihara et al. [63] proposed a design for a haptic display which is able to create a height adjustable three-dimensional surface from a flat surface using variations and manipulations of shapes of internal material air-pressure-controlled and surface material excess for expansion haptic shape rendering. The ClaytricSurface interactive surface and its system hardware are shown in figure 2.4.



FIGURE 2.4: The ClaytricSurface interactive surface for shape rendering by dynamic flexibility control [10].
a) Surface in a soft state (left) and hard state (right) , b) System hardware

Bordegoni et al. [11] presented a kinesthetic haptic device based on the concept of a bendable strip which permits the user to obtain a 6-DOF translation and orientation for rendering the curves of a digital prototype. It permits haptic evaluation of its shape along user-defined geodesic trajectories to feel the resulting rendered shapes with his free hands as illustrated in figure 2.5. Benko et al. [12] investigated a 6-DOF hand-held force-feedback haptic display for high-fidelity shape rendering of 3D virtual objects in Virtual Reality (VR) environments. The shape rendering is obtained through physical shape displacement, enabling users to feel 3D surfaces, textures, and forces that match the visual rendering. The authors have developed two 6-DOF controllers named *TextureTouch* and *NormalTouch* to produce spatially-registered haptic feedback to a user's fingertip for rendering of various 3D shapes. *TextureTouch* renders the shape of 3D virtual objects via 16 individual actuated pins, arranged in a 4×4 grid, to render the fine-grained surface details to the user's fingertip. *NormalTouch* renders the 3D surface normal of virtual objects using a flexible and tiltable platform. Five device prototypes which include three *NormalTouch* and two *TextureTouch* are shown in figure 2.6. Klare et al. [64] presented a design for kinesthetic 3D-shape interface with a high resolution to render basic shapes like cylinders or spheres.

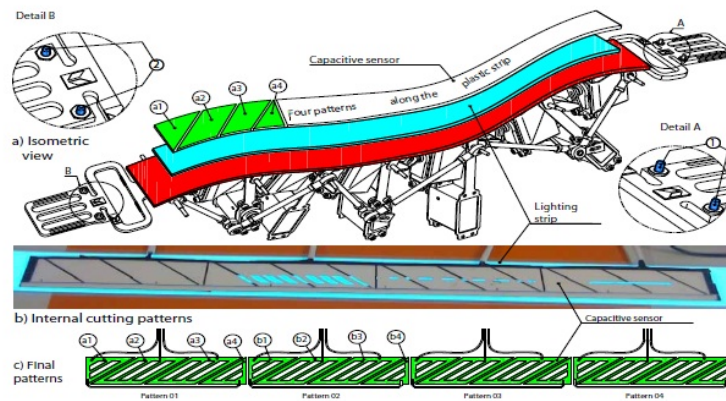

FIGURE 2.5: A self-deformable haptic strip for shape rendering of digital surfaces [11]

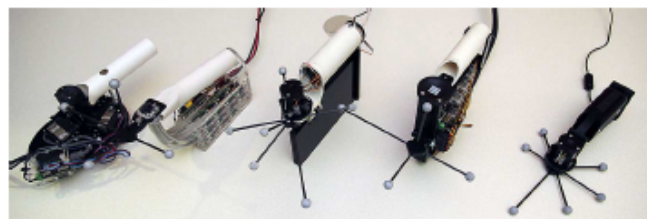

FIGURE 2.6: Five high-fidelity 3D haptic device prototypes for shape rendering including three NormalTouch and two TextureTouch [12]

Minsky [65] proposed a design of a force-feedback device to render textured surfaces based on using both physically-based and perceptually-based of familiar types of objects. The haptic device is called “Sandpaper” which uses a force-feedback joystick and a lateral-force gradient algorithm in order to create real-world surface textures, haptic simulations of mechanical systems, solid materials, non-physical materials, and some haptic representations of medical imagery and a user interface prototype.

Robles-De-La-Torre and Hayward [13] showed that geometrical and force cues are not correlated while exploring and perceiving the shape of an object through active touch. They showed that regardless of surface geometry, users were able to identify and locate shape features on the basis of force cues or their correlates on a force-feedback haptic device. For instance, users perceived a bump while combining the force cues of a bump with the geometry of a hole or reversely, when combining the force cues of a hole with the geometry of a bump, users typically perceived a hole as illustrated in in figure 2.7

Robles-De-La-Torre and Hayward [14] also proposed the use of Lateral force fields (LFFs) in a kinesthetic haptic interface to render shape perception. They described how the lateral force fields encode shape information in the magnitude of unidimensional force vectors which simulate the experience of touching a real 3D object to the user's fingertip during the interaction as demonstrated in figure 2.7. Hayward [15] described three different haptic devices for shape rendering by means of fingertip deformations laterally for large objects, and by stretching and compressing the finger skin locally for small objects as illustrated in figure 2.8.

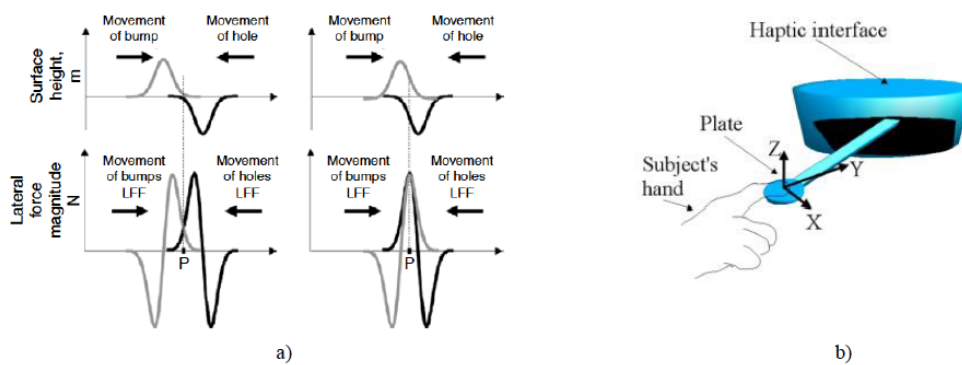

FIGURE 2.7: a) Force cues overcome surface geometry for shape perception of bumps or holes during an active touch using a force-feedback device [13].
 b) A haptic surface for shape rendering by using Lateral force fields(LFFs) [14]

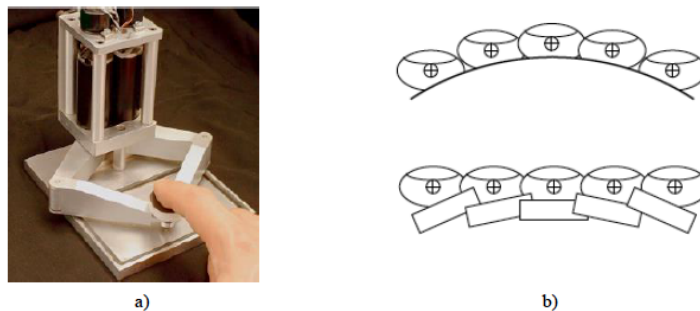

FIGURE 2.8: a) The Pantograph haptic device for shape rendering by using lateral force, b) Rolling fingertip deformation as a method for haptic shape rendering [15]

Zeng et al. [16, 66] proposed a 3-DOF haptic interface for spatial texture and shape rendering simultaneously by coupling a tactile plate and two Falcon kinesthetic devices. This device permits the texture and shape perception of various curved surfaces by orienting, elevating and translating a flat tactile plate mounted on the kinesthetic device as illustrated in figure 2.9.



FIGURE 2.9: A 3-DOF haptic interface for spatial texture and shape rendering
a) tactile plate, b) force sensor, c) two falcon kinesthetic device, d) control PC [16]

2.5 Haptic feedback technologies on tactile displays

Texture rendering has a major role on tactile displays for obtaining a suitable haptic feedback of the surface to user's fingertip. In fact, a lot of information of the surface of an object concern its texture i.e. to realize whether it is smooth, rough, slippery or patterned while touching with a finger. Therefore, the texture simulation of the haptic surface is considered to be a relevant approach to identify common materials in our daily life such as: paper, plastic, wood, glass etc. We just need to slide our fingers back and forth on the surfaces to recognize them. Accordingly, lots of effort have been made to simulate the texture on tactile displays. As mentioned before tactile devices stimulate the skin by two different techniques:

1. Local stimulation technique: when the stimulation is modulated only on the surface of the user's fingertip typically by leveraging pin arrays.
2. Global stimulation technique: when we have a uniform stimulation on the user's fingertip area.

We describe each technique with some appropriate examples in the following sections.

2.5.1 Local Stimulation Techniques

The local stimulation technique occurs when the stimulation is modulated only on the surface of the user's fingertip. In local stimulation technique, pin arrays with normal or tangential displacements, quasi-static or vibratory displacements, or electric stimulation are commonly used for texture rendering on user's fingertip. These techniques can represent tactile textures by regenerating their shapes on a flat surface based on a geometrical modulation of the contacted surface and a user's fingertip. In literature we may find different studies by applying local stimulation techniques for textured surface generation. As an example, Shinohara et al. [67] developed a tactile display device by utilizing 64×64 arrangement of pin arrays with 3 mm inter-spacing which enable tangible relief graphics for visually impaired persons.

Kaczmarek et al. [17, 68] designed a tactile device consisting of 7×7 arrangement of 0.89mm diameter pin arrays which is able to produce controlled, localized touch sensations through electrical stimulation on the fingertips as represented in figure 2.10. This device also permits users to identify simple geometric patterns via tactile exploration of the interface. Pasquero and Hayward [18] designed a tactile device leveraging piezo-electric tactile actuators which is capable of generating rapid sequences of tactile images refreshed at the frequency of 700 Hz. This tactile device uses an array of one hundred skin actuators with tangential vibratory displacement designed to create a time-varying programmable strains patterns at the fingertip with high temporal and high spatial resolution as shown in figure 2.10. Velázquez et al. [69] proposed a low-cost and lightweight tactile device with high portability for blind people. This device consists of an 8×8 arrangement of tactile pins actuated by shape memory alloys (SMAs) with 2.6 mm spatial resolution and 1 mm vertical excursion.

Wagner et al. [19] proposed a 6×6 pin arrays tactile shape display that uses commercial RC servomotors to actuate an array of mechanical pin arrays with a maximum pin deflection of 2 mm, a resolution of 4 bits and able to generate frequencies up to 25 Hz (see figure 2.10). Yang et al. [21] developed a tactile display device composed of a 6×5 pin-array that is actuated by 30 piezoelectric actuators that is able to generate micro shape vibrotactile feedback and thermal feedback. It also produces various planar distributed patterns which displayed as braille cell patterns. The thermal feedback which is also provided by this device is composed of a thin film resistance temperature

detector (RTD), a Peltier thermo-electric heat pump and a water cooling jacket that enable users to distinguish various materials taking into account the temperature variation that can be sensed as they touch an object's surface as represented in figure 2.10. Iwata et al. [20] have designed a haptic interface using a flexible screen, an actuator array and a projector in order to combine tactile sensation with computer graphics to create a new interactive technique. The actuator deforms the flexible screen onto which the image is projected so that users can touch and feel the shape and rigidity of the provided image directly as shown in figure 2.10.

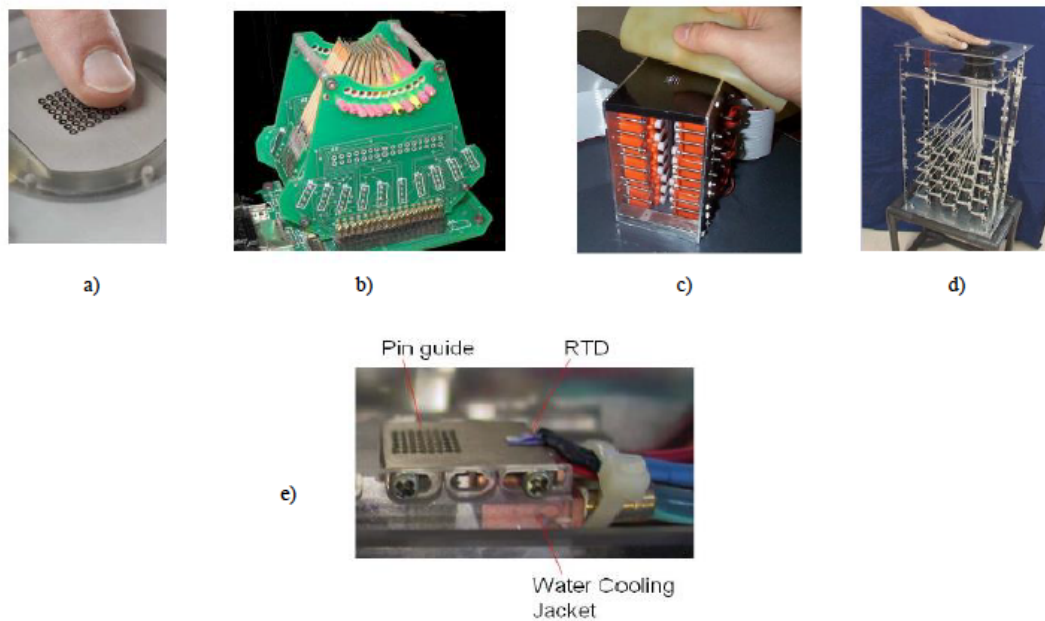

FIGURE 2.10: A few examples of haptic feedback devices based on local stimulation technique. a) Electro-tactile device [17] , b) STReSS tactile device [18] , c) Pin arrays haptic device using RC servomotors [19], d) The FEELEX device for adding haptic to computer graphics [20] e) Thermal and vibroactile feedback device [21]

2.5.2 Global Stimulation Techniques

As we described in the previous section, the local stimulation technique requires complicated mechanical design and development to achieve a high tactile density stimulation on the fingertip. Therefore, it might not be an appropriate solution for tactile rendering on touchscreens such as tablets and smartphones. Due to the limitations and the hardware design complexity of the local stimulation technique for tactile rendering on touchscreens, the global stimulation technique in which we may have a uniform stimulation on the user's fingertip area has been proposed. There are different technologies

for the global stimulation technique to provide tactile rendering which are mostly based on the friction modulations between the touched surface and user's fingertip. The various friction force modulations between the finger and the surface while the finger is sliding, give an illusion of texture to the users.

We can divide the global stimulation technique into four different technologies for tactile rendering: 1- Vibrotactile actuators (such as solenoids, vibrotactile coils and ERM motors) , 2- Surface acoustic wave (SAW) 3- Electro-static vibrations , 4- Ultrasonic vibrations. We describe each of these technologies with proper examples for each in the next sections.

2.5.2.1 Vibrotactile Actuation

In this section we review vibrotactile actuators and displays in literature in order to have a better understanding of tactile rendering on haptic displays for various applications. While a user is touching and interacting with a tactile display, it is important to distinguish two concepts, i.e. passive and active touch. In passive touch, tactile sensations are transmitted to the users without voluntary movement or active involvement on the part of the touched interface; such as ring-tone's vibrations of smart-phones which do not depend on user's voluntary movement. But in active touch there is a voluntary movement of the users in response to the provided tactile sensation; for example the perception of a texture on a tactile display is directly rely on the finger's position and how user's touch and interact with the textured surface [70]. However, it is shown in [71] that active touch has higher and more significant perceptual performance for tactile sensation and textured surfaces' explorations.

A various types of actuators such as solenoid, generic voice coil, vibrotactile voice coil, eccentric rotating mass vibration motor (ERM) and piezoelectric actuator can be used to create the tactile feeling on the fingertip. These actuators are utilized to reproduce various haptic sensations by modulating amplitudes, frequencies and waveforms. Designers of haptic displays must consider the cost, availability, size, shape, speed of response, robustness and power consumption of each actuator to choose the most appropriate to be used. These actuators are used presently on mobile phones, tablets and smart-watches to generate typically on-or-off tactile sensations.

Poupyrev and Maruyama [22] designed a haptic interface for small touchscreens by using a piezoceramic actuator in a Sony PDA and enriched its basic GUI element with tactile feedback as illustrated in 2.11. Hence, users can feel it with their fingers while pressing the touchscreen. Sinclair et al. [24] developed a novel 3D touchscreen with force feedback and haptic texture rendering, called *TouchMover 2.0* by combining 2D touch sensing, 3D stereoscopic visual rendering, 3D interactive display with touch force feedback that is robotically actuated in the Z-direction and vibrotactile actuators. The vibrotactile actuators are used to render information as high-frequency vibrations and simulating different surface textures. This permits users to feel and distinguish the textures of different terrain types such as forest, water, rocks or grasslands. The *TouchMover 2.0* haptic interface and its system schematic is represented in 2.11. Israr and Poupyrev [72] proposed a haptic display called *Tactile Brush* that use a low-resolution grid of vibrotactile actuators with varying frequency, intensity, velocity and direction of motion to produce high resolution tactile feedback on user's finger. Jansen et al. [23] developed a haptic display which is able to generate localized active haptic feedback on multitouch screens by using electromagnetic actuators as shown in 2.11. The localized actuation signals are capable of reproducing the full frequency range of human perception and to vary the softness of the touched surface.

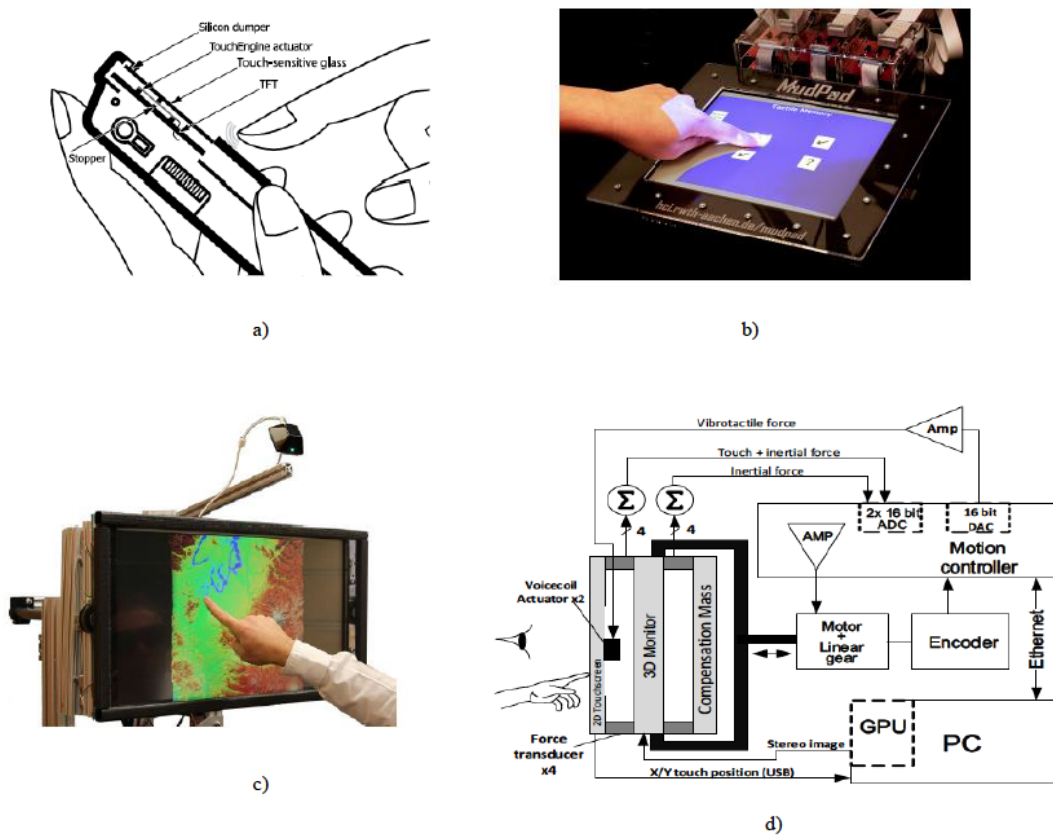

FIGURE 2.11: Examples of vibrotactile haptic displays a) Haptic interface for small touchscreens [22], b) MudPad haptic display for generating localized tactile feedback [23], c) TouchMover 2.0 haptic display with force feedback and haptic texture rendering, d) TouchMover 2.0 system schematic [24]

2.5.2.2 Surface Acoustic Wave (SAW)

The idea of using a surface acoustic wave (SAW) to provide tactile rendering on haptic displays was first described by Takasaki et al. in [73]. In this approach, a switching applied voltage (on/off) excites temporal distribution of friction or shear force on the surface of a SAW substrate. The piezoelectric material is used to generate the operating frequency of SAW within a range a few megahertz (MHz) to provide the tactile sensation of roughness to the fingertip. Takasaki et al. [25] later developed a haptic display based on the principle of SAW to reproduce a tactile sensation of various rough surfaces. They used an inter-digital transducer (IDT) on a transparent piezoelectric substrate for excitation of a Rayleigh wave, while an AC driving voltage is applied to the IDT. The operating frequency of this tactile display is 15 MHz with a vibration amplitude of around 10 nm in which the friction shift can be controlled by switching

SAW excitation (On/Off) using a Rayleigh wave. This enables to excite a frequency of about 1 kHz for an artificial generation of roughness on user's fingertip while sliding on the surface. The detailed structure of the SAW haptic display is illustrated in figure 2.12.

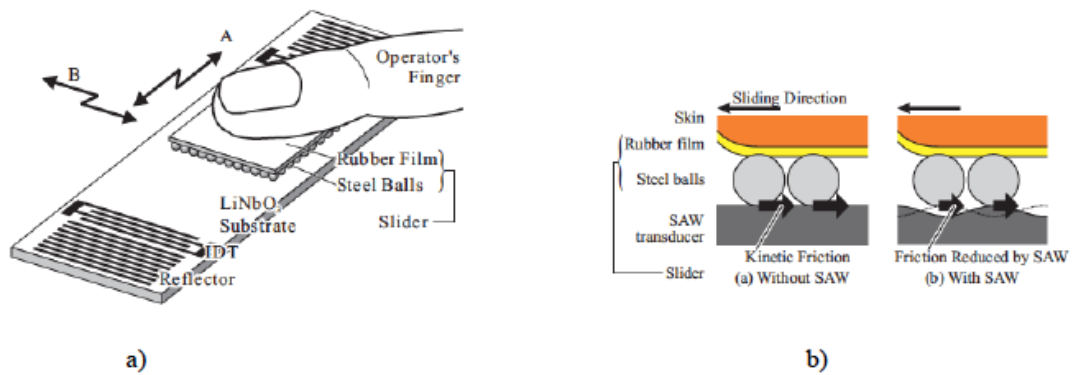

FIGURE 2.12: Implementation of surface acoustic wave (SAW) principle for haptic displays. a) Basic structure of SAW for tactile feedback display , b) Friction shift by switching the SAW [25]

2.5.2.3 Electrostatic Vibrations

The effect of electro-vibration was discovered by Mallinckrodt and his colleagues in 1954 [74] while dragging a dry finger over a conductive surface (electrode) covered with a thin insulating layer and excited with a 110 V signal. As the authors reported in [74], this effect will make a rubbery feeling by the electrostatic force (attraction force) between the conductive surface and the finger while applying a high alternating voltage. In fact when the finger slides on the surface, friction force between the fingertip and the plate is increased as the condenser is charged. However, the effect will not occur when the fingertip is wet, since it has a low resistance.

The electrostatic force was used by Strong and Troxel [75] for the first time in order to develop an electrode-array haptic display. They used an increased friction between the user's finger and the surface, generated by electrostatic force attraction to reproduce texture sensations on the display. They performed several experiments in their studies to show that the intensity of the vibration sensation for texture generation was primarily due to the peak applied voltage to the surface. Hence, they concluded that a user could clearly distinguish the texture effect from the usual type of electrical stimulation and perceived details presented by the provided electrotactile display. Kaczmarek et

al. [76] then investigated the effect of voltage polarity i.e. the differences in detection for positive and negative voltages.

We recall that the capacitance of a parallel plate capacitor with a single dielectric, i.e. just two parallel plates separated by a distance, d , can be calculated with the following expression:

$$C = \frac{k\varepsilon_0 A}{d} \quad (2.1)$$

in which :

- k is the relative permittivity of the plates ($k = 1$ for vacuum and air),
- ε_0 is the permittivity of the space,
- A is the surface area of the plates,
- d is the distance between the plates

Therefore, regarding to the Coulomb electrostatic force between the plates of a parallel plate capacitor with a single dielectric can be expressed by the following expression:

$$F_e = \frac{k\varepsilon_0 A v^2}{2d^2} \quad (2.2)$$

where v is the difference of the voltage applied to the plates and d is the thickness of the insulator.

Regarding to the electrostatic force model and its calculation proposed by Kaczmarek et al. [76] and the Coulomb law, we can show the relationship between the electrostatic force and the friction with the following expression:

$$F_t = \mu(F_n + F_e) \quad (2.3)$$

where F_t is the total tangential friction force, μ is the friction coefficient between the fingertip and the surface, F_n is the normal force applied by the finger and F_e is the electrostatic force produced by the electrovibration effect. As we may realize from this

equation, there is a linear relationship between F_e and the tangential friction force. So by increasing the electrostatic force, the friction force increased accordingly which leads to feel different sensation while touch by the user's finger.

The general principle of the electrovibration effect is illustrated in figure 2.13.

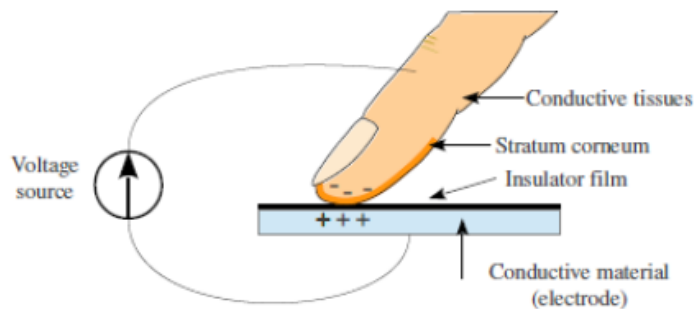

FIGURE 2.13: The general principle of the electrovibration effect

Bau et al. [26] also took advantage of electrovibration effect to enhance touchscreens with tactile feedback. The TeslaTouch technology can vary the friction between sliding fingers and a capacitive-based 3M micro-touch panel with programmable friction to generate different textures. It does not use any moving parts and provides a wide variety of haptic feedback on user's finger to feel virtual elements through touch. The TeslaTouch haptic display and its operating principle are represented in the figure 2.14. Bau and Poupyrev [77] then utilized the TeslaTouch haptic display for the purpose of augmented reality (AR) which provided the tactile feeling of real objects by augmenting them with virtual tactile textures to users. Azuma [78] described the principle of augmented reality systems as: 1) combine real and virtual objects in a real environment, 2) run interactively and in real time, and 3) register real and virtual objects spatially in relation to each other. Based on this description, Bau and Poupyrev [77] developed the REVEL augmented reality tactile technology by using the electrovibration principle and appropriate *signal shape*, *frequency* and *amplitude* to create a rich variety of tactile sensations on users finger. Kim et al. [79] proposed a tactile-rendering algorithm based on modulating lateral forces for simulating 3D geometric features such as bumps on a variety of visual content and 3D models (with different textures and patterns) by using the TeslaTouch haptic display. Israr et al. [80] also leveraged haptic effect generated by electrovibration to enrich storytelling on virtual tactile book.

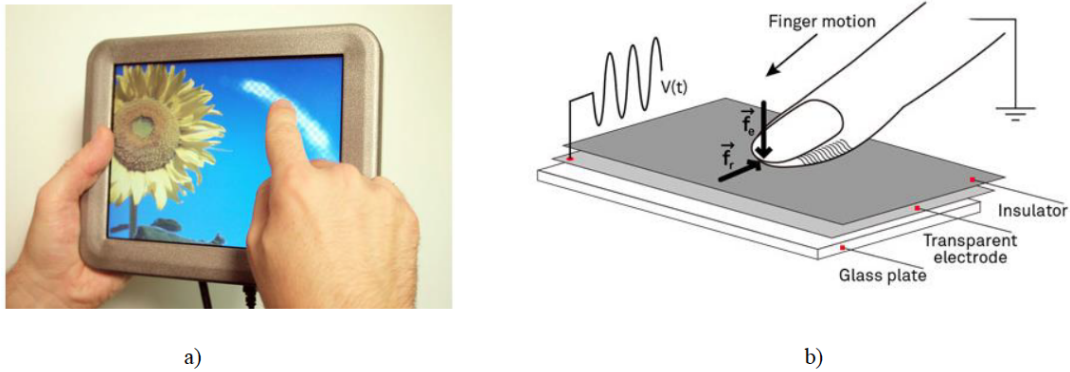

FIGURE 2.14: a) The TeslaTouch haptic display for various texture rendering , b) The principle of the TeslaTouch based on the electrovibration effect. By applying a periodic electrical signal $V(t)$ with sufficient amplitude, an attractive force f_e develops between a sliding finger and the surface which eventually increase the dynamic friction f_r [26].

Meyer et al. [27] developed a haptic display based on modulating surface friction through electrostatic force attraction. They have shown that the user's fingertip is highly sensitive to lateral forces by measuring the lateral frictional forces on a fingertip via a tribometer under conditions with accurate controlled. The authors used a 3M-MicroTouch tactile touchscreen consisted of two thin layers of indium tin oxide (ITO) with 40 nanometers thick and a thin layer of silica (SiO_2) about one micron thick. Their preliminary measurements indicated an electrostatic friction force of around 100 mN. Therefore, they used an ATI Nano17 force/torque sensor with 3mN resolution and a resonant frequency of 7200 Hz which was mounted below the tactile surface. The authors' results of measuring the normal force and lateral friction force for a 10 Hz sine wave as well as a 10 Hz squared wave with an applied voltage of 140 Volts is shown in figure 2.15. Besides, Vezzoli et al. [81] explained the frequency dependence of the electrostatic force by analyzing a new model of electrovibration effect.

A Finnish company called SensegTM [82, 83] as well as an American enterprise called Tanvas [84] have already commercialized haptic displays based on the electrovibration effect. These haptic surfaces permit users to feel dynamic textures for various daily life applications such as automotive, online shopping, gaming, visual impairment, virtual and augmented reality and etc. However, it seems that due to the high cost of the thin layers conductive materials (ITO, SiO_2) used for the touchscreens and necessary precautions of the applied voltage to the user's fingertip; it is still difficult for these companies to find a mass market.

Shultz et al. [47] proposed a haptic display by leveraging electrostatic force on the finger through DC excitation via “electroadhesion effect”. The electroadhesion effect was first studied in 1923 by Johnsen and Rahbek in [85] and later in [86] to improve the dielectric quality used in electrostatic chucking devices. Johnsen and Rahbek reported in [85] while working with polished lithographic stone and metal surfaces in order to describe the physical phenomenon of adhesion. In fact they noticed that the electroadhesion effect occurs when a highly resistive slab of semi-conductive material was placed on top of a metal plate and a high amount of voltage was applied between them. In contrast to the electrovibration effect which apply AC excitation voltage to the surface; the electroadhesion effect refers to the the DC excitation current to the surface to generate the electrostatic force on the user’s finger. Shultz et al. [87] recently proposed an approach to control and record friction forces up to a frequency of 6 kHz for an electroadhesion based device for audio-haptic applications.

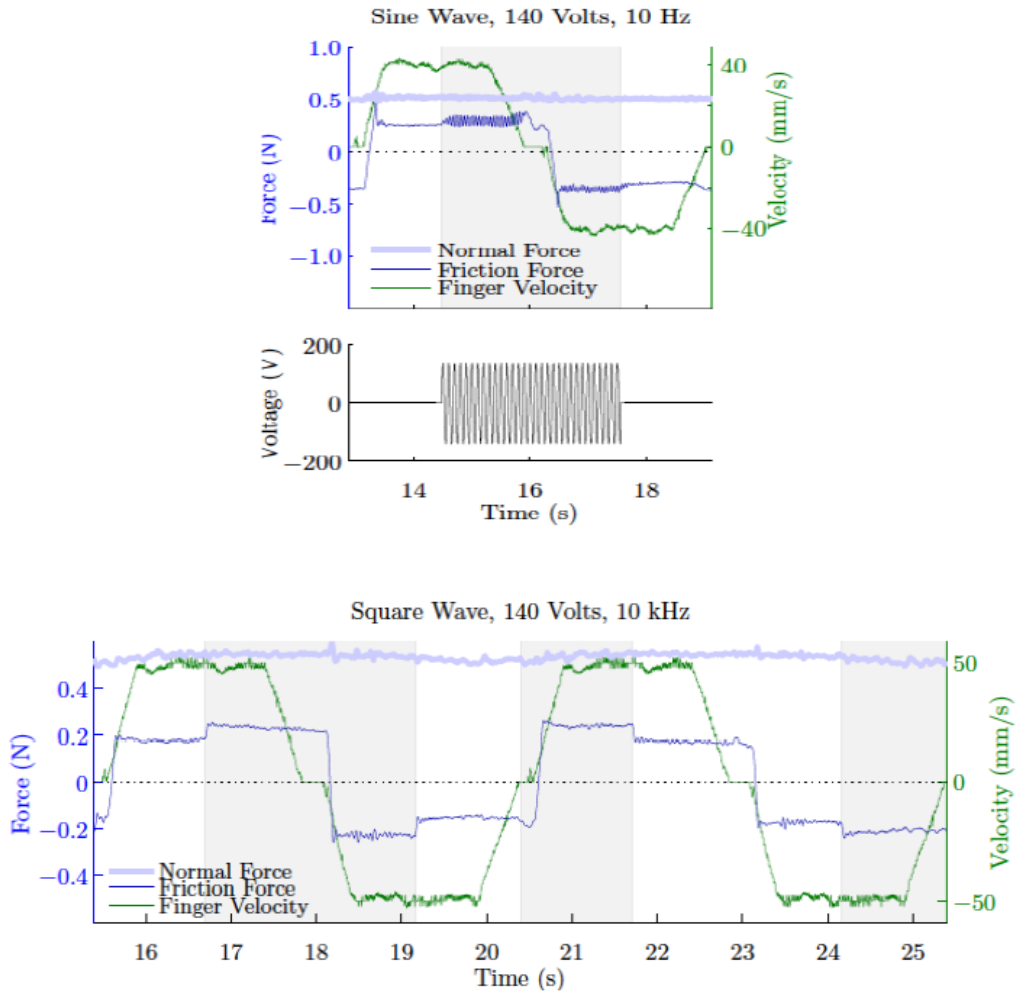

FIGURE 2.15: The results of Normal Force and Friction Force for 10 kHz sine wave (up) and 10 kHz square wave (down) with 140 Volts applied voltage. The gray area demonstrates when the electrovibration effect is turned on. [27]

The electrostatic force model proposed by Johnsen and Rahbek in [85] for the electroadhesion effect concerns to the description of two electrically relevant layers. The first layer consisted of bulk of the semi-conductor material also called the dielectric layer and the second layer consisted of the dielectric/metal surface gap. The electrostatic force model on an air filled parallel plate capacitor in terms of the gap separation (d_g) model can be expressed as the following expression:

$$F_e = \frac{A\varepsilon_0\varepsilon_g}{2} \left(\frac{v_g}{d_g}\right)^2 \quad (2.4)$$

in which:

- F_e is the electrostatic force generated by the electroadhesion effect,
- ϵ_g and ϵ_0 are the permittivities of the relative gap and the free space respectively,
- A is the surface area of the plates,
- V_g is the gap voltage and d_g is the gap separation .

If we consider a gap voltage of $V_g=100$ Volts, a gap thickness of $d_g=1 \mu\text{m}$ and a relative permittivity of $\epsilon_g=1$ (for air), an electrostatic force of 4.4 N/cm^2 will be obtained.

2.5.2.4 Ultrasonic Vibrations

This section is focused on the ultrasonic and lateral force-based haptic displays. By looking at the previous studies in literature on ultrasonic-based haptic displays, a classic approach is based on a phenomenon called the "Squeeze film effect". As mentioned in the previous section, a common method for tactile rendering on touchscreens is to modify and control the friction force between the user's finger and the touched surface.

The "*Squeeze film effect*" is an over-pressure phenomenon while generates an ultra-thin air film between two surfaces, similar to the way an air hockey table allows the puck to float with low friction. To create this air gap, an ultrasonic vibration of a few micrometers is applied to the surface. This pushes the surfaces slightly apart, allowing one surface to slide more easily across the other. In haptic rendering, the surfaces are the display screen which vibrates and the user's finger which is pushed slightly away from the surface by the ultrasonic vibrations.

The first theory and equations to explain the squeeze film phenomenon in fluid dynamics was described by Osborne Reynolds (1842-1912) in [88] and then applied to human finger on a haptic device by Watanabe and Fukui in 1995 [89]. As described in [89], ultrasonic vibration with a few micrometers amplitude was applied to a planar surface for controlling and varying the tactile sensation of its roughness by creating a smoother feeling on user's finger. They have also proposed the following experimental results:

- As the applied vibration amplitude of the surface became larger, the tactile feeling became smoother.

- The higher vibration amplitude was needed to generate a smooth feeling for the rougher surface.
- The tactile sensation of smoothness occurred only when the applied vibration frequency was above 20 kHz.

In figure 2.16 the principle of the squeeze film effect is shown.

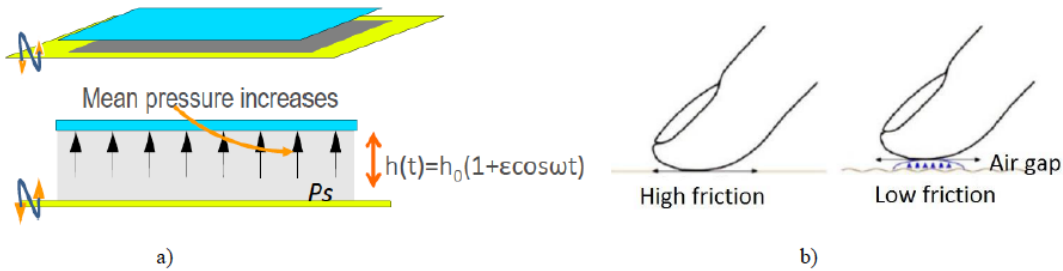

FIGURE 2.16: a) The principle of the squeeze film effect between two plates in which the one in above vibrates at ultrasonic frequencies. b) Ultrasonic vibration creates an air gap which reduces the friction and gives a slippery feeling on the user’s finger.

The squeeze film phenomenon was then used by Biet et al. [28, 90] for designing and implementing an ultrasonic tactile feedback plate. Biet et al. [28] proposed a squeeze film model taken into account the geometrical properties of the finger pad (or epidermal ridges) and the thin air-gap created between the finger and the vibrating plate which is actually based on the Reynold’s equation described in [88] and the study developed by Wiesendanger [91]. Regarding the fingertip as an undulated surface sliding on a planar surface with a sinusoidal vibration the thickness of the film as illustrated in figure 2.17 can be calculated with the equation below:

$$h(x, t) = h_r + h_{vib}[1 + \cos(\omega_0 t)] + h_e[1 + \cos(\frac{2\pi}{L}x)] \quad (2.5)$$

in which: h_r is the surface roughness, h_{vib} is the amplitude of vibration, ω_0 is the vibrating frequency of the plate and L is the period of the fingerprints ridges. By taking into account the Reynold’s equation [88] and the concerning calculations reported in [28], we may summarize the calculation of the “Squeeze number” (σ) with the following equation:

$$\sigma = \frac{12\eta\omega_0 l_0^2}{p_0 h_0^2} \quad (2.6)$$

where: η is the dynamic viscosity of air, ω_0 is the vibrating frequency of the plate, l_0 is the contact length between the finger and the plate and p_0 is the atmospheric pressure.

Therefore, the coefficient of friction reduction can be calculated with the expression below:

$$\mu = \mu_0 \left(1 - \frac{P_\infty}{P_0}\right) \quad (2.7)$$

where: μ_0 is the initial friction coefficient between the finger and the surface, P_∞ the overpressure phenomenon produced by the squeeze film effect, P_0 is the initial contact pressure which is typically $1N/cm^2$.

The important principle as reported in [28, 89] is that in order the squeeze film effect occurs, the squeeze number must be larger than 10 ($\sigma > 10$).

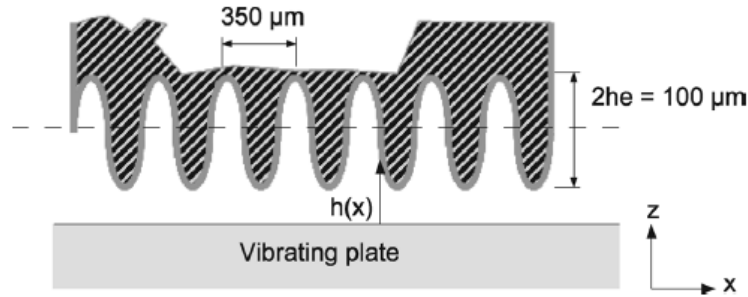

FIGURE 2.17: Approximate profile of a finger pad ridges concerning to the Reynold's equation for ultrasonic vibrations on a tactile plate. h_r is the surface roughness, h_{vib} is the amplitude of vibration, L is the period of the fingerprints ridges and ω_0 is the vibrating frequency of the plate [28].

The squeeze film effect has been leveraged in L2EP laboratory at University of Lille 1 since several years now in the STIMTAC project [29] to design tactile feedback devices based on ultrasonic frequency vibrations. STIMTAC is a tactile device based on the friction reduction which uses piezoceramic actuators, an ultrasonic frequency vibration and a few micrometers amplitude to create an air bearing between a user's finger and the touched surface. Since the frequency vibrations are above the bandwidth of human finger's mechanoreceptors, user's can not feel these vibrations, but the consequence of it

i.e. a smoother surface, will be felt. As mentioned before, in order to let the squeeze film effect occurs on the STIMTAC touchpad devices, specific conditions must be taken into account; i.e. ultrasonic frequencies from 20 kHz to 100 kHz, wave amplitude around $1\mu\text{m}$ and squeeze number greater than 10 ($\sigma > 10$). Yang et al. [92] then designed a large area STIMTAC by using 8 piezoelectric actuators based on the squeeze film effect. The evolution of the STIMTAC tactile plate design at L2EP lab is demonstrated in figure 2.18. Generally in these devices, the applied vibration amplitude changed in function of finger position while sliding on the surface to generate texture sensation. For example in [93] a squared wave was used to control the vibration amplitude to simulate square gratings textures. Furthermore, Ben Messaoud [94] developed a similar ultrasonic haptic device called SMARTAC, by leveraging new force sensors to measure and control directly the coefficient of friction between user's fingertip and touched surface. The SMARTAC device is capable of simulating complex types of textures (such as textile fabrics) with a success rate of 78% matching to real textures.



FIGURE 2.18: The evolution of the STIMTAC tactile plate design at L2EP lab. From left to right: 1D prefiguration (2004) with the free stator of a USR60 ultrasonic motor and a ring shaped resonator, 2D feedback (2007) with a tactile plate on top and piezoelectric ceramics at the bottom, 2D input and tactile feedback (2008) and compact standalone USB opaque prototype (2010) [29].

These efforts led the L2EP lab to design a transparent tactile stimulator and its integration on a mobile package as presented in [30, 95]. Giraud et al. [30] used a LCD panel as a vibrating glass plate to produce a squeeze film bearing as well as force sensors to calculate the position of the user's fingertip. In fact, an accurate measurement of finger position has an important role for texture rendering on these kinds of surfaces. Hence, using force sensors might be a good idea at the beginning, but they can not be integrated on today touchscreens which mostly used capacitive or resistive sensors to calculate the user's finger position on a display. For this purpose, L2EP lab has

collaborated with STMicroelectronics to develop the STIMTAC device with resistive and capacitive touchscreens. These haptic displays are illustrated in figure 2.19.

Giraud et al. [96] also leveraged the principle of squeeze film air bearing to design and control a haptic knob. An ultrasonic frequency (above 25 kHz) and low vibration amplitude (about 1 μm) were used to generate programmable tactile feedback on a haptic knob that might be useful to be replaced by a wheel in MP3 players. In this haptic knob device, when the vibration amplitude increased, the friction force between the user's thumb and the knob decreased and thus created tactile patterns. Winter [97] also used the similar principle to design a click-wheel tactile interface (haptic knob) based on friction reduction to enrich commercial MP3 players and an existing gaming mouse with haptic feedback.

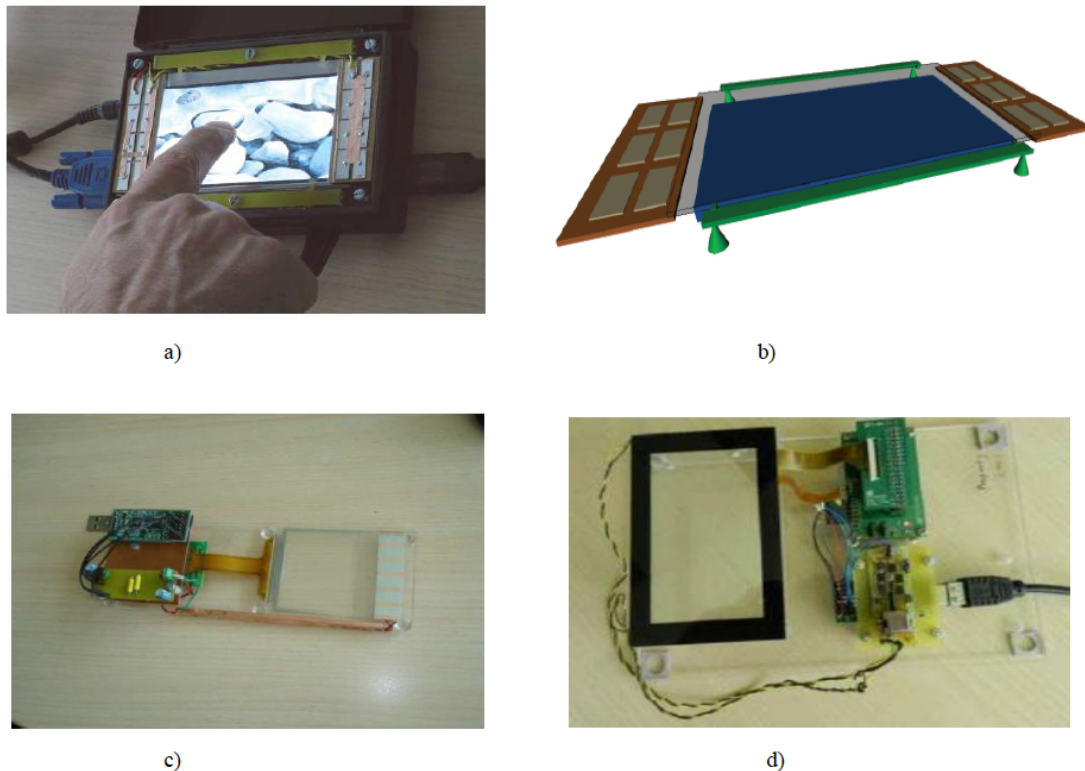

FIGURE 2.19: a) The transparent tactile stimulator based on the squeeze film effect , b) The LCD screen (in blue) and the force sensors (in green) to calculate the finger position on the transparent tactile stimulator [30], c) Using resistive touchscreen for enhancement of finger positioning measurement of Stimtac device, and d) capacitive haptic touchscreen

I have personally developed several applications for the transparent version of STIM-TAC; shown in figure 2.19(c), by using processing [98] and Java. This version of

transparent STIMTAC is made of a Piccolo DSP-USB microcontroller for transmitting information, a capacitive sensor which detects the position of the user's finger and a few capacitances. The communication between the device and PC is through serial ports for sending and receiving information. The Processing language provides a programming class for serial communication protocol which seems to be a more compelling way to reduce development time and energy for STIMTAC applications in comparison to the previous programming tools used in L2EP lab. For generating haptic effect on the device, appropriate vibration amplitudes of square wave grating have to be chosen within the range of 0 to 1 μm (1 = maximal haptic effect and 0 = no haptic feedback). For image based haptic rendering, a friction map is used where the texture is associated to the gray scale value of an image. Among all the developed applications, two examples have been illustrated in figure 2.20

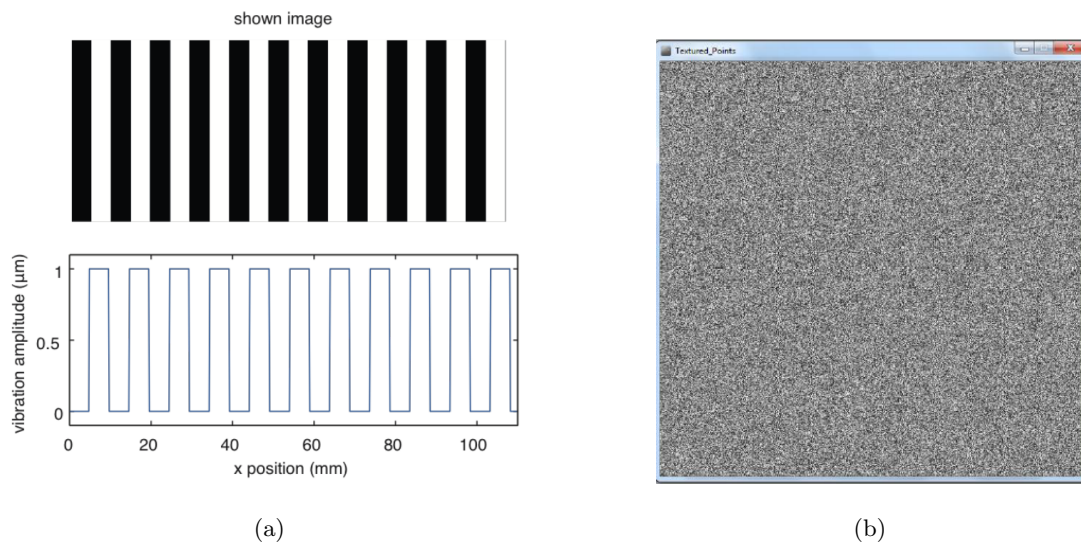

FIGURE 2.20: a) An example application of square wave grating shown on the PC screen and the appropriate chosen vibration amplitude in function of x position of a user's finger. b) An example of a textured surface (such as sand) shown on the PC screen. The provided texture is perceived while users slide a finger on the capacitive sensor of the device.

Furthermore, I have also developed another application related to a 3D model of a vase belonging to the Musée des Beaux Arts de Lille for texture rendering within the context of cultural heritage. The 3D form of the vase was constructed of a large number of triangles meshes and therefore needed to be simplified for texture rendering with STIMTAC device. For this purpose, I created a normal map of the vase which

represented its surface gradient, where the RGB values corresponded to the XYZ coordinates of the normal vector. The appropriate vibration amplitudes were then set to the normal vectors to create a haptic illusion of touching a real vase. A complete description of texture rendering techniques for haptic surfaces, including normal mapping, can be found in [99, 100]. The 3D model of the vase and its normal mapping used for texture rendering are shown in figure 2.21.

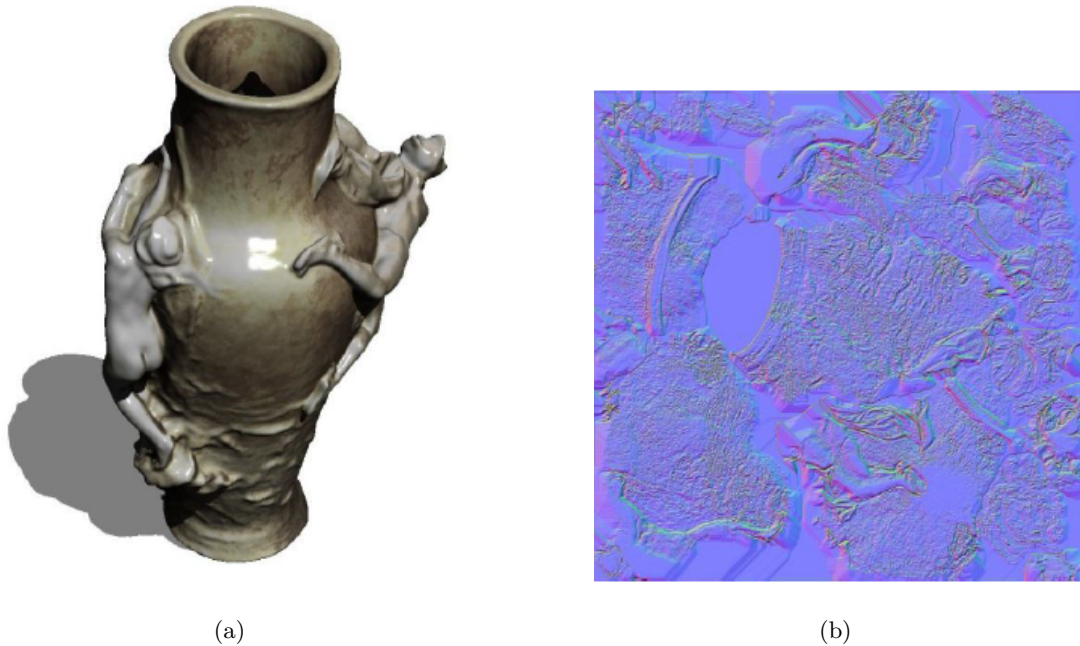

FIGURE 2.21: a) A 3D model of a vase with the collaboration of Musée des Beaux Arts de Lille. b) Normal mapping of the vase used for texture rendering

Alongside the STIMTAC project in L2EP lab in France, the Surface Haptic project at Northwestern University (USA) used the same principle of the squeeze film effect to design ultrasonic based tactile displays. For this purpose, Edward Colgate and his colleagues proposed the T-PAD tactile feedback display [31]. As described in [31] the Tactile Pattern Display (T-PAD) used a circular piezoelectric bending element to reduce the coefficient of friction and modulating the shear forces between the finger pad and a surface to generate the haptic illusion of textures. It has been shown in [101] that lateral forces may create the haptic illusion of bumps and holes, therefore this idea led the authors of T-PAD to create texture sensations with lateral (shear) forces modulations on ultrasonic vibrations tactile display. The T-PAD project then led to the development of a hand-held haptic tablet which is a variable friction haptic surface integrated with a Kindle FireTM tablet computer for generating various textures and

applications [102]. The communication protocol between the T-PAD Fire tablet and the micro-controller is supported by the Android operating system which enables users to program different applications with the provided online libraries [103].

Furthermore, the “Surface haptics” team have developed several other haptic displays based on friction force modulation via ultrasonic frequency vibrations called “ActivePaD” [32], “ShiverPaD” [33] and “LateralPaD” [34]. Their main idea is to reproduce programmable haptic effects on touchscreens by controlling the lateral or shear forces between the user’s fingertip and the touched surface. We give a brief description of each of these haptic displays as following.

In ActivePaD [32] an impedance controlled planar mechanism is combined with a variable friction haptic display i.e. the Large Area T-PaD. It permit users to control and modify the coefficient of surface friction (by using the 4×4 squared T-PAD), surface lateral forces and velocity. The T-PAD display is mounted to a planar mechanism which allows motion in all degrees of freedom which is controlled with brushed DC motors fitted with high resolution encoders.

The ShiverPaD [33] is a 1-DOF haptic device that is able to control shear force on a fingertip which basically consists of a T-PAD variable friction display (vibrated at 20-100 kHz horizontally), a voice coil to provide the actuation for the shiver motion and a linear slide to ensure that the motion is horizontal. As the squeeze film effect is active and friction is reduced, a plate moves in one direction and conversely when the squeeze film effect is turned-off the plate moves to the opposite direction with increased friction.

In LateralPaD [34] the tactile plate is vibrated simultaneously in both normal and lateral directions by using two sets of piezoelectric actuators that generate lateral force on a bare fingertip. The piezoelectric actuators drive normal and lateral resonances at the same ultrasonic frequency which is about 22.3 kHz. Hence the generated forces on the fingertip can be controlled by modulating the relative phase of the two resonances. A Laser Doppler Vibrometer (LDV) is used to measure the fingertip position on the surface as well as the motion of a glass plate.

The haptic interfaces developed at Northwestern University are illustrated in figure 2.22.

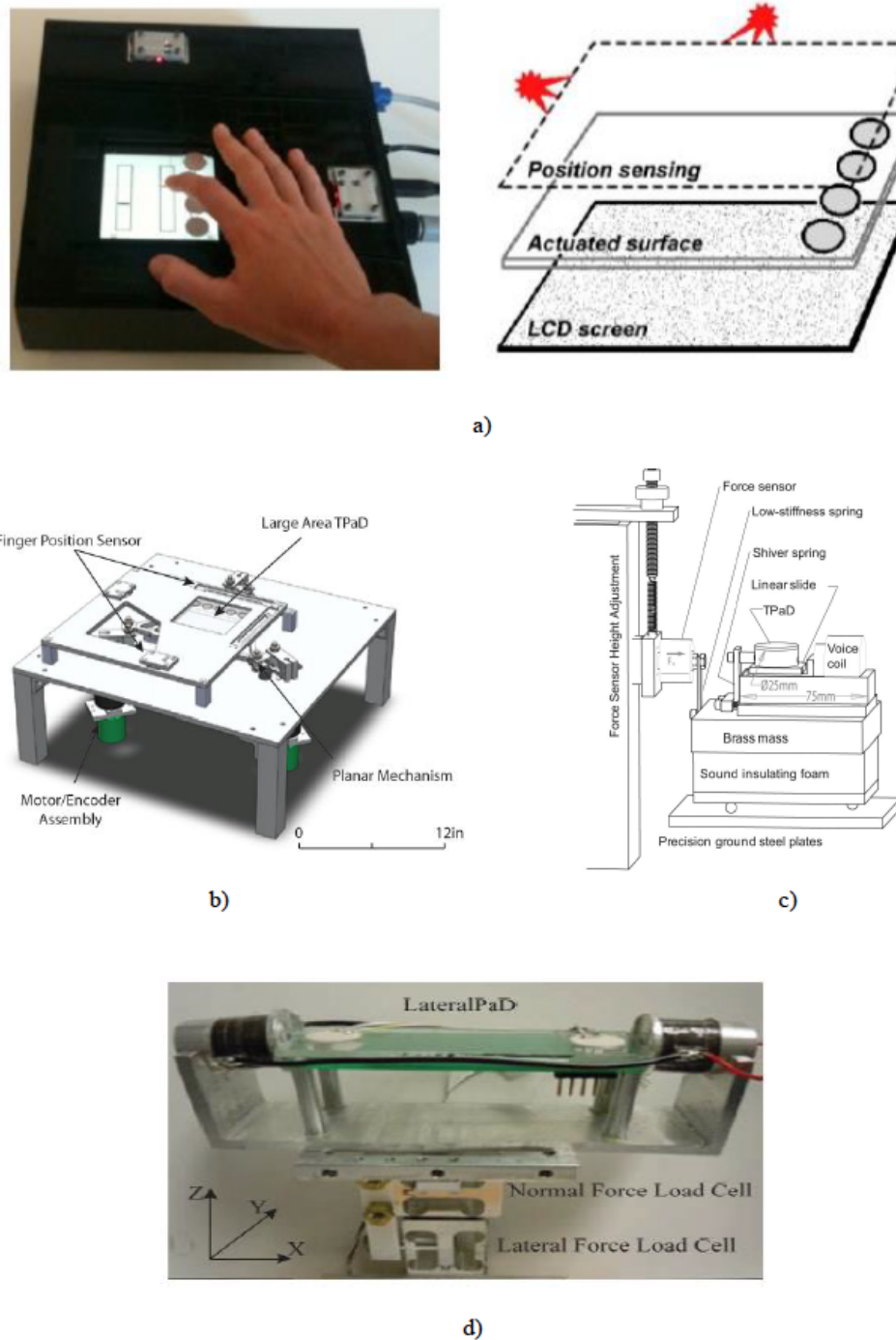

FIGURE 2.22: Haptic surface devices developed at Northwestern University
a) Tactile Pattern Display (T-PAD) and its touchscreen principle [31], b) ActivePad [32], c) ShiverPaD [33], d) LateralPaD [34]

Besides, Wiertlewski et al. [104] developed a high fidelity surface haptic device based on ultrasonic vibrations which can reproduce features as small as $25\mu\text{m}$ and high bandwidth of 800 Hz temporal sine wave.

Furthermore, Saga and Raskar [105] proposed a haptic display capable of tactile rendering of large bumps and small textures by employing high frequency vibrations and controlling lateral forces between user’s finger and surface.

A summary of different haptic feedback technologies on tactile interfaces and their interaction modes is illustrated in figure 2.23.

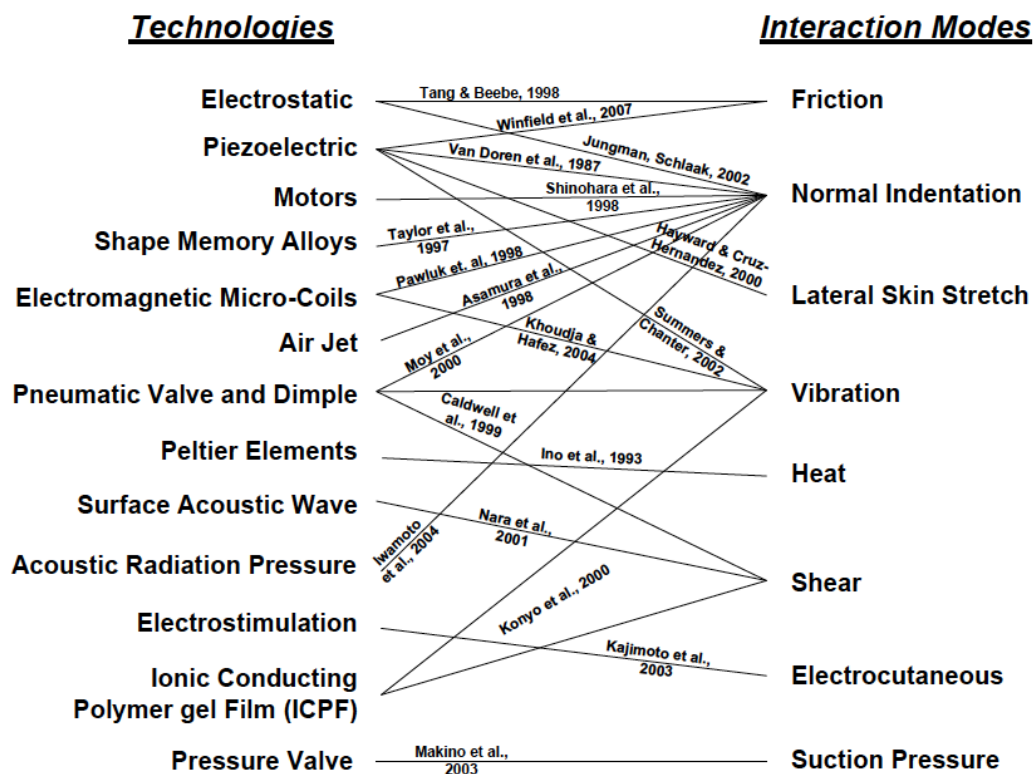

FIGURE 2.23: A summary of haptic feedback technologies on tactile interfaces and their interaction modes. (adapted from [35])

2.5.3 Merging Electro vibration and Ultrasonic Vibration Technologies

It was investigated in [106] that the electrovibration effect and ultrasonic vibration devices based on the squeeze film effect are compatible and can be merged on a same device, since the first technique increases the coefficient of friction and the second one decreases it while touching the surface. Hence, it may be possible to leverage the two techniques simultaneously on a tactile stimulator in order to enhance the

frequency range for texture reproductions. Vezzoli et al. [36, 107] have later shown that there is no influence between these two technologies for tactile rendering and they act independently with a physical and perceptual points of view. Taking into account the measurements performed in [36] the physical independence of the two technologies can be confirmed which leads to the validity of the following equation:

$$F_t = \mu - \Delta\mu(F_n + F_e) \quad (2.8)$$

where: μ is the friction coefficient between the fingertip and the surface, $\Delta\mu$ is the induced variation of the friction coefficient performed by the ultrasonic vibrations, F_n is the normal force applied by the finger and F_e is the induced electrostatic force between the finger and the surface.

The evaluation of normal forces applied by user's fingertip which determine the coupling possibility of the two technologies are shown in 2.24. In this figure, the friction coefficient (μ) is calculated for each of the following conditions:

$\mu(0, UV)$ is when the ultrasonic vibration effect is applied, $\mu(EV, 0)$ is when the electrovibration effect is applied, $\mu(0, 0)$ is when there is no friction modulation and $\mu(EV, UV)$ is when the two effects are applied simultaneously. Therefore, the phase ratio is equal to $1 - \mu(EV, UV) / \mu(0, 0)$.

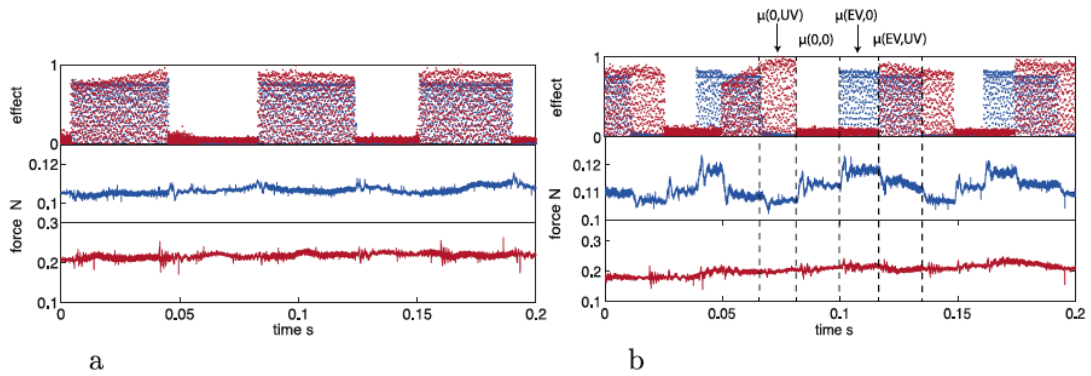

FIGURE 2.24: Evaluation of coupling of electrovibration and ultrasonic vibrations in phase (a), and in quadrature (b). In the first graph, the presence of the electrovibration effect (blue) and ultrasonic vibrations (red) are represented. In the second graph the recorded lateral force (blue color) is shown. In the third graph the measured normal force (red color) is illustrated [36].

Furthermore, the dynamic behaviour of the friction modulation using a vibrating plate and a fast response time has been also analyzed in [36] as demonstrated in figure 2.25.

The response time has been measured between the vibration amplitude ($2 \mu\text{m}$ peak to peak) and the normal force ($\approx 0.3 \text{ N}$) with the presence of the finger. In figure 2.25 the green line is the vibration amplitude of the plate, the blue line is the applied voltage envelope for electrovibration effect and the red lines are related to the measured friction modulation while coupling the two technologies.

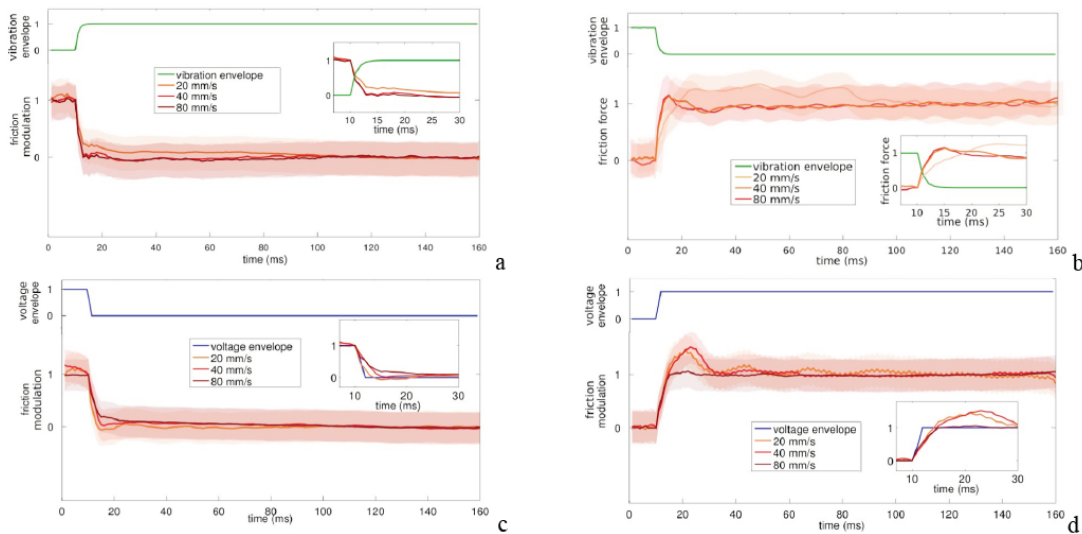

FIGURE 2.25: Friction modulation for different finger speeds related to the measured plate vibration or voltage envelope reported in the figure. The shadowed area represents the measure standard deviation. (a), descending friction for ultrasonic devices, (b) increasing friction for ultrasonic devices, (c) decreasing friction for electrovibration effect and (d) increasing friction for electrovibration effect. [36].

As we may realize from the figure 2.25, by considering most of the measured cases, the rising time of the two effects are compatible as well which leads to be coupled successfully as a static and dynamic point of view. The coupling of the two mentioned haptic feedback technologies will enable users to feel a much expanded range of tactile sensations and variety types of textures while sliding a finger on a surface.

2.6 Conclusion

In this chapter the state of the art of the human haptic sense, two general types of haptic devices, i.e. force- feedback (kinesthetic) and tactile displays, different technologies for tactile rendering and their applications have been reviewed. The differences between the two techniques of local stimulation and global stimulation for tactile rendering on

tactile displays have been then pointed out. Furthermore, the principles of four common technologies for haptic rendering through the global stimulation technique called: 1- Vibrotactile actuation , 2- Surface acoustic wave (SAW) 3- Electro-static vibrations and 4- Ultrasonic vibrations have been described with appropriate examples. The possibility of coupling the two main technologies of ultrasonic vibration and electro-vibration for enhancing the haptic sensation range has been also presented. In the remainder chapters of this thesis I am particularly interested in ultrasonic vibrations haptic displays and therefore we will discuss users' texture perception and interaction with these kinds of haptic touchscreens with HCI point of view.

Chapter 3

Texture Perception on Ultrasonic Haptic Displays

Contents

3.1 Haptic Texture	45
3.1.1 Duplex Theory of Texture Perception	45
3.1.2 Texture Perception on Tactile Surfaces	46
3.2 Experiment 1	47
3.2.1 Participants	48
3.2.2 Experimental Apparatus: The E-ViTa Haptic Display	48
3.2.3 General Procedure	50
3.3 Results of The Experiment 1	52
3.3.1 One-finger Exploration	52
3.3.2 Multi-finger Exploration	55
3.3.3 Discussion & Perspectives	57
3.4 Concept of Taxel	58
3.5 Experiment 2	59
3.5.1 Design of the Experiment 2	60
3.5.2 Procedure of the Experiment 2	60
3.5.3 Results of the Experiment 2	61
3.6 Experiment 3	62
3.6.1 General Procedure of the Experiment 3	62
3.6.2 Results of the Experiment 3	64

3.6.3 Discussion	66
3.7 Application Examples	67
3.7.1 Designing the Visual Interface for E-ViTa	67
3.7.2 Gaming	68
3.7.3 Haptic Painting	69

This work was published by:

F. Kalantari, L. Grisoni, F.Giraud, and Y. Rekik. “Finding the Minimum Perceivable Size of a Tactile Element on an Ultrasonic Based Haptic Tablet”, In Proceedings of ISS ’16, 11th ACM International Conference on Interactive Surfaces and Spaces, Niagara Falls, ON, Canada, pages 379-384, ACM (2016)

F. Kalantari, D. Gueorguiev, E. Lank, N. Bremard, and L. Grisoni. “Exploring Fingers’ Limitation of Texture Density Perception on Ultrasonic Haptic Displays”, In Proceedings of EuroHaptics 2018, Pisa, Italy, pages 354-365, Springer (2018)

3.1 Haptic Texture

Haptic texture is one of the most important factor for the perception of surfaces and material properties while the human finger is in contact with an object or sliding on a surface. The nature of a contacted surface demonstrates also its mechanical behaviours such as friction, roughness and temperature which are all essentials for obtaining information and manipulation of our environment. It is well-documented in literature that the human sense of touch has a fundamental role in the haptic perception of different surfaces. Touch is quite sensitive in perceiving different materials [108] and textures [52], and we leverage this sensitivity in haptic effects by taking into account its fundamental limits [109]. The texture perception of the human sense of touch remains a complex phenomenon which varies between different people and is mediated by the user's fingers' mechanoreceptors [3]. In this chapter I am particularly interested in *texture perception* on ultrasonic based haptic displays, those that leverage the squeeze film effect.

3.1.1 Duplex Theory of Texture Perception

Back to 1925, David Katz in *The World of Touch* [54] proposed that perception of texture depends on two cues: 1) Spatial cues which are determined by the size, shape, and distribution of surface elements. 2) Temporal cues which are determined by the rate of vibration as human finger moves across finely textured surfaces. Two different types of mechanoreceptors are considered to be responsible for detecting this spatial and temporal cues, called "*The duplex theory of texture perception*". Hollins and Risner [110] have then performed the study of Katz more accurately with three different experiments. They noted that fine textures that are easily discriminated when moved across the skin are indistinguishable in the absence of movement. However, coarse textures are equally distinguishable in both the moving and stationary conditions. Hollins and Risner [110] then proposed an exact definition of the duplex theory as follows. In the case of fine textures with element sizes below 100 μm , vibration is the main cue for texture perception which indicates increasing of roughness with increasing of particle size. In other words, for fine textures; eliminating movement reduces the range in which subjective roughness magnitude are reported in contrast to coarse textures. For coarse textures with element sizes above 100 μm ; spatial cues are progressively

used for texture perception. As described before in Chapter 2, two different types of mechanoreceptors are used for each texture types, FA type II are sensitive to friction and vibrations of fine textures and SA type I are sensitive to coarse texture.

3.1.2 Texture Perception on Tactile Surfaces

The complexity of touch perception has resulted in various investigations to better understand and explore haptic perception difficulties, particularly on tactile surfaces. Yoshioka et al. [111] showed that the neural mechanisms underlying texture perception of a variety of real textured surfaces and objects encountered daily (e.g. corduroy, paper, and rubber), differ between the direct touch (through a finger) and indirect touch (through a probe). The neural coding of texture perception ultimately relies on understanding the relationship between the neural responses and behavior of both scanning modes. Furthermore, Eck et al. [112] studied the neural effect of texture perception between physical and perceptual space for dot pattern stimuli in order to show the effect of visual cortex to tactile roughness perception. Gaffary et al. [113] studied the perception of tactile directional cues by one or two fingers, using either the index, middle, or ring finger, or any of their combination to perceive directional stimuli on recognition accuracy. Hughes et al. [114] investigated the participants' abilities to discriminate spatial density gradients of different textures. Yau et al. [115] showed that the haptic perception of multi-texture surfaces depends on multi-modal spectral cues of tactile and auditory signals. Shirado and Maeno [116] described the relationship between the texture perception and physical properties of surface which resulted a preliminary mathematical model for it.

Furthermore, several studies have been performed to study the perceptual sensory threshold of textures on haptic displays. Nefs et al. [117] measured discrimination thresholds for sinusoidal gratings using active dynamic touch and found that amplitude differences as small as $2 \mu\text{m}$ can be detected with spatial periods between 0.25 and 1 cm. Verrillo et al. [118] studied the relationship between vibration frequency and perceived intensity of the stimuli who showed that it obeys a power law function with an exponent of 0.89 for frequencies under 350 Hz. Wijekoon et al. [119] demonstrated that there are significant correlations between intensity perception and signal frequency

and amplitude of texture waveform for texture perception on electrovibration haptic displays, and the highest sensitivity was found at a frequency of 80 Hz.

Besides, in the case of tactile perception of ultrasonic haptic displays; i.e. our current case in the present dissertation, several studies have been carried out. Biet al. [93] studied the differential sensory thresholds for the spatial periods of real and virtual square-wave gratings on an ultrasonic haptic plate. Kalantari et al. [120] have studied the limitation of tactile elements for texture perception and how to optimize interaction performance of end users through the perception of different haptic effects [121], as well as how tactile and auditory signals can be combined to enhance user's perception specially in musical interactions on ultrasonic displays [122]. Besides, Gueorguiev et al. [123, 124] have investigated the tactile perception of transient changes of different frictional signals on ultrasonic based haptic devices.

Despite all of this work, however, in all of the mentioned studies only one finger (index in most cases) for texture perception of tactile surfaces has been examined; we are aware of no work that has contrasted finger sensitivity, nor any work that explores single versus multi-finger sensitivity. Given that single-touch interaction need not be limited to the index finger, and given the prevalence of multi-touch as an input paradigm on touch screens, one can ask the following: Do we have identical texture perception among all our fingers and hands while interacting with a haptic display? Do we have the same sensory threshold for perceiving different kinds of textures? What are the differences between the tactile perception of one-finger and multi-finger explorations on haptic displays? In this chapter, we explore the limitation of individual human fingers and different hands on texture density perception in the case of two waveform types for ultrasonic-based haptic displays.

3.2 Experiment 1

We carried out a psychophysical experiment to explore the limitations of touch perception of different finger types (index, middle, etc.) in dynamic active touch. We investigated both single and multi-finger tactile explorations of sinusoidal and square-wave textures on ultrasonic-based tactile displays. In this study, *texture* is defined as the sequence of periodic haptic feedback effects generated by a specific type of signal

waveform (such as square or sine) and accordingly its specific value of spatial period and amplitude. We have investigated the spatial period of determined textures (with a constant amplitude of $1.25 \mu\text{m}$ peak to peak) which can be accurately perceivable by participants.

The experiment conformed to the principles of the Declaration of Helsinki and a general explanation of the experimental task was given to each participant before beginning the experimental procedure.

3.2.1 Participants

Fifteen healthy volunteers (5 females) from the age of 22 to 34 with a mean age of 28.4 (SD=3.48) took part in our experiment. By design, all of the participants were right-handed. The total experiment time was 50-60 minutes for each participant. Participants wore active noise-cancelling headphones (Panasonic RP-DJS200, Japan) during the experiment, while Gaussian white noise was played at a comfortable listening level in order to prevent potential interference from external auditory cues.

3.2.2 Experimental Apparatus: The E-ViT_a Haptic Display

We used an enhanced visual-tactile actuator (*E-ViT_a*), a tactile feedback display based on ultrasonic vibrations for haptic rendering [37]. E-ViT_a is developed on a Banana Pi, a single-board computer (Shenzhen LeMaker Technology Co. Ltd, China) with a 1 GHz ARM Cortex-A7, dual-core CPU and 1 GB of RAM working in parallel with STM32f4 microcontroller (STMicroelectronics, France). The communication between the microcontroller and the single board computer is provided via the Serial Peripheral Interface (SPI) bus at 10 kHz. This single-board computer is connected to a 12.5cm capacitive touchscreen (Banana-LCD 5"-TS, MAREL, China) for detecting the user's finger position on the display with a sampling frequency of 62 Hz.

Ten $14 \times 6 \times 0.5$ mm piezoelectric cells actuate a $154 \times 81 \times 1.6$ mm fixed glass plate, resonating at 60750 Hz with a half wavelength of 8 mm. A power electronic circuit converts a 12V DC voltage source into an AC voltage, controlled in amplitude and frequency and supplied to the piezoelectric cells. The microcontroller synthesizes a pulse-width modulation (PWM) signal to drive a voltage inverter that actuates the

piezoceramics. The detailed structure of E-ViT_a haptic display and its equivalent electrical scheme are illustrated in figure 3.1.

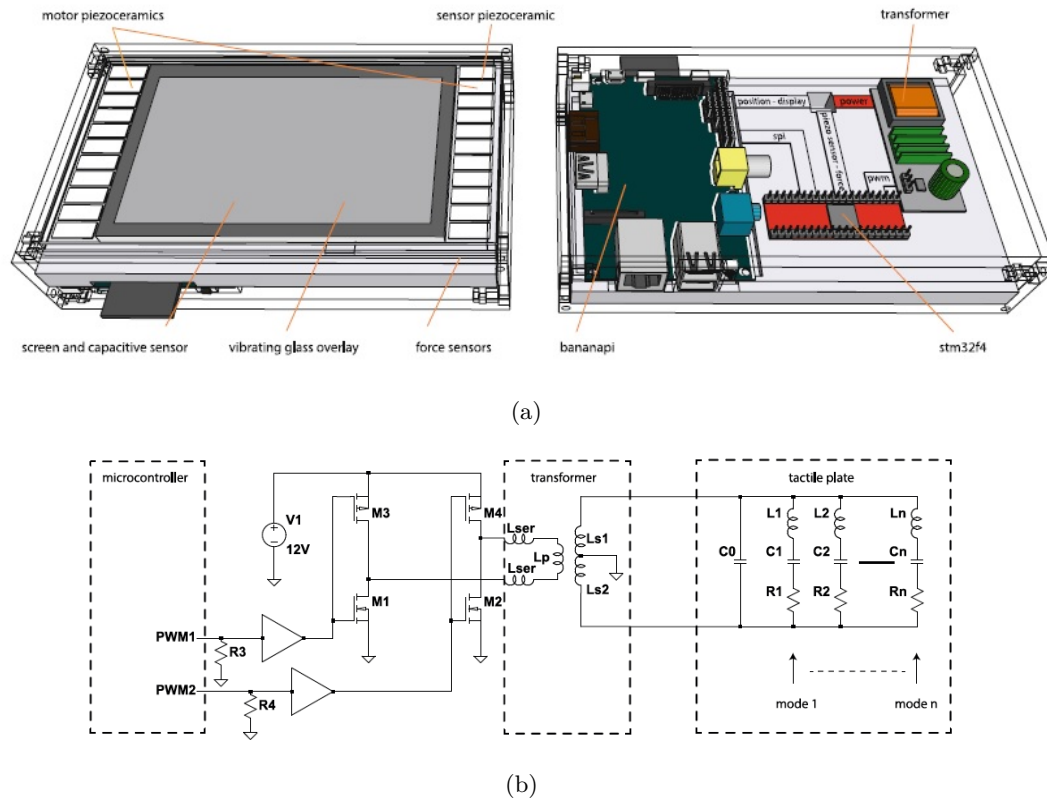

FIGURE 3.1: a) The detailed structure of *E-ViT_a* haptic feedback display based on ultrasonic vibrations. b) The equivalent electrical scheme of *E-ViT_a* display, the PWM signal drives the inverter which supplies the transformer powering the vibrating plate. For each resonant mode m of vibration there are series of RLC circuit illustrated at the right side of the scheme [37].

In E-ViT_a, a closed loop control is implemented within the microcontroller to acquire the value of amplitude vibration using 2 piezoelectric sensors. The controller is a PI and its parameters are tuned with the Ziegler-Nichols method. The device provides a bandwidth of 400 Hz at $2\mu\text{m}$ peak to peak. The closed loop control produces an amplitude stability within a tolerance of 50 nm, for a normal force applied by a fingertip which is lower than 3 N. The cartography of the vibration amplitude of the plate is demonstrated in figure 3.2. The E-ViT_a display has been recently commercialized by the Hap2U company [125] located in Grenoble in France.

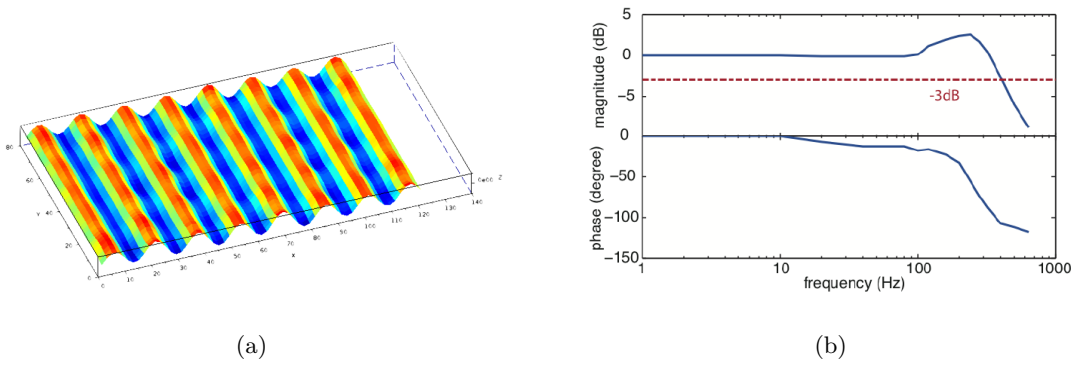

FIGURE 3.2: a) The cartography of the ultrasonic vibrating plate. b) Bode diagram of the vibration frequency response of the plate. The dashed line at -3 dB shows the bandwidth of the plate up to 400 Hz [37].

3.2.3 General Procedure

A *one-up-one-down staircase procedure (adaptive procedure)* with fixed step sizes, commonly used in psychophysics [126, 127] was used in our investigation. In this procedure the stimulus level at any trial is determined by the previous response of a participant. The 1-up-1-down staircase procedure offers the compelling advantage of reducing the total time of our experiment, since we investigate a high number of trials and conditions for each participant.

The stimuli consisted of textures with *sinusoidal* and *square* wave gratings, which were tested on all fingers of both hands. Tactile exploration was also performed with the right and left hands (multi-finger exploration) for the two types of gratings. In the latter experimental situation, the participants were asked to use all their fingers except thumb in order to have sufficient active region of haptic feedback on the *E-ViT*a 5" display. The procedure for each finger continued until one of the following predefined conditions was obtained: maximum number of 30 trials or five consecutive turnover points (reversals), i.e. when a participant's response was different from the preceding trial (Fig. 2). Therefore, the total number of performed trials was equal to or less than 720 ($[10 \text{ finger types} + 2 \text{ hands}] \times 2 \text{ signal waveforms} \times 30 \text{ trials} = 720$) for each participant in this experiment.

In our study, the initial texture (stimulus) had a spatial period of $1000 \mu\text{m}$ for both sine and square grating and a constant amplitude of $1.25 \mu\text{m}$ (peak to peak) with a response step of $50 \mu\text{m}$ for each trial. This means that for each correct response

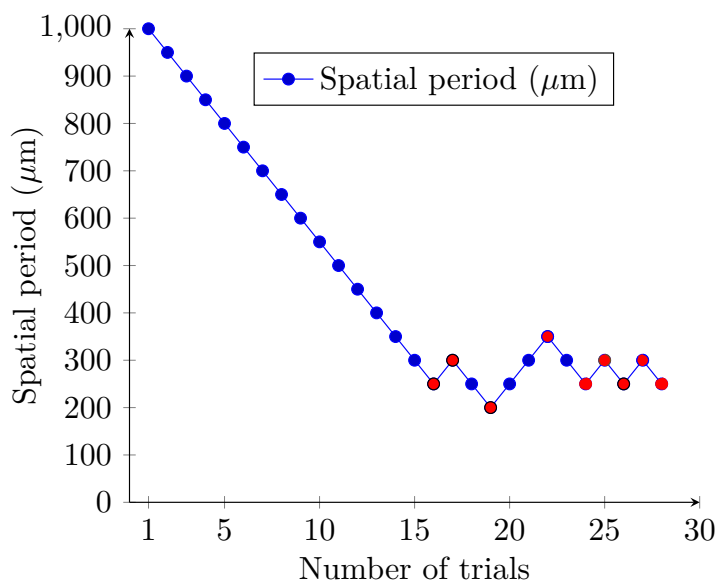
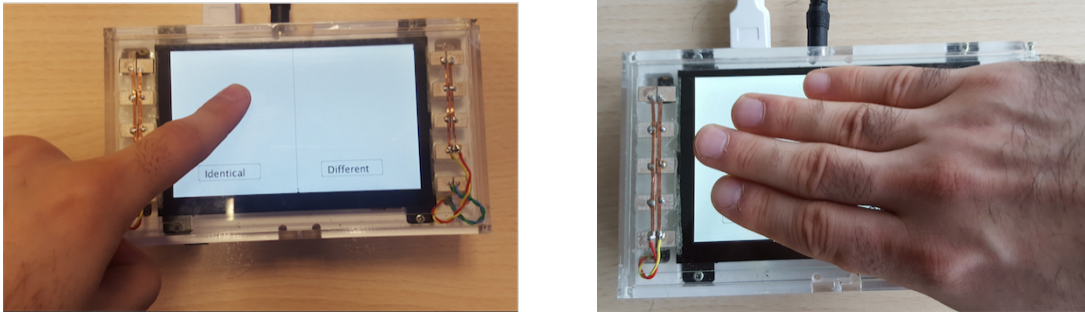

FIGURE 3.3: Sample of data collected from a single participant using 1-up 1-down staircase procedure. Turnover points (reversals) are marked with red color. The sensory threshold was calculated by averaging the correct detected texture over the last five turnover points.

the spatial period of our stimulus is decreased by $50 \mu\text{m}$ and vice-versa for a wrong answer it will be increased by the same $50 \mu\text{m}$ of step-size. A reference texture for both sine and square gratings was set at a constant spatial period of $100 \mu\text{m}$ and an amplitude of $1.25 \mu\text{m}$ was also set. The *E-ViT*a ultrasonic haptic display was divided into 2 equal sections as illustrated in figure 3.4. On the left half of the display, the reference texture was provided, while on the other half, the stimulus which must be recognized and compared to the reference texture was placed. The participants were free to explore the surface as long as they wanted. At each trial they were asked to select the “*identical*” or “*different*” button regarding one-finger or multi-finger tactile perception of the provided (reference and stimulus) textures. The order of two gratings and users’ fingers were randomized among participants during the trials in order to prevent any potential learning or habituation effects on the final results.



(a) One-finger exploration

(b) Multi-finger exploration with four fingers (except thumb)

FIGURE 3.4: The setup of our experiment in two tactile exploration conditions

3.3 Results of The Experiment 1

The perceptual thresholds for both one-finger and multi-finger explorations of the spatial period of sinusoidal and square-wave gratings were analyzed.

3.3.1 One-finger Exploration

The median values of the individual fingers' 50% perceptual thresholds for discriminating from the 100 μm reference spatial period ranged between 150 μm and 300 μm for the sinusoidal grating and from 200 μm to 350 μm for the square grating. On both hands, we computed a Friedman non-parametric statistical test to estimate the effect of the finger type on the perceptual threshold as shown in figure 3.5. The finger with which the exploration takes place was found to significantly affect the perception of the virtual gratings for both the sinusoidal ($\chi^2 = 50.35$, $p < 0.0001$ for the right hand and $\chi^2 = 36.72$, $p < 0.0001$ for the left hand) and square virtual grating ($\chi^2 = 34.10$, $p < 0.0001$ for the right hand and $\chi^2 = 44.27$, $p < 0.0001$ for the left hand). The little finger was the least sensitive, i.e., had the highest perceptual threshold level in all conditions, and the ring finger was the second least sensitive in all conditions.

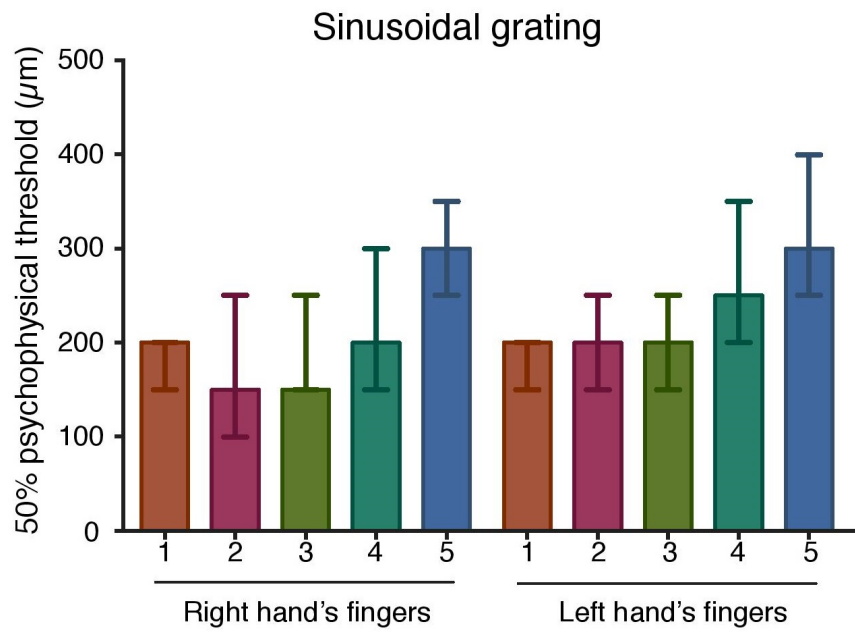

(a)

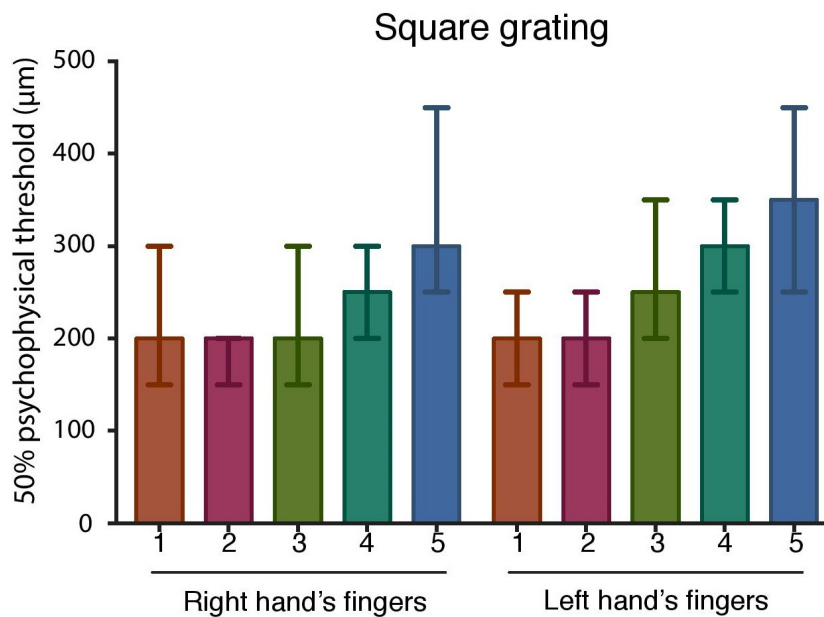

(b)

FIGURE 3.5: The psychophysical threshold, computed as the 50% just noticeable difference between the comparison and reference stimuli of all finger types of both hands. The experiment was performed for a) sinusoidal gratings and b) square gratings. The finger types are as follow: (1) thumb, (2) index, (3)middle, (4) ring, (5) little. The boxplots show the median value and the error bars show the interquartile range.

For completeness, we also compared the sensory perception of the index finger, thumb and middle finger using a Wilcoxon matched-pairs signed rank test for all conditions

as illustrated in figure 3.6(a). The pairwise comparison was performed across the two gratings and hands (60 pairs in total) in order to focus solely on the finger type. Index finger was found to be more sensitive than middle finger (Wilcoxon matched-pairs signed rank test: $N=60$, $W=594$, $p < 0.0001$) in all conditions. However, the comparison between the index finger and the thumb revealed no significant difference (Wilcoxon matched-pairs signed rank test: $N=60$, $W=-293$, $p=0.0797$) for the perceptual thresholds in any conditions. Similarly, the thumb and the middle finger differences in sensitivity did not rise to the level of statistical significance (Wilcoxon matched-pairs signed rank test: $N=60$, $W=228$, $p=0.0891$) considering all conditions. Altogether, our results indicate that the index finger and the thumb have similar sensitivity in all conditions and are therefore the most sensitive fingers for spatial period perception of both gratings among all fingers.

To estimate the overall sensitivity thresholds of the right and left hands, we averaged the perceptual thresholds for all the fingers of each hand across the two types of gratings as represented in 3.6(b). We then compared them with a Wilcoxon matched-pairs signed rank test. The median spatial period that participants were able to discriminate from the $100 \mu\text{m}$ reference stimulus 50% of the time (50% just noticeable difference) was $230 \mu\text{m}$ (IQR: 272.5-177.5) for the right hand and $255 \mu\text{m}$ (IQR: 310-200) for the left hand. The right hand of the participants, which was also their dominant hand, was significantly more sensitive than their left hand ($N=30$, $W=383$, $p < 0.0001$).

We used the same procedure to estimate the difference between the perception of square and sinusoidal gratings as illustrated in figure 3.6(c). In that case, the 50% perceptual threshold for discriminating from the reference grating was found to be $225 \mu\text{m}$ (IQR: 267.5-177.5) for the sinusoidal grating and $245 \mu\text{m}$ (IQR: 312.5-197.5) for the square grating. Participants were found to be significantly more sensitive to differences in the spatial period of the sinusoidal grating ($N=30$, $W=366$, $p < 0.0001$).

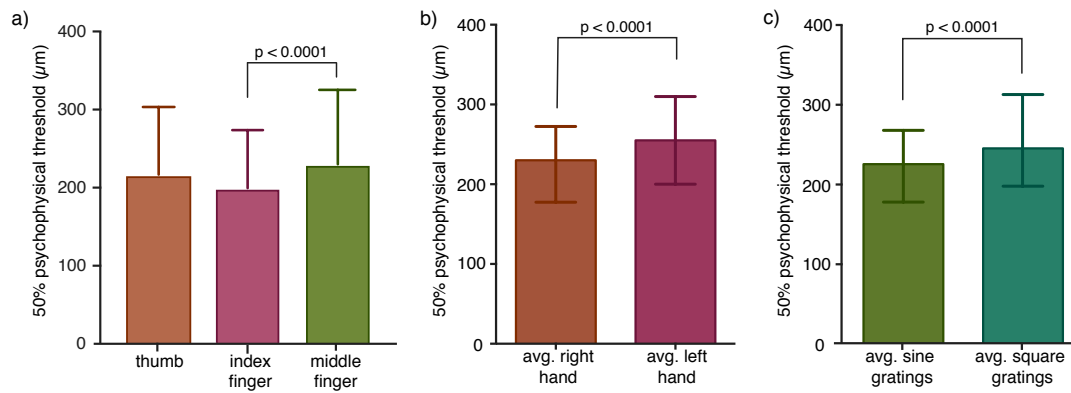

FIGURE 3.6: a) The psychophysical threshold, computed as the 50% just noticeable difference for comparing the sensory thresholds (median \pm IQR) of *thumb*, *index* and *middle* fingers for both gratings. b) 50 % psychophysical thresholds for all finger types across both types of gratings were averaged for each participants. The resulting thresholds (median \pm IQR) were compared between the right and left hand. c) The same procedure was performed to compare the psychophysical thresholds (median \pm IQR) between both types of gratings.

3.3.2 Multi-finger Exploration

Participants performed the same task by exploring the actuated surface simultaneously with four fingers (except thumb). The results from multi-finger exploration showed similar trends to the exploration with one finger (Fig. 3.7). On the sinusoidal grating, the median 50% psychophysical threshold for discriminating between the 100 μm grating was 150 μm (IQR: 250-150) for the right hand and 250 μm (IQR: 300-200) for the left hand. On the square grating, the median 50% psychophysical threshold was 200 μm (IQR: 250-150) for the right hand and 250 μm (IQR: 300-200) for the left hand. As for the one finger exploration, significant differences were found between conditions. The right hand was found to be more sensitive on both types of gratings (Wilcoxon matched-pairs signed rank test: $N=15$, $W=105$, $p = 0.0001$ for the sinusoidal grating and $N=15$, $W=93$, $p = 0.0015$ for the square grating.)

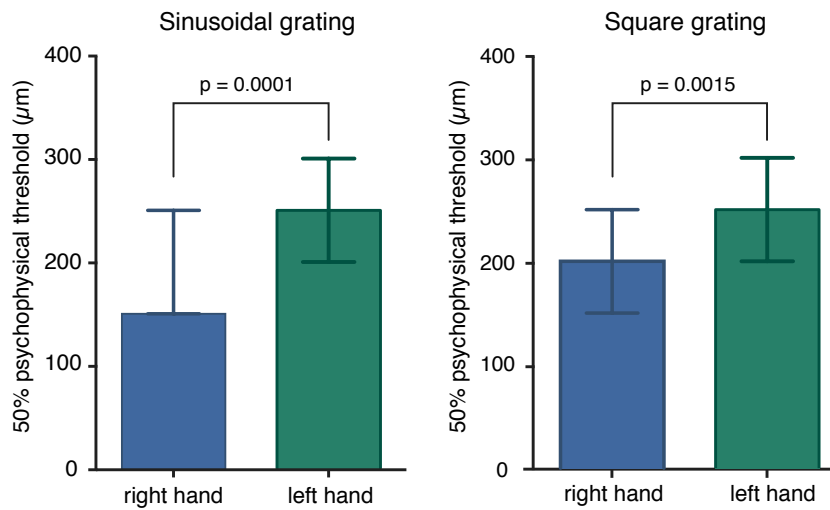

FIGURE 3.7: Left: the 50 % psychophysical thresholds (median \pm IQR) when exploration was simultaneously performed with four fingers on a sinusoidal grating were compared between the right and left hand. Right: The same comparison was made for the exploration of the square grating.

For both, the right and left hand, we compared the sensitivity of the index finger, which is the exploring finger in most studies on tactile perception and was also found to be the most sensitive in our experiments as shown in figure 3.8. For the right hand, we did not observe a significant difference between the two exploratory techniques for any of the two types of gratings (Wilcoxon matched-pairs signed rank test: $N=15$, $W=39$, $p = 0.09$ for the sinusoidal grating and $N=15$, $W=17$, $p = 0.30$ for the square grating). On the other hand, the left hand exhibited significant differences between the one-finger and multi-fingers explorations (Wilcoxon matched-pairs signed rank test: $N=15$, $W=66$, $p = 0.001$ for the sinusoidal grating and $N=15$, $W=48$, $p = 0.05$ for the square grating). Thus, multi-finger exploration was found to be statistically similar in sensitivity to the index finger when performed with the dominant hand while multi-finger significantly impaired participant sensitivity to the spatial period of virtual gratings when performed with the non-dominant hand.

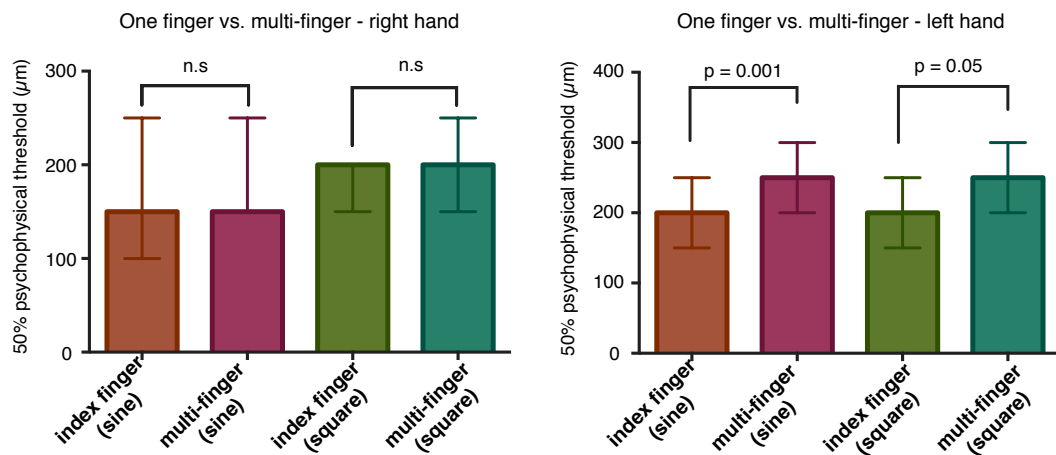

FIGURE 3.8: Comparison of the 50 % psychophysical thresholds (median±IQR) between when tactile exploration of the gratings was performed with the index finger and when it was performed with four fingers simultaneously. The comparison was made for both hands.

3.3.3 Discussion & Perspectives

We investigated the effects and limitations of different human fingers for texture density perception for both single and multi-finger exploratory techniques and for both sine and square wave gratings of right-handed participants by leveraging ultrasonic vibration. To the best of our knowledge, this is the first study that systematically investigates different finger types' perception on haptic feedback touchscreens and the first study that explores multi-finger versus single-finger perception.

Our results indicate that the index and the thumb are the most sensitive fingers for perceiving differences in spatial textures for both sine and square virtual gratings; the little finger, followed by the ring, is the least sensitive for texture perception in one-finger exploration for the two types of gratings. The texture perception of the sinusoidal grating was also found to be more sensitive than the square grating. In multi-finger exploration, the dominant hand (right hand) was significantly more sensitive than the non-dominant hand for both gratings. This suggests that the dominant hand is more trained to perceive subtle spatial features. Furthermore, our findings showed that there was no significant difference between the sensitivity rate of the index finger (the most sensitive single-finger type) and multi-finger tactile exploration for users' dominant hand. In contrast, we observed significant differences between participants' left index

finger and left-hand multifinger sensitivity perception. The dominant hand's preserved ability for spatial detection during multi-finger exploration may come from its ability to better perform synchronous dexterous motion. This enhanced perception sensitivity permits the dominant hand to control exploratory motion in order to optimize the consistency of tactile feedback across fingers. Given these results, we hypothesize the index finger has a major impact on the overall multi-finger sensitivity of the user's dominant hand for both types of gratings.

In the future, we would like to investigate if these results generalize to left-handed users, which would confirm the importance of hand dominance. While hand dominance is most likely the driving force behind variable sensitivity, it is possible that perceptual differences could result from left-right physiological differences. A sufficiently large pool of left-handed participants is necessary to validate hand dominance versus left-right physiology. It would also be interesting to investigate in greater depth differences in the dynamics of multi-finger tactile exploration between both hands.

In terms of implications for designers, these results provide guidance on the need to vary haptic stimuli depending on whether the stimulus is designed for the dominant or non-dominant hand, depending on whether it is designed for the index finger or for any finger, and depending on whether it is to be a single-finger or multi-finger interaction. As well, a potential use of different sensory thresholds of finger types, which we found in our study, is to leverage these sensitivities to novel finger identification techniques on tactile displays [128, 129] in order to allow users to perform different interaction tasks. For instance, possible gestures (such as: selecting an object, dragging or swapping) could be linked via textures to the fingers involved in the interaction.

3.4 Concept of Taxel

Eye and ear are used by humans for retrieving most of information in the real, physical, world; both sense channels are quite well handled by technology. However, the sense of touch in human is complex and varies on different people and is not an absolute phenomenon and accordingly less understood. People usually make poor use of hands as a way to retrieve information, with few exceptions (e.g. in the case of

visual disabilities). As noted before, the tactile information perception might be influenced by environmental conditions such as temperature and strongly based on our finger mechanoreceptors. Therefore, the existing interactive technologies allowing to provide user to retrieve information through tactile sense are still emerging and many parameters appear to make it difficult for applications to handle tactile feedback in a shared, generic way. In particular, each tactile technology still demands a specific development and adaptation.

In the field of technologies for visual feedback, the concept of *pixel* had a huge consequence on display technology and provides a conceptual common basis between higher level software architectures, and lower-level, electronic systems that is used for display. Such common concept is still missing for tactile feedback; we still lack a common, shared reference of an elementary tactile information, both in terms of spatial resolution, and information nature; can we go up to a normalization level comparable to the one that pixels provide for visual information?

In the following, we introduce a step toward the concept of *taxel* (Tactile Element), by suggesting an 1-up-1-down response protocol (adaptive procedure) in psychophysics [126, 127] that allows, for ultrasonic based tactile feedback displays, to measure the minimum size on which tactile information can be retrieved. We define the notion of *texture waveform* as the elementary signal shape that we provide to the tactile feedback technology, that is used as periodical signal for tactile stimulation. Such notion is a standard, usable term for all existing tactile feedback technologies. We provide a first experiment that identifies few elementary textures that can be easily identified by user. Among the 24 textures proposed to user, we identify three that all users can identify accurately. From this experiment, we derive a second experiment that evaluates the minimum size of the tactile element at which user can differentiate textures accurately. We conclude that the texture type influences the minimum size of the tactile element.

3.5 Experiment 2

We carried out an experiment to find at least 3 different textures that could be perceived and distinguished properly by all users. We selected 3 types of textures to reduce the total time of the experiments performed by each participant. Ten unpaid

volunteers (4 female and 6 male) from the age of 21 to 36 and the mean age of 28.4 were participated in our experiments. They were all right-handed and used the right index finger during the experiment. The experiment 2 took on average 40 minutes for each of participant.

3.5.1 Design of the Experiment 2

In order to design our second experiment, we defined 4 types of texture waveforms as *square*, *sine*, *dirac* and *sawtooth* with the constant amplitude of $1.25 \mu\text{m}$ and the following spatial periods: $50 \mu\text{m}$, $100 \mu\text{m}$, $500 \mu\text{m}$, $1000 \mu\text{m}$, $5000 \mu\text{m}$ and $10000 \mu\text{m}$. Thus we had ($6 \times 4 = 24$) types of textures totally. The setup of the experiment 2 is illustrated in figure 3.9 which was coded with Java and Processing language [98].

As it is shown in figure 3.9 the haptic touchscreen (size: $11 \text{ cm} \times 6.7 \text{ cm}$) was divided into 4 equal sections. On each part a specific texture waveform was set and so the value of spatial period could be selected.

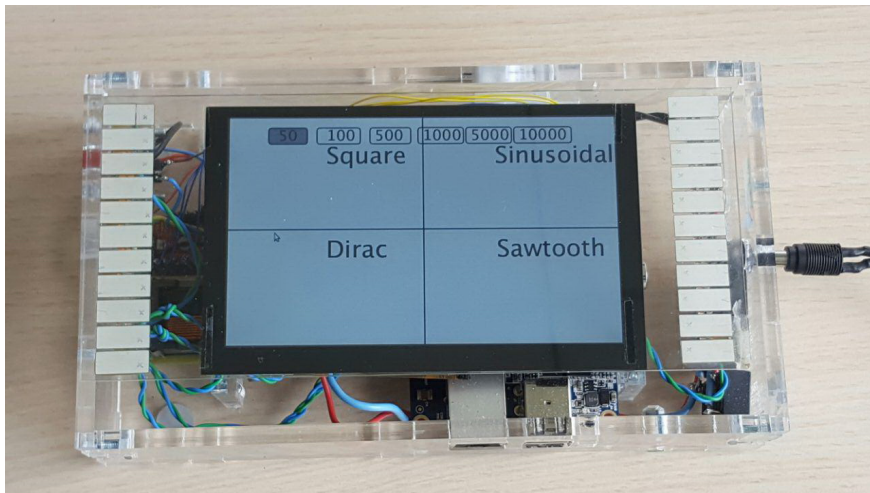

FIGURE 3.9: The setup of the experiment 2

3.5.2 Procedure of the Experiment 2

First of all a brief description of the task as well as the principles of our haptic device was given to each participant. We asked all participants to choose 3 or 4 textures that they were able to completely sense and distinguish among all the 24 provided textures. The participants were free to explore the surface as long as they wanted and then wrote

the results on a piece of paper. Participants wore active noise-cancelling headphones during the experiment, while Gaussian white noise was played at a comfortable listening level in order to prevent potential interference from external auditory cues.

3.5.3 Results of the Experiment 2

The analysis of results as illustrated in table 3.1, showed that several participants could distinguish between 5 to 7 different textures. In overall the results demonstrated that all participants could perceive and distinguish the following textures perfectly: square texture, sinusoidal texture and dirac texture with the spatial period of 500 μm , 1000 μm and 1000 μm respectively.

Participants	Square (μm)	Sinusoidal (μm)	Dirac (μm)	Sawtooth (μm)
1	500	1000	1000	5000
2	500	1000	1000	10000
3	500	1000	1000	5000
4	500	500,1000	1000	500,1000,5000
5	500,1000,5000	1000	1000	5000
6	500,1000	500,1000	1000	5000,10000
7	500,1000	500,1000	500,1000	10000
8	500,1000	1000	500,1000	10000
9	500	1000	500,1000	1000
10	500	1000	1000	10000

TABLE 3.1: The results of the chosen textures from experiment 2. The common chosen textures of participants are square, sinusoidal and dirac with the spatial period of 500, 1000 and 1000 μm respectively.

We also noted that in lots of cases the perception of dirac and sawtooth texture waveforms were more or less similar for participants and therefore rather hard to be distinguished appropriately. Besides, the sinusoidal texture with the spatial periods of 5000 μm and 10000 μm were not perceivable for participants. The most important purpose of this experiment was to give us a definite idea to choose the proper 3 textures for the following experiment of our study

3.6 Experiment 3

The goal of the experiment 3 was to determine the minimum size of a tactile element (taxel) on ultrasonic haptic touchscreens on which participants are able to distinguish the 3 textures founded from the results of the experiment 2. The tactile element is called *taxel*. As before we defined 3 textures due to the time constraints to accomplish the task by participants. We asked ten participants (4 female and 6 male) from the age of 22 to 36 and the mean age of 28.1 to take part in our study. They were all right-handed and used the right index finger in the experiment. The experiment took 45 minutes in average for each participant.

3.6.1 General Procedure of the Experiment 3

We used an 1-up-1-down staircase procedure (adaptive method) with the total number of 25 trials for each of 3 textures. Thus, the minimum size of the tactile elements was calculated as the average of the last turnover points (reversals) after 25 tests for each texture condition. Therefore, the total number of trials was equal to or less than 750 for each participant ($10 \text{ participants} \times 3 \text{ textures} \times 25 \text{ times} = 750$). As described before, in staircase procedure the presentation of the next stimulus depends on previous response of a participant as illustrated in 3.10. We displayed 4 squares with the identical initial size of 10 mm (1cm) that were situated in parallel as shown in figure 3.11. These squares were considered to be the taxels.

At each step there was a specific texture on the first square which was always constant during the trial and the 25 repetitions. This texture changed for the second and third texture conditions. The participants were not informed of the utilized texture, so that their responses would not be influenced. They were asked to find the accurate corresponding textures among the 3 other squares at each try. The textures provided on the following 3 squares were randomized for each try. We repeated the same procedure for the next two conditions with the second and third determined texture on the first square and the same number of 25 repetitions for each participant. As we mentioned before, the initial size of all the squares in all trials was 10 mm. At each try if the participants had a correct answer for the texture detection, the size of all squares decreased by 0.5 mm simultaneously and for the wrong answers it increased by 0.5 mm.

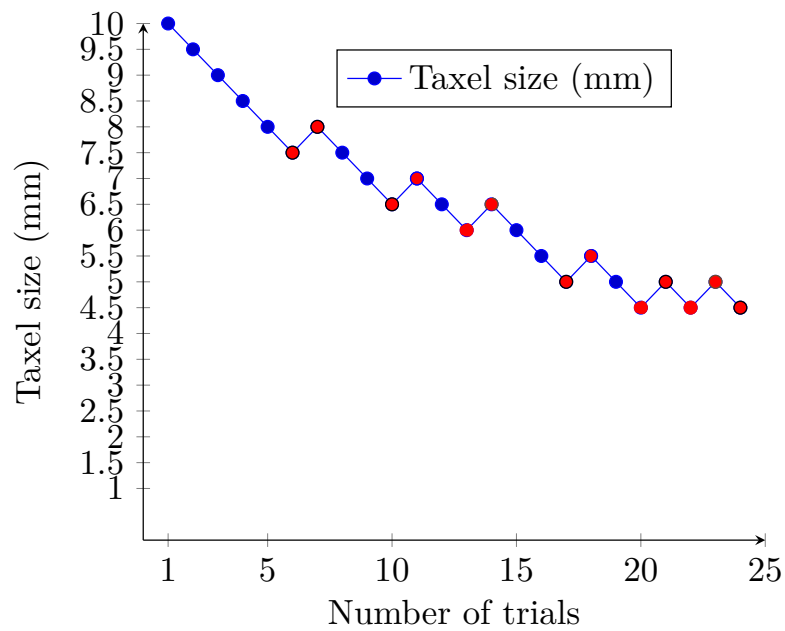

FIGURE 3.10: Sample of data collected from a single participant using 1-up 1-down staircase procedure. Turnover points (reversals) are marked with red color. The sensory threshold was calculated by averaging the correct detected texture over the last five turnover points.

The participants had to click on (1), (2) or (3) on the keyboard regarding the correct answer of texture perception. Similarly to the previous experiments, participants wore active noise-cancelling headphones (Panasonic RP-DJS200, Japan) during the experiment, while Gaussian white noise was played at a comfortable listening level in order to prevent potential interference from external auditory cues. The total experiment time was about 45 minutes for each participant.

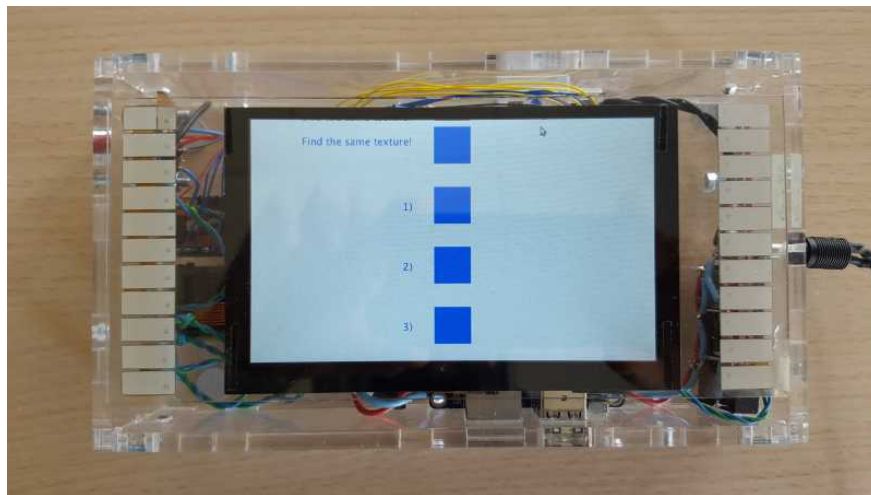

FIGURE 3.11: The setup of the experiment 3. The represented squares are considered to be the *taxel*.

3.6.2 Results of the Experiment 3

For the first condition we applied a square signal waveform (texture) with the spatial period of $500 \mu\text{m}$ and the amplitude of $1.25 \mu\text{m}$ to the first square object (taxel) and asked participants to find it among the 3 following squares with a randomized texture on each one. We analyzed the result of each participant after finishing the total number of 25 repetitions. The result of this trial is shown in the figure 3.12. All the results of our 3 trials in figure 3.12, are sorted in an ascendant manner. As it is shown in figure 3.12, the majority of the participants (90%) were able to distinguish the given square texture with the other textures for the minimum size of 6.5 mm of the taxel. Only one participant reached at the 12 mm size of the squares for the given texture.

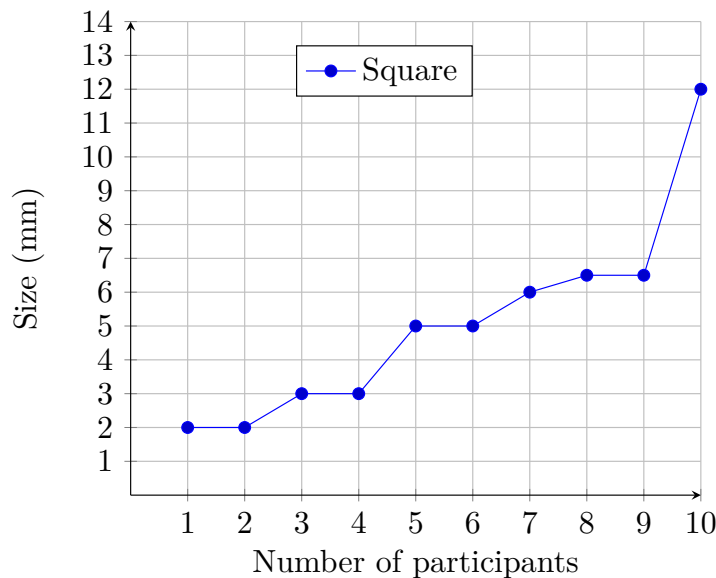

FIGURE 3.12: Minimum taxel size for a square texture. For the aim of better visibility of the data in order to find the minimum size of taxels, the data are sorted in an ascendant manner. The minimum size of taxel is 6.5 mm for 90% of participants.

In the second trial we exerted a sine wave with the spatial period of $1000 \mu\text{m}$ and the amplitude of $1.25 \mu\text{m}$ to the first taxel. We used the same procedure as before. The results are illustrated in the figure 3.13. As we find out from figure 3.13, the minimum size of the square was 13.5 mm for all participants to distinguish the provided texture.

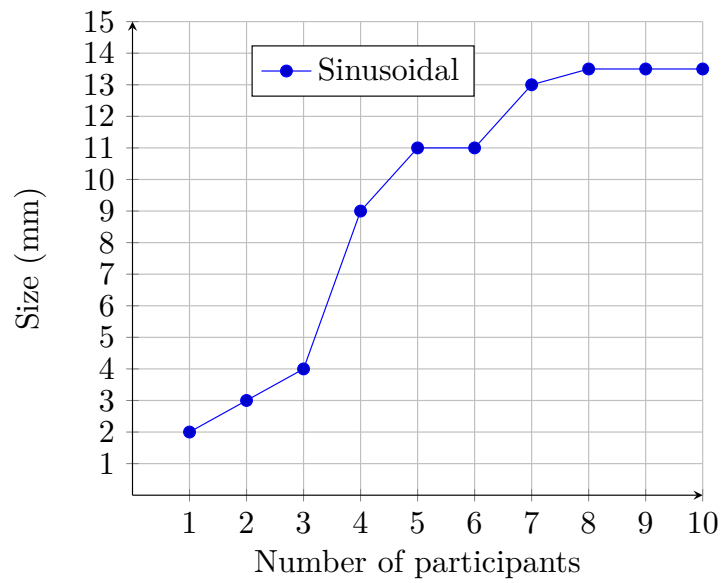

FIGURE 3.13: Minimum taxel size for a sinusoidal texture. As for the square texture the data are sorted in an ascendant manner. The minimum size of taxel is 13.5 mm for all participants.

In the third trial we applied a dirac texture with the spatial period of $1000 \mu\text{m}$ and the amplitude of $1.25 \mu\text{m}$ to the first square. We performed the same procedure as before. The results of the participants are given in figure 3.14.

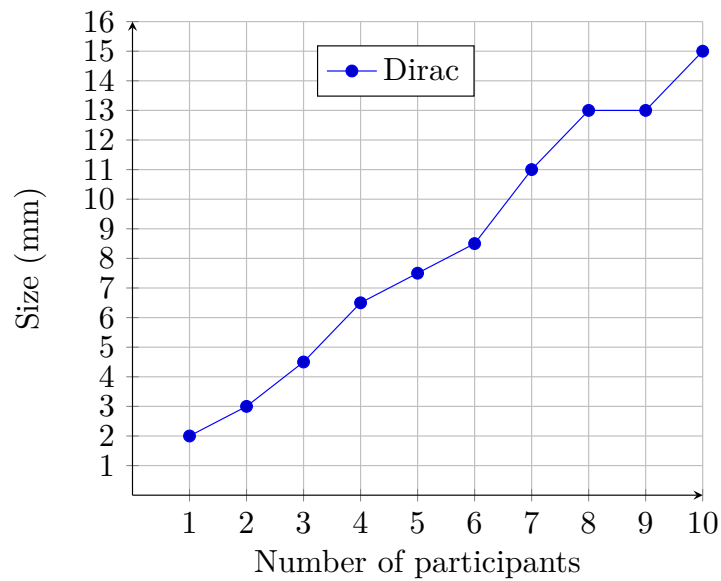

FIGURE 3.14: Minimum taxel size for a dirac texture. As for the two previous textures, the data are sorted in an ascendant manner. The minimum size of taxel is 13 mm for 90% of participants.

As we realize from the figure 3.14, the minimum size of the square is 13 mm for the majority of the participants (90%) for the given texture. However, there was still one participant who achieved the size of 15 mm.

3.6.3 Discussion

In figure 3.15 the detailed results of the minimum size of the taxel for the 3 given textures are illustrated. The size of taxels do vary as follows:

- For the Square texture, the size of taxel is in the range of 2 mm to 12 mm, with the size of 6.5mm for the 90% of participants.
- For the sinusoidal texture, the size of taxel is in the range of 2 mm to 13.5 mm, with the size of 13 mm for 70% of participants.
- For the dirac texture, the size of taxel is in the range of 2 mm to 15 mm, with the size of 13 mm for the 90% of participants.

We can conclude from this diagram that the minimum size of the tactile element for distinguishing all the 3 given textures (square, sinusoidal and dirac) is 13.5 mm for almost every participants (9 out of 10).

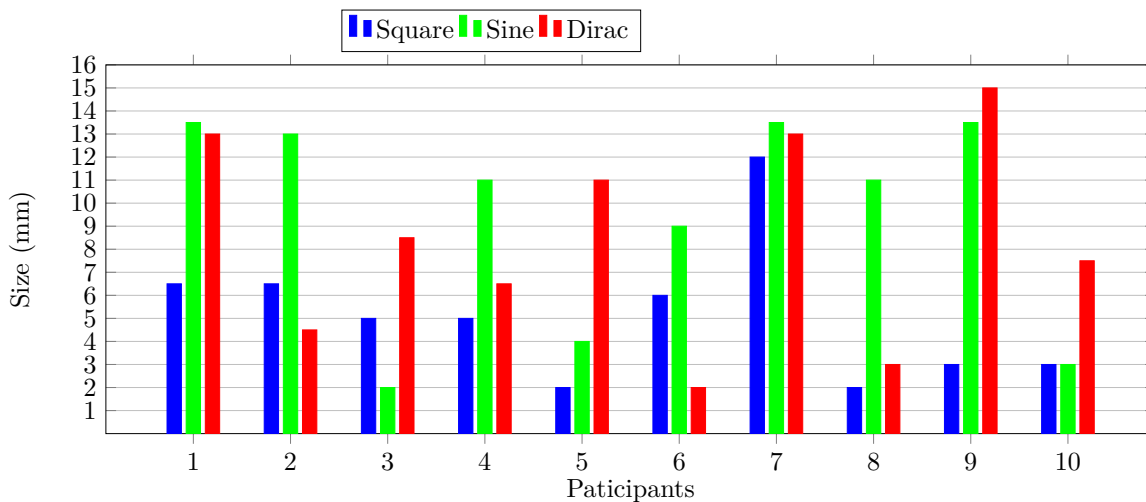

FIGURE 3.15: The detailed results of each participant for the minimum dimension of the tactile element for the 3 given textures

Our results indicate that the minimum perceivable size of the tactile element depends on the nature of texture waveform. The standard range in our case is from few millimeters to about one centimeter, depending on the texture waveform. Our findings also demonstrate that the textures with square waveform might be more perceivable with small sizes (6.5 mm). Hence, textures with square signal waveform is the most suitable texture for tactile rendering of small size of virtual objects on the ultrasonic based haptic feedback touchscreens. It is possible to perform a similar study to find out the minimum size of taxels with other geometrical shapes (such as circle or triangle) and compare to our case with a square shape of taxel. In the next chapter, we will take advantage of our findings concerning the texture perception on ultrasonic haptic displays in order to understand and optimize the users' interaction performances on these kinds of displays.

3.7 Application Examples

3.7.1 Designing the Visual Interface for E-ViT_a

I proposed to design the visual interface of E-ViT_a haptic display with Processing [98] which I consider a robust development tool for programming various applications for the device. As mentioned before, to generate haptic effect on E-ViT_a, a user must slide his/her finger on its touchscreen. For this reason, I used the mouse event functions of Processing (*mousePressed*, *mouseDragged* and *mouseReleased*) that consider a user's finger as an primary input, rather than the mouse, to interact with the display. Therefore, *mousePressed* is called when a user's finger touch the E-ViT_a display, *mouseDragged* to slide a finger on the display (e.g. dragging a virtual object) and generate haptic effect, and *mouseReleased* when there is no touch interaction between a user's finger and the E-Vita interface. These functions transmit information to the E-ViT_a microcontroller through an Open Sound Control (OSC) protocol and then receive texture signal properties (waveform, amplitude and spatial period) to render haptic effects on the touchscreen. A few example of the applications that I have developed are described as follows just to provide a general idea of the development procedure.

3.7.2 Gaming

Two applications of gaming have been developed. The first one is a maze game in which a user has to control and drag a virtual blue box from the entrance to the exit of pathways. A haptic feedback with a specific texture is rendered and perceived under user's finger all along the gaming procedure in order to prevent any collision with the maze edges. This enables even visually impaired users to play the game. For any errors during the game i.e. when there is a collision between the blue box with the maze edges, another kind of texture will be perceived by user's finger and the background color of display turns to red. The setup of the maze game is illustrated in figure 3.16.

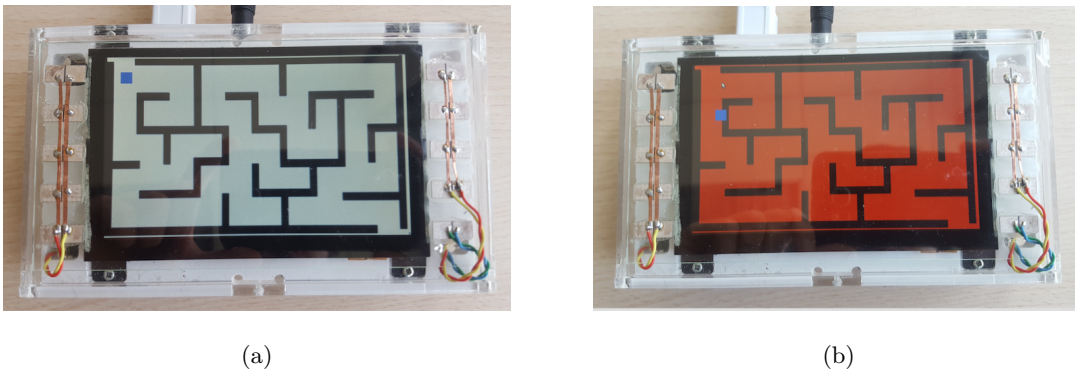

FIGURE 3.16: a) The setup of the “maze game” which is most suitable for visually impaired users. The virtual blue box with a haptic feedback has to be successfully controlled and dragged from entrance to exit. b) For any error in the game i.e. when there is a collision between the blue box with the maze edges, the texture perception is changed and the background color of E-Vita turns to red.

The second application is a “pong game” which can be played also by visually impaired users. Two different types of haptic textures are provided over the blue virtual paddle. The first texture is set when a user slides the paddle in the correct direction of the red bouncing ball, otherwise a second texture will be perceived to warn users that they are in a wrong direction. For each successful action to obtain the bouncing ball, the total score of users will be increased. The setup of the pong game is shown in figure 3.17.



FIGURE 3.17: The setup of the pong game which enables visually impaired users to play. Two different kinds of textures can be perceived for each correct or wrong direction of sliding the blue paddle to get the red bouncing ball.

3.7.3 Haptic Painting

The third application that I developed is a “painting interface” for haptic drawing on E-ViT_a display. Eleven colors are provided and a specific haptic texture is set for each color. This will enable users to feel what they are painting and might be interesting as an interactive interface for children to draw and sense colors simultaneously. The setup of the paint application is shown in figure 3.18.



FIGURE 3.18: The setup of the paint application. Each color is associated to a specific texture which allows users to *feel* and *draw* at the same time. The white color is served as an eraser tool.

Chapter 4

Understanding Interaction Performances on Haptic Feedback Displays

Contents

4.1	Introduction	73
4.2	Optimizing the Targeting Performance on Ultrasonic Haptic Displays	76
4.3	Experiment 1	77
4.3.1	Apparatus	77
4.3.2	Participants	77
4.3.3	Experimental Design and Variables	77
4.3.4	Procedure and Task	78
4.4	Results of The Experiment 1	79
4.4.1	Error Rate	80
4.4.2	Number of Failed Attempts	81
4.4.3	Number of Overshoots	81
4.4.4	Trial Time	81
4.4.5	Qualitative Ranking	82
4.4.6	Discussion	83
4.5	Effect of Variable Friction for Interaction with Electrostatic Display on Different Age Group	85

4.6	Experiment 2	85
4.6.1	Apparatus	86
4.6.2	Participants	86
4.6.3	Procedure and Task	87
4.7	Results of The Experiment 2	89
4.7.1	Acquisition Time	89
4.7.2	Trial Time	90
4.7.3	Error Rate Analysis	91
4.7.4	Overshoots Analysis	91
4.7.5	Subjective Results	91
4.8	Conclusion	93

A part of this work was published by:

F. Kalantari, E. Lank, Y. Rekik, L. Grisoni, and F. Giraud. “Determining the Haptic Feedback Position for Optimizing the Targeting Performance on Ultrasonic Tactile Displays”, In Proceedings of 2018 IEEE Haptics Symposium (HAPTICS), San Fransisco, USA, pages 204-209, IEEE (2018)

4.1 Introduction

Touch interactions with tactile interfaces such as smart-phones, tablets and ultra portable computers have become more and more ubiquitous in our daily life during the past decade. These tactile interfaces typically leverage touch as a primary input modality. Touch is an attractive input modality because the dexterity and sensitivity of our fingers makes possible a wide range of fine-grained manipulations and subtle variations of force. While touchscreen devices originally sensed touch as a binary state – touching or not-touching – recently we see ever-finer capture of characteristics of touch. For instance, Android devices sometimes examine touch contact area to provide an estimate of pressure and recent Apple touch sensors have incorporated force sensors to accurately capture force applied during input. However there is still a lack of dynamic haptic feedback on these interfaces to the user’s finger. As it was analyzed in 1985 by Buxton et al. [1], flat touchscreens need haptic feedback in order to ease the users’ common interaction tasks with widgets and icons, to enhance the efficiency of the interfaces as well as increasing the realism feeling of visual environments. Therefore, numerous efforts have been recently carried out to provide haptic feedback on touchscreens to end-users through different technologies as described previously in Chapter 2. Researchers have explored fine-grained haptic feedback in order to enhance performances of different interaction techniques on touchscreen devices.

Casiez et al. [130] described a pointing facilitation technique called *Surfpad*, that does not decrease target distance (D) or increase target width (W) in either control or display space, regarding to Fitts’ law, by using the STIMTAC [29] haptic touch-pad. We recall that Fitts’ law defines the movement time to acquire a target of width (W) at a distance (D), as a linear function of the index of difficulty (ID) with the following expression:

$$ID = \log_2\left(\frac{D}{W} + 1\right) \quad (4.1)$$

The *Surfpad* technique [130] used the programmable squeeze film effect of the STIMTAC to reduce the touch-pad’s coefficient of friction at all times except when the cursor

is over a target in a pointing task and then compared to *Semantic Pointing* technique reported in [131]. *Surfpad* was shown to improve the performance of pointing task close to 9% compared to no haptic feedback pointing task on small targets. It was also robust to high distractors (non-target objects), keeping an average performance improvement of nearly 10% in comparison to the performance of *Semantic Pointing* technique without any haptic feedback.

Lévesque et al. [38] used a Large Area Tactile Pattern Display (LATPaD) based on friction reduction to evaluate the role of programmable friction haptic effect on touch interactions by means of a targeting task. The authors have shown the three following statements concerning the speed and accuracy of a target selection task with and without variable friction in their studies: 1) Variable friction (VF) across the surface, with high friction (HF) over the target, improved selection speed and accuracy. 2) There was no significant difference between selection speed and accuracy when using a constant low friction (LF) and a constant high level of friction (HF). 3) Variable friction did negatively affect targeting performance in the presence of distractor targets. Furthermore, Lévesque et al. [38] have also shown that variable friction display improved user’s interactions in different daily life widget-based applications or playing games by means of a qualitative approach as the two examples shown in figure 4.1.

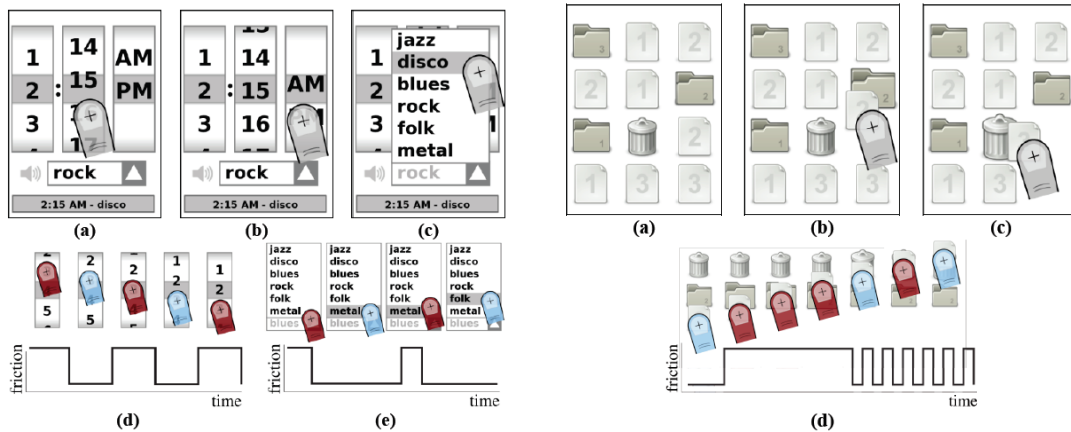

(a) Alarm Clock: a) hour and minute wheels, b) AM/PM wheel, c) sound combo box and friction patterns while selecting d) hour and e) sound. The finger color changes from light blue to dark red as friction increases.

(b) File Manager: a) initial screen, dragging and dropping a file into b) a folder or c) recycle bin, and d) friction patterns while over a folder or bin. The finger color changes from light blue to dark red as friction increases.

FIGURE 4.1: Two examples of daily life user interaction tasks enriched with variable friction haptic feedback [38]

It was found in [132–134] that TPaD Tablet which combined an Android tablet with a variable friction haptic touch-screen based on the squeeze film effect, enabled users many novel interaction tasks. For instance, specific textures could be attributed to different icons, boxes or buttons via Android Accessibility-Service to produce haptic effects for enhancing user interactions. Or to generate a remote-touch which represented both haptically and visually a tactile sense of tapping to a user’s finger. As well as a haptic sketching application which enabled users to draw directly on the display and immediately sense what they have drawn. Dai et al. [39] have designed a variable friction haptic display which provided both sliding and button-clicking interaction techniques to user’s finger. Sliding feedback enables the sliding finger to feel interactive objects or scrolling a widget on a touchscreen through friction reduction via squeeze film effect. Clicking feedback generated a key-click sensation for simulating a key or button click as shown in figure 4.2.

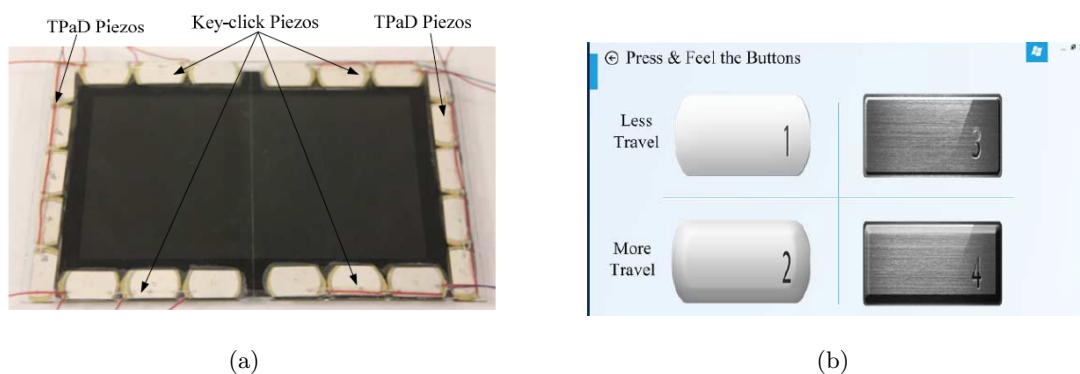

FIGURE 4.2: a) SlickFeel setup to provide both sliding and tapping interactions techniques to users. TPaD piezos are activated at 30 kHz to produce squeeze film effect for sliding feedback. Keyclick piezos are activated with 3 cycles of a 500 Hz raised sinusoidal signal to generate tapping feedback. b) Button-click interface [39].

Alongside the performed studies to evaluate the performances of interaction techniques for ultrasonic lubrication based on the squeeze film effect that we discussed, similar investigations can be also found for electrovibration based haptic touchscreens. Zhang and Harrison [135] compared user performance for a targeting task between no feedback and four different haptic feedback designs on either physical or electrostatic vibration tactile feedback. They have shown that electrovibration haptic feedback improved targeting speed by 7.5% comparing to normal flat touchscreen. More recently, Liu et al. [136] explored the accuracy and efficiency of pan gestures with and without tactile feedback on electrostatic haptic touchscreens by exploring the evolution manner of

completion time (CT) with different indices of difficulties (ID). They have presented that the accuracy and completion time of pan gestures with haptic feedback was significantly better than no haptic feedback conditions and they found that the relationship between CT and ID satisfied Fitts' Law with a correlation coefficient of 0.9.

Hoggan et al. [137] explored the comparison between physical keyboard, standard touchscreen and haptic feedback touchscreen for entering text and phone numbers. They showed the addition of haptic feedback to touchscreens significantly improved user's finger-based text entry interactions. In literature we can also find several studies using haptic pens for evaluating and improving the performances of different interaction techniques in Fitts-style experiments as explained in [138–140].

4.2 Optimizing the Targeting Performance on Ultrasonic Haptic Displays

Alongside questions of how to create haptic effects on displays via alternative hardware, recent work has explored rendering options with respect to haptic effects, i.e. when and where to provide haptic feedback. In 2015, Zhang and Harrison [135] examined how different haptic rendering techniques affect target acquisition times and error rates for one type of haptic effect, electrostatic haptic feedback. However, given the significant differences between haptic effects, it seems reasonable to assume that different types of haptic effects might have different optimal renderings. In particular, they showed that, both from the perspective of time and errors, providing a tactile sensation across the entire target – electrostatic Fill – was the best strategy for designing dynamic haptic feedback as opposed to providing more localized haptic feedback (e.g. along one edge, in the centre, or in the background). In this chapter, we work with a dynamic haptic feedback system that leverages the squeeze film effect to provide dynamic haptic feedback. Furthermore, because the squeeze film effect works differently than electrostatic vibration – reducing rather than increasing friction – it was unclear to us whether, given the different sensations, electrostatic Fill would remain the optimal technique to enhance targeting. Therefore, we have applied the same comparative approach and procedure as in [135] to determine the positioning of haptic feedback for improving the user's targeting performance on ultrasonic based touchscreens using the squeeze film effect.

4.3 Experiment 1

With the exception of our haptic display technology, to preserve experimental validity we use the same experimental design of Zhang and Harrison [135]. We use an identical number of participants and an identical set of haptic feedback techniques while substituting squeeze film effect haptic output. For completeness, this section describes our apparatus, participants, and method.

4.3.1 Apparatus

We used *E-ViT*a (Enhanced Visual-Tactile Actuator), a tactile feedback tablet based on ultrasonic vibrations to create the squeeze-film effect for haptic rendering [37] as described completely in Chapter 3. A sine-wave grating with a spatial period of 1000 μm and an amplitude of 1.25 μm was applied to generate haptic feedback sensation to a user's fingertip.

4.3.2 Participants

Twenty healthy volunteers (9 females) from the age of 24 to 37 and the mean age of 29.4 (SD = 4.2 years) participated in our experiment. All participants were right-handed. They were all naive to the aim of the study and had no previous experience with haptic feedback displays. Participants were wearing active noise-cancelling headphones (Panasonic RP-DJS200, Japan) during the experiment, while Gaussian white noise was played at a comfortable listening level in order to prevent potential interference from auditory cues. The experiment took on average approximately 40 minutes.

4.3.3 Experimental Design and Variables

The experiment was a $5 \times 3 \times 5$ repeated measures within-subjects design. To determine significant main effects, repeated measures analysis of variance was applied for the following independent variables: *feedback* (*No Feedback*, *Line Leading Edge*, *Line Background*, *Line Center* and *Fill*), *target width* (SMALL: 30 pixels = 4.125mm, MEDIUM: 50 pixels = 6.85mm and LARGE: 80 pixels = 11mm and *amplitude* (*shortest*: 114 pixels = 15.675mm, *short*: 228 pixels = 31.35mm, *medium*: 342 pixels = 47.025mm, *long*:

456 pixels = 62.7mm, *longest*: 570 pixels = 78.375mm where *amplitude* corresponds to the distance between the center of the control area and the center of the target area. The four haptic feedback designs as well as the *No Feedback* condition is illustrated in Figure 4.3.

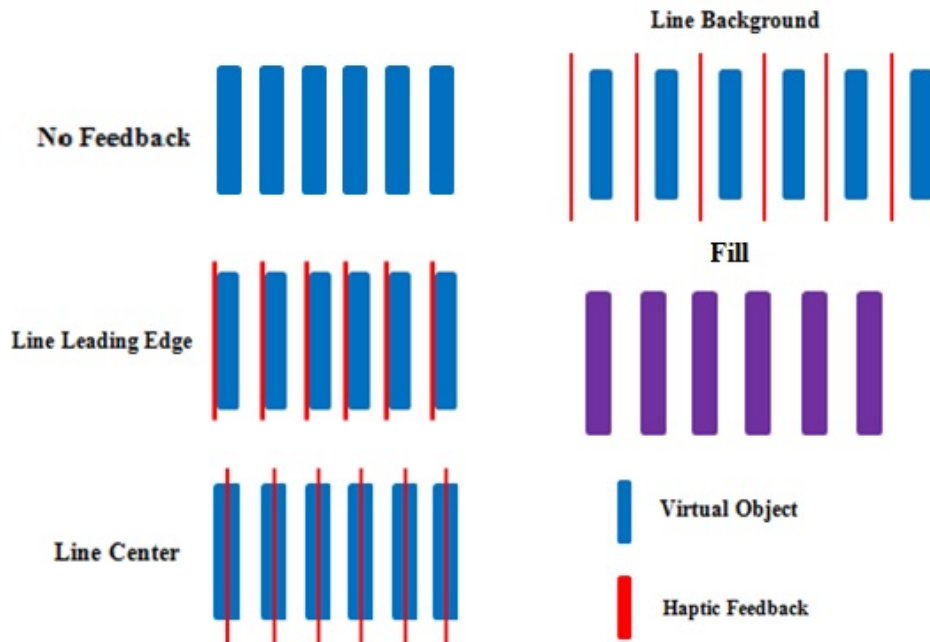

FIGURE 4.3: Four haptic feedback and *No Feedback* designs in our experiment

The order of *feedback* conditions was counterbalanced among the participants. Under each *feedback* condition and for each *target width* \times *amplitude* combination, participants completed five trials. *Target width* \times *amplitude* combinations were presented in a random order. Overall, we have a total of 5 *feedback* \times 3 *target width* \times 5 *amplitude* \times 5 repetitions = 375 trials performed by each participant.

4.3.4 Procedure and Task

The experiment proceeded as follows. First, a brief description of our task as well as all the necessary instructions for interacting with our haptic feedback display were given to each participant. Participants were given about 10 minutes of training and familiarization before beginning the main task. We used a drag and drop task identical to past experiments contrasting haptic rendering techniques [135]. As illustrated in Figure 5.5, for each trial, the participant was required to correctly select the blue

rectangular virtual object. Then the selected object had to be dragged and successfully dropped on a specified target, a red virtual object (Figure 5.4). The black objects were considered distractors. The red target became green to confirm that the trial had been successfully completed and the participant proceeded to the next trial. The trials in which participants were not able to perform the task correctly were marked as errors. The trials were repeated for each of the five haptic feedback options (No Feedback, Line Leading, Line Background, Line Center, and Fill) with the different target widths and distances as noted in the section on Experimental Design.

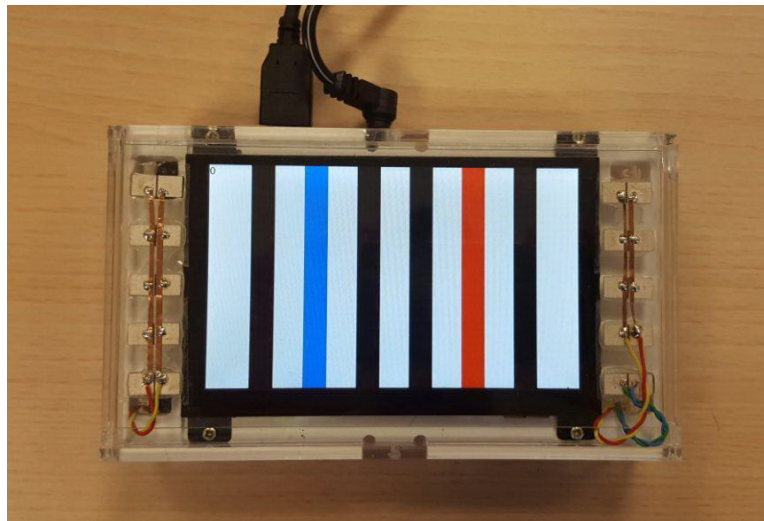

FIGURE 4.4: An example setup of the trials in our experiment

4.4 Results of The Experiment 1

To understand the effect of different haptic rendering techniques, we analyze the effect of independent parameters on *error rate*, *number of failed attempts*, *number of overshoots* and *trial time* (our dependent measures). We also analyzed the subjective responses of participants vis a vis the five haptic feedback options. While our primary interest is in determining the effect that haptic feedback options have on these dependent measures, to further determine potential interaction effects between independent variables, all analyses were multi-way ANOVA. Tukey tests were used post-hoc when significant effects were found. In the following, we report the results for each of the dependent variables.

4.4.1 Error Rate

Targets that were not selected on first attempt were marked as errors. There were significant main effects of *target width* ($F_{2,28}=54.76$, $p < 0.0001$) on *error rate* but there was also a significant effect of *target width* \times *distance* ($F_{8,112} = 2.63$, $p = 0.01$) and *distance* \times *feedback* ($F_{16,224} = 2.28$, $p < 0.005$) interactions. Post-hoc tests revealed that for SMALL *target width*, performance deteriorated more significantly among decreasing *distance* ($p < 0.05$). Similarly, we found that for all *distance* conditions, performance deteriorated more significantly among decreasing *target width* ($p < 0.05$). Importantly, we found that for the *Fill* condition, *error rate* was significantly higher for LONGEST *distance* (mean 10.22 %, S.D 4.24%) than for SHORTEST *distance* (mean 23.11 %, S.D 7.77%) ($p < 0.05$).

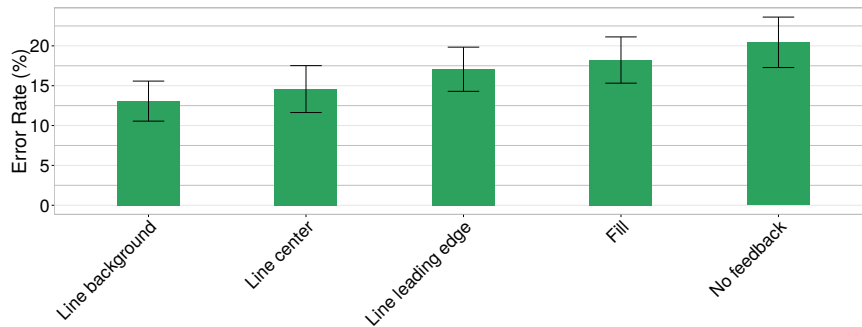

FIGURE 4.5: Average error rate cross feedback conditions. Error bars are standard error across participants (95% CI).

The most compelling *haptic feedback* position, with respect to *error rate* was *Line Background* (mean 13.06%, S.D 2.51%) followed by *Line Center* (mean 14.57%, S.D 2.94%), *Line Leading Edge* (mean 17.06%, S.D 2.77%), *Fill* (mean 18.22%, S.D 2.90%) and *No Feedback* (mean 20.44%, S.D 3.16%) condition (see Figure 4.5). These results are in contrast to the findings of [135] when using electro-static based haptic display in which the *Fill* condition was found to provide the best performance. However and similar to [135], post-hoc tests showed no significant differences between different *line haptic feedback* types.

4.4.2 Number of Failed Attempts

We found that there was a significant main effect of *target width* ($F_{2,28} = 5.88$, $p < 0.001$) on *number of failed attempts*. Post-hoc tests revealed that the *number of failed attempts* is significantly higher with SMALL *target width* than with MEDIUM or LARGE *target widths* ($p < 0.05$). We correlated these results with comments from participants who felt that selecting and dragging virtual objects with small size was difficult. The major reason for these difficulties (as explained in [120]) is due to the limitation of the object size which can be accurately perceived by the user's finger on ultrasonic (squeeze-film effect) haptic displays.

4.4.3 Number of Overshoots

Number of overshoots were measured as the number of times when the participants enter and leave the target without selecting it. There was a significant main effect of *target width* ($F_{2,28} = 10.63$, $p < 0.05$) on *overshoots*. Post-hoc tests revealed that the *number of overshoots* is significantly larger with SMALL *target width* than with MEDIUM or LARGE *target widths* ($p < 0.05$).

4.4.4 Trial Time

Trial time was measured from the first control area movement, to target successfully selected. There were significant main effects of *target width* ($F_{2,28} = 120.04$, $p < 0.0001$) and *distance* ($F_{4,56} = 99.78$, $p < 0.0001$) on *trial time*, but there was also a significant main effect of *target width* \times *distance* ($F_{8,112} = 2.79$, $p < 0.001$) interaction. Post-hoc tests revealed that the *trial time* increased more significantly for the SMALL *target width* among decreasing *distance* ($p < 0.05$). Similarly, the *trial time* increased more significantly for the *shortest*, *short* and the *medium distance* respectively among decreasing *target width* ($p < 0.05$).

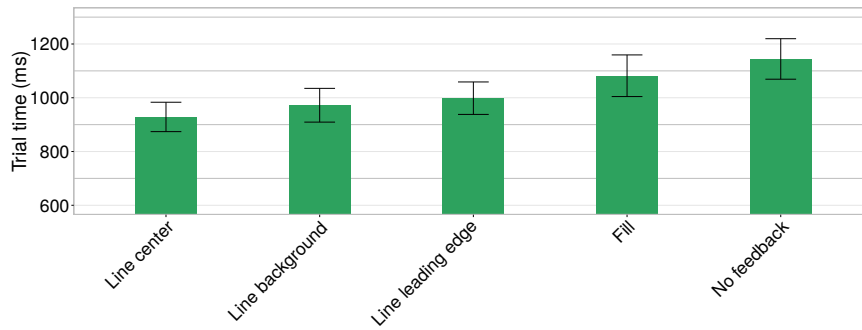

FIGURE 4.6: Average trial time cross feedback conditions. Error bars are standard error across participants (95% CI).

The best *feedback* position, with respect to *trial time* was *Line Center* followed by *Line Background*, *Line Leading Edge* and *Fill* which lowered the trial time by respectively 18.84%, 15.04%, 12.75% and 5.45% compared to *No Feedback* condition (see Figure 4.6). For *error rate*, these results are in contrast to the findings of [135] in the case of electrostatic haptic displays in which the *Fill* condition has been found to provide the shortest *trial time*. We have also found a significant main effect of *Line Center*, *Line Background* and *Line Leading Edge* feedback conditions compared to *No Feedback* ($p < 0.05$) on *trial time*.

4.4.5 Qualitative Ranking

Participants were also asked to rank the five haptic feedback positions after completing the experiment. *Line Center* was the most preferred feedback with an average score of 4.2 (SD = 0.94), followed by *Line Background* with an average score of 3.8 (SD = 1.14), *Line Leading Edge* with an average score of 3 (SD = 0.96), and *Fill* feedback with an average score of 2.4 (SD = 0.73). The *No Feedback* condition received the lowest average score of 1.53 (SD = 1.40). These results present an interesting contrast with Zhang and Harrison [135], where *Fill* was most preferred and *Line Center* and *Line Background* least preferred.

We correlate these results with the comments of participants who felt that the three line haptic feedback conditions had better performance, required less concentration, and were less frustrating for accomplishing the experimental task. In particular one participant noted that he or she was “*comfortable with the line haptic feedback particularly in order to select and drag the small size of objects and ... to select the target*”.

Another found advantages in precision, i.e. that “*when the tactile feedback is a line, I think that I can select the target even if my eyes are closed... those tactile feedback conditions tell me that there is either a distractor or the target, so I just need to count to know whether I’m on the target or not!*”. In contrast, for the *Fill* condition, the participants felt that it was cumbersome and required more concentration and time. One participant noted that the “*high amount of vibrations under my finger is not very pleasant and I’d prefer the other haptic feedback designs*”. Several participants also found a delay in notification for the *Fill* technique, with one claiming that he or she “*preferred the [line-based forms] of haptic feedback [because they] warned me before arriving at the target*”, thus increasing accuracy. Finally one participant noted that he or she was “*frustrated with [Fill] feedback... [because] it disturbs me and [requires] more concentration*”.

Despite the relative advantages of *Line Centre/Background* over the *Fill* condition, all participants found that haptic feedback of any form was an advantage. In the case of *No Feedback*, the participants declared that, “*Without any haptic feedback [it] is definitely harder to select and drag the objects, specially for the small sizes... I need lots of concentration in order not to pass the target and finish each trial successfully*” and that, “*If I wanted to do the task with a high velocity of touching the object with no haptic feedback, it was kinda impossible to finish each trial without several attempts and repetitions! Therefore it became a bit boring after several attempts.*”

4.4.6 Discussion

While all haptic feedback techniques clearly perform better than the *No Feedback* condition, analyzing our haptic feedback techniques using both qualitative ranking and quantitative effects, the main take-away from this work is that *Line Center* seems an optimal feedback technique balancing user preference (most preferred), speed (fastest selection time) and error rate (second lowest error rate) when using squeeze film effect haptic rendering techniques. *Line Background* and *Line Leading Edge* might also be possible rendering options for haptic effects. Finally, for squeeze film effects, *Fill* seems a poor choice both from the perspective of user preference (least preferred), time (slowest), and errors (highest).

As we noted before, for a competing haptic feedback technology, electrostatic vibration, Zhang and Harrison found that *Fill* was the best technique and that *Line Center* and *Line Background* were typically poor performers in time, error, and user preference when compared to *Fill*.

Alongside haptic rendering techniques, we note that our experiment results in a higher error rate than Zhang and Harrison [135]. In their work, they obtained an error rate of approximately 8%, compared to our error rate of 16.67%. While it is possible that haptic rendering differences may result in higher or lower error rates, we believe that other potential confounds may explain this discrepancy. These include factors such as touchscreen performance (Zhang and Harrison used 3M Microtouch capacitive panels over a standard LCD screen whereas we used the E-Vita, a standalone portable device) and participants (Zhang and Harrison's participants were significantly younger than ours – adults average age 24 versus adults average age 29 in our experiments). This is particularly true because of the discrepancy in the No Feedback condition. If haptic effects were responsible for increased error rate, one would expect that the No Feedback conditions would remain similar.

While we were surprised by these results, it may be the case that post-hoc rationale exists for the contradictory effects. After all, the squeeze film effect serves to reduce friction when active, whereas electrostatic techniques then to increase friction when active. It may be the case that participants can effectively sense increase in friction, thus arguing for the advantage of background based feedback techniques. However, the overall advantage of *Line Center* are not fully explained by this rationale. We believe that the overall message of this work is simply that different haptic technologies produce different physical sensations for the end user. These differences in physical sensation limit the overall generalizability of rendering options between competing technologies. As new techniques are developed, additional work will be required to explore how best to perform haptic feedback such that speed and accuracy are maximized.

One additional data point that both Zhang and Harrison [135] and our work presented here demonstrate is that effective haptic feedback continues to show advantages over no haptic feedback. Optimal haptic rendering techniques exhibit a 15 - 25% improvement in both speed and error rate. However, poor haptic rendering choices significantly effect these performance improvements. For the Squeeze Film Effect (our technique), choosing *Fill* haptic feedback results in less than 10% improvement, and, for electrostatic

vibration (Zhang and Harrison's technique), choosing *Line Center* haptic feedback results in almost no improvement in time or error. As a result, the argument for haptic feedback is nuanced, thus we highlight the implications of this work to the *generalizability* of haptic feedback: Haptic feedback appears to improve time, errors, and user satisfaction, but *only if* the correct form of feedback is used for the specific haptic feedback technology generated by the hardware.

4.5 Effect of Variable Friction for Interaction with Electrostatic Display on Different Age Group

As we mentioned earlier, the operating principle and the tactile sensation provided through the two common used haptic feedback technologies (ultrasonic vibrations based on the squeeze film effect and the electrostatic vibration) are rather different. With the comparison of the two technologies we may realize, for instance the following: Electrostatic touchscreens suffer from a decrease in perception accuracy when sliding repeatedly as reported in [141]. Ultrasonic haptic displays present higher power consumption in active state than electrostatic touchscreens for a similar form factor which is due to continuous damping of the air against the vibrating plate. Taking into account these differences, we performed the following experiment for completeness of this chapter.

4.6 Experiment 2

We study the effect of variable friction on an electrostatic haptic display using a pointing task in order to evaluate its influence on different age of participants including both children and adults. This study carried out in collaboration with Romain Belmonte, a former graduate student in our lab for his Master internship during summer 2015. The experiment conformed to the principles of the Declaration of Helsinki and a general explanation of the demanded task was given to each participant before beginning the experimental procedure. Based on the theoretical ability of variable friction for a pointing interaction task, we had the following assumptions:

- **Assumption 1:** A variable friction (VF) on the surface which was a high friction (HF) over the target and the low friction (LF) elsewhere might improve the acquisition time (speed) and accuracy for selecting a target. However, there will be no significant difference between the acquisition and accuracy for selecting the target while using a constant low level of friction.
- **Assumption 2:** Our second assumption was that the high friction based feeling will be stronger in children than in adults, because of their capacity of sensory-motor that is still developing and hence more sensitive. Therefore, a variable friction and a high constant friction may both significantly improve the speed and accuracy of pointing the target for children. But the same high level of friction might not have significant effect for adults' performances. Furthermore, a high level of friction also assured that the finger of the children was uninterruptedly in contact with the surface of the display.
- **Assumption 3:** All the three variable friction (VF), high level of friction (HF) and low friction (LF) conditions might improve the speed and accuracy of selecting a target for adults much more compelling than children.

4.6.1 Apparatus

We used an Asus Nexus 7 tablet (year 2013) with the Feel-Screen technology of Senseg [82] based on electro-vibration effect for haptic rendering. Senseg has developed its SDK based on Android in order to permit the developers to make their own applications by using the different provided classes for having various types of tactile feedback sensations to the user's finger. The following experiences have been developed by using the Android SDK of Senseg and Processing language.

4.6.2 Participants

Sixteen healthy volunteers, 8 adults from the age of 24 to 31 (average 26.3 years) and 8 children from the age of 8 to 11 (average 9.6) participated in our experiment. All the adult participants were regular users of at least one tactile display (smart-phones or tablet) without haptic effects in their daily life. However, all the 16 participants were naive to the target of the study and had no previous experience with any kind of

haptic feedback displays. They were all wearing an active noise-cancelling headphone in order to prevent potential interference from auditory cues.

4.6.3 Procedure and Task

At first, a detailed description of the demanded task as well as all the required instructions to be followed during the experiment was given to participants. Since none of the participants had any previous experience of interaction with haptic displays, they were also given few minutes of training and familiarization before beginning the main task. We have used the similar procedure as proposed in [38], while leveraging electrostatic vibration rather than ultrasonic vibrations (squeeze film effect) as well as children participation. Each trial consists of the following steps to be performed by each participant:

1. At the initial state a blue “control line” and a red “target” appear on the display.
2. Acquire the blue control line by touching and holding it continuously. For any movement off the control line or off the display surface, the trial is repeated.
3. Free the control line and begin the pointing task. After holding for 0.2 seconds, an audible beep is heard, the control line is freed to move and the clock starts to calculate the movement time.
4. Dragging the control line and drop it over the target. The target turns green to confirm the blue control line is over the red target and in some conditions friction changes over the target.
5. Raising the finger off the target. The target will turn back from green to red just in a second and the steps will be repeated for the next trial.

Participants were given the opportunity to fulfill 30 trials (10 for each *interface condition* of training task with a 5.62 mm target width. After finishing this preparation, each participant then performed 336 trials including three factors: *interface*, *direction* and *target width*. The three *interface* conditions were constant high friction (HF), constant low friction (LF) and variable friction (VF). In our case a constant low friction (LF) was related to no-feedback effect, i.e. while Senseg oscillations were turned off

and a constant high friction (HF) was when the Feel-Screen haptic effect of Senseg was active maximally. In the condition of variable friction (VF), friction was higher over the target (Senseg on) and low friction (no feedback effect) everywhere else. We did not investigate inverse variable friction, i.e. low over the target and high elsewhere since it does not make sense for the aim of our study, neither offer the psychophysical advantages of VF while sliding a finger on the display. The four levels of *direction* were north (N), south (D), east (E), and west (W); and the four levels of *width* were 0.94, 1.87, 3.74 and 7.49 mm. The Senseg display was physically rotated when changing direction axis (N/S, E/W) so that user's finger movement remained within an optimal active friction surface on the screen. An example experimental setup of the trials in east direction for a pointing task is shown in figure 4.7.

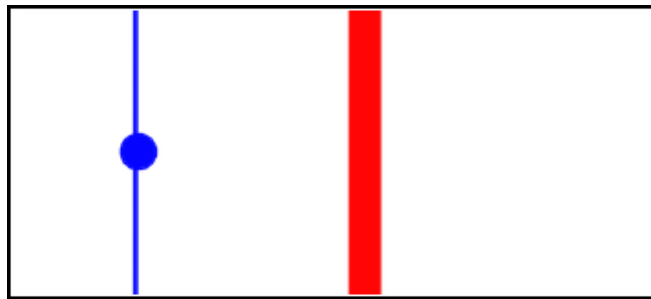

FIGURE 4.7: An example setup of the trials in east direction for a pointing task

The movement distance between the control line and the target was constantly set to 35.1 mm. All 336 trials were administered as blocks of 14 trials and each block shared an interface level (LF, HF, VF), target width (0.94, 1.87, 3.74 and 7.49 mm) and direction axis (N/S, E/W). The first 4 trials of each block were discarded to permit each participant to adapt for new condition adaptations. Block sets were counterbalanced among participants so that all combinations of $2! = 2$ direction axis orderings and $3! = 6$ interface level orderings were performed by each. Initial direction and target width were randomized for each block and a total number of 24 blocks (2 direction axis $\times 3$ interface conditions $\times 4$ target widths) were performed.

4.7 Results of The Experiment 2

4.7.1 Acquisition Time

We computed a Friedman non-parametric statistical test to evaluate the effect of *interfaces* for the acquisition time. The acquisition time was calculated as the time a trial has been successfully performed i.e. the control line selected, dragged and accurately dropped on the target. Surprisingly, Friedman test did not reveal any significant effect of *interfaces* for acquisition time ($\chi^2 = 2.39$, $p > 0.05$) for adult participants with the means of 1215 ms (SD=330) for LF, 1244 ms (SD=384) for HF and 1255ms (SD=543) for VF. Similarly, no significant effect of *interfaces* was found for acquisition time of children ($\chi^2 = 2.26$, $p > 0.05$) with the means of 1453 ms (SD=556) for LF, 1485 ms, (SD=559) for HF and 1492 ms (SD=788) for VF. These results are illustrated in the figure 4.8.

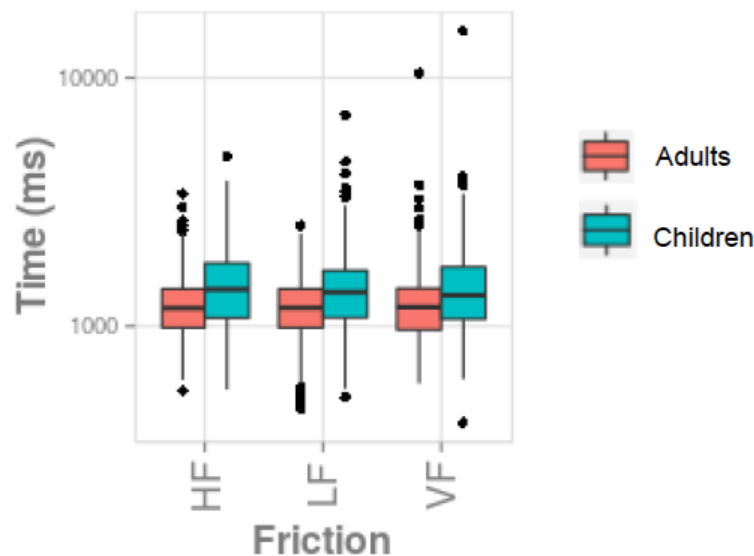

FIGURE 4.8: The acquisition time of different interfaces (LF, HF, VF) for both adults and children

However, post hoc analysis with Wilcoxon signed-rank tests revealed a significant effect of the *age group* of participants for the acquisition time ($W=1$, $Z=-3.08$, $p < 0.001$, $r=0.08$ for LF, $W=1$, $Z=-2.12$, $p < 0.001$, $r=0.05$ for HF and $W=1$, $Z=-4.30$, $p < 0.001$, $r=0.12$ for VF). In summary, adults were significantly faster than children for a pointing task taking into account all conditions.

4.7.2 Trial Time

In our study, target time was defined as the time between the moment the control line arrived over the target and the validation of successfully performed task until the next trial. As for the acquisition time, we have not found any significant effect of *interfaces* on target time for adult participants ($\chi^2 = 3.46$, $p > 0.05$) with the means of of 389 ms (SD=175) for LF, 406 ms (SD=178) for HF and 416 ms (SD=389) for VF. Similarly, for children participants a Friedman test shows that there was no significant effect of *interfaces* on target time ($\chi^2 = 1.39$, $p > 0.05$) with the means of of 455 ms (SD=344) for LF, 455 ms (SD=288) for HF and 473 ms (SD=294) for VF. These results are shown in the figure 4.9.

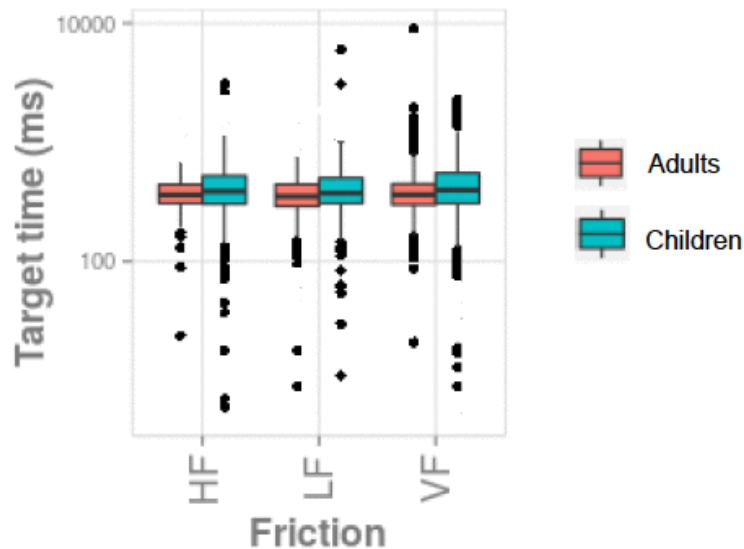

FIGURE 4.9: The target time of different interfaces (LF, HF, VF) for both adults and children

Interestingly, post hoc analysis with Wilcoxon signed-rank tests revealed a significant effect of participants' *age group* for the target time ($W=1$, $Z=-4.55$, $p < 0.001$, $r=0.12$ for LF, $W=1$, $Z=-3.27$, $p < 0.001$, $r=0.09$ for HF and $W=1$, $Z=-4.48$, $p < 0.001$, $r=0.12$ for VF). As the same manner with acquisition time, adults were significantly faster than children in all of the conditions.

4.7.3 Error Rate Analysis

Targets that were not selected on the first attempt were marked as errors. The overall rate of errors for adult participants were 7% for LF, 8% for HF and 6% for VF. Therefore, the error rate of variable friction for adults on electrostatic haptic display used in our study is 2.2% less than the error rate reported for ultrasonic vibration device (8.2%) in [38]. However and similarly to Levesque et al. [38], analysis of count of trials per block containing an error showed no significant effect of *interfaces* ($\chi^2 = 0.89$, $p > 0.05$) for adult participants. Friedman test for children participants also showed no significant effect of the *interfaces* on number of errors ($\chi^2 = 0.52$, $p > 0.05$) with the overall rate of 16%, 14% and 14% for LF, HF and VF respectively. Wilcoxon signed-rank tests revealed that *accuracy* of target selection is significantly better for adults compared to children ($W=1$, $Z= -4.55$, $p < 0.001$, $r= 0.12$ for LF, $W =1$, $Z= -3.27$, $p < 0.001$, $r= 0.09$ for HF and $W=1$, $Z= -4.48$, $p < 0.001$, $r= 0.12$ for VF). The results also indicated the factor which has significant effect on error rate was *target width* ($p < 0.001$).

4.7.4 Overshoots Analysis

Number of overshoots were calculated as the number of times when the participants enter and leave the target without selecting it. Analysis of overshoots showed no significant effect of *interfaces* ($\chi^2 = 2.94$, $p > 0.05$) for adults with similar means of 0.05 overshoots for LF (SD=0.18), 0.05 (SD=0.24) for HF and 0.05 (SD=0.24) for VF. Similarly, no significant effect of *interfaces* was found for number of overshoots for children ($\chi^2 = 3.31$, $p > 0.05$) with similar means of 0.20 overshoots for LF (SD=0.28), 0.06 (SD=0.26) for HF and 0.06 (SD=0.20) for VF. Our findings indicated that although adult participants produced less overshoots than the children in all conditions, these differences were not significant.

4.7.5 Subjective Results

After finishing the trials for each of the 3 conditions, participants were asked to respond to 5-point Likert-scale questions to rank each interface. This questionnaire concerned to the mental, physical, temporal, performance, effort and frustration aspects of the

participants’ performances during the experiment: “ How mentally demanding was the task? How physically demanding was the task? How hurried or rushed was the pace of the task? How successful were you in accomplishing what you are asked to do? How hard did you have to work to accomplish your level of performance? How insecure, discouraged, irritated, stressed or annoyed where you? The detailed subjective results are illustrated in figure 4.10.

	Low Friction		High Friction		Variable Friction		$\chi^2(2)$
	MEAN	SD	MEAN	SD	MEAN	SD	
Mental : How mentally demanding was the task ?							
Adults	1.75	1.06	1.75	1	1.93	1.43	0
Children	2.12	1.40	2.31	1.49	2.25	1.52	2
Z (r)	-0.95 (0.16)		-1.49 (0.26)		-1.21 (0.210)		-
Physical : How physically demanding was the task ?)							
Adults	1.81	1.04	1.93	1.06	1.75	1	2.33
Children	1.81	0.98	2.06	1.06	1.81	0.91	1.95
Z (r)	0 (0)		-0.22 (0.03)		-0.74 (-0.13)		-
Temporal : How hurried or rushed was the pace of the task ?							
Adults	1.68	0.79	1.68	0.87	1.62	0.80	0.4
Children	2.37	1.36	2.62	1.31	2.5	1.21	1.64
Z (r)	-1.37 (0.24)		-1.79 (0.31)		-1.73(0.30)		-
Performance : How successful were you in accomplishing what you are asked to do ?							
Adults	4.06	0.68	4.06	0.99	4.18	0.65	0.8
Children	4.18	0.91	4.31	1.01	4.56	0.81	6.09*
Z (r)	-0.70(0.12)		-0.82 (0.14)		-1.70 (0.30)		-
Effort : How hard did you have to work to accomplish your level of performance ?							
Adults	2	1.09	2.12	1.08	1.68	0.94	4.90
Children	2.06	0.99	2.06	0.92	1.87	0.88	1.28
Z (r)	-0.46 (0.08)		0.26(0.04)		-1.28 (0.22)		-
Frustration : How insecure, discouraged, irritated, stressed, and annoyed were you ?							
Adults	2.18	0.91	2.25	0.93	2	0.89	3.07
Children	1.43	0.72	1.37	0.80	1.5	0.816	1.5
Z (r)	2.40 (0.42)*		2.60 (0.45)*		1.48 (0.26)		-

FIGURE 4.10: Mean and standard deviation (SD) of questionnaire responses with 1 = strongly disagree (Failure of performance), and 5 = strongly agree (Perfect for performance). Results of Friedman test are reported to evaluate the effect of each interface on adults and children. Results of Wilcoxon-Signed-Rank test are also reported to study the effect of age group. The significant effects (p< 0.05) revealed from the tests are highlighted with green.

For adult participants, VF was ranked first 75% of the time, second 12.5% and third 12.5%, HF was ranked first 50% of the time and third 50%. Mean rankings of VF was 2 for adults. For children participants, we found VF was ranked first 62.5% of the time and second 37.5% with a mean ranking of 1.37. Then, LF which was ranked first 12.5% of the time, second 37.5% and third 50% with a mean ranking of 2.25. HF was ranked first 25% of the time, second 12.5% and third 62.5%. Our findings also indicate that, adults needed less mental, physical, temporal and lower effort for the experiment compared to children. However, children were significantly less frustrated than adults.

4.8 Conclusion

We have conducted two experiments in this chapter. The aim of the first experiment was to determine the best tactile feedback position on ultrasonic (squeeze-film effect) haptic displays for targeting tasks. In contrast to prior work of Zhang and Harrison [135], our results indicate that positioning the haptic feedback as a discrete linear stimulus centred on the target (*Line Center*) provides an optimal trade-off between speed, accuracy, and user preference. The purpose of the second experiment was to study the effect of variable friction for a pointing task on electrostatic haptic touchscreen for different age group of participants. Surprisingly, we have not found a significant effect of haptic on electrovibration display in particular for children participants for time and accuracy of a pointing task. We believe this is due to their age group. Generally, we note that the contrast between these results and past research on haptic feedback techniques advocates for a need for caution when attempting to generalize results across different hardware configurations and for different age group of users. In terms of future study, I propose to examine different target shapes (rather than rectangular virtual objects in our case) in the different configurations and compare the results.

In the next chapter, we will discuss how tactile feedback and auditory signals can be combined on ultrasonic tactile displays to enrich users' interactions in a multimodal context. Since I'm a pianist, I will be particularly interested in musical interactions.

Chapter 5

Musical Interaction with Programmable Friction Haptic Displays

Contents

5.1	Introduction	97
5.2	Exploring Gesture-sound Mappings and Haptics	99
5.3	Experiment	101
5.3.1	Design	101
5.3.2	Task and Procedure	103
5.4	Results and Discussion	104
5.5	Conclusion & Perspective	111

This work was published by:

F. Kalantari, F. Berthaut, and L. Grisoni. “Enriching Musical Interaction on Tactile Feedback Surfaces with Programmable Friction”, In Proceedings of 13th International Symposium on Computer Music Multidisciplinary Research (CMMR 2017), Porto, Portugal, pages 261-271, (2017)

F. Kalantari, F. Berthaut, and L. Grisoni. “Enriching Musical Interaction on Tactile Feedback Surfaces with Programmable Friction”, Lecture Notes in Computer Science (LNCS), Springer, In preparation

5.1 Introduction

Music can be defined as a vocal or instrumental sounds (or both) combined in such a way as to produce beauty of form, harmony, and expression of emotion. Claude Debussy (1862–1918), a famous french composer and musician defined music as follows: *“Music is the space between the notes. It is something to be felt. Although it does not have a concrete and precise definition. All of us know that music is every sound that reaches our ears and our heart says that it is something fabulous...that is music!”* Musicians believe that they not only hear, but also “feel” music. In this context, the haptic sensation seems to be an important factor to be taken into account in designing musical interfaces. Consequently, in the recent years a great interest has emerged to enhance musical interfaces with haptic effects.

Chu [142] reported as early as in 1996 that there is a close relationship between haptic feedback and sound production in computer music performances. The author also demonstrated that the lack of haptic feedback sensation is a major concern in computer music performances between a musical performer and the sound being produced. In fact, music is an extreme cognitive process which requires an accurate understanding of its modalities before developing an audio-haptic tactile interface. The first investigation to add haptic feedback to a tactile musical interface was proposed by Chafe [143], by leveraging vibration modulations to design two vibro-tactile audio cues. Serafin and Young [144] investigated the role of friction modulation for musical interactions by proposing several musical instruments that operate by means of a friction-based excitation. Chang and O’Sullivan [145] proposed a design of audio-haptic effects to enhance the user interface on mobile phones. The authors discussed two audio manipulation techniques specific to the multi-function transducer (MFT) technology, called Haptic Inheritance and Synthesis and Matching methods. The two methods based on creation of vibration content via a speaker which generated both audible and vibrotactile output from an audio signal in order to enhance the perception of audio quality. Birnbaum and Wanderley [146] described an approach for the design and integration of vibrotactile feedback into digital musical instruments (DMIs). Their method was based on leveraging vibrotactile actuator placement, vibration synthesis, and a mapping from

audio to vibrotactile feedback parameters by using neuro-physiological studies to model musical haptic perception in a useful way. Furthermore, a review and a comparison between different technologies of vibrotactile actuators for musical application in DMIs is discussed in [147].

Ménélas et al. [148] showed that the combination of audio and haptic cues improve the acquisition of a desired targeting task within virtual environments. Huang et al. [149] have investigated the contribution of haptic information in “*feeling*” musical rhythm by evaluating how the auditory and tactile inputs are integrated in humans performing a musical meter recognition task. Beamish et al. [150] developed “D’GROOVE”, an intelligent Disc Jockey (DJ) tactile interface by using a haptic turntable for controlling the playback of digital audio effects. D’GROOVE provided haptic feedback for the tempo of a song to improve auditory navigation for DJs musical interactions. Baillie et al. [151] proposed a mobile music player, enhanced with haptic feedback to generate a novel method of audio playback on a mobile device. The authors demonstrated that their method enrich user experiences not only to hear the music but also to feel it. Lim et al. [152] developed a haptic library that creates tactile feedback by converting an audio source to tactile output through analyzing its audio data that may be utilized in various musical applications.

Overholt [153] designed a new tangible musical interface with haptic feedback called MATRIX (Multipurpose Array of Tactile Rods for Interactive expression) which has a total of 144 rods of clear plexiglass (acrylic) in a 12 by 12 grid, with a density of about 4 rods per square inch. The MATRIX acts as a real-time interface that can manipulate and control the parameters of a sound synthesis technique or effect algorithm in response to a performer’s expressive gestures. Papetti et al. [154] designed a novel hardware/software system for rendering multi-point, localized vibrotactile feedback in a multi-touch musical interface by leveraging piezoelectric actuators. The development of different haptic interfaces for the purpose of granular sound synthesis technique for musical performances can be found in [155, 156]. Researchers also explored in [157, 158] how haptic feedback may be a useful tool for visually impaired musicians and sound producers in order to improve their different musical interactions.

5.2 Exploring Gesture-sound Mappings and Haptics

The mapping between different sensory stimuli is one of the key issues when considering the relevance of haptic feedback interfaces in a multimodal context and particularly in audio-haptic DMIs, i.e. our case in the present section. Our underlying hypothesis is that some specific information related to a stimulus feature could more naturally match with another stimulus evocation by mapping gesture and audio-haptic. Before exploring the different opportunities for this purpose, a review of the term “*Gesture*” in Human–Computer Interaction (HCI) and music seems to be essential.

Gesture is generally defined as a movement or position of the hand, arm, body, head, or face to express an idea, meaning or emotion. In the context of HCI, Kurtenbach and Hulteen [159] defined *gesture* in 1990 as following: “A gesture is a motion of the body that contains information. Waving goodbye is a gesture. Pressing a key on a keyboard is not a gesture because the motion of a finger on its way to hitting a key is neither observed nor significant by the keyboard. All that matters is which key was pressed.” Besides, in the context of music, gesture is more complex and is still considered to be an ambiguous term between musicians and sound producers. Metois [160] proposed a definition of gesture in music as follows: “There is a diversified set of objects spanning the gap between the lowest-level musical intention (cognition, psychology, musicology) and a simple wave form (physics). These objects will be referred to as musical gestures and they should be seen as the features based on which musical intentions will eventually be recovered through some decision making. The gestures that are fed to the instrument are of a physical nature (fingering, pressure, energy, etc.) whereas the gestures resulting from our auditory perception are not. However, both present the ability to communicate musical intentions at a higher level than an audio wave form. The similarity of their level of abstraction motivated the author to label them both as Musical Gestures.” Cadoz and Wanderley [161] analyzed gesture in music and consider gestures as equivalent to physical (playing) techniques, performer actions or simply a hand sign where any instrument manipulation is performed.

In this section we discuss mapping opportunities for tactile feedback with programmable friction. In fact, the control of the parameters of the sound is considered to be an important factor which defines the relationship between gesture and music (also called

mapping) in DMIs. As reported by Doornbusch in [162], *mapping* concerns the connection between structures, or gestures and audible results in a musical performance or composition. This control over the inputs and the outputs of an interactive multimedia system, is of major importance and has made both the scientific and artistic interest to rise during the last years for designing musical and expressive interfaces. In our study we notice that, due to the nature of the technology used for the tactile feedback i.e. ultrasonic lubrication, haptic feedback occurs only when sliding the finger on the surface. Therefore musical gestures which can be augmented correspond to fingers displacements on the surface, i.e. not tapping. Usable musical gesture parameters, which can be mapped to sound parameters, therefore include speed, curvature, shape, direction and so on.

We propose to classify feedback according to its relation with both sound parameters and gestural parameters. We define four categories, labelled C1 to C4.

	Separated from Audio	Combined with audio
Separated from gesture	C1	C2
Combined with gesture	C4	C3

TABLE 5.1: Classification of tactile feedback with programmable friction

- In category **C1**, the feedback is independent from both input gestures and audio feedback, which means it can change and provide information without changes in the sound perceived or in the gestural parameters. This can be used to provide information on current gesture to sound mappings before their results are heard, as a sort of feed-forward that guides the musicians' interactions.
- In category **C2**, the tactile feedback amplifies audio feedback but is still separated from input gestures. This can be used to provide feedback on sound parameters which are mapped to non-gestural parameter (e.g. position) while the sound is heard.
- In category **C3**, the tactile feedback is combined with both audio and gestures, and might amplify both of them. It can be used as in [154] to amplify both or either of the gesture and audio feedback, for example increasing self-agency of the musician with the instrument, i.e. provide a better sensation of control over the instrument.

- Finally, in **C4** the feedback is combined with the gesture but separated from the audio, which can be used for preparation gestures. For example it may provide information on gestural parameters before reaching a zone where the gesture will actually trigger sound, allowing the musician to anticipate the sonic result of their actions.

5.3 Experiment

We carried out an experiment to find out how the ultrasonic based haptic interface with programmable friction might influence and enrich the sound perception and musical production for interacting with DMIs. Six volunteers (4 male and 2 female) from the age of 27 to 33 with a mean age of 29.14 (SD=1.95) took part in our experiment. They were all regular users of at least one tactile display (i.e. smartphone or tablet) daily. The experiment took on average approximately 35 minutes for each of the participants. All the participants used an active noise-cancelling headphone (Panasonic RP-DJS200, Japan) in order to prevent the influence of the little noises produced by the haptic tablet in their performances.

5.3.1 Design

We have used a basic form of Frequency Modulation (FM) synthesis with only two oscillators using *Pure Data* [163] to generate the auditory signals. In FM synthesis [40], the timbre of a simple waveform is changed by modulating its frequency in the audio range which leads to a more complex waveform with a different-sounding tone. In our case we have two sine waves: modulating wave and carrier wave in which the modulating wave changes the frequency of the carrier wave as illustrated in figure 5.1. The communication between the PC (which generates the FM synthesis) and the haptic feedback tablet is via an Open Sound Control (OSC) protocol. We have to note that in the *E-ViT*a haptic feedback tablet, the generated tactile feedback (with a specific spatial frequency and amplitude) is always proportional to the user's finger velocity as explained in [37]. In other words, there is a linear function between the tactile signal's spatial frequency (μm) and the sound signal frequency (Hz) which is inversely

proportional to the user's finger velocity (mm/s) at each moment. This relationship can be expressed as the following equation:

$$\text{Sound Signal Frequency (Hz)} = \frac{\text{Tactile Signal Spatial Frequency } (\mu m)}{\text{Finger Velocity (mm/s)}} \quad (5.1)$$

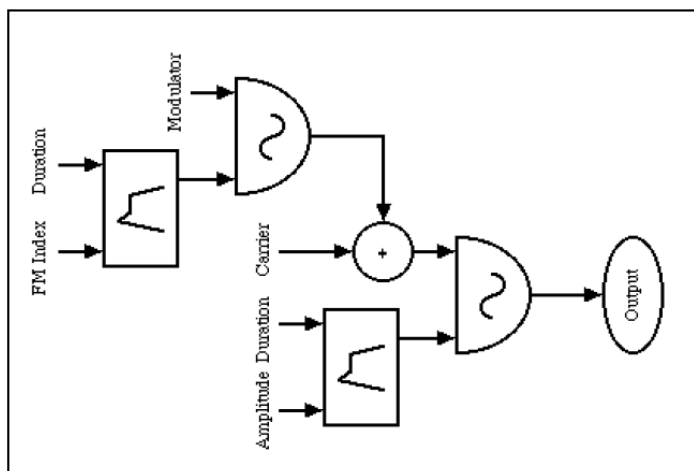

FIGURE 5.1: The structure of FM sound synthesis technique with two operators [40]. The modulator and the carrier are both periodic oscillators with specific frequency, amplitude and waveform (sinusoidal in our case).

In all mappings, the amplitude of the sound is mapped to the speed of the gesture, i.e. the speed at which the user's finger moves on the surface, and the frequency of the sound is mapped to the Y axis of the tablet. We then defined 3 different mappings between the auditory and tactile signals as following. The order of three tested mappings was counterbalanced among participants.

- **Mapping 1:** In the first mapping, the tactile signal is associated to the *envelope* of the produced sound, i.e. the time it takes for the sound to fade out. The more resonance there is the less friction can be felt. However this parameter is only heard when the user's gesture stops. The resonance parameter is mapped to the X axis on the tablet. It corresponds to category C2. (see table 5.1)
- **Mapping 2:** In the second mapping, the tactile signal is associated to the *roughness* of the sound, which is produced by modifying the modulation amplitude of the FM synthesis. The higher the amplitude of the modulation is,

the rougher the sound is, and the more friction felt by finger. This parameter is mapped to the X axis of the tablet. It corresponds to category C2 (see table 5.1)

- **Mapping 3:** In the third mapping, the friction is only mapped to the gesture speed and therefore to the *amplitude* of the sound signal. It corresponds to category C3 of classification provided in table 5.1.

The general structure of mapping between sound control parameters and gestures in our interactive musical system, which also used previously in literature as in [164] and the *E-ViT*a haptic display used in our experiment are shown in figure 5.2.

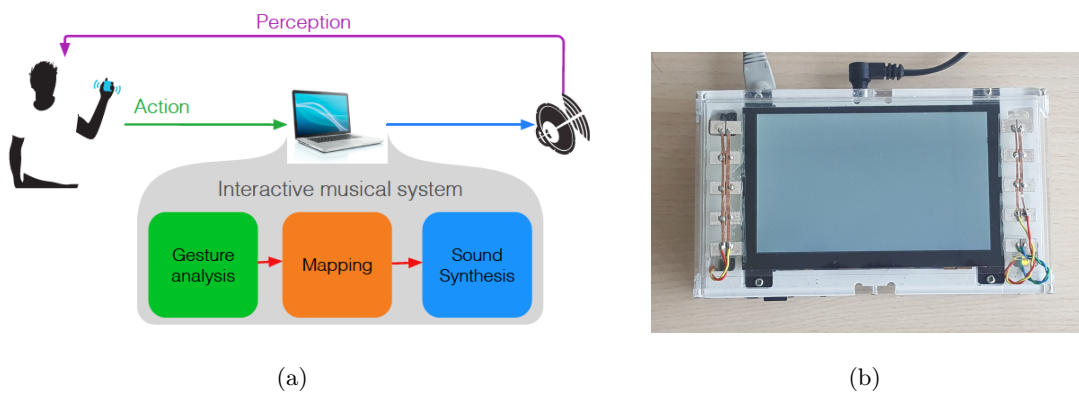

FIGURE 5.2: a) The general structure of mapping between sound control parameters and gestures in our interactive musical system. b) E-ViT a haptic display used in our experiment for tactile feedback perception while sliding their finger to perform different gesture. No visual feedback was shown to participants during the experiment.

5.3.2 Task and Procedure

First of all a brief description of our task as well as all the necessary instructions for interacting with our audio/haptic tactile interface were given to each participant. We asked participants to do a *replication task* of previously recorded sounds with a duration of few seconds for each of the 3 provided mappings. There were two pre-recorded sounds for each of the mappings and thus 12 total trials for each participant (3 mappings \times 2 pre-recorded sounds \times 2 feedback conditions = 12 total trials). In order to prevent any influence on the participants' performances of the given task, the order of three tested mappings was randomized. The participants were free to explore the surface as long as they wanted and then replicated the provided sounds. We have

also saved the gesture trajectory of finger movements of each participant for the further analysis in our study. The setup of our experimental procedure is shown in figure 5.3.

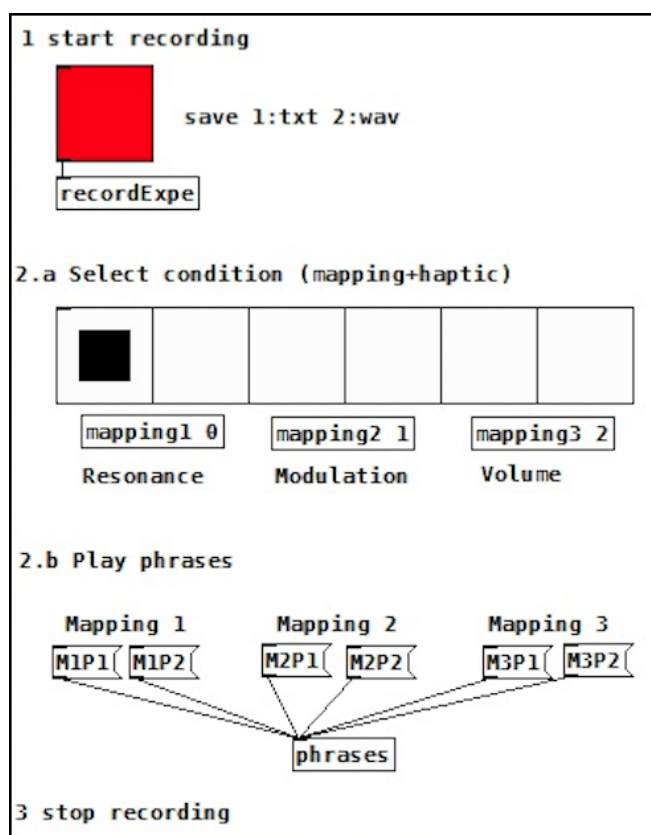

FIGURE 5.3: The setup of our experimental procedure using *Pure Data*.

5.4 Results and Discussion

We used the same qualitative evaluation methods as previously proposed to evaluate Digital Music Instruments (DMIs) and musical performances in [165, 166].

We have thoughtfully designed our questionnaire in order to avoid influencing the participant's answers. Thus, we asked the following questions from the participants:

1. How do you feel about the sound you created?
2. How do you describe your experiment with our audio/haptic interface?
3. Can you identify and distinguish each of the 3 mappings?
4. How do you compare the 3 mappings and which one you preferred most?

5. Do you consider haptic feedback as a useful tool for sound synthesis and musical performances?

In summary, all the participants declared that the audio/haptic interface is very useful and interesting to enrich their musical perception. In particular, they expressed that the provided friction-based haptic feedback allowed them to feel the interaction with the real instruments as well as feeling what they hear simultaneously. They were all able to correctly identify and distinguish the three provided mappings. This means that they were all capable to detect which sound parameters in the 3 cases were associated to the corresponding tactile feedback.

50% of the participants preferred *mapping 1* in which the tactile signal was mapped to the resonance of the sound. Followed by *mapping 1*, the rest 50% of the participants preferred *mapping 3*, in which the intensity of generated sound was correlated with the gesture speed. This does make sense, taking into account that by principle; our audio/haptic interface exploit user's gesture velocity for tactile feedback rendering.

We have also analyzed the gesture trajectories for each of the 3 mappings in order to study the influence of tactile feedback for users' performances of each musical gesture. The trajectories of participants when replicating a reference sound, shown in the figures 5.4 to 5.9, suggest that the tactile feedback has an slight effect on the trajectory accuracy of the performed gestures compared to the reference one, since some variations can be seen for several participants. However, further experiments and investigations by means of a quantitative approach seems to be required to better evaluate the tactile feedback effect on musical gestures, with more participants as well. In all the figures related to gesture trajectory of different mappings, x and y correspond to the X and Y axis of the haptic tablet with the resolution of 800 * 480 pixels.

Some of the participants' comments with haptic feedback are as follow: *"I think that it's a very enjoyable and interesting experience"*. *"I feel that I'm playing the real string musical instrument (such as a guitar), taking into account the haptic feedback and the various types of sounds that I'm able to create."* Or, *"I have never played a DMI before, however this interface may considerably facilitate the process of learning the sound synthesis and musical productions for me. The haptic feedback also help me to have a better feeling of the sounds that I create."*

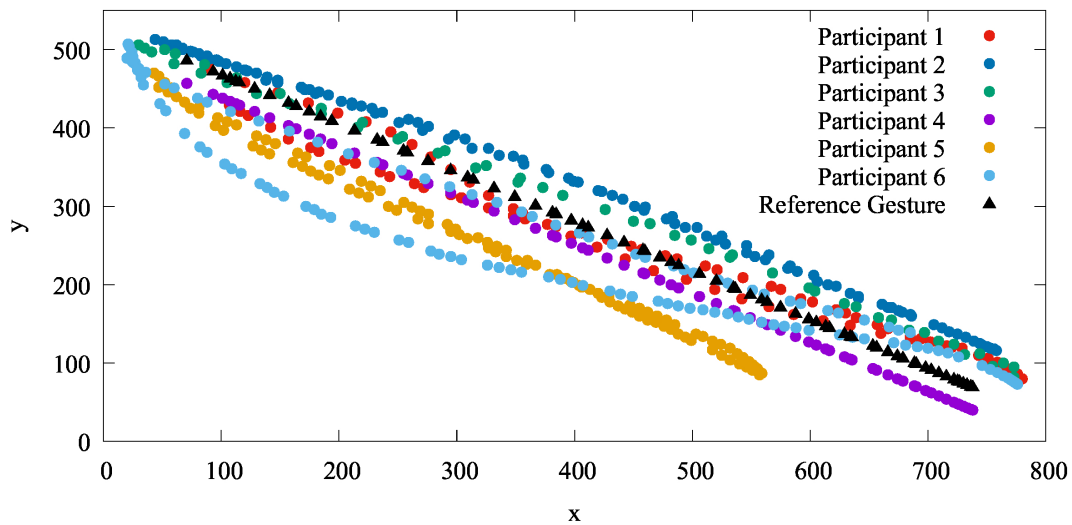

(a) No feedback

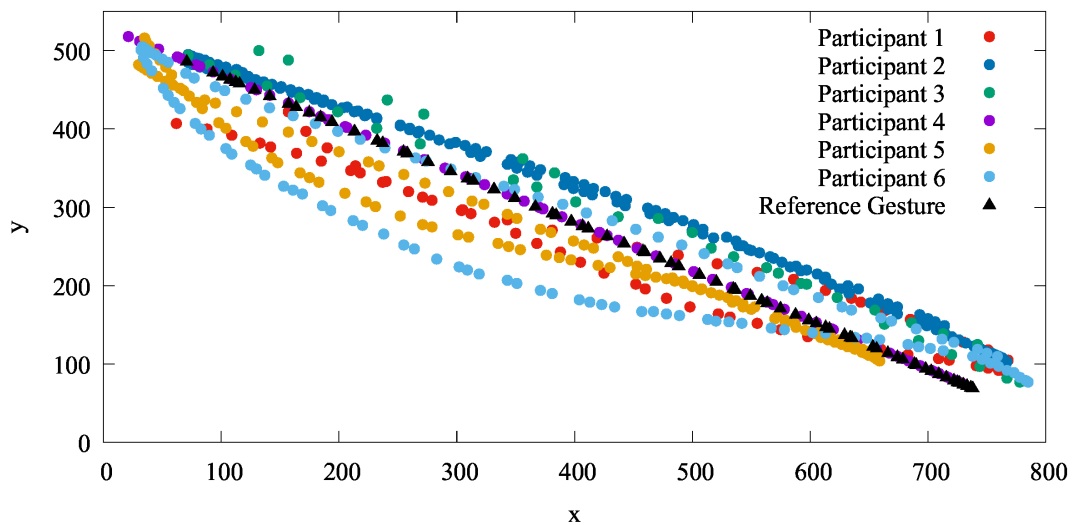

(b) Tactile feedback

FIGURE 5.4: The tactile exploration of gesture trajectory of **mapping 1** for the first pre-recorded sound where the tactile signal is associated to the resonance of the generated sound.

Also, “As a musician I believe this audio/haptic tactile display, enables us to enhance our perception of the basic principles of theory and harmony in music productions. It may also be useful to teach basic musical performances to beginner users as they are capable of hearing and feeling the sounds simultaneously.” Or “The provided haptic feedback permits me to perform the appropriate gesture faster and easier for each mapping (specially for mapping 3), even without looking at the device.” Or “The tactile

feedback gives me an extra dimension to the music which I have never experienced before. In fact it provides a novel sensational feeling to the music that I used to only hear it.”

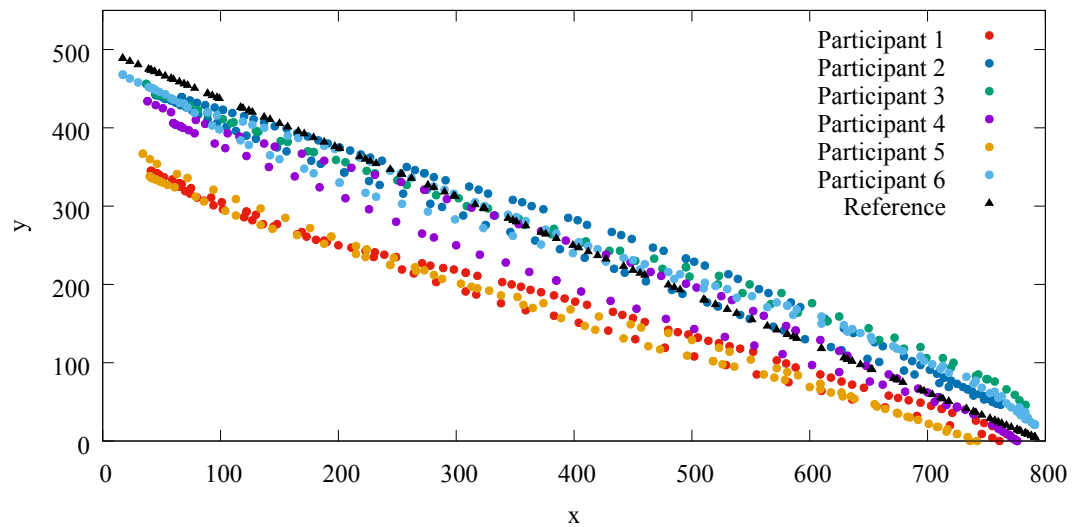

(a) No feedback

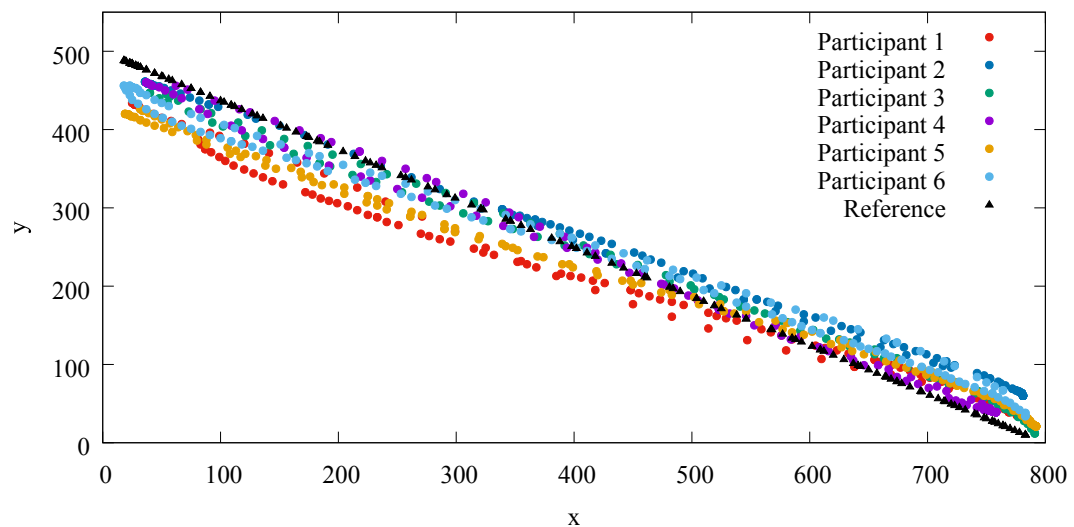

(b) Tactile feedback

FIGURE 5.5: The tactile exploration of gesture trajectory of **mapping 1** for the second pre-recorded sound where the tactile signal is associated to the resonance of the generated sound.

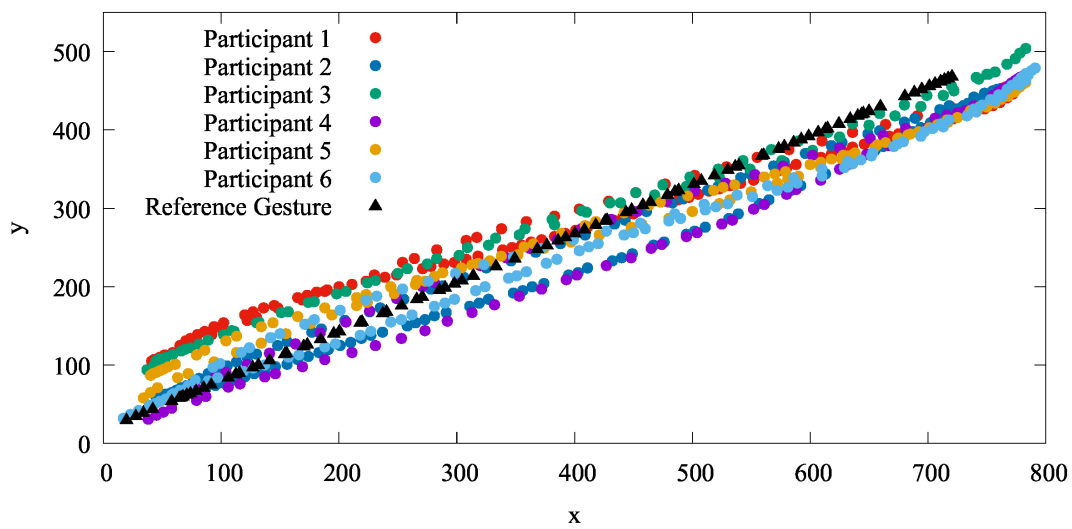

(a) No feedback

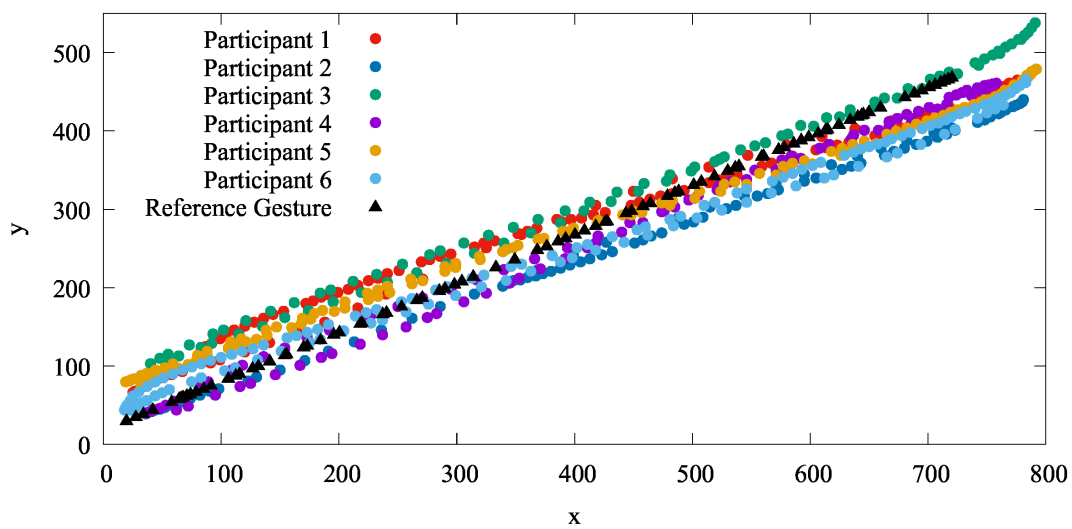

(b) Tactile feedback

FIGURE 5.6: The tactile exploration of gesture trajectory for **mapping 2** for the first pre-recorded sound where the tactile signal is associated to the roughness of the generated sound.

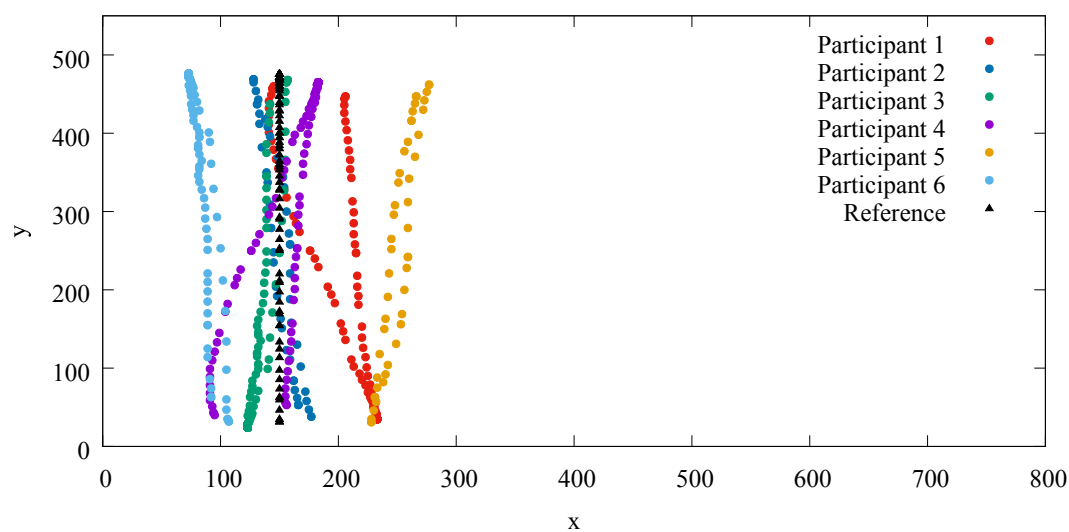

(a) No feedback

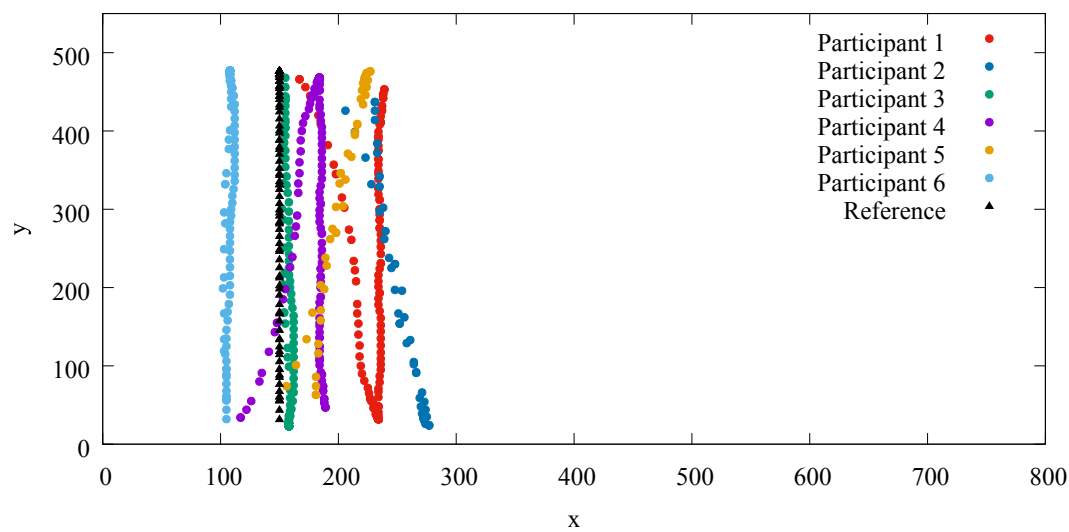

(b) Tactile feedback

FIGURE 5.7: The tactile exploration of gesture trajectory of **mapping 2** for the second pre-recorded sound where the tactile signal is associated to the roughness of the generated sound.

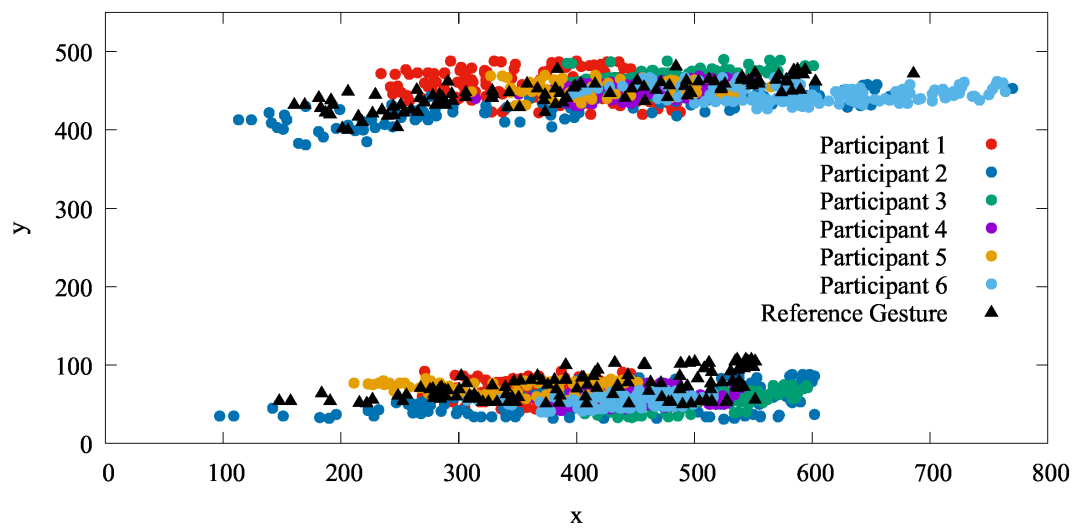

(a) No feedback

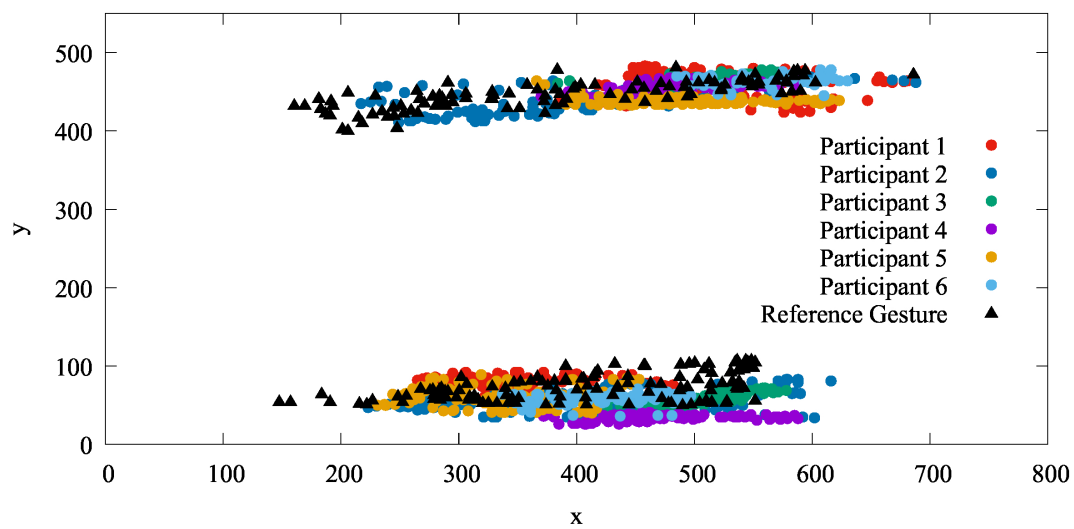

(b) Tactile feedback

FIGURE 5.8: The tactile exploration of gesture trajectory of **mapping 3** for the first pre-recorded sound where the tactile signal is associated to the gesture speed and thus the volume of the generated sound.

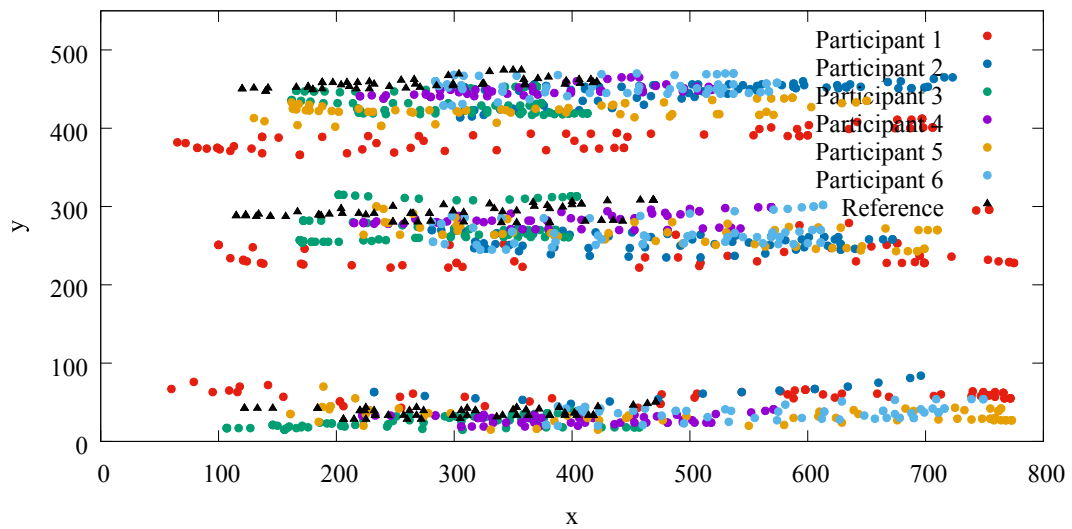

(a) No feedback

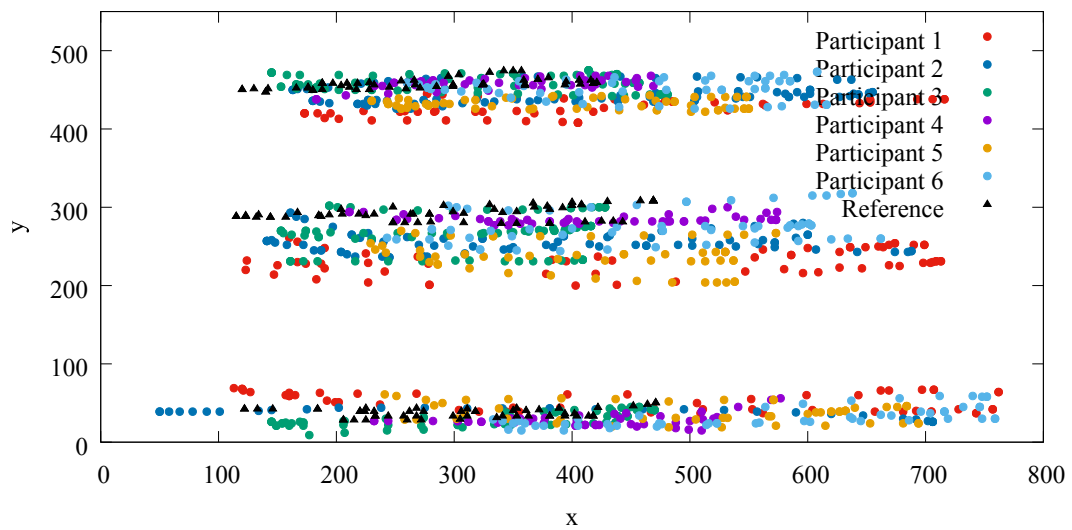

(b) Tactile feedback

FIGURE 5.9: The tactile exploration of gesture trajectory of **mapping 3** for the second pre-recorded sound where the tactile signal is associated to the gesture speed and thus the volume of the generated sound.

5.5 Conclusion & Perspective

In this section we have reported our preliminary investigations regarding to the potential influences of tactile feedback displays with programmable friction on users' musical interactions by means of a qualitative approach. We have proposed four categories of mappings between the sound parameters and tactile feedback and analyzed

user's experiences with three mapping conditions and two repetitions concerning to two pre-recorded sounds. Our preliminary results suggest that all the users consider the friction-based tactile feedback as a useful and interesting phenomenon for enhancing musical interactions, performances and learning.

For the future works, we aim to investigate the tapping gesture with our audio/haptic interface which could allow us to simulate a wide range of instruments (e.g. touching the piano keyboard). We may also leverage other sound synthesis techniques in our future study (such as: granular synthesis, amplitude modulation etc.) rather than FM synthesis. A complete survey of digital sound synthesis technique in computer music can be found in [167]. Furthermore, it will be interesting to use quantitative approach for data analysis in terms of future lines of research, for instance using psychophysics for estimating discrimination thresholds between two sounds within a given mapping. The study of perceptual sensory discrimination may be of value to determine the best mapping to be used, and/or establish whether the subjects' preferences are linked to their actual perceptual abilities in DMIs.

Chapter 6

Conclusions and Perspectives

The aim of this thesis was to investigate users' tactile perception and to improve their touch interaction performances on ultrasonic based haptic displays which leverage squeeze film effect for haptic rendering. In the context of human tactile perception on ultrasonic haptic touchscreens, we first investigated the perceptual threshold of individual fingers on both the right and left hand of right-handed participants using active dynamic touch for spatial period discrimination of both sinusoidal and square-wave gratings by means of psychophysical experiments. Both one-finger and multi-finger touch were studied and compared. Our results indicate that users' finger identity (index finger, middle finger, etc.) significantly affect the perception of both gratings in the case of one-finger exploration. We have shown that index finger and thumb are the most sensitive in all conditions whereas little finger followed by ring are the least sensitive for haptic perception. For multi-finger exploration, the right hand was found to be more sensitive than the left hand for both gratings. Our findings also demonstrated similar perception sensitivity between multi-finger exploration and the index finger of users' right hands (i.e. dominant hand in our study), while significant difference was found between single and multi-finger perception sensitivity for the left hand. We have also demonstrated that the index finger has a major impact on the overall multi-finger sensitivity of the user's dominant hand for both types of gratings.

For the future work, I propose to investigate if these results generalize to left-handed users, which would confirm the importance of hand dominance. While hand dominance is most likely the driving force behind variable sensitivity, it is possible that perceptual differences could result from left-right physiological differences. A sufficiently large pool

of left-handed participants will be necessary to validate hand dominance versus left-right physiology. It would also be interesting to investigate in greater depth differences in the dynamics of multi-finger tactile exploration between both hands. In terms of guidelines for HCI designers, these results provide guidance on the need to vary haptic stimuli depending on whether the stimulus is designed for the dominant or non-dominant hand, depending on whether it is designed for the index finger or for any finger, and depending on whether it is to be a single-finger or multi-finger interaction. As well, a potential use of different sensory thresholds of finger types, which we found in our study, is to leverage these sensitivities to novel finger identification techniques on tactile displays in order to allow users to perform different interaction tasks. For instance, possible gestures (such as: selecting an object, dragging or swapping) could be linked via textures to the fingers involved in the interaction. This is feasible with the development of multi-touch haptic displays on the near future.

Furthermore, I proposed a novel concept, called *taxel* concerning to user's perception of minimum size of tactile elements on ultrasonic haptic touchscreens. We have shown the minimum perceivable size of the tactile element depends on the nature of texture signal waveform and was found to be vary between the range of few millimeters to about one centimeter for most of end users. We have also shown that textures with square wave might be more perceivable with small sizes (6.5 mm), hence most suitable texture for tactile rendering of small size of virtual objects while leveraging ultrasonic based haptic touchscreens. I consider *taxel*, a suitable concept to compare different haptic technologies on touch screen with the same manner as different characteristics are defined for comparing flat displays (such as image resolution). In the field of haptic feedback touchscreens, appropriate criteria of comparison between different technologies are still missed, thus *taxel* seems to be a compelling basis for this purpose.

We then explored the best tactile feedback position on ultrasonic haptic displays for targeting tasks, which is considered to be a common interaction task in HCI, to optimize interaction performances of users. We have demonstrated that the *Line Center* condition provides the most compelling balance of improved speed, accuracy, and user satisfaction compared to other haptic position techniques. We also noted that the contrast between our results and past research on haptic feedback techniques advocates for a need for caution when attempting to generalize results across different hardware configurations and for different age group of end users. For the future study, I propose

to examine different target shape (rather than rectangular virtual objects in our case) in the different configurations and compare the results.

Finally, we proposed how to best leverage ultrasonic haptic feedback effect with programmable friction for musical interactions by means of a qualitative approach. We have proposed four categories of mappings between the sound parameters and tactile feedback and analyzed user's experiences with three of them. We have shown that combining auditory and tactile signals on friction-based tactile feedback display is a useful and interesting phenomenon for enhancing musical interactions, performances and learning for musicians and sound producers. In terms of future study, I propose to explore the tapping gesture to our audio/haptic interface which allow musicians to simulate a wide range of instruments (e.g. touching the piano keyboard). We may also use other sound synthesis techniques in our future study (such as: granular synthesis, amplitude modulation etc.) rather than FM synthesis.

A potential and interesting line of research on haptic feedback touchscreens, relates to creating realistic virtual textures of daily life objects with more convincing sensation to end users compared to present works. Few studies for this purpose exist in literature using a haptic pen or a kinesthetic device [168, 169] which seems to be applicable on haptic touchscreens for realistic texture rendering. Indeed, the development of an optimized haptic touchscreen with a sufficiently broad bandwidth of haptic rendering will be essential for this target, for instance, by combining two haptic feedback technologies on a same device [170].

Appendix A

Structure of the Mappings used in our Haptic Musical Interface

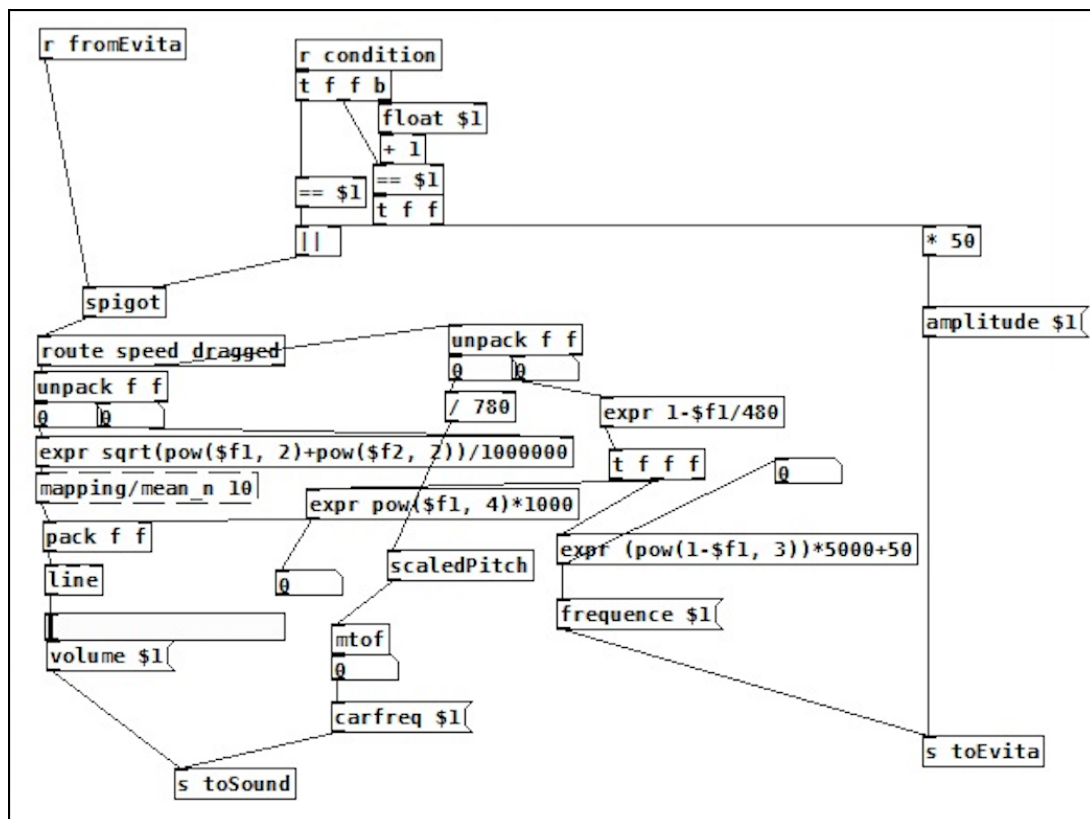

FIGURE A.1: A detailed structure of **mapping 1** in our audio/haptic musical interface using *Pure Data*

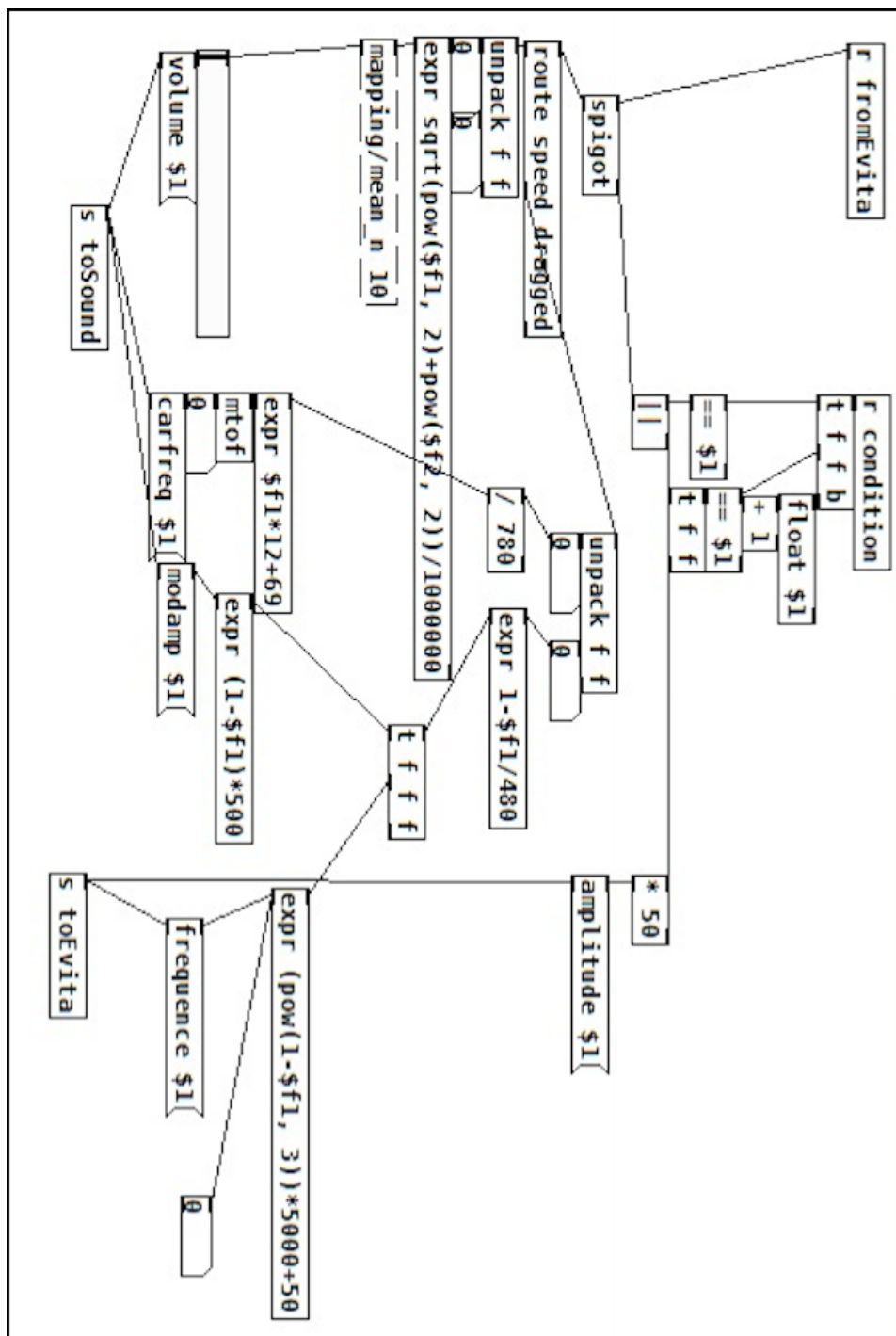

FIGURE A.2: A detailed structure of **mapping 2** in our audio/haptic musical interface using *Pure Data*

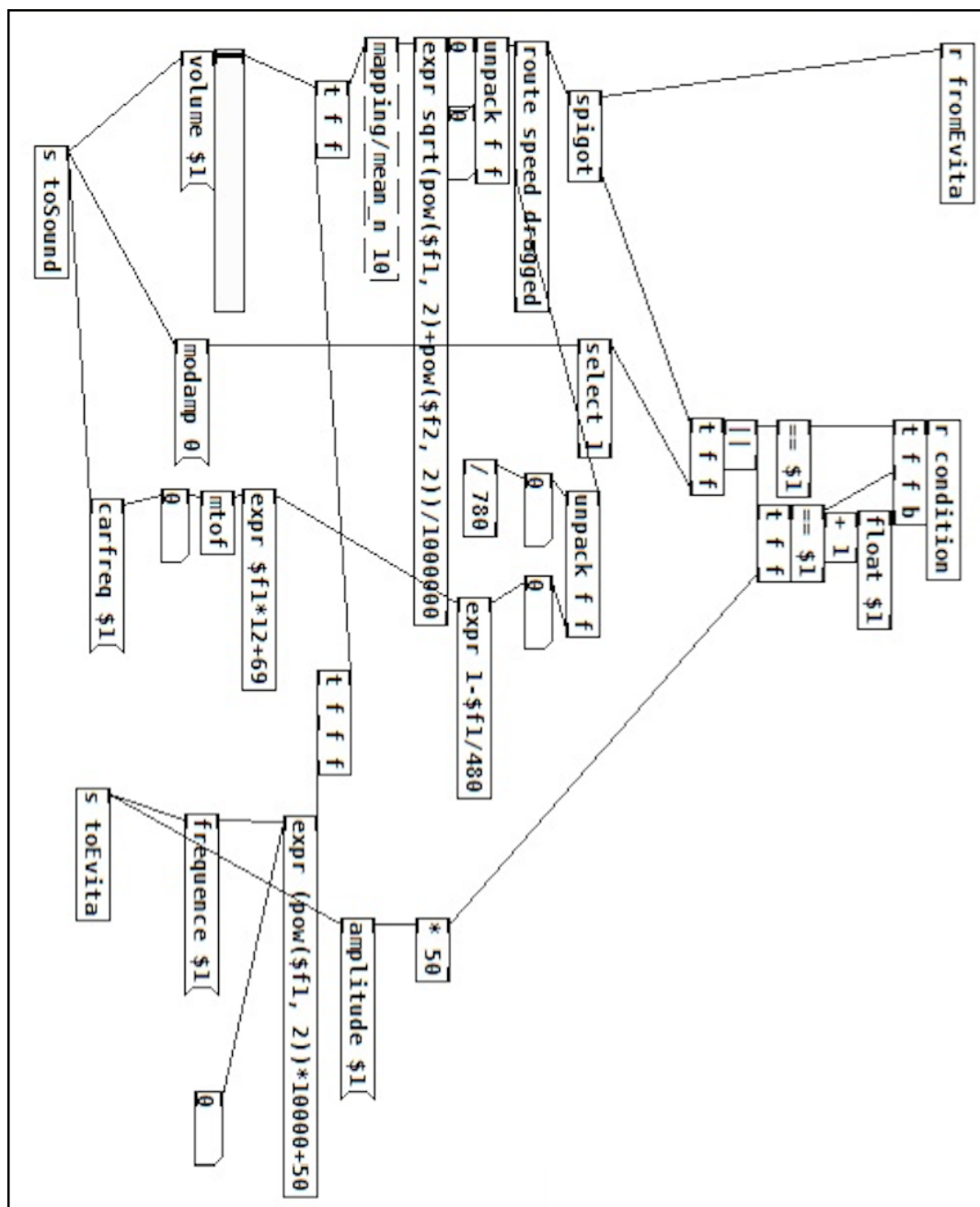

FIGURE A.3: A detailed structure of **mapping 3** in our audio/haptic musical interface using *Pure Data*

Appendix B

Other Scientific Activities

Besides the publications listed in Chapter 1, I had the opportunity to carry out the following scientific activities during my three years of thesis:

- Participating as a volunteer student of MINT Team at IHM'14, 26^{ème} conférence francophone sur l'Interaction Homme-Machine, 28-31 Octobre 2014, Lille, France
- Participating at “Prototouch summer school on Human sensing and applications to robotics and haptic displays”, 18-22 May 2015, Lille, France
- Student organizer of MINT Team for preparing “Journée de doctorat” (Ph.D students' day), CNRS/IRCICA, University of Lille 1, 2015
- Participating at “Intel® seminar day” for innovation in research and development, CNRS/IRCICA, University of Lille 1, 2015
- Attending and obtaining 61 credits of doctoral school of University of Lille 1 - Sciences & Technologies for different training courses proposed to Ph.D students

Bibliography

- [1] William Buxton, Ralph Hill, and Peter Rowley. Issues and techniques in touch sensitive tablet input. In *Proceedings of the 12th Annual Conference on Computer Graphics and Interactive Techniques*, SIGGRAPH '85, pages 215–224. ACM, 1985.
- [2] LuxResearch. Driven by touch-screen devices, haptics market to grow 16-fold to \$13.8 billion in 2025. <http://www.luxresearchinc.com/news-and-events/press-releases/read/driven-touch-screen-devices-haptics-market-grow-16-fold-138>, 2017.
- [3] Dave. Purves. *Neuroscience, 2nd Edition*. Oxford University Press, 2001.
- [4] Novint Falcon ®. <http://www.novint.com/index.php/novintfalcon>, 2017.
- [5] A. J. Silva, O. A. D. Ramirez, V. P. Vega, and J. P. O. Oliver. Phantom omni haptic device: Kinematic and manipulability. In *2009 Electronics, Robotics and Automotive Mechanics Conference (CERMA)*, pages 193–198, Sept 2009.
- [6] Omega ®. <http://www.forcedimension.com/products/omega-7/overview>, 2017.
- [7] Sean Follmer, Daniel Leithinger, Alex Olwal, Akimitsu Hogge, and Hiroshi Ishii. inform: Dynamic physical affordances and constraints through shape and object actuation. In *Proceedings of the 26th Annual ACM Symposium on User Interface Software and Technology*, UIST '13, pages 417–426. ACM, 2013.
- [8] Daniel Leithinger, Sean Follmer, Alex Olwal, Samuel Luescher, Akimitsu Hogge, Jinha Lee, and Hiroshi Ishii. Sublimate: State-changing virtual and physical rendering to augment interaction with shape displays. In *Proceedings of the*

- SIGCHI Conference on Human Factors in Computing Systems*, CHI '13, pages 1441–1450. ACM, 2013.
- [9] Lining Yao, Ryuma Niiyama, Jifei Ou, Sean Follmer, Clark Della Silva, and Hiroshi Ishii. Pneui: Pneumatically actuated soft composite materials for shape changing interfaces. In *Proceedings of the 26th Annual ACM Symposium on User Interface Software and Technology*, UIST '13, pages 13–22. ACM, 2013.
- [10] Yasushi Matoba, Toshiki Sato, Nobuhiro Takahashi, and Hideki Koike. Claytric-surface: An interactive surface with dynamic softness control capability. In *ACM SIGGRAPH 2012 Emerging Technologies*, SIGGRAPH '12, pages 6:1–6:1. ACM, 2012.
- [11] Monica Bordegoni, Umberto Cugini, Mario Covarrubias, and Michele Antolini. A force and touch sensitive self-deformable haptic strip for exploration and deformation of digital surfaces. In *Proceedings of the 2010 International Conference on Haptics - Generating and Perceiving Tangible Sensations: Part II*, EuroHaptics'10, pages 65–72. Springer-Verlag, 2010.
- [12] Hrvoje Benko, Christian Holz, Mike Sinclair, and Eyal Ofek. Normaltouch and texturetouch: High-fidelity 3d haptic shape rendering on handheld virtual reality controllers. In *Proceedings of the 29th Annual Symposium on User Interface Software and Technology*, UIST '16, pages 717–728. ACM, 2016.
- [13] Gabriel Robles-De-La-Torre and Vincent Hayward. Force can overcome object geometry in the perception of shape through active touch. *Nature*, 412:445–458, 2001.
- [14] G. Robles De La Torre and V. Hayward. Virtual surfaces and haptic shape perception. In *Proceedings ASME IMECE Symposium on Haptic Interfaces for Virtual Environments and Teleoperator Systems*, volume DSC-69-2, pages 1081–1087, 2000.
- [15] V. Hayward. Display of haptic shape at different scales. In *Proceedings of Eurohaptics 2004 (Keynote Paper)*, Munich, Germany, 2004. invited conference.
- [16] T. Zeng, B. Lemaire-Semail, F. Giraud, and M. Amberg. Contribution of slip cue to curvature perception through active and dynamic touch. *IEEE Transactions on Haptics*, 6(4):408–416, Oct 2013.

- [17] K. A. Kaczmarek and S. J. Haase. Pattern identification as a function of stimulation on a fingertip-scanned electro tactile display. *IEEE Transactions on Neural Systems and Rehabilitation Engineering*, 11(3):269–275, Sept 2003.
- [18] Jérôme Pasquero and Vincent Hayward. Stress: A practical tactile display system with one millimeter spatial resolution and 700 hz refresh rate. In *in Proc. Eurohaptics 2003*, pages 94–110, 2003.
- [19] C. R. Wagner, S. J. Lederman, and R. D. Howe. A tactile shape display using rc servomotors. In *Proceedings 10th Symposium on Haptic Interfaces for Virtual Environment and Teleoperator Systems. HAPTICS 2002*, pages 354–355, 2002.
- [20] Hiroo Iwata, Hiroaki Yano, Fumitaka Nakaizumi, and Ryo Kawamura. Project feelix: Adding haptic surface to graphics. In *Proceedings of the 28th Annual Conference on Computer Graphics and Interactive Techniques, SIGGRAPH '01*, pages 469–476. ACM, 2001.
- [21] Gi-Hun Yang, Ki-Uk Kyung, M. A. Srinivasan, and Dong-Soo Kwon. Quantitative tactile display device with pin-array type tactile feedback and thermal feedback. In *Proceedings 2006 IEEE International Conference on Robotics and Automation, 2006. ICRA 2006.*, pages 3917–3922, May 2006.
- [22] Ivan Poupyrev and Shigeaki Maruyama. Tactile interfaces for small touch screens. In *Proceedings of the 16th Annual ACM Symposium on User Interface Software and Technology, UIST '03*, pages 217–220. ACM, 2003.
- [23] Yvonne Jansen, Thorsten Karrer, and Jan Borchers. Mudpad: Tactile feedback and haptic texture overlay for touch surfaces. In *ACM International Conference on Interactive Tabletops and Surfaces, ITS '10*, pages 11–14. ACM, 2010.
- [24] M. Sinclair, M. Pahud, and H. Benko. Touchmover 2.0 - 3d touchscreen with force feedback and haptic texture. In *2014 IEEE Haptics Symposium (HAPTICS)*, pages 1–6, Feb 2014.
- [25] M. Takasaki, H. Kotani, T. Mizuno, and T. Nara. Two-dimensional active type surface acoustic wave tactile display on a computer screen. In *2006 14th Symposium on Haptic Interfaces for Virtual Environment and Teleoperator Systems*, pages 49–54, March 2006.

- [26] Olivier Bau, Ivan Poupyrev, Ali Israr, and Chris Harrison. Teslatouch: Electrovi-
bration for touch surfaces. In *Proceedings of the 23rd Annual ACM Symposium
on User Interface Software and Technology*, UIST '10, pages 283–292. ACM,
2010.
- [27] D. J. Meyer, M. A. Peshkin, and J. E. Colgate. Fingertip friction modulation
due to electrostatic attraction. In *2013 World Haptics Conference (WHC)*, pages
43–48, April 2013.
- [28] M. Biet, F. Giraud, and B. Lemaire-Semail. Squeeze film effect for the design
of an ultrasonic tactile plate. *IEEE Transactions on Ultrasonics, Ferroelectrics,
and Frequency Control*, 54(12):2678–2688, December 2007.
- [29] Michel Amberg, Frédéric Giraud, Betty Semail, Paolo Olivo, Géry Casiez, and
Nicolas Roussel. Stimtac: A tactile input device with programmable friction.
In *Proceedings of the 24th Annual ACM Symposium Adjunct on User Interface
Software and Technology*, UIST '11 Adjunct, pages 7–8. ACM, 2011.
- [30] F. Giraud, M. Amberg, B. Lemaire-Semail, and G. casiez. Design of a transparent
tactile stimulator. In *2012 IEEE Haptics Symposium (HAPTICS)*, pages 485–
489, March 2012.
- [31] L. Winfield, J. Glassmire, J. E. Colgate, and M. Peshkin. T-pad: Tactile pat-
tern display through variable friction reduction. In *Second Joint EuroHaptics
Conference and Symposium on Haptic Interfaces for Virtual Environment and
Teleoperator Systems (WHC'07)*, pages 421–426, March 2007.
- [32] J. Mullenbach, D. Johnson, J. E. Colgate, and M. A. Peshkin. Activepad surface
haptic device. In *2012 IEEE Haptics Symposium (HAPTICS)*, pages 407–414,
March 2012.
- [33] E. C. Chubb, J. E. Colgate, and M. A. Peshkin. Shiverpad: A glass haptic surface
that produces shear force on a bare finger. *IEEE Transactions on Haptics*, 3(3):
189–198, July 2010.
- [34] Xiaowei Dai, J. E. Colgate, and M. A. Peshkin. Lateralpad: A surface-haptic
device that produces lateral forces on a bare finger. In *2012 IEEE Haptics
Symposium (HAPTICS)*, pages 7–14, March 2012.

- [35] Jérôme Pasquero. *Tactile display for mobile interaction*. Ph.D dissertation, McGill University, 2008.
- [36] E. Vezzoli, W. B. Messaoud, M. Amberg, F. Giraud, B. Lemaire-Semail, and M. A. Bueno. Physical and perceptual independence of ultrasonic vibration and electrovibration for friction modulation. *IEEE Transactions on Haptics*, 8(2): 235–239, April 2015.
- [37] Eric Vezzoli, Thomas Sednaoui, Michel Amberg, Frédéric Giraud, and Betty Lemaire-Semail. Texture Rendering Strategies with a High Fidelity - Capacitive Visual-Haptic Friction Control Device. In *Haptics: Perception, Devices, Control, and Applications, EuroHaptics '16*. Springer, 2016.
- [38] Vincent Levesque, Louise Oram, Karon MacLean, Andy Cockburn, Nicholas D. Marchuk, Dan Johnson, J. Edward Colgate, and Michael A. Peshkin. Enhancing physicality in touch interaction with programmable friction. In *Proceedings of the SIGCHI Conference on Human Factors in Computing Systems, CHI '11*, pages 2481–2490. ACM, 2011.
- [39] Xiaowei Dai, Jiawei Gu, Xiang Cao, J. Edward Colgate, and Hong Tan. Slickfeel: Sliding and clicking haptic feedback on a touchscreen. In *Adjunct Proceedings of the 25th Annual ACM Symposium on User Interface Software and Technology, UIST Adjunct Proceedings '12*, pages 21–22. ACM, 2012.
- [40] John Chowning and David Bristow. *Fm Theory and Applications: By Musicians for Musicians*. Hal Leonard Corp, 1987.
- [41] R.S. Johansson and A.B. Vallbo. Tactile sensory coding in the glabrous skin of the human hand. *Trends in Neurosciences*, 6(Supplement C):27 – 32, 1983.
- [42] A B Vallbo and R.S Johansson. Properties of cutaneous mechanoreceptors in the human hand related to touch sensation. *Hum Neurobiol*, 3:3–14, 1984.
- [43] K O Johnson, , and S S Hsiao. Neural mechanisms of tactual form and texture perception. *Annual Review of Neuroscience*, 15(1):227–250, 1992.
- [44] K.O Johnson. The roles and functions of cutaneous mechanoreceptors. *Current Opinion in Neurobiology*, 11(4):455 – 461, 2001.

- [45] S. Choi and K. J. Kuchenbecker. Vibrotactile display: Perception, technology, and applications. *Proceedings of the IEEE*, 101(9):2093–2104, September 2013.
- [46] Jan B. F. VanErp. Guidelines for the use of vibro-tactile displays in human computer interaction. In *Proceedings of Eurohaptics '02*, volume 2002, 2002.
- [47] C. D. Shultz, M. A. Peshkin, and J. E. Colgate. Surface haptics via electroadhesion: Expanding electrovibration with johnsen and rahbek. In *2015 IEEE World Haptics Conference (WHC)*, pages 57–62, June 2015.
- [48] Thorsten A. Kern. *Engineering Haptic Devices: A Beginner's Guide for Engineers*. Springer Publishing Company, Incorporated, 1st edition, 2009. ISBN 3540882472, 9783540882473.
- [49] Ming C. Lin, Miguel Otaduy, Ming C. Lin, and Miguel Otaduy. *Haptic Rendering: Foundations, Algorithms and Applications*. A. K. Peters, Ltd., 2008. ISBN 1568813325, 9781568813325.
- [50] James C. Craig and Gary B. Rollman. Somesthesia. *Annual Review of Psychology*, 50(1):305–331, 1999.
- [51] Carl E. Sherrick. Touch as a communicative sense: Introduction. *The Journal of the Acoustical Society of America*, 77(1):218–219, 1985.
- [52] S. J. Lederman and R. L. Klatzky. Haptic perception: A tutorial. *Attention, Perception, & Psychophysics*, 71(7):1439–1459, October 2009.
- [53] Vincent Hayward, O R Ashley, Cruz M Hernandez, Danny Grant, and G Robles-De-La-Torre. Haptic interfaces and devices. *Sensor Review*, 24:16–29, 03 2004.
- [54] Lester E. Krueger. David katz's der aufbau der tastwelt (the world of touch): A synopsis. *Perception & Psychophysics*, 7(6):337–341, Nov 1970.
- [55] R.S. Johansson and A.B. Vallbo. Tactile sensibility in the human hand: Relative and absolute density of four types of mechanoreceptive units in glabrous skin. *The Journal of physiology*, 286:283–300, February 1979.
- [56] Susan J Lederman and Roberta L Klatzky. Haptic classification of common objects: Knowledge-driven exploration. *Cognitive Psychology*, 22(4):421 – 459, 1990.

- [57] Adrien Girard, Maud Marchal, Florian Gosselin, Anthony Chabrier, François Louveau, and Anatole Lécuyer. Haptip: Displaying haptic shear forces at the fingertips for multi-finger interaction in virtual environments. *Frontiers in ICT*, 3:6, 2016.
- [58] F. Chinello, C. Pacchierotti, N. G. Tsagarakis, and D. Prattichizzo. Design of a wearable skin stretch cutaneous device for the upper limb. In *2016 IEEE Haptics Symposium (HAPTICS)*, pages 14–20, April 2016.
- [59] C. Pacchierotti, G. Salvietti, I. Hussain, L. Meli, and D. Prattichizzo. The hring: A wearable haptic device to avoid occlusions in hand tracking. In *2016 IEEE Haptics Symposium (HAPTICS)*, pages 134–139, April 2016.
- [60] Merwan Achibet, Benoît Le Gouis, Maud Marchal, Pierre-Alexandre Leziart, Ferran Argelaguet Sanz, Adrien Girard, Anatole Lécuyer, and Hiroyuki Kajimoto. FlexiFingers: Multi-Finger Interaction in VR Combining Passive Haptics and Pseudo-Haptics. In *IEEE Symposium on 3D User Interfaces*, Los Angeles, United States, 2017.
- [61] D. Tsetserukou, S. Hosokawa, and K. Terashima. Linktouch: A wearable haptic device with five-bar linkage mechanism for presentation of two-dof force feedback at the fingerpad. In *2014 IEEE Haptics Symposium (HAPTICS)*, pages 307–312, February 2014.
- [62] Go Touch VR. <https://www.gotouchvr.com/>, 2018.
- [63] Noriyuki Aihara, Toshiki Sato, and Hideki Koike. Highly deformable interactive 3d surface display. In *Adjunct Proceedings of the 25th Annual ACM Symposium on User Interface Software and Technology*, UIST Adjunct Proceedings '12, pages 91–92. ACM, 2012.
- [64] S. Klare and A. Peer. The formable object: A 24-degree-of-freedom shape-rendering interface. *IEEE/ASME Transactions on Mechatronics*, 20(3):1360–1371, June 2015.
- [65] M.D.R. Minsky. *Computational Haptics: The Sandpaper System for Synthesizing Texture for a Force-feedback Display*. Massachusetts Institute of Technology Ph.D Dissertation. Program in Media Arts and Sciences, School of Architecture and Planning, 1995.

- [66] T. Zeng, F. Giraud, B. Lemaire-Semail, and M. Amberg. Haptic perception of curvature through active touch. In *2011 IEEE World Haptics Conference*, pages 533–538, June 2011.
- [67] M. Shinohara, Y. Shimizu, and A. Mochizuki. Three-dimensional tactile display for the blind. *IEEE Transactions on Rehabilitation Engineering*, 6(3):249–256, September 1998.
- [68] K. A. Kaczmarek. Electrotactile adaptation on the abdomen: preliminary results. *IEEE Transactions on Rehabilitation Engineering*, 8(4):499–505, Dec 2000.
- [69] R. Velazquez, E. E. Pissaloux, and M. Wiertlewski. A compact tactile display for the blind with shape memory alloys. In *Proceedings 2006 IEEE International Conference on Robotics and Automation, 2006. ICRA 2006.*, pages 3905–3910, May 2006.
- [70] James J. Gibson. Observations on active touch. *Psychological review*, 69:477–491, 1962.
- [71] Susan J Lederman and Roberta L Klatzky. Hand movements: A window into haptic object recognition. *Cognitive Psychology*, 19(3):342 – 368, 1987.
- [72] Ali Israr and Ivan Poupyrev. Tactile brush: Drawing on skin with a tactile grid display. In *Proceedings of the SIGCHI Conference on Human Factors in Computing Systems, CHI '11*, pages 2019–2028. ACM, 2011.
- [73] M. Takasaki, T. Nara, S. Tachi, and T. Higuchi. A tactile display using surface acoustic wave. In *Proceedings 9th IEEE International Workshop on Robot and Human Interactive Communication. IEEE RO-MAN 2000 (Cat. No.00TH8499)*, pages 364–367, 2000.
- [74] Edward Mallinckrodt, A. L. Hughes, and William Sleator. Perception by the skin of electrically induced vibrations. *Science*, 118(3062):277–278, 1953.
- [75] R. M. Strong and D. E. Troxel. An electrotactile display. *IEEE Transactions on Man-Machine Systems*, 11(1):72–79, March 1970.
- [76] K. A. Kaczmarek, K. Nammi, A. K. Agarwal, M. E. Tyler, S. J. Haase, and D. J. Beebe. Polarity effect in electrovibration for tactile display. *IEEE Transactions on Biomedical Engineering*, 53(10):2047–2054, Oct 2006.

- [77] Olivier Bau and Ivan Poupyrev. Revel: Tactile feedback technology for augmented reality. *ACM Transactions on Graphics*, 31(4):89:1–89:11, July 2012.
- [78] Ronald T. Azuma. A survey of augmented reality. *Presence: Teleoper. Virtual Environ.*, 6(4):355–385, 1997.
- [79] Seung-Chan Kim, Ali Israr, and Ivan Poupyrev. Tactile rendering of 3d features on touch surfaces. In *Proceedings of the 26th Annual ACM Symposium on User Interface Software and Technology*, UIST '13, pages 531–538. ACM, 2013.
- [80] Ali Israr, Siyan Zhao, Kaitlyn Schwalje, Roberta Klatzky, and Jill Lehman. Feel effects: Enriching storytelling with haptic feedback. *ACM Transactions on Applied Perception*, 11(3):11:1–11:17, September 2014.
- [81] Eric Vezzoli, Michel Amberg, Frédéric Giraud, and Betty Lemaire-Semail. Electrovibration modeling analysis. In *Haptics: Neuroscience, Devices, Modeling, and Applications, EuroHaptics '14*, pages 369–376. Springer, 2014.
- [82] SensegTM. <http://www.senseg.com/>, 2017.
- [83] Jukka Linjama and Ville Mäkinen. E-sense screen: Novel haptic display with capacitive electrosensory interface. In *International Workshop on Haptic and Audio Interaction Design (HAID '09)*. Springer, 2009.
- [84] TanvasTM. <https://tanvas.co/>, 2017.
- [85] A. Johnsen and K. Rahbek. A physical phenomenon and its applications to telegraphy, telephony, etc. *Electrical Engineers, Journal of the Institution of*, 61(320):713–725, July 1923.
- [86] Shu Qin and Allen McTeer. Wafer dependence of johnsen–rahbek type electrostatic chuck for semiconductor processes. *Journal of Applied Physics*, 102(6), 2007.
- [87] C. D. Shultz, M. A. Peshkin, and J. E. Colgate. The application of tactile, audible, and ultrasonic forces to human fingertips using broadband electroadhesion. In *2017 IEEE World Haptics Conference (WHC)*, pages 119–124, June 2017.
- [88] Osborne Reynolds. Iv. on the theory of lubrication and its application to mr. beauchamp tower's experiments, including an experimental determination of the

- viscosity of olive oil. *Philosophical Transactions of the Royal Society of London*, 177:157–234, 1886.
- [89] T. Watanabe and S. Fukui. A method for controlling tactile sensation of surface roughness using ultrasonic vibration. In *Proceedings of 1995 IEEE International Conference on Robotics and Automation*, volume 1, pages 1134–1139, vol.1, May 1995.
- [90] Biet, M., Giraud, F., and Lemaire-Semail, B. Implementation of tactile feedback by modifying the perceived friction. *The european physical journal, Applied physics*, 43(1):123–135, April 2008.
- [91] Markus Wiesendanger. *Squeeze film air bearings using piezoelectric bending elements*. PhD thesis, EPFL, Lausanne, 2001.
- [92] Yi Yang, Betty Lemaire-Semail, Frédéric Giraud, Michel Amberg, Yuru Zhang, and Christophe Giraud-Audine. Power analysis for the design of a large area ultrasonic tactile touch panel. *European Physical Journal: Applied Physics*, 72(1):11, 2015.
- [93] M. Biet, G. Casiez, F. Giraud, and B. Lemaire-Semail. Discrimination of virtual square gratings by dynamic touch on friction based tactile displays. In *2008 Symposium on Haptic Interfaces for Virtual Environment and Teleoperator Systems*, pages 41–48, March 2008.
- [94] Wael Ben Messaoud. *Design and Control of a Tactile Stimulator for Real Texture Simulation: Application to Textile Fabrics*. Ph.d thesis, Université Lille 1 : Sciences et Technologies, June 2016.
- [95] F. Giraud, M. Amberg, B. Lemaire-Semail, and C. Giraud-Audine. Using an ultrasonic transducer to produce tactile rendering on a touchscreen. In *2014 Joint IEEE International Symposium on the Applications of Ferroelectric, International Workshop on Acoustic Transduction Materials and Devices Workshop on Piezoresponse Force Microscopy*, pages 1–4, May 2014.
- [96] Frédéric Giraud, Michel Amberg, and Betty Lemaire-Semail. Design and control of a haptic knob. *Sensors and Actuators A: Physical*, 196(Supplement C):78–85, 2013.

- [97] Christophe Winter. *Friction feedback actuators using squeeze film effect*. PhD thesis, EPFL, Lausanne, 2014.
- [98] Processing. <http://processing.org/>, 2017.
- [99] Victor Theoktisto, Marta Fairén González, Isabel Navazo Álvaro, and Eva Monclús Lahoya. Rendering detailed haptic textures. In *Workshop on Virtual Reality Interactions and Physical Simulation*, pages 16–23, 2005.
- [100] Stephen D Laycock and AM Day. A survey of haptic rendering techniques. *Computer Graphics Forum*, 26(1):50–65, 2007.
- [101] Gabriel Robles-De-La-Torre. Comparing the role of lateral force during active and passive touch: Lateral force and its correlates are inherently ambiguous cues for shape perception under passive touch conditions. In *proc. of EuroHaptics '02*, 2002.
- [102] Joe Mullenbach, Craig Shultz, Anne Marie Piper, Michael A. Peshkin, and J.E Colgate. Tpad fire: Surface haptic tablet. In *HAIID Haptic and Audio Interaction Design*, Daejeon, Korea, 2013. Springer.
- [103] T-PAD Fire Project. <http://tpadtablet.org/>, 2017.
- [104] Michaël Wiertlewski, Daniele Leonardis, David J. Meyer, Michael A. Peshkin, and J. Edward Colgate. A high-fidelity surface-haptic device for texture rendering on bare finger. In *Haptics: Neuroscience, Devices, Modeling, and Applications*, pages 241–248. Springer Berlin Heidelberg, 2014.
- [105] Satoshi Saga and Ramesh Raskar. Feel through window: Simultaneous geometry and texture display based on lateral force. In *SIGGRAPH Asia 2012 Emerging Technologies*, SA '12, pages 81–83. ACM, 2012.
- [106] F. Giraud, M. Amberg, and B. Lemaire-Semail. Merging two tactile stimulation principles: electrovibration and squeeze film effect. In *2013 World Haptics Conference (WHC)*, pages 199–203, April 2013.
- [107] Eric Vezzoli, Wael Ben messaoud, Clément Nadal, Giraud Frédéric, Michel Amberg, Betty Lemaire-Semail, and M. A. Bueno. Coupling of ultrasonic vibration and electrovibration for tactile stimulation. *European Journal of Electrical Engineering*, 17:377–395, December 2015.

- [108] David Gueorguiev, S er ena Bochereau, Andr e Mouraux, Vincent Hayward, and Jean-Louis Thonnard. Touch uses frictional cues to discriminate flat materials. *Scientific Reports*, 6:25553, May 2016.
- [109] Lisa Skedung, Martin Arvidsson, Jun Young Chung, Christopher Stafford, Birgitta Berglund, and Mark Rutland. Feeling small: Exploring the tactile perception limits. *Scientific reports*, 3:2617, 2013.
- [110] Mark Hollins and S. Ryan Risner. Evidence for the duplex theory of tactile texture perception. *Perception & Psychophysics*, 62(4):695–705, January 2000.
- [111] T. Yoshioka, S. J. Bensma ia, J. C. Craig, and S. S. Hsiao. Texture perception through direct and indirect touch: An analysis of perceptual space for tactile textures in two modes of exploration. *Somatosensory & Motor Research*, 24(1-2):53–70, 2007.
- [112] Judith Eck, Amanda L. Kaas, Joost L. Mulders, Lars Hausfeld, Zoe Kourtzi, and Rainer Goebel. The effect of task instruction on haptic texture processing: The neural underpinning of roughness and spatial density perception. *Cerebral Cortex*, 26(1):384–401, 2016.
- [113] Yoren Gaffary, Maud Marchal, Adrien Girard, Marine Pellan, Anouk Asselin, Benoit Peigne, Mathieu Emily, Florian Gosselin, Anthony Chabrier, and Anatole L ecuyer. Studying one and two-finger perception of tactile directional cues. In *Haptics: Perception, Devices, Control, and Applications*, pages 396–405. Springer International Publishing, 2016.
- [114] B. Hughes, J. Wang, D. Rosic, and K. Palmer. Texture gradients and perceptual constancy under haptic exploration. In *Second Joint EuroHaptics Conference and Symposium on Haptic Interfaces for Virtual Environment and Teleoperator Systems (WHC’07)*, pages 66–71, March 2007.
- [115] Jeffrey Yau, Mark Hollins, and Sliman Bensmaia. Textural timbre: The perception of surface microtexture depends in part on multimodal spectral cues. *Communicative & integrative biology*, 2:344–6, 2009.
- [116] H. Shirado and T. Maeno. Modeling of human texture perception for tactile displays and sensors. In *First Joint Eurohaptics Conference and Symposium*

- on Haptic Interfaces for Virtual Environment and Teleoperator Systems. World Haptics Conference*, pages 629–630, March 2005.
- [117] Harold T Nefs, Astrid M L Kappers, and Jan J Koenderink. Amplitude and spatial-period discrimination in sinusoidal gratings by dynamic touch. *Perception*, 30(10):1263–1274, 2001.
- [118] Ronald T. Verrillo, Anthony J. Fraioli, and Robert L. Smith. Sensation magnitude of vibrotactile stimuli. *Perception & Psychophysics*, 6(6):366–372, November 1969.
- [119] Dinesh Wijekoon, Marta E. Cecchinato, Eve Hoggan, and Jukka Linjama. Electrostatic modulated friction as tactile feedback: Intensity perception. In *Proceedings of the EuroHaptics’12*, pages 613–624. Springer, 2012.
- [120] Farzan Kalantari, Laurent Grisoni, Frédéric Giraud, and Yosra Rekik. Finding the minimum perceivable size of a tactile element on an ultrasonic based haptic tablet. In *Proceedings of the 2016 ACM on Interactive Surfaces and Spaces, ISS ’16*, pages 379–384. ACM, 2016.
- [121] Farzan Kalantari, Edward Lank, Yosra Rekik, Laurent Grisoni, and Frédéric Giraud. Determining the Haptic Feedback Position for Optimizing the Targeting Performance on Ultrasonic Tactile Displays. In *IEEE Haptics Symposium (HAPTICS 2018)*, San Fransisco, United States, 2018.
- [122] Farzan Kalantari, Florent Berthaut, and Laurent Grisoni. Enriching Musical Interaction on Tactile Feedback Surfaces with Programmable Friction. In *International Symposium on Computer Music Multidisciplinary Research (CMMR 2017)*, Porto, Portugal, 2017. Springer-Verlag.
- [123] D. Gueorguiev, E. Vezzoli, T. Sednaoui, L. Grisoni, and B. Lemaire-Semail. Feeling multiple edges: The tactile perception of short ultrasonic square reductions of the finger-surface friction. In *2017 IEEE World Haptics Conference (WHC)*, pages 125–129, June 2017.
- [124] David Gueorguiev, Eric Vezzoli, André Mouraux, Betty Lemaire-Semail, and Jean-Louis Thonnard. The tactile perception of transient changes in friction. *Journal of The Royal Society Interface*, 14(137), 2017.

- [125] Hap2UTM. <http://www.hap2u.net/>, 2018.
- [126] Bernhard Treutwein. Adaptive psychophysical procedures. *Vision Research*, 35(17):2503 – 2522, 1995.
- [127] Marjorie R. Leek. Adaptive procedures in psychophysical research. *Perception & Psychophysics*, 2001.
- [128] Alix Goguey, Daniel Vogel, Fanny Chevalier, Thomas Pietrzak, Nicolas Roussel, and Géry Casiez. Leveraging finger identification to integrate multi-touch command selection and parameter manipulation. *International Journal of Human-Computer Studies*, 99:21 – 36, 2017.
- [129] Damien Masson, Alix Goguey, Sylvain Malacria, and Géry Casiez. Whichfingers: Identifying fingers on touch surfaces and keyboards using vibration sensors. In *Proceedings of the 30th Annual ACM Symposium on User Interface Software and Technology*, UIST '17, pages 41–48. ACM, 2017.
- [130] Géry Casiez, Nicolas Roussel, Romuald Vanbellegem, and Frédéric Giraud. Surfpad: Riding towards targets on a squeeze film effect. In *Proceedings of the SIGCHI Conference on Human Factors in Computing Systems*, CHI '11, pages 2491–2500. ACM, 2011.
- [131] Renaud Blanch, Yves Guiard, and Michel Beaudouin-Lafon. Semantic pointing: Improving target acquisition with control-display ratio adaptation. In *Proceedings of the SIGCHI Conference on Human Factors in Computing Systems*, CHI '04, pages 519–526. ACM, 2004.
- [132] Joe Mullenbach, Craig Shultz, Anne Marie Piper, Michael Peshkin, and J. Edward Colgate. Surface haptic interactions with a tpad tablet. In *Proceedings of the Adjunct Publication of the 26th Annual ACM Symposium on User Interface Software and Technology*, UIST '13 Adjunct, pages 7–8. ACM, 2013.
- [133] Suhong Jin, Joe Mullenbach, Craig Shultz, J. Edward Colgate, and Anne Marie Piper. Os-level surface haptics for touch-screen accessibility. In *Proceedings of the 16th International ACM SIGACCESS Conference on Computers & Accessibility*, ASSETS '14, pages 315–316. ACM, 2014.

- [134] Joe Mullenbach, Craig Shultz, J. Edward Colgate, and Anne Marie Piper. Exploring affective communication through variable-friction surface haptics. In *Proceedings of the 32nd Annual ACM Conference on Human Factors in Computing Systems*, CHI '14, pages 3963–3972. ACM, 2014.
- [135] Yang Zhang and Chris Harrison. Quantifying the targeting performance benefit of electrostatic haptic feedback on touchscreens. In *Proceedings of the 2015 International Conference on Interactive Tabletops & Surfaces*, ITS '15, pages 43–46. ACM, 2015.
- [136] G. Liu, X. Sun, D. Wang, Y. Liu, and Y. Zhang. Effect of electrostatic tactile feedback on accuracy and efficiency of pan gestures on touch screens. *IEEE Transactions on Haptics*, PP(99), December 2017.
- [137] Eve Hoggan, Stephen A. Brewster, and Jody Johnston. Investigating the effectiveness of tactile feedback for mobile touchscreens. In *Proceedings of the SIGCHI Conference on Human Factors in Computing Systems*, CHI '08, pages 1573–1582. ACM, 2008.
- [138] Clifton Forlines and Ravin Balakrishnan. Evaluating tactile feedback and direct vs. indirect stylus input in pointing and crossing selection tasks. In *Proceedings of the SIGCHI Conference on Human Factors in Computing Systems*, CHI '08, pages 1563–1572. ACM, 2008.
- [139] Ivan Poupyrev, Makoto Okabe, and Shigeaki Maruyama. Haptic feedback for pen computing: Directions and strategies. In *CHI '04 Extended Abstracts on Human Factors in Computing Systems*, CHI EA '04, pages 1309–1312. ACM, 2004.
- [140] Qinglong Wang, Xiangshi Ren, Sayan Sarcar, and Xiaoying Sun. Ev-pen: Leveraging electrovibration haptic feedback in pen interaction. In *Proceedings of the 2016 ACM on Interactive Surfaces and Spaces*, ISS '16, pages 57–66. ACM, 2016.
- [141] K. A. Kaczmarek, K. Nammi, A. K. Agarwal, M. E. Tyler, S. J. Haase, and D. J. Beebe. Polarity effect in electrovibration for tactile display. *IEEE Transactions on Biomedical Engineering*, 53(10):2047–2054, October 2006.
- [142] Lonny L. Chu. Haptic feedback in computer music performance. In *Proceedings of International Computer Music Conference (ICMC '96)*, pages 57–58, 1996.

- [143] Chris Chafe. Tactile audio feedback. In *Proceedings of International Computer Music Conference (ICMC '93)*, pages 76–79, 1993.
- [144] Stefania Serafin and Diana Young. Toward a generalized friction controller: From the bowed string to unusual musical instruments. In *Proceedings of International Conference on New Interfaces for Musical Expression (NIME '04)*, pages 181–191. Springer, 2004.
- [145] Angela Chang and Conor O’Sullivan. Audio-haptic feedback in mobile phones. In *CHI '05 Extended Abstracts on Human Factors in Computing Systems, CHI EA '05*, pages 1264–1267. ACM, 2005.
- [146] David M. Birnbaum and Marcelo M. Wanderley. A systematic approach to musical vibrotactile feedback. In *Proceedings of International Computer Music Conference (ICMC '07)*, pages 397–404, 2007.
- [147] Mark T. Marshall and Marcelo M. Wanderley. Vibrotactile feedback in digital musical instruments. In *Proceedings of the 2006 Conference on New Interfaces for Musical Expression, NIME '06*, pages 226–229, Paris, France, 2006. IRCAM & Centre Pompidou.
- [148] B. Ménélas, L. Picinalli, B. F. G. Katz, and P. Bourdot. Audio haptic feedbacks for an acquisition task in a multi-target context. In *2010 IEEE Symposium on 3D User Interfaces (3DUI)*, pages 51–54, March 2010.
- [149] Juan Huang, Darik Gamble, Kristine Sarnlertsophon, Xiaoqin Wang, and Steven Hsiao. Feeling music: Integration of auditory and tactile inputs in musical meter perception. *PLOS ONE*, 7(10):1–11, October 2012.
- [150] T. Beamish K. Maclean S. Fels K., Van Den Doel. D’groove: A haptic turntable for digital audio control. In *Proceedings of the International Conference on Auditory Display (ICAD '03)*, July 2003.
- [151] Lynne Baillie, David Beattie, and Lee Morton. Feel what you hear: Haptic feedback as an accompaniment to mobile music playback. In *Proceedings of Interacting with Sound Workshop: Exploring Context-Aware, Local and Social Audio Applications, IwS '11*, pages 1–6. ACM, 2011.

- [152] J. M. Lim, J. U. Lee, K. U. Kyung, and J. C. Ryou. An audio-haptic feedbacks for enhancing user experience in mobile devices. In *2013 IEEE International Conference on Consumer Electronics (ICCE '13)*, pages 49–50, January 2013.
- [153] Dan Overholt. The matrix: A novel controller for musical expression. In *Proceedings of the 2001 Conference on New Interfaces for Musical Expression*, NIME '01, pages 1–4. National University of Singapore, 2001.
- [154] Stefano Papetti, Sébastien Schiesser, and Martin Fröhlich. Multi-point vibrotactile feedback for an expressive musical interface. In *Proceedings of the International Conference on New Interfaces for Musical Expression*, NIME, 2015.
- [155] Sile O'Modhrain and Georg Essl. Pebblebox and crumblebag: Tactile interfaces for granular synthesis. In *Proceedings of the International Conference on New Interfaces for Musical Expression*, NIME '04, pages 74–79. National University of Singapore, 2004.
- [156] Mayank Sangneria and Kurt Werner. Grainproc: a real-time granular synthesis interface for live performance. In *Proceedings of the International Conference on New Interfaces for Musical Expression*, NIME '13, pages 223–226, 2013.
- [157] Atau Tanaka and Adam Parkinson. Haptic wave: A cross-modal interface for visually impaired audio producers. In *Proceedings of the 2016 CHI Conference on Human Factors in Computing Systems*, CHI '16, pages 2150–2161. ACM, 2016.
- [158] Oussama Metatla, Fiore Martin, Adam Parkinson, Nick Bryan-Kinns, Tony Stockman, and Atau Tanaka. Audio-haptic interfaces for digital audio workstations. *Journal on Multimodal User Interfaces*, 10(3):247–258, September 2016.
- [159] Gord Kurtenbach and Eric Hulteen. *Gestures in Human-Computer Communication*. Addison-Wesley Longman Publishing Co., May 1990.
- [160] Eric Metois. *Musical sound information : musical gestures and embedding synthesis*. Ph.d thesis, Massachusetts Institute of Technology, 1997.
- [161] Claude Cadoz and Marcelo M. Wanderley. Gesture - Music. In Paris Marcelo Wanderley et Marc Battier, IRCAM-Centre Pompidou, editor, *Trends in Gestural Control of Music*. 2000.

-
- [162] Paul Doornbusch. A brief survey of mapping in algorithmic composition. In *Proceedings of International Computer Music Conference (ICMC '02)*, 2002.
- [163] Pure Data. <https://puredata.info/>, 2017.
- [164] Jules François. Gesture–sound mapping by demonstration in interactive music systems. In *Proceedings of the 21st ACM International Conference on Multimedia, MM '13*, pages 1051–1054. ACM, 2013.
- [165] Mahtab Ghamsari, Amandine Pras, and Marcelo Wanderley. Combining musical tasks and improvisation in evaluating novel digital musical instruments. In *Proc. of the 10th International Symposium on Computer Music Multidisciplinary Research, CMMR '13*. Springer, 2013.
- [166] Jeronimo Barbosa, Joseph Malloch, Marcelo M. Wanderley, and Stéphane Huot. What does “Evaluation” mean for the NIME community? In *15th International Conference on New Interfaces for Musical Expression, NIME '15*, pages 156–161, Baton Rouge, United States, May 2015. Louisiana State University.
- [167] Giovanni De Poli. A tutorial on digital sound synthesis techniques. *Computer Music Journal, MIT press*, 7(4):8–26, 1983.
- [168] Joseph M. Romano and Katherine J. Kuchenbecker. Creating realistic virtual textures from contact acceleration data. *IEEE Transactions on Haptics*, 5(2): 109–119, April 2012.
- [169] Heather Culbertson and Katherine J. Kuchenbecker. Importance of matching physical friction, hardness, and texture in creating realistic haptic virtual surfaces. *IEEE Transactions on Haptics*, 10(1):63–74, January 2017.
- [170] Trevor A. Smith and Jenna L. Gorlewicz. Hue: A hybrid ultrasonic and electrostatic variable friction touchscreen. In *2017 IEEE World Haptics Conference (WHC)*, pages 635–640, June 2017.