



HAL
open science

Semi-Definite Programming Methods for the Stability Analysis of Nonlinear Systems

Giorgio Valmorbida

► **To cite this version:**

Giorgio Valmorbida. Semi-Definite Programming Methods for the Stability Analysis of Nonlinear Systems. Automatic. Université Paris Saclay, 2021. tel-04363983

HAL Id: tel-04363983

<https://hal.science/tel-04363983v1>

Submitted on 26 Dec 2023

HAL is a multi-disciplinary open access archive for the deposit and dissemination of scientific research documents, whether they are published or not. The documents may come from teaching and research institutions in France or abroad, or from public or private research centers.

L'archive ouverte pluridisciplinaire **HAL**, est destinée au dépôt et à la diffusion de documents scientifiques de niveau recherche, publiés ou non, émanant des établissements d'enseignement et de recherche français ou étrangers, des laboratoires publics ou privés.

Semi-Definite Programming Methods for the Stability Analysis of Nonlinear Systems

Mémoire soumis en vue de l'obtention de l'habilitation à diriger des recherches en sciences

Giorgio Valmorbida

To Claire, Eleonora and Vittorio

“La vraie division humaine est celle-ci : les lumineux et les ténébreux.

Diminuer le nombre des ténébreux, augmenter le nombre des lumineux, voilà le but. C'est pourquoi nous crions : enseignement ! science ! Apprendre à lire, c'est allumer du feu ; toute syllabe épelée étincelle.

Du reste qui dit lumière ne dit pas nécessairement joie. On souffre dans la lumière ; l'excès brûle. La flamme est ennemie de l'aile. Brûler sans cesser de voler, c'est là le prodige du génie.”

Victor Hugo, *Les Misérables Tome IV*

“Considerate la vostra semenza:
fatti non foste a viver come bruti,
ma per seguir virtute e canoscenza”

Dante Alighieri, *Inferno - Canto 26*

“Reconhece a queda e não desanima
Levanta, sacode a poeira e dá a volta por cima”

Paolo Vanzolini, *Volta por cima*

Preface

This document presents a selection of research results obtained over the last six years, period coinciding with the beginning of my associate professorship at CentraleSupélec and my affiliation to the Laboratoire de Signaux et Systèmes in September 2015. The choice of the contents of the manuscript reflects the current most active research activities with collaborators and, in my view, also the most promising. This choice has allowed me to write a coherent document regarding the use of convex optimization to study classes of nonlinear feedback control systems. Nonetheless, the contents of the manuscript reflect the evolution of previous research in related topics, acquired since my Ph.D. in 2010.

The manuscript is divided into two parts; each part contains two chapters. The two parts are independent and can be read separately. It ends with a brief description of ongoing work and research perspectives followed by conclusions.

The presented results focus on particular classes of nonlinear systems that can be expressed as the interconnection of linear systems and static nonlinearities. The main problems we study are the stability and input-output analysis of nonlinear systems. The solutions to these problems are stability conditions that can be checked with convex optimization, namely semidefinite program. These conditions are sufficient stability conditions cast as inequalities where the unknowns are the parameters of Lyapunov function candidates. The numerical solutions provide the values of the parameters defining these functions.

In several instances, we show that the proposed conditions reduce the conservatism and simplify the analysis when compared to existing methods. The conservatism reduction is achieved thanks to particular choices of Lyapunov Function structures and their parametrization. Importantly, such functions are chosen to exploit the information available from the classes of nonlinearities we study: in the first part, we assume the nonlinear terms are slope-restricted, while in the second part, we consider nonlinear loops with several nonlinearities of a single type, the ramp function. The potential of the proposed framework is enforced by a result showing that ill-posed algebraic loop involving ramp functions yield set-valued discontinuous mappings.

The results in the Chapters 1, 3, 4 have already been published [174], [75] [175], while the results in Chapter 2 are the Discrete-time counterpart for the ones in Chapter 1, and are currently under review. While the main ideas are the same as in the published papers, the presentation here is expanded with different examples and figures included. The classes of systems we consider and the studied problems are summarized in Table 1.

	Class of systems	Time	Vector field	Problems
Ch. 1	Slope-restricted Lurie MIMO systems	Continuous	Continuous	1, 2, 3
Ch. 2	Slope-restricted Lurie SISO systems	Discrete	Continuous	1, 2, 4
Ch. 3	Piecewise Affine	Discrete	Continuous	1
Ch. 4	Quantized	Discrete	Discontinuous	1

Table 1: Studied problems in the manuscript: 1) Global stability analysis 2) Local stability analysis 3) \mathcal{L}_2 Gains, 4) ℓ_2 Gains.

Some of the research topics I have also studied in recent years are not included in this text. Namely, results on Polynomial Optimization methods for nonlinear systems, on numerical methods for the stability analysis of Infinite Dimensional Systems, and on the analysis of time-varying systems and applications. The reason for excluding these topics and the associated publications was to narrow the scope of the manuscript. The publications related to these topics and other lines of research can be found in the reference list of Appendix B while current and past projects of supervised Ph.D. students are listed in Appendix C.

Acknowledgements

I would first like to thank the reviewers, who accepted to read and report on the manuscript: J. Daafouz, D. Peaucelle and C. Prieur.

I would like to sincerely thank who made the research work reported in this manuscript possible as well as those who contribute to develop and maintain the undergraduate and graduate teaching:

The two directors of CentraleSupélec, H. Biauxser and R. Soubeyran, the directors for Research E. Iacona, O. Gicquel, and P. H. Cournède, and the directors of Undergraduate studies L. Gabet and D. Dumur, for their commitment to excellence in both research and teaching.

The heads of the L2S, S. Niculescu and P. Bondon, for all their efforts on setting the highest ambitions for research and for providing opportunities to early career researchers. To the heads of department D. Dumur, G. Sandou for the opportunities, for the careful planning of the teachings, for the efforts on keeping the experimental activities and close ties with industry.

The research funding provided by the institutional funds from CentraleSupélec, Inria, CNRS, Università di Roma “Tor Vergata”, and the funding agencies CNPQ, FAPESP, CAPES, EU through Alban Programme, EPSRC, Campus France, ANR, and ANRT.

The students of CentraleSupélec for making us improve every year and transforming teaching in an enjoyable and gratifying duty.

All my colleagues from the *Pôle Automatique et Systèmes* of the L2S: N. Amini, J. Auriol, F. Bonnans, D. Beauvois, C. Bonnet, I. Boussaada, A. Chaillet, Y. Chitour, S. Diop, G. Duc, D. Dumur, S. Font, A. Girard, E. Godoy, L. Greco, A. Iovine, F. Lamnabhi-Lagarrigue, H. Lhachemi, A. Loria, M. Makarov, C. Maniu, P. Mason, G. Mazanti, F. Mazenc, H. Mounier, S.-I. Niculescu, D. Normand-Cyrot, S. Olaru, R. Ortega, E. Panteley, W. Pasillas-Lepine, L. Pfeiffer, D. Prandi, P. Rodriguez-Ayerbe, G. Sandou, H. Siguerdidjane, S. Tebbani, S. Tliba, and C. Vlad. In particular, for the welcome to CS and the L2S by A. Chaillet, Y. Chitour, S. Olaru, E. Panteley, S. Niculescu, W. Pasillas-Lepine and D. Beauvois.

The colleagues of the Signal Processing and Optimization courses and of the Pôle Projets Systèmes Cyber-Physiques.

The colleagues chairing the ATSI - Master program in Control, Signal and Image Processing of Université Paris-Saclay and its administrative staff. Especially for the recruitment efforts.

The administrative and technical staff of the L2S and the Control Department: A. Bertinet, P. Debever, S. Douesnard, M. Giron, L. Antunes, L. Marquet, C. Charles, M. Paleczny and P. Lepeltier.

The Inria DISCO team (current and past) members F. Bonnans, C. Bonnet, I. Boussaada, G. Mazanti, F. Mazenc, H. Mounier, S.-I. Niculescu, S. Olaru, L. Pfeiffer, and G. Sandou.

To all the partners of the IRN SPaDisCo: W. Michiels and the KU Leuven team, D. Breda and the Udine team, P. Pepe and the L’Aquila team, H. Ozbay and the Bilkent team, K. H. Johansson and the KTH team, A. Papachristodoulou and the Oxford team.

The members of the ANR HANDY project.

The members of the STICAmSud CoDySCo2 project.

To M. Hovd for the collaboration with NTNU on the Aurora-Control, and Observation of Nonlinear Systems project.

My PhD students: M. Ahmadi, A. Diab, L. B. Groff, N. Michel, D. Penco. Special thanks to my colleagues with whom I shared the Ph.D. and MSc students’ supervision: A. Papachristodoulou, S. Olaru, S. Bertrand, D. Dumur, E. Panteley, H., Siguerdidjane, J. M. Gomes da Silva Jr., E. Godoy, P. Kvieska, J. Davins-Valldaura, and W. Pasillas-Lepine.

The “jovens” from the Mestrado years at UNICAMP: Ricardo, Valter, Vinicius. Special thanks to Pedro for all the support over the last seventeen years.

Isabelle, Germain, Denis, Didier, Dimitri, Sophie, Frédéric, Lucie, Thomas, Luca, Alexandre, Vincent, and Christophe, for all the support from and the time spent with the MAC group at LAAS. Choosing an academic career was highly influenced by the intellectual environment I had during my Ph.D. years and later visits to the lab. Special thanks to Sophie and Germain for their thorough supervision and for encouraging me to develop my ideas (always quickly scrutinized by Sophie’s unmatched lightning algebra).

Luca, Sergio, Daniele, Laura, Mario and Fulvio for the enriching exchange during the Post-Doc years in Roma at the Università degli Studi di Roma Tor Vergata.

The SySOS team: Antonis, James, Edward, Reza, Andreas, Dhruva for the extraordinary Post-Doc years spent in Oxford. Antonis, for the support and generosity. Stephen and Ross, for the fruitful collaboration. The SOSTOOLS team. The “SOS for Stability and Control of Fluid Flows” project teams in Southampton and Imperial College. The Sommerville College fellowship with special thanks to R. Stone and B. Choubey for the tutorial teachings.

I would particularly like to thank J. M. Gomes da Silva Jr., L. B. Groff, F. Ferrante, S. Duncan, and R. Drummond for the collaboration on the works leading to the results in this manuscript.

Finally, the much procrastinated task of writing this document would not have been completed without the strong support of Claire, whom I thank with love.

Giorgio Valmorbida
Gif-sur-Yvette, December 26, 2023

Contents

Preface	ix
List of Figures	xvi
List of Tables	xvii
List of Symbols	xx
Acronyms	xxi
General Introduction	1
I Lurie Systems with sector and slope restricted nonlinearities	5
Introduction of Part I	7
1 Analysis of Continuous-time Slope-Restricted Lurie Systems	9
1.1 Problem statement	9
1.1.1 Conditions for Well Posedness of the algebraic loop	9
1.2 Sector inequalities	11
1.3 Regional Stability Analysis, Reachable Sets and Nonlinear Gains	12
1.3.1 Inclusion conditions	15
1.3.2 Discussion on the proposed Lyapunov Function	15
1.3.3 LMIs from Theorem 1.1	16
1.4 Numerical Examples	17
1.4.1 Optimal sector and slope bounds	17
1.4.2 Local Stability	18
1.4.3 Gain Curves	19
1.4.4 Discussion: Sector bounds for global stability	19
1.5 Conclusions	20
2 Analysis of Discrete-time Slope-Restricted Lurie Systems	21
2.1 Introduction	21
2.2 Generalised quadratic and integral Lyapunov functions	21
2.2.1 Proposed Lyapunov Function	22
2.2.2 Discussion on the Proposed Function	22
2.3 Stability analysis of Discrete-Time Lurie Systems	25
2.3.1 Global Stability Analysis	26
2.3.2 Regional Stability Analysis	27
2.3.3 Input-Output Analysis	29
2.3.4 LMI conditions	30
2.4 Numerical examples	32
2.4.1 Maximum Achievable Sector	32
2.4.2 Regional Analysis	33
2.4.3 Bounding the Worst Case Input-Output Gain	34
2.5 Conclusions	35
Notes and References	37

II	Analysis of Piecewise Affine Discrete-Time Systems	43
	Introduction of Part II	45
3	Piecewise Affine Systems	49
3.1	Implicit Representation of Continuous PWA Functions	49
3.1.1	Conditions for well-posedness	51
3.2	Ramp Functions description from KKT conditions	52
3.2.1	Conditions for the Non-negativity of Generalized Quadratic Forms	53
3.3	Stability Analysis of PWA Systems with PWQ Lyapunov Functions	54
3.3.1	LMI conditions	56
3.3.2	Uncertain Systems Case	58
3.3.3	LMI conditions for uncertain systems	60
3.4	Numerical Examples	61
3.4.1	Piecewise Quadratic function for Global Stability	61
3.4.2	Asymmetric Saturation	62
3.4.3	Explicit MPC law	63
3.4.4	Uncertainty in the Partition	65
3.5	Relation to other representations	65
3.6	Conclusions	68
4	Systems with Quantization nonlinearities	69
4.1	Linear Systems with input quantization	69
4.2	KKT characterization of the set-valued step mapping	71
4.3	PWQ Lyapunov Functions for systems with input Quantization	73
4.3.1	LMI conditions	76
4.4	Numerical Examples	78
4.4.1	Ternary Control	78
4.4.2	Binary Control	79
4.4.3	Stabilization with a finite alphabet	80
4.5	Conclusions	81
	Perspectives and Concluding Remarks	85
	Perspectives	85
P.1	Synthesis of feedback laws for slope-restricted nonlinearities	85
P.2	PWQ Lyapunov functions for continuous-time systems	85
P.3	Linear switching and polytopic uncertain systems	88
P.4	Discontinuous PWA systems	90
P.5	Conditions for the regional positivity of a PWQ function	91
P.6	Further research directions	95
P.7	Proofs of the claims in the chapter	96
P.7.1	Proof of Lemma P.4	97
P.7.2	Proof of Lemma P.5	99
	Conclusions	101
A	Curriculum Vitae	115
B	List of Publications	119
B.1	Submitted Journal Papers	119
B.2	Journal Papers	119
B.3	Conference Papers	120
B.4	Book Chapters	124
B.5	Edited Volumes	124
B.6	Software	124
B.7	Patents	124
B.8	Theses	124
B.9	Citations	124

C	Supervision	125
C.1	Ph.D. Supervision	125
C.1.1	Concluded supervision - Thesis abstracts	125
C.1.2	Ongoing supervision - Thesis projects	126
C.2	Joint publications with early career researchers, Ph.D. students and Post-Docs . .	128
D	List of teaching activities	129
D.1	Teaching Activities	129

List of Figures

1.1	Estimate of the region of attraction with the Lyapunov function (1.11) (dark blue). Trajectories asymptotically converging to the origin are shown in green, while diverging trajectories are depicted in red	19
1.2	Induced \mathcal{L}_2 gain bounds for an idealised Stirling engine.	19
2.1	Feedback representation of a Lurie system.	21
2.2	Stability of the Lurie system can be shown via passivity of the above feedback system, where G is the linear system, M is the multiplier and $\phi(\cdot)$ is the nonlinearity.	23
2.3	Maximum sector δ obtained by Proposition 2.1 for $G_4(z)$ as a function of the horizon $N \in [1, 10]$. We also plot the bounds achieved using the Circle criterion, the Tsypkin Lyapunov function and the function from [132]. The upper limit set by the Nyquist gain is also plotted.	33
2.4	Regional stability of the second numerical example. Positive invariant sets of the Lyapunov function $V(x)$ from (2.5) are shown in blue, with blue dashed lines corresponding to sub-level sets. Light blue corresponds to $N = 4$ and dark blue to $N = 1$. Black dashed lines denote the limits $\{x : \nu_0(x) = \bar{y}, \nu_0(x) = \underline{y}\}$. Initial conditions from the red region did not converge to the origin.	34
2.5	Worst-case input output gain ω bounding $\ z\ _2^2 \leq \omega \ w\ _2^2$ as a function of the horizon length N in $V(x)$	35
2.6	Feedback representation of a Lurie system is here used to represent PWA systems. In this part, ϕ will be a vector of ramp functions. The term f_5 is a constant vector that is added to the output of the linear block $G(z)$ to generate the input y of the nonlinearity ϕ	46
3.1	Ramp function $r(y_i)$	49
3.2	Partition of \mathbb{R}^2 for $f(x)$ defined by (3.2), (3.3).	50
3.3	Partition of \mathbb{R}^2 for $f(x)$ defined in (3.4).	51
3.4	System trajectories and Lyapunov function level sets for Example I.	62
3.5	System trajectory and Lyapunov function level sets for Example II.	63
3.6	One system trajectory and level sets of the Lyapunov function for Example III.	64
3.7	Two different partitions of \mathbb{R}^2 are obtained for different values of d_1 and d_2 . These partitions differ also in the number of sets defining them. On the left, $d_1 = -d_2 > 0$, we obtain a partition with four sets. On the right, with $d_1 = d_2 < 0$, we obtain a partition with six sets. The dashed line corresponds to the set where $y_3 = 0$	65
3.8	The tree structure corresponding to (3.50) using the composition rules of (3.48).	67
4.1	Step function $s(v)$	69
4.2	Regularization of the step function $\mathbf{s}(v)$	70
4.3	Krasovskii regularization of the step function $\widehat{\mathbf{s}}(v)$	71
4.4	Prototype of set-valued mapping $V(x, y)$	75
4.5	Illustration of the conditions in Theorem 4.3 for the case in which $\mathbf{y}(x_a)$ is not a singleton. The set of values for $V(x, y)$ is given in red in coordinate axis. In this case, the regularized dynamics give a set-valued mapping illustrated here by the set x_a^+ , which in turn gives the set of values for $V(x^+, y^+)$ - depicted in blue in the coordinate axis. The theorem asks for all points in the green set to be below the red set. In this case the single valued function W is guaranteed to decrease.	76
4.6	Function $W(x) = \max V(x)$ in Example 4.4.1.	79

4.7	Simulations in Example 4.4.1. Level sets of the function $W(x) = \max V(x)$ and the trajectory σ of (4.29) starting from $(1, 0)$ (dashed-crossed line). The dashed line indicates the set where $Kx + d = 0$, namely, the set where the argument of the ramp function and the step function is equal to zero.	79
4.8	Level sets of the function $W(x)$ in Example 4.4.2 and the trajectory of (4.29) starting from $(1, 0)$ (dashed-crossed line). The dashed line indicates the set where $Kx + d = 0$, namely, the set where the argument of the ramp function and the step function is equal to zero.	80
4.9	Lyapunov function $W(x)$ for Example 4.4.3.	81
4.10	Trajectories for the system along with the partitioning of the state space introduced in (4.30). Initial conditions are selected as $(0.9, 3)$, $(-1, 0.5)$. Note that the level sets of the computed Lyapunov function are disconnected. These disconnected sets appear, for instance in the set $\{x \mid x_1 \geq 1, x_2 \leq 1\}$ close to the point $(1, 1)$	81
P.11	Regularization of the step function $\mathbf{s}(\theta, \rho)$	87
P.12	Partition of \mathbb{R}^2 of the vector field defined by R , where $\Gamma_n = \{x \mid \tilde{x}_1 \tilde{x}_2 < 0, \tilde{x} = Rx\}$, $\Gamma_p = \{x \mid \tilde{x}_1 \tilde{x}_2 \geq 0, \tilde{x} = Rx\}$	92
P.13	Plots of the two components of $f(x) = A_n x + A_p R^{-1} H_1 \phi(u)$ in (4.53) with the data in (4.54) (plots were obtained with the PWA description, without the use of explicit representation).	93

List of Tables

1	Studied problems in the manuscript: 1) Global stability analysis 2) Local stability analysis 3) \mathcal{L}_2 Gains, 4) ℓ_2 Gains.	vii
1.1	Maximum bound on parameter ϵ , denoted ϵ^* , for global stability of system $G_{1c}(s)$.	18
1.2	Local sector and slope bounds for $\ln(1 + \tilde{y}_j)$ and $\frac{\tilde{y}_j}{1 + \tilde{y}_j}$ for \mathcal{X}_0 as in (1.16) with $\tilde{y}_j > -1$.	18
2.1	Various linear systems used as tests in the numerical examples. Set of examples taken from [27].	33
2.2	Achievable maximum sectors for various tests. N^* is the value of N in $V(x)$ of (2.5) giving the maximum sector.	33
3.1	Explicit MPC law: inequalities defining the sets of the partition and the corresponding affine control law.	64

List of Symbols

The next list describes several symbols that will be later used within the body of the document

$0_{n,m}$	The matrix of zeros dimensions $n \times m$.
Δ	The forward difference of a function $V : \mathbb{R}^n \rightarrow \mathbb{R}_{\geq 0}$ along the solution of a discrete-time system $x[k+1] = f(x)$, i.e. $\Delta V[k] := V(x[k+1]) - V(x[k])$
$\dot{x}, \frac{dx}{dt}$	The time-derivative of a function of time x .
$ x $	The absolute value of a scalar $x \in \mathbb{R}$.
\mathbb{D}^n	The set of diagonal matrices of dimension $n \times n$.
$\mathbb{D}_{\geq 0}^n$	The set of positive semi-definite diagonal matrices of dimension $n \times n$.
\mathbb{N}^n	The set of non-negative integers numbers.
\mathbb{P}^n	The set of symmetric matrices of dimension $n \times n$ with non-negative entries.
$\mathbb{R}^{n \times m}$	The set of real valued matrices of dimensions $n \times m$.
\mathbb{R}^n	n th dimensional Euclidean space.
$\mathbb{R}_{\geq 0}^n$	Set of vectors with non-negative entries.
$\mathbb{R}_{\geq 0}$	The set of non-negative real numbers.
\mathbb{S}^n	The set of symmetric matrices of dimension $n \times n$.
$\mathbb{S}_{\geq 0}^n$	The set of positive semi-definite symmetric matrices of dimension $n \times n$
$\mathbb{U}_{\geq 0}^n$	The set of upper-triangular matrices of dimension $n \times n$ with non-negative entries.
\mathbb{Z}	The set of integers.
$\mathbb{Z}_{>0}$	The set of positive integers.
$\mathbb{Z}_{\geq 0}$	The set of non-negative integers.
\mathbf{e}_i^n	The canonical basis vector $\mathbf{e}_i^n \in \mathbb{R}^n$, composed of zeros everywhere except a 1 at element i .
\mathcal{D}°	The interior of a set $\mathcal{D} \subset \mathbb{R}^m$.
$\mathcal{E}(V, \rho)$	The ρ sublevel set of a function $V : \mathbb{R}^n \rightarrow \mathbb{R}$, i.e. $\{x \in \mathbb{R}^n \mid V(x) \leq \rho\}$
$\mathcal{W}(\rho)$	The set of discrete-time signals with ℓ_2 norm bounded by $\sqrt{\rho}$, $\mathcal{W}(\rho) = \{w \mid \ w\ _2^2 \leq \rho\}$.
\max	The maximum of a set.
\otimes	$A \otimes B$ indicates the Kronecker product of matrices A and B
$\bar{\Omega}$	The closure of the set Ω .
$\bar{\sigma}(M)$	The largest singular value of matrix $M \in \mathbb{R}^{n \times m}$.
∂	The generalized derivative operator.
$\text{rge } f$	The image of the function f .

- $diag(M, N)$ For $M \in \mathbb{R}^{m \times m}$ $N \in \mathbb{R}^{n \times n}$, the block diagonal matrix of dimensions $m + n$ with diagonal blocks given by M and N .
- He For a matrix $A \in \mathbb{R}^{n \times n}$, $He(A) = A + A^\top$
- I_n The identity matrix of dimension n .
- M^\top The transpose of a matrix $M \in \mathbb{R}^{n \times m}$.
- M_\perp Any matrix having as columns a basis of $\ker M$.
- $M_{i,j}$ For $M \in \mathbb{R}^{n \times m}$ (i, j) entry of a matrix M
- v_i For $v \in \mathbb{R}^n$ i th entry of a vector v
- $y[k]$ The value of a discrete-time signal y at instant k

We may drop the arguments of some functions when it is clear from the context.

Acronyms

- AW** Anti-Windup. [40](#)
- CT** Continuous-Time. [38](#), [85](#), [88](#)
- DT** Discrete-Time. [38](#), [88](#)
- ERA** Estimate of the Region of Attraction. [39](#)
- ISS** Input-to-State Stability. [41](#)
- KKT** Karush-Kuhn-Tucker. [46](#)
- KYP** Kalman-Yakubovic-Popov. [37](#)
- LCP** Linear Complementarity Problem. [53](#)
- LDI** Linear Differential Inclusion. [88](#)
- LF** Lyapunov Function. [7](#), [37](#)
- LMI** Linear Matrix Inequality. [39](#), [46](#)
- LP** Linear Programming. [90](#)
- LPV** Linear Parameter Varying. [88](#)
- LTI** Linear Time-Invariant. [37](#)
- MIMO** Multi-Input Multi-Output. [39](#)
- MPC** Model Predictive Control. [45](#), [90](#)
- NN** Neural Networks. [95](#)
- PWA** Piecewise Affine. [45](#), [49](#)
- PWL** Piecewise Linear. [89](#)
- PWQ** Piecewise Quadratic. [45](#), [49](#)
- ReLU** Rectifier Linear Unit. [95](#)
- SDP** Semidefinite Programming. [7](#), [41](#)
- SISO** Single-Input Single-Output. [37](#)
- ZF** Zames & Falb. [38](#)

General Introduction

Incorporating knowledge about nonlinearities and understanding the phenomena they induce is of utmost importance to the analysis and design of feedback control systems. Fundamental results put forward in the last century still shape the general approaches to study nonlinear control systems. The absolute stability framework, studying feedback loops composed of linear dynamical systems and static nonlinearities — also called Lurie systems — is one of these approaches. Early contributions indicated how linear analysis tools could be generalized to nonlinear systems and were first applied to the interconnections of linear time-invariant systems and sector-bounded nonlinearities. These methods proposed stability conditions and provided insightful ways to assess closed-loop behavior for classes of nonlinearities.

However, in practice, the nonlinearities are either known or belong to subsets of the sector descriptions used as surrogates. Examples from practical control systems are actuator nonlinearities such as saturations, deadzones, quantization, relays, hysteresis. For this reason, the sector models become only a rough representation of the actual nonlinear elements. The unavoidable consequences of replacing specific nonlinearities by sector models is that we may only obtain conservative estimates of stability bounds, regions of attraction, and induced gains. Concerning control design, the use of sector only information may lead to feedback laws that underperform with the nonlinear actuators, or some optimal performance is only met in a reduced operating set.

One successful approach to reduce the set of nonlinearities by narrowing down the sector, was proposed for the saturation nonlinearity [89, 164]. The local sector conditions allow to obtain invariant sets as estimates of the region of attraction of the origin as level sets of quadratic Lyapunov functions. The Lyapunov stability theory methods are perhaps the most straightforward and versatile stability analysis and control design methods for nonlinear systems. They allow to assess the robustness of solutions, to evaluate regional stability, and to evaluate performance degradation according to the levels of disturbances.

The stability conditions based on the theory introduced by Lyapunov were initially solved analytically, and, more recently, thanks to the advances in convex optimization, they could also be solved numerically. The interest in obtaining a Lyapunov Function (LF) numerically was already pointed out in [104]

actually the “second method” is more accurately described as a point of view, a philosophy of approach, rather than a systematic method. At present, much depends on the ingenuity of the user. In the future, we can hope that systematic procedures will be made possible by machine computation.

However, obtaining numerical solutions depends on a parametrization of the stability certificates — the Lyapunov functions — by a finite number of parameters. The classical and simplest parametrization is the quadratic function, of which the existence is necessary and sufficient for the stability of linear systems. Unfortunately, quadratic functions are of limited interest whenever studying the stability of systems containing specific nonlinearities from which we can obtain a more detailed description than with sector inequalities. Defining the class of functions giving necessary and sufficient stability conditions for specific nonlinearities might be difficult. The reason for this is that the converse theorems leading to suitable classes of Lyapunov functions require the knowledge of the solutions of the systems, which are, in general, difficult to obtain for nonlinear systems. Therefore, these converse results are scarce, and most of the proposals for Lyapunov functions candidates yield only sufficient stability conditions.

For some systems, it is nonetheless possible to establish properties of the desired classes of LF. For instance, the characterization of the LFs is possible in the case of sector inequalities with arbitrary variations or switching systems [127]. The parametrization for numerical computations may not be immediate though. In the specific case of uncertain systems, a convex optimization approach can be obtained using homogeneous polynomials as LF and Sum-of-Squares program-

ming [33]. Other classes of homogeneous functions have also been proposed, piecewise affine (PWA) functions for example.

Regarding the numerical computation of Lyapunov functions, linear programming and semi-definite programming were used to obtain stability certificates and performance assessment for nonlinear systems. These methods are based on the computation of LF parameters by setting the Lyapunov inequalities as constraints of an optimization problem. In comparison to analytical approaches solving Lyapunov or (generalizations of) Riccati equation, the solution to inequalities make possible to assess input-output properties, to introduce decay rate bounds, and to treat of uncertainties using differential inclusions in a straightforward manner.

More sophisticated LF candidates and the formulations of conditions to check the associated inequalities may take advantage of the information on the nonlinearity. With more general class of LF (or storage function) and the detailed description of the nonlinearity we may expect to obtain better performance estimates of reachable sets, nonlinear gains, and estimates of the basin of attraction.

On the other hand, nonlinearities may also be introduced by the control laws to improve the system's performance or for constraint handling. The use of optimization-based approaches for constraint handling might seem disconnected from more classical static feedbacks strategies. They have, however, been shown to belong to the class of piecewise affine (PWA) of nonlinear functions [16]. A unified view of these optimization based approaches as Model Predictive Control with the more classical approaches to treat the input saturation, such as the anti-windup compensator is still missing. In this manuscript we present mathematical tools leading to a common framework for the analysis of input-constrained systems, namely a PWA modelling and the description of the model in terms of a single affine function, the ramp function. Finally, the study of switched dynamics and their closed-loop strategies [152] has not been considered within the Lurie systems framework. We indicate how we plan to tie these classes of systems using the PWA system analysis presented here.

Outline of the manuscript

The manuscript is organized into two parts. Each part starts with an introduction where the motivation the studied problems is presented and a brief literature review is provided. Each part has two chapters and the first part also presents *Notes and References* for a more thorough review of the litterature on the absolute stability problem.

Part I presents results for the analysis of the sector and slope-restricted nonlinearities. For continuous- and discrete-time systems, we have proposed LF structures that encompasses the existing ones in the literature. The results also include the regional stability analysis with strategies to estimate the region of attraction of the origin.

Chapter 1 presents a numerical formulation to treat slope-restricted nonlinearities with generalized quadratic plus integral terms. The main contribution of this work was to highlight that more straightforward conditions on the parameters of the Lyapunov function can be obtained, thus relaxing conditions the function parameters given by matrices and coefficients. Surprisingly, the relaxed positivity constraints of the generalized quadratic matrix we proposed, trace back to [185]. To our knowledge, they had not been used with optimization-based methods for stability analysis.

In a similar vein, but for discrete-time settings, in Chapter 2, we present recent results on the generalization of Tsyppkin criterion for slope restricted and monotone nonlinearities. Differently from the continuous time-case where the integral term appears naturally, the integral terms appear to replace an infinite sum. Monotonicity of the nonlinearity is required to treat these integral terms of the LF. The conditions on the parameters of a Lyapunov function for its positivity simplify existing results in the literature.

Part II presents the stability analysis for classes of PWA discrete-time systems. These results are built upon an implicit representation of the vector field. This implicit representation is described in terms of ramp functions and an algebraic loop.

Chapter 3 considers the analysis of PWA systems. The main contrast with the literature is on the representation of the PWA systems. Our main argument in this chapter is that a suitable representation based on ramp functions can lead to more straightforward stability and robustness analysis tools.

Chapter 4 considers the analysis of systems with input quantization. The key result in this chapter is to show that the quantization is obtained from an ill-posed algebraic loop involving two ramps. Thanks to the “two-ramp” model for the step, we formulate stability conditions for

set-valued maps, that are solved numerically using the same tools as the ones used in the analysis of continuous PWA systems.

The manuscript ends with the exposition of some ongoing works and perspectives and a conclusion summarizing the presented material.

Part I

Lurie Systems with sector and slope restricted nonlinearities

Introduction of Part I

The stability analysis of feedback loops consisting of linear time-invariant systems and sector bounded nonlinearities is known as the *absolute stability problem*. The stability of the origin of this feedback interconnection can be studied via the passivity properties of its elements; in particular, two celebrated results are given by the Circle and Popov criteria [107], where the only assumption on the nonlinearity is that it belongs to a sector. This problem has its roots in [122] and its importance is evident since actuator devices in control loops are modeled, in general, as static nonlinearities.

Assuming that the nonlinearity is only sector-bounded might be overly conservative whenever the nonlinearities are known, or their slopes can be bounded. The study of the class of slope-restricted nonlinear systems using the framework of absolute stability theory was first proposed in two papers; a frequency domain condition given in [52] and a geometrical condition based upon the construction of a Lyapunov function (LF) in [185]. When compared to conditions of the sector-bounded only case, it is noted that the conditions on the parameters of the LF to guarantee its positivity were already relaxed in [185].

In addition to the Lyapunov functions associated with the Circle and Popov criteria, different LFs have been proposed for studying Lurie systems: composite LFs [87]; LFs with quadratic components on both the nonlinearities and the states and Lurie-Postnikov terms were studied in [185, 159, 133, 171]. For the quadratic LFs associated with the Circle criterion, the positivity of the LF is enforced with a positive-definite Lyapunov matrix [107]. In the case of LFs with a Lurie-Postnikov type term, associated with the Popov criterion, the positivity of the LF requires the positivity of the Lyapunov matrix and imposes the positivity of the coefficients in the Lurie-Postnikov integral terms for sector-bounded nonlinearities.

For the case of nonlinearities that are sector- and slope- bounded in a set containing the origin, we can obtain *local* certificates for gains, reachable sets, and estimates of the basin of attraction. Thanks to a local characterization of the nonlinearities, we can obtain tighter estimates of gain properties and study nonlinearities with unbounded discontinuities. Examples of systems modeled with unbounded nonlinearities include the driven Stirling engine [80] and electrical energy storage devices known as supercapacitors [54], modeled using the logarithm nonlinearity. Estimates of regions of attraction for sector bound nonlinear systems obtained with the Popov criterion have been considered in [179, 177, 150], and more recently in [84] using Semidefinite Programming (SDP), the same type of numerical stability conditions we pursue in this part.

A fundamental difference in the study of continuous- and discrete-time Lurie systems is that, for the global stability of DT systems, the least conservative Lyapunov function without assumptions on the slope is the quadratic function. It is thus fair to say that there remain gaps in the understanding of the absolute stability problem, which focuses on the stability analysis of Lurie systems. In particular, methods proposed for the stability analysis of discrete-time systems remain underdeveloped compared to those for continuous-time systems; for example, the widely adopted formulation of the Popov criterion in discrete time requires extra conditions on the nonlinearity, including monotonicity [169].

Several recent applications, including the stability analysis of neural network-based control policies [36] and the convergence analysis of first-order optimization algorithms [115], can be understood within the context of discrete-time Lurie systems. These applications' impact has motivated us to revisit the absolute stability problem in discrete time to improve its theoretical understanding. Such a better understanding should allow even more complex classes of systems to be analyzed with less conservative performance certificates to be obtained.

This part also explores the stability analysis of discrete-time Lurie systems with slope-restricted nonlinearities as a step in this direction. A new class of Lyapunov function is proposed with a simplified structure than the current state-of-the-art [132, 27] and conditions are developed for the regional stability analysis and bounding input-output gains of these systems.

Summary of contributions of Part I

The results presented in this part focus on the local analysis of Lurie-type systems with slope-restricted nonlinearities. We develop quadratic LFs in both the state and the nonlinear terms and contain Lurie-Postnikov integral terms. We present conditions for the positivity of the LF that *do not impose* the positivity of the Lurie-Postnikov terms coefficients nor require that the quadratic terms on the nonlinearities are positive definite. We also present connections between our results and recent results in the literature that use similar LF structures.

The presented conditions for stability analysis and gain assessment are cast as dissipation inequalities. These inequalities are obtained upon inequalities associated with the sector and the slope bounds. In cases where the sector inequalities hold only locally, we discuss how to guarantee the inclusion of level sets in the region where the sector inequalities hold. These inclusion conditions allow us to estimate the region of attraction using contractive and invariant sets defined by some level sets of the computed LF. This allows us to analyze the effect of additive exogenous inputs and outputs to derive conditions for the computation of reachable sets and local induced gains.

Structure of Part I

Chapter 1 studies Lurie systems in *continuous time*. These systems are assumed to have local bounds for both sector and slope. We characterize these sector and slope bounds in terms of inequalities which are used to verify Lyapunov inequalities. The regional analysis is then performed thanks to inclusions conditions to guarantee that the level sets of the computed LF are within the set where the bounds hold. Importantly, we treat feedbacks containing direct transmission terms. We thus generalized conditions for the well-posedness of the algebraic loops containing sector and slope bounds. We also highlight the constraints of the convex optimization formulation used to illustrate the results with numerical examples.

In **Chapter 2**, we present strategies for the local stability analysis of *discrete-time* Lurie systems. Here, we provide a different Lyapunov function candidate than the one used in the continuous-time case for systems with slope restriction. The proposed function is built by considering the propagation from a point taken as the initial condition of the dynamics and considers a quadratic form with the nonlinearities with several integral terms, thus generalizing the Tsytkin structure [167, 161]. The presented results generalize the LF structures existing in the literature with a reduced number of parameters in the LF. For clarity of presentation, we consider only the single-input and the single-output case without direct transmission terms in the feedback. The semidefinite programming formulations allow us to obtain numerical examples to illustrate the proposed stability conditions.

This part ends with **Notes and References** providing a bibliography review in the study of Lurie systems. This review focuses on the global and local stability analysis of Lurie systems. It discusses results using leading to convex optimization-based conditions, thereby providing a perspective on how the contents of the two chapters in this part relate to the literature on the topic.

Chapter 1

Analysis of Continuous-time Slope-Restricted Lurie Systems

1.1 Problem statement

Consider the linear time-invariant (LTI) system

$$\begin{cases} \dot{x} &= Ax + B\phi(y) + B_w w \\ y &= Cx + D\phi(y) + D_w w \\ z &= C_z x + D_z \phi(y) + D_{zw} w \end{cases} \quad (1.1)$$

with $x \in \mathbb{R}^n$, $y \in \mathbb{R}^m$, $w \in \mathbb{R}^{m_w}$, $A \in \mathbb{R}^{n \times n}$, $B \in \mathbb{R}^{n \times m}$, $B_w \in \mathbb{R}^{n \times m_w}$, $C \in \mathbb{R}^{p \times n}$, $D \in \mathbb{R}^{p \times m}$, $D_w \in \mathbb{R}^{p \times m_w}$, $C_z \in \mathbb{R}^{p_z \times n}$, $D \in \mathbb{R}^{p_z \times m}$, $D_w \in \mathbb{R}^{p_z \times m_w}$.

The nonlinearity $\phi : \mathcal{Y} \rightarrow \mathbb{R}^m$, $\mathcal{Y} \subseteq \mathbb{R}^m$, is assumed to be *time-invariant*, *memoryless*, *Lipschitz* on \mathcal{Y}° , *decentralized*

$$\phi(y) = [\phi_1(y_1) \quad \phi_2(y_2) \quad \dots \quad \phi_m(y_m)]^\top, \quad (1.2a)$$

sector bounded

$$\frac{\phi_i(y_i)}{y_i} \in [\underline{\delta}_i, \bar{\delta}_i] \quad \forall y \in \mathcal{Y}_0 \subseteq \mathcal{Y} \quad (1.2b)$$

which implies $\phi(0) = 0$, $\underline{\delta}_i \in \mathbb{R}$, $\bar{\delta}_i \in \mathbb{R}$, and *slope restricted*

$$\partial\phi_i(y_i) \in [\underline{\gamma}_i, \bar{\gamma}_i] \quad \forall y \in \mathcal{Y}_0 \subseteq \mathcal{Y}, \quad (1.2c)$$

where $\underline{\gamma}_i \leq \underline{\delta}_i$ and $\bar{\delta}_i \leq \bar{\gamma}_i$. We also introduce the matrices

$$\underline{\Delta} := \text{diag}(\underline{\delta}_1, \dots, \underline{\delta}_m),$$

$$\bar{\Delta} := \text{diag}(\bar{\delta}_1, \dots, \bar{\delta}_m),$$

$$\underline{\Gamma} := \text{diag}(\underline{\gamma}_1, \dots, \underline{\gamma}_m),$$

$$\bar{\Gamma} := \text{diag}(\bar{\gamma}_1, \dots, \bar{\gamma}_m),$$

to compactly express the sector and slope bounds. The Lipschitz assumption on ϕ implies that $\partial\phi_i(y_i) = \frac{d\phi_i}{dy_i}$ almost everywhere, relaxing the requirement for the nonlinearity to be continuously differentiable [171, Section 2].

1.1.1 Conditions for Well Posedness of the algebraic loop

The well posedness of the algebraic loop in (1.1) is guaranteed if there exists a unique solution to the implicit equation $F(y) := y - D\phi(y) = \zeta$, that is, a mapping $y(\zeta)$ satisfying $F(y(\zeta)) = \zeta$. Following [187, Claim 1], for functions ϕ that are differentiable almost everywhere, the well-posedness of the loop is obtained if $JF(y)$, the Jacobian of F , where it is defined, belongs to a compact and convex set of invertible matrices for almost all values of y (see [187, Proposition 2]).

The Jacobian of $F(y)$ is given by $JF(y) = I - D\phi(y)$ a.e.. Thanks to the slope restriction of $\phi(y)$ in (1.2c), for almost all y , $JF(y) \in \mathcal{M} := \overline{\text{co}}\{I - D\Gamma, \Gamma \in \mathcal{G}\}$, where

$$\mathcal{G} := \left\{ \Gamma \in \mathbb{D} : \Gamma = \text{diag}(\gamma_1, \gamma_2, \dots, \gamma_m), \gamma_i \in [\underline{\gamma}_i, \bar{\gamma}_i], \forall i \right\}$$

and $\overline{\text{co}}(\mathcal{A})$ denotes the closed convex hull of the set \mathcal{A} . From the above description we have that the set \mathcal{M} is convex and compact, the proposition below sets conditions for the matrices in the set \mathcal{M} to be nonsingular, thus guaranteeing that the solution to the algebraic loop exists and is unique. The only difference to the reasoning presented in [187, Proposition 2] is given by conditions related to the non-singularity of the Jacobian of $F(y)$.

Proposition 1.1

Given a matrix $D \in \mathbb{R}^{m \times m}$, if there exists a matrix $W \in \mathbb{D}_{\geq 0}^m$ such that $2W - W(I - D\underline{\Gamma})^{-1}D(\overline{\Gamma} - \underline{\Gamma}) - (\overline{\Gamma} - \underline{\Gamma})D^T W((I - D\underline{\Gamma})^{-1})^T > 0$ then $I - D\Gamma$ is nonsingular for all matrices Γ belonging to the set \mathcal{G} .

Proof. If $(I - D\Gamma)$ is singular then there exists $z \in \mathbb{R}^m$, $z \neq 0$ such that $0 = (I - D\Gamma)z = ((I - D\underline{\Gamma}) - D(\Gamma - \underline{\Gamma}))z = (I - D\underline{\Gamma})z - D(\overline{\Gamma} - \underline{\Gamma})(\overline{\Gamma} - \underline{\Gamma})^{-1}(\Gamma - \underline{\Gamma})z$. Define $\bar{z} = (\overline{\Gamma} - \underline{\Gamma})^{-1}(\Gamma - \underline{\Gamma})z$ to obtain

$$(I - D\underline{\Gamma}) [z - (I - D\underline{\Gamma})^{-1}D(\overline{\Gamma} - \underline{\Gamma})\bar{z}] = 0.$$

Multiply the above expression on the left by $\bar{z}^T W(I - D\underline{\Gamma})^{-1}$, to obtain

$$\bar{z}^T W z - \bar{z}^T W(I - D\underline{\Gamma})^{-1}D(\overline{\Gamma} - \underline{\Gamma})\bar{z} = 0.$$

Since for $\underline{\gamma}_i \leq \gamma_i \leq \overline{\gamma}_i$, $1 \geq (\overline{\gamma}_i - \underline{\gamma}_i)^{-1}(\gamma_i - \underline{\gamma}_i) \geq 0$ we have $\bar{z}^T W z = z^T (\overline{\Gamma} - \underline{\Gamma})^{-1}(\Gamma - \underline{\Gamma})W z \geq z^T (\overline{\Gamma} - \underline{\Gamma})^{-2}(\Gamma - \underline{\Gamma})^2 W z = \bar{z}^T W \bar{z}$. Thus, if $(I - D\Gamma)$ is singular we must have

$$\bar{z}^T \left(W - \frac{1}{2} \text{He}(W(I - D\underline{\Gamma})^{-1}D(\overline{\Gamma} - \underline{\Gamma})) \right) \bar{z} \leq 0,$$

which contradicts the inequality of the claim. Hence if the inequality in the claim holds the matrix $(I - D\Gamma)$ is non-singular for any $\Gamma \in \mathcal{G}$. \square

From the above result, the following assumption on matrix D and bounds $\overline{\Gamma}$ and $\underline{\Gamma}$, will guarantee the well-posedness of the algebraic loop.

Assumption 1.1: Well-posedness

There exists a matrix $W \in \mathbb{D}_{\geq 0}^m$ such that

$$2W - \text{He}(W(I - D\underline{\Gamma})^{-1}D(\overline{\Gamma} - \underline{\Gamma})) > 0. \quad (1.3)$$

Provided Assumption 1.1 holds, we can define the following set

$$\mathcal{X}_0 := \{x \in \mathbb{R}^n \mid y \in \mathcal{Y}_0, F(y) = Cx\}, \quad (1.4)$$

where $\mathcal{Y}_0 \subseteq \mathcal{Y} \subseteq \mathbb{R}^m$ corresponds to the set where the sector and the slope restrictions hold, as defined in (1.2). We also define the following set

$$\mathcal{XW}_0 := \{(x, w) \in \mathbb{R}^n \times \mathbb{R}^{m_w} \mid y \in \mathcal{Y}_0, x \in \mathcal{X}_0, F(y) = Cx + D_w w\}. \quad (1.5)$$

Under Assumption 1.1, this chapter provides a solution to the following problem.

Problem 1.1

For system (1.1) with ϕ satisfying (1.2):

- For $w \equiv 0$, certify the stability of the origin with an estimate of the region of attraction (ERA) contained in \mathcal{X}_0 ;
- Compute reachable sets contained in \mathcal{X}_0 for disturbances satisfying $w \in \{w \in \mathcal{L}_2 \mid \|w\|_2 \leq \rho^{\frac{1}{2}}\}$, and $(x(t), w(t)) \in \mathcal{XW}_0$;
- Compute the (local) induced \mathcal{L}_2 gains between w and z , with $w \in \{w \in \mathcal{L}_2 \mid \|w\|_2 \leq \rho^{\frac{1}{2}}\}$, and $(x(t), w(t)) \in \mathcal{XW}_0$.

In case the sector and slope bounds (1.2b) and (1.2c) hold globally, i.e. $\mathcal{Y}_0 = \mathbb{R}^m$, global properties will be obtained by setting $\mathcal{X}_0 = \mathbb{R}^n$ and $\mathcal{XW}_0 \in \mathbb{R}^n \times \mathbb{R}^{m_w}$.

1.2 Sector inequalities

In this section we present inequalities related to the sector and slope bounds of the nonlinearities in system (1.1).

Define $s_1 : \mathbb{R}^{m \times m} \times \mathbb{R}^m \times \mathbb{R}^m \rightarrow \mathbb{R}$, $s_2 : \mathbb{R}^{m \times m} \times \mathbb{R}^m \times \mathbb{R}^m \rightarrow \mathbb{R}$, $s_3 : \mathbb{R}^{m \times m} \times \mathbb{R}^m \times \mathbb{R}^m \times \mathbb{R}^m \times \mathbb{R}^m \rightarrow \mathbb{R}$ as

$$\begin{aligned} s_1(T, \phi, \theta) &:= (\phi - \underline{\Delta}\theta) T (\overline{\Delta}\theta - \phi) \\ s_2(T, \phi, \theta) &:= (\phi - \underline{\Gamma}\theta) T (\overline{\Gamma}\theta - \phi) \\ s_3(T, \phi_1, \phi_2, \theta_1, \theta_2) &:= ((\phi_1 - \phi_2) - \underline{\Gamma}(\theta_1 - \theta_2)) T (\overline{\Gamma}(\theta_1 - \theta_2) - (\phi_1 - \phi_2)). \end{aligned}$$

The following lemma is associated with the sector boundedness of the functions ϕ_i .

Lemma 1.1

If $T_1 \in \mathbb{D}_{\geq 0}^m$ and $\phi : \mathbb{R}^m \rightarrow \mathbb{R}^m$ satisfies (1.2), then

$$s_1(T_1, \phi(\theta), \theta) \geq 0 \quad (1.6)$$

for all $\theta \in \mathcal{Y}_0$.

Proof. For $T_1 \in \mathbb{D}^m$ we have $s_1(T_1, \phi(\theta), \theta) = \sum_{i=1}^m T_{1(i,i)} (\phi_i(\theta_i) - \underline{\delta}_i \theta_i(x)) (\overline{\delta}_i \theta_i(x) - \phi_i(\theta_i))$.

$$s_1(T_1, \phi(\theta), \theta) = \sum_{i=1}^m T_{1(i,i)} (\phi_i(\theta) - \underline{\delta}_i \theta_i(x)) (\overline{\delta}_i \theta_i(x) - \phi_i(\theta_i)).$$

If ϕ satisfies (1.2a), (1.2b), we have $\left(\frac{\phi_i(\theta_i)}{\theta_i} - \underline{\delta}_i\right) \left(\overline{\delta}_i - \frac{\phi_i(\theta_i)}{\theta_i}\right) \geq 0$, which, when multiplied by θ_i^2 gives $(\phi_i(\theta_i) - \underline{\delta}_i \theta_i) (\overline{\delta}_i \theta_i - \phi_i(\theta_i)) \geq 0$, $i = 1, \dots, m$ for $\theta \in \mathcal{Y}_0$. Since $T_{1(i,i)} \geq 0$, and (1.2) hold then (1.6) holds for all $\theta \in \mathcal{Y}_0$. \square

In the following two lemmas, we consider $\theta : [0, \infty) \rightarrow \mathcal{Y}_0$, $\theta(t) \in \mathcal{C}^1(t)$ to obtain inequalities related to the slope restrictions (1.2c) of ϕ .

Lemma 1.2

If $T_2 \in \mathbb{D}_{\geq 0}^m$ and $\phi : \mathbb{R}^m \rightarrow \mathbb{R}^m$ satisfies (1.2), then

$$s_2(T_2, \dot{\phi}(\theta), \dot{\theta}) \geq 0 \quad (1.7)$$

almost everywhere for $\theta \in \mathcal{Y}_0$.

Proof. From (1.2c) we have $(\partial\phi_i(\theta_i) - \underline{\gamma}_i)(\overline{\gamma}_i - \partial\phi_i(\theta_i)) \geq 0$.

$$\left(\partial\phi_i - \underline{\gamma}_i\right) (\overline{\gamma}_i - \partial\phi_i) \geq 0.$$

Multiplying this expression by $\dot{\theta}_i^2$, gives

$$\begin{aligned} 0 &\leq \dot{\theta}_i^2 \left(\partial\phi_i(\theta_i) - \underline{\gamma}_i\right) (\overline{\gamma}_i - \partial\phi_i(\theta_i)) \\ &= \left(\partial\phi_i(\theta_i)\dot{\theta}_i - \underline{\gamma}_i\dot{\theta}_i\right) \left(\overline{\gamma}_i\dot{\theta}_i - \partial\phi_i(\theta_i)\dot{\theta}_i\right) \\ &= \left(\dot{\phi}_i(\theta_i) - \underline{\gamma}_i\dot{\theta}_i\right) \left(\overline{\gamma}_i\dot{\theta}_i - \dot{\phi}_i(\theta_i)\right). \end{aligned} \quad (1.8)$$

For $T_2 \in \mathbb{D}_{\geq 0}^m$ we have $s_2(T_2, \dot{\phi}(\theta), \dot{\theta}) = \sum_{i=1}^m T_{2(i,i)} \left(\dot{\phi}_i(\theta_i) - \underline{\gamma}_i\dot{\theta}_i(x)\right) \left(\overline{\gamma}_i\dot{\theta}_i(x) - \dot{\phi}_i(\theta_i)\right)$, and, from (1.8) then (1.7) holds. \square

Lemma 1.3

If $T_3 \in \mathbb{D}_{\geq 0}^m$ and $\phi : \mathbb{R}^m \rightarrow \mathbb{R}^m$ satisfies (1.2c), then

$$s_3(T_3, \phi(\theta_1), \phi(\theta_2), \theta_1, \theta_2) \geq 0 \quad (1.9)$$

for all $\theta_1, \theta_2 \in \mathcal{Y}_0$.

Proof. For $i = 1, \dots, m$, define

$$\begin{aligned}\hat{\phi}_{ai}(\theta_i) &:= (\phi_i(\theta_i) - \underline{\gamma}_i \theta_i), \\ \hat{\phi}_{bi}(\theta_i) &:= (\bar{\gamma}_i \theta_i - \phi_i(\theta_i)).\end{aligned}$$

Provided (1.2c) holds, then $\hat{\phi}_{ai}, \hat{\phi}_{bi}$ satisfy $\partial_{\theta_i} \hat{\phi}_{ai}(\theta_i) \geq 0$, $\partial_{\theta_i} \hat{\phi}_{bi}(\theta_i) \geq 0$, hence, for any $\theta_1, \theta_2 \in \mathcal{Y}_0$,

$$\frac{\hat{\phi}_{ai}(\theta_{1i}) - \hat{\phi}_{ai}(\theta_{2i})}{\theta_{1i} - \theta_{2i}} \geq 0, \quad \frac{\hat{\phi}_{bi}(\theta_{1i}) - \hat{\phi}_{bi}(\theta_{2i})}{\theta_{1i} - \theta_{2i}} \geq 0. \quad (1.10)$$

For $T_3 \in \mathbb{D}_{\geq 0}^m$ we have

$$\begin{aligned}s_3(T_3, \phi(\theta_1), \phi(\theta_2), \theta_1, \theta_2) &= \sum_{i=1}^m T_{3(i,i)} \left((\phi_i(\theta_{1i}) - \phi_i(\theta_{2i})) - \underline{\gamma}_i (\theta_{1i} - \theta_{2i}) \right) (\bar{\gamma}_i (\theta_{1i} - \theta_{2i}) - (\phi_i(\theta_{1i}) - \phi_i(\theta_{2i}))) \\ &= \sum_{i=1}^m T_{3(i,i)} \left(\hat{\phi}_{ai}(\theta_{1i}) - \hat{\phi}_{ai}(\theta_{2i}) \right) \left(\hat{\phi}_{bi}(\theta_{1i}) - \hat{\phi}_{bi}(\theta_{2i}) \right) \\ &= \sum_{i=1}^m T_{3(i,i)} (\theta_{1i} - \theta_{2i})^2 \left(\frac{\hat{\phi}_{ai}(\theta_{1i}) - \hat{\phi}_{ai}(\theta_{2i})}{\theta_{1i} - \theta_{2i}} \right) \left(\frac{\hat{\phi}_{bi}(\theta_{1i}) - \hat{\phi}_{bi}(\theta_{2i})}{\theta_{1i} - \theta_{2i}} \right)\end{aligned}$$

Since $T_{3(i,i)} \geq 0$ and (1.10) hold, then (1.9) holds. \square

The above lemma shows that the slope restriction with non-negative bounds satisfies the *incremental sector boundedness property* [191, Definition 1].

1.3 Regional Stability Analysis, Reachable Sets and Nonlinear Gains

This section is concerned with functions of the form

$$V(x) = V_0(x) + \sum_{i=1}^m \lambda_i \int_0^{\tilde{y}_i(x)} (\phi_i(s) - \underline{\delta}_i s) ds, \quad (1.11a)$$

where

$$V_0(x) = \begin{bmatrix} x \\ \phi(\tilde{y}(x)) \end{bmatrix}^T \begin{bmatrix} P_{11} & P_{12} \\ P_{12}^T & P_{22} \end{bmatrix} \begin{bmatrix} x \\ \phi(\tilde{y}(x)) \end{bmatrix}, \quad (1.11b)$$

and \tilde{y} is the the solution of the implicit equation

$$\tilde{y} - D\phi(\tilde{y}) = Cx. \quad (1.11c)$$

with $P_{11} \in \mathbb{R}^{n \times n}$, $P_{12} \in \mathbb{R}^{n \times m}$, $P_{22} \in \mathbb{R}^{m \times m}$ and $\lambda \in \mathbb{R}^m$. These functions will be considered as Lyapunov candidate functions for system (1.1). We refer to the integral terms in (1.11a) as the *Lurie-Postnikov terms*. For the sake of compactness of notation we use $\tilde{\phi}$ to denote $\phi(\tilde{y}(x))$.

One straightforward way to enforce the positivity of $V(x)$ is to impose $P > 0$ and $\lambda_i \geq 0$. The lemma below, instead, gives conditions for V to be positive definite without imposing positive-definiteness of P , nor the non-negativity of the coefficients λ_i . The lemma uses only the sector properties of the nonlinearity ϕ . In [134, 82, 5], the relaxation of the non-negativity of the coefficients λ_i however in these references, V_0 was considered with $P_{12} = 0$, $P_{22} = 0$.

Lemma 1.4

Consider V in (1.11) defined by some $P_{11} \in \mathbb{R}^{n \times n}$, $P_{12} \in \mathbb{R}^{n \times m}$, $P_{22} \in \mathbb{R}^{m \times m}$ and $\lambda \in \mathbb{R}^m$ and where ϕ satisfies (1.2a)-(1.2b) and Assumption 1.1 holds. With $\Lambda := \text{diag}(\lambda_1, \dots, \lambda_m)$, if there exists a matrix $\tilde{\Lambda} \in \mathbb{D}_{\geq 0}^m$ such that

$$\Lambda \geq -\tilde{\Lambda}, \quad (1.12a)$$

$$V_0(x) - \frac{1}{2} \tilde{y}^T(x) (\bar{\Delta} - \underline{\Delta}) \tilde{\Lambda} \tilde{y}(x) > 0, \quad \forall x \in \mathcal{X}_0 \setminus \{0\}, \quad (1.12b)$$

then $V(x) > 0, \forall x \in \mathcal{X}_0 \setminus \{0\} \subset \mathbb{R}^n$.

Proof. Use (1.12a) to obtain a positive-definite lower bound for (1.11a) as follows. If Assumption 1.1 holds, the mapping $\tilde{y} : \mathcal{X}_0 \rightarrow \mathcal{Y}_0$ is well defined. We can then prove that $V(x)$ is positive-definite in \mathcal{X}_0 by obtaining a positive-definite lower bound as follows

$$\begin{aligned}
V(x) &= V_0(x) + \sum_{i=1}^m \lambda_i \int_0^{\tilde{y}_i(x)} (\phi_i(s) - \underline{\delta}_i s) ds \\
&\geq V_0(x) - \sum_{i=1}^m \tilde{\lambda}_i \int_0^{\tilde{y}_i(x)} (\phi_i(s) - \underline{\delta}_i s) ds \\
&= V_0(x) - \frac{1}{2} \tilde{y}^T(x) (\bar{\Delta} - \underline{\Delta}) \tilde{\Lambda} \tilde{y}(x) - \sum_{i=1}^m \tilde{\lambda}_i \int_0^{\tilde{y}_i(x)} (\phi_i(s) - \underline{\delta}_i s) ds \\
&= V_0(x) - \frac{1}{2} \tilde{y}^T(x) (\bar{\Delta} - \underline{\Delta} - \underline{\Delta}) \tilde{\Lambda} \tilde{y}(x) - \sum_{i=1}^m \tilde{\lambda}_i \int_0^{\tilde{y}_i(x)} \phi_i(s) ds \\
&= V_0(x) - \frac{1}{2} \tilde{y}^T(x) (\bar{\Delta} - \underline{\Delta}) \tilde{\Lambda} \tilde{y}(x) + \sum_{i=1}^m \tilde{\lambda}_i \int_0^{\tilde{y}_i(x)} ((\bar{\delta}_i s - \phi_i(s))) ds \\
&= \underbrace{V_0(x) - \frac{1}{2} \tilde{y}^T(x) (\bar{\Delta} - \underline{\Delta}) \tilde{\Lambda} \tilde{y}(x)}_{>0 \text{ from (1.12b)}} + \underbrace{\sum_{i=1}^m \tilde{\lambda}_i \int_0^{\tilde{y}_i(x)} (\bar{\delta}_i s - \phi_i(s)) ds}_{\geq 0 \text{ from } \bar{\lambda} \geq 0 \text{ and (1.2b)}}.
\end{aligned} \tag{1.13}$$

□

The following theorem presents conditions for the stability of the origin of Lurie system (1.1) with slope-restricted nonlinearities:

Theorem 1.1

For nonlinearities ϕ satisfying (1.2) if there exists a matrix $P \in \mathbb{R}^{(n+m) \times (n+m)}$, matrices $\Lambda \in \mathbb{D}^m$, $\tilde{\Lambda}, T_j \in \mathbb{D}_{\geq 0}^m$, $j \in \{0, \dots, 4\}$, and a scalar $\rho > 0$ such that (1.12a) holds,

$$V_0(x) - \frac{1}{2} \tilde{y}^T(x) (\bar{\Delta} - \underline{\Delta}) \tilde{\Lambda} \tilde{y}(x) - s_1(T_0, \tilde{\phi}, \tilde{y}(x)) > 0 \tag{1.14a}$$

$\forall x \in \mathbb{R}^n, \tilde{\phi} \in \mathbb{R}^m,$

$$\begin{aligned}
- \left\langle \begin{bmatrix} \nabla_x V \\ \nabla_{\tilde{\phi}} V \end{bmatrix}, \begin{bmatrix} \dot{z} \\ \dot{\phi} \end{bmatrix} \right\rangle - \Psi(z, w) - s_1(T_1, \tilde{\phi}, \tilde{y}(x)) - s_1(T_2, \phi, y(x, w)) - s_2(T_3, \dot{\phi}, \dot{\tilde{\phi}}, \phi, w) \\
- s_3(T_4, \tilde{\phi}, \phi, \tilde{y}(x), y(x, w)) > 0
\end{aligned} \tag{1.14b}$$

$\forall x \in \mathbb{R}^n, \phi \in \mathbb{R}^m, \tilde{\phi} \in \mathbb{R}^m, \dot{\phi} \in \mathbb{R}^m, w \in \mathbb{R}^{m_w}$ and

$$\mathcal{E}(V, \rho) \subseteq \mathcal{X}_0 \tag{1.14c}$$

hold with

- a) $\Psi \equiv 0$ and $w \equiv 0$ (which gives $\tilde{\phi} = \phi$ so that $s_3 \equiv 0$ and allows us to set $T_2 = 0$);
- b) $\Psi(z, w) = w^T w$;
- c) $\Psi(z, w) = w^T w - \eta^{-2} z^T z$;

then

- a) (stability) the origin of (1.1) is locally asymptotically stable and $\mathcal{E}(V, \rho)$ is an estimate of its region of attraction. In the case $\mathcal{X}_0 = \mathbb{R}^n$, the origin is globally asymptotically stable.
- b) (reachable set) $x(0) = 0$ and $\|w\|_2 \leq \rho^{\frac{1}{2}}$, $(x(t), w(t)) \in \mathcal{XW}_0$, so that $x(t) \in \mathcal{E}^\circ(V, \rho)$ for all $t \geq 0$;
- c) (local finite \mathcal{L}_2 -gain) $x(0) = 0$ and $\|w\|_2 \leq \rho^{\frac{1}{2}}$, $(x(t), w(t)) \in \mathcal{XW}_0$, imply $\|z\|_2 < \eta \|w\|_2$, that is, the induced \mathcal{L}_2 gain from w to z is bounded by η for every input satisfying $\|w\|_2 \leq \rho^{\frac{1}{2}}$.

Proof. If (1.14a) holds,

$$V_0(x) - \frac{1}{2} \tilde{y}^T(x) (\bar{\Delta} - \underline{\Delta}) \tilde{\Lambda} \tilde{y}(x) > s_1(T_0, \tilde{\phi}, \tilde{y}(x))$$

from Lemma 1.1 and $s_1(T_0, \phi(\tilde{y}), \tilde{y}) \geq 0$ holds for all $x \in \mathcal{X}_0$, thus (1.12b) holds. Following Lemma 1.4 if (1.12a) also holds, then $V(x) \geq 0, \forall x \in \mathcal{X}_0$.

We use $\dot{V}(x, \tilde{\phi}, \dot{\tilde{\phi}}, \phi, w)$ to express the time-derivative of $V(x)$ along the trajectories of (1.1)

$$\dot{V}(x, \tilde{\phi}, \dot{\tilde{\phi}}, \phi, w) = \left\langle \begin{bmatrix} \nabla_x V \\ \nabla_{\tilde{\phi}} V \end{bmatrix}, \begin{bmatrix} Ax + B\phi + B_w w \\ \dot{\tilde{\phi}} \end{bmatrix} \right\rangle.$$

From (1.14b) we have

$$-\dot{V}(x, \tilde{\phi}, \dot{\tilde{\phi}}, \phi, w) - \Psi(z, w) > s_1(T_1, \tilde{\phi}, \tilde{y}(x, \tilde{\phi})) + s_1(T_2, \phi, y(x, \phi, w)) + s_2(T_3, \dot{\tilde{\phi}}, \dot{\tilde{y}}(x, \dot{\tilde{\phi}}, \phi, w)) \\ + s_3(T_4, \tilde{\phi}, \phi, \tilde{y}(x, \tilde{\phi}), y(x, \phi, w)).$$

If (1.2) holds, the relations in Lemmas 1.1-1.3 give

$$-\dot{V}(x, \tilde{\phi}, \dot{\tilde{\phi}}, \phi, w) - \Psi(z, w) > 0, \quad \forall x \in \mathcal{X}_0. \quad (1.15)$$

Thus if

- a) $\Psi(z, w) \equiv 0$, we have that \dot{V} is negative for all $x \in \mathcal{X}_0$. Since from (1.14c) the time-derivative of V is negative along the trajectories of system (1.1) provided the sector inequalities hold, that is, provided the trajectories belong to the set \mathcal{X}_0 which, from (1.14c) contains the set $\mathcal{E}(V, \rho)$. Following [107, Theorem 4.1], with (1.14a) and (1.14b) that hold in the sublevel set, $\mathcal{E}(V, \rho)$ is an invariant and contractive set and hence provides an estimate of the region of attraction of (1.1).
- b) $\Psi(z, w) = -w^T w$, $x_0 = 0$, integrate (1.15) from 0 to t^* to obtain $\int_0^{t^*} w^T(\tau)w(\tau)d\tau > V(t^*)$ since $V(0) = 0$. Hence, provided $\|w\|_2^2 = \int_0^{t^*} w^T(\tau)w(\tau)d\tau \leq \rho$ we have that $x(t^*) \in \mathcal{E}^\circ(V(x), \rho)$. From (1.14c) the sector inequalities hold so (1.14a) and (1.14b) hold.
- c) $\Psi(z, w) = -w^T w + \eta^{-2} z^T z$ and $x_0 = 0$, integrate from 0 to t^* to obtain $\int_0^{t^*} w^T(\tau)w(\tau)d\tau > \int_0^{t^*} \eta^{-2} z^T(\tau)z(\tau)d\tau + V(x(t^*))$. Since $V(x(t^*)) \geq 0$, then $\|w\|_2^2 > \eta^{-2} \|z\|_2^2$ for any $t^* \in [0, \infty)$. From $\|w\|_2 \leq \rho^{\frac{1}{2}}$ and $\int_0^{t^*} \eta z^T(\tau)z(\tau)d\tau \geq 0$ the above inequality implies $V(x(t^*)) < \rho$, thus from (1.14c) we have $x(t^*) \in \mathcal{X}_0$ for any $t^* \in [0, \infty)$, hence (1.14a) and (1.14b) hold for $\|w\|_2 \leq \rho^{\frac{1}{2}}$.

□

Remark 1.1

The use of Lemma 2 in the proof of Theorem 1.1, requires \tilde{y} to be differentiable. From (1.11c) we have $\frac{d\tilde{y}}{dt} = C \frac{dx}{dt} + D\partial\phi(\tilde{y}) \frac{d\tilde{y}}{dt}$, which can be written as $(I - D\partial\phi(\tilde{y})) \frac{d\tilde{y}}{dt} = C \frac{dx}{dt}$. Thus if $(I - D\partial\phi(\tilde{y}))$, is non-singular for all $\tilde{y} \in \mathcal{Y}_0$, $\frac{d\tilde{y}}{dt}$ exists and is given by $\frac{d\tilde{y}}{dt} = (I - D\partial\phi(\tilde{y}))^{-1} C \frac{dx}{dt}$. From Proposition 1.1 we have that Assumption 1.1 guarantees the invertibility of $(I - D\partial\phi(\tilde{y}))$ thus, the existence of $\frac{d\tilde{y}}{dt}$.

Note that the set inclusion (1.14c) is required to guarantee that the sector inequalities in Lemmas 1.1-1.3 hold so that (1.14b) implies (1.15). Moreover, from Assumption 1.1 and the fact that $(x(t), w(t)) \in \mathcal{XW}_0$ we have $y(t) \in \mathcal{Y}_0 \forall t \geq 0$. The condition on the disturbance $(x(t), w(t)) \in \mathcal{XW}_0$ can be dropped in two cases: 1) for $D_w = 0$, we have $\tilde{y} \equiv y$ and (1.14c) implies that $y(t) \in \mathcal{Y}_0$, for all $t \geq 0$; 2) for the case $\mathcal{Y}_0 = \mathbb{R}^m$, the inequalities from Lemmas 1.1-1.3 hold globally so (1.14c) is trivially satisfied.

A convenient property of the quadratic inequalities (1.14a)-(1.14b) is the affine dependence on $P, \Lambda, \tilde{\Lambda}, T_i, i = \{0, \dots, 4\}$. Whenever the inclusion (1.14c) is also formulated in terms of affine inequalities on these variables and the system matrices $(A, B, B_w, C, D, D_w, C_z, D_z, D_{zw})$ and the sector and slope bounds $\underline{\Delta}, \overline{\Delta}, \underline{\Gamma}, \overline{\Gamma}$ are given, we can set the problem of computing these variables as a convex semi-definite program. Numerical examples illustrate the solution to these convex semi-definite programs in Section 3.4 and the corresponding linear matrix inequalities (LMIs) are detailed in the Appendix.

1.3.1 Inclusion conditions

To satisfy local properties of (1.1) with Theorem 1.1 we have to guarantee the inclusion (1.14c). For sets of the form

$$\mathcal{X}_0 = \left\{ x \in \mathbb{R}^n \mid (\tilde{y}_j(x) - \underline{\tilde{y}}_j)(\tilde{y}_j(x) - \bar{\tilde{y}}_j) \leq 0, j = 1 \dots m \right\}, \quad (1.16)$$

a condition for the set inclusion is provided by the following lemma.

Lemma 1.5

If there exist scalars $\alpha_j > 0$ such that

$$-\alpha_j(\tilde{y}_j(x) - \underline{\tilde{y}}_j)(\tilde{y}_j(x) - \bar{\tilde{y}}_j) \geq (\rho - V(x)) \quad (1.17)$$

$j = 1, \dots, m$ then (1.14c) holds.

Proof. If the above inequality holds, then for all x satisfying $(\rho - V(x)) \geq 0$ the inequality $-(\tilde{y}_j(x) - \underline{\tilde{y}}_j)(\tilde{y}_j(x) - \bar{\tilde{y}}_j) \geq 0$ holds and $x \in \mathcal{X}_0 \forall x \in \mathcal{E}(V, \rho)$, hence the set inclusion. \square

For the function $V(x)$ in (1.11), the inequalities (1.17) become

$$-\alpha_j \tilde{y}_j \bar{\tilde{y}}_j - \rho + \alpha_j(\underline{\tilde{y}}_j + \bar{\tilde{y}}_j)\tilde{y}_j(x) - \alpha_j \tilde{y}_j^2(x) + V_0(x) + \sum_{i=1}^m \lambda_i \int_0^{\tilde{y}_i} \phi_i(s) - \underline{\delta}_i s \, ds \geq 0, \quad (1.18)$$

$j = 1, \dots, m$. The reason for expressing nonlinearities in quadratic-like forms is to frame the inclusion condition of Theorem 1.1 as a set of affine matrix inequalities on the unknown coefficients λ_i . Whenever only its bounds are given, as in (1.2b), consider $\tilde{\lambda}_i$ satisfying $\lambda_i \geq -\tilde{\lambda}_i$ to obtain the following lower bound for the Lurie-Postnikov terms in (1.18) (see (1.13))

$$\sum_{i=1}^m \lambda_i \int_0^{\tilde{y}_i} \phi_i(s) - \underline{\delta}_i s \, ds \geq -\frac{1}{2} \tilde{y}^T(x) (\bar{\Delta} - \underline{\Delta}) \tilde{\Lambda} \tilde{y}(x) \geq 0. \quad (1.19)$$

Finally, provided the inequalities

$$-\alpha_j \tilde{y}_j \bar{\tilde{y}}_j - \rho + \alpha_j(\underline{\tilde{y}}_j + \bar{\tilde{y}}_j)\tilde{y}_j(x) - \alpha_j \tilde{y}_j^2(x) + V_0(x) - \frac{1}{2} \tilde{y}^T(x) (\bar{\Delta} - \underline{\Delta}) \tilde{\Lambda} \tilde{y}(x) \geq 0, \quad (1.20)$$

$j = 1, \dots, m$, hold, we have that (1.18) holds and hence guarantees set inclusion (1.14c). A lower bound on the Lurie-Postnikov terms that guarantee inclusion conditions for sector nonlinearities similar to (1.19), was proposed in [84].

1.3.2 Discussion on the proposed Lyapunov Function

The function (1.11) was introduced in [185] to study single-input single-output (SISO) systems with slope-restricted nonlinearities satisfying $\underline{\gamma} = -\infty$ or $\bar{\gamma} = \infty$. The main result in [185] yields a graphical criterion involving the frequency response of the linear part. The same Lyapunov structure was used in [97] where the extension of the frequency domain criteria of [185] to the MIMO case was proposed. As pointed out above, neither the Lurie-Postnikov coefficient λ nor the corresponding P_{22} block (scalar in the SISO case) are required to be positive definite.

The use of function $V_0(x)$, with $\phi(\tilde{y})$ was proposed in [41] in the context of the analysis of systems with input saturation, where $\begin{bmatrix} P_{11} & P_{12} \\ P_{12}^T & P_{22} \end{bmatrix} > 0$ was used to enforce the positive definiteness of $V_0(x)$. Convex optimization based approaches using the quadratic-like term V_0 in (1.11) have also been proposed [159, 133, 171], although none of these references addresses the positivity of the LF as proposed by Lemma 1.4. In [159], the positivity of (1.11) is obtained by imposing $P > 0$ and $\Lambda > 0$ and the slope restriction is addressed by considering a norm-bounded inequality. In [133] and [171], the slope restriction is studied with the inequality of Lemma 1.2 and the proposed Lyapunov functions contain additional Lurie-Postnikov type terms with non-negative coefficients and impose $P \geq 0$ ($P > 0$ in [171]). The remark below shows that the additional terms on these references can be recast in the form (1.11) where the block P_{22} is not sign-defined.

Remark 1.2: Additional Lurie-Postnikov terms for slope-restricted nonlinearities

In [133] and [171], Lyapunov function structures containing the term $V_0(x)$ as in (1.11b) were studied for the stability and induced \mathcal{L}_2 gain analysis for system (1.1). When compared to (1.11a) the structures in [133] and [171] use additional integral terms. It is shown in [171] that some of the additional Lurie-Postnikov terms in [133] were redundant. We now discuss how (1.11a) compares with the LF of [171], which can be written as

$$\bar{V}(x) = \begin{bmatrix} x \\ \tilde{\phi} \end{bmatrix}^T \bar{P} \begin{bmatrix} x \\ \tilde{\phi} \end{bmatrix} + \sum_{j=1}^4 \sum_{i=1}^m \mu_{j,i} \int_0^{\tilde{y}_i(x)} \bar{g}_{j,i}(s) ds \quad (1.21)$$

where

$$\begin{aligned} \bar{g}_{1,i}(s) &= \phi_i(s), \\ \bar{g}_{2,i}(s) &= \bar{\delta}_i s - \phi_i(s), \\ \bar{g}_{3,i}(s) &= (\bar{\gamma}_i - \partial\phi_i(s)) s, \\ \bar{g}_{4,i}(s) &= \partial\phi_i(s) (\bar{\delta}_i s - \phi_i(s)), \end{aligned}$$

$\bar{P} > 0$, and $\mu_{j,i} \geq 0$, $i = 1, \dots, m$, $j = 1, \dots, 4$. For ϕ satisfying (1.2) with $\underline{\delta}_i = \underline{\gamma}_i = 0$, $i = 1, \dots, m$ we clearly have $g_{j,i}(x) \geq 0$, $j = 1, \dots, 4$, $i = 1, \dots, m$.

By using the relations

$$\begin{aligned} \int_0^{\tilde{y}_i} \phi_i(s) \partial\phi_i(s) ds &= \frac{1}{2} \phi_i^2(\tilde{y}_i) \\ \int_0^{\tilde{y}_i} \partial\phi_i(s) s ds &= \phi_i(\tilde{y}_i) \tilde{y}_i + \int_0^{\tilde{y}_i} \phi_i(s) ds, \end{aligned}$$

it is straightforward to obtain

$$\sum_{j=1}^4 \sum_{i=1}^m g_{j,i}(x) = \begin{bmatrix} x \\ \phi(\tilde{y}(x)) \end{bmatrix}^T M \begin{bmatrix} x \\ \phi(\tilde{y}(x)) \end{bmatrix} + \sum_{i=1}^m (\mu_{1,i} - \mu_{2,i} + \mu_{3,i} - \bar{\delta}_i \mu_{4,i}) \int_0^{\tilde{y}_i(x)} \phi_i(s) ds$$

with

$$M = \begin{bmatrix} C^T & 0 \\ D^T & I \end{bmatrix} \begin{bmatrix} \bar{\Delta} M_2 + \bar{\Gamma} M_3 & \frac{1}{2} (\bar{\Delta} M_4 - M_3) \\ \frac{1}{2} (\bar{\Delta} M_4 - M_3) & -\frac{1}{2} M_4 \end{bmatrix} \begin{bmatrix} C & D \\ 0 & I \end{bmatrix}$$

where $M_j = \text{diag}(\mu_{j,1}, \dots, \mu_{j,m})$, $j = 1, \dots, 4$. Thus (1.11a) is obtained from (1.21) by setting $P = \bar{P} + M$ and $\lambda_i = (\mu_{1,i} - \mu_{2,i} + \mu_{3,i} - \bar{\delta}_i \mu_{4,i})$. Note that the matrix $\bar{P} + M$ is not necessarily positive definite since its lower, right diagonal block, $\bar{P}_{22} - \frac{1}{2} M_4$, may not be positive definite. Note also that the Lurie-Postnikov term coefficients $\bar{\mu}_i := (\mu_{1,i} - \mu_{2,i} + \mu_{3,i} - \bar{\delta}_i \mu_{4,i})$ can also be negative since $\mu_{j,i} \geq 0$ does not imply $\bar{\mu}_i \geq 0$.

For the specific case of saturation or deadzone nonlinearities, the integral terms can be incorporated to the quadratic-like term V_0 . This fact has been observed in [41]. In [68], the slope restriction of the deadzone is accounted for (see [68, Fact 2]). In both [41] and [68], the positive definiteness of $V_0(x)$ is obtained by imposing $P > 0$.

1.3.3 LMIs from Theorem 1.1

The quadratic inequalities in Theorem 1.1 and the inequality (1.20), which is a sufficient condition for (1.14c), are equivalent to linear matrix inequalities (1.22) below, where a generic matrix M_Ψ is introduced to represent terms $\Psi(w, z)$ as $\Psi(w, z) = \xi^T M_\Psi \xi$ with $\xi = \begin{bmatrix} x^T & \tilde{\phi}^T & \dot{\tilde{\phi}}^T & \phi^T & w^T \end{bmatrix}^T$. The inequality (1.12a) appears in (1.22a), inequalities (1.14a) and (1.14b) correspond respectively to (1.22b) and (1.22c), and (1.20) corresponds to (1.22d).

Whenever the nonlinearity is known and the Lurie term is expressed as a quadratic form, *ad hoc* inequalities may replace (1.22d).

$$\tilde{\Lambda} \geq 0, \Lambda \geq -\tilde{\Lambda}, T_i \geq 0, i = 0, \dots, 4, T_{c,j} \geq 0, j = 0, \dots, m, \quad (1.22a)$$

$$\begin{aligned} & \begin{bmatrix} P_{11} & P_{12} \\ P_{12}^T & P_{22} \end{bmatrix} - \frac{1}{2} \begin{bmatrix} C^T \\ D^T \end{bmatrix} (\bar{\Delta} - \underline{\Delta}) \tilde{\Lambda} \begin{bmatrix} C & D \end{bmatrix} \\ & + He \left(\frac{1}{2} \begin{bmatrix} (\underline{\Delta}C)^T \\ (\underline{\Delta}D^T - I_m)^T \end{bmatrix} T_0 \begin{bmatrix} \bar{\Delta}C & (\bar{\Delta}D^T - I_m) \end{bmatrix} \right) > 0, \quad (1.22b) \end{aligned}$$

$$\begin{aligned} & - He \left(\left(\begin{bmatrix} P_{11} & P_{12} \\ P_{12}^T & P_{22} \end{bmatrix} + \frac{1}{2} \begin{bmatrix} -(\underline{\Delta}C)^T \\ (I - \underline{\Delta}D)^T \\ 0 \\ 0 \\ 0 \end{bmatrix} \begin{bmatrix} \Lambda C & \Lambda D \end{bmatrix} \right) \begin{bmatrix} A & 0 & 0 & B & B_w \\ 0 & 0 & I_m & 0 & 0 \end{bmatrix} \right. \\ & + \frac{1}{2} \begin{bmatrix} (\underline{\Delta}C)^T \\ (\underline{\Delta}D - I_m)^T \\ 0 \\ 0 \\ 0 \end{bmatrix} T_1 \begin{bmatrix} \bar{\Delta}C & (\bar{\Delta}D - I_m) & 0 & 0 & 0 \end{bmatrix} \\ & + \frac{1}{2} \begin{bmatrix} (\underline{\Delta}C)^T \\ 0 \\ 0 \\ (\underline{\Delta}D - I_m)^T \\ (\underline{\Delta}D_w)^T \end{bmatrix} T_2 \begin{bmatrix} \bar{\Delta}C & 0 & 0 & (\bar{\Delta}D - I_m) & \bar{\Delta}D_w \end{bmatrix} \\ & + \frac{1}{2} \begin{bmatrix} A^T & 0 \\ 0 & 0 \\ 0 & I_m \\ B^T & 0 \\ B_w^T & 0 \end{bmatrix} \begin{bmatrix} (\underline{\Gamma}C)^T \\ (\underline{\Gamma}D - I_m)^T \end{bmatrix} T_3 \begin{bmatrix} \bar{\Gamma}C & (\bar{\Gamma}D - I_m) \end{bmatrix} \begin{bmatrix} A & 0 & 0 & B & B_w \\ 0 & 0 & I_m & 0 & 0 \end{bmatrix} \\ & \left. + \frac{1}{2} \begin{bmatrix} 0 \\ (I - \underline{\Gamma}D) \\ 0 \\ -(I - \underline{\Gamma}D) \\ \underline{\Gamma}D_w \end{bmatrix} T_4 \begin{bmatrix} 0 & (I - \bar{\Gamma}D) & 0 & -(I - \bar{\Gamma}D) & \bar{\Gamma}D_w \end{bmatrix} + M_\Psi \right) > 0, \quad (1.22c) \end{aligned}$$

$$\begin{aligned} & \begin{bmatrix} -(\underline{\tilde{y}}_j \bar{\tilde{y}}_j + \rho) & \frac{\underline{\tilde{y}}_j + \bar{\tilde{y}}_j}{2} C_j & \frac{\underline{\tilde{y}}_j + \bar{\tilde{y}}_j}{2} D_j \\ \frac{\underline{\tilde{y}}_j + \bar{\tilde{y}}_j}{2} C_j^T & -C_j^T C_j + P_{11} - \frac{1}{2} C^T (\bar{\Delta} - \underline{\Delta}) \tilde{\Lambda} C & -C_j^T D_j + P_{12} - \frac{1}{2} C^T (\bar{\Delta} - \underline{\Delta}) \tilde{\Lambda} D \\ \frac{\underline{\tilde{y}}_j + \bar{\tilde{y}}_j}{2} D_j^T & -D_j^T C_j + P_{12}^T - \frac{1}{2} D^T (\bar{\Delta} - \underline{\Delta}) \tilde{\Lambda} C & -D_j^T D_j + P_{22} - \frac{1}{2} D^T (\bar{\Delta} - \underline{\Delta}) \tilde{\Lambda} D \end{bmatrix} \\ & + He \left(\frac{1}{2} \begin{bmatrix} 0 \\ (\underline{\Delta}C)^T \\ (\underline{\Delta}D^T - I_m)^T \end{bmatrix} T_{c,j} \begin{bmatrix} 0 & \bar{\Delta}C & (\bar{\Delta}D^T - I_m) \end{bmatrix} \right) \geq 0 \quad j = 1, \dots, m. \quad (1.22d) \end{aligned}$$

1.4 Numerical Examples

In this section we present numerical solutions for the inequalities presented in Theorem 1.1. The computation of the stability certificates, reachable sets and local induced \mathcal{L}_2 -gains are based on the solution to the SDPs obtained from the inequalities of Theorem 1.1. The associated constraints to the SDP we solve are detailed in the end of this section. For nonlinearities that yield sector and slope bounds that hold only locally, we guarantee the set inclusion (1.14c) by solving the inequalities (1.18) for the case where the nonlinearity is known and has an explicit quadratic-like representation, or, if it is only known to satisfy sector bounds we use a lower bound to the integral term and solve (1.20) otherwise.

1.4.1 Optimal sector and slope bounds

This example computes the maximum sector and slope restriction for the SISO system described by

$$G_{1c}(s) = \frac{0.2s^2}{s^4 + 0.4s^3 + 6s^2 + 0.1s + 1}$$

. The sector and slope conditions are defined by a parameter ϵ , as $\underline{\delta} = 0$, $\bar{\delta} = \epsilon$, $\underline{\gamma} = -0.5\epsilon$, $\bar{\gamma} = 1.5\epsilon$. Via a bisection algorithm, we obtain bounds for the parameter ϵ such that the global stability of system (1.1) is guaranteed. Table 1.1 gives the results comparing the bounds of $V(x)$ to the bounds obtained with $V_0(x)$, together with the special cases of V given by

$$V_Q := x^T P_{11} x$$

and

$$V_{LP} := x^T P_{11} x + \sum_{i=1}^m \lambda_i \int_0^{y_i} \phi(s) ds$$

Table 1.1: Maximum bound on parameter ϵ , denoted ϵ^* , for global stability of system $G_{1c}(s)$.

	V_Q	V_{LP}	V_0	V
ϵ^*	0.730	1.272	0.730	2.422

1.4.2 Local Stability

When the nonlinearity that satisfies the sector condition is known, in some cases it is possible to explicitly write the Lurie-Postnikov term in a quadratic-like form. As an example, consider the nonlinearities $\ln(1 + \tilde{y}_i)$ and $\frac{\tilde{y}_i}{1+\tilde{y}_i}$

$$\begin{aligned} \int_0^{\tilde{y}_i} \ln(1+s) - \underline{\delta}_i s \, ds &= \ln(1+\tilde{y}_i)(1+\tilde{y}_i) - \tilde{y}_i - \frac{1}{2}\underline{\delta}_i \tilde{y}_i^2 \\ \int_0^{\tilde{y}_i} \frac{s}{1+s} - \underline{\delta}_i s \, ds &= -\ln(1+\tilde{y}_i) + \tilde{y}_i - \frac{1}{2}\underline{\delta}_i \tilde{y}_i^2, \end{aligned} \quad (1.23)$$

which can be expressed as quadratic-like forms in the vector $[1 \ \tilde{y}_i \ \ln(1+\tilde{y}_i)]^\top$. These nonlinearities present sector and slope bounds that hold only in the interval $[\underline{\tilde{y}}_j, \bar{\tilde{y}}_j]$ as detailed in the table below

Table 1.2: Local sector and slope bounds for $\ln(1 + \tilde{y}_j)$ and $\frac{\tilde{y}_j}{1+\tilde{y}_j}$ for \mathcal{X}_0 as in (1.16) with $\underline{\tilde{y}}_j > -1$.

$\phi(\tilde{y}_j)$	$\underline{\delta}$	$\bar{\delta}$	$\underline{\gamma}$	$\bar{\gamma}$
$\ln(1 + \tilde{y}_j)$	$\frac{\ln(1+\bar{\tilde{y}}_j)}{\bar{\tilde{y}}_j}$	$\frac{\ln(1+\underline{\tilde{y}}_j)}{\underline{\tilde{y}}_j}$	$\frac{1}{1+\bar{\tilde{y}}_j}$	$\frac{1}{1+\underline{\tilde{y}}_j}$
$\frac{\tilde{y}_j}{1+\tilde{y}_j}$	$\frac{1}{1+\bar{\tilde{y}}_j}$	$\frac{1}{1+\underline{\tilde{y}}_j}$	$\frac{\underline{\tilde{y}}_j}{(1+\underline{\tilde{y}}_j)^2}$	$\frac{\bar{\tilde{y}}_j}{(1+\bar{\tilde{y}}_j)^2}$

note that for both $\ln(1 + \tilde{y}_j)$ and $\frac{\tilde{y}_j}{1+\tilde{y}_j}$, (1.2) holds with $\mathcal{Y} = (-1, \infty)$ thus $\mathcal{Y}_0 = [\underline{\tilde{y}}_j, \bar{\tilde{y}}_j]$ is defined with $-1 < \underline{\tilde{y}}_j < 0$ and $0 < \bar{\tilde{y}}_j$. These bounds are used in the system below.

Consider the system

$$\begin{cases} \dot{x}_1 &= -x_2 + \ln(1 + y_1) + 2\frac{y_2}{1+y_2} \\ \dot{x}_2 &= x_1 - 0.65x_2 + \ln(1 + y_1) + \frac{y_2}{1+y_2} \\ y_1 &= 0.1(x_1 + x_2) - 0.2\frac{y_2}{1+y_2} \\ y_2 &= 0.1(x_2 - x_1). \end{cases}$$

This system can be readily put in the form (1.1) with $\phi_1(y_1) = \ln(1 + y_1)$, $\phi_2(y_2) = \frac{y_2}{1+y_2}$. In order to compute a region of attraction of its origin, we fix the interval of interest $y_1 \in [-.4, 50]$, $y_2 \in [-.5, 50]$ thus defining the slope and sector bounds for the nonlinearities according to Table 1.2. We obtain the inclusion inequality (1.18) by explicitly computing the Lurie-Postnikov terms as in (1.23) and fixing $\rho = 1$. We then obtain an ERA by solving the convex optimization problem that minimizes $\text{Trace}(P_{11})$ subject to (1.22a)-(1.22c), (1.18). The level sets obtained are depicted in Figure 1.1. Inner level sets of the LF are also depicted and show that incorporating the Lurie-Postnikov terms and the nonlinearities in V_0 may yield an asymmetric ERA with respect to the origin. Note also that the innermost level set resembles an ellipsoid, showing that close to the equilibrium point, the term $x^T P_{11} x$ dominates the non-quadratic terms of the LF.

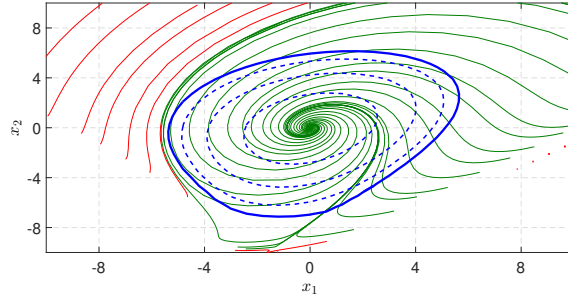

Figure 1.1: Estimate of the region of attraction with the Lyapunov function (1.11) (dark blue). Trajectories asymptotically converging to the origin are shown in green, while diverging trajectories are depicted in red .

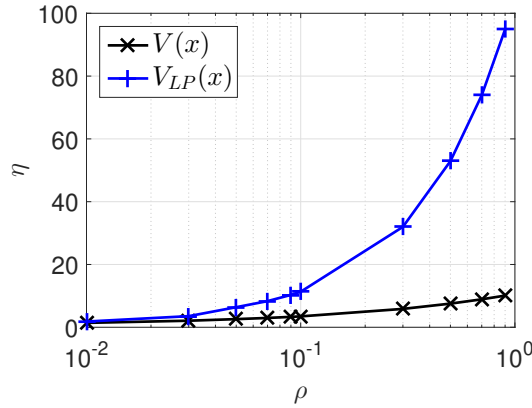

Figure 1.2: Induced \mathcal{L}_2 gain bounds for an idealised Stirling engine.

1.4.3 Gain Curves

This example computes upper bounds for the local induced \mathcal{L}_2 gain η of an idealised Stirling engine presented in [80, eq. 3] with damping factor $c = 50$ and the nonlinearity $\phi(y) = y/(1 + y)$

$$\begin{aligned}\dot{x}_1 &= x_2 - cx_1 - cw \\ \dot{x}_2 &= -\frac{x_1}{1 + x_1} \\ y &= x_1 \\ z &= x_1.\end{aligned}$$

The induced gains depend upon both the local domain and the magnitude of the disturbance whose norm is upper bounded by $\|w\|_2 \leq \rho^{\frac{1}{2}}$. For this example, the upper bound on the domain is set as $\bar{y} = 0.5$ and η is computed for each $\{\bar{y}, \rho\} = \{1, 2, 5, 6, 8\} \times 10^{\{-2, -1\}}$. Figure 1.2 shows minimal upper bounds for η searched over the values of \bar{y} for fixed ρ . The bounds were computed using $V(x)$ subject to (1.22a)-(1.22c), (1.18) and a local Popov criterion obtained using $V_{LP}(x)$ and the substitution of a lower bound for the LF given by V_Q into (1.17), a similar method used in [84]. Tighter bounds were obtained using V for all values.

1.4.4 Discussion: Sector bounds for global stability

As pointed out in Remark 1.2, a single Lurie-Postnikov term may replace the four non-negative Lurie-Postnikov terms associated to each input in the Lyapunov function studied in [171, Theorem 5]. However, in this chapter, these terms and the matrix P_{22} are not necessarily non-negative. On the other hand, Theorem 1.1 offers a simpler expression for the *same* Lyapunov function, therefore no improvement over the existing bounds should be expected. Indeed, we have performed the global stability and gain computations for the examples in [28] and [171] to illustrate the fact that the global analysis using the presented results yield the same results as the ones obtained with a more complex Lyapunov function. Indeed, the conditions of Theorem 1.1 matched the stability bounds obtained with the results of [133] for the balanced realization of all transfer functions in

[28, Table 3]. Similarly, the solution to the inequalities of Theorem 1.1 give the same \mathcal{L}_2 gain bounds as the ones in [171, Theorem 5] for the systems defined in of [171, Table 2].

1.5 Conclusions

In this chapter, the stability analysis of Lurie type systems with slope-restricted nonlinearities was carried out using LFs that have a quadratic-like term on the state and the nonlinearity and Lurie-Postnikov type terms. We have proposed relaxed conditions for the positivity of the LF (cf. Lemma 1.4) and have used sector inequalities to propose conditions for the global and local properties of solutions to Lurie systems. Importantly, the LF structure allows for negative coefficients in the Lurie-Postnikov term.

Numerical solutions to the dissipation inequalities of the main result (cf. Theorem 1.1) can be obtained with the solutions to SDPs. The proposed numerical formulation is a convex optimisation problem since the SDP constraints are affine both on the Lyapunov/storage function coefficients and the multipliers associated to sector inequalities. The local stability analysis with the computation of ERAs and local gain analysis are illustrated with numerical examples.

Chapter 2

Analysis of Discrete-time Slope-Restricted Lurie Systems

2.1 Introduction

Consider a single-input single-output discrete-time Lurie system described by the feedback interconnection of a strictly proper, linear system, with transfer function $G(z)$, and a function $\phi : \mathbb{R} \rightarrow \mathbb{R}$, as illustrated in Figure 2.1.

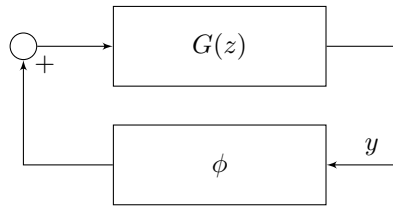

Figure 2.1: Feedback representation of a Lurie system.

Here, $G(z)$ is assumed to admit a minimal state-space realisation

$$x[k+1] = Ax[k] + B\phi(y[k]), \quad (2.1a)$$

$$y[k] = Cx[k], \quad (2.1b)$$

with $A \in \mathbb{R}^{n \times n}$, $B \in \mathbb{R}^{n \times 1}$ and $C \in \mathbb{R}^{1 \times n}$. The nonlinearity ϕ is assumed to be *static*, $\phi(0) = 0$ and *sector bounded* with sector $[\underline{\delta}, \bar{\delta}]$

$$(\bar{\delta}\sigma - \phi(\sigma))(\phi(\sigma) - \underline{\delta}\sigma) \geq 0, \quad \forall \sigma \in \mathbb{R}, \quad (2.2a)$$

as in $\phi(\sigma)/\sigma \in [\underline{\delta}, \bar{\delta}]$. If $\underline{\delta} > 0$ the sector is said to be *strict*.

We say the nonlinearity is *slope restricted* if

$$\frac{\phi(\sigma_1) - \phi(\sigma_2)}{\sigma_1 - \sigma_2} \in [\underline{\gamma}, \bar{\gamma}], \quad \forall \sigma_1, \sigma_2 \in \mathbb{R} \quad (2.2b)$$

for some $\underline{\gamma}, \bar{\gamma} \in \mathbb{R}$ and *monotonic* if $\underline{\gamma} \geq 0$. Note that monotonicity can always be obtained by loop transformations whenever the nonlinearity is slope-bounded.

2.2 Generalised quadratic and integral Lyapunov functions

A class of Lyapunov function for discrete-time Lurie systems is presented. We use the LF in Theorem 2.1, the main result of the chapter, to study the stability of systems with monotone nonlinearities. Importantly, the parameters of the considered function, namely a matrix in a generalized quadratic form and the scaling terms in integrals, need not be positive definite.

2.2.1 Proposed Lyapunov Function

Given a function $\phi : \mathbb{R} \rightarrow \mathbb{R}$, define the vector function $\nu : \mathbb{R}^n \rightarrow \mathbb{R}^{N+1}$, $\chi \mapsto \nu(\chi)$, with ν_j denoting the j^{th} element of ν as

$$\nu_j(\chi) = \begin{cases} C\chi, & j = 0, \\ CA^j\chi + \sum_{i=1}^j CA^{j-i}B\phi(\nu_{i-1}), & 1 \leq j \leq N. \end{cases} \quad (2.3)$$

From the above definition, we have that $\nu_j(\chi)$ is the j^{th} -step propagation of y in (2.1) from $x[0] = \chi$. Let us also introduce the vector function $\xi_N : \mathbb{R}^n \rightarrow \mathbb{R}^{n+N+1}$

$$\xi_N(\chi) = \begin{bmatrix} \chi \\ \phi(\nu_0(\chi)) \\ \vdots \\ \phi(\nu_N(\chi)) \end{bmatrix}. \quad (2.4)$$

For a fixed $N \in \mathbb{N} \cup \{0\}$, we can thus define the function $V : \mathbb{R}^n \rightarrow \mathbb{R}$, $x \mapsto V(x)$

$$V(x) = V_0(x) + \sum_{j=0}^N \lambda_j \int_0^{\nu_j(x)} \phi(s) ds \quad (2.5)$$

with

$$V_0(x) = \xi_N(x)^\top P \xi_N(x),$$

$\lambda \in \mathbb{R}^{N+1}$, and $P \in \mathbb{S}^{n+N+1}$. In the rest of the chapter, we may omit the dependence on x of ξ_N and ν_j to simplify the notation and may also avoid denoting explicitly the dependence of $V(x)$ on N .

The above function is composed of a *generalised quadratic* term $V_0(x)$ and the *integral* terms. It will be used as a Lyapunov candidate function to show stability of (2.1). Namely, we will formulate inequalities imposing conditions on its parameters P and λ for the stability of the origin of (2.1).

2.2.2 Discussion on the Proposed Function

We now discuss the structure of the above function and its connection to the Popov-type stability criteria for both continuous- and discrete-time Lurie systems.

Firstly, it is noted how the function generalizes the *Tsytkin Lyapunov function* for discrete-time systems

$$V_{\text{Tsytkin}}(x) = x^\top P_0 x + \eta \int_0^{Cx} \phi(\sigma) d\sigma \quad (2.6)$$

which is obtained setting $N = 0$. The above V_{Tsytkin} first appeared in [161] with $P_0 \in \mathbb{S}^n$ and parameter $\eta \in \mathbb{R}$ (not sign-defined).

Continuous-time systems

It can also be observed that (2.6) also appears from the derivation of Popov-type stability criteria of continuous-time Lurie systems using passivity. Roughly speaking, this stability criterion considers the loop-transformed Lurie system of Figure 2.2. It follows from passivity (under some additional assumptions, see [107, Chapter 6] for details) that the stability of this system can be inferred as long as both the upper linear subsystem and the lower nonlinear subsystem can be shown to be passive. Since the upper subsystem is linear, it admits a quadratic storage function, but the passivity of the nonlinear subsystem requires exploiting the sector bounds.

Indeed, with the *Popov* multiplier $M(s) = (1 + \eta s)$, in the linear branch, passivity for the nonlinear branch can be shown provided there exists a storage function $S : \mathbb{R} \rightarrow \mathbb{R}$ satisfying

$$\frac{dS(t)}{dt} \leq \phi(y(t)) \left(y(t) + \eta \frac{dy(t)}{dt} \right).$$

Since the nonlinearity ϕ lies within the sector $[0, \bar{\delta}]$, we have $\phi(y)y \geq 0$. To verify the above inequality, it thus suffices to obtain a function $S : \mathbb{R} \rightarrow \mathbb{R}$ satisfying

$$\frac{dS(y(t))}{dt} = \eta \phi(y(t)) \frac{dy(t)}{dt}$$

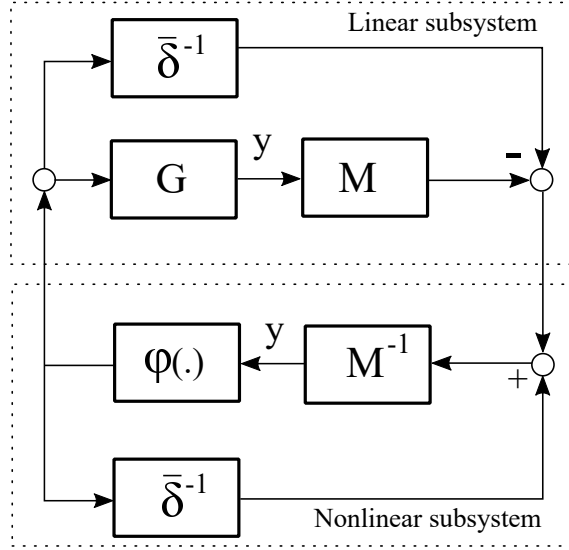

Figure 2.2: Stability of the Lurie system can be shown via passivity of the above feedback system, where G is the linear system, M is the multiplier and $\phi(\cdot)$ is the nonlinearity.

or, in its integral form,

$$\begin{aligned}
 S(y(T)) - S(y(0)) &= \eta \int_0^T \phi(y(t)) \frac{dy(t)}{dt} dt \\
 &= \eta \int_{y(0)}^{y(T)} \phi(\sigma) d\sigma \\
 &= \eta \int_0^{y(T)} \phi(\sigma) d\sigma - \eta \int_0^{y(0)} \phi(\sigma) d\sigma.
 \end{aligned} \tag{2.7}$$

Thus, by identifying terms in the above equation, we can use the function $S(y) = \eta \int_0^y \phi(\sigma) d\sigma$ as a *storage function* for the nonlinear branch of the loop-transformed system, and, since $y = Cx$, S can be expressed as the mapping $x \mapsto S(Cx)$. The sum of a quadratic function as the storage function certifying the passivity of the linear subsystem and the integral term as the storage function for the nonlinear subsystem gives V_{Tysp} as a candidate Lyapunov function for the continuous-time Lurie system.

Discrete-time systems

The following details a similar passivity-based analysis on the use of the function but for discrete-time Lurie systems. For these systems, with an equivalent feedback structure to Figure 2.2, it is usual to substitute the continuous-time multiplier multiplier $(1 + \eta s)$ by a discrete-time *Popov* multiplier $M(z) = (1 + \eta(1 - z^{-1}))$ [105, 134]. By replacing the structure of this multiplier by $M(z) = 1 + \eta \sum_{i=0}^N c_i z^i$ for some real coefficients c_i , the passivity of the nonlinear subsystem can be shown if we can find a function $S : \mathbb{R} \rightarrow \mathbb{R}$ satisfying

$$S(y[k]) - S(y[k-1]) = \eta \left(\sum_{i=0}^N c_i y[k+i] \right) \phi(y[k]),$$

or, in its summation form,

$$\begin{aligned}
 S(y[K]) - S(y[0]) &= \eta \sum_{k=1}^K \left(\sum_{i=0}^N c_i y[k+i] \right) \phi(y_k), \\
 &= -\eta \sum_{k=K+1}^{\infty} \left(\sum_{i=0}^N c_i y[k+i] \right) \phi(y_k) + \eta \sum_{k=0+1}^{\infty} \left(\sum_{i=0}^N c_i y[k+i] \right) \phi(y_k).
 \end{aligned}$$

By identifying terms, the infinite sum $S(y[\ell]) = -\eta \sum_{k=\ell+1}^{\infty} \left(\sum_{i=0}^N c_i y[k+i] \right) \phi(y_{k+1})$ can be associated to a storage function. However, note that the above is in contrast with (2.7) since to

compute the values of S for a given time instant, that is $S(y[\ell])$, the signal y from the solution of the system must be known. For the continuous-time case, the integral in (2.7) allows for the dependence on time of the output signal y to be dropped.

It follows that adding a quadratic storage function $S_{\text{lin}}(x) = x^\top P_0 x$, $P_0 \in \mathbb{S}_{>0}^n$ for the linear subsystem to the above expression (below we also replace y in the above sum by ν since we have $\nu_j = y[j]$ from (2.3)), then corresponding Lyapunov function structure should be

$$V_{\text{Pop}}(x) := x^\top P_0 x - \eta \sum_{k=1}^{\infty} \left(\sum_{i=0}^N c_i \nu_{k+i}(x) \right) \phi(\nu_k) \quad (2.8)$$

which contains a sum, not an integral as in (2.6).

By rearranging terms in the double sum and regrouping the terms ν_{k+i} into a single index $j = k + i$, we obtain scalars \tilde{c}_j , such that

$$\sum_{k=1}^{\infty} \left(\sum_{i=0}^N c_i \nu_{k+i}(x) \right) \phi(\nu_k) = \sum_{j=1}^N \tilde{c}_j \nu_j \phi(\nu_j) + \sum_{j=N+1}^{\infty} \tilde{c}_j \nu_j \phi(\nu_j).$$

The first term above can be written as a quadratic form in $\xi_N(x)$ namely $\sum_{j=1}^N \tilde{c}_j \nu_j \phi(\nu_j) = \xi_N(x)^\top P_T \xi_N(x)$, with $P_T \in \mathbb{S}^{n+N+1}$. Hence, adding this first term to the quadratic function $x^\top P_0 x$, we obtain a term as in $V_0(x)$ of (2.5). We are left with the sum $\sum_{j=N+1}^{\infty} \tilde{c}_j \nu_j \phi(\nu_j)$. In case this remaining term is bounded, we can then consider the integrals of (2.5) as approximations of this infinite sum. Thus (2.5) gives an approximation of the function in (2.8).

In the above discussion, the storage function showing the passivity of the nonlinear branch of the continuous-time system was obtained using only the sector information. Unfortunately, when the sums are replaced by the integral terms for the discrete-time problem, it is no longer possible to carry out the stability analysis considering only sector information since the integrals need to be bounded by quadratic terms using slope information as in [167, 105, 134]. We thus have to also assume monotonicity of the nonlinearity hereafter. We will use Lemma 2.1 below to bound integrals.

Remark 2.1

We now show that, $V(x)$ in (2.5) includes the recently developed Lyapunov function of [132] as a special case when $N = 2$. To show this, consider the Lyapunov function $\hat{V}(x)$ from [132] which can be expressed as

$$\hat{V}(x) = V_1(x) + V_2(x) + V_3(x) + V_3'(x) \quad (2.9)$$

with parameters $\bar{P} \in \mathbb{S}_{>0}^{2n+2}$, $\{m_1, m_2, n_1, n_2, n_3, n_4\} \in \mathbb{R}_{\geq 0}$ and

$$\zeta = \begin{bmatrix} x \\ x[k+1] \\ \phi(\nu_0(x)) \\ \phi(\nu_1(x)) \end{bmatrix}$$

defining

$$V_1(x) = \zeta^\top \bar{P} \zeta$$

$$\begin{aligned} V_2(x) &= 2m_1 \int_{\nu_0(x)}^{\nu_1(x)} \phi(\sigma) - \phi(\nu_0(x)) d\sigma + 2m_2 \int_{\nu_0(x)}^{\nu_1(x)} \bar{\gamma}(\sigma - \nu_0(x)) - (\phi(\sigma) - \phi(\nu_0(x))) d\sigma, \\ &= 2m_1 \left(\int_0^{\nu_1} \phi(\sigma) d\sigma - \int_0^{\nu_0} \phi(\sigma) d\sigma - \phi(\nu_0)(\nu_1 - \nu_0) \right) \\ &\quad + 2m_2 \left(\frac{\bar{\gamma}}{2} (\nu_1^2 - 2\nu_0\nu_1 + \nu_0^2) - \int_0^{\nu_1} \phi(\sigma) d\sigma + \int_0^{\nu_0} \phi(\sigma) d\sigma + \phi(\nu_0)(\nu_1 - \nu_0) \right), \end{aligned}$$

$$\begin{aligned} V_3(x) &= 2n_1 \int_0^{\nu_0(x)} \phi(\sigma) d\sigma + 2n_2 \int_0^{\nu_0(x)} \delta\sigma - \phi(\sigma) d\sigma, \\ &= 2n_1 \int_0^{\nu_0} \phi(\sigma) d\sigma + 2n_2 \left(\frac{\delta\nu_0(x)^2}{2} - \int_0^{\nu_0} \phi(\sigma) d\sigma \right), \end{aligned}$$

$$\begin{aligned} V_3'(x) &= 2n_3 \int_0^{\nu_1(x)} \phi(\sigma) d\sigma + 2n_4 \int_0^{\nu_1(x)} \delta\sigma - \phi(\sigma) d\sigma, \\ &= 2n_3 \int_0^{\nu_1} \phi(\sigma) d\sigma + 2n_4 \left(\frac{\delta\nu_1(x)^2}{2} - \int_0^{\nu_1} \phi(\sigma) d\sigma \right). \end{aligned}$$

Collecting terms in the integrals of V_2 , V_3 , and V_3' above, we have that $\bar{V}(x)$ can be written as (2.5) with $N = 1$. Indeed, we obtain $\lambda_0 = 2(-m_1 + m_2 + n_1 - n_2)$, $\lambda_1 = 2(m_1 - m_2 + n_3 - n_4)$. Finally, noting that $\zeta = M\xi_1$ with

$$M = \begin{bmatrix} 0 & 0 & I_n & 0 & 0 \\ 0 & 0 & A & B & 0 \\ 0 & 0 & 0 & 1 & 0 \\ 0 & 0 & 0 & 0 & 1 \end{bmatrix},$$

and

$$\nu_0 = [0 \ 0 \ C \ 0 \ 0] \xi_1, \quad \nu_1 = [0 \ 0 \ CA \ CB \ 0] \xi_1, \quad \phi(\nu_0) = [0 \ 1 \ 0] \xi_1.$$

We retrieve matrix P in (2.5) as a function of coefficients \bar{P} , m_1 , m_2 , n_2 and n_4 by identifying terms in the expression below

$$\begin{aligned} \xi_1^\top P \xi_1 &= \xi_1^\top M^\top \bar{P} M \xi_1 - 2m_1 \phi(\nu_0)(\nu_1 - \nu_0) + 2m_2 \left(\frac{\bar{\gamma}}{2} (\nu_1^2 - 2\nu_0\nu_1 + \nu_0^2) + \phi(\nu_0)(\nu_1 - \nu_0) \right) \\ &\quad + n_2 \delta\nu_0^2 + n_4 \delta\nu_1^2. \end{aligned}$$

It is further noted that another stability test was stated in [50, Thm 5(a), Sec 7, Chap VI] which does not require monotonicity of ϕ , instead only that ϕ satisfy a strict sector condition with $\underline{\delta} > 0$. As far as the authors are aware, no equivalent formulation in terms of Lyapunov functions for this result is known.

2.3 Stability analysis of Discrete-Time Lurie Systems

Stability conditions using (2.5) as the candidate Lyapunov function are now stated for the discrete-time Lurie system (2.1) with a monotonic nonlinearity. We first introduce some quadratic constraints related to the sector-bounded and slope-restricted, monotone, nonlinearities. For a nonlinearity with sector bounds $[\underline{\delta}, \bar{\delta}]$, we define

$$s_{\text{sec}}(\sigma_i) := (\bar{\delta}\sigma_i - \phi(\sigma_i))(\phi(\sigma_i) - \underline{\delta}\sigma_i) \geq 0 \quad (2.11)$$

$\forall \sigma_i \in \mathbb{R}$. The relation below exploits (2.2b) and monotonicity of ϕ ,

$$s_{\text{slo}}(\sigma_i, \sigma_j) := (\bar{\gamma}(\sigma_i - \sigma_j) - (\phi_i - \phi_j))((\phi_i - \phi_j)) \geq 0, \quad (2.12)$$

$\forall \sigma_i, \sigma_j \in \mathbb{R}$, with $\phi_i = \phi(\sigma_i)$ and $\phi_j = \phi(\sigma_j)$. The above inequality is obtained, from (2.2b) and monotonicity since we have $\frac{\sigma_i - \sigma_j}{\phi_i - \phi_j} \geq \frac{1}{\bar{\gamma}}$, which gives $\frac{(\sigma_i - \sigma_j)(\phi_i - \phi_j)^2}{(\phi_i - \phi_j)} \geq \frac{(\phi_i - \phi_j)^2}{\bar{\gamma}}$. The inequalities in the lemma below are obtained using the slope restrictions

Lemma 2.1: [131, Lemma 1]

If ϕ is slope restricted (2.2b) with $\underline{\gamma} \geq 0$ then $\forall \sigma_i, \sigma_j \in \mathbb{R}$

$$L(\sigma_j, \sigma_i) \leq \int_{\sigma_j}^{\sigma_i} \phi(\sigma) d\sigma \leq U(\sigma_j, \sigma_i) \quad (2.13)$$

where

$$\begin{aligned} L(\sigma_j, \sigma_i) &= \phi(\sigma_j)(\sigma_i - \sigma_j) + \frac{1}{2\underline{\gamma}}(\phi(\sigma_i) - \phi(\sigma_j))^2, \\ U(\sigma_j, \sigma_i) &= \phi(\sigma_i)(\sigma_i - \sigma_j) - \frac{1}{2\underline{\gamma}}(\phi(\sigma_i) - \phi(\sigma_j))^2. \end{aligned}$$

The bounds (2.13) give the inequality below

$$\lambda^p L(\sigma_j, \sigma_i) - \lambda^n U(\sigma_j, \sigma_i) \leq (\lambda^p - \lambda^n) \int_{\sigma_j}^{\sigma_i} \phi(s) ds \leq \lambda^p U(\sigma_j, \sigma_i) - \lambda^n L(\sigma_j, \sigma_i) \quad (2.15)$$

that will be used to upper and lower bound the integral terms in the Lyapunov inequalities.

2.3.1 Global Stability Analysis

With the inequalities (2.11), (2.12), and (2.15) in hand, global stability conditions with the Lyapunov function $V(x)$ can be formulated.

Theorem 2.1: Global Stability Analysis Discrete-Time Systems

Consider the Lurie system of (2.1) with the nonlinearity ϕ both sector bounded (2.2a) and slope restricted (2.2b) with $\gamma \geq 0$. If there exist $P \in \mathbb{S}^{n+N+1}$, $\{\lambda^p, \lambda^n\} \in \mathbb{R}_{\geq 0}^{N+1}$, $\{\tau^{\text{sec}}, \psi^{\text{sec}}, \theta^{\text{sec}}\} \in \mathbb{R}_{\geq 0}^{N+1}$, $\{\tau^{\text{slo}}, \psi^{\text{slo}}, \theta^{\text{slo}}\} \in \mathbb{U}_{\geq 0}^{N+1}$, $\epsilon_2 \geq \epsilon_1 > 0$, and $\epsilon_3 > 0$ such that, $\forall x \in \mathbb{R}^n \setminus \{0\}$

$$\epsilon_1 \|x\|^2 \leq \underline{V}(x), \quad (2.16a)$$

$$\overline{V}(x) \leq \epsilon_2 \|x\|^2, \quad (2.16b)$$

$$\overline{\Delta V}(x) \leq -\epsilon_3 \|x\|^2, \quad (2.16c)$$

with

$$\underline{V}(x) = V_0(\xi_N) + \sum_{j=0}^N \lambda_j^p L(0, \nu_j) - \lambda_j^n U(0, \nu_j) - \sum_{j=-N}^N \tau_j^{\text{sec}} s_{\text{sec}}(\nu_j) - \sum_{j=-N}^{N-1} \sum_{g=j+1}^N \tau_{j,g}^{\text{slo}} s_{\text{slo}}(\nu_j, \nu_g), \quad (2.17a)$$

$$\overline{V}(x) = V_0(\xi_N) + \sum_{j=0}^N \lambda_j^p U(0, \nu_j) - \lambda_j^n L(0, \nu_j) + \sum_{j=-N}^N \psi_j^{\text{sec}} s_{\text{sec}}(\nu_j) + \sum_{j=-N}^{N-1} \sum_{g=j+1}^N \psi_{j,g}^{\text{slo}} s_{\text{slo}}(\nu_j, \nu_g), \quad (2.17b)$$

$$\begin{aligned} \overline{\Delta V}(x) &= \Delta V_0(\xi_N) + \sum_{j=0}^N \lambda_j^p U(\nu_j, \nu_{j+1}) - \lambda_j^n L(\nu_j, \nu_{j+1}) \\ &\quad + \sum_{j=-N}^{N+1} \theta_j^{\text{sec}} s_{\text{sec}}(\nu_j) + \sum_{j=-N}^N \sum_{g=j+1}^{N+1} \theta_{j,g}^{\text{slo}} s_{\text{slo}}(\nu_j, \nu_g), \end{aligned} \quad (2.17c)$$

then (2.1) is globally exponentially stable and $x[k] \in \mathcal{E}(V, V(x[0]))$ with V as in (2.5) with $\lambda = \lambda^p - \lambda^n$.

Proof. From the quadratic bounds (2.11), (2.12) and the lower bound to the integral term in (2.15), it follows that $\underline{V}(x) \leq V(x) \forall x$, with V defined by $\lambda = \lambda^p - \lambda^n$ in (2.5). Thus (2.16a) implies $\epsilon_1 \|x\| \leq V(x)$. Similarly, we show that $\overline{V}(x)$ is an upper bound to $V(x)$ thus (2.16b) implies $V(x) \leq \epsilon_2 \|x\|$, hence

$$\epsilon_1 \|x\|^2 \leq V(x) \leq \epsilon_2 \|x\|^2. \quad (2.18a)$$

We have

$$\Delta V(x[k]) = V_0(\xi_N(x[k+1])) - V_0(\xi_N(x[k])) + \sum_{i=0}^N \lambda_i \int_{\nu_i}^{\nu_{i+1}} \phi(s) ds.$$

Using the inequalities (2.11), (2.12) and both bounds to the integral terms in (2.15) we conclude that $\Delta V(x) \leq \overline{\Delta V}(x)$, hence the satisfaction of $\overline{\Delta V}(x) < -\epsilon_2 \|x\|^2$ implies

$$\Delta V(x) < -\epsilon_2 \|x\|^2. \quad (2.18b)$$

To conclude, if the conditions of the theorem are satisfied, we use (2.18) to obtain $\|x[k]\|^2 \leq \frac{\epsilon_2}{\epsilon_1} \left(1 - \frac{\epsilon_3}{\epsilon_2}\right)^k \|x[0]\|^2$. \square

Remark 2.2

Since the inequalities that need to be checked in Theorem 2.1 are quadratic expressions, they can be cast as linear matrix inequalities (LMIs). They are obtained by expressing the terms in (2.17a), (2.17b) as quadratic forms in the vector ξ_N , and in (2.17c) as quadratic forms in the vector ξ_{N+1} . These LMIs are solved to obtain the numerical results reported in Section 2.4. Due to space limitations the matrices corresponding to the LMIs are not reported here.

Remark 2.3

A key feature of Proposition 2.1 is related to the set of parameters defining V in (2.5). Note that the positivity of the elements of λ in V can be relaxed in Proposition 2.1, since they are given by $\lambda = \lambda^p - \lambda^n$ where λ^p and λ^n are non-negative vectors. The sign definiteness of the matrix P can also be relaxed. These relaxations parallel the results by the authors for continuous-time Lurie systems [174] and those with rational vector fields [55] where the positivity of the LF parameters have also been relaxed.

2.3.2 Regional Stability Analysis

In many cases, a regional stability analysis is often desired since global stability may not be achieved for nonlinear systems. This is the case when the domain of the nonlinearity is not \mathbb{R} (e.g. with $\phi(\sigma) = \ln(1 + \sigma)$) or when the region of attraction of the origin is some set $\mathcal{R}_0 \subset \mathbb{R}^n$ with $0 \in \mathcal{R}_0$. The previous section demonstrated how the function (2.5) could be used for a global stability analysis of a Lurie system, corresponding to a region of attraction of the origin given by \mathbb{R}^n .

This section follows a similar approach to [174] where the regional stability for continuous-time systems was studied, and provides conditions to obtain estimates of the region of attraction of the origin using (2.5). Such estimates will be invariant sets given by level sets of the Lyapunov function. We guarantee the inclusion of these level sets within a subset of the state space where (local) sector and slopes bounds for the nonlinearities hold. We characterize these sets by considering scalars $\underline{y} \leq 0, \bar{y} \geq 0$ that define

$$\mathcal{X}_0 = \{x \in \mathbb{R}^n : (\bar{y} - \nu_0(x))(\nu_0(x) - \underline{y}) \geq 0\},$$

that is, $\forall x \in \mathcal{X}_0, \nu_0(x) \in [\underline{y}, \bar{y}]$. The values \underline{y}, \bar{y} give the interval of the domain of the nonlinearity ϕ in (2.1), where sector and slope bounds will be assumed to hold.

We thus assume that $\forall \sigma_i \in [\underline{y}, \bar{y}]$, we have

$$s_{\text{sec,loc}}(\sigma_i) := (\bar{\delta}_{\text{loc}}(\underline{y}, \bar{y})\sigma_i - \phi(\sigma_i)) (\phi(\sigma_i) - \underline{\delta}_{\text{loc}}(\underline{y}, \bar{y})\sigma_i) \geq 0 \quad (2.19)$$

with $\underline{\delta} \leq \underline{\delta}_{\text{loc}}(\underline{y}, \bar{y}) \leq \bar{\delta}_{\text{loc}}(\underline{y}, \bar{y}) \leq \bar{\delta}$, with the global sector bounds as in (2.2a) satisfied with $\underline{\delta}$ and $\bar{\delta}$. Similarly, we assume $\forall \sigma_i, \sigma_j \in [\underline{y}, \bar{y}]$

$$s_{\text{slo,loc}}(\sigma_i, \sigma_j) := (\bar{\gamma}_{\text{loc}}(\underline{y}, \bar{y})(\sigma_i - \sigma_j) - (\phi_i - \phi_j)) ((\phi_i - \phi_j) - \underline{\gamma}_{\text{loc}}(\underline{y}, \bar{y})(\sigma_i - \sigma_j)) \geq 0, \quad (2.20)$$

with $0 \leq \underline{\gamma}_{\text{loc}}(\underline{y}, \bar{y}) \leq \bar{\gamma}_{\text{loc}}(\underline{y}, \bar{y}) \leq \bar{\gamma}$, with the global sector bounds as in (2.2b) satisfied with $\underline{\gamma} = 0$ and $\bar{\gamma}$. The use of sector and slope bounds depending on \underline{y} and \bar{y} can help reduce the conservatism in the estimates of the region of attraction obtained, as the numerical examples below will illustrate.

To guarantee that the above sector and slope inequalities are verified for all trajectories starting in an invariant level set of (2.5), we should establish a condition for the inclusion of a level set of (2.5) in a given set $\mathcal{X}_0 \subset \mathbb{R}^n$. The lemma below provides this inclusion condition.

Lemma 2.2: [131, Lemma 1]

Given a function $W : \mathbb{R}^n \rightarrow \mathbb{R}$, if there exists a scalar $\alpha > 0$ such that

$$\alpha(\bar{y} - \nu_0(x))(\nu_0(x) - \underline{y}) \geq \rho - W(x), \quad (2.21)$$

then the following set inclusion holds

$$\mathcal{E}(W, \rho) \subseteq \mathcal{X}_0.$$

Proof. If (2.21) holds, then whenever $W(x) \leq \rho$, we have that the inequality $(\bar{y} - \nu_0(x))(\nu_0(x) - \underline{y}) \geq 0$ is satisfied. Hence, $x \in \mathcal{E}(W, \rho) \subseteq \mathcal{X}_0$, giving the set inclusion. \square

The inclusion condition of Lemma 2.2 and the stability conditions of Theorem 2.1 are combined in the following regional stability analysis result.

Theorem 2.2: Regional Stability Analysis Discrete-Time Systems

Consider the Lurie system of (2.1) with the nonlinearity ϕ both sector bounded (2.2a) and slope restricted (2.2b) with $\underline{\gamma} \geq 0$ and bounds on the nonlinearity \underline{y}, \bar{y} defining the set \mathcal{X}_0 and sector and slope bounds as $\underline{\delta}_{\text{loc}}(\underline{y}, \bar{y}), \bar{\delta}_{\text{loc}}(\underline{y}, \bar{y}), \underline{\gamma}_{\text{loc}}(\underline{y}, \bar{y}), \bar{\gamma}_{\text{loc}}(\underline{y}, \bar{y})$ in (2.19)-(2.20). If there exist $P \in \mathbb{S}^{n+N+1}$, $\{\lambda^p, \lambda^n\} \in \mathbb{R}_{\geq 0}^{N+1}$, $\{\tau^{\text{sec}}, \psi^{\text{sec}}, \theta^{\text{sec}}\} \in \mathbb{R}_{\geq 0}^{N+1}$, $\{\tau^{\text{slo}}, \psi^{\text{slo}}, \theta^{\text{slo}}\} \in \mathbb{U}_{\geq 0}^{N+1}$ and $\epsilon_2 \geq \epsilon_1 > 0$, and $\epsilon_3 > 0$ such that, $\forall x \in \mathbb{R}^n \setminus \{0\}$, the inequalities in (2.16) hold with

$$\underline{V}(x) = V_0(\xi_N) + \sum_{j=0}^N \lambda_j^p L(0, \nu_j) - \lambda_j^n U(0, \nu_j) - \sum_{j=-N}^N \tau_j^{\text{sec}} s_{\text{sec}, \text{loc}}(\nu_j) - \sum_{j=-N}^{N-1} \sum_{g=j+1}^N \tau_{j,g}^{\text{slo}} s_{\text{slo}, \text{loc}}(\nu_j, \nu_g), \quad (2.22a)$$

$$\bar{V}(x) = V_0(\xi_N) + \sum_{j=0}^N \lambda_j^p U(0, \nu_j) - \lambda_j^n L(0, \nu_j) + \sum_{j=-N}^N \psi_j^{\text{sec}} s_{\text{sec}, \text{loc}}(\nu_j) + \sum_{j=-N}^{N-1} \sum_{g=j+1}^N \psi_{j,g}^{\text{slo}} s_{\text{slo}, \text{loc}}(\nu_j, \nu_g), \quad (2.22b)$$

$$\begin{aligned} \Delta \bar{V}(x) &= \Delta V_0(\xi_N) + \sum_{j=0}^N \lambda_j^p U(\nu_j, \nu_{j+1}) - \lambda_j^n L(\nu_j, \nu_{j+1}) \\ &\quad + \sum_{j=-N}^{N+1} \theta_j^{\text{sec}} s_{\text{sec}, \text{loc}}(\nu_j) + \sum_{j=-N}^N \sum_{g=j+1}^{N+1} \theta_{j,g}^{\text{slo}} s_{\text{slo}, \text{loc}}(\nu_j, \nu_g), \end{aligned} \quad (2.22c)$$

and a scalar $\alpha > 0$ such that

$$\alpha(\bar{y} - \nu_0(x))(\nu_0(x) - \underline{y}) \geq \rho - \underline{V}(x), \quad \forall x \in \mathbb{R}^n \setminus \{0\} \quad (2.23)$$

holds, then all solutions of (2.1) satisfying $x[0] \in \mathcal{E}(V, \rho) \subseteq \mathcal{X}_0$, with V defined by P and $\lambda = \lambda^p - \lambda^n$, also satisfy $\mathcal{E}(V(x[k]), \rho) \subseteq \mathcal{X}_0$ for all $k \in \mathbb{N}$. Moreover, the origin of (2.1) is (locally) exponentially stable.

Proof. Since we have $V(x) \geq \underline{V}(x)$, then $V(x) \leq \rho$ implies $\underline{V}(x) \leq \rho$ hence $\mathcal{E}(V, \rho) \subseteq \mathcal{E}(\underline{V}, \rho)$. Following Lemma 2.2, if (2.23) holds, we conclude that $\mathcal{E}(\underline{V}, \rho) \subseteq \mathcal{X}_0$ thus implying $\mathcal{E}(V, \rho) \subseteq \mathcal{X}_0$.

Note also that if (2.16) holds, we have $\underline{V}(x) > 0$, giving $V(x[0]) > 0$ and $\Delta \bar{V}(x) < 0$ gives $\Delta V(x[k]) < 0 \forall k \in \mathbb{N}$. Thus, for $V(x[0]) \leq \rho$ we get $0 < V(x[k]) \leq \rho \forall k \in \mathbb{N}$. Since $\underline{V}(x) \leq V(x)$, we also have that $\underline{V}(x[k]) \leq \rho \forall k \in \mathbb{N}$. Hence, the set $\mathcal{E}(V, \rho)$ is invariant and is contained in the set where $\Delta V(x)$ is strictly negative with an upper quadratic bound as in (2.16c). Exponential stability of the origin within the set $\mathcal{E}(V, \rho)$ can then be concluded. \square

Remark 2.4

The following particular case of the function (2.5) has been proposed in [74]

$$V_{\text{GJD}}(x) = x^T P x + \lambda \nu_0 \phi(\nu_0)$$

for the regional analysis of Lurie systems. Interestingly, with the above structure the stability analysis can be carried out using only sector bounds. Also, the level sets of the above function can be disconnected therefore yielding disconnected level sets for estimates of the region of attraction. On the other hand, the above function does not appear to be more effective than a simple quadratic function when assessing global stability.

2.3.3 Input-Output Analysis

This section considers the open Lurie system

$$x[k+1] = Ax[k] + B\phi(y[k]) + B_w w[k], \quad (2.24a)$$

$$y[k] = Cx[k], \quad (2.24b)$$

$$z[k] = C_z x[k], \quad (2.24c)$$

with the input given by an external disturbance $w \in \mathcal{W} \subseteq \ell_2$, and z a performance output signal to be assessed. To evaluate the impact of the input signals w in z , in this section, we propose a strategy to compute gains yielding worst-case bounds of the form $\|z\|_2 \leq \omega \|w\|_2$.

To compute the input-output induced gains we use the storage function is given by V as in (2.5). It is important to observe that (2.5) *does not depend* on w , since ν_i , $i \in \{1, N\}$ in (2.3) and the vector ξ_N in (2.4) defining the expression $V(x)$ depend only on its argument x and not on w . On the other hand, to analyse the input-output gains of (2.24), the forward difference $\Delta V(x[k]) = V(x[k+1]) - V(x[k])$ has to be computed using $x[k+1]$ as in (2.24). To obtain $V(x[k+1])$ we use (2.3) and (2.24a) to arrive at the expressions

$$\nu_j(x[k+1]) = \begin{cases} C(Ax[k] + B\phi(Cx[k]) + B_w w[k]) & j = 0 \\ CA^j(Ax[k] + B\phi(Cx[k]) + B_w w[k]) + \sum_{i=1}^j CA^{j-i} B\phi(\nu_{i-1}(x[k+1])), & 1 \leq j \leq N. \end{cases}$$

We thus observe that $\nu_j(x[k+1])$ depends on $w[k]$ which is different from $\nu_{j+1}(x[k])$. Let us define $\nu_j^+(x[k], w[k]) := \nu_j(x[k+1])$ that will help avoid expressions with multiple indexing. Using the above expression, we obtain

$$\nu_j^+(x, w) = \begin{cases} C(Ax + B\phi(\nu_0) + B_w w), & j = 0, \\ CA^j(Ax + B\phi(\nu_0) + B_w w) + \sum_{i=1}^j CA^{j-i} B\phi(\nu_{i-1}^+), & 1 \leq j \leq N, \end{cases} \quad (2.25)$$

and $\xi_N^+(x[k], w[k]) := \xi_N(x[k+1])$, that is

$$\xi_N^+(x, w) = \begin{bmatrix} x^+ \\ \phi(\nu_0^+) \\ \vdots \\ \phi(\nu_N^+) \end{bmatrix}. \quad (2.26)$$

Theorem 2.3: Regional Stability Analysis Discrete-Time Systems

Consider the open Lurie system of (2.24) with the nonlinearity ϕ both sector bounded (2.2a) and slope restricted (2.2b) with $\underline{\gamma} \geq 0$. If there exist $P \in \mathbb{S}^{n+N+1}$, $\{\lambda^p, \lambda^n\} \in \mathbb{R}_{\geq 0}^{N+1}$, $\{\tau^{\text{sec}}, \psi^{\text{sec}}, \theta^{\text{sec}}, \theta^{\text{sec}+}\} \in \mathbb{R}_{>0}^{N+1}$, $\{\tau^{\text{slo}}, \psi^{\text{slo}}, \theta^{\text{slo}}, \theta^{\text{slo}+}\} \in \mathbb{U}_{\geq 0}^{N+1}$, $\epsilon_2 \geq \epsilon_1 > 0$, and $\epsilon_3 > 0$ such that, $\forall x \in \mathbb{R}^n \setminus \{0\}$, (2.16a)-(2.16b) hold with (2.17a)-(2.17b), and

$$\overline{\Delta V}(x) \leq -(\omega^{-2})z^2 + w^2, \quad (2.27)$$

with $\overline{\Delta V}(x)$ given by

$$\begin{aligned} \overline{\Delta V}(x) = & \xi_N^+(x)^\top P \xi_N^+(x) - \xi_N(x)^\top P \xi_N(x) + \sum_{j=0}^N \lambda_j^p U(\nu_j, \nu_j^+) - \lambda_j^n L(\nu_j, \nu_j^+) \\ & + \sum_{j=1}^N \theta_j^{\text{sec}} s_{\text{sec}}(\nu_j) + \theta_j^{\text{sec}+} s_{\text{sec}}(\nu_j^+) + \sum_{j=1}^{N-1} \sum_{g=j+1}^N \theta_{j,g}^{\text{slo}} s_{\text{slo}}(\nu_j, \nu_g) + \theta_{j,g}^{\text{slo}+} s_{\text{slo}}(\nu_j^+, \nu_g^+) \end{aligned} \quad (2.28)$$

then

$$\|z\|_2 \leq \omega \|w\|_2, \quad \forall w \in \ell_2. \quad (2.29)$$

Moreover, for $x[0] = 0$, we have that $V(x[k]) \leq \|w\|_2^2$, $\forall k \in \mathbb{N}$.

Proof. Since $\Delta V \leq \overline{\Delta V}(x)$, from (2.27) we have $\Delta V(x[k]) \leq -(\omega^{-2})z[k]^2 + w[k]^2 \forall k \in \mathbb{N}$. Summing this expression from to 0 to k , we obtain,

$$V(x[k]) - V(x[0]) \leq -(\omega^{-2}) \sum_{i=0}^k \|z\|_2^2 + \sum_{i=0}^k \|w\|_2^2 \quad \forall k.$$

Letting $k \rightarrow \infty$, we get $(\omega^{-2})\|z\|_2^2 \leq V(x[0]) + \|w\|_2^2$ and since the bias term $V(x[0])$ satisfies $V(x[0]) \geq 0$, we have

$$\|z\|_2 \leq \omega \|w\|_2.$$

That is, the input-output induced ℓ_2 gain is bounded by ω .

Moreover, we have that

$$V(x[k]) + \sum_{i=0}^k (\omega^{-2}) \|z[i]\|^2 \leq V(x[0]) + \sum_{i=0}^k \|w[i]\|^2, \quad \forall k$$

and since $\|z[i]\| \geq 0 \forall i$, if $x[0] = 0$ (thus $V(x[0]) = 0$), we obtain

$$V(x[k]) \leq \sum_{i=0}^k \|w[i]\|^2 \leq \sum_{i=0}^{\infty} \|w[i]\|^2 = \|w\|_2^2, \quad \forall k.$$

We thus conclude that, if $\|w\|_2^2 \leq \rho$, that is, if the ℓ_2 norm of the input is bounded by a scalar $\sqrt{\rho}$, we have that $\forall k \in \mathbb{N}$, $x[k] \in \mathcal{E}(V, \rho)$. \square

2.3.4 LMI conditions

This section illustrates how the relations (2.16a) and (2.16c) in Theorem 2.1. can be written in the generic quadratic with an affine dependence on P , $\lambda^p, \lambda^n, \tau^{\text{sec}}, \psi^{\text{sec}}, \theta^{\text{sec}}, \tau^{\text{slo}}, \psi^{\text{slo}}, \theta^{\text{slo}}$. Thanks to these generic quadratic forms, conditions expressed as LMI can be obtained to ensure (2.16a) and (2.16c). This is formalized below with corollary to Theorem 2.1. Similar formulations are obtained for theorems 2.2 and 2.3.

Corollary 2.1

Consider the Lurie system of (2.1) with the nonlinearity ϕ both sector bounded (2.2a) and slope restricted (2.2b) with $\gamma \geq 0$. If there exist $P \in \mathbb{S}^{n+N+1}$, $\{\lambda^p, \lambda^n\} \in \mathbb{R}_{\geq 0}^{N+1}$, $\{\tau^{\text{sec}}, \psi^{\text{sec}}, \theta^{\text{sec}}\} \in \mathbb{R}_{\geq 0}^{N+1}$, $\{\tau^{\text{slo}}, \psi^{\text{slo}}, \theta^{\text{slo}}\} \in \mathbb{U}_{\geq 0}^{N+1}$, $\epsilon_2 \geq \epsilon_1 > 0$, and $\epsilon_3 > 0$ such that,

$$P - \epsilon_1 \mathcal{I}_{nN} + \Omega_{\text{LU}}^0(N, \lambda^p, \lambda^n) - \Omega_{\text{sec}}(N, \tau^{\text{sec}}) - \Omega_{\text{slo}}(N, \tau^{\text{slo}}) \geq 0, \quad (2.30a)$$

$$\epsilon_2 \mathcal{I}_{nN} - P - \Omega_{\text{UL}}^0(N, \lambda^p, \lambda^n) - \Omega_{\text{sec}}(N, \psi^{\text{sec}}) - \Omega_{\text{slo}}(N, \psi^{\text{slo}}) \geq 0, \quad (2.30b)$$

$$-(\check{\Omega}^\top P \check{\Omega} - \text{diag}(P, 0) - \epsilon_3 \mathcal{I}_{n(N+1)} + \Omega_{\text{UL}}(N, \lambda^p, \lambda^n) + \Omega_{\text{sec}}(N+1, \theta^{\text{sec}}) + \Omega_{\text{slo}}(N+1, \theta^{\text{slo}})) \geq 0, \quad (2.30c)$$

where $\mathcal{I}_{nN} = \text{diag}(I_n, 0_{N,N})$, $\mathcal{I}_{n(N+1)} = \text{diag}(I_n, 0_{N+1, N+1})$

$$\check{\Omega} = \begin{bmatrix} A & [B & 0_{n,N}] \\ 0_{N,n} & [0_{N,1} & I_N] \end{bmatrix}.$$

and matrices Ω_{LU}^0 , Ω_{UL} , Ω_{sec} , and Ω_{slo} as in in (2.31), then (2.1) is globally exponentially stable and $x[k] \in \mathcal{E}(V, V(x[0]))$ with V as in (2.5) with $\lambda = \lambda^p - \lambda^n$.

We the expressions Theorem 2.1 as quadratic expressions in vectors ξ_N and ξ_{N+1} . The term involving the sector inequality

$$\sum_{j=0}^N \tau_j^{\text{sec}} s_{\text{sec}}(\nu_j) = \xi_N^\top \Omega_{\text{sec}}(N, \tau^{\text{sec}}) \xi_N \quad (2.31a)$$

with

$$\Omega_{\text{sec}}(N, \tau^{\text{sec}}) = \frac{1}{2} \sum_{j=0}^N \tau_j^{\text{sec}} He(\Omega_{\text{sec},j}) \quad (2.31b)$$

where

$$\Omega_{\text{sec},j} = \begin{bmatrix} [(\bar{\delta} + \underline{\delta}) [CA^j \quad CA^{j-1}B \quad \dots \quad CA^0B] \quad -1 \quad 0_{1,N+1-j}] \\ 0_{n+(N-j),n+N+1} \\ -\bar{\delta}\underline{\delta} \begin{bmatrix} (CA^j)^\top \\ (CA^{j-1}B)^\top \\ \vdots \\ (CA^0B)^\top \\ 0_{N-j,1} \end{bmatrix} \end{bmatrix} \begin{bmatrix} [CA^j \quad CA^{j-1}B \quad \dots \quad CA^0B] \quad 0_{1,N-j} \end{bmatrix}.$$

The term involving the slope inequality

$$\sum_{j=0}^{N-1} \sum_{g=j+1}^N \tau_{j,g}^{\text{slo}} \delta_{\text{slo}}(\nu_j, \nu_g) = \xi_N^\top \Omega_{\text{slo}}(N, \tau^{\text{slo}}) \xi_N \quad (2.31c)$$

where

$$\Omega_{\text{slo}}(N, \tau^{\text{slo}}) = \frac{1}{2} \sum_{j=0}^{N-1} \sum_{g=j+1}^N \tau_{j,g}^{\text{slo}} He(\Omega_{\text{slo},j,g}) \quad (2.31d)$$

with

$$\Omega_{\text{slo},j,g} = \left(\begin{bmatrix} [\bar{\gamma} [CA^j \quad CA^{j-1}B \quad \dots \quad CA^0B] \quad 0_{1,N-j}] \\ 0_{n+(N-j),n+N+1} \end{bmatrix} - \begin{bmatrix} [\bar{\gamma} [CA^g \quad CA^{g-1}B \quad \dots \quad CA^0B] \quad 0_{1,N-g}] \\ 0_{n+(N-g),n+N+1} \end{bmatrix} - \begin{bmatrix} 0_{n+j,n+N+1} \\ [0_{1,n} \quad \mathbf{e}_{j+1}^{(N+1)\top}]^\top \\ 0_{n+(N-j),n+N+1} \end{bmatrix}^\top - \begin{bmatrix} 0_{n+g,n+N+1} \\ [0_{1,n} \quad \mathbf{e}_{g+1}^{(N+1)\top}]^\top \\ 0_{n+(N-g),n+N+1} \end{bmatrix}^\top \right) \left(\begin{bmatrix} 0_{n+j,n+N+1} \\ [0_{1,n} \quad \mathbf{e}_{j+1}^{(N+1)\top}]^\top \\ 0_{n+(N-j),n+N+1} \end{bmatrix} - \begin{bmatrix} 0_{n+g,n+N+1} \\ [0_{1,n} \quad \mathbf{e}_{g+1}^{(N+1)\top}]^\top \\ 0_{n+(N-g),n+N+1} \end{bmatrix} \right).$$

The bounds obtained using the integral terms, for (2.16a)

$$\sum_{j=0}^N \lambda_j^p L(0, \nu_j) - \lambda_j^n U(0, \nu_j) = \xi_N^\top \Omega_{\text{LU}}^0(N, \lambda^p, \lambda^n) \xi_N \quad (2.31e)$$

where

$$\Omega_{\text{LU}}^0(N, \lambda^p, \lambda^n) = \frac{1}{2} \sum_{j=0}^N He(\Omega_{\text{LU},j}^0) \quad (2.31f)$$

with

$$\Omega_{\text{LU},j}^0 = \begin{bmatrix} [-\lambda_j^n [CA^j \quad CA^{j-1}B \quad \dots \quad CA^0B] \quad \frac{1}{2\bar{\gamma}}(\lambda_j^p + \lambda_j^n) \quad 0_{1,N-j}] \\ 0_{n+(N-j),n+N+1} \end{bmatrix};$$

for (2.16b)

$$\sum_{j=0}^N \lambda_j^p U(0, \nu_j) - \lambda_j^n L(0, \nu_j) = \xi_N^\top \Omega_{\text{UL}}^0(N, \lambda^p, \lambda^n) \xi_N \quad (2.31g)$$

where

$$\Omega_{\text{UL}}^0(N, \lambda^p, \lambda^n) = \frac{1}{2} \sum_{j=0}^N He(\Omega_{\text{UL},j}^0) \quad (2.31h)$$

with

$$\Omega_{\text{UL},j}^0 = \begin{bmatrix} \lambda_j^p [CA^j & CA^{j-1}B & \dots & CA^0B] & -\frac{1}{2\bar{\gamma}}(\lambda_j^p + \lambda_j^n) & 0_{1,N-j} \\ 0_{n+j,n+N+1} & & & & & \\ 0_{n+(N-j),n+N+1} & & & & & \end{bmatrix};$$

for (4.18)

$$\sum_{j=0}^N \lambda_j^p U(\nu_j, \nu_{j+1}) - \lambda_j^n L(\nu_j, \nu_{j+1}) = \xi_N^\top \Omega_{\text{UL}}(N, \lambda^p, \lambda^n) \xi_N \quad (2.31i)$$

where

$$\Omega_{\text{UL}}(N, \lambda^p, \lambda^n) = \frac{1}{2} \sum_{j=0}^N He(\Omega_{\text{UL},j}) \quad (2.31j)$$

with

$$\Omega_{\text{UL},j} = \begin{bmatrix} -\lambda_j^n [C(A^{j+1} - A^j) & C(A^j - A^{j-1})B & \dots & C(A - I_n)B] & -\lambda_j^n CA^0B - \frac{1}{2\bar{\gamma}}(\lambda_j^p + \lambda_j^n) & \frac{1}{\bar{\gamma}}(\lambda_j^p + \lambda_j^n) & 0_{1,N-j} \\ \lambda_j^p [C(A^{j+1} - A^j) & C(A^j - A^{j-1})B & \dots & C(A - I_n)B & CA^0B] & -\frac{1}{2\bar{\gamma}}(\lambda_j^p + \lambda_j^n) & 0_{1,N-j} \\ 0_{n+j,n+N+1} & & & & & & \\ 0_{n+(N-j),n+N+1} & & & & & & \end{bmatrix}.$$

2.4 Numerical examples

The proposed Lyapunov function structure is now evaluated through three numerical examples i) assessing the maximal achievable sector for a global analysis using benchmark LTI systems from the literature ii) computing estimates of the region of attraction, and iii) computing bounds for the worst-case input-output gains. The LMIs corresponding to each stability conditions were solved using YALMIP [120] and MOSEK [8].

2.4.1 Maximum Achievable Sector

We first evaluate the conditions for global stability of system (2.1) using (2.5) on minimal realizations of the seven systems given in Table 2.1 with equal sector and slope bounds, as in $\underline{\delta} = \underline{\gamma} = 0$, and $\bar{\gamma} = \bar{\delta}$. We then look for the maximum value of $\bar{\delta}$ for which stability could be verified. The tests were carried out by using a sequence of increasing values of the integer N .

Table 2.2 compares the maximum achievable $\bar{\delta}$ obtained by solving the inequalities in Theorem 2.1 against other modern methods, including the Zames-Falb multipliers of [27] and [170], and the Lyapunov functions of [132] and [2].

For $G_2(z)$, $G_3(z)$ and $G_4(z)$, the proposed Lyapunov function $V(x)$ provides less conservative sector bounds δ than the Lyapunov function $\hat{V}(x)$ from [132], as in (2.9). Furthermore, as discussed in Remark 2.1, the sector bounds obtained with $V(x)$ and $N = 1$ match the ones obtained with $\hat{V}(x)$. Thus, showing that V could encompass and generalise \hat{V} . For $G_2(z)$, $G_3(z)$ and $G_4(z)$, extending the *horizon length* N of V beyond $N = 1$ led to some conservatism reduction in the achievable sector $\bar{\delta}$, with the horizon length yielding the maximum achievable sector reported in Table 2.2. Figure 2.3 illustrates the effect of the horizon length N on the achievable sector by showing the maximum achievable sector bound $\bar{\delta}^*$ for $G_4(z)$ as a function of the horizon length N , with a clear increase at $N = 3$. It must also be said that the Zames-Falb multipliers of [27] and [170] could still achieve superior sector bounds for $G_4(z)$, $G_5(z)$ and $G_7(z)$, however, the Lyapunov function approach for stability analysis considered in this chapter still offers advantages. In particular, Lyapunov functions provide a more natural framework to conduct a regional analysis.

Example	Plant
$G_1(z)$ [2]	$\frac{0.1z}{z^2-1.8z+0.81}$
$G_2(z)$ [2]	$\frac{z^3-1.95z^2+0.9z+0.05}{z^4-2.8z^3+3.5z^2-2.412z+0.7209}$
$G_3(z)$ [2]	$-\frac{z^3-1.95z^2+0.9z+0.05}{z^4-2.8z^3+3.5z^2-2.412z+0.7209}$
$G_4(z)$ [2]	$\frac{z^4-1.5z^3+0.5z^2-0.5z+0.5}{4.4z^5-8.957z^4+9.893z^3-5.671z^2+2.207z-0.5}$
$G_5(z)$ [2]	$\frac{-0.5z+0.1}{z^3-0.9z^2+0.79z+0.089}$
$G_6(z)$ [81]	$\frac{2z+0.092}{z^2-0.5z}$
$G_7(z)$ [27]	$\frac{1.341z^4-1.221z^3+0.6285z^2-0.5618z+0.1993}{z^5-0.935z^4+0.7697z^3-1.118z^2+0.6917z-0.1352}$

Table 2.1: Various linear systems used as tests in the numerical examples. Set of examples taken from [27].

Plant	Max δ						
	$G_1(z)$	$G_2(z)$	$G_3(z)$	$G_4(z)$	$G_5(z)$	$G_6(z)$	$G_7(z)$
Lyapunov functions							
Circle criterion [167]	0.7934	0.1984	0.1379	1.5313	1.0273	0.6510	0.1069
Tspkin criterion [105]	3.8000	0.2427	0.1379	1.6911	1.0273	0.6510	0.1069
Ahmad et. al. [2]	12.4309	0.7261	0.3027	2.5904	2.4475	0.9067	0.1695
Park et al. [132]	12.9960	0.7397	0.3054	2.5904	2.4475	0.9108	0.1695
Zames-Falb multipliers							
Best in [170]	3.9043	0.4365	0.2063	3.0192	2.4451	1.0236	0.2337
Best in [27]	13.0283	0.8027	0.3120	3.8240	2.4475	0.9115	0.4922
New theorem							
Theorem 2.1, $N = 1$	12.9959	0.7396	0.3053	2.5903	2.4474	0.9108	0.1694
Theorem 2.1 (N^*)	12.9959(1)	0.7934(7)	0.3118(8)	3.2662(3)	2.4474(1)	0.9108(1)	0.1695(19)
Upper limit							
Nyquist gain	36.1000	2.7455	0.3126	7.9070	2.4475	1.0870	1.1766

Table 2.2: Achievable maximum sectors for various tests. N^* is the value of N in $V(x)$ of (2.5) giving the maximum sector.

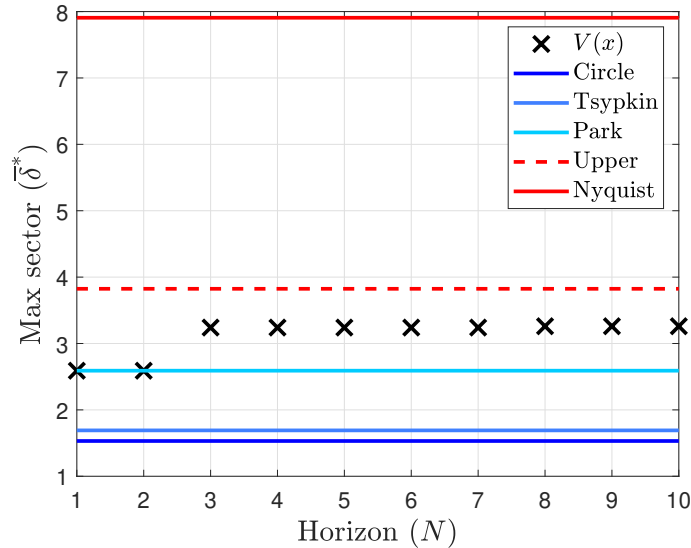

Figure 2.3: Maximum sector δ obtained by Proposition 2.1 for $G_4(z)$ as a function of the horizon $N \in [1, 10]$. We also plot the bounds achieved using the Circle criterion, the Tsytkin Lyapunov function and the function from [132]. The upper limit set by the Nyquist gain is also plotted.

2.4.2 Regional Analysis

The second numerical example uses $V(x)$ from (2.5) to estimate the region of attraction of the Lurie system (2.1). Consider a balanced realization of the plant $G_6(z)$ from Table 2.1, the polynomial

$$p(\sigma) = c\sigma(\sigma - r_1)(\sigma + r_1)(\sigma - r_2)(\sigma + r_2),$$

and

$$\underline{\gamma}_p(\underline{y}, \bar{y}) = \min_{\sigma \in [\underline{y}, \bar{y}]} \frac{dp(\sigma)}{d\sigma}$$

defining the nonlinearity

$$\phi(\sigma) = p(\sigma) - \underline{\gamma}_p(\underline{y}, \bar{y})\sigma.$$

Note that ϕ above is monotonic in the interval $[\underline{y}, \bar{y}]$ and it is sector bounded and slope restricted with

$$\begin{aligned} \underline{\delta}_{\text{loc}}(\underline{y}, \bar{y}) &= \min_{\sigma \in [\underline{y}, \bar{y}]} \frac{\phi(\sigma)}{\sigma}, & \bar{\delta}_{\text{loc}}(\underline{y}, \bar{y}) &= \max_{\sigma \in [\underline{y}, \bar{y}]} \frac{\phi(\sigma)}{\sigma}, \\ \underline{\gamma}_{\text{loc}}(\underline{y}, \bar{y}) &= 0, & \bar{\gamma}_{\text{loc}}(\underline{y}, \bar{y}) &= \max_{\sigma \in [\underline{y}, \bar{y}]} \frac{d\phi(\sigma)}{d\sigma}. \end{aligned}$$

Since the nonlinearity ϕ is a polynomial, the terms $\phi(\nu_j(x))$ in the vector ξ_N and the integrals of (2.5) also become polynomials on the variable x . In the following, the parameters of the nonlinearity and the interval were set to $r_1 = 1$, $r_2 = 2$, $c = 8 \times 10^{-3}$ and $\bar{y} = -\underline{y} = 5.28$.

We formulate a semidefinite program using the inequalities in Theorem 2.2. To optimise the estimates of the region of attraction, we used the trace of the quadratic matrix defining \underline{V} as the cost function. Figure 2.4 shows the estimates of the obtained region of attractions - denoted by the blue curves in the figure- obtained for horizon lengths $N = 1$ (dark blue) and $N = 4$ (light blue), with the blue dashed lines being sublevel sets of the corresponding $V(x)$. The red area displays the set of initial values generating trajectories that did not converge to the origin and the black dashed lines correspond to $\{x : \nu_0(x) = \underline{y}, \nu_0(x) = \bar{y}\}$. The figure shows that increasing the horizon length N in $V(x)$ can generate non-convex estimates of the region of attraction with larger volumes than those obtained using ellipsoidal sets.

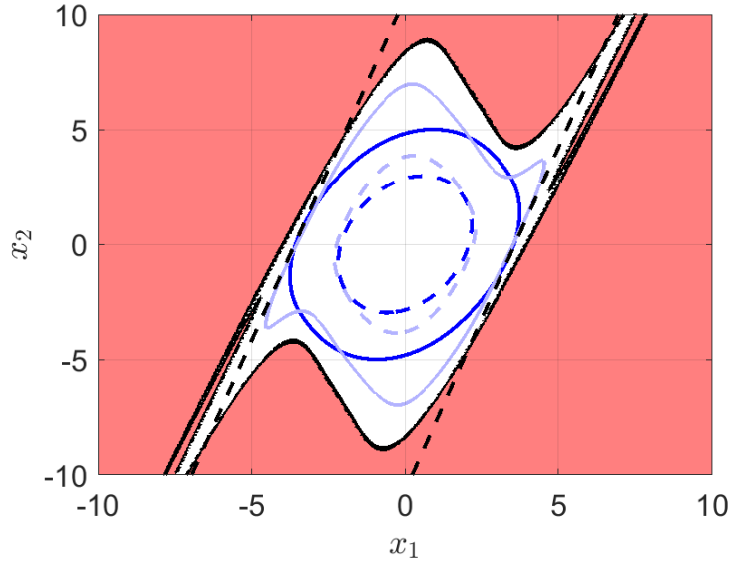

Figure 2.4: Regional stability of the second numerical example. Positive invariant sets of the Lyapunov function $V(x)$ from (2.5) are shown in blue, with blue dashed lines corresponding to sub-level sets. Light blue corresponds to $N = 4$ and dark blue to $N = 1$. Black dashed lines denote the limits $\{x : \nu_0(x) = \bar{y}, \nu_0(x) = \underline{y}\}$. Initial conditions from the red region did not converge to the origin.

2.4.3 Bounding the Worst Case Input-Output Gain

Thus final numerical example highlights the potential of $V(x)$ in (2.5) for bounding the worst-case input-output gain of the Lurie system (2.24). Consider a balanced realization (A, B, C) of $G_4(z)$ from Table 2.1 and assume a global analysis (so $\mathcal{X}_0 = \mathbb{R}^n$). Furthermore, assume that the nonlinearity is bounded by $\bar{\delta} = \bar{\gamma} = 2.55$ and $\underline{\delta} = \underline{\gamma} = 0$ and take $B_w = B$ (as in the input vector of the disturbance equals that of the nonlinearity) and, similarly, $C_z = C$.

Figure 2.5 shows the computed values of ω from Theorem 2.3 defining the worst-case bound $\|z\|_2 \leq \omega \|w\|_2$ for all $\|w\|_2 \in \ell_2$ as a function of the horizon length N of $V(x)$. As N increased, there was a significant drop in ω , going from 6.08×10^3 with $N = 1$ to 3.13×10^1 at $N = 4$ before reaching a plateau. This noticeable drop in ω suggests longer horizons N in $V(x)$ may prove important for tight bounds of the input-outputs of Lurie systems.

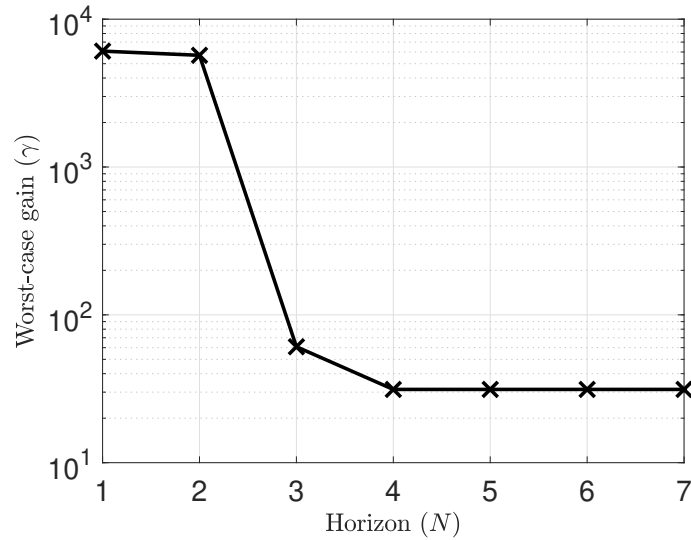

Figure 2.5: Worst-case input output gain ω bounding $\|z\|_2^2 \leq \omega \|w\|_2^2$ as a function of the horizon length N in $V(x)$.

2.5 Conclusions

The absolute stability problem for discrete-time Lurie systems with monotonic nonlinearities was considered. A class of Lyapunov function composed of a generalised quadratic term plus a sum of Lurie-Postnikov type integral terms was proposed. It was shown that sign-definiteness of both the quadratic matrix of the Lyapunov function and the scalars in front of the various integral terms could be relaxed. It was also shown that the proposed Lyapunov function generalised existing Lyapunov function structures and its derivation from applying passivity theory to the feedback Lurie system was discussed. Numerical examples demonstrated the value of the proposed candidate Lyapunov functions for i) increasing the maximum achievable sector bound for verifying global stability, ii) estimating the region of attraction of the Lurie system, and iii) bounding the worst-case input-output gain of the system.

Notes and References

This part ends with notes and references on the absolute stability problem. Since its formulation in [122], the absolute stability problem is at the origin of a significant number of contributions in the Automatic Control literature, including robust control analysis and synthesis and the analysis of nonlinear actuators, stability guarantees for optimization-based strategies. The short literature review presented below highlights some of the results motivating the problems studied in the first two chapters of the manuscript.

The absolute stability problem and the Lurie Lyapunov function

Motivated by the stability analysis of a continuous-time linear SISO system in feedback with a relay (on-off switch), Lurie and Postnikov proposed in [122] a Lyapunov function to study the stability of the origin of the feedback of a class of linear systems and a class of nonlinearities described by a sector inequality. The two researchers were primarily motivated to study this problem related to several practical problems that appear as the interconnection of a linear system and nonlinear static elements. The most straightforward instances of such elements are actuator nonlinearities such as saturation or relay.

This simple description of a family of nonlinear functions raised a question, the Aizerman conjecture [4], of whether the stability of the feedback of the same linear system replacing the nonlinearity by linear gains within the sector was sufficient to guarantee the stability for every nonlinearity within the sector. This conjecture can be stated as:

Conjecture 2.1: Aizerman Conjecture

The equilibrium state $x = 0$ of the system $\dot{x} = Ax + b\phi(y)$, $y = cx$, is absolutely stable on an arbitrary open sector L ($\frac{\phi(y)}{y} \in L$) when the origin in the associated linear system $\dot{x} = (A + bkc)x$, asymptotically stable for all $k \in L$.

The conjecture is not valid in general, the first counterexamples being reported in [111, 141, 51, 64]. These refutations of the conjecture presented systems satisfying the conditions but showing periodic trajectories. Recent results propose the systematic construction of counterexamples [114].

The approaches developed to study the absolute stability problem in the '50s and the '60s are reported in [121, 116, 5, 128]. It is fair to credit the most important result from the early years to Popov, Yakubovic, and Kalman [143, 184, 103]. Their contribution became known as the Kalman-Yakubovic-Popov (KYP) Lemma or Positive Real Lemma. Two of these influential contributions are also presented in [14] where the seminal papers [143] and [184] are shortly presented by J. C. Willems and P. V. Kokotovic, respectively.

The KYP Lemma characterizes the set of linear time-invariant (LTI) SISO systems that are strictly positive real and, as a consequence, stable in closed-loop with passive time-invariant nonlinearities. For this class of systems, the KYP gives a quadratic LF. The KYP lemma can also be applied to loop-transformed systems, allowing to conclude on the stability of the feedback with an LF containing the integral term proposed in [122]. The relation to the (strict) positive realness of the transfer function provides a stability criteria in terms of the frequency response of the LTI system. This frequency response characterization for SISO systems was introduced by Popov [143], the Popov criteria, and the proof of the lemma includes the case of systems with closed left half plane poles.

The two classical criteria for verifying the stability of Lurie systems, the circle, and the Popov criteria, provide graphical interpretations for the SISO case and associate a Lyapunov function to stable systems (a quadratic function for the circle criterion and a quadratic plus integral term for the Popov criterion). By establishing stability criteria with graphical interpretation allowed to

connect to standard linear system analysis. When these results were proposed, the analysis tools used experimental models based on the frequency response.

Slope restrictions

Following the refutation of the Aizerman conjecture, there was still interest in using linear systems to infer the stability of nonlinear Lurie systems. This led to the Kalman conjecture [102] that asks whether the linear stability for all gains in the sector would be sufficient to guarantee the stability of the feedback for all nonlinearities with *slope restrictions* in the sector. It can be stated as:

Conjecture 2.2: Kalman Conjecture

The equilibrium state $x = 0$ of the system $\dot{x} = Ax + b\phi(y)$, $y = cx$, is stable for all differentiable nonlinearities satisfying $\frac{d\phi(y)}{dy} \in L$ on an arbitrary open sector L when the origin in the associated linear system $\dot{x} = (A + bkc)x$ is asymptotically stable for all $k \in L$.

However, the Kalman conjecture was also disproved by counterexamples in continuous-time [64, 11], and the discrete-time case [81]. Since the Kalman conjecture is false, it is essential to formulate methods to assess the stability of SISO systems with slope-restricted nonlinearities. In general, the slope restriction does not impose differentiability of the nonlinearity. Continuous but non-differentiable nonlinearities are appealing in practice since slope bounded nonlinearities appear in saturating actuators and other nonlinear elements modeled with globally Lipschitz functions.

For continuous-time systems, the first and rather general conditions involving slope restriction appeared in [185], where inequalities characterizing the slope restriction were introduced. More recently, the stability analysis with Lyapunov functions, which exploit slope information, has received renewed attention [134, 77].

The main contributions in the study of slope-restricted nonlinearities appeared in the context of the input-output analysis [189, 50]. The input-output methods drew inspiration from the result by Popov, by generalizing its loop transformations by including general transfer functions in the loop, the *multipliers*. Upon showing the existence of such multipliers, stability certificates are obtained. The methods leading to these multipliers offer an alternative to the Lyapunov inequalities yielding Lyapunov functions as stability certificates.

In short, by transforming the feedback loop with multipliers, we can set conditions on the passivity of the linear part combined with the multiplier to conclude upon the stability of the loop. Monotone and slope-restricted nonlinearities introduce a specific class of multipliers. For the class of monotone nonlinearities, these multipliers are called the Zames and Falb (ZF) multipliers [189]. The survey [29] gives an overview of the first contributions to characterize this class of multipliers introduced in the works of O'Shea [130] and Zames & Falb [189]. The discrete-time counterpart of the ZF multipliers was introduced in [182]. By using a particular class of multipliers, [66] listed conditions on the parameters of 4th order systems that satisfy both Aizerman and Kalman conjectures. Regarding the computational formulation, numerical searches for the ZF multipliers were proposed in [148]. Also, for the discrete-time case, several results were recently obtained [170, 27]. More recently, ZF multipliers could be extended to verify stability within some region of the state-space [62].

Assuming slope restrictions also help enlarge the set of LF that can be used to study the stability for *time-varying nonlinearities*. For instance, instead of using only a quadratic function, it is possible to use the integral Lurie term whenever the slope is restricted. In this case, quadratic bounds can be obtained to the term $\int_0^y \phi(s)ds$, that appear in the Lyapunov function derivative.

The discrete-time case

In [160], a quadratic Lyapunov function was used to study the stability of a discrete-time Lurie system. In [161] Szegö introduced a Lyapunov function mimicking the Lurie function with an integral term used for continuous-time systems by then. The derivation of these time-domain conditions for DT systems were thus less formal than the CT counterpart. As a result, the stability conditions with the same LF structure require different assumptions on the nonlinearity. Indeed, for DT systems, it was also required to impose a slope constraint on the nonlinearity. Interestingly, already in this paper, the stability conditions allow the coefficient of the integral term in the LF to be a real number; namely, it is not required to be non-negative as in the continuous-time analysis (where no slope restriction is imposed). The discrete-time counterpart to the Popov frequency-domain tests for absolute stability was proposed by Tsympkin [167, 168]. A summary of these early

contributions is presented in [112]. In both approaches, the LF function with integral terms and the discrete-time Popov multiplier [168] the nonlinearity must be *monotonic and slope restricted*. Technically, such a restriction bounds an integral of the nonlinearity between two instants by a quadratic expression.

Even though the extensions from the continuous-time case led to the first stability analysis results in discrete-time, the choice of the Lyapunov function was not evident, as Szegö observed in [168, Discussion]:

Even if we now have some fairly good results on this problem, the status of stability theory for sampled-data systems has still not reached a satisfactory stage as in the continuous case. Further work is needed, and improvements can be achieved by using the new method of Popov and very likely by using some more sophisticated Lyapunov functions.

Another critical aspect of these methods is that approximation of the integrals is crucial to reducing the conservatism of the stability conditions. The impact of the integral approximation when assessing the inequality involving the variation of the LF was discussed in [154]:

Various area inequalities can be found for the integral of $\int_{y[k]}^{y[k+1]} \phi(s)ds$, and it appears that, by combining these results, a better and more versatile stability condition may be obtained. Further work is being done to obtain a suitable discrete equivalent of the area integral, yielding a better stability boundary.

Indeed, better approximations of the integral term were proposed by [3, 131], using the bounds on the slope of the nonlinearities.

Analysis methods based on optimization also renewed the interest in the stability of discrete-time Lurie systems. The paper [76] reinterprets the results from the previous decades within a Riccati equation framework. The authors propose to study multivariable nonlinearities with multivariable sector inequality and decentralized slope inequalities. On the other hand, the LF therein is a direct generalization of the one introduced in [161], namely the sum of integrals, thus requiring the same type of approximations of integral terms. This sum of integrals in a MIMO decentralized nonlinearity was already adopted in [151]. The results in [76] paved the way to LMI formulations since matrix inequalities later replaced the Riccati equations formulation. LMI results for discrete-time systems with slope restrictions are detailed in [105] and [134]. Both papers seem to have neglected that the constraints on the positivity of the integral term could be dropped as in [161] (even though in [134], the several integrals that are used make a simplified quadratic plus integral expression have real coefficients in a single integral, see Remark 2.1 of this manuscript). In the wake of these formulations, the LMI approaches have mainly imposed these coefficients to be positive since they provide a rather simple way of parameterizing the positivity of the LF.

Local analysis of Lurie Systems

In some practical cases, verifying the global stability of an equilibrium point is not possible for Lurie Systems, for example, the situation where the trajectories converge to an attractor such as a limit cycle or a chaotic trajectory or the cases where the set of initial conditions of converging trajectories to the equilibrium point is a subset of the state space. The main challenge in such cases is to characterize the set of initial conditions converging to the equilibrium either asymptotically or in finite time. Such a task can be carried out by solving the Zubov equations [192]. However, the Zubov method can be involved since it consists of a set of partial differential equations in \mathbb{R}^n . Alternatively, we can obtain estimates of it in terms of inner or outer approximations of the *region of attraction*, namely the set of all initial conditions generating trajectories converging to the equilibrium.

For the Absolute stability problem, a first result for the local stability appeared in [110] providing estimates of the region of attraction (ERA) in terms of Lyapunov level sets. The approach consisted of using bounds for the sector for an imposed region in the state space. A similar approach was proposed in [177] where the regions where the sector inequalities hold are also limited. In these early results, the ERA is given by a level set of an LF, and it is obtained by checking some set containment conditions. These set containment essentially guarantee that the Lyapunov inequalities hold within the set where the sector conditions hold. These additional set containment conditions can be obtained for specific nonlinearities. The results in [179] show how to obtain the maximum level set in terms of bounds of the nonlinearity input for a quadratic LF.

Saturation and quantization within the absolute stability framework

Even though the relay was the first nonlinearity to be studied in the context of absolute stability, the saturation nonlinearity is perhaps the most significant nonlinear static element in control systems [162, 88]. Saturation appears due to limits in actuators for safety or technological reasons. A nonlinearity closely related to the saturation is the deadzone. Indeed, saturation and deadzones are alike for Lurie systems since they can be transformed into one another via a linear loop transformation.

In practice, to prevent actuators from reaching their physical limits, the software implements the saturation, and in these cases, an exact model is obtained for analysis and design purposes. On the other hand, we may consider the saturation as a class of static mappings within the more general framework of absolute stability for simplicity or because the actuator gains, limits, and the actual saturation mappings are not precisely known.

Even though the sector characterization of the saturation introduces conservatism in the analysis, it does not impose the analysis to be carried out only in the linear region and thus allows to study trajectories with input signals that undergo saturation. This flexibility is beneficial when computing estimates of the region of attraction or when assessing the local properties such as induced gains. Allowing the input signals to saturate is in contrast with approaches imposing the signals to remain in the non-saturating regions [93].

The first results to consider saturation as a sector nonlinearity trace back [138] where discrete-time systems were studied using the Lyapunov function from Szegö [161]. The results are illustrated with saturating systems to highlight the benefits of the integral terms over a simple quadratic LF for the absolute stability problem.

More recently, optimization methods were used to compute add-ons to the feedback loops to reduce the performance degradation induced by saturation. These methods give formal proofs for the global or local stability of saturating feedback and introduce elements in the feedback loop that become active in the event of saturation. These elements, known as *anti-windup* (AW) compensators, had been initially introduced in industrial applications containing SISO loops with integral action and saturation in actuators to prevent the state of the analog devices, often implemented using capacitors, to “wind-up”. The first strategies were empirical, following heuristics and relying on the operator experience (for details on the development of AW techniques, see the surveys [165, 67]. With the use of sector conditions and semidefinite programming, the AW design can be systematic and allows to improve the performance of saturating systems whenever the input signal saturates [188]. In the development of AW compensators, a refinement of the sector conditions for saturating nonlinearities was introduced. The proposed generalized sector condition is reported in [89, 73]. Roughly speaking, the idea behind this generalization is to narrow the sector within which the saturation lies. Unlike previous local analysis results for Lurie systems, this approach does not impose the set in which the narrowed sector holds, making it attractive in an optimization context since the parameters defining the set where it holds are decision variables of the problem. These parameters are thus used to enlarge estimates of the regions of attraction.

However, in most existing methods for the design of feedback gains for saturating systems or for the design of AW compensators, the LF structure is a simple quadratic function. Analyzing these feedback loops to compute gain curves or ERAs can benefit from more complex Lyapunov functions, such as LFs with the integral of the nonlinearity. In this case, it is important to observe that for a piecewise affine function, such as saturation input, the Lurie integral term becomes a quadratic [41] term. The resulting LF is thus a generalized quadratic form involving both the state and the nonlinear function. However, one aspect in [41, 68] (also in [159] for general Lurie systems) was overlooked when casting conditions for the positive definiteness of the LF with conditions on the matrix describing the generalized quadratic form. In these papers, the extended matrix was required to be positive definite. However, this is only a sufficient condition for the positivity of the LF, since in general, the matrix in the generalized quadratic forms needs not to be positive definite. Relaxing the positivity of the extra blocks in generalized quadratic forms helps improve the ERA estimates and the local gains computation as highlighted in [174] and [176]. We can mention [90] that already proposed the relaxation of the positive definiteness of the matrix in the generalized quadratic form.

Since the static, time-invariant nonlinearities within a sector need not be continuous in the absolute stability framework, it is also possible to analyze systems with relays and quantization. The absolute stability applied to systems with input quantization is pursued in the works by [59, 60, 94, 39].

The case of MIMO Nonlinearities

A sector nonlinearity is any mapping of a single variable between two linear maps, the sector containing the nonlinearity can be easily depicted graphically. The bounds by linear maps are also easily described by an inequality. For MIMO nonlinear loops with a static MIMO nonlinearity, the graphical interpretation is no longer possible. The most common approach is then to directly characterize the nonlinearity by inequality as $\phi^\top(y)(y - K\phi(y)) \geq 0$ for some positive semidefinite matrix K .

However, the MIMO nonlinearity can be a simple combination of several SISO terms; this is called the *decentralized* case. In practice, some nonlinearities are not decentralized, and examples are actuators that saturate in the norm of multivariable inputs. This way, the magnitude bounds for each channel depends on the current values of the outputs of the other channels.

Due to the difficulties in describing a multivariable sector inequality, the absolute stability problem for MIMO systems has not been studied in detail as the SISO case. Most of the existing results rely on sufficient conditions to compute Lyapunov functions and consider the decentralized case. In [6] a proposal to generalize sector inequalities for MIMO nonlinearities was presented. More recently, the equivalence of the frequency-domain conditions and the time-domain conditions for the Circle Criterion in the MIMO setting is discussed in [119]. For systems with multiple slope-restricted nonlinearities, a frequency domain criterion generalizing previous results for SISO systems and the associated multipliers has been proposed in [78, 43, 149].

Generalizations of absolute stability

If instead of sector bounds, the nonlinearity is bounded by other nonlinear maps, inequalities generalizing sector inequalities can be formulated [87, 123, 79, 55]. These approaches offer alternatives to linear sector description to reduce the set in which a given nonlinearity lies.

Also, for the case of nonlinearities that belong to a sector only outside a neighborhood of the origin, a robustness problem can be formulated by assuming a global sector and bounded disturbances with the notion of input-to-state stability (ISS) [94]. The ISS framework is also used to study reachability under bounded disturbances [9].

Semidefinite programming for Lurie systems

The first methods to obtain the parameters of Lurie functions were based on the analytical solution to algebraic equations. These methods generalized the approaches based on the solution of a Lyapunov equation $A^\top P + PA = -Q$, to show the stability of a linear time-invariant system. In the above equation, the matrix Q is a fixed positive definite matrix. However, it is important to keep in mind that the LF parameters showing the stability of a system may not be unique. Indeed, different choices for Q give different matrices P . The set of solutions is convex (an LMI set [22]). Such a set characterizes all parameters of the Lyapunov matrix, satisfying the Lyapunov inequalities.

The existence of these convex sets motivates the use of inequalities instead of equations to obtain stability certificates as LF. The main advantage of the inequality description of the set of LFs for LTI systems is that it can be solved with Semidefinite Programming (SDP), a class of convex optimization problems. Thanks to the inequalities description, it is also simpler to use the finite-dimensional parametrization of Lyapunov functions to study uncertain systems, incorporate constraints in the nonlinear analysis (often described by set containment conditions), or add optimization goals to estimate input-output gains. The applications of SDP in Automatic Control increased its popularity and contributed to its development. The potential of LMIs for stability and performance analysis was observed in [181], [185].

Furthermore, fundamental results trace back to Yakubovic with the formulation of the S -procedure for quadratic forms, which permeates the LMI literature. The reader can refer to [22, Section 1.2, and Chapter 5 Notes and References] for an account of the relation between the study of Lurie systems and the development of numerical solutions to Lyapunov inequalities. Checking the positivity of the LF with Lurie integral terms for systems with sector bounded nonlinearities has an immediate SDP formulation. On the other hand, the application to other problems requires more insight into inclusion conditions. This is the case of local stability analysis, where the use of SDP to compute estimates of the region of attraction for Lurie Systems appeared in [84], and [140].

Also, the solution to Lyapunov inequalities for control law design has led to stabilizability conditions solved by semidefinite programs. The local sector conditions for quadratic stabilizability

have been successfully used for the local stabilization of linear saturating systems. More complex LFs and ZF multipliers have been used for the analysis, resulting in better stability bounds or performance estimates. For this reason, it appears that the use of more complex LF for nonlinear control design will help obtain better closed-loop performance. Such a generalization to other LF may lead to Anti-Windup strategies that will improve performance at the expense of a more complicated control law with possibly the need for online algebraic loop solutions.

Moreover, understanding the fundamental results of Lurie system analysis is crucial to understanding and contributing to emerging applications. Indeed, applications of SDP formulations for Lurie systems appear in the study of multi-agent with nonlinear interconnections [42, 191, 145] in the study of systems with forced oscillations [142] or the design of numerical optimization algorithms [115].

Part II

Analysis of Piecewise Affine Discrete-Time Systems

Introduction of Part II

The widespread availability and the decreasing costs of digital devices have promoted the implementation of control systems in discrete time. In these control systems, the actuation devices introduce static nonlinearities such as saturation, deadzones, or quantizations, leading to piecewise affine (PWA) systems [72, 113]. Moreover, engineered systems such as nonlinear circuits [99, 100] and mechanical elements [106, 85] are suitably modeled by PWA systems. The Receding Horizon Optimal Control (ROHC) [16], or Model Predictive Control (MPC), also leads to PWA functions. This optimization-based strategy that allows handling state and input constraints easily, can be formulated as a multi-parametric linear or quadratic programs. The solutions to these problems are PWA functions that can be computed offline, the so-called Explicit Model Predictive Control (EMPC) [16, 95].

Nonlinear elements in feedback control systems may induce limit cycles, chaotic behavior, possibly leading to poor performance and instability. This is not different for the PWA systems. The stability analysis of systems presenting these nonlinearities introduces several theoretical challenges. In particular, within the framework of Lyapunov stability analysis, different steps for their study raise important questions: the choice of system representation, the choice of the Lyapunov function, and the methods for the verification of the Lyapunov inequalities.

The stability analysis of PWA systems traces back to [155], where the following explicit representation was introduced for a PWA function $f : \mathbb{R}^n \rightarrow \mathbb{R}^n$

$$f(x) = A_i x + b_i, \quad \forall x \in \Gamma_i \subset \mathbb{R}^n, \quad (\text{II.1})$$

$i = 1, \dots, n_s$, $A_i \in \mathbb{R}^{n \times n}$, $b_i \in \mathbb{R}^n$ with the sets Γ_i defining a partition of \mathbb{R}^n , i.e. $\cup_{i=1}^{n_s} \Gamma_i = \mathbb{R}^n$. The analysis continuous-time systems using the explicit representation (II.1), has been mainly studied with piecewise quadratic Lyapunov functions (LF) [96, 92, 91]. In [96], the sets Γ_i are described by the intersections of half-spaces. In [92] the particular case of conewise linear systems is addressed. In [91], a representation of the polyhedral regions of the state space partition by vertices and cone rays is considered. The Lyapunov stability inequalities are tested with sufficient conditions based on the cone rays and the vertices representing each set Γ_i in the partition.

On the other hand, the stability analysis of discrete-time PWA systems has been studied, for instance, in [58, 61, 86, 147]. Similar to [96], polyhedral partitions described by the intersections of half-spaces are considered in these works. Discontinuous piecewise quadratic Lyapunov functions can be studied for discrete-time systems. The additional difficulty in the analysis with a piecewise quadratic (PWQ) function for each set Γ_i is that it requires the enumeration of all possible transitions between sets in the partition and the evaluation of the associated decrease of the LF.

A particular class of discontinuous PWA systems is motivated by the implementation of control laws in digital devices and networks that often require the input and output signals to be suitably encoded/decoded into finite alphabets. The limited number of values leads to a fundamental limitation in digital control systems: the quantization of sensors and actuators. An attempt to tackle the negative impact of quantization in control systems can be traced back to work by Kalman featured in [101], where stochastic methods were used to reduce the influence of quantization in the useful bandwidth. This approach can be effective whenever the level of specification is rather modest and the quantization somehow restrained.

The work by Delchamps [47, 48] introduced a different viewpoint by proposing to model the quantization by a static nonlinear function, the *quantizer*, mapping a real variable into a variable belonging to a countable set, thus enabling the analysis and the design of quantized control systems via deterministic nonlinear control theoretical tools. Consider a plant with $n_u \in \mathbb{N}$ inputs taking values into the set

$$\mathcal{Q} := \{0, \delta_1\} \times \{0, \delta_2\} \times \dots \times \{0, \delta_{n_u}\},$$

where $\delta_i \in \mathbb{R}$, for all $i \in \{1, 2, \dots, n_u\}$, are some given *levels*, controlled by an static state feedback law $v : \mathbb{R}^n \rightarrow \mathbb{R}^{n_u}$. In this case, we can describe the quantizer by the function $Q : \mathbb{R}^{n_u} \rightarrow \mathcal{Q}$ defined as

$$Q(v) = \Delta S(v)$$

$\Delta := \text{diag}\{\delta_1, \delta_2, \dots, \delta_{n_u}\}$, and $S : \mathbb{R}^{n_u} \rightarrow \mathbb{R}^{n_u}$, $S(u) := (s(u_1), s(u_2), \dots, s(u_{n_u}))$ where, for all $\theta \in \mathbb{R}$,

$$s(\theta) := \begin{cases} 1 & \text{if } \theta > 0 \\ 0 & \text{if } \theta \leq 0. \end{cases} \quad (\text{II.2})$$

This setup is rather general and includes the case in which actuators are subject to finite-level quantization.

The first attempts hinging upon this model approach for SISO systems are detailed in [126]. In particular, in [126], the authors study the problem of having quantized measurements in a linear control system by first bounding the quantization error and then by pursuing a Lyapunov approach to establish ultimate boundedness. Later on, this approach has been extended in [23] to general linear control systems with quantized measurements and in [117] to nonlinear systems in the presence of quantized control inputs or quantized measurements. In [65], the authors analyze discrete-time linear quantized control systems by encapsulating quantization error into a bounded sector. The stability analysis and controller design for quantized LTI continuous-time systems based on a sector bounded representation are addressed in [163, 59, 60]. Other results on quantized control systems can be found in [30, 39, 118, 158] and in the very recent works [53, 178], showing a vivid interest in quantization in the controls community.

Summary of Contributions of Part II

This part studies discrete-time systems by introducing an implicit representation for PWA systems based on ramp functions. We follow the rationale of the absolute stability problem by recasting the class of nonlinear PWA systems as the feedback interconnection of a linear block and ramp functions, as in the figure below.

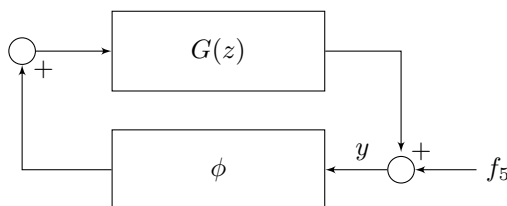

Figure 2.6: Feedback representation of a Lurie system is here used to represent PWA systems. In this part, ϕ will be a vector of ramp functions. The term f_5 is a constant vector that is added to the output of the linear block $G(z)$ to generate the input y of the nonlinearity ϕ .

Since the nonlinearity in the feedback is known, instead of using a sector inequality, we use the optimality Karush-Kuhn-Tucker (KKT) conditions to characterize the ramp function. Thanks to this characterization, given by two linear inequalities and one quadratic identity, we can formulate conditions to verify generalized quadratic inequalities. These conditions are based on semidefiniteness constraints of matrices associated to the generalized quadratic forms.

The verification of generalized quadratic inequalities appears in stability conditions of PWA system using PWQ Lyapunov functions. These PWQ functions are generalized quadratic forms on the states and nonlinearity and the ramp function. Conditions for robust stability analysis are also presented. In this context, the use of polytopic sets to represent uncertainties helps describe uncertainty in the partition.

We also exploit the characterization of the ramp function and the verification of generalized quadratic inequalities in a slightly different context: to verify the positivity of discontinuous PWQ function. Again, using KKT optimality conditions, we show how to describe a regularized step function. The description of the step function as KKT conditions, enable us to study systems with discontinuities. In this context, we propose global stability conditions for discrete-time systems with quantization of the inputs. This framework also allows us to compute discontinuous Lyapunov functions.

Structure of Part II

In **Chapter 3**, we investigate stability conditions for discrete-time PWA systems. With this aim, we introduce an implicit representation of PWA functions. The proposed representation allows us to avoid some shortcomings of the explicit representation (II.1). In particular, we use generalized quadratic forms to parametrize continuous piecewise quadratic Lyapunov functions. The stability of PWA systems can thus be assessed by evaluating Lyapunov stability conditions in terms of linear matrix inequalities (LMI) and does not require the enumeration of transitions between the partition sets. Furthermore, we show that the proposed representation easily copes with uncertainties in the partition, which is rather difficult with the existing methods.

Chapter 4 of this part focus on the analysis of systems with quantization. We propose a representation of a *regularized* step mapping based on an ill-posed algebraic loop containing two ramp functions. The relation to ramp functions is obtained thanks to the KKT necessary conditions for

optimality. We carry out the stability analysis using generalized quadratic functions. In particular, we propose a Lyapunov function including the considered set-valued nonlinearity [41, 74, 26, 174] that is quadratic in the plant state and the nonlinearity. We then propose sufficient conditions in the form of LMIs to certify global exponential stability of the origin of linear systems with input quantization. Those conditions can be efficiently checked by using semidefinite programming and numerical examples to illustrate the proposed method's effectiveness.

Chapter 3

Piecewise Affine Systems

This chapter is organized as follows: Section 3.1 presents the proposed implicit representation for PWA functions that rely on ramp functions, illustrates it with examples. Section 3.2 characterizes ramp functions in terms of quadratic identities and inequalities and presents conditions for verifying positivity of piecewise quadratic forms. In Section 3.3 we apply the positivity verification to formulate conditions for stability of discrete-time PWA systems using Piecewise Quadratic (PWQ) Lyapunov functions. Finally we illustrate the obtained results with numerical examples in Section 3.4 and present concluding remarks and perspectives in Section 3.6. The relation of the proposed implicit representation to other representations of PWA functions in the literature is discussed in Section 3.5.

3.1 Implicit Representation of Continuous PWA Functions

In this chapter we study the stability of piecewise affine discrete-time dynamical systems by

$$x[k+1] = f(x[k]) \quad (3.1)$$

where $x \in \mathbb{R}^n$ is the state and $f(x)$ is a continuous piecewise affine vector function.

The methods we propose here are based on the implicit representation for piecewise affine vector functions $f : \mathbb{R}^n \rightarrow \mathbb{R}^n$ as follows

$$f(x) = F_1x + F_2\phi(y(x)) \quad (3.2a)$$

$$y(x) = F_3x + F_4\phi(y(x)) + f_5 \quad (3.2b)$$

where $x \in \mathbb{R}^n$, $y \in \mathbb{R}^{n_y}$, $F_1 \in \mathbb{R}^{n_f \times n}$, $F_2 \in \mathbb{R}^{n_f \times n_y}$, $F_3 \in \mathbb{R}^{n_y \times n}$, $F_4 \in \mathbb{R}^{n_y \times n_y}$, $f_5 \in \mathbb{R}^{n_y}$ and the vector function $\phi : \mathbb{R}^{n_y} \rightarrow \mathbb{R}^{n_y}$ is defined elementwise by the ramp function as

$$\phi_i(y) = r(y_i) := \begin{cases} 0 & \text{if } y_i \leq 0 \\ y_i & \text{if } y_i > 0 \end{cases}, i = 1, \dots, n_y \quad (3.2c)$$

as depicted in Figure 3.1.

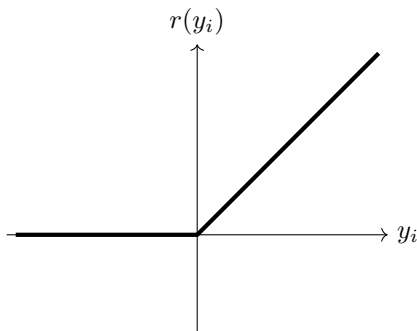

Figure 3.1: Ramp function $r(y_i)$.

The use of (3.2)-(3.2c) to model continuous PWA functions avoids the explicit definition of partitions and the associated affine functions, as in the standard representation (II.1).

Some structures of matrix F_4 can yield explicit solutions to (3.2b). For instance, with strictly upper or lower triangular matrices we obtain recursive expressions of y allowing for an explicit dependence on x . However, in general, it is an implicit equation and we will assume its *well-posedness* (see Section 3.1.1).

We should also observe that thanks to the well-posedness of equation (3.2b) and the continuity of the ramp functions in ϕ , f is a continuous function. We illustrate below two examples of (3.2).

Example 3.1. Consider (3.2) with $n = 2, n_y = 2, n_f = 1$ and

$$\begin{aligned} F_1 &= \begin{bmatrix} 0 & 1 \\ -1 & -1 \end{bmatrix}, & F_2 &= \begin{bmatrix} 1 & 1 \\ 0 & -\frac{2}{3} \end{bmatrix}, \\ F_3 &= \begin{bmatrix} -1 & -1 \\ 1 & -1 \end{bmatrix}, & F_4 &= \begin{bmatrix} 0 & -\frac{2}{3} \\ -1 & 0 \end{bmatrix}, & f_5 &= \begin{bmatrix} 0 \\ 0 \end{bmatrix}. \end{aligned} \quad (3.3)$$

The corresponding partition of \mathbb{R}^2 for (3.2) with the matrices in (3.3) is given by

$$\begin{aligned} \Gamma_1 &= \{x \in \mathbb{R}^2 \mid \phi_1(y(x)) = 0, \phi_2(y(x)) = 0\}, \\ \Gamma_2 &= \{x \in \mathbb{R}^2 \mid \phi_1(y(x)) \geq 0, \phi_2(y(x)) = 0\}, \\ \Gamma_3 &= \{x \in \mathbb{R}^2 \mid \phi_1(y(x)) = 0, \phi_2(y(x)) \geq 0\}, \\ \Gamma_4 &= \{x \in \mathbb{R}^2 \mid \phi_1(y(x)) \geq 0, \phi_2(y(x)) \geq 0\}. \end{aligned}$$

and is depicted in Figure 3.2. An explicit representation for $f(x)$ as in (II.1) is given by

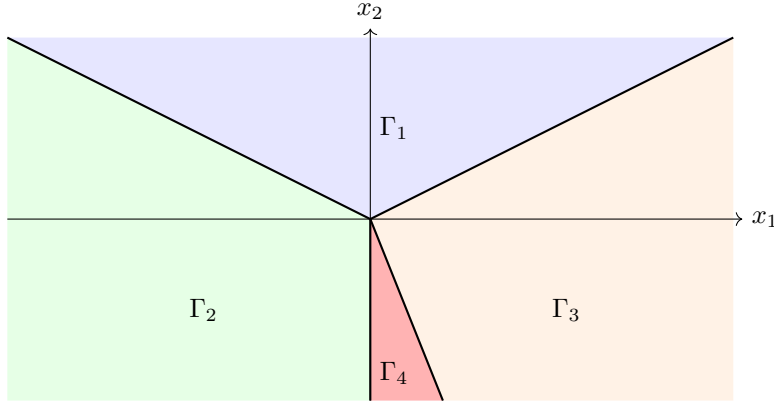

Figure 3.2: Partition of \mathbb{R}^2 for $f(x)$ defined by (3.2), (3.3).

$$f(x) = \begin{cases} x_2, & x \in \Gamma_1 = \{x \in \mathbb{R}^2 \mid -x_1 \leq x_2; x_1 \leq x_2\}, \\ -x_1, & x \in \Gamma_2 = \{x \in \mathbb{R}^2 \mid x_1 \leq 0; x_2 \leq -x_1\}, \\ x_1, & x \in \Gamma_3 = \{x \in \mathbb{R}^2 \mid x_2 \leq x_1; x_2 \geq -5x_1\}, \\ x_1, & x \in \Gamma_4 = \{x \in \mathbb{R}^2 \mid 0 \leq x_1; x_2 \leq -5x_1\}. \end{cases}$$

Note that the sets in the partition do not satisfy $\Gamma_i \cap \Gamma_j = \emptyset$ for $i \neq j$. However, f is uniquely defined since the functions are continuous and coincide on the boundary of the sets.

Example 3.2. Given a matrix $K \in \mathbb{R}^{n_f \times n}$ and vectors $\bar{\mu} \in \mathbb{R}^{n_f}$, $\underline{\mu} \in \mathbb{R}^{n_f}$ satisfying $\underline{\mu} \preceq \bar{\mu}$, the saturation function $f(x) = \text{sat}_{[\underline{\mu}, \bar{\mu}]}(Kx)$, is defined elementwise as follows

$$f_i(x) = \begin{cases} \underline{\mu}_i & x \in \Gamma_1 = \{x \in \mathbb{R}^n \mid (Kx)_i \leq \underline{\mu}_i\} \\ K_i x & x \in \Gamma_2 = \{x \in \mathbb{R}^n \mid \underline{\mu}_i \leq (Kx)_i \leq \bar{\mu}_i\} \\ \bar{\mu}_i & x \in \Gamma_3 = \{x \in \mathbb{R}^n \mid (Kx)_i \geq \bar{\mu}_i\}, \end{cases}$$

$i = 1, \dots, n_f$.

For instance, with $n = 2$, $n_f = 1$, $K = [-1 \ 1]$, $\underline{\mu} = -1$ and $\bar{\mu} = 2$ we obtain the partition depicted in Figure 3.3, corresponding to the explicit representation as in (II.1) given by

$$f(x) = \begin{cases} -1, & x \in \Gamma_1 = \{x \in \mathbb{R}^2 \mid Kx \leq -1\} \\ Kx, & x \in \Gamma_2 = \{x \in \mathbb{R}^2 \mid -1 \leq Kx \leq 2\} \\ 2, & x \in \Gamma_3 = \{x \in \mathbb{R}^2 \mid 2 \leq Kx\}. \end{cases}$$

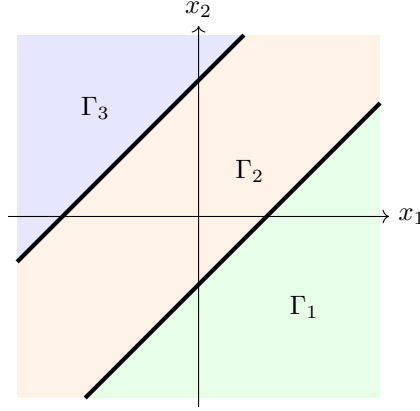
Figure 3.3: Partition of \mathbb{R}^2 for $f(x)$ defined in (3.4).

This function can be described as in (3.2) using

$$\begin{aligned} F_1 &= K, & F_2 &= \begin{bmatrix} -I_{n_f} & I_{n_f} \end{bmatrix} \\ F_3 &= \begin{bmatrix} K \\ -K \end{bmatrix}, & F_4 &= 0_{n_y \times n_y} & f_5 &= \begin{bmatrix} -\underline{\mu} \\ \bar{\mu} \end{bmatrix} \end{aligned} \quad (3.4)$$

with $n_y = 2n_f$ and the induced partition of \mathbb{R}^2 is expressed as

$$\begin{aligned} \Gamma_1 &= \{x \in \mathbb{R}^2 \mid \phi_2(y(x)) \geq 0\} \\ \Gamma_2 &= \{x \in \mathbb{R}^2 \mid \phi_1(y(x)) = \phi_2(y(x)) = 0\} \\ \Gamma_3 &= \{x \in \mathbb{R}^2 \mid \phi_1(y(x)) \geq 0\}. \end{aligned}$$

To formulate stability conditions for piecewise affine systems (3.2) we will characterize the ramp function by a two inequalities and a complementarity relation. These relations will be obtained by expressing the ramp function as the solution to an optimization problem and will be detailed in Section 3.2. Thanks to these relations we will study the piecewise affine system as the feedback interconnection of a linear system and a nonlinearity. The difference with general framework for interconnection analysis, is that here we treat *only* the ramp function and not a set of functions as it is the case in the absolute stability. Also, thanks to the implicit representation, it will be easier to define piecewise quadratic Lyapunov function candidates by with generalized quadratic forms containing ramp function as detailed in the next section.

Different models for PWA functions have been proposed in the literature in the context of nonlinear circuits and control systems. A comparison among several models and results showing their equivalence are presented in [83]. In Section 3.5, we relate the proposed model to other models that do not explicitly define the partition as (II.1).

3.1.1 Conditions for well-posedness

In Example 3.2 above we have $F_4 = 0$ giving an explicit solution to the equation (3.2b) expressed as $y = F_3x + f_5$ thus giving $f(x) = F_1x + F_2\phi(F_3x + f_5)$.

In general, with $F_4 \neq 0$, as in Example 3.1 above, (3.2b) is an implicit equation and its *well-posedness*, namely the existence and uniqueness of a solution y for all $x \in \mathbb{R}^n$ must be ensured. To ensure the well posedness of (3.2b), below we provide a condition for the well-posedness of the equation

$$F(y) := y - F_4\phi(y) = \zeta \quad \forall \zeta \in \mathbb{R}^{n_y}, \quad (3.5)$$

In Section 1.1.1 we formulated a condition for the well posedness of slope-restricted nonlinearities. Note that the slope bounds for the vector of ramp functions ϕ are $\bar{\Gamma} = I_{n_y}$ and $\underline{\Gamma} = 0_{n_y}$. This way we obtain a particular case of the conditions in Proposition 1.1. We refer to this particular case, introduced in [187, Proposition 1], in the proposition below

Proposition 3.1: [187, Proposition 1]

If there exist a matrix $W \in \mathbb{D}^{n_y}$, $W > 0$ such that

$$2W - WF_4 + F_4^\top W > 0$$

then $(I - F_4\Delta)$ is non-singular $\forall \Delta \in \mathcal{D}\{\Delta \in \mathbb{D}^{n_y} \mid \Delta_{(i,i)} \in [0, 1]\}$.

In the rest of the chapter, we will assume that the condition for well-posedness of (3.5) given in Proposition 3.1 holds. For implementation purposes, for instance when the PWA function has to be computed to generate a control input, a well posed equation (3.5) can be solved from the solution of a Linear Complementarity Problem [38] (see Remark 3.1 below).

3.2 Ramp Functions description from KKT conditions

Several results to verify the positivity of generalized quadratic forms involving sector nonlinearities rely on sector inequalities that hold either globally or locally [162, 89]. These standard sector inequalities cover a broad class of nonlinearities lying in the considered sector. In the following, we show how to obtain an exact characterization of the ramp function (3.2c), by using some identities and inequalities.

It is possible to use the Karush-Kuhn-Tucker (KKT) optimality conditions to implicitly characterize nonlinearities in terms of identities and inequalities. Such an idea was detailed in [144] for the saturation nonlinearity. We illustrate this approach for the ramp function, which can be expressed as the solution to the optimization problem parameterized in θ as follows

$$\underset{r}{\text{minimize}} \quad \frac{1}{2}(r - \theta)^2 \quad \text{subject to} \quad r \geq 0. \quad (3.6)$$

With the Lagrangian associated to the optimization problem,

$$\mathcal{L}(r, \lambda) = \frac{1}{2}(r - \theta)^2 - \lambda r,$$

we obtain the KKT conditions

$$\begin{aligned} (r - \theta) - \lambda &= 0 \\ \lambda r &= 0 \\ r &\geq 0 \\ \lambda &\geq 0 \end{aligned}$$

which are necessary conditions for optimality.

These relations offer a characterization in terms of linear and quadratic identities and inequalities in three variables (θ, r, λ) . To obtain a description in the variables (θ, r) one can use $\lambda = (r - \theta)$ above to obtain

$$r(r - \theta) = 0 \quad (3.8a)$$

$$r \geq 0 \quad (3.8b)$$

$$(r - \theta) \geq 0. \quad (3.8c)$$

Since the vector function ϕ is composed of ramp functions, we can use (3.7) to prove the relations in the following lemmas

Lemma 3.1

For any $T \in \mathbb{D}^{n_y}$ the function ϕ in (3.2c) satisfies

$$s_1(T, y) := \phi^\top(y)T(\phi(y) - y) = 0, \quad \forall y \in \mathbb{R}^{n_y}. \quad (3.9)$$

Proof. Since (3.8a) holds for all $\theta \in \mathbb{R}$ and the elements of ϕ are ramp functions, that is $\phi_i(y) = r(y_i)$ we have

$$s_1(T_1, y) = \sum_{i=1}^{n_y} T_{i,i} r(y_i) (r(y_i) - y_i) = 0.$$

□

Lemma 3.2

For any matrix $M \in \mathbb{P}^{(1+2n_y) \times (1+2n_y)}$ the vector function ϕ in (3.2c) satisfies the inequality

$$s_2(M, y) := \begin{bmatrix} 1 \\ \phi(y) \\ \phi(y) - y \end{bmatrix}^\top M \begin{bmatrix} 1 \\ \phi(y) \\ \phi(y) - y \end{bmatrix} \geq 0. \quad (3.10)$$

$\forall y \in \mathbb{R}^{n_y}$.

Proof. Since (3.8b)-(3.8c) hold and $\phi_i(y) = r(y_i)$, $\phi_i(y) - y_i = r(y_i) - y_i$, $\forall i = 1, \dots, n_y$ and all entries of M are nonnegative scalars, it follows that $s_2(M, y)$ is a nonnegative scalar. \square

Remark 3.1

The above relations (3.8) can be used to obtain a solution to the algebraic loop (3.2b). With (3.8) and (3.2c), we have

$$\begin{aligned} (\phi_i - y_i)\phi_i &= 0 \\ \phi_i &\geq 0 \\ (\phi_i - y_i) &\geq 0, \end{aligned}$$

$i = 1, \dots, n_y$. Set $\zeta = F_3x + f_5$ in equation (3.2b), and use $y_i = (F_4\phi + \zeta)_i$ in the above expressions to obtain respectively

$$((I - F_4)\phi - \zeta)_i \phi_i = 0 \quad (3.12a)$$

$$\phi_i \geq 0 \quad (3.12b)$$

$$((I - F_4)\phi - \zeta)_i \geq 0. \quad (3.12c)$$

$i = 1, \dots, n_y$. The problem of solving on ϕ the inequalities (3.12c), (3.12b), affine in ϕ , and equations (3.12a), quadratic in ϕ , is called a mixed Linear Complementarity Problem (LCP). For a given ζ , the solution ϕ to (3.12) provides a solution to the implicit equation $y - F_4\phi(y) = \zeta$. Please refer to the Lemke algorithm presented in [1, Section 5.1] for a strategy to solve LCPs yielding solutions to algebraic loops. Also, as one should expect, the condition for the well posedness of LCPs in [1, Proposition 7.1] applied to (3.12) holds if the condition in Proposition 3.1 is satisfied.

3.2.1 Conditions for the Non-negativity of Generalized Quadratic Forms

In this section we use the above lemmas to set conditions to verify the positivity of generalized quadratic forms of the type

$$h(x) = \chi(x)^\top H \chi(x). \quad (3.13)$$

with $H \in \mathbb{R}^{n+2m \times n+2m}$,

$$\chi(x) = \begin{bmatrix} 1 \\ x \\ \phi(y(x)) \end{bmatrix}$$

and $y(x)$ as in (3.2b).

Proposition 3.2

Given a generalized quadratic form $h(x)$ as in (3.13), if there exist matrices $T \in \mathbb{D}^{n_y}$, $M \in \mathbb{P}^{(1+2n_y) \times (1+2n_y)}$ such that

$$h(x) + s_1(T, y(x)) - s_2(M, y(x)) \geq 0, \quad \forall x \in \mathbb{R}^n \quad (3.14)$$

then

$$h(x) \geq 0, \quad \forall x \in \mathbb{R}^n. \quad (3.15)$$

Proof. From Lemma 3.1, we have that $s_1(T, y(x)) = 0 \forall x \in \mathbb{R}^n$. If (3.14) is satisfied it follows that

$$h(x) \geq s_2(M, y(x)), \forall x \in \mathbb{R}^n.$$

With Lemma 3.2 we conclude that $h(x) \geq 0, \forall x \in \mathbb{R}^n$. \square

Remark 3.2

Setting conditions to verify the non-negativity of a generalized quadratic form as (3.13) by solving the inequality (3.14) makes possible the solution to the Lyapunov inequalities related to the stability of PWA systems. These inequalities are studied in the next section.

Using lemmas 3.1 and 3.2, we restrict the elements of a generic nonlinearity ϕ in the generalized quadratic forms treated in Proposition 3.2 to be ramp functions and not a set of functions.

The remark below points out to the fact that other functions may satisfy the relation in Lemma 3.1.

Remark 3.3

Consider a set $\Omega \subset \mathbb{R}$ satisfying the *complementarity property* that if $\theta \in \Omega$ then $-\theta \notin \Omega$ and consider the function $\rho_\Omega : \mathbb{R} \rightarrow \mathbb{R}$

$$\rho_\Omega(\theta) = \mathbf{1}_\Omega(\theta)\theta \quad (3.16)$$

where $\mathbf{1}_\Omega$ is the indicator function of a set $\Omega \in \mathbb{R}$, that is, $\mathbf{1}_\Omega(\theta) = 1$ if $\theta \in \Omega$, and $\mathbf{1}_\Omega(\theta) = 0$ if $\theta \in \Omega^c$, with $\Omega^c = \mathbb{R} \setminus \Omega$. The ramp function can be expressed in the above form with $\Omega = [0, \infty)$, i.e. $r(\theta) = \rho_{[0, \infty)}(\theta)$. We also have $r(-\theta) = \rho_{(-\infty, 0]}(-\theta)$.

It follows that the complementarity relation (3.8) also holds if r is replaced by any function in the class (3.16). Indeed, using (3.16) we have $\rho_\Omega(\theta)(\rho_\Omega(\theta) - \theta) = \mathbf{1}_\Omega(\theta)\theta(\mathbf{1}_\Omega(\theta)\theta - \theta) = \mathbf{1}_\Omega(\theta)\theta(\mathbf{1}_{\Omega^c}(\theta)\theta) = 0$.

However, following (3.16) and the complementarity property of the set Ω above, the only instance of Ω satisfying $\rho_\Omega(\theta) \geq 0 \forall \theta \in \mathbb{R}$ is $\Omega = [0, \infty)$, that is, the ramp function is the only nonlinearity in this class that satisfies (3.8b) and (3.8c) $\forall \theta \in \mathbb{R}$.

3.3 Stability Analysis of PWA Systems with PWQ Lyapunov Functions

In this section we apply the results for the verification of non-negativity of generalized quadratic forms presented in the previous section to study the stability of the origin of a discrete-time systems defined by the implicit PWA function (3.2).

Consider discrete-time systems of the form

$$x^+ = f(x), \quad (3.17)$$

where $x \in \mathbb{R}^n$, $f : \mathbb{R}^n \rightarrow \mathbb{R}^n$ is a PWA function defined by matrices $F_i, i = 1, \dots, 4$, and f_5 as in (3.2) and x^+ is the value of the state at next time instant. We assume that $\phi(y(0)) = 0$ and thus the origin is an equilibrium point, since $f(0) = 0$ in this case.

The stability analysis of the origin of system (3.17), is studied with a continuous piecewise quadratic Lyapunov function given by a generalized quadratic form on x and the function $\phi(y(x))$. Hence, differently from previous approaches, the definition of an explicit quadratic form on x for each set of the partition is not required. More precisely, we consider Lyapunov candidate functions $V : \mathbb{R}^n \rightarrow \mathbb{R}_{\geq 0}$, $V(0) = 0$ given by

$$V(x) = \begin{bmatrix} x \\ \phi(y(x)) \end{bmatrix}^\top P \begin{bmatrix} x \\ \phi(y(x)) \end{bmatrix}. \quad (3.18)$$

with $P = \begin{bmatrix} P_1 & P_2 \\ P_2^\top & P_3 \end{bmatrix}$, $P_1 \in \mathbb{S}^n$, $P_2 \in \mathbb{R}^{n \times n_y}$ and $P_3 \in \mathbb{S}^{n_y}$, and $y(x)$ from (3.2b). The expression of the candidate Lyapunov function evaluated at x^+ for system (3.17) is given by

$$V(x^+) = \begin{bmatrix} x^+ \\ \phi(y(x^+)) \end{bmatrix}^\top P \begin{bmatrix} x^+ \\ \phi(y(x^+)) \end{bmatrix} \quad (3.19)$$

with y^+ satisfying

$$y^+ = F_3 F_1 x + F_3 F_2 \phi(y(x)) + F_4 \phi(y^+) + f_5. \quad (3.20)$$

The theorem below presents conditions for the global exponential stability of the origin of (3.17) using (3.18) as a Lyapunov function candidate.

Theorem 3.1

If there exist matrices $P \in \mathbb{S}^{(n+n_y) \times (n+n_y)}$, $T \in \mathbb{D}^{n_y}$, $M \in \mathbb{P}^{(1+2n_y) \times (1+2n_y)}$, $T_u \in \mathbb{D}^{n_y}$, $M_u \in \mathbb{P}^{(1+2n_y) \times (1+2n_y)}$ and positive scalars ϵ_1 and ϵ_2 such that

$$(V(x) - \epsilon_1 x^\top x) + s_1(T, y) - s_2(M, y) \geq 0 \quad (3.21a)$$

$$(-V(x) + \epsilon_2 x^\top x) + s_1(T_u, y) - s_2(M_u, y) \geq 0 \quad (3.21b)$$

matrices $\tilde{T} \in \mathbb{D}^{2n_y}$, $\tilde{M} \in \mathbb{P}^{(1+4n_y) \times (1+4n_y)}$ and a scalar $\eta \in (0, 1)$ such that

$$-(V(x^+) - (1 - \eta)V(x)) + s_1(\tilde{T}, \tilde{y}) - s_2(\tilde{M}, \tilde{y}) \geq 0 \quad (3.22)$$

with x^+ from (3.17)-(3.2),

$$\tilde{y} = [y^\top \quad y^{+\top}]^\top \quad (3.23)$$

y^+ as in (3.20), then the origin of (3.17) is globally exponentially stable.

Proof. From Proposition 3.2, if (3.21) and (3.22) hold it respectively follows that

$$\epsilon_1 \|x\|^2 \leq V(x) \leq \epsilon_2 \|x\|^2 \quad (3.24a)$$

$$V(x^+) \leq (1 - \eta)V(x). \quad (3.24b)$$

Thus, (3.24) allows to conclude that $\|x(k)\| \leq C e^{\delta k} \|x(0)\|$ with $C = (\frac{\epsilon_2}{\epsilon_1})^{\frac{1}{2}}$, $\delta = \ln(\sqrt{1 - \eta})$, $\forall x(0) \in \mathbb{R}^n$. Moreover, (3.24a) implies that $V(x)$ is radially unbounded. \square

Remark 3.4

The generalized quadratic form involving the the state and a nonlinearity as in (3.18) has been studied in the context of stability analysis of continuous-time linear complementarity systems [26]. Here, the generic formulation presented in [26] is used considering ramp functions, that also satisfy complementarity conditions. In that paper the authors suggest that their stability conditions could benefit from a numerical formulation exploiting co-positivity conditions. The co-positivity is here accounted for by considering the inequalities of Lemma 3.2 in Theorem 3.1.

Remark 3.5

In case $f_{5i} \leq 0$, $\forall i \in \{1, \dots, n_y\}$, we easily show that the generalize quadratic form $V(x)$ has a quadratic upper bound. To see this we first compute an upper bound for $\|\phi\|^2$. With $\bar{y} := y - f_5$, (3.2b) gives

$$\bar{y} = F_3 x + F_4 \phi(\bar{y} + f_5). \quad (3.25)$$

Assuming $f_{5i} \leq 0$, $\forall i \in \{1, \dots, n_y\}$ the monotonicity of r gives $0 \leq r(y_i + f_5) \leq r(y_i)$. We thus have that

$$\phi(\bar{y} + f_5) = \Delta \bar{y}$$

with some $\Delta \in \mathcal{D} := \{\Delta \in \mathbb{D}^{n_y} \mid \Delta_{i,i} \in [0, 1]\}$.

From the well-posedness assumption, we have that $(I - F_4 \Delta)$ is invertible for all $\Delta \in \mathcal{D}$, thus using (3.25) we obtain

$$\bar{y} = (I - F_4 \Delta)^{-1} F_3 x$$

and

$$\phi(y) = \phi(\bar{y} + f_5) = \Delta \bar{y} = \Delta (I - F_4 \Delta)^{-1} F_3 x,$$

yielding

$$\|\phi(y(x))\| \leq \sigma \|x\|,$$

with $\sigma = \max_{\Delta \in \mathcal{D}} \|\Delta(I - F_4\Delta)^{-1}F_3\|$. Finally, using (3.18), it follows that

$$\begin{aligned} V(x) &\leq \|P_1\| \|x\|^2 + 2\|P_2\| \|x\| \|\phi\| + \|P_3\| \|\phi\|^2 \\ &\leq (\|P_1\| + 2\sigma\|P_2\| + \sigma^2\|P_3\|) \|x\|^2 \end{aligned} \quad (3.26)$$

thus showing that $V(x)$ has an upper-bound of the form $\epsilon_2 \|x\|^2$.

3.3.1 LMI conditions

The relations (3.21) and (3.22) can be written in the generic quadratic form given by (3.13)-(3.14), where the corresponding matrices H present an affine dependence on the elements of matrix P . Hence, conditions in LMI form can be obtained to ensure (3.21) and (3.22). This is formalized in the following Corollary to Theorem 3.1.

Corollary 3.1

If there exist matrices $P_1 \in \mathbb{S}^n$, $P_2 \in \mathbb{R}^{n \times n_y}$, $P_3 \in \mathbb{S}^{n_y}$, $T \in \mathbb{D}^{n_y}$, $T_{uj} \in \mathbb{D}^{n_y}$, $\tilde{T} \in \mathbb{D}^{2n_y}$, symmetric matrices $M \in \mathbb{P}^{(1+2n_y) \times (1+2n_y)}$, $M_u \in \mathbb{P}^{(1+2n_y) \times (1+2n_y)}$ and $\tilde{M} \in \mathbb{P}^{(1+4n_y) \times (1+4n_y)}$, and positive scalars $0 < \eta < 1$, ϵ_1 and ϵ_2 such that the following LMIs are verified

$$\mathcal{I}^\top P \mathcal{I} - \epsilon_1 \mathcal{I}_x^\top \mathcal{I}_x + \frac{1}{2} He(\mathcal{I}_\phi^\top T \mathcal{I}_{\phi-y}) - \mathcal{I}_\chi^\top M \mathcal{I}_\chi \geq 0_{1+n+n_y} \quad (3.27a)$$

$$-\mathcal{I}^\top P \mathcal{I} + \epsilon_2 \mathcal{I}_x^\top \mathcal{I}_x + \frac{1}{2} He(\mathcal{I}_\phi^\top T_u \mathcal{I}_{\phi-y}) - \mathcal{I}_\chi^\top M_u \mathcal{I}_\chi \geq 0_{1+n+n_y} \quad (3.27b)$$

$$-\mathcal{I}_+^\top P \mathcal{I}_+ + (1-\eta) \mathcal{I}_0^\top P \mathcal{I}_0 + \frac{1}{2} He(\mathcal{I}_{\tilde{\phi}}^\top \tilde{T} \mathcal{I}_{\tilde{\phi}-\tilde{y}}) - \mathcal{I}_{\tilde{\chi}}^\top \tilde{M} \mathcal{I}_{\tilde{\chi}} \geq 0_{1+n+2n_y} \quad (3.27c)$$

where

$$\begin{aligned} \mathcal{I} &= \begin{bmatrix} 0_{n+n_y,1} & I_{n+n_y} \end{bmatrix}, \\ \mathcal{I}_x &= \begin{bmatrix} 0_{n,1} & I_n & 0_{n,n_y} \end{bmatrix}, \\ \mathcal{I}_\phi &= \begin{bmatrix} 0_{n_y,1+n} & I_{n_y} \end{bmatrix}, \\ \mathcal{I}_{\phi-y} &= \begin{bmatrix} -f_5 & -F_3 & I_{n_y} - F_4 \end{bmatrix}, \\ \mathcal{I}_\chi &= \begin{bmatrix} [1 & 0_{1,n+n_y}] \\ \mathcal{I}_\phi \\ \mathcal{I}_{\phi-y} \end{bmatrix}, \end{aligned}$$

$$\begin{aligned} \mathcal{I}_+ &= \begin{bmatrix} 0_{n,1} & F_1 & F_2 & 0_{n,n_y} \\ 0_{n_y,1} & 0_{n_y,n} & 0_{n_y} & I_{n_y} \end{bmatrix}, \\ \mathcal{I}_0 &= \begin{bmatrix} 0_{n+n_y,1} & I_{n+n_y} & 0_{n+n_y,n_y} \end{bmatrix}, \\ \mathcal{I}_{\tilde{\phi}} &= \begin{bmatrix} 0_{2n_y,1+n} & I_{2n_y} \end{bmatrix}, \\ \mathcal{I}_{\tilde{\phi}-\tilde{y}} &= \begin{bmatrix} -f_5 & -F_3 & I_{n_y} - F_4 & 0_{n_y} \\ -f_5 & -F_3 F_1 & -F_3 F_2 & I_{n_y} - F_4 \end{bmatrix}, \\ \mathcal{I}_{\tilde{\chi}} &= \begin{bmatrix} [1 & 0_{1,n+2n_y}] \\ \mathcal{I}_{\tilde{\phi}} \\ \mathcal{I}_{\tilde{\phi}-\tilde{y}} \end{bmatrix}, \end{aligned}$$

then the origin of (3.17) is globally exponentially stable.

Proof. Consider $V(x)$ defined as in (3.18). To show that if (3.27a), (3.27b) and (3.27c) hold then the conditions (3.21) and (3.22) in Theorem 3.1 also hold. Consider

$$\chi(x) = \begin{bmatrix} 1 \\ x \\ \phi(y(x)) \end{bmatrix}$$

$$\tilde{\chi}(x) = \begin{bmatrix} 1 \\ x \\ \phi(\tilde{y}(x)) \end{bmatrix}$$

and note that

$$\begin{aligned} \begin{bmatrix} x \\ \phi(y(x)) \end{bmatrix} &= \mathcal{I}\chi(x), \\ x &= \mathcal{I}_x\chi(x) \\ \phi(y(x)) &= \mathcal{I}_\phi\chi(x) \\ \phi(y(x)) - y(x) &= \mathcal{I}_{\phi-y}\chi(x), \\ \begin{bmatrix} 1 \\ \phi(y(x)) \\ \phi(y(x)) - y(x) \end{bmatrix} &= \mathcal{I}_\chi\chi(x) \end{aligned}$$

and

$$\begin{aligned} \begin{bmatrix} x^+ \\ \phi(y^+(x)) \end{bmatrix} &= \mathcal{I}_+\tilde{\chi}(x), \\ \begin{bmatrix} x \\ \phi(y(x)) \end{bmatrix} &= \mathcal{I}_0\tilde{\chi}(x), \\ \phi(\tilde{y}(x)) &= \mathcal{I}_{\tilde{\phi}}\tilde{\chi}(x) \\ \phi(\tilde{y}(x)) - \tilde{y}(x) &= \mathcal{I}_{\tilde{\phi}-\tilde{y}}\tilde{\chi}(x) \\ \begin{bmatrix} 1 \\ \phi(\tilde{y}(x)) \\ \phi(\tilde{y}(x)) - \tilde{y}(x) \end{bmatrix} &= \mathcal{I}_{\tilde{\chi}}\tilde{\chi}(x). \end{aligned}$$

We have

$$\begin{aligned} \chi(x)^\top \left(\mathcal{I}^\top P\mathcal{I} - \epsilon_1 \mathcal{I}_x^\top \mathcal{I}_x + \frac{1}{2} He \left(\mathcal{I}_\phi^\top T \mathcal{I}_{\phi-y} \right) - \mathcal{I}_\chi^\top M \mathcal{I}_\chi \right) \chi(x) \\ = (V(x) - \epsilon_1 x^\top x) + s_1(T, y) - s_2(M, y) \end{aligned}$$

$$\begin{aligned} \chi(x)^\top \left(-\mathcal{I}^\top P\mathcal{I} + \epsilon_2 \mathcal{I}_x^\top \mathcal{I}_x + \frac{1}{2} He \left(\mathcal{I}_\phi^\top T_u \mathcal{I}_{\phi-y} \right) - \mathcal{I}_\chi^\top M_u \mathcal{I}_\chi \right) \chi(x) \\ = (-V(x) + \epsilon_2 x^\top x) + s_1(T_u, y) - s_2(M_u, y) \end{aligned}$$

$$\begin{aligned} \tilde{\chi}(x)^\top \left(-\mathcal{I}_+^\top P\mathcal{I}_+ + (1-\eta)\mathcal{I}_0^\top P\mathcal{I}_0 + \frac{1}{2} He \left(\mathcal{I}_{\tilde{\phi}}^\top \tilde{T} \mathcal{I}_{\tilde{\phi}-\tilde{y}} \right) - \mathcal{I}_{\tilde{\chi}}^\top \tilde{M} \mathcal{I}_{\tilde{\chi}} \right) \tilde{\chi}(x) \\ = -(V(x^+) - (1-\eta)V(x)) + s_1(\tilde{T}, \tilde{y}) - s_2(\tilde{M}, \tilde{y}) \end{aligned}$$

Thus the matrix inequalities in (3.27) imply the inequalities expressed as the generalized quadratic forms in (3.21) and (3.22). \square

Remark 3.6

Thanks to the expression (3.2) to express piecewise functions, all possible transitions between sets in the partition of system (3.17) are implicitly taken into account and no enumeration is required to set up the stability conditions. As a result, only three LMIs are needed to assess the stability of the PWA system.

This is in sharp contrast with the results in the literature that use descriptions with polyhedral partitions expressed by hyperplanes (e.g. [96, 58, 61]) or by vertices and cone rays (e.g. [92, 91]). Note that in the aforementioned works, an LMI has to relate each possible state transition from a region Γ_j to a region Γ_i . These inequalities are required to enforce the strictly decrease of the LF. Moreover, for each region Γ_j , an LMI constraint is needed to ensure the positivity of the piecewise quadratic Lyapunov function.

3.3.2 Uncertain Systems Case

One major obstacle for the stability analysis using explicit representations of PWA systems concerns the presence of uncertainties in the partition. Uncertainties in the partition may occur for instance whenever PWA control laws as for instance the ones obtained with MPC contain rounding errors. Also, the sets of the partition can be modified or even be removed whenever the parameters defining them are uncertain. In this case, methods using explicit representation and with the enumeration of transitions can no longer be applied.

An important aspect of (3.2) is that handling uncertainties in the partition induced by is simpler since it can be cast as uncertainties on the matrices F_3 , F_4 and f_5 . This section studies the case of polytopic matrix uncertainties [22] inducing uncertainties in the partition.

We consider the *time-invariant* differential inclusion

$$f(x) \in F_1 x + F_2 \phi(y(x)) \quad (3.31a)$$

$$y(x) = F_3 x + F_4 \phi(y(x)) + f_5 \quad (3.31b)$$

with the system matrices satisfying

$$\begin{bmatrix} F_1 & F_2 & 0_{n,1} \\ F_3 & F_4 & f_5 \end{bmatrix} \in \mathcal{F}$$

$$\mathcal{F} = \left\{ M \in \mathbb{R}^{n_y \times 1+n+n_y} \mid M = \sum_{j=1}^N \alpha_j \begin{bmatrix} F_{1j} & F_{2j} & 0_{n,1} \\ F_{3j} & F_{4j} & f_{5j} \end{bmatrix}, \sum_{j=1}^N \alpha_j = 1, \alpha_j \in [0 \ 1], \forall j = 1, \dots, N \right\}.$$

To treat the case where uncertainties affect all parameters of the system let us define

$$\zeta := \begin{bmatrix} 1 \\ x \\ \phi(y) \\ \phi(y) - y \end{bmatrix} \quad \xi := \begin{bmatrix} 1 \\ x \\ x^+ \\ \phi(y) \\ \phi(y^+) \\ \phi(y) - y \\ \phi(y^+) - y^+ \end{bmatrix} \quad (3.32)$$

and consider

$$0 = \underbrace{[f_5 \quad F_3 \quad F_4 - I_{n_y} \quad I_{n_y}]}_{=: S_\phi} \zeta \quad (3.33)$$

obtained from the identity $y = \phi(y) - (\phi(y) - y)$, and the identities below, obtained from (3.2).

$$0 = \underbrace{[0_{n,1} \quad F_1 \quad -I_n \quad F_2 \quad 0_{n,n_y} \quad 0_{n,n_y} \quad 0_{n,n_y}]}_{=: \tilde{S}_f} \xi \quad (3.34)$$

and

$$0 = \underbrace{\begin{bmatrix} f_5 & F_3 & 0_{n_y,n} & F_4 - I_{n_y} & 0_{n_y} & I_{n_y} & 0_{n_y} \\ f_5 & 0_{n_y,n} & F_3 & 0_{n_y} & F_4 - I_{n_y} & 0_{n_y} & I_{n_y} \end{bmatrix}}_{=: \tilde{S}_\phi} \xi \quad (3.35)$$

where the first row is obtained from the identity $y = \phi(y) - (\phi(y) - y)$, the second row is obtained from $y^+ = \phi(y^+) - (\phi(y^+) - y^+)$.

Let us define the following matrices considering the matrices in the vertices of the polytopic set \mathcal{F}

$$S_j = [f_{5j} \quad F_{3j} \quad 0_{n_y,n} \quad F_{4j} - I_{n_y} \quad I_{n_y}] \quad (3.36)$$

$$\tilde{S}_j = \begin{bmatrix} 0_{n,1} & F_{1j} & -I_n & F_{2j} & 0_{n,n_y} & 0_{n,n_y} & 0_{n,n_y} \\ f_{5j} & F_{3j} & 0_{n_y,n} & F_{4j} - I_{n_y} & 0_{n_y} & I_{n_y} & 0_{n_y} \\ f_{5j} & 0_{n_y,n} & F_{3j} & 0_{n_y} & F_{4j} - I_{n_y} & 0_{n_y} & I_{n_y} \end{bmatrix} \quad (3.37)$$

and note that, following the definition of the set \mathcal{F} , for scalars $\sum_{j=1}^N \alpha_j = 1, \alpha_j \in [0 \ 1], \forall j = 1, \dots, N$, we have

$$\sum_{j=1}^N \alpha_j S_j = S_\phi \quad (3.38)$$

and

$$\sum_{j=1}^N \alpha_j \tilde{S}_j = \begin{bmatrix} \tilde{S}_f \\ \tilde{S}_\phi \end{bmatrix}. \quad (3.39)$$

We thus clearly obtain

$$\left(\sum_{j=1}^N \alpha_j S_j \right) \zeta = 0_{n_y,1} \quad (3.40)$$

and

$$\left(\sum_{j=1}^N \alpha_j \tilde{S}_j \right) \xi = 0_{n+2n_y,1}. \quad (3.41)$$

The theorem below presents conditions for the global exponential stability of the origin of an uncertain system (3.17) using a parameter-dependent function as a Lyapunov function candidate.

Theorem 3.2

If there exist matrices $P_j \in \mathbb{S}^{(n+n_y) \times (n+n_y)}$, $T_j \in \mathbb{D}^{n_y}$, $M_j \in \mathbb{P}^{(1+2n_y) \times (1+2n_y)}$, $T_{uj} \in \mathbb{D}^{n_y}$, $M_{uj} \in \mathbb{P}^{(1+2n_y) \times (1+2n_y)}$, $j = 1, \dots, N$, matrices $R \in \mathbb{R}^{1+n+2n_y}$, $R_u \in \mathbb{R}^{1+n+2n_y}$ and positive scalars ϵ_1 and ϵ_2 such that

$$(V_j(x) - \epsilon_1 x^\top x) + s_1(T_j, y) - s_2(M_j, y) + \zeta^\top R S_j \zeta \geq 0 \quad (3.42a)$$

$$(-V_j(x) + \epsilon_2 x^\top x) + s_1(T_{uj}, y) - s_2(M_{uj}, y) + \zeta^\top R_u S_j \zeta \geq 0 \quad (3.42b)$$

$j = 1, \dots, N$, matrices $\tilde{T}_j \in \mathbb{D}^{2n_y}$, $\tilde{M}_j \in \mathbb{P}^{(1+4n_y) \times (1+4n_y)}$, $j = 1, \dots, N$, a matrix $\tilde{R} \in \mathbb{R}^{1+2n+4n_y}$ and a scalar $\eta \in (0, 1)$ such that

$$-(V_j(x^+) - (1-\eta)V_j(x)) + s_1(\tilde{T}_j, \tilde{y}) - s_2(\tilde{M}_j, \tilde{y}) + \xi^\top \tilde{R} \tilde{S}_j \xi \geq 0 \quad (3.43)$$

$i = 1, \dots, N$, then the origin of (3.17) is globally exponentially stable.

Proof. The proof follows the same lines of the proof of Theorem 3.1, namely the satisfaction of (3.24) allows to show the exponential stability of the origin. Let us show that (3.42)-(3.43) imply the existence of a PWQ Lyapunov function for the systems defined by elements of the polytopic set \mathcal{F} . Note that in (3.42)-(3.43) the system matrices appear only in the matrices S_j and \tilde{S}_j . By defining

$$P = \sum_{j=1}^N \alpha_j P_j$$

$$T = \sum_{j=1}^N \alpha_j T_j, \quad T_u = \sum_{j=1}^N \alpha_j T_{uj}, \quad \tilde{T} = \sum_{j=1}^N \alpha_j \tilde{T}_j$$

$$M = \sum_{j=1}^N \alpha_j M_j, \quad M_u = \sum_{j=1}^N \alpha_j M_{uj}, \quad \tilde{M} = \sum_{j=1}^N \alpha_j \tilde{M}_j$$

and using (3.39)-(3.40) we have that, along the trajectories of system (3.31)

$$\begin{aligned} \sum_{j=1}^N \alpha_j ((V_j(x) - \epsilon_1 x^\top x) + s_1(T_j, y) - s_2(M_j, y) + \zeta^\top R S_j \zeta) \\ = (V(x) - \epsilon_1 x^\top x) + s_1(T, y) - s_2(M, y) \end{aligned}$$

$$\begin{aligned} \sum_{j=1}^N \alpha_j ((-V_j(x) + \epsilon_2 x^\top x) + s_1(T_{uj}, y) - s_2(M_{uj}, y) + \zeta^\top R_u S_j \zeta) \\ = (-V(x) + \epsilon_2 x^\top x) + s_1(T_u, y) - s_2(M_u, y) \end{aligned}$$

$$\begin{aligned} \sum_{j=1}^N \alpha_j \left(- (V_j(x^+) - (1 - \eta)V_j(x)) + s_1(\tilde{T}_j, \tilde{y}) - s_2(\tilde{M}_j, \tilde{y}) + \xi^\top \tilde{R} \tilde{S}_j \xi \right) \\ = - (V(x^+) - (1 - \eta)V(x)) + s_1(\tilde{T}, \tilde{y}) - s_2(\tilde{M}, \tilde{y}) \end{aligned}$$

thus, from the inequalities (3.42)-(3.43) we have

$$\begin{aligned} (V(x) - \epsilon_1 x^\top x) + s_1(T, y) - s_2(M, y) &\geq 0 \\ (-V(x) + \epsilon_2 x^\top x) + s_1(T_u, y) - s_2(M_u, y) &\geq 0 \\ - (V(x^+) - (1 - \eta)V(x)) + s_1(\tilde{T}, \tilde{y}) - s_2(\tilde{M}, \tilde{y}) &\geq 0 \end{aligned}$$

and the proof is completed following the steps in the proof of Theorem 3.1. \square

3.3.3 LMI conditions for uncertain systems

The relations (3.42) and (3.43) can be written in the generic quadratic forms respectively on vectors ζ and ξ with an affine dependence on matrices P_j , T_j , T_{uj} , \tilde{T}_j , M_j , M_{uj} , \tilde{M}_j , R and R_u . Hence, conditions in LMI form can be obtained to ensure (3.42) and (3.43). This is formalized in the following corollary to Theorem 3.2.

Corollary 3.2

If there exist matrices $P_1 \in \mathbb{S}^n$, $P_2 \in \mathbb{R}^{n \times n_y}$, $P_3 \in \mathbb{S}^{n_y}$, $T \in \mathbb{D}^{n_y}$, $T_{uj} \in \mathbb{D}^{n_y}$, $\tilde{T} \in \mathbb{D}^{2n_y}$, symmetric matrices $M \in \mathbb{P}^{(1+2n_y) \times (1+2n_y)}$, $M_u \in \mathbb{P}^{(1+2n_y) \times (1+2n_y)}$ and $\tilde{M} \in \mathbb{P}^{(1+4n_y) \times (1+4n_y)}$, $R \in \mathbb{R}^{1+n+2n_y}$, $R_u \in \mathbb{R}^{1+n+2n_y}$, $\tilde{R} \in \mathbb{R}^{1+2n+4n_y}$ and positive scalars $0 < \eta < 1$, ϵ_1 and ϵ_2 such that the following LMIs are verified

$$\tilde{\mathcal{I}}^\top P_j \tilde{\mathcal{I}} - \epsilon_1 \tilde{\mathcal{I}}_x^\top \tilde{\mathcal{I}}_x + \frac{1}{2} He(\tilde{\mathcal{I}}_\phi^\top T_j \tilde{\mathcal{I}}_{\phi-y}) - \tilde{\mathcal{I}}_\chi^\top M_j \tilde{\mathcal{I}}_\chi + \frac{1}{2} He(R S_j) \geq 0_{1+n+n_y} \quad (3.44a)$$

$$-\tilde{\mathcal{I}}^\top P_j \tilde{\mathcal{I}} + \epsilon_2 \tilde{\mathcal{I}}_x^\top \tilde{\mathcal{I}}_x + \frac{1}{2} He(\tilde{\mathcal{I}}_\phi^\top T_{uj} \tilde{\mathcal{I}}_{\phi-y}) - \tilde{\mathcal{I}}_\chi^\top M_{uj} \tilde{\mathcal{I}}_\chi + \frac{1}{2} He(R_u S_j) \geq 0_{1+n+n_y} \quad (3.44b)$$

$$-\tilde{\mathcal{I}}_+^\top P_j \tilde{\mathcal{I}}_+ + (1 - \eta) \tilde{\mathcal{I}}_0^\top P_j \tilde{\mathcal{I}}_0 + \frac{1}{2} He(\tilde{\mathcal{I}}_\phi^\top \tilde{T}_j \tilde{\mathcal{I}}_{\phi-\tilde{y}}) - \tilde{\mathcal{I}}_\chi^\top \tilde{M}_j \tilde{\mathcal{I}}_\chi + \frac{1}{2} He(\tilde{R} \tilde{S}_j) \geq 0_{1+2n+4n_y} \quad (3.44c)$$

$j = 1, \dots, N$, where

$$\begin{aligned} \tilde{\mathcal{I}} &= [0_{n+n_y, 1} \quad I_{n+n_y} \quad 0_{n+n_y, n_y}], \\ \tilde{\mathcal{I}}_x &= [0_{n, 1} \quad I_n \quad 0_{n, 2n_y}], \\ \tilde{\mathcal{I}}_\phi &= [0_{n_y, 1+n} \quad I_{n_y} \quad 0_{n_y, n_y}], \\ \tilde{\mathcal{I}}_{\phi-y} &= [0_{n_y, 1+n} \quad 0_{n_y, n_y} \quad I_{n_y}], \\ \tilde{\mathcal{I}}_\chi &= \begin{bmatrix} 1 & 0_{1, n+2n_y} \\ \tilde{\mathcal{I}}_\phi \\ \tilde{\mathcal{I}}_{\phi-y} \end{bmatrix}, \end{aligned}$$

$$\begin{aligned} \tilde{\mathcal{I}}_+ &= [0_{n, 1} \quad 0_n \quad I_n \quad 0_{n, 4n_y}], \\ \tilde{\mathcal{I}}_0 &= [0_{n, 1} \quad I_n \quad 0_n \quad 0_{n, n_y} \quad 0_{n, 3n_y}], \\ \tilde{\mathcal{I}}_\phi &= [0_{2n_y, 1+2n} \quad I_{2n_y} \quad 0_{2n_y, 2n_y}], \\ \tilde{\mathcal{I}}_{\phi-\tilde{y}} &= [0_{2n_y, 1+2n} \quad 0_{2n_y, 2n_y} \quad I_{2n_y}], \\ \tilde{\mathcal{I}}_\chi &= \begin{bmatrix} 1 & 0_{1, 2n+2n_y} \\ \tilde{\mathcal{I}}_\phi \\ \tilde{\mathcal{I}}_{\phi-\tilde{y}} \end{bmatrix}, \end{aligned}$$

then the origin of (3.17) is globally exponentially stable.

Proof. Consider $V(x)$ defined as in (3.18). To show that if (3.27a), (3.27b) and (3.27c) hold then the conditions (3.21) and (3.22) in Theorem 3.1 also hold. Consider vectors ζ and ξ in (3.32) and note that

$$\begin{aligned} \begin{bmatrix} x \\ \phi(y(x)) \end{bmatrix} &= \bar{\mathcal{I}}\zeta, \\ x &= \bar{\mathcal{I}}_x\zeta \\ \phi(y(x)) &= \bar{\mathcal{I}}_\phi\zeta \\ \phi(y(x)) - y(x) &= \bar{\mathcal{I}}_{\phi-y}\zeta, \\ \begin{bmatrix} 1 \\ \phi(y(x)) \\ \phi(y(x)) - y(x) \end{bmatrix} &= \bar{\mathcal{I}}_\chi\zeta \end{aligned}$$

and

$$\begin{aligned} \begin{bmatrix} x^+ \\ \phi(y^+(x)) \end{bmatrix} &= \bar{\mathcal{I}}_+\xi, \\ \begin{bmatrix} x \\ \phi(y(x)) \end{bmatrix} &= \bar{\mathcal{I}}_0\xi, \\ \phi(\tilde{y}(x)) &= \bar{\mathcal{I}}_{\tilde{\phi}}\xi \\ \phi(\tilde{y}(x)) - \tilde{y}(x) &= \bar{\mathcal{I}}_{\tilde{\phi}-\tilde{y}}\xi \\ \begin{bmatrix} 1 \\ \phi(\tilde{y}(x)) \\ \phi(\tilde{y}(x)) - \tilde{y}(x) \end{bmatrix} &= \bar{\mathcal{I}}_{\tilde{\chi}}\xi. \end{aligned}$$

We have

$$\begin{aligned} \zeta^\top \left(\bar{\mathcal{I}}^\top P\bar{\mathcal{I}} - \epsilon_1 \bar{\mathcal{I}}_x^\top \bar{\mathcal{I}}_x + \frac{1}{2} He \left(\bar{\mathcal{I}}_\phi^\top T \bar{\mathcal{I}}_{\phi-y} \right) - \bar{\mathcal{I}}_\chi^\top M \bar{\mathcal{I}}_\chi + \frac{1}{2} He(RS_j) \right) \zeta \\ = (V(x) - \epsilon_1 x^\top x) + s_1(T, y) - s_2(M, y) + \zeta^\top RS_j \zeta \end{aligned}$$

$$\begin{aligned} \zeta^\top \left(-\bar{\mathcal{I}}^\top P\bar{\mathcal{I}} + \epsilon_2 \bar{\mathcal{I}}_x^\top \bar{\mathcal{I}}_x + \frac{1}{2} He \left(\bar{\mathcal{I}}_\phi^\top T_u \bar{\mathcal{I}}_{\phi-y} \right) - \bar{\mathcal{I}}_\chi^\top M_u \bar{\mathcal{I}}_\chi + \frac{1}{2} He(R_u S_j) \right) \zeta \\ = (-V(x) + \epsilon_2 x^\top x) + s_1(T_u, y) - s_2(M_u, y) + \zeta^\top R_u S_j \zeta \end{aligned}$$

$$\begin{aligned} \xi^\top \left(-\bar{\mathcal{I}}_+^\top P\bar{\mathcal{I}}_+ + (1-\eta)\bar{\mathcal{I}}_0^\top P\bar{\mathcal{I}}_0 + \frac{1}{2} He \left(\bar{\mathcal{I}}_{\tilde{\phi}}^\top \tilde{T} \bar{\mathcal{I}}_{\tilde{\phi}-\tilde{y}} \right) - \bar{\mathcal{I}}_{\tilde{\chi}}^\top \tilde{M} \bar{\mathcal{I}}_{\tilde{\chi}} + \frac{1}{2} He(\tilde{R}\tilde{S}_j) \right) \xi \\ = -(V(x^+) - (1-\eta)V(x)) + s_1(\tilde{T}, \tilde{y}) - s_2(\tilde{M}, \tilde{y}) + \xi^\top \tilde{R}\tilde{S}_j \xi \end{aligned}$$

□

3.4 Numerical Examples

In this section, we illustrate the results of Theorem 3.1 with four numerical examples. In the first example, we demonstrate the global stability of a piecewise linear system. In the second example, we analyze the global stability of a linear system subject to actuator saturation. A third example treats a benchmark example of MPC control laws. Finally, an example illustrates how partition uncertainties are handled by considering the uncertain matrices in equation (3.2b)

3.4.1 Piecewise Quadratic function for Global Stability

Consider a piecewise linear system given by (3.17) with

$$F_1 = \begin{bmatrix} 0.5 & 0.1 + \kappa \\ -1 & 0.5 \end{bmatrix} \quad F_2 = \kappa \begin{bmatrix} 1 & 1 \\ 0 & 0 \end{bmatrix}$$

and F_3 , F_4 and f_5 as in (3.3) and where κ is a scalar. We try to obtain the largest value of κ for which we can prove the stability of the origin of (3.17) with the above data. Note that obtained system is homogeneous of degree 1, namely $f(\lambda x) = \lambda f(x)$ for $\lambda \geq 0$. Applying the conditions of Theorem 3.1 through the LMI formulations in Corollary 3.1, we obtain the largest value allowing to show globally stable for $\kappa^* = 0.699$.

For comparison, the dual problem formulation presented in [58, Section II] demonstrates that there does not exist a quadratic Lyapunov function for this system, that is $V(x) = x^\top P_1 x$, with $P_1 \in \mathbb{S}^n$, that certifies the stability for $\kappa \geq 0.357$, and through simulation, we observe that the origin of the system is stable for $-0.35 < \kappa < 0.7$. We also test the method proposed in [58], using a piecewise quadratic Lyapunov function (using all possible transitions between sets). With that method, the stability limit for parameter was bounded by $\kappa \geq 0.51$, which shows that our conditions lead to less conservative results.

The computed Lyapunov function (3.18) for this system is defined by matrix

$$P = \begin{bmatrix} 2.2172 & -0.0151 & -0.4494 & 0.0094 \\ -0.0151 & 1.6462 & 0.0094 & 0.3570 \\ -0.4494 & 0.0094 & -1.2060 & -0.8242 \\ 0.0094 & 0.3570 & -0.8242 & -0.4758 \end{bmatrix}.$$

Note that the matrix P is not positive definite. Indeed, the positive definiteness of matrix P is not imposed by the conditions in Theorem 3.1. However, since (3.21) holds we have that the Lyapunov function is guaranteed to be positive definite. Some trajectories of the system are shown in Figure 3.4, along with the level sets of the decreasing Lyapunov function.

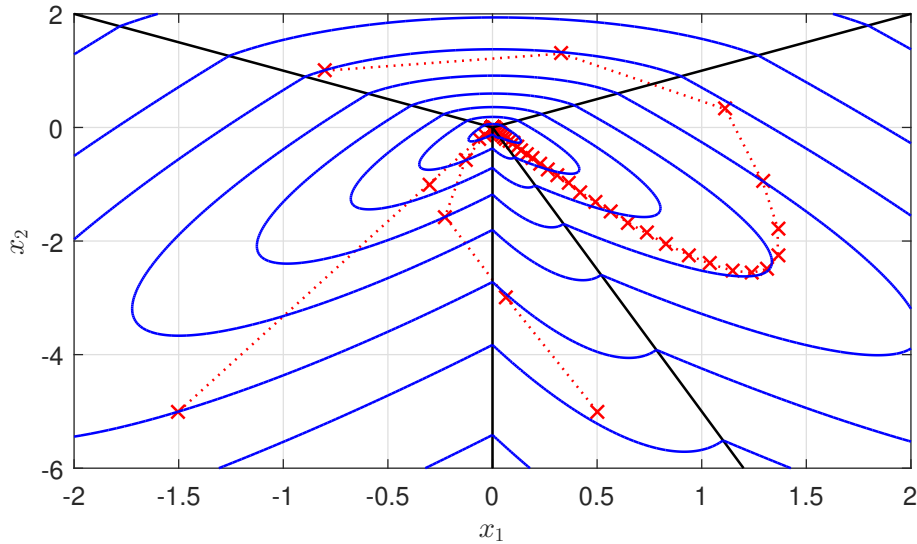

Figure 3.4: System trajectories and Lyapunov function level sets for Example I.

3.4.2 Asymmetric Saturation

Consider the following system, taken from [55], discretized with a sampling period of 100ms, and subject to asymmetric actuator saturation

$$x^+ = Ax + B \text{sat}_{[-1,15]}(Kx)$$

with

$$A = \begin{bmatrix} 0.9464 & 0.0957 \\ -0.9568 & 0.9033 \end{bmatrix}, \quad B = \begin{bmatrix} 0.0049 \\ 0.0959 \end{bmatrix}, \\ K = \begin{bmatrix} 9.9000 & 0.4950 \end{bmatrix}.$$

From (3.4) we have that the right hand side of the above system is written as (3.17) with $f(x)$ defined by

$$F_1 = A + BK, \quad F_2 = \begin{bmatrix} -B & B \end{bmatrix}$$

and F_3 , F_4 and f_5 as in (3.4).

It can be shown (see [58, Section II]) that there does not exist a common quadratic Lyapunov function for the linear systems defined by A and $(A + BK)$. Since the quadratic global stability of a linear system subject to a saturating linear state feedback imposes the existence of a common Lyapunov function for the open-loop and the closed-loop without saturation, we conclude that there is no quadratic function to assess the global stability of the origin of system [24]. However, considering a piecewise quadratic Lyapunov function as in (3.18) and applying Theorem 1, we can certify that the origin is globally exponentially stable with

$$P = \begin{bmatrix} 0.1372 & 0.1684 & -0.0030 & -0.0241 \\ 0.1684 & 1.0349 & -0.0241 & 0.0668 \\ -0.0030 & -0.0241 & 0.1042 & -0.0073 \\ -0.0241 & 0.0668 & -0.0073 & 0.0934 \end{bmatrix}.$$

This matrix was obtained from the solution to the LMIs described in Corollary 3.1.

In Figure 3.5, a trajectory of the system and the level sets of the decreasing Lyapunov function are depicted.

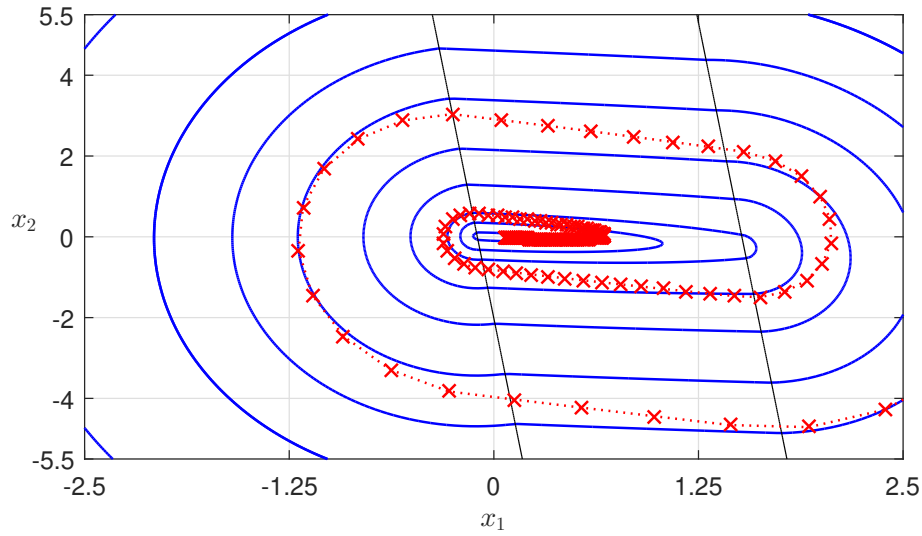

Figure 3.5: System trajectory and Lyapunov function level sets for Example II.

3.4.3 Explicit MPC law

Consider the following closed-loop system

$$x^+ = Ax + Bu,$$

$$A = \begin{bmatrix} 0.7326 & -0.0861 \\ 0.1722 & 0.9909 \end{bmatrix}, \quad B = \begin{bmatrix} 0.0609 \\ 0.0064 \end{bmatrix},$$

with u given by the explicit MPC law computed in [16] leading to the explicit PWA representation (II.1) with the partition defined in Table 3.1.

The MPC control law can be expressed by the closed-loop system (3.17), with $f(x)$ in (3.2) with

$$F_1 = A + BK_1, \quad F_2 = B \begin{bmatrix} 1 & -1 & 1 & -1 \end{bmatrix} \phi(y)$$

$$F_3 = \begin{bmatrix} K_2 - K_1 \\ K_1 - K_2 \\ -K_1 \\ K_1 \end{bmatrix}, \quad F_4 = \begin{bmatrix} 0 & 0 & 0 & 0 \\ 1 & 0 & 0 & 0 \\ -1 & 1 & 0 & 0 \\ 1 & -1 & 1 & 0 \end{bmatrix},$$

$$f_5^T = [-0.6423 \quad -0.6423 \quad -2 \quad -2]$$

$$K_1 = [-5.9220 \quad -6.8883], \quad K_2 = [-6.4159 \quad -4.6953].$$

Inequalities defining the sets Γ_i	Control law u_i
$\begin{bmatrix} -5.9220 & -6.8883 \\ 5.9229 & 6.8883 \\ -1.5379 & 6.8296 \\ 1.5379 & -6.8296 \end{bmatrix} x \leq \begin{bmatrix} 2 \\ 2 \\ 2 \\ 2 \end{bmatrix}$	$[-5.9220 \quad -6.8883] x$
$\begin{bmatrix} -6.4159 & -4.6953 \\ -0.0275 & 0.1220 \\ 6.4159 & 4.6953 \end{bmatrix} x \leq \begin{bmatrix} 1.3577 \\ -0.0357 \\ 2.6423 \end{bmatrix}$	$[-6.4159 \quad -4.6953] x + 0.6423$
$\begin{bmatrix} 6.4159 & 4.6953 \\ 0.0275 & -0.1220 \\ -6.4159 & -4.6953 \end{bmatrix} x \leq \begin{bmatrix} 1.3577 \\ -0.0357 \\ 2.6423 \end{bmatrix}$	$[-6.4159 \quad -4.6953] x - 0.6423$
$\begin{bmatrix} -3.4155 & 4.6452 \\ 0.1044 & 0.1215 \\ 0.1259 & 0.0922 \end{bmatrix} x \leq \begin{bmatrix} 2.6341 \\ -0.0353 \\ -0.0267 \end{bmatrix}$	2
$\begin{bmatrix} 0.0679 & -0.0924 \\ 0.1259 & 0.0922 \end{bmatrix} x \leq \begin{bmatrix} -0.0524 \\ -0.0519 \end{bmatrix}$	2
$\begin{bmatrix} -0.0679 & 0.0924 \\ -0.1259 & -0.0922 \end{bmatrix} x \leq \begin{bmatrix} -0.0524 \\ -0.0519 \end{bmatrix}$	-2
$\begin{bmatrix} 3.4155 & -4.6452 \\ -0.1044 & -0.1215 \\ -0.1259 & -0.0922 \end{bmatrix} x \leq \begin{bmatrix} 2.6341 \\ -0.0353 \\ -0.0267 \end{bmatrix}$	-2

Table 3.1: Explicit MPC law: inequalities defining the sets of the partition and the corresponding affine control law.

By applying Theorem 1, we could obtain a quadratic Lyapunov function that certifies the global stability of the origin. Clearly, a quadratic function is obtained by setting $P_2 = 0$ and $P_3 = 0$ in (3.18). The computed values for $V(x) = x^\top P_1 x$ are given by

$$P_1 = \begin{bmatrix} 0.9262 & 0.4674 \\ 0.4674 & 1.0815 \end{bmatrix}.$$

A trajectory and the level sets of the obtained Lyapunov function are shown in Figure 3.6.

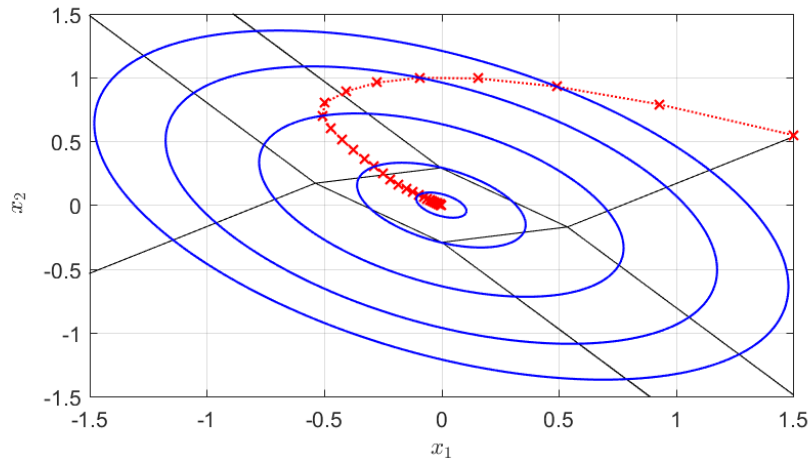

Figure 3.6: One system trajectory and level sets of the Lyapunov function for Example III.

3.4.4 Uncertainty in the Partition

Consider an uncertain piecewise linear system given by (3.17) with

$$F_1 = \begin{bmatrix} 0.85 & 0.25 \\ -0.8 & 0.8 \end{bmatrix}, \quad F_2 = \begin{bmatrix} -1 & 1 & 1 \\ 0 & 0 & 0 \end{bmatrix},$$

$$F_3 = \begin{bmatrix} -0.15 & 0.15 \\ 0.15 & -0.15 \\ d_1 & d_2 \end{bmatrix}, \quad F_4 = 0_3, \quad f_5 = \begin{bmatrix} -1 \\ -1 \\ 0 \end{bmatrix},$$

For this example, the enumeration of possible transitions between the sets in the partition is not possible since the number of regions may vary according on the values of the parameters d_1 and d_2 , as can be seen in Figure 3.7.

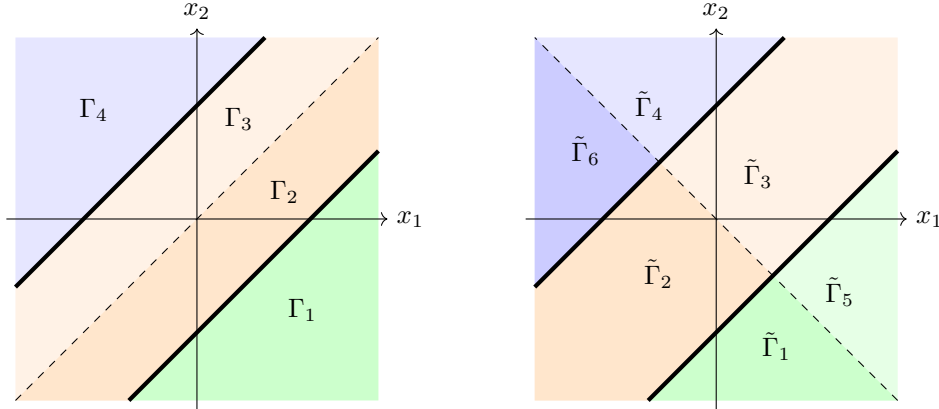

Figure 3.7: Two different partitions of \mathbb{R}^2 are obtained for different values of d_1 and d_2 . These partitions differ also in the number of sets defining them. On the left, $d_1 = -d_2 > 0$, we obtain a partition with four sets. On the right, with $d_1 = d_2 < 0$, we obtain a partition with six sets. The dashed line corresponds to the set where $y_3 = 0$.

Considering d_1 and d_2 as uncertain parameters, for all values in the set defined by

$$-0.1 \leq d_1 \leq 0.06, \quad -0.03 \leq d_2 \leq 0.05.$$

we compute a single piecewise quadratic function as (3.18) to certify the global stability of the uncertain system with

$$P = \begin{bmatrix} 5.9646 & -0.7936 & -4.8724 & 3.7880 & 1.3481 \\ -0.7936 & 1.6585 & -1.7570 & 2.1793 & 3.2269 \\ -4.8724 & -1.7570 & 2.5663 & -1.6874 & -0.0837 \\ 3.7880 & 2.1793 & -1.6874 & 4.0464 & 2.3755 \\ 1.3481 & 3.2269 & -0.0837 & 2.3755 & 3.7548 \end{bmatrix}.$$

This example shows that the proposed approach allows for a simpler formulation of the uncertainty analysis. Thanks to the implicit parametrization of the vector field and the Lyapunov functions we can easily formulate the conditions for the transitions between uncertain sets.

3.5 Relation to other representations

We present two PWA models that result in equation (3.2b) with a structured matrix F_4 . As discussed above, a structured matrix F_4 may give an explicit solution to (3.2b).

MMPS functions

This section relates the representation (3.2) to max-min-plus-scaling (MMPS) models, which are equivalent to other models discussed in [83]. From the arguments detailed in [83] we can then conclude on the equivalence to the other models studied in that paper.

An MMPS function is a mapping $f : \mathbb{R}^n \rightarrow \mathbb{R}$ which is recursively defined by a grammar [46]

$$g(x, g_k, g_\ell) := (x_i |\alpha| \max(g_k, g_\ell) | \min(g_k, g_\ell) | g_k) + (g_\ell | \beta g_k) \quad (3.48)$$

where g_k and g_ℓ are themselves MMPS expressions. The symbol “|” in expression (3.48) denotes an “or” operator (see details in [46]).

- To obtain (3.2) from an MMPS expression it suffices to consider the identities

$$\begin{aligned}\max(g_k, g_\ell) &= g_k + r(g_\ell - g_k), \\ \min(g_k, g_\ell) &= -\max(-g_k, -g_\ell),\end{aligned}$$

and perform the composition of terms using the corresponding expressions g_i .

- To obtain an MMPS model from (3.2), we can write the ramp function as the MMPS function

$$r(y_i(x)) = \max(0, y_i(x)) \quad (3.49)$$

which is an expression (3.48) with $g_k = 0$ and $g_\ell = y_i$. Hence, using (3.49), we can write $f(x)$ in (3.2) as an MMPS expression as in the example below.

Consider Example 2 above (3.4) with $n_f = 1$, $n = 2$, giving the scalar equations

$$\begin{cases} f(x) = K_{11}x_1 + K_{12}x_2 - r(y_1) + r(y_2) \\ y_1 = K_{11}x_1 + K_{12}x_2 - \bar{\mu} \\ y_2 = -K_{11}x_1 - K_{12}x_2 + \underline{\mu}. \end{cases}$$

With (3.49), we obtain

$$f(x) = K_{11}x_1 + K_{12}x_2 - \max(0, K_{11}x_1 + K_{12}x_2 - \bar{\mu}) + \max(0, -K_{11}x_1 - K_{12}x_2 + \underline{\mu}), \quad (3.50)$$

which can be expressed as an MMPS with

$$\begin{aligned}g_1 &= x_1, \\ g_2 &= x_2, \\ g_3 &= K_{11}g_1, \\ g_4 &= K_{12}g_2, \\ g_5 &= g_3 + g_4, \\ g_6 &= -\bar{\mu}, \\ g_7 &= \underline{\mu}, \\ g_8 &= (-1)g_5, \\ g_9 &= g_5 + g_6, \\ g_{10} &= g_7 + g_8, \\ g_{11} &= \max(0, g_9), \\ g_{12} &= \max(0, g_{10}), \\ g_{13} &= (-1)g_{11}, \\ g_{14} &= g_{12} + g_{13}, \\ f(x) &= g_5 + g_{14}.\end{aligned}$$

Using the expression (3.48) it is possible to extract a tree structure using the above expressions, where a node has two children nodes in case both terms in the sum (3.48) are not zero, this is the case for nodes g_5 , g_9 , g_{10} , g_{14} , and f . The nodes with a single child can be obtained by setting either $\alpha = 0$ or $\beta = 0$ in (3.48). The end nodes correspond to the input values of x_1 and x_2 or constants as in g_6 and g_7 .

PWA Canonical Representation

We now relate the proposed representation (3.2) to the canonical representation for PWA functions [100, 98]. In particular, we show that from the canonical representation it is always possible to obtain a representation as in (3.2) with a lower triangular block structure for matrix F_4 .

We briefly recall the main definitions of the canonical representation, as presented in [98]. The basic element for obtaining the canonical form are the N_h hyperplanes generating the partition of the state space. Each of these hyperplanes can be described by a PWA function $q_i : \mathbb{R}^n \rightarrow \mathbb{R}$, $i = 1, \dots, N_h$, as in

$$\{x \in \mathbb{R}^n \mid q_i(x) = \alpha_i^\top x + \beta_i\}, \quad (3.51)$$

$\alpha_i \in \mathbb{R}^n$, $\beta_i \in \mathbb{R}$. Furthermore, a generating function $\gamma : \mathbb{R} \times \mathbb{R} \rightarrow \mathbb{R}$ is defined as follows

$$\gamma(v_1, v_2) = ||-v_1| + v_2| - ||v_2| - v_1| + |-v_1| + |v_2| - |-v_1 + v_2| \quad (3.52)$$

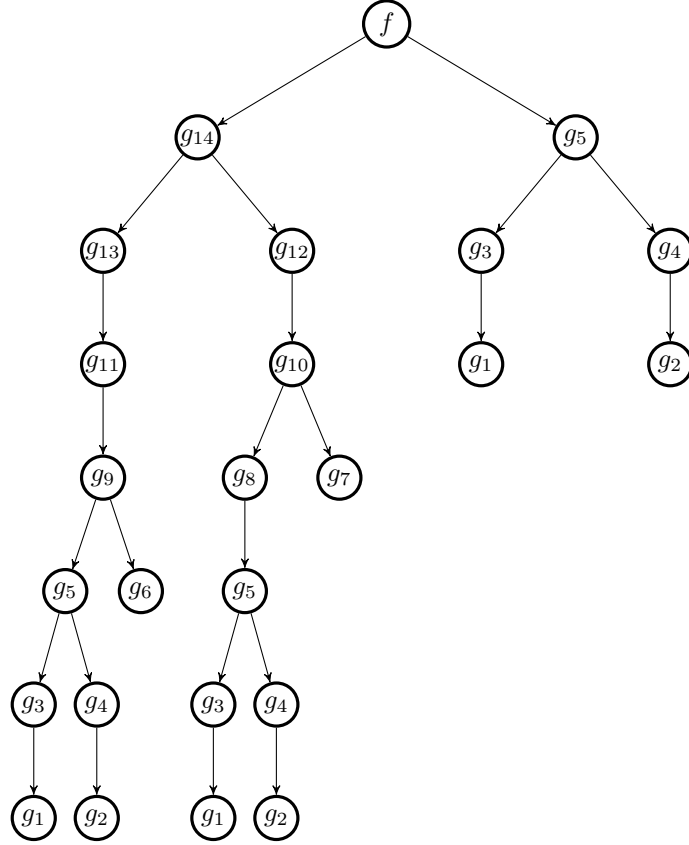

Figure 3.8: The tree structure corresponding to (3.50) using the composition rules of (3.48).

with $|\cdot|$ the absolute value of a scalar argument, from which a family of nested functions γ^k can be obtained using (3.52) and defining

$$\begin{aligned}
 \gamma^0(v_1) &= v_1, \\
 \gamma^1(v_1) &= \gamma(v_1, v_1), \\
 \gamma^2(v_1, v_2) &= \gamma(v_1, v_2), \\
 \gamma^3(v_1, v_2, v_3) &= \gamma(v_1, \gamma^2(v_2, v_3)), \\
 &\vdots \\
 \gamma^k(v_1, v_2, \dots, v_k) &= \gamma(v_1, \gamma^{k-1}(v_2, \dots, v_k)).
 \end{aligned} \tag{3.53}$$

As stated in [98, Theorem 1], any PWA function $f : \mathbb{R}^n \rightarrow \mathbb{R}$ can be expressed by a canonical form of level k , $k \geq 1$, as

$$f(x) = a^\top x + b + \sum_{j=1}^k \sum_{\ell=1}^{N_k(j)} c_{j,\ell} \gamma^j(d_1^{(j),\ell,m} \tilde{q}_1^{(j),\ell}, \dots, d_j^{(j),\ell,m} \tilde{q}_j^{(j),\ell} x) \tag{3.54}$$

$a \in \mathbb{R}^n$, $b \in \mathbb{R}$, $c_{j,\ell} \in \mathbb{R}$, $m \in \mathbb{N}$ where each pair $d_k^{(j),\ell,m} \in \mathbb{R}$, $\tilde{q}_k^{(j),\ell,j} \in \mathbb{R}^{1 \times n}$, $k = 1, \dots, j$, is associated to the hyperplanes as in (3.51), and j corresponds to the order of a *degenerate* intersection from which the arguments of function γ^j are computed. Roughly speaking, a degenerate intersection allows to create partitions that are more general than parallel hyperplanes thanks to the nested use of the absolute value in (3.52). The parameter $N_k(j)$ denotes the number of degenerate intersections of order j in the partition, and m is the index associated to one of the degenerated intersections of level $j - 1$ that creates the intersection of level j with index l . More details about how to obtain the parameters $c_{j,\ell} \in \mathbb{R}$, $m \in \mathbb{N}$, $d_k^{(j),\ell,m} \in \mathbb{R}$, $\tilde{q}_k^{(j),\ell,j} \in \mathbb{R}^{1 \times n}$ in (3.54), using an example in \mathbb{R}^3 , can be found in [98, Section IV].

To relate the above description to the proposed representation in terms of ramp functions note that $\forall \theta \in \mathbb{R}$ we have

$$\begin{aligned}
 |\theta| &= 2r(\theta) - \theta \\
 r(-\theta) &= r(\theta) - \theta
 \end{aligned}$$

we can rewrite the terms in (3.52) as

$$\begin{aligned}
\gamma(v_1, v_2) &= 2r(2r(v_1) - v_1 + v_2) - (2r(v_1) - v_1 + v_2) \\
&\quad - 2r(2r(v_2) - v_1 - v_2) - (2r(v_2) - v_1 - v_2) \\
&\quad + 2r(v_1) - v_1 \\
&\quad + 2r(v_2) - v_2 \\
&\quad - 2r(-v_1 + v_2) - (-v_1 + v_2) \\
&= -2r(-v_1 + v_2) + 2r(2r(v_1) - v_1 + v_2) - 2r(2r(v_2) - v_1 - v_2) + 2v_1 - 2v_2
\end{aligned}$$

which, in turn, is expressed as (3.2) as follows

$$\begin{aligned}
\gamma(v_1, v_2) &= [2 \quad -2] \begin{bmatrix} v_1 \\ v_2 \end{bmatrix} + [0 \quad 0 \quad -2 \quad 2 \quad -2] \phi(y) \\
y &= \begin{bmatrix} 1 & 0 \\ 0 & 1 \\ -1 & 1 \\ -1 & 1 \\ -1 & -1 \end{bmatrix} \begin{bmatrix} v_1 \\ v_2 \end{bmatrix} + \begin{bmatrix} 0 & 0 & 0 & 0 & 0 \\ 0 & 0 & 0 & 0 & 0 \\ 0 & 0 & 0 & 0 & 0 \\ 1 & 0 & 0 & 0 & 0 \\ 0 & 1 & 0 & 0 & 0 \end{bmatrix} \phi(y)
\end{aligned}$$

that is, (3.2) using a structured algebraic equation (block triangular matrix F_4) for which an explicit expression can be easily obtained.

For each expression of γ in the recursive definition of γ^k in (3.53), we can use the above matrices to obtain (3.54) using ramp functions. We can then compose the different terms in (3.53) to obtain vector functions $f : \mathbb{R}^n \rightarrow \mathbb{R}^{n_f}$, describing each level j , with vectors $y^{(j)} \in \mathbb{R}^{n_{y^{(j)}}}$ and corresponding vectors of ramp functions $\phi(y^{(j)})$, leading to a representation (3.2)

3.6 Conclusions

In this chapter, we presented a framework for the stability analysis of discrete-time PWA systems. To this end, we introduced an implicit representation of PWA functions based on ramp functions. Since several other implicit models for PWA exist, we established the relation to some of these models.

The main advantage of the proposed representation concerns the analysis of PWA systems. Indeed, by exploiting some properties of ramp functions in the form of identities and inequalities, we verify Lyapunov inequalities related to piecewise quadratic Lyapunov functions candidates. This analysis is carried out by casting these inequalities in a generalized quadratic form depending on the ramp functions, leading to stability conditions given by LMIs. We illustrated numerical solutions of the proposed stability conditions in examples.

Importantly, in the proposed approach there is no need to define the quadratic function associated to each set of the partition since it is implicitly obtained with a generalized quadratic form. Moreover, there is no need to enumerate all possible transitions between sets in the partition. The use of continuous piecewise quadratic function is simpler than the methods in the literature since, thanks to the generalized quadratic forms involving ramp functions, no additional continuity conditions are required.

Regarding the verification of generalized quadratic forms, the use of properties associated to ramp functions applies only this class of function and therefore are less conservative than generic sector bounded conditions. For the case of uncertain PWA systems, we formulated stability tests allowing to consider uncertainties in the partition.

Chapter 4

Systems with Quantization nonlinearities

In this chapter, we focus on the stability analysis of discrete-time quantized control systems. The main goal of this chapter is to formulate sufficient conditions for global exponential stability analysis of systems with a finite number of quantization levels. The key result to obtain these conditions is to represent the *regularized* step function as an ill-posed algebraic loop containing ramp functions. Thanks to this representation and in contrast with the existing literature of quantized control systems, we do not rely on any sector bound approach and introduce a class of piecewise quadratic Lyapunov functions.

4.1 Linear Systems with input quantization

We consider a scenario in which a linear plant is controlled via an affine static state feedback law taking values into the set $\mathcal{Q} := \{0, \delta_1\} \times \{0, \delta_2\} \times \dots \times \{0, \delta_m\}$, where $m \in \mathbb{N}$ is the number of control inputs and $\delta_i \in \mathbb{R}$, for all $i \in \{1, 2, \dots, m\}$, are some given *levels*. More specifically, we focus on the following class of nonlinear discrete-time systems

$$x^+ = Ax + B\Delta S(Kx + d) \quad (4.1)$$

where $A \in \mathbb{R}^{n \times n}$, $B \in \mathbb{R}^{n \times m}$, $K \in \mathbb{R}^{m \times n}$, $\Delta := \text{diag}\{\delta_1, \delta_2, \dots, \delta_m\}$, $d \in \mathbb{R}^m$, and $S: \mathbb{R}^m \rightarrow \mathbb{R}^m$ is defined as follows

$$S(u) := \begin{bmatrix} s(u_1) \\ s(u_2) \\ \vdots \\ s(u_m) \end{bmatrix} \quad (4.2)$$

where for all $v \in \mathbb{R}$

$$s(v) := \begin{cases} 1 & \text{if } v > 0 \\ 0 & \text{if } v \leq 0 \end{cases} \quad (4.3)$$

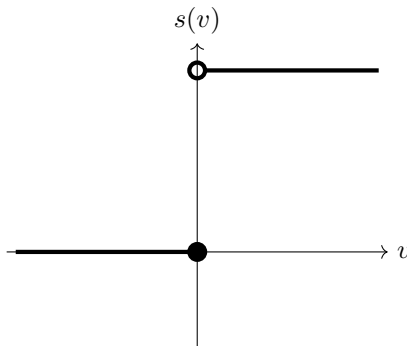

Figure 4.1: Step function $s(v)$.

Due to the discontinuity of S at zero, (4.1) is a discontinuous dynamical system. In discrete-time dynamical systems, discontinuities do not lead to the technical problems found in their continuous-time counterparts (see, e.g., [37, 31, 60, 59, 63]). However, they generally lead to a lack of robustness, with stability properties being fragile in the presence of vanishing perturbations; see [70, Example 4.4, page 76].

To avoid this lack of robustness, we consider the following set-valued *regularization* of (4.1)

$$x^+ \in Ax + B\Delta\mathbf{S}(Kx + d) \quad (4.4a)$$

where the set-valued mapping $\mathbf{S}: \mathbb{R}^m \rightrightarrows \mathbb{R}^m$ is defined as follows

$$\mathbf{S}(u) := \begin{bmatrix} \mathbf{s}(u_1) \\ \mathbf{s}(u_2) \\ \vdots \\ \mathbf{s}(u_m) \end{bmatrix} \quad (4.4b)$$

with, for all $v \in \mathbb{R}$,

$$\mathbf{s}(v) := \begin{cases} 1 & \text{if } v > 0 \\ 0 & \text{if } v < 0 \\ [0, 1] & \text{if } v = 0. \end{cases} \quad (4.4c)$$

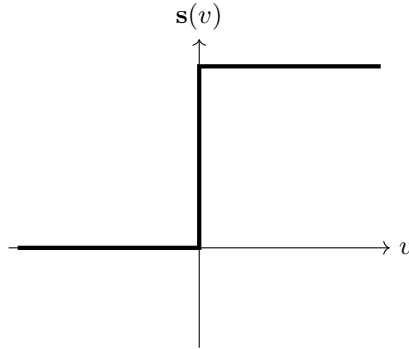

Figure 4.2: Regularization of the step function $\mathbf{s}(v)$.

Observe that, due to $S(\mathbb{R}^m) \subset \mathbf{S}(\mathbb{R}^m)$, solutions to (4.1) are solutions to (4.4a). Thus, stability properties concerning all solution to (4.4a) carry over (4.1).

Remark 4.1

Clearly, \mathbf{S} contains the so-called (discrete-time) Krasovskii regularization of the step function S , which writes as

$$\widehat{\mathbf{S}}(u) := \begin{bmatrix} \widehat{\mathbf{s}}(u_1) \\ \widehat{\mathbf{s}}(u_2) \\ \vdots \\ \widehat{\mathbf{s}}(u_m) \end{bmatrix},$$

with, for all $v \in \mathbb{R}$

$$\widehat{\mathbf{s}}(v) = \begin{cases} 1 & \text{if } v > 0 \\ \{0, 1\} & \text{if } v = 0 \\ 0 & \text{if } v < 0. \end{cases}$$

see, e.g., [70, Definition 4.13]. Therefore, (4.4a) captures all possible solutions to (4.1) obtained by introducing vanishing state perturbations, i.e., Hermes solutions; see [70, Chapter 4]. Thus ensuring that the origin of (4.1) is robustly stable in the presence of vanishing perturbations, thereby making our results appealing in practice. The fact that we consider a larger regularization of (4.1) than its Krasovskii regularization is due to the approach we propose in Section 4.2 to represent \mathbf{S} that inherently requires $\mathbf{S}(u)$ to be convex-valued for all $u \in \mathbb{R}^m$.

The following proposition concerns the solutions to (4.4a). For definitions of maximal and complete solutions and details about solutions to difference inclusions as (4.4a) see Section 4.3.

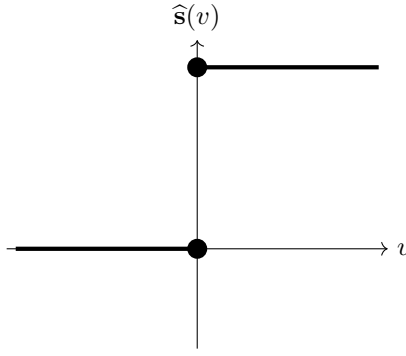
Figure 4.3: Krasovskii regularization of the step function $\widehat{\mathbf{s}}(v)$.

Proposition 4.1. *For any $\xi \in \mathbb{R}^n$, there exists a maximal solution σ to (4.4a) such that $\sigma(0) = \xi$. Moreover, σ is complete.*

Proof. The proof follows simply from the fact that \mathbf{S} is defined everywhere; see, e.g., [70, Proposition 2.10]. \square

4.2 KKT characterization of the set-valued step mapping

In this subsection we illustrate the key result of this chapter. This result yields a tight characterization of the mapping \mathbf{s} in (4.4c) in terms of linear and quadratic inequalities. To achieve this goal, we pursue a similar approach as in [144] and rely on optimization-based representation of the mapping \mathbf{s} along with Karush-Kuhn-Tucker (KKT) optimality conditions.

Let us observe that, for all $\theta \in \mathbb{R}$, we can express (4.4c) as

$$\mathbf{s}(\theta) \in \arg \min_{w \in [0,1]} -\theta w. \quad (4.5)$$

Clearly, if $\theta < 0$, one has $\mathbf{s}(\theta) = 0$, if $\theta > 0$, one has $\mathbf{s}(\theta) = 1$, while when $\theta = 0$, $\mathbf{s}(\theta) \in [0, 1]$, which is consistent with (4.4c).

Building upon (4.5), we can obtain a characterization of the mapping \mathbf{s} via the application of the Karush-Kuhn-Tucker (KKT) optimality conditions. This is formally stated in the result given next.

Theorem 4.1

Let \mathbf{s} be defined as in (4.4c), $\theta \in \mathbb{R}$, and $s \in \mathbb{R}$. Then, the following items are equivalent

(i) $s \in \mathbf{s}(u)$

(ii) there exist $\lambda_1, \lambda_2 \in \mathbb{R}$ such that

$$-\theta - \lambda_1 + \lambda_2 = 0 \quad (4.6a)$$

$$\lambda_1 s = 0 \quad (4.6b)$$

$$\lambda_2(1 - s) = 0 \quad (4.6c)$$

$$-\lambda_1 \leq 0 \quad (4.6d)$$

$$-\lambda_2 \leq 0 \quad (4.6e)$$

$$-s \leq 0 \quad (4.6f)$$

$$-1 + s \leq 0 \quad (4.6g)$$

Proof. Proof of (i) \implies (ii). Using (4.5), it follows that

$$\mathbf{s}(\theta) \in \arg \min_{w \in [0,1]} -\theta w \quad (4.7)$$

The Lagrangian associated to (4.7) writes

$$\mathcal{L}_\theta(w, \lambda) = -\theta w + \begin{bmatrix} \lambda_1 \\ \lambda_2 \end{bmatrix}^\top \left(\begin{bmatrix} -1 \\ 1 \end{bmatrix} w + \begin{bmatrix} 0 \\ -1 \end{bmatrix} \right).$$

From the Karush-Khun-Tucker (KKT) necessary conditions for optimality, one has that for any optimal solution w^* to (4.7), there exists a unique $\lambda^* := (\lambda_1^*, \lambda_2^*)$ such that

$$\frac{d}{dw} \mathcal{L}_\theta(w^*, \lambda^*) = 0 \quad (4.8a)$$

$$\lambda_1^* w^* = 0, \quad (4.8b)$$

$$\lambda_2^* (1 - w^*) = 0 \quad (4.8c)$$

$$\lambda_1^* \geq 0, \quad (4.8d)$$

$$\lambda_2^* \geq 0, \quad (4.8e)$$

$$w^* \geq 0, \quad (4.8f)$$

$$w^* \leq 1 \quad (4.8g)$$

which reads as (4.6). Hence, recalling that s is an optimal solution to (4.7), i.e., $w^* = s$ satisfies (4.8a), the implication is established.

Proof of (ii) \implies (i). This implication can be readily shown by observing that since (4.7) is convex (for all θ), the satisfaction of (4.6) (KKT conditions) implies (4.7). This establishes the result. \square

As a consequence of the fact that $\mathbf{S}(u)$ is a decentralized nonlinearity composed by set-valued mappings \mathbf{s} , Theorem 4.1 shows that for all $u \in \mathbb{R}^m$ and $s \in \mathbf{S}(u)$, there exist $\lambda_1, \lambda_2 \in \mathbb{R}^m$ such that satisfying the above relations for each channel.

The result given next shows that the multipliers λ_1 and λ_2 introduced in Theorem 4.1 can be expressed as ramp functions of the input u .

Lemma 4.1

The set valued step mapping (4.4c) is expressed in terms of ramp functions as

$$\mathbf{s}(\theta) = r(y_1) \quad (4.9a)$$

$$\begin{bmatrix} y_1 \\ y_2 \end{bmatrix} = \begin{bmatrix} 1 \\ 0 \end{bmatrix} \theta + \begin{bmatrix} 1 & -1 \\ 1 & 1 \end{bmatrix} \begin{bmatrix} r(y_1) \\ r(y_2) \end{bmatrix} + \begin{bmatrix} 0 \\ -1 \end{bmatrix}. \quad (4.9b)$$

Moreover we have $r(\theta) = r(y_2)$.

Proof. To obtain the above expression, we consider (4.6) and set $\mathbf{s}(\theta) = \mathbf{s}^*$ the solution of the parameterized problem (4.5). Next, relate the complementarity inequalities (4.6b)-(4.6c) to the ramp function complementarity inequality (3.8a) of some inputs y_1 and y_2 to be determined. To this end, let us set the relations

$$\lambda_1 \mathbf{s} = r(y_1)(r(y_1) - y_1) \quad (4.10a)$$

$$\lambda_2 (1 - \mathbf{s}) = r(y_2)(r(y_2) - y_2). \quad (4.10b)$$

and associate the following terms to λ_1 and λ_2

$$\lambda_1 = (r(y_1) - y_1) \quad (4.11a)$$

$$\lambda_2 = r(y_2). \quad (4.11b)$$

we have that the relations (4.10)-(4.11) hold if

$$r(y_1) = \mathbf{s} \quad (4.12a)$$

$$(r(y_2) - y_2) = (1 - \mathbf{s}). \quad (4.12b)$$

where y_1 and y_2 are defined below.

Moreover, the inequalities of (3.8b)-(3.8c) respectively hold for any y_1 and y_2 since the dual feasibility inequalities (4.6d)-(4.6e) hold. Similarly, the inequalities (3.8c)-(3.8b) respectively hold for any y_1 and y_2 since the primal feasibility inequalities (4.6f)-(4.6g) hold.

With (4.11), we have that (4.6a) gives $-\theta - (r(y_1) - y_1) + r(y_2) = 0$, therefore

$$y_1 = \theta + r(y_1) - r(y_2), \quad (4.13a)$$

and by adding the two equations in in (4.12) we can eliminate \mathbf{s} to obtain

$$y_2 = -1 + r(y_1) + r(y_2). \quad (4.13b)$$

Therefore, with (4.12a), (4.13) we obtain (4.9).

We now show that $r(\theta) = r(y_2)$. Note that (4.13a) gives

$$r(y_2) = \theta + (r(y_1) - y_1).$$

From the complementarity conditions (4.10a), we have $0 = (r(y_1) - y_1)\mathbf{s}$.

- i) Since for $\theta > 0$, $\mathbf{s}(\theta) = 1$, we conclude that $(r(y_1) - y_1) = 0$, and using the above equation we obtain

$$r(y_2) = \theta \text{ for } \theta \geq 0. \quad (4.14a)$$

- ii) From (4.12a) we have that for $\theta < 0$, $r(y_1) = 0$, thus (4.13b) gives $y_2 = r(y_2) - 1$ of which the unique solution is $y_2 = -1$. Following the definition of the ramp function we have $r(y_2) = 0$. Thus

$$r(y_2) = 0 \text{ for } \theta < 0. \quad (4.14b)$$

- iii) Similarly, for $\theta = 0$, we have $r(y_1) \in [0, 1]$, hence $y_2 = r(y_2) - (-r(y_1) + 1) = r(y_2) - \beta$ with $\beta \in [0, 1]$ of which a solution can be any $y_2 \in [-1, 0]$, which gives $r(y_2) = 0$. Thus, combined with (4.14), we have $r(y_2) = r(\theta)$.

□

Remark 4.2

The implicit equation (4.9b) is not well-posed since for $\theta = 0$ any $y_1 \in [0, 1]$ gives a solution. The matrix $(I_2 - F_4\Delta)$ with $F_4 = \begin{bmatrix} 1 & -1 \\ 1 & 1 \end{bmatrix}$ is not invertible for $\Delta = \begin{bmatrix} 1 & 0 \\ 0 & 0 \end{bmatrix}$ and for $\Delta = \begin{bmatrix} 0 & 0 \\ 0 & 1 \end{bmatrix}$. Therefore the inequality provided in Proposition 3.1 as a condition for well-posedness cannot hold.

With the above characterization of the set-valued step \mathbf{s} , we can write system (4.4a) in terms of ramp functions as a PWA system with the mapping

$$x^+ = F_1x + F_2\phi(y) \quad (4.15a)$$

$$y = F_3x + F_4\phi(y) + f_5 \quad (4.15b)$$

for some $y \in \mathbf{y}(x) = \{y \in \mathbb{R}^{2m} \mid y - F_4\phi(y) = F_3x + f_5\}$, with matrices

$$F_1 = A \quad (4.15c)$$

$$F_2 = B\Delta (I_m \otimes [1 \ 0]) \quad (4.15d)$$

$$F_3 = K \otimes \begin{bmatrix} 1 \\ 0 \end{bmatrix} \quad (4.15e)$$

$$F_4 = I_m \otimes \begin{bmatrix} 1 & -1 \\ 1 & 1 \end{bmatrix} \quad (4.15f)$$

$$f_5 = d \otimes \begin{bmatrix} 1 \\ 0 \end{bmatrix} + \mathbf{1}_{m,1} \otimes \begin{bmatrix} 0 \\ -1 \end{bmatrix}. \quad (4.15g)$$

From Lemma 4.1, we have that

$$\phi(y(x)) = \begin{bmatrix} \mathbf{s}(K_1x + d_1) \\ r(K_1x + d_1) \\ \mathbf{s}(K_2x + d_2) \\ r(K_2x + d_2) \\ \vdots \\ \mathbf{s}(K_mx + d_m) \\ r(K_mx + d_m) \end{bmatrix}.$$

4.3 PWQ Lyapunov Functions for systems with input Quantization

Since the systems we are studying are set-valued dynamics of the form

$$x^+ \in G(x) \quad (4.16)$$

where $x \in \mathbb{R}^n$ is the system state and $G: \mathbb{R}^n \rightrightarrows \mathbb{R}^n$ is a set-valued map, we need to recall some definitions of solutions to this class of systems since, for a given initial conditions, they might not be unique. A *solution* to (4.16) is any function $\sigma: \text{dom } \sigma \rightarrow \mathbb{R}^n$ with $\text{dom } \sigma = \mathbb{N} \cap \{0, 1, \dots, \bar{J}\}$ for some $\bar{J} \in \mathbb{N} \cup \{\infty\}$ such that for all $j \in \text{dom } \sigma$, with $j+1 \in \text{dom } \sigma$, $\sigma(j+1) \in G(\sigma(j))$. We say that a solution σ is *maximal* if it cannot be extended and it is *complete* if $\max \text{dom } \sigma = \infty$. In particular, in the setting of this chapter, namely for system (4.4a), maximal solutions to (4.16) are complete.

The following notion of global exponential stability is used in the chapter.

Definition 4.1

We say the the origin is globally exponentially stable for (4.16) if there exists $\lambda, \kappa > 0$ such that any maximal solution σ to (4.16) satisfies

$$\|\sigma(j)\| \leq \kappa e^{-\lambda j} \|\sigma(0)\| \quad \forall j \in \text{dom } \sigma.$$

The result below provides sufficient conditions global exponential stability of a the origin of (4.16). Those conditions are formulated in terms of Lyapunov inequalities involving a set-valued function V .

Theorem 4.2

Suppose that there exists $V: \mathbb{R}^n \rightrightarrows \mathbb{R}$, and positive real numbers c_1, c_2, c_3 , and p such that

$$c_1 \|x\|^p \leq \max V(x) \leq c_2 \|x\|^p \quad \forall x \in \mathbb{R}^n, \quad (4.17)$$

$$\max V(g) - \max V(x) \leq -c_3 \|x\|^p \quad \forall x \in \mathbb{R}^n, \forall g \in G(x). \quad (4.18)$$

Then, the origin is globally exponentially stable for (4.16).

Proof. For all $x \in \mathbb{R}^n$, define $W(x) := \max V(x)$. The proof of the statement follows directly by observing that W is a standard single-valued Lyapunov function for (4.16). \square

Remark 4.3

The use of set-valued Lyapunov functions for stability analysis has also been pursued in [69, 7]. However, the approach outlined here is tailored to the stability analysis of system (4.4a).

The conditions given in Theorem 4.2 are in general difficult to check. To formulate conditions that can be more easily verified we will propose a result that provides sufficient conditions to satisfy those in Theorem 4.2. The main reason for introducing the above theorem is that we would like to construct a set-valued function given by the generalized quadratic form involving the regularized step function, namely the set-valued mapping

$$V(x) = \bigcup_{y \in \mathbf{y}(x)} \begin{bmatrix} x \\ \phi(y) \end{bmatrix}^\top P \begin{bmatrix} x \\ \phi(y) \end{bmatrix}. \quad (4.19)$$

with $\mathbf{y}(x)$ given by the set of solutions to the algebraic loop (4.15b). In Figure 4.4, we depict (4.19) for all possible values of y in \mathbf{y} for a function (4.9) for $x \in \mathbb{R}$ and $m = 2$ with $K = \begin{bmatrix} 1 \\ -2 \end{bmatrix}$ and $d = \begin{bmatrix} -1 \\ -1 \end{bmatrix}$ and matrix

$$P = \begin{bmatrix} 1 & 0 & 0 & 0 & 0 \\ 0 & 1 & 0 & 0 & 0 \\ 0 & 0 & -0.8 & 0 & 0 \\ 0 & 0 & 0 & -2 & 0 \\ 0 & 0 & 0 & 0 & -0.5 \end{bmatrix}.$$

We are now in a position to state the main result of this chapter. To provide sufficient conditions for global exponential stability of (4.4a) in the form of matrix inequalities. To this end, we use the following Lyapunov function candidate

$$W(x) = \max V(x, y) \quad (4.20)$$

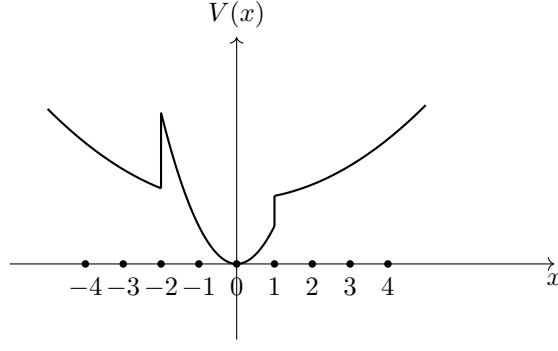
 Figure 4.4: Prototype of set-valued mapping $V(x, y)$.

with V as in (4.19). To formulate conditions for the decrease of W at each time step for all possible values of in the set-valued mapping defining the system, let us define the algebraic loop

$$\bar{y} = \begin{bmatrix} F_3 \\ F_3 F_1 \end{bmatrix} x + \begin{bmatrix} F_4 & 0_{n_y} \\ F_3 F_2 & F_4 \end{bmatrix} \phi(\bar{y}) + \begin{bmatrix} f_5 \\ f_5 \end{bmatrix} \quad (4.21)$$

with matrices in (4.15), and with \bar{y} decomposed as

$$\bar{y} = \begin{bmatrix} \bar{y}_0 \\ \bar{y}_0^+ \end{bmatrix}. \quad (4.22)$$

Note that the above algebraic loop has a block-triangular structure for the matrix multiplying $\phi(\bar{y})$. Thus the components \bar{y}_0 do not depend on the components \bar{y}_0^+ .

Since the above algebraic loop may have multiple solutions, given that the matrix F_4 is the same as in (4.15f), the set of its solutions is given by the set

$$\bar{\mathbf{y}}(x) = \left\{ \bar{y} \in \mathbb{R}^{4m} \mid \bar{y} - \begin{bmatrix} F_4 & 0_{n_y} \\ F_3 F_2 & F_4 \end{bmatrix} \phi(\bar{y}) = \begin{bmatrix} F_3 \\ F_3 F_1 \end{bmatrix} x + \begin{bmatrix} f_5 \\ f_5 \end{bmatrix} \right\}.$$

For a given $\bar{y} \in \bar{\mathbf{y}}(x)$, from (4.15a), we obtain

$$x^+ = F_1 x + F_2 \phi(\bar{y}_0).$$

Theorem 4.3

If there exist matrices $P \in \mathbb{S}^{(n+2m) \times (n+2m)}$, $T \in \mathbb{D}^{2m}$, $M \in \mathbb{P}^{(1+2m) \times (1+2m)}$, $T_u \in \mathbb{D}^{2m}$, $M_u \in \mathbb{P}^{(1+2m) \times (1+2m)}$ and positive scalars ϵ_1 and ϵ_2 such that, $\forall x \in \mathbb{R}^n$, $\forall y \in \mathbf{y}(x)$,

$$(V(x, y) - \epsilon_1 x^\top x) + s_1(T, y) - s_2(M, y) \geq 0 \quad (4.23a)$$

$$(-V(x, y) + \epsilon_2 x^\top x) + s_1(T_u, y) - s_2(M_u, y) \geq 0 \quad (4.23b)$$

matrices $\tilde{T} \in \mathbb{D}^{6m}$, $\tilde{M} \in \mathbb{P}^{(1+6m) \times (1+6m)}$ and a scalar $\eta \in (0, 1)$ such that $\forall x \in \mathbb{R}^n$, $\forall y \in \mathbf{y}(x)$, $\forall \bar{y} \in \bar{\mathbf{y}}(x)$

$$- (V(F_1 x + F_2 \phi(\bar{y}_0), \bar{y}_0^+) - V(x, y) + \eta x^\top x) + s_1(\tilde{T}, \tilde{y}) - s_2(\tilde{M}, \tilde{y}) \geq 0 \quad (4.24)$$

with $\tilde{y} = \begin{bmatrix} \bar{y}^\top & y^\top \end{bmatrix}^\top$, y as in (4.15b) \bar{y} as in (4.21) then the origin of (4.15) is globally exponentially stable.

Proof. Take $W(x)$ as in (4.20). Since the inequalities (4.23) hold for all $y \in \mathbf{y}$ they hold in particular for $W(x)$

$$\epsilon_1 x^\top x \leq W(x) \leq \epsilon_2 x^\top x \quad (4.25)$$

Let us denote $V(x^+, \bar{y}(x^+)) = V(F_1 x + F_2 \phi(\bar{y}_0), \bar{y}_0^+)$ We have

- i) if $\mathbf{y}(x)$ contains only one point, namely $\mathbf{y}(x) = y(x)$, then $W(x) = V(x, y(x))$ and x^+ is uniquely defined. In this case, $\bar{\mathbf{y}}$ can either be
 - a) a singleton, in which case $W(x^+) = V(x^+, \bar{y}(x^+))$

b) a set, in which case, $W(x^+) = \max_{\bar{y} \in \bar{\mathbf{y}}(x)} V(x^+, y_0^+)$

in both cases, since the decrease in (4.24) should hold for all $\bar{y} \in \bar{\mathbf{y}}(x)$ it will hold, in particular, for the value of \bar{y} yielding $W(x^+)$.

ii) if $\mathbf{y}(x)$ is a set we have $W(x) = \max_{y \in \mathbf{y}(x)} V(x, y)$. In this case, $\bar{\mathbf{y}}$ is a set since \bar{y}_0 also belongs to a set. For any value in this set, we have $x^+ = F_1 x + F_2 \phi(\bar{y}_0)$ for some value in the solution \bar{y} (note that here, since we consider any solution to (4.21), \bar{y}_0 can take a value for \bar{y}_0 different from the value of y used to define $W(x)$). From the value of \bar{y}_0 , the value of \bar{y}_0^+ can either be

a) a singleton, in which case $W(x^+) = V(x^+, \bar{y}(x^+))$

b) a set, in which case, $W(x^+) = \max_{\bar{y} \in \bar{\mathbf{y}}(x)} V(x^+, y_0^+)$.

Since, from (4.24), the decrease is guaranteed for any value in the sets \mathbf{y} and $\bar{\mathbf{y}}$, if we choose any value within these sets the decrease is guaranteed, in particular when choosing the max over these sets, which gives, according to the above cases for $W(x^+)$ and $W(x)$,

$$W(x^+) - W(x) \leq -\eta x^\top x \quad (4.26)$$

$\forall x, \forall x^+$. Thus $W(x)$ is a single-valued Lyapunov function. \square

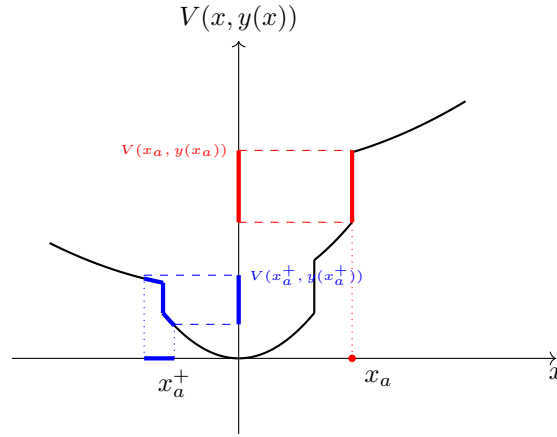

Figure 4.5: Illustration of the conditions in Theorem 4.3 for the case in which $\mathbf{y}(x_a)$ is not a singleton. The set of values for $V(x, y)$ is given in red in coordinate axis. In this case, the regularized dynamics give a set-valued mapping illustrated here by the set x_a^+ , which in turn gives the set of values for $V(x^+, y^+)$ - depicted in blue in the coordinate axis. The theorem asks for all points in the green set to be below the red set. In this case the single valued function W is guaranteed to decrease.

4.3.1 LMI conditions

The relations (4.23) and (4.24) can be written in the generic quadratic with an affine dependence on the elements of matrix P . Hence, conditions in LMI form can be obtained to ensure (4.23) and (4.24). This is formalized in the following corollary to Theorem 4.3.

Corollary 4.1

If there exist matrices $P_1 \in \mathbb{S}^n$, $P_2 \in \mathbb{R}^{n \times n_y}$, $P_3 \in \mathbb{S}^{n_y}$, $T \in \mathbb{D}^{n_y}$, $\tilde{T} \in \mathbb{D}^{2n_y}$, symmetric matrices $M \in \mathbb{P}^{(1+2n_y) \times (1+3n_y)}$ and $\tilde{M} \in \mathbb{P}^{(1+6n_y) \times (1+6n_y)}$, and positive scalars $0 < \eta < 1$, ϵ_1 and ϵ_2 such that the following LMIs are verified

$$\mathcal{I}^\top P \mathcal{I} - \epsilon_1 \mathcal{I}_x^\top \mathcal{I}_x + \frac{1}{2} H e \left(\mathcal{I}_\phi^\top T \mathcal{I}_{\phi-y} \right) - \mathcal{I}_\chi^\top M \mathcal{I}_\chi \geq 0_{1+n+2n_y} \quad (4.27a)$$

$$-\mathcal{I}^\top P \mathcal{I} + \epsilon_2 \mathcal{I}_x^\top \mathcal{I}_x + \frac{1}{2} H e \left(\mathcal{I}_\phi^\top T_u \mathcal{I}_{\phi-y} \right) - \mathcal{I}_\chi^\top M_u \mathcal{I}_\chi \geq 0_{1+n+2n_y} \quad (4.27b)$$

$$-\mathcal{I}_+^\top P \mathcal{I}_+ + (1 - \eta) \mathcal{I}_0^\top P \mathcal{I}_0 + \frac{1}{2} H e \left(\mathcal{I}_\phi^\top \tilde{T} \mathcal{I}_{\phi-\bar{y}} \right) - \mathcal{I}_\chi^\top \tilde{M} \mathcal{I}_\chi \geq 0_{1+n+4n_y} \quad (4.27c)$$

where

$$\begin{aligned}
\mathcal{I} &= \begin{bmatrix} 0_{n+n_y,1} & I_{n+n_y} \end{bmatrix}, \\
\mathcal{I}_x &= \begin{bmatrix} 0_{n,1} & I_n & 0_{n,n_y} \end{bmatrix}, \\
\mathcal{I}_\phi &= \begin{bmatrix} 0_{n_y,1+n} & I_{n_y} \end{bmatrix}, \\
\mathcal{I}_{\phi-y} &= \begin{bmatrix} -f_5 & -F_3 & (I_{n_y} - F_4) \end{bmatrix}, \\
\mathcal{I}_\chi &= \begin{bmatrix} 1 & 0_{1,n+n_y} \\ \mathcal{I}_\phi \\ \mathcal{I}_{\phi-y} \end{bmatrix}, \\
\mathcal{I}_+ &= \begin{bmatrix} 0_{n,1} & F_1 & 0_{n,n_y} & F_2 & 0_{n,n_y} \\ 0_{n_y,1} & 0_{n_y,n} & 0_{n_y} & 0_{n_y} & I_{n_y} \end{bmatrix}, \\
\mathcal{I}_0 &= \begin{bmatrix} 0_{n+n_y,1} & I_{n+n_y} & 0_{n+n_y,2n_y} \end{bmatrix}, \\
\mathcal{I}_{\tilde{\phi}} &= \begin{bmatrix} 0_{3n_y,1+n} & I_{3n_y} \end{bmatrix}, \\
\mathcal{I}_{\tilde{\phi}-\tilde{y}} &= \begin{bmatrix} -f_5 & -F_3 & (I_{n_y} - F_4) & 0_{n_y} & 0_{n_y} \\ -f_5 & -F_3 & 0_{n_y} & (I_{n_y} - F_4) & 0_{n_y} \\ -f_5 & -F_3 F_1 & 0_{n_y} & -F_3 F_2 & (I_{n_y} - F_4) \end{bmatrix}, \\
\mathcal{I}_{\tilde{\chi}} &= \begin{bmatrix} 1 & 0_{1,n+3n_y} \\ \mathcal{I}_{\tilde{\phi}} \\ \mathcal{I}_{\tilde{\phi}-\tilde{y}} \end{bmatrix},
\end{aligned}$$

then the origin of (4.1) is globally exponentially stable.

Proof. Consider $V(x)$ defined as in (4.19). To show that if (4.27a), (4.27b) and (4.27c) hold then the conditions (4.23) and (4.24) in Theorem 4.3 also hold. Consider

$$\begin{aligned}
\chi(x) &= \begin{bmatrix} 1 \\ x \\ \phi(y(x)) \end{bmatrix} \\
\tilde{\chi}(x) &= \begin{bmatrix} 1 \\ x \\ \phi(\tilde{y}(x)) \end{bmatrix}
\end{aligned}$$

with $\tilde{y} = \begin{bmatrix} y \\ \bar{y} \end{bmatrix}$ and note that

$$\begin{aligned}
\begin{bmatrix} x \\ \phi(y(x)) \end{bmatrix} &= \mathcal{I}\chi(x), \\
x &= \mathcal{I}_x\chi(x) \\
\phi(y(x)) &= \mathcal{I}_\phi\chi(x) \\
\phi(y(x)) - y(x) &= \mathcal{I}_{\phi-y}\chi(x), \\
\begin{bmatrix} 1 \\ \phi(y(x)) \\ \phi(y(x)) - y(x) \end{bmatrix} &= \mathcal{I}_{\tilde{\chi}}\chi(x)
\end{aligned}$$

and

$$\begin{aligned}
\begin{bmatrix} x^+ \\ \phi(y^+(x)) \end{bmatrix} &= \mathcal{I}_+\tilde{\chi}(x), \\
\begin{bmatrix} x \\ \phi(y(x)) \end{bmatrix} &= \mathcal{I}_0\tilde{\chi}(x), \\
\phi(\tilde{y}(x)) &= \mathcal{I}_{\tilde{\phi}}\tilde{\chi}(x) \\
\phi(\tilde{y}(x)) - \tilde{y}(x) &= \mathcal{I}_{\tilde{\phi}-\tilde{y}}\tilde{\chi}(x)
\end{aligned}$$

$$\begin{bmatrix} 1 \\ \phi(\tilde{y}(x)) \\ \phi(\tilde{y}(x)) - \tilde{y}(x) \end{bmatrix} = \mathcal{I}_{\tilde{\chi}} \tilde{\chi}(x).$$

We have

$$\begin{aligned} \chi(x)^\top (\mathcal{I}^\top P \mathcal{I} - \epsilon_1 \mathcal{I}_x^\top \mathcal{I}_x + \frac{1}{2} He (\mathcal{I}_\phi^\top T \mathcal{I}_{\phi-y}) - \mathcal{I}_\chi^\top M \mathcal{I}_\chi) \chi(x) \\ = (V(x, y) - \epsilon_1 x^\top x) + s_1(T, y) - s_2(M, y) \end{aligned}$$

$$\begin{aligned} \chi(x)^\top \left(-\mathcal{I}^\top P \mathcal{I} + \epsilon_2 \mathcal{I}_x^\top \mathcal{I}_x + \frac{1}{2} He (\mathcal{I}_\phi^\top T_u \mathcal{I}_{\phi-y}) - \mathcal{I}_\chi^\top M_u \mathcal{I}_\chi \right) \chi(x) \\ = (-V(x, y) + \epsilon_2 x^\top x) + s_1(T_u, y) - s_2(M_u, y) \end{aligned}$$

$$\begin{aligned} \tilde{\chi}(x)^\top \left(-\mathcal{I}_+^\top P \mathcal{I}_+ + (1 - \eta) \mathcal{I}_0^\top P \mathcal{I}_0 + \frac{1}{2} He (\mathcal{I}_\phi^\top \tilde{T} \mathcal{I}_{\tilde{\phi}-\tilde{y}}) - \mathcal{I}_{\tilde{\chi}}^\top \tilde{M} \mathcal{I}_{\tilde{\chi}} \right) \tilde{\chi}(x) \\ = -(V(F_1 x + F_2 \phi(\tilde{y}_0), \tilde{y}_0^+) - V(x, y) + \eta x^\top x) + s_1(\tilde{T}, \tilde{y}) - s_2(\tilde{M}, \tilde{y}) \end{aligned}$$

Thus the matrix inequalities in (4.27) imply the inequalities expressed as the generalized quadratic forms in (4.23) and (4.24). \square

4.4 Numerical Examples

In this section we showcase the effectiveness of the proposed methodology in some numerical examples. Specifically, we consider the following dynamical system

$$x^+ = Ax + \bar{B}\varphi(x) \quad (4.29)$$

with

$$A = \begin{bmatrix} 0.9464 & 0.0957 \\ -0.9568 & 0.9033 \end{bmatrix}$$

and \bar{B} and φ defined in each of the examples below, where we solve the stability LMIs (4.27) with $\epsilon_1 = 1 \times 10^{-7}$, $\epsilon_2 = 1 \times 10^5$ and $\eta = 1 \times 10^{-7}$. In all examples we solve the conditions in (4.27) in YALMIP [120] and the solver SeDuMi [157],

4.4.1 Ternary Control

In this first example, we pick

$$\begin{aligned} \bar{B} &= \begin{bmatrix} 0.0049 \\ 0.0959 \end{bmatrix}, \\ \bar{K} &= [9.9 \quad 0.495], \end{aligned}$$

and analyze the case of ternary control systems; see, e.g., [45, 175]. More specifically, we select $\varphi(x) = \tau(\bar{K}x)$, where for all $u \in \mathbb{R}$

$$\tau(u) := \begin{cases} 1 & \text{if } u > 1 \\ 0 & \text{if } u \in [-1, 1] \\ -1 & \text{if } u < -1 \end{cases}$$

The regularized nonlinearity written in terms of the step function is then given by

$$\varphi(x) = \mathbf{s}(\bar{K}x - 1) - \mathbf{s}(-\bar{K}x - 1)$$

and system (4.29) can be rewritten as (4.4a) by taking

$$B = [\bar{B} \quad -\bar{B}], K = \begin{bmatrix} \bar{K} \\ -\bar{K} \end{bmatrix},$$

$d = -\mathbf{1}_2$, and $\Delta = I_2$.

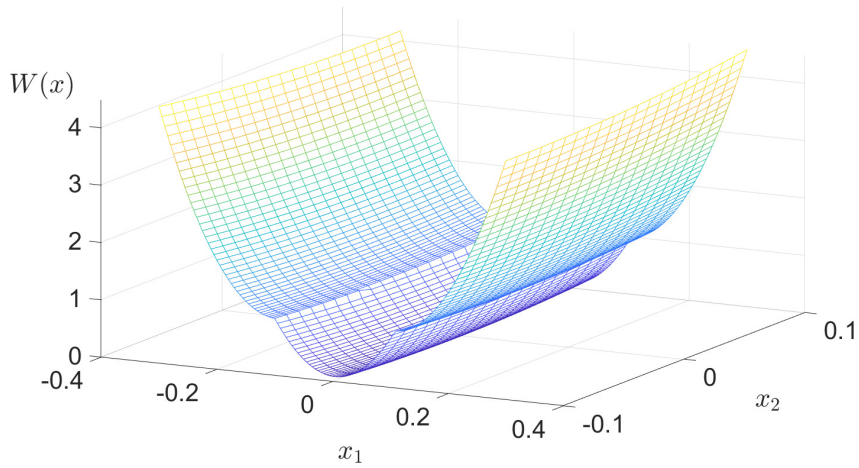
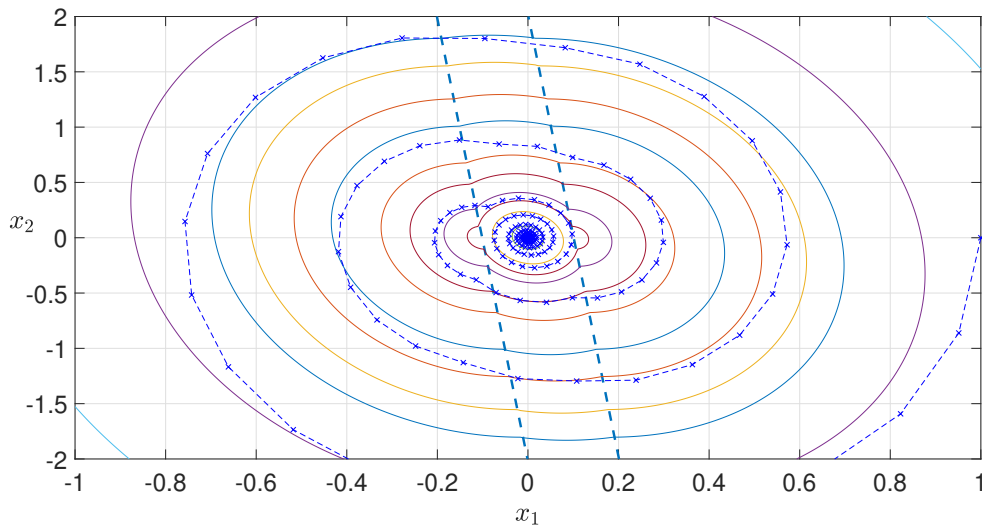
Figure 4.6: Function $W(x) = \max V(x)$ in Example 4.4.1.Figure 4.7: Simulations in Example 4.4.1. Level sets of the function $W(x) = \max V(x)$ and the trajectory σ of (4.29) starting from $(1, 0)$ (dashed-crossed line). The dashed line indicates the set where $Kx + d = 0$, namely, the set where the argument of the ramp function and the step function is equal to zero.

For this example, no common quadratic function exists to certify exponential stability of the matrices A and $A + \bar{B}\bar{K}$. This prevents from using a quadratic Lyapunov function to certify the global exponential stability of the origin. The proposed methodology instead enables to certify global exponential stability. We obtain

$$P = \begin{bmatrix} 82.9572 & 3.8632 & 0.5475 & 0.0000 & -0.5474 & 0.0000 \\ 3.8632 & 9.1279 & 0.0563 & 0.0000 & -0.0563 & 0.0000 \\ 0.5475 & 0.0563 & -0.0530 & -0.8915 & 0.0530 & 0.0000 \\ 0.0000 & 0.0000 & -0.8915 & 0.0000 & 0.0000 & 0.0000 \\ -0.5474 & -0.0563 & 0.0530 & 0.0000 & -0.0530 & -0.8915 \\ 0.0000 & 0.0000 & 0.0000 & 0.0000 & -0.8915 & 0.0000 \end{bmatrix}$$

The Lyapunov function $W(x) = \max V(x)$ with V defined as in (4.4) is depicted in Figure 4.6. while Figure 4.7 depicts level sets of the corresponding function along with a trajectory of the system.

4.4.2 Binary Control

In this second example, we take \bar{B} and \bar{K} as in Example 4.4.1 and the regularized nonlinearity with $\varphi(x) = \mathbf{s}(\bar{K}x - 1)$ thus yielding (4.4a) with $B = [\bar{B}]$, $K = [\bar{K}]$, $d = -1$, and $\Delta = 1$. In this example, we obtain

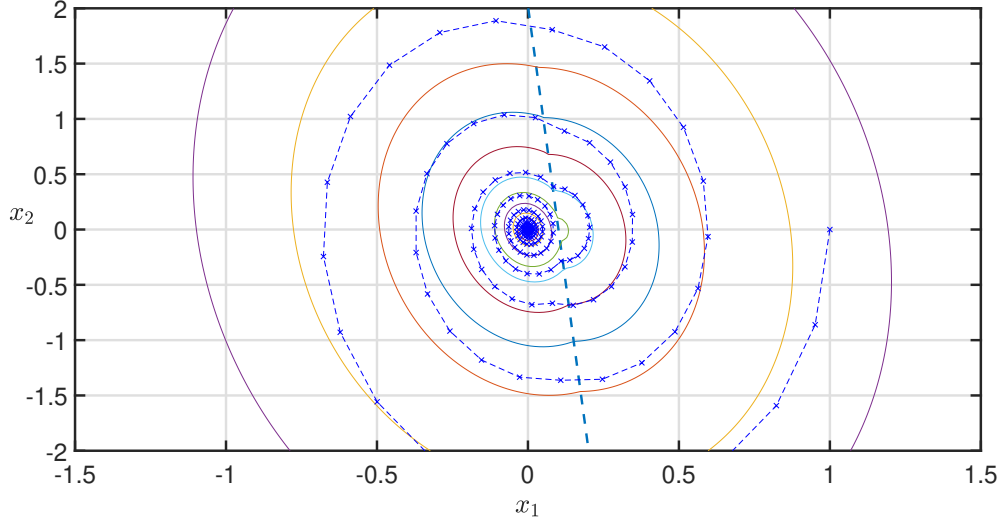

Figure 4.8: Level sets of the function $W(x)$ in Example 4.4.2 and the trajectory of (4.29) starting from $(1, 0)$ (dashed-crossed line). The dashed line indicates the set where $Kx + d = 0$, namely, the set where the argument of the ramp function and the step function is equal to zero.

$$P = \begin{bmatrix} 82.9257 & 3.8800 & 0.5083 & 0.0000 \\ 3.8800 & 9.0786 & 0.0478 & 0.0000 \\ 0.5083 & 0.0478 & -0.0493 & -0.8872 \\ 0.0000 & 0.0000 & -0.8872 & 0.0000 \end{bmatrix}.$$

Figure 4.8 illustrates some level sets of the function W along with the solution to (4.29) starting from $(1, 0)$. The picture clearly shows that the lack of symmetry of the nonlinearity s reflects on the function W .

4.4.3 Stabilization with a finite alphabet

In this example we select $\bar{B} = I_2$ and consider a scenario in which the control input takes values in the set $\mathcal{Q} := \{(0, 0), (0, -1), (-1, 0), (-1, -1)\}$, depending on the value of the state. In particular, we consider

$$\varphi(x) = \begin{cases} \begin{bmatrix} 0 \\ 0 \end{bmatrix} & \text{if } x \in (-\infty, 1] \times (-\infty, 1] \\ \begin{bmatrix} -1 \\ 0 \end{bmatrix} & \text{if } x \in (1, \infty) \times (-\infty, 1] \\ \begin{bmatrix} 0 \\ -1 \end{bmatrix} & \text{if } x \in (-\infty, 1] \times [1, \infty) \\ \begin{bmatrix} -1 \\ -1 \end{bmatrix} & \text{if } x \in (1, \infty) \times [1, \infty) \end{cases} \quad (4.30)$$

To analyze (4.29) via the tools presented in this chapter, we rewrite φ as $\varphi(x) = \mathbf{S} \left(\begin{bmatrix} x_1 - 1 \\ x_2 - 1 \end{bmatrix} \right)$, where \mathbf{S} is the step function defined in (4.4c). This enables us to rewrite (4.29) as (4.4a) with $K = I_2$, $d = -\mathbf{1}_2$, and $\Delta = I_2$. We obtain

$$P = \begin{bmatrix} 9.6376 & -0.0289 & -2.9186 & -0.0000 & 0.9474 & 0.0000 \\ -0.0289 & 1.0155 & -0.5239 & -0.0000 & -0.3571 & 0.0000 \\ -2.9186 & -0.5239 & 1.6011 & 0.3795 & -0.0009 & 0.0005 \\ -0.0000 & -0.0000 & 0.3795 & -0.0000 & -0.1719 & 0.0000 \\ 0.9474 & -0.3571 & -0.0009 & -0.1719 & 0.4369 & 0.6290 \\ 0.0000 & 0.0000 & 0.0005 & 0.0000 & 0.6290 & -0.0000 \end{bmatrix}.$$

The Lyapunov function $W(x) = \max V(x)$ with V defined as in (4.4) is depicted in Figure 4.9, while Figure 4.10 depicts level sets of the corresponding function along with a trajectory of the system.

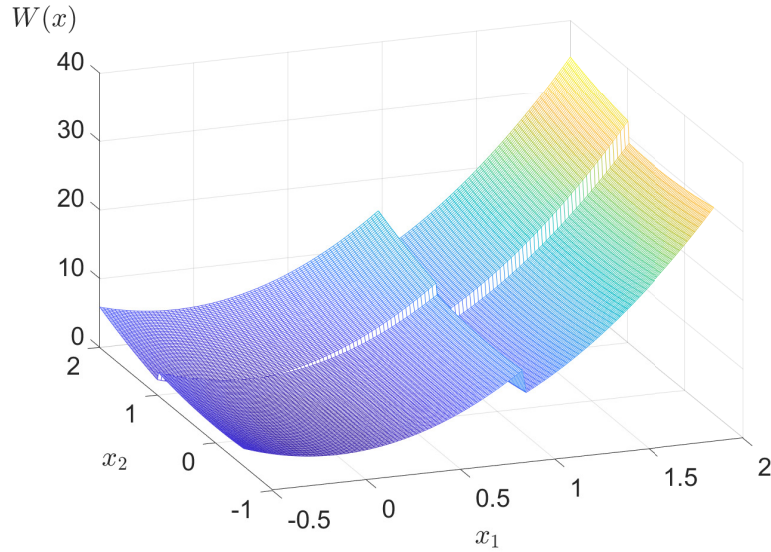

Figure 4.9: Lyapunov function $W(x)$ for Example 4.4.3.

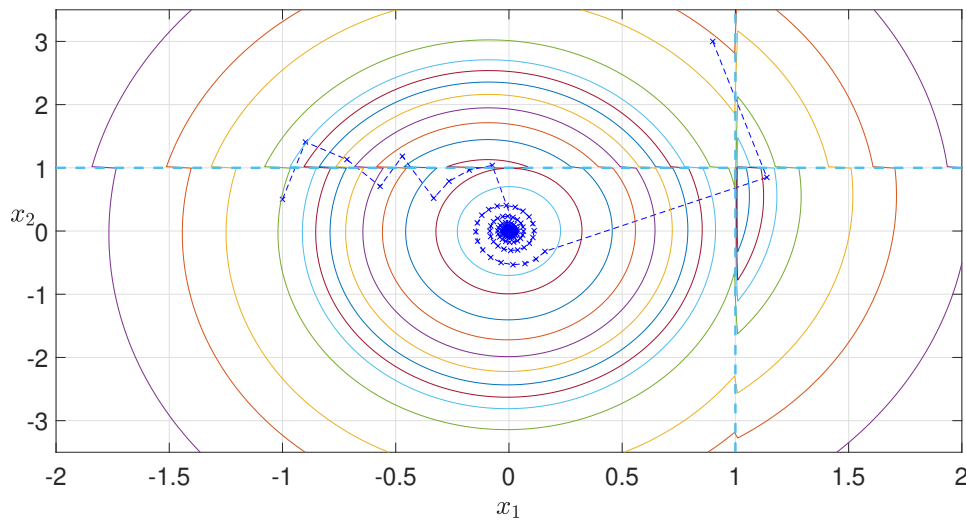

Figure 4.10: Trajectories for the system along with the partitioning of the state space introduced in (4.30). Initial conditions are selected as $(0.9, 3)$, $(-1, 0.5)$. Note that the level sets of the computed Lyapunov function are disconnected. These disconnected sets appear, for instance in the set $\{x \mid x_1 \geq 1, x_2 \leq 1\}$ close to the point $(1, 1)$.

4.5 Conclusions

This chapter proposed a characterization of the set-valued step mapping based on quadratic/linear constraints stemming from KKT necessary conditions for optimality to study the stability of finite-level quantized feedback control systems. Based on the proposed characterization, we use a generalized quadratic set-valued Lyapunov function to study the stability of linear systems in feedback with quantization functions.

We give sufficient LMI conditions for the global exponential stability of the origin of the studied discontinuous nonlinear control systems. Three numerical illustrate the effectiveness of the methodology, which have highlighted the potential of our approach in systematically generating generalized quadratic Lyapunov functions.

An essential aspect of the proposed results is that it does not rely on sector representation of the nonlinearities. As discussed in Chapter 2, it is difficult to use nonquadratic Lyapunov functions to study systems with nonlinearities without slope restrictions. This chapter offers an alternative to the simple quadratic functions for global stability analysis of systems with discontinuous nonlinearities.

A preliminary version of the results in this chapter is presented in [175]. The main difference here is that we carry out the analysis of a set-valued regularized version of the discontinuous dynamics in (4.1). This ensures that, despite the discontinuous nature of the right-hand side of (4.1), the stability properties certified via our methodology are robust to vanishing perturbations. Such an extension naturally leads to the use of set-valued Lyapunov functions, which require proper handling.

Perspectives and Concluding Remarks

Perspectives

This chapter presents perspectives and ongoing work that build upon the results presented in Parts I-II. The ideas and claims introduced in this chapter will be presented without proof since some are still preliminary. The goal of this part is to highlight the potential of the results in the manuscript, mainly regarding the study of piecewise affine systems using the implicit representation presented in Part II.

P.1 Synthesis of feedback laws for slope-restricted nonlinearities

In the results presented in Part I for linear systems with slope-restricted nonlinearities, we proposed classes of Lyapunov/storage functions leading to stability/gain analysis based on convex optimization. In these results, we aimed to reduce the number of parameters in the LF.

The natural question that can be raised regards the use of these functions to design control laws. Interestingly, in the conclusion of the survey [109] it is observed:

Most of the surveyed tools and design procedures are analytical, while only a few relied on LMI computations. Symbolic and numerical procedures will strengthen analytical design methods.

However, systematic convex conditions for the control law design are challenging to formulate except for simple LF candidates. This is the case of quadratic functions, which can be used for the synthesis of state feedback laws. For this simple function, the conjugate quadratic function [71] allows for a change of coordinates followed by a change of variables yielding a convex optimization computation of the feedback gains.

In the context of input-saturating systems, we have recently proposed an iterative-based strategy to compute the feedback gains [146]. This strategy relies on the conditions of Finsler's lemma. However, to obtain a convex optimization formulation, we have to impose structure of a multiplier, which is a way to avoid the product of some terms which would otherwise give a non-convex set of constraints. We also proposed a similar convex-optimization based approach in [17] based on Lyapunov function stability conditions, and in [17], based on a Zames-Falb multiplier condition.

We would like next to exploit the proposed parameterization for the synthesis of state feedback gains with a *direct convex* formulation. These convex conditions will be investigated for both the continuous-time and the discrete-time cases.

P.2 PWQ Lyapunov functions for continuous-time systems

Consider the PWA continuous-time system, defined using the implicit PWA function with ramp functions as introduced in Part II for discrete-time systems.

$$\frac{dx}{dt} = Ax + B\phi(y) \quad (4.31a)$$

$$y = Cx + D\phi(y) + e \quad (4.31b)$$

with $A \in \mathbb{R}^{n \times n}$, $B \in \mathbb{R}^{n \times m_y}$, $C \in \mathbb{R}^{m_y \times n}$, $D \in \mathbb{R}^{m_y \times m_y}$, $e \in \mathbb{R}^{m_y \times 1}$.

In Chapter 4 we showed that the algebraic loop can be ill-posed, in which case a set-valued mapping is obtained and the resulting nonlinear function $y : \mathbb{R}^n \rightarrow \mathbb{R}^{m_y}$ can be discontinuous. Since both continuous and discontinuous vector fields can be obtained with the above algebraic loop, it enables the study of both continuous or discontinuous [37] CT dynamics. The main objective of the perspectives presented in this section is to point out the potential of the implicit PWA representation to solve analysis problems that are difficult to be addressed with the usual explicit representation. Indeed, in the partition-based analysis using explicit PWA representation for CT

systems, the dynamics on the boundary between regions must be studied separately [49] as sliding modes can appear.

The main challenges to extend the results of Part II to continuous-time systems in an implicit form, with either continuous or discontinuous vector fields, are related to the use of more complex LF than simple quadratic functions. The main difficulties are related to the non-differentiability of the ramp function, as discussed below.

Consider the generalized quadratic forms as the LF candidates

$$V(x) = \frac{1}{2} \begin{bmatrix} x \\ \phi(\xi(x)) \end{bmatrix}^\top \begin{bmatrix} P_1 & P_2 \\ P_2^\top & P_3 \end{bmatrix} \begin{bmatrix} x \\ \phi(\xi(x)) \end{bmatrix} \quad (4.32a)$$

$$\xi = C_\xi x + D_\xi \phi(\xi) + e_\xi, \quad (4.32b)$$

where the parameters $P_1 \in \mathbb{R}^{n \times n}$, $P_2 \in \mathbb{R}^{n \times m}$, $P_3 \in \mathbb{R}^{m \times m}$ are to be computed, and the parameters $C_\xi \in \mathbb{R}^{m \times n}$, $D_\xi \in \mathbb{R}^{m \times m}$, $e_\xi \in \mathbb{R}^{m \times 1}$ are given. The algebraic loop defining the value of ξ for each x , is assumed to be well-posed, thus resulting in a continuous function. The matrices in the above algebraic loop can be different from the matrices defining the partition of the continuous-time PWA system through variable y in (4.31).

The difficulties of using the above function as an LF candidate are related to the fact that the ramp functions are not differentiable. Indeed, the expression for its derivative along the trajectories of (4.31) is

$$\dot{V} = \begin{bmatrix} x \\ \phi(\xi(x)) \end{bmatrix}^\top \begin{bmatrix} P_1 & P_2 \\ P_2^\top & P_3 \end{bmatrix} \begin{bmatrix} \frac{dx(t)}{dt} \\ \frac{d\phi(\xi(x(t)))}{dt} \end{bmatrix} \quad (4.33)$$

where the term $\frac{d\phi(\xi(x(t)))}{dt}$, is not differentiable $\forall t$ for all possible trajectories since the ramp function defining the vector $\phi(\xi)$ is not differentiable at the origin.

Remark P.4

For the particular case of saturating systems, the above generalized quadratic forms were used in [41, 68, 176]. In these papers, $\frac{d\phi(\xi(x))}{dt}$ is treated as an independent variable satisfying some identities in the same spirit as the sector inequalities. It is, however, important to show that the set where the function is not differentiable is not an invariant set, which roughly speaking, guarantees the decrease of the LF for almost all time. This way, it is still possible to use the above function with some conservatism. On the other hand, in light of the results of Part II, we can exploit the set-valued step mapping to represent the generalized derivative of the step as discussed below.

The following lemma, generalizes Lemma 4.1 and will be instrumental to represent regularized discontinuous functions and generalized derivatives.

Lemma P.2

The set-valued step mapping of magnitude $\rho \geq 0$ on variable θ is expressed in terms of ramp functions as

$$\mathbf{s}(\theta, \rho) = r(\eta_1) \quad (4.34a)$$

$$\begin{bmatrix} \eta_1 \\ \eta_2 \end{bmatrix} = \begin{bmatrix} \theta \\ -\rho \end{bmatrix} + \begin{bmatrix} 1 & -1 \\ 1 & 1 \end{bmatrix} \begin{bmatrix} r(\eta_1) \\ r(\eta_2) \end{bmatrix}. \quad (4.34b)$$

We do not provide the proof of the lemma as it follows closely the proof of Lemma 4.1.

As indicated in the above lemma, relation (4.37b) holds true only for non-negative values of the scalar ρ , which gives the step magnitude. For negative values of ρ , the following Lemma applies

Lemma P.3

The set-valued step mapping of magnitude $\rho \leq 0$ on variable θ is expressed in terms of ramp functions as

$$\mathbf{s}(\theta, \rho) = -r(\eta_1) \quad (4.35a)$$

$$\begin{bmatrix} \eta_1 \\ \eta_2 \end{bmatrix} = \begin{bmatrix} \theta \\ \rho \end{bmatrix} + \begin{bmatrix} 1 & -1 \\ 1 & 1 \end{bmatrix} \begin{bmatrix} r(\eta_1) \\ r(\eta_2) \end{bmatrix}. \quad (4.35b)$$

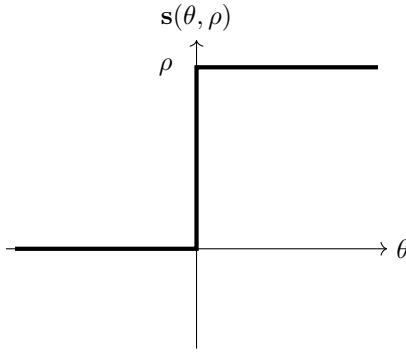
 Figure P.11: Regularization of the step function $s(\theta, \rho)$.

To allow for both positive and negative values ρ of the step we may then write separately two expressions for the positive and the negative magnitudes

$$\bar{s}(\theta, \rho) := s(\theta, r(\rho)) - s(\theta, r(-\rho)) \quad (4.36)$$

which, using (4.34) to write one expression for $s(\theta, \rho)$ and another expression for $s(\theta, -\rho)$, becomes

$$\bar{s}(\theta, \rho) = r(\eta_1) - r(\eta_3) \quad (4.37a)$$

$$\begin{bmatrix} \eta_1 \\ \eta_2 \\ \eta_3 \\ \eta_4 \end{bmatrix} = \begin{bmatrix} 1 & 0 & 0 \\ 0 & -1 & 0 \\ 1 & 0 & 0 \\ 0 & 0 & -1 \end{bmatrix} \begin{bmatrix} \theta \\ r(\rho) \\ r(-\rho) \end{bmatrix} + \begin{bmatrix} 1 & -1 & 0 & 0 \\ 1 & 1 & 0 & 0 \\ 0 & 0 & 1 & -1 \\ 0 & 0 & 1 & 1 \end{bmatrix} \begin{bmatrix} r(\eta_1) \\ r(\eta_2) \\ r(\eta_3) \\ r(\eta_4) \end{bmatrix} \quad (4.37b)$$

alternatively

$$\bar{s}(\theta, \rho) = \begin{bmatrix} 1 & 0 & -1 & 0 & 0 & 0 \end{bmatrix} \begin{bmatrix} r(\eta_1) \\ r(\eta_2) \\ r(\eta_3) \\ r(\eta_4) \\ r(\eta_5) \\ r(\eta_6) \end{bmatrix} \quad (4.38a)$$

$$\begin{bmatrix} \eta_1 \\ \eta_2 \\ \eta_3 \\ \eta_4 \\ \eta_5 \\ \eta_6 \end{bmatrix} = \begin{bmatrix} 1 & 0 \\ 0 & 0 \\ 1 & 0 \\ 0 & 0 \\ 0 & 1 \\ 0 & -1 \end{bmatrix} \begin{bmatrix} \theta \\ \rho \end{bmatrix} + \begin{bmatrix} 1 & -1 & 0 & 0 & 0 & 0 \\ 1 & 1 & 0 & 0 & -1 & 0 \\ 0 & 0 & 1 & -1 & 0 & 0 \\ 0 & 0 & 1 & 1 & 0 & -1 \\ 0 & 0 & 0 & 0 & 0 & 0 \\ 0 & 0 & 0 & 0 & 0 & 0 \end{bmatrix} \begin{bmatrix} r(\eta_1) \\ r(\eta_2) \\ r(\eta_3) \\ r(\eta_4) \\ r(\eta_5) \\ r(\eta_6) \end{bmatrix}. \quad (4.38b)$$

Note that the above general step function is also given by the product of a unit step function and its magnitude

$$\bar{s}(\theta, \rho) = s(\theta, 1)\rho. \quad (4.39)$$

The lemma below states that the term $\frac{d\phi(\xi(x))}{dt}$ in the expression of \dot{V} in (4.33) is an implicit algebraic expression in terms of ramp functions.

Lemma P.4

The time derivative of $\frac{d\phi(\xi(x))}{dt}$ can be expressed as a set-valued mapping defined by the implicit relation

$$\frac{d\phi(\xi(x(t)))}{dt} = \bar{F}\phi(\bar{\eta}) \quad (4.40a)$$

$$\bar{\eta} = \bar{C}x + \bar{D}_\xi\phi(\xi) + \bar{D}_y\phi(y) + \bar{e} + \bar{D}\phi(\bar{\eta}) \quad (4.40b)$$

with $\bar{F} \in \mathbb{R}^{m \times 6m}$, $\bar{C} \in \mathbb{R}^{6m \times n}$, $\bar{D}_\xi \in \mathbb{R}^{6m \times m}$, $\bar{D}_y \in \mathbb{R}^{6m \times m_y}$, $\bar{D} \in \mathbb{R}^{6m \times 6m}$, and $\bar{e} \in \mathbb{R}^{6m \times 1}$ as

$$\bar{F} = (I_m \otimes N_0), \quad (4.41a)$$

$$\bar{C} = (I_m \otimes N_{11})C_\xi + (I_m \otimes N_{12})C_\xi A \quad (4.41b)$$

$$\bar{D}_\xi = (I_m \otimes N_{11})D_\xi, \quad (4.41c)$$

$$\bar{D}_y = (I_m \otimes N_{12})C_\xi B, \quad (4.41d)$$

$$\bar{e} = (I_m \otimes N_{11})e_\xi, \quad (4.41e)$$

$$\bar{D} = (I_m \otimes N_{12})D_\xi(I_m \otimes N_0) + I_m \otimes N_2, \quad (4.41f)$$

with $N_0 = [1 \ 0 \ -1 \ 0 \ 0 \ 0]$,

$$N_{11} = \begin{bmatrix} 1 \\ 0 \\ 1 \\ 0 \\ 0 \\ 0 \end{bmatrix} \quad N_{12} = \begin{bmatrix} 0 \\ 0 \\ 0 \\ 0 \\ 1 \\ -1 \end{bmatrix} \quad N_2 = \begin{bmatrix} 1 & -1 & 0 & 0 & 0 & 0 \\ 1 & 1 & 0 & 0 & -1 & 0 \\ 0 & 0 & 1 & -1 & 0 & 0 \\ 0 & 0 & 1 & 1 & 0 & -1 \\ 0 & 0 & 0 & 0 & 0 & 0 \\ 0 & 0 & 0 & 0 & 0 & 0 \end{bmatrix}.$$

The proof of the Lemma is given at the end of this chapter.

With the above results, we have

$$\dot{V} = \begin{bmatrix} x \\ \phi(\xi(x)) \end{bmatrix}^\top \begin{bmatrix} P_1 & P_2 \\ P_2^\top & P_3 \end{bmatrix} \begin{bmatrix} A & B & 0_{n,n_\xi} & 0_{n,n_\eta} \\ 0_{n_\xi,n} & 0_{n_\xi,n_y} & 0_{n_\xi,n_\xi} & F \end{bmatrix} \begin{bmatrix} x \\ \phi(y(x)) \\ \phi(\xi(x)) \\ \phi(\bar{\eta}(x)) \end{bmatrix}$$

with y , ξ and $\bar{\eta}$, given by the solution to the algebraic loops (4.31b), (4.32b), and (4.40b). These algebraic relations can be combined in a single algebraic equation as

$$\begin{bmatrix} y \\ \xi \\ \bar{\eta} \end{bmatrix} = \begin{bmatrix} C \\ C_\xi \\ \bar{C} \end{bmatrix} x + \begin{bmatrix} D & 0_{n_y,n_\xi} & 0_{n_y,n_\eta} \\ 0_{n_\xi,n_y} & D_\xi & 0_{n_\xi,n_\eta} \\ \bar{D}_y & \bar{D}_\xi & \bar{D} \end{bmatrix} \begin{bmatrix} \phi(y) \\ \phi(\xi) \\ \phi(\bar{\eta}) \end{bmatrix} + \begin{bmatrix} e \\ e_\xi \\ \bar{e} \end{bmatrix}. \quad (4.42)$$

Hence $-\dot{V}$ is a PWQ function, and its global non-negativity can be checked using the conditions in Proposition 3.2. The PWQ structure for the LF candidate may be used in different problems. Some of these are discussed in the sections below.

P.3 Linear switching and polytopic uncertain systems

Linear Differential/Difference Inclusions (LDI) [22, Chapter 4] for CT and DT systems model a broad class of uncertain time-invariant and time-varying linear systems, including LPV systems with arbitrary variations, switching systems, and nonlinear systems with sector inequalities. It has been shown that the stability of the switching system is equivalent to the stability of the differential inclusion resulting from the polytopic convex hull of systems [127]. Also, for exponentially stable LDI, the existence of a convex Lyapunov function of quadratic growth has been shown to be necessary and sufficient [127] for stability. Notably, the universal classes that should be considered are norms [10]. Note that the convexity of the LF for these classes is in contrast with the class of switched systems, where non-convex functions might be needed [21] as discussed in the section below.

In [127], two classes of homogeneous LF functions are suggested to study differential inclusions: PWQ functions and polynomial forms. Even if the computation of these universal Lyapunov

functions can be challenging, whenever the number of parameters is fixed, different computational methods [71, 190, 33, 183] have been put forward. For the max of quadratics proposed in [183], the stability conditions are cast as bilinear matrix inequalities. Based on the fact that the stability of dual LDI system is a necessary and sufficient condition for the stability of the primal LDI system [12], in [71], the max of quadratics is used to show the stability of the dual LDI system whenever the same function does not show the stability of the primal LDI. An LF function for the primal LDI is then constructed from the convex conjugate function to the LF of the dual LDI. SDP solutions have been obtained for polynomial functions whenever the degree of the form is fixed [35]. The computation of LF is also pursued in [18] where polyhedral functions are searched with the solution to LP.

Moreover, for the class of uncertain polytopic systems, several methods consider quadratic growth LF with polynomial dependence on uncertain parameters describing the polytopic set instead of considering a parameter independent but not quadratic on the state [44, 139, 40, 34, 129].

To study the stability of switching and uncertain systems in both CT and DT, we will parameterize homogeneous PWQ LF candidates as

$$V(x) = \frac{1}{2} \phi(\xi(x))^\top \begin{bmatrix} I_{n_\xi} \\ I_{n_\xi} \end{bmatrix} P \begin{bmatrix} I_{n_\xi} & I_{n_\xi} \end{bmatrix} \phi(\xi(x)) \quad (4.43a)$$

$$\xi = \begin{bmatrix} C_\xi \\ -C_\xi \end{bmatrix} x, \quad (4.43b)$$

with a fixed matrix $C_\xi \in \mathbb{R}^{n \times n_\xi}$, $\text{rank}(C_\xi) = n$ and $P \in \mathbb{S}^{n_\xi}$, such that $V(x) = V(-x)$. The above form representation with ramp functions prevents additional constraints for the continuity of the LF at the boundaries as in [96].

Another important motivation for the analysis with the PWQ function approach is its extension to design nonlinear feedback for switching and uncertain linear systems. The advantage of using a nonlinear, possibly discontinuous, feedback control law is to obtain better performance than linear feedback laws [20]. The performance can be measured as the increase of the achievable convergence rate or reduction of induced gains for systems with exogenous inputs. For continuous-time systems as

$$\dot{x} = Ax + Bu, \quad (A, B) \in (\mathcal{A}, \mathcal{B}) \subset \mathbb{R}^{n \times n+m}, \quad (4.44)$$

we will focus on computing nonlinear control laws [71] as

$$u = K \left(\frac{dV}{dx} \right)^\top. \quad (4.45)$$

with $K \in \mathbb{R}^{m \times n}$. For the proposed class of PWQ systems, the resulting control laws will be homogeneous piecewise linear (PWL) functions, leading to a switched closed-loop system since the gain will depend on the partition induced by $\phi(\xi(x))$. To see this, observe that

$$\frac{dV}{dx} = \phi(\xi(x))^\top \begin{bmatrix} I_{n_\xi} \\ I_{n_\xi} \end{bmatrix} P \begin{bmatrix} I_{n_\xi} & I_{n_\xi} \end{bmatrix} \frac{d\phi(\xi(x))}{d\xi} \begin{bmatrix} C_\xi \\ -C_\xi \end{bmatrix}. \quad (4.46)$$

The discontinuity on $\frac{dV}{dx}$ appears due to the term $\frac{d\phi(\xi)}{d\xi}$ that is discontinuous in the set $\{x \in \mathbb{R}^n \mid \xi_i(x) = 0, i = 1, \dots, n_\xi\}$, $\forall i \in n_\xi$. Note that $\frac{d\phi(\xi_i)}{d\xi_i} \in \{0, 1\}$ and $\frac{d\phi(\xi_i)}{d\xi_j} = 0$ for $i \neq j$, thus the matrix $\frac{d\phi(\xi(x))}{d\xi}$ is a diagonal matrix with diagonal elements in $\{0, 1\}$, thus giving

$$\frac{d\phi(\xi)}{d\xi} = \text{diag} \left(\begin{bmatrix} \mathbf{s}(C_{\xi_1} x, 1) \\ \vdots \\ \mathbf{s}(C_{\xi_{n_\xi}} x, 1) \\ \mathbf{s}(-C_{\xi_1} x, 1) \\ \vdots \\ \mathbf{s}(-C_{\xi_{n_\xi}} x, 1) \end{bmatrix} \right).$$

We then obtain

$$\frac{dV}{dx} = (\phi(C_\xi x)^\top + \phi(-C_\xi x)^\top) P \left(\text{diag} \left(\begin{bmatrix} \mathbf{s}(C_{\xi_1} x, 1) \\ \vdots \\ \mathbf{s}(C_{\xi_{n_\xi}} x, 1) \end{bmatrix} \right) - \text{diag} \left(\begin{bmatrix} \mathbf{s}(-C_{\xi_1} x, 1) \\ \vdots \\ \mathbf{s}(-C_{\xi_{n_\xi}} x, 1) \end{bmatrix} \right) \right) C_\xi. \quad (4.47)$$

since the terms $\phi(C_\xi x)$ are PWL on x and the terms $\mathbf{s}(-C_{\xi n_\xi} x, 1)$ are piecewise constant on x , the function $\frac{dV}{dx}$ is PWL with a conic partition defined by $\xi = C_\xi x$.

We will also study the characterization of the classes of systems that can be stabilized with the proposed switched laws. For the particular case of quadratic stabilizability of switching systems, these conditions have been proposed in [180].

P.4 Discontinuous PWA systems

Discontinuous vector fields appear in both CT and DT feedback loops due to different reasons:

- the plant dynamics changes according to some partition in the state space. This is the case for instance where some discontinuous forces, such as dry friction, appear in the system;
- technological constraints introduce only a finite number of levels in actuators or sensors as discussed in Chapter 4 for DT systems with input quantization;
- the control law is discontinuous. This type of discontinuity appears for performance improvement of the closed-loop either when finite-time convergence is sought or when sliding-mode control is adopted. Optimization-based control strategies can also introduce discontinuities, for instance, in the use of LP MPC [15].

The quantization control, perhaps the simplest case introducing discontinuities, has been studied as a sector nonlinearity [59, 65, 39]. These simple systems were then analyzed with quadratic LF in the CT and DT cases thanks to the sector inequalities. On the other hand, more complex discontinuous dynamics, such as the ones appearing in sliding-mode control laws [172, 153], are most often modeled as an explicit switched system. The models used for these discontinuous systems determine the methods for their analysis. In this context, we would like to formulate a unified framework to study discontinuous systems as discussed below.

Despite the progress in the study of switched systems [152], we point out the fact that the use of explicit representations has several flaws or difficulties. Perhaps the most significant one is the choice and parameterization of PWQ Lyapunov functions. Indeed, when formulating stability conditions, several constraints need to be explicitly imposed, such as the continuity of the function along the boundaries of the partition defining the LF (4.32a). Other difficulties are related to the test for the decrease of the LF only on the partition where it is active and the possible existence of sliding modes. Due to these reasons, the existing results lead to numerically tractable conditions only in simple instances. Moreover, the study of local stability, computation of induced gains in the presence of disturbances, and control design by extending approaches based on explicit representation are not appealing.

Using an algebraic loop to represent the set-valued step mapping allows us to describe other discontinuous mappings, such as the ones appearing in the switched systems. The advantage of the set-valued mappings is that they also provide a regularized version of the discontinuity since the set-valued maps appear only in the points of discontinuity [49].

LF functions for switched systems need not be convex, as pointed out by [21]. Therefore, the general (non-differentiable) PWQ function defined in a partition should be parametrized. Note that the partition of the PWQ can be different from the partition of the system. Moreover, a single framework will simplify the numerical construction of Lyapunov conditions, reducing the number of constraints to be checked.

In the rest of this section, we give a simple example of using algebraic loops to represent discontinuous functions defined on conic partitions. Thanks to this representation, one can then use the (continuous) function in (4.32a) as the LF candidate for the switched system described by the proposed discontinuous functions. Following the discussion in the previous section, the derivatives of the PWQ LF have an implicit algebraic loop description. The approach to study this class of system would then consist of verifying just two inequalities: the Lyapunov inequality for positive-definiteness of LF and the negative-definiteness of its derivative. The method to check these inequalities is the same as in Proposition 3.2. With the obtained PWA implicit model and the more straightforward analysis conditions obtained, we will have a framework to study other problems such as the local stability (see Section P.5 below).

To motivate this problem, consider the following explicit planar CT switched system with two modes

$$\dot{x} = \begin{cases} A_1 x & \text{if } x_1 x_2 < 0 \\ A_2 x & \text{if } x_1 x_2 \geq 0 \end{cases}$$

that can be rewritten as

$$\dot{x} = A_n x + \begin{cases} 0_{2,1} & \text{if } x_1 x_2 < 0 \\ A_p x & \text{if } x_1 x_2 \geq 0 \end{cases} \quad (4.48)$$

with $A_n = A_1$ and $A_p = A_2 - A_1$. To write the linear expression $A_p x$ restricted to the set $\{x \in \mathbb{R}^2 \mid x_1 x_2 \geq 0\}$ we can use an implicit equation to represent both x_1 and x_2 restricted to this set as in the lemma below.

Lemma P.5

The mapping

$$x_r(x) = H_1 \phi(u) \quad (4.49a)$$

$$u = H_2 x + H_3 \phi(u) \quad (4.49b)$$

with $H_1 = (I_2 \otimes [1 \ 0 \ 0 \ -1 \ 0 \ 0])$;

$$H_2 = \begin{bmatrix} N_1 \\ -N_1 \\ N_2 \\ -N_2 \end{bmatrix}; N_1 = \begin{bmatrix} 0 & 1 \\ 0 & 0 \\ 1 & 0 \end{bmatrix}, N_2 = \begin{bmatrix} 1 & 0 \\ 0 & 0 \\ 0 & 1 \end{bmatrix}; H_3 = (I_4 \otimes M); M = \begin{bmatrix} 1 & -1 & 0 \\ 1 & 1 & -1 \\ 0 & 0 & 0 \end{bmatrix}.$$

satisfies

$$x_r(x) = \begin{cases} 0_{2,1} & \text{if } x_1 x_2 < 0 \\ \text{co}\{0_{2,1}, x\} & \text{if } x_1 x_2 = 0 \\ x & \text{if } x_1 x_2 > 0 \end{cases} \quad (4.50)$$

The proof of the lemma is presented in the last section of this chapter.

With the above lemma, we have

$$A_p x_r(x) = \begin{cases} 0_{2,1} & \text{if } x_1 x_2 < 0 \\ \text{co}\{0_{2,1}, A_p x\} & \text{if } x_1 x_2 = 0 \\ A_p x & \text{if } x_1 x_2 > 0. \end{cases}$$

Hence, with (4.49), we have that (4.48) becomes the regularized switched system

$$\dot{x} = A_n x + A_p H_1 \phi(u) \quad (4.51a)$$

$$u = H_2 x + H_3 \phi(u), \quad (4.51b)$$

which is a particular case of (4.31).

Note that the above result is not restricted to a partition defined by the orthants. In the more general case where the switched planar system is defined in another conic partition defined by $R \in \mathbb{S}^2$ as in

$$\dot{x} = A_n x + \begin{cases} 0_{2,1} & \text{if } \tilde{x}_1 \tilde{x}_2 < 0 \\ A_p x & \text{if } \tilde{x}_1 \tilde{x}_2 \geq 0 \end{cases} \quad \tilde{x} = R x \quad (4.52)$$

the switched system is then given by

$$\dot{x} = A_n x + A_p R^{-1} H_1 \phi(u) \quad (4.53a)$$

$$u = H_2 R x + H_3 \phi(u). \quad (4.53b)$$

Example To illustrate the above switched system, consider the following data taken from [21]

$$A_n = \begin{bmatrix} 1 & 0 \\ 0 & -1 \end{bmatrix}, A_p = \begin{bmatrix} \gamma - 1 & -1 \\ 1 & \gamma + 1 \end{bmatrix}, R = \begin{bmatrix} \tau & 1 \\ 1 & \epsilon \end{bmatrix} \quad (4.54)$$

with $\tau = \frac{1}{\gamma + \sqrt{\gamma^2 + 1}}$ and the numerical values of $\gamma = 1.1$, $\epsilon = 0.01$. The partition is illustrated in Figure P.12 and the resulting functions are plotted in Figure P.13.

P.5 Conditions for the regional positivity of a PWQ function

To formulate conditions for the local stability of nonlinear PWA systems, we need a result that allows verifying the positivity of a PWQ function only in a set. This section presents a generalization of Proposition 3.2. To this aim, we first propose a straightforward generalization of Lemma 3.2

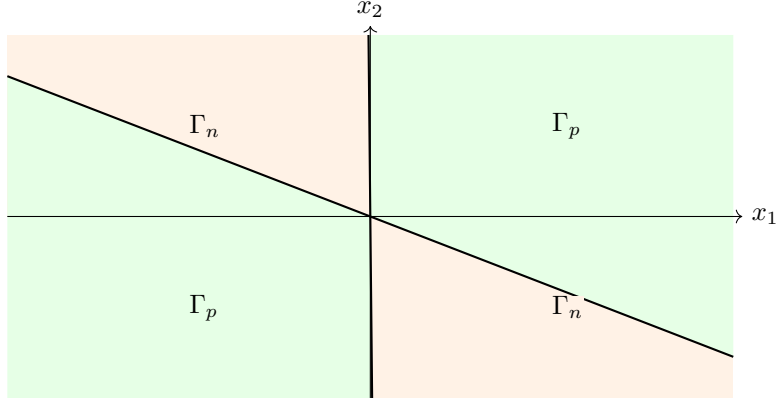

Figure P.12: Partition of \mathbb{R}^2 of the vector field defined by R , where $\Gamma_n = \{x \mid \tilde{x}_1 \tilde{x}_2 < 0, \tilde{x} = Rx\}$, $\Gamma_p = \{x \mid \tilde{x}_1 \tilde{x}_2 \geq 0, \tilde{x} = Rx\}$.

Lemma P.6

Given any function $y : \mathbb{R}^n \rightarrow \mathbb{R}^{n_y}$, and a set $\mathcal{R} \subset \mathbb{R}^n$, for any matrix function $M : \mathbb{R}^n \rightarrow \mathbb{R}^{(1+2n_y) \times (1+2n_y)}$, satisfying

$$M(x) \in \mathbb{P}^{(1+2n_y) \times (1+2n_y)} \quad \forall x \in \mathcal{R},$$

then

$$s_2(M(x), y(x)) := \begin{bmatrix} 1 \\ \phi(y(x)) \\ \phi(y(x)) - y(x) \end{bmatrix}^\top M(x) \begin{bmatrix} 1 \\ \phi(y(x)) \\ \phi(y(x)) - y(x) \end{bmatrix} \geq 0 \quad \forall x \in \mathcal{R}. \quad (4.55)$$

Given the structure of the generalized quadratic form in (4.55), we have that for particular structures of the matrix $M(x)$ the resulting expression is still a generalized quadratic form. To observe this fact, consider the following structure for $M(x)$

$$M(x) = \begin{bmatrix} M_{1,1}(x) & M_{1\phi}(x) \\ M_{1\phi}^\top(x) & M_\phi \end{bmatrix} \quad (4.56)$$

with $M_\phi \in \mathbb{P}^{2n_y \times 2n_y}$ and terms for the first row and column of $M(x)$, $M_{1,1} : \mathbb{R}^n \rightarrow \mathbb{R}$, $M_{1\phi} : \mathbb{R}^n \rightarrow \mathbb{R}^{1 \times 2n_y}$ given by

$$M_{1,1}(x) = \begin{bmatrix} 1 \\ \phi(y(x)) \\ \phi(y(x)) - y(x) \end{bmatrix}^\top \bar{M}_{1,1} \begin{bmatrix} 1 \\ \phi(y(x)) \\ \phi(y(x)) - y(x) \end{bmatrix} \quad (4.57a)$$

$$M_{1\phi}(x) = \begin{bmatrix} 1 \\ \phi(y(x)) \\ \phi(y(x)) - y(x) \end{bmatrix}^\top \bar{M}_{1\phi} \quad (4.57b)$$

with $\bar{M}_{1,1} \in \mathbb{R}^{(1+2n_y) \times (1+2n_y)}$ and $\bar{M}_{1\phi} \in \mathbb{R}^{(1+2n_y) \times (2n_y)}$. With (4.56) we obtain for (4.55)

$$s_2(M(x), y(x)) = \begin{bmatrix} 1 \\ \phi(y(x)) \\ \phi(y(x)) - y(x) \end{bmatrix}^\top \tilde{M} \begin{bmatrix} 1 \\ \phi(y(x)) \\ \phi(y(x)) - y(x) \end{bmatrix}$$

where

$$\tilde{M} = \bar{M}_{1,1} + He \left(\begin{bmatrix} 0_{1+2n_y,1} & \bar{M}_{1\phi} \end{bmatrix} \right) + \begin{bmatrix} 0 & 0_{1,2n_y} \\ 0_{2n_y,1} & M_\phi \end{bmatrix}.$$

which is also a PWQ function. We can thus state the following corollary to the above lemma.

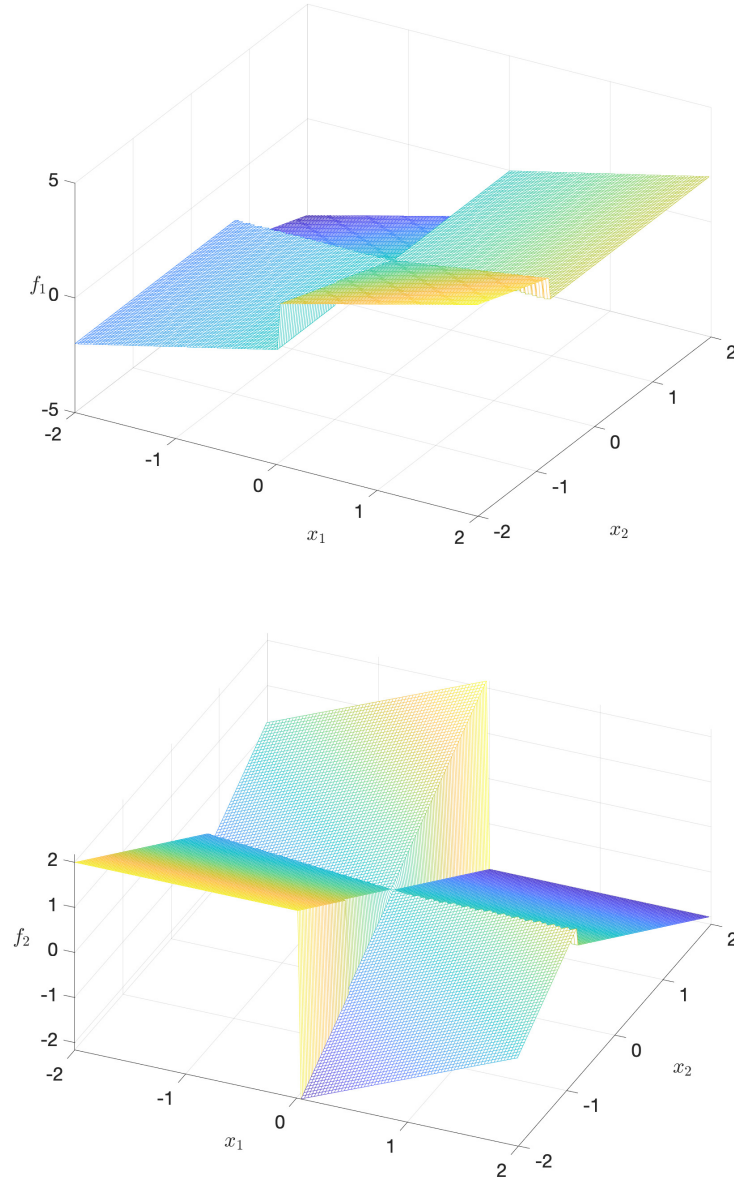

Figure P.13: Plots of the two components of $f(x) = A_n x + A_p R^{-1} H_1 \phi(u)$ in (4.53) with the data in (4.54) (plots were obtained with the PWA description, without the use of explicit representation).

Lemma P.7

Given any function $y : \mathbb{R}^n \rightarrow \mathbb{R}^{n_y}$, and matrices $\bar{M}_{1,1} \in \mathbb{R}^{(1+2n_y) \times (1+2n_y)}$, $M_{1\phi} : \mathbb{R}^n \rightarrow \mathbb{R}^{1 \times 2n_y}$, as in (4.57), and a set $\mathcal{R} \subset \mathbb{R}^n$, satisfying

$$M_{1,1}(x) \in \mathbb{P}, M_{1\phi}(x) \in \mathbb{P}^{1 \times 2n_y} \quad \forall x \in \mathcal{R}, \quad (4.58)$$

then

$$s_2(M(x), y(x)) \geq 0 \quad \forall x \in \mathcal{R}.$$

In the above lemma, (4.58) requires checking whether a piecewise quadratic function is positive within the set \mathcal{R} . Let us consider a particular case of such a set \mathcal{R} , described by the intersection

of a set of piecewise quadratic functions as

$$\mathcal{R} = \left\{ x \in \mathbb{R}^n \mid r_i(x) = \begin{bmatrix} 1 \\ \phi(y(x)) \\ \phi(y(x)) - y(x) \end{bmatrix}^\top R_i \begin{bmatrix} 1 \\ \phi(y(x)) \\ \phi(y(x)) - y(x) \end{bmatrix} \geq 0, i = 1, \dots, n_r \right\}. \quad (4.59)$$

The lemma below gives sufficient condition for set inclusion involving sets defined by PWQ functions.

Lemma P.8

Given a matrix $S \in \mathbb{R}^{(1+2n_y) \times (1+2n_y)}$ defining a PWQ function as

$$s(x) = \begin{bmatrix} 1 \\ \phi(y(x)) \\ \phi(y(x)) - y(x) \end{bmatrix}^\top S \begin{bmatrix} 1 \\ \phi(y(x)) \\ \phi(y(x)) - y(x) \end{bmatrix} \quad (4.60)$$

and matrices $R_i \in \mathbb{R}^{(1+2n_y) \times (1+2n_y)}$, $i = 1, \dots, n_r$ defining the set \mathcal{R} as in (4.59), if there exist scalars $\beta_i \geq 0$, $i = 1, \dots, n_r$ such that

$$s(x) - \beta_i r_i(x) \geq 0 \quad \forall x \in \mathbb{R}^n, \quad (4.61)$$

then

$$s(x) \geq 0 \quad \forall x \in \mathcal{R}.$$

Namely, $\{x \in \mathbb{R}^n \mid s(x) \geq 0\} \subseteq \mathcal{R}$.

Since the expressions in (4.61) are PWQ functions required to be globally non-negative, Proposition 3.2 can be used to check the inequalities (4.61).

We can now present the following proposition to test the non-negativity of a PWQ function, paralleling the global results presented in Proposition 3.2.

Proposition P.1

Given a generalized quadratic form $h_\ell(x)$ and a set \mathcal{R} defined by matrices $R_i \in \mathbb{R}^{(1+2n_y) \times (1+2n_y)}$, $i = 1, \dots, n_r$, if there exist matrices $T \in \mathbb{D}^{n_y}$, $\bar{M}_{1,1} \in \mathbb{R}^{(1+2n_y) \times (1+2n_y)}$ and $\bar{M}_{1\phi} \in \mathbb{R}^{(1+2n_y) \times (1 \times 2n_y)}$, $M_\phi \in \mathbb{P}^{2n_y \times 2n_y}$ defining $M(x)$ as in (4.56) such that

$$h_\ell(x) + s_1(T, y(x)) - s_2(M(x), y(x)) \geq 0, \quad \forall x \in \mathbb{R}^n \quad (4.62)$$

and scalars $\beta_i \geq 0$, $i = 1, \dots, n_r$, $\gamma_{i,j} \geq 0$, $i = 1, \dots, n_r$, $j = 1, \dots, 2n_y$ such that

$$M_{1,1}(x) - \beta_i r_i(x) \geq 0 \quad \forall x \in \mathbb{R}^n, \quad (4.63a)$$

$$M_{1\phi_j}(x) - \gamma_{i,j} r_i(x) \geq 0 \quad \forall x \in \mathbb{R}^n, \quad \forall j = 1, \dots, 2n_y, \quad (4.63b)$$

then

$$h(x) \geq 0 \quad \forall x \in \mathcal{R}. \quad (4.64)$$

The above proposition uses Lemma P.8 to guarantee (4.58), thus, according to Lemma P.7, that $s_2(M(x), y(x))$ is not negative in the set \mathcal{R} . Note that the entries of $M_{1\phi}$ as in (4.57b) are PWL functions, thus a particular case of PWQ function of the form (4.60), yielding (4.63b). The numerical verification of (4.62) and the conditions obtained with (4.63) and Proposition 3.2 can then be carried out with semidefinite programming following the lines of Corollary 3.1.

Proposition P.1 can be applied to any PWQ function. For the analysis of dynamical systems, its interest lies mainly in the local stability analysis. Whenever a region of interest \mathcal{R} is fixed, similar conditions to Theorem 3.1 can be formulated, where the expressions for the positivity of the LF and the negativity of its derivative on the set \mathcal{R} enter as the function $h_\ell(x)$ in Proposition P.1. A second step in the regional analysis consists of computing an ERA using the inclusion conditions of Lemma P.8. These ERA can be determined by a level set of the LF included in the set \mathcal{R} or by invariant sets that are not level sets of the LF as in [173].

P.6 Further research directions

In this section, we briefly mention other research directions stemming from the results presented in this manuscript.

- **Robustness analysis to bounded disturbances.** In Sections 3.3.2, 3.3.3, we introduced the analysis for uncertain PWA system given by polytopic differential inclusions. These results enabled studying systems with time-varying partitions. On the other hand, the robustness of the stability properties should also hold for exogenous disturbances. For DT systems, these exogenous disturbances may appear as in

$$x[k+1] = F_1x[k] + F_2\phi(y(x)) + w_1[k] \quad (4.65a)$$

$$y(x[k]) = F_3x[k] + F_4\phi(y(x[k])) + f_5 + w_2[k] \quad (4.65b)$$

where the signals w_1 or w_2 are assumed to be in a given set. The most common robustness analysis concentrate on signals in ℓ_∞ , ℓ_2 , namely bounded or energy-bounded signals. These signals may result from unmodeled dynamics or time-varying external signals. When the control law introduces the algebraic loop, we can reasonably suppose that real-time implementation constraints do not allow to solve the algebraic loop exactly. Instead, for a given x , an approximate solution of the equation $y = F_3x + F_4\phi(y) + f_5$ would satisfy, at each time instant, a different equation

$$y(x[k]) = F_3x[k] + F_4\phi(y(x[k])) + f_5 + w_1[k]$$

where the value of w_1 indicates the error in the solution of the algebraic loop. The above equation indicates that the Input-to-state [156] stability analysis of (4.65), suitable to bounded disturbances, is fundamental to evaluate the numerical errors related to the solution of the implicit equation.

- **Model Predictive Control: Analysis and Implementation.** A PWA control strategy issued from an optimization-based control is MPC [16]. For MPC strategies with QP or LP [15], our goal will be to directly obtain the control law in the form of an algebraic loop involving ramp functions without passing through its explicit representation [16, 166]. Interestingly, the MPC can be readily written as a Linear Complementarity Problem (LCP) [25], we can then use the LCP form as the starting point to obtain an implicit equation using ramp functions.

The aim of such a representation will be twofold: for the analysis, it should allow studying directly closed-loop systems with MPC within the framework presented in this manuscript for PWA systems. We would also like to exploit the structured — given by the ramp functions — implicit equation to propose a strategy to solve the implicit equation issued from MPC to generate the control input. The root-finding strategies to solve the implicit equation exploiting the ramp functions will be compared with QP-based strategies.

- **Neural Networks with ReLU activation functions**

The results in Part II study PWA discrete-time systems thanks to the verification of the non-negativity of PWQ functions. An application of these techniques relates to the recent use of NN in different applications, including dynamical systems. An activation function used in NNs is the Rectifier Linear Unit ReLU, a niche term for ramp functions. Indeed, a DT linear dynamical systems in feedback with Rectifier Linear Unit Neural Network ReLU NN are PWA DT systems as the ones studied in Chapter 3. The study of dynamical systems with NN in the loop is not new [159, 13] and have recently been revisited in [108], where the need for an LF to capture the slope properties was highlighted. Actually, already in [13], it was observed that

In contrast, current stability methods can not distinguish between any two types of nonlinearities as long as these nonlinearities belong to the same sector, monotone and time-invariant. One avenue for future research is to develop methods enhancing discriminatory capabilities of the stability criteria for Recurrent NN, i.e., to permit them to distinguish between nonlinearities of different kinds, thereby mitigating their conservatism.

therefore, a tighter description of the activation function, like the one obtained with ramp functions, will help analyze the stability, reachability, and safety under disturbances.

Feedforward NNs can be expressed as explicit algebraic loops like the one detailed in (3.40). This fact has been considered to study dynamical NN controller in [108], and in [186], where local sector bounds, similar to the ones used in Part I were applied to compute ERA.

On the other hand, for ReLU NN, the SDP formulations to solve Lyapunov inequalities can still be conservative since the positivity of the expressions can be formulated as a copositivity of a matrix [56]. Polynomial optimization should be considered to reduce this conservatism [135, Chapter 5]. Alternatives to LF analysis, with IQCs and ZF multipliers, should also be considered in this context [136, 186].

Besides the stability analysis of dynamical systems with NN, another critical problem related to the robustness of NN classifiers is the estimation of Lipschitz constants of ReLU neural networks [32, 137]. Such a problem can be studied using the PWQ functions detailed in this manuscript. Moreover, fully interconnected NN with feedback paths lead to nonlinear implicit equations. Both structures — feedforward and feedback NN — can be used to approximate nonlinear functions, and the respective advantages are the simplicity to compute outputs and the compactness of representation. Recent results [57] investigate the implicit optimization, relying only on the implicit models. An understanding of ways to convert between the structured feedforward NN and fully implicit equations is still lacking.

- **Linear programming to verify the non-negativity of PWL functions.** Some results in the literature have used LP as the optimization approach for the study of linear and PWA system [19, 124, 125]. The use of LP contrasts with the results in this manuscript, where we have explored an SDP formulation to solve PWQ inequalities. For PWL inequalities, however, we would like to propose an LP-based method for inequality verification.

The main challenge in formulating LP tests for PWL inequalities based on implicit expressions is to add the complementarity condition. Namely the expression $\phi_i(y)(\phi_i(y)-y) = 0$ obtained to describe the ramp function, which is a quadratic expression on $\phi_i(y)$ and y .

With an LP formulation at hand, we will extend the analysis of PWA systems with PWL LF candidates (yielding polyhedral LF), paralleling the SDP-based results presented in this manuscript for PWQ inequalities stemming from stability analysis. Also, the solution to dissipation inequalities using storage functions with linear growth seems to be the suitable tool for the assessment of induced \mathcal{L}_1 and ℓ_1 gains.

- **Develop a toolbox for PWQ programming.** Algebraic operations on PWQ functions such as a sum of PWQ functions and products between PWL yielding PWQ may appear in the expressions we presented for stability analysis in this manuscript. So far, these expressions are obtained on a case-by-case basis.

To avoid the manual steps for the PWQ inequalities, we would like to develop a toolbox to manipulate these PWQ expressions. For instance, it should help automate merging two algebraic loops whenever the PWQ function contains ramp functions of different algebraic loops and help obtain the derivative of PWQ expressions.

Such a toolbox should also assist in the process of setting up sums of expressions containing variables to be set up as decision variables (Lyapunov function coefficient, for instance). The main goal of such a numerical tool will be to let the user manipulate only scalarized expressions and define each algebraic loop in the PWQ and PWL functions. We believe this is a fundamental step to make the proposed analysis tools available to a larger public.

P.7 Proofs of the claims in the chapter

This section presents the proofs for some of the claims in the chapter.

P.7.1 Proof of Lemma P.4

Proof. Given that the ramp function is not differentiable for the values of x giving $\xi_i(x) = 0$ we have to consider the generalized set-valued derivative for

$$\frac{d\phi(\xi(x(t)))}{dt} = \begin{bmatrix} \frac{d\phi(\xi_1(x(t)))}{dt} \\ \frac{d\phi(\xi_2(x(t)))}{dt} \\ \vdots \\ \frac{d\phi(\xi_m(x(t)))}{dt} \end{bmatrix}. \quad (4.66)$$

We have

$$\frac{d\xi(x(t))}{dt} = C_\xi \frac{d(x(t))}{dt} + D_\xi \frac{d\phi(\xi(x(t)))}{dt} \quad (4.67)$$

$$= C_\xi Ax + C_\xi B\phi(y) + D_\xi \frac{d\phi(\xi(x(t)))}{dt} \quad (4.68)$$

hence the i th entries of the vectors ξ and $\frac{d\xi(x(t))}{dt}$ are given by

$$\xi_i = C_{\xi_i}x + D_{\xi_i}\phi(\xi) + e_{\xi_i} \quad (4.69a)$$

$$\frac{d\xi_i(x(t))}{dt} = C_{\xi_i}Ax + C_{\xi_i}B\phi(y) + D_{\xi_i} \frac{d\phi(\xi(x(t)))}{dt}. \quad (4.69b)$$

For each entry, the chain rule gives $\frac{d\phi(\xi_i(x(t)))}{dt} = \frac{d\phi(\xi_i)}{d\xi_i} \frac{d\xi_i(x(t))}{dt}$. The generalized derivative of the ramp function is the step function of its argument, that is

$$\frac{d\phi(\xi_i)}{d\xi_i} = \mathbf{s}(\xi_i, 1)$$

we then have, using (4.39),

$$\frac{d\phi(\xi_i(x(t)))}{dt} = \frac{d\phi(\xi_i)}{d\xi_i} \frac{d\xi_i(x(t))}{dt} \quad (4.70)$$

$$= \mathbf{s}(\xi_i, 1) \frac{d\xi_i(x(t))}{dt} \quad (4.71)$$

$$= \bar{\mathbf{s}} \left(\xi_i, \frac{d\xi_i(x(t))}{dt} \right) \quad (4.72)$$

thus, using (4.66),

$$\frac{d\phi(\xi(x(t)))}{dt} = \begin{bmatrix} \bar{\mathbf{s}} \left(\xi_1, \frac{d\xi_1(x(t))}{dt} \right) \\ \bar{\mathbf{s}} \left(\xi_2, \frac{d\xi_2(x(t))}{dt} \right) \\ \vdots \\ \bar{\mathbf{s}} \left(\xi_m, \frac{d\xi_m(x(t))}{dt} \right) \end{bmatrix}. \quad (4.73)$$

With the above expression, we have that the time derivative of the vector ramp function is expressed as step functions whose level depends on the time derivative of each of its arguments. Thanks to the description of the step function as ramp functions, we now show that this derivative is also written as an algebraic loop involving ramp functions.

With (4.36) we have

$$\bar{\mathbf{s}} \left(\xi_i, \frac{d\xi_i(x(t))}{dt} \right) = r(\eta_{i1}) - r(\eta_{i3}) \quad (4.74a)$$

$$\begin{bmatrix} \eta_{i1} \\ \eta_{i2} \\ \eta_{i3} \\ \eta_{i4} \end{bmatrix} = \begin{bmatrix} 1 & 0 & 0 \\ 0 & -1 & 0 \\ 1 & 0 & 0 \\ 0 & 0 & -1 \end{bmatrix} \begin{bmatrix} \xi_i \\ r\left(\frac{d\xi_i(x(t))}{dt}\right) \\ r\left(-\frac{d\xi_i(x(t))}{dt}\right) \end{bmatrix} + \begin{bmatrix} 1 & -1 & 0 & 0 \\ 1 & 1 & 0 & 0 \\ 0 & 0 & 1 & -1 \\ 0 & 0 & 1 & 1 \end{bmatrix} \begin{bmatrix} r(\eta_{i1}) \\ r(\eta_{i2}) \\ r(\eta_{i3}) \\ r(\eta_{i4}) \end{bmatrix} \quad (4.74b)$$

and, using (4.69), we obtain

$$\bar{s} \left(\xi_i, \frac{d\xi_i(x(t))}{dt} \right) = [1 \ 0 \ -1 \ 0] r(\eta_i) \quad (4.75a)$$

$$\eta_i = \tilde{C}_i x + \tilde{D}_{\xi_i} \phi(\xi) + \tilde{D}_{y_i} \phi(y) + \tilde{D}_i r(\bar{\eta}) + \tilde{e}_i + \begin{bmatrix} 1 & -1 & 0 & 0 \\ 1 & 1 & 0 & 0 \\ 0 & 0 & 1 & -1 \\ 0 & 0 & 1 & 1 \end{bmatrix} r(\eta_i) \quad (4.75b)$$

with $\eta_i := [\eta_{i1} \ \eta_{i2} \ \eta_{i3} \ \eta_{i4}]^\top$, $\bar{\eta}^\top := [\eta_1^\top \ \eta_2^\top \ \eta_3^\top \ \dots \ \eta_m^\top]^\top$ and

$$\begin{aligned} \tilde{C}_i &= \begin{bmatrix} 1 \\ 0 \\ 1 \\ 0 \end{bmatrix} C_{\xi_i} + \begin{bmatrix} 0 \\ -1 \\ 0 \\ 1 \end{bmatrix} C_{\xi_i} A \\ \tilde{D}_{\xi_i} &= \begin{bmatrix} 1 \\ 0 \\ 1 \\ 0 \end{bmatrix} D_{\xi_i} \\ \tilde{D}_{y_i} &= \begin{bmatrix} 0 \\ -1 \\ 0 \\ 1 \end{bmatrix} C_{\xi_i} B \\ \tilde{D}_i &= \begin{bmatrix} 0 \\ -1 \\ 0 \\ 1 \end{bmatrix} D_{\xi_i} (I_m \otimes [1 \ 0 \ -1 \ 0]), \\ \tilde{e}_i &= \begin{bmatrix} 1 \\ 0 \\ 1 \\ 0 \end{bmatrix} e_{\xi_i}. \end{aligned}$$

Finally, we can write $\frac{d\phi(\xi(x(t)))}{dt}$ as the solution of the algebraic loop

$$\frac{d\phi(\xi(x(t)))}{dt} = \bar{F} \phi(\bar{\eta}) \quad (4.76a)$$

$$\bar{\eta} = \bar{C} x + \bar{D}_\xi \phi(\xi) + \bar{D}_y \phi(y) + \bar{D} \phi(\bar{\eta}) + \bar{e} \quad (4.76b)$$

with $\bar{F} \in \mathbb{R}^{m \times 4m}$, $\bar{C} \in \mathbb{R}^{4m \times n}$, $\bar{D}_\xi \in \mathbb{R}^{4m \times m}$, $\bar{D}_y \in \mathbb{R}^{4m \times m_y}$, $\bar{D} \in \mathbb{R}^{4m \times 4m}$, and $\bar{e} \in \mathbb{R}^{4m \times 1}$ as

$$\begin{aligned} \bar{F} &= (I_m \otimes [1 \ 0 \ -1 \ 0]) \\ \bar{C} &= \left(I_m \otimes \begin{bmatrix} 1 \\ 0 \\ 1 \\ 0 \end{bmatrix} \right) C_\xi + \left(I_m \otimes \begin{bmatrix} 0 \\ -1 \\ 0 \\ 1 \end{bmatrix} \right) C_\xi A \\ \bar{D}_\xi &= \left(I_m \otimes \begin{bmatrix} 1 \\ 0 \\ 1 \\ 0 \end{bmatrix} \right) D_\xi \\ \bar{D}_y &= \left(I_m \otimes \begin{bmatrix} 0 \\ -1 \\ 0 \\ 1 \end{bmatrix} \right) C_\xi B \\ \bar{D} &= \left(I_m \otimes \begin{bmatrix} 0 \\ -1 \\ 0 \\ 1 \end{bmatrix} \right) \begin{bmatrix} D_{\xi 1} & 0_{1,m} & \dots & 0_{1,m} \\ 0_{1,m} & D_{\xi 2} & \dots & 0_{1,m} \\ \vdots & \vdots & \ddots & \vdots \\ 0_{1,m} & 0_{1,m} & \dots & D_{\xi m} \end{bmatrix} (I_m \otimes [1 \ 0 \ -1 \ 0]) + I_m \otimes \begin{bmatrix} 1 & -1 & 0 & 0 \\ 1 & 1 & 0 & 0 \\ 0 & 0 & 1 & -1 \\ 0 & 0 & 1 & 1 \end{bmatrix} \end{aligned}$$

$$\bar{e} = \left(I_m \otimes \begin{bmatrix} 1 \\ 0 \\ 1 \\ 0 \end{bmatrix} \right) e_\xi.$$

□

P.7.2 Proof of Lemma P.5

Proof. We proceed by noticing that x_1 restricted to the set of where $x_2 \geq 0$ can be expressed using the ramp function as

$$x_1 = \mathbf{s}(x_2, 1)x_1$$

and, for $x_1 \geq 0$, we have

$$x_1 = \mathbf{s}(x_2, 1)r(x_1)$$

with (4.39), we obtain

$$x_1 = \mathbf{s}(x_2, r(x_1))$$

that holds for $\{x \in \mathbb{R}^2 \mid x_1 \geq 0, x_2 \geq 0\}$. Using the expression for the step with arbitrary magnitude in (4.34), we obtain

$$\begin{aligned} x_1 &= r(\eta_1) \\ \begin{bmatrix} \eta_1 \\ \eta_2 \end{bmatrix} &= \begin{bmatrix} x_2 \\ -r(x_1) \end{bmatrix} + \begin{bmatrix} 1 & -1 \\ 1 & 1 \end{bmatrix} \begin{bmatrix} r(\eta_1) \\ r(\eta_2) \end{bmatrix} \end{aligned}$$

that is

$$x_1 = r(\eta_1) \tag{4.78a}$$

$$\begin{bmatrix} \eta_1 \\ \eta_2 \\ \eta_3 \end{bmatrix} = \begin{bmatrix} 0 & 1 \\ 0 & 0 \\ 1 & 0 \end{bmatrix} \begin{bmatrix} x_1 \\ x_2 \end{bmatrix} + \begin{bmatrix} 1 & -1 & 0 \\ 1 & 1 & -1 \\ 0 & 0 & 0 \end{bmatrix} \begin{bmatrix} r(\eta_1) \\ r(\eta_2) \\ r(\eta_3) \end{bmatrix}, \tag{4.78b}$$

which holds for $\{x \in \mathbb{R}^2 \mid x_1 \geq 0, x_2 \geq 0\}$.

Repeating the above steps, we have

$$x_2 = \mathbf{s}(x_1, r(x_2)) \tag{4.79}$$

that holds for $\{x \in \mathbb{R}^2 \mid x_1 \geq 0, x_2 \geq 0\}$, which can be written as

$$x_2 = r(\eta_3) \tag{4.80a}$$

$$\begin{bmatrix} \eta_4 \\ \eta_5 \\ \eta_6 \end{bmatrix} = \begin{bmatrix} 1 & 0 \\ 0 & 0 \\ 0 & 1 \end{bmatrix} \begin{bmatrix} x_1 \\ x_2 \end{bmatrix} + \begin{bmatrix} 1 & -1 & 0 \\ 1 & 1 & -1 \\ 0 & 0 & 0 \end{bmatrix} \begin{bmatrix} r(\eta_4) \\ r(\eta_5) \\ r(\eta_6) \end{bmatrix}, \tag{4.80b}$$

Similarly, for $\{x \in \mathbb{R}^2 \mid x_1 \leq 0, x_2 \leq 0\}$, we obtain

$$\begin{aligned} x_1 &= -\mathbf{s}(-x_2, r(-x_1)) \\ x_2 &= -\mathbf{s}(-x_1, r(-x_2)). \end{aligned}$$

which also give expressions similar to (4.78), (4.80).

By merging the above expressions and the sets $\{x \in \mathbb{R}^2 \mid x_1 \geq 0, x_2 \geq 0\}$ and $\{x \in \mathbb{R}^2 \mid x_1 \leq 0, x_2 \leq 0\}$, we obtain the following identity

$$\begin{aligned} \begin{bmatrix} x_1 \\ x_2 \end{bmatrix} &= \left(\begin{bmatrix} 1 & 0 \\ 0 & 1 \end{bmatrix} \otimes [1 \ 0 \ 0 \ -1 \ 0 \ 0] \right) \phi(u) \\ u &= \begin{bmatrix} N_1 \\ -N_1 \\ N_2 \\ -N_2 \end{bmatrix} x + (I_4 \otimes M) \phi(u) \end{aligned}$$

with

$$N_1 = \begin{bmatrix} 0 & 1 \\ 0 & 0 \\ 1 & 0 \end{bmatrix}, N_2 = \begin{bmatrix} 1 & 0 \\ 0 & 0 \\ 0 & 1 \end{bmatrix}, M = \begin{bmatrix} 1 & -1 & 0 \\ 1 & 1 & -1 \\ 0 & 0 & 0 \end{bmatrix}$$

that holds for $\{x \in \mathbb{R}^2 \mid x_1 x_2 \geq 0\}$.

□

Conclusions

This manuscript presented methods based on convex optimization for the stability analysis of Lurie nonlinear systems. A common feature of the presented results is a refined description of the nonlinear elements in the system. In Part I, the nonlinearities are sector- and slope-restricted, with the sector and slope bounds valid either globally or in a region containing the origin. In Part II, the nonlinearities are ramp or step functions that are precisely described thanks to relations obtained from KKT optimality conditions. In both parts, the machinery to verify that generalized quadratic forms are not negative share a common framework: to describe the nonlinearities by a set of inequalities and identities and to use these relations to bound the expression to be certified non-negative. Convex optimization problems are then obtained of which the constraints are the (linear) matrix inequalities extracted from generalized quadratic forms.

The results in Part I should allow for researchers and practitioners to carry out a more detailed analysis whenever the studied nonlinear functions are slope restricted. The central aspect that allows the proposed stability analysis conditions to improve over other Lyapunov-based stability conditions is the choice of LF functions structures. These choices make it possible to use inequalities related to slope information.

We can only claim the sufficiency of the proposed stability conditions. However, we these sufficient conditions allow for a convex optimization based calculation of stability certificates. Moreover, the numerical formulation requires as data only the bounds of the nonlinearities and the state-space representation of the linear part.

The proposed results pave the way to study the relevant problems of feedback law design with LF that are more complex than the quadratic ones. We highlight, however, that the sector and slope inequalities description were obtained for decentralized nonlinearities, thus corresponding to a SISO description of the nonlinear elements. In some applications, though, nonlinearities may present multiple channels that are not independent of one another. The study of these actuators with multiple inputs and outputs has not achieved the same maturity as the SISO or the decentralized case and is a topic for future work.

The results in Part II focus on the stability analysis of PWA systems described by an implicit representation. Chapter 3 introduced an implicit model to describe PWA systems as the feedback interconnection of an LTI system and static nonlinearities, more precisely, ramp functions. Such a representation offers a different view on the stability problem. The proposed numerical formulation exploits the implicit representation and avoids conditions requiring a preliminary reachability analysis of each set in the partition of a PWA system.

In Chapter 4, we show that the step function is obtained with an ill-posed algebraic loop involving two ramp functions. The key aspect of this result is that it enables the analysis of continuous and discontinuous generalized quadratic functions within the same framework.

We acknowledge that second-order systems presented in the numerical examples are used for illustration purposes. The potential of the proposed framework to assess the non-negativity of PWQ functions deserves a more thorough investigation. A study on the scalability of the developed methods should be carried out to understand the limiting dimensions of the number of states and the elements of the vector of ramp functions in the generalized quadratic form. Moreover, even though we obtained a sufficient condition exploiting the positivity of the ramp functions, an in-depth analysis is required to understand whether other techniques for co-positivity verification can be less conservative. Also, in this manuscript, we have only proposed an SDP formulation of the problem; an open question is whether we can use similar inequalities describing the ramp function to study the non-negativity of PWL functions with an LP formulation.

Further work should also provide a better understanding of the particular use of the PWQ non-negativity tests in the analysis of discrete-time PWA systems in Part II. Unfortunately, we can not claim that the LFs we use in the results of Part II, inheriting the same partition of the system, are the most suitable class. The results of Chapter 2 show that adding future steps can improve the stability bounds for slope-restricted systems. If the same reasoning is applied to the

systems in Part II, we should add future values of the nonlinearities into the LF, hence create a partition with additional sets. Also, the proposed Lyapunov methods and LF structures should be compared with IQC approaches.

As another perspective, we can also exploit the results of Chapter 2 in the analysis of systems with other SISO discontinuous nonlinearities. Clearly, functions composed of continuous Lipschitz functions and bounded discontinuities can be described as the sum of continuous function and step functions. Hence, provided these continuous functions belong to some class of sector- or slope-restricted nonlinearities, we can combine the results of the Part I with the results of Chapter 4 using the step function characterization proposed therein.

Perhaps the main question regarding Chapter 3 that is not answered in this manuscript is: *how to obtain the proposed implicit representation for PWA systems?* From a different perspective, we should also ask: *how artificial is the explicit PWA representation?* The answer to both questions should relate to the practical applications leading to PWA models. Our understanding is that the most complex PWA models in terms of the number of sets in the partition appear in optimization-based schemes. In this context, instead of carrying out an additional step to obtain an explicit representation [16], we can exploit the KKT conditions associated with the problems leading to the PWA laws to directly obtain implicit representations.

Bibliography

- [1] A. A. Adegbege and W. P. Heath. A framework for multivariable algebraic loops in linear anti-windup implementations. *Automatica*, 83:81 – 90, 2017.
- [2] N. S. Ahmad, J. Carrasco, and W. P. Heath. A less conservative LMI condition for stability of discrete-time systems with slope-restricted nonlinearities. *IEEE Transactions on Automatic Control*, 60(6):1692–1697, 2015.
- [3] N. S. Ahmad, W. P. Heath, and G. Li. LMI-based stability criteria for discrete-time Lur’e systems with monotonic, sector- and slope-restricted nonlinearities. *IEEE Transactions on Automatic Control*, 58(2):459–465, 2013.
- [4] M. A. Aizerman. On a problem concerning the stability “in the large” of dynamical systems. *Uspekhi matematicheskikh nauk*, 4(4):187–188, 1949.
- [5] M. A. Aizerman and F. R. Gantmacher. *Absolute stability of regulator systems*. Holden-Day, Oakland, CA, 1964.
- [6] B. D. O. Anderson. Stability of control systems with multiple nonlinearities. *Journal of the Franklin Institute*, 282(3):155–160, 1966.
- [7] D. Angeli and P. A. Bliman. Stability of leaderless discrete-time multi-agent systems. *Math. Control Signals Syst.*, 18:293–322, 2006.
- [8] MOSEK ApS. *The MOSEK optimization toolbox for MATLAB manual. Version 9.0.*, 2019.
- [9] M. Arcak and A. Teel. Input-to-state stability and boundedness in Lurie systems. In *Proceedings of the 2002 American Control Conference (IEEE Cat. No.CH37301)*, volume 1, pages 62–67 vol.1, 2002.
- [10] N. E. Barabanov. Absolute characteristic exponent of a class of linear nonstationary systems of differential equations. *Siberian Mathematical Journal*, 29(4):521–530, 1988.
- [11] N. E. Barabanov. On the Kalman problem. *Siberian Mathematical Journal*, 29:333–341, 1988.
- [12] N. E. Barabanov. Stability of inclusions of linear type. In *Proceedings of 1995 American Control Conference - ACC’95*, volume 5, pages 3366–3370 vol.5, 1995.
- [13] N. E. Barabanov and D. V. Prokhorov. Stability analysis of discrete-time recurrent neural networks. *IEEE Transactions on Neural Networks*, 13(2):292–303, 2002.
- [14] T. Basar. *Control Theory: Twenty-Five Seminal Papers (1932-1981)*. Wiley-IEEE Press, USA, 2001.
- [15] A. Bemporad, F. Borrelli, and M. Morari. Model predictive control based on linear programming - the explicit solution. *IEEE Transactions on Automatic Control*, 47(12):1974–1985, 2002.
- [16] A. Bemporad, M. Morari, V. Dua, and E. N. Pistikopoulos. The explicit linear quadratic regulator for constrained systems. *Automatica*, 38(1):3–20, 2002.
- [17] A. L. J. Bertolin, P. L. D. Peres, R. C. L. F. Oliveira, and G. Valmorbidia. An LMI-based iterative algorithm for state and output feedback stabilization of discrete-time Lur’e systems. In *2020 59th IEEE Conference on Decision and Control (CDC)*, pages 2561–2566, 2020.

- [18] F. Blanchini. Nonquadratic Lyapunov functions for robust control. *Automatica*, 31(3):451–461, mar 1995.
- [19] F. Blanchini. Set invariance in control. *Automatica*, 35(11):1747–1767, 1999.
- [20] F. Blanchini and A. Megretski. Robust state feedback control of LTV systems: nonlinear is better than linear. *IEEE Transactions on Automatic Control*, 44(4):802–807, 1999.
- [21] F. Blanchini and C. Savorgnan. Stabilizability of switched linear systems does not imply the existence of convex Lyapunov functions. *Automatica*, 44(4):1166–1170, apr 2008.
- [22] S. Boyd, L. El Ghaoui, E. Feron, and V. Balakrishnan. *Linear Matrix Inequalities in System and Control Theory*. SIAM, Philadelphia, 1994.
- [23] R. W. Brockett and D. Liberzon. Quantized feedback stabilization of linear systems. *IEEE Transactions on Automatic Control*, 45(7):1279–1289, 2000.
- [24] C. Burgat and S. Tarbouriech. Stability and control of saturated linear systems. In A.J. Fossard and D. Normand-Cyrot D., editors, *Nonlinear Systems*. Springer, Boston, MA, USA, 1996.
- [25] E. F. Camacho. Constrained Generalized Predictive Control. *IEEE Transactions on Automatic Control*, 38(2):327–332, 1993.
- [26] M. K. Camlibel, J. S. Pang, and J. Shen. Lyapunov stability of complementarity and extended systems. *SIAM Journal on Optimization*, 17(4):1056–1101, 2006.
- [27] J. Carrasco, W. P. Heath, J. Zhang, N. S. Ahmad, and S. Wang. Convex searches for discrete-time Zames–Falb multipliers. *IEEE Transactions on Automatic Control*, 65(11):4538–4553, 2020.
- [28] J. Carrasco, M. Maya-Gonzalez, A. Lanzon, and W. P. Heath. LMI searches for anticausal and noncausal rational Zames–Falb multipliers. *Systems & Control Letters*, 70:17–22, 2014.
- [29] J. Carrasco, M. C. Turner, and W. P. Heath. Zames–Falb multipliers for absolute stability: From O’Shea’s contribution to convex searches. *European Journal of Control*, 28:1 – 19, 2016.
- [30] F. Ceragioli and C. De Persis. Discontinuous stabilization of nonlinear systems: Quantized and switching controls. *Systems & control letters*, 56(7):461–473, 2007.
- [31] F. Ceragioli, C. De Persis, and P. Frasca. Discontinuities and hysteresis in quantized average consensus. *Automatica*, 47:1919–1928, 2011.
- [32] T. Chen, J.-B. Lasserre, V. Magron, and E. Pauwels. Semialgebraic optimization for lipschitz constants of ReLU networks, 2020.
- [33] G. Chesi, A. Garulli, A. Tesi, and A. Vicino. Homogeneous Lyapunov functions for systems with structured uncertainties. *Automatica*, 39(6):1027–1035, 2003.
- [34] G. Chesi, A. Garulli, A. Tesi, and A. Vicino. Polynomially parameter-dependent Lyapunov functions for robust stability of polytopic systems: an LMI approach. *IEEE Transactions on Automatic Control*, 50(3):365–370, 2005.
- [35] G. Chesi, A. Garulli, A. Tesi, and A. Vicino. *Homogeneous Polynomial Forms for Robustness Analysis of Uncertain Systems*, volume 390 of *Lecture Notes in Control and Information Sciences*. Springer London, London, 2009.
- [36] Y.-C. Chu and K. Glover. Bounds of the induced norm and model reduction errors for systems with repeated scalar nonlinearities. *IEEE Transactions on Automatic Control*, 44(3):471–483, 1999.
- [37] J. Cortés. Discontinuous dynamical systems. *Control Systems Magazine*, 28(3):36–73, 2008.
- [38] R. Cottle, J.-S. Pang, and R. E. Stone. *The Linear Complementarity Problem*. Academic Press, Upper Saddle River, NJ, USA, 1992.
- [39] D. F. Coutinho, M. Fu, and C. E. de Souza. Input and output quantized feedback linear systems. *IEEE Transactions on Automatic Control*, 55(3):761–766, 2010.

- [40] J. Daafouz and J. Bernussou. Parameter dependent Lyapunov functions for discrete time systems with time varying parametric uncertainties. *Systems & Control Letters*, 43(5):355–359, 2001.
- [41] D. Dai, T. Hu, A. R. Teel, and L. Zaccarian. Piecewise-quadratic Lyapunov functions for systems with deadzones or saturations. *Systems & Control Letters*, 58(5):365–371, 2009.
- [42] L. Dal Col, I. Queinnec, S. Tarbouriech, and L. Zaccarian. Regional H_∞ synchronization of identical linear multiagent systems under input saturation. *IEEE Transactions on Control of Network Systems*, 6(2):789–799, 2019.
- [43] F. J. D’amato, M. A. Rotea, A. V. Megretski, and U. T. Jönsson. New results for analysis of systems with repeated nonlinearities. *Automatica*, 37(5):739–747, 2001.
- [44] S. Dasgupta, G. Chockalingam, B. D. O. Anderson, and M. Fu. Lyapunov functions for uncertain systems with applications to the stability of time varying systems. *IEEE Transactions on Circuits and Systems I: Fundamental Theory and Applications*, 41(2):93–106, 1994.
- [45] C. De Persis and P. Frasca. Robust self-triggered coordination with ternary controllers. *IEEE Transactions on Automatic Control*, 58(12):3024–3038, 2013.
- [46] B. De Schutter and T. J. J. van den Boom. Model predictive control for max-min-plus-scaling systems. In *Proceedings of the 2001 American Control Conference*, pages 319–324, Arlington, Virginia, 2001.
- [47] D. F. Delchamps. Extracting state information from a quantized output record. *Systems & Control Letters*, 13(5):365–372, 1989.
- [48] D. F. Delchamps. Stabilizing a linear system with quantized state feedback. *IEEE Transactions on Automatic Control*, 35(8):916–924, 8 1990.
- [49] M. Della Rossa, A. Tanwani, and L. Zaccarian. Max–min Lyapunov functions for switched systems and related differential inclusions. *Automatica*, 120:109123, 2020.
- [50] C. A. Desoer and M. Vidyasagar. *Feedback Systems: Input–Output Properties*. Academic Press, 1975.
- [51] A. Dewey and E. Jury. A note on Aizerman’s conjecture. *IEEE Transactions on Automatic Control*, 10(4):482–483, 1965.
- [52] A. G. Dewey. On the stability of feedback systems with one differentiable nonlinear element. *IEEE Transactions on Automatic Control*, 11(3):485–491, 1966.
- [53] M. Di Ferdinando, P. Pepe, and A. Borri. On practical stability preservation under fast sampling and accurate quantization of feedbacks for nonlinear time-delay systems. *IEEE Transactions on Automatic Control*, 2020.
- [54] R. Drummond, D.A. Howey, and S.R. Duncan. Low-order mathematical modelling of electric double layer supercapacitors using spectral methods. *Journal of Power Sources*, 277:317–328, 2015.
- [55] R. Drummond, G. Valmorbida, and S. R. Duncan. Generalized absolute stability using Lyapunov functions with relaxed positivity conditions. *IEEE Control Systems Letters*, 2(2):207–212, 2017.
- [56] Y. Ebihara, H. Waki, V. Magron, N. H. A. Mai, D. Peaucelle, and S. Tarbouriech. l_2 induced norm analysis of discrete-time LTI systems for nonnegative input signals and its application to stability analysis of recurrent neural networks, 2020.
- [57] L. El Ghaoui, F. Gu, B. Travacca, A. Askari, and A. Y. Tsai. Implicit deep learning, 2020.
- [58] G. Feng. Stability analysis of piecewise discrete-time linear systems. *IEEE Transactions on Automatic Control*, 47(7):1108–1112, 2002.
- [59] F. Ferrante, F. Gouaisbaut, and S. Tarbouriech. Stabilization of continuous-time linear systems subject to input quantization. *Automatica*, 58:167–172, 2015.

- [60] F. Ferrante, F. Gouaisbaut, and S. Tarbouriech. On sensor quantization in linear control systems: Krasovskii solutions meet semidefinite programming. *IMA Journal of Mathematical Control and Information*, 2019.
- [61] G. Ferrari-Trecate, F. A. Cuzzola, D. Mignone, and M. Morari. Analysis of discrete-time piecewise affine and hybrid systems. *Automatica*, 38(12):2139–2146, 2002.
- [62] M. Fetzner and C. W. Scherer. Zames-Falb multipliers for invariance. *IEEE Control Systems Letters*, 1(2):412–417, 2017.
- [63] A. F. Filippov. *Differential equations with discontinuous right-hand side*. Kluwer, Dordrecht, The Netherlands, 1988.
- [64] R. Fitts. Two counterexamples to Aizerman’s conjecture. *IEEE Transactions on Automatic Control*, 11(3):553–556, 1966.
- [65] M. Fu and L. Xie. The sector bound approach to quantized feedback control. *IEEE Transactions on Automatic Control*, 50(11):1698–1711, 2005.
- [66] K. Fujii and K. Shoji. Verification of the Aizerman and/or Kalman conjecture. *IEEE Transactions on Automatic Control*, 17(3):406–408, 1972.
- [67] S. Galeani, S. Tarbouriech, M. Turner, and L. Zaccarian. A tutorial on modern anti-windup design. *European Journal of Control*, 15(3):418–440, 2009.
- [68] A. Garulli, A. Masi, G. Valmorbida, and L. Zaccarian. Global stability and finite \mathcal{L}_{2m} -gain of saturated uncertain systems via piecewise polynomial Lyapunov functions. *IEEE Transactions on Automatic Control*, 58(1):242–246, Jan 2013.
- [69] R. Goebel. Set-valued Lyapunov functions for difference inclusions. *Automatica*, 47(1):127–132, 2011.
- [70] R. Goebel, R. G. Sanfelice, and A. R. Teel. *Hybrid Dynamical Systems: Modeling, Stability, and Robustness*. Princeton University Press, 2012.
- [71] R. Goebel, A. R. Teel, T. Hu, and Z. Lin. Conjugate convex Lyapunov functions for dual linear differential inclusions. *IEEE Transactions on Automatic Control*, 51(4):661–666, 2006.
- [72] J. M. Gomes da Silva Jr. and S. Tarbouriech. Polyhedral regions of local stability for linear discrete-time systems with saturating controls. *IEEE Transactions on Automatic Control*, 44(11):2081–2085, Nov 1999.
- [73] J. M. Gomes da Silva Jr and S. Tarbouriech. Anti-windup design with guaranteed regions of stability for discrete-time linear systems. *Systems & Control Letters*, 55(3):184–192, 2006.
- [74] C. A. C. Gonzaga, M. Jungers, and J. Daafouz. Stability analysis of discrete-time Lur’e systems. *Automatica*, 48(9):2277–2283, 2012.
- [75] L. B. Groff, G. Valmorbida, and J.M. Gomes da Silva Jr. Stability analysis of piecewise affine discrete-time systems. In *Proceedings of the 58th IEEE Conference on Decision and Control*, pages 8172–8177. IEEE, 2019.
- [76] W. M. Haddad and D. S. Bernstein. Explicit construction of quadratic Lyapunov functions for the small gain, positivity, circle, and Popov theorems and their application to robust stability. part II: Discrete-time theory. *International Journal of Robust and Nonlinear Control*, 4(2):249–265, 1994.
- [77] W. M. Haddad and V. Kapila. Absolute stability criteria for multiple slope-restricted monotonic nonlinearities. *IEEE Transactions on Automatic Control*, 40(2):361–365, 1995.
- [78] A. Halanay and V. Rasvan. Absolute stability of feedback systems with several differentiable non-linearities. *International Journal of Systems Science*, 22(10):1911–1927, 1991.
- [79] E. J. Hancock and A. Papachristodoulou. Generalised absolute stability and sum of squares. *Automatica*, 49(4):960–967, 2013.
- [80] J. Hauser and B. Bamieh. Dynamics of a driven Stirling engine. In *Proceedings of the 54th IEEE Conference on Decision and Control*, pages 3730–3735, Osaka, Japan, 2015. IEEE.

- [81] W. P. Heath, J. Carrasco, and M. de la Sen. Second-order counterexamples to the discrete-time Kalman conjecture. *Automatica*, 60:140–144, 2015.
- [82] W. P. Heath and G. Li. Lyapunov functions for the multivariable Popov criterion with indefinite multipliers. *Automatica*, 45(12):2977–2981, 2009.
- [83] W. P. M. H. Heemels, B. De Schutter, and A. Bemporad. Equivalence of hybrid dynamical models. *Automatica*, 37:1085–1091, 2001.
- [84] H. Hindi and S. Boyd. Analysis of linear systems with saturation using convex optimization. In *Proc. of the 37th IEEE Conference on Decision and Control*, volume 1, pages 903–908, Tampa, FL, 1998. IEEE.
- [85] MD. Z. Hossain, K. Mizutani, and H. Sawai. Chaos and multiple periods in an unsymmetrical spring and damping system with clearance. *Journal of Sound and Vibration*, 250(2):229–245, 2002.
- [86] M. Hovd and S. Olaru. Relaxing PWQ Lyapunov stability criteria for PWA systems. *Automatica*, 49(2):667–670, 2013.
- [87] T. Hu, B. Huang, and Z. Lin. Absolute stability with a generalized sector condition. *IEEE Transactions on Automatic Control*, 49(4):535–548, April 2004.
- [88] T. Hu and Z. Lin. *Control Systems with Actuator Saturation: Analysis and Design*. Birkhäuser Boston, 2001.
- [89] T. Hu, A. R. Teel, and L. Zaccarian. Stability and performance for saturated systems via quadratic and nonquadratic Lyapunov functions. *IEEE Transactions on Automatic Control*, 51(11):1770–1786, 2006.
- [90] T. Hu, T. Thibodeau, and A. R. Teel. A unified Lyapunov approach to analysis of oscillations and stability for systems with piecewise linear elements. *IEEE Transactions on Automatic Control*, 55(12):2864–2869, 2010.
- [91] R. Iervolino, D. Tancredi, and F. Vasca. Lyapunov stability for piecewise affine systems via cone-copositivity. *Automatica*, 81:22–29, 2017.
- [92] R. Iervolino, F. Vasca, and L. Iannelli. Cone-copositive piecewise quadratic Lyapunov functions for conewise linear systems. *IEEE Transactions on Automatic Control*, 60(11):3077–3082, 2015.
- [93] Z. Jarvis-Wloszek, R. Feeley, W. Tan, K. Sun, and A. Packard. Control applications of sum of squares programming. In *Positive Polynomials in Control*, pages 3–22. Springer, 2005.
- [94] B. Jayawardhana, H. Logemann, and E. P. Ryan. The circle criterion and input-to-state stability. *IEEE Control Systems Magazine*, 31(4):32–67, 2011.
- [95] T. A. Johansen, W. Jackson, R. Schreiber, and P. Tøndel. Hardware synthesis of explicit model predictive controllers. *IEEE Transactions on control systems technology*, 15(1):191–197, 2007.
- [96] M. Johansson and A. Rantzer. Computation of piecewise quadratic Lyapunov functions for hybrid systems. *IEEE Transactions on Automatic Control*, 43(4):555–559, 1998.
- [97] R. Josselson and G. V. S. Raju. Absolute stability of control systems with many sector and slope-restricted non-linearities. *International Journal of Control*, 19(3):609–614, 1974.
- [98] P. Julian. The complete canonical piecewise-linear representation: functional form for minimal degenerate intersections. *IEEE Transactions on Circuits and Systems I: Fundamental Theory and Applications*, 50(5):357–396, 2003.
- [99] P. Julian, A. Desages, and O. Agamennoni. High-level canonical piecewise linear representation using a simplicial partition. *IEEE Transactions on Circuits and Systems I: Fundamental Theory and Applications*, 46(4):463–480, 1999.
- [100] C. Kahlert and L. O. Chua. The complete canonical piecewise-linear representation. I. The geometry of the domain space. *IEEE Transactions on Circuits and Systems I: Fundamental Theory and Applications*, 39(3):222–236, 1992.

- [101] R. E. Kalman. Nonlinear aspects of sampled-data control systems. In *Proceedings of the symposium on nonlinear circuit theory*, 1956.
- [102] R. E. Kalman. Physical and mathematical mechanisms of instability in nonlinear automatic control systems. *Transactions of the ASME*, 79(3):553–566, 1957.
- [103] R. E. Kalman. Lyapunov functions for the problem of Lur’e in automatic control. *Proceedings of the National Academy of Sciences of the United States of America*, 1:201–205, 1963.
- [104] R. E. Kalman and J. E. Bertram. Control system analysis and design via the “second method” of Lyapunov: II discrete-time systems. *Journal of Fluids Engineering, Transactions of the ASME*, 82(2):394–400, 1960.
- [105] V. Kapila and W.M. Haddad. A multivariable extension of the Tsypkin criterion using a Lyapunov-function approach. *IEEE Transactions on Automatic Control*, 41(1):149–152, 1996.
- [106] S. Kawamura, M. Suzuki, H. Zahid, and H. Minamoto. A modeling concept of a mechanical system having a piecewise linear spring property for its diagnosis. *Applied Acoustics*, 70(11):1393–1399, 2009.
- [107] H. K. Khalil. *Nonlinear systems*, volume 3. Prentice-Hall. Upper Saddle River, NJ, 2002.
- [108] K.-K. K. Kim, E. R. Patrón, and R. D. Braatz. Standard representation and unified stability analysis for dynamic artificial neural network models. *Neural Networks*, 98:251–262, 2018.
- [109] P. V. Kokotovic and M. Arcak. Constructive nonlinear control: a historical perspective. *Automatica*, 37:637–662, 2001. survey paper.
- [110] G. L. Komarova and G. A. Leonov. On Estimating the Attraction Regions of the Equilibrium States of Dynamic Systems By the Direct Lyapunov Method. *Journal of Applied Mathematics and Mechanics*, 49(6):900–906, 1965.
- [111] N. N. Krasovskii. Theorems on stability of motions determined by a system of two equations. *Akad. Nauk SSSR. Prikl. Mat. Meh.*, 16:547–554, 1952. In Russian.
- [112] M. Larsen and P. V. Kokotović. A brief look at the Tsypkin criterion: from analysis to design. *International Journal of Adaptive Control and Signal Processing*, 15(2):121–128, 2001.
- [113] T. Lathuilière, G. Valmorbidia, and E. Panteley. Periodic orbits in planar linear systems with input saturation. *IEEE Control Systems Letters*, 2(3):435–440, July 2018.
- [114] G. A. Leonov and N. V. Kuznetsov. Hidden attractors in dynamical systems. From hidden oscillations in Hilbert–Kolmogorov, Aizerman and Kalman problems to hidden chaotic attractor in Chua circuits. *International Journal of Bifurcation and Chaos*, 23(01):1330002, 2013.
- [115] L. Lessard, B. Recht, and A. Packard. Analysis and Design of Optimization Algorithms via Integral Quadratic Constraints. *SIAM Journal on Optimization*, 26(1):57–95, jan 2016.
- [116] A. Letov. *Stability in Nonlinear Control Systems*. Princeton University Press, 1961.
- [117] D. Liberzon. Hybrid feedback stabilization of systems with quantized signals. *Automatica*, 39:1543–1554, 2003.
- [118] D. Liberzon. *Switching in Systems and Control*. Birkhauser, Boston, USA, 2003.
- [119] M. Lipkovich and A. Fradkov. Equivalence of MIMO circle criterion to existence of quadratic Lyapunov function. *IEEE Transactions on Automatic Control*, 61(7):1895–1899, 2016.
- [120] J. Löfberg. YALMIP : A toolbox for modeling and optimization in MATLAB. In *In Proceedings of the CACSD Conference*, Taipei, Taiwan, 2004.
- [121] A. I. Lurie. *Some Nonlinear Problems in the Theory of Automatic Control*. H. M. Stationery Office, London, 1957. In Russian, 1951.
- [122] A. I. Lurie and V. Postnikov. On the theory of stability of control systems. *Appl. Math. Mech.*, 8(3):246–248, 1944.

- [123] A. C. P. Martins, L. F. C. Alberto, and N. G. Bretas. Uniform estimates of attracting sets of extended Lurie systems using LMIs. *IEEE Transactions on Automatic Control*, 51(10):1675–1678, 2006.
- [124] B. E. A. Milani. Piecewise-affine Lyapunov functions for discrete-time linear systems with saturating controls. *Automatica*, 38(12):2177–2184, 2002.
- [125] B. E. A. Milani. Piecewise-affine Lyapunov functions for continuous-time linear systems with saturating controls. In *Proceedings of the 2004 American Control Conference*, volume 1, pages 429–434 vol.1, 2004.
- [126] R. K. Miller, M. S. Mousa, and A. N. Michel. Quantization and overflow effects in digital implementations of linear dynamic controllers. *IEEE Transactions on Automatic Control*, 33(7):698–704, 7 1988.
- [127] A. P. Molchanov and Ye. S. Pyatnitskiy. Criteria of asymptotic stability of differential and difference inclusions encountered in control theory. *Systems & Control Letters*, 13(1):59–64, 1989.
- [128] K. S. Narendra and J. H. Taylor. *Frequency Domain Criteria for Absolute Stability*. Academic, New York, 1973.
- [129] R. C. L. F. Oliveira and P. L. D. Peres. Parameter-dependent LMIs in robust analysis: Characterization of homogeneous polynomially parameter-dependent solutions via LMI relaxations. *IEEE Transactions on Automatic Control*, 52(7):1334–1340, 2007.
- [130] R. E. O’Shea. An improved frequency-time domain stability criterion for autonomous continuous systems. *IEEE Transactions on Automatic Control*, 12(6):725–731, 1967.
- [131] B. Y. Park, P. Park, and N. K. Kwon. An improved stability criterion for discrete-time Lur’e systems with sector- and slope-restrictions. *Automatica*, 51:255–258, jan 2015.
- [132] J. Park, S. Y. Lee, and P. Park. A less conservative stability criterion for discrete-time Lur’e systems with sector and slope restrictions. *IEEE Transactions on Automatic Control*, 64(10):4391–4395, 2019.
- [133] P. Park. Stability criteria of sector-and slope-restricted Lur’e systems. *IEEE Transactions on Automatic Control*, 47(2):308–313, 2002.
- [134] P. Park and S. W. Kim. A revisited Tsytkin criterion for discrete-time nonlinear Lur’e systems with monotonic sector-restrictions. *Automatica*, 34(11):1417–1420, 1998.
- [135] P. A. Parrilo. *Structured Semidefinite Programs and Semialgebraic Geometry Methods in Robustness and Optimization*. PhD thesis, Caltech, Pasadena, CA, 2000.
- [136] P. Pauli, D. Gramlich, J. Berberich, and F. Allgöwer. Linear systems with neural network nonlinearities: Improved stability analysis via acausal zames-falb multipliers, 2021.
- [137] P. Pauli, A. Koch, J. Berberich, P. Kohler, and F. Allgöwer. Training robust neural networks using lipschitz bounds. *IEEE Control Systems Letters*, 6:121–126, 2022.
- [138] J. B. Pearson and J. E. Gibson. On the asymptotic stability of a class of saturating sampled-data systems. *IEEE Transactions on Applications and Industry*, 83(71):81–86, 1964.
- [139] D. Peaucelle, D. Arzelier, O. Bachelier, and J. Bernussou. A new robust d-stability condition for real convex polytopic uncertainty. *Systems & Control Letters*, 40(1):21–30, 2000.
- [140] C. Pittet, S. Tarbouriech, and C. Burgat. Stability regions for linear systems with saturating controls via circle and Popov criteria. In *Proceedings of the 36th IEEE Conference on Decision and Control*, volume 5, pages 4518–4523 vol.5, 1997.
- [141] V. A. Pliss. Certain problems in the theory of stability of motion in the whole. Technical report, NASA, 1958. English Version: NASA TT F-280.
- [142] A. Y. Pogromsky and A. S. Matveev. A non-quadratic criterion for stability of forced oscillations. *Systems & Control Letters*, 62(5):408–412, 2013.

- [143] V. M. Popov. On absolute stability of non-linear automatic control systems. *Avtomat. i Telemekh.*, 22(8):961–979, 1961.
- [144] J. A. Primbs and M. Giannelli. Kuhn-Tucker-based stability conditions for systems with saturation. *IEEE Transactions on Automatic Control*, 46(10):1643–1647, Oct 2001.
- [145] A. V. Proskurnikov and A. S. Matveev. Tsytkin and Jury–Lee Criteria for Synchronization and Stability of Discrete-Time Multiagent Systems. *Automation and Remote Control*, 79(6):1057–1073, jun 2018.
- [146] I. Queinnec, S. Tarbouriech, G. Valmorbida, and L. Zaccarian. Design of saturating state-feedback with sign-indefinite quadratic forms. *IEEE Transactions on Automatic Control*, pages 1–1, 2021.
- [147] M. Rubagotti, L. Zaccarian, and A. Bemporad. A Lyapunov method for stability analysis of piecewise-affine systems over non-invariant domains. *International Journal of Control*, 89(5):950–959, 2016.
- [148] M. Safonov. Computer-aided stability analysis renders Popov criterion obsolete. *IEEE Transactions on Automatic Control*, 32(12):1128–1131, 1987.
- [149] M. Safonov and V. V. Kulkarni. Zames-Falb multipliers for MIMO nonlinearities. *International Journal of Robust and Nonlinear Control*, 10(11-12):1025–1038, 2000.
- [150] V. R. Sastry. Finite regions of attraction for the problem of Lur’e. *International Journal of Control*, 14(4):789–790, 1971.
- [151] T. Sharma and V. Singh. On the absolute stability of multivariable discrete-time nonlinear systems. *IEEE Transactions on Automatic Control*, 26(2):585–586, 1981.
- [152] R. Shorten, F. Wirth, O. Mason, K. Wulff, and C. King. Stability criteria for switched and hybrid systems. *SIAM Review*, 49(4):545–592, 2007.
- [153] Y. Shtessel, C. Edwards, L. Fridman, and A. Levant. *Sliding Mode Control and Observation*. Control Engineering. Birkhäuser, New York, NY, 2014.
- [154] J. I. Soliman and H. Kwok. Absolute stability of a class of nonlinear sampled-data systems. *Proceedings of the Institution of Electrical Engineers*, 116(1):145, 1969.
- [155] E. Sontag. Nonlinear regulation: the piecewise linear approach. *IEEE Transactions on Automatic Control*, 26(2):346–358, 1981.
- [156] E. D. Sontag and Y. Wang. New characterizations of input-to-state stability. *IEEE Transactions on Automatic Control*, 41(9):1283–1294, 1996.
- [157] J. F. Sturm. Using SeDuMi 1.02, a MATLAB toolbox for optimization over symmetric cones. *Optimization methods and software*, 11(1-4):625–653, 1999.
- [158] J. Sur and B. Paden. Observers for linear systems with quantized outputs. In *Proceedings of the American Control Conference.*, volume 5, pages 3012–3016, 1997.
- [159] J. A. K. Suykens, J. Vandewalle, and B. De Moor. An absolute stability criterion for the Lur’e problem with sector and slope restricted nonlinearities. *IEEE Transactions on Circuits and Systems. Part I: Fundamental Theory and Applications*, 45:1007–1009, 1998.
- [160] G. Szegö and R. E. Kalman. Sur la stabilité absolue d’un système d’équations aux différences finies. *Comptes Rendus de l’Académie des Sciences*, 257:388–390, 1963.
- [161] G.P. Szegö. On the absolute stability of sampled-data control systems. *Proceedings of the National Academy of Sciences of the United States of America*, 50(3):558, 1963.
- [162] S. Tarbouriech, G. Garcia, J. M. Gomes da Silva Jr, and I. Queinnec. *Stability and Stabilization of Linear Systems with Saturating Actuators*. Springer Verlag, London, 2011.
- [163] S. Tarbouriech and F. Gouaisbaut. Control design for quantized linear systems with saturations. *IEEE Transactions on Automatic Control*, 57(7):1883–1889, 2012.

- [164] S. Tarbouriech, C. Prieur, and J. M. Gomes da Silva Jr. Stability analysis and stabilization of systems presenting nested saturation. *IEEE Transactions on Automatic Control*, 51(8):1364–1371, 2006.
- [165] S. Tarbouriech and M. Turner. Anti-windup design: an overview of some recent advances and open problems. *IET Control Theory & Applications*, 3:1–19(18), January 2009.
- [166] P. Tøndel, T. A. Johansen, and A. Bemporad. Evaluation of piecewise affine control via binary search tree. *Automatica*, 39(5):945–950, 2003.
- [167] Y. Z. Tsypkin. On the stability in the large of nonlinear sampled-data systems. In *Dokl. Akad. Nauk SSSR*, volume 145, pages 52–55, 1962.
- [168] Y. Z. Tsypkin. Fundamentals of the Theory of Non-Linear Pulse Control Systems. In *Proceedings of the Second Congress of International Federation of Automatic Control*, pages 172–180, 1963.
- [169] Y. Z. Tsypkin. Frequency criteria for the absolute stability of nonlinear sampled-data systems. *Automatika i Telemekhanika*, 25(3):281–289, 1964.
- [170] M. C. Turner and R. Drummond. Discrete-time systems with slope restricted nonlinearities: Zames–Falb multiplier analysis using external positivity. *International Journal of Robust and Nonlinear Control*, 31(6):2255–2273, 2021.
- [171] M. C. Turner and M. Kerr. Lyapunov functions and \mathcal{L}_2 gain bounds for systems with slope restricted nonlinearities. *Systems & Control Letters*, 69:1–6, 2014.
- [172] V. I. Utkin. *Sliding Modes in Control and Optimization*. Communications and Control Engineering Series. Springer, Berlin, Heidelberg, 1st edition, 1992.
- [173] G. Valmorbida and J. Anderson. Region of attraction estimation using invariant sets and rational Lyapunov functions. *Automatica*, 75:37–45, 2017.
- [174] G. Valmorbida, R. Drummond, and S. R. Duncan. Regional analysis of slope-restricted Lurie systems. *IEEE Transactions on Automatic Control*, 64(3):1201–1208, 2018.
- [175] G. Valmorbida and F. Ferrante. On quantization in discrete-time control systems: Stability analysis of ternary controllers. In *Proceedings of the 59th IEEE Conference on Decision and Control*, pages 2543–2548. IEEE, 2020.
- [176] G. Valmorbida, A. Garulli, and L. Zaccarian. Regional \mathcal{L}_{2m} gain analysis for linear saturating systems. *Automatica*, 76:164–168, 2017.
- [177] J. A. Walker and N. H. McClamroch. Finite regions of attraction for the problem of Lur’e. *International Journal of Control*, 6(4):331–336, 1967.
- [178] J. Wang. Quantized feedback control based on spherical polar coordinate quantizer. *IEEE Transactions on Automatic Control*, 2021.
- [179] S. Weissenberger. Application of results from the absolute stability problem to the computation of finite stability domains. *IEEE Transactions on Automatic Control*, 13(1):124–125, Feb 1968.
- [180] M. A. Wicks, P. Peleties, and R. A. DeCarlo. Construction of piecewise Lyapunov functions for stabilizing switched systems. In *Proceedings of 1994 33rd IEEE Conference on Decision and Control*, volume 4, pages 3492–3497. IEEE, 1994.
- [181] J. Willems. Least squares stationary optimal control and the algebraic Riccati equation. *IEEE Transactions on Automatic Control*, 16(6):621–634, 1971.
- [182] J. Willems and R. Brockett. Some new rearrangement inequalities having application in stability analysis. *IEEE Transactions on Automatic Control*, 13(5):539–549, 1968.
- [183] L. Xie, S. Shishkin, and M. Fu. Piecewise Lyapunov functions for robust stability of linear time-varying systems. *Systems & Control Letters*, 31(3):165–171, 1997.
- [184] V. A. Yakubovich. On absolute stability of non-linear automatic control systems. *Dokl. Akad. Nauk SSSR*, 143(6):1304–1307, 1962.

- [185] V. A. Yakubovich. The method of matrix inequalities in the stability theory of nonlinear control systems: II. Absolute stability in a class of nonlinearities with a condition on the derivative. *Avtom. i Telemekh.*, 26:577–592, 1965.
- [186] H. Yin, P. Seiler, and M. Arcak. Stability analysis using quadratic constraints for systems with neural network controllers. *IEEE Transactions on Automatic Control*, pages 1–1, 2021. Available online.
- [187] L. Zaccarian and A. R. Teel. A common framework for anti-windup, bumpless transfer and reliable designs. *Automatica*, 38(10):1735 – 1744, 2002.
- [188] L. Zaccarian and A. R. Teel. *Modern anti-windup synthesis: control augmentation for actuator saturation*. Princeton University Press, Princeton (NJ), 2011.
- [189] G. Zames and P. L. Falb. Stability conditions for systems with monotone and slope-restricted nonlinearities. *SIAM Journal on Control*, 6(1):89–108, 1968.
- [190] A. L. Zelentsovsky. Nonquadratic Lyapunov functions for robust stability analysis of linear uncertain systems. *IEEE Transactions on Automatic Control*, 39(1):135–138, 1994.
- [191] F. Zhang, H. L. Trentelman, and J. M. A. Scherpen. Dynamic feedback synchronization of Lur’e networks via incremental sector boundedness. *IEEE Transactions on Automatic Control*, 61(9):2579–2584, 2016.
- [192] V. I. Zubov. *Methods of AM Lyapunov and their Application*. Noordhoff Groningen, 1964.

Appendices

Appendix A

Curriculum Vitae

Giorgio Valmorbida

Brazilian / Italian - Passport FH090334 (Brazil) Passport YA5266565 (Italy).
Married, two children.

Contact information

Laboratoire des Signaux et Systèmes,
Département d'Automatique, CentraleSupélec
3, rue Joliot Curie, 91192 Gif-sur-Yvette France
e-mail: giorgio.valmorbida@centralesupelec.fr

Telephone: +33 (0)169851974

Mobile: +33 (0)752591619

Webpage: <https://l2s.centralesupelec.fr/en/u/valmorbida-giorgio/>

Research Interests

Nonlinear Systems, Distributed Parameter Systems, Hybrid Systems, Saturating Actuators, Optimization Methods, Semi-Definite Programming

Current Position

CentraleSupélec, L2S, Département d'Automatique, Gif-sur-Yvette, France. **September 2015 to present** Associate Professor (Enseignant-Chercheur).

Memberships

Inria Saclay, Member of projet DISCO.

L2S, Member of Laboratory Board (Conseil de Laboratoire).

IFAC, Member of the IFAC Technical Committee 2.1 - Control Design.

Post-Doctoral Appointments

January 2013 to September 2015 - *University of Oxford*, Department of Engineering Science, Oxford, United Kingdom.

Post-Doctoral Research Assistant. Project: Sum-of-Squares Approach to Global Stability and Control of Fluid Flows.

Junior Research Fellow. Fulford Junior Research Fellowship. *University of Oxford*, Somerville College

September 2010 to June 2012 - *Università degli Studi di Roma - "Tor Vergata"*, Dipartimento di Informatica, Sistemi e Produzione, Roma, Italia

Post-Doctoral Researcher (Assegnista di Ricerca): Nonlinear and Optimal Approaches for the Control of Nonlinear Polynomials Plants with Saturating Inputs and/or Outputs.

Education

December 2006 to July 2010 - Ph.D. in [Automatic Control Systems](#)

LAAS, CNRS - Laboratoire d'Analyse et d'Architecture des Systèmes

INSA - Institut National des Sciences Appliquées, Toulouse, France

- Thesis: *Analyse en Stabilité et Synthèse de Lois de Commande pour des Systèmes Polynomiaux Saturants (Stability Analysis and Control Design for Polynomial Saturating Systems)*
- Advisors: DR. Sophie Tarbouriech, Prof. Germain Garcia
- Funding: Alban Programme

April 2004 to April 2006 - M.S. Electrical Engineering - Automatic Control

UNICAMP, Universidade Estadual de Campinas, Campinas, Brasil

- Thesis: *Estabilidade de Sistemas com Atraso: Análise de Incertezas e de Saturação Empregando Desigualdades Matriciais Lineares (Stability of Time-Delay Systems: Uncertainty Analysis and Saturating Inputs Analysis with Linear Matrix Inequalities)*
- Advisor: Prof. Pedro Luis Dias Peres
- Area of Study: Control Engineering
- Funding: FAPESP

April 1999 to April 2004 - B.S. Automatic Control Engineering

UFSC, Universidade Federal de Santa Catarina, Florianópolis, Brasil

- Funding: Iniciação Científica CNPQ

Editorial Activities

- **May 2020 to present** Associate Editor, IMA Journal of Mathematical Control and Information.
- **June 2020 to present** Associate Editor, Journal of Control, Automation and Electrical Systems.
- **June 2018 to present** Associate Editor, Conference Editorial Board IEEE CSS.
- Main editor of the volume “Delays and Interconnections: Methodology, Algorithms and Applications” in the series *Advances on Delays and Dynamics at Springer*. Vol 10. 2019.
- Main editor of the volume “Incorporating constraints on the Analysis of Delay and Distributed Parameter Systems” In: *Advances on Delays and Dynamics at Springer*. In print.

Invited Talks

- **2019** *Scientific Computing Across Scales: Extreme Events and Criticality in Fluid Mechanics*. April 16th, 2019, Toronto, Canada.
- **2018** *2nd Workshop DECOD - Delays and Constraints on Distributed Parameter Systems*. November 21st, 2018, Toulouse, France.
- **2018** *2nd Workshop on Stability and Control of Infinite-Dimensional Systems (SCINDIS-2018)*. October 10-12, 2018, Wurzburg, Germany.
- **2017** *1st Workshop DECOD - Delays and Constraints on Distributed Parameter Systems*. November 23rd, 2017, Gif-sur-Yvette, France.
- **2015** *4th Workshop DelSys - Delays and Interconnections: Methodology, Algorithms and Applications*. November 26th, 2015, Gif-sur-Yvette, France.
- **2015** *Control & Optimisation UK*. September 15th, 2015, Oxford, UK.

Workshop & Seminars Organization

- Co-organiser of the Workshop “Control and Optimisation UK”. September 14-15, 2015, St John’s College, Oxford (organising committee: James Anderson and Giorgio Valmorbida), 15 speakers, 60 attendees.
- Co-organiser of the 4ème DelSys Workshop, 25-27 November 2015, CentraleSupélec, Gif-sur-Yvette, France (organising committee: Giorgio Valmorbida, Silviu Niculescu, Islam Bousaada et Alexandre Seuret), 60 attendees.
- Co-organiser of the 1st Workshop DECOD, 22-24 November 2017, CentraleSupélec, Gif-sur-Yvette, France (organising committee: Giorgio Valmorbida, Silviu Niculescu, Islam Bousaada) 60 attendees.
- Co-organiser of the 2nd Workshop DECOD, 21-23 November 2018, Toulouse, France (organising committee: Dimos Dimarogonas, Alexandre Seuret, Sophie Tarbouriech, Giorgio Valmorbida) 60 attendees.
- Co-organiser of the 3rd Workshop DECOD, 23-26 November 2021, Toulouse, France (organising committee: Jean Auriol, Guilherme Mazanti, Giorgio Valmorbida) 70 attendees expected.
- Organiser of the PhD students seminars of the “pôle Automatique” of the Laboratoire de Signaux et Systèmes.

PhD Supervision

- **September 2019 to present date** Mr. Ali Diab, “*Commande par filtrage non linéaire des systèmes d’assistance de direction*”. École Doctorale STIC, L2S, CentraleSupélec. Contrat doctoral Ministère de l’Enseignement Supérieur et de la Recherche.
- **March 2019 to present date** Mr. Dario Penco, “*Contrôle véhicule autonome : contrôle robuste et haute performance pour permettre les manœuvres à haute dynamique des véhicules autonomes*”. École Doctorale STIC, L2S, CentraleSupélec. CIFRE PhD Thesis in partnership with Renault.
- **June 2018 to September 2020** Mr. Leonardo Groff, “*Periodic Event-Triggered Control*”. École Doctorale STIC, L2S, CentraleSupélec. Double degree with Universidade Federal do Rio Grande do Sul.
- **November 2016 to September 2020** Mr. Nathan Michel, “*Commande prédictive robuste pour un drone en environnement intérieur*” École Doctorale STIC, CentraleSupélec, L2S, ONERA. Co-supervised with Sylvain Bertrand, Sorin Oлару (main supervisor) and Didier Dumur.
- **September 2013 to October 2016** Mr. Mohamadreza Ahmadi, “*Analysis of Systems Described by Partial Differential Equations Using Convex Optimization*” Department of Engineering Science (Clarendon Scholarship). Co-supervised with Antonis Papachristodoulou. Currently Post-Doctoral Researcher at CALTECH.

MSc Supervision

- **April 2017 to September 2017** Mr. Yuxi Wang, “*Analyse et Projet des Oscillateurs avec Non-linéarités statiques*”. Laboratoire de Signaux et Systèmes, funding iCode and projet L2S Jeunes Chercheurs. Co-supervision with DR. Elena Panteley.
- **April 2017 to September 2017** Mr. Thomas Lathuilière, “*Étude de la robustesse de la stabilisation et des performances de commandes non-linéaires d’un pendule inversé*”. Laboratoire de Signaux et Systèmes, funding iCode. Co-supervision with Prof. Houria Siguerdidjane.
- **June 2017 to November 2017** Mr. Bastien Ovcар, “*Comparaison des techniques de commande basées sur la passivité et la commande linéaire pour la commande d’un pendule inversé*”. Laboratoire de Signaux et Systèmes.

Member of PhD panel

- **January 2018** Member of panel of PhD defense of Fabien Niel “Modeling and control of a wing at low Reynolds number with high amplitude aeroelastic oscillations” ISAE - Institut Supérieur de l’Aéronautique et de l’Espace.

Member of PhD qualifying committee

- **July 2021** Member of PhD qualifying committee of Mathieu Bajodek “Analysis and design of heterogeneous cyber-physical systems” École doctorale EDSYS.
- **May 2021** Member of PhD qualifying committee of Daniel Denardi Huff “Stability Analysis and Stabilization of Linear Aperiodic Sampled-Data Systems subject to Input Constraints” Double degree UFRGS/ Université de Grenoble Rhône-Alpes.

Projects

- Coordinator of the International Research Network SPa-DisCo “Systèmes à paramètres distribués et Contraintes”. April 2017 to December 2021.
- Member of Project STIC AmSud, CoDysCo2 “Control of Dynamical Systems under Communication Constraints”. January 2018 to December 2019.
- Member of Project ANR, HANDY “Hybrid And Networked Dynamical sYstems”. September 2018 to September 2022.
- Coordinator of PHC Aurora Project “Control and Observation of Nonlinear Systems”. January 2019 to December 2019.

Appendix B

List of Publications

Publications by the author of the manuscript as of December 26, 2023.

B.1 Submitted Journal Papers

- SJ1 Ross Drummond and Giorgio Valmorbida. Generalised Lyapunov functions for discrete-time Lurie systems with slope-restricted nonlinearities. *Under review*, 2021.
- SJ2 Ariadne Bertolin, Ricardo Oliveira Giorgio Valmorbida, and Pedro Peres. Control design of uncertain discrete-time Lur’e systems with sector and slope bounded nonlinearities. *Under review*, 2021.
- SJ3 Francesco Ferrante and Giorgio Valmorbida. A Novel Approach to Stability Analysis of Finite-Level Quantized Feedback Control Systems. *Under review*, 2021.
- SJ4 Leonardo Groff, Giorgio Valmorbida, and Joao Manoel Gomes da Silva Jr. An implicit representation for the analysis of piecewise affine discrete-time systems. *3rd round of Reviews*, 2021.

B.2 Journal Papers

- J1 Isabelle Queinnec, Sophie Tarbouriech, Giorgio Valmorbida, and Luca Zaccarian. Design of saturating state-feedback with sign-indefinite quadratic forms. *IEEE Transactions on Automatic Control*, pages 1–1, 2021.
- J2 Giorgio Valmorbida and Antonis Papachristodoulou. State-feedback design for nonlinear saturating systems. *IEEE Transactions on Automatic Control*, pages 1–1, 2021.
- J3 Ariádne L. J. Bertolin, Ricardo C. L. F. Oliveira, Giorgio Valmorbida, and Pedro L. D. Peres. An LMI approach for stability analysis and output-feedback stabilization of discrete-time Lurie systems using Zames-Falb multipliers. *IEEE Control Systems Letters*, 6:710–715, 2022.
- J4 Aditya Gahlawat and Giorgio Valmorbida. Stability analysis of linear partial differential equations with generalized energy functions. *IEEE Transactions on Automatic Control*, 65(5):1924–1939, 2020.
- J5 Ye Wang, Sorin Olaru, Giorgio Valmorbida, Vicenç Puig, and Gabriela Cembrano. Set-invariance characterizations of discrete-time descriptor systems with application to active mode detection. *Automatica*, 107:255–263, 2019.
- J6 Giorgio Valmorbida, Ross Drummond, and Stephen R. Duncan. Regional analysis of slope-restricted Lurie systems. *IEEE Transactions on Automatic Control*, 64(3):1201–1208, 2019.
- J7 Mohamadreza Ahmadi, Giorgio Valmorbida, Dennice Gayme, and Antonis Papachristodoulou. A framework for input–output analysis of wall-bounded shear flows. *Journal of Fluid Mechanics*, 873:742–785, 2019.
- J8 Thomas Lathuilière, Giorgio Valmorbida, and Elena Panteley. Periodic orbits in planar linear systems with input saturation. *IEEE Control Systems Letters*, 2(3):435–440, 2018.

- J9 Ross Drummond, Giorgio Valmorbida, and Stephen R. Duncan. Generalized absolute stability using Lyapunov functions with relaxed positivity conditions. *IEEE Control Systems Letters*, 2(2):207–212, 2018.
- J10 Giorgio Valmorbida, Luca Zaccarian, Sophie Tarbouriech, Isabelle Queinnec, and Antonis Papachristodoulou. Nonlinear static state feedback for saturated linear plants via a polynomial approach. *IEEE Transactions on Automatic Control*, 62(1):469–474, 2017.
- J11 Giorgio Valmorbida, Andrea Garulli, and Luca Zaccarian. Regional \mathcal{L}_{2m} gain analysis for linear saturating systems. *Automatica*, 76:164–168, 2017.
- J12 Giorgio Valmorbida and James Anderson. Region of attraction estimation using invariant sets and rational Lyapunov functions. *Automatica*, 75:37–45, 2017.
- J13 Mohamadreza Ahmadi, Giorgio Valmorbida, and Antonis Papachristodoulou. Safety verification for distributed parameter systems using barrier functionals. *Systems & Control Letters*, 108:33–39, 2017.
- J14 Giorgio Valmorbida, Mohamadreza Ahmadi, and Antonis Papachristodoulou. Stability analysis for a class of partial differential equations via semidefinite programming. *IEEE Transactions on Automatic Control*, 61(6):1649–1654, 2016.
- J15 Mohamadreza Ahmadi, Giorgio Valmorbida, and Antonis Papachristodoulou. Dissipation inequalities for the analysis of a class of PDEs. *Automatica*, 66:163–171, 2016.
- J16 Giorgio Valmorbida, Sophie Tarbouriech, Matthew Turner, and Germain Garcia. Anti-windup design for saturating quadratic systems. *Systems & Control Letters*, 62(5):367–376, 2013.
- J17 Giorgio Valmorbida, Sophie Tarbouriech, and Germain Garcia. Design of polynomial control laws for polynomial systems subject to actuator saturation. *IEEE Transactions on Automatic Control*, 58(7):1758–1770, 2013.
- J18 Dragan Nešić, Andrew R. Teel, Giorgio Valmorbida, and Luca Zaccarian. Finite-gain \mathcal{L}_p stability for hybrid dynamical systems. *Automatica*, 49(8):2384–2396, 2013.
- J19 Andrea Garulli, Alfio Masi, Giorgio Valmorbida, and Luca Zaccarian. Global stability and finite \mathcal{L}_{2m} -gain of saturated uncertain systems via piecewise polynomial Lyapunov functions. *IEEE Transactions on Automatic Control*, 58(1):242–246, 2013.
- J20 Giorgio Valmorbida, Sophie Tarbouriech, and Germain Garcia. State feedback design for input-saturating quadratic systems. *Automatica*, 46(7):1196–1202, 2010.
- J21 Giorgio Valmorbida, Sophie Tarbouriech, and Germain Garcia. Analyse de stabilité pour un système soumis à des saturations et avec des dynamiques négligées. *Journal Européen des Systèmes Automatisés*, 43:217–239, 2009.
- J22 Giorgio Valmorbida, Valter J. S. Leite, and Pedro Luis Dias Peres. Condições LMI do teorema do ganho pequeno escalonado para análise de estabilidade de sistemas incertos com atraso. *Controle & Automação*, 18:447–458, 2007.

B.3 Conference Papers

- C1 Leonardo Cabral, João M. Gomes da Silva, and Giorgio Valmorbida. Stabilization of discrete-time piecewise affine systems in implicit representation. In *2021 60th IEEE Conference on Decision and Control (CDC)*, 2021.
- C2 Matthias G. TITTON, João M. Gomes da Silva, Giorgio Valmorbida, and Marc Jungers. Stabilization of sampled-data Lure systems with slope-restricted nonlinearities. In *2021 60th IEEE Conference on Decision and Control (CDC)*, 2021.
- C3 Dario Penco, Joan Davins-Valladaura, Emmanuel Godoy, Pedro Kvieska, and Giorgio Valmorbida. Self-scheduled \mathcal{H}_∞ control of autonomous vehicle in collision avoidance maneuvers. In *4th IFAC Workshop on Linear Parameter Varying Systems (LPVS'21)*, 2021.

- C4 Dario Penco, Joan Davins-Valldaura, Emmanuel Godoy, Pedro Kvieska, and Giorgio Valmorbida. Control for autonomous vehicles in high dynamics maneuvers: LPV modeling and static feedback controller. In *2021 IEEE Conference on Control Technology and Applications (CTA)*, 2021.
- C5 Mohammad Ali Abooshahab, Morten Hovd, Giorgio Valmorbida, and Marc Jungers. Optimal sensor placement for partially known power system dynamic estimation. In *IEEE PES Innovative Smart Grid Technologies Europe 2021*, 2021.
- C6 Giorgio Valmorbida and Francesco Ferrante. On quantization in discrete-time control systems: Stability analysis of ternary controllers. In *2020 59th IEEE Conference on Decision and Control (CDC)*, pages 2543–2548, 2020.
- C7 Ariádne L. J. Bertolin, Pedro L. D. Peres, Ricardo C. L. F. Oliveira, and Giorgio Valmorbida. An LMI-based iterative algorithm for state and output feedback stabilization of discrete-time Lur’e systems. In *2020 59th IEEE Conference on Decision and Control (CDC)*, pages 2561–2566, 2020.
- C8 Cyrille Chenavier, Rosane Ushirobira, and Giorgio Valmorbida. A geometric stabilization of planar switched systems. In *21th IFAC World Congress*, volume 53, pages 6446–6451, 2020.
- C9 Ariádne L. J. Bertolin, Ricardo C. L. F. Oliveira, Giorgio Valmorbida, and Pedro L. D. Peres. Estabilização quadrática por realimentação de saída de sistemas Lur’e a tempo contínuo via LMIs. In *Congresso Brasileiro de Automática-2020*, 2020.
- C10 Matthias G. TITTON, João M. Gomes da Silva, and Giorgio Valmorbida. Stability of sampled-data control for Lurie systems with slope-restricted nonlinearities. In *Congresso Brasileiro de Automática-2020*, 2020.
- C11 Leonardo B. Groff, Giorgio Valmorbida, and João M. Gomes da Silva. Stability analysis of piecewise affine discrete-time systems. In *2019 IEEE 58th Conference on Decision and Control (CDC)*, pages 8172–8177, 2019.
- C12 Leonardo B. Groff, João M. Gomes da Silva, and Giorgio Valmorbida. Regional stability of discrete-time linear systems subject to asymmetric input saturation. In *2019 IEEE 58th Conference on Decision and Control (CDC)*, pages 169–174, 2019.
- C13 Nathan Michel, Sylvain Bertrand, Sorin Olaru, Giorgio Valmorbida, and Didier Dumur. Design and flight experiments of a tube-based model predictive controller for the AR.Drone 2.0 quadrotor. In *1st IFAC Workshop on Robot Control WROCO 2019*, volume 52, pages 112–117, 2019.
- C14 Nathan Michel, Sorin Olaru, Giorgio Valmorbida, Sylvain Bertrand, and Didier Dumur. Invariant sets for discrete-time constrained linear systems using a sliding mode approach. In *2018 European Control Conference (ECC)*, pages 2929–2934, 2018.
- C15 Nathan Michel, Sorin Olaru, Sylvain Bertrand, Giorgio Valmorbida, and Didier Dumur. Invariant set design for constrained discrete-time linear systems with bounded matched disturbance. In *9th IFAC Symposium on Robust Control Design ROCOND 2018*, pages 55–60, 2018.
- C16 Thomas Lathuilière, Giorgio Valmorbida, and Elena Panteley. Limit cycles in Liénard systems with saturation. In *5th IFAC Conference on Analysis and Control of Chaotic Systems CHAOS 2018*, volume 51, pages 127–131, 2018.
- C17 Aditya Gahlawat and Giorgio Valmorbida. A semi-definite programming approach to stability analysis of linear partial differential equations. In *2017 IEEE 56th Annual Conference on Decision and Control (CDC)*, pages 1882–1887, 2017.
- C18 Ye Wang, Sorin Olaru, Giorgio Valmorbida, Vicenç Puig, and Gabriela Cembrano. Robust invariant sets and active mode detection for discrete-time uncertain descriptor systems. In *2017 IEEE 56th Annual Conference on Decision and Control (CDC)*, pages 5648–5653, 2017.
- C19 Ross Drummond, Giorgio Valmorbida, and Stephen R. Duncan. Equivalent circuits for electrochemical supercapacitor models. In *20th IFAC World Congress*, volume 50, pages 2671–2676, 2017.

- C20 Nathan Michel, Sylvain Bertrand, Giorgio Valmorbida, Sorin Olaru, and Didier Dumur. Design and parameter tuning of a robust model predictive controller for UAVs. In *20th IFAC World Congress*, 2017. (Extended Abstract).
- C21 Giorgio Valmorbida, Ross Drummond, and Stephen R. Duncan. Positivity conditions of Lyapunov functions for systems with slope restricted nonlinearities. In *2016 American Control Conference (ACC)*, pages 258–263, 2016.
- C22 Simone Baldi, Giorgio Valmorbida, Antonis Papachristodoulou, and Elias B. Kosmatopoulos. Online policy iterations for optimal control of input-saturated systems. In *2016 American Control Conference (ACC)*, pages 5734–5739, 2016.
- C23 Ross Drummond, Giorgio Valmorbida, and Stephen R. Duncan. Lyapunov analysis of nonlinear systems with rational vector field and Jacobian. In *2016 UKACC 11th International Conference on Control (CONTROL)*, pages 1–4, 2016.
- C24 Giorgio Valmorbida, Mohamadreza Ahmadi, and Antonis Papachristodoulou. Convex solutions to integral inequalities in two-dimensional domains. In *2015 54th IEEE Conference on Decision and Control (CDC)*, pages 7268–7273, 2015.
- C25 Márcio J. Lacerda, Giorgio Valmorbida, and Pedro L. D. Peres. Linear filter design for continuous-time polynomial systems with \mathcal{L}_2 -gain guaranteed bound. In *2015 54th IEEE Conference on Decision and Control (CDC)*, pages 5026–5030, 2015.
- C26 Sergio Galeani, Mario Sassano, and Giorgio Valmorbida. Relaxed stabilizability conditions for hybrid linear systems on periodic time domains. In *2015 54th IEEE Conference on Decision and Control (CDC)*, pages 2859–2864, 2015.
- C27 Mohamadreza Ahmadi, Giorgio Valmorbida, and Antonis Papachristodoulou. A convex approach to hydrodynamic analysis. In *2015 54th IEEE Conference on Decision and Control (CDC)*, pages 7262–7267, 2015.
- C28 Giorgio Valmorbida, Dhruva Raman, and James Anderson. Bounds for input- and state-to-output properties of uncertain linear systems. In *8th IFAC Symposium on Robust Control Design ROCOND 2015*, volume 48, pages 1–6, 2015.
- C29 Giorgio Valmorbida and Antonis Papachristodoulou. Introducing INTSOSTOOLS: A SOS-TOOLS plug-in for integral inequalities. In *2015 European Control Conference (ECC)*, pages 1231–1236, 2015.
- C30 Simone Baldi, Giorgio Valmorbida, Antonis Papachristodoulou, and Elias B. Kosmatopoulos. Piecewise polynomial policy iterations for synthesis of optimal control laws in input-saturated systems. In *2015 American Control Conference (ACC)*, pages 2850–2855, 2015.
- C31 Mohamadreza Ahmadi, Giorgio Valmorbida, and Antonis Papachristodoulou. Barrier functionals for output functional estimation of PDEs. In *2015 American Control Conference (ACC)*, pages 2594–2599, 2015.
- C32 Giorgio Valmorbida, Luca Zaccarian, Sophie Tarbouriech, Isabelle Queinnec, and Antonis Papachristodoulou. A polynomial approach to nonlinear state feedback stabilization of saturated linear systems. In *53rd IEEE Conference on Decision and Control*, pages 6317–6322, 2014.
- C33 Giorgio Valmorbida, Mohamadreza Ahmadi, and Antonis Papachristodoulou. Semi-definite programming and functional inequalities for distributed parameter systems. In *53rd IEEE Conference on Decision and Control*, pages 4304–4309, 2014.
- C34 Mohamadreza Ahmadi, Giorgio Valmorbida, and Antonis Papachristodoulou. Input-output analysis of distributed parameter systems using convex optimization. In *53rd IEEE Conference on Decision and Control*, pages 4310–4315, 2014.
- C35 Giorgio Valmorbida and James Anderson. Region of attraction analysis via invariant sets. In *2014 American Control Conference*, pages 3591–3596, 2014.
- C36 Giorgio Valmorbida and Sergio Galeani. Nonlinear output regulation for over-actuated linear systems. In *52nd IEEE Conference on Decision and Control*, pages 4485–4490, 2013.

- C37 Sergio Galeani and Giorgio Valmorbida. Nonlinear regulation for linear fat plants: The constant reference/disturbance case. In *21st Mediterranean Conference on Control and Automation*, pages 683–690, 2013.
- C38 Giorgio Valmorbida, Sophie Tarbouriech, Germain Garcia, and Luca Zaccarian. Synthesis of polynomial static state feedback laws and analysis for discrete-time polynomial systems with saturating inputs. In *2012 American Control Conference (ACC)*, pages 2325–2330, June 2012.
- C39 Dragan Nešić, Andrew R. Teel, Giorgio Valmorbida, and Luca Zaccarian. On finite gain \mathcal{L}_p stability for hybrid systems. In *4th IFAC Conference on Analysis and Design of Hybrid Systems (ADHS 12)*, Eindhoven, Netherlands, 2012.
- C40 Andrea Garulli, Alfio Masi, Giorgio Valmorbida, and Luca Zaccarian. Piecewise polynomial Lyapunov functions for stability and nonlinear \mathcal{L}_{2m} gain computation of saturated uncertain systems. In *2011 50th IEEE Conference on Decision and Control and European Control Conference*, pages 308–313, 2011.
- C41 Giorgio Valmorbida, Sophie Tarbouriech, Matthew C. Turner, and Germain Garcia. Anti-windup for NDI quadratic systems. In *8th IFAC Symposium on Nonlinear Control Systems*, 2010.
- C42 Giorgio Valmorbida, Sophie Tarbouriech, Germain Garcia, and Jean-Marc Biannic. Stability and performance analysis for input and output-constrained linear systems subject to multiplicative neglected dynamics. In *2009 American Control Conference*, pages 1225–1230, 2009.
- C43 Giorgio Valmorbida, Sophie Tarbouriech, and Germain Garcia. State feedback design for input-saturating nonlinear quadratic systems. In *2009 American Control Conference*, pages 1231–1236, 2009.
- C44 Giorgio Valmorbida, Sophie Tarbouriech, and Germain Garcia. Region of attraction estimates for polynomial systems. In *Proceedings of the 48th IEEE Conference on Decision and Control (CDC) held jointly with 2009 28th Chinese Control Conference*, pages 5947–5952, Dec 2009.
- C45 Sophie Tarbouriech, Giorgio Valmorbida, Germain Garcia, and Jean-Marc Biannic. Stability and performance analysis for linear systems with actuator and sensor saturations subject to unmodeled dynamics. In *2008 American Control Conference*, pages 401–406, 2008.
- C46 Renato A. Borges, Vinícius F. Montagner, Giorgio Valmorbida, Ricardo C. L. Oliveira, and P. L. D. Peres. Filtragem LPV \mathcal{H}_∞ de sistemas contínuos variantes no tempo com atraso no estado: uma abordagem por relaxações LMIs. In *XVII Congresso Brasileiro de Automática - CBA 2008, Juiz de Fora*, 2008.
- C47 Giorgio Valmorbida, Valter J. S. Leite, and Pedro L. D. Peres. Scaled small gain conditions for robust stability of time-delay systems: An LMI approach. In *Proceedings of the 45th IEEE Conference on Decision and Control*, pages 5138–5143, 2006.
- C48 Giorgio Valmorbida, Isabelle Queinnec, Pedro L. D. Peres, and Sophie Tarbouriech. Synthèse de contrôleurs pour des systèmes avec retard et entrée saturée. In *Annales de la Conférence Internationale Francophone d’Automatique CIFA 2006, Bordeaux.*, 2006.
- C49 Giorgio Valmorbida, Isabelle Queinnec, Pedro L. D. Peres, and Sophie Tarbouriech. Controle descentralizado para sistemas saturados com atrasos. In *Anais do CBA 2006 - XVI Congresso Brasileiro de Automática, 2006, Salvador.*, 2006.
- C50 Vinícius F. Montagner, Giorgio Valmorbida, and Pedro L. D. Peres. \mathcal{H}_∞ guaranteed cost of linear systems with arbitrarily time-varying uncertain parameters through piecewise Lyapunov functions. In *3rd IFAC Workshop on Control Applications of Optimization (3rd CAO)*, pages 380–385, 2006.
- C51 Giorgio Valmorbida and Pedro L. D. Peres. Estabilização robusta de saída para sistemas com atraso: Uma abordagem por LMIs e algoritmos genéticos. In *Anais do VII SBAI - Simpósio Brasileiro de Automação Inteligente*, 2005.
- C52 Giorgio Valmorbida and Pedro L. D. Peres. Condições LMI do teorema do pequeno ganho escalonado para análise de estabilidade de sistemas com atraso. In *Anais do XXVIII CNMAC - Congresso Nacional de Matemática Aplicada e Computacional, 2005, São Paulo*, 2005.

B.4 Book Chapters

- C1 Aditya Gahlawat and Giorgio Valmorbida. Analysis of Linear Partial Differential Equations Using Convex Optimization. In *Delays and interconnections: Methodology, Algorithms and Applications. Series: Advances in Delays and Dynamics*. Springer International Publishing, 2019.

B.5 Edited Volumes

- V1 Giorgio Valmorbida, Wim Michiels, and Pierdomenico Pepe. Accounting for Constraints in Delay Systems. *Series: Advances in Delays and Dynamics*. Springer International Publishing, 2021.
- V2 Giorgio Valmorbida, Alexandre Seuret, Islam Boussaada, and Rifat Sipahi. Delays and interconnections: Methodology, Algorithms and Applications. *Series: Advances in Delays and Dynamics*. Springer International Publishing, 2019.

B.6 Software

- S1 Antonis Papachristodoulou, James Anderson, Giorgio Valmorbida, Stephen Prajna, Pete Seiler, and Pablo Parrilo. SOSTOOLS Version 3.00 Sum of Squares Optimization Toolbox for MATLAB.

B.7 Patents

- P1 Claire Boucher, Emmanuel Godoy, Mathieu Guerpillon, Stefan Kardaszewicz, Pape Sene, Manon Tschupp, and Giorgio Valmorbida. Procédé et système d'aide au stationnement d'un véhicule automobile. Société Anonyme dite : Renault s.a.s. et Nissan. (Submitted)

B.8 Theses

- T1 Giorgio Valmorbida. Analyse en Stabilité et Synthèse de Lois de Commande pour des Systèmes Polynomiaux Saturants. *PhD, Institut National des Sciences Appliquées de Toulouse (INSA Toulouse)*, 2010.
- T2 Giorgio Valmorbida. Estabilidade de Sistemas com Atraso: Análise de Incertezas e de Saturação Empregando Desigualdades Matriciais Lineares. *Mestrado, Universidade Estadual de Campinas*, 2006.

B.9 Citations

Citations as of December 26, 2023.

	Citations	h-index
Publons	358	10
Scopus	470	12
Google Scholar	1123	15

Appendix C

Supervision

C.1 Ph.D. Supervision

C.1.1 Concluded supervision - Thesis abstracts

1. **Dr. Mohammadreza Ahmadi** (sep 2013-oct 2016) *Analysis of Systems Described by Partial Differential Equations Using Convex Optimization*

In the thesis, computational methods based on convex optimization, for the analysis of systems described by partial differential equations (PDEs), were proposed. Firstly, motivated by the integral inequalities encountered in the Lyapunov stability analysis of PDEs, a method based on sum-of-squares (SOS) programming was proposed to verify integral inequalities with polynomial integrands. This method parallels the schemes based on linear matrix inequalities (LMIs) for the analysis of linear systems and approaches based on SOS programming for the analysis of polynomial nonlinear systems.

Secondly, dissipation inequalities for input-state/output analysis of PDE systems were formulated. Similar to the case of systems described by ordinary differential equations (ODEs), it was demonstrated that the dissipation inequalities can be used to check inputstate/ output properties, such as passivity, reachability, induced norms, and input-to-state stability (ISS). Furthermore, it was shown that the proposed input-state/output analysis method based on dissipation inequalities allows one to infer properties of interconnected PDE-PDE or PDE-ODE systems. In this regard, interconnections at the boundaries and interconnections over the domain are considered. It is also shown that an appropriate choice of the storage functional structure casts the dissipation inequalities into integral inequalities, which can be checked via convex optimization.

Thirdly, a method was proposed for safety verification of PDE systems. That is, the problem of checking whether all the solutions of a PDE, starting from a given set of initial conditions, do not enter some undesired or unsafe set. The method hinges on an extension of barrier certificates to infinite-dimensional systems. To this end, a functional of the states of the PDE called the barrier functional is introduced. If this functional satisfies two inequalities along the solutions of the PDE, then the safety of the solutions is verified. If the barrier functional takes the form of an integral functional, the inequalities convert to integral inequalities that can be checked using convex optimization in the case of polynomial data. Furthermore, the proposed safety verification method was used for bounding output functionals of PDEs.

Finally, the tools developed in the thesis were applied to study the stability and input-output analysis problems of fluid flows. In particular, incompressible viscous flows with constant perturbations in one of the coordinates were studied. The stability and input-output analysis is based on Lyapunov and dissipativity theories, respectively, and subsumes exponential stability, energy amplification, worst case input amplification and ISS. It was shown that an appropriate choice of the Lyapunov/storage functional leads to integral inequalities with quadratic integrands. For polynomial base flows and polynomial data on flow geometry, the integral inequalities can be solved using convex optimization. This analysis includes both channel flows and pipe flows. For illustration, the proposed method was used for input-output analysis of several flows, including Taylor-Couette flow, plane Couette flow, plane Poiseuille flow and (pipe) Hagen-Poiseuille flow.

2. **Dr. Nathan Michel** (Nov 2016-Sep 2020)

Unmanned Aerial Vehicles (UAVs) quadrotors are versatile platforms capable of agile motion and stable hovering. The use of drones in civil application and industry has considerably increased in the last years, and is foreseen to continue growing. The design of autonomous UAVs should take into account safety and technological constraints, such as distance to obstacles, actuator limitations or real-time computational constraints for embedded implementation.

In this thesis, we focus on quadrotor control for applications in a cluttered environment, where we want to account for the presence of external disturbances. External disturbances and modelling mismatches can affect the execution of a mission and its impact on the closed-loop trajectories must be assessed. A systematic way to assess the influence of disturbances is to compute invariant sets. The goal is to compute control laws that generate collision-free trajectories by bounding them within safe flight regions, characterized set-wise by invariant sets, where all constraints satisfaction is guaranteed. In particular, we study the design of control laws leading to invariant sets that are as small as possible.

3. Dr. Leonardo Broering Groff (Jun 2018-Sep 2020)

We study the problems of stability analysis of piecewise-affine (PWA) discrete-time systems, and trigger-function design for discrete-time event-triggered control systems. We propose a representation for piecewise-affine systems in terms of ramp functions, and we rely on Lyapunov theory for the stability analysis.

The proposed implicit piecewise-affine representation prevents the shortcomings of the existing stability analysis approaches of PWA systems. Namely, the need to enumerate regions and allowed transitions of the explicit representations. In this context, we can emphasize two benefits of the proposed approach: first, it makes possible the analysis of uncertainty in the partition and, thus, the transitions. Secondly, it enables the analysis of event-triggered control systems for the class of PWA systems since, for ETC, the transitions cannot be determined as a function of the state variables. The proposed representation, on the other hand, implicitly encodes the partition and the transitions.

The stability analysis is performed with Lyapunov theory techniques. We then present conditions for exponential stability. Thanks to the implicit representation, the use of piecewise quadratic Lyapunov functions candidates becomes simple. These conditions can be solved numerically using a linear matrix inequality formulation. The numerical analysis exploits quadratic expressions that describe ramp functions to verify the positiveness of extended quadratic forms.

For ETC, a piecewise quadratic trigger function defines the event generator. We find suitable parameters for the trigger function with an optimization procedure. As a result, this function uses the information on the partition to reduce the number of events, achieving better results than the standard quadratic trigger functions found in the literature

C.1.2 Ongoing supervision - Thesis projects

1. Mr. Dario Penco (Mar 2019-present) *Autonomous vehicle control: Robust and high performance control to enable high dynamics range maneuvering of autonomous vehicles*

The design of automobiles is moving towards the automation of driving and the development of driver assistance functions. Its main objectives are the safety of the driver, passengers, and road users and the comfort of the driver and passengers. The driving conditions of so-called autonomous vehicles include extremely varied real situations, to which it is necessary to respond in a precise and robust manner with limited intervention by the driver. In this context, the various control systems and laws must, in particular, respond to situations during:

- slow maneuvers, called weak dynamics, such as comfort maneuvers;
- fast maneuvers, called high dynamics, such as avoidance maneuvers.

The first versions of autonomous vehicles proposed by the various manufacturers of motor vehicles are developed with several assistance driving systems as, for instance, the system "Traffic Jam Pilot," which has for objective to control the vehicle in situations of traffic jam at low speed and highway at high speed.

Currently, autonomous vehicles must operate within a reasonably extended set defined by the radius of curvature of the trajectory and the longitudinal speed. Nevertheless, the existing

architectures encounter significant difficulties in meeting the specifications for high dynamic maneuvers. In addition, all the different environmental conditions, such as grip, road profile, and the state of the vehicle, namely the mass and tires condition, among other factors, require that the control systems be robust in the face of the variation of a large number of parameters. The design of the control laws is finally confronted with the last source of uncertainties linked to the sensors of the environmental perception system (which provides the data for the generation of the reference trajectory on the one hand, and the measurements of the position of the vehicle with respect to its trajectory on the other hand). Indeed, these measurements are inherently noisy and affected by other sources of uncertainty, such as quantifications and biases.

In this context, the objectives of this thesis concern the methodological development of control laws for autonomous vehicles. ADAS systems are classified according to different levels of autonomy of a vehicle. The classification established by the Society of Automotive Engineers (SAE) is made up of six different levels, ranging from driving that requires full operator intervention to fully automated driving. The work of the thesis will focus on levels 3 and 4, where the systems must manage high dynamic situations without the assistance of the driver ("eyes-off" systems). In these levels of autonomy, it is not possible to limit the operating range only to nominal situations. The level of robustness must be significantly increased to cover the largest possible operating assembly, even in cases of low probability of occurrence use.

The work is organized in three phases:

1. Study of the transition from an autonomous vehicle level 2 to levels 3 and 4. The main goal is to assess the limitations of level 2 from both the point of view of available information and that of trajectory planning. Then we aim to refine the specifications and guide the choice of new control methods for autonomous vehicles. Recalling that in level 2, the driver must always be attentive and take control quickly in difficult situations or the event of an "eye-on" system problem.
 2. Develop a new control law for high dynamic maneuvers (obstacle avoidance) explicitly designed for level 3 and 4 autonomous vehicles. This phase will initially consist of the vehicle's dynamic modeling (bicycle model, four-wheel model) and the methodological development of new structures/control methods. The development of control laws will have to consider aspects of trajectory planning, robustness to parametric variations related to the vehicle (e. g., mass, tire stiffness), and road grip, and the complexity of the solution, and by considering the criteria for its implementation (embeddability of control laws on current vehicle computers, for example). The automatic tuning/tune-up aspects should also be addressed to facilitate the transfer to the automotive industry of the proposed methods.
 3. Validate the proposed control laws in a vehicle.
2. **Mr. Ali Diab** (Sep 2019-present) *Robust nonlinear control and filtering for steer by wire systems*

The introduction of computing units in a network connecting sensor and actuators allows to develop the so called by-wire technologies, therefore allowing to remove mechanical links between the driving interfaces and the wheels of the vehicle. In the case of the steering system, the sensors are incremental encoders and the actuators are electric motors. These electrical drives are placed at the rack allowing the wheels to move and in the steering wheel allowing a reaction torque that provides the driver a feeling of the forces acting on the wheels. The electronic control unit computes the control signals sent to the two electric motors. The communication network makes it possible to connect the elements. They introduce however delays in the feedback loops. This set of components replaces the role of the steering column. The two main interests of the steering wheel removal are a reduced risk in the case of an accident and an increased number of possible configurations for the interior of the vehicle. It also makes it easier the task of integrating driver and autopilot demands.

The goal of the thesis is to analyze the constraints imposed by the stability of the feedback system generating the steering wheel torque for steer-by-wire systems considering non-linear control laws. The studied problem is similar to the questions addressed in robotics, in the context of bilateral teleoperation, in which a human operator controls the position of a slave robot by acting on a master robot, returning a feeling of effort associated with the environment forces on the slave robot. In this scenario the position tracking problem can be

solved quite easily. On the other hand, for the force feedback, the problem is much more difficult since adding a force sensor is not always desirable (due to cost, reliability, and design constraints). Moreover, even with a force sensor, information transmission delays (between sensors, processors and actuators) can destabilize the loop encompassing position and effort control, especially when the forces transmitted between two robots are amplified (energy injection).

Our goal will be to design and analyze new control laws for steer-by-wire systems to increase (compared to current strategies) the delay margin of the system, similarly to what is done on interconnected systems, while allowing the injection of energy into it. These algorithms will rely on classical proportional/derivative control architectures, and will be augmented by a non-linear filtering of the assistance to reduce the destabilizing action associated with energy injection.

C.2 Joint publications with early career researchers, Ph.D. students and Post-Docs

The publication references correspond to the publications in the previous appendix.

In collaboration with supervised Ph.D. Students :

- Mohamadreza Ahmadi: J8, J14, J15, J16, C24, C27, C31, C33, C34;
- Nathan Michel: C13, C14, C15, C20;
- Leonardo B. Groff: J1, C11, C12;
- Dario Penco: C3, C4.

In collaboration with supervised MSc. Students :

- Thomas Lathuilière: J9, C16.

In collaboration with Post-Docs :

- Aditya Gahlawat: J5, C17;
- Ye Wang: J6, C18.
- Ross Drummond: J7, J10, C19, C21, C23

In collaboration with Ph.D. Students :

- Matthias G. Titton: C2, C10
- Leonardo Cabral: C1
- Ariádne L. J. Bertolin: J4, C7, C9;
- Mohammad Ali Abooshahab: C5;
- Marcio Lacerda: C25;
- Dhruva Raman: C28

Appendix D

List of teaching activities

D.1 Teaching Activities

Université Paris-Saclay, Gif-sur-Yvette & Saclay, France.

Master ATSI (Automatique et Traitement du Signal et Images):

- *Comportement des Systèmes Dynamiques*
Lyapunov theory and Input-Output Analysis.

Academic Year	hours
2016-2017	13.5hETD
2017-2018	27hETD
2018-2019	13.5hETD
2019-2020	27hETD
2019-2021	18hETD
Total	81hETD

Master Nuclear Energy:

- *Control*
Course on frequency based analysis and design of feedback systems.

Academic Year	hours
2016-2017	40.5hETD
2017-2018	40.5hETD
2018-2019	40.5hETD
2019-2020	40.5hETD
2019-2021	37.5hETD
Total	199.5hETD

CentraleSupélec

Cursus CentraleSupélec, Gif-sur-Yvette & Chatenay-Malabry, France.

Première Année CentraleSupélec:

- *Traitement du Signal*
Cours Magistraux, Travaux Dirigés, Responsabilité pédagogique

Academic Year	hours
2018-2019	35.5hETD
2018-2019	42hETD
2020-2021	53hETD
Total	130.5hETD

- *Modélisation*
Travaux Dirigés

Academic Year	hours
2018-2019	13.5hETD
2019-2020	18hETD
Total	31.5hETD

Deuxième Année CentraleSupélec:

- *Optimisation*

Cours Magistraux, Travaux Dirigés

Academic Year	hours
2019-2020	44.25hETD
2020-2021	44.25hETD
Total	89.5hETD

- *Complément d'Optimisation - Parcours Recherche*

Cours Magistraux

Academic Year	hours
2019-2020	27hETD
2020-2021	27hETD
Total	54hETD

- *Automatique*

Travaux Dirigés, Travaux Pratiques, Responsabilité pédagogique

Academic Year	hours
2019-2020	45hETD
2020-2021	52hETD
Total	97hETD

- *Enseignement d'intégration*

Pilottage d'un Nanosatellite. Partenaire Industriel : Thalès Alenia Space.

Academic Year	hours
2019-2020	27hETD
2020-2021	27hETD
Total	54hETD

Troisième Année CentraleSupélec:

- *Systèmes Hybrides*

Cours Magistraux, Travaux Dirigés

Academic Year	hours
2020-2021	15hETD
Total	15hETD

- *Encadrement*

* Projets encadrés par entreprise

2020-2021 *Estimation de la consommation d'électricité pour la simulation de la fréquence dans les grands systèmes électriques.* Partenaire industriel : RTE.

Academic Year	hours
2020-2021	6hETD
Total	6hETD

* Projets Étude de cas filière recherche.

2020-2021 *Les algorithmes de pré-traitement et de post-traitement de la somme des carrés en pratique.* L. F. Toso, I. Ayadi, M. Hamdouche, E. Miri.

Academic Year	hours
2020-2021	10hETD
Total	10hETD

- Tuteur de "Stage de fin d'études"

* 2020-2021. L. F. Toso. University of Oxford.

* 2020-2021. A. Mhiri. University of Oxford.

Academic Year	hours
2020-2021	4hETD
Total	4hETD

Projets Cursus CentraleSupélec:

- *Responsabilité*

Responsable du pôle projets *Systèmes Cyber-Physiques*

Academic Year	hours
2019-2020	13hETD
2019-2020	26hETD
2020-2021	40hETD
Total	79hETD

- *Encadrement de projets 1A*

2019-2020 *Synchronisation de circuits de Chua pour le cryptage chaotique de communications*. A. Krasniqi, L. Ryckelink, R. Ayache, Q. Derville.

2020-2021 *Synchronisation de circuits de Chua pour le cryptage chaotique de communications*. A. Baccar, L. Vandecastelle, R. Dalle.

Academic Year	hours
2019-2020	10hETD
2020-2021	6hETD
Total	16hETD

- *Encadrement de projets 2A*

2019-2020 *Commande d'un Chariot Avec Remorques*. G. Cohen, I. N. Alves da Cunha, P. Minigher, M. Rossi.

2020-2021 *Development of a simulated self-driving vehicle*. J. Goicoechea Secilla, I. Blas Gonzales.

2020-2021 *Circuits de Chua Synchronisation - pour le cryptage chaotique de communications*. J. J. Guillen Garcia.

Academic Year	hours
2019-2020	20hETD
2020-2021	14hETD
Total	34hETD

Parcours Recherche

2019-2021 Encadrement de projets du Parcours Recherche *Etude théorique et développement d'outils numériques pour l'analyse et la commande des systèmes échantillonnés périodiques*. L. F. Toso.

Academic Year	hours
2019-2020	35hETD
2020-2021	15hETD
Total	50hETD

Ateliers Cursus CentraleSupélec:

Animation d'Ateliers pratique de l'ingénieur & Ateliers Pratique Professionnelle

Academic Year	hours
2018-2019	36hETD
2019-2020	12hETD
2020-2021	15hETD
Total	63hETD

Cursus Supélec, Gif-sur-Yvette, France.

Première Année Cursus Supélec:

- *Signaux et Systèmes 1*

Travaux Dirigés et examens oraux

Academic Year	hours
2016-2017	10.5hETD
2017-2018	10.32hETD
Total	20.82hETD

- *Signaux et Systèmes 2*

Études de Laboratoire & Responsabilité de cours (EL).

Academic Year	hours
2015-2016	85.5hETD
2016-2017	31.25hETD
2017-2018	38hETD
Total	144.75hETD

- *Signaux et Systèmes 2 - Voie Apprentis*

Études de Laboratoire

Academic Year	hours
2015-2016	4.5hETD
2016-2017	4.5hETD
2017-2018	4.5hETD
Total	13.5hETD

- *Encadrement*

Tuteur de stages

Academic Year	hours
2015-2016	1.6hETD
2016-2017	1.6hETD
2017-2018	1.6hETD
Total	3.2hETD

Tuteur de "Projets de Conception"

* 2017-2018 *Asservissement de position d'un panneau solaire*, H. El Gholabzouri, Z. Poupard.

* 2017-2018 *Optimisation polynomiale pour la classification de données*, S. Olive and Raphaël Bolut.

Academic Year	hours
2017-2018	2.25hETD
Total	2.25hETD

Deuxième Année Coursus Supélec:

- Automatique

Travaux Dirigés et examens oraux

Academic Year	hours
2017-2018	12hETD
2018-2019	11.82hETD
Total	23.82hETD

- Méthodes Numériques et Optimisation

Travaux Dirigés et correction d'examens

Academic Year	hours
2015-2016	9.52hETD
2015-2016	8hETD
2017-2018	7.25hETD
2018-2019	8.1hETD
Total	32.87hETD

- Commande d'Entraînements de Vitesse Variable

Travaux Dirigés et correction d'examens

Academic Year	hours
2015-2016	18hETD
2016-2017	17hETD
2017-2018	15.4hETD
2018-2019	16.2hETD
Total	66.6hETD

- *Encadrement*

* Tuteur de "Projets de Synthèse"

2015-2016 *Modélisation et Observation d'État d'un Supercondensateur*, N. Skatchkovsky, G. Larmandier, M. Coret;

2015-2016 *Étude de la Formation de Régularités: Mécanismes de Turing*, P. Tarascon, H. Fincker.

2017-2018 *Optimisation Polynomiale pour la classification de données*, Elèves A. A. Seng et E. Liang.

2018-2019 *Optimisation Polynomiale pour la classification de données*, Elèves C. Barret, M. Bouatra et A. Zeddoun.

Academic Year	hours
2015-2016	5.625hETD
2017-2018	2.25hETD
2018-2019	2.25hETD
Total	10.125hETD

- * Tuteur de “Projet Long” *Projet d’une centrale de production d’énergie photovoltaïque*, C. Chahbazian, S. Olinger, M. Asensio Velasco, N. Tachet;

Academic Year	hours
2016-2017	18hETD
Total	18hETD

- * Tuteur de Stage

Academic Year	hours
2016-2017	3.2hETD
2017-2018	3.2hETD
2018-2019	3.2hETD
Total	9.6hETD

- * Tuteur d’élève *out-going*

Academic Year	hours
2017-2018	1hETD
2018-2019	1hETD
Total	2hETD

Troisième Année Cursus Supélec:

- *Encadrement*

- * Encadrement de Convention d’Études Industriels

- 2015-2016 *Guidage et Stabilisation d’un Lanceurs par son Spin*, A. Rauzier, V. Planchenault. Industrial Partner: CNES;
- 2015-2016 *Asservissement en Fréquence d’un Oscillateur*, T. Henry, W. Wang. Industrial Partner: Spectracom;
- 2016-2017 *Stratégie de décollage d’un lanceur pour l’évitement des infrastructures sol*, J. Goyard, R. Merhej, A. Jourquin. Industrial Partner: CNES;
- 2017-2018 *Etude du contrôle latéral d’un véhicule dans le cadre d’une manœuvre de parking automatisée*, S. Picard, A. Pastouret. Industrial Partner: Renault;
- 2017-2018 *Étude d’un pistage innovant appliqué aux détections radar*, A. Christensen, A. Lefeuvre. Industrial Partner: Thalès;
- 2018-2019 *Etude de robustesse pour le contrôleur latéral de la fonction AES (Advanced Evasive Steering)*, A. Diab, J. El Feghali, and L. Taupin. Industrial Partner: Renault;
- 2018-2019 *Etude de la planification de trajectoire en ligne dans le cadre d’une manoeuvre de parking automatisée*, C. Boucher, M. Tschupp, S. Kardaszewicz. Industrial Partner: Renault;
- 2019-2020 *Classification Automatique de Signaux électriques par Apprentissage Non Supervisé*, H. Deng, J. Brunel. Industrial Partner: Schneider Electric;
- 2019-2020 *Classification Automatique de Signaux électriques par Apprentissage Supervisé*, E. Fromont, C. Zion. Industrial Partner: Schneider Electric;

Academic Year	hours
2015-2016	30hETD
2016-2017	15hETD
2017-2018	30hETD
2018-2019	30hETD
2019-2020	30hETD
Total	135hETD

- * Tuteur de “Stage de fin d’études”
 - 2015-2016. J. Bénichou. MBDA.
 - 2017-2018. A. Salaun. SAP.
 - 2017-2018. T. Freitas. Renault.
 - 2018-2019. C. Chahbazian. Schlumberger.

- 2018-2019. A. Diab. ENS Cachan.
- 2019-2020. H. Ghileb. L2S, CentraleSupélec.

Academic Year	hours
2015-2016	2hETD
2017-2018	3hETD
2018-2019	4hETD
2019-2020	2hETD
Total	13hETD

- Tuteur d'élève "out-going"

- 2018-2019. N. Tachet, Columbia University.

Academic Year	hours
2018-2019	1hETD
Total	1hETD

- Tuteur d'élève apprenti

- 2018-2019. Projet CEI "Conception d'un boîtier de diagnostic sonore"; Projet Stage Fin d'études "Gestion et Reconnaissance automatique de Signaux Electriques dans une Base de Données"; O. Ould Tahar. Schneider Electric.

Academic Year	hours
2018-2019	12hETD
Total	12hETD

Cursus Centrale, Gif-sur-Yvette & Chatenay-Malabry, France.

Première Année Cursus Centrale:

- *Systèmes Embarqués*
Séances PC

Academic Year	hours
2015-2016	7.5hETD
2016-2017	7.5hETD
2017-2018	7.5hETD
Total	22.5hETD

Deuxième Année Cursus Centrale:

- *Systèmes Automatiques*
Séances PC

Academic Year	hours
2015-2016	9hETD
2016-2017	15hETD
2017-2018	15hETD
Total	39hETD

- *Encadrement*

2018-2019 Projet Associatif: "Promotion de l'intégration des élèves étrangers à CentraleSupélec". P. Gómes de Olea, O. Samim, M. Stuardo, Y. Takeda.

Academic Year	hours
2018-2019	6hETD
Total	6hETD

Formation Continue, Gif-sur-Yvette, France.

- *Synthèse des lois de commande des systèmes non-linéaires dynamiques*

Academic Year	hours
2018-2019	3hETD
Total	3hETD

University of Oxford, Oxford, United Kingdom.

Janvier à Mars 2015 - Somerville College, University of Oxford, Tutorial teaching

- Engineering Science 1st year: Circuit Analysis, Active Devices, Digital Electronics (12hours).
- Engineering Science 2nd year: Electrical Machines, Discrete Systems (15hours).

Novembre 2014 - *Teaching Assistant, AIMS Centre of Doctoral Training*

- Introduction to Modern Control, Autonomous and Intelligent Machines & Systems CDT, University of Oxford. Preparation of assessment and non-assessment questions, teaching assistance, marking (16 hours).

Février 2015 - *Department of Engineering Science*

- C2002: Linear Matrix Inequalities of the paper C20 Multivariable Control (1 hour).

Janvier 2013 à Février 2015 - *Demonstrator*

- A5 Instrumentation and Control Laboratory (February 2015 - 3 hours of laboratory classes/January to March 2014 - 13 hours of laboratory classes/January to March 2013 - 14 hours of laboratory classes).
- Control Engineering Coursework Module (April 2014 - 17 hours of laboratory classes/April 2013 - 14 hours of laboratory classes).

Institut National des Sciences Appliquées de Toulouse (INSA), Toulouse, France

Janvier 2008 à Mars 2009 *Travaux Dirigés et Travaux Pratiques*

- Enseignant de I3MAAU20: Commande des systèmes linéaires continus (Janvier à Mars 2009, 7h30 heures/Janvier 2008 à Mai 2008, 27 heures).

Institut Supérieur de l'Aéronautique et de l'Espace (ISAE), Toulouse, France

Novembre 2008 à Novembre 2009 *Teaching Assistant*

- Enseignant de “Bureaux d'études Automatique” (Novembre 2008 à Décembre 2008, 27 heures/Novembre 2009, 27 heures).

CentraleSupélec		
<i>Master Automatique et Traitement du Signal et Images</i>		
Comportement des Systèmes Dynamiques	2016-2021	81hETD
<i>Master Nuclear Energy</i>		
Control	2016-2021	199.5hETD
<i>Cursus CentraleSupélec</i>		
1A Traitement du Signal	2018-2021	130.5hETD
1A Modélisation	2018-2020	31.5hETD
2A Optimisation	2019-2021	89.5hETD
2A PR Complément d'Optimisation	2019-2020	54hETD
2A Automatique	2019-2021	97hETD
2A Enseignement d'Intégration	2019-2021	54hETD
3A Systèmes Hybrides	2020-2021	15hETD
3A Encadrement projets	2020-2021	16hETD
3A Tuteur stages	2020-2021	4hETD
Projets - Responsabilité et Encadrement de projets	2019-2021	129hETD
Ateliers Cursus CS	2019-2021	63hETD
Total Cursus CentraleSupélec	2019-2021	683.5hETD
<i>Cursus Supélec</i>		
1A TD Signaux et Systèmes 1	2016-2018	20.82hETD
1A EL Signaux et Systèmes 2	2015-2018	144.75hETD
1A EL Signaux et Systèmes 2 Apprentis	2015-2018	13.5hETD
1A Encadrements Projets et Tutorat stage	2015-2018	5.45hETD
2A TD Méthodes Numériques et Optimisation	2015-2019	32.87hETD
2A TD Commande d'Entraînements de Vitesse Variable	2015-2019	66.6hETD
2A TD Automatique	2017-2019	23.82hETD
2A Encadrement de "Projets de Synthèse", "Projets Longs"	2015-2019	28.125hETD
2A Tuteur de Stage & élève <i>out-going</i>	2016-2019	11.6hETD
3A Encadrement de Convention d'Études Industriels	2015-2020	135hETD
3A Tuteur de "Stage de fin d'études"	2015-2020	11h
Total Cursus Supélec	2015-2020	493.535hETD
<i>Cursus Centrale</i>		
1A SPC - Systèmes Embarqués	2015-2018	7.5hETD
2A SPC - Systèmes Automatiques	2015-2018	9hETD
2A Encadrement Projets	2018-2019	6h
Total Cursus Centrale	2019-2021	22.5hETD
TOTAL CS	2019-2021	1480.035hETD
University of Oxford		
1st year tutorial teaching	2014-2015	12h
2nd year tutorial teaching	2014-2015	15h
Introduction to Modern Control	2014-2015	16h
C20 Multivariable Control	2014-2015	1h
A5 Instrumentation and Control Laboratory	2012-2013	14h
A5 Instrumentation and Control Laboratory	2013-2014	13h
A5 Instrumentation and Control Laboratory	2014-2015	3h
Control Engineering Coursework Module	2012-2013	17h
Control Engineering Coursework Module	2013-2014	14h
TOTAL University of Oxford		105h
Institut National des Sciences Appliquées de Toulouse (INSA)		
Commande des systèmes linéaires continus	2007-2008	7.5h
Commande des systèmes linéaires continus	2008-2009	27h
TOTAL INSA		35.5h
Institut Supérieur de l'Aéronautique et de l'Espace (ISAE)		
Bureau d'études Automatique	2008-2009	27h
Bureau d'études Automatique	2009-2010	27h
TOTAL ISAE		52h
TOTAL		1672.535h