



HAL
open science

Impacts of pelagic habitat modifications on the behavior and physiological condition of tropical tuna

Amaël Dupaix

► **To cite this version:**

Amaël Dupaix. Impacts of pelagic habitat modifications on the behavior and physiological condition of tropical tuna. Biodiversity and Ecology. Université de Montpellier, 2023. English. NNT: . tel-04331154v1

HAL Id: tel-04331154

<https://hal.science/tel-04331154v1>

Submitted on 8 Dec 2023 (v1), last revised 20 Jun 2024 (v2)

HAL is a multi-disciplinary open access archive for the deposit and dissemination of scientific research documents, whether they are published or not. The documents may come from teaching and research institutions in France or abroad, or from public or private research centers.

L'archive ouverte pluridisciplinaire **HAL**, est destinée au dépôt et à la diffusion de documents scientifiques de niveau recherche, publiés ou non, émanant des établissements d'enseignement et de recherche français ou étrangers, des laboratoires publics ou privés.



Distributed under a Creative Commons Attribution 4.0 International License

THÈSE POUR OBTENIR LE GRADE DE DOCTEUR DE L'UNIVERSITÉ DE MONTPELLIER

En : Sciences de la mer

École doctorale : GAIA

Unité de recherche : UMR MARBEC

Impacts des modifications de l'habitat pélagique sur le comportement et la condition physiologique des thons tropicaux

Présentée par Amaël DUPAIX

Le 9 novembre 2023

Sous la direction de Laurent DAGORN et Jean-Louis
DENEUBOURG

Devant le jury composé de :

Catherine ALIAUME, Professeur, Université de Montpellier	Présidente du jury
Kim HOLLAND, Professor, Hawai'i Institute of Marine Biology	Rapporteur
Hilario MURUA, Senior Scientist, ISSF	Rapporteur
Manuela CAPELLO, Chargée de Recherche, IRD	Co-encadrante de thèse
Invités	
Laurent DAGORN, Directeur de Recherche, IRD	Directeur de thèse
Jean-Louis DENEUBOURG, Professeur, ULB	Co-directeur de thèse



UNIVERSITÉ
DE MONTPELLIER

À Alain,

ma thèse est certes en anglais
mais j'aurais été extrêmement fier de te la montrer



Remerciements

Ceci étant une thèse, je ne pouvais pas déceimement signer "Amaël Dupaix, encadrants, collègues, famille et amis". Pourtant, c'est probablement le travail le moins individuel que j'ai réalisé au cours de ma vie. Les remerciements sont donc de mise.

Pour commencer, merci à Manuela, Laurent et Jean-Louis, mes co-encadrante/directeur/co-directeur. Je suis persuadé qu'une très grande partie du bon déroulement d'une thèse vient de la bonne entente avec les encadrant.es et de la capacité à travailler ensemble. De ce côté, j'ai eu beaucoup de chance, et c'est avec plaisir que je me rends compte que je vous considère maintenant plus comme des collègues et ami.es que comme des encadrant.es.

Merci Manuela pour ta présence tout au long de ma thèse, pour tes remarques toujours pertinentes et poussées qui m'ont amené (après parfois un petit instant à me dire que "mince, je pensais en avoir fini avec cette partie") à me dépasser et à améliorer mon travail. Ton enthousiasme est très communicatif et il a fallu que j'apprenne parfois à te dire que, malheureusement, je n'aurais pas le temps de tout faire. Je ne sais pas encore parfaitement le dire. Mais c'est aussi cet enthousiasme qui a parfois participé à me remotiver. Merci aussi de l'écoute et du soutien dont tu as fait preuve dans les moments où j'en avais besoin.

Laurent, merci de t'être rendu disponible malgré un emploi du temps qui m'effraye chaque fois que je l'aperçois sur ton écran. À certaines périodes il était plus difficile d'avoir un moment pour discuter avec toi, mais il y avait alors toujours un pot de départ à la retraite, une pause-déjeuner ou une conférence me permettant de te trouver. J'ai à chaque fois été impressionné de ta capacité de synthèse et je te remercie pour le recul que tu m'as apporté au cours de cette thèse.

Merci Jean-Louis de faire de chaque échange une source d'inspiration. Mon séjour à Bruxelles a été un grand moment, et tout au long de ma thèse j'ai eu un vrai plaisir, sans doute inculqué depuis le plus jeune âge, à me lancer dans de longs calculs mathématiques puis à en comparer les résultats avec toi.

Merci à vous trois pour la confiance, le soutien et la liberté que vous m'avez accordés tout au long de ces trois années. Et merci aussi pour tous les autres bons moments passés en votre compagnie.

Vient ensuite le tour de tous.tes les collègues/ami.es, la frontière est parfois extrêmement floue, de Sète et d'ailleurs. Anaïs, Adrien, Yoluène, Jonathan, Fabien, Quentin, Witold, Manon, et bien d'autres. J'aurais bien une petite phrase pour chacun.e, pour remercier d'avoir refait le monde de nombreuses fois jusqu'au bout de la nuit avec moi, de m'avoir aidé à m'ouvrir à d'autres choses que les mathématiques et l'halieutique, pour tous ces week-ends de badminton, pour l'invitation à marquer des requins et à voir des DCP pour la première fois, la plongée, l'escalade, etc. Mais ce serait vraiment long, ça sera plus sympa de vive voix, et j'ai vraiment envie de rendre ce manuscrit.

Merci aux collègues de l'Ob7, sans qui presque aucun des chapitres de cette thèse n'existerait, aux collègues de Sète ou d'ailleurs avec qui j'ai eu la chance de collaborer pendant ces trois an-

nées, aux membres de mon comité de suivi pour avoir pris le temps chaque année de m'écouter leur dire que tout se passait bien et pour m'avoir donné de nouvelles idées, à Jeanne pour avoir fait de cette première expérience d'encadrement quelque chose que j'ai envie de renouveler. Merci à toutes et tous les autres que j'oublie et qui ne s'en vexeront pas.

Pour finir, je voudrais remercier ma famille. Mes parents pour m'avoir encouragé dans cette curiosité que j'ai toujours, il me semble, eu. Merci pour votre amour et votre soutien, merci de venir me voir dès que vous en avez l'occasion, et merci d'avoir pris part à ces compétitions de calcul de limites que j'ai organisées. Merci Edwin et Ewen. Vous n'avez pas participé directement à cette thèse, mais je n'en serais pas là sans vous deux. Merci de traverser la France pour venir me voir alors que j'ai appelé la veille, ou de m'accepter des semaines entières à la Réunion. Merci de faire qu'à chaque fois qu'on se voit ce soit toujours aussi beau. Merci aux Collemboles, avec vous tous.tes comme avec mes frères, c'est toujours aussi bien de se retrouver. Et enfin merci Lucie, pour l'ouverture que tu m'apportes, ton goût des livres et de la poésie, pour ton amour et ta présence. Pour le chamboulement que tu as apporté à ma vie.

Résumé / Abstract

Les thons tropicaux, comme d'autres poissons pélagiques, s'associent aux objets flottants. Si ce comportement associatif est connu depuis près de deux millénaires, les raisons sous-jacentes sont encore méconnues. Les pêcheurs exploitent ce comportement associatif pour faciliter la recherche et la capture de poissons. Dans les années 1980, les pêcheurs industriels ont commencé à construire et à déployer leurs propres objets flottants artificiels, les dispositifs de concentration de poissons dérivants (DCPd). Depuis, le déploiement de DCPd a augmenté drastiquement, ce qui a plusieurs impacts écologiques sur les thons tropicaux. Les DCPd ont de nombreux impacts directs (liés à la mortalité par pêche) : ils augmentent l'efficacité des senneurs, modifient la composition spécifique des captures et augmentent les captures de petits albacores (*Thunnus albacares*) et thons obèses (*Thunnus obesus*). Outre ces impacts directs, les DCPd pourraient avoir des impacts indirects sur les thons tropicaux de par leur seule présence. Cette thèse vise à (1) faire le point sur les impacts indirects des DCPd, (2) quantifier les modifications induites par les DCPd et d'autres activités anthropiques sur l'habitat, et (3) caractériser les impacts directs et indirects de ces modifications en considérant le comportement et la condition physiologique des thons tropicaux.

Une revue de littérature a permis de montrer que les DCPd modifient l'habitat des thons tropicaux, mais que les quantifications manquent. Il n'existe pas de résultats scientifiques convergents concernant les impacts indirects des DCPd sur le comportement et la biologie des thons tropicaux (Chapitre 2). Dans l'ouest de l'océan Indien, les DCPd représentent 85 % des objets flottants, augmentant ainsi fortement leur densité (Chapitre 3). Les autres activités humaines (*e.g.* déforestation, changement climatique) n'ont pas induit de variations claires de la densité d'objets flottants naturels, suggérant que les DCPd sont le principal moteur des modifications de l'habitat des thons tropicaux (Chapitre 4). Grâce à un modèle de comportement de thons, nous avons pu estimer que l'augmentation de la densité de DCPd a fortement augmenté le pourcentage de temps que les individus passent associés aux DCPd, de 20 % à 68 % dans l'ouest de l'océan Indien (Chapitre 5). Elle a aussi un impact sur le comportement associatif des agrégations de thons (Chapitre 6). Les DCPd ont donc un impact direct, en augmentant le temps que les thons passent associés et ainsi leur capturabilité par les thoniers senneurs. Une analyse de données taille poids d'albacores sur plus de vingt ans montre que l'augmentation de la densité d'objets flottants induite par les DCPd ne se traduit pas par un impact à long terme sur leur condition dans l'océan Indien (Chapitre 7). Il faut donc poursuivre les recherches sur le lien de causalité entre l'association des thons avec les DCPd et leur faible condition, qui peut être testé à l'aide du modèle développé au Chapitre 8.

Le travail développé dans cette thèse a permis d'améliorer notre compréhension des impacts des DCPd sur les thons tropicaux, ce qui a plusieurs implications en termes de gestion. D'autres travaux expérimentaux et de terrain sont nécessaires pour explorer ces impacts potentiels et des séries temporelles d'indicateurs à long terme devraient être récoltées pour les évaluer. Comme les impacts indirects des DCPd peuvent agir comme facteurs aggravants sur les populations de thons, il est urgent de les caractériser. En outre, cette thèse apporte de nouveaux éléments sur les raisons sous-jacentes au comportement associatif des thons et sur les impacts des DCPd qui en résultent. Dans l'Océan Indien, la situation des populations de thons est alarmante, l'albacore et le thon obèse étant surexploités. Les résultats de cette thèse peuvent aider à un meilleur diagnostic de l'impact des DCPd sur les thons tropicaux et ainsi contribuer à une meilleure gestion de cette ressource commune.

Mots-clés: dispositif de concentration de poissons dérivant ; pêche à la senne ; habitat ; comportement associatif ; condition physiologique ; Océan Indien ; gestion durable des pêches ; *Katsuwonus pelamis* ; *Thunnus albacares* ; *Thunnus obesus*.

Tropical tunas, as many pelagic fish species are known to associate with floating objects (FOBs). If this associative behavior has been known for almost 2 millennia, the reasons underlying it are still largely unknown. Fishers exploit this associative behavior to facilitate the search and catch of fish. In particular, in the 1980s, industrial fishers began to build and deploy their own man-made floating objects, drifting fish aggregating devices (DFADs). Since then, the deployment of DFADs has increased massively, which has several ecological impacts, on the environment and directly on marine species. This thesis focuses on DFADs ecological impacts on tropical tuna. DFADs impact tropical tuna directly by increasing purse seine fleets' efficiency, yield and by expanding their fishing grounds. They also change species catch composition and increase the catch of small yellowfin (*Thunnus albacares*) and bigeye (*Thunnus obesus*) tunas. Besides these direct impacts (related with fishing mortality), DFADs could impact tropical tunas indirectly by their sole presence in the ocean. This thesis aims at (1) reviewing the indirect impacts of DFADs in tropical tuna, (2) quantifying the modifications induced by DFADs and other anthropic activities on tropical tuna surface habitat, and (3) characterizing the direct and indirect impacts of these modifications, considering tropical tuna behavior and condition.

Based on a literature review, Chapter 2 outlines that DFADs do modify tropical tuna habitat, but quantitative characterizations are missing. There is a lack of clear converging scientific evidences on the indirect impacts of DFADs on the behavior and biology of tropical tuna. In the Western Indian Ocean, DFADs strongly increased FOB density, representing around 85 % of the encountered FOBs by observers onboard purse seine vessels (Chapter 3). Other human activities, like deforestation or climate change, did not induce any clear variation of natural floating objects density, suggesting that DFADs are the main driver of tropical tuna surface habitat modifications in the Indian Ocean (Chapter 4). The increase of DFAD density impacts the associative behavior of tropical tuna. A model of tuna behavior shows that this change strongly increased the percentage of time individual tuna spend associated with FOBs, from 20 % to 68 % in the Western Indian Ocean (Chapter 5). DFADs also impact the associative behavior of tuna aggregations, which is also driven by biophysical characteristics of the environment (Chapter 6). Hence DFADs have a direct impact, through an increase of the time tropical tuna spend associated with FOBS, and consequently their catchability. The analysis of a 20-year dataset on size and weight of yellowfin tuna shows that the increase of FOB density induced by DFADs does not translate into a long-term impact on their condition in the Western Indian Ocean (Chapter 7). This calls for further investigation into the causal link between tuna association with DFADs and their low condition, which can be tested using the mathematical framework developed in Chapter 8.

Finally, the work developed in this thesis allowed to improve our understanding of the impacts of DFADs on tropical tuna, which has several implications in terms of management. Further experimental and field work are needed to explore these potential impacts and long-term time series of indicators should be monitored to assess them. As DFADs indirect impacts can act as worsening factors on tuna populations, characterizing them is urgent. Also, this thesis brings new evidence on the reasons underlying tuna associative behavior with FOBs and on the resulting impacts of DFADs. In the Indian Ocean, the situation of tropical tuna stock is alarming, with both yellowfin and bigeye tunas being overexploited. The results of this thesis can help to better determine the impacts of DFADs on tropical tuna and thus contribute to improving the management of this common resource.

Keywords: drifting fish aggregating device; purse seine fisheries; habitat; associative behavior; physiological condition; Indian Ocean; sustainable fisheries; *Katsuwonus pelamis*; *Thunnus albacares*; *Thunnus obesus*.



Contents

Résumé / Abstract	7
List of figures	17
List of tables	17
List of publications	19
Glossary	21
Synthèse en français	23
1 General introduction	37
1.1 Tuna fisheries	38
1.2 Biology of tuna	40
1.3 Tuna associative behavior	41
1.4 Use of tuna associative behavior by fishers	43
1.5 Impacts of Drifting Fish Aggregating Devices	45
1.5.1 Stranding, and pollution	45
1.5.2 Ghost fishing and bycatch	46
1.5.3 Direct ecological impacts on tuna	47
1.5.4 Indirect ecological impacts on tuna	48
1.6 Research questions	51
2 The challenge of assessing the effects of drifting fish aggregating devices on the behaviour and biology of tropical tuna	53
2.1 Introduction	54
2.2 How much do DFADs change the habitat of tropical tunas?	57
2.3 Do DFADs modify the migration and the schooling behaviour of tropical tunas?	60
2.3.1 Effects on individual large-scale movements	60
2.3.2 Effects on individual fine-scale movements	61
2.3.3 Effects on schooling behaviour	64
2.4 Do DFADs modify the life-history parameters of tropical tunas?	65
2.4.1 Effects on feeding	65
2.4.2 Effects on body condition	66
2.4.3 Effects on reproduction and growth	67
2.5 What are the scientific challenges to fill the knowledge gaps?	68
2.6 Conclusion	70
2.7 Supplementary Materials: estimation of the maximum number of operational buoys	71
Transition	73

I	Human induced modifications of tropical tuna surface habitat	75
3	Surface habitat modification through industrial tuna fishery practices	77
3.1	Introduction	78
3.2	Material and methods	79
3.2.1	FOB data	79
3.2.2	FOB spatial distribution from observer data	79
3.2.3	FOB spatial distribution from GPS data	80
3.2.4	Lagrangian simulations of NLOGs	81
3.3	Results	81
3.3.1	Modification of FOBs distribution from observer data	81
3.3.2	Modification of FOBs spatial distribution from GPS data	85
3.3.3	Simulated trajectories	85
3.4	Discussion	87
3.4.1	Modification of the FOB distribution in the western IO	87
3.4.2	Modification of the FOB distribution in the eastern IO	89
3.4.3	Robustness of Lagrangian simulations	90
3.4.4	Possible consequences of the pelagic habitat modifications on tropical tuna and associated species	91
3.5	Supplementary Materials	93
	Transition	102
4	Floating objects in the open ocean: unveiling modifications of the pelagic habitat induced by global change	103
4.1	Introduction	104
4.2	Material and Methods	106
4.2.1	Lagrangian simulations	106
4.2.2	Datasets used for the different scenarios	106
4.2.3	Weighting scenarios	107
4.2.4	Study regions	108
4.2.5	Comparison with observers data	110
4.2.6	Assessing NLOG density in the IO	110
4.3	Results	111
4.3.1	Best performing scenarios	111
4.3.2	Distribution of NLOGs in the Indian Ocean	113
4.3.3	Seasonal variations of NLOG density	113
4.3.4	Trends of NLOG numbers in the Indian Ocean	115
4.4	Discussion	115
4.5	Supplementary Materials	119
	Transition	123
II	Impacts of DFADs on tropical tuna associative behavior	125
5	Quantifying the impact of habitat modifications on species behavior and mortality: Case-study on floating objects and tropical tuna	127
5.1	Introduction	128
5.2	Methods	130
5.2.1	Simulations	130
5.2.2	CAT trends for different FAD densities	130
5.2.3	FOB density calculation	131

5.2.4	Prediction of mean Continuous Absence Time and Percentage of time associated in the IO	131
5.3	Results	136
5.3.1	Simulated Continuous Absence Time trends	136
5.3.2	Operational buoy densities	136
5.3.3	Predictions of Continuous Absence Time and Percentage of time associated	137
5.3.4	Impact of DFAD on tuna availability	137
5.4	Discussion	137
5.4.1	Conclusion and perspectives	140
5.5	Supplementary Materials	141
	Transition	157
6	Determining the drivers of the associative dynamics of tropical tuna aggregations	159
6.1	Introduction	160
6.2	Material and Methods	162
6.2.1	Percentage of inhabited FOBs	162
6.2.2	Explanatory variables	162
6.2.3	Statistical analysis	164
6.3	Results	164
6.3.1	Relationships between explanatory variables	164
6.3.2	Drivers of the percentage of FOBs occupied by tuna	166
6.4	Discussion	167
6.5	Supplementary Materials	172
	Transition	174
III	Impacts of DFADs on tropical tuna physiological condition	175
7	No evidence from long-term analysis of yellowfin tuna condition that Drifting Fish Aggregating Devices act as ecological traps	177
7.1	Introduction	178
7.2	Material and Methods	180
7.2.1	Biological data	180
7.2.2	Relative condition factor	180
7.2.3	Statistical analysis	180
7.3	Results	181
7.3.1	Mean relative condition factors	181
7.3.2	Yearly variations of K_n	181
7.4	Discussion	181
7.5	Supplementary Materials	185
	Transition	197
8	The low condition of tropical tuna associated with drifting Fish Aggregating Devices, a chicken-and-egg story	199
8.1	Introduction	200
8.2	Material and Methods	201
8.2.1	General model formulation	201
8.2.2	Hypothesis 1: The association to DFADs induces a bad condition	203
8.2.3	Hypothesis 2: Individuals with a bad condition tend to associate	203
8.2.4	Equilibrium model solution	203

8.3	Results	203
8.3.1	Comparison of the mean condition of associated and free-swimming populations	204
8.3.2	Variations of the mean condition of the associated population for an increasing number of DFADs	204
8.3.3	Variations of the mean condition of the free-swimming population for an increasing number of DFADs	205
8.4	Discussion	206
8.5	Supplementary Materials 1 - Equilibrium model solution	210
8.6	Supplementary Materials 2	215
9	Discussion	217
9.1	Overview of the main results	218
9.2	Framework to assess DFADs ecological impacts on tuna	220
9.2.1	DFADs as ecological traps for tropical tuna	220
9.2.2	Other ecological impacts of DFADs on tuna	221
9.2.3	Direct <i>vs</i> indirect impacts	223
9.3	Why do tropical tuna associate with FOBs?	223
9.3.1	Indicator-log hypothesis	224
9.3.2	Meeting-point hypothesis	224
9.3.3	Individual, school and aggregation behavior	225
9.3.4	Accounting for specificities	227
9.3.5	Summary	228
9.4	What are the potential indirect impacts of DFADs on tuna?	229
9.5	How to characterize the indirect impacts of DFADs on tuna?	230
9.6	Socio-economic impacts of DFADs	232
9.7	Tropical tuna fisheries in the Indian Ocean in light of the commons	233
	References	237
	Appendices	261
	Appendix A Correlated Random Walk of tuna in arrays of Fish Aggregating Devices	263
	Appendix B Questioning the validity of the indicator-log hypothesis for tropical tuna in the Western Indian Ocean	277
	Appendix C Is FAD fishing an economic trap? Effects of seasonal closures and other management measures on a purse-seine tuna fleet	297

List of Figures

1.1	Illustration of a purse-seine set	39
1.2	Tuna catch per country in the Indian Ocean	40
1.3	Illustration of the three main target tropical tuna species	42
1.4	Pictures of Drifting Fish Aggregating Devices	44
1.5	Ecological impacts of DFADs	49
2.1	Schematic representation of the ecological trap hypothesis	55
2.2	Schematic representation of potential effects of DFADs on tuna schooling behavior	56
3.1	Change in the number of observed FOBs in the IO (2006-2018)	82
3.2	Median distance between two consecutive encounters of FOBs	83
3.3	DFAD multiplication factor in the WIO	84
3.4	Spatial distribution of FOBs in the WIO	86
3.5	Spatial distribution of instrumented FOBs and buoy deployments	87
3.6	Simulated spatial distribution of NLOGs (2014)	88
3.7	Change in the number of FOBs from randomly encountered FOBs only	93
3.8	Median distance between two consecutive encounters of FOBs from randomly encountered FOBs only	94
3.9	DFAD multiplication factor in the WIO from randomly encountered FOBs only	95
3.10	Spatial distribution of FOBs in the WIO from randomly encountered FOBs only	96
3.11	Spatial distribution of observed FOBs per quarter (2011-2018)	97
3.12	Spatial distribution of instrumented FOBs per quarter (2011-2018)	98
3.13	Spatial distribution of deactivation of buoys deployed on DFADs	99
3.14	Influence of the transport duration on the simulated spatial distribution of NLOGs	99
3.15	Influence of the current product on the simulated spatial distribution of NLOGs	100
3.16	Proportion of simulated NLOGs stranding	100
3.17	Influence of the release location (rivers/mangrove) on the simulated spatial dis- tribution of NLOGs	101
4.1	Schematic representation of the weighting scenarios	107
4.2	Map of the different areas considered	109
4.3	Comparison between simulated and observed NLOG density	111
4.4	Simulated density of NLOGs averaged over 2000-2019	112
4.5	Seasonal variations of simulated NLOG density per area	114
4.6	Anomaly of the simulated NLOG density from 2000 to 2019, averaged over the entire Indian Ocean	116
4.7	Different seas considered in the study	119
4.8	Monthly precipitations in the IO (2000-2019)	119
4.9	Anomaly of the simulated NLOG density from 2000 to 2019, averaged over the Arabian Sea region	120

4.10	Anomaly of the simulated NLOG density from 2000 to 2019, averaged over the Mozambique region	121
4.11	Simulated NLOG density per quarter with the RCp scenario (2000-2019)	122
5.1	CAT as a function of FAD density	132
5.2	Mean monthly buoy density in the WIO (2020)	133
5.3	Mean monthly predicted CAT in the WIO	134
5.4	Mean monthly predicted percentage of time associated (P_a)	135
5.5	Comparison of P_a predictions obtained with all FOBs or LOGs only	138
5.6	Mean distance traveled by tuna during a CAT as a function of FAD density	144
5.7	Mean CAT as a function of FAD density	144
5.8	Mean monthly predicted CAT_{diff} in the WIO	145
5.9	Mean monthly predicted CAT_{return} in the WIO	146
5.10	Mean monthly predicted R in the WIO	147
5.11	Mean monthly predicted CAT in the WIO based on FOB density	148
5.12	Mean monthly predicted CAT in the WIO based on LOG density	149
5.13	Mean monthly predicted P_a in the WIO based on FOB density	150
5.14	Mean monthly predicted P_a in the WIO based on LOG density	151
5.15	CAT as a function of FAD density ($v = 0.5 \text{ m.s}^{-1}$ and $R_0 = 2 \text{ km}$)	152
5.16	Mean monthly predicted CAT in the WIO ($v = 0.5 \text{ m.s}^{-1}$ and $R_0 = 2 \text{ km}$)	153
5.17	Mean monthly predicted P_a in the WIO ($v = 0.5 \text{ m.s}^{-1}$ and $R_0 = 2 \text{ km}$)	154
5.18	Comparison of P_a predictions obtained with all FOBs or LOGs only ($v = 0.5 \text{ m.s}^{-1}$ and $R_0 = 2 \text{ km}$)	155
6.1	Principal Component Analysis performed on explanatory variables	165
6.2	Percentage of FOBs occupied by tuna (f)	166
6.3	Predictions of f obtained from the GAM	168
6.4	Predictions of the number of FOBs occupied ($n_{FOB} \times f$)	169
6.5	Diagnostic plots of the GAM	172
6.6	SE on the spatial predictions of the number of FOBs occupied ($n_{FOB} \times f$)	173
6.7	Purse seine effort in the Indian Ocean (2010-2019)	173
7.1	Schematic representation of the ecological trap applied to DFADs and tuna	179
7.2	No observed trend in yellowfin tuna condition	182
7.3	Coefficients of GAMs per size class	187
7.4	Coefficients of GAM with fishing mode	188
7.5	Coefficients of GAM on FOB-associated tuna only	189
7.6	Diagnostic plots of four randomly picked GAMs	190
7.7	Coefficients of the GAM presented in the main manuscript	191
7.8	Spatial prediction of the GAM	192
7.9	Fork length of sampled tuna per year	193
7.10	Allometric relationship between W and FL	194
7.11	Result of the Geary-Hinkley transformation	195
7.12	Relative condition factor as a function of FOB number (2013-2019)	196
8.1	Schematic of the models used in the study	202
8.2	Variations of \bar{e}_A and \bar{e}_F as a function of the number of DFADs (n).	204
8.3	\bar{e}_A and \bar{e}_F as a function of n for different α values.	215
9.1	Schematic representation of the potential impacts of DFADs	222
9.2	Schematic representation of the drivers of school size	226
9.3	How to characterize DFADs indirect impacts on tropical tuna	231

List of Tables

2.1	Summary of the number of DFADs and operational buoys	59
2.2	Summary of measured Continuous Absence and Residence Times	62
4.1	Details of the weighting scenarios	108
4.2	Temporal trends of natural floating objects density	115
5.1	Parameters used in the simulations	130
5.2	Continuous Absence Time values for each simulated FAD density	136
5.3	Summary of the fitted parameter values	136
5.4	Summary of monthly <i>CAT</i> and P_a values	137
6.1	Variance Inflation Factors of the explanatory variables	163
6.2	Characteristics of the environmental data used in the study	164
6.3	Selected Generalized Additive Model of the percentage of occupied floating objects in the Western Indian Ocean	167
8.1	Summary of the studies demonstrating a lower condition for associated tuna compared to tuna in free-swimming schools	206
9.1	Summary of potential impacts of DFADs on tropical tuna	221
9.2	Summary of the hypotheses formulated to explain tropical tuna associative behavior	228



List of publications

A series of manuscripts arose from this thesis, which are to be submitted, are submitted or published in peer-reviewed journals.

Published papers

Dupaix, A., M. Capello, C. Lett, M. Andrello, N. Barrier, G. Viennois, & L. Dagorn (2021). Surface habitat modification through industrial tuna fishery practices. *ICES Journal of Marine Science*, 78(9), 3075–3088. <https://doi.org/10.1093/icesjms/fsab175>. (Chapter 3)

Dupaix, A., L. Dagorn, A. Duparc, A. Guillou, J.-L. Deneubourg, & M. Capello (2023). No evidence from long- term analysis of yellowfin tuna condition that Drifting Fish Aggregating Devices act as ecological traps. *Marine Ecology Progress Series*, 711, 121–127. <https://doi.org/10.3354/meps14313>. (Chapter 7)

Papers under review

Dupaix, A., F. Ménard, J. D. Filmlalter, Y. Baidai, N. Bodin, M. Capello, E. Chassot, H. Demarcq, J.-L. Deneubourg, A. Fonteneau, F. Forget, F. Forrestal, D. Gaertner, M. Hall, K. N. Holland, D. Itano, D. M. Kaplan, J. Lopez, F. Marsac, . . . L. Dagorn (Under review). The challenge of assessing the effects of drifting fish aggregating devices on the behaviour and biology of tropical tuna. *Fish and Fisheries*. <https://hal.science/hal-04047298>. (Chapter 2)

Dupaix, A., L. Dagorn, J.-L. Deneubourg, & M. Capello (Under review). Quantifying the impact of habitat modifications on species behavior and mortality: Case-study on floating objects and tropical tuna. *Ecological Applications*. <https://hal.science/hal-04094705>. (Chapter 5)

Papers in preparation

Dupaix, A., M. Andrello, N. Barrier, L. Dagorn, M. Lengaigne, G. Viennois, & M. Capello (In prep.). Floating objects in the open ocean: unveiling modifications of the pelagic habitat induced by global change. (Chapter 4)

Dupaix, A., J.-L. Deneubourg, L. Dagorn, M. Simier, & M. Capello (In prep.). Determining the drivers of the associative dynamics of tropical tuna aggregations (Chapter 6)

Dupaix, A., J.-L. Deneubourg, L. Dagorn, & M. Capello (In prep.). The low condition of tropical tuna associated with drifting Fish Aggregating Devices, a chicken-and-egg story. (**Chapter 8**)

Dupaix, A., M. Capello, L. Dagorn, J. Guibert, M. Soria, M. Tolotti, & F. Forget (In prep.). Conceptual framework to assess the ecological impacts of DFADs on tuna. (**Discussion**)

Papers as a coauthor

Pérez, G., **A. Dupaix**, L. Dagorn, J.-L. Deneubourg, K. N. Holland, S. Beeharry, & M. Capello (2022). Correlated Random Walk of tuna in arrays of Fish Aggregating Devices: A field-based model from passive acoustic tagging. *Ecological Modelling*, 470, 110006. <https://doi.org/10.1016/j.ecolmodel.2022.110006> (**Appendix A**)

Guibert, J., **A. Dupaix**, M. Andrello, M. Lengaigne, & M. Capello (In prep.). Questioning the validity of the indicator-log hypothesis for tropical tuna in the Western Indian Ocean. (**Appendix B**)

Guillotreau, P., F. Salladarré, M. Capello, **A. Dupaix**, L. Floch, A. Tidd, M. Tolotti, & L. Dagorn (2023). Is FAD fishing an economic trap? Effects of seasonal closures and other management measures on a purse-seine tuna fleet. *Fish and Fisheries*. <https://doi.org/10.1111/faf.12799> (**Appendix C**)

Glossary

AFAD	Anchored Fish Aggregating Device
ALD	Abandoned, Lost or Discarded
ALOG	Artificial floating object other than FADs
AO	Atlantic Ocean
BET	Bigeye tuna - <i>Thunnus obesus</i>
CAT	Continuous Absence Time
CMM	Conservation and Management Measure
CPO	Central Pacific Ocean
CPUE	Catch Per Unit of Effort
CRT	Continuous Residence Time
CRW	Correlated Random Walk
CTOI	Commission du Thon de l'Océan Indien (anglais: IOTC)
DCP	Dispositif de Concentration de Poissons (anglais: FAD)
DCPd	Dispositif de Concentration de Poissons dérivant (anglais: DFAD)
DFAD	Drifting Fish Aggregating Device
EAO	Eastern Atlantic Ocean
EPO	Eastern Pacific Ocean
FAD	Fish Aggregating Device
FOB	Floating object
FSC	Free-swimming school
GAM	Generalized Additive Model
IATTC	Inter-American Tropical Tuna Commission
ICCAT	International Commission for the Conservation of Atlantic Tunas
IO	Indian Ocean
IOD	Indian Ocean Dipole
IOTC	Indian Ocean Tuna Commission
MSY	Maximum Sustainable Yield
NLOG	Natural floating object
ORGPt	Organisation Régionale de Gestion des Pêches thonières (anglais: tRFMO)
SKJ	Skipjack tuna - <i>Katsuwonus pelamis</i>
SSCI	Sea Surface Current Intensity
SST	Sea Surface Temperature
TAC	Total Allowable Catch
tRFMO	tuna Regional Fisheries Management Organisation
WCPFC	Western and Central Pacific Fisheries Commission
WCPO	Western and Central Pacific Ocean
WIO	Western Indian Ocean
YFT	Yellowfin tuna - <i>Thunnus albacares</i>



Synthèse en français

Introduction

Les secteurs de la pêche et de l'aquaculture jouent un rôle clé dans la sécurité alimentaire et la nutrition mondiales, fournissant 17 % des protéines animales dans le monde et plus de 50 % dans certains pays (FAO 2022). En 2020, la production de la pêche et de l'aquaculture s'élevait à 214 millions de tonnes (Mt), et 600 millions de personnes en dépendaient pour leur subsistance (comprenant les personnes directement dépendantes et les travailleurs du secteur secondaire ; FAO 2022). Les captures marines représentent 78,8 Mt et exploitent 7 500 espèces de poissons et d'invertébrés aquatiques sauvages (FAO 2022; IPBES 2022b). Cependant, les ressources halieutiques sont en déclin, le principal facteur de ce déclin étant l'exploitation directe, suivie par la pollution terrestre et marine et le changement d'usage de la mer, incluant le développement d'infrastructures côtières (IPBES 2019). Les thons et les espèces apparentées présentent un intérêt commercial majeur dans le monde entier et n'échappent pas à ce déclin général d'abondance des poissons exploités. Environ 8 Mt de thons sont capturées chaque année, ce qui représente 10 % des captures mondiales d'espèces marines (FAO 2022) et une valeur finale de 41 milliards de US\$ en 2018 (McKinney et al. 2020). Parmi ces 8 Mt, trois espèces de thons tropicaux (l'albacore ou thon à nageoires jaunes - *Thunnus albacares* ; le thon obèse - *T. obesus* ; et la bonite à ventre rayé ou listao - *Katsuwonus pelamis*) représentent environ 60 % des 8 Mt capturées annuellement : 2,90 Mt, 1,52 Mt et 0,40 Mt de listao, albacore et thon obèse respectivement.

Les thons tropicaux, comme de nombreuses espèces de poissons pélagiques, s'associent aux objets flottants (Castro et al. 2002; Fréon and Dagorn 2000). La première mention historique de ce comportement associatif fait part de l'observation de dorades coryphènes (*Coryphaena hippurus*) s'associant à des épaves de navires, dans les *Halieutiques* de l'auteur romain Oppien (Oppian 200 AD). Si ce comportement est connu depuis près de deux millénaires, les raisons qui le sous-tendent sont encore largement méconnues. Les premières hypothèses pour l'expliquer ont également été formulées par Oppien, qui affirmait que les coryphènes aiment se frotter le dos contre les planches et que les poissons-pilotes recherchent l'ombre (Oppian 200 AD). Depuis les années 1980, de nombreuses hypothèses ont été formulées. Les deux principales hypothèses retenues pour les thons tropicaux sont les hypothèses de l'*indicator-log* et du *meeting-point* (Fréon and Dagorn 2000; Castro et al. 2002). L'hypothèse de l'*indicator-log* postule que les thons s'associent aux objets flottants pour trouver des zones riches (Hall 1992; Castro et al. 2002). Les objets flottants naturels (NLOG) sont principalement des troncs, ou d'autres morceaux d'arbres et ils indiqueraient des zones riches car ils proviennent des rivières et peuvent s'accumuler dans des zones frontales riches (Castro et al. 2002; Hallier and Gaertner 2008). Le comportement associatif aurait donc été sélectionné au court de l'Évolution car il permettrait aux thons de rester dans ces zones riches. L'hypothèse du *meeting-point* stipule que les espèces pélagiques s'associent avec des objets flottants pour faciliter la formation de bancs (Fréon and Dagorn 2000) : l'association avec des objets flottants pourrait augmenter la probabilité de rencontrer d'autres congénères. Le comportement de formation de bancs peut être considéré comme un compromis évolutif entre, d'une part, l'augmentation de la protection contre les prédateurs, les rencontres de partenaires pour la reproduction, la recherche de nourriture et l'efficacité de nage et, d'autre part, l'augmentation de la détection par les prédateurs et la compétition interindividuelle (Rubenstein 1978; Ioannou 2017; Maury 2017). Si ces deux hypothèses ont été formulées il y a près de 30 ans, aucune étude n'a été réalisée sur les thons tropicaux permettant de les infirmer ou de les confirmer.

Les pêcheurs utilisent ce comportement associatif pour faciliter la recherche et la capture de poissons. Oppien faisait déjà mention de l'utilisation par les pêcheurs du comportement

d'association des dorades coryphènes, et des mentions existent au 14 et 16^e siècle en Méditerranée (Taquet 2013), du déploiement d'objets construits pour faciliter la captures des poissons. Ces objets sont nommés Dispositifs de Concentration de Poissons (DCP), qui dans ce cas étaient ancrés. L'utilisation d'objets flottants dérivants pour faciliter la capture de thons tropicaux a quant à elle connu une expansion rapide au cours des dernières décennies, en raison de l'importance croissante de ces structures flottantes pour la stratégie et l'efficacité des flottilles de senneurs visant les thons tropicaux (Dagorn et al. 2012; Fonteneau et al. 2000; Fonteneau et al. 2013; Leroy et al. 2013; Miyake et al. 2010). Depuis le début de la pêche au thon tropical par des senneurs industriels, les pêcheurs ont tiré parti du comportement d'association des thons avec les objets flottants et ont activement cherché des objets flottants naturels pour améliorer leurs captures (Greenblatt 1979; Hallier and Parajua 1999; Scott et al. 1999). Vers la fin des années 1980, les pêcheurs ont commencé à construire et à déployer leurs propres objets flottants, les Dispositifs de Concentration de Poissons dérivants et y attacher des bouées radio pour les localiser (Ariz et al. 1999; Hallier and Parajua 1999; Hall 1992; Scott et al. 1999; Lopez et al. 2014; Marsac et al. 2014; Moreno et al. 2007; Morón 2001; Stéquert and Marsac 1986). Les DCP dérivants (DCPd) sont généralement composés d'une structure flottante (telle qu'un radeau en bambou ou en métal dont la flottabilité est assurée par des bouées, etc.) et d'une structure immergée (faite de cordes, de vieux filets, de toile, de poids, etc.). Au cours des deux dernières décennies, les bouées radio ont été remplacées par des bouées GPS communiquant directement avec les navires de pêche par satellite. Plus récemment, au cours de la dernière décennie (2010-2020), la plupart des DCPd ont été équipés de bouées échosondeurs, fournissant une estimation de la biomasse de thons agrégée en plus de fournir la position du DCPd (désignée comme *bouées opérationnelles* lorsqu'elles sont déployées et transmettent des informations aux pêcheurs ; Lopez et al. 2014).

La dernière estimation du nombre global de DCPd déployés chaque année a été réalisée par Gershman et al. 2015, qui a estimé entre 81 000 et 121 000 déploiements en 2013. Depuis, aucune évaluation globale n'a été réalisée et les données montrent des tendances différentes selon les océans. Dans l'océan Indien, une forte augmentation du nombre de bouées opérationnelles a été observée avant 2013 (Maufroy et al. 2017), mais ce nombre pourrait avoir diminué à nouveau après 2015, bien que les données permettant ces estimations récentes soient peu fiables (IOTC 2022e). Dans l'océan Pacifique Occidental et Central et dans l'océan Pacifique Oriental, où les estimations sont plus fiables, aucune tendance claire et une nette augmentation du nombre de déploiements de DCPd ont pu être détectées, respectivement (Escalle et al. 2020; Lopez et al. 2021). Enfin, de 2007 à 2013, dans l'océan Atlantique, Maufroy et al. 2017 a estimé que l'augmentation de l'utilisation des DCPd était encore plus importante que celle observée dans l'océan Indien, mais il n'existe pas d'estimation récente du nombre de déploiements de DCPd dans cet océan. Ces différentes tendances pourraient résulter de mesures de conservation et de gestion différentes adoptées par les Organisations Régionales de Gestion des Pêches thonières (ORGPT). Les quatre ORGPT ont adopté des mesures visant à limiter le nombre de bouées opérationnelles attachées aux DCPd, en fixant différentes limites par navire (IATTC 2021 : jusqu'à 340 en fonction de la taille du navire, Res C-21-04 ; ICCAT 2022 : 300 dans la Rec 22-01 ; IOTC 2019; IOTC 2023b : 300 dans Res 19/02, contraignant, 250 dans Res 23/02, non contraignant ; WCPFC 2021 : 350 dans CMM 2021-01). Comme ces limites concernent les bouées opérationnelles et non le déploiement de DCPd, il est difficile de déterminer la contribution réelle qu'elles ont quant à la diminution/augmentation du nombre de DCPd.

L'augmentation massive de l'utilisation des DCPd depuis les années 1980 a plusieurs impacts écologiques. Ces impacts peuvent être classés selon deux catégories : les impacts sur l'environnement / l'habitat et les impacts directs sur les espèces marines. Peuvent être égale-

ment différenciés les impacts des DCPd sur les espèces non ciblées et ceux sur les thons tropicaux.

Tout d’abord, de nombreux DCPd sont laissés à la dérive et finissent par s’échouer sur les récifs côtiers ou les plages, endommageant les habitats côtiers (Escalle et al. 2019b; Imzilen et al. 2021; Imzilen et al. 2022; Escalle et al. 2023b). Les DCPd sont aussi responsables de pollution marine, lorsqu’ils coulent ou s’échouent. Des dizaines de milliers de DCPd sont déployés chaque année et un pourcentage non négligeable d’entre eux contribue aux équipements de pêche abandonnés, perdus ou rejetés (Imzilen et al. 2022; Escalle et al. 2023a). Les DCPd peuvent également avoir un impact sur les espèces pélagiques non ciblées, en provoquant de la pêche fantôme (via l’enchevêtrement dans les filets dont leur structure est constituée) : *e.g.* Filmalter et al. 2013 ont estimé le chiffre impressionnant de 480 000 à 960 000 requins soyeux (*Carcharhinus falciformis*) s’emmêlant chaque année dans les traînes des DCPd dans le seul océan Indien. Les DCPd ont également un impact sur les taux de prises accessoires des thoniers senneurs tropicaux industriels (Gilman 2011). Comparée à d’autres engins de pêche ciblant les thonidés, tels que la palangre et le filet maillant pélagique, la senne présente des taux de prises accessoires plus faibles (Amandè et al. 2008; Gilman 2011), bien que les estimations puissent être améliorées (Amandè et al. 2012). Cependant, la pêche sur DCPd augmente considérablement les taux de prises accessoires des senneurs par rapport à la pêche sur bancs libres (Amandè et al. 2008).

Les DCPd ont aussi des impacts écologiques sur les thons tropicaux (Figure 1). Dans cette thèse, j’ai séparé ces impacts en deux catégories : (1) les impacts sur les populations de thons liés à une augmentation de la mortalité par pêche induite par les DCPd (appelés impacts *directs*) et (2) les impacts non liés à la mortalité par pêche et induits par la seule présence des DCPd à la surface de l’océan (appelés impacts *indirects*).

L’un des impacts directs des DCPd est l’augmentation de l’efficacité des thoniers senneurs tropicaux. Par conséquent, ces flottes ciblent de préférence les bancs de poissons associés aux DCPd (Lopez et al. 2014; Fonteneau et al. 2015). Le taux de réussite des coups de pêche sur des bancs associés à des objets flottants est beaucoup plus élevé que celui sur les bancs libres (Dagorn et al. 2013b). La pêche sur DCPd améliore le rendement des flottilles de senneurs et entraîne également une expansion de leurs zones de pêche (Taquet 2013; Tolotti et al. 2022). Par exemple, dans l’océan Indien, l’augmentation de la proportion de coups de pêche sur DCPd par la flottille française de thoniers senneurs l’a conduite à étendre son effort de pêche au nord, en mer d’Arabie (Tolotti et al. 2022). Depuis les années 2010, l’association de bouées échosondeurs aux DCPd permet aux pêcheurs de disposer d’informations sur leur localisation et sur une estimation de la biomasse associée. L’utilisation de ces bouées échosondeurs a conduit à une expansion encore plus importante des zones de pêche et à une plus grande augmentation de l’efficacité de cette pêcherie que les DCPd seuls (Lopez et al. 2014; Tidd et al. 2017; Wain et al. 2021).

Ensuite, l’utilisation des DCPd par les senneurs modifie les proportions des espèces capturées et augmente les captures de petits albacores et thons obèses. La pêche sur DCPd augmente la proportion de listao capturée et diminue la proportion de grands albacores, ces proportions variant en fonction de l’océan (Guillotreau et al. 2011; Dagorn et al. 2013b). Étant donné que le listao se reproduit toute l’année et que son cycle de vie est plus rapide que celui de l’albacore ou du thon obèse, la pêche sur DCPd pourrait être considérée comme un moyen de cibler cette espèce plus résiliente. Cependant, malgré la diminution de la proportion de grands albacores, la pêche sur DCPd augmente les captures de petits albacores et thons obèses (Bromhead et al. 2003; Davies et al. 2014b). Les albacores, thons obèses et listaos capturés en bancs associés ont une longueur à la fourche moyenne d’environ 50 cm (IOTC 2022e). Si les listaos de 50 cm sont souvent des individus matures, les albacores et thons obèses de cette taille sont des juvéniles.

Cette facilitation de la recherche et de la capture des thons par les DCPd et les technologies qui y sont associées peut entraîner une surpêche (Davies et al. 2014b). Bien que l'on sache que ces impacts directs sont réels, il est difficile d'en déterminer l'ampleur. Les stocks d'albacore et de thon obèse sont surexploités et/ou sujets à la surexploitation dans plusieurs océans, mais comme il n'existe pas de relation claire entre l'ampleur des captures sur les DCPd et le fait qu'un stock soit surexploité ou non, il est difficile d'évaluer le rôle exact des DCPd. Cependant, même s'il est difficile de déterminer l'ampleur des impacts directs des DCPd, la mise en place de mesures de gestion réduisant la mortalité par pêche des albacores et des thons obèses dans certains océans est urgente, y compris en réduisant les captures sous DCPd.

Les impacts des DCPd sur les thons tropicaux peuvent également être indirects, *i.e.* ne résultant pas d'une augmentation de la mortalité par pêche. Il est difficile de déterminer l'ampleur de ces impacts indirects, en particulier au niveau populationnel, mais ces impacts potentiels sont nombreux et pourraient aggraver les impacts directs déjà existants. Premièrement, les DCPd induisent des modifications de l'habitat de surface des thons, en impactant la densité et la distribution des objets flottants (Dagorn et al. 2013a; Phillips et al. 2019a; Dupaix et al. 2021a). Bien que ces modifications de l'habitat soient mal caractérisées, elles peuvent avoir plusieurs impacts sur le comportement des thons, ce qui pourrait au final impacter leur fitness¹. En particulier, les DCPd pourraient perturber la dynamique associative des thons tropicaux avec les objets flottants. Sur la base de l'hypothèse du *meeting-point* (les thons s'associent aux objets flottants pour faciliter la formation de bancs; Fréon and Dagorn 2000), on peut formuler un impact indirect potentiel des DCPd sur le comportement des thons. En augmentant la densité des objets flottants, les DCPd pourraient disperser les thons entre ces objets, affectant la formation de bancs et réduisant leur taille (Sempo et al. 2013; Capello et al. 2022).

Il y a plus de vingt ans, l'augmentation massive du nombre de DCPd déployés dans les océans a également conduit des scientifiques à émettre l'hypothèse que les DCPd pourraient agir comme un *piège écologique* pour les thons tropicaux (Marsac et al. 2000; Hallier and Gaertner 2008). Un piège écologique se produit lorsque des individus choisissent mal un habitat, étant induits en erreur par des indices qui ne sont plus corrélés à la qualité de cet habitat (Battin 2004; Gilroy and Sutherland 2007). Ce mauvais choix d'habitat entraîne une réduction de la fitness individuelle, ce qui peut avoir des répercussions au niveau de la population. En ayant un impact sur la densité et la distribution des objets flottants, le déploiement de DCPd pourrait retenir ou transporter des individus dans des zones qui ne leur conviennent pas d'un point de vue écologique, ce qui pourrait en fin de compte avoir un impact sur les populations de thonidés (Marsac et al. 2000; Fonteneau et al. 2013). L'un des résultats qui a conduit à la formulation de l'hypothèse du piège écologique est le fait que les thons associés aux objets flottants ont souvent une condition physiologique inférieure à celle des thons en banc libre (Marsac et al. 2000; Ménard et al. 2000b; Hallier and Gaertner 2008; Zudaire et al. 2014; Ashida et al. 2017). Bien que les thons semblent être en moins bonne condition lorsqu'ils sont associés à des objets flottants, la causalité de cette relation n'a pas encore été déterminée, *i.e.* nous ne savons pas si un thon s'associe aux objets flottants parce qu'il est en moins bonne condition physiologique ou si sa condition diminue suite à son association.

Bien que les DCPd soient très largement utilisés pour faciliter la recherche et la capture de thons tropicaux, l'évaluation de leur impact reste un défi majeur. Dans l'océan Indien, l'albacore et le thon obèse sont tous deux surexploités (IOTC 2022a; IOTC 2022c). Les DCPd pourraient augmenter la pression des activités anthropiques sur ces populations et agir comme facteurs aggravants. L'objectif principal de cette thèse est de déterminer quels sont les impacts des DCPd sur les thons tropicaux. En particulier, quels sont les impacts indirects et comment

¹capacité d'un individu à laisser une descendance à la génération suivante.

les caractériser ? Plus précisément, je cherche à répondre aux questions suivantes :

- Les DCPd modifient l'habitat des thons tropicaux en modifiant la distribution et la densité des objets flottants, mais quelle est l'ampleur de cette modification ?
- D'autres activités anthropiques ont-elles un impact significatif sur cette composante de l'habitat des thons tropicaux ?
- Quel est l'impact de cette modification de l'habitat sur le comportement des thons ?
- Quels impacts directs et indirects les changements de comportement associatif peuvent-ils avoir sur les populations de thons ? Ces impacts peuvent-ils être quantifiés ?
- Comment la condition physiologique des thons, en tant qu'indicateur de leur fitness, est-elle affectée par les changements d'habitat induits par les DCPd ?
- Comment les hypothèses expliquant le comportement associatif des thons déterminent-elles la façon dont les DCPd peuvent impacter les populations de thons ?

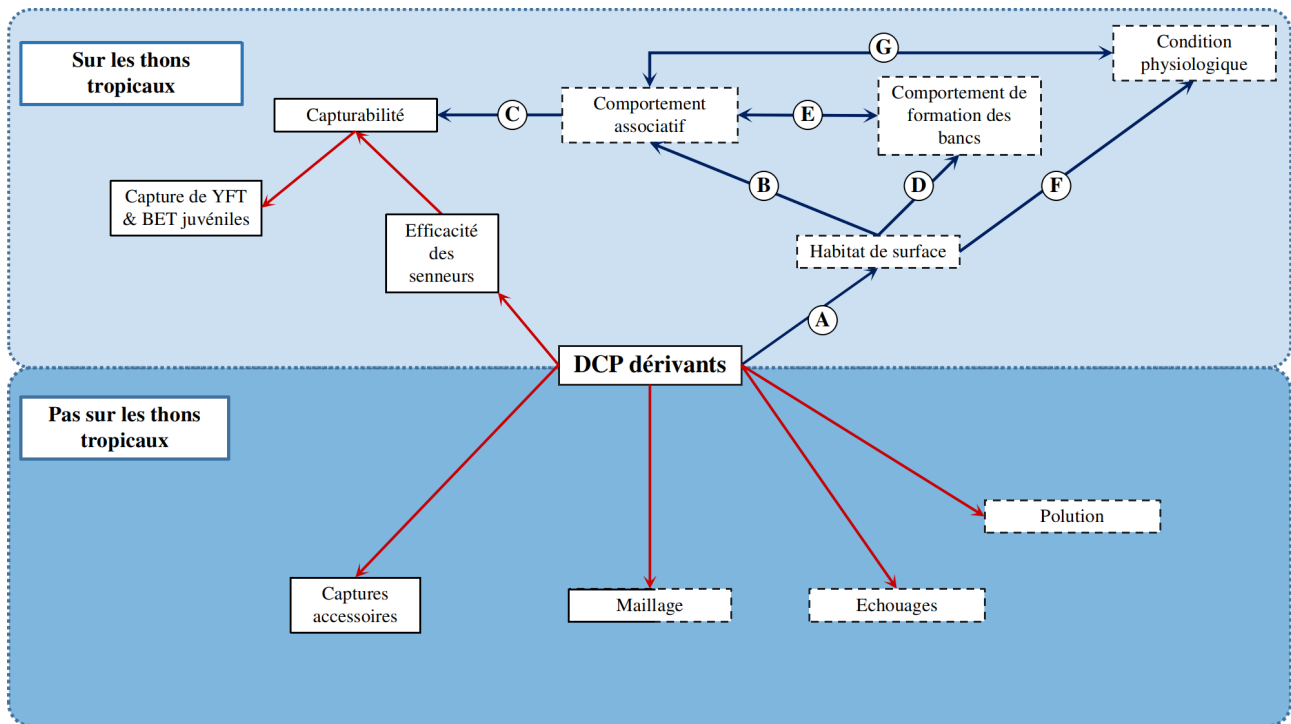

Figure 1: Schéma conceptuel des impacts écologiques des Dispositifs de Concentration de Poissons dérivants. Les *impacts directs* (encadrés par une ligne continue) sont définis comme les impacts induisant une augmentation de la mortalité par pêche. Les *impacts indirects* (encadrés par une ligne discontinue) sont définis comme les impacts qui ne sont pas liés à la mortalité par pêche. Le maillage peut être considéré comme un impact direct, si les DCPd sont considérés comme des engins de pêche actifs (comme dans Hanich et al. 2019), ou indirects. Les flèches bleues avec des lettres sont les relations explorées pendant cette thèse, les flèches rouges n'ont pas été étudiées. Les flèches doubles signifient que les deux processus peuvent s'influencer mutuellement.

Etat des lieux des connaissances sur les impacts écologiques indirects des DCPd sur les thons tropicaux

Dans le **Chapitre 2** est présenté un état des lieux des connaissances sur les impacts indirects des DCPd sur les thons tropicaux. Bien qu'il soit connu que les DCPd modifient l'habitat

des thons tropicaux, la caractérisation quantitative de cette modification de l'habitat fait défaut dans plusieurs océans. Cette caractérisation peut être réalisée grâce au suivi continu d'indicateurs collectés par les ORGPt (densité spatialisée des DCPd et des objets flottants naturels - NLOGs, ratio entre DCPd et NLOG, etc.).

L'impact de ces modifications de l'habitat sur le comportement des thons tropicaux (comportement à grande échelle, à petite échelle et de formation de bancs) est encore largement méconnue. Les études évaluant l'impact des DCPd sur les mouvements à grande échelle des thons fournissent des résultats contradictoires. La proportion de temps que les thons passent associés aux objets flottants montre une forte variabilité inter- et intra-spécifique ainsi qu'océanique. Cependant, l'effet de la méthodologie utilisée (marques archives *vs* marques acoustiques) mériterait d'être étudié. À ce jour, en dehors des études théoriques, aucune preuve n'a été apportée quant à l'impact des DCP dérivants sur le comportement associatif et de formation des bancs.

Cette modification de l'habitat pourrait également avoir un impact sur la biologie des thons. Les DCPd ont probablement un impact sur la condition des thons à court terme, mais cela n'implique pas nécessairement un effet négatif à plus long terme et devrait être confirmé par de longues séries temporelles d'indicateurs de condition, préalablement validés. Les résultats concernant l'impact des DCPd sur d'autres paramètres du cycle de vie du thon ne sont pas concluants.

La principale conclusion de ce chapitre est l'absence de résultats scientifiques clairs et convergents sur les impacts indirects des DCPd sur le comportement et la biologie des thons tropicaux. Il est important que les efforts scientifiques ne se concentrent pas uniquement sur les effets directs des DCPd sur les captures (espèces cibles et prises accessoires), mais également sur d'autres impacts possibles, tels que les effets dépendant de la densité d'objets flottants sur le comportement et la biologie des thons. L'absence actuelle de résultats convergents justifie un effort scientifique important et urgent, en termes de collecte de données, de recherche expérimentale et de modélisation, afin de déterminer définitivement si l'augmentation des déploiements de DCPd pourrait avoir des effets indirects impactant les populations de thons tropicaux.

Modification de l'habitat des thons induites par les activités anthropiques

La **Partie I** confirme que les DCPd modifient effectivement l'habitat des thons tropicaux, en augmentant fortement la densité des objets flottants à la surface de l'océan. Un certain nombre d'indicateurs, utilisant des données issues d'observateurs embarqués à bord des thoniers senneurs, ont été développés dans le **Chapitre 3** afin de quantifier la modification de l'habitat provoquée par les DCPd dans l'ouest de l'océan Indien. Dans un premier temps, le nombre total et la proportion des différents types d'objets flottants rencontrés par les observateurs ont été calculés annuellement entre 2006 et 2018. Ces indicateurs ont permis de démontrer la forte augmentation du nombre de DCPd dans l'ouest de l'océan Indien, passant de 0,5 à plus de 2,5 observations par jour entre le début et la fin de l'étude. De plus, cela a permis de montrer que les DCPd représentent environ 85 % des objets flottants rencontrés par les observateurs. Ce résultat a été confirmé par le calcul d'un autre indicateur, la distance moyenne entre deux rencontres de DCPd, qui a drastiquement chuté sur la seconde période de l'étude (2014-2018), reflétant une importante augmentation de la densité de DCPd dans la région. Le calcul d'un facteur multiplicatif ($\frac{DCPd+NLOG}{NLOG}$) a permis de montrer que cette forte augmentation du nombre de DCPd a modifié l'habitat naturel des thons: la densité d'objets flottants a été multipliée par

au minimum deux dans tout l'ouest de l'océan Indien en 2014-2018, et ce facteur multiplicatif atteint même 62 dans certaines zones. La cartographie de la distribution spatiale des objets flottants à partir des données observateurs a permis de confirmer l'augmentation du nombre de DCPd entre 2006-2008 et 2014-2018. Cela a aussi permis de montrer que si les NLOGs sont observés principalement dans le canal du Mozambique, les DCPd sont présents en plus forte densité dans tout l'ouest de l'océan Indien.

Une des limites principales de cette étude est l'impossibilité de calculer ces indicateurs dans l'est de l'océan Indien, où les thoniers senneurs n'opèrent pas. Dans cette zone, l'utilisation de données issues des bouées échosondeurs (pour les DCPd) et de simulations Lagrangiennes (pour les NLOGs) a permis de montrer que l'impact des DCPd sur l'habitat des thons semble moindre. Cependant, ces méthodologies ne permettent pas de quantifier proprement cet impact. Une seconde limite de cette étude est de considérer les NLOGs comme représentatifs d'un habitat vierge de tout impact anthropique. Hors, le nombre de NLOG pourrait être considérablement affecté par d'autres activités humaines, telles que la déforestation et le changement climatique induit par l'homme, qui peut avoir un impact sur les courants océaniques (Krajick 2001; Thiel and Gutow 2005; Russell et al. 2014). Le nombre de NLOGs peut également présenter de fortes variations saisonnières et interannuelles, influencées par des facteurs tels que les précipitations, les modifications des courants de surface et les événements climatiques extrêmes ayant un impact sur l'entrée de NLOG à partir de sources telles que les rivières et les forêts côtières et leur circulation (Caddy and Majkowski 1996; Hinojosa et al. 2011). Par exemple, à Taïwan, le typhon Morakot de 2009 a entraîné l'entrée de plus de trois millions d'arbres dans la mer (Doong et al. 2011). Comme il est attendu que le changement climatique augmente la fréquence de ces événements extrêmes (impactant l'entrée de NLOGs) et modifie les courants océaniques (impactant le transport des NLOG), il est probable qu'il influence la distribution des NLOGs. La caractérisation de l'impact des activités humaines sur l'habitat des thons tropicaux nécessite donc non seulement de caractériser les modifications de cet habitat induites par l'utilisation des DCPd, mais aussi d'évaluer les changements du nombre de NLOG résultant d'autres activités anthropiques.

Le **Chapitre 4** s'appuie sur des simulations lagrangiennes de 2000 à 2019 afin de caractériser les modifications de la distribution des NLOGs dans l'ensemble de l'océan Indien. Les simulations lagrangiennes sont réalisées avec l'outil *Ichthyop v3.3.12* (Lett et al. 2008), en relachant des particules toutes les semaines le long des côtes et en forçant leur dérive à partir de courants de surface issus du modèle NEMO (Madec 2016). Différents scénarios de pondération de ces simulations sont développés, prenant en compte le couvert forestier côtier, le couvert forestier associé aux rivières et le débit des rivières, ainsi que les précipitations. Les résultats de ces différents scénarios sont ensuite comparés aux données observateurs dans l'ouest de l'océan Indien, afin de déterminer le scénario performant le mieux. Les variations saisonnières dans les différentes régions et la présence ou absence de tendance du nombre de NLOG entre 2000 et 2019 sont ensuite étudiés.

Cette étude a permis de montrer que les scénarios reposant sur le couvert forestier côtier semblent être ceux qui fournissent les résultats les plus proches des données. De plus, ces simulations montrent qu'un changement des courants de surface, probablement dû au changement climatique, semble augmenter la rétention des NLOGs dans le bassin océanique. Cependant, la prise en compte du couvert forestier donne lieu à une absence de tendance à l'échelle du bassin océanique, suggérant que la déforestation n'est pas suffisamment forte au point de provoquer une tendance négative significative entre 2000 et 2019. Les simulations montrent de fortes variations locales saisonnières, qui pourraient être étudiées plus en détails en s'appuyant sur les savoirs locaux des pêcheurs de différentes régions de l'océan Indien. Cette étude montre enfin

que les autres activités anthropiques n'impactent pas l'habitat pélagique dans des proportions similaires aux DCPd.

Impacts des modifications de l'habitat induites par les DCPd sur le comportement associatif des thons tropicaux

La Partie I a permis de montrer que l'impact principal des DCPd sur l'habitat des thons tropicaux est la forte augmentation de la densité d'objets flottants. La **Partie II** cherche à caractériser et quantifier l'impact de cette augmentation de densité des objets flottants sur le comportement associatif des thons.

Dans un premier temps, dans le **Chapitre 5**, j'ai cherché à quantifier l'impact de la modification de l'habitat de surface dans l'ouest de l'océan Indien, caractérisée dans le Chapitre 3, sur le comportement associatif individuel des thons tropicaux. Pour cela, j'ai participé au développement puis utilisé un modèle individu centré de déplacement de thons dans un réseau de DCP (Dupaix et al. 2023b). Ce modèle, permettant de simuler le temps entre deux associations à des DCP, repose sur trois règles comportementales principales: (i) les individus se déplacent en suivant une marche aléatoire corrélée, *i.e.* à chaque pas de temps l'individu se déplace dans une direction corrélée à la direction du déplacement du pas de temps précédent; (ii) arrivés à une certaine distance d'un DCP, ils s'orientent vers celui-ci et (iii) ce comportement d'association est uniquement diurne. Ce modèle a fait l'objet d'une validation puis d'une calibration à partir de données de marquage acoustique passif d'albacores dans deux réseaux de DCP ancrés (Maurice et Hawai'i, Appendix A, Pérez et al. 2022). L'application de ce modèle dans des réseaux de DCP théoriques, à différentes densités, a permis de déterminer une relation générale entre la densité de DCP et le temps moyen entre deux associations. En utilisant des données fournies par la Commission du Thon de l'Océan Indien et des données d'observateurs embarqués à bord des thoniers senneurs français, en 2020, cette relation a été appliquée dans l'ouest de l'océan Indien, afin de quantifier l'impact des DCPd sur le pourcentage de temps passé associé par les thons dans la région. Cette étude a permis de montrer que l'utilisation de DCPd a fortement augmenté le pourcentage de leur temps que les thons passent associés, passant de 20 % sans les DCPd à 68 % avec les DCPd. Ce résultat démontre qu'en augmentant fortement leur disponibilité pour les thoniers senneurs, les DCPd ont un impact direct sur les thons tropicaux.

Le comportement associatif des thons est probablement dépendant des conditions environnementales ainsi que de leur comportement social. Par exemple, Sempo et al. 2013 ont démontré théoriquement qu'en fonction du comportement social, une augmentation de la densité de DCP pouvait provoquer soit la concentration des individus autour de quelques DCP, soit leur dispersion. Ces deux composantes n'étant pas prises en compte dans le Chapitre 5, le **Chapitre 6** cherche à déterminer l'impact de la densité d'objets flottants et d'autres caractéristiques biophysiques de l'environnement sur le comportement des agrégations de thons tropicaux. Pour cela, il s'appuie sur la méthodologie développée par Baidai et al. 2020b qui utilise un Random Forest appliqué à des données de balises échosondeurs afin de déterminer la présence / absence d'une agrégation sous un DCPd. A partir des données de présence / absence obtenues, de données de la Commission du Thon de l'Océan Indien et d'observateurs, pour accéder à la densité d'objets flottants, et de données issues de Copernicus Marine Service (<https://data.marine.copernicus.eu/products>), j'ai étudié la réponse du pourcentage d'objets flottants occupés aux variations environnementales et de densité d'objets flottants. Ce pourcentage est impacté par la concentration en chlorophyll a, l'anomalie du niveau de la mer et la

densité d'objets flottants. En réponse à la densité d'objets flottants, le pourcentage augmente fortement à des densités faibles puis se stabilise autour de 20 % quand la densité dépasse 100 objets par cellule de 2°.

Ce résultat a deux implications. Il confirme les résultats du Chapitre 5 selon lesquels une augmentation de la densité d'objets flottants va augmenter la disponibilité des thons tropicaux pour les thoniers senneurs. Il suggère aussi que les thons pourraient être piégés par les DCPd quand la densité locale augmente fortement, comme cela avait été formulé par Marsac et al. 2000. La Partie II a donc permis de confirmer et de quantifier l'impact de l'augmentation de la densité d'objets flottants sur le comportement associatif des thons, à l'échelle individuelle et à celle des agrégations. Cet impact est direct puisqu'il augmente la disponibilité des thons pour les senneurs. Il est potentiellement indirect aussi, bien que l'impact de l'augmentation du temps associé ou de la potentielle dispersion des individus parmi les DCPd sur la mortalité naturelle soit encore à déterminer et quantifier.

Impacts des modifications de l'habitat induites par les DCPd sur la condition physiologique des thons tropicaux

Suite à la Partie II, caractérisant l'impact des DCPd sur le comportement des thons tropicaux, la **Partie III** cherche à déterminer l'impact des DCPd sur un indicateur de leur fitness, leur condition physiologique. La condition physiologique des individus peut être considérée comme un bon indicateur de leur fitness, car liée à la fois à la survie et la reproduction (Lloret et al. 2014). Dans un premier temps, le **Chapitre 7** teste l'hypothèse du piège écologique telle que formulée il y a vingt ans par Marsac et al. 2000. Selon cette hypothèse, l'augmentation de l'utilisation des DCPd depuis les années 90 dans l'océan Indien aurait dû impacter la condition des thons sur le long terme. Le test de cette hypothèse se base sur des données de taille et de poids d'albacores, mesurés à la conserverie de Victoria (Seychelles) de 1987 à 2019 (Guillou et al. 2021). Ces données permettent le calcul de l'indicateur relatif de condition de Le Cren (K_n Le Cren 1951). Cet indicateur détermine si un individu est en meilleure ou moins bonne condition qu'un individu moyen de la même taille. Il a permis de montrer qu'aucune tendance à la baisse de la condition moyenne des thons n'était observée entre 1987 et 2019, et ce en prenant en compte les effets liés à l'année, la saison, la taille de l'individu et la localisation géographique du coup de pêche. Ce résultat semble aller à l'encontre de l'hypothèse du piège écologique dans l'ouest de l'océan Indien, pour l'albacore. Cependant, d'autres variations environnementales auraient pu agir sur la condition moyenne des albacores sur la même période et compenser un effet délétère des DCPd. Un impact négatif des DCPd sur la fitness des thons pourrait également se manifester via d'autres processus biologiques et ne pas se traduire par une baisse de la condition.

Un des résultats menant à la formulation de l'hypothèse du piège écologique est que la condition moyenne des thons associés est plus faible que celle des thons en bancs libre (Marsac et al. 2000; Hallier and Gaertner 2008). Or, comme cela a été relevé par Robert et al. 2014a, cette condition moyenne plus faible ne signifie pas que les thons sont en moins bonne condition en raison de leur association. La relation inverse peut également être vraie: les thons pourraient s'associer préférentiellement quand ils sont en moins bonne condition. Pour déterminer la causalité de cette relation, dans le **Chapitre 8**, j'ai développé un cadre mathématique faisant soit l'hypothèse que (H_1) les thons sont en mauvaise condition parce qu'ils sont associés à un objet flottant ou que (H_2) les thons s'associent parce qu'ils sont en mauvaise condition. Ce modèle permet de démontrer que selon l'hypothèse formulée, la réponse à une augmentation de

la densité de DCP de la condition moyenne de la fraction de la population qui est associée et de celle de la fraction libre différent. Si l'hypothèse selon laquelle les thons sont en mauvaise condition car associés est vraie, une augmentation de la densité de DCP va provoquer une diminution de la condition moyenne de la fraction associée et de la fraction libre. A l'inverse, si les thons s'associent parce qu'ils sont en mauvaise condition, une augmentation de la densité de DCP n'impactera pas la condition moyenne des thons associés et va provoquer une augmentation de la condition moyenne de la fraction libre de la population. Ces résultats permettent donc de donner un cadre théorique afin de tester la causalité entre l'association aux objets flottants et la faible condition des thons, en utilisant des données de terrain. Comme il a été vu que l'association des thons aux DCPd est influencées par les conditions environnementales (Chapitre 6), les mesures expérimentales réalisées pour tester ces hypothèses devront prendre en compte les variations environnementales.

La Partie III permet donc de mieux caractériser le lien entre la densité de DCPd et la condition des thons tropicaux. Bien qu'il semble y avoir un lien à court terme entre les DCPd et la faible condition des thons tropicaux, cela ne semble pas se traduire par un impact à long terme. De plus, ce lien à court terme devrait être exploré plus en détails car il va influencer les impacts indirects que les DCPd auront sur les thons, ce que va permettre le travail développé dans le Chapitre 8. Déterminer si les thons sont en mauvaise condition parce qu'ils s'associent aux objets flottants ou l'inverse va permettre d'apporter des nouveaux éléments importants pour la gestion des DCPd et pour la meilleure compréhension du comportement des thons.

Discussion et conclusion

Cette thèse a permis de caractériser un certain nombre d'impacts des DCPd sur les thons tropicaux (Figure 2) et de mettre en lumière un certain nombre d'éléments concernant l'étude de ces impacts:

1. L'étude de ces impacts a besoin d'un cadre clair, différenciant les impacts *directs* (provoqués par une augmentation de la mortalité par pêche) et les impacts *indirects* (induits par la seule présence des DCPd à l'eau). Si les impacts directs sont avérés, leur ampleur reste à mieux caractériser. Les impacts indirects, quant à eux, semblent exister au moins à une petite échelle spatio-temporelle, mais leurs conséquences à plus grande échelle ne sont pas évidentes. Ils sont potentiellement plus nombreux que le seul piège écologique tel que formulé par Marsac et al. 2000, ce qui suggère de prendre des précautions quant à l'utilisation de ce terme qui a une définition très précise. Ces deux types d'impacts, directs et indirects, ont des implications différentes en terme de gestion : si les impacts directs peuvent être atténués en fixant des limites de captures, les impacts indirects nécessitent des mesures différentes, qui de plus diffèrent selon l'impact.
2. La détermination des impacts des DCPd sur le comportement des thons tropicaux se heurte à un certain nombre de limites importantes. La première difficulté est de faire le lien entre le comportement individuel et le comportement collectif, découlant du fait que les outils de terrain ne permettent d'étudier que l'individu et/ou l'agrégation (qui est souvent composée d'un ensemble de bancs). Ensuite, il est difficile de caractériser le lien entre un impact à petite échelle géographique, qui semble être confirmé pour les DCP ancrés, d'un point de vue individuel, et un impact à grande échelle. Enfin, les incohérences entre les différentes méthodologies utilisées, mise en lumière dans le Chapitre 2, doivent être étudiées plus avant.

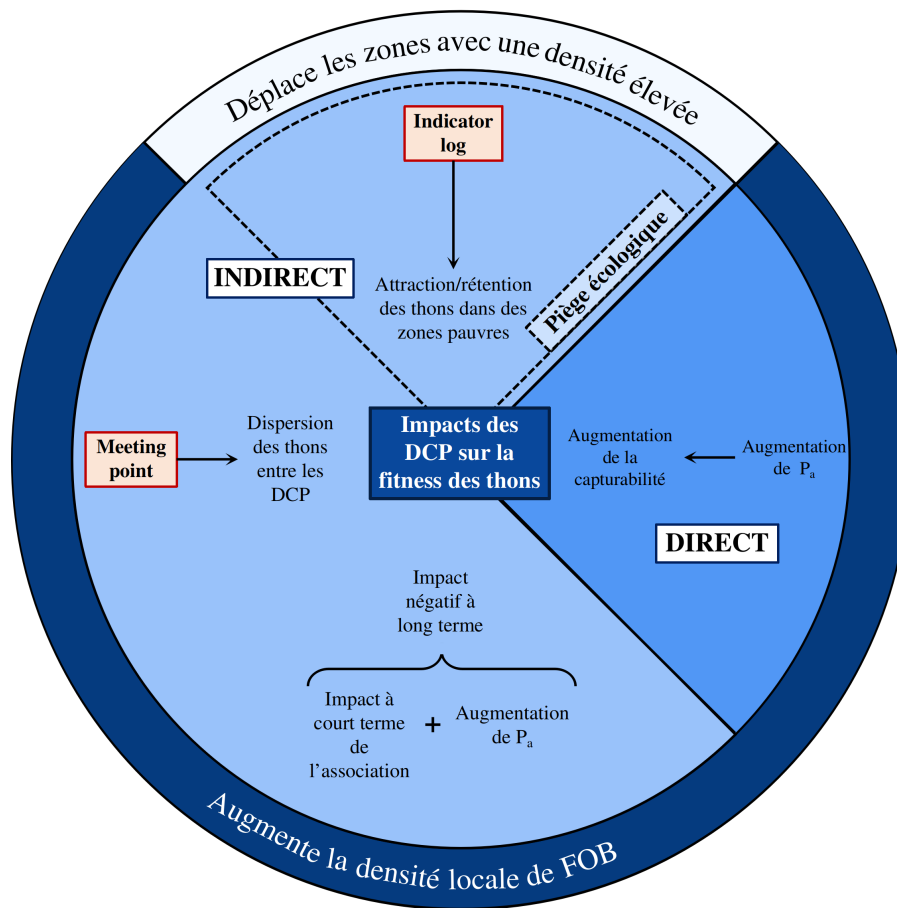

Figure 2: Représentation schématique des impacts potentiels des DCP dérivants sur les thons tropicaux étudiés lors de cette thèse. Le cercle extérieur contient les modifications de l'habitat de surface induites par les DCP dérivants, qui à leur tour vont induire des impacts dans le cercle intérieur. Cadres rouges: hypothèses comportementales expliquant le comportement associatif des thons tropicaux. FOB: objet flottant. P_a : pourcentage de temps passé associé.

3. L'étude des impacts des DCPd sur la fitness des thons est également freinée par certaines limites. Dans un premier temps, le lien entre la condition d'un individu et sa fitness nécessite d'être exploré plus en détails. Les indicateurs utilisés pour caractériser la condition des thons n'ont pas été validés, ne permettant pas de déterminer l'impact qu'une valeur donnée de condition peut avoir sur la survie ou la reproduction de l'individu. Des études expérimentales permettant de valider et calibrer ces indicateurs sont donc nécessaires. Ensuite, le problème de l'échelle se pose également, avec le besoin de faire le lien entre des impacts localisés et à court terme des DCPd et des impacts potentiels à plus large échelle.
4. Cette thèse a apporté de nouveaux éléments concernant les raisons évolutives expliquant l'association des thons avec les objets flottants. Un certain nombre de ces éléments semblent rejeter l'hypothèse de l'*indicator-log*, stipulant que les thons s'associent pour trouver des zones riches (Appendix B). L'hypothèse du *meeting-point*, selon laquelle les thons s'associent pour faciliter la formation de bancs, semble la plus plausible, mais d'autres études sont nécessaires pour la tester. Ces études doivent s'efforcer de prendre en compte les différences potentielles entre espèces, individus (liées à la taille par exemple) et entre océans, ainsi que l'influence des conditions environnementales sur le comportement associatif. Bien que les raisons expliquant le comportement associatif des espèces pélagiques sont encore méconnues après deux mille ans, elles ont des conséquences potentielles im-

portantes sur les impacts que les DCPd peuvent avoir sur ces espèces et doivent donc être étudiées.

Enfin, ces impacts écologiques des DCPd, sur les thons (étudiés dans cette thèse) mais également sur d'autres composantes de l'écosystème, ne sont pas les seuls impacts potentiels. En modifiant fortement l'efficacité des flottilles de thoniers senneurs tropicaux, les DCPd ont de nombreux impacts sociaux et économiques. Par exemple, ils modifient le métier des marins pêcheurs embarqués à bord de ces navires et impactent leurs stratégies. Cela impacte la consommation de fuel de ces navires, les pousse à prospecter des zones plus grandes, mais pourrait également les amener à être piégés dans cette stratégie centrée sur les DCPd lorsque les stocks sont surexploités comme dans l'océan Indien (Appendix C).

Les DCP dérivants sont au cœur des discussions au sein des ORGPt. Par exemple, une session extraordinaire de la Commission du Thon de l'Océan Indien s'est tenue en février 2023 avec comme vocation "d'adopter une mesure de conservation et de gestion des DCP" (ancrés et dérivants). Bien qu'ils semblent au cœur des débats, la limitation de leurs impacts n'en est pas moins difficile et les débats quant à leur gestion semblent refléter des tensions plus profondes entre pays. La session extraordinaire de la Commission, si elle a permis l'adoption d'une mesure de gestion sur les DCP ancrés, n'a pas permis l'adoption de mesure sur les DCP dérivants: bien qu'ayant été adoptée au vote, la Resolution 23/02 n'est plus contraignante depuis le 08/08/2023 suite à l'objection de 11 pays. Les impacts des DCPd sur les populations de thons sont réels et ne doivent pas être minimisés. L'état des stocks de thons tropicaux dans l'océan Indien montre qu'afin de tendre vers une gestion durable de cette ressource, il est nécessaire de dépasser ces tensions et de tendre vers une meilleure coopération entre acteurs qui en dépendent. Les théories développées sur la gouvernance durable des ressources communes et les principes de conception d'institutions permettant une exploitation durable pourrait apporter de nouveaux éléments (voir Ostrom 2008b; Stern 2011). Leur application à la gestion des thons dans l'océan Indien, à défaut d'apporter des solutions toutes faites, peut permettre de tendre vers une exploitation plus durable de ces espèces.



Chapter 1

General introduction

1.1 Tuna fisheries

Aquatic food plays a key role in food security and nutrition, providing 17 % of animal protein worldwide and over 50 % in some countries (FAO 2022). In 2020, the production of fisheries and aquaculture was 214 Mt, with 600 million people (including subsistence and secondary sector workers) depending on it for their livelihood (FAO 2022). Among this, marine capture fisheries represented 78.8 Mt, using 7,500 different wild species of fish and aquatic invertebrates (FAO 2022; IPBES 2022b). However, fisheries resources are declining, the main driver of this decline being direct exploitation, followed by land- and sea-based pollution and sea-use change, including the development of coastal infrastructures (IPBES 2019). In 2019, only 64.6 % of fishery stocks were in sustainable levels, even though 82.5 % of landings (in weight) came from sustainable stocks (FAO 2022).

Tunas and tuna-like species are of major commercial interest worldwide and are no exception to this general decline of exploited fish abundance. Around 8 Mt of tunas are captured each year, representing 10 % of total marine capture production (FAO 2022) and an end value of 41 billion US\$ in 2018 (McKinney et al. 2020). Among these 8 Mt, seven species of tuna represented 5.1 Mt of capture per year in 2017-2021: 3 species of bluefin tuna (*Thunnus thynnus*, *T. orientalis* and *T. maccoyii*), albacore (*T. alalunga*), yellowfin tuna (YFT, *T. albacares*), bigeye tuna (BET, *T. obesus*), and skipjack tuna (SKJ, *Katsuwonus pelamis*; ISSF 2023). The three last species (YFT, BET and SKJ), classified as tropical, represent around 60 % of the 8 Mt caught yearly: 2.90 Mt, 1.52 Mt and 0.40 Mt of SKJ, YFT and BET respectively. At the global scale, 61 % of exploited tuna stocks are not overfished (the biomass of the stock is above the biomass leading to the Maximum Sustainable Yield – B_{MSY}) and 78 % of them are not facing overfishing (the fishing mortality is below the fishing mortality rate that produces the MSY – F_{MSY}). Tunas are fished in all tropical and temperate oceans, with the major fishing ground being the Western and Central Pacific Ocean (noted WCPO, 51 % of the global catch of tuna), followed by the Indian Ocean (IO, 22 %), the Eastern Pacific Ocean (EPO, 13 %) and the Atlantic Ocean (AO, 11 %; ISSF 2023).

Several fishing gears are used to target tunas, but more than half the yearly catch comes from purse-seine fleets (66 %). The rest is caught by longline (9 %), pole-and-line (also called baitboat, 7 %) and gillnet (4 %) fisheries, with the 14 % remaining being caught by other gears such as *e.g.* handline or troll line (ISSF 2023). Concerning tropical tunas, the vast majority of SKJ and YFT is caught by purse-seine vessels, while BET are caught equally by longline and purse-seine (ISSF 2023). Industrial purse-seine (PS) fisheries targeting tropical tuna started to develop in the late 1950s in the EPO, followed by the AO and the WCPO in the late 1960s and later, in the 1980s in the IO (IOTC 2022e). PS fishing is based on the use of a surrounding net, called seine, which hangs vertically in the water and is deployed from a boat, using a skiff to maintain the net while the boat surrounds the fish school (Figure 1.1). The bottom of the seine is then closed, the net tightened and the fish are pulled out of the water onto the deck using a brail. Tropical tuna caught by PS vessels feeds the canning market, with tuna mainly being canned in southern countries (*e.g.* Thailand, Ecuador, Mauritius, Seychelles, Guillotreau et al. 2023a) and mainly exported to the United-States and Europe (55 % of canned tuna imports in 2006, Miyake et al. 2010, Figures 59 & 60).

Tuna fisheries in the Indian Ocean has a number of specific features compared with other tropical oceans. Of the 1.1 Mt of tuna caught in 2020, 45 % were caught by PS fisheries (percentage over 2016-2020, compared to 66 % globally), followed by gillnet and baitboat (IOTC 2022d; ISSF 2022; ISSF 2023). The SKJ stock in the IO is not overfished nor subject to overfishing, but the BET and YFT stocks are both overfished and subject to overfishing (IOTC 2022a; IOTC 2022c; IOTC 2022b). Main countries targeting tuna are Spain (15 % of the catch, exclusively PS), Indonesia (14 %, half of which by small-scale PS) and Maldives (13 %, with

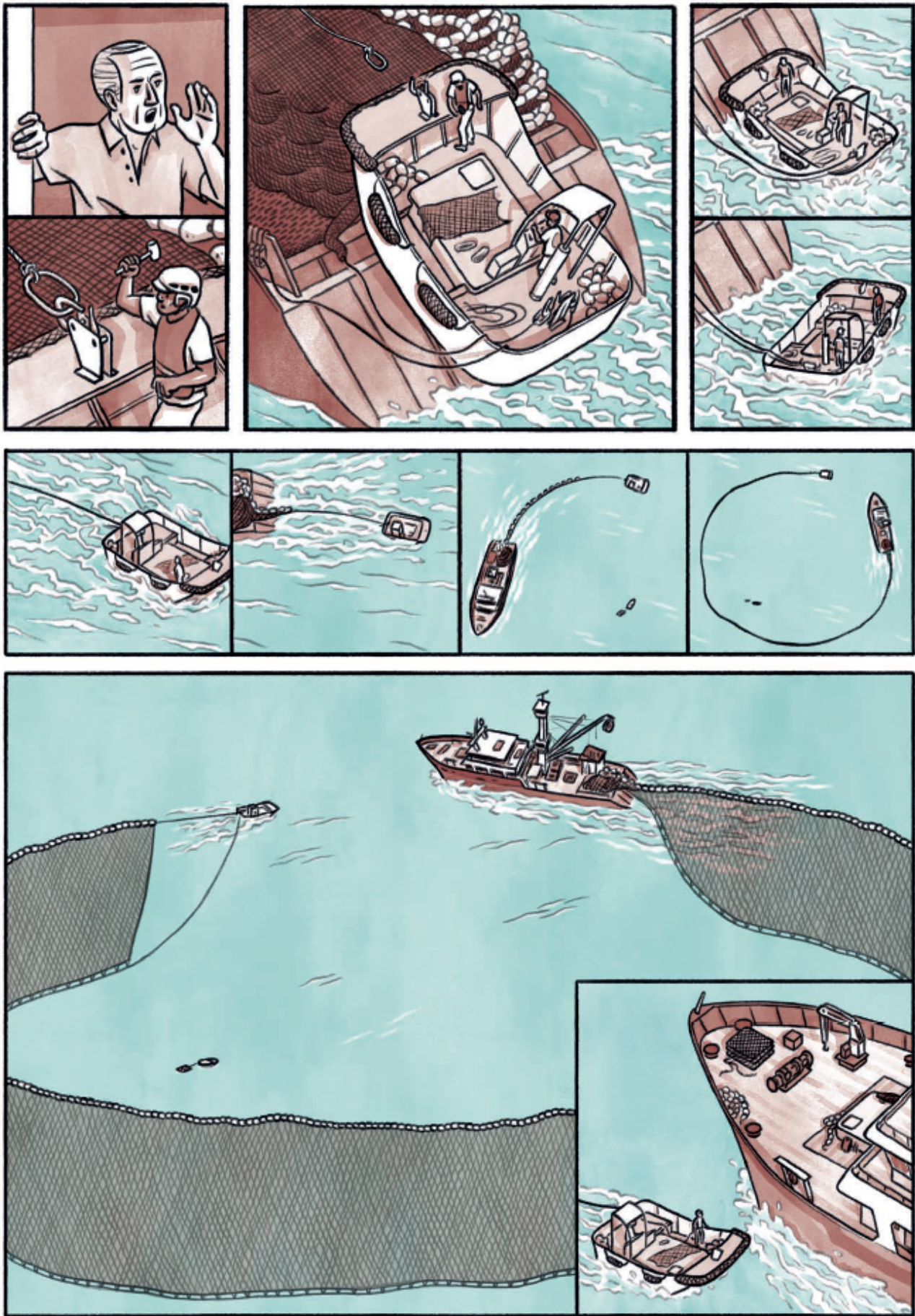

Figure 1.1: Illustration of a tropical tuna purse-seine set. Thomas Vieille / Manon Airaud ([MetMut](#) and [MANFAD](#) projects).

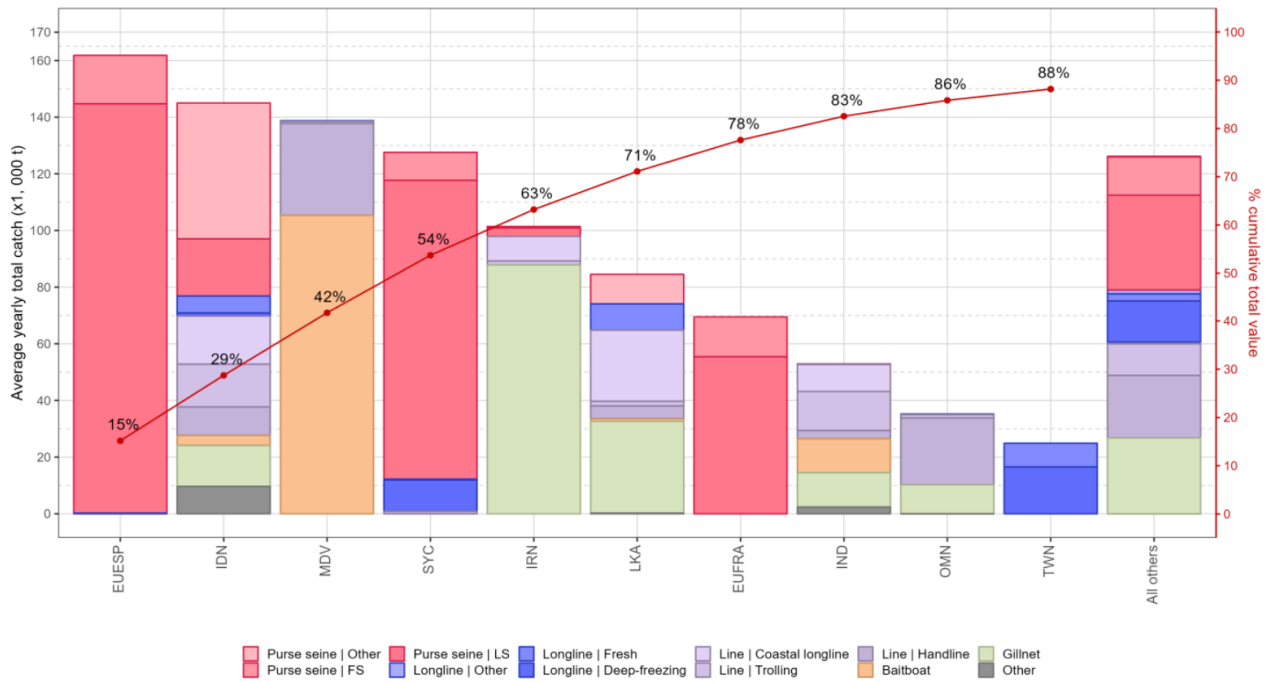

Figure 1.2: Mean annual tuna catch per country in the Indian Ocean in 2016-2020, with indication of cumulative catches. FS: free-swimming schools; LS: schools associated with floating objects. Baitboat is also called pole-and-line. EUESP: Spain; IDN: Indonesia; MDV: Maldives; SYC: Seychelles; IRN: Iran; LKA: Sri Lanka; EUFRA: France; IND: India; OMM: Oman; TWN: Taiwan. Extracted from IOTC 2022d (Figure 6).

pole-and-line and line, Figure 1.2). The industrial PS fisheries that operate in the Western IO developed in the 1980s, later than in other oceans, following exploratory fishing trips of Japanese, French and Spanish purse seine vessels in 1979 to 1983 (Marsac et al. 2014). In 1984, a "massive exodus" of purse seine vessels from the AO occurred, with the PS catch increasing from less than 10 % of the total catch in the IO in 1982 to 15 % in 1983 and around 40 % in 1984 (Marsac et al. 2014; IOTC 2022d). Since then, the major tuna PS fleets are registered in Spain, Seychelles, France and Mauritius, and belong to French and Spanish companies. Main canning factories, transforming most of the tuna caught by industrial PS vessels in the IO, are located in Port-Louis (Mauritius) and Port Victoria (Mahé, Seychelles; Miyake et al. 2010; Marsac et al. 2014).

Tropical tuna fisheries are managed by tuna Regional Fisheries Management Organizations (tRFMOs). The tRFMO in the IO is the Indian Ocean Tuna Commission (IOTC). The objectives of the IOTC are "to [ensure], through appropriate management, the conservation and optimum utilisation of stocks [...] and [encourage] the sustainable development of fisheries based on such stocks" (IOTC website, URL: <https://iotc.org/about-iotc>). To meet these objectives of sustainability, the IOTC adopts Conservation and Management Measures (CMM), which apply to the member countries of the Commissions. These CMM are to be adopted "on the basis of scientific evidence". Hence, there is a need for scientific research and expertise to inform decision-making institution such as the IOTC and to improve the management of tropical tuna stocks.

1.2 Biology of tuna

Tunas (Scombridae) are pelagic migratory fish, widely spread on all oceans. Among tunas, the Thunnini tribe comprises 18 species of 4 genera (8 *Thunnus*, 5 *Auxis*, 4 *Euthynnus* species and *Katsuwonus pelamis*, Froese and Pauly 2023). These species are social opportunistic predators,

most of them forming schools and feeding on small fish, crustaceans and cephalopods. Among tunas and tuna-like species, SKJ, YFT and BET are widely spread on all of the world's tropical oceans although having differing life-history traits.

SKJ is the smallest of the three species, with a maximum fork length (FL) of 110 cm. The length at which 50 % of SKJ individuals are mature (L_{50}) ranges from 38 to 45 cm FL (Grande et al. 2014; Ashida and Horie 2015; Froese and Pauly 2023). Yellowfin and bigeye tunas are bigger (maximum length of 239 and 250 cm FL respectively), with a slower life cycle (Artetxe-Arrate et al. 2021). Their L_{50} are of 75 - 140 and 100 - 125 cm FL, for YFT and BET respectively (depending on the ocean and the criteria used to consider an individual as mature; Farley et al. 2006; Zudaire et al. 2013; Schaefer and Fuller 2022; Froese and Pauly 2023). SKJ is highly fecund, with a fast growth, making it considered as more resilient to fisheries than BET and YFT (Davies et al. 2014b). YFT and SKJ mainly occur in shallow waters, often not being found below 260 m depth. Large BET on the other hand can descend to much higher depths and tolerate lower depth and oxygen concentrations (Arrizabalaga et al. 2015; Artetxe-Arrate et al. 2021), which allows them to dive to more than 300 m on a daily basis and sometimes as deep as 1,500 m depth (Schaefer and Fuller 2010; Froese and Pauly 2023). For example, in the Indian Ocean, adult YFT preferred habitat was described to be depths of 100 to 180 m at temperatures of 15-18°C, while adult BET's preferred habitat were depths of 240-280 m and water temperatures of 12-14°C (Artetxe-Arrate et al. 2021).

1.3 Tuna associative behavior

Many pelagic fish species, such as tropical tunas, are known to associate with floating objects (FOBs, Fréon and Dagorn 2000; Castro et al. 2002), which are a natural component of their habitat. Natural floating objects (NLOGs) are mainly parts of trees, originating from rivers and coastal forests, floating out in the ocean (Thiel and Gutow 2005). The first historical mention of the associative behavior of pelagic fish under floating objects was about dolphinfish (*Coryphaena hippurus*), stating that "Hippurus, when they behold anything floating in the waves, all follow it, closely in a body" (Oppian 200 AD). If this associative behavior has been known for almost 2 millennia, the reasons underlying it are still largely unknown. The first hypotheses to explain this behavior were also formulated by Oppian, who stated that dolphinfish like to rub their backs against the reeds and that pilot fish "equally [are] set upon desire for shade" (Oppian 200 AD). Since the 1980s, numerous hypotheses were formulated to explain species associative behavior. In a review on pelagic species associative behavior, Fréon and Dagorn 2000 listed six non mutually exclusive hypotheses formulated to explain the associative behavior of tuna with floating objects, among which two are considered as most probable.

First, the *shelter from predators* hypothesis stipulates that tuna would use FOBs as a protection against predators. However, Fréon and Dagorn 2000 reject the hypothesis for tropical tunas, arguing that floating objects are often too small and tuna too numerous to take shelter under them. Then, the *concentration of food supply* suggests that FOBs aggregate small fish that would be predated by tuna. Again, the authors argue that no evidence was found suggesting the presence of enough prey in the vicinity of FOBs to sustain large amounts of tunas. Several evidence, based on stomach content analysis, also suggest that tuna could be fasting when they are associated with FOBs (Marsac et al. 2000; Ménard et al. 2000b; Hallier and Gaertner 2008). However, this evidence have to be taken with caution because tunas which are not associated with FOBs (in free-swimming school, noted FSC) are often detected and caught while feeding and, except in Hallier and Gaertner 2008, tunas were not sampled at the same time of the day when in FSC and when FOB-associated.

According to the *spatial reference* hypothesis, tunas would use FOBs as reference points, to orient themselves in an otherwise unstructured pelagic environment (Klimley and Holloway

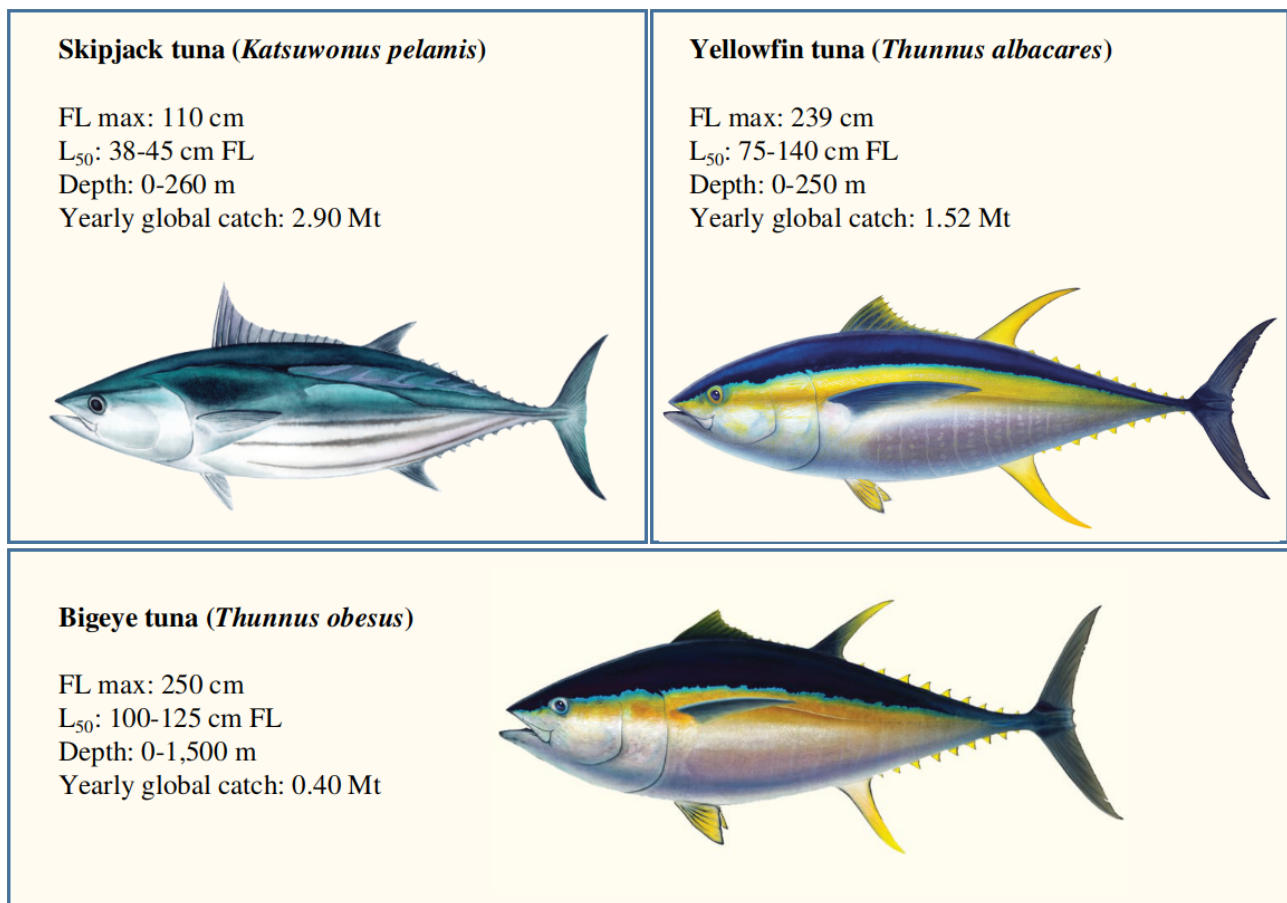

Figure 1.3: Illustration of the three main tropical tuna species targeted by fisheries. Yearly global catch (2017-2021 average) from ISSF 2023, other data from Froese and Pauly 2023. Bigeye and yellowfin tuna illustrations from Nick Mayer (URLs: <https://www.anglersjournal.com/adventure/bigeye-tuna-with-an-attitude> ; <https://www.anglersjournal.com/saltwater/yellowfin-tuna> ; <https://www.nickmayerart.com/>). Skipjack tuna illustration from <https://swimnut.wordpress.com/2015/12/01/swimming-fins/skipjack-tuna/>.

1999). If this hypothesis could be relevant to fixed floating objects, its generalization to drifting FOBs seems difficult. The last hypothesis reviewed by Fréon and Dagorn 2000 and considered as unlikely by the authors, is the *comfortability stipulation* hypothesis which suggests that tuna would stay near FOBs to rest after foraging in the area (Batalyants 1993). This hypothesis, based on evidence that tuna tend to have more empty stomachs when associated than when caught in FSC (Marsac et al. 2000; Ménard et al. 2000b; Hallier and Gaertner 2008), does not indicate why tuna would stay around FOBs rather than elsewhere. Hence, to date, two main hypotheses are retained to explain the associative behavior of tuna with FOBs: the *indicator-log* and the *meeting-point* hypotheses.

The *indicator-log* hypothesis posits that tuna would associate with FOBs to find rich areas (Hall 1992; Castro et al. 2002). NLOGs are mainly parts of trees and they would indicate rich areas because they originate from rivers and can accumulate in rich frontal zones (Castro et al. 2002; Hallier and Gaertner 2008). The associative behavior would then result from an evolutionary process where tuna uses FOBs to stay in rich waters. This hypothesis is based on the fact that tuna would detect FOBs more easily than they would detect preys. To date, no evidence was found that support or reject this hypothesis, nor evidence was found demonstrating higher FOBs densities in areas considered as rich for tunas.

The *meeting-point* hypothesis states that pelagic species would associate with FOBs to facilitate school formation (Fréon and Dagorn 2000). Provided that tuna can detect floating objects from further away than they can detect other schools, associating with floating objects could increase the probability to encounter other conspecifics. Schooling behavior can be seen

as a trade-off between, on the one hand, increasing protection against predators, encounters of reproduction partners, foraging and swimming efficiency and, on the other hand, increasing detection by predators and inter-individual competition (Rubenstein 1978; Ioannou 2017; Maury 2017). If this hypothesis was first formulated almost 30 years ago, in Dagorn 1995, only one study provided some supporting evidence. Soria et al. 2009 used passive acoustic tagging on a small pelagic fish species, the bigeye scad (*Selar crumenophthalmus*) and found that the simultaneity of departures was greater than the simultaneity of arrivals, suggesting that bigeye scads would use FOBs as meeting points to facilitate the formation of bigger schools. To date, no study was performed on tuna to assess the validity of the *meeting-point* hypothesis.

1.4 Use of tuna associative behavior by fishers

The first known mention of fishers taking advantage of fish associative behavior is in Oppian's *Halieutica*: Greek fishers used ship wrecks to facilitate the capture of dolphinfish (Oppian 200 AD). Several fisheries have used FOBs to facilitate the catch of fish for centuries, *e.g.* this is the case in the Maldives, where pole-and-line is used to target SKJ since the 12th century (Doumenge 2005). Fishers also deployed their own floating objects called fish aggregating devices (FADs) *i.e.* floating objects deployed to facilitate search and catch of fish (Taquet 2013). Mentions exist of FAD use in the Mediterranean Sea in the 14th century and in the 18th century in Malta (Taquet 2013). These FADs, which were first moored to the bottom are designated as anchored FADs (AFADs). Since the 1980s, AFADs use has strongly increased and it is viewed as an important tool to develop artisanal fisheries (Désurmont and Chapman 2000; Taquet 2013; Gillett et al. 2018; Jauharee et al. 2021).

Textbox 1: Drifting Fish Aggregating Devices structure

DFADs are often composed of a floating structure (the "raft") and a submerged structure (the "tails", Figure 1.4; Escalle et al. 2023a). Fishers often deploy an echosounder buoy with DFADs, which allow them to locate the object and get information on the associated tuna biomass (Lopez et al. 2014). DFAD design is highly variable and reflects a constant innovation from fishers. The raft contains elements to insure the DFAD buoyancy, such as bamboo, buoys, floats or drums. When fishers encounter a DFAD which does not pertain to them, they often switch the associated buoy with their own buoy. This has led the recent development of "stealthy" rafts, making DFADs harder to find by other fishers who do not have location information. The tails are done to anchor the DFAD in the water column to insure that they drift with currents and not with wind, and for attracting fish. They are composed of ropes or old seine nets, which can be tied in sausages or left free, and measure between 10-15 m to more than 100 m depending on the ocean (Dagorn et al. 2013b; Zudaire et al. 2019).

PS fisheries targeting tropical tuna also started to deploy their own FOBs, drifting FADs (DFADs), and to attach radio buoys to them in the 1980s, to facilitate the search and capture of tunas (Hall 1992; Ariz et al. 1999; Hallier and Parajua 1999; Marsac et al. 2014). Since then, there has been a sharp increase in the use of DFADs (Dagorn et al. 2013a; Gershman et al. 2015; Maufroy et al. 2017). DFADs are a highly efficient fishing tool that increases the catchability of tuna, leading PS fleets to extend their fishing zones and preferentially targeting FOB-associated schools (Lopez et al. 2014; Fonteneau et al. 2015; Lennert-Cody et al. 2018; Tolotti et al. 2022). In 2017-2021, more than 40 % of tuna caught globally by purse-seine vessels were caught on associated schools (ISSF 2023). During the last two decades, echosounder buoys have replaced radio buoys. Echosounder buoys transmit GPS data and estimates of aggregated biomass under instrumented FOBs directly to fishing vessels via satellite (Lopez et al. 2014).

These buoys are designated as "operational" when they are attached to a FOB and are tracked by one or several fishing vessels (IOTC 2019; ICCAT 2022).

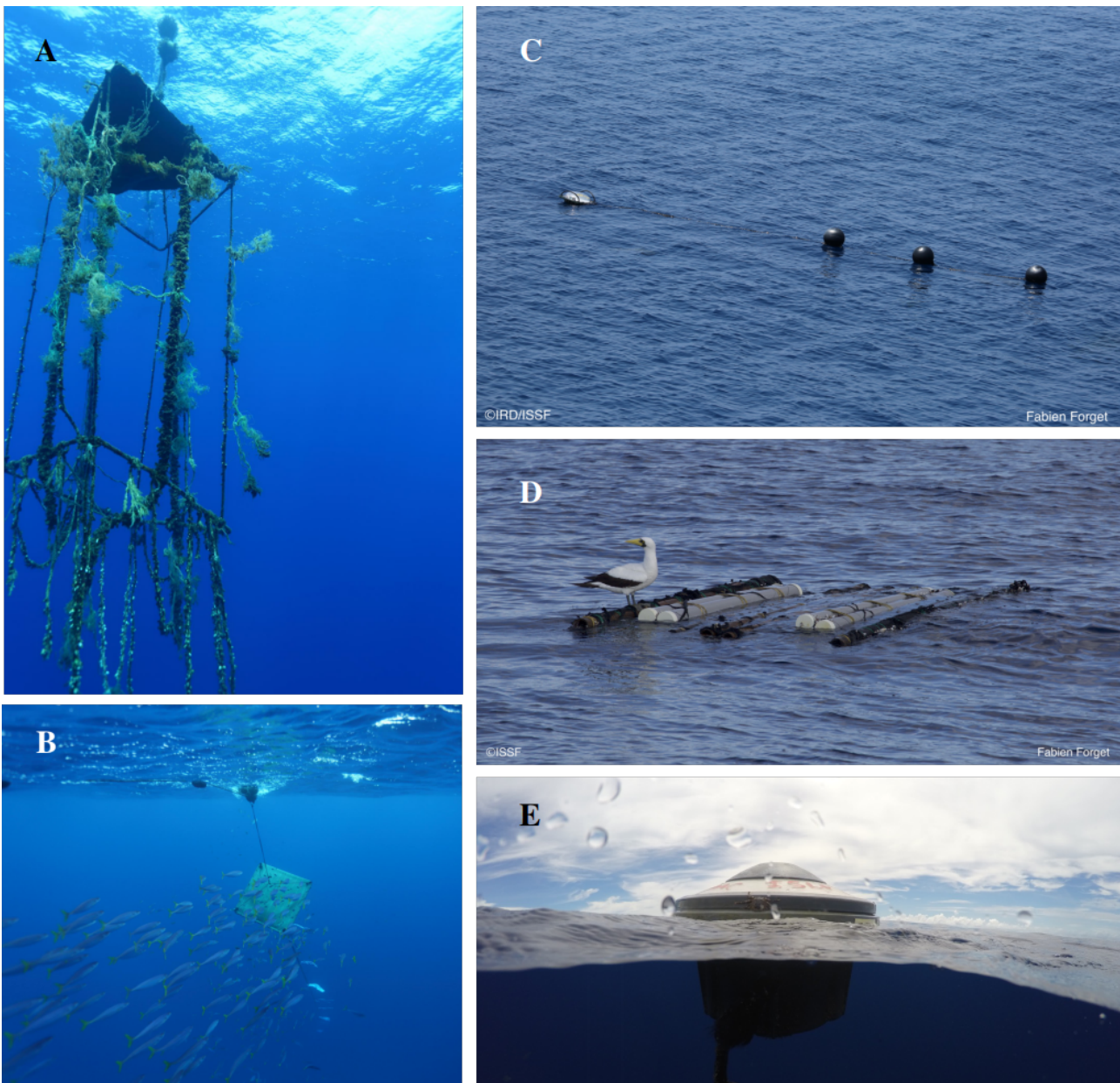

Figure 1.4: Pictures of Drifting Fish Aggregating Devices (DFADs). (A,B) Examples of sub-surface structures, (C,D) surface structures, and (E) associated echosounder buoy. Pictures: Fabien Forget, ©IRD/ISSF.

The last estimation of the global number of DFADs deployed yearly was performed by Gershman et al. 2015, who estimated between 81,000 and 121,000 deployment in 2013. Since then no global assessment was performed and evidence show different trends depending on the oceans. In the IO, Maufroy et al. 2017 demonstrated a four-fold increase in the number of operational buoys from 2,250 buoys in 2007 to 10,300 in 2013. But, after 2015, the number of DFAD deployments could have decreased again in the IO, with around 16,000 deployments declared in 2021 (but these declarations are probably underestimated and the IOTC Secretariat describes the dataset as "not fully accurate", IOTC 2022e). However, recently, tuna PS fleets in the IO have strategies relying almost exclusively on DFADs, with more than 85 % of tuna catch occurring on FOB-associated schools (IOTC 2022e). In the WCPO, where estimations are more reliable, no clear trend in the number of DFAD deployments could be detected and

between 30,000 and 40,000 DFAD deployments per year were estimated in 2011-2019 (Escalle et al. 2020). In the EPO, a clear increasing trend of DFAD deployments was observed from 2005 to 2021, reaching around 25,000 deployments in 2021 (Lopez et al. 2021). Finally, from 2007 to 2013 in the AO, Maufroy et al. 2017 estimated an even greater increase of the use of DFADs than what was observed in the IO (from 1,175 operational buoys in January 2007 to 8,575 in August 2013). To my knowledge, no recent estimation of the number of DFAD deployments exist in the AO. These different trends could be a result of CMMs adopted by the different tRFMOs. All four tRFMOs adopted measures to limit the number of operational buoys attached to DFADs, setting different limits per vessel (IATTC 2021: up to 340 depending on the vessel size, Res C-21-04; ICCAT 2022: 300 in Rec 22-01; IOTC 2023b: 250 in Res 23/02; WCPFC 2021: 350 in CMM 2021-01). As these limits relate to operational buoys and not to DFAD deployment, it is difficult to determine the actual contribution they make to the decrease/increase in the number of DFADs.

1.5 Impacts of Drifting Fish Aggregating Devices

The massive increase in the use of DFADs since the 1980s has several ecological impacts (Figure 1.5). We can classify these impacts into those on the environment/habitats and those impacting directly marine species. We can also differentiate DFADs impacts on non-target species and on tuna. Impacts on tuna are manifold, either through an increase of fishing mortality (which we will designate as *direct* impacts) or through other means (designated as *indirect* impacts).

1.5.1 Stranding, and pollution

First, a lot of DFADs are left adrift and end up stranding on coastal reefs or beaches, causing damage to coastal habitats. Most literature on the subject designate the events of DFADs ending up ashore as "beaching" events (Escalle et al. 2019b; Imzilen et al. 2021; Imzilen et al. 2022; Escalle et al. 2023b). However, as a beaching designates the action of a mobile animal or boat to actively move from the water to the beach, we will here use the term "stranding", which implies that the movement is passive. Imzilen et al. 2021 estimated that, after 2013, 15-20 % and 19-22 % of deployed DFADs stranded in the IO and the AO respectively. With a conservative estimate of 16,000 DFAD deployments per year in the IO (see Section 1.4, IOTC 2022e), this would represent between 2,400 and 3,200 stranding events per year in this ocean. In the WCPO, Escalle et al. 2019b estimated a much lower percentage of DFADs stranding, 5.8%, which would represent around 1,750 events per year (Escalle et al. 2020). In the whole Pacific Ocean, out of 2,199 stranding events recorded from 2006-2023 in 10 Pacific Island Countries and Territories, damage on coral reefs were recorded in 6.8 % of the case (Escalle et al. 2023b). These stranding events display a strong seasonal variability and hotspots can be observed, *e.g.* Papua New Guinea and Solomon Islands in the WCPO, Mozambique Channel, eastern and northern Madagascar and Maldives in the WIO (Escalle et al. 2019b; Imzilen et al. 2021). Several means of mitigating these stranding events have been studied. First, spatial management of DFAD deployments could allow to limit these numbers, by prohibiting deployments in areas/periods with a high-stranding risk (Imzilen et al. 2021). DFADs recovery programs could also be developed. For example, in the IO, 20 % of lost DFADs pass within 50 km of major ports, indicating that port-based programs could be effective in limiting the number of DFAD stranding events (Imzilen et al. 2022). Finally, the easiest way of limiting the number of stranding events would be through the limitation of the number of DFAD deployments. However, to date, tRFMOs adopted CMMs limiting the number of operational buoys (see Section 1.4), but did not limit the number of DFAD deployments. Only the IOTC introduced a

DFAD registry in the Resolution 23/02, which would allow the limitation of DFAD deployments, but most countries with PS fleets using DFADs objected to the Res. 23/02.

Another impact of DFADs is the marine pollution they provoke. Tens of thousands of DFADs are deployed yearly and a non-negligible percentage of them contributes to abandoned, lost or discarded (ADL) fishing equipment. In the IO and AO, Imzilen et al. 2022 found that more than 40 % of deployed DFADs drifted out of fishing grounds, becoming ALD fishing equipment. To limit this pollution, since 2019, tRFMOs have been encouraging the construction and deployment of biodegradable DFADs (IATTC 2021; ICCAT 2022; IOTC 2023b), which became mandatory within the WCPO in 2022 (WCPFC 2021; Escalle et al. 2023a). This encouraged modification of DFAD design seems to be slow, *e.g.* in the WCPO, in 2011-2019, only 2.3 % of DFADs were fully built with natural materials, 32.9 % with solely synthetic materials and the rest with a mix of the two in different proportions (Escalle et al. 2023a). Research efforts have been put into new entirely biodegradable designs, trying to develop new designs which are not too costly, have the same drifting and aggregating patterns as conventional DFADs and are made of only biodegradable materials (Moreno et al. 2023). Even though the best way of reducing DFAD-induced pollution seems to be the reduction of the number of deployed DFADs, some of these new designs, like the Jelly-FAD (Moreno et al. 2023), seem promising. However, no matter the materials used for the construction of DFADs, electronic devices that are associated to it, like echosounder buoys, will never be biodegradable.

1.5.2 Ghost fishing and bycatch

DFADs can also impact non-targeted pelagic species, through ghost fishing (via the entanglement in the nets that constitute their structure) and bycatch. They can provoke the entanglement of species such as skarks or turtles. Filmlalter et al. 2013 estimated the impressive figure of between 480,000 and 960,000 silky sharks (*Carcharhinus falciformis*) getting entangled yearly in the tails of DFADs in the IO alone. This potential impact is strongly tackled by tRFMOs, which promote the use of non- or low-entangling DFADs (IATTC 2021; WCPFC 2021; ICCAT 2022; IOTC 2023b). The IOTC and ICCAT prohibit the use of meshing materials both in the underwater and surface structure of DFADs since 2020 and 2021 respectively (Escalle et al. 2023a). The IATTC authorizes the use of low-entangling DFADs: mesh net can be used if the mesh size is small enough or, in the underwater structure, if the net is tied in the form of sausages (IATTC 2021; Escalle et al. 2023a). In the WCPO, DFADs have to be low-entangling since 2020 and shall be non-entangling starting 2024 (WCPFC 2021; Escalle et al. 2023a). However, even though the use of meshing materials is strongly limited in the WCPO, Escalle et al. 2023a found that the design of most DFADs deployed in 2011-2020 corresponds to DFADs with high entanglement risk, with only 11 % of over 145,000 DFADs not using netting in their construction. According to the authors, one of the main reasons why moving to non-entangling DFADs is so slow is because most materials used to build DFADs are re-used or low cost materials (*e.g.* old purse seine nets, bamboos, salt bags), when new materials are often not available locally (*e.g.* biodegradable ropes or canvas). Also, low-entangling DFADs (with netting materials but tied in sausages) can be subject to degradation while in the water and become entangling. While the risks of DFAD entanglement are taken into account by tRFMOs, the question of whether the number of entanglements has decreased over the last decade remains highly controversial.

DFADs also impact bycatch rates of industrial tropical purse-seine fisheries (Gilman 2011). The term "bycatch" can either designate the incidental catch of undersized target species and other non-target species, or the incidental catch of non-target species only (Dagorn et al. 2013b). Here, we opt for the latter definition focusing solely on non-target species. When compared with other fishing gears that target tuna, such as longline and pelagic gillnet, purse seine has

lower bycatch rates (Amandè et al. 2008; Gilman 2011), although estimates could be improved (Amandè et al. 2012). Yet, fishing on DFADs significantly increases purse seine bycatch rates compared to FSC. This increase results from a higher diversity in the species composition of FOB sets, relative to FSC sets, which includes sharks, rays, turtles, billfishes and other teleost fish (Bourjea et al. 2014; Torres-Irineo et al. 2014; Lezama-Ochoa et al. 2017; Lezama-Ochoa et al. 2018). Amandè et al. 2008, for example, estimated that bycatch in FOB-associated sets represented 26.6 t for every 1000 t of tuna caught, when it represented 2.4 t / 1000 t of tuna in FSC sets in the IO. The frequency at which different species are encountered at DFADs and eventually become bycatch varies greatly (Hall and Roman 2013). In the EPO, common dolphinfish (*Coryphaena hippurus*) was estimated to be caught in around 80 % of the DFAD sets while the critically endangered oceanic whitetip shark (*Carcharinus longimanus*) was present in around 15 % of the DFAD sets (Hall and Roman 2013). Although less frequently caught, endangered and biologically sensitive species like the oceanic whitetip shark tend to receive more attention and mobilize further management efforts. The fragile state of elasmobranch populations as a result of the increasing fisheries-induced mortality across their range is well documented (Dulvy et al. 2008; Worm et al. 2013). Even if purse seine is not the main source of fishing mortality, any augmentation in fishing pressure on threatened species poses an important ecological risk. These bycatch issues strongly call for an ecosystem-based fisheries management, which remains a challenge. Tuna-RFMOs have incorporated an ecosystem approach to fisheries management into their mandate but implementation is slow (Tolotti et al. 2022). For example, in 2017, the IOTC introduced a catch limit on YFT, to reduce the impact on its stock which was, and still is, both overfished and subject to overfishing (IOTC 2022c). This management measure made purse seine fleets switch towards a higher percentage of DFAD sets and extend their fishing grounds northward, which resulted in an increase of silky shark bycatch by 18 % (Tolotti et al. 2022).

1.5.3 Direct ecological impacts on tuna

DFADs also have a number of impacts on target species (tropical tunas), some of which are scientifically proven and others still the subject of debate (Figure 1.5). In this thesis, I will separate these impacts into two categories: (1) the impacts on tuna populations related with an increase of fishing mortality induced by DFADs (called *direct* impacts) and (2) the impacts not related to fishing mortality and induced by the sole presence of DFADs at the ocean's surface (called *indirect* impacts).

In terms of direct impacts, the use of DFADs increases purse seine fishing efficiency and hence can increase fishing mortality of tropical tunas (Bromhead et al. 2003). FSC detection by purse seine vessels relies mainly on the detection of surface activity caused by tunas or the presence of birds. FSC targeted by purse seine vessels are often eating and therefore on the move, which is not the case for FOB schools. As a result, the success rate associated with FOB school fishing is much higher than that associated with FSC (96 % *vs* 81 % in Dagorn et al. 2013b, 90 % *vs* 50 % in Basurko et al. 2022 and 96 % *vs* 80 % in the AO and 94 % *vs* 58 % in the IO in Escalle et al. 2019a). DFAD fishing improves purse seine fleets yield and also lead to an expansion of their fishing grounds (Taquet 2013; Tolotti et al. 2022). For example, in the IO, an increase in the proportion of DFAD sets by the French PS fleet led them to increase their fishing effort further North, in the Arabian Sea (Tolotti et al. 2022). This expansion of PS fishing grounds is supported by the fact that these vessels consume more fuel when targeting DFAD schools than when targeting FSC (Parker et al. 2015; Chassot et al. 2021; Basurko et al. 2022). Since the 2010s, DFADs are equipped with echosounder buoys, giving fishers information on the location of DFADs and on an estimation of the associated biomass. Fishing on equipped DFADs also impacts the spatial distribution of fishing effort. In the WCPO, Tidd et al. 2017

demonstrated that fishing on DFADs decreased the patchiness of the fishing effort, compared to fishing on FSC. Hence, DFAD fishing would increase an apparently random behavior of the fleets, which would reflect the use of echosounder buoys giving remote information to fishers. Instead of staying in areas with high tuna abundances to target FSC, or to fish in areas with known presence of NLOGs, the use of DFADs would allow to target tuna in areas devoid of NLOGs but that are favorable for tuna aggregations. The use of these echosounder buoys led to an even greater expansion of purse seine fishing grounds than DFADs alone (Lopez et al. 2014; Tidd et al. 2017). Finally, echosounder buoys increased fishing efficiency: if it had no effect on the set success rate, the use of echosounder buoys was demonstrated to increase the catch per set by 10 % in the IO (Wain et al. 2021).

Then, DFADs use by PS vessels changes species catch proportion and increases the catch of juvenile YFT and BET. Globally, when fishing on FSC, the catch of tropical tuna is composed of 63 % of SKJ, 35 % of YFT, and 2 % of BET. DFAD catch is composed of more SKJ (75 %), less YFT (16 %) and more BET (9 %; Dagorn et al. 2013b). These proportions vary depending on the ocean, *e.g.* in the IO, DFAD catch is composed of 67 % SKJ, 25 % YFT and 8 % BET, and FSC catch of 22 % SKJ, 72 % YFT, 6 % BET (Dagorn et al. 2013b). Hence, fishing on DFADs increases the proportion of caught SKJ and decreases the proportion of large YFT. In the IO, Guillotreau et al. 2011 demonstrated that, all other things being equal, raising the proportion of DFAD fishing by 1 % would increase SKJ catch by 1.3 % and decrease large YFT catch by 1.7 %. As SKJ spawns all year round and has a faster life cycle than YFT or BET, DFAD fishing could be considered as a way to target more resilient species. However, despite decreasing the proportion of large YFT, DFAD fishing increases juvenile YFT and BET catch (Bromhead et al. 2003; Davies et al. 2014b). YFT, BET and SKJ captured at DFADs have a mean FL of around 50 cm (IOTC 2022e). If 50 cm SKJ are often mature individuals, YFT and BET of that size are juveniles (see Section 1.2).

This facilitation of tuna search and catch by DFADs and associated technologies could result in overfishing and in a potential loss of spawning capacity (by catching smaller fish which have not had time to reproduce; Davies et al. 2014b). Although these impacts are known to be real, it is difficult to characterize their extent. YFT and BET stocks are overfished and/or subject to overfishing in several oceans, but it is difficult to assess the role of DFADs. First, no clear relationship exists between the magnitude of the catch on DFADs and whether a stock is overfished (Davies et al. 2014b). This is probably due to the fact that these species are targeted by many other gears, which can also participate to the overfishing. In the IO, where both YFT and BET are overfished and subject to overfishing, PS fisheries represented 33.6 % of YFT catch in 2017-2021, the rest being targeted mainly by line (35.4 %) and gillnet (18.3 %; IOTC 2022c), and 41.7 % of BET was caught by PS, followed by longline (37 %) and line (13.5 %; IOTC 2022a). Even though it is difficult to determine the extent of DFAD direct impacts, there is an urgent need for management measures reducing fishing mortality for YFT and BET in some oceans. Still in the IO, despite the depleted state of the stocks, the catch of YFT is well above the Maximum Sustainable Yield (MSY). The Total Allowable Catch (TAC), set to reach the MSY, was of 349,000 t in 2020, when 434,383 t of YFT were caught (IOTC 2022c). Also, the catch of BET was of 94,803 t in 2021 and will need to decrease to reach the recommended TAC in 2024 (80,583t; IOTC 2022a).

1.5.4 Indirect ecological impacts on tuna

DFAD impacts on tropical tuna can also be indirect, *i.e.* they do not result from an increase in tuna fishing mortality caused by DFADs. It is difficult to know the extent of indirect DFAD impacts on tuna, especially at the population level, but these potential impacts are numerous and could worsen already existing direct impacts.

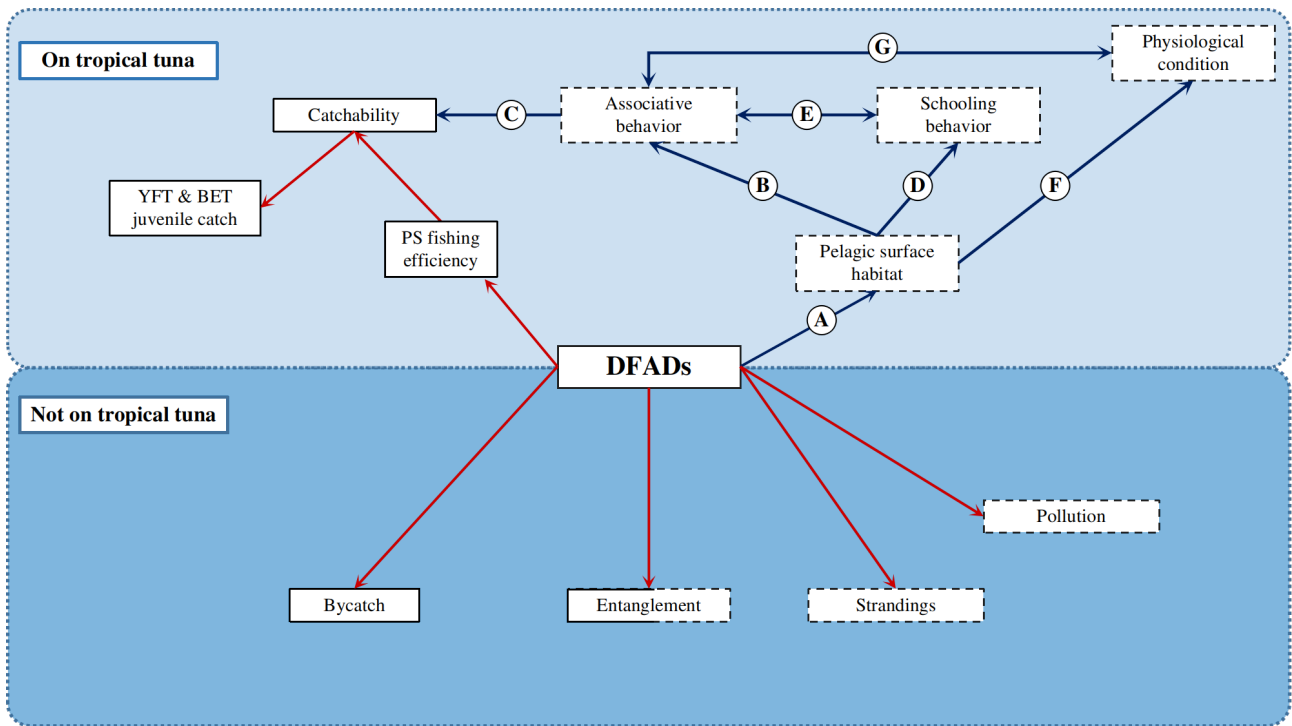

Figure 1.5: Conceptual scheme of the ecological impacts of Drifting Fish Aggregating Devices. *Direct impacts* (framed by a continuous line) are defined as impacts inducing an increase of fishing mortality. *Indirect impacts* (framed by a discontinuous line) are defined as those which are not related with fishing mortality. Entanglement can be considered as direct, if DFADs are considered as active fishing gears (as in Hanich et al. 2019), or indirect. Blue arrows with letters are relationships assessed during this thesis, red arrows were not explored. Double arrows mean that the two processes can influence each other.

First, DFADs induce modifications of tuna surface habitat, by impacting the density and distribution of floating objects (Dagorn et al. 2013a; Phillips et al. 2019a; Dupaix et al. 2021a). As developed in Section 1.4, well established and reliable numbers of DFAD deployments are missing in the IO and AO. If DFAD deployments are well estimated in the Pacific Ocean, the extent to which these deployments have modified the distribution and observed density of FOBs regionally still need to be further assessed. Prior to the development of this thesis, only two studies compared the distribution of DFADs with that of NLOGs (considered as the natural pristine state of the pelagic surface habitat). Dagorn et al. 2013a compared data from observers onboard French purse seine vessels in 2007-2008 and found that the number of floating objects had at least doubled in the whole WIO, being multiplied by 20 to 40 in some areas. The deployment of DFADs also modified the distribution of FOBs, changing the areas where the highest densities were observed. The same results were observed in the WCPO, relying on observers data and Lagrangian simulations, where DFADs caused the multiplication of highest FOB densities by around four (Phillips et al. 2019a). Although these habitat modifications are poorly characterized, they can have several impacts on tuna behavior, which could ultimately impact their fitness.

Habitat modifications induced by DFADs can have behavioral and/or behaviorally mediated impacts on tropical tuna. Pérez et al. 2020 demonstrated with passive acoustic tuna tagging data in arrays of AFADs, that an increase of AFAD density increases the proportion of their time that tuna spend associated. Even though differences in behavior may be observed between AFADs and DFADs, Dagorn et al. 2010 argue that both types of FADs alter the natural environment and, because AFADs are more easily accessible, they should be used to assess indirect impacts of DFADs on tropical tuna. DFADs could disturb the associative dynamics of tropical tuna with floating objects, which could ultimately impact their fitness. Based on the

meeting-point hypothesis (tuna associate to FOBs to facilitate school formation, Section 1.2; Fréon and Dagorn 2000), one can formulate another potential indirect impact of DFADs on tuna behavior. By increasing FOB density, DFADs could disperse tuna among FOBs, affecting their schooling behavior and reducing the size of free schools (Sempo et al. 2013; Capello et al. 2022).

Textbox 2: The *ecological trap* theory

The *ecological trap* theory was first formulated by Dwernychuk and Boag 1972. Studying the reproductive success of several duck species nesting in association with gulls (*Larus californicus* and *L. delawarensis*) in Miquelon Lake, Alberta, they demonstrated that the close association of the duck's nesting site with gulls' nesting sites protected it from the attacks of egg-eating birds. However, after hatching, gulls ate ducklings, strongly reducing survival, which declined to zero when the number of nesting gulls in the vicinity approached 500 pairs. The authors argue that ducks would select nesting sites based on the presence of gulls because the most abundant larids nesting historically in Miquelon Lake were common terns (*Sterna hirundo*), which offer the same egg protection than gulls, without eating the ducklings afterwards.

Efforts to theorize ecological traps took place in the early 2000s and several non-exclusive definitions can be given. Battin 2004 defines an ecological trap as a "low-quality habitat that animals prefer over other available habitats of higher quality". The "low-quality habitat" in Dwernychuk and Boag 1972 being nesting sites with the presence of nesting gulls, compared to other nesting sites without gulls. The idea of "cues" that individuals use to select the habitat (the presence of nesting larids in Dwernychuk and Boag 1972) is also important: in an ecological trap, these cues were correlated with habitat quality but are not anymore (Schlaepfer et al. 2002; Patten and Kelly 2010; Fletcher et al. 2012). Some authors consider that the cue-habitat correlation has to be broken due to a change of anthropic origin (Schlaepfer et al. 2002; Gilroy and Sutherland 2007), when others consider that ecological traps can occur without any anthropic influence (Robertson and Hutto 2006; Swearer et al. 2021; Teske et al. 2021). Hence, to demonstrate an ecological trap, one needs to demonstrate that (1) individuals prefer a given habitat over other available ones and (2) this given habitat is associated with a decrease of fitness. This theory, formulated at the individual level can then be generalized in terms of its population-level effects, more relevant for management, by considering that an ecological trap occurs when preferred habitat are of sufficiently low quality to cause population declines (Hale and Swearer 2016).

While this concept has been proposed regularly in the face of human-induced environmental modifications, very few studies have empirically demonstrated the existence of such traps (Hale and Swearer 2016; Swearer et al. 2021). In a systematic literature review on ecological traps, Hale and Swearer 2016 found that such traps were demonstrated in less than 23 % of the studies. In the marine environment, out of 518 studies assessing the potential of human-induced environmental changes to act as ecological traps, only 3.4 % (18 studies) combined experimental tests of habitat preference and fitness estimates that would provide the strongest evidence to assess an ecological trap (Swearer et al. 2021). Of these 18 studies, six found evidence consistent with an ecological trap.

More than twenty years ago, the massive increase in the number of deployed DFADs in the oceans also led scientists to hypothesize that DFADs could act as an *ecological trap* for tropical tuna (Marsac et al. 2000; Hallier and Gaertner 2008). An ecological trap occurs when individuals make poor habitat choices when they are misled by cues that are no longer correlated with habitat quality (Textbox 2; Battin 2004; Gilroy and Sutherland 2007). This poor habitat selection leads to a reduction of individual fitness, which can lead to population level impacts. The ecological trap hypothesis applied to DFADs and tuna relied on the *indicator-log* hypothesis (tuna associate with NLOGs because they are indicators of rich areas, Section 1.2; Marsac et al. 2000; Castro et al. 2002; Dagorn et al. 2010). By impacting the density and distribution

of FOBs, the deployment of DFADs could retain or transport individuals in areas that are ecologically unsuitable for them, which could ultimately impact tuna populations (Marsac et al. 2000; Fonteneau et al. 2013).

One of the findings that led to the formulation of the ecological trap hypothesis is the fact that FOB-associated tuna are often in lower physiological condition than FSC tuna (Marsac et al. 2000; Ménard et al. 2000b; Hallier and Gaertner 2008; Zudaire et al. 2014; Ashida et al. 2017). Marsac et al. 2000 and Hallier and Gaertner 2008 compared the thorax girth (body width divided by fork length) of SKJ and YFT caught at DFADs to those caught in FSC and found that DFAD-associated tuna were in lower condition than FSC tuna in the IO and the AO. Similar results were found in the WCPO, when comparing the relative condition factor of SKJ (which measures the deviation of an individual to the mean weight at length; Ashida et al. 2017). Robert et al. 2014a found similar results in an area (Mozambique Channel, WIO) rich in NLOGs and which had been only marginally modified by DFAD deployments at the time (Dagorn et al. 2013a). Hence, while tuna may be in a lower condition when associated with floating objects, the causality of this relationship has not been determined yet, *i.e.* we do not know if tuna associate with FOBs because they are in lower physiological condition or if their condition decreases following their association with FOBs.

1.6 Research questions

Despite the wide use of DFADs to facilitate tropical tuna search and catch, assessing their impact remains a major challenge. In the Indian Ocean, both YFT and BET are overfished and subject to overfishing (Section 1.1; IOTC 2022a; IOTC 2022c). DFADs could increase the pressure of anthropic activities on these populations and act as worsening factors. The main objective of this thesis is to characterize the impacts of DFADs on tropical tuna habitat, behavior and fitness. More precisely, I try to answer the following questions:

- a What are the impacts of DFADs on tropical tuna ? And specifically, what are their indirect impacts and how to characterize them?
- b DFADs modify the habitat of tropical tunas by modifying FOB distribution and density, but what is the extent of this modification?
- c Do other human activities significantly impact this component of tropical tuna habitat?
- d How does this habitat modification impact tuna behavior?
- e What potential direct and indirect impacts can behavioral changes have on tuna populations? And can these impacts be quantified?
- f How is tuna physiological condition, as a proxy of their fitness, impacted by DFAD induced habitat changes?
- g How will the reasons underlying tuna associative behavior determine the way DFADs can impact tuna populations?

To try and answer these questions, I divided this thesis into seven chapters. First, in **Chapter 2**, the current literature existing on indirect impacts of DFADs on tropical tuna is reviewed, trying to answer Question a. A special attention is given to the determination of the impacts which are well supported by scientific evidence and the ones that are characterized by a lack of converging scientific results.

Part I is focused on characterizing the modifications of the FOB component of tuna surface habitat:

-
- In **Chapter 3**, using data from observers onboard French purse-seine vessels, location data from echosounder buoys and Lagrangian simulations, I develop several indicators to characterize the extent of habitat modifications induced by DFADs (Question b, Figure 1.5A).
 - **Chapter 4**, using Lagrangian simulations, focuses on the impact of other human activities on the distribution of NLOGs, considered in previous studies as a pristine state of tuna surface habitat (Question c).

Part II focuses on the impact of DFADs on tuna associative behavior (Questions d & e):

- **Chapter 5** uses an individual-based model (Dupaix et al. 2023b), developed and validated in Pérez et al. 2022, to determine a general relationship between FAD density and the time YFT spend between two associations. This general relationship is then applied to the IO, to determine how DFAD induced habitat modifications impact tuna individual associative behavior which will in turn impact their catchability (Figure 1.5A,B&C).
- **Chapter 6** relies on echosounder buoys acoustic data and on a Random-Forest algorithm developed in Baidai et al. 2020b, to determine the impact of DFAD density on tuna aggregations and characterize the drivers of the associative behavior of tuna aggregation (Figure 1.5B,D&E).

Part III addresses the question of the impact of DFAD density on the physiological condition of tropical tuna:

- In **Chapter 7**, relying on a long-term time series of weight and length measurements of YFT in the WIO, I test the ecological trap hypothesis, formulated more than twenty years ago. Using the length-weight data, I calculate a condition indicator and determine the presence/absence of a decreasing condition trend concurrently with DFAD increasing use (Question f, Figure 1.5A&F).
- **Chapter 8** develops a mathematical framework to determine if the observed lower condition of tuna at FOBs is the cause or the consequence of their associative behavior. The consequences of the increased DFAD density in lights of these two hypotheses are then discussed (Question g, Figure 1.5B,F&G).

In the **Discussion** I review the results obtained in this thesis. The implications of these results for what we know about the causes of tuna associative behavior are discussed, as are their implications for the potential impacts of DFADs on tropical tuna. I also discuss the need to use the term *ecological trap* with caution when assessing the indirect impacts of DFADs on tropical tunas, as it may lead to other potential impacts being overlooked. Finally, I briefly discuss how the research performed on the governance of common-pool resources could be applied to tropical tuna fisheries in the IO and contribute to their sustainable exploitation.

Chapter 2

The challenge of assessing the effects of drifting fish aggregating devices on the behaviour and biology of tropical tuna

Publication

Dupaix, A., F. Ménard, J. D. Filmalter, Y. Baidai, N. Bodin, M. Capello, E. Chassot, H. Demarcq, J.-L. Deneubourg, A. Fonteneau, F. Forget, F. Forrestal, D. Gaertner, M. Hall, K. Holland, D. Itano, D. M. Kaplan, J. Lopez, F. Marsac, ... L. Dagorn (Under review). The challenge of assessing the effects of drifting fish aggregating devices on the behaviour and biology of tropical tuna. *Fish and Fisheries*. <https://hal.science/hal-04047298>.

2.1 Introduction

Many fish species are known to associate with floating objects (Castro et al. 2002; Fréon and Dagorn 2000), with the first known descriptions of fishers exploiting these associations dating from 200 AD in the Mediterranean Sea by the Roman author Oppian (cited in Taquet 2013). In particular, the use of floating objects to facilitate the capture of tropical tunas (skipjack SKJ – *Katsuwonus pelamis*; yellowfin YFT – *Thunnus albacares*; and bigeye BET – *T. obesus*), has undergone rapid expansion in recent decades, as a result of the growing importance of these floating structures to the strategy and efficiency of tropical tuna purse seine fleets (Dagorn et al. 2012; Fonteneau et al. 2000; Fonteneau et al. 2013; Leroy et al. 2013; Miyake et al. 2010). Since the onset of the tropical tuna purse seine fishery, fishers took advantage of the associative behaviour of tunas with floating objects and actively searched for natural floating objects to improve their catches (Greenblatt 1979; Hallier and Parajua 1999; Scott et al. 1999). Towards the end of the 1980s, fishers began to build and deploy man-made drifting fish aggregating devices (DFADs), and to attach radio buoys to locate them (Ariz et al. 1999; Hallier and Parajua 1999; Hall 1992; Scott et al. 1999; Lopez et al. 2014; Marsac et al. 2014; Moreno et al. 2007; Morón 2001; Stéquert and Marsac 1986). DFADs are commonly composed of a floating structure (such as a bamboo or metal raft with buoyancy provided by corks, etc.) and a submerged structure (made of ropes, old netting, canvas, weights, etc.). During the last two decades, radio buoys have been replaced by GPS buoys communicating via satellite directly with fishing vessels. In the last decade (2010-2020), most DFADs have been equipped with echosounder buoys, providing estimates of aggregated biomass (Lopez et al. 2014). Some fleets also use supply vessels to maintain their DFAD array and to inform the fishing vessels of tuna aggregations, allowing these fleets to manage more efficiently their DFAD stock (Arrizabalaga et al. 2001; Ramos et al. 2010). DFADs represent very efficient fishing tools that increased the catchability of tunas, leading purse-seine fleets to target preferentially associated schools and expanding their fishing grounds (Lopez et al. 2014; Fonteneau et al. 2015).

Over time, given the growing contribution of purse seine fleets to world tuna catches and the increasing importance of DFAD fishing in the strategy of purse seine fleets, managing DFADs has become a priority for all tuna Regional Fishery Management Organisations (tRFMOs). In this paper we will use “operational” or “active” buoys to designate buoys attached to a floating object (FOB) that are tracked by one or several purse seine fishing vessel(s). Tuna RFMOs set limits of the number of operational buoys (with the very first limit by the IOTC, Indian Ocean Tuna Commission, in 2015) to mitigate the different risks induced by the deployment and use of DFADs (most recent resolutions: IOTC 2023b; ICCAT 2022; ICCAT 2022; WCPFC 2021). Fishing at FOBs was demonstrated to increase by-catch rates, compared to fishing on free-swimming schools (Amandè et al. 2012; Escalle et al. 2019a), and to increase the proportion of small BET and YFT (IOTC 2022d). Other major DFAD-related measures concerned the design of these objects, following the discovery of sharks getting entangled in the netting composing the structure of DFADs (Filmlalter et al. 2013). Limiting the pollution induced by DFADs in the ocean is also in front of the agendas of tRFMOs, after realizing the large quantity of plastic used in DFADs and the large numbers of DFAD beaching events in sensitive coastal ecosystems (Escalle et al. 2019b; Imzilen et al. 2021; Imzilen et al. 2022). However, other impacts on tuna populations (unrelated to fishery vulnerability) and ecosystems may be induced by the increased presence of DFADs in their habitat (Marsac et al. 2000; Bromhead et al. 2003; Hallier and Gaertner 2008). Despite the limits on operational buoys, DFADs number in the water has increased (Dagorn et al. 2013a; Maufroy et al. 2017; Imzilen et al. 2021; Dupaix et al. 2021a). As such, while logs and branches have always been components of the habitat of tropical tunas (originating from rivers, mangroves or shorelines), the massive use of man-made DFADs has changed their habitat.

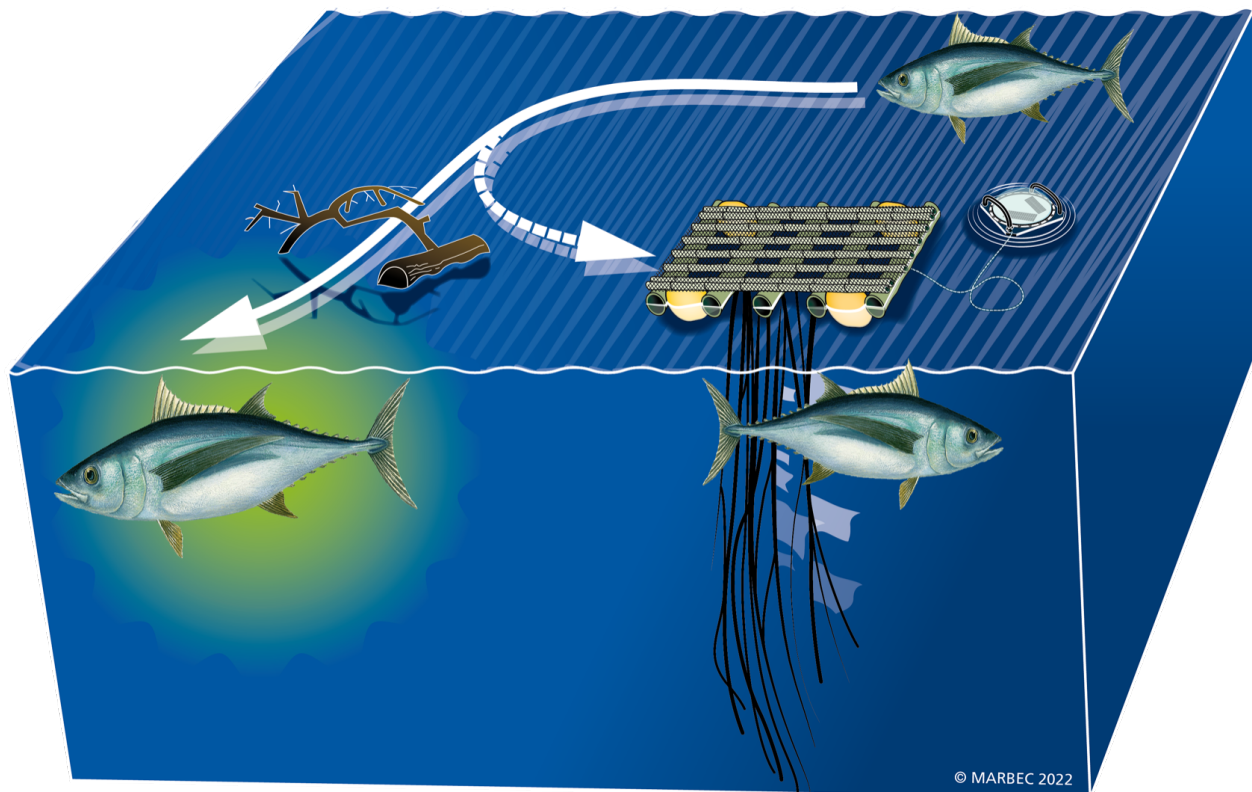

Figure 2.1: Schematic representation of the ecological trap hypothesis applied to Drifting Fish Aggregating Devices (DFADs), as originally formulated. Under this hypothesis, before DFADs introduction, when only natural floating objects (NLOGs) were present, floating objects were indicators of productive areas. Hence, by associating with floating objects, tuna selected high quality habitats. DFAD massive deployment modified the distribution of floating objects (FOBs), which are not representative of rich areas anymore. By associating with FOBs, tunas can be attracted to or retained in habitats of lesser quality.

Changing a habitat can positively or negatively impact the ecology of wild animals inhabiting it. For example, artificial habitats could benefit some reef species (Lee et al. 2018). Contrarily, alterations could also reduce habitat quality, *e.g.* by reducing the number of shelters or nests for some species, or by decreasing their food resources (often through the alteration of the habitat of these resources themselves, Mullu 2016). In some cases, animals are misled by cues that were previously correlated with the habitat quality but no longer are, due to anthropogenic influences (Sherley et al. 2017; Swearer et al. 2021). Such impacts form the basis of the ecological trap theory and result in the preferential selection of low-quality habitats by animals, when better alternatives exist (Battin 2004; Schlaepfer et al. 2002). It is worth noting that, depending on the definition, an ecological trap can occur without any anthropogenic influence (Robertson and Hutto 2006; Swearer et al. 2021; Teske et al. 2021). In this paper, we will consider that ecological traps occur because of a sudden anthropogenic change in the environment, *i.e.* in the case of tropical tuna, the modification of their surface habitat by the increased deployment of DFADs (Gilroy and Sutherland 2007; Hallier and Gaertner 2008; Schlaepfer et al. 2002). While this theory has been proposed regularly in the face of anthropogenic environmental modifications and their impacts on various species, few studies have empirically demonstrated the existence of such traps (Battin 2004; Swearer et al. 2021).

Noting the increasing number of floating objects being deployed by fishers during the 1990s, some scientists hypothesized that the increase in the number of DFADs could lead to an ecological trap, altering the ecological value of floating objects for tropical tunas associated to DFADs (Marsac et al. 2000). It is hypothesized that large numbers of DFADs may alter certain biological characteristics of epipelagic populations associated with them: migration, schooling

behaviour, growth, fish condition and bioenergetics, predation and natural mortality (Figures 2.1&2.2). TRFMOs primarily focus on developing management schemes to address the known effects of DFADs on catches (particularly of small YFT and BET, as well as sharks) or their stranding on coasts. However, there is also a need to assess whether DFADs, through their presence on the ocean, can alter the life history parameters and behaviour of tunas, so as to manage the number of DFADs deployed at sea if negative impacts are suspected or demonstrated.

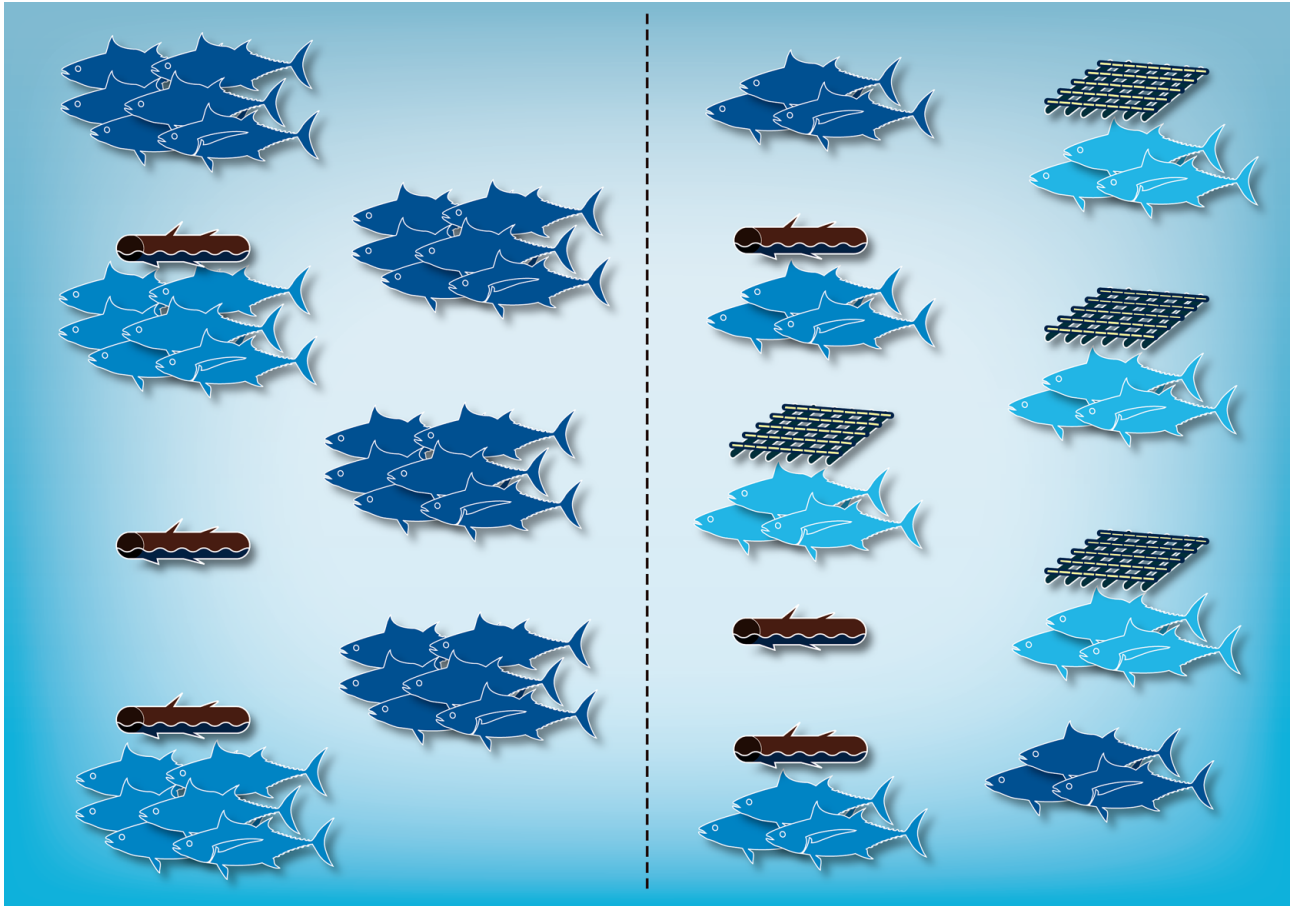

Figure 2.2: Schematic representation of potential effects of Drifting Fish Aggregating Devices (DFADs) on tuna schooling behaviour. The left side represents an ocean with natural floating objects (NLOGs) only (no DFAD), while the right side represents an ocean with both NLOGs and DFADs, *i.e.* more floating objects (FOBs). Dark blue represents tuna in free-swimming schools, intermediate blue tuna associated with NLOGs and light blue tuna associated with DFADs. An increase in FOB density (right panel) could lead both to (i) more tuna associated to FOBs and less free-swimming schools, (ii) more numerous but smaller FOB-associated schools.

Almost 20 years ago, Dempster 2004 made a systematic review of the published literature on FADs and concluded that further research should assess the use of DFADs by pelagic species, the mechanisms underlying their associative behaviour and the ecological consequences of the presence of DFADs at sea on pelagic fish stocks. Since then, several papers reviewed existing evidence and/or proposed future research directions to address the impacts of DFADs on tropical tuna (Dagorn et al. 2013b; Evans et al. 2015; Davies et al. 2014b; Fonteneau et al. 2015; Leroy et al. 2013; Taquet 2013). Yet, most of these papers, except Taquet 2013, addressed these impacts at a regional scale and all were mainly focussing on the direct impacts of DFADs (induced by an increase of fishing mortality), even though they mentioned potential indirect impacts (not related to fishing mortality increase). The objective and originality of this paper is to review the current knowledge on the impacts of DFADs on the ecology and life history traits of tropical tuna, focussing only on the indirect effects (consequences of fishing on DFADs are not addressed here). The reason for this is that this particular question has generated a

global scientific debate for years, precluding management bodies from having a complete and synthetic view of the current knowledge. An in-depth literature review provides an overview of the state of the art in this area, identifies knowledge gaps, and proposes future research priorities. This paper is structured around four major questions:

- i. How much do DFADs change the habitat of tropical tunas?
- ii. Do DFADs modify the migration and the schooling behaviour of tropical tunas?
- iii. Do DFADs modify the life history parameters of tropical tunas?
- iv. What are the scientific challenges to fill the knowledge gaps?

2.2 How much do DFADs change the habitat of tropical tunas?

Natural floating objects, primarily tree trunks or branches carried by rivers, have always been a component of tuna habitat. It should be noted that the current largest tuna purse seine fishery in the world was first developed in the Western and Central Pacific Ocean (WCPO) by Japanese exploratory fishing cruises that perfected methods for seining tuna schools found in association with natural floating logs that later evolved into DFAD fisheries in all oceans (Watanabe et al. 1988). Human activities (logging, coastal development, shipping, etc.) modified the number of floating objects at sea, in some cases even before modern purse-seine tuna fishing began (Caddy and Majkowski 1996; Thiel and Gutow 2005). Some of these activities may have consistently increased (coastal development, shipping), whereas others, such as logging, may have varied due to increased global trade and subsequent deforestation of some areas (Caddy and Majkowski 1996). In addition, environmental changes also affect the production and movement of floating objects (*e.g.* floods, El Niño events, tsunamis), with global warming supposed to increase the frequency of extreme events. In recent years, the increase in the number of DFADs deployed by fishers raised the question of the impacts of this practice on tropical tuna habitat. It is therefore essential to assess the extent to which DFADs have changed the habitat of tunas, in comparison to the historical pristine state when only natural floating objects existed.

Two types of floating objects (referred to as FOBs) are commonly considered: (i) man-made FADs (which can be drifting, DFADs, or anchored, AFADs) and (ii) natural objects (trees, branches, etc., referred to as NLOGs) or artificial objects (wreckage, nets, washing machines, etc., referred to as ALOGs) that are not deployed for the specific purpose of fishing (collectively called LOGs) (collectively called LOGs; Gaertner et al. 2018). Fishers fish on DFADs and LOGs and can equip any of those objects with a satellite-tracking buoy, becoming therefore a fishing tool monitored by a fishing vessel. For the particular question of habitat change addressed in this study, only DFADs – which are the dominant type of man-made floating objects used in the industrial purse seine fishery (Dagorn et al. 2013a; Maufroy et al. 2017; Dupaix et al. 2021a) – are considered and not AFADs.

Habitat changes due to DFADs can be assessed by estimating and comparing densities of objects (with information on their nature: LOGs or DFADs) and distance between objects (nearest neighbour), with both parameters being closely related. These parameters depend upon the rates at which DFADs are added or removed from the ocean (by sinking, beaching or retrieved by humans), as well as their drift. For every oceanic spatio-temporal unit (*e.g.* region and season), comparing these parameters with those of natural floating objects and for all types together (natural and artificial) is challenging, the primary concern being to identify the origin of the floating object.

The number of DFADs have regularly increased (Maufroy et al. 2017), but it is necessary to put this in perspective with respect to all floating objects. Using data from observers onboard tuna purse seine vessels in the Indian Ocean (IO), noting all FOBs encountered when the vessel cruises, Dupaix et al. 2021a (Chapter 3) highlighted a drastic increase in the total number of floating objects in the western IO, from 2006 to 2018, with multiplication factors greater than 2 in every region and reaching as high as 60 in some areas (*e.g.* Somali area). The entire western IO is affected, with DFADs comprising over 85 % of the total FOBs and DFADs contributing to reduce the distances between floating objects (mean distances between DFADs and between NLOGs of 37 km and 89 km, respectively, in 2014-2018). The impact of DFADs on tuna habitat reducing the distance between FOBs was observed in the study both when considering all DFADs or only randomly encountered DFADs (objects which do not belong to the vessel or its fishing company), to account for a potential sampling bias. Phillips et al. 2019a, using data from 2016 and 2017 and Lagrangian simulations in the Western and Central Pacific Ocean (WCPO), also showed an increase in FOB densities induced by DFAD deployments, and observed a shift of the area with the highest FOB densities, from the North-Eastern area of the Bismark Sea to the Tuvalu archipelago. Unfortunately, to our knowledge, no similar detailed study has been conducted in the other oceans, precluding from estimating the extent of the change of the habitat of tunas due to the addition of new floating objects globally.

Most of the management effort by tRFMOs is focused on the monitoring and control of satellite-tracked buoys attached to floating objects (either to DFADs or to LOGs), emitting positions (and other variables) to vessels and qualified as operational buoys, as this variable is strongly related to fishing effort. This also explains why most scientific studies prioritized the estimate of operational buoys rather than the number of DFADs in the ocean (Table 2.1). Currently, all tRFMOs have implemented a limit on the instantaneous number of operational satellite buoys per vessel, and, except in the Atlantic Ocean (AO), limited the re-activation of buoys while at sea, but only the IOTC has limited the number of buoys purchased and in stock per year, per vessel (IOTC Res 19/02, ICCAT Rec 22-01, IATTC Res C-21-04, WCPFC CMM 2021-01). This clearly reflects a lack of concerted action worldwide to limit the number of new floating objects deployed in the oceans. Even under the limit of active DFADs at sea per vessel, the actual total numbers of DFADs in the ocean could have increased. So far, few studies have produced estimates of the total number of DFADs deployed annually, with estimations providing a range of 81,000 to 121,000 deployments worldwide, but these global estimates were made a decade ago (Baske et al. 2012; Gershman et al. 2015; Scott and Lopez 2014). As a comparison, AFADs seem to be less numerous worldwide (13,000 AFADs estimated in Scott and Lopez 2014), although there may be few areas with very high densities of AFADs, such as Indonesia (5,000-10,000, Proctor et al. 2019), the Philippines or Papua New Guinea.

In practice, despite efforts by tRFMOs to require the submission of DFAD data, accurately determining a simple indicator such as the total number of DFADs that are drifting in the world's oceans is a major challenge. The easiest way would be to monitor the number of deployments through logbooks or onboard observers or set up a FAD register (see Res 23/02, not adopted, IOTC 2023b). The number of operational buoys does not correspond to the number of DFADs in the water (and/or deployed) as some buoys can be attached to LOGs, can be deactivated, and some DFADs may lack positional trackers, but it can be used as a proxy to illustrate the trend in numbers. Therefore, as the number of operational buoys does not effectively limit DFAD deployments, the number of DFADs in the water and/or deployments could be larger than the limits adopted by the tRFMOs. Under the assumption that the number of natural floating objects remains relatively constant, the increasing number of electronic buoys used reflects an increase of the number of FOBs. In recent years, DFAD deployments were stable in the WCPO (2011-2019; Escalle et al. 2020), decreased in the IO (2016-2021; IOTC 2022e), increased in the Eastern Pacific Ocean (EPO, 2015-2020; Lopez et al. 2021) and buoy

Table 2.1: Summary of main findings from previous studies on the numbers of monitored floating objects or the number of DFADs used in large-scale tropical tuna purse seine fisheries.

Area	Period	Indicator	Associated number of vessels	Estimation	Reference
All oceans	2006-2011	DFADs deployed yearly		47,000-103,000	Baske et al. 2012
	2010s	DFADs deployed yearly		91,000	Scott and Lopez 2014
	2013	DFADs deployed yearly		81,000-121,000	Gershman et al. 2015
Atlantic Ocean	1998	Radio buoys	45 vessels	3,000	Ménard et al. 2000a
	2004-2014	Buoys deployed yearly	Per vessel (French PS fleet)	From 41 (2004) to 200 (2014)	Fonteneau et al. 2015
	2007-2013	Monthly buoys active		From 1,289 (2007) to 8,856 (2013)	Maufroy et al. 2017
Indian Ocean	2003-2005	Daily buoys active	45 vessels	2,100	Moreno et al. 2007
	2007-2013	Monthly buoys active		From 2,679 (2007) to 10,929 (2013)	Maufroy et al. 2017
	2010-2012	Daily buoys active	34 vessels	3,750-7,500	Filmalter et al. 2013
	2010-2014	Quarterly buoys active	25 vessels	1,200	Chassot et al. 2014
	2013	Quarterly buoys active	19 vessels	6,015	Delgado de Molina et al. 2014
	2013	DFADs deployed yearly	19 vessels	12,813	Delgado de Molina et al. 2014
	2016-2021	DFADs deployed yearly	Whole ocean	10,514-24,550	IOTC 2022e
Western and Central Pacific Ocean	2011-2019	Daily buoys active	Per vessel	45-75	Escalle et al. 2021a
	2011-2019	DFADs deployed yearly	268 to 322 vessels (whole ocean)	20,000-40,000	Escalle et al. 2020 ; Escalle et al. 2021a
	2016-2019	Buoys deployed yearly	Whole ocean	31,000-39,500	Escalle et al. 2020
	2016-2020	Buoys deployed yearly	187 to 235 vessels	16,000-22,000	Escalle et al. 2021b
Eastern Pacific Ocean	2018-2020	Daily buoys active	100 to 140 vessels	8,000-11,000	Lopez et al. 2021
	2015-2020	DFADs deployed yearly	100 to 140 vessels	20,000-40,000	Lopez et al. 2021

deployments increased in the AO (2007-2013; Maufroy et al. 2017). Hence, a characterisation of DFAD deployment trends at the global scale is needed. However, the clear trend in the number of DFAD sets or DFAD catches (FIRMS Global Tuna Atlas cited in IOTC 2022e; Floch et al. 2019; Restrepo et al. 2017) suggests that DFAD deployment has also increased.

2.3 Do DFADs modify the migration and the schooling behaviour of tropical tunas?

DFADs may affect both the movements of tunas and their schooling behaviour. Large-scale movements of tunas can be impacted in the following two ways: (i) DFADs could cause tunas to relocate to new areas and (ii) they could increase residence times in some areas. Ideally, the best approach for investigating such potential effects would be to compare the large-scale movement patterns of tunas before and after the period in which the increase of DFAD numbers occurred (*i.e.* before or after the 1990's). To our knowledge, historical data to assess large-scale movement patterns before fishers started to massively deploy DFADs, necessary for this type of analysis, exist only in the WCPO (Kim 2015) and in the EAO (Cayré et al. 1986) and we do not know of any long-term study that compared movement patterns before and after DFAD use increased.

2.3.1 Effects on individual large-scale movements

Wang et al. 2014 found that the spatial dynamics of free-swimming school sets in the WCPO were influenced by the onset of El Niño Southern Oscillation (ENSO) events, while these events had no effects on the location of floating-object-associated school sets. Catch data, however, reflect the movements of the available catchable portion of the stocks and the catchability of different set types (*e.g.* DFAD sets catching smaller individuals than the free-school sets), and not the true movements of populations.

Hallier and Gaertner 2008 analysed conventional tagging data of SKJ and YFT in the Eastern Atlantic Ocean (EAO). Different migratory directional patterns and displacement rates were observed between fish recaptures associated with DFADs and those in free-swimming schools. Displacement rates were significantly larger for both YFT and SKJ recaptured in association with DFADs (13 and 15 nm/day, respectively) than those recaptured in free-swimming schools (3 and 4.5 nm/day, respectively), which suggests that DFADs could relocate tunas to new areas. In the IO, Stehfest and Dagorn 2010 found similar results for SKJ, YFT and BET, but with lower displacement rates differences than in the AO. Hallier and Gaertner 2008 interpreted these results as indicating significant modifications of migratory patterns due to associations with DFADs, suggesting an influence of DFAD association strong-enough to disturb tropical tuna migratory patterns. However, Stehfest and Dagorn 2010 argue that it could only reflect an artefact of the non-uniform distribution of DFAD fishing. Also, authors of both studies agree that school type at recapture might not be representative of the associative history of individuals before their recapture. Using an advection-diffusion model, Kim 2015 also showed that including a DFAD attraction component to the model better fitted SKJ tagging data in the WCPO, suggesting an effect of DFADs on SKJ migratory patterns. Comparing DFAD induced movements in the 2000s with those in the 1990s, they showed that the rising DFAD density increased this modification of migration patterns. These studies were the only ones to assess differences of movement patterns induced by DFADs and, due to species and ocean differences, more studies would be needed to interpret these results at a global scale.

DFADs potential to modify large-scale movements of tunas can be investigated through archival tags by comparing tuna movements with the general drift patterns of DFADs. In the

equatorial EPO, evaluation of archival tag data sets from 96 BET (54-159 cm in length, 1-5.5 years of age) tagged between 2000 – 2005 (Schaefer et al. 2009; Schaefer and Fuller 2010) did not support the hypothesis that the most probable BET tracks were related to the general drift patterns of DFADs. This suggests that the large-scale spatial dynamics of BET are not strongly influenced by DFADs at the densities and conditions found in the EPO. However, in the Central Pacific Ocean (CPO), a predominantly eastward extensive dispersion of BET tagged with conventional tags and archival tags was observed (Schaefer et al. 2015). The authors explain the strong regional fidelity of BET in the equatorial EPO by the high concentration of food, leading to their residence and retention in that area. In the equatorial CPO, the strong eastward-flowing North equatorial countercurrent and BET searching for higher prey concentrations could explain the predominantly eastward dispersion of BET.

2.3.2 Effects on individual fine-scale movements

In addition, the possibility of DFADs influencing the large-scale movements of tunas could be evaluated through the measure of the time tunas spend associated with DFADs and the time they spend unassociated (or between two DFAD associations). It could be considered that the longer tunas remain associated with DFADs, the larger the influence DFADs could have on their large-scale movements. Acoustic tags and archival tags (only when a species exhibits a distinct vertical behaviour when associating with a floating object, as observed for BET or sometimes YFT) have been used by scientists to measure these parameters (Table 2.2). Passive acoustic tagging studies on DFADs revealed that the majority of residence times of tunas (i.e. continuous periods of time spent associated with a given DFAD) were of a few days. Mean values ranged from 0.2 to 4.6 days for SKJ (Dagorn et al. 2007; Govinden et al. 2021; Matsumoto et al. 2014; Matsumoto et al. 2016), from 1.0 to 6.6 days for YFT and 1.4 to 10 days for BET (Dagorn et al. 2007; Govinden et al. 2021; Matsumoto et al. 2016; Phillips et al. 2019b). Long associations, however, have been observed on rare occasions – *e.g.* 27 days for YFT in the IO (Govinden et al. 2021) and up to 18, 50 and 30 days for SKJ, YFT and BET respectively, in the WCPO (Phillips et al. 2017; Phillips et al. 2019b). A recent study in the EAO (Tolotti et al. 2020) reported significantly larger mean residence times for the three tuna species, from 9 days (SKJ) to 19 days (YFT) and 25 days (BET), with record values of 55 days and 600 km travelled associated to a DFAD for both BET and YFT.

These studies suggest that residence times at a single DFAD vary between oceanic regions and species. Without more studies, it is difficult to assess whether the long DFAD associations observed are restricted to specific areas and time periods, or if they can often occur. In fact, even short DFAD residence times as those observed in the Indian and Pacific oceans do not prove that DFADs cannot influence large-scale movements. The short residence times suggest that a single DFAD does not significantly impact the behaviour of tunas for long enough to influence their large-scale movements. However, in an array of DFADs, a tuna can “switch” from one DFAD to a neighbouring one, which could retain it in the array. It is therefore important to also measure the time tunas spend between two associations (or unassociated), or in other words, the total percentage of time a tuna spends associated over long periods. This variable is likely to depend on the density of all floating objects in the area. So far, very few durations between two DFAD associations have been measured using acoustic tags because it is difficult to locate and exhaustively instrument with acoustic receivers all DFADs in an area.

Table 2.2: Summary of main findings from previous studies on tuna individual CRT and CAT assessed under anchored and drifting FADs. CRT: Continuous Residence Time – continuous bouts of time spent at the same FAD without any absence longer than 24h. CAT: Continuous Absence Time – the time between two associations with a FAD. FL: fork length, YFT: *Thunnus albacares*, SKJ: *Katsuwonus pelamis*, BET: *Thunnus obesus*).

FAD type	Study location	Metric	Findings	Reference
Drifting	Eastern Atlantic Ocean	CRT	YFT (34-82 cm FL): mean 19.15 days (max 55 days)	Tolotti et al. 2020
			SKJ (39-61 cm FL): mean 9.19 days (max 15 days)	
			BET (45-61 cm FL): mean 25.31 days (max 55 days)	
	Mozambique Channel (Western Indian Ocean)	CRT	YFT (29-60 cm FL): 0.00-26.72 days with median 9.98 days	Govinden et al. 2021
			SKJ (47-57 cm FL): 0.09-18.33 days with median 4.47days BET (54-56 cm FL): 0.00-6.56 days with median 3.89 days	
	Western and Central Pacific Ocean	CRT	SKJ (46-60 cm FL): median 1 day (max 18 days)	Phillips et al. 2019b
			YFT (36-98 cm FL): median 2 days (max 50 days)	
			BET (38-90 cm FL): median 10 days (max 30 days)	
	Equatorial Central Pacific Ocean	CAT	BET (38-90 cm FL): median 3.2 days (max 48.2 days)	Matsumoto et al. 2014
		CRT	SKJ (36-65 cm FL): 0.0-6.4 days (mean 2.3 days)	
CRT		SKJ (34.5–65.0 cm FL): less than 7 days YFT (31.6–93.5 cm FL): less than 7 days BET (33.5–85.5 cm FL): less than 7 days	Matsumoto et al. 2016	
Anchored	Philippines (Indian Ocean)	CRT	Juvenile YFT (19–31 cm FL) : between 1 and 6 days	Mitsunaga et al. 2012
	Maldives Islands (Indian Ocean)	CRT	SKJ (37-54 cm FL): 0.20-3.75 days	Govinden et al. 2013
			YFT (35-53 cm FL): 0.61-0.70 days	
	Mauritius Islands (Indian Ocean)	CRT	SKJ (41 -59 cm FL): 2.5 days	Rodriguez-Tress et al. 2017
			YFT (46 -81cm FL): 9.6 days	
		CAT	BET (48 - 60 cm FL): 5.2 days	
			SKJ (41 -59 cm FL): 2.9 days YFT (46 -81cm FL): 1.4 days BET (48 - 60 cm FL): 0.8 days	
	Hawai'i Islands (Pacific Ocean)	CRT	Small YFT (30-39 cm FL) : 13.58 days	Robert et al. 2012
			Large YFT (63-68 cm FL): 9.44 days	
		CAT	4 days for small YFT and 1.65 days for large YFT	
CRT		4 behavioural modes reported (YFT 54-95 cm FL): Brief association : 13.1 minutes Short association: 2.9 days Two long association modes : 13.8 and 23.2 days	Robert et al. 2013a	
	2 behavioural modes:			
	CAT			

Table 2.2: Summary of main findings from previous studies on tuna individual CRT and CAT assessed under anchored and drifting FADs. CRT: Continuous Residence Time – continuous bouts of time spent at the same FAD without any absence longer than 24h. CAT: Continuous Absence Time – the time between two associations with a FAD. FL: fork length, YFT: *Thunnus albacares*, SKJ: *Katsuwonus pelamis*, BET: *Thunnus obesus*).

FAD type	Study location	Metric	Findings	Reference
			Short : 2.8 days Long: infinite	
	South Western Taiwan (Pacific Ocean)	CRT	YFT (35–81 cm FL) : mean 2.1 days (max 31 days)	Weng et al. 2013
	Okinawa Island (Pacific Ocean)	CRT	YFT (40-119 cm FL): median 7.9 days (max 55 days) BET (50-77 cm FL): median 7.0 days (max 34 days)	Ohta and Kakuma 2005
	Palau Islands (Pacific Ocean)	CRT	YFT (50-60cm FL): mean 16 days (max 123 days) YFT (60-100cm FL): mean 2 days (max 33 days)	Filous et al. 2020

In the WCPO, 25 BET, 6 YFT and 2 SKJ displayed “homing” behaviour by returning to the same DFAD with absences greater than a day (Phillips et al. 2019b). Most of these absences were short for BET (median: 3.2 days) and longer for YFT (median: 10.5 days) but with a low sample size not allowing to be conclusive. In the other tropical oceans, even fewer tunas were observed performing such homing behaviour: one BET in the AO (out of 23 tagged fish, Tolotti et al. 2020), one YFT and two SKJ in the IO (out of 31 and 17 tagged fish respectively, Govinden et al. 2021), and these absences lasted less than two days.

Because BET and sometimes YFT exhibit different vertical behaviour patterns when associated or non-associated with floating objects (Abascal et al. 2018; Holland et al. 1990), archival tags have been used to assess residence times at and between floating objects, and therefore percentage of days associated with floating objects, without the need to instrument all objects with acoustic receivers. Using satellite archival tagging data where individual BET tracks could be recorded over several months or even years, the percentage of time associated with floating objects was estimated to be between 4 % and 17 % depending on the size of the fish and the oceanic region (Fuller et al. 2015; Leroy et al. 2013; Phillips et al. 2017; Schaefer and Fuller 2002; Schaefer and Fuller 2010). Associative and non-associative behaviour with floating objects have also been described with archival tags for YFT (Leroy et al. 2013; Phillips et al. 2017; Schaefer et al. 2009; Schaefer and Fuller 2013), with estimates of the percentage of time spent associated with floating objects between 10 % and 23 %. These percentages are much lower than those estimated from acoustic telemetry data (*e.g.* 75 % for small BET based on the measurements in Phillips et al. 2019b).

This inconsistency between studies using different tagging methods could result from the size of tagged individuals or the way the percentage of time spent by tuna associated and non-associated is calculated. Individuals monitored with archival tags were generally larger (fork length: 50-146 cm YFT and 46-102 cm BET in Phillips et al. 2017, 51-134 cm BET in Fuller et al. 2015, 88-134 cm BET in Schaefer and Fuller 2002, 54-159 cm BET in Schaefer and Fuller 2010) than those marked with passive acoustic tags (38-90 cm BET in Phillips et al. 2019b), even though size ranges largely overlap. This suggests that small BET spend a higher proportion of their time associated with FOBs than large individuals. This agrees with observed size distributions of DFAD catches, where smaller individuals are caught, and with the negative correlation between BET individual length and percentage of time associated found by Schaefer and Fuller 2002. However, Schaefer et al. 2009 found lower association percentages with archival tags on small tunas (10.4 and 15.9 % of the time associated for 51-60 cm FL YFT and 65-99 cm FL BET respectively) than the work of Phillips et al. 2019b with acoustic tagging. This could suggest a potential bias of the different methodologies that should be further investigated, as a small percentage of time associated with floating objects would indicate no or little influence of DFADs, while a high percentage could indicate a potentially significant influence of DFADs on large-scale movements, which could result in an ecological trap.

We are therefore far from understanding the effects of different densities of floating objects on tuna fine-scale movements nor the link between fine-scale and large-scale movements. Most electronic tagging efforts have been done on YFT and to a lesser extent BET, but more behavioural data are clearly needed for all three tropical tuna species. One of the main difficulty is to disentangle the effects of DFADs from the impacts of other external signals (*e.g.* prey density) which can also influence tuna associative behaviour (Lopez et al. 2017; Nooteboom et al. 2023b; Schaefer et al. 2009; Schaefer and Fuller 2010).

2.3.3 Effects on schooling behaviour

DFADs could also affect schooling behaviour, which can have a wide range of consequences on the life-history parameters and the movements of tunas. Dagorn and Fréon 1999 and Fréon and

Dagorn 2000 suggested that tunas could associate with floating objects for social advantages such as facilitating schooling behaviour. To date no result has been obtained on tropical tuna from DFADs regarding this question. If floating objects facilitate the schooling behaviour of tunas, then the deployment of large numbers of DFADs may have effects on school size, either by facilitating the formation of large (but less) schools or decreasing school size with DFADs offering too many aggregation sites (Figure 2.2, Dagorn et al. 2010). DFADs could also modify the size structure of tuna schools, allowing the formation of large aggregations composed of several unassociated schools of different size structures (Wang et al. 2012). Sempo et al. 2013 modelled the impact of the increasing deployment of DFADs on the distribution of social fish species such as tunas. They demonstrated that for social species, increasing the number of DFADs does not necessarily lead to an increase in the total amount of tuna associated with DFADs, a non-intuitive result. Capello et al. 2022 also showed that the number of DFADs with associated schools and the size of associated schools were not linearly related to the total number of DFADs and that this relationship varied according to the considered social scenario.

2.4 Do DFADs modify the life-history parameters of tropical tunas?

The increasing number of DFADs at sea also raises questions regarding their effect on the feeding strategy of tropical tuna, and related energy-dependent traits such as tuna health (monitored for example by body condition), growth, reproduction and natural mortality.

2.4.1 Effects on feeding

In his review on DFAD impacts on tropical tunas, Taquet 2013 recommended comparative analyses of stomach contents on tropical tunas. Such analyses have shown that small-sized tunas may not feed while associated with DFADs in the Atlantic (Hallier and Gaertner 2008; Ménard et al. 2000b), Indian (Grande 2013; Hallier and Gaertner 2008; Jaquemet et al. 2011; Malone et al. 2011; Zudaire et al. 2015) and Western and Central Pacific (Machful et al. 2021) oceans. Small YFT and SKJ captured in DFAD-associated schools had a higher fraction of empty stomachs, lower stomach fullness or daily food rates (in the EAO; Hallier and Gaertner 2008, Ménard et al. 2000b; and in the IO, Hallier and Gaertner 2008), and lower prey weight (in the IO; Grande 2013; Zudaire et al. 2015) than those captured in free-swimming schools. These results support the hypothesis that the quantity of prey present in DFAD assemblages is not sufficient to sustain the dietary requirements of large aggregations of small-sized tunas commonly found at DFADs (several tens of tons, Fréon and Dagorn 2000). However, except in Hallier and Gaertner 2008, the influence of the sampling time of tunas on the stomach content was not taken into account. Purse seine vessels mainly fish on DFADs at dawn (Forget et al. 2015) and on free-swimming schools during daytime. First, feeding activities are believed to often take place in the early evening on organisms performing diel vertical migration between the deep scattering layer and the surface (Schaefer and Fuller 2002), resulting in prey being fully digested by the time the fish are caught and sampled, at dawn. Second, free-swimming schools of tunas are almost exclusively caught when actively feeding at the sea surface, hence higher levels of stomach fullness are to be expected. Nevertheless, the association of tunas with DFADs could also affect the composition and quality of their diet, as shown for YFT in the Western IO (WIO) and WCPO and for SKJ in the WCPO (Allain 2010; Zudaire et al. 2015). Differences of diet composition were observed for these species, that may be due to their associative behaviour despite the above-mentioned sampling bias, with associated tuna in the WCPO feeding on shallower prey than free-swimming tunas (Allain 2010), which is in

agreement with YFT staying closer to the surface when associated (Holland et al. 1990; Schaefer et al. 2009).

Independently of the trophic role of DFADs, the deployment and the drift trajectories of DFADs could create new zones of high floating object densities, which may be unfavourable for the foraging success of tunas (Marsac et al. 2000). Jaquemet et al. 2011 partitioned their samples in “rich” (*i.e.* no limiting food) versus “poor” forage areas in the Indian Ocean, in relation to an exceptional demographic outburst of a pelagic stomatopod (Crustacea), which composed the bulk of tuna diet in this region (Potier et al. 2004; Potier et al. 2007). These authors found that in “rich” forage areas, DFADs have no impact on the feeding pattern of tunas, whereas in “poor” forage areas, tunas associated with DFADs had lower stomach fullness compared to tunas in free-swimming schools. Jaquemet et al. 2011 suggested that the impact of DFADs on feeding success could be location-dependent. This led the authors to emphasize the possible detrimental effect on the condition of tuna associated with DFADs if associated tunas drift towards areas with poor forage resources. However, such an effect relies on the assumption that a tuna’s probability to depart from a DFAD is independent of their local environment which seems in disagreement with behavioral studies (Fuller et al. 2015; Nooteboom et al. 2023b).

In the Pacific Ocean, Hunsicker et al. 2012 observed that predation on SKJ and YFT by large pelagic fishes sampled from DFAD sets was greater than for those captured via other fishing methods (*e.g.* free-swimming schools). These authors concluded that by aggregating small-sized SKJ, YFT, and BET, DFADs enhance their vulnerability to predators such as sharks and billfishes, and thus increase natural mortality of small sized tunas. To our knowledge, this is the only study assessing the impact of DFADs on tuna vulnerability to predators, hence additional data from other regions would be needed for further testing these assumptions.

2.4.2 Effects on body condition

Tuna condition has been investigated using different methods: biometric condition factors (*e.g.* plumpness), and biochemical indices (*e.g.* fat and water contents, lipid class composition). Gaertner et al. 1999 in a preliminary investigation did not find evidence of a morphometric difference between free-swimming school or DFAD-caught tunas in the EAO. But Marsac et al. 2000 in the EAO and Hallier and Gaertner 2008 in the WIO found that individuals associated with DFADs were in lower condition than those in free-swimming schools, using morphometric indicators (thorax width or girth, plumpness of fish) as fish health indicators. Robert et al. 2014a measured the condition of SKJ using BIA (Bioelectrical Impedance Analysis), a non-invasive field tool that estimates body water content (inversely correlated with body fat content), and determines total lipid and main lipid class concentrations. They confirmed the lower condition of SKJ associated with floating objects compared to those in free-swimming schools. Because the studied area (Mozambique Channel, WIO) is naturally rich with NLOGs and had undergone little habitat modifications due to DFADs at the time of the study (Dagorn et al. 2013a; Dupaix et al. 2021a), the authors concluded that before the use of DFADs, tunas associated with logs could have also been in lower condition than tunas in free-swimming schools. These results can mean that (1) a lower measured condition could reflect normal variations and does not necessarily imply detrimental physiological consequences, or (2) some specific areas where NLOGs have always been in high numbers could also have negatively impacted the condition of tunas that passed through and stayed in these areas.

As a lower condition measured at DFADs does not necessarily imply longer-term detrimental consequences for tuna, there is a need to monitor tuna condition and other biological parameters on a longer term and determine if they are influenced by the density of DFADs in the area. Dupaix et al. 2023a, using length-weight data from 1987 to 2018 in the WIO, found no decreasing trend of YFT condition over the studied period, during which the number of DFADs has

increased. Hence, this study, using one morphometric indicator as a proxy for condition (Le Cren's relative condition factor), suggests the absence of a long-term impact of DFADs on YFT condition, under the conditions encountered in the WIO in the last three decades. Nevertheless, it should be noted that other factors could also have counteracted potential negative effects of DFADs on tuna condition.

Studies that investigated potential DFAD impacts on tuna condition mainly suggest that the condition of associated tuna is lower than that of free-swimming tuna. These results are reinforced by the example of the preparation of *katsuobushi* (shaved dried SKJ) in Japan. Indeed the Japanese tuna industry prefers SKJ caught on DFADs as they have less fat than those from free-swimming schools (Nishida, pers. comm.). However, Sardenne et al. 2016, when comparing biometric and biochemical indicators found inconsistencies due to a high variability of biometric indicators with season and ontogeny. They concluded that biometric indicators measured on whole tuna (*e.g.* thorax girth, fish plumpness, Le Cren's K_n) should be interpreted with caution as they may not always reflect the energetic condition measured in the tissues of the fish. Experimental validation of the condition factors used is needed to determine the potential impacts and the underlying mechanisms of the difference in tuna condition. For example, condition factors could be calibrated and validated by monitoring them during fasting experiments on captive tuna, although measuring some of them regularly in experimental conditions could represent a methodological challenge.

2.4.3 Effects on reproduction and growth

In the WIO, Zudaire et al. 2014; Zudaire et al. 2015 found (i) a significantly higher proportion of energy-rich fish prey in the diet (stomach contents, Zudaire et al. 2015), as well as (ii) significantly higher total lipid concentrations and triacylglycerol to sterol (TAG:ST) ratio, indicators of energetic condition, in the gonads of YFT females caught in free-swimming schools compared to females associated with DFADs (Zudaire et al. 2014). This can be interpreted as simply reflecting differences in prey availability and feeding activity and thus differential lipid incorporation to tissues between DFAD-associated and non-associated tunas. It could also highlight higher energetic investment to reproduction in free-swimming YFT due to a higher condition (*i.e.* better health), keeping in mind the potential bias provoked by an uneven size distribution between school types in these studies. However, the study failed to demonstrate a direct effect on the fecundity, most likely due to the low number of actively spawning females analysed and the high inter-individual fecundity variability observed in YFT (Pecoraro et al. 2017).

Similarly, Ashida et al. 2017 investigated the difference in reproductive traits of female SKJ, of similar size distribution, between school types in the WCPO, highlighting a significant higher proportion of mature females in free swimming schools, characterised by higher relative condition factor, than associated with DFADs. However, as for YFT in the IO (Zudaire et al. 2014), no significant effect of the school type was observed on the WCPO SKJ fecundity, which corroborates previous results observed for WIO SKJ (Grande 2013; Grande et al. 2014). The lack of relationship between condition and fecundity of SKJ could be related to their energy allocation and reproductive strategies. SKJ tuna females fuel their gametes with energy gained concomitantly during reproduction (*i.e.* income breeding strategy, Grande et al. 2016). However, YFT females can store additional energy reserves prior to spawning, which define them as income-capital breeder (Zudaire et al. 2014) unlike SKJ. Therefore, as SKJ females exhibit better condition when free swimming, it can be assumed that their reproductive efficiency is lower when associated with DFADs, but the same conclusion cannot be made for YFT.

Using tagging data collected in the EAO, Hallier and Gaertner 2008 estimated and compared the growth rates of SKJ and YFT associated with DFADs versus free-swimming schools.

Released and recaptured SKJ associated with DFADs had a significantly lower growth rate than those in free-swimming schools, but the difference was not significant for YFT (though it was lower, as for SKJ). However, the history experienced by individual fish between release and recapture was unknown. The “experimental” design could not be controlled as the time one specimen spent associated with DFADs and in free-swimming schools is not available. In addition, the authors were only able to process a small sample of free-swimming YFT ($n = 10$).

2.5 What are the scientific challenges to fill the knowledge gaps?

DFADs have been representing one of the key management priorities and challenges of tRFMOs over the last decade. Since fishers started using them, DFADs numbers continuously increased until first management measures limiting the number of operational buoys were adopted in the mid-2010s (Song and Shen 2022). The massive use of DFADs in all oceans has been generating major concerns on the sustainability of this fishing mode. DFADs increase the catchability of tropical tunas leading to large catches of small BET and YFT (Dagorn et al. 2013b; Fonteneau et al. 2013), generate more bycatch, including vulnerable species such as some shark species, silky (*Carcharhinus falciformis*) and oceanic whitetip (*Carcharhinus longimanus*) sharks (Dagorn et al. 2013b; Fonteneau et al. 2013; Leroy et al. 2013), and can strand on coastal areas causing damage to marine habitats (Imzilen et al. 2021; Maufroy et al. 2015; Escalle et al. 2019b). Although there is increasing knowledge and literature on DFADs, the issue of their indirect impacts (not related to fishing mortality) on tropical tuna remains a scientific debate. All knowledge collected and reviewed on the behaviour and life-history parameters of tunas at DFADs clearly reveals a lack of converging scientific results on the long term consequences on tuna (at the individual or population levels) of increased numbers of floating objects. Therefore, if DFADs seem to affect the short-term condition of tropical tunas, we are not currently able to conclude whether DFADs affect the movements and/or other life-history parameters of tunas in a way that could significantly affect the fitness of individuals and the demography of their populations. As such, there is a need to improve the observation and understand this associative phenomenon to provide scientific advice on the effects of DFADs on the life-history parameters and behaviour of tropical tunas and other associated species.

A major gap in tuna and DFAD science is the lack of time series of key parameters such as the numbers of DFADs and natural floating objects, residence and absence times at DFADs as well as large movements between oceanic regions, school sizes, condition and reproduction indices. The first research priority in this context is to initiate or continue time series of such indicators (Capello et al. 2023). Setting long-term monitoring programs in every ocean appears to be a priority, as effects of DFADs could vary depending on the species, the characteristics of each ecosystem and on the density of floating objects. Moreover, it would facilitate comparative analyses between oceans to better understand the drivers of tuna associative behaviour. The collection of some parameters will require dedicated scientific surveys (*e.g.* electronic tagging, biological sampling) while others (*e.g.* numbers of DFADs and natural objects, biological condition factors) have started to be routinely collected by tRFMOs through FAD-specific data requirements included in conservation and management measures (Báez et al. 2022; Grande et al. 2018; Song and Shen 2022) as well as government and industry initiatives (*e.g.* routine fishery monitoring and at-sea observer programs).

Another research priority is to develop experimental studies to identify the biological and behavioural processes involved in the associative behaviour. The only scientific consensus is the fact that in a given area, conditions of tunas associated with floating objects seem to often be lower than those of fish in free-swimming schools. However, the different indicators used to

assess tuna condition are not always well correlated (Sardenne et al. 2016), and experimental studies are needed to validate them against proper benchmarks, allowing to determine how representative they are of individuals' health. Then, understanding how fast these indicators change with the fish's associative behaviour appears essential. This could also be achieved through studies on captive tropical tunas (*e.g.* Estess et al. 2017), but non lethal observations should be promoted (*e.g.* BIA) in order to track changes throughout the fish lifespan. No evidence exists suggesting whether the lower condition at DFADs is the consequence or the cause of their association with DFADs. Often the robustness of the findings of investigation on the life-history parameters of tunas was hampered by the lack of knowledge of the time spent associated with a DFAD or in an array of DFADs by each specimen analysed. The history of each individual tuna is a hidden variable that must be taken into account in statistical analyses, which is a challenge. Studies combining behavioural observations (tagging) and condition of the individuals (*e.g.* BIA or biochemical analyses of biopsies made at the time of tagging) should then be encouraged. Ideally, tags equipped with physiological sensors would clearly help understanding the interplay between associative behaviour and tuna physiology. Such tags, however, are only starting to be developed.

Studies on AFADs could provide insights to the questions addressed in this manuscript: as argued by Dagorn et al. 2010, AFADs also alter the natural environment (by adding floating objects to the ocean). However, it remains questionable if they are comparable due to the fact that AFADs are generally located nearshore, with corresponding particular oceanographic conditions, and they do not move with water masses. Papua New Guinea, the Philippines and Indonesia are examples of areas with very high numbers of AFADs (Proctor et al. 2019) and as such, these dense arrays of AFADs could generate the same concerns on tuna life-history parameters and behaviour that those expressed for DFADs. Understanding the behaviour of tunas around AFADs can also improve our general understanding of tunas around all types of floating objects and help design new, well focused studies for DFADs. For practical reasons, more studies have been performed on the behaviour of tuna at AFADs than at DFADs (*e.g.* Dagorn et al. 2007; Govinden et al. 2013; Holland et al. 1990; Ohta and Kakuma 2005; Rodriguez-Tress et al. 2017). They provided estimates of residence times between two AFAD associations and therefore of the percentage of time spent associated to AFADs (*e.g.* Pérez et al. 2020; Robert et al. 2013a; Rodriguez-Tress et al. 2017), which still needs to be further explored at DFADs. For example, Pérez et al. 2020 used acoustic tagging data on AFAD arrays to demonstrate that when inter-AFAD distance decreases, tuna visit more AFADs, spend less time travelling between AFADs and more time associated with them. Concerning DFADs, as actual densities of drifting floating objects are difficult to obtain, studies using a modelling approach based on experimental data should be promoted (Pérez et al. 2022; Capello et al. 2023). These studies should investigate the consequences of changes in floating object density on tuna school sizes and associative behaviour. These modelling studies could be complemented and/or calibrated by studies which use data from echosounder buoys deployed by fishers on floating objects. Recent methodological advances allowed the prediction of tuna presence or absence under FOBs (Baidai et al. 2020b; Orue et al. 2020). Using an extensive dataset from echosounder buoys in the WCPO (more than 3.8 million transmissions), Escalle et al. 2021c determined different profiles of acoustic signals related to different types of aggregations. Other studies also show that multi-frequency echosounder buoys could allow the discrimination of tropical tuna species under DFADs (Moreno et al. 2019; Sobradillo et al. 2023). These new methodological developments, in combination with tagging data both conventional and electronic, and modelling approaches offer promising perspectives for the study of tuna aggregation behaviour under FOBs and the potential impact of DFAD density on tuna schooling behaviour.

Tuna RFMOs set limits on the number of operational buoys (IATTC: up to 340 depending on the vessel size, Res C-21-04; ICCAT: 300 in Rec 22-01; IOTC: 300 in Res 19/02; WCPFC:

350 in CMM 2021-01). These limits are essentially set to control the fishing effort and the catches of tunas and non-target species, but how such limits also limit the number of deployed DFADs is not known. In theory, all purse seine vessels could use at least the same amount of DFADs than the maximum number of operational buoys authorized in each of the regions. Multiplying this maximum number of operational buoys authorized per vessel by the number of purse seine vessels in each ocean provides a global authorized limit of about 238,000 operational buoys (Section 2.7). This number is about twice higher than the estimate of the global number of DFADs deployments made by Gershman et al. 2015, based on data from 2013. Hence, it would mean that the global purse seine fishery could have increased the number of DFADs in the ocean while still respecting the current limits on the number of active buoys. Most tRFMOs now require that DFAD identification, characteristics, deployment date and deployment location are reported (*e.g.* ICCAT Rec 22-01; IOTC Res. 19/02; IATTC C-21-04). Some studies evidenced different regional trends of DFAD deployments (IOTC 2022e; Escalle et al. 2020; Lopez et al. 2021; Floch et al. 2019; Maufroy et al. 2017), but no study assessed this trend on a global scale after 2013 (Gershman et al. 2015). Tuna RFMOs should continue to collect and make fine-scale DFAD data available to scientists to allow regular estimations of the extent of the habitat modifications generated by DFADs, which should be addressed at a global scale.

2.6 Conclusion

To summarize the questions formulated in this study:

- i. although the deployment of DFADs has undoubtedly modified the habitat of tropical tunas, the extent of this modification still needs to be better characterized in some regions. This characterization can be achieved through the continued monitoring of indicators (*e.g.* spatialized DFAD and NLOG densities, DFAD/NLOG ratio) collected by tRFMOs.
- ii. studies assessing the impacts of DFADs on tuna large-scale movements show contradictory results. Strong ocean and species specific variability is observed for the proportion of time spent associated with FOBs. However, the effect of the methodology used (archival tagging *vs* acoustic tagging) should be investigated. To date, besides theoretical studies, no evidence has been shown on the impact of DFADs on associative and schooling behaviour.
- iii. DFADs probably impact tuna short-term condition, but it does not necessarily imply a longer-term detrimental effect and should be confirmed with long-term time series of validated condition indicators. The results on the impacts of DFADs on other life-history parameters are inconclusive.
- iv. The main conclusion of this work is the lack of clear converging scientific results on the indirect impacts of DFADs on the behaviour and life-history parameters of tropical tuna. It should therefore be underlined that scientific efforts should not only focus on the direct effects of DFADs on catches (target and non-target species) but should also address other possible impacts, such as density dependent effects on the behaviour and life-history parameters of tunas. This current lack of converging results justifies a major and urgent scientific effort, in terms of data collection, experimental research and modelling to tackle definitively whether the increased deployment of DFADs could lead to indirect impacts on tropical tuna populations.

2.7 Supplementary Materials: estimation of the maximum number of operational buoys

2.7.1 Summary

The total number of authorized operational buoys was calculated considering the large-scale purse seine vessels only, with data from an International Seafood Sustainability Foundation (ISSF) report (Justel-Rubio and Recio 2023, for ICCAT, IOTC and WCPFC vessels) and data from the IATTC website. This method gives an estimated total maximum potential number of 237,870 operational buoys at each moment, which is much higher than the last global estimate of DFADs deployments (81,000 to 121,000 deployments in 2013 estimated by Gershman et al. 2015).

2.7.2 Data and calculation

Large-Scale Purse-Seine vessels (LSPS) having 335 m³ fish hold volume or greater were considered (Justel-Rubio and Recio 2023). The number of LSPS vessels considered was based on the Table 5 in Justel-Rubio and Recio 2023 (Figure 2.3).

	CCSBT	IATTC	ICCAT	IOTC	WCPFC
CCSBT	0				
IATTC		222	19	1	28
ICCAT			108	14	18
IOTC				96	29
WCPFC					326

Figure 2.3: Table 5 from Justel-Rubio and Recio 2023: Number of large-scale tropical purse seine vessels (≥ 335 m³ FHV) with tRFMO authorizations. Numbers in yellow represent the total number of vessels authorized in the tRFMO (including both vessels authorized by that tRFMO only and vessels authorized also in other tRFMOs).

IATTC: The limit on the number of operational buoys in the IATTC depends on the vessel class (IATTC 2021). For that reason, the calculation was performed using IATTC data. The vessel list was downloaded from the following web page on March, the 14th 2023: <https://www.iattc.org/en-US/Management/Vessel-register>.

tRFMOs limit the number of operational buoys to 300, 300 and 350 per vessels for the ICCAT (ICCAT 2022), IOTC (IOTC 2019) and WCPFC (WCPFC 2021) respectively.

2.7.3 Results

The obtained limits, per tRFMO, of the potential number of operational buoys when considering only the large-scale purse-seine vessels, were:

- **IATTC:** 62,570 operational buoys
- **ICCAT:** 32,400 operational buoys
- **IOTC:** 28,800 operational buoys
- **WCPFC:** 114,100 operational buoys

-
- **Total:** 237,870 operational buoys

Transition

In this chapter, I reviewed the current scientific evidence on the indirect impacts of DFADs on tropical tuna. The main result of this chapter is the current lack of converging scientific results on these impacts. This lack of converging results justifies an important scientific effort, in terms of data collection, experimental research and modelling to tackle definitively whether the increased deployment of DFADs could lead to indirect impacts on tropical tuna populations.

Although we know that DFADs modify the habitat of tropical tuna, the quantitative characterization of this habitat modification is missing in several oceans. Hence, in Part I, I assess the modifications of tropical tuna surface habitat. First, I quantify these habitat modifications caused by DFADs in the Western Indian Ocean (Chapter 3). Then I assess the potential modifications of tuna habitat caused by climate change and other human activities such as deforestation (Chapter 4).

This review also evidenced that the impact of habitat modifications on tropical tuna behavior (large-scale, small-scale and schooling behavior) is still largely unknown. In Part II, I assess the impact of an increase of FOB density, induced by DFADs, on the associative behavior of tropical tuna. This impact is assessed both at the individual (Chapter 5) and aggregation level (Chapter 6), and the resulting impact on tropical tuna catchability is characterized.

Finally, this habitat modification could also impact tuna's life history parameters (*e.g.* condition or reproduction), but the only converging result is the lower physiological condition of tuna associated with DFADs when compared with that of FSC tuna. Based on that result, in Part III, I first assess if this short-term difference in condition results in a long-term impact on YFT condition concurrently with the massive increase in DFAD use in the IO (Chapter 7). Also, I develop a mathematical framework to determine if this lower condition is the cause or the consequence of tuna associative behavior with FOBs (Chapter 8).



Part I

Human induced modifications of tropical tuna surface habitat

Chapter 3

Surface habitat modification through industrial tuna fishery practices

Publications

Peer-reviewed

Dupaix, A., Capello, M., Lett, C., Andrello, M., Barrier, N., Viennois, G., & Dagorn, L. (2021). Surface habitat modification through industrial tuna fishery practices. *ICES Journal of Marine Science*, 78(9): 3075–3088. <https://doi.org/10.1093/icesjms/fsab175>

Technical paper

Dupaix, A., Capello, M., Lett, C., Andrello, M., Barrier, N., Viennois, G., & Dagorn, L. (2021). Surface habitat modification through industrial tuna fishery practices (IOTC Ad Hoc Working Group on FADs (WGFAD2) *IOTC-2021-WGFAD02-INF11*). Indian Ocean Tuna Commission. <https://iotc.org/documents/surface-habitat-modification-through-industrial-tuna-fishery-practices>

3.1 Introduction

Studying the impact of human activities on natural ecosystems is a central issue in marine ecology and conservation (Halpern et al. 2008; Cigliano et al. 2015; Díaz et al. 2019). The majority of studies that address human-induced modifications of marine habitats are related to climate change, where most research focuses on shifts in biomass and distribution of marine species due to ocean acidification and warming (Dueri et al. 2014; Bryndum-Buchholz et al. 2019; Lotze et al. 2019). However, fisheries can also cause modifications of marine habitats, *e.g.* by altering the seabed (Neumann et al. 2016).

Many pelagic species, such as tropical tuna, are known to associate with floating objects (FOBs) (Fréon and Dagorn 2000; Castro et al. 2002). The first FOBs were all natural, mainly parts of trees (logs) floating out in the ocean. Taking advantage of the associative behaviour of pelagic species, tuna purse seine vessels began using Fish Aggregating Devices (FADs), *i.e.* man-made objects, in the early 1990s (Davies et al. 2014a). Throughout this paper, we will refer to drifting fish aggregating devices as “DFADs”, to natural FOBs (such as logs or parts of trees) as “NLOGs”, to artificial drifting objects other than FADs (*e.g.* originating from human pollution) as “ALOGs”, and to any type of floating objects (FADs, NLOGs, or ALOGs) as “FOBs”. The exact number of DFADs is unknown, however, a drastic increase has occurred since fishers began using them three decades ago. In the Indian Ocean (IO), a fourfold increase in the number of DFADs was estimated between 2007 and 2013, with 10300 active DFADs recorded in September 2013 (Maufroy et al. 2017). In the same period, the number of DFAD deployments increased, with an estimation of 14000 deployments in 2013 (Gershman et al. 2015) and this increase continued until 2018 (Katara et al. 2018; Floch et al. 2019). The increasing use of DFADs was observed mainly where purse seine fleets operate, *i.e.* in the western IO (Báez et al. 2020). Consequently, the proportion of tuna captured around FOBs in the IO has increased, with approximately 86 % of tuna caught by purse seine fleets in 2018 originating from FOBs. Purse seine catch on FOBs represents 40 % of the total tuna catch in this ocean, all gears and fishing modes included (IOTC 2020c; IOTC 2020d; IOTC 2020e). Purse seine fishing around FOBs, when compared to targeting free-swimming schools, has the advantage of both reducing the search effort and increasing the catchability of tuna (Dagorn et al. 2013a). However, this fishing mode also leads to higher by-catch rates (Dagorn et al. 2013b; Davies et al. 2014a) and increased catches of small yellowfin (*Thunnus albacares*) and bigeye tuna (*Thunnus obesus*), which are currently both subject to overfishing in the IO (IOTC 2020a; Merino et al. 2020). These direct impacts of DFAD fishing are regularly receiving research attention (*e.g.* Filmalter et al. 2013; Dagorn et al. 2013b; Wain et al. 2021) and are considered by regional fisheries management organizations (RFMO) for developing and adopting conservation measures. For example, the Indian Ocean Tuna Commission (IOTC) aimed at “[reducing] juvenile Bigeye tuna and Yellowfin tuna mortalities from fishing effort on Fish Aggregating Devices” through a resolution limiting the number of DFADs to 500 per vessel per year in 2019 (IOTC 2019). Moreover, this fishing practice also increases the number of FOBs at sea, which can modify the habitat of animals, which naturally associate with such structures (Dagorn et al. 2013a), with possible consequences on their ecology. Furthermore, it also generates coastal and marine pollution when DFADs wash ashore (Imzilen et al. 2021). The indirect impacts of the presence of a large number of DFADs drifting in the ocean on marine species is yet to be fully assessed and considered in fisheries management.

It has been hypothesized that high numbers of DFADs could result in an “ecological trap” for tropical tuna (Marsac et al. 2000; Hallier and Gaertner 2008). An ecological trap occurs when individuals select poor-quality habitats when they are misled by cues that are no longer correlated to habitat quality due to anthropogenic changes (Battin 2004; Gilroy and Sutherland 2007). This selection of poor-quality habitat then leads to a reduction in their fitness. It

has been hypothesized that, by modifying the density and spatial distribution of FOBs, the massive deployment of DFADs could retain or transport individuals in areas that are ecologically unsuitable for them (Marsac et al. 2000; Fonteneau et al. 2013). Moreover, this mechanism could lead to an export of tuna biomass out of large marine protected areas, undermining their effectiveness (Boerder et al. 2017; Curnick et al. 2021).

This study aims at determining the modifications of the surface habitat of tropical tuna related to the intensive deployment of DFADs in the IO, 10 years after an initial short-term (2007–2008) assessment by Dagorn et al. 2013a in the western IO. We consider that natural floating objects (NLOGs) constitute a natural feature of this habitat while DFADs represent the major human-induced change (as in Dagorn et al. 2013a). Hence, we assess the increase in the number of DFADs relative to the number of NLOGs, and the resulting modifications on FOBs distribution. In the present study, we aim at (i) quantifying the surface habitat changes in the western IO (the main fishing grounds of the purse seine fleet) over 2006–2018, due to the deployment of DFADs by fishers, and (ii) undertaking an initial evaluation in the eastern IO, beyond the main fishing grounds of the purse seine fleet.

3.2 Material and methods

3.2.1 FOB data

DFADs and NLOGs locations were obtained from (i) data recorded by scientific observers onboard purse seine vessels (2006–2018), and (ii) Global Positioning System (GPS) positions from tracking buoys deployed on FOBs by purse seine vessels (2014–2018).

Observer data were collected on-board French purse seine vessels operating in the tropical western IO. The French fleet is one of the main purse seine fleets operating in the IO, after the Spanish and Seychellois fleets, and is responsible for about 15 % of the total IO purse seine catch (IOTC 2020b). Like the other purse seine fleets, the French fleet operates mainly in the western IO. Between 2006 and 2018, it was composed of 6 (in 2007) to 12 (in 2018) purse seine vessels, for a total carrying capacity increasing from ~ 3600 to ~ 11700 t. Supply vessels are also in use since 2016 (one since 2016 and a second one since 2018; Floch et al. 2019). Observer coverage of the fleet increased from 7 % in 2013 to more than 25 % in 2017 and 2018 (IOTC 2020f). The observer data include the date, time, and location of the main activities of the vessel (*e.g.* fishing sets, installation or modification of FOBs, and searching for FOBs). For every activity occurring on a FOB, the type of operation (*e.g.* deployment, removal, and observation of a FOB) and the type of object (DFAD, NLOG, or ALOG) are reported. When the observed FOB is equipped with a satellite-linked tracking buoy, the type of operation on the buoy (deployment, removal, observation, etc.) and the buoy's unique identification number are also reported.

The GPS position dataset contains the unique identification number of the buoys, the date and time of the buoy's GPS positions and their associated geographical coordinates. The elapsed time between two positions recorded from the buoys can be remotely controlled by the vessels and ranged between 2 and 12 hours. To determine when a buoy was at sea and attached to a FOB, rather than onboard a vessel before deployment or following recovery, the dataset was filtered using the algorithm developed by Baidai et al. 2017.

3.2.2 FOB spatial distribution from observer data

We calculated the overall number and proportion of the different FOB types on an annual basis from the observer data between 2006 and 2018. We also report the number of observation days during the same period. An observation day corresponds to a day where at least one activity

was registered by an observer onboard a fishing vessel. The remaining analysis focused on two time periods when observer coverage was highest (2007–2008 and 2014–2018). The choice of these two periods also allowed us to compare our estimates to those obtained in a previous assessment (Dagorn et al. 2013a). Only a portion of ALOGs originate from fisheries, and mainly from other fishing modes than purse seine fishing. Hence, as our study aimed at determining the impact of industrial DFAD fisheries on the pelagic habitat, the rest of the analysis focused on the comparison between the spatial distributions of DFADs and NLOGs.

As an estimate of the density of FOBs encountered by observers, we determined, for each study period, the median spatial Euclidean distance between the locations of two consecutive encounters of FOBs on a quarterly basis. Two consecutive FOB encounters were defined as two observations consecutive on the observer record and performed by the same vessel, during the same trip. This distance was calculated for all FOBs together (DFADs, NLOGs, and ALOGs), for DFADs only and for NLOGs only. For each FOB type and each quarter, we also calculated the standard error (SE) of the distance, with: $SE = \frac{SD}{\sqrt{N}}$, where SD is the standard deviation and N is the number of distances. For each of the two considered study periods (2007–2008 and 2014–2018), we performed Wilcoxon rank sum tests to determine if the distance was different depending on the FOB type. We also performed Wilcoxon tests to determine if, when considering one type of FOB, the distance differed between the two study periods. A FOB multiplication factor was also calculated, on a quarterly basis, for each study period. This factor was calculated as the ratio of the sum of observed DFADs and NLOGs divided by the number of NLOGs, and was calculated for each macro-area used in Dagorn et al. 2013a: Somalia, South-East Seychelles, North-West Seychelles, Mozambique Channel, and Chagos. Hence, a multiplication factor greater than 2 means that more DFADs were observed than NLOGs. This calculation was performed for every quarter with at least one NLOG observation. For all calculations, the quarters used were defined according to the seasonality of purse seine fleet (Dagorn et al. 2013a): Q1, December to February; Q2, March to May; Q3, June to August; and Q4, September to November. To test whether the multiplication factor significantly differed between macro-areas, we performed a Kruskal–Wallis test. Also, in order to assess a possible modification of the multiplication factor between the two study periods (2007–2008 and 2014–2018), we performed Wilcoxon tests.

In addition, the spatial distributions of observed DFADs and NLOGs were assessed for each study period, considering the total number of observations of each FOB type per 2° square cell. This figure was then divided by the observation effort, which was the number of observation days in each cell. A vessel was considered to have spent a day in a cell when the first entry of the day, in the observer data, was located in this cell. Cells with too few data (*i.e.* less than 10 vessel days), were discarded (~ 0.3 % of all data, with cells located at the border of the main fishing grounds). Spatial maps of the FOB multiplication factor were also constructed for each study period using the ratio of the sum of the number of observed DFADs and NLOGs divided by the number of NLOGs for each 2° cell with at least one NLOG.

3.2.3 FOB spatial distribution from GPS data

In order to investigate the spatial distribution of FOBs beyond the industrial purse seine fishing grounds (*i.e.* where observer data are not collected), we also considered the data provided by the satellite linked tracking buoys attached to FOBs. To achieve this, GPS positions of FOBs equipped with buoys were merged with the observer data, using the buoys unique identification number common to the two databases to determine the FOB type to which each buoy was attached. The trajectories obtained from the GPS data were reconstructed at a regular 6-hours interval using the R package *trajectories* v. 0.2–1 (Moradi et al., 2018). For each type of FOB considered in the study (DFADs and NLOGs), spatial densities, expressed as the mean number

of reconstructed GPS positions per day, were estimated in 2° cells, between 2014 and 2018. Finally, the number of buoys deployed on each FOB type was also estimated for the same time period.

3.2.4 Lagrangian simulations of NLOGs

Observations of NLOG by scientific observers onboard industrial purse seine vessels are inherently limited to their fishing grounds (Western IO). To overcome this bias, these datasets were complemented with Lagrangian simulations. The Lagrangian simulations assumed that NLOGs are transported by ocean currents like water parcels, building on previous results showing that FOBs drift similarly to oceanographic drifters in the IO (Imzilen et al. 2019) and can therefore be simulated using Lagrangian models (Imzilen et al. 2016; Davies et al. 2017; Phillips et al. 2019a). We used the Lagrangian tool *Ichthyop v.3.3*. (Lett et al. 2008) to simulate the drift of NLOGs.

NLOGs likely originate from multiple terrestrial sources, including mangrove forests and rivers (Thiel and Gutow 2005). Here, we explored the distribution of virtual NLOGs originating from both sources. Firstly, mangrove locations used as a potential NLOG source were obtained from the Global Mangrove Watch (GMW) 2016 (Lucas et al. 2014). A total of 10000 mangrove polygons were randomly sampled from the 173051 polygons that compose the IO portion of the GMW 2016 shapefile (mean surface area of a polygon: 0.2 km^2). Secondly, 10000 river mouths locations were sampled out of the 18703 obtained from the HydroATLAS database v1.0 (Linke et al. 2019). For both mangroves and river mouths locations, particles were released at the center of the closest sea cell. One particle was released from each point every month from July 2013 to December 2014. To transport these particles, the surface currents obtained through the three-dimensional hydrodynamic model NEMO were used (Madec 2016, ; spatial resolution: $1/12^\circ$; temporal resolution: 1 day). Particles were transported for 180 days, after which they were considered sunk and were removed from the simulations. The sensitivity of the obtained results to the drifting time was assessed, testing drifting times ranging from 30 to 360 days. As little variation of particles distribution were observed for times ranging from 180 to 360 days, the smallest value was used (180 days). Advection was simulated using a Forward Euler integration scheme and a diffusion component was added using a dissipation rate of $1 \times 10^{-9} \text{ m}^2 \cdot \text{s}^{-3}$ (following Peliz et al. 2007). Similarly to the FOB GPS data, the particle trajectories obtained from the simulations were then used to generate standardized distribution maps of virtual NLOGs, where the total number of particles in each 2° cell during 2014 was divided by the number of days. As such, these maps represent the mean number of particles per simulation day in each 2° cell.

3.3 Results

3.3.1 Modification of FOBs distribution from observer data

The observer data included 22657 observations of FOBs from 2006 to 2018, 19,155 (84.5 %) of which were DFADs, 1,666 (7.4 %) were NLOGs and 1836 (8.1 %) were ALOGs. The number of FOB observations increased after 2013, with more than 4000 observations per year since 2015 (Figure 3.1A). This increase was due to both better coverage of the French purse seine fleet (from less than 500 days during the initial years of the study period to more than 1,200 days since 2014, Figure 3.1A) and a higher number of DFADs per day (Figure 3.1B). The number of observations of DFADs per day increased over the years from a minimum of 0.51 observations per day in 2006 to a maximum of 2.83 in 2017 (Figure 3.1B). Conversely, the number of observations per day of both NLOGs (minimum value = 0.09 in 2006 and maximum

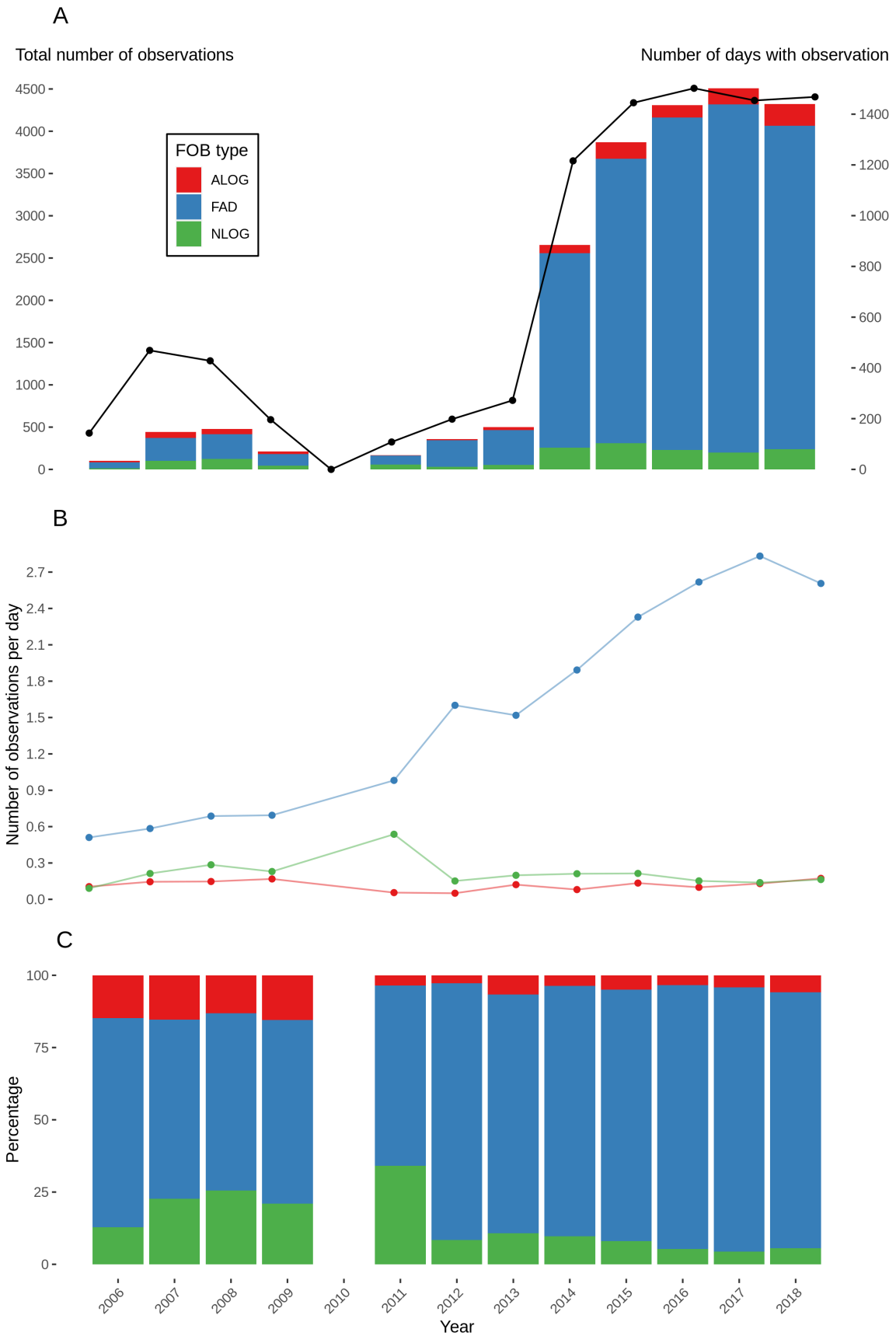

Figure 3.1: Change in the number of FOBs observed from 2006 to 2018 in the IO. (A) Number of FOBs observed over time, by FOB type, and number of days with observations per year (black line). (B) Number of observed FOBs, by FOB type, divided by the number of days of observation. (C) Proportion of each FOB type per year. FAD (in blue): drifting fish aggregating device; NLOG (in green): natural floating object; ALOG (in red): artificial log resulting from human activity (other than FADs).

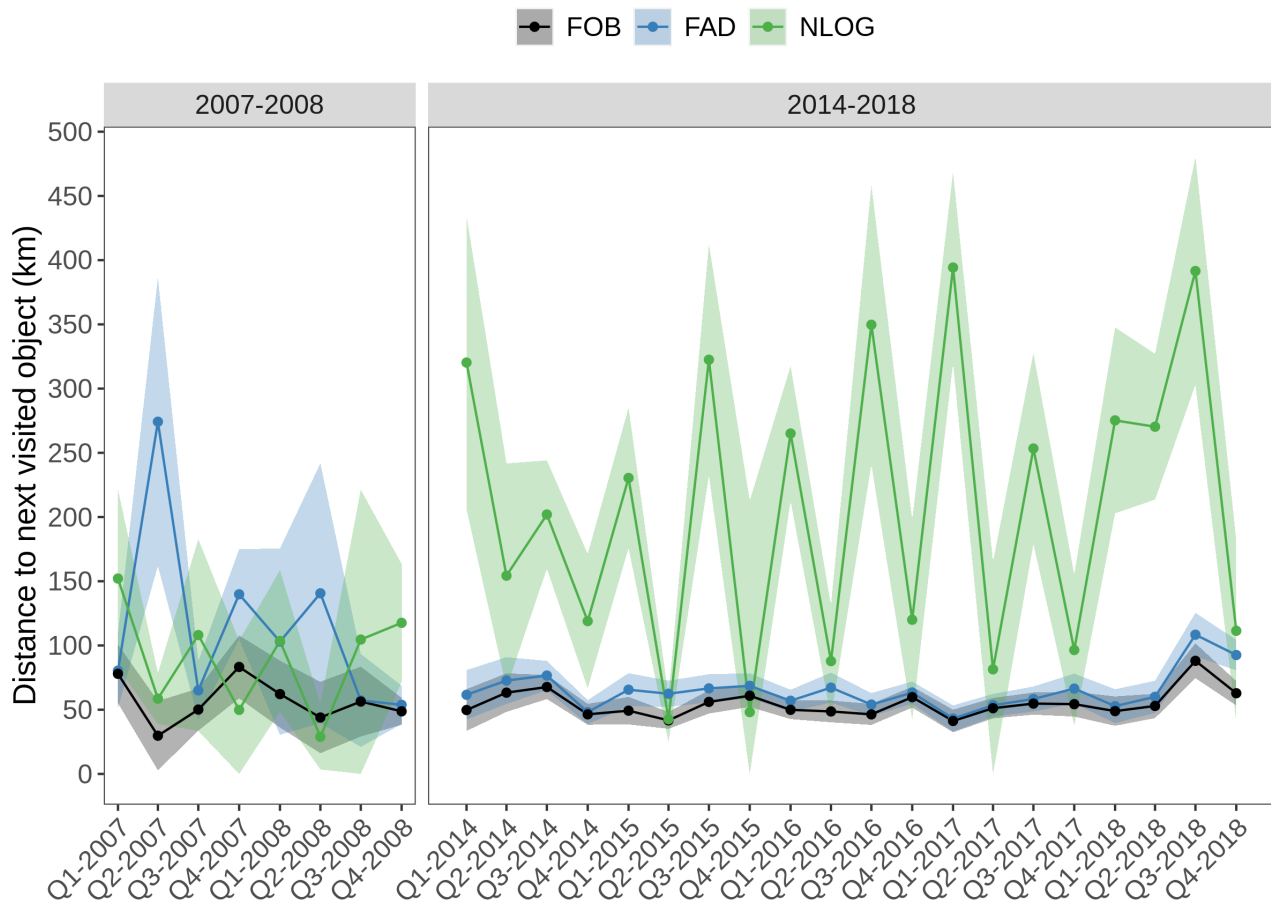

Figure 3.2: Quarterly median spatial distance between two consecutive encounters of FOBs for the two study periods (2007-2008 and 2014-2018). The distance was calculated between two consecutive encounters of any type of FOBs (FAD, ALOG, or NLOG; black line), between encounters of FADs only (blue line) and between encounters of NLOGs only (green line). The colored areas around the lines represent the SE.

value = 0.54 in 2011) and ALOGs (minimum value = 0.05 in 2012 and maximum value = 0.17 in 2018) remained stable over the study period. Similarly, the percentage of observed DFADs increased in time with a clear transition occurring in 2012 (Figure 3.1C), from 63 % during 2006–2011 to 89 % in 2012–2018. The percentage of NLOGs simultaneously decreased from 24 % in 2006-2011 to only 6% in 2012–2018 (Figure 3.1C).

The median distance between two consecutive FOB encounters, during 2007–2008, showed no major difference between DFADs and NLOGs (70 km and 74 km, respectively; $W = 5.2 \times 10^4$, $p = 0.84$). During this period, the median distance between two consecutive FOBs of any type was significantly lower than when considering only DFADs or only NLOGs: median distance of 56 km ($W = 2.2 \times 10^5$, $p = 2.4 \times 10^{-3}$ with DFADs and $W = 9.4 \times 10^4$, $p = 2.3 \times 10^{-2}$ with NLOGs). During 2014–2018, the distance between two consecutive DFADs became significantly lower than between two consecutive NLOGs (37 km and 89 km, respectively; $W = 1.1 \times 10^7$, $p = 3.0 \times 10^{-49}$). The median distance between two consecutive FOBs of any type stayed lower than when considering only one FOB type ($W = 1.6 \times 10^8$, $p = 5.3 \times 10^{-9}$ with DFADs and $W = 1.3 \times 10^7$, $p = 2.0 \times 10^{-59}$ with NLOGs). The median distance between two consecutive NLOGs did not significantly differ between the two study periods ($W = 9.2 \times 10^4$, $p = 0.36$). However, the median distance between two consecutive DFADs or between two FOBs of any type decreased ($W = 5.8 \times 10^6$, $p = 9.5 \times 10^{-23}$ and $W = 1.0 \times 10^7$, $p = 2.0 \times 10^{-20}$, respectively) after 2014. Finally, seasonal differences were observed in the distance between NLOGs, with larger distances in quarters 1 (December-February) and

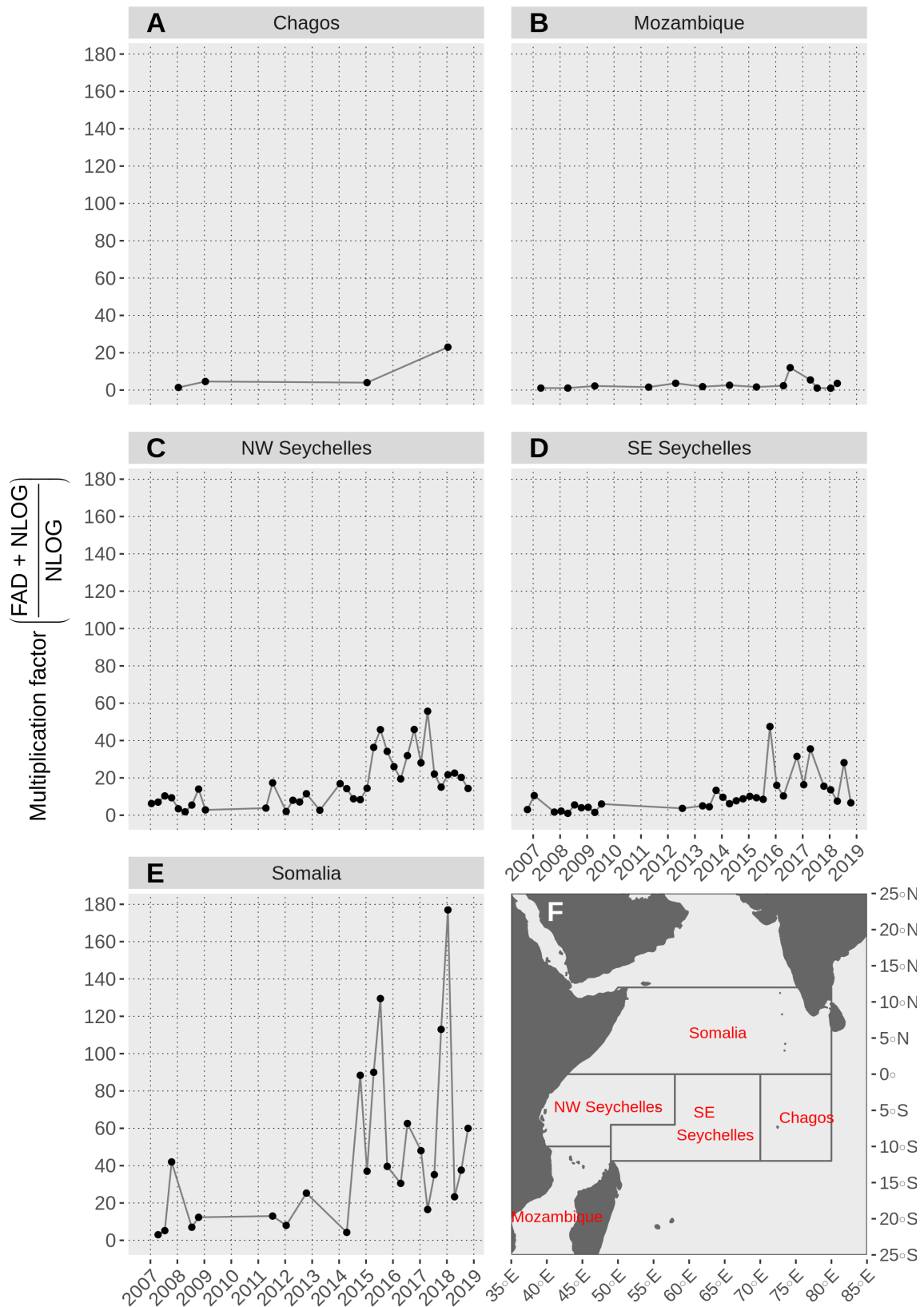

Figure 3.3: Quarterly multiplication factor in the different IOTC areas from 2007 to 2018 in Chagos (A), Mozambique Channel (B), North-West Seychelles (C), South-East Seychelles (D), and Somalia (E). Map of the IOTC areas as defined in Dagorn et al. 2013a (F). The multiplication factor was calculated only for the quarters with observations of both NLOGs and FADs.

3 (June–August) than in quarters 2 (March–May) and 4 (September–November, Figure 3.2).

The FOB multiplication factor (the ratio of the sum of observed DFADs and NLOGs divided by the number of NLOGs) differed significantly between macro-areas (Kruskal–Wallis test: $\chi^2 = 36.3$, $p = 2.5 \times 10^{-7}$). It also seemed to increase through time in every macroarea (Figure 3.3), except in the Chagos region, where a lack of observations precluded a conclusive analysis (Figure 3.3A). The Mozambique Channel was the region with the lowest multiplication factor values: 1.1 in 2007–2008 (hence 10 times more NLOGs than DFADs); the factor increased to 3.7 (SD = 3.7) in 2014–2018, but this increase was not significant (Wilcoxon test: $W = 10$, $p = 0.4$). A higher number of DFADs than NLOGs (multiplication factor > 2) was already evident in the first study period in the other regions [mean multiplication factor in 2007–2008: 13.9 (SD = 16.1) in Somalia, 7.2 (SD = 3.9) in North-West Seychelles, and 4.0 (SD = 3.2) in SouthEast Seychelles]. However, the multiplication factor increased further in recent years: mean values in 2014–2018 of 62.0 (SD = 46.5), 25.1 (SD = 13.0), and 16.0 (SD = 11.8); Wilcoxon tests: $W = 11$, $p = 1.5 \times 10^{-2}$; $W = 6$, $p = 1.9 \times 10^{-5}$; and $W = 10$, $p = 1.9 \times 10^{-3}$ in Somalia, North-West Seychelles, and South-East Seychelles, respectively. The maximum observed multiplication factor was 177, 56, and 48 in Somalia (1st quarter 2018), North-West Seychelles (2nd quarter 2017) and South-East Seychelles (4th quarter 2015), respectively.

The maps of FOB spatial distributions obtained from observer data confirmed a clear increase in the number of DFADs between the two study periods while maintaining similar spatial patterns (Figure 3.4). In 2007–2008, DFADs were mainly present in the western part of the study area, close to the border of the Somalian Exclusive Economic Zone (EEZ) (Figure 3.4A). In 2014–2018, the number of DFADs per day of observation was much higher, with DFADs present in nearly the entire sampled area but still with higher numbers close to the border of the Somalian EEZ (Figure 3.4B). In both study periods, NLOGs were observed mainly in the Mozambique Channel (Figure 3.4C&D). In 2014–2018, less than 20 % of NLOG observations occurred North of 5°S (Figure 3.4D). Overall, there were more DFADs than NLOGs everywhere in the sampled area except in some parts of the northern Mozambique Channel (Figure 3.4E&F).

3.3.2 Modification of FOBs spatial distribution from GPS data

Matching the unique buoy identification number between the observer and buoy databases allowed for the identification of FOB type for 6136 different FOB trajectories, 5686 (92.7 %) of which were DFADs, and 450 (7.3 %) were NLOGs. Higher densities were found around the Seychelles and close to the Somalian EEZ, both for DFADs (Figure 3.5A) and buoy-equipped NLOGs (Figure 3.5C). The average density of buoys associated to DFADs (3.18×10^{-1} DFAD/cell) was around ten times higher than the density of instrumented NLOGs (3.60×10^{-2} NLOG/cell). The distribution of buoy deployment obtained from the observer data was slightly different for NLOGs and DFADs, with the majority of buoys associated with DFADs being deployed west of the Seychelles (Figure 3.5B) and a high proportion of deployment on NLOGs around the Seychelles and in the Mozambique Channel (Figure 3.5D). The main difference was observed in the Mozambique Channel, where buoy deployments were essentially conducted on NLOGs only.

3.3.3 Simulated trajectories

Figure 3.6 shows the distribution of virtual NLOGs obtained from the Lagrangian trajectories starting from mangrove areas and river mouths and transported for 180 days (results for other lifetime values with NEMO at surface in Supplementary Figure 3.14, with other forcing products in Supplementary Figure 3.15). Results were similar when considering inputs either

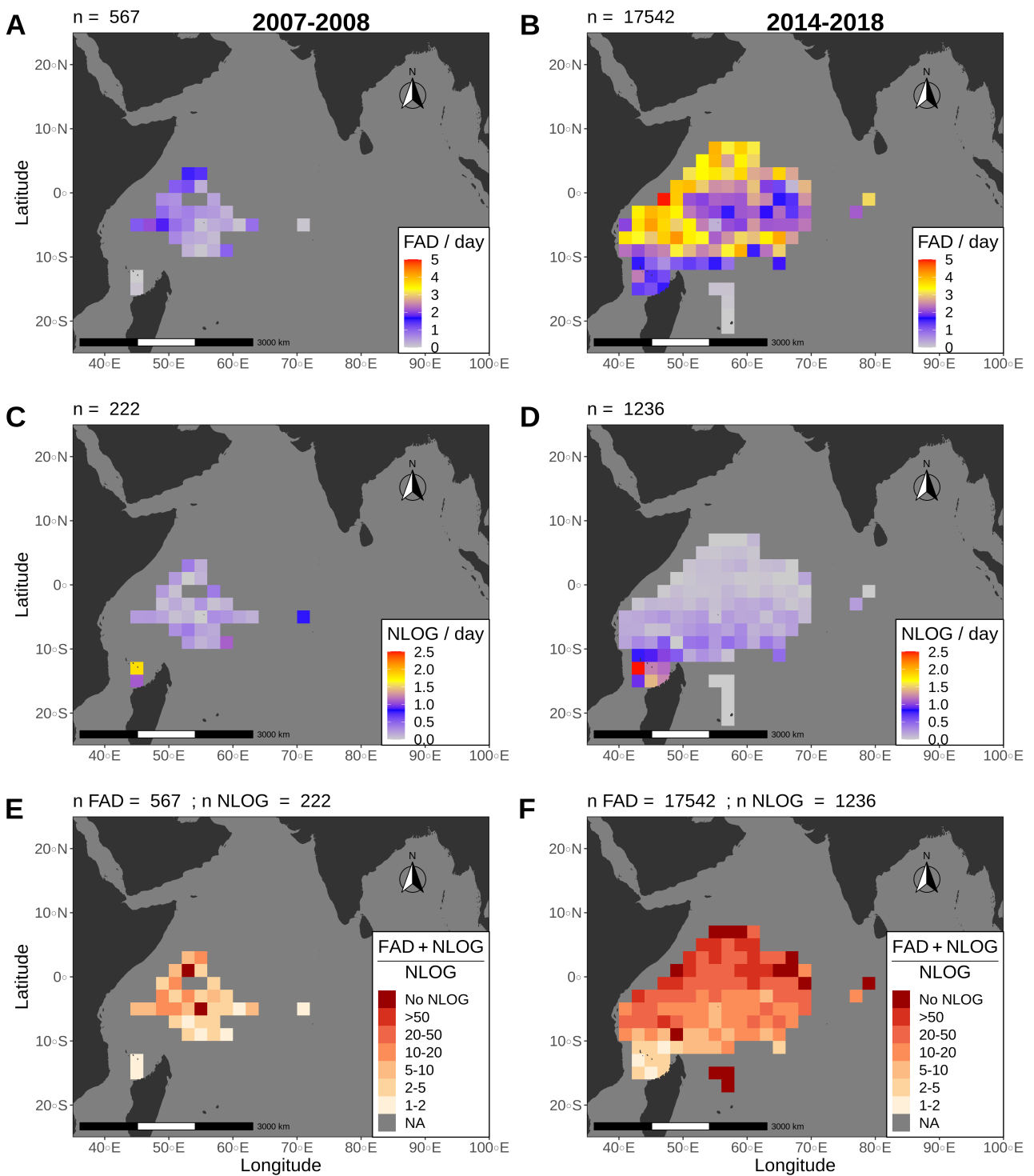

Figure 3.4: Spatial distribution of FOBs observed in the western IO for the two periods (2007-2008 and 2014-2018). (A–B) Number of DFAD observations divided by the number of days of observations. (C–D) Number of NLOG observations divided by the number of days of observations. (E–F) multiplication factor (ratio of DFADs + NLOGs over NLOGs). Dark grey: less than 10 days of observation per cell.

from mangroves only or from rivers only (Supplementary Figure 3.17). The highest numbers of simulated NLOGs were observed in the Mozambique Channel, in the Bay of Bengal, and in the eastern part of the Arabian Sea. Only small densities of simulated objects were found offshore (between 5°N and 10°S), with densities one to two orders of magnitude smaller than in the Bay of Bengal or in the Mozambique Channel (Figure 3.6B).

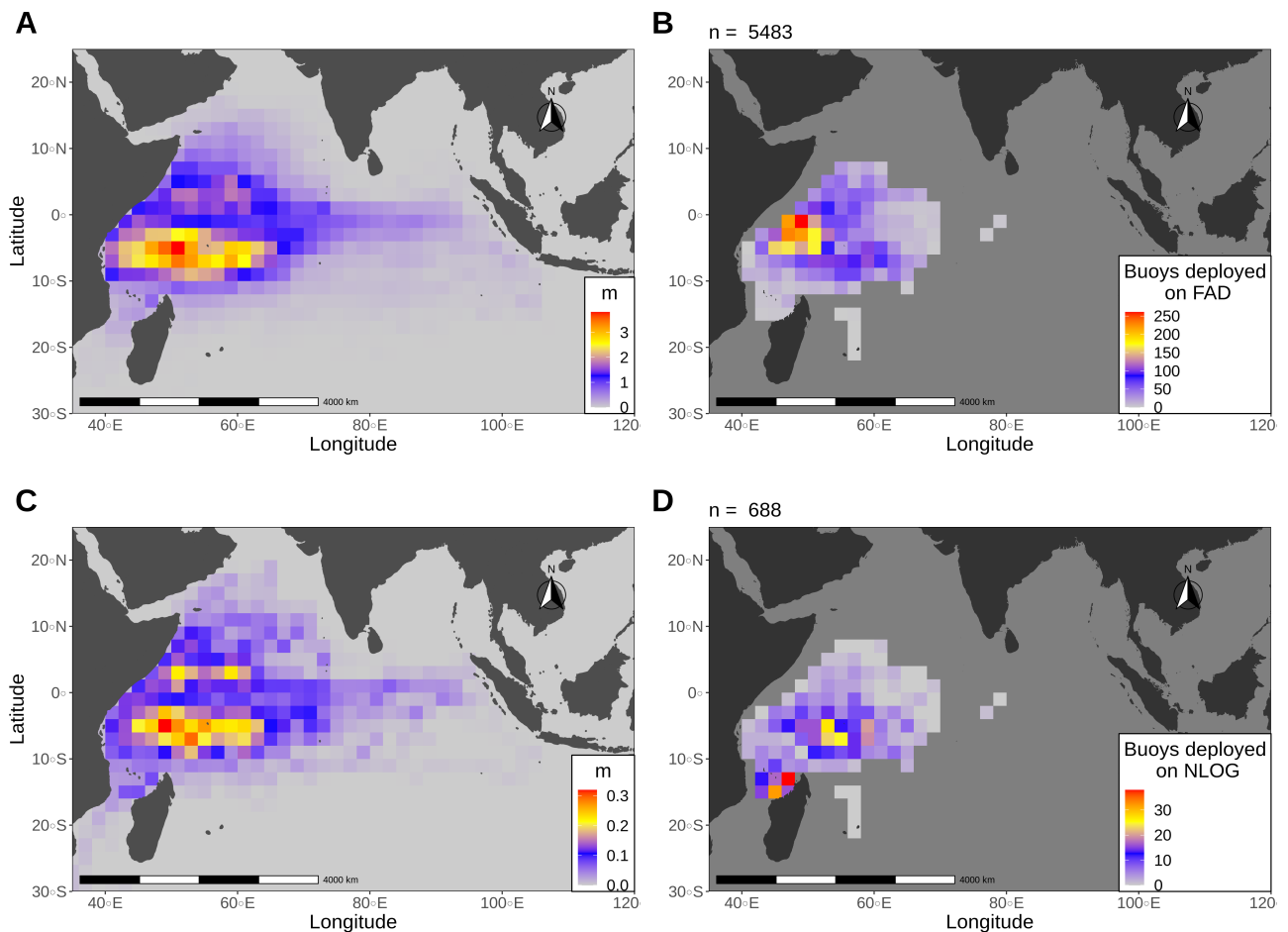

Figure 3.5: Spatial distribution of instrumented FOBs, from 2014 to 2018. Mean number of buoys associated with an object per day per cell (m), obtained from the GPS buoy trajectories dataset, for DFADs (A) and NLOGs (C). Number of buoys deployment per cell, obtained from the observers' dataset, on DFADs (B) and on NLOGs (D); n: total number of deployments. Dark grey: less than 10 days of observation per cell.

3.4 Discussion

3.4.1 Modification of the FOB distribution in the western IO

Our results show that DFAD numbers in the IO have increased between 2007 and 2017, which is in agreement with previous studies (Morgan 2011; MRAG 2017; Maufroy et al. 2017). Assessing the recent evolution of DFAD numbers in the IO is important, as the latest assessment was based on data from 2007 to 2013 (Maufroy et al. 2017). Resolutions adopted by the IOTC limited the number of active buoys associated with DFADs to 350 per vessel in 2017 and then to 300 per vessel in 2019, with an annual maximum number of 500 DFADs deployed per vessel (IOTC 2019; IOTC 2017). It is still too early to assess the impact of such resolutions, but it would be important to determine if the stabilization of the number of DFADs observed in our study from 2017 to 2018 persists in the near future.

This study also reveals a significant increase in the proportion of DFADs compared to other FOB types in the western IO, increasing from 60 to 70 % of the observations between 2006 and 2010 to more than 85 % in recent years (2014–2018). A very limited number of studies compared the numbers and distributions of NLOGs and DFADs. Phillips et al. 2019a, using data from 2016 and 2017 and Lagrangian simulations, showed an increase in FOB densities induced by DFAD deployments in the western Pacific Ocean as well as a modification of the areas where the highest FOB densities are observed. In the western IO, Dagorn et al. 2013a,

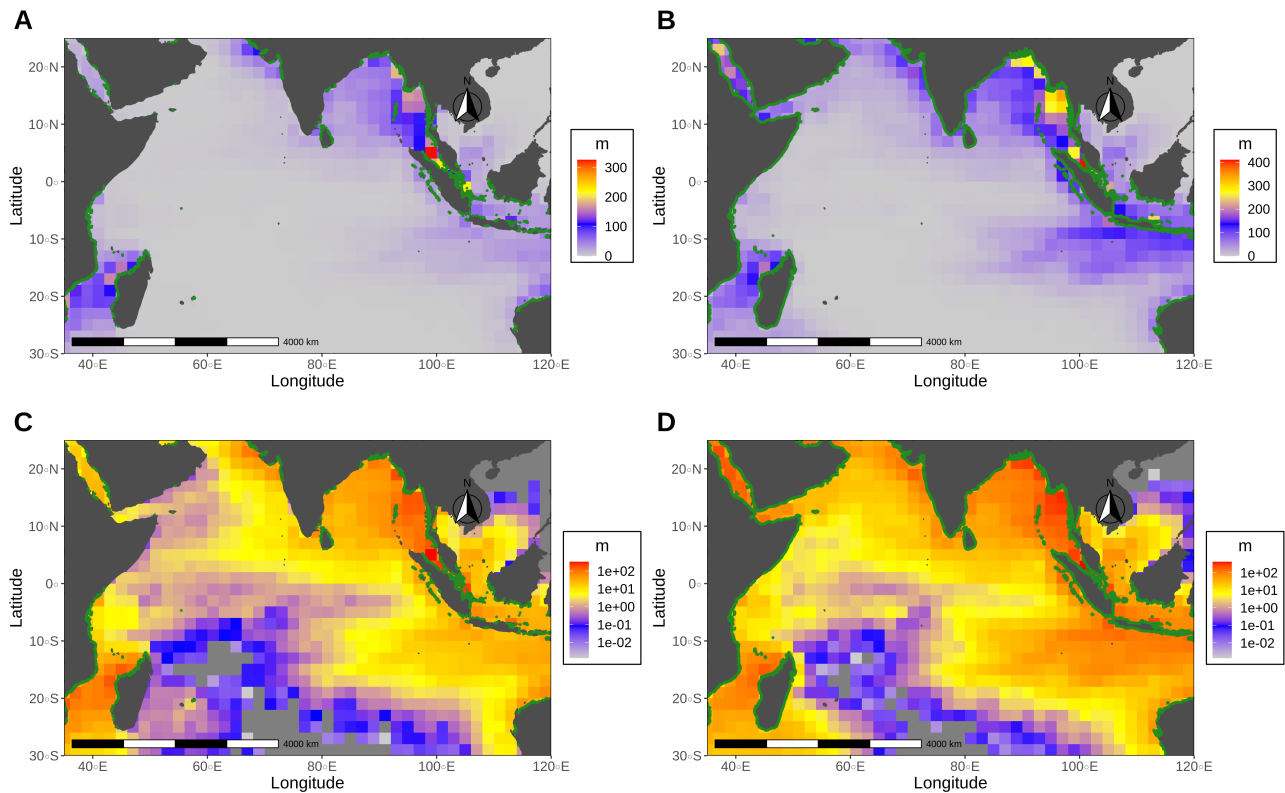

Figure 3.6: Putative spatial distribution of NLOGs obtained from simulated trajectories for the IO, in 2014. The mean number of simulated NLOG per cell is shown (m), aggregated over a transport time of 360 days, using forcing currents produced by NEMO at surface. Linear color scale (A) and log transformed color scale (B).

using data from 2007 and 2008, found that DFADs did not create new FOB areas (*i.e.* they were not present in areas that were previously free of FOBs) as both types of FOBs were found everywhere. The number of FOBs, however, at least doubled in all fishing grounds used by the purse seine fleet, and was multiplied by 20 or 40 in some areas (*e.g.* Somalia area). Ten years after this study, and under the hypothesis that the number of NLOGs remained stable, we found that even the Mozambique Channel, where NLOG were still more numerous than DFADs at the time, has shown an increase in the proportion of DFADs, with DFADs multiplying the number of FOBs by ~ 3.7 in 2014–2018. Somalia is still the most impacted area, ahead of North-West Seychelles and South-East Seychelles, and multiplication factors have increased three to fourfold between 2007–2008 and 2014–2018 in the entire western IO. Therefore, our study does not only confirm Dagorn et al. 2013a’s results for 2007–2008, but with the number of NLOGs remaining stable, it also shows that the number of FOBs has increased even more since then, with the Mozambique Channel even being impacted. This trend is shown by the reduction of the mean distance between two consecutive DFAD encounters in 2014–2018 relative to that of 2007–2008, with FOBs now found closer to each other. In recent years, the fishing strategy of the French purse seine vessels rapidly evolved from fishing mainly on FOBs encountered at random (*i.e.* not equipped with their own tracking buoys; Snouck-Hurgronje et al. 2018) to deploying a higher number of buoy-equipped DFADs and fishing mainly on their own objects (Marsac 2017). Indeed, the proportion of DFADs deployed by the French fleet that were equipped with echosounder buoys went from 0 % up until 2009 to 100 % after 2014 (Marsac 2017). This shift in fishing strategy could artificially increase the observed number of DFADs in our data. However, when assessing the same metrics discussed above using observations of randomly encountered objects only (objects which do not belong to the vessel or its fishing company), the results showed similar trends (Supplementary Figures 3.7-3.10). The only difference was

that the increase in the number of DFADs in recent years was less drastic (Figure 3.1B).

In the western IO, the DFAD distribution obtained from GPS data (Figure 3.5A) showed broad agreement with that obtained from observer data (Figure 3.4B), with slight differences mainly observed in the north of the fishing grounds. These differences can be explained by the sampling schemes specific to each dataset. The observer data provide access to every encountered FOB, but only in the areas where fishing vessels with onboard observers are present. Because some regions are only fished at a given time of the year (*e.g.* the Mozambique Channel from March to May, Supplementary Figure 3.11), this seasonal coverage precludes the balanced sampling of all regions. Buoy GPS data do not suffer such bias as it is independent of the trajectories of fishing vessels. However, it is also important to note that only a subset of NLOG and DFAD trajectories could be identified in the GPS database, as cross referencing the unique buoy identifiers in the observer data reduced the number of exploitable trajectories. Furthermore, only the data from the French buoys were available for this study. Three major purse seine fleets operate in the western IO (French, Seychellois, and Spanish). Despite these fleets historically showing different fishing strategies in relation to DFADs (Guillotreau et al. 2011; Marsac 2017; Maufroy et al. 2017; Snouck-Hurgronje et al. 2018), recent studies highlighted high spatial correlations between the deployment locations of DFADs exploited by these fleets in recent years (Katara et al. 2018). Although the total number of DFADs cannot be calculated from the available data, the spatial patterns of DFADs obtained from the GPS buoys can be considered reliable. In the study by Katara et al. 2018, lower correlations were found in the first half of the year. The difference observed in the second half of the year explains why, when considering the spatial distributions of DFADs by quarter (Supplementary Figures 3.11 & 3.12), results from the two datasets showed more similarity in quarters 1 and 4 than in quarters 2 and 3. The spatial distribution of NLOGs obtained from the observer data (Figure 3.4C&D) differed in general terms with that obtained from the GPS positions of buoys (Figure 3.5C). Here, it is important to note that the purse seine vessels generally do not instrument (with satellite-linked buoys) all the NLOGs that they encounter. This is particularly true in locations where the NLOG abundance is high, like the Mozambique Channel, thus introducing a possible bias between the real number of NLOGs and the number of NLOGs equipped with a buoy. Furthermore, buoys cannot be deployed on NLOGs that do not pass through the fishing grounds, which may further bias results obtained using satellite-linked buoy data. As such, observer data still remain the most reliable data source to assess DFAD and NLOG relative distributions in the western IO.

3.4.2 Modification of the FOB distribution in the eastern IO

As tuna purse seine fishing grounds are mostly located in the western IO, the impact of DFAD deployment on the eastern IO cannot be studied using observer data. Furthermore, comparing NLOG and DFAD spatial distributions in the eastern IO using GPS data from satellite-linked buoys was not possible either, as explained above.

To obtain a more accurate prediction of the NLOG distribution in the eastern IO, we performed a Lagrangian simulation of NLOG trajectories. Contrary to the GPS-based distributions, the NLOG distribution obtained from the simulation (Figure 3.6) were in agreement with those obtained from the observer data in the western IO (Figure 3.4C&D). They also indicate high numbers of NLOGs in the east of the Arabian Sea and in the Bay of Bengal. Van der Stocken et al. 2019 simulated the dispersal of mangrove propagules and also observed high densities of particles in the Mozambique Channel, in the eastern Arabian Sea and the Bay of Bengal. Other studies simulating the dispersal of plastic waste from rivers into the ocean also obtained similar areas with high densities (Lebreton et al. 2012; Van Sebille et al. 2015; Viatte et al. 2020).

In our study, NLOG distributions obtained from Lagrangian simulations and DFADs distributions obtained from GPS buoy data show that DFAD deployments probably have a low impact in the Bay of Bengal and in the eastern Arabian Sea. DFADs seem to be in very low densities in these regions, whereas NLOGs occur in high densities. The results obtained here also suggest low densities of both DFADs and NLOGs in the equatorial eastern IO. However, it is not possible to assess the impact of DFAD deployments in this area with certainty for two reasons. Firstly, buoy data could lead to an underestimation of DFAD densities in the equatorial eastern IO, as buoys can be deactivated by fishers when they leave the fishing grounds (*e.g.* they enter a Marine Protected Area or drift too far from the fished area). However, we are confident that this bias is limited in its extent, as, in our data, less than 2 % of all equipped DFADs were deactivated in the eastern IO (see Supplementary Figure 3.13). Secondly, lagrangian simulations do not allow for quantitative comparisons with actual data.

3.4.3 Robustness of Lagrangian simulations

The assessment of the NLOG distribution in the eastern IO relies on Lagrangian simulations. The impact of the current product used on the simulated distributions was tested (Supplementary Figure 3.15). It showed little influence on the relative distribution of simulated NLOGs, in line with results obtained previously (Amemou et al. 2020).

Previous modeling studies pointed at particle lifetime as a key parameter influencing the distributions obtained from simulations, particularly in studies conducted at large spatial scales (Pineda et al. 2007; Huret et al. 2010; Van der Stocken et al. 2019), including in the IO (Stelfox et al. 2020; Crochelet et al. 2020). Particle lifetime is often uncertain, as is the case in our study due to very limited knowledge on the lifetime of NLOGs. Reported estimations of NLOG lifetimes vary between half a day to more than 1000 days (Thiel and Gutow 2005). However, the spatial distributions of NLOGs and the areas with highest putative NLOG densities obtained for different lifetimes (from 60 to 360 days, Supplementary Figure 3.14) were very similar. A large proportion of particles beached (*i.e.* they entered a cell classified as land in the current product) before the end of their lifetime, which could possibly explain the minor impact of the lifetime duration (Supplementary Figure 3.16). Previous studies also found particles accumulation in the southern IO, which was not observed here (Van Sebille et al. 2015; Viatte et al. 2020). However, these studies focused on plastic debris or microplastics, using a much larger drifting time than ours, varying from 20 to 50 years. Hence, while our study suggests that the influence of drifting time on the distribution of simulated NLOGs may be low, if NLOGs were to drift for several years before sinking, new accumulation areas could be formed.

Other important parameters which might influence the distributions calculated from the Lagrangian simulations are the location of NLOG inputs in the ocean and the magnitude and seasonality of this input. Some studies simulating DFAD trajectories showed that these parameters could strongly influence the resulting DFAD distributions (Davies et al. 2017; Curnick et al. 2021). Mangrove and rivers are the two most likely sources of NLOGs (Thiel and Gutow 2005; Caddy and Majkowski 1996; Krajick 2001). The NLOG distributions obtained from these two sources independently were consistent (Supplementary Figure 3.17) and are in line with previously obtained results in the IO (Lebreton et al. 2012; Van Sebille et al. 2015; Viatte et al. 2020). The timing of the particle releases can also have an influence on the simulation results (Siegel et al. 2003; Curnick et al. 2021). Seasonal variability in the input of NLOGs from rivers has been reported (Caddy and Majkowski 1996; Hinojosa et al. 2011) and there may also be a seasonal pattern in the drift of NLOGs away from mangroves and out into the open ocean. Other important drivers of NLOGs release could be storms, which are also seasonal, or extreme once-off events like tsunamis. Doong et al. 2011 estimated that in Taiwan, the Morakot typhoon was responsible for the release of more than three million trees, of which less than 50 % washed

up on the Taiwanese coast. Studying the effects of the magnitude, location, and seasonality of input of NLOG into the ocean is therefore an important area for further research.

3.4.4 Possible consequences of the pelagic habitat modifications on tropical tuna and associated species

Demonstrating habitat changes due to human activities is the first step in the investigation of the ecological trap hypothesis (Marsac et al. 2000; Gilroy and Sutherland 2007). Our study clearly highlights that DFADs significantly modify the “floating object component” of the habitat of pelagic species. In the western IO, this change is more pronounced in 2014–2018 than in 2007–2008 (Dagorn et al. 2013a). Our study shows that, depending on the currents, DFADs generally leave the western fishing grounds and drift towards the east of the IO. Densities of FOBs (natural or artificial) seem to remain low, suggesting a lesser impact in the Eastern IO, but further observations are clearly needed. Because this area is not used by purse seine vessels, scientists cannot use observer data to assess the extent to which DFADs modify the eastern IO. Considering both sides of the IO, our results confirm those of Dagorn et al. 2013a: the first condition for an ecological trap (namely, a rapid habitat modification) seems verified. However, considering the current state of knowledge, the consequences on the ecology of species which naturally associate with FOBs cannot be directly deduced (Dagorn et al. 2013a).

An increase in FOB density (due to the addition of DFADs) could potentially have positive or negative consequences on the ecology of species that naturally associate with them. Some evidence has shown that DFADs act as meeting points for a small pelagic species (*Selar crumenophthalmus*; Soria et al. 2009), helping fish to form schools or increase the size of their schools. In such cases, increased numbers of FOBs could have a positive influence for associated species. However, a behavioural model developed by Sempo et al. 2013 suggests that increasing FOB densities would modify fish distribution among FOBs. Fish would either be scattered among FOBs or aggregate around a single FOB, depending on the level of sociality displayed by the species and on the FOB density. An increase in FOB density could also impact the time fish spend associated with FOBs, decreasing the propensity to leave an area (Kleiber and Hampton 1994; Robert et al. 2014b).

Recently, Pérez et al. 2020 used empirical data in arrays of anchored FADs and demonstrated that a decrease in inter-FAD distances affects the associative behaviour of tuna by increasing the amount of time they spend associated with FADs. Currently, there are no scientific results to indicate that the associative behaviour to anchored or drifting FADs results from different behavioural processes (Dagorn et al. 2010). Tunas seem to orient themselves towards anchored and drifting FADs from similar distances (Girard et al. 2004; Moreno et al. 2007), and association times are similar for both FAD types (Robert et al. 2012; Dagorn et al. 2007; Tolotti et al. 2020). It is therefore coherent, following Pérez et al. 2020, to consider that an increase in drifting FAD densities increases the time spent by tuna associated to FADs. It is noteworthy to remember that a behavioural change induced by an habitat modification could be both beneficial or deleterious for the associated species.

The indicator-log hypothesis posits that natural FOBs are located in productive areas and are therefore used by fish to find such areas or stay there (Dagorn et al. 2013b). Under this hypothesis, and under the assumption that the physiological state of tuna does not influence their associative behaviour, DFADs would trap tuna and other pelagic species in poorer areas and an increase in their density would enhance this trap.

The residence time around FOBs is highly variable among species, with some species (such as the oceanic triggerfish, *Canthidermis maculata*, or the rainbow runner, *Elagatis bipinnulata*) associating with DFADs for up to two to three months at a time (Tolotti et al. 2020; Forget et al. 2015). DFADs could therefore have an impact on large scale movements, *e.g.* modify

migration patterns or facilitate dispersal of species with low movement capabilities. Moreover, past studies highlighted differences in fish plumpness, growth rate, and stomach fullness between tuna caught at DFADs and in free swimming schools (Marsac et al. 2000; Hallier and Gaertner 2008; Robert et al. 2014a). It is important to note that such differences in body conditions were also noticed several decades ago when Japanese fishermen, in order to catch tuna for the katsuobushi (dried tuna), were targeting skipjack associated to FOBs as they knew they were leaner than fish in free-swimming schools. While most studies concluded that tuna are in poorer physiological conditions when associated with FOBs, it is not known if this poorer condition is the result or the cause of their association (Dagorn et al. 2013b; Robert et al. 2014a). In order to assess the impacts of DFADs , which increase the number of FOBs in the ocean, on tuna and the other associated species, future studies should investigate how these changes could affect their physiological conditions. It will also be necessary to investigate if their associative behaviour, *e.g.* the probability to associate to FOBs, changes with their condition.

Similar studies comparing DFAD and NLOG distributions do not yet exist in other oceans. RFMOs set limits on the number of DFADs to be used by purse seine vessels, with the primary objective of limiting the catches of small yellowfin and bigeye tuna as well as other bycatch species. Even if some RFMOs are starting to consider other possible impacts that do not directly concern catches (*e.g.* induced marine pollution by the Western and Central Pacific Commission; Hanich et al. 2019), they are often of lower priority. However, the extent of the modification of the surface habitat by the deployment of DFADs , and the increasing trend observed over the last decade, strongly suggest the need for increased awareness among RFMOs for including these considerations in DFAD management plans. We recommend that similar studies be conducted in the other oceans in order to obtain a global view of the modification of the surface habitat induced by DFADs and continue to alert RFMOs of this potential issue.

3.5 Supplementary Materials

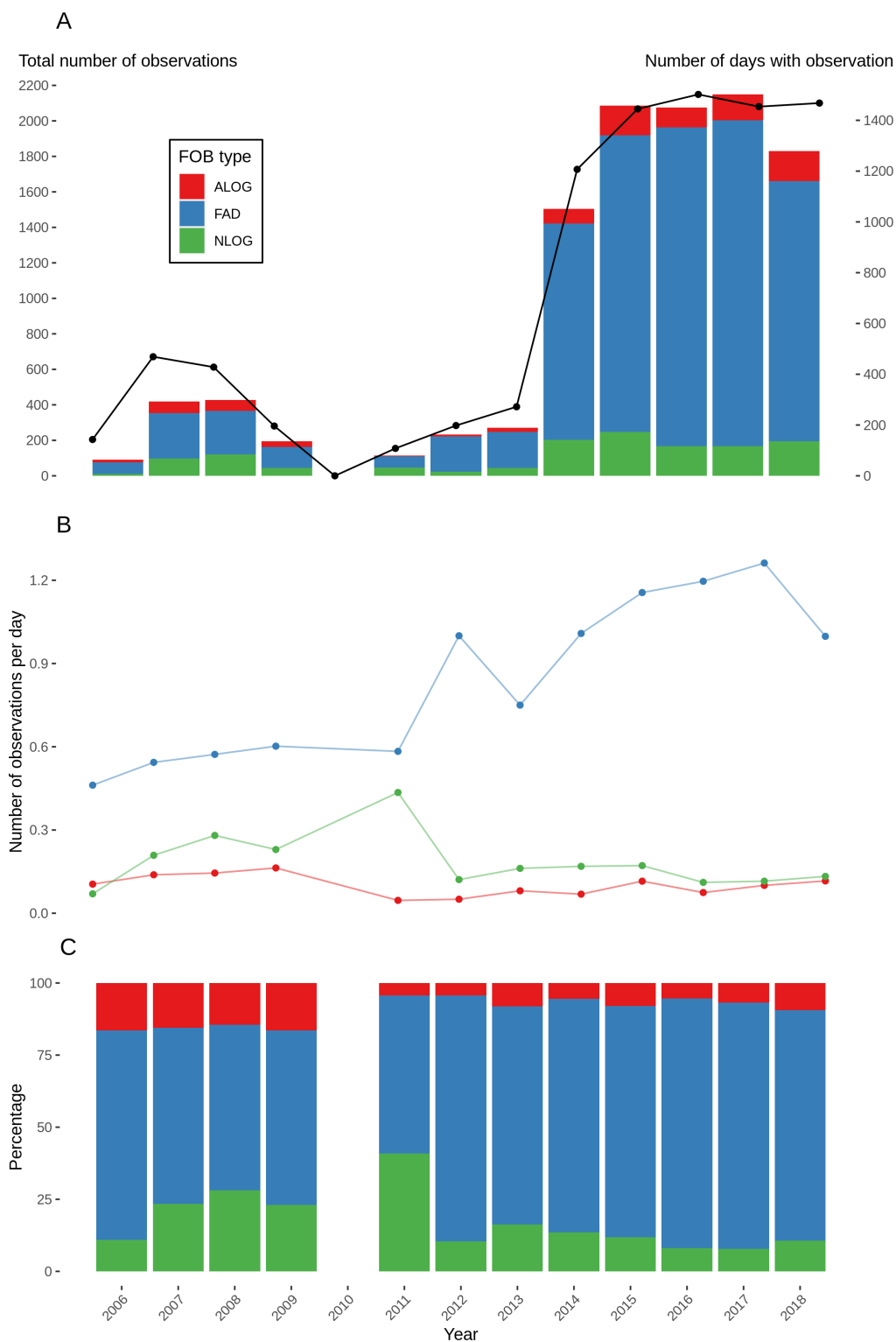

Figure 3.7: Change in the number of FOBs observed from 2006 to 2018 in the IO, but considering only the observations of randomly encountered FOBs. (A) Number of FOBs observed over time, by FOB type, and number of days with observations per year (black line). (B) Number of observed FOBs, by FOB type, divided by the number of days of observation. (C) Proportion of each FOB type per year. FAD (in blue): drifting fish aggregating device; NLOG (in green): natural floating object; ALOG (in red): artificial log resulting from human activity (other than FADs).

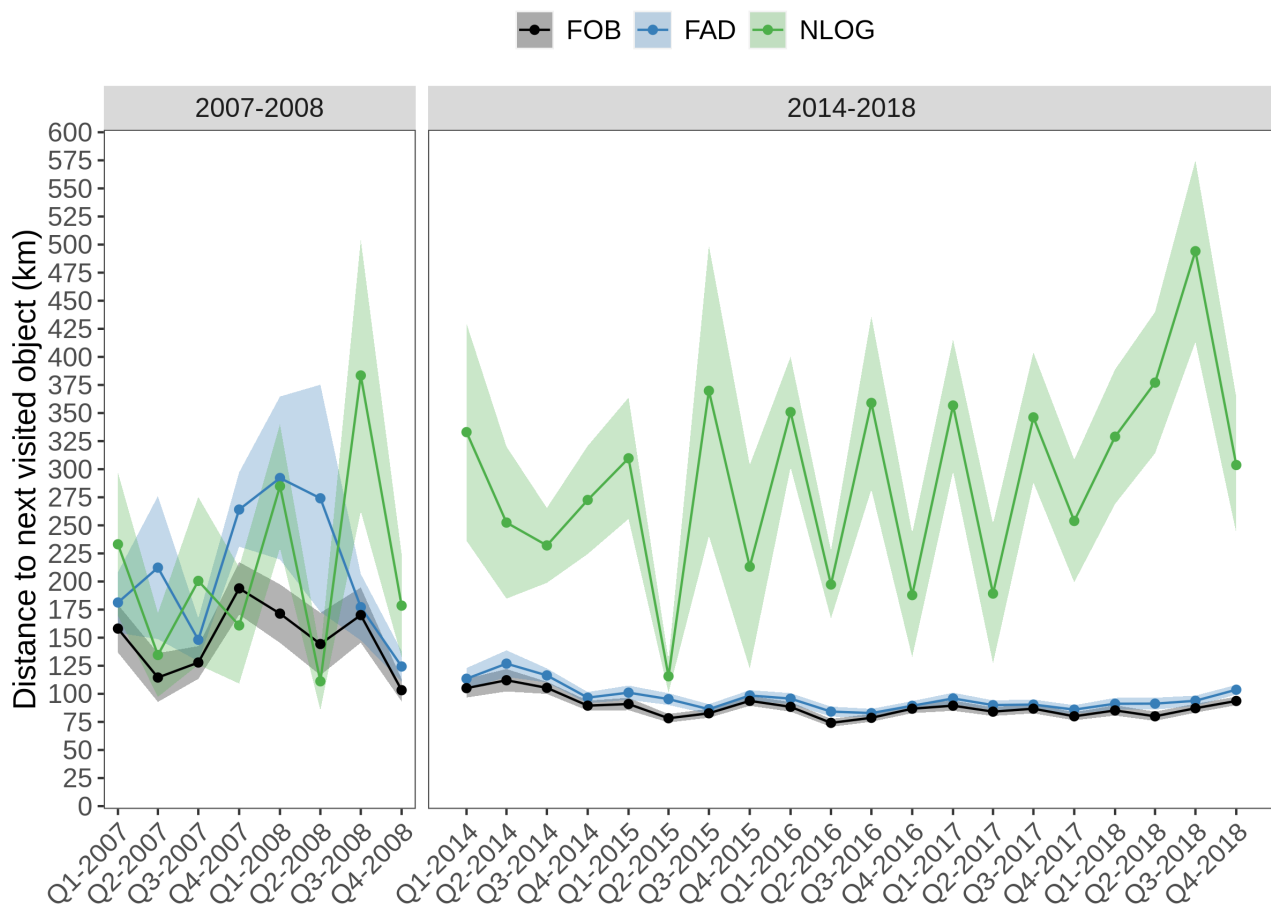

Figure 3.8: Quarterly median spatial distance between two consecutive encounters of FOBs for the two study periods (2007-2008 and 2014-2018), but considering only the observations of randomly encountered floating objects. The distance was calculated between two consecutive encounters of any type of FOBs (FAD, ALOG, or NLOG; black line), between encounters of FADs only (blue line) and between encounters of NLOGs only (green line). The colored areas around the lines represent the SE.

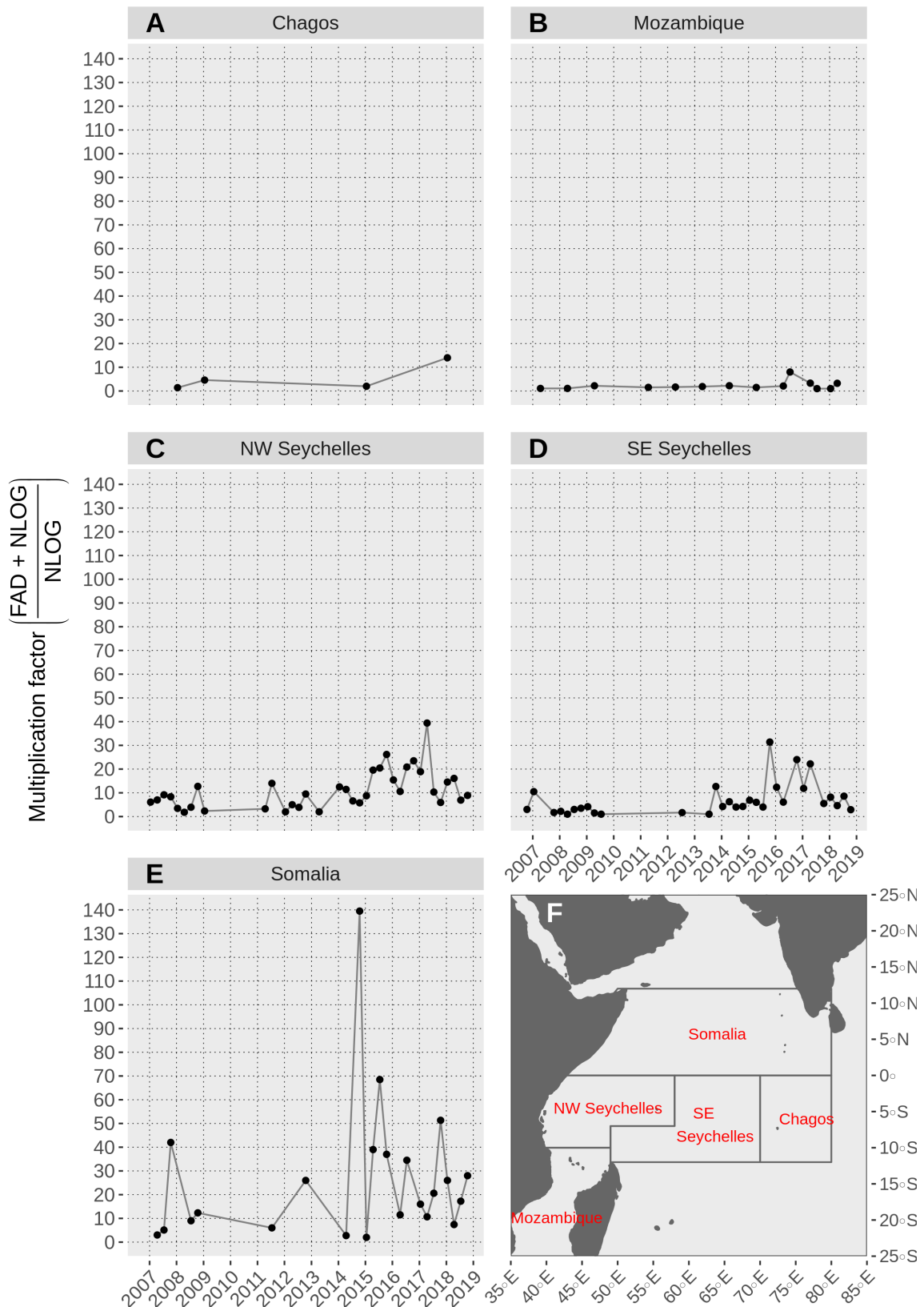

Figure 3.9: Quarterly multiplication factor in the different IOTC areas from 2007 to 2018, but considering only the observations of randomly encountered floating objects. In Chagos (A), Mozambique Channel (B), North-West Seychelles (C), South-East Seychelles (D), and Somalia (E). Map of the IOTC areas as defined in Dagorn et al. 2013a (F). The multiplication factor was calculated only for the quarters with observations of both NLOGs and FADs.

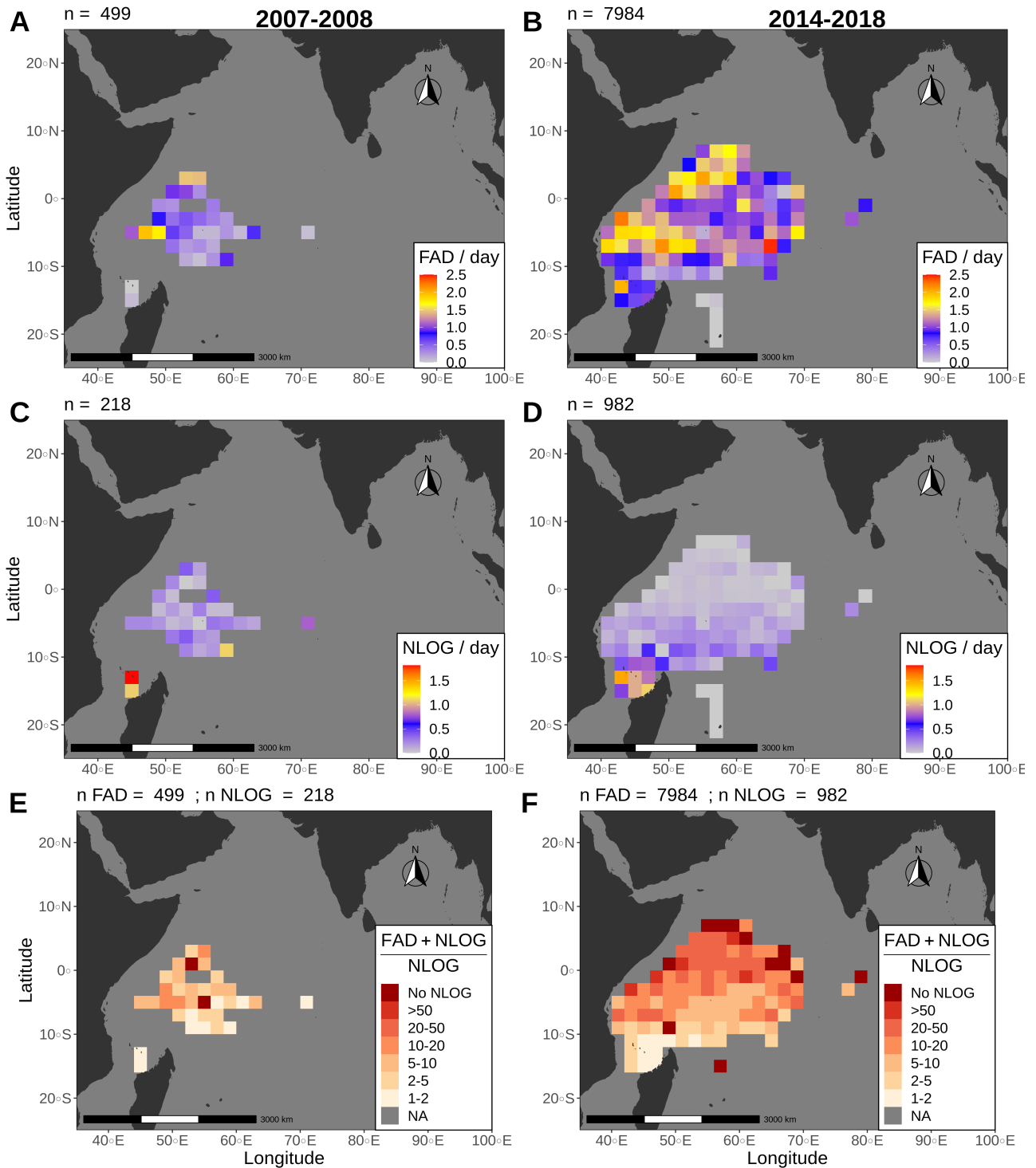

Figure 3.10: Spatial distribution of FOBs observed in the western IO for the two periods (2007-2008 and 2014-2018) but considering only the observations of randomly encountered floating objects. (A-B) Number of DFAD observations divided by the number of days of observations. (C-D) Number of NLOG observations divided by the number of days of observations. (E-F) multiplication factor (ratio of DFADs + NLOGs over NLOGs). Dark grey: less than 10 days of observation per cell.

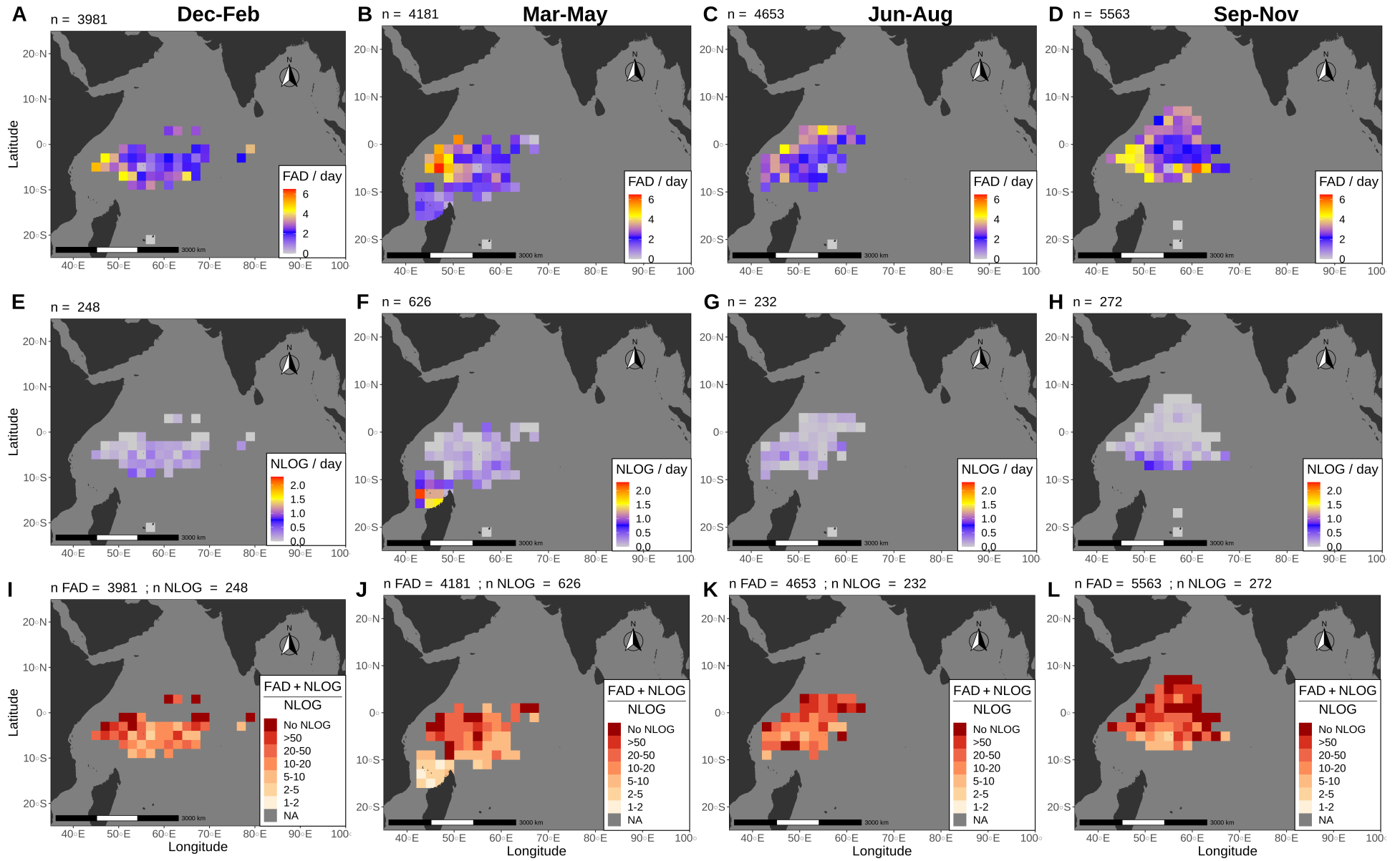

Figure 3.11: Spatial distribution of floating objects observed per quarter in the western Indian Ocean (mean value between 2011 and 2018). FADs (A-D), NLOGs (E-H) and multiplication factor (I-L)

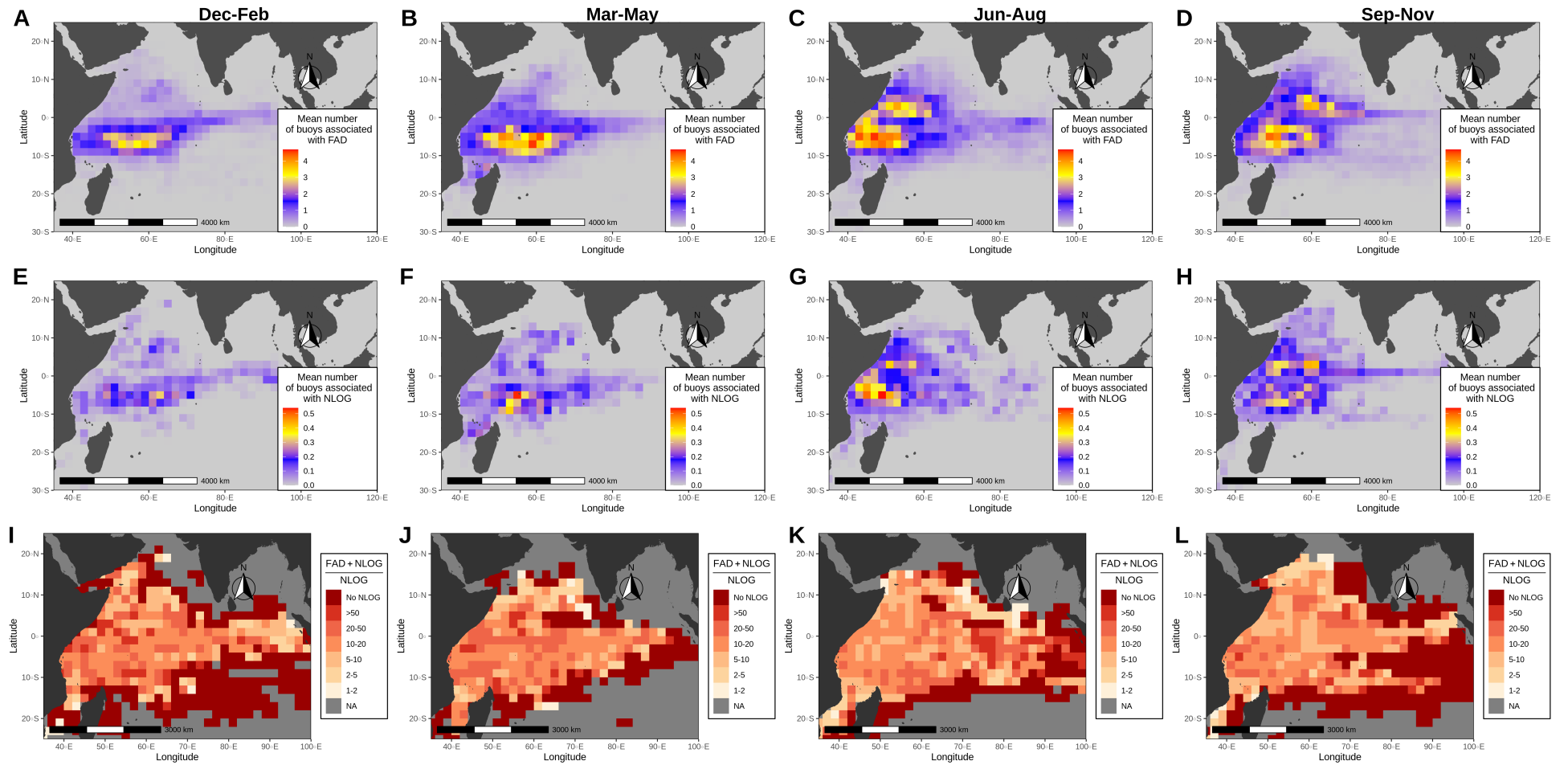

Figure 3.12: Spatial distribution of instrumented FOBs per quarter in 2011-2018. Instrumented FADs (A-D) and NLOGs (E-F).

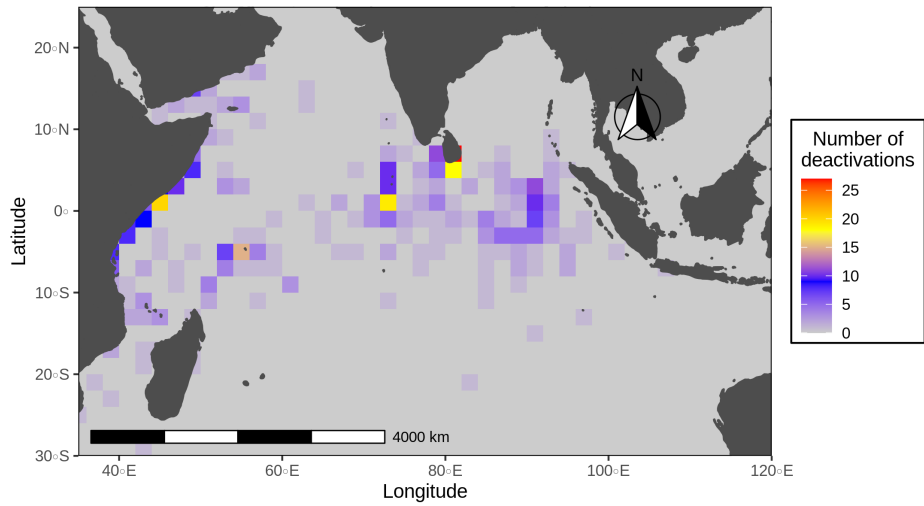

Figure 3.13: Map of deactivation of buoys deployed on DFADs. The observer data was filtered to keep only the buoys for which a GPS position was available on the deactivation day (*i.e.*, the buoys was supposed to be still emitting when deactivated). Among the 5,686 FAD trajectories available, only 482 trajectories were deactivated while still emitting (8.5 %). Among them, 110 were located in the Eastern Indian Ocean (out of the fishing grounds, at longitudes larger than 82°E) representing less than 2 % of all DFADs.

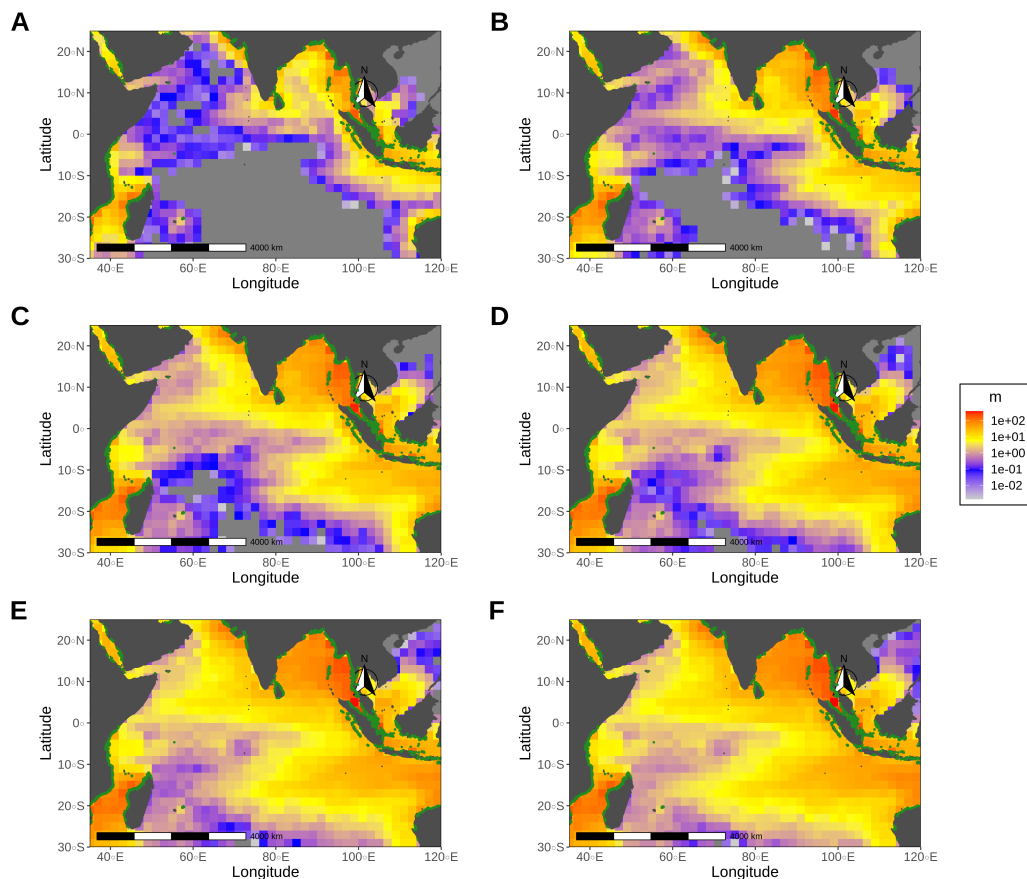

Figure 3.14: Same as Figure 3.6, using NEMO surface currents, for a transport time of 60 (A), 120 (B), 180 (C), 240 (D), 300 (E) and 360 days (F). Color scale was log-transformed. Green dots represent the location at which particles were released, corresponding to the spatial distribution of mangrove forests. *m*: mean number of simulated NLOGs.

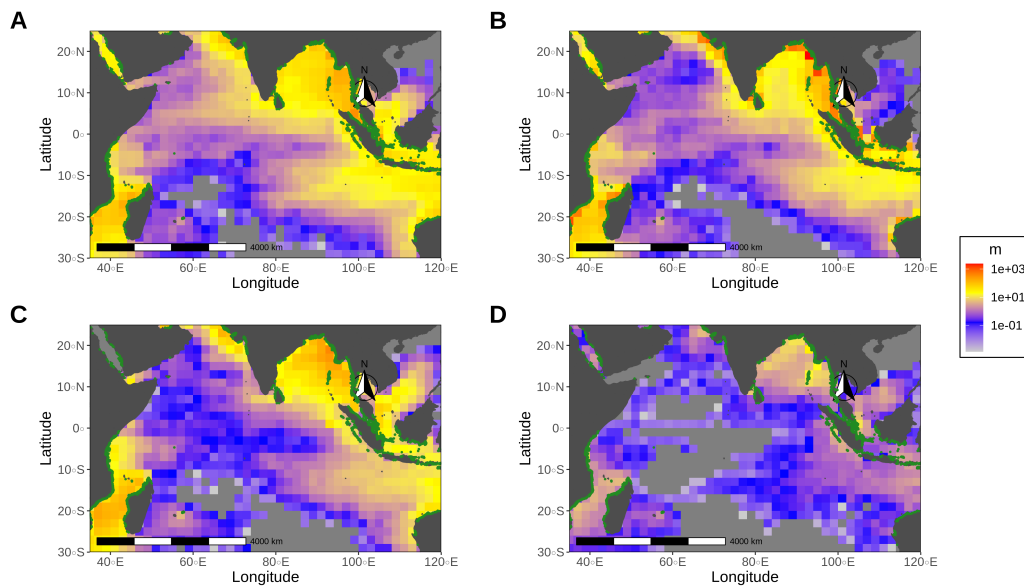

Figure 3.15: Influence of the current product on the putative spatial distribution of NLOGs obtained from simulated trajectories for the whole Indian Ocean, in 2014. Current product used: (A) NEMO at surface, as in the main manuscript, (B) NEMO at 15m depth, (C) OSCAR (Lagerloef et al. 1999, surface currents with spatial resolution: $1/3^\circ$; temporal resolution: 5 days), (D) GlobCurrent (Rio et al. 2015, surface currents, $1/4^\circ$; 1 day). Green dots represent the location at which particles were released, corresponding to the spatial distribution of mangrove forests. m: mean number of simulated NLOGs.

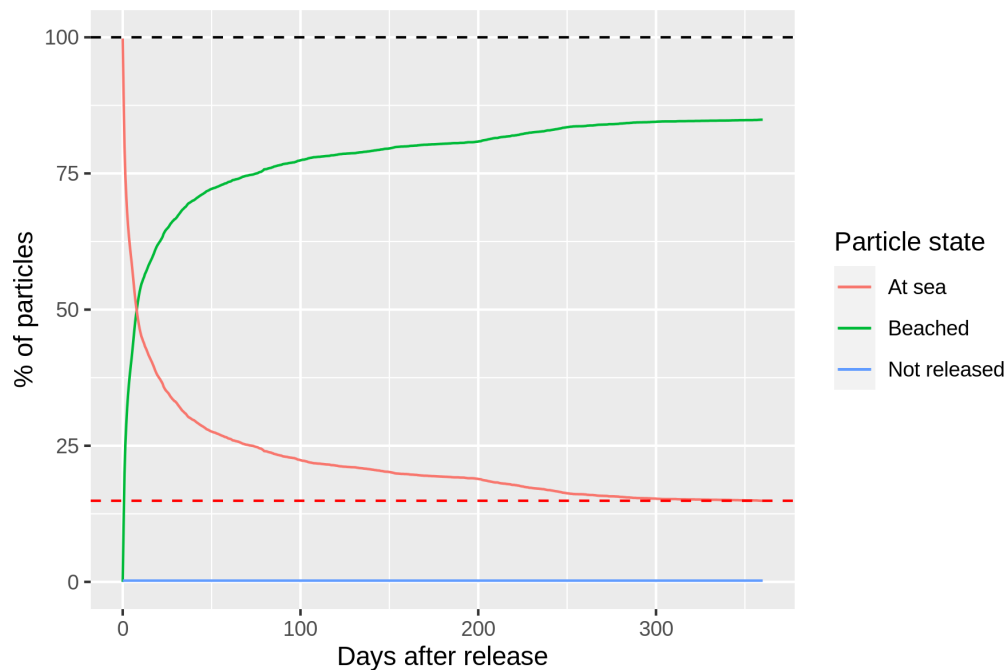

Figure 3.16: Example of the proportion of simulated NLOGs stranding through time. Simulation used for the plot: NEMO current, release at mangroves, on the first release date (1st of July 2013).

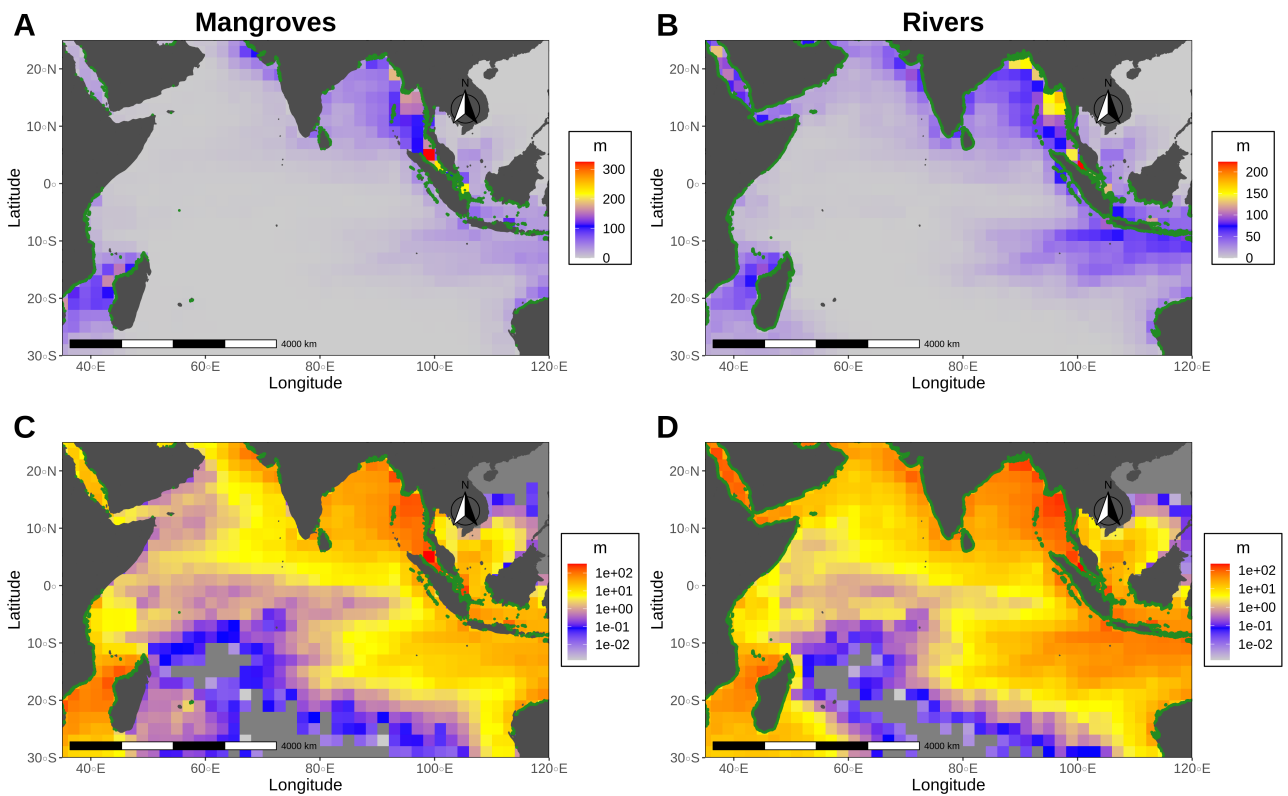

Figure 3.17: Putative spatial distribution of NLOGs obtained from simulated trajectories for the Indian Ocean, in 2014. The mean number of simulated NLOG per cell is shown (m), aggregated over a transport time of 180 days, using forcing currents produced by NEMO at surface. Linear color scale (A-B) and log transformed color scale (C-D). Green dots represent the location at which particles were released, corresponding to the spatial distribution of mangrove forests (A-C) and of river mouths (B-D).

Transition

In this chapter, I quantified the modifications of tuna surface habitat induced by the introduction of DFADs in the Indian Ocean, using several indicators. DFADs represented more than 85 % of the FOBs encountered by purse seine vessels in 2014-2018 and their presence in the ocean strongly increased the number and density of FOBs in the WIO. The extent of the habitat change induced by DFADs in the Eastern IO is harder to determine. This study relies on one main assumption, which is to consider the distribution of natural floating objects (NLOGs) as a "pristine" state of pelagic surface habitat, not impacted by human activities. Human activities, other than fisheries, could also impact the distribution of FOBs by impacting NLOGs. For example, deforestation for agricultural purposes could modify NLOGs input in the oceans, modifications of surface currents or an increased frequency of extreme climatic events induced by climate change could also impact NLOGs transport and input respectively. Hence, there is a need to assess the modifications of the distribution of NLOGs in the ocean and try to determine their extent relative to DFAD induced modifications which will be the content of the next chapter (Chapter 4).

Chapter 4

Floating objects in the open ocean: unveiling modifications of the pelagic habitat induced by global change

Publication

Dupaix, A., Andrello, M., Barrier, N., Dagorn, L., Gusmai, Q., Lengaigne M., Viennois, G., & Capello, M. (In prep.). Floating objects in the open ocean: unveiling modifications of the pelagic habitat induced by global change.

4.1 Introduction

In the context of global change, ocean biodiversity is facing degradation due to several direct and indirect drivers (IPBES 2019). Among these, the exploitation of fish and seafood by fisheries stands as the foremost direct driver, imposing largest impacts (IPBES 2019). The consequences of increased fishing activities extend beyond mere depletion of marine resources; they also trigger indirect impacts by altering natural habitats (Neumann et al. 2016; IPBES 2018). For example, research has shown that fishing activities influence the functional composition of benthic species communities (Neumann et al. 2016; Dupaix et al. 2021b) and modify pelagic species habitat (Dupaix et al. 2021a). These habitat modifications, in turn, can substantially affect marine species in terms of distribution, reproduction, behavior and ultimately their fitness (Macura et al. 2019). Consequently, it becomes crucial to understand and assess the scale of these habitat modifications, which result either from global change or direct exploitation of animals.

Numerous pelagic species, including tropical tuna, have a well-known association with floating objects (FOBs, Fréon and Dagorn 2000; Castro et al. 2002). Originally, FOBs were primarily natural debris like parts of trees floating out in the oceans (designated as NLOGs). Fishers have exploited the associative behavior of pelagic species for centuries to aid in their search and catch. Oppian, a Greek poet, detailed in his poem *Halieutica* written in the 2nd century, how fishers use ship wrecks to facilitate the catch of dolphinfish (*Coryphaena hippurus*; Oppian 200 AD). Historical evidence also points to the use of anchored fish aggregating devices (AFADs) - *i.e.* man-made objects, moored in coastal areas, to attract targeted fish species. Artisanal fishers in the Mediterranean were deploying AFADs as early as in the 14th century (Taquet 2013), while a similar practice was observed in Japan during the 17th century (Nakamae 1991). In more recent times, industrial tuna purse seine vessels introduced drifting fish aggregating devices (DFADs; Davies et al. 2014b) in the 1980s. The deployment of DFADs has surged over the years, with most recent global estimates ranging from 81,000 to 121,000 deployments yearly (Gershman et al. 2015). Specifically, in the Indian Ocean (IO), Maufroy et al. 2017 reported a fourfold increase in the use of DFADs from 2007 to 2013.

The rising number of FOBs in the open ocean, primarily due to the increasing use of DFADs, has led to various ecological impacts on tropical tuna populations. Firstly, the presence of DFADs reduces the search effort required by purse seiners, significantly increasing tuna catchability and consequently their fishing mortality (Wain et al. 2021; Song and Shen 2022). Secondly, this fishing approach results in a higher proportion of juvenile YFT and BET being caught compared to targeting them in free-swimming schools (not associated with FOBs; IOTC 2022e; Merino et al. 2020). Within the IO, two out of the three tropical tuna targeted by purse seiners, namely yellowfin tuna (YFT, *Thunnus albacares*) and bigeye tuna (BET, *T. obsesus*) are currently facing challenges of overfishing (IOTC 2022a; IOTC 2022c). This means that their biomass is below the biomass reference point for maximum sustainable yield. Purse seine vessels account for 34 % of the yearly catch of YFT and 42 % of BET in the IO (IOTC 2022a; IOTC 2022c). Consequently, the management of these species necessitates careful consideration of the two aforementioned impacts caused by drifting fish aggregating devices (DFADs).

Beyond the direct effects of increasing fishing mortality, DFADs have the potential to induce indirect ecological impacts on tunas by modifying tuna habitat. Evidence indicates that tuna caught in association with FOBs exhibit lower body condition compared to those caught in free-swimming schools (Hallier and Gaertner 2008; Marsac et al. 2000; Robert et al. 2014a). Furthermore, alteration in FOBs density may disturb the large-scale movements of tuna, leading to individuals being retained or transported to ecologically unsuitable areas (Marsac et al. 2000; Fonteneau et al. 2013; Schaefer et al. 2015), and potentially influencing tuna schooling behaviour

(Capello et al. 2022; Sempo et al. 2013). While scientific consensus on the extent of indirect impacts of DFADs on tuna behaviour and life-history parameters (*e.g.* condition, reproduction, Chapter 2) is yet to be reached, these potential impacts emphasize the need to characterize pelagic surface habitat modifications induced by human activities. A study by Dupaix et al. 2021a focused on the Western IO (WIO) and provided insights into the modifications of the pelagic habitat induced by DFADs. By analyzing data from observers onboard purse seine vessels, they revealed a strong increase in the total number of FOBs from 2006 to 2018. The entire WIO was impacted: DFADs represent over 85 % of the total number of FOBs and the number of FOB observations per day has been multiplied by 5 between 2006 and 2018. To assess these modifications, Dupaix et al. 2021a utilized the number of observed NLOGs in the WIO as a reference state, representing conditions unaltered by human activities.

The number of NLOGs, mainly composed of trees parts transported by surface currents, could also be significantly affected by human activities, such as deforestation, and human-induced climate change, which can impact oceanic currents (Krajick 2001; Thiel and Gutow 2005; Russell et al. 2014). Deforestation, involving the human-induced conversion of forested land into non-forested land, is mainly driven by agriculture and logging (IPBES 2018). Since 2000, global logging, for materials, construction and energy production, has seen a substantial increase, with 20% of tropical forests experiencing selective logging (IPBES 2022b). While estimates of the deforestation extent may vary, it is undeniable that forested land surface has decreased globally in recent decades. For example, tropical forest loss is estimated to be approximately 10 million hectares per year, with 60 to 90 % attributed to agriculture (Pendrill et al. 2022). The number of NLOGs can also exhibit strong seasonal and inter-annual variations, influenced by factors like precipitation, modifications in surface currents, and extreme climatic events impacting the release and circulation of NLOGs from sources like rivers and coastal forests (Caddy and Majkowski 1996; Hinojosa et al. 2011). For example, in Taiwan, the Morakot typhoon in 2009 led to the release of over three million trees into the sea Doong et al. 2011. As climate change is expected to increase the frequency of such extreme events (impacting NLOG release) and to modify oceanic currents (impacting NLOG transport), it is likely to further influence the distribution of NLOGs. Although the reasons why tuna and other pelagic species associate with FOBs remain unknown, this behavior is widespread, involving numerous predator and prey species (Fréon and Dagorn 2000). Understanding the spatial and temporal variability of this key aspect of pelagic habitats is vital to gain insight into the ecology of these species. Additionally, characterizing the impact of human activities on tropical tuna habitat requires not only characterizing the modifications of this habitat by DFAD use, but also assessing changes in the number of NLOGs resulting from other human activities.

In the absence of trajectory and/or position data of NLOGs across the entire ocean, employing Lagrangian simulation models with virtual NLOGs becomes valuable in estimating their distribution (Van Sebille et al. 2018). NLOGs are most likely sourced from river basins or coastal forests (Thiel and Gutow 2005; Doong et al. 2011), and previous studies have indicated that FOBs drift in a manner similar to oceanic drifters (Imzilen et al. 2019). NLOG's drift can thus predominantly be attributed to surface oceanic currents. This study focuses on characterizing the natural surface habitat of tropical tuna in the IO and determining how human activities, such as deforestation and global change, induce modifications in this habitat. While the use of DFADs by purse seine vessels has strongly altered this surface habitat, other human activities might either offset or exacerbate this impact. Given the absence of precise estimations of NLOG distribution in the IO, we aim to (1) describe the distribution of NLOGs and their seasonal variations at the scale of the entire oceanic basin and (2) assess any potential trends in NLOG numbers, which could be linked to deforestation or climate change driven modifications of surface currents.

4.2 Material and Methods

4.2.1 Lagrangian simulations

Lagrangian simulations were performed from 2000 to 2019 to simulate the distribution of NLOGs in the Indian Ocean (IO) using the Ichthyop computational tool *v3.3.12* (Lett et al. 2008). In these simulations, various parameters were carefully chosen, as they could affect the resulting large-scale distributions. These parameters include particle lifetime (Pineda et al. 2007; Huret et al. 2010; Van der Stocken et al. 2019), release location (Davies et al. 2017; Curnick et al. 2021) and release time (Siegel et al. 2003; Curnick et al. 2021). The lifetime of NLOGs, dependent on wood property and on its susceptibility to destruction by secondary consumers, remains poorly known (Thiel and Gutow 2005). However, our simulations revealed that the results were relatively insensitive to lifetime in the IO (Dupaix et al. 2021a). To consider the potential impacts of release location and time on NLOG distribution, it is crucial to take into account different sources, including coastal and river basin forests, as well as seasonal variations.

For the transportation of particles, surface currents were extracted from an eddy-resolving ($1/12^\circ$) simulation performed using NEMO Ocean General Circulation Model (Madec 2016) in the framework of the OceaniC Chaos - ImPacts strUcture predicTability (OCCIPUT) project (<https://meom-group.github.io/projects/occiput>; Penduff et al. 2014; Bessières et al. 2017). The main OCCIPUT ensemble is made of 50 global oceanic hindcasts based on the version 3.5 of Nucleus for European Modelling of the Ocean (NEMO; Madec 2016), run over a 56 years period (1960–2015). This simulation is driven by the 3-hourly fully-varying atmospheric forcing (the DFS5.2 oceanic forcing product, derived from the ERA-I re-analysis; Dussin et al. 2016). A total of 6,408 cells ($1/12^\circ \times 1/12^\circ$) were identified as coastal cells, defined as cells whose centers lie within $1/12^\circ$ distance from the coastline. The coastline data was obtained from the IHO (International Hydrographic Organization) coastline shapefile, updated annually and covering a total area of 67 million km^2 . Within each coastal cell, 1000 particles were released every week and transported for a period of 500 days. The positions of these particles were saved as an Eulerian field every 7 days for each release location and date. To simulate particles mortality, a Poisson law with a mean 360 days was applied to the Eulerian field, resulting in an average drifting time of approximately one year. The simulations were initiated 500 days before 2000-01-01, to allow the equilibrium to be reached at the beginning of the study period.

4.2.2 Datasets used for the different scenarios

To better approximate real NLOG distributions, we developed different weighting scenarios. For each release location and date, we consider the following factors: (i) associated precipitations, (ii) associated rivers and their discharge, (iii) the length of the associated coastline and (iv) the surface area covered by forests. Precipitations data at the release location and date were extracted from Adler et al. 2003, which provides global monthly precipitations estimates in 2° cells. Information about rivers were obtained from the HydroAtlas database v1.0 (Linke et al. 2019). We selected rivers with a mouth maximum discharge equal to or greater than $100 \text{ m}^3 \cdot \text{s}^{-1}$, totaling over 195,000 km of river length. Each river was exclusively associated with the nearest release location to its mouth. To account for forest cover, we created a 1 km^2 buffer around the rivers and coastline.

We used Global Forest Change products GFC 2020v1.8, Hansen et al. 2013, which provide time series analysis results of Landsat images, to characterize global forest extent in 2000 and changes in global forest cover from 2000 to 2020 at 30-meter resolution. For mapping coastal forest cover in the IO and adjacent open seas (Mozambique Channel, Bay of Bengal, Arabian Sea, Andaman Sea, and Laccadive Sea, excluding enclosed seas, see Supplementary Figure

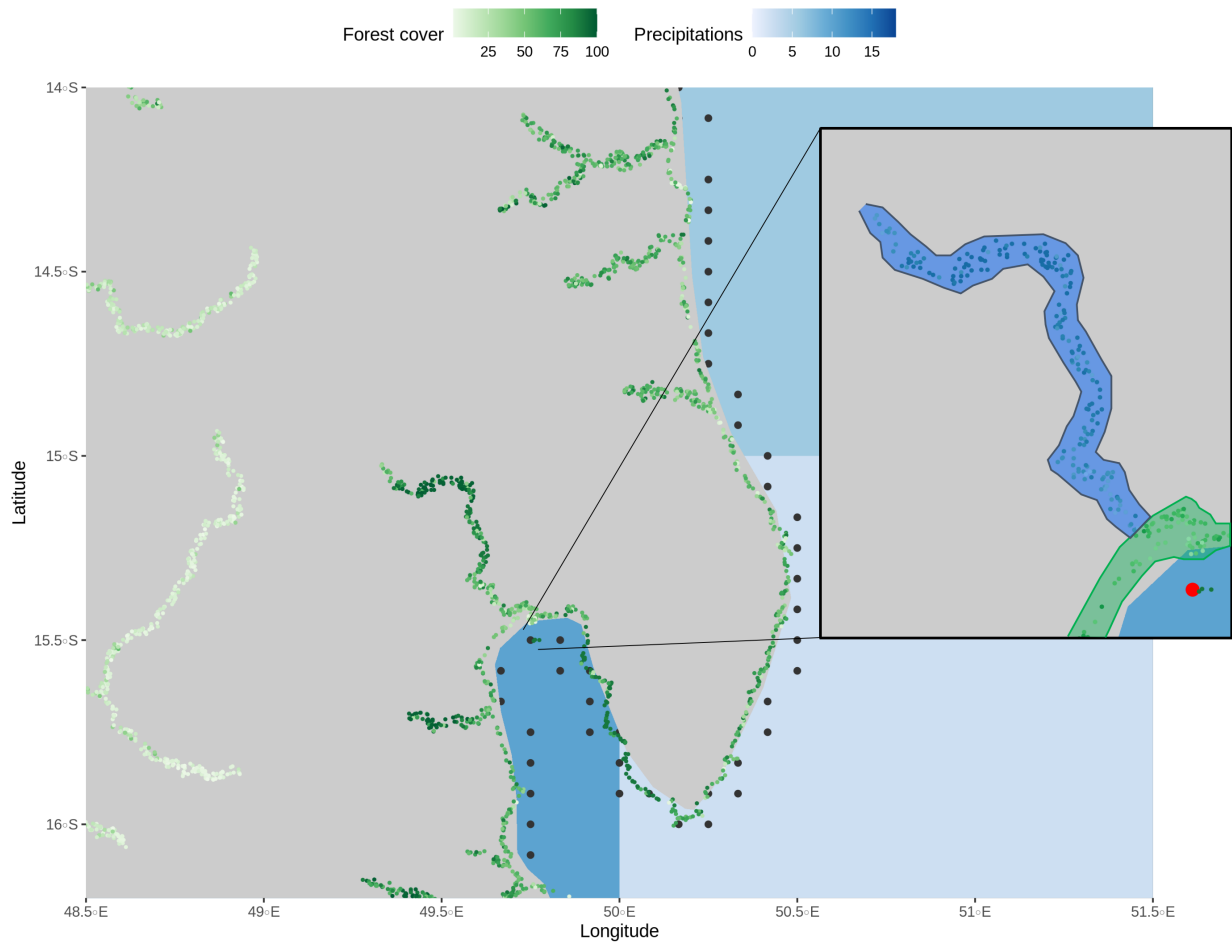

Figure 4.1: Schematic representation of the weighting scenarios used in the study. The release points are shown in grey, forest cover (in % of the cell surface, subsampled for this figure) is represented in green. The blue squares in the background represent the mean precipitations (in $\text{mm}\cdot\text{day}^{-1}$). On the zoomed section, the weight scenarios for the release point in red are as follows: CL: total surface of the coastline buffer (green area); CC: sum of the forest cover in the coastline buffer (green area); RC: sum of the forest cover in the river buffer (blue area) multiplied by the mean river discharge at river mouth; CCp: CC multiplied by the precipitations at the release point; RCp: RC multiplied by the precipitations at the release point; R&CC: sum of the forest cover in the union of the coastal and river buffers (green and the blue areas respectively).

4.7), Google Earth Engine (GEE), an application programming interface (API) using image processing algorithms, was used. The GFC 2020v1.8 product was available in GEE, which also allows the import of data, in our case, the previously modeled buffer zone. For each year after 2000, the GFC pixels were successively compared to identify losses and gains of forest area. The yearly raster map of forest cover was produced, representing forest presence for each pixel with values ranging from 0 (no forest) to 100 % (fully forested pixel). The resolution was then reduced to 90 m by averaging the pixels.

4.2.3 Weighting scenarios

After conducting the simulations, various weighting scenarios were applied by multiplying the obtained Eulerian fields with specific weights, based on the release date and location (Figure 4.1). The following scenarios were proposed and summarized in Table 4.1 and Figure 4.1:

- **Coastal Length - CL:** In this scenario, particles were uniformly released along the coastline. The weight for each release location-date was determined by measuring the total surface area of the associated coastline buffer.

Table 4.1: Details of the different weighting scenarios.

Designation	Details
CL	Coastline Length
CC	Coastal forest Cover surface
RC	River forest Cover surface multiplied by the mean river discharge at river mouth
CCp	Coastal forest Cover surface multiplied by the Precipitations at release point
RCp	River forest Cover surface multiplied by the mean river discharge at river mouth and by the Precipitations at release point
R&CC	River plus Coastal forest Cover surface

- **Coastal Cover - CC:** This scenario involved releasing particles in proportion to the coastal forest cover. Similar to CL scenario, the weight was calculated based on the coastal forest cover surface associated with each release location and date.
- **River Cover - RC:** In this scenario, particles were released in proportion to the forest cover associated with the rivers and the rivers discharge. For each release location and date, the weight was determined by multiplying the forest cover surface of the associated rivers with the discharge at the river' mouths.
- **Coastal Cover and precipitations - CCp:** This scenario was similar to CC but introduced seasonality by considering precipitations. The weight of each release location and date was calculated by multiplying the corresponding forest cover surface with precipitations.
- **River Cover and precipitations - RCp:** The protocol is similar to CCp, except that river forest cover is considered instead of coastal cover. The weight was determined by multiplying the forest cover surface of the associated rivers with the discharge at the rivers' mouths and the precipitations at the release location and date.
- **River and Coastal Cover - R&CC:** The final scenario considered the overall forest cover. For each release location and date, the weight was calculated by summing the coastal forest cover surface and the forest cover surface associated with rivers.

4.2.4 Study regions

This study focuses on eight oceanic regions defined to examine simulated abundances, which were selected based on purse seine fleet behavior in the Western IO (WIO) and oceanographic specificity (Figure 4.2; Dagorn et al. 2013a; Schott et al. 2009).

- **Mozambique:** Encompassing the Mozambique Channel, this region is characterized by the presence of numerous oceanic eddies and a dominant southward flowing current throughout the year. Notably, it is rich in NLOGs from March to May, as purse-seine vessels primarily target FOB-associated tuna schools in this area (Chassot et al. 2019).
- **SCTR** (Seychelles-Chagos Thermocline Ridge): serving as the central fishing ground of the industrial purse-seine fleets operating in the WIO. this region is marked by a westward current bifurcating northward upon reaching the Madagascar coast. It features an open ocean upwelling structure is present in the area, concentrated in the west from September

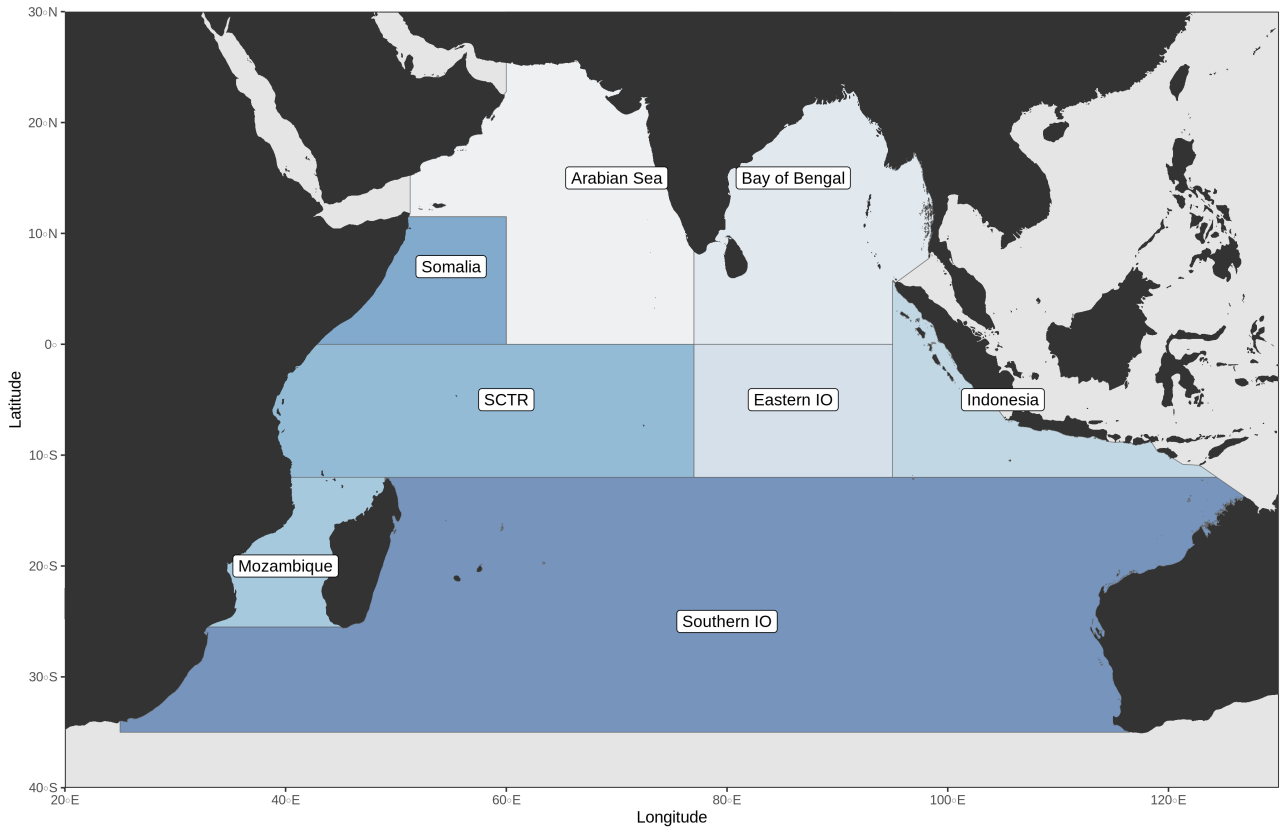

Figure 4.2: Map of the different areas considered in the study. IO: Indian Ocean. SCTR: Seychelles-Chagos Thermocline Ridge.

to February and forming a zonally elongated ridge during the other half of the year (Hermes and Reason 2008).

- **Somalia:** Known for its strong coastal upwelling during the summer monsoon (July-August) with a northeastward current, this region experiences a reversal of currents during the winter monsoon. It represents an important fishing ground for purse-seine fleets, particularly present in the area after the upwelling, mainly from August to November (Fonteneau 2003; IOTC 2022d).
- **Arabian Sea:** This region includes the Arabian Sea and the waters surrounding the Maldives. Surface currents enter the area from the Bay of Bengal during the winter monsoon (January-February) and reverse in the summer monsoon. Purse-seine fishing effort was limited until 2018, when purse seine fishing grounds expanded northward (IOTC 2022d; Tolotti et al. 2022). The region also hosts an important long-line fishery in the Maldivian waters (Jauharee et al. 2021).
- **Bay of Bengal:** this region covers the Bay of Bengal and the area south of Sri Lanka, including the massive Ganges river. It is a relatively enclosed sea, except for a strong entering or exiting current in its western boundary in the summer and winter monsoon respectively.
- **Eastern IO (Indian Ocean):** during the summer monsoon, this region is characterized by a southward current, entering from the Bay of Bengal region and exiting in the Southern IO region, which reverses in the winter monsoon (Schott et al. 2009). During positive Indian Ocean Dipole (IOD) events, this region is characterized by important negative Sea

Surface Temperature (SST) anomalies and a shallower thermocline from July to October (Saji et al. 1999).

- **Indonesia:** This region includes the coastal waters of Indonesia, where an important artisanal purse-seine fishery occurs (IOTC 2022d). Surface currents flow southward along the coast of Sumatra and are stronger during the winter monsoon. Additionally, a westward current flows the South of the region, directed towards the Eastern and Southern IO regions (Schott et al. 2009).
- **Southern IO:** Encompassing the entire IO south of 10°S and the region south of Madagascar in the western part of the region, this region is characterized by westward surface currents and minimal tuna fishing effort (IOTC 2022e; Schott et al. 2009).

4.2.5 Comparison with observers data

NLOG positions were derived from data collected by observers onboard French purse seine vessels operating in the WIO from 2014 to 2019. These observer data included the date, time and location of the vessel's main activities. For each activity taking place on a floating object, the object type was recorded, enabling the discrimination of NLOGs from other FOBs like DFADs. Using this dataset, we computed an index of NLOG abundance per 2° cell per month, employing the methodology established in Dupaix et al. 2021a. To ensure robustness, only cells with more than 10 observation days were retained, with an observation day defined as a day where at least one activity was recorded by an observer onboard a fishing vessel. For each of the retained cells, we extracted the NLOG abundance from the different simulation scenarios. Both simulated and observed abundances were normalized by dividing them by the maximum NLOG abundance value in the retained cells. Subsequently, these values were then averaged over the years for each quarter and oceanic region where the French purse seine fleet operates, namely the Arabian Sea, Mozambique, SCTR, Somalia and Southern IO. For each scenario, a linear regression was performed between the observed and simulated NLOG abundances to determine which scenario performed the best.

4.2.6 Assessing NLOG density in the IO

Using the outcome of the different scenarios described in Section 4.2.3, we calculated the average NLOG density in the entire IO and oceanic region on a weekly basis. To standardize density estimations, these values were divided by the mean NLOG density in each respective region. Next, we used these standardized density estimations to extract the mean seasonal variations for each region. By removing the seasonal variations from the density estimation, we obtained a NLOG density anomaly (noted A).

To assess the presence or absence of trends in NLOG density across the oceanic basin, linear regressions were performed on A , with time as an explanatory variable ($A(t) = at + b$ with t the time). To evaluate temporal autocorrelation, the maximum time lag (Δt) for which the Pearson's correlation coefficient $\rho \geq 0.2$ was determined – *i.e.* the maximum value Δt such that $\rho[A(t), A(t - \Delta t)] \geq 0.2$. A Student t-test was then performed to evaluate if the slope coefficient (a) significantly differed from zero. The test uses $\frac{\sqrt{n-2}}{\sqrt{\Delta t}}$ degrees of freedom, with n representing the number of values in the time series.

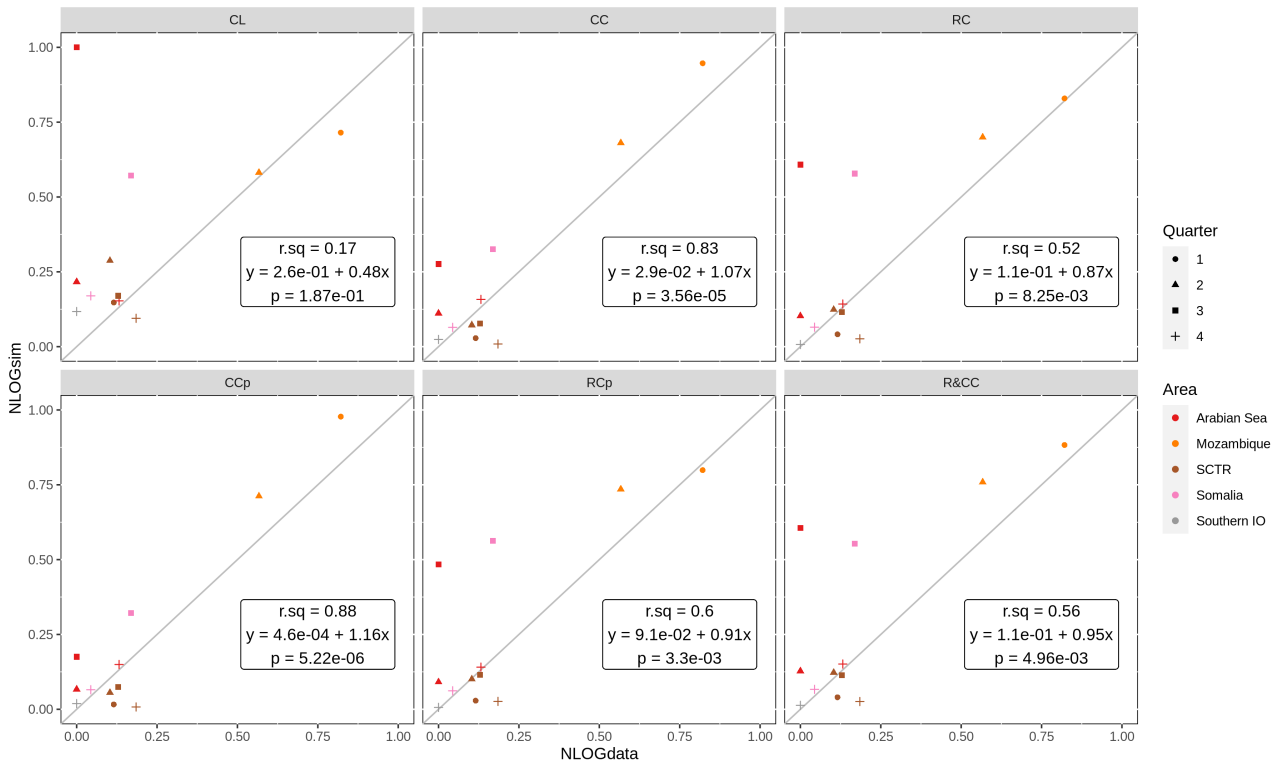

Figure 4.3: Comparison between NLOG density obtained from simulations (NLOGsim) and density obtained from observers data (NLOGdata) per weighting scenario. CL: Coastline Length; CC: Coastal forest Cover; RC: River forest Cover multiplied by river discharge; CCp: Coastal forest Cover multiplied by precipitations; RCp: River forest Cover multiplied by river discharge and by precipitations; R&CC: River plus Coastal forest Cover. SCRT: Seychelles-Chagos Thermocline Ridge. On each panel, $r.sq$: R^2 of the linear regression; p : p-value of the Student's t-test testing if the slope coefficient of the linear relationship significantly differs from zero.

4.3 Results

4.3.1 Best performing scenarios

Figure 4.3 displays the comparison between observed and simulated NLOG abundances within the oceanic regions and quarters sampled by scientific observers on-board purse seiners (see Section 4.2.5). The Coastline Length (CL) scenario notably overestimates NLOG density in the Arabian Sea and Somalia in the 3rd quarter, resulting in an insignificant relationship between modelled and observed NLOG abundances between regions and seasons (p -value = 0.18). Simulated abundance obtained with other scenarios display a significant linear relationship with the observed NLOG abundance (Linear regressions, p -value of 3.56×10^{-5} , 8.25×10^{-3} , 5.22×10^{-6} , 3.30×10^{-3} and 4.96×10^{-3} for CC, RC, CCp, RCp and R&CC scenarios respectively). However, scenarios based solely on coastal forest cover (CC and CCp; R^2 of 0.83 and 0.88, respectively) exhibit a better fit to the observed abundance than scenarios incorporating river forest cover (RC, RCp, R&CC; R^2 of 0.52, 0.60 and 0.56, respectively).

Scenarios including river forest cover result in a substantial overestimation of NLOG abundance in the Somalia regions in July-September (by 241 %, 232 % and 227 % for RC, RCp and R&CC respectively). In contrast, scenarios based on coastal cover exhibit a comparatively smaller overestimation (92 % and 90 % for CC and CCp respectively). Also, observed NLOG density was null in the Arabian Sea region in July-September, when all scenarios predicted non-null values. However, the predicted values were lower with scenarios based solely on coastal forest cover than (NLOGsim = 0.28 and 0.18 for CC and CCp respectively) than with scenarios including river forest cover (NLOGsim = 0.61, 0.48 and 0.61 for RC, RCp and R&CC

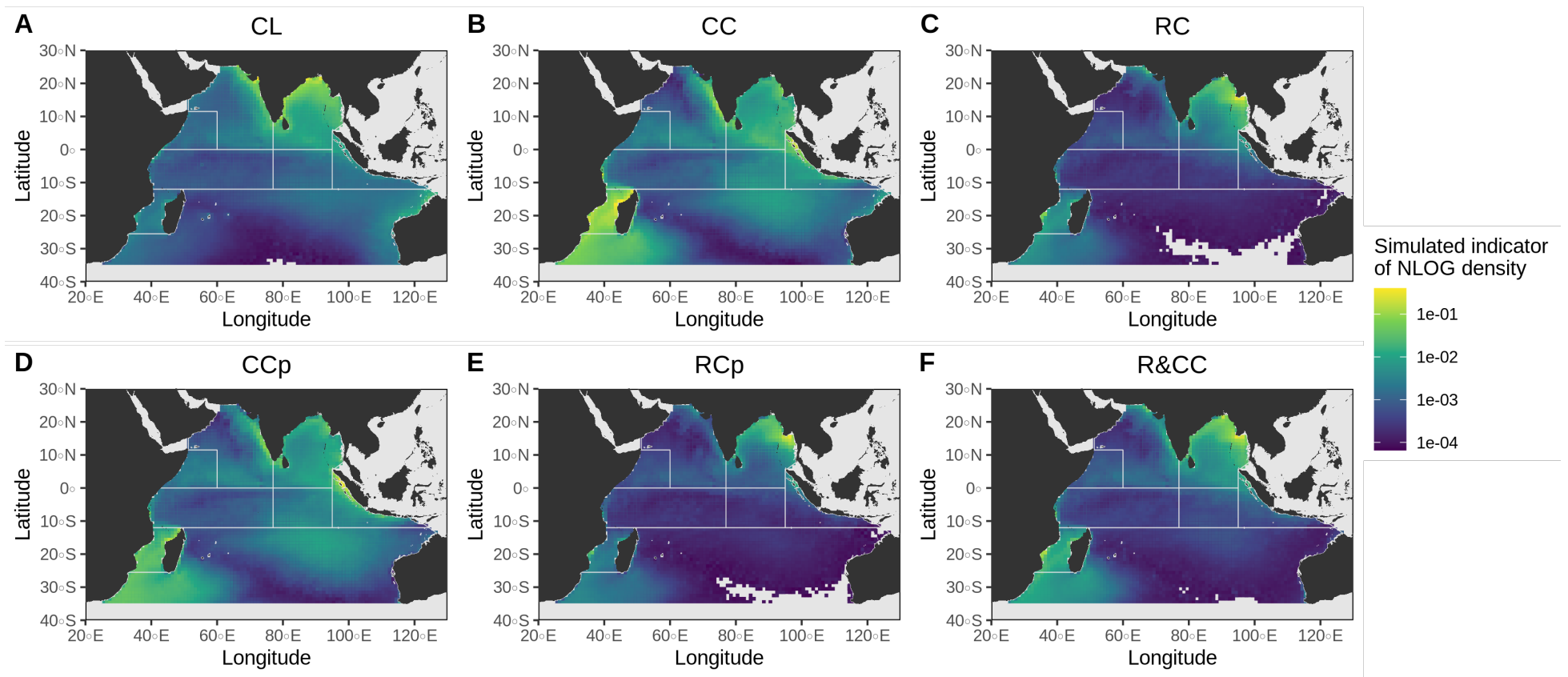

Figure 4.4: Simulated density of NLOGs averaged over 2000-2019 for the different weighting scenarios. Maximum value was set to 1 and values below 10^{-4} were discarded. CL: Coastline Length; CC: Coastal forest Cover; RC: River forest Cover multiplied by river discharge; CCp: Coastal forest Cover multiplied by precipitations; RCp: River forest Cover multiplied by river discharge and by precipitations; R&CC: River plus Coastal forest Cover.

respectively).

To conclude, CL is the scenario performing the worst, highlighting the need to take forest cover into account. Scenarios relying on coastal forest cover (CC and CCp) perform better than other scenarios that take river forest cover into account (RC, RCp and R&CC). All scenarios tend to overestimate NLOG abundance in some regions at given quarters (*e.g.* Arabian Sea and Somalia regions in July-September).

4.3.2 Distribution of NLOGs in the Indian Ocean

Figure 4.4 displays simulated climatological density maps for the different scenarios. Among all scenarios, the Mozambique Channel, the Bay of Bengal and the western coast of India exhibited the highest NLOG densities, designating them as probable sources (*i.e.* regions with an important input) of NLOGs in the IO. However, the relative importance of these areas strongly varies as a function of the scenario considered. In the CL scenario (Coastal Length, uniform release along the coast), the highest densities are located along the coast of India and in the Bay of Bengal, with relatively lower densities in the Mozambique Channel (Figure 4.4A). Considering the coastal cover (scenarios CC and CCp) increased the relative density in the Mozambique Channel and more broadly across the rest of the oceanic basin, specifically in Somalia, Eastern IO and Southern IO regions (Figure 4.4B&D). The increase in the Southern IO region probably results from an increased relative density on the coast of Sumatra (Indonesia region) which suggests that the important coastal forest cover in the region could also make it a potential source of NLOGs. In scenarios incorporating river cover (scenarios RC and RCp), the density in the Bay of Bengal was notably higher than in any other region, with a very high density in the south of Myanmar, likely originating from the Gange delta (Figure 4.4C&E). The R&CC scenario (Figure 4.4F) displayed intermediate NLOG distribution, falling between those obtained with coastal cover only (CC and CCp) and with river cover only (RC and RCp). Hence, all scenarios designate the Mozambique Channel, the Bay of Bengal and the western coast of India as the main sources of NLOGs, which then drift towards the oceanic basin. NLOGs originating from the Mozambique Channel feed the WIO (West of SCTR, Somalia and South of Arabian Sea regions), when the western coast of India, the Bay of Bengal and probably Indonesia feed the Eastern and Southern IO regions.

4.3.3 Seasonal variations of NLOG density

Figure 4.5 illustrates the seasonal variations in NLOG densities relative to the mean NLOG density in different areas. In some regions, these variations were marginally influenced by the considered scenario, namely the Arabian Sea, Eastern IO, SCTR and Somalia. Hence, in these regions, the seasonality was mainly driven by the seasonality of the surface currents rather than by that of NLOG input. Density maxima were observed in the Arabian Sea between February and May, in the Eastern IO between August and November, in the SCTR between March and April and in Somalia in August (Figure 4.5A,C,F&G). However, small differences were still noticeable. For example, in the Eastern IO, the density maximum occurred from July to November depending on the scenario (Figure 4.5C). Similarly, in Somalia, the CL scenario showed an earlier maximum compared to other scenarios (Figure 4.5G). In the Bay of Bengal, Indonesia, Mozambique and Southern IO, the seasonality varied depending to the considered scenario (Figure 4.5B,D,E&H). In the Bay of Bengal, scenario considering the river forest cover induced a strong seasonality, with a density peak in May (RC and R&CC), while accounting for precipitations partially compensated for this seasonality and resulted in a smaller density peak later in June-July (CCp and RCp, Figure 4.5B). In the Indonesia region, scenarios accounting for precipitations (CCp and RCp) predicted a maximum density in the first half of the year,

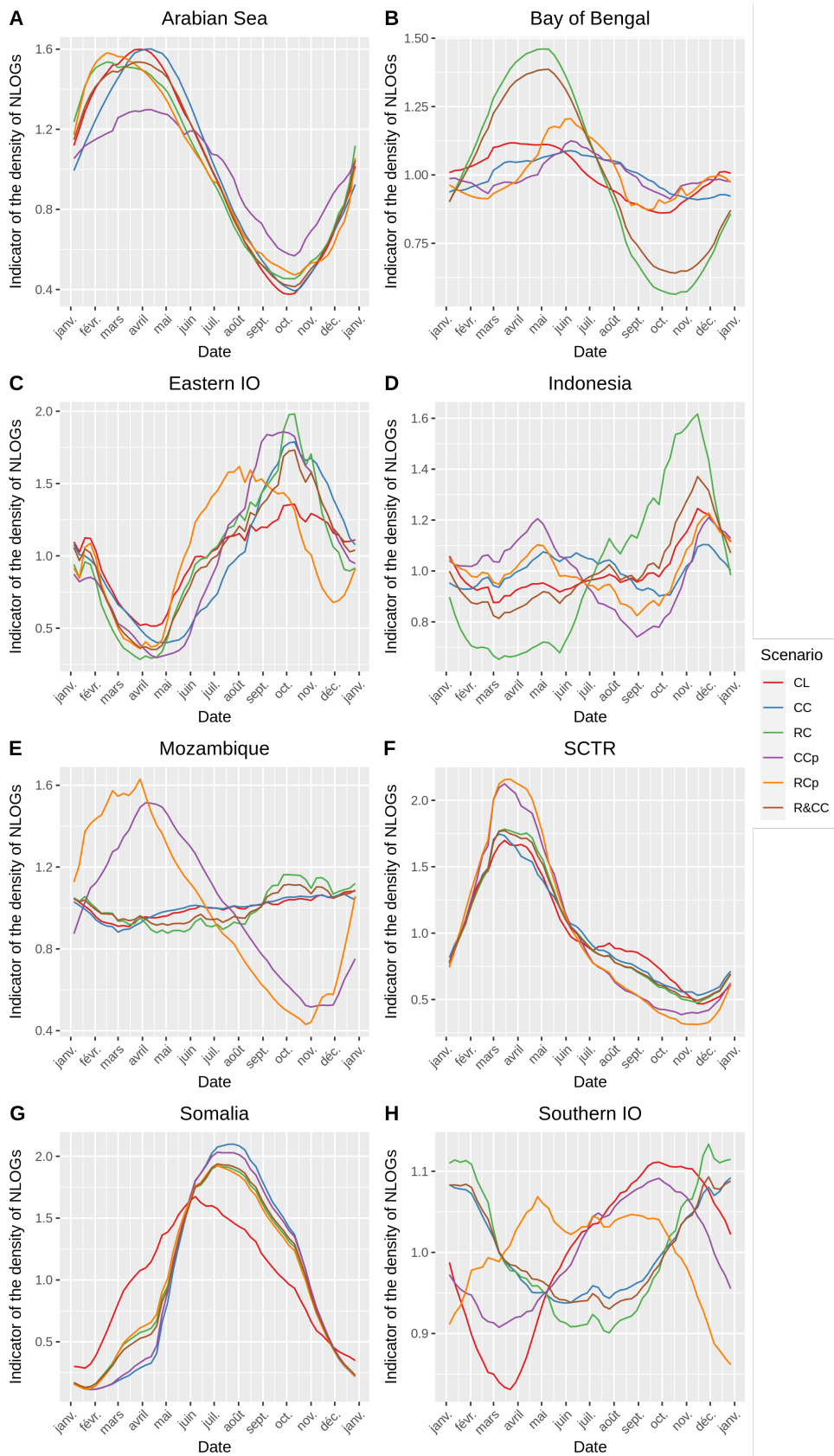

Figure 4.5: Seasonal variations of the mean simulated density of NLOGs per area. The densities are scaled for each scenario and area. Note that the scales do not allow for direct comparison between different areas. CL: Coastline Length; CC: Coastal forest Cover; RC: River forest Cover multiplied by river discharge; CCp: Coastal forest Cover multiplied by precipitations; RCp: River forest Cover multiplied by river discharge and by precipitations; R&CC: River plus Coastal forest Cover. IO: Indian Ocean; SCTR: Seychelles-Chagos Thermocline Ridge.

which is in agreement with the higher precipitations observed in the area from November to April (Supplementary Figure 4.8). However, considering rivers led a maximum density being observed in the second half of the year in the Indonesia region (RC and R&CC, Figure 4.5D). In the Mozambique region, very few seasonal variations were observed except in scenarios considering the precipitations, where the maximum density occurred in February-April and in April-May for the CCp and RCp scenarios, respectively (Figure 4.5E).

Table 4.2: Results of the linear regressions performed between the NLOG density anomaly (A) and time, represented on Figure 4.6, for the different weighting scenarios. Significant slope coefficients are in bold. Δt : maximum time lag such that Pearson’s correlation coefficient $\rho[A(t), A(t-\Delta t)] \geq 0.2$. CL: Coastline Length; CC: Coastal forest Cover; RC: River forest Cover multiplied by river discharge; CCp: Coastal forest Cover multiplied by precipitations; RCp: River forest Cover multiplied by river discharge and by precipitations; R&CC: River plus Coastal forest Cover.

Scenario	Slope estimate (% per day)	Δt (weeks)	p-value
CL	3.4×10^{-5}	21	4.4×10^{-2}
CC	8.4×10^{-5}	29	6.2×10^{-2}
RC	-8.2×10^{-6}	25	6.6×10^{-1}
CCp	3.0×10^{-5}	29	2.8×10^{-1}
RCp	-6.1×10^{-5}	31	8.8×10^{-1}
R&CC	-1.0×10^{-6}	30	5.2×10^{-1}

4.3.4 Trends of NLOG numbers in the Indian Ocean

Figure 4.6 depicts the variations in simulated density anomalies, averaged over the entire oceanic basin, from 2000 to 2019. Among all scenarios, only the CL scenario exhibited a significant positive trend (corrected p.value 4.4×10^{-2} , Table 4.2). For CC and CCp scenarios, there was a non-significant increasing trend (corrected p.values 6.3×10^{-2} and 2.8×10^{-1} respectively). However, when considering the river forest cover (RC, RCp and R&CC), the mean NLOG density showed a non-significant decreasing trend (corrected p.values 6.6×10^{-1} , 8.8×10^{-1} and 5.2×10^{-1} respectively). In the CL scenario, where the input of particles remained constant over the years, the slightly positive trend must originate from changes in currents that could lead to higher particles retention within the oceanic basin. Including a decreasing coastal forest cover over years did not compensate for this trend due to surface current changes, resulting in the positive but non-significant trends observed in the CC and CCp scenarios. However, when considering the forest cover associated with river basins (RC, RCp), the previously observed increasing trend was reversed, although it remained non-significant. This reversal might be attributed to loss of forest cover over the study period.

4.4 Discussion

This study provides the first-ever estimations of relative NLOG densities on the scale of the Indian Ocean, offering insights into their seasonal and long-term variability. All tested scenarios indicate that the areas with highest NLOG densities are the Bay of Bengal, the Mozambique Channel and the Eastern Arabian Sea. Among the scenarios, the ones considering coastal forest cover as input (CC and CCp) performed best. Surprisingly, these scenarios suggest no decreasing trend in NLOG densities across the entire IO, despite the observed loss of forested lands globally (IPBES 2019). Instead, they propose that the loss of coastal forest was compensated by an increase in NLOG density due to changes in surface currents. This is further supported by the fact that when forest cover from river basins was also considered,

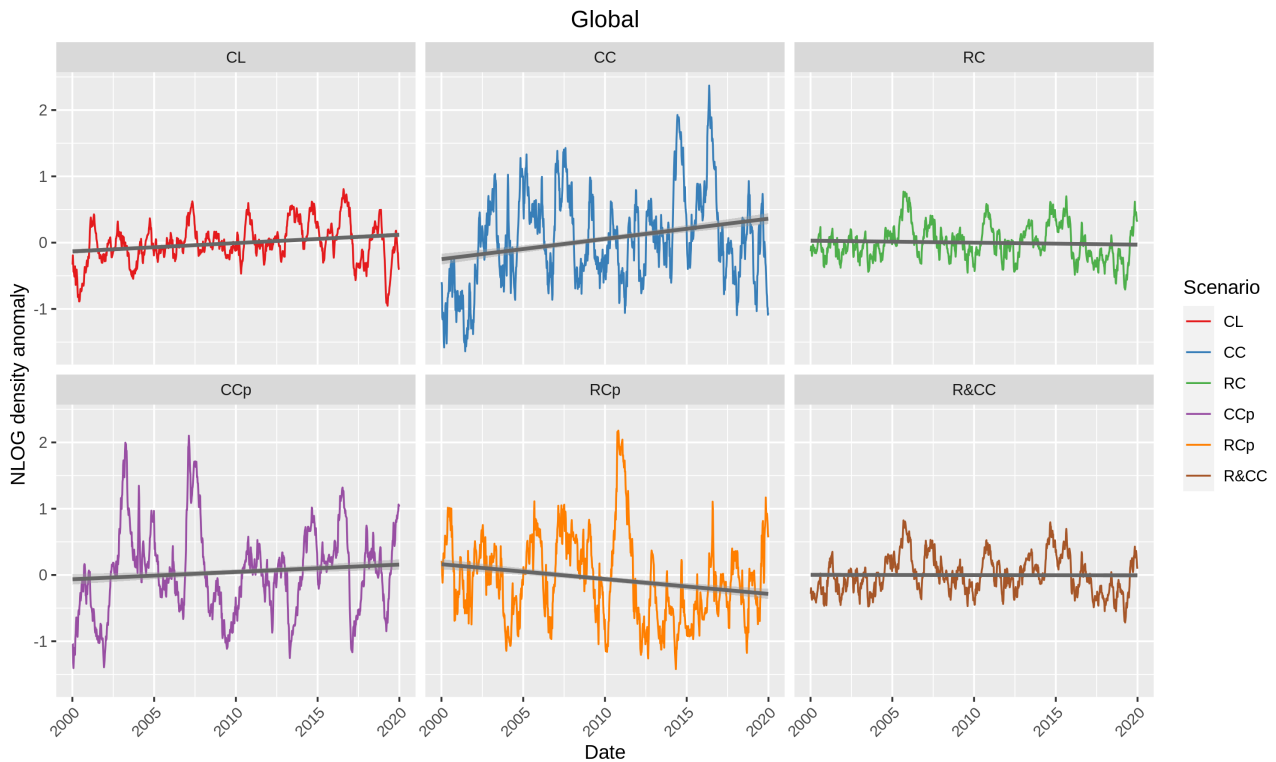

Figure 4.6: Anomaly of the simulated density of NLOGs from 2000 to 2019, averaged over the entire Indian Ocean. The NLOG density anomaly was obtained by subtracting mean seasonal variations from the raw densities. The grey line represents a linear regression between the NLOG density anomaly and time. CL: Coastline Length (corrected p.value for linear regression slope significance: 4.4×10^{-2}); CC: Coastal forest Cover (corrected p.value 6.2×10^{-1}); RC: River forest Cover multiplied by river discharge (corrected p.value 6.6×10^{-1}); CCp: Coastal forest Cover multiplied by precipitations (corrected p.value 2.8×10^{-1}); RCp: River forest Cover multiplied by river discharge and by precipitations (corrected p.value 8.8×10^{-1}); R&CC: River plus Coastal forest Cover (corrected p.value 5.2×10^{-1}).

the trend was reversed, although non significantly. Furthermore, these simulations revealed significant regional differences. For example, the Arabian Sea displayed a positive trend with both CL and CC scenarios (corrected p.values 3.7×10^{-2} and 1.2×10^{-2} respectively), while the Mozambique region displayed no significant trend for any scenario (all corrected p.values above 2.6×10^{-1} ; Figures 4.9&4.10). These findings highlight the complex and region-specific dynamics influencing NLOG densities in the Indian Ocean.

Van der Stocken et al. 2019 conducted simulations on the global dispersion of mangrove propagules and found high densities in the Mozambique Channel, Bay of Bengal and in the Eastern Arabian Sea. The global density patterns obtained in our study also align with Lagrangian simulations performed to determine the global distribution of plastics debris or microplastics (Van Sebille et al. 2015; Viatte et al. 2020). However, these studies on plastic distribution identified an accumulation area in the eastern southern IO, which was not present in our simulations. This discrepancy could be attributed to difference in drift time used in the simulations. In Van Sebille et al. 2018 and Viatte et al. 2020, simulations were carried out with much longer drift times, ranging from 20 to 50 years, emphasizing the importance of carefully considering particles lifetimes (Crochelet et al. 2020; Stelfox et al. 2020). Considering that estimations of driftwood lifetimes range from a few days to 1000 days (Thiel and Gutow 2005) and previous simulations showed little effect of drift time on our simulations (Dupaix et al. 2021a), we are confident that simulating NLOG drift for 360 days was appropriate. Confirmation of these simulated drift times could be achieved by conducting field-based estimations of NLOG drifting times through the study of fixed organisms and wood degradation. However,

such estimations face challenges due to the dependence of wood colonization by fixed organisms on the richness of the crossed zones, and the variability of wood degradation based on species characteristics (Russell et al. 2014). Additionally, limited information exists on the tree species found at sea, further complicating such estimates. Alternative methodologies to determine drift times could involve the use of backward-in-time lagrangian simulations using NLOGs observed at sea as release locations. Furthermore, the duration for which echosounder buoys, deployed on both DFADs and NLOGs by purse seine fleets, remain active, could also provide insight into the drifting time of NLOGs. However, echosounder buoys are deployed on NLOGs which are already at sea and can be deactivated remotely, making them suitable only as a lower boundary for drift time estimates.

Purse seine fleets in the IO primarily fish in the Mozambique Channel from March to May (Chassot et al. 2019; IOTC 2022e), mainly targeting tuna associated with natural floating objects since the early days of the fishery (Fonteneau 2003; Chassot et al. 2019; IOTC 2022e). Only the CCp and RCp scenarios (Figure 4.5E) can predict the highest NLOG densities during this season, highlighting the need to take precipitations into account to reveal seasonal patterns. However, it remains unclear whether the absence of NLOGs in the Mozambique area during the rest of year explains the lack of purse seine fishing activity or if other oceanographic factors, such as the upwelling in the Somalia area during the summer monsoon (July-August; Schott et al. 2009), redirect fishers to different areas. In the Maldives, a study using Local Ecological Knowledge (LEK) by (Jauharee et al. 2021) indicated that fishing activity targeting NLOG-associated tuna occurs from December to April and in October. Our findings with all scenarios are consistent with this fishing activity during the first part of the year (Dec-Apr, Figure 4.5A). However, no scenario suggest an increase of NLOG density in the Arabian Sea in October. It is essential to note that the Arabian Sea area used in this study is much larger than the waters surrounding the Maldives, and more detailed examinations of the dynamics in that specific area would be needed. When examining quarterly simulated density maps, the scenario that aligns best with Jauharee et al. 2021's results would be the RCp scenario (Figure 4.11). Conducting more localized studies in areas where fishers use NLOGs could be carried out using the simulations presented here, relying on LEK to improve the proposed scenarios.

The significant modifications of pelagic surface habitat caused by DFADs have led scientists to hypothesize that DFADs could indirectly impact tropical tunas and act as an "ecological trap" (Marsac et al. 2000; Hallier and Gaertner 2008). An ecological trap occurs when individuals select habitat that no longer offer suitable conditions due to anthropic changes, negatively affecting their fitness and potentially impacting the population (Battin 2004; Gilroy and Sutherland 2007; Swearer et al. 2021). The *indicator-log* hypothesis suggests that tuna would associate with NLOGs to find rich areas, as NLOGs originate from rivers and accumulate in rich frontal zones (Fréon and Dagorn 2000; Castro et al. 2002). The ecological trap hypothesis applied to DFADs and tropical tunas proposes that DFADs could alter the density and distribution of FOBs, potentially leading to the retention or transport of tunas to unsuitable areas Marsac et al. 2000. If NLOGs densities decrease in historically high-density areas, it could exacerbate this ecological trap. However, the best fitting scenarios (CC and CCp) predicted a non-significant increase in NLOG numbers in the Bay of Bengal and no trend in the Mozambique Channel, the areas with highest simulated NLOG densities.

The increase in FOB density induced by DFADs may have other potential indirect ecological impacts on tunas. It could lead to increased time spent by tuna associated with FOBs and disturb their schooling behavior (Fréon and Dagorn 2000; Pérez et al. 2020; Soria et al. 2009). The *meeting-point* hypothesis is another hypothesis of the associative behavior of tuna, positing that tuna use FOBs to facilitate encounters with conspecifics and promote schooling behaviour (Fréon and Dagorn 2000). An increase of FOB density could disperse tuna among FOBs and hinder the formation of large schools (Capello et al. 2022; Sempo et al. 2013). If NLOG density

were to increase despite forest cover loss (as suggested by the CC and CCp scenarios), it could potentially compound the impacts of DFADs on schooling behavior.

FOBs play a crucial role in marine species' habitat, benefiting a wide range of species from fixed organisms to large pelagic predators (Fréon and Dagorn 2000; Thiel and Gutow 2005). In recent decades, human activities, such as fishing, plastic waste, logging, agriculture have significantly altered their distribution (Dupaix et al. 2021a; Thiel and Gutow 2005; Van Sebille et al. 2015). While large plastic debris distribution is well-studied (Mendenhall 2018), the impacts of DFAD fishing and other human activities on FOB distribution remain relatively unknown. Studies have mainly focused on the WIO and Western and Central Pacific Ocean, considering NLOGs as a reference, and have shown that DFADs strongly increase the number of FOBs at sea (Dagorn et al. 2013a; Dupaix et al. 2021a; Phillips et al. 2019a). However, the impact of other human activities like agriculture or logging (causing deforestation) and human-induced climate change, which can also modify the NLOGs distribution has not been extensively studied. This exploratory study, showing limited influence of human activities on NLOG numbers but strong seasonal variations, is an initial step towards better understanding this important component of marine habitats.

This study presents first-ever simulations assessing the long-term impacts of human activities on a crucial natural component of the pelagic surface habitat. Our results not only provide estimates of NLOG density across the entire IO but also enable more accurate local estimations of NLOG densities and variations. These local estimates can be invaluable for fisheries management and ecological studies aiming to understand the effects of DFAD fisheries on tropical tuna and other species associating with FOBs. The simulations reveal diverse trends across regions, although many are not statistically significant (see Supplementary Figures 4.9&4.10), warranting further exploration through Local Ecological Knowledge in areas where artisanal fisheries rely on driftwood and/or anchored FADs to enhance their tuna catches (Indonesia, Maldives; Jauharee et al. 2021). The best fitting scenarios, based on coastal forest cover, suggest no significant increase in average NLOG densities in the ocean. However, these preliminary findings underscore the limited understanding of this critical element of pelagic species habitat. Therefore, there is pressing need to intensify monitoring efforts for pelagic species habitat and raise awareness about potential indirect impacts of habitat modifications on tuna and other pelagic species. These impacts should be further investigated and better considered by regional fisheries management organizations to ensure the sustainable management of marine resources.

4.5 Supplementary Materials

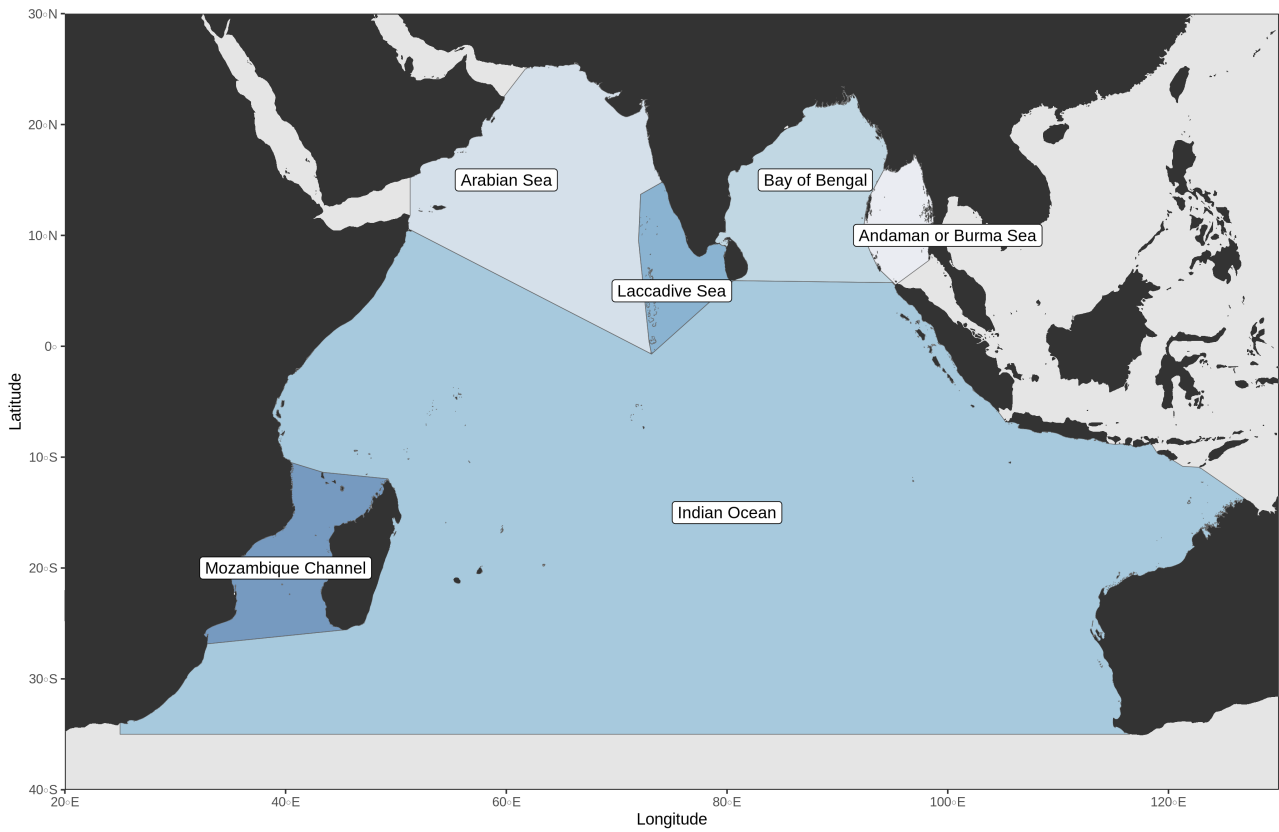

Figure 4.7: Map of the different seas considered in the study.

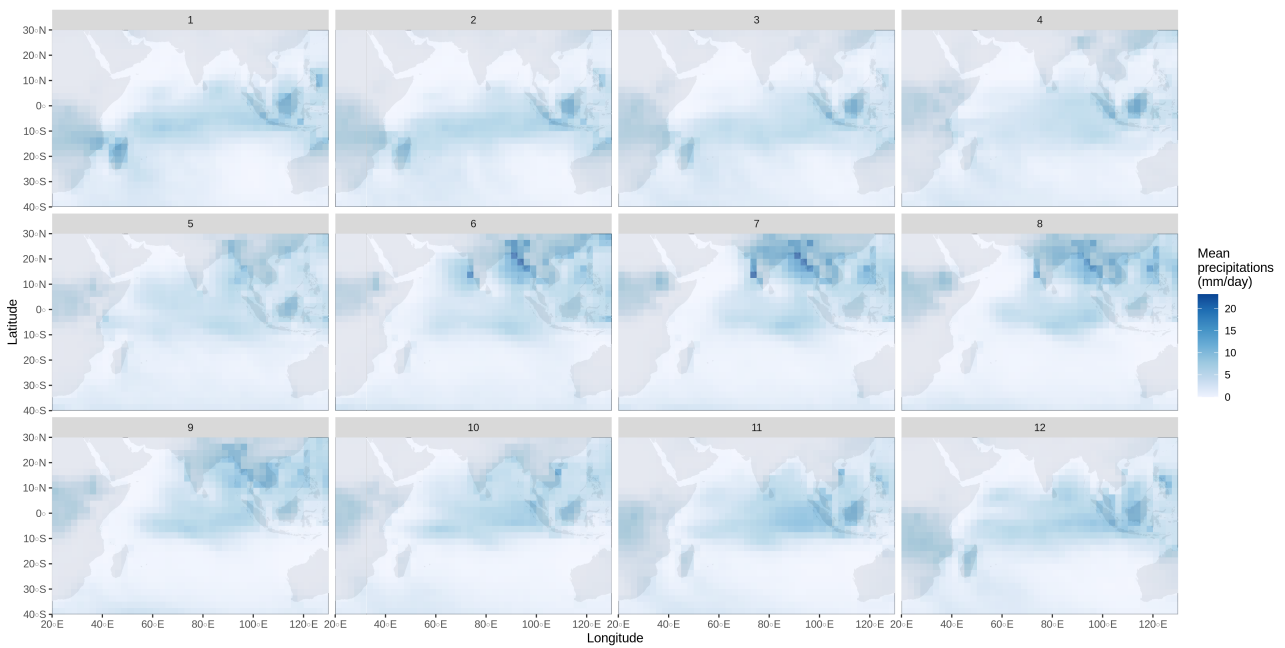

Figure 4.8: Mean monthly precipitations in the Indian Ocean averaged over 2000-2019.

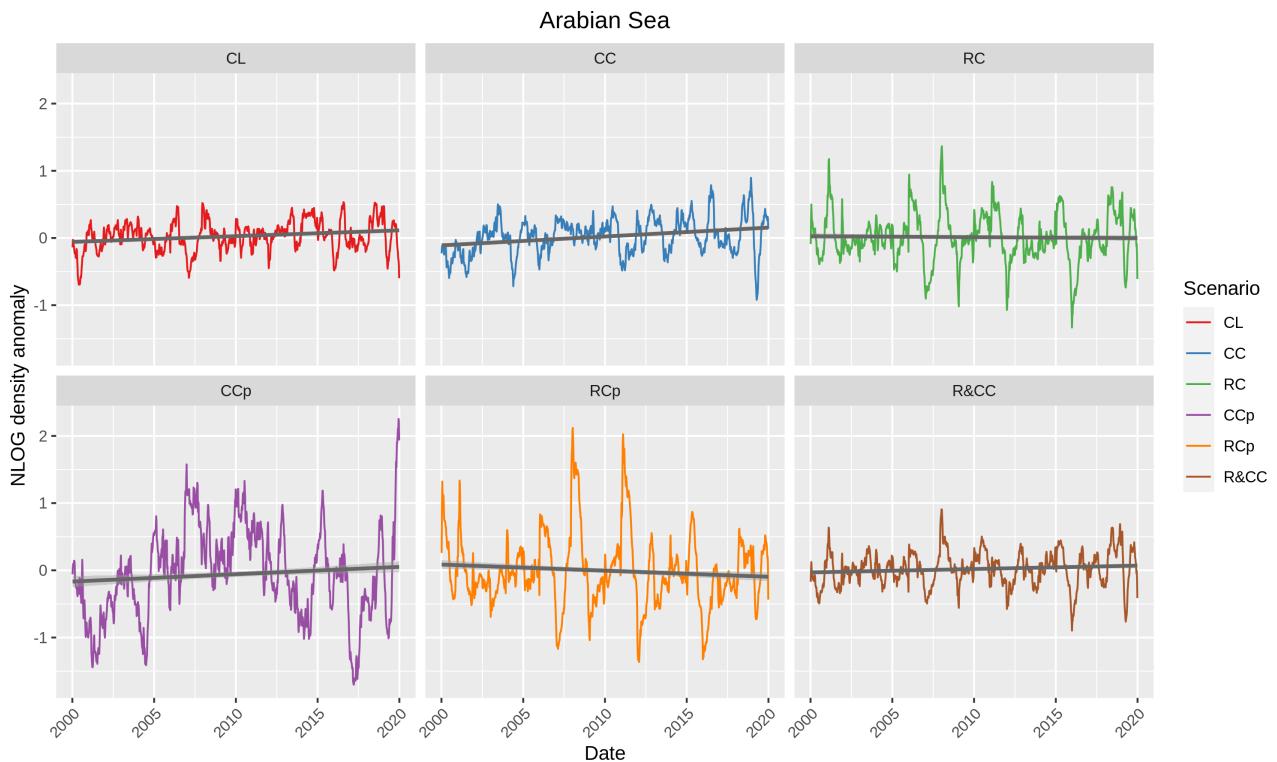

Figure 4.9: Anomaly of the simulated density of NLOGs from 2000 to 2019, averaged over the Arabian Sea region. The mean seasonal variations were subtracted to the raw densities to obtain an NLOG density anomaly. The grey line represents a linear regression between the NLOG density anomaly and the time. CL: Coastline Length (corrected p.value for slope 3.7×10^{-2}); CC: Coastal forest Cover (corrected p.value 1.2×10^{-2}); RC: River forest Cover multiplied by river discharge (corrected p.value 5.6×10^{-1}); CCp: Coastal forest Cover multiplied by precipitations (corrected p.value 3.5×10^{-1}); RCp: River forest Cover multiplied by river discharge and by precipitations (corrected p.value 7.4×10^{-1}); R&CC: River plus Coastal forest Cover (corrected p.value 1.8×10^{-1}).

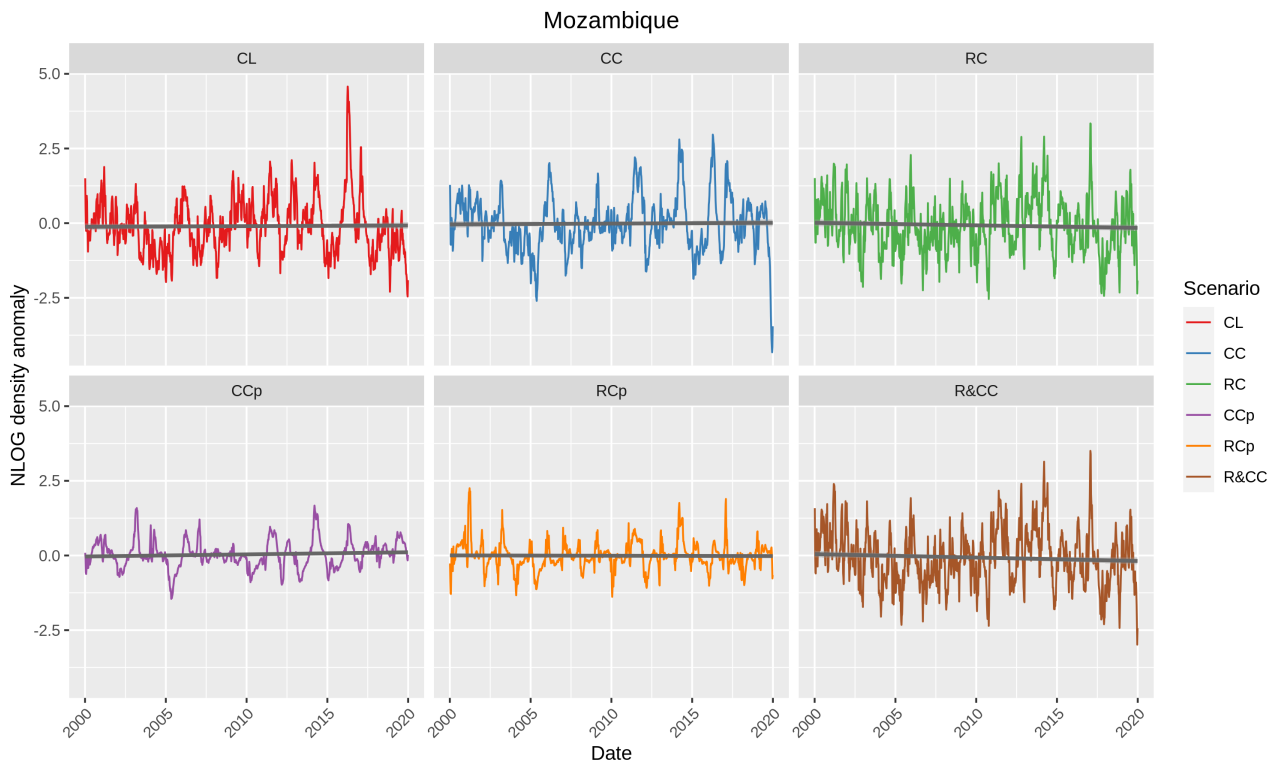

Figure 4.10: Anomaly of the simulated density of NLOGs from 2000 to 2019, averaged over the Mozambique region. The mean seasonal variations were subtracted to the raw densities to obtain an NLOG density anomaly. The grey line represents a linear regression between the NLOG density anomaly and the time. CL: Coastline Length (corrected p.value 4.6×10^{-1}); CC: Coastal forest Cover (corrected p.value 4.5×10^{-1}); RC: River forest Cover multiplied by river discharge (corrected p.value 7.0×10^{-1}); CCp: Coastal forest Cover multiplied by precipitations (corrected p.value 2.6×10^{-1}); RCp: River forest Cover multiplied by river discharge and by precipitations (corrected p.value 5.5×10^{-1}); R&CC: River plus Coastal forest Cover (corrected p.value 7.4×10^{-1}).

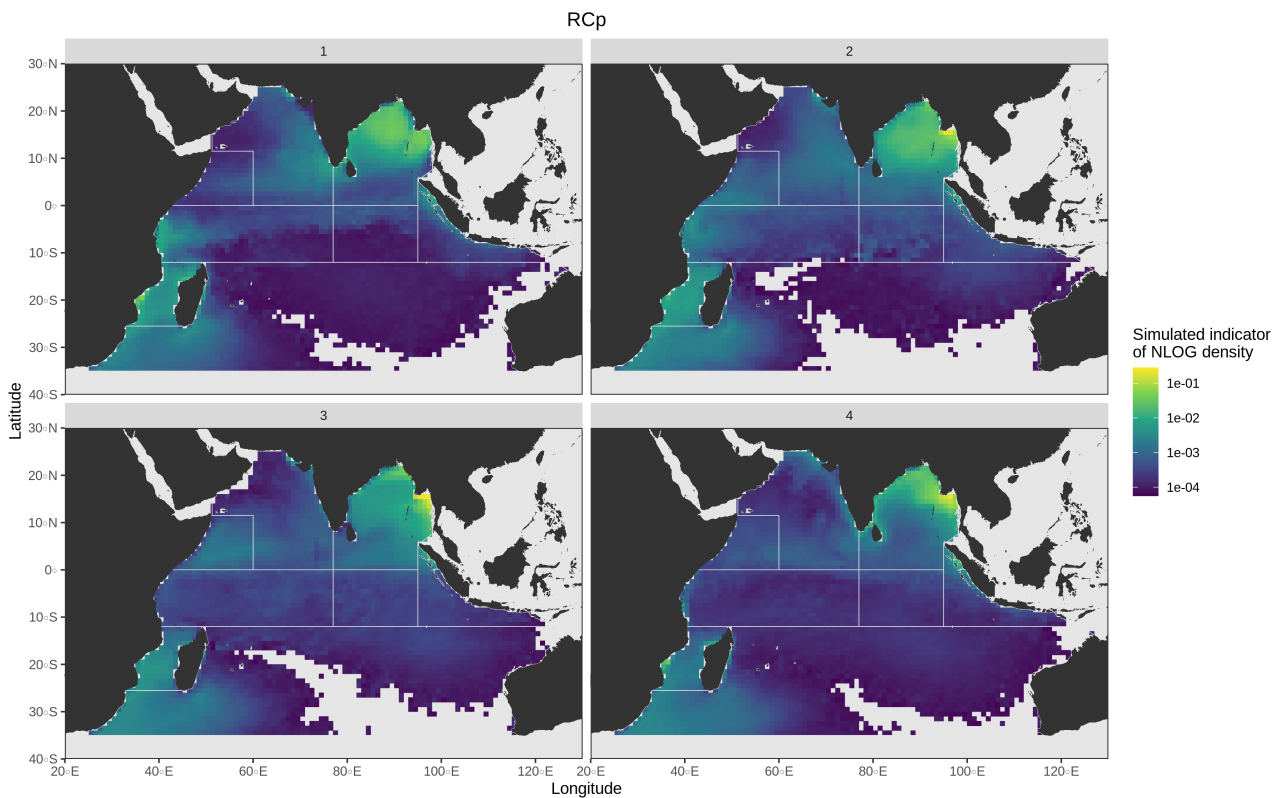

Figure 4.11: Simulated density of NLOGs per quarter averaged over 2000-2019 for the RCp scenario. Maximum value was set to 1 and values below 10^{-4} were discarded. RCp: River forest Cover multiplied by river discharge and by precipitations.

Transition

In this Chapter, I assessed the potential modifications induced by global change on a component of tropical tuna habitat: the distribution of natural floating objects (NLOGs). As no data on NLOGs is available at the scale of the whole IO, I used Lagrangian simulations with several release scenarios. Best performing scenarios were the ones relying on coastal forest cover, suggesting that it could be the most important source of NLOGs. No significant trend in NLOG number at the scale of the ocean was observed, suggesting a low impact of deforestation and surface currents modifications. However, several different regional trends could be observed, stressing the need to use this type of approach at a local scale too. Simulations also evidenced strong seasonal variations, which could impact tropical tuna habitat.

In Part I, I assessed the extent of the modifications of pelagic surface habitat induced by human activities. The development of several indicators allowed to quantify the impact induced by DFADs, which seems to be the greatest. Other human activities, such as deforestation or modifications of surface currents induced by climate change, seem to have a lower impact at the oceanic basin scale but could have important impacts locally. One of the main modification of pelagic surface habitat evidenced is an important increase of FOB density.

This increase of FOB density can impact tuna behavior, although no converging results exist allowing to be conclusive on the extent of these impacts as well as on their consequences (see Section 2.3). In Part II, I characterize the impacts of the FOB density increase induced by DFADs on the associative behavior of tuna. In Chapter 5, I focus on the individual-scale, and quantify the increase of the percentage of time tuna spend associated with FOBs induced by DFADs. In Chapter 6, I focus on the aggregation-scale and determine the relationship between the percentage of FOBs that are occupied by tuna and FOB density and other biophysical characteristics of the environment.



Part II

Impacts of DFADs on tropical tuna associative behavior

Chapter 5

Quantifying the impact of habitat modifications on species behavior and mortality: Case-study on floating objects and tropical tuna

Publications

Peer-reviewed

Dupaix, A., Dagorn, L., Deneubourg, J.-L., & Capello, M. (Under review). Quantifying the impact of habitat modifications on species behavior and mortality: Case-study on floating objects and tropical tuna. *Ecological Applications*. <https://hal.science/hal-04094705>

Pérez, G., **Dupaix, A.**, Dagorn, L., Deneubourg, J.-L., Holland, K., Beeharry, S., & Capello, M. (2022). Correlated Random Walk of tuna in arrays of Fish Aggregating Devices: A field-based model from passive acoustic tagging. *Ecological Modelling*, 470, 110006. <https://doi.org/10.1016/j.ecolmodel.2022.110006>. (**Appendix A**)

Technical paper & Software

Dupaix, A., Dagorn, L., Deneubourg, J. L., & Capello, M. (2022). Impact of DFAD density on tuna associative behavior and catchability in the Indian Ocean (IOTC Ad Hoc Working Group on FADs (WGFAD3) *IOTC-2022-WGFAD03-06*). Indian Ocean Tuna Commission. <https://iotc.org/documents/WGFAD/03/06>

Dupaix, A., Pérez, G., & Capello, M. (2023). FAT albaCoRaW (v1.4). Zenodo. <https://doi.org/10.5281/zenodo.5834056>

5.1 Introduction

In the context of global change, biodiversity and ecosystem functions are deteriorating under the pressure of several direct and indirect drivers (IPBES 2019). In terrestrial and freshwater ecosystems, land-use increase, induced by agriculture, forestry and urbanization, is the driver with the largest relative impact, while direct exploitation of fish and seafood has the largest relative impact in the oceans (IPBES 2019). Increased exploitation of land and sea directly impacts populations but also modifies natural habitat, *e.g.* by reducing its surface (Hooke and Martín-Duque 2012; Neumann et al. 2016) or degrading and fragmenting it (IPBES 2018). Such habitat modifications can impact wild species distribution, reproduction, behavior and ultimately their fitness (Mullu 2016; Macura et al. 2019; Fischer and Lindenmayer 2007). Hence, it is central to determine to what extent these modifications, driven by global change or direct exploitation of animals, can impact species fitness, both in terrestrial and marine ecosystems.

The impact of landscape modification and habitat fragmentation have been extensively studied in terrestrial ecosystems (Fischer and Lindenmayer 2007). For example, evidence shows that 82 % of endangered bird species are threatened by habitat loss, as are most amphibian species, with some of them now only breeding in modified habitats (IPBES 2018). Anthropogenic disturbances also impact terrestrial ecosystem functions, reducing plant production (Hooper et al. 2012), and the impact of terrestrial habitat fragmentation on population connectivity is regularly assessed (IPBES 2018).

However, the extent to which habitat modifications determine the behavior, survival and fitness of marine species is still largely unknown (Hays et al. 2016). Research on the topic mainly focuses on estuaries and coastal marine ecosystems. Habitat modifications in coastal areas come from fisheries and development of infrastructures and aquaculture (IPBES 2019). Climate change is also an important driver, with most striking impacts in the poles and the tropics (Doney et al. 2012). Induced warming temperatures and ocean acidification are likely to drive the degradation of most warm-water coral reefs by 2040-2050 (Hoegh-Guldberg et al. 2017), and mangroves are predicted to move poleward (Alongi 2015). Pollution is also a driver of marine habitat modification, through acidification, oil spills or plastics, which can lead to changes in population dynamics (4.2.1.6.5 in IPBES 2022b). Marine habitat modifications also impact benthic community composition and sensitivity (Neumann et al. 2016), and could affect fish recruitment (Macura et al. 2019).

In pelagic environments, fewer studies have assessed habitat modifications (Dupaix et al. 2021a) and their impact on species behavior, condition and survival (Hallier and Gaertner 2008). Detailed movement data can be more cumbersome to acquire for marine than for terrestrial species, due to the limitations of satellite communication in the ocean. It is possible to record horizontal and vertical movements of pelagic species, but the deployment of such tracking devices is costly and operationally challenging (Ogburn et al. 2017). For example, using active acoustic tagging, one can have a good estimation of an individual trajectory but needs to follow the individual by boat. Pop-up satellite archival tags are also increasingly used and allow to record the movement and depth of marine animals without having to follow them. However, these tags, based on Global Location Sensors (GLS) only allow to track movement at a large geographical scale. Finally, presence-absence data can be obtained through passive acoustic telemetry, by deploying networks of acoustic receivers allowing the detection of tagged individuals when they are in the vicinity (Pérez et al. 2020).

Tropical tunas are of major commercial interest worldwide (\$40.8 billion in 2018, McKinney et al. 2020) and are subject to an important fishing pressure (5 million tons of tuna caught annually in 2017-2021, ISSF 2023). Yellowfin tuna (*Thunnus albacares*, designated as YFT) is one of the three main targeted species, with the skipjack (*Katsuwonus pelamis*) and bigeye (*Thunnus obsesus*) tunas. The main fishing gear targeting tropical tunas is purse seining, which

made around 66% of the global catch from 2017 to 2021 (ISSF 2023). Many pelagic species, like tunas, are known to associate with floating objects (FOBs, Fréon and Dagorn 2000; Castro et al. 2002), such as tree logs which are a natural component of their habitat. In the 1990s, tuna purse seine vessels started to deploy their own artificial floating objects, called Fish Aggregating Devices (FADs), to exploit this associative behavior.

Since then, the deployment and use of drifting FADs (DFADs) has increased, and the last global estimate is between 81,000 and 121,000 DFAD deployed in 2013 (Gershman et al. 2015). In the beginning of the 2010s, fishers started equipping DFADs with echosounder buoys, transmitting the position of the DFAD and an estimation of the tuna biomass under it (and designated as operational buoys when transmitting), further increasing their efficiency (Wain et al. 2021). In 2017-2021, around 56 % of global purse seine catch was performed on FOBs, representing around 1.8 million tons per year (ISSF 2023), and this proportion can be much higher in some regions, *e.g.* with more than 85 % of purse seine catch around FOBs in the Indian Ocean (IOTC 2022e). The use of DFADs and their equipment with echosounder buoys directly impact tuna populations, by increasing fishing efficiency (Wain et al. 2021) and the proportion of juvenile tuna (Guillotreau et al. 2011). It also has an impact on pelagic species habitat, which can be quantified by comparing DFAD densities with that of LOGs (floating objects other than FADs). For example, using data from observers onboard tuna purse seine vessels, Dupaix et al. 2021a highlighted the habitat modifications provoked by the drastic increase of DFAD use in the Western Indian Ocean (WIO) from 2006 to 2018. DFADs multiplied the densities of FOBs by at least 2 and represented more than 85 % of the overall FOBs.

This massive DFAD deployment is a major concern and offers an important case study to assess the impact of habitat modifications on pelagic species behavior and mortality (Marsac et al. 2000; Hallier and Gaertner 2008). Pérez et al. 2020 demonstrated, on arrays of anchored fish aggregating devices (AFADs), that a decrease of inter-AFAD distance leads to an increase in the percentage of time tuna spend associated. By comparing passive acoustic tagging data from three arrays with different inter-AFAD distances, the authors found that when the distance decreases, tuna both spent more time associated to a given AFAD and less time between two associations. If an increase of DFAD density also increases the percentage of time tunas spend associated, it would strongly impact their catchability and therefore their mortality.

Several acoustic tagging studies characterized the behavior of tuna around AFADs, both through active (Girard et al. 2004) and passive tagging (Pérez et al. 2020; Robert et al. 2012). These studies allowed to determine both residence times and duration between two associations. On DFADs, residence times were measured and showed important variations between oceans and species, ranging from 1.0 to 6.6 days, 0.2 to 4.6 days and 1.4 to 7.6 days for yellowfin, skipjack and bigeye tuna respectively (Dagorn et al. 2007; Govinden et al. 2021; Matsumoto et al. 2016). However, times between two DFAD associations are not known because neighbor DFADs are difficult to locate and exhaustively instrument with acoustic receivers. Without these measures, the percentage of time tuna spend associated with DFADs cannot be assessed, nor can the consequences of an increase of DFAD density on tuna.

This study focuses on the impact of pelagic habitat modifications, driven by fisheries, on a pelagic species, the YFT. We use an individual-based model, based on a Correlated Random Walk (Pérez et al. 2022), and fisheries data to predict the time tuna spend between two associations to DFADs in the Western IO in 2020. Using these predictions, we assess the impact of the modification of the pelagic habitat – DFAD density increase – on the percentage of their time YFT spend associated. This percentage of time spent associated has a direct impact on tuna availability to fishers and can have other potential indirect impacts on tuna's fitness.

5.2 Methods

5.2.1 Simulations

Simulations were performed using the FAT albaCoRaW model v1.4 (Dupaix et al. 2023b), an individual-based model simulating tuna trajectories in an array of fish aggregating devices (FADs) based on a Correlated Random Walk (Pérez et al. 2022). This model is build upon three behavioral rules: (i) tuna display a random search behavior between two associations to FADs, (ii) at a certain distance from FADs (the orientation radius R_0) tuna show oriented movements towards FADs and (iii) the tuna association dynamics follow a diel rythm. The random search between two associations is based on three parameters: the time-step Δt , determining the time interval between two positions, the speed v , determining the length of each displacement at each time step, and the sinuosity coefficient c , determining the sinuosity of the path, from strait to a simple random walk. These parameters were fitted on passive acoustic tagging data of 70 cm long YFT in arrays of AFADs, in Pérez et al. 2022 (Table 5.1). We considered twelve different FAD densities (noted ρ), ranging from 1.00×10^{-4} to 4.44×10^{-3} FAD.km⁻². These densities correspond to a distance to the nearest neighbor in a regular square lattice ranging from 100 to 15 km respectively (Table 5.1). For each of these densities, 100 different random arrays were generated, with FAD longitude and latitude being randomly picked. A thousand individual tunas were released from a random FAD in each of these arrays. As in Pérez et al. 2020, we define a Continuous Absence Time (CAT) as the time spent between two associations to a FAD. A tuna was considered associated when it was located at less than 500 m from a FAD, which corresponds to the distance at which a tagged tuna can be detected by an acoustic receiver. CATs were separated into two categories: (i) CAT_{diff} when the movement occurred between two different FADs and (ii) CAT_{return} when the tuna returned to its departure FAD after more than 24 h. Studies processing experimental acoustic tagging data of tropical tuna relied on a Maximum Blanking Period of 24 h, *i.e.* below a temporal separation of 24 h between two subsequent acoustic detections at the same FAD, the fish is considered to be still associated (Capello et al. 2015; Pérez et al. 2022). Hence, each time a CAT_{return} of less than 24 h was recorded, this movement was discarded and the simulation time was reset to the beginning. The simulation was stopped when the individual either performed a CAT_{diff} , a CAT_{return} or after 1,500 days of simulation. The obtained Continuous Absence Time (CAT) was saved. A total of 100,000 CATs were simulated per FAD density, totaling 1,200,000 simulated CATs.

Table 5.1: Parameters used in the simulations, performed using Dupaix et al. 2023b and based on the calibration in Pérez et al. 2022. Δt : time-step; v : speed; R_0 : orientation radius; c : sinuosity coefficient; D : mean inter-FAD distance.

Δt	v	R_0	c	D
100 s	0.7 m.s ⁻¹	5 km	0.99	15, 20, 25, 30, 35, 40, 50, 60, 70, 80, 90, 100 km

5.2.2 CAT trends for different FAD densities

For each FAD density, the mean Continuous Absence Time (noted \overline{CAT}) was considered, based on the individual CAT values simulated above. Because the CAT_{diff} and CAT_{return} were demonstrated to follow different processes (Pérez et al. 2020), we assessed the relationship between these two metrics and FAD density separately. The \overline{CAT}_{diff} (in days) was related to FAD density (ρ) as follow:

$$\overline{CAT}_{diff}(\rho) = \frac{a_d}{\rho^{b_d}} \quad (5.1)$$

with $(a_d, b_d) \in \mathbb{R}_+^2$. By construction, a CAT_{return} cannot be shorter than 24h (Pérez et al. 2022; Capello et al. 2015). Hence, $\overline{CAT_{return}}$ (in days) was related to ρ as follow:

$$\overline{CAT_{return}}(\rho) = 1 + \frac{a_r}{\rho^{b_r}} \quad (5.2)$$

with $(a_r, b_r) \in \mathbb{R}_+^2$. Then, the mean Continuous Absence Time $\overline{CAT}(\rho)$ can be expressed as follow (see Section 5.5.1 for more details):

$$\overline{CAT}(\rho) = \frac{R(\rho)\overline{CAT_{diff}}(\rho) + \overline{CAT_{return}}(\rho)}{R(\rho) + 1} \quad (5.3)$$

where $R = \frac{A}{B}$, the ratio between the number of CAT_{diff} (A) and that of CAT_{return} (B). The ratio R as a function of ρ was fitted based on the following equation:

$$R(\rho) = a\rho^c \exp(b \times \rho) \quad (5.4)$$

with $(a, b, c) \in \mathbb{R}_+^3$. The values of a_d, b_d, a_r, b_r, a, b and c were determined using the *nls* function of the R package *stats* v3.6.3.

5.2.3 FOB density calculation

Predictions of the $\overline{CAT}(\rho)$ in 2020 in the Indian Ocean (IO) were performed on three different densities: DFAD, FOB and LOG (floating objects other than DFADs, either of natural origin or originating from pollution) densities. Buoy density data, provided by the Indian Ocean Tuna Commission (IOTC), was used as a proxy for DFAD data (IOTC 2021b). This dataset contains the monthly mean of the number of operational buoys for each $1^\circ \times 1^\circ$ cell of the Indian Ocean. This value was divided by the sea area of each cell, to obtain a mean monthly DFAD density (ρ_{DFAD}). Densities were then averaged over 5° cells to predict CATs (for more elements on the spatial and temporal resolution choice see Section 5.5.2).

FOB and LOG densities were calculated using DFAD densities and data recorded by scientific observers on board French purse seine vessels (2014-2019). Observer data include the date, time, and location of the main activities of the fishing vessel (*e.g.* fishing sets, installation or modification of FOBs, searching for FOBs). For every activity occurring on a FOB, the type of operation (*e.g.* deployment, removal, and observation of a FOB) and the type of floating object (DFAD or LOG) are recorded. Using the methodology developed in Dupaix et al. 2021a applied to these observations, we calculated a mean monthly ratio $m = \frac{n_{LOG}}{n_{DFAD}}$ (with n_{LOG} and n_{DFAD} the number of LOG and DFAD observations respectively) per 5° cell which was used to calculate the density of FOBs ($\rho_{FOB} = (1 + m)\rho_{DFAD}$) and the density of LOGs ($\rho_{LOG} = m\rho_{DFAD}$). Because observers data are only available in areas where purse seine vessels are actively fishing, the calculation of the m ratio restricted the study area to the purse seine fishing zones.

5.2.4 Prediction of mean Continuous Absence Time and Percentage of time associated in the IO

Using the density values calculated above and the coefficients of the models fitted in section 5.2.3, monthly \overline{CAT} values were predicted for each 5° cells in 2020.

The percentage of time a tuna spends associated with a FAD (noted P_a) can be expressed as follow :

$$P_a(\rho) = \frac{\overline{CRT}}{\overline{CRT} + \overline{CAT}(\rho)} \times 100 \quad (5.5)$$

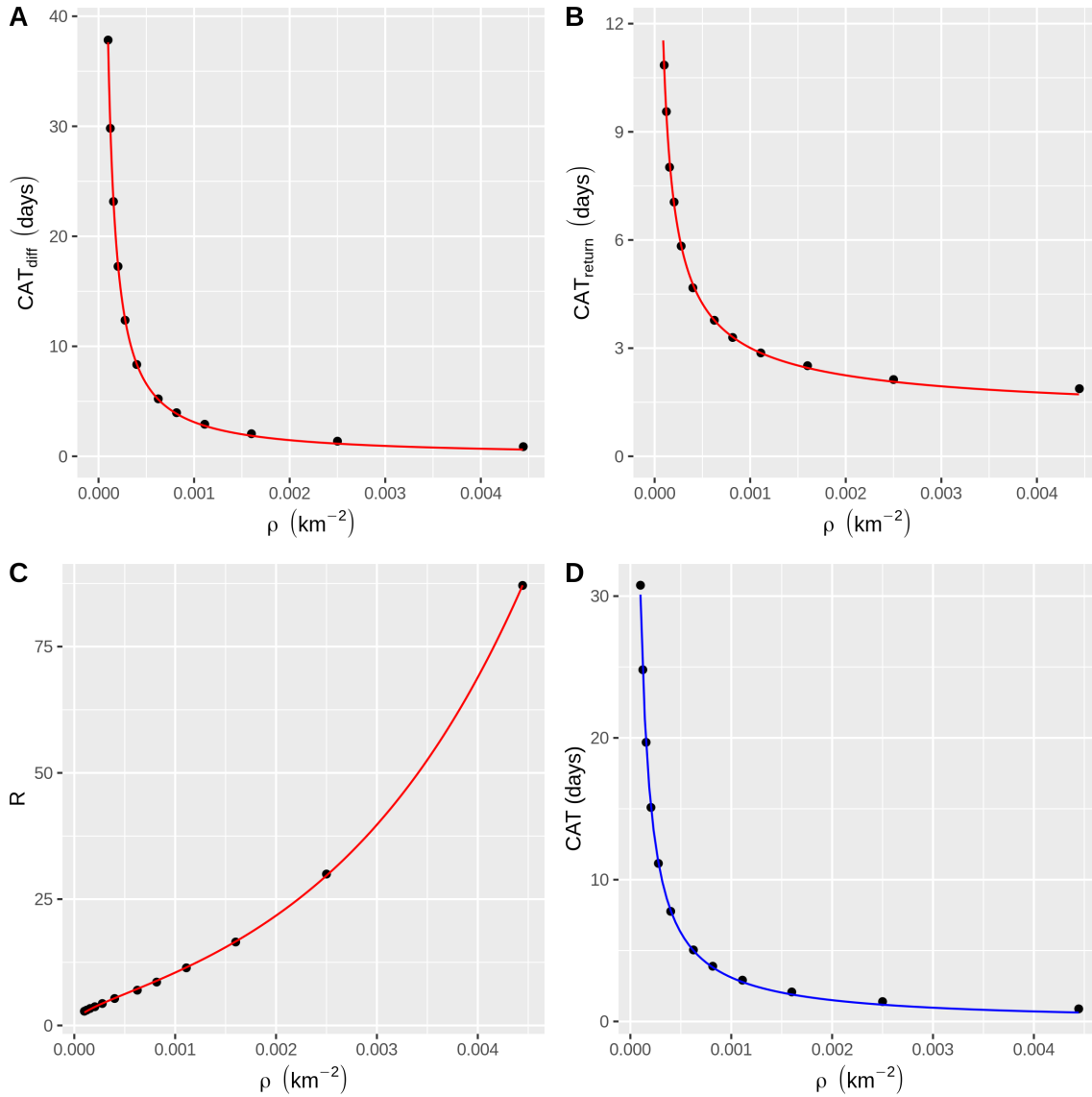

Figure 5.1: Continuous Absence Times (CATs) trends as a function of FAD density, obtained from the simulations. (A) \overline{CAT}_{diff} fitted according to Equation 5.1. (B) \overline{CAT}_{return} fitted according to Equation 5.2. (C) Ratio between the number of CAT_{diff} and the number of CAT_{return} (R) fitted according to Equation 5.4. Parameter values are available in Table 5.3. (D) Mean \overline{CAT} . The blue line is obtained from the fits in panels A,B and C and from Equation (5.3). ρ : FAD density.

with \overline{CRT} the mean Continuous Residence Time, defined as continuous bouts of time spent at the same FAD without any day-scale absence (>24 h, Capello et al. 2015). Pérez et al. 2020 showed that \overline{CRT} depends on AFAD density but to a lesser extent than \overline{CAT} . Hence, \overline{CRT} was considered constant and estimated to be 6.64 days, as measured on YFT at DFADs in the Western Indian Ocean by Govinden et al. 2021. Using this value and the predicted $\overline{CAT}(\rho)$, we predicted the monthly values of $P_a(\rho)$ in each 5° cells in 2020, for each floating objects categories (DFAD, FOB, LOG). Because the calculation of the m ratio reduced greatly the study area, we first predicted \overline{CAT} and P_a values based on the density of DFADs (ρ_{DFAD}). However, to determine the impact of DFADs on the predicted associative behavior, we compared the predicted values of \overline{CAT} and P_a obtained with ρ_{FOB} and ρ_{LOG} . This comparison allows to determine the impact of the DFADs induced habitat modification on tuna availability to fishers.

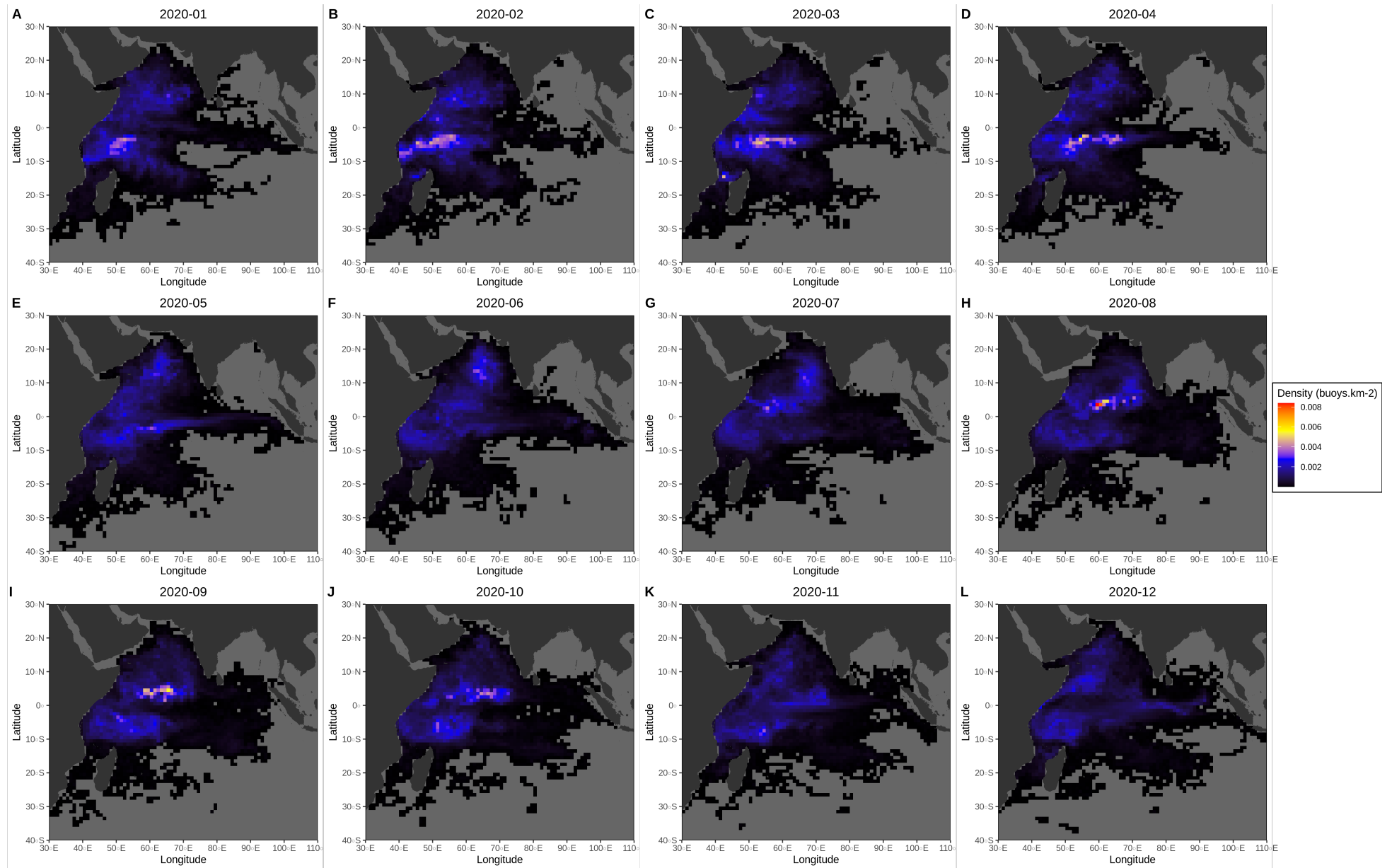

Figure 5.2: Mean monthly buoy densities per 1° cells in the western Indian Ocean calculated from IOTC 2021b, expressed in buoys.km^{-2} . Buoy densities are considered as DFAD densities, see details in section 5.2.3

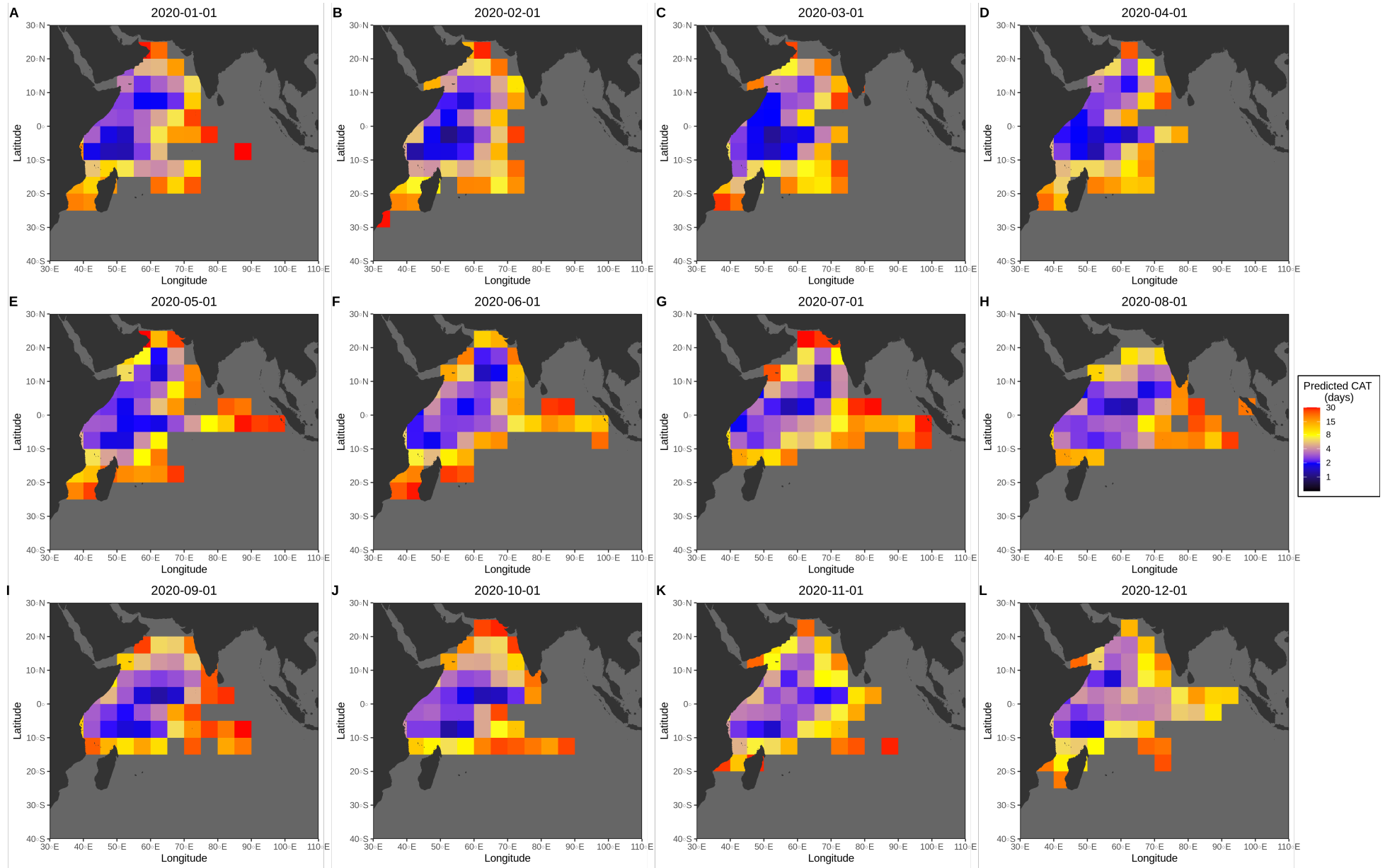

Figure 5.3: Mean monthly Continuous Absence Times of individual yellowfin tunas predicted using DFAD density ($\overline{CAT}(\rho_{DFAD})$, in days) per 5° cells in the western Indian Ocean in 2020. The color scale is log transformed. $\overline{CAT}(\rho_{DFAD})$ longer than 30 days were not represented.

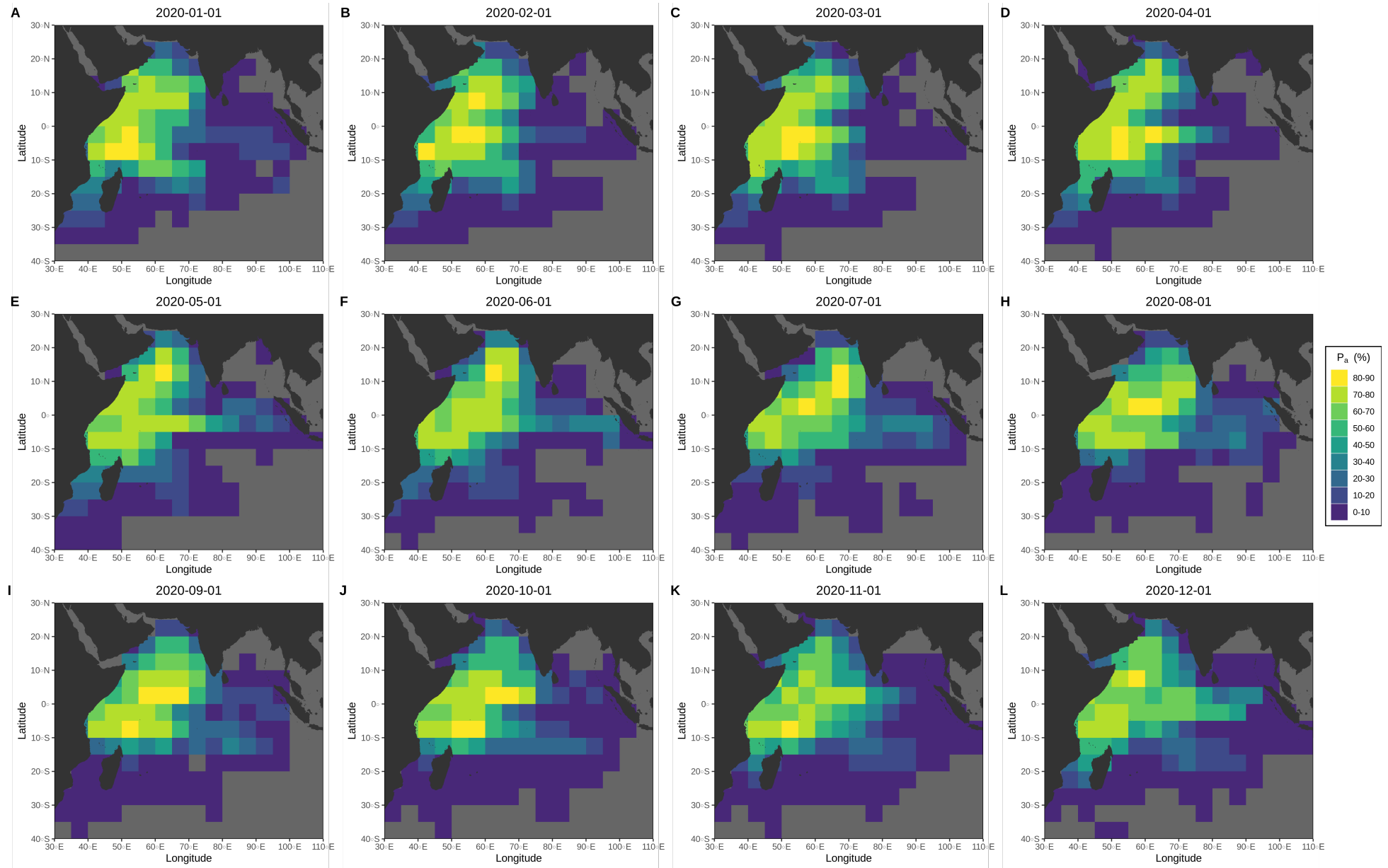

Figure 5.4: Mean monthly percentage of time spent associated by individual yellowfin tunas predicted using DFAD density ($P_a(\rho_{DFAD})$) per 5° cells in the Western Indian Ocean in 2020.

5.3 Results

5.3.1 Simulated Continuous Absence Time trends

Table 5.2: Values of CATs for each of the simulated FAD density. D: mean inter-FAD distance in a regular square lattice (in km); ρ : FAD density (in km^{-2}); \overline{CAT} : mean Continuous Absence Time (in days); \overline{CAT}_{diff} : mean Continuous Absence Time when the movement occurred between two different FADs (in days); \overline{CAT}_{return} : mean Continuous Absence Time when the individual returned to the departure FAD (in days); R: ratio between the number of \overline{CAT}_{diff} and the number of \overline{CAT}_{return} .

D	ρ	\overline{CAT}	\overline{CAT}_{diff}	\overline{CAT}_{return}	R
100	1.00×10^{-4}	30.77	37.84	10.85	2.82
90	1.23×10^{-4}	24.81	29.81	9.56	3.04
80	1.56×10^{-4}	19.69	23.16	8.02	3.36
70	2.04×10^{-4}	15.09	17.26	7.05	3.71
60	2.78×10^{-4}	11.15	12.37	5.83	4.35
50	4.00×10^{-4}	7.77	8.35	4.67	5.33
40	6.25×10^{-4}	5.04	5.23	3.77	6.98
35	8.16×10^{-4}	3.89	3.96	3.30	8.59
30	1.11×10^{-3}	2.91	2.92	2.87	11.41
25	1.60×10^{-3}	2.08	2.05	2.51	16.52
20	2.50×10^{-3}	1.40	1.38	2.13	29.97
15	4.44×10^{-3}	0.89	0.88	1.88	87.11

Simulated \overline{CAT} , \overline{CAT}_{diff} and \overline{CAT}_{return} values varied from 0.89 to 30.77 days, from 0.88 to 37.84 days, and from 1.88 to 10.85 days respectively. Shorter values were obtained for higher densities (Figure 5.1 & Table 5.2). R was always above 1, meaning that the majority of CATs were performed between two different FADs (\overline{CAT}_{diff}). It varied from 2.82, for the lowest density ($\rho = 1.00 \times 10^{-4} \text{ km}^{-2}$), with \overline{CAT}_{return} representing 26.18 % of the number of \overline{CAT} , to 87.11 for the highest density ($\rho = 4.44 \times 10^{-3} \text{ km}^{-2}$), with \overline{CAT}_{return} representing 1.13 % of the total number of simulated \overline{CAT} . Hence, when ρ decreases, tuna tend to return to the departure FAD more often. Consequently, \overline{CAT} values were shorter than \overline{CAT}_{diff} for lower densities, due to the higher proportion of \overline{CAT}_{return} , but were almost exclusively driven by \overline{CAT}_{diff} for high densities (Figure 5.1 & Table 5.2). Obtained parameters of the models fitting $\overline{CAT}_{diff}(\rho)$, $\overline{CAT}_{return}(\rho)$ and $R(\rho)$ are presented in Table 5.3

Table 5.3: Summary of the fitted parameter values.

Metric	Formula	Fitted values	Standard Error
\overline{CAT}_{diff}	$a_d \times \rho^{-b_d}$	$a_d = 1.8 \times 10^{-3}$	1.10×10^{-4}
		$b_d = 1.08$	1.40×10^{-2}
\overline{CAT}_{return}	$1 + a_r \times \rho^{-b_r}$	$a_r = 1.7 \times 10^{-2}$	1.35×10^{-3}
		$b_r = 6.9 \times 10^{-1}$	1.78×10^{-2}
R	$a\rho^c \exp(b \times \rho)$	$a = 150$	16
		$b = 422$	7
		$c = 4.5 \times 10^{-1}$	1.5×10^{-2}

5.3.2 Operational buoy densities

Buoy densities obtained from the IOTC data, considered as DFAD densities (ρ_{DFAD}) are presented in Figure 5.2. The maximum observed density in a 1° cell was $\rho = 8.39 \times 10^{-3} \text{ km}^{-2}$,

in August, which corresponds to 84 operational buoys in a 100 km \times 100 km square and a mean distance to the nearest neighbor (in a regular square lattice) of 10.9 km. After averaging the densities on a 5° grid, highest observed density was $\rho = 2.8 \times 10^{-3} \text{ km}^{-2}$, corresponding to 28 operational buoys in a 100 km \times 100 km square. Mean density over the whole area was $\bar{\rho} = 3.45 \times 10^{-4} \text{ km}^{-2}$, corresponding to 3.45 buoys per 100 km \times 100 km square. Areas with highest buoys densities were different according to the month, moving from the West to the East of the Seychelles from January to April. Highest buoys densities could then be observed in the Arabian Sea, from May to July. In September and forward, highest densities were observed around the Seychelles and East of the Somalian EEZ. The obtained maps showed a high number of buoys around the Maldives in May and December, suggesting a high number of buoys drifting towards the Eastern IO (Figure 5.2E&L).

5.3.3 Predictions of Continuous Absence Time and Percentage of time associated

Predicted $\overline{CAT(\rho_{DFAD})}$ values in 5° cells are presented in Figure 5.3 (see 5.5.3 for predictions of $\overline{CAT_{diff}(\rho_{DFAD})}$, $\overline{CAT_{return}(\rho_{DFAD})}$ and $R(\rho_{DFAD})$, and 5.5.4 for predictions on ρ_{FOB} and ρ_{LOG}). Minimum $\overline{CAT(\rho_{DFAD})}$ predicted value was 1.06 days in February 2020. The area with shortest predicted $\overline{CAT(\rho_{DFAD})}$ was spatially conserved through time: low values were observed from the North of the Mozambique Channel to the Arabian Sea, and from the African coast to 65°E. However, for each month, a peak of short $\overline{CAT(\rho_{DFAD})}$ was observed and moved from the South of the area to the North, from January to June (Figure 5.3A-F), and back to the South of the area from June to December (Figure 5.3F-L). The percentage of time spent by tuna associated with a DFAD ($P_a(\rho_{DFAD})$) displayed similar spatial patterns as $\overline{CAT(\rho_{DFAD})}$ (Figure 5.4).

5.3.4 Impact of DFAD on tuna availability

The comparison of the predictions obtained with FOB and LOG densities is presented in Figure 5.5 and Table 5.4. The mean density of all types of FOBs ($\bar{\rho}_{FOB} = 1.32 \times 10^{-3} \text{ km}^{-2}$) was 6.6 times higher than the mean LOG density ($\bar{\rho}_{LOG} = 2.00 \times 10^{-4} \text{ km}^{-2}$), resulting in much shorter \overline{CAT} with mean values, averaged over cells and months, of 5 and 46 days predicted from FOB and LOG densities respectively. The strong density increase induced by DFADs also resulted in a increase of the predicted proportion of time tuna spent associated (P_a), with $\overline{P_a(\rho_{FOB})} = 68 \%$ and $\overline{P_a(\rho_{LOG})} = 20 \%$.

Table 5.4: Summary of monthly CAT and P_a values per 5° cell in the Indian Ocean in 2020, predicted using FOB and LOG densities (ρ_{FOB} and ρ_{LOG}).

FOB type	$\rho \text{ (km}^{-2}\text{)}$		$CAT \text{ (days)}$		$P_a \text{ (\%)}$	
	mean	SE	mean	SE	mean	SE
FOB	1.32×10^{-3}	4.52×10^{-6}	4.97	6.30×10^{-2}	68.3	8.00×10^{-2}
LOG	2.00×10^{-4}	3.38×10^{-6}	46.3	3.43×10^{-1}	20.5	8.30×10^{-2}

5.4 Discussion

Human induced habitat modifications can impact species behavior and ultimately their fitness (Swearer et al. 2021). Continuous Absence Times (CATs) and Continuous Residence Times (CRTs) are two behavioral metrics allowing to assess the impact of the modification of one

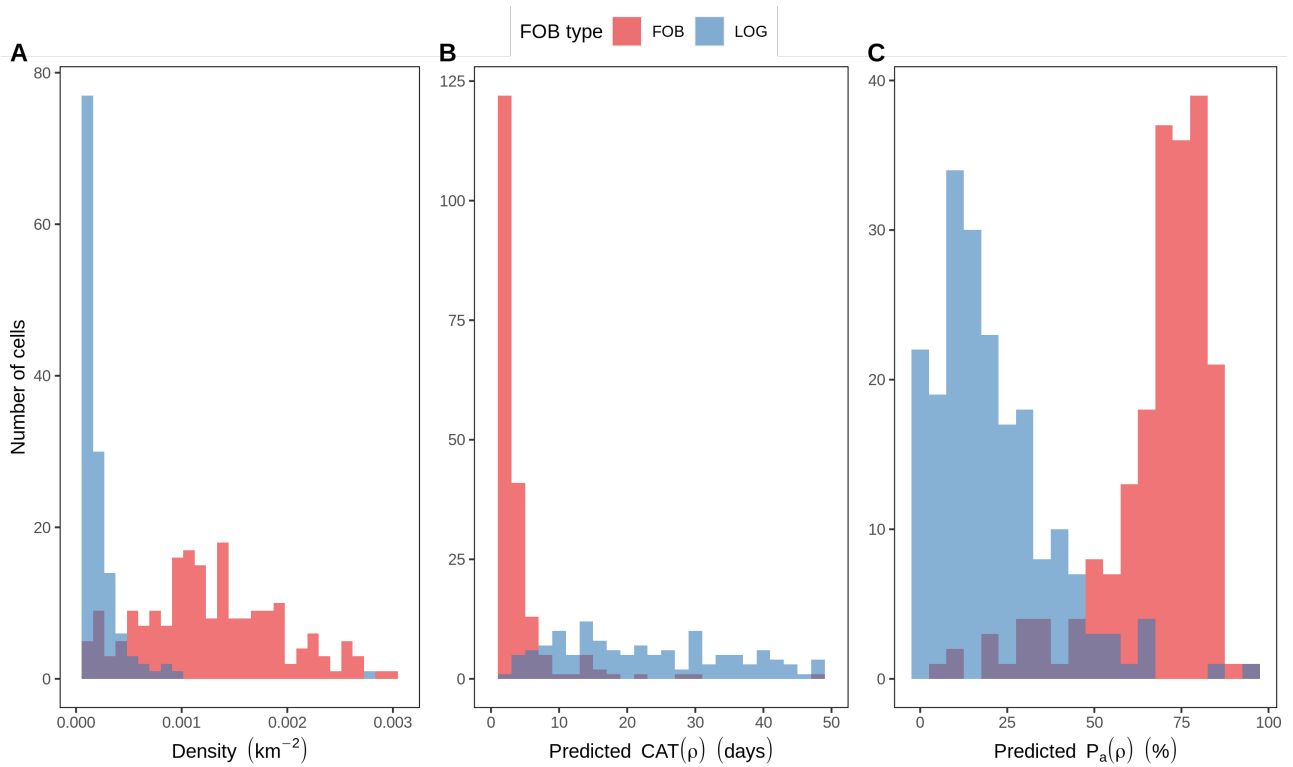

Figure 5.5: Comparison between predictions performed on the density of all FOBs (ρ_{FOB} , in red) and LOGs only (ρ_{LOG} , in blue) density. Monthly mean density of floating object (A), predicted mean monthly Continuous Absence Time ($\overline{CAT}(\rho)$) (B) and percentage of time spent associated ($P_a(\rho)$) (C), per 5° cell.

habitat component – the density of floating objects – on pelagic species. Several studies measured CATs (Robert et al. 2012; Robert et al. 2013b; Rodriguez-Tress et al. 2017) or CRTs (Robert et al. 2013b; Robert et al. 2012; Govinden et al. 2013) in arrays of anchored FADs. CRTs were also measured at drifting FADs (Matsumoto et al. 2016; Tolotti et al. 2020; Govinden et al. 2021). However, experimentally measuring CATs in an array of FADs requires the equipment of the whole array with acoustic receivers. When these FADs are drifting, finding, equipping and recovering them is difficult and has never been achieved. This study is, to our knowledge, the first to give estimates of CATs of yellowfin tuna (YFT) in arrays of DFADs. These estimates show a strong influence of fisheries induced habitat modifications on tuna associative behavior in the Western Indian Ocean (WIO). By modifying tuna habitat, purse seine fisheries increase the percentage of time tuna spend associated (P_a), which has a direct influence on YFT availability to fishers, which can impact fishing mortality and tuna’s fitness.

Numerous factors could affect the obtained \overline{CAT} and P_a predictions. Predictions were made based on operational buoys densities deployed on FOBs (IOTC 2021b), which is a proxy of the actual DFAD density in the ocean. Among equipped FOBs, those for which the buoy was turned-off are not present in the data. Moreover, if most Contracting Parties provided their buoys’ positions to the IOTC, some countries did not share their data (IOTC 2021b), so densities could be underestimated.

The other datasets used for the predictions are french observers data and measurement of CRTs. The use of french observers data restricted the study area, highlighting the need to better share this data among countries, as it is done for instrumented buoys, and to increase observers coverage. Only the mean CRT value for the WIO was used in our study (measured in Govinden et al. 2021) and we considered CRT as constant. This approximation could influence the predictions, as it was demonstrated that CRTs also depend on FAD density, even if to a lesser extent than CATs (Pérez et al. 2020). CRT measurements on DFADs also showed

a variability between oceans as well as strong inter-individual variations (Tolotti et al. 2020; Govinden et al. 2013; Govinden et al. 2021; Matsumoto et al. 2016). Further measurements of CRTs at DFADs and some modelling approach would then be needed to take this variability into account. However, Pérez et al. 2020 found that, as AFAD density increases, CRT also increases, suggesting that the increase in catchability observed in this study should be conserved or even intensified.

The model used for the predictions was fitted on passive acoustic tagging data from YFT of fork length 70 ± 10 cm, tagged in an array of AFADs (Pérez et al. 2022). At DFADs, two main size classes of YFT are found: individuals around 50 cm and individuals around 120 cm (IOTC 2022e, p. 52). Fitting the model on bigger individuals (70 cm instead of 50 cm) should not change drastically the obtained parameters, but could change slightly individual speed (fitted value $v = 0.7 \text{ m.s}^{-1}$ in Pérez et al. 2022). Also, as tuna orient themselves towards FADs several kilometers away (4 to 17 km, Girard et al. 2004), it was suggested that they could detect FADs using acoustic stimuli (Pérez et al. 2022). Although FAD design has not been identified to influence the attractiveness of FADs (Fréon and Dagorn 2000), there might be a difference in detectability between anchored, which are composed of a bigger structure containing a metal chain, and drifting FADs. Hence, both the type of FAD (anchored or drifting) and tuna size class could change some model parameters, such as the orientation radius (R_0 , fitted value of 5 km) and swimming speed (v , fitted value of 0.7 m.s^{-1}). To account for these uncertainties, we also performed predictions using other parameters ($v = 0.5 \text{ m.s}^{-1}$ and $R_0 = 2 \text{ km}$). The obtained \overline{CAT} were longer, resulting in smaller P_a values (see Section 5.5.5). However, it should be noted that changing the parameters do not change the observed trend: the habitat modification induced by DFAD increases YFT catchability, whatever the parameter set considered.

Since 2016, in the IO, more than 80 % of purse seine catch on tropical tuna was made on floating objects, reaching a maximum of almost 95 % in 2018 (see Figure 5 in IOTC 2022e). YFT caught by industrial purse seine vessels on FOBs in the IO has steadily increased since 2008 and represented around 22 % of the total YFT catch, by all gear types, in 2021 (ISSF 2023; IOTC 2022e). The predicted P_a were very high in the Western IO, with a mean of 68 % (calculated on all FOBs), mainly due to DFAD introduction (mean prediction without DFADs of 21 %). As the habitat modification induced by DFADs strongly increases the percentage of their time YFT spend associated with floating objects, it increases their vulnerability to purse seine sets. In the IO, the YFT stock is currently overfished (*i.e.* the biomass is below the biomass reference point corresponding to the maximum sustainable yield) and subject to overfishing (*i.e.* the fishing mortality is above the reference point corresponding to the maximum sustainable yield; IOTC 2021a). It is important to note that this current status is the result of the fishing mortality induced by all fishing gears and not only purse seine fleets. The Indian Ocean Tuna Commission (IOTC) imposes limits on the number of operational buoys (buoys which transmit DFAD position and other information to fishers) at 300 per vessel at any one time (IOTC 2019). The present results show that limiting the number of floating objects and of operational buoys directly affects tuna catchability by purse seine vessels. Therefore, if the yellowfin tuna stock is to remain overfished, efforts should be made to further limit the number of floating objects in the ocean, through limits on operational buoy numbers and on DFAD deployments. However, the IOTC also implemented yellowfin tuna catch reductions to member states (IOTC 2021c), and these catch limits, if respected, can also be a solution to YFT overexploitation in the Indian Ocean.

In addition to the increase of fishing availability to fishers, the observed increase of the percentage of time associated (P_a) could also have indirect impacts (*i.e.* not linked with fishing mortality) on YFT and other associated species. One of the main hypothesis to explain the association of tuna with floating objects is the *meeting-point* hypothesis (Fréon and Dagorn

2000). Under this hypothesis, tuna would use FOBs as meeting-points to form larger schools. Fish schools can be viewed as an evolutionary trade-off: increasing school size would increase protection, mate choice and information, but would also increase inter-individual competition and the propensity to be detected by predators (Maury 2017). The increase of FOB density, inducing an increase of P_a , could result in a disruption of schooling behavior and provoke the dispersion of individuals among FOBs. Capello et al. 2022 developed a model to study school behavior in a heterogeneous habitat, using tuna and FADs as a case study. Using several social scenarios, they demonstrated that social behavior has an influence on how the fraction of schools which are associated varies with FAD density. Considering social behavior could help further understanding tuna behavior and its link with fitness. Echosounder buoys data allow to determine tuna aggregation dynamics (Baidai et al. 2020b), and could be used to assess the impact of DFADs on tuna association dynamics, taking their social behavior into account.

Also, Marsac et al. 2000 suggested that DFADs could act as ecological traps on tropical tuna. This hypothesis was based on another behavioral hypothesis, the *indicator-log*, which suggests that tuna associate with FOBs to select rich areas. Natural FOBs would be located mainly in rich areas because they originate from rivers and accumulate in rich frontal zones (Castro et al. 2002). By modifying the distribution of FOBs, DFADs could attract or retain individual tuna in areas that are detrimental to them and ultimately impact their fitness. Recent evidence, using a condition indicator as a proxy for tuna's fitness, tend to suggest that DFADs did not act as an ecological trap in the WIO. However, DFAD impact could have been counteracted by other environmental effects or could have act on other biological processes than condition (Dupaix et al. 2023a). Tuna associative behavior can also be influenced by climate change, which modifies prey abundance and physical characteristics of the environment (Arrizabalaga et al. 2015; Druon et al. 2017). Nevertheless, the increase of FOB density increases P_a and FOB array connectivity (increase of R , *i.e.* of the proportion of CAT_{diff}). Added to previous evidence suggesting that an increase of FAD density induces an increase of tuna residence times around FADs (Pérez et al. 2020), it suggests that DFAD use could retain tuna in some areas. Whether these areas can be considered poor for tropical tuna and the impact this retention can have on tuna's fitness – through other biological parameters than condition – still needs to be investigated further.

5.4.1 Conclusion and perspectives

Human activities impact species habitat, potentially impacting their fitness (IPBES 2019). Several studies assessed the direct impact of habitat modifications on species fitness, or on fitness proxies (Mullu 2016; IPBES 2018). These impacts on fitness can also be behaviorally mediated, *e.g.* through ecological traps (Swearer et al. 2021; Gilroy and Sutherland 2007; Dwernychuk and Boag 1972; Marsac et al. 2000). Hence, there's a need to assess the impact of habitat modifications on species behavior and mortality. In the case of exploited species, such as tuna, behavioral change can have even greater impacts on fitness because it can also increase their availability to fishers and hence their catchability and fishing mortality. Yellowfin tuna and Drifting Fish Aggregating Devices are an important case-study, as they allow to assess the impact of the modification of one habitat component, FOB density, on the associative behavior of a commercially important species, this behavior being strongly linked to survival. The simple modelling framework used here could predict such impacts and can be used as a tool to take into account indirect impacts of fisheries on tuna's mortality. This framework can also be used as a base to assess how more complex processes such as social behavior and environmental changes could impact species survival and their vulnerability to human activities.

5.5 Supplementary Materials

5.5.1 Development and limits of the mean Continuous Absence Time (\overline{CAT})

5.5.1.1 \overline{CAT} formula

We have,

$$\overline{CAT}_{diff}(\rho) = \frac{a_d}{\rho^{b_d}} \quad (5.6)$$

$$\overline{CAT}_{return}(\rho) = 1 + \frac{a_r}{\rho^{b_r}} \quad (5.7)$$

and

$$R(\rho) = a\rho^c \exp(b \times \rho) \quad (5.8)$$

with $(a_d, b_d, a_r, b_r, a, b, c) \in \mathbb{R}_+^7$

Hence,

$$\begin{aligned} \overline{CAT}(\rho) &= \frac{A(\rho)\overline{CAT}_{diff}(\rho) + B(\rho)\overline{CAT}_{return}(\rho)}{A(\rho) + B(\rho)} \\ &= \frac{R(\rho)\overline{CAT}_{diff}(\rho) + \overline{CAT}_{return}(\rho)}{R(\rho) + 1} \\ &= \frac{a\rho^c \exp(b\rho)a_d\rho^{-b_d} + 1 + a_r\rho^{-b_r}}{a\rho^c \exp(b\rho) + 1} \end{aligned}$$

5.5.1.2 Limit when $\rho \mapsto +\infty$

$$\begin{aligned} \overline{CAT}(\rho) &= \frac{a\rho^c \exp(b\rho)a_d\rho^{-b_d} + 1 + a_r\rho^{-b_r}}{a\rho^c \exp(b\rho) + 1} \\ &= \frac{a_d\rho^{-b_d} + \frac{1}{a}\rho^{-c} \exp(-b\rho) + \frac{a_r}{a}\rho^{-b_r-c} \exp(-b\rho)}{1 + \frac{1}{a}\rho^{-c} \exp(-b\rho)} \end{aligned} \quad (5.9)$$

We note $N_{inf} = a_d\rho^{-b_d} + \frac{1}{a}\rho^{-c} \exp(-b\rho) + \frac{a_r}{a}\rho^{-b_r-c} \exp(-b\rho)$
and $D_{inf} = 1 + \frac{1}{a}\rho^{-c} \exp(-b\rho)$

We have,

$$\lim_{\rho \rightarrow +\infty} a_d\rho^{-b_d} = 0$$

$$\lim_{\rho \rightarrow +\infty} \frac{1}{a}\rho^{-c} \exp(-b\rho) = 0$$

and

$$\lim_{\rho \rightarrow +\infty} \frac{a_r}{a} \rho^{-b_r - c} \exp(-b\rho) = 0$$

So

$$\lim_{\rho \rightarrow +\infty} N_{inf} = 0$$

and

$$\lim_{\rho \rightarrow +\infty} D_{inf} = 1$$

Hence

$$\lim_{\rho \rightarrow +\infty} \overline{CAT}(\rho) = 0 \quad (5.10)$$

5.5.1.3 Limit when $\rho \mapsto 0$

$$\begin{aligned} \overline{CAT}(\rho) &= \frac{a\rho^c \exp(b \times \rho) \times a_d \rho^{-b_d} + 1 + a_r \rho^{-b_r}}{a\rho^c \exp(b \times \rho) + 1} \\ &= \frac{a \times a_d \times \rho^{c-b_d} \exp(b \times \rho) + 1 + a_r \rho^{-b_r}}{a\rho^c \exp(b \times \rho) + 1} \end{aligned} \quad (5.11)$$

We note $N_0 = a \times a_d \times \rho^{c-b_d} \exp(b \times \rho) + 1 + a_r \rho^{-b_r}$
and $D_0 = a\rho^c \exp(b \times \rho) + 1$

Denominator (D_0)

We have

$$\lim_{\rho \rightarrow 0} a\rho^c \exp(b\rho) = 0$$

So

$$\lim_{\rho \rightarrow 0} D_0 = \lim_{\rho \rightarrow 0} a\rho^c \exp(b\rho) + 1 = 1$$

Numerator (N_0)

We have

$$\lim_{\rho \rightarrow 0} (1 + a_r \rho^{-b_r}) = +\infty$$

If $c - b_d > 0$

$$\lim_{\rho \rightarrow 0} (a a_d \rho^{c-b_d} \exp(b\rho)) = 0$$

and

$$\lim_{\rho \rightarrow 0} N_0 = +\infty$$

If $c - b_d < 0$

$$\lim_{\rho \rightarrow 0} (a a_d \rho^{c-b_d} \exp(b\rho)) = +\infty$$

hence

$$\lim_{\rho \rightarrow 0} N_0 = +\infty$$

If $c - b_d = 0$

$$\lim_{\rho \rightarrow 0} \left(a a_d \rho^{c-b_d} \exp(b\rho) \right) = a a_d$$

hence

$$\lim_{\rho \rightarrow 0} N_0 = +\infty$$

Conclusion

$\forall (c, b_d) \in \mathbb{R}_+^2$ $\lim_{\rho \rightarrow 0} N_0 = +\infty$
and $\lim_{\rho \rightarrow 0} D_0 = 1$, hence,

$$\lim_{\rho \rightarrow 0} \overline{CAT}(\rho) = +\infty \tag{5.12}$$

5.5.2 Determining the spatial and temporal resolution of the prediction

Before building maps of the mean Continuous Absence Times in the IO, by applying the regression obtained from the FAT albaCoRaW model (Dupaix et al. 2023b), we need to determine the spatial and temporal resolution at which we can make the predictions. We want to be able to consider the units we use (both temporal, *i.e.* the month, and spatial, *i.e.* the cell size) as homogeneous. For example, if we predict in a $1^\circ \times 1^\circ$ cell that the mean CAT will be 10 days and that in average tuna travel a distance of 500 km in 10 days, it would be a problem. Hence, we use the predicted mean values of CAT and traveled distances in the interval of observed FAD densities, to determine if the chosen resolution can be considered as homogeneous.

Using simulations performed in randomly generated arrays, at different FAD densities, we determined the mean distance between the two visited FADs during a CAT, as well as the mean CAT duration. We then determined the minimum, mean and maximum DFAD densities observed in the IOTC buoy data (IOTC 2021b). The mean distance between two visited FADs was comprised between 35 and 100 km for the densities observed in the Indian Ocean (Figure 5.6). Hence, if we consider cells of $5^\circ \times 5^\circ$, each cell can be considered as a homogeneous unit. The mean CAT is comprised between 3 and 20 days for the densities observed in the Indian Ocean (Figure 5.7). Hence, by considering a temporal resolution of 1 month, each cell can be considered as a homogeneous unit.

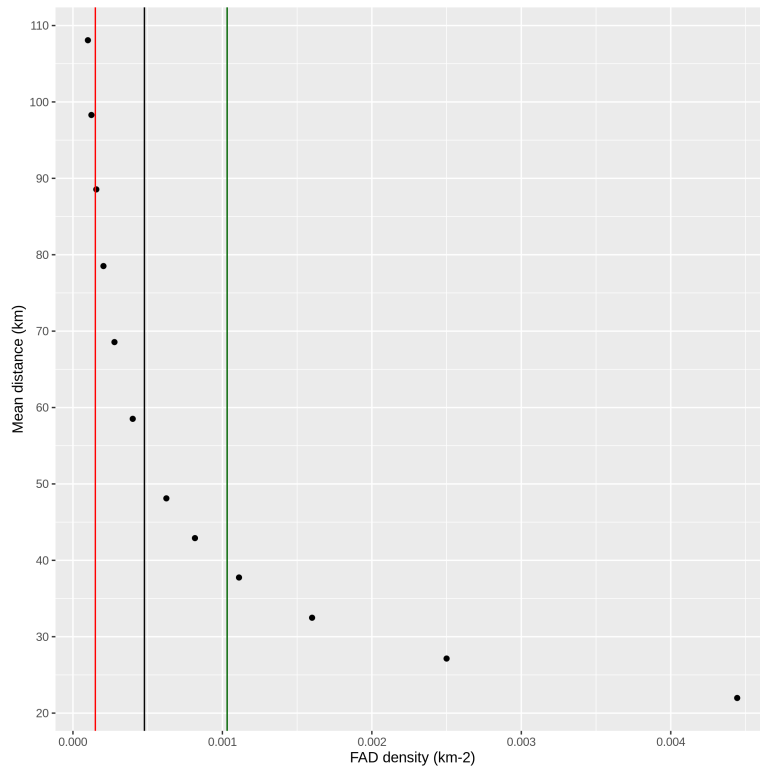

Figure 5.6: Mean distance traveled by tuna during a CAT in the simulations as a function of FAD density. The red, black and green lines represent the minimum, mean and maximum operational buoy density per cell averaged over the whole IO respectively.

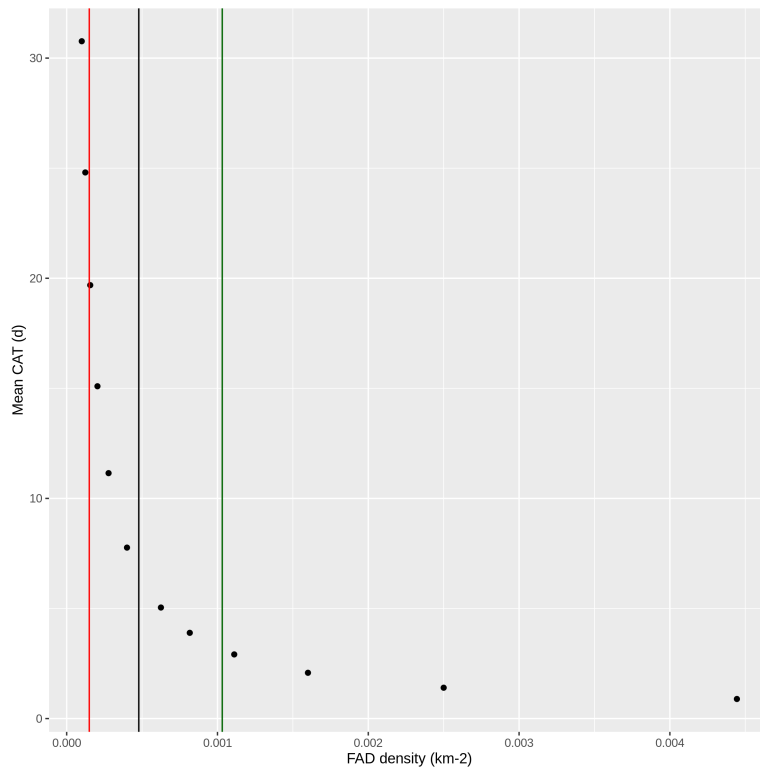

Figure 5.7: Mean Continuous Absence Time measured in the simulations as a function of FAD density. The red, black and green lines represent the minimum, mean and maximum operational buoy density per cell averaged over the whole IO respectively.

5.5.3 Prediction maps of \overline{CAT}_{diff} , \overline{CAT}_{return} and R

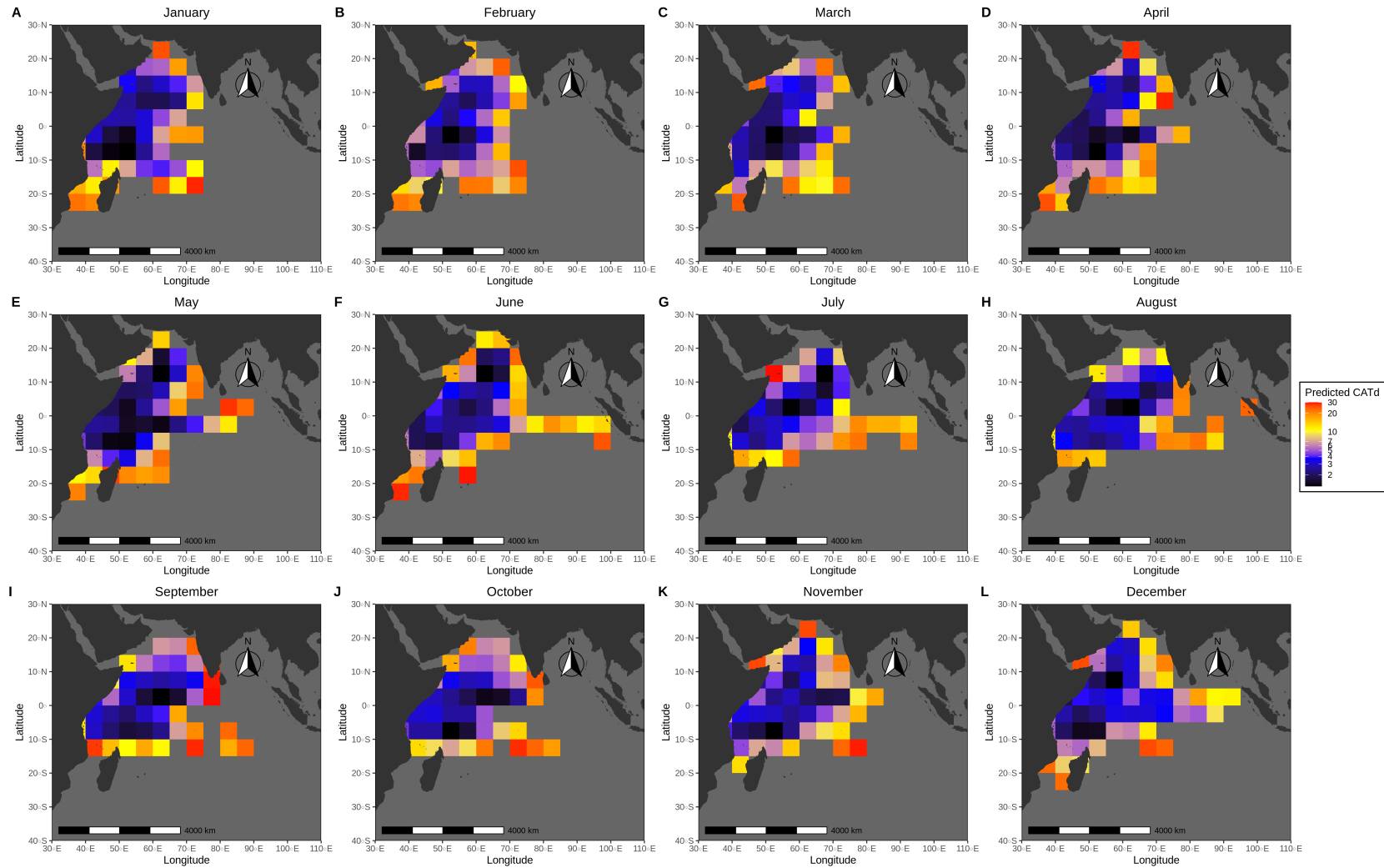

Figure 5.8: Predicted monthly mean \overline{CAT}_{diff} of individual YFT (in days) per 5° cells in the western Indian Ocean in 2020. The color scale is log transformed. \overline{CAT}_{diff} longer than 30 days, out of the main fishing grounds, were not represented.

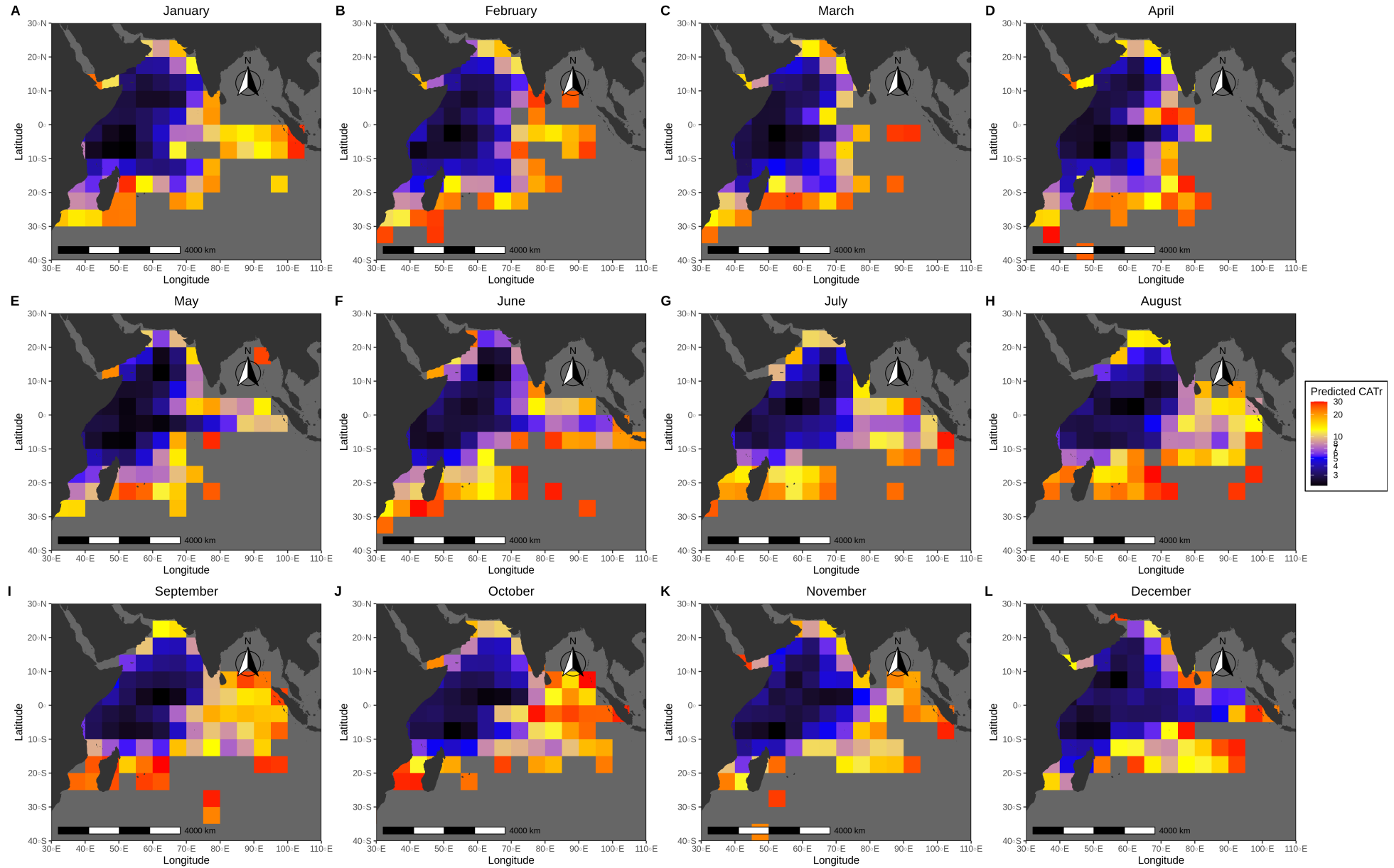

Figure 5.9: Predicted monthly mean \overline{CAT}_{return} of individual YFT (in days) per 5° cells in the western Indian Ocean in 2020. The color scale is log transformed. \overline{CAT}_{return} longer than 30 days, out of the main fishing grounds, were not represented.

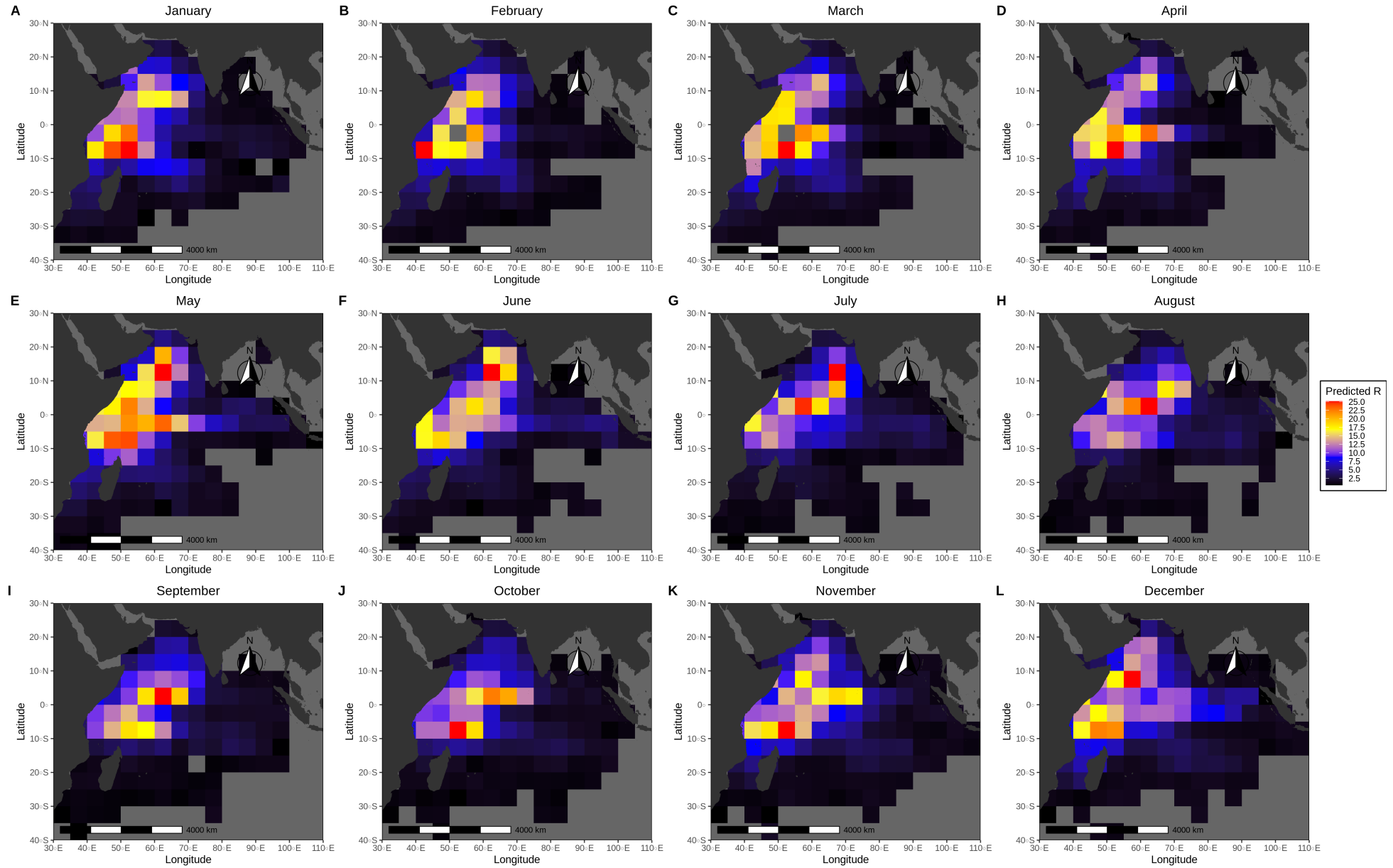

Figure 5.10: Predicted monthly mean ratio between the number of CAT_{diff} and the number of CAT_{return} (R) of individual YFT (in days) per 5° cells in the western Indian Ocean in 2020.

5.5.4 Prediction maps of \overline{CAT} and P_a based on FOB and LOG densities

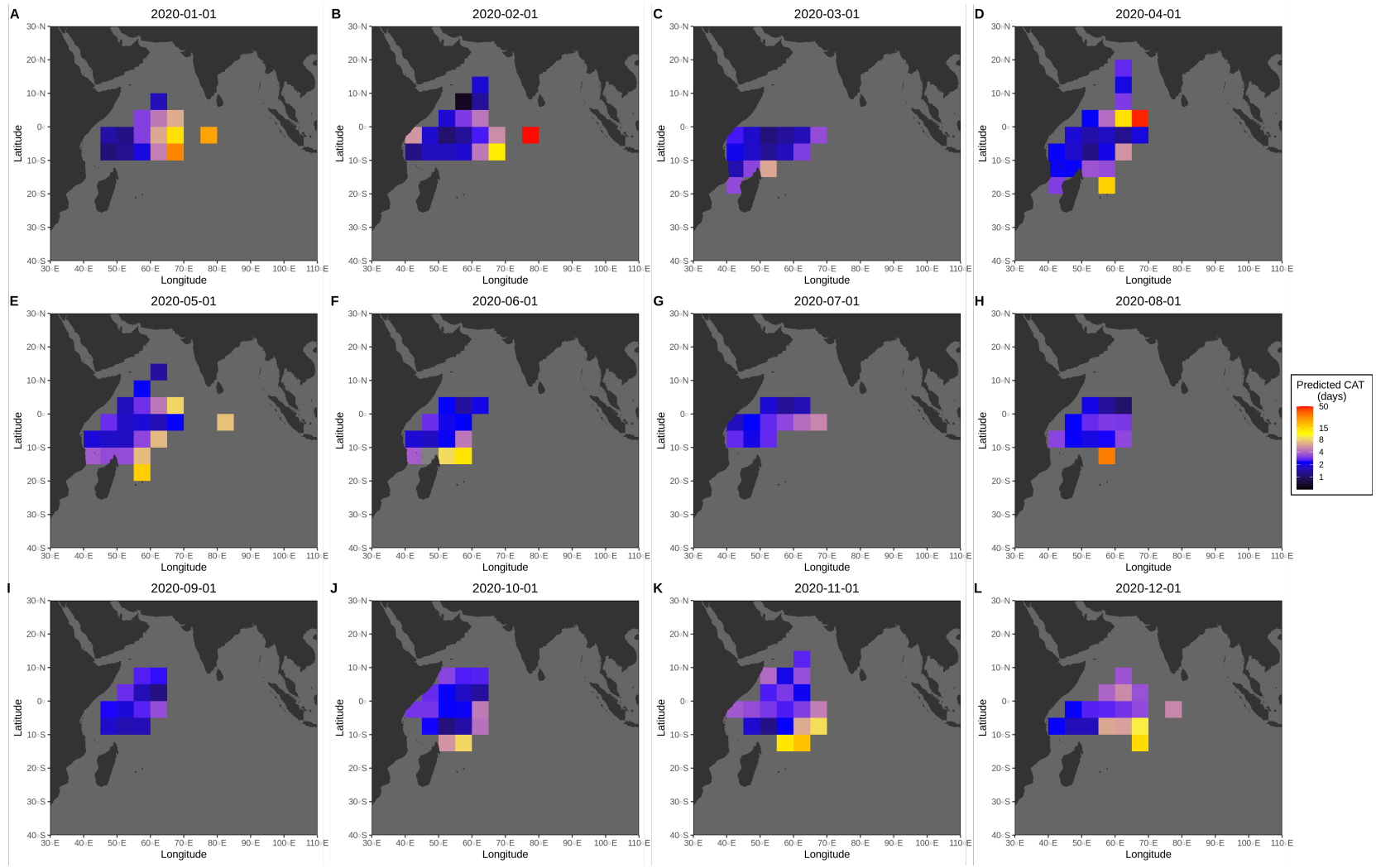

Figure 5.11: Mean monthly \overline{CAT} of individual YFT (in days), predicted on densities of all floating objects (FOB), per 5° cells in the western Indian Ocean in 2020. The color scale is log transformed. \overline{CAT}_{diff} longer than 50 days were not represented.

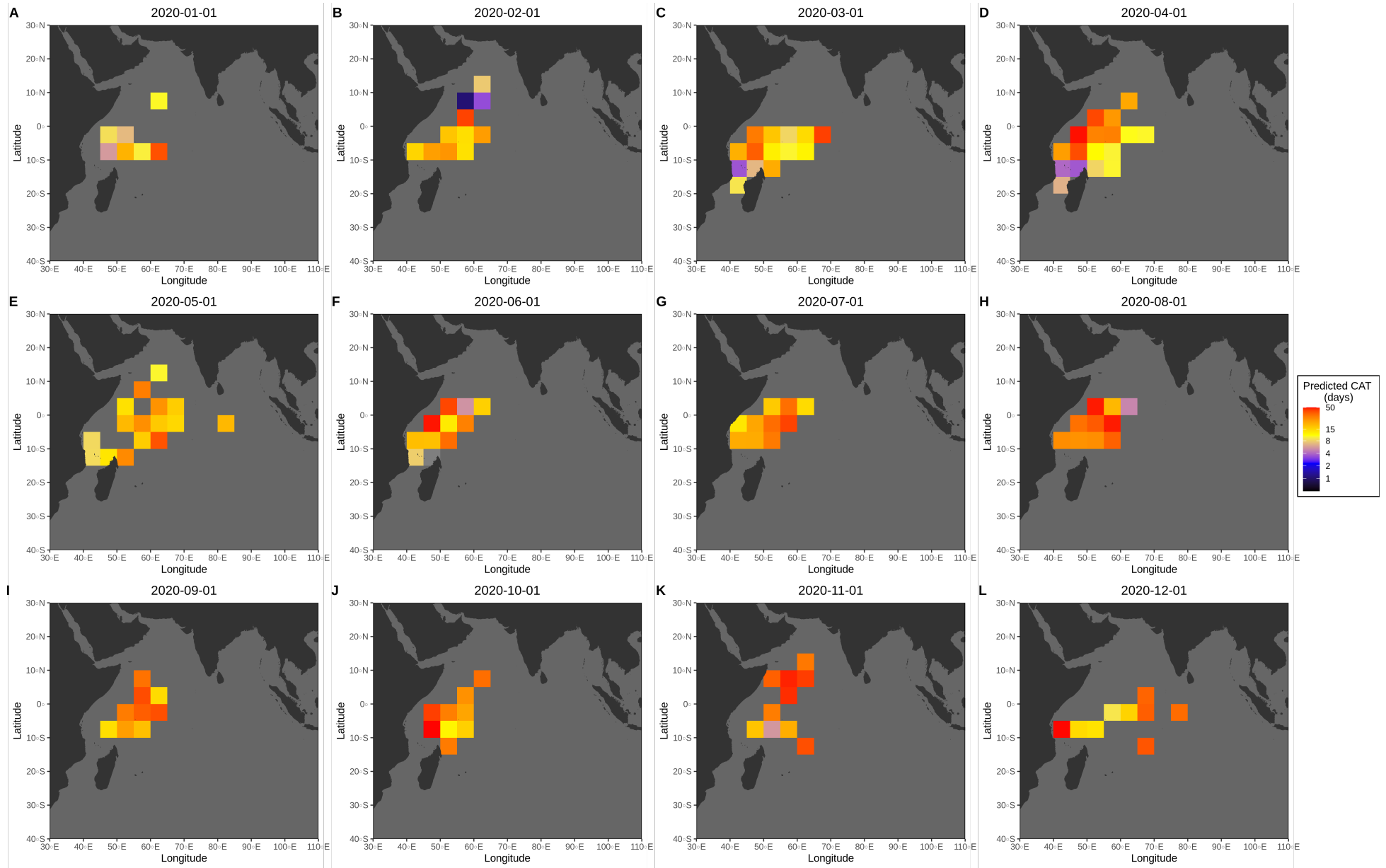

Figure 5.12: Mean monthly \overline{CAT} of individual YFT (in days), predicted on densities of LOGs only, per 5° cells in the western Indian Ocean in 2020. The color scale is log transformed. \overline{CAT}_{diff} longer than 50 days were not represented.

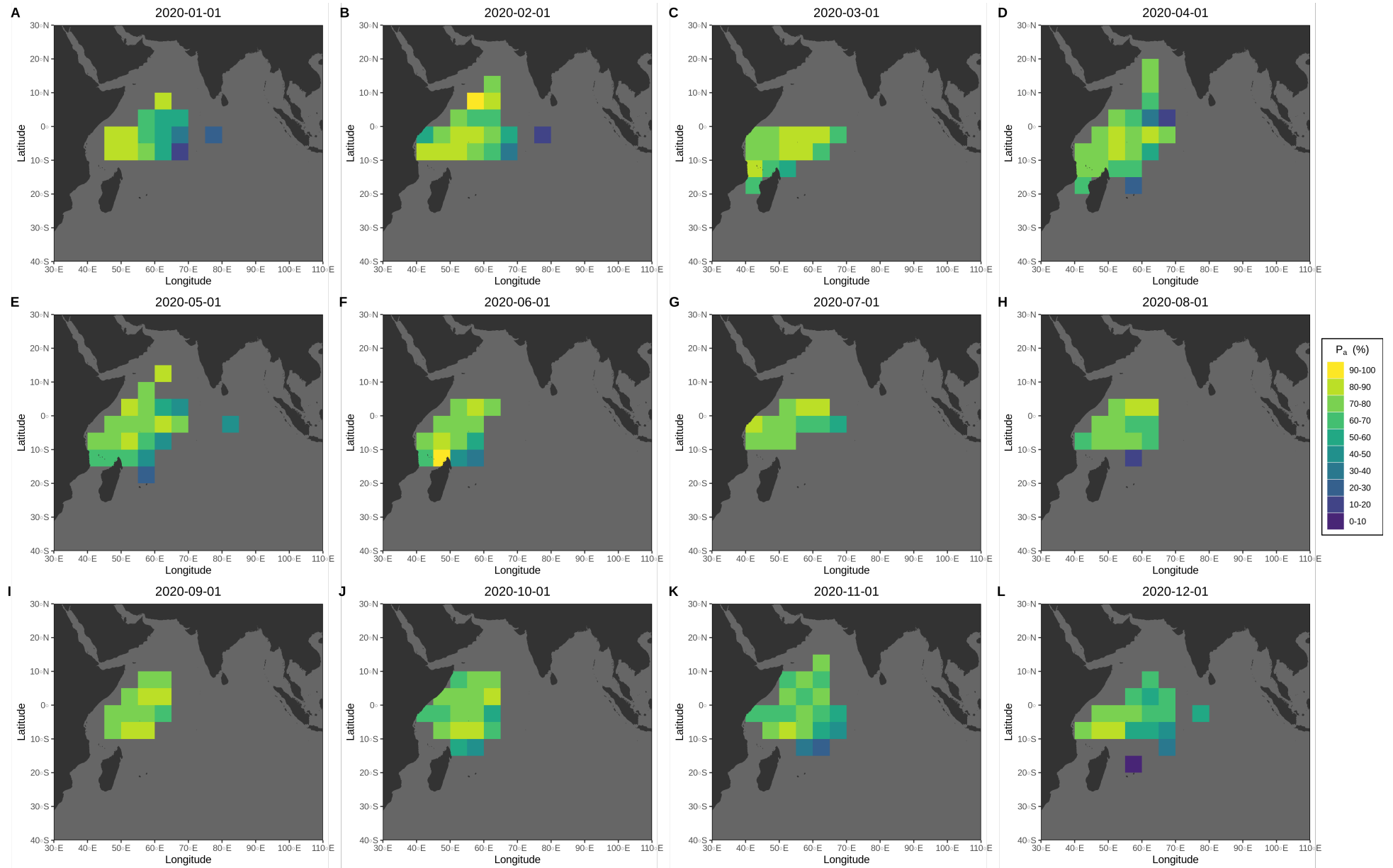

Figure 5.13: Mean monthly P_a of individual YFT (in days), predicted on densities of all floating objects (FOB), per 5° cells in the western Indian Ocean in 2020.

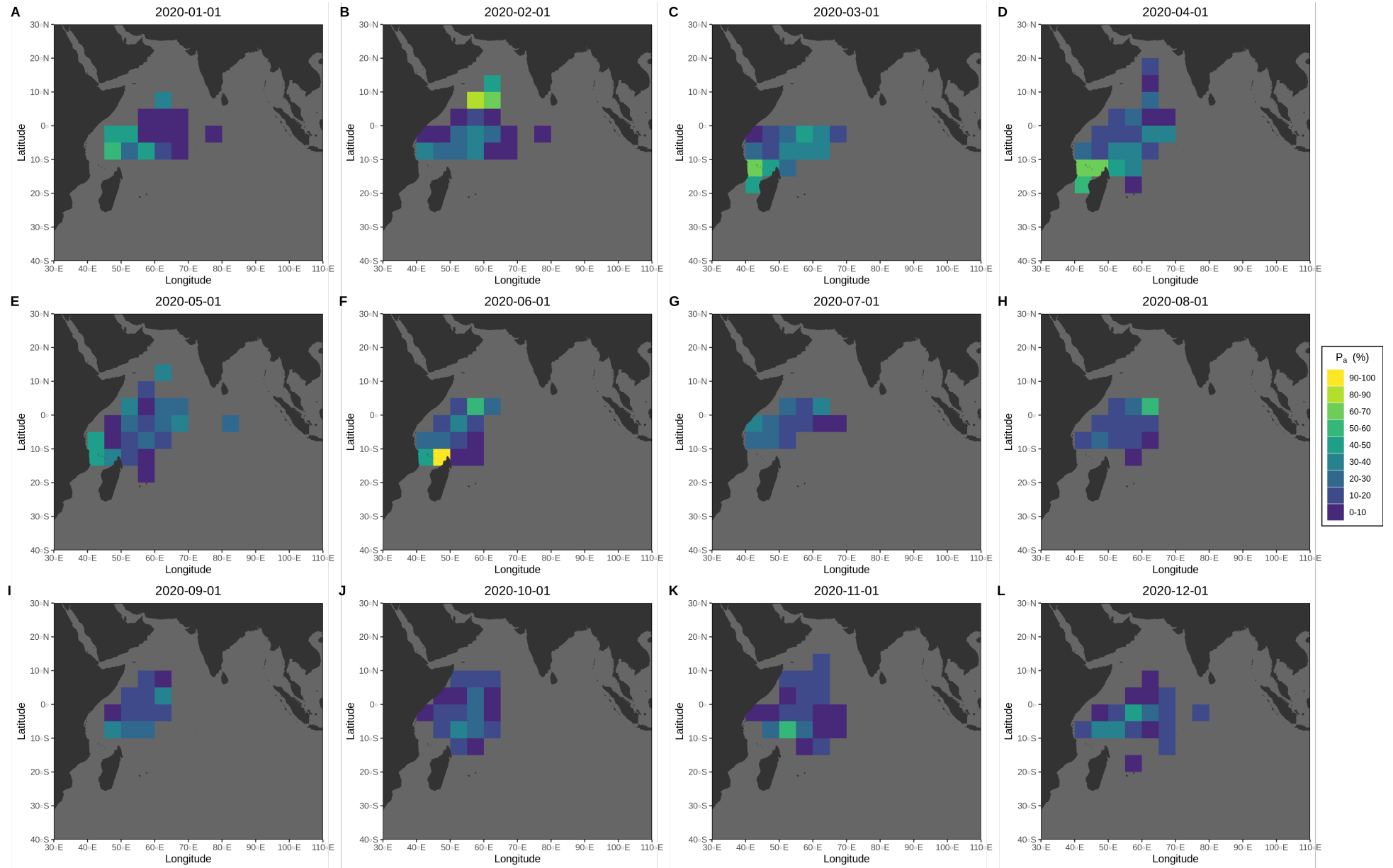

Figure 5.14: Mean monthly P_a of individual YFT (in days), predicted on densities of LOGs only, per 5° cells in the western Indian Ocean in 2020.

5.5.5 Results obtained with $v = 0.5 \text{ m.s}^{-1}$ and $R_0 = 2 \text{ km}$

To obtain the Figures and Tables presented here, the method developed in the main document was applied. However, instead of using the model parameters fitted in Pérez et al. 2022 to simulate tuna trajectories, the parameters presented in Table 5.5 were used: the speed v was replaced by $v = 0.5 \text{ m.s}^{-1}$ and the orientation radius R_0 was replaced by $R_0 = 2 \text{ km}$.

Table 5.5: Parameters used in the simulations presented in Section 5.5.5. Δt : time-step; v : speed; R_0 : orientation radius; c : sinuosity coefficient; D : mean inter-FAD distance.

Δt	v	R_0	c	D
100 s	0.5 m.s^{-1}	2 km	0.99	15, 20, 25, 30, 35, 40, 50, 60, 70, 80, 90, 100 km

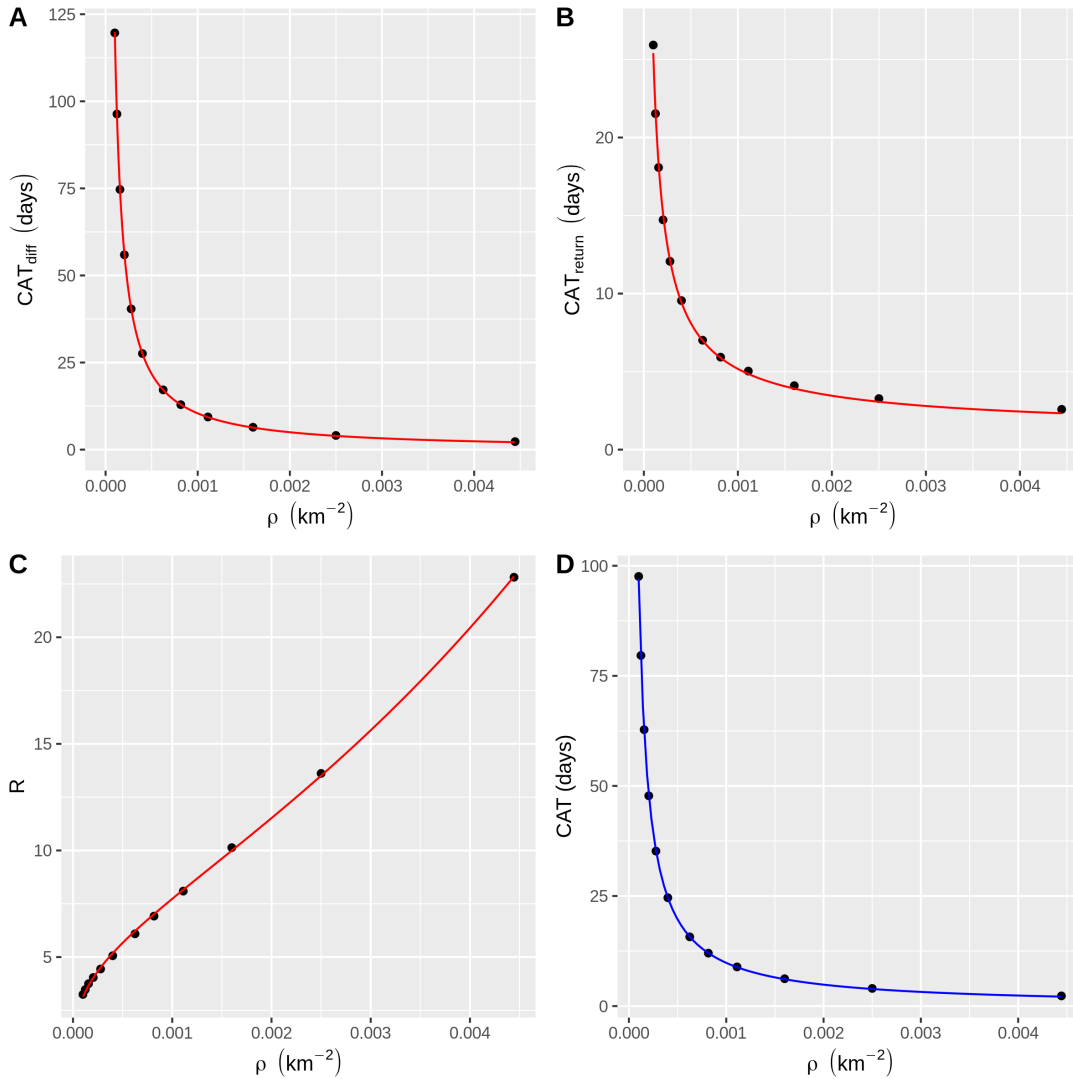

Figure 5.15: Continuous Absence Times (CATs) trends as a function of FAD density, obtained from the simulations, performed with $v = 0.5 \text{ m.s}^{-1}$ and $R_0 = 2 \text{ km}$. (A) \overline{CAT}_{diff} fitted according to Equation 5.1; parameter values: $a_d = 6.84 \times 10^{-3}$; $b_d = 1.06$. (B) \overline{CAT}_{return} fitted according to Equation 5.2; parameter values: $a_r = 2.28 \times 10^{-2}$; $b_r = 7.56 \times 10^{-1}$. (C) Ratio of the number of \overline{CAT}_{diff} over the number of \overline{CAT}_{return} (R) fitted according to Equation 5.4; parameter values: $a = 60.62$; $b = 175.48$ and $c = 3.24 \times 10^{-1}$. (D) Mean \overline{CAT} . The blue line is obtained from the fits in panels A,B and C and from Equation 5.3. ρ : FAD density.

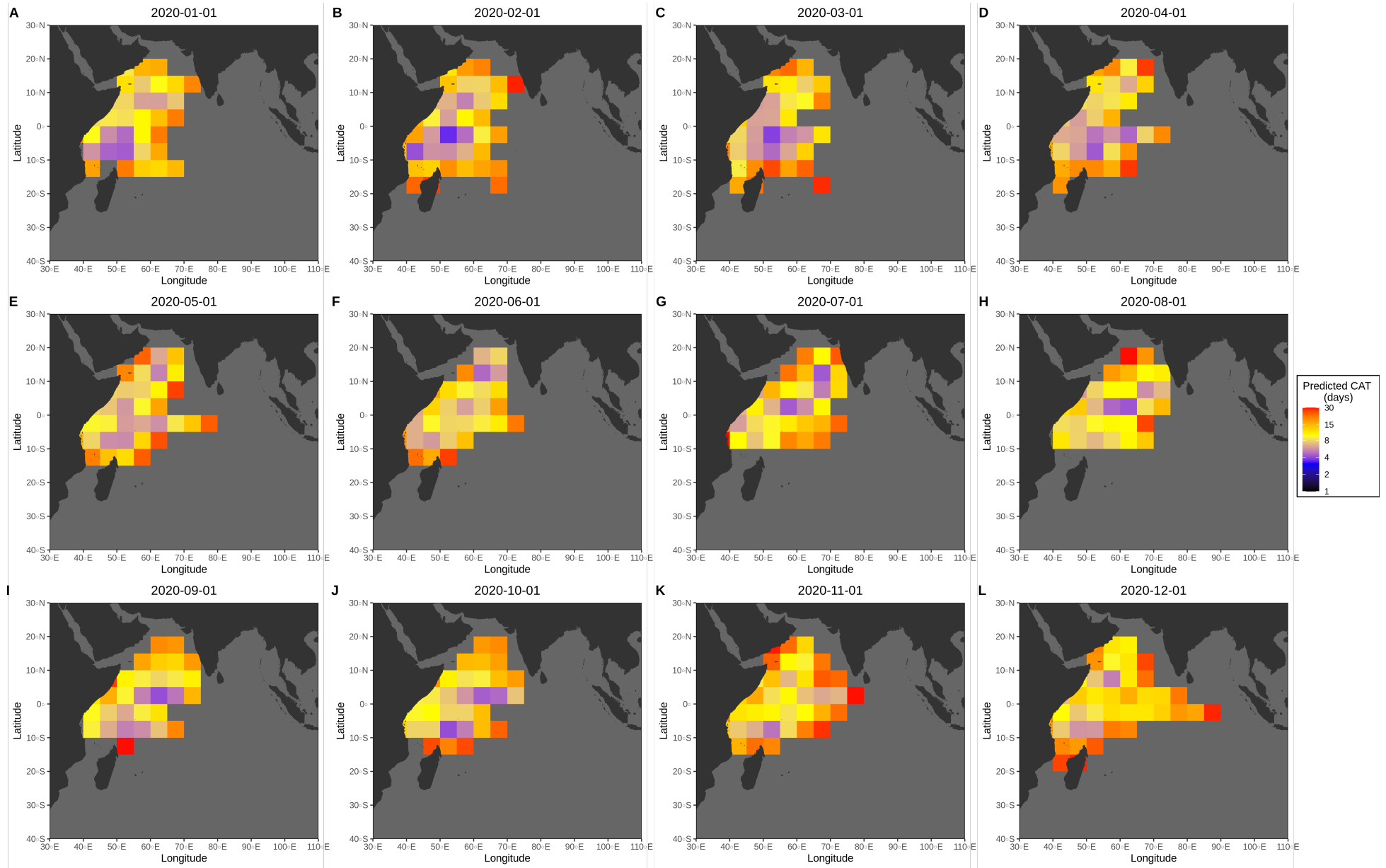

Figure 5.16: Predicted monthly mean Continuous Absence Times of individual yellowfin tunas (\overline{CAT} , in days) per 5° cells in the western Indian Ocean. Simulations were performed with $v = 0.5 \text{ m}\cdot\text{s}^{-1}$ and $R_0 = 2 \text{ km}$. The color scale is log transformed. \overline{CAT} longer than 30 days, out of the main fishing grounds, were not represented.

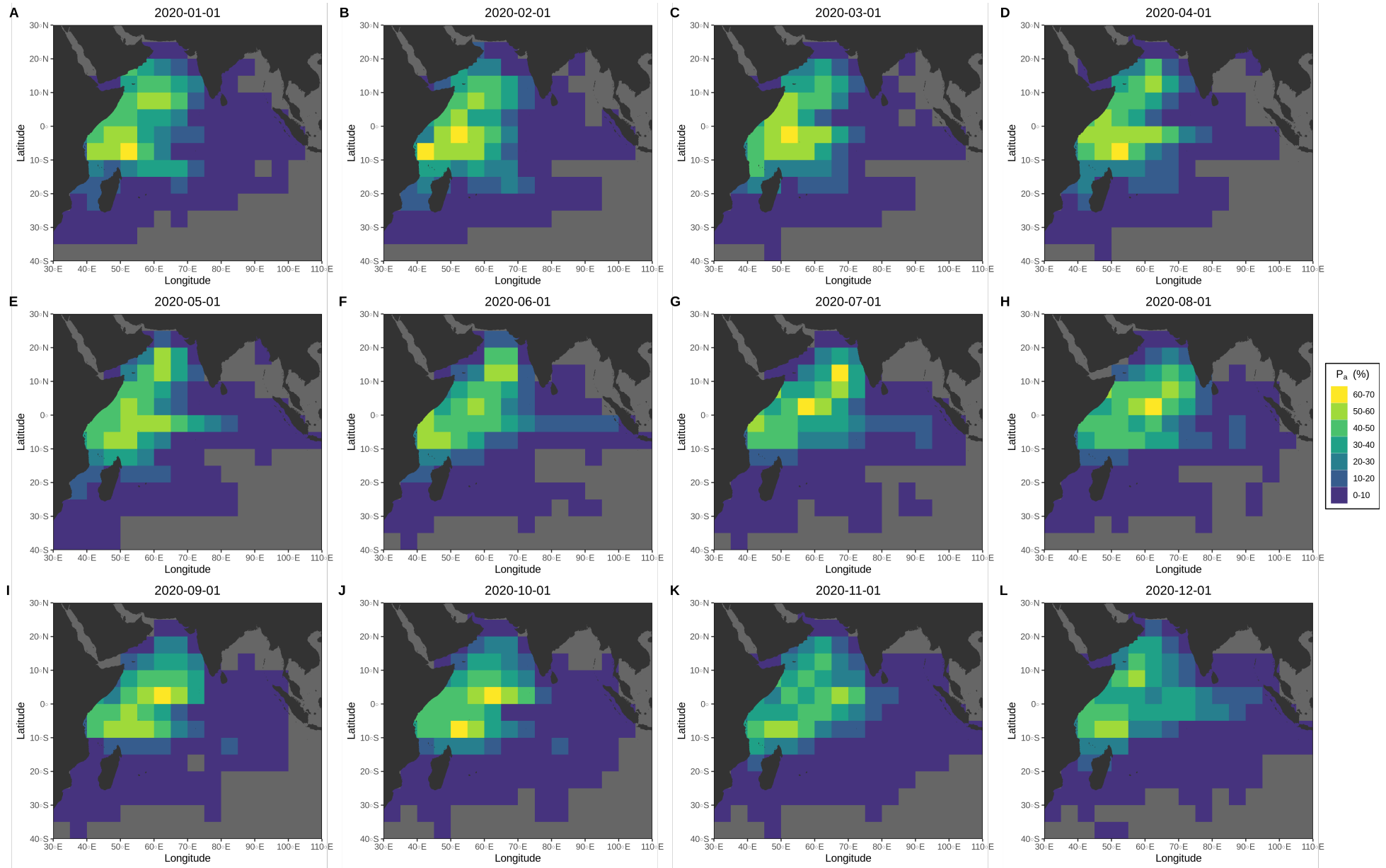

Figure 5.17: Predicted monthly percentage of time spent associated by individual yellowfin tunas (P_a) per 5° cells in the Western Indian Ocean. Simulations were performed with $v = 0.5 \text{ m}\cdot\text{s}^{-1}$ and $R_0 = 2 \text{ km}$.

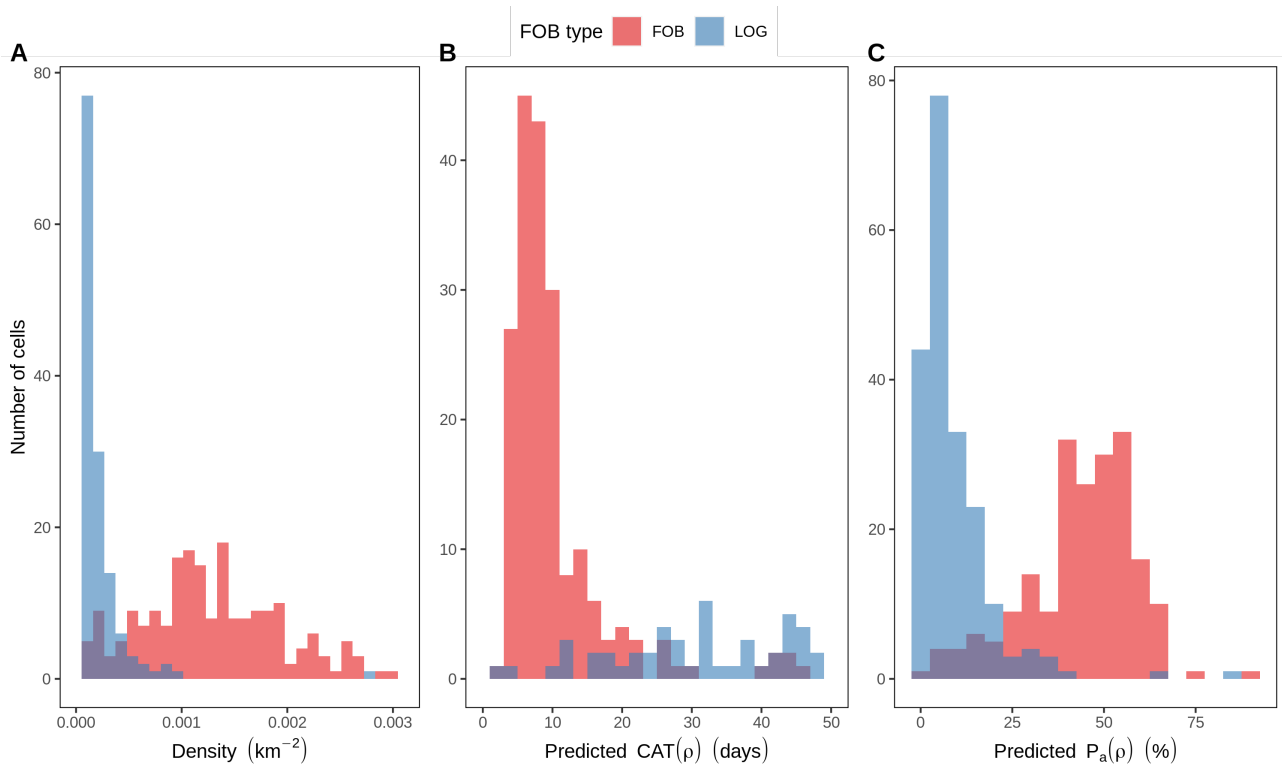

Figure 5.18: Comparison between predictions performed on the density of all FOBs (ρ_{FOB} , in red) and LOGs only (ρ_{LOG} , in blue) density. Monthly mean density of floating object (A), predicted mean monthly CAT (B) and P_a (C), per 5° cell. Simulations were performed with $v = 0.5 \text{ m.s}^{-1}$ and $R_0 = 2 \text{ km}$.

Table 5.6: Trends of CAT , measured using the model, for each of the tested density. Simulations were performed with $v = 0.5 \text{ m.s}^{-1}$ and $R_0 = 2 \text{ km}$. ρ : FAD density (in km^{-1}); D: mean inter-FAD distance in a regular square lattice (in km); \overline{CAT} : mean Continuous Absence Time (in days); \overline{CAT}_{diff} : mean Continuous Absence Time when the movement occurred between two different FADs (in days); \overline{CAT}_{return} : mean Continuous Absence Time when the individual returned to the departure FAD (in days); R: ratio of the number of CAT_{diff} divided by the number of CAT_{return} .

ρ	D	\overline{CAT}	\overline{CAT}_{diff}	\overline{CAT}_{return}	R
4.44×10^{-3}	15	2.32	2.31	2.54	22.89
2.50×10^{-3}	20	4.03	4.08	3.26	13.69
1.60×10^{-3}	25	6.24	6.46	4.04	9.99
1.11×10^{-3}	30	8.89	9.36	4.98	8.16
8.16×10^{-4}	35	12.13	13.02	5.97	6.96
6.25×10^{-4}	40	15.82	17.26	7.08	6.08
4.00×10^{-4}	50	24.60	27.59	9.39	5.10
2.78×10^{-4}	60	35.21	40.39	11.96	4.48
2.04×10^{-4}	70	47.98	56.31	14.72	3.99
1.56×10^{-4}	80	62.61	74.69	18.18	3.68
1.23×10^{-4}	90	79.54	96.32	21.03	3.49
1.00×10^{-4}	100	97.67	120.06	25.38	3.23

Table 5.7: Summary of the fitted metrics and the obtained parameter values for simulations performed with $v = 0.5 \text{ m.s}^{-1}$ and $R_0 = 2 \text{ km}$.

Metric	Formula	Fitted values	Standard Error
\overline{CAT}_{diff}	$a_d \times \rho^{-b_d}$	$a_d = 6.84 \times 10^{-3}$ $b_d = 1.06$	1.19×10^{-4} 3.89×10^{-3}
\overline{CAT}_{return}	$1 + a_r \times \rho^{-b_r}$	$a_r = 2.28 \times 10^{-2}$ $b_r = 7.56 \times 10^{-1}$	1.93×10^{-3} 1.93×10^{-2}
R	$a\rho^c \exp(b \times \rho)$	$a = 60.62$ $b = 175.48$ $c = 3.24 \times 10^{-1}$	3.72 4.64 7.91×10^{-3}

Transition

In this chapter, I used an individual-based model, based on a Correlated Random Walk to determine a general relationship between DFAD density and the time tuna spend between two associations. Using this relationship, I was able to quantify the impact that pelagic surface habitat modifications induced by DFADs have on the associative behavior of tropical tuna. The massive deployment of DFADs strongly increased the percentage of time tuna spend associated with DFADs, from an average of 20 % if only LOGs were present to 68 % with DFADs. This increase can have important implications on the availability of tuna to purse-seine fisheries, which can increase tuna catchability and hence their fishing mortality. One of the main drawbacks of this study is the fact that no social interactions between tunas were considered nor was the impact of environmental conditions. Environmental conditions can impact tuna associative behavior, *e.g.* by impacting prey availability (Arrizabalaga et al. 2015; Druon et al. 2017), and it has been demonstrated that social behavior is an important factor impacting tuna associative behavior (Sempo et al. 2013; Capello et al. 2022). Therefore, in Chapter 6, I will present preliminary results assessing the drivers of tuna associative behavior, taking their social behavior into account.



Chapter 6

Determining the drivers of the associative dynamics of tropical tuna aggregations

Publication

Dupaix, A., Deneubourg, J.-L., Baidai, Y., Dagorn, L., Simier, M., & Capello, M. (In prep.). Determining the drivers of the associative dynamics of tropical tuna aggregations.

6.1 Introduction

Many pelagic species, like tropical tunas, associate with floating objects (FOBs, Fréon and Dagorn 2000; Castro et al. 2002). This behavior has been known for centuries, with the first known mention in Oppian's *Halieutica*, a Greek poet, in the second century (Oppian 200 AD). However, the motivations underlying this associative behavior are still poorly known (Fréon and Dagorn 2000; Castro et al. 2002). Two main hypotheses are retained to explain the association of tropical tunas with FOBs. First, the *meeting-point* hypothesis stipulates that tuna would use FOBs as meeting points to increase their encounter with conspecifics and facilitate the formation of larger schools (Fréon and Dagorn 2000). Tuna associative behavior would have been selected because schooling behavior provides several evolutionary advantages. It can be seen as an evolutionary trade-off between (i) increasing protection against predators, swimming and foraging efficiency, mating, and (ii) increasing detection by predators and intra- and inter-specific competition (Rubenstein 1978; Ioannou 2017; Maury 2017). The other main hypothesis to explain associative behavior is the *indicator-log* hypothesis. Initially, FOBs were all of natural origin, mainly logs and parts of trees (designated as NLOGs), originating from rivers and potentially accumulating in rich frontal zones (Marsac et al. 2000; Hallier and Gaertner 2008). FOBs would then be representative of rich areas and tuna would use these objects to stay in such areas (Castro et al. 2002).

Fishers use pelagic fish associative behavior to facilitate search and catch of fish. Mentions exist of Anchored Fish Aggregating Devices (AFADs) – *i.e.* human-made floating objects deployed to aggregate fish – use in the Mediterranean sea in the 14th and 18th century (Taquet 2013). In the 1980s, industrial purse seine vessels targeting tropical tuna also started to deploy their own artificial floating objects, called Drifting Fish Aggregating Devices (DFADs), to exploit this associative behavior. Tropical tuna targeted by purse seine vessels are mainly skipjack (SKJ - *Katsuwonus pelamis*), yellowfin (YFT, *Thunnus albacares*) and bigeye tunas (BET, *T. obesus*). Since the 1980s, DFAD use has sharply increased with a last global estimation of around 100,000 DFAD deployments in 2013 (Gershman et al. 2015). Nowadays, more than 50 % of tropical tuna caught by purse seine vessels are caught around FOBs, representing around 1.9 million tons yearly (2017-2021; ISSF 2023). Fishing FOB-associated schools influences the catch composition of purse seine vessels, being composed mainly of small SKJ and YFT. In the Indian Ocean, FOB-associated catch is composed on average of 67 % SKJ, 27 % YFT and 6 % BET (estimated on the total FOB-associated catch in 2017-2021; IOTC 2022e). Since the 2010s, echosounder buoys are deployed with DFADs, allowing fishers to have access to DFAD position and to an estimation of the associated tuna biomass. DFAD fishing and echosounder buoys' use increase purse seine fleets efficiency, improving their yield and also leading to an expansion of their fishing grounds (Taquet 2013; Tolotti et al. 2022). For example, Wain et al. 2021 demonstrated that the use of echosounder buoys increases the catch-per-set of around 10 % in the Western Indian Ocean (WIO). This could provoke overfishing, although, because tropical tuna are targeted by several gears (ISSF 2023), no clear relationship exists between DFAD use and overfishing (Taquet 2013).

DFADs can also have indirect impacts on tropical tuna, *i.e.* impacts that are not related with an increase of fishing mortality. The massive use of DFADs has modified the habitat of pelagic fish, increasing FOB density and modifying their distribution. Two studies compared the distribution of NLOGs with that of DFADs, allowing to quantify this habitat modification. In the WIO, DFADs were shown to represent around 85 % of all FOBs, and to be responsible of a multiplication of FOB density by at least 2 in the whole area (Chapter 3; Dupaix et al. 2021a). In the Western and Central Pacific Ocean (WCPO), the use of DFADs changed the areas where FOB densities are highest and multiplied this maximum densities by around 4 (Phillips et al. 2019a). This massive increase of DFAD use and the resulting increase of FOB

density alerted scientists on the potential indirect impacts of this habitat modification (Marsac et al. 2000; Dagorn et al. 2013b). Twenty years ago, Marsac et al. 2000 formulated the *ecological trap* hypothesis, positing that by modifying the distribution and density of FOBs, DFADs could attract and/or retain tuna in areas that are unsuitable for them. Under this hypothesis, which relies on the *indicator-log* hypothesis (Dagorn et al. 2010), the massive deployment of DFADs could impact tuna's fitness. If we consider the *meeting-point* hypothesis, the DFAD induced increase of FOB density could also impact tuna schooling behavior and ultimately their fitness. With the increased density of FOBs, tuna could get dispersed between FOBs, disturbing their schooling behavior and preventing the formation of large schools (Sempo et al. 2013).

Several studies demonstrated that an increase of FOB density would impact the associative behavior of tuna individuals. Pérez et al. 2020 used passive acoustic tuna tagging data of tuna in different arrays of AFADs to study the impact of FOB density on the individual associative behavior. They demonstrated that when the density increases tuna spend longer continuous periods of time associated and shorter periods between two associations. Hence, when FOB density increases, tuna spend a higher percentage of their time associated with FOBs. Pérez et al. 2022 developed an individual-based model, based on a Correlated Random Walk (CRW), validated and calibrated on passive acoustic tuna tagging data in arrays of AFADs, which allows to simulate trajectories of individual tunas in arrays of FADs. Using this model, in Chapter 5, we demonstrated that the deployment of DFADs strongly increased the percentage of time individual tuna spend associated in the WIO in 2020, from an average of 20 % to 68 %. Hence, DFADs both increase the efficiency of purse seine fishing fleets (Taquet 2013; Wain et al. 2021), but also increase the availability of tropical tuna, increasing their catchability.

The response of tuna to an increase of FOB density could be impacted by environmental conditions and tuna social behavior. Tuna associative behavior can be influenced by climate change, which modifies prey abundance and biophysical characteristics of the environment (Arrizabalaga et al. 2015; Druon et al. 2017). In the WIO, Nataniel et al. 2022 showed that SKJ catch, which is caught almost exclusively at FOBs (IOTC 2022b), was correlated with several environmental variables, among which Chlorophyll-a concentration or sea surface currents. Tropical tuna presence and catch under DFADs is also driven by sea surface temperature and sea level anomaly (Orue et al. 2020). The strength of the social interactions between tuna individuals also impacts their distribution among DFADs: tuna will either be homogeneously distributed among FOBs or select one or a few FOBs (Sempo et al. 2013). In a recent study, Capello et al. 2022 developed a modelling framework to study the associative behavior of tuna in an array of FADs, accounting for their schooling dynamics. They define either non-social, social and highly social behavioral scenarios (to account for possible collective departures of FAD-associated schools to form larger schools), as well as school fission (separation of a large school into smaller schools) and fusion (formation of a larger school from smaller schools) when tuna are not associated. They show that the percentage of FOBs occupied by at least one tuna school and the average size of associated tuna aggregations will respond differently to an increasing number of FOBs depending on the considered social scenario. Here, an aggregation is defined as a gathering of individuals leading to a local density greater than that of neighboring regions (Camazine et al. 2001). It is important to distinguish tuna aggregations from tuna schools: a tuna aggregation in the vicinity of a FOB can be formed by several tuna schools, not necessarily of the same size-class and/or species.

Echosounder buoys, deployed with DFADs, can provide important information on the associative dynamics of tuna aggregations. Recent methodological advances allow the prediction of tuna presence or absence under DFADs using data from echosounder buoys (Baidai et al. 2020b; Orue et al. 2019; Navarro-García et al. 2023). This presence/absence data allows the characterization of tuna aggregation dynamics under FOBs. For example, Baidai et al. 2020a determined the colonization time of DFADs by tuna and showed that, on average, DFADs

were continuously occupied by tuna for 6 and 9 days in the IO and Atlantic Ocean respectively. Using an extensive dataset from echosounder buoys in the WCPO, Escalle et al. 2021c also determined different profiles of acoustic signals related to different types of multispecific aggregations.

Relying on the scenarios of Capello et al. 2022 and the methodologies to process the echosounder buoys data developed in Baidai et al. 2020a and Baidai et al. 2020b, this study aims (i) to identify the main social and environmental drivers that affect the aggregation dynamics of tropical tuna, and (ii) to better inform tropical tuna management by determining the links between environmental conditions, FOB density and tuna catchability in the WIO. In the preliminary analysis presented in this Chapter, we focus on the percentage of FOBs occupied by tuna, obtained from echosounder buoys data (Baidai et al. 2020b), and assess its response to environmental drivers and to FOB density.

6.2 Material and Methods

6.2.1 Percentage of inhabited FOBs

The proportion of FOBs occupied by tuna was estimated using data from Marine Instrument M3I echosounder buoys (<https://www.marineinstruments.es>) and the Random Forest (RF) algorithm developed in Baidai et al. 2020b.

The M3I buoy includes a solar powered echosounder operating at a frequency of 50 kHz, with a beam angle of 36° and has a total detection range of 150 m depth. Acoustic samples, informing on the backscattered acoustic energy recorded underneath the buoy, are recorded every 2 hours in the M3I buoy default mode. An acoustic sample corresponds to 50 acoustic scores (integer numbers ranging from 0 to 7), each corresponding to a 3 m depth layer. This raw data is pre-processed to (1) remove the two shallowest layers, (2) average the acoustic samples over 4-hour periods, (3) identify homogeneous groups of depth layers using a clustering method and (4) for each homogeneous group, sum and rescale the acoustic scores of all the layers. The pre-processing returns, for each buoy and each day, a 6×6 matrix, with six homogeneous depth groups and six 4-hour intervals, containing acoustic scores scaled between 0 and 1.

Presence/absence data is obtained from fishing logbooks of French purse seine vessels and on-board observers data, which gives access to purse seine fishing sets (presence of tuna) and to deployments and visits at FOBs without any fishing set (absence of tuna). The training dataset for the RF is obtained by cross-matching this presence/absence data with the daily acoustic matrices. Hence, this RF provides estimations of presence/absence of a tuna aggregation under a FOB, on a daily basis. It was demonstrated to have a 85 % accuracy in the Indian Ocean (for further details see Baidai et al. 2020b).

For each 2° cell on a daily basis, the number of M3I buoys with presence of tuna was divided by the total number of M3I buoys present in the same cell and day. Only cells with at least 5 buoys were kept. This daily fraction was then averaged over a month and multiplied by 100, to obtain the monthly percentage of FOBs inhabited by a tuna aggregation (f) at a spatial resolution of 2°.

6.2.2 Explanatory variables

To determine the drivers of the association dynamics of tuna aggregations, we calculated mean monthly values of environmental variables in each 2° cell.

Table 6.1: Variance Inflation Factors of the explanatory variables. n_{FOB} : number of floating objects; Chl-a: Chlorophyll-a concentration ($\text{mg}\cdot\text{m}^{-3}$); SLA: Sea Level Anomaly (m); SSCI: Sea Surface Current Intensity ($\text{m}\cdot\text{s}^{-1}$); SST: Sea Surface Temperature ($^{\circ}\text{C}$); Long: Longitude; Lat: Latitude.

Variable	VIF with all variables	VIF without SST
n_{FOB}	1.26	1.26
Chl-a	3.68	1.22
SLA	1.64	1.18
SSCI	1.12	1.12
SST	4.63	–
Long	1.74	1.65
Lat	1.45	1.41

6.2.2.1 Number of floating objects

The mean monthly number of FOBs per 2° cell was obtained from instrumented buoys data provided by the IOTC Secretariat, which gives access to a mean monthly number of active buoys per 1° cell in 2020-2021 (IOTC 2023a). This average monthly number of buoys was summed over 2° cells, to attain the desired spatial resolution and used as a proxy for DFAD number. Although DFADs are the most numerous FOBs in the WIO, other floating objects, designated as LOGs (either NLOGs or ALOGs, other floating objects originating from pollution), are also present which could change local densities (Dupaix et al. 2021a). To estimate the total number of FOBs, we used data from scientific observers onboard French purse seine vessels and the methodology developed in Dupaix et al. 2021a. We calculated a mean yearly ratio per 2° cell (R):

$$R = \frac{n_{LOG}}{n_{DFAD}} \quad (6.1)$$

with n_{LOG} and n_{DFAD} being the number of LOG and DFAD observations respectively. This ratio was used to calculate the number of FOBs per 2° cell, as follow: $n_{FOB} = n_{DFAD} \times (1 + R)$.

6.2.2.2 Other environmental variables

To determine the environmental processes driving the association dynamics of tuna aggregations related to biotic and abiotic oceanographic variables, we extracted the mean monthly value in 2° cells of Chlorophyll-a concentration (Chl-a, in $\text{mg}\cdot\text{m}^{-3}$), Sea Level Anomaly (SLA, in m), Sea Surface Current Intensity (SSCI, in $\text{m}\cdot\text{s}^{-1}$) and Sea Surface Temperature (SST, in $^{\circ}\text{C}$). These variables were selected as they have been demonstrated to be relevant to the characterization of favourable habitats of tropical tunas.

Chl-a is a major variable to determine the productivity of an area and is correlated with areas of high prey abundance for tunas (Druon et al. 2017; Zainuddin et al. 2017). SLA allows the identification of large scale structures, such as gyres, eddies or upwelling regions and is highly representative of the thermocline depth (Arrizabalaga et al. 2015; Zainuddin et al. 2017; Marshall and Plumb 1989). SSCI can influence tuna habitat preferences (Druon et al. 2017) and primary productivity of rich upwelling regions (Vinayachandran et al. 2021). SST is known to affect the distribution of tropical tunas, *e.g.* it has been demonstrated to be one of the main environmental factors influencing SKJ presence in the Mozambique Channel (Nataniel et al. 2022).

These variables were extracted from the Copernicus Marine Service (Table 6.2). Their resolution was degraded to mean monthly $2 \times 2^{\circ}$ cell values, to match the values of f calculated in Section 6.2.1.

Table 6.2: Characteristics of the environmental data used in the study.

Acronym	Environmental variable	Spatial resolution	Temporal resolution	Source
Chl-a	Chlorophyll concentration (mg.m ⁻³)	4×4 km	Monthly	https://data.marine.copernicus.eu/product/OCEANCOLOUR_GLO_BGC_L4_MY_009_104
SLA	Sea Level Anomaly (m)	0.25×0.25°	Monthly	https://data.marine.copernicus.eu/product/SEALEVEL_GLO_PHY_L4_MY_008_047
SSCI	Sea Surface Current Intensity (m.s ⁻¹)	0.25×0.25°	Monthly	https://data.marine.copernicus.eu/product/MULTIOBS_GLO_PHY_TSUV_3D_MYNRT_015_012
SST	Sea Surface Temperature (°C)	0.25×0.25°	Monthly	https://data.marine.copernicus.eu/product/MULTIOBS_GLO_PHY_TSUV_3D_MYNRT_015_012

6.2.3 Statistical analysis

To determine the relationship between explanatory variables, we first performed a principal component analysis (PCA). Each variable was scaled prior to the PCA, dividing it by its standard deviation. Furthermore, to characterize the effect of space and time on the explanatory variables we defined two categorical variables: quarter with four classes (Q1: Jan-Mar, Q2: Apr-Jun, Q3: Jul-Sept, Q4: Oct-Dec) and regions. Five 10° cells were used as regions to account for larger scale features (*e.g.* Somali upwelling, Figure 6.1C).

To assess the drivers of the association of tuna aggregations with FOBs, we performed a Generalized Additive Model (GAM) with f as the explanatory variable. First, to account for collinearity between explanatory variables, we calculated the variance inflation factor (VIF), and discarded variables with a value above 3 (Zuur et al. 2009). Based on VIF values, the SST was removed from the analysis (Table 6.1). Because spatial autocorrelation was detected in the data (Moran's $I = 0.11$, p-value = 0.01) and because it improved the fit of the model (preliminary analysis, not shown) spatial terms were included (Long and Lat). To summarize, the initial model was based on the following equation:

$$\ln(f + 1) = s(n_{FOB}) + s(Chla) + s(SLA) + s(SSCI) + s(Long, Lat)$$

where s represents the penalized spline smooth function. The maximum number of degrees of freedom allowed was fixed to 6 for the main effects and to 15 for the Long,Lat interaction (Nataniel et al. 2022). The best model was selected based on the lowest Aikake Information Criterion (AIC), allowing to determine the model with the best trade-off between goodness-of-fit and the number of model parameters (Borcard et al. 2011). To assess the goodness-of-fit of the model we considered the percentage of variance explained and the absence of spatial autocorrelation of the residuals was verified using a permutation test on Moran's I . All statistical analyses were performed using the R statistical software *v3.6.3* (R Core Team 2020).

6.3 Results

6.3.1 Relationships between explanatory variables

The first two principal components of the PCA explained 41.3 % and 26.7 % of the total variance in the dataset (total variance explained with PC1 and PC2: 68.0 %). The first axis (PC1) discriminated between cells with low Chl-a and high SST and SLA values on the one

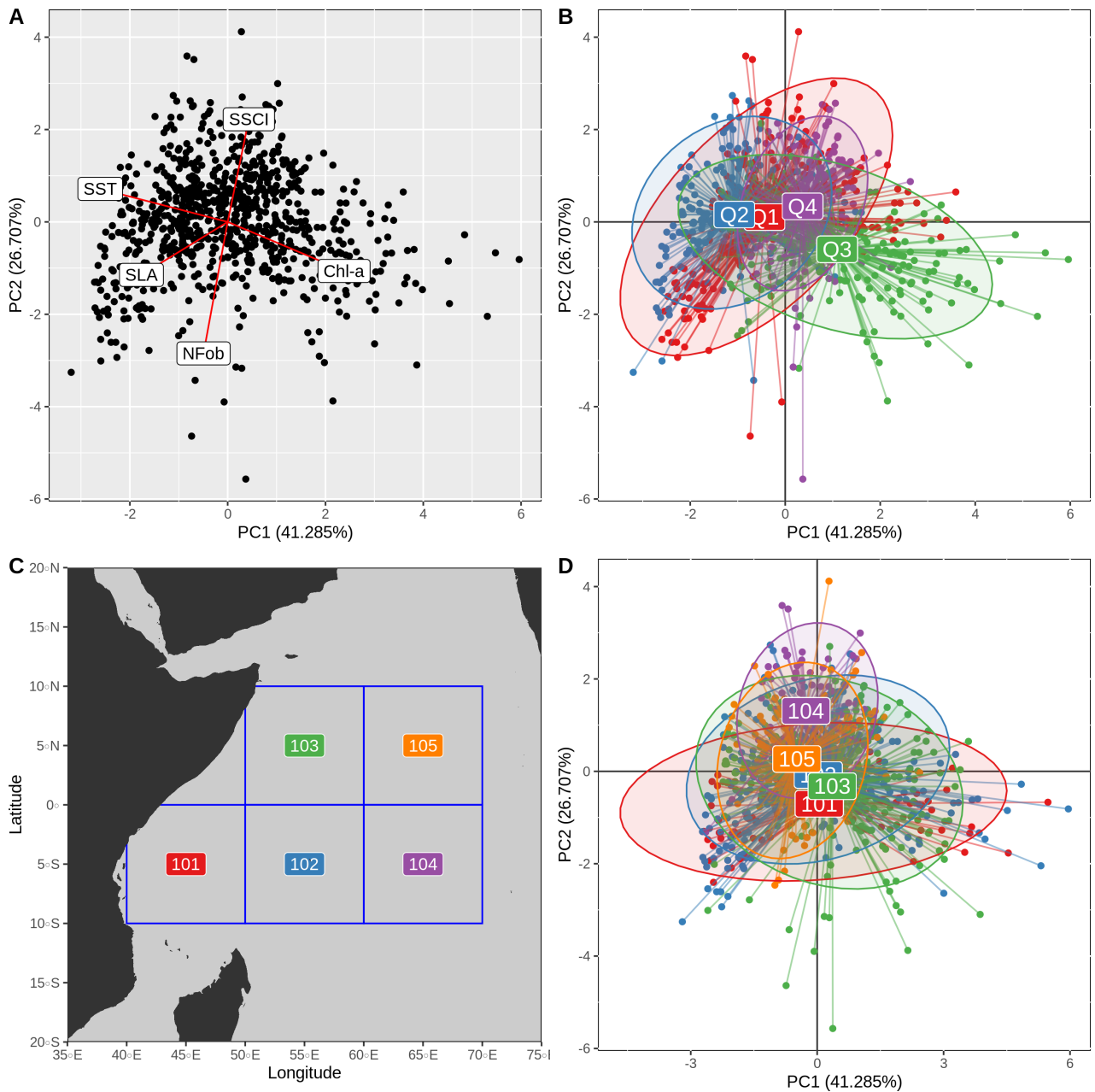

Figure 6.1: Results of the Principal Component Analysis performed on explanatory variables. (A) First two principal components of the PCA. The red lines, representing the coordinates of the variables on the axes, are not at scale to facilitate reading. (B) Projection of the Quarter categories and of their center of gravity on the PCA axes (C) Map of the defined study regions. (D) Projection of the 10° cell categories and of their center of gravity on the PCA axes. NFob: number of floating objects; Chl-a: Chlorophyll-a concentration ($\text{mg}\cdot\text{m}^{-3}$); SLA: Sea Level Anomaly (m); SSCI: Sea Surface Current Intensity ($\text{m}\cdot\text{s}^{-1}$).

side and high Chl-a, low SST and low SLA on the other side (Figure 6.1A). It showed a strong negative correlation between Chl-a and SST, confirmed when performing a Pearson's correlation test (Pearson's $\rho = -0.82$, p .value < 0.001). Hence, PC1 allows to discriminate between areas that could be considered as rich (high productivity, low SST and SLA) and areas that can be considered as poorer.

The second axis (PC2) discriminates between cells with high n_{FOB} and low SSCI values, and cells with low n_{FOB} and high SSCI values, highlighting a negative correlation between the two variables (Pearson's $\rho = -0.26$, p .value < 0.001). PC2 shows that in areas with high sea surface currents speed, FOB numbers are lower. This result was expected. As FOBs drift like surface water parcels (Imzilen et al. 2019), the higher the current speed, the faster the FOBs

will leave the area.

From April to June (Q2), SST tended to be higher and Chl-a lower whereas in the following quarter (Q3, July-September), the sampled cells were more likely to be located in richer areas (high Chl-a, low SST; Figure 6.1B). Spatially, the values sampled in cell 104 (Figure 6.1C) differed from the other, being characterized by low values of n_{FOB} and high SSCI values.

6.3.2 Drivers of the percentage of FOBs occupied by tuna

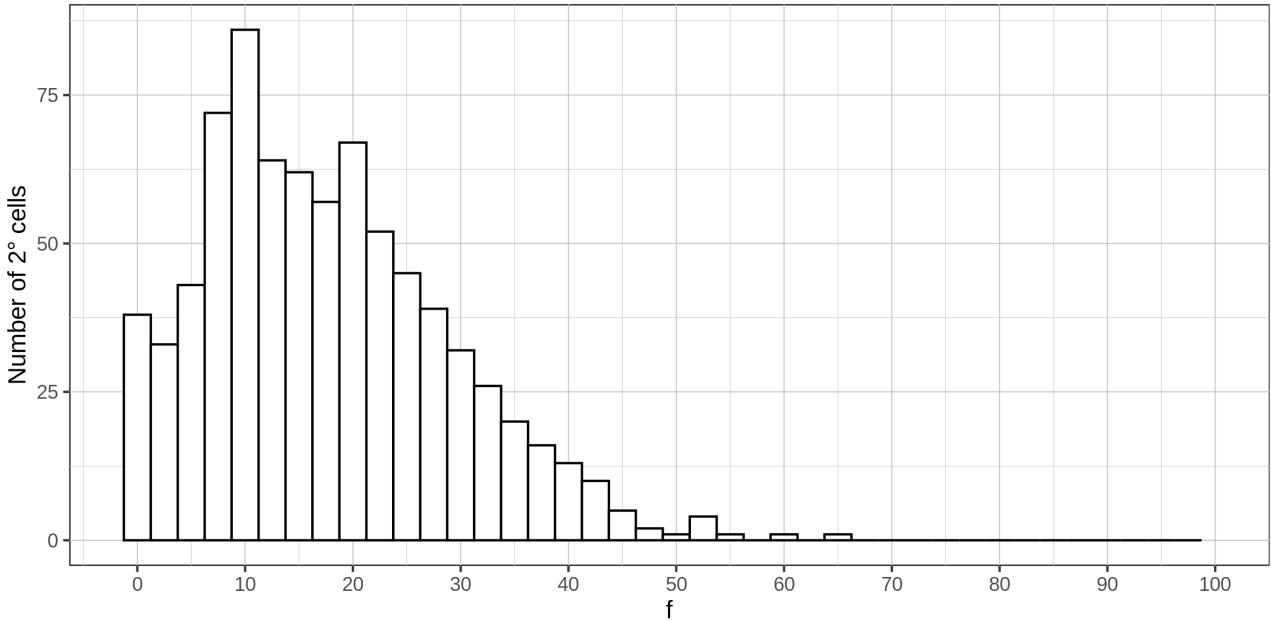

Figure 6.2: Distribution of the percentage of FOBs occupied by tuna (f).

The percentage of FOBs occupied (f) was available for a total of 790 2° cell-month. It ranged from 0 % to 65.7 %, with a mean value of 17.6 % (Figure 6.2). Most values were comprised between 1.8 (5 % quantile) and 38.5 % (95 % quantile).

Based on the AIC, the best model selected included n_{FOB} , Chl-a, SLA and Long×Lat interaction (Table 6.3). The relationships between f and environmental variables are summarized in Table 6.3 along with model parameters (explained variance, estimated degrees of freedom, AIC). The GAM explained 29.7 % of the total variance. The permutation test on Moran’s I statistic showed no significant spatial autocorrelation in the model residuals (Moran’s $I = -4.3 \times 10^{-3}$, p.value = 0.60), residuals were normally distributed and showed no heteroscedasticity (Supplementary Figure 6.5). All variables selected in the model were significant (p.values in Table 6.3). f was most explained by the Long×Lat interaction, followed by SLA, Chl-a and n_{FOB} .

Figure 6.3 provides the predictions of the GAM, for each explanatory variable independently, considering the median value of other explanatory variables. f first displayed an increase for an increasing number of FOBs (n_{FOB}) from 0 to around 100 FOBs per 2° cell. 100 FOBs per 2° cell corresponds to a density of 2.1×10^{-3} FOB.km⁻², corresponding to 21 FOBs in an area of 100×100 km². f then stabilized and stayed constant, with a value of 20 %, when the number of FOBs increased further, and showed a high variance above 200 FOBs per 2° cell due to a lack of data (Figure 6.3A).

The GAM predicted a quasi-linear relationship between the number of occupied FOBs (obtained by multiplying the predicted f by n_{FOB}) and the number of FOBs (Figure 6.4). It predicted around 20 occupied FOBs for 100 FOBs per 2° cell, and around 35 occupied FOBs when the number of FOBs increased to 200 per 2° cell.

Table 6.3: Selected GAM of the percentage of occupied FOBs in the WIO. AIC: Aikake Information Criterion; Dev. explained: deviance explained by all the variables in the model; Dev. variable: deviance explained by each variable in the model; EDF: effective degrees of freedom. n_{FOB} : number of floating objects; Chl-a: Chlorophyll-a concentration ($\text{mg}\cdot\text{m}^{-3}$); SLA: Sea Level Anomaly (m); Long: Longitude; Lat: Latitude.

Explanatory variable	EDF	p.value	Dev. variable (%)
n_{FOB}	3.08	7.2×10^{-5}	2.57
Chl-a	4.69	4.0×10^{-6}	2.91
SLA	3.01	4.4×10^{-7}	3.98
Long \times Lat	10.64	< 0.001	15.64
Adjusted R^2	0.28		
Dev. explained (%)	29.7 %		
AIC	-1727		

The selected model predicted higher f values in the North-eastern part of the study area (from 60 to 70°E and 0 to 7°N), with values reaching 25 % (Figure 6.3D). Predicted f values were minimal in the Southern part of the study area, with predicted values around 10 %.

Concerning the response to Chl-a, f displayed an increase for low Chl-a values (predicted increase of 2 % from 0 to 0.1 $\text{mg}\cdot\text{m}^{-3}$) and a steep decreasing trend for higher values, showing a high variance above 0.3 $\text{mg}\cdot\text{m}^{-3}$ (Figure 6.3B). The response of f to SLA was almost linearly increasing, from $f = 10$ % to $f = 30$ % in the $[-0.1 \text{ m}; 0.3 \text{ m}]$ interval (Figure 6.3C). Due to SLA distribution, predicted f displayed a high variance on both sides of the $[-0.1 \text{ m}; 0.3 \text{ m}]$ interval.

6.4 Discussion

The massive use of DFADs by industrial purse seine fisheries has alerted on the potential ecological impacts these objects could have on tropical tuna (Marsac et al. 2000; Fonteneau et al. 2013; Taquet 2013). DFADs provoke an increase of purse seine fishing efficiency (Taquet 2013; Wain et al. 2021), but they could also impact tuna behavior and have both indirect (not linked with an increase in fishing mortality) and direct impacts (through an increase of fishing mortality, see General introduction; Dagorn et al. 2013b). For example, by increasing the time tuna spend associated, DFADs increase their availability to fishers and can increase their catchability (*direct impact*, see Chapter 5). As formulated twenty years ago, by modifying the distribution of FOBs and increasing their density (Dagorn et al. 2013a; Dupaix et al. 2021a), DFADs could also attract or retain tunas in areas that are unsuitable for them (the *ecological trap* hypothesis, *indirect impact*, Marsac et al. 2000). Tuna associative behavior also depends on its social behavior, which can strongly influence the response to an increasing density of DFADs (Sempo et al. 2013; Capello et al. 2022). In this study we focus on tuna aggregations because it allows to take tuna social behavior into account and to get insights on the dynamics of the population at a local scale. Using echosounder buoys data and data from observers onboard purse seine vessels, we show that the percentage of FOBs occupied by tropical tunas (f) is driven by biophysical parameters of the environment (Chlorophyll-a concentration, Sea Level Anomaly) and by the number of FOBs in the area (*i.e.* FOB density). The obtained preliminary results have several implications, both in terms of tuna behavioral ecology – *i.e.* on the mechanisms explaining tuna association with FOBs – and fisheries science – *i.e.* on the impacts DFADs and climate change could have on the availability of tropical tuna to purse seine fisheries.

The values of f measured in this study show that, in average, the occupancy rate of FOBs in an area is low, with most values being below 40 %. Sempo et al. 2013 showed that as the density

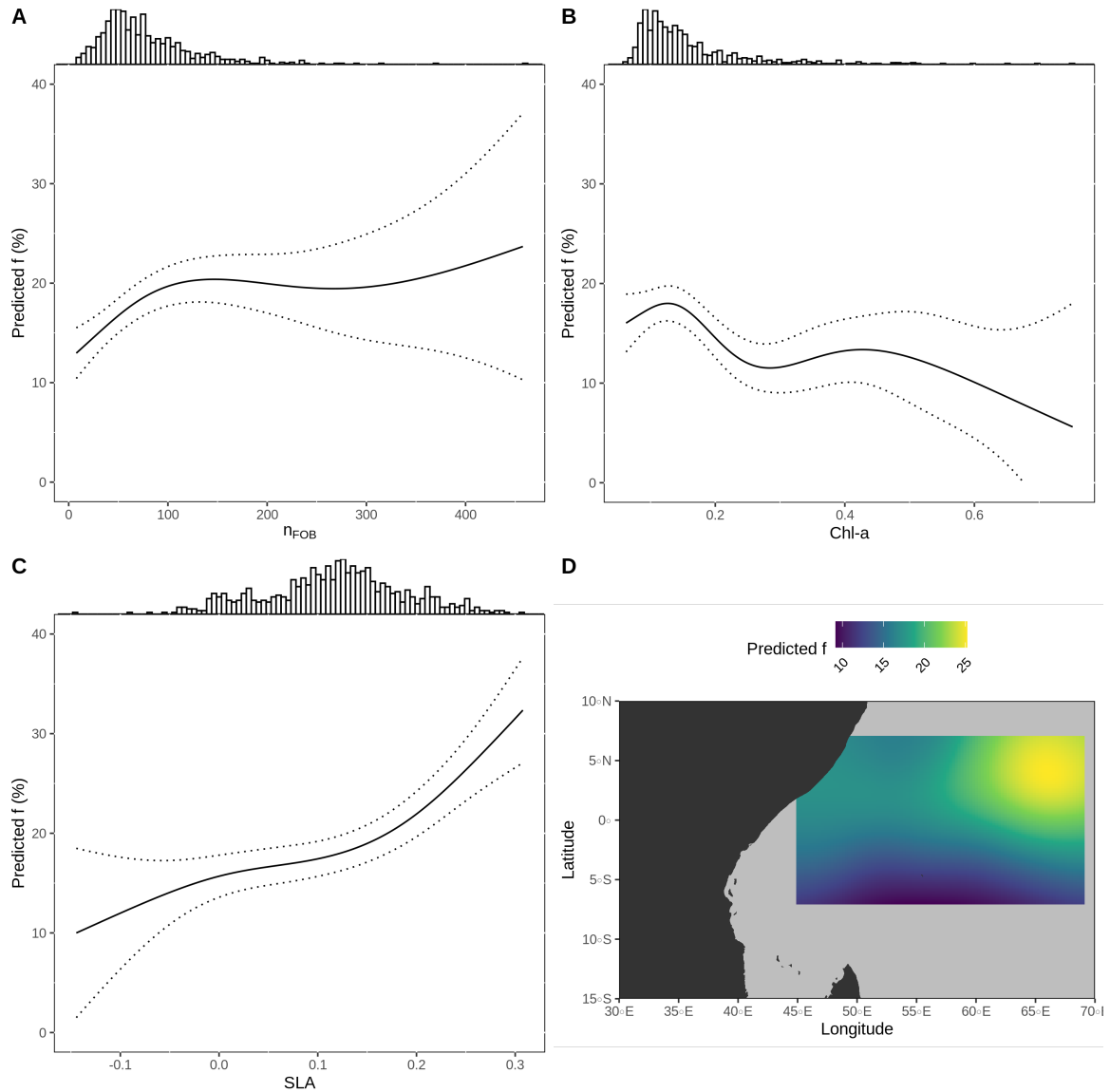

Figure 6.3: Predictions of the percentage of FOBs occupied (f) obtained from the GAM, for the observed range of values of (A) n_{FOB} : the number of FOBs; (B) Chl-a: Chlorophyll-a concentration ($\text{mg}\cdot\text{m}^{-3}$); (C) SLA: Sea Level Anomaly (m); (D) Long \times Lat interaction. Standard-error on the Long \times Lat interaction prediction are available in Supplementary Figure 6.6. For each panel, f values were predicted considering the median value of other explanatory variables (noted \bar{X} for variable X). $\bar{n}_{FOB} = 66$, $\bar{Chla} = 0.13$ $\text{mg}\cdot\text{m}^{-3}$, $\bar{SLA} = 0.12$ m, $(\bar{Long}; \bar{Lat}) = (57; -1)$. Histograms on top of panels A-C represent the observed data distribution. Dotted lines delimit the 95 % confidence interval of the smooth plots.

of FOBs increases tuna will eventually occupy all the FOBs in the area. However, the density at which this dispersion among FOBs occurs will depend on the social behavior of the species, with non social species occupying all FOBs at lower densities than social species. Hence, these result rejects non social scenarios and highlights the strong social behavior of tropical tuna.

The GAM performed in this study shows that the Long \times Lat interaction explains most of the variance. Biophysical characteristics and FOB density explained a smaller part of the variance, which was unexpected. This suggests the presence of other explanatory variables, not taken into account in our study, which would influence the percentage of occupied FOBs. One of them could be purse seine fishing effort: the lowest predicted f values are observed in the South of the study area, close to the Seychelles, where purse seine fishing effort is high, while the highest values are observed in the North-Eastern part of the study area, where fishing effort is lower (Supplementary Figure 6.7, IOTC 2022d). This could reflect a direct impact of DFAD fishing,

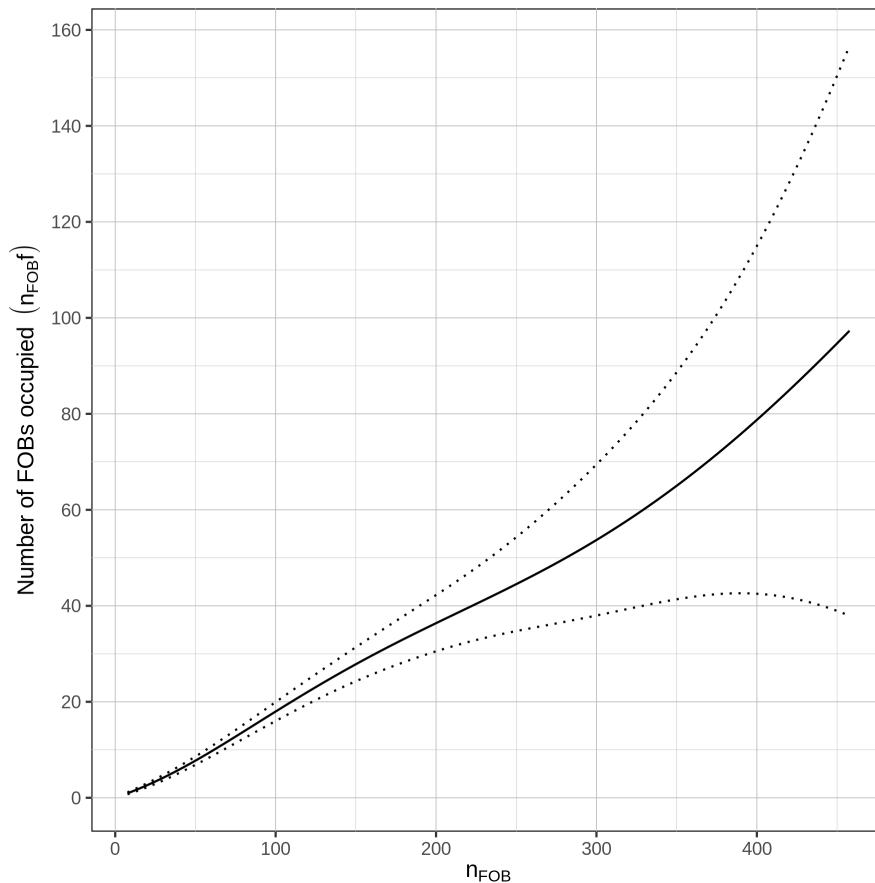

Figure 6.4: Predictions of the number of FOBs occupied ($n_{FOB} \times f$) deduced from the GAM, obtained by multiplying the predicted f by the number of FOBs in the 2° cell. Dotted lines delimit the 95 % confidence interval.

with tuna aggregations being removed in areas where the fishing effort is high, explaining the lower f values. This result highlights the need to take fishing effort into account to assess the drivers of the percentage of FOBs occupied by tropical tuna. Another variable which is likely to influence the percentage of FOBs occupied by tuna is the local tuna abundance in the area (Sempo et al. 2013; Capello et al. 2022). However, tuna abundance indices are often calculated at the scale of the oceanic basin, which precludes an assessment of local abundance (Kaplan et al. 2023; Medley et al. 2023). Spatialized indices relying on echosounder buoy data have been developed recently, but they include f in their calculation (*e.g.* the ABBI - Associative Behavior-Based abundance Index, Baidai et al. 2023).

Although to a lesser extent, the associative behavior of tuna aggregations is influenced by biophysical characteristics of the environment, namely SLA and Chl-a. We found an almost linear increasing trend of f with SLA. Arrizabalaga et al. 2015 found that SKJ and YFT prefer SLA around 0 and 0.5 m respectively, and Zainuddin et al. 2017 found highest SKJ Catch per Unit of Effort (CPUE) for SLA values around 0.05 m. It suggests that the response of f to SLA is independent from the local abundance. SLA is representative of the thermocline depth: the higher the SLA, the deeper the thermocline (Marshall and Plumb 1989). As the thermocline acts as a barrier for small tunas (Artetxe-Arrate et al. 2021), high values of SLA mean that small tuna will be able to go deeper. As the thermocline is generally shallow in the IO, compared to other oceans, the increasing trend of f could be linked with a difference in tuna detection by echosounder buoys. When the SLA is low, the thermocline is shallow, and tuna could be harder to detect due to the narrow beam width of echosounders (36° for M3I buoys, Baidai et al. 2020b). Also, tuna most likely detect FOBs based on acoustic cues (Girard

et al. 2004). The thermocline depth, by influencing the propagation of soundwaves (Christ and Wernli 2014), could influence the distance at which tuna detect FOBs, in turn influencing f .

f is mostly decreasing as a response to Chl-a concentration. A potential explanation for the observed lower values of f at higher Chl-a concentrations is that tuna would associate less, maybe because they spend more time foraging in the vicinity. As the Chl-a decreases, tuna would spend less time foraging and/or would need to associate more (either to rest or to form schools, see the *comfortability stipulation* and *meeting point* hypotheses, Section 1.3). However, Chl-a does not directly reflect the richness of an area for tunas, only the area's productivity, which is not always representative of the presence of small pelagic preys (*e.g.* see the low correlation between Chl-a and micronekton in Figure B.8 in Appendix B). Furthermore, as Sea Surface Temperature (SST) displayed a strong negative correlation with Chl-a, the observed variations of f with an increasing Chl-a concentration could also reflect variations correlated with a decreasing SST. This would be in agreement with Orue et al. 2020, who used both echosounder and catch data, and found that the probability of tuna presence under DFADs increases when SST increases.

f displays an increase for small FOB densities and then remains constant above a given threshold (around 100 FOB per 2° cell). This stabilization could reflect a saturation effect. Pérez et al. 2022 (Appendix A) developed an individual-based model of tuna association in an array of FADs. Calibrating this model on passive acoustic tuna tagging data, in arrays of Anchored FADs (AFADs), they demonstrated that tuna most likely orient themselves at a distance of 10 km from an AFAD, in agreement with previous evidence using active acoustic tagging (Girard et al. 2004). The FOB density at which f stabilizes (100 FOBs per 2° cell) corresponds to a mean distance between two neighbor FOBs of around $\frac{222}{\sqrt{100}} = 22$ km. Following the model of Pérez et al. 2022 and its application in Chapter 5, such a density would result in very short Continuous Absence Times (CATs), and tuna individuals being attracted to a FOB directly after leaving the previous one. Hence, further increasing the density of FOBs would not further increase f . This stabilization could also be due to tuna getting dispersed among FOBs when the density increases, without changing the local abundance, resulting in smaller associated aggregations. This second explanation could be tested using fisheries data and assessing if the catch-per-set of purse seine vessels decreases as FOB density increases. This assessment would need to take into account the effect of echosounder buoys, which have been demonstrated to increase purse seine catch-per-set by 10 % in the WIO (Wain et al. 2021).

The increase of f for small FOB densities could result from fishers strategy who would not deploy DFADs in an area where the local abundance of tuna is low (Pons et al. 2023). Also, this increase of f could be due to the fact that, at low FOB density, tuna would not stay in the area and the local abundance would be lower. At low FOB density, the mean distance between two objects is high, which would result in longer CATs (Chapter 5, Pérez et al. 2020; Pérez et al. 2022). Tuna spending longer time between two associations, not finding FOBs could result in a lower proportion of the tuna population being associated. If the social interactions between tuna are high, as suggested by the observed range of f values, this lower proportion of the population being associated could result in a lower occupancy of FOBs in the area.

Capello et al. 2022 developed five different social scenarios and determined the trend of f for an increasing number of FOBs. In most of their scenarios, as well as in Sempo et al. 2013, f decreases with an increasing number of FOBs, where we observed an increase followed by a stabilization. Only the social scenario in Capello et al. 2022 (S+ff), with high local abundances and very low FOB densities predicts a slight increase of f . Capello et al. 2022 model considers a fixed local abundance in the area, which is not necessarily true. The trend of f observed in our study could result from a local abundance that increases with the density of FOBs. The increase of FOB density could provoke an increase of local abundance either by attracting (increasing the number of tuna entering) or retaining (decreasing the number of tuna leaving)

tuna in the area, with both suggesting that DFADs could act as "traps" (Marsac et al. 2000; Hallier and Gaertner 2008). This attraction or retention of tuna in an area would increase their catchability (as shown in Chapter 5) and it could also have indirect ecological impacts.

The relationship between the number of occupied FOBs and the number of FOBs in the area is almost linear (Figure 6.4). Hence, if fishers further increase the number of deployed DFADs, it will increase the availability of FOB-associated tuna, with one fifth of the FOBs being occupied. For low densities, f is lower, but these FOB densities correspond to areas at the margin of the fishing grounds, with very little fishing effort (see Figure 5.2 in Chapter 5). The use of DFADs has several impacts on the environment and has become highly controversial, leading all tuna Regional Fisheries Management Organisations (tRFMO) to adopt Conservation and Management Measures (CMMs) to try and set limits to their use (IATTC 2021; WCPFC 2021; ICCAT 2022; IOTC 2019). However, the actual number of DFADs display differing trends depending on the ocean (see Section 1.4). This suggests that these CMMs have limited effectiveness in limiting the number of DFAD deployed. If there are no strong incentive to reduce the number of DFADs from tRFMOs, purse seine fleets' interest would be to increase DFAD deployments, as f does not decrease. However, with climate change, tuna preys and SST are expected to decrease in the WIO (Dueri et al. 2014), which could impact f , in turn impacting the availability of associated tuna to industrial purse seine fisheries. Climate change has been demonstrated to impact the abundance of tropical tunas (Dueri et al. 2014; Erauskin-Extramiana et al. 2019), but it could also impact the behavior of tuna, impacting their availability to fishers. Further efforts are needed to better characterize these behavioral impacts of climate change on tuna and the extent to which they could impact both tuna populations and fisheries.

To conclude, this study allowed to demonstrate that the associative behavior of tuna aggregations is correlated with biophysical characteristics of their environment and with the density of floating objects. Other variables, such as the local tuna abundance, could also have an impact. Also, there could be a direct impact of purse seine fisheries on the associative behavior of tuna aggregations, with less FOBs occupied by tuna as a result of high purse seine fishing effort. This study brings new insights to the understanding of tuna associative behavior and can help inform fisheries management. Specifically, it brings back to light the potential of DFADs to act as "traps" for tropical tunas (Marsac et al. 2000), by retaining or attracting them in some areas or dispersing them among FOBs, which could disturb their schooling behavior. As both the number of FOBs and biophysical characteristics of the environment drive tuna aggregations' associative dynamics, efforts are needed to better characterize this link and to determine the induced impacts at the population scale.

6.5 Supplementary Materials

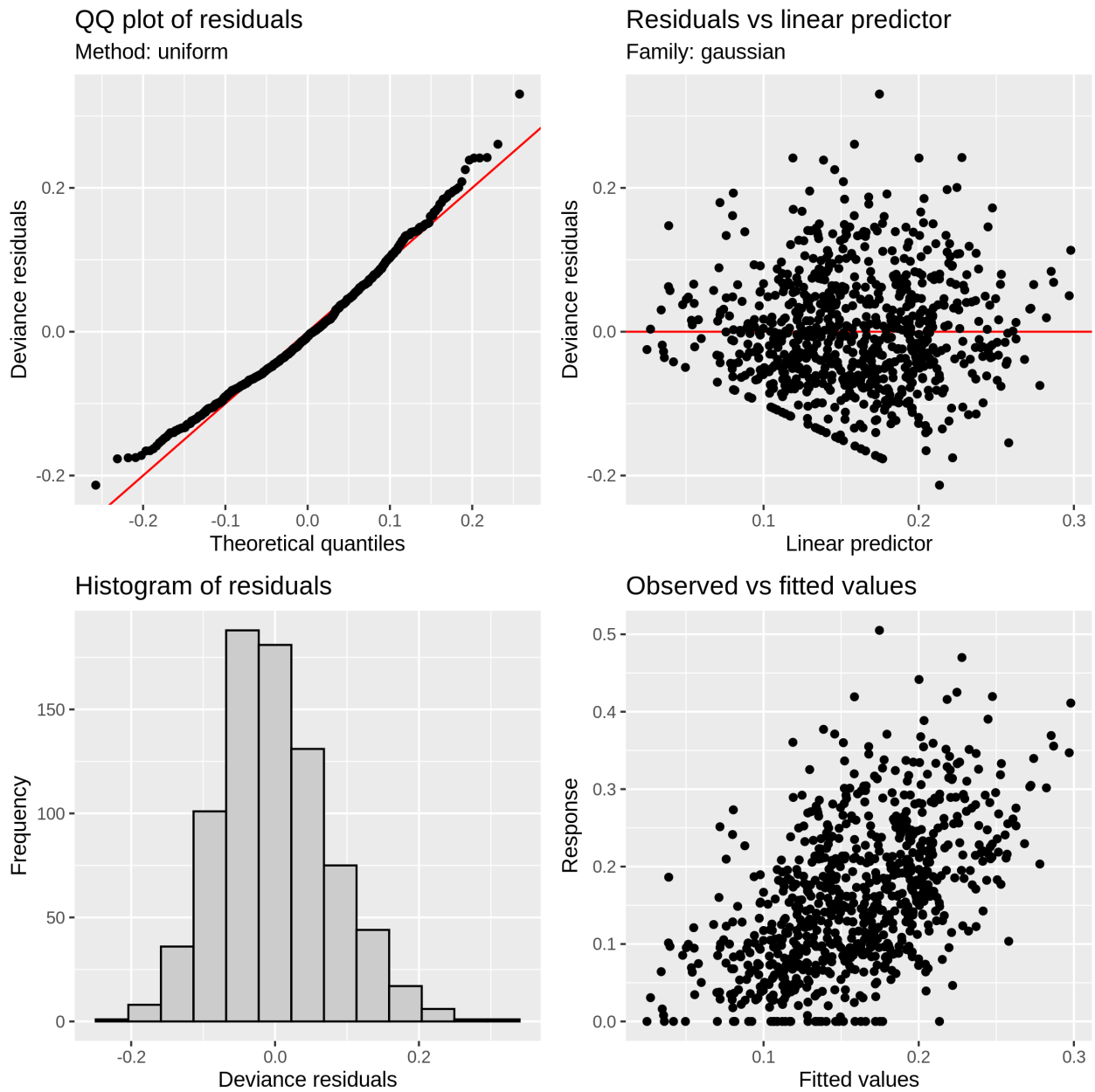

Figure 6.5: Diagnostic plots of the GAM.

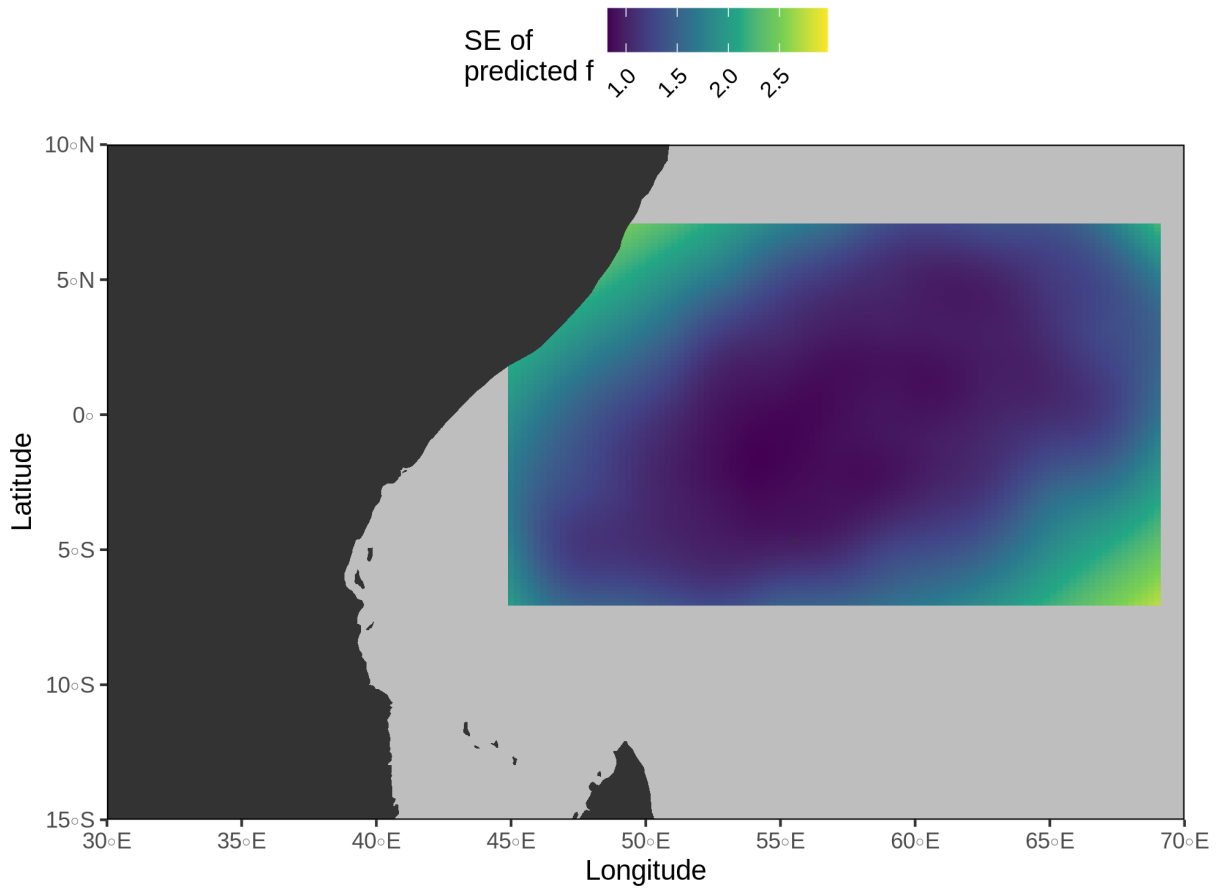

Figure 6.6: Standard error on the spatial predictions of the number of FOBs occupied ($n_{FOB} \times f$) deduced from the GAM. SE: Standard-Error.

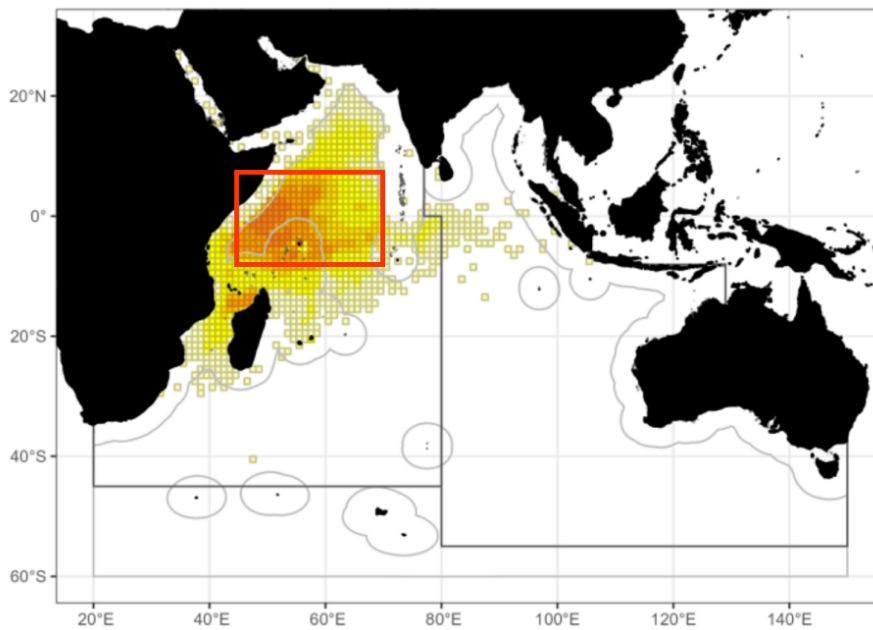

Figure 6.7: Mean purse seine effort in the Indian Ocean from 2010 to 2019. Figure adapted from Figure 13 in IOTC 2022d. The red rectangle shows the area studied in this Chapter.

Transition

In this chapter, I used data from several sources (echosounder buoys, IOTC, observers, and remote-sensing data) to characterize the impact of DFADs and environmental variables on the associative behavior of tuna aggregations. The percentage of FOBs occupied by tuna in a given area is impacted by the biophysical characteristics of the area and by the number of FOBs. The results obtained here give new insights into the reasons underlying the association of tuna with FOBs. They also inform on potential DFADs impacts, highlighting that DFADs, by increasing FOB density, could retain individuals in some areas and/or disperse them among FOBs. These results can be used to better assess the impacts of climate change on purse seine fisheries and to inform different scenarios of DFAD use reduction.

In Part II, I assessed the impact of an increase of FOB density, induced by DFADs (see Chapter 3), on the associative behavior of tropical tuna. This increase of density impacts both the percentage of time tuna individuals spend associated (Chapter 5) and the percentage of FOBs that are occupied by tuna (Chapter 6). Both these results evidence an increase of the availability of tropical tuna for purse seine fleets, which will in turn increase their catchability and can increase their fishing mortality. They also evidence that DFADs could lead tuna to get retained in areas of high FOB density. The increase of FOB density impacts the associative behavior of tropical tuna which could in turn impact some of their life-history parameters (*i.e.* biological parameters linked with their fitness, *e.g.* physiological condition, reproduction). Several studies agree that tuna are in lower physiological condition when caught in FOB-associated schools than in free-swimming schools. An increase in the time spent associated with DFADs could then impact the physiological condition of tuna, which could in turn impact their fitness.

In Part III, I explore these links between DFAD density, associative behavior and physiological condition of tuna. In Chapter 7, I test the presence of a long-term impact of DFAD use on YFT condition, using length-weight data, in the WIO. Then, in Chapter 8, a mathematical framework is developed to explore the causal link between tuna physiological condition and associative behavior and determine the resulting consequences of an increase of DFAD density.

Part III

Impacts of DFADs on tropical tuna physiological condition

Chapter 7

No evidence from long-term analysis of yellowfin tuna condition that Drifting Fish Aggregating Devices act as ecological traps

Publications

Peer-reviewed

Dupaix, A., Dagorn, L., Duparc, A., Guillou, A., Deneubourg, J.-L., & Capello, M. (2023). No evidence from long-term analysis of yellowfin tuna condition that Drifting Fish Aggregating Devices act as ecological traps. *Marine Ecology Progress Series* 711: 121–127. <https://doi.org/10.3354/meps14313>

Technical paper

Dupaix, A., Dagorn, L., Duparc, A., Guillou, A., Deneubourg, J.-L., & Capello, M. (2023). No evidence from long-term analysis of yellowfin tuna condition that Drifting Fish Aggregating Devices act as ecological traps (IOTC Working Group on FADs (WGFAD4) *IOTC-2023-WGFAD04-09*). Indian Ocean Tuna Commission. <https://iotc.org/documents/WGFAD/04/09>

7.1 Introduction

Natural floating objects (FOBs) such as logs or branches (designated as NLOGs) are a component of the oceanic habitat of tropical tunas, and tunas are known to associate with them. Although the reasons for this associative behavior are poorly understood, fishers traditionally used this behavior to find and capture associated fish (Fréon and Dagorn 2000). In the early 1980s, industrial tropical tuna purse-seine fleets began to commonly attach buoys on NLOGs and to construct and deploy their own man-made floating objects (FOBs), called drifting Fish Aggregating Devices (DFADs) (Dagorn et al. 2013b). In the Indian Ocean (IO), deployment and use of DFADs began in the 1990s and has steadily increased since then, such that from 2012-2018, DFADs were demonstrated to represent more than 85 % of the total FOBs in the western IO (Dupaix et al. 2021a).

Soon after their wide-scale use began, it was hypothesized that DFADs may act as *ecological traps* for tropical tunas (Figure 7.1) (Marsac et al. 2000; Hallier and Gaertner 2008). An ecological trap occurs when individuals exhibit a higher or equal preference for a poor-quality habitat (*i.e.* associated with a lower fitness) over another habitat, being misled by cues that no longer correlate to habitat quality due to anthropogenic changes (Robertson and Hutto 2006; Gilroy and Sutherland 2007). This decorelation between habitat quality and habitat selection cues ultimately leads to a reduction in the fitness of individuals (Gilroy and Sutherland 2007; Swearer et al. 2021). The hypothesis that DFADs act as an ecological trap, as it was first formulated, relies on one of the hypotheses suggested as an explanation for tuna associative behavior: the indicator-log hypothesis (Fréon and Dagorn 2000); this posits that NLOGs are located in productive areas because they originate from rivers and tend to accumulate in rich frontal areas (Hall 1992; Hallier and Gaertner 2008). Thus, tropical tunas and other associated species would select NLOGs as a cue for good-quality habitat. The massive deployment of DFADs would modify the density and spatial distribution of FOBs, with potentially large numbers of artificial objects occurring in areas that are not optimal for tunas, creating the risk of an ecological trap. Hence, there is an urgent need to assess the likelihood of DFADs acting as ecological traps.

A proxy to assess tuna fitness is physiological condition. Tunas caught at DFADs may be considered to be in poorer condition than those caught in freeswimming schools (FSC), which infers a negative biological consequence from the association with DFADs (Marsac et al. 2000; Hallier and Gaertner 2008). Robert et al. 2014a also found a difference between the condition of associated and non-associated tunas, but in an area (the Mozambique Channel, Western IO) that was rich in NLOGs and thus only marginally modified by the addition of DFADs. Hence, it is possible that the association with a FOB results in poorer condition, but that the evolutionary advantage of the associative behavior would not be related to short-term trophic benefits. Tunas could recover faster after associating because they are in a more productive area or in larger schools (Fréon and Dagorn 2000). This led us to consider the ecological trap hypothesis over a long period of time, to examine the condition of tuna before and after the use of DFADs.

The objective of this study was to test the hypothesis that the body condition of yellowfin tuna has decreased since the widespread use of DFADs began in the IO in the 1990s. We used length and weight measurements to calculate Le Cren's relative condition factor (K_n) and investigated the temporal evolution of the body condition of yellowfin tuna *Thunnus albacares* from 1987-2019 in the IO.

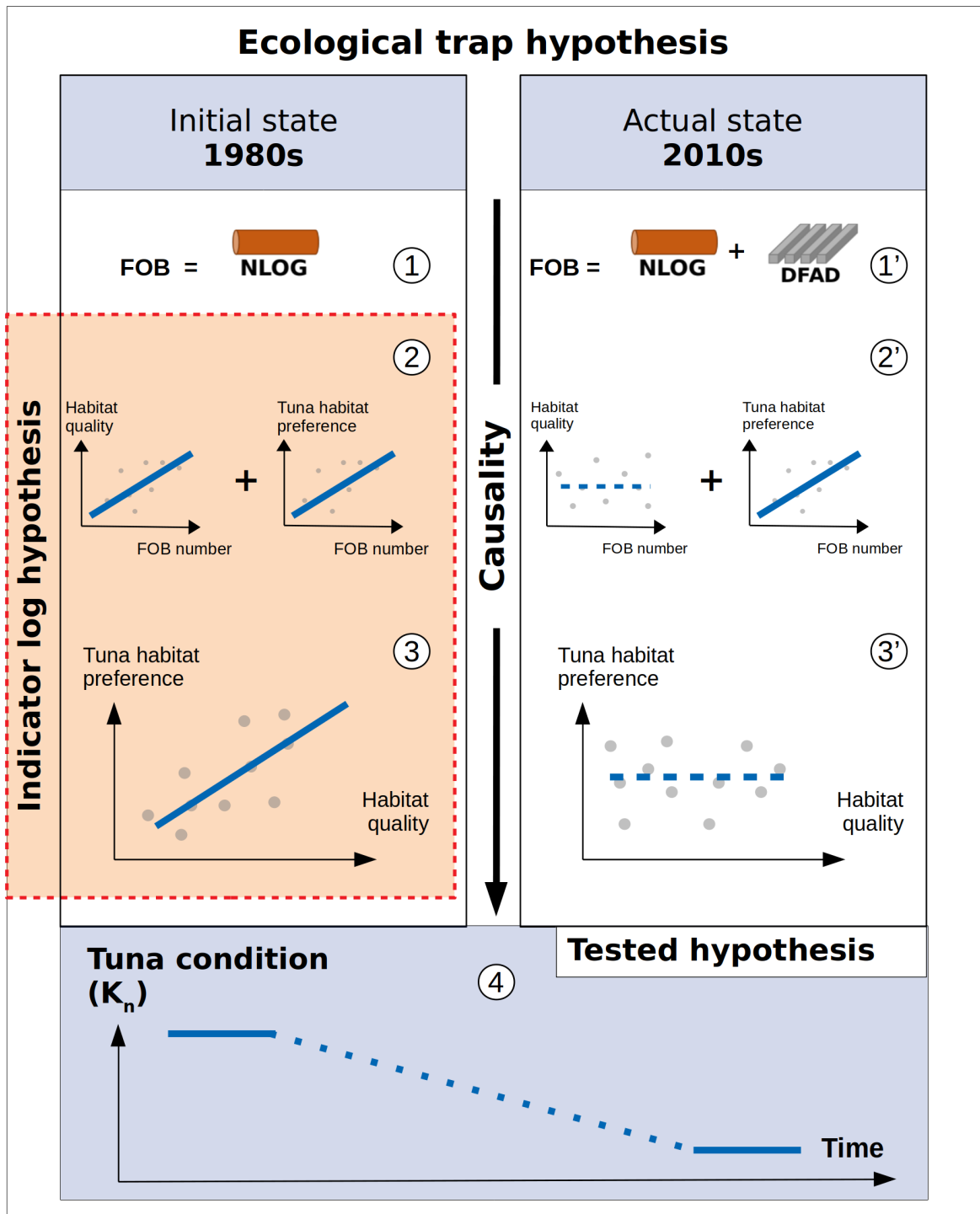

Figure 7.1: Schematic representation of the ecological trap hypothesis applied to Fish Aggregating Devices and tropical tuna. FOB: Floating object of any kind; DFAD: Fish Aggregating Device; NLOG: Natural floating object. Under this hypothesis, before DFAD introduction, when only NLOGs were present (1), floating objects were distributed in productive areas (2), hence tunas, which associate with floating objects, preferred high quality habitats (3). Since DFAD introduction (1'), the distribution of floating objects has been modified and is no longer correlated with habitat quality (2'). Hence, tunas, which still associate with floating objects, do not select high quality habitat anymore (3'). As a consequence of this habitat modification, the physiological condition of tunas would have decreased since the 1990s (4). Preference is defined here as the likelihood of a resource being chosen if offered as an option with other available options.

7.2 Material and Methods

7.2.1 Biological data

A total of 25,914 yellowfin tuna *Thunnus albacares* were sampled from 1987-2019 in the Indian Ocean Tuna canning factory in Victoria, Seychelles (Guillou et al. 2021). All sampled fish were caught by purse-seine vessels in the western IO (details of the sample sizes are provided in Tables 7.1 & 7.2). The total weight (W) of the individuals and their fork length (FL) were measured. For each sampled tuna, the fishing vessel and the fishing trip were recorded, but not the specific fishing set from which it was caught. As a consequence, all fishing sets from a trip are a potential catch location for every sample (see Section 7.2.3 for details on how the uncertainty on location and date was managed). The type of school (either FOB-associated or FSC) was not considered in the main analysis because it was unknown for a large proportion of the sampled fish (around 75%; Table 7.1). The year (Y) and quarter (Q) of the catch of each tuna were estimated from the middle of the interval covered by the fishing trip dates. Quarters were defined to be synchronous with the general movement of the fleet, fishing seasons and areas (Dupaix et al. 2021a, - Q1: December-February; Q2: March-May; Q3: June-August; and Q4: September-November). The total range of FL was divided into 3 intervals, defining size classes (SCs) as small (< 75 cm), medium (75-120 cm) and large (>120 cm).

7.2.2 Relative condition factor

To calculate the theoretical weight of individuals (W_{th}), FL and W measures for the whole period were used to estimate the parameters of the length-weight allometric relationship, using the theoretical power-law equation:

$$W_{th} = aFL^b \quad (7.1)$$

Details on the fit of this power-law are presented in Section 7.5.2. Secondly, for each individual fish, $K_n(i)$ (Le Cren 1951) was calculated as:

$$K_n(i) = \frac{W(i)}{W_{th}(i)} \quad (7.2)$$

where $W_{th}(i)$ is the theoretical weight of individual i calculated from length-weight allometric relationship coefficients according to $FL(i)$, and $W(i)$ is the measured total weight. By definition, $K_n(i)$ measures the deviation of an individual from the weight of a mean individual of the same length.

7.2.3 Statistical analysis

To determine if K_n decreased with the concurrent increase in DFAD numbers during the study period, a generalized additive model (GAM) was performed considering $K_n(i)$ as the dependent variable, with a Gaussian link function to account for explanatory variables. Explanatory variables were chosen to assess the effect of the fishing Y, season (fishing Q), size of the individuals (SC), and fishing location (longitude, Lon; latitude, Lat; see details below). Lon and Lat were included in the model as a smoothed term, and other variables were considered as factors. No precise time-series of DFAD numbers exist in the IO over 1987-2018, but the deployment of DFADs increased during that period; hence, we considered fishing Y as a proxy for DFAD density.

Because K_n is the ratio of 2 correlated random variables (Pearson's correlation coefficient between W and W_{th} , Pearson's $\rho = 0.99$), it did not follow a normal distribution and displayed

overdispersion. For this reason, and because it did not change the interpretation of the GAM results, we transformed the $K_n(i)$ using a Geary-Hinkley transformation before performing the GAM (Geary 1930, see Section 7.5.3). The GAM was performed on the transformed $K_n(i)$, noted $T[K_n(i)]$. Complementary analyses showed that SC and its interaction with other explanatory variables and fishing mode (Figures 7.3 & 7.4 respectively) did not impact the main results of the study. These results remained consistent when considering only fish from FOB-associated schools (Figure 7.5).

As the exact geographic coordinates were not available for most of the sampled fish, a bootstrap process was applied: a data set was generated by sampling one set of coordinates from all the fishing sets of the trip for each individual, and a GAM was then performed. This operation was repeated 1000 times, and for every model built, we selected the most parsimonious explanatory variables based on Akaike's information criterion (AIC), using a step-wise selection procedure and a threshold of 2. The iterated GAM coefficients of the explanatory variables considered as factors (Y, Q and SC) were averaged over the bootstrap replica, and their standard deviation was calculated.

All analyses were performed using R software v.4.0.3 (R Core Team 2020), and the scripts used for the study are available on GitHub (https://github.com/adupaix/Historical_YFT_condition; <https://doi.org/10.5281/zenodo.6123417>).

7.3 Results

7.3.1 Mean relative condition factors

The K_n value was 1.01 ± 0.088 and mean annual K_n values varied between 0.93 ± 0.064 (in 1987) and 1.07 ± 0.079 (in 2012). K_n displayed annual variations, with low values in 1987-1990 and around 2005-2007, and the highest K_n values observed around 2012 (Figure 7.2A). The mean annual K_n displayed similar variations per size class as when all the sampled fish were considered together (Figure 7.2A). No clear trend in K_n variations were observed.

7.3.2 Yearly variations of K_n

The most parsimonious model, selected using the AIC, included Y, Q, SC and the smoothed term for Lon and Lat. The selected model explained 29.2 % of the deviance. The residuals displayed no spatial autocorrelation and their distribution was not significantly different from a Gaussian distribution (Figure 7.6). The GAM performed on the transformed relative condition factor, $T[K_n(i)]$, showed that strongest $T[K_n(i)]$ variations were significantly correlated with Y (Figure 7.2B; Figures 7.7 & 7.8). The annual GAM coefficients displayed a non-monotonous trend which was non-decreasing in time, with 1987 being the year with the lowest coefficient (-0.475 ± 0.007) while 2012 was the year with the highest coefficient (0.673 ± 0.006 ; Figure 7.2B). The observed patterns were similar to those displayed when considering only the mean annual K_n (Figures 7.2A&B).

7.4 Discussion

Ecological traps for animals are likely to become more common as human-induced environmental changes increase. These traps can increase extinction risk locally and regionally, impacting population persistence and presenting an important challenge for the management of animal populations (Battin 2004; Hale et al. 2015; Swearer et al. 2021). The yellowfin tuna population in the IO is currently overfished and subject to overfishing (IOTC 2021a). It is therefore

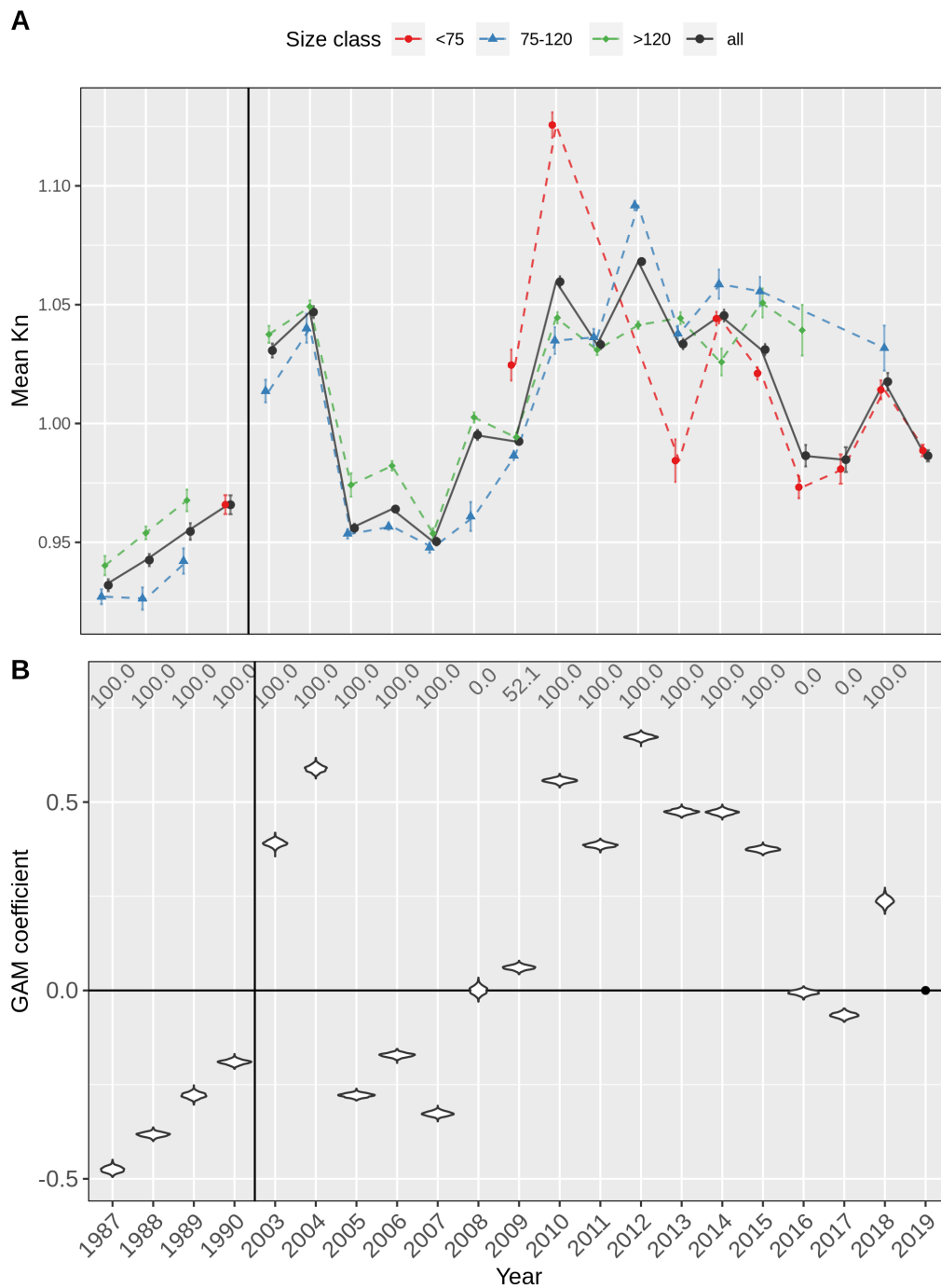

Figure 7.2: No observed trend in yellowfin tuna condition: (A) Mean relative condition factor per year. The K_n is represented for all individuals (all, black circles), for small individuals (<75, red circles), medium-size individuals (75-120, blue triangles) and large individuals (>120, green diamonds). Values are represented only when more than 50 individuals of the given class were measured. Error bars represent the standard error of the mean. (B) Coefficients of the fishing year in the Generalized Additive Model. Each coefficient represents the mean deviation of the transformed K_n ($T[K_n]$, see Section 7.2.3) from the values for a year of reference (2019, represented by a black dot). The shape of the points represents the distribution of the values obtained with the bootstrap process. Numbers in grey in the upper part of the panels represent the percentage of the models generated in the bootstrap for which a given category was significantly different from the category of reference.

critical to assess not only the direct impacts of DFADs – through fisheries – but also potential indirect impacts which could also negatively impact tuna populations (Hallier and Gaertner 2008). The hypothesis that DFADs could act as ecological traps was developed more than 20 yr ago (Marsac et al. 2000) and implies that the introduction of DFADs would have negatively

impacted the condition of tunas, following roughly 3 decades of DFAD deployment (Figure 7.1). Following the hypothesis that DFAD number increased during the study period, we expected a decrease in yellowfin tuna condition throughout the years. The $K_n(i)$ values obtained here did not display any clear temporal trend over the study period (Figure 7.2), which does not support the tested hypothesis. Hence, the present study suggests that under the conditions encountered by yellowfin tuna in the IO during the last 3 decades, the addition of DFADs to the pelagic environment has not led to the creation of an ecological trap for this species.

Data used in this study were not uniformly distributed across size classes and years (Figure 7.9), and tunas from both fishing modes (FOB-associated and FSC) were considered, which could have influenced the results (Hallier and Gaertner 2008; Robert et al. 2014a). However, no decreasing trend in K_n was observed concurrently with increasing DFAD use when performing a GAM on data of each size class independently (Figure 7.3). In addition, even though the mean K_n of FOB-associated tuna was lower than that of FSC tuna, no decreasing trend in condition was observed when considering the fishing mode (Figures 7.4 & 7.5).

For a habitat modification to lead to an ecological trap, individuals selecting the modified habitat must experience a reduction in their fitness, namely their reproductive success, which includes survival and reproduction. Physiological condition can be considered a good proxy for individual fitness, as it can impact both an individual's survival and reproduction. The morphometric index used here, K_n , was the only condition indicator for which a long time-series was available. Other indices can be used to assess physiological condition, such as bio-impedance analysis (Robert et al. 2014a), organosomatic indices or measurements of biomarkers (Lloret et al. 2014). Sardenne et al. 2016 warned that different morphometric indices could show inconsistency and are not always the best proxies for tropical tuna condition. These caveats stress the need to develop experimental approaches – measuring a set of condition indices on captive tuna under various feeding/fasting conditions – to better understand the validity of these indices. DFADs could also impact the biology of tuna in a variety of complex ways, impacting other biological processes leading to a reduction of fitness, such as growth rate (Hallier and Gaertner 2008) or reproduction (Zudaire et al. 2014). This highlights the need to monitor tuna physiological condition more thoroughly by performing regular biological data collection.

Many studies have demonstrated that tuna associated with DFADs tend to be in lower condition than FSC tunas (Marsac et al. 2000; Hallier and Gaertner 2008; Jaquemet et al. 2011). However, Robert et al. 2014a observed a similar result when comparing tuna associated with NLOGs and FSC tuna and concluded that the associative behavior could be the consequence - not the cause - of a lower physiological condition. These studies testing the ecological trap hypothesis were performed on short temporal scales of up to a few months and therefore were not able to determine a potential long-term impact of DFADs. Other long-term phenomena could also impact the physiology of tropical tuna. For example, climate change has impacted tuna habitat since the 1980s by inducing changes in sea surface temperature or oxygen concentration (Erauskin-Extramiana et al. 2019). Erauskin-Extramiana et al. 2019 predicted that yellowfin tuna will become more abundant under a climate change scenario. To our knowledge, our study is the first performed on a time-series long enough to allow the potential long-term impact of the increase of DFAD density on tuna condition to be assessed. A decreasing trend in the condition of small tunas was observed in the later years of the study (Figure 7.2), which was not correlated with the number of FOBs (Section 7.5.4). Hence, to investigate possible long-term physiological changes due to climate change and/or any environmental disturbances, continuous effort to develop routine biological sampling and regularly monitor fish condition should be established to develop long time-series of biological indices. This effort should be combined with the collection of data on habitat modifications induced by DFADs.

Tuna associative behavior plays a key role in determining the potential indirect impacts of DFADs on tuna condition. This associative behavior could also depend on several factors other

than DFAD density, such as environmental conditions or social behavior (Capello et al. 2022). It could also be impacted by their physiological condition; for example, one could hypothesize that tuna would associate with a DFAD until its condition decreases to a given threshold value that would cause it to leave. Several hypotheses, *e.g.* the association being a consequence of a low condition and individuals departing from FOBs beyond a given condition threshold, could explain the absence of a long-term impact of DFADs on tuna condition, which need to be further explored.

By demonstrating the absence of any decreasing trend in yellowfin tuna condition during the past 3 decades in the IO concurrent with the observed increasing DFAD density, this study rejects the ecological trap hypothesis as it was originally formulated more than 20 yr ago. To continue assessing the indirect impacts of DFADs on tuna condition, experimental studies are needed to determine the relevant temporal scales and indices to monitor these impacts. Finally, it is necessary to establish long-term monitoring programs to track (1) habitat changes (*e.g.* DFAD density), (2) variations in tuna behavioral features (*e.g.* association dynamics) and (3) temporal variations of biological indicators of fitness.

7.5 Supplementary Materials

7.5.1 Supplementary Figures and Tables

Table 7.1: Number of sampled yellowfin tuna per school type per year.

Year	FOB-associated	Free-school	Unknown	Total
1987	0	0	659	659
1988	0	0	664	664
1989	0	0	401	401
1990	279	119	407	805
2003	78	75	342	496
2004	0	82	691	773
2005	235	10	979	1,224
2006	105	337	3,339	3,781
2007	61	34	1,524	1,619
2008	9	27	926	962
2009	513	100	2,008	2,621
2010	433	123	944	1,500
2011	629	591	604	1,824
2012	233	510	2,688	3,431
2013	381	36	944	1,361
2014	523	178	402	1,103
2015	598	37	425	1,060
2016	0	0	294	294
2017	114	0	140	254
2018	165	0	251	416
2019	0	0	666	666
Total	4,356	2,259	19,299	25,914

Table 7.2: Number of sampled yellowfin tuna per size class per year.

Year	< 75 cm	75 - 120 cm	> 120 cm
1987	13	423	223
1988	11	254	399
1989	19	189	193
1990	804	1	0
2003	0	166	330
2004	0	157	616
2005	0	1,089	135
2006	0	2,670	1,111
2007	0	960	659
2008	0	163	799
2009	158	1,244	1,219
2010	331	304	865
2011	31	752	1,041
2012	16	1,781	1,634
2013	189	462	710
2014	678	272	153
2015	751	229	80
2016	230	4	60
2017	197	24	33
2018	342	74	0
2019	640	26	0
Total	4,410	11,244	10,260

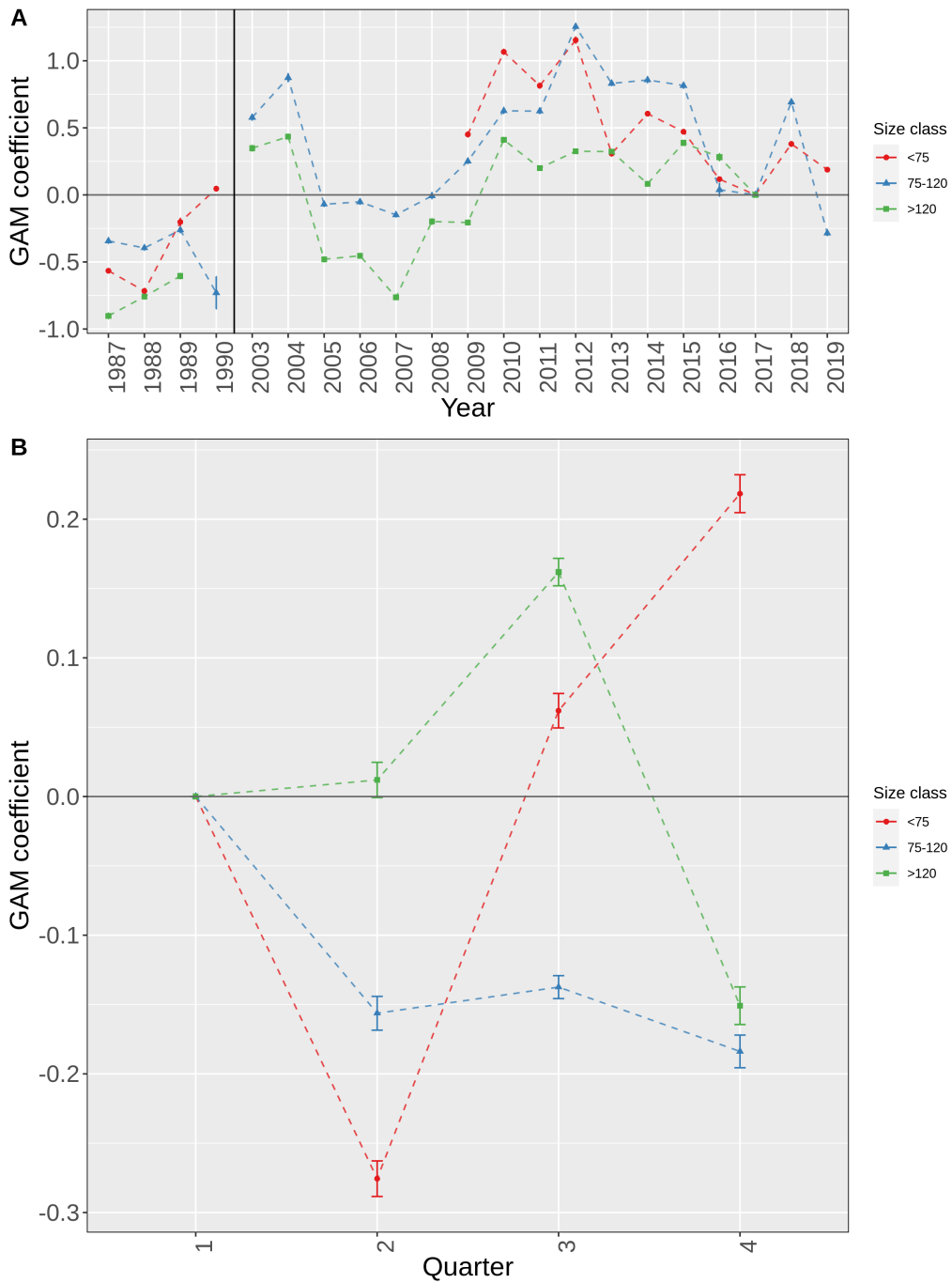

Figure 7.3: Coefficients of the Generalized Additive Models considering a subset of data. Only small fish (< 75cm, red circles), only medium fish (75-120 cm, blue triangles) or only large fish (> 120cm, green squares). Coefficients of the fishing year (A) and of the quarter (B). Each coefficient represent the mean deviation of $T(K_n)$ from the values at a given level of reference. The error bars represent the standard deviation. Considered categories of reference: Y: 2017; Q: Q1. The year 2017 was chosen as the reference year because it is the most recent year with all size classes measured.

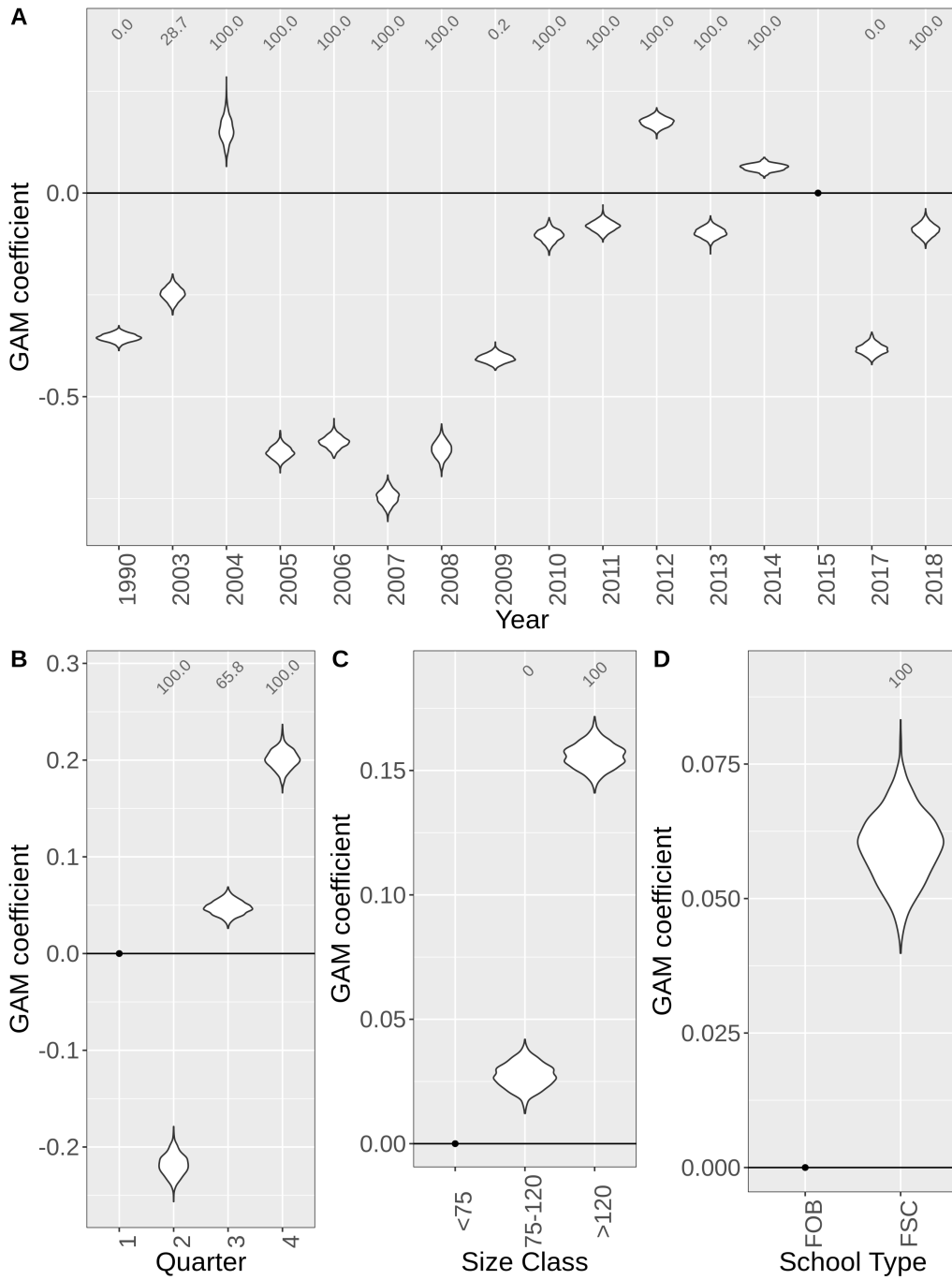

Figure 7.4: Coefficients of the Generalized Additive Model with fishing mode as an explanatory variable. Coefficients of the fishing year (A), of the quarter (B), of the size class (C) and of the fishing mode (D). Please note that each coefficient represents the mean deviation of $T[K_n]$ from the values for a given category of reference. The shape of the point represents the distribution of the obtained values. The numbers in grey in the upper part of the panels represent the percentage of the models generated in the bootstrap for which the given category was significantly different from the category of reference. Considered categories of reference, represented by a black dot: Y: 2015; Q: Q1; SC: < 75 cm, FM: FOB. 2015 was chosen as the reference year because it is the most recent year with both FOB-associated and FSC tuna, as only FOB-associated tuna were sampled in 2016 and 2017. The $T[K_n]$ of FSC was significantly higher than that of FOB-associated tuna in all the models generated in the bootstrap (see panel D).

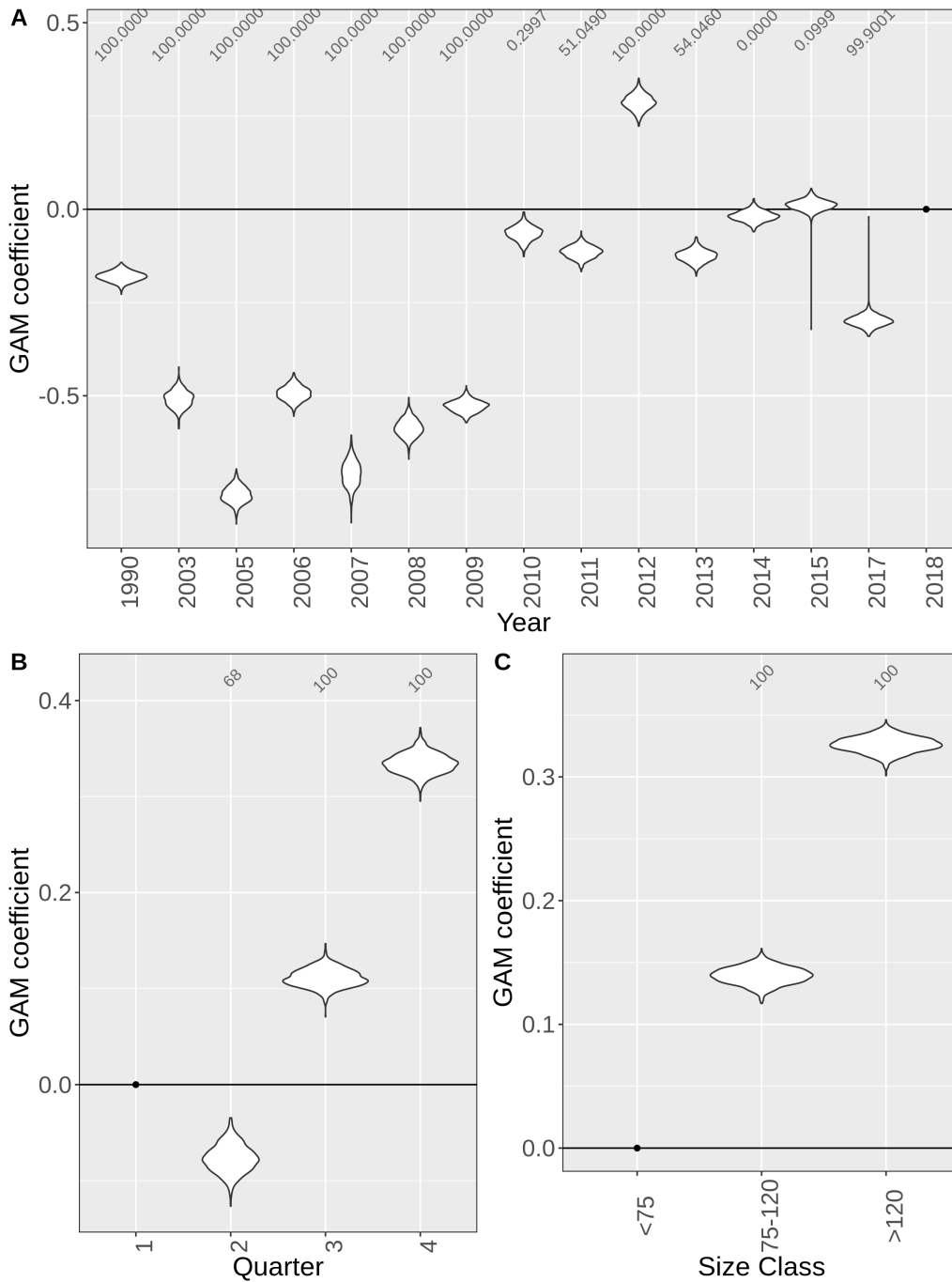

Figure 7.5: Coefficients of the Generalized Additive Models considering only fish caught in FOB-associated schools. Coefficients of the fishing year (A) of the quarter (B) and of the size class (C). Each coefficient represent the mean deviation of $T[K_n]$ from the values for a given category of reference. The shape of the point represents the distribution of the obtained values. The numbers in grey in the upper part of the panels represent the percentage of the models generated in the bootstrap for which the given category was significantly different from the category of reference. Considered categories of reference: Y: 2018; Q: Q1; SC: < 75 cm.

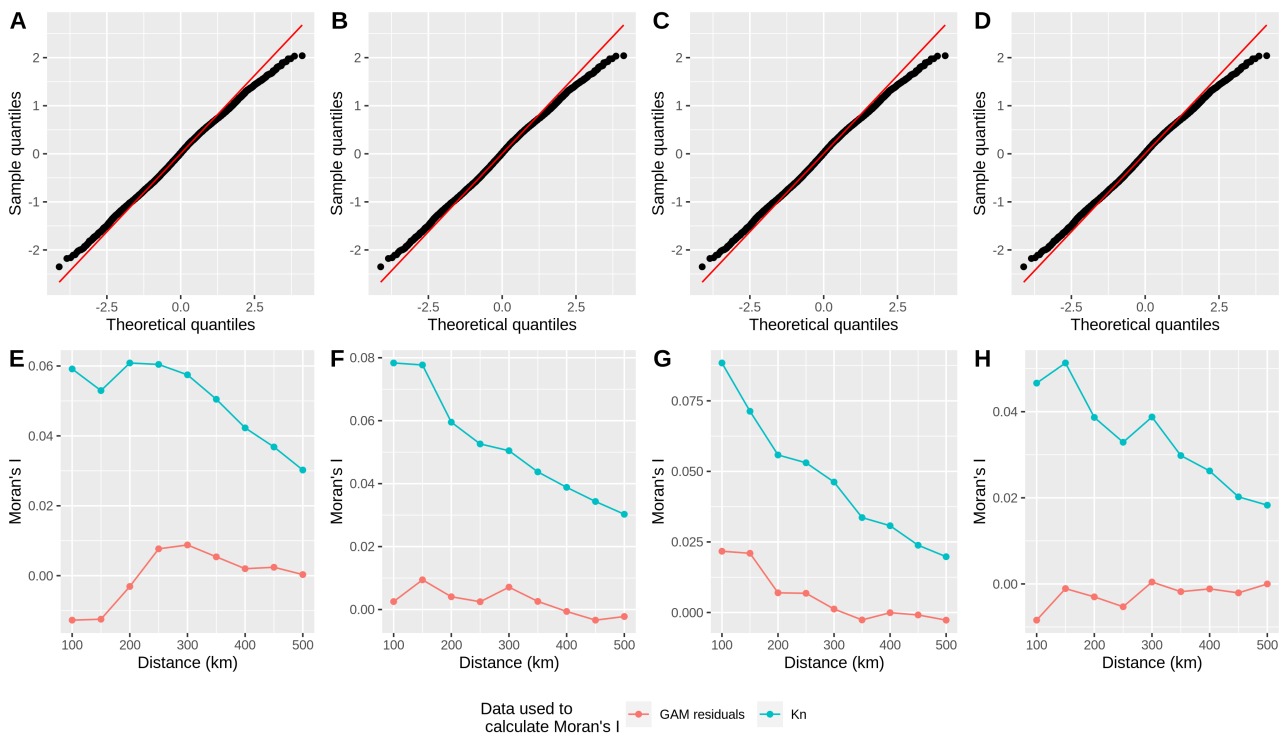

Figure 7.6: Diagnostic plots of the residuals of 4 randomly picked Generalized Additive Models performed. (A-D) Quantile-quantile plots of the residuals. (E-H) Plot of the Moran's I in the data, in blue, and in the model residuals, in red. Distances on x axis is the distance used to define two points as "linked" in the Moran's I calculation (see details of the *dnearneigh* function in the *spdep* package in R).

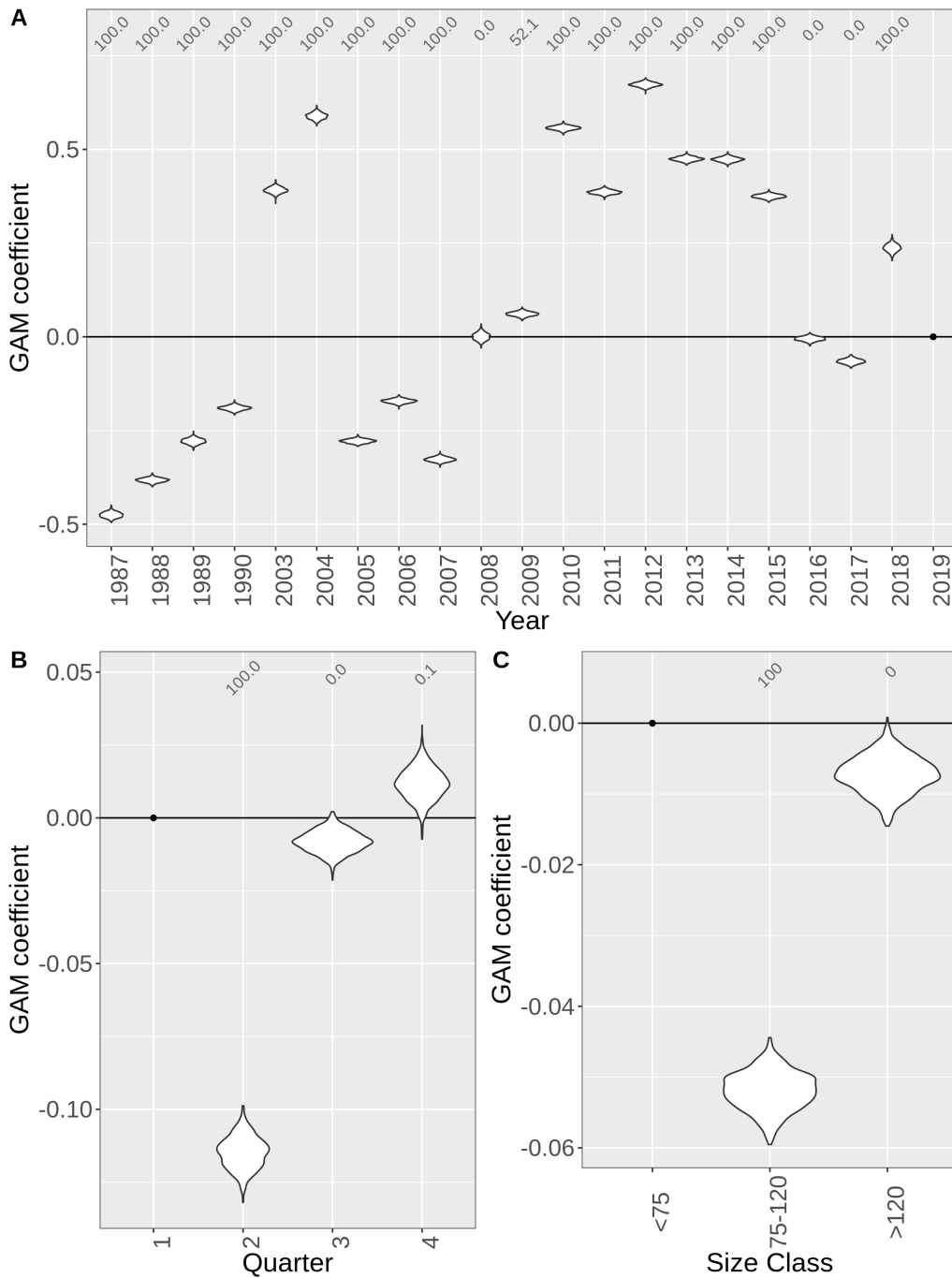

Figure 7.7: Coefficients of the Generalized Additive Model presented in the main manuscript. Coefficients of the fishing year (A) (same as panel B of Figure 7.2), of the quarter (B) and of the size class (C). Each coefficient represents the mean deviation of $T[K_n]$ from the values for a category of reference. The shape of the points represents the distribution of the values obtained with the bootstrap process. Numbers in grey in the upper part of the panels represent the percentage of the models generated in the bootstrap for which a given category was significantly different from the category of reference. Considered category of reference, represented by a black dot: Y: 2019; Q: Q1; SC: < 75 cm.

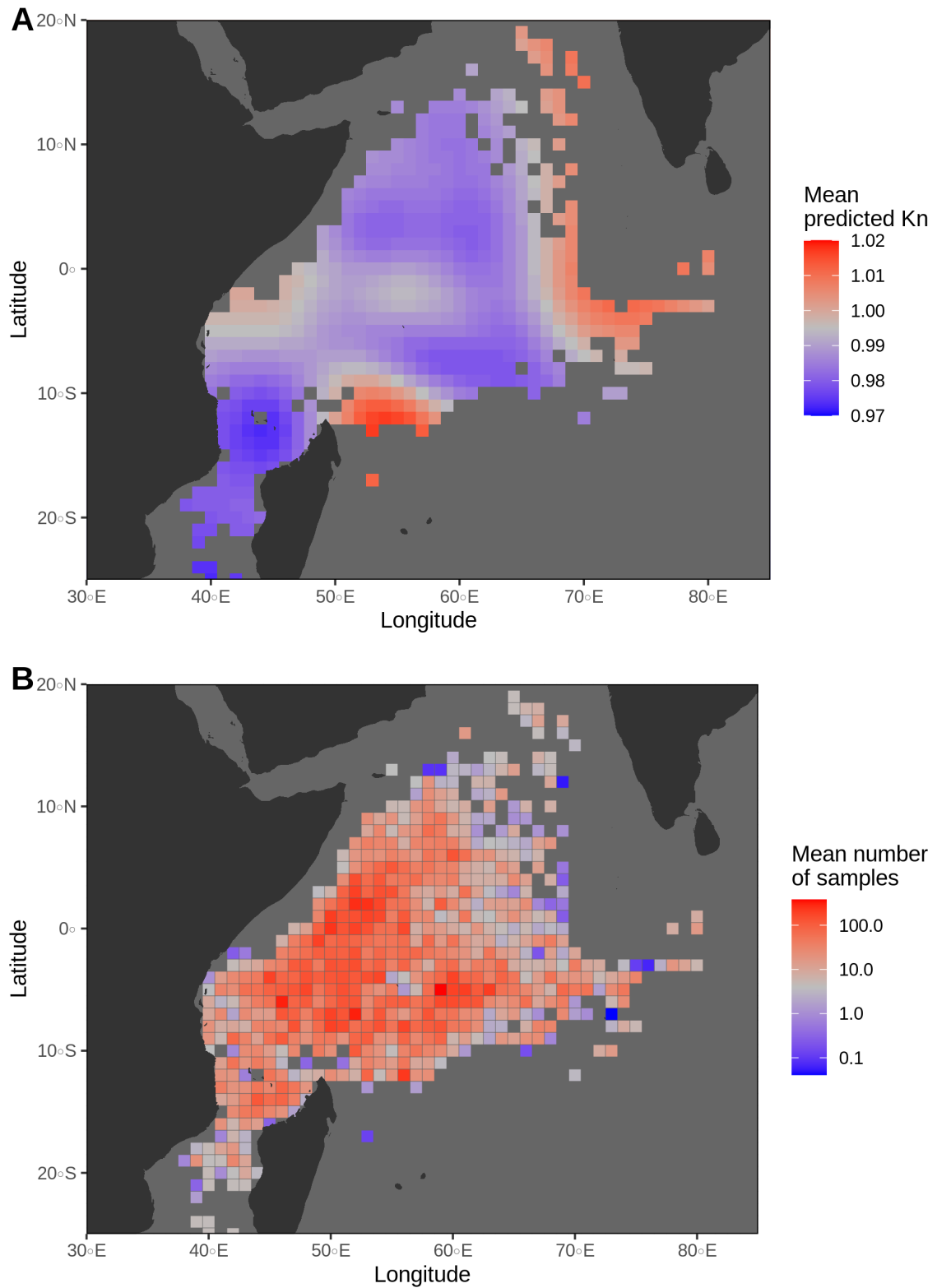

Figure 7.8: Spatial prediction of the Generalized Additive Models. (A) Mean predicted value of K_n . (B) Mean number of samples in the data used as input in the model. Dark grey cells represent cells in which no tuna was sampled. Considered categories of reference for the prediction: Y: 2019; Q: Q1; size class: < 75 cm.

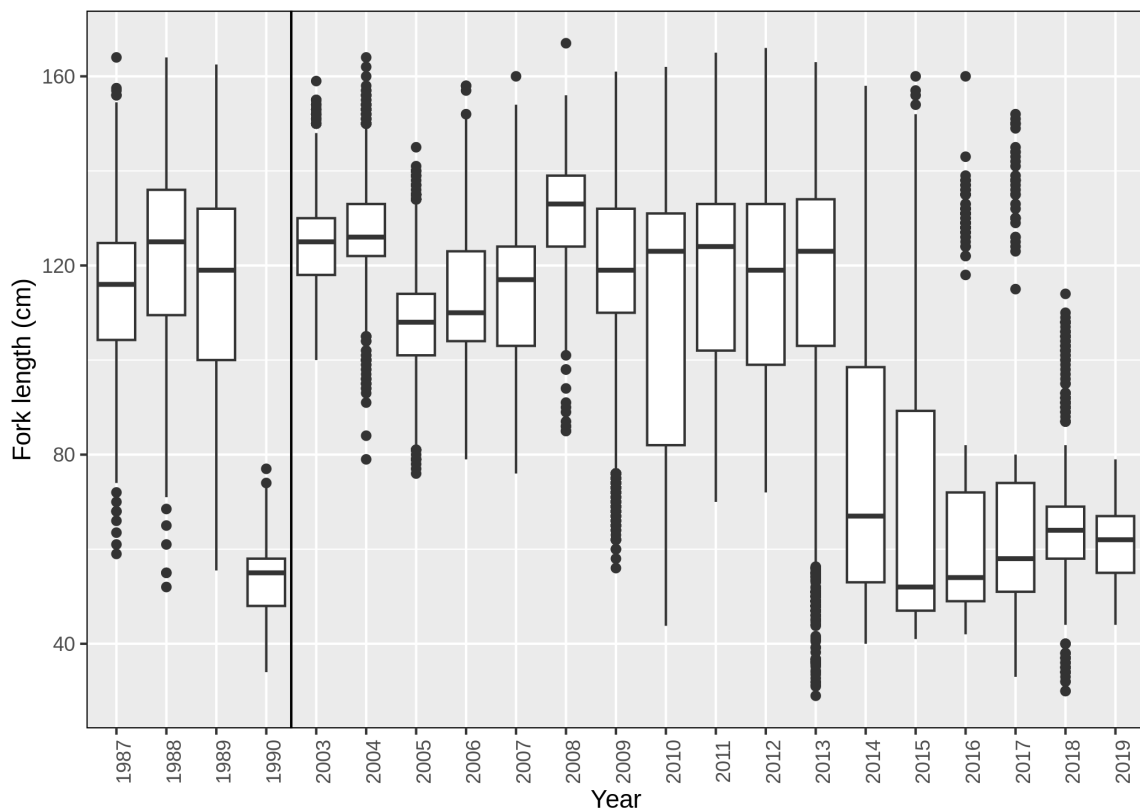

Figure 7.9: Boxplot of the fork length of sampled tuna per year. The uneven distribution of the sampling is mainly due to the fact that data comes from different research projects, which do not always aim at studying the same size class.

7.5.2 Fit of the allometric relationship

The power-law function $W = aFL^b$ was used to fit the fish weight as a function of the fork length data recorded throughout the study period (Figure 7.10), using a linear regression procedure of the log- transformed data (using the *lm* function of the package *stats* in R). The parameters presented in Table 7.3 were obtained.

Table 7.3: Values of the parameters fitted for the relation between Weight and Fork Length:
 $W = aFL^b$

	Value	Standard deviation	p-value
$\ln(a)$	-10.658	$7.5 \cdot 10^{-3}$	$< 10^{-16}$
a	$2.35 \cdot 10^{-5}$		
b	2.976	$1.6 \cdot 10^{-3}$	$< 10^{-16}$

Hence, $W_{th} = 2.35 \times 10^{-5} FL^{2.976}$, $R^2 = 0.992$; where W_{th} is the predicted weight, in kilograms, and FL is the fork length, in centimeters.

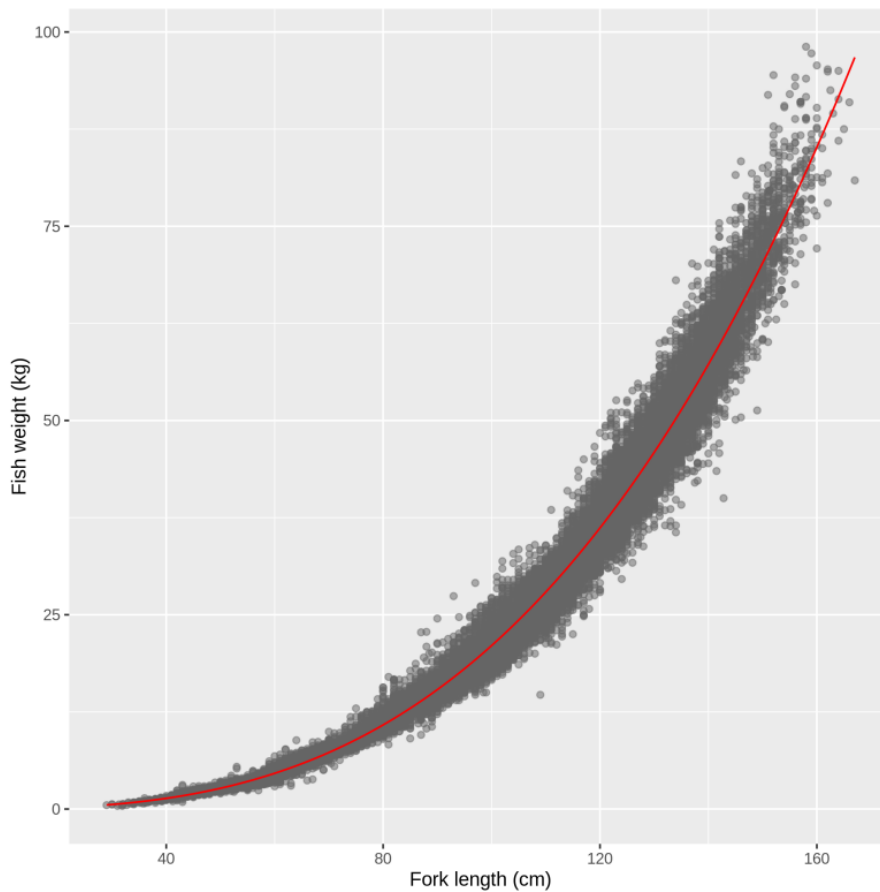

Figure 7.10: Relationship between fish weight and fork length.

7.5.3 Geary-Hinkley transformation applied to K_n

The transformed $T[K_n(i)]$ was obtained as follows:

$$T[K_n(i)] = \frac{\overline{W_{th}}K_n(i) - \overline{W}}{\sqrt{\sigma_{th}^2 K_n(i)^2 - 2\rho\sigma\sigma_{th}K_n(i) + \sigma^2}} \quad (7.3)$$

where $K_n(i)$ is the relative condition factor of individual (i); \overline{W} is the mean measured weight, and σ its standard deviation; $\overline{W_{th}}$ is the mean theoretical weight, and σ_{th} its standard deviation. Geary 1930 demonstrated that $T[K_n(i)]$ is normally distributed with mean zero and standard deviation unity.

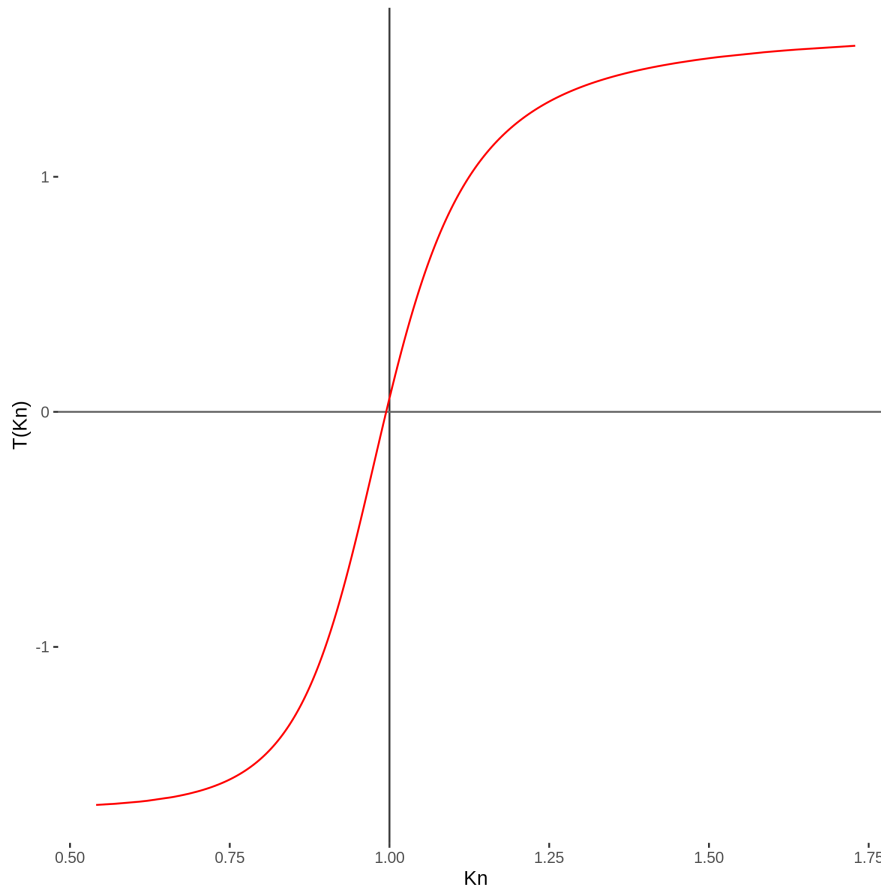

Figure 7.11: Result of the Geary-Hinkley transformation performed on $K_n(i)$.

7.5.4 Correlation between the number of FOBs and K_n in 2013-2019

The number of DFADs used in the Indian Ocean has increased during the study period (1987-2019) but no exact trend of floating objects (FOBs) number exist covering the whole period. The total number of FOBs for 2013-2019 was estimated in Baidai 2020, using the number of buoys used by the french purse seine fleets and raising factors from Katara et al. 2018 and Dupaix et al. 2021a.

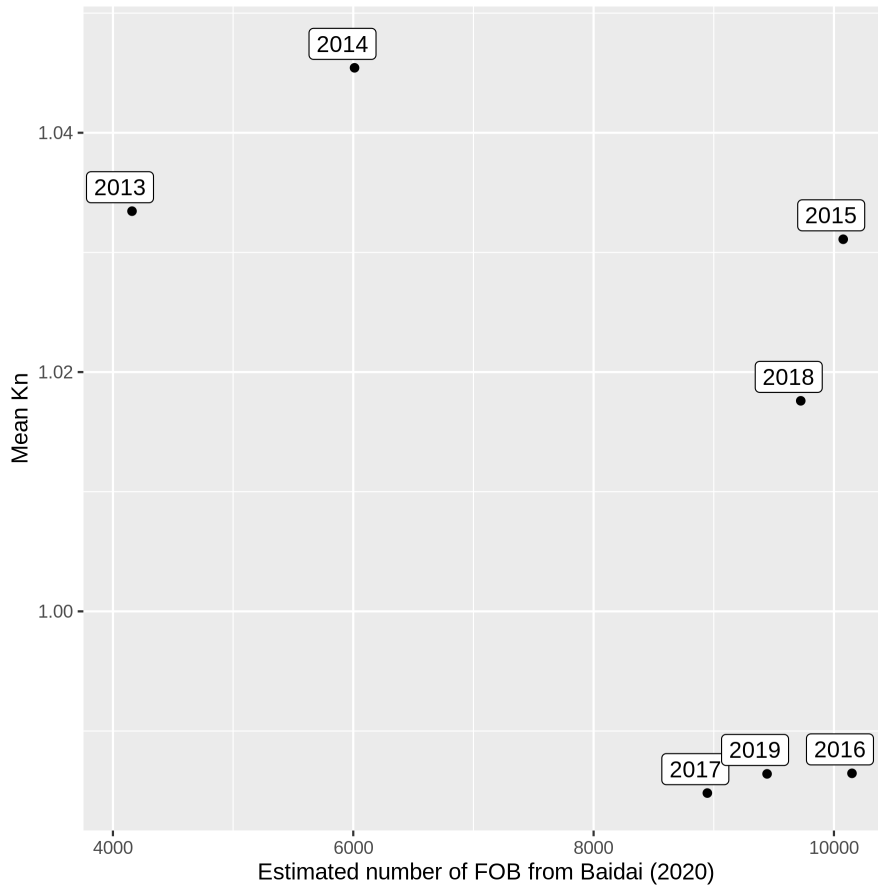

Figure 7.12: Relationship between the mean relative condition factor (K_n) and the mean number of floating objects (FOBs) in 2013-2019.

Using Baidai 2020's estimation, we tested if a correlation could be observed between the mean relative condition factor (K_n) and the mean total number of FOBs in the Indian Ocean in 2013-2019 (Figure 7.12), using a Spearman's rank correlation test. No correlation was observed: $\rho = -0.357$; p-value = 0.44.

Transition

In this chapter, I assessed the long-term impact of DFADs on tuna condition and found no decreasing trend of physiological condition of YFT from 1987 to 2019 in the WIO. With this work, I found no evidence of the ecological trap hypothesis as formulated 20 years ago in Marsac et al. 2000. The ecological trap hypothesis stipulates that DFADs could retain or attract tuna in areas that are detrimental to them, and relies on the fact that tuna are in a lower condition when associated than when caught in FSC. Although this fact is more or less consensual (see Chapter 2), the causal relationship between tuna associative behavior and a lower condition is unknown (Robert et al. 2014a): we do not know if tuna are in a lower condition because they are associated or if they associate with DFADs because they are in a lower condition. This causal relationship could have great implications for the potential indirect impacts of DFADs on tropical tuna. In the next chapter (Chapter 8) I develop a mathematical framework to determine this causal relationship.



Chapter 8

The low condition of tropical tuna associated with drifting Fish Aggregating Devices, a chicken-and-egg story

Publication

Dupaix, A., Deneubourg, J.-L., Dagorn, L., & Capello, M. (In prep.). The low condition of tropical tuna associated with drifting Fish Aggregating Devices, a chicken-and-egg story.

8.1 Introduction

Several species of pelagic fish associate with floating objects, such as logs or branches, which are natural components of their habitat (referred to as NLOGs). Although the reasons for this behavior are not well understood, fishers have traditionally exploited it to locate and capture associated fish (Fréon and Dagorn 2000). The use of this associative behavior by fishers was first mentioned in the *Halieutica* by Oppian, a Greek poet in the 2nd century (Oppian 200 AD), and mentions of the deployment of man-made floating objects moored to the ocean floor (called anchored fish aggregating devices) were found in the 14th and 18th century in the Mediterranean Sea (Taquet 2013). Since the early 1980s, industrial tropical tuna purse-seine fleets have been using radio and GPS buoys to follow NLOGs and have also been constructing and deploying their own man-made floating objects, left adrift (called drifting fish aggregating devices DFADs; Dagorn et al. 2013b). The deployment of DFADs has increased significantly over the past few decades, with the latest global estimate suggesting between 81,000 and 121,000 deployments per year (Gershman et al. 2015). In the Indian Ocean (IO), deployment and use of DFADs began in the 1990s and has also increased since then, such that from 2012 to 2018, DFADs represented more than 85% of the total floating objects in the western IO (Dupaix et al. 2021a).

The widespread use of DFADs has led to several ecological impacts, including pollution, damage to coasts through stranding, increased bycatch, and ghost fishing (Imzilen et al. 2021; Tolotti et al. 2022; Filmalter et al. 2013). Moreover, for tropical tuna (skipjack SKJ – *Katsuwonus pelamis* –, yellowfin YFT – *Thunnus albacares* – and bigeye BET – *Thunnus obsesus* – tunas), the use of DFADs has increased purse seine fleets efficiency and tuna availability to this fishery by increasing the time tuna spend associated with floating objects (noted FOBs, Chapter 5). More than 50 % of the tuna caught worldwide by purse seine vessels is caught on floating objects and it goes up to 90 % in the Indian Ocean (ISSF 2023; IOTC 2022e). Skipjack tuna stocks are currently not overfished, *i.e.* their biomass is above the maximum sustainable yield reference point, and they are not subject to overfishing, *i.e.* their fishing mortality is below the maximum sustainable yield reference point. However, bigeye tuna stocks in the Indian, Atlantic, and Eastern Pacific Oceans are overfished, with two of them also subject to overfishing (ISSF 2023). Additionally, in the Indian Ocean, yellowfin tuna stocks are currently both overfished and subject to overfishing (IOTC 2022a). Hence, based on the increased purse-seine fleets efficiency (Fonteneau et al. 2015) and yield of juvenile yellowfin and bigeye tunas (IOTC 2022e) due to DFADs, and on tuna stock assessments (ISSF 2023), it is indisputable that DFADs have an impact on tropical tuna populations, at least in some oceans.

However, soon after their wide-scale use began, it was also hypothesized that DFADs may act as *ecological traps* for tropical tunas, *i.e.* indirectly impact tuna’s fitness (Marsac et al. 2000; Hallier and Gaertner 2008). An ecological trap occurs when individuals exhibit a higher or equal preference for a poor-quality habitat (*i.e.* associated with a lower fitness) over another habitat, being misled by cues that no longer correlate to habitat quality due to anthropogenic changes (Robertson and Hutto 2006; Gilroy and Sutherland 2007). This decorrelation between habitat quality and habitat selection cues ultimately leads to a reduction in the fitness of individuals (Gilroy and Sutherland 2007; Swearer et al. 2021). The hypothesis of DFADs acting as ecological traps, relies on the *indicator-log* hypothesis, one of the hypotheses formulated to explain tuna associative behavior (Castro et al. 2002; Fréon and Dagorn 2000). This hypothesis posits that tunas and other associated species use natural floating objects as cues to select good-quality habitat (Hall 1992; Hallier and Gaertner 2008). NLOGs would be located in productive areas because they originate from rivers and tend to accumulate in rich frontal zones. Hence, the massive deployment of DFADs could modify the spatial distribution of floating objects, with potentially large numbers of objects occurring in poor areas, creating the risk of an ecological trap.

A proxy to assess tuna fitness is their physiological condition. Marsac et al. 2000 and Hallier and Gaertner 2008 compared the thorax girth (body width divided by fork length) of tuna caught at DFADs to those caught in free-swimming schools (FSC) and found that DFAD-associated tuna were in lower condition than FSC tuna in the Indian and Atlantic Oceans. This evidence was seen as supporting the ecological trap hypothesis, suggesting that DFAD could have a negative impact on tuna condition. However, Robert et al. 2014a used Bioelectrical Impedance Analysis to compare the condition of associated and non-associated tunas in the Mozambique Channel, Western Indian Ocean, an area rich in NLOGs, *i.e.* only marginally modified by the addition of DFADs at the time. They also found that FOB-associated tuna condition was lower than FSC tuna condition. Hence, while tuna may be in a lower condition when associated with floating objects, the causality of this relationship has not yet been determined, *i.e.* we do not know if tuna associate with FOBs because they are in lower physiological condition or if their condition decreases following their association with FOBs. The *meeting-point* hypothesis (Fréon and Dagorn 2000; Soria et al. 2009) suggests that tuna associate with floating objects to find conspecifics and form bigger schools, which may improve foraging efficiency (Ioannou 2017; Maury 2017; Rubenstein 1978). It is then possible that tuna associate with floating objects when they are in a low condition to form schools and increase their condition recovery afterwards. Therefore, the correlation between tuna association with floating objects and low individual condition could imply either that the association with a floating object results in a poorer condition (Hypothesis H_1 , which would be in agreement with studies arguing that tuna are fasting when associated with FOBs; Hallier and Gaertner 2008; Marsac et al. 2000; Ménard et al. 2000b) or that tuna tend to associate when they are in a lower condition (Hypothesis H_2).

The objective of this study is to design a framework that would allow to determine whether the low condition of tuna is the cause or the consequence of their association with floating objects. We design a simple mathematical model accounting for both the associative behavior of tuna with DFADs and their physiological condition. The model is used to test two different hypotheses that can explain a lower condition of DFAD-associated tuna: either (H_1) tuna association to DFADs induces a decrease of condition or (H_2) tuna with a lower condition are more prone to associating with DFADs. Based on these two hypotheses, we determine the influence of an increase of DFAD number on the mean condition of associated and non-associated tuna. This model allows the design of field data collection programs measuring the mean physiological condition of associated and/or free-swimming tuna at different DFAD densities to determine if the low condition of associated tuna is the cause or the consequence of their association with DFADs.

8.2 Material and Methods

8.2.1 General model formulation

Tuna individuals are considered in two states relative to their association with DFADs: they are either associated with DFADs (noted A) or free-swimming (noted F, Figure 8.1A). In each state A or F, individuals can be in two discrete and binary physiological states: they are either in "good" (with a given physiological variable equal to e^+) or "bad" (e^-) physiological condition. The physiological condition of individuals is a continuous variable but fish individuals can be in three different physiological "phases" during fasting (Bar and Volkoff 2012; Le Maho et al. 1981). During the phase I, they mainly produce energy from carbohydrates and lipids, and we can consider them in a "good" physiological state. Then, in phase II, they mobilize stored lipids, and we consider them to be in a "bad" physiological state. If individuals experience starving for too long, they can enter a "critical" phase III, where they have depleted their lipid

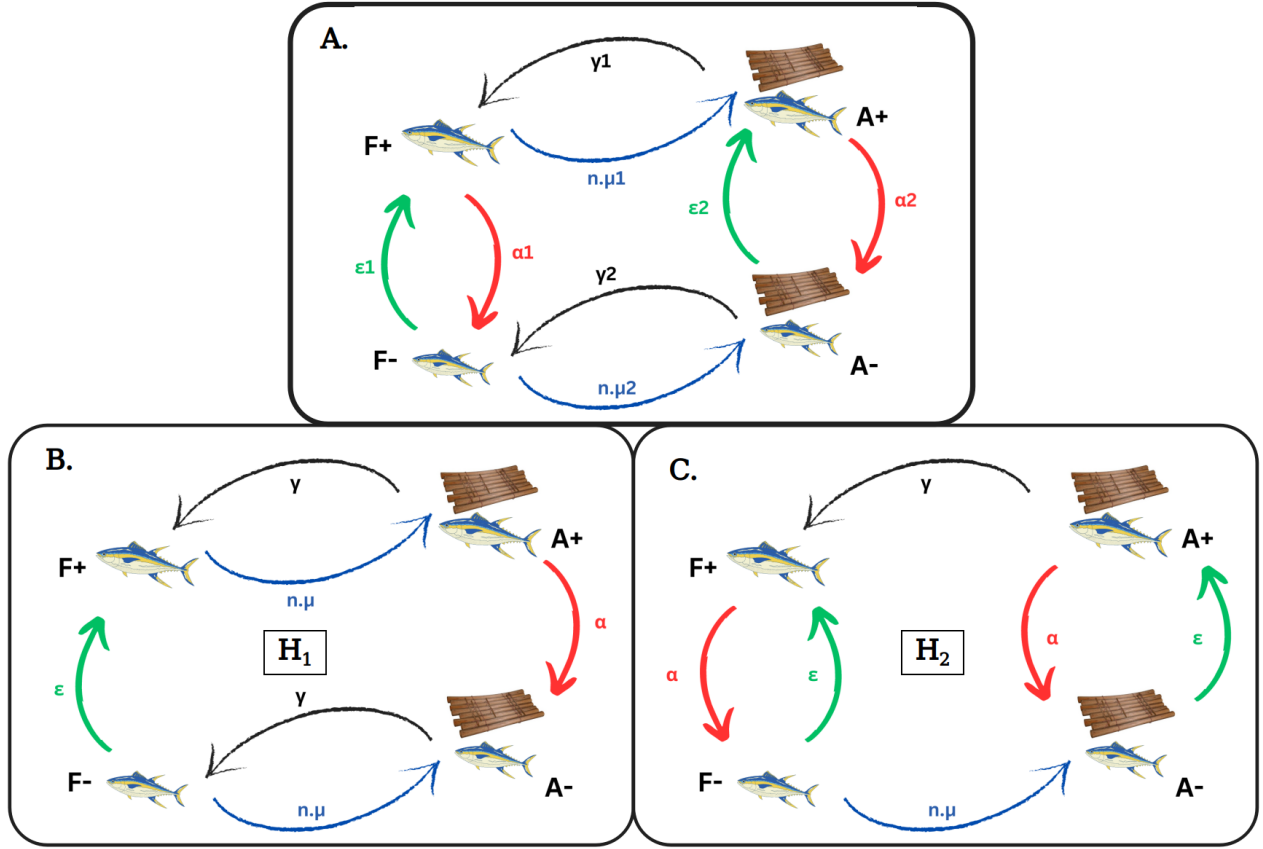

Figure 8.1: Schematic of the models used in the study. (A) General model, (B) H_1 model following the hypothesis that tuna association with DFADs induces a reduction of their condition, (C) H_2 model following the hypothesis that tuna associate with DFADs because they are in low condition. F^+ and F^- : free-swimming state with high condition and low condition respectively. A^+ and A^- : associated state with high condition and low condition respectively.

reserves and start degrading proteins to produce energy. However, as phase III is happening late in the fasting process, we did not consider it in our study.

The overall model describing the behavior and physiology of tuna corresponds to a 4-state model: A^+ (associated with good condition), A^- (associated with bad condition), F^+ (free-swimming with good condition) and F^- (free-swimming with bad condition). The temporal evolution of the number of individuals in each state (N_{A^+} , N_{A^-} , N_{F^+} and N_{F^-}) can be written using the following equations:

$$\begin{cases} \frac{dN_{A^+}}{dt} = -(\gamma_1 + \alpha_2)N_{A^+} + \epsilon_2N_{A^-} + \mu_1nN_{F^+} \\ \frac{dN_{A^-}}{dt} = -(\gamma_2 + \epsilon_2)N_{A^-} + \alpha_2N_{A^+} + \mu_2nN_{F^-} \\ \frac{dN_{F^+}}{dt} = -(\mu_1n + \alpha_1)N_{F^+} + \gamma_1N_{A^+} + \epsilon_1N_{F^-} \\ \frac{dN_{F^-}}{dt} = -(\mu_2n + \epsilon_1)N_{F^-} + \gamma_2N_{A^-} + \alpha_1N_{F^+} \end{cases} \quad (8.1)$$

where $\mu_i n$, γ_i , ϵ_i and α_i ($i \in \{1, 2\}$) are probabilities to change state per unit-time ($\in [0, 1]$) and n is the number of DFADs ($\in \mathbb{N}^+$). The model assumes that the probability to associate with DFADs is directly proportional to n (Figure 8.1A).

We introduce the mean condition of the associated fraction (\bar{e}_A) and the mean condition of the free-swimming fraction of the population (\bar{e}_F). \bar{e}_A and \bar{e}_F are both functions of n and can be expressed as follow:

$$\bar{e}_A(n) = \frac{N_{A^+}(n)}{N_{A^+}(n) + N_{A^-}(n)}e^+ + \frac{N_{A^-}(n)}{N_{A^+}(n) + N_{A^-}(n)}e^- \quad (8.2)$$

$$\bar{e}_F(n) = \frac{N_{F^+}(n)}{N_{F^+}(n) + N_{F^-}(n)}e^+ + \frac{N_{F^-}(n)}{N_{F^+}(n) + N_{F^-}(n)}e^- \quad (8.3)$$

8.2.2 Hypothesis 1: The association to DFADs induces a bad condition

To formulate the first hypothesis (H_1 : tuna are in bad condition at DFADs because their condition decreases when they are associated, Figure 8.1B) using Eq. 8.1 we consider that (i) tuna associative behavior is independent of their condition ($\mu_1 = \mu_2 = \mu$ and $\gamma_1 = \gamma_2 = \gamma$) and (ii) tuna condition always decreases when they are associated with DFADs ($\epsilon_2 = 0$) and always increases when they are in free-schools ($\alpha_1 = 0$). We obtain a model with the following equations:

$$\begin{cases} \frac{dN_{A^+}}{dt} &= -(\gamma + \alpha)N_{A^+} + \mu n N_{F^+} \\ \frac{dN_{A^-}}{dt} &= -\gamma N_{A^-} + \alpha N_{A^+} + \mu n N_{F^-} \\ \frac{dN_{F^+}}{dt} &= -\mu n N_{F^+} + \gamma N_{A^+} + \epsilon N_{F^-} \\ \frac{dN_{F^-}}{dt} &= -(\mu n + \epsilon)N_{F^-} + \gamma N_{A^-} \end{cases} \quad (8.4)$$

8.2.3 Hypothesis 2: Individuals with a bad condition tend to associate

To formulate the second hypothesis (H_2 : tuna associate with DFADs because they have a low condition, Figure 8.1C), using Eq. 8.1 we consider that (i) changes in tuna condition are independent of their association ($\alpha_1 = \alpha_2 = \alpha$ and $\epsilon_1 = \epsilon_2 = \epsilon$) and (ii) tuna associate with DFADs only when they are in bad condition ($\mu_1 = 0$) and depart from DFADs only when they are in good condition ($\gamma_2 = 0$). We obtain a model with the following equations:

$$\begin{cases} \frac{dN_{A^+}}{dt} &= -(\gamma + \alpha)N_{A^+} + \epsilon N_{A^-} \\ \frac{dN_{A^-}}{dt} &= -\epsilon N_{A^-} + \alpha N_{A^+} + \mu n N_{F^-} \\ \frac{dN_{F^+}}{dt} &= -\alpha N_{F^+} + \gamma N_{A^+} + \epsilon N_{F^-} \\ \frac{dN_{F^-}}{dt} &= -(\mu n + \epsilon)N_{F^-} + \alpha N_{F^+} \end{cases} \quad (8.5)$$

8.2.4 Equilibrium model solution

For the two hypotheses, we first verified that the mean condition of the associated fraction was lower to the mean condition of the free-swimming fraction of the population for any number of DFADs ($\forall n \in \mathbb{N}^+$, $\bar{e}_A(n) < \bar{e}_F(n)$). Then, because the aim was to determine the impact of DFADs on the condition of tuna, we determined the variations of $\bar{e}_A(n)$ and $\bar{e}_F(n)$ and the limits of $\bar{e}_A(n)$ and $\bar{e}_F(n)$ when $n \mapsto +\infty$.

8.3 Results

All the detailed calculation of the results mentioned below are presented in Supplementary Materials (Section 8.5).

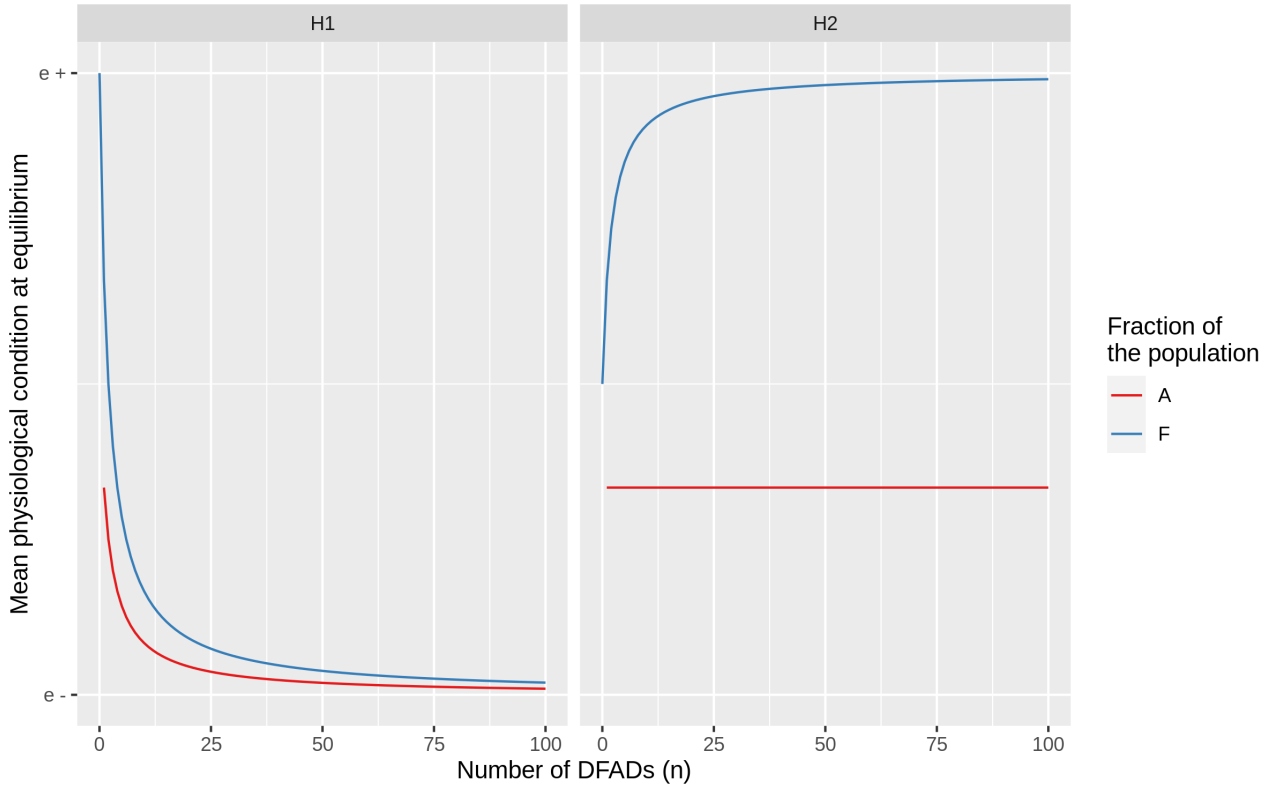

Figure 8.2: Variations of \bar{e}_A and \bar{e}_F as a function of the number of DFADs (n). Left panel: H_1 model following the hypothesis that tuna association with DFADs *induces* a reduction of their condition. Right panel: H_2 model following the hypothesis that tuna associate with DFADs *because* they are in low condition. A : DFAD-associated state; F : free-swimming state. Example with $\alpha = 10^{-2}$, $\epsilon = 10^{-2}$, $\gamma = 10^{-2}$ and $\mu = 10^{-2}$.

8.3.1 Comparison of the mean condition of associated and free-swimming populations

In the model formulated according to H_1 (the association to DFADs induces a bad physiological condition), we can demonstrate that

$$\bar{e}_A < \bar{e}_F \Leftrightarrow \epsilon + \mu n \frac{\alpha}{\gamma} + \epsilon \frac{\alpha}{\gamma} > 0 \quad (8.6)$$

which is always true, as ϵ , μ , α , γ and n are all strictly positive (see Section 8.5.1.5).

In the second model, formulated according to H_2 (only individuals in a bad physiological condition associate with DFADs), we can demonstrate that

$$\bar{e}_A < \bar{e}_F \Leftrightarrow \left[\frac{\gamma}{\alpha} + 1 \right] \left[\frac{\mu n}{\epsilon} + 1 \right] > 1 \quad (8.7)$$

Because γ , ϵ , μ and α are strictly positive, $\frac{\gamma}{\alpha} + 1 > 1$ and $\frac{\mu n}{\epsilon} + 1 > 1$. Hence, Eq. 8.7 is always true (see Section 8.5.2.5).

Both formulated models verify that $\forall n \in \mathbb{N}^+$, $\bar{e}_A(n) < \bar{e}_F(n)$. Hence, the models do verify that the mean condition of associated tuna is lower than the mean condition of free-swimming tuna.

8.3.2 Variations of the mean condition of the associated population for an increasing number of DFADs

In the model based on H_1 (the association to DFADs induces a bad physiological condition) we can demonstrate that

$$\bar{e}_A(n) = \frac{\frac{\epsilon\gamma}{\alpha}e^+ + (\mu n + \epsilon)e^-}{\frac{\epsilon\gamma}{\alpha} + (\mu n + \epsilon)} \quad (8.8)$$

Hence $\lim_{n \rightarrow +\infty} \bar{e}_A = e^-$. Also, we can show that

$$\bar{e}_A(n) > \bar{e}_A(n+1) \Leftrightarrow \frac{\mu\epsilon\gamma}{\alpha}(e^+ - e^-) > 0 \quad (8.9)$$

Therefore, under H_1 , because $e^+ > e^-$, we have $\forall n \in \mathbb{N}^+$, $\bar{e}_A(n) > \bar{e}_A(n+1)$, *i.e.* \bar{e}_A is a decreasing sequence of n (see Section 8.5.1.1).

In the model based on H_2 (only individuals in a bad physiological condition associate with DFADs) we can demonstrate that

$$\bar{e}_A(n) = \frac{\epsilon e^+ + (\gamma + \alpha)e^-}{\epsilon + (\gamma + \alpha)} \quad (8.10)$$

meaning that under H_2 , \bar{e}_A is independent from n (see Section 8.5.2.1).

To summarize, under the hypothesis that the association to DFADs induces a bad physiological condition (H_1), we can demonstrate that an increasing number of DFADs will reduce the mean condition of the associated population (Figure 8.2). When we hypothesize that only individuals in bad condition associate with DFADs (H_2), an increasing number of DFADs will not impact the condition of the associated population (Figure 8.2).

8.3.3 Variations of the mean condition of the free-swimming population for an increasing number of DFADs

In the model formulated according to H_1 (the association to DFADs induces a bad physiological condition) we can demonstrate that

$$\bar{e}_F(n) = \frac{\epsilon(1 + \frac{\gamma}{\alpha})e^+ + \mu n e^-}{\epsilon(1 + \frac{\gamma}{\alpha}) + \mu n} \quad (8.11)$$

Hence $\lim_{n \rightarrow +\infty} \bar{e}_F = e^-$. We can also show that

$$\bar{e}_F(n) > \bar{e}_F(n+1) \Leftrightarrow \mu\epsilon(1 + \frac{\gamma}{\alpha})(e^+ - e^-) > 0 \quad (8.12)$$

Therefore, under H_1 , because $e^+ > e^-$, we have $\forall n \in \mathbb{N}^+$, $\bar{e}_F(n) > \bar{e}_F(n+1)$, *i.e.* \bar{e}_F is a decreasing sequence of n (see Section 8.5.1.3).

In the model based on H_2 (only individuals in a bad physiological condition associate with DFADs) we can demonstrate that

$$\bar{e}_F(n) = \frac{(\mu n + \epsilon)e^+ + \alpha e^-}{\mu n + \epsilon + \alpha} \quad (8.13)$$

Hence, under H_2 , $\lim_{n \rightarrow +\infty} \bar{e}_F = e^+$. Also,

$$H_2 \Rightarrow \bar{e}_F(n) < \bar{e}_F(n+1) \Leftrightarrow \mu\alpha(e^- - e^+) < 0 \quad (8.14)$$

Therefore, under H_2 , because $e^+ > e^-$, we have $\forall n \in \mathbb{N}^+$, $\bar{e}_F(n) < \bar{e}_F(n+1)$, *i.e.* \bar{e}_F is an increasing sequence of n (see Section 8.5.2.3).

Hence, if we consider that the association to DFADs induces a reduction of individuals condition (H_1), an increasing number of DFADs will provoke a decrease of the mean condition of the free-swimming population (Figure 8.2). On the contrary, if we hypothesize that only individuals in a bad physiological condition will associate with DFADs (H_2), an increasing number

of DFADs will provoke an increase of the mean condition of the free-swimming population (Figure 8.2).

8.4 Discussion

Tropical tunas are among the most targeted species worldwide, with around 5 million tons caught yearly in 2017-2021, and the main fishing gear targeting them is purse seining, with 66 % of the global catch (ISSF 2023). Since the 1990s, tuna purse seine vessels started to rely increasingly on drifting Fish Aggregating Devices (DFADs), strongly increasing the number of floating objects at sea (Dupaix et al. 2021a; Fonteneau et al. 2013). With several tropical tuna stocks being overfished and subject to overfishing in the world (ISSF 2023) the increase of purse seiners' efficiency due to DFAD fishing is considered a major issue by tuna Regional Fisheries Management Organizations (Miyake et al. 2010; Fonteneau et al. 2015; Wain et al. 2021). Besides the direct effects of DFADs (*i.e.* linked with an increase of fishing mortality), the fact that tuna are in lower condition when associated with floating objects than in free schools has lead to the hypothesis that DFADs could also have indirect ecological impacts on tunas, affecting their fitness and lowering the productivity of tuna stocks (Marsac et al. 2000; Hallier and Gaertner 2008).

Table 8.1: Studies demonstrating that tuna are in lower physiological condition in associated schools than in free-swimming schools. WIO, AO, WCPO: Western Indian, Atlantic and Western and Central Pacific Oceans respectively

Species	Ocean	Indicator used	Study
Skipjack tuna	WIO	Phase angle (Bioelectrical Impedance Analysis)	Robert et al. 2014a
	WIO & AO	Thorax Girth (TG)	Hallier and Gaertner 2008
	AO	Body width divided by fork length	Marsac et al. 2000
	WCPO AO	Relative condition factor (K_n) Stomach fullness	Ashida et al. 2017 Ménard et al. 2000b
Yellowfin tuna	WIO	Lipid content (in gonads)	Zudaire et al. 2014
	WIO & AO	TG	Hallier and Gaertner 2008
	WIO	K_n	Dupaix et al. 2023a in Supplement
	AO	Stomach fullness	Ménard et al. 2000b
Bigeye tuna	AO	Stomach fulness	Ménard et al. 2000b

Both models in this study provide an average lower condition for DFAD-associated tuna than tuna in free-swimming schools (FSC), in agreement with previous studies conducted considering various condition indicators (Table 8.1). As FSC tuna are caught while actively feeding, caution must be taken when interpreting the conclusions drawn from indicators such as thorax girth and stomach fullness (Hallier and Gaertner 2008; Marsac et al. 2000; Ménard et al. 2000b), as these indicators are probably responding to tuna alimentation on a very short-term basis. In addition, Sardenne et al. 2016 compared morphometric indices such as thorax girth or relative condition factor (K_n , used in Ashida et al. 2017; Dupaix et al. 2023a) with energy contents in the tissues and showed that such indices should be used carefully on tropical tunas as they do not always properly reflect individuals' condition. Other evidence by Zudaire et al. 2014, which found a difference in total lipid content in female yellowfin tuna gonads, could also be attributed to a different reproductive strategy rather than a difference in physiological

condition. Therefore, apart from the results obtained by Robert et al. 2014a, which relied on the phase angle measured by Bioelectrical Impedance Analysis, most studies that show a difference in condition between FSC and FOB-associated tuna relied on indicators that require careful interpretation. To be able to rely on condition indicators, experimental validation of indicators are needed. This validation could be performed experimentally, by monitoring a set of condition indicators on captive tuna while fasting. It would allow the confirmation of the fact that tuna are in lower condition when associated, but it would also allow to determine the exact meaning of this difference of tuna's condition.

The causality link between the low condition at floating objects and the associative behavior of tuna is yet to be determined (Robert et al. 2014a). This study develops a theoretical framework allowing to determine if (H_1) tuna condition decreases when they are associated or if (H_2) tuna tend to associate more when they are in a lower condition. We show that, as the number of DFADs increases, the mean condition of the associated and free-swimming fractions of a tuna population will not vary identically depending on the causality hypothesis made. Hence, by measuring the mean condition of associated and/or free-swimming tuna at different DFAD densities, one can determine the causal link between tuna low condition and association to DFADs. Dupaix et al. 2023a found no decreasing trend of the mean condition of associated yellowfin tuna (assessed through the relative condition factor K_n , see their Figure S3) concurrently with the increasing use of DFADs from 1987 to 2019. This would suggest that tuna would tend to associate when they are in poor condition (H_2). However, between 1987 and 2019, several other parameters (*e.g.* climate change, reduction of yellowfin tuna abundance) than DFADs, which could have impacted tuna condition and counterbalance potential effects of DFADs, could not be taken into account by the authors. Hence, there is a need to perform more studies monitoring the condition of tropical tunas, at different FOB densities and similar environmental conditions, to confirm these results.

Probabilities that tuna associate with (μ) and depart from (γ) a DFAD can be assessed through the measurement of Continuous Residence Times (CRTs, continuous bouts of time spent at a given FOB without any day-scale absence) and Continuous Absence Times (CATs, time spent between two associations to a FOB; Capello et al. 2015). Several studies measured CATs and CRTs using passive acoustic tuna tagging in arrays of FADs (*e.g.* Robert et al. 2014b; Robert et al. 2012; Mitsunaga et al. 2012; Govinden et al. 2013; Govinden et al. 2021; Phillips et al. 2019b). Measuring CRTs, combined with the measurement of the condition of tagged individual tunas at the time of release could allow to determine if the probability to depart from a FAD is independent (as in hypothesis H_1) or varies (as in H_2) depending on individual's condition. To date, the temporal scale of physiological condition variations are unknown, giving no information on the probabilities to become in good (ϵ) or bad (α) condition. If the associative process and the condition variations were to vary on different time scales, it could complexify the results obtained in our study. For example, under H_1 , if tuna condition was to decrease very slowly, compared to the time scale of associative processes (α much smaller than other probabilities), the decrease of the mean condition of the associated population with an increasing DFAD number might be too slow to be detected on field data, leading to the conclusion that H_2 is true (Figure 8.3). Hence, there is a need to determine the temporal scale at which condition indicators vary and compare it with associative processes. This could also be done monitoring condition indicators during fasting experiments on captive tuna.

Pérez et al. 2020 compared several arrays of anchored FADs, with different densities and showed that as FAD density increases, the mean CAT decreases and the mean CRT increases. As CRTs depend on the density of FADs to a lesser extent than CATs (*e.g.* for yellowfin tunas of 70 cm, CRTs are multiplied by 1.4 between Hawai'i and Mauritius arrays, when CATs are divided by more than 3.5; Pérez et al. 2020), we chose to formulate the models with only the CAT depending on the number of DFADs. Both CRT and CAT measurements show that

an increase of floating object density would increase the proportion of their time tuna spend associated (Pérez et al. 2020). This result, combined with the hypothesis that tuna condition decreases when they are associated (H_1), has important implications. Indeed, under hypothesis H_1 , increasing the density of DFADs would strongly impact the condition of tuna, not leaving them enough time free-swimming to recover.

On the other hand, if the second hypothesis is true (H_2 , tuna tend to associate more when they are in lower condition), the increasing density of floating objects due to DFAD deployment would not directly impact the condition of tropical tuna. However, the *meeting-point* hypothesis, which is one of the main hypotheses formulated to explain tuna associative behavior, suggest that tuna would associate with floating objects to facilitate school formation (Fréon and Dagorn 2000). Under the *meeting-point* hypothesis, an increase in FOB density could spread tuna among FOBs, hindering school formation. In our model, we considered a direct proportion between the number of DFADs and the probability to associate. Capello et al. 2022, using a model with several social scenarios, demonstrated that social behavior influences the way the fraction of schools which are associated varies with DFAD density. This model could be calibrated using data from echo-sounder buoys associated with DFADs, which can be used to determine the presence or absence of associated tuna aggregations under DFADs (Baidai et al. 2020b). Then, adding a physiological state variable would allow to determine the impact of an increasing DFAD density on tuna condition, accounting for both their associative and social behavior.

Individual fitness is a combination of survival and reproduction. When assessing impacts of a human activity, such as DFAD deployment, on tuna's ecology the aim is to determine if this activity can impact individual fitness and how this could impact tuna populations. Physiological condition can be considered a good proxy of individual fitness as it impacts both individual survival and reproduction. However, as the condition indicators used on tropical tuna are not well validated (*e.g.* we are not able to traduce a given value of a given indicator in survival effects, Sardenne et al. 2016), it is difficult to determine if an impact of DFADs on tuna physiological condition would impact tuna populations. Moreover, several other parameters than DFADs can impact tuna behavior and condition. Tuna associative behavior can be influenced by climate change, which modifies prey abundance and physical characteristics of the environment (Arrizabalaga et al. 2015; Druon et al. 2015; Druon et al. 2017). Also, climate change impacts on tuna populations and habitat are complex: although tropical tuna are expected to move poleward, it would lead to different abundance trends depending on the region and tuna species considered (Dueri et al. 2014; Erauskin-Extramiana et al. 2019; Nicol et al. 2022). Fisheries also have an important impact on tropical tuna abundance and an increased fishing mortality, leading to a decrease in abundance, could reduce intra- and inter-specific competition and lead to an increase of individual physiological condition.

The impact of DFADs on tuna's fitness could be measured through the assessment of impacts on their reproduction. Ashida et al. 2017 found a higher proportion of mature skipjack tuna in FSC that at DFADs, in the Western and Central Pacific Ocean. Evidence also showed higher lipid contents in gonads for FSC than for DFAD-associated YFT in the Indian Ocean (Zudaire et al. 2014). If this could suggest a potential impact of DFADs on tropical tuna reproduction, no difference in fecundity was found (Grande et al. 2014; Zudaire et al. 2014). Any impact of DFADs on reproduction will also depend on the species reproductive strategy: SKJ are considered income breeder (*i.e.* gamete production is fueled directly with energy gained during reproduction, Grande et al. 2016), when YFT and BET are considered mixed capital-income breeders (*i.e.* stored energy is also used to fuel gamete production, lacking evidence for BET, Zudaire et al. 2014; Sardenne et al. 2017). Hence, there is a need not only to consider the impact of DFADs on tropical tuna condition but also to continue research efforts to determine how variations in condition are related to individual survival, reproduction and to population

abundance and to continue such efforts considering species specificity.

The model presented in this study, coupled with field and experimental studies, will allow to advance our understanding of tuna behavior and of the processes underlying the association with floating objects. However, much remains to be done to understand how tuna association to DFADs is influenced by both individual motivations and social behavior. Although this model will allow the determination of the causal link between tuna condition and their association to DFADs, there is still a need to assess the implications of condition variations for individual fitness and population abundance.

8.5 Supplementary Materials 1 - Equilibrium model solution

All the solutions are determined when the system is at equilibrium, *i.e* when

$$\frac{dN_{A^+}}{dt} = \frac{dN_{A^-}}{dt} = \frac{dN_{F^+}}{dt} = \frac{dN_{F^-}}{dt} = 0$$

8.5.1 Case 1: The association to DFADs induces a bad condition (H_1)

8.5.1.1 Calculation of \bar{e}_A

At equilibrium, we have (based on Eq. 8.4)

$$\begin{aligned} & -(\gamma + \alpha)N_{A^+} + \mu n N_{F^+} = 0 \\ \Leftrightarrow & N_{F^+} = \frac{\alpha + \gamma}{\mu n} N_{A^+} \end{aligned} \quad (8.15)$$

Also based on Eq. 8.4 we have

$$\begin{aligned} \epsilon N_{F^-} + \gamma N_{A^+} - \mu n N_{F^+} = 0 & \Leftrightarrow \epsilon N_{F^-} + \gamma N_{A^+} - (\alpha + \gamma)N_{A^+} = 0 \\ & \Leftrightarrow N_{F^-} = \frac{\alpha}{\epsilon} N_{A^+} \end{aligned} \quad (8.16)$$

Finally, Eq. 8.4 also gives

$$\begin{aligned} & \gamma N_{A^-} - \frac{\alpha}{\epsilon} \mu n N_{A^+} - \alpha N_{A^+} = 0 \\ \Leftrightarrow & \gamma N_{A^-} = \alpha \left(\frac{\mu n}{\epsilon} + 1 \right) N_{A^+} \\ \Leftrightarrow & N_{A^-} = \frac{\alpha}{\gamma} \left(\frac{\mu n}{\epsilon} + 1 \right) N_{A^+} \end{aligned} \quad (8.17)$$

Hence, according to Eq. 8.2 & 8.17

$$\begin{aligned} \bar{e}_A &= \frac{N_{A^+}}{N_{A^+} + N_{A^-}} e^+ + \frac{N_{A^-}}{N_{A^+} + N_{A^-}} e^- \\ &= \frac{e^+ + \frac{\alpha}{\gamma} \left(\frac{\mu n}{\epsilon} + 1 \right) e^-}{1 + \frac{\alpha}{\gamma} \left(\frac{\mu n}{\epsilon} + 1 \right)} \end{aligned} \quad (8.18)$$

$$= \frac{\frac{\epsilon \gamma}{\alpha} e^+ + (\mu n + \epsilon) e^-}{\frac{\epsilon \gamma}{\alpha} + (\mu n + \epsilon)} \quad (8.19)$$

8.5.1.2 Variations and limit of \bar{e}_A

Limit: from Eq. 8.19 we have $\lim_{n \rightarrow +\infty} \bar{e}_A = e^-$

Variations:

$$\begin{aligned} \bar{e}_A(n) - \bar{e}_A(n+1) &= \frac{\frac{\epsilon \gamma}{\alpha} e^+ + (\mu n + \epsilon) e^-}{\frac{\epsilon \gamma}{\alpha} + (\mu n + \epsilon)} - \frac{\frac{\epsilon \gamma}{\alpha} e^+ + (\mu(n+1) + \epsilon) e^-}{\frac{\epsilon \gamma}{\alpha} + (\mu(n+1) + \epsilon)} \\ &= \frac{\left[\frac{\epsilon \gamma}{\alpha} e^+ + (\mu n + \epsilon) e^- \right] \left[\frac{\epsilon \gamma}{\alpha} + (\mu(n+1) + \epsilon) \right] - \left[\frac{\epsilon \gamma}{\alpha} e^+ + (\mu(n+1) + \epsilon) e^- \right] \left[\frac{\epsilon \gamma}{\alpha} + (\mu n + \epsilon) \right]}{\left[\frac{\epsilon \gamma}{\alpha} + (\mu n + \epsilon) \right] \left[\frac{\epsilon \gamma}{\alpha} + (\mu(n+1) + \epsilon) \right]} \end{aligned}$$

Which is of the same sign as

$$\begin{aligned}
& \left[\frac{\epsilon\gamma}{\alpha} e^+ + (\mu n + \epsilon) e^- \right] \left[\frac{\epsilon\gamma}{\alpha} + (\mu(n+1) + \epsilon) \right] - \left[\frac{\epsilon\gamma}{\alpha} e^+ + (\mu(n+1) + \epsilon) e^- \right] \left[\frac{\epsilon\gamma}{\alpha} + (\mu n + \epsilon) \right] \\
&= \frac{\epsilon^2\gamma^2}{\alpha^2} e^+ + \frac{\epsilon\gamma}{\alpha} (\mu(n+1) + \epsilon) e^+ + \frac{\epsilon\gamma}{\alpha} (\mu n + \epsilon) e^- + (\mu n + \epsilon) (\mu(n+1) + \epsilon) e^- - \\
& \quad \frac{\epsilon^2\gamma^2}{\alpha^2} e^+ - \frac{\epsilon\gamma}{\alpha} (\mu n + \epsilon) e^+ - \frac{\epsilon\gamma}{\alpha} (\mu(n+1) + \epsilon) e^- - (\mu n + \epsilon) (\mu(n+1) + \epsilon) e^- \\
&= \frac{\epsilon\gamma}{\alpha} (\mu(n+1) + \epsilon) e^+ + \frac{\epsilon\gamma}{\alpha} (\mu n + \epsilon) e^- - \frac{\epsilon\gamma}{\alpha} (\mu n + \epsilon) e^+ - \frac{\epsilon\gamma}{\alpha} (\mu(n+1) + \epsilon) e^- \\
&= \frac{\epsilon\gamma}{\alpha} \left[(\mu n + \mu + \epsilon - \mu n - \epsilon) e^+ + (\mu n + \epsilon - \mu n - \mu - \epsilon) e^- \right] \\
&= \frac{\mu\epsilon\gamma}{\alpha} (e^+ - e^-)
\end{aligned}$$

Hence, because $e^+ > e^-$, we have $\forall n \in \mathbb{N}^+$, $\bar{e}_A(n) > \bar{e}_A(n+1)$, *i.e.* \bar{e}_A is a decreasing sequence of n .

8.5.1.3 Calculation of \bar{e}_F

According to Eq. 8.4

$$\begin{aligned}
N_{F^+} &= \frac{\alpha + \gamma}{\mu n} \frac{\epsilon}{\alpha} N_{F^-} \\
&= \frac{\epsilon(1 + \frac{\gamma}{\alpha})}{\mu n} N_{F^-}
\end{aligned}$$

Hence,

$$\bar{e}_F = \frac{\frac{\epsilon(1 + \frac{\gamma}{\alpha})}{\mu n} e^+ + e^-}{\frac{\epsilon(1 + \frac{\gamma}{\alpha})}{\mu n} + 1} \quad (8.20)$$

$$= \frac{\epsilon(1 + \frac{\gamma}{\alpha}) e^+ + \mu n e^-}{\epsilon(1 + \frac{\gamma}{\alpha}) + \mu n} \quad (8.21)$$

8.5.1.4 Variations and limit of \bar{e}_F

Limit: from Eq. 8.21 we have $\lim_{n \rightarrow +\infty} \bar{e}_F = e^-$

Variations:

$$\begin{aligned}
\bar{e}_F(n) - \bar{e}_F(n+1) &= \frac{\epsilon(1 + \frac{\gamma}{\alpha}) e^+ + \mu n e^-}{\epsilon(1 + \frac{\gamma}{\alpha}) + \mu n} - \frac{\epsilon(1 + \frac{\gamma}{\alpha}) e^+ + \mu(n+1) e^-}{\epsilon(1 + \frac{\gamma}{\alpha}) + \mu(n+1)} \\
&= \frac{\left[\epsilon(1 + \frac{\gamma}{\alpha}) e^+ + \mu n e^- \right] \left[\epsilon(1 + \frac{\gamma}{\alpha}) + \mu(n+1) \right] - \left[\epsilon(1 + \frac{\gamma}{\alpha}) + \mu n \right] \left[\epsilon(1 + \frac{\gamma}{\alpha}) e^+ + \mu(n+1) e^- \right]}{\left[\epsilon(1 + \frac{\gamma}{\alpha}) + \mu n \right] \left[\epsilon(1 + \frac{\gamma}{\alpha}) + \mu(n+1) \right]}
\end{aligned}$$

Which is of the same sign as

$$\begin{aligned}
& \left[\epsilon \left(1 + \frac{\gamma}{\alpha}\right) e^+ + \mu n e^- \right] \left[\epsilon \left(1 + \frac{\gamma}{\alpha}\right) + \mu(n+1) \right] - \left[\epsilon \left(1 + \frac{\gamma}{\alpha}\right) + \mu n \right] \left[\epsilon \left(1 + \frac{\gamma}{\alpha}\right) e^+ + \mu(n+1) e^- \right] \\
&= \epsilon^2 \left(1 + \frac{\gamma}{\alpha}\right)^2 e^+ + \epsilon \left(1 + \frac{\gamma}{\alpha}\right) \mu(n+1) e^+ + \epsilon \left(1 + \frac{\gamma}{\alpha}\right) \mu n e^- + \mu^2 n(n+1) e^- - \\
&\quad \epsilon^2 \left(1 + \frac{\gamma}{\alpha}\right)^2 e^+ - \epsilon \left(1 + \frac{\gamma}{\alpha}\right) \mu(n+1) e^- - \epsilon \left(1 + \frac{\gamma}{\alpha}\right) \mu n e^+ - \mu^2 n(n+1) e^- \\
&= \epsilon \left(1 + \frac{\gamma}{\alpha}\right) \mu(n+1) e^+ + \epsilon \left(1 + \frac{\gamma}{\alpha}\right) \mu n e^- - \epsilon \left(1 + \frac{\gamma}{\alpha}\right) \mu(n+1) e^- - \epsilon \left(1 + \frac{\gamma}{\alpha}\right) \mu n e^+ \\
&= \epsilon \left(1 + \frac{\gamma}{\alpha}\right) \left[(\mu(n+1) - \mu n) e^+ + (\mu n - \mu(n+1)) e^- \right] \\
&= \mu \epsilon \left(1 + \frac{\gamma}{\alpha}\right) (e^+ - e^-)
\end{aligned}$$

Hence, because $e^+ > e^-$, we have $\forall n \in \mathbb{N}^+$, $\bar{e}_F(n) > \bar{e}_F(n+1)$, *i.e.* \bar{e}_F is a decreasing sequence of n .

8.5.1.5 Verification that $\bar{e}_F > \bar{e}_A$

Let us consider $C = \frac{\alpha}{\gamma} \left(\frac{\mu n}{\epsilon} + 1 \right)$ and $D = \frac{\epsilon(1 + \frac{\gamma}{\alpha})}{\mu n}$. According to Eq. 8.18 & 8.20, we have

$$\bar{e}_A - \bar{e}_F = \frac{e^+ + C e^-}{1 + C} - \frac{D e^+ + e^-}{1 + D}$$

Hence,

$$\begin{aligned}
& \bar{e}_A < \bar{e}_F \\
& \Leftrightarrow \bar{e}_A - \bar{e}_F < 0 \\
& \Leftrightarrow \frac{e^+ + C e^-}{1 + C} - \frac{D e^+ + e^-}{1 + D} < 0 \\
& \Leftrightarrow \frac{e^+ + C e^-}{1 + C} < \frac{D e^+ + e^-}{1 + D} \\
& \Leftrightarrow (e^+ + C e^-)(1 + D) < (D e^+ + e^-)(1 + C) \\
& \Leftrightarrow e^+ + D e^+ + C e^- + C D e^- < D e^+ + C D e^+ + e^- + C e^- \\
& \Leftrightarrow e^+ + C D e^- < C D e^+ + e^- \\
& \Leftrightarrow e^+ + C D e^- - C D e^+ - e^- < 0 \\
& \Leftrightarrow (e^+ - e^-)(1 - C D) < 0 \\
& \Leftrightarrow C D > 1 \\
& \Leftrightarrow \left[\frac{\alpha}{\gamma} \left(\frac{\mu n}{\epsilon} + 1 \right) \right] \left[\frac{\epsilon(1 + \frac{\gamma}{\alpha})}{\mu n} \right] > 1
\end{aligned}$$

Let us consider $\alpha' = \frac{\alpha}{\gamma}$. Then

$$\begin{aligned}
& \left[\frac{\alpha}{\gamma} \left(\frac{\mu n}{\epsilon} + 1 \right) \right] \left[\frac{\epsilon(1 + \frac{\gamma}{\alpha})}{\mu n} \right] > 1 \\
\Leftrightarrow & (\mu n + \epsilon) \frac{(\alpha' + 1)}{\mu n} > 1 \\
\Leftrightarrow & (\mu n + \epsilon)(\alpha' + 1) > \mu n \\
\Leftrightarrow & \mu n + \epsilon + \mu n \alpha' + \epsilon \alpha' > \mu n \\
\Leftrightarrow & \epsilon + \mu n \alpha' + \epsilon \alpha' > 0
\end{aligned} \tag{8.22}$$

Because ϵ , μ , α' and n are positive, Eq. 8.22 is always true.
Hence, $\forall n \in \mathbb{N}^+$ and $\forall (\epsilon, \alpha, \gamma, \mu) \in]0; 1]^4$, $\bar{e}_F > \bar{e}_A$

8.5.2 Case 2: Individuals with a bad condition tend to associate (H_2)

8.5.2.1 Calculation of \bar{e}_A

At equilibrium, Eq. 8.5 gives

$$N_{A^-} = \frac{\gamma + \alpha}{\epsilon} N_{A^+} \tag{8.23}$$

Hence

$$\begin{aligned}
\bar{e}_A &= \frac{N_{A^+}}{N_{A^+} + N_{A^-}} e^+ + \frac{N_{A^-}}{N_{A^+} + N_{A^-}} e^- \\
&= \frac{e^+ + \frac{\gamma + \alpha}{\epsilon} e^-}{1 + \frac{\gamma + \alpha}{\epsilon}} \\
&= \frac{\epsilon e^+ + (\gamma + \alpha) e^-}{\epsilon + (\gamma + \alpha)}
\end{aligned} \tag{8.24}$$

8.5.2.2 Variations and limit of \bar{e}_A

From Eq. 8.24, \bar{e}_A is independent from n .

8.5.2.3 Calculation of \bar{e}_F

At equilibrium, according to Eq. 8.5

$$N_{F^+} = \frac{\mu n + \epsilon}{\alpha} N_{F^-} \tag{8.25}$$

Hence

$$\begin{aligned}
\bar{e}_F &= \frac{N_{F^+} e^+ + N_{F^-} e^-}{N_{F^+} + N_{F^-}} \\
&= \frac{\frac{\mu n + \epsilon}{\alpha} e^+ + e^-}{\frac{\mu n + \epsilon}{\alpha} + 1} \\
&= \frac{(\mu n + \epsilon) e^+ + \alpha e^-}{\mu n + \epsilon + \alpha}
\end{aligned} \tag{8.26}$$

8.5.2.4 Variations and limit of \overline{e}_F

Limit: from Eq. 8.26 we have $\lim_{n \rightarrow +\infty} \overline{e}_F = e^+$

Variations:

$$\begin{aligned} \overline{e}_F(n) - \overline{e}_F(n+1) &= \frac{(\mu n + \epsilon)e^+ + \alpha e^-}{\mu n + \epsilon + \alpha} - \frac{(\mu(n+1) + \epsilon)e^+ + \alpha e^-}{\mu(n+1) + \epsilon + \alpha} \\ &= \frac{\left[(\mu n + \epsilon)e^+ + \alpha e^- \right] \left[\mu(n+1) + \epsilon + \alpha \right] - \left[(\mu(n+1) + \epsilon)e^+ + \alpha e^- \right] \left[\mu n + \epsilon + \alpha \right]}{\left[\mu n + \epsilon + \alpha \right] \left[\mu(n+1) + \epsilon + \alpha \right]} \end{aligned}$$

Which is of the same sign as

$$\begin{aligned} &\left[(\mu n + \epsilon)e^+ + \alpha e^- \right] \left[\mu(n+1) + \epsilon + \alpha \right] - \left[(\mu(n+1) + \epsilon)e^+ + \alpha e^- \right] \left[\mu n + \epsilon + \alpha \right] \\ &= (\mu n + \epsilon)(\mu(n+1) + \epsilon)e^+ + \alpha(\mu n + \epsilon)e^+ + \alpha(\mu(n+1) + \epsilon)e^- + \alpha^2 e^- - \\ &\quad (\mu(n+1) + \epsilon)(\mu n + \epsilon)e^+ - \alpha(\mu(n+1) + \epsilon)e^+ - \alpha(\mu n + \epsilon)e^- - \alpha^2 e^- \\ &= \alpha(\mu n + \epsilon)e^+ + \alpha(\mu(n+1) + \epsilon)e^- - \alpha(\mu(n+1) + \epsilon)e^+ - \alpha(\mu n + \epsilon)e^- \\ &= \alpha \left[(\mu n - \mu(n+1) + \epsilon - \epsilon)e^+ + (\mu(n+1) - \mu n + \epsilon - \epsilon)e^- \right] \\ &= \mu\alpha(e^- - e^+) \end{aligned}$$

Hence, because $e^+ > e^-$, we have $\forall n \in \mathbb{N}^+$, $\overline{e}_F(n) < \overline{e}_F(n+1)$, *i.e.* \overline{e}_F is an increasing sequence of n .

8.5.2.5 Verification that $\overline{e}_F > \overline{e}_A$

Let us consider $E = \frac{\gamma + \alpha}{\epsilon}$ and $G = \frac{\mu n + \epsilon}{\alpha}$. According to Eq. 8.24 & 8.26, we have

$$\overline{e}_A - \overline{e}_F = \frac{e^+ + Ee^-}{1 + E} - \frac{Ge^+ + e^-}{1 + G}$$

Hence,

$$\begin{aligned}
& \bar{e}_A < \bar{e}_F \\
\Leftrightarrow & \bar{e}_A - \bar{e}_F < 0 \\
\Leftrightarrow & \frac{e^+ + Ee^-}{1 + E} - \frac{Ge^+ + e^-}{1 + G} < 0 \\
\Leftrightarrow & \frac{e^+ + Ee^-}{1 + E} < \frac{Ge^+ + e^-}{1 + G} \\
\Leftrightarrow & (e^+ + Ee^-)(1 + G) < (Ge^+ + e^-)(1 + E) \\
\Leftrightarrow & e^+ + Ge^+ + Ee^- + EGe^- < Ge^+ + EGe^+ + e^- + Ee^- \\
\Leftrightarrow & e^+ + EGe^- < EGe^+ + e^- \\
\Leftrightarrow & e^+ + EGe^- - EGe^+ - e^- < 0 \\
\Leftrightarrow & (e^+ - e^-)(1 - EG) < 0 \\
\Leftrightarrow & EG > 1 \\
\Leftrightarrow & \left[\frac{\gamma + \alpha}{\epsilon} \right] \left[\frac{\mu n + \epsilon}{\alpha} \right] > 1 \\
\Leftrightarrow & \frac{(\gamma + \alpha)(\mu n + \epsilon)}{\alpha \epsilon} > 1 \\
\Leftrightarrow & \left[\frac{\gamma}{\alpha} + 1 \right] \left[\frac{\mu n}{\epsilon} + 1 \right] > 1
\end{aligned} \tag{8.27}$$

Because γ , ϵ , μ and α are positive, $\frac{\gamma}{\alpha} + 1 > 1$ and $\frac{\mu n}{\epsilon} + 1 > 1$. Hence, Eq. 8.27 is always true. Therefore, $\forall n \in \mathbb{N}^+$ and $\forall (\epsilon, \alpha, \gamma, \mu) \in]0; 1]^4$, $\bar{e}_F > \bar{e}_A$

8.6 Supplementary Materials 2

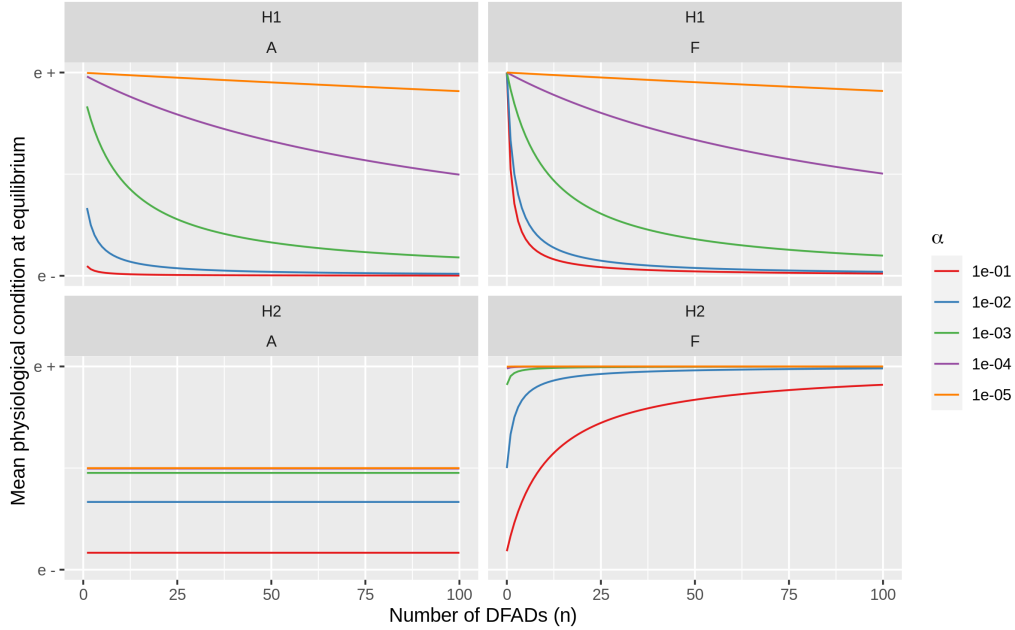

Figure 8.3: Variations of \bar{e}_A and \bar{e}_F as a function of the number of DFADs (n). H_1 model following the hypothesis that tuna association with DFADs induces a reduction of their condition. H_2 model following the hypothesis that tuna associate with DFADs because they are in low condition. A : DFAD-associated state; F : free-swimming state. The color of the line corresponds to the solution for different α values. Results with $\epsilon = 10^{-2}$, $\gamma = 10^{-2}$ and $\mu = 10^{-4}$.



Chapter 9

Discussion

Publication

Dupaix, A., Capello, M., Dagorn, L., Guibert, J., Soria, M., Tolotti, M., & Forget, F. (In prep.) Conceptual framework to assess the ecological impacts of Drifting Fish Aggregating Devices on tropical tuna.

9.1 Overview of the main results

In this thesis, I explored several potential ecological impacts of Drifting Fish Aggregating Devices (DFADs) and other human activities on tropical tuna habitat, behavior and condition in the Indian Ocean (IO). The impacts on tuna fishing mortality, through the increase of purse seine fleet fishing efficiency, are recognized and taken into account in fisheries management. On the other hand, other impacts of DFADs are still controversial and therefore, for some, less a priority for tuna Regional Fisheries Management Organizations. The literature review performed in Chapter 2 revealed a lack of converging scientific results concerning the indirect impacts of DFADs on the behavior and biology of tropical tuna. It showed that although we know that DFADs modify the habitat of tropical tuna, the quantitative characterization of this habitat modification is missing in several oceans. The impact of such habitat modifications on tropical tuna behavior (large-scale, small-scale and schooling behavior) is still largely unknown, due to the complexity induced by the interplay of social, environmental and physiological drivers. Also, differing results have been obtained, based on the methodology used on the field. This habitat modification could also impact tuna's life history parameters, defined as biological parameters that influence the fitness of an individual, *e.g.* condition or reproduction. Apart from the lower physiological condition of tuna associated with DFADs when compared with that of FSC tuna, no converging results have been found on these potential impacts neither.

Part I quantified the habitat modification induced by DFADs in the Western Indian Ocean (WIO), strongly increasing the density of FOBs at the ocean surface (Chapter 3). Developing several indicators to characterize this habitat modification, I was able to show that, in the WIO, where industrial purse seine fleets operate, DFADs represent around 85 % of the FOBs encountered by observers onboard purse seine vessels. Due to DFAD use, the density of FOBs has been multiplied by at least two in 2014-2018, and by up to 62 in some areas (Somalia region). In the eastern IO, where no DFADs are deployed, the impact seems less massive than in the WIO, but further work is needed to better estimate its extent. No data from observers onboard purse seine vessels is available in this region. Hence, this estimation could rely both on Lagrangian simulations and on Local Ecological Knowledge from fishers, to compare the densities of DFADs with that of NLOGs. Other human activities (*e.g.* deforestation, human induced climate change) do not seem to impact the pelagic surface habitat to such an extent as DFADs, with a relative stability of NLOG numbers found from Lagrangian simulations performed from 2000 to 2019. However, NLOGs display important local seasonal variations, the extent of which should be further explored (Chapter 4).

This important surface habitat modification, induced by DFADs, has several impacts on the associative behavior of tuna individuals and aggregations, which I characterized in Part II. In Chapter 5, using an individual-based model (Dupaix et al. 2023b), based on a Correlated Random Walk, validated and calibrated on passive acoustic tagging data of yellowfin tuna (YFT; Pérez et al. 2022), I determined a general relationship between FOB density and the time tuna spend between two associations (Continuous Absence Time, CAT). Applying this relationship to the FOB densities observed in the IO allowed to quantify the impact of DFADs on individual tuna associative behavior. In average, individual YFT spend 68 % of their time associated, where they would spend 20 % if no DFADs had been deployed in the area. The density of DFADs can also impact the behavior of tuna aggregations. In Chapter 6, I used echosounder buoys data, data from the Indian Ocean Tuna Commission (IOTC), from observers onboard French purse seine vessels and environmental data downloaded from Copernicus Marine Service. I showed that, after an increase at low DFAD density values, the percentage of DFADs occupied by tuna (f) remains constant when DFAD density increases, suggesting that tuna could get dispersed among DFADs and highlighting the potential of DFADs to trap tuna in areas with high density. Chlorophyll-a concentration and Sea Level Anomaly also impact f ,

stressing the need to better characterize the drivers of tuna association with DFADs, to better estimate the projected impacts of climate change on tuna associative behavior. However, the variations of f could also be due to tuna abundance or purse seine fishing effort, which would need to be tested. Both chapters of Part II showed an impacts of DFAD density on the associative behavior of both tuna individuals and aggregations. These chapters show that, by increasing both the percentage of time spent associated and the number of DFADs occupied by tuna aggregations, DFADs increase the availability of tuna to purse seine fleets. This increase of availability will increase tuna catchability, which can in turn further increase tuna fishing mortality. Hence, the increase of FOB density induced by DFADs can have a behaviorally mediated impact, further increasing DFADs direct ecological impacts. These two chapters also stress the potential of DFADs to act as traps, retaining tuna in areas with high density, which could have indirect ecological impacts.

The chapters in Part III tackle the impacts of DFADs on tropical tuna physiological condition, which could have been induced by DFAD impacts on behavior. The fact that tuna are in lower condition when associated with FOBs, the strong increase of FOB density induced by DFADs and the increased percentage of time spent associated by tuna, could have suggested a long-term impact on tuna physiological condition. As physiological condition can be considered a good proxy of individual's fitness (Lloret et al. 2014), such a long-term impact would have confirmed the ecological trap hypothesis as formulated by Marsac et al. 2000. Using a long-term times series of length-weight data of yellowfin tuna in the WIO, we found no decreasing trend of YFT condition from 1987 to 2019, concurrently with an increasing trend of DFAD numbers (Chapter 7). Although several other parameters could have counterbalanced an effect induced by DFADs, this chapter seems to reject the ecological trap hypothesis for YFT in the WIO. It also highlighted the need to determine the causal link between the lower condition of tuna when associated with FOBs and the associative behavior. The need to assess this link had already been risen by Robert et al. 2014a who showed that tuna were also in lower condition when associated with NLOGs, in an area little influenced by DFADs at the time. In Chapter 8, I developed a mathematical framework allowing to determine this causal relationship using field data. If the lower condition of associated tunas *is induced by* their association with DFADs, the mean condition of the associated and free-swimming fraction of the population will decrease when DFAD density increases. On the other hand, if tuna tend to associate with DFADs *because* they are in a lower condition, the mean condition of associated tuna will not vary and that of free-swimming tuna will increase when DFAD density increases. This mathematical framework will allow to test the hypothesis of the lower condition factor of tunas associated with FOBs being the cause or the consequence of their association. This will bring further insights into the reasons underlying tuna associative behavior and also to better understand the indirect ecological impacts of DFADs on tropical tuna. Hence, although tuna are in lower condition when associated with DFADs, the massive use of DFADs does not translate into a long-term impact on YFT condition in the Indian Ocean. This could result from tuna associating with FOBs *because* they are in lower condition, which can now be tested using the framework developed in this thesis.

In conclusion, the results of this thesis have significantly advanced our knowledge of the ecological impacts of DFADs on tropical tuna. DFADs have a substantial impact on the habitat of tropical tuna, more so than any other human activities, and this modification can be measured using specific indicators. One of the primary modifications is an increase in the density of FOBs, which strongly affects the associative behavior of tuna, consequently leading to increased availability for purse seine fishers. The question of whether DFADs can act as "traps" on tropical tuna - retaining them in areas of bad quality due to the high density of FOBs - remains unanswered, and further research is necessary to address it. However, while DFADs affect the associative behavior of tuna, there is no conclusive evidence to suggest that DFADs

significantly impact the condition of tuna on the long-term, impacting their fitness, which is the key question in terms of indirect impacts. Only short-term differences in physiological condition between FOB-associated and FSC tropical tuna have been observed, the causes of which are still unknown. This absence of evidence underlines the need for more field and experimental research and for the investigation of the potential impacts on other components of tropical tuna's fitness, such as reproduction and survival.

9.2 Framework to assess DFADs ecological impacts on tuna

9.2.1 DFADs as ecological traps for tropical tuna

When I started my PhD, the subject was "Floating objects of artificial origin : ecological trap or facilitator for the associated marine species?". With my supervisors, we designed the theme in such a way as to give me the freedom to choose the precise question I wanted to explore during these three years: "floating objects of artificial origin" instead of "fish aggregating devices" to possibly work on pollution, "associated marine species" instead of "tropical tuna" to possibly consider bycatch species, fish larvae or fixed organisms found at FOBs. The term "facilitator" was considered to stress that FOBs could also have positive impacts for some species, *e.g.* through the facilitation of dispersion or of other biological functions. During the constrained duration of my PhD work, I eventually did not address these questions in order to focus on the impacts of DFADs on tropical tunas, the only remaining term of the initial subject being the "ecological trap". Hence, I will here discuss the new evidence this thesis brings in the understanding of the ecological trap hypothesis applied to tropical tunas and drifting fish aggregating devices. However, it is worth noting that all the considerations discussed in this thesis on the indirect impacts of DFADs on tuna could be relevant to other species associating with FOBs. As each species has a different life-history and associative behavior, the nature and extent of DFADs indirect impacts may vary. These impacts also need to be considered when managing other species associating with FOBs.

An ecological trap occurs when individuals choose poor quality habitats being misled by cues that no longer correlate with habitat quality, due to recent and rapid habitat modifications (see Textbox 2 in General introduction; Schlaepfer et al. 2002; Gilroy and Sutherland 2007). Ecological traps are part of a broader phenomenon, evolutionary traps, which imply a dissociation between the cues individuals use to choose a resource – their mate, food, habitat (in the case of an ecological trap), etc. – and the fitness outcomes of this choice (Schlaepfer et al. 2002). The definition of an ecological trap assumes (i) a modification, either of human origin or not, of the natural habitat of a species; (ii) this change does not modify the cues that individuals use to select their habitat, but (iii) it leads to a reduction of the individual fitness (its survival and/or reproduction) associated with this habitat (Patten and Kelly 2010; Fletcher et al. 2012). In this discussion, we consider the habitat to be an “area with a combination of resources and environmental conditions that promotes occupancy by individuals of a given species and allows those individuals to survive and reproduce”, as defined in Morrison et al. 2007. Hence, we consider that a tuna habitat is an oceanic region characterized by a combination of environmental conditions such as the abundance of prey, the values of abiotic parameters or the density of FOBs, compatible with tuna physiological needs.

Marsac et al. 2000 suggested that DFADs could act as ecological traps for tropical tuna (Table 9.1). The assumption behind their hypothesis is that, before the use of DFADs, there was a correlation between the number of FOBs and the quality of the habitat, hence using FOBs as cues allowed tuna to select good-quality habitats (the *indicator-log* hypothesis). Purse seine fisheries would then introduce new cues (DFADs) which are used by tuna as any other floating objects but are not necessarily linked to the richness of the area. Because DFADs modify the

distribution of FOBs in the ocean, the density of FOB is not correlated with the habitat quality anymore. Associating with DFADs could then attract or retain them to poorer areas, which would ultimately impact their fitness, leading to an ecological trap (Figure 9.1). The results obtained in Part II suggest that DFADs could indeed retain or attract tropical tuna in areas of high FOB density. However, in Chapter 7 (Dupaix et al. 2023a), relying on a long-term time-series (1987-2018) of length-weight data of yellowfin tuna in the western Indian Ocean, I found no evidence of any decrease of tuna condition concurrently with DFAD use. Even though other factors may have counteracted possible negative effects of DFADs, which calls for a long-term monitoring of tuna habitat and condition, this study seems to reject the ecological trap hypothesis.

Table 9.1: Summary of potential impacts of DFADs on tropical tuna. Evolutionary trap: any resource (*e.g.*, mate, food, or habitat) that an organism finds equally or more attractive than other available resources, despite a reduced fitness value (Robertson et al. 2013). **Ecological trap:** a habitat that an organism finds equally or more attractive than other available habitats, despite experiencing reduced fitness while occupying it; a form of ecological trap (Robertson et al. 2013).

Hypothesis	Underlying behavioral hypothesis	Type of trap	Induced by fishing mortality	Scientific evidence	
				In favor	Against
Originally formulated ecological trap	Indicator-log	Ecological	No	Marsac et al. 2000; Castro et al. 2002; Hallier and Gaertner 2008	Dupaix et al. 2023a, Appendix B
Fishery trap	–	Evolutionary	Yes	Swearer et al. 2021; IOTC 2022e	–
Schooling trap	Meeting-point	Evolutionary	No	Soria et al. 2009; Chapters 5&6	–

9.2.2 Other ecological impacts of DFADs on tuna

The ecological trap hypothesis, as formulated by Marsac et al. 2000, tackled the question of indirect impacts (*i.e.* fitness reduction which is not linked with an increase of fishing mortality) of DFADs on tuna (Table 9.1). However, DFADs increase purse seine efficiency (Bromhead et al. 2003; Wain et al. 2021), and the increase of FOB density induced by DFADs increases tuna availability to purse seine fisheries (Chapters 5&6). Also, as more than 50 % of the tuna caught worldwide by purse seine vessels are caught on FOBs (IOTC 2022e; ISSF 2023), there is no doubt that due to the increasing use of DFADs, associating with floating objects has led to an increase in fishing mortality, and hence a reduction of tuna’s fitness. We will designate this increase of fishing mortality induced by DFADs as the *fishery trap* in the rest of the discussion. Swearer et al. 2021, in their review on marine ecological traps, argue, based on that *fishery trap*, that DFADs, “by their very nature, meet the criteria required to demonstrate an ecological trap”. Relying on the definitions used here (DFADs are cues, not habitats) I would argue that DFADs meet the criteria to demonstrate an evolutionary trap, not an ecological trap: tuna make a choice (*i.e.* associating with DFADs) due to which they experience a fitness costs (*i.e.* fishing mortality increase; Robertson and Hutto 2006, Table 9.1).

Based on the *meeting-point* hypothesis (Fréon and Dagorn 2000), another potential impact could arise from the massive use of DFADs. The *meeting-point* hypothesis suggests that tuna

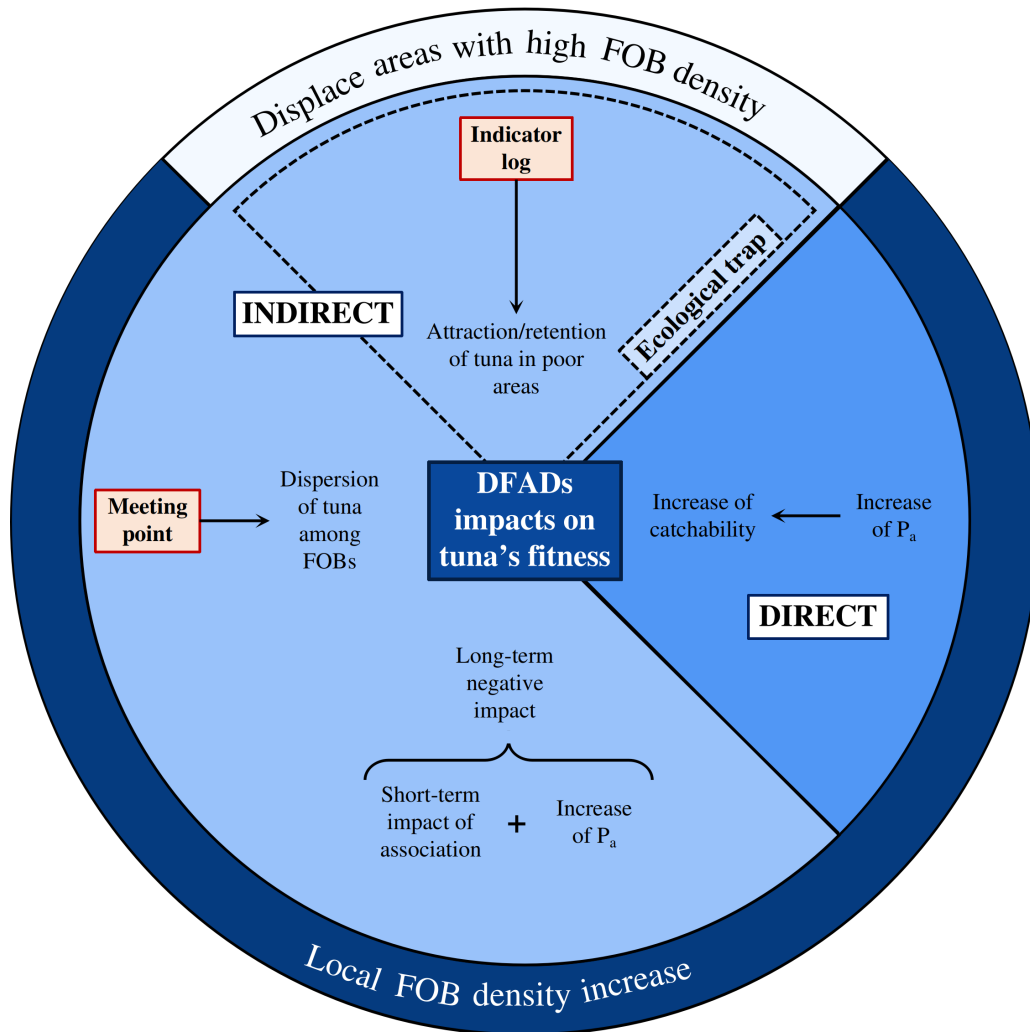

Figure 9.1: Schematic representation of the potential impacts of DFADs assessed in this thesis. The outer circle contains habitat modifications induced by DFADs which will in turn induce impacts in the inner circle. In red boxes: behavioral hypotheses to explain tuna associative behavior. P_a : percentage of time spent associated.

would use FOBs as meeting-points, to encounter conspecifics and facilitate the formation of schools (Fréon and Dagorn 2000). By strongly increasing the density of FOBs, DFADs could provoke the dispersion of tuna among FOBs and prevent the formation of large-enough schools, which could impact tuna's fitness. Hence, based on the *meeting-point* hypothesis, DFADs could also act as an evolutionary trap on tuna. We designate this potential impact as the *schooling trap* (Table 9.1). This hypothesis could seem simplistic, as tuna associative behavior most likely depends on several other parameters than FOB density only (see Section 9.3). However, results obtained by Pérez et al. 2020, suggesting that, as anchored FAD density increases, tuna spend longer continuous residence times around FADs, are in line with this hypothesis.

Several studies suggested that tuna are in better physiological condition when they are fished on free-swimming schools than on FOB-associated schools (see Table 8.1 in Chapter 8). This conclusion has to be taken with caution as sets on free-swimming schools are mostly performed when tuna are actively foraging on the surface, which is often not the case for FOB-associated schools. If tuna are in lower physiological condition when caught in FOB-associated schools as a consequence of their association (hypothesis H_1 in Chapter 8), an increase of FOB density induced by DFADs will result in a decrease of the mean condition of the population. Hence, under most of the behavioral hypothesis considered, if DFADs increase the proportion of time that tuna spend associated (as shown in Chapter 5), it could reduce the ability of tuna to

recover from association and have an indirect impact on tuna's fitness. Hence, by increasing FOB density, DFADs could indirectly impact tuna's fitness, which would also constitute an evolutionary trap.

9.2.3 Direct vs indirect impacts

An important distinction made throughout this thesis, essential to characterize and mitigate the ecological impacts of DFADs on tuna, is whether they are directly linked with an increase of fishing mortality – and can be tackled through a reduction of fishing effort – or they are not – and would then need other management measures. DFADs could impact tuna's fitness indirectly by acting as ecological traps but also through other processes not linked with their habitat selection (*e.g.* by affecting tuna schooling behavior, Figure 9.1). *Ecological trap* is a buzzword, which should be carefully used because of its high communication potential. Finding no evidence of an ecological trap, based on very specific criteria, like in Chapter 7, can be interpreted as demonstrating no effect of DFADs on tropical tuna when transferred to the civil society. Moreover, in Swearer et al. 2021, only 3.4 % of the reviewed studies combined experimental tests of habitat preference and fitness estimates that would provide the strongest evidence to assess an ecological trap, showing that demonstrating such hypothesis is difficult. I fear that focusing on the potential of DFADs to act as an ecological trap for tropical tuna will draw too much attention to that specific impact and overshadow other potential indirect ecological impacts on tropical tuna (*e.g.* see in Zudaire et al. 2020; Pons et al. 2023).

Hence, instead of using the term *ecological trap*, I would recommend to focus on DFAD impacts on tuna's fitness as being either direct – related to fishing mortality, which include the *fishery trap* – or indirect impacts – not related to fishing mortality, which include the *ecological trap* as originally formulated, the *schooling trap* hypotheses and other potential impacts (Table 9.1, Figure 9.1). Direct impacts can be assessed through well developed methodologies, by determining the fishing effort, the increase of fishing efficiency provoked by DFADs and stock status (Wain et al. 2021; IOTC 2022a). Given the amount of tuna caught each year, this impact is probably the most important, but indirect impacts are manifold and could represent aggravating factors. Globally, 39 % of major exploited tuna stocks are either overfished or at intermediate levels¹, and 13 % are subject to overfishing (ISSF 2023). Therefore, it seems important to continue research efforts to characterize DFADs indirect ecological impacts on tuna, as well as applying a precautionary approach even though these impacts are not perfectly understood nor quantified (Wang 2011; Calderwood and Ulmer 2023). Potential indirect impacts depend on the reasons underlying tuna association with FOBs (Figure 9.1), so studying such indirect impacts requires a better understanding of these reasons.

9.3 Why do tropical tuna associate with FOBs?

The results obtained in this thesis bring new insights on the evolutionary reasons explaining why tuna associative behavior with FOBs would have appeared. To date, two main non exclusive hypotheses are retained to explain this association behavior, the *indicator-log* and *meeting-point* hypotheses (see Section 1.3). These hypotheses were formulated for all tropical tunas, which is probably an oversimplification. Tropical tuna found associated with FOBs are mostly individuals of around 50 cm FL, hence juvenile YFT and BET, and mature SKJ (IOTC 2022e). The reasons explaining the association of tropical tuna most likely depend on the species and size-class considered. In this section, I will review the two above-mentioned hypotheses, in

¹the spawning biomass is below the spawning biomass at Maximum Sustainable Yield (SSB_{MSY}) but it has been stable, increasing, or fluctuating around SSB_{MSY} because the stock is being managed at F_{MSY} (fishing mortality at MSY, ISSF 2023)

lights of the new evidence obtained in this thesis and then try to discuss how to improve our understanding of tuna associative behavior.

9.3.1 Indicator-log hypothesis

First, the *indicator-log* hypothesis stipulates that tuna associate with NLOGs because NLOGs are representative of rich areas, as they originate from rivers and accumulate in rich frontal zones (Marsac et al. 2000; Castro et al. 2002; Hallier and Gaertner 2008). This hypothesis does not account for upwelling areas, which are rich areas but characterized by outward flowing surface currents that would chase NLOGs away (Imzilen et al. 2019). Also, this hypothesis does not explain why only given size-classes of tuna display an associative behavior (BET, SKJ and YFT around 50 cm FL, BET and YFT above 100 cm FL) and others do not (BET and YFT around 80 cm FL; IOTC 2022e): if NLOGs are representative of rich areas, there is no reason why individuals YFT and BET, after reaching a given size, would stop associating with FOBs. However, the *indicator-log* hypothesis is not an exception, no hypothesis formulated to date explain why BET and YFT around 80 cm FL are not found associated with FOBs (Table 9.2). Finally, in a study to test the indicator-log hypothesis, we found no correlation between environmental variables and the density of NLOGs (see Textbox 3 and Appendix B). Therefore, as NLOGs are not specifically located in rich areas, the hypothesis that tuna associative behavior would have been selected because it allowed them to find rich areas seems to be rejected. Hence, several elements and results obtained during this thesis are in disagreement with the *indicator-log* hypothesis.

Textbox 3: Testing the *indicator-log* hypothesis

The study presented in Appendix B tests the validity of this indicator-log hypothesis in the Western Indian Ocean at a large spatio-temporal scale (2°/month) by investigating possible relationships between the presence and abundance of NLOGs and environmental characteristics that are relevant to tropical tunas. It relies on observers' data collected on-board French purse seine vessels between 2014 and 2019 (1,278 observed NLOGs) and on remote sensing data. Using this data, we compare the values of environmental variables in areas with and without NLOGs and test for correlations between the number of NLOGs and these environmental variables. Our results indicate a lack of statistical relationship between NLOG abundance and environmental variables. Hence, we conclude that NLOGs are not specifically located in rich areas, which invalidates the indicator-log hypothesis at this spatio-temporal scale.

9.3.2 Meeting-point hypothesis

Under the *meeting-point* hypothesis, tuna association with FOBs promotes the formation of schools of larger sizes. This implies that the simultaneity of departures should be greater than the simultaneity of arrivals, which was observed for bigeye scads (*Selar crumenophthalmus*; Soria et al. 2009). It also implies that, as FOB density increases, tuna should spend longer Continuous Residence Times (CRT) at FOBs, because they would wait longer before forming large-enough schools. This result was observed by Pérez et al. 2020 when comparing the CRTs of YFT and SKJ, measured using passive acoustic tagging, in several AFAD arrays. Although the low percentage of FOBs occupied by tuna whatever the FOB density, measured in Chapter 6, does not validate nor invalidate the meeting-point hypothesis, it highlights the strong social behavior of tropical tuna.

An important distinction has to be made between schooling and shoaling. "Shoal" has no implication on the structure of the fish group, the criteria which defines a shoal being the

fact that there is a social assembly. "School" on the other hand relies on a "synchronised swimming behavior" (Pitcher 1986; Vicsek and Zafeiris 2012). The *meeting-point* hypothesis stipulates that FOBs are used to facilitate schooling behavior (Fréon and Dagorn 2000). A spawning aggregation is a "repeated concentration of conspecific marine animals, gathered for the purpose of spawning", and is not necessarily a fish school (Domeier 2012). Therefore, we will consider that the meeting-point hypothesis does not include the fact that tuna could associate with FOBs to facilitate reproduction, by enhancing the formation of spawning aggregations.

Also, to properly discuss this hypothesis, one needs to rapidly review the reasons underlying schooling behavior from an evolutionary perspective. Schooling behavior appeared 200-220 million years ago and might have disappeared and appeared again several times in different groups of teleosts (Kasumyan and Pavlov 2018). It is seen as an evolutionary trade-off, that would lead to the apparition of an optimal school size, which depends on several factors (Figure 9.2; Maury 2017). Schooling can reduce predation, because scattered preys would be detected more often by predators than groups and because grouped individuals have a smaller probability of getting eaten when attacked by predators (Brock and Riffenburgh 1960). This will lead to an increase of the school size, which will be compensated by the fact that, as school size increases, it gets detected from farther away by predators. Schooling also allows to increase foraging efficiency through an improved ability to acquire and share information among conspecifics (Pitcher 2009; Ioannou et al. 2011). Again, the size of the school will be a compromise between the advantages of faster food detection, the ability to spend more time swimming and eating due to the hydrodynamic gains associated with schooling, and the disadvantages of increasing the size of the school, namely increased intra-group competition for food (Pitcher 2009). These trade-offs lead to the emergence of an optimal school size, which is the school size at which individuals receive the highest fitness output from their schooling behavior (Figure 9.2). However, all the above-mentioned processes (detection by predator, detection of prey, etc.) are also driven by the abundance of prey and that of predator, on which the optimal school size will depend. This leads to individuals "constantly [reappraising] the costs and benefits of being social, taking decisions to join, stay or leave group" (Pitcher 1986). Considering the *meeting-point* hypothesis, tuna would associate with a FOB, wait until they reach that optimal school size, then leave. Hence, the behavior of schools at FOBs should depend not only on the local FOB density, but also on prey and predator abundances in the area, which would be a way of testing the meeting-point hypothesis.

9.3.3 Individual, school and aggregation behavior

As discussed in Section 6.1, one of the main issue when studying the associative behavior of tuna is the difference between schools and aggregations. An aggregation is the gathering of individuals or schools leading to a local density greater than that of neighboring regions (Camazine et al. 2001). Tuna aggregations around FOBs can then be composed of one or several schools, of different species and size composition. To date, methodology exist that allow to assess the associative behavior of tuna individuals (active and passive acoustic tagging, archival tags recording depth; Girard et al. 2004; Phillips et al. 2019b; Pérez et al. 2020), or aggregations (echosounder buoys; Baidai et al. 2020b; Escalle et al. 2021c). The lack of proper methodology allowing to assess the behavior of schools, added to the technical difficulty to work on FOBs that are drifting (DFADs), hinders the testing of hypotheses such as the meeting-point hypothesis. In that respect, new methodological developments, which aim at discriminating between tuna species and determining average size class using echosounder and sonar data (Moreno et al. 2019; Sobradillo et al. 2023), could be promising to get insights into school behavior.

As a result of this gap in methodologies allowing to assess school behavior, one limitation

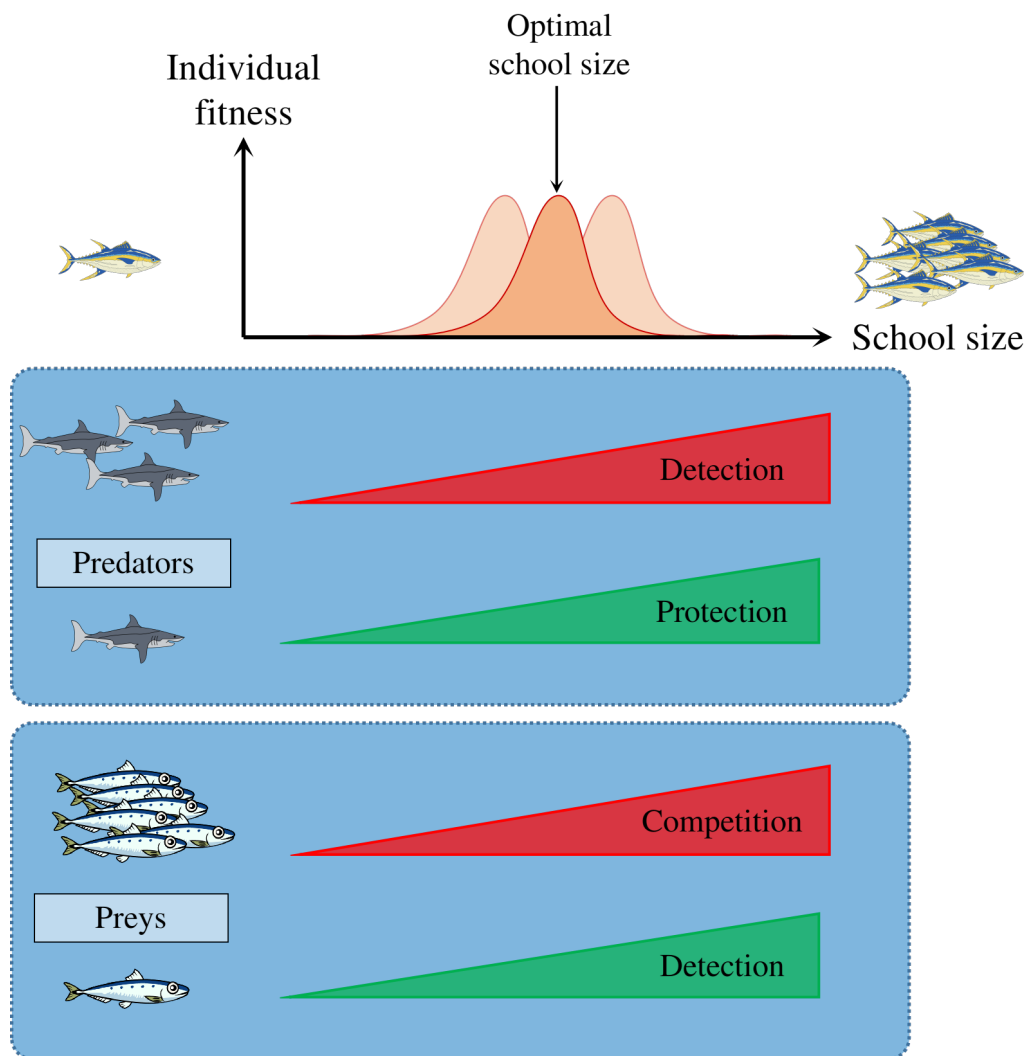

Figure 9.2: Schematic representation of the drivers of school size. Increasing school size will increase detection by predators and intra-group competition for food (negative impact on fitness, in red), but it will also increase protection against predators and prey detection (positive impact on fitness, in green). These four elements are also impacted by the abundance of preys and predators, which will influence the optimal school size.

of this thesis when assessing the impact of DFADs on tropical tuna behavior is that it assessed them either at the individual or at the aggregation scale, without bridging the gap between individual and collective behavior. One way of testing different behavioral hypotheses would be to develop a modelling framework similar to the one used in Chapter 5, with tuna individuals following a Correlated Random Walk and being attracted by DFADs, but adding social behavior. This could be done by adding inter-individual attraction (Couzin et al. 2002). This modelling framework could also include a state-variable representing individual condition and an attraction towards preys, like it was developed in Nootboom et al. 2023b and Nootboom et al. 2023a. The meeting-point hypothesis could be simulated by specifying that DFAD attraction depends on the number of conspecifics in the direct vicinity of the individual. Nevertheless, such a modelling framework would rely on a high number of hypotheses and parameters, which would make the validation and calibration, using passive acoustic tagging data (as in Appendix A; Pérez et al. 2022) and echosounder buoys data from FAD arrays, challenging.

Another approach would be to rely on a modelling framework such as the one developed in Capello et al. 2022, which considers school units instead of considering individuals. This modelling framework has the advantage of bridging the gap between school and aggregation

behavior, the latter of which can be measured. It would allow to test for the *meeting-point* hypothesis and could be validated using echosounder buoy data, as it was intended in Chapter 6. Adding a state-variable representing the individual condition, with the hypothesis that all individuals in a school unit have a similar physiological condition, could allow to test for other behavioral hypotheses (*e.g.* the *comfortability stipulation*). However, the response to an increase of FOB density predicted by the model in Capello et al. 2022 did not concur with the measured response with echosounder buoys (see Section 6.4). As modelling approaches with limited number of hypotheses and of parameters are likely to be the most effective in testing behavioral hypotheses, further effort should be made to validate and then calibrate these approaches.

9.3.4 Accounting for specificities

As mentioned in the first paragraph of this Section (9.3), SKJ individuals found at DFADs are mostly mature individuals. Then, SKJ could use FOBs to facilitate conspecific encounters and form spawning aggregations (which would be close, but still different from the *meeting-point* hypothesis), which is not the case for YFT and BET. Moreover, measures through passive acoustic tagging showed that the different tuna species display different association dynamics (see Table 2.2 in Chapter 2). The characteristics of BET associative behavior were found to differ between size class in the CPO (Fuller et al. 2015). The *food concentration* hypothesis suggests that tuna would associate with FOBs because FOBs aggregate small fish that could be predated (see Section 1.3; Fréon and Dagorn 2000). This hypothesis does not hold for small tunas, which are found in too large aggregations to be sustained by small fish present in the vicinity of FOBs. However, it could be a reason why large BET and YFT are sometimes found associated with FOBs. As associative behavior depends on size-class and species, the model application presented in Chapter 5 applies to YFT of 70 ± 10 cm FL only, *e.g.* calculated values of P_a probably do not apply to YFT of different size or to individuals of other species.

Schaefer et al. 2009; Schaefer and Fuller 2010 and Schaefer et al. 2015 found that BET follow DFADs drift pattern in the Central Pacific Ocean (CPO), characterized by a strong eastward surface current, but not in the Eastern Pacific Ocean (EPO), characterized by a high concentration of food and no strong current. In Chapter 6, I also found that biophysical characteristics of the environments influence the fraction of FOBs occupied, and hence probably tuna associative behavior (although it could also result from a difference in tuna abundance or purse seine fishing effort). Also, the modelling framework validated and calibrated in Pérez et al. 2022 (Appendix A; Dupaix et al. 2023b) on data from anchored FAD arrays in Mauritius and Hawai'i could not explain the associative behavior of YFT in the Maldives, specifically the fact that almost no Continuous Absence Times (CAT, time between two associations with a FAD) were measured there (results not shown). In the Maldives, a high proportion of tagged SKJ and YFT stayed at the anchored FAD (AFAD) of tagging for a few days and then were never detected again in the AFAD array (Govinden et al. 2013; Pérez et al. 2020). This suggests that other processes could determine tuna associative behavior in the Maldives than in Mauritius or Hawai'i, or that tuna were only transiting in the area when they were caught. This highlights the need to take other environmental variables than FOB density into account when modelling and studying tuna associative behavior.

Trying to determine a single reason for tuna associative behavior is probably bound to fail, and it is very likely that no single reason exists. The reasons probably depend at least on the species and size of the individual, and are probably influenced by space and time. Also, hypotheses trying to explain tuna associative behavior are not mutually exclusive, and the actual reasons are probably a mix of several hypotheses.

9.3.5 Summary

Table 9.2: Summary of the hypotheses formulated to explain tropical tuna associative behavior. Details on all the mentioned hypotheses can be found in Fréon and Dagorn 2000. Note that none of the hypotheses explain why BET and YFT around 80 cm FL do not associate with FOBs. "Test" indicate ways of testing the hypothesis. CRT: Continuous Residence Time.

Hypothesis	Pros/Cons/Hypothesis testing	Reference
<i>Comfortability stipulation</i>	Con: does not explain why tuna would rest around FOBs rather than elsewhere Con: No difference in speed between associated and non-associated periods Tests: Measures of activity markers (<i>e.g.</i> Citrate Synthase) Measures of activity through accelerometer coupled with depthmeter	Fréon and Dagorn 2000 Girard et al. 2004
<i>Concentration of food supply</i>	Con: Small tuna are found in too big aggregations to be able to feed at FOBs Con: No difference in speed between associated and non-associated periods Con: Small SKJ and YFT have more empty stomachs when associated	Fréon and Dagorn 2000 Girard et al. 2004 Section 2.4.1
<i>Indicator-log</i>	Con: Upwelling are rich areas with outward surface currents Con: No correlation found between NLOG density and other environmental variables Con: Decreasing percentage of FOBs occupied when chlorophyll-a increases	Marshall and Plumb 1989 Appendix B Chapter 6
<i>Meeting-point</i>	Pro: Evidence found in <i>Selar crumenophthalmus</i> Pro: Longer CRTs for small YFT and SKJ when AFAD density increases Con: Large YFT and BET do not rely as much on schools as smaller individuals Tests: Through an individual-based modelling framework Applying Soria et al. 2009's methodology on tuna	Soria et al. 2009 Pérez et al. 2020
<i>Shelter from predators</i>	Con: No correlation between FOB size and attraction	Fréon and Dagorn 2000
<i>Spatial reference</i>	Pro: Site fidelity of YFT in Hawai'i Con: Does not apply to DFADs Test: long-term monitoring of AFAD arrays	Klimley and Holloway 1999 Fréon and Dagorn 2000

Studies trying to determine the reasons underlying tuna associative behavior and the impacts of DFADs on such behavior should keep individuals' and environmental specificity of their study sites in mind.

First, the distinction between anchored and drifting FADs needs to be considered. As stated by Dagorn et al. 2010, both AFADs and DFADs alter the environment and DFADs can be challenging to work with. Understanding the behavior of tuna around AFADs can improve our general understanding of tuna behavior and help determine general reasons underlying the associative behavior of tropical tuna. Additionally, they provide crucial insights into the possible impacts that DFADs might have on tropical tuna populations. Klimley and Holloway

1999 tagged 38 YFT at AFADs in Hawai'i and 27 of them returned to tagging site, after absences ranging from 1 to 257 days. This site fidelity led the authors to posit that YFT could use AFADs as "way-points", to help them follow migratory pathways (the *spatial reference* hypothesis). This hypothesis could work for anchored FADs, but cannot be generalized to drifting FOBs (Fréon and Dagorn 2000). It highlights the need to carefully consider the potential differences between AFADs and DFADs, but also to monitor tuna presence/absence at AFADs through the maintenance of long-term arrays of acoustic receivers.

Few large BET and YFT are found in association with FOBs. They seem to spend less time associated than smaller individuals (CRT measurements in Robert et al. 2012; Schaefer et al. 2015; Filous et al. 2020; Pérez et al. 2020), but some studies show contradictory results (CAT measurements in Robert et al. 2012) and this could be confirmed through a meta-analysis of tagging data in arrays of FADs. As these large individuals are top predators, the advantages they gain from forming schools are probably much lower than for smaller individuals. Hence, either the *meeting-point* hypothesis does not apply to large BET and YFT, or the lesser need to form schools could be an explanation of the smaller percentage of time spent associated by these individuals. The *concentration of food supply* hypothesis could also apply to large tuna individuals, as they are typically found in smaller numbers than small individuals when associated. Also, evidence that FOB-associated tuna have more empty stomachs than FSC tuna was only found in small SKJ and YFT (see Section 2.4.1). However, Girard et al. 2004 found no difference in speed for both small and large YFT, when associated and not associated with AFADs. According to the authors, it suggests that YFT do not preferentially eat at AFADs, because efficient foraging usually involves movement alterations.

For small BET and YFT, the most likely hypothesis seems to be the *meeting-point* hypothesis. So far, there is no evidence to reject this hypothesis for small tropical tunas, but there is also no supporting evidence. Therefore, research should be carried out to test this hypothesis for small BET and YFT found at FADs. One way to confirm this hypothesis would be to use passive acoustic tagging and echosounder buoys data at FADs, to assess the synchronicity of departure between individuals and aggregations, considering that aggregations are often composed of several schools. A study similar to the one carried out by Soria et al. 2009, assessing the synchronicity of arrival and departure of tagged tuna could also help to test the meeting-point hypothesis for tropical tuna.

The *meeting-point* hypothesis could also be applicable to SKJ which warrants further investigations. It should be noted that, unlike BET and YFT, SKJ's reproductive behavior might also play a role in their associative behavior. However, Ashida et al. 2017 found a significantly higher proportion of mature SKJ females in free swimming schools, characterised by higher relative condition factor, than associated with DFADs in the WCPO. Furthermore, they did not observe any significant effect of the school type on SKJ fecundity, which is consistent with previous findings on SKJ in the WIO (Grande 2013; Grande et al. 2014). It suggests that SKJ association is not linked with any reproductive behavior. Investigating whether there are any seasonal changes in SKJ's associative behavior that are consistent with peak reproductive seasons could confirm these findings.

9.4 What are the potential indirect impacts of DFADs on tuna?

Based on the reasons underlying tuna association to FOBs, DFADs could have different impacts on tuna. Instead of reviewing what we know on the indirect impacts of DFADs on tropical tuna, which was done in Chapter 2, here I will try to review, from a theoretical point of view, what the potential indirect impacts can be, based on the behavioral hypotheses developed in Section 9.3

(see also Figure 9.1). I will also discuss how the reasons underlying tuna association with FOBs can influence the type of management measures needed to mitigate indirect DFAD impacts.

First, the potential indirect impacts of DFADs based on the *indicator-log* hypothesis have been thoroughly developed in this thesis (*e.g.* in Chapter 7, or Section 9.3.1). If tuna associate with FOBs to find rich areas, a modification of FOB distribution due to DFADs could result in an ecological trap as formulated by Marsac et al. 2000. Although a sum of evidence seem to reject the *indicator-log* hypothesis (Chapter 6, Appendix B), if it were true DFAD impact on tropical tunas would come from the fact that DFADs changed the location of high FOB density areas. Hence, in that case, management measures to limit indirect impacts of DFADs on tuna would involve preventing the increase of DFAD density in areas where NLOG density is low. Under this hypothesis, increasing DFAD density in areas where NLOG density was originally high would not strongly impact tunas.

Then, considering the *meeting-point* hypothesis, DFADs, by increasing the density of FOBs, could provoke the dispersion of tuna, disturbing schooling behavior (Fréon and Dagorn 2000). This dispersion would be in agreement with the results obtained in Chapter 5 and in Pérez et al. 2020 which showed that individual tuna spend more time associated when the density of FADs increases. It could also be an explanation for the stable percentage of FOBs occupied by tunas (f) for an increasing FOB density, observed in Chapter 6. If the *meeting-point* hypothesis was to be verified, mitigating DFADs impact would involve keeping the density of FOBs under a given threshold value, which would depend on the local tuna abundance and above which DFADs would impact tuna schooling. Under this hypothesis, increasing DFAD density in areas where NLOG density is low would not impact tropical tuna as long as the resulting density remains under a given threshold.

Considering the *comfortability stipulation* hypothesis (Batalyants 1993; Fréon and Dagorn 2000), which suggests that tuna use FOBs as resting places, an increase of FOB density should not have any indirect impact. However, under the *concentration of food supply*, an increase of FOB density could have the same type of effect as if we consider the *meeting-point hypothesis*. DFADs could disperse preys among FOBs and therefore have an indirect impact on tropical tunas.

Finally, under most of the behavioral mechanisms underlying the association of tropical tuna with floating objects, the increase of FOB density induced by DFADs can have an indirect impact. Chapter 5 shows that as FOB density increases, the percentage of time tuna spend associated increases. If the association induces a short-term negative impact, as suggested by the lower condition of tuna associated with FOBs (see Chapter 8), an increase of FOB density would induce a indirect impact. Also, due to the very short times between two associations when the density of DFADs is high (Chapter 5), the increase of FOB density due to DFADs could retain tuna in an area, increasing the local abundance, as suggested by Chapter 6. Although the most probable hypothesis to explain tropical tuna associative behavior seems to be the *meeting-point* hypothesis, to date it has not been confirmed. The reasons underlying tropical tuna associative behavior can influence the way DFADs can impact tropical tunas, and has to be considered because it has direct implications on the type of management measures that would be effective to mitigate DFAD impacts on tropical tuna.

9.5 How to characterize the indirect impacts of DFADs on tuna?

When assessing if DFADs have an impact on tuna one wants to determine if tuna populations will be impacted by DFADs, meaning if DFADs have an impact on individuals' fitness leading to an impact on the population. The fitness of an individual, which is the combination of its

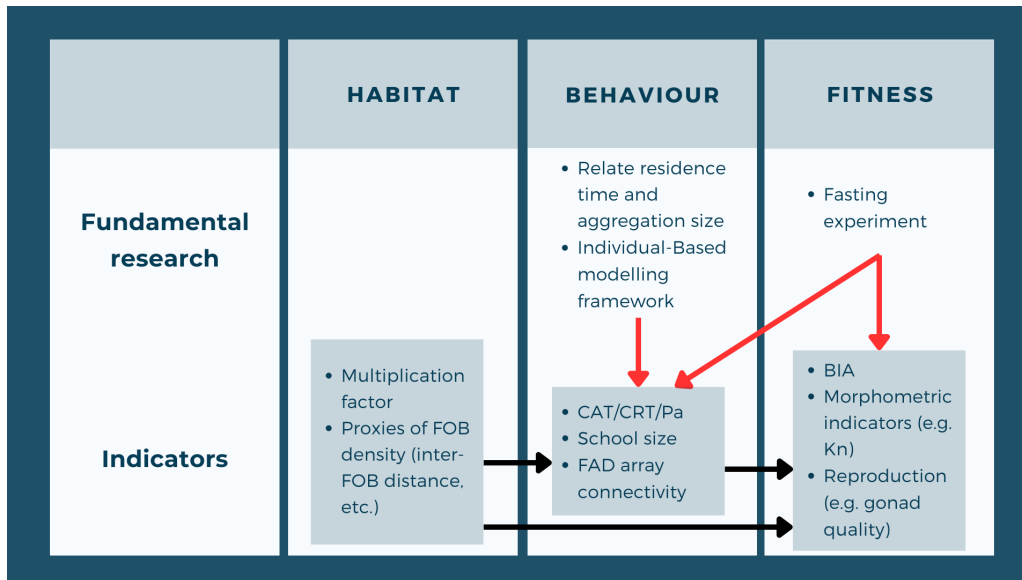

Figure 9.3: How to characterize indirect impacts of DFADs on tropical tuna habitat, behavior and fitness. Black arrow: can inform through operating model. Red arrow: can help to determine relevant indicators.

survival and its reproduction, is challenging to measure and is often attained through proxies. To my knowledge, studies that assessed the impact of DFADs on tuna’s fitness focused on their diet (Jaquet et al. 2011; Zudaire et al. 2015), or on their physiological condition, used as a proxy of their survival (Marsac et al. 2000; Hallier and Gaertner 2008; Robert et al. 2014a) or of their reproduction (Zudaire et al. 2014; Ashida et al. 2017). The common feature of these studies is that they compared tuna caught in free-swimming schools versus tuna caught in FOB-schools. However, a short-term impact of FOB association does not necessarily imply a longer-term impact on fitness (Chapter 7). To demonstrate an indirect impact of DFADs on tuna populations, taking into account the variations of other environmental conditions, we need to rely on long-term time series of indicators (Capello et al. 2023).

First, modifications of tuna surface habitat induced by DFADs should to be monitored (Figure 9.3). To that end, we need to rely on indicators allowing to measure the extent of the habitat modification, hence to compare the current habitat with a putative habitat without the introduction of DFADs. Several indicators, like the ones developed in Chapter 3, can be used: (i) multiplication factor, summarizing by how much the number of NLOGs has been multiplied, (ii) inter-DFAD and inter-NLOG distance (as a proxy of their densities), (iii) ratio between DFAD and NLOG numbers. These indicators would rely on data collected by observers onboard purse seine vessels.

Secondly, as the indirect impacts of DFADs on tuna’s fitness are behaviorally mediated, behavioral indicators should be monitored too (Figure 9.3). However, depending on the behavioral hypothesis considered, mitigating DFAD impacts cannot be achieved through the same management measures. Hence, both theoretical and experimental efforts should be renewed to determine the mechanisms underlying tuna associative behavior. In the meantime, even without complete understanding of the underlying mechanisms, effort should be made to characterize tuna association dynamics, through the measurement or the estimation, using operating models (Capello et al. 2023), of indicators such as the Continuous Absence/Residence Times (CAT/CRT) or the percentage of time tuna spend associated (P_a , Chapter 5). These metrics were demonstrated to vary depending on AFAD density (Pérez et al. 2020) and their measurement could allow the assessment of DFAD array connectivity and of the impact of DFAD density on individual associative behavior. Also, as tuna is a social species, their associative behavior is very likely to involve social behavior. Further research would then be needed to

link tuna individual behavior with aggregation and school dynamics, allowing to assess the underlying social processes and the arising DFAD impacts.

Indicators of tuna condition and reproduction, as proxies of population fitness (Haberle et al. 2023), should also be monitored on the long-term (Figure 9.3). However, most indicators used to date are not well correlated and are not validated against proper benchmark (Sardenne et al. 2016), hence they can only be used to compare individuals, not to determine the health of a given individual. *In vivo* experiments should be designed to properly validate the different indicators, *e.g.* through their monitoring during fasting (see Section 8.4). In the meantime, effort should be made to continue measuring morphometric indicators for which time-series already exist (*e.g.* the length-weight data in the IO; Guillou et al. 2021).

Finally, there's an urgent need to determine which potential impacts are to be assessed in priority, and based on these impacts, collect and share long-term time series of appropriate indicators. These indicators must make it possible to monitor tuna habitat (*e.g.* through the comparison of DFADs vs NLOG densities; Dupaix et al. 2021a), their biology (through morphometric and biochemical indicators; Lloret et al. 2014) and their behavior (*e.g.* through the estimation of the mean duration of associations; Baidai et al. 2020a; Pérez et al. 2020).

9.6 Socio-economic impacts of DFADs

As we have seen in General introduction, DFADs have ecological impacts on tropical tuna, both direct and indirect, and on other species and their environment - ghost fishing, bycatch, stranding, pollution (see Section 1.5; Filmalter et al. 2013; Lezama-Ochoa et al. 2018; Tolotti et al. 2022; Escalle et al. 2019b; Imzilen et al. 2021). DFADs also have significant socio-economic impacts on various stakeholders involved in the fishing industry, including fishers, tuna Regional Fisheries Management Organizations, fishing companies, and coastal states.

DFAD fishing strongly increases PS fishing efficiency: *e.g.* in the IO, the total catch response to a 1 % increase of sets on FOBs was found twice greater than the catch response to the number of sets on FSC (0.453 vs 0.230, respectively, Wolff et al. 2013). Also, PS fishers spend less time searching for schools when using DFADs, and because FOB-associated schools are often less mobile, the risk of a null set is highly reduced (Dagorn et al. 2013b). For example, in 2003–2015, the European PS fleet reported 96 % and 94 % of positive FOB sets, in the Atlantic Ocean (AO) and Indian Ocean (IO), respectively, compared to 80 % and 58 % of positive FSC sets, respectively (Escalle et al. 2019a). Not only do DFADs increase PS fishing efficiency, the efficiency of DFAD fishing has also been enhanced by the technical changes embodied in buoys. Several regime shifts in the Catch Per Unit of Effort (CPUE) were directly caused by the introduction of radio beacons, followed by GPS buoys and echosounder buoys of different generations (Torres-Irineo et al. 2014; Lopez et al. 2014; Gaertner et al. 2008; Gaertner et al. 2018; Maufroy 2016; Guillotreau et al. 2023b). Now, all DFADs are 100 % equipped and the detection technology did not stop improving, thus increasing the catchability of tuna stocks (Lopez et al. 2014; Tidd et al. 2016; Gaertner et al. 2018). This increased efficiency directly impact the strategies and the work of PS fishers.

Since the onset of DFAD use in the IO, purse seine fishers have relied increasingly on DFADs for fishing, *e.g.* in the IO, FOB-associated catch went from around 60 % of PS catch in the 1980s to around 90 % in recent years (IOTC 2022e). According to French purse seine fishers working in the Atlantic ocean, interviewed by Reyes and Airaud 2022, the use of DFADs has transformed their work from "hunting", associated with a higher symbolic value, to "harvesting". Some authors predicted that DFAD fishing would result in lower fuel consumption per tonne of landed fish because of a reduced searching time (Dagorn et al. 2013b; Parker et al. 2015; Hanich et al. 2019; Holmes et al. 2019). However, based on individual purse-seine data on fuel consumption by type of fishing, the DFAD strategy proved to be more energy-consuming than the FSC

strategy, presumably because vessels were moving more frequently at full speed (Maufroy 2016; Chassot et al. 2021; Basurko et al. 2022).

DFADs are taking centre stage in tuna Regional Fisheries Management Organizations debates, and DFAD management plans have been implemented in every ocean. First, detailed information and reporting about the use of FADs was expected, as well as responsible FAD management (improved design, monitoring, retrieval actions, etc.), without any binding measures. These DFAD management plans then relied on time-area closures, which originally were not specific to DFAD fishing. In the WCPF, DFAD closure periods have been adopted since 2009 in the Parties to Nauru Agreement (PNA) waters. In the IO, due to the pressure on BET and YFT, IOTC also implemented time-area closures for both longline and purse seine vessels for one month from November 2011 (IOTC Res. 10/1) until 2014 (Song and Shen 2022). Then, limitations to a maximum number of operational buoys followed by any PS vessel at any one time were also implemented, and the authorized maximum decreases little by little in every ocean, although they are still high (see Section 2.5). In the Indian Ocean, due to the state of both BET and YFT stocks, several measures have been proposed but none could be adopted due to objections from purse seine fishing countries. In June 2021, an amendment was proposed to resolution 19/02 so as to halve the maximum authorized number of operational buoys per purse-seine vessel from 300 to 150 at sea at any one time. In February 2023, some countries coalesced to propose a 72-day DFAD moratorium which was voted with a two-third majority for an implementation starting in July 2024 (IOTC Res. 23/02). Eleven countries (on August 8th, 2023), among which the European Union, have objected to this resolution, making it non binding.

From these proposed measures, and through several econometric models and a machine learning approach, in Appendix C (Guillotreau et al. 2023b), we evaluate the consequences of three management scenarios on the catch and profit of the French purse-seine fleet operating in the Indian Ocean: 1) a half reduction in the number of authorized buoys per vessel, 2) a 72-day ban of DFAD fishing with and 3) without re-allocation of effort on free schools. The results show a significant decrease of fleet profits by 7 %, 10 % and 18 %, respectively. We hypothesize an *economic trap* of DFAD fishing caused by the far greater efficiency of this harvesting technique for larger vessels searching for economies of scale, and by the overfished status of yellowfin tuna stocks in the Indian Ocean. The increase in purse seine vessel size resulting from strategic choices made a few years ago and the overfishing of YFT in the Indian Ocean have now left purse seine fleets with no choice but to fish on DFADs to maintain profitability. Therefore, the focus on short-term profitability is most likely to lead to long-term collapse.

9.7 Tropical tuna fisheries in the Indian Ocean in light of the commons

This thesis focused mainly, but not exclusively, on the indirect ecological impacts of DFADs on tropical tuna (Chapters 2, 3, 7&8), and on the potential impacts of other human activities (Chapter 4). The indirect impacts of DFADs on tuna need to be characterized further as they can act as confounding factors, but they should not divert our attention from other ecological impacts of DFADs that have also been characterized. DFADs directly affect tropical tunas, by increasing catchability through increased tuna availability (Chapters 6&5) and purse seine fleet efficiency (Bromhead et al. 2003; Wain et al. 2021). The main threat to wild marine species is overexploitation (IPBES 2022b), and tropical tuna is no exception to this rule. In the Indian Ocean, both YFT and BET are overfished, as well as subject to overfishing (IOTC 2022a; IOTC 2022c). The estimated Maximum Sustainable Yield for the YFT stock in the Indian Ocean is 349,000 t ($\pm 63,000$ t) and the average yearly catch in 2016-2020 was 434,000 t (IOTC 2022c).

Of this catch, around 34 % are caught by purse seine vessels, almost exclusively on DFADs. DFAD fishing is one of the factors responsible for tropical tuna overfishing, but it is not the only one (Dagorn et al. 2013b). Hence, if we continue overfishing, the tuna populations will collapse regardless of whether DFADs have confounding effects on them through indirect impacts.

Tropical tuna situation in the Western Indian Ocean can appear as an illustration of the *Tragedy of the Commons*, defined and illustrated by Hardin 1968 as follow:

"Picture a pasture open to all. It is to be expected that each herdsman will try to keep as many cattle as possible on the commons. [...] As a rational being, each herdsman seeks to maximize his gain [...] [and] concludes that the only sensible course for him to pursue is to add another animal to his herd. And another; and another... [...] Therein is the tragedy. Each man is locked into a system that compels him to increase his herd without limit – in a world that is limited."

This theory has become famous and was widely cited. It supports that when property rights do not exist related to a valuable resource, the resource will be overexploited (Ostrom 2008a). It relies on the assumption that humans are rational beings, a principle that has since been widely criticised (Rubin 1998; Renn et al. 2000; Ostrom and Laurent 2012; Ahdieh 2011). When applying this theory to tropical tunas in the Indian Ocean, the scale considered may lead to view stakeholders as being States and/or large companies, which can be deemed rational (Hovenkamp 1991). This situation is not specific to tropical tunas in the Indian Ocean, globally 35.4 % of marine fish stocks are exploited to unsustainable levels and this percentage is increasing regularly since the first Food and Agriculture Organization assessment in 1974 (FAO 2022). McWhinnie 2009, performing a meta-analysis of fish stocks status, demonstrated that fish stocks shared among several countries are more often illustrations of the tragedy of the commons than non-shared stocks. They showed that when the number of countries exploiting a given stock increased, the risk of overexploitation increased, although species fished in the high seas (out of Economic Exclusive Zones) presented lower risk of overexploitation (McWhinnie 2009).

Hardin gave two solutions to the tragedy of the commons, strongly influenced by the global political state of the world during the Cold War: either the "State" solution, with a superior authority regulating the use of the common resource, or the "privatization" solution, where the common resource is divided into private properties. Since Hardin's *Tragedy of the Commons*, extensive literature has been published on common resources. Hardin's work has been strongly criticized and deemed over-simplistic (Ostrom 2008a). First, it was stated that Hardin mixed two different types of resources which were properly defined afterwards: common-pool resources and open-access resources. According to Ostrom 2008b, common-pool resources "are sufficiently large that it is difficult, but not impossible, to define recognized users and exclude other users altogether. Further, each person's use of such resources subtracts benefits that others might enjoy". This distinction is important because it underlines that the access to common-pool resources can be regulated, contrarily to open-access resources which are common-pool resources that anyone can harvest. Hardin's tragedy was a tragedy of open-access resources, and the proposed solutions were to change that open-access resource into a common-pool resource under the governance of the State, or to make the resource private. Evidence indicated that the two solutions he mentioned are not the only available options, nor are they always effective (Ostrom 2008a). Elinor Ostrom, who obtained the Nobel Prize in Economic Sciences for her "analysis of economic governance, especially the commons", demonstrated based on field evidence that users of a resource could find ways to organize themselves and sustainably exploit that resource

(Ostrom 2008a)

The Indian Ocean Tuna Commission (IOTC), established in 1993, is a tuna Regional Fisheries Management Organization that unites most countries of the Indian Ocean and distant water countries targeting tropical tuna. It is organized to promote cooperation among these countries and aims to operate by consensus like other tuna Regional Fisheries Management Organizations. The IOTC can adopt Conservation and Management Measures, either by consensus or through a vote, for the conservation and optimum utilisation of stocks covered by the organisation's establishing Agreement (among which tropical tuna species). After 120 days, these Conservation and Management Measures become binding to members of the IOTC. During these 120 days, every member has the possibility to object to the measure which will then no longer be binding on the member. Although the IOTC was designed to allow the sustainable exploitation of tropical tuna through cooperation, the current status of bigeye and yellowfin tuna stocks raises questions about whether it properly achieves its objectives.

Ostrom defined eight main principles to design institutions sustainably governing common-pool resources, insisting that these principles were often observed in sustainable institutional regimes but that no general solution existed (Ostrom 2008b). For example, among these principles are *clearly defined boundaries* - the boundaries of the resource and the individuals with rights to harvest it are clearly defined - , *monitoring* - both the resource and users behavior are monitored - , *collective-choice arrangement* - many of the users are included in the elaboration/modification of the rules - or *graduated sanctions* - users who violate rules-in-use are likely to receive graduated sanctions. However, she recognized that effective governance of common-pool resources at the global scale is more difficult than at the local scale (Ostrom 2008b). Also, among common-pool resources, authors described sustainable pelagic fisheries as one of the most difficult issue (Buck 1998; Ostrom 2011). Buck 1998 even stated that the "management of sustainable fisheries may prove to be an elusive dream". One of the reason for this difficulty is that the technology for extracting resources from the oceans have developed more rapidly than the appropriate legal mechanisms to establish an effective property regime (Ostrom A., foreword of Buck 1998). One of these legal mechanisms could be the new international legally binding instrument to foster conservation and sustainable use of marine biological diversity of areas beyond national jurisdiction (the BBNJ treaty), adopted by the United Nations, on June 19th 2023.

If the work on common-pool resources has been more extensive on local resources, research exist on global commons (Berge and Laerhoven 2011). Moreover, examples show that the exploitation of high-seas fish can be sustainable (IPBES 2022a). Atlantic bluefin tuna (*Thunnus thynnus*) has been sustainably exploited for two millennia by traditional fisheries, but following an increased demand in the 1980s, it faced critical overexploitation in the 1990s and 2000s. During the 2000s, environmental nongovernmental organizations efficiently communicated to call attention on the poor stock status of bluefin tuna, making the problem known to a wider audience, and pushing the balance of power towards of a more sustainable exploitation of bluefin tuna, which led to the implementation of a rebuilding plan in 2007 (ICCAT, Resolution 07-05, Fromentin et al. 2014). As a result of this plan, the Atlantic bluefin tuna population has been rebuilt and is now sustainably exploited (IPBES 2022a).

Stern 2011 focuses on global commons, including global fossil fuel supply, global climate and oceans and the "services they provide to humanity, defined by a set of criteria differing from those defining local commons. He introduces at set of principles, adapted from Ostrom's design principles (Ostrom 2008b), to sustainably govern global common-pool resources. First, he assesses whether Ostrom's principles can be applied to global commons. Although most of these principles do apply, new challenges are introduced by the scale of the common-pool resource. For example, the *monitoring* principle is made difficult for global commons because there is a need for global monitoring, and a greater difficulty to establish accountability across

jurisdiction. The *collective-choice arrangement* is also complicated by the large number of users, which can be the whole human population for some global commons, although . Stern 2011 then introduces seven design principles specific to the sustainable governance of global common-pool resources. These principles include *e.g.* a specific attention given to the independence of the resource monitoring, or the facilitation of the participation of lower-level actors by higher-level actors.

Although tropical tuna fishery in the Indian Ocean does not perfectly fit in the global common-pool resource definition introduced by Stern 2011, much is to be learned from considering this resource in light of the work done on the commons. Ostrom's, Stern's and other authors' research show that common-pool resources can be sustainably exploited through self-governance, both at the local and global scale. The effective or potential application of the different design principles to the exploitation of tropical tuna in the Indian Ocean should be assessed, keeping in mind that these principles are not perfect solutions but principles observed in many sustainably used common-pool resources. This sustainable exploitation should also rely on cooperation between actors, who need to stop defending short-term individualistic positions which will lead to the collapse of the resource, and on the application of the precautionary approach (Dietz et al. 2003). These are merely suggestions that we should be considering, not solutions, but hopefully, considering them will help to ensure that sustainable exploitation of tropical tuna in the Indian Ocean is not just an "elusive dream".

References

- Abascal, F. J., T. Peatman, B. Leroy, S. Nicol, K. Schaefer, D. W. Fuller, and J. Hampton (2018). “Spatiotemporal variability in bigeye vertical distribution in the Pacific Ocean”. In: *Fisheries Research* 204, pp. 371–379. DOI: [10.1016/j.fishres.2018.03.013](https://doi.org/10.1016/j.fishres.2018.03.013).
- Adler, R. F. et al. (2003). “The Version 2 Global Precipitation Climatology Project (GPCP) Monthly Precipitation Analysis (1979–Present)”. In: *Journal of Hydrometeorology* 4.6, pp. 1147–1167. DOI: [10.1175/1525-7541\(2003\)004<1147:TVGPCP>2.0.CO;2](https://doi.org/10.1175/1525-7541(2003)004<1147:TVGPCP>2.0.CO;2).
- Ahdieh, R. B. (2011). “Beyond Individualism in Law and Economics”. In: *SSRN Electronic Journal*. DOI: [10.2139/ssrn.1518836](https://doi.org/10.2139/ssrn.1518836).
- Allain, V. (2010). *Trophic structure of the pelagic ecosystems of the western and central Pacific Ocean*. 6th Regular Session of the Scientific Commity EB-IP-10. Nukualofa, Tonga: Western and Central Pacific Fisheries Commission.
- Alongi, D. M. (2015). “The Impact of Climate Change on Mangrove Forests”. In: *Current Climate Change Reports* 1.1, pp. 30–39. DOI: [10.1007/s40641-015-0002-x](https://doi.org/10.1007/s40641-015-0002-x).
- Amandè, M., J. Ariz, E. Chassot, C. Pierre, M. Delgado, D. Gaertner, H. Murua, R. Pianet, and J. Ruiz (2008). *By-catch and discards of the european purse seine tuna fishery in the Indian Ocean : estimation and characteristics for the 2003-2007 period*. Working Party on Ecosystem and Bycatch IOTC-2008-WPEB-12. Bangkok, Thailand: Indian Ocean Tuna Commission.
- Amandè, M. J., E. Chassot, P. Chavance, H. Murua, A. D. de Molina, and N. Bez (2012). “Precision in bycatch estimates: the case of tuna purse-seine fisheries in the Indian Ocean”. In: *ICES Journal of Marine Science* 69.8, pp. 1501–1510. DOI: [10.1093/icesjms/fss106](https://doi.org/10.1093/icesjms/fss106).
- Amemou, H., V. Koné, A. Aman, and C. Lett (2020). “Assessment of a Lagrangian model using trajectories of oceanographic drifters and fishing devices in the Tropical Atlantic Ocean”. In: *Progress in Oceanography* 188, p. 102426. DOI: [10.1016/j.pocean.2020.102426](https://doi.org/10.1016/j.pocean.2020.102426).
- Ariz, J., A. Delgado, A. Fonteneau, F. Gonzalez Costas, and P. Pallares (1999). “Logs and tunas in the Eastern Tropical Atlantic. A review of present knowledge and uncertainties.” In: *Proceedings of the International Workshop on Fishing for Tunas Associated with Floating Objects*. Ed. by M. D. Scott, W. H. Bayliff, C. E. Lennert-Cody, and K. M. Schaefer. Vol. 11. La Jolla, CA, February 11-13, 1992: Inter-American Tropical Tuna Commission, pp. 21–65.
- Arrizabalaga, H., J. Ariz, X. Mina, A. D. De Molina, I. Artetxe, P. Pallares, and A. Iriondo (2001). *Analysis of the activities of supply vessels in the Indian Ocean from observers data*. Working Party on Tropical Tunas (WPTT) IOTC-2001-WPTT-11. Indian Ocean Tuna Commission.
- Arrizabalaga, H. et al. (2015). “Global habitat preferences of commercially valuable tuna”. In: *Deep Sea Research Part II: Topical Studies in Oceanography* 113, pp. 102–112. DOI: [10.1016/j.dsr2.2014.07.001](https://doi.org/10.1016/j.dsr2.2014.07.001).
- Artetxe-Arrate, I., I. Fraile, F. Marsac, J. H. Farley, N. Rodriguez-Ezpeleta, C. R. Davies, N. P. Clear, P. Grewe, and H. Murua (2021). “A review of the fisheries, life history and stock structure of tropical tuna (skipjack *Katsuwonus pelamis*, yellowfin *Thunnus albacares* and bigeye *Thunnus obesus*) in the Indian Ocean”. In: *Advances in Marine Biology* 88, pp. 39–89. DOI: [10.1016/bs.amb.2020.09.002](https://doi.org/10.1016/bs.amb.2020.09.002).

-
- Ashida, H. and M. Horie (2015). “Reproductive condition, spawning season, batch fecundity and spawning fraction of skipjack tuna *Katsuwonus pelamis* caught around Amami-Oshima, Kagoshima, Japan”. In: *Fisheries Science* 81.5, pp. 861–869. DOI: [10.1007/s12562-015-0909-0](https://doi.org/10.1007/s12562-015-0909-0).
- Ashida, H., T. Tanabe, and N. Suzuki (2017). “Difference on reproductive trait of skipjack tuna *Katsuwonus pelamis* female between schools (free vs FAD school) in the tropical western and central Pacific Ocean”. In: *Environmental Biology of Fishes* 100.8, pp. 935–945. DOI: [10.1007/s10641-017-0621-2](https://doi.org/10.1007/s10641-017-0621-2).
- Báez, J. C., M. L. Ramos, M. Herrera, H. Murua, J. L. Cort, S. Déniz, V. Rojo, J. Ruiz, P. J. Pascual-Alayón, and A. Muniategi (2020). “Monitoring of Spanish flagged purse seine fishery targeting tropical tuna in the Indian ocean: Timeline and history”. In: *Marine Policy* 119, p. 104094. DOI: [10.1016/j.marpol.2020.104094](https://doi.org/10.1016/j.marpol.2020.104094).
- Báez, J. C. et al. (2022). “Data Provision for Science-Based FAD Fishery Management: Spanish FAD Management Plan as a Case Study”. In: *Sustainability* 14.6, p. 3278. DOI: [10.3390/su14063278](https://doi.org/10.3390/su14063278).
- Baidai, Y., M. Capello, J. Amandé, N. Billet, L. Floch, M. Simier, P. Sabbaros, and L. Dagorn (2017). *Towards the derivation of fisheries-independent abundance indices for tropical tunas: Progress in the echosounders buoys data analysis*. Working Party on Tropical Tunas (WPTT) IOTC-2017-WPTT19-22_Rev1. Mahé, Seychelles: Indian Ocean Tuna Commission, p. 12.
- Baidai, Y., L. Dagorn, M. J. Amande, D. Gaertner, and M. Capello (2020a). “Tuna aggregation dynamics at Drifting Fish Aggregating Devices: A view through the eyes of commercial echosounder buoys”. In: *ICES Journal of Marine Science* 77.7-8, pp. 2960–2970. DOI: [10.1093/icesjms/fsaa178](https://doi.org/10.1093/icesjms/fsaa178).
- Baidai, Y., L. Dagorn, M. J. Amande, D. Gaertner, and M. Capello (2020b). “Machine learning for characterizing tropical tuna aggregations under Drifting Fish Aggregating Devices (DFADs) from commercial echosounder buoys data”. In: *Fisheries Research* 229, p. 105613. DOI: [10.1016/j.fishres.2020.105613](https://doi.org/10.1016/j.fishres.2020.105613).
- Baidai, Y. (2020). “Derivation of direct abundance index for tropical tunas based on their associative behavior with floating objects”. PhD. Montpellier, France: Université de Montpellier.
- Baidai, Y., A. Dupaix, A. Duparc, L. Dagorn, J. L. Deneubourg, and M. Capello (2023). *Associative Behavior-Based abundance Index (ABBI) for western Indian Ocean skipjack tuna (*Katsuwonus pelamis*) obtained from echosounder buoys data*. IOTC Working Party on Tropical Tuna: Data Preparatory Meeting IOTC-2023-WPTT25(DP)-12. Indian Ocean Tuna Commission.
- Bar, N. and H. Volkoff (2012). “Adaptation of the Physiological, Endocrine, and Digestive System Functions to Prolonged Food Deprivation in Fish”. In: *Comparative Physiology of Fasting, Starvation, and Food Limitation*. Ed. by M. D. McCue. Berlin, Heidelberg: Springer, pp. 69–89. DOI: [10.1007/978-3-642-29056-5_6](https://doi.org/10.1007/978-3-642-29056-5_6).
- Baske, A., J. Gibbon, J. Benn, and A. Nickson (2012). “Estimating the use of drifting Fish Aggregation Devices (FADs) around the globe”. In: *PEW Environment Group - Discussion Paper*, pp. 1–8.
- Basurko, O. C., G. Gabiña, J. Lopez, I. Granado, H. Murua, J. A. Fernandes, I. Krug, J. Ruiz, and Z. Uriondo (2022). “Fuel consumption of free-swimming school versus FAD strategies in tropical tuna purse seine fishing”. In: *Fisheries Research* 245, p. 106139. DOI: [10.1016/j.fishres.2021.106139](https://doi.org/10.1016/j.fishres.2021.106139).
- Batalyants, K. Y. (1993). “On the hypothesis of comfortability stipulation of tuna association with natural and artificial floating objects”. In: *ICCAT Coll. Vol. Sci. Pap* 40.2, pp. 447–453.

-
- Battin, J. (2004). “When Good Animals Love Bad Habitats: Ecological Traps and the Conservation of Animal Populations”. In: *Conservation Biology* 18.6, pp. 1482–1491. DOI: [10.1111/j.1523-1739.2004.00417.x](https://doi.org/10.1111/j.1523-1739.2004.00417.x).
- Berge, E. and F. v. Laerhoven (2011). “Governing the Commons for two decades: A complex story”. In: *International Journal of the Commons*. Collection: The 20th anniversary of ‘Governing the Commons’: Part 2 5.2, p. 160. DOI: [10.18352/ijc.325](https://doi.org/10.18352/ijc.325).
- Bessières, L., S. Leroux, J.-M. Brankart, J.-M. Molines, M.-P. Moine, P.-A. Bouttier, T. Penduff, L. Terray, B. Barnier, and G. Sérazin (2017). “Development of a probabilistic ocean modelling system based on NEMO 3.5: Application at eddying resolution”. In: *Geoscientific Model Development* 10.3, pp. 1091–1106. DOI: [10.5194/gmd-10-1091-2017](https://doi.org/10.5194/gmd-10-1091-2017).
- Boerder, K., A. Bryndum-Buchholz, and B. Worm (2017). “Interactions of tuna fisheries with the Galápagos marine reserve”. In: *Marine Ecology Progress Series* 585, pp. 1–15. DOI: [10.3354/meps12399](https://doi.org/10.3354/meps12399).
- Borcard, D., F. Gillet, and P. Legendre (2011). *Numerical Ecology with R*. Vol. 1. Use R! New York, NY: Springer New York. DOI: [10.1007/978-1-4419-7976-6](https://doi.org/10.1007/978-1-4419-7976-6).
- Bourjea, J., S. Clermont, A. Delgado, H. Murua, J. Ruiz, S. Ciccione, and P. Chavance (2014). “Marine turtle interaction with purse-seine fishery in the Atlantic and Indian oceans: Lessons for management”. In: *Biological Conservation* 178, pp. 74–87. DOI: [10.1016/j.biocon.2014.06.020](https://doi.org/10.1016/j.biocon.2014.06.020).
- Brill, R. W. (1994). “A review of temperature and oxygen tolerance studies of tunas pertinent to fisheries oceanography, movement models and stock assessments”. In: *Fisheries Oceanography* 3.3, pp. 204–216. DOI: [10.1111/j.1365-2419.1994.tb00098.x](https://doi.org/10.1111/j.1365-2419.1994.tb00098.x).
- Brock, V. E. and R. H. Riffenburgh (1960). “Fish Schooling: A Possible Factor in Reducing Predation”. In: *ICES Journal of Marine Science* 25.3, pp. 307–317. DOI: [10.1093/icesjms/25.3.307](https://doi.org/10.1093/icesjms/25.3.307).
- Bromhead, D., J. Foster, R. Attard, J. Findlay, and J. Kalish (2003). *A review of the impact of fish aggregating devices (fads) on tuna fisheries: Final report to the fisheries resources research fund*. Canberra, Australia: Bureau of Rural Sciences.
- Bryndum-Buchholz, A., D. P. Tittensor, J. L. Blanchard, W. W. L. Cheung, M. Coll, E. D. Galbraith, S. Jennings, O. Maury, and H. K. Lotze (2019). “Twenty-first-century climate change impacts on marine animal biomass and ecosystem structure across ocean basins”. In: *Global Change Biology* 25.2, pp. 459–472. DOI: [10.1111/gcb.14512](https://doi.org/10.1111/gcb.14512).
- Buck, S. J. (1998). “The Oceans”. In: *The Global Commons - An Introduction*. Island Press.
- Caddy, J. F. and J. Majkowski (1996). “Tuna and trees: a reflection on a long-term perspective for tuna fishing around floating logs”. In: *Fisheries Research* 25.3, pp. 369–376. DOI: [10.1016/0165-7836\(95\)00449-1](https://doi.org/10.1016/0165-7836(95)00449-1).
- Calderwood, C. and F. A. Ulmer (2023). “The Central Arctic Ocean fisheries moratorium: A rare example of the precautionary principle in fisheries management”. In: *Polar Record* 59, E1. DOI: [10.1017/S0032247422000389](https://doi.org/10.1017/S0032247422000389).
- Camazine, S., J.-L. Deneubourg, N. R. Franks, J. Sneyd, G. Theraulaz, and E. Bonabeau (2001). *Self-Organization in Biological Systems*. Princeton Studies in Complexity. Princeton University Press.
- Capello, M., G. Merino, M. Tolotti, H. Murua, and L. Dagorn (2023). “Developing a science-based framework for the management of drifting Fish Aggregating Devices”. In: *Marine Policy* 153, p. 105657. DOI: [10.1016/j.marpol.2023.105657](https://doi.org/10.1016/j.marpol.2023.105657).
- Capello, M., J. Rault, J.-L. Deneubourg, and L. Dagorn (2022). “Schooling in habitats with aggregative sites: The case of tropical tuna and floating objects”. In: *Journal of Theoretical Biology* 547, p. 111163. DOI: [10.1016/j.jtbi.2022.111163](https://doi.org/10.1016/j.jtbi.2022.111163).
- Capello, M., M. Robert, M. Soria, G. Potin, D. Itano, K. Holland, J.-L. Deneubourg, and L. Dagorn (2015). “A Methodological Framework to Estimate the Site Fidelity of Tagged

-
- Animals Using Passive Acoustic Telemetry”. In: *PLOS ONE* 10.8, e0134002. DOI: [10.1371/journal.pone.0134002](https://doi.org/10.1371/journal.pone.0134002).
- Castro, J. J., J. A. Santiago, and A. T. Santana-Ortega (2002). “A general theory on fish aggregation to floating objects: An alternative to the meeting point hypothesis”. In: *Reviews in Fish Biology and Fisheries* 11, pp. 255–277. DOI: [10.1023/A:1020302414472](https://doi.org/10.1023/A:1020302414472).
- Cayré, P., T. Diouf, A. Fonteneau, and M. Santa-Rita Vieira (1986). *Analyse de Données de Marquages et Recaptures de Listao (Katsuwonus pelamis) réalisées par le Sénégal et la République du Cap-Vert*. Tech. rep. International Commission for the Conservation of Atlantic Tunas, pp. 309–316.
- Chassot, E., S. Antoine, P. Guillotreau, J. Lucas, C. Assan, M. Marguerite, and N. Bodin (2021). “Fuel consumption and air emissions in one of the world’s largest commercial fisheries”. In: *Environmental Pollution* 273, p. 116454. DOI: [10.1016/j.envpol.2021.116454](https://doi.org/10.1016/j.envpol.2021.116454).
- Chassot, E., N. Bodin, F. Sardenne, and D. Obura (2019). “The key role of the Northern Mozambique Channel for Indian Ocean tropical tuna fisheries”. In: *Reviews in Fish Biology and Fisheries* 29.3, pp. 613–638. DOI: [10.1007/s11160-019-09569-9](https://doi.org/10.1007/s11160-019-09569-9).
- Chassot, E., M. Goujon, A. Maufroy, P. Cauquil, A. Fonteneau, and D. Gaertner (2014). *The use of artificial fish aggregating devices by the French tropical tuna purse seine fleet: Historical perspective and current practice in the Indian Ocean*. Working Party on Tropical Tunas (WPTT) IOTC–2014–WPTT16–20 Rev_1. Victoria, Seychelles: Indian Ocean Tuna Commission.
- Christ, R. D. and R. L. Wernli (2014). “Chapter 2 - The Ocean Environment”. In: *The ROV Manual (Second Edition)*. Ed. by R. D. Christ and R. L. Wernli. Oxford: Butterworth-Heinemann, pp. 21–52. DOI: [10.1016/B978-0-08-098288-5.00002-6](https://doi.org/10.1016/B978-0-08-098288-5.00002-6).
- Cigliano, J. A., R. Meyer, H. L. Ballard, A. Freitag, T. B. Phillips, and A. Wasser (2015). “Making marine and coastal citizen science matter”. In: *Ocean & Coastal Management* 115, pp. 77–87. DOI: [10.1016/j.ocecoaman.2015.06.012](https://doi.org/10.1016/j.ocecoaman.2015.06.012).
- Couzin, I. D., J. Krause, R. James, G. D. Ruxton, and N. R. Franks (2002). “Collective Memory and Spatial Sorting in Animal Groups”. In: *Journal of Theoretical Biology* 218.1, pp. 1–11. DOI: [10.1006/jtbi.2002.3065](https://doi.org/10.1006/jtbi.2002.3065).
- Crochelet, E., N. Barrier, M. Andreollo, F. Marsac, A. Spadone, and C. Lett (2020). “Connectivity between seamounts and coastal ecosystems in the Southwestern Indian Ocean”. In: *Deep Sea Research Part II: Topical Studies in Oceanography* 176, p. 104774. DOI: [10.1016/j.dsr2.2020.104774](https://doi.org/10.1016/j.dsr2.2020.104774).
- Curnick, D. J., D. A. Feary, and G. H. Cavalcante (2021). “Risks to large marine protected areas posed by drifting fish aggregation devices”. In: *Conservation Biology* 35.4, pp. 1222–1232. DOI: [10.1111/cobi.13684](https://doi.org/10.1111/cobi.13684).
- Dagorn, L. (1995). “Le comportement des thons tropicaux modélisé selon les principes de la vie artificielle”. PhD Thesis. Rennes, France: Ecole Nationale Supérieure Agronomique de Rennes.
- Dagorn, L., N. Bez, T. Fauvel, and E. Walker (2013a). “How much do fish aggregating devices (FADs) modify the floating object environment in the ocean?” In: *Fisheries Oceanography* 22.3, pp. 147–153. DOI: [10.1111/fog.12014](https://doi.org/10.1111/fog.12014).
- Dagorn, L., J. D. Filmalter, F. Forget, M. J. Amandè, M. A. Hall, P. Williams, H. Murua, J. Ariz, P. Chavance, and N. Bez (2012). “Targeting bigger schools can reduce ecosystem impacts of fisheries”. In: *Canadian Journal of Fisheries and Aquatic Sciences* 69.9, pp. 1463–1467. DOI: [10.1139/f2012-089](https://doi.org/10.1139/f2012-089).
- Dagorn, L. and P. Fréon (1999). “Tropical tuna associated with floating objects: a simulation study of the meeting point hypothesis”. In: *Canadian Journal of Fisheries and Aquatic Sciences* 56.6, pp. 984–993. DOI: [10.1139/f98-209](https://doi.org/10.1139/f98-209).

-
- Dagnon, L., K. N. Holland, and J. Filmalter (2010). “Are drifting FADs essential for testing the ecological trap hypothesis?” In: *Fisheries Research* 106.1, pp. 60–63. DOI: [10.1016/j.fishres.2010.07.002](https://doi.org/10.1016/j.fishres.2010.07.002).
- Dagnon, L., K. N. Holland, and D. G. Itano (2007). “Behavior of yellowfin (*Thunnus albacares*) and bigeye (*T. obesus*) tuna in a network of fish aggregating devices (FADs)”. In: *Marine Biology* 151.2, pp. 595–606. DOI: [10.1007/s00227-006-0511-1](https://doi.org/10.1007/s00227-006-0511-1).
- Dagnon, L., K. N. Holland, V. Restrepo, and G. Moreno (2013b). “Is it good or bad to fish with FADs? What are the real impacts of the use of drifting FADs on pelagic marine ecosystems?” In: *Fish and Fisheries* 14.3, pp. 391–415. DOI: [10.1111/j.1467-2979.2012.00478.x](https://doi.org/10.1111/j.1467-2979.2012.00478.x).
- Davies, T., D. Curnick, J. Barde, and E. Chassot (2017). *Potential environmental impacts caused by beaching of drifting fish aggregating devices and identification of management solutions and uncertainties*. Ad-hoc Working Group on FADs IOTC-2017-WGFAD01-08. Indian Ocean Tuna Commission.
- Davies, T. K., C. C. Mees, and E. J. Milner-Gulland (2014a). “Modelling the spatial behaviour of a tropical tuna purse seine fleet”. In: *PLOS ONE* 9.12, e114037. DOI: [10.1371/journal.pone.0114037](https://doi.org/10.1371/journal.pone.0114037).
- (2014b). “The past, present and future use of drifting fish aggregating devices (FADs) in the Indian Ocean”. In: *Marine Policy* 45, pp. 163–170. DOI: [10.1016/j.marpol.2013.12.014](https://doi.org/10.1016/j.marpol.2013.12.014).
- Delgado de Molina, A., J. Ariz, H. Murua, J. C. Santana, L. Ramos, and M. Soto (2014). *Spanish Fish Aggregating Device Management Plan. Preliminary data in the Indian Ocean*. Working Party on Tropical Tunas (WPTT) IOTC-2014-WPTT16-19. Bali, Indonesia: Indian Ocean Tuna Commission.
- Dempster, T. (2004). “Biology of fish associated with moored fish aggregation devices (FADs): implications for the development of a FAD fishery in New South Wales, Australia”. In: *Fisheries Research* 68.1-3, pp. 189–201. DOI: [10.1016/j.fishres.2003.12.008](https://doi.org/10.1016/j.fishres.2003.12.008).
- Dempster, T. and M. Taquet (2004). “Fish aggregation device (FAD) research: gaps in current knowledge and future directions for ecological studies”. In: *Reviews in Fish Biology and Fisheries* 14.1, pp. 21–42. DOI: [10.1007/s11160-004-3151-x](https://doi.org/10.1007/s11160-004-3151-x).
- Désurmont, A. and L. Chapman (2000). “The use of anchored FADs in the area served by the Secretariat of the Pacific Community (SPC): regional synthesis”. In: Caribbean-Martinique.
- Díaz, S. et al. (2019). *IPBES (2019): Summary for policymakers of the global assessment report on biodiversity and ecosystem services of the Intergovernmental Science-Policy Platform on Biodiversity and Ecosystem Services*. Tech. rep. Bonn, Germany: Intergovernmental Science-Policy Platform on Biodiversity and Ecosystem Services (IPBES), p. 56.
- Dietz, T., E. Ostrom, and P. C. Stern (2003). “The Struggle to Govern the Commons”. In: *Science* 302.5652, pp. 1907–1912. DOI: [10.1126/science.1091015](https://doi.org/10.1126/science.1091015).
- Domeier, M. L. (2012). “Revisiting Spawning Aggregations: Definitions and Challenges”. In: *Reef Fish Spawning Aggregations: Biology, Research and Management*. Ed. by Y. Sadovy de Mitcheson and P. L. Colin. Fish & Fisheries Series. Dordrecht: Springer Netherlands, pp. 1–20. DOI: [10.1007/978-94-007-1980-4_1](https://doi.org/10.1007/978-94-007-1980-4_1).
- Doney, S. C. et al. (2012). “Climate Change Impacts on Marine Ecosystems”. In: *Annual Review of Marine Science* 4.1, pp. 11–37. DOI: [10.1146/annurev-marine-041911-111611](https://doi.org/10.1146/annurev-marine-041911-111611).
- Doong, D.-J., H.-C. Chuang, C.-L. Shieh, and J.-H. Hu (2011). “Quantity, distribution, and impacts of coastal driftwood triggered by a typhoon”. In: *Marine pollution bulletin* 62.7, pp. 1446–1454. DOI: [10.1016/j.marpolbul.2011.04.021](https://doi.org/10.1016/j.marpolbul.2011.04.021).
- Doumenge, F. (2005). “L’halieutique maldivienne, une ethno-culture millénaire”. In: *Archipel* 70.1, pp. 67–138. DOI: [10.3406/arch.2005.3973](https://doi.org/10.3406/arch.2005.3973).
- Druon, J. N., E. Chassot, L. Floch, and A. Maufray (2015). *Preferred habitat of tropical tuna species in the Eastern Atlantic and Western Indian Oceans: a comparative analysis between*

-
- FAD-associated and free-swimming schools*. Working Party on Tropical Tunas (WPTT) IOTC-WPTT-17-31. Montpellier, France: Indian Ocean Tuna Commission.
- Druon, J.-N., E. Chassot, H. Murua, and J. Lopez (2017). “Skipjack Tuna Availability for Purse Seine Fisheries Is Driven by Suitable Feeding Habitat Dynamics in the Atlantic and Indian Oceans”. In: *Frontiers in Marine Science* 4. DOI: [10.3389/fmars.2017.00315](https://doi.org/10.3389/fmars.2017.00315).
- Dueri, S., L. Bopp, and O. Maury (2014). “Projecting the impacts of climate change on skipjack tuna abundance and spatial distribution”. In: *Global Change Biology* 20.3, pp. 742–753. DOI: [10.1111/gcb.12460](https://doi.org/10.1111/gcb.12460).
- Dulvy, N. K. et al. (2008). “You can swim but you can’t hide: the global status and conservation of oceanic pelagic sharks and rays”. In: *Aquatic Conservation: Marine and Freshwater Ecosystems* 18.5, pp. 459–482. DOI: [10.1002/aqc.975](https://doi.org/10.1002/aqc.975).
- Dupaix, A., M. Capello, C. Lett, M. Andrello, N. Barrier, G. Viennois, and L. Dagorn (2021a). “Surface habitat modification through industrial tuna fishery practices”. In: *ICES Journal of Marine Science* 78.9, pp. 3075–3088. DOI: [10.1093/icesjms/fsab175](https://doi.org/10.1093/icesjms/fsab175).
- Dupaix, A., L. Dagorn, A. Duparc, A. Guillou, J.-L. Deneubourg, and M. Capello (2023a). “No evidence from long-term analysis of yellowfin tuna condition that Drifting Fish Aggregating Devices act as ecological traps”. In: *Marine Ecology Progress Series* 711, pp. 121–127. DOI: [10.3354/meps14313](https://doi.org/10.3354/meps14313).
- Dupaix, A., L. Mérillet, D. Kopp, M. Mouchet, and M. Robert (2021b). “Using biological traits to get insights into the benthic-demersal community sensitivity to trawling in the Celtic Sea”. In: *ICES Journal of Marine Science* 78.3, pp. 1063–1073. DOI: [10.1093/icesjms/fsab011](https://doi.org/10.1093/icesjms/fsab011).
- Dupaix, A., G. Pérez, and M. Capello (2023b). *FAT albaCoRaW*. DOI: [10.5281/zenodo.5834056](https://doi.org/10.5281/zenodo.5834056).
- Dussin, R., B. Barnier, L. Brodeau, and J. M. Molines (2016). *Drakkar forcing set DFS5*. Tech. rep. MyOcean Report.
- Dwernychuk, L. W. and D. A. Boag (1972). “Ducks nesting in association with gulls - an ecological trap?” In: *Canadian Journal of Zoology* 50.5, pp. 559–563. DOI: [10.1139/z72-076](https://doi.org/10.1139/z72-076).
- Erauskin-Extramiana, M., H. Arrizabalaga, A. J. Hobday, A. Cabré, L. Ibaibarriaga, I. Arregui, H. Murua, and G. Chust (2019). “Large-scale distribution of tuna species in a warming ocean”. In: *Global Change Biology* 25.6, pp. 2043–2060. DOI: [10.1111/gcb.14630](https://doi.org/10.1111/gcb.14630).
- Escalle, L., D. Gaertner, P. Chavance, H. Murua, M. Simier, P. J. Pascual-Alayón, F. Ménard, J. Ruiz, F. Abascal, and B. Mérigot (2019a). “Catch and bycatch captured by tropical tuna purse-seine fishery in whale and whale shark associated sets: comparison with free school and FAD sets”. In: *Biodiversity and Conservation* 28.2, pp. 467–499. DOI: [10.1007/s10531-018-1672-1](https://doi.org/10.1007/s10531-018-1672-1).
- Escalle, L., S. R. Hare, T. Vidal, M. Brownjohn, P. Hamer, and G. Pilling (2021a). “Quantifying drifting Fish Aggregating Device use by the world’s largest tuna fishery”. In: *ICES Journal of Marine Science* 78.7, pp. 2432–2447. DOI: [10.1093/icesjms/fsab116](https://doi.org/10.1093/icesjms/fsab116).
- Escalle, L., J. Mourot, P. Hamer, S. R. Hare, N. B. Phillip, and G. M. Pilling (2023a). “Towards non-entangling and biodegradable drifting fish aggregating devices – Baselines and transition in the world’s largest tuna purse seine fishery”. In: *Marine Policy* 149, p. 105500. DOI: [10.1016/j.marpol.2023.105500](https://doi.org/10.1016/j.marpol.2023.105500).
- Escalle, L., B. Muller, T. Vidal, S. Hare, P. Hamer, and P. Office (2021b). *Report on analyses of the 2016/2021 PNA FAD tracking programme*. 17th Regular Session of the Scientific Commity SC17-MI-IP-04. Online: Western and Central Pacific Fisheries Commission.
- Escalle, L., J. S. Phillips, M. Brownjohn, S. Brouwer, A. S. Gupta, E. V. Sebille, J. Hampton, and G. Pilling (2019b). “Environmental versus operational drivers of drifting FAD beaching in the Western and Central Pacific Ocean”. In: *Scientific Reports* 9.1, pp. 1–12. DOI: [10.1038/s41598-019-50364-0](https://doi.org/10.1038/s41598-019-50364-0).
- Escalle, L., T. Vidal, S. Hare, P. Hamer, G. Pilling, and P. Office (2020). *Estimates of the number of FAD deployments and active FADs per vessel in the WCPO*. 16th Regular Session

-
- of the Scientific Commity SC16-MI-IP-13. Online: Western and Central Pacific Fisheries Commission.
- Escalle, L., T. Vidal, B. Heuvel, R. Clarke, S. Hare, P. Hamer, and G. Pilling (2021c). *Project 88 final report: Acoustic FAD analyses*. 17th Regular Session of the Scientific Commity SC17-MI-IP-05. Online: Western and Central Pacific Fisheries Commission.
- Escalle, L. et al. (2023b). *Analyses of the regional database of stranded (dFAD) in the EPO*. 7th ad-hoc permanent working group on FADs FAD-07-INF-A. La Jolla, CA: Inter-American Tropical Tuna Commission.
- Estess, E. E., D. H. Klinger, D. M. Coffey, A. C. Gleiss, I. Rowbotham, A. C. Seitz, L. Rodriguez, A. Norton, B. Block, and C. Farwell (2017). “Bioenergetics of captive yellowfin tuna (*Thunnus albacares*)”. In: *Aquaculture* 468, pp. 71–79. DOI: [10.1016/j.aquaculture.2016.09.053](https://doi.org/10.1016/j.aquaculture.2016.09.053).
- Evans, K. et al. (2015). “Optimising fisheries management in relation to tuna catches in the western central Pacific Ocean: A review of research priorities and opportunities”. In: *Marine Policy* 59, pp. 94–104. DOI: [10.1016/j.marpol.2015.05.003](https://doi.org/10.1016/j.marpol.2015.05.003).
- FAO (2022). *The State of World Fisheries and Aquaculture 2022: Towards Blue Transformation*. The State of World Fisheries and Aquaculture (SOFIA) 2022. Rome, Italy: FAO. DOI: [10.4060/cc0461en](https://doi.org/10.4060/cc0461en).
- Farley, J. H., N. P. Clear, B. Leroy, T. L. O. Davis, G. McPherson, J. H. Farley, N. P. Clear, B. Leroy, T. L. O. Davis, and G. McPherson (2006). “Age, growth and preliminary estimates of maturity of bigeye tuna, *Thunnus obesus*, in the Australian region”. In: *Marine and Freshwater Research* 57.7, pp. 713–724. DOI: [10.1071/MF05255](https://doi.org/10.1071/MF05255).
- Filmalter, J. D., M. Capello, J.-L. Deneubourg, P. D. Cowley, and L. Dagorn (2013). “Looking behind the curtain: quantifying massive shark mortality in fish aggregating devices”. In: *Frontiers in Ecology and the Environment* 11.6, pp. 291–296. DOI: [10.1890/130045](https://doi.org/10.1890/130045).
- Filous, A., A. M. Friedlander, L. Griffin, R. J. Lennox, A. J. Danylchuk, G. Mereb, and Y. Golbuu (2020). “Movements of juvenile yellowfin tuna (*Thunnus albacares*) within the coastal FAD network adjacent to the Palau National Marine Sanctuary: Implications for local fisheries development”. In: *Fisheries Research* 230, p. 105688. DOI: [10.1016/j.fishres.2020.105688](https://doi.org/10.1016/j.fishres.2020.105688).
- Fischer, J. and D. B. Lindenmayer (2007). “Landscape modification and habitat fragmentation: a synthesis”. In: *Global Ecology and Biogeography* 16.3, pp. 265–280. DOI: [10.1111/j.1466-8238.2007.00287.x](https://doi.org/10.1111/j.1466-8238.2007.00287.x).
- Fletcher, R. J., J. L. Orrock, and B. A. Robertson (2012). “How the type of anthropogenic change alters the consequences of ecological traps”. In: *Proceedings of the Royal Society B: Biological Sciences* 279.1738, pp. 2546–2552. DOI: [10.1098/rspb.2012.0139](https://doi.org/10.1098/rspb.2012.0139).
- Floch, L., M. Depetris, P. Dewals, and A. Duparc (2019). *Statistics of the French Purse Seine Fishing Fleet Targeting Tropical Tunas in the Indian Ocean (1981-2018)*. Working Party on Tropical Tunas (WPTT) IOTC-2019-WPTT21-11_Rev1. Donostia-San Sebastian, Spain: Indian Ocean Tuna Commission, pp. 1–27.
- Fonteneau, A. (2003). “Prospects for the management of FAD fisheries in the Indian Ocean”. In: *IOTC proceedings*. Vol. 6, pp. 030–047.
- Fonteneau, A., E. Chassot, and N. Bodin (2013). “Global spatio-temporal patterns in tropical tuna purse seine fisheries on drifting fish aggregating devices (DFADs): Taking a historical perspective to inform current challenges”. In: *Aquatic Living Resources* 26.1, pp. 37–48. DOI: [10.1051/alr/2013046](https://doi.org/10.1051/alr/2013046).
- Fonteneau, A., E. Chassot, and D. Gaertner (2015). “Managing tropical tuna purse seine fisheries through limiting the number of drifting fish aggregating devices in the Atlantic: food for thought”. In: *Collect. Vol. Sci. Pap. ICCAT* 71.1, pp. 460–475.
- Fonteneau, A., P. Pallarés, and R. Pianet (2000). “A worldwide review of purse seine fisheries on FADs”. In: *Caribbean-Martinique*, pp. 15–35.

-
- Forget, F. G., M. Capello, J. D. Filmalter, R. Govinden, M. Soria, P. D. Cowley, and L. Dagorn (2015). “Behaviour and vulnerability of target and non-target species at drifting fish aggregating devices (FADs) in the tropical tuna purse seine fishery determined by acoustic telemetry”. In: *Canadian Journal of Fisheries and Aquatic Sciences* 72.9, pp. 1398–1405. DOI: [10.1139/cjfas-2014-0458](https://doi.org/10.1139/cjfas-2014-0458).
- Fréon, P. and L. Dagorn (2000). “Review of fish associative behaviour: toward a generalisation of the meeting point hypothesis”. In: *Reviews in Fish Biology and Fisheries* 10, pp. 183–207. DOI: [10.1023/A:1016666108540](https://doi.org/10.1023/A:1016666108540).
- Froese, R. and D. Pauly (2023). “FishBase. World Wide Web electronic publication”. In: *www.fishbase.org, version (02/2023)*.
- Fromentin, J.-M., S. Bonhommeau, H. Arrizabalaga, and L. T. Kell (2014). “The spectre of uncertainty in management of exploited fish stocks: The illustrative case of Atlantic bluefin tuna”. In: *Marine Policy* 47, pp. 8–14. DOI: [10.1016/j.marpol.2014.01.018](https://doi.org/10.1016/j.marpol.2014.01.018).
- Fuller, D. W., K. M. Schaefer, J. Hampton, S. Caillot, B. M. Leroy, and D. G. Itano (2015). “Vertical movements, behavior, and habitat of bigeye tuna (*Thunnus obesus*) in the equatorial central Pacific Ocean”. In: *Fisheries Research* 172, pp. 57–70. DOI: [10.1016/j.fishres.2015.06.024](https://doi.org/10.1016/j.fishres.2015.06.024).
- Gaertner, D., J. Ariz, N. Bez, S. Clermidy, G. Moreno, H. Murua, and M. Soto (2018). “Results achieved within the framework of the EU research project: Catch, effort, and ECOsystem impacts of FAD-fishing (CECOFAD)”. In: *Collect. Vol. Sci. Pap. ICCAT*, 74.5, pp. 2243–2267.
- Gaertner, D., M. Pagavino, and J. Marcano (1996). “Utilisation de modèles linéaires généralisés pour évaluer les stratégies de pêche thonière à la senne en présence d’espèces associées dans l’Atlantique ouest”. In: *Aquatic Living Resources* 9.4, pp. 305–323. DOI: [10.1051/alr:1996034](https://doi.org/10.1051/alr:1996034).
- Gaertner, D., M. Pagavino, and J. Marcano (1999). “Influence of fishers’ behaviour on the catchability of surface tuna schools in the Venezuelan purse-seiner fishery in the Caribbean Sea”. In: *Canadian Journal of Fisheries and Aquatic Sciences* 56.3, pp. 394–406. DOI: [10.1139/f98-191](https://doi.org/10.1139/f98-191).
- Gaertner, J. C., M. Taquet, L. Dagorn, B. Mérigot, R. Aumeeruddy, G. Sancho, and D. Itano (2008). “Visual censuses around drifting fish aggregating devices (FADs): a new approach for assessing the diversity of fish in open-ocean waters”. In: *Marine Ecology Progress Series* 366, pp. 175–186. DOI: [10.3354/meps07554](https://doi.org/10.3354/meps07554).
- Geary, R. C. (1930). “The Frequency Distribution of the Quotient of Two Normal Variates”. In: *Journal of the Royal Statistical Society* 93.3, pp. 442–446. DOI: [10.2307/2342070](https://doi.org/10.2307/2342070).
- Gershman, D., A. Nickson, and M. O’Toole (2015). *Estimating the Use of FADs Around the World*. Tech. rep. PEW Charitable Trusts.
- Gillett, R., M. Blanc, I. Cartwright, M. Batty, M. Savins, J. Albert, N. Idechong, M. Tanetoa, T. Emberson, and W. Sokimi (2018). “Forty years of small-scale tuna fishery development in the Pacific Islands: Lessons learned”. In: *SPC Fisheries Newsletter* 157, pp. 60–68.
- Gilman, E. L. (2011). “Bycatch governance and best practice mitigation technology in global tuna fisheries”. In: *Marine Policy* 35.5, pp. 590–609. DOI: [10.1016/j.marpol.2011.01.021](https://doi.org/10.1016/j.marpol.2011.01.021).
- Gilroy, J. and W. Sutherland (2007). “Beyond ecological traps: perceptual errors and undervalued resources”. In: *Trends in Ecology & Evolution* 22.7, pp. 351–356. DOI: [10.1016/j.tree.2007.03.014](https://doi.org/10.1016/j.tree.2007.03.014).
- Girard, C., S. Benhamou, and L. Dagorn (2004). “FAD : Fish Aggregating Device or Fish Attracting Device? A new analysis of yellowfin tuna movements around floating objects”. In: *Animal Behaviour* 67.2, pp. 319–326. DOI: [10.1016/j.anbehav.2003.07.007](https://doi.org/10.1016/j.anbehav.2003.07.007).
- Govinden, R., M. Capello, F. Forget, J. D. Filmalter, and L. Dagorn (2021). “Behavior of skipjack (*Katsuwonus pelamis*), yellowfin (*Thunnus albacares*), and bigeye (*T. obesus*) tunas associated with drifting fish aggregating devices (dFADs) in the Indian Ocean, assessed

-
- through acoustic telemetry”. In: *Fisheries Oceanography* 30.5, pp. 542–555. DOI: [10.1111/fog.12536](https://doi.org/10.1111/fog.12536).
- Govinden, R., R. Jauhary, J. Filmalter, F. Forget, M. Soria, S. Adam, and L. Dagorn (2013). “Movement behaviour of skipjack (*Katsuwonus pelamis*) and yellowfin (*Thunnus albacares*) tuna at anchored fish aggregating devices (FADs) in the Maldives, investigated by acoustic telemetry”. In: *Aquatic Living Resources* 26.1, pp. 69–77. DOI: [10.1051/alr/2012022](https://doi.org/10.1051/alr/2012022).
- Grande, M., H. Murua, I. Zudaire, E. J. Arsenault-Pernet, F. Pernet, and N. Bodin (2016). “Energy allocation strategy of skipjack tuna *Katsuwonus pelamis* during their reproductive cycle”. In: *Journal of Fish Biology* 89.5, pp. 2434–2448. DOI: [10.1111/jfb.13125](https://doi.org/10.1111/jfb.13125).
- Grande, M. (2013). “The reproductive biology, condition and feeding ecology of the skipjack, *Katsuwonus pelamis*, in the Western Indian Ocean”. PhD thesis. Universidad del País Vasco-Euskal Herriko Unibertsitatea.
- Grande, M., H. Murua, I. Zudaire, N. Goñi, and N. Bodin (2014). “Reproductive timing and reproductive capacity of the Skipjack Tuna (*Katsuwonus pelamis*) in the western Indian Ocean”. In: *Fisheries Research* 156, pp. 14–22. DOI: [10.1016/j.fishres.2014.04.011](https://doi.org/10.1016/j.fishres.2014.04.011).
- Grande, M. et al. (2018). *Best standards for data collection and reporting requirements on FOBs: towards a science-based FOB fishery management*. Working Party on Data Collection and Statistics (WPDCS) IOTC-2018-WPDCS14-39. Mahé, Seychelles: Indian Ocean Tuna Commission.
- Greenblatt R., P. (1979). “Associations of tuna with flotsam in the Eastern Tropical Pacific”. In: *Fishery Bulletin* 77.1, pp. 147–155.
- Guillotreau, P., S. Antoine, K. Bistoquet, E. Chassot, and K. Rassool (2023a). “How fisheries can support a small island economy in pandemic times: the Seychelles case”. In: *Aquatic Living Resources* 36, p. 24. DOI: [10.1051/alr/2023020](https://doi.org/10.1051/alr/2023020).
- Guillotreau, P., F. Salladarré, M. Capello, A. Dupaix, L. Floc’h, A. Tidd, M. Tolotti, and L. Dagorn (2023b). “Is FAD fishing an economic trap? Effects of seasonal closures and other management measures on a purse-seine tuna fleet”. In: *Fish and Fisheries*. DOI: [10.1111/faf.12799](https://doi.org/10.1111/faf.12799).
- Guillotreau, P., F. Salladarré, P. Dewals, and L. Dagorn (2011). “Fishing tuna around Fish Aggregating Devices (FADs) vs free swimming schools: Skipper decision and other determining factors”. In: *Fisheries Research* 109.2, pp. 234–242. DOI: [10.1016/j.fishres.2011.02.007](https://doi.org/10.1016/j.fishres.2011.02.007).
- Guillou, A. et al. (2021). *Tunabio: biological traits of tropical tuna and bycatch species caught by purse seine fisheries in the Western Indian and Eastern Central Atlantic Oceans*. DOI: [10.17882/73500](https://doi.org/10.17882/73500).
- Haberle, I., L. Bavčević, and T. Klanjscek (2023). “Fish condition as an indicator of stock status: Insights from condition index in a food-limiting environment”. In: *Fish and Fisheries* 24.4, pp. 567–581. DOI: [10.1111/faf.12744](https://doi.org/10.1111/faf.12744).
- Hale, R. and S. E. Swearer (2016). “Ecological traps: current evidence and future directions”. In: *Proceedings of the Royal Society B: Biological Sciences* 283.1824, p. 20152647. DOI: [10.1098/rspb.2015.2647](https://doi.org/10.1098/rspb.2015.2647).
- Hale, R., E. A. Treml, and S. E. Swearer (2015). “Evaluating the metapopulation consequences of ecological traps”. In: *Proceedings of the Royal Society B: Biological Sciences* 282.1804, p. 20142930. DOI: [10.1098/rspb.2014.2930](https://doi.org/10.1098/rspb.2014.2930).
- Hall, M. (1992). “The association of tunas with floating objects and dolphins in the Eastern Pacific Ocean. 1992. Part VII. Some hypotheses on the mechanisms governing the association of tunas with floating objects and dolphins.” In: *International Workshop on Fishing for Tunas Associated with Floating Objects*. Ed. by M. D. Scott, W. H. Bayliff, C. E. Lennert-Cody, and K. M. Schaefer. La Jolla, CA, February 11-13, 1992: Inter-American Tropical Tuna Commission.

-
- Hall, M. and M. Roman (2013). *Bycatch and non-tuna catch in the tropical tuna purse seine fisheries of the world*. FAO Fisheries and Aquaculture Technical paper 568. Food and Agriculture Organization.
- Hallier, J.-P. and D. Gaertner (2008). “Drifting fish aggregation devices could act as an ecological trap for tropical tuna species”. In: *Marine Ecology Progress Series* 353, pp. 255–264. DOI: [10.3354/meps07180](https://doi.org/10.3354/meps07180).
- Hallier, J.-P. and J. Parajua (1999). “Review of tuna fisheries on floating objects in the Indian Ocean”. In: *Proceedings of the International Workshop on Fishing for Tunas Associated with Floating Objects*. Ed. by M. D. Scott, W. H. Bayliff, C. E. Lennert-Cody, and K. M. Schaefer. Vol. 11. La Jolla, CA, February 11-13, 1992: Inter-American Tropical Tuna Commission, pp. 195–221.
- Halpern, B. S. et al. (2008). “A Global Map of Human Impact on Marine Ecosystems”. In: *Science* 319.5865, pp. 948–952. DOI: [10.1126/science.1149345](https://doi.org/10.1126/science.1149345).
- Hanich, Q., R. Davis, G. Holmes, E.-R. Amidjogbe, and B. Campbell (2019). “Drifting Fish Aggregating Devices (FADs) deploying, soaking and setting - when is a FAD ‘fishing’?” In: *The International Journal of Marine and Coastal Law* 34.4, pp. 731–754. DOI: [10.1163/15718085-23441103](https://doi.org/10.1163/15718085-23441103).
- Hansen, M. C. et al. (2013). “High-resolution global maps of 21st-century forest cover change”. In: *Science* 342.6160, pp. 850–853. DOI: [10.1126/science.1244693](https://doi.org/10.1126/science.1244693).
- Hardin, G. (1968). “The Tragedy of the Commons”. In: *Science* 162.3859, pp. 1243–1248. DOI: [10.1126/science.162.3859.1243](https://doi.org/10.1126/science.162.3859.1243).
- Hariri, S. (2022). “Analysis of mixing structures in the Adriatic Sea using finite-size Lyapunov exponents”. In: *Geophysical & Astrophysical Fluid Dynamics* 116.1, pp. 20–37. DOI: [10.1080/03091929.2021.1962851](https://doi.org/10.1080/03091929.2021.1962851).
- Hays, G. C. et al. (2016). “Key Questions in Marine Megafauna Movement Ecology”. In: *Trends in Ecology & Evolution* 31.6, pp. 463–475. DOI: [10.1016/j.tree.2016.02.015](https://doi.org/10.1016/j.tree.2016.02.015).
- Hermes, J. C. and C. J. C. Reason (2008). “Annual cycle of the South Indian Ocean (Seychelles-Chagos) thermocline ridge in a regional ocean model”. In: *Journal of Geophysical Research: Oceans* 113.C4. DOI: [10.1029/2007JC004363](https://doi.org/10.1029/2007JC004363).
- Hinojosa, I. A., M. M. Rivadeneira, and M. Thiel (2011). “Temporal and spatial distribution of floating objects in coastal waters of central-southern Chile and Patagonian fjords”. In: *Continental Shelf Research* 31.3-4, pp. 172–186. DOI: [10.1016/j.csr.2010.04.013](https://doi.org/10.1016/j.csr.2010.04.013).
- Hoegh-Guldberg, O., E. S. Poloczanska, W. Skirving, and S. Dove (2017). “Coral Reef Ecosystems under Climate Change and Ocean Acidification”. In: *Frontiers in Marine Science* 4. DOI: [10.3389/fmars.2017.00158](https://doi.org/10.3389/fmars.2017.00158).
- Holland, K. N., R. W. Brill, and R. K. Chang (1990). “Horizontal and vertical movements of yellowfin and bigeye tuna associated with fish aggregating devices”. In: *Fishery Bulletin* 88.3, pp. 494–507.
- Holmes, G., Q. Hanich, and M. Soboil (2019). “Economic benefits of FAD set limits throughout the supply chain”. In: *Marine Policy* 103, pp. 1–8. DOI: [10.1016/j.marpol.2019.02.006](https://doi.org/10.1016/j.marpol.2019.02.006).
- Hooke, R. L. and J. F. Martín-Duque (2012). “Land transformation by humans: A review”. In: *GSA Today* 12.12, pp. 4–10. DOI: [10.1130/GSAT151A.1](https://doi.org/10.1130/GSAT151A.1).
- Hooper, D. U., E. C. Adair, B. J. Cardinale, J. E. K. Byrnes, B. A. Hungate, K. L. Matulich, A. Gonzalez, J. E. Duffy, L. Gamfeldt, and M. I. O’Connor (2012). “A global synthesis reveals biodiversity loss as a major driver of ecosystem change”. In: *Nature* 486.7401, pp. 105–108. DOI: [10.1038/nature11118](https://doi.org/10.1038/nature11118).
- Hovenkamp, H. (1991). “Rationality in Law and Economics”. In: *George Washington Law Review* 60, p. 293.
- Hunsicker, M. E., R. J. Olson, T. E. Essington, M. N. Maunder, L. M. Duffy, and J. F. Kitchell (2012). “Potential for top-down control on tropical tunas based on size structure of predator-

-
- prey interactions”. In: *Marine Ecology Progress Series* 445, pp. 263–277. DOI: [10.3354/meps09494](https://doi.org/10.3354/meps09494).
- Huret, M., P. Petitgas, and M. Woillez (2010). “Dispersal kernels and their drivers captured with a hydrodynamic model and spatial indices: A case study on anchovy (*Engraulis encrasicolus*) early life stages in the Bay of Biscay”. In: *Progress in Oceanography*. 3rd GLOBEC OSM: From ecosystem function to ecosystem prediction 87.1, pp. 6–17. DOI: [10.1016/j.pocean.2010.09.023](https://doi.org/10.1016/j.pocean.2010.09.023).
- IATTC (2021). *Resolution on the conservation measures for tropical tunas in the Eastern Pacific Ocean during 2022-2024*. Resolution C-21-04. Inter-American Tropical Tuna Commission.
- ICCAT (2022). *Recommendation by ICCAT replacing Recommendation 21-01 on a multianual conservation and management programme for tropical tunas*. Tech. rep. Rec 22-01. International Commission for the Conservation of Atlantic Tunas.
- Imzilen, T., E. Chassot, J. Barde, H. Demarcq, A. Maufroy, L. Roa-Pascuali, J.-F. TERNON, and C. Lett (2019). “Fish aggregating devices drift like oceanographic drifters in the near-surface currents of the Atlantic and Indian Oceans”. In: *Progress in Oceanography* 171, pp. 108–127. DOI: [10.1016/j.pocean.2018.11.007](https://doi.org/10.1016/j.pocean.2018.11.007).
- Imzilen, T., C. Lett, E. Chassot, and J. Barde (2016). *Modeling trajectories of fish aggregating devices with satellite images : use cases related to fisheries*. Working Party on Data Collection and Statistics (WPDCS) IOTC-2016-WPDCS12. Mahé, Seychelles: Indian Ocean Tuna Commission.
- Imzilen, T., C. Lett, E. Chassot, and D. M. Kaplan (2021). “Spatial management can significantly reduce dFAD beachings in Indian and Atlantic Ocean tropical tuna purse seine fisheries”. In: *Biological Conservation* 254, p. 108939. DOI: [10.1016/j.biocon.2020.108939](https://doi.org/10.1016/j.biocon.2020.108939).
- Imzilen, T., C. Lett, E. Chassot, A. Maufroy, M. Goujon, and D. M. Kaplan (2022). “Recovery at sea of abandoned, lost or discarded drifting fish aggregating devices”. In: *Nature Sustainability*, pp. 1–10. DOI: [10.1038/s41893-022-00883-y](https://doi.org/10.1038/s41893-022-00883-y).
- Ioannou, C. (2017). “Grouping and Predation”. In: *Encyclopedia of Evolutionary Psychological Science*. Ed. by T. K. Shackelford and V. A. Weekes-Shackelford. Cham: Springer International Publishing. DOI: [10.1007/978-3-319-16999-6_2699-1](https://doi.org/10.1007/978-3-319-16999-6_2699-1).
- Ioannou, C. C., I. D. Couzin, R. James, D. P. Croft, and J. Krause (2011). “Social organisation and information transfer in schooling fish”. In: *Fish cognition and behavior*. Ed. by C. Brown, K. Laland, and J. Krause. Second Edition. Vol. 2. Blackwell Publishing Ltd., pp. 217–239.
- IOTC (2022a). *Executive Summary Bigeye Tuna (2022)*. Tech. rep. Indian Ocean Tuna Commission.
- (2022b). *Executive Summary Skipjack Tuna (2022)*. Tech. rep. Indian Ocean Tuna Commission.
- (2021a). *Executive Summary Yellowfin Tuna (2021)*. Tech. rep. Indian Ocean Tuna Commission.
- (2022c). *Executive Summary Yellowfin Tuna (2022)*. Tech. rep. Indian Ocean Tuna Commission.
- (2023a). *Instrumented buoy data (Jan 2020 - December 2022)*. IOTC ad hoc Working Group on FADs (WGFAD4) IOTC-2023-WGFAD04-DATA04_Rev1.
- (2021b). *Instrumented buoy data (Jan 2020 - May 2021)*. IOTC ad hoc Working Group on FADs (WGFAD2).
- (2022d). *Overview of Indian Ocean tropical tuna fisheries*. Working Party on Tropical Tunas: Data Preparatory Meeting IOTC-2022-WPTT24(DP)-07-TROPICAL. Online: Indian Ocean Tuna Commission.
- (2020a). *Report of the 24th Session of the Indian Ocean Tuna Commission*. Tech. rep. Indian Ocean Tuna Commission.

-
- IOTC (2017). *Resolution 17/08 - Procedures on a Fish Aggregating Devices (FADs) Management Plan, Including a limitation of the number of FADs, more detailed specifications of catch reporting from FAD sets, and the development of improved FAD designs to reduce the incidence of entanglement of non-target species*. Tech. rep. IOTC-2017-WPDCS13-INF02.
- (2019). *Resolution 19/02 - Procedures on a Fish Aggregating Devices (FADs) Management Plan*. Tech. rep.
- (2021c). *Resolution 21/01 on an interim plan for rebuilding the Indian Ocean yellowfin tuna stock in the IOTC area of competence*. Tech. rep.
- (2023b). *Resolution 23/02 on the management of drifting fish aggregating devices (DFAD) in the IOTC area of competence*. Tech. rep.
- (2022e). *Review of data on Drifting Fish Aggregating Devices*. IOTC ad hoc Working Group on FADs (WGFAD) IOTC-2022-WGFAD03-03-Rev2. Online: Indian Ocean Tuna Commission.
- (2020b). *Review of the statistical data and fishery trends for tropical tunas*. Working Party on Tropical Tunas: Stock Assessment Meeting IOTC-2020-WPTT22(AS)-03_Rev4. Online: Indian Ocean Tuna Commission.
- (2020c). *Stock Status Summary Albacore Tuna (ALB: Thunnus alalunga)*. Tech. rep. Indian Ocean Tuna Commission.
- (2020d). *Stock Status Summary Bigeye tuna (BET: Thunnus obesus)*. Tech. rep. Indian Ocean Tuna Commission.
- (2020e). *Stock Status Summary Skipjack Tuna (SKJ: Katsuwonus pelamis)*. Tech. rep. Indian Ocean Tuna Commission.
- (2020f). *Update on the implementation of the IOTC Regional Observer Scheme*. Working Party on Ecosystems and Bycatch IOTC-2020-WPEB16-08. Indian Ocean Tuna Commission.
- IPBES (2019). *Global assessment report on biodiversity and ecosystem services of the Intergovernmental Science-Policy Platform on Biodiversity and Ecosystem Services*. Tech. rep. Zenodo. DOI: [10.5281/zenodo.6417333](https://doi.org/10.5281/zenodo.6417333).
- (2022a). *Summary for policymakers of the thematic assessment of the sustainable use of wild species of the Intergovernmental Science-Policy Platform on Biodiversity and Ecosystem Services (IPBES)*. Tech. rep. IPBES Secretariat, Bonn, Germany: Zenodo, 33 pages. DOI: [10.5281/zenodo.6810036](https://doi.org/10.5281/zenodo.6810036).
- (2018). *The IPBES assessment report on land degradation and restoration*. Tech. rep. Zenodo. DOI: [10.5281/zenodo.3237393](https://doi.org/10.5281/zenodo.3237393).
- (2022b). *Thematic assessment of the sustainable use of wild species of the Intergovernmental Science-Policy Platform on Biodiversity and Ecosystem Services*. Ed. by J.-M. Fromentin et al. Bonn, Germany: IPBES secretariat. DOI: [10.5281/zenodo.7755805](https://doi.org/10.5281/zenodo.7755805).
- ISSF (2022). *Status of the World Fisheries for Tuna: July 2022*. ISSF Technical Report. International Seafood Sustainability Foundation.
- (2023). *Status of the World Fisheries for Tuna: March 2023*. ISSF Technical Report. International Seafood Sustainability Foundation.
- Jaquemet, S., M. Potier, and F. Ménard (2011). “Do drifting and anchored Fish Aggregating Devices (FADs) similarly influence tuna feeding habits? A case study from the western Indian Ocean”. In: *Fisheries Research* 107.1, pp. 283–290. DOI: [10.1016/j.fishres.2010.11.011](https://doi.org/10.1016/j.fishres.2010.11.011).
- Jauharee, A. R., M. Capello, M. Simier, F. Forget, M. S. Adam, and L. Dagorn (2021). “Tuna behaviour at anchored FADs inferred from Local Ecological Knowledge (LEK) of pole-and-line tuna fishers in the Maldives”. In: *PLOS ONE* 16.7, e0254617. DOI: [10.1371/journal.pone.0254617](https://doi.org/10.1371/journal.pone.0254617).

-
- Justel-Rubio, A. and L. Recio (2023). *A snapshot of the large-scale tropical tuna purse seine fishing fleets as of June 2023 (Version 11)*. ISSF Technical Report 2023-04. Pittsburgh, PA, USA: International Seafood Sustainability Foundation.
- Kaplan, D. M., M. Grande, M. L. Ramos Alonso, J. C. Báez, J. Uranga, A. Duparc, T. Imzilen, L. Floch, and J. Santiago (2023). *CPUE standardization for skipjack tuna (*Katsuwonus pelamis*) of the EU purse-seine fishery on floating objects (FOB) in the Indian Ocean*. IOTC Working Party on Tropical Tuna: Data Preparatory Meeting IOTC-2023-WPTT25(DP)-11_Rev1. Indian Ocean Tuna Commission.
- Kasumyan, A. O. and D. S. Pavlov (2018). “Evolution of Schooling Behavior in Fish”. In: *Journal of Ichthyology* 58.5, pp. 670–678. DOI: [10.1134/S0032945218050090](https://doi.org/10.1134/S0032945218050090).
- Katara, I. et al. (2018). *Standardisation of yellowfin tuna CPUE for the EU purse seine fleet operating in the Indian Ocean*. Working Party on Tropical Tunas (WPTT) IOTC-2018-WPTT20-36. Mahé, Seychelles: Indian Ocean Tuna Commission.
- Kim, E. (2015). “Effects of Fish Aggregating Devices (FADs) on tuna movement”. PhD Thesis. Manoa: University of Hawai‘i.
- Kleiber, P. and J. Hampton (1994). “Modeling Effects of FADs and Islands on Movement of Skipjack Tuna (*Katsuwonus pelamis*): Estimating Parameters from Tagging Data”. In: *Canadian Journal of Fisheries and Aquatic Sciences* 51.12, pp. 2642–2653. DOI: [10.1139/f94-264](https://doi.org/10.1139/f94-264).
- Klimley, A. P. and C. F. Holloway (1999). “School fidelity and homing synchronicity of yellowfin tuna, *Thunnus albacares*”. In: *Marine Biology* 133.2, pp. 307–317. DOI: [10.1007/s002270050469](https://doi.org/10.1007/s002270050469).
- Kloser, R. J., T. E. Ryan, J. W. Young, and M. E. Lewis (2009). “Acoustic observations of micronekton fish on the scale of an ocean basin: potential and challenges”. In: *ICES Journal of Marine Science* 66.6, pp. 998–1006. DOI: [10.1093/icesjms/fsp077](https://doi.org/10.1093/icesjms/fsp077).
- Krajick, K. (2001). “Defending Deadwood”. In: *Science* 293.5535, pp. 1579–1581. DOI: [10.1126/science.293.5535.1579](https://doi.org/10.1126/science.293.5535.1579).
- Lagerloef, G. S. E., G. T. Mitchum, R. B. Lukas, and P. P. Niiler (1999). “Tropical Pacific near-surface currents estimated from altimeter, wind, and drifter data”. In: *Journal of Geophysical Research: Oceans* 104.C10, pp. 23313–23326. DOI: [10.1029/1999JC900197](https://doi.org/10.1029/1999JC900197).
- Lakshmi, R. S., A. Chatterjee, S. Prakash, and T. Mathew (2020). “Biophysical Interactions in Driving the Summer Monsoon Chlorophyll Bloom Off the Somalia Coast”. In: *Journal of Geophysical Research: Oceans* 125.3, e2019JC015549. DOI: [10.1029/2019JC015549](https://doi.org/10.1029/2019JC015549).
- Le Cren, E. D. (1951). “The Length-Weight Relationship and Seasonal Cycle in Gonad Weight and Condition in the Perch (*Perca fluviatilis*)”. In: *The Journal of Animal Ecology* 20.2, p. 201. DOI: [10.2307/1540](https://doi.org/10.2307/1540).
- Le Maho, Y., H. Vu Van Kha, H. Koubi, G. Dewasmes, J. Girard, P. Ferre, and M. Cagnard (1981). “Body composition, energy expenditure, and plasma metabolites in long-term fasting geese”. In: *American Journal of Physiology-Endocrinology and Metabolism* 241.5, E342–E354. DOI: [10.1152/ajpendo.1981.241.5.E342](https://doi.org/10.1152/ajpendo.1981.241.5.E342).
- Lebranchu, J. et al. (2022). *UE-France - Rapport national destiné au Comité Scientifique de la Commission des Thons de l’Océan Indien, 2022*. Scientific Committee IOTC-2022-SC35-NR06_Annex1. Victoria, Seychelles: Indian Ocean Tuna Commission.
- Lebreton, L.-M., S. D. Greer, and J. C. Borrero (2012). “Numerical modelling of floating debris in the world’s oceans”. In: *Marine Pollution Bulletin* 64.3, pp. 653–661. DOI: [10.1016/j.marpolbul.2011.10.027](https://doi.org/10.1016/j.marpolbul.2011.10.027).
- Lee, M. O., S. Otake, and J. K. Kim (2018). “Transition of artificial reefs (ARs) research and its prospects”. In: *Ocean & Coastal Management* 154, pp. 55–65. DOI: [10.1016/j.ocecoaman.2018.01.010](https://doi.org/10.1016/j.ocecoaman.2018.01.010).

-
- Lennert-Cody, C. E., G. Moreno, V. Restrepo, M. H. Román, and M. N. Maunder (2018). “Recent purse-seine FAD fishing strategies in the eastern Pacific Ocean: what is the appropriate number of FADs at sea?” In: *ICES Journal of Marine Science* 75.5, pp. 1748–1757. DOI: [10.1093/icesjms/fsy046](https://doi.org/10.1093/icesjms/fsy046).
- Leroy, B., J. S. Phillips, S. Nicol, G. M. Pilling, S. Harley, D. Bromhead, S. Hoyle, S. Caillot, V. Allain, and J. Hampton (2013). “A critique of the ecosystem impacts of drifting and anchored FADs use by purse-seine tuna fisheries in the Western and Central Pacific Ocean”. In: *Aquatic Living Resources* 26.1, pp. 49–61. DOI: [10.1051/alr/2012033](https://doi.org/10.1051/alr/2012033).
- Lett, C., P. Verley, C. Mullon, C. Parada, T. Brochier, P. Penven, and B. Blanke (2008). “A Lagrangian tool for modelling ichthyoplankton dynamics”. In: *Environmental Modelling & Software* 23.9, pp. 1210–1214. DOI: [10.1016/j.envsoft.2008.02.005](https://doi.org/10.1016/j.envsoft.2008.02.005).
- Lezama-Ochoa, N., H. Murua, M. Hall, M. Román, J. Ruiz, N. Vogel, A. Caballero, and I. Sancristobal (2017). “Biodiversity and Habitat Characteristics of the Bycatch Assemblages in Fish Aggregating Devices (FADs) and School Sets in the Eastern Pacific Ocean”. In: *Frontiers in Marine Science* 4. DOI: [10.3389/fmars.2017.00265](https://doi.org/10.3389/fmars.2017.00265).
- Lezama-Ochoa, N., H. Murua, J. Ruiz, P. Chavance, A. Delgado de Molina, A. Caballero, and I. Sancristobal (2018). “Biodiversity and environmental characteristics of the bycatch assemblages from the tropical tuna purse seine fisheries in the eastern Atlantic Ocean”. In: *Marine Ecology* 39.3, e12504. DOI: [10.1111/maec.12504](https://doi.org/10.1111/maec.12504).
- Linke, S. et al. (2019). “Global hydro-environmental sub-basin and river reach characteristics at high spatial resolution”. In: *Scientific Data* 6.1, p. 283. DOI: [10.1038/s41597-019-0300-6](https://doi.org/10.1038/s41597-019-0300-6).
- Lloret, J., G. E. Shulman, and R. M. Love (2014). *Condition and health indicators of exploited marine fishes*. Chichester, West Sussex ; Hoboken, NJ: Wiley Blackwell.
- Lopez, J., G. Moreno, L. Ibaibarriaga, and L. Dagorn (2017). “Diel behaviour of tuna and non-tuna species at drifting fish aggregating devices (DFADs) in the Western Indian Ocean, determined by fishers’ echo-sounder buoys”. In: *Marine Biology* 164, p. 44. DOI: [10.1007/s00227-017-3075-3](https://doi.org/10.1007/s00227-017-3075-3).
- Lopez, J., G. Moreno, I. Sancristobal, and J. Murua (2014). “Evolution and current state of the technology of echo-sounder buoys used by Spanish tropical tuna purse seiners in the Atlantic, Indian and Pacific Oceans”. In: *Fisheries Research* 155, pp. 127–137. DOI: [10.1016/j.fishres.2014.02.033](https://doi.org/10.1016/j.fishres.2014.02.033).
- Lopez, J., M. H. Román, C. E. Lennert-Cody, M. N. Maunder, N. Vogel, and L. M. Fuller (2021). *Floating-objects fishery indicators: a 2021 report*. Tech. rep. Inter-American Tropical Tuna Commission.
- Lotze, H. K. et al. (2019). “Global ensemble projections reveal trophic amplification of ocean biomass declines with climate change”. In: *Proceedings of the National Academy of Sciences* 116.26, pp. 12907–12912. DOI: [10.1073/pnas.1900194116](https://doi.org/10.1073/pnas.1900194116).
- Lucas, R. et al. (2014). “Contribution of L-band SAR to systematic global mangrove monitoring”. In: *Marine and Freshwater Research* 65.7, pp. 589–603. DOI: [10.1071/MF13177](https://doi.org/10.1071/MF13177).
- Machful, P., A. Portal, J. Macdonald, V. Allain, J. S. Phillips, and S. Nicol (2021). “Tuna stomachs: Is the glass half full, or half empty?” In: *SPC Fisheries Newsletter* 166, pp. 38–44.
- Macura, B., P. Byström, L. Airoldi, B. K. Eriksson, L. Rudstam, and J. G. Støttrup (2019). “Impact of structural habitat modifications in coastal temperate systems on fish recruitment: a systematic review”. In: *Environmental Evidence* 8.1, p. 14. DOI: [10.1186/s13750-019-0157-3](https://doi.org/10.1186/s13750-019-0157-3).
- Madec, G. (2016). “the NEMO team: NEMO ocean engine”. In: *Note du Pôle de modélisation, Institut Pierre-Simon Laplace (IPSL), France* 27, pp. 1288–1619.
- Malone, M. A., K. M. Buck, G. Moreno, and G. Sancho (2011). “Diet of three large pelagic fishes associated with drifting fish aggregating devices (DFADs) in the western equatorial

-
- Indian Ocean”. In: *Animal Biodiversity and Conservation* 34.2, pp. 287–294. DOI: [10.32800/abc.2011.34.0287](https://doi.org/10.32800/abc.2011.34.0287).
- Marsac, F., A. Fonteneau, and A. Michaud (2014). *L’or bleu des Seychelles : Histoire de la pêche industrielle au thon dans l’océan Indien*.
- Marsac, F. (2017). “The Seychelles Tuna Fishery and Climate Change”. In: *Climate Change Impacts on Fisheries and Aquaculture*. Ed. by B. F. Phillips and M. Pérez-Ramírez. Chichester, UK: John Wiley & Sons, Ltd, pp. 523–568. DOI: [10.1002/9781119154051.ch16](https://doi.org/10.1002/9781119154051.ch16).
- Marsac, F., A. Fonteneau, and F. Ménard (2000). “Drifting FADs used in tuna fisheries: an ecological trap?” In: *Pêche Thonière et Dispositifs de Concentration de Poissons* 28, pp. 537–552.
- Marshall, J. and R. A. Plumb (1989). *Atmosphere, Ocean and Climate Dynamics: An Introductory Text*. Academic Press.
- Matsumoto, T., K. Satoh, Y. Semba, and M. Toyonaga (2016). “Comparison of the behavior of skipjack (*Katsuwonus pelamis*), yellowfin (*Thunnus albacares*) and bigeye (*T. obesus*) tuna associated with drifting FADs in the equatorial central Pacific Ocean”. In: *Fisheries Oceanography* 25.6, pp. 565–581. DOI: [10.1111/fog.12173](https://doi.org/10.1111/fog.12173).
- Matsumoto, T., K. Satoh, and M. Toyonaga (2014). “Behavior of skipjack tuna (*Katsuwonus pelamis*) associated with a drifting FAD monitored with ultrasonic transmitters in the equatorial central Pacific Ocean”. In: *Fisheries Research* 157, pp. 78–85. DOI: [10.1016/j.fishres.2014.03.023](https://doi.org/10.1016/j.fishres.2014.03.023).
- Maufroy, A. (2016). “Drifting Fish Aggregating Devices of the Atlantic and Indian Oceans: modalities of use, fishing efficiency and potential management”. PhD Thesis. Université Montpellier.
- Maufroy, A., E. Chassot, R. Joo, and D. M. Kaplan (2015). “Large-Scale Examination of Spatio-Temporal Patterns of Drifting Fish Aggregating Devices (dFADs) from Tropical Tuna Fisheries of the Indian and Atlantic Oceans”. In: *PLOS ONE* 10.5, e0128023. DOI: [10.1371/journal.pone.0128023](https://doi.org/10.1371/journal.pone.0128023).
- Maufroy, A., D. M. Kaplan, N. Bez, A. D. De Molina, H. Murua, L. Floch, and E. Chassot (2017). “Massive increase in the use of drifting Fish Aggregating Devices (dFADs) by tropical tuna purse seine fisheries in the Atlantic and Indian oceans”. In: *ICES Journal of Marine Science* 74.1, pp. 215–225. DOI: [10.1093/icesjms/fsw175](https://doi.org/10.1093/icesjms/fsw175).
- Maury, O. (2017). “Can schooling regulate marine populations and ecosystems?” In: *Progress in Oceanography* 156, pp. 91–103. DOI: [10.1016/j.pocean.2017.06.003](https://doi.org/10.1016/j.pocean.2017.06.003).
- McKinney, R., J. Gibbon, E. Wozniak, and G. Galland (2020). *Netting Billions 2020: a Global Tuna Valuation*. Tech. rep. PEW Charitable Trusts.
- McWhinnie, S. F. (2009). “The tragedy of the commons in international fisheries: An empirical examination”. In: *Journal of Environmental Economics and Management* 57.3, pp. 321–333. DOI: [10.1016/j.jeem.2008.07.008](https://doi.org/10.1016/j.jeem.2008.07.008).
- Medley, P., M. Ahusan, and M. S. Adam (2023). *Bayesian Skipjack and Yellowfin Tuna CPUE Standardisation Model for Maldives Pole and Line 1995-2020*. IOTC Working Party on Tropical Tuna: Data Preparatory Meeting IOTC-2023-WPTT25(DP)-13. Indian Ocean Tuna Commission.
- Ménard, F., A. Fonteneau, D. Gaertner, V. Nordstrom, B. Stéquert, and E. Marchal (2000a). “Exploitation of small tunas by a purse-seine fishery with fish aggregating devices and their feeding ecology in an eastern tropical Atlantic ecosystem”. In: *ICES Journal of Marine Science* 57.3, pp. 525–530. DOI: [10.1006/jmsc.2000.0717](https://doi.org/10.1006/jmsc.2000.0717).
- Ménard, F., B. Stéquert, A. Rubin, M. Herrera, and É. Marchal (2000b). “Food consumption of tuna in the Equatorial Atlantic ocean: FAD-associated versus unassociated schools”. In: *Aquatic Living Resources* 13.4, pp. 233–240. DOI: [10.1016/S0990-7440\(00\)01066-4](https://doi.org/10.1016/S0990-7440(00)01066-4).

-
- Mendenhall, E. (2018). “Oceans of plastic: A research agenda to propel policy development”. In: *Marine Policy* 96, pp. 291–298. DOI: [10.1016/j.marpol.2018.05.005](https://doi.org/10.1016/j.marpol.2018.05.005).
- Merino, G., H. Murua, J. Santiago, H. Arrizabalaga, and V. Restrepo (2020). “Characterization, Communication, and Management of Uncertainty in Tuna Fisheries”. In: *Sustainability* 12.19, p. 8245. DOI: [10.3390/su12198245](https://doi.org/10.3390/su12198245).
- Mitsunaga, Y., C. Endo, K. Anraku, C. M. Selorio, and R. P. Babaran (2012). “Association of early juvenile yellowfin tuna *Thunnus albacares* with a network of payaos in the Philippines”. In: *Fisheries Science* 78.1, pp. 15–22. DOI: [10.1007/s12562-011-0431-y](https://doi.org/10.1007/s12562-011-0431-y).
- Miyake, M., P. Guillotreau, C. Sun, and G. Ishimura, eds. (2010). *Recent developments in the tuna industry: stocks, fisheries, management, processing, trade and markets*. FAO fisheries and aquaculture technical paper 543. Rome: Food and Agriculture Organization of the United Nations.
- Mondal, S., A. H. Vayghan, M.-A. Lee, Y.-C. Wang, and B. Semedi (2021). “Habitat Suitability Modeling for the Feeding Ground of Immature Albacore in the Southern Indian Ocean Using Satellite-Derived Sea Surface Temperature and Chlorophyll Data”. In: *Remote Sensing* 13.14, p. 2669. DOI: [10.3390/rs13142669](https://doi.org/10.3390/rs13142669).
- Moreno, G., G. Boyra, I. Sancristobal, D. Itano, and V. Restrepo (2019). “Towards acoustic discrimination of tropical tuna associated with Fish Aggregating Devices”. In: *PLOS ONE* 14.6, e0216353. DOI: [10.1371/journal.pone.0216353](https://doi.org/10.1371/journal.pone.0216353).
- Moreno, G., L. Dagorn, G. Sancho, and D. Itano (2007). “Fish behaviour from fishers’ knowledge: the case study of tropical tuna around drifting fish aggregating devices (DFADs)”. In: *Canadian Journal of Fisheries and Aquatic Sciences* 64.11, pp. 1517–1528. DOI: [10.1139/f07-113](https://doi.org/10.1139/f07-113).
- Moreno, G., J. Salvador, I. Zudaire, J. Murua, J. L. Pelegrí, J. Uranga, H. Murua, M. Grande, J. Santiago, and V. Restrepo (2023). “The Jelly-FAD: A paradigm shift in the design of biodegradable Fish Aggregating Devices”. In: *Marine Policy* 147, p. 105352. DOI: [10.1016/j.marpol.2022.105352](https://doi.org/10.1016/j.marpol.2022.105352).
- Morgan, A. C. (2011). *Fish Aggregating Devices (FADs) and Tuna: Impacts and Management Options*. Tech. rep. PEW Environment Group, p. 20.
- Morón, J. (2001). *Report on Management Measures for the European Tuna Purse Seine Fleet*. Working Paper for the Standing Committee on Tuna and Billfish (SCTB14). International Commission for the Conservation of Atlantic Tunas.
- Morrison, M., B. Marcot, and R. Mannan (2007). *Wildlife-Habitat Relationships: Concepts and Applications*. Third Edition. Washington DC: Island Press.
- MRAG (2017). *An analysis of the uses, impacts and benefits of fish aggregating devices (FADs) in the global tuna industry*. Tech. rep. A report produced for WWF-UK by MRAG Ltd. London, UK. pp. 51.
- Mullu, D. (2016). “A review on the effect of habitat fragmentation on ecosystem”. In: *Journal of Natural Sciences Research* 6.15, pp. 1–15.
- Nakamae, A. (1991). “Artificial reef projects in Japan”. In: Colombo, Sri Lanka.
- Nataniel, A., M. G. Pennino, J. Lopez, and M. Soto (2022). “Modelling the impacts of climate change on skipjack tuna (*Katsuwonus pelamis*) in the Mozambique Channel”. In: *Fisheries Oceanography* 31.2, pp. 149–163. DOI: [10.1111/fog.12568](https://doi.org/10.1111/fog.12568).
- Navarro-García, M., D. Precioso, K. Gavira-O'Neill, A. Torres-Barrán, D. G. Gómez, V. Gallego, and D. Gómez-Ullate (2023). “Aggregation dynamics of tropical tunas around drifting floating objects based on large-scale echo-sounder data”. In: *Marine Ecology Progress Series* 715, pp. 129–143. DOI: [10.3354/meps14338](https://doi.org/10.3354/meps14338).
- Neumann, H., R. Diekmann, and I. Kröncke (2016). “Functional composition of epifauna in the south-eastern North Sea in relation to habitat characteristics and fishing effort”. In: *Estuarine, Coastal and Shelf Science* 169, pp. 182–194. DOI: [10.1016/j.ecss.2015.12.011](https://doi.org/10.1016/j.ecss.2015.12.011).

-
- Nicol, S. et al. (2022). “Ocean Futures for the World’s Largest Yellowfin Tuna Population Under the Combined Effects of Ocean Warming and Acidification”. In: *Frontiers in Marine Science* 9. DOI: [10.3389/fmars.2022.816772](https://doi.org/10.3389/fmars.2022.816772).
- Nooteboom, P. D., J. Scutt Phillips, I. Senina, E. van Sebille, and S. Nicol (2023a). “Individual-based model simulations indicate a non-linear catch equation of drifting Fish Aggregating Device-associated tuna”. In: *ICES Journal of Marine Science* 80.6, pp. 1746–1757. DOI: [10.1093/icesjms/fsad105](https://doi.org/10.1093/icesjms/fsad105).
- Nooteboom, P. D., J. Scutt Phillips, C. Kehl, S. Nicol, and E. van Sebille (2023b). “Modelling of tuna around fish aggregating devices: The importance of ocean flow and prey”. In: *Ecological Modelling* 475, p. 110188. DOI: [10.1016/j.ecolmodel.2022.110188](https://doi.org/10.1016/j.ecolmodel.2022.110188).
- Ogburn, M. B., A.-L. Harrison, F. G. Whoriskey, S. J. Cooke, J. E. Mills Flemming, and L. G. Torres (2017). “Addressing Challenges in the Application of Animal Movement Ecology to Aquatic Conservation and Management”. In: *Frontiers in Marine Science* 4. DOI: [10.3389/fmars.2017.00070](https://doi.org/10.3389/fmars.2017.00070).
- Ohta, I. and S. Kakuma (2005). “Periodic behavior and residence time of yellowfin and bigeye tuna associated with fish aggregating devices around Okinawa Islands, as identified with automated listening stations”. In: *Marine Biology* 146.3, pp. 581–594. DOI: [10.1007/s00227-004-1456-x](https://doi.org/10.1007/s00227-004-1456-x).
- Oppian (200 AD). *Halieutica*. Trans. by A. Mair. Vol. 4. London: Loeb Classical Library, London, Heinemann, 1963.
- Orue, B., J. Lopez, G. Moreno, J. Santiago, M. Soto, and H. Murua (2019). “Aggregation process of drifting fish aggregating devices (DFADs) in the Western Indian Ocean: Who arrives first, tuna or non-tuna species?” In: *PLOS ONE* 14.1, e0210435. DOI: [10.1371/journal.pone.0210435](https://doi.org/10.1371/journal.pone.0210435).
- Orue, B., J. Lopez, M. G. Pennino, G. Moreno, J. Santiago, and H. Murua (2020). “Comparing the distribution of tropical tuna associated with drifting fish aggregating devices (DFADs) resulting from catch dependent and independent data”. In: *Deep Sea Research Part II: Topical Studies in Oceanography* 175, p. 104747. DOI: [10.1016/j.dsr2.2020.104747](https://doi.org/10.1016/j.dsr2.2020.104747).
- Ostrom, E. (2008a). “Design principles of robust property-rights institutions: what have we learned?” In: *Workshop in Political Theory and Policy Analysis*. Indiana University.
- (2011). “Plaidoyer pour la complexité”. In: *Ecologie & politique* N°41.1, p. 111. DOI: [10.3917/ecopo.041.0111](https://doi.org/10.3917/ecopo.041.0111).
- (2008b). “The Challenge of Common-Pool Resources”. In: *Environment: Science and Policy for Sustainable Development* 50.4, pp. 8–21. DOI: [10.3200/ENVT.50.4.8-21](https://doi.org/10.3200/ENVT.50.4.8-21).
- Ostrom, E. and É. Laurent (2012). “Par-delà les marchés et les États: La gouvernance polycentrique des systèmes économiques complexes”. In: *Revue de l’OFCE* n° 120.1, pp. 13–72. DOI: [10.3917/reof.120.0013](https://doi.org/10.3917/reof.120.0013).
- Parker, R. W. R., I. Vázquez-Rowe, and P. H. Tyedmers (2015). “Fuel performance and carbon footprint of the global purse seine tuna fleet”. In: *Journal of Cleaner Production*. Carbon Emissions Reduction: Policies, Technologies, Monitoring, Assessment and Modeling 103, pp. 517–524. DOI: [10.1016/j.jclepro.2014.05.017](https://doi.org/10.1016/j.jclepro.2014.05.017).
- Patten, M. A. and J. F. Kelly (2010). “Habitat selection and the perceptual trap”. In: *Ecological Applications* 20.8, pp. 2148–2156. DOI: [10.1890/09-2370.1](https://doi.org/10.1890/09-2370.1).
- Pecoraro, C., I. Zudaire, N. Bodin, H. Murua, P. Taconet, P. Díaz-Jaimes, A. Cariani, F. Tinti, and E. Chassot (2017). “Putting all the pieces together: integrating current knowledge of the biology, ecology, fisheries status, stock structure and management of yellowfin tuna (*Thunnus albacares*)”. In: *Reviews in Fish Biology and Fisheries* 27.4, pp. 811–841. DOI: [10.1007/s11160-016-9460-z](https://doi.org/10.1007/s11160-016-9460-z).

-
- Peliz, A., P. Marchesiello, J. Dubert, M. Marta-Almeida, C. Roy, and H. Queiroga (2007). “A study of crab larvae dispersal on the Western Iberian Shelf: Physical processes”. In: *Journal of Marine Systems* 68.1, pp. 215–236. DOI: [10.1016/j.jmarsys.2006.11.007](https://doi.org/10.1016/j.jmarsys.2006.11.007).
- Pendrill, F. et al. (2022). “Disentangling the numbers behind agriculture-driven tropical deforestation”. In: *Science* 377.6611, eabm9267. DOI: [10.1126/science.abm9267](https://doi.org/10.1126/science.abm9267).
- Penduff, T., B. Barnier, L. Terray, L. Bessières, G. Sérazin, S. Gregorio, J. M. Brankart, M. P. Moine, J. M. Molines, and P. Brasseur (2014). “Ensembles of eddying ocean simulations for climate”. In: *CLIVAR Exchanges, Special Issue on High Resolution Ocean Climate Modelling* 19.
- Pérez, G., A. Dupaix, L. Dagorn, J.-L. Deneubourg, K. Holland, S. Beeharry, and M. Capello (2022). “Correlated Random Walk of tuna in arrays of Fish Aggregating Devices: A field-based model from passive acoustic tagging”. In: *Ecological Modelling* 470, p. 110006. DOI: [10.1016/j.ecolmodel.2022.110006](https://doi.org/10.1016/j.ecolmodel.2022.110006).
- Pérez, G. et al. (2020). “Effects of habitat modifications on the movement behavior of animals: the case study of Fish Aggregating Devices (FADs) and tropical tunas”. In: *Movement Ecology* 8.1, p. 47. DOI: [10.1186/s40462-020-00230-w](https://doi.org/10.1186/s40462-020-00230-w).
- Phillips, J. S., L. Escalle, G. Pilling, A. S. Gupta, and E. v. Sebille (2019a). “Regional connectivity and spatial densities of drifting fish aggregating devices, simulated from fishing events in the Western and Central Pacific Ocean”. In: *Environmental Research Communications* 1.5, p. 055001. DOI: [10.1088/2515-7620/ab21e9](https://doi.org/10.1088/2515-7620/ab21e9).
- Phillips, J. S., T. Peatman, L. Escalle, B. Leroy, and N. Smith (2019b). *Electronic tagging for the mitigation of bigeye and yellowfin tuna juveniles by purse seine fisheries*. 15th Regular Session of the Scientific Commity SC15-EB-WP-08. Pohnpei, Federated States of Micronesia: Western and Central Pacific Fisheries Commission.
- Phillips, J. S., G. M. Pilling, B. Leroy, K. Evans, T. Usu, C. H. Lam, K. M. Schaefer, and S. Nicol (2017). “Revisiting the vulnerability of juvenile bigeye (*Thunnus obesus*) and yellowfin (*T. albacares*) tuna caught by purse-seine fisheries while associating with surface waters and floating objects”. In: *PLOS ONE* 12.6, e0179045. DOI: [10.1371/journal.pone.0179045](https://doi.org/10.1371/journal.pone.0179045).
- Pineda, J., J. Hare, and S. Sponaugle (2007). “Larval Transport and Dispersal in the Coastal Ocean and Consequences for Population Connectivity”. In: *Oceanography* 20.3, pp. 22–39. DOI: [10.5670/oceanog.2007.27](https://doi.org/10.5670/oceanog.2007.27).
- Pitcher, T. (2009). “Fish schooling”. In: *Encyclopedia of ocean sciences: marine biology*. Academic Press, pp. 337–349.
- Pitcher, T. J. (1986). “Functions of Shoaling Behaviour in Teleosts”. In: *The Behaviour of Teleost Fishes*. Ed. by T. J. Pitcher. Boston, MA: Springer US, pp. 294–337. DOI: [10.1007/978-1-4684-8261-4_12](https://doi.org/10.1007/978-1-4684-8261-4_12).
- Pons, M., D. Kaplan, G. Moreno, L. Escalle, F. Abascal, M. Hall, V. Restrepo, and R. Hilborn (2023). “Benefits, concerns, and solutions of fishing for tunas with drifting fish aggregation devices”. In: *Fish and Fisheries* 24.6, pp. 979–1002. DOI: [10.1111/faf.12780](https://doi.org/10.1111/faf.12780).
- Potier, M., F. Marsac, Y. Cherel, V. Lucas, R. Sabatié, O. Maury, and F. Ménard (2007). “Forage fauna in the diet of three large pelagic fishes (lancetfish, swordfish and yellowfin tuna) in the western equatorial Indian Ocean”. In: *Fisheries Research* 83.1, pp. 60–72. DOI: [10.1016/j.fishres.2006.08.020](https://doi.org/10.1016/j.fishres.2006.08.020).
- Potier, M., F. Marsac, V. Lucas, R. Sabatié, J.-P. Hallier, and F. Ménard (2004). “Feeding partitioning among tuna taken in surface and mid-water layers: the case of yellowfin (*Thunnus albacares*) and bigeye (*T. obesus*) in the western tropical Indian Ocean”. In: *Western Indian Ocean Journal of Marine Science* 3.1, pp. 51–62.
- Proctor, C., Hobart, and Tasmania (2019). *Project final report developing research capacity for management of Indonesia’s pelagic fisheries resources - final report*. Tech. rep. FR2019/01. ACIAR Final Reports.

-
- R Core Team (2020). *R: A Language and Environment for Statistical Computing*. Vienna, Austria: R Foundation for Statistical Computing.
- Ramos, M. L., A. Delgado de Molina, and J. Ariz (2010). *Analysis of activity data obtained from supply vessel's logbooks implemented by the Spanish fleet and associated in Indian Ocean*. Working Party on Tropical Tunas (WPTT) IOTC-2010-WPTT-22. Victoria, Seychelles: Indian Ocean Tuna Commission, pp. 18–25.
- Renn, O., C. C. Jaeger, E. A. Rosa, and T. Webler (2000). “The Rational Actor Paradigm in Risk Theories: Analysis and Critique”. In: *Risk in the Modern Age: Social Theory, Science and Environmental Decision-Making*. Ed. by M. J. Cohen. London: Palgrave Macmillan UK, pp. 35–61. DOI: [10.1007/978-1-349-62201-6_2](https://doi.org/10.1007/978-1-349-62201-6_2).
- Restrepo, V., L. Dagorn, D. Itano, A. Justel-Rubio, F. Forget, and G. Moreno (2017). *A Summary of Bycatch Issues and ISSF Mitigation Activities to date in purse seine fisheries, with emphasis on FADs*. Tech. rep. 2017-06. Washington, D.C., USA: International Seafood Sustainability Foundation (ISSF), p. 41.
- Reyes, N. and M. Airaud (2022). “Le DCP dérivant pour et par l’arène thonière tropicale - Un dispositif sociotechnique en débat”. In: *Revue d’anthropologie des connaissances* 16.2. DOI: [10.4000/rac.27205](https://doi.org/10.4000/rac.27205).
- Rio, M.-H., J. A. Johannessen, and C. Donlon (2015). *Globcurrent Product Data Handbook: The Combined Geostrophy + Ekman Currents*. Tech. rep. GlobCurrent, p. 28.
- Robert, M., L. Dagorn, N. Bodin, F. Pernet, E.-J. Arsenault-Pernet, and J.-L. Deneubourg (2014a). “Comparison of condition factors of skipjack tuna (*Katsuwonus pelamis*) associated or not with floating objects in an area known to be naturally enriched with logs”. In: *Canadian Journal of Fisheries and Aquatic Sciences* 71.3, pp. 472–478. DOI: [10.1139/cjfas-2013-0389](https://doi.org/10.1139/cjfas-2013-0389).
- Robert, M., L. Dagorn, and J. L. Deneubourg (2014b). “The aggregation of tuna around floating objects: What could be the underlying social mechanisms?” In: *Journal of Theoretical Biology* 359, pp. 161–170. DOI: [10.1016/j.jtbi.2014.06.010](https://doi.org/10.1016/j.jtbi.2014.06.010).
- Robert, M., L. Dagorn, J. L. Deneubourg, D. Itano, and K. Holland (2012). “Size-dependent behavior of tuna in an array of fish aggregating devices (FADs)”. In: *Marine biology* 159.4, pp. 907–914. DOI: [10.1007/s00227-011-1868-3](https://doi.org/10.1007/s00227-011-1868-3).
- Robert, M., L. Dagorn, J. D. Filmalter, J.-L. Deneubourg, D. Itano, and K. Holland (2013a). “Intra-individual behavioral variability displayed by tuna at fish aggregating devices (FADs)”. In: *Marine Ecology Progress Series* 484, pp. 239–247. DOI: [10.3354/meps10303](https://doi.org/10.3354/meps10303).
- Robert, M., L. Dagorn, J. Lopez, G. Moreno, and J.-L. Deneubourg (2013b). “Does social behavior influence the dynamics of aggregations formed by tropical tunas around floating objects? An experimental approach”. In: *Journal of Experimental Marine Biology and Ecology* 440, pp. 238–243. DOI: [10.1016/j.jembe.2013.01.005](https://doi.org/10.1016/j.jembe.2013.01.005).
- Robertson, B. A. and R. L. Hutto (2006). “A framework for understanding ecological traps and an evaluation of existing evidence”. In: *Ecology* 87.5, pp. 1075–1085. DOI: [10.1890/0012-9658\(2006\)87\[1075:AFFUET\]2.0.CO;2](https://doi.org/10.1890/0012-9658(2006)87[1075:AFFUET]2.0.CO;2).
- Robertson, B. A., J. S. Rehage, and A. Sih (2013). “Ecological novelty and the emergence of evolutionary traps”. In: *Trends in Ecology & Evolution* 28.9, pp. 552–560. DOI: [10.1016/j.tree.2013.04.004](https://doi.org/10.1016/j.tree.2013.04.004).
- Rodriguez-Tress, P., M. Capello, F. Forget, M. Soria, S. P. Beeharry, N. Dussooa, and L. Dagorn (2017). “Associative behavior of yellowfin *Thunnus albacares*, skipjack *Katsuwonus pelamis*, and bigeye tuna *T. obesus* at anchored fish aggregating devices (FADs) off the coast of Mauritius”. In: *Marine Ecology Progress Series* 570, pp. 213–222. DOI: [10.3354/meps12101](https://doi.org/10.3354/meps12101).
- Roger, C. (1994). “The plankton of the tropical western Indian ocean as a biomass indirectly supporting surface tunas (yellowfin, *Thunnus albacares* and skipjack, *Katsuwonus pelamis*)”. In: *Environmental Biology of Fishes* 39.2, pp. 161–172. DOI: [10.1007/BF00004934](https://doi.org/10.1007/BF00004934).

-
- Rubenstein, D. I. (1978). “On Predation, Competition, and the Advantages of Group Living”. In: *Social Behavior*. Ed. by P. P. G. Bateson and P. H. Klopfer. Perspectives in Ethology. Boston, MA: Springer US, pp. 205–231. DOI: [10.1007/978-1-4684-2901-5_9](https://doi.org/10.1007/978-1-4684-2901-5_9).
- Rubin, E. L. (1998). “Putting Rational Actors in Their Place: Economics and Phenomenology”. In: *Vanderbilt Law Review* 51, p. 1705.
- Russell, M. B., C. W. Woodall, A. W. D’Amato, S. Fraver, and J. B. Bradford (2014). “Technical Note: Linking climate change and downed woody debris decomposition across forests of the eastern United States”. In: *Biogeosciences* 11.22, pp. 6417–6425. DOI: [10.5194/bg-11-6417-2014](https://doi.org/10.5194/bg-11-6417-2014).
- Saji, N. H., B. N. Goswami, P. N. Vinayachandran, and T. Yamagata (1999). “A dipole mode in the tropical Indian Ocean”. In: *Nature* 401.6751, pp. 360–363. DOI: [10.1038/43854](https://doi.org/10.1038/43854).
- Sardenne, F., E. Chassot, E. Fouché, F. Ménard, V. Lucas, and N. Bodin (2016). “Are condition factors powerful proxies of energy content in wild tropical tunas?” In: *Ecological Indicators* 71, pp. 467–476. DOI: [10.1016/j.ecolind.2016.06.031](https://doi.org/10.1016/j.ecolind.2016.06.031).
- Sardenne, F., E. Kraffe, A. Amiel, E. Fouché, L. Debrauwer, F. Ménard, and N. Bodin (2017). “Biological and environmental influence on tissue fatty acid compositions in wild tropical tunas”. In: *Comparative Biochemistry and Physiology Part A: Molecular & Integrative Physiology* 204, pp. 17–27. DOI: [10.1016/j.cbpa.2016.11.007](https://doi.org/10.1016/j.cbpa.2016.11.007).
- Schaefer, K. M. and D. W. Fuller (2002). “Movements, behavior, and habitat selection of bigeye tuna (*Thunnus obesus*) in the eastern equatorial Pacific, ascertained through archival tags”. In: *Fishery Bulletin* 100.4, pp. 765–788.
- (2013). “Simultaneous behavior of skipjack (*Katsuwonus pelamis*), bigeye (*Thunnus obesus*), and yellowfin (*T. albacares*) tunas, within large multi-species aggregations associated with drifting fish aggregating devices (FADs) in the equatorial eastern Pacific Ocean”. In: *Marine Biology* 160.11, pp. 3005–3014. DOI: [10.1007/s00227-013-2290-9](https://doi.org/10.1007/s00227-013-2290-9).
- (2022). “Spatiotemporal variability in the reproductive biology of yellowfin tuna (*Thunnus albacares*) in the eastern Pacific Ocean”. In: *Fisheries Research* 248, p. 106225. DOI: [10.1016/j.fishres.2022.106225](https://doi.org/10.1016/j.fishres.2022.106225).
- (2010). “Vertical movements, behavior, and habitat of bigeye tuna (*Thunnus obesus*) in the equatorial eastern Pacific Ocean, ascertained from archival tag data”. In: *Marine Biology* 157.12, pp. 2625–2642. DOI: [10.1007/s00227-010-1524-3](https://doi.org/10.1007/s00227-010-1524-3).
- Schaefer, K. M., D. W. Fuller, and B. A. Block (2009). “Vertical movements and habitat utilization of skipjack (*Katsuwonus pelamis*), yellowfin (*Thunnus albacares*), and bigeye (*Thunnus obesus*) tunas in the equatorial eastern Pacific Ocean, ascertained through archival tag data”. In: *Tagging and tracking of marine animals with electronic devices*. Springer, pp. 121–144.
- Schaefer, K. M., D. W. Fuller, J. Hampton, S. Caillot, B. Leroy, and D. Itano (2015). “Movements, dispersion, and mixing of bigeye tuna (*Thunnus obesus*) tagged and released in the equatorial Central Pacific Ocean, with conventional and archival tags”. In: *Fisheries research* 161, pp. 336–355. DOI: [10.1016/j.fishres.2014.08.018](https://doi.org/10.1016/j.fishres.2014.08.018).
- Schlaepfer, M. A., M. C. Runge, and P. W. Sherman (2002). “Ecological and evolutionary traps”. In: *Trends in Ecology & Evolution* 17.10, pp. 474–480. DOI: [10.1016/S0169-5347\(02\)02580-6](https://doi.org/10.1016/S0169-5347(02)02580-6).
- Schott, F. A., S.-P. Xie, and J. P. McCreary (2009). “Indian Ocean circulation and climate variability”. In: *Reviews of Geophysics* 47.1, RG1002. DOI: [10.1029/2007RG000245](https://doi.org/10.1029/2007RG000245).
- Scott, G. P. and J. Lopez (2014). *The Use of Fads in Tuna Fisheries*. Tech. rep. Directorate General for Internal Policies, European Parliament, Committee in Fisheries.
- Scott, M. D., W. H. Bayliff, C. E. Lennert-Cody, and K. M. Schaefer (1999). *Proceedings of the international workshop on the ecology and fisheries for tunas associated with floating objects*. Inter-American Tropical Tuna Commission Special Report. La Jolla, CA, February 11-13, 1992: IATTC, p. 478.

-
- Sempo, G., L. Dagorn, M. Robert, and J.-L. Deneubourg (2013). “Impact of increasing deployment of artificial floating objects on the spatial distribution of social fish species”. In: *Journal of Applied Ecology* 50.5, pp. 1081–1092. DOI: [10.1111/1365-2664.12140](https://doi.org/10.1111/1365-2664.12140).
- Sherley, R. B., K. Ludynia, B. M. Dyer, T. Lamont, A. B. Makhado, J.-P. Roux, K. L. Scales, L. G. Underhill, and S. C. Votier (2017). “Metapopulation Tracking Juvenile Penguins Reveals an Ecosystem-wide Ecological Trap”. In: *Current Biology* 27.4, pp. 563–568. DOI: [10.1016/j.cub.2016.12.054](https://doi.org/10.1016/j.cub.2016.12.054).
- Siegel, D., B. Kinlan, B. Gaylord, and S. Gaines (2003). “Lagrangian descriptions of marine larval dispersion”. In: *Marine Ecology Progress Series* 260, pp. 83–96. DOI: [10.3354/meps260083](https://doi.org/10.3354/meps260083).
- Snouck-Hurgronje, J., D. Kaplan, E. Chassot, A. Maufroy, and D. Gaertner (2018). “Fishing on floating objects (FOBs): How French tropical tuna purse seiners split fishing effort between GPS-monitored and unmonitored FOBs”. In: *Canadian Journal of Fisheries and Aquatic Sciences* 75.11, pp. 1849–1858. DOI: [10.1139/cjfas-2017-0152](https://doi.org/10.1139/cjfas-2017-0152).
- Sobradillo, B., G. Boyra, J. Uranga, and G. Moreno (2023). *TS measurements of ex-situ yellowfin tuna (Thunnus albacares) and frequency-response discrimination for tropical tuna species*. 7th Meeting of the Ad Hoc Working Group on FADs. La Jolla, CA: Inter-American Tropical Tuna Commission.
- Solana-Soares, R. (2001). “Floating objects of the eastern pacific: types, spatial distribution and temporal changes”. In: *Ciencias Marinas* 27.3, pp. 423–443. DOI: [10.7773/cm.v27i3.473](https://doi.org/10.7773/cm.v27i3.473).
- Song, L. and H. Shen (2022). “An integrated scheme for the management of drifting fish aggregating devices in tuna purse seine fisheries”. In: *Fisheries Management and Ecology* 30.1, pp. 56–69. DOI: [10.1111/fme.12600](https://doi.org/10.1111/fme.12600).
- Soria, M., L. Dagorn, G. Potin, and P. Fréon (2009). “First field-based experiment supporting the meeting point hypothesis for schooling in pelagic fish”. In: *Animal Behaviour* 78.6, pp. 1441–1446. DOI: [10.1016/j.anbehav.2009.09.025](https://doi.org/10.1016/j.anbehav.2009.09.025).
- Stehfest, K. M. and L. Dagorn (2010). *Differences in large-scale movement between free swimming and fish aggregating device (FAD) caught tuna*. Working Party on Tropical Tunas (WPTT) IOTC-2010-WPTT-06. Victoria, Seychelles: Indian Ocean Tuna Commission, p. 24.
- Stelfox, M., C. Lett, G. Reid, G. Souch, and M. Sweet (2020). “Minimum drift times infer trajectories of ghost nets found in the Maldives”. In: *Marine Pollution Bulletin* 154, p. 111037. DOI: [10.1016/j.marpolbul.2020.111037](https://doi.org/10.1016/j.marpolbul.2020.111037).
- Stéquert, B. and F. Marsac (1986). *La pêche de surface des thonidés tropicaux dans l’Océan Indien*. 282. Food & Agriculture Org.
- Stern, P. C. (2011). “Design principles for global commons: natural resources and emerging technologies”. In: *International Journal of the Commons*. Collection: The 20th anniversary of ‘Governing the Commons’: Part 2 5.2, pp. 213–232. DOI: [10.18352/ijc.305](https://doi.org/10.18352/ijc.305).
- Swearer, S. E., R. L. Morris, L. T. Barrett, M. Sievers, T. Dempster, and R. Hale (2021). “An overview of ecological traps in marine ecosystems”. In: *Frontiers in Ecology and the Environment* 19.4, pp. 234–242. DOI: [10.1002/fee.2322](https://doi.org/10.1002/fee.2322).
- Taquet, M. (2013). “Fish aggregating devices (FADs): good or bad fishing tools? A question of scale and knowledge”. In: *Aquatic Living Resources* 26.1, pp. 25–35. DOI: [10.1051/alr/2013043](https://doi.org/10.1051/alr/2013043).
- Teske, P. R., A. Emami-Khoyi, T. R. Golla, J. Sandoval-Castillo, T. Lamont, B. Chiazzari, C. D. McQuaid, L. B. Beheregaray, and C. D. van der Lingen (2021). “The sardine run in southeastern Africa is a mass migration into an ecological trap”. In: *Science Advances* 7.38. DOI: [10.1126/sciadv.abf4514](https://doi.org/10.1126/sciadv.abf4514).
- Tew Kai, E., V. Rossi, J. Sudre, H. Weimerskirch, C. Lopez, E. Hernandez-Garcia, F. Marsac, and V. Garçon (2009). “Top marine predators track Lagrangian coherent structures”. In:

-
- Proceedings of the National Academy of Sciences* 106.20, pp. 8245–8250. DOI: [10.1073/pnas.0811034106](https://doi.org/10.1073/pnas.0811034106).
- Thiel, M. and L. Gutow (2005). “The ecology of rafting in the marine environment. I. The floating substrata”. In: *Oceanography and Marine Biology: an annual review*. Ed. by R. N. Gibson, R. J. A. Atkinson, and J. D. M. Gordon. CRC Press. Vol. 42, pp. 181–264.
- Tidd, A., S. Brouwer, and G. Pilling (2017). “Shooting fish in a barrel? Assessing fisher-driven changes in catchability within tropical tuna purse seine fleets”. In: *Fish and Fisheries* 18.5, pp. 808–820. DOI: [10.1111/faf.12207](https://doi.org/10.1111/faf.12207).
- Tidd, A. N., C. Reid, G. M. Pilling, and S. J. Harley (2016). “Estimating productivity, technical and efficiency changes in the Western Pacific purse-seine fleets”. In: *ICES Journal of Marine Science* 73.4, pp. 1226–1234.
- Tolotti, M., P. Guillotreau, F. Forget, M. Capello, and L. Dagorn (2022). “Unintended effects of single-species fisheries management”. In: *Environment, Development and Sustainability*. DOI: [10.1007/s10668-022-02432-1](https://doi.org/10.1007/s10668-022-02432-1).
- Tolotti, M. T., F. Forget, M. Capello, J. D. Filmalter, M. Hutchinson, D. Itano, K. Holland, and L. Dagorn (2020). “Association dynamics of tuna and purse seine bycatch species with drifting fish aggregating devices (FADs) in the tropical eastern Atlantic Ocean”. In: *Fisheries Research* 226, p. 105521. DOI: [10.1016/j.fishres.2020.105521](https://doi.org/10.1016/j.fishres.2020.105521).
- Torres-Irineo, E., M. J. Amandè, D. Gaertner, A. D. de Molina, H. Murua, P. Chavance, J. Ariz, J. Ruiz, and N. Lezama-Ochoa (2014). “Bycatch species composition over time by tuna purse-seine fishery in the eastern tropical Atlantic Ocean”. In: *Biodiversity and Conservation* 23.5, pp. 1157–1173. DOI: [10.1007/s10531-014-0655-0](https://doi.org/10.1007/s10531-014-0655-0).
- Van der Stocken, T., D. Carroll, D. Menemenlis, M. Simard, and N. Koedam (2019). “Global-scale dispersal and connectivity in mangroves”. In: *Proceedings of the National Academy of Sciences* 116.3, pp. 915–922. DOI: [10.1073/pnas.1812470116](https://doi.org/10.1073/pnas.1812470116).
- Van Sebille, E., S. M. Griffies, R. Abernathey, T. P. Adams, P. Berloff, A. Biastoch, B. Blanke, E. P. Chassignet, Y. Cheng, and C. J. Cotter (2018). “Lagrangian ocean analysis: Fundamentals and practices”. In: *Ocean Modelling* 121, pp. 49–75. DOI: [10.1016/j.ocemod.2017.11.008](https://doi.org/10.1016/j.ocemod.2017.11.008).
- Van Sebille, E., C. Wilcox, L. Lebreton, N. Maximenko, B. D. Hardesty, J. A. Van Franeker, M. Eriksen, D. Siegel, F. Galgani, and K. L. Law (2015). “A global inventory of small floating plastic debris”. In: *Environmental Research Letters* 10.12, p. 124006. DOI: [10.1088/1748-9326/10/12/124006](https://doi.org/10.1088/1748-9326/10/12/124006).
- Viatte, C., C. Clerbaux, C. Maes, P. Daniel, R. Garello, S. Safieddine, and F. Ardhuin (2020). “Air Pollution and Sea Pollution Seen from Space”. In: *Surveys in Geophysics* 41, pp. 1583–1609. DOI: [10.1007/s10712-020-09599-0](https://doi.org/10.1007/s10712-020-09599-0).
- Vicsek, T. and A. Zafeiris (2012). “Collective motion”. In: *Physics Reports* 517.3-4, pp. 71–140. DOI: [10.1016/j.physrep.2012.03.004](https://doi.org/10.1016/j.physrep.2012.03.004).
- Vinayachandran, P. N. M. et al. (2021). “Reviews and syntheses: Physical and biogeochemical processes associated with upwelling in the Indian Ocean”. In: *Biogeosciences* 18.22, pp. 5967–6029. DOI: [10.5194/bg-18-5967-2021](https://doi.org/10.5194/bg-18-5967-2021).
- Wain, G., L. Guéry, D. M. Kaplan, and D. Gaertner (2021). “Quantifying the increase in fishing efficiency due to the use of drifting FADs equipped with echosounders in tropical tuna purse seine fisheries”. In: *ICES Journal of Marine Science* 78.1, pp. 235–245. DOI: [10.1093/icesjms/fsaa216](https://doi.org/10.1093/icesjms/fsaa216).
- Wang, R. (2011). “The precautionary principle in maritime affairs”. In: *WMU Journal of Maritime Affairs* 10.2, pp. 143–165. DOI: [10.1007/s13437-011-0009-7](https://doi.org/10.1007/s13437-011-0009-7).
- Wang, X., Y. Chen, S. Truesdell, L. Xu, J. Cao, and W. Guan (2014). “The large-scale deployment of fish aggregation devices alters environmentally-based migratory behavior of skipjack tuna in the Western Pacific Ocean”. In: *PLOS ONE* 9.5, e98226. DOI: [10.1371/journal.pone.0098226](https://doi.org/10.1371/journal.pone.0098226).

-
- Wang, X., L. Xu, Y. Chen, G. Zhu, S. Tian, and J. Zhu (2012). “Impacts of fish aggregation devices on size structures of skipjack tuna *Katsuwonus pelamis*”. In: *Aquatic Ecology* 46.3, pp. 343–352. DOI: [10.1007/s10452-012-9405-0](https://doi.org/10.1007/s10452-012-9405-0).
- Watanabe, Y., T. Tsunekawa, M. Takahashi, M. Tabuchi, and T. Sugawara (1988). “Results on the experimental purse seine fishing with FADs in the Indian ocean by R/V Nippon Maru”. In: *IPTP Collect. Vol. Work. Doc.* 3, pp. 227–232.
- WCPFC (2021). *Conservation and Management Measure for bigeye, yellowfin and skipjack tuna in the Western and Central Pacific Ocean*. Tech. rep. CMM-2021-01. Western and Central Pacific Fisheries Commission.
- Weng, J.-S., M.-K. Hung, C.-C. Lai, L.-J. Wu, M.-A. Lee, and K.-M. Liu (2013). “Fine-scale vertical and horizontal movements of juvenile yellowfin tuna (*Thunnus albacares*) associated with a subsurface fish aggregating device (FAD) off southwestern Taiwan”. In: *Journal of Applied Ichthyology* 29.5, pp. 990–1000. DOI: [10.1111/jai.12265](https://doi.org/10.1111/jai.12265).
- Williams, A. T., D. T. Tudor, and M. R. Gregory (2005). “Marine Debris-Onshore, Offshore, Seafloor Litter”. In: *Encyclopedia of Coastal Science*. Ed. by M. L. Schwartz. Encyclopedia of Earth Science Series. Dordrecht: Springer Netherlands, pp. 623–628. DOI: [10.1007/1-4020-3880-1_207](https://doi.org/10.1007/1-4020-3880-1_207).
- Wolff, F.-C., D. Squires, and P. Guillotreau (2013). “The Firm’s Management in Production: Management, Firm, and Time Effects in an Indian Ocean Tuna Fishery”. In: *American Journal of Agricultural Economics* 95.3, pp. 547–567. DOI: [10.1093/ajae/aas140](https://doi.org/10.1093/ajae/aas140).
- Worm, B., B. Davis, L. Kettner, C. A. Ward-Paige, D. Chapman, M. R. Heithaus, S. T. Kessel, and S. H. Gruber (2013). “Global catches, exploitation rates, and rebuilding options for sharks”. In: *Marine Policy* 40, pp. 194–204. DOI: [10.1016/j.marpol.2012.12.034](https://doi.org/10.1016/j.marpol.2012.12.034).
- Young, J. W., M. J. Lansdell, R. A. Campbell, S. P. Cooper, F. Juanes, and M. A. Guest (2010). “Feeding ecology and niche segregation in oceanic top predators off eastern Australia”. In: *Marine Biology* 157.11, pp. 2347–2368. DOI: [10.1007/s00227-010-1500-y](https://doi.org/10.1007/s00227-010-1500-y).
- Young, J. W. et al. (2015). “The trophodynamics of marine top predators: Current knowledge, recent advances and challenges”. In: *Deep Sea Research Part II: Topical Studies in Oceanography*. Impacts of climate on marine top predators 113, pp. 170–187. DOI: [10.1016/j.dsr2.2014.05.015](https://doi.org/10.1016/j.dsr2.2014.05.015).
- Zainuddin, M., A. Farhum, S. Safruddin, M. B. Selamat, S. Sudirman, N. Nurdin, M. Syamsuddin, M. Ridwan, and S.-I. Saitoh (2017). “Detection of pelagic habitat hotspots for skipjack tuna in the Gulf of Bone-Flores Sea, southwestern Coral Triangle tuna, Indonesia”. In: *PLOS ONE* 12.10, e0185601. DOI: [10.1371/journal.pone.0185601](https://doi.org/10.1371/journal.pone.0185601).
- Zudaire, I. et al. (2020). *Testing designs and identify options to mitigate impacts of drifting FADs on the ecosystem*. Second Interim Report. European Commission. Specific Contract No. 7 EASME/EMFF/2017/1.3.2.6 under Framework Contract No. EASME/EMFF/2016/008. P. 193.
- Zudaire, I., H. Murua, M. Grande, and N. Bodin (2013). “Reproductive potential of Yellowfin Tuna (*Thunnus albacares*) in the western Indian Ocean”. In: *Fishery Bulletin* 111.3, pp. 252–264. DOI: [10.7755/FB.111.3.4](https://doi.org/10.7755/FB.111.3.4).
- Zudaire, I., H. Murua, M. Grande, N. Goñi, M. Potier, F. Ménard, E. Chassot, and N. Bodin (2015). “Variations in the diet and stable isotope ratios during the ovarian development of female yellowfin tuna (*Thunnus albacares*) in the Western Indian Ocean”. In: *Marine Biology* 162.12, pp. 2363–2377. DOI: [10.1007/s00227-015-2763-0](https://doi.org/10.1007/s00227-015-2763-0).
- Zudaire, I., H. Murua, M. Grande, F. Pernet, and N. Bodin (2014). “Accumulation and mobilization of lipids in relation to reproduction of yellowfin tuna (*Thunnus albacares*) in the Western Indian Ocean”. In: *Fisheries Research* 160, pp. 50–59. DOI: [10.1016/j.fishres.2013.12.010](https://doi.org/10.1016/j.fishres.2013.12.010).

-
- Zudaire, I. et al. (2019). *Towards the use of non-entangling and biodegradable dFADs: actions to mitigate their negative effects in the ecosystem*. J-T-RFMO FAD WG 2019 Zudaire S:10. Joint tuna Regional Fisheries Management Organisation meeting.
- Zuur, A. F., E. N. Ieno, N. Walker, A. A. Saveliev, and G. M. Smith (2009). *Mixed effects models and extensions in ecology with R*. Statistics for Biology and Health. New York, NY: Springer New York.

Appendices

Appendix A

Correlated Random Walk of tuna in arrays of Fish Aggregating Devices: A field-based model from passive acoustic tagging

Publication

Pérez, G., **Dupaix, A.**, Dagorn, L., Deneubourg, J.-L., Holland, K., Beeharry, S., & Capello, M. (2022). Correlated Random Walk of tuna in arrays of Fish Aggregating Devices: A field-based model from passive acoustic tagging. *Ecological Modelling*, 470, 110006. <https://doi.org/10.1016/j.ecolmodel.2022.110006>



Contents lists available at ScienceDirect

Ecological Modelling

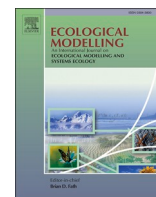
journal homepage: www.elsevier.com/locate/ecolmodel

Correlated Random Walk of tuna in arrays of Fish Aggregating Devices: A field-based model from passive acoustic tagging

Géraldine Pérez^{a,*}, Amaël Dupaix^a, Laurent Dagorn^a, Jean-Louis Deneubourg^b, Kim Holland^c, Sunil Beeharry^d, Manuela Capello^a

^a MARBEC, Univ Montpellier, CNRS, Ifremer, IRD, Sète, France

^b Unit of Social Ecology, Université Libre de Bruxelles (ULB), Bruxelles, Belgium

^c Hawai'i Institute of Marine Biology at University of Hawai'i, Kane'ohe, Hawai'i, United States of America

^d Ministry of Ocean Economy, Marine Resources, Fisheries and Shipping, Mauritius

ARTICLE INFO

Keywords:

Correlated Random Walk
Tropical tuna
Spatial model
Fish Aggregating Device
Acoustic tagging
Survival curve
Tuna motion
Residency

ABSTRACT

For centuries fishers have exploited the propensity for tuna to associate with floating objects, yet the reasons and mechanisms behind this behavior remain unclear. The number of man-made floating objects (FADs, Fish Aggregating Devices) undergone a dramatic increase in recent decades, with the development of industrial tuna purse seine fishing. However, current knowledge does not allow for the evaluation of the consequences of this increase on the ecology of tuna. Here, we developed a model of tuna movements in an array of FADs, using passive acoustic tagging data. The model was built using four behavioral rules: (1) when no FAD is perceived, tuna exhibit a random search behavior, (2) individuals can orient directly to a FAD when they perceive it (within a given orientation radius), (3) the associative dynamics of tuna follow a daily rhythm and (4) Continuous Residence Time (CRTs – time spent at FAD by tuna) are independent from previous Continuous Absent Time (CATs- time between two consecutive CRTs). The model is based on only four parameters: swimming speed, path sinuosity, orientation distance and a loss term to account for natural and fishing mortality events. The model was calibrated on 70±10 cm yellowfin tuna (*Thunnus albacares*), acoustically tagged in two different networks of anchored FADs (Oahu, Hawaii, U.S.A. and Mauritius) with different FAD densities. Our results show that the model can reproduce the time tuna spent traveling between FADs (i.e., time away from the FADs), as well as the total time spent by the fish in the FAD array (total residence time) at both study sites. The parameter sets that best reproduce the experimental data correspond to a steering radius between 2 and 5 km, a sinuosity (correlated random walk parameter) between 0.9 and 0.995 and mortality rates between 1 and 3% per day. This model, thus parameterized, could be used in future studies to predict tuna movements in arrays of different FAD densities and thus provide scientific advice for their management. The same approach can be used for modeling the movements of marine and terrestrial animals detected near aggregation sites.

1. Introduction

With more than 5.3 million tonnes caught in 2019 (ISSF, 2021) tropical tuna constitutes one of the major harvested fish species. Currently, yellowfin tuna (*Thunnus albacares*), bigeye tuna (*T. obesus*) and skipjack (*Katsuwonus pelamis*) represent almost 95% of the global tuna catches (Murua et al., 2021). Tropical tunas display an associative behavior with floating objects, forming large multi-specific aggregations around them. The reasons why tuna associate with floating objects are still unknown. Two main hypotheses are widely accepted: (1) the

meeting-point hypothesis (Dagorn and Fréon 1999; Fréon and Dagorn, 2000) and (2) the indicator-log hypothesis (Hall, 1992). The meeting-point hypothesis posits that floating objects act as meeting-points, where tuna gather to form bigger schools. The indicator-log hypothesis posits that natural floating objects, such as logs, are more numerous in productive areas, as they concentrate in river mouths, estuaries and frontal structures. Following this hypothesis, tuna could use floating objects as indicators of productive areas.

Fishers have used this associative behavior to their advantage for centuries (Dempster and Taquet, 2004) and, more recently, have

* Corresponding author.

E-mail address: geraldine.perez@ntymail.com (G. Pérez).

<https://doi.org/10.1016/j.ecolmodel.2022.110006>

Received 29 October 2021; Received in revised form 5 April 2022; Accepted 25 April 2022

Available online 8 May 2022

0304-3800/© 2022 Elsevier B.V. All rights reserved.

deployed human-made floating objects, called Fish Aggregating Device (FAD), to increase their catches. In the open ocean, drifting FADs are primarily used by industrial purse seine fleets, while, in coastal areas, anchored FADs are used by artisanal and semi-industrial fisheries (Dagorn et al., 2013a; Dempster and Taquet, 2004; Scott and Lopez, 2014). About 37% of the tropical tuna catches (all fishing gears) are made by purse seiners on drifting FADs, ranging between 32% to 51% depending of the ocean (Dagorn et al., 2013b; Murua et al., 2021). The number of FADs has drastically increased in the three past decades, with more than 100,000 FADs deployed globally, each year (Scott and Lopez, 2014), although precise numbers are difficult to obtain. This increase raised concerns over possible impacts on tuna populations, because FADs increase the vulnerability of tunas to capture but also because increasing the number of floating objects (Dagorn et al., 2013b) could affect their ecology. Marsac et al. (2000), were the first to suggest that FADs could act as an ecological trap for tunas. Following the indicator-log hypothesis, FADs could mislead tuna if they are deployed or drift into biologically poor areas and if tuna do not differentiate between natural and man-made objects. Therefore, tuna could remain associated with FADs even if their surrounding environment is detrimental to their fitness (Marsac et al., 2000). However, current knowledge does not allow for the assessment of the effects of increasing FAD densities on tuna ecology, even when the environment (other than floating objects) remains constant.

Acoustic telemetry has been widely used to monitor tuna movements and behavior within FAD arrays. With this technology, acoustically tagged fish (i.e., fish equipped by an acoustic tag) can be either actively tracked or detected by a set of fixed acoustic receivers. In the former case, known as *active tracking*, the recorded path of the receiver, which is considered as a proxy of the animal path, generally corresponds to short periods of time (few days at most) (Girard et al., 2004; 2007). In the latter case, known as *passive acoustic telemetry*, a time series of acoustic detections is recorded within the array of receivers (Dagorn et al., 2007; Tolotti et al., 2020). The acoustic receivers are generally placed in proximity of aggregation/attraction sites (FADs in this case), where it is more likely to detect the tagged individuals. Passive acoustic telemetry has the advantage to cover longer period of time (up to several months or even more than a year, depending on the tag battery life and the fish residency within the array). However, the time series of acoustic detections recorded at aggregation sites cannot be easily translated into movement rules.

Previous passive acoustic telemetry studies conducted in anchored FAD arrays quantified the amount of time that tuna spend associated with these floating objects (residence times), as well as the time they spend traveling between two objects (absence times) (Dagorn et al., 2007; Govinden et al., 2013; Robert et al., 2013; Rodriguez-Tress et al., 2017). These studies highlighted the variability of such durations according to both the size of the tagged individuals (Robert et al., 2013) as well as the species (Rodriguez-Tress et al., 2017). Recently, Pérez et al. (2020) compared the residence and absence times recorded for individual tuna tagged within different FAD arrays, demonstrating that tuna spend less time traveling between FADs and more time in association as FAD density increases. Passive and active acoustic telemetry studies have also shown a diel rhythm in the associative behavior of tunas, with close association occurring mostly during the daytime while regular excursions away from the FAD are undertaken at night (Dagorn et al., 2000; Forget et al., 2015; Holland et al., 1990; Marsac and Cayré, 1998; Tolotti et al., 2020). Furthermore, active tracking studies allowed the fine-scale movements of tagged individuals in arrays of FADs to be investigated. Using acoustic telemetry data from actively tracked yellowfin tuna in anchored FAD arrays in the Pacific and Indian oceans, Girard et al. (2004) found that tuna adopt a random search behavior until they perceive a FAD, then orient towards the device at distances ranging between 4 and 17 km.

Recently, Pérez et al. (2020), used a simple random walk model to assess whether the observed trends in behavioural indices, obtained

from passive acoustic tagging data across increasing FAD densities, could result from the random-search component in tuna behavior suggested in previous experiments (Girard et al., 2004). While this simple model was able to explain the observed trends of shorter absence times for increasing FAD densities, it could not quantitatively predict their durations, since it did not account for the oriented movements (Girard et al., 2004) or for the diel pattern in tuna behavior (Forget et al., 2015; Marsac and Cayré, 1998). Correlated Random Walk (CRW) models are frequently used to reconstruct animal paths from active tracking data (e.g. Cramer et al., 2021; Girard et al., 2004; McClintock et al., 2012; Patterson et al., 2009), as well as to simulate their movements (Byers, 2001; Carita et al., 2012; Ahearn et al., 2017; Cramer et al., 2021). These models are used because, unlike a simple random walk, they account for the tendency of animals to go forward. A CRW model is thus a better choice than a simple random walk for animals with bilateral symmetry such as tuna. On the other hand, despite the large availability of passive acoustic telemetry data for tuna and their large temporal coverage, this data has not been used so far to construct this type of models, due to the discrete nature of the data (acoustic detections) recorded both in time and space.

The aim of this study was to develop a data-based model of tuna movements in an array of FADs, which can reproduce the motion of tuna from one FAD association to another detected through passive acoustic telemetry. Such model constitutes the first step to predict the effects of increasing FAD numbers on tuna behavior and ecology. The model was calibrated using passive acoustic telemetry data collected at two study sites (Mauritius, see Rodriguez-Tress et al., 2017, and Oahu, Hawaii, U. S.A., see Dagorn et al., 2007; Robert et al., 2013) with different FAD densities (Pérez et al., 2020).

2. Materials & methods

2.1. Field data

Passive acoustic telemetry data were used to characterize tuna movements in FAD arrays. This technology is based on the transmission of an acoustic signal between an acoustic transmitter (or tag) implanted in a tuna and acoustic receivers (or hydrophones) installed at specific study sites. The identification of the tagged fish is possible when the fish is located close to the receivers, within a given detection range. Passive acoustic tagging data were collected in two anchored FAD arrays, one around the island of Mauritius (Rodriguez-Tress et al., 2017) in the Western Indian Ocean, and the other around the island of Oahu (Robert et al., 2013), within the Hawaiian archipelago in the Central Pacific Ocean (Fig. 1). These anchored FAD arrays differ in their inter-FAD distances, with the Mauritian array having shorter nearest and next-nearest neighboring distances than the Hawaiian array (Pérez et al., 2020). The Mauritian array consisted of 9 FADs with 7 equipped with acoustic receivers, and the Hawaiian array comprised 13 FADs, all of which were equipped with acoustic receivers (see Dagorn et al., 2007; Rodriguez-Tress et al., 2017 for specifications of acoustic receivers). In both arrays, FADs were moored in depths of between 1000 and 2500 m. The design of FADs was similar within the same array, but differed slightly between arrays.

Since previous studies outlined species and size-dependent variability in the associative behavior of tuna at FADs (Pérez et al., 2020; Robert et al., 2013; Rodriguez-Tress et al., 2017), this study focused on a single species (yellowfin tuna) and size of ~70 cm fork length (fork length range: 60–80 cm), named YFT-70, which was common to both study sites. For the Mauritian array, due to the short duration of the experiment (Rodriguez-Tress et al., 2017), the data recorded during the first 38 days was considered, resulting in the smallest observation time. For the Hawaiian array, where the experiment lasted more than one year, only the initial 120 days after tagging were considered because 95% of the time between the first and the last detection at a FAD lasted less than 120 days (Robert et al., 2013). As a result, the field data

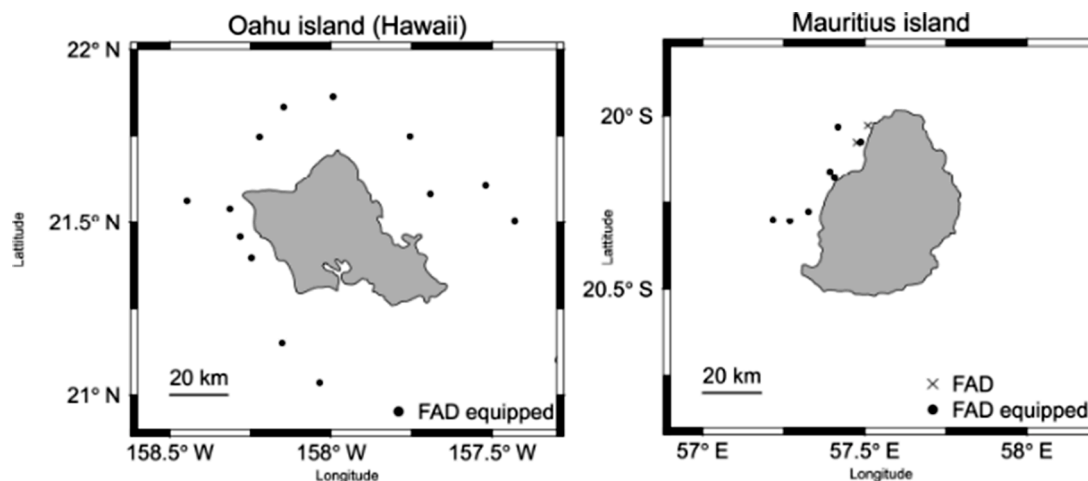

Fig. 1. Anchored FAD arrays of Mauritius (left) and Oahu (right). Positions of the anchored FADs are represented by a black dot when equipped with an acoustic receiver, and by a black cross otherwise.

consisted of 14 YFT-70 tagged in the Mauritian array and 56 YFT-70 individuals in the Hawaiian array (Table 1). Details on the tagging procedures can be found in Rodriguez-Tress et al. (2017) for the Mauritian array and in Robert et al. (2013) for the Hawaiian array.

2.2. Residence and absence times in the FAD array

Acoustic telemetry data were processed to obtain information on durations of presence at and absence from instrumented FADs displayed by tagged tuna, following the procedure described in Capello et al. (2015). This procedure translates the discrete time series of acoustic detections into continuous bouts of time. It relies on the definition of a maximum blanking period (MBP), i.e., a maximum temporal separation between two subsequent acoustic detections at the same FAD (or receiver), where fish is still considered to be associated. The definition of a MBP not only allows to account for small data gaps related to detection issues and sonic collisions (Forget et al., 2015), but also for fish excursions out of the detection range of the receiver. In the case of tropical tuna, a MBP value of 24 h was chosen, in order to account for the regular diel excursions that tuna perform out of the FAD at nighttime (Dagorn et al., 2000; Forget et al., 2015; Holland et al., 1990; Marsac and Cayré, 1998). Following this procedure, the Continuous Residence Times (CRTs) (Capello et al., 2015; Dagorn et al., 2007; Ohta and Kakuma 2005), corresponded to continuous bouts of time spent at the same FAD without any day-scale absence (>24 h). Conversely, the time spent away from FADs were defined as Continuous Absence Times (CAT) (Capello et al., 2015; Govinden et al., 2013). Absence times related to movements between two different FADs were referred to as CAT_{diff} (Pérez et al., 2020). Finally, for each individual, the sum of all recorded CRTs and CATs corresponded to the Total Residence Time (TRT), namely the time between the first and the last detection recorded in the FAD array (Fig. 2).

Table 1

Number of yellowfin tuna of ~70 cm tagged (N_{tuna}), total number of CRTs (excluding the first CRT, NCRT) and total number of CAT_{diff} (NCAT_{diff}) recorded in the Mauritian and the Hawaiian array.

	Hawaii	Mauritius
N_{tuna}	56	14
NCRT	111	29
NCAT _{diff}	59	19

2.3. Model

The model was built upon four behavioral rules, based on the current knowledge of the associative behavior of tuna at FADs (Fig. 3): (1) Tuna display a random search behavior between two FAD associations (Girard et al., 2004; Pérez et al., 2020), (2) at a certain distance from FADs tuna show oriented movements towards FADs (Girard et al., 2004), (3) the tuna association dynamics follows a diel rhythm (Dagorn et al., 2000; Forget et al., 2015; Govinden et al., 2021; Holland et al., 1990; Marsac and Cayré 1998; Tolotti et al., 2020), and (4) CRTs were independent from previous CATs (Robert et al., 2013).

As tuna, like most animals, have a tendency to move forward, the random-search movements were simulated using a Correlated Random Walk model (Ahearn et al., 2017; Carita et al., 2000; Codling et al., 2008; Kareiva and Shigesada, 1983). These models are based on a Markov process where consecutive changes in the animal's consecutive direction are correlated. For each time step Δt , the position of an individual at time t depends on its previous position at time $t-\Delta t$ and the turning angle α , defining the change in direction relative to the previous time step. Turning angles were randomly sampled from a normal distribution defined in the range $[-\pi; \pi]$, with zero mean and standard deviation σ following the method of Bovet & Benhamou (1988), using the `scipy.stats.truncnorm` python function. Standard deviation $\sigma = 0$ correspond to straight trajectories whereas in the limit $\sigma \rightarrow \infty$ the model converges to a simple random walk. In the following, σ was expressed in terms of the coefficient of sinuosity (c) according to the relationship, $\sigma = \sqrt{-2\ln(c)}$ with $c \in]0,1[$ (Benhamou 2004; Bovet and Benhamou, 1988). The limit $c \rightarrow 0$ corresponds to a simple random walk (highest sinuosity) whereas increasing c decreases the sinuosity, with straight trajectories for $c = 1$. A total of 9 coefficients of sinuosity were tested, ranging between 0.2 and 0.9999 (Table 2). Fig. 4 illustrates the distribution of turning angles and an example of a tuna trajectory for each coefficient of sinuosity tested.

In order to account for the orientation behavior of tuna towards FADs, different values of the orientation radius were tested (Fig. 4, Table 2 and Supplementary Information 1). Each time a tuna enters within this radius, its path changes to a straight trajectory oriented towards the FAD location. If the tuna was located within the orientation radius of multiple FADs, a FAD was randomly selected between them using a uniform distribution. A total of six orientation radii were tested, ranging between 0 (no orientation) to 20 km, see Table 2. The diel rhythm in the associative behavior of tunas was accounted for by defining two behavioral modes ("daytime" and "nighttime") with a periodicity of 24 h each. During the 12 h of "daytime" tuna displayed an orientation behavior towards FADs (if located within the orientation

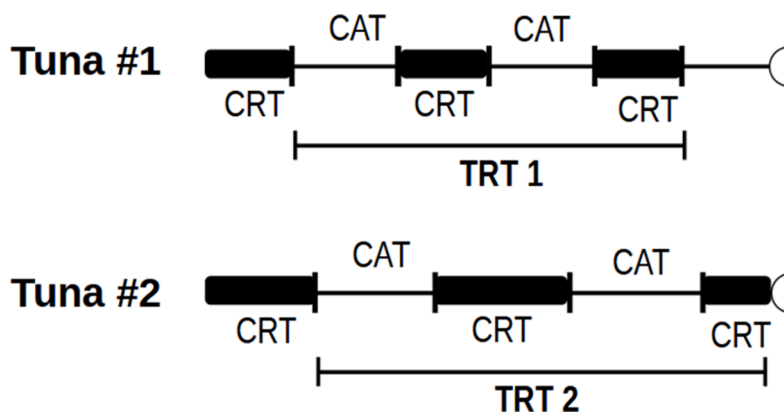

Fig. 2. Schematic diagram of behavioral sequences and Total Residence Time (TRT) definition. The tuna #1 presents a TRT ending at the end of the last Continuous Residence Time (CRT), recorded before the end of the experiment (indicated by a C-shape). The tuna #2 presents a TRT ending during a CRT because the experiment stopped, while the tuna was associated. CAT corresponds to Continuous Absence Times.

radius). Conversely, during the 12 h of “nighttime” tuna did not exhibit a long-range attraction to FADs (no oriented behavior within the orientation radius) and therefore followed a simple CRW dynamic. In both “daytime” and “nighttime” behavioral modes a tuna was, however, considered to be associated with a FAD when it was located within 500 m of it. This value is in accordance with both the observations of tuna when they were associated with FADs (see Josse et al., 2000; Moreno et al., 2007), and the detection range of acoustic tags used in telemetry studies around instrumented FADs (see Forget et al., 2015).

The model did not represent the association time of tuna at FADs (CRT), but these durations were needed to compare the model with the field data. Therefore, the CRTs recorded from field data were used as a model input. Each time a tuna reaches a FAD (i.e., it was located within 500 m of it), a CRT value was randomly sampled from the actual CRT data of the corresponding array and the simulated individuals do not move away from the FAD during the entire duration of the CRT. The CRTs recorded from field data in each array are shown in the Supplementary Information 2. Once this time has elapsed, individuals could leave the FAD in a random direction sampled from a uniform distribution between $[-\pi; \pi]$. To avoid immediate returns, during the 24 h following the end of a CRT, fish was not affected by the association radius (R_0) of the FAD of departure. Similarly, returns due to tuna re-entering the detection range within 24 h (which were already taken into account in the CRT duration) were neglected. For this purpose, each time a CAT_{return} of less than 24 h was recorded after a CRT, this movement was discarded and the simulation time was reset to the end of the last CRT recorded (Fig. 3). This procedure ensured that CRT durations were consistent with field data. Since the CRTs recorded immediately after tagging were significantly longer than the other CRTs in the Hawaii field experiments and slightly longer in the Mauritius field data, (see Supplementary Information 2) they were not considered in the above procedure. Accordingly, the first CRT were also subtracted from the TRT to ensure data consistency.

Finally, a mortality rate (m) was considered to account for natural and fishing mortality events that may cause the interruption of the acoustic detections for some tagged individuals. For this purpose, a Monte Carlo algorithm was applied where, for each individual and at each time step, a random number ε was sampled from a uniform distribution in the interval $[0,1]$ and compared with the corresponding mortality rate using a Bernoulli test. A death was accepted for $\varepsilon < m \cdot T$. The constant T depends on the time step Δt and on the temporal units of the mortality rate. Different mortality rates were tested, ranging between 0 and 5% per day (Table 2). For a mortality rate expressed in days^{-1} and Δt in seconds, $T = \Delta t / (3600 \times 24)$. The upper bound of 5% per day was estimated from survival analyses of field data (see Supplementary Information 3). TRTs values therefore depended on both the

CRW dynamics (which affects the number of tuna associations, thus the time at which the last FAD detections occur) and the mortality rates (Fig. 2).

The model was run in a continuous unbounded space, centered around the actual FAD arrays of Mauritius and Hawaii. The topography of each island was considered using data from the R package “rworldmap” (South 2011). Each time simulated individuals were at risk of crossing island boundaries, the distribution of turning angles α was sub-sampled in order to avoid the island.

A total of 1000 individuals were considered in each FAD array, for each combination of model parameters. For each individual, the simulations started at one of the FADs of tagging, in order to reproduce the experimental design as accurately as possible. The probability to start at a given FAD was obtained considering the number of tuna tagged at the FAD, relative to the total number of tuna tagged in the field experiment (see Supplementary Information 4). Two different swimming speeds were tested: 0.7 and 1.4 m/s, corresponding to one and two body-lengths per second respectively (see swimming speeds in Girard et al., 2004 and tagging studies used in this study: Robert et al., 2013 and Rodriguez-Tress et al., 2017). Time steps (Δt) lasted 100 s and each resulted in individual fish movements of 70 and 140 m depending on the speed.

A summary of all model parameters can be found in Table 2. All the simulations were performed using the Python 3 programming language (Python Software Foundation, version 3.8.5).

2.4. Comparison between simulated and field data

Since the model aimed at fitting the time that tuna spent between two FAD associations (CAT_{diff}), the comparison between the model and the field data focused on this metric. However, the distribution of CAT_{diff} also depends on the total time spent in the FAD array (i.e. longer CAT_{diff} can only be observed for longer TRT). As such, the comparison between the model and the field data was performed for both metrics. For this purpose, CAT_{diff} and TRT were obtained from the simulated data using the same procedures applied to the field data. The selection of model parameters which best fitted the field data was made using a survival analysis, by comparing the theoretical survival curves of the TRT and the CAT_{diff} with those obtained from field data, through a bootstrap method. Experimental survival curves $S(t)$ were constructed (Capello et al., 2015), which represented the proportion of events (TRT or CAT_{diff}) longer than a given duration t . For each set of parameters the survival curve of the field data was compared 1000 times with a sub-sample of the same size as the field data, i.e. 56 individuals for Hawaii and 14 for Mauritius (Table 1), randomly sampled from the 1000 simulated individuals. For each of the bootstrap sample, survival curves obtained

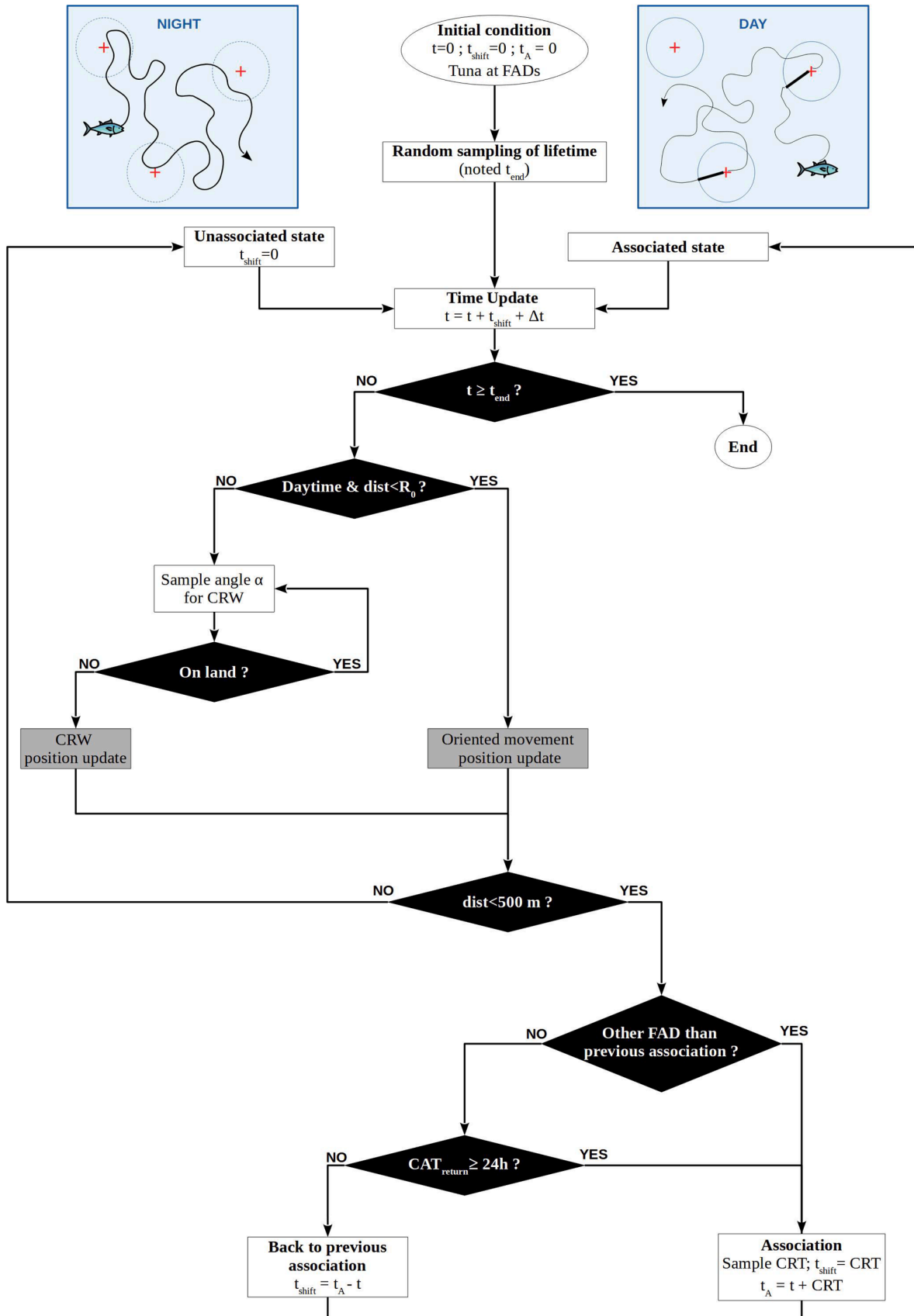

Fig. 3. Flow-Chart diagram illustrating the model algorithm. CRW denotes Correlated Random Walk, R_0 corresponds to the orientation radius, $dist$ corresponds to the distance between the tuna and the closest Fish Aggregating Device (FAD) and the value t_{end} takes into account the death of tuna as well as the end of the experimentation.

Table 2
Model parameters that gives the 648 sets of parameters tested.

Parameters	Values
Tested parameters	
v Speed (m/s)	0.7, 1.4
m Rate of mortality (%/day)	0, 1, 2, 3, 4, 5
R ₀ Orientation radius (km)	0, 2, 5, 10, 15, 20
c Coefficient of sinuosity	0.2, 0.7, 0.9, 0.97, 0.99, 0.995, 0.997, 0.999, 0.9999
Fixed parameters	
Δt Time step (s)	100
N No. of simulated individuals	1000
T Total duration (day)	38 (Mauritius), 120 (Hawaii)

from the simulated and field data were compared using Cox proportional hazards regressions. The statistical significance of the model was assessed using the p-value from a logrank test, which tested the null hypothesis of identical hazards between the model and the field data. For each survival curve (TRT and CAT_{diff}) and FAD array (Mauritius and Hawaii), the percentage of retained bootstrap tests was calculated, corresponding to the number of bootstrap tests showing p-values > 0.05 over the 1000 tests performed. Finally, each set of parameters was assigned the lower percentage of retained bootstraps estimated over survival curves (TRT and CAT_{diff}) and FAD arrays (Hawaii and Mauritius).

The Cox proportional hazards regressions and logrank tests were performed using the R software (R Core Team 2018 version 3.4.4) with the function “coxph” in the “survival” package version 3.1–8 (Therneau and Grambsch 2000).

3. Results

A total of 648 sets of parameters were tested (Table 2), of which 7 appeared to best fit both the CAT_{diff} and TRT recorded in the Mauritian and Hawaiian arrays considering a percentage of retained bootstrap tests ≥ 85% (Table 3 and Supplementary Information 5). That is, over the 1000 tests performed for each set of parameters, 7 sets were not statistically different from the field data in more than 85% of the tests performed on both survival curves (TRT and CAT_{diff}) and FAD arrays (Mauritius and Hawaii). Fig. 5 and Fig. 6 present the CAT_{diff} and TRT survival curves for each FAD array, for the two sets of parameters performing the best.

The complete results of the bootstrap test are available in Supplementary Information 6. Any speed values between the tested ones (0.7 and 1.4 m/s) will reflected the field behavior (Fig. 7 and Supplementary Information 7). In the same way, all values of the mortality rate can be retained. However, null mortalities ($m = 0$), showed poorer bootstrap results (higher percentage of retained bootstraps of 62.2%, see Fig. 7, Supplementary Information 6 and 7). Similarly, mortality rates of 5% and 1% did not appear among the 7 best fits (Table 3). However, combinations of parameters exist with high percentages of retained bootstraps (83.5% for $m = 5\%/day$ and 80.1% for $m = 1\%/day$, see Fig. 7, Supplementary Information 6 and 7). On the opposite, orientation radii of 2 and 5 km clearly stand out (Fig. 7 and Supplementary Information 7), all the other values having a percentage of retained bootstraps below 55% (Fig. 7, Supplementary Information 6) and even below 20% for orientation radii of 15 and 20 km (Fig. 7, Supplementary Information 6). Finally, the coefficients of sinuosity (c) performing the best range from 0.9 to 0.995 (all with a percentage of retained bootstraps above 80%, Fig. 7, Supplementary Information 6 and 7). Coefficients of $c = 0.2$, 0.999 and 0.9999 showed poorer results (percentage of retained bootstraps respectively 37.2%, 51.3% and 7%, see Fig. 7, Supplementary Information 6 and 7).

4. Discussion

The study of animal behavior made considerable progress in the last decades, thanks to the development of electronic tagging and camera trapping technologies (Hughey et al., 2018; Swann and Perkins, 2014). However, characterizing the movement of animals in their own environment still remains a challenging task, particularly in marine environments, where GPS technologies can rarely be used. Here, through the use a field-based modeling approach and passive acoustic telemetry data, we provide, for the first time, a method for describing the movement behavior of tunas in FAD arrays. The model is built upon four main behavioral components, based on the state-of-the-art knowledge of the associative dynamics of tunas at FADs: random walk dynamics, orientation capabilities, diel behavior and a lack in correlation between the duration of consecutive CRTs and CATs. A relatively small number of parameters drive the model's properties: swimming speed, path sinuosity, orientation radius and mortality rate. Despite the model's structural simplicity and the reduced number of parameters, it was able to reproduce both of the investigated movement metrics (time between two FAD associations and total time spent in the array) in two different FAD arrays.

The four parameters tested can be related to the physiological capabilities and condition of tuna, as well as their environment (including the FADs, other tuna and non-tuna species present in the array). The two swimming speeds tested (corresponding to the 0.7 and 1.4 m/s) stem from previous studies showing that swimming speed typically range between 1 and 2 body lengths per second (Dagorn et al., 2013b; Girard et al., 2004). In contrast, despite previous evidences of a random walk behavior in tuna movements between FADs (Girard et al., 2004; Pérez et al., 2020), no empirical studies have estimated the sinuosity of a tuna path in a FAD array. As a consequence, large ranges of sinuosity were considered. The results show that, while both speed values could be retained by the simulations, only a limited subset of sinuosity coefficients emerged. The majority of sinuosity coefficients that were retained indicated a rather skewed distribution of turning angles (Fig. 3, Table 3). Lower sinuosity coefficients were mostly found for the highest swimming speed (Table 3). This is to be expected considering that for a given average distance traveled during a correlated random walk, higher speeds imply lower sinuosity coefficients and vice-versa (Hall 1977; Kareiva and Shigesada 1983; Marsh and Jones 1988). Hence, the values of the sinuosity coefficient (c) retained are valid considering the chosen time step ($\Delta t = 100$ s). It is likely that the tuna movement characteristics (speed and sinuosity) also depend on the fine-scale environmental characteristics within the FAD array, such as the type and distribution of prey, or the physiological conditions of the tuna itself. In future, the consideration of a range of swimming speeds and path sinuosity, as opposed to single values, could provide a more realistic picture of tuna movements. However, the range of values used in this study provides an initial set of movement characteristics that are compatible with field observations, thus contributing to the poorly understood dynamics of tuna in a FAD array.

The mortality rate (which accounts for both natural and fishing mortality) is primarily influenced by risks associated with fishing activity, natural predation and disease. A previous study using conventional tags from the Hawaii Tuna Tagging Project (HTTP) showed a natural mortality rate of 0.36% per day and a fishing mortality of 0.67% per day for yellowfin tuna larger than 56 cm (Adam et al., 2003). As such, the global mortality rates estimated through our simulations appear to be higher than previous findings. This difference could be due to a specific mortality in each study site and period considered. Indeed, even if in both cases the Hawaiian archipelago was considered, these studies concern different islands and study periods, for which the fishing pressure might differ as well as the natural mortality.

Acoustic telemetry data do not allow for the direct estimation of mortality rate, but do provide information on the time at which an individual is no longer detected by receivers deployed on FADs. Generally,

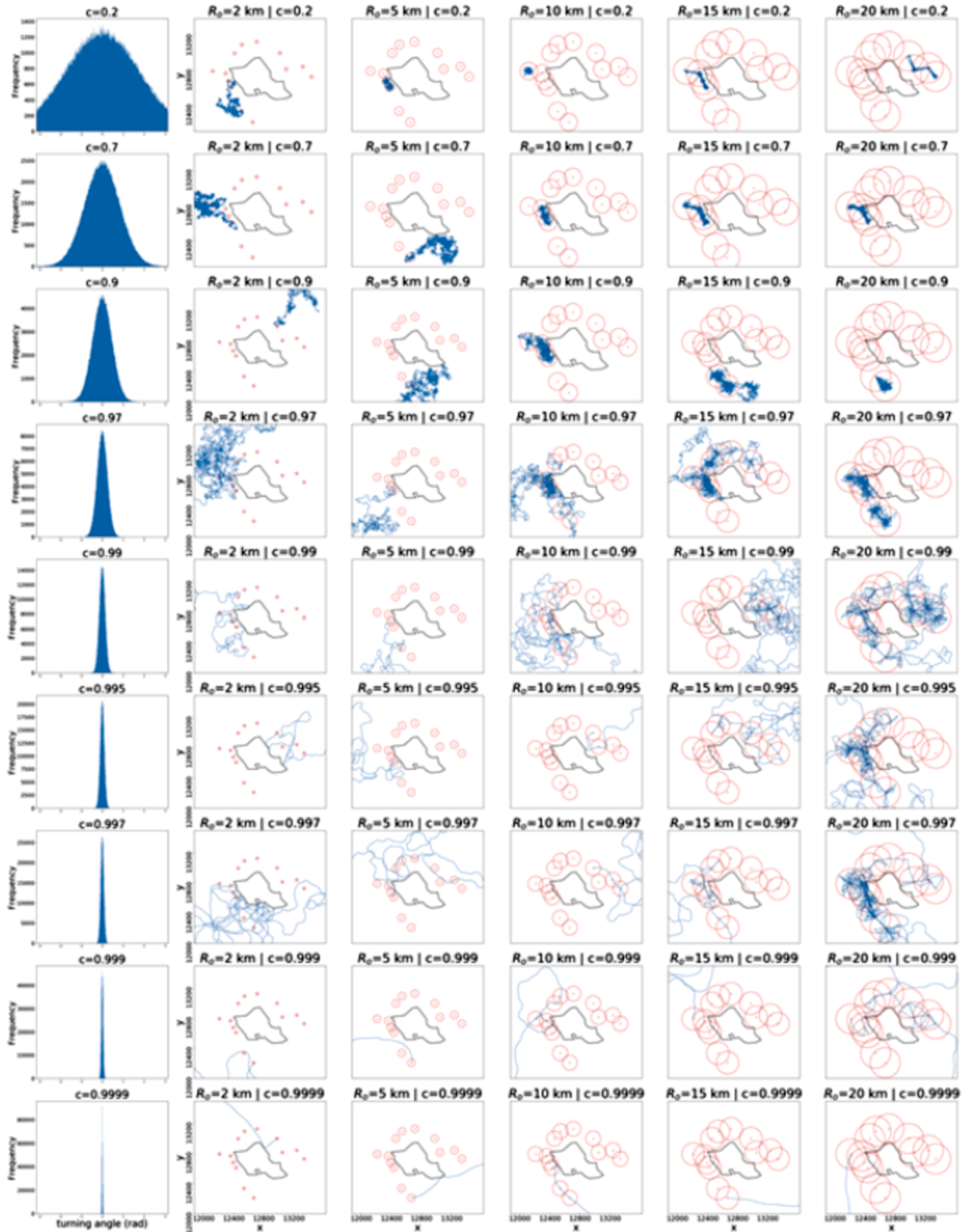

Fig. 4. Example of tuna path trajectories according to the coefficient of sinuosity (c ; rows) and the orientation radius (R_0 , columns) tested for the Hawaiian array. The first column shows the distribution of turning angles (α in radians) for each coefficient of sinuosity tested. The orientation radii are represented by red circles centered around each FAD and the case $R_0=0$ is not represented. For the Mauritian array, see Supplementary Information 2.

a lack of acoustic detections indicates that tuna have either left the FAD array or died. Movement dynamics of tuna can explain the first potential causes for a lack of detection. Within the model, the propensity of an individual to depart from the array is directly linked to the sinuosity of its path, its swimming speed and its orientation radius. For instance, large path sinuosity (resulting from small values of the sinuosity coefficient c) primarily leads to movements close to the FAD of departure

and little or no detections at the other FADs. Conversely, small path sinuosity (from high values of the coefficient of sinuosity c) generally results in individuals rapidly leaving the array (Fig. 3 and Supplementary Information 1). In this way, the model provides direct information on the rate at which tuna are lost from FAD arrays. Fitting the model to the field data allows for differentiation between loss through randomness of movement and loss due to mortality (Table 2 and Supplementary

Table 3

Set of retained model parameters for which more that 85% of the bootstrap tests fit the field data. .

v (m/s)	m (%/day)	R_o (km)	c	Retained Bootstraps (%)
0.7	2	5	0.99	91.5
1.4	2	2	0.97	90.7
1.4	3	2	0.9	89.8
0.7	2	5	0.995	89.7
1.4	4	2	0.9	89.4
1.4	2	2	0.9	87.5
0.7	3	5	0.99	86.6

Information 3). As such this field-based movement model could provide a new and alternative methodology for estimating the mortality rates of tuna in a FAD array.

In the model, the orientation radius represents the distance from

which tunas are able to orient themselves towards FADs them, while on the field tuna could be able to perceive FADs before orienting themselves toward them. No data is available on the distance at which tunas perceive FADs, but tuna movements provide input on the distance at which tunas start to orient themselves toward FADs. Therefore, the FAD perception radius was not considered in this study. This distance naturally depends on the tuna's ability to perceive its surrounding environment, as well as on the physical characteristics of the area. Given the large distances from which tuna can orient themselves towards FADs, highlighted in previous studies (Girard et al., 2004), as well as those found in this study, the use of visual cues as explanatory factors can be discarded. As sound can travel great distances underwater, the perception of acoustic stimuli could be a valid hypothesis for explaining the ability of tunas to orient towards FADs from such large distances. Environmental characteristics may impact the propagation of sounds between FADs and tunas and influence how strong these sound stimuli

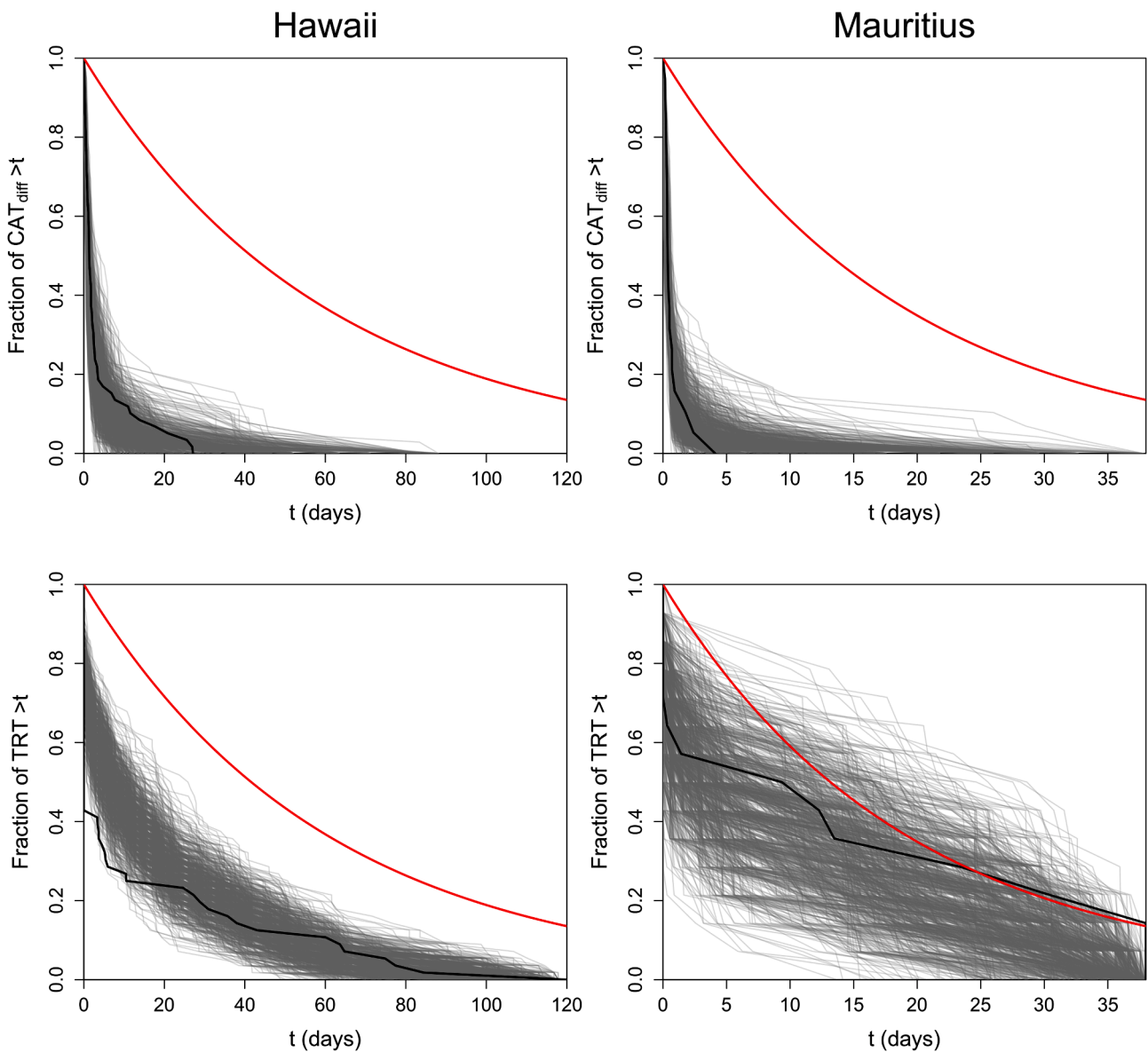

Fig. 5. Comparison of survival curves obtained from field data (black) and from the 1000 bootstrap samples (gray) for a speed $v = 0.7 \text{ m s}^{-1}$, a mortality $m = 2\%$, a orientation radius $R_o = 5 \text{ km}$ and a coefficient of sinuosity $c = 0.99$ (with% retained bootstrap = 91.5%, see Table 3). The first row corresponds to the survival curves of CAT_{diff} (A and B) and the second row to the TRT (C and D). The first column denotes the Hawaiian FAD array (A and C) and the second column the Mauritian array (B and D). The red line corresponds to the theoretical curve ($\exp(-mt)$) representing the upper bound of TRT.

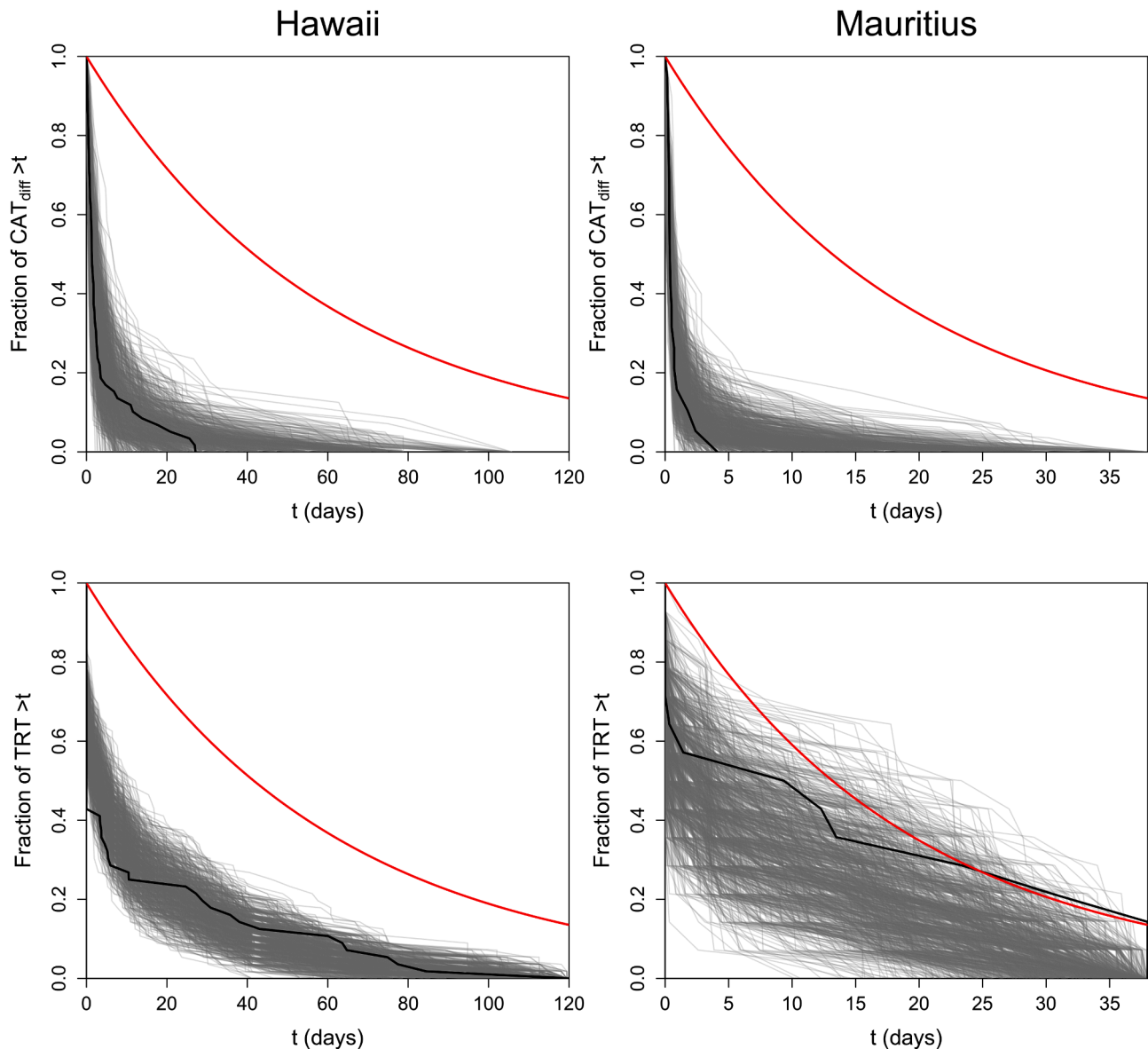

Fig. 6. Comparison of survival curves obtained from field data (black) and from the 1000 bootstrap samples (gray) for a speed $v = 1.4 \text{ m s}^{-1}$, a mortality $m = 2\%$, a orientation radius $R_o = 2 \text{ km}$ and a coefficient of sinuosity $c = 0.97$ (with % retained bootstrap = 90.7%, see Table 3). The first row corresponds to the survival curves of CAT_{diff} (A and B) and the second row to the TRT (C and D). The first column denotes the Hawaiian FAD array (A and C) and the second column the Mauritian array (B and D). The red line corresponds to the theoretical curve ($\exp(-mt)$) representing the upper bound of TRT.

are. The physical characteristics of the water mass are known to affect the propagation of sound waves (Lee et al., 2017; Siddiqui and Dong 2019). Furthermore, the topology of the FAD array and its location relative to the coastline could also affect underwater sound propagation. As sounds may be produced by the FAD structures themselves, they can vary depending on the materials used and the design of each structure, which often differ among FAD arrays. Although FAD design has not been identified as influencing the attractiveness of FADs (Fréon and Dagorn 2000), it may impact their detectability. Tunas may also perceive the presence of a FAD through the emission of noise generated by the fish aggregation itself. In such a situation the intensity of the noise could be dependent on the quantity of fish present, but also on the types of species and their activities. Considering these multiple potential sources of environmental variability, the distance at which tuna are able to perceive FADs (orientation radius) is likely to vary both within and between FAD arrays. No single value of the orientation radius can exist, but rather a distribution of these distances with a subset of values for

which the probability of being located in the environment is greatest. A general model that describes the movements of tuna in different FAD arrays with the same parameters, such as the one developed in this study, provides a subset of the most probable orientation distances. However, it is likely that a distribution of orientation distances could be more realistic and for a particular FAD, the orientation radius could have its own dynamics according to local environmental conditions.

A previous study by Girard et al. (2004) determined orientation radii between 4 and 17 km, with a mode around 10 km. This study was based on 14 yellowfin tuna (YFT) from 47 cm to 167 cm FL, that were acoustically tracked in different FAD arrays (Brill et al., 1999; Dagorn et al., 2000; Holland et al., 1990; Marsac and Cayré, 1998) and included the specie-size category considered in our simulations (YFT of $\sim 70 \text{ cm}$). These 14 individuals were actively tracked over short durations, between 12 and 86 h (due to the constraints of active tracking) rather than passively monitored as in our study. The radii found in our 7 sets of parameters (5 km and 2 km in one set) are similar to the lower range of

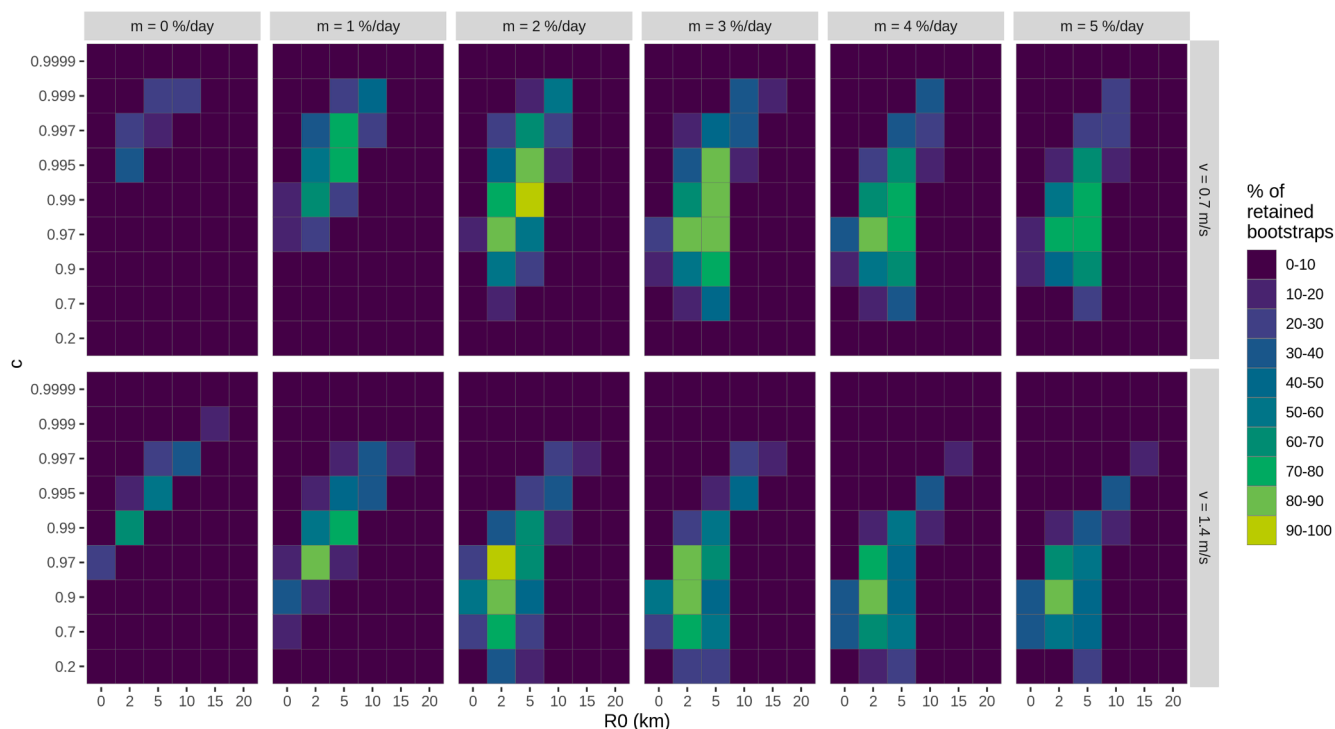

Fig. 7. Heatmap of the percentage of retained bootstraps that fit the field data for each set of model parameters. Rows corresponds to the tested speeds (v), columns denote the mortality rates (m). Tested values of the orientation radius (R_0) are shown in the x-axis and tested coefficients of sinuosity (c) in the y-axis.

the orientation distances (4–17 km) found by Girard et al. (2004). The longer orientation distances identified in that study could be attributed to the inclusion of only long paths (more than 7 km away from the FADs) in their analysis. Furthermore, the authors considered that the longest orientation distances (e.g. > 15 km) could be the result of tuna patrolling along the coast, thus using some bathymetric information rather than signals from FADs. As such, the distances found by Girard et al. (2004) may represent maximum orientation distances, while the average could be shorter, and more similar to the values we found (2–5 km).

Finally, it is important to note that the two studies considered different datasets collected in different regions, and possible inter-FAD array variability in the orientation radius cannot be excluded. It is important to stress that the retention of the model parameters was very conservative: only those valid for both metrics (TRT and CATdiff) and FAD arrays were kept. In doing so, possible local variability in tuna behavior (for example, a different orientation radius depending on the study site) were excluded. This choice was made to obtaining the minimal, and most general model, that could reproduce the observations. Considering a threshold of 85% for the percentage of retained bootstraps provides 7 sets of parameter values over the 648 tested. These values (radius of orientation ranging between 2 and 5 km, coefficient of sinuosity between 0.9 and 0.995, mortality rates between 2 and 3%) provide the main characteristics of tuna movements in FAD arrays. To avoid any scaling issue, the same data treatment was applied to both field and simulated data sets. Therefore, the model can be considered to correctly reproduce the tuna movements between FADs at the dayscale, i.e., the scale related to a maximum blanking period of 24 h (Capello et al., 2015), which was used to process the acoustic data. Further studies, across a greater number of study sites, could provide insight into how these model parameters could vary between FAD arrays. Similarly, it would be of interest to consider how this model, fitted for YFT-70, is able to describe the behavior of other tuna species and sizes. This model could also be used for other non-tuna species that associate with FADs and in particular vulnerable species such as the silky sharks (*Carcharhinus falciformis*).

As this model aimed to simulate tuna movements in FAD arrays, the time tuna spent associated with FADs (CRT) was not simulated and the experimental CRT distribution was used as an input of the model. Further model developments, which consider social interactions at FADs (Pérez et al., 2020; Robert et al., 2014), may allow the CRT durations within different FAD arrays to also be integrated into the model. This integration of CRTs into the model would involve adding social interactions between individuals and behavioral rules of social retention at the FAD that follow the meeting point hypothesis (Dagorn and Fréon 1999; Fréon and Dagorn, 2000; Robert et al., 2014).

5. Conclusion

Building on current knowledge of the associative behavior tuna at FADs from acoustic telemetry data, our model is the first to reproduce the movement behavior of tunas in a FAD array. A total of 7 sets of parameters (Table 3) were able to reproduce, with a high confidence, the movements of yellowfin tuna (fork length 70 cm) in two different FAD arrays, suggesting the model is robust. Future model improvements could consider distributions of speeds, sinuosity, detection radii and mortality rates (rather than fixed values) which may provide a better reflection of the variability induced by the local environment and the physiological conditions of the tuna themselves.

This model can be used on all species that display associative behavior with floating object. This includes species such as dolphinfish (*Coryphaena hippurus*) or the vulnerable silky shark (*Carcharhinus falciformis*). When combined with acoustic telemetry data, the model can provide an alternative method for determining the mortality rate of tuna and other associated species in a FAD array. Given the difficulty in assessing natural and fishing mortality for wild marine species, this novel approach could be of interest for the stock assessment community. Moreover, the model could be used to predict how increasing numbers of FADs affect the ecology of tunas ecology, both in terms of the time spent away from FADs and the total time spent in a FAD array. This study offers a new tool to provide science-based advice for the management of

FAD fisheries, since the more time fish spend associated, the more vulnerable these individuals are to the fishery. Scenarios could be extended to drifting FADs in open ocean areas, as both anchored and drifting FADs alter the environment in a similar way (Dagorn et al., 2010). While acoustic telemetry experiments have successfully characterized residence times at drifting FADs (Forget et al., 2015; Govinden et al., 2010), measuring in situ absence times of tunas within drifting FAD arrays is a major research challenge and these parameters are key for the development of robust FAD management plans by Tuna Regional Fisheries Management Organisations (RFMOs). Our model provides a method for estimate these parameters in the absence of data from acoustically tagged tuna in drifting FAD arrays.

Finally, the same approach can be used to study the movement behavior of other marine and terrestrial species that manifest an associative behavior with aggregating sites, and for which presence/absence data are recorded at these sites. For instance, our model could be used to study the movements of terrestrial animals who show associative behaviors with waterholes (O'Farrill et al., 2014; Zvidzai et al., 2013) detected through camera traps (Hughey et al., 2018; Swann and Perkins, 2014.). More generally, this method could be used even without any associative behavior at specific sites, as long as the study site is equipped with regularly spaced and sufficiently numerous receivers where individuals can be identified.

Authors' contributions

S.B., K.H. and L.D. collected the raw data in the field. G.P. developed the model, with major contribution of A.D. and M.C. G.P. analysed the data and wrote the paper with major contribution of M.C., L.D., J.L.D. and A.D. All authors read and approved the final manuscript.

Funding

This project was co-funded by the ANR project BLUEMED (ANR-14-ACHN-0002), "Observatoire des Ecosystèmes Pélagiques Tropicaux exploités" (Ob7) from IRD/MARBEC and by the International Pole-and-line Foundation (IPNLF).

Data availability statement

Simulations were performed with the model FAT albaCoRaW v1.3. All scripts and data used in this study are available on GitHub (https://github.com/adupaix/FAT_albaCoRaW, doi: 10.5281/zenodo.583405 6.).

Declaration of Competing Interest

The authors declare that they have no known competing financial interests or personal relationships that could have appeared to influence the work reported in this paper.

Acknowledgements

The authors would like to acknowledge the two anonymous reviewers for their extensive and constructive feedback.

Supplementary materials

Supplementary data associated with this article can be found, in the online version, at [10.1016/j.ecolmodel.2022.110006](https://doi.org/10.1016/j.ecolmodel.2022.110006).

References

Adam, M.S., Sibert, J., Itano, D., Holland, K., 2003. Dynamics of bigeye (*Thunnus obesus*) and yellowfin (*T. albacares*) tuna in Hawaii's pelagic fisheries: analysis of tagging data with a bulk transfer model incorporating size-specific attrition. *Fish. Bull.* 101 (2), 215–228.

- Ahearn, S.C., Dodge, S., Simcharoen, A., Xavier, G., Smith, J.L.D., 2017. A context-sensitive correlated random walk: a new simulation model for movement. *Int. J. Geogr. Inf. Sci.* 31 (5), 867–883. <https://doi.org/10.1080/13658816.2016.1224887>.
- Benhamou, S., 2004. How to reliably estimate the tortuosity of an animal's path: straightness, sinuosity, or fractal dimension? *J. Theor. Biol.* 229 (2), 209–220. <https://doi.org/10.1016/j.jtbi.2004.03.016>.
- Bovet, P., Benhamou, S., 1988. Spatial analysis of animals' movements using a correlated random walk model. *J. Theor. Biol.* 131 (4), 419–433. [https://doi.org/10.1016/S0022-5193\(88\)80038-9](https://doi.org/10.1016/S0022-5193(88)80038-9).
- Brill, R.W., Block, B.A., Boggs, C.H., Bigelow, K.A., Freund, E.V., Marcinek, D.J., 1999. Horizontal movements and depth distribution of large adult yellowfin tuna (*Thunnus albacares*) near the Hawaiian Islands, recorded using ultrasonic telemetry: implications for the physiological ecology of pelagic fishes. *Mar. Biol.* 133, 395–408. <https://doi.org/10.1007/s002270050478>.
- Byers, J.A., 2001. Correlated random walk equations of animal dispersal resolved by simulation. *Ecology* 82 (6), 1680–1690. [https://doi.org/10.1890/0012-9658\(2001\)082\[1680:CRWEOA\]2.0.CO;2](https://doi.org/10.1890/0012-9658(2001)082[1680:CRWEOA]2.0.CO;2).
- Capello, M., Robert, M., Soria, M., Potin, G., Itano, D., Holland, K., Dagorn, L., 2015. A methodological framework to estimate the site fidelity of tagged animals using passive acoustic telemetry. *PLoS ONE* 10 (8), 1–19. <https://doi.org/10.1371/journal.pone.0134002>.
- Carita, M.B., James, A.S., L., S.N., 2000. Caribou movement as a correlated random walk. *Oecologia* 123, 364–374.
- Codling, E.A., Plank, M.J., Benhamou, S., 2008. Random walk models in biology. *J. R. Soc., Interface* 5 (25), 813–834. <https://doi.org/10.1098/rsif.2008.0014>.
- Cramer, A., Katz, S., Kogan, C., Lindholm, J., 2021. Distinguishing residency behavior from random movements using passive acoustic telemetry. *Mar. Ecol. Prog. Ser.* 672, 73–87. <https://doi.org/10.3354/meps13760>.
- Dagorn, L., Fréon, P., 1999. Tropical tuna associated with floating objects: a simulation study of the meeting point hypothesis. *Can. J. Fish. Aquat. Sci.* 56 (6), 984–993. <https://doi.org/10.1139/cjfas-56-6-984>.
- Dagorn, L., Holland, K.N., Restrepo, V., Moreno, G., 2013a. Is it good or bad to fish with FADs? What are the real impacts of the use of drifting FADs on pelagic marine ecosystems? *Fish. Fish.* 14 (3), 391–415. <https://doi.org/10.1111/j.1467-2979.2012.00478.x>.
- Dagorn, L., Bez, N., Fauvel, T., Walker, E., 2013b. How much do fish aggregating devices (FADs) modify the floating object environment in the ocean? *Fish. Oceanogr.* 22 (3), 147–153. <https://doi.org/10.1111/fog.12014>.
- Dagorn, L., Holland, K.N., Filmalter, J.D., 2010. Are drifting FADs essential for testing the ecological trap hypothesis? *Fish. Res.* 106 (1), 60–63. <https://doi.org/10.1016/j.fishres.2010.07.002>.
- Dagorn, L., Holland, K.N., Itano, D., 2007. Behavior of yellowfin (*Thunnus albacares*) and bigeye (*T. obesus*) tuna in a network of fish aggregating devices (FADs). *Mar. Biol.* 151 (2), 595–606. <https://doi.org/10.1007/s00227-006-0511-1>.
- Dagorn, L., Josse, E., Bach, P., Bertrand, A., 2000. Modeling tuna behaviour near floating objects: from individuals to aggregations. *Aquat. Living Resour.* 13 (4), 203–211. [https://doi.org/10.1016/S0990-7440\(00\)01065-2](https://doi.org/10.1016/S0990-7440(00)01065-2).
- Dempster, T., Taquet, M., 2004. Fish aggregation device (FAD) research: gaps in current knowledge and future directions for ecological studies. *Rev. Fish Biol. Fish.* 14 (1), 21–42. <https://doi.org/10.1007/s11160-004-3151-x>.
- Forget, F., Capello, M., Filmalter, J.D., Govinden, R., Soria, M., Cowley, P.D., Dagorn, L., 2015. Behaviour and vulnerability of target and non-target species at drifting fish aggregating devices (FADs) in the tropical tuna purse seine fishery determined by acoustic telemetry. *Can. J. Fish. Aquat. Sci.* 72 (9), 1398–1405. <https://doi.org/10.1139/cjfas-2014-0458>.
- Fréon, P., Dagorn, L., 2000. Review of fish associative behaviour: toward a generalisation of the meeting point hypothesis. *Rev. Fish Biol. Fish.* 10 (2), 183–207. <https://doi.org/10.1023/A:1016666108540>.
- Girard, C., Benhamou, S., Dagorn, L., 2004. FAD: Fish Aggregating Device or Fish Attracting Device? A new analysis of yellowfin tuna movements around floating objects. *Anim. Behav.* 67 (2), 319–326. <https://doi.org/10.1016/j.anbehav.2003.07.007>.
- Girard, C., Dagorn, L., Taquet, M., Aumeeruddy, R., Peignon, C., Benhamou, S., 2007. Homing abilities of dolphinfish (*Coryphaena hippurus*) displaced from fish aggregating devices (FADs) determined using ultrasonic telemetry. *Aquat. Living Resour.* 321 (2007), 313–321. <https://doi.org/10.1051/alr:2008005>.
- Govinden, R., Capello, M., Forget, F., Filmalter, J.D., Dagorn, L., 2021. Behavior of skipjack (*Katsuwonus pelamis*), yellowfin (*Thunnus albacares*), and bigeye (*T. obesus*) tunas associated with drifting fish aggregating devices (dFADs) in the Indian Ocean, assessed through acoustic telemetry. *Fish. Oceanogr.* <https://doi.org/10.1111/fog.12536>.
- Govinden, R., Dagorn, L., Soria, M., & Filmalter, J. (2010). Behaviour of tuna associated with drifting Fish Aggregating Devices (FADs) in the Mozambique Channel, 1–22.
- Govinden, R., Jauhary, R., Filmalter, J.D., Forget, F., Soria, M., Adam, M.S., Dagorn, L., 2013. Movement behaviour of skipjack (*Katsuwonus pelamis*) and yellowfin (*Thunnus albacares*) tuna at anchored fish aggregating devices (FADs) in the Maldives, investigated by acoustic telemetry. *Aquat. Living Resour.* 26 (1), 69–77. <https://doi.org/10.1051/alr/2012022>.
- Hall, R.L., 1977. Amoeboid movement as a correlated walk. *J. Math. Biol.* 4, 327–335. <https://doi.org/10.1177/1077546311406307>.
- Hall, M.A., 1992. The association of tunas with floating objects and dolphins in the Eastern Pacific ocean: VII. Some hypotheses on the mechanisms governing the association of tunas with floating objects and dolphins. In: *Background Document for the International Workshop on the Ecology and Fisheries for Tunas Associated with Floating Objects, February 11-13 1992, La Jolla, CA, January, 6*.

- Holland, K.N., Brill, R.W., Chang, R.K.C., 1990. Horizontal and vertical movements of yellowfin and bigeye tuna associated with fish aggregating devices. *Fish. Bull.* 88 (3), 493–507.
- Hughey, L.F., Hein, A.M., Strandburg-Peshkin, A., Jensen, F.H., 2018. Challenges and solutions for studying collective animal behaviour in the wild. *Philos. Trans. R. Soc., B, Biol. Sci.* 373 (1746), 1–13. <https://doi.org/10.1098/rstb.2017.0005>.
- Josse, E., Dagorn, L., Bertrand, A., 2000. Typology and behaviour of tuna aggregations around fish aggregating devices from acoustic surveys in French Polynesia. *Aquat. Living Resour.* 13 (4), 183–192. [https://doi.org/10.1016/S0990-7440\(00\)00051-6](https://doi.org/10.1016/S0990-7440(00)00051-6).
- Kareiva, P.M., Shigesada, N., 1983. Analyzing insect movement as a correlated random walk. *Oecologia* 56 (2), 234–238.
- Lee, K.M., Ballard, M.S., McNeese, A.R., Wilson, P.S., 2017. Sound speed and attenuation measurements within a seagrass meadow from the water column into the seabed. *J. Acoust. Soc. Am.* 141 (4), 402–406. <https://doi.org/10.1121/1.4979302>.
- Marsac, F., Cayré, P., 1998. Telemetry 'applied to behaviour analysis of yellowfin tuna (*Thunnus albacares*, Bonnaterre, 1788) movements in a network of fish aggregating devices. *Hydrobiologia* (May 1998), 155–171. <https://doi.org/10.1023/A>.
- Marsac, F., Fonteneau, A., Ménard, F., 2000. Drifting FADs used in tuna fisheries: an ecological trap? *Biologie and Behaviour of Pelagic Fish Aggregations* 537–552.
- Marsh, L.M., Jones, R.E., 1988. The form and consequences of random walk movement models. *J. Theor. Biol.* 133 (1), 113–131. [https://doi.org/10.1016/S0022-5193\(88\)80028-6](https://doi.org/10.1016/S0022-5193(88)80028-6).
- McClintock, B.T., King, R., Thomas, L., Matthiopoulos, J., McConnell, B.J., Morales, J.M., 2012. A general discrete-time modeling framework for animal movement using multistate random walks. *Ecol. Monogr.* 82 (3), 335–349. <https://doi.org/10.1890/11-0326.1>.
- Moreno, G., Dagorn, L., Sancho, G., Itano, D., 2007. Fish behaviour from fishers' knowledge: the case study of tropical tuna around drifting fish aggregating devices (DFADs). *Can. J. Fish. Aquat. Sci.* 64 (11), 1517–1528. <https://doi.org/10.1139/f07-113>.
- Murua, H., Dagorn, L., Justel-Rubio, A., Moreno, G., Restrepo, V., 2021. Questions and Answers about FADs and Bycatch (Version 3). In: ISSF Technical Report 2021-11. Washington, D.C., USA. International Seafood Sustainability Foundation.
- O'Farrill, G., Schampaert, K.G., Rayfield, B., Bodin, Ö., Calmé, S., Sengupta, R., Gonzalez, A., 2014. The potential connectivity of waterhole networks and the effectiveness of a protected area under various drought scenarios. *PLoS One* 9 (5). <https://doi.org/10.1371/journal.pone.0095049>.
- Ohta, I., Kakuma, S., 2005. Periodic behavior and residence time of yellowfin and bigeye tuna associated with fish aggregating devices around Okinawa Islands, as identified with automated listening stations. *Mar. Biol.* 146 (3), 581–594. <https://doi.org/10.1007/s00227-004-1456-x>.
- Patterson, T.A., Basson, M., Bravington, M.V., Gunn, J.S., 2009. Classifying movement behaviour in relation to environmental conditions using hidden Markov models. *J. Anim. Ecol.* 78 (6), 1113–1123. <https://doi.org/10.1111/j.1365-2656.2009.01583.x>.
- Pérez, G., Dagorn, L., Deneubourg, J., Forget, F., Filmlalter, J.D., Holland, K., Capello, M., 2020. Effects of habitat modifications on the movement behavior of animals : the case study of Fish Aggregating Devices (FADs) and tropical tunas. *Mov. Ecol.* 8 (47), 1–10.
- Robert, M., Dagorn, L., Deneubourg, J.L., 2014. The aggregation of tuna around floating objects: what could be the underlying social mechanisms? *J. Theor. Biol.* 359 (October), 161–170. <https://doi.org/10.1016/j.jtbi.2014.06.010>.
- Robert, M., Dagorn, L., Filmlalter, J.D., Deneubourg, J.L., Itano, D., Holland, K., 2013. Intra-individual behavioral variability displayed by tuna at fish aggregating devices (FADs). *Mar. Ecol. Prog. Ser.* 484, 239–247. <https://doi.org/10.3354/meps10303>.
- Rodriguez-Tress, P., Capello, M., Forget, F., Soria, M., Beeharry, S.P., Dussooa, N., Dagorn, L., 2017. Associative behavior of yellowfin *Thunnus albacares*, skipjack *Katsuwonus pelamis*, and bigeye tuna *T. obesus* at anchored fish aggregating devices (FADs) off the coast of Mauritius. *Mar. Ecol. Prog. Ser.* 570, 213–222. <https://doi.org/10.3354/meps12101>.
- Scott, G.P., & Lopez, J. (2014). The use of FADs in tuna fisheries.
- Siddiqui, S.I., Dong, H., 2019. Effects of Water Column Variations on Sound Propagation and Underwater Acoustic Communications. *Sensors (Basel)* 19 (9). <https://doi.org/10.3390/s19092105>.
- South, A., 2011. rworldmap: A new R package for Mapping Global Data. *R J.* 3 (1), 35–43.
- Swann, D.E., Perkins, N., 2014. Camera trapping for animal monitoring and management: a review of applications. In: *Camera Trapping*, pp. 3–11.
- Therneau, T.M., Grambsch, P.M., 2000. *Modeling Survival Data: Extending the Cox Model*. Springer.
- Tolotti, M.T., Forget, F., Capello, M., Filmlalter, J.D., Hutchinson, M., Itano, D., Dagorn, L., 2020. Association dynamics of tuna and purse seine bycatch species with drifting fish aggregating devices (FADs) in the tropical eastern Atlantic Ocean. *Fish. Res.* 226, 105521. <https://doi.org/10.1016/j.fishres.2020.105521>. June 2019.
- Zvidzai, M., Murwira, A., Caron, A., de Garine-Wichatitsky, M., 2013. Waterhole use patterns at the wildlife/livestock interface in a semi-arid savanna of Southern Africa. *Int. J. Dev. Sustain.* 2 (2), 455–471.



Appendix B

Questioning the validity of the indicator-log hypothesis for tropical tuna in the Western Indian Ocean

Publication

Guibert, J., **Dupaix, A.**, Andrello, M., Lengaigne, M., & Capello, M. (In prep.). Questioning the validity of the indicator-log hypothesis for tropical tuna in the Western Indian Ocean.

B.1 Introduction

Tropical tunas, like many other pelagic species, are known to associate with floating objects (Fréon and Dagorn 2000; Castro et al. 2002, designated as FOBs;). According to Fréon and Dagorn 2000, an association is defined as “the spatial relationship between an animal (or group) of one species and an animal of another species or an object, based on the decision of at least one of the two individuals to maintain contact but not to feed on the other”. FOBs are of various kinds and can be of terrestrial or marine origin, plant or animal, natural or anthropogenic. The most common natural FOB comes from trees (logs and branches), macroalgae and other terrestrial or marine plants (Solana-Soares 2001; Castro et al. 2002; Williams et al. 2005; Hinojosa et al. 2011). Tunas may also associate with slow-swimming organisms, like whale sharks (*Rhincodon typus*, Smith 1828) as well as with the corpses of marine mammals such as whales (Gaertner et al. 1996; Solana-Soares 2001; Castro et al. 2002). In addition, marine debris originating from human pollution and fisheries that are considered artificial logs (such as buoys, nets and other fishing equipment) are also commonly found drifting in the open ocean (Solana-Soares 2001). All these objects, whether natural or artificial, drift on the ocean surface under the influence of wind, tides, waves, and ocean currents (Solana-Soares 2001; Hinojosa et al. 2011).

The associative behavior of pelagic fish species with floating objects has been used by fishers to facilitate their catches for thousands of years. The Roman author Oppian (cited by Dempster and Taquet 2004) first described the use of floating objects to catch dolphinfish (*Coryphaena hippurus*, Linnaeus 1758) in the Mediterranean Sea more than 1800 years ago. As FOBs increase the catchability of fish by gathering large quantities of fishes in a single place, fishers have constructed their own FOBs, known as Fish Aggregating Devices (designated as FADs; Marsac et al. 2000). FADs are man-made floating objects that can be anchored in coastal areas or left drifting in the open ocean. Anchored FADs are generally exploited by artisanal or semi-industrial fisheries in coastal countries (Dagorn et al. 2013b), while drifting FADs are used by industrial tropical tuna purse-seine fisheries (IOTC 2022e). Despite recent studies characterising the associative behavior of tuna with FOBs (Forget et al. 2015; Pérez et al. 2020; Tolotti et al. 2020), the hypotheses on why tuna associate with FOBs have not changed since they were formulated and are still poorly understood (Fréon and Dagorn 2000; Castro et al. 2002; Dempster 2004). The two main hypotheses put forward, which are not necessarily mutually exclusive, are the "meeting point" hypothesis and the "indicator-log" hypothesis (Fréon and Dagorn 2000; Castro et al. 2002). The “meeting-point” hypothesis considers that tunas use FOBs to form larger schools. It relies on the assumption that tunas can detect FOBs from further away than they can detect other schools, thus facilitating their encounter rate (Fréon and Dagorn 2000). However, to date, this hypothesis has only been validated for one small pelagic fish species (bigeye scad, *Selar crumenophthalmus*, Bloch 1793; Soria et al. 2009). The “indicator-log” hypothesis postulates that floating objects of natural origin (designated as NLOGs) are located in productive areas and that tunas associate with them in order to reach and remain in these rich areas (Hall 1992; Castro et al. 2002). NLOGs would indicate productive areas because they mainly originate from river mouths or mangroves (Hall 1992) but also because they accumulate in rich frontal areas (Hallier and Gaertner 2008). The indicator-log hypothesis suggests that tunas would better locate NLOGs than preys, which has not yet been demonstrated (Fréon and Dagorn 2000).

Between 2016 and 2020, drifting FADs (DFADs) accounted for 55 % of the tropical tuna catches conducted by purse seine vessels, representing about 36 % of the total 5.1 million tons caught annually by all gears combined (ISSF 2022). This massive exploitation of DFADs in recent years has led to an increase in the number of their deployments in all tropical oceans. In the Indian Ocean, the number of DFADs increased fourfold between 2007 and 2013 (Maufroy

et al. 2017). As a result, FADs accounted for over 85 % of the overall FOBs between 2012 and 2018 while NLOGs accounted for less than 10 % (Dupaix et al. 2021a). The spatial distribution of floating objects was then modified by this massive introduction of FADs (Dagorn et al. 2013a; Dupaix et al. 2021a). Such a change in surface pelagic habitat could alter the behavior and biology of tunas and thus constitute ecological traps for tropical tunas (Marsac et al. 2000). Drifting FADs deployed would trap tunas by altering their natural movements and bringing them to or holding them in areas they would usually avoid or leave, thus affecting their fitness, growth and survival (Marsac et al. 2000; Hallier and Gaertner 2008).

The ecological trap is an evolutionary concept developed 50 years ago by Dwernychuk and Boag 1972 that hypothesises the possible consequences of an environmental change on the behavior of animals and subsequently on other aspects of their biology and ecology, which may result in a reduction in their fitness. In this context, animals would make errors in habitat assessment because of the mismatch between the environmental cues they used to select habitats and the actual quality of the habitat. This failure in habitat selection is often the result of a recent anthropogenic modification of the environment (Schlaepfer et al. 2002; Battin 2004). Individuals then settle in poor habitats that appear to be the same or preferable to more favourable ones instead of settling in other available and normally favoured habitats (Battin 2004; Robertson and Hutto 2006; Gilroy and Sutherland 2007).

For tropical tuna, the ecological trap hypothesis is directly related to the indicator-log hypothesis described above. Indeed, if NLOGs are used by tuna to identify rich areas, the introduction of FADs could mislead them if they are deployed or drift into biologically poor areas and if tunas do not differentiate between natural and man-made objects (Hallier and Gaertner 2008). Therefore, assessing the validity of the indicator-log hypothesis would be a first step in determining whether FADs can constitute an ecological trap for tunas. The validity of this hypothesis, formulated more than thirty years ago, has never been tested. Taking advantage of a large database of observations of NLOGs recorded by observers on-board purse-seine vessels, this study tests the validity of the indicator-log hypothesis in the Western Indian Ocean. To this purpose, it examines the possible link between the presence and abundance of NLOGs and environmental characteristics of oceanic zones that are relevant for tropical tunas.

B.2 Material and Methods

B.2.1 Study area and period

The study was conducted in the Western Indian Ocean (35°E to 85°W, 25°N to 25°S) over a 6-year period (2014-2019). The study region was divided into two sub-regions: north of 10°S (designated as $\geq 10^\circ\text{S}$) and south of 10°S (designated as $< 10^\circ\text{S}$) (Fig. B.1). These two regions indeed display very different oceanographic characteristics. The Somali region ($\geq 10^\circ\text{S}$) is known to be the fifth largest upwelling region in the global ocean and one of the most productive regions in the world (Lakshmi et al. 2020) while the northern Mozambique Channel ($< 10^\circ\text{S}$) is known to have high mesoscale activity leading to surface water enrichment (Chassot et al. 2019). The Sea Surface Currents Intensity (SSCI) and the epipelagic MicroNekton weight (MN_Epi) values were on average significantly lower in the $\geq 10^\circ\text{S}$ zone than in the $< 10^\circ\text{S}$ zone (Wilcoxon test, $n_{\geq 10^\circ\text{S}} = 270$, $n_{< 10^\circ\text{S}} = 31$, $P_{SSCI} = 7.358\text{e-}05$, $P_{MN_Epi} = 3.331\text{e-}04$) and conversely for the Finite Size Lyapunov Exponent (FSLE) (Wilcoxon test, $n_{\geq 10^\circ\text{S}} = 270$, $n_{< 10^\circ\text{S}} = 31$, $P < 2.2\text{e-}16$), justifying treating these two regions separately.

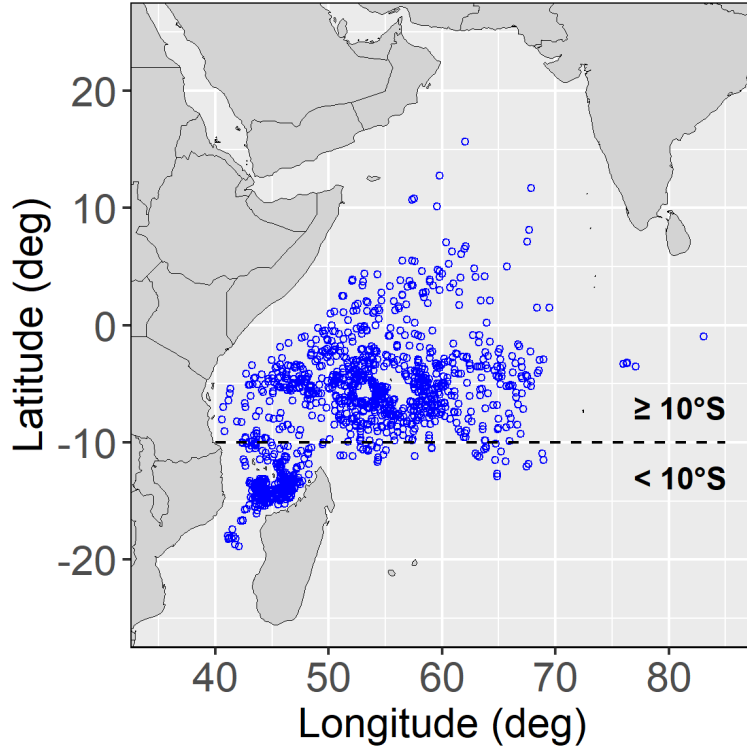

Figure B.1: Study area. Blue circles represent NLOG observations ($n = 1,278$). The dotted line represents the separation between the area north of 10°S ($\geq 10^\circ\text{S}$) and south of 10°S ($< 10^\circ\text{S}$).

B.2.2 Observers' Data

Data were collected by scientific observers on-board French purse seine vessels operating in the Western Indian Ocean. Observers collect the date, time and location of the main activities carried out on the fishing vessels (*i.e.* fishing sets, visiting, deploying, modifying and searching for FOBs). Whenever a FOB is observed, its constitutive elements, allowing to deduce its type (*e.g.*, man-made, natural origin, debris), and geographical coordinates are recorded by the observers. In the following analysis, only FOBs of natural origin (NLOGs) are considered, which excludes Fish Aggregating Devices (FADs) and other artificial floating objects. Over the period 2014-2019, the observer coverage varied between 32 % and 49 % of the total fishing effort (Lebranchu et al. 2022). A total of 1,278 observations of NLOGs are available for the study period (Fig. B.1-B.2), including 911 observations located in the area north of 10°S ($\geq 10^\circ\text{S}$) and 367 observations located south of 10°S ($< 10^\circ\text{S}$) (Fig. B.1).

B.2.3 NLOG abundance index

A monthly NLOG abundance index ($A_{i,m}$) was calculated considering a spatio-temporal resolution of $2^\circ/\text{month}$, by dividing the monthly number of observed NLOGs by the observation effort recorded in each 2° cell, following:

$$A_{i,m} = \frac{\sum_{d=1}^{D_m} N_{i,d}}{\sum_{d=1}^{D_m} O_{i,d}} \quad (\text{B.1})$$

where $A_{i,m}$ represents the NLOG abundance index for cell i and month m , $N_{i,d}$ indicates the number of NLOGs observed in cell i on day d , $O_{i,d}$ represents the number of vessels present in cell i on day d and D_m indicates the total number of days for month m . A vessel was considered present in cell i on day d if it has performed at least one activity in the cell on that day. The denominator of Eq.B.1 represents the “observation effort”. Cells with a low observation effort

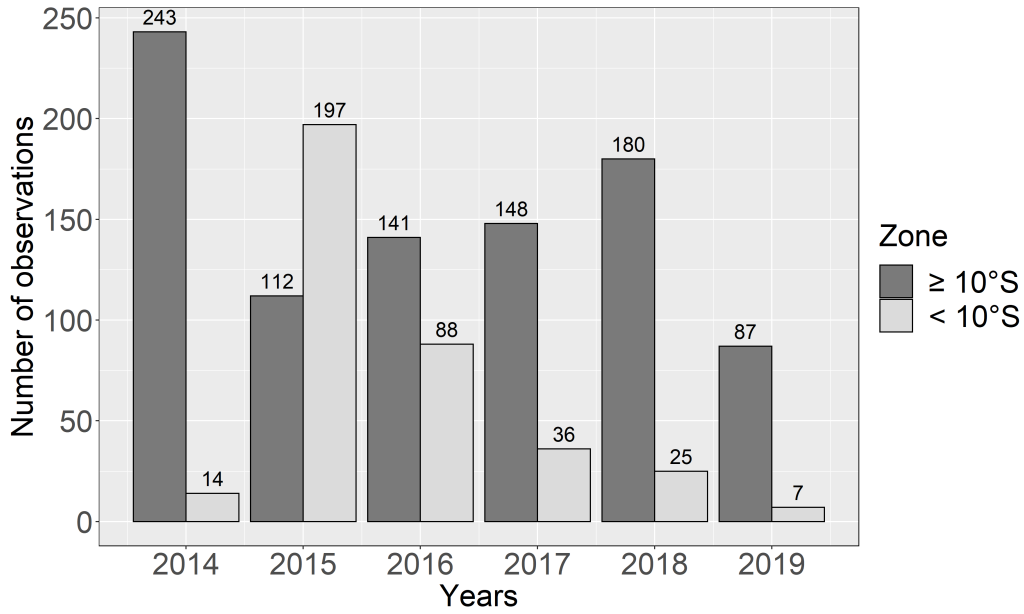

Figure B.2: Yearly number of NLOG observations recorded by scientific observers on-board French purse seine vessels over the study period, for the $\geq 10^\circ\text{S}$ zone (dark grey) and the $< 10^\circ\text{S}$ zone (light grey) ($n = 1,278$). Note that as observers' coverage vary between 32 % and 49 % during the study period (Lebranchu et al. 2022), these numbers are not representative of NLOG abundance.

(*i.e.* $\sum_{d=1}^{D_m} O_{i,d} \leq T$) were excluded. In the following, an observation effort threshold $T = 6$ was considered. A sensitivity analysis was conducted to test the impact of the observation effort threshold by comparing results with those obtained for a larger threshold ($T = 10$).

B.2.4 Environmental variables

Table B.1: Characteristics of the environmental variables used in the study.

Acronym	Environmental variable	Type	Processing Level	Spatial resolution	Temporal resolution	Source
SST	Sea Surface Temperature in $^\circ\text{C}$ (Abiotic)	Observation (satellite + in situ)	L4	$0.25 \times 0.25^\circ$	Monthly mean	Copernicus
SSCI	Sea Surface Current Intensity in m.s^{-1} (Abiotic)	Observation (satellite)	L4	$0.25 \times 0.25^\circ$	Monthly mean	Copernicus
SLA	Sea Level Anomaly in m (Abiotic)	Observation (satellite)	L4	$0.25 \times 0.25^\circ$	Monthly mean	Copernicus
FSLE	Finite Size Lyapunov Exponent in days^{-1} (Abiotic)	Observation (satellite)	L4	$0.04 \times 0.04^\circ$	Daily mean	Aviso
MN_Epi	Mass content of Microplankton in g.m^{-2} (Biotic)	Numerical model	L4	$0.083 \times 0.083^\circ$	Daily	Copernicus
Chl-a	Chlorophyll a concentration in mg.m^{-3} (Biotic)	Observation (satellite)	L4	$4 \times 4 \text{ km}$	Monthly mean	Copernicus

The environmental variables considered to characterise the environmental properties in the presence or absence of NLOGs are Sea Surface Temperature (SST, in $^\circ\text{C}$), Sea Surface Currents

Intensity (SSCI, in $\text{m}\cdot\text{s}^{-1}$; calculated as $\sqrt{u^2 + v^2}$ where u and v respectively represents the geostrophic eastward and northward sea surface velocity), Sea Level Anomalies (SLA, in m), Finite Size Lyapunov Exponent (FSLE, in days^{-1}), epipelagic MicroNekton weight (MN_Epi, in $\text{g}\cdot\text{m}^{-2}$) and Chlorophyll-a concentration (Chl-a, in $\text{mg}\cdot\text{m}^{-3}$). These variables, whether abiotic or biotic, were selected because they are known to be relevant to the characterisation of favourable habitats for tropical tunas. Indeed, SST has been shown to affect the spatial distribution of tunas by modifying their movements (Brill 1994). SSCI is considered a key variable as it influences tuna habitat preferences (Druon et al. 2017) and primary productivity of rich areas in upwelling regions (Vinayachandran et al. 2021). SLA allows identifying gyres and eddies, as well as frontal systems around these gyres, which are also thought to have the capacity to accumulate plankton and tuna preys (Arrizabalaga et al. 2015; Zainuddin et al. 2017). FSLE is a measurement of near-track divergence rate, an indicator for oceanic convergence and divergence zones (Hariri 2022). Top marine predators can follow FSLE ridges to locate food patches (Tew Kai et al. 2009). In terms of biotic variables, micronekton (including gelatinous taxa, crustaceans, small fish, and cephalopods; Kloser et al. 2009) are the primary prey of most pelagic predators, such as tunas (Roger 1994; Young et al. 2010) and constitute therefore a key variable. Pelagic predators are directly influenced by micronekton abundance, which in turn depend on lower trophic levels (phytoplankton and zooplankton; Young et al. 2015). As major component of primary production that supports zooplankton production and higher trophic levels (Druon et al. 2017), Chl-a concentration is also a key variable for identifying productive areas for tunas. Chlorophyll-rich areas are related to areas of high productivity and relatively high prey abundance for tunas and can be used as an indicator of their presence (Druon et al. 2017; Zainuddin et al. 2017). All these environmental data were retrieved from the EU’s Copernicus maritime service (<https://resources.marine.copernicus.eu/products>) with the exception of the FSLE that was processed by SSALTO/DUACS and distributed by AVISO+ (<https://www.aviso.altimetry.fr>) (Table B.1).

Each environmental variable was averaged by month and by 2° cell to match the spatio-temporal resolution of the NLOG abundance index. For all analyses (correlation tests and comparison of medians tests), non-parametric tests were chosen because of the non-normal distribution of the variables (Shapiro tests, $p.\text{value} < 0.05$, with the R function *shapiro.test*).

With respect to micronekton, we hypothesised that areas could be considered rich in the presence of micronekton, even if they were not of the same type. Five types of micronekton were selected. The epipelagic micronekton (MN_Epi), the upper mesopelagic micronekton (MN_Um), the migrant upper mesopelagic micronekton (MN_Mum), the migrant lower mesopelagic micronekton (MN_Mlm) and the highly migrant lower mesopelagic micronekton (MN_Hmlm). Correlations between these different types of micronekton and those between the averaged environmental variables were investigated with correlation matrices using the R function *chart.Correlation* issued from the package *PerformanceAnalytics*. The correlation matrices were complemented by Kendall correlation tests using the R function *cor.test*. To account for the number of tests performed, a Bonferroni correction was applied. For the micronekton’s tests, a test was considered significant when $p.\text{value} < 0.05/n = 0.005$, where n is the number of tests performed (*i.e.* one between each of the variables, $n = 10$) whereas regarding the environmental variables’ tests, it was considered significant when $p.\text{value} < 0.05/n = 3.33\text{e-}03$ ($n = 15$).

B.2.5 Comparison of environmental variables in the presence/absence of NLOGs

According to the indicator-log hypothesis, the presence of NLOGs indicates rich areas. However, the opposite is not necessarily true: the absence of NLOGs can occur both in rich and poor

areas. Therefore, different distributions of environmental variables are expected between areas with and areas without NLOGs. In order to verify this assertion, the distributions of each environmental variable corresponding to the presence of NLOGs (*i.e.* for monthly/2° cells with a NLOG abundance index $A_{i,m} > 0$, see Eq.B.1) were compared to those found in the absence of NLOG ($A_{i,m} = 0$) using non-parametric tests (Wilcoxon tests, with the R function *wilcox.test*). Again, to account for the number of tests performed, a Bonferroni correction was applied and a test was considered significant when $p.value < 0.05/n = 0.005$, (*i.e.* one test for each of the two zones and the five environmental variables, $n = 10$).

B.2.6 Relationship between NLOG abundance index and environmental variables

The indicator-log hypothesis implies that NLOGs should be concentrated in rich areas. In other words, the abundance of NLOGs should be correlated with environmental characteristics of oceanic areas. To test this hypothesis, correlations between NLOG abundance and environmental characteristics were performed by considering monthly/2° cells with at least one NLOG observation ($A_{i,m} > 0$), using non-parametric tests (Kendall tests, with the R function *cor.test*). Again, to account for the number of tests performed, a Bonferroni correction was applied and a test was considered significant when $p < 0.005$ ($n = 10$).

Finally, to account for potential non-linear relationships between NLOG abundance and environmental variables, a generalized additive model (Gam) was run for the area north of 10°S (designated as $\text{Gam}_{\geq 10^\circ S}$), see Eq.B.2. Too few observations were available in the area south of 10°S to perform a Gam but preliminary results (not shown) suggested linear relationships. Therefore, a linear model was run for this area (designated as $\text{Lm}_{< 10^\circ S}$), see Eq.B.3. NLOG abundance index ($A_{i,m}$) was considered as the dependent variable and environmental variables recorded in each monthly/2° cell ($\text{Chl-}a_{i,m}$, $\text{SLA}_{i,m}$, $\text{SSCI}_{i,m}$, $\text{FSLE}_{i,m}$, and $\text{MN_Epi}_{i,m}$) as explanatory variables. For both models, the dependent variable was log-transformed to approximate normality (Figure B.6). Explanatory variables were scaled to enable the comparison of their marginal effect on the NLOG abundance index and extreme values of Chl-a were excluded because of their potential influence.

$$\text{gam}(\log(A_{i,m}) \sim \text{Chla}_{i,m} + \text{SLA}_{i,m} + \text{SSCI}_{i,m} + \text{FSLE}_{i,m} + \text{MN_Epi}_{i,m}) \quad (\text{B.2})$$

$$\text{lm}(\log(A_{i,m}) \sim \text{Chla}_{i,m} + \text{SLA}_{i,m} + \text{SSCI}_{i,m} + \text{FSLE}_{i,m} + \text{MN_Epi}_{i,m}) \quad (\text{B.3})$$

The $\text{Gam}_{\geq 10^\circ S}$ was performed using the R function *gam* from the package *mgcv*. Best models were selected based on explanatory variables' significance (variables with $p.value > 0.05$ were excluded) and lowest Akaike Information Criterion (AIC) (using the R function *stepAIC* from the package *MASS* for the $\text{Lm}_{< 10^\circ S}$). Diagnostic plots were performed to check the homogeneity of the variance of the residuals and their normality, allowing to validate these models (using the R function *gam.check* from the package *mgcv* for the $\text{Gam}_{\geq 10^\circ S}$, and the function *plot* for the $\text{Lm}_{< 10^\circ S}$). Adjusted R-squared (R^2) were used to further examine the robustness of the models. All statistical analyses were performed using R v3.6.2 (R Core Team 2020).

B.3 Results

A total of 874 monthly/2° cells had an observation effort above the threshold (*i.e.*, $\sum_{d=1}^{D_m} O_{i,d} > T$ in the denominator of Eq.B.1, with $T = 6$), of which 301 cells contained at least one NLOG observation (total number of NLOG observations = 852). Of these, 270 cells were located in

Table B.2: Number of monthly/ 2° cells (N cell) considered in the study. Only cells with an observation effort larger than the threshold were considered (*i.e.* $\sum_{d=1}^{D_m} O_{i,d} \geq T$, with $T = 6$). The first column ($A_{i,m} = 0$) denotes cells without NLOG observation. The second column indicates cells with at least one NLOG observation ($A_{i,m} > 0$). Rows denote the zones ($\geq 10^\circ\text{S}$ and $< 10^\circ\text{S}$).

	N cell		Total
	$A_{i,m} = 0$	$A_{i,m} > 0$	
$\geq 10^\circ\text{S}$	565	270	835
$< 10^\circ\text{S}$	8	31	39
Total	573	301	874

the $\geq 10^\circ\text{S}$ zone (with 558 NLOG observations) and 31 cells were located in the $< 10^\circ\text{S}$ zone (with 294 NLOG observations) (Table B.2).

We first investigate in Tables B.4 and B.5 and Figures B.7 and B.8 the existing relationships between the different explanatory variables. For micronekton, the correlation matrix (Figure B.7) between the different types and associated correlation tests (Table B.4) indicate that all micronekton types were correlated with each other. For the sake of simplicity, it was therefore decided to keep only the epipelagic micronekton (MN_Epi). For environmental variables (Chl-a, SST, SLA, SSCI, FSLE and MN_Epi) recorded over the 874 cells considered, nine significant correlations were found (Figure B.8 - Table B.5). The highest correlations were found between Chl-a and SST (Kendall test, $\tau = -0.628$, $P < 2.2 \times 10^{-16}$), FSLE and MN_Epi (Kendall test, $\tau = -0.276$, $P < 2.2 \times 10^{-16}$), SST and SLA (Kendall test, $\tau = 0.212$, $P < 2.2 \times 10^{-16}$) and Chl-a and SLA (Kendall test, $\tau = -0.198$, $P < 2.2 \times 10^{-16}$) (Figure B.8 - Table B.5). To avoid redundancy of information, to improve the quality of models and because Chl-a is considered a more major variable than SST in the identification of productive areas for tunas, the SST was removed from the statistical analyses.

The distribution of environmental variables in both areas showed no significant differences in the presence and the absence of NLOGs (Wilcoxon test, $P < 0.005$) (Fig. B.3). The sensitivity analysis conducted considering a higher observation effort threshold ($T = 10$) showed consistent results (Table B.6).

The NLOG abundance index ($A_{i,m}$) was higher in the $< 10^\circ\text{S}$ zone (mean = 0.66, SD = 0.52) than in the $\geq 10^\circ\text{S}$ zone (mean = 0.17, SD = 0.66) when considering only $A_{i,m} > 0$ (Fig. B.4, Table B.2). However, $A_{i,m}$ was not significantly correlated with any of the environmental variables in either zones (Fig. B.4, Table B.7). The same results were obtained for a higher observation effort threshold $T = 10$ (Table B.8).

The explanatory variables retained in models on the basis of explanatory variables significance and AIC model selection are Chl-a and SLA for the $\geq 10^\circ\text{S}$ zone and only SLA for the $< 10^\circ\text{S}$ zone (Table B.3). For both models, the residuals were homogeneously distributed around 0 (between -1.5 and 1.5 for the $\geq 10^\circ\text{S}$ zone and between -1 and 1 for the $< 10^\circ\text{S}$ zone) (Fig. B.5a-c) and follow a normal distribution (Fig. B.5b-d). However, the adjusted R^2 values were very low (0.055 for the $\geq 10^\circ\text{S}$ zone and 0.114 for the $< 10^\circ\text{S}$ zone, Table B.3), indicating that they poorly predict NLOG abundance values (Figure B.9). Models fitted on data considering a higher observation effort threshold ($T = 10$) also poorly predict NLOG abundance values (Table B.9).

B.4 Discussion

Although formulated more than 30 years ago (Hall 1992), the indicator-log hypothesis has not yet been tested for tropical tunas, due to the difficulty of assessing the presence and abundance of NLOGs in the open ocean. Taking advantage of a large dataset of NLOGs observations

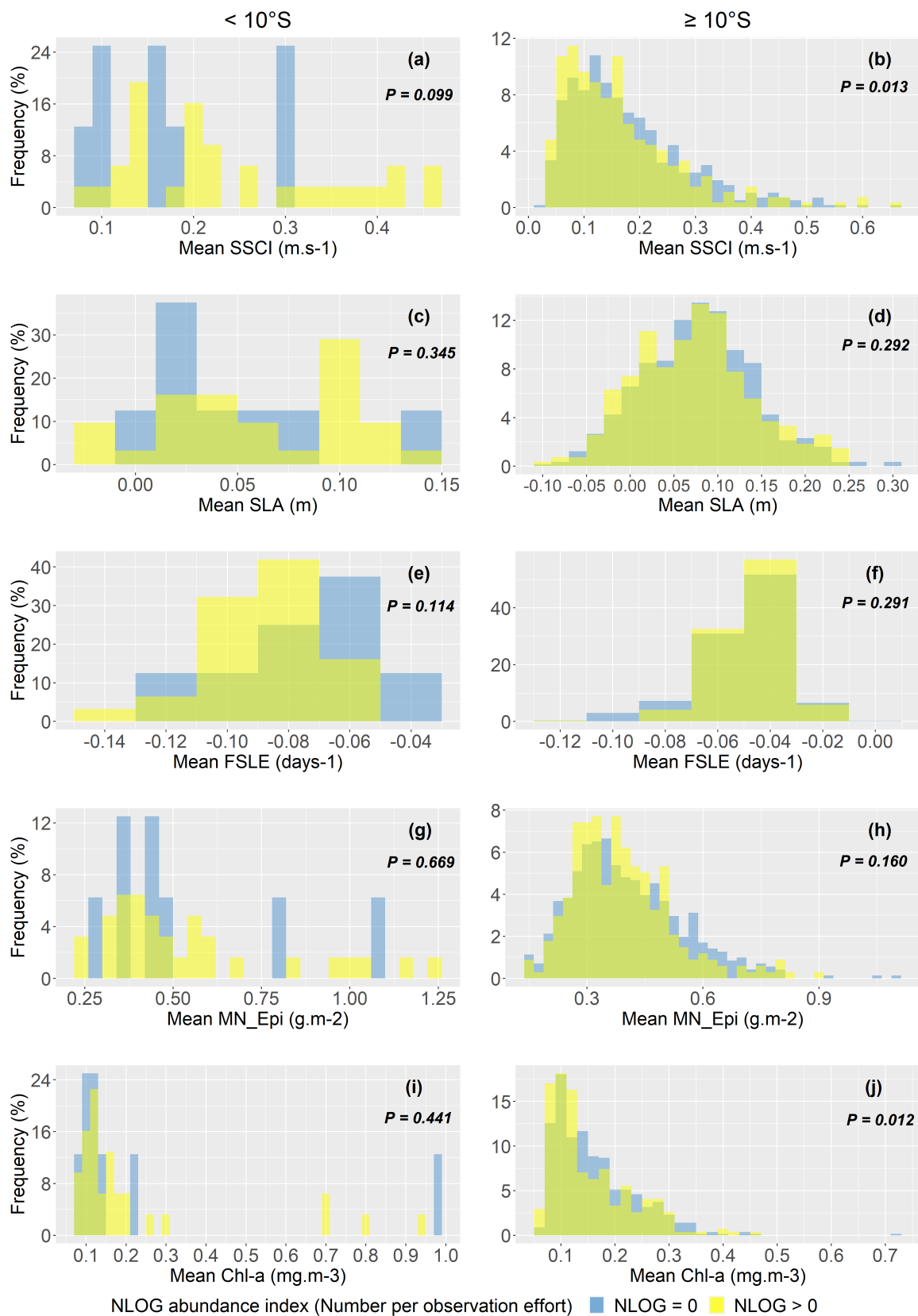

Figure B.3: Distribution of the environmental variables. SSCI (a & b), SLA (c & d), FSLE (e & f), MN_Epi (g & h) and Chl-a (i & j) in the absence (blue) and the presence (yellow) of NLOGs. The histograms in the left column represent the $<10^{\circ}\text{S}$ zone whereas histograms in the right column represent the $\geq 10^{\circ}\text{S}$ zone.

recorded by observers on-board purse seine vessels, this study demonstrates that the presence and abundance of natural floating objects found in the Western Indian Ocean are not

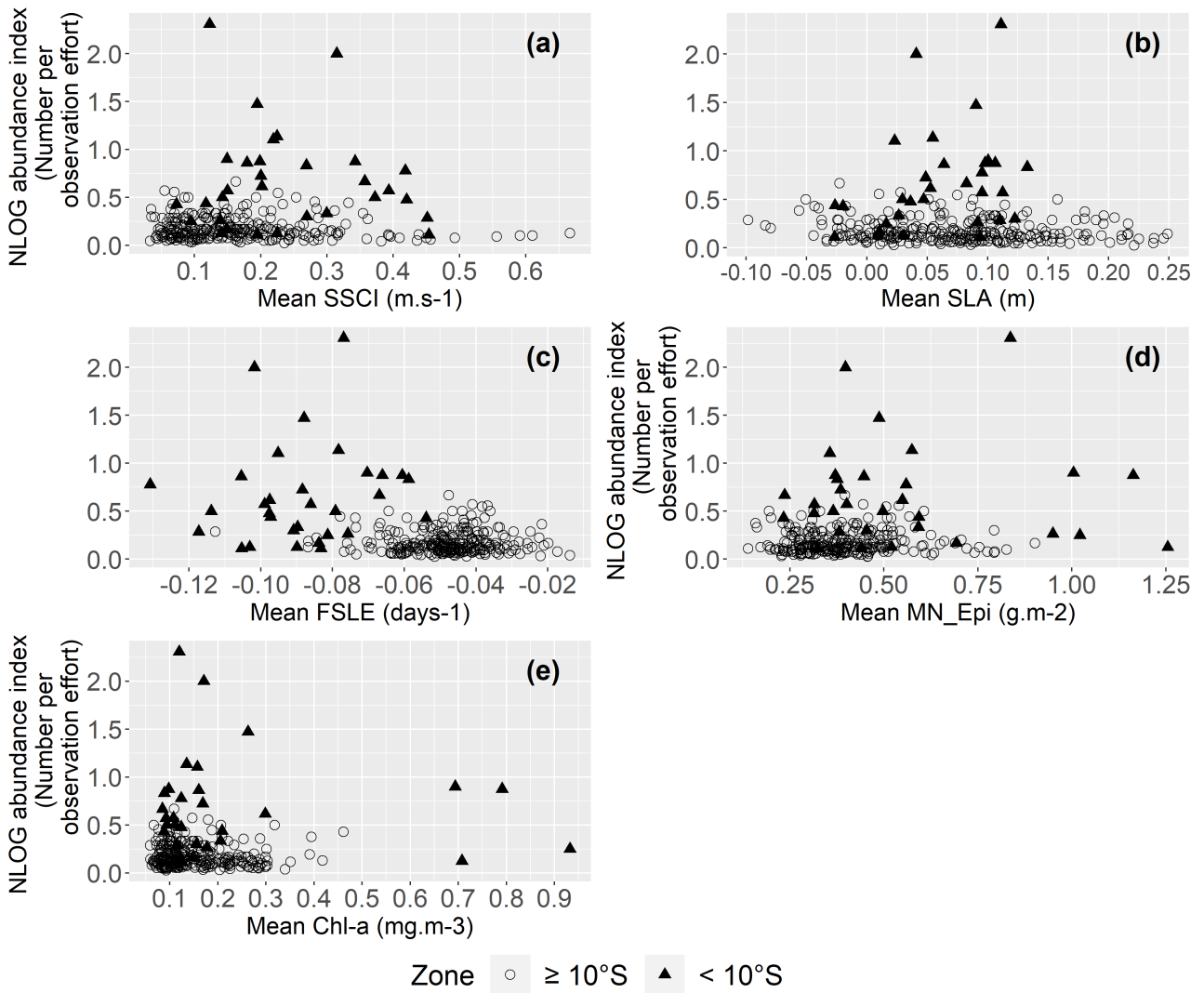

Figure B.4: Scatterplots of NLOG abundance index ($A_{i,m} > 0$) versus environmental variables recorded over each monthly/ 2° cell for the $\geq 10^{\circ}\text{S}$ zone (circles) and the $< 10^{\circ}\text{S}$ zone (triangles) for a) SSCI, b) SLA, c) FSLE, d) MN_Epi and e) Chl-a.

Table B.3: Summary table of models ($\text{Gam}_{\geq 10^{\circ}\text{S}}$ and $\text{Lm}_{> 10^{\circ}\text{S}}$): Selected explanatory variables, type of relationship, associated p-values and the adjusted R-squared (R^2) for the $\geq 10^{\circ}\text{S}$ zone and the $< 10^{\circ}\text{S}$ zone.

Zones	$\geq 10^{\circ}\text{S}$ ($\text{Gam}_{\geq 10^{\circ}\text{S}}$)	$< 10^{\circ}\text{S}$ ($\text{Lm}_{> 10^{\circ}\text{S}}$)
Explanatory variables	Chl-a	SLA
Type of relationship	Negative relation	Positive relation (Estimate = 0.309)
Significance	9.52e-04	3.54e-04
R^2	0.055	0.114

related with relevant environmental variables for tropical tunas and their preys, challenging the indicator-log hypothesis.

According to the indicator-log hypothesis, the presence of NLOGs would indicate a rich area but their absence does not give information on the richness of the area which may be either rich or poor. This means that differences should be apparent in the values of environmental variables recorded between areas where NLOGs are present and those where they are absent. Also, although defining an area's richness for tropical tuna is difficult, under the indicator-log hypothesis we would expect significant relationships between NLOG abundance and biophysical

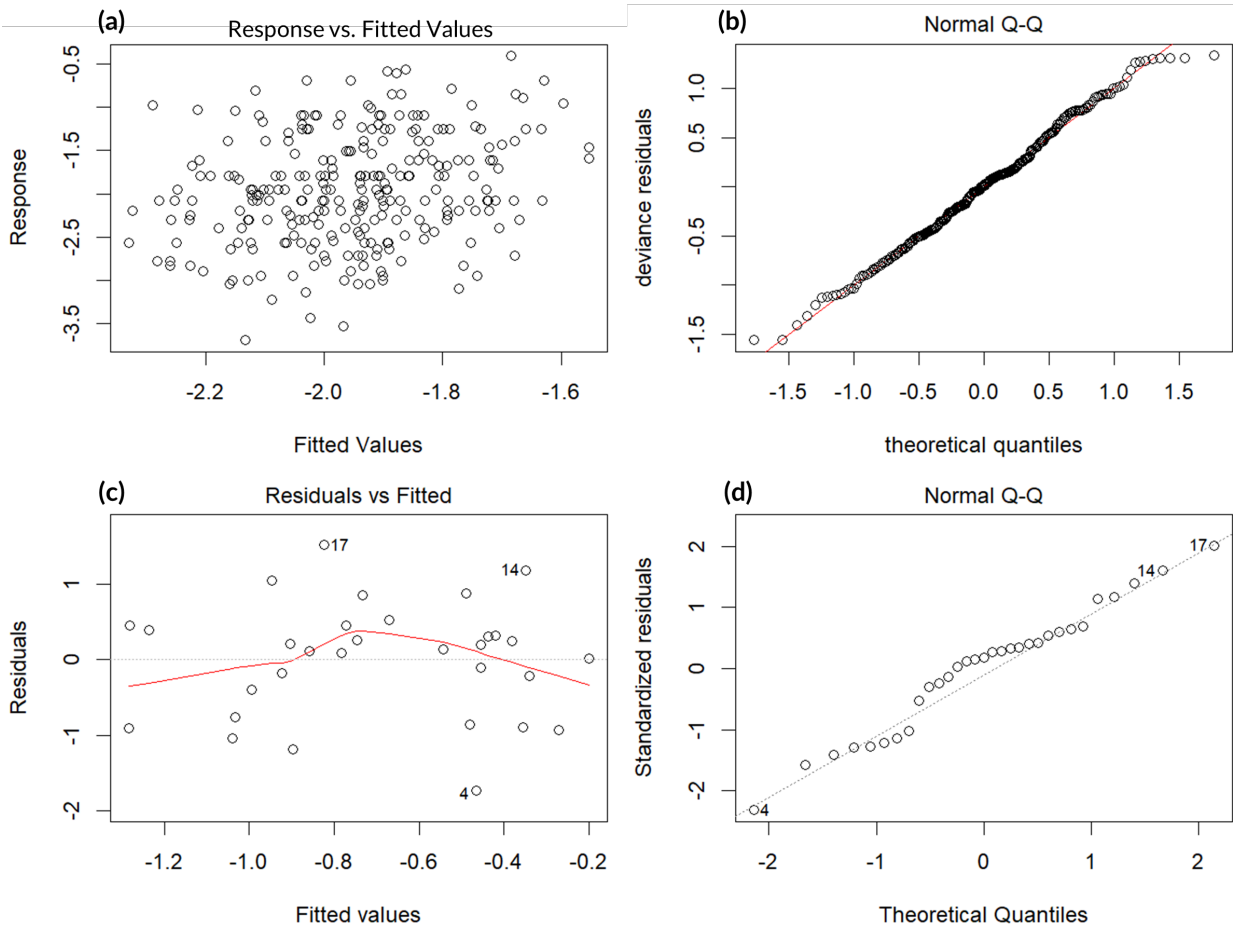

Figure B.5: Diagnostic plots for the two models. Response versus fitted values (a), residuals vs fitted values (c) and Normal quantile-quantile plots (b & d). The first row refers to the $\text{GAM}_{\geq 10^{\circ}S}$ (a & b) while the second row refers to the $\text{Lm}_{< 10^{\circ}S}$ (c & d).

variables of tuna's environment. However, the distribution of monthly means of the environmental variables recorded over 2° cells was not significantly different whether measured in the presence or absence of NLOGs, which is inconsistent with the indicator-log hypothesis. Furthermore, NLOG abundance was not significantly correlated with any environmental variable and models did not identify any strong relationship between the two. These results hold for both sub-regions considered ($\geq 10^{\circ}S$ and $< 10^{\circ}S$), and sensitivity analyses performed with a larger threshold of observation effort confirmed them all (see Tables B.6-B.8-B.9). The weakness of the model's predictions (Table B.3, Figure B.9) and the contrasting results obtained for the two zones highlight that no clear evidence of a strong relationship between NLOG abundance and other environmental variables could be demonstrated.

For cells where at least one NLOG was recorded, the lack of positive correlation between NLOG abundance and environmental variables was unexpected, especially for Chl-a, FSLE and MN_Epi. Indeed, Chl-a is considered a good proxy for the presence of preys (Druon et al. 2017; Zainuddin et al. 2017) and the possible time lag between chlorophyll blooms and prey arrivals was implicitly accounted for by the monthly scale used (Mondal et al. 2021). In addition, eddies, here estimated using FSLE, are rich areas in forage species and associated top predators searching for food, such as tunas (Tew Kai et al. 2009) but no correlation was found with NLOG abundance. It is likewise for micronekton, a very important variable in indicating the richness of an area since they are the prey of these top predators (Young et al. 2010). Nevertheless, these results may be dependent on the spatio-temporal scale considered. Future work could be carried out at the mesoscale, focusing for example directly on environmental

variables found along the vessels' trajectories or along NLOGs' trajectories tracked through echosounder buoys (Dupaix et al. 2021a). This mesoscale could be particularly important for assessing the correlation between NLOGs and FSLE, which reflects fine-scale eddy structures.

In addition, sampling heterogeneity could have biased our results. Indeed, observers' records are highly dependent on the fishing grounds chosen by captains. Purse-seine vessels activities in the Indian Ocean exhibit seasonal patterns since they visit different areas at different seasons (Maufroy et al. 2017). Furthermore, skippers are constantly searching for "good locations" that are favourable for tunas. All sampled locations could then be considered to correspond to favourable environmental conditions. To test this possible source of bias, for each area, a set of environmental variables was randomly sampled from 2° /monthly cells showing an observation effort below the threshold ($T < 6$) (Appendices B). In the $\geq 10^\circ\text{S}$ zone, few differences were observed between the environmental variables from the cells used in the study and those from the random cells, but a more notable difference was found in the $< 10^\circ\text{S}$ zone. In general, fishing activities conducted by the purse seiners in the Mozambique Channel ($< 10^\circ\text{S}$ zone) are more seasonal and mainly occur during March, April and May (Nataniel et al. 2022). This short temporal coverage could explain the observed differences between the environmental variables used in the study and those recorded on random cells for this specific area. While these results suggest that analysis are robust for the $\geq 10^\circ\text{S}$ region without sampling bias, they highlight potential limitations of the seasonal coverage for the $< 10^\circ\text{S}$ region. However, because the range of environmental values observed in the sampled cells is similar to that observed in the random cells (Figure B.10), it implies that the observers did not sample only rich areas and that these sampling biases should have only a modest impact on our results. To complement this fisheries-dependent approach, further studies based on Lagrangian simulations of the distribution of NLOGs (Phillips et al. 2019a; Dupaix et al. 2021a) should be performed. These would allow coverage of seasons and regions of the Indian Ocean, beyond the fishing areas, providing a more homogeneous representation of their distribution in space and time.

This study reveals that in the Western Indian Ocean, NLOGs do not concentrate in rich areas and consequently that tunas do not associate with them to reach and remain in these rich areas. Our results strongly suggest that the indicator-log hypothesis is therefore not valid at the monthly/ 2° scale. Since NLOGs are not predominantly found in rich areas, this implies that FADs do not particularly attract tunas to poor areas, which are unfavourable to them. Under the indicator-log hypothesis, FADs cannot be considered as an ecological trap for tuna in the Western Indian Ocean. However, FADs could still impact the ecology of tunas in a variety of ways. On average, 1.8 million tons of tuna were caught annually by purse-seine vessels on floating objects from 2016 to 2020 (ISSF 2022), indicating that tuna associative behavior impact their fitness through fishing mortality. Other hypotheses seek to explain the associative behavior of tunas with floating objects and further lead to indirect ecological impacts of FAD. The meeting-point hypothesis, for example, considers that tunas associate with floating objects to form larger schools (Fréon and Dagorn 2000). Schooling behavior is considered to facilitate reproduction, protection against predators and foraging (Maury 2017). Under the meeting-point hypothesis, an increase in FAD density could impact schooling behavior by potentially fragmenting schools and ultimately impacting their fitness. Furthermore, if tunas are found in a dense FAD network, the time spent in association with them could increase, which could both increase their catchability and fishing mortality and decrease the time spent foraging. Indeed, tunas associated with FADs show a higher percentage of empty stomachs, a reduced growth rate and a smaller size than tunas in free schools (Hallier and Gaertner 2008). Hence, even if this study discards the ecological trap of FADs according to the indicator-log hypothesis, in the area and on the spatio-temporal scale considered, other potential impacts remain to be assessed. It therefore calls for the development of long-term monitoring of the behavior, habitat, and biology of tuna.

B.5 Conclusion

In conclusion, this study indicates that, in the Western Indian Ocean, the indicator-log hypothesis cannot be validated at the monthly/2° scale. Consequently, and in the context of this hypothesis, FADs would not result in an ecological trap for tunas. In other words, if NLOGs are not found in areas characterised by environmental zones that are favourable for tunas, this means that tunas do not use them as a proxy of a prey-rich zone. Consequently, the introduction of FADs does not attract or retain tunas into regions where they would not have been driven otherwise. However, other hypotheses could explain the association of tuna with floating objects. Therefore, the possibility that FADs indirectly impact tuna ecology should not be excluded. Hence, it is important to continue efforts aiming at better observing and understanding tuna associative behavior to characterise the effects of FADs on the ecology of tropical tunas.

B.6 Supplementary Materials 1: Tables and figures

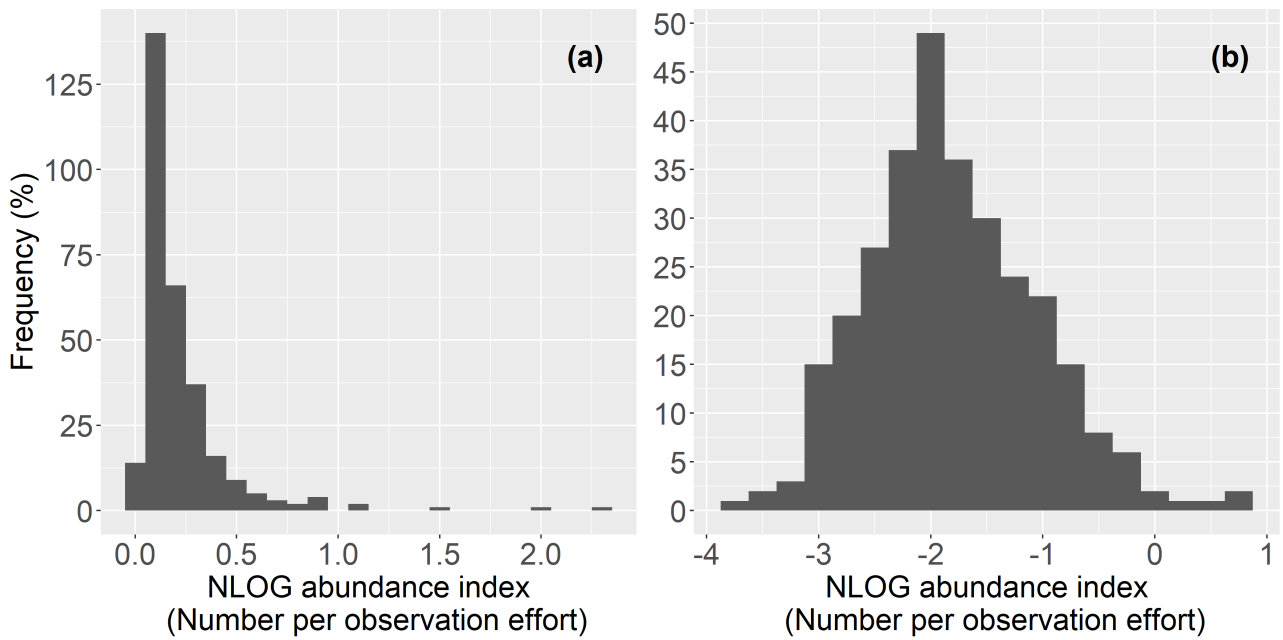

Figure B.6: Distribution of the NLOG abundance index ($A_{i,m} > 0$) a) before and b) after log-transformation.

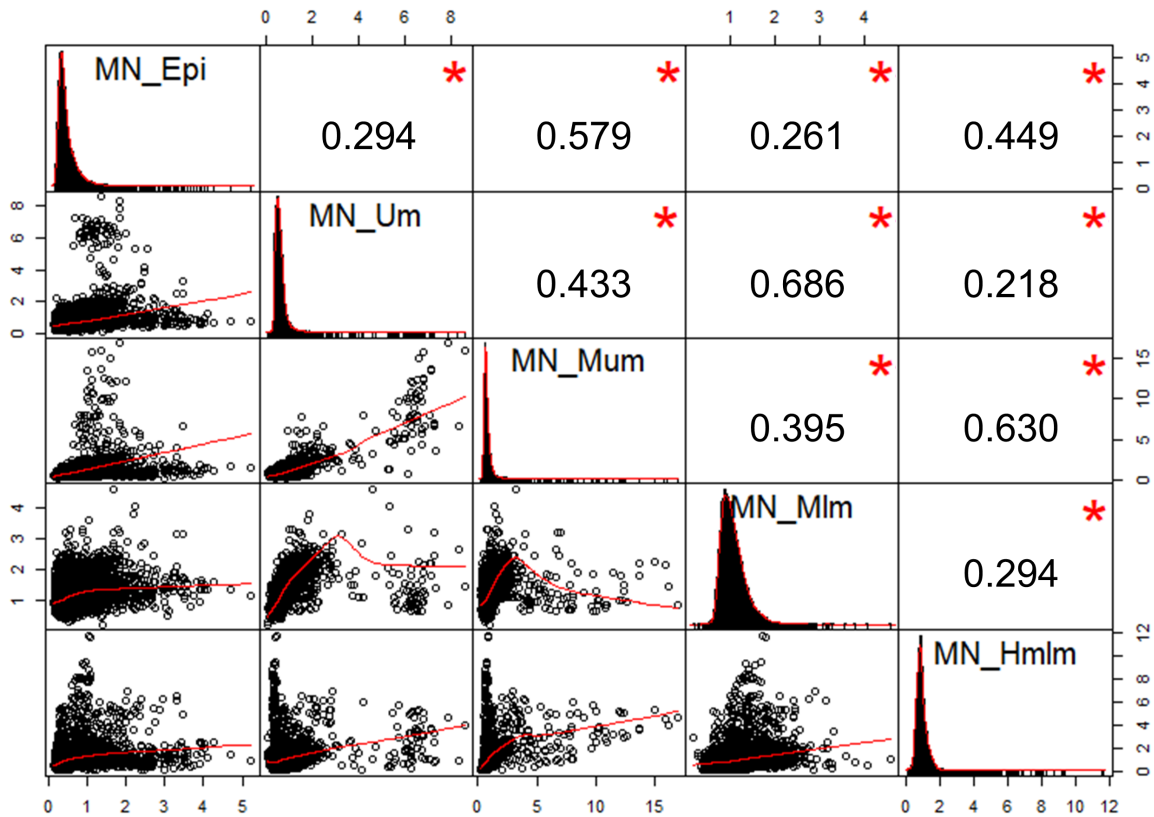

Figure B.7: Correlation matrix of different micronekton types (Epi, Um, Mum, Mlm and Hmlm). The distribution of each of them is shown on the diagonal. The scatter plots between variables are presented below the diagonal and the associated correlation coefficients (τ) are presented above it. Correlation coefficients with a red star represent the significant ones (p .value < 0.005).

Table B.4: Results of the correlation test (Kendall test) between the different micronekton types. The correlation coefficients (τ) are presented above the diagonal while the corresponding p.values are presented below the diagonal.

	MN_Epi	MN_Um	MN_Mum	MN_Mlm	MN_Hmlm
MN_Epi		0.294	0.579	0.261	0.449
MN_Um	<2.2e-16		0.433	0.686	0.218
MN_Mum	<2.2e-16	<2.2e-16		0.395	0.630
MN_Mlm	<2.2e-16	<2.2e-16	<2.2e-16		0.294
MN_Hmlm	<2.2e-16	<2.2e-16	<2.2e-16	<2.2e-16	

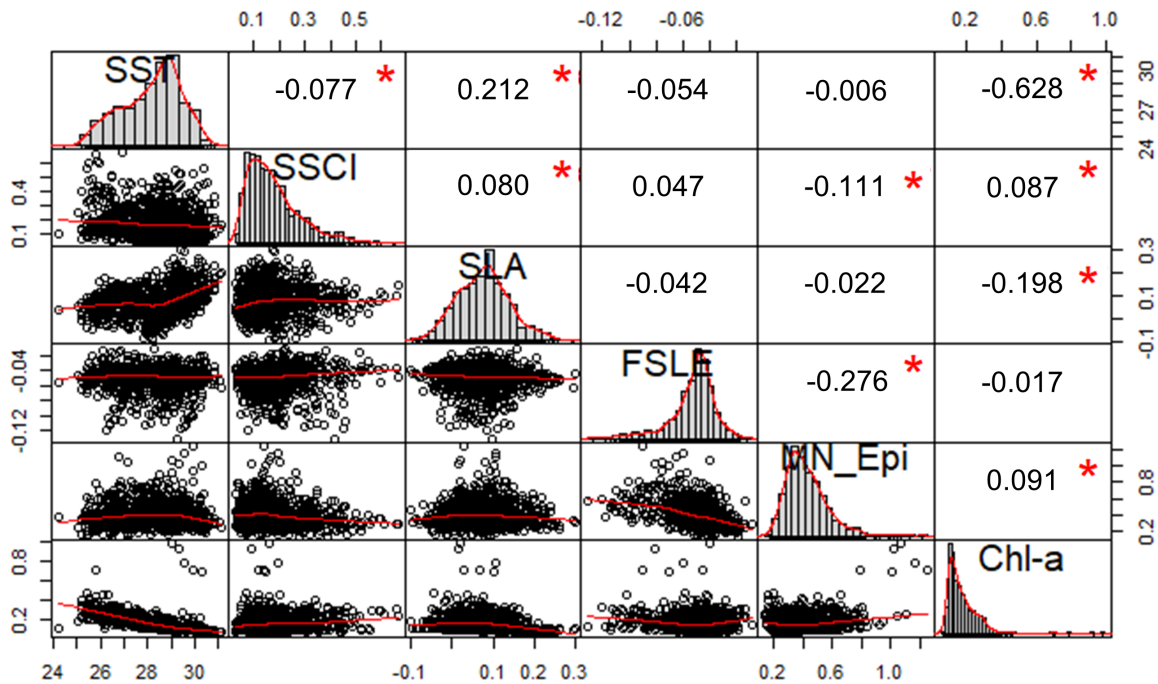

Figure B.8: Correlation matrix of environmental variables (SST, SSCI, SLA, FSLE, MN_Epi and Chl-a). The distribution of each variable is shown on the diagonal. The scatter plots between variables are presented below the diagonal and the associated correlation coefficients (τ) are presented above it. Correlation coefficients with a red star represent the significant ones (p.value <3.33e-03).

Table B.5: Results of the correlation test (Kendall test) between environmental variables. The correlation coefficients (τ) are presented above the diagonal while the corresponding p.values are presented below the diagonal. Bold values indicate a significant correlation between the variables (p.value <3.33e-03).

	SST	SSCI	SLA	FSLE	MN_Epi	Chl-a
SST		-0.077	0.212	-0.054	-0.006	-0.628
SSCI	5.71e-04		0.080	0.047	-0.111	0.087
SLA	<2.2e-16	3.81e-04		-0.042	-0.022	-0.198
FLSE	0.016	0.037	0.060		-0.276	-0.017
MN_Epi	0.788	7.56e-07	0.330	<2.2e-16		0.091
Chl-a	<2.2e-16	1.14e-04	<2.2e-16	0.444	5.21e-05	

Table B.6: Results of the Wilcoxon test of comparison between the values of environmental variables recorded in the presence and in the absence of NLOGs, with an effort observation threshold $T = 10$. Bold values indicate a significant test (p.value < 0.005).

	Zone	p.value
SSCI	$< 10^\circ\text{S}$	0.266
	$\geq 10^\circ\text{S}$	0.149
SLA	$< 10^\circ\text{S}$	0.816
	$\geq 10^\circ\text{S}$	0.373
FSLE	$< 10^\circ\text{S}$	0.333
	$\geq 10^\circ\text{S}$	0.235
MN_Epi	$< 10^\circ\text{S}$	0.933
	$\geq 10^\circ\text{S}$	0.760
Chl-a	$< 10^\circ\text{S}$	0.816
	$\geq 10^\circ\text{S}$	0.016

Table B.7: Results of the correlation test (Kendall test) between NLOG abundance index and environmental variables with an effort observation threshold $T = 6$. Bold values indicate a significant correlation (p.value < 0.005). τ : correlation coefficient.

	Zone	τ	p.value
SSCI	$< 10^\circ\text{S}$	0.012	0.918
	$\geq 10^\circ\text{S}$	-0.049	0.234
SLA	$< 10^\circ\text{S}$	0.307	0.015
	$\geq 10^\circ\text{S}$	-0.092	0.025
FSLE	$< 10^\circ\text{S}$	0.121	0.340
	$\geq 10^\circ\text{S}$	0.015	0.709
MN_Epi	$< 10^\circ\text{S}$	-0.030	0.811
	$\geq 10^\circ\text{S}$	0.054	0.193
Chl-a	$< 10^\circ\text{S}$	0.017	0.891
	$\geq 10^\circ\text{S}$	-0.062	0.134

Table B.8: Results of the correlation test (Kendall test) between NLOG abundance index and environmental variables with an effort observation threshold $T = 10$. Bold values indicate a significant correlation (p.value < 0.005). τ : correlation coefficient.

	Zone	τ	p.value
SSCI	$< 10^\circ\text{S}$	0.054	0.829
	$\geq 10^\circ\text{S}$	-0.076	0.158
SLA	$< 10^\circ\text{S}$	0.318	0.126
	$\geq 10^\circ\text{S}$	-0.135	0.011
FSLE	$< 10^\circ\text{S}$	0.098	0.667
	$\geq 10^\circ\text{S}$	-0.008	0.881
MN_Epi	$< 10^\circ\text{S}$	-0.010	1
	$\geq 10^\circ\text{S}$	0.050	0.348
Chl-a	$< 10^\circ\text{S}$	-0.010	1
	$\geq 10^\circ\text{S}$	-0.044	0.414

Table B.9: Summary table of the generalized additive model for the $\geq 10^\circ\text{S}$ zone, with an effort observation threshold $T = 10$: selected explanatory variables, associated p.values and Multiple R-squared (R^2).

Explanatory variable	Significance	R^2
Chl-a	9.91e-03	0.066
SLA	2.11e-03	

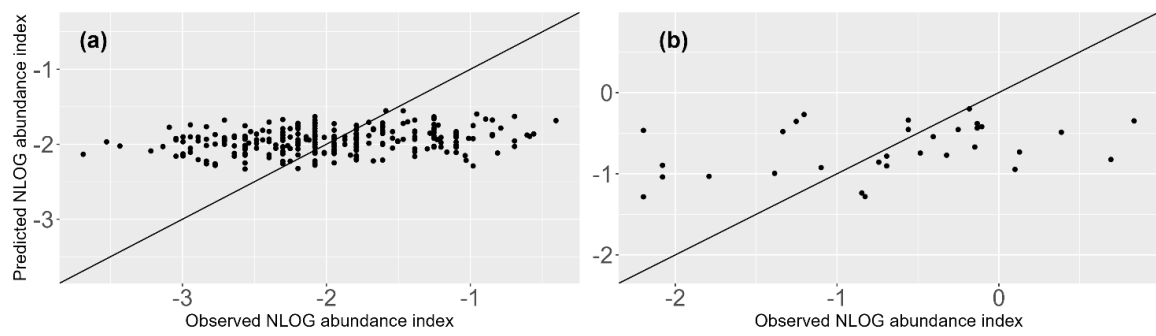

Figure B.9: Predicted *vs* observed NLOG abundance index scatter plots derived from the generalized additive model a) $\text{Gam}_{\geq 10^\circ S}$ and the linear model b) $\text{Lm}_{< 10^\circ S}$. Black lines indicate $y = x$.

B.7 Supplementary Materials 2: Testing sampling bias

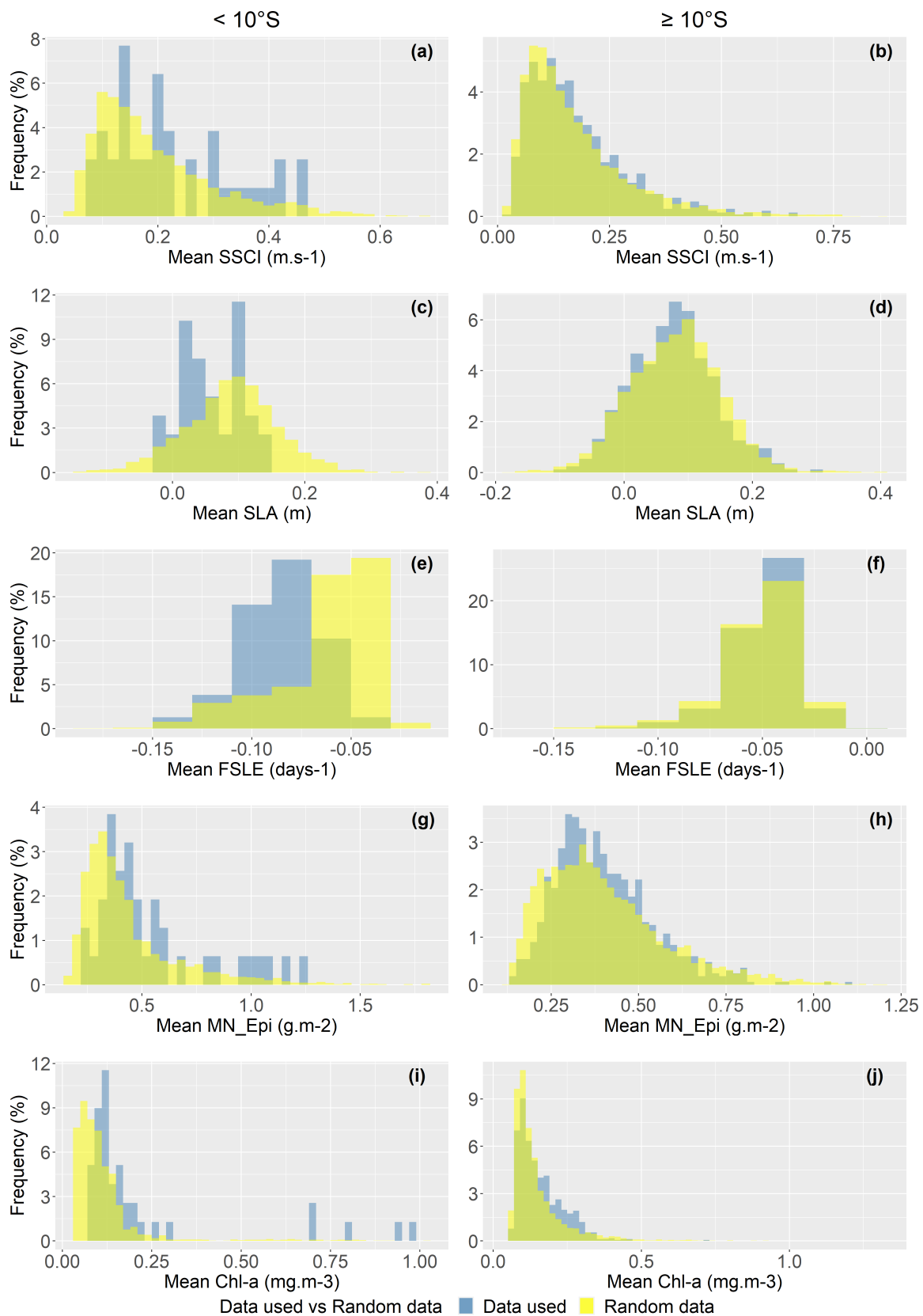

Figure B.10: Distribution of the environmental variables SSCI (a & b), SLA (c & d), FSLE (e & f), MN_Epi (g & h) and Chl-a (i & j) for the data used in the study (blue) and the randomly sampled data (yellow). The histograms in the left column represent the $<10^{\circ}\text{S}$ zone whereas histograms in the right column represent the $\ge 10^{\circ}\text{S}$ zone.

The data used in this study were collected by scientific observers on-board French purse seine vessels. This method of data collection could generate a bias. Indeed, purse seine vessels generally only visit areas where there is tuna. It is therefore possible that observers are exclusively sampling rich areas.

To verify how far this method of data collection deviates from completely random sampling, the data used in this study were compared to randomly selected data. The data used in the study are those with a minimum observation effort of $T = 6$ (i.e. $\sum_{d=1}^{D_m} O_{i,d} \geq T$, see Eq.B.1). The random sampling was carried out among the data with an observation effort lower than $T = 6$. From these, 100 samples were randomly selected for each month of each year (7200 samples in total). Subsequently, the data used in the study were compared to the randomly sampled data using Wilcoxon tests and illustrated with histograms (Figure B.10 – Table B.10).

Overall, for the $\geq 10^\circ\text{S}$ zone, the environmental variables recorded for the randomly sampled cells showed unimodal distributions that are qualitatively similar to those found for the cells being sampled by the observers with a more pronounced difference for the $< 10^\circ\text{S}$ zone. The statistical tests of comparison run between the distributions of environmental variables recorded for the sampled and random cells revealed that for the $\geq 10^\circ$ zone only Chl-a showed a significant difference, with higher median values of Chl-a for the sampled cells (Figure B.10 – Table B.10). However, the two distributions are largely overlapping (Figure B.10). On the other hand, a larger difference was found in the $< 10^\circ\text{S}$ zone (all variables apart from SSCI were significantly different between the random and sampled cells). These results were not sensitive to the sample size (Table B.11).

Table B.10: Results of the Wilcoxon test of comparison between the values of environmental variables recorded for the data used in the study with an effort observation threshold $T = 6$ and the randomly sampled data with an effort observation threshold $T < 6$ (sample size = 100), with their respective medians (Used data median and Random data median). Bold values indicate a significant difference between the two medians. A “+” symbol indicates the median higher than the other and inversely for the “-” symbol.

Environmental variable	Zone	Used data median	Random data median	p.value
SSCI	$< 10^\circ\text{S}$	0.198	0.163	0.028
	$\geq 10^\circ\text{S}$	0.150	0.138	0.028
SLA	$< 10^\circ\text{S}$	0.052 (-)	0.091	8.31e-04
	$\geq 10^\circ\text{S}$	0.078	0.082	0.089
FSLE	$< 10^\circ\text{S}$	-0.087 (-)	-0.053	6.39e-10
	$\geq 10^\circ\text{S}$	-0.047	-0.048	0.400
MN_Epi	$< 10^\circ\text{S}$	0.447 (+)	0.365	9.83e-04
	$\geq 10^\circ\text{S}$	0.377	0.367	0.040
Chl-a	$< 10^\circ\text{S}$	0.125 (+)	0.089	2.66e-08
	$\geq 10^\circ\text{S}$	0.136 (+)	0.115	1.05e-14

Table B.11: Results of the Wilcoxon test of comparison between the values of environmental variables recorded for the data used in the study with an effort observation threshold $T = 6$ and the randomly sampled data with an effort observation threshold $T < 6$, with different sample sizes (50 and 150). Bold values indicate a significant difference between the medians from the data used and those from the randomly sampled data ($p < 0.005$).

Environmental variable	Zone	<i>Sample size: 50</i>	<i>Sample size: 150</i>
		p.value	p.value
SSCI	<10°S	0.051	0.032
	≥10°S	0.027	0.123
SLA	<10°S	5.88e-04	7.89e-04
	≥10°S	0.052	0.109
FSLE	<10°S	1.01e-09	7.15e-10
	≥10°S	0.022	0.264
MN_Epi	<10°S	1.14e-03	1.38e-03
	≥10°S	0.395	0.058
Chl-a	<10°S	1.17e-08	2.01e-08
	≥10°S	6.51e-12	2.12e-14

Appendix C

Is FAD fishing an economic trap? Effects of seasonal closures and other management measures on a purse-seine tuna fleet

Publication

Guillotreau, P., Salladarré, F., Capello, M., **Dupaix, A.**, Floch, L., Tidd, A., Tolotti, M., & Dagorn, L. (2023). Is FAD fishing an economic trap? Effects of seasonal closures and other management measures on a purse-seine tuna fleet. *Fish and Fisheries*. <https://doi.org/10.1111/faf.12799>

Is FAD fishing an economic trap? Effects of seasonal closures and other management measures on a purse-seine tuna fleet

P. Guillotreau¹  | F. Salladarré² | M. Capello¹ | A. Dupaix¹  | L. Floc'h¹ | A. Tidd¹ | M. Tolotti¹ | L. Dagorn¹

¹MARBEC, Univ Montpellier, CNRS, Ifremer, IRD, Sète, France

²Nantes Université, LEMNA, Nantes, France

Correspondence

P. Guillotreau, MARBEC, Univ Montpellier, CNRS, Ifremer, IRD, Avenue Jean Monnet, 34203 Sète Cedex, France.

Email: patrice.guillotreau@ird.fr

Funding information

France Filière Pêche

Abstract

The management of fish aggregating devices (FAD) creates heated debates in tuna fishery management organizations striving to reduce the number of deployed floating objects. Through several econometric models and a machine learning approach, we evaluate the consequences of three management scenarios on the catch and profit of the French purse-seine fleet operating in the Indian Ocean: (1) a half reduction in the number of authorized buoys per vessel, (2) a 72-day closure of FAD fishing with and (3) without re-allocation of effort on free schools. The results show a significant decrease of fleet profits by 7%, 10% and 18% respectively. We hypothesize an “economic trap” of FAD fishing caused by the far greater efficiency of this harvesting technique for larger vessels searching for economies of scale, and by the overfished status and catch limitation of yellowfin (*Thunnus albacares*) and bigeye (*Thunnus obesus*) tunas in the Indian Ocean. The results are compared with other studies looking at the impact of FAD management measures in other oceans.

KEYWORDS

economic impact, FAD moratorium, machine learning, RFMO, SIDS, tuna fisheries

1 | INTRODUCTION

The use of drifting fish aggregating devices (FADs) within tuna purse-seine fisheries has been a game changer by substantially increasing fishing efficiency over the last three decades. FADs (fish aggregating devices) are floating objects deployed by fishers to attract fish and are tracked by satellite buoys, thus increasing fishing efficiency. This technique potentially doubles the proportion of positive sets relative to fishing on free-swimming schools (FSC) (Fonteneau & Hallier, 1993). It has also raised vigorous debates within tuna Regional Fisheries Management Organizations (RFMO) resulting in conservation management measures. At the 6th Special Session of the Indian Ocean Tuna Commission (IOTC) held in Mombasa (Kenya) in February 2023, a resolution was adopted by contracting parties (CPCs) to create a 72-day annual ban on FADs (IOTC resolution 23/02), to which several countries have objected. On September 4th, 2023, at least 11 countries had already objected to this management

measure: Comoros, Oman, Somalia (withdrew on March 25th), Philippines, Seychelles, Kenya, European Union, France, Tanzania, Yemen (withdrew on August 8th), Mauritius, Thailand, and Republic of Korea. Objecting members representing more than one third of the 30 IOTC members, it means that even other members “shall not be bound by that measure; but this shall not preclude any or all of them from giving effect thereto” (IOTC Circular 2023-51, August 8th, 2023). The disagreement between CPCs depending on FADs, and other contracting parties remains heated, competing for the same migratory stocks of tuna with a different perception of the causes of some degraded stock status.

The conflict is not easy to address because of entangled interests between purse-seine fleets of developed states and tuna-dependent coastal states. Tuna is one of the most consumed fish in the world, and one of the most harvested with more than five million tonnes in 2020 for the major species (FAO, 2022), representing an end value of USD 40.8 billion in 2018 (McKinney

et al., 2020). Three quarters of the caught tuna are sold to fish canneries, and landing ports and processing facilities are often located in developing countries, creating jobs, export revenues and other positive economic effects, not even mentioning substantial government revenues coming from fishing rights fees paid by Distant Water Fishing Nations (DWFNs; Bell et al., 2021). The latter also interact or compete with local fisheries targeting the same species and markets (e.g. pole and line skipjack [*Katsuwonus pelamis*, Scombridae] fishery in Maldives, coastal longline yellowfin tuna [*Thunnus albacares*, Scombridae] fishery in Seychelles or Sri Lanka, etc.). Since the early 1990s, the worldwide deployment of drifting FADs and the increased use of instrumented buoys to monitor all types of Floating Objects (FOB) at sea has become a critical issue for the whole value chain (Holmes et al., 2019; Lennert-Cody et al., 2018).

Fishing strategies that use FADs are put under pressure by conservationists because of catches of juvenile yellowfin and big-eye tuna (*Thunnus obesus*, Scombridae), bycatch and “ghost fishing” (accidental catches from net entanglement beneath FADs) of vulnerable species (sharks, turtles...), abnormal movements of fish, disturbed pelagic ecosystems, marine pollution and habitat damages due to discarded FAD plastics after sinking or stranding (Churchill, 2021; Dagorn et al., 2013; Hallier & Gaertner, 2008; Marsac et al., 2000). The four RFMOs managing tropical tuna fisheries strive to restrict the use of FADs by implementing time and area closures, limiting numbers of buoys, creating monitoring plans, adopting bycatch reduction measures, using biodegradable and non-entangling materials and restricting the use of supply vessels, etc. (Holmes et al., 2019; Lennert-Cody et al., 2018). Society also responds to the problem through retailers' and consumers' associations by deciding on trade bans on FAD-caught tuna (Davies et al., 2014; Leadbitter & Benguerel, 2014). Stock assessment scientists consider that both yellowfin and bigeye tuna stocks are overfished and subject to overfishing in the Indian Ocean (with a probability of 68% for yellowfin and 79% for bigeye tuna; Status summary for species of tuna and tuna-like species under the IOTC mandate, www.iotc.org). They strongly recommend that all contracting parties should apply the interim plan for the rebuilding of stocks by reducing the level of catch and fishing mortality (IOTC Res. 21/01 and 22/03).

If the literature dealing with the ecological consequences of FAD fishing is abundant, scarcer are research works showing the economic effects of FAD management plans (Hanich, 2012; Holmes et al., 2019; Ovando et al., 2021). What could be the consequences of removing FADs for fishing companies and coastal states? Would purse-seine vessels remain profitable in the current economic context? Who should bear the burden of FAD management plans? As other authors have stressed the possible ecological trap of FAD fishing (Hallier & Gaertner, 2008; Marsac et al., 2000), we hypothesize the existence of an ‘economic trap’ for the purse-seine fleets using FADs and benefiting from important increasing returns to scale, technical innovations and efficiency gains over the past three decades, but also contributing to the overfishing

Table of contents

1.	INTRODUCTION	1
2.	LITERATURE REVIEW	3
2.1	Number of FADs deployed by purse seiners and supply vessels	3
2.2	Technical change and strategic efficiency of FADs	3
2.3	Catch composition and economic gain of a FAD strategy	4
2.4	FAD Management plans and economic consequences	4
3.	STYLIZED FACTS ON FAD USE IN THE IO	5
3.1	Data	5
3.2	Stylized facts about the use of FADs	6
4.	METHODS	7
4.1	Econometric strategy	8
4.2	Machine learning approach	9
5.	RESULTS	9
5.1	FAD deployment, type of fishing effort and catch by species	9
5.2	Converting catches into profits with a machine learning approach	9
5.3	Predictions under three scenarios of FAD management	11
5.3.1	Scenario 1: 50% reduction of the total number of buoys	11
5.3.2	Scenario 2: 72-day ban on FAD fishing with transfer of effort to FSC	12
5.3.3	Scenario 3: 72-day ban on FAD fishing with vessels staying at port	12
6.	DISCUSSION	13
7.	CONCLUSION	15
	ACKNOWLEDGEMENT	15
	CONFLICT OF INTEREST STATEMENT	15
	DATA AVAILABILITY STATEMENT	15
	REFERENCES	15

problem of vulnerable species like yellowfin and bigeye tunas subject to recovery plans and catch limitation. Restricting FAD use may reduce the catch of some species (namely skipjack) without any possibility to reallocate effort on free schools because of catch limitations on other tuna species, hence this hypothesis of ‘economic trap’. What could be the price to pay to come back to the *status quo ante* situation, with twice as fewer buoys at sea or under a seasonal FAD moratorium?

We propose to answer this question by looking at the profitability of the French Purse-Seine (PS) fishery operating in the Indian Ocean (IO). After some stylized facts showing the generalized use of FADs by the French PS fleet and some of its economic

effects, a quadratic catch-effort model is estimated to stress a possible “optimal” number of FADs, if ever existing. Vessel and time-fixed effects behind the technical choice of FAD versus FSC fishing are also considered. The effects of fishing effort and strategies on individual profits are analysed by a random forest model to explain the rationale of FAD fishing and the difficulty of shifting to other strategies.

2 | LITERATURE REVIEW

A great deal of literature about FADs focuses on their detrimental ecological impacts (Churchill, 2021; Dagorn et al., 2013; Davies et al., 2014; Gomez et al., 2020; Hallier & Gaertner, 2008; Hanich et al., 2019; Tolotti et al., 2022), which are well studied and not at the core of this research. Another strand of research is looking at efficiency gains with a FAD strategy relative to fishing on FSC (Guillotreau et al., 2011; Maufroy, 2016; Maufroy et al., 2015; Tidd et al., 2016; Wain et al., 2021; Wolff et al., 2013), sometimes in the perspective of standardizing Catch Per Unit Effort (CPUE) for stock assessment objectives (Chassot et al., 2012; Torres-Irineo et al., 2014; Katara et al., 2016; Gaertner et al., 2018). Finally, other authors are more interested in FAD management plans and their consequences on fisheries and ecosystems (Fonteneau et al., 2015; Gomez et al., 2020; Hanich et al., 2019; Holmes et al., 2019; Lennert-Cody et al., 2018; Ovando et al., 2021).

Our contribution lies in this last research arena, attempting to study the economic consequences of more stringent FAD management measures. In particular, an important goal would be to discover, if ever existing, an ecologically and economically optimal number of monitored FADs per vessel (Fonteneau et al., 2015; Lennert-Cody et al., 2018). This is particularly challenging because of many influences affecting the use of FADs (ecological conditions, embodied technology, the assistance of supply vessels, shared equipment, stolen or abandoned buoys and piracy events). The first step is to know precisely the number of instrumented floating objects at sea. A second research issue is to find a relationship between the investment of fishing companies in instrumented buoys, and the use and efficiency of FADs for purse-seine vessels. We expect a significantly positive causality between investment and use of FADs, but skippers may prefer one fishing technique or another (FAD vs. FSC), have opportunistic behaviours when environmental conditions favour FSC fishing, harvest on other vessels' FADs or do not have supply vessels. FAD use can also be stimulated by management measures. For instance, the IOTC has implemented a total allowable catch for yellowfin tuna, active since 2017 (IOTC Resolution 16/01), which led PS fishers to intensify their use of FADs to comply with the quota and remain at sea throughout the year. By doing so the bycatch amount of silky sharks in the IO has increased significantly (Tolotti et al., 2022). Let us review the current knowledge about some of these issues along the historical development of the IO tropical tuna purse-seine tuna fishery.

2.1 | Number of FADs deployed by purse seiners and supply vessels

The number of buoy-tracked floating objects used by the purse-seine fleet worldwide has expanded since the early 1990s (Fonteneau & Hallier, 1993; Lennert-Cody et al., 2018). Some observers estimated up to 120,000 buoys at any time at sea, of which 65,000 were found in the west-central Pacific Ocean in 2017 (Hanich et al., 2019). In the IO, this number has tremendously increased from a few hundred in the 1990s to more than 2000 in the late 2000s and certainly beyond 10,000 since the mid-2010s, explaining why over 80% of tuna is now caught on FADs (IOTC, 2022a; Maufroy et al., 2017; Wain et al., 2021). IOTC reported 16,000 FAD deployments in 2021 by purse seiners and their support vessels, of which 56% by Spanish-owned vessels and 25% by French ones, but only 10,000 of these objects were daily monitored at sea (IOTC, 2022b). The number of buoys seeded yearly by French PS has increased from 41 per vessel in 2004 to 200 buoys a decade later (Gaertner et al., 2018) and it is limited since 2019 to 300 per PS vessel by IOTC resolution 19/02. However, this number of active buoys is not evenly distributed in space and time. A cluster analysis of FAD drifting movements helped to distinguish four fishing seasons and spatial patterns in the IO. The number of operational FADs at sea for the whole French PS fleet fluctuates between 590 in February when the boats are fishing eastward near the Chagos islands (free school season) and 2252 in October, the peak of the FAD fishing season off the Somalian coast (Maufroy et al., 2017).

The massive deployment of drifting FADs and instrumented floating objects has been made possible by the use of support (supply) vessels, seeding and monitoring FADs for the sake of one or several purse seiners (Hanich et al., 2019). Support vessels were introduced in the mid-1990s in the Indian Ocean, and their number has sharply increased from seven at the turn of the 2010s to a record number of 22 in 2016, before a gradual decrease to 11 bigger boats in 2021 (32m long on average in 2003, up to 40m in 2021), shared by several fishing vessels (IOTC, 2022b, IOTC Res. 17/01). Most of these supply vessels are owned and used by the Spanish (domestic or Seychelles-flagged) fleet, with the French fleet operating only one of these support vessels in 2021 (against three in the two previous years, according to IOTC, 2022b). In the IO, supply vessels contributed to an increase of the catch per day by 45%, the number of fishing sets per day by 20% and the distance travelled per day by 4.5% (Maufroy et al., 2015).

2.2 | Technical change and strategic efficiency of FADs

The efficiency of FAD fishing has been enhanced by the technical change embodied in buoys, increasing the detection capacity of skippers for fish. Several regime shifts in the CPUE were directly caused

by the introduction of new equipment (Torres-Irineo et al., 2014; Lopez et al., 2014; Hallier & Gaertner, 2008; Maufroy, 2016). A first structural break was observed in the early 1990s after the introduction of radio beacons and the deployment of FADs (Torres-Irineo et al., 2014). A second turning point was caused by the use of Global Positioning System (GPS) technology. First introduced in 1996 in the IO, 100% of the buoys adopted a GPS in the late 2000s (Gaertner et al., 2018; Lopez et al., 2014). At the turn of the millennium, the first generation of echosounder buoys was able to detect biomass remotely under the monitored floating objects. The year 2009 marked another major shift after the investment in the second generation of echo-sounders, accelerating the use of FADs up to 75% of FAD sets at that time for the Spanish fleet (Lopez et al., 2014), soon followed by the French fleet in the same proportion (Maufroy et al., 2017). Five years later, all buoys were 100% equipped and the detection technology did not stop improving, thus increasing the catchability of tuna stocks (Gaertner et al., 2018; Lopez et al., 2014; Tidd et al., 2016).

This continuously upgrading detection technology, the use of support vessels and the increase of FAD fishing effort make it difficult to standardize CPUE to estimate the biomass level (Chassot et al., 2012; Katara et al., 2016; Gaertner et al., 2018). Maufroy (2016) showed a clear superiority of the FAD strategy over the FSC strategy in terms of efficiency in both Atlantic and Indian oceans. Estimating different types of efficiency (CPUE per day, per set, per travelled distance), the latter study made a distinction between technical efficiency (TE=CPUE under fixed biomass abundance and vulnerability conditions) and strategic efficiency (SE=CPUE under fixed month effect, vessel characteristics and support vessel assistance), total efficiency being the product of TE by SE. With glm and logit models, the author found that increasing the proportion of FOB sets at the annual rate of 3% between 2003 and 2014 in the IO had increased the total efficiency of the PS fleet at a rate between 0.87% and 2.15% per year in the IO. All CPUE indices and the distance per day would be positively affected, but a higher proportion of FAD sets would also reduce the number of sets per day because of a greater percentage of positive sets on FADs in contrast to FSC sets (Fonteneau et al., 2013).

With non-parametric techniques (data envelopment approach and Malmquist productivity index) over the period 1993–2010 in the west-central Pacific Ocean (WCPO), other authors have found an annual growth rate of 3.8% in productivity, most of it being attributable to technical change (displacement of the technology frontier for all vessels) rather than to technical efficiency (better use of inputs for one vessel's output relatively to others) (Tidd et al., 2016). The difference in growth rates can, therefore, be easily explained by different contexts (Pacific vs. Indian Ocean), periods including various technical shifts and environmental conditions and methods (linear models with a focus on FADs vs. non-parametric approach for all strategies). Interestingly, the strongest efficiency gain in the IO took place after 2008, when GPS-tracked buoys instrumented with echo-sounders were disseminated across the whole fleet (Maufroy, 2016). The use of echo-sounders has enhanced FAD efficiency by 10%, i.e., +2.0 to 2.5 tonnes per successful set according to Wain et al. (2021). Considering the unit cost of an echo-sounder buoy is around US\$ 1000–1500, with each buoy being

used three or four times on average, the net revenue gain would represent between US\$ 5000 and 7000 per buoy (Ibid.). The return on investment was even estimated at USD 35,000 for a USD 5200 unit cost in just one set (Gomez et al., 2020).

2.3 | Catch composition and economic gain of a FAD strategy

Fishing on floating objects does not only improve efficiency but also affects the catch composition by species towards more skipjack and less yellowfin and bigeye tunas (Dagorn et al., 2013; Escalle et al., 2019; Fonteneau & Hallier, 1993). The elasticity of catch to the proportion of FAD sets in a random effect panel data model was deemed significantly negative for yellowfin tuna (−1.690) and positive for skipjack (+1.319) (Guillotreau et al., 2011). In other words, any 10% increase in the proportion of FAD sets would reduce the yellowfin tuna catch by 17% and increase that of skipjack by 13%. The share of FAD sets having increased from 42%, on average, in the 1984–1995 period up to 49% during the 1996–2007 period, this would have raised by 9% the landings of skipjack and reduced by 13.6% the landings of yellowfin tuna, other things being equal. Theoretically, this should contract the sales value by less than 1.5% because of lower prices for skipjack. However, the loss was more than offset by the greater efficiency of FADs mentioned above: the total catch response to a 1% increase of sets on floating objects was found twice greater than the catch response to the number of sets on free-swimming school (0.453 vs. 0.230, respectively, Wolff et al., 2013), considering the greater proportion of positive sets for FADs. Some authors argued that this greater efficiency of FAD fishing could be undermined by the significant reduction in the size of fish (Fonteneau et al., 2002; Hanich et al., 2019).

On a more economic ground, what could be the relative energy costs of FAD and FSC strategies? Some authors may consider that FAD fishing should result in lower fuel consumption per tonne of landed fish because of a reduced searching time (Dagorn et al., 2013; Hanich et al., 2019; Holmes et al., 2019; Parker et al., 2015). Surprisingly, based on individual purse-seine data on fuel consumption by type of fishing, the FAD strategy proved to be more energy-consuming than the FSC strategy, presumably because vessels were moving more frequently at full speed (Basurko et al., 2022; Chassot et al., 2021; Maufroy, 2016). Yet, this would not degrade the vessel profitability either, because of this higher efficiency of FADs over a FSC strategy (Hamjan & Mallawa, 2020). In that respect, what could be the effects of management plans aiming at shortening FAD seasons, limiting FAD sets or the authorized number of buoys at sea?

2.4 | FAD management plans and economic consequences

FAD management plans were implemented in almost every ocean by RFMOs for a long time. Reviews of FAD management measures

taken by RFMOs can be found in Davies et al. (2014), Song and Shen (2022) or Baidai et al. (2022). In the west-central Pacific Ocean, FAD closure periods have been adopted since 2009 in the Parties to Nauru Agreement (PNA) waters. In the IO, due to the pressure on yellowfin and bigeye tunas, IOTC also implemented time-area closures for both longline and purse-seine vessels for 1 month from November 2011 (IOTC Res. 10/1) until 2014 (Song & Shen, 2022). However, such resolution was not specific to FADs. An important change occurred in 2012, when IOTC first introduced a resolution requiring the elaboration of FAD management plans from the fleets (Res. 12/08 *Procedures on a fish aggregating devices (FADs) management plan*). Detailed information and reporting about the use of FADs was expected, as well as responsible FAD management (improved design, monitoring, retrieval actions...), but nothing concerning restrictions on their use. Such measures really started with resolutions 15/08 and the following ones, including a limitation to a maximum number of operational buoys and followed by any purse-seine vessel at 550 at any one time, and no more than 1100 instrumented buoys acquired annually. These numbers were reduced the first time in 2016 to 425 operational and 850 acquired annually, then to 350 operational buoys at sea and 700 instrumented buoys acquired annually by each vessel in 2017, and since 2020 to a maximum of 300 operational buoys at sea and 500 instrumented buoys acquired annually per vessel (IOTC Res. 19/02). At the 25th session of the IOTC in June 2021, a group of nine CPCs (Indonesia, Kenya, Maldives, Mozambique, Pakistan, Somalia, South Africa, Sri Lanka and Tanzania) is opposed to intensive FAD use by purse seiners, preferring small-scale fishing gears like pole and line, gillnet, coastal longline, etc. and proposed an amendment to resolution 19/02 so as to halve the maximum authorized number of FADs per purse-seine vessel from 300 to 150 operational buoys at sea at any one time. As consensus could not be reached, this group of CPCs called for a vote whose outcomes were not validated at the end of the process in November 2021. Opposing points of view between FAD-using CPCs and other contracting parties remain a critical issue to make decisions in IOTC. In February 2023, some of the coastal countries coalesced to propose a 72-day FAD moratorium which was voted with a two-third majority for an implementation starting in July 2024 (IOTC Res. 23-02). Several other members (11 states up to September 4th, 2023) have objected to this resolution which becomes non-binding for all CPCs but reveals a tense situation around the FAD issue.

A limited number of deployed FAD buoys as well as seasonal closures represent effective ways of containing the FAD fishing capacity, rather than the closure of FAD strata or limitations in the number of FAD sets which might be more difficult to enforce (Fonteneau et al., 2015), although some authors expect some benefits from FAD set limits (Holmes et al., 2019). A 6-month moratorium on FAD sets was simulated by an iterative “fishing-day” model to look at the consequences on catch and bycatch (Escalle et al., 2017). The model took into consideration the probability of occurrence of different fishing events (visual cues, size and species of tuna schools...) and skippers' decisions based on EU PS data 2005–2014 in both the Atlantic and Indian Oceans. Various scenarios of fishing effort

reallocation or changing fishing practices were explored through Monte Carlo simulations. Not surprisingly, the model predicted a decreasing number of FAD sets and an increase in FSC sets with lower catches of small tuna (<10 kg) and higher catches of large tuna (equal to or more than 10 kg).

Another attempt was made for the Pacific Ocean to look at the economic benefits of setting FAD limits instead of closure periods (Holmes et al., 2019). FAD closures were deemed ineffective because they had just the effect of increasing fishing pressure in non-closure periods/areas, except for fleets relying on FAD fishing during lower tuna price periods. A linear operating model was developed for a generic purse-seine vessel to simulate the effect of a FAD closure of 3 months within WCPO countries' EEZ, plus an additional 2-month closure in the high seas. Such a closure period could result in a net loss of US\$ 250,000 per trip with an average skipjack price of US\$ 1860 per tonne, and even worse under lower skipjack prices because it could not be offset by additional income from the non-closure period. This would also reduce the fisheries revenues of some Pacific small island developing states relying to a large extent on access fees paid by DWFN fleets to the government (Bell et al., 2021). Other authors estimated the effects of FAD removal on catches of bigeye and skipjack (Ovando et al., 2021). With a bioeconomic age-structured model and a random forest model, they calculated the effect of moving from FAD fishing to FSC fishing with respect to the catch rates of both species. They found that the reduction of skipjack catches was greater than that of Bigeye to achieve the maximum sustainable yield (MSY) of the latter species. Two thirds of the FADs covered by vessel day scheme (VDS) licences should be removed to achieve the MSY of bigeye tuna.

Our research is fairly close to these two last studies looking at the economic effects of reduced use of FADs. Our hypothesis is that a half reduction of authorized FADs at sea from 300 to 150 operational buoys per vessel (corresponding to the amendment proposed by a group of IO countries to resolution 19/02 above mentioned) would not be profitable for the IO French PS fleet and that FADs could represent “economic traps” for fishing companies. First, larger vessels have joined the DWFN fleets, increasing their FAD dependence. Secondly, because of the quota constraint set on yellowfin catch since 2017 (IOTC Res. 16/01), DWFN fleets might not be able to stay profitable while reducing their use of drifting FADs, creating a sort of irreversible ratchet effect if efficiency was meant to be reduced.

3 | STYLIZED FACTS ON FADS IN THE IO

3.1 | Data

The number of large purse seiners operating in the IO has been more or less stable for the past two decades, around 45–50 vessels, after a peak of 61 boats in 2006, with increasing average size of vessels from 70 to 90m long over the same period (IOTC, 2022b). The French purse seiners represent one third of the fishing effort

with 15 vessels on average over the sample period, Spain being the undisputable leader of the Indian Ocean large-scale PS fishery with nearly two thirds when including the number of Seychelles-flagged vessels owned by Spanish companies (Ibid.). The analysed data were collected and processed by the Ob7 (“*Observatoire des Ecosystèmes Pélagiques Tropicaux Exploités*”) in Sète (IRD, France). Observations are fishing trips since 2012, described by a set of variables representing the tuna landings by species (skipjack, yellowfin, bigeye, albacore) and by size category (large yellowfin and bigeye tunas >10 kg, skipjack and mixed tunas which are a mixture of juvenile albacore, bigeye and yellowfin tunas <10 kg), the fishing effort – days at sea, fishing days, number of sets by fishing technique, the landing date, physical characteristics and identity of vessels, number of buoys per vessel and for the entire fleet – length overall, size category (from 4 to 8), the first year of service, a skipper identifier. The observations can be easily disaggregated into panel characteristics (time, vessel, skipper). The vessels and skippers with less than 10 observations over the entire period were removed. The vessels realize nine trips per year on average, with a duration of 28 days per trip, i.e., 254 days at sea per year. Environmental data were collected from different sources: the Spawning Stock Biomass (SSB) of yellowfin tuna was kindly transmitted by the stock assessment division of IOTC (quarterly series). The dipole mode index (DMI) was collected from the NOAA website <https://psl.noaa.gov>. This climate index measures the Indian Ocean dipole effect, represented by anomalous sea surface temperatures (SST) along a gradient between the western equatorial Indian Ocean (50E–70E and 10S–10N) and the south-eastern equatorial IO (90E–110E and 10S–0N). It is associated with wind and rainfall anomalies (Saji et al., 1999).

Economic data were added to the data set with monthly price series. Prices of skipjack, large yellowfin and mixed tunas were collected from Sovetco, a French trading company setting ex-vessel frozen tuna prices in the Atlantic and Indian oceans on the basis of Bangkok prices, shipping costs and exchange rates between Euro and US dollar. Cost data were also collected to estimate gross value added (GVA). One of the most important variable expenses of fishing activity is fuel cost, because of its dependence on days at sea, distance in miles, power and speed of vessels, auxiliary engines used for freezing the fish aboard, etc. Bunker costs represented 23% of total costs, on average, between 2012 and 2020 for EU large purse seiners (Berkenhagen et al., 2021). Using a generalized additive model (GAM) of fuel consumption relying on the number of sets on FADs, sets on free schools, number of days at sea, landing date, year of first service and vessel length (Chassot et al., 2021), we estimated the fuel consumption per day for each fishing trip in our sample. The gasoil price in USD per tonne in Port Victoria in Seychelles was collected from Seypec, the local petroleum company, between January 2013 and December 2019 and complemented with predicted values from its correlation model with the New York Harbor Heating Oil Future Contract 3 (www.eia.org). The two prices were found non-stationary but had a single long-run (cointegrating) relation without intercept: $P_{\text{seypec}} - 1.34717 * P_{\text{nyhofc3}} = \hat{\epsilon}$. All tuna and oil prices were converted into USD (with ECB rates) and deflated by

the OECD production price index based in 2015 (<https://data.oecd.org>). GVA on variable costs could, therefore, be estimated (per day, per trip, per year) as a proxy of gross profit. Net profit could be easily inferred by a raising factor of 4.3 on bunker costs to represent total costs. After the elimination of missing values and the truncation of data after 2012, the data set included 1217 observations (fishing trips) between January 2012 and December 2020.

3.2 | Stylized facts about the use of FADs

Figure 1 gathers several charts showing the increasing importance of FAD fishing for the French PS fleet operating in the IO, and its relationship with catch level and composition as well as effects on gross profit.

The French purse-seine fleet operating in the WIO between 2012 and 2020 included 14 or 15 vessels. The average yearly catch was 78,665 tonnes, with a minimum of 55,432 tonnes in 2012 and a maximum of 97,731 tonnes in 2019 (Figure 1a). The bulk of the catch concerned two species: skipjack (46% on average), yellowfin (33%) and mixed tunas for the remaining share (21%), but the variability between the first two species could be high over time (Figure 1b). FAD sets represented 68.5% of all sets on average, depending on seasons and years (Figure 1c). Since 2017, a total allowable catch has been implemented on yellowfin (IOTC resolutions 16/01 and 17/01), thus intensifying the use of FADs by purse seiners to avoid the big yellowfin (>10 kg) caught on free schools. The average proportion of FAD sets raised to 78% on average against 61% before 2017 but even more interesting is the homogenous trend of using FADs across the whole fleet, as seen by the declining coefficient of variation (% st.-dev./mean) over the period. Previously, some skippers could prefer the more rewarding technique of free schools, because of higher catches of high-valued large yellowfin, but it appeared to be no longer the case after the quota implementation. Increasing the proportion of FAD sets results in a higher catch of skipjack and mixed tunas, which are sold ~\$325 lower per tonne (Figure 1d). The real oil price stood around \$1000 per tonne until 2014, before reaching a lower level since then. Real prices of tunas were fairly volatile throughout time. The yellowfin tuna real price oscillated between constant USD 1000 and 2700 per tonne, and the skipjack or mixed tuna prices were between USD 500 and 2100 per tonne. However, the proportion of positive sets being so much higher on FADs (90% of positive sets vs. 50% for free school sets on average; Fonteneau et al., 2013), the larger catch does more than compensate for the decline in unit values, as shown by the gross value added (GVA, proxy of gross profit), i.e., the difference between revenues and fuel costs, which is maintained at a high level between US\$0.5 and US\$1 million per fishing trip in real terms (Figure 1e). The intensive FAD strategy of the last few years proved to be far more rewarding than the free school strategy, as shown in Figure 1f. For instance, in 2018, a vessel owner would earn, on average, \$930,000 of GVA by FAD trip against only \$130,000 per FSC trip, presumably because of success rates of FAD sets and economies of scale.

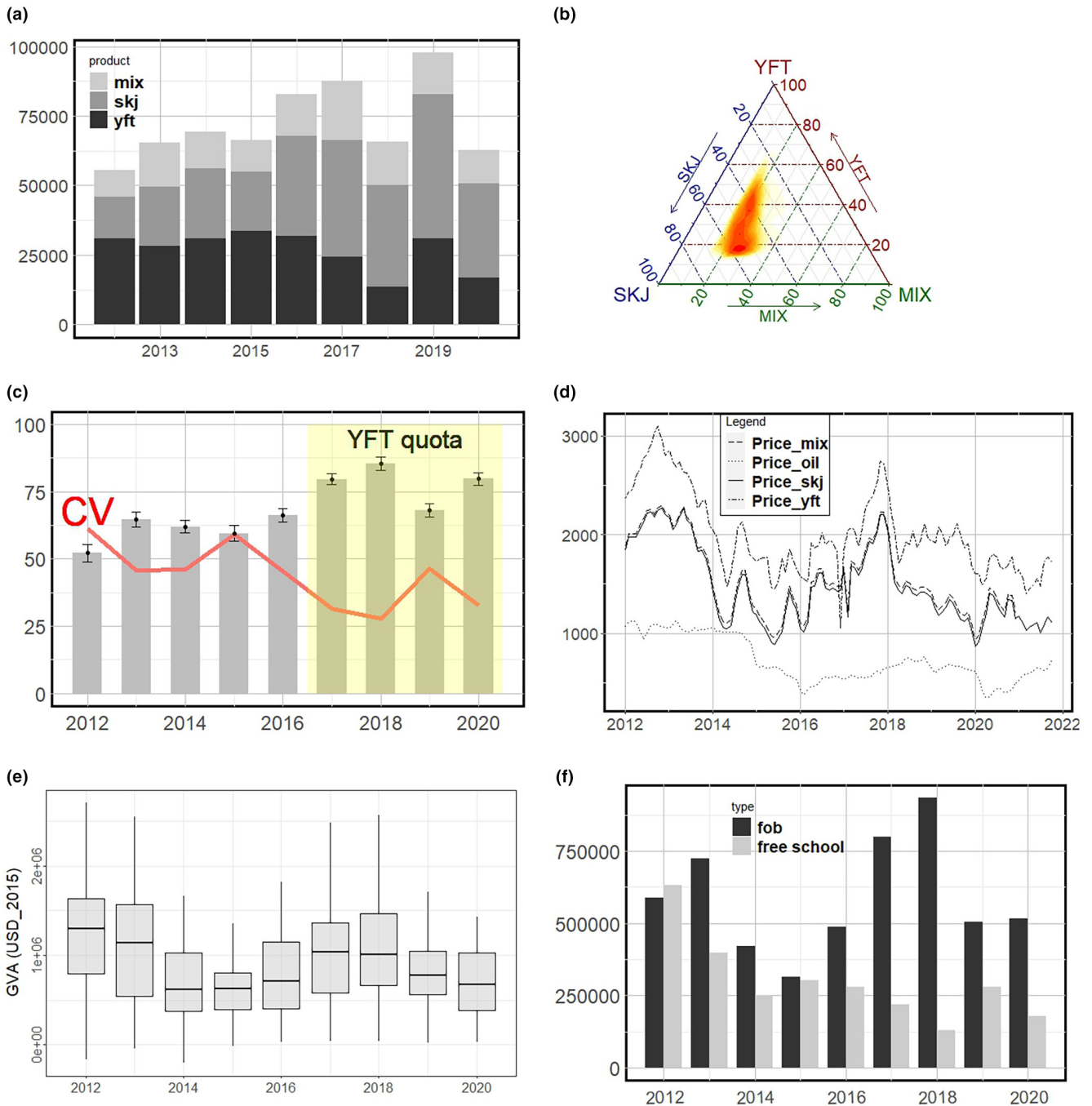

FIGURE 1 (a) Tuna catch of the PS French fleet (tonnes). (b) Distribution of catch shares by species. (c) Proportion of FAD sets (%) + standard errors. (d) Real monthly prices (USD_2015). (e) GVA per trip (USD_2015). (f) GVA by fishing technique per trip (USD_2015).

4 | METHODS

The approach is defined in three steps. The core model lies in a classical catch-effort relationship tested by linear equations (Gaertner et al., 2018; Guillotreau et al., 2011; Maufroy, 2016; Wolff et al., 2013). However, we considered that the fishing strategy is also determined by the environmental conditions and capital investment, including the number of deployed buoys, hence a simultaneous equation treatment (Figure 2). SSB and DMI were selected as environmental indices to consider the effects of climate anomalies

on the fishing strategy (fishing on FADs or free schools) resulting from the surface catchability of skipjack, large yellowfin and mixed tunas. Finally, the economic consequences of the fishing strategy on revenues and gross profits are also analysed through predicted values with a machine learning approach.

Several models with two time-fixed effects (month and year) were first estimated for the French purse-seine fishing trips. The models were derived from a Cobb–Douglas production function (Wolff et al., 2013) to explain the catch levels of three tuna product categories: large yellowfin tuna (>10 kg), skipjack and mixed tunas

(bigeye, albacore and yellowfin <10kg). The fishing effort was captured by the number of days at sea, but also by the technical choice between the number of FAD sets and FSC sets during a fishing trip. We introduced non-linear (quadratic) terms so as to look at the marginal response of catch to fishing effort, potentially bending beyond a threshold. The increasing size and physical features of vessels (e.g. length, gross tonnage or engine power) were included as vessel-fixed effects. The skipper skills were also introduced as individual fixed effects (Guillotreau et al., 2011; Squires & Kirkley, 1999) but gave no significant result, as if fishing behaviour and efficiency tend nowadays to homogenize within the fleet.

4.1 | Econometric strategy

The catches of skipjack, large yellowfin and mixed tunas were retained as dependent variables. From the review of literature and descriptive analysis of the data, we hypothesize that these catches can be explained by several factors characterizing the fishing effort in a simultaneous equation model combining effects of capital, environment and fishing effort on tuna catch. With such a model, we were able to analyse both the relationships between the variables and their multiple dependencies. This approach allows for the

simultaneous estimation of the coefficients and carries out estimates of the standard errors that take into account the contemporaneous correlations for FAD and FSC equations due to their Gaussian error distributions. This is useful when testing multiple sets of associations between variables simultaneously in a single modelling framework (Figure 2). The model can be written as:

$$FAD_i = \alpha + \beta B_i + \beta' B_i^2 + \gamma X_i + \gamma' X_i^2 + \varepsilon_i \quad (1)$$

$$FSC_i = \varphi + \delta B_i + \delta' B_i^2 + \eta X_i + \eta' X_i^2 + \omega_i \quad (2)$$

$$SKJ_i = \pi + \nu FAD_i + \nu' FAD_i^2 + \theta FSC_i + \theta' FSC_i^2 + \omega D_i + \omega' D_i^2 + \kappa Z_i + \vartheta_i \quad (3)$$

$$YFT_i = \rho + \zeta FAD_i + \zeta' FAD_i^2 + \xi FSC_i + \xi' FSC_i^2 + \rho D_i + \rho' D_i^2 + \iota Z_i + \phi_i \quad (4)$$

$$MIX_i = \psi + \zeta FAD_i + \zeta' FAD_i^2 + \eta FSC_i + \eta' FSC_i^2 + \mu D_i + \mu' D_i^2 + \epsilon Z_i + \varsigma_i \quad (5)$$

where FAD_i and FSC_i denote the natural logarithm of the number of FAD or FSC sets per fishing trip i . B_i reflects the logarithm of the total number of buoys deployed by the French PS fleet (highly correlated with the number of buoys deployed by each vessel) and X_i is a vector

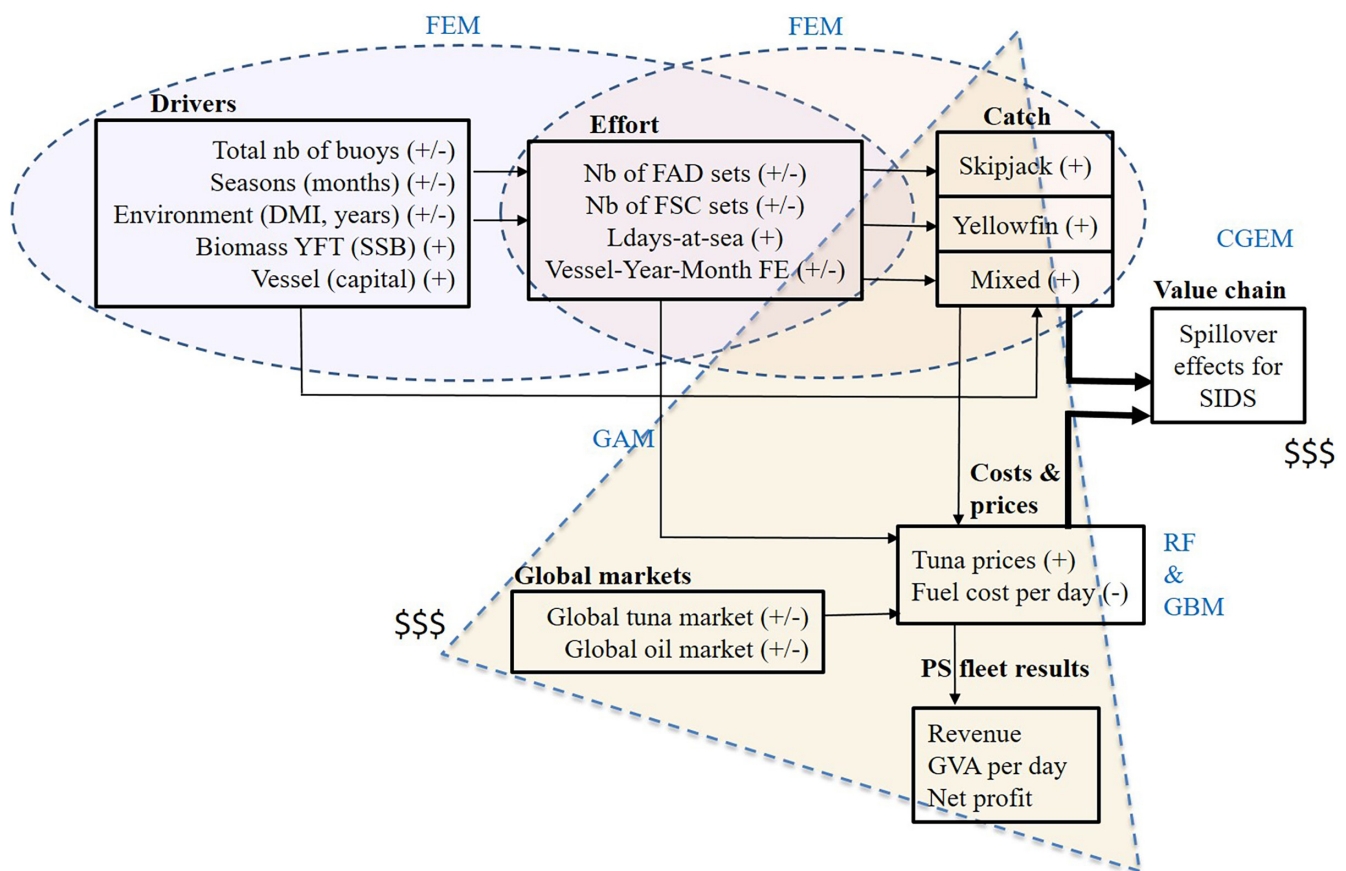

FIGURE 2 Three-step modelling approach. signs + and - indicate the expected causal effect of variables; FE, Fixed-effect models; GAM, General Additive Model; RF, Random Forest; GBM, Gradient Boosting Model.

of characteristics influencing the FAD/FSC sets: it includes the quarterly level of yellowfin spawning stock biomass (SSB), the dipole mode index (DMI), monthly effects, yearly effects and vessel effects. SKJ_t , YFT_t and MIX_t represent the catch quantity (logarithm of tonnes) of skipjack, yellowfin and mixed tunas. D_t reflects the logarithm of the number of days, and Z_t is a vector of characteristics influencing the SKJ, YFT and MIX catches: the DMI, monthly effects, yearly effects and vessel effects.

Finally, $\alpha, \beta, \beta', \gamma, \gamma', \varphi, \delta, \delta', \eta, \eta', \pi, \nu, \nu', \theta, \theta', \omega, \omega', \kappa, \sigma, \zeta, \zeta', \xi, \xi', \rho, \rho', \iota, \psi, \zeta, \zeta', \eta, \eta', \mu, \mu'$ and ϵ are the corresponding parameters to estimate and $\varepsilon_t, \omega_t, \theta_t, \phi_t$ and ζ_t are residual error terms (expected to be uncorrelated with the explanatory variables). Furthermore, the model was estimated with quasi-maximum likelihood estimation.

4.2 | Machine learning approach

A machine learning approach was developed to better understand the variability of purse-seine vessels' gross value added (GVA) per day with predictors issued from the full data set (Breiman, 2001). A classification and regression tree (CART) model helped to identify drivers predicting the level of GVA by fishing trip (R libraries *rpart* and *party*, Scikit-learn Python libraries *sklearn.tree* and *sklearn.linear_model*), sorted out by their relative importance in the result. The accuracy of the model was improved by a random forest (RF) algorithm growing the number of trees to stabilize the influence of variables (R library *randomForest* and Python library *sklearn.ensemble.RandomForestRegressor*), and corrected by a gradient boosting regression tree approach to learning from each preceding tree in the forest. Both linear and machine learning models' outputs could then be used to simulate various use rates of FADs and check whether the breakeven level of profit would be achieved or not.

5 | RESULTS

5.1 | FAD deployment, type of fishing effort and catch by species

The results of estimated models are introduced in Table 1. Models 1–5 describe both the relationship between capital and environmental conditions on the type of fishing effort (free school, FSC, and FAD sets) and the resulting causality with the catch level by tuna product. Models 6–10 estimate the same relationships after including vessel and time-fixed effects.

Although not very powerful, the first two models show the influence of buoy investment on the individual fishing strategy, as well as the abundance of yellowfin tuna, with the right expected signs. Greater availability of buoys and less abundant yellowfin tuna result in more FAD fishing, and vice versa. This influence is even stronger when seasonal effects are introduced (models 6 and 7), interestingly with quadratic term estimates of opposite signs

with regard to the first parameter. There would be a marginally decreasing use of FAD sets whenever the buoy equipment overcomes a certain threshold versus a marginally increasing effort on free school sets. However, environmental conditions disappear when time-fixed effects are introduced, probably because they are captured by the yearly and monthly fixed effects which may also include other characteristics (e.g. technical change, market conditions, etc.). From the estimates, we can compute the mean-centred elasticities of skipjack and mixed tuna catch to FAD sets which were 0.64 and 0.71, respectively, but the yellowfin tuna catch was found more sensitive to the free school sets (0.59), as found in Wolff et al. (2013). Conversely, small tuna (skipjack and mix) catches do not respond at all to free school sets.

From the models included in Table 1, it is possible to show an indirect and positive correlation, although weakly significant, between the aggregate number of buoys of the fleet and the catch per vessel per fishing trip. The catch level by species as a function of the number of buoys deployed by the French PS fleet is obtained from a structural model (Figure 3). These catch levels were obtained from the predicted values of FAD and FSC sets given by models 6 and 7, and from predicted catches of skipjack, yellowfin and mixed tunas obtained from models 8–10. The fitted values of catch were thereby related to the number of buoys by a smooth quadratic function with a confidence interval of 95%.

Overall, we observe that catch (hence profit) would significantly decrease by reducing the number of buoys at sea from 4500 to half of this number. Decreasing further the number of operational buoys at sea would reduce the catch of small tunas (skipjack and mixed tunas) but increase that of large yellowfin tuna if a full reallocation of effort on free schools is made possible by the national quota. Symmetrically when augmenting the number of buoys at sea, the catch of small tunas describes a marginally decreasing yield pattern resulting from the quadratic models 6, 8 and 10 in Table 1, showing that a reduction in the number of FADs would not affect too much the catch of skipjack and mixed tunas. In this trade-off between catching fewer small tunas on FADs and more yellowfin tuna on free schools, reducing the number of buoys from 4500 to 3000 (i.e. from 300 to 200 per vessel) would represent a 14% decrease of catches overall while minimizing the tonnage of yellowfin tuna harvested, which can be an option to restore the level of stocks for this vulnerable species.

5.2 | Converting catches into profits with a machine learning approach

Thirteen selected variables were introduced in a random forest model to explain the GVA per day on the basis of the model shown in Figure 2: catches on FSC and FOB per day, real prices of yellowfin tuna, skipjack, mixed tunas and marine diesel oil (in USD_2015 per tonne), the aggregate number of buoys, fuel consumption in tonnes per day, vessel length, DMI, SSB, landing month and year. The full sample was split into a training set for 70% of fishing trips (840 obs.) and 30% for the

TABLE 1 Results.

	(1)	(2)	(3)	(4)	(5)	(6)	(7)	(8)	(9)	(10)
	FAD	FSC	SKJ	YFT	MIX	FAD	FSC	SKJ	YFT	MIX
Lbuoytot	0.10*** (0.036)	-2.35*** (0.622)				5.07*** (1.287)	-5.58*** (1.536)			
Lbuoytot ²		0.13*** (0.036)				-0.25*** (0.075)	0.32*** (0.091)			
Lssb	-1.04** (0.458)	2.59*** (0.552)				1.29 (0.991)	0.95 (1.230)			
Dmi	0.00 (0.111)	0.08 (0.132)	0.10 (0.104)	-0.55*** (0.146)	-0.27*** (0.097)	0.26* (0.139)	0.04 (0.171)	-0.22* (0.121)	-0.43** (0.179)	0.01 (0.113)
Lsetfad			1.09*** (0.196)	-0.39*** (0.152)	1.18*** (0.169)			1.02*** (0.179)	-0.31** (0.152)	1.14*** (0.162)
Lsetfad ²				0.12*** (0.036)	-0.07* (0.038)			-0.08** (0.039)	0.11*** (0.036)	-0.09** (0.037)
Lsetfsc			-0.02 (0.025)	0.50*** (0.106)	-0.09*** (0.025)			-0.01 (0.027)	0.40*** (0.106)	-0.04 (0.027)
Lsetfsc ²				0.05 (0.033)					0.07** (0.033)	
Lday			-0.34*** (0.086)	1.85** (0.784)	-0.22*** (0.075)			-0.01 (0.098)	1.86* (0.780)	-0.12 (0.088)
Lday ²				-0.29** (0.128)					-0.30** (0.128)	
Constant	15.99** (6.584)	-23.92*** (7.753)	3.77*** (0.294)	1.17 (1.164)	2.74*** (0.264)	-39.25*** (14.810)	12.20 (18.537)	2.65*** (0.282)	1.57 (1.162)	2.17*** (0.313)
Fixed-effects										
Year						X	X	X	X	X
Month						X	X	X	X	X
Vessel						X	X	X	X	X
Cov		-0.23*** (0.031)					-0.10*** (0.025)			
Pseudo-R ²	0.03	0.08	0.39	0.29	0.45	0.23	0.26	0.47	0.34	0.50
Pseudo-likelihood			-10800.75	-14780.61	-10748.41			-1697.18	-5490.33	-1661.17
Observations			1217	1217	1217			1217	1217	1217

Note: Robust standard errors are in parentheses.

*** $p < 0.01$. ** $p < 0.05$. * $p < 0.1$.

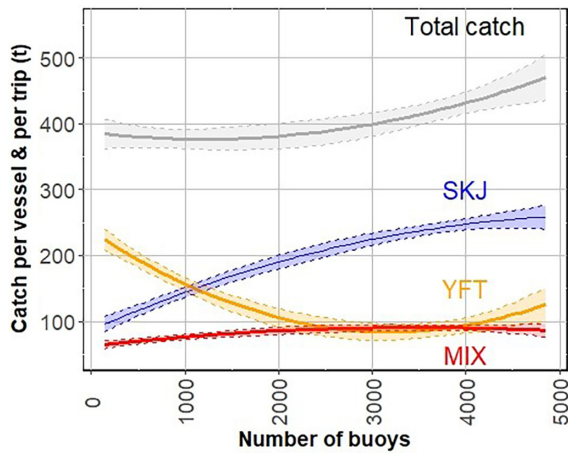

FIGURE 3 Predictions of catches by group of species as function of the total number of buoys deployed by the French PS fleet in the IO. Mean predicted catch from models (8, 9, and 10) as function of the reported number of buoys deployed by the French PS fleet (IOTC, 2022b). Because of shared buoys, the adjustment factor is approximately 18% of the number of buoys included in the data set. Shaded colours depict the 95% confidence intervals of fitted values.

test set (360 obs.). The accuracy rate (predicting capacity measured by the mean squared error of out-of-bag (OOB) trips, comparing observed and fitted values) on the training set was 93.1%, and 87.0% on the test set, which indicated a possible overfitting effect on the training sample. We used fivefold cross-validation (i.e. the full data set was divided into five sub-sets where each sub-set plays the role of test set alternatively, the four others represent the training sets; the accuracy rates are then averaged) to check the accuracy of the model, with a mean score of 66% with a certain sensitivity to the selected subsets. This is why we compared the results with a GBM approach, where each tree learns from previous ones. This approach narrows down the gap between training and test subsets (99.6% and 95.4% respectively) and improves the average validation score (88%). The GBM was marginally enhanced by reducing the maximum depth of trees and changing the learning rate from previous trees. We can accept this short lag, meaning that a few fishing trips belonging to one of the two sets are probably outliers which were difficult to predict whatever the model.

Both RF and GBM approaches estimated the variable importance (VI) in a similar way. The absolute importance of each of the 13 variables is measured by the permutation of the variable in the OOB sets. The percentage increase of mean squared errors by changing the position of variables is a good indicator of the VI (Breiman, 2001). Both RF and GBM gave more or less the same ranking order of variables: FSC catch (49.9% of variance), FOB catch (40.4%), YFT price (4.8%) and SKJ prices (1.8%). Other variables, including the number of buoys, year, seasonality, fuel consumption, etc. played a marginal role in the model. In other words, the gross profit per fishing day and per vessel depended to a great extent on the catch levels rather than unit values and variable costs. The R-package VSURF allowed us to estimate the marginal effects of each feature on the GVA per day variable (Figure 4).

GVA per day is mostly sensitive to catch quantity on free schools and FOBs, far beyond any other feature. Fifty tonnes per day in one or two sets provide nearly USD 100,000, which is far beyond the breakeven point between ~USD 30,000 and 35,000 per day. To a lesser extent, GVA relied on tuna prices, with positive profit margins whenever the yellowfin and skipjack prices are greater than USD 1700 and USD 1400 per tonne respectively. The total number of active buoys deployed at sea by the French PS fleet has also a positive influence on gross profits, but to a much lesser extent at about +2–3% when doubling the number of buoys from 10,000 to 20,000. The fuel consumption, despite the cost it may represent, would enhance profits beyond 13 tonnes per day through a more effective effort, especially on FADs. Seasonality (month), oil unit price and climate oscillations played a minor role in wealth creation, although positive dipole anomalies (warmer sea surface temperatures) would reduce the GVA per day by ~USD 250 by additional 0.25 points of DMI, other things being equal.

5.3 | Predictions under three scenarios of FAD management

Our hypothesis was to consider an economic trap behind FAD fishing, like the so-called ecological trap emphasized by some fishery scientists (Hallier & Gaertner, 2008): shipowners have little alternative but to keep fishing on floating objects to remain profitable.

Fixed effect and machine learning models were used to test this hypothesis through predicted values. Three scenarios were considered with respect to the various resolutions or amendment proposals about FAD management mentioned above. The first one relied on a 50% reduction of authorized operational FOB buoys for the fleet. The second scenario explored the impact of a 72-day closure of FAD fisheries (IOTC Res. 23-02). In this second scenario, the PS vessels would re-allocate the effort to free schools during the yearly FAD closure, providing that the yellowfin quota implemented annually since January 2017 is not exhausted. In the case where the yellowfin tuna quota would not be sufficient to keep on fishing during this closure period, a third scenario envisaged a full stop of vessels remaining idle at port for this 2.5-month period. The predicted economic results of the PS fleet are presented below.

5.3.1 | Scenario 1: 50% reduction of the total number of buoys

According to models 6 and 7 in Table 1, the average predicted number of FAD sets per trip is 35% lower and the average predicted number of FSC sets per trip is 36% higher with half the number of buoys. Reinjecting these changes of actual sets into catch–effort equations 8 to 10 would shift the average catch combination of SKJ–YFT–MIX from 193, 146 and 88 tonnes per trip to 150, 173 and 66 tonnes after halving the number of buoys, respectively. The first impact of the measure would, therefore, lie in lower yearly catches at the fleet level (–12%).

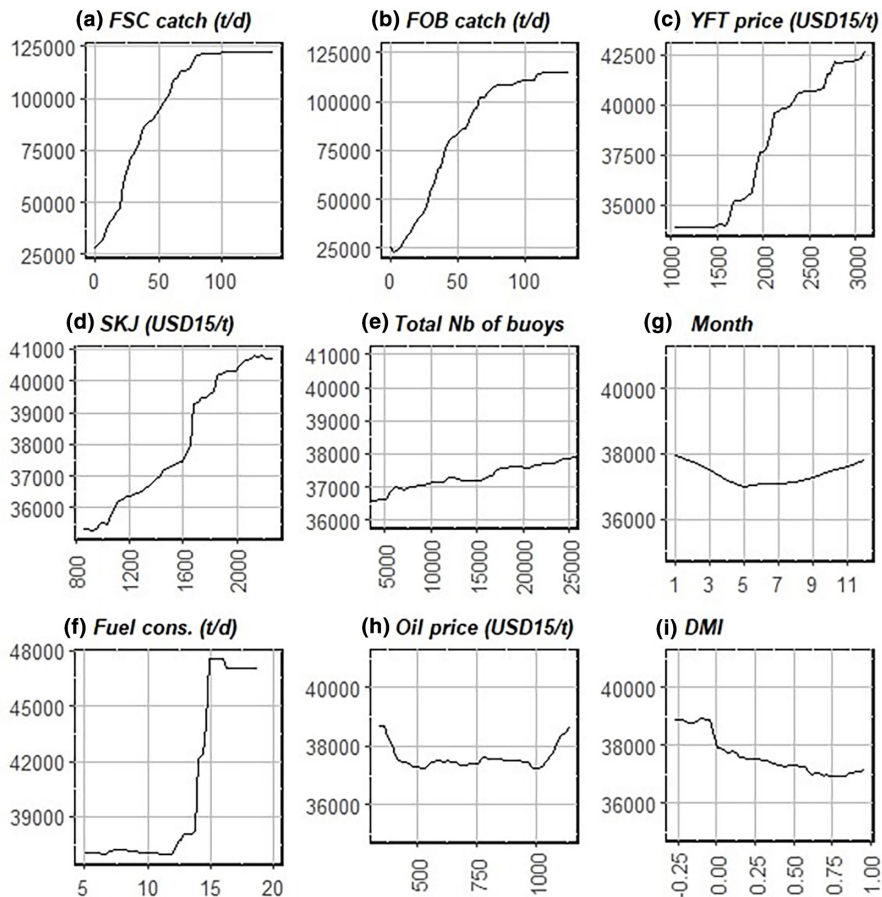

FIGURE 4 Marginal effects of nine variables on GVA per day (in USD_2015, y-axis): predicted values from a random forest (500 trees, max-depth=4, accuracy rate on test data set=0.87).

Other things being equal, this would represent a catch reduction of SKJ by 22% and of mixed tuna by 24%, while catches of large YFT would increase by 18% if the quota for this species is not exhausted. New catch levels on FADs and FSC were introduced in the random forest model for predictions of GVA per day explained by 13 selected variables displayed in Figure 2. With the respective average prices of species and variable costs per fishing day, this would result in 7.1% GVA loss per vessel. When aggregated to the whole French PS fleet over the year (for nine trips on average and 15 vessels), the GVA loss would amount to some USD 6.5 million per year and a net profit decreasing by USD 1.2 million when extrapolated to actual fleet costs and earnings of the French PS fleet operating in the Indian Ocean (STECF, 2022). However, if the yellowfin tuna quota was fully fished out and no re-allocation of effort towards FSC fishing was made possible, then the catch would decrease by 17.4%, the fleet GVA by USD 11M and the net profit by USD 1.7M.

5.3.2 | Scenario 2: 72-day ban of FAD fishing with transfer of effort to FSC

In the second scenario, vessels would not be authorized to seed and use FADs during a 72-day period starting from July 1st to mid-September. However, they could re-allocate their fishing effort to free schools during the FAD ban period, thus increasing the FSC catch (with larger yellowfin tuna) by 18% and decreasing the FAD catches by 24%. The consequences on the total yearly catch for the fleet are

approximately the same as in the previous scenario, i.e., -14%. The median GVA per day would fall from USD 24,117 per day per vessel to USD 21,780 (i.e. -9.7%), hence a USD 8.9M GVA loss and USD 1.6M decrease in net profits for the French PS fleet.

5.3.3 | Scenario 3: 72-day ban of FAD fishing with vessels staying at port

In the third scenario, vessels would stop fishing and remain idle at the port between July 1st and September 10th, not incurring the variable costs of fishing operations (crew, fuel expenditure, communications, etc.) but still paying fixed costs (financial charges, insurance, port dues, etc.). The main reason to immobilize vessels is to avoid the risk of fishing large yellowfin tuna on free schools beyond the authorized quota. The national quota is set at 29,500 tonnes for the whole fleet, i.e., less than 2000 tonnes per vessel. This quota can be rapidly exhausted during the high season of free school fishing, usually between November and February (Maufroy, 2016). Consequently, fishing companies would not perceive any revenue during 2 or 3 months in this scenario, although facing fixed costs. The impact on total fleet catch per year is stronger than those in previous scenarios (-19%). The GVA per day and per vessel would decrease from USD 24,117 to USD 19,732 (-18.2%). At the fleet level, this would represent a loss of USD 16.7M per annum, equivalent to a USD 3M reduction of net profits for the fleet.

A synthesis is proposed in Figure 5a comparing the outcomes of the three scenarios to the actual case in terms of GVA per day per vessel in constant USD of 2015. The third scenario represents the worst case in economic terms. The actual and predicted values of GVA being non-normally distributed, Wilcoxon and Kruskal–Wallis tests are performed and showed that median values are equivalent between the actual case and the first two scenarios ($p > 0.10$) but are different between the actual and third scenario ($p < 0.00005$). However, if the YFT quota was exhausted and no-reallocation was possible in scenario 1, then the median would also have differences between the actual and scenario 1.

When compared to the actual net profit margins in Figure 5b, we can realize how the French fleet could be severely affected by the FAD limitation measures. Sales value can be very close to total costs for some years. We have seen that revenues rely to a great extent on landings and a reduction between 12% and 19% may certainly jeopardize their activity. This was all the truer as the transfer of effort to free school fishing is bounded by the national quota of 29,500 tonnes of YFT. Catching around 2000 tonnes of yellowfin tuna per year and per vessel, there is just enough quota for 15 vessels. As a result, increasing by 18% the catch quantity of yellowfin, as observed in scenarios 1 and 2, is impossible under the yellowfin tuna quota limit.

6 | DISCUSSION

This study looked at the consequences of management measures restricting the use of FADs for the French industrial purse-seine fleet in the Indian Ocean. We showed a significant impact of an increasing number of buoys on the fishing strategy followed by purse seiners over the past decade, amplifying the fishing effort on FADs and reducing that on free schools, as revealed by previous studies (Maufroy, 2016; Torres-Irriego et al., 2014; Wain et al., 2021; Wolff et al., 2013). The catch composition changes towards smaller tunas (skipjack and juveniles of bigeye and yellowfin tuna) and fewer large individuals of the latter species (Dagorn et al., 2013; Escalle et al., 2019). In the IO, this strategic shift of effort and catch has been intensified after the implementation of the IOTC resolution setting a TAC on yellowfin tuna since January 2017, because skippers have avoided fishing thereafter too heavily on free schools, from which large yellowfin are harvested (IOTC Res. 16/01). Some unintended effects occurred with an increasing number of silky sharks caught accidentally by PS vessels, particularly in the northern area of the IO where tuna vessels were not used to fish with fewer active FADs at sea (Tolotti et al., 2022). Because of important social costs related to bycatch, stranding, ocean pollution, etc., FADs are under scrutiny by RFMOs, and many experts around the world advocate for a more stringent limitation of their use (Fonteneau et al., 2015; Lennert-Cody et al., 2018; Hanich et al., 2019; Gomez et al., 2020; Song & Shen, 2022).

In the Indian Ocean, FAD management measures have been implemented by IOTC since 2012, reducing gradually the number

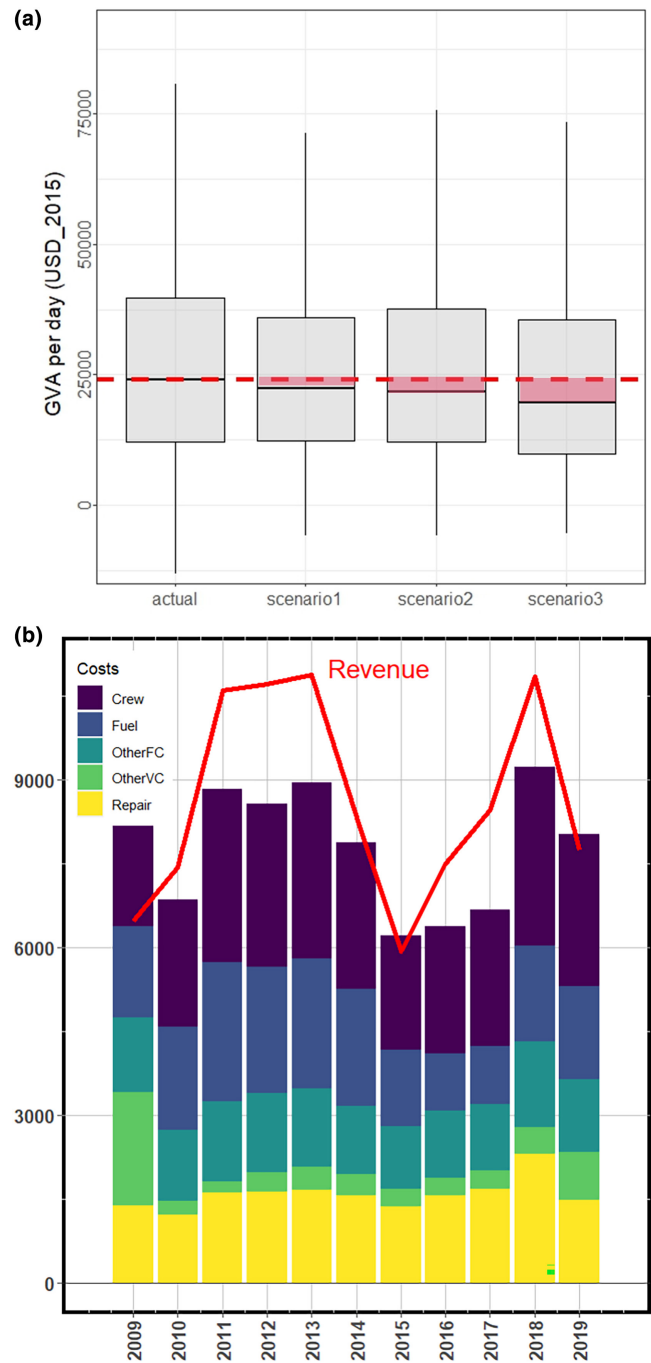

FIGURE 5 (a) GVA per day under three FAD limitation scenarios and (b) Actual revenues and costs per vessel in the French PS tuna fleet (in '000 USD). (a) dashed red line = USD 24,117, actual median value with no FAD limitation, the red rectangles = GVA loss w.r.t. actual case; (b) Actual STECF, 2022 data = average results of 18–22 vessels; red line = revenue; OtherVC = other variable costs, OtherFC = other fixed costs; Repair, repair & maintenance costs).

of authorized buoys per vessel (from 550 to 300 between 2015 and 2019, IOTC Res. 19/02), the latter helping to track remotely floating objects by GPS and echosounder transmission across the ocean, thus tremendously increasing FAD efficiency (Gaertner et al., 2018; Maufroy, 2016; Tidd et al., 2016; Wain et al., 2021). In June 2021, a group of coastal countries having an interest in

tuna fisheries suggested through an amendment to IOTC resolution 19/02 to further reduce the number of authorized buoys to 150 per vessel, which was approximately the number in use by the French fleet at the turn of the 2010s. In February 2023, the IOTC Commission voted on a new resolution creating a 72-day FAD use closure per year starting from July 2024 (IOTC Res. 23/02). Several countries, among which Seychelles, Philippines, Oman, Comoros, France, European Union, Tanzania, Mauritius, Thailand and Republic of Korea, objected to this resolution, claiming that this measure was not scientifically grounded and that several of the proposed management tools are not enforceable. More analysis is, therefore, needed to better understand the economic consequences of FAD use restrictions.

Our findings highlight some important economic consequences for the French PS fleet, supporting the hypothesis of an “economic trap” behind FAD fishing. Actually, there is little alternative for PS vessels because of the overfished situation in which the yellowfin tuna stock stands in the Indian Ocean (IOTC, accessed April 15th, 2023, <https://iotc.org/node/3379>). Due to the negative relationship between the number of FAD buoys in use and the effort on free schools, vessels cannot compensate for the resulting lower use of FADs by a more intensive effort on FSC, because they would be likely then to catch bigger quantities of large yellowfin tuna, far beyond their quota limit set by IOTC. Furthermore, there is also a positive relationship between the carrying capacity of vessels and the number of deployed floating objects (Davies et al., 2014). In the IO, the share of PS vessels longer than 80 m of LOA has increased from 15% in the early 2000s to 75% of the fleet in 2022, and the mean LOA has increased from 70 to 88 m within the same time frame, not even mentioning the increasing role of supply vessels in the deployment of FADs (IOTC, 2022b). The massive investment in larger vessels, fishing equipment and supply vessels, may well create economies of scale for the fleet but makes the fishery less sustainable and more vulnerable to stricter conservation management measures. Under all these aspects, PS vessels remain trapped between the greater efficiency of FAD fishing and the impossibility to re-allocate the fishing effort to free schools. Another question can immediately be raised after such an observation: would this ‘economic trap’ be permanent or not? Probably not if fishing companies accept to reduce their capacity and fishing effort on FADs until the status of vulnerable stocks (particularly yellowfin and bigeye tunas) has improved within safer biological limits. Such a reduction should also be achieved in conjunction with full compliance of all fleets, including artisanal ones, to other conservation measures applied to these stocks, like the TAC of yellowfin tuna (IOTC Res. 16/01 to which several CPCs have objected).

Some economic consequences must also be expected for small island economies (Seychelles, Mauritius, Comoros, etc.). Many studies have shown the importance of PS landings for local economies. Several pre-harvest and post-harvest industries create value added from the presence of domestic or foreign vessels through the revenues collected from fishing rights agreements, port dues,

bunkering and stevedoring operations, processing facilities, other port services, etc. (Bell et al., 2021; Robinson et al., 2010). The mere example of Seychelles illustrates the entanglement of interests between its coastal and offshore fleets (36 coastal longliners, 54 offshore longliners and 13 purse seiners were Seychelles-flagged in 2021, source www.sfa.sc), the reliance on fish exports (95% of merchandise exports are made up with canned tuna from the local cannery which is the main private employer of the archipelago with 2000 workers) (source: www.nbs.gov.sc). During the COVID-19 pandemic crisis, the volume of exports has even increased by 20%, and the value by nearly 40% between 2019 and 2020 (NBS Trade statistics, same source). The storage capacity of frozen tuna available for the canning plant does not allow to maintain the processing activity for too long in case of FAD fishing ban. According to the managers of the Thai Union factory in Seychelles, the cannery could shut down for a period between 2 and 6 weeks per year, causing a drop in sales between 4% and 12% (CEO of IOT Ltd, personal communication, May 2nd, 2023). The loss for the coastal economies would be even more important when considering the number of suspended port operations and other activities relying on the national landings of frozen tuna. The Seafood hub in Mauritius, located quite far away from the landing site of Seychelles, must also include a shipping delay that would even extend the shutdown of processing units to 130 days (pers. com. of an IBL Seafood manager, March 28th, 2023). The economic impact of FAD use restrictions has also been estimated for small island developing economies in the western and central Pacific Ocean. The 4 months of FAD closure would cost a 15% cut in fisheries revenue for one of them, Tokelau, where fishing rights fees reach 84% of the public revenue (Bell et al., 2021; Holmes et al., 2019). Finally, another economic effect created by the shortage of tuna during the summer period because of fishing bans in the three major oceans (West and East Pacific + Indian Oceans) would be a substantial increase of tuna prices, which is detrimental to consumer welfare around the world.

The estimated economic impact of FAD restrictions can also be usefully compared to other studies. Previous authors have estimated the impact of a 6-month FAD moratorium in the Atlantic and Indian Oceans, with a re-allocation of effort on free schools, thus increasing the proportion of large tunas. Overall, the moratorium resulted in a decrease in tuna catch of about 600–1800 tonnes per year and per boat (i.e. 12%–37% of yearly catch) in the IO, and a reduction of bycatch for all fishing groups (Escalle et al., 2017). By the proportion of catch decrease, our results (–12% to –19%) are consistent with these estimations. In the Pacific Ocean, a 4-month closure was also evaluated, resulting in a net loss of USD 250,000 per trip (Holmes et al., 2019). Our estimation would fetch a bit lower for a 3-month closure, ~USD 200,000, which seems again fairly consistent.

Holmes et al. (2019) considered many advantages of replacing the FAD closure by a FAD set limit scheme, such as creating incentives for fishing operators to change their fishing strategy and stabilizing market prices while increasing the value of access fees for coastal nations, just like the VDS regime did. Another study

suggested also that incentives could be created through tradeable FAD sets in a Coasean market, just like other authors did when estimating the effects of FAD removal on catches of bigeye and skipjack (Ovando et al., 2021). The authors reported a too high opportunity cost of lowering skipjack catches to achieve maximum sustainable yield for bigeye tuna. The required two-third cut in the number of FADs would result in a net loss of US\$ 3.3 billion for skipjack revenues which is not offset by the additional net present revenues of adult Bigeye catch by longliners (US\$ 1.9 billion only), not even mentioning the distributional aspects of this trade-off, i.e., increasing welfare for Japanese consumers but decreasing surplus for the WCPO small island developing states (SIDS). Only limited FAD removals (~15%) could produce benefits exceeding costs (Ovando et al., 2021). Obviously, transaction costs can be high for these markets of tradeable fishing rights which should not be considered a panacea for FAD reduction schemes.

These case studies show how thorny FAD management can be, although a scientific consensus exists about the excessive use of drifting FADs in tuna fisheries (Fonteneau et al., 2015; Gomez et al., 2020; Hanich et al., 2019; Lennert-Cody et al., 2018; Maufroy et al., 2017). However, the entanglement of interests with coastal states (employment in processing plants, income from fishing agreements) and with other conservation measures (e.g. yellowfin tuna TAC) demonstrate that the devil is in the details. In the IO, a restriction on FAD fishing had yet to be experimented through a time–area closure in November 2011 (IOTC Res. 10/1), with mixed results in reducing total annual catches of bigeye and yellowfin on FADs by less than 3% compared to a reference period (Davies et al., 2014). The question of an optimal number of FADs in the ocean remains an open question but should be considered on both ecological and economic grounds. In that respect, more scientific work needs to be done in order to search for fair and effective management of FADs. A fair and scientific analysis must also compare the economic loss of DWFN fleets shown in this study with other countries and fleets that could make a profit out of a seasonal closure of FADs, such as the Pole and Line fleet in the Maldives, the longline and gillnet fleets of northern coastal countries (Indonesia, India, Iran, ...), not even mentioning the environmental benefits in terms of enhanced ecosystem services (avoided costs of bycatch, pollution at sea, beach clean-up programs, etc.). Such research work of cost–benefit valuation still needs to be undertaken at a larger scale.

7 | CONCLUSION

This study evaluates the consequences of several FAD management measures on the economic performance of the French PS fleet in the Indian Ocean. It suggests that there is an economic trap of FAD fishing because of far greater efficiency compared to free school sets and because of binding constraints coming from other conservation measures such as the TAC on yellowfin tuna. On the basis of fixed-effect models and a machine learning approach (random forest

and gradient boosting models), we first demonstrated the relationship between the aggregate number of deployed buoys and the increasing FAD fishing strategy. The main outcome lies in a greater proportion of skipjack and small tuna caught by PS vessels. Despite lower unit prices, fishing smaller tunas on FADs is rewarded with the greater efficiency and higher profits.

We built three scenarios of possible FAD management measures in the Indian Ocean: a half reduction in the number of authorized buoys for the fleet with no YFT quota limitation, a yearly 72-day FAD fishing ban with re-allocation of effort on free schools and without such effort transfer, the vessels staying at port during 2.5 months every year. The incurred profit loss would be -7.1%, -9.7% and -18.2% respectively. The economic consequences could also be detrimental to coastal states relying on tuna landings (e.g. the Seychelles and Mauritius economies may be heavily affected). Despite the consensus about the excessive use of FADs, more scientific knowledge is required to support the RFMO decision-making process before implementing any stringent regulation that might produce economic damages for both distant fleets and coastal states. Some authors suggested to replace FAD closures by FAD set limits, which could effectively reduce the fishing effort on FADs and avoid unintended consequences for other species and for some tuna fishery-dependent economies.

ACKNOWLEDGEMENTS

We acknowledge *France Filière Pêche (FFP)* which has funded the MANFAD project of which this research is carried out. We express our sincere thanks to ORTHONGEL for making their FAD tracking data available and to the IRD's Ob7 ("*Observatoire des Ecosystèmes Pélagiques Tropicaux Exploités*") in charge of data collection, processing, management and for sharing the data used in this study. The authors also thank ISSF for its involvement in the overall project. Finally, we are grateful for the helpful comments of Quentin Hanich, another reviewer and the editors, on the first draft of the manuscript.

CONFLICT OF INTEREST STATEMENT

The authors declare that they have no known competing financial interests or personal relationships that could have appeared to influence the work reported in this paper.

DATA AVAILABILITY STATEMENT

The data are only available under reasonable request due to confidentiality agreements between IRD and the industry.

ORCID

P. Guillotreau  <https://orcid.org/0000-0002-3083-1230>

A. Dupaix  <https://orcid.org/0000-0001-9925-5756>

REFERENCES

- Baidai, Y., Dagorn, L., Capello, M., Guillotreau, P., & Lemeur, P.-Y. (2022). Les dispositifs de concentration de poissons dans la zone de convention de la COMHAFAT, Final Report IRD-COMHAFAT. 138 p.

- Basurko, O. C., Gabiña, G., Lopez, J., Granado, I., Murua, H., Fernandes, J. A., Krug, I., Ruiz, J., & Uriondo, Z. (2022). Fuel consumption of free-swimming school versus FAD strategies in tropical tuna purse seine fishing. *Fisheries Research*, 245, 106139. <https://doi.org/10.1016/j.fishres.2021.106139>
- Bell, J. D., Senina, I., Adams, T., Aumont, O., Calmettes, B., Clark, S., Dessert, M., Gehlen, M., Gorgues, T., Hampton, J., Hanich, Q., Harden-Davies, H., Hare, S. R., Holmes, G., Lehodey, P., Lengaigne, M., Mansfield, W., Menkes, C., Nicol, S., ... Williams, P. (2021). Pathways to sustaining tuna-dependent Pacific Island economies during climate change. *Nature Sustainability*, 4(10), 900–910. <https://doi.org/10.1038/s41893-021-00745-z>
- Berkenhagen, J., Döring, R., Kraak, S. B., & Stransky, C. (2021). Scientific, Technical and Economic Committee for Fisheries (STECF): The 2021 Annual Economic Report on the EU Fishing Fleet (STECF 21-08). Retrieved from <https://policycommons.net/artifacts/2089767/scientific-technical-and-economic-committee-for-fisheries-stecf/2845065/> on 06 Oct 2023. CID: 20.500.12592/vtv19s.
- Breiman, L. (2001). Random forests. *Machine Learning*, 45, 5–32. <https://doi.org/10.1023/A:1010933404324>
- Chassot, E., Antoine, S., Guillotreau, P., Lucas, J., Assan, C., Marguerite, M., & Bodin, N. (2021). Fuel consumption and air emissions in one of the world's largest commercial fisheries. *Environmental Pollution*, 273, 116454. <https://doi.org/10.1016/j.envpol.2021.116454>
- Chassot, E., Dubroca, L., Delgado de Molina, A., Assan, C., Soto, M., Floch, L., & Fonteneau, A. (2012). Decomposing purse seine CPUEs to estimate an abundance index for yellowfin free-swimming schools in the Indian Ocean during 1981–2011. IOTC-2012-WPTT14-33.
- Churchill, R. (2021). Just a harmless fishing FAD—Or does the use of FADs contravene international marine pollution law? *Ocean Development & International Law*, 52(2), 169–192. <https://doi.org/10.1080/00908320.2021.1901342>
- Dagorn, L., Holland, K. N., Restrepo, V., & Moreno, G. (2013). Is it good or bad to fish with FADs? What are the real impacts of the use of drifting FADs on pelagic marine ecosystems? *Fish and Fisheries*, 14(3), 391–415. <https://doi.org/10.1111/j.1467-2979.2012.00478.x>
- Davies, T. K., Mees, C. C., & Milner-Gulland, E. J. (2014). The past, present and future use of drifting fish aggregating devices (FADs) in the Indian Ocean. *Marine Policy*, 45, 163–170. <https://doi.org/10.1016/j.marpol.2013.12.014>
- Escalle, L., Gaertner, D., Chavance, P., Delgado de Molina, A., Ariz, J., & Mérigot, B. (2017). Forecasted consequences of simulated FAD moratoria in the Atlantic and Indian oceans on catches and bycatches. *ICES Journal of Marine Science*, 74(3), 780–792. <https://doi.org/10.1093/icesjms/fsw187>
- Escalle, L., Gaertner, D., Chavance, P., Murua, H., Simier, M., Pascual-Alayón, P. J., Ménard, F., Ruiz, J., Abascal, F., & Mérigot, B. (2019). Catch and bycatch captured by tropical tuna purse-seine fishery in whale and whale shark associated sets: Comparison with free school and FAD sets. *Biodiversity and Conservation*, 28(2), 467–499. <https://doi.org/10.1007/s10531-018-1672-1>
- FAO. (2022). The state of world fisheries and aquaculture (SOFIA), Rome. www.fao.org/publications
- Fonteneau, A., Chassot, E., & Bodin, N. (2013). Global spatio-temporal patterns in tropical tuna purse seine fisheries on drifting fish aggregating devices (dFADs): Taking a historical perspective to inform current challenges. *Aquatic Living Resources*, 26, 37–48. <https://doi.org/10.1051/alr/2013046>
- Fonteneau, A., Chassot, E., & Gaertner, D. (2015). Managing tropical tuna PS fisheries through limiting the number of dFADs in the Atlantic: Food for thought. *Collective Volume of Scientific Papers ICCAT*, 71(1), 460–475.
- Fonteneau, A., & Hallier, J. (1993). La pesca del atun bajo objetos flotantes. *Mundo Científico*, 131, 76–77.
- Fonteneau, A., Pallares, P., Sibert, J., & Suzuki, Z. (2002). The effect of tuna fisheries on tuna resources and offshore pelagic ecosystems. *Ocean Yearbook Online*, 16(1), 142–170. <https://doi.org/10.1163/221160002X00141>
- Gaertner, D., Ariz, J., Bez, N., Clermidy, S., Moreno, G., & Murua, H. (2018). Results achieved within the framework of the EU research project: Catch, effort, and eCOsystem impacts of FAD-fishing (CECOFAD). *Collective Volume of Scientific Papers ICCAT*, 74(5), 2243–2267.
- Gomez, G., Farquhar, S., Bell, H., Laschever, E., & Hall, S. (2020). The IUU nature of FADs: Implications for tuna management and markets. *Coastal Management*, 48(6), 534–558. <https://doi.org/10.1080/08920753.2020.1845585>
- Guillotreau, P., Salladarré, F., Dewals, P., & Dagorn, L. (2011). Fishing tuna around fish aggregating devices (FADs) vs free swimming schools: Skipper decision and other determining factors. *Fisheries Research*, 109(2–3), 234–242. <https://doi.org/10.1016/j.fishres.2011.02.007>
- Hallier, J. P., & Gaertner, D. (2008). Drifting fish aggregation devices could act as an ecological trap for tropical tuna species. *Marine Ecology Progress Series*, 353, 255–264. <https://doi.org/10.3354/meps07180>
- Hamjan, D. F., & Mallawa, A. (2020). Performance analysis of purse seine with FADs and without FADs at Lappa fishing port, Sinjai regency. *International Journal of Environment, Agriculture and Biotechnology*, 5(5), 1362–1371.
- Hanich, Q. (2012). Distributing the bigeye conservation burden in the western and central pacific fisheries. *Marine Policy*, 36(2), 327–332. <https://doi.org/10.1016/j.marpol.2011.07.008>
- Hanich, Q., Davis, R., Holmes, G., Amidjogbe, E. R., & Campbell, B. (2019). Drifting fish aggregating devices (FADs): Deploying, soaking and setting—when is a FAD ‘fishing’? *The International Journal of Marine and Coastal Law*, 34(4), 731–754. <https://doi.org/10.1163/15718085-23441103>
- Holmes, G., Hanich, Q., & Soboil, M. (2019). Economic benefits of FAD set limits throughout the supply chain. *Marine Policy*, 103, 1–8. <https://doi.org/10.1016/j.marpol.2019.02.006>
- IOTC. (2022a). Review of data on drifting fish aggregating devices [IOTC ad hoc working group on FADs (WGFAD)]. Indian Ocean Tuna Commission.
- IOTC. (2022b). Indicators and dashboard for monitoring FAD fishing, IOTC Secretariat, IOTC-2022-WGFAD03.
- Katara, I., Gaertner, D., Maufroy, A., & Chassot, E. (2016). Standardization of catch rates for the eastern tropical Atlantic bigeye tuna caught by the French purse seine DFAD fishery. *Collective Volume of Scientific Papers ICCAT*, 72, 406–414.
- Leadbitter, D., & Benguerel, R. (2014). Sustainable tuna – Can the marketplace improve fishery management? *Business Strategy and the Environment*, 23(6), 417–432. <https://doi.org/10.1002/bse.1794>
- Lennert-Cody, C. E., Moreno, G., Restrepo, V., Román, M. H., & Maunder, M. N. (2018). Recent purse-seine FAD fishing strategies in the eastern Pacific Ocean: What is the appropriate number of FADs at sea? *ICES Journal of Marine Science*, 75(5), 1748–1757. <https://doi.org/10.1093/icesjms/fsy046>
- Lopez, J., Moreno, G., Sancristobal, I., & Murua, J. (2014). Evolution and current state of the technology of echo-sounder buoys used by Spanish tropical tuna purse seiners in the Atlantic, Indian and Pacific Oceans. *Fisheries Research*, 155, 127–137. <https://doi.org/10.1016/j.fishres.2014.02.033>
- Marsac, F., Fonteneau, A., & Ménard, F. (2000). Drifting FADs used in tuna fisheries: An ecological trap? *Pêche thonière et Dispositifs de Concentration de Poissons, Caribbean-Martinique*, 15–19 Oct 1999.
- Maufroy, A. (2016). Drifting fish aggregating devices of the Atlantic and Indian oceans: Modalities of use, fishing efficiency and potential management. Animal biology. PhD Thesis, University of Montpellier, NNT: 2016MONTT150, 181 p.
- Maufroy, A., Gaertner, D., Kaplan, D. M., Bez, N., Soto, M., Assan, C., Lucas, J., & Chassot, E. (2015). Evaluating the efficacy of tropical tuna purse seiners in the Indian Ocean: First steps towards a measure of fishing effort. IOTC-2015-WPTT17-14 Rev 1, 18p.

- Maufroy, A., Kaplan, D. M., Bez, N., De Molina, A. D., Murua, H., Floch, L., & Chassot, E. (2017). Massive increase in the use of drifting fish aggregating devices (dFADs) by tropical tuna purse seine fisheries in the Atlantic and Indian oceans. *ICES Journal of Marine Science*, 74(1), 215–225. <https://doi.org/10.1093/icesjms/fsw175>
- McKinney, R., Gibbon, J., Wozniak, E., & Galland, G. (2020). Netting billions 2020: A global tuna valuation. <https://digitalcommons.fiu.edu>
- Ovando, D., Libecap, G. D., Millage, K. D., & Thomas, L. (2021). Coasean approaches to address overfishing: Bigeye tuna conservation in the Western and Central Pacific Ocean. *Marine Resource Economics*, 36(1), 91–109.
- Parker, R. W., Vázquez-Rowe, I., & Tyedmers, P. H. (2015). Fuel performance and carbon footprint of the global purse seine tuna fleet. *Journal of Cleaner Production*, 103, 517–524. <https://doi.org/10.1016/j.jclepro.2014.05.017>
- Robinson, J., Guillotreau, P., Jiménez-Toribio, R., Lantz, F., Nadzon, L., Dorizo, J., Gerry, C., & Marsac, F. (2010). Impacts of climate variability on the tuna economy of Seychelles. *Climate Research*, 43(3), 149–162. <https://doi.org/10.3354/cr00890>
- Saji, N. H., Goswami, B. N., Vinayachandran, P. N., & Yamagata, T. (1999). A dipole mode in the tropical Indian Ocean. *Nature*, 401(6751), 360–363. <https://doi.org/10.1038/43854>
- Song, L., & Shen, H. (2022). An integrated scheme for the management of drifting fish aggregating devices in tuna purse seine fisheries. *Fisheries Management and Ecology*, 30, 56–69. <https://doi.org/10.1111/fme.12600>
- Squires, D., & Kirkley, J. (1999). Skipper skill and panel data in fishing industries. *Canadian Journal of Fisheries and Aquatic Sciences*, 56(11), 2011–2018. <https://doi.org/10.1139/f99-135>
- STECF. (2022). In R. Pallezo, E. Sabatella, J. Virtanen, & J. Guillen (Eds.), *The 2022 annual economic report on the EU fishing Fleet (scientific, technical and economic Committee for Fisheries – STECF 22-06)* (Vol. 2022). Publications Office of the European Union. <https://doi.org/10.2760/120462>, JRC130578.
- Tidd, A. N., Reid, C., Pilling, G. M., & Harley, S. J. (2016). Estimating productivity, technical and efficiency changes in the Western Pacific purse-seine fleets. *ICES Journal of Marine Science*, 73(4), 1226–1234. <https://doi.org/10.1093/icesjms/fsv262>
- Tolotti, M., Guillotreau, P., Forget, F., Capello, M., & Dagorn, L. (2022). Unintended effects of single-species fisheries management. *Environment, Development and Sustainability*, 25, 9227–9250. <https://doi.org/10.1007/s10668-022-02432-1>
- Torres-Irineo, E., Gaertner, D., Chassot, E., & Dreyfus-León, M. (2014). Changes in fishing power and fishing strategies driven by new technologies: The case of tropical tuna purse seiners in the eastern Atlantic Ocean. *Fisheries Research*, 155, 10–19. <https://doi.org/10.1016/j.fishres.2014.02.017>
- Wain, G., Guéry, L., Kaplan, D. M., & Gaertner, D. (2021). Quantifying the increase in fishing efficiency due to the use of drifting FADs equipped with echosounders in tropical tuna purse seine fisheries. *ICES Journal of Marine Science*, 78(1), 235–245. <https://doi.org/10.1093/icesjms/fsaa216>
- Wolff, F. C., Squires, D., & Guillotreau, P. (2013). The firm's management in production: Management, firm, and time effects in an Indian Ocean tuna fishery. *American Journal of Agricultural Economics*, 95(3), 547–567. <https://doi.org/10.1093/ajae/aas140>

How to cite this article: Guillotreau, P., Salladarré, F., Capello, M., Dupaix, A., Floch, L., Tidd, A., Tolotti, M., & Dagorn, L. (2023). Is FAD fishing an economic trap? Effects of seasonal closures and other management measures on a purse-seine tuna fleet. *Fish and Fisheries*, 00, 1–17. <https://doi.org/10.1111/faf.12799>