



**HAL**  
open science

# Toward a cleaner mobility : Developing Charging Infrastructure for Electric Vehicle Transition

Marc-Olivier Metais

► **To cite this version:**

Marc-Olivier Metais. Toward a cleaner mobility : Developing Charging Infrastructure for Electric Vehicle Transition. Other. Université Paris Saclay, 2023. English. NNT: . tel-04325900

**HAL Id: tel-04325900**

**<https://hal.science/tel-04325900>**

Submitted on 6 Dec 2023

**HAL** is a multi-disciplinary open access archive for the deposit and dissemination of scientific research documents, whether they are published or not. The documents may come from teaching and research institutions in France or abroad, or from public or private research centers.

L'archive ouverte pluridisciplinaire **HAL**, est destinée au dépôt et à la diffusion de documents scientifiques de niveau recherche, publiés ou non, émanant des établissements d'enseignement et de recherche français ou étrangers, des laboratoires publics ou privés.

# Toward a cleaner mobility : Developing Charging Infrastructure for Electric Vehicle Transition

*Vers une mobilité plus propre : développer une infrastructure de recharge  
pour véhicules électriques*

## Thèse de doctorat de l'université Paris-Saclay

École doctorale n°573 : interfaces : matériaux, systèmes, usages (INTERFACES)  
Spécialité de doctorat : Génie Industriel  
Graduate School : Sciences de l'ingénierie et des systèmes. Référent : CentraleSupélec

Thèse préparée dans l'unité de recherche Laboratoire de Génie Industriel  
(CentraleSupélec, Université Paris Saclay), sous la direction de **Oualid JOUINI**,  
Professeur à CentraleSupélec, la co-direction de **Yannick PEREZ**, Professeur à  
CentraleSupélec, et la supervision de **Jaafar BERRADA**, Directeur de domaine (Institut  
Vedecom) et de **Emilia SUOMALAINEN**, Chargée de recherche (Syke)

Thèse soutenue à Paris-Saclay, le 31 mars 2023, par

**Marc-Olivier METAIS**

## Composition du Jury

Membres du jury avec voix délibérative

<b>Marija JANKOVIC</b> Professeure, CentraleSupélec	Présidente
<b>Fabrice CHAUVET</b> Chef de programme, Dr.(HDR), Enedis	Rapporteur & Examineur
<b>Mahdi ZARGAYOUNA</b> Professeur, Université Gustave Eiffel	Rapporteur & Examineur
<b>Hans AUER</b> Professeur, TU Wien	Examineur
<b>Willett KEMPTON</b> Professeur, University of Delaware	Examineur
<b>Olivier MASSOL</b> Professeur, IFP School	Examineur





**Titre :** Vers une mobilité plus propre : développer une infrastructure de recharge pour véhicules électriques

**Mots clés :** Véhicule électrique, infrastructure de charge, électromobilité, optimisation, économie

**Résumé :** L'adoption à grande échelle de la mobilité électrique nécessitera une infrastructure de charge répondant aux nouveaux besoins émanant de ce défi. Actuellement, les infrastructures de recharge pour véhicules électriques sont encore au début de leur développement, notamment à cause du faible nombre de véhicules électriques. Les pouvoirs publics prévoient ainsi un investissement massif dans la filière de la mobilité électrique. Néanmoins, de nombreuses questions se posent quant au dimensionnement et à l'optimisation de ces infrastructures, à la fois du point de vue opérationnel et économique. Bien que cette optimisation ait fait l'objet de nombreuses études durant ces dix dernières années, des lacunes persistent, notamment en ce qui concerne le panachage de différentes solutions de recharge (normale, accélérée, rapide, piste à induction...) ainsi que sur les aspects économiques et opérationnels. De plus, le rapport de l'utilisateur à la voiture particulière est en forte évolution, et les comportements de recharge des utilisateurs ne sont pas encore bien établis.

Cette thèse vise à embrasser l'ensemble de ces considérations, pour contribuer au développement d'un outil d'aide à la décision pour les acteurs de la mobilité électrique afin d'optimiser le déploiement de cette nouvelle infrastructure de charge,

qui se devra d'être adaptée aux besoins d'utilisateurs habitués à la facilité d'utilisation et de ravitaillement du véhicule thermique individuel. Elle présente une nouvelle méthode permettant d'évaluer, principalement pour des charges à destination, l'intérêt de déployer des stations à certains endroits, ainsi que de choisir celles qui seront les plus adéquates pour ces emplacements. Cette méthode de déploiement d'infrastructure s'appuie sur une approche multicritères basée sur des données de déplacement des conducteurs. Le but est de permettre un déploiement des stations à grande échelle, coordonné et en adéquation avec les besoins des conducteurs, tout en intégrant les contraintes d'installation et d'exploitation auxquelles font face les opérateurs de ces stations

Les principaux résultats montrent que le déploiement des stations de charge lentes est prioritaire, de même que l'accès à une solution de charge résidentielle pour un maximum d'utilisateurs. Les stations de charge plus rapides, bien qu'ayant une vraie valeur assurantielle pour les utilisateurs craignant d'être à court de batterie avant de pouvoir se charger, ont surtout une utilité réelle pour des cas bien spécifiques tels que les longs trajets.

**Title :** Toward a cleaner mobility: Developing Charging Infrastructure for Electric Vehicle Transition

**Keywords :** Electric vehicle, charging infrastructure, electromobility, optimization, economics

**Abstract :** The widespread adoption of electric mobility will require a charging infrastructure that meets the new needs arising from this challenge. Currently, charging infrastructure for electric vehicles is still in the early stages of development, mainly due to the low number of electric vehicles. The public authorities are therefore planning a massive investment in the electric mobility sector.

Nevertheless, many questions arise regarding the dimensioning and optimization of these infrastructures, both from an operational and economic point of view. Although this optimization has been the subject of numerous studies over the past ten years, there are still gaps, particularly with regard to the mix of different charging solutions (normal, accelerated, fast, induction track, etc.) as well as on the economic and operational aspects. Moreover, the relationship between the user and the private car is strongly evolving, and the charging behavior of the users is not yet well established.

This thesis aims at covering all these considerations, in order to contribute to the development of a decision support tool for the actors of electric

mobility in order to optimize the deployment of this new charging infrastructure, which will have to be adapted to the needs of users used to the ease of use and patterns of refueling of individual internal combustion engine vehicles.

It presents a new method to evaluate, mainly for "at destination" charging, the interest in deploying charging stations at certain locations, as well as to choose the most suitable ones for these locations. This infrastructure deployment method is based on a multi-criteria approach based on driver travel data. The aim is to enable large-scale, coordinated deployment of stations in line with drivers' needs while integrating the installation and operational constraints the station operators face.

The main results of this thesis show that the deployment of slow charging stations is a priority, as is access to a residential charging solution for a maximum number of users. Faster charging stations, while having a real value to decrease users' range anxiety, have actual usefulness for very specific cases such as long journeys.



# Acknowledgements

First of all, I'd like to address a huge thank you to my two thesis supervisors, Oualid Jouini and Yannick Perez, who have supported and accompanied me in the best possible way over these three years. Their encouragement, confidence, and advice were essential for my first step into the great world of research.

I would also like to extend my heartfelt thanks to my supervisors at the Vedecom Institute, Emilia Suomalainen, who started this project with me, and Jaafar Berrada, who advised me throughout the long process right up to the end, and with whom I am delighted to continue working today.

A huge thank you also to the members of the jury for accepting the invitation, for reading my thesis, for discussing its content with me and for giving me relevant feedback: Marija Jankovic, Fabrice Chauvet, Mahdi Zargayouna, Hans Auer, Willett Kempton and Olivier Massol. I experienced my defense as a real dialogue with you, which made it a very pleasant moment, thanks to you.

Of course, this thesis would not have been the same without the people I met along the way at LGI. I'm thinking in particular of Bassem, Icaro, Emma, Yasmine, Tjark, Gustavo, Mariana, Francisco, Emilien, Rémi, Fawaz, Camille, Benoît, Julien, Robin, Joseph, Diego, Michele, Ghada, Alejandro, Delphine, the *Gens de la Côte*, and all the others, PhD students or not, whom I haven't mentioned in this already long list and with whom I've had the pleasure of sharing good times. Still on the LGI side, a special thank you to Tarek for the months of work he saved me thanks to his invaluable help. I've also met some great people at Vedecom, and I'd like to thank Ludo, Nadim, Paul, Salim, Ali, Joao, Valentin, Quentin, Benoît, Ilango, Guy, Nihed and the whole D3 team for all the great times we've had together. Many of these people are no longer just colleagues, but true friends today.

I'm also very lucky to have a family who have always been there for me, and without whom I wouldn't have got this far today. Dad, Mum, Hermance, Victor, I can't thank you enough for all your support and love over the years.

And finally, a very special thank you to my love Elsa, who has been by my side since the very start of this adventure, and that's only the beginning.





# Contents

<b>1 Introduction</b>	<b>1</b>
1.1 Overview	1
1.1.1 Climate change and mobility	1
1.1.2 Electric vehicles	3
1.1.3 Electric Vehicles as a solution to more sustainable mobility	4
1.1.4 Barriers to massive EV adoption	5
1.1.5 Charging infrastructure	6
1.1.6 Charging infrastructure and economic issues	7
1.2 Contributions of this dissertation	8
1.2.1 Too much or not enough? Planning electric vehicle charging infrastructure: A review of modeling options	9
1.2.2 From user to operator: Rationalizing the charging infrastructure deployment.	9
1.2.3 Tenerife's Infrastructure Plan for Electromobility: A MATSim Evaluation	9
<b>2 Too much or not enough? Planning electric vehicle charging infrastructure: A review of modeling options</b>	<b>11</b>
2.1 Introduction	13
2.2 Background on charging infrastructure and the allied issues	15
2.2.1 Technical overview of charging devices	16
2.2.2 Charging infrastructure and EV acceptance	17
2.2.3 Economical issues	19
2.2.4 Power grid issues	20
2.2.5 Summary	21
2.3 Overview and scope of planning simulation models	22
2.3.1 Users and charging infrastructure utilization	23
2.3.2 Optimization goals	24
2.3.3 Sizing charging infrastructure	25

2.4	Location methods	27
2.4.1	Node-based approach	29
2.4.2	Path-based approach	34
2.4.3	Tour-based approach	37
2.4.4	Discussion	41
2.5	Conclusion	44
<b>3</b>	<b>From user to operator: Rationalizing the charging infrastructure deployment</b>	<b>47</b>
3.1	Introduction & literature review	48
3.2	Model formulation	54
3.2.1	Method overview	54
3.2.2	Score calculation	56
3.2.3	Optimization model	65
3.3	Case study: a MATSim simulation of Berlin	66
3.3.1	Simulation model (based on the MATSim OpenBerlin scenario)	67
3.3.2	Observations and lessons learned from results	72
3.4	Conclusion	88
<b>4</b>	<b>Tenerife's infrastructure plan for electromobility: a MATSim evaluation</b>	<b>91</b>
4.1	Introduction	92
4.2	Analysis of EVs potential in Tenerife	94
4.2.1	Case study	95
4.2.2	Impact of transport electrification on electricity generation	96
4.2.3	Analysis of the strategies and policies on EVs of the Canary Islands	
	Government	99
4.3	Software preparation	102
4.3.1	MATSim Fundamentals	102
4.3.2	Mobility data	104
4.4	Results and Discussion	106
4.4.1	Simulation with progressive EV quotas	108
4.4.2	Comparison between a simulation with progressive and non-progressive	
	EV quotas	117
4.5	Conclusions	119

<b>5 General conclusion</b>	<b>123</b>
5.1 Chapter 2: Too much or not enough? Planning electric vehicle charging infrastructure: A review of modeling options . . . . .	124
5.2 Chapter 3: From user to operator: Rationalizing the charging infrastructure deployment. . . . .	125
5.3 Chapter 4: Tenerife’s Infrastructure Plan for Electromobility: A MATSim Evaluation . . . . .	126
5.4 Future work . . . . .	127
<b>A Appendix to Chapter 2: Litterature Table</b>	<b>129</b>
<b>B Appendix to Chapter 3: Simulation results</b>	<b>141</b>
B.1 step 0 . . . . .	142
B.2 step 1 . . . . .	145
B.3 step 2 . . . . .	148
B.4 step 3 . . . . .	151
B.5 step 4 . . . . .	154
B.6 step 5 . . . . .	157
<b>C Bibliography</b>	<b>161</b>

# List of Figures

- 1.1 Global CO2 emissions from transport by subsector, 2000-2030 [1] . . . . . 2
- 2.1 Overview of the charging infrastructure framework . . . . . 16
- 2.2 Simplified architecture of EV charging . . . . . 17
- 2.3 Simplified principle of a node-based approach . . . . . 28
- 2.4 Simplified principle of a path-based approach . . . . . 28
- 2.5 Simplified principle of a tour-based approach . . . . . 29
- 2.6 Overview of location methods . . . . . 41
- 2.7 Example of three paths . . . . . 43
- 3.1 Model principle overview . . . . . 55
- 3.2 Parking duration scoring function . . . . . 61
- 3.3 SOC scoring function . . . . . 63
- 3.4 Example of charging infrastructure after 5 iterations . . . . . 74
- 3.5 Evolution of the charging infrastructure over steps . . . . . 75
- 3.6 Number of agents with range anxiety and variation of this number over  
deployment steps . . . . . 76
- 3.7 Distance driven with range anxiety and variation of this distance over de-  
ployment steps . . . . . 76
- 3.8 Number of agents running out of battery and variation of this number over  
deployment steps . . . . . 79
- 3.9 Distance driven with empty batteries and variation of this distance over  
deployment steps . . . . . 79
- 4.1 Distribution of the population on the island of Tenerife . . . . . 95
- 4.2 Electricity consumption increase in Tenerife associated with the transport  
sector between 2018-2040 [2] . . . . . 97
- 4.3 Reduction of CO2 emissions to the atmosphere by type of vehicle. . . . . 98
- 4.4 Evolution of the population on the island of Tenerife between 2000-2050. . 100
- 4.5 Evolution of GDP on the island of Tenerife between 2000-2050. . . . . 100

4.6 Evolution of the electric car fleet on the island of Tenerife between 2018-	
2040 [2].	101
4.7 MATSim simulation principle	103
4.8 Transport zones into which Tenerife has been divided.	105
4.9 MATSim simulation scores statistics	107
4.10 Screenshot of the synthetic agents in movement visualised in Simunto Via,	
in San Isidro, municipality of Granadilla de Abona.	108
4.11 Maps of the distribution of the charging points obtained in Tenerife over	
time.	110
4.12 Concentration of charging points by municipality on the island of Tenerife	
in 2037.	113
4.13 Distribution of charging points in the metropolitan area of Tenerife.	114
4.14 Distribution of charging points in La Orotava Valley.	114
4.15 Distribution of charging points in the touristic areas of the South of Tenerife	
(Arona - Adeje).	115
4.16 Distribution of charging points in Granadilla and San Miguel de Abona.	116
4.17 Distribution of charging points in Güímar Valley.	116
4.18 Distribution of charging points in the northeast region of Tenerife.	117
4.19 Distribution of charging points in Tenerife in 2028 for the progressive and	
non-progressive cases.	119

# List of Tables

2.1	Electric vehicle supply equipment (EVSE) purchase and installation costs in the U.S. [3]	20
2.2	Summary of articles using the node-based approach	31
2.2	Summary of articles using the node-based approach	32
2.2	Summary of articles using the node-based approach	33
2.3	Summary of articles using the path-based approach	35
2.3	Summary of articles using the path-based approach	36
2.4	Summary of articles using the tour-based approach	38
2.4	Summary of articles using the tour-based approach	39
2.5	Main points of comparison between location methods	44
3.1	Values of simulations parameters	72
3.2	Simulation results - Users with range anxiety - Final infrastructure	78
3.3	Simulation results-Vehicles out of battery	81
3.4	Simulation results-Average distance to a charger when a vehicle stops	82
3.5	Simulation results- Average number of chargers under the searching range when a vehicle stops	84
3.6	Simulation results- Average number of chargers under the searching range when a vehicle stops	87
4.1	Number of EV charging points per power.	109
4.2	Number of EV charging points per municipality	111
4.3	Number of EV charging points per power with progressive and non-progressive EVs quotas.	118

# Chapter 1

## Introduction

### 1.1 Overview

#### 1.1.1 Climate change and mobility

Climate change and air pollution are two of the most pressing environmental issues facing the world today. Under the effect of increasing anthropogenic greenhouse gas emissions, due to the use of fossil fuels, the greenhouse effect is intensifying. This causes an increase in the average temperature at the surface of the planet, disturbing the balance of existing ecosystems, causing among others melting of polar ice caps, rising sea levels, and more frequent and intense natural disasters [4]. At the same time, the World Health Organization points out air pollution as a major public health concern, with particulate matter, nitrogen oxides, and sulfur dioxide being among the most harmful pollutants. This air pollution is having a devastating impact on human health, causing respiratory problems and other serious illnesses. These two problems are intricately linked and have a profound impact on the world's population, and the transport sector is a major contributor to those issues.

Over the past century, transportation activity has considerably grown. For a long time, the increase in transport flows was one of the driving forces behind the economic growth of a globalized world where travel times were becoming shorter and shorter, and this economic growth itself accentuated the need for transport [5]. The increase in mobility is not without effects on the climate.

The transport sector relies heavily on fossil fuels, and the burning of those fuels by ships, airplanes and especially road transports (cars, trucks, buses...) releases significant amounts of carbon dioxide and other greenhouse gases into the atmosphere, contributing to the warming of the planet. Additionally, emissions from transportation strongly contribute to air pollution, particularly in densely populated urban areas where emissions



are concentrated and trapped by tall buildings and other structures, creating localized air pollution hotspots. [6]

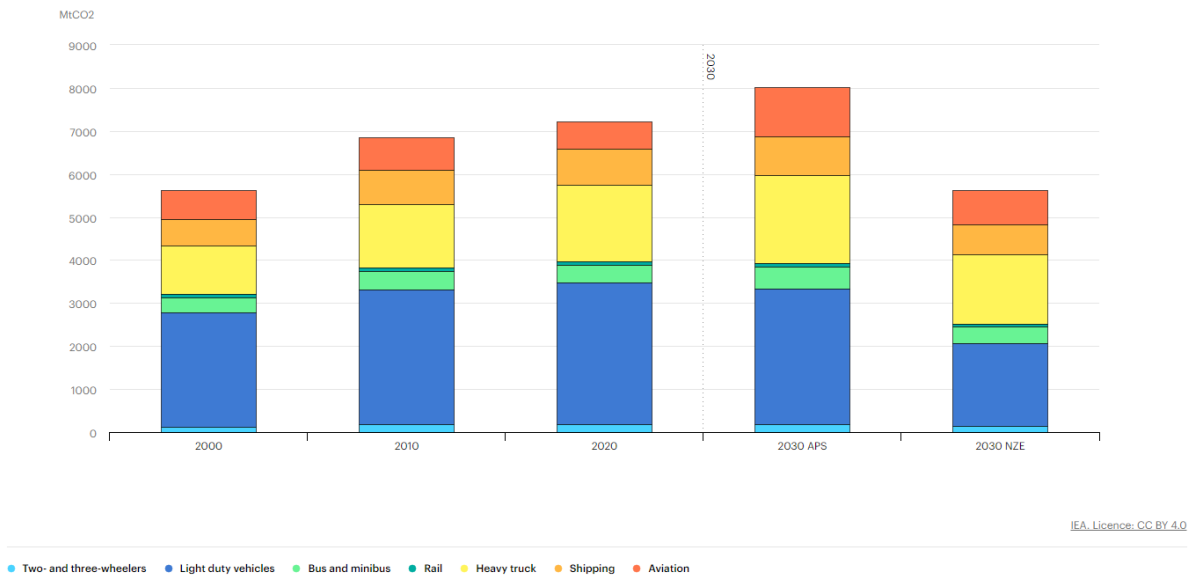

Figure 1.1: Global CO2 emissions from transport by subsector, 2000-2030 [1]

*APS: Announced Pledges Scenario ; NZE: Net Zero Emission by 2050 scenario [7]*

To significantly reduce these emissions, profound changes in our travel habits are needed. But over the past century, individual mobility has become so ingrained in our habits and lifestyles that these changes are structural changes that will probably take several decades [8]. This is particularly true for road transport, and especially for the case of private cars. Private cars are responsible for nearly half of the emissions from the transport sector, as shown in Figure 1.1. Nevertheless, it has been at the core of land-use planning policies in recent decades and has therefore profoundly marked these developments, making it essential. It has even become a symbol of freedom and social success. Reducing its use is therefore likely to be one of the most time-consuming changes to implement, since it affects many aspects of society’s organization and so involves the transformation of an entire system, including infrastructure, regulations, and consumer behavior.

Relying on traditional fossil-fuel vehicles during this transition period is absolutely not compatible with the urgent need to decarbonize all parts of our economy. This is why more sustainable transition solutions must be found.

## 1.1.2 Electric vehicles

In order to accelerate this transition, the European Union has voted to ban the sale of new Internal Combustion Engine Vehicles (ICEVs), with the aim of having a fleet without any tailpipe emissions. To reach this goal of zero net tailpipe emissions, the actual trend is the massive electrification of the transportation sector.

By definition, an electric vehicle is a vehicle powered by one or more electric motors. These vehicles can be onboard energy vehicles, meaning that the energy needed for their operation is stored inside the vehicle, or can be connected to an external source, as is the case for the train. In this study, we will only consider onboard energy vehicles. This definition can include several types of vehicles :

- The **Battery Electric Vehicle** (BEV), whose main energy source is an on-board battery, that power an electric engine. These batteries can be charged from the electrical grid, from domestic sockets, or from dedicated charging points.
- The **Hybrid Electric Vehicle** (HEV), a vehicle whose main engine is an internal combustion engine vehicle. This main engine is assisted by one or more electric motors, which are powered by a small battery. The battery is charged by recovering energy while driving the vehicle. The electric motor is mainly used to start the vehicle, for acceleration, and sometimes to drive at low speeds.
- The **Plug-in Hybrid Electric Vehicle** is in fact a Hybrid Electric Vehicle but has a larger battery, which can be charged by connecting it to the electrical grid, as a BEV. These vehicles generally run in full electric mode up to 50km/h (sometimes faster), and the combustion engine takes over after a certain speed or if the vehicle runs out of battery.
- The **Fuel Cell Electric Vehicle** is a rather particular type of electric vehicle. It is only powered by an electric motor and the electricity necessary for its operation is produced from a redox reaction between the oxygen contained in the air and the hydrogen in its tank.

According to the zero net emission transport targets set by the European Commission, HEVs and PHEVs will be banned from sale in the same way as internal combustion vehicles by 2035.

Different formats of electric vehicles exist, ranging from electric scooters to semi-trailer trucks. In this thesis, we will focus on light Battery Electric Vehicles, such as battery electric cars or light-duty battery vehicles, which will be referred to as electric vehicles or EVs in the rest of this dissertation.

### 1.1.3 Electric Vehicles as a solution to more sustainable mobility

Electric vehicles, even if they are far from being a perfect solution, have many advantages that make them an acceptable compromise as a first step towards more sustainable mobility.

Firstly, and this is their main advantage, electric vehicles produce significantly less greenhouse gas emissions and air pollutants than internal combustion vehicles, making them a cleaner and more environmentally friendly option. Of course, their manufacture has a non-negligible environmental impact, especially for the production of the battery, a very energy-consuming process that uses many very polluting chemicals, in particular for the refining of lithium and cobalt. However, once this manufacturing stage is over, the electric vehicle is much less polluting than its internal combustion equivalent [9]. Over its entire life cycle, an electric vehicle can halve the CO<sub>2</sub> emitted compared to a combustion vehicle, especially if it is used in countries with a low-carbon energy mix. This has an effect on the global greenhouse effect, but also more locally, where air quality is greatly improved. Indeed, the replacement of internal combustion engine vehicles by electric vehicles reduces local concentrations of CO<sub>2</sub>, but also of fine particles, nitrogen oxides, and other dangerous pollutants, which are not or not much emitted by electric vehicles. By reducing air pollution, EVs can improve public health and reduce the incidence of respiratory disease. In terms of public health, we can also note reduced noise pollution, which is a significant improvement in urban areas and other densely populated areas.

Moreover, in a time of major tensions in the energy market, electric vehicles can increase energy security. Having a transportation system that does not rely exclusively on oil but on electricity, whose sources of production are much more diversified, allows to be less dependent on oil-producing countries, and by extension on the prices they impose on the world's energy market. EVs reduce the need for imported oil, which can have substantial geopolitical and economic benefits for countries [10]. This positive effect is further enhanced by the massive adoption of renewable energies, which can itself be facilitated by the use of electric vehicles, while the energy sector is still by far the largest emitter of greenhouse gases and must decarbonize at least as fast as the mobility sector in this climate crisis. One of the obstacles to a more important renewable energy production comes from its intermittent character, especially for solar and wind energy, and the difficulty to store energy. Electric vehicles, through various mechanisms, can help to absorb this intermittent nature, and thus facilitate the increase in the share of renewable energy in the energy mix. Still, on the subject of energy, electric vehicles are more efficient than combustion engine vehicles. According to the ADEME, the French Agency for the Environment and Energy Management, taking into account the whole energy production chain, the "well-to-wheel" energy efficiency of a thermal vehicle is around 30%, while that

of an electric car is estimated at a little over 60% (these rates are respectively 40% and 90% if only the vehicle is taken into account).

Additionally, from an economic point of view, electric vehicles also have beneficial effects. The development of the electric mobility sector creates new jobs and economic growth, and drives innovation in many sectors, for example batteries, with positive effects on other sectors than mobility.

And more anecdotally, but still important from a driver’s point of view, many EVs have instant torque and responsive acceleration, providing an enjoyable driving experience.

So overall, the increased use of EVs is seen as a step towards a more sustainable and environmentally friendly transportation future.

### 1.1.4 Barriers to massive EV adoption

However, all these advantages do not make the electric vehicle a perfect solution for more sustainable mobility, and some challenges are still to be tackled.

First of all, even if it is not the subject of this thesis, we would like to remind that the social and environmental impact of electric vehicles is far from zero. Even if EVs have no tailpipe emissions and therefore bring improvements to the places where they are used, their production, and more particularly the production of their batteries, represents a significant social and environmental cost. Today, the rare earth needed to produce batteries is mostly produced in countries where workers’ rights and environmental standards are little or not at all respected. In addition, the construction of an electric vehicle uses resources that are becoming increasingly scarce, and tensions in the supply of certain materials are beginning to emerge. Moreover, the absence of tailpipe emissions should not make forgotten that the electric energy produced upstream to operate the vehicle must also be decarbonized if the switch to electric vehicles is to be truly beneficial for the climate. A lot of work needs to be done on the entire supply chain and end of life of the vehicle in order to make the electric vehicle socially and environmentally acceptable.

Even without considering these aspects, the transition from a fleet of ICE vehicles to a fleet of electric vehicles raises several important issues on the consumer side [11, 12].

The first barrier is the price of electric vehicles, combined with the lack of alternative offers for all uses: today, an electric vehicle still costs at least 30% more than its internal combustion engine equivalent. But public subsidies already exist for the purchase of electric vehicles, and their price is set to fall in the next few years to converge in the medium term with that of internal combustion vehicles, and in some markets, fuel and maintenance savings are already making them less expensive over their entire life cycle. Moreover, if the options of EVs connected to their environments in bidirectional mode develop at the level of electricity transmission networks, distribution networks, individual

homes, and buildings, then the costs of using these EVs should fall even further, thereby erasing this obstacle to the electrification of vehicles.

The second barrier is range anxiety. This notion refers to the fear of drivers that they will not be able to travel in an electric vehicle as they would with a combustion engine vehicle, because of their lesser autonomy and the difficulty of finding a charging solution. This fear is a much more structural barrier than the price of the vehicles. To remove this barrier, there are two main solutions. The first solution is to increase the autonomy of each car by increasing the capacity of the battery... which only shifts the problem a few kilometers, since the fear of not being able to charge when needed remains. Moreover, increasing the autonomy of vehicles, and therefore the size of their battery, which is already sufficient for most daily trips, increases the selling price of these vehicles as well as their environmental impact. The second possible solution is to increase the supply of charging points. If EV drivers can be sure that they will be able to find charging solutions corresponding to their needs when they need them, range anxiety will be greatly reduced. There is a trade-off between battery capacity per EV and investment in infrastructure, but in any case, the democratization of EVs will necessarily require the deployment of a network of charging stations adapted to the needs of users, who do not all have access to an electrified parking space [13].

### 1.1.5 Charging infrastructure

An EV charging station infrastructure is a coherent set of charging solutions that ensure an efficient charging solution for electric vehicles present on or using, the roads of the concerned territory. This package of solutions includes an assortment of charging stations that can be roughly classified into three categories: slow, intermediate, or fast. Slow charging stations, with a power of 1.5 to 7 kW, fully charge a vehicle in about ten hours; intermediate charging stations, often with a power of 22 kW to 50 kW, achieve this in about 3 hours; finally, fast charging stations, with a power of 150 to 350 kW, are able to charge a battery in a few minutes, which can be very interesting for urgent uses. However, the installation price of a fast-charging station can be more than 100 times higher than that of a slow charging one. This is due to the price of the charging station itself, but also to all the costs related to the electrical and IT environment and the operational security of the charging point [14]. For example, the installation of a 350 kW charging point - which corresponds to the power consumed by 20 houses - requires more precautions and investment in terms of user safety than a 3 kW charging point (about the power of a washing machine), knowing that 4-10 charging points are usually installed in the same place rather than one!

The fastest charging stations, generally from 50kW upwards, are most often "DC"

stations, meaning that the electrical power they deliver is transferred directly to the battery in the form of direct current. The lower power chargers are rather "AC" chargers, which means that they deliver an alternating current to the vehicle. This alternating current is then transformed into direct current in the vehicle thanks to an onboard charger, then used to charge the battery.

These different types of chargers are not compatible with all vehicles. While almost all vehicles accept AC charges of up to 7kW, a significant proportion does not support high-power DC charges. In addition to these compatibility problems, there are also challenges in standardizing connectors and communication protocols of the charging stations. Even though standardization is beginning to emerge on a regional scale, an international standard is not yet in place.

### 1.1.6 Charging infrastructure and economic issues

The financial stakes for charging infrastructure are very high. The electric vehicle (EV) charging infrastructure market is projected to grow significantly in the coming years as the demand for EVs increases. According to a report by Precedence Research, the global EV charging station market size is expected to grow from around \$30 billion in 2020 to more than 400 billion by 2030.

Investment in electric vehicle charging stations can come from several sources.

First, governments can provide subsidies and tax incentives to encourage the development of charging infrastructure. For example, in many countries, governments have established subsidy programs for companies and individuals who install charging stations. Governments may also directly fund the construction of charging stations.

Local public services can also invest in charging infrastructure to meet the growing demand for electric energy. They can also offer special charging rates to encourage the use of electric energy and help fund the installation of new charging stations.

Then, electric vehicle manufacturers can invest in charging infrastructure to support demand for their vehicles. Some electric vehicle manufacturers have partnered with charging companies to facilitate the installation of charging stations, such as in the Ionomy consortium, a fast charging station deployment initiative created by five of the world's largest automakers.

Finally, companies specializing in the sale of charging solutions can of course invest in their own charging infrastructure to meet the growing demand for electric vehicle charging services. These companies can also offer partnerships with other companies to install charging stations in locations frequented by electric vehicle drivers. Private investors may also invest in electric vehicle charging infrastructure, such as venture capital funds that invest in charging companies, or individual investors who fund the construction of new

charging stations.

While this may be an opportunity, as it multiplies the opportunities for infrastructure development, this diversity of players in this still immature and growing market requires a lot of coordination between them.

This extremely rapid growth of the market, regarding the costs involved, is quite risky, especially because of the upfront costs associated with installation. The cost of installing an EV charging station can range from a few thousand dollars to hundreds of thousands of dollars, for very different services provided, and inappropriate decisions can result in a significant waste of resources, or even doom the profitability of the infrastructure in a market still full of uncertainties. One of the biggest challenges for businesses and property owners is generating revenue from EV charging infrastructure. While some companies offer free charging to attract customers, most businesses charge a fee for using their charging stations, and the revenue generated from charging fees may not be sufficient to cover the upfront and ongoing costs of the charging infrastructure in case of wrong investments.

Finally, there is the issue of geographic coverage. Today, while electric vehicle sales are increasing rapidly, the number of charging stations is not keeping pace. This means that in some areas, there may be a shortage of charging stations, which can discourage consumers from purchasing EVs. In order to encourage the adoption of electric vehicles, it is important to ensure that charging infrastructure is widely available and easily accessible.

## 1.2 Contributions of this dissertation

The development of a charging infrastructure, which is crucial for the electrification of the vehicle fleet, is therefore not trivial, and the issues related to it are very important. This development responds in particular to economic, technical, social, psychological, and regulatory issues.

This dissertation explores the development of charging infrastructure through a multi-criteria approach, primarily centered around the interests of current and potential users of the infrastructure. It is organized into 3 chapters. In what follows, we describe the research problems addressed in the 3 chapters. This dissertation ends with a concluding chapter that summarizes the contributions of the thesis and highlights future research directions.

### **1.2.1 Too much or not enough? Planning electric vehicle charging infrastructure: A review of modeling options**

This chapter focuses on the analysis of the deployment methods of an electric vehicle charging infrastructure on a territory, through a literature review.

It explores some of the technical, economic and psychological issues of the links between the development of the electric vehicle and the associated charging infrastructure.

First, we reviewed the issues related to the development of a charging infrastructure in a transitioning mobility landscape, particularly its link to the acceptability of the electric vehicle as a main vehicle. The different uses of the infrastructure are listed, then the objectives and methods used to develop a charging infrastructure capable of meeting these uses are classified and compared. This helps us to define which type of deployment model is best suited to achieve an infrastructure that accompanies and supports the development of the electric vehicle.

*This chapter has been published in Renewable and Sustainable Energy Reviews (Elsevier) [15].*

### **1.2.2 From user to operator: Rationalizing the charging infrastructure deployment.**

Based on the analysis made in the previous chapter, we propose in this section a new deployment model for coordinated charging infrastructure at the scale of a large territory. This multi-criteria model is centered on the needs of the users. It integrates a progressive dimension of the infrastructure deployment, by proposing a step-by-step optimization of the infrastructure at each stage of its development. This optimization model also integrates the possibility of deploying different types of charging stations, always with the aim of going hand in hand with the progressive electrification of the vehicle fleet.

We then apply this model to the Berlin region using a MATSim multi-agent simulation, in order to analyze the effects of our model on the population under consideration and to draw lessons on infrastructure deployment.

*This chapter is under a submission process in Transportation Research Part. B (Elsevier)*

### **1.2.3 Tenerife’s Infrastructure Plan for Electromobility: A MATSim Evaluation**

This third chapter is a case study of the deployment of charging infrastructure in the Canary Islands (Spain). The government is pushing for the complete decarbonization of



the transportation system on the islands by 2040, while there are still very few charging solutions, which cannot support a 100-electric vehicle fleet.

In this study, we apply our model to the island of Tenerife, still using a MATSim multi-agent simulation. We introduce two main novelties compared to the previous study. First, we take into account the charging stations already existing on the island and develop the infrastructure from this base. Second, we progressively introduce electric vehicles during the deployment stages, using a probabilistic model based on the agents' income.

*This chapter has been published in *Energies* (MDPI) [\[16\]](#)*

## Chapter 2

# Too much or not enough? Planning electric vehicle charging infrastructure: A review of modeling options

\*

While the transportation sector is responsible for a growing share of greenhouse gas emissions, electric vehicles (EVs) offer solutions for greener mobility. The proportion of electric vehicles in transportation fleets is increasing, but wider adoption will not be possible without an appropriate charging infrastructure. The deployment of such infrastructure should follow a strategy that considers both the environment in which it is deployed and the behavior patterns of electric vehicle users. If these aspects are not taken into consideration, there is a risk of failing to meet users' needs and generating additional costs. Here we review the literature on location problems for electric vehicle charging stations. We aim to draw up a comparative overview of approaches that have been used up to 2020 for optimizing the locations of charging infrastructure. We first briefly review the issues raised by the deployment of charging infrastructure, namely technical, economic and user acceptance concerns. We then look at the goals of the infrastructure location models in the literature. Schematically, those goals fall into two categories: minimizing the cost of charging infrastructure for a given level of service, or maximizing the service provided for a given cost. Finally, we focus on the approaches used to achieve these goals. Three categories of approaches are identified: node, path, and tour- or activity-based approaches. We then discuss these approaches in relation to technical, economic and user acceptance factors in order to provide a comprehensive analysis for stakeholders involved in EV charging infrastructure planning. Directions are given for future research to develop models that better reflect the real-world picture.

\*

## 2.1 Introduction

The climate emergency requires a drastic and rapid reduction in anthropogenic greenhouse gas (GHG) emissions, which are the cause of the fastest global warming ever observed [17]. The transportation sector is responsible for about 15% of global GHG emissions (27% in the European Union), and this rate is expected to increase in the coming years [18]. A transition from internal combustion engine (ICE) vehicles to greener transportation could be a major lever for reducing global GHG emissions.

For road transportation and individual mobility, which account for the largest share of transportation-sector emissions, electric vehicles (EVs) emerge as a major alternative to ICE vehicles. Considering the whole lifetime of the vehicle, EVs have a lower global warming potential than ICE vehicles, especially if they are coupled with low-carbon electricity production systems [19]. Moreover, EVs have many other benefits, such as no tailpipe emissions—which could help avoid air pollution and exposure to nitrogen oxides, volatile organic compounds, and carbon monoxide in urban areas, and reduce particulate matter emissions—and far less noise than ICE vehicles.

Despite all these benefits, large-scale uptake of EVs is bottlenecked by a number of different barriers [12]. A first major barrier is the high purchase price of EVs compared to ICE vehicles, although the purchase price impact is expected to diminish shortly. When considering total cost of ownership over the whole life cycle, an EV is already less expensive than an ICE vehicle in countries such as Norway or France [20]. Moreover, the purchase price of EVs is projected to drop below that of ICE vehicles by 2025 [21]. The second main barrier for users is tied to range anxiety. Most EVs have a lower driving range than ICE vehicles. Even though the range offered by a full-charge battery is sufficient for daily use for a large majority of users, they fear that they will run out of battery before being able to finish their trips or find a charging point. User anxiety is thus the main problem to address to enable large-scale EV adoption. The way forward could be to increase battery capacity to improve EV range or to provide an efficient charging infrastructure to better cover charging needs. However, even with a larger range, the fear of not being able to

charge EVs when the battery is empty is still the same [22], so large-scale EV deployment cannot be achieved without a prior appropriate charging infrastructure [13]. Furthermore, research shows that investing in charging infrastructure is more efficient than subsidizing larger batteries as long as the investments in charging infrastructure are not sufficient to cover the whole territory [23, 24, 25].

However, deploying a charging infrastructure is hugely expensive and comes with several technical and economic constraints. The Energy Transition for Green Growth act in France sets a target of 7 million EV charging stations (public and private) by 2030, which corresponds to a minimum cost of around 2 billion euros [26] while an International Council on Clean Transportation (ICCT) report projects an estimated 1 billion dollars in investment over the 2019–2025 period for the USA to fill its public charging infrastructure gap [3]. These huge costs warrant a proper deployment strategy to efficiently locate and scale new charging stations in order to favor large-scale EV adoption while avoiding resource waste or underinvestment for infrastructure investors. This deployment, with the costs it entails, also faces a chicken-and-egg problem: drivers will be reluctant to buy an EV without adequate infrastructure, while operators will refuse to invest in infrastructure until there is sufficient demand to make it profitable. To ease this bottleneck, the first step must be taken by operators [27].

Once the first step has been taken, the issue of optimal deployment of a vehicle refueling infrastructure is not a new challenge. Coverage and location models, such as those of Toregas [28] or Hodgson [29], have been around for a relatively long time and are perfectly applicable to gas refueling stations. However, EVs have different demands to ICE vehicles (charging takes longer than refueling), which makes these coverage models incompatible with routine EV use. Models taking these specificities into account have thus been developed since the end of the 2000s.

Nevertheless, few of them seem to take advantage of the benefits offered by electric vehicle charging, which does not require the user to be present during charging time. Moreover, the deployment of such an infrastructure does not happen all at once, partly

because of the problem of the development costs it would generate without a guaranteed return on investment from a demand that will take a long time to come, which brings us back to the previous chicken-and-egg problem. An incremental and over-time deployment must be considered, considering the early stages of the infrastructure already present in the territory.

This literature review aims to provide an overview of the timely problem of EV charging infrastructure planning in terms of the optimization models used to determine optimal locations of charging points, and sizing. It explores and compares a rapidly growing scientific literature proposing strategies and simulation models for deployment of electric charging infrastructures, considering the technical, economic and user-side aspects of EVs.

To identify the first relevant articles, the Google Scholar database was searched with combination of keywords : {EV, electric vehicles, charging infrastructure, charging stations} and {planning, location, model, optimization}. We kept a sample of 287 articles containing literature reviews and papers on infrastructure optimisation and deployment models cited as references in this field. The articles cited in these papers and the articles also citing them were then screened, and we added 63 relevant articles to our review.

The paper is structured as follows. Section [2.2](#) explains the different charging technologies and the issues involved in deploying charging infrastructure. Section [2.3](#) presents the objectives and targets of infrastructure deployment. Section [2.4](#) then covers the methods for locating and sizing infrastructure in a territory, and Section [2.5](#) highlights gaps in the literature and avenues for future research.

## 2.2 Background on charging infrastructure and the allied issues

The issue of deploying charging infrastructure for EVs is set in the following framework: EV users with limited autonomy travel the road network. Making these trips consumes energy, which in turn decreases the state of charge of the EV battery and creates a need to

charge, which can be met in two ways: either through home/office charging, or through public (or semi-public) charging infrastructure. This infrastructure needs to stay at a reasonable cost for operators, who have limited investment capacity, while giving EV users the transportation network coverage they need. The goal is to enable drivers to use their EVs with less range anxiety, knowing that they can rely on public charging infrastructure when they need it. As public charging infrastructure supplies energy from the grid, infrastructure deployment needs to consider the constraints linked to power grid operation.

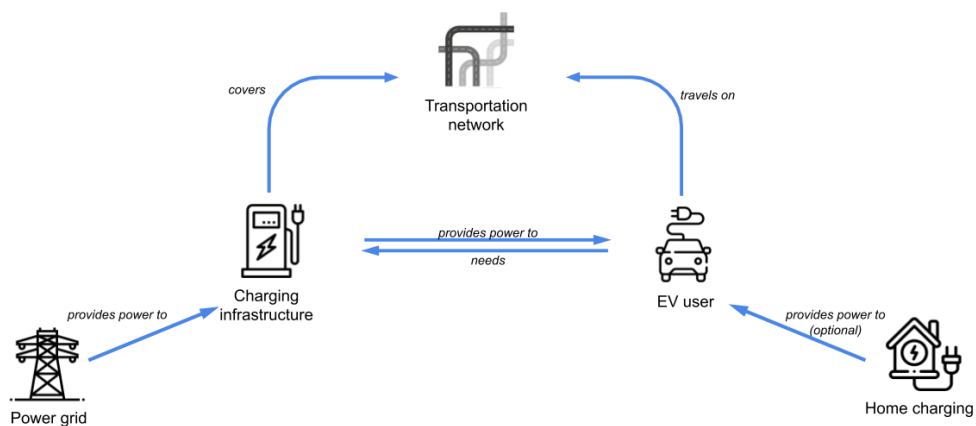

Figure 2.1: Overview of the charging infrastructure framework

In this framework, three main types of issues are to consider when deploying charging infrastructure : technical, economic and user-centred issues.

### 2.2.1 Technical overview of charging devices

Charging devices provide the link between electricity grid and EVs by converting AC power into DC power, which can charge a battery. They can be on-board or off-board, depending on the type of charging.

The International Electrotechnical Commission (IEC) defines four charging modes [30]. In the first three modes, the EV is directly connected to the AC distribution network, and the conversion to DC is done through the vehicle’s onboard charger. The main difference

between these three levels lies in the level of safety and charging control, which allow the vehicle battery to be charged with more or less power. For example, mode 1, which is used for low-power charging, is equivalent to plugging the vehicle into an electrical outlet, while mode 3 allows advanced charging control and higher charging power. The mode 4 is mostly used for fast charging applications. Unlike the three first modes, here the connection of EVs to the AC grid is not direct: the AC power is converted into DC power in an off-board charger, and then used to charge the EV's battery. Figure 2.2 gives a simplified illustration of EV charging.

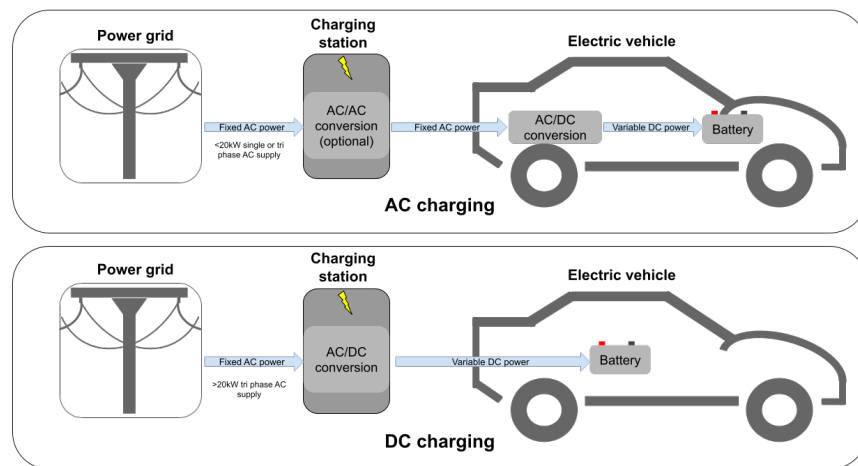

Figure 2.2: Simplified architecture of EV charging

## 2.2.2 Charging infrastructure and EV acceptance

Charging EVs generally requires much more time than filling up an ICE vehicle gas tank. Charging times go from a few dozen minutes for the fastest chargers up to more than 20 hours for the slow ones [31]. Charging stations thus have different design and management imperatives to conventional gas stations. EVs have different refueling behaviors due to different required charge-times and charging locations, especially when taking into account one of the major conveniences offered by EVs, i.e. that EV batteries can charge while the vehicle is not in use for mobility purposes (while parked at home, the workplace, in mall parking, etc.). Home EV charging does not require any effort from the driver other



than plugging in the EV. It also does not require any specific installation—at least not for slow charging [30] - even if the majority of EV drivers install specific equipment to increase charging speed and for safety aspects. Moreover, in 90% of cases, trips do not exceed 80 km, whereas the typical range for an EV is about 200 km<sup>1</sup> [33, 34]. Thus, home charging should be sufficient for a large majority of users: with a fully charged battery when leaving home, they could complete their daily trips and charge their EV once back home, ready for the next day.

However, home charging has some limits. First, if trips—or a succession of trips—exceed the EV range, then drivers need to be able to charge their EV elsewhere than at home. If this is not possible, then EVs will remain as a second car for the wealthiest percentiles of the population, since users will not be able to use it to make occasional long journeys and will therefore prefer an ICE vehicle [13]. Moreover, in many countries, a large part of the population do not have a single-family home with a private parking space where they can install a charging point [35]. This illustrates that relying solely on home charging for the transition from ICE vehicles to EVs will leave important barriers to the adoption of electric mobility, justifying the need for an appropriate public charging infrastructure.

The range and charging constraints of EVs make it illusory to envisage the broad diffusion of EVs without sufficient charging infrastructure. At the same time, if there are not enough EVs on the road, there will not be enough interest in setting up an expensive, unprofitable charging infrastructure. But without this infrastructure, it is illusory to envisage the democratization of EVs... The chicken-and-egg problem in this two-sided market has been studied by Delacretaz et al. [36] who show that an initial infrastructure has little immediate positive effect on EV adoption but that positive effect does increase over time. They also show a snowball effect: the demand elasticity for EVs relative to charging infrastructure provision increases with infrastructure development. In other

---

<sup>1</sup>Note : This is valid for the European market, where the population densities are rather high and the distances to be travelled relatively small. In the case of the US or similar markets, the distances involved may be higher. However, they remain well below 200km, which is already a pessimistic estimate of the range of a standard electric vehicle. [32]

words, the more charging stations there are, the greater the increase in EV demand with further investment in charging infrastructure.

This raises the question of marginal—or incremental—infrastructure development. An infrastructure is deployed in a spatial context, but also in a temporal one, and it is unrealistic to consider instantaneous deployment of a complete set [37]. It is therefore important to define a temporal deployment sequence along with a spatial set of locations to determine the most cost-effective investments [38]. Otherwise, the risk is to end up with an infrastructure unsuited to driver needs at the beginning, which would not allow the diffusion of EVs to start and thus discourage additional investments in infrastructure, and so on (again, a chicken-and-egg paradigm). In addition, even though charging stations are often deployed without a global vision, they nevertheless already exist in the territory, and it would be a mistake not to consider this existing resource. We must therefore think about the problem of placing ‘one more charging station’ and the value of this station when there is already a set of operational stations, while almost all the models focus on optimising the final charging infrastructure without considering the process to get there.

### 2.2.3 Economical issues

A naive approach would be to consider the best option is to put fast chargers everywhere, as people value the option to charge quickly [39]. However, a DC fast charging station costs much more than a slower one. The average cost for a level 2 public charging station is \$3000, while the average cost of a DC fast charging station is nine times more (Table 2.1).

Table 2.1: Electric vehicle supply equipment (EVSE) purchase and installation costs in the U.S. [3]

EVSE Type	Average public installation cost	Average home installation cost
Level 1	\$4000	\$400 -\$900
Level 2	\$6000	\$680-\$4100
DC Fast Charging (50 kW)	\$73,000	Not available
DC Fast Charging (150 kW)	\$120,000	Not available
DC Fast Charging (350 kW)	\$205,000	Not available

Since more expensive infrastructure should lead to more expensive charging service for users, a poor choice of electric vehicle supply equipment (EVSE) penalizes not just the consumer but also the operator for whom a charging station adapted to local needs guarantees a better return on investment. Let us explain this with a simple example. Suppose a charger able to fully charge an EV in three hours is placed in a site where parking times are usually eight hours. A person who leaves their EV parked and plugged in will charge for a maximum of three hours but then unnecessarily occupy the terminal for the remaining time. However, for the same budget, several slower charging stations could have been installed which would maximize the profit for the operator and the level of service for users.

Finally, it is important in the case of several operators that they coordinate with each other to ensure interoperability and good global coverage. But it is also important to put in place regulations to prevent the creation of local private monopolies in public parking areas, which would be harmful to users [40].

### 2.2.4 Power grid issues

Another issue in charging station location concerns the power grid. Level 1 infrastructure only requires about 3kW from the power network, which is no more than common household appliances. This should not have a big impact on the wider grid, even when several EVs are simultaneously charging, or at least not one that a small tariff incentive could

not solve. However, current fast chargers can require up to 150kW from the grid, which is not necessarily scaled for that, especially if there are several fast chargers at the same place, as is the case with charging hubs. Placing chargers requiring too much power in non-adapted locations can stress the existing infrastructure and lead to the need for grid reinforcement, which can be very expensive [41].

The choice of charging station type and placement can therefore be a source of cost inefficiencies. To control the total cost of the infrastructure, this choice must be considered in relation to the real needs of users, as well as the capacity of the power grid.

Charging EVs is not simply a source of grid stress but also a potential source of grid stability if combined with smart grid management to exploit positive synergy with renewable energy production. Renewable energies are a source of stress for the electricity grid, as they are not or only partially controllable. Therefore, they sometimes produce too much energy with respect to the needs, and this surplus of energy has to be used. The batteries of EVs can then store this surplus energy produced by renewables to smooth out excess power output. Scheduling the charging of vehicles according to the constraints of the electrical grid is often called "smart charging".

EVs can also provide additional power to the grid during grid stress episodes by injecting electrical power from their battery into the grid, like a generator [42]. This bi-directional mechanism is commonly called Vehicle-to-Grid (V2G). Through this mechanism, EVs can notably flatten consumption peaks and play a role in regulating grid incidents by providing ancillary services to the grid, such as frequency regulation, resource adequacy, network deferral, energy arbitrage, spinning reserve, etc. [?] They can also directly fast-charge other vehicles, avoiding power demand peaks from fast charging on the distribution network [43].

### 2.2.5 Summary

In summary, the charging infrastructure for EVs needs to address technical issues linked to the technology used and the constraints it places on existing grid infrastructures. It

also meets financial challenges: the costs related to charging infrastructure are relatively high, so it is important for operators to avoid making unnecessary investments and to be assured of a return on their investments. Finally, charging infrastructure needs to respond to user demand in order to garner user acceptance of EVs.

The financial stakes and public acceptance of EVs are closely linked: insufficient coverage of the territory, i.e. underinvestment or unwise investment, will discourage users from buying and using an EV. This in turn will have consequences on return on investment, as would prohibitively high utilization cost of the infrastructure. The technical constraints linked to the charging station energy supply can lead to significant additional costs linked to the electrical network. Finally, the adoption of EVs requires a charging infrastructure technology that meets users' expectations. Users expect to have at their disposal an infrastructure that suits their needs in a convenient way, and that they can rely on.

## 2.3 Overview and scope of planning simulation models

An appropriate EV charging infrastructure has to satisfy technical, economic and acceptability constraints. The infrastructure must address a threefold issue: its location, i.e. its distribution on the transport network, its capacity, i.e. the demand it can serve, and its users. In addition, infrastructure deployment can serve different goals depending on the interests of those deploying it on the transportation network.

To describe a transportation network in a location problem, we decompose it into nodes and paths (or links). The simplest strategy is to define one in relation to the other: a path or route is a link between two nodes, and a node is the intersection point of two paths, or can be the end of a path too.

Users make trips in the transportation network, i.e. they travel between two nodes. They also make tours, i.e. series of trips. During those trips, EV users use energy from their batteries, and sometimes need to charge their EVs with charging infrastructure in

public space.

### 2.3.1 Users and charging infrastructure utilization

Location and sizing of the charging infrastructure must meet user demand. The literature mainly focuses on three types of charging-infrastructure users: buses, taxis, or private vehicles. A classification has been made in the table in the Appendix [A](#).

Charging infrastructure is easier to design for buses, as buses have fixed tours with (more or less) precise time schedules, so uncertainties about their state of charge, availability or itinerary is quite low. For this problem, there are two options. If the buses have enough autonomy to run all day long without being charged, they can simply be charged at the end of their shift at charging stations installed at the depot. The second option is to place fast charging stations at bus stops to allow all buses to complete their tours, as described by Wang et al. [\[44\]](#). The stops at charging points do not even have to be longer than at other bus stops, as current flash charging technology is able to charge two or three kWh into bus batteries in a couple of seconds. In this case, the choice could even be made to place a fast charging point at each bus stop, allowing the buses to be equipped with low-capacity batteries. These two options are not mutually exclusive, and it is possible to charge buses at night and add charging stations for buses that are unable to complete their tours.

For taxis, as fuel is a large part of their costs and they mainly make short trips, EVs could be an excellent option, and taxis could become a good showcase for the usefulness of EVs<sup>2</sup>, but the charging infrastructure has to meet specific requirements. First, electric taxis cannot charge during trips with a customer: they have to charge during idle time. However, these downtimes must be as short as possible. This is why it is critical here to consider the time spent at the charging station (waiting time and charging time), as

---

<sup>2</sup>Note: In Amsterdam Airport Schiphol, where there is the largest Tesla taxi fleet, taxis are massively using the free infrastructure provided by the car company, making it the most intensively used charging infrastructure in the world.

it is idle time for the driver. Taxis already have many idle time situations, typically when waiting for customers. Charging time should not be an additional heavy constraint. Ideally, it should be available where and when taxis have idle time. Then, because it is common for taxi drivers to share a vehicle, home charging is not always an option: the charging infrastructure for taxis must allow them to operate continuously. The fast charging option is therefore often preferred for taxis.

Most of the literature focuses on private vehicles, which account for the biggest share of the vehicle fleet, or at least considers that an infrastructure can be developed for all light vehicles. Private vehicle owners have a wide variety of uses for their vehicles depending on their environment (rural, urban), travel habits (distance from their main points of interest, frequency of travel), and many other factors. The different ways of looking at the case of private vehicles are detailed in the rest of the paper.

### 2.3.2 Optimization goals

The literature has considered several optimization goals to effectively meet user charging demand.

Many studies aim to minimize the infrastructure costs for meeting a given demand, thus taking demand as a constraint. Like infrastructure costs, some papers only take the installation costs into account. These can be a simple fixed cost for any charging station, which can be actualized considering its life-cycle as in Dong et al. [45]. In this case, the objective narrows down to finding the configuration that allows to have as few stations as possible. The cost of charging infrastructure can also be made more complex if we consider the different costs of chargers and the construction costs, land costs as in Mehar et al. [46], or network reinforcement costs as in Rajabi-Ghahnavieh et al. [47]. Others take into account both investment and operation costs, such as maintenance costs or cost of electricity (Jia et al. [48]).

With a view to achieving profitability, several papers also aim to maximize the utilisation of chargers (Cai et al. [49], Pevec et al. [50]).

Other studies choose to deal not with the infrastructure cost but with minimizing the user’s costs. User costs are mainly tied to time spent waiting at charging stations (Hanabusa et al. [51], Tu et al. [52]), and the trip—or the deviation from their original path—they have to make to charge their vehicle (Ge et al. [53], Xu et al. [54]).

Some papers choose to focus on maximizing the number of EVs that could be charged at the station. In other words, the objective is to maximize EV flow at the charging station, based on the rationale that the more people have access to the infrastructure, the more useful it is. Some models only consider a location problem and provide a geographical coverage of the demand (Wang and Wang [55], Motoaki [56]). In this case, the objective is to have a maximum number of EVs with access to a potentially available station, and the charging station locations are uncorrelated to the charging station sizes. Other works consider the availability of the station, by introducing charging time during which the station is unavailable (Sun et al. [57]), or queuing models (Yang et al. [58]). This allows to address the question of sizing the infrastructure.

An alternative to maximizing EV flow is to maximize the amount of energy charged by the EVs (Chen et al. [59], Csizar et al. [60]) or the global distance they can travel (Wang et al. [61]), which is almost the same. This prevents many vehicles being covered by a single station, as can be the case with the previous objective. However, in this case charging 10 kWh in a single EV is the same as charging 1 kWh in ten vehicles, regardless of whether the intended trip is feasible for the vehicles. This is why some papers aim to build a charging infrastructure that minimizes failed—or maximize feasible—trips (Asamer et al. [62], Micari et al. [63]).

These optimization objectives are implemented using various location methods, as detailed in Section 2.4

### 2.3.3 Sizing charging infrastructure

With the problem of location comes the problem of sizing the charging stations at the chosen locations. This is mainly a matter of answering two questions: how many charg-



ing points should be placed at a location, and which charging speed should be chosen. Locations are also dependent on station capacity, *i.e.* the number of vehicles that can be served within a certain period. For example, if a station with a large service capacity is installed at one location, there is limited interest in placing another station near it.

Some studies only focus on the problem of locating charging stations, sometimes considering an infinite capacity [55, 64] which does not represent a real situation where charging points can only accommodate a limited number of vehicles. But once locations have been found without considering this limited capacity, charging stations can be sized according to the demand at each station, as in Micari et al. [63]. The sizing can be done simply with the number of EVs likely to need each station, or by more sophisticated models such as queuing models that can consider the randomness of charging demand, as in Zhu et al. [65]. However, not considering the capacity of charging stations in a first step of charging station location planning can lead to sub-optimal results, as the size of the stations influences their distribution over a territory.

Some models directly take into account limited capacity of their charging stations as a constraint, like the models proposed by Upchurch et al. [66] or Gavranovic et al. [67]. By doing so, it is possible to consider disparities in demand and avoid, for example, an area with a high concentration of demand being covered by only one station that will not be able to satisfy all the demand in its area. In addition, multiplying the number of stations in areas of high demand reduces the impact of a failure of one of them, which is important for the reliability of the infrastructure. Unlike the previous method, however, this approach leaves little flexibility in terms of the size of each station, since this parameter must be set beforehand.

Sizing the charging infrastructure is not just a matter of deciding the number of vehicles that can be accommodated, but also the time spent at the station. It is not always inconvenient that the charging process takes several hours, but this is not always acceptable, such as during long journeys requiring a quick charge to reach the destination. That is why it is also important to wisely choose the power level of charging stations based

on the use case, and many models incorporate power sizing (You et al. [68], Wang et al. [69]). This sizing can also be done with each type of station chosen according to the type of targeted route, which allows fast charging stations to be placed where a quick charge is most useful. Indeed, even if increasing the charging speed of a station also increases its capacity as it serves EVs faster, slow charging stations are a more cost-effective option to meet the needs of a whole territory (Sun et al. [57]).

Finally, charging stations must be sized by considering grid capacity at the location of the charging points. As explained earlier, a large number of charging points at the same place or high power charging points cannot be installed where the electrical grid is too weak, at the risk of causing instabilities due to excessive power demand [70]. Some studies choose to take the characteristics of the electrical grid as a constraint (Zhu et al. [65], Zhang et al. [71]), and a few consider the possibility of reinforcing the electrical grid (Sadeghi-Barzani et al. [72], Guo & Zhao [73]). Other grid-related issues, such as peaks in demand or power quality, may also arise because of charging infrastructure that does not take the power grid into account [74] or because of a power grid that does not take the charging infrastructure into account, depending on the point of view.

## 2.4 Location methods

Several methods to locate charging infrastructure have been developed, and most can be grouped into three main categories: node, path, or tour-based approaches [75].

The node-based approach is the most popular method for locating charging stations. It deals with the location problem as a facility location problem, which has been extensively studied for many applications [76]. The problem to be solved is formulated as follows. Given candidate locations which are the nodes, the objective is to place facilities, i.e. the charging stations, to meet the demand at the nodes. Even if it seems a simple formulation, this problem belongs to the NP-hard class, meaning that we are not able to find exact solutions in a reasonable time because the corresponding resolution algorithms have an

execution time that increases exponentially in the problem dimension. Heuristic methods are often used to provide approximate solutions in a reasonable computing time. The principle of the method is illustrated in Figure 2.3.

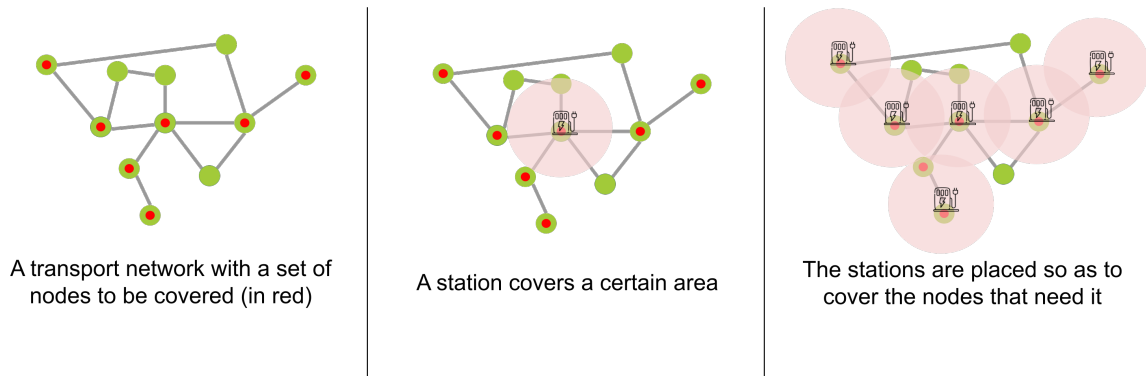

Figure 2.3: Simplified principle of a node-based approach

A second approach that has been considered is the path-based approach, introduced by Hodgson [29] and illustrated in Figure 2.4. This approach relies on a flow-capturing model: the objective is to place charging stations along paths with the highest flows of vehicles, considering origin–destination trips, in order to serve as many users as possible. It considers effects that only emerge from the demand emanating from vehicle flows, whereas the node-based approach offers a relatively static view of demand.

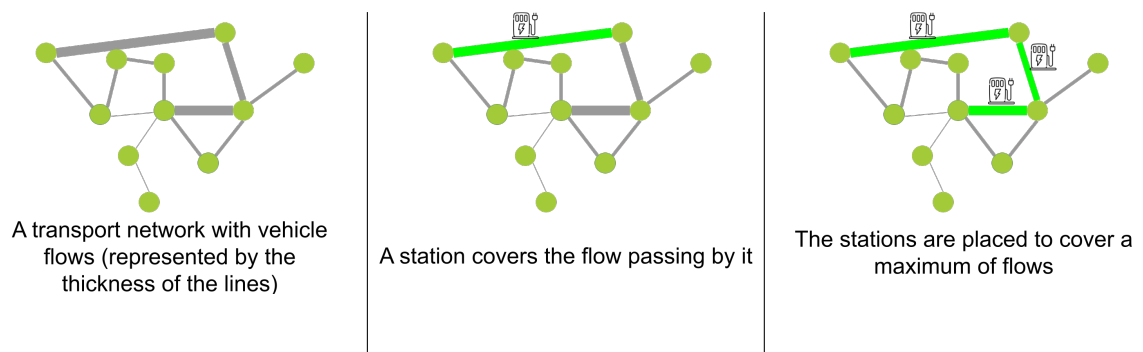

Figure 2.4: Simplified principle of a path-based approach

Last, the tour-based approach, illustrated in Figure 2.5, does not just consider individual origin–destination trips but the entire activity of an agent and its vehicle during a period. It considers origin, destination, distance traveled, vehicle paths and dwell times, to choose the best places to put charging infrastructures according to users' behavior.

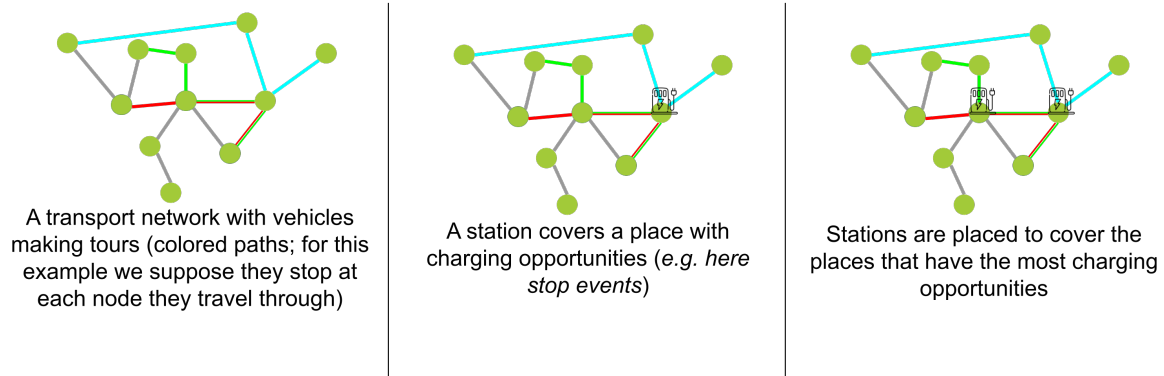

Figure 2.5: Simplified principle of a tour-based approach

### 2.4.1 Node-based approach

The Set Covering Location Model (SCLM) is a facility location model that aims to minimize the number of facilities while covering all the demand from the customers [28]. In this model, facilities are located in such a way that all demand points are not further from a plant than a certain determined distance. It assures all the consumers that they can find a facility under this distance, but does not consider the demand: all the demand points have the same weight, they just have to be covered. Wang and Lin [77] adapted this method and proposed a refueling-station-location model using a mixed integer programming method based on vehicle-routing logics with the aim of making all transportation network nodes accessible to each other. Later, Wang and Wang [55] used an SCLM to cover the maximum demand for both intra- and inter-city trips while minimizing cost, assuming that the capacity of each station is unlimited.

Another node-based approach is the Maximum Covering Location Model (MCLM) [78]. Its objective is to locate a given number of facilities to maximize coverage of the demand, considering a critical distance as the SCLM does: a facility covers a demand node if the distance from facility to node is under this critical distance. Unlike the SCLM, the MCLM allows some demand nodes to not be covered, so can be used when resources are insufficient to cover all the demand nodes, as is often the case in reality. However, both SCLM and MCLM consider the distance to determine if the demand node

is geographically covered by the facility, without taking into account the impact of that distance: placing a plant at a demand node or at the node's critical distance is the same thing. Frade et al. [79] used the MCLM in a case study in Lisbon, Portugal to determine the locations of charging stations and then sized the stations according to the demand in each zone covered. Sun et al. [57] used a node-based maximum coverage model to locate slow charging stations in competition with fast charging stations placed with a flow-capturing model (see later). Wagner et al. [80] used a maximum coverage optimization and quantified the value of putting a charging station at points of interest such as schools or stores.

The  $p$ -median model first introduced by S. Hakimi [81] is now one of the most widely-used models in facility location problems. The objective of a  $p$ -median problem is to determine where to place  $p$  facilities among candidate locations to minimize the transportation cost (or weighted distance) between customers and facilities, with each customer assigned to a facility. The problem can be capacitated, meaning that the facilities have capacity restrictions on the amount of demand they can serve, and so the demand from customers assigned to this facility cannot exceed this capacity. In the case of charging stations, this means that only a limited number of cars can be served within a certain period, and therefore the availability of the station depends directly on its capacity. Gavranovic et al. [67] used this model on a subset of potential locations in Turkey, considering the demand and the preferences of local stakeholders. Jia et al. [82] separated the need for fast and slow charging, and used the  $p$ -median model to locate fast-charging stations. Jung et al. [83] also used the  $p$ -median in a bi-level problem to locate charging stations for taxis, while minimizing both distance to travel to the station and queue at the station. He et al. [84] estimated charging demand through socio-demographic data in Beijing and used this estimation as an input for all three node-based models (SCLM, MCLM and  $p$ -median). They found that the  $p$ -median model outperform SCLM and MCLM, and gives more stable solutions. An et al. [85] developed a two-stage optimization framework that considers the disruptions that could lead to charging demand changes.

Table 2.2 gives an overview of the node-based methods applied to EV charging stations location.

Table 2.2: Summary of articles using the node-based approach

Method	Problem	Main optimization goal	Paper
MCLM	Location	Maximize the number of EVs charged	Frade et al. (2011) [79]
MCLM	Location	Maximize the number of EVs charged	Guo & Zhao (2015) [73]
MCLM	Location and sizing (capacity [3])	Maximize the number of EVs charged	Wang et al. (2013) [69]
MCLM	Location and sizing (capacity)	Maximize the number of EVs charged	Gopalakrishnan et al. (2016) [86]
MCLM	Location and sizing (power [4] and capacity)	Minimize the infrastructure cost for a given demand	Yang et al. (2017) [58]
MCLM	Location and sizing (power)	Maximize the amount of energy charged	Wagner et al. (2013) [80]
MCLM	Location and sizing (power)	Maximize the number of EVs charged	Liu, J. (2012) [87]
MCLM	Location and sizing (power)	Minimize the infrastructure cost for a given demand	Deb et al. (2019) [88]
p-median	Location	Minimize the distance (or deviation) to a charging station	Xu et al. (2013) [54]

Table 2.2: Summary of articles using the node-based approach

Method	Problem	Main optimization goal	Paper
p-median	Location	Minimize the distance (or deviation) to a charging station	Gavranović et al. (2014) [67]
p-median	Location	Minimize the infrastructure cost for a given demand	Jia et al. (2014) [82]
p-median	Location and sizing (capacity)	Minimize the distance (or deviation) to a charging station	Ge et al. (2011) [53]
p-median	Location and sizing (capacity)	Minimize the infrastructure cost for a given demand	Mehar et al. (2013) [46]
p-median	Location and sizing (capacity)	Minimize the infrastructure cost for a given demand	Sadeghi-Barzani et al. (2014) [72]
p-median	Location and sizing (capacity)	Minimize the infrastructure cost for a given demand	Zhu et al. (2017) [65]
SCLM	Location	Maximize the number of EVs charged	Wang & Lin (2009) [77]
SCLM	Location	Maximize the number of EVs charged	Wang & Wang (2010) [55]
SCLM	Location and sizing (capacity)	Maximize the amount of energy charged	Csiszár et al. (2019) [60]

Table 2.2: Summary of articles using the node-based approach

Method	Problem	Main optimization goal	Paper
SCLM	Location and sizing (capacity)	Minimize the infrastructure cost for a given demand	Andrenacci et al. (2016) [89]
SCLM	Location and sizing (capacity)	Minimize the infrastructure cost for a given demand	Ghamami et al. (2016) [90]
SCLM	Location and sizing (capacity)	Minimize the infrastructure cost for a given demand	Davidov & Pantoš (2017) [91]
SCLM	Location and sizing (capacity)	Minimize the infrastructure cost for a given demand	Vazifeh et al. (2019) [92]
SCLM	Location and sizing (power)	Minimize the infrastructure cost for a given demand	Li et al (2011) [93]
Unclassified (node-based)	Location	Maximize charger utilization	Pevec et al. (2018) [50]
Unclassified (node-based)	Location	Minimize the infrastructure cost for a given demand	Rajabi-Ghahnavie & Sadeghi-Barzani (2017) [47]
Unclassified (node-based)	Location and sizing (capacity)	Maximize the number of EVs charged	He et al. (2016) [84]
Unclassified (node-based)	Location and sizing (power)	Maximize the distance traveled	Wang et al. (2019) [61]



## 2.4.2 Path-based approach

Instead of dealing with demand at nodes, Hodgson [29] introduced a path-based version of the MCLM called the Flow-Capturing Location Model (FCLM) with the hypothesis that traffic in a network can be served by several facilities located on common paths. The FCLM considers origin–destination pairs and aims to maximize the flow captured on the shortest path between origins and destinations. In this model, the path is considered covered if it passes through at least one node with a charging station.

The FCLM was later extended. Kuby and Lim [94] developed the Flow-Refueling Location Problem (FRLM) especially for alternative-fuel vehicles that considers the limited range of the vehicles, as a vehicle may have to stop at more than one refueling station in order to complete a path. They found that placing charging stations only at nodes would not be sufficient to provide total coverage, and then developed a method to locate stations on links [95]. Then, with Upchurch [66], they went on to develop the CFRLM, which is a FRLM with capacity constraints on the refueling stations. Wang et al. [69] used this model to place different kinds of stations, as previous models only take into account one type of charging stations. Kim and Kuby [96] then devised an optimization model that considers the deviations from the shortest path that drivers should have to make to refuel their vehicle, and Huang et al. [97] proposed a model with the possibility of multiple deviation paths. Li et al [38] proposed a ‘multi-period multi-path’ FRLM with the objective to minimize the total cost of installations while making each trip feasible via at least one path between origin and destination within a reasonable tolerance compared to the shortest path, and considering the dynamics of the network over time. Further, Wu and Sioshansi [98] developed a stochastic FCLM model that takes into account the uncertainty of EV charging demand as soon as the infrastructure is built in anticipation of future EV adoption. Table 2.3 gives an overview of path-based methods.

---

<sup>3</sup>The sizing in capacity refers to number of EVs that can be served per unit of time

<sup>4</sup>The sizing in power refers to charging speed (higher charging power means higher charging speed)

Table 2.3: Summary of articles using the path-based approach

Method	Problem	Main optimization goal	Paper
FCLM	Location	Maximize number of EVs charged	He et al. (2018) <a href="#">[99]</a>
FCLM	Location	Maximize number of EVs charged	Motoaki, Y (2019) <a href="#">[56]</a>
FCLM	Location	Maximize number of EVs charged	Riemann et al. (2015) <a href="#">[100]</a>
FCLM	Location	Maximize number of EVs charged	Wu & Sioshansi (2017) <a href="#">[98]</a>
FCLM	Location	Minimize the infrastructure cost for a given demand	Li et al (2016) <a href="#">[38]</a>
FCLM	Location	Minimize waiting time at the station	Hanabusa & Horiguchi (2011) <a href="#">[51]</a>
FCLM	Location and sizing (capacity)	Minimize failed trips (or maximize number of possible trips)	Micari et al. (2017) <a href="#">[63]</a>
FCLM	Location and sizing (capacity)	Minimize the infrastructure cost for a given demand	Dong et al. (2016) <a href="#">[45]</a>
FCLM	Location and sizing (capacity)	Minimize the infrastructure cost for a given demand	Xiang et al. (2016) <a href="#">[101]</a>
FRLM	Location	Maximize number of EVs charged	Kuby et al. (2005) <a href="#">[94]</a>

Table 2.3: Summary of articles using the path-based approach

Method	Problem	Main optimization goal	Paper
FRLM	Location	Maximize number of EVs charged	Kuby et al. (2007) [95]
FRLM	Location	Minimize the infrastructure cost for a given demand	Huang et al. (2015) [97]
FRLM	Location	Minimize the infrastructure cost for a given demand	Li & Huang (2014) [25]
FRLM	Location and sizing (capacity)	Maximize number of EVs charged	Upchurch et al. (2009) [66]
FRLM	Location and sizing (capacity)	Maximize number of EVs charged	Zhang et al. (2018) [71]
Hybrid approach: node and path-based	Location	Minimize failed trips (or maximize number of possible trips)	Upchurch & Kuby (2010) [102]
Hybrid approach: path-based (fast charging) and node-based (slow charging)	Location	Minimize the infrastructure cost for a given demand	Huang et al. (2016) [103]
Hybrid approach: path-based (fast charging) and node-based (slow charging)	Location and sizing (power)	Maximize number of EVs charged	Sun et al. (2018) [57]

### 2.4.3 Tour-based approach

The third method is the tour-based approach, sometimes also called activity-based. Jia et al. [48] proposed a model with the estimation of vehicle charging demand based on parking demand, measured in *vehicle-hours*. They assumed that the more occupied the parking slots are, the more charging demand there will be, regardless of turnover. Chen et al. [59] developed a parking-based model that considers the duration of parking time but excludes home parking. Cavadas et al. [104] also considered the possibility of demand transference between charging sites for users, meaning that the charging demand on distinct places can be transferred between those sites according to the users' activities. You et al. [68] adopted a strategy based on missed trips in tours. Their optimization model tries to minimize the number of tours that could not be done due to a lack of charging stations. Andrews et al. [105] adopted a similar approach on missed trips but considering the available charging infrastructure. They developed a 'user charging model' that determines where and how EV users need to charge given the available charging methods. If a vehicle fails its trip due to a lack of infrastructure, it is taken as an input in an optimization program to place new charging stations. Cai et al. [49] proposed a data-driven method based on taxi data to put charging stations in existing gas stations. They extracted stop events to find charging opportunities at the different stations and estimated the potential charging demand for stop points in gas stations by evaluating state of charge according to previous tours. Shahraki et al. [106] used a similar method but focused on plug-in hybrid electric vehicles (PHEV). They looked at dwelling time between trips and estimated the state of charge of batteries after each trip, then placed charging stations to minimize the distance traveled by PHEV in combustion-engine mode. Gonzalez et al. [107] adopted a similar approach from simulation data, with an optimization concerning vehicles not able to complete their daily trips without modifying their initial behavior to charge their EV while considering electricity price fluctuations in order to minimize charging cost. He et al. [64] determined a bi-level tour-based model with traffic network equilibrium considering interactions between trips and charging needs in the lower level and aiming to maximize

social welfare in the upper level. Xi et al. [108] adopted a lower-resolution model, dividing a region into sub-regions for which the trip data between sub-regions is available. Their aim was to maximize the number of EVs that charge, or the amount of battery charged, with a trade-off between level 1 and 2 infrastructures under a budget constraint. They found that the efficiency of privileging level 1 or 2 infrastructure depends on the objective chosen, but that level 1 chargers are more cost-efficient if sufficient funds are unavailable.

An overview of the tour-based literature is given in Table 2.4. The tour-based methods are not really categorized, so the "Method" column does not appear contrary to the two previous tables.

Table 2.4: Summary of articles using the tour-based approach

<b>Problem</b>	<b>Main optimization goal</b>	<b>Paper</b>
Location	Maximize distance traveled	Shahraki et al. (2015) [106]
Location	Maximize number of EVs charged	He et al. (2015) [64]
Location	Minimize the distance (or deviation) to a charging station	Andrew et al. (2013) [105]
Location	Minimize failed trips (or maximize number of possible trips)	Asamer et al. (2016) [62]
Location	Minimize the infrastructure cost for a given demand	Wang et al. (2017) [44]
Location	Minimize waiting time at the station	Jung et al. (2014) [83]

Table 2.4: Summary of articles using the tour-based approach

<b>Problem</b>	<b>Main optimization goal</b>	<b>Paper</b>
Location	Minimize waiting time at the station	Tu et al. (2016) [52]
Location and sizing (capacity)	Maximize charger utilization	Cai et al. (2014) [49]
Location and sizing (capacity)	Maximize number of EVs charged	Cavadas et al. (2015) [104]
Location and sizing (capacity)	Minimize failed trips (or maximize the number of possible trips)	Dong et al. (2012) [109]
Location and sizing (capacity)	Minimize the infrastructure cost for a given demand	Han et al. (2016) [110]
Location and sizing (capacity)	Minimize the infrastructure cost for a given demand	Jia et al. (2012) [48]
Location and sizing (power and capacity)	Maximize the amount of energy charged	Chen et al. (2013) [59]
Location and sizing (power and capacity)	Maximize number of EVs charged or maximize the amount of energy charged	Xi et al. (2013) [111]
Location and sizing (power)	Minimize failed trips (or maximize number of possible trips)	You & Hsieh (2014) [68]
Location and sizing (power)	Minimize waiting time at the station	Kameda & Mukai (2011) [112]

Tour-based models often require a lot of data, which is often difficult to access for privacy reasons. Agent-based models—or multi agent models—can informatively simulate data and analyze traffic dynamics [61]. Chen et al. [113] used an agent-based model with autonomous EVs to place charging stations. This kind of model can be built from real travel data (travel surveys, etc.) and be used to compare users’ behaviors among different charging infrastructure deployment strategies. Agent-based models can also be built to scenarios for study, which can be useful if there is insufficient data to validate a model principle. This can be valuable in the case of data-greedy tour-based models. Multi-agent models make it possible to track each agent in a studied population individually, and therefore carry out analyses in relation to the activities of that population, and provide explicit representations of tours [114]. Moreover, modeling tools like the MATSim project [115] have been developed to simulate populations’ behavior with regard to the transport system, and they can be used to model energy demand [116].

## 2.4.4 Discussion

To sum up, Figure 2.6 gives an overview of the methods previously discussed.

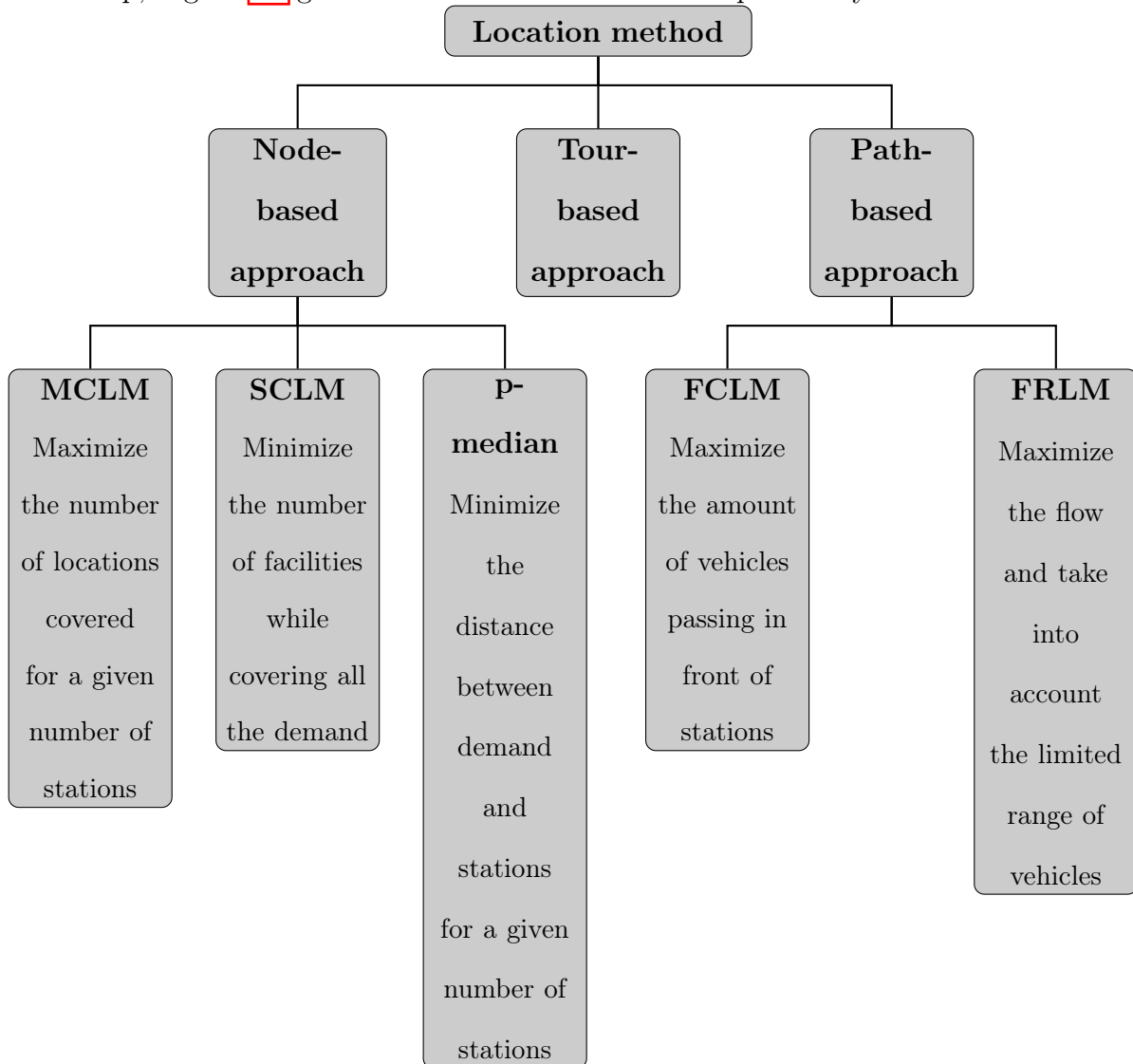

Figure 2.6: Overview of location methods

The main advantage of the node-based approach is that it needs little data, only requiring population density, which is relatively accessible. This makes the node-based approach an easy first estimate of charging station locations. However, there are limits to this type of coverage. For instance, the uncapacitated models only deal with coverage without considering the amount of demand. Second, this resolution pathway offers a static vision of the charging demand, which is not the case in reality: as previously stated, one



of the main advantages of a flow-based model over a nodal approach is that it can take into account issues that only emerge from the description of vehicle flows. Another issue is that node-based coverage can lead to a poor representation of charging needs. According to Hodgson [29], the demand in a network is not always expressed at nodes, as people generally will not make a trip from home to the charging station just to charge their vehicle. Furthermore, a node-based approach fails to deal with issues emerging from traffic flows such as cannibalization, meaning that charging stations cut into each other's coverage areas. In addition, Upchurch et al. [102] found that the flow-based method is more stable as the number of charging stations to place increases, which is really important when planning over time. That is why many studies explicitly integrate the effect of flows into the location of charging stations [38].

However, this flow-based approach is not suitable for all cases. Flow-based methods consider that EV charging will be done quickly before continuing the trip to the primary destination, just as any ICE vehicle user would do. While this solution is possible with fast charging stations, which can refuel an EV in a dozen minutes, it is not possible for slow charging stations where EV batteries can take several hours to charge. Thus, the flow-based approach is not a substitute for the node-based approach, but complementary to it, depending on objective, territory, type of charging stations, etc. However, many studies only use one or the other category. Sun et al. [57] used a mixed-method approach, with location of fast charging stations for vehicle interception and a node-based approach to place slow charging stations in places where a long charging time is acceptable. However, flow-capturing models often fail to capture the uncertainty of EV charging demand, which can lead to less robust locations [98].

Given the issues with the flow-based approach, the tour-based approach is based not only on user driving patterns but more generally on user behaviors. This type of approach is sometimes also referred to as 'activity-based'. By considering events around the details of the sequence of trips, it allows a better representation of drivers' charging needs than the two previous approaches. By using real and individual data, the tour-based approach

captures the randomness in the behavior of users, and allows to serve all users, which cannot be done with aggregated data, as illustrated in Figure 2.7. In this case, both green and yellow paths pass through nodes 1 and 2, and the red path passes through node 3. If two stations were placed based on aggregated data, they would be at nodes 1 and 2 that have the most traffic passing through, but the green and yellow vehicles would be served twice and the red one would not be served at all, which could have been avoided if using individual data.

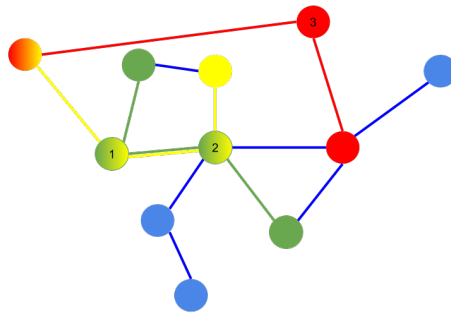

Figure 2.7: Example of three paths

However, as noted in most of the tour-based works, this method is often data-driven, with real or at least simulated data. It requires a large amount of highly detailed data, drilling down to at least the detail of individual trips and stops for a sufficiently large sample size to make the model realistic. This data can be hard to obtain. The main points of comparison between approaches are summarized in Table 2.5

Table 2.5: Main points of comparison between location methods

Criteria \ Method	Node-based	Path-based	Tour-based
Urban territory	+	--	++
Highways	-	++	+
Representation of charging needs	-/+	+	++
User behavior	-	-/+	++
Data requirements	Very low	Low	Very high

To conclude this section, note that many studies have been conducted for the purpose of planning the best possible charging infrastructure. They have been carried out with different criteria to be optimized according to the desired objective. However, while it is easy to check whether chosen criteria have been optimized, it is harder to measure the impact of this model on the population, in other words whether the criteria chosen are the right ones. The high cost of the infrastructure makes large-scale testing unfeasible. To overcome this problem, multi-agent models can help, as explained above. However, these models may be subject to simulation bias, and may therefore give an erroneous view of user behaviour.

## 2.5 Conclusion

This paper analyzed models for deploying charging infrastructure and discussed the allied technical, economic, and user behavior-related issues.

The wide diffusion of EVs is a step towards greener mobility, which is one of today's big challenges. This transition from ICE vehicles to EVs cannot take place without in-

infrastructure that greatly reduces early users' range anxiety and reassures potential future users that EVs are capable of providing the same services as ICE vehicles. For the time being, infrastructures have been developed with a limited real coherent overarching strategy. However, the underlying costs of necessary infrastructure to meet the needs of a large number of EV users, as well as the physical limitations of the electricity grid, make it imperative to coordinate and optimize the large-scale deployment of an electric charging infrastructure, failing which there is a risk of wasting valuable resources and of ending up with an infrastructure that is not adapted to user needs.

The scholarship has used several approaches for optimizing the deployment of charging infrastructure. These approaches can be collapsed into three categories: node-based, path-based, and tour-based. Although not specific to EV charging infrastructure planning, these approaches can readily adapt to consider the specificities of EVs instead of copying the gas station model, and facilitate the transition from ICE vehicles to EVs easier by minimizing the constraints of using EVs.

The node-based approach is easy to implement and suitable for certain areas such as residential neighborhoods, but it fails to capture the problems arising from vehicle flows. The path-based approach can address this gap, but it is better suited for highway use-cases and has the downside of leading to time-consuming infrastructure, which may prove a barrier for users to make the transition from ICE vehicles to EVs. The tour-based approach requires a lot of data and is therefore more difficult to implement, but it is able to consider user activities in order to get the best-adapted and least-restrictive infrastructure possible for users. With data on the activities of users, points of interest can be exploited to provide charging solutions at locations where there is demand, without users having to change their behavior [117].

The methods adopt different response strategies, regardless of the approach used. Some focus on maximizing served demand for a fixed budget, which can be expressed in terms of the number of vehicles to be charged, volume of energy to be charged, time saved or number of feasible trips. Others consider charging demand as the primal condition

and try to minimize the budget needed to satisfy it. While early work focused on the geographical placement of charging stations to meet charging demand, more recent models now also integrate the service capacity of the stations, introducing station sizing into the results. Charging speed used is rarely considered: many models consider only one type of charging station, thus defining only the number (and not quality) of charging points needed.

Few of the models other than node and parking-based models look to take advantage of the benefits offered by EV charging, which does not require the user to be present during charging time. This key advantage should be considered in order to plan a charging infrastructure that matches charging opportunities, to make EV use as unrestrictive as possible and thus encourage EV diffusion .

To conclude, the optimization models reviewed in this manuscript do not consider any temporality in deployment: for a given budget, the infrastructure is optimized as if all the stations were placed simultaneously. However, this kind an infrastructure does not get deployed all in one go, partly because of the development costs it would generate without a guaranteed return on investment from a demand that will take a long time to come. Charging infrastructure deployment will take place over a period that may last several years, and this factor should now be explored in order to have an infrastructure that provides acceptable coverage from the very beginning of its deployment, and not just once the last charging points have been installed. An incremental ‘over-time’ deployment must therefore be considered, factoring in the early-stage infrastructure already present in the territory, which very few models do (see Appendix [A](#)), and the action of ‘adding one more station’.

## Chapter 3

# From user to operator: Rationalizing the charging infrastructure deployment

\*

The environmental objectives set by the various international summits call for greening the transportation sector, which is responsible for a significant share of greenhouse gas emissions. The current trend is a transition from the current fleet of vehicles to a fleet of electric vehicles. To allow this transition, it is necessary to ensure the acceptance of the electric vehicle among its users. This acceptance requires the deployment of a charging infrastructure adapted to user needs. In this study, we propose a multi-criteria charging infrastructure deployment model, not only geographically but also incrementally, to reflect the timing of the deployment of such an infrastructure. The model is oriented to meet the needs of users, assuming that charging demand will follow if a suitable infrastructure is proposed. We then apply the proposed methodology to the Berlin region, using a MATSim multi-agent simulation. Our main results show that slow chargers are more cost-efficient than faster ones. They also show that home - or residential -charging is key for electric vehicle acceptance and that a coherent deployment agenda helps reduce the range anxiety faster and ensure the coherence of the final charging infrastructure.

\*

### 3.1 Introduction & literature review

The current climate issue requires a drastic reduction in anthropogenic greenhouse gas emissions. Among the highest emitting sectors, road transport accounts for between 20 and 25% of these emissions in Europe and the US [18]. A transition in this sector towards greener mobility is therefore an important lever to reducing global greenhouse gas emissions. The solution currently at work is to transform the fleet of internal combustion vehicles into a fleet of electric vehicles (EVs), with much lower emissions, especially if used in an environment with clean electricity production [19]. Even if it is not a perfect solution, it represents a significant improvement necessary for a more sustainable mobility. But such a transformation cannot take place without the acceptance of electric vehicles by users. This acceptance among the whole population is slowed down by a number of barriers, the two main ones being the price of vehicles and the range anxiety [12], *i.e.* the fear for an electric vehicle user that the car’s battery will run out of power before they can be able to reach their destination or a suitable charging point.

As the high price of electric vehicles is mainly explained by the (relative) youth of the technology, which is still in development, this barrier is expected to disappear in a quite short term according to several car manufacturers and consulting firms analyses [118]. But the range anxiety barrier is tougher. To overcome this fear of not being able to finish trips without running out of battery, there are two solutions: either increase the size of the batteries or improve the charging infrastructure. However, increasing battery size is a false solution to the problem, for at least three reasons.

First, the electric battery accounts for about one-third of the cost of an electric vehicle. Increasing the size of the battery would therefore substantially increase the price of electric vehicles, resurrecting a disappearing barrier. It seems that current battery capacities (around 50kWh) are more than enough for typical daily use and that advances in battery technology should rather be used to lower costs at constant capacity than to increase battery size at constant price [119]. The price difference caused by a bigger battery could be smoothed out by subsidizing the purchase of electric vehicles, but EVs are already

highly subsidized in many places, and even if more investments are made, subsidizing a charging infrastructure is today more economically efficient than subsidizing electric cars [120].

Second, this leads to an ecological problem, while electric vehicles are supposed to contribute to more sustainable mobility. Even if the total carbon footprint of an electric vehicle is better than that of a thermal vehicle, EVs are not a perfect solution for sustainable mobility. This better solution should not make us forget that the manufacturing of an electric vehicle represents a very high environmental cost both in terms of CO<sub>2</sub> emissions and in terms of soil and water pollution, pollution mainly due to the manufacturing of the battery. Increasing the size of the battery means increasing the negative environmental impact of the electric vehicle, which would not be coherent for an ecological solution.

And third, this does not solve the final problem: even with a battery providing the same driving range as a combustion engine vehicle, there will come a time when the vehicle will have to be charged. If the infrastructure is not adapted, the problem will remain the same: the user will perceive risks regarding the impossibility of charging. This anxiety, although reduced, will therefore remain a brake on the acquisition of an electric vehicle as a primary vehicle.

The solution is therefore to be found on the infrastructure side. However, sufficient charging infrastructure is more of a structural issue and requires a real effort on the part of the actors in the field. To achieve user acceptance, electric vehicles must be as convenient as internal combustion engine vehicles (ICEV) in their daily use, including for those who cannot charge their vehicle at home. A critical step required to achieve this goal is the existence of a public charging infrastructure adapted to the behavior of vehicle users [13]. And such an infrastructure is not so simple to implement. It is not enough to put charging stations everywhere: not only would it be a waste of resources, but we will see that the simple criterion of geographical coverage is not sufficient to ensure the appropriateness of the infrastructure.

Several types of charging stations exist, allowing more or less long charging times, but



also imposing different constraints on the electrical network, on costs... It is sometimes essential to have fast charging solutions. We have seen that one of the major problems in the transition from an ICEV to an electric vehicle is the range anxiety. For this, fast chargers can play an important role. An experiment by the Tokyo Electric Power Company showed that the presence of a fast charger paradoxically increased the use of other chargers, without the fast charger being used very much: its mere presence reassured drivers, who therefore used their electric vehicle to go to places where they would not otherwise have gone, simply because they knew they had the possibility of charging if they needed to (even if this need turned out to be non-existent) [121]. Fast chargers therefore have a strong insurance value that may be essential for the democratization of EVs. In addition to this insurance value, fast chargers are essential to solve the problem of long journeys in electric vehicles, where the time spent charging is lost time, and therefore where charging stations must be used like conventional service stations [117]. The same is true for taxis and emergency services, which cannot afford to spend several hours charging and must have vehicles quickly available and fully functional [61]. Facing these issues, several models to specifically place fast charging stations have been proposed [47, 82, 45, 98, 49, 44]. However, these fast chargers are very expensive, cannot be used by every vehicle, and represent an important constraint for the power grid [122], in addition to causing accelerated degradation of the batteries compared to a slower charge [123].

This is why, while it is sometimes essential to have fast charging solutions, a slower charger can be sufficient for users' needs. One of the major advantages of the electric vehicle is that it is not necessary to be at the vehicle during charging. So when EVs are parked for several hours, their charge can be spread over several hours. A slow charger, which is much cheaper and less constraining for the power grid and the vehicle, is much easier to install and can satisfy the charging needs if it is placed in the right place. Several models also exist to place slow charging stations, although most are not specifically made for slow charging stations, but rather for one type of charging station, without specifying which one, while using the features of slow chargers [50, 79, 73, 54, 104].

Based on these different utilities, characteristics, and constraints, it is necessary to carefully choose the right charging stations at the right places, in order to ensure the adequacy between charging needs and resource allocations, and thus maximize the utility of the infrastructure while avoiding a waste of resources that could be used for improving the infrastructure. Models proposing to deploy different types of stations in a coordinated way on the same territory exist, but are already less numerous when talking about spatial deployment and often centered on which power to choose [84, 80, 93, 103].

To tackle the charging infrastructure deployment problem, the existing literature lists a wide range of models with different goals. Those goals can be minimizing the waiting time at the charging stations [52, 83], as charging an electric car is longer than charging a conventional one and no one wants to spend hours waiting in the queue at the charging station. Some models also try to maximize the number of EVs that can be served under cost considerations [55, 99], or also to maximize the feasible trips with an electric car also with cost constraints [63, 102]. Conversely, some models try to minimize the costs for a certain level of service given [58, 48]. Here, we gave a quick overview, but a lot of other infrastructure goals can be found in the literature [15].

In order to achieve these goals, the approaches taken can broadly be clustered into three approaches [75].

First, the node-based approach transforms the charging station location problem into a land coverage problem, very close to the classical facility location problem. In this approach, the idea is to minimize the distance between the demand points and the charging stations. A variant is to consider that a station covers a certain zone, and try to get the most possible part of the demand (or all the demand) inside those covered areas. This model is rather well suited for city centers, where demand is dense and rather static. On the other hand, it fails to capture the demand coming from traffic flows.

Second, the path-based approach, which sees the problem as a flow capture problem. The models with this approach try to capture the maximum amount of vehicle flows, i.e. placing charging stations where there are the biggest vehicle flows. This model is

particularly well suited for highways, where stops are made "en route" when the battery's state of charge becomes insufficient. It is also quite suitable for the fastest charging stations, where charging an electric vehicle does not take much longer than filling up a conventional car. On the other hand, it is much less suitable for slower charging stations and short trips: stopping for several tens of minutes, or even several hours, in the middle of a trip is clearly not an option if electric vehicles want to guarantee a comfort of use which is comparable to that of an internal combustion engine vehicle (ICEV).

And third, the tour-based approach, or activity based; consists of capturing the charging opportunities for the vehicles. To explain it simply, in this type of approach we consider several parameters (routes, parking time, state of charge of the battery...) on a succession of trips called tours. According to these parameters, we place charging stations at the places where they will be the most useful. Those kinds of approaches are mainly data-driven.

But due to the high cost of deploying full charging infrastructure, it cannot be a prerequisite for the pre-eminence of electric vehicles in the fleet on the road: as electric vehicles on one side and charging stations on the other form a two-sided market, the infrastructure cannot precede the democratization of electric vehicles but must go with it, as the lack of certainty of a return on investment and the high costs involved in achieving a final charging infrastructure prevent it to be deployed all at once. [23]. However, the existing literature mainly focuses on the final optimality of the charging infrastructure, without taking into account its development according to a temporal pattern consistent with user needs [15]. This mismatch with users' needs during the charging infrastructure deployment risks slowing down the adoption of electric vehicles, and therefore investment in the charging infrastructure, which may never exist in its final version because of this vicious circle [36]. So the deployment of the infrastructure must be done according to coherent planning to be as useful as possible to the users, and this as soon as the first charging stations are installed, in order to ensure the growth of the fleet of EVs necessary for the growth of the infrastructure.

In this chapter, we propose a new model for infrastructure deployment. This model focuses on the development of the infrastructure according to users' needs. We optimize the deployment of the infrastructure for charging at the destination: the objective being that electric vehicle drivers have stations where they need them and that charging is not a waste of time for them. Therefore, in our model, we do not allow for "en-route" charging. In order to take into account these users' needs as accurately as possible, we use five criteria to quantify the need for charging. The criteria are based on parking data and on the coverage of the territory by the infrastructure.

In order to account for EV users needs, since the charging needs are not the same everywhere, several types of stations can be deployed. In this study, we limit ourselves to three types of stations deployed on the territory: slow (7kW), medium (22kW), and fast (100kW), without distinguishing between brands or compatibility with certain vehicles. The sizing of the charge points is done at the same time as the choice of their location: several charging stations can be placed in the same place, potentially of several types, and not necessarily at the same stage of infrastructure deployment. We consider a single operator, but in the case of several players, this can lead to competition that may be interesting to study in future research.

As explained above, a complete infrastructure is deployed in a spatial, but also a temporal context. In order to integrate the sequential aspect of the infrastructure deployment, which is crucial, we adopt a marginal approach. We propose a stepwise deployment of the infrastructure so that it is as useful as possible from the first stations installed, taking into account at each step of the deployment the new data due to the previously added stations.

Our results show that for an optimal infrastructure, the slowest chargers -which are also the cheapest- are to be preferred, although fast chargers remain required for some particular cases. Home charging is a determining factor in the acceptability of the electric vehicle, but it is not possible everywhere and is not necessarily the most efficient in terms of overall costs. However, it must be taken into account in the deployment of the

infrastructure, at the risk of having under-used stations. Finally, in order to maximize its usefulness, investment in charging infrastructure must be coupled with investment in the education of electric vehicle drivers, so that they adopt the best possible practices.

In the rest of this chapter, we present our methodology for the deployment of the charging infrastructure. We then apply this methodology to the Berlin region through a MATSim multi-agent simulation, and draw lessons and key points from the results.

## 3.2 Model formulation

We need to think the development of charging infrastructure in a way that accompanies the democratization of electric vehicles. We, therefore, need a deployment model that offers an infrastructure that best suits the needs of users. This model must integrate not only the spatial and quantitative aspect of the charging infrastructure - basically where, how many, and which type of charging stations are placed - but also a temporal aspect: when to place these stations, or more exactly in what order, so that the number of charging stations and electric vehicles grows together? And this with taking into account the existing infrastructure, since many places are already starting to have charging stations not considering them may result in wrong investments.

### 3.2.1 Method overview

While most of the existing methods in the literature aim to find a final infrastructure optimized according to a chosen criterion, the placement methodology we propose follows an incremental logic. Here we want the deployment of the infrastructure to accompany the growth in the number of electric vehicles and to follow the evolution of the users' needs. This justifies an incremental approach according to the system evolution rather than a one-shot optimization.

It is expected that the placement of a new charging point at a location will induce a change in the behavior of users. For example, some drivers may change their usual route

if a charging station is on their way, which may change the choice of the next charging station to be placed. It is therefore important not to plan the deployment of the entire charging infrastructure and then blindly deploy it. It is rather better to wait for the behavior change to happen after each step of the deployment, in order to make the best choice in choosing the next station to be deployed. This would lead to an infrastructure that supports effectively the increase of the proportion of electric vehicles.

The overall principle of the method we propose is shown in Figure 3.1. The steps of the model are given below.

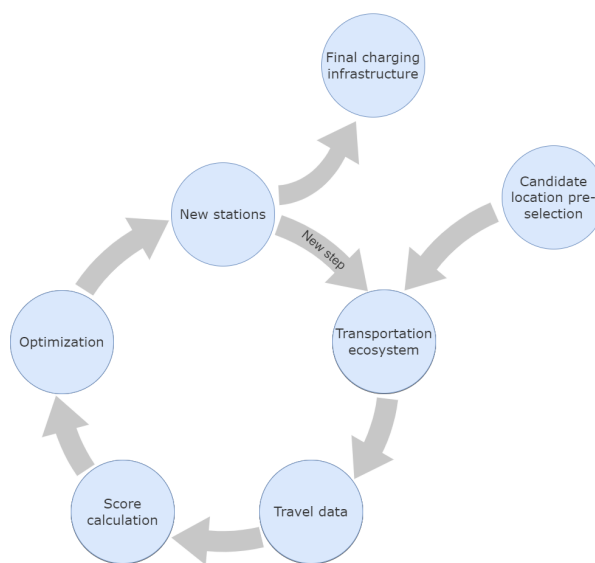

Figure 3.1: Model principle overview

1. First of all, we start by pre-selecting candidate locations for receiving a charging station in the area under consideration. This pre-selection is not mandatory, but it reduces the size of the problem. In our case, the pre-selection is made according to the attendance of the considered places. A budget is also set for each deployment step.
2. A score is calculated for each of the candidate locations. This score represents the interest in placing a station at a location and is calculated according to the criteria detailed later.
3. According to these scores, we choose the stations to place in order to maximize the

total score of the infrastructure, under budget constraints. The model allows for the choice of different types of stations (slow, medium, fast...).

4. Then the scores are updated with the new data, which may have changed due to the addition of the new stations. It is important to note that a location where a station was placed is not removed from the list of candidate locations, its score is just updated according to the new data. Therefore, several stations can be placed at the same candidate location.
5. Now the scores are updated, we choose again charging stations to place under a budget constraint.
6. And so on, until the last step of the infrastructure deployment.

This incremental approach allows us to model the effect of a step-by-step development of the infrastructure, and the choices to be considered when extending it. It then remains to calculate the score to assess the usefulness of placing stations at certain locations according to relevant criteria.

### 3.2.2 Score calculation

In order to optimize the deployment of the infrastructure, we seek to evaluate the interest in placing a station at a candidate location. To do so, we calculate a score for each candidate location.

For this purpose, we have selected 5 criteria that will determine the usefulness of placing a charging station at a location. Those criteria are the number of vehicles that park at the considered location, the number of distinct vehicles that park at the location, the parking duration at the location, the state of charge of the vehicles when parking, and finally the land coverage of the considered region.

Each of these criteria is evaluated individually with a score between 0 and 1, and the sum of all those normalized scores associated with each criterion gives the overall score

of the location to be evaluated. The advantage of having such a modular function is that it is easy to give more or less importance to a criterion by playing on the coefficients of each one. For example, the criterion relating to the number of distinct vehicles can be increased if we aim to serve as many different people as possible, or the one related to the land coverage can be reduced if we want to give more importance to the profitability of the infrastructure (at least on the short term).

### Number of parking events

This selection criterion is quite intuitive: if we want a charging point to benefit the greatest number of people, it makes sense to place it where the most cars are parked. In order to evaluate the interest of a candidate location, the number of vehicles parking at a location is a common criterion in station placement models [59, 49]. To evaluate the utility  $U_n$  relative to the number of cars, we simply count the number of vehicles that park at each location over the period being evaluated, and bring this count between 0 and 1 for the normalized score function:

$$U_n(p) = \frac{N_n(p)}{\max_{r \in R} N_n(r)}, \quad (3.1)$$

with

- $N_c$  the number of parking events at the considered location  $p$ ,
- $\max_{r \in R} N_n(r)$  the maximum number of parking events in a location in the considered region  $R$ .

In this way, the location with the most parking events over the studied period gets the maximum score of 1, and the others a lower relative score. One way of preselecting candidate locations for charging stations is to calculate this score for all locations, which is relatively fast, and eliminate those below a certain threshold, which will not receive sufficient traffic.



**Number of distinct vehicles parking events**

This criterion is relatively similar to the previous one. The only difference is that instead of counting the number of parking events, each user is counted only once. Although it seems redundant with the first one, this criterion ensures that it is not always the same people who have access to a station. Thus, the infrastructure benefits as many users as possible, which serves the goal of the democratization of EVs.

The score function  $U_v$  is slightly the same as the previous one:

$$U_v(p) = \frac{N_v(p)}{\max_{r \in R} N_v(r)}, \quad (3.2)$$

with

- $N_v(p)$  the number of distinct users that park at the considered location  $p$ ,
- $\max_{r \in R} N_v(r)$  the maximum number of distinct users that park at a location in the considered region  $R$ .

This way of doing also gives a score between 0 and 1, with 1 reached by the most interesting place according to this criterion.

In order to maximize the number of different vehicles served, we can also consider the interdependencies of the locations. If a large number of people pass through the same places, it may be more interesting if these places are a little less equipped, since users will be able to charge in other visited places.

To do this, we can add to  $U'_v$  a function that takes into account the users' tours:

$$U'_v = \frac{1}{N_e} \sum_{i=1}^{N_a} \frac{1}{\mathcal{N}_i}, \quad (3.3)$$

with

- $\mathcal{N}_i$  the number of places already equipped visited by the agent  $i$  during his whole trip,
- $N_e$  the number of parking events at the considered place.

Thus, with this additional function, the score is maximal if no agent parking at the considered location has access to a charging station during his journey, and the more agents have had access to charging stations, the more it decreases. At first, we will not include this part in our model, because the calculation of the tours adds a non-negligible complexity, but it could be considered in further extensions.

### Parking duration

The parking time score mainly determines what type of station is most useful to deploy. Given the price differences between the different types of stations and the constraints inherent to faster charging, the choice of suitable charging stations is crucial for good resource allocation. As an example, if the average parking time at a location is 6 hours, installing a costly fast charger that can charge a vehicle in 30 minutes would be a waste of resources, as a fifty times less expensive slow charger could have been sufficient to meet users' needs.

Based on this observation, we built a function  $U_d$  to quantify the usefulness of installing a certain type of station according to the time spent by users on the location considered. It is given by

$$U_d(p) = \sum_{j \in T} b_j \mathcal{G}_j(\bar{t}_p) = \sum_{j \in T} b_j e^{-\frac{(\bar{t}_p - \mu_j)^2}{2\sigma_j^2}}, \quad (3.4)$$

with

- $\bar{t}_p$  the mean parking time at the location  $p$ ,
- $\mu_j$  the time needed to charge 80% of a standard battery with the type of station  $j$ ,

- $\sigma_j$  that is set at  $\frac{\mu_j}{3}$ , so as to have the value of the 3 sigma Gaussian corresponding to a stop of no duration,
- $T$  the set of the different types of stations available,
- $b_j \in \{0; 1\}$  and  $\sum_{j \in T} b_j = 1$ . The variable  $b_j$  is a boolean equal to 1 if the chosen station type is  $j$ , it represents the choice of the type of charging station we want to place at the considered location.

In the absence of a previously constructed function, it seems appropriate at first sight to construct a three-part Gaussian function, with each part centered on the average time of a vehicle load for a station type.

Let's explain what is hidden behind this scoring function. In simple terms, if the time required to charge 80% of a battery with a charging station corresponds to the mean parking time at a location, the choice of the corresponding station is valued. If the charging station takes too much time to charge the vehicle, users' needs are not met so the score is low. And if the charger is too fast, already charged vehicles will continue to occupy charging stations, which means that there has been an overinvestment, thus wasting resources that could have been used elsewhere in the infrastructure. The score will therefore be lower. We choose the time to charge 80% of a standard battery capacity as a reference because users usually never arrive with an empty battery at a location, and it is very rare to have to charge a vehicle from 0% to 100%. Having to charge 80% of a battery in a charge is therefore more realistic. Even if this is still higher than the charging behavior observed today, with users often charging less than half of their battery, a significant amount of EV users are charging more [124]. It is therefore preferable to keep a safety margin, as a charge that is too slow may be badly perceived by users, unlike a charge that is a little too fast.

To illustrate this reasoning, let's take as an example three types of chargers: fast, medium, and slow. They can charge a standard vehicle to 80% in 30 minutes, 3 hours, and 10 hours, respectively (these values are commonly observed charging times). The

possible values of the utility function are shown in Figure 3.2.

Now, we consider a place where the average parking time is 4 hours, represented in Figure 3.2 by the vertical red mixed dotted line.

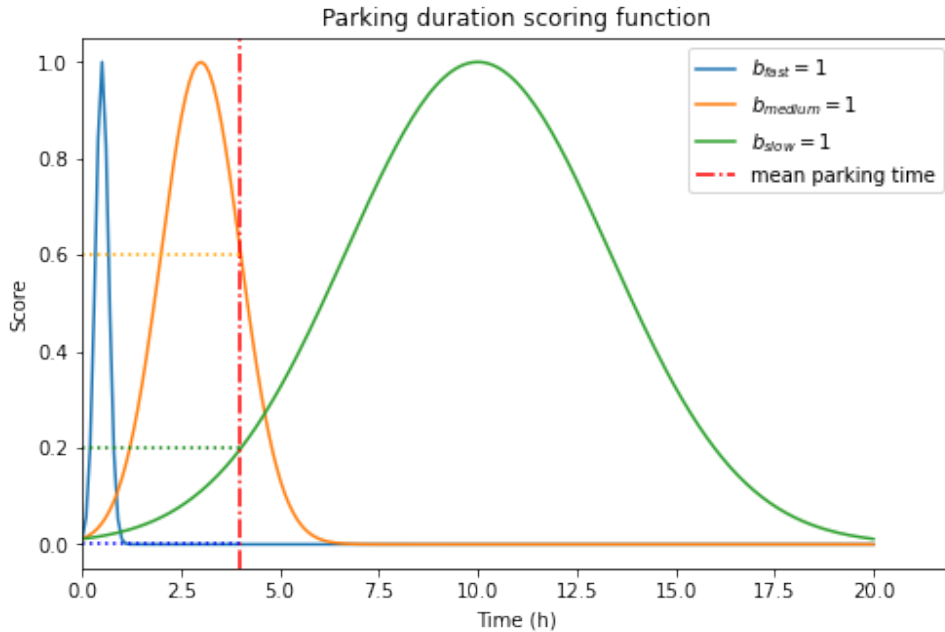

Figure 3.2: Parking duration scoring function

In this case, choosing to place a fast charging station, whose score function is represented by the blue curve, will not be valued at all. With such a station, on average users would charge for 30 minutes and would monopolize the station for nothing during the remaining 3h30 of parking. Given the much higher cost of a fast charging station compared to others, this choice would not be very efficient.

In contrast, choosing to place a medium station, whose score is represented by the orange curve, would be highly valued. Here, the average parking time almost corresponds to the charging time that would be required to charge 80% of a battery, which would be the most efficient allocation of resources: users are served adequately and at a minimal cost.

Opting for a slower station, whose score is represented by the green curve, would be less valuable, but still interesting. In addition, the low cost of these stations (about 50 or 100 times less than fast charging stations) makes them very interesting, so their interest

is increased in a logic of limited budget. However, for short parking times, they do not correspond at all to the needs of users.

### State of charge

The state of charge criterion responds to a very simple logic, which is sometimes used in the literature: a charging station is most useful where users have their batteries empty.

On the contrary, even if there are a lot of vehicles parked in a place, there is no point in offering them charging if they all have their battery full for one reason or another (for example, a supermarket near a residential area where all the customers have home charging, or at the proximity of a company offering charging solutions to its employees). If the targeted users do not need to charge at a place, putting a charging station there represents a waste of resources that could be better used to achieve a more useful infrastructure for the user, in addition to an economic loss for the operator, who could have a more profitable station.

To quantify the usefulness of placing a station according to the state of charge (SOC) of vehicles at a location, we chose the simplified function  $U_{soc}$  to quantify the user's range anxiety, and so his willingness to charge. It is given by:

$$U_{soc}(p) = (1 - \overline{SOC}_p)^a, \quad (3.5)$$

with

- $\overline{SOC}_p$  the average state of charge of the vehicles at the considered location  $p$  (in % of their total battery capacity),
- $a$  a number that represents the tolerance to range anxiety of users ( $a > 0$ ). The higher  $a$  is, the higher the user tolerance to range anxiety (*i.e* the less users fear having a low remaining SOC).

As we did not find a model quantifying the range anxiety and the need to charge, we have chosen to build a realistic model. As illustrated in Figure 3.3, the utility is a decreasing function of the remaining SOC, and for the same SOC value, the score can be higher or lower depending on the sensitivity of the users to the range anxiety. For  $a = 1$ , i.e., a fairly high sensitivity, the need to charge is strong, and therefore the placement of a terminal is valued. On the other hand, for  $a = 4$ , i.e., a quite low sensitivity, this same investment is clearly less valued

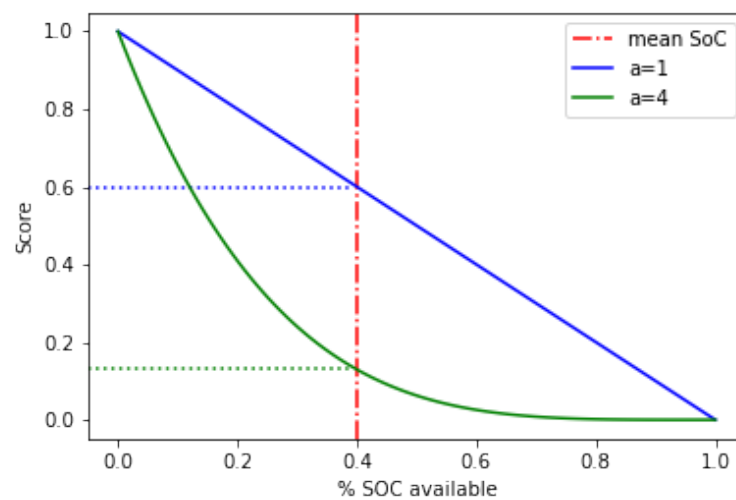

Figure 3.3: SOC scoring function

For the sake of simplicity, in our model  $a$  will be constant for all our locations and all our agents<sup>1</sup>. In a more refined model, it can be adapted according to the location considered, and to groups of agents. For example in an isolated location with no charging solution around, the sensitivity of users to range anxiety may be greater than in a location already well-equipped with charging stations. It can also be adapted according to each user, but this requires an extremely detailed understanding of the behavior of each agent, which seems to us to be rather unrealistic.

<sup>1</sup>In this first exploratory approach, this exponent will be fixed at 1. The calibration of this exponent should be subject to a sensitivity analysis which could be the subject of a future whole study, so we choose to set it arbitrarily in this study.

## Land coverage

As we explained earlier, the major challenge of charging infrastructure for electric vehicles is to prevent range anxiety, i.e., the fear that users will not have sufficient range and will not be able to charge their vehicles when needed. It is therefore important, when developing a charging infrastructure, to ensure that there are no "white zones", i.e., parts of the region that have no charging stations and are therefore not very accessible for electric vehicles.

This is the objective of this part of the score. As the problems of spatial coverage at minimal cost are NP-complete problems, we have chosen instead an approach consisting in valuing the placement of stations in areas with little charging infrastructure. For this, we assign the following score to the candidate locations:

$$U_c(p) = \frac{1}{N_s(r_c) + 1}, \quad (3.6)$$

with  $N_s(r_c)$  the number of already existing stations within a characteristic range  $r_c$  of the location  $p$ . By doing so, we have a maximum score if no stations are already present under this range, which encourages the placement of stations in uncovered areas. Initially, for the sake of simplification, we will set  $r_c$  arbitrarily and equally over the entire region under consideration, but we can later imagine a calculation based for example on the population density or the typical distances traveled by users.

## Final scoring function

The total score associated with a candidate location is calculated by a weighted summation of the terms described above, using coefficients that reflect the importance that we want to give to each criteria. We have

$$U(p) = \alpha U_n(p) + \beta U_v(p) + \gamma U_d(p) + \eta U_{soc}(p) + \mu U_c(p), \quad (3.7)$$

with  $\alpha, \beta, \gamma, \eta, \mu \in [0, 1]$ .

Each candidate location is therefore assigned a total score, corresponding to the usefulness of placing a certain type of station there according to our model.

### 3.2.3 Optimization model

Now we use the calculated scores to determine which stations to place. As a reminder, we adopt an iterative deployment approach, in order to model the progressive aspect of the development of a charging infrastructure. At each step of this iterative process, a budget is set. This budget must then be used in the best possible way to place stations. Mathematically, this results in the following optimization problem:

$$\max \left( \sum_{r \in R} \sum_{j \in T} b_j(r) U_j(r) \right) \quad (3.8)$$

subject to:

$$\sum_{r \in R} \sum_{j \in T} b_j(r) c_j(r) < C_{max}, \quad (3.9)$$

with :

- $R$  the set of the candidates locations over the map,
- $T$  the set of the different types of stations available,
- $b_j(r)$  a boolean equal to 1 if we choose to put a station of type  $j$  at location  $r$ , and 0 otherwise. We still have  $\sum_{j \in T} b_j = 1$ ,
- $U_j(r)$  the score of the considered location  $r$  for the station type  $j$ , calculated as described above,



- $c_j(r)$  the cost of putting a station of type  $j$  at location  $r$ .
- $C_{max}$  the maximum budget for this deployment step

In order to take into account that several stations could be placed at the same location, we have multiplied the locations for each candidate location. So, in practice, for  $N$  candidate locations, in the model we actually have  $kN$  locations to put a station in, with  $k$  being the maximum number of stations that can be placed in a location during a deployment step (this does not mean that more cannot be added in further steps). To account for the change in score within the step due to adding a station, we divide the land coverage part of the score. For instance, for a candidate location with several station slots, there will be a land coverage score  $U_c$  for the first slot,  $\frac{U_c}{2}$  for the second slot,  $\frac{U_c}{3}$  for the third, and so on.

This optimization problem follows a knapsack problem formulation. It is then NP-hard, and realistic problem instances need to be solved more likely through approximate methods.

### 3.3 Case study: a MATSim simulation of Berlin

We apply our proposed methodology to a large territory in order to evaluate the effects of such a deployment for electric vehicle drivers. As a reminder of the key points, this optimization method is multi-criteria and is centered around the needs of the driver or future driver of an electric vehicle. It proposes a marginal (or step-by-step) deployment of the charging infrastructure, in order to reflect its evolving aspect, and offers the possibility of deploying several types of charging stations. For this case study, we focus on the Berlin region.

### 3.3.1 Simulation model (based on the MATSim OpenBerlin scenario)

We simulate the Berlin area using MATSim, an "open-source framework for implementing large-scale agent-based transport simulations" [115]. In this type of multi-agent model, individual agents make decisions in order to maximize their own interest - represented by a score - but still interact with other agents. For example, too many agents deciding to take the same road thinking to decrease their own travel time will create a traffic jam, and thus increase the travel time of each agent who took this decision.

In this framework, the MATSim Open Berlin Scenario is a transportation simulation scenario for the Berlin metropolitan area [125]. The scenario is designed by cross-referencing several travel databases and is calibrated to realistically represent the traffic in the region. It takes into account all significant transport modes (car, public transport, bicycle, walking...) used by people over 18 years old living in the Berlin area, with possible modal shifts between these different modes. The calibration of this model was performed for a number of agents representing a sample of 10% of the Berlin population. However, mainly for computational time reasons, we will use a sample of 1% of the population, adapting the capacities of the transportation network.

We simulate agent trips over a 5-day period. The OpenBerlin scenario we use models a typical day in the Berlin area, which is not sufficient to obtain charge and discharge cycles of electric vehicle batteries, as most daily trips can be covered by a single battery charge. Therefore, we extended this scenario to 5 days to model a week, without the weekend since agent behaviors are different during the two weekend days, and we did not have weekend traveling data.

#### Electric vehicles

We then introduce electric vehicles in the Berlin area simulation. We consider in our simulation that all individual cars are electric, for several reasons:

The first one is the aim of the study. We are looking for a way to democratize EVs as

much as possible, and as explained in the introduction, this democratization necessarily requires a charging infrastructure that is adapted and accessible to everyone, not only to the pioneers of EVs who already own one.

Second, with the various subsidies and the development of the second-hand market, EVs are beginning to be accessible to an increasingly large part of the population, and the number of sales increases year after year [126]. Households who need to buy a car may therefore switch to an electric vehicle if an acceptable infrastructure is offered, generating a new charging demand, which would benefit to the operators.

Third, many western countries are in the process of banning the sale of new ICE vehicles by 2035, or even 2030 for some [127]. At the end of this very short period of time given the work to be made, the charging infrastructure must be adapted so that anyone can have an electric vehicle. In addition, car manufacturers anticipate this ban on ICE vehicles and sometimes go faster than the regulations.

And last, although electric vehicle charging infrastructure is still in its early stages, it has developed significantly in recent years. As today's infrastructure uses are not necessarily tomorrow's (e.g today EVs are the prerogative of a rather well-to-do fringe of the population that can often charge their vehicles at home, which will potentially not be the case for more modest future EV users, who will have to rely on the public infrastructure), it may be useful to now consider an all-electric fleet to start thinking about the future of the infrastructure

For at least these reasons, it makes sense to study the impact of a 100% electric fleet. However, we are aware that the economic reality of infrastructure deployment dictates that charging stations should be placed in priority where the demand already exists. In order to make the electric fleet evolves we could have introduced a growing share of electric vehicles over the simulation. Still, we would not have been able to simulate a realistic evolution of this share without an in-depth sociological study on the adoption of electric vehicles<sup>2</sup>, which is why we are postponing this work for further studies. In the

---

<sup>2</sup>randomly distributing EVs within the total fleet of vehicles without taking into account user profiles is not much more realistic than having all vehicles be electric

meantime, we consider 100% of the fleet to be electric, which allows us to see the impact of the infrastructure we propose on each potential electric vehicle, and thus to be able to estimate in which areas EVs are more likely to develop independently of the income of the studied populations. A comparison between the impact of a "universal" development and that of a targeted development in areas of demand with realistic electric vehicle fleet evolution will be carried out in future work, in order to study the positive externalities of such infrastructure on EV adoption.

In this study, all the electric vehicles have a standard 50kWh battery and start the week with a random state of charge centered at 45kWh, i.e., 90% of the battery. We made this choice because it is observed that most electric car users start the week with the battery charged or almost charged according to diverse representations of EV charging <sup>3</sup> [128, 129, 130], hence an average value close to 100%.

Also, a specificity of our study is vehicles that run out of battery in the simulation do not break down and stop: they continue their journeys as if they were hybrids. We will use this number of kilometers driven without a battery (which in reality cannot be driven) as an indicator of the efficiency of the infrastructure.

### **Charging infrastructure and charging behavior**

We do not want users to have to adapt their behaviors to the proposed infrastructure in order to use an electric vehicle, but the infrastructure must be developed to match their behaviors - otherwise, the adoption of electric vehicles would be greatly hindered. This is why we prohibit charging-specific stops in our simulation: only charging at the destination is allowed, so the user's plans are not altered in any way compared to those of an ICE vehicle. We are aware that a classical charging behavior includes charges "at destination" and "en-route" charges, but the en-route charge is an additional time to a trip. We want to optimize the system to do without and consider the en-route charge as

---

<sup>3</sup>It is quite difficult to find studies directly on the state of charge of batteries, but by observing the charging profiles and in particular a peak on Sunday evening, we can easily deduce that the batteries are charged on Monday morning

a very particular solution.

In order to model the charging behavior, agents receive a small penalty on their score when they travel with range anxiety, *i.e* when agents drive below a certain battery threshold which corresponds to the state of charge at which drivers would start to experience range anxiety. This penalty increases as the battery state of charge decreases. In this way, the agents, who each want to maximize their score, are encouraged to charge up as soon as they start to feel range anxiety, *i.e* to be under their range anxiety battery threshold, and even avoid reaching this threshold so as not to be penalized. They also receive a large penalty when their battery charging level reaches zero, which corresponds to a failure, so they are encouraged to avoid running out of battery at all costs.

Another study prohibiting vehicles with empty batteries from continuing their journeys but allowing charging "en route" and evaluating the time lost due to this charging and the number of breakdowns will be conducted in future work.

We simulate 5 iterations for the development of the infrastructure. Each iteration is allocated a maximum budget to place charging stations at the candidate locations that are in the given territory.

### Simulation parameters

The simulation model has many parameters. We have selected and varied the 4 parameters that stand out as the most important in terms of their impact on the users' charging behaviors.

The first one is the **range anxiety threshold**, *i.e* the battery threshold at which electric vehicle users start to experience range anxiety. A lower range anxiety threshold should lead to more cautious charging behavior and higher utilization of the charging infrastructure by users, as they will tend to want to charge earlier. Second, the **home charging rate**, *i.e* the rate of users who can do home charging. This should have an impact on the use of public infrastructure, as well as on the number of vehicles that run out of battery, since access to charging will be easier for those who can rely on

home charging. Third, the **searching range**, *i.e.* the search radius in which users look for a charging station around the destination. As we are developing a model exclusively based on charging at the destination, this should also have an influence. And last, the **max budget**, *i.e.* the maximum budget per stage to deploy charging stations. For the installation costs, we used three types of stations, with the standard prices practiced by European operators: 4 500€ for a 7kW charging station, 6 000€ for a 22kWh charging station, and 100 000€ for a 150kWh charging station. As a simplification, we use the same costs for all the stations of the same type, wherever the place we put it (*i.e.* we assume that the electric grid is able to cope with the charging infrastructure)<sup>4</sup>.

It should be noted that, apart from the maximum budget, each of these parameters is difficult to control in reality. Indeed, if it is possible to choose the budget allocated to the deployment of an infrastructure, it is more difficult, if not impossible, to choose when users will worry about the state of charge of their battery, or how many car owners will have a charger at home. However, it is possible to estimate these parameters in a population, which makes it interesting to study those parameters and the effects they have on the optimal infrastructure and its usages: since depending on them, different optimal deployment choices can be made.

Also, in reality, endogenous effects can occur. For example, the range anxiety threshold may depend strongly on the existing charging infrastructure: a better infrastructure will increase the confidence of users, who may then accept a lower battery state of charge without any range anxiety. An interesting work would be to establish a relationship between the existing infrastructure and these parameters and to make them evolve during the deployment steps.

Here we have kept these parameters fixed during the deployment steps. The values taken by the parameters are described in Table [3.1](#).

---

<sup>4</sup>Overcoming this approximation is feasible, but requires a lot of data, especially on the costs of land, the costs of reinforcing the electrical network, and the capacity of the electrical network

Table 3.1: Values of simulations parameters

<b>Parameters</b>	Range anxiety threshold <i>(% of remaining battery)</i>	Home charging rate <i>(% of population)</i>	Searching range <i>(m)</i>	Max budget
<b>Possible</b>	20	0	500	500 000
<b>values</b>	50	25	1000	1 000 000

We ran a simulation for each of the combinations of these different parameter values, for a total of 16 simulations, each simulation being a 5 steps infrastructure deployment.

### Scoring parameters

For our first case study, for simplicity reasons each of the coefficients  $\alpha, \beta, \gamma, \eta, \mu$  in the final scoring function [3.7](#) presented in section [3.2](#) is set to 1, so each criterion has the same weight. Further analysis would allow us to refine the value of these coefficients according to the specific criteria of each situation.

### 3.3.2 Observations and lessons learned from results

During all the steps of these 16 simulations, we have collected a certain number of data, of which we have grouped all the observations in the table in Appendix [B](#). We present here the main findings from our analysis.

#### Charger types : Are fast chargers useless ?

The first thing that stands out is the type of chargers installed. Regardless of the set of parameters considered, there are no fast chargers [5](#).

This result can be explained quite simply: a fast charger costs about 20 times more than a slow charger. Even if it can be very useful at a specific location, it will be very

---

<sup>5</sup>We noted that in a quick test with a 1 billion max budget per step a few fast chargers started to appear

difficult for a fast charger to be more useful<sup>6</sup> than 20 slow chargers, unless slow chargers has already equipped all the critical locations, which would require a much higher budget.

However, this result should be taken with caution. As explained in the introduction, even if they are not the most useful, fast chargers are a required component of the acceptability of electric vehicles, and these chargers may be the key for the switch from ICEVs to EVs. They are also essential to respond to the problem of long journeys on highways, during which it is not acceptable to have charging times of several hours.

So what we can draw from this result is not that fast chargers are useless, but rather that they are not intended to be daily chargers for intra-regional travel, which is the framework of our study. Rather, they should be reserved for highways, where quick "en route" charging is required, with optionally a few fast chargers in key points for emergency situations. Today, fast chargers are installed in urban and peri-urban areas for daily use, and appear to be profitable. However, it is important to remember that the charging infrastructure is still in its beginning stages, and so that those fast chargers are often the only option available. The widespread introduction of other chargers that are slower but cheaper for the energy they provide and consistent with the needs of the users at locations where they are installed may greatly reduce the usefulness of fast chargers. Fast chargers might then have more of an insurance value - certainly essential, but not profitable - than a commercial one. It could be then interesting to think of a remuneration mechanism for fast chargers, on the same principle as the remuneration of production reserves for electricity producers.

---

<sup>6</sup>According to our criterion of course



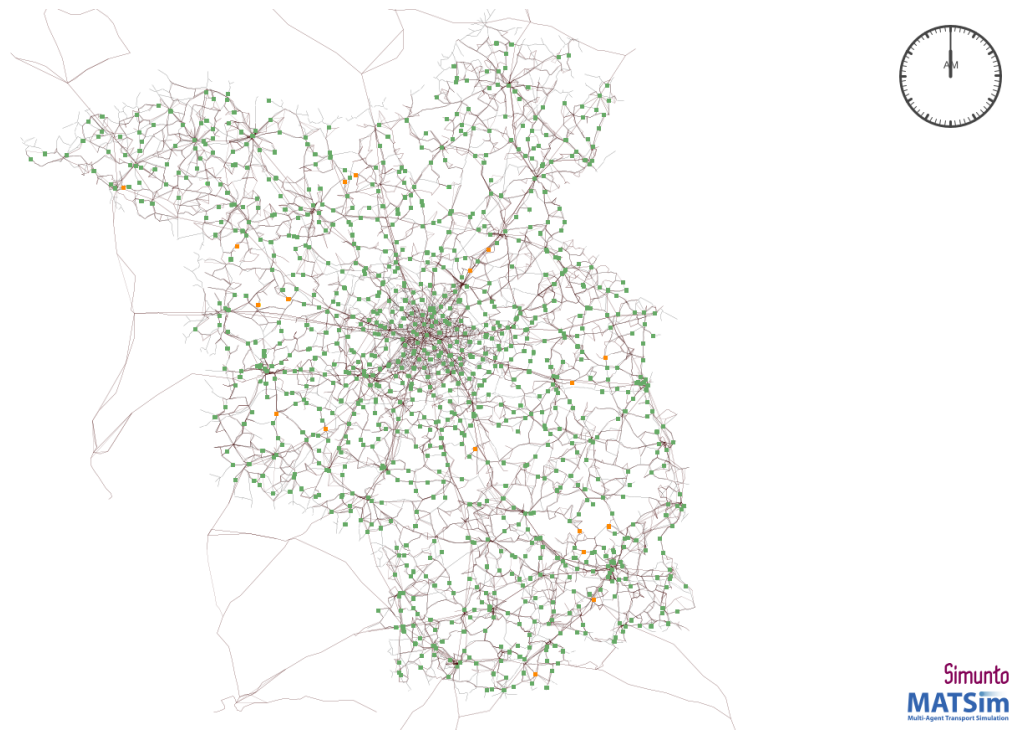

Figure 3.4: Example of charging infrastructure after 5 iterations

*Range anxiety threshold 20%, Home charging rate 25%, Searching range 1000m, Max. budget 1 000 000.*

*Red dots are 150kWh chargers, orange dots 22kWh chargers and green dots 7kWh chargers*

As we can see in the example of Figure 3.4, 22kWh chargers are also underrepresented, especially when the budget is lower. When the budget is doubled, we observe a few more 22kWh chargers, but the vast majority of chargers remain slow chargers, despite a small difference in cost between the two. In a logic of maximizing the utility of the infrastructure, slow chargers seem to be initially more cost-effective than medium chargers, despite the time savings that they bring. However, there are some cases where the 22kWh chargers utility is indisputable, as shown by the deployment pattern found in all the simulations. In each of them, three medium chargers are systematically installed during the first iteration, i.e., despite their higher cost, they are more useful than slow chargers in other places. Then, in the following deployment steps, only slow chargers are installed, and only in the simulations with the largest budgets do new medium chargers reappear, once the base of the charging infrastructure is laid with slow chargers. The evolution to the final infrastructure shown in Figure 3.4 is presented in Figure 3.5.

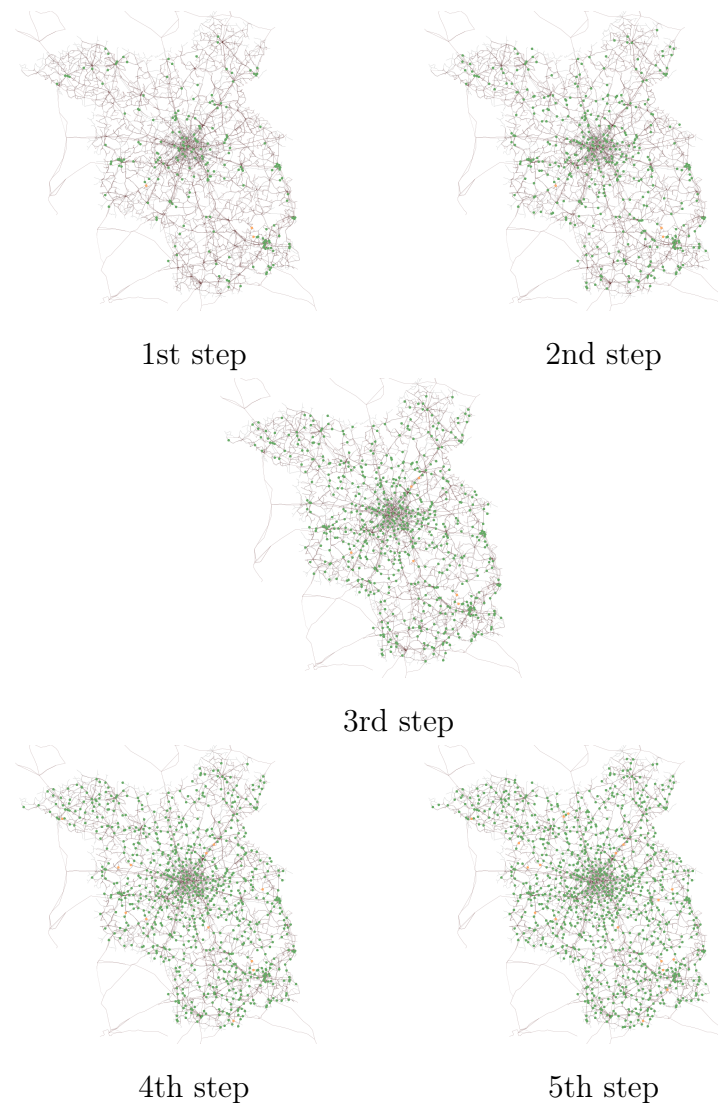

Figure 3.5: Evolution of the charging infrastructure over steps

### Range anxiety : Can we do without home charging ?

Range anxiety is a major obstacle to the acceptance of electric vehicles. It is therefore important that the charging infrastructure effectively reduces this anxiety. We therefore collected two indicators related to this range anxiety: the number of people falling below their range anxiety threshold, and the number of kilometers traveled by agents with range anxiety.

First, we notice that the decrease in range anxiety is not linear. The more the infrastructure is developed, the higher the marginal cost to decrease the range anxiety. This

shows that the critical points are covered first by our deployment model, which was our goal<sup>7</sup>. It would appear that on average there is a tendency towards a linear relationship once the initial stages have been passed, but more deployment stages would be required to state this with certainty.

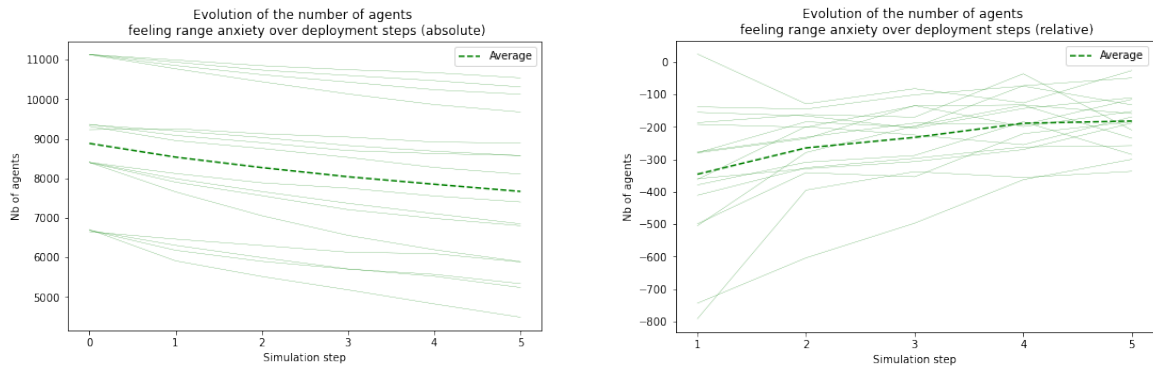

Figure 3.6: Number of agents with range anxiety and variation of this number over deployment steps

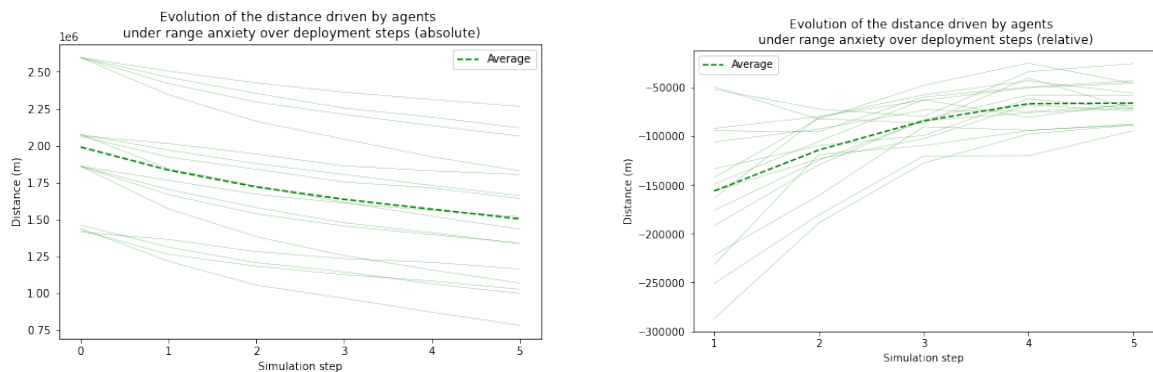

Figure 3.7: Distance driven with range anxiety and variation of this distance over deployment steps

In both Figures 3.6 and 3.7, on the left-hand side showing the number of people experiencing range anxiety and the number of kilometers traveled, we clearly observe 4 distinct groups of simulations. Logically enough, the two highest groups correspond to the simulations where the range anxiety threshold is the highest: the more sensitive the agents are to range anxiety, the more likely they are to feel it.

<sup>7</sup>A counter-simulation performed as a test with a single set of parameters shows that a different order of terminal installation leads to a slower start of the range anxiety decrease.

For the same range anxiety threshold, we have two quite distinct subgroups of simulations, which correspond to the access or not to home charging. We see that the number of agents falling below their range anxiety threshold decreases sharply when there is a possibility of home charging<sup>8</sup>. The same is true for the number of kilometers travelled by the agents under range anxiety. Home charging is thus a key lever for reducing this feeling of range anxiety. It is therefore important to invest in residential areas where private home charging is not possible, e.g. because of the lack of private parking spaces. In addition, having charging stations near agents' homes increases the visibility of the infrastructure and reassures agents about their ability to charge their EVs, which helps to lower their range anxiety threshold, and thus mechanically its perception, making residential investment even more efficient. This effectiveness is further reinforced by the observation we made that when the range anxiety threshold is lower, the same investment contributes slightly more to reducing the number of kilometers driven with range anxiety than when the threshold is high.

More anecdotally, we find that increasing the search radius of a charger significantly decreases the feeling of range anxiety and makes infrastructure investments more efficient: at the last step, with a searching range of 500, doubling the budget allocated to the infrastructure reduces the distance travelled under range anxiety by 10%, and up to 20% if the searching range is 1000m. So education on the best practices to have with an electric vehicle to reinforce the investments in the infrastructure can only be beneficial.

---

<sup>8</sup>Again, a test simulation was run with a reduced number of agents and 100 percent home charging. (Home charging significantly increases simulation times, hence the need to reduce the population). With this test with 100% of the population able to charge at home, we observe extremely few agents below their range anxiety threshold

Table 3.2: Simulation results - Users with range anxiety - Final infrastructure

Range anxiety threshold	Home charging rate	Searching range	Max budget	Nb users with range anxiety	Total distance driven with range anxiety
0.2	0	500	500000	7401	1519147
0.2	0	500	1000000	6803	1340603
0.2	0	1000	500000	6848	1337198
0.2	0	1000	1000000	5894	1070990
0.2	0.25	500	500000	5885	1165318
0.2	0.25	500	1000000	5336	1028968
0.2	0.25	1000	500000	5239	999897
0.2	0.25	1000	1000000	4487	785348
0.5	0	500	500000	10540	2266606
0.5	0	500	1000000	10125	2065109
0.5	0	1000	500000	10311	2120862
0.5	0	1000	1000000	9676	1830319
0.5	0.25	500	500000	8892	1804692
0.5	0.25	500	1000000	8578	1642919
0.5	0.25	1000	500000	8576	1662729
0.5	0.25	1000	1000000	8106	1435630

### Vehicles out of battery: a problem of range anxiety ?

If range anxiety generates discomfort, running out of battery is the concretization of this anxiety, which is more problematic.

The management of empty batteries in our simulations is a bit special: vehicles that run out of battery continue to drive. In reality, any driver will try to charge before running out of battery, but we want to adapt the infrastructure to the users, not the other way around. So we do not allow *en route* charging, nor do we allow an agent to change their plans to charge their EV. Agents should behave according to their initial plans, and charge only if they have the opportunity to do so during their usual trips. It is therefore normal

for some agents to end up with empty batteries during the simulation, and to drive miles with an empty battery (sometimes called "missed miles"). These missed miles would obviously not be driven in reality, but we use them as an indicator of the performance of our charging infrastructure.

As for range anxiety, the number of vehicles running out of battery as well as the number of missed miles is very dependent on home charging: access to home charging is the principle factor that drastically reduces the number of vehicles with empty batteries, as it can be seen with the two distinct groups in Figures 3.8 and 3.9. The infrastructure budget is the second most important factor, with a doubling of the budget reducing the number of out-of-battery cars by 10 to 20% depending on the searching range, and the number of missed miles by 13 to 25 percent.

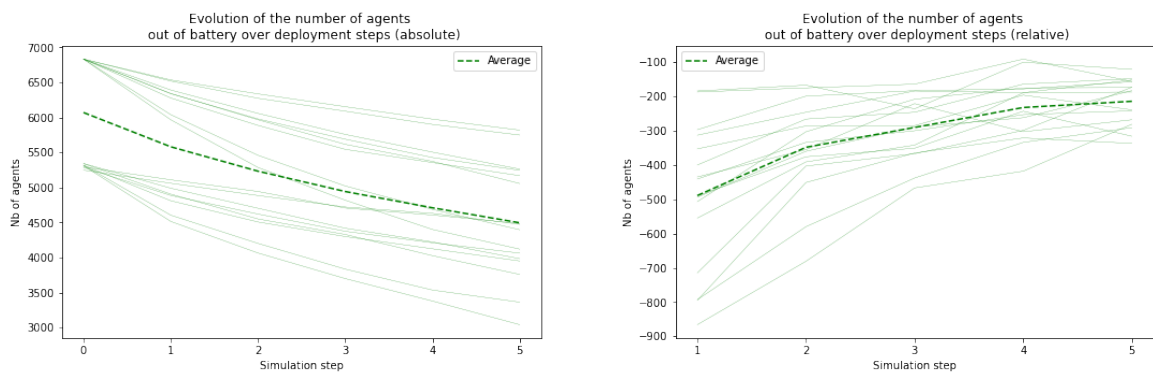

Figure 3.8: Number of agents running out of battery and variation of this number over deployment steps

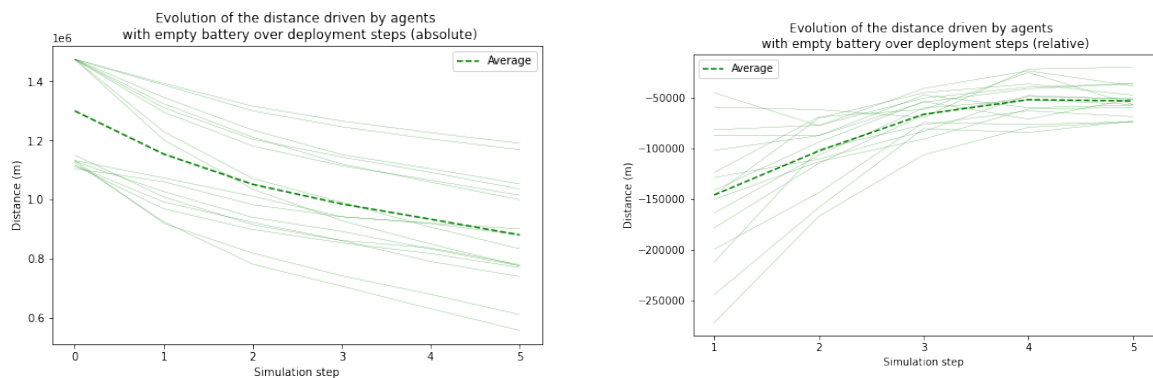

Figure 3.9: Distance driven with empty batteries and variation of this distance over deployment steps

The range anxiety threshold has a surprising effect on the number of cars running out of battery: while a higher threshold encourages drivers to charge earlier, there are more vehicles running out of battery when the range anxiety threshold is high! Actually, this counter-intuitive result can be explained by the availability of chargers. As users are more anxious, they tend to occupy the chargers more. This means that there are fewer chargers available for those who need them most. This can be seen by comparing the average distance to a charger and the average distance to an available charger when parked: at equal home charging rate, max budget and searching range, the average distance to a charger is slightly lower for a range anxiety threshold of 0.5 than for a range anxiety threshold of 0.2, but the average distance to an available charger is about 100 meters higher. This again shows the importance, in parallel with infrastructure development, of the education of electric vehicle users so that they adopt charging behavior that is beneficial both to them and to all drivers. We also remind that a good charging infrastructure will tend to lower the range anxiety threshold, thus improving the charging infrastructure increases even more its marginal efficiency. This can even be seen in the simulation results: with a lower range anxiety threshold, an increase in the infrastructure budget seems to decrease the number of vehicles running out of battery slightly more than when the threshold is high.

Table 3.3: Simulation results-Vehicles out of battery

Range anxiety threshold	Home charging rate	Searching range	Max budget	Nb vehicles out of battery	Total distance driven with empty battery
0.2	0	500	500000	5749	1169249
0.2	0	500	1000000	5169	1015316
0.2	0	1000	500000	5057	1000144
0.2	0	1000	1000000	4120	776668
0.2	0.25	500	500000	4475	881088
0.2	0.25	500	1000000	3951	770926
0.2	0.25	1000	500000	3759	740361
0.2	0.25	1000	1000000	3042	558302
0.5	0	500	500000	5819	1190603
0.5	0	500	1000000	5245	1036093
0.5	0	1000	500000	5263	1053403
0.5	0	1000	1000000	4397	834484
0.5	0.25	500	500000	4486	901440
0.5	0.25	500	1000000	4063	780782
0.5	0.25	1000	500000	3984	776450
0.5	0.25	1000	1000000	3363	611968

Given the results presented in this section and the previous one, it is clear that home charging has a huge impact on the acceptability and practicality of electric vehicles. Thus, we could believe that it would be more useful to subsidize home charging than to develop the public infrastructure. This is not necessarily true for at least two reasons. First, home charging is not possible everywhere, especially in dense urban environments. Second, the share of home charging considered in this simulation is 25 percent, which represents about 10,000 stations, at an average unit cost of about \$1,500, well above the budget for public infrastructure (only 2.5 or 5 million over the 5 stages depending on the max budget set). These results rather highlight the importance of investing in residential, *i.e.* near-to-home public charging, especially in locations where home charging would be impossible.



### Charging infrastructure accessibility

The accessibility of the charging infrastructure is another key point to ensure that it meets the needs of the users. The infrastructure should not only be sufficient to allow charging when needed but also easy to access and convenient to use in daily life. Having a large number of chargers in only one place is theoretically sufficient to meet the energy demand, however, it is not convenient for users, so, it does not meet the *charging* demand. As our simulations only use "at destination" charging, the results on range anxiety and battery short vehicles already give a first idea of the accessibility of the charging infrastructure. We will have a closer look at it.

Table 3.4: Simulation results-Average distance to a charger when a vehicle stops

<b>Range anxiety threshold</b>	<b>Home charging rate</b>	<b>Searching range</b>	<b>Max budget</b>	<b>Avg. distance to closest charger</b> <i>(m)</i>	<b>Avg. distance to closest available charger</b> <i>(m)</i>	<b>Avg. walking distance to destination</b> <i>(m)</i>
0.2	0	500	500000	1978	2205	285
0.2	0	500	1000000	1381	1507	277
0.2	0	1000	500000	2040	2641	525
0.2	0	1000	1000000	1428	1787	503
0.2	0.25	500	500000	1989	2148	51
0.2	0.25	500	1000000	1408	1508	70
0.2	0.25	1000	500000	2030	2481	162
0.2	0.25	1000	1000000	1441	1705	197
0.5	0	500	500000	1945	2316	287
0.5	0	500	1000000	1340	1554	276
0.5	0	1000	500000	1960	2755	529
0.5	0	1000	1000000	1385	1831	512
0.5	0.25	500	500000	1959	2238	61
0.5	0.25	500	1000000	1344	1495	81
0.5	0.25	1000	500000	2023	2617	170
0.5	0.25	1000	1000000	1397	1773	225

An interesting point to observe is the average distance to the nearest public charger when a vehicle stops (without taking into account home chargers). Indeed, this gives an idea of the accessibility of the stations when parking as it allows to see how accessible the stations are from the points of interest with a compromise on the proximity of the parking. This is a good indicator of the feeling users have that they can charge wherever they may need to for minimal constraint and so enhance the comfort of using an electric vehicle.

Not surprisingly, the maximum budget allocated to the infrastructure is the most decisive criterion for reducing this distance: since an increase in the budget favors an increase in the number of charging stations rather than an increase in the power of the stations, a higher budget will result in a higher density of stations, and thus on average the stations will be closer to the users' destinations: we have an average distance to a charger of 2km with the smallest budget, and an average distance of 1.4km for the biggest. The other parameters do not seem to have a real influence on this result. On the other hand, if we are only interested in the available stations, the budget factor remains predominant, but the searching range seems to also play a role: for the same budget, the available chargers are closer when the searching range is low. However, this has nothing to do with the layout of the stations. It is rather explained by the charger occupancy rate: this rate is lower when the searching range is small (see Table [3.6](#)), and therefore the chargers tend to be more available.

Table 3.5: Simulation results- Average number of chargers under the searching range when a vehicle stops

Range anxiety threshold	Home charging rate	Searching range	Max budget	Nb. chargers under range	Nb. available chargers under range	Nb. chargers under range with r.a*	Nb. available chargers under range with r.a
0.2	0	500	500000	0.1	0.08	0.08	0.08
0.2	0	500	1000000	0.15	0.13	0.13	0.12
0.2	0	1000	500000	0.26	0.17	0.24	0.2
0.2	0	1000	1000000	0.39	0.28	0.38	0.32
0.2	0.25	500	500000	0.28	0.26	0.14	0.14
0.2	0.25	500	1000000	0.35	0.33	0.2	0.19
0.2	0.25	1000	500000	0.46	0.38	0.3	0.26
0.2	0.25	1000	1000000	0.6	0.51	0.46	0.4
0.5	0	500	500000	0.11	0.09	0.11	0.1
0.5	0	500	1000000	0.18	0.15	0.18	0.17
0.5	0	1000	500000	0.29	0.18	0.29	0.21
0.5	0	1000	1000000	0.45	0.31	0.46	0.36
0.5	0.25	500	500000	0.29	0.27	0.22	0.2
0.5	0.25	500	1000000	0.37	0.34	0.28	0.27
0.5	0.25	1000	500000	0.47	0.38	0.38	0.32
0.5	0.25	1000	1000000	0.66	0.53	0.57	0.48

(\*r.a = range anxiety)

Still on the topic of charger accessibility, it may be interesting to look at the number of chargers available in the searching range. Our results show that home charging is the most important way to ensure that a charger is available close to users' centers of interest: for the same search radius, we triple the average number of chargers at the destination. Once again, where it is possible, developing home charging remains a good idea (while always keeping in mind that this solution is not the most efficient in terms of overall cost, since a charger serves only one vehicle). About the budget allocated to the infrastructure,

it plays, as for the average distance to the chargers, an important role in the access to the public infrastructure. In the scenarios without home charging, we see an increase in the number of chargers in the search radius of between 65 and 75% when we double the allocated budget: the leverage effect is certainly less than 1, but it is still significant. In the end, however, the most effective effect lies once again in the goodwill of the users (and therefore in their education): all other parameters being equal, doubling the searching range more than doubles the number of chargers available under the searching range.

However, we see a result that is contradictory to the deployment philosophy of our model: it is supposed to result in infrastructure that is available when and where users need it. But when comparing the columns of the Table [3.6](#), we see that the number of chargers available when users feel range anxiety, i.e., when they need a charger, is systematically lower than the number of chargers available, which can be considered as a failure if we want to minimize user anxiety. In this respect, the state of charge of the users should have been taken into account more. This is confirmed by the results of a simulation in which we increased the weight of the state of charge criterion in the utility function of the infrastructure (equation [3.7](#)). These results reverse this relationship and favor station placement in locations with higher range anxiety. However, this changes other results: for example, the number of kWh provided by the public infrastructure, and thus its profitability, decreases. This shows the importance of calibrating the utility function of the infrastructure according to the objective in which the charging infrastructure is deployed: our model does not give *"the"* optimal charging infrastructure, but *"an"* optimal way of developing the charging infrastructure on the Pareto front of optimal infrastructures according to the choices made for its development.

### **Charging infrastructure utilisation**

Finally, it can be interesting to look at the way the infrastructure is used, and what lessons a charging station operator could learn from it.

First of all, we notice that the lower the budget, the higher the occupancy rate of the

stations: as the budget is more or less proportional to the number of stations, putting fewer stations makes them individually more profitable. An operator who is not in a monopoly situation will therefore have to take into account this drop in revenue in the event of additional stations being installed by potential competitors, at the risk of ending up with stations operating at a loss. On the other hand, all other things being equal, doubling the number of stations does not halve their occupancy rate, even at the last stage of deployment, i.e., when there are the most stations, and therefore in theory when the marginal utility of an additional station is the lowest: there is still potential demand for new stations.

The second notable thing is the effect of home charging, which competes directly with the public charging infrastructure: when it is available, there is quite logically a drop in the occupancy of public chargers and a lower proportion of charging on public infrastructure. However, this occupancy rate does not fall so drastically, by about 10% in the worst case. Rather, it is the amount of energy supplied by the infrastructure for a charge that is affected: it can be halved, which represents a big loss for the station operators. Several strategies are therefore possible for operators. One is to abandon areas where home charging has a high potential for development, but at the risk of creating white zones for travellers outside the area. Conversely, they can choose to invest and be ahead of demand in these areas, and thus propose an offer that allows electric vehicle users to do without home charging. It should be noted, however, that this strategy, although economically viable if we consider rational agents, will probably not withstand a psychological analysis, due to an endowment effect.

Table 3.6: Simulation results- Average number of chargers under the searching range when a vehicle stops

<b>Range anxiety threshold</b>	<b>Home charging rate</b>	<b>Searching range</b>	<b>Max budget</b>	<b>Charger occupancy</b> <i>(% of time)</i>	<b>Share of public charging</b> <i>(% of all charges)</i>	<b>Average SoC at charge start</b> <i>(kWh)</i>	<b>Average energy supplied per charge</b> <i>(kWh)</i>
0.2	0	500	500000	44	100	24,5	11,9
0.2	0	500	1000000	34	100	25	12
0.2	0	1000	500000	69	100	23,8	10.5
0.2	0	1000	1000000	53	100	24,8	10.6
0.2	0.25	500	500000	35	26	33,4	6,1
0.2	0.25	500	1000000	28	35	33	6,7
0.2	0.25	1000	500000	58	37	32,4	6,5
0.2	0.25	1000	1000000	44	46	31,8	7
0.5	0	500	500000	56	100	28,1	10.1
0.5	0	500	1000000	45	100	29,1	10.1
0.5	0	1000	500000	80	100	27,1	9
0.5	0	1000	1000000	65	100	28,3	8,9
0.5	0.25	500	500000	47	27	35,8	6,2
0.5	0.25	500	1000000	37	37	35,3	6,5
0.5	0.25	1000	500000	69	35	34,6	6,3
0.5	0.25	1000	1000000	56	47	34,1	6,8

Finally, it is interesting to point out that the drop in the use of public infrastructure due to home charging is certainly significant, but nevertheless much less than if home charging is not taken into account during deployment: in a test simulation with an infrastructure developed without home charging, and the introduction of home charging afterwards, we observe a drop of almost 20% in the occupancy rate of chargers, and of more than 25% in average energy supplied per charge.

## 3.4 Conclusion

In this chapter, we proposed a model for the development of a charging infrastructure on a territory, centered on the behavior of potential users of this infrastructure. This model is multi-criteria, and integrates the progressive aspect of the deployment of such an infrastructure by its incremental aspect. This particularity allows the development of an infrastructure on a territory without any installation, as well as taking into account the already existing charging stations to develop a coherent infrastructure.

We applied our model to the city of Berlin, using data from a representative sample of the population, i.e., more than 30 000 agents, over a typical week. We collected this data for 16 different parameter configurations. Among the main results, we note the absence of fast chargers in the final infrastructure. Although essential for their insurance value, they are not very effective from a purely business point of view. We also note that home charging and more broadly residential charging are the keys to EV acceptability. They considerably reduce range anxiety, which is the ultimate proof of the efficiency of an infrastructure on the consumer side. The decrease in range anxiety in the population even increases the efficiency of the infrastructure through a positive externality effect. On the other hand, home charging considerably reduces the utility and profitability of public stations. It is therefore very important to take this into account when installing chargers. Finally, investing in the education - or the orientation, via nudges for example - of the users would considerably increase the efficiency of a public infrastructure.

However, this model obviously has its limitations. First of all, it is an incremental method, whereby we try to maximise the utility of the next station to be installed. This approach is therefore not a global optimisation of the problem. The aim of this method is to propose a path towards a complete infrastructure that favours the adoption of electric vehicles, so concessions are made on the final infrastructure obtained, which may be sub-optimal. Secondly, while this model is very "user-friendly", it is not very "operator-friendly". We are not trying to maximise the profit of the charging station operators, but the utility of the infrastructure for the users, regardless of who provides the service. This

method may repel private operators in competition, who naturally seek to maximise their own profit, and not the global one.

There are also some limitations in the calculation of the score. As we briefly mentioned, the calibration of the score function is quite complex. We also identified a weakness in the calculation of the score as a function of parking time. We reason on an average parking duration at locations, but if there are two groups of people with totally different behaviours in one place the average of these behaviors may not represent anything. Still on the subject of parking, the capacity and availability of parking was not taken into account, while in practice it is not always possible to park in a place.

For the same reasons, this way of calculating the score leads to almost always have only one type of charging station in one place, when a mix could be interesting. Further statistical work seems necessary to solve this problem.

There may also be side effects on the calculation of the battery score, for example with parking close to homes where home charging would be available: people with a low state of charge could park in a place close to their home, and not need to charge since they can do it at home, but this will not be identified by the model.

And to finish, one of the strong assumptions of the chapter is that the infrastructure can be developed, and the number of electric cars will follow. The simulations are done to have an infrastructure that meets the needs of a given number of electric cars estimated according to predictive models. We would like to examine this aspect in more detail by studying the real impact of a deployment as proposed on the evolution of the electric vehicle population, rather than taking it as an input parameter.





## Chapter 4

# Tenerife 's infrastructure plan for electromobility: a MATSim evaluation

\*

According to the Canarian government's plans, a complete decarbonization of the Canary Islands economy is foreseen from 2040 onwards, which includes the electrification of land transport in the archipelago. However, due to the current low penetration rate of electric vehicles (EVs) on the islands, the number of EVs in circulation is expected to grow significantly in the coming years. Despite this, the network of charging points in Tenerife is currently totally insufficient, which is why it is essential to carry out a study to design the network of charging points in such a way that it can absorb the entire fleet of EVs that is expected to be in place by 2040. To this end, there are studies on the capacity, in terms of parking space, available for the installation of these charging points. Still, to date, there are no studies on this subject supported by mobility data. For this reason, a traffic simulation in Tenerife in 2040 has been carried out using MATSim (Multi-Agent Transport Simulation) to determine the ideal places to install these charging points and find the number of charging points needed for the network.

\*

## 4.1 Introduction

Faced with the challenge posed by the current climate emergency, it is essential to accelerate the so-called Energy Transition to mitigate the harmful effects on the planet caused by the increase in greenhouse gas emissions in its atmosphere over the last few decades [131]. One of the main pillars of this transition is the decarbonization of the economy, which includes the electrification of the transport sector, accompanied by a commitment to the generation of energy from 100% renewable sources.

In order to carry out this electrification of transport, the Spanish Government has committed in its Climate Change and Energy Transition Law (LCCTE) [132] to the complete decarbonization of the transport sector throughout the national territory by 2050, following the Communication of the European Green Pact of December 2019 [133]. This Pact establishes a new growth strategy that aims to transform the economy of the European Union in a competitive and efficient way in the use of its resources, with the aim of achieving climate neutrality in the continent by that year. It is in this context that this national legislation is framed, which in turn contemplates the development of regulations and laws at the regional level, such as the Preliminary Draft Bill of the Canary Islands Climate Change and Energy Transition Law approved by the Canary Islands Government in November 2021 [134]. This bill sets the complete decarbonization of the economy of the archipelago for 2040, i.e. ten years earlier than in the rest of the national territory. In line with this Draft Bill, a series of energy planning instruments are included in the Canary Islands Energy Transition Plan 2030 (PTECan) [135], which establishes the main strategies to be followed in energy matters in the Canary Islands.

Against this background and anticipating the growing market demand for electric vehicles (EVs), which according to government plans will replace current internal combustion vehicles (ICEs) by 2040, it is essential to design a network of charging points capable of supporting the technical viability of the transport sector in the future. To design such a network, it must be considered that there are different types of electric vehicle charging points, with different charging power. It will therefore be necessary to dimension the

charging infrastructure and power networks according to the maximum power that will be required during a given period. For practical purposes, electric vehicles are seen by the electricity grid as batteries that demand a certain amount of energy, assuming a charging power that is established according to the type of connector to which it is plugged in (with slow charging normally at 3.7 kW; semi-fast charging at 11-22 kW and fast charging at 40-80 kW. Thus, in order to charge an electric vehicle battery, slow charging requires a continuous flow of energy between the vehicle and the power grid of 5-7 hours, semi-fast charging of 2-4 hours, and fast charging of less than 30 minutes [2]. In addition to being classified by charging speed, charging infrastructures could also be differentiated according to the point at which the system is installed, with the following three possibilities:

- Origin: Located at the starting point of the trip, these are usually slow-charging systems located in the garages of private homes or community buildings.
- Destination: Located at the end point of the trip, these are also usually slow charging systems, located in workplace parking lots.
- In itinerant: These are semi-fast or fast charging systems located in shopping centers, public roads, or parking lots. This group also includes the so-called charging stations, which always consist of fast charging systems.

Due to the relationship between the speed of charging systems and their location, it will be necessary to consider that the nature of vehicle travel will condition the type of charging system to be installed at each site. By elaborating our study, based on open-source software, we will provide a new approach to the need to infrastructure deployment based on mobility needs and compare it with the actual methodology used by the local government. By doing so, we will provide a counter-evaluation of the needs and show the limit of the current policy analytical frame.

Given the absence of studies to date based on the analysis of existing traffic for the design of a network of charging points, this study aims to provide a clear methodology for that purpose, so that charging points are not placed randomly but according to mobility

criteria, achieving an optimized network. In this way, users will not have to change their usual behavior to charge their vehicles, but rather the charging points will be strategically located where they are best suited to their needs. This methodology will be developed in this paper, which is structured as follows.

First, the current status and potential of the electrification of land transport in the case study, Tenerife (Spain), will be analyzed. In addition, the main strategies proposed by the Government of the Canary Islands to achieve the goal of complete electrification of the vehicle fleet will be examined. Subsequently, the principles on which the transport simulation software used for the development of this methodology, MATSim, is based will be detailed. The supplementary material will also explain in more detail the procedure followed to carry out the simulation. Finally, the results obtained will be presented, which include both an analysis of the geographical distribution of charging points for a specific configuration of the software parameters, in order to check the feasibility of the methodology used, and a comparison between two case studies, one with progressive electric vehicle penetration quotas and the other with non-progressive quotas.

## 4.2 Analysis of EVs potential in Tenerife.

Given the scenario presented, in which a large increase in the volume of EVs in circulation in Tenerife is foreseen, it is essential to design the charging infrastructure that will support this future transport network on the island. The study carried out by the Canary Islands Technological Institute (ITC), which depends on the Canary Islands Government, has been taken as a reference, setting out the main strategies to be followed in terms of EVs with the aim of achieving the complete decarbonization of land transport in the archipelago by 2040 [2]. This study, which is part of the PTECan 2030 [135], will allow a comparative analysis between the plans proposed by the Government of the Canary Islands and the results obtained by our study.

### 4.2.1 Case study

The island of Tenerife, located in the Atlantic Ocean in southwestern Spain, 330 km from the coast of Morocco and with coordinates 28°28' N, 16°15' W, has a population of 927,993 inhabitants in 2021 [136]. This population is distributed and dispersed mainly along the coastline of the island, as can be seen in Figure 4.1. The main areas with the highest concentration of population are the metropolitan area formed by Santa Cruz de Tenerife and San Cristóbal de La Laguna located to the northeast, the Orotava Valley located to the north and the southwest of the island, where most tourist activity is concentrated.

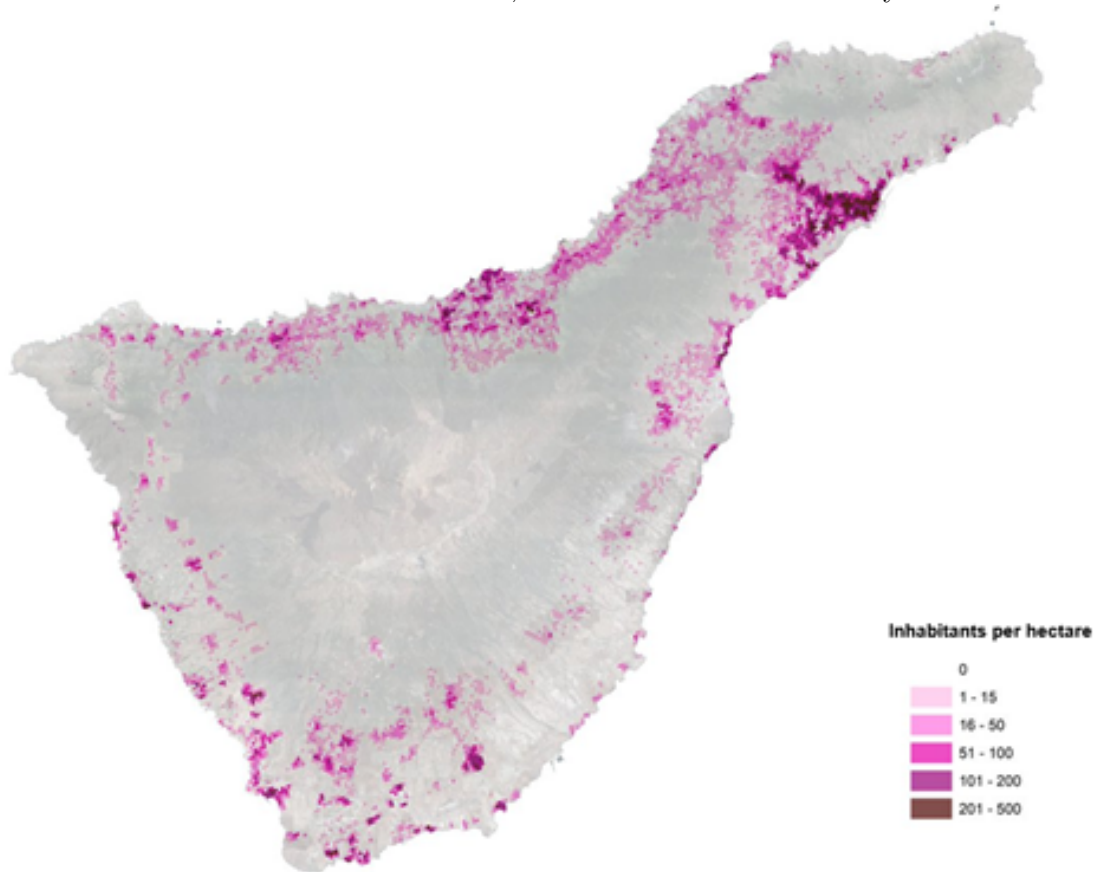

Figure 4.1: Distribution of the population on the island of Tenerife.

At present, with the latest available data for 2019, Tenerife’s vehicle fleet is dominated by gasoline ICE (internal combustion engine) vehicles (67.18%) and, to a lesser extent, diesel (32.57%). EVs are relegated to a third position with only 7,827 units out of a total of 751,702, which implies a penetration rate of 1.04%, and surpassing only the group of LPG (liquefied petroleum gas) vehicles [137], which barely account for 0.11% of the total

[138]. It should be noted that considering the population of the island and the total number of vehicles, the rate of vehicles per inhabitant for that year was 0.828, which is considerably higher than the average for Spain.

These figures, together with the goal of complete electrification of the vehicle fleet by 2040, highlight the foreseeable large increase in the number of EVs in circulation on the island in the coming years, with the consequent need for planning and construction of an architecture of charging points for this increase in EV demand, which has yet to be realized.

It should be noted that, given the insular nature of the case study, the implementation of such a network, with the consequent increase in energy demand that will be associated with it, may pose a great challenge, not only for the case of Tenerife but for the whole of the Canary Islands in general. However, this fragmentation of the territory should not be seen as an added disadvantage, but as a window of opportunity in which the massive implementation of EVs, together with intelligent mechanisms for demand control, energy generation and storage, can help to provide the electric grid with greater flexibility, reliability and compensate for the current weaknesses associated with the isolation of its electric systems, both among themselves and from the rest of the national territory [139]. Furthermore, under this scenario, the Canary Islands could become a test bench which, if successful, could export this energy model of sustainable mobility to any continental region of Europe [140]

### 4.2.2 Impact of transport electrification on electricity generation

The complete electrification of the transport sector in Tenerife will lead to an increase in the demand for electricity. Specifically, it has been estimated that, for the year of complete electrification, 2040, the increase in this demand will be 2510 GWh/year, which, considering that current electricity consumption on the island is 3514 GWh/year, represents an increase in demand of 71.2%, as can be seen in Figure 4.2 [2]. However, this increase in electricity demand should not be considered as a negative point, since the final

impact will mainly depend on the type of management carried out with the massive entry of EVs in Tenerife [141].

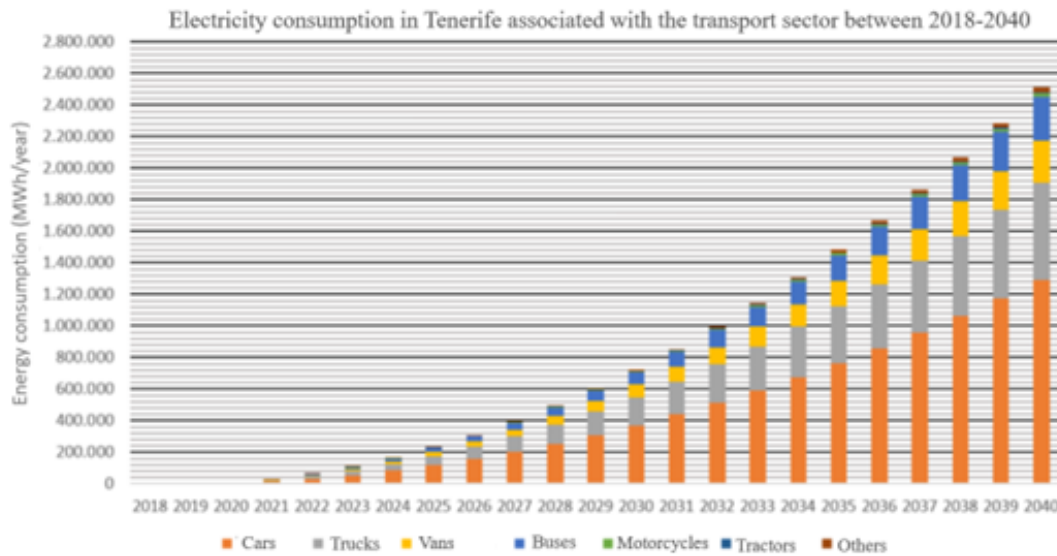

Figure 4.2: Electricity consumption increase in Tenerife associated with the transport sector between 2018-2040 [2]

Therefore, in addition to supplying this increase with non-manageable energy, mainly wind and photovoltaic energy, it would be desirable to apply an autonomous energy management system which, considering the state of charge of the vehicle’s battery and the signal generated by the electricity system, and according to energy predictions, prioritises EV charging at times when it is faced with a scenario of the greatest possible amount of renewable energy [142]. If this management system is also combined with the use of V2G technology, in which EVs go from being mere loads for the system to also becoming electricity suppliers during peak demand hours [143]. V2G, would provide the electricity system with a great capacity for manageability, helping to flatten the demand curve and therefore optimising the energy production system. Additional benefits are also expected by reducing the storage capacity required and minimising renewable energy curtailments [144]. It is therefore advisable that the charging points to be installed are, whenever possible, slow charging points, as these are the ones that allow the system to be more manageable for the reasons mentioned above [15].

On the other hand, in view of the increase in demand [145], the transmission, and distribution networks as well as the generation on the island will have to be repowered.



To this end, and according to the estimates made by the Instituto Tecnológico de Canarias S.A. (hereafter ITC) using the ISLA (Insular Energy System Long-term Assessment tool) optimisation model, the necessary renewable power equivalent to 1,600 MW has been obtained, in addition to a storage capacity of approximately 600 MW/15,000 MWh. Such a system would produce annually about 3,554 GWh of which 1084 GWh could not be consumed, since despite taking into account the improvements with smart grids mentioned above, this surplus would be required to ensure the demand for EVs even at the worst possible time, i.e., when the available resource is minimal [146]. However, this surplus energy should not be considered as a waste as it could be absorbed by the system for other uses such as the production of hydrogen by electrolysis, which in turn could be used in a complementary way in land vehicles or maritime transport.

Finally, also according to the forecasts of the ITC, it should be noted that the complete electrification of the land transport system in Tenerife, under the scenario in which this electrification is supported entirely by renewable energies, would mean an annual saving in pollutant emissions into the atmosphere of 674,915 kt of CO<sub>2</sub> eq. Figure 4.3 shows a pie chart of the reduction of CO<sub>2</sub> emissions to the atmosphere by type of vehicle.

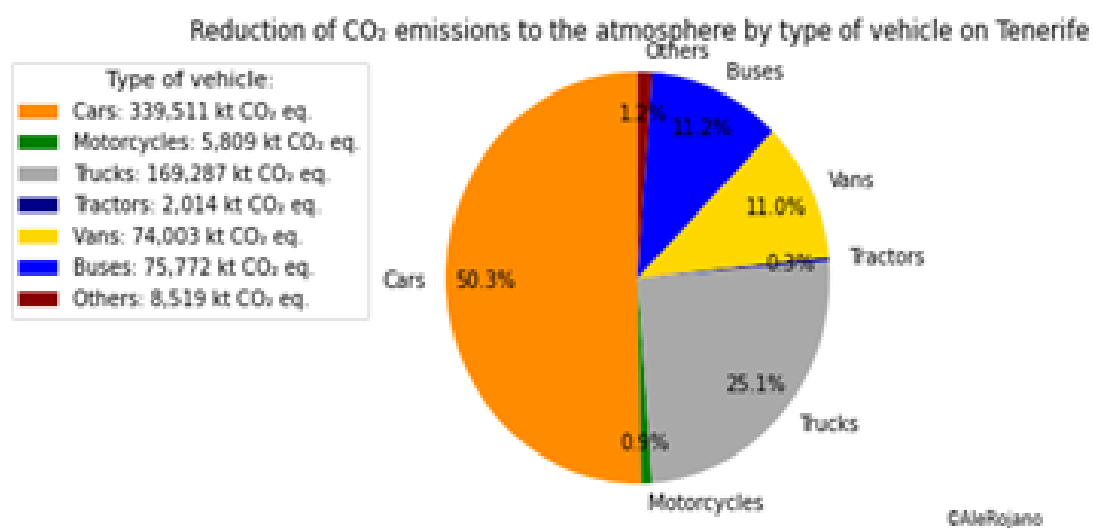

Figure 4.3: Reduction of CO<sub>2</sub> emissions to the atmosphere by type of vehicle.

### 4.2.3 Analysis of the strategies and policies on EVs of the Canary Islands Government

As mentioned, the starting point was the ITC study on the strategy to be followed for the electrification of land transport in the Canary Islands, the main objective of which was to calculate the number of EV charging points of each type to be installed on all the islands. In our study, we have focused on the case of Tenerife, so that after obtaining our own results, a comparative analysis can be made between the latter and those of the ITC study. The main steps followed by this study to arrive at the desired result will be detailed below.

Firstly, the total number of vehicles in circulation in Tenerife in the year 2040 was estimated. To do this, the latest data available at the time of the study was used, which is from 2019, with a total of 751,702 vehicles on the island. Subsequently, a multivariate regression model was applied to describe the relationship between a series of socioeconomic variables and the vehicle fleet, to estimate the vehicle fleet in 2040. Specifically, the historical evolution of the population and the Gross Domestic Product (GDP) have been used as variables, and the Machine Learning technique known as Random Forest has been applied to find patterns between the evolution of these variables that can be used to estimate the vehicle fleet [2]. Figure 4.4 shows the data on the evolution and projections of the population on the island of Tenerife from the year 2000 to 2050 and Figure 4.5 shows the same data, but for the case of GDP.

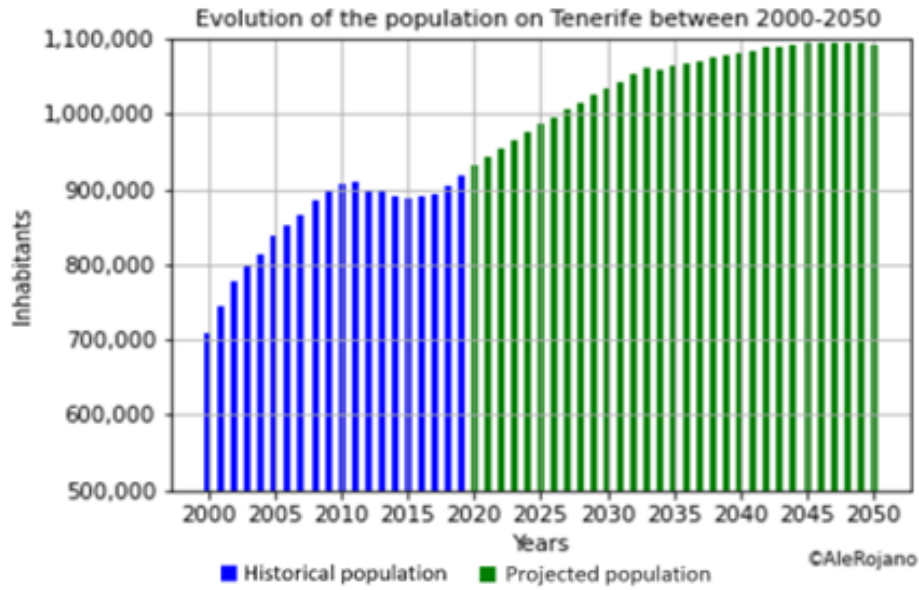

Figure 4.4: Evolution of the population on the island of Tenerife between 2000-2050.

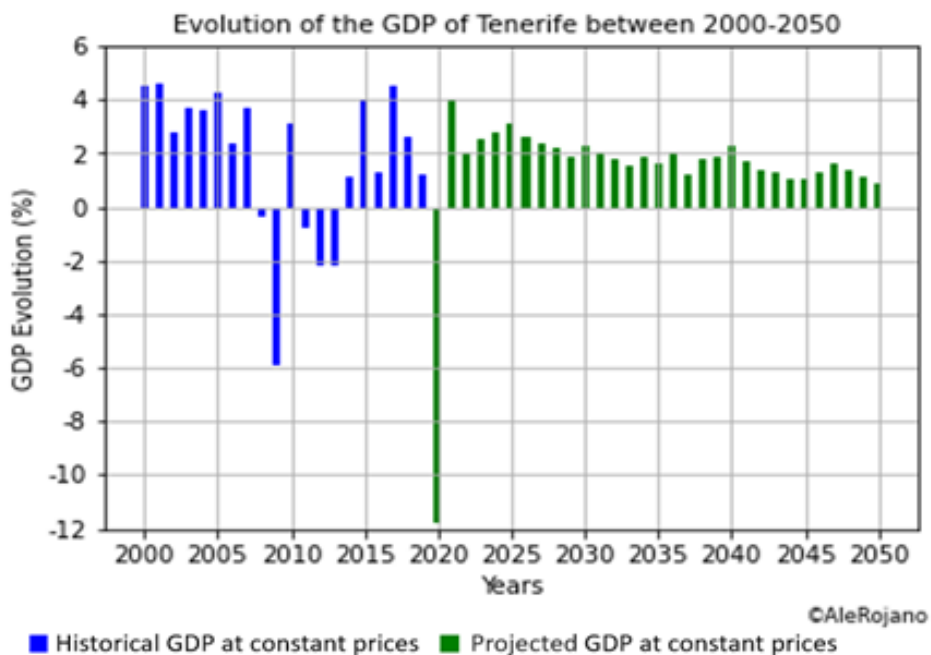

Figure 4.5: Evolution of GDP on the island of Tenerife between 2000-2050.

Finally, to evaluate the correlation, a linear correlation analysis was carried out using Pearson’s method, obtaining a correlation between population and GDP with the vehicle fleet of more than 70% in both cases. Figure 4.6 shows the data obtained on the estimation of the car fleet in Tenerife up to 2050, giving a total of 693,439 vehicles in the year 2040, in which the simulations will be carried out. It will be assumed, given the regulations,

that the totality of this fleet corresponds to EVs.

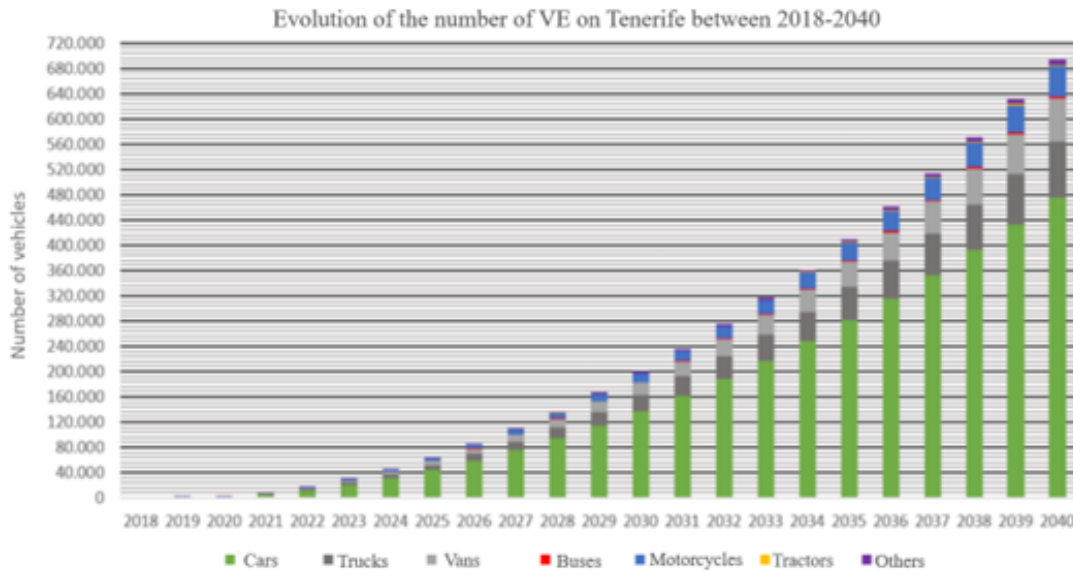

Figure 4.6: Evolution of the electric car fleet on the island of Tenerife between 2018-2040 [2].

Once the fleet of electric vehicles had been estimated, the number of charging points required for this volume of vehicles was calculated. To do this, we used the information available from the Dirección General de Catastro del Ministerio de Hacienda [147] relating to data on buildings, plots and infrastructures. On the other hand, data collected by the Instituto Geográfico Nacional (IGN) [148] and published in the Spanish Land Occupancy Information System (SIOSE) [149], related to service stations in Tenerife, as well as access to the entire road network of the island and parking areas in buildings and above ground, were also used.

In the case of private buildings, whether residential, commercial or workplace, the number of parking spaces available was estimated based on data obtained from the DGC and occupancy rates, which were determined by means of telephone surveys in the case of residential buildings and via web-based information in the case of commercial buildings. A total of 252,873 parking spaces were made available in homes (charging systems at source) and 108,800 in shops, hotels, and workplaces (charging systems at destination), which will be used as far as possible as slow charging points, covering 52.16% of Tenerife’s total vehicle fleet in 2040.

Subsequently, it was checked that the parking capacity on urban and conventional roads was sufficient to cover the remaining demand corresponding to 47.84%, which would use the "in itinerant" charging system. In this case, priority would also be given to slow charging systems, although it is foreseeable that in this group of charging points a higher proportion of semi-fast charging points, and even fast charging points in some cases, would be necessary. The total capacity of these roads was found to be 1,626,103 charging points, which is more than sufficient for the unmet demand of 331,766 vehicles.

Finally, the study carried out by the ITC also includes additional analysis of the current service stations as a complement to the network, as these will provide a network of fast charging points that will support the network in the event of possible contingencies. Specifically, a total of 205 stations were counted in Tenerife, which would provide the system with 4,315 fast charging points, considering that the surface area of the stations for this use accounts for approximately 40% of the total. This figure is considered sufficient to ensure that the support provided to the network is of sufficient quality to deal with the contingencies mentioned above.

## 4.3 Software preparation

After the analysis of the study explained in the previous section, we proceeded to the correct configuration of the simulation software, MATSim (Multi-Agent Transport Simulation), and the subsequent launching of its simulation to obtain the expected results. This section will describe the fundamentals of this software, as well as the process necessary for its preparation before proceeding to perform the relevant simulations. This procedure will be further detailed in the supplementary material part.

### 4.3.1 MATSim Fundamentals

MATSim is an open-source multi-agent simulation framework implemented in Java language. It is based on the principle of coevolution, i.e., each agent (vehicle in our case)

repeatedly optimizes its daily activity schedule while competing for the same time slots with all other agents in the transportation infrastructure [150]. Each MATSim run contains a configurable number of iterations consisting of the following stages summarized in Figure 4.7.

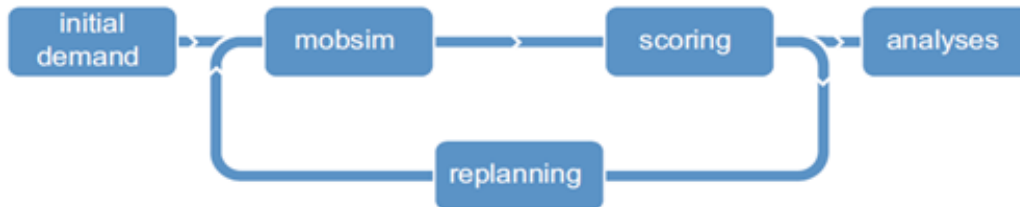

Figure 4.7: MATSim simulation principle

On the one hand, the initial demand comes from the population’s daily activity chains. The people modelled are called agents, who have daily plans, where in turn each plan is composed of a daily activity chain and a score associated with that activity, known as an econometric utility function. On the other hand, there is the mobility simulation itself, known as Mobsim. This stage consists mainly in that, in each iteration, each agent selects a plan from its memory according to the scores assigned to each plan, which are calculated in each mobsim run. Finally, the replanning module produces the modifications of the plans, with the objective of finding the optimal option. For this, MATSim considers four characteristic parameters of the simulation: the departure time, the planned route, the way in which it will be carried out and the destination of the activity. The described iterative process is repeated completely until the average score of the population stabilises [115].

Another important note is that since MATSim is designed for large-scale scenarios, the software adopts the queuing approach, i.e., an agent enters a network link or road segment from an intersection and is added to the queue. Such an agent will remain there until the time to traverse the link has elapsed, it is at the head of the queue and the next link allows it to enter. Therefore, the MATSim traffic model is based on two attributes of the links: on the one hand, the storage capacity, which denotes the number of cars entering a link in the network, and on the other hand, the flow capacity, which is nothing

more than the exit capacity of a link, i.e., the number of agents that can leave the link per unit of time.

It should be noted that to carry out the simulations, the MATSim model needs at least the following files as inputs:

- **Config:** It contains all the possible MATSim configuration options. In this section you will specify among other parameters, the "controller", the number of iterations, the type of parameters and the configuration of the parameters of the utility function, which will assign scores to the different plans, which will be used probabilistically for the choice of each plan by the software.
- **Network:** It is the infrastructure where agents can move, which consists of a set of nodes and links. The simplest network format should contain information regarding the length of the link, the link capacity, the number of lanes available in the specified direction and the list of modes allowed on the link.
- **Population:** The population contains the data of the set of agents and their plans. Specifically, the files contain a list of people, which in turn each person contains a list of plans, and each plan contains a list of different activities. Each population file needs at least one plan associated with each person, for which it is not necessary to have a certain score assigned, as this can be obtained by MATSim. In addition, the activities can be located only by their coordinates and the section only needs one mode, so it is not necessary to specify the routes.

The procedure followed to obtain each of the files will be detailed in the supplementary material.

### 4.3.2 Mobility data

Before the simulations could be carried out, it was necessary to prepare the model, specifically the three files described above. For this purpose, the following methodology has been followed as detailed in this section.

We started from the mobility study conducted by the Cabildo de Tenerife in October 2018 [115] to analyse travel on the island and to allow access to citizenship, through a series of applications, of the data obtained, after processing and debugging them. Specifically, the information obtained from the geolocation records of mobile terminals, travel data from the Ten+ island public transport card, capacity data and surveys of both residents and non-residents were used.

For this purpose, the island was divided into 150 zones, called transport zones, which can be seen in Figure 4.8. Since the study carried out by the Cabildo does not include information on these zones anywhere, a name has been assigned to each one of them, as well as the municipality to which they belong, and they are presented in Annex C in an orderly fashion.

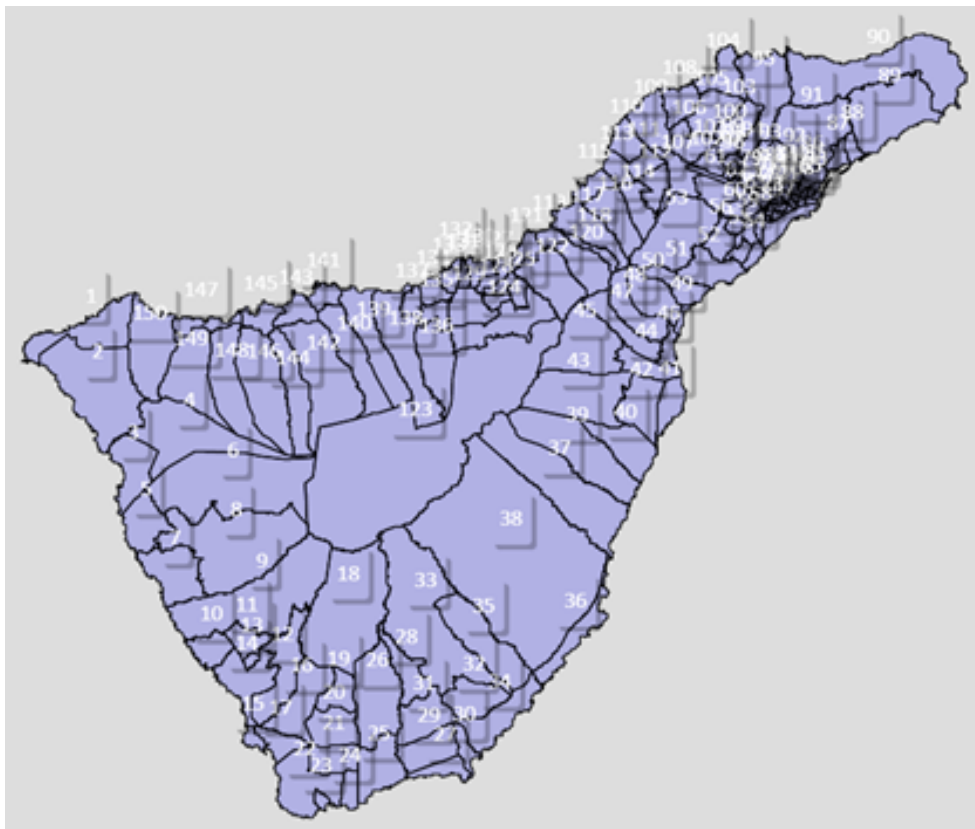

Figure 4.8: Transport zones into which Tenerife has been divided.

The result of the mobility study is a square matrix of rank 150, which describes the number of journeys made between the different transport zones during the month of



October 2018, the period covered by the study, with the rows being the transport zones of origin of each journey and the columns being the transport zones of destination. In addition, the study carried out by the Cabildo also allows the information to be filtered by time of the start of each journey or by distance, in the latter case it is only possible to filter the information into two different groups: journeys whose distance is equal to or less than 1 km and journeys with distances greater than 1 km.

All this information will be very important to consider when creating the necessary input files required by MATSim to carry out the simulation, which is why it has been detailed in this section. As mentioned above, this procedure is detailed in the supplementary material section.

## 4.4 Results and Discussion

This section will present the results obtained after the simulation, the methodology of which has been defined above, as well as in the supplementary material. Specifically, for this simulation, the model has been configured with about 250 iterations, which, as can be seen in Figure [4.9](#), are sufficient for the statistics of the utility function scores to stabilize, so that they can provide reliable results. Furthermore, the full simulation period is 5 days, which corresponds to a typical week between Monday and Friday.

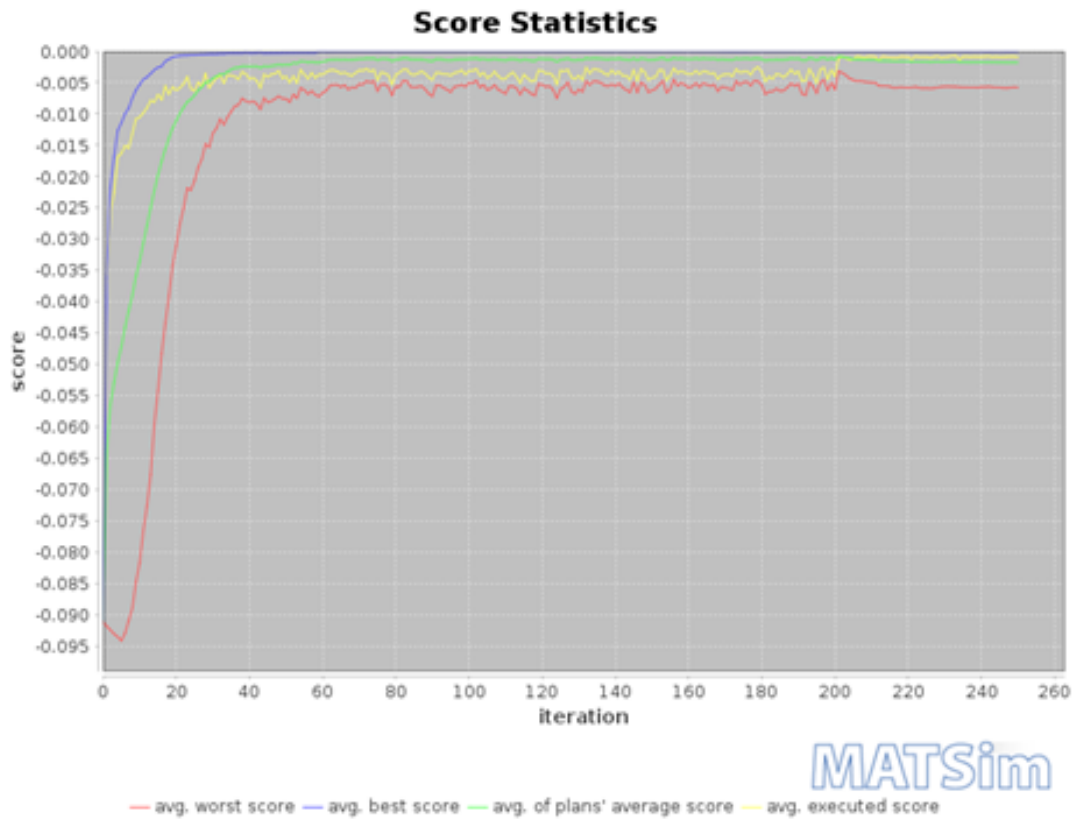

Figure 4.9: MATSim simulation scores statistics

Before obtaining the results corresponding to the location of the charging points, a dynamic representation of the mobility has been obtained, corresponding to the 5 days of simulation considered, and for which a synthetic population has been used. As an example, Figure [4.10](#) shows a screenshot of the synthetic agents in movement visualized in Simunto Via, corresponding to the town of San Isidro, municipality of Granadilla de Abona.



Figure 4.10: Screenshot of the synthetic agents in movement visualised in Simunto Via, in San Isidro, municipality of Granadilla de Abona.

#### 4.4.1 Simulation with progressive EV quotas

In this simulation, the penetration rates of electric vehicles estimated by the ITC were used [2]. A three-year budget of 5 million euros was considered for this case. In addition, the power of the chargers is not fixed, so that MATSim determines the charging power point accordingly.

Once the simulation process was completed, for this configuration described, the following points were obtained, as shown in Table 4.1.

Table 4.1: Number of EV charging points per power.

Years	Share of EVs (%)	Accumulated budget (€)	Number of 7kW chargers	Number of 22kW chargers
2022	2.29	5,000,000	781	141
2025	8.40	10,000,000	1,883	144
2028	18.10	15,000,000	2,988	144
2031	31.36	20,000,000	4,09	144
2035	49.65	25,000,000	5,191	144
2037	72.20	30,000,000	6,294	144

It can be seen that in the first step, 141 semi-fast chargers (22 kW power) and the rest slow chargers are obtained (7 kW power). These semi-fast chargers will practically remain constant while the slow chargers will increase over time.

Figure 4.11 show the distribution of charging points throughout the island of Tenerife in the different years, where each red dot corresponds to a charging point.

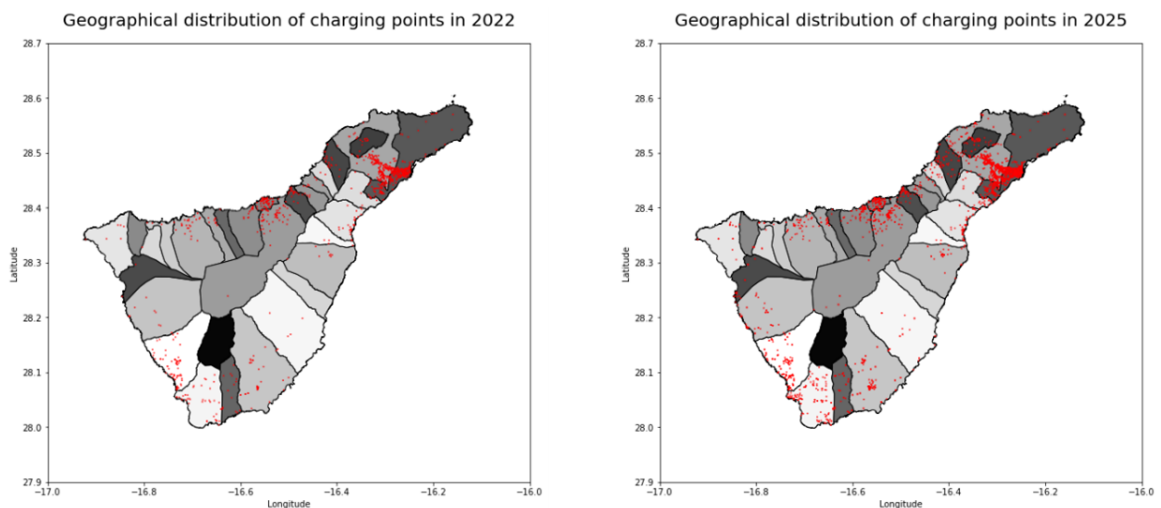

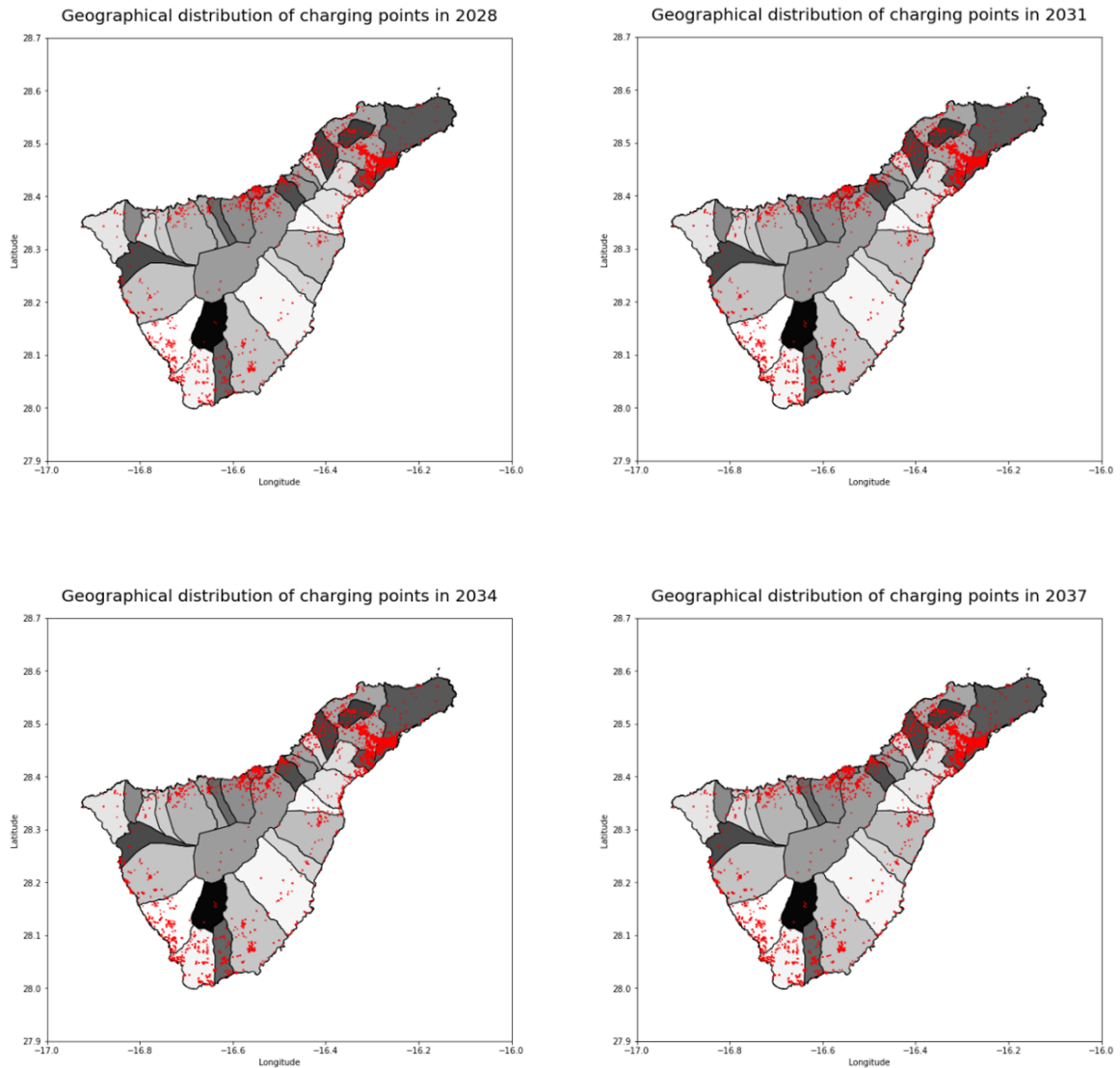

Figure 4.11: Maps of the distribution of the charging points obtained in Tenerife over time.

These previous maps have been elaborated after applying a data treatment in Python to the results provided by MATSim.

In total, with a budget of 30,000,000 euros, 6,294 EV charging points with a power of 7 kW and 144 points with a power of 22 kW were obtained, corresponding to slow and semi-fast charging points respectively. These points have been grouped by municipality by means of data processing to obtain Table 4.2, which shows the exact number of EV charging points obtained in each municipality of the island of Tenerife and in each step of the simulation.

It should be noted that these results do not correspond to census population criteria, but to the simulation built by synthetic agents from the mobility data available in the study conducted by the Cabildo de Tenerife in October 2018 [24]. Moreover, these results correspond to the optimal distribution of charging points for an available budget of 30,000,000 euros, and this parameter could have varied and, therefore, different results could have been obtained. Therefore, the possibility of adapting the results according to the specific needs of each moment remains open.

Table 4.2: Number of EV charging points per municipality

Municipality	Years					
	2022	2025	2028	2031	2034	2037
Santa Cruz de Tenerife	259	477	666	844	1014	1178
La Laguna	200	416	614	812	993	1166
Arona	39	133	229	320	408	485
Adeje	69	127	203	276	344	415
Granadilla de Abona	33	88	144	208	266	329
La Orotava	61	130	181	225	266	302
Puerto de la Cruz	59	102	158	205	253	296
Los Realejos	14	59	111	157	205	253
Guía de Isora	10	43	77	116	165	214
Tegueste	13	47	74	105	146	182
Tacoronte	17	48	77	111	143	179
Icod de los Vinos	25	44	73	105	139	177
San Miguel de Abona	14	34	66	101	138	174
Güímar	8	30	50	79	113	151
Santa Úrsula	22	42	63	87	110	131
Arico	6	22	40	62	92	124
El Rosario	6	29	50	72	95	118
Candelaria	27	50	68	81	96	113
El Sauzal	3	16	38	59	82	107
La Guancha	9	18	28	38	48	59
Santiago del Teide	2	17	24	32	44	54
El Tanque	1	5	9	22	29	40
Buenavista del Norte	6	16	24	29	32	39
Garachico	3	5	12	16	20	29
Fasnia	3	0	2	8	14	27
La Matanza de Acentejo	5	10	13	16	20	26
Arafo	4	5	10	11	15	20
La Victoria de Acentejo	6	11	13	15	18	19
San Juan de la Rambla	1	2	9	8	13	14
Los Silos	0	1	3	5	7	9
Vilafior	0	0	3	7	7	8
<b>Total</b>	<b>922</b>	<b>2027</b>	<b>3132</b>	<b>4234</b>	<b>5335</b>	<b>6438</b>

It can be seen, both visually on the map and in Table [4.2](#), that there are 2 municipalities that stand out above the rest, such as the metropolitan area formed by Santa Cruz de Tenerife and La Laguna, which between them account for 36.41% of the total charging points on the whole island in 2037. Other areas with significant concentrations of points are the tourist municipalities in the south of the island, with the following standing out in particular Arona, Adeje and Granadilla de Abona with third, fourth and fifth place respectively in the ranking of municipalities with the highest concentration of points. The municipalities of the Orotava Valley, i.e. La Orotava, Puerto de la Cruz and Los Realejos, also stand out, occupying in this case the sixth, seventh and eighth positions, all of them with more than 200 charging points in the year 2037. The rest of the municipalities of Tenerife have a lower concentration of charging points, although it should be noted that of the 31 municipalities, the simulation results show more than 10 charging points in 29 municipalities, with Los Silos and Vilaflor being the only municipalities with a lower concentration of points, with 9 and 8 chargers respectively. This information can be seen more graphically in Figure [4.12](#), where the two municipalities of the metropolitan area clearly dominate: Santa Cruz de Tenerife and La Laguna.

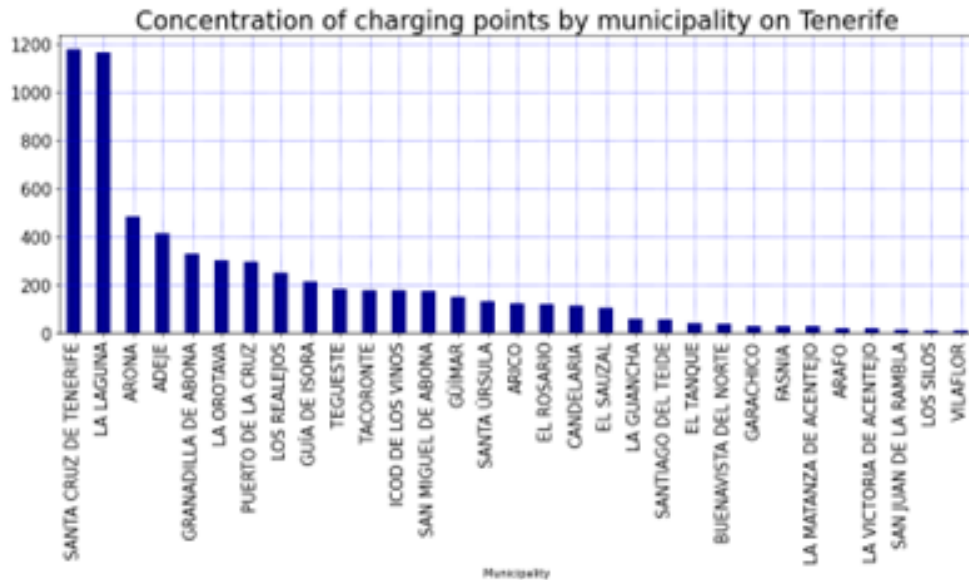

Figure 4.12: Concentration of charging points by municipality on the island of Tenerife in 2037.

To better visualize these areas where there is a higher density of points, it has been decided to represent, with a higher resolution and in urban-type map, the places where the charging points obtained are located in the year 2037. These maps are shown in Figures 4.13 to 4.18, which correspond to the metropolitan area (formed by the most populated areas of the municipalities of Santa Cruz de Tenerife and La Laguna), La Orotava Valley (formed by the municipalities of La Orotava, Puerto de la Cruz and Los Realejos), the most touristic areas in the South of the island (corresponding to the municipalities of Arona and Adeje), the municipalities of Granadilla and San Miguel de Abona, Güímar Valley (formed by Candelaria, Arafo and Güímar) and the northeast region (comprising Santa Úrsula, La Victoria and La Matanza de Acentejo, El Sauzal and Tacoronte), respectively.



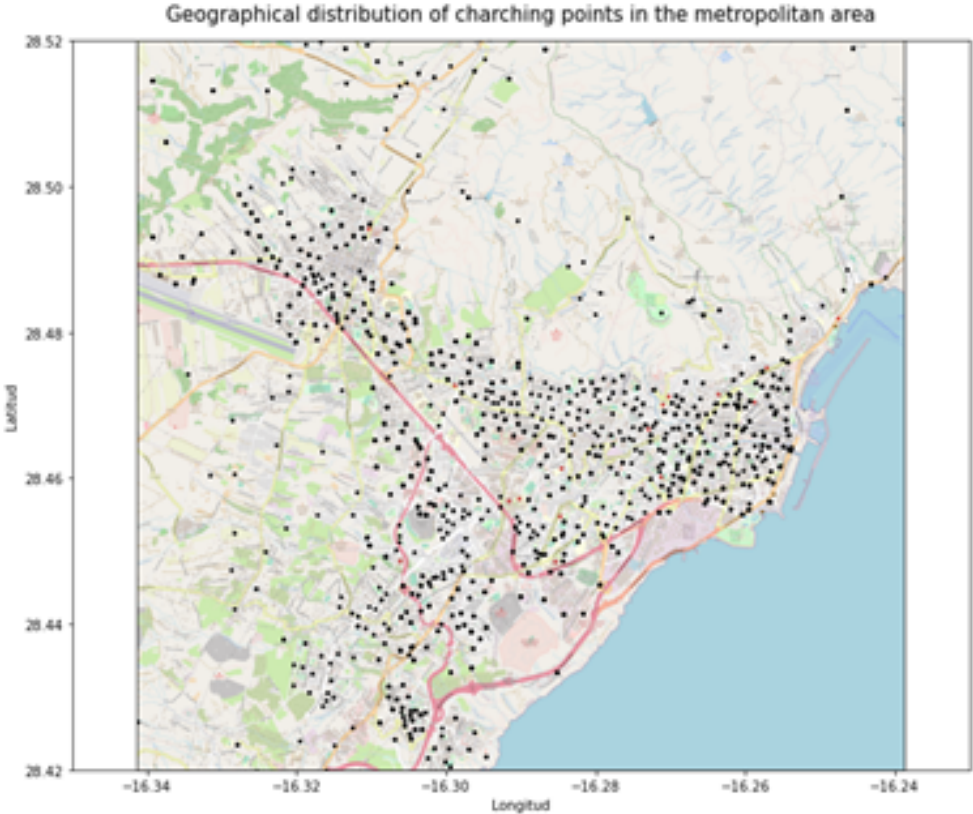

Figure 4.13: Distribution of charging points in the metropolitan area of Tenerife.

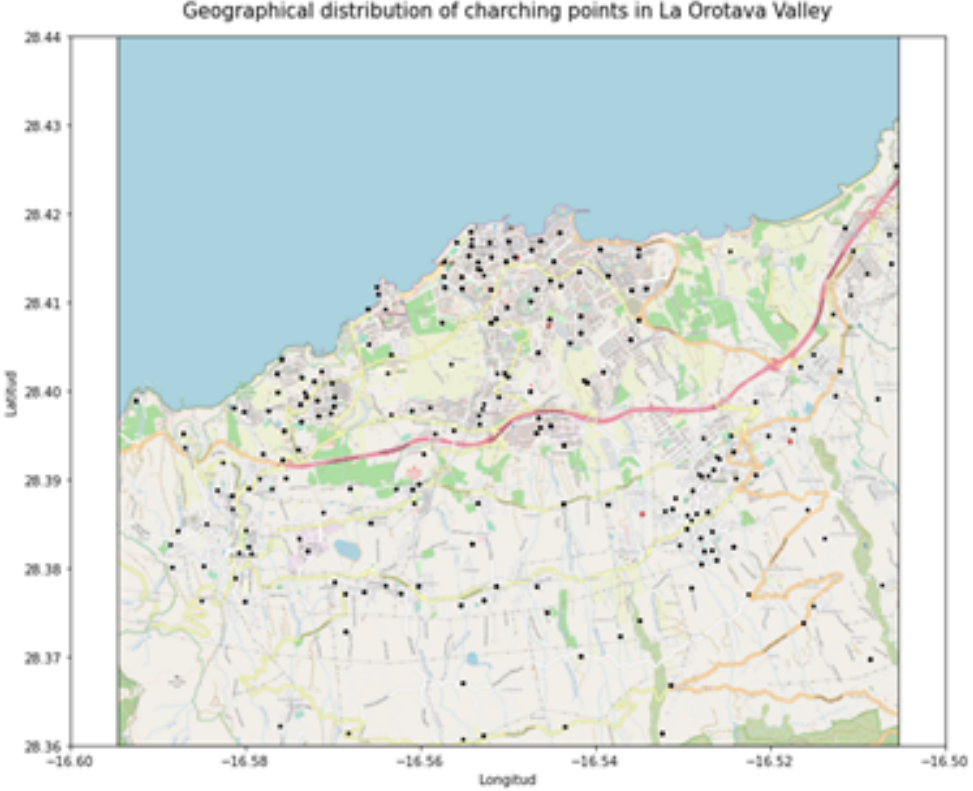

Figure 4.14: Distribution of charging points in La Orotava Valley.



Figure 4.15: Distribution of charging points in the touristic areas of the South of Tenerife (Arona - Adeje).



Figure 4.16: Distribution of charging points in Granadilla and San Miguel de Abona.

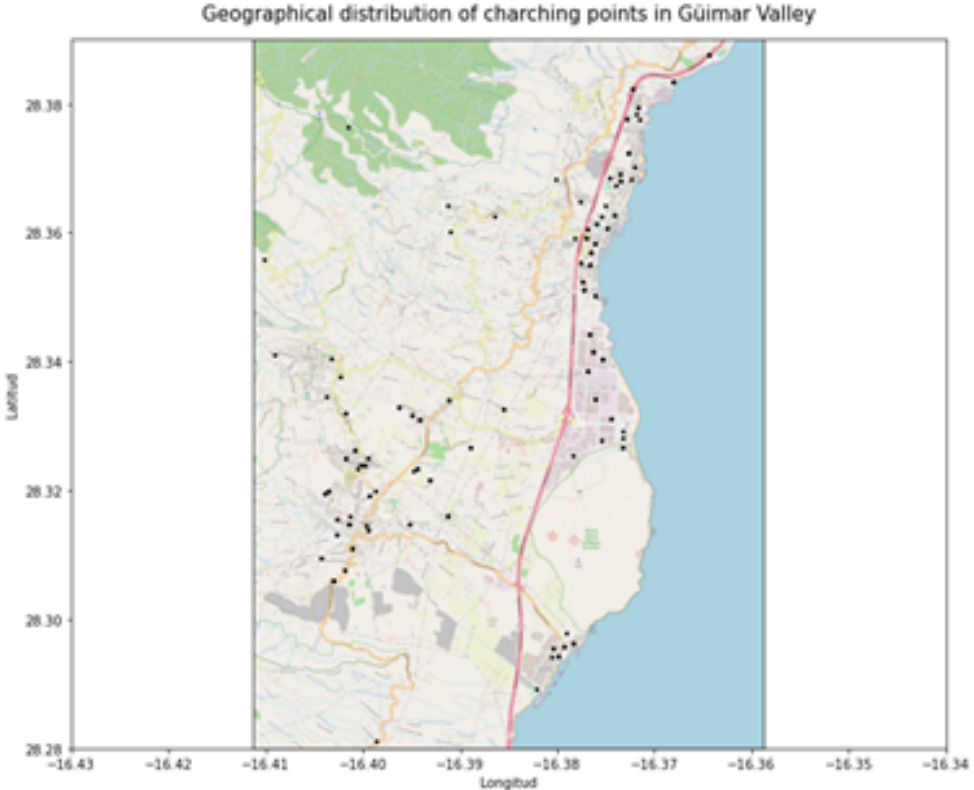

Figure 4.17: Distribution of charging points in Güímar Valley.

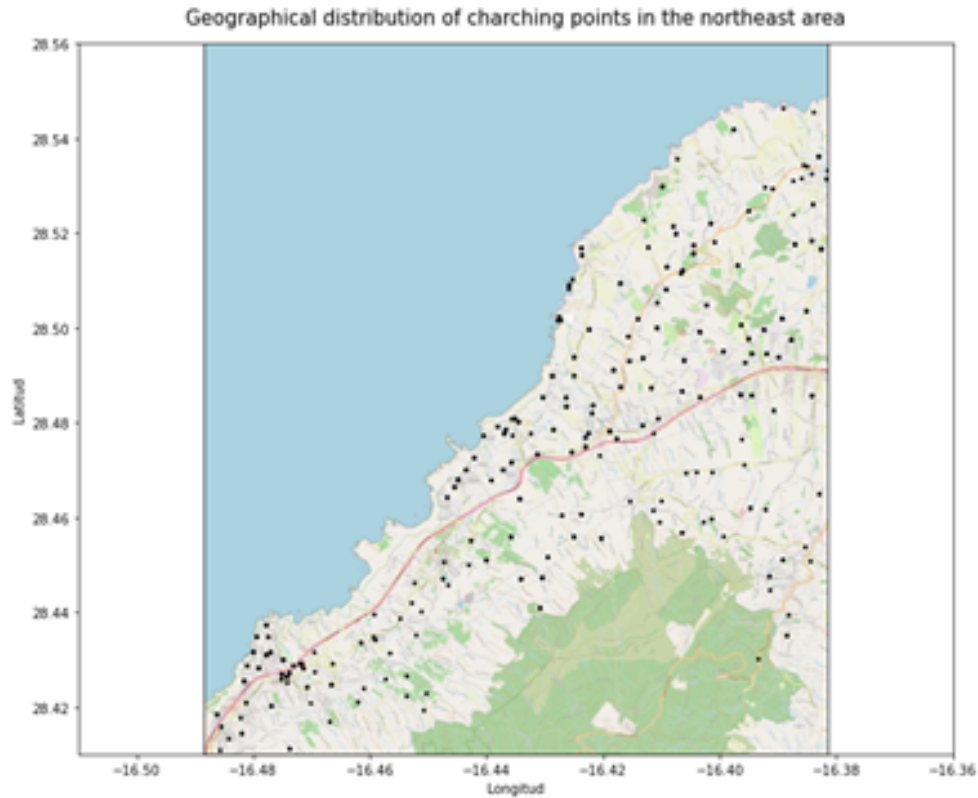

Figure 4.18: Distribution of charging points in the northeast region of Tenerife.

#### 4.4.2 Comparison between a simulation with progressive and non-progressive EV quotas

In this case, a simulation was carried out in which the initial percentage of EVs in the year 2022 was considered to be 100%, so the differences between the previous simulation in which the population gradually acquired an EV and this latest simulation in which the land-based vehicle fleet is purely electric will be analyzed. For this case, the same budget of 5 million euros per step was set, starting in 2022, and 3 steps were simulated, with each step again being triennial. The results are presented in Table [4.3](#).

Table 4.3: Number of EV charging points per power with progressive and non-progressive EVs quotas.

Years	Accumulated budget (€)	Progressive EVs quotas		Non-progressive EVs quotas	
		Number of	Number of	Number of	Number of
		7kW chargers	22kW chargers	7kW chargers	22kW chargers
2022	5,000,000	781	141	1,111	0
2025	10,000,000	1,883	144	2,215	3
2028	15,000,000	2,988	144	3,326	3

It can be seen that while in the case of the simulation with progressive VE quotas 141 semi-fast chargers (22 kW) are obtained in the first step, in the case of the non-progressive simulation none are obtained. This is probably due to the fact that not being progressive, all users have an electric vehicle and therefore MATSim will prioritise slow chargers (7kW), which are cheaper than semi-fast chargers and therefore a greater number of points is obtained, in order to place a charging point for the greatest possible number of agents.

This would explain why in the case of the above simulation, as in the first step the share of electric vehicles was small (2.29%), there was enough budget to place several semi-fast chargers, but as the share of electric vehicles increased, and not in a way that would have been possible in the first step, there would have been enough budget to place several semi-fast chargers.

Finally, it is noteworthy that for the second step of the non-progressive simulation, 3 semi-fast chargers appear, which is the same increase of this type of chargers as in the progressive simulation, so it may be due to a residual error of MATSim.

Figure 4.19 shows the distribution of points for 2028 for both cases, progressive and non-progressive, where it can be seen that in the latter there is a greater number of points distributed more homogeneously throughout the island, as the semi-fast charging points are disregarded compared to the slow charging points.

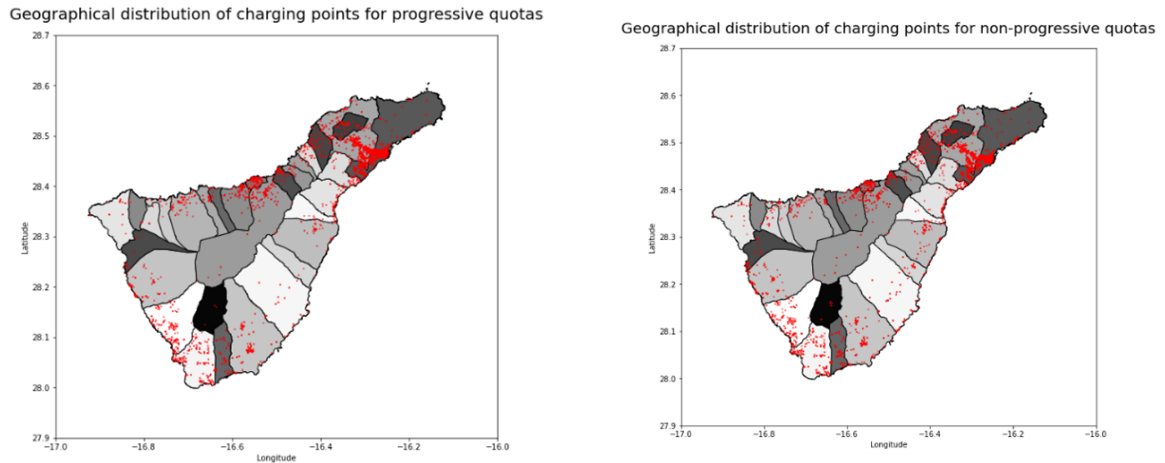

Figure 4.19: Distribution of charging points in Tenerife in 2028 for the progressive and non-progressive cases.

## 4.5 Conclusions

In this study we first obtained the most efficient geographical distribution of electric vehicle charging points to be installed on the island of Tenerife for a budget of 30,000,000 euros and with a horizon until 2037. For this purpose, a simulation of the island’s traffic was carried out using MATSim, a multi-agent traffic simulation software. For the elaboration of such simulation, a synthetic population elaborated in Python was used from the data obtained from a mobility study carried out by the Cabildo de Tenerife in October 2018. Prior to the elaboration of the simulation, the different governmental plans and studies carried out to date in the Canary Islands on the preparation of the network of charging points for the growing number of EVs expected in the coming years were analyzed. In fact, these government plans contemplate that by the year 2040 all land vehicles will be electric, with the consequent preparation and design of the network of charging points that this entails, which is still pending.

With the allocated budget, the results obtained satisfy 10% of the synthetic population of the island, reflecting the optimal location of the 6,438 charging points to be installed. This budget has been intentionally assigned to cover this percentage of the

population and not to excessively lengthen the computation time of the simulations, since it has been considered a sufficient percentage to check the suitability of the results. This distribution of points, as can be seen in the paper, is coherent with the distribution of population density on the island, so it is deduced that it will make sense according to population mobility criteria. Therefore, the initial objective of the study, which was to obtain a methodology that could design the network of charging points for EVs based on mobility studies, and that is reliable, yielding consistent results, so that the model can be extrapolated to other regions, has been demonstrated.

Furthermore, these results represent an advance over the governmental plans prepared by ITC, since the latter are based solely on available parking space, whereas this study incorporates the analysis of population movements, allowing the network to be designed based on technical criteria. On the other hand, having carried out the study with progressive quotas of electric vehicle penetration and having obtained results every 3 years, it is possible to check how the installation of charging points would be gradual.

However, this study is subject to future improvements and extensions in order to achieve greater accuracy of its results for the design of an adequate electromobility infrastructure plan on the island of Tenerife. It would be desirable to have new, more up-to-date mobility studies carried out over a longer period, so that the synthetic population constructed for the simulations is as close as possible to the real population. The study was conducted with the data available to date corresponding to October 2018, but since it is data prior to the Covid-2019 pandemic, it would be convenient to have subsequent mobility studies to check how the mobility of the island has changed. It is also open to the possibility of considering the charging demand as the primary condition and trying to minimize the budget needed to satisfy it or also considering the charging speed as a variable, combining charging points with different power, and therefore with different charging speed, as was done in the second part of the results where we compared the case of progressive EV quotas with non-progressive quotas.

In addition to these improvements in the configuration of the simulations, another

series of factors that may condition the reliability of the results must also be pondered.

Firstly, it is necessary to estimate the future number of public transport users, which is expected to increase due to the planning of new infrastructures under development, such as the railroad lines in the north and south of the island. Moreover, a possible modal change in mobility is expected, where the use of carpooling, bicycle transport for short distances or the option of teleworking for those cases in which it is feasible. All of this could lead to a reduction in the number of vehicles per inhabitant, which should be considered. Another variable to be studied is the construction of new road transport infrastructures, as is the case of the highway island ring, which may cause changes in mobility and therefore also in the results obtained in relation to charging points.

Finally, according to ITC estimates, the complete electrification of road transport in Tenerife will mean an increase in energy demand of 71.2%, which will have to be covered by renewable energies, mainly photovoltaic and wind. However, this increase in energy demand is not necessarily a negative point; on the contrary, it will serve to make the electricity system more robust, since in an energy production system where renewable energies account for around 100% of production, the correct management of this increase in demand associated with the electrification of the transport system makes it possible to prioritize the charging of electric vehicles at times of greater availability of renewable energy, thus avoiding spills and energy losses. This flattens the energy demand curve by shifting the increase in energy demand to the off-peak hours of the curve, making the electricity system more efficient.

Moreover, the positive effect on the grid will be even greater if V2G technology is added to this, which considers cars as batteries as well and thus also avoids oversizing energy storage. In this way, EVs would act as manageable loads that absorb electricity from the grid during off-peak hours and supply energy during peak hours. Having a V2G network is more costly than a simple one-way charging infrastructure and this additional cost need to be carefully evaluated to exhibit a positive final contribution for the electricity system. However, studies have shown that if government support is provided through subsidies



to offset the initial investment losses, the use of V2G technology is economically viable, and the optimal case, i.e., the one requiring minimal financial support, is when the V2G service operator adds AC chargers.

For all these reasons explained, this study is essential to lay the foundations for the preparation of an adequate network of EV charging points in Tenerife, as the methodology has been shown to work in the sense that it yields consistent and coherent results, and can be applied to other different case studies. Such a charging infrastructure, as explained above, will not only be necessary due to the expected increase in the number of EVs in circulation, but will also improve the electricity system, helping to correct the weakest points of non-manageable energies.

# Chapter 5

## General conclusion

\*

This dissertation investigated key elements of the development of a charging infrastructure, in a context of transition of our mobility habits motivated by the urgency to reduce our impact on the climate.

We explored the link between charging infrastructure and electric vehicle acceptability, to propose a model for the deployment of this infrastructure that adapts to the behaviors of electric vehicle drivers in order to reduce their range anxiety.

We present here a summary of the key takeaways from each chapter, as well as proposals for future research.

\*

## 5.1 Chapter 2: Too much or not enough? Planning electric vehicle charging infrastructure: A review of modeling options

The massive adoption of electric vehicles as a primary mode of transport goes hand in hand with the development of a network of charging stations allowing the use of these vehicles. These charging stations, whether slow or fast, are the link between the electric grid and the vehicles. The deployment of these charging stations must be done in such a way as to make electric vehicles acceptable to those who can charge at home, as well as those who cannot. For this, the charging stations and their locations must be carefully chosen, taking also into account the technical and economic constraints faced by the operators of these stations.

Most of the time, the proposed models for the placement of charging stations focus on a particular goal. They can be mainly divided into two categories: models with a predetermined demand, which seek to meet this demand by minimizing investment and/or operational costs, and models with a maximum cost constraint and seeking to maximize the service provided. To meet this goal, different localization approaches are used, which can be separated into three groups:

- The *node-based* approach, which sees this goal as maximizing geographic coverage. Vehicles generate demand points, and stations must cover these points - or be as close to them as possible. This static approach to demand is appropriate for urban environments.
- The *path-based* approach, which sees this objective as capturing vehicle flows. Vehicles drive past the stations and stop when needed. This vision is particularly suited for deployment on highways for fast charging stations.
- The *tour-based* approach, which sees this objective as a problem of capturing charging opportunities. Tours are successions of trips, and charging opportunities appear

during these tours. This often data-intensive approach is adaptable to any territory and allows for territory-wide infrastructure coordination.

Regardless of the approach used, existing deployment models focus on the optimality of the final infrastructure, without integrating the time aspect of infrastructure deployment, which is spread over several years.

## **5.2 Chapter 3: From user to operator: Rationalizing the charging infrastructure deployment.**

Based on the analysis of the previous chapter, we conclude that the deployment of a charging infrastructure must be done in a way that supports the democratization of the electric vehicle. In this chapter, we propose a multi-criteria, tour-based model, centered around the potential users of the infrastructure, and which integrates the incremental aspect of the development of a charging infrastructure on a territory scale.

To integrate the incremental aspect, this model works under an iterative way. A set of locations where charging stations can be placed is defined beforehand. Then, a score is assigned to each of these locations, calculated from travel data according to several criteria, notably related to the frequency of use of the locations considered. Based on these scores, the stations are selected and placed, under the constraint of a maximum budget. These new stations modify the users' behaviors, and new scores are calculated from the new data collected. The new scores are used to determine the new stations to be deployed, and so on until the last step of the infrastructure deployment.

The application of this model to the Berlin area, through a multi-agent simulation performed with MATSim, under the assumption that all vehicles in the simulation are the same electric vehicle and various parameter variations, gives us several results. The most notable is that slow charging stations are to be preferred, at least in the first stages of infrastructure deployment, and that fast charging stations are not very interesting for daily use and should be restricted to specific purposes. We also note that access

to residential charging, whether by a public or private charger, is an essential aspect of electric vehicle acceptability.

### **5.3 Chapter 4: Tenerife’s Infrastructure Plan for Electromobility: A MATSim Evaluation**

The model developed in the previous chapter was applied to the island of Tenerife, Spain. For this purpose, a mobility model of the island was built, based on open-source data. Such an island model is a closed system, and no vehicles are simply in transit.

In the previous chapter, the presented results were based on the strong assumption that 100% of the vehicles were electric. This choice was justified, among other things, by the fact that the purpose of the model was to allow the democratization of electric vehicles, and therefore that the infrastructure should serve both early adopters and create opportunities for future electric vehicle users. However, this vision is not very compatible with the economic reality of the deployment of charging infrastructure by private actors, who will seek to maximize their return on investment by targeting electric vehicle hotspots. A gradual transformation of the fleet from internal combustion engine to electric vehicles was therefore modeled, by building a probabilistic model of electric vehicle adoption based on the income of agents in each zone. A rate of 2 percent electric vehicles in 2022 was assumed, rising to nearly three-quarters of the fleet being electric in 2037. The first stages of this phased deployment scenario were also compared with a all-electric vehicle scenario from the start.

The main difference observed is in the types of chargers deployed. While the absence of fast chargers is still notable, the number of "semi-fast" chargers installed during deployment with a growing fleet of electric vehicles is much higher than when all vehicles are electric, and they are almost all installed in the first stage of deployment. These charging stations are therefore most useful in the early stages of deployment, and then their usefulness diminishes as the number of stations and electric vehicles increases.

In this scenario, the chargers are also more concentrated with almost one-third of the chargers concentrated in two of the 31 municipalities in Tenerife.

## 5.4 Future work

The work done in this thesis is only the beginning of a vast field of research, which opens the way to many possible developments. Here are the main points we would like to explore, in addition to those related to the model and raised in the second chapter of this manuscript.

First, it would be interesting to integrate a competition game between charging infrastructure operators. The studies done during this thesis aim at coordinating the infrastructure at a territorial scale, but do not care about the station where the vehicles charge as long as they can charge, which more or less amounts to an implicit assumption of monopoly on the infrastructure. In reality, the infrastructure will not be owned by a single player, but by several competing players. Such a competition game raises the issue of the profitability not of a global infrastructure, but of several infrastructures distributed differently over the territory, with potential cannibalization effects between competitors. This, therefore, raises the issue of information sharing between competitors, or even a market for vehicle charging information. This information sharing could also be extended to include price signals not only from operators to users but also from energy producers and suppliers to operators so that the latter can adapt their offers according to local and global tensions in the electrical system.

A second area of research to be explored would be the integration of the operational constraints of infrastructure deployment. First of all, taking into account the constraints related to the electrical network. We have chosen to integrate a constraint on the network by an additional cost for the installation of a station, but in the absence of easily accessible data, we had to use identical installation costs for all stations of the same type. The integration of these data can bring a real addition to this model, without really increasing

its complexity. Secondly, our model considers that charging stations can be installed at any location, and that the parking capacity of a location is more or less unlimited. In practice, especially in urban environments, a parking space is not always available, nor is a space to install a charging station. A more detailed geographical analysis is needed for this aspect, which is crucial for a truly applicable deployment model.

Finally, there are the operating constraints of the infrastructure. Our model focuses on the deployment of the infrastructure, and considers that a terminal in place is always operational. Practice shows that this is far from being the case. The robustness of the infrastructure to operational hazards, which is inevitable for a system of this size, is also a subject of study that deserves to be pursued.

# Appendix A

## Appendix to Chapter 2: Litterature

### Table



Paper	Approach	Problem	Limited re-sources	Charging type	Main optimization goal	Use case	Target environment	Home charging available	Electric grid aspect	Previous existing infrastructure
Wang & Lin (2013) [69]	Mixed approach	Location and sizing (power and capacity)	Yes (constraint)	Mixed	Minimize failed trips (or maximize the number of possible trips)	Private vehicle	Mixed environment	Unspecified	No	No
Upchurch & Kuby (2010) [102]	Node and path-based	Location	Yes (constraint)	Unique	Minimize failed trips (or maximize the number of possible trips)	Private vehicle	Highway	Unspecified	No	No
He et al. (2016) [84]	Node-based	Location and sizing (capacity)	Yes (constraint)	Mixed	Maximize the number of EVs charged	Private vehicle	Urban environment	Yes, not for all	No	No
Rajabi-Ghahnavie & Sadeghi-Barzani (2017) [? ]	Node-based	Location	No (budget to optimize)	Fast charging	Minimize the infrastructure cost for a given demand	Private vehicle	Urban environment	Yes, for all	Yes, as a parameter	No
Pevec et al. (2018) [50]	Node-based	Location	Yes (constraint)	Unique	Maximize the charger's utilization	Private vehicle	Mixed environment	Yes, not for all	No	Yes
Wang et al. (2019) [61]	Node-based	Location and sizing (power)	Yes (constraint)	Mixed	Maximize the distance traveled	Taxis and private vehicles	Urban environment	Yes, not for all	No	No

Paper	Approach	Problem	Limited re-sources	Charging type	Main optimization goal	Use case	Target environment	Home charging available	Electric grid aspect	Previous existing infrastructure
Frade et al. (2011) [79]	Node-based (MCLM)	Location	Yes (constraint)	Slow charging	Maximize the number of EVs charged	Private vehicle	Urban environment	Yes, not for all	No	No
Liu, J. (2012) [87]	Node-based (MCLM)	Location and sizing (power)	Yes (constraint)	Mixed	Maximize the number of EVs charged	Private vehicle	Urban environment	Yes, not for all	Yes, as a constraint	No
Wagner et al. (2013) [80]	Node-based (MCLM)	Location and sizing (power)	Yes (constraint)	Mixed	Maximize the amount of energy charged	Private vehicle	Semi-urban environment	Unspecified	No	No
Wang et al. (2013) [69]	Node-based (MCLM)	Location and sizing (capacity)	Yes (constraint)	Mixed	Maximize the number of EVs charged	Private vehicle	Unspecified	Unspecified	Yes, as a constraint	No
Guo & Zhao (2015) [73]	Node-based (MCLM)	Location	Yes (constraint)	Unique	Maximize the number of EVs charged	Private vehicle	Urban environment	Unspecified	Yes, as a parameter	No
Gopalakrishnan et al. (2016) [86]	Node-based (MCLM)	Location and sizing (capacity)	Yes (constraint)	Unique	Maximize the number of EVs charged	Private vehicle	Unspecified	Unspecified	No	No
Yang et al. (2017) [58]	Node-based (MCLM)	Location and sizing (power and capacity)	Yes (constraint)	Unique	Minimize the infrastructure cost for a given demand	Taxi fleet	Semi-urban environment	Unspecified	No	Yes

Paper	Approach	Problem	Limited re-sources	Charging type	Main optimization goal	Use case	Target environment	Home charging available	Electric grid aspect	Previous existing infrastructure
Deb et al. (2019) <a href="#">88</a>	Node-based (MCLM)	Location and sizing (power)	No (budget to optimize)	Mixed	Minimize the infrastructure cost for a given demand	Private vehicle	Urban environment	Unspecified	Yes, as a parameter	No
Ge et al. (2011) <a href="#">53</a>	Node-based (p-median)	Location and sizing (capacity)	Yes (constraint)	Unique	Minimize the distance (or the deviation) to a charging station	Private vehicle	Mixed environment	Unspecified	No	No
Xu et al. (2013) <a href="#">54</a>	Node-based (p-median)	Location	Yes (constraint)	Unique	Minimize the distance (or the deviation) to a charging station	Private vehicle	Urban environment	Unspecified	No	No
Mehar et al. (2013) <a href="#">46</a>	Node-based (p-median)	Location and sizing (capacity)	No (budget to optimize)	Unique	Minimize the infrastructure cost for a given demand	Private vehicle	Unspecified	Unspecified	Yes, as a constraint	Yes
Gavranović et al. (2014) <a href="#">67</a>	Node-based (p-median)	Location	Yes (constraint)	Unique	Minimize the distance (or the deviation) to a charging station	Private vehicle	Mixed environment	Unspecified	No	No

Paper	Approach	Problem	Limited re-sources	Charging type	Main optimization goal	Use case	Target environment	Home charging available	Electric grid aspect	Previous existing infrastructure
Jia et al. (2014) [82]	Node-based (p-median)	Location	No (budget to optimize)	Fast charging	Minimize the infrastructure cost for a given demand	Private vehicle with home charging	Semi-urban environment	Yes, for all	No	No
Sadeghi-barzani et al. (2014) [72]	Node-based (p-median)	Location and sizing (capacity)	No (budget to optimize)	Fast charging	Minimize the infrastructure cost for a given demand	Private vehicle	Unspecified	Unspecified	Yes, as a parameter	No
Zhu et al. (2017) [65]	Node-based (p-median)	Location and sizing (capacity)	No (budget to optimize)	Unique	Minimize the infrastructure cost for a given demand	Private vehicle	Unspecified	Unspecified	Yes, as a parameter	No
Wang & Lin (2009) [77]	Node-based (SCLM)	Location	Yes (constraint)	Unique	Maximize the number of EVs charged	Private vehicle	Unspecified	Unspecified	No	No
Wang & Wang (2010) [55]	Node-based (SCLM)	Location	Yes (constraint)	Unique	Maximize the number of EVs charged	Private vehicle	Unspecified	Unspecified	No	No
Li et al. (2011) [93]	Node-based (SCLM)	Location and sizing (power)	No (budget to optimize)	Mixed	Minimize the infrastructure cost for a given demand	Private vehicle	Unspecified	Unspecified	No	No

Paper	Approach	Problem	Limited re-sources	Charging type	Main optimization goal	Use case	Target environment	Home charging available	Electric grid aspect	Previous existing infrastructure
Andrenacci et al. (2016) [89]	Node-based (SCLM)	Location and sizing (capacity)	No (budget to optimize)	Unique	Minimize the infrastructure cost for a given demand	Private vehicle	Semi-urban environment	Yes, for all	No	No
Ghamami et al. (2016) [90]	Node-based (SCLM)	Location and sizing (capacity)	No (budget to optimize)	Unique	Minimize the infrastructure cost for a given demand	Private vehicle	Urban environment	No	No	No
Davidov & Pantoš (2017) [91]	Node-based (SCLM)	Location and sizing (capacity)	No (budget to optimize)	Unique	Minimize the infrastructure cost for a given demand	Private vehicle	Unspecified	Unspecified	No	No
Csiszár et al. (2019) [60]	Node-based (SCLM)	Location and sizing (capacity)	Yes (constraint)	Unique	Maximize the amount of energy charged	Private vehicle	Unspecified	Yes, not for all	No	No
Vazifeh et al. (2019) [92]	Node-based (SCLM)	Location and sizing (capacity)	No (budget to optimize)	Unique	Minimize the infrastructure cost for a given demand	Private vehicle	Semi-urban environment	Yes, for all	No	No

Paper	Approach	Problem	Limited re-sources	Charging type	Main optimization goal	Use case	Target environment	Home charging available	Electric grid aspect	Previous existing infrastructure
Huang et al. (2016) [103]	Path-based (fast charging) and node-based (slow charging)	Location	No (budget to optimize)	Mixed	Minimize the infrastructure cost for a given demand	Private vehicle	Semi-urban environment	Unspecified	No	No
Sun et al. (2018) [57]	Path-based (fast charging) and node-based (slow charging)	Location and sizing (power)	Yes (constraint)	Mixed	Maximize the number of EVs charged	Private vehicle	Mixed environment	Yes, for all	No	No
Hanabusa & Horiguchi (2011) [51]	Path-based (FCLM)	Location	Yes (constraint)	Unique	Minimize the waiting time at the station	Private vehicle	Unspecified	Unspecified	Yes, as a constraint	No
Riemann et al. (2015) [100]	Path-based (FCLM)	Location	Yes (constraint)	Unique	Maximize the number of EVs charged	Private vehicle	Mixed environment	Yes, for all	No	No

Paper	Approach	Problem	Limited re-sources	Charging type	Main optimization goal	Use case	Target environment	Home charging available	Electric grid aspect	Previous existing infrastructure
Dong et al. (2016) [45]	Path-based (FCLM)	Location and sizing (capacity)	No (budget to optimize)	Fast charging	Minimize the infrastructure cost for a given demand	Private vehicle	Highway	Unspecified	No	No
Li et al. (2016) [38]	Path-based (FCLM)	Location	No (budget to optimize)	Unique	Minimize the infrastructure cost for a given demand	Private vehicle	Mixed environment	Yes, for all	No	Yes
Xiang et al. (2016) [101]	Path-based (FCLM)	Location and sizing (capacity)	No (budget to optimize)	Unique	Minimize the infrastructure cost for a given demand	Private vehicle	Unspecified	Unspecified	Yes, as a constraint	No
Wu & Siohansi (2017) [98]	Path-based (FCLM)	Location	Yes (constraint)	Fast charging	Maximize the number of EVs charged	Private vehicle	Mixed environment	Yes, for all	No	No
Micari et al. (2017) [63]	Path-based (FCLM)	Location and sizing (capacity)	Yes (constraint)	Unique	Minimize failed trips (or maximize the number of possible trips)	Private vehicle	Highway	Unspecified	No	No
He et al. (2018) [99]	Path-based (FCLM)	Location	Yes (constraint)	Fast charging	Maximize the number of EVs charged	Private vehicle	Unspecified	Yes, for all	No	No

Paper	Approach	Problem	Limited re-sources	Charging type	Main optimization goal	Use case	Target environment	Home charging available	Electric grid aspect	Previous existing infrastructure
Motoaki, Y. (2019) <a href="#">56</a>	Path-based (FCLM)	Location	Yes (constraint)	Fast charging	Maximize the number of EVs charged	Private vehicle	Unspecified	Yes, for all	Yes, as a constraint	Yes
Kuby et al. (2005) <a href="#">94</a>	Path-based (FRLM)	Location	Yes (constraint)	Unique	Maximize the number of EVs charged	Private vehicle	Unspecified	Unspecified	No	No
Kuby et al. (2007) <a href="#">95</a>	Path-based (FRLM)	Location	Yes (constraint)	Unique	Maximize the number of EVs charged	Private vehicle	Unspecified	Unspecified	No	No
Upchurch et al. (2009) <a href="#">66</a>	Path-based (FRLM)	Location and sizing (capacity)	Yes (constraint)	Unique	Maximize the number of EVs charged	Private vehicle	Unspecified	Unspecified	No	No
Li & Huang (2014) <a href="#">25</a>	Path-based (FRLM)	Location	No (budget to optimize)	Unique	Minimize the infrastructure cost for a given demand	Private vehicle	Unspecified	Yes, for all	No	No
Huang et al. (2015) <a href="#">97</a>	Path-based (FRLM)	Location	No (budget to optimize)	Unique	Minimize the infrastructure cost for a given demand	Private vehicle	Unspecified	Unspecified	No	No
Zhang et al. (2018) <a href="#">71</a>	Path-based (FRLM)	Location and sizing (capacity)	Yes (constraint)	Fast charging	Maximize the number of EVs charged	Private vehicle	Mixed environment	Yes, for all	Yes, as a constraint	No



Paper	Approach	Problem	Limited re-sources	Charging type	Main optimization goal	Use case	Target environment	Home charging available	Electric grid aspect	Previous existing infrastructure
Kameda & Mukai (2011) [112]	Tour-Based	Location and sizing (power)	Yes (constraint)	Fast charging	Minimize the waiting time at the station	Bus or public transport	Urban environment	No	No	No
Dong et al. (2012) [109]	Tour-Based	Location and sizing (capacity)	Yes (constraint)	Mixed	Minimize failed trips (or maximize the number of possible trips)	Private vehicle	Semi-urban environment	Yes, for all	No	No
Jia et al. (2012) [48]	Tour-Based	Location and sizing (capacity)	No (budget to optimize)	Fast charging	Minimize the infrastructure cost for a given demand	Private vehicle	Urban environment	Unspecified	No	No
Chen et al. (2013) [59]	Tour-Based	Location and sizing (power and capacity)	Yes (constraint)	Mixed	Maximize the amount of energy charged	Private vehicle	Unspecified	Yes, not for all	No	No
Xi et al. (2013) [111]	Tour-Based	Location and sizing (power and capacity)	Yes (constraint)	Mixed (medium and slow charging)	Maximize the number of EVs charged or maximize the amount of energy charged	Private vehicle	Mixed environment	Yes, for all	No	No

Paper	Approach	Problem	Limited re-sources	Charging type	Main optimization goal	Use case	Target environment	Home charging available	Electric grid aspect	Previous existing infrastructure
Andrew et al. (2013) [102]	Tour-Based	Location	Yes (constraint)	Medium charging	Minimize the distance (or the deviation) to a charging station	Private vehicle	Semi-urban environment	Yes, for all	No	No
Cai et al. (2014) [49]	Tour-Based	Location and sizing (capacity)	Yes (constraint)	Fast charging	Maximize the charger's utilization	Taxi fleet	Semi-urban environment	Yes, for all	No	No
You & Hsieh (2014) [68]	Tour-Based	Location and sizing (power)	Yes (constraint)	Mixed	Minimize failed trips (or maximize the number of possible trips)	Private vehicle	Unspecified	Unspecified	No	No
Jung et al. (2014) [83]	Tour-Based	Location	Yes (constraint)	Fast charging	Minimize the waiting time at the station	Taxi fleet	Urban environment	Unspecified	No	No
Shahraki et al. (2015) [106]	Tour-Based	Location	Yes (constraint)	Unique	Maximize the distance traveled	Taxi fleet	Semi-urban environment	Yes, for all	No	No
Cavadas et al. (2015) [104]	Tour-Based	Location and sizing (capacity)	Yes (constraint)	Slow charging	Maximize the number of EVs charged	Private vehicle	Urban environment	Yes, not for all	No	No

Paper	Approach	Problem	Limited re-sources	Charging type	Main optimization goal	Use case	Target environment	Home charging available	Electric grid aspect	Previous existing infrastructure
He et al. (2015) [64]	Tour-Based	Location	Yes (constraint)	Medium charging	Maximize the number of EVs charged	Private vehicle	Unspecified	Yes, for all	No	No
Asamer et al. (2016) [62]	Tour-Based	Location	Yes (constraint)	Mixed (medium and fast charging)	Minimize failed trips (or maximize the number of possible trips)	Taxi fleet	Urban environment	No	No	No
Han et al. (2016) [110]	Tour-Based	Location and sizing (capacity)	No (budget to optimize)	Fast charging	Minimize the infrastructure cost for a given demand	Taxi fleet	Semi-urban environment	Yes, for all	No	No
Tu et al. (2016) [52]	Tour-Based	Location	Yes (constraint)	Fast charging	Minimize the waiting time at the station	Taxi fleet	Semi-urban environment	Unspecified	No	No
Wang et al. (2017) [44]	Tour-Based	Location	No (budget to optimize)	Fast charging	Minimize the infrastructure cost for a given demand	Bus or public transport	Urban environment	Unspecified	No	No

# Appendix B

## Appendix to Chapter 3: Simulation results

We present here all the results of the Chapter 3 extracted from our simulations at each stage of the infrastructure deployment, in the form of raw data tables.

## B.1 step 0

Range anxiety trigger	Home charging rate	Searching range	Max budget	Nb of chargers	Car share	Nb under range anxiety	Nb out of battery	Distance with range anxiety	Distance out of battery	Charger occupancy rate	Avg distance to closest charger	Max distance to closest charger	Avg distance to closest available charger
0.2	0.0	500	500000	0	0,387	8402	6833	1860184	1474310			0	
0.2	0.0	500	1000000	0	0,387	8402	6833	1860184	1474310			0	
0.2	0.0	1000	500000	0	0,387	8402	6833	1860184	1474310			0	
0.2	0.0	1000	1000000	0	0,387	8402	6833	1860184	1474310			0	
0.2	0.25	500	500000	0	0,382	6650	5248	1414811	1105586		14908,33	164194,5	14908,33
0.2	0.25	500	1000000	0	0,382	6685	5318	1428264	1114933		14820,46	127964,1	14820,46
0.2	0.25	1000	500000	0	0,382	6684	5341	1462598	1150530		14270,79	133958,1	14270,79
0.2	0.25	1000	1000000	0	0,382	6705	5311	1439746	1125206		15098,13	138685,1	15098,13
0.5	0.0	500	500000	0	0,387	11130	6833	2595909	1474310			0	
0.5	0.0	500	1000000	0	0,387	11130	6833	2595909	1474310			0	
0.5	0.0	1000	500000	0	0,387	11130	6833	2595909	1474310			0	
0.5	0.0	1000	1000000	0	0,387	11130	6833	2595909	1474310			0	
0.5	0.25	500	500000	0	0,382	9230	5294	2066433	1132460		14148,54	132801	14148,54
0.5	0.25	500	1000000	0	0,382	9365	5287	2064470	1115963		14824,38	164194,5	14824,38
0.5	0.25	1000	500000	0	0,382	9354	5343	2076208	1129368		14631,49	145957,8	14631,49
0.5	0.25	1000	1000000	0	0,382	9316	5320	2076190	1132462		14654,1	133787,3	14654,1

Range anxiety trigger	Home charging rate	Searching range	Max budget	Max distance to closest available charger	Nb chargers under range	Nb available charger under range	Nb chargers under range with r.a	Nb available charger under range with r.a	Share public charging	Walking distance	Starting SoC	Charging rate	Charged kWh	Charging duration
0.2	0.0	500	500000	0	0	0	0	0	0	0,295582	35,03339	0,280181	5,068588	2095,35
0.2	0.0	500	1000000	0	0	0	0	0	0	0,616247	34,80645	0,276028	5,010835	2065,611
0.2	0.0	1000	500000	0	0	0	0	0	0	1,038245	35,42753	0,267829	4,809433	2005,103
0.2	0.0	1000	1000000	0	0	0	0	0	0	1,445479	35,34683	0,271176	5,008159	2080,576
0.2	0.25	500	500000	164194,5	0,177	0,177	0,055657	0,055657	0	0,295582	35,03339	0,280181	5,068588	2095,35
0.2	0.25	500	1000000	127964,1	0,172271	0,172271	0,051636	0,051636	0	0,616247	34,80645	0,276028	5,010835	2065,611
0.2	0.25	1000	500000	133958,1	0,177536	0,177536	0,048268	0,048268	0	1,038245	35,42753	0,267829	4,809433	2005,103
0.2	0.25	1000	1000000	138685,1	0,175902	0,175902	0,053051	0,053051	0	1,445479	35,34683	0,271176	5,008159	2080,576
0.5	0.0	500	500000	0	0	0	0	0	0	0	0	0	0	0
0.5	0.0	500	1000000	0	0	0	0	0	0	0	0	0	0	0
0.5	0.0	1000	500000	0	0	0	0	0	0	0	0	0	0	0
0.5	0.0	1000	1000000	0	0	0	0	0	0	0	0	0	0	0
0.5	0.25	500	500000	132801	0,188094	0,188094	0,090185	0,090185	0	0,527179	37,69057	0,305643	4,877585	2106,127
0.5	0.25	500	1000000	164194,5	0,177208	0,177208	0,092431	0,092431	0	0,647697	37,26864	0,302675	5,222737	2243,65
0.5	0.25	1000	500000	145957,8	0,179023	0,179023	0,086643	0,086643	0	1,978231	37,39371	0,304192	5,065204	2182,414
0.5	0.25	1000	1000000	133787,3	0,183957	0,183957	0,089015	0,089015	0	1,912663	37,58677	0,296675	5,006499	2153,258

## B.2 step 1



Range anxiety trigger	Home charging rate	Searching range	Max budget	Nb of 7.0kW chargers	Nb of 22.0kW chargers	Nb of chargers	Car share	Nb under range anxiety	Nb out of battery	Distance with range anxiety	Distance out of battery	Charger occupancy rate	Avg distance to closest charger	Max distance to closest charger
0.2	0.0	500	500000	104	3	107	0,384	8122	6520	1765983	1387551	0,622679	8690,084	40957,88
0.2	0.0	500	1000000	208	6	214	0,382	7903	6278	1668546	1296032	0,603618	4068,4	30071,03
0.2	0.0	1000	500000	104	3	107	0,381	7991	6343	1704114	1324161	0,981406	8724,69	40957,88
0.2	0.0	1000	1000000	208	6	214	0,376	7658	5967	1573031	1202337	0,901798	4105,736	30071,03
0.2	0.25	500	500000	104	3	107	0,38	6463	5061	1365611	1060775	0,521561	6705,159	36284,56
0.2	0.25	500	1000000	208	6	214	0,377	6180	4811	1264898	969292	0,506064	3883,64	30831,66
0.2	0.25	1000	500000	104	3	107	0,377	6305	4906	1313579	1009299	0,857556	6518,927	40957,88
0.2	0.25	1000	1000000	215	3	218	0,372	5913	4516	1217918	925672	0,792486	3821,207	29783,54
0.5	0.0	500	500000	104	3	107	0,384	10992	6536	2504173	1392976	0,788815	8674,294	40957,88
0.5	0.0	500	1000000	208	6	214	0,382	10853	6339	2419954	1310674	0,730434	4034,918	30071,03
0.5	0.0	1000	500000	104	3	107	0,381	10938	6392	2462542	1345603	1,103822	8674,772	40957,88
0.5	0.0	1000	1000000	208	6	214	0,376	10770	6040	2344912	1229863	1,032487	4065,07	30071,03
0.5	0.25	500	500000	104	3	107	0,38	9255	5110	2014909	1073407	0,661826	6612,819	40957,88
0.5	0.25	500	1000000	215	3	218	0,378	9085	4887	1922433	992325	0,608013	3875,623	32766,96
0.5	0.25	1000	500000	104	3	107	0,377	9199	4990	1970450	1027553	1,013834	6240,765	36559,78
0.5	0.25	1000	1000000	215	3	218	0,372	8954	4605	1844585	920288	0,884745	3737,231	31001,58

Range anxiety trigger	Home charging rate	Searching range	Max budget	Avg distance to closest available charger	Max distance to closest available charger	Nb chargers under range with r.a	Nb available charger under range with r.a	Share public charging	Walking distance	Starting SoC	Charging rate	Charged kWh	Charging duration	
0.2	0.0	500	500000	9212,764	40957,88	0,027517	0,022768	0,023019	1	309,3572	22,98812	0,590525	11,62421	6363,126
0.2	0.0	500	1000000	4502,298	30877,33	0,052442	0,041859	0,04701	1	295,7137	23,38518	0,591642	12,10648	6636,054
0.2	0.0	1000	500000	10035,72	53541,07	0,072571	0,048152	0,076438	1	546,5195	21,91906	0,585112	10,19251	5555,744
0.2	0.0	1000	1000000	5121,154	32250,58	0,1435	0,08712	0,139553	1	540,3319	22,82199	0,571136	10,4351	5666,205
0.2	0.25	500	500000	7131,719	38758,95	0,202059	0,198028	0,079659	0,090264	18,91186	34,50767	0,294379	5,411282	2349,408
0.2	0.25	500	1000000	4114,064	30831,66	0,238759	0,229793	0,104624	0,15959	30,77276	34,13297	0,306595	5,741808	2554,494
0.2	0.25	1000	500000	7640,585	40957,88	0,253674	0,23143	0,123565	0,140036	63,56948	34,01104	0,303781	5,589733	2483,885
0.2	0.25	1000	1000000	4479,038	30948,13	0,340554	0,286082	0,195336	0,234286	106,4842	33,3572	0,326214	5,882562	2727,751
0.5	0.0	500	500000	9468,784	40957,88	0,031791	0,025935	0,034576	0,030176	1	27,48534	0,566445	10,31353	5771,783
0.5	0.0	500	1000000	4698,819	30877,33	0,061251	0,047857	0,06196	0,053611	1	26,96769	0,571272	10,40521	5781,734
0.5	0.0	1000	500000	10689,03	58765,87	0,080897	0,050906	0,085348	0,060868	1	25,03298	0,573273	9,099593	5043,821
0.5	0.0	1000	1000000	5407,133	31399,45	0,159023	0,095108	0,162793	0,116102	1	25,74355	0,558945	9,079423	5006,184
0.5	0.25	500	500000	7371,08	59817,53	0,211719	0,206669	0,123894	0,119509	21,59939	36,84457	0,319718	5,373772	2412,129
0.5	0.25	500	1000000	4257,399	40373,51	0,241653	0,231517	0,16181	0,155056	37,53093	36,25582	0,332855	5,717797	2635,263
0.5	0.25	1000	500000	7881,364	81652,23	0,260608	0,232819	0,17907	0,156472	68,28259	36,3283	0,331523	5,541878	2531,585
0.5	0.25	1000	1000000	4570,894	33378,36	0,358318	0,294895	0,269228	0,210946	115,0021	35,53518	0,35316	5,866619	2765,533

## B.3 step 2

Range anxiety trigger	Home charging rate	Searching range	Max budget	Nb of 7.0kW chargers	Nb of 22.0kW chargers	Nb of chargers	Car share	Nb under range anxiety	Nb out of battery	Distance with range anxiety	Distance out of battery	Charger occupancy rate	Avg distance to closest charger	Max distance to closest charger
0.2	0.0	500	500000	215	3	218	0,382	7886	6274	1670870	1300343	0,59273	3665,936	30071,03
0.2	0.0	500	1000000	430	6	436	0,379	7562	5887	1539456	1181468	0,510053	2409,387	28657,41
0.2	0.0	1000	500000	215	3	218	0,375	7665	5967	1581103	1211258	0,876083	3716,68	30071,03
0.2	0.0	1000	1000000	430	6	436	0,368	7054	5286	1384271	1035507	0,773245	2459,489	28657,41
0.2	0.25	500	500000	215	3	218	0,378	6301	4886	1283221	983230	0,468224	3682,175	32766,96
0.2	0.25	500	1000000	430	6	436	0,375	5901	4508	1184648	899338	0,402449	2384,842	23062,01
0.2	0.25	1000	500000	215	3	218	0,372	5996	4551	1208437	915660	0,774675	3623,492	30071,03
0.2	0.25	1000	1000000	437	3	440	0,367	5518	4065	1057287	782255	0,662373	2411,712	27771,83
0.5	0.0	500	500000	215	3	218	0,382	10847	6337	2424667	1315974	0,717147	3646,936	30071,03
0.5	0.0	500	1000000	430	6	436	0,378	10621	5979	2295501	1204109	0,621623	2382,58	28657,41
0.5	0.0	1000	500000	215	3	218	0,375	10737	6058	2353129	1235221	1,009849	3584,392	30071,03
0.5	0.0	1000	1000000	430	6	436	0,368	10441	5460	2164412	1071691	0,88673	2401,188	28657,41
0.5	0.25	500	500000	215	3	218	0,378	9126	4943	1943004	1011779	0,596505	3544,112	30918,76
0.5	0.25	500	1000000	437	3	440	0,375	8901	4621	1840900	923510	0,517944	2287,605	25924,2
0.5	0.25	1000	500000	215	3	218	0,372	9033	4704	1878083	940291	0,895746	3572,144	30071,03
0.5	0.25	1000	1000000	437	3	440	0,367	8755	4202	1726118	819526	0,768942	2333,065	27771,83

Range anxiety trigger	Home charging rate	Searching range	Max budget	Avg distance to closest available charger	Max distance to closest available charger	Nb chargers under range with r.a	Nb available charger under range with r.a	Share public charging	Walking distance	Starting SoC	Charging rate	Charged kWh	Charging duration
0.2	0.0	500	500000	4062,576	32200,35	0,045358	0,040745	1	296,1421	24,00739	0,581909	11,95707	6611,465
0.2	0.0	500	1000000	2631,752	28657,41	0,080803	0,074742	1	282,3207	23,98101	0,574253	11,81261	6518,816
0.2	0.0	1000	500000	4692,418	33378,36	0,137622	0,104993	1	541,3313	22,57407	0,567218	10,40338	5712,806
0.2	0.0	1000	1000000	3033,701	28657,41	0,242279	0,152347	1	530,2959	23,52398	0,556836	10,36535	5696,802
0.2	0.25	500	500000	3900,066	46643,33	0,231913	0,223774	0,15245	32,50248	34,00036	0,303798	5,710875	2543,203
0.2	0.25	500	1000000	2543,196	23062,01	0,277303	0,265457	0,235933	47,35435	33,75018	0,325178	5,982565	2764,286
0.2	0.25	1000	500000	4283,393	35448,98	0,336996	0,283879	0,234033	107,5465	33,25531	0,328745	5,907297	2737,164
0.2	0.25	1000	1000000	2920,955	27771,83	0,42391	0,347437	0,356086	156,4251	32,27817	0,351325	6,494699	3120,661
0.5	0.0	500	500000	4249,01	31399,79	0,058892	0,046731	1	296,2375	26,87624	0,57831	10,56046	5942,839
0.5	0.0	500	1000000	2745,347	28657,41	0,103143	0,082223	1	285,0465	27,82976	0,564214	10,34925	5805,519
0.5	0.0	1000	500000	4905,662	38550,14	0,163352	0,095938	1	546,6376	25,4677	0,563433	8,935735	4974,859
0.5	0.0	1000	1000000	3193,045	32766,96	0,278656	0,169195	1	540,5971	26,45792	0,547862	8,88148	4956,175
0.5	0.25	500	500000	3946,467	30918,76	0,240517	0,228933	0,157149	37,16795	36,5282	0,334949	5,680864	2622,622
0.5	0.25	500	1000000	2508,12	25924,2	0,279312	0,265328	0,246293	55,4444	35,8525	0,350425	6,041793	2877,699
0.5	0.25	1000	500000	4532,499	35448,98	0,347308	0,28259	0,22167	117,5494	35,36384	0,35735	5,8753	2780,218
0.5	0.25	1000	1000000	3012,486	27771,83	0,446324	0,354564	0,330513	166,8411	34,59378	0,376653	6,239793	3065,096

## B.4 step 3

Range anxiety trigger	Home charging rate	Searching range	Max budget	Nb of 7.0kW chargers	Nb of 22.0kW chargers	Nb of chargers	Car share	Nb under range anxiety	Nb out of battery	Distance with range anxiety	Distance out of battery	Charger occupancy rate	Avg distance to closest charger	Max distance to closest charger
0.2	0.0	500	500000	326	3	329	0,38	7752	6090	1611448	1246162	0,521868	2763,276	30071,03
0.2	0.0	500	1000000	645	9	654	0,376	7208	5545	1456371	1114791	0,43707	1827,639	14875,23
0.2	0.0	1000	500000	326	3	329	0,372	7368	5616	1478663	1120510	0,800305	2848,664	30071,03
0.2	0.0	1000	1000000	652	6	658	0,363	6557	4819	1256927	929276	0,66379	1899,35	14875,23
0.2	0.25	500	500000	326	3	329	0,377	6131	4722	1235584	942542	0,412813	2767,556	30071,03
0.2	0.25	500	1000000	647	9	656	0,373	5704	4300	1127474	854425	0,35174	1855,219	23836,54
0.2	0.25	1000	500000	326	3	329	0,369	5708	4330	1146152	862103	0,692961	2779,117	28657,41
0.2	0.25	1000	1000000	652	6	658	0,363	5180	3700	967243	708030	0,571461	1882,329	14875,23
0.5	0.0	500	500000	326	3	329	0,381	10746	6154	2361738	1265839	0,63104	2736,83	30071,03
0.5	0.0	500	1000000	645	9	654	0,376	10433	5690	2211663	1144198	0,549936	1799,351	14875,23
0.5	0.0	1000	500000	326	3	329	0,372	10602	5758	2254063	1152312	0,914839	2787,756	30071,03
0.5	0.0	1000	1000000	645	9	654	0,364	10134	5022	2044401	991306	0,785366	1832,322	14875,23
0.5	0.25	500	500000	326	3	329	0,376	9044	4707	1863421	942445	0,544415	2707,872	28657,41
0.5	0.25	500	1000000	659	3	662	0,373	8700	4375	1754537	862106	0,460523	1786,819	13316,89
0.5	0.25	1000	500000	326	3	329	0,37	8829	4419	1805200	893149	0,811116	2799,481	27741,36
0.5	0.25	1000	1000000	653	6	659	0,364	8530	3835	1616722	743225	0,683589	1852,637	15178,38

Range anxiety trigger	Home charging rate	Searching range	Max budget	Avg distance		Max distance to closest available charger	Nb chargers		Nb available charger		Share public charging	Walking distance	Starting SoC	Charging rate	Charged kWh	Charging duration
				to closest available charger	range		under range with r.a	under range with r.a								
0.2	0.0	500	500000	3082,375	30071,03	0,067	0,054456	0,061123	0,055785	1	292,6727	23,92356	0,585884	12,16836	6736,454	
0.2	0.0	500	1000000	2009,236	14875,23	0,115054	0,097856	0,099508	0,093846	1	280,8583	24,54999	0,575747	11,56737	6391,098	
0.2	0.0	1000	500000	3642,719	30071,03	0,179707	0,112448	0,174374	0,139024	1	532,5111	23,10442	0,56468	10,62714	5863,07	
0.2	0.0	1000	1000000	2345,374	14875,23	0,308666	0,205578	0,296353	0,2447	1	517,8777	23,84533	0,541121	10,37575	5729,82	
0.2	0.25	500	500000	2979,566	30071,03	0,24589	0,236152	0,117535	0,114125	0,196277	39,14323	33,90847	0,317375	5,921885	2683,573	
0.2	0.25	500	1000000	1982,057	23836,54	0,303708	0,289949	0,153347	0,14722	0,292708	57,52187	33,38577	0,327938	6,279914	2955,888	
0.2	0.25	1000	500000	3312,567	28657,41	0,379046	0,312724	0,231261	0,196651	0,295957	130,9106	32,77451	0,337255	6,194012	2928,418	
0.2	0.25	1000	1000000	2284,622	14875,23	0,495248	0,410274	0,34101	0,297694	0,41714	176,4779	32,11729	0,359161	6,720278	3298,653	
0.5	0.0	500	500000	3198,776	30071,03	0,076821	0,062142	0,078251	0,069319	1	288,8083	27,48298	0,574624	10,22987	5763,352	
0.5	0.0	500	1000000	2076,609	14875,23	0,134721	0,110241	0,134745	0,121178	1	282,4969	28,29081	0,55889	10,1911	5739,446	
0.5	0.0	1000	500000	3806,413	30071,03	0,205655	0,124154	0,210694	0,153752	1	543,7054	26,06693	0,564116	9,162858	5125,817	
0.5	0.0	1000	1000000	2428,976	14875,23	0,349905	0,221686	0,357257	0,263378	1	530,6337	27,19273	0,543592	8,761525	4914,438	
0.5	0.25	500	500000	3030,469	28657,41	0,262992	0,249015	0,187032	0,178701	0,200824	47,02691	35,96485	0,346127	5,953185	2782,453	
0.5	0.25	500	1000000	1988,843	13933,77	0,315563	0,297522	0,230457	0,2189	0,303325	66,51917	35,61929	0,364033	6,242644	3022,815	
0.5	0.25	1000	500000	3638,979	28366,21	0,38841	0,315154	0,299828	0,248117	0,276412	137,4655	35,05945	0,360806	6,047236	2921,809	
0.5	0.25	1000	1000000	2413,127	15178,38	0,520691	0,41383	0,443917	0,370178	0,399848	191,1133	34,43609	0,388158	6,469673	3242,91	



## B.5 step 4

Range anxiety trigger	Home charging rate	Searching range	Max budget	Nb of 7.0kW chargers	Nb of 22.0kW chargers	Nb of chargers	Car share	Nb under range anxiety	Nb out of battery	Distance with range anxiety	Distance out of battery	Charger occupancy rate	Avg distance to closest charger	Max distance to closest charger
0.2	0.0	500	500000	437	3	440	0,379	7553	5901	1562090	1205212	0,484492	2304,091	28657,41
0.2	0.0	500	1000000	854	15	869	0,374	6987	5356	1398815	1066140	0,38535	1546,679	12495,28
0.2	0.0	1000	500000	437	3	440	0,369	7106	5373	1411150	1059562	0,723499	2398,136	28657,41
0.2	0.0	1000	1000000	867	9	876	0,36	6194	4401	1159283	850341	0,5793	1586,979	10540,46
0.2	0.25	500	500000	437	3	440	0,376	6095	4631	1210892	919388	0,383586	2270,426	25924,2
0.2	0.25	500	1000000	856	15	871	0,372	5571	4125	1084519	818141	0,30663	1558,425	12495,28
0.2	0.25	1000	500000	437	3	440	0,367	5524	4027	1065610	791216	0,631347	2325,915	27771,83
0.2	0.25	1000	1000000	862	12	874	0,361	4824	3379	873597	631831	0,483119	1616,027	14875,23
0.5	0.0	500	500000	437	3	440	0,379	10672	5976	2311755	1236492	0,587439	2268,595	28657,41
0.5	0.0	500	1000000	854	15	869	0,374	10240	5428	2136086	1092561	0,494507	1506,999	14875,23
0.5	0.0	1000	500000	437	3	440	0,37	10470	5505	2192731	1104704	0,845865	2303,959	28657,41
0.5	0.0	1000	1000000	854	15	869	0,361	9864	4688	1924527	907194	0,711516	1538,327	12495,28
0.5	0.25	500	500000	437	3	440	0,376	8918	4607	1829897	920989	0,479817	2266,307	25145,48
0.5	0.25	500	1000000	869	9	878	0,372	8627	4211	1714513	837278	0,411408	1522,474	12495,28
0.5	0.25	1000	500000	437	3	440	0,367	8686	4223	1730810	833482	0,754394	2307,156	22005,39
0.5	0.25	1000	1000000	862	12	874	0,362	8275	3536	1522676	680508	0,601812	1559,167	14875,23

Range anxiety trigger	Home charging rate	Searching range	Max budget	Avg distance to closest available charger	Max distance to closest available charger	Nb chargers under range	Nb available charger under range	Nb chargers under range with r.a	Nb available charger under range with r.a	Share public charging	Walking distance	Starting SoC	Charging rate	Charged kWh	Charging duration
0.2	0.0	500	500000	2579,011	28657,41	0,079938	0,066178	0,070924	0,06637	1	287,6132	24,51576	0,587718	12,15014	6748,738
0.2	0.0	500	1000000	1705,753	12495,28	0,134348	0,116419	0,114842	0,107918	1	278,9663	24,90325	0,563154	11,75048	6510,899
0.2	0.0	1000	500000	3100,885	28657,41	0,212136	0,135606	0,202007	0,162433	1	526,6549	23,27514	0,568735	10,71511	5930,922
0.2	0.0	1000	1000000	2001,837	13933,77	0,356707	0,245815	0,339828	0,288414	1	513,343	24,57866	0,547917	10,3649	5728,78
0.2	0.25	500	500000	2441,746	25924,2	0,263844	0,25292	0,126917	0,123016	0,234452	46,39133	33,80568	0,322732	6,035265	2792,743
0.2	0.25	500	1000000	1671,565	12495,28	0,315713	0,302096	0,180679	0,175182	0,333345	65,87507	32,95638	0,34182	6,606401	3138,649
0.2	0.25	1000	500000	2831,844	27771,83	0,41832	0,346428	0,268369	0,23789	0,335689	144,0559	32,52837	0,351386	6,506287	3109,65
0.2	0.25	1000	1000000	1947,107	14875,23	0,540218	0,457512	0,398403	0,356536	0,434506	185,3197	31,95964	0,370649	6,938126	3426,643
0.5	0.0	500	500000	2654,317	28657,41	0,093729	0,075269	0,096284	0,086161	1	286,7961	27,98288	0,566895	10,2826	5813,497
0.5	0.0	500	1000000	1773,731	14875,23	0,158309	0,132899	0,156711	0,140354	1	278,3254	28,8461	0,560276	10,04294	5662,965
0.5	0.0	1000	500000	3193,377	30071,03	0,24484	0,15092	0,251093	0,187237	1	538,949	26,25382	0,554575	9,081029	5098,847
0.5	0.0	1000	1000000	2066,18	12495,28	0,402223	0,267864	0,406216	0,313628	1	519,4568	28,02096	0,538183	8,840961	4951,11
0.5	0.25	500	500000	2528,397	25145,48	0,281957	0,267466	0,19854	0,190252	0,227676	52,65943	36,10122	0,349538	5,917964	2801,553
0.5	0.25	500	1000000	1695,223	13703,55	0,336611	0,317344	0,253743	0,241852	0,342091	75,84244	35,54017	0,368549	6,349411	3128,804
0.5	0.25	1000	500000	3009,053	22005,39	0,433218	0,349566	0,348124	0,290398	0,324898	161,0381	34,81	0,374239	6,205634	3043,4
0.5	0.25	1000	1000000	2026,584	14875,23	0,584366	0,470198	0,505263	0,427847	0,431148	203,6698	34,33084	0,390993	6,498484	3282,301

## B.6 step 5

Range anxiety trigger	Home charging rate	Searching range	Max budget	Nb of 7.0kW chargers	Nb of 22.0kW chargers	Nb of chargers	Car share	Nb under range anxiety	Nb out of battery	Distance with range anxiety	Distance out of battery	Charger occupancy rate	Avg distance to closest charger	Max distance to closest charger
0.2	0.0	500	500000	548	3	551	0,377	7401	5749	1519147	1169249	0,443147	1978,242	14875,23
0.2	0.0	500	1000000	1058	24	1082	0,373	6803	5169	1340603	1015316	0,344263	1380,696	10540,46
0.2	0.0	1000	500000	548	3	551	0,366	6848	5057	1337198	1000144	0,687333	2039,992	14875,23
0.2	0.0	1000	1000000	1076	15	1091	0,357	5894	4120	1070990	776668	0,525342	1428,208	10540,46
0.2	0.25	500	500000	548	3	551	0,375	5885	4475	1165318	881088	0,351779	1988,904	14875,23
0.2	0.25	500	1000000	1068	21	1089	0,37	5336	3951	1028968	770926	0,27847	1407,552	9629,215
0.2	0.25	1000	500000	548	3	551	0,365	5239	3759	999897	740361	0,584145	2029,985	13570,35
0.2	0.25	1000	1000000	1074	18	1092	0,359	4487	3042	785348	558302	0,436447	1440,702	9737,502
0.5	0.0	500	500000	548	3	551	0,378	10540	5819	2266606	1190603	0,564297	1944,529	14875,23
0.5	0.0	500	1000000	1059	24	1083	0,373	10125	5245	2065109	1036093	0,454108	1339,817	10540,46
0.5	0.0	1000	500000	548	3	551	0,367	10311	5263	2120862	1053403	0,795213	1959,659	14875,23
0.5	0.0	1000	1000000	1063	21	1084	0,359	9676	4397	1830319	834484	0,651618	1385,355	10540,46
0.5	0.25	500	500000	548	3	551	0,374	8892	4486	1804692	901440	0,469285	1958,616	23836,54
0.5	0.25	500	1000000	1077	18	1095	0,371	8578	4063	1642919	780782	0,370636	1344,332	8957,392
0.5	0.25	1000	500000	542	6	548	0,366	8576	3984	1662729	776450	0,692759	2022,915	23836,54
0.5	0.25	1000	1000000	1068	21	1089	0,359	8106	3363	1435630	611968	0,558116	1397,332	10540,46

Range anxiety trigger	Home charging rate	Searching range	Max budget	Avg distance to closest available charger	Max distance to closest available charger	Nb chargers under range	Nb available charger under range	Nb chargers under range with r.a	Nb available charger under range with r.a	Share public charging	Walking distance	Starting SoC	Charging rate	Charged kWh	Charging duration
0.2	0.0	500	500000	2204,996	14875,23	0,095811	0,079982	0,082871	0,077854	1	284,8314	24,45924	0,573467	11,85092	6583,218
0.2	0.0	500	1000000	1507,294	10540,46	0,152612	0,134117	0,129609	0,12307	1	277,3851	24,96915	0,56385	11,97754	6610,767
0.2	0.0	1000	500000	2640,646	14875,23	0,255968	0,165889	0,241435	0,195016	1	524,8814	23,78457	0,552259	10,47995	5805,686
0.2	0.0	1000	1000000	1787,024	10540,46	0,393491	0,276143	0,381088	0,320621	1	502,8281	24,84555	0,547483	10,59861	5853,828
0.2	0.25	500	500000	2148,229	14875,23	0,277507	0,264924	0,142115	0,137563	0,260141	51,06498	33,37631	0,328208	6,124963	2843,346
0.2	0.25	500	1000000	1508,338	9629,215	0,346032	0,331729	0,196886	0,191074	0,349058	70,40278	33,0482	0,340453	6,683586	3202,737
0.2	0.25	1000	500000	2481,128	15617,66	0,457217	0,376648	0,301343	0,264659	0,365515	161,7632	32,42037	0,353091	6,479435	3136,548
0.2	0.25	1000	1000000	1705,362	10144,25	0,60432	0,511291	0,456095	0,404848	0,462953	196,5023	31,83702	0,377207	6,957527	3447,904
0.5	0.0	500	500000	2315,898	18693,9	0,110298	0,089614	0,110193	0,098012	1	286,7935	28,08528	0,560586	10,14523	5743,64
0.5	0.0	500	1000000	1553,841	10540,46	0,178945	0,152168	0,18181	0,166049	1	275,7639	29,10804	0,556023	10,14438	5715,241
0.5	0.0	1000	500000	2755,244	20106,45	0,287214	0,177559	0,286557	0,21489	1	529,4291	27,10863	0,551532	8,982739	5054,885
0.5	0.0	1000	1000000	1831,28	10540,46	0,453287	0,309912	0,463269	0,361372	1	511,6421	28,31585	0,534908	8,942487	5014,737
0.5	0.25	500	500000	2237,652	23836,54	0,292823	0,274165	0,215879	0,20429	0,267128	61,0325	35,81556	0,352086	6,188681	2967,989
0.5	0.25	500	1000000	1494,636	10144,25	0,36507	0,344202	0,284049	0,272012	0,370905	81,40627	35,2859	0,372596	6,53632	3228,173
0.5	0.25	1000	500000	2616,507	23836,54	0,472767	0,383544	0,382692	0,322295	0,350414	170,232	34,64367	0,379767	6,340622	3123,849
0.5	0.25	1000	1000000	1773,114	10540,46	0,659081	0,526464	0,57073	0,481802	0,468568	224,8966	34,06448	0,398583	6,801859	3465,848



# Appendix C

## Bibliography



# Bibliography

- [1] International Energy Agency. Global CO2 emissions from transport by subsector, 2000-2030,.
- [2] S.A Instituto Tecnológico de Canarias. Estrategia del vehículo eléctrico de canarias (vol. 1). dirección general de energía del gobierno de canarias. 2020.
- [3] Michael Nicholas. Estimating electric vehicle charging infrastructure costs across major U.S. metropolitan areas. *ICCT*, 2019.
- [4] Intergovernmental Panel on Climate Change. IPCC, 2022: Summary for Policy-makers. 9781107025:3–22, 2022.
- [5] Lee Chapman. Transport and climate change: a review. *Journal of Transport Geography*, 15(5):354–367, 2007.
- [6] European Environment Agency. *Transport and environment report 2021: Decarbonising road transport - the role of vehicles, fuels and transport demand*. Number 02. 2022.
- [7] International Energy Agency. Understanding gec model scenarios, 2023.
- [8] Gerald Berger, Peter H. Feindt, Erling Holden, and Frieder Rubik. Sustainable Mobility—Challenges for a Complex Transition. *Journal of Environmental Policy and Planning*, 16(3):303–320, 2014.
- [9] International Council on Clean Transportation. Effects of battery manufacturing on electric vehicle life-cycle greenhouse gas emissions. *International Council on Clean Transportation*, (February), 2017.
- [10] Benjamin K. Sovacool, Jonn Axsen, and Willett Kempton. The Future Promise of Vehicle-to-Grid (V2G) Integration: A Sociotechnical Review and Research Agenda. *Annual Review of Environment and Resources*, 42:377–406, 2017.

- [11] Thomas Franke, Isabel Neumann, Franziska Bühler, Peter Cocron, and Josef F. Krems. Experiencing Range in an Electric Vehicle: Understanding Psychological Barriers. *Applied Psychology*, 61(3):368–391, 2012.
- [12] Nigel Berkeley, David Jarvis, and Andrew Jones. Analysing the take up of battery electric vehicles: An investigation of barriers amongst drivers in the UK. *Transportation Research Part D: Transport and Environment*, 63:466–481, 2018.
- [13] France Stratégie. Panorama des politiques publiques en faveur des véhicules à très faibles émissions - Note de synthèse. page 140, 2018.
- [14] RTE. Rapport RTE Electromobilité. 2019.
- [15] M. O. Metais, O. Jouini, Y. Perez, J. Berrada, and E. Suomalainen. Too much or not enough? Planning electric vehicle charging infrastructure: A review of modeling options. *Renewable and Sustainable Energy Reviews*, 153(November 2020):111719, 2022.
- [16] Alejandro Rojan-Padron, Marc Olivier Metais, Francisco J Ramos-real, and Yannick Perez. Tenerife ’ s Infrastructure Plan for Electromobility : A MATSim Evaluation. *Energies*, 2023.
- [17] John Cook, Dana Nuccitelli, Sarah A Green, Mark Richardson, Bärbel Winkler, Rob Painting, Robert Way, Peter Jacobs, and Andrew Skuce. Quantifying the consensus on anthropogenic global warming in the scientific literature. *Environmental Research Letters*, 8(2):024024, may 2013.
- [18] European Environment Agency. Greenhouse gas emissions from transport in europe, 2019.
- [19] Troy R. Hawkins, Bhawna Singh, Guillaume Majeau-Bettez, and Anders Hammer Strømman. Comparative Environmental Life Cycle Assessment of Conventional and Electric Vehicles. *Journal of Industrial Ecology*, 17(1):53–64, 2013.
- [20] Shiyu Yan. The economic and environmental impacts of tax incentives for battery electric vehicles in Europe. *Energy Policy*, 123(August 2017):53–63, 2018.
- [21] Nikolas Soulopoulos. When Will Electric Vehicles be Cheaper than Conventional Vehicles? *Bloomberg New Energy Finance*, 2017.
- [22] International Energy Agency. Global EV Outlook 2019. pages 1–40, 2019.

- [23] Katalin Springel. Network Externality and Subsidy Structure in Two-Sided Markets : Evidence from Electric Vehicle Incentives Resources. pages 1–63, 2017.
- [24] Yiyi Zhou and Shanjun Li. Technology Adoption and Critical Mass: The Case of the U.S. Electric Vehicle Market. *Journal of Industrial Economics*, 66(2):423–480, 2018.
- [25] Shanjun Li, Lang Tong, Jianwei Xing, and Yiyi Zhou. The Market for Electric Vehicles: Indirect Network Effects and Policy Impacts. *SSRN Electronic Journal*, 4(1), 2014.
- [26] Ministère de l’environnement de l’énergie et de la mer. La Loi de Transition Énergétique pour la Croissance Verte. page 4, 2016.
- [27] Marc Melaina and Joel Bremson. Refueling availability for alternative fuel vehicle markets: Sufficient urban station coverage. *Energy Policy*, 36(8):3233–3241, 2008.
- [28] Constantine Toregas, Ralph Swain, Charles ReVelle, and Lawrence Bergman. The Location of Emergency Service Facilities. *Operations Research*, 19(6):1363–1373, 1971.
- [29] M. John Hodgson. A Flow-Capturing Location-Allocation Model. *Geographical Analysis*, 22(3):270–279, 1990.
- [30] International Electrotechnical Commission. Norme Européenne IEC 61851-1. 33(0), 2014.
- [31] Office of Energy Efficiency and Renewable Energy. Vehicle charging. 2020.
- [32] Nathaniel S. Pearre, Willett Kempton, Randall L. Guensler, and Vetri V. Elango. Electric vehicles: How much range is required for a day’s driving? *Transportation Research Part C: Emerging Technologies*, 19(6):1171–1184, 2011.
- [33] Jimmy Armoogum, Jean-paul Hubert, Sophie Roux, and Thomas Le Jeannic. Enquête Nationale Transports et Déplacement 2008 - Introduction. *La Revue - Commissariat général au développement durable – Service de l’observation et des statistiques*, (Décembre):5–24, 2010.
- [34] Guzay Pasaoglu, Alyona Zubaryeva, Davide Fiorello, and Christian Thiel. Analysis of European mobility surveys and their potential to support studies on the impact of electric vehicles on energy and infrastructure needs in Europe. *Technological Forecasting and Social Change*, 87:41–50, 2014.

- [35] Eurostat. Housing statistics. 2020.
- [36] Nathan Delacrétaz, Bruno Lanz, and Jeremy Van Dijk. The chicken or the egg: Technology adoption and network infrastructure in the market for electric vehicles. *IRENE Working Papers*, 20(08), 2020.
- [37] George O. Wesolowsky. Dynamic Facility Location. *Management Science*, 19(11):1241–1548, 1973.
- [38] Shengyin Li, Yongxi Huang, and Scott J. Mason. A multi-period optimization model for the deployment of public electric vehicle charging stations on network. *Transportation Research Part C: Emerging Technologies*, 65:128–143, 2016.
- [39] Michael Nicholas, Gil Tal, Jamie Davies, and Justin Woodjack. DC Fast as the Only Public Charging Option? Scenario Testing From GPS Tracked Vehicles. *Transportation Research Board Conference*, pages 1–20, 2012.
- [40] Tomás Gómez San Román, Ilan Momber, Michel Rivier Abbad, and Álvaro Sánchez Miralles. Regulatory framework and business models for charging plug-in electric vehicles: Infrastructure, agents, and commercial relationships. *Energy Policy*, 39(10):6360–6375, 2011.
- [41] Robert C. Green, Lingfeng Wang, and Mansoor Alam. The impact of plug-in hybrid electric vehicles on distribution networks: A review and outlook. *IEEE PES General Meeting, PES 2010*, pages 1–8, 2010.
- [42] Icaro Silvestre Freitas Gomes, Yannick Perez, and Emilia Suomalainen. Coupling small batteries and PV generation: A review. *Renewable and Sustainable Energy Reviews*, 126(March):109835, 2020.
- [43] Yacine Sehim, Emilia Suomalainen, K. Almaksour, and B. Robyns. Mitigating the impact of fast charging on distribution grids using Vehicle-to-vehicle Power Transfer : a Paris case study. *4th E-Mobility Power Integration Symposium*, 2020.
- [44] Xiumin Wang, Chau Yuen, Naveed Ul Hassan, Ning An, and Weiwei Wu. Electric Vehicle Charging Station Placement for Urban Public Bus Systems. *IEEE Transactions on Intelligent Transportation Systems*, 18(1):128–139, 2017.
- [45] Xiaohong Dong, Yunfei Mu, Hongjie Jia, Jianzhong Wu, and Xiaodan Yu. Planning of Fast EV Charging Stations on a Round Freeway. *IEEE Transactions on Sustainable Energy*, 7(4):1452–1461, 2016.

- [46] Sara Mehar, Sara Mehar, and Sidi Mohammed Senouci. An Optimization Location Scheme for Electric Charging Stations. (May), 2013.
- [47] Abbas Rajabi-Ghahnavieh and Payam Sadeghi-Barzani. Optimal Zonal Fast-Charging Station Placement Considering Urban Traffic Circulation. *IEEE Transactions on Vehicular Technology*, 66(1):45–56, 2017.
- [48] Long Jia, Zechun Hu, Yonghua Song, and Zhuowei Luo. Optimal siting and sizing of electric vehicle charging stations. *2012 IEEE International Electric Vehicle Conference*, 36(3):54–59, 2012.
- [49] Hua Cai, Xiaoping Jia, Anthony S.F. Chiu, Xiaojun Hu, and Ming Xu. Siting public electric vehicle charging stations in Beijing using big-data informed travel patterns of the taxi fleet. *Transportation Research Part D: Transport and Environment*, 33:39–46, 2014.
- [50] Dario Pevec, Jurica Babic, Martin A. Kayser, Arthur Carvalho, Yashar Ghiassi-Farrokhfal, and Vedran Podobnik. A data-driven statistical approach for extending electric vehicle charging infrastructure. *International Journal of Energy Research*, 42(9):3102–3120, 2018.
- [51] Hisatomo Hanabusa and Ryota Horiguchi. A study of the analytical method for the location planning of charging stations for electric vehicles. *Lecture Notes in Computer Science (including subseries Lecture Notes in Artificial Intelligence and Lecture Notes in Bioinformatics)*, 6883 LNAI(PART 3):596–605, 2011.
- [52] Wei Tu, Qingquan Li, Zhixiang Fang, Shih-lung Shaw, and Baoding Zhou. Optimizing the locations of electric taxi charging stations : A spatial – temporal demand coverage approach. *Transportation Research Part C*, 65(3688):172–189, 2016.
- [53] Shaoyun Ge, Liang Feng, and Hong Liu. The planning of electric vehicle charging station based on Grid partition method. *2011 International Conference on Electrical and Control Engineering, ICECE 2011 - Proceedings*, pages 2726–2730, 2011.
- [54] Hao Xu, Shihong Miao, Chunyong Zhang, and Dongyuan Shi. Optimal placement of charging infrastructures for large-scale integration of pure electric vehicles into grid. *International Journal of Electrical Power and Energy Systems*, 53(1):159–165, 2013.
- [55] Ying Wei Wang and Chuan Ren Wang. Locating passenger vehicle refueling stations. *Transportation Research Part E: Logistics and Transportation Review*, 46(5):791–801, 2010.

- [56] Yutaka Motoaki. Location-allocation of electric vehicle fast chargers-research and practice. *World Electric Vehicle Journal*, 10(1):10–16, 2019.
- [57] Zhuo Sun, Wei Gao, Bin Li, and Longlong Wang. Locating charging stations for electric vehicles. *Transport Policy*, (May):1–7, 2018.
- [58] Jie Yang, Jing Dong, and Liang Hu. A data-driven optimization-based approach for siting and sizing of electric taxi charging stations. *Transportation Research Part C: Emerging Technologies*, 77(2):462–477, 2017.
- [59] T Donna Chen, Kara M Kockelman, and Moby Khan. The Electric Vehicle Charging Station Location Problem: A Parking-Based Assignment Method for Seattle. *Proceedings of the 92nd Annual Meeting of the Transportation Research Board in Washington DC, January 2013, and forthcoming in Transportation Research Record*, page 22, 2013.
- [60] Csaba Csiszár, Bálint Csonka, Dávid Földes, Ervin Wirth, and Tamás Lovas. Urban public charging station locating method for electric vehicles based on land use approach. *Journal of Transport Geography*, 74(November 2018):173–180, 2019.
- [61] Hua Wang, De Zhao, Qiang Meng, Ghim Ping Ong, and Der Horng Lee. A four-step method for electric-vehicle charging facility deployment in a dense city: An empirical study in Singapore. *Transportation Research Part A: Policy and Practice*, 119(July 2018):224–237, 2019.
- [62] Johannes Asamer, Martin Reinthaler, Mario Ruthmair, Markus Straub, and Jakob Puchinger. Optimizing charging station locations for urban taxi providers. *Transportation Research Part A: Policy and Practice*, 85:233–246, 2016.
- [63] Salvatore Micari, Antonio Polimeni, Giuseppe Napoli, Laura Andaloro, and Vincenzo Antonucci. Electric vehicle charging infrastructure planning in a road network. *Renewable and Sustainable Energy Reviews*, 80(May 2016):98–108, 2017.
- [64] Fang He, Yafeng Yin, and Jing Zhou. Deploying public charging stations for electric vehicles on urban road networks. *Transportation Research Part C: Emerging Technologies*, 2015.
- [65] Jie Zhu, Yixin Li, Jun Yang, Xianglong Li, Shuang Zeng, and Yanxie Chen. Planning of electric vehicle charging station based on queuing theory. *The Journal of Engineering*, 2017(13):1867–1871, 2017.
- [66] Christopher Upchurch, Michael Kubly, and Seow Lim. A model for location of capacitated alternative-fuel stations. *Geographical Analysis*, 41(1):127–148, 2009.

- [67] Haris Gavranović, Alper Barut, Gürdal Ertek, Orkun Berk Yüzbaşıoğlu, Osman Pekpostalci, and Önder Tomuş. Optimizing the electric charge station network of EŞARJ. *Procedia Computer Science*, 31:15–21, 2014.
- [68] Peng Sheng You and Yi Chih Hsieh. A hybrid heuristic approach to the problem of the location of vehicle charging stations. *Computers and Industrial Engineering*, 2014.
- [69] Ying Wei Wang and Chuah Chih Lin. Locating multiple types of recharging stations for battery-powered electric vehicle transport. *Transportation Research Part E: Logistics and Transportation Review*, 58:76–87, 2013.
- [70] C. H. Dharmakeerthi, N. Mithulananthan, and T. K. Saha. Impact of electric vehicle fast charging on power system voltage stability. *International Journal of Electrical Power and Energy Systems*, 57:241–249, 2014.
- [71] Hongcai Zhang, Scott J. Moura, Zechun Hu, and Yonghua Song. PEV Fast-Charging Station Siting and Sizing on Coupled Transportation and Power Networks. *IEEE Transactions on Smart Grid*, 9(4):2595–2605, 2018.
- [72] Payam Sadeghi-barzani, Abbas Rajabi-ghahnavieh, and Hosein Kazemi-karegar. Optimal fast charging station placing and sizing. *Applied Energy*, 125:289–299, 2014.
- [73] Sen Guo and Huiru Zhao. Optimal site selection of electric vehicle charging station by using fuzzy TOPSIS based on sustainability perspective. *Applied Energy*, 158:390–402, 2015.
- [74] Hussain Shareef, Md Mainul Islam, and Azah Mohamed. A review of the stage-of-the-art charging technologies, placement methodologies, and impacts of electric vehicles. *Renewable and Sustainable Energy Reviews*, 64:403–420, 2016.
- [75] Sanchari Deb, Kari Tammi, Karuna Kalita, and Pinakeswar Mahanta. Review of recent trends in charging infrastructure planning for electric vehicles. *Wiley Interdisciplinary Reviews: Energy and Environment*, 7(6):1–26, 2018.
- [76] Susan Hesse Owen and Mark S. Daskin. Strategic facility location: A review. *European Journal of Operational Research*, 111(3):423–447, 1998.
- [77] Ying Wei Wang and Chuah Chih Lin. Locating road-vehicle refueling stations. *Transportation Research Part E: Logistics and Transportation Review*, 45(5):821–829, 2009.

- [78] Richard L. Church and Charles Revelle. The maximal covering location problem. *Papers of the Regional Science Association*, 32:101–118, 1974.
- [79] Inês Frade, Anabela Ribeiro, Gonçalo Gonçalves, and António Antunes. Optimal location of charging stations for electric vehicles in a neighborhood in Lisbon, Portugal. *Transportation Research Record*, (2252):91–98, 2011.
- [80] Sebastian Wagner, Markus Götzinger, and Dirk Neumann. Optimal location of charging stations in smart cities: A point of interest based approach. *International Conference on Information Systems (ICIS 2013): Reshaping Society Through Information Systems Design*, 3:2838–2855, 2013.
- [81] S. L. Hakimi. Optimum Locations of Switching Centers and the Absolute Centers and Medians of a Graph. *Operations Research*, 12(3):450–459, 1964.
- [82] Long Jia, Zechun Hu, Wenju Liang, Wenzuo Lang, and Yonghua Song. A novel approach for urban electric vehicle charging facility planning considering combination of slow and fast charging. *POWERCON 2014 - 2014 International Conference on Power System Technology: Towards Green, Efficient and Smart Power System, Proceedings*, (Powercon):3354–3360, 2014.
- [83] Jaeyoung Jung, Joseph Y J Chow, R Jayakrishnan, and Ji Young. Stochastic dynamic itinerary interception refueling location problem with queue delay for electric taxi charging stations. *Transportation Research Part C*, 40:123–142, 2014.
- [84] Sylvia Y. He, Yong Hong Kuo, and Dan Wu. Incorporating institutional and spatial factors in the selection of the optimal locations of public electric vehicle charging facilities: A case study of Beijing, China. *Transportation Research Part C: Emerging Technologies*, 2016.
- [85] Yu An, Bo Zeng, Yu Zhang, and Long Zhao. Reliable p-median facility location problem: Two-stage robust models and algorithms. *Transportation Research Part B: Methodological*, 64:54–72, 2014.
- [86] Ragavendran Gopalakrishnan, Arpita Biswas, Alefiya Lightwala, Skanda Vasudevan, Partha Dutta, and Abhishek Tripathi. Demand prediction and placement optimization for electric vehicle charging stations. *IJCAI International Joint Conference on Artificial Intelligence*, 2016-January:3117–3123, 2016.
- [87] Jian Liu. Electric vehicle charging infrastructure assignment and power grid impacts assessment in Beijing. *Energy Policy*, 51:544–557, 2012.



- [88] Sanchari Deb, Kari Tammi, Karuna Kalita, and Pinakeswar Mahanta. Charging Station Placement for Electric Vehicles: A Case Study of Guwahati City, India. *IEEE Access*, 7:100270–100282, 2019.
- [89] N. Andrenacci, R. Ragona, and G. Valenti. A demand-side approach to the optimal deployment of electric vehicle charging stations in metropolitan areas. *Applied Energy*, 182:39–46, 2016.
- [90] Mehrnaz Ghamami, Yu (Marco) Nie, and Ali Zockaie. Planning charging infrastructure for plug-in electric vehicles in city centers. *International Journal of Sustainable Transportation*, 10(4):343–353, 2016.
- [91] Sreten Davidov and Miloš Pantoš. Planning of electric vehicle infrastructure based on charging reliability and quality of service. *Energy*, 118:1156–1167, 2017.
- [92] Mohammad M. Vazifeh, Hongmou Zhang, Paolo Santi, and Carlo Ratti. Optimizing the deployment of electric vehicle charging stations using pervasive mobility data. *Transportation Research Part A: Policy and Practice*, 2019.
- [93] Yanqing Li, Ling Li, Jing Yong, Yuhai Yao, and Zhiwei Li. Layout Planning of Electrical Vehicle Charging Stations. pages 661–668, 2011.
- [94] Michael Kuby and Seow Lim. The flow-refueling location problem for alternative-fuel vehicles. *Socio-Economic Planning Sciences*, 39(2):125–145, 2005.
- [95] Michael Kuby and Seow Lim. Location of alternative-fuel stations using the Flow-Refueling Location Model and dispersion of candidate sites on Arcs. *Networks and Spatial Economics*, 7(2):129–152, 2007.
- [96] Jong Geun Kim and Michael Kuby. The deviation-flow refueling location model for optimizing a network of refueling stations. *International Journal of Hydrogen Energy*, 37(6):5406–5420, 2012.
- [97] Yongxi Huang, Shengyin Li, and Zhen Sean Qian. Optimal Deployment of Alternative Fueling Stations on Transportation Networks Considering Deviation Paths. *Networks and Spatial Economics*, 15(1):183–204, 2015.
- [98] Fei Wu and Ramtean Sioshansi. A stochastic flow-capturing model to optimize the location of fast-charging stations with uncertain electric vehicle flows. *Transportation Research Part D*, 53:354–376, 2017.

- [99] Jia He, Hai Yang, Tie Qiao Tang, and Hai Jun Huang. An optimal charging station location model with the consideration of electric vehicle's driving range. *Transportation Research Part C: Emerging Technologies*, 86(December 2016):641–654, 2018.
- [100] Raffaella Riemann, David Z.W. Wang, and Fritz Busch. Optimal location of wireless charging facilities for electric vehicles: Flow capturing location model with stochastic user equilibrium. *Transportation Research Part C: Emerging Technologies*, 58(Part A):1–12, 2015.
- [101] Yue Xiang, Junyong Liu, Ran Li, Furong Li, Chenghong Gu, and Shuoya Tang. Economic planning of electric vehicle charging stations considering traffic constraints and load profile templates. *Applied Energy*, 178:647–659, 2016.
- [102] Christopher Upchurch and Michael Kuby. Comparing the p-median and flow-refueling models for locating alternative-fuel stations. *Journal of Transport Geography*, 18(6):750–758, 2010.
- [103] Kai Huang, Pavlos Kanaroglou, and Xiaozhou Zhang. The design of electric vehicle charging network. *Transportation Research Part D: Transport and Environment*, 49:1–17, 2016.
- [104] Joana Cavadas, Gonçalo Homem de Almeida Correia, and João Gouveia. A MIP model for locating slow-charging stations for electric vehicles in urban areas accounting for driver tours. *Transportation Research Part E: Logistics and Transportation Review*, 2015.
- [105] Matthew Andrew, Mustafa K. Dogru, John D. Hobby, Yue Jin, and Gabriel H. Tucci. Modeling and optimization for electric vehicle charging infrastructure. 2013.
- [106] Narges Shahraki, Hua Cai, Metin Turkay, and Ming Xu. Optimal locations of electric public charging stations using real world vehicle travel patterns. *Transportation Research Part D: Transport and Environment*, 41(2015):165–176, 2015.
- [107] Jairo González, Roberto Alvaro, Carlos Gamallo, Manuel Fuentes, Jesús Fraile-Ardanuy, Luk Knapen, and Davy Janssens. Determining electric vehicle charging point locations considering drivers' daily activities. *Procedia Computer Science*, 32:647–654, 2014.
- [108] Xiaomin Xi, Ramteen Sioshansi, and Vincenzo Marano. Simulation-optimization model for location of a public electric vehicle charging infrastructure. *Transportation Research Part D: Transport and Environment*, 22:60–69, 2013.

- [109] Jing Dong, Changzheng Liu, and Zhenhong Lin. Charging Infrastructure Planning for Promoting All-Electric Vehicle Market: An Activity-Based Assessment Using Multiday Travel Data Jing Dong (Corresponding author). *Phone*, (865):946–1308, 2012.
- [110] Daehee Han, Yongjun Ahn, Sunkyu Park, and Hwasoo Yeo. Trajectory-interception based method for electric vehicle taxi charging station problem with real taxi data. *International Journal of Sustainable Transportation*, 10(8):671–682, 2016.
- [111] Xiaomin Xi, Ramteen Sioshansi, and Vincenzo Marano. Simulation – optimization model for location of a public electric vehicle charging infrastructure. *Transportation Research Part.*, 22:60–69, 2013.
- [112] Hisashi Kameda and Naoto Mukai. Optimization of Charging Station Placement by Using Taxi Probe Data for On-Demand. pages 606–615, 2011.
- [113] T. Donna Chen, Kara M. Kockelman, and Josiah P. Hanna. Operations of a shared, autonomous, electric vehicle fleet: Implications of vehicle & charging infrastructure decisions. *Transportation Research Part A: Policy and Practice*, 94:243–254, 2016.
- [114] J. D. Hunt and K. J. Stefan. Tour-based microsimulation of urban commercial movements. *Transportation Research Part B: Methodological*, 41(9):981–1013, 2007.
- [115] Kay W. Axhausen, Andreas Horni, and Kai Nagel. *The Multi-Agent Transport Simulation MATSim*. 2016.
- [116] T. Novosel, L. Perković, M. Ban, H. Keko, T. Pukšec, G. Krajačić, and N. Duić. Agent based modelling and energy planning - Utilization of MATSim for transport energy demand modelling. *Energy*, 92:466–475, 2015.
- [117] Rick Wolbertus and Robert Van den Hoed. Electric Vehicle Fast Charging Needs in Cities and along Corridors. *World Electric Vehicle Journal*, 10(2):45, jun 2019.
- [118] Bloomberg New Energy Finance. Electric Vehicle Outlook 2022.
- [119] Andrew W Thompson. Essais sur la participation des véhicules électriques sur les marchés de l'énergie : aspects économiques véhicule-à-réseau (V2X) et considérations relatives à la dégradation des batteries. 2020.
- [120] Mads Greaker. Optimal regulatory policies for charging of electric vehicles . *Transportation Research Part D*, 97(June):102922, 2021.

- [121] Charles Botsford and Adam Szczepanek. Fast Charging vs . Slow Charging : Pros and cons for the New Age of Electric Vehicles 20 Years of EV History 1989 to 2009. *EVS24 International Battery, Hybrid and Fuel Cell Electric Vehicle Symposium*, pages 1–9, 2009.
- [122] Lu Wang, Zian Qin, Tim Slangen, Pavol Bauer, and Thijs Van Wijk. Grid Impact of Electric Vehicle Fast Charging Stations: Trends, Standards, Issues and Mitigation Measures - An Overview. *IEEE Open Journal of Power Electronics*, 2(February):56–74, 2021.
- [123] Anna Tomaszewska, Zhengyu Chu, Xuning Feng, Simon O’Kane, Xinhua Liu, Jingyi Chen, Chenzhen Ji, Elizabeth Endler, Ruihe Li, Lishuo Liu, Yalun Li, Siqi Zheng, Sebastian Vetterlein, Ming Gao, Jiuyu Du, Michael Parkes, Minggao Ouyang, Monica Marinescu, Gregory Offer, and Billy Wu. Lithium-ion battery fast charging: A review. *eTransportation*, 1:100011, 2019.
- [124] Ahmad Almaghrebi, Fares Aljuheshi, Mostafa Rafaie, Kevin James, and Mahmoud Alahmad. Data-driven charging demand prediction at public charging stations using supervised machine learning regression methods. *Energies*, 13(6), 2020.
- [125] Dominik Ziemke, Ihab Kaddoura, and Kai Nagel. The MATSim open Berlin scenario: A multimodal agent-based transport simulation scenario based on synthetic demand modeling and open data. *Procedia Computer Science*, 151(2018):870–877, 2019.
- [126] IEA. Global EV Outlook 2022 Securing supplies for an electric future, Part 1: Trends and developments in EV markets. 2022.
- [127] IEA. Global EV Outlook 2022 Securing supplies for an electric future, Part 2: Policies to promote EV deployment. 2022.
- [128] Jairo Quiros-Tortos, Alejandro Navarro-Espinosa, Luis F. Ochoa, and Tim Butler. Statistical representation of EV charging: Real data analysis and applications. *20th Power Systems Computation Conference, PSCC 2018*, pages 2013–2015, 2018.
- [129] Stavros G. Mitrakoudis and Minas C. Alexiadis. Modelling Electric Vehicle Charge Demand: Implementation for the Greek Power System. *World Electric Vehicle Journal*, 13(7), 2022.
- [130] Jun Su, T. T. Lie, and Ramon Zamora. Modelling of large-scale electric vehicles charging demand: A New Zealand case study. *Electric Power Systems Research*, 167(October 2018):171–182, 2019.

- [131] John Cook, Dana Nuccitelli, Sarah A. Green, Mark Richardson, Bärbel Winkler, Rob Painting, Robert Way, Peter Jacobs, and Andrew Skuce. Quantifying the consensus on anthropogenic global warming in the scientific literature. *Environmental Research Letters*, 8(2), 2013.
- [132] España. Ley 7/2021, de 20 de mayo, de cambio climático y transición energética. Boletín Oficial del Estado, 21 de mayo de 2021, núm. 121, pp. 62009 a 62052. 2021.
- [133] European Commission. Communication from the Commission. The European Green Deal, 11 December 2019, COM (2019) 640 final.
- [134] Canarias. Proyecto de Ley 10L/PL-0018 de 12 de noviembre, de Cambio Climático y Transición Energética de Canarias. Boletín Oficial del Parlamento de Canarias, 13 de noviembre de 2021, núm. 524, pp. 1 a 43. 2021.
- [135] Lucha contra el Cambio Climático y Planificación Territorial del Gobierno de Canarias. Consejería de Transición Ecológica. Plan de Transición Energética de Canarias 2030 (PTECan). Observatorio de la Energía de Canarias (OECan). 2021.
- [136] ISTAC Instituto Canario de Estadística. “población según sexos. municipios por islas de canarias y años” [database]. 2022.
- [137] J. Barrera-Santana A. Ramírez-Díaz, F. J. Ramos-Real. Fuel life cycle analysis for different types of vehicles in the canary islands. *IAEE 2021*, 2022.
- [138] ISTAC Instituto Canario de Estadística. Parque de vehículos en circulación según tipos de vehículo por municipios de canarias y periodos [database]. 2022.
- [139] Alfredo Ramírez Díaz, Francisco J. Ramos-Real, Gustavo A. Marrero, and Yannick Perez. Impact of electric vehicles as distributed energy storage in isolated systems: The case of tenerife. *Sustainability (Switzerland)*, 7(11):15152–15178, 2015.
- [140] Francisco M. Arrabal-Campos, Juan Martínez-Lao, Francisco G. Montoya, Alfredo Alcayde, and Raúl Baños. Impact on the Spanish electricity network due to the massive incorporation of electric vehicles. *Renewable Energy and Power Quality Journal*, 19(19):540–545, 2021.
- [141] Alfredo Ramirez-Diaz, Francisco Javier, Ramos Real, Gustavo Alberto, and Marrero Díaz. Electromobility as enhancer of renewable share in electric power system for isolated regions: the case of Canary Islands [Tesis doctoral, Universidad de La Laguna]. pages 1–100, 2018.

- [142] Quentin Hoarau and Yannick Perez. Interactions between electric mobility and photovoltaic generation: A review. *Renewable and Sustainable Energy Reviews*, 94(February):510–522, 2018.
- [143] Junhyung Kim, Jinho Kim, and Hwanmin Jeong. Key Parameters for Economic Valuation of V2G Applied to Ancillary Service: Data-Driven Approach. *Energies*, 15(23), 2022.
- [144] Tobias Boström, Bilal Babar, Jonas Berg Hansen, and Clara Good. The pure PV-EV energy system – A conceptual study of a nationwide energy system based solely on photovoltaics and electric vehicles. *Smart Energy*, 1, 2021.
- [145] Francisco J. Ramos-Real, Alfredo Ramírez-Díaz, Gustavo A. Marrero, and Yannick Perez. Willingness to pay for electric vehicles in island regions: The case of Tenerife (Canary Islands). *Renewable and Sustainable Energy Reviews*, 98(November 2017):140–149, 2018.
- [146] S.A Instituto Tecnológico de Canarias. Estrategia de la generación gestionable de canarias (vol. 1). dirección general de energía del gobierno de canarias.
- [147] Dirección General de Catastro del Ministerio de Hacienda. Sede electrónica del catastro. *Ministerio de Hacienda y Función Pública del Gobierno de España*, 2021.
- [148] Instituto Geográfico Nacional (IGN). Cartografía y datos geográficos. *Ministerio de Transportes, Movilidad y Agenda Urbana del Gobierno de España*.
- [149] Plan Nacional de Observación del Territorio. Sistema de información de ocupación del suelo de españa (siose). *Ministerio de Transportes, Movilidad y Agenda Urbana del Gobierno de España*.
- [150] Christopher Tchervenkov, Sebastian Hörl, Milos Balac, Thibaut Dubernet, and Kay W. Axhausen. An improved replanning strategy for congested traffic conditions in MATSim. *Procedia Computer Science*, 170:779–784, 2020.

**Titre:** Vers une mobilité plus propre : développer une infrastructure de recharge pour véhicules électriques

**Mots clés:** Véhicule électrique, infrastructure de charge, électromobilité, optimisation, économie

**Résumé:**

L'adoption à grande échelle de la mobilité électrique nécessitera une infrastructure de charge répondant aux nouveaux besoins émanant de ce défi. Actuellement, les infrastructures de recharge pour véhicules électriques sont encore au début de leur développement, notamment à cause du faible nombre de véhicules électriques. Les pouvoirs publics prévoient ainsi un investissement massif dans la filière de la mobilité électrique. Néanmoins, de nombreuses questions se posent quant au dimensionnement et à l'optimisation de ces infrastructures, à la fois du point de vue opérationnel et économique. Bien que cette optimisation ait fait l'objet de nombreuses études durant ces dix dernières années, des lacunes persistent, notamment en ce qui concerne le panachage de différentes solutions de recharge (normale, accélérée, rapide, piste à induction...) ainsi que sur les aspects économiques et opérationnels. De plus, le rapport de l'utilisateur à la voiture particulière est en forte évolution, et les comportements de recharge des utilisateurs ne sont pas encore bien établis.

Cette thèse vise à embrasser l'ensemble de ces considérations, pour contribuer au développement d'un outil d'aide à la décision pour les acteurs de la mobilité électrique afin d'optimiser le dé-

ploiement de cette nouvelle infrastructure de charge, qui se devra d'être adaptée aux besoins d'utilisateurs habitués à la facilité d'utilisation et de ravitaillement du véhicule thermique individuel.

Elle présente une nouvelle méthode permettant d'évaluer, principalement pour des charges à destination, l'intérêt de déployer des stations à certains endroits, ainsi que de choisir celles qui seront les plus adéquates pour ces emplacements. Cette méthode de déploiement d'infrastructure s'appuie sur une approche multicritères basée sur des données de déplacement des conducteurs. Le but est de permettre un déploiement des stations à grande échelle, coordonné et en adéquation avec les besoins des conducteurs, tout en intégrant les contraintes d'installation et d'exploitation auxquelles font face les opérateurs de ces stations.

Les principaux résultats montrent que le déploiement des stations de charge lentes est prioritaire, de même que l'accès à une solution de charge résidentielle pour un maximum d'utilisateurs. Les stations de charge plus rapides, bien qu'ayant une vraie valeur assurantielle pour les utilisateurs craignant d'être à court de batterie avant de pouvoir se charger, ont surtout une utilité réelle pour des cas bien spécifiques tels que les longs trajets.

**Title:** Toward a cleaner mobility: Developing Charging Infrastructure for Electric Vehicle Transition

**Keywords:** Electric vehicle, charging infrastructure, electromobility, optimization, economics

**Abstract:** The widespread adoption of electric mobility will require a charging infrastructure that meets the new needs arising from this challenge. Currently, charging infrastructure for electric vehicles is still in the early stages of development, mainly due to the low number of electric vehicles. The public authorities are therefore planning a massive investment in the electric mobility sector.

Nevertheless, many questions arise regarding the dimensioning and optimization of these infrastructures, both from an operational and economic point of view. Although this optimization has been the subject of numerous studies over the past ten years, there are still gaps, particularly with regard to the mix of different charging solutions (normal, accelerated, fast, induction track, etc.) as well as on the economic and operational aspects. Moreover, the relationship between the user and the private car is strongly evolving, and the charging behavior of the users is not yet well established.

This thesis aims at covering all these considerations, in order to contribute to the development of a decision support tool

for the actors of electric mobility in order to optimize the deployment of this new charging infrastructure, which will have to be adapted to the needs of users used to the ease of use and patterns of refueling of individual internal combustion engine vehicles.

It presents a new method to evaluate, mainly for "at destination" charging, the interest in deploying charging stations at certain locations, as well as to choose the most suitable ones for these locations. This infrastructure deployment method is based on a multi-criteria approach based on driver travel data. The aim is to enable large-scale, coordinated deployment of stations in line with drivers' needs while integrating the installation and operational constraints the station operators face.

The main results of this thesis show that the deployment of slow charging stations is a priority, as is access to a residential charging solution for a maximum number of users. Faster charging stations, while having a real value to decrease users' range anxiety, have actual usefulness for very specific cases such as long journeys.

