



HAL
open science

Supplier performance measurement system for sustainable supply chain Management : application to Thai electronics industry

Salinee Santiteerakul

► **To cite this version:**

Salinee Santiteerakul. Supplier performance measurement system for sustainable supply chain Management : application to Thai electronics industry. Computer Science [cs]. Université Lumière Lyon 2, 2014. English. NNT: . tel-04186553

HAL Id: tel-04186553

<https://hal.science/tel-04186553>

Submitted on 25 Aug 2023

HAL is a multi-disciplinary open access archive for the deposit and dissemination of scientific research documents, whether they are published or not. The documents may come from teaching and research institutions in France or abroad, or from public or private research centers.

L'archive ouverte pluridisciplinaire **HAL**, est destinée au dépôt et à la diffusion de documents scientifiques de niveau recherche, publiés ou non, émanant des établissements d'enseignement et de recherche français ou étrangers, des laboratoires publics ou privés.



Thèse présentée à

UNIVERSITE LUMIERE LYON 2

Ecole Doctorale Informatique et Mathématiques Lyon(InfoMaths)

Decision & Information Sciences for Production Systems (DISP)

CHIANG MAI UNIVERSITY

Faculty of Engineering (Thailand)

Salinee SANTITEERAKUL

Pour l'obtention du grade de

Docteur en Informatique

Supplier Performance Measurement System for Sustainable Supply Chain Management: Application for Thai Electronics Industry

Soutenue le 15 juillet 2014

Directeur de thèse: Abdelaziz BOURAS, Apichat SOPADANG

Co-encadrant: Aicha SEKHARI

Devant un jury composé de :

M Sebti FOUFOU	Université de Bourgogne	Rapporteur
M. Bernard GRABOT	Universités à l'ENIT	Rapporteur
Mlle Kanchana SETHANAN	Université de Khon Kan	Examineur
M. Sermkiat JOMJUNYONG	Université de Chiang Mai	Examineur
M. Abdelaziz BOURAS	Université Lumière Lyon 2	Directeur de these
M. Apichat SOPADANG	Université de Chiang Mai	Directeur de these
Mme Aicha SEKHARI	Université Lumière Lyon 2	Co-encadrant

Contents

Chapter 1. General Introduction.....	0
1.1. Motivation and Background	0
1.2. Thai Electronics Industry.....	3
1.3. Research Problem	5
1.4. Research Objectives	5
Chapter 2. : State of the art: Sustainability performance measurement in supply chain management.....	6
2.1. Sustainable Development Context	6
2.1.1 Why we need sustainable development.....	6
2.1.2 Sustainability in the industrial sector	8
2.2. Introduction to sSCM	9
2.3. Conceptual Framework	10
2.4. Characteristics of sSCM.....	13
2.5. Managing Sustainability in Industrial Sector.....	19
2.5.1 Sustainability in product point of view	20
2.5.2 Sustainability in process point of view	21
2.6. Standards and guide lines related to sustainability issues	26
2.6.1 Economic dimension	27
2.6.2 Environmental dimension	27
2.6.3 Social dimension	28
2.7. Performance Measurement System.....	29
2.7.1 Measures, metrics, and indicators	31
2.7.2 Leading and lagging indicators	32
2.8. Existing approaches to measure sustainability performance	33
2.8.1 Using performance measurement system (PMS).....	34
2.8.2 Reporting Systems	34
2.8.3 Using multi-criteria decision making approach.....	35
2.9. Comparative Analysis of Existing Approaches.....	36
2.9.1 Comparative framework.....	36

2.9.2	Comparative Analysis	37
2.9.3	Results of comparative analysis	42
2.9.4	Discussion on Existing Approaches	48
2.10.	Sustainability performance measurement in supply chain	48
2.10.1	Fundamental Steps of Sustainability Performance Measurement Framework	48
2.10.2	Triggers of Supply Chain Performance Measurement	50
2.10.3	Performance Measurement Metrics	53
2.11.	Conclusion	59
Chapter 3.	sSCM Conceptual Framework.....	61
3.1.	Interpreting 'needs' in sustainable development	61
3.1.1	Physical Needs	63
3.1.2	Non-physical needs.....	64
3.1.3	The needs and the triple bottom line (TBL) concept.....	67
3.1.4	Goals for sustainable development.....	69
3.2.	Sustainable Development in Industrial Sector.....	70
3.2.1	Contributions of industrial sector to support SD	70
3.2.2	Goals for sustainable supply chain management (sSCM)	72
3.3.	Proposed sSCM Framework.....	73
3.3.1	Sustainability Criteria	73
3.3.2	Sustainability dimension and long-term perspective.....	74
3.3.3	Engagement level of supply chain	75
3.3.4	Location/Process of measures.....	76
3.3.5	Decision levels.....	78
3.4.	Approach to construct sustainability metrics	79
3.4.1	Process based analysis	79
3.5.	Supplier's sustainability performance assessment.....	81
3.5.1	Supplier evaluation and selection criteria	82
3.5.2	Supplier's sustainability metrics and measures	86
3.6.	Conclusion	88
Chapter 4.	Multi-Criteria Model Formalization.....	89

4.1.	Introduction.....	89
4.2.	Supplier performance evaluation.....	89
4.3.	Multi criteria decision problem.....	90
4.3.1	Multiple criteria decision making (MCDM).....	90
4.3.2	Multiple criteria decision aid (MCDA)	91
4.3.3	Decision aiding process of MCDA.....	93
4.3.4	MCDA methods	95
4.3.5	The criteria for selecting MCDA.....	96
4.4.	Identify problem situations in the context of supplier's performance evaluation	97
4.4.1	Determine objective of decision problem	97
4.4.2	Determining a set of feasible alternatives.....	98
4.4.3	Analyzing criteria characteristics	98
4.5.	Selecting MCDA method	99
4.5.1	Multiple attribute utility theory (MAUT).....	99
4.5.2	Analytical hierarchy process (AHP).....	100
4.5.3	EvaMix.....	100
4.6.	The selected approach: Fuzzy Analytical Hierarchy Process (FAHP)	102
4.7.	Theoretical of Analytic Hierarchy Process and Fuzzy Set.....	103
4.7.1	Analytic Hierarchy Process (AHP).....	103
4.7.2	Fuzzy sets theory	105
4.8.	Fuzzy AHP Methodology	107
4.9.	The review of Extent Analysis and Lambda Max method.....	110
4.9.1	Extent Analysis Method	110
4.9.2	Lambda-Max Method	112
4.10.	Numerical Example: Comparing Extent Analysis and Lambda-Max.....	115
4.11.	Proposed FAHP approach.....	119
4.11.1	Method-I: Modified the Extent Analysis Method.....	122
4.11.2	Method-II: Modified the normalization method.....	122
4.11.3	Method-III: Employ the weakest T-norm arithmetic.....	122
4.12.	Numerical Illustration	123

4.12.1	Results of proposed FAHP methods.....	123
4.13.	Conclusion	125
Chapter 5. Application and Validation of Sustainability Model for Supplier Assessment 126		
5.1.	Introduction.....	126
5.2.	Problem Definition	128
5.3.	Structure Hierarchy.....	129
5.3.1	Selecting sustainability criteria and measures.....	129
5.3.2	Defining measurement scale.....	132
5.4.	Construct a set of pairwise comparison matrices.....	132
5.4.1	Pairwise analysis of main criteria: sustainability dimensions.....	133
5.4.2	Pairwise analysis of sub-criteria: sustainability indicators	134
5.4.3	Pairwise analysis of sub-criteria: sustainability measures	135
5.5.	Determining the fuzzy priority weight.....	138
5.5.1	Determining the local and global priority weight.....	138
5.5.2	Assessing supplier's performance	144
5.5.3	Determining priority and ranking supplier's performance	146
5.6.	Synthesizing the results.....	150
5.6.1	Economic performance	150
5.6.2	Environmental performance.....	152
5.6.3	Social performance	154
5.7.	Model Validation.....	158
5.7.1	Model validation techniques.....	158
5.7.2	The techniques adopted for validating the sustainability measurement model	159
5.8.	Conclusion.....	163
Chapter 6. Conclusion and Research Perspectives		
6.1.	Introduction.....	165
6.2.	Review of aim and objectives.....	165
6.3.	Summary of research.....	166
6.4.	Managerial implications	168

6.5. Limitations and research perspectives	168
--	-----

List of Tables

Table 2.1: Conceptual framework analysis	12
Table 2.2 Definitions of corporate sustainability	14
Table 2.3 Definitions of green supply chain management (GSCM).....	14
Table 2.4 Definitions of sustainable supply chain management (sSCM).....	15
Table 2.5 Key SCM characteristics addressed by the definitions.....	15
Table 2.6 Key sustainability or green characteristics addressed by the definitions	17
Table 2.7 Sustainability in product and process point of view.....	20
Table 2.8 Sustainability practices associated with business activities	24
Table 2.9 Category of sustainable dimension and management system.....	26
Table 2.10 Performance measurement level and key considerations.....	29
Table 2.11 Definitions: measure, metric, performance indicator (PI).....	32
Table 2.12 Analysis issues by PMS level	37
Table 2.13 The comparative analysis of existing approaches for measuring sustainability performance	44
Table 2.14 Classification criteria in traditional supply chain performance measurement	54
Table 2.15 Categories of green/sustainability performance measurement in SCM	58
Table 3.1 Max-Neef’s fundamental of human needs	62
Table 3.2 Principles and guidance to achieve sustainable development	65
Table 3.3 Analysis of Guidelines/Standards/Tools regarding to sustainability criteria ..	68
Table 3.4 Goals for sustainable supply chain.....	72
Table 3.5 Short-term and long-term perspectives of SD contribution	74
Table 3.6 Criteria of sustainability/green supplier evaluation and selection	83
Table 3.7 Judgment approach for assessing sustainability measures	87
Table 4.1 Differences between multi-criteria decision making (MCDM) and multi-criteria decision aiding (MCDA)	92
Table 4.2 Characteristics of each MCDA category.....	95
Table 4.3 Guideline to analyze characteristics of decision problem for selection MCDA method	96
Table 4.4 Summarized of problem characteristics in the first stage.....	98

Table 4.5 Characteristics of sSCM performance measurement problem	98
Table 4.6 Guideline to analyze characteristics of decision problem for selection MCDA method	100
Table 4.7 Fuzzy Comparison Matrix with Respect to the goal	116
Table 4.8 Fuzzy Comparison Matrix with respect to hygiene	116
Table 4.9 Fuzzy Comparison Matrix with respect to quality of meal	116
Table 4.10 Fuzzy Comparison Matrix with respect to quality of service	116
Table 4.11 The linguistic performance rating of three catering firm's performance	117
Table 4.12 Fuzzy performance rating of three catering firm's performance	117
Table 4.13 Fuzzy Comparison Matrix with Respect to the goal	117
Table 4.14 Fuzzy Comparison Matrix with respect to hygiene	117
Table 4.15 Fuzzy Comparison Matrix with respect to quality of meal	117
Table 4.16 Fuzzy Comparison Matrix with respect to quality of service	118
Table 4.17 Global Weight of three catering firms	118
Table 4.18 Linguistic scales for relative important	121
Table 4.19 Fuzzy Comparison Matrix with Respect to the goal	123
Table 4.20 Fuzzy Comparison Matrix with respect to hygiene	123
Table 4.21 Fuzzy Comparison Matrix with respect to quality of meal	124
Table 4.22 Fuzzy Comparison Matrix with respect to quality of service	124
Table 4.23 Fuzzy global weight of three catering firms obtained by proposed method	124
Table 5.1 Number of suppliers classified by supplier location	129
Table 5.2 Sustainability indicators and metrics for evaluating supplier's performance	129
Table 5.3 Criteria rating for flexibility	132
Table 5.4 Criteria rating for initiatives to implement green technology	132
Table 5.5 The linguistic scale for pairwise comparison	133
Table 5.6 Linguistic comparison matrix with respect to <i>Sustainability</i>	134
Table 5.7 Fuzzy Comparison Matrix with Respect to <i>Sustainability</i>	134
Table 5.8 Fuzzy Comparison Matrix with respect to <i>Economic (EC)</i>	134
Table 5.9 Fuzzy Comparison Matrix with respect to <i>Environment (EN)</i>	135
Table 5.10 Fuzzy Comparison Matrix with respect to <i>Social (SO)</i>	135

Table 5.11 Fuzzy Comparison Matrix with Respect to <i>Supplier quality performance (EC1)</i>	135
Table 5.12 Fuzzy Comparison Matrix with Respect to <i>Supplier business performance (EC2)</i>	135
Table 5.13 Fuzzy Comparison Matrix with respect to <i>Energy efficiency (EN1)</i>	136
Table 5.14 Fuzzy Comparison Matrix with respect to <i>Resource used efficiency (EN2)</i>	136
Table 5.15 Fuzzy Comparison Matrix with respect to <i>Emission (EN3)</i>	136
Table 5.16 Fuzzy Comparison Matrix with respect to <i>Green competencies (EN4)</i>	136
Table 5.17 Fuzzy Comparison Matrix with respect to <i>Employee health & safety (SO1)</i>	137
Table 5.18 Fuzzy Comparison Matrix with respect to <i>Hazardous substances (SO2)</i>	137
Table 5.19 Fuzzy Comparison Matrix with respect to <i>Fair trade and Ethical issues (SO3)</i>	137
Table 5.20 Fuzzy Comparison Matrix with respect to <i>Social responsible competencies (SO4)</i>	137
Table 5.21 Fuzzy and crisp values of local priority weight in sustainable dimension	139
Table 5.22 Local weight of all matrices: Proposed Method-III	139
Table 5.23 Global fuzzy and crisp weights of all matrices: Proposed Method-III	141
Table 5.24 Linguistic judgment of supplier's performance rating	144
Table 5.25 The linguistic scale for supplier performance judgment	145
Table 5.26 Fuzzy score of supplier's performance rating	145
Table 5.27 Global performances of the five suppliers using FAHP method	147
Table 5.28 Fuzzy performance of suppliers: <i>Proposed Method-III</i>	148
Table 5.29 Crisp performance of suppliers: <i>Proposed Method-III</i>	148
Table 5.30 Global crisp performances of five suppliers: <i>Economic dimension</i>	151
Table 5.31 Global crisp performances of five suppliers: <i>Environmental dimension</i>	153
Table 5.32 Global crisp performances of five suppliers: <i>Social dimension</i>	155
Table 5.33 Final fuzzy scores of sustainability performance: <i>Lambda-Max Method</i>	160
Table 5.34 Final crisp scores of supplier's sustainability performance: <i>Lambda-Max</i>	160
Table 5.35 Comparison of the results for sustainable supplier evaluation	161
Table 5.36 Number of multiplication for determining sustainability criteria weights	163
Table 5.37 Number of multiplication for determining final weight of suppliers	163

List of Figures

Figure 2.1 Causes and effects to develop the sustainable development concept	7
Figure 2.2 The policy directions of Brundtland Commission on sustainable development	8
Figure 2.3 Conceptual framework of sustainable development and sSCM	11
Figure 2.4 SCOR is organized around five management processes.	38
Figure 2.5 The GreenSCOR model (Source: Supply Chain Council (2008)).....	39
Figure 2.6 Framework for developing sustainability performance measurement.....	49
Figure 2.7 The complexity level of supply chain	51
Figure 2.8 : Stages of performance measurement: (1) core process only. (2) all company processes. (3) company processes and links with suppliers and customers. (4) SC performance measurement (includes all SC partners).....	53
Figure 2.9 Steps for developing the conceptual framework of sSCM performance measurement system	60
Figure 3.1 Maslow's hierarchy of human needs	62
Figure 3.2 Role of industrial sector: Promoting cleaner production	71
Figure 3.3 Role of industrial sector: Promoting responsible entrepreneurship.....	72
Figure 3.4 Sustainability Criteria Categorization.....	74
Figure 3.5 The sustainable supply chain management (sSCM) framework.....	76
Figure 3.6 The value chain model.....	77
Figure 3.7 Process-based Approach for measuring supply chain performance.....	81
Figure 4.1The framework of decision aiding process in MCDA (adapted from Roy, 1985)	94
Figure 4.2 Structure of the decision hierarchy.....	104
Figure 4.3 A triangular fuzzy number	106
Figure 4.4 The degree of possibility of when comparing two fuzzy numbers	111
Figure 4.5 Hierarchy of catering firm selection problem.....	116
Figure 4.6 Global fuzzy weights of catering firms obtained by Extent Analysis.....	118
Figure 4.7 Global fuzzy weights of catering firms obtained by Lambda-Max.....	119
Figure 4.8 Global weight of three firms obtained by Extent Analysis.....	119
Figure 4.9 Global weight of three firms obtained by Lambda-Max.....	119

Figure 4.10 Linguistic scale for relative important	121
Figure 4.11 Global fuzzy weights of catering firms obtained by Method-I.....	124
Figure 4.12 Global fuzzy weights of catering firms obtained by Method-II	125
Figure 4.13 Global fuzzy weights of catering firms obtained by Method-III.....	125
Figure 5.1 Product components of hard disk drive	129
Figure 5.2 The AHP structure of supplier’s sustainability measurement	131
Figure 5.3 Local priority weight of sustainable dimension.....	139
Figure 5.4 Global priority weights for sustainability performance measurement in supplier assessment problem.....	143
Figure 5.5 Fuzzy number of linguistic judgment for supplier assessment.....	145
Figure 5.6 Fuzzy global weights of suppliers: Proposed Method-III.....	149
Figure 5.7 Sustainability performances of suppliers with proposed method.....	149
Figure 5.8 Global weights of economic measures	150
Figure 5.9 Supplier performances in economic dimension	151
Figure 5.10 Global weights of environmental measures.....	152
Figure 5.11 Supplier performances in environmental dimension	154
Figure 5.12 Global weights of social measures	155
Figure 5.13 Supplier performances in social dimension.....	156
Figure 5.14 Supplier performances in each sustainability measures.....	157
Figure 5.15 Fuzzy global weights of suppliers: Lambda-Max method	160
Figure 5.16 Sustainability performance of suppliers with Lambda-Max method	160
Figure 5.17 Fuzziness comparison between proposed and LM method	162

Chapter 1.

GENERAL INTRODUCTION

1.1. MOTIVATION AND BACKGROUND

Managing supply chains in a sustainable context has been widely of interest in the last two decades for industrial and academic sectors because of drivers from political agenda after the Brundtland commission report (World Commission on Environment and Development (WECD), 1987) has been published. The report popularized the most commonly used definition of sustainable development: “Development that meets the needs of current generations without compromising the ability of future generations to meet their own needs” (WCED, 1987, p. 45). This report enhanced the decreasing of quality of life due to the limitation of natural resources, increasing of human consumption, and environmental distortion from human activities. Thus, the world development cannot be considered only economic growth but it should be considered in term of environmental and social impacts as well. The sustainable development (SD) concept and practices are discussed from an international collaboration to an organization implementation.

The Brundtland report provided the momentum for the Rio Summit in 1992 that laid the foundations for the global institutionalization of sustainable development. The Earth Summit adopted the Rio Declaration on Environment and Development and Agenda 21, a global plan of action for sustainable development. The “Rio Declaration” contained 27 principles of sustainable development, including principle eight on “sustainable production and consumption”. It states “to achieve sustainable development and a higher quality of life for all people, States should reduce and eliminate unsustainable patterns of production and consumption and promote appropriate demographic policies” (United Nations (UN), 1993).

Agenda 21 included 40 separate chapters, setting out actions in regard to the social and economic dimensions of sustainable development, conservation and management of natural resources, the role of major groups, and means of implementation. In chapter 30 of Agenda 21, strengthening the role of business and industry, two programs are proposed for developing sustainability for business and industry: promoting cleaner production and promoting responsible entrepreneurship (United Nations (UN), 1993). The results of the Rio summit conference lead to the establishment of several standards, guidelines, and regulations to respond to the sustainable development such as ISO 14000 family of standards, the waste electrical and electronic equipment directive (WEEE Directive) and the restriction on hazardous substances directive (RoHS Directive), ISO 26000:2010.

- In 1993, ISO technical committee ISO/TC 207, *Environmental management*, which is responsible for developing and maintaining the ISO 14000 family of standards, was established as a result of ISO's responsibility to respond to the complex challenge of "sustainable development" articulated at the 1992 United Nations Conference on Environment and Development in Rio de Janeiro. The published documents and ongoing of ISO 14000 family address the following areas: environmental management system (EMS), environmental auditing and related environmental investigations, environmental performance evaluation, environmental labeling, life cycle assessment (LCA), environmental communication, environmental aspects of product design and development, environmental aspects in product standards, greenhouse gas management and related activities, measuring the carbon footprint of products .
- The Waste Electrical and Electronic Equipment Directive (WEEE Directive) is the European Community directive 2002/96/EC on waste electrical and electronic equipment (WEEE) which, together with the Restriction on Hazardous Substances Directive (RoHS Directive) 2002/95/EC, became European Law in February 2003. The purpose of WEEE Directive is the prevention of WEEE and the reuse, recycling and other forms of recovery of such wastes so as to reduce the disposal of waste. The purpose of RoHS Directive is to restrict of the use of hazardous substances in electrical and electronic equipment.
- ISO 26000:2010 is intended to assist companies in contributing to sustainable development. It is not a management system standard but it is intended to provide organizations with guidance concerning social responsibility.

Companies in the industrial sector are pressured by legal demands/regulation, responses to the stakeholders, the competitive advantage, the customer demands, the reputation loss, and the environmental and social pressure groups to adopt a commitment on sustainability practices. The legal demands are the most frequently mentioned, closely followed by customer demands and response to stakeholders. This initially switched companies onto a competitive way of thinking about environmental performance and then corporate citizenship and corporate social responsibility.

Corporate sustainability is a new area of study and many researchers have tried clearly to define the sustainability terminology. Most researchers do not provide definitions but attempt to explain what companies are supposed to do to achieve sustainability (Bourne et al., 2002; Coelho, 2005). Moreover when the focal company is pressured, it usually passes this pressure on to suppliers. This situation leads to increase a consideration in sustainable supply chain management (sSCM) and the rise of research exploring the issue of sustainability in supply chain (Beamon, 2008; Carter and Rogers, 2008; Clark, 2007)

This raises an intersection between sustainable development (SD) and supply chain management. The researchers and practitioners extended the operational aspects in traditional SCM, which considers only an economic dimension, by adding environmental and social dimension in their attention. Companies have to satisfy economic goals while the environmental and social impacts need to be fulfilled by stakeholders and supply chain members. Managers have challenges in dealing with multiple decision makers and assessing the environmental and social impacts in supply chain and concerning diverse processes for designing, sourcing, producing, and distributing products.

The problems for managers in the industrial sector are, how can they implement sustainability practices in their business? How can they measure and improve their sustainability performance to increase business competitiveness? Within this context, the Global Reporting Initiative (GRI), which provides the framework and metrics to measure sustainability performance of the company, have been proposed by industry (GRI, 2006). The GRI focuses on sustainability of companies and does not take into account of supply chain management principle.

Meanwhile academia has developed a body of knowledge related to sSCM by integrate the concept of sustainability with supply chain management. In the early stage (during 1991-2000) of sSCM and green supply chain management (GSCM) has been more focus on environmental aspects. To some degree, the term “sustainability” and “environment” have been used interchangeably. Social aspects have been recognized since 2001 (Carter and Easton, 2011) after the well-known sustainability framework, which is called the triple bottom line (TBL), has been proposed by Elkington in 1994 (Elkington, 1999). His argument was that companies should be preparing three different bottom lines. One is the traditional measure of corporate profit (economic concerns). The second is the bottom line of the company's people account (social concerns), a measure of how socially responsible an organization has been throughout its operations. The third is a measure of how a business impacts on the natural environment. The triple bottom line (TBL) thus consists of three dimensions: economic, environment and society. It aims to measure the economic, social and environmental performance of the corporation over a period of time.

Many different frameworks of sSCM exist, starting from conceptual of sSCM (Carter and Rogers, 2008; Seuring and Müller, 2008; Teuteberg and Wittstruch, 2010), definitions of sSCM (Carter and Rogers, 2008; Ciliberti et al., 2008; Font et al., 2008; Haake and Seuring, 2009; Jorgensen and Knudsen, 2006; Pagell and Wu, 2009; Seuring and Müller, 2008; Wolf, 2011), practices to implement sustainability into supply chain (Beamon, 2008; Gunasekaran and Spalanzani, 2012; Sarkis, 1999; Seuring, 2004; Zailani et al., 2012; Zhu and Sarkis, 2004; Zhu et al., 2012), and the modeling approaches related to sSCM (Bai and Sarkis, 2010; Büyüközkan and Çifçi, 2011; Lee et al., 2009; Tseng and Chiu, 2013).

The conceptual frameworks of sSCM have been developed respect to TBL concept (Carter and Rogers, 2008; Seuring and Müller, 2008; Teuteberg and Wittstruch, 2010). In order to measure sustainability performance of supply chain, the TBL is adopted to identify sustainability strategy, select indicators and measures of sustainability performance. However the broad categorization will make the difficulty for manager to identify their sustainability strategy and link with tactical or operational level. Thus, the need of developing frameworks for measuring sustainability of sSCM that explains sub-dimension of TBL and links supply chain strategy with tactical and operational level is a challenge in the research field. Moreover, the implementation in this research field still focuses on environmental issues. Social and ethical issues were seen as less tangible and more difficult to address than environmental issue. Thus, an approach to integrate social dimension with economic and environmental dimensions is still a challenge in sSCM research field.

The supply chain management perspective is important for designing performance measurement system. There are difference perspective for measuring sustainability of supply chain such as measuring sustainability performance along the whole supply chain by using lifecycle analysis (LCA) or product lifecycle management (PLM) concept(Beamon, 2008; Seuring, 2004). Some research works measure sustainability performance of the focal company and taking indicators related to suppliers and/or customers into account. Some research works measure sustainability performance in business function of the company i.e. supplier selection, inventory management, production, distribution, etc. Hence, in order to improve performance measurement system, the level of measurement should be identified.

This thesis aims to clarify a sustainability implementation into supply chain and to develop a tool for measuring sustainability performance for sSCM by selecting one of supply chain activity as a case for developing measurement model. The developed measurement model will be implemented in the case study company which is an electronics industry in Thailand.

1.2. THAI ELECTRONICS INDUSTRY

Thai electrical and electronic industries (TEEI) have developed much since the middle of the 20th century. This industry sector in Thailand has been a major driver of export growth for the country and the sector has seen substantial growth in recent years. The development in the TEEI is above all due to high investments from Japan, South Korea and Taiwan to mitigate the high production costs in the countries. Today goes almost half of the total annual exports to Japan, the US and EU. Out of the total export more than 40% is related to Electrical and Electronic Equipment (EEE) (EEI 2007). The rest of the

export goes mainly to China and Association of South East Asian Nations (ASEAN) countries.

According to Thailand Electrical and Electronics Institute (EEI) the EEE sectors consist of about 2,045 factories, with 601,954 employees (2013) and these numbers were growing every year. These are to a high extent consisting of Thai entrepreneurs with small electrical businesses, international entrepreneurs with small to medium sized electronics businesses, whilst the medium to large sized electronics business are most often joint ventures between Thai and foreign investors. Over 60% of the employees within the sector are employed by larger companies i.e. companies with over 200 employees or over 6 million USD in assets for manufacturing (APO 2008).

The currently existing environmental regulation and legislations in Thailand are compared to the ones in EU and Japan quite few and harmless. Compliance of foreign regulation is what most companies relies on for the ability of export to foreign customers and their demands. Main adjustments for Restriction of Hazardous Substances (RoHS) and Waste Electrical and Electronic Equipment (WEEE) directive have been made according to EEI (2007). However the burden is extensive especially for Small and Medium Sized Enterprises (SME). The main efforts are put on adjustments to RoHS more than design for recycling in compliance with WEEE.

Adjustment to the legislations remains difficult since proof and monitoring of compliance, new material quality and reliability testing are hard to regulate without proper certification bodies. Time and resources are also difficult matters as always with expenses and whom these are credited. Another big problem in Thailand is that personnel with knowledge in the environmental legislation areas often get poached by larger companies enticed by higher wages. Leading to the small and medium size enterprises (SMEs) missing the crucial information.

According to the country report on Thai Electronics sector (EEI, 2007) and Wallerius and Zakrisson, (2010) found that most of the need of compliance with regulation in Thai companies comes from mother companies abroad. This implies that these demands will drive many companies within the first tier of suppliers. Following the chain to the second tier the compliance decreases dramatically. This compliance will though drive some of the environmental work such as the need of certification, audits and documentation.

The Thai government is aware of the need of sustainability to create competitiveness in the global market. Both short- and long term projects in several different areas concerning environment and sustainability were initiated by the Thai government in 2005. Recognizing the sustainable development of the electrical and electronics industry as a priority for the Kingdom, the Thai Government has launched proactive investment

policies and measures, which have attracted investments from many multinational companies and led the industry to prosperity in Thailand (BOI, 2013).

1.3. RESEARCH PROBLEM

Companies and their supply chains need assistance in the development of a practical performance evaluation approach. Such an approach needs to be able to integrate their sustainability strategy with tactical and operational activities. Several reviews provide different perspectives on sustainability performance measurement in supply chain management such as eco-product design, product lifecycle assessment, supplier management, cleaner production, closed-loop supply chain, implementation of sustainability practices, corporate sustainability etc. This difference perspective leads to the difference of sustainability performance measurement model. The links between existing conceptual frameworks (Carter and Rogers, 2008; Seuring and Müller, 2008; Teuteberg and Wittstruch, 2010) and the perspectives to measure sustainability performance in sSCM are still missing. In order to assist managers to develop a practical performance measurement system, a framework with sub-dimension should be developed.

1.4. RESEARCH OBJECTIVES

1. To provide a conceptual framework of sustainable supply chain and a model for measuring sustainability performance
2. To develop sustainability performance measurement system which
 - Reflecting company's approach in sustainable supply chain perspective
 - Measuring sustainability performance in business functional level
 - Supporting company's decision to improve supplier's sustainability performance

This research has been divided into three parts; the first part is to clarify a sustainability measurement framework in supply chain. The sSCM measurement framework consists of key characteristics in both sustainability and supply chain management concepts. This framework enhances the sustainability needs in industrial sector and engagement level among elements in supply chain. The second part is to develop an sSCM performance measurement model. This model consists of economic, environmental and social perspective. Afterwards, this model will investigate the implementation for a company in an electrical industry field. Finally, this model improves the sustainability performance for the company's operations.

Chapter 2.:

STATE OF THE ART:

SUSTAINABILITY PERFORMANCE

MEASUREMENT IN SUPPLY CHAIN MANAGEMENT

Nowadays many various researches on sSCM have been published. This provides a lot of framework in difference perspective. In order to understanding the principle of sSCM research field, this chapter presents an exploration of theoretical framework and existing researches on sustainable development concept, corporate sustainability, and sustainability performance measurement in supply chain management.

As the separation of three pillars of sustainability, i.e. economic, environmental and social dimensions, connections between each other were distracted. This chapter provides a background to understand current trends in this multidisciplinary field and proposes the sSCM framework for this research. Using the current literature and the result of an empirical study, the results of comparative study enhance the important role of considering the integration among core three dimensions (economic, environment and social) and how to enhance sustainability issue in supply chain management framework.

2.1. SUSTAINABLE DEVELOPMENT CONTEXT

2.1.1 WHY WE NEED SUSTAINABLE DEVELOPMENT

According to the “*Our Common Future Report*” (WECD, 1987), the sustainable development (SD) concept was developed regarding a reorganization of a threatened future. Many regions face risks of irreversible damage to the human environment. Environmental stress has often seen as the result of the increasing growth of the population, technology growth and development, and the rising living standards of the affluent.

Growth of population

The impact of increasing growth of population can be seen as a growing demand on scarce resources, which including raw-material, fossil fuels, food, and other natural elements, and the poverty. An increasing amount of resource consumption is effect to the lack of resource for future generation. The poverty can be caused of an environmental pollution by destroying their environment in order to survive, e.g. cutting down the forests; overusing marginal land; in growing numbers they will crowd into congested cities. Moreover, a deficiency of basic needs management in the community of poverty people is one of the significant causes of communicable diseases and negative impacts to human health.

Technology growth and development

An increasing of growth and development of technology and industry is also impact to increasing number of resources. Moreover, much of the improvement in the past has been based on the creation of pollution by using hazardous chemicals, disposing of toxic wastes, and generated hazardous emission. These are caused by the greenhouse effect, depletion of atmosphere ozone, and lack of good-quality natural resources (air, water, soil, ocean, etc.). The consequence of environmental pollution is negative impacts on both human health and ecosystem.

Rising of human living standards

Although to rising living standards of human can improve a quality of life and increasing a human well-being but in the other hand it leads to increase the amount of resource consumption i.e. raw-materials, food, energy, and natural resources as well. Consequently, future generation will face the scarce of resources.

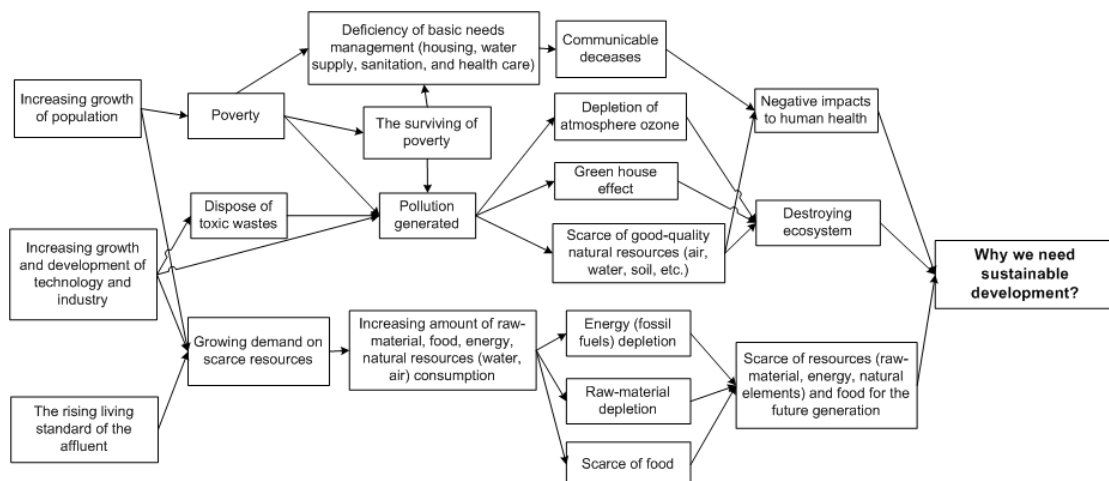

Figure 2.1 Causes and effects to develop the sustainable development concept

Figure 2.1 shows the negative impacts from these three root causes into three categories i.e. the negative impacts to human health, ecosystem distortion and the lacking of resources. An establishment of sustainable development concept begins with an environmental concern and its impacts to both human and environment. However, the conceptual of SD does not only prevent these negative impacts but also aims to enhance human resource capability which will be explained in the next section.

Human Resource Perspective

Role of human resource in sustainable development can be considered into two perspectives. In one hand, it can be considered just as numbers in term of population.

Increasing population growth rates affects to scarce natural resources situation, as we have explained in section 2.1.1. In another hand, human resource can be considered as a society asset because people are a creative resource. To enhance that asset, people’s physical well-being must be improved. Also, education must be provided to help them to become more capable and creative, skillful, and productive.

However, dealing with managing population growth is out of scope of this research work. Thus, we consider human resource only in the asset of society perspective. Human resources in supply chain are the company’s employees, customers, and people in the local community. To improve human well-being, supply chain managers should provide safety working condition for their employees, encourage an education to improve skill and knowledge, and ensure that company’s activities will not affect negative impacts to health and safety of their customer and people in the local community.

2.1.2 SUSTAINABILITY IN THE INDUSTRIAL SECTOR

Despite a multi-discipline of sustainable development context, the UN has divided areas of policy direction into six areas which is shown in Figure 2.2: population and human resources, food security, species and ecosystems, energy, industry, and the urban challenge (United Nations (UN), 1987). This research is interesting only in sustainability for industry because this work aims to develop a performance measurement system for supporting the manufacturing supply chain.

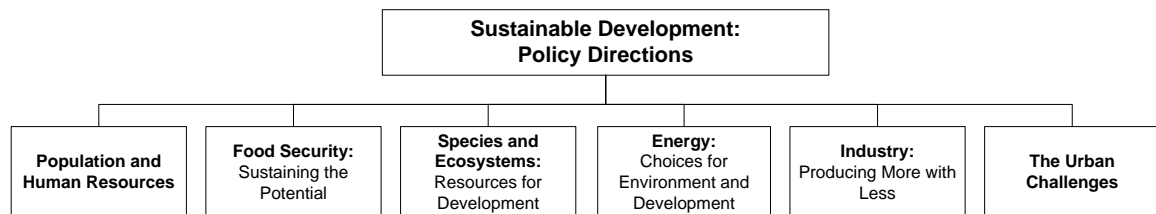

Figure 2.2 The policy directions of Brundtland Commission on sustainable development

At the beginning, industrial sector mainly focused on environmental dimension because the policy direction, which is published in Brundtland commission, aims to integrate resource and environmental considerations into industrial planning and decision-making processes of industry. This will allow a steady reduction in the energy and resources by increasing the efficiency of resource use, reducing waste, and encouraging resource recovery and recycling. The social dimension has been enhanced for sustainable industry in term of entrepreneurship responsibility after the Agenda 21, which is an action plan for sustainable development, was published in 1993. Enterprises have the responsibility to ensure that the management and utilization of natural resources and ethical management of products and process from the point view of health, safety and environmental aspects including managerial skills and technological know-how are implemented in the enterprises.

It is clearly that sustainability in the industrial sector involves with an increasing of resource utilization, reducing the quantity of waste, and taking into account of health, safety, and environmental impacts.

2.2. INTRODUCTION TO sSCM

From the 1990s, the research efforts focused to understanding the technical and operational considerations in the area of sourcing and remanufacturing of returned products (including production planning, scheduling and control, inventory management, and reverse logistics issues). Flesichmann et al (1997) focus on quantitative models of reverse logistics. They divide the reverse logistics activities into three areas, which are distribution planning, inventory control, and production planning. In 1999, Gungor and Gupta focus on environmentally conscious manufacturing and product recovery. Recycling and remanufacturing were addressed by Guidel et al. (1999), and Guide and Van Wassenhove (2002). Researchers concentrated their activities on the environmental aspects of supply chains, looking at the intra-organization of companies arising from research on supply chain management and green practices. The environmental aspects of supply chain management have been leading focus of research during 1991 – 2000. To some degree, the term ‘sustainability’ and ‘environment’ have been used interchangeably, both in academic and industrial sector. However, during 2001 – 2010, the perspectives have begun to converge, an increasingly understanding and application of the term sustainability as an intersection between three dimensions of the TBL (Carter and Easton, 2011). The social dimension was recognized as corporate social responsibility (CSR) over the last 10 years.

Since the 2000s, the interaction between sustainability and supply chain became critical (Corbett and Kleindorder, 2003). The research focus extended to various sustainability themes related to operational aspects; including concepts such as environmental management, reverse logistics, closed-loop supply chain, and product lifecycle management (PLM). While important contributions have been made in relation to a wide range of topics including environmental operations and policy, strategy, finance, product design, supplier relationships and customer management, it became critical to move forward to the systemic issues that exist at the intersection of sustainability, environmental management, and supply chains (Linton et al., 2007). The researchers were trying to develop the conceptual framework of green supply chain management (GSCM) and sSCM. The concept of GSCM has been developed by Sarkis (1999). After that, Zhu and Sarkis, (2004); Zhu et al., (2012, 2005) have adopted this conceptual framework in an empirical researches on GSCM in China industry. Carter and Rogers (2008) use conceptual theory building for setting the foundation of sSCM theory. The core of this conceptualization is Elkington’s TBL: intersection of economic, environmental, and social performance. This framework provides guidelines for further theory development including in the area of performance measurement.

At the same time, several studies focused on analytical models to implement sustainability: practices ((Sarkis, 1999; Zhu and Sarkis, 2004; Zhu et al., 2005), supplier selection (Bai and Sarkis, 2010; Hutchins and Sutherland, 2008; Lee et al., 2009; Tseng and Chiu, 2013), production (Veleva et al., 2001), and product lifecycle concept (Seuring, 2011, 2004). The analytical models are performed based on the conceptual framework of sustainability and/or sSCM. However, converting sustainability from conceptual framework to analytical models exists as research challenges. It was clear the matter was not only about models or tools aiming to analyze one (or more than one) sustainability dimension but to extend them to a new holistic view.

The sustainability studies about supply chains extended beyond the core of traditional supply chain management and tried to improve and refine concepts like product lifecycle extension, product end-of-life issues, environmental and social impacts in operational management across the supply chain. Consequently the sustainability performance measurement is one of the pillars to support achievement of sustainability implementation.

2.3. CONCEPTUAL FRAMEWORK

While sustainable supply chain management could have considered a hot topic in both of academic research and corporate practicable side but the limited implementation and integration between sustainable and supply chain management can be observed (Carter and Rogers, 2008; Seuring et al., 2008; Teuteberg and Wittstruch, 2010). One possible reason for this is that sustainability is an immaterial value which eludes a precise mathematical definition or economic monitoring. In order to measure sustainability performance in supply chain, first we have to enhance the features in this issue. Therefore, a feature of the sustainability issue is clarified by analyzed conceptual frameworks of sustainable development and sustainable supply chain management (sSCM) (Santiteerakul et al., 2010).

There are various conceptual frameworks in sSCM but one of the most referred conceptual frameworks is the triple bottom line (TBL), which is proposed by (Elkington, 1999) This framework divides sustainability into three dimensions, i.e. economic, environment and society. The other frameworks are derived based on the TBL. The six conceptual frameworks of sustainable development and sustainable supply chain management (sSCM), which are shown in Figure 2.3, are analyzed. The first three frameworks (Figure 2.3 (a) to (c)) (Elkington (1998), Gidding et al. (2002)) relate on three components (economic, environment, and social) with different relation perspectives among the components. The others three frameworks (Figure 2.3 (d) to (f)) (Carter and Rogers, 2008; Mongsawad, 2009; Teuteberg and Wittstruch, 2010) are derived base on the TBL model and adding business functions or support contributions for sSCM.

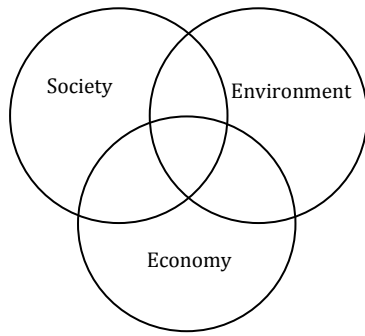

(a) Triple bottom line (TBL)

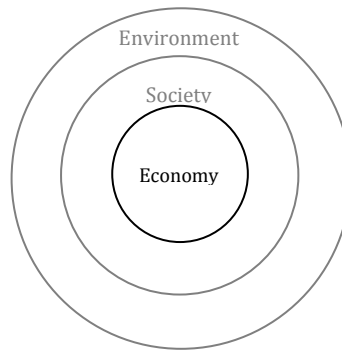

(b) Nested model

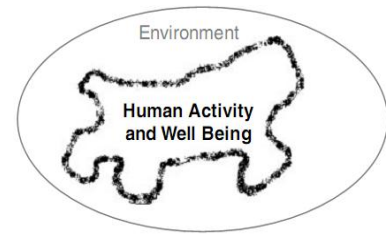

(c) breaking down boundaries

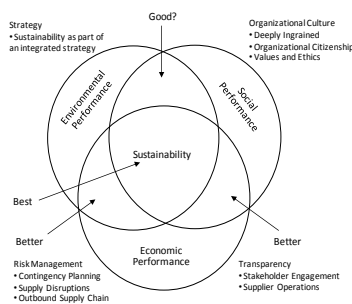

(d) TBL+4 facets

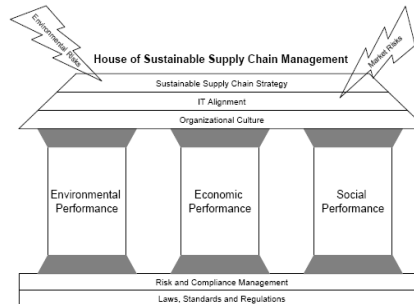

(e) House of sSCM

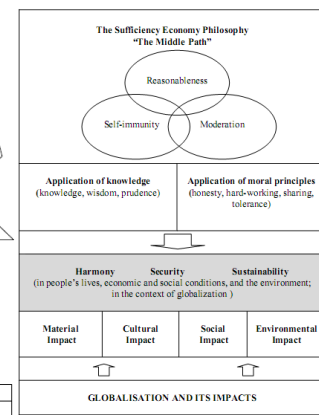

(f) Sufficiency economy

Figure 2.3 Conceptual framework of sustainable development and sSCM

According to the comparative of frameworks as shown in Table 2.1, the first group points out that economic, environmental and social dimension have an interrelation among sectors. Considering only economic-environmental or economic-social sector cannot achieve sustainability goals. We cannot separate the impacts of human actions into distinct compartment. Thus, sustainable development will be an integrated of three dimensions with a relation among components.

Research Proposition 1: The term sustainability consists of three components which are economic, environmental and social dimension.

As the second group, sustainability in the supply chain management perspective does not focus only three dimensions but also others support components. A long-term perspective is enhanced in term of risk management, transparency, knowledge and morality conditions, and ethical issues.

Research Proposition 2: A long-term perspective should be taken into account for measuring sustainability performance in supply chain.

Table 2.1: Conceptual framework analysis

Conceptual Framework	Description	Dimensions				
		ECN	ENV	SOC	LT	SCM
Triple Bottom Line (TBL) (Elkington, 1998)	The TBL consist of three components: the natural environment, society, and economic performance. At the intersection of all three components, there are activities that organizations can engage in which not only positively affect the natural environment and society, but also result in long-term economic benefits and competitive for the firm.	×	×	×		
Nested Model (Gidding, et al., 2002)	This model presents The relationship between society, economy and environment. The nested model was formed based on the idea that all human activities occur in the environment. The economy or market activity is part of the society, and without it the economy cannot emerge. Placing the economy in the center does not mean that it should be seen as the hub around which the other sectors and activities revolve. Rather it is a subset of others and is dependent upon them. Human society depends on the environment although in contrast the environment would continue without society (Lovelock, 1988). The ‘Nested’ model rather than the TBL model encourages a conceptual outlook sympathetic to integration.	×	×	×		
Breaking Boundaries (Gidding, et al., 2002)	This model based on the idea that all activities occurring in the society and the economy can be counted toward human activity and which contribute to people’s well-being. Hence, the boundary between the society and the economy has been eliminated. These human activities have impacts on the environment. Of course, human well-being significantly depends on these interactions. This close relationship between the environment and humans is represented by the fuzzy boundary between the two. To achieve sustainable development, we cannot separate the environment from human activities. What humans have taken from the environment and have done to the environment will reflect on human well-being.	×	×	×		
TBL+4 facets (Carter and Roger, 2008)	Carter et al. (2008) defined the sSCM which based on the TBL and the four supporting facets of sustainability – risk management, transparency, strategy, and cultured. Interrelationship among the four supporting facets is not intended to be entire mutually exclusive. They advocate that all four of these supporting facets are an integrated part of sSCM practices.	×	×	×	×	×
House of sSCM (Teuteberg, et al., 2010)	The three dimensions of sustainability are visualized here as pillars which are necessary to maintain balance. Risk and compliance management form the building’s foundation. In order to achieve long-term profits, all the potential risks must be identified and mitigated. Laws, guidelines and standards serve as a starting point for the implementation of sustainability principles and practices along the supply chain. In addition, sSCM requires the establishment of values and ethics throughout the organization, an efficient, and flexible and “green” IT environment as well as the alignment of corporate strategy to sustainable development. If these measures are taken, they effectively protect the network against environmental and social threats and risks. Most of these compliances bring supply chain to sustainability.	×	×	×	×	×
Sufficiency economy (Mongsawad, 2009)	The three rings represent the three principles, which are moderation, reasonableness and self-immunity. The knowledge and morality content are two necessary conditions to achieve the three main principles. The knowledge condition requires a thorough study of all available information and experience in order to make prudent decisions. The morality condition stresses integrity, trustworthiness, honesty and the hard-work of individuals. By practicing Sufficiency Economy, people would live in harmony and with security in a sustainable society and environment; and they would be able to tolerate and cope with all kinds of malign impacts of globalization.	×	×	×	×	

ECN: relating to economic perspective, ENV: relating to environmental perspective, SOC: relating to social perspective, LT: relating to the long-term development perspective, SCM: relating to supply chain management perspective

2.4. CHARACTERISTICS OF SSCM

The three dimensions categorization can explain SD context in philosophical level. However, it does not provide many guidance on how these models should be implemented at company and supply chain level. Elkington (1999) suggested that a business need to measure and report economic, social, and environmental business performance in order to achieve corporate sustainability. This requires an interpretation of economic, social, and ecological performance in order to investigate sustainability strategy and transfer to tactical and operational implementation. However, the complexity of sustainability in supply chain is due to the presence a large number of factors and interactions among these elements. The presence of direct or indirect related elements complicates the structure of the system. It becomes difficult to deal with such a system in which the structure is not clearly defined. Thus, it needs the process that transforms an unclear sustainability terminology into a visible and well-defined structure.

The supply chain management (SCM) concept has been introduced since 1980s. It has been used to describe the planning, and control of materials, information flows, and the logistics activities within the company and between companies (Lambert et al., 1998). The growing interest in SCM has led to the development of various definitions to describe its characteristics. The SCM focuses on managing flows of materials, services, and information in order to meet the needs of customers and stakeholders (Lambert et al., 1998). There is a clear emphasis on the need for coordination within and between firms (Lambert et al., 1998; Mentzer et al., 2001). Burgess et al. (2006) identified the key themes in supply chain management as intra-and inter-organizational relationships, logistics process, information system, and business results and outcomes. Thus, the key characteristics of SCM may be expressed as: (1) flow focus, (2) coordination focus, (3) stakeholder focus, (4) intra-and inter-organizational processes, and (5) performance focus.

The performance focus of sSCM can be considered as a sustainability performance in supply chain. The conceptual frameworks of sSCM enhance an integration of TBL and long-term perspective as key components of the sustainability issue. Sustainability in a corporate and supply chain context should focus on these two components. Moreover, the sustainability drivers are pressed by stakeholder needs (Dyllick and Hockerts, 2002). Hence the key characteristics of sustainability may be expressed as (1) economic focus, (2) environmental focus, (3) social focus, (4) long-term focus, (5) stakeholders focus.

In order to understanding sustainability characteristics (integrating at least environmental or social performance with economic performance) in supply chain management, the exploration of definition of corporate sustainability, GSCM, and sSCM are provided. The definitions of business sustainability are shown in Table 2.2,

definitions of GSCM are shown in Table 2.3 and definitions of sSCM are shown in respectively.

Table 2.2 Definitions of corporate sustainability

Source	Definition
Deloitte and Touche, 1992	Adopting business strategies and activities that meet the needs of the enterprise and its stakeholders today while protecting, sustaining and enhancing the human and natural resources that will be needed in the future.
Figge et al., 2002	An improvement of corporate performance in all three dimensions of sustainability - economic, environmental, and social- simultaneously.
Dyllick and Hockerts, 2002	Corporate sustainability can accordingly be defined as meeting the needs of a firm's direct and indirect stakeholders (such as shareholders, employees, clients, pressure groups, communities, etc.)
Sikdar, 2003	Business strive to be sustainability by practicing cleaner technologies, recycling by-products, eliminating waste products, reducing emissions of GHGs, eliminating the use of toxic substances, and reducing energy intensity of processes.
Marrewijk, (2003)	Corporate sustainability refers to company activities - voluntary by definition- demonstrating the inclusion of social and environmental concerns in business operations and interactions with stakeholders.
Szekely and Knirsch, 2005	Sustainability is about building a society in which a proper balance is created between economic, social and ecological aims.

Table 2.3 Definitions of green supply chain management (GSCM)

Source	Definition
Handfield et al., 1997	Application of environmental management principles to the entire set of activities across the whole customer order cycle, including design, procurement, manufacturing and assembly, packaging, logistics, and distribution.
Zhu et al., 2005	Green Purchasing + Green Manufacturing/Materials Management + Green Distribution/Marketing + Reverse Logistics
Srivastava, 2007	Integrating environmental thinking into supply-chain management, including product design, material sourcing and selection, manufacturing processes, delivery of the final product to the consumers as well as end-of-life management of the product after its useful life.
Lee and Klassen, 2008	A buying organization's plans and activities that integrate environmental issues into supply chain management in order to improve the environmental performance of suppliers and customers
Wee et al., 2011	Integration of environment considerations into supply chain management, including product design, material sourcing and selection, manufacturing processes, delivery of the final product to the consumers, and end-of-life management of the greening products.
Sarkis et al., 2011	Integrating environmental concerns into the inter-organizational practices of SCM including reverse logistics.

Table 2.4 Definitions of sustainable supply chain management (sSCM)

Source	Definition
Jorgensen and Knudsen, 2006	The means by which companies manager their social responsibilities across dislocated production processes spanning organizational and geographical boundaries.
Carter and Rogers, 2008	The strategic, transparent integration and achievement of an organization’s social, environmental, and economic goals in the systemic coordination of key inter-organizational business processes for improving the long-term economic performance of the individual company and its supply chains
Seuring and Muller, 2008	The management of material, information and capital flows as well as cooperation among companies along the supply chain while taking goals from all three dimensions of sustainable development i.e. economic, environmental and social, into account which are derived from customer and stakeholder requirements.
Seuring 2008	The integration of sustainable development and supply chain management by merging these two concepts, environmental and social aspects along the supply chain have to be taken into account, thereby avoiding related problems, but also looking at more sustainable products and processes.
Ciliberti et al., 2008	The management of supply chain where all the three dimensions of sustainability, namely the economic, environmental, and social ones, are taken into account.
Font et al, 2008	Adding sustainability to existing supply chain management processes, to consider environmental, social and economic impacts of business activities.
Pagell and Wu, 2009	The specific managerial actions that are taken to make the supply chain more sustainable with an end goal of creating a truly sustainable chain.
Haake and Seuring, 2009	The set of supply chain management policies held, actions, taken, and relationships formed in response to concerns related to the natural environment and social issues with regard to the design, acquisition, production, distribution, use, reuse, and disposal of the firm’s goods and services.
Wolf, 2011	The degree to which a manufacturer strategically collaborates with its supply chain partners and collaboratively manages intra- and inter-organization processes for sustainability.

Theses definitions are analyzed in term of five characteristics of SCM and five characteristics of the sustainability issue. However, the intra-and inter-organizational business processes and the sub-dimension of each bottom line will be extracted in order to make a clearly defined on the sustainability terminology.

Table 2.5 Key SCM characteristics addressed by the definitions

Source	SCM Characteristics					Highlighted of intra/inter organizational processes
	Flow focus ^a	Coordination focus ^b	Stakeholder focus ^c	Intra/Inter organization processes ^d	Performance focus ^e	
GSCM						
Handfield et al., 1997	X	X	X	X		Design, procurement, manufacturing and assembly, packaging, logistics, and distribution.
Zhu et al., 2005				X		Purchasing, manufacturing management, material management, distribution, marketing,

Source	SCM Characteristics					Highlighted of intra/inter organizational processes
	Flow focus ^a	Coordination focus ^b	Stakeholder focus ^c	Intra/inter organization processes ^d	Performance focus ^e	
GSCM						
						reverse logistics.
Srivastava, 2007	X	X	X	X		Product design, material sourcing and selection, manufacturing processes, delivery, end-of-life management
Lee and Klassen, 2008	X	X	X		X	
Wee et al., 2011	X	X	X	X		Product design, material sourcing and selection, manufacturing processes, delivery, and end-of-life management.
Sarkis et al., 2011	X	X		X		Reverse logistics
sSCM						
Jorgensen and Knudsen, 2006		X		X		Production processes
Carter and Rogers, 2008		X		X	X	Key inter-organizational business processes
Seuring and Muller, 2008	X	X	X		X	
Seuring 2008	X	X				
Ciliberti et al., 2008	X	X				
Font et al, 2008	X	X		X		Business activities
Pagell and Wu, 2009		X			X	
Haake and Seuring, 2009	X	X		X		Design, acquisition, production, distribution, use, reuse, and disposal
Wolf, 2011		X		X		Intra-and inter-organizational business processes

^aFlow focus: The definition includes language related to the flows of materials, services, or information. Reference to the supply chain management is considered to implicitly refer to this area.

^bCoordination focus: The definition includes reference to coordination within or between organizations. Reference to the supply chain management is considered to implicitly refer to this area.

^cStakeholder focus: The definition includes explicit reference to stakeholder, including customers, suppliers, consumers.

^dIntra/Inter-organizational processes: The definition includes intra-and inter-organizational processes, including business processes, reverse logistics, end-of-life management

^ePerformance focus: The definition includes reference to performance, including applying performance measure, improving performance and achieving goals.

^fHighlighted of intra/inter-organizational processes: The definition enhances key intra-or inter-organizational processes.

Table 2.6 Key sustainability or green characteristics addressed by the definitions

Source	SCM Characteristics					Highlighted sub-dimension of triple bottom line ^f
	Economic focus	Environmental focus	Social focus	Long-term focus	Stakeholder focus	
Corporate sustainability						
Deloitte and Touche, 1992		X	X	X	X	Human resources, natural resources
Figge et al., 2002	X	X	X			(N/A)
Dyllick and Hockerts, 2002	X	X	X		X	(N/A)
Sikdar, 2003		X		X		Cleaner technologies, recycling by-products, waste products, GHGs emission, toxic substances, energy intensity
Marrewijk, (2003)		X	X		X	(N/A)
Szekely and Knirsch, 2005	X	X	X			(N/A)
GSCM						
Handfield et al., 1997		X				(N/A)
Zhu et al., 2005		X				(N/A)
Srivastava, 2007		X		X	X	(N/A)
Lee and Klassen, 2008		X			X	(N/A)
Wee et al., 2011		X		X	X	(N/A)
Sarkis et al., 2011		X		X		(N/A)
sSCM						
Jorgensen and Knudsen, 2006			X			(N/A)
Carter and Rogers, 2008	X	X	X	X	X	(N/A)
Seuring and Muller, 2008	X	X	X		X	(N/A)
Seuring 2008		X	X			(N/A)
Ciliberti et al., 2008	X	X	X			(N/A)
Font et al, 2008	X	X	X			(N/A)
Pagell and Wu, 2009	X	X	X			(N/A)
Haake and Seuring, 2009		X	X		X	(N/A)
Wolf, 2011	X	X	X		X	(N/A)

^aEconomic focus: the definition includes language related to the economic dimension

^bEnvironmental focus: the definition includes language related to the environmental dimension

^cSocial focus: the definition includes language related to the economic dimension

^dLong-term focus: the definition includes reference to the long-term nature of sustainability. Reference to end-of-life management, reuse, recycle, product recovery, reverse logistics, the product lifecycle are taken as indication of a long-term focus.

^fHighlighted sub-dimension of triple bottom line: The definition which enhances sub-dimensions or categories in at least one bottom line (economic, environmental, social).

In the definitions for GSCM and sSCM, the analysis results of SCM characteristics are shown in Table 2.5. found that the most commonly addressed SCM characteristics are coordination focus, flow focus, and intra-and inter-organizational processes. The coordination focus was addressed in 14 (93%) definitions, while flow focus and intra-and inter-organizational processes each were appeared in 10 (67%) definitions. The coordination and flow characteristics were addressed implicitly through the use of terms “supply chain management” in definitions. The highlighted of intra-organizational processes commonly respect to flow of material from product design, sourcing/purchasing, production, and delivery or distribution. The inter-organizational processes in GSCM and sSCM extend beyond traditional supply chain by considering reverse logistics and product’s end-of-life management. Of the remaining of SCM characteristics, four (27%) of the definitions addressed the performance focus.

The results of definition analysis in term of sustainability or green characteristics are shown in

Table 2.6. In the published definition of GSCM, all of the definitions were addressed only environmental dimension. The focus on environmental issues was to be expected given the nature of term “GSCM”, which clearly emphasizes this dimension of sustainability. Some of definitions addressed the long-term focus and stakeholder focus categories. Three (50%) of definitions demonstrated some focus on the long-term perspective. Srivastava, (2007) and Wee et al. (2011) indicated long-term focus through product’s end-of-life management. While (Sarkis et al., 2011) referenced this through reverse logistics. Only three (33%) definitions demonstrated focus on stakeholders. The stakeholders that were mentioned included consumers (Srivastava, 2007; Wee et al., 2011), suppliers, and customers (Lee and Klassen, 2008).

An analysis of corporate sustainability and sSCM definitions found that although all three dimensions of TBL were explicitly addressed, they were not present in all suggested definitions. Nine (60%) of corporate sustainability and sSCM definitions were addressed all three dimensions of TBL. While four (27%) were addressed environmental and social focus (Deloitte and Touche, 1992; Haake and Seuring, 2009; Marrewijk, 2003; Seuring et al., 2008). Jorgensen and Knudsen, 2006 were the only authors that focus in only social dimension. Sikdar, (2003) was the only author that focused in only environmental dimension. The focus on the long-term perspective was addressed by three definitions (Carter and Rogers, 2008; Deloitte and Touche, 1992; Sikdar, 2003). Seven (47%) definitions addressed the stakeholder focus characteristics. Stakeholders were broadly referred to in three definitions, while the others mentioned suppliers, customers.

The highlighted sub-dimension of triple bottom line would help researchers or manager in narrow focus in order to implement sustainability practices in supply chain. Unfortunately, only two definitions (9%) indicated some sub-dimension of TBL. Deloitte and Touche, (1992) referred human resources in the social dimension and natural resources in environmental dimension. Sikdar, (2003) who focused only environmental dimension indicated cleaner technologies, waste, greenhouse gas (GHG) emission, toxic hazardous, and energy as related issues in sustainability. Other authors were broadly addressed the sustainability dimensions respect to the TBL.

It is clearly that the sustainability terminology is still broadly and poorly defined in order to achieve in company or supply chain level. The well-defined of sub-dimension or categories in each TBL dimension is one of the challenges in sSCM research field. This thesis will fulfill this gap by developing conceptual framework which transforms the TBL philosophy into strategic, tactical, and operational level of implementation.

Research Proposition 3: The terminology of “sustainability” should be defined in order to translate the philosophy into strategic, tactical, and operational level for companies.

2.5. MANAGING SUSTAINABILITY IN INDUSTRIAL SECTOR

In the field of sSCM academic research, several ideas are adopted to address sustainability in the industrial sector e.g. product lifecycle, green supply chain, sustainable supply chain, industrial ecology.(Seuring, 2004) enhanced that the concepts of lifecycle management (LCM), environmental supply chain management (ESCM), and sSCM relate to an integration of company strategies and business activities to achieve environmental (or sustainable) performance. The difference point of these two concepts is LCM emphasizes environmental and/or social impacts of products during each product life-cycle phase (design, manufacturing, use, and disposal). Meanwhile, ESCM and sSCM emphasize the managerial on business processes and collaboration with company's network. Hence, this thesis divides the sustainability management in business into two aspects, i.e. product (Beamon, 2008; Seuring and Müller, 2008; Seuring, 2011, 2004) and process (Clark, 2007; Dyllick and Hockerts, 2002; Epstein and Roy, 2001)(Clark 2007; Dyllick and Hockerts 2002; Epstein and Roy 2001) point of view.

Table 2.7 Sustainability in product and process point of view

	Product point of view	Process point view
Principle	Product sustainability	Corporate sustainability
Drivers	RoHS, WEEE, EuP, energy labeling, eco-label	Sustainability competitiveness
Concepts	Product lifecycle assessment (LCA), Product lifecycle management (PLM), Extended product responsibility (EPR), Product end-of-life (EOL)	Corporate social responsibility (CSR), Green supply chain management (GSCM), Sustainable supply chain management (sSCM), reverse logistics, cleaner production, close-loop supply chain
Standards/ Guide lines	LCA: ISO14040, ISO14044, ISO14048, ISO14049 Environmental label: ISO14020 Eco-design: ISO14006 Carbon-footprint: ISO14067	QMS: ISO9001 EMS: ISO14001, ISO14004, ISO14031 H&S MS: OHSAS 18000, OHSAS 18001 Social: SA8000, AA1000, ISO26000, GRI Risk MS: ISO31000
Area of interest	Product/process design and development, remanufacturing/reuse /recycle product, product lifecycle	Sustainable management, Sustainable purchasing, Sustainable production, Sustainable transportation/distribution, reverse logistics
References	Beamon (2008), Seuring (2004, 2011), Seuring and Muller (2008)	Clark (2007), Dyllick and Hockerts(2002), Epstein and Roy (2001)

2.5.1 SUSTAINABILITY IN PRODUCT POINT OF VIEW

Sustainability in product point of view is focusing on economic, environmental, and social performance of product lifecycle. The pressure from regulations, laws and standards drives companies to take environmental impacts into account. For example, the European Union (EU) has adopted three main regulatory instruments in order to improve the environmental lifecycle performance of electrical and electronic equipment (EEE): the EuP, RoHS and WEEE Directives. The WEEE and RoHS Directives deal mainly with waste and hazardous substances, hence, components and material of products

should be designed to comply with the reuse/recycle/recovery conditions in WEEE and the use of hazardous substances in RoHS. Meanwhile EuP is wider in scope and has the potential to regulate the number of lifecycle-related impacts and provide producers with incentives for ecodesign. Moreover, there are other directives that related to product point of view such as the Energy label and the European Eco-label.

The concepts of lifecycle assessment (LCA), product lifecycle management (PLM), extended product lifecycle responsibility (EPR), and product end-of-life (EOL) are adopted to manage or assess sustainability performance of products (Beamon, 2008; Seuring, 2004). In practical, there are various standards and guidelines which help companies to implement these concepts in sustainability assessment as follow:

- **Lifecycle assessment:** ISO14040 (principles and guidelines), ISO14044 (requirements and guidelines), ISO14048 (data documentation format), ISO14049 (examples of application of ISO 14041 to goal and scope definition and inventory analysis)
- **Environmental label and declaration:** ISO14020 (general principles), ISO14021 (self-declared environmental claim: type II environmental labeling), ISO14024 (self-declared environmental claim: type I environmental labeling), ISO14025 (self-declared environmental claim: type III environmental labeling),
- **Eco-design:** ISO14006 (guideline for incorporating eco-design), ISO14062 (integrating environmental aspects in product design and development)
- **Carbon-footprint:** ISO14067(carbon footprint of products -- requirements and guidelines for quantification and communication)

The standards and guidelines are more focus on environmental impacts- by evaluating material and energy consumption, natural resources consumption (water, electricity), waste generated, pollution emission, carbon emission- of the products in each lifecycle phase. The social impacts are considered in term of customer's health and safety in a use phase attempting to reduce hazardous substances of the product in a design phase. It is difficult to consider other social issues e.g. human rights, child labor, local community, etc. in term of product impacts because these issues are more relate to management approach of the company than the sustainability of the products. Hence, these social issues should be taken into account in the process point of view, which will be explained in the next section.

2.5.2 SUSTAINABILITY IN PROCESS POINT OF VIEW

Sustainability in the process point of view is focusing on business activities of companies and its network. This view interests in how companies manage or integrate sustainable development concept into their strategies and how companies implement sustainability practices in their business activities. According to (Clark, 2007), process-oriented strategies can effectively reduce the environmental impact associated with product

design and manufacturing. The concept of corporate social responsibility (CSR), green supply chain management (GSCM), sustainable supply chain management (sSCM), reverse logistics, cleaner production, close-loop supply chain are adopted in this point of view.

Business processes in supply chain management can be divided regarding flow of material. Sarkis (1999) defined the supply chain as a system that includes purchasing and inbound logistics, production and distribution (outbound logistics and marketing), and reverse logistics. The Supply Chain Operations Reference (SCOR) model (SCC, 2010, 2008) has been developed to describe business activities in supply chain. This model is organized around the five primary business processes i.e. plan, source, make, deliver, and return. The SCOR model can measure economic performance in term of cost, assets, reliability, responsiveness, and agility of supply chain. According to the sustainability concerns, the Supply Chain Council has developed GreenSCOR model that focuses only environmental impacts regarding to five primary business processes. In GreenSCOR model, the environmental impacts are measured in term of (1) carbon-emission (2) air pollutant emission (3) liquid waste generated (4) solid waste generated and (5) percent recycled waste. In order to integrate sustainable development concept with business and/or supply chain management, many researchers considered sustainability practices and sustainability performance associated with business process.

Even though, the purpose of sustainable development is to integrate environmental and social issues into economic development but an implementation of the social dimension has not received due attention in sSCM (Gunasekaran and Spalanzani, 2012; Seuring and Müller, 2008). Thus, this research includes the GSCM concept into the analysis in order to extract sustainability practices of supply chain in environmental issue. Sarkis (1999) proposed significant practices in GSCM associated with purchasing and inbound logistics, production and distribution, and reverse logistics. Zhu and Sarkis (2004) and Zhu et al., (2012) modified Sarkis's model and enhanced an important of eco-design for a GSCM practices.

The research works associated with sSCM are discussed here. (Zailani et al., 2012) use a survey method to investigate the extent of implementation on sSCM practices among 400 manufacturing firms in Malaysia. Although Zailani et al. discussed on sustainability practices but almost of the practices on their proposed model are environmental practices. There are only two practices related to social issues, e.g. using packaging which made from materials healthy in all end-of-life scenarios; and using packaging which beneficial, safe and healthy for communities throughout its lifecycle. Gunasekaran and Spalanzani (2012) classified sSCM literatures in term of sustainability in product/process design and development, sustainability in supply operations, sustainability in production operations, sustainability in distribution operations, sustainability through remanufacturing, recycling, and reverse logistics. They discussed

sustainability practices from literatures in each business process. The significant sustainability practices associated with business activities are shown in Table 2.8.

From literatures, we found that companies can implement sustainability practices in respect of business process (or activity). The product/process design and development activity are enhanced as a significant issue for GSCM and sSCM and it grows significantly in the academic field of the sustainable product development as it is already discussed in section 2.5.1.

Reverse logistics incorporates the return of materials, components and products, which resulting from reuse, recycling, or disposal with minimization of waste, back into the forward logistics. This issue is taken sustainability practices into account for a close-loop supply chain (Gunasekaran and Spalanzani, 2012). Research issues in reverse logistics include logistics network design, inventory management, and product design for disassembly (Sarkis, 1999). Nonetheless, this thesis does not focus on close-loop supply chain or end-of-life phase. Hence, the reverse logistics activity is not included in the proposed model.

In practical term, managers can adopt existing standards and guidelines associated to sustainability issues for managing sustainability performance in the companies as follow:

- **Quality management system:** ISO 9001 (Quality management)
- **Environmental management system:** ISO14001 (Requirements with guidance for use), ISO14031 (Environmental performance evaluation – guidelines)
- **Health and safety management system:** OHSAS18000 (Occupational health and safety management system) OHSAS 18001 Occupation health and safety assessment series)
- **Social:** SA 8000 (Social accountability), AA 1000 (Account ability), ISO 26000 (Corporate social responsibility), GRI (Global Reporting Initiative)
- **Risk management:** ISO31000 (Risk management)

This research aims to integrate all three dimension of sustainability and tries to reduce the research gaps on social dimension issue. According to section 2.5.1, it is difficult to allocate social impacts into product point of view. Therefore, we focus on sustainability in process point of view.

Research Proposition 4: Develop a sustainability measurement model based on the process point of view.

Table 2.8 Sustainability practices associated with business activities

References	Product design and development	Supply operation	Production and operation	Distribution	Reverse, remanufacturing
Sarkis (1999)	(N/A)	<ul style="list-style-type: none"> Green Purchasing Vendor selection Mode of transport selection Just In Time (JIT) 	<ul style="list-style-type: none"> Total quality environmental management (TQEM) Demanufacturing Close-loop manufacturing 	<i>Customer relationship</i> <ul style="list-style-type: none"> Green marketing Product stewardship <i>Outbound logistics</i> <ul style="list-style-type: none"> Warehousing design Delivery design Packaging design 	<ul style="list-style-type: none"> Managing reverse logistics channels
Zhu et al. (2004), (2012)	<i>Eco-design</i> Design of product for <ul style="list-style-type: none"> Reduce material/energy consumption Reuse, recycle, recover of materials Avoid or reduce use of hazardous substance in products and process 	<i>Green Purchasing</i> <ul style="list-style-type: none"> Supplier's environmental auditing programs Cooperation with suppliers on environmental objectives Supplier's ISO14000 certification Second-tier supplier environmentally friendly practice 	<i>Internal GSCM practices</i> <ul style="list-style-type: none"> Total quality environmental management (TQEM) Environmental management system (EMS) Commitment of GSCM from managers Cooperation for environmental improvements Environmental compliance and auditing programs ISO 14001 certification 	<i>Customer cooperation</i> Cooperation with customer for <ul style="list-style-type: none"> Eco-design Cleaner production Green packaging 	<i>Investment recovery</i> <ul style="list-style-type: none"> Investment recovery of excess inventories /materials Sales of scrap and used materials Sales of excess capital assets
Zailani et al. (2012)	<i>Sustainable packaging</i> <ul style="list-style-type: none"> Effectively recovered and utilized package Beneficial, safe, and 	<i>Environmental purchasing</i> <ul style="list-style-type: none"> Purchased recycled packaging 	<ul style="list-style-type: none"> Cleaner production 	(N/A)	(N/A)

References	Product design and development	Supply operation	Production and operation	Distribution	Reverse, remanufacturing
	<p>healthy for communities</p> <ul style="list-style-type: none"> • Physical designed to optimized materials and energy • Sourced, manufactured, transported and recycled using renewable energy • Meet markets criteria • Made from materials healthy in all end-of-life scenarios 	<ul style="list-style-type: none"> • Purchase lighter weight packaging • Participates in the design of product for disassembly • Participates in the design of product for recycling or reuse • Use LCA to evaluate environmental impacts • Ask supplier to commit to waste reduction 			
Gunasekaran and Spalanzani (2012)	<ul style="list-style-type: none"> • Compliance with eco-label • Using life-cycle thinking to design product • Design for reuse, remanufacture, recycle products • Look at sustainability from a closed loop SC perspective 	<ul style="list-style-type: none"> • Technological integration with major suppliers and customers for environmental monitoring and evaluation • Selecting supplier with ISO14001 certification • Green procurement 	<ul style="list-style-type: none"> • Pollution prevention • Cleaner production • Extended producer responsibility • Using LCA to evaluate environmental impact of manufacturing process • Waste minimization 	<ul style="list-style-type: none"> • Design of sustainable logistic networks (but the criteria concern only economic and environmental) 	<ul style="list-style-type: none"> • Hazardous-waste reverse logistics management • Using concept of extended product responsibility (EPR) • Using reverse logistics concept to manage end-of-life products/wastes.

2.6. STANDARDS AND GUIDE LINES RELATED TO SUSTAINABILITY ISSUES

For using management system (MS), the most widely implemented are the ISO standards. The MS which relate to sustainable supply chain management can be grouped into three categories following the TBL concept:

- (1) quality management system (e.g. ISO 9001:2000, ISO 9004: 2000, ISO 31000: 2009, ISO 28000: 2007) which relate to economic performance),
- (2) environmental management system (e.g. ISO14001, ISO14004, ISO14301) which relate to environmental performance,
- (3) standards relate to social performance which are work health and safety (WHS) management system (e.g. OHSAS18001, and AS/NZS 4801:2001) and corporate social management system (e.g. ISO26000, SA8000, AA1000).

This thesis divides management systems that involve sustainability and supply chain context into three groups following sustainable dimensions: economic, environmental and social (Santiteerakul et al., 2010). Category of sustainable dimension and management systems are illustrated in Table 2.9

Organizations do not directly evaluate sustainability performance through these management systems but they can adopt and integrate sustainable development concept through these management systems. These management systems include standard and guideline requirements from existing management systems.

All of the management systems use PDCA principle even do not provide performance metrics and indicators but organizations are required to establish and maintain procedures to monitor and measure their performance in Check and Action phase (except ISO 14301, which is a standard that gives guidance on the design and use of environmental performance evaluation (EPE)). Moreover, these MS provide organization know 'how' to manage and improve their performance.

Table 2.9 Category of sustainable dimension and management system

Sustainable Dimension	Considered Management System
Economic	Quality management system: ISO 9001:2000, ISO 9004: 2000 Risk management system: ISO 31000: 2009 Supply chain security management system: ISO 28000: 2007
Environmental	Environmental management system: ISO 4001, ISO 4004, EMAS, ISO14301
Social	Workplace, health and safety management system: AS/NZS 4801:2001, OHSAS 18001:1999 Corporation Responsible management system:

Sustainable Dimension	Considered Management System
	SA 8000, AA 1000, ISO 26000

2.6.1 ECONOMIC DIMENSION

Economic or generic performance dimension relate with quality, risk management and supply chain security performance. The well-known quality management standard is ISO 9001:2000. ISO 9001:2000 promotes the adoption of a process approach when developing, implementing, and improving the effectiveness of a QMS to enhance customer satisfaction by meeting customer requirements. It was developed, together with ISO 9004:2000, as a consistent pair of QMS standards which have been designed to complement each other but can also be used independently (International Organization for Standardization 2000).

ISO 31000 is a risk management: principles and guidelines. It suggests risk management framework processes and activities that should be followed to help organizations better meet their goals and objectives by using PDCA (Plan-Do-Check-Action) principle. It is non-certifiable but does provide guidance on best practices.

ISO 28000 is a specification for security management systems for the supply chain. The PDCA management systems structure was adopted in this standard. Integrate the paradigm of risk, security and supply chain management.

2.6.2 ENVIRONMENTAL DIMENSION

Environmental dimension relates with environmental management system (EMS). EMS determines the organization's environmental policy, objectives and targets. ISO 14001 specifies the requirements for an EMS that may be audited for certification. ISO 14004 (environmental management systems – general guidelines on principles, systems, and supporting techniques) (International Organization for Standardization 2004a) only provides guidance to help an organization establish, implement and improvement EMS.

The other recognized standard in the area is the “*Eco Management and Audit Scheme*” (EMAS) standard of the European Commission. (European Council 2001) Both ISO and EMAS have the same approaches to management, as they are based on the PDCA and continual improvement principles. The major differences are: to comply with EMAS have to undertake an initial environmental review before implementing and have to develop an environmental statement after each auditing, but with ISO it is not compulsory for both issues.

ISO 14301:2000 is the environmental performance evaluation guideline (International Organization for Standardization 2000). ISO 14301 provides six environmental aspects,

which are the scale and nature of material and energy use, emissions, risks, the condition of environments, the possibility of incidents, and legal regularities and other requirements to which the organization subscribes. The indicators described in ISO 14301 are divided into two types e.g. (1) environmental performance indicators (EPs) – provide information about management effort to influence the performance of organization's operation and information about performance of operation's organization and (2) environmental condition indicators (ECIs) – provide information about the condition of the environment. Both types of indicators consist of quantitative and qualitative. However, the selection of indicators is at the discretion of the organization even the standard suggests that indicators should address.

2.6.3 SOCIAL DIMENSION

Social dimension relates with workplace healthy and safety management system, and corporation responsible management system. The well-known documents used by organizations in the implementation of workplace health and safety management systems are AS/NZS 48001:2001 – *Occupational Health and Safety Management Systems – Specification and Guidance for Use* (Standards Australia and Standard New Zealand 2001) and OHSAS 18001: 1999 – *Occupational Health and Safety Management Systems – Specification* (British Standards Institution 1999) (Santiteerakul et al., 2011). These two standards have the same approaches of management, which based on the PDCA and continual improvement principles, and they do not have any substantial differences.

SA 8000 – *Social Accountability 8000* (Social Accountability International, SAI 1998) is an international standard developed by Social Accountability International, a charitable human rights organization dedicate to improving workplaces and communities. It is a workplace standard that covers key labor rights. It works within the human resources area of organizations and as a complement of the occupational, health and safety management systems. It does not address any kind of issues related to the external social responsibility of organization.

AA 1000 – *the Institute developed Assurance Standard Guidance for Social and Ethical Accountability*, an international organization based in the UK that encourages ethical behavior in business and is based on assessment of reports against three assurance principles: materiality, completeness, and responsiveness. The standard is designed to complement the GRI. The series and framework was developed to help users to improve accountability and performance by learning through stakeholder engagement.

ISO 26000 is the guidance on social responsibility. This standard offers guidance on socially responsible behavior and possible actions; it does not contain requirements and is not certifiable. ISO 26000 provide seven core subjects for corporate social responsibility which are: organizational governance, human rights, labor practices, fair operating and practices, environment, customer issues, and community involvement

and development. This standard does not provide metrics for core subjects but provide a guideline to organization how to adopt each core subject to their organization.

All these management systems based on PDCA principles and organizations can adopt sustainability management through MS but they have to implement at least three management systems to complete all three dimension. Nevertheless, adopt at least three management systems cannot reflect sustainability performance of organization because they do not integrate these MSs into the same system. However, implementing management system helps the organization to learn how to manage and improve their performance and it is a basic approach to implementing sustainability or others concept management to organization.

2.7. PERFORMANCE MEASUREMENT SYSTEM

Performance measurement is defined as the process of quantifying effectiveness and efficiency of action (Neely et al., 1995). Effectiveness is the extent to which customers' requirements are met while efficiency measures how economically a firm's resources are utilized when providing a pre-specified level of customer satisfaction. Performance measurement systems are described as the overall set of metrics used to quantify both the efficiency and effectiveness of action.

Neely et al. (1995) categorized performance measurement system into three levels: the individual metrics; the set of measures or performance measurement as an entity; and the relationship between the measurement system and the internal and external environment in which it operates. Some of the principal considerations they offered for analyzing performance measurement systems are illustrated in Table 2.10.

Table 2.10 Performance measurement level and key considerations

Level	Considerations
<i>Individual performance measures</i>	<ul style="list-style-type: none"> What performance measures are used? What they are used for? How much the cost? What benefit do they provide?
<i>Performance measurement systems</i>	<ul style="list-style-type: none"> Have all the appropriate elements (internal, external, financial, non-financial) been covered? Have measures that relate to the rate of improvement been introduced? Have measures that relate to the long-term and short-term objectives of the business been introduced? Have the measures been integrated, both vertically and horizontally? Do any of the measure conflict with one another?
<i>Relationship with internal and external environments</i>	<ul style="list-style-type: none"> Do the measures reinforce the firm's strategy? Do the measures match the organizational culture? Are thy consistent with the recognition and reward structure? Do some measures focus on customer satisfaction? Do some measures focus on what the competition is doing?

Source: content abridged from Neely et al. (1995)

Neely et al. (1995) identified a number of approaches to performance measurement, including: the balanced scorecard (BSC) (Kaplan and Norton 1992); the performance measurement matrix (Keegan et al. 1989); performance measurement questionnaires (Dixon et al. 1990); criteria for measurement system design (Globerson 1985); and, computer aided manufacturing approaches. Rather than performance measurement frameworks, other authors preferred to provide criteria for performance measurement system design. The suggested performance measurement criteria from Globerson (1985); Maskell (1989), for example, are as follows:

- Performance criteria must be chosen from the company's objectives
- Performance criteria must make possible the comparison of organizations which are in the same business
- The purpose of each performance criterion must be clear
- Non-financial measures should be adopted
- The measures should be simple and easy to use
- The measures should provide fast feedback
- The measured should be designed so that the stimulate continuous improvement rather than simply monitor

The overview of performance measurement provided by Neely et al. (1995) has been widely cited in recent research into supply chain performance measurement systems and metrics (Beamon 1999; Beamon and Chen 2001; Gunasekaran et al. 2001, 2004, Shepherd and Günter 2006).

Because of the complexity of supply chains, collating and delineating performance metrics is a difficult task (Shephard and Günter 2006). Many researchers attempted to systematically collate measures for evaluating the performance of supply chains. Moreover, there is a disputation over the most appropriate way to categorize them. For example, they have been grouped according to:

- Whether they are qualitative or quantitative (Beamon 1999; Chan 2003)
- What they measure: cost and non-cost (Gunasekaran 2001); quality, cost, delivery, and flexibility (Schonsleben 2004); cost, quality, resource utilization, flexibility, visibility, trust and innovativeness (Chan 2003); resources, outputs and flexibility (Beamon, 1999); supply chain collaboration efficiency and configuration (Hieber 2002); and, input, output and composite measures (Chan and Qi 2003)
- Their strategic, operational or tactical focus (Gunasekaran et al 2001)
- The process in the supply chain they relate to (e.g. Chan and Qi 2003; Huang et al. 2004; Stepherns 2001)
- The critical issues of supply chain performance measurement are:

- Lack of considering supply chain relationships and the supply chain as a whole (Lambert and Pohlen, 2001). However, the management of the entire supply chain performance is indeed very difficult and, may be, not in existence (Wong and Wong 2007; Banomyong and Supan 2010).
- The paucity of qualitative metrics and non-financial measures of innovativeness and customer satisfaction should be also addressed.
- Human resource management and modern manufacturing practices should be included into supply chain performance measurement system design
- The factors influencing the success or failure of attempt to implement measurement systems for supply chain should be investigated
- Treating measurement systems as dynamic entities that respond to environmental and strategic changes

2.7.1 MEASURES, METRICS, AND INDICATORS

In order to assess performance of interesting things (e.g. activities, processes, products, services) adequate measurement instruments are required. From literature on performance measurement in supply chain, the use of terms: “performance measures”, “performance metrics”, and “performance indicators” has gained in important in this research field. Various works use these three terms interchangeably.

Neely et al. (1995) uses the term “performance measures”, which is defined as a metric used to quantify the efficiency and/or effectiveness of the action, in their work to explain the performance measurement system (PMS) design. Beamon (1999) uses the term “performance measures” in his work to evaluate supply chain performance. He proposes a universal framework for the selection of performance measures, which are categorized into three types i.e. resources, output, and flexibility, for supply chain systems. Chan and Qi (2003) use the term “performance measures” in their method for measuring supply chain management performance. Gunasekaran et al. (2001) use the terms “performance measures and metrics” in their works to proposed a framework for respectively measuring the performance from strategic, tactical, and operational levels in supply chain. Gunasekaran and Kobu (2007) have reviewed performance measures and metrics in SCM and address 27 key performance measures and metrics which cover all decision level. Meanwhile the term “performance indicator” is used in ISO14031 for measuring environmental management performance and using in GRI for evaluating organization’s sustainability performance. The performance indicator is defined as a specific expression that provides information about organization’s performance.

From the above literature review, it seems that the terms measures, metrics, and indicators can be used interchangeably for assessing the efficiency and/or effectiveness of interesting things. However there are available works that enhance the differences definition among these three terms. Although Neely et al., (1995) uses the term

performance measure in his PMS, but he explains the term “metric” that refers to the formula, definition of the measure, how it will be calculated, who will be carrying out the calculation, and form where the data will be obtained. The main difference between measure and metric is that the metric embodies additional information about the referent. For example, companies may use defects rate as a performance metric which consists of two measures i.e. number of defects and total input items. In some case performance metric and measure can be the same variable, for example, companies may use energy cost to reflect the environmental performance. In this case performance metric consists of one measure that is energy cost of the company.

Gladden (2005), which is cited by Samsonova (2012), states that indicator provides not only quantitative information but also an alternate parameter, whose characteristic or variation allows the inferring of another parameter that is considered to be important. With this explanation, performance indicator contains more information to express performance than metric and/or measure. Samsonova (2012) analyzes and enhances the difference of measures, metrics, and indicators definition (as shown in Table 2.11).

Table 2.11 Definitions: measure, metric, performance indicator (PI)

Term	Definition
Measure	A quantify value
Metric	A metric puts a measure into a certain context. The context is given by an item or an object or a set of items or objects. It defines a unit of measure and a reference unit
Performance indicator	A performance indicator is an auxiliary metric that partially reflects the performance of an organizational unit

In this thesis, the definitions of performance measure, metric, and indicator are in regards to Samsonova’s definitions. In order to assess sustainability performance of SCM, decision maker should identify performance indicators in each sustainability criterion. Each indicator consists of a set of metrics that used to quantify the efficiency and/or effectiveness of processes, activities, or actions. The performance indicators can be quantitative or qualitative variables. An important issue is how to define performance metrics with measurement method.

2.7.2 LEADING AND LAGGING INDICATORS

Measuring sustainability performance is complicated by its multi-dimensional nature and due to the wide range of reporting practices for environmental, social and corporate governance risks. Companies tend to measure and report their sustainability results with the idea that these measurements provide an indication of their sustainability performance. The outcomes reported are referred as performance indicators which called *lagging indicators*. For example, economic performance can be evaluated by using sales, revenues, profit, or market share as outcome indicators. Environmental performance can be evaluated by measuring material consumption, energy (electricity, fuel, gas) consumption, CO₂ emission, or total weight of waste, etc. And social

performance can be evaluated by using total workforce of employee, rate of injury or occupational disease, average hours of training per employee per year, total number of business units analyzed for risks related to corruption, etc.

Although lagging indicator is useful for benchmarking with historical period or with other companies. But it does not provide enough information to guide future actions. Pojasek (2009) addresses that lagging indicator may not be sufficient to address sustainability practices because of there is a time delay between actions we take and the outcomes that result, the outcomes rates may not provide adequate feedback for effective management of processes, and outcomes may be the result of many factors hence it may not provide useful information to improve performance. In addition, because of sustainability concept involves with intangible assets such as quality of life, human rights, human knowledge, and consumption attitude. It is difficult to evaluate outcome performance of these assets. It is more convenience to evaluate management practices on intangible assets instead.

There is another type of indicator, called *leading indicator*, which provide information of how companies take actions on their interesting issue. Leading indicators provide information to predict outcomes of activities and can be used to monitor the effectiveness of control systems and give warning of any weaknesses before problems appear. Thus leading indicators should be considered to raise a more proactive and preventive approach to sustainability. For example, the work-related injury rate is a lagging measure of health and safety management efficiency, which is a leading indicator in social performance. Szekely and Knirsch (2005) review sustainability report of 20 companies in Germany. They found that most organizations focus on lagging indicators to manage their sustainability performance. They suggest using leading indicators for risk prevention and performance improvement.

2.8. EXISTING APPROACHES TO MEASURE SUSTAINABILITY PERFORMANCE

Organization sustainability is a new area of study and many researchers have tried to clearly define the sustainability terminology. Most researchers do not provide definitions but attempt to explain what companies are supposed to do to achieve sustainability (Bourne et al., 2002; Coelho, 2005). But focusing only on organization sustainability is not enough because organizations become more dependent on their supply chains and/or networks – hence the rise of research exploring the issue of sustainability in supply chain (Beamon, 1999; Carter and Rogers, 2008).

There are various approaches for measuring, monitoring and assessing an organization's progress towards sustainability e.g. using standards and codes, sustainability indicators, metrics for sustainability performance. The approaches, which organizations used to evaluate their sustainability performance, can be grouped into three groups:

- Using performance measurement system (PMS) model as a tool for evaluating sustainability performance.
- Using reporting systems as guideline for evaluating sustainability performance
- Using multi-criteria decision making approach

2.8.1 USING PERFORMANCE MEASUREMENT SYSTEM (PMS)

There are various PMS model as a tool for evaluating organization performance and the best-known ones such as the BSC (Kaplan and Norton, 1996) or the EFQM Excellence Model (EFQM, 2010). Mainly geared towards measuring autonomous entities (companies, subsidiaries, business units, etc.), these models did not take the complexity of supply chain into account. Nevertheless, supply chain performance measurement models developed in recent years include Supply Chain Operation Reference (SCOR) model (Lockamy and McCormack 2004), Global Supply Chain Forum (GSF) (Cooper et al. 1997), quick scan audit methodology (Naim et al. 2002), SCM logistics scorecard (LSC) (Arashida et al., 2004), Supply Chain Assessment Tool (SCPAT) (Banomyong and Supan 2010), etc. There are two solutions to use PMS model as a tool for evaluating sustainability performance:

1. Integrate or add sustainability aspect into existing PMS model, for example, Figge et al. (2002) developed the sustainability balanced scorecard (SBSC) for linking sustainability management to business strategy. SBSC has been formulated by classified and integrated environmental and social aspects into the scorecard system. Moreover, Figge et al. (2002) added “non-market” perspective into the balanced scorecard. Thus SBSC has five performance perspectives: financial, customer, internal process, learning and growth, and non-market perspective. Environmental and social aspects have been integrated according to their strategic relevance in each perspective. Another PMS model which added sustainability aspect is SCOR model and called “Green SCOR”. (SCC, 2008). Green SCOR provides a framework for structuring and communicating environmental supply chain management programs and also includes risk management processes, practices, and performance indicators.
2. Developing new sustainability performance metrics for organization level such as eco-efficiency (WBCSD), specific sustainability indicators (Delai and Takahashi, 2011) or supply chain level such as Lowell Center for sustainable production (LCSP) indicator (Veleva and Ellenbecker 2001).

2.8.2 REPORTING SYSTEMS

The Global Reporting Initiative (GRI) (Global Reporting Initiative – GRI 2002; Jung et al. 2001; Pojasek 2001) is example of performance reporting used as a framework by organizations for sustainability performance measurement. GRI is built over the bottom line approach (Coelho 2005). About 68 percent of the Global 250 firms generated a

separate annual sustainability report in 2004 that considered environmental, social, and economic issues. In addition 80 percent of these reports discuss supply chain-related issues (Carter and Rogers, 2008).

There are 6 performance aspects in GRI report systems: economic, environmental, labor practices and decent work, human rights, society, and product responsibility. GRI provides performance indicators in term of quantitative and qualitative in each aspect. Though organizations cannot complete all of indicators item of GRI because there is a large number of indicators in this report guideline (6 performance aspects, 34 metrics, 84 indicators and more than 100 sub-indicators), but it has emphasized that the GRI report approach is the best one available for companies that want to report according to sustainability principles (Coelho 2005).

The criticisms of GRI are: the approach gives conditions to organizations to know 'what' to do but not 'how' to develop reporting process (Byren et al. 2002; Pojasek 2001), organizations cannot justify its use if they do not interconnect the GRI report with their performance evaluation and management system (Coelho 2005), there are no examples of integrated metrics (Hussey et al. 2001)

2.8.3 USING MULTI-CRITERIA DECISION MAKING APPROACH

The multi-criteria decision approach provides decision makers with the possibility to understand the trade-off between different aspects of sustainable dimension on the supply chain management. In this approach the sustainability performance is measured in order to support the decision making in supply chain problems. For this topic, we use the proposed model from Erol et al. (2011) and Singh et al., (2007)proposed as an example to analyze characteristics of sustainability performance.

Erol et al. (2011) proposed a fuzzy multi-attribute utility for evaluating and comparing the company performances in terms of sustainable supply chain. The sustainability metrics are categorized with respect to the TBL. The economics, environmental, and social dimension consists of 10, 12, and 15 indicators respectively. They selected indicators by consider relevance to key objectives, measurability data, data availability, administrative burden, reliability of information source, and cost of collecting data.

Singh et al. (2007) proposed a decision model by using an analytical hierarchy process (AHP) to evaluating the impact of organization's sustainability performance and applied this model in a case study for a steel company. This model consists of five dimensions which are organizational governance (12 indicators), technical aspects (14 indicators), economic (5 indicators), environmental (15 indicators), and social (14 indicators). The indicators were selected by 15 experts in the steel industry by determining analytical soundness, measurability, cost effectiveness, and time series completeness.

2.9. COMPARATIVE ANALYSIS OF EXISTING APPROACHES

This section introduces the comparative analysis of the existing approaches to measure sustainable supply chain performance. We categorized the existing approaches into four categories, which are using performance measurement system model, reporting system and other approaches.

2.9.1 COMPARATIVE FRAMEWORK

This section used a performance measurement system consideration design from Neely et al. (1995) as a framework for analyzing four categories of existing performance measurement system (using MS, PMS, reporting system and others approaches) in a context of sustainable supply chain management. Performance metrics and indicators are defined and categorized in an individual performance measures level. The key dimensions of manufacturing's performance can be defined in terms of quality, delivery speed, delivery reliability, price (cost), and flexibility (Neely et al. 1995). However there is more complex metrics in term of supply chain management performance and sustainability performance because supply chain does not focus only manufacture entity but covers others all of entities since upstream to downstream such as transporter, distributor, retailer, and customer entities. Researchers attempted to categorize group of supply chain performance metrics. Existing supply chain performance measurement systems have different characteristics both in term of group of metrics and methodology. Moreover, to measure sustainability performance of supply chain makes performance metrics categorization more complicate.

Thus structure of sustainability performance metrics is analyzed. In addition, some existing PMS provided indicators for sustainability metrics. Type of an indicator was analyzed in term of quantitative and qualitative indicators. Reflection of indicators was be analyzed in term of leading or lagging indicators.

The second level, performance measurement systems, analyzed balancing between financial and non-financial, and short-term and long-term performance. Moreover, supply chain maturity was analyzed to measure scope of supply chain performance consideration. Supply chain maturity categorized into organization, partnership and whole supply chain level.

Relationship with internal and external environment has been considered organization or supply chain performance with internal environment, which defined as organization's strategies and cultures, and external environment, which consists of two elements: customer and competitor. Some existing model formulated performance metrics from organization's strategy thus relation between strategy and performance metrics was considered as a relationship between PMS model and internal environment. Some existing model can reflects customer's satisfactions or can benchmark performance with others competitors thus the relationship between performances attribute with customer

and competitor was analyzed in this level. Analysis issues of three levels performance measurement system are summarized in Table 2.12

Table 2.12 Analysis issues by PMS level

Level	Analysis Issues
<i>Individual performance measures</i>	Categorization of sustainability criteria Type of indicators (quantitative and qualitative) Reflection of indicators to performance aspect (leading or lagging indicator)
<i>Performance measurement systems</i>	Balanced between financial and non-financial aspects, short-term and long-term. Balanced between economic, environmental, and social dimension Supply chain maturity level (organization, partnership, whole supply chain)
<i>Relationship with internal and external environments</i>	Related with organization and/or supply chain strategy Link between performance attribute with customer satisfaction or competitor performance

2.9.2 COMPARATIVE ANALYSIS

A) Performance Measurement System Models

According to two solutions for using PMS model as a tool for evaluating sustainability performance. First solution is integrating or adding sustainability aspect into existing PMS model, which are SBSC (Figge et al. 2002) and SCOR 9.0 and GreenSCOR model. Second solution is develop new sustainability performance metrics, which are eco-efficiency (WBCSD), specific sustainability indicators (Figge and Hahn, 2004; Jain 2005) and Lowell Center for sustainable production (LCSP) indicator (Veleva and Ellenbecker 2001).

Sustainability Balanced Scorecard (BSC)

The well-known performance measurement model is the balanced scorecard (BSC). Figge et al. (2002) developed Sustainability Balanced Scorecard (SBSC) by integrated environmental and social aspects in to the main management system of a firm. SBSC integrated environmental and social aspects by identified the environmental and social exposure of a business unit. Environmental exposure categorized into eight criteria: emissions, waste, material input/material intensity, energy intensity, noise and vibrations, waste heat, radiation, and direct interventions on nature and landscape. Social exposure categorized into two criteria: direct stakeholders and indirect stakeholders. Then determine the strategic relevance of environmental and social aspects. In order to determine the strategic relevance, lagging and leading indicators are defined. Lagging indicators represent strategic core issues and leading indicators represent performance drivers.

Individual measures of SBSC consists of five performance criteria based on four criteria from general BSC and a new added criteria, which are: financial, customer, internal process, learning and growth, and non-market. Indicator determination based on organization strategy and objective but organizations should consider environmental and social aspects into five performance criteria.

Performance measurement system of SBSC reflects both financial (financial perspective performance) and non-financial (customer, internal process, learning and growth, and non-market perspective performance). But for supply chain maturity level implementation of SBSC is only in organization performance level because this model does not consider partnerships and supply chains sustainability performance.

Relationship with internal and external environment of SBSC can reflect customer's satisfaction because customer is the one of performance perspective. And SBSC directly reflects relationship between organization performance and strategy level because this model formulated performance metrics and indicators from organization's objectives.

SCOR 9.0 model

SCOR, has been developed in 1996 by the Supply Chain Council (SCC), is a supply chain process reference model containing over 200 process elements, 550 metrics, and 500 best practices which including risk and environmental management in the ninth version (SCOR9.0) (as shown in Figure 2.4) It can be regarded as a closely related concept for SSCM. However, it is not more consider in social dimension.

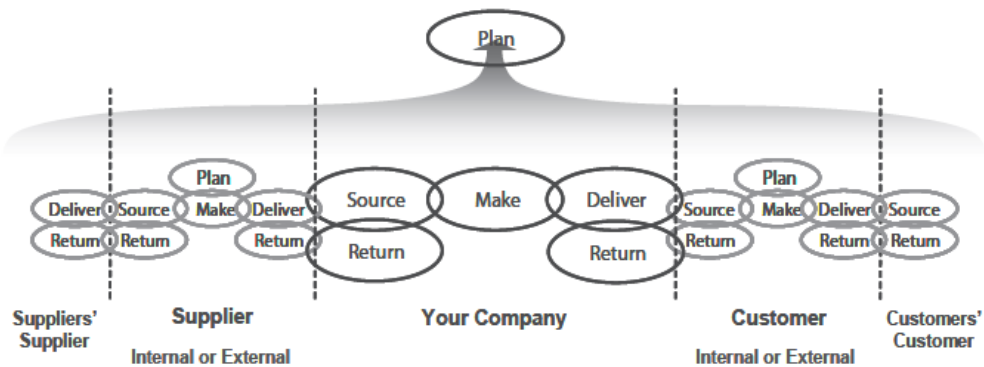

Figure 2.4 SCOR is organized around five management processes.

(Source: Supply Chain Council (2008))

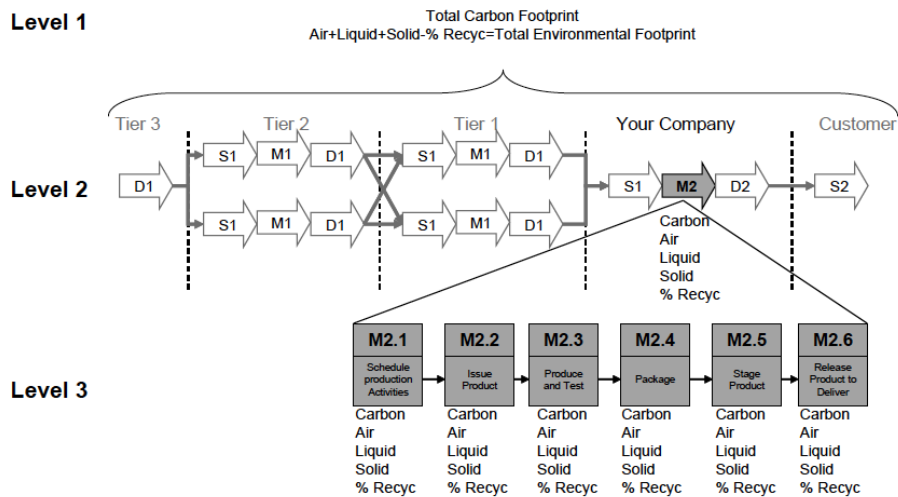

Figure 2.5 The GreenSCOR model (Source: Supply Chain Council (2008))

This model organized process in supply chain management into five processes, e.g. plan, source, make, deliver, and return. Even SCOR provides the GreenSCOR (as shown in Figure 2.5) model and practices in SCOR9.0 but it does not include product design/development activity and human resource issue, which are important factors for social and long-term perspectives. In the sustainable supply chain context, SCOR and GreenSCOR is still lack of social dimension perspective. Thus, SCOR model cannot be used as a framework for analyzing business activities in our research work.

Individual measures of SCOR and GreenSCOR are constructed by five management processes, which are plan, source, make, deliver, and return. SCOR provides ten performance metrics, which are perfect order fulfillment, order fulfillment cycle time, upside supply chain flexibility, upside supply chain adaptability, downside supply chain adaptability, supply chain management cost, cost of goods sold, cash-to-cash cycle time, return on supply chain fixed assets, and return on working capital. Both quantitative and qualitative indicators are proposed in each metrics and constructed by three management levels, which are strategic, tactical, and operational. Moreover, leading and lagging indicators determine by mapping indicators and metrics relationship. The risk management metric and GreenSCOR metric are proposed in SCOR9.0, which constructed by management processes and levels but for GreenSCOR, only environmental in term of carbon emissions, air pollutant emissions, liquid waste generated, solid waste generated, and percent of recycled waste.

Performance measurement system of SCOR represents by *attribute performances*, which are reliability, responsiveness, agility, costs and assets. SCOR reflects both financial (cost and assets attribute performance) and non-financial (reliability, responsiveness, and agility attribute performance). In addition, SCOR covers whole supply chain maturity.

However, it is complicated and takes a long-time to complete whole supply chain performance evaluation by using SCOR.

Relationship with internal and external environment of SCOR can reflect both internal and external environment. Internal environment represents by customer-facing attribute performance, which consists of reliability, responsiveness, and agility. External environment represents by internal-facing attribute performance, which consists of costs and assets. However, risk management and GreenSCOR metrics have been not integrated with attribute performance metrics. Thus, attributes performance reflect only economic dimension of sustainable supply chain management context.

Developing new sustainability performance metrics

Creating sustainability performance metrics is usually used for measure sustainability in supply chain. The processes to develop sustainability metrics are as follow:

- Define sustainability scope
- Define an important aspect (lagging indicators) and important factors (leading indicators)
- Collecting data
- Assess sustainability performance
- Check feedback and improve

Individual measures of sustainability metric depends on determine sustainability defining process, for example, eco-efficiency is determine sustainability scope only in environmental dimension while sustainability metrics of LCSP and Delai and Takahashi (2011) cover both environmental and social dimensions. Eco-efficiency focuses on only environmental perspective of organization. This model consists of two metrics e.g. product/service value and product/service creation environmental influence metrics. Most of indicators are quantitative and this model does not define leading and lagging indicators.

LCSP provides six sustainability metrics e.g. energy and material use, natural environment, economic performance, community development and social issues, workers, and products. Indicators in this model are defined into five types of implementation indicators e.g. facility of compliance/conformance indicators, facility material and performance indicators, facility affect indicators, supply chain and product life indicators, and sustainable system indicators. However, most of suggested and implemented indicators of their case studies are facility of material and performance indicators. It means in a practical implementation, organizations still adopted sustainability performance measurement of their organization and did not adopt in supply chain level.

Delai and Takahashi (2011) proposed model consists of three sustainability metrics e.g. environmental, social and economic metrics. Each metrics contain both quantitative and qualitative indicators. Nevertheless this model does not directly defined leading and lagging indicators but developers discussed about this issued that leading indicators play an important role for long-term achievement of organization.

Performance measurement system of sustainability metrics: eco-efficiency focuses on only environmental efficiency of organization and however there are non-financial indicators but mainly consider on manufacturing process. LCSP reflects both financial and non-financial performance of organization and provides how to implement the set of indicators in a higher level (expand from organization to supply chain level). Delai and Takahashi reflects both financial and non-financial performance but this model considers only sustainability of organization not supply chain. Hence, this model can reflects supply chain maturity of organization's level

Relationship with internal and external environment of three PMS models: eco-efficiency and LCSP focus on organization's environmental impacts and organization's production sustainability respectively, thus these two models do not link sustainability performance with customer's perspective. Meanwhile, Delai and Takahashi's model considered customer perspective in social dimension as a customer relationship metric. However, all of these models are not directly enhance relationship between sustainability organizations and/or supply chain performance with their organizations and/or supply chain's strategies

Hence, developing new sustainability PMS to measure organization and/or supply chain sustainability performance is more flexible than adding sustainable context in existing PMS model but the weakness is lacking a relationship between PMS model with internal and external environment.

B) Using reporting systems

Global Reporting Initiative (GRI) (Global Reporting Initiative – GRI 200) is the most worldwide sustainability reporting guideline (Jung et al. 2001; Pojasek 2001).

Individual measures of GRI: there are 6 performance aspects in GRI report systems: economic, environmental, labor practices and decent work, human rights, society, and product responsibility. GRI provides performance indicators in term of quantitative and qualitative in each aspect. However, GRI does not determine leading and lagging indicators.

Performance measurement system of GRI reflects both financial and non-financial performance of organization. GRI reflects supply chain maturity in partnership level by suggests organization to define their stakeholders in term of suppliers, partners, customers and local communities.

Relationship with internal and external environment of GRI reflects relationship between organizations with customer perspectives by some indicators in product responsibility performance metric and reflects relationship with organization's strategies in determining organization's policy process, which is the first process for creating sustainability report.

However, companies cannot complete all of indicators item of GRI because there is a large number of indicators in this report guideline (6 performance aspects, 34 metrics, 84 indicators and more than 100 sub-indicators), but it has emphasized that the GRI report approach is the best one available for companies that want to report according to sustainability principles (Coelho 2005).

C) Using multi-criteria decision making approach

This approach is similar to developing a new sustainability PMS model but may adding aggregation or integration indicators method for evaluating sustainable supply chain performance. This approach can reduce obstacles about integrating qualitative with quantitative performance measures, which is a criticism of supply chain performance measurement.

Individual measure of Erol's model consists of three sustainability performance metrics, which are environmental, social and economic performance, which consists of 10, 12, and 15 indicators respectively. Indicators both in quantitative and qualitative are assigned. There is not a determination of leading indicators in this model. The model of Singh et al. considered the three dimensions of TBL and added the organization governance and technical aspects as the fourth and fifth dimensions of sustainability. The leading indicators are assigned in these fourth and fifth dimensions. This model consists of both quantitative and qualitative indicators.

Performance measurement system of Erol's model and Singh et al.'s model reflect both financial and non-financial performance of organization. Both Erol's model and Singh's model reflect supply chain maturity in partnership level because these models use some indicators to measure an effectiveness of stakeholder involvement and supplier's issues.

Relationship with internal and external environment of Erol's model does not reflect relationship between organizations with customer perspectives and also does not reflect relationship with organization's strategies. Meanwhile Singh's model reflects customer satisfaction in society dimension.

2.9.3 RESULTS OF COMPARATIVE ANALYSIS

The results of comparative analysis are shown in Table 2.13. We found that almost of the existing approaches covers all three dimensions of the TBL except SCOR9.0+GreenSCOR and eco-efficiency models which do not taking social dimension into account. There is

none of the existing approaches that tackle all sustainability issues. These existing approaches provide framework of sustainability criteria and allow organization to select indicators from list of relevant sustainability indicators. Although SCOR9.0+GreenSCOR and LCSP model provide a measurement framework to apply in supply chain level but in practical it is implemented in only organization and partnership level.

The existing approaches for adding sustainability context to existing PMS model, which is SBSC, is still lack of link relationship between performance measurement model and supply chain perspective. In the other hand, existing PMS model such as SCOR 9.0 and GreenSCOR, which includes supply chain perspective in consideration, does not contain social dimension in the model. Using the reporting system such as GRI covers all three dimensions of the TBL and also enhances an important of labor practices, human rights and product aspects in sustainability performance. Using multi-criteria decision making approach can reduces criticism of aggregating and integrating qualitative indicators with quantitative indicators. However, the existing models do not consider relationship between sustainability with customer and organization's strategies perspective.

Table 2.13 The comparative analysis of existing approaches for measuring sustainability performance

	Individual performance measures					Performance measurement systems								Relationship with internal and external environments		
	Sustainability Criteria	Types of indicators				Financial issue		Sustainable Dimension			SC Maturity Level			Internal	External	
		Qt	QI	LD	LG	FC	NFC	EC	EN	SO	OG	PN	SC	Strategy	Customer	
<i>1) Using performance measurement system (PMS): Integrating sustainability into existing PMS model</i>																
SBSC	Sustainable balanced scorecard (SBSC) <ul style="list-style-type: none"> • Financial • Customer • Process • Learning and growth • Non-market Environmental aspect <ul style="list-style-type: none"> • Emissions • Waste • Material input/Material intensity • Energy intensity • Noise and vibrations • Waste heat • Radiation • Direct interventions on nature and landscape Social aspects <ul style="list-style-type: none"> • Direct stakeholders • Indirect stakeholders 	X	X	X	X	X	X	X	X	X	X	X	-	-	X	X
SCOR9.0 + GreenSCOR	Performance attribute <ul style="list-style-type: none"> • Cost • Assets 	X	X	X	X	X	X	X	X	-	X	X	X	X	X	

	Individual performance measures				Performance measurement systems									Relationship with internal and external environments	
	Sustainability Criteria	Types of indicators				Financial issue		Sustainable Dimension			SC Maturity Level			Internal	External
		Qt	QI	LD	LG	FC	NFC	EC	EN	SO	OG	PN	SC	Strategy	Customer
	<ul style="list-style-type: none"> Reliability Responsiveness Agility Environmental impacts <ul style="list-style-type: none"> Carbon-emission Air pollutant emission Liquid waste generated Solid waste generated Percent recycled waste 														
<i>1) Using performance measurement system (PMS): Developing new sustainability PMS</i>															
Eco-efficiency	Product/Service Value <ul style="list-style-type: none"> Volume Mass Monetary Function Other potentially relevant information Product/Service environment influence creation <ul style="list-style-type: none"> Energy consumption Material consumption Natural resource consumption Non-product output Unintended events Product/Service 	X	-	-	X	X	X	X	X	-	X	-	-	-	-

	Individual performance measures				Performance measurement systems									Relationship with internal and external environments		
	Sustainability Criteria	Types of indicators				Financial issue		Sustainable Dimension			SC Maturity Level			Internal	External	
		Qt	QI	LD	LG	FC	NFC	EC	EN	SO	OG	PN	SC	Strategy	Customer	
	<ul style="list-style-type: none"> • Packaging waste • Emission during use and disposal 															
Delai and Takahashi (2011)	Sustainability metrics <ul style="list-style-type: none"> • Environmental • Social • Economic 	X	X	-	X	X	X	X	X	X	X	X	-	-	X	
LCSP	Sustainability dimension <ul style="list-style-type: none"> • Energy and material use • The natural environment • Economic performance • Community development and social justice • Workers • Products 	X	X	-	X	X	X	X	X	X	X	X	X	-	-	
<i>2) Using reporting system</i>																
GRI	Sustainability performance <ul style="list-style-type: none"> • Economic • Environmental • Labor practices • Human rights • Society • Product 	X	X	X	X	X	X	X	X	X	X	X	X	-	X	X
<i>3) Using multi-criteria decision approach</i>																
Erol's model	Sustainability performance metrics <ul style="list-style-type: none"> • Environmental • Social • Economic 	X	X	-	X	X	X	X	X	X	X	X	X	-	-	-

	Individual performance measures					Performance measurement systems								Relationship with internal and external environments	
	Sustainability Criteria	Types of indicators				Financial issue		Sustainable Dimension			SC Maturity Level			Internal	External
		Qt	QI	LD	LG	FC	NFC	EC	EN	SO	OG	PN	SC	Strategy	Customer
Singh et al (2007)	Sustainability indicators <ul style="list-style-type: none"> • Organization governance • Technical aspects • Economic • Environmental • Society 	X	X	X	X	X	X	X	X	X	X	X	-	X	X

2.9.4 DISCUSSION ON EXISTING APPROACHES

The result of this comparative analysis leads to the directions for designing sustainable supply chain performance measurement model. We found that sustainability measurement in supply chain context has not yet fully matured and is still facing some important challenges. Sustainable supply chain performance measurement system should consider relationship between sustainability performance with organization strategies and objectives, define leading and lagging indicators for enhancing key success indicators to achieve a long-term sustainable supply chain, include using decision-making or mathematical model to integrate and aggregate qualitative indicators (especially in social dimension) leads to more precise for evaluating sustainability performance.

Moreover, the main criticism of measure sustainability in supply chain is difficulties to evaluate sustainability along supply chain, not only organization or partnership level. Hence, future research should more focus on how performance measurement model can evaluate sustainability across organizations in their supply chain.

2.10. SUSTAINABILITY PERFORMANCE MEASUREMENT IN SUPPLY CHAIN

2.10.1 FUNDAMENTAL STEPS OF SUSTAINABILITY PERFORMANCE MEASUREMENT FRAMEWORK

It is critical that any measurement system start out with the well-defined goals and objectives. These elements assist in guiding the subsequent of implementing sustainability practices. This section provides the framework for developing sustainability performance measurement which consists of four steps, which is shown in Figure 2.6.

1. Understanding sustainability
2. Defining sustainability goals
3. Defining sustainability objectives
4. Developing sustainability performance measurement system.

The following working definitions for are used to assist the development of sustainability performance measurement system:

Sustainability Criteria: Criteria are relevant elements which represent the characteristics of sustainability.

Goal: A goal is a board statement of what supply chain hopes to achieve.

Objectives: Objectives are specific and achievable statements of what will be done to achieve goals.

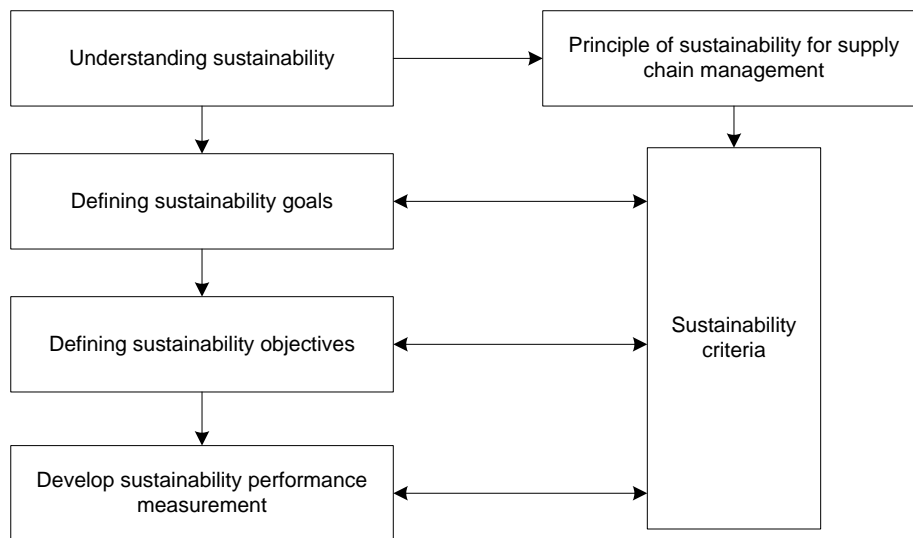

Figure 2.6 Framework for developing sustainability performance measurement

Step 1: Understanding sustainability

Understanding what sustainability means is the first step in being able to apply a framework for developing sustainability performance measurement system. The definition of sustainability should be grounded in the basic principles of sustainability. However the term sustainability is still very vague, particularly in the industrial context, as we discussed in section 2.4, the term sustainability is mostly considered as an integration of three dimensions with respect to both short- and long-term perspective. Hence the context in which sustainability is being considered is important in setting boundaries of measurement system. These considerations include level of decision-making, function, scope, and stakeholders.

The boundaries of measurement system should be clearly defined. The measurement system can be implemented to measure sustainability performance of corporate operation or specific process e.g. purchasing, inventory management, production, packaging, transportation, marketing, product design, research and development, human resource management, etc. The sustainability criteria selection depends on company strategy and the function of system boundaries. For example, the sustainability in purchasing may focus on quality of material, hazardous substances of raw material, the environmental management system certification and employee management system certification of suppliers. Meanwhile the sustainability in production may focus on energy usage, emission, waste generation, safety and working condition.

Step 2: Defining sustainability goals

The sustainability principles provide a guidance to define sustainability goals. A set of goals that covers sustainability principles ensures that company and/or supply chain has considered all sustainability criteria. For example, INDITEX which is the fashion distributor company realizes the importance of sustainability and environmental responsibility. Hence INDITEX established the Pro-Kyoto project which aims to reduce transportation greenhouse gas emissions (Cetinkaya et al., 2011). In this case this company focuses only in environmental dimension of sustainability and the main goal is to reduce greenhouse gas emissions in transportation.

Step 3: Defining sustainability objectives

The objectives provide specific actions to achieve sustainability goals. According to the previous example of INDITEX in order to achieve the goal of reducing greenhouse gas emissions, INDITEX has established three objectives as follow:

- Increasing the transportation vehicles that run on bio-diesel
- Training the drivers on fuel-efficient driving
- Reducing greenhouse gas emissions of vehicles

Step 4: Developing sustainability performance measurement system

The performance measurement system is designed based on the boundaries of measurement, sustainability goals, and sustainability objectives. The performance measures are selected to assess the progress toward each objective. The next section will describe the details of performance measurement system and how to design the system for measuring sustainability performance.

2.10.2 TRIGGERS OF SUPPLY CHAIN PERFORMANCE MEASUREMENT

A) Complexity level of supply chain

Beamon (1998) defined a supply chain as an integrated process wherein a number of various business entities (i.e. suppliers, manufacturers, distributors, and retailers) work together in an effort to: (1) acquire raw materials, (2) convert these raw materials into specified final products, and (3) deliver these final products to retailers. Lambert et al. (1998) state the supply chain management is the integration of key business processes from end user through original suppliers that provides products, services, and information that add value for customers and other stakeholders. Mentzer et al. (2001) defined a supply chain as a set of three or more entities (organizations or individual)

directly involved in the upstream flows of products, services, finances, and/or information from a source to a customer.

Moreover, Mentzer et al. (2001) identified three degrees of supply chain complexity: a direct supply chain, and extended supply chain and an ultimate supply chain. As shown in Figure 2.7 , a direct supply chain consists of a company, a supplier and a customer involved in the upstream and/or downstream flows of products, services, finances, and/or information. (a.). An extended supply chain includes suppliers of the immediate supplier and customers of the immediate customer, all involved in the upstream and/or downstream flows of products, services, finances, and/or information (b.). An ultimate supply chain includes all the organizations involved in the upstream and downstream flows of products, services, finances, and information from the ultimate supplier to the ultimate customer (c.).

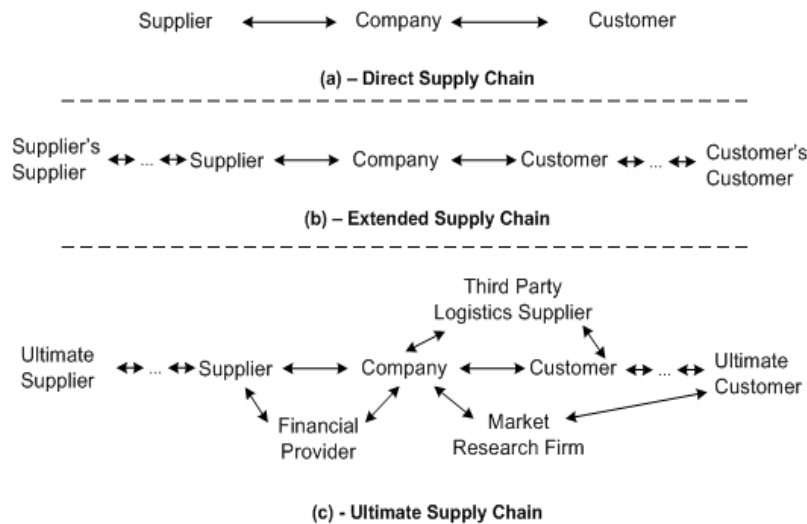

Figure 2.7 The complexity level of supply chain

One of the challenges in sustainable supply chain management is dealing with a wide range of objectives, criteria, and elements in supply chain. Because of sSCM has to take into account a longer part of supply chain. The complexity of supply chain makes an establishing sustainability strategy to be complex. A clearly boarder of supply chain scope can help company and its supply chain get a precise strategic direction and performance measurement system. Thus, a boarder of supply chain scope has to be identified based on a complexity level of supply chain.

Research Proposition 4: A complexity level of supply chain should be identified in order to define a supply chain scope for measuring sustainability performance.

B) Stage of Supply Chain Performance Measurement

The management of the entire supply chain performance is indeed very difficult and, may be, not in existence (Banomyong and Supan 2008, Beamon 1999, Wong and Wong 2007). Although there are available approaches to measure performance through a whole supply chain in term of carbon emission, cost, material or energy consumption by using product lifecycle concept. But the lifecycle concept is now concern only environmental impacts and analyze based on product perspective. Other approaches which assess sustainability performance e.g. ISO26000, GRI, SBSC of company and its supply chain are concentrated in company activities or includes only the nearest supply chain partners, such as suppliers and customers, and often only on the point of contact, or on the shared processes that link two companies – supplier performance, or customer satisfaction are examples of such measures. Hence, an establishment of system that can measure sustainability performance across company is still a research challenge in this field.

In fact, companies are at various stages of performance measurement implementation. Thus, in order to identify performance metrics, company has to define stage of performance measurement. Regarding to Figge et al., (2002) Cetinkaya et al (2011), the stages of supply chain performance measurement (as shown in Figure 2.8) are categorized into four stages as follow:

1. Core process only,
2. All company processes,
3. Company processes and link with suppliers and customers,
4. Supply chain performance measurement (includes all SC partners)

In practice, some companies measure sustainability only their core processes, other are sharing metrics with business partners, while some large organizations are able to look at their end-to-end supply chain. However, there are some limitations to measure the whole supply chain and certain elements are excluded.

Thus a feasibility method to measure sustainability performance of supply chain management is to identify the stage of performance measurement in order to select key performance metrics and indicators.

Research Proposition 5: The sustainability performance measurement system should measure sustainability across company in supply chain.

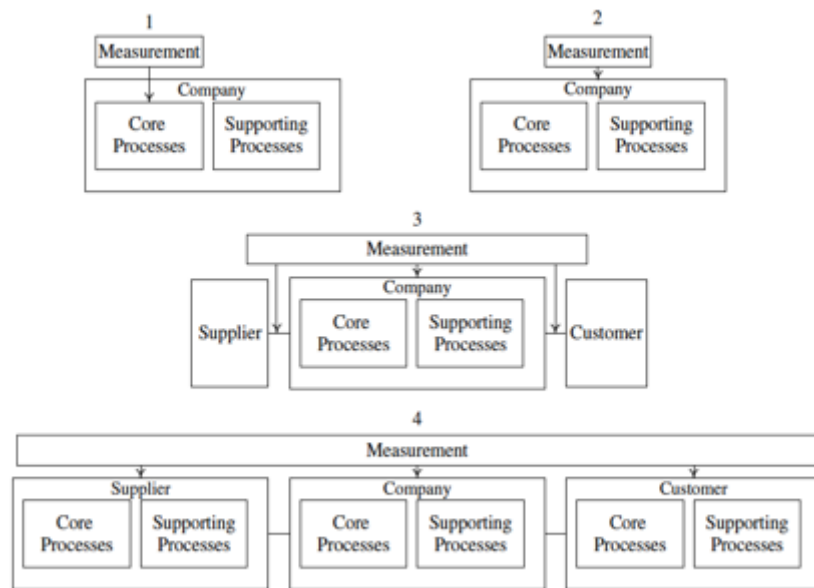

Figure 2.8 : Stages of performance measurement: (1) core process only. (2) all company processes. (3) company processes and links with suppliers and customers. (4) SC performance measurement (includes all SC partners)

2.10.3 PERFORMANCE MEASUREMENT METRICS

A) Traditional supply chain management

Available literature regarding traditional supply chain performance metrics and measures has classified according to several different criteria (Gunasekaran and Kobu, 2007). The classification criteria can be considered into two aspects. The first aspect is classified by component of measures. This aspect focuses on measuring variables i.e. using types or characteristics of measure for classification. For example, Beamon (1999) classified performance measures in SC into three types e.g. resource utilization, output, and flexibility. De Toni and Tonchia (2001) and Gunasekaran et al (2001) classified performance measures into financial and non-financial measures. Banomyong and Supan (2003) developed a tool called “Supply Chain Performance Assessment Tool: SCPAT” for evaluating SCM performance of SMEs by measuring cost, time and reliability. Chan and Qi (2002) proposed a process-based approach to measure supply chain performance based on seven types of metrics, which are cost, time, capacity, capability, productivity, utilization, and outcome. SCOR model provides an evaluation of SC performance in term of cost, assets, reliability, responsiveness, and agility.

Another aspect is classified by components of supply chain. This aspect focuses on how to categorize components in supply chain. Components of supply chain can be considered as processes/activities which occur from original suppliers and

manufacturers to retailers that add value for the end customer. Banomyong and Supan (2003) utilized the nine key supply chain activities provided by Grant et al (2006) as a framework to develop the SCPAT. Chan and Qi (2002) adopted six components (which are suppliers, inbound logistics, core manufacturer, outbound logistics, marketing and sales, and end customers) as a framework of performance measurement. These core components are considered as the typical function areas in supply chain. For example, suppliers assume the functions of sourcing materials, and some outsourcing function. Gunasekaran et al (2001) classified PMS framework by using decision making level as strategic, tactical, and operational. Then Gunasekaran et al (2004) proposed performance metrics framework by conjunction the decision level with supply chain process framework. SCOR model is developed based on five core processes in supply chain, which are plan, source, make, deliver, and return with regard to three levels of processes details which are top level (level1), configuration level (level2), and process elements level (level 3). The summary of classification criteria in traditional supply chain performance measurement is shown in Table 2.14

Table 2.14 Classification criteria in traditional supply chain performance measurement

References	Component of measures	Component in supply chain
Beamon (1999)	Type of measures <ul style="list-style-type: none"> • Resources • Outputs • Flexibility 	(N/A)
De Toni and Tonchia (2001)	Type of measures <ul style="list-style-type: none"> • Financial • Non-financial 	(N/A)
Gunasekaran et al (2001)	Type of measures <ul style="list-style-type: none"> • Financial • Non-financial 	Decision level <ul style="list-style-type: none"> • Strategic • Tactical • Operational
Banomyong and Supan (2003)	Dimension of measures <ul style="list-style-type: none"> • Time • Cost • Reliability 	Supply chain activity <ul style="list-style-type: none"> • Customer service and support • Demand forecasting and planning • Purchasing and procurement • Inventory management • Order processing and logistics communication • Material handling and packaging • Transportation • Facilities site selection, warehousing and storage • Return goods handling and logistics
Chan and Qi (2002)	Board of performance metrics <ul style="list-style-type: none"> • Cost • Time • Capacity 	Supply chain processes <ul style="list-style-type: none"> • Suppliers • Inbound logistics • Core manufacturer

References	Component of measures	Component in supply chain
	<ul style="list-style-type: none"> • Capability (effectiveness, reliability, availability, flexibility) • Productivity • Utilization • Outcome 	<ul style="list-style-type: none"> • Outbound logistics • Marketing & sales and customers
Gunasekaran et al (2004)	Type of measures <ul style="list-style-type: none"> • Time • Financial (cost, profit) • Effectiveness • Efficiency • Productivity • Flexibility 	Decision level <ul style="list-style-type: none"> • Strategic • Tactical • Operational Supply chain process <ul style="list-style-type: none"> • Plan • Source • Make/Assemble • Deliver
SCOR 9.0	Performance attribute <ul style="list-style-type: none"> • Cost • Assets • Reliability • Responsiveness • Agility 	Core management processes <ul style="list-style-type: none"> • Plan • Source • Make • Deliver • Return Level of process details <ul style="list-style-type: none"> • Top level (level 1) • Configuration level (level 2) • Process elements level (level3)

It is clear that in order to select the performance metrics and measures, the framework of PMS, regarding component of measures and/or component of supply chain, should be clearly defined. Consequently, there are many particular aspects to define performance measurement framework. It allows companies to select the framework which suitable for their implementation.

Nevertheless, there is no discussion of sustainability metrics from above performance measurement metrics classification. There is a scarcity of research which comprehensively addressed the three dimensions of sustainability (economy, environment, and society) (Hassini et al., 2012). The classification of sustainability metrics will be discussed in the next section.

B) Sustainable supply chain management

While the social and the environmental are clearly associated in the sustainable development context, there is very little research addressing the social dimension. A comprehensive literature review on SSCM identified that out of 191 papers, 140 addressed the environmental dimension while only 20 addressed the social dimension

(Seuring, 2008). Hence, the literatures which consider at least two sustainability dimensions will be reviewed in this section.

Similarly with the classification criteria from traditional supply chain, two aspects which are component of measures and component in supply chain are adopted for analyzing sustainability metrics. In traditional SCM, the component of measures focus only economic dimension. Meanwhile component of measures in sSCM has extended to environmental and social dimension. Most of literatures use the TBL developed by Elkington, (1999) to classified sustainability criteria, as shown in , (Hassini et al., 2012; Veleva and Ellenbecker, 2001; Veleva et al., 2001; Zhu and Sarkis, 2004; Zhu et al., 2012)(Veleva et al. (2001), Veleva and Ellenbecker (2001), Szekely and Knirsch (2005), Hassini et al (2012), Zhu and Sarkis (2004, 2012)). Except Figge et al., (2002) adopted the balanced scorecard (BSC) to classified performance measures in sustainability context by adding environmental and social aspects to business strategy. In addition, they proposed a new perspective called non-market perspective in order to integrate strategically relevant but not market-integrated environmental and social aspects. Indicators in non-market aspect can impact company's performance in all four perspectives of the conventional BSC. For example, indicators relevant to legality or human rights can effect to expenditure of company, employee satisfaction, or customer satisfaction.

Veleva et al. (2001) argued that sustainable production indicators should also include economic and social measures. They also proposed a framework that consists of five levels for categorizing existing indicators relative to the basic principles of sustainability. Their study provided a method of evaluating a set of indicators that focus on environmental, health and safety aspects of production, and work is underway to expand their method to include social and economic aspects to inform decision-makers and measure progress towards more sustainable production. Furthermore, Veleva and Ellenbecker (2001) presented a set of indicators of sustainable production for promoting business sustainability. They first introduce the concept of sustainable production which includes six dimensions and desirable qualities. Based on that framework, they suggested five stages of core and supplemental indicators for raising the awareness of firms and measuring their progress toward sustainable production systems. The six dimensions are, namely, (1) energy and material use, (2) the natural environment, (3) economic performance, (4) community development and social justice, (5) workers, and (6) products.

Phillis and Davis (2009) proposed a multi-stage fuzzy model to assess a corporation's sustainability. This model consists of two fundamental components: human and ecological. The human component has four inputs: economic, political, knowledge, and

welfare. The ecological component has also four inputs: air, water, land and biodiversity. However, this model is used to assess only lagging indicators of corporation's sustainability. It is suitable to monitor historical evolution, and compare the company with competitors. But it is not suitable for managing risk or giving improvement actions.

Another aspect is using component in supply chain as a criteria to identify performance metrics. Components in supply chain can be considered by processes, sustainable practices, or partners in SCM. Zhu and Sarkis (2004) developed GSCM practices metrics to measure an extent of adopting GSCM practices in their companies. They collect the data, using survey approach, in 186 respondents of Chinese manufacturing. The respondents were requested to indicate, using a five-point Likert-type scale, the perceived extent of adopting each of the GSCM practices. They classified the practices into four groups based on SC processes which are (1) internal environmental management (2) external GSCM practices (3) investment recovery and (4) eco-design. Then Zhu et al. (2007) has separated the second group (external GSCM practices) into two groups. Hence the new evaluation of GSCM practices are classified into five groups, which are (1) internal environmental management (IEM) (2) green purchasing (GP) (3) customer cooperative (CC), (4) investment recovery (IR) and (5) eco-design (ECO). They studied the adoption of GSCM practices in different industry (Zhu et al., 2008), examined the relationship between GSCM practice and GSCM performance (Zhu and Sarkis (2004), Zhu et al. (2007, 2012)). Again a five-point Likert scale was used to determine if associated with their implementation of GSCM practices. The GSCM performance is classified into three groups which are (1) environmental performance (EP), (2) positive economic performance, and (3) operational performance (OP).

Process and partner in supply chain can be used for classify performance metrics in sustainable supply chain. Hassini et al (2009) proposed a framework for sSC metrics using TBL principle and supply chain partner (supplier, manufacturer, distributor, retailer, and customer). Moreover, they addressed to use decision level (strategic, tactical, and operational) at the stage of choosing appropriate measures.

In addition to consider performance metric from research works, the metrics from existing tool and guideline are analyzed in this section, which are GreenSCOR and GRI. The GreenSCOR is separated from conventional SCOR in version 9.0. This model focuses only environmental dimension and measures environmental impacts in term of carbon emission, air pollutant emission, liquid waste generated, solid waste generated, and percent recycled waste. GRI is a guideline to report company sustainability performance. Performance metrics are classified into six categories: economic, environmental, labor practices and decent work, human rights, society, and product responsibility.

Table 2.15 Categories of green/sustainability performance measurement in SCM

References	Component of measures	Component in supply chain
Veleva et al. (2001) Veleva and Ellenbecker (2001)	Sustainability dimension <ul style="list-style-type: none"> • Energy and material use • The natural environment • Economic performance • Community development and social justice • Workers • Products 	Sustainable production level <ul style="list-style-type: none"> • Level 1: Facility Compliance/conformance • Level 2: Facility Material Use and Performance • Level 3: Facility Effects • Level 4: Supply Chain and Product Life-Cycle • Level 5: Sustainable Systems
Szekely and Knirsch (2005)	Sustainability criteria <ul style="list-style-type: none"> • Economic sustainability • Environmental sustainability • Social sustainability • Integrated sustainability 	(N/A)
Figge et al (2002)	Sustainable balanced scorecard (SBSC) <ul style="list-style-type: none"> • Financial • Customer • Process • Learning and growth • Non-market 	(N/A)
Zhu and Sarkis (2004)	GSCM performance <ul style="list-style-type: none"> • Environmental performance • Positive economic performance • Negative economic performance 	GSCM practices <ul style="list-style-type: none"> • Internal environmental management • External GSCM practices • Investment recovery • Eco-design
Zhu et al. (2007, 2012)	GSCM performance <ul style="list-style-type: none"> • Environmental performance (EP) • Positive economic performance (PEP) • Operational performance (OP) 	GSCM practices <ul style="list-style-type: none"> • Internal environment management (IEM) • Green purchasing (GP) • Customer cooperation (CC) • Investment recovery (IR) • Eco-design (ECO)
Zhu et al. (2008)	(N/A)	GSCM practices <ul style="list-style-type: none"> • Internal environment management (IEM) • Green purchasing (GP) • Customer cooperation (CC) • Investment recovery (IR) • Eco-design (ECO)
Phillis and Davis (2009)	Overall sustainability <ul style="list-style-type: none"> • Ecological system • Human system 	(N/A)
Hassini et al (2012)	Sustainability criteria <ul style="list-style-type: none"> • Economic • Environmental • Society 	Partners <ul style="list-style-type: none"> • Supplier • Manufacturer • Distributor

References	Component of measures	Component in supply chain
		<ul style="list-style-type: none"> • Retailor • Customer Decision level <ul style="list-style-type: none"> • Strategic • Tactical • Operational
SCOR 9.0 + GreenSCOR	Performance attribute <ul style="list-style-type: none"> • Cost • Assets • Reliability • Responsiveness • Agility Environmental impacts <ul style="list-style-type: none"> • Carbon-emission • Air pollutant emission • Liquid waste generated • Solid waste generated • Percent recycled waste 	Core management processes <ul style="list-style-type: none"> • Plan • Source • Make • Deliver • Return Level of process details <ul style="list-style-type: none"> • Top level (level 1) • Configuration level (level 2) • Process elements level (level3)
GRI	Performance aspects <ul style="list-style-type: none"> • Economic • Environmental • Labor practices and decent work • Human rights • Society • Product responsibility 	(N/A)

It is clearly that the existing sustainability performance measurement systems provide performance indicators from an aspect of component of measures, which will be called as sustainability criteria, and/or an aspect of component in supply chain. The performance indicators are selected based on the basis of industrial expert opinions (Sarkis, 1999; Veleva and Ellenbecker, 2001; Zhu and Sarkis, 2004; Zhu et al., 2005) or based on a company's decision (Figge et al., 2002; Hassini et al., 2012; Phillis and Davis, 2009) or a company selects the indicators from the list which is provided by industrial experts (GRI, 2006; SCC, 2010).

2.11. CONCLUSION

This chapter provides a holistically view on the sustainable development context and an integration between sustainability and supply chain management. Both of sustainability and supply chain management are very complex but impose new challenges for academic and practitioners. From the detailed literature review we found that the sSCM should consists of the supply chain management and sustainability characteristics. The supply chain management characteristics are (1) flow focus, (2) coordination focus, (3)

stakeholder focus, (4) intra-and inter-organizational processes, and (5) performance focus. And the sustainability characteristics are (1) economic focus, (2) environmental focus, (3) social focus, (4) long-term focus, and (5) stakeholder's focus.

However, the term sustainability is still broadly defined and difficult to implement for measuring performance in practical level. Different measurement models and approaches are under development and show that it is an active field of research. From an extensive literature review, we found that it is lack of the framework for translating the concept of sustainability into practical level. This framework should clarify the sustainability criteria and the measured component in supply chain. Hence this thesis will develop the conceptual framework based on both sustainability and supply chain aspects. The conceptual framework will clarify the sustainability criteria and the measured component in supply chain. Figure 2.9 shows the steps for developing the conceptual framework of sSCM performance measurement system.

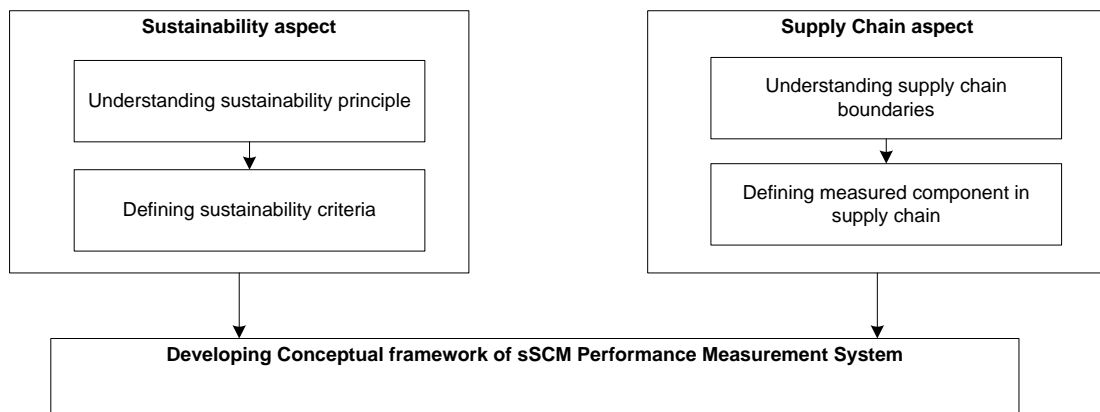

Figure 2.9 Steps for developing the conceptual framework of sSCM performance measurement system

Chapter 3. sSCM CONCEPTUAL FRAMEWORK

Despite of the sustainability terminology is unclear, as we discussed in chapter 2, and the link between sustainability and SCM is still missing. Therefore, the sustainability criteria must be defined and assured to satisfy a sustainable development's objectives. This chapter presents a new conceptual framework that assists to clarify sustainability criteria in a supply chain performance measurement. The conceptual framework composes of two features which are component of measure (sustainability criteria) and measured component in supply chain. The sustainability criteria are derived from the concept of human needs in SD and categorized regarding to the TBL dimension. The measured component in supply chain is the boundary for measurement. Companies can adopt this new conceptual framework for designing their sustainability performance measurement system.

This chapter is organized into five sections. First section provides an interpreting of human needs in sustainable development. Then the next section provides the sustainability perspective in industrial sector. After that, the sSCM framework for measure sustainability performance is proposed. This framework compose of sustainability criteria, perspective of short and long term contribution of SD, and an engagement level in supply chain. The process based approach is proposed in order to construct the sustainability measures in supply chain management. Finally, in order to verify this sSCM framework, the supplier evaluation is selected to apply as a case study.

3.1. INTERPRETING 'NEEDS' IN SUSTAINABLE DEVELOPMENT

According to the definition of sustainable development from *Our Common Future* report as "development that meets the needs of the present without compromising the ability of future generations to meet their needs." (United Nations (UN), 1987), it contains within it two key concepts: the concept of "need" and the idea of limitation imposed by the state of technology and social organization on the environment's ability to meet present and future needs. It emphasizes the important of long-term consideration in the development process and draws attention to the needs of people in the present and future generation. This definition raises two questions. Firstly, what are the needs of present and future generations? Secondly, how does supply chain contribute to sustainable development to meet these needs?

The work on fundamental human needs has been developed by Abraham Maslow (Maslow, 1943). He argued that people are motivated by a series of five types of needs which arranged in a hierarchy and represented as a pyramid (as shown in Figure 3.1). These needs consist of physiological needs, needs for safety, belongingness, self-esteem,

and self-actualization. In summary, *Physiological needs* include requirement for food, water, sleep, warmth. *Safety needs* contain the need for security, structure, shelter, and protection. *Belongingness* involves the need to feel a sense of belonging and acceptance among social groups. *Esteem needs* contain self-respect and recognition by others of our worth and competence. *Self-actualization needs* encompass the attainment of an individual's full potential. Maslow suggested that these needs must be satisfied in order of importance. As soon as needs on a lower level is fulfilled, the needs on the next level will emerge and demand satisfaction.

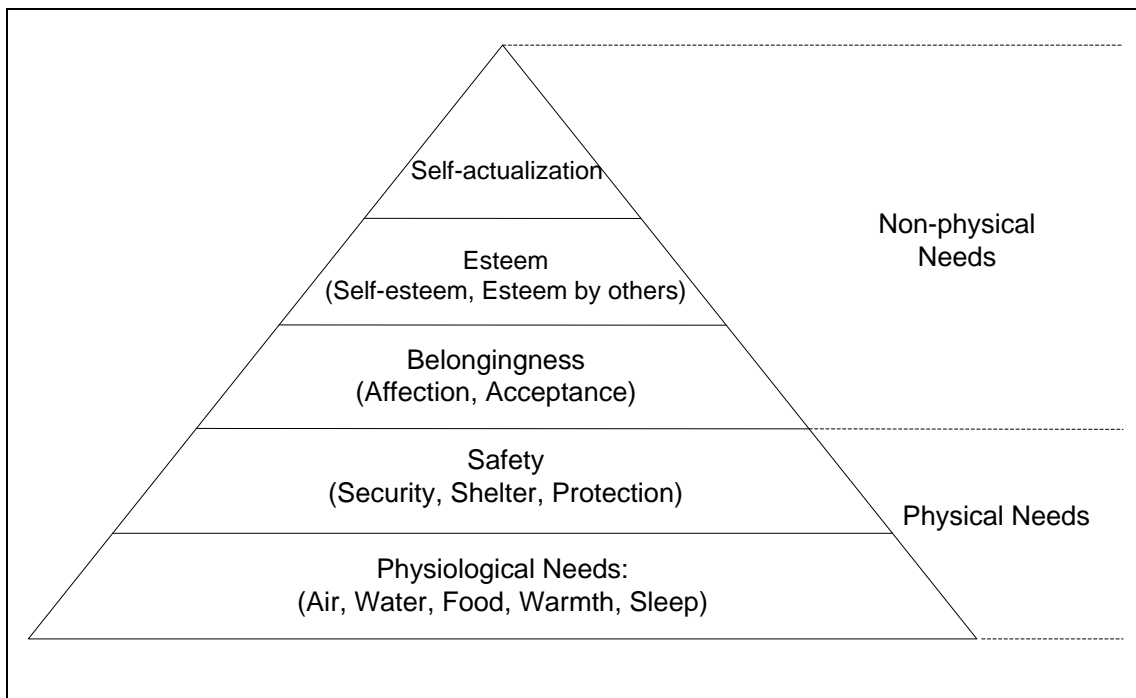

Figure 3.1 Maslow's hierarchy of human needs

Table 3.1 Max-Neef's fundamental of human needs

Physical needs	Subsistence Protection
Non-physical needs	Affection Understanding Participation Idleness Creation Identity Freedom

Another work on the human needs categorization that much discussed in the literature, is proposed by Max-Neef, (1992). He identified nine types of fundamental human needs (as shown in Table 3.1), which are subsistence, protection, affection, understanding, participation, idleness, creation, identity, and freedom. According to Maslow, (1943) and

Max-Neef, (1992) categorization, this study divides the human needs into two types: physical and non-physical needs.

3.1.1 PHYSICAL NEEDS

The physical needs are the basic human needs for a livelihood. Maslow, (1943) and Max-Neef, (1992) were talking about the same things. Maslow referred to the physiological needs and safety while Max-Neef referred to subsistence and protection. People need food, material, water supply, air, energy, health sanitation and safety for their physical well-being (United Nations (UN), 1987). The physical needs require an economic security such as employment to allow people to pay for their food, housing, clothing and necessary goods. Moreover, its desire sufficient energy and natural resources, cleaned environment, and safety condition for physical health. It means that the physical needs consist of economic, environmental and social dimensions of sustainability. The satisfaction of these needs can be met through reductions in poverty, eco-system protection, and improvements in human health.

1. *Employment* is a component of economic security for people. It is an essential activity towards meeting the physical requirements. Compensation for work allows people to pay for food, housing, clothing and other necessities goods and services.
2. *Natural resources* are useful materials from the Earth. People use natural resources (water, air, soil) and raw materials to manufacture or create products and services (Giddings et al., 2002).
3. *Clean environment*. For a good physical well-being, people must have access to not only the sufficient natural resources but also the clean environment. The prevention and reduction of air and water pollution will remain a critical task of resource conservation. Air and water quality come under pressure from such activities as fertilizer and pesticide use, fossil fuel burning, the use of certain chemicals, and the various other industrial activities. Each of these is expected to increase the pollution load on the biosphere substantially. Hence, it is needed to prevent these pollution problems by enforcing emission standards, promoting low-waste technologies, and anticipating the impact of new products, technologies, and wastes (United Nations (UN), 1987, chap. 2).
4. *Energy* is necessary for daily survival. Future development crucially depends on its long-term availability quantities from sources that are dependable, safe, and environmentally sound. Energy provides essential services for human life such as heat for warmth, cooking, manufacturing, power for transport and mechanical work. At the present, the energy to provide these services comes from fuels – oil, gas, coal, nuclear, wood, and other primary sources (solar, wind, or water

power). The primary sources of energy are mainly non-renewable: natural gas, oil, coal, and conventional nuclear power. However there are also renewable sources, including solar, falling water, wind, and geothermal sources. The key elements of sustainability energy that have to be conciliated are sufficient growth of energy supplies to meet energy consumption, utilizing the energy usage efficiency, and public health impacts from energy usage (United Nations (UN), 1987, chap. 7).

5. *Sanitation, health and safety* are also important. Good health is the foundation of human welfare and productivity. Deficiencies in these areas are visible manifestations of environmental stress. The failure of meeting sanitation, health and safety needs is one of the major causes of many communicable diseases (United Nations (UN), 1987, chap. 2), accidents and injuries (Wood, 1991). The critical of ill health are related to environmental conditions and development problems. Examples of links between development, environmental conditions, and health are air pollution and respiratory illness. It brings the impacts of housing conditions on the spread of tuberculosis, the effects of toxic substances, and the exposure to hazard in the workplace. Beyond this, it is necessary to identify vulnerable groups and their health risks are taken into account in sustainable development policy (United Nations (UN), 1987, chap. 9).

3.1.2 NON-PHYSICAL NEEDS

The non-physical needs are the needs to fulfill emotional and morale of human. Maslow, (1943) referred to belongingness, esteem, and self-actualization. Max-Neef, (1992) referred to affection, understanding, participation, idleness, creation, identity, and freedom. The non-physical needs relate to individual and social psychology. They are more about processes (personal, social, and cultural) than they are about objects (financial, material, natural resources, products, etc.) (Hutchins and Sutherland, 2008).

These needs can be met through human development, equity, and ethical issues. According to the TBL concept, the non-physical needs are focusing only in the social dimension.

1. *Human capabilities development.* All human have a desire for self-respect or self-esteem and for the esteem of others. Satisfaction of the self-esteem need leads to feelings of self-confidence, worth, strength, capability and adequacy of being useful and necessary in the world (Maslow, 1943). Education and training would help people to find and improve their potential capability.
2. *Harmony among human beings and between humanity and nature.* Human need to live with a harmony among human beings and between humanity and nature.

In order to live with harmony among human beings, people have responsibility to respect human rights of each other. There are two categories of human rights. The first category concern civil and political rights and includes such rights as the right to life and liberty, equality. The second category concerns economic, social, and cultural rights and includes such rights as the right to work, the right to health, the right to education, and the right to social security(United Nations (UN), 1987, chap. 2). The reorientation of technology is the key link between humans and nature. The capacity for technological innovation needs to be enhanced and to pay attention to environmental factors. Technologies are needed to product social goods, such as improved air quality or increased product life (United Nations (UN), 1987, chap. 2).

The concepts of sustainable development are summarized in term of principle and guidance which is shown in Table 3.2. It is accepted that the interventions needed to achieve sustainable development must be conceived by integration between the three pillars of economic development (income, productivity, innovation technology), social equity (sanitation, health care, human potential capabilities, education, etc.), and environmental protection (natural resources, material, energy). Realizing that all of these are connected and cannot be treated in isolation one from another. For example, an emission from human activities impacts the quality of ecological system and also human health and safety, or an education helps to improve skills and knowledge performance, that leads to an increasing of productivity in economic point of view, and also leads to an innovation technology development to shift to less (or non) – polluting products/technologies in environmental point of view.

Table 3.2 Principles and guidance to achieve sustainable development

	Needs	Principles	Guiding for SD
Physical	1) Economic security	<ul style="list-style-type: none"> • Reduce poverty • Better income distribution 	<ul style="list-style-type: none"> • Equitable income distribution
	2) Natural resources (raw material, air, water, soil)	<ul style="list-style-type: none"> • Sufficient material, water and land for livelihood • Reduced vulnerability to natural disasters and technological risks 	<ul style="list-style-type: none"> • Improving material usage efficiency • Conserving and efficiently using natural resources. Efficiency can be improved by considered using, recycling, and substitution capability. • Promote less material products and technologies • Assess potential impacts of new technologies before they are widely used, in order to ensure that their production, use, and disposal do not overstress environmental resources.
	3) Clean environment	<ul style="list-style-type: none"> • Living in a clean environment (clean 	<ul style="list-style-type: none"> • Prevent and reduce air, water, and soils pollution.

	Needs	Principles	Guiding for SD
		air, water, soils)	
	4) Energy	<ul style="list-style-type: none"> • Sufficient energy needs for livelihood 	<ul style="list-style-type: none"> • Conserving and efficiently using energy by reduce energy consumption • Using renewable energy • Assess potential impacts of new technologies before they are widely used, in order to ensure that their production, use, and disposal do not overstress energy sources. • Improvements in energy efficiency and a shift towards less energy-intensive sectors. • Encourage a shift to non-polluting sources and technologies
	5) Sanitation, health and safety	<ul style="list-style-type: none"> • Living in a good quality condition (safe and healthy) • Improving health care condition. 	<ul style="list-style-type: none"> • Providing primary health care facilities and making sure that everyone has the opportunity to use them are appropriate starting points. • Reduce environmental and development problems which impact on health and well-being • Health care must be supplemented by effective health education • New techniques and technologies for safety design and control, accident prevention, contingency planning, damage mitigation, and provision of relief. • Assess potential impacts of new technologies before they are widely used, in order to ensure that their production, use, and disposal do not negative impacts to human health.
Non-physical	6) Human capabilities development	<ul style="list-style-type: none"> • Improved individual potential capabilities • Improved community potential capabilities 	<ul style="list-style-type: none"> • Encourage in education to improve human skills and knowledge performance • Embed sustainability, equity, social justice, and security in to account regarding to a safe environmentally sound energy as a component of decision making

	Needs	Principles	Guiding for SD
	7) Harmony among human beings and between humanity and nature	<ul style="list-style-type: none"> • Encourage and promote harmony among human beings and between humanity and nature • Encouraging a long-term development • Community knowledge and support, which entails greater public participation in the decisions that affect the environment 	<ul style="list-style-type: none"> • Changing in attitudes and objectives and in institutional arrangements at every level to integrate economic and ecological considerations in decision-making. • Policy decisions must focus on the source of environmental damage rather than the symptoms. • Changing people's values, attitudes, perspectives and life-styles towards environment and development - indeed, towards society and work at home, on farms, and in factories

Source: Analyzed from Brundtland commission (United Nations (UN), 1987)

3.1.3 THE NEEDS AND THE TRIPLE BOTTOM LINE (TBL) CONCEPT

According to the physical and non-physical needs in the previous section, these needs can be categorized by using the TBL concept in order to analyze in the sustainability context in industrial perspective. The economic perspective involves with the need of economic security of both company and employees. The environmental perspective involves with the need of natural resources, clean environment, and energy. The social perspective involves with the sanitation health and safety, human capabilities development, and harmony among human beings and between humanity and nature.

The needs categorization based on the TBL concept can be used as a framework for defining metrics to evaluate sustainability performance. Santiteerakul et al., (2012) adopted this categorization to identify the measures and metrics in each category (see the details of metrics in Appendix I).

Existing guidelines/regulations/standards can be used as operational practices to identify leading performance indicators. From the literature review of sustainability initiatives guidelines, we found that ISO26000 and GRI cover all three sustainability dimensions. ISO26000 offers guidance on socially responsible behavior and possible actions. Even this standard does not provide metrics to measure outcome performance but companies can use it to develop their leading indicators to measure their sustainability actions. An analysis of ISO26000 core subject and sustainability criteria is shown in Table 3.2. Meanwhile GRI provide outcome performance indicators allowing companies to monitor and benchmark their sustainability performance. An analysis of

sustainability indicators from GRI in regard with sustainability criteria is shown in Appendix II.

In addition to ISO26000 and GRI, there are various practices which can be used to identify leading or lagging indicators. Companies may use ISO9001 or SCOR model to manage economic performance. ISO14000 series and eco-efficiency may be used to manage environmental performance. SA8000 may be used in labor management in social dimension. Hence, companies should, first, determine relevance and significances of sustainability criteria to their strategic direction. Then, companies should explore guidelines/standards/regulations or tools which provide sustainability practices in their interested issues. After that, they can develop performance indicators based on the selected guidelines. Table 3.4 provides an analysis of other references (guidelines, regulations, tools) in regard with sustainability criteria and the details of sustainability issues in each reference are shown in Appendix II.

Table 3.3 Analysis of Guidelines/Standards/Tools regarding to sustainability criteria

Sustainability criteria		Providing lagging indicators				Providing sustainability practices to identify leading indicators						
		GRI	ISO14031	Eco-Efficiency	SCOR 9.0	ISO 9001	ISO 14001	ISO14004	ISO 14040	ISO 14044	ISO 26000	SA 8000
C1	Financial performance											
C1.1	Company's financial	X	X	X	X	X					X	
C1.2	Economic distributed	X									X	
C2	Non-financial performance											
C2.1	Quality	X			X	X					X	
C2.2	Time	X			X	X						
C2.3	Flexibility				X	X						
C3	Material											
C3.1	Material conservation	X	X	X	X		X	X	X	X	X	
C3.2	Hazardous substances/material	X	X	X					X	X	X	
C4	Natural Resources (water, air, soil)											
C4.1	Natural Resources conservation	X	X	X	X		X	X	X	X	X	
C4.2	Environmental prevention	X	X	X	X		X	X	X	X	X	
C5	Energy											
C5.1	Energy conservation	X	X	X	X		X	X	X	X	X	

Sustainability criteria		Providing lagging indicators				Providing sustainability practices to identify leading indicators						
		GRI	ISO14031	Eco-Efficiency	SCOR 9.0	ISO 9001	ISO 14001	ISO14004	ISO 14040	ISO 14044	ISO 26000	SA 8000
C5.2	Renewable energy	X			X						X	
C6	Health and Safety											
C6.1	Employee's Health and Safety	X	X	X							X	X
C6.2	Stakeholder's Health and Safety	X	X					X	X	X		
C7	Human Capabilities											
C7.1	Knowledge and working skills	X				X	X	X			X	
C7.2	Morality	X									X	X
C8	Ethical Practices											
C8.1	Human rights	X									X	X
C8.2	Other ethical issues (community initiatives, corruption, compliance)	X									X	X

3.1.4 GOALS FOR SUSTAINABLE DEVELOPMENT

In order to achieve human needs by using guiding principle for SD in Table 3.2, we categorize the goals for SD regarding to the triple bottom line and a long-term aspect as follow:

1. **Economic perspective:** SD aims to increasing economic prosperity. In national development point of view, economic prosperity might be seen as GDP growth rate or GDP per capita. In business point of view, economic prosperity might be seen as profit, revenue, or market share.
2. **Environmental perspective:** SD aims to reducing negative impacts on natural resources by using resource more efficiently and reducing environmental pollution.
3. **Social perspective:** this perspective consisting of two goals which are reducing negative impacts on human health and improving human capabilities by encouraging education and technology innovation.
4. **Long-term perspective:** SD aims to meet the needs for future generations. It means that innovation of cleaner technologies, ethical issues for encouraging human moral and knowledge management are needed to support long-term development.

The sustainability goals are defined by the company and its networks strategy. Hence the sub-dimension is required to help managers implement the sustainability practices in their company.

3.2. SUSTAINABLE DEVELOPMENT IN INDUSTRIAL SECTOR

In the Our Common Future report provided seven areas of interest in SD context which are population and human resources, food security, species and ecosystems, energy, industry and urban challenge. This research is interesting only in sustainability for industry because the proposed framework aims to support the manufacturing supply chain. Thus the impacts of industrial and the strategies for sustainable industrial development are considered as the needs for sSCM.

3.2.1 CONTRIBUTIONS OF INDUSTRIAL SECTOR TO SUPPORT SD

Industrial sector has two important roles to support sustainable development, which are identified in chapter 30 of agenda 21. These roles are promoting cleaner production (as shown in Figure 3.2) and promoting responsible entrepreneurship (as shown in Figure 3.3).

A) Promoting cleaner production

The first role aims to increase the efficiency of resource utilization and reduce the quality of waste discharge per unit of economic output by preventing material, natural resources, and energy depletion. The actions in each elements of industry sector are required to achieve promoting cleaner production. Actions from individual company, collaboration among companies in their supply chain, and collaboration among companies, industrial cluster, national organization, or academic organization are shown in Figure 3.2. An individual company should work on cleaner production issue. It is beginning with policy establishment, implementing in its operation, education training with workers, improving environmental awareness, and reporting environmental performance to stakeholders. Then, individual company should work within their supply chain by managing their collaboration regarding to sustainable development concept. Finally, individual company and their supply chain should work with relating organization e.g. academic organization, national organization, etc. to support an achievement for sustainable development.

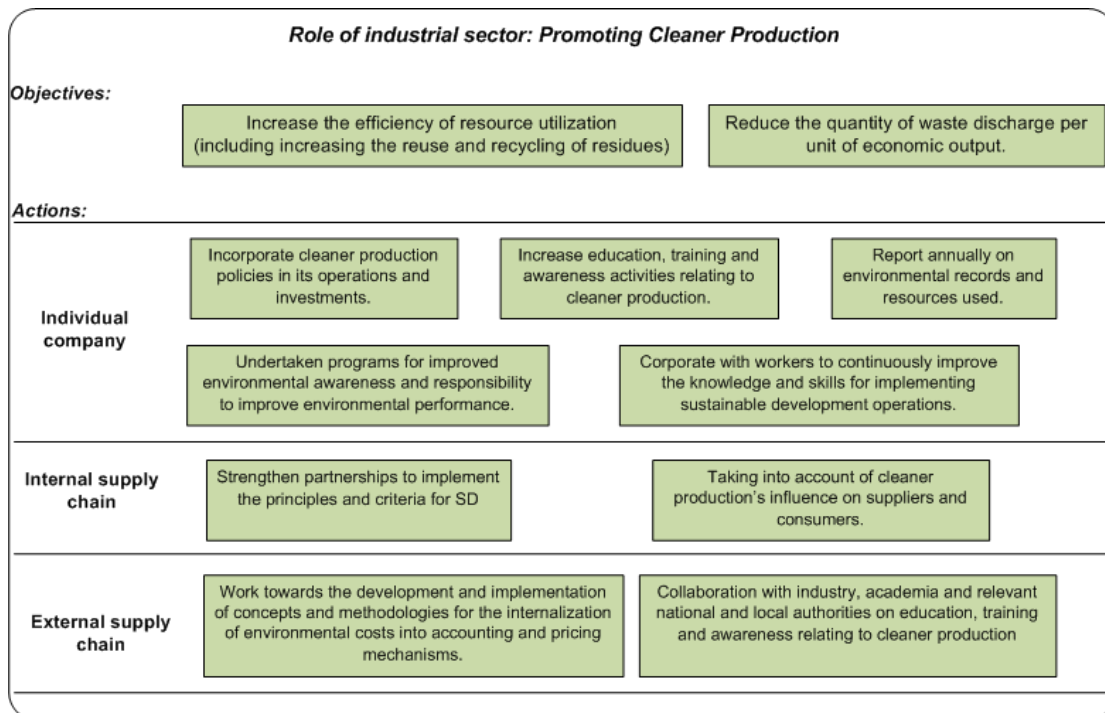

Figure 3.2 Role of industrial sector: Promoting cleaner production

B) Promoting responsible entrepreneurship

The second role aims to encourage the concept stewardship in the management and utilization of natural resources. And to increase the number of entrepreneur's engagement to implement sustainable development policies. The management and utilization of natural resources focus both on utilization efficiency and reduce pollution emissions. The engagement to sustainable is considered to ensure that responsible and ethical management of products and process from the point view of health, safety and environmental aspects is implemented in the enterprises. The second role of industry is trying to achieve the item 2 (in term of pollution emission), 4, and 5 in the human needs.

The actions, which are required to achieve promoting responsible entrepreneurship, are shown in Figure 3.3. An individual company should work to ensure that its products and processes are based on responsible and ethical management. Company and its supply chain may work together to establish self-regulation or code of conduct, which appropriates to health, safety and environmental aspects. Organizations, which are not directly an internal supply chain e.g. national organization, academic organization, etc. play an important role for supporting responsible entrepreneurship by collaborate with company and supply chain to increase research and development of environmentally technologies, environmental management systems, and facilitate appropriate knowledge training relating to responsible entrepreneurship.

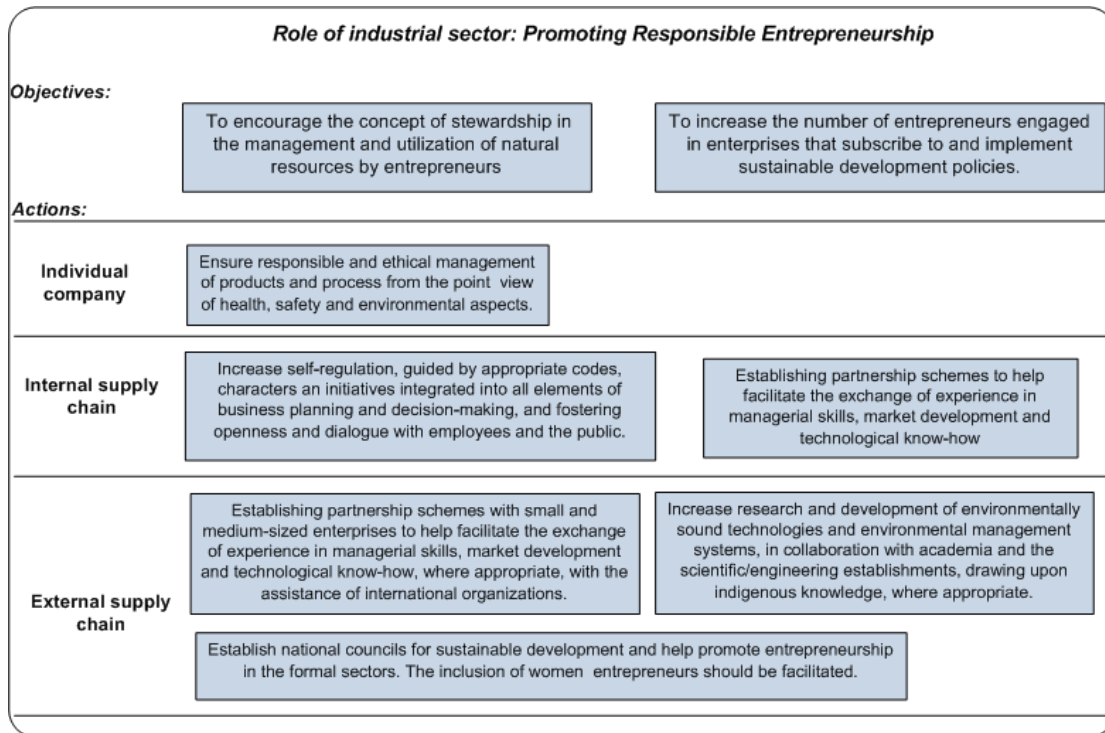

Figure 3.3 Role of industrial sector: Promoting responsible entrepreneurship

3.2.2 GOALS FOR SUSTAINABLE SUPPLY CHAIN MANAGEMENT (SSCM)

The sSCM goals and activities to achieve SD objectives are identified by extracting contexts from industrial roles, which are shown in Table 3.4. The goals of sustainable supply chain management are divided into seven categories:

1. Increasing economic performance
2. Increasing the efficiency of resources utilization
3. Reducing environmental pollution
4. Reducing negative impacts on human health and safety
5. Encouraging ethical management in supply chain
6. Encouraging human capability development
7. Encouraging innovation and technology development

Table 3.4 Goals for sustainable supply chain

Sustainable development principles	Sustainable supply chain management goals (Industrial sector)	Activities of sustainable supply chain to support sustainable development
Increasing prosperity	<ul style="list-style-type: none"> • Increasing economic performance 	<ul style="list-style-type: none"> • Provide trading, employment and livelihood opportunities in economic and social system.
Reducing negative impacts on resource use and the environment	<ul style="list-style-type: none"> • Using resource more efficiently • Reducing environmental pollution 	<ul style="list-style-type: none"> • Through more efficient production processes, preventive strategies, cleaner production technologies and

Sustainable development principles	Sustainable supply chain management goals (Industrial sector)	Activities of sustainable supply chain to support sustainable development
		procedure throughout the product lifecycle, minimizing or avoiding wastes.
Reducing negative impacts on human health and society	<ul style="list-style-type: none"> • Reducing negative impacts on human health and safety 	<ul style="list-style-type: none"> • Ensure responsible of products and process from the point of view of health and safety aspects. • Implementing responsible care and product stewardship policies, fostering openness and dialogue with employee and the public, and carrying out environmental assessment of compliance.
Improving human skills and encouraging a long-term development.	<ul style="list-style-type: none"> • Encouraging human capability development • Encouraging innovation and technology development • Encouraging ethical management in supply chain 	<ul style="list-style-type: none"> • Support for research and development on improving technological and managerial requirement for sustainable development. • Providing human resource training and knowledge management for sustainable development. • Ensuring responsible and ethical management of products and processes.

3.3. PROPOSED SSCM FRAMEWORK

3.3.1 SUSTAINABILITY CRITERIA

Conceptualizing sustainability in three dimensions seems to be widely accepted (Dyllick and Hockert, 2002). It allows an easy comprehension of the integration of economic, environmental and social issues. But with these three dimensions is too large to identify sustainability metrics. There are various aspects to categorized sustainability criteria. Beamon (2008) categorized sustainability based on inputs (human resource, material, and fuel) and outputs (products, service, and solid waste) of supply chain.

In this work, sustainability criteria are categorized regarding to the definition of human needs and goals of sustainable supply chain. We can divide the criteria into eight categories which are (1) financial, (2) non-financial, (3) material, (4) natural resources, (5) energy, (6) health and safety, (7) human capabilities, and (8) ethics. All sustainability criteria are based on long-term development perspective. The risk management and innovation point of views are adopted as a lens for considering the long-term

perspective (Santiteerakul et al., 2012b; Sekhari et al., 2010). The sustainability criteria categorization illustrated in this work is schematically represented in Figure 3.4.



Figure 3.4 Sustainability Criteria Categorization

3.3.2 SUSTAINABILITY DIMENSION AND LONG-TERM PERSPECTIVE

In order to implement sustainable development in company and supply chain, the guiding principles in Table 3.2 can be used for setting supply chain strategy direction. These principles lead to a sustainable development in both short and long term perspectives as shown in Table 3.5. Sustainability in short-term perspective is the ability of activities to meet the needs of present and future generations. In the other hand, sustainability in long-term perspective is the ability of activities to shift human activities to non-polluting products/technologies, less -material and energy- usage era, changing people attitudes, life style and behavior toward sustainable path. Increasing sustainability performance must be considered both short and long term perspectives.

Table 3.5 Short-term and long-term perspectives of SD contribution

Dimensions	Short-term	Long-term
Economic		
Financial	<ul style="list-style-type: none"> Increasing revenue, profit, market share of supply chain Reducing cost of operation 	<ul style="list-style-type: none"> Equitable income for employees Equitable income distribution for local community Equitable income distribution for all
Non-financial	<ul style="list-style-type: none"> Increasing quality, delivery performance, reputation of supply chain. 	<ul style="list-style-type: none"> Increasing trusts, flexibility, agility of supply chain
Environmental		
Raw material	<ul style="list-style-type: none"> Conserve and enhance the raw material by efficiently using through reduce, reuse, recycle concepts. Reducing hazardous material usage 	<ul style="list-style-type: none"> Shift to less-material usage products and technologies

Dimensions	Short-term	Long-term
Natural resources (air, water, soils)	<ul style="list-style-type: none"> • Conserve and enhance the natural resources base by efficiently using and reduce environmental emission 	<ul style="list-style-type: none"> • Assess potential environmental impacts of new technologies before they are widely used • Shift to non-polluting products and technologies era
Energy	<ul style="list-style-type: none"> • Conserve and enhance energy resources by efficiently using and reduce energy consumption 	<ul style="list-style-type: none"> • Assess energy usage impacts of new technologies before they are widely used • Substitution of renewable energy • Shift to less-energy usage products and technologies
Social		
Health and safety	<ul style="list-style-type: none"> • Providing primary health care facilities • Reduce environmental and development problems which impact on health and well-being 	<ul style="list-style-type: none"> • Assess and reduce potential health impacts of new technologies before they are widely used • New techniques and technologies for safety design and control, accident prevention, contingency planning, damage mitigation, and provision of relief.
Potential capabilities for human well-being	<ul style="list-style-type: none"> • Encourage in education to improve human skills and knowledge performance 	<ul style="list-style-type: none"> • Embed sustainability, equity, social justice, and security in to account regarding to a safe environmentally sound energy as a component of decision making • Changing people attitudes, life style and behaviour toward sustainable path
Ethics	<ul style="list-style-type: none"> • Respect local and international laws on business and human rights. 	<ul style="list-style-type: none"> • Encouraging fair operating practice issues which arise in the areas of anti-corruption, responsible involvement in the public sphere, fair competition, socially responsible behaviour, in relations with other organizations and respect for property rights.

3.3.3 ENGAGEMENT LEVEL OF SUPPLY CHAIN

In order to measure sustainability performance for supply chain management, it is needed to link the concepts of supply chain and sustainability. The term “supply chain” consists of multiple firms, both upstream and downstream, and the ultimate consumer and involves with flows of products, materials, information, and finances from a source to a customer (Mentzer et al., 2001; Santiteerakul et al., 2012b). Activities in supply chain concept have to be identified by an engagement level both upstream and downstream. The engagement divided into three levels, which are company level, supply chain level, and stakeholder level.

- **Company level** considers activities of owned company which does not engage with any external groups or companies.

- **Supply chain level** considers activities under taken to create opportunities for negotiation, consultation or simply exchange of information between or among company and the its supply chain (suppliers, outsourced companies, customers, users or others). However, in supply chain level consists of three sub-levels which are direct supply chain, extended supply chain, and ultimate supply chain following degrees of supply chain complexity from Mentzer et al (2001)
- **Stakeholders level** consider activities under taken to create opportunities for negotiation, consultation or simply exchange of information between or among company and stakeholders. In this work, stakeholder is defined as individual or group that has an interest in any decision or activity of a company including second-tier suppliers, customer’s customers, users, and so on.

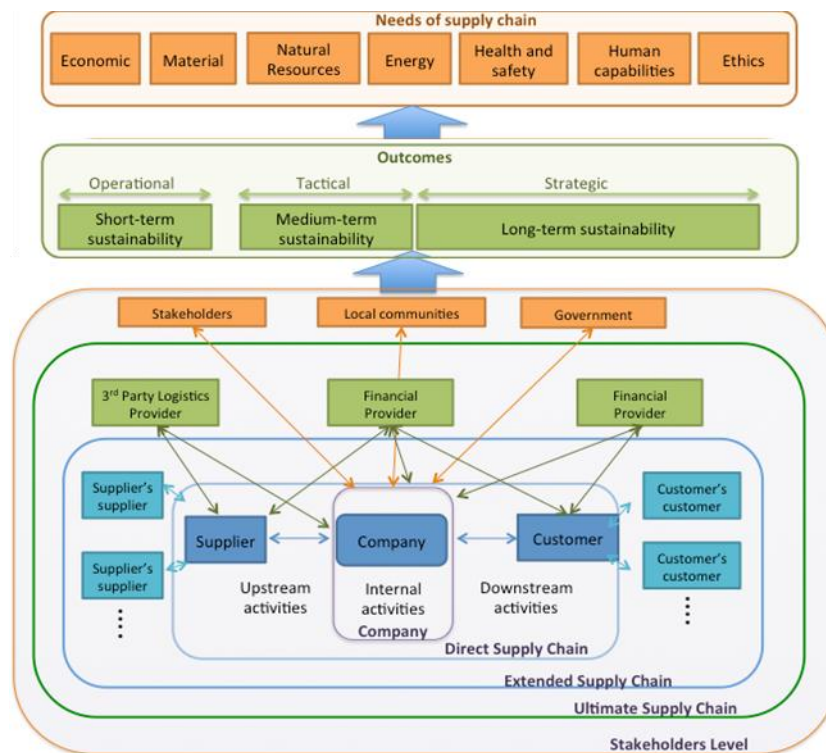

Figure 3.5 The sustainable supply chain management (sSCM) framework

3.3.4 LOCATION/PROCESS OF MEASURES

Companies can implement sustainability practices in respect of business process (or activity). In order to construct the metrics structure, a model describing activities in supply chain is considered as a framework to analyze. In general supply chain management context, the most referred model to measure performance is the SCOR model. This model organized process in supply chain management into five processes, e.g. plan, source, make, deliver, and return. Even SCOR provides the GreenSCOR model

and practices in SCOR9.0 but it does not include product design/development activity and human resource issue, which are important factors for social and long-term perspectives. In the sustainable supply chain context, SCOR is still lack of social dimension perspective. Thus, SCOR model cannot be used as a framework for analyzing business activities in our research work.

Meanwhile Porter, M.E. (1985) proposed the value chain model, which described an organization's activities (Porter, 2008, 1991). The value chain model divided organization's activities into primary and support activities. The detail of each activity is as follows:

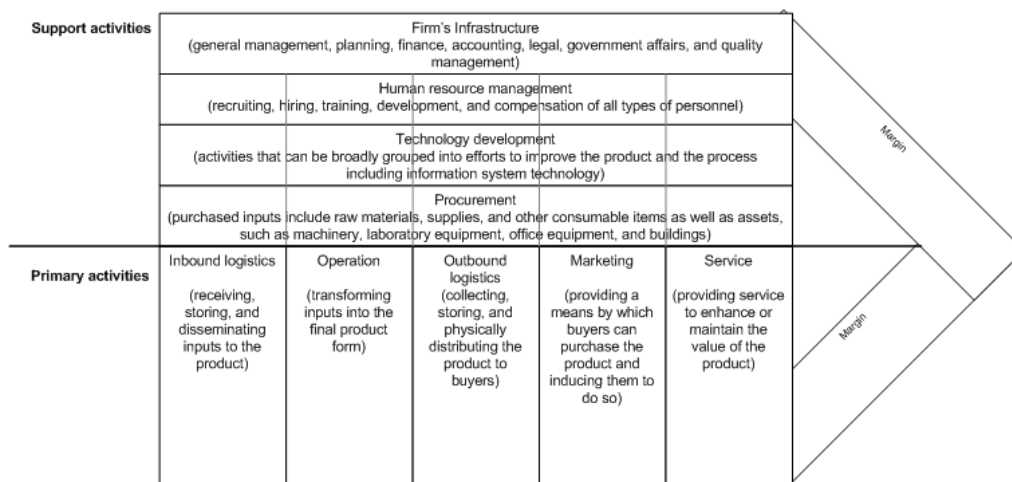

Figure 3.6 The value chain model

Primary activities

- **Inbound Logistics:** Activities associated with receiving, storing, and disseminating inputs to the product, such as material handling, warehousing, inventory control, vehicle scheduling, and returns to suppliers.
- **Operations:** Activities associated with transforming inputs into the final product form, such as machining, packaging, assembly, equipment maintenance, testing, printing, and facility operations.
- **Outbound Logistics:** Activities with collecting, storing, and physically distributing the product to buyers, such as finished goods warehousing, material handling, delivery vehicle operation, order processing, and scheduling.
- **Marketing and Sales:** Activities associated with providing a means by which buyers can purchase the product and inducing them to do so, such as advertising, promotion, sales force, quoting, channel selection, channel relations, and pricing.
- **Service:** Activities associated with providing service to enhance or maintain the value of the product, such as installation, repair, training, parts supply, and product adjustment.

Support activities

- Procurement refers to the function of purchasing inputs used in the firm's value chain, not to the purchased inputs themselves. Purchased inputs include raw materials, supplies, and other consumable items as well as assets, such as machinery, laboratory equipment, office equipment, and buildings.
- Technology development consists of a range of activities that can be broadly grouped into efforts to improve the product and the process including information system technology.
- Human resource management consists of activities involved in the recruiting, hiring, training, development, and compensation of all types of personnel. HRM supports both individual primary and support activities (e.g., hiring of engineers) and the entire value chain (e.g., labor negotiations).
- Firm Infrastructure consists of a number of activities including general management, planning, finance, accounting, legal, government affairs, and quality management.

According to the value chain model in Figure 3.6, activities relating to health and safety of employee (such as safety management, working condition regulation, etc.), human capability development (such as human resources development, training, etc.), and human rights are fallen in to “Human resource management” activity. The activities relating to local community involvement (such as social activities to promote sustainable consumption, social activities for valuing, protecting, and restoring ecosystems, etc.) are fallen into a strategic level of “Marketing management” activity, a “Firm infrastructure” activity covers activities relating to ethical issues (such as legality compliance, company governance, corruption, fair competitiveness, etc.). Moreover, activities relating to eco-design or product development are fallen into “Technology development” activity. Thus, the value chain model can cover activities in economic, environmental and social dimensions while SCOR model can cover activities in economic and environmental dimensions (in SCOR version 9.0 providing GreenSCOR metrics and best practices). Thus the value chain model is selected as a framework to analyze supply chain activities in this research work

3.3.5 DECISION LEVELS

Within business activities, management decisions may differ, depending on the timing and the responsibility of the decision-makers. These decisions would most commonly be identified as strategic, tactical, or operational:

Strategic decisions support the organization's vision, mission, values, and have significant resource allocation impact. They set precedents or the tone for decisions further down in the organization, occur infrequently, may be irreversible, and have a

potentially material effect on the organization's competitiveness within its marketplace. They are made by top managers and affect the organization's business direction.

Tactical decisions are less all-encompassing than strategic ones; they involve formulating and implementing policies for the organization. They are usually made by mid-level managers and often materially affect functions such as marketing, accounting, production, or a business unit or product as opposed to the entire organization. Tactical decisions generally have fewer resource implications than strategic decisions.

Operational decisions support the day-to-day decisions needed to operate the organization; they take effect over a few days or weeks. Typically made by a lower-level manager, operational decisions differ from tactical and strategic decisions in that they are made frequently and often on the fly. Operational decisions tend to be highly structured, often with well-defined procedure manuals or within readily understood parameters.

For measuring sustainability performance, the decision making in strategic and tactical level involve with both practices and outcomes performance. Meanwhile the decision making in operational level is more involve with outcomes performance. As discussed from the literature review, it is difficult to measure performance in social and long-term perspectives in term of outcomes performance. These two perspectives can be measured by an implementation level of sustainability practices. Hence, to keep all three sustainability dimension and long-term perspective into our sustainability objectives, the proposed model will be developed based on strategic and/or tactical decision making level.

3.4. APPROACH TO CONSTRUCT SUSTAINABILITY METRICS

3.4.1 PROCESS BASED ANALYSIS

Chan and Qi (2003) proposed the method of performance of activity (POA) for assessing process performance and its impacts. An approach of process-based performance measurement is considered. The main advantages of adopting process-based performance measurement that can be achieved in SCM are highlighted as follow:

- To provide the opportunity of recognizing the problems in operations and taking corrective action before these problems escalate (Kueng, 2000)
- To facilitate linking with the operational strategies, identifying success, and testing the effect of strategies
- To support in monitoring the progress
- To assist in direct management attention and resources allocation

- To enhance communication of process objectives and position among the processes involved in the supply chain

The steps and processes of analyzing and decomposing the processes to be measured:

1. Identifying and linking the involved processes of inter- and intra-organization. The related processes in the supply chain are identified according to the domains to be measured. These domains may be boarder process performing a set of specific functions regarding to the value chain model activities. In this step, all the related processes can be taken into considerations.
2. Defining and confining the core processes. Core processes can be defined based on the strategic objectives of sustainable supply chains by taking into account the sSCM goals and the value chain model.
3. Deriving the missions, responsibilities and functions of core processes. The responsibilities and functions of each process should be made clear. The missions and responsibilities that state what the process does provide overall guidance and direction for managers and cooperators understanding what to manage and measure.
4. Sub-processes identification and decomposition. The core processes are aggregation of a board set of sub-processes. It is necessary to decompose core process into detailed sub-processes on the lower level.
5. Deriving the responsibilities and functions of sub-processes. The responsibilities and functions of each sub-process are derived from the strategies and missions, and defined into statements to enhance understanding and communication. In contrast with those of the core process, the definitions of sub-process's responsibilities are more detailed, and closer to operational directions.
6. Decomposing and identifying the elementary activities of sub-processes.
7. Linking goals to each hierarchy from process to elementary activity. All the involved processes are decomposed into measurable elements. When supply chain managers set up the strategies and common goals for the entire system, the goals for the processes always may be quantitative value, such as percentage of increasing and decreasing, or qualitative expression.

The decomposition of process hierarchies draws a clear picture of processes and their activities. It provides an opportunity for re-examining and re-designing the processes, and easy access to measuring process performance. Most importantly, the process

framework of hierarchical structure provides the base of measuring process performance, through the method of performance of activity (POA).

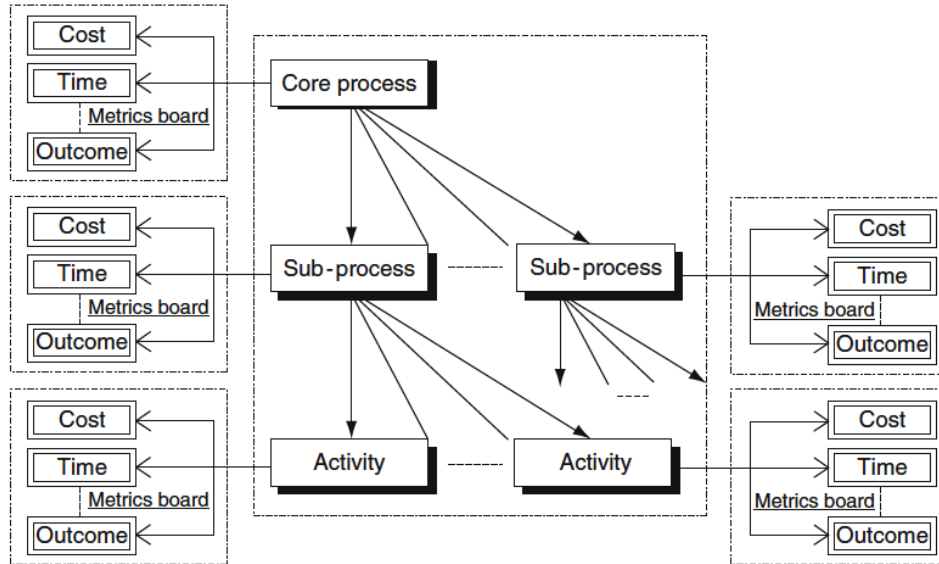

Figure 3.7 Process-based Approach for measuring supply chain performance

After identifying core process, sub-process and main activities of process hierarchies, the metrics board should be identified to indicate sustainability performance as shown in Figure 3.7. The board of performance metrics is suggested summarily as cost, time, capacity, capability, productivity, utilization and outcome.

According to the function of metric, which are divided into two types (metrics to measure performance of implementation sSC practices and metric to measure outcome performance of supply chain activities), the board of performance metric is measuring outcome performance of activities. Measuring performance of sSC practices implementation are measured using a point scales ranging method for example Koh et al. (2007) using a seven-point scales ranging from “strongly disagree” to “strongly agree” to construct measuring dimensions of supply chain practice were adopted.

3.5. SUPPLIER’S SUSTAINABILITY PERFORMANCE ASSESSMENT

Supplier performance assessment is a multi-criteria decision making problem containing many quantitative and qualitative factors because there are more than criterion needed to be taken into consideration in evaluating a supply source (Zeydan et al (2011), Ho et al (2010), Govindan et al (2013)). The supplier’s performance assessment activity is applied for supplier evaluation and selection problem in SCM. Among the traditional supplier assessment research neither environmental nor social criteria have been emphasized (Bai and Sarkis (2010). In this section, the literature

review on supplier evaluation criteria and supplier's sustainability metrics are described as follows;

3.5.1 SUPPLIER EVALUATION AND SELECTION CRITERIA

Supplier selection decisions are complicated by the fact that various criteria must be considered in decision-making processes. The analysis of such criteria for the selection and performance evaluation of potential suppliers has been the focus of many researchers and purchasing practitioners since the 1960s. Dickson (1966) was one of the first ones in this field of study. He identified 23 different criteria for supplier selection based on a questionnaire sent to managers of companies in North America. These criteria include quality, delivery, performance, warranty and claim policy, production facilities and capacity, net price, and technical capabilities. Dickson concluded that quality, delivery, and performance history are the three most important criteria respectively.

Weber et al. (1991) have reviewed 74 articles of supplier evaluation methods on the past research during 1966 to 1990 and concluded that price was the highest-ranked criteria, followed by delivery and quality. In addition they enhanced important criteria for vendors of just-in-time (JIT) system and they found that the most popular JIT criteria for supplier selection are quality, deliver, and net price respectively. It indicates that the rank of criteria depends on the context of supplier evaluation and selection.

Ho et al. (2010) reviewed the literature of the MCDM approaches for supplier evaluation and selection. Related articles appearing in international journals from 2000 to 2008 are gathered and analyzed to address the most popular criterion considered by the decision-makers for supplier evaluation and selection. The most popular criterion is quality, followed by delivery, price (cost), manufacturing capability, and service. Liao and Kao (2011) summarized the economic criteria that have appeared in literature since 1966 and concluded most of the related articles suggest that quality, price, and delivery performance are the most important supplier selection economic criteria. It is clearly that the top three of supplier evaluation and selection criteria are quality, price (or cost) and delivery in economic performance.

Social and green supplier development is also necessary for effective sSCM. In addition, the consideration of both environmental and social factors needs to be at the forefront of organizations' supplier selection agenda (Bai and Sarkis, 2010). Supplier selection in GSCM is clearly a critical activity in purchasing management because a firm's environmental sustainability and ecological performance can be demonstrated by its suppliers (Kuo et al., 2010). Because of the complexity of sustainability performance measurement as described in chapter 1 and chapter 2, companies have taken various

approaches to address the supplier selection criteria and have interpreted them in a variety of ways. Table 3.6 provides criteria for evaluating or selecting sustainable/green supplier from the literatures (Hutchins and Sutherland (2008), Lee et al (2009), Bai and Sarkis (2010), Tseng and Chiu (2010), Amindoust et al (2012), Buyukozkan and Cifi (2012), Shen et al (2012)). Their proposed criteria are selected based on their research context. The criteria that have been selected are not meant to describe thoroughly the sustainable performance of a supplier, but rather to serve as an example of the measures that could be established. Therefore, the sustainability criteria selection in this thesis depends on the strategic policy and aims of the case study company. However, initial criteria are based on the proposed sustainability criteria (Figure 3.4) in chapter 2.

Table 3.6 Criteria of sustainability/green supplier evaluation and selection

References	Supplier evaluation criteria	Dimension			Indicator	
		EC	EN	SO	LD	LG
Hutchins and Sutherland (2008)	Social sustainability criteria					
	- Labor equity			X		X
	- Health care			X	X	
	- Safety			X		X
	- Philanthropy			X		X
Lee et al (2009)	Green supplier selection					
	Quality (C1)					
	- Quality related certificates (SC11)	X			X	
	- Capability of quality management (SC12)	X			X	
	- Capability of handling abnormal quality (SC13)	X				X
	Technology capability (C2)					
	- Technology level (SC21)	X		X	X	
	- Capability of R&D (SC22)	X		X	X	
	- Capability of design (SC23)	X			X	
	- Capability of preventing pollution (SC24)		X		X	
	Pollution control (C3)					
	- Air emissions (SC31)		X			X
	- Waste water (SC32)		X			X
	- Solid wastes (SC33)		X			X
	- Energy consumption (SC34)		X			X
	- Use of harmful materials (SC35)		X			X
	Environment management (C4)					
	- Environment-related certificates (SC41)		X			
	- Continuous monitoring and regulatory compliance (SC42)		X			X
	- Internal control process (SC43)		X			X
	- Green process planning (SC44)		X			X
	Green product (C5)					
	- Recycle (SC51)		X			X
	- Green packaging (SC52)		X			X
	- Cost of component disposal (SC53)		X			X
	Green competencies (C6)					
	- Materials used in the supplied components that reduce the impact on natural resources (SC61)		X			X
- Ability to alter process and product for reducing the impact on natural resources (SC62)		X			X	
- Social responsibility (SC63)				X	X	

References	Supplier evaluation criteria	Dimension			Indicator	
		EC	EN	SO	LD	LG
	- Ratio of green customers to total customers (SC64)		X	X		X
Bai and Sarkis (2010)	<p>Strategic performance</p> <ul style="list-style-type: none"> - Cost - Quality - Time - Flexibility <p>Organizational factors</p> <ul style="list-style-type: none"> - Culture - Technology - Relationship <p>Environmental practices</p> <ul style="list-style-type: none"> - Pollution controls - Pollution prevention - Environmental management system <p>Environmental performance</p> <ul style="list-style-type: none"> - Resource consumption - Pollution production <p>Internal social criteria</p> <ul style="list-style-type: none"> - Employment practices - Health and safety <p>External social criteria</p> <ul style="list-style-type: none"> - Local communities influence - Contractual stakeholders influence - Other stakeholders influence 	<ul style="list-style-type: none"> X X X X <ul style="list-style-type: none"> X X X <ul style="list-style-type: none"> X X X <ul style="list-style-type: none"> X X <ul style="list-style-type: none"> X X <ul style="list-style-type: none"> X X <ul style="list-style-type: none"> X X <ul style="list-style-type: none"> X X 			<ul style="list-style-type: none"> X X X X <ul style="list-style-type: none"> X X X <ul style="list-style-type: none"> X X <ul style="list-style-type: none"> X X <ul style="list-style-type: none"> X X <ul style="list-style-type: none"> X X <ul style="list-style-type: none"> X X 	<ul style="list-style-type: none"> X X <ul style="list-style-type: none"> X X
Tseng and Chiu (2010)	<p>GSCM criteria</p> <ul style="list-style-type: none"> - Delivery reliability (C1) - Supplier chain practices (C2) - Supplier relationship closeness (C3) - Competitiveness to satisfy customer needs (C4) - Product conformance quality (C5) - Flexibility of supplier (C6) - Internal service quality (C7) - Green design (C8) - Green purchasing practices (C9) - Life cycle assessment practices (C10) - Environmental management system (EMS) certificate (C11) - Internal green production plan (C12) - Firm's management support (C13) - Cleaner production practices (C14) - Long-term cooperation with suppliers (C15) - Knowledge-based EMS support (C16) - Number of patents (C17) - Degree of innovativeness of R&D green products (C18) 	<ul style="list-style-type: none"> X X X X X X X X X X X X X X X X X 	<ul style="list-style-type: none"> X X X X X X X X X X X X X X X X X 		<ul style="list-style-type: none"> X X X X X X X X X X X X X X X X X 	
Amindoust et al (2012)	<p>Sustainable supplier selection criteria</p> <p>Economic criteria</p> <ul style="list-style-type: none"> - Profit - Quality - Delivery - Service <p>Environmental criteria</p>	<ul style="list-style-type: none"> X X X X 			<ul style="list-style-type: none"> X X X X 	<ul style="list-style-type: none"> X X

References	Supplier evaluation criteria	Dimension			Indicator	
		EC	EN	SO	LD	LG
	<ul style="list-style-type: none"> - Environmental management system (EMS) - Environmental competencies (EC) <p>Social criteria</p> <ul style="list-style-type: none"> - The rights of stakeholders (TRS) - Work safety and labor healthy (WS&LH) 		X X		X X X	X X
Buyukozkan and Cifi (2012)	<p>Green supplier selection</p> <ul style="list-style-type: none"> - Organizations - Financial performance - Service quality - Technology - Green competencies 	X X X X	X X X X		X X X X	X X
Shen et al (2012)	<p>Criteria for selecting and evaluating</p> <ul style="list-style-type: none"> - Pollution production (C1) - Resource consumption (C2) - Eco-design (C3) - Green image (C4) - Environmental management system (C5) - Commitment of GSCM from managers (C6) - Use of environmentally friendly technology (C7) - Use of environmentally friendly materials (C8) - Staff environmental training (C9) 		X X X X X X X X		X X X X X X X	X X
Govindan et al (2013a)	<p>Sustainability supplier selection</p> <p>Economic criteria</p> <ul style="list-style-type: none"> - Cost (EC1) - Delivery reliability (EC2) - Quality (EC3) - Technology capability (EC4) <p>Environmental criteria</p> <ul style="list-style-type: none"> - Pollution production (EN1) - Resource consumption (EN2) - Eco-design (EN3) - Environmental management system (EN4) <p>Social criteria</p> <ul style="list-style-type: none"> - Employment practices (SO1) - Health and safety (SO2) - Local communities influence (SO3) - Contractual stakeholder influence (SO4) 	X X X X			X X X X	X X X X

Note: Dimension: EC = Economic, EN = Environmental, SO= Social
Indicator: LD = Leading indicator, LG = Lagging indicator

According to the criteria in Table 3.6, we found that all of these works provide a description in each criterion in order to help decision maker to understand how to evaluate supplier performance. The criteria in literatures consist of both leading and lagging indicators as shown in the last two columns Table 3.6. The indicator type identification is analyzed based on criterion description in literatures. Almost of these literatures evaluate supplier performance in each criterion by using the subjective judgment in qualitative aspect. Except an evaluation by Hutchins and Sutherland (2008) which proposed formula to calculate social metrics in term of quantitative value (the

formula of each metric is shown in Table 3.7 in the next section). However this calculation is suitable for small number of indicators and suppliers because it will make a difficulty of gathering data from a large number of indicators or suppliers. The next section will explain how to evaluate supplier's performance in each criterion in term of subjective judgment.

3.5.2 SUPPLIER'S SUSTAINABILITY METRICS AND MEASURES

The previous section provides sustainability criteria of supplier evaluation and selection from literatures. Almost of these literatures evaluate supplier performance by using subjective judgment in each criterion. Decision maker can judge supplier's performance by using rating scale in term of linguistic value (Bai and Sarkis (2010), Tseng and Chiu (2010), Amindoust et al (2012), Buyukozkan and Cifi (2012), Shen et al (2012), Govindan et al (2013a)). For example, decision maker assess level of supplier's performance in term of very bad (VB), bad (B), average (AVG), good (G), or very good (VG) level. With this approach, the ranking of the criteria is completely independent of the particular alternatives (suppliers) of the decision problem.

Gonvindan et al (2013b) has reviewed 33 papers from peer-reviewed academic journals and proceedings on GSCM supplier selection. They found that the most widely used approach for multi-criteria decision making for green supplier selection is analytical hierarchy process (AHP) (including fuzzy AHP, FAHP). The AHP approach (Saaty, 1998) in supplier evaluation problem allows decision maker to judge supplier's performance in to approaches. The first called *absolute measurement* is an approach to rate performance in each criterion by using performance rating scale (as the same approach which explained in the previous paragraph). Another approach called *relative measurement*, decision maker has to judge supplier's performance by comparing with others in each criterion. For example, Lee et al (2009) compare the social responsibility performance between supplier A and B. Decision maker has to judge that supplier A has equal, weak, strong, very strong, or absolutely strong of social responsibility performance when comparing with supplier B. Nevertheless the relative measurement will be more difficulties if there are a large number of alternatives (suppliers) because decision maker has to compare all pair of suppliers in all criteria.

Supplier performance assessment activity can be used for selecting supplier or managing supplier performance of company. In practical when company is sourcing supplier to support parts or components of product, sourcing manager has to make a decision of supplier selection by evaluating supplier performance. Supplier selection problem may face a situation for selecting among a small number of suppliers (less than 10 suppliers). However, in supplier performance management, company may have to

assess their existing suppliers which are a large numbers for dealing with. Therefore, the relative measurement is suitable for supplier selection problem which dealing with a small number of suppliers and the absolute measurement can be adopted for both assessing supplier for supplier performance management and selecting supplier problems.

Table 3.7 Judgment approach for assessing sustainability measures

References	Sustainability metrics and measures
Hutchins and Sutherland (2008)	Evaluating supplier's performance among 5 suppliers by using <i>absolute measurement</i> . The formulas to calculate each performance criterion are as follow; <ul style="list-style-type: none"> - Labor equity (ratio of the average hourly labor cost (including benefits and taxes) to the total compensation package (converted to an hourly measure) for the company's highest paid employee (often the Chief Executive Officer or CEO) - Health care (ratio of company paid healthcare expenses per employee to the market capitalization per employee) (health maintenance (or wellness) expenses per employee) - Safety (ratio of average days not injured to the total days worked (per employee)) - Philanthropy (ratio of charitable contributions to market capitalization)
Lee et al (2009)	Evaluating supplier's performance among 3 suppliers by using <i>relative measurement</i> among other suppliers with respect to each criterion.
Bai and Sarkis (2010)	Evaluating supplier's performance among 30 suppliers by using <i>the scale of performance rating</i> . The seven-scale of linguistic rating are very poor (VP), Poor (P), Somewhat fair (SF), Fair (F), Somewhat good (SG), Good (G), and Very good (VG)
Tseng and Chiu (2010)	Evaluating supplier's performance among 4 suppliers by using <i>the scale of performance rating</i> . The five-scale of linguistic rating are very poor (VP), Poor (P), Fair (F), Good (G), and Very good (VG)
Amindoust et al (2012)	Evaluating supplier's performance among 5 suppliers by using <i>the scale of performance rating</i> . The four-scale of linguistic rating are weakly preferred (WP), moderate preferred (MP), strongly preferred (SP), and extremely preferred (EP)
Buyukozkan and Cifi (2012)	Evaluating supplier's performance among 5 suppliers by using <i>the scale of performance rating</i> . The eleven-scale of linguistic rating are none (N), very low (VL), low (L), fairly low (FL), more or less low (ML), medium (M), more or less good (MG), fairly good (FG), good (G), very good (VG), and excellent (E)
Shen et al (2012)	Evaluating supplier's performance among 3 suppliers by using <i>the scale of performance rating</i> . The seven-scale of linguistic rating are very poor (VP), poor (P), medium poor (MP), fair (F), medium good (MG), good (G), and very good

References	Sustainability metrics and measures
	(VG)
Govindan et al (2013a)	Evaluating supplier's performance among 4 suppliers by using <i>the scale of performance rating</i> . The five-scale of linguistic rating are very poor (VP), Poor (P), Fair (F), Good (G), and Very good (VG)

3.6. CONCLUSION

The purpose of this chapter is to identify sustainability criteria in the supply chain management context by using the sustainable development concept from Bruntland commission as a framework. The sSCM needs was identified regarding to physical and non-physical needs from an industrial side. The main criticism of measure sustainability in supply chain is the difficulties to evaluate sustainability along whole supply chain. It is still a challenge for supply chain performance evaluation. Thus, this research work considers supply chain as a direct supply chain (focusing on focal company and its first tier suppliers and customers). There are three main features to construct sustainability metrics which are (1) supply chain needs identification must covers all of three core dimension, (2) metrics should reflect both short-term and long-term perspective, and (3) engagement level of activities must covers supply chain level.

Eight categories of sustainability criteria are proposed and we found that six of eight sustainability criteria, which are financial, non-financial, material, natural resources, energy, and health and safety metrics, can be evaluated in supply chain level but the other two criteria (human capabilities and ethics) can be evaluated in only company level especially in employee's moral and ethical issues.

In order to construct sustainability metrics and measures, there are several of criteria to categorized performance metrics. We proposed to use sustainability criteria as component of measures and use business process/activities and decision level as criteria to consider supply chain component. These proposed criteria can guide decision maker to construct sustainability metrics in general performance measurement system. However, this thesis focuses on supplier performance assessment. Therefore the sustainability criteria and metrics are discussed in the last section. We found that even focusing on one process, the sustainability criteria and metrics.

Chapter 4. MULTI-CRITERIA MODEL FORMALIZATION

4.1. INTRODUCTION

Sustainability performance evaluation in supplier assessment process consists of multiple aspects based on each sustainable dimension. Difficulties do arise from the increased levels of complexity involved considering various supplier performance, therefore a number of criteria may be utilized. Supplier evaluation is a multi-objective and criteria decision problem containing many quantitative and qualitative measures (Zeydan et al, 2011). In this chapter a multi-criteria decision model will be analyzed and selected for establishing sustainability performance measurement system. This chapter divided into eleven parts. The first part describes the supplier performance evaluation problem in sustainability context and provides a literature review on sustainability criteria and judgment approaches to evaluate supplier's performance. Then, the multi criteria decision problem and the criteria for selecting a multi criteria decision approach are explained. The third part is an identification of the supplier's sustainability evaluation problem. The next part is an analysis for selecting the method for evaluating sustainability performance in this thesis. The results from this selection indicate that this thesis will use an analytical hierarchy process (AHP) and fuzzy set theory to develop the performance measurement system. Then the theoretical and literature on fuzzy AHP (FAHP) are provided in section 6 and section 7 and section 8. The numerical example for explaining the existing FAHP approaches are shown in section 9. Then, the proposed FAHP approach is described in section 10 with the numerical illustration in section 11.

4.2. SUPPLIER PERFORMANCE EVALUATION

Supplier evaluation decisions are complicated by the fact that various criteria must be considered in decision-making processes. The analysis of such criteria for the selection and performance evaluation of potential suppliers has been the focus of many researchers and purchasing practitioners since the 1960s. Dickson (1966) was one of the first ones in this field of study. He identified 23 different criteria for supplier selection based on a questionnaire sent to managers of companies in North America. These criteria include quality, delivery, performance, warranty and claim policy, production facilities and capacity, net price, and technical capabilities. Dickson concluded that quality, delivery, and performance history are the three most important criteria respectively.

Weber et al. (1991) have reviewed 74 articles of supplier evaluation methods on the past research during 1966 to 1990 and concluded that price was the highest-ranked

criteria, followed by delivery and quality. In addition they enhanced important criteria for vendors of just-in-time (JIT) system and they found that the most popular JIT criteria for supplier selection are quality, deliver, and net price respectively. It indicates that the rank of criteria depends on the context of supplier evaluation and selection.

Ho et al. (2010) reviewed the literature of the MCDM approaches for supplier evaluation and selection. Related articles appearing in international journals from 2000 to 2008 are gathered and analyzed to address the most popular criterion considered by the decision-makers for supplier evaluation and selection. The most popular criterion is quality, followed by delivery, price (cost), manufacturing capability, and service. Liao and Kao (2011) summarized the economic criteria that have appeared in literature since 1966 and concluded most of the related articles suggest that quality, price, and delivery performance are the most important supplier selection economic criteria. It is clearly that the top three of supplier evaluation and selection criteria are quality, price (or cost) and delivery in economic performance.

Social and green supplier development is also necessary for effective sSCM. In addition, the consideration of both environmental and social factors needs to be at the forefront of organizations' supplier selection agenda (Bai and Sarkis, 2010). Supplier selection in GSCM is clearly a critical activity in purchasing management because a firm's environmental sustainability and ecological performance can be demonstrated by its suppliers (Kuo et al., 2010). Because of the complexity of sustainability performance measurement as described in chapter 1 and chapter 2, companies have taken various approaches to address the supplier selection criteria and have interpreted them in a variety of ways. Table 3.6 provides criteria for evaluating or selecting sustainable/green supplier from the literatures (Hutchins and Sutherland (2008), Lee et al (2009), Bai and Sarkis (2010), Tseng and Chiu (2010), Amindoust et al (2012), Buyukozkan and Cifi (2012), Shen et al (2012)). Their proposed criteria are selected based on their research context. The criteria that have been selected are not meant to describe thoroughly the sustainable performance of a supplier, but rather to serve as an example of the measures that could be established.

4.3. MULTI CRITERIA DECISION PROBLEM

4.3.1 MULTIPLE CRITERIA DECISION MAKING (MCDM)

Multiple criteria decision making is defined as a formal approach to types of problem solving (or mess reduction), lies in attempting to represent such imprecise goals in terms of a number of individual (relatively precise, but generally conflicting) criteria (Stewart, 1992). The first stage of the development of multi-criteria decision theory was characterized by the methodological principle of multi-criteria decision-making

(MCDM). A classical multi-criterion problem is still presented in the form of an optimization problem. Thus a classical MCDM is formalized in term of mathematical model and the main objective of decision-making is to discover the optimal alternative among feasible alternatives.

Because of the main objective in traditional MCDM principle is to find a solution from the existing alternatives regarding to the way the problem is stated. So, decision maker has to clearly identify a set of feasible alternatives, a well-constructed preference model by enhancing a set of criteria, which relates to the problem. Moreover, if the rationality corresponding to axioms is accepted, decision maker must agree with the solution obtained. However real world problems are more complicate than making a decision based on only existing feasible alternatives or formulated a well-defined preference model. In practice, many decision-making situations relate to several people who take part in the decision process, a fuzzy boarder line between defining feasible alternatives, and uncertainty or imperfect data to evaluate performance of alternative. Hence, researchers in multi-criteria decision field have been developed a new perspective, which called *decision-aiding*, in order to help decision maker to make a better decisions subject to the presence of ambiguity, uncertainty and contradiction in a real world problem.

4.3.2 MULTIPLE CRITERIA DECISION AID (MCDA)

The principal aim of decision aiding (DA) is not to discover a solution, but to construct or create something that is viewed as liable to help "an actor taking part in a decision process either to shape (and/or to transform) his preferences, or to make a decision in conformity with his goals" (Roy, 1990). Roy (2005) referred his work on 1996 to the definition of DA as "the activity of the person who, through the use of explicit but not necessarily completely formalized models, helps obtain elements of response to the questions posted by a stakeholder in a decision process". The concepts of DA has been developed in order to meet the characteristics of complicated situation in the real world, which are e.g. involved with multi-decision maker, much of data are imprecise, uncertain, or ill-defined, nonrestrictive of feasible alternatives.

Meanwhile, the traditional decision making (DM) problems are formalized on three basic bases: (1) a well-defined set of feasible alternatives, (2) a model of preferences is clearly defined in decision maker's mind, and (3) a well-formulated mathematical problem. These basic characteristics of traditional DM problems can be considered as the limitations for complicated problems. Hence, DA context has been increasingly recognized from researchers in decision-making area.

Decision problem usually falls in multi-criteria problem because of decision making process is generally a multi-actor process and it is difficult to clearly define the most important criteria as a single. In addition the context of sustainability performance relate to multi-dimension, which are economic, environment and society (Santiteerakul et al., 2011) and from the previous work we found that our research problem is a multi-criteria (in term of multi-indicators) problem. Hence, a mono criterion problem is not considered in our research work.

The differences between MCDM and MCDA have been discussed by Roy (1990) and have been summarized as shown in Table 4.1. There are three different points of view between MCDM and MCDA which related to a set of alternatives, a set of criteria and problematic.

Table 4.1 Differences between multi-criteria decision making (MCDM) and multi-criteria decision aiding (MCDA)

Characteristic	MCDM	MCDA
<p>Alternative <i>A</i> is a set of alternatives <i>a</i>. The alternatives for decision problem can be denoted as: $A = \{a_1, \dots, a_n\}$</p>	<p>A set of <i>feasible alternatives (A)</i> is supposed to be a well-defined set by means of mathematical formulations (in case of continuous alternatives) or by a list of alternatives (in case of discrete alternatives).</p>	<p>The term of <i>potential action</i> is used in the same way as <i>alternative</i>. But a set of potential actions (<i>A</i>) is positively imposed and need not to assume as a stable set. An action is qualified as potential when it is deemed possible to implement it. In addition, there are cases where appropriate potential actions can be modelled by jointly implementing of other actions.</p>
<p>Criterion A criterion <i>g</i> is a tool constructed for the purpose of comparing and evaluating alternatives (or potential actions). The evaluation <i>g(a)</i> of alternative (or action) <i>a</i> on a criterion <i>g</i> is called a performance of criterion <i>g</i>. Multicriteria decision problem can be denoted a set of criteria <i>g</i> as: $G = \{g_1, \dots, g_k\}$</p>	<p>Decision maker is a person who constructs a preference model based on criteria of decision problem. A set of criteria <i>G</i> and a preference model are supposed to be clearly defined in decision maker's mind. The comparison between two alternatives <i>a</i> and <i>a'</i> is done by comparing the value of <i>g(a)</i> and <i>g(a')</i>. And decision maker prefers <i>a</i> over <i>a'</i> if and only if the values of <i>g(a')</i> is greater than <i>g(a)</i>.</p>	<p>The preferences can be formalized from one or several actors. The actors are either decision maker(s) or stakeholders who involve with decision process or consequence. Each criterion must take into account one or more precise attributes. Thus, the term of <i>family of criteria</i> is used for considering criteria in decision problem. Moreover, in MCDA can take uncertainty, imprecision and inaccurate determination criteria into account.</p>
<p>Problematic</p>	<p>A well-formulated mathematical problem leads to find a solution by discovering an optimal alternative <i>a*</i>, which contains a maximum value of an aggregated performance of criteria, in a set of feasible alternatives.</p>	<p>MCDA does not lead to a well-stated optimisation problem. But leads to an ill-defined mathematical problem, which provides four problematic perspectives; (1) choice problematic (P.α), (2) sorting problematic (P.β), (3) ranking problematic (P.γ), and (4) description problematic (P.δ).</p>

According to Table 4.1, MCDA perspective is more flexible than MCDM. The set of alternatives (or potential actions) in MCDA allows decision maker to create new potential actions by combining other actions. Moreover, MCDA takes into account of a board range of requirements among relevant actors, preserves the original evaluations for each actor by making a family of criteria. A family of criteria has been built by considering a perspective of each stakeholder, comparing potential actions with each criterion, and considered all criteria together to satisfy the problem requirements. Meanwhile a set of criteria in MCDM is constructed by stakeholder's preferences. Finally, the problematic in MCDA is used as a way in which DA may be envisaged. DA does not attempt to formulate any instructions or recommendations but to help decision maker (or actor) clearly understanding the purpose, type of results, and appropriate procedure to investigate of the problem. Other expressions, such as statement, problem formulation, or problem type have seldom been used as substitute but may lead to misunderstanding.

4.3.3 DECISION AIDING PROCESS OF MCDA

Roy (1985, cited by Roy (1990)) introduced a general framework of decision aiding process consists of four levels as shown in Figure 4.1. In the first level stage, the decision problematic is determined i.e. choice of best alternative, ranking of the alternatives from the best to worst, classification/sorting of the alternatives into appropriate groups, or description of the alternatives. The next level involves identification of relevant criteria (or attributes) in decision in term of a family of criteria. A consistent family of criteria can have a one of three properties; monotonicity, completeness, or non-redundancy. When a consistent family of criteria has been specified, the third step is to proceed with either the multiple criteria aggregation procedure (MCAP) (in case of a synthesize preference approach or descriptive approach) or an exploitation procedure (in case of outranking approach). Finally, the meaningful information is provided to help decision maker analyzing and justification the appropriate actions regarding to the model's consequences.

Tsoukias (2007) enhanced four cognitive results from the decision aiding process based on Roy's framework;

A representation of the problem situation: is an important result to help decision makers clearly understand the problem situation and their position within the decision process by defining the relevant actors, objectives, expected results after making decision, considering relevant criteria.

A problem formulation: is a formulating process by using information from the previous step to construct a problem model. This is an effort to translate descriptive information

to a formal problem. Set of feasible and realistic alternative actions are proposed in this process. Decision makers have to identify which problem category will be applied in their problem, e.g. predefined, chosen one, ranking, sorting, classification, etc. In order to formulate problem model, it is possible to choose more than one category regarding to the problem characteristics and the stakeholder requirements.

An evaluation model: is constructed by choosing the method, which produces the result of the problem. The constraints should be applied here. Decision makers can choose more than one method depending on the typed of procedure. In addition, they can construct more than one model and then compare the result in each model.

A final recommendation: represents the return to reality for the decision aiding process. To guarantee that the result from an evaluation model is consistent with the stakeholder’s concern. Before decision makers formulate the final recommendation, at least three precautions should take into account; sensitivity analysis, robustness analysis, and legitimation.

The context of this section focuses on the first and second step. Problem situation and problem formulation are enhanced as the results. Moreover, the preliminary methods to construct an evaluation model are presented in a conclusion section.

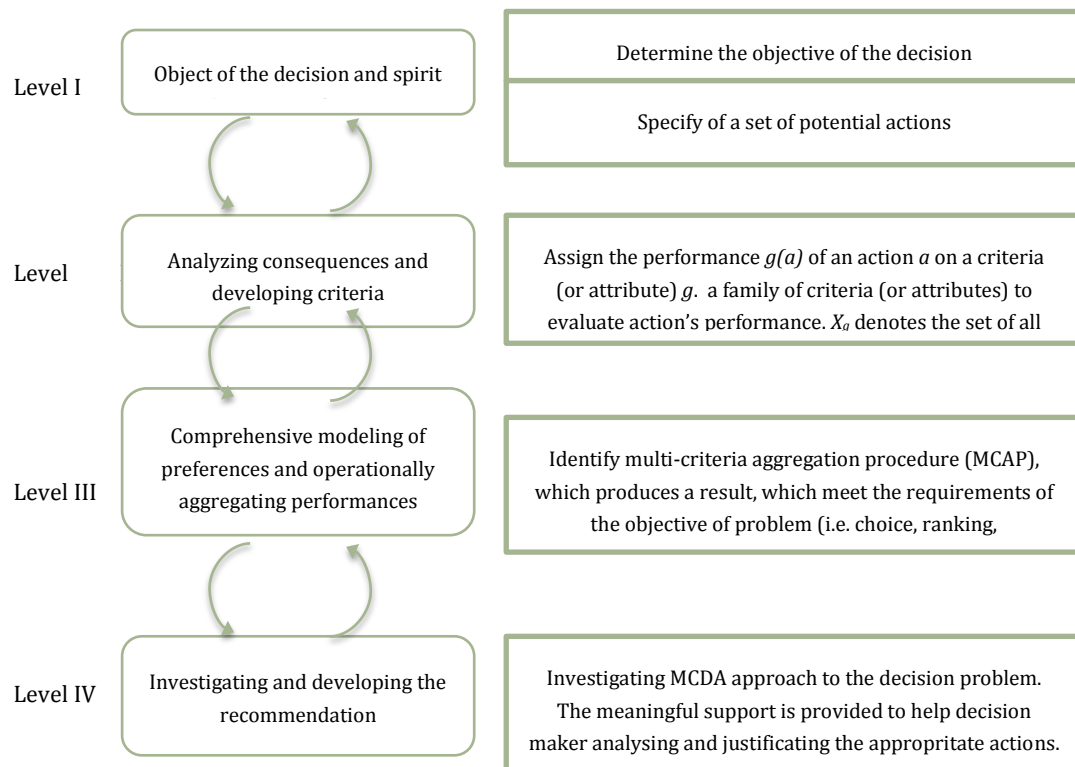

Figure 4.1 The framework of decision aiding process in MCDA (adapted from Roy, 1985)

4.3.4 MCDA METHODS

MCDA methods can be categorized by means of operational approach in decision process. Roy divided multiple criteria methods into three operative approaches:

(1) Methods based on the use of a single synthesizing criterion without incomparability i.e. multi attribute utility theory (MAUT), simple attribute rating technique (SMART), analytical hierarchy process (AHP)

(2) Methods based on the synthesis by outranking with incomparability i.e. evaluation ELECTRE methods, PROMETHEE, novel approach to imprecise assessment and decision environment (NAIADE) and

(3) Methods based on interactive local judgments with trial-and-error iteration. The first and the second approaches provide a clear mathematical structure, but the third does not use any formal model of the decision maker's preference system.

The third approach is based on a formal procedure organizing a dynamic sequence of questions that the decision maker must answer.

Another point of view to divide MCDA methods is based on the set of alternatives characteristic (Voogd, 1981). If the set of alternatives is finite, it would be categorized as discrete methods, which corresponds with single synthesizing criterion and outranking methods. If the set of alternatives is infinite, it would be categorized as continuous methods (programming methods). The MCDA method characteristics in each category are summarized in Table 4.2.

Table 4.2 Characteristics of each MCDA category

Category	Characteristics	Examples
Discrete Methods		
Single synthesizing criterion methods	<p>Each performance of alternative a on g criterion is defined to assign a well-defined degree;</p> <p>The aggregation procedure is addressed in this approach leads to defining a complete pre-order on set A;</p> <p>Most often, the formal rules consist in mathematical formulas is used to define and explicit definition of a unique criterion;</p> <p>Excluding the existence of any incomparability and to imposing the transitivity of preferences and indifferences;</p> <p>Taking account of imperfect knowledge and ill determination essentially through probability distribution, fuzzy numbers, or in some cases through rough set theory;</p>	<p>MAVT</p> <p>MAUT</p> <p>SMART</p> <p>TOPSIS</p> <p>MACBETH</p> <p>AHP</p>

Category	Characteristics	Examples
	Never through preferences or indifference thresholds	
Outranking methods	<p>The aggregation procedure does not be addressed in this method</p> <p>Based on less ‘strong’ assumptions than single criterion methods</p> <p>Encourage interaction between model and decision maker by avoiding complete ranking being identified too early</p> <p>Facilitating the identification of compromise solutions in a transparent and fair way</p>	<p>ELECTRE</p> <p>PROMETHEE</p> <p>Regime</p> <p>NAIADE</p>
Continuous Methods		
Programming methods	<p>Not choose from a finite number of alternatives;</p> <p>Alternatives are generated during the solution process on the basis of a mathematical model formulation</p>	<p>MOP</p> <p>GP</p>

4.3.5 THE CRITERIA FOR SELECTING MCDA

MCDA methods differ in the way of the idea of multiple criteria is operationalized. There is no the best method which can be used in all problems. Each method shows its own properties with respect to the problem characteristics i.e. the way of constructing criteria, the application and computation of weights, the mathematical algorithm utilized, the model of preferences, the data characteristics, and stakeholders who participate in the decision process. So, decision maker has to select an appropriate MCDA method, which respects to the problem situation, to utilize the results of decision making to meet decision maker’s objective.

De Montis et al. (2002) proposed the criteria for to selecting MCDA method divided into three categories. The first is criteria concerning the theoretical foundations of operational component elements. The second is criteria concerning the user context. The last one is the criteria concerning problem structure. In each category consists of sub-criteria to analyze the decision problem situations. Table 4.3 shows the sub-criteria in each quality criterion.

Table 4.3 Guideline to analyze characteristics of decision problem for selection MCDA method

Criteria: Operational Components of Methods	
Criteria characteristics	<ul style="list-style-type: none"> Decision maker should identify the quality of criteria in the context of three possible characteristics, which are interdependence of criteria, sensitivity of the results with respect to the completeness of criteria, and possibility for the consideration of non-linear preferences.
Weight of criteria	<ul style="list-style-type: none"> Transparency of the weighting process is explicit or implicit? The meaning of criteria’s weight is an importance or trade-off?
Solution finding procedure	<ul style="list-style-type: none"> Decision maker has to define the solution finding procedure. It is selecting, sorting, ranking, non-dominated options or a mixture of different procedure.

Criteria: Operational Components of Methods	
Issued addressed by results	<ul style="list-style-type: none"> This feature helps decision maker to consider future perspective after getting the result from decision process. Decision maker should provide solutions for idle issues or consider different concurrent or opposite aspects.
Criteria: User Context	
Project constraints	<ul style="list-style-type: none"> Decision maker should select MCDA method, which is suitable subject to costs of method application and time constraint to implement the method.
Problem solving process	<ul style="list-style-type: none"> Stakeholder participation Suitability for structuring problems Applicability for learning about the problem structure Transparency of decision processing and results Possibility for communication between different parties
Criteria: Problem Structure	
Indicators Characteristics	<ul style="list-style-type: none"> MCDA methods selection depends on flexibility of the methodology to different characteristics of indicators. Decision maker should consider geographical scales of indicators, linkage between actors on different level, societal and technical problems and combination with other methods.
Data situation	<ul style="list-style-type: none"> Decision maker should identify the data situation in preferences system. The sub-categories in this sub criterion are type of data (quantitative, qualitative, crisp, and fuzzy), uncertainties of data, and amount of data processing.

4.4. IDENTIFY PROBLEM SITUATIONS IN THE CONTEXT OF SUPPLIER'S PERFORMANCE EVALUATION

According to the objective of this part, which is selecting MCDA method to evaluate sustainability performance of suppliers, we use the framework of decision aiding process (Figure 4.1) as a framework to identify problem situations.

4.4.1 DETERMINE OBJECTIVE OF DECISION PROBLEM

This step involves the context of defining decision maker's objective, preferences model characteristics, which relate to potential actions (or alternatives); criteria building procedure; data characteristics, and expected result from decision process.

There are two research questions of our research work, which are (1) how to measure sustainability of suppliers, and (2) how to improve sustainability performance. Moreover, this work focuses on an electronic industry in Thailand and considers the activities in sourcing process. Hence, the research objective is to develop sSCM performance evaluation model which can be enhance the level of sustainability performance and gives a direction to improve sustainability to company among the supply chain.

The expected result is divided into two stages regarding to the research questions. The result of first stage is level of sustainability performance of organization. The managers of organization can benchmark their overall sustainability with other competitors or other companies in the supply chain. Thus, the problematic in this stage falls in *ranking problematic* area. After that, the result of second stage will support the recommendation

for organization’s manager on how to improve sustainability performance to a higher level. Hence, the second results should provide the information of important factors which effect to overall sustainability performance and how to increase the performance of each factor. The second preference model is an extension analysis regarding to the results of first model. Hence, this thesis focuses on the first preference model and will work on the second preference model later in the future work.

4.4.2 DETERMINING A SET OF FEASIBLE ALTERNATIVES

According to the definition of feasible alternatives (or potential actions) is considered as the solution of decision problem. This work considers a set of feasible alternatives as set of the suppliers that the focal company wants to evaluate their sustainability performance. Hence we use a term of *considered* suppliers as a same meaning as *feasible* alternatives. A is a set considered suppliers a_i consisting of m companies can be denoted as ; $A = (a_1, \dots, a_m)$.

Because of set A is a discrete set, the characteristic of MCDA approach falls in a discrete method and the aggregation of overall sustainability performance is required to address in the model. So the feasible MCDA methods will base on the use of a single synthesizing criterion without incomparability. The summarized characteristics of the research problem are shown in Table 4.4

Table 4.4 Summarized of problem characteristics in the first stage

Level of decision process	Problem characteristic	MCDA method required properties
Level I	<ul style="list-style-type: none"> • A set of feasible alternatives is finite • Problematic determination: Ranking problematic 	<ul style="list-style-type: none"> • Discrete methods • Aggregation procedure is required to address

4.4.3 ANALYZING CRITERIA CHARACTERISTICS

A set of criteria (or attributes) can be considered as relevant factors which significantly effect to the decision problem. In the context of sustainable supply chain management, the objective of companies is to increase their sustainability performance. The objective value of our research work is an overall sustainability performance, and then the sustainability indicators can be considered as the attributes of company’s sustainability.

According to sustainability aspects in research work Figure 3.4, a set of sustainability indicators (attributes) contains both of quantitative and qualitative data. This work uses the criteria proposed by De Montis (2000) to analyze preferences model characteristics and the detail of analysis is shown in Table 4.5

Table 4.5 Characteristics of sSCM performance measurement problem

Criteria: Operational Components of Methods	
Criteria characteristics	Interdependence of criteria: <i>Interdependence</i> Completeness of criteria: <i>Complete criteria</i> Non-linear preferences: <i>(have not taken into account yet)</i>
Weight of criteria	The meaning of criteria's weight: <i>importance</i>
Solution finding procedure	Ranking problematic
Issues addressed by results	The aggregated overall performance results lead to the comparison of sustainability performance of organization in the supply chain. Then, the disaggregated from overall performance into economic, environmental and society performance leads to improving direction to be a higher level for the higher level.
Criteria: User Context	
Project constraints	Cost and time constraints have not been taken into account yet
Problem solving process	Stakeholder participation: <i>participate with several stakeholders</i> Set of family of criteria (or attributes) = <i>sustainability indicators</i> Evaluating sustainability performance by organization's self-assessment. The assessment process involves linguistic variables and fuzzy assessment. Need a transparency property to enhance sustainability performance
Criteria: Problem Structure	
Indicators Characteristics	A set of indicator consists of different geographical scales. The linkage between actors has not been taken into account yet It possible to taking both societal and technical indicators Model does not consider to combine with other methods
Data situation	Model contains both qualitative and quantitative data There are both fuzzy and crisp data in term of performance of alternative The model has not identified amount of data processing yet

4.5. SELECTING MCDA METHOD

The MCDA method which meets the problem characteristics is based on the use of a single synthesizing criterion without incomparability (Santiteerakul et al., 2012a). This section provides the analysis of frequently used methods in a single synthesizing category, which are MAUT, AHP, and EvaMix methods. The comparison of method characteristics following by De Montis et al. (2002) and our problem characteristics is shown in Table 4.6. The briefly descriptions of each method are introduced as follow:

4.5.1 MULTIPLE ATTRIBUTE UTILITY THEORY (MAUT)

MAUT is based on utility theory and uses directly assessed preferences with aggregation procedure by using utility function. The concept of utility function is inherently probabilistic in nature. The utility function model can be written as

$$U_i = \sum_j w_j \cdot u_{ij}$$

where U_i is the overall value of the i th alternative, u_{ij} is the utility of the i th alternative with respect to the j th attribute measured by means of the utility function, and the weight w_j is a normalized weight or scaling constant for attribute j , so that, $\sum_j w_j = 1$

4.5.2 ANALYTICAL HIERARCHY PROCESS (AHP)

The AHP method, which was developed by Saaty (1980), is based on three principles; decomposition, comparative judgment and synthesis of priorities.

- The decomposition principle requires the decision problem to be decomposed into a hierarchy, which can capture the essential elements of the problem
- The principle of comparative judgment requires pairwise comparisons of elements within a level of hierarchical structure.
- The synthesis principle takes each of the derived ratio-scale priorities in the various levels of the hierarchy and constructs a composite set of priorities.

4.5.3 EvAMix

The EvaMix method allows using quantitative as well as qualitative data. This method is typically used to cope with decision making problems at different geographical scales. EvaMix supports stakeholder participation in weighting assignment process. This method consists of five steps, which are (1) make a distinction between ordinal and cardinal criteria ; (2) calculate dominance scores for all ordinal and cardinal criteria ; (3) calculate standardized dominance scores for all criteria ; (4) calculate overall dominance scores ; and (5) calculate appraisal scores (De Montis et al., 2012).

Table 4.6 Guideline to analyze characteristics of decision problem for selection MCDA method

		Research Problem	MAUT	AHP	EvaMix
Criteria: Operational Components of Methods					
Criteria characteristics	Allowing of interdependence	Interdependence	Not allowed	Allowed	Not allowed
	Need for the completeness criteria	Complete criteria	Allowed		
	Possibility to express non-linear valuation patterns	N/A	Allowed	Not allowed	Not allowed
Weight of criteria	Type of the procedure to deriving weight value	N/A	Cardinal weight	Cardinal weight	Ordinal weight
	Meaning of weight	Importance	Trade-offs	Importance	Importance
Solution procedure	Type of solution finding	Ranking	Complete ranking		
Criteria: User Context					
Project constraints	Cost	N/A	Depending on numbers of attributes, stakeholders involved, etc.		
	Time	N/A			
Problem solving process	Stakeholder participation	Necessary	Necessary	Necessary	Supported
	Structuring	Via the construction of sustainability indicators and organisation's self-assessment	Via the construction of utility functions	Via the construction of suitable hierarchies	Via the construction of the evaluation matrix

		Research Problem	MAUT	AHP	EvaMix
Criteria: Operational Components of Methods					
	Tool for learning	N/A	Appropriate	Appropriate	Not appropriate
	Transparency	Need transparency property	High		
	Actors communication	N/A	Via the integration of stakeholders		
Criteria: Problem Structure					
Indicators Characteristics	Geographical	Consists of a different geographical scale	Different can be treated		
	Micro-macro link	N/A	Possible		
	Societal/technical issues	Need both societal and technical indicators	Different issues are possible		
	Combination methods	Not need	Possible		
Data situation	Type of data	Consists of quantitative, qualitative, fuzzy and crisp data	Quantitative and qualitative are possible		
	Risk/Uncertainties	Data uncertainties	Risky outcomes; Probabilities, sensitivity analysis	Via sensitivity analysis	Via ordinal criteria only
	Data processing amount	N/A	High	Medium	Low
	Non-substitutability	N/A	Not possible		

According to the comparison of MCDA methods in Table 4.6, we found that only AHP method meets all of the problem characteristics. MAUT method cannot achieve the inter-dependence criteria characteristics and the weight meaning. Meanwhile Evamix method cannot achieve the inter-dependence criteria. Hence, the preference model for evaluating sSCM performance will be constructed by AHP method.

An evaluation of sustainability performance in supply chain context has faced the challenges to reduce the criticisms of existing approaches because of sustainability involves to multi-dimensional performance. In addition, sustainability in supply chain context consists of more complicated elements i.e. involving with several stakeholders, the complexity of supply chain, uncertainties or fuzzy assessment in evaluation process, etc. Thus MCDA method, which is a tool for support and help decision makers to make a better decision, is taken account to construct an evaluation model.

In order to enhance a meaningful of the consequence, selecting an appropriate method for constructing a preference model is an important process. Starting with a clearly identify relevant issues of sSCM performance measurement problem. An explicit objective of sSCM preference model is to ranking an overall sustainability performance in a set of considered companies. The analysis of sustainability indicators in term of a family of attribute helps us to determine the requirement properties in an expected preference model. And we found that the sSCM performance model is based on a single synthesizing criterion without incomparability. Finally, AHP method is the only method, which achieves all of requirements.

4.6. THE SELECTED APPROACH: FUZZY ANALYTICAL HIERARCHY PROCESS (FAHP)

According to the previous section, AHP is selected to employ as a MCDA approach for evaluating supplier's performance. Moreover, from the literature review on green supplier selection various researchers adopted the AHP or fuzzy AHP for supplier selection problem. Handfield et al., (2002) illustrated the case of AHP as a decision support tool for helping managers understand the trade-offs between environmental criteria. They demonstrated how AHP can be used to evaluate the relative importance of various environmental traits and to access the relative performance of several suppliers along with the traits. Chiou et al., (2008) applied FAHP to solve the green supplier selection problem by a ranking system based on different weights using four environmental criteria among six major criteria. This application was to determine the relative importance of selecting green suppliers across a multicultural setting including American, Japanese, and Taiwanese electronic industries in China. Lee et al., (2009) applied FAHP integrated with the Delphi method for green supplier evaluation. The Delphi method was initially used to differentiate the criteria for evaluating traditional and green suppliers. FAHP is used to solve the green supplier selection process; they focused on the efficiencies of FAHP. They used 11 main criteria and 41 sub criteria. Grisi et al., (2010) implemented a fuzzy AHP for green supplier evaluation. Fuzzy logic was adopted to overcome uncertainty arising from human qualitative judgment. This approach allows better management of data involved in global decisions, covers the use and integration of quantitative and qualitative data, provides the necessary flexibility for the analysis of problem, and facilitates tasks of verification for the robustness of the decision taken.

As the supplier selection or evaluation problem involves both qualitative and quantitative criteria, AHP not only can handle adequately the inherent uncertainty and impression of human decision making process, but also it can provide the robustness and flexibility needed for the decision maker to understand the decision problem. AHP shows the performance of a supplier with respect to each sub criteria and main criteria, so it shows the supplier status on each criterion. Also, mathematically and philosophically, AHP provides an easily understandable and defensible approach to practitioners. It allows practitioners to be involved in the analysis and actually to guide the decision more effectively. This managerial transparency and lack of complexity allow for greater acceptance by both researchers and practitioners. The consistency verification operation of AHP contributes greatly to prevent inconsistency because it acts as a feedback mechanism for the makers to review and revise the judgment.

AHP is not without its critics, however, so ample consideration should be given to its limitations. The growth and application of AHP may derive more from a convenience and simplification perspective rather than from a strong theoretical mathematical perspective. The utilization and integration of fuzzy techniques may be advantageous for some settings, but criticism has also been targeted to the overreliance on fuzzy mathematics for these decision environments. Additional research on the ultimate solution quality under fuzzy and regular numerical valuations is necessary to determine whether the addition of fuzzy logic is a worthwhile effort.

4.7. THEORETICAL OF ANALYTIC HIERARCHY PROCESS AND FUZZY SET

4.7.1 ANALYTIC HIERARCHY PROCESS (AHP)

AHP (Saaty 1980) is a well-known multi-criterion decision making technique. It is a useful, simple and systematic approach. In this approach first a hierarchy is developed from more general (upper levels) criterion to the particular (bottom levels) or from the uncertain or uncontrollable to the more certain or controllable one.

The hierarchy of the decision variables is the subject of a pairwise comparison of the AHP. In the traditional AHP, the pairwise comparison is made using a nine-point scale (1–9) which converts the human preferences between available alternatives as equally, moderately, strongly, very strongly or extremely preferred. Thus the AHP uses only absolute scale numbers for judgments and for their resulting priorities. Even though the discrete scale of AHP has the advantages of simplicity and ease of use, it is not sufficient to take in account the uncertainty associated with the mapping of one's perception to a number. In spite of its popularity and simplicity in concept, this method is often criticized for its inability to adequately handle the inherent uncertainty and imprecision associated with the mapping of the decision-maker's perception to exact numbers. In the traditional formulation of the AHP, human's judgments are represented as exact (or crisp, according to the fuzzy logic terminology) numbers.

To make a decision in an organized way to generate priorities, decision maker needs to decompose the decision into the following steps.

Step 1 Define the problem and determine the kind of knowledge sought.

Step 2 Structure the decision hierarchy (as shown in Figure 4.2) from the top with the goal of the decision, then the objectives from a broad perspective, through the intermediate levels (criteria on which subsequent elements depend) to the lowest level (which usually is a set of the alternatives).

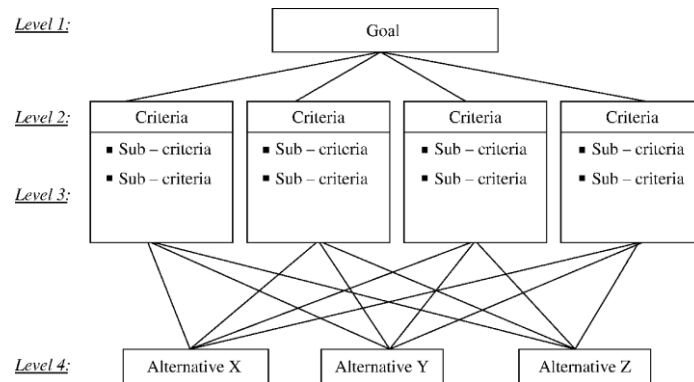

Figure 4.2 Structure of the decision hierarchy

Step 3 Construct a set of pairwise comparison matrices. Each element in an upper level is used to compare the elements in the level immediately below with respect to it. In this step

Step 4 Use the priorities obtained from the comparisons to weigh the priorities in the level immediately below. Do this for every element. Then for each element in the level below add its weighed values and obtain its overall or global priority. Continue this process of weighing and adding until the final priorities of the alternatives in the bottom most level are obtained.

In order to determine the final priorities of the alternatives in step 4, the relation between criteria and alternatives should be concerned. There are two ways in which the criteria are related to the alternatives dealing with the cases of independence and quasi-independence of the criteria from the alternatives which are:

1. *Absolute Measurement.* The ranking of the criteria is completely independent of the particular alternatives, of the decision problem being considered, and of their number and measurements. This case has the closest parallel with multi attribute utility theory (MAUT). This approach is used when it is desired to rank alternatives according to standards established through the experience of experts even if one may disagree with these standards. Given the priorities of the criteria, absolute measurement involves a normative assessment by introducing intensities or degrees with which an alternative is rated with respect to a criterion. One of an advantage of the absolute measurement of the AHP is there can never be reversal in the rank of the alternatives by adding or deleting other alternatives.
2. *Relative Measurement.* The ranking of the criteria is initially independent of the particular alternatives in the decision problem being considered, but the results are later rescaled as a result of the measurements of the alternatives. This

approach carried out by pairwise comparing the alternatives according to their relative dominance with respect to each criterion. In relative measurement the preference for an alternative is determined by all other alternatives. It means that the alternatives are not independent from each other for the determination of their priorities. This dependence among the alternatives may be reinterpreted as a rescaling of the priorities of the criteria depending on how many alternatives there are. The rank can be reversal when adding new alternatives or deleting others.

However, in many practical cases the human preference model is uncertain and decision-makers might be reluctant or unable to assign exact numerical values to the comparison judgments. Since some of the evaluation criteria are subjective and qualitative in nature, it is very difficult for the decision-maker to express the preferences using exact numerical values and to provide exact pairwise comparison judgments. The traditional AHP cannot straightforwardly be applied to solving uncertain decision-making problems.

In order to eliminate this limitation, in the next section we discuss the fuzzy set theory, which is capable for tackling the uncertainty and imprecision of evaluation process. It is more desirable for decision makers to use interval or fuzzy evaluations to handle the vagueness of the data involved in multi-criterion decision-making problems.

4.7.2 FUZZY SETS THEORY

Fuzzy set theory has proven advantages within vague, imprecise and uncertain contexts and it resembles human reasoning in its use of approximate information and uncertainty to generate decisions. It was specially designed to mathematically represent uncertainty and vagueness and provide formalized tools for dealing with the imprecision intrinsic to many decision problems. Fuzzy set theory implements classes and grouping of data with boundaries that are not sharply defined (i.e. fuzzy).

Fuzzy set theory includes the fuzzy logic, fuzzy arithmetic, fuzzy mathematical programming, fuzzy graph theory and fuzzy data analysis, usually the term fuzzy logic is used to describe all of these. The major contribution of fuzzy set theory is its capability of representing vague data.

A fuzzy set is characterized by a membership function, which assigns to each object a grade of membership ranging between 0 and 1. In this set the general terms such as 'large', 'medium' and 'small' each will be used to capture a range of numerical values.

The basic definitions of the fuzzy sets and fuzzy numbers from literatures (Chang and Hung, 2006; Klir and Yuan, 1995; Zadeh, 1965) in fuzzy multi-criteria decision making are discussed as follow:

Definition 1: The membership function of a triangular fuzzy number (see Figure 4.3) that described by $\tilde{c}_{ij} = (l_{ij}, m_{ij}, u_{ij})$ where $l, m, u \in \mathbb{R}, l < m < u$. If \tilde{c} is a fuzzy set, then $\tilde{c}(x)$ is the value of the membership function at $x \in \mathbb{R}$. An α -cut of \tilde{c} is written as \tilde{c}^α , is defined as $\{x | \tilde{c}^\alpha \geq \alpha\}$ for $\alpha \in [0, 1]$. The support of \tilde{c} , written as \tilde{c}^0 , is the closure of the union of $\tilde{c}^\alpha, \alpha \in [0, 1]$ (Klir and Yuan, 1995)

$$\tilde{c}(x) = \begin{cases} 0 & \text{if } x < l \text{ or } x > u \\ \frac{(x-l)}{(m-l)} & \text{if } l \leq x < m \\ \frac{(u-x)}{(u-m)} & \text{if } m \leq x \leq u \end{cases} \quad (4-1)$$

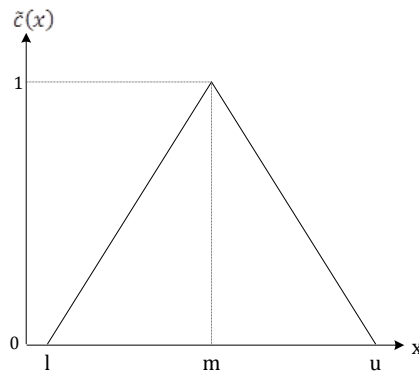

Figure 4.3 A triangular fuzzy number

Definition 2: The height of a fuzzy set is the largest membership grade attained by any element in that set. A fuzzy set \tilde{c} in the universe of discourse \mathbb{R} is called normalized when the height of \tilde{c} is equal to 1.

Definition 3: A matrix \tilde{r} is called a fuzzy matrix if at least one element of it is a fuzzy number. The summation \oplus and subtraction \ominus of any two triangular fuzzy numbers are also a triangular fuzzy number, but the multiplication \otimes of any two triangular fuzzy numbers is only an approximate triangular fuzzy number. If $\tilde{c}_1 = (l_1, m_1, u_1)$ and $\tilde{c}_2 = (l_2, m_2, u_2)$ are two triangular fuzzy numbers then the operational laws of them can be expressed as follows:

$$\tilde{c}_1 \oplus \tilde{c}_2 = (l_1 + l_2, m_1 + m_2, u_1 + u_2) \quad (4-2)$$

$$\tilde{c}_1 \ominus \tilde{c}_2 = (l_1 - l_2, m_1 - m_2, u_1 - u_2) \quad (4-3)$$

$$\tilde{c}_1 \otimes \tilde{c}_2 \cong (l_1 l_2, m_1 m_2, u_1 u_2) \quad (4-4)$$

$$\lambda \otimes \tilde{c}_1 = (\lambda l_1, \lambda m_1, \lambda u_1), \text{ where } \lambda > 0, \lambda \in \mathbb{R} \quad (4-5)$$

4.8. FUZZY AHP METHODOLOGY

In traditional AHP approach, the pairwise comparison matrices are treated as crisp matrices. In fuzzy AHP (FAHP), one uses fuzzy numbers for the pairwise comparisons and the main problem is to compute the corresponding fuzzy weights. Direct computation of fuzzy eigenvalues and fuzzy eigenvectors from a fuzzy, positive, reciprocal matrix is very complicated. Various methods deviate from the original procedure used by Saaty in AHP for finding the weights are still too computationally difficult.

Step 1 Define the problem and determine the kind of knowledge sought.

The objective of this performance measurement system is to measure sustainability performance of suppliers.

Step 2 Structure the decision hierarchy from the top with the goal of the decision, then the objectives from a broad perspective, through the intermediate levels (criteria on which subsequent elements depend) to the lowest level (which usually is a set of the alternatives).

Step 3 Construct a set of pairwise comparison matrices by comparing important weight criteria. Each element in an upper level is used to compare the elements in the level immediately below with respect to it.

Step 3.1: Comparing important weight criteria

In the problem consists of n criteria, decision-maker is required to give a relative important in each pair of criterion. The membership function of comparison ratio \tilde{c}_{ij} is a triangular fuzzy number, with $\tilde{c}_{ij} = (l_{ij}, m_{ij}, u_{ij})$ and \tilde{c}_{ji} is taken as $(\tilde{c}_{ij})^{-1} = (l_{ij}, m_{ij}, u_{ij})^{-1}$. (Van Laarhoven and Pedrycz, 1983) estimated $(\tilde{c}_{ij})^{-1}$ for triangular fuzzy number as;

If a triangular fuzzy number $\tilde{c}_{ij} = (l_{ij}, m_{ij}, u_{ij})$, then

$$\tilde{c}_{ji} = (\tilde{c}_{ij})^{-1} = (l_{ij}, m_{ij}, u_{ij})^{-1} \approx \left(\frac{1}{u_{ij}}, \frac{1}{m_{ij}}, \frac{1}{l_{ij}} \right) \quad (4-6)$$

This step results in a fuzzy comparison matrix $\tilde{C} = [\tilde{c}_{ij}]$ which is a fuzzy, positive, reciprocal matrix.

Step 3.2: Checking consistency

Before calculate a priority weight vector of criteria $W = (w_1, w_2, \dots, w_n)^T$, decision maker has to check the consistency of comparison matrix. If the decision-makers generate "perfect" judgment, the comparison matrix $C = [c_{ij}]$ is said to be "consistent" when $c_{ij} = c_{ik} \cdot c_{kj}$ for all i, j and k and the largest eigenvalue (λ_{\max}) is always equal to n . In this situation the comparison matrix obviously satisfies the transitivity property for all pairwise comparisons.

For example, indicator p is more important than q 3 times and indicator q is more important than r 2 times. Such that, p should be more important than r 6 times and we can call this comparison is consistent. But for the human judgment in practical, decision-makers cannot make a precise judgment, the condition $c_{ij} = c_{ik} \cdot c_{kj}$ does not hold as human judgments are inconsistent to a greater or lesser degree. (Csutora and Buckley, 2001) Saaty (1980) has calculated large samples of random matrices of increasing order and the Consistency Indices (CI) of matrices. A true Consistency Ratio (CR) is calculated by dividing the CI for the set of judgments by the index for the corresponding random matrix. Saaty (1980) suggests that if that ratio exceeds 0.1 the set of judgments may be too inconsistent to be reliable

In the case of fuzzy comparison matrix, a fuzzy, positive, reciprocal matrix $\tilde{C} = [\tilde{c}_{ij}]$ for all i, j, k is defined (Csutora and Buckley, 2001) to be consistent when

$$\tilde{c}_{ij} = \tilde{c}_{ik} \cdot \tilde{c}_{kj} \quad (4-7)$$

Csutora and Buckley (2001) proved that a fuzzy positive, reciprocal matrix $\tilde{C} = [\tilde{c}_{ij}]$ is defined as consistent when $\tilde{c}_{ik} \otimes \tilde{c}_{kj} \approx \tilde{c}_{ij}$.

Let $\tilde{C} = [\tilde{c}_{ij}]$ be a fuzzy, positive, reciprocal matrix with $\tilde{c}_{ij} = (l_{ij}, m_{ij}, n_{ij}, u_{ij})$. Choose a crisp number $c_{ij} \in [m_{ij}, n_{ij}]$ and form the crisp matrix $C_c = [c_{ij}]$. If C_c is consistent, then the fuzzy matrix \tilde{C} is consistent.

In this work, $\tilde{c}_{ij} = (l_{ij}, m_{ij}, n_{ij}, u_{ij})$ is a triangular fuzzy number, thus m_{ij} is equal to n_{ij} . To form the crisp matrix, we choose a crisp number $c_{ij} \in [m_{ij}]$ for calculating the consistency index (CI) and consistency ratio (CR). A random index (RI) is a constant value depending on number of criteria (Saaty, 1980).

$$CI = \frac{\lambda_{\max} - n}{n - 1} \quad (4-8)$$

$$CR = \frac{CI}{RI} \quad (4-9)$$

Step 4 Determining the fuzzy priority weight.

There are many alternative approaches for determining the fuzzy priority weight (Van Laarhoven and Pedrycz (1983), Buckley (1985), Boender et al. (1989), Chang (1996), Csutora and Buckley (2001), Mikhailov (2003, 2004)). Van Laarhoven and Pedrycz (1983) extended the crisp AHP method from Graan (1980) and Lootsma (1982) to FAHP based on triangular membership functions. In addition, they defined the operations on fuzzy numbers for FAHP based on the extension principle. Buckley (1985) proposed the geometric mean (GM) method for calculate the fuzzy weights. This procedure easily extends to the multi decision makers situation. Boender et al. (1989) modified van Laarhoven and Pedrycz (1983) method by using an optimization of logarithmic regression function. Chang (1996) proposed a new approach, called the extent analysis (EA) method, to obtain fuzzy priority weight. Csutora and Buckley (2001) proposed a new method, called Lambda-Max (LM) method, of finding the fuzzy weights. The LM method is the direct fuzzification of the λ_{\max} method, used by Saaty. Mikhailov, (2003) proposed a FAHP programming method to derive optimal crisp priorities, which are obtained from fuzzy pairwise comparison judgments based on α -cuts decomposition of the fuzzy judgments into a series of interval compositions. Even the fuzzy programming method claimed its superiority over some of the existing fuzzy prioritization method (Buckley, 1985; Van Laarhoven and Pedrycz, 1983) but the mathematical complexity involved may restrict its practicability (Chan and Kumar, 2007).

Comparing all these proposed approaches on FAHP, only the GM method and LM method do not need to be approximately by triangular membership function, other approaches need to calculate based on triangular fuzzy number. Among the above approaches, the EA method is relatively easier than others because of the simplicity of calculation and less time taking (Chan and Kumar, 2007; Chang, 1996). Thus, the EA method is widely used in an application of FAHP for solving practical multi-criteria decision making problems. Numerous researchers employed FAHP with the EA method to supplier selection problem. Chan and Kumar, (2007) used the EA method to select the best global supplier for a manufacturing firm based on the risk factor criteria. Kilincci and Onal (2011) employed the EA method in supplier selection problem in a washing machine company in Turkey based on three main criteria and 14 sub-criteria. The results of Kilincci and Onal (2011) shown that four sub-criteria obtained the zero priority weight. It means that these four sub-criteria are eliminated from the decision maker's consideration. Therefore, the weights determined by the EA method may lead to a wrong decision-making because some useful information such as decision criteria may not to be considered. However, this thesis will show the zero weight situations by numerical example in section 0.

Step 5 Ranking the final weight of alternatives

The importance degree of alternatives in the objective can be incorporated into the formulation using fuzzy priorities and rating of alternatives. For each criterion A_k (indicator, metric, measure, etc.). Decision maker obtains the fuzzy positive reciprocal matrix \tilde{C} from the pairwise comparison of criteria. Fuzzy weights for criteria $\tilde{W} = (\tilde{w}_1, \tilde{w}_2, \dots, \tilde{w}_k)$ are computed from matrix \tilde{C} . If A is a set of alternative, $A = \{A_1, A_2, \dots, A_n\}$, the decision maker obtains a performance matrix \tilde{E}_i for alternative A_i of all k criteria by the rating evaluation. The final fuzzy weight of alternative A_i can be obtained by using the fuzzy weight average,

$$f_i = (\tilde{w}_1 \odot \tilde{e}_{i1}) \oplus (\tilde{w}_2 \odot \tilde{e}_{i2}) \oplus \dots \oplus (\tilde{w}_k \odot \tilde{e}_{ik}) \quad (4-10)$$

4.9. THE REVIEW OF EXTENT ANALYSIS AND LAMBDA MAX METHOD

4.9.1 EXTENT ANALYSIS METHOD

The priority vector is calculated by comparing a fuzzy number of the value of fuzzy synthetic extent with respect to the i -th criterion (S_i). The fuzzy synthetic extent value is defined as

$$\tilde{S}_i = \sum_{j=1}^m \tilde{c}_{ij} \otimes \left[\sum_{i=1}^n \sum_{j=1}^m \tilde{c}_{ij} \right]^{-1} \quad (4-11)$$

where as $\sum_{j=1}^m \tilde{c}_{ij} = \tilde{c}_{i1} \oplus \tilde{c}_{i2} \oplus \dots \oplus \tilde{c}_{im}$

The symbol \oplus is the fuzzy additive operator (Klir and Yuan, 1995). For the fuzzy triangular number,

$$\tilde{c}_1 \oplus \tilde{c}_2 \approx (l_1 + l_2, m_1 + m_2, u_1 + u_2) \quad (4-12)$$

The symbol \otimes is the fuzzy multiplicative operator (Klir and Yuan, 1995).

If $\tilde{c}_1 = (l_1, m_1, u_1)$ and $\tilde{c}_2 = (l_2, m_2, u_2)$ are both triangular fuzzy number, then $\tilde{c}_1 \otimes \tilde{c}_2 \approx (l_1 l_2, m_1 m_2, u_1 u_2)$, which is proven by Laarhoven and Pedrycz (1983).

To obtain the estimates for the vectors of weight under each criterion, a principle of comparison for fuzzy numbers is considered.

Let \tilde{M} and \tilde{N} be two fuzzy numbers with its membership function $\mu_m(x)$ and $\mu_n(y)$ respectively. The degree of possibility of \tilde{M} is greater than \tilde{N} is defined as

$$c = \sup[\min(\tilde{M}, \tilde{N})] = \sup[\min(\mu_m(x), \mu_n(y))] \quad (4-13)$$

When a pair (x,y) exists such that $x \geq y$ and $\mu_m(x) = \mu_n(y)$

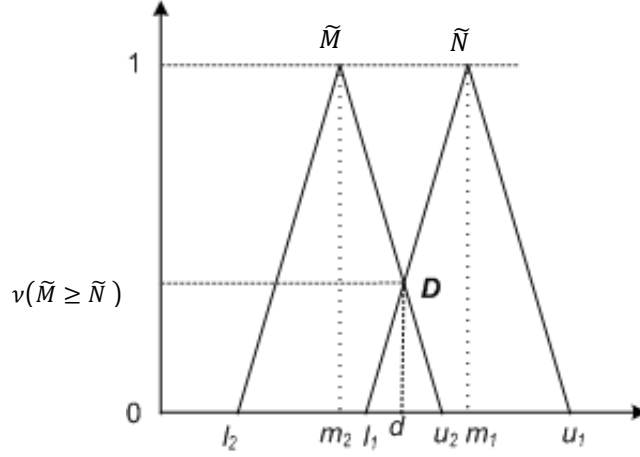

Figure 4.4 The degree of possibility of when comparing two fuzzy numbers

Step1: The value of fuzzy synthetic extent with respect to i th indicator is defined as:

$$\tilde{S}_i \approx \sum_{j=1}^m \tilde{M}_{ij} \otimes [\sum_{i=1}^n \sum_{j=1}^m \tilde{M}_{ij}]^{-1} \quad (4-14)$$

where \otimes denotes the extended multiplication of two fuzzy numbers. In order to obtain $\sum_{j=1}^m \tilde{M}_{ij}$, perform the fuzzy addition operation of m extent analysis values for a particular matrix such that

$$\sum_{j=1}^m \tilde{M}_{ij} = (\sum_{j=1}^m l_{ij}, \sum_{j=1}^m m_{ij}, \sum_{j=1}^m u_{ij}) \quad (4-15)$$

and to obtain $[\sum_{i=1}^n \sum_{j=1}^m \tilde{M}_{ij}]^{-1}$ perform the fuzzy addition operation of $\sum_{j=1}^m \tilde{M}_{ij}$ ($j = 1, 2, \dots, m$) values such that

$$\sum_{i=1}^n \sum_{j=1}^m \tilde{M}_{ij} = (\sum_{i=1}^n \sum_{j=1}^m l_{ij}, \sum_{i=1}^n \sum_{j=1}^m m_{ij}, \sum_{i=1}^n \sum_{j=1}^m u_{ij}) \quad (4-16)$$

and then compute the inverse of the vector $\sum_{i=1}^n \sum_{j=1}^m \tilde{M}_{ij}$, such that

$$[\sum_{i=1}^n \sum_{j=1}^m \tilde{M}_{ij}]^{-1} = \left(\frac{1}{\sum_{i=1}^n \sum_{j=1}^m u_{ij}}, \frac{1}{\sum_{i=1}^n \sum_{j=1}^m m_{ij}}, \frac{1}{\sum_{i=1}^n \sum_{j=1}^m l_{ij}} \right) \quad (4-17)$$

The value of fuzzy synthetic extent ($\tilde{S}_i = (\tilde{S}_1, \tilde{S}_2, \dots, \tilde{S}_n)^T$) is the eigenvector of the comparison matrix \tilde{C}

Step 2: The degree of possibility of $\tilde{N} = (l_1, m_1, u_1) \geq \tilde{M} = (l_2, m_2, u_2)$ is defined as

$$v(\tilde{M} \geq \tilde{N}) = \sup[\min(\tilde{M}, \tilde{N})] = \sup[\min(\mu_m(x), \mu_n(y))] \quad (4-18)$$

and can be equivalently express as follow

$$v(\tilde{M} \geq \tilde{N}) = \sup(\tilde{M} \cap \tilde{N}) = \begin{cases} 1 & \text{if, } m_2 \geq m_1 \\ 0 & \text{if, } l_1 \geq u_2 \\ \frac{l_1 - u_2}{(m_2 - u_2) - (m_1 - l_1)} & \text{otherwise} \end{cases} \quad (4-19)$$

To compare \tilde{M} and \tilde{N} , we need both of the value $v(\tilde{M} \geq \tilde{N})$ and $v(\tilde{N} \geq \tilde{M})$.

Step 3: The degree possibility for a convex fuzzy number to be greater than k convex fuzzy number \tilde{M}_i ($i = 1, 2, 3, \dots, k$) can be defined by

$$v(\tilde{M} \geq \tilde{M}_1, \tilde{M}_2, \dots, \tilde{M}_k) = \min v(\tilde{M} \geq \tilde{M}_i), i = 1, 2, \dots, k \quad (4-20)$$

Step 4: Finally, $W = (\min v(\tilde{S}_1 \geq \tilde{S}_k), \min v(\tilde{S}_2 \geq \tilde{S}_k), \dots, \min v(\tilde{S}_n \geq \tilde{S}_k))^T$ is the weight vector for $k = 1, 2, \dots, n$

4.9.2 LAMBDA-MAX METHOD

Csutora and Buckley (2001) proposed a method to find the fuzzy priority weights in fuzzy AHP, which is called the Lambda-Max method. This method obtains a fuzzy weight vector by using α -cuts and interval arithmetic.

The decision-makers are asked to give relative paired comparisons of indicators by using fuzzy ratios. For n indicators, the $n \times n$ matrix $\tilde{C} = [\tilde{c}_{ij}]$ is a fuzzy, positive, reciprocal matrix. If $\tilde{c}_{ij} = (l_{ij}, m_{ij}, u_{ij})$, then

$$\tilde{c}_{ji} = (\tilde{c}_{ij})^{-1} = (l_{ij}, m_{ij}, u_{ij})^{-1} = (u_{ij}^{-1}, m_{ij}^{-1}, l_{ij}^{-1}) \approx \left(\frac{1}{u_{ij}}, \frac{1}{m_{ij}}, \frac{1}{l_{ij}}\right) \quad (4-21)$$

Note that \tilde{c}_{ij} is a triangular fuzzy number, but $(\tilde{c}_{ij})^{-1}$ is not exactly a triangular fuzzy number.

We need the α -cuts of all the $\tilde{c}_{ij}, i \neq j$. If $\tilde{c}_{ij} = (l_{ij}, m_{ij}, u_{ij})$, then set

$$\tilde{c}_{ij}^\alpha = [c_{ij_{inf}}^\alpha, c_{ij_{sup}}^\alpha] \quad (4-22)$$

$$(\tilde{c}_{ij}^\alpha)^{-1} = \left[(c_{ij_{sup}}^\alpha)^{-1}, (c_{ij_{inf}}^\alpha)^{-1} \right] \quad (4-23)$$

where $c_{ij_{inf}}^\alpha$ is a lower bound of c_{ij}^α and $c_{ij_{sup}}^\alpha$ is an upper bound of c_{ij}^α . In our problem, we will use $\alpha \in \{0, 0.25, 0.5, 0.75, 1\}$.

For finding the fuzzy weight vector for a fuzzy, positive, reciprocal matrix with the Lambda-Max method, the computation of important weight is described by using a numerical example in the next section:

Let \tilde{C} be an $n \times n$ fuzzy, positive, reciprocal matrix with elements \tilde{c}_{ij} . Let $\tilde{c}_{ij}^\alpha = [c_{ij_{inf}}^\alpha, c_{ij_{sup}}^\alpha]$.

$$\text{If } i = j, \text{ then } c_{ij_{inf}}^\alpha = c_{ij_{sup}}^\alpha = 1. \quad (4-24)$$

$$\text{If } \tilde{c}_{ji} = (\tilde{c}_{ij})^{-1}, \text{ then } c_{ji_{inf}}^\alpha = (c_{ij_{sup}}^\alpha)^{-1}, c_{ji_{sup}}^\alpha = (c_{ij_{inf}}^\alpha)^{-1}. \quad (4-25)$$

Define $n \times n$ matrices $C_{inf}^\alpha = [c_{ij_{inf}}^\alpha]$, $C_{sup}^\alpha = [c_{ij_{sup}}^\alpha]$, for $\alpha \in [0, 1]$. For all, $i \neq j$ there is a unique $x = c_{ij_m}$ so that $\tilde{c}(c_{ij_m}) = 1$.

Defines $C_m = [c_{ij_m}]$ where $c_{ii_m} = 1$ for all i . Note that C_{inf}^α and C_{sup}^α are positive matrices but they are no longer reciprocal matrices.

Each matrix $C_{inf}^\alpha > 0$, $C_{sup}^\alpha > 0$, and $C_m^\alpha > 0$ has a positive, dominant eigenvalue, called λ_{max} :

λ_{inf}^α is the largest eigenvalue λ_{max} for C_{inf}^α

λ_{sup}^α is the largest eigenvalue λ_{max} for C_{sup}^α

λ_m is the largest eigenvalue λ_{max} for C_m^α

where $\lambda_{inf}^0 < \lambda_{inf}^1 < \lambda_m < \lambda_{sup}^1 < \lambda_{sup}^0$ for $\alpha \in [0, 1]$.

Let $\tilde{\lambda}_{max}$ the triangular-shaped fuzzy number specified by the α -cuts $[\lambda_{inf}^\alpha, \lambda_{sup}^\alpha]$.

Let W_m be an $n \times 1$ unique, positive, normalized eigenvector corresponding to λ_m . Then $C_m \cdot W_m = \lambda_m \cdot W_m$ and if $W_m^T = (w_{1m}, w_{2m}, \dots, w_{nm})^T$, then $w_{im} > 0, w_{1m} + w_{2m} + \dots + w_{nm} = 1$.

Let w_{inf}^α (and w_{sup}^α respectively) be an $n \times 1$ unique, positive, normalized eigenvector corresponding to λ_{inf}^α (and λ_{sup}^α respectively), so that the constant K_{inf}^α and K_{sup}^α with $0 < K_{inf}^\alpha \leq 1, 1 \leq K_{sup}^\alpha$ and $K_{inf}^\alpha, K_{sup}^\alpha$ depend only on $\alpha, 0 \leq \alpha \leq 1$.

$$w_{inf}^{*\alpha} = K_{inf}^\alpha \cdot w_{inf}^\alpha \quad \text{[2]} \quad (4-26)$$

$$w_{sup}^{*\alpha} = K_{sup}^\alpha \cdot w_{sup}^\alpha \quad (4-27)$$

for $\alpha \in [0, 1]$.

$$\text{Let } (w_{inf}^{\alpha})^T = (w_{inf}^{*\alpha_1}, w_{inf}^{*\alpha_2}, \dots, w_{inf}^{*\alpha_n}), \quad (w_{sup}^{\alpha})^T = (w_{sup}^{*\alpha_1}, w_{sup}^{*\alpha_2}, \dots, w_{sup}^{*\alpha_n}), \\ (w_{inf}^{\alpha})^T = (w_{inf}^{\alpha_1}, w_{inf}^{\alpha_2}, \dots, w_{inf}^{\alpha_n}), \quad (w_{sup}^{\alpha})^T = (w_{sup}^{\alpha_1}, w_{sup}^{\alpha_2}, \dots, w_{sup}^{\alpha_n}).$$

If $0 \leq \alpha_2 < \alpha_1 < 1$, then $0 \leq w_{inf}^{*\alpha_2} \leq w_{inf}^{*\alpha_1} \leq w_{im} \leq w_{sup}^{*\alpha_1} \leq w_{sup}^{*\alpha_2}$, for all $i = 1, 2, \dots, n$. This means that the α -cuts $[w_{inf}^{*\alpha}, w_{sup}^{*\alpha}]$ specify a fuzzy number \tilde{w}_i^* , $1 \leq i \leq n$. Set $\tilde{W}^T = (\tilde{w}_1^*, \tilde{w}_2^*, \dots, \tilde{w}_n^*)^T$. The fuzzy important weights will be \tilde{w}_i^* , $1 \leq i \leq n$. We argue that

$$\square \quad \tilde{C} \otimes \tilde{W}^* = \tilde{\lambda}_{max} \otimes \tilde{W}^* \quad (4-28)$$

and with the equivalent system, we obtain :

$$C_{inf}^{\alpha} \cdot w_{inf}^{*\alpha} = \lambda_{inf}^{\alpha} \cdot w_{inf}^{*\alpha} \quad (4-29)$$

$$C_{sup}^{\alpha} \cdot w_{sup}^{*\alpha} = \lambda_{sup}^{\alpha} \cdot w_{sup}^{*\alpha} \quad (4-30)$$

Computation of the constant K_{inf}^{α} and K_{sup}^{α}

The lambda-max method uses the constant K_{inf}^{α} and K_{sup}^{α} to minimize the fuzziness of the \tilde{w}_i^* . The fuzziness is meant the lengths of the α -cuts (Csutora and Buckley, 2001). To calculate K_{inf}^{α} and K_{sup}^{α} , we have to choose α_i in $[0, 1]$, so that $0 = \alpha_m < \alpha_{m-1} < \dots < \alpha_1 \leq 1$.

We first find $w_{inf}^{*\alpha_1}, w_{sup}^{*\alpha_1}$, $1 \leq i \leq n$ with α_1 . Then, using the results we determine $w_{inf}^{*\alpha_2}, w_{sup}^{*\alpha_2}$, $1 \leq i \leq n$ with α_2 . The process will be iterative, we work with the same algorithm until we obtain $w_{inf}^{*0}, w_{sup}^{*0}$, $1 \leq i \leq n$ with $\alpha_m = 0$.

First, beginning with α_1 . Define

$$K_{inf}^{\alpha_1} = \min \left\{ \frac{w_{im}}{w_{i inf}^{\alpha_1}} \mid 1 \leq i \leq n \right\} \quad (4-31)$$

$$K_{sup}^{\alpha_1} = \max \left\{ \frac{w_{im}}{w_{i sup}^{\alpha_1}} \mid 1 \leq i \leq n \right\} \quad (4-32)$$

Then we obtain $w_{inf}^{*\alpha_1}, w_{sup}^{*\alpha_1}$ where $w_{inf}^{*\alpha_1} \leq w_{im} \leq w_{sup}^{*\alpha_1}$ for all i .

Next, we move to α_2 , $0 < \alpha_2 < \alpha_1$. Define

$$K_{inf}^{\alpha_2} = \min \left\{ \frac{w_{i inf}^{*\alpha_1}}{w_{i inf}^{\alpha_2}} \mid 1 \leq i \leq n \right\} \quad (4-33)$$

$$K_{sup}^{\alpha_2} = \max \left\{ \frac{w_{i inf}^{*\alpha_1}}{w_{i sup}^{\alpha_2}} \mid 1 \leq i \leq n \right\} \quad (4-34)$$

and we obtain $0 < w_{i inf}^{*\alpha_2} \leq w_{i inf}^{*\alpha_1} \leq w_{im} \leq w_{i sup}^{*\alpha_1} \leq w_{i sup}^{*\alpha_2}$ for all i . Then work down with the same algorithm from $\alpha_2, \alpha_3, \dots, \alpha_m$, until $\alpha_m = 0$. To find the constant K_{inf}^α and K_{sup}^α from α_2 to α_m , for all i , we define

$$K_{inf}^{\alpha_m} = \min \left\{ \frac{w_{i inf}^{*\alpha_{m-1}}}{w_{i inf}^{\alpha_m}} \mid 1 \leq i \leq n \right\} \quad (4-35)$$

$$K_{sup}^{\alpha_m} = \max \left\{ \frac{w_{i inf}^{*\alpha_{m-1}}}{w_{i sup}^{\alpha_m}} \mid 1 \leq i \leq n \right\} \quad (4-36)$$

4.10. NUMERICAL EXAMPLE: COMPARING EXTENT ANALYSIS AND LAMBDA-MAX

This section shows by example that the weights determined by the EA method do not represent the relative importance decision criteria and cannot be used as their priorities. The EA and LM methods are applied to an example from (Wang and Taha, 2006) with a slight change.

A big textile company in Turkey has to select the best catering firm. There are three firms involved, which are *Durusu*, *Mertol* and *Afiyetle*. The criteria to be considered are hygiene (H), quality of meal (QM), and quality of service (QS). Under these three main criteria, its consist of 11 sub-criteria, i.e. hygiene of meal (HM), hygiene of service personnel (HSP), hygiene of service vehicles (HSV), variety of meal (VM), complementary meals in a day (CoM), calorie of meal (CaM), taste of meal (TM), behavior of service personnel (BSP), service time (ST), communication on phone (CP), and problem solving (PS) ability. Figure 4.5 shows the hierarchy structure of the problem. The pairwise comparison matrices of criteria importance are shown in Table 4.7 to Table 4.10. The performance of three catering firms in each sub-criterion is evaluated by using the performance rating with subjective measurement by using the five-scale of linguistic rating, which are very poor (VP), Poor (P), Fair (F), Good (G), and Very good (VG). Table 4.11 shows the catering's performance in each criterion.

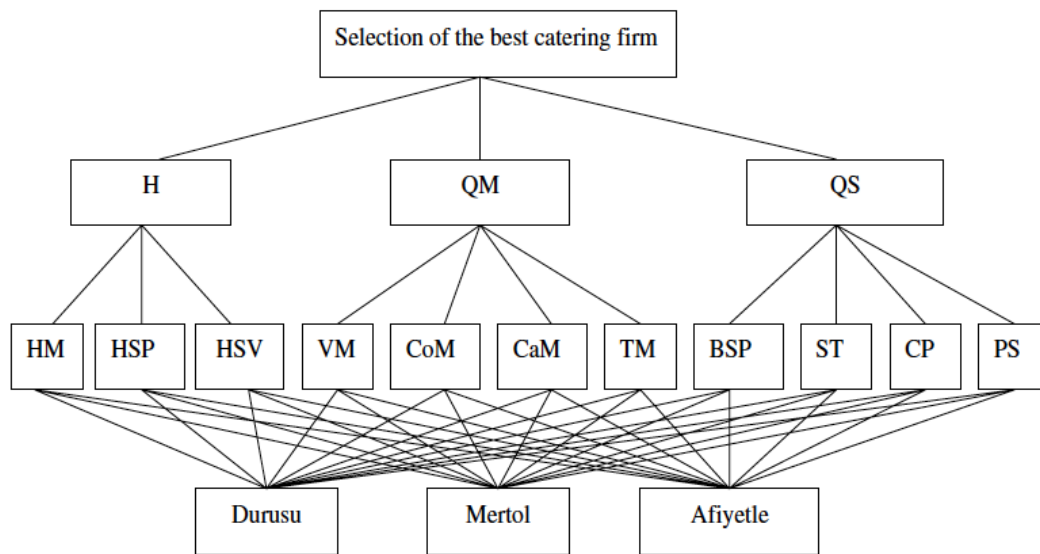

Figure 4.5 Hierarchy of catering firm selection problem

Table 4.7 Fuzzy Comparison Matrix with Respect to the goal

Criteria	H	QM	QS
H	(1,1,1)	(2/3, 1, 3/2)	(2/7, 1/3, 2/5)
QM	(2/3, 1, 3/2)	(1,1,1)	(2/5, 1/2, 2/3)
QS	(5/2, 3, 7/2)	(3/2, 2, 5/2)	(1,1,1)

Table 4.8 Fuzzy Comparison Matrix with respect to hygiene

Criteria	HM	HSP	HSV
HM	(1,1,1)	(3/2, 2, 5/2)	(3/2, 2, 5/2)
HSP	(2/5, 1/2, 2/3)	(1,1,1)	(2/3, 1, 3/2)
HSV	(2/5, 1/2, 2/3)	(2/3, 1, 3/2)	(1,1,1)

Table 4.9 Fuzzy Comparison Matrix with respect to quality of meal

Criteria	VM	CoM	CaM	TM
VM	(1,1,1)	(3/2, 2, 5/2)	(2/7, 1/3, 2/5)	(5/2, 3, 7/2)
CoM	(2/5, 1/2, 2/3)	(1,1,1)	(2/7, 1/3, 2/5)	(7/2, 4, 9/2)
CaM	(5/2, 3, 7/2)	(5/2, 3, 7/2)	(1,1,1)	(5/2, 3, 7/2)
TM	(2/7, 1/3, 2/5)	(2/9, 1/4, 2/7)	(2/7, 1/3, 2/5)	(1, 1, 1)

Table 4.10 Fuzzy Comparison Matrix with respect to quality of service

Criteria	BSP	ST	CP	PS
BSP	(1,1,1)	(2/9, 1/4, 2/7)	(7/2, 4, 9/2)	(2/7, 1/3, 2/5)
ST	(7/2, 4, 9/2)	(1,1,1)	(7/2, 4, 9/2)	(5/2, 3, 7/2)
CP	(2/9, 1/4, 2/7)	(2/9, 1/4, 2/7)	(1,1,1)	(2/7, 1/3, 2/5)
PS	(5/2, 3, 7/2)	(2/7, 1/3, 2/5)	(5/2, 3, 7/2)	(1, 1, 1)

Table 4.11 The linguistic performance rating of three catering firm's performance

Criteria	Sub-criteria	Durusu	Mertol	Afyetle
Hygiene (H)	HM	VB	AVG	G
	HSP	G	B	VB
	HSV	B	AVG	G
Quality of Meal	VM	AVG	VG	AVG
	CoM	B	B	B
	CaM	G	AVG	AVG
	TM	B	G	VG
Quality of Service	BSP	VB	VG	VB
	ST	B	AVG	AVG
	CP	VB	G	VB
	PS	AVG	G	VG

Table 4.12 Fuzzy performance rating of three catering firm's performance

Criteria	Sub-criteria	Durusu	Mertol	Afyetle
Hygiene (H)	HM	(0.0, 0.2, 0.4)	(0.4, 0.6, 0.8)	(0.6, 0.8, 1.0)
	HSP	(0.6, 0.8, 1.0)	(0.2, 0.4, 0.6)	(0.0, 0.2, 0.4)
	HSV	(0.2, 0.4, 0.6)	(0.4, 0.6, 0.8)	(0.6, 0.8, 1.0)
Quality of Meal (QM)	VM	(0.4, 0.6, 0.8)	(0.8, 1.0, 1.0)	(0.4, 0.6, 0.8)
	CoM	(0.2, 0.4, 0.6)	(0.2, 0.4, 0.6)	(0.2, 0.4, 0.6)
	CaM	(0.6, 0.8, 1.0)	(0.4, 0.6, 0.8)	(0.4, 0.6, 0.8)
	TM	(0.2, 0.4, 0.6)	(0.6, 0.8, 1.0)	(0.8, 1.0, 1.0)
Quality of Service (S)	BSP	(0.0, 0.2, 0.4)	(0.8, 1.0, 1.0)	(0.0, 0.2, 0.4)
	ST	(0.2, 0.4, 0.6)	(0.4, 0.6, 0.8)	(0.4, 0.6, 0.8)
	CP	(0.0, 0.2, 0.4)	(0.6, 0.8, 1.0)	(0.0, 0.2, 0.4)
	PS	(0.4, 0.6, 0.8)	(0.6, 0.8, 1.0)	(0.8, 1.0, 1.0)

The weights obtained for three main criteria and 11 sub-criteria are synthesized using the EA and LM method respectively. The priority weights in each level are shown in Table 4.13 to Table 4.16. According to results of EA method in Table 4.13, the hygiene and quality of meal criteria are eliminated from the decision making because these two criteria obtain the zero weight. Similarly with the zero weight of criterion taste of meal (TM) in Table 4.15 and the zero weight of criteria behavior of service personnel (BSP) and communication on phone (CP) in Table 4.16.

Table 4.13 Fuzzy Comparison Matrix with Respect to the goal

Criteria	Criteria Priority Weight	
	Extent Analysis (EA)	Lambda-Max (LM)
H	0.000	(0.1528, 0.3275, 0.3275)
QM	0.000	(0.1709, 0.2599, 0.3883)
QS	1.000	(0.4126, 0.4126, 0.8001)

Table 4.14 Fuzzy Comparison Matrix with respect to hygiene

Criteria	Criteria Priority Weight	
	Extent Analysis (EA)	Lambda-Max (LM)
HM	0.708	(0.5000, 0.5000, 0.5000)
HSP	0.146	(0.2456, 0.2500, 0.2714)
HSV	0.146	(0.2456, 0.2500, 0.2714)

Table 4.15 Fuzzy Comparison Matrix with respect to quality of meal

Criteria	Criteria Priority Weight
----------	--------------------------

	Extent Analysis (EA)	Lambda-Max (LM)
VM	0.187	(0.2367, 0.2488, 0.2549)
CoM	0.033	(0.1851, 0.1890, 0.1950)
CaM	0.780	(0.4626, 0.4768, 0.4768)
TM	0.000	(0.0854, 0.0854, 0.0862)

Table 4.16 Fuzzy Comparison Matrix with respect to quality of service

Criteria	Criteria Priority Weight	
	Extent Analysis (EA)	Lambda-Max (LM)
BSP	0.000	(0.1488, 0.1493, 0.1510)
ST	0.959	(0.5097, 0.5173, 0.5173)
CP	0.000	(0.0747, 0.0747, 0.0758)
PS	0.041	(0.2504, 0.2587, 0.2653)

The final weights obtained for the three main criteria Hygiene (H), Quality of Meal (QM), and Quality of Service (QS) are synthesized using the EA and LM to obtain the global weights of each catering firm's performance. The synthesized weights are shown in Table 4.17. Figure 4.8 and Figure 4.9 show the global weight and the local weight of three main criteria obtained by EA and LM method respectively.

Table 4.17 Global Weight of three catering firms

Catering Firm	Alternative Priority Weight	
	Extent Analysis (EA)	Lambda-Max (LM)
Durusu	0.4081	(0.1528, 0.3275, 0.3275)
Mertol	0.6081	(0.1709, 0.2599, 0.3883)
Afiyetle	0.6136	(0.4126, 0.4126, 0.8001)

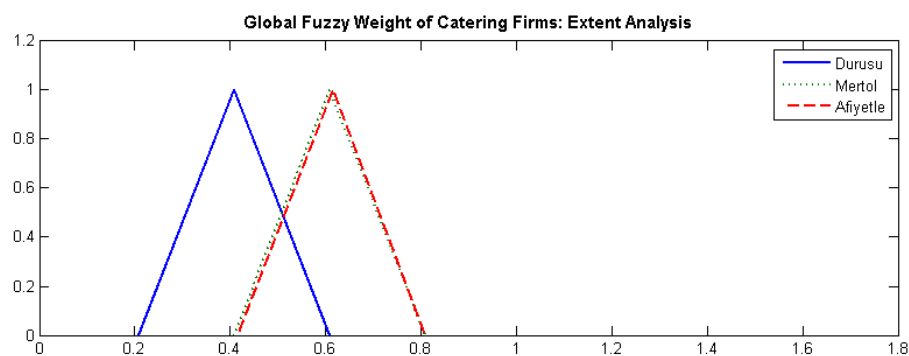

Figure 4.6 Global fuzzy weights of catering firms obtained by Extent Analysis

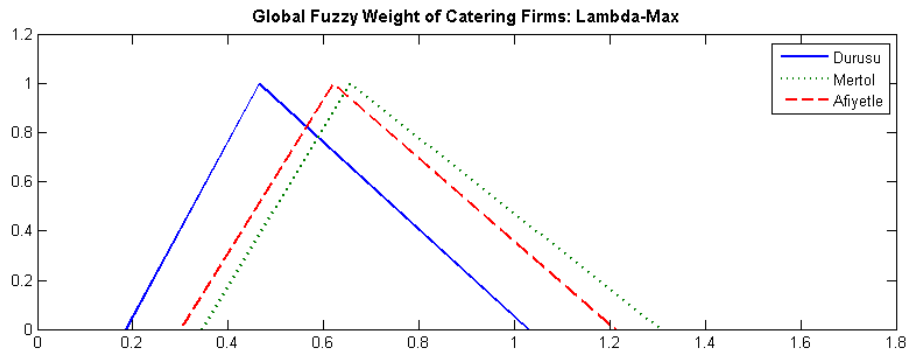

Figure 4.7 Global fuzzy weights of catering firms obtained by Lambda-Max

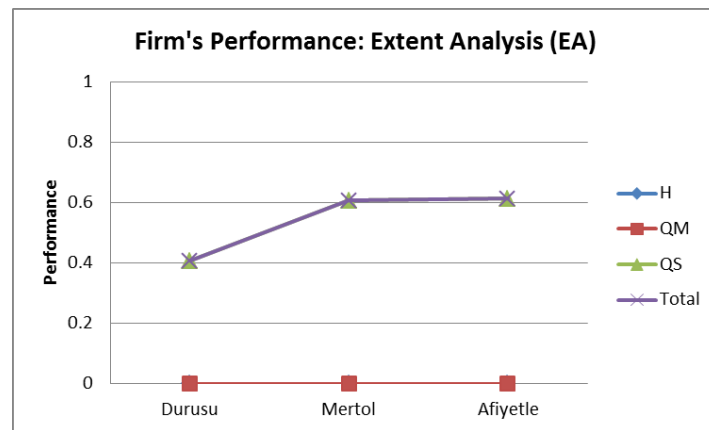

Figure 4.8 Global weight of three firms obtained by Extent Analysis

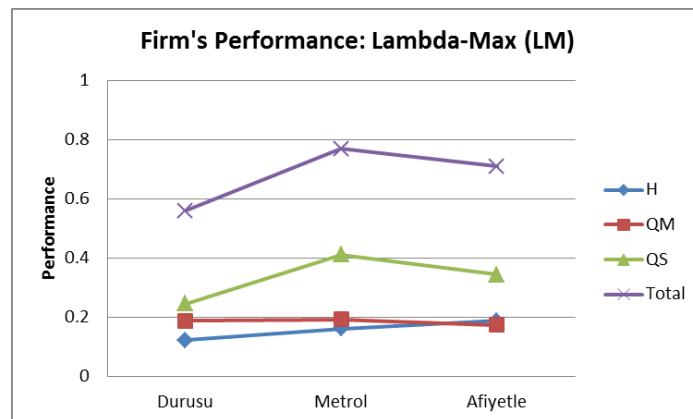

Figure 4.9 Global weight of three firms obtained by Lambda-Max

4.11. PROPOSED FAHP APPROACH

The fuzzy multi criteria decision aiding was developed based on FAHP approach and adapted for the supplier performance measurement problem. The decision maker's

knowledge for measuring sustainability performance was represented first through fuzzy linguistic variables, and then gave an important weight of criteria through pairwise comparison matrices, and finally defined criteria rating for assessing supplier's performance in each criterion.

According to the numerical example comparing EA and LM method, we found that if there is a dominant criterion as shown in Figure 4.10, it is possible to obtain zero weight for other criteria when using the EA method. Meanwhile the LM method contains a complexity of calculation which is difficult for implementing in the real-life situation. Therefore, this thesis proposes the FAHP method which aims to provide an easily method to handle a complex problem, which involves with various indicators and alternatives, in real-life problem.

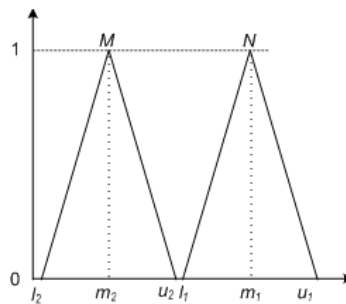

Figure 4.10 A comparison of two fuzzy numbers when one is dominance important

This method consists of five steps for measuring sustainability performance. The first four steps following FAHP approach, which are (1) define the problem and determine the kind of knowledge sought, (2) structure the decision hierarchy, (3) construct a set of pairwise comparison matrices, and (4) finding fuzzy priority weight of supplier's performance. In the fourth step, this thesis proposes three alternative methods for calculating the priority weight of suppliers.

- Method-I: Modified the Extent Analysis method
- Method-II: Modified the normalization method
- Method-III: Employ the weakest t-norm arithmetic

The details of these three methods are explained in section 4.10.1 to 4.10.3 respectively. After the FAHP method, supplier's performance is ranked by defuzzification method. The details in each step are shown as follows:

Step 1 Define the problem and determine the kind of knowledge sought.

The objective of this performance measurement system is to measure sustainability performance of suppliers.

Step 2 Structure the decision hierarchy from the top with the goal of the decision, then the objectives from a broad perspective, through the intermediate levels (criteria on which subsequent elements depend) to the lowest level (which usually is a set of the alternatives).

Step 3 Construct a set of pairwise comparison matrices. Each element in an upper level is used to compare the elements in the level immediately below with respect to it.

In the problem consists of n criteria, decision-maker is required to give a relative important in each pair of criterion. The pairwise comparison between criteria (C_i and C_j) represents by triangular fuzzy number as shown in Figure 4.11 and linguistic scale regarding relative importance is given in Table 4.18. This scale is given by Kahraman et al.

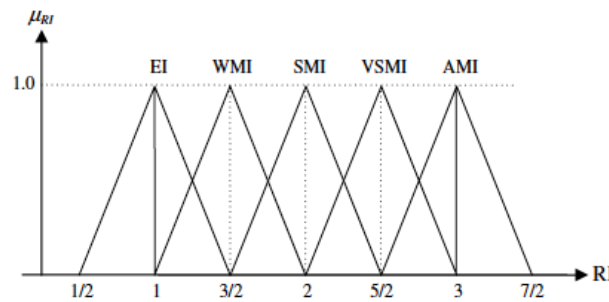

Figure 4.11 Linguistic scale for relative important

Table 4.18 Linguistic scales for relative important

Linguistic scale for important	Fuzzy number
Just equal	(1, 1, 1)
Equal important (EI)	(1/2, 1, 3/2)
Weakly more important (WMI)	(1, 3/2, 2)
Strongly more important (SMI)	(3/2, 2, 5/2)
Very strongly more important (VSMI)	(2, 5/2, 3)
Absolutely more important (AMI)	(5/2, 3, 7/2)

Step 4 Use the priorities obtained from the comparisons to weigh the priorities in the level immediately below. Do this for every element. Then for each element in the level below add its weighed values and obtain its overall or global priority. Continue this process of weighing and adding until the final priorities of the alternatives in the bottom most level are obtained.

4.11.1 METHOD-I: MODIFIED THE EXTENT ANALYSIS METHOD

We found that an extent analysis method can lead to misapplication on FAHP. The EA method uses a crisp value as a priority weight of criteria by using the degree of possibility. The degree of possibility defined by EA method is an index for comparing two triangular fuzzy numbers rather than an index for calculating their relative importance. Thus, normalized degrees of possibility can only show to what degree a triangular fuzzy number is greater than the others, but cannot used to represent their relative importance.

Assume that we get a consistent comparison matrix. For finding fuzzy priority weight we proposed the additive extent principles to find summation row to obtain fuzzy priority. Firstly, using the additive extent principles to find the row summation to obtain fuzzy priority value of each criterion:

$$\tilde{R}_i = \sum_{j=1}^n \tilde{c}_{ij} = (\sum_{j=1}^n l_{ij}, \sum_{j=1}^n m_{ij}, \sum_{j=1}^n u_{ij}), i = 1, 2, \dots, n \quad (4-37)$$

Then, normalize the row summation. Generally, the normalization method for a set of triangular fuzzy weights \tilde{w}_i by using the following equation:

$$\tilde{w}_i = \left(\frac{\sum_{j=1}^n l_{ij}}{\sum_{i=1}^n \sum_{j=1}^n u_{ij}}, \frac{\sum_{j=1}^n m_{ij}}{\sum_{i=1}^n \sum_{j=1}^n m_{ij}}, \frac{\sum_{j=1}^n u_{ij}}{\sum_{i=1}^n \sum_{j=1}^n l_{ij}} \right) \quad (4-38)$$

4.11.2 METHOD-II: MODIFIED THE NORMALIZATION METHOD

Because of interval and fuzzy weights often need to be normalized in multiple criteria decision analysis (MCDA) with uncertainty especially in analytic hierarchy process (AHP) with interval or fuzzy judgments. The existing normalization methods based on interval arithmetic and fuzzy arithmetic are found flawed and need to be revised. Wang and Elhag, (2006) proposed the normalization method which produces consistent, stable, realistic and normalized weight intervals as shown in equation (4-39)

$$\tilde{w}_i = \left(\frac{\sum_{j=1}^n l_{ij}}{\sum_{j=1}^n l_{ij} + \sum_{i=1, i \neq j}^n \sum_{j=1}^n u_{ij}}, \frac{\sum_{j=1}^n m_{ij}}{\sum_{i=1}^n \sum_{j=1}^n m_{ij}}, \frac{\sum_{j=1}^n u_{ij}}{\sum_{j=1}^n u_{ij} + \sum_{i=1, i \neq j}^n \sum_{j=1}^n l_{ij}} \right) \quad (4-39)$$

Thus, the proposed FAHP method-II employs Wang and Elhag, (2006) method in equation (4-39) instead of using the row summation in equation (4-38) for calculating the fuzzy priority weight.

4.11.3 METHOD-III: EMPLOY THE WEAKEST T-NORM ARITHMETIC

This proposed FAHP method-III uses the weakest t -norm arithmetic to approach final fuzzy priority weight of supplier's performance. T_w arithmetic can be observed by two characteristics. First, it is well known that the addition/subtraction/multiplication/division of fuzzy numbers by T_w preserves the original shape of the fuzzy numbers. Second, the weakest t -norm operations achieve a more exact performance, which means smaller fuzzy spreads under uncertain environments (Chang et al., 2006, Lin et al., 2012). By T_w , the fuzzy priority weight can be formulated as follow:

$$X_j = (w_1 \times T_w C_{j1} + T_w w_2 C_{j2} + \dots + T_w w_n C_{jn}) / T_w (w_1 + T_w w_2 + \dots + T_w w_n) \quad (4-40)$$

After the FAHP method, the alternative substitutions obtained their fuzzy performances. In order to assist in the decision-making, we adopt the defuzzification method to specify a decision point and rank supplier's performance. The most widely use method to defuzzify fuzzy number is the center of gravity (COG) method. The COG can be defined as:

$$COG(x) = \frac{\int_R \tilde{A}(x) x dx}{\int_R \tilde{A}(x) dx} \quad (4-41)$$

4.12. NUMERICAL ILLUSTRATION

4.12.1 RESULTS OF PROPOSED FAHP METHODS

This section shows by example that the weights determined by the EA method do not represent the relative importance decision criteria and cannot be used as their priorities. The three proposed methods are applied to an example from (Wang and Taha, 2006) with a slight change, which is explained in section 4.10

The weights obtained for three main criteria and 11 sub-criteria are synthesized using the three proposed methods. The priority weights in each level are shown in Table 4.13 to Table 4.16.

Table 4.19 Fuzzy Comparison Matrix with Respect to the goal

Criteria	Criteria Priority Weight		
	Method-I	Method-II	Method-III
H	(0.1494, 0.3158, 0.3215)	(0.1611, 0.3158, 0.291)	(0.1611, 0.3158, 0.291)
QM	(0.1582, 0.2632, 0.3511)	(0.1727, 0.2632, 0.3129)	(0.1727, 0.2632, 0.3129)
QS	(0.3827, 0.4211, 0.7761)	(0.4518, 0.4211, 0.6353)	(0.4518, 0.4211, 0.6353)

Table 4.20 Fuzzy Comparison Matrix with respect to hygiene

Criteria	Criteria Priority Weight
----------	--------------------------

	Method-I	Method-II	Method-III
HM	(0.3243, 0.5, 0.7377)	(0.3871, 0.5, 0.5921)	(0.3871, 0.5, 0.5921)
HSP	(0.1676, 0.25, 0.3893)	(0.184, 0.25, 0.343)	(0.184, 0.25, 0.343)
HSV	(0.1676, 0.25, 0.3893)	(0.184, 0.25, 0.343)	(0.184, 0.25, 0.343)

Table 4.21 Fuzzy Comparison Matrix with respect to quality of meal

Criteria	Criteria Priority Weight		
	Method-I	Method-II	Method-III
VM	(0.1918, 0.263, 0.3564)	(0.2078, 0.263, 0.3234)	(0.2078, 0.2630, 0.3234)
CoM	(0.1882, 0.2422, 0.3162)	(0.1981, 0.2422, 0.2965)	(0.1981, 0.2422, 0.2965)
CaM	(0.3085, 0.4152, 0.5538)	(0.3462, 0.4152, 0.4839)	(0.3462, 0.4152, 0.4839)
TM	(0.0651, 0.0796, 0.1004)	(0.0658, 0.0796, 0.0991)	(0.0658, 0.0796, 0.0991)

Table 4.22 Fuzzy Comparison Matrix with respect to quality of service

Criteria	Criteria Priority Weight		
	Method-I	Method-II	Method-III
BSP	(0.1666, 0.2087, 0.263)	(0.1734, 0.2087, 0.2504)	(0.1734, 0.2087, 0.2504)
ST	(0.3493, 0.4486, 0.5739)	(0.3881, 0.4486, 0.5090)	(0.3881, 0.4486, 0.5090)
CP	(0.0576, 0.0685, 0.0838)	(0.0580, 0.0685, 0.0830)	(0.0580, 0.0685, 0.0830)
PS	(0.2091, 0.2741, 0.3571)	(0.2249, 0.2741, 0.3276)	(0.2249, 0.2741, 0.3276)

Table 4.23 Fuzzy global weight of three catering firms obtained by proposed method

Criteria	Criteria Priority Weight		
	Method-I	Method-II	Method-III
Durusu	(0.1282, 0.4573, 1.2741)	(0.1588, 0.4573, 0.9805)	(0.2335, 0.4573, 0.6778)
Mertol	(0.256, 0.6673, 1.6502)	(0.3185, 0.6673, 1.2652)	(0.4329, 0.6673, 0.9481)
Afiyetle	(0.2074, 0.6109, 1.5111)	(0.2608, 0.6109, 1.1523)	(0.3613, 0.6109, 0.875)

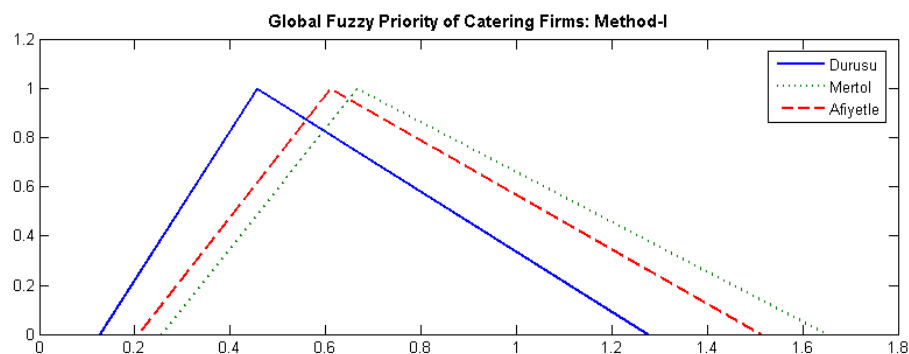

Figure 4.12 Global fuzzy weights of catering firms obtained by Method-I

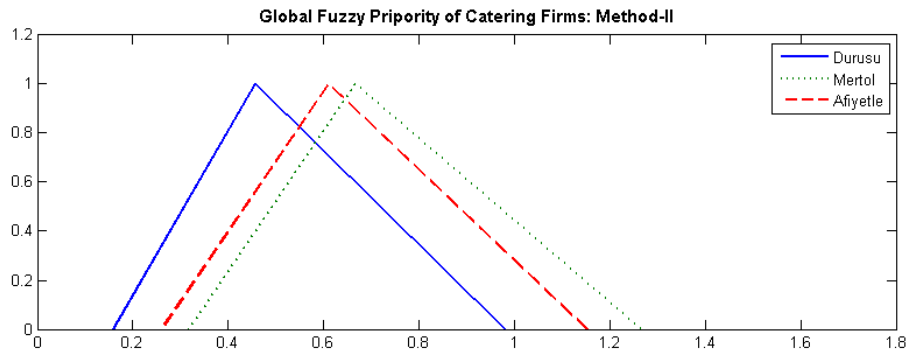

Figure 4.13 Global fuzzy weights of catering firms obtained by Method-II

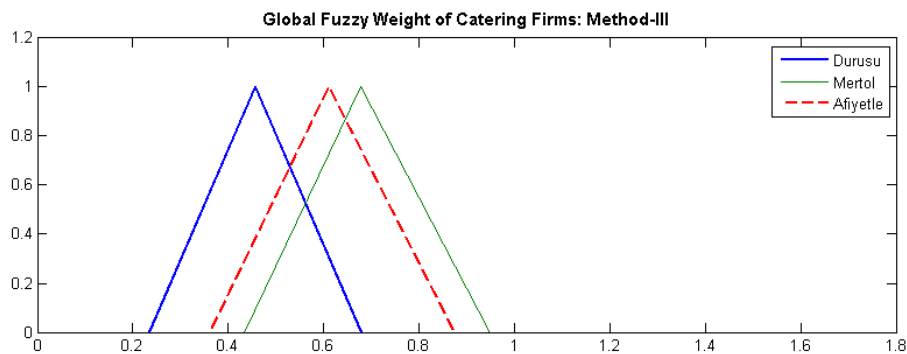

Figure 4.14 Global fuzzy weights of catering firms obtained by Method-III

4.13. CONCLUSION

The supplier performance evaluation in sustainability context is a multi-criteria decision problem. The performance measurement model in this thesis employed the FAHP approach for evaluating sustainability performance. Among the various methods in determining the criteria weights of FAHP, the LM method gives better results compared to the EA method in terms of weight accuracy. The EA method may assign an irrational zero weight to decision making problems. However, the LM method is quite complex for implementing in a practical situation. Thus, this thesis proposed three new approaches by modified the EA method, modified a normalization method, and using the weakest T-norm for aggregation in order to evaluate sustainability performance of supplier.

The proposed FAHP approaches obtained the rank of alternative as same as the results from the lambda-max method. These proposed FAHP methods have ability to capture vagueness of human thinking and effectively solve multi-criteria decision making problem. The illustrative example has demonstrated the thoughtfulness, flexibility, and efficiency of the proposed model to directly tap the subjectivity and preferences of the decision makers.

Chapter 5. APPLICATION AND VALIDATION OF SUSTAINABILITY MODEL FOR SUPPLIER ASSESSMENT

5.1. INTRODUCTION

The research objective posed in chapter one including developing a sustainability performance assessment model for aggregation sustainability measures into supplier's performance. The model formulations of three proposed models (Method-I, Method-II, and Method-III) were described in chapter 4. The Method-III is selected to apply in the practical application because of it provides the best results comparing with other two methods. The aim of this chapter is to demonstrate this model in practical application to supplier evaluation problem. This chapter first provides the background of the selected case study company and data collection procedures for the sustainability performance evaluation model. In view of the complexity nature of the research, case study was chosen as the best means to validate the model and show how the sustainability evaluation model works to rank supplier's performance.

Electronics industry is forced by environmental regulations such as RoHS and WEEE to realize and take environmental impacts into account of its operation. The companies in electronics industry are trying to reduce negative environmental impacts and extend business perspective from environmental friendly to sustainable development. In this chapter, we implement our FAHP approach which described in chapter 4 into a hard disk drive manufacturing in electronics industry in Thailand.

The company manufactures hard disk drives (HDD) for external storage, internal storage, networking storage and home entertainment. The main manufacturing facilities are in Thailand and Malaysia. The main suppliers to the company are also located in Asia. There are two plants in Thailand. The first one is more emphasizes on research and development activity, it undertakes the following activities: slider fabrication; assembly of head gimbals and head stacks; research and development. And the main activities of the manufacturing facility in the second plant comprise the assembly of hard disk drives and head stacks.

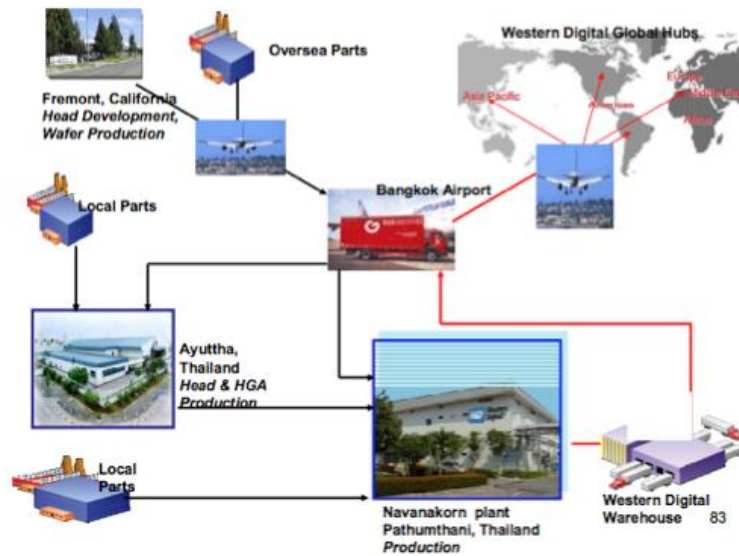

Figure 5.1 Supply chain network of the company

The company's commitment to sound corporate citizenship starts with maintaining a strong company that invests resources wisely and operates ethically and efficiently. Company works with fellow members of the Electronics Industry Citizenship Coalition (EICC) to improve working and living conditions in these communities by raising labor, health, safety and environmental standards.

The case study company joined the EICC to help the industry improve social, economic and environmental outcomes for all those involved in the electronics supply chain. Thus, the case study company works with its business partners to drive the goals set forth in the EICC Code of Conduct through its supply chain to ensure that all of its supply partners are in compliance with the EICC Code and its goals.

The company aims to motivate suppliers for participating in EICC (Electronics Industry Citizenship Coalition) program. And it needs to measure supplier's sustainability performance based on EICC code of conducts. Moreover, the case study company needs to integrate sustainability performance of their suppliers with their existing supplier performance assessment system for supporting company's decision-making.

Section 2 provides the supplier's sustainability performance assessment by using the proposed FAHP method-III, which is described in chapter 4. The results of an assessment are also discussed. Next the model validation by comparing rank preservation with two existing methods is discussed. The discussion of results is shown in section 5. The final section is a conclusion of the case study.

5.2. PROBLEM DEFINITION

HDD is the main product of this company. HDD consists of five main components namely head stack assembly, spindle motor base, print circuit board assembly (PCBA), glass disk substrate, and top and cover base. Each main component consists of product parts, the structure of HDD parts and components are shown in Figure 5.2. The company works with 247 suppliers who produce parts and components for manufacturing HDD. 127 suppliers are located in Thailand, 36 suppliers are located in China, 21 suppliers in Malaysia and 21 suppliers in Singapore respectively. The number of suppliers classified by location is shown in

Table 5.1. Because of 50 percent of total suppliers are located in Thailand, therefore it is comfort to communicate and motivate suppliers for adopt sustainability practices in their business operation. The performance measurement will be developed for assessing supplier's sustainability and will be explained in this section.

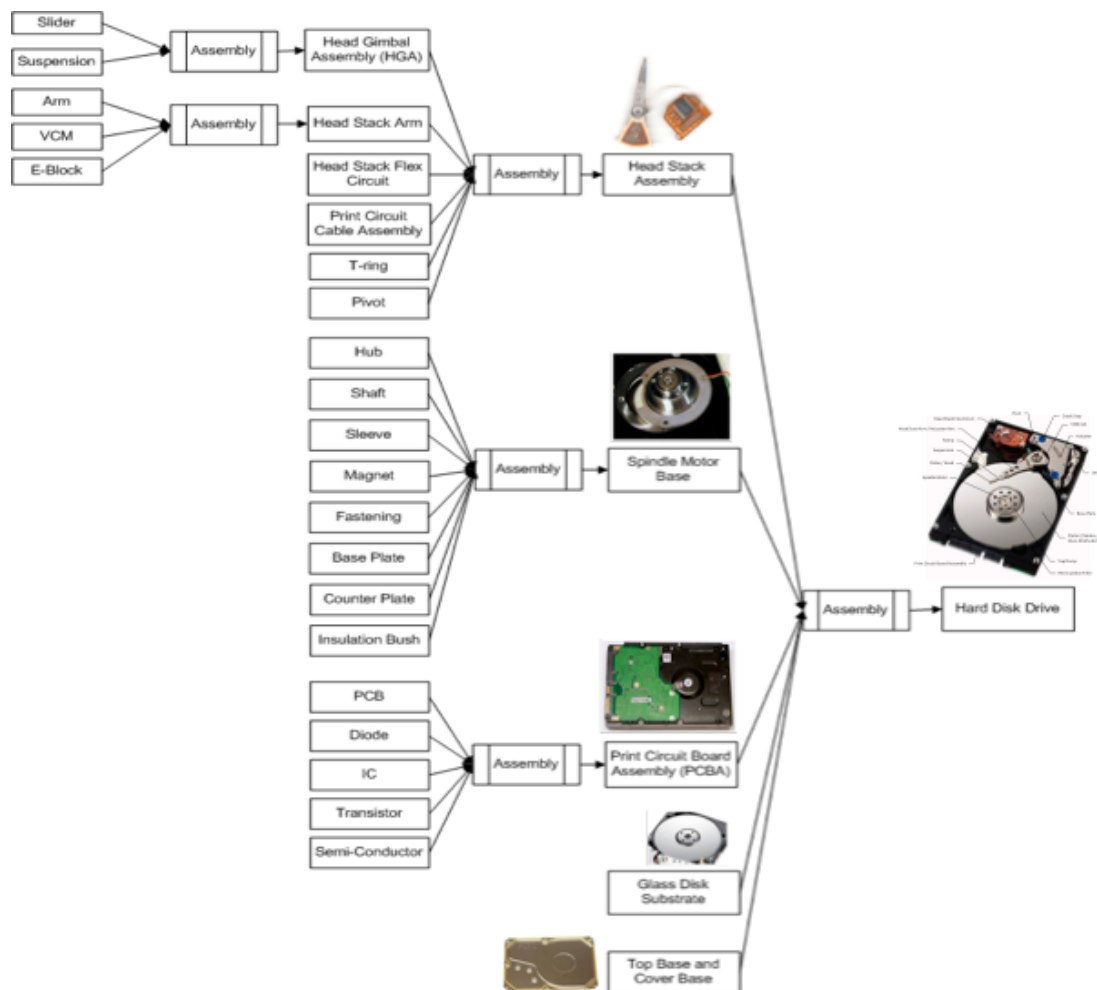

Figure 5.1 Product components of hard disk drive

Table 5.1 Number of suppliers classified by supplier location

Country	Number of Company
Thailand	127
China	36
Malaysia	21
Singapore	21
Taiwan	14
Philippines	8
Japan	5
South Korea	5
India	3
Australia	2
UK	2
Vietnam	2
USA	1
Total	247

5.3. STRUCTURE HIERARCHY

5.3.1 SELECTING SUSTAINABILITY CRITERIA AND MEASURES

According to the sustainability framework developed in chapter2, a set of indicators based on three dimensions (economic, environmental, and social) is selected by using questionnaire. The manager selects these indicators with regards to the policy of the company. After indicators are selected, the metrics which indicate the performance indicators are selected and identified. In this measurement system, the performance metrics and measures are in the same level. The selected indicators and metrics are shown in Table 5.2

Table 5.2 Sustainability indicators and metrics for evaluating supplier's performance

Level 1 Dimension	Level 2 Indicators	Level 3 Measures	
Economic (EC)	Supplier Quality Performance (EC1)	EC1.1	Supplier process capability
		EC1.2	Number of line interruption
		EC1.3	Sub supplier management
	Supplier Business Performance (EC2)	EC2.1	Cost
		EC2.2	Delivery performance
		EC2.3	Flexibility

Level 1 Dimension	Level 2 Indicators	Level 3 Measures	
Environmental (EN)	Energy efficiency (EN1)	EN1.1	Energy consumption monitoring program
		EN1.2	Implementation of energy efficiency program
	Resource used efficiency (EN2)	EN2.1	Resource consumption monitoring program
		EN2.2	Implementation of resource efficiency program
	Emission (EN3)	EN3.1	Pollution emission
		EN3.2	Program to reporting and reducing of global warming gases (GWGs)
	Green competencies (EN4)	EN4.1	Eco-design implementation
		EN4.2	Implementing product life cycle analysis
		EN4.3	Initiative to implement green technology
	Social (SO)	Employee health and safety (SO1)	SO1.1
SO1.2			Initiatives to increase safety in company
SO1.3			Workplace conditions
Hazardous substances (SO2)		SO2.1	Programs to manage hazardous substances
		SO2.2	Compliance with RoHS
Fair trade and Ethical issues (SO3)		SO3.1	Policy and program to increase employee's quality of life
		SO3.2	Ethical issues in employee management policy
		SO3.3	Program to monitor an involuntary or child labor of first-tier supplier
Social responsible competencies (SO4)		SO4.1	Human resource skill and knowledge development system
		SO4.2	Program to improve human well-being of local community

Figure 5.2 shows the AHP structure with five levels is constructed: the goal, dimensions, indicators, measures, and alternatives. The goal of this decision is to measure sustainability performance of supplier. The sustainability performance consists of three dimensions which are economic, environmental, and social dimension. Economic dimension consists of two indicators which are supplier quality performance and supplier business performance. Environmental dimension consists of four indicators which are energy efficiency, resources used efficiency, emission, and green competencies. Social dimension consists of four indicators which are employee health and safety, hazardous substances, fair trade and ethical issues, and social responsible competencies.

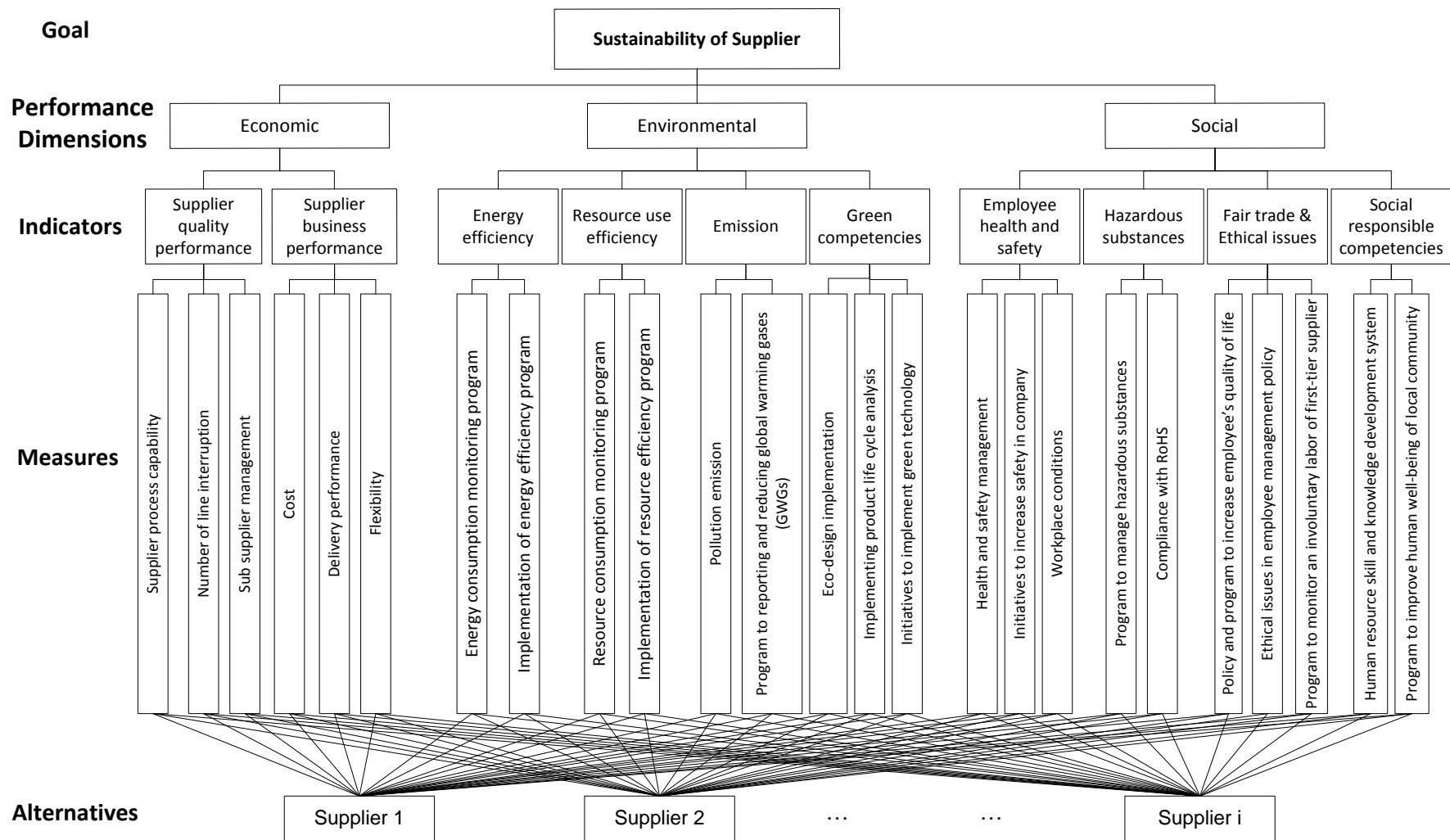

Figure 5.2 The AHP structure of supplier's sustainability measurement

5.3.2 DEFINING MEASUREMENT SCALE

The case study company works with more than 200 suppliers. Hence, the performance measurement system should suit for dealing with a large number of suppliers. As the discussed in chapter 3 that in order to measure performance of several suppliers, an absolute measurement approach should be adopted. Hence, company should construct the criteria rating in each criterion for judgment. This step is to determine the fuzzy normalization rating to convert supplier performance from quantitative or qualitative values to fuzzy numbers. Company has to develop the rating condition in each measure to convert quantitative or qualitative value into fuzzy number. An example of criteria rating of quantitative indicator is shown Table 5.3. An example of criteria rating of qualitative indicator is shown in Table 5.4.

Table 5.3 Criteria rating for flexibility

Metrics	VB	B	AVG	G	VG
Flexibility	Meet < 70% of request	Meet 70% - 79% of request	Meet 80% - 89% of request	Meet 90% - 99% of request	Meet 100% of request

Table 5.4 Criteria rating for initiatives to implement green technology

Metrics	VB	B	AVG	G	VG
Initiatives to implement green technology	No action in this moment but company aware of an importance of this issue	Assessing company's position, preparing for collecting information to implement green technology	Implement some item of green technology to improve environmental performance	Company has matured in this issue supplier and conducts activities on innovation of green technology and/or extends to first-tier supplier	Company has wide spread innovation and extends this issue to its supply chain

5.4. CONSTRUCT A SET OF PAIRWISE COMPARISON MATRICES

After constructing the hierarchy, pairwise comparisons were performed systematically to include all the combinations of criteria in all level (dimensions, indicators, and measures). The criteria were compared according to their relative importance with respect to the parent element in the adjacent upper level. This approach is found to be very useful in collecting data. This determination is performed through using pairwise comparisons. The function of the pairwise comparisons is by finding the relative importance of the criteria and sub criteria which is rated by and linguistic scale regarding relative importance is given in, which indicates the level of relative

importance from just equal, equal important, weakly more important, strongly more important, very strongly more important, and absolutely more important.

Table 5.5 The linguistic scale for pairwise comparison

Linguistic scale	Fuzzy number
Just equal	(1, 1, 1)
Equal important (EI)	(1/2, 1, 3/2)
Weakly more important (WMI)	(1, 3/2, 2)
Strongly more important (SMI)	(3/2, 2, 5/2)
Very strongly more important (VSMI)	(2, 5/2, 3)
Absolutely more important (AMI)	(5/2, 3, 7/2)

5.4.1 PAIRWISE ANALYSIS OF MAIN CRITERIA: SUSTAINABILITY DIMENSIONS

The supply chain manager of the company is the respondent who filled the pairwise comparison matrices by using the linguistic scale that is shown in Table 5.5. The questionnaire including all possible pairwise comparison combinations was distributed to the manager for collecting the data.

The manager made all the pairwise comparisons using semantic terms from the fundamental scale and then translated these to the corresponding fuzzy numbers. The questions to ask when comparing two criteria being compared, which is considered more important by the manager while evaluating supplier performance, and how much more important is it with respect to selection. Table 5.6 represents the principal matrix of comparison, which contains the comparison between sustainability dimensions in relation to the overall objective of the problem i.e. the evaluation of supplier's sustainability performance. From Table 5.6, the supply chain manager judged that the economic (EC) performance is strong more important (SMI) than environmental (EN) performance and absolutely more important than social (SO) performance. Next, the environmental performance is very strongly more important (VSMI) than the social dimension. After that, the linguistic values are transformed into the fuzzy numbers that are shown in Table 5.7.

The consistency test is one of the essential features of the AHP method which aims to eliminate the possible inconsistency revealed in the criteria weights, through the computation of consistency level of each matrix. The consistency ratio (CR) was used to determine and justify the inconsistency in the pairwise comparison made by the respondents. Based on Saaty's empirical suggestion that the judgment of a respondent is accepted if $CR \leq 0.10$ (Saaty, 1980), it is concluded that the foregoing pairwise comparisons to obtain attribute weights are reasonably consistent. If $CR \leq 0.10$, the weight result are valid and consistent. In contrast, if > 0.10 , the matrix results are

inconsistence and are exempted for the further analysis. The respondent was requested to carefully evaluate the criteria until consistency was achieved. According to the respondent judgment in Table 5.6 and Table 5.7, the *CR* value is calculated following the formula in equation (4-8) and (4-9).

Table 5.6 Linguistic comparison matrix with respect to *Sustainability*

	EC	EN	SO
EC	JE	SMI	AMI
EN	1/SMI	JE	VSMI
SO	1/AMI	1/VSMI	JE

Table 5.7 Fuzzy Comparison Matrix with Respect to *Sustainability*

	EC	EN	SO
EC	(1, 1, 1)	(3/2, 2, 5/2)	(5/2, 3, 7/2)
EN	(2/5, 1/2, 2/3)	(1, 1, 1)	(2, 5/2, 3)
SO	(2/7, 1/3, 2/5)	(1/3, 2/5, 1/2)	(1, 1, 1)

$\lambda_{\max}= 3.0291,$ $CR=0.02505$

In this case, the comparison matrix of main criteria is considered as consistent because the *CR* value is lower than 0.10. The same procedure is then carried out for the other comparison matrices in this case study.

5.4.2 PAIRWISE ANALYSIS OF SUB-CRITERIA: SUSTAINABILITY INDICATORS

Each sustainability dimension consists of the indicators. After manager compared the relative important of sustainability dimension, the next step is a pairwise analysis of the lower level i.e. sustainability indicators level. Two indicators i.e. supplier quality performance (EC1) and supplier business performance (EC2) belong to the economic dimension. Four indicators i.e. energy efficiency (EN1), resource used efficiency (EN2), emission (EN3), and emission (EN4) belong to the environmental dimension. Four indicators i.e. employee health and safety (SO1), hazardous substances (SO2), fair trade and ethical issues (SO3), and social responsible competencies (SO4) belong to the social dimension. The same calculations done for the main criteria matrix are employed for these matrices as well. Table 5.8 to Table 5.10 show the results of the pairwise analysis for sustainability indicators. The consistency ration for each matrix were computed and displayed on each corresponding table. All the pairwise comparison matrices are consistence.

Table 5.8 Fuzzy Comparison Matrix with respect to *Economic (EC)*

	EC1	EC2
EC1	(1, 1, 1)	(1/2, 1, 3/2)
EC2	(2/3, 1, 2)	(1, 1, 1)

$\lambda_{\max}=2.0000,$ $CR=0.0000$

Table 5.9 Fuzzy Comparison Matrix with respect to *Environment (EN)*

	EN1	EN2	EN3	EN4
EN1	(1, 1, 1)	(1/2, 1, 3/2)	(1/2, 2/3, 1)	(2/5, 1/2, 2/3)
EN2	(2/3, 1, 2)	(1, 1, 1)	(1/2, 2/3, 1)	(2/5, 1/2, 2/3)
EN3	(1, 3/2, 2)	(1, 3/2, 2)	(1, 1, 1)	(1/3, 2/5, 1/2)
EN4	(3/2, 2, 5/2)	(3/2, 2, 5/2)	(2, 5/2, 3)	(1, 1, 1)

$\lambda_{\max}= 4.0496,$ CR=0.0184

Table 5.10 Fuzzy Comparison Matrix with respect to *Social (SO)*

	SO1	SO2	SO3	SO4
SO1	(1, 1, 1)	(1, 1, 1)	(1, 3/2, 2)	(1, 3/2, 2)
SO2	(1, 1, 1)	(1, 1, 1)	(1, 3/2, 2)	(2/5, 1/2, 2/3)
SO3	(1/2, 2/3, 1)	(1/2, 2/3, 1)	(1, 1, 1)	(2/5, 1/2, 2/3)
SO4	(1/2, 2/3, 1)	(3/2, 2, 5/2)	(3/2, 2, 5/2)	(1, 1, 1)

$\lambda_{\max}= 4.1171,$ CR=0.0434

5.4.3 PAIRWISE ANALYSIS OF SUB-CRITERIA: SUSTAINABILITY MEASURES

Each indicator of economic, environmental and social dimension consists of the sustainability measures. The next step is a pairwise analysis of sustainability measures in each indicator.

A) *Economic dimension*

The economic dimension consists of two indicators. First, the supplier quality performance (EC1) is indicated by three measures i.e. supplier process capability (EC1.1), number of line interruption (EC1.2), and sub supplier management (EC1.3). The second indicator is supplier business performance (EC2) which is indicated by three measures i.e. cost (EC2.1) delivery performance (EC2.2), and flexibility (EC2.3). The results are shown in Table 5.11 and Table 5.12. It is found that both comparison matrices are consistence.

Table 5.11 Fuzzy Comparison Matrix with Respect to *Supplier quality performance (EC1)*

	EC1.1	EC1.2	EC1.3
EC1.1	(1, 1, 1)	(1/3, 2/5, 1/2)	(1, 3/2, 2)
EC1.2	(2, 5/2, 3)	(1, 1, 1)	(5/2, 3, 7/2)
EC1.3	(1/2, 2/3, 1)	(2/7, 1/3, 2/5)	(1, 1, 1)

$\lambda_{\max}= 3.0055,$ CR=0.0048

Table 5.12 Fuzzy Comparison Matrix with Respect to *Supplier business performance (EC2)*

	EC2.1	EC2.2	EC2.3
EC2.1	(1, 1, 1)	(3/2, 2, 5/2)	(3/2, 2, 5/2)
EC2.2	(2/5, 1/2, 2/3)	(1, 1, 1)	(3/2, 2, 5/2)
EC2.3	(2/5, 1/2, 2/3)	(2/5, 1/2, 2/3)	(1, 1, 1)

$\lambda_{\max}= 30536,$ CR=0.0462

B) *Environmental dimension*

The environmental dimension consists of four indicators as follow:

- Energy efficiency (EN1) which is indicated by two measures i.e. energy consumption monitoring program (EN1.1) and implementation of energy efficiency program (EN1.2)
- Resource used efficiency (EN2) which is indicated by two measures i.e. resource consumption monitoring program (EN2.1) and implementation of resource efficiency program (EN2.2)
- Emission (EN3) which is indicated by two measures i.e. pollution emission (EN3.1) and program to reporting and reducing of global warming gases (GWGs) (EN3.2).
- Green competencies (EN4) which is indicated by three measures i.e. eco-design implementation (EN4.1), implementing product life cycle analysis (EN4.2), and initiatives to implement green technology (EN4.3)

The results of the pairwise analysis for these four indicators are shown in Table 5.13 to Table 5.16. All these four comparison matrices are consistence.

Table 5.13 Fuzzy Comparison Matrix with respect to *Energy efficiency (EN1)*

	EN1.1	EN1.2
EN1.1	(1, 1, 1)	(1, 3/2, 2)
EN1.2	(1/2, 2/3, 1)	(1, 1, 1)
$\lambda_{\max}= 2.0000,$	CR=0.0000	

Table 5.14 Fuzzy Comparison Matrix with respect to *Resource used efficiency (EN2)*

	EN2.1	EN2.2
EN2.1	(1, 1, 1)	(3/2, 2, 5/2)
EN2.2	(2/5, 1/2, 2/3)	(1, 1, 1)
$\lambda_{\max}= 2.0000,$	CR=0.0000	

Table 5.15 Fuzzy Comparison Matrix with respect to *Emission (EN3)*

	EN3.1	EN3.2
EN3.1	(1, 1, 1)	(1/3, 2/5, 1/2)
EN3.2	(2, 5/2, 3)	(1, 1, 1)
$\lambda_{\max}= 2.0000,$	CR=0.0000	

Table 5.16 Fuzzy Comparison Matrix with respect to *Green competencies (EN4)*

	EN4.1	EN4.2	EN4.3
EN4.1	(1, 1, 1)	(1, 3/2, 2)	(2/3, 1, 2)
EN4.2	(1/2, 2/3, 1)	(1, 1, 1)	(2/5, 1/2, 2/3)
EN4.3	(1/2, 1, 3/2)	(3/2, 2, 5/2)	(1, 1, 1)
$\lambda_{\max}= 3.0092,$	CR=0.0079		

C) *Social dimension*

The social dimension consists of four indicators as follow:

- Employee health and safety (SO1) which is indicated by three measures i.e. health and safety management (SO1.1), initiatives to increase safety in company (SO1.2), workplace conditions (SO1.3)
- Hazardous substances (SO2) which is indicated by two measures i.e. program to manage hazardous substances (SO2.1) and compliance with RoHS (SO2.2)
- Fair trade and ethical issues (SO3) which is indicated by three measures i.e. policy and program to increase employee's quality of life (SO3.1), ethical issues in employee management policy (SO3.2), and program to monitor and involuntary labor of first-tier supplier (SO2.3)
- Social responsible competencies (SO3) which is indicated by two measures i.e. human resource skill and knowledge development system (SO3.1) and program to improve human well-being of local community (SO3.2)

The results of the pairwise analysis for these four indicators are shown in Table 5.17 to Table 5.20. All these four comparison matrices are consistence.

Table 5.17 Fuzzy Comparison Matrix with respect to *Employee health & safety (SO1)*

	SO1.1	SO1.2	SO1.3
SO1.1	(1, 1, 1)	(1, 3/2, 2)	(2/3, 1, 2)
SO1.2	(1/2, 2/3, 1)	(1, 1, 1)	(2/5, 1/2, 2/3)
SO1.3	(1/2, 1, 3/2)	(3/2, 2, 5/2)	(1, 1, 1)

$\lambda_{\max}= 3.0092,$ $CR=0.0079$

Table 5.18 Fuzzy Comparison Matrix with respect to *Hazardous substances (SO2)*

	SO2.1	SO2.2
SO2.1	(1, 1, 1)	(3/2, 2, 5/2)
SO2.2	(2/5, 1/2, 2/3)	(1, 1, 1)

$\lambda_{\max}= 2.0000,$ $CR=0.0000$

Table 5.19 Fuzzy Comparison Matrix with respect to *Fair trade and Ethical issues (SO3)*

	SO3.1	SO3.2	SO3.3
SO3.1	(1, 1, 1)	(2/5, 1/2, 2/3)	(2/5, 1/2, 2/3)
SO3.2	(3/2, 2, 5/2)	(1, 1, 1)	(1, 3/2, 2)
SO3.3	(3/2, 2, 5/2)	(1, 3/2, 2)	(1, 1, 1)

$\lambda_{\max}= 3.0092,$ $CR=0.0079$

Table 5.20 Fuzzy Comparison Matrix with respect to *Social responsible competencies (SO4)*

	SO4.1	SO4.2
SO4.1	(1, 1, 1)	(5/2, 3, 7/2)
SO4.2	(5/2, 3, 7/2)	(1, 1, 1)

$\lambda_{\max}= 2.0000,$ $CR=0.0000$

5.5. DETERMINING THE FUZZY PRIORITY WEIGHT

According to the proposed FAHP methods which are described in Chapter 4, the FAHP Method-III is selected to implement for this case study to obtain the fuzzy priority weight and to rank the supplier's performance. This section consists of three steps as follow:

5.5.1 DETERMINING THE LOCAL AND GLOBAL PRIORITY WEIGHT

A) Local priority weight

A local priority weight vector can be generated for the matrix of judgments (Table 5.7 to Table 5.20) in each level of hierarchy structure by using the normalization method in equation (4-32). The normalized fuzzy local weights shown in Table 5.22 represent the relative importance of the criterion in each hierarchy level.

According to the pairwise comparison matrix of sustainable dimension in Table 5.11, the normalized fuzzy priority weight of criterion i can be obtained by

$$\tilde{w}_i = \left(\frac{\sum_{j=1}^n l_{ij}}{\sum_{j=1}^n l_{ij} + \sum_{i=1, i \neq j}^n \sum_{j=1}^n u_{ij}}, \frac{\sum_{j=1}^n m_{ij}}{\sum_{i=1}^n \sum_{j=1}^n m_{ij}}, \frac{\sum_{j=1}^n u_{ij}}{\sum_{j=1}^n u_{ij} + \sum_{i=1, i \neq j}^n \sum_{j=1}^n l_{ij}} \right)$$

In order to compute \tilde{w}_{EC}

$$(\tilde{w}_{EC})_l = \frac{\sum_{j=1}^n l_{ij}}{\sum_{j=1}^n l_{ij} + \sum_{i=1, i \neq j}^n \sum_{j=1}^n u_{ij}} = \frac{(1 + \frac{3}{2} + \frac{5}{2})}{(1 + \frac{3}{2} + \frac{5}{2}) + (\frac{2}{3} + 1 + 3) + (\frac{2}{5} + \frac{1}{2} + 1)} = 0.4323$$

$$(\tilde{w}_{EC})_m = \frac{\sum_{j=1}^n m_{ij}}{\sum_{i=1}^n \sum_{j=1}^n m_{ij}} = \frac{(1 + 2 + 3)}{(1 + 2 + 3) + (\frac{1}{2} + 1 + \frac{5}{2}) + (\frac{1}{3} + \frac{2}{5} + 1)} = 0.5114$$

$$(\tilde{w}_{EC})_u = \frac{\sum_{j=1}^n u_{ij}}{\sum_{j=1}^n u_{ij} + \sum_{i=1, i \neq j}^n \sum_{j=1}^n l_{ij}} = \frac{(1 + \frac{5}{2} + \frac{7}{2})}{(1 + \frac{5}{2} + \frac{7}{2}) + (\frac{2}{5} + 1 + 2) + (\frac{2}{7} + \frac{1}{3} + 1)} = 0.5824$$

Hence, the local priority weight of the economic dimension (\tilde{w}_{EC}) is (0.4323, 0.5114, 0.5824). Based on the similar computation, the local priority weight of the environmental dimension (\tilde{w}_{EN}) is (0.2764, 0.3409, 0.4135) and the local priority weight of the social dimension is (0.1219, 0.1477, 0.1845). Figure 5.3 shows local priority weights of sustainable dimensions which belong to the goal of sustainability performance. The crisp value of each fuzzy priority weight can be obtained by using the center of gravity method in equation (4-41). The crisp values of local priority weights are shown in Table 5.21. It is found that the weight of economic, environmental, and

social dimension are 0.51, 0.34, and 0.14 respectively. It means that the economic performance of supplier is the most important for the case study company followed by the environmental and social performance respectively.

Table 5.21 Fuzzy and crisp values of local priority weight in sustainable dimension

Dimension	Proposed Method-III	
	Fuzzy priority weight	Crisp value
<i>Sustainability Performance</i>		
EC	(0.4323, 0.5114, 0.5824)	0.5087
EN	(0.2764, 0.3409, 0.4135)	0.3436
SO	(0.1219, 0.1477, 0.1845)	0.1514

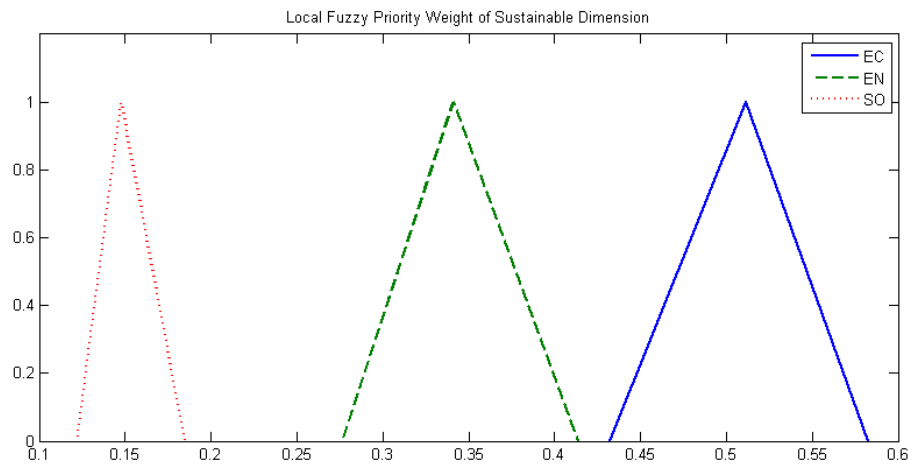

Figure 5.3 Local priority weight of sustainable dimension

The same procedure is carried out for the other comparison matrices in all level. The local weights in both fuzzy and crisp values are shown in Table 5.22

Table 5.22 Local weight of all matrices: Proposed Method-III

Hierarchy level	Dimension	Proposed Method-III	
		Local weight	Crisp value
<i>Goal</i>			
Level 0	Sustainability performance	(1.0000, 1.0000, 1.0000)	1.0000
<i>Sustainability Performance</i>			
Level 1	EC	(0.4323, 0.5114, 0.5824)	0.5087
	EN	(0.2764, 0.3409, 0.4135)	0.3436
	SO	(0.1219, 0.1477, 0.1845)	0.1514
<i>Economic (EC)</i>			
Level 2	EC1	(0.3333, 0.5000, 0.6000)	0.4778
	EC2	(0.4000, 0.5000, 0.6667)	0.5222
<i>Environmental (EN)</i>			
Level 2	EN1	(0.1113, 0.1737, 0.2593)	0.1814

Hierarchy level	Dimension	Proposed Method-III	
		Local weight	Crisp value
	EN2	(0.1209, 0.1737, 0.2846)	0.1931
	EN3	(0.1575, 0.2413, 0.3340)	0.2443
	EN4	(0.2951, 0.4113, 0.5202)	0.4089
Level 1	<i>Social (SO)</i>		
Level 2	SO1	(0.2069, 0.2857, 0.3681)	0.2869
	SO2	(0.1694, 0.2286, 0.2998)	0.2326
	SO3	(0.1196, 0.1619, 0.2355)	0.1723
	SO4	(0.2389, 0.3238, 0.4167)	0.3265
Level 2	<i>Supplier quality performance (EC1)</i>		
Level 3	EC1.1	(0.1907, 0.2544, 0.3245)	0.2565
	EC1.2	(0.4825, 0.5702, 0.6455)	0.5661
	EC1.3	(0.1397, 0.1754, 0.2345)	0.1832
Level 2	<i>Supplier business performance (EC2)</i>		
Level 3	EC2.1	(0.3810, 0.4762, 0.5607)	0.4726
	EC2.2	(0.2582, 0.3333, 0.4181)	0.3365
	EC2.3	(0.1504, 0.1905, 0.2527)	0.1979
Level 2	<i>Energy efficiency (EN1)</i>		
Level 3	EN1.1	(0.5000, 0.6000, 0.6667)	0.5889
	EN1.2	(0.3333, 0.4000, 0.5000)	0.4111
Level 2	<i>Resource used efficiency (EN2)</i>		
Level 3	EN2.1	(0.6000, 0.6667, 0.7143)	0.6603
	EN2.2	(0.2857, 0.3333, 0.4000)	0.3397
Level 2	<i>Emission (EN3)</i>		
Level 3	EN3.1	(0.2500, 0.2857, 0.3333)	0.2897
	EN3.2	(0.6667, 0.7143, 0.7500)	0.7103
Level 2	<i>Green competencies (EN4)</i>		
Level 3	EN4.1	(0.2581, 0.3621, 0.5051)	0.3751
	EN4.2	(0.1597, 0.2241, 0.3200)	0.2346
	EN4.3	(0.2813, 0.4138, 0.5226)	0.4059
Level 2	<i>Employee health & safety (SO1)</i>		
Level 3	SO1.1	(0.2581, 0.3621, 0.5051)	0.3751
	SO1.2	(0.1597, 0.2241, 0.3200)	0.2346
	SO1.3	(0.2813, 0.4138, 0.5226)	0.4059
Level 2	<i>Hazardous substances (SO2)</i>		
Level 3	SO2.1	(0.6000, 0.6667, 0.7143)	0.6603
	SO2.2	(0.2857, 0.3333, 0.4000)	0.3397
Level 2	<i>Fair trade and Ethical issues (SO3)</i>		
Level 3	SO3.1	(0.1525, 0.1967, 0.2642)	0.2045
	SO3.2	(0.3387, 0.4426, 0.5340)	0.4384
	SO3.3	(0.2769, 0.3607, 0.4592)	0.3656
Level 2	<i>Social responsible competencies (SO4)</i>		
Level 3	SO4.1	(0.7143, 0.7500, 0.7778)	0.7474
	SO4.2	(0.2222, 0.2500, 0.2857)	0.2526

B) Global priority weight

The global sustainability weight of each sustainability measure (level 3), indicator (level 2), and dimension (level 1) can be achieved through multiplying the local weight by its corresponding parent. The larger the final weight of criteria is the higher priority of importance. The results of the weighting vector for standing sustainability criteria list are arranged in Table 5.23 and Figure 5.4.

Table 5.23 Global fuzzy and crisp weights of all matrices: Proposed Method-III

	Dimension	Proposed Method-III	
		Global weight	Crisp value
	<i>Goal</i>		
Level 0	Sustainability performance	(1.0000, 1.0000, 1.0000)	1.000
Level 0	<i>Sustainability Performance</i>		
Level 1	EC	(0.4323, 0.5114, 0.5824)	0.5087
	EN	(0.2764, 0.3409, 0.4135)	0.3436
	SO	(0.1219, 0.1477, 0.1845)	0.1514
Level 1	<i>Economic (EC)</i>		
Level 2	EC1	(0.1441, 0.2557, 0.3494)	0.2497
	EC2	(0.1729, 0.2557, 0.3883)	0.2723
Level 1	<i>Environmental (EN)</i>		
Level 2	EN1	(0.0308, 0.0592, 0.1072)	0.0657
	EN2	(0.0334, 0.0592, 0.1177)	0.0701
	EN3	(0.0435, 0.0823, 0.1381)	0.0880
	EN4	(0.0816, 0.1402, 0.2151)	0.1456
Level 1	<i>Social (SO)</i>		
Level 2	SO1	(0.0252, 0.0422, 0.0679)	0.0451
	SO2	(0.0206, 0.0338, 0.0553)	0.0366
	SO3	(0.0146, 0.0239, 0.0435)	0.0273
	SO4	(0.0291, 0.0478, 0.0769)	0.0513
Level 2	<i>Supplier quality performance (EC1)</i>		
Level 3	EC1.1	(0.0275, 0.0650, 0.1134)	0.0686
	EC1.2	(0.0695, 0.1458, 0.2256)	0.1470
	EC1.3	(0.0201, 0.0449, 0.0820)	0.0490
Level 2	<i>Supplier business performance (EC2)</i>		
Level 3	EC2.1	(0.0659, 0.1218, 0.2177)	0.1351
	EC2.2	(0.0446, 0.0852, 0.1623)	0.0974
	EC2.3	(0.0260, 0.0487, 0.0981)	0.0576
Level 2	<i>Energy efficiency (EN1)</i>		
Level 3	EN1.1	(0.0154, 0.0355, 0.0715)	0.0408
	EN1.2	(0.0103, 0.0237, 0.0536)	0.0292
Level 2	<i>Resource used efficiency (EN2)</i>		
Level 3	EN2.1	(0.0200, 0.0395, 0.0840)	0.0479
	EN2.2	(0.0095, 0.0197, 0.0471)	0.0254
Level 2	<i>Emission (EN3)</i>		
Level 3	EN3.1	(0.0109, 0.0235, 0.0460)	0.02681
	EN3.2	(0.0290, 0.0588, 0.1036)	0.06379

Level	Dimension	Proposed Method-III	
		Global weight	Crisp value
Level 2	<i>Green competencies (EN4)</i>		
Level 3	EN4.1	(0.0210, 0.0508, 0.1086)	0.0268
	EN4.2	(0.0130, 0.0314, 0.0688)	0.0638
	EN4.3	(0.0229, 0.0580, 0.1124)	0.0268
Level 2	<i>Employee health & safety (SO1)</i>		
Level 3	SO1.1	(0.0065, 0.0153, 0.0343)	0.0602
	SO1.2	(0.0040, 0.0095, 0.0217)	0.0378
	SO1.3	(0.0071, 0.0175, 0.0355)	0.0645
Level 2	<i>Hazardous substances (SO2)</i>		
Level 3	SO2.1	(0.0124, 0.0225, 0.0395)	0.0248
	SO2.2	(0.0059, 0.0113, 0.0221)	0.0131
Level 2	<i>Fair trade and Ethical issues (SO3)</i>		
Level 3	SO3.1	(0.0022, 0.0047, 0.0115)	0.0061
	SO3.2	(0.0049, 0.0106, 0.0232)	0.0129
	SO3.3	(0.0040, 0.0086, 0.0200)	0.0109
Level 2	<i>Social responsible competencies (SO4)</i>		
Level 3	SO4.1	(0.0208, 0.0359, 0.0598)	0.0388
	SO4.2	(0.0065, 0.0120, 0.0220)	0.0135

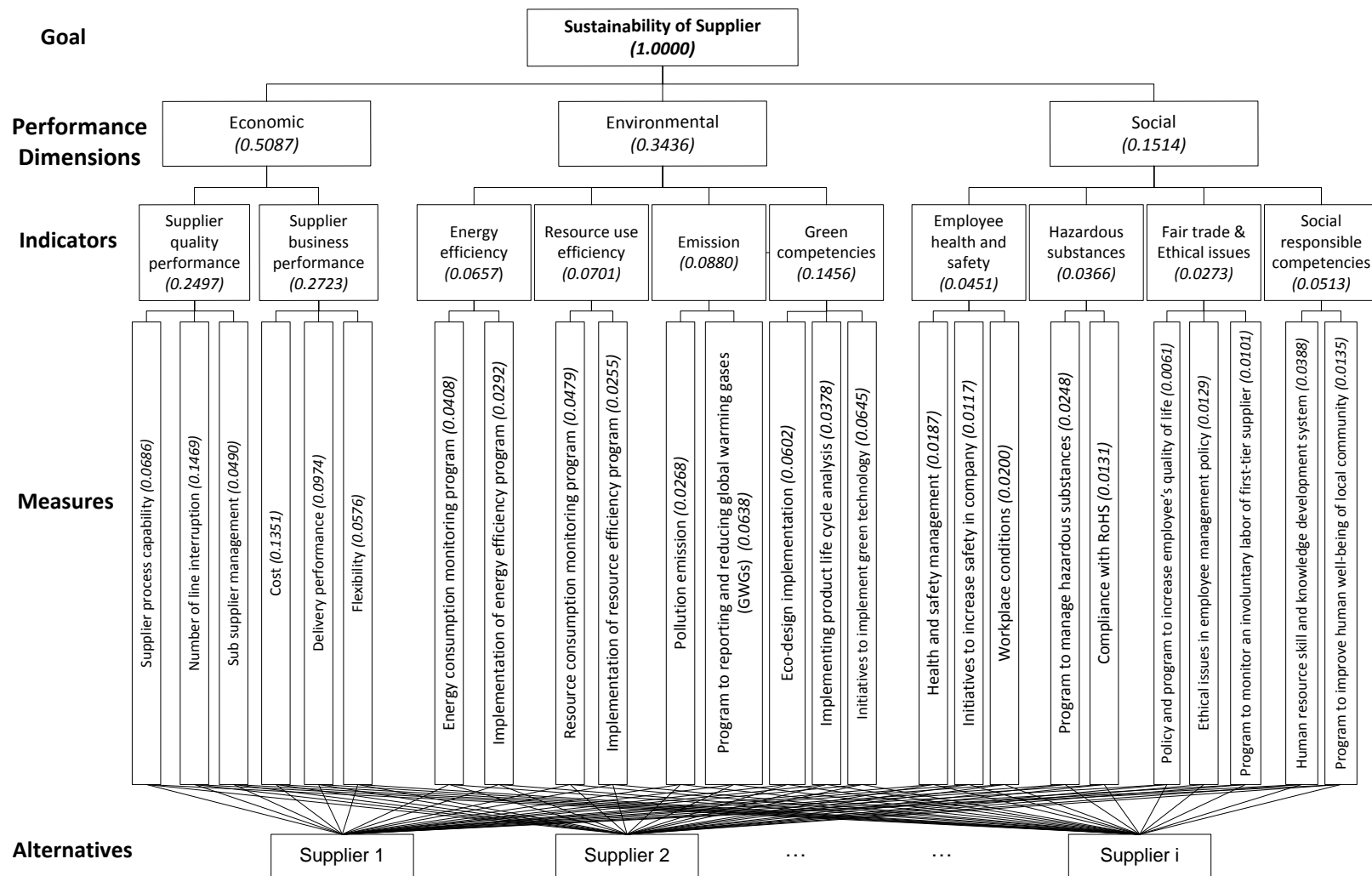

Figure 5.4 Global priority weights for sustainability performance measurement in supplier assessment problem

5.5.2 ASSESSING SUPPLIER'S PERFORMANCE

The main objective for adopting this measurement method is the evaluation of supplier for a hard disk drive manufacturing company. After weighting the FAHP model for determining priority weight for alternatives, the decision maker evaluates suppliers in each sustainability measure (level 3) by using the measurement rating scale described in section 5.3.2. The five suppliers are selected to use as an example for the practical application of the proposed FAHP model (Method-III). The five-scale of linguistic rating, which are very weak (VW), Weak (W), Average (AVG), Good (G), and Very good (VG), is used for evaluating supplier's performance in each measure.

The supplier's performance in each measure is judged and the results are shown in Table 5.24. These linguistic judgments can be converted into fuzzy number by using the converting table shown in Table 5.25. The result in this step is determined as the local priority weight for suppliers. The supplier's performance in all measures in term of fuzzy score are shown in Table 5.26

Table 5.24 Linguistic judgment of supplier's performance rating

Level 1	Level 2	Level3	Supplier A	Supplier B	Supplier C	Supplier D	Supplier E
Economic (EC)	Supplier Quality Performance (EC1)	EC1.1	AVG	W	VW	AVG	G
		EC1.2	AVG	AVG	G	G	AVG
		EC1.3	W	AVG	W	G	VW
	Supplier Business Performance (EC2)	EC2.1	W	AVG	VW	VG	AVG
		EC2.2	W	W	G	VG	G
		EC2.3	AVG	AVG	W	W	G
Environmental (EN)	Energy efficiency (EN1)	EN1.1	AVG	AVG	AVG	G	VG
		EN1.2	G	AVG	W	VW	VW
	Resource used efficiency (EN2)	EN2.1	VW	VW	G	G	VG
		EN2.2	VW	G	VG	G	VG
	Emission (EN3)	EN3.1	AVG	AVG	VG	W	AVG
		EN3.2	W	W	VG	W	W
	Green competencies (EN4)	EN4.1	VW	G	VW	VW	VW
		EN4.2	W	W	VG	W	G
		EN4.3	AVG	VG	VW	W	W
Social (SO)	Employee health and safety (SO1)	SO1.1	W	VG	G	AVG	W
		SO1.2	VW	VG	W	G	G
		SO1.3	G	AVG	VW	G	AVG
	Hazardous substances (SO2)	SO2.1	G	AVG	W	AVG	W
		SO2.2	G	G	G	VW	G
	Fair trade and Ethical issues	SO3.1	VW	VG	VW	VG	G
SO3.2		AVG	W	W	W	VW	

Level 1	Level 2	Level3	Supplier A	Supplier B	Supplier C	Supplier D	Supplier E
	(S03)	S03.3	VW	VG	VW	AVG	VG
	Social responsible competencies (S04)	S04.1	G	G	G	AVG	VW
		S04.2	W	G	VW	AVG	VW

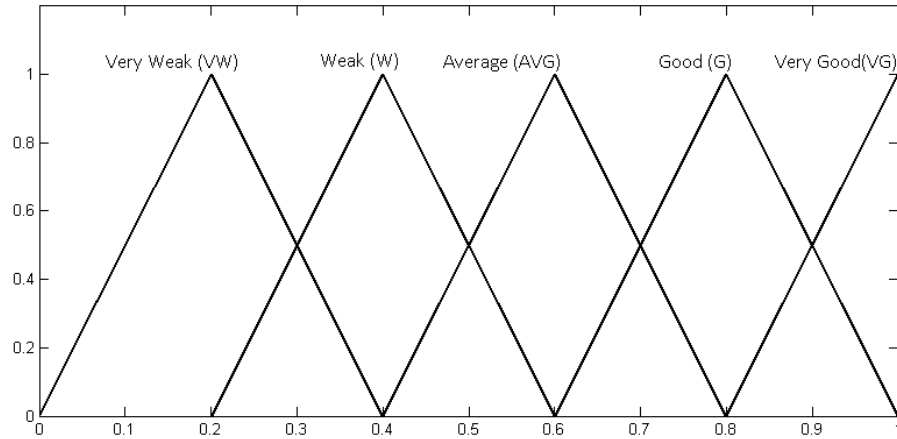

Figure 5.5 Fuzzy number of linguistic judgment for supplier assessment

Table 5.25 The linguistic scale for supplier performance judgment

Linguistic scale	Fuzzy number
Very weak (VW)	(0, 0.2, 0.4)
Weak (W)	(0.2, 0.4, 0.6)
Average (AVG)	(0.4, 0.6, 0.8)
Good (G)	(0.6, 0.8, 1.0)
Very good (VG)	(0.8, 1.0, 1.0)

Table 5.26 Fuzzy score of supplier's performance rating

Level 1	Level 2	Level3	Local weight of supplier performance				
			Supplier A	Supplier B	Supplier C	Supplier D	Supplier E
EC	EC 1	EC1.1	(0.4, 0.6, 0.8)	(0.2, 0.4, 0.6)	(0, 0.2, 0.4)	(0.4, 0.6, 0.8)	(0.6, 0.8, 1)
		EC1.2	(0.4, 0.6, 0.8)	(0.4, 0.6, 0.8)	(0.6, 0.8, 1)	(0.6, 0.8, 1)	(0.4, 0.6, 0.8)
		EC1.3	(0.2, 0.4, 0.6)	(0.4, 0.6, 0.8)	(0.2, 0.4, 0.6)	(0.6, 0.8, 1)	(0, 0.2, 0.4)
	EC 2	EC2.1	(0.2, 0.4, 0.6)	(0.4, 0.6, 0.8)	(0, 0.2, 0.4)	(0.8, 1, 1)	(0.4, 0.6, 0.8)
		EC2.2	(0.2, 0.4, 0.6)	(0.2, 0.4, 0.6)	(0.6, 0.8, 1)	(0.8, 1, 1)	(0.6, 0.8, 1)
		EC2.3	(0.4, 0.6, 0.8)	(0.4, 0.6, 0.8)	(0.2, 0.4, 0.6)	(0.2, 0.4, 0.6)	(0.6, 0.8, 1)
EN	EN 1	EN1.1	(0.4, 0.6, 0.8)	(0.4, 0.6, 0.8)	(0.4, 0.6, 0.8)	(0.6, 0.8, 1)	(0.8, 1, 1)
		EN1.2	(0.6, 0.8, 1)	(0.4, 0.6, 0.8)	(0.2, 0.4, 0.6)	(0, 0.2, 0.4)	(0, 0.2, 0.4)
	EN 2	EN2.1	(0, 0.2, 0.4)	(0, 0.2, 0.4)	(0.6, 0.8, 1)	(0.6, 0.8, 1)	(0.8, 1, 1)
		EN2.2	(0, 0.2, 0.4)	(0.6, 0.8, 1)	(0.8, 1, 1)	(0.6, 0.8, 1)	(0.8, 1, 1)
	EN 3	EN3.1	(0.4, 0.6, 0.8)	(0.4, 0.6, 0.8)	(0.8, 1, 1)	(0.2, 0.4, 0.6)	(0.4, 0.6, 0.8)
		EN3.2	(0.2, 0.4, 0.6)	(0.2, 0.4, 0.6)	(0.8, 1, 1)	(0.2, 0.4, 0.6)	(0.2, 0.4, 0.6)

Level 1	Level 2	Level3	Local weight of supplier performance				
			Supplier A	Supplier B	Supplier C	Supplier D	Supplier E
	EN 4	EN4.1	(0, 0.2, 0.4)	(0.6, 0.8, 1)	(0, 0.2, 0.4)	(0, 0.2, 0.4)	(0, 0.2, 0.4)
		EN4.2	(0.2, 0.4, 0.6)	(0.2, 0.4, 0.6)	(0.8, 1, 1)	(0.2, 0.4, 0.6)	(0.6, 0.8, 1)
		EN4.3	(0.4, 0.6, 0.8)	(0.8, 1, 1)	(0, 0.2, 0.4)	(0.2, 0.4, 0.6)	(0.2, 0.4, 0.6)
SO	SO 1	SO1.1	(0.2, 0.4, 0.6)	(0.8, 1, 1)	(0.6, 0.8, 1)	(0.4, 0.6, 0.8)	(0.2, 0.4, 0.6)
		SO1.2	(0, 0.2, 0.4)	(0.8, 1, 1)	(0.2, 0.4, 0.6)	(0.6, 0.8, 1)	(0.6, 0.8, 1)
		SO1.3	(0.6, 0.8, 1)	(0.4, 0.6, 0.8)	(0, 0.2, 0.4)	(0.6, 0.8, 1)	(0.4, 0.6, 0.8)
	SO 2	SO2.1	(0.6, 0.8, 1)	(0.4, 0.6, 0.8)	(0.2, 0.4, 0.6)	(0.4, 0.6, 0.8)	(0.2, 0.4, 0.6)
		SO2.2	(0.6, 0.8, 1)	(0.6, 0.8, 1)	(0.6, 0.8, 1)	(0, 0.2, 0.4)	(0.6, 0.8, 1)
	SO 3	SO3.1	(0, 0.2, 0.4)	(0.8, 1, 1)	(0, 0.2, 0.4)	(0.8, 1, 1)	(0.6, 0.8, 1)
		SO3.2	(0.4, 0.6, 0.8)	(0.2, 0.4, 0.6)	(0.2, 0.4, 0.6)	(0.2, 0.4, 0.6)	(0, 0.2, 0.4)
		SO3.3	(0, 0.2, 0.4)	(0.8, 1, 1)	(0, 0.2, 0.4)	(0.4, 0.6, 0.8)	(0.8, 1, 1)
	SO 4	SO4.1	(0.6, 0.8, 1)	(0.6, 0.8, 1)	(0.6, 0.8, 1)	(0.4, 0.6, 0.8)	(0, 0.2, 0.4)
		SO4.2	(0.2, 0.4, 0.6)	(0.6, 0.8, 1)	(0, 0.2, 0.4)	(0.4, 0.6, 0.8)	(0, 0.2, 0.4)

5.5.3 DETERMINING PRIORITY AND RANKING SUPPLIER'S PERFORMANCE

Based on the global priority weight of sustainability measures (as shown in Table 5.23) and the supplier performance rating (as shown in Table 5.26), the the final priority weight of each supplier can be evaluated by using equation (4-40). The results of supplier's performance in each sustainability measure are shown in Table 5.27. The results of overall sustainability performance in each supplier are shown in Table 5.28 and Figure 5.6. It can be noted that among five given suppliers, supplier D has the highest sustainability performance followed by supplier B, E, C, and A respectively. Therefore, the sustainability performance ranking among five suppliers is D>B>E>C>A.

The decision maker may derive the crisp values of these fuzzy weights performance by using the center of gravity method which is described in section 0. Table 5.29 shows the crisp values of supplier's performance and these results are illustrated as representing in Figure 5.7 An analysis of supplier's performance in economic, environmental, and social dimension found that for economic performance, supplier D is the best performance followed by E, C, B, and A respectively. For environmental performance, the best supplier is C, followed by B, E, D, and A respectively. For social performance, the best supplier is B, followed by A, D, C, and E respectively.

Table 5.27 Global performances of the five suppliers using FAHP method

Level 1	Level 2	Level3	Global performance of supplier				
			Supplier A	Supplier B	Supplier C	Supplier D	Supplier E
EC	EC 1	EC1.1	(0.026, 0.039, 0.052)	(0.013, 0.026, 0.039)	(0, 0.013, 0.026)	(0.026, 0.039, 0.052)	(0.035, 0.052, 0.066)
		EC1.2	(0.058, 0.087, 0.117)	(0.058, 0.087, 0.117)	(0.078, 0.117, 0.146)	(0.078, 0.117, 0.146)	(0.058, 0.087, 0.117)
		EC1.3	(0.009, 0.018, 0.027)	(0.018, 0.027, 0.036)	(0.009, 0.018, 0.027)	(0.024, 0.036, 0.048)	(0, 0.009, 0.018)
	EC 2	EC2.1	(0.024, 0.049, 0.073)	(0.049, 0.073, 0.097)	(0, 0.024, 0.049)	(0.097, 0.122, 0.162)	(0.049, 0.073, 0.097)
		EC2.2	(0.017, 0.034, 0.051)	(0.017, 0.034, 0.051)	(0.051, 0.068, 0.091)	(0.066, 0.085, 0.114)	(0.051, 0.068, 0.091)
		EC2.3	(0.019, 0.029, 0.039)	(0.019, 0.029, 0.039)	(0.01, 0.019, 0.029)	(0.01, 0.019, 0.029)	(0.029, 0.039, 0.052)
EN	EN 1	EN1.1	(0.014, 0.021, 0.032)	(0.014, 0.021, 0.032)	(0.014, 0.021, 0.032)	(0.018, 0.028, 0.042)	(0.023, 0.036, 0.053)
		EN1.2	(0.012, 0.019, 0.028)	(0.009, 0.014, 0.021)	(0.005, 0.009, 0.014)	(0, 0.005, 0.009)	(0, 0.005, 0.009)
	EN 2	EN2.1	(0, 0.008, 0.016)	(0, 0.008, 0.016)	(0.022, 0.032, 0.052)	(0.022, 0.032, 0.052)	(0.027, 0.039, 0.065)
		EN2.2	(0, 0.004, 0.008)	(0.011, 0.016, 0.026)	(0.014, 0.02, 0.032)	(0.011, 0.016, 0.026)	(0.014, 0.02, 0.032)
	EN 3	EN3.1	(0.009, 0.014, 0.02)	(0.009, 0.014, 0.02)	(0.015, 0.024, 0.033)	(0.005, 0.009, 0.014)	(0.009, 0.014, 0.02)
		EN3.2	(0.012, 0.024, 0.035)	(0.012, 0.024, 0.035)	(0.038, 0.059, 0.081)	(0.012, 0.024, 0.035)	(0.012, 0.024, 0.035)
	EN 4	EN4.1	(0, 0.01, 0.02)	(0.029, 0.041, 0.057)	(0, 0.01, 0.02)	(0, 0.01, 0.02)	(0, 0.01, 0.02)
		EN4.2	(0.006, 0.013, 0.019)	(0.006, 0.013, 0.019)	(0.022, 0.031, 0.045)	(0.006, 0.013, 0.019)	(0.018, 0.025, 0.036)
		EN4.3	(0.023, 0.035, 0.046)	(0.039, 0.058, 0.073)	(0, 0.012, 0.023)	(0.012, 0.023, 0.035)	(0.012, 0.023, 0.035)
SO	SO 1	SO1.1	(0.003, 0.006, 0.009)	(0.011, 0.015, 0.021)	(0.009, 0.012, 0.017)	(0.006, 0.009, 0.013)	(0.003, 0.006, 0.009)
		SO1.2	(0, 0.002, 0.004)	(0.007, 0.009, 0.014)	(0.002, 0.004, 0.006)	(0.005, 0.008, 0.011)	(0.005, 0.008, 0.011)
		SO1.3	(0.009, 0.014, 0.018)	(0.007, 0.01, 0.014)	(0, 0.003, 0.007)	(0.009, 0.014, 0.018)	(0.007, 0.01, 0.014)
	SO 2	SO2.1	(0.013, 0.018, 0.024)	(0.009, 0.014, 0.018)	(0.005, 0.009, 0.014)	(0.009, 0.014, 0.018)	(0.005, 0.009, 0.014)
		SO2.2	(0.007, 0.009, 0.012)	(0.007, 0.009, 0.012)	(0.007, 0.009, 0.012)	(0, 0.002, 0.005)	(0.007, 0.009, 0.012)
	SO 3	SO3.1	(0, 0.001, 0.002)	(0.003, 0.005, 0.007)	(0, 0.001, 0.002)	(0.003, 0.005, 0.007)	(0.003, 0.004, 0.005)
		SO3.2	(0.004, 0.006, 0.009)	(0.002, 0.004, 0.006)	(0.002, 0.004, 0.006)	(0.002, 0.004, 0.006)	(0, 0.002, 0.004)
SO3.3		(0, 0.002, 0.003)	(0.006, 0.009, 0.013)	(0, 0.002, 0.003)	(0.003, 0.005, 0.008)	(0.006, 0.009, 0.013)	

Level 1	Level 2	Level3	Global performance of supplier				
			Supplier A	Supplier B	Supplier C	Supplier D	Supplier E
	SO 4	SO4.1	(0.021, 0.029, 0.037)	(0.021, 0.029, 0.037)	(0.021, 0.029, 0.037)	(0.014, 0.022, 0.029)	(0, 0.007, 0.014)
		SO4.2	(0.002, 0.005, 0.007)	(0.007, 0.01, 0.012)	(0, 0.002, 0.005)	(0.005, 0.007, 0.01)	(0, 0.002, 0.005)

Table 5.28 Fuzzy performance of suppliers: *Proposed Method-III*

Supplier	Economic	Environmental	Social	Sustainability
<i>weight</i>	<i>(0.43, 0.51, 0.58)</i>	<i>(0.28, 0.34, 0.41)</i>	<i>(0.12, 0.15, 0.18)</i>	<i>(0.83, 1.00, 1.18)</i>
A	(0.15, 0.26, 0.36)	(0.08, 0.15, 0.22)	(0.06, 0.09, 0.13)	(0.29, 0.5, 0.71)
B	(0.17, 0.28, 0.38)	(0.13, 0.21, 0.3)	(0.08, 0.11, 0.15)	(0.38, 0.6, 0.83)
C	(0.15, 0.26, 0.37)	(0.13, 0.22, 0.33)	(0.05, 0.08, 0.11)	(0.32, 0.55, 0.81)
D	(0.3, 0.42, 0.55)	(0.09, 0.16, 0.25)	(0.06, 0.09, 0.12)	(0.44, 0.67, 0.93)
E	(0.22, 0.33, 0.44)	(0.11, 0.2, 0.31)	(0.04, 0.07, 0.10)	(0.37, 0.59, 0.85)

Table 5.29 Crisp performance of suppliers: *Proposed Method-III*

Supplier	Economic	Environment	Social	Sustainability
<i>weight</i>	<i>0.509</i>	<i>0.344</i>	<i>0.151</i>	<i>1.004</i>
A	0.256	0.149	0.092	0.498
B	0.277	0.212	0.116	0.604
C	0.259	0.227	0.076	0.561
D	0.423	0.166	0.090	0.680
E	0.331	0.205	0.068	0.603

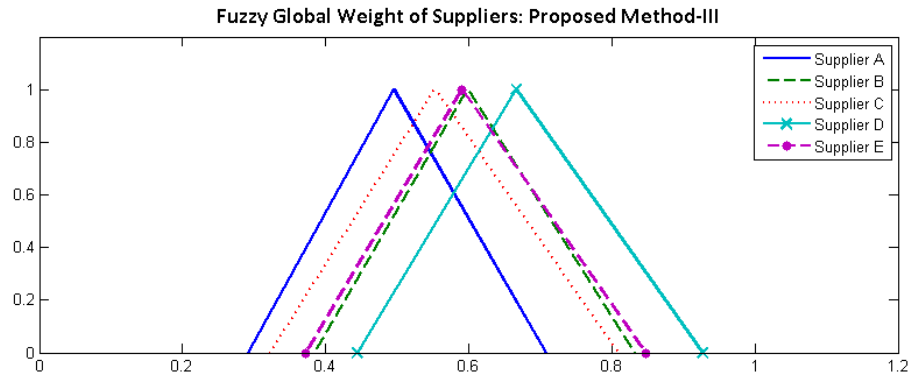

Figure 5.6 Fuzzy global weights of suppliers: Proposed Method-III

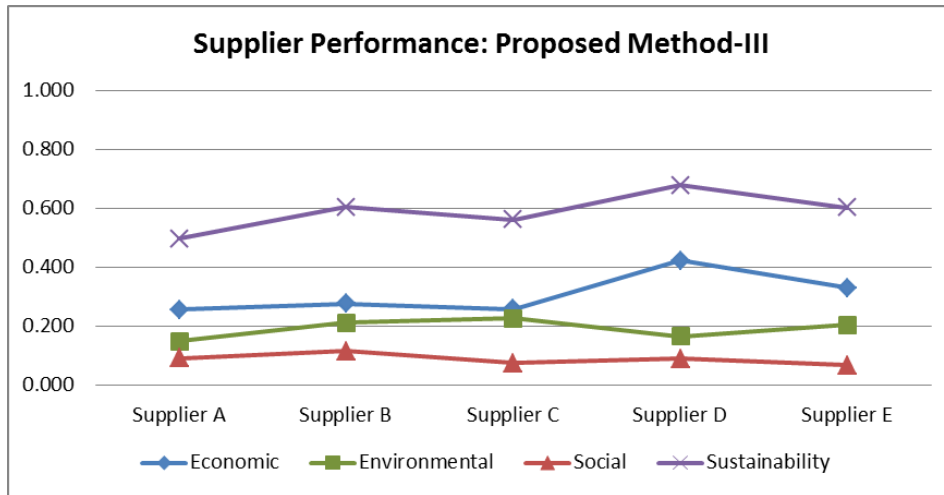

Figure 5.7 Sustainability performances of suppliers with proposed method

According to these results, supplier D is the best in sustainability because of its economic performance. However, the environmental performance of supplier D is lower than supplier C, B, and E respectively and the social performance of supplier D is lower than supplier B and A. The decision maker may encourage supplier D to improve its environmental and/or social performance in order to balance these three sustainable dimensions.

The decision maker can use the results of this evaluation for establishing sustainability improvement strategy in the supplier management module. The detailed analysis in each sustainable dimension will present in the next section.

5.6. SYNTHESIZING THE RESULTS

This section is concentrating in synthesizing the results which are achieved by the proposed FAHP method-III. Each sub-section describes the results of the main criteria (i.e. economic, environmental, and social dimension) and shows the suppliers ranking by the weights they achieved.

5.6.1 ECONOMIC PERFORMANCE

A) Synthesizing weight of sustainability measures

The economic performance in this sustainability evaluation is conducting from two indicators which are supplier quality performance and supplier business performance. Each indicator consists of three measures which were explained in section 5.3. According to the global priority weight of sustainability measures in economic dimension (see Table 5.23), considering in sustainability measure level (level3), the most important measures is number of line interruption (EC1.2) and the less important measure is sub-supplier management (EC1.3).

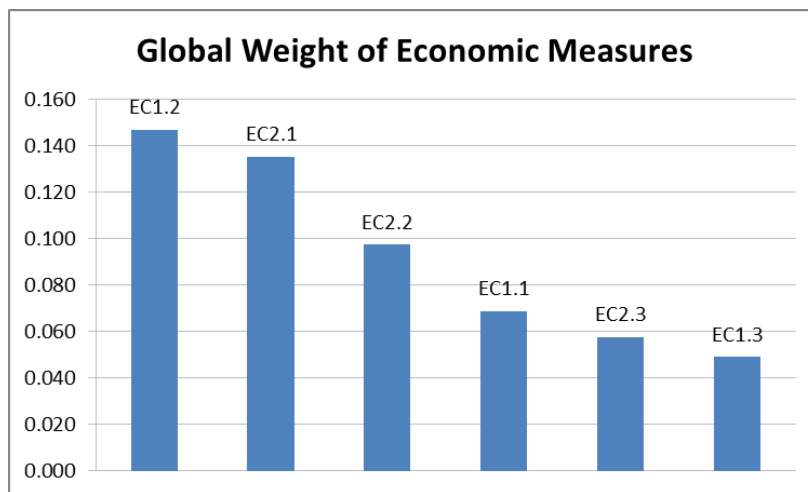

Figure 5.8 Global weights of economic measures

B) Synthesizing supplier's performance

According to Table 5.27, the global performances of supplier in each economic measure are defuzzified and shown in Table 5.30. The results show that supplier D is the best performance of supplier quality performance (EC1) indicator and supplier ranking in this indicator is $D > E > A > C > B$. Considering supplier business performance (EC2), it is clearly that supplier D is the best supplier in this indicator and supplier ranking in EC2 is $D > E > B > C > A$. Hence, the supplier D is showing that it can perform the best out of all suppliers in both quality and business performance. Supplier E is the second rank in both indicators as well. Moreover, supplier E performs a better performance

than supplier D in term of process capability (EC1.1) and flexibility (EC2.3). Meanwhile supplier A, B, and C are fairly close to each other. The supply chain manager can suggest supplier A, B, and C to improve their economic performance by analyzing in each sustainability measure (see Figure 5.9) and using the rating scale as a guideline to improvement.

Table 5.30 Global crisp performances of five suppliers: *Economic dimension*

Level 3	global weight	Supplier A	Supplier B	Supplier C	Supplier D	Supplier E
<i>Supplier Quality Performance (EC1)</i>						
EC1.1	0.069	0.039	0.026	0.013	0.039	0.051
EC1.2	0.147	0.087	0.087	0.113	0.113	0.087
EC1.3	0.049	0.018	0.027	0.018	0.036	0.009
Total EC1	0.2497	0.1444	0.1404	0.1443	0.1883	0.1475
<i>Supplier Business Performance (EC2)</i>						
EC2.1	0.135	0.049	0.073	0.024	0.127	0.073
EC2.2	0.097	0.034	0.034	0.070	0.088	0.070
EC2.3	0.058	0.029	0.029	0.019	0.019	0.040
Total EC2	0.2723	0.1120	0.1364	0.1139	0.2349	0.1832
Total EC	0.5087	0.2565	0.2768	0.2582	0.4233	0.3306

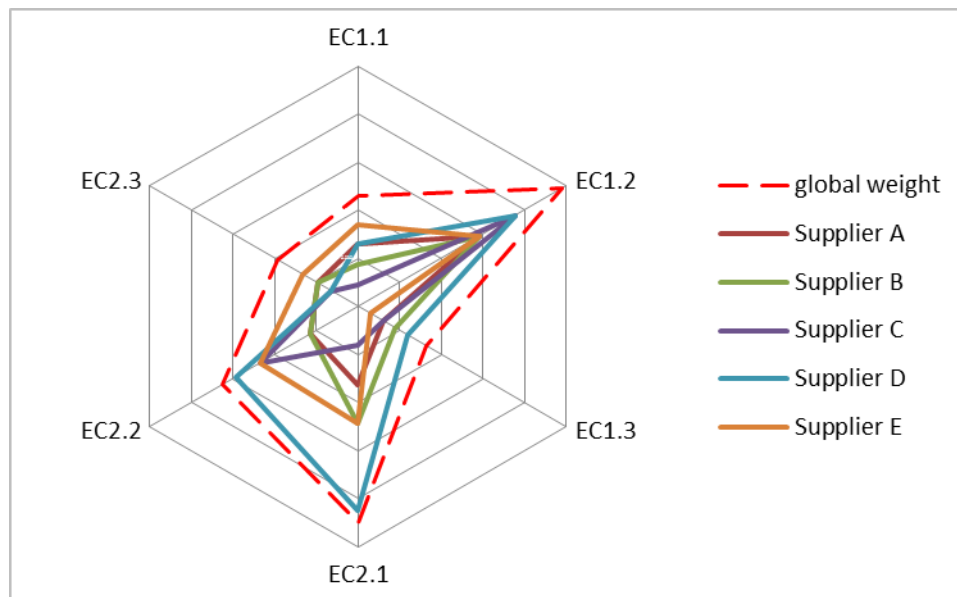

Figure 5.9 Supplier performances in economic dimension

5.6.2 ENVIRONMENTAL PERFORMANCE

A) Synthesizing weight of sustainability measures

The performance in environmental dimension consists of four indicators which are energy efficiency (EN1), resource used efficiency (EN2), emission (EN3), and green competencies (EN4). EN1 and EN2 consist of two measures meanwhile EN3 and EN4 consist of three measures (see section 5.3). According to the global priority weight of sustainability measures in environmental dimension (see Table 5.23), considering the global weight in an indicator level (level 2), we found that green competencies (EN4) is the most important indicator for environmental performance. The other indicators are closely importance of each other. However, the less important indicator is energy efficiency (EN1). Considering an importance in sustainability measure level (level 3), the most important measure is an initiatives to implement green technology (EN4.3) followed by a program to reporting and reducing of global warming gases (EN3.2) and an initiative to implement green technology (EN4.1). The less important measure is an implementation of resource efficiency program (EN2.2) which is closely with a pollution emission (EN3.1) and an implementation of energy efficiency program (EN1.2).

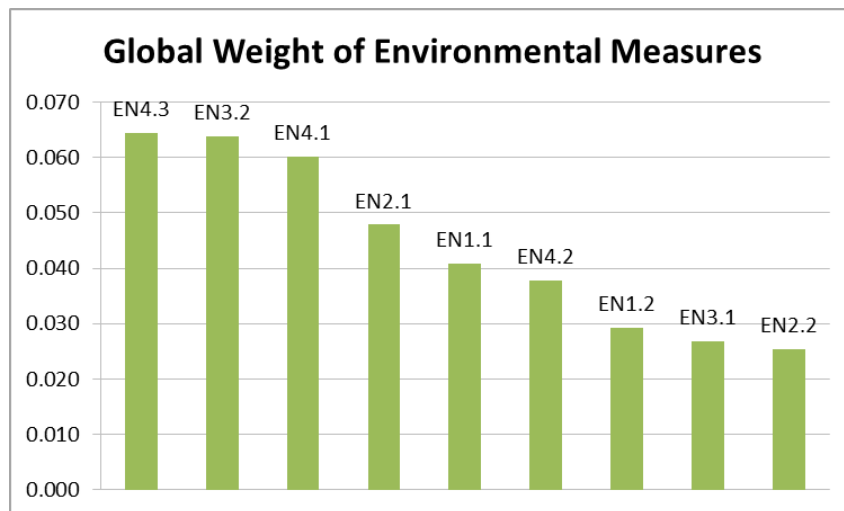

Figure 5.10 Global weights of environmental measures

B) Synthesizing of supplier's performance

According to Table 5.27,, the global performances of supplier in each environmental measure (level 3) are defuzzified and shown in Table 5.31. The results show that supplier A is the best performance of energy efficiency (EN1) indicator and supplier ranking in this indicator is $A > E > B > D > C$. Considering resource used efficiency (EN2), supplier E is the best supplier in this indicator and supplier ranking in EN2 is $E > D > C > B > A$. Considering emission (EN3) indicator, supplier C is the best in this

indicator. Supplier A, B, and E obtain the same performance score and followed by supplier D. Finally, supplier D is the best in green competencies (EN4) indicator. The supplier ranking in this supplier is $D > E > B > C > A$.

Hence, in environmental performance each supplier has a difference strength issue. It is observed that the first ranked of each indicator is different. Figure 5.11 shows the global performance of each supplier in environmental dimension. Manager can use this information to suggest suppliers for improving their environmental performance in each measure.

Table 5.31 Global crisp performances of five suppliers: *Environmental dimension*

Level 3	global weight	Supplier A	Supplier B	Supplier C	Supplier D	Supplier E
<i>Energy efficiency (EN1)</i>						
EN1.1	0.04080	0.02227	0.02227	0.02227	0.02969	0.03711
EN1.2	0.02918	0.01979	0.01484	0.00947	0.00474	0.00474
Total EN1	0.0657	0.0421	0.0371	0.0317	0.0344	0.0418
<i>Resource used efficiency (EN2)</i>						
EN2.1	0.04785	0.00789	0.00789	0.03510	0.03510	0.04387
EN2.2	0.02545	0.00395	0.01755	0.02194	0.01755	0.02194
Total EN2	0.0701	0.0118	0.0254	0.0570	0.0526	0.0658
<i>Emission (EN3)</i>						
EN3.1	0.02681	0.01428	0.01428	0.02379	0.00940	0.01428
EN3.2	0.06379	0.02350	0.02350	0.05948	0.02350	0.02350
Total EN3	0.0880	0.0378	0.0378	0.0833	0.0329	0.0378
<i>Green competencies (EN4)</i>						
EN4.1	0.06016	0.01015	0.04208	0.01015	0.01015	0.01015
EN4.2	0.03776	0.01257	0.01257	0.03290	0.01257	0.02632
EN4.3	0.06447	0.03482	0.05695	0.01161	0.02321	0.02321
Total EN4	0.5087	0.2565	0.2768	0.2582	0.4233	0.3306
Total EN	0.3436	0.1492	0.2119	0.2267	0.1659	0.2051

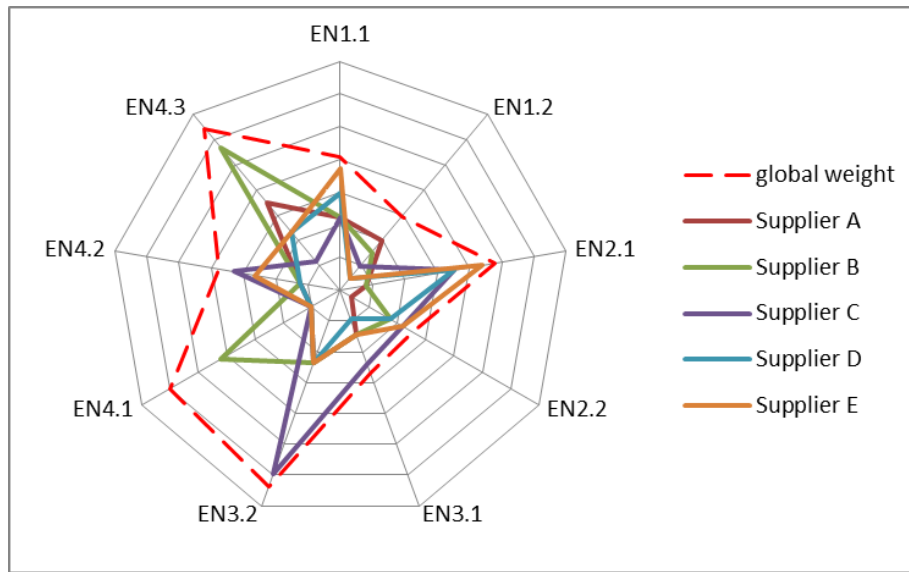

Figure 5.11 Supplier performances in environmental dimension

5.6.3 SOCIAL PERFORMANCE

A) *Synthesizing weight of sustainability measures*

The performance in social dimension consists of four indicators which are employee health and safety (S01), hazardous substances (S02), fair trade and ethical issues (S03) and social responsible competencies (S04). S01 and S03 consist of three measures meanwhile S02 and S04 consist of two measures (see section 5.3). According to the global priority weight of sustainability measures in social dimension (see Table 5.23), considering the global weight in an indicator level (level 2), we found that a social responsible competencies (S04) indicator is the most important for social performance. The less important indicator is fair trade and ethical issues (S03). Considering an importance in sustainability measure level (level 3) which is shown in Figure 5.12, it shows that the most important measure is a human resource skill and knowledge development measure (S04.1). It means that this case study company focuses on the system for knowledge development of its suppliers. The next three measures which obtain closely importance are program to manage hazardous substances (S02.1), work place conditions (S01.3), and health and safety management (S01.1). The less important measure in social dimension is policy and program to increase employee's quality of life (S03.1)

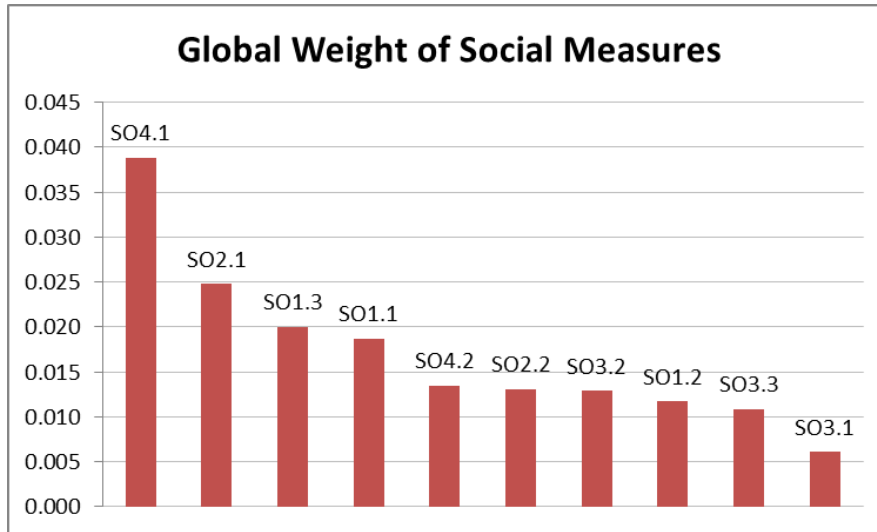

Figure 5.12 Global weights of social measures

B) Synthesizing supplier's performance

The global fuzzy weights of supplier performance in Table 5.27 are defuzzified into crisp values that shown in Table 5.32. The results show that supplier B is the best performance of employee health and safety (SO1) indicator and supplier ranking in this indicator is $B > D > E > A > C$. Considering a hazardous substances (SO2) indicator, supplier A achieves the highest performance, the supplier ranking of SO2 is $A > B > C = E > D$. Considering a fair trade and ethical issues indicator (SO3), supplier B obtains the highest performance, the supplier ranking in this indicator is $E > B > D > A > C$. Finally, considering a social responsibility competencies (SO4), the supplier ranking is $B > A > C > D > E$.

Table 5.32 Global crisp performances of five suppliers: *Social dimension*

Level 3	global weight	Supplier A	Supplier B	Supplier C	Supplier D	Supplier E
<i>Employee health and safety (SO1)</i>						
SO1.1	0.01869	0.00611	0.01583	0.01266	0.00936	0.00611
SO1.2	0.01174	0.00189	0.00990	0.00378	0.00792	0.00792
SO1.3	0.02002	0.01382	0.01048	0.00349	0.01382	0.01048
Total SO1	0.0451	0.0218	0.0362	0.0199	0.0311	0.0245
<i>Hazardous substances (SO2)</i>						
SO2.1	0.02480	0.01833	0.01351	0.00900	0.01351	0.00900
SO2.2	0.01309	0.00916	0.00916	0.00916	0.00225	0.00916
Total SO2	0.0366	0.0275	0.0227	0.0182	0.0158	0.0182
<i>Fair trade and ethical issues (SO3)</i>						
SO3.1	0.00614	0.00094	0.00501	0.00094	0.00501	0.00401
SO3.2	0.01291	0.00661	0.00423	0.00423	0.00423	0.00212

Level 3	global weight	Supplier A	Supplier B	Supplier C	Supplier D	Supplier E
SO3.3	0.01087	0.00173	0.00918	0.00173	0.00539	0.00918
Total SO3	0.0273	0.0093	0.0184	0.0069	0.0146	0.0153
<i>Social responsible competencies (SO4)</i>						
SO4.1	0.03882	0.02894	0.02894	0.02894	0.02153	0.00718
SO4.2	0.01346	0.00478	0.00965	0.00239	0.00718	0.00239
Total SO4	0.0513	0.0337	0.0386	0.0313	0.0287	0.0096
Total SO	0.1514	0.0923	0.1159	0.0763	0.0902	0.0676

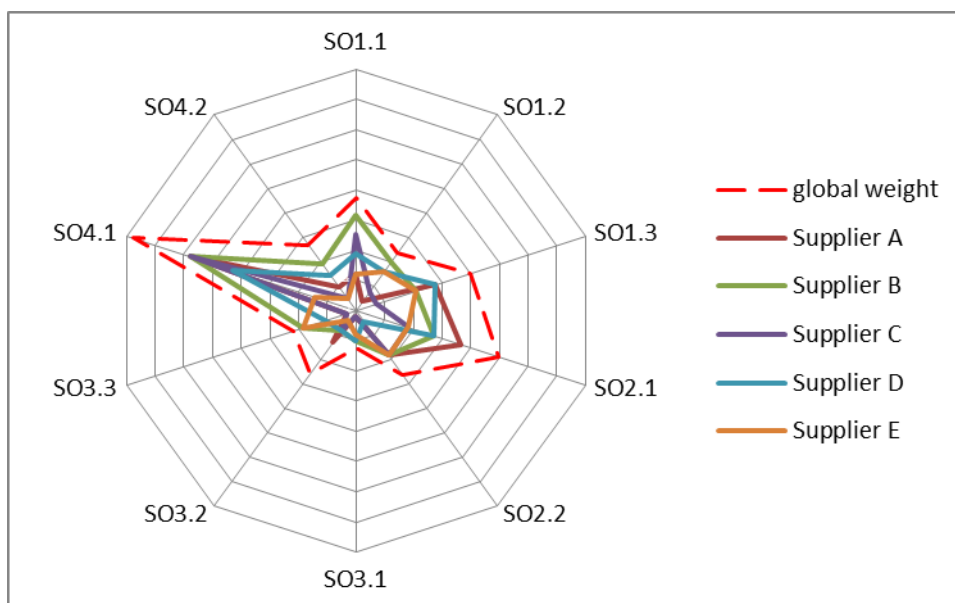

Figure 5.13 Supplier performances in social dimension

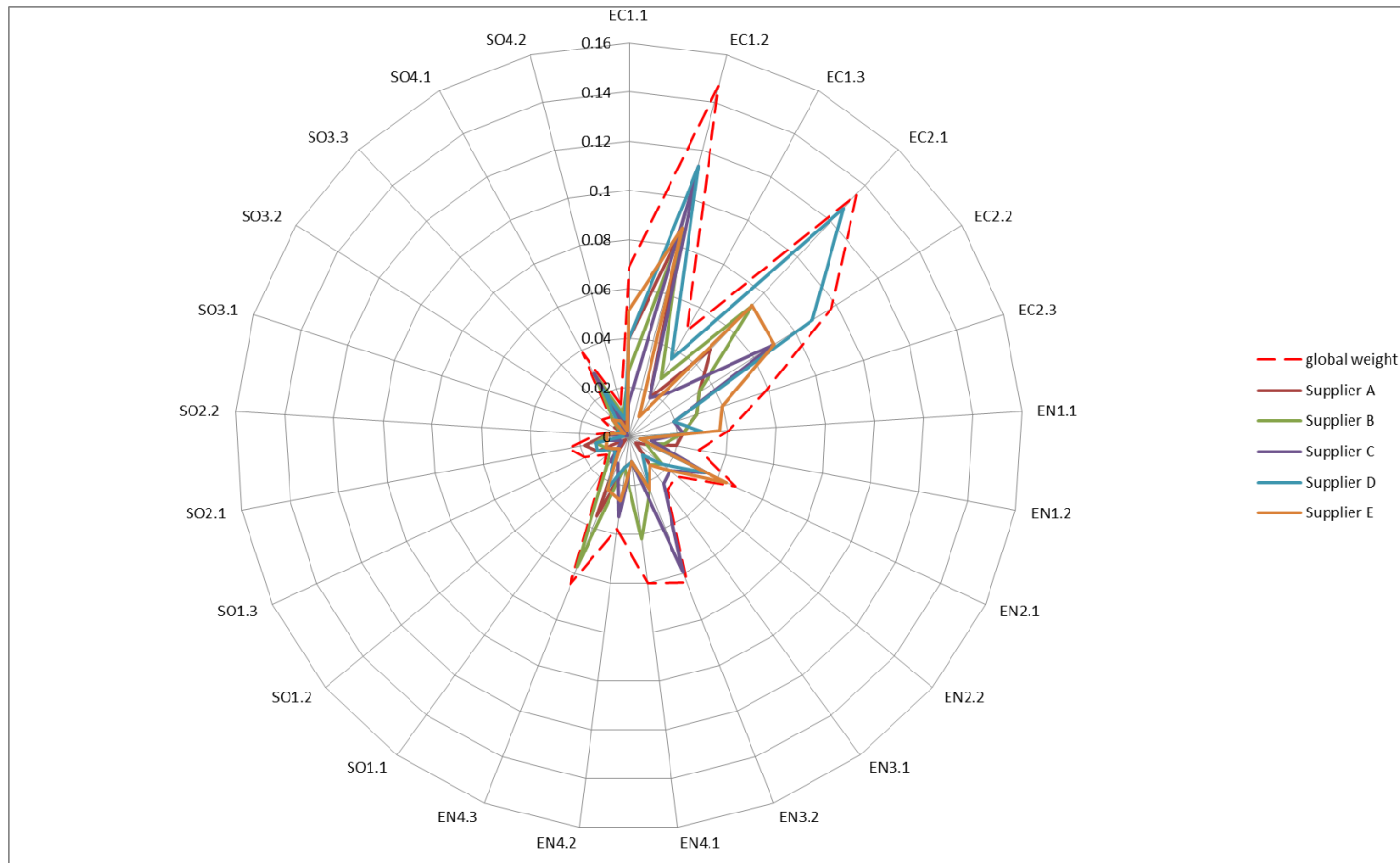

Figure 5.14 Supplier performances in each sustainability measures

5.7. MODEL VALIDATION

Validation is a key part of model development process which increases confidence in the model and make it more valuable. This section provides the validation process and its finding. However, as background information, the section first outlines the various techniques available for performing validation process and the rationale behind the adoption of the technique used for validating this model.

5.7.1 MODEL VALIDATION TECHNIQUES

There are various techniques for validating a model, each of which can be used either subjectively or objectively. The latter referring to the use of some type of statistical or mathematical procedures (Sargent, 2013). The basic idea behind any of these technique is the accumulation evidence regarding the credibility and applicability of the model by an independent, interested party (Gass, 1983). This section describes validation techniques commonly used in model validation. Most of the technique described here are found in the literatures (Gass, 1983; Sargent, 2013). Brief descriptions of these techniques are presents follow:

- *Animation*: The model's operational behavior is displayed graphically and compared with the actual system.
- *Comparison to Other Models*: The output of the model being validated is compared to the results of other valid models. This is applicable if such valid models are already available.
- *Degenerate Test*: The model behavior is known to degenerate at certain situations. The model can be tested to see if it degenerates as expected by simulating such situations in the model using appropriate selection values of the input and internal parameters.
- *Extreme Condition Tests*: This approach is similar to the degeneracy tests. The model can be tested by running it under extreme conditions to see if the model would behave as would be expected.
- *Event Validity*: The "events" of occurrences of the model are compared to the real system to determine that they are similar.
- *Face Validity*: An assessment of this approach is by asking individual knowledgeable about the system whether the model and/or its behavior are reasonable. This technique can be used when no observations on the real system are available.
- *Historical Data Validation*: If historical data exist, part of the data is used to build the model and the remaining data are used to determine whether the model behaves as the system does.

- *Sensitivity Analysis*: This technique consists of changing the values of the input and internal parameters of a model to determine the effect upon the model's behavior and its output.
- *Traces*: The behavior of different types of specific entities in the model is traced through the model to determine if the model's logic is correct and if the necessary accuracy is obtained.
- *Turning Test*: People who are knowledgeable about the operations of the system being modeled are asked if they can discriminate between system and model outputs.

5.7.2 THE TECHNIQUES ADOPTED FOR VALIDATING THE SUSTAINABILITY MEASUREMENT MODEL

The appropriate technique to use for validating a model mainly depends on the real world aspect being analyzed and the type of model being used (Gass, 1983). This thesis adopts a comparison to other model technique to validate the proposed FAHP approach. According to the literatures that adopted the fuzzy AHP method for evaluating supplier's performance, there are various acceptable approaches for determining the fuzzy criteria weights. However, the most popular approach, which is the extent analysis (EA) method, may lead to an elimination of some criteria when it faces a zero weight situation. This work has proved that a zero weight situation can be occurred in chapter 4. Another approach to determine a fuzzy priority weight is the Lambda-Max (LM) method proposed by Csutora and Buckley, (2001). Hence, to present the validity of the proposed method, this work compares the results with the LM approach.

The model validation is divided into three parts. The first part is to compare the ranking of supplier performance which obtained by the proposed and the LM methods. The next part is a comparison analysis of fuzzy spread of global supplier performance. The final part is to compare the complexity of calculation between these two approaches.

The results by using LM method are shown in Table 5.33, Table 5.34, Figure 5.16, and Figure 5.16. Considering an overall sustainability performance, supplier D is the best performance supplier followed by B, E, C, and A respectively. For economic performance, supplier D is the best performance followed by E, C, B, and A respectively. For environmental performance, the best supplier is B, followed by C, E, A, and D respectively. For social performance, the best supplier is B, followed by A, D, C, and E respectively. The next three sub-sections describe a comparison analysis for validating the proposed FAHP method-III.

Table 5.33 Final fuzzy scores of sustainability performance: *Lambda-Max Method*

Supplier	Economic	Environment	Social	Sustainability
<i>weight</i>	<i>(0.51, 0.53, 0.53)</i>	<i>(0.30, 0.32, 0.33)</i>	<i>(0.15, 0.15, 0.15)</i>	<i>(0.97, 1.00, 1.01)</i>
A	(0.14, 0.27, 0.41)	(0.06, 0.14, 0.22)	(0.06, 0.09, 0.13)	(0.26, 0.5, 0.76)
B	(0.16, 0.29, 0.44)	(0.11, 0.19, 0.28)	(0.08, 0.12, 0.15)	(0.35, 0.6, 0.86)
C	(0.14, 0.27, 0.41)	(0.12, 0.2, 0.27)	(0.04, 0.08, 0.11)	(0.31, 0.54, 0.8)
D	(0.29, 0.44, 0.55)	(0.08, 0.15, 0.24)	(0.06, 0.09, 0.13)	(0.42, 0.67, 0.92)
E	(0.21, 0.34, 0.5)	(0.11, 0.18, 0.26)	(0.03, 0.07, 0.10)	(0.35, 0.59, 0.86)

Table 5.34 Final crisp scores of supplier's sustainability performance: *Lambda-Max*

Supplier	Economic	Environment	Social	Sustainability
<i>weight</i>	<i>0.526</i>	<i>0.316</i>	<i>0.151</i>	<i>0.992</i>
A	0.272	0.141	0.093	0.507
B	0.296	0.195	0.114	0.605
C	0.273	0.199	0.078	0.550
D	0.424	0.155	0.092	0.671
E	0.348	0.183	0.069	0.599

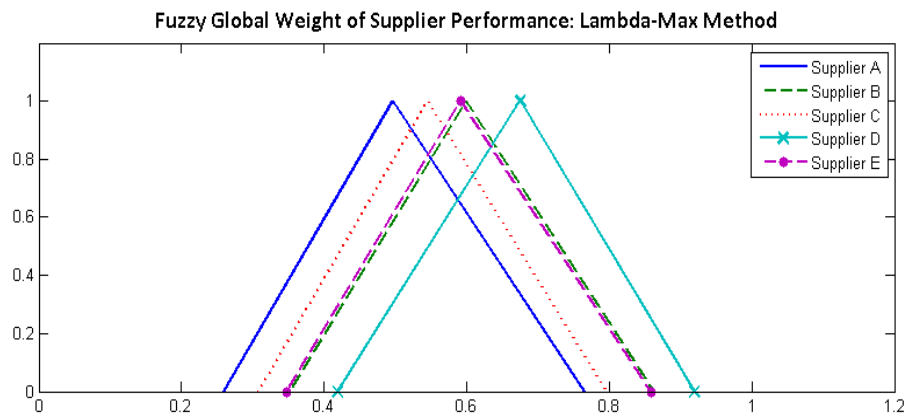

Figure 5.15 Fuzzy global weights of suppliers: Lambda-Max method

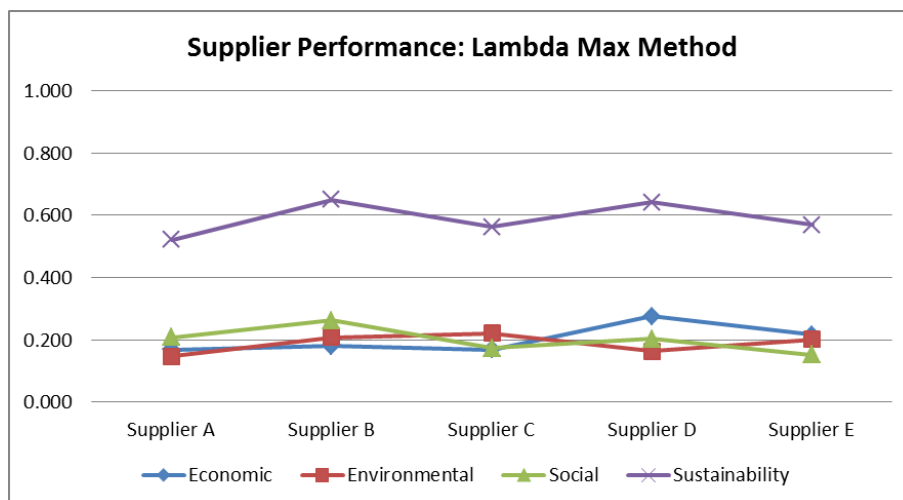

Figure 5.16 Sustainability performance of suppliers with Lambda-Max method

A) Rank of supplier's performance

According to the calculations of the proposed method-III in section 5.5 and the LM method, the results in both approaches are the same. Table 5.35 compares the supplier ranking obtained by proposed method-III and LM. For an overall sustainability performance, supplier ranking is as D, B, E, C, and A. For each sustainable dimension, the supplier ranking of economic is D, B, E, C, and A. For environmental dimension, the supplier ranking is C, B, E, D, and A. Finally, for social dimension, the supplier ranking is B, A, D, C, and E. It means that the proposed approach for evaluating sustainability of suppliers is consistent and valid.

Table 5.35 Comparison of the results for sustainable supplier evaluation

Level	Criteria	Supplier ranking	
		Proposed Method-III	Lambda-Max
Level 0	Sustainability	D>B>E>C>A	D>B>E>C>A
Level 1	EC	D>B>E>C>A	D>B>E>C>A
	EN	C>B>E>D>A	C>B>E>D>A
	SO	B>A>D>C>E	B>A>D>C>E

B) Fuzzy spread comparative analysis

Generally, the fuzzy weight average (FWA) approach is commonly used for aggregating the fuzzy performance of alternatives with respect to a set of criteria. However, FWA presents the problem that the result could be an overestimation of the correct result (Klir, 1997; Lin et al., 2012). In order to avoid this problem, this thesis employs the weakest t-norm arithmetic, which preserves the original shape of the fuzzy numbers (Hong, 2001; Lin et al., 2012), for an aggregation process. The weakest t-norm operations achieve a more exact performance, which means smaller fuzzy spreads under uncertain environment. The spread of triangular fuzzy numbers can be calculated by using the minimum and maximum values at α -cuts (Chen and Lu, 2002). The fuzzy spread δ of a fuzzy numbers \tilde{A} can be defined as:

$$\delta = r - l \quad (5-1)$$

Where l and r is the minimum and maximum value of \tilde{A} respectively and are defined as follows:

$$l = \min\{x|x \in \tilde{A}\} \forall \alpha \in (0,1]$$

$$r = \max\{x|x \in \tilde{A}\} \forall \alpha \in (0,1]$$

It means that the less fuzzy spread of the result is the better performance of an aggregation approach. Hence, this section compares a spread of final weights of suppliers between the proposed FAHP method-III and the LM method. The comparison

of fuzzy spread is shown in Figure 5.17. It shows that the proposed method-III generates a smaller fuzzy spread than the LM method.

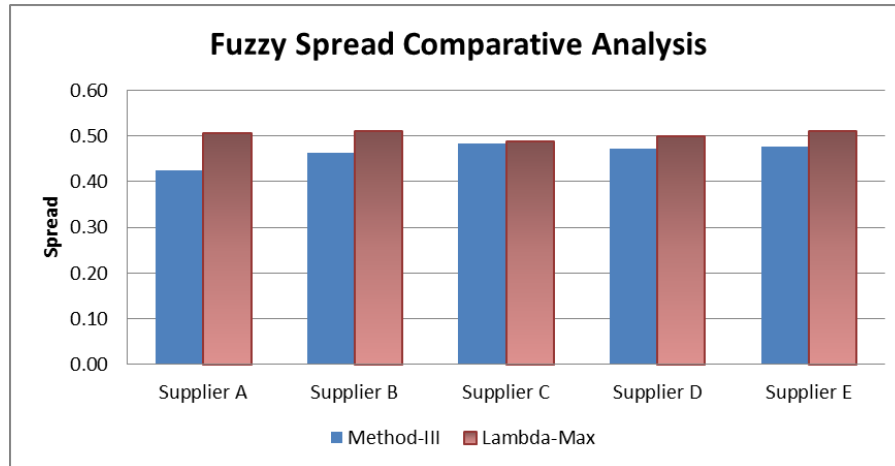

Figure 5.17 Fuzziness comparison between proposed and LM method

C) Complexity comparative analysis

Efficiency of algorithm can be measured in term of space complexity or time complexity. The space complexity is the amount of memory required which an algorithm needs. The time complexity is a measure of the amount of time required to execute an algorithm. This thesis uses only the time complexity for algorithm analysis. The simplified analysis of time complexity can be measured base on number of operations performed (Chang, 1996). This work uses the number of times of multiplication as a measure to indicate algorithm complexity.

Assume that a decision maker gives $n \times n$ fuzzy pairwise comparison matrix, by using the proposed FAHP method-III and the LM method. The number of time of multiplication for determining sustainability criteria weight for the proposed method III and the LM method are computed as follows:

- For the proposed method-III: In equation (4-39), to determine the sustainability criteria weights it needs to use multiplication $6n$ times.
- For the LM method: The equations (4-26) to (4-36) are major formulas to determine the sustainability criteria weights. If a is a number of α using for $\alpha - cut$ approach, the number of times of multiplication for $n \times n$ fuzzy pairwise comparison matrix is $a(an^2 + 13n - 3)$

The number of multiplication for determining final weight of suppliers for the proposed method-III and the LM method are obtained as follows:

- For the proposed method-III: In equation (4-40), to determine final weight of suppliers, the number of times of multiplication is $7(N_{CM} \cdot N_l \cdot N_s)$, when N_{CM} is the number of comparison matrix in the last level (in this case is level 3), N_l is number of level, and N_s is the number of suppliers.
- For the LM method: to determine the final weight of supplier's performance, the number of times of multiplication is $3(N_{CM} \cdot N_l \cdot N_s)$, when N_{CM} is the number of comparison matrix in the last level (in this case is level 3), N_l is number of level, and N_s is the number of suppliers.

The results of time complexity are shown in Table 5.36 and Table 5.37. From these results, the total number of multiplication of the proposed method-III and the LM method are 2,853 and 6,135 times. It is clearly that the proposed method-III is less complicate than the LM method. Hence, this proposed method helps manager to implement in the real-life situations.

Table 5.36 Number of multiplication for determining sustainability criteria weights

Level	Criteria	n	Method-III	Lambda Max
Level 0	Sustainability	3	18	405
Level 1	EC	2	12	215
	EN	4	24	645
	SO	4	24	645
Level 2	EC1	3	18	405
	EC2	3	18	405
	EN1	2	12	215
	EN2	2	12	215
	EN3	2	12	215
	EN4	3	18	405
	SO1	3	18	405
	SO2	2	12	215
	SO3	3	18	405
	SO4	2	12	215
Total			228	5,010

Table 5.37 Number of multiplication for determining final weight of suppliers

	Method-III	Lambda-Max
Number of multiplication	2,625	1,125

5.8. CONCLUSION

Efficient supplier is always important for the firm because the failure of its coordination results in excessive delays and ultimately leads to poor customer services. In this thesis a new fuzzy AHP approach is proposed and used to evaluate sustainability performance

of supplier. The sustainability indicators and measures, regarding the TBL (i.e. economic, environmental, and social) dimension, are selected corresponding to sustainability policy of the company. The large number of indicators and measures show that the evaluation of sustainability is not an easy task. The FAHP model proposed in this thesis is proved to be simple, less time taking and having less computational expense operation and so it is easy to handle the multi-criteria decision making problems. It has ability to capture the vagueness of human thinking and effectively solve multi-criteria decision making problems.

This chapter demonstrated the application of supplier evaluation model in the hard disk drive manufacturing company. The model is adopted to rank sustainability performance of considered suppliers. It also describes the validation of the model. This case study application verifies that the proposed sustainability measurement model is able to provide rankings of suppliers in term of an overall sustainability, sustainable dimension (economic, environmental, and social), and sustainability measures.

The case study company aims to assess sustainability performance of suppliers in order to improve their sustainability practices. The performance criteria are constructed based on three sustainability dimension. Most of these criteria are leading indicators and measures by qualitative variables.

Chapter 6. CONCLUSION AND RESEARCH PERSPECTIVES

6.1. INTRODUCTION

This chapter presents a summary of the study. It embraces the finding from the literature review, the sustainability performance measurement in supply chain, sustainability practices, indicators and measures for supplier evaluation, and the development of a multi criteria assessment and model to aggregate sustainability attributes into a sustainable performance for supplier assessment. This conclusion links and integrates the research findings. The recommendations provide suggestions for future research which have emerged as a result of the findings in this study.

This thesis critically examines the sustainability concern associated with supply chain management, and investigates ways of establishing sustainability performance measurement system in supply chain. In acknowledging the importance of considering sustainability issue in supply chain management, the sustainability performance measurement approach of decision-making was examined and discussed. This was explored by identifying and measuring the principal sustainable development criteria that embrace both environmental and social considerations within a sustainable assessment framework for supply chain management.

The supplier performance assessment activity is selected to verify an implementation of the proposed framework. It is also investigates sustainability assessment methods used in supplier evaluation and their deficiencies as a tool to evaluate sustainability performance.

The remainder of this chapter has been divided into several sections to discuss and summarize the research findings. It includes a review of aim and objectives for this research, a summary of the research, conclusions, policy implications arising from the study, limitations and areas for further research.

6.2. REVIEW OF AIM AND OBJECTIVES

This research consists of two objectives. The first one is to provide a conceptual framework of sustainable supply chain and a model for measuring sustainability performance. It relates to a general context of performance measurement for sSCM. The second one is to develop sustainability performance measurement system. It relates to an implementation of the proposed framework and approach in supplier performance assessment activity.

This thesis has satisfied the aims and objectives specified in the introduction. It has established the performance measurement framework for sustainable supply chain

management. Eight sustainability criteria are identified based on the human needs corresponding to the TBL concepts. The model for constructing the sustainability measures is developed by using the process based analysis approach. The supplier performance assessment is selected as a practical case study for implementing this conceptual framework. The performance measurement system uses a multi-criteria decision approach to assess sustainability and evaluate supplier's performance.

6.3. SUMMARY OF RESEARCH

This research provides three major contributions. First, this thesis has developed the framework to measure sustainability performance for sSCM. This framework allows decision makers identifying the sustainability measures based on their interesting area in sustainability criteria. There are eight categories of sustainability criteria in this framework which are financial, non-financial, raw material, natural resources, energy, human health and safety, human resources development, and ethical issues. The sustainability criteria in this framework have developed based on the concept of human needs and the TBL concept and have justified by analyze with standards, guide lines, and regulation involving sustainable development perspective. Moreover, this proposed framework enhances an engagement level of elements in supply chain as an important perspective to identifying the sustainability measures. After developing the conceptual framework for measuring sustainability performance, this thesis has proposed an approach to construct the performance measurement model. According to the literature review, the existing process categorization in sSCM focus on primary activities regarding to material flow process but the human resource management and business ethics are supporting (or secondary) activities. Therefore, the processes or activities, which relating to social dimension, are missing in consideration in sSCM. This work enhances the valuable of adopting the value chain model (Porter, 2008) which covers both primary and secondary activities for constructing the sustainability performance measurement model. Hence the value chain model and the process based approach (Chan and Qi, 2003) are adopted for constructing the sustainability measures model. This leads to an implementation of the proposed framework allowing decision makers to measures sustainability performance in any process or activity in the company and its supply chain. In order to implementing the proposed conceptual framework and the model construction method in practical situation, this thesis has selected the supplier performance evaluation problem for measuring sustainability performance.

The second contribution of this work is the development of the tool for measuring sustainability performance by focusing on supplier evaluation problem. Because of sustainability context consists of multi-criteria decision. Therefore the measurement tool is developed based on multi-criteria decision method. This multi-criteria decision model is not used for making a decision such as selecting the best supplier but it is a multi-criteria decision aiding which help manager to establish supplier improvement program based on the results. The measurement tool is developed based on FAHP

approach. According to the literature review on adopting FAHP in practical implementation, the extent analysis is the most widely used because it is proved to be simple and less time taking for computation (Chan and Kumar, 2007; Lee et al., 2009; Singh et al., 2007). However, this thesis has proved that the extent analysis method leads to an elimination of some criteria and obtains a zero weight situation if there is a dominance important criteria. Hence, this thesis has proposed three FAHP methods by modified the extent analysis method (Method-I), modified the normalization approach (Method-II), and employed the weakest t-norm arithmetic (Method-III) for determining the fuzzy priority weight. These methods are easy to adopt in real-life problem in industry. The method-I is less complexity than method-II and method-III respectively but the method-I also obtains the larger fuzzy spread than method-II and method-III respectively. However, all three proposed methods obtain the same ranking of supplier's performance and it is the same ranking when adopting the lambda-max method as well. It is depends on the decision makers to select the proposed FAHP among these three methods for implementing in their situations. The results from supplier's performance help manager for setting the direction to improve supplier's sustainability by using the normalization rating from measurement model.

The third contribution of this thesis is an implementation of the proposed framework and proposed FAHP in the case study company in Thai electronics industry. The case study company aims to evaluate sustainability performance of their suppliers in order to manage and improve supplier's performance. The sustainability performance measurement model consists of 10 indicators and 25 sustainability measures based on three dimensions (economic, environmental, and social). The result of an importance comparison found that the importance weight of economic, environmental, and social dimension are 50.87%, 34.86%, and 15.14% respectively. It means that an economic performance is still the most important and the social performance is the less important of supplier's evaluation. However, if considering the global weight of sustainability measures, some environmental measures are more importance than economic measures. For example, an initiatives to implement green technology and eco-design implementation are more importance that a sub-supplier management. The case study company works with more than 200 suppliers. In term of assessing supplier's performance, an absolute measurement approach is proposed because it is suitable for dealing with a large number of suppliers. Company should construct the criteria rating in each criterion for judgment. However, this work has selected five suppliers as an example to implement and validate the proposed model. The result of implementation in the case study shows that the proposed FAHP can be adopted in the real-life situation and it is less complicate that the lambda-max method which is an accepted FAHP method.

6.4. MANAGERIAL IMPLICATIONS

Sustainable development is of growing importance to the industrial sector because the current exploitation and lacking affection of resources use, together with the pollution generated cannot continue at present rates. Moreover, the negative social impacts are increasing because of the industrial operations. The development of sustainability performance measurement demonstrates a significant contribution to enhance and implement sustainable development and exhibits a way to manage sustainability in supply chain.

An effective of method for sustainable supplier assessment with emphasis on sSCM subjects has been developed. Managers related industries can use the purpose model to evaluate their suppliers or to select the best sustainable supplier for cooperation. Based on the implementation of a sustainable supplier evaluation, companies identify and prioritize opportunities for improvement which may lead to the reduction of impacts of environmental and social impacts that are associated with their activities. Furthermore, the results from proposed approach can be used for benchmarking, to improve sustainability performance and to develop better sustainable processes.

The results guide companies to assess the best supplier among the candidates. They may decide to continue to working with a certain group of suppliers or they may request that their suppliers improve certain defects. The results help managers assign orders after ranking all their suppliers and managers also complete

6.5. LIMITATIONS AND RESEARCH PERSPECTIVES

The research carried out in this thesis is significant and the findings from the study are useful for the supply chain managers, helping them to taking sustainability into account of operation management. However, there are limitations associated with this study.

Because of there are two aspects for managing sustainability in business i.e. sustainability of product and sustainability of process. This research focuses on the second aspect. Hence, the sustainability performance measurement model is developed based on process point of view. Moreover, our research work focuses more on strategic and tactical level more that operational level in order to dealing with an implementation of sustainability practices in company. The limitations of our research are:

- An approach to construct sustainability indicators and metrics is based on sustainability in process point of view. In other words, this performance measurement system measures corporate sustainability competitiveness. The proposed approach is not suitable to construct sustainability indicators and metrics for product life cycle assessment or product life cycle management.
- The selected sustainability indicators and metrics are specific to implement only in the case study company. These indicators and metrics are not covering all

sustainability criteria. It depends on the strategy of company. This supplier assessment measurement model is a “tailor-made” model. It means that if other companies need to measure sustainability performance of their suppliers. They should construct their own performance indicators and metrics. However, in the first part of this work, we provide a generic approach to construct sustainability indicators and metrics for the company.

Due to the limitation of complexities in sustainability context, available data in company, and future extension of the proposed performance measurement model, this research work can be developed in both academic and industrial domains.

- This work provides a generic framework for measuring sustainability performance for sSCM. Researchers can adopt this framework and a process-based approach to construct sustainability metrics for measuring performance at different process and different decision making level.
- Because of the research work on measuring social performance in supply chain is still in the beginning stage. Researchers can adopted the proposed sustainability criteria to enhance key social practices for sSCM in industrial sector.
- This performance measurement model focuses on leading indicators to provide improvement actions for supplier. However, company can construct another set of indicators which are lagging indicator. Then company can find the correlation between sustainability practices and outcome performance of suppliers.
- According to our limitation that this work focuses the sustainability only in process point of view. However, there are various research works that try to measure sustainability of product. This work has proposed well-defined sustainability criteria in industrial sector and it can be adopted as criteria for sustainability of product. The research challenges are how we can adopt these sustainability criteria into the product aspect and how we can integrate these two aspects for considering the sustainability in supply chain at same time.
- The supplier performance measurement model in this case study is not too complicated. We asked for one decision maker to define the priority ranking of indicators for establishing the FAHP model. Therefore, in case of we faced an inconsistent situation in comparison matrix it is not too difficult for asking the decision maker to revise his priority ranking. However, if there is more than one decision maker or there are various indicators for consideration. The proposed FAHP model can be extended to deal with an inconsistent situation in pairwise comparison matrix or to deal with multiple decision maker for giving a priority ranking of the system.

Bibliography

- Bai, C., Sarkis, J., 2010. Integrating sustainability into supplier selection with grey system and rough set methodologies. *Int. J. Prod. Econ.* 124, 252–264.
doi:10.1016/j.ijpe.2009.11.023
- Beamon, B.M., 1999. Measuring supply chain performance. *Int. J. Oper. Prod. Manag.* 19, 275–292. doi:10.1108/01443579910249714
- Beamon, B.M., 2008. Sustainability and the future of supply chain management. *Oper. Supply Chain Manag.* 1, 4–18.
- Bourne, M., Neely, A., Platts, K., Mills, J., 2002. The success and failure of performance measurement initiatives: Perceptions of participating managers. *Int. J. Oper. Prod. Manag.* 22, 1288–1310. doi:10.1108/01443570210450329
- Buckley, J.J., 1985. Fuzzy hierarchical analysis. *Fuzzy Sets Syst.* 17, 233–247.
doi:10.1016/0165-0114(85)90090-9
- Burgess, K., Singh, P.J., Koroglu, R., 2006. Supply chain management: a structured literature review and implications for future research. *Int. J. Oper. Prod. Manag.* 26, 703–729.
doi:10.1108/01443570610672202
- Büyüközkan, G., Çifçi, G., 2011. A novel fuzzy multi-criteria decision framework for sustainable supplier selection with incomplete information. *Comput. Ind.* 62, 164–174. doi:10.1016/j.compind.2010.10.009
- Carter, C.R., Easton, P.L., 2011. Sustainable supply chain management: evolution and future directions. *Int. J. Phys. Distrib. Logist. Manag.* 41, 46–62.
- Carter, C.R., Rogers, D.S., 2008. A framework of sustainable supply chain management: moving toward new theory. *Int. J. Phys. Distrib. Logist. Manag.* 38, 360–387.
doi:10.1108/09600030810882816
- Cetinkaya, Ba., Cuthbertson, R., Ewer, G., Klaas-Wissing, T., Piotrowicz, W., Tyssen, C., 2011. *Sustainable Supply Chain Management - Practical Ideas for Moving Towards Best Practice*. Springer.
- Chan, F.T.S., Kumar, N., 2007. Global supplier development considering risk factors using fuzzy extended AHP-based approach. *Omega* 35, 417–431.

- Chan, F.T.S., Qi, H.J., 2003. An innovative performance measurement method for supply chain management. *Supply Chain Manag. Int. J.* 8, 209–223.
doi:10.1108/13598540310484618
- Chang, D.-Y., 1996. Applications of the extent analysis method on fuzzy AHP. *Eur. J. Oper. Res.* 95, 649–655. doi:10.1016/0377-2217(95)00300-2
- Chang, P.T., Hung, K.-C., 2006. A comparison of discrete algorithm for fuzzy weighted average. *IEEE Trans. Fuzzy Syst.* 14, 663–675.
- Chen, L., Lu, H.W., 2002. The preference order of fuzzy numbers. *Comput. Math. Appl.* 44, 1455–1465.
- Chiou, C.Y., Hsu, C.-F., Hwang, W.Y., 2008. Comparative investigation on green supplier selection of the American, Japanese and Taiwanese Electronics Industry in China. *Int. Conf. IEEM IEEE* 1909–1914.
- Ciliberti, F., Pontrandolfo, P., Scozzi, B., 2008. Investigating corporate social responsibility in supply chains: a SME perspective. *J. Clean. Prod.* 16, 1579–1588.
doi:10.1016/j.jclepro.2008.04.016
- Clark, G., 2007. Evolution of the global sustainable consumption and production policy and the United Nations Environment Programme's (UNEP) supporting activities. *J. Clean. Prod.* 15, 492–498. doi:10.1016/j.jclepro.2006.05.017
- Coelho, J.F.G.M., 2005. Sustainability evaluation management system model for individual organization and supply chain. of Center Queensland University.
- Csutora, R., Buckley, J.J., 2001. Fuzzy hierarchical analysis: the Lambda-Max method. *Fuzzy Sets Syst.* 120, 181–195. doi:10.1016/S0165-0114(99)00155-4
- Delai, I., Takahashi, S., 2011. Sustainability measurement system: a reference model proposal. *Soc. Responsib. J.* 7, 438–471. doi:10.1108/17471111111154563
- Deloitte, Touche, 1992. Business strategy for sustainable development: leadership and accountability for the '90s. International Institute for Sustainable Development.
- Dyllick, T., Hockerts, K., 2002. Beyond the business case for corporate sustainability. *Bus. Strategy Environ.* John Wiley Sons Inc 11, 130–141. doi:10.1002/bse.323

- Elkington, J., 1999. *Cannibals with forks: the triple bottom line of 21st century business*. Capstone, Oxford.
- Epstein, M.J., Roy, M.J., 2001. Sustainability in action: Identifying and measuring the key performance drivers. *Long Range Plann.* 34, 585–604.
- Erol, I., Sencer, S., Sari, R., 2011. A new fuzzy multi-criteria framework for measuring sustainability performance of a supply chain. *Ecol. Econ. J.* 70, 1088–1100.
- Figge, F., Hahn, T., Schaltegger, S., Wagner, M., 2002. The Sustainability Balanced Scorecard – linking sustainability management to business strategy. *Bus. Strategy Environ.* 11, 269–284. doi:10.1002/bse.339
- Font, X., Tapper, R., Schwartz, K., Kornilaki, M., 2008. Sustainable supply chain management in tourism. *Bus. Strategy Environ.* 17, 260–271. doi:10.1002/bse.527
- Gass, S.I., 1983. Feature Article—Decision-Aiding Models: Validation, Assessment, and Related Issues for Policy Analysis. *Oper. Res.* 31, 603–631. doi:10.1287/opre.31.4.603
- Giddings, B., Hopwood, B., O'Brien, G., 2002. Environment, economy and society: fitting them together into sustainable development. *Sustain. Dev.* 10, 187–196. doi:10.1002/sd.199
- GRI, 2006. *Sustainability reporting guidelines (Version 3.0)*.
- Grisi, R.M., Guerra, L., Naviglio, G., 2010. Supplier Performance Evaluation for Green Supply Chain Management. *Bus. Perform. Meas. Manag.* 149–163.
- Gunasekaran, A., Kobu, B., 2007. Performance measures and metrics in logistics and supply chain management: a review of recent literature (1995–2004) for research and applications. *Int. J. Prod. Res.* 45, 2819–2840. doi:10.1080/00207540600806513
- Gunasekaran, A., Patel, C., Tirtiroglu, E., 2001. Performance measures and metrics in a supply chain environment. *Int. J. Oper. Prod. Manag.* 21, 71–87. doi:10.1108/01443570110358468
- Gunasekaran, A., Spalanzani, A., 2012. Sustainability of manufacturing and services: Investigations for research and applications. *Int. J. Prod. Econ.* 140, 35–47.

- Haake, H., Seuring, S., 2009. Sustainable procurement of minor items - exploring limits to sustainability. *Sustain. Dev.* 17, 284–294. doi:10.1002/sd.424
- Handfield, R.B., Walton, S.V., Seegers, L.K., Melnyk, S.A., 1997. “Green” value chain practices in the furniture industry. *J. Oper. Manag.* 15, 293–315. doi:10.1016/S0272-6963(97)00004-1
- Handfield, R.B., Walton, S.V., Sroufe, R., Melnyk, S.A., 2002. Applying environmental criteria to supplier assessment: A study in the application of the Analytical Hierarchy Process. *Eur. J. Oper. Res.* 141, 70–87.
- Hassini, E., Sutri, C., Searcy, C., 2012. A literature review and a case study of sustainable supply chains with a focus on metrics. *Int. J. Prod. Econ.* 140, 69–82.
- Hong, D.H., 2001. Shape preserving multiplications of fuzzy numbers. *Fuzzy Sets Syst.* 123, 81–84.
- Hutchins, M.J., Sutherland, J.W., 2008. An exploration of measures of social sustainability and their application to supply chain decisions. *J. Clean. Prod.* 16, 1688–1698.
- Jorgensen, A.L., Knudsen, J.S., 2006. Sustainable competitiveness in global value chains: how do small Danish firms behave? *Corp. Gov.* 6, 449–462.
doi:10.1108/14720700610689568
- Klir, G.J., Yuan, B., 1995. *Fuzzy sets and fuzzy logic: Theory and applications*. Prentice-Hall: Englewood Cliffs.
- Klir, G.L., 1997. Fuzzy arithmetic with requisite constraints. *Fuzzy Sets Syst.* 91, 165–175.
- Lambert, D.M., Cooper, M.C., Pagh, J.D., 1998. Supply Chain Management: Implementation Issues and Research Opportunities. *Int. J. Logist. Manag.* 9, 1–20.
doi:10.1108/09574099810805807
- Lee, A.H., Kang, H.-Y., Hsu, C.-F., Hung, H.-C., 2009. A green supplier selection model for high-tech industry. *Expert Syst. Appl.* 36, 7917–7927.
- Lee, S.-Y., Klassen, R.D., 2008. Drivers and Enablers That Foster Environmental Management Capabilities in Small- and Medium-Sized Suppliers in Supply Chains. *Prod. Oper. Manag.* 17, 573–586. doi:10.3401/poms.1080.0063

- Lin, K.-P., Ho, H.-P., Hung, K.-C., Pai, P.-F., 2012. Combining fuzzy weight average with fuzzy inference system for material substitution selection in electric industry. *Comput. Ind. Eng.* 62, 1034–1045.
- Linton, J.D., Klassen, R., Jayaraman, V., 2007. Vaidyanathan Sustainable supply chains: An introduction. *J. Oper. Manag.* 25, 1075–1082.
- Marrewijk, M. van, 2003. Concepts and Definitions of CSR and Corporate Sustainability: Between Agency and Communion. *J. Bus. Ethics* 44, 95–105.
doi:10.1023/A:1023331212247
- Maslow, A., 1943. A Theory of Human Motivation. *Psychol. Rev.* 50, 370–396.
- Max-Neef, M., 1992. Development and human needs, in: *Real-Life Economics: Understanding Wealth Creation*, Edited by: Ekins, P. and Max-Neef, M. Routledge, London, pp. 197–213.
- Mentzer, J.T., DeWitt, W., Keebler, J.S., Min, S., Nix, N.W., Smith, C.D., Zacharia, Z.G., 2001. Defining Supply Chain Management. *J. Bus. Logist.* 22, 1–25.
doi:10.1002/j.2158-1592.2001.tb00001.x
- Mikhailov, L., 2003. Deriving priorities from fuzzy pairwise comparison judgments. *Fuzzy Sets Syst.* 134, 365–85.
- Mongsawad, P., 2009. Sufficiency Economy: A Contribution to Economic. *Int. J. Soc. Sci.* 4, 144–151.
- Neely, A., Gregory, M., Platts, K., 1995. Performance measurement system design: A literature review and research agenda. *Int. J. Oper. Prod. Manag.* 15, 80–116.
doi:10.1108/01443579510083622
- Pagell, M., Wu, Z., 2009. Building a More Complete Theory of Sustainable Supply Chain Management Using Case Studies of 10 Exemplars. *J. Supply Chain Manag.* 45, 37–56. doi:10.1111/j.1745-493X.2009.03162.x
- Phillis, Y.A., Davis, B.J., 2009. Assessment of Corporate Sustainability via Fuzzy Logic. *J. Intell. Robot. Syst.* 55, 3–20. doi:10.1007/s10846-008-9289-3
- Porter, M.E., 1991. Towards a dynamic theory of strategy. *Strateg. Manag. J.* 12, 95–117.
doi:10.1002/smj.4250121008

- Porter, M.E., 2008. *Competitive Advantage: Creating and Sustaining Superior Performance*. Simon and Schuster.
- Saaty, T.L., 1980. *The analytic hierarchy process*. McGraw-Hill, New York.
- Santiteerakul, S., Sekhari, A., Bouras, Abdelaziz, 2012a. *Selecting Multiple Criteria Decision Aid for Measuring Sustainability Supply Chain Performance*. Presented at the International conference on Green Supply Chain (GSC) 2012, Arras, France, p. 12 p.
- Santiteerakul, S., Sekhari, A., Bouras, Abdelaziz, Sopadang, A., 2012b. *Sustainability Indicators for Evaluating Sustainable Supply Chain*. Presented at the International Conference on Green and Sustainable Innovation (ICGSI) 2012, Chiang Mai, Thailand, p. 15 p.
- Santiteerakul, S., Sekhari, A., Ouzrout, Y., Bouras, Abdelaziz, 2010. *An Exploration of Sustainable Supply Chain Perspective: Comparative Analysis*. Presented at the International Conference on Logistics and Transportation (ICLT) 2010, Canterbury, New Zealand.
- Santiteerakul, S., Sekhari, A., Ouzrout, Y., Bouras, Abdelaziz, 2011. *Social Indicators for Sustainable Supply Chain Performance Measurement*. Presented at the International Conference on Software, Knowledge, Information Management and Applications (SKIMA), Benevento, Italy, p. 11.
- Sargent, R.G., 2013. *Verification and validation of simulation models*. *J. Simul.* 7, 12–24.
- Sarkis, J., 1999. *How green is the supply chain? Practice and research*.
- Sarkis, J., Zhu, Q., Lai, K., 2011. *An organizational theoretic review of green supply chain management literature*. *Int. J. Prod. Econ.* 130, 1–15. doi:10.1016/j.ijpe.2010.11.010
- SCC, 2008. *SCOR: The Supply Chain Operations Reference Model version9.0*.
- SCC, 2010. *SCOR: The Supply Chain Operations Reference Model version 10.0*.
- Sekhari, A., Hossain, S.A., Santiteerakul, S., Bouras, A., 2010. *Sustainable Supply Chain Management from the Perspectives of Risk Management*. Presented at the International Conference on Advances in Production Management Systems (APMS), Cernobbio, Italy.

- Seuring, S., 2004. Industrial ecology, life cycles, supply chains: differences and interrelations. *Bus. Strategy Environ.* 13, 306–319. doi:10.1002/bse.418
- Seuring, S., 2011. Supply chain management for sustainable products – insights from research applying mixed methodologies. *Bus. Strategy Environ.* 20, 471–484. doi:10.1002/bse.702
- Seuring, S., Müller, M., 2008. From a literature review to a conceptual framework for sustainable supply chain management. *J. Clean. Prod.* 16, 1699–1710. doi:10.1016/j.jclepro.2008.04.020
- Seuring, S., Sarkis, J., Müller, M., Rao, P., 2008. Sustainability and supply chain management – An introduction to the special issue. *J. Clean. Prod.* 16, 1545–1551. doi:10.1016/j.jclepro.2008.02.002
- Sikdar, S.K., 2003. Sustainable development and sustainability metrics. *AIChE J.* 49, 1928–1932. doi:10.1002/aic.690490802
- Singh, R.K., Musty, H.R., Gupta, S.K., Dikshit, A.K., 2007. Development of composite sustainability performance index for steel industry. *Ecol. Indic.* 7, 565–588.
- Srivastava, S.K., 2007. Green supply-chain management: A state-of-the-art literature review. *Int. J. Manag. Rev.* 9, 53–80. doi:10.1111/j.1468-2370.2007.00202.x
- Teuteberg, F., Wittstruch, D., 2010. A Systematic Review of Sustainable Supply Chain Management Research, in: *Accounting and Information Systems University of Osnabriick*. Presented at the MKWI 2010, pp. 1001–1015.
- Tseng, M.-L., Chiu, A.S.F., 2013. Evaluating firm’s green supply chain management in linguistic preferences. *J. Clean. Prod.* 40, 22–31. doi:10.1016/j.jclepro.2010.08.007
- United Nations (UN), 1987. United Nations World Commission on Environment and Development (WCED): Our common future. World Commission on Environment and Development (WECD).
- United Nations (UN), 1993. Report of the United Nations Conference on Environment and Development. United Nations, Rio de Janeiro.
- Van Laarhoven, P.J.M., Pedrycz, W., 1983. A fuzzy extension of Saaty’s priority theory. *Fuzzy Sets Syst.* 11, 199–227. doi:10.1016/S0165-0114(83)80082-7

- Veleva, V., Ellenbecker, M., 2001. Indicators of sustainable production: framework and methodology. *J. Clean. Prod.* 9, 519–549. doi:10.1016/S0959-6526(01)00010-5
- Veleva, V., Hart, M., Greiner, T., Crumbley, C., 2001. Indicators of Sustainable Production. *J. Clean. Prod.* 9, 447–452.
- Wallerius, J., Zakrisson, M., 2010. Green Supply Chain Management in Thailand : An Investigation of the Use in the Electrical and Electronics Industry.
- Wang, Y.-M., Elhag, T.M.S., 2006. On the normalization of interval and fuzzy weights. *Fuzzy Sets Syst.* 157, 2456–2471. doi:10.1016/j.fss.2006.06.008
- Wang, Y.-M., Taha, M.S., 2006. A modified fuzzy logarithmic least squares method for fuzzy analytical hierarchy process. *Fuzzy Sets Syst.* 157, 3055–3071.
- Wee, H.-M., Lee, M.-C., Yu, J.C.P., Edward Wang, C., 2011. Optimal replenishment policy for a deteriorating green product: Life cycle costing analysis. *Int. J. Prod. Econ.* 133, 603–611. doi:10.1016/j.ijpe.2011.05.001
- Wolf, J., 2011. Sustainable Supply Chain Management Integration: A Qualitative Analysis of the German Manufacturing Industry. *J. Bus. Ethics* 102, 221–235. doi:10.1007/s10551-011-0806-0
- Zadeh, L.A., 1965. Fuzzy Sets. *Inf. Control* 8, 338–353.
- Zailani, S., Jeyaraman, K., Vengadasan, G., Premkumar, R., 2012. Sustainable supply chain management (SSCM) in Malaysia: A survey. *Int. J. Prod. Econ.* 140, 330–340. doi:10.1016/j.ijpe.2012.02.008
- Zhu, Q., Sarkis, J., 2004. Relationships between operational practices and performance among early adopters of green supply chain management practices in Chinese manufacturing enterprises. *J. Oper. Manag.* 22, 265–289. doi:10.1016/j.jom.2004.01.005
- Zhu, Q., Sarkis, J., Geng, Y., 2005. Green supply chain management in China: pressures, practices and performance. *Int. J. Oper. Prod. Manag.* 25, 449–468. doi:10.1108/01443570510593148
- Zhu, Q., Sarkis, J., Lai, K., 2012. Green supply chain management innovation diffusion and its relationship to organizational improvement: An ecological modernization

perspective. *J. Eng. Technol. Manag.* 29, 168–185.
doi:10.1016/j.jengtecman.2011.09.012

Directive and Standards

Directive 2005/32/EC establishing a framework for the setting of ecodesign requirements for energy-using products and amending Council Directive 92/42/EEC and Directives 96/57/EC and 2000/55/EC.

Directive 2002/96/EC on waste electrical and electronic equipment.

Directive 2002/95/EC on the restriction of the use of certain hazardous substances in electrical and electronic equipment.

Directive 92/75/EEC on the indication by labeling and standard product information of the consumption of energy and other resources by household appliances

ARNOF (2000), The European Standard EN ISO 14301 : 1999 Environmental performance evaluation : Guidelines, pp.32

Appendix I

***Sustainability metrics categorized
by sustainability criteria and
supply chain engagement level***

Table I-1 Sustainability metrics: Economic

Category	Company level	Supply chain level	Stakeholders level
Financial	<ul style="list-style-type: none"> • Sales • Production volumes • Total income • Total cost • Net revenue • Total expenditure of employee's salary • Equivalent monetary value of all benefits to employee • The structure of retirement plans offered to employee • Personnel costs (wages, salaries, social welfare contributions, pension plan expenses, employee benefits) 	<ul style="list-style-type: none"> • Equivalent monetary value of cost reduction from activities/projects collaborating with suppliers • Equivalent monetary value of cost reduction from activities/projects collaborating with customers 	<ul style="list-style-type: none"> • Taxes paid to all tax-levying authorities • State subsidies and assistance • Total number of activities to increase shareholder's earning
Economic value distributed	<ul style="list-style-type: none"> • Percentage of local employee • Percentage budget that spent on local suppliers • Policy or common practices for preferring locally based supplier • Total number of activities for generating income to local community 	<ul style="list-style-type: none"> • Percentage of suppliers who include preferring locally based into their strategic policy 	<ul style="list-style-type: none"> • (None identified)

Table I-2 Sustainability metrics: Material

Category	Company level	Supply chain level	Stakeholders level
Material conservation	<ul style="list-style-type: none"> • Total material consumption • Percentage of material consumption reduction • Percentage of recycled and/or reused material • Percentage of recyclable and/or reusable material • Equivalent 	<ul style="list-style-type: none"> • Percentage of suppliers who commit to increase material consumption efficiency • Equivalent monetary value of material consumption reduction from activities/projects collaborating with 	<ul style="list-style-type: none"> • Total number of products/product families which participate in to take-back program

	<p>monetary value of cost saving from material conservation activities</p> <ul style="list-style-type: none"> • Total number or equivalent monetary value of re-design products/processes to reduce material consumption 	<p>suppliers</p> <ul style="list-style-type: none"> • Equivalent monetary value of material consumption reduction from activities/projects collaborating with customers • Percentage of customers who the company commit to increase material consumption efficiency 	
Hazardous substances/material	<ul style="list-style-type: none"> • Percentage of hazardous material • Percentage of hazardous substances reduction • Percentage of suppliers which meet hazardous substances criteria • Percentage of non-compliance incoming material in hazardous issues • Percentage of products which provide hazardous information to customers • Total number of non-compliance issues relating to hazardous substances issue from customers 	<ul style="list-style-type: none"> • Percentage of suppliers who completed hazardous substances information • Total number of practices/projects collaborating with suppliers for reducing hazardous substances • Total number of practices/projects collaborating with customers for reducing hazardous substances 	<ul style="list-style-type: none"> • Total expenditure to communicate with stakeholders on hazardous substances issue

Table I-3 Sustainability metrics: Natural resources

Category	Company level	Supply chain level	Stakeholders level
Resources conservation	<ul style="list-style-type: none"> • Water consumption • Percentage of recycled water • Percentage of water used reduction • Percentage of complement or replace non-renewable resources with alternative renewable and low 	<ul style="list-style-type: none"> • Total number of practices/projects collaborating with suppliers for conserving water resources • Total number of practices/projects collaborating with customers for conserving water resources 	<ul style="list-style-type: none"> • Total expenditure in social activities to promote sustainable consumption.

	impact sources		
Environmental prevention	<ul style="list-style-type: none"> • CO2 emissions • GHG emissions • Water emissions • Significant quantities of spilled chemicals, oils, and fuels • Total quantities of solid waste • Percentage of waste recycling • Fines and sanctions for non-compliance with applicable international declarations, conventions, and treaties, as well as with national, regional, and local regulations relating to environmental issues • Cost saving from implementing clean technology • Ratio of products/product family using LCA thinking to assess environmental impacts before they are widely used • Percentage of suppliers who meet environmental criteria 	<ul style="list-style-type: none"> • Total number of practices/projects collaborating with suppliers to reduce environmental emissions • Total number of practices/projects collaborating with customers to reduce environmental emissions • Ratio of products/product family using Eco-design by collaborating with suppliers and customers 	<ul style="list-style-type: none"> • Total expenditure in social activities for valuing, protecting, and restoring ecosystems

Table I-4 Sustainability metrics: Energy

Category	Company level	Supply chain level	Stakeholders level
Energy conservation	<ul style="list-style-type: none"> • Total energy consumption • Total fuels consumption • Percentage of energy consumption reduction • Percentage of fuels consumption reduction • Cost saving from implementing low energy or renewable energy in company 	<ul style="list-style-type: none"> • Percentage of suppliers who commit to increase energy consumption efficiency • Percentage of re-designed product or process to increase energy efficiency by mean of collaborating with suppliers and/or customers • Equivalent monetary value of energy 	<ul style="list-style-type: none"> • Total number of products/product families which participate in to take-back program

Category	Company level	Supply chain level	Stakeholders level
	<ul style="list-style-type: none"> Total number of activities/projects which assessing energy usage impacts of new technologies before they are widely used 	<ul style="list-style-type: none"> consumption reduction from activities/projects collaborating with suppliers Equivalent monetary value of energy consumption reduction from activities/projects collaborating with customers Percentage of customers who the company commit to increase energy consumption efficiency 	
Renewable energy	<ul style="list-style-type: none"> Percentage of alternative renewable energy implementation 	<ul style="list-style-type: none"> Equivalent monetary value of energy consumption reduction from activities/projects collaborating with suppliers Equivalent monetary value of energy consumption reduction from activities/projects collaborating with customers 	(None identified)

Table I-5 Sustainability metrics: Health and Safety

Category	Company level	Supply chain level	Stakeholders level
Impacts to employee	<ul style="list-style-type: none"> Injury rate (IR) Occupational disease rate (ODR) Absent rate (AR) Percentage of the total workforce represented in formal joint management-worker health and safety committees Percentage of suppliers who meet health and safety criteria Risk mitigation of safety work place and work condition 	<ul style="list-style-type: none"> Percentage of suppliers who commit to reduce risk in working condition Total number of activities/projects collaborating with suppliers to reduce risk in employee's health and safety Total number of activities/projects collaborating with customers to reduce risk in employee's health and safety 	<ul style="list-style-type: none"> (None identified)
Impacts to customer	<ul style="list-style-type: none"> Total number of non-compliance events in 	<ul style="list-style-type: none"> Total number of re-designed product or 	<ul style="list-style-type: none"> Total number of incidents of non-

Category	Company level	Supply chain level	Stakeholders level
	health and safety	process to reduce negative health impacts to customers by mean of collaborating with suppliers.	compliance with the health and safety impacts of products and services <ul style="list-style-type: none"> • Customer satisfaction in health and safety issues

Table I-6 Sustainability metrics: Human capabilities

Category	Company level	Supply chain level	Stakeholders level
Knowledge and working skills	<ul style="list-style-type: none"> • Average hours of training per year per employee-by-employee category. • Total number of training courses which encourage sustainable attitude • Total number of patents 	<ul style="list-style-type: none"> • Total training hours which collaborating with suppliers and/or customers 	<ul style="list-style-type: none"> • Total expenditure in social activities for education. • Total number of activities/projects which encourage knowledge development for stakeholders
Employee's Moral	<ul style="list-style-type: none"> • Employee's turnover rate • Employee training satisfaction • Employee job satisfaction 	(None identified)	(None identified)

Table I-7 Sustainability metrics: Ethics

Category	Company level	Supply chain level	Stakeholders level
Human Rights	<ul style="list-style-type: none"> • Total hours of employee training on policies and procedures concerning aspects of human rights that are relevant to operations, including the percentage of employees trained. • Percentage of contracts with significant suppliers and contractors that were either declined or imposed performance conditions, or were subject to other actions as a result of human rights screening. 	<ul style="list-style-type: none"> • Percentage and number of agreements with suppliers that include human rights or that have undergone human rights screening 	(None identified)

Category	Company level	Supply chain level	Stakeholders level
Ethical issues	<ul style="list-style-type: none"> • Total number of standards of ethical behavior which are applied in the company • Total number of Actions taken in response to incidents of corruption. • Percentage of employees trained in organization's anti-corruption policies and procedures. • Percentage and total number of business units analyzed for risks related to corruption. 	(None identified)	(None identified)

Appendix II

***An analysis of standards, guide line,
and regulations regarding to the
sustainability criteria***

Standard/ Regulation/Guideline	Code	Description		
			C1	C2
GRI	EC1	Direct economic value generated and distributed, including revenues, operating costs, employee compensation, donations and other community investments, retained earnings, and payments to capital providers and governments.	Financial	
			C1.1	Company's financial
			C1.2	Economic distributed
			Non-Financial	
			C2.1	Quality
			C2.2	Time
			C2.3	Flexibility
			Material	
			C2.1	Material conservation
			C2.2	Hazardous substances/material
			Natural Resources	
			C3.1	Natural Resources conservation
			C3.2	Environmental prevention
			Energy	
			C4.1	Energy conservation
			C4.2	Renewable energy
			Health and Safety	
			C5.1	Employee's Health and Safety
			C5.2	Customer's Health and Safety
			Human Capabilities	
			C6.1	Knowledge and working skills
C6.2	Morality			
Ethics				
C7.1	Human rights			
C7.2	Other Ethical issues			

Standard/ Regulation/Guideline	Code	Description	Financial	Company's financial	Economic distributed	Non-Financial	Quality	Time	Flexibility	Material	Material conservation	Hazardous substances/material	Natural Resources	Natural Resources conservation	Environmental prevention	Energy	Energy conservation	Renewable energy	Health and Safety	Employee's Health and Safety	Customer's Health and Safety	Human Capabilities	Knowledge and working skills	Morality	Ethics	Human rights	Other Ethical issues
			C1	C1.1	C1.2	C2	C2.1	C2.2	C2.3	C2	C2.1	C2.2	C3	C3.1	C3.2	C4	C4.1	C4.2	C5	C5.1	C5.2	C6	C6.1	C6.2	C7	C7.1	C7.2
		government.																									
	EC5	Range of ratios of standard entry level wage by gender compared to local minimum wage at significant locations of operation.			X			X																			
	EC6	Policy, practices, and proportion of spending on locally-based suppliers at significant locations of			X			X																			

Standard/ Regulation/Guideline	Code	Description																																																		
			C1	Financial	C1.1	Company's financial	C1.2	Economic distributed	C2	Non-Financial	C2.1	Quality	C2.2	Time	C2.3	Flexibility	C2	Material	C2.1	Material conservation	C2.2	Hazardous substances/material	C3	Natural Resources	C3.1	Natural Resources conservation	C3.2	Environmental prevention	C4	Energy	C4.1	Energy conservation	C4.2	Renewable energy	C5	Health and Safety	C5.1	Employee's Health and Safety	C5.2	Customer's Health and Safety	C6	Human Capabilities	C6.1	Knowledge and working skills	C6.2	Morality	C7	Ethics	C7.1	Human rights	C7.2	Other Ethical issues
		operation.																																																		
	EC7	Procedures for local hiring and proportion of senior management hired from the local community at significant locations of operation.				X					X																																									
	EC8	Development and impact of infrastructure investments and services provided																																																		

Standard/ Regulation/Guideline	Code	Description																												
			C1	Financial	Company's financial	Economic distributed	C2 Non-Financial	Quality	Time	Flexibility	C2 Material	Material conservation	Hazardous substances/material	C3 Natural Resources	Natural Resources conservation	Environmental prevention	C4 Energy	Energy conservation	Renewable energy	C5 Health and Safety	Employee's Health and Safety	Customer's Health and Safety	C6 Human Capabilities	Knowledge and working skills	Morality	C7 Ethics	Human rights	Other Ethical issues		
		primarily for public benefit through commercial, in-kind, or pro bono engagement.																												
	EC9	Understanding and describing significant indirect economic impacts, including the extent of impacts.																												
	EN1	Materials used by weight or volume.										X																		
	EN2	Percentage of										X																		

Standard/ Regulation/Guideline	Code	Description																			
			C1	Financial		Non-Financial		Material			Natural Resources		Energy		Health and Safety		Human Capabilities		Ethics		
				Company's financial	Economic distributed	Quality	Time	Flexibility	Material conservation	Hazardous substances/material	Natural Resources conservation	Environmental prevention	Energy conservation	Renewable energy	Employee's Health and Safety	Customer's Health and Safety	Knowledge and working skills	Morality	Human rights	Other Ethical issues	
		materials used that are recycled input materials.																			
	EN3	Direct energy consumption by primary energy source.												X							
	EN4	Indirect energy consumption by primary source.												X							
	EN5	Energy saved due to conservation and efficiency improvements.											X								

Standard/ Regulation/Guide line	Code	Description	C1	Financial	C1.1	Company's financial	C1.2	Economic distributed	C2	Non-Financial	C2.1	Quality	C2.2	Time	C2.3	Flexibility	C2	Material	C2.1	Material conservation	C2.2	Hazardous substances/material	C3	Natural Resources	C3.1	Natural Resources conservation	C3.2	Environmental prevention	C4	Energy	C4.1	Energy conservation	C4.2	Renewable energy	C5	Health and Safety	C5.1	Employee's Health and Safety	C5.2	Customer's Health and Safety	C6	Human Capabilities	C6.1	Knowledge and working skills	C6.2	Morality	C7	Ethics	C7.1	Human rights	C7.2	Other Ethical issues									
				EN6	Initiatives to provide energy-efficient or renewable energy based products and services, and reductions in energy requirements as a result of these initiatives.																																X																								
	EN7	Initiatives to reduce indirect energy consumption and reductions achieved.																													X																														

Standard/ Regulation/Guideline	Code	Description																									
			C1 Financial	C1.1 Company's financial	C1.2 Economic distributed	C2 Non-Financial	C2.1 Quality	C2.2 Time	C2.3 Flexibility	C2 Material	C2.1 Material conservation	C2.2 Hazardous substances/material	C3 Natural Resources	C3.1 Natural Resources conservation	C3.2 Environmental prevention	C4 Energy	C4.1 Energy conservation	C4.2 Renewable energy	C5 Health and Safety	C5.1 Employee's Health and Safety	C5.2 Customer's Health and Safety	C6 Human Capabilities	C6.1 Knowledge and working skills	C6.2 Morality	C7 Ethics	C7.1 Human rights	C7.2 Other Ethical issues
	EN8	Total water withdrawal by source.											X														
	EN9	Water sources significantly affected by withdrawal of water.											X														
	EN10	Percentage and total volume of water recycled and reused.											X														
	EN11	Location and size of land owned, leased, managed in, or adjacent to, protected											X														

Standard/ Regulation/Guideline	Code	Description																																	
			C1	Financial	Company's financial	Economic distributed	C2	Non-Financial	Quality	Time	Flexibility	C2	Material	Material conservation	Hazardous substances/material	C3	Natural Resources	Natural Resources conservation	Environmental prevention	C4	Energy	Energy conservation	Renewable energy	C5	Health and Safety	Employee's Health and Safety	Customer's Health and Safety	C6	Human Capabilities	Knowledge and working skills	Morality	C7	Ethics	Human rights	Other Ethical issues
		restored.																																	
	EN14	Strategies, current actions, and future plans for managing impacts on biodiversity.															X																		
	EN15	Number of IUCN Red List species and national conservation list species with habitats in areas affected by operations, by level of extinction risk.															X																		

Standard/ Regulation/Guideline	Code	Description	C1	C1.1	C1.2	C2	C2.1	C2.2	C2.3	C2	C2.1	C2.2	C3	C3.1	C3.2	C4	C4.1	C4.2	C5	C5.1	C5.2	C6	C6.1	C6.2	C7	C7.1	C7.2
			Financial	Company's financial	Economic distributed	Non-Financial	Quality	Time	Flexibility	Material	Material conservation	Hazardous substances/material	Natural Resources	Natural Resources conservation	Environmental prevention	Energy	Energy conservation	Renewable energy	Health and Safety	Employee's Health and Safety	Customer's Health and Safety	Human Capabilities	Knowledge and working skills	Morality	Ethics	Human rights	Other Ethical issues
		by weight.																									
	EN20	NOx, SOx, and other significant air emissions by type and weight.													X												
	EN21	Total water discharge by quality and destination.													X												
	EN22	Total weight of waste by type and disposal method.													X												
	EN23	Total number and volume of significant spills.													X												

Standard/ Regulation/Guideline	Code	Description																																															
			C1	Financial	C1.1	Company's financial	C1.2	Economic distributed	C2	Non-Financial	C2.1	Quality	C2.2	Time	C2.3	Flexibility	C2	Material	C2.1	Material conservation	C2.2	Hazardous substances/material	C3	Natural Resources	C3.1	Natural Resources conservation	C3.2	Environmental prevention	C4	Energy	C4.1	Energy conservation	C4.2	Renewable energy	C5	Health and Safety	C5.1	Employee's Health and Safety	C5.2	Customer's Health and Safety	C6	Human Capabilities	C6.1	Knowledge and working skills	C6.2	Morality	C7	Ethics	C7.1
	EN2 4	Weight of transported, imported, exported, or treated waste deemed hazardous under the terms of the Basel Convention Annex I, II, III, and VIII, and percentage of transported waste shipped internationally.																							X																								
	EN2 5	Identity, size, protected status, and																							X																								

Standard/ Regulation/ Guideline	Code	Description	C1 Financial C1.1 Company's financial C1.2 Economic distributed C2 Non-Financial C2.1 Quality C2.2 Time C2.3 Flexibility C2 Material C2.1 Material conservation C2.2 Hazardous substances/material C3 Natural Resources C3.1 Natural Resources conservation C3.2 Environmental prevention C4 Energy C4.1 Energy conservation C4.2 Renewable energy C5 Health and Safety C5.1 Employee's Health and Safety C5.2 Customer's Health and Safety C6 Human Capabilities C6.1 Knowledge and working skills C6.2 Morality C7 Ethics C7.1 Human rights C7.2 Other Ethical issues																
		biodiversity value of water bodies and related habitats significantly affected by the reporting organization's discharges of water and runoff.																	
	EN26	Initiatives to mitigate environmental impacts of products and services, and extent of impact mitigation.									X	X						X	
	EN27	Percentage of									X								

Standard/ Regulation/Guideline	Code	Description		
			C1	Financial
			C1.1	Company's financial
			C1.2	Economic distributed
			C2	Non-Financial
			C2.1	Quality
			C2.2	Time
			C2.3	Flexibility
			C2	Material
			C2.1	Material conservation
			C2.2	Hazardous substances/material
			C3	Natural Resources
			C3.1	Natural Resources conservation
			C3.2	Environmental prevention
			C4	Energy
			C4.1	Energy conservation
			C4.2	Renewable energy
			C5	Health and Safety
			C5.1	Employee's Health and Safety
			C5.2	Customer's Health and Safety
			C6	Human Capabilities
			C6.1	Knowledge and working skills
			C6.2	Morality
			C7	Ethics
			C7.1	Human rights
			C7.2	Other Ethical issues
		products sold and their packaging materials that are reclaimed by category.		
	EN28	Monetary value of significant fines and total number of non-monetary sanctions for non-compliance with environmental laws and regulations.		

Standard/ Regulation/Guideline	Code	Description	Financial	Non-Financial	Material	Natural Resources	Energy	Health and Safety	Human Capabilities	Ethics	Other Ethical issues	
			C1	C2	C2	C3	C4	C5	C6	C7	C7.1	C7.2
	EN29	Significant environmental impacts of transporting products and other goods and materials used for the organization's operations, and transporting members of the workforce.										
	EN30	Total environmental protection expenditures and investments by type.										

Standard/ Regulation/Guideline	Code	Description	Financial	Company's financial	Economic distributed	Non-Financial	Quality	Time	Flexibility	Material	Material conservation	Hazardous substances/material	Natural Resources	Natural Resources conservation	Environmental prevention	Energy	Energy conservation	Renewable energy	Health and Safety	Employee's Health and Safety	Customer's Health and Safety	Human Capabilities	Knowledge and working skills	Morality	Ethics	Human rights	Other Ethical issues
			C1	C1.1	C1.2	C2	C2.1	C2.2	C2.3	C2	C2.1	C2.2	C3	C3.1	C3.2	C4	C4.1	C4.2	C5	C5.1	C5.2	C6	C6.1	C6.2	C7	C7.1	C7.2
	LA5	Minimum notice period(s) regarding significant operational changes, including whether it is specified in collective agreements.																						X			
	LA6	Percentage of total workforce represented in formal joint management-worker health and safety																		X							

Standard/ Regulation/Guideline	Code	Description	C1	Financial
		committees that help monitor and advise on occupational health and safety programs.		
LA7		Rates of injury, occupational diseases, lost days, and absenteeism, and number of work-related fatalities by region and gender.		
			C1.1	Company's financial
			C1.2	Economic distributed
			C2	Non-Financial
			C2.1	Quality
			C2.2	Time
			C2.3	Flexibility
			C2	Material
			C2.1	Material conservation
			C2.2	Hazardous substances/material
			C3	Natural Resources
			C3.1	Natural Resources conservation
			C3.2	Environmental prevention
			C4	Energy
			C4.1	Energy conservation
			C4.2	Renewable energy
			C5	Health and Safety
			C5.1	Employee's Health and Safety
			C5.2	Customer's Health and Safety
			C6	Human Capabilities
			C6.1	Knowledge and working skills
			C6.2	Morality
			C7	Ethics
			C7.1	Human rights
			C7.2	Other Ethical issues

Standard/ Regulation/Guideline	Code	Description	Financial	Company's financial	Economic distributed	Non-Financial	Quality	Time	Flexibility	Material	Material conservation	Hazardous substances/material	Natural Resources	Natural Resources conservation	Environmental prevention	Energy	Energy conservation	Renewable energy	Health and Safety	Employee's Health and Safety	Customer's Health and Safety	Human Capabilities	Knowledge and working skills	Morality	Ethics	Human rights	Other Ethical issues
			C1	C1.1	C1.2	C2	C2.1	C2.2	C2.3	C2	C2.1	C2.2	C3	C3.1	C3.2	C4	C4.1	C4.2	C5	C5.1	C5.2	C6	C6.1	C6.2	C7	C7.1	C7.2
		agreements with trade unions.																									
	LA10	Average hours of training per year per employee by gender and by employee category.																							X		
	LA11	Programs for skills management and lifelong learning that support the continued employability of employees and assist them in																							X		

Standard/ Regulation/Guideline	Code	Description																																													
			C1	Financial	Company's financial	C1.1	Economic distributed	C1.2	Non-Financial	Quality	C2.1	Time	C2.2	Flexibility	C2.3	Material	Material conservation	C2.1	Hazardous substances/material	C2.2	Natural Resources	Natural Resources conservation	C3.1	Environmental prevention	C3.2	Energy	Energy conservation	C4.1	Renewable energy	C4.2	Health and Safety	Employee's Health and Safety	C5.1	Customer's Health and Safety	C5.2	Human Capabilities	Knowledge and working skills	C6.1	Morality	C6.2	Ethics	Human rights	C7.1	Other Ethical issues	C7.2		
		managing career endings.																																													
	LA1 2	Percentage of employees receiving regular performance and career development reviews by gender.																																												X	X
	LA1 3	Composition of governance bodies and breakdown of employees per employee category according to gender, age																																												X	

Standard/ Regulation/Guide line	Code	Description																																													
			C1	Financial																																											
			C1.1	Company's financial	C1.2	Economic distributed	C2	Non-Financial	C2.1	Quality	C2.2	Time	C2.3	Flexibility	C2	Material	C2.1	Material conservation	C2.2	Hazardous substances/material	C3	Natural Resources	C3.1	Natural Resources conservation	C3.2	Environmental prevention	C4	Energy	C4.1	Energy conservation	C4.2	Renewable energy	C5	Health and Safety	C5.1	Employee's Health and Safety	C5.2	Customer's Health and Safety	C6	Human Capabilities	C6.1	Knowledge and working skills	C6.2	Morality	C7	Ethics	C7.1
		group, minority group membership, and other indicators of diversity.																																													
	LA14	Ratio of basic salary of men to women by employee category.																																				X									
	HR1	Percentage and total number of significant investment agreements and contracts that include human rights clauses or																																					X								

Standard/ Regulation/Guide line	Code	Description																									
			C1 Financial	C1.1 Company's financial	C1.2 Economic distributed	C2 Non-Financial	C2.1 Quality	C2.2 Time	C2.3 Flexibility	C2 Material	C2.1 Material conservation	C2.2 Hazardous substances/material	C3 Natural Resources	C3.1 Natural Resources conservation	C3.2 Environmental prevention	C4 Energy	C4.1 Energy conservation	C4.2 Renewable energy	C5 Health and Safety	C5.1 Employee's Health and Safety	C5.2 Customer's Health and Safety	C6 Human Capabilities	C6.1 Knowledge and working skills	C6.2 Morality	C7 Ethics	C7.1 Human rights	C7.2 Other Ethical issues
		concerning aspects of human rights that are relevant to operations, including the percentage of employees trained.																									
	HR4	Total number of incidents of discrimination and corrective actions taken.																									X
	HR5	Operations and significant suppliers identified in																								X	

Standard/ Regulation/Guideline	Code	Description																										
			C1 Financial	C1.1 Company's financial	C1.2 Economic distributed	C2 Non-Financial	C2.1 Quality	C2.2 Time	C2.3 Flexibility	C2 Material	C2.1 Material conservation	C2.2 Hazardous substances/material	C3 Natural Resources	C3.1 Natural Resources conservation	C3.2 Environmental prevention	C4 Energy	C4.1 Energy conservation	C4.2 Renewable energy	C5 Health and Safety	C5.1 Employee's Health and Safety	C5.2 Customer's Health and Safety	C6 Human Capabilities	C6.1 Knowledge and working skills	C6.2 Morality	C7 Ethics	C7.1 Human rights	C7.2 Other Ethical issues	
		which the right to exercise freedom of association and collective bargaining may be at significant risk, and actions taken to support these rights.																										
	HR6	Operations and significant suppliers identified as having significant risk for incidents of																								X		

Standard/ Regulation/Guid eline	Code	Description																																															
			C1	Financial	C1.1	Company's financial	C1.2	Economic distributed	C2	Non-Financial	C2.1	Quality	C2.2	Time	C2.3	Flexibility	C2	Material	C2.1	Material conservation	C2.2	Hazardous substances/material	C3	Natural Resources	C3.1	Natural Resources conservation	C3.2	Environmental prevention	C4	Energy	C4.1	Energy conservation	C4.2	Renewable energy	C5	Health and Safety	C5.1	Employee's Health and Safety	C5.2	Customer's Health and Safety	C6	Human Capabilities	C6.1	Knowledge and working skills	C6.2	Morality	C7	Ethics	C7.1
		impacts on local communities.																																															
	S010	Prevention and mitigation measures implemented in operations with significant potential or actual negative impacts on local communities.																																												X			
	S02	Percentage and total number of business units																																													X		

Standard/ Regulation/Guideline	Code	Description	C1																																
			Financial	Company's financial	Economic distributed	Non-Financial	Quality	Time	Flexibility	Material	Material conservation	Hazardous substances/material	Natural Resources	Natural Resources conservation	Environmental prevention	Energy	Energy conservation	Renewable energy	Health and Safety	Employee's Health and Safety	Customer's Health and Safety	Human Capabilities	Knowledge and working skills	Morality	Ethics	Human rights	Other Ethical issues								
		analyzed for risks related to corruption.																																	
	S03	Percentage of employees trained in organization's anti-corruption policies and procedures.																																	X
	S04	Actions taken in response to incidents of corruption.																																	X
	S05	Public policy positions and participation in public policy development and lobbying.																																	X

Standard/ Regulation/Guideline	Code	Description	Financial	Non-Financial	Quality	Time	Flexibility	Material	Natural Resources	Energy	Health and Safety	Human Capabilities	Ethics	Other Ethical issues													
			C1	C2	C2.1	C2.2	C2.3	C2	C2.1	C2.2	C3	C3.1	C3.2	C4	C4.1	C4.2	C5	C5.1	C5.2	C6	C6.1	C6.2	C7	C7.1	C7.2		
	S06	Total value of financial and in-kind contributions to political parties, politicians, and related institutions by country.																									X
	S07	Total number of legal actions for anti-competitive behavior, anti-trust, and monopoly practices and their outcomes.																									X

Standard/ Regulation/Guid eline	Code	Description	Financial	Non-Financial						Material							Natural Resources		Energy		Health and Safety		Human Capabilities		Ethics				
			C1	C1.1	C1.2	C2	C2.1	C2.2	C2.3	C2	C2.1	C2.2	C3	C3.1	C3.2	C4	C4.1	C4.2	C5	C5.1	C5.2	C6	C6.1	C6.2	C7	C7.1	C7.2		
	S08	Monetary value of significant fines and total number of non-monetary sanctions for non-compliance with laws and regulations.																											X
	PR1	Life cycle stages in which health and safety impacts of products and services are assessed for improvement																		X									

Standard/ Regulation/Guideline	Code	Description		
			C1	Financial
				Company's financial
			C1.1	Economic distributed
			C1.2	
			C2	Non-Financial
			C2.1	Quality
			C2.2	Time
			C2.3	Flexibility
			C2	Material
			C2.1	Material conservation
			C2.2	Hazardous substances/material
			C3	Natural Resources
			C3.1	Natural Resources conservation
			C3.2	Environmental prevention
			C4	Energy
			C4.1	Energy conservation
			C4.2	Renewable energy
			C5	Health and Safety
			C5.1	Employee's Health and Safety
			C5.2	Customer's Health and Safety
			C6	Human Capabilities
			C6.1	Knowledge and working skills
			C6.2	Morality
			C7	Ethics
			C7.1	Human rights
			C7.2	Other Ethical issues
		, and percentage of significant products and services categories subject to such procedures.		
	PR2	Total number of incidents of non-compliance with regulations and voluntary codes concerning health and safety impacts of		

Standard/ Regulation/Guideline	Code	Description	C1	C1.1	C1.2	C2	C2.1	C2.2	C2.3	C2	C2.1	C2.2	C3	C3.1	C3.2	C4	C4.1	C4.2	C5	C5.1	C5.2	C6	C6.1	C6.2	C7	C7.1	C7.2
			Financial	Company's financial	Economic distributed	Non-Financial	Quality	Time	Flexibility	Material	Material conservation	Hazardous substances/material	Natural Resources	Natural Resources conservation	Environmental prevention	Energy	Energy conservation	Renewable energy	Health and Safety	Employee's Health and Safety	Customer's Health and Safety	Human Capabilities	Knowledge and working skills	Morality	Ethics	Human rights	Other Ethical issues
		surveys measuring customer satisfaction.																									
	PR6	Programs for adherence to laws, standards, and voluntary codes related to marketing communications, including advertising, promotion, and sponsorship.																				X					
	PR7	Total number of incidents of non-compliance																									

Standard/ Regulation/Guideline	Code	Description	C1	C1.1	C1.2	C2	C2.1	C2.2	C2.3	C2	C2.1	C2.2	C3	C3.1	C3.2	C4	C4.1	C4.2	C5	C5.1	C5.2	C6	C6.1	C6.2	C7	C7.1	C7.2	
			Financial	Company's financial	Economic distributed	Non-Financial	Quality	Time	Flexibility	Material	Material conservation	Hazardous substances/material	Natural Resources	Natural Resources conservation	Environmental prevention	Energy	Energy conservation	Renewable energy	Health and Safety	Employee's Health and Safety	Customer's Health and Safety	Human Capabilities	Knowledge and working skills	Morality	Ethics	Human rights	Other Ethical issues	
		with regulations and voluntary codes concerning marketing communications, including advertising, promotion, and sponsorship by type of outcomes.																										
	PR8	Total number of substantiated complaints regarding breaches of customer																			X							

Standard/ Regulation/Guideline	Code	Description																																																		
			C1	Financial	C1.1	Company's financial	C1.2	Economic distributed	C2	Non-Financial	C2.1	Quality	C2.2	Time	C2.3	Flexibility	C2	Material	C2.1	Material conservation	C2.2	Hazardous substances/material	C3	Natural Resources	C3.1	Natural Resources conservation	C3.2	Environmental prevention	C4	Energy	C4.1	Energy conservation	C4.2	Renewable energy	C5	Health and Safety	C5.1	Employee's Health and Safety	C5.2	Customer's Health and Safety	C6	Human Capabilities	C6.1	Knowledge and working skills	C6.2	Morality	C7	Ethics	C7.1	Human rights	C7.2	Other Ethical issues
		privacy and losses of customer data.																																																		
	PR9	Monetary value of significant fines for non-compliance with laws and regulations concerning the provision and use of products and services.																																																		
ISO14031		the effectiveness of																																																		

Standard/ Regulation/Guideline	Code	Description		
			C1	C2
		management systems in achieving conformance with requirements or expectations		
		relationship of environmental performance to financial performance	X	X
		programmes in local communities with respect to environmental issues,		

Standard/ Regulation/Guideline	Code	Description	C1	C2	C3	C4	C5	C6	C7
		management systems in achieving conformance with requirements or expectations							
		relationship of environmental performance to financial performance	X	X					
		programmes in local communities with respect to environmental issues,							

Standard/ Regulation/Guideline	Code	Description																									
			C1 Financial	C1.1 Company's financial	C1.2 Economic distributed	C2 Non-Financial	C2.1 Quality	C2.2 Time	C2.3 Flexibility	C2 Material	C2.1 Material conservation	C2.2 Hazardous substances/material	C3 Natural Resources	C3.1 Natural Resources conservation	C3.2 Environmental prevention	C4 Energy	C4.1 Energy conservation	C4.2 Renewable energy	C5 Health and Safety	C5.1 Employee's Health and Safety	C5.2 Customer's Health and Safety	C6 Human Capabilities	C6.1 Knowledge and working skills	C6.2 Morality	C7 Ethics	C7.1 Human rights	C7.2 Other Ethical issues
		Material								X	X		X														
		Energy types and energy used														X											
		Service supporting and organization's operation								X	X		X														
		Physical facilities and equipments										X	X		X				X								
		Supply and delivery											X		X												
		Products								X	X		X		X						X						
		Service provided by organization													X												
		Wastes								X	X		X														

Standard/ Regulation/Guide line	Code	Description	Financial	Company's financial	Economic distributed	Non-Financial	Quality	Time	Flexibility	Material	Material conservation	Hazardous substances/material	Natural Resources	Natural Resources conservation	Environmental prevention	Energy	Energy conservation	Renewable energy	Health and Safety	Employee's Health and Safety	Customer's Health and Safety	Human Capabilities	Knowledge and working skills	Morality	Ethics	Human rights	Other Ethical issues
			C1	C1.1	C1.2	C2	C2.1	C2.2	C2.3	C2	C2.1	C2.2	C3	C3.1	C3.2	C4	C4.1	C4.2	C5	C5.1	C5.2	C6	C6.1	C6.2	C7	C7.1	C7.2
		Emissions to air													X												
		Emissions to land and water													X												
		Other emissions													X												
				X			X				X	X		X	X		X			X	X						
ISO26000	6.2	organizational governance																									
	6.3	Human rights																									
	6.3.3	Due diligence																								X	
	6.3.4	Human rights risks situations																								X	
	6.3.5	Avoidance of complicity																								X	X
	6.3.6	Resolving grievances																								X	X

Standard/ Regulation/Guide line	Code	Description	Impact Assessment Categories																						
			C1	C1 Financial			C2	C2 Non-Financial			C2	C2 Material		C3	C3 Natural Resources		C4	C4 Energy		C5	C5 Health and Safety		C6	C6 Human Capabilities	
			Company's financial	Economic distributed	Quality	Time	Flexibility	Material conservation	Hazardous substances/material	Natural Resources conservation	Environmental prevention	Energy conservation	Renewable energy	Employee's Health and Safety	Customer's Health and Safety	Knowledge and working skills	Morality	Human rights	Other Ethical issues						
	6.3.7	Discrimination and vulnerable groups																		X					
	6.3.8	Civil and political rights																		X					
	6.3.9	Economic, social and cultural rights																		X					
	6.3.10	Fundamental rights at work																		X					
	6.4	Labor practices																							
	6.4.3	Employment and employment relationships																		X					
	6.4.4	Conditions of work and													X					X					

Standard/ Regulation/Guideline	Code	Description	Financial		Non-Financial			Material			Natural Resources		Energy		Health and Safety		Human Capabilities		Ethics								
			C1	C1.1	C1.2	C2	C2.1	C2.2	C2.3	C2	C2.1	C2.2	C3	C3.1	C3.2	C4	C4.1	C4.2	C5	C5.1	C5.2	C6	C6.1	C6.2	C7	C7.1	C7.2
		adaptation																									
	6.5.6	Protection and restoration of the natural environment											X														
	6.6	Fair operating practices																									
	6.6.3	Anti-corruption																								X	
	6.6.4	Responsible political involvement																								X	
	6.6.5	Fair competition																								X	
	6.6.6	Promotion social responsibility in the sphere of influence								X	X		X	X		X	X		X	X		X	X		X	X	

Standard/ Regulation/Guideline	Code	Description																																															
			C1	Financial	C1.1	Company's financial	C1.2	Economic distributed	C2	Non-Financial	C2.1	Quality	C2.2	Time	C2.3	Flexibility	C2	Material	C2.1	Material conservation	C2.2	Hazardous substances/material	C3	Natural Resources	C3.1	Natural Resources conservation	C3.2	Environmental prevention	C4	Energy	C4.1	Energy conservation	C4.2	Renewable energy	C5	Health and Safety	C5.1	Employee's Health and Safety	C5.2	Customer's Health and Safety	C6	Human Capabilities	C6.1	Knowledge and working skills	C6.2	Morality	C7	Ethics	C7.1
	6.6.7	Respect for property rights																																													X		
	6.7	Customer issues																																															
	6.7.3	Fair marketing, information and contractual practices																																												X			
	6.7.4	Protecting consumer's health and safety																																							X								
	6.7.5	Sustainable consumption																		X	X			X	X			X	X						X														
	6.7.6	Consumer service, support, and dispute resolution																	X																														

Standard/ Regulation/Guideline	Code	Description																																	
			C1	Financial	Company's financial	Economic distributed	C2	Non-Financial	Quality	Time	Flexibility	C2	Material	Material conservation	Hazardous substances/material	C3	Natural Resources	Natural Resources conservation	Environmental prevention	C4	Energy	Energy conservation	Renewable energy	C5	Health and Safety	Employee's Health and Safety	Customer's Health and Safety	C6	Human Capabilities	Knowledge and working skills	Morality	C7	Ethics	Human rights	Other Ethical issues
	6.7.7	Consumer data protection and privacy																																	X
	6.7.8	Access to essential services																																	X
	6.7.9	Education and awareness																															X		
	6.8	Community involvement and development																																	
	6.8.3	Community involvement																																	X
	6.8.4	Education and culture																												X			X		
	6.8.5	Employment creation and skills development																												X					

Standard/ Regulation/Guideline	Code	Description	Financial	Company's financial	Economic distributed	Non-Financial	Quality	Time	Flexibility	Material	Material conservation	Hazardous substances/material	Natural Resources	Natural Resources conservation	Environmental prevention	Energy	Energy conservation	Renewable energy	Health and Safety	Employee's Health and Safety	Customer's Health and Safety	Human Capabilities	Knowledge and working skills	Morality	Ethics	Human rights	Other Ethical issues
			C1	C1.1	C1.2	C2	C2.1	C2.2	C2.3	C2	C2.1	C2.2	C3	C3.1	C3.2	C4	C4.1	C4.2	C5	C5.1	C5.2	C6	C6.1	C6.2	C7	C7.1	C7.2
	6.8.6	Technology development									X	X												X			
	6.8.7	Wealth and income creation																			X						
	6.8.8	Health																									
	6.8.9	Social investment			X			X																			
					X		X			X	X		X	X		X	X		X	X		X	X		X	X	
Eco-Efficiency		Volume		X			X																				
		Mass		X			X																				
		Monetary		X			X																				
		Function		X			X																				
		Other Potentially Relevant Information		X			X																				

Standard/ Regulation/Guideline	Code	Description																						
			C1	Financial		Non-Financial		Material			Natural Resources		Energy		Health and Safety		Human Capabilities		Ethics					
			C1.1	C1.2	C2.1	C2.2	C2.3	C2.1	C2.2	C3	C3.1	C3.2	C4	C4.1	C4.2	C5	C5.1	C5.2	C6	C6.1	C6.2	C7	C7.1	C7.2
SCOR 9.0		Cost	X																					
		Asset	X																					
		Responsiveness			X																			
		Reliability				X	X																	
		Agility				X	X																	
		Carbon emission						X			X	X		X	X									
			X		X	X	X	X			X	X		X	X									
ISO9001	4.2	Documentation requirements			X																			
	5	Management responsibility																						
	5.1	Management commitment			X																			
	5.2	Customer focus			X	X																		

Standard/ Regulation/Guideline	Code	Description																										
			Financial	Company's financial		Economic distributed	Non-Financial	Quality	Time	Flexibility	Material	Material conservation	Hazardous substances/material	Natural Resources	Natural Resources conservation	Environmental prevention	Energy	Energy conservation	Renewable energy	Health and Safety	Employee's Health and Safety	Customer's Health and Safety	Human Capabilities	Knowledge and working skills	Morality	Ethics	Human rights	Other Ethical issues
			C1	C1.1	C1.2	C2	C2.1	C2.2	C2.3	C2	C2.1	C2.2	C3	C3.1	C3.2	C4	C4.1	C4.2	C5	C5.1	C5.2	C6	C6.1	C6.2	C7	C7.1	C7.2	
	5.3	Quality policy						X																				
	5.4	Planning					X	X	X																			
	5.5	Responsibility, authority and communication					X																					
	5.6	Management review					X	X	X																			
	6	Resource management																										
	6.1	Provision of resources					X				X		X		X													
	6.2	Human resources																				X						
	6.3	Infrastructure		X																								
	6.4	Work environment																	X									
	7	Product																										

Standard/ Regulation/Guideline	Code	Description	C1	C1.1	C1.2	C2	C2.1	C2.2	C2.3	C2	C2.1	C2.2	C3	C3.1	C3.2	C4	C4.1	C4.2	C5	C5.1	C5.2	C6	C6.1	C6.2	C7	C7.1	C7.2
			Financial	Company's financial	Economic distributed	Non-Financial	Quality	Time	Flexibility	Material	Material conservation	Hazardous substances/material	Natural Resources	Natural Resources conservation	Environmental prevention	Energy	Energy conservation	Renewable energy	Health and Safety	Employee's Health and Safety	Customer's Health and Safety	Human Capabilities	Knowledge and working skills	Morality	Ethics	Human rights	Other Ethical issues
		realization																									
	7.1	Planning of product realization					X																				
	7.2	Customer-related processes					X																				
	7.3	Design and development					X																				
	7.4	Purchasing					X																				
	7.5	Production and service provision					X																				
	7.6	Control of monitoring and measuring equipment																									
	8	Measurement, analysis and improvement																									

Standard/ Regulation/Guide line	Code	Description																										
			C1	Financial		Non-Financial			Material			Natural Resources		Energy		Health and Safety		Human Capabilities		Ethics		C7.1	C7.2					
			C1	C1.1	C1.2	C2	C2.1	C2.2	C2.3	C2	C2.1	C2.2	C3	C3.1	C3.2	C4	C4.1	C4.2	C5	C5.1	C5.2	C6	C6.1	C6.2	C7	C7.1	C7.2	
	8.1	General																										
	8.2	Monitoring and measurement					X																					
	8.3	Control of nonconformi ng product					X																					
	8.4	Analysis of data					X																					
	8.5	Improvement					X																					
				X			X	X	X		X			X			X			X			X					
ISO14001		Environment al aspects									X			X	X		X											
		Legals and Regulations																									X	
		Competence, training and awareness													X								X					

Standard/ Regulation/Guideline	Code	Description																									
			C1 Financial	C1.1 Company's financial	C1.2 Economic distributed	C2 Non-Financial	C2.1 Quality	C2.2 Time	C2.3 Flexibility	C2 Material	C2.1 Material conservation	C2.2 Hazardous substances/material	C3 Natural Resources	C3.1 Natural Resources conservation	C3.2 Environmental prevention	C4 Energy	C4.1 Energy conservation	C4.2 Renewable energy	C5 Health and Safety	C5.1 Employee's Health and Safety	C5.2 Customer's Health and Safety	C6 Human Capabilities	C6.1 Knowledge and working skills	C6.2 Morality	C7 Ethics	C7.1 Human rights	C7.2 Other Ethical issues
										X			X	X		X						X					X
ISO 14040		Environmental aspects in system boundary								X	X		X			X											
		Impact categories								X			X								X						
										X	X		X	X		X					X						
SA 8000		1. Child Labour																								X	
		2. Forced and Compulsory Labour																								X	
		3. Health and Safety																	X							X	
		4. Freedom of Association & Right to Collective Bargaining																							X		

Standard/ Regulation/Guide line	Code	Description	Financial			Non-Financial			Material			Natural Resources			Energy			Health and Safety							
			C1	C1.1	C1.2	C2	C2.1	C2.2	C2.3	C2	C2.1	C2.2	C3	C3.1	C3.2	C4	C4.1	C4.2	C5	C5.1	C5.2				
			Company's financial	Economic distributed	Quality	Time	Flexibility	Material conservation	Hazardous substances/material	Natural Resources conservation	Environmental prevention	Energy conservation	Renewable energy	Employee's Health and Safety	Customer's Health and Safety	Knowledge and working skills	Morality	Ethics	Human rights	Other Ethical issues					
		5. Discrimination																				X			
		6. Disciplinary Practices																						X	
		7. Working Hours																	X					X	
		8. Remuneration																				X		X	
		9. Management Systems																	X				X		X
																					X			X	