



HAL
open science

Adaptive Decision Support System for Smart Agricultural Crop Cultivation to Support Food Safety Standard

Paweena Suebsombut

► **To cite this version:**

Paweena Suebsombut. Adaptive Decision Support System for Smart Agricultural Crop Cultivation to Support Food Safety Standard. Artificial Intelligence [cs.AI]. Université Lumière Lyon2, 2021. English. NNT: . tel-04173540

HAL Id: tel-04173540

<https://hal.science/tel-04173540v1>

Submitted on 6 Aug 2023

HAL is a multi-disciplinary open access archive for the deposit and dissemination of scientific research documents, whether they are published or not. The documents may come from teaching and research institutions in France or abroad, or from public or private research centers.

L'archive ouverte pluridisciplinaire **HAL**, est destinée au dépôt et à la diffusion de documents scientifiques de niveau recherche, publiés ou non, émanant des établissements d'enseignement et de recherche français ou étrangers, des laboratoires publics ou privés.



THESE de DOCTORAT DE L'UNIVERSITÉ DE LYON

Opérée au sein de

L'UNIVERSITÉ LUMIÈRE LYON 2

Ecole doctorale : Informatique et Mathématiques

ED 512

Discipline : Informatique

ET

CHIANG MAI UNIVERSITY

Ecole doctorale : Gestion des connaissances

Discipline : Gestion des connaissances

Soutenue publiquement le 24 septembre 2021, par

PAWEENA SUEBSOMBUT

**Système d'aide à la décision adaptatif pour la culture agricole intelligente
afin de soutenir la norme de sécurité alimentaire**

Jury

M. Keshav DAHAL,
Mme. Punnarumol Temdee,
M. Seti FOUFOU,
M. Abu Baker Md SULTAN,
M. Abdelaziz BOURAS,
M. Pradorn SUREEPHONG,
Mme Aicha SEKHARI,

Professor, University of the West of Scotland, UK
Associate professor, Mae Fah Luang University, Thailand
Professor, Université de Bourgogne, France
Professor, Universiti Putra Malaysia, Malaysia
Professor, Université Lumière Lyon 2, France
Assistant professor, Chiang Mai University, Thailand
Associate professor, Université Lumière Lyon 2, France

Rapporteur
Rapporteur
Examineur
Examineur
Directeur
Directeur
Co-encadrant



DOCTORATE THESIS OF THE UNIVERSITY OF LYON

Operated within

UNIVERSITÉ LUMIÈRE LYON 2

Doctoral school: Computer science and Mathematics

ED 512

Discipline: Computer science

AND

CHIANG MAI UNIVERSITY

Doctoral school: Knowledge management

The degree in: Knowledge management

Publicly supported September 2021, by

PAWEENA SUEBSOMBUT

Adaptive Decision Support System for Smart Agricultural Crop Cultivation to Support Food Safety Standard

Jury

Mr. Keshav DAHAL,	Professor, University of the West of Scotland, UK	Member
Ms. Punnarumol Temdee,	Associate professor, Mae Fah Luang University, Thailand	Member
Mr. Seti FOUFOU,	Professor, Université de Bourgogne, France	Examiner
Mr. Abu Baker Md SULTAN,	Professor, Universiti Putra Malaysia, Malaysia	Examiner
Mr. Abdelaziz BOURAS,	Professor, Université Lumière Lyon 2, France	Director
Mr. Pradorn SUREEPHONG,	Assistant professor, Chiang Mai University, Thailand	Director
Ms. Aicha SEKHARI,	Associate professor, Université Lumière Lyon 2, France	Co-supervisor

COPYRIGHT OF Université Lumière Lyon 2
ACKNOWLEDGEMENTS

This research is part of a joint degree program (cotutelle) between the Decision and Information Systems for Production Systems (DISP) Laboratory at Université Lumière Lyon 2 in France and the College of Arts, Media, and Technology (CAMT) at Chiang Mai University in Thailand. As a result, I would like to begin by expressing my heartfelt gratitude to my advisors, Prof. Abdelaziz Bouras (Université Lumière Lyon 2) and Asst. Prof. Pradorn Sureephong (Chiang Mai University), who agreed to serve as co-directors of this thesis. They both dedicated their time and knowledge to advising on this research. Furthermore, they broadened my horizons not only in terms of research, but also in terms of international collaborations. These opportunities were valuable byproducts of my thesis.

I am extremely grateful to Assoc. Prof. Aicha Sekhari (Université Lumière Lyon 2) for agreeing to serve as co-advisers on this thesis. I find this incredibly fortunate to have them as advisors. My time under their tutorship was an amazing period in my life. Their suggestions have helped to improve the quality of my research. I am also thankful to Dr. Tanachai Pankasemsuk for agreeing to validate the rule-base section. I would also like to thank Prof. Sebti FOUFOU, Prof. Abu Bakar Md Sultan, Prof. Keshav Dahal, and Assoc. Prof. Punnarumol Temdee for agreeing to serve on the thesis's examining committee. My heartfelt thanks goes to Ms. Faranaaz Moolajee, my proofreader.

I would like to thank the SmartLink program scholarship (Erasmus Mundus program) for generously covering my travel, tuition fees, housing, and monthly expenses during my stay in France.

Additionally, I would like to thank my colleagues at the College of Arts, Media, and Technology, I.U.T. Lumière, and friends for their encouragement, assistance, and advice over the years. Finally, I am absolutely grateful to my beloved parents and older brother for their encouragement, wise counsel, sympathetic ear, and unwavering support and always being there for me.

Paweena Suebsombut

Thesis Title Adaptive Decision Support System for Smart Agricultural Crop Cultivation to Support Food Safety Standard

Author Ms. Paweena Suebsombut

The list of supervisors

Prof. Abdelaziz BOURAS

Assoc. Prof. Aicha SEKHARI

Asst. Prof. Pradorn SUREEPHONG

ABSTRACT

Agriculture is crucial since it provides food for the world's people. To meet market demands, farmers must control yield quality and quantity throughout crop cultivation. Farmers must therefore be knowledgeable in order to develop and preserve crops. During the crop's life cycle, crop management activities safeguard the crop cultivation from difficulties that affect yields, such as weather, infections, and insects, among others. To meet the aim of crop cultivation in each cultivation stage, a range of cultural treatments may be required.

The Food and Agriculture Organization of the United Nations (FAO) predicts that by 2050, the world's population will have risen to 9.1 billion people [FAO, 2009]. Food demand has risen in tandem with global population growth. To supply this demand for food, farmers must plant crops. As a result, agricultural resource use will rise. Water is the most vital resource for cultivation, followed by fertilizers, herbicides, and crop disease control agents, among other things. Because water is the most crucial ingredient in plant growth, agriculture's water consumption, as well as fertilizer, pesticides, and plant diseases, must increase as a result of the increased production volume. However, each crop has different water, fertilizer, and pesticide requirements, and crop diseases vary depending on the growing season. As a result, understanding how to manage these resources is essential. Furthermore, the current climate change issue has had a significant impact on agricultural production and quality [United States Environmental Protection Agency, 2016]. As an outcome, the use of smart technology for agriculture, also known as "Smart Agriculture," is another way to assist farmers in improving their crop cultivation processes in the current situation.

Smart Agriculture is a trend that emphasizes the use of information and communication technology in agriculture field. Smart Agriculture assists in guiding actions required to modify and reorient agricultural systems in order to effectively support development and ensure food safety (production and quality of yields) in an ever-changing climate. Smart agriculture technology is made up of various technological implementations and information, such as smart sensing and monitoring, smart control, cloud-based computing, smart analysis and planning to manage

cultivation production as an automatic system, decision support system, or expert system. At the moment, the existing decision support system for smart agriculture relies solely on data collected by intelligent sensors. According to experts, this is insufficient for making crop-maintenance decisions. Furthermore, existing knowledge-based systems or expert systems rely solely on data captured from human experts, which is insufficient for crop maintenance decisions. As a result, improving the functionality of decision-making systems requires combining smart technologies and human experts to provide appropriate recommendations to farmers based on data collected from smart sensors and technologies and expert judgment, which is the primary goal of this research.

As a result, in this thesis, an Adaptive Decision Support System (Adaptive DSS) was proposed to analyze data collected through the use of intelligent technology, both on and off the farm. Including rules for caring for plants in each growing season obtained from expert knowledge. Through a chat application, farmers will be given appropriate advice on how to care for their crops during each growing season or crop life-cycle, which includes watering, fertilizing, pest control, crop disease control, and weed control. This research is divided into three sections: Knowledge Engineering (KE), Adaptive Decision Support System (Adaptive DSS), and Data Visualization.

The first section involves using knowledge engineering (KE) approaches to capture knowledge from experts, extract knowledge from experts, and create rules for crop management in each growth phase based on the knowledge captured by experts. A knowledge matrix is used to define cognitive conflicts between experts by matching captured and extracted expert knowledge to the body of knowledge and crop maintenance process parameters. The crop maintenance rule-base was developed based on best practices and an analysis of expert knowledge conflicts. Furthermore, crop maintenance knowledge videos were created. These videos discuss the effects of each parameter on crops, as well as the reading and interpretation of data captured by sensor technology for use in sharing knowledge with farmers. Adaptive DSS is a system that analyzes on-farm and off-farm data, as well as the crop maintenance rule-base, in order to provide farmers with appropriate crop maintenance recommendations. The sensors are used to collect data on farms. The open weather station website is used to collect data from off-farm sources. As the management of water resources in crop cultivation is critical due to today's limited availability of natural fresh water, water management also needs to be anticipated. In crop irrigation, soil moisture value is very important to help determine if soil water is sufficient for crop growth or not. The soil moisture value in the near future is also predicted in the Adaptive DSS using a Long-Short Term Memory (LSTM) machine learning approach (Machine Learning, ML) to provide recommendations to farmers for water management on their farm. In terms of data visualization, it functions similarly to an interface used to control and communicate between the system and farmers via a mobile chat application. Farmers can monitor their farms and control crop maintenance of their own farm crops at any time and from any location. Farmers were overwhelmingly pleased with it, giving it a 96% satisfaction rating based on the implementation results.

Titre de la thèse Système d'aide à la décision adaptatif pour la culture agricole intelligente afin de soutenir la norme de sécurité alimentaire

Auteure Ms. Paweena Suebsombut

La liste des encadrants

Prof. Abdelaziz Bouras

Assoc. Prof. Aicha SEKHARI

Asst. Prof. Pradorn SUREEPHONG

ABSTRAIT

L'agriculture est cruciale car elle fournit de la nourriture à la population mondiale. Pour répondre aux demandes du marché, les agriculteurs doivent contrôler la qualité et la quantité des rendements tout au long de la culture. Les agriculteurs doivent donc être bien informés pour développer et préserver les cultures. Pendant le cycle de vie de la culture, les activités de gestion des cultures protègent la culture des difficultés qui affectent les rendements, telles que les conditions météorologiques, les infections et les insectes, entre autres. Pour atteindre l'objectif de la culture à chaque étape de la culture, une gamme de traitements culturels peut être nécessaire.

L'Organisation des Nations Unies pour l'alimentation et l'agriculture (FAO) prévoit que d'ici 2050, la population mondiale atteindra 9,1 milliards de personnes [FAO, 2009]. La demande alimentaire a augmenté parallèlement à la croissance démographique mondiale. Pour répondre à cette demande de nourriture, les agriculteurs doivent planter des cultures. En conséquence, l'utilisation des ressources agricoles augmentera. L'eau est la ressource la plus vitale pour la culture, suivie par les engrais, les herbicides et les agents de lutte contre les maladies des cultures, entre autres. Parce que l'eau est l'ingrédient le plus crucial dans la croissance des plantes, la consommation d'eau de l'agriculture, ainsi que les engrais, les pesticides et les maladies des plantes, doit augmenter en raison de l'augmentation du volume de production. Cependant, chaque culture a des besoins différents en eau, en engrais et en pesticides, et les maladies des cultures varient en fonction de la saison de croissance. Par conséquent, il est essentiel de comprendre comment gérer ces ressources. De plus, le problème actuel du changement climatique a eu un impact significatif sur la production et la qualité agricoles [United States Environmental Protection Agency, 2016]. En conséquence, l'utilisation de la technologie intelligente pour l'agriculture, également connue sous le nom '*d'agriculture intelligente*', est un autre moyen d'aider les agriculteurs à améliorer leurs processus de culture dans la situation actuelle.

L'agriculture intelligente est une tendance qui met l'accent sur l'utilisation des technologies de l'information et de la communication dans le domaine agricole. Smart Agriculture aide à orienter

les actions nécessaires pour modifier et réorienter les systèmes agricoles afin de soutenir efficacement le développement et d'assurer la sécurité alimentaire (production et qualité des rendements) dans un climat en constante évolution. La technologie de l'agriculture intelligente est composée de diverses implémentations et informations technologiques, telles que la détection et la surveillance intelligentes, le contrôle intelligent, l'informatique basée sur le potentiel, l'analyse intelligente et la planification pour gérer la production agricole en tant que système automatique, système d'aide à la décision ou système expert. À l'heure actuelle, le système d'aide à la décision existant pour l'agriculture intelligente repose uniquement sur des données collectées par des capteurs intelligents. Selon les experts, cela est insuffisant pour prendre des décisions en matière d'entretien des cultures. De plus, les systèmes basés sur les connaissances ou les systèmes experts existants reposent uniquement sur des données recueillies auprès d'experts humains, ce qui est insuffisant pour les décisions d'entretien des cultures. En conséquence, l'amélioration de la fonctionnalité des systèmes de prise de décision nécessite de combiner des technologies intelligentes et des experts humains pour fournir des recommandations appropriées aux agriculteurs sur la base des données collectées à partir de capteurs et de technologies intelligents et du jugement d'experts, ce qui est l'objectif principal de cette recherche.

En conséquence, dans cette thèse, un système d'aide à la décision adaptatif (Adaptatif DSS) a été proposé pour analyser les données collectées grâce à l'utilisation de technologies intelligentes, à la fois sur et hors de la ferme. Y compris les règles d'entretien des plantes à chaque saison de croissance obtenues à partir des connaissances d'experts. Grâce à une application de chat, les agriculteurs recevront des conseils appropriés sur la façon de prendre soin de leurs cultures au cours de chaque saison de croissance ou cycle de vie des cultures, ce qui comprend l'arrosage, la fertilisation, la lutte antiparasitaire, la lutte contre les maladies des cultures et la lutte contre les mauvaises herbes. Cette recherche est divisée en trois sections : l'ingénierie des connaissances (KE), le système d'aide à la décision adaptatif (Adaptatif DSS) et la visualisation des données.

La première section implique l'utilisation d'approches d'ingénierie des connaissances (KE) pour capturer les connaissances des experts, extraire les connaissances des experts et créer des règles pour la gestion des cultures dans chaque phase de croissance sur la base des connaissances capturées par les experts. Une matrice de connaissances est utilisée pour définir les conflits cognitifs entre experts en faisant correspondre les connaissances d'experts capturées et extraites au corpus de connaissances et aux paramètres du processus d'entretien des cultures. La base de règles d'entretien des cultures a été développée sur la base des meilleures pratiques et d'une analyse des conflits de connaissances des experts. De plus, des vidéos de connaissances sur l'entretien des cultures ont été créées. Ces vidéos traitent des effets de chaque paramètre sur les cultures, ainsi que de la lecture et de l'interprétation des données capturées par la technologie des capteurs pour une utilisation dans le partage des connaissances avec les agriculteurs. Adaptive DSS est un système qui analyse les données à la ferme et hors ferme, ainsi que la base de règles d'entretien des cultures, afin de fournir aux agriculteurs des recommandations appropriées pour l'entretien des cultures. Des équipements intelligents et la technologie des capteurs sont utilisés pour collecter des données dans les fermes. Le site Web ouvert de la station météorologique est utilisé pour collecter des données provenant de sources extérieures à la ferme. Comme la gestion des ressources en eau dans les cultures est critique en raison de la disponibilité limitée actuelle de l'eau naturelle, la gestion de

l'eau doit également être anticipée. Dans l'irrigation des cultures, la valeur de l'humidité du sol est très importante pour aider à déterminer si l'eau du sol est suffisante pour la croissance des cultures ou non. La valeur de l'humidité du sol dans un avenir proche est également prédite dans le DSS adaptatif à l'aide d'une approche d'apprentissage automatique à mémoire à long terme (LSTM) (Machine Learning, ML) pour fournir des recommandations aux agriculteurs pour la gestion de l'eau sur leur ferme. En termes de visualisation des données, il fonctionne de manière similaire à une interface utilisée pour contrôler et communiquer entre le système et les agriculteurs via une application de chat mobile. Les agriculteurs peuvent surveiller leurs exploitations et contrôler l'entretien de leurs propres cultures à tout moment et à partir de n'importe quel endroit. Sur la base du résultat de la mise en œuvre, les agriculteurs en étaient extrêmement satisfaits, lui attribuant un taux de satisfaction de 96 %.

TABLE OF CONTENTS

Contents	Page
Abstract	iv
Table of Contents	ix
List of Tables	xii
List of Figures	xiv
Introduction	1
Chapter I Context and Problematic	4
I.1. Introduction to Agriculture Context	4
I.2. Smart Agriculture (SA)	10
I.2.1. Smart Agriculture Technologies	10
I.2.2. Applications of Smart Agriculture Technologies	12
I.3. Research problematics and contribution	15
Chapter II Literature Review and Related Works	15
II.1. Crop's Cultivation and Maintenance	18
II.1.1. Crop's Life-cycle	18
II.1.2. Crop's Production and Maintenance Processes	19
II.1.3. Data relevant to crop production and maintenance	20
II.1.3.1. Parameters relevant to crop production and maintenance	20
II.1.3.2. Data collected relevance using IoTs technology	23
II.1.3.3. Summary data can be collected.	25
II.2. Smart Agriculture (SA)	26
II.2.1. Agriculture Sensor Technologies	26
II.2.2. Internet of Things Database	29
II.2.2.1. Cellular	29
II.2.2.2. ZigBee	30
II.2.2.3. RFID	30
II.2.2.4. Wi-Fi	30
II.2.2.5. LoRaWAN	31
II.2.2.6. Bluetooth	31
II.2.2.7. Message Queuing Telemetry Transport	31
II.2.2.8. Node-Red	32
II.2.2.9. Database	32
II.3. Knowledge Engineering (KE)	33
II.3.1 Knowledge Engineering Methodology	34

	Page
II.3.2.1. MOKA	34
II.3.2.2. Knowledge Matrix	35
II.3.2.3. CommonKADS	36
II.3.2.4. Knowledge Engineering Methodology Selection	38
II.4. Decision Support Systems (DSS)	39
II.4.1. DSS Technologies	39
II.4.2. Adaptive Decision Support System (ADSS)	40
II.4.3. Machine Learning (ML) based DSS/ADSS	43
II.4.3.1. ML Approach	43
II.4.3.2. ML Tools	44
II.4.3.2.1. Tensorflow Keras	44
II.4.3.2.2. Python Programming	45
II.4.3.2.3. Scikit-Learn	45
II.4.3.2.4. DialogFlow	45
II.4.3.2.5. PHP Script	46
II.5. User Interface: Chatbot Applications	47
II.5.1. Slack	47
II.5.2. WhatsApp	48
II.5.3. Line	48
Chapter III Proposed Methodology	50
III.1. Thesis Framework	50
III.2. Thesis Methodology	51
III.2.1. Knowledge Engineering	51
III.2.2.1. Knowledge Capture	51
III.2.2.2. Knowledge Processing	53
III.2.2.3. Rule-base Creation	54
III.2.2. Adaptive Decision Support System	58
III.2.2.1. Data Collection	59
III.2.2.2. Data Processing and Storage	61
III.2.2.3. Data Analysis (Adaptive DSS Model)	61
III.2.2.3.1. Recommendation system	61
III.2.2.3.2. Soil Moisture Forecasting Model	62
III.2.3. Data Virtualization	63

	Page
III.3. System Architecture	63
III.3.1. Knowledge Engineering architecture	63
III.3.2. Adaptive DSS architecture	65
III.3.2.1. On-farm and off farm data collection	65
III.3.2.2. Data storage source	66
III.3.2.3. Proposed Adaptive DSS model	66
III.3.3. Data Visualization	67
Chapter IV Rule-base Creation of Crops Recommendation	70
IV.1. Knowledge Capture	70
IV.2. Knowledge extraction	72
IV.3. Rule-based Creation	81
IV.4. Knowledge Videos	82
Chapter V Proposed Adaptive Decision Support System	84
V.1. Data Collection	84
V.2. Data Preprocessing and Storage	88
V.3. Adaptive Decision Support System (Adaptive DSS) Model	88
V.3.1. The Design of Soil Moisture Forecasting Model	89
V.3.1.1. Soil Moisture Forecasting Designing	89
V.3.1.2. Performance of Proposed Soil Moisture Forecasting Model	93
V.3.2. Recommendation System	98
Chapter VI Data Visualization and System Implementation	101
VI.1. Data visualization	101
VI.1.1. IoTs platform	101
VI.1.2. Line Chatbot Application	102
VI.2. Software (system) Implementation	104
Conclusion and Perspectives	112
References	115
Appendix	122

LIST OF TABLES

Tables	Page
I.1: Six main types of technologies involved in agriculture	11
I.2: Summary of smart agriculture technologies applications	14
II.1: Relevance parameters to plant's production	20
II.2: Parameters relevance to methods of crop maintenance	22
II.3: Current data collected using IoTs devices/technology	23
II.4: List of agriculture sensors [RF Wireless World, 2012]	27
II.5: List of most common sensors used in the agriculture domain	27
II.6 : IoT Protocols used in Smart Agriculture (SA)	32
II.7: Summary of literature review	43
III.1: List of questions to interview experts	52
III.2: List of criteria to select experts	53
III.3: Descriptions of parameters relevant to each crops maintenance processes	54
III.4: Structure to create the rule-base using 'IF-THEN' conditions	57
III.5: List of data collection for Adaptive DSS	60
IV.1: List of experts' profile	70
IV.2: Sample of knowledge captured to cultivate Lettuce from expert E1	72
IV.3: Sample of knowledge captured to cultivate Lettuce from expert E2	73
IV.4: Sample of knowledge captured to cultivate Lettuce from expert E3	74
IV.5: Sample of knowledge captured to cultivate Lettuce from expert E4	75
IV.6: Sample of knowledge captured to cultivate Lettuce from secondary knowledge	76
IV.7: Sample of knowledge matching matrix of day 1 from the first expert (E1)	77
IV.8: Sample of knowledge matching matrix of day 1 from the second expert (E2)	77
IV.9: Sample of knowledge matching matrix of day 1 from the third expert (E3)	78
IV.10: Sample of knowledge matching matrix of day 1 from the fourth expert (E4)	79
IV.11: Sample of knowledge matching matrix of day 1 from the secondary knowledge	80
IV.12: Sample of rule-base creation	81
V.1: List and purposes of data collected	86
V.2: Sample of data collected	88
V.3: Sample of data processed	88
V.4: The best hyperparameters based on our empirical study	90
V.5: List of 12 cases of learning rate (lr) and split ratio (sr)	91
V.6: Comparison of cross validation result of soil moisture forecasting model	97
VI.1: User satisfaction survey	104

Tables	Page
VI.2: List of sensors installed and data collected	105
VI.3: Result of satisfaction survey	111
Appendix	12

LIST OF FIGURES

Figures	Page
Schematic of thesis chapters	3
I.1: Share of world's farms and farmland area, by family and non-family farm status	4
I.2: Share of economic sectors in the global gross domestic product (GDP) from 2008 to 2018	5
I.3: Thailand: Share of economic sectors in the gross domestic product (GDP) from 2010 to 2020	6
I.4: Real GDP growth of the agriculture sector in Thailand from 2015 to 2018	7
I.5: World Population (1965 – 2050)	7
I.6: Global Agricultural Productivity (GAP) Index	8
I.7: IoTs in agriculture	13
I.8: Application of IoT in agriculture	13
II.1: Crops Life-cycle	18
II.2: Crops Maintenance Processes	19
II.3: List of parameters relevant to crops maintenance	25
II.4: Basic architectural components of a smart sensor	27
II.5: Sample of diagram to identify data flow and integration for smart agriculture	29
II.6 : MQTT Architecture	31
II.7: Classification of the most popular databases considering SQL and NoSQL structure	33
II.8: MOKA formal model	35
II.9: Domain Knowledge Matrix Model (DKMM)	36
II.10: CommonKADS model suite	37
II.11: Components and Structure of DSS (Architecture)	40
II.12: Architecture of ADSS	41
II.13: Machine learning techniques	43
II.14: the processing flow diagram of DialogFlow	46
II.15: Survey result of Thai farmer's technology usage	48
III.1: Thesis framework	50
III.2: Methodology of knowledge engineering part	51
III.3: Procedure to capture knowledge from experts	51
III.4: Knowledge Matrix	54
III.5: Methodology of Adaptive DSS part	59
III.6: Data collection using sensor devices diagram	60
III.7: Adaptive DSS diagram for recommendation system	62

Figures	Page
III.8: Irrigation Optimization Diagram	62
III.9: Design data visualization methodology	63
III.10: Architecture of knowledge engineering part	64
III.11: Architecture of On-farm and off-farm data collection	65
III.12: Architecture of IoTs data storage	66
III.13: Architecture of data analyzing (proposed ADSS model)	66
III.14: Recommendation system architecture	67
III.15: IoTs dashboard architecture	67
III.16: System Architecture	69
IV.1: Farm visiting during interviewing experts	71
IV.2: List of knowledge video	82
V.1: List of parameters relevant to crops maintenance	84
V.2: Data collection location	85
V.3: Multiple sensors installed for data collection (4 soil moisture sensors, (1 air indoor sensor, and 1 weather station)	87
V.4: Proposed model architecture	89
V.5: Prediction in different time stems and time steps	91
V. 6: Comparison error results of Soil Moisture value forecasting in different cases of learning rate (lr) and split ratio (sr) – LSTM model	94
V.7: Comparison error results of Soil Moisture value forecasting in different cases of learning rate (lr) and split ratio (sr) – Bi-LSTM model	94
V. 8: Comparison error results of Soil Moisture value forecasting in Different time interval (LSTM model)	95
V.9: Comparison error results of Soil Moisture value forecasting in Different time interval (Bi-LSTM model)	95
V.10: Result of soil moisture forecasting	96
V.11: Zoom in of the red box in (a) Figure 16(a) (b) Figure 16(b)	97
V.12 : Flow of Recommendation System	99
V. 13: Demonstration of data processing using Adaptive DSS on day 1 and 2	100
VI.1: Login page of IoTs platform	101
VI.2: Functions of the IoTs Platform	102
VI.3: Flow of the ‘AgriRec’ Line chatbot application	103
VI.4: Methodology for software (system) implementation	104
VI.5: Dimension of Greenhouse, weather station installation and control box setup	106
VI.6: Comparison of implementation	107
VI.7: QR code to login to AgriRec Line chatbot application	108
VI.8: Demonstration of data processing sample on day 1 and day 2	108

Figures	Page
VI.9: Main page and Start menu of Line AgriRec chatbot	109
VI.10: Field information, situation, and knowledge video	109
VI.11: Irrigation page	110
VI.12: Monitor page	110

Introduction

Nowadays, smart technologies play an important key role in the agriculture sector which is enhancing farm production efficiently. This is related to Smart Agriculture (PA) which is the process of collecting, processing, analyzing the data. This uses extensive technology automation (such as Internet of Things or IoTs) to make the farm intelligently supported [Aioti, 2015]. Smart Agriculture is adopted as an important solution for agriculture to enhance crop cultivation and maintenance processes and to improve the quality of productivity. Smart Agriculture helps to guide actions required to modify and reorient the agricultural systems to effectively support the development and guarantee food safety and food security during an ever-changing climate [Aniket Patil, 2016].

With the implementation and interconnection of different technological solutions through the use of Information and Communication Technology (ICT), producers are able to replace conventional agricultural tools, obtaining a more intelligent, efficient, reliable, and sustainable system [Chapman R, et al., 2002]. There is a large number of ICT solutions that can be applied to the agricultural sector such as smart agriculture, tracking systems, food safety and quality management, food processing and manufacturing, and consumer food awareness. These solutions can be categorized fundamentally into five main types of technologies: monitoring and environmental sensing, specialized hardware and software, telematics and positional reference, communication systems (IoT, 5G, Wifi, etc.), and analysis of Information systems [Collado, Edwin, et al., 2019]. The existing decision systems use only data measured by using intelligent sensors and smart systems such as sensor networks and technology to predict/control cultivation practices in the whole cycle of cultivation, or use only expert's knowledge to suggest the solution or best practices for cultivation and maintenance of crops. Indeed, using only measured data or only captured knowledge is not enough for current agriculture production. Consequently, we need to combine the smart technology with the high-level cognitive support with the expert knowledge and decision-making process to provide a high level platform for agriculture. Our thesis aims to aggregate smart agriculture technologies and expert's knowledge and best practices to support the agricultural production of the farmers. We focus on four research questions as follows.

- *What are the parameters and relevant data for crop production and maintenance?* Since several factors impact the different stages of crop life-cycle and maintenance processes, we need to define the relevant factors and their parameters impacting the crop cultivation, including the data that can be collected, using smart technologies and the cultivation knowledge from experts.
- *What is the typology of data and where does it originate?* After we've defined the parameters and data, we need to figure out what each data type is and where it comes from. In this activity, we will categorize the data that will be collected based on the type of data source.
- *How should data be gathered and pre-processed?* These activities involve the specification of the data collection and pre-processing methods and processes. The collected data will be prepared before being analyzed.
- *How to analyze the data to provide an appropriate recommendation?* This activity is needed to achieve a specific decision support system based on the collected data and captured knowledge for a specific field.

This leads us to organize our work into six chapters as follows:

Chapter one is dedicated to the description of the context in which the research work has been conducted. In the context part, we introduce the smart agriculture concept, and its benefits and constraints. The present smart agriculture situation in Thailand and northern Thailand are described, including relevant Thailand government's policy enhancement perspective linked to Sustainable Development Goals (SDG). The principal hypothesis and problematic are defined and the contribution of this thesis is presented.

Chapter two focuses on smart agriculture technology and knowledge engineering (KE) context which were divided into five parts. In a first part describing the concept and process of crop's cultivation/ maintenance, the factors, parameters and data are defined. A second part of this chapter aims at studying the current smart agriculture systems and issues. A third part studies the knowledge engineering concept and methodology which helps to capture experts' knowledge and to share this knowledge. A fourth part focuses on the decision support system application in the agriculture field and a final part describes a method to evaluate the farmer's knowledge through the use of the proposed system.

Chapter three mainly focuses on the proposed research methodology for designing the decision support system for agricultural production. The methodology and system architecture are described step by step through three parts: Knowledge Engineering (KE), Adaptive Decision Support System (Adaptive DSS), and Data Visualization. The Knowledge Engineering section includes knowledge capture, knowledge processing and storage, and rule-base creation. The Adaptive DSS component includes sensing data collection, data processing and storage, and data analysis to provide an appropriate recommendation based on the rule-base and sensing data. The data visualization component serves as the user interface for communicating between the user and the system through the chatbots application. The proposed methodology and architecture can be applied to other areas of agriculture (with different crop types).

Chapter four concentrates on the construction of the recommendation rule-base. The technique and list of knowledge captured are described, then the Knowledge Engineering (KE) technique is used for knowledge extraction. The knowledge matrix is created to match between extracted expert's knowledge and parameters relevant to crops maintenance processes as reviewed in chapter II. The results of this chapter are the list of rule-base as it is a list.

Chapter five concentrates on the proposed Adaptive Decision Support System (Adaptive DSS). The architecture and implementation results of the recommendation system based on crops maintenance processes are described. The architecture is also described and the results of irrigation optimization with the proposed soil moisture forecasting model based on a Deep Learning approach. The data pre-processing method and the results are also described to define and prepare a dataset for the proposed forecasting model. Then, the appropriate Python programming and a Long-Short Term Memory (LSTM) Deep Learning approach are described to construct the proposed soil moisture forecasting model. Finally, the results of the proposed forecasting model are provided. Then, the integration architecture and flow are highlighted. The outcomes from this chapter are an architecture and scenarios of the Adaptive DSS.

Chapter six concentrates on the data visualization using chatbot application and system implementation. The Line chat application is used as the user interface to communicate between Adaptive DSS and user. The php script and DialogFlow are described to the proposed Line chatbots functions. The user receives the recommendations and monitors the farm climatic

conditions via Line chatbots application. The proposed Adaptive DSS was implemented in Chiang Mai province, Thailand, to make tests in the real field. The implementation steps and results are explained in this chapter.

As a result, three scenarios are demonstrated. The first scenario focuses on the knowledge engineering process. It demonstrates how to capture, extract, and construct rules from expert knowledge to support the crop maintenance process. The second scenario focuses on the added value of the decision-making system, which is an Adaptive DSS model based on the described aggregation of sensing data and rule-base to provide recommendations for crop maintenance processes. In this scenario, the soil moisture forecasting model is also focused, as part of the proposed Adaptive DSS irrigation optimization. Based on geological data collected from smart sensors, the forecasting model aids in predicting the future soil moisture values. The final scenario displays the user interface for data visualization to the user via the Line chatbot application. It focuses on the functions of the Line chatbots application, which includes data monitoring, irrigation control, and a main page to receive relevant data and recommendations.

Based on the descriptions of each chapter provided above, we can create a link between all of these chapters to better understand their relationship, as illustrated in Figure 1. It depicts a schematic overview of the relationship between the thesis chapters. The Introduction refers to Chapter 1, which is relevant to the explanation and issues discussed in the Introduction section. The research questions one and two (Q1 and Q2) are linked to chapter 2, which is the literature review and related works to define the appropriate method/technique for this thesis. The research questions three and four (Q3 and Q4) refer to the main tasks of this thesis, which are covered in chapters 4, 5, and 6. Chapter 3 connects to Chapter 4 and then to Chapter 6, which is the framework and architecture of each scenario component.

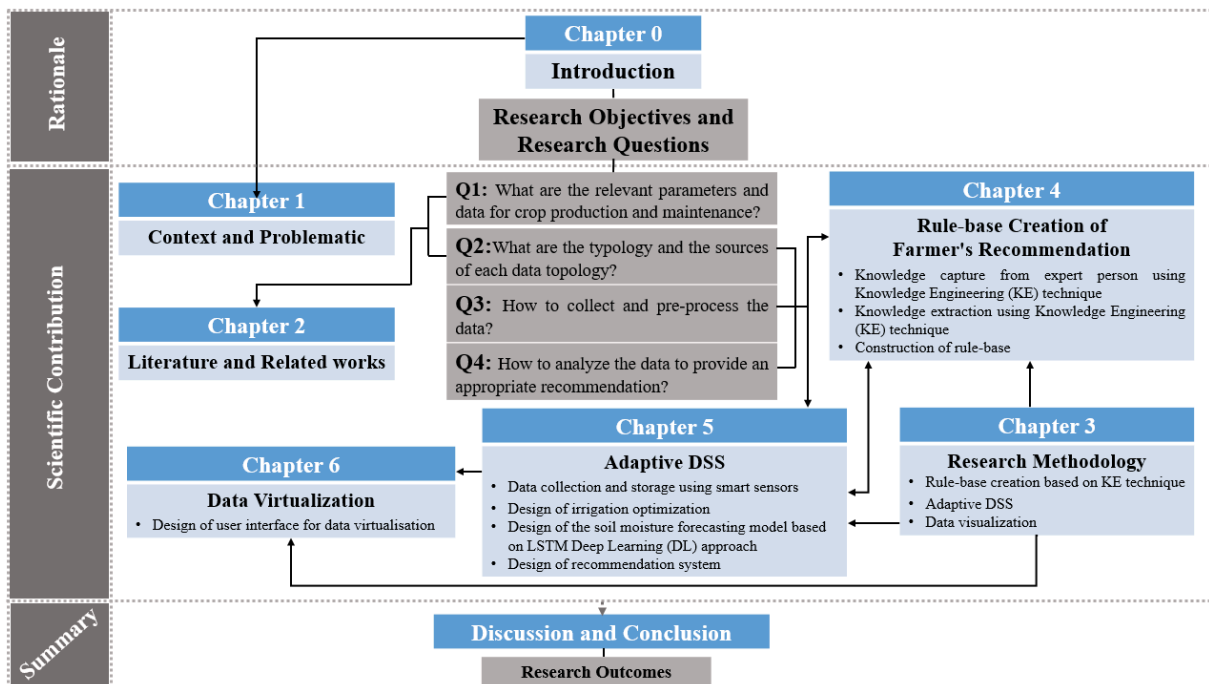

Figure 1. Schematic of the thesis chapters

CHAPTER I

Context and Problematic

In this chapter, the general context of agriculture is described including the agricultural practice issues. The second section focuses on the smart agriculture technologies and application, and issues of smart agriculture systems are described. The final section describes the problematics and thesis' contribution as well as the research questions based on the problematic. The main objective of this chapter is to better understand the agriculture and its issues, the smart agriculture context, as well as the issues surrounding smart agriculture applications.

I.1. Introduction to Agriculture Context

Agriculture, also known as farming, is the farm practices, activities of crops production and livestock to produce the vast majority of the world's food supply [Ben G. Bareja., 2014; Kipps, M.S., 1970]. Agriculture was the key development in the rise of sedentary human civilization, whereby farming of domesticated species created food surpluses that enabled people to live in cities. Agricultural products have been a main stay of the human diet for many thousands of years. The earliest known farming has been found to have derived from Southeast Asia almost 10,000 years ago [Montgomery D. Dirt, 2008], and widely established for only 7,000 years [Bulliet RW, et al., 2008]. People began to shift away from hunting and gathering to planting crops and raising livestock for food.

Agriculture is very important to human because more than 60% of world population depends on agriculture for survival [Gianluca Zavatta, 2014] and 65% of poor working adults made a living through agriculture according to the report of Food and Agricultural Organization, FAO, [World bank, 2019; Castaneda, Raul, et al, 2016]. The world's total number of farms is presently projected to be around 570 million farms. The estimate is based on surveys from six rounds of the World Census of Agriculture (from 1960 to 2010), and each country is given the most recent estimate available. As indicated in Figure I. 1, more than 90% of farms are owned and operated by a single person or a family, and they rely heavily on family labor. Family farms account for a significant portion of global agricultural lands and produce over 80% of the world's food.

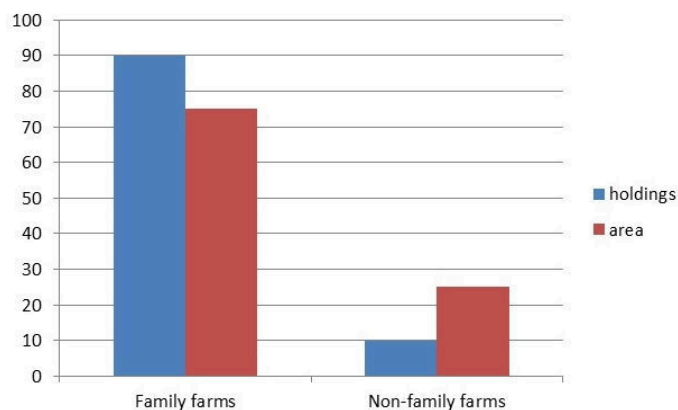

Figure I.1: Share of world's farms and farmland area, by family and non-family farm status [Sarah Lowder, et al., 2014]

Agricultural sector plays a strategic role in the process of economic development of a country. It has already made a considerable contribution to industrialized countries' economic success, and its role in emerging countries' economic development is crucial. Agriculture is equally important for economic growth: it accounted for 4% of global GDP in 2018 [Aaron O'Neill, 2020], as illustrated in Figure I.2, and it can account for more than 25% of GDP in some developing nations [World Bank, 2020]. Global agricultural production has grown at a pace of between 2% and 4% yearly over the past 50 years, according to a World Bank report from 2012 [Gianluca Zavatta, 2014]. Between 1961 and 2011, global farmers' income increased by 746 billion dollars to 2,397 billion dollars [Alston, Julian M., et al., 2014].

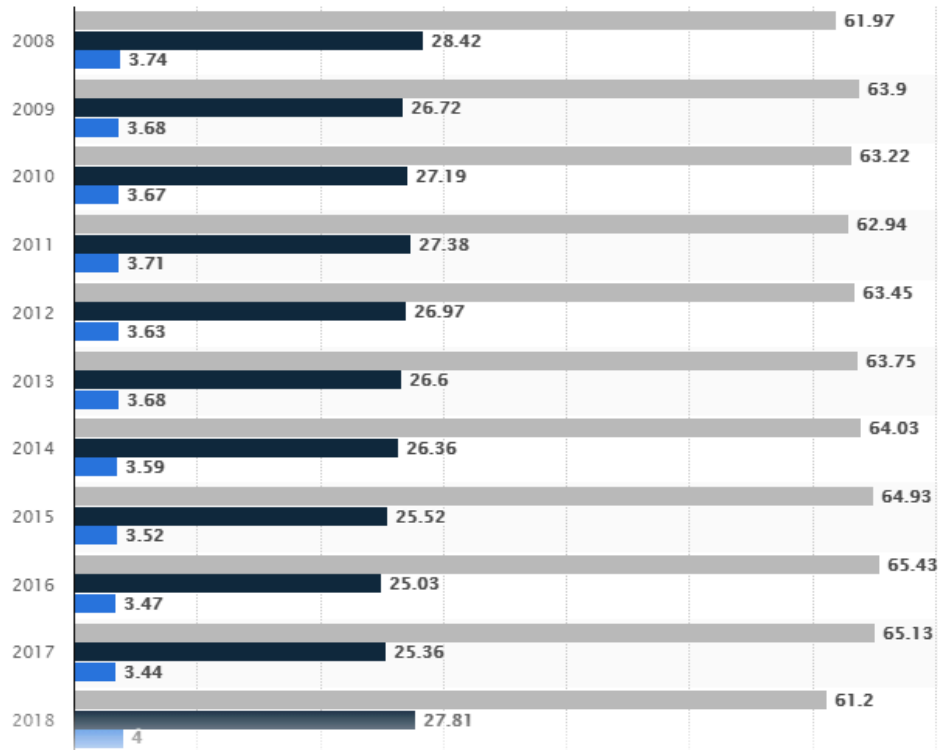

Figure I.2: Share of economic sectors in the global gross domestic product (GDP) from 2008 to 2018 [Aaron O'Neill, 2021]

It is seen that increased agricultural output and productivity tend to contribute substantially to an overall economic development. Even developed countries lay emphasis on agricultural development. According to Muir, “Agricultural progress is essential to provide food for growing non-agricultural labor force, raw materials for industrial production and saving and tax revenue to support development of the rest of the economy, to earn foreign exchange and to provide a growing market for domestic manufactures.” It will be rational and appropriate to place greater emphasis on further development of the agricultural sector.

Thailand is a main exporter and manufacturer country of agricultural products. Agricultural sector in Thailand has long been playing its important role in terms of serving the global demand for both basic and processed agricultural products. However, the characteristics of Thai farming is considered small-scaled since most of farms are owned and operated by family members and inherited from one generation to the next. That basis was reaffirmed by the fact that agricultural GDP of Thailand was only 12% whereas more than 30% of populations were in the sector. Throughout the country, Thailand’s farmland area is about 24 million hectares

- 68% for field crops, 23% for perennial trees - with limitation of irrigation, which takes up 40% of the country's land [Singhapreecha, Charuk, 2014]. Agriculture sector in Thailand employs around 30 percent of total labor force covering 6.4 million households [United Nation, 2020] with 4 members per household on average. The average farm-size is only 4 hectares per household and having 16.2 million labor forces involved in agriculture activities. In an individual household, the level of cash income is as low as 0.24 million Thai Baht per year - about 60% come from farm income.

The agriculture in Thailand can be categorized into rice farming, vegetables, rubber plantation, fruits plantation, farming plants, and raising livestock. Rice is the nation's highly exported agricultural product. Other agricultural exports are cassava, fresh fruits, orchid, corn, and rubber. Thai agricultural exports have earned tens of thousands Baht or more each year [Beecham Research, 2014]. According to a report of GDP from Agriculture in Thailand by the National Economic and Social Development Board (NESDB) Thailand, GDP from Agriculture in Thailand in the second quarter of 2016 is 124,333 million Thai Baht (THB) that is increased from 121,350 million Thai Baht in the first quarter of 2016 [Trading Economics, 2016]. In 2019, the share of agriculture in Thailand's gross domestic product was 8.14 percent and 8.64 percent in 2020 as shown in Figure I.3. GDP from agriculture in Thailand in 2019 is around 533,055 million Thai Baht.

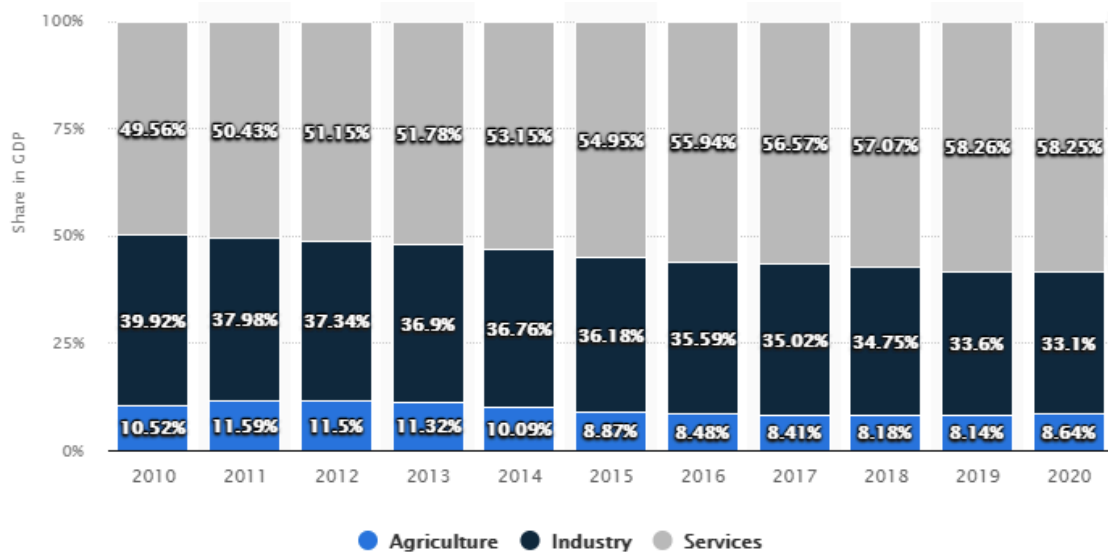

Figure I.3: Thailand: Share of economic sectors in the gross domestic product (GDP) from 2010 to 2020 [Statista, 2021]

In addition, since 2015, the GDP growth of agriculture in Thailand had been slowly increasing and reached its highest GDP growth percentage in 2018 as shown in Figure I.4.

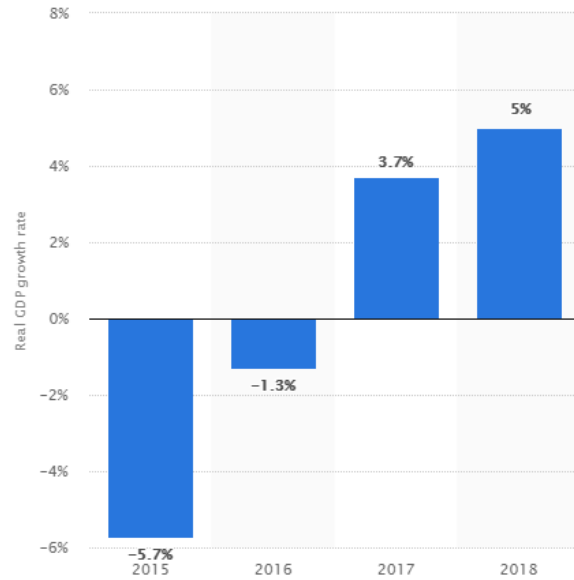

Figure I.4: Real GDP growth of the agriculture sector in Thailand from 2015 to 2018 [Hansa Manakitsomboon, 2020]

In 2020, the total value of agricultural products exported from Thailand reached 1.58 trillion Thai Baht. In 2019, Thailand was the 14th largest export market for U.S. agricultural products (including seafood and forestry products). U.S. exports of agricultural and related products to Thailand in 2019 decreased by 14 percent, from about \$2.24 billion in 2018 to \$1.9 billion. U.S. imports of Thai agricultural fishery and forest products in 2019 increased by 5.5 percent from \$3.98 billion in 2018 to \$4.2 billion. Consumer-oriented products accounted for the largest share of U.S. agricultural product imports from Thailand in 2019 at 40 percent, followed by seafood products 29.5 percent, bulk commodities 24.5 percent, intermediate products 3 percent, and forest products 2 percent, respectively. It is seen that the increase share of agriculture in gross domestic product (GDP) in Thailand tend to contribute substantially to the overall economy of the country.



Figure I.5: World Population (1965 – 2050) [Nations Secretariat , 2007]

According to the prediction of the Food and Agriculture Organization (FAO), the world population will increase to over nine billion people in the year 2050 (see Figure I.5) that emphasizes on the necessity and importance to increase the awareness on quality, quantity, and sufficiency of food for the population in the world [Beecham Research, 2014]. Balancing between population growths and the food supply is the aim of food security. Food production is not expanding fast enough to feed the world sustainably in 2050, according to a report by the Global Harvest Initiative (GHI) as indicated in Figure I.6. The food productivity gap is particularly severe in low-income nations, which are not increasing food production at a rate fast enough to meet future demand. According to the GAP study, "Total Factor Productivity" in low-income nations and the global economy is rising at 0.96 % and 1.51 % annually, respectively, which is lower than predicted growth over the previous two years. This is significantly below the pace of growth required to meet the long-term targets of doubling food productivity in low-income countries and attaining "zero hunger" by 2050. Global agricultural productivity must improve by 1.75 % annually to meet the estimated demand of 10 billion people in 2050, according to the GAP research. Therefore, new chain cooperation and applications can lead to a more responsive and dynamic food production network. This can be accomplished by an attempt on making an appropriate distribution of food to all parts of the world.

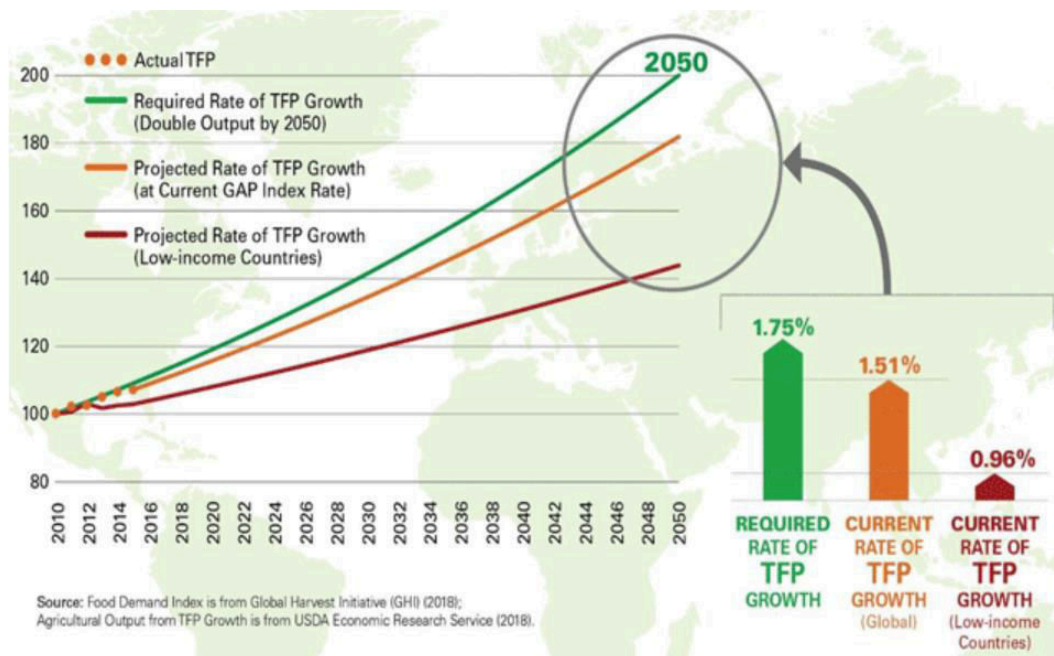

Figure I.6: Global Agricultural Productivity (GAP) Index

Based on the increasing of food demand, production and maintenance crops are also increase the input usage such as water, fertilizer, pesticide, etc. Production of crops is water-intensive as a result agriculture is the largest water user accounting 70% of global water withdrawal and rest 30% is used by municipal, energy and industrial sectors. The global demand for food is expected to increase by 70% by 2050 [The United Nations, 2017]. Water is important for food security, crop growth, livestock, and food markets. Lack of water can be a major cause of famine and undernourishment, especially in areas where people depend on local agriculture for food and livelihoods. OECD projected that 3.9 billion people - in total over 40% of the world's population - are likely to be living in river basins under severe water stress by 2050.

Near East/North Africa and Northern China are water scarce regions. Thus, water optimization is significant to manage water use for agriculture production.

As important of water to agriculture production, water plays essential roles in crops as a constituent because crops are composed about 70% of water and can be as much as 95% of water in some types of crop [Julie Cook, et al., 2018; Kramer, Paul, et al., 1995]. All stages of a crop's life require water that are various functions of water in crops comprising to maintain cell turgidity for structure and growth of crops and root, to dissolve minerals and nutrients from the soil surrounding the root system, to transport nutrients and organic compounds throughout the stems and leaves, transpiration, photosynthesis, and to be a buffer of the plants against wide temperature fluctuations [Paul, et al., 1995]. Maintaining cell turgidity for structure and growth of crops and root, water fills the cells of plants providing firm support so that is why crops wilt when deprived of water and perk up after receiving water. Transpiration is the process of maintaining the crops within a tolerable temperature range that water moves up the stem of a crops from root to leaf when water is lost from the crops due to evaporation occurring at the stomata (tiny microscopic pores present on the surface of leaves) to allow for the exchange of oxygen and carbon dioxide with the atmosphere during photosynthesis. Photosynthesis is the process of crops used to convert the sun's energy into food. Water molecules combine with carbon to produce glucose, which the crop uses as food. Hence, water is very significant to crops growth and yield. The crops require an appropriate irrigation during crops' cultivation and life-cycle, otherwise, its growth and yield will reduce due to water deficit [Bouazzama, B., et al., 2012; Sun, Shuhong, et al., 2015; Van Ha, C., et al., 2014; Osakabe, Yuriko, et al., 2014; Najihah, Tuan Syaripah, et al., 2019; Al-Kaisi, Mahdi M., et al., 2009; Lipiec, Jerzy, et al., 2013] (see chapter II).

In addition, due to unpredictable environmental situation, such as climate change, which is a major issue for cultivation, is impact to the food safety. Climate change can create unwanted risks to the environment. The consequences of experiencing heavy rainfalls, more extreme droughts, flooding, and the increasing in emissions of greenhouse gases resulting from human activities can abruptly change the seasonal life cycle events of crops [4]. From the Intergovernmental Panel in Climate Change (IPCC) report in 2010, the emissions of Global Greenhouse Gas by forestry, agriculture, and other land use sector is around 24% excluding CO₂ [6]. Mostly greenhouse gas emissions from agricultural sector occur from agriculture in both cultivation and livestock, and deforestation to make way for cultivation of crops and livestock. Moreover, the shifting distribution of pests and diseases also has an impact on food production in the future (see chapter II).

To achieve food security, the agricultural crops cultivation needs to be controlled due to the higher consumer's demand and unpredictable environment likes climate change. Therefore, current agricultural practices require smart technology as supporting due to several issues such as the climate change impact on the crops maintenance processes and the quality of agriculture products. Consequently, to reduce the risk from highly damages of farming operation based on food safety standard is to adopt the concept of '*Smart Agriculture*' for farms management by following the conditions of farm situation.

I.2. Smart Agriculture

According to the concept of Smart Farming from European Network Mainstreaming Smart Farming Technologies among the European farmer community (Smart AKIS Network), ‘*Smart Agriculture (SA)*’ is one of the three pillars of modern information and communication technologies (ICT) application which is a concept of farm management to observe and measure variance in cultivation using smart technology and decision support system (DDS) for managing whole farm including fertilizing, irrigation, pesticides, etc., and enhancing quality of productivity [Bongiovanni, Rodolfo, et al., 2004]. Smart Agriculture is an application of collecting, processing, and analyzing of data, and automation technology to make farm intelligent supported by Internet of Things (IoTs) that relate to Smart Agriculture (PA) and Precision Livestock Farming (PLF) [AIOTI, 2015].

The smart agriculture is a concept of farm management to observe and measure variance in cultivation using smart technology and decision support system (DDS) for managing whole farm including seeding, crop yield, fertilizer, irrigation, pesticides etc. and enhancing quality of yields. Smart agriculture technology is composed of a variety of different technological implementations and information, such as smart sensing and monitoring, smart control, cloud-based computing, smart analysis and planning that are applied in a variety of areas in the world, which has an effect of climate change for improving production and the quality of yields [Banhazi, Thomas M., et al., 2012]. The main aim of smart agriculture is to increase the agricultural productivity and incomes. Agricultural yield has surged since the implementation of smart agriculture solutions. The quality of produce has improved and increased substantially. Additional, Farmers can decrease in the use of pesticides, fertilizers, and water that means there are low disposal of chemicals into agricultural yields. Furthermore, we can trace the production process and quality of yield from data collected by smart agriculture system (IoTs technology) [Wongpatikaseree, Konlakorn, et al., 2018].

Smart Agriculture is being adopted as an important solution for agriculture in order to improve crop production and maintenance processes as well as productivity quality. Smart Agriculture assists in guiding actions required to modify and reorient agricultural systems in order to effectively support development while also ensuring food safety and security in an ever-changing climate [Aniket Patil, 2016]. Smart Agriculture is a concept that emphasizes the use of information and communication technology (ICT) in the farm management cycle [Wolfert, Sjaak, et al., 2017].

I.2.1. Smart Agriculture Technologies

Nowadays, smart technologies play an important key role into agriculture sector which is enhancing farm production efficiently. Smart Farming is primarily comprised of ICT, but it also includes Biotechnology and Nanotechnology [Collado, Edwin, et al., 2019]. It has a significant application in agriculture because it enables producers to increase crop productivity, implement pest and disease resistance mechanisms, develop strategies to combat climate change, and improve the quality and durability of products during harvest or shipment [Abah J, et al., 2010]. Nanotechnology is the scientific principle that allows materials and equipment to manipulate physical and chemical properties. This technology can be used in all stages of agriculture, including production, processing, storage, packaging, and transportation [Mousavi

SR, et al., 2011; Prasad R, et al., 2014]. Among the most notable applications are smart agriculture, improved plant nutrient absorption, efficient and targeted input use, disease detection and control, mechanisms of resistance to climate change, food processing, storage, and packaging tools, use of nanoparticles in animal sciences, and detection of environmental contamination [Collado, Edwin, et al. 2019].

In the agricultural sector, with the implementation and interconnection of different technological solutions through the use of ICT, producers will be able to replace conventional agricultural tools, obtaining a more intelligent, efficient, reliable, and sustainable system [Chapman R, et al., 2002]. There are a large number of ICT solutions that can be applied to the agricultural sector such as smart agriculture, tracking, and animal tracking systems, food safety and quality management, food processing and manufacturing, consumer food awareness. These can be categorized fundamentally into six main types of technologies: sensing technologies, software applications, communication systems (cellular, wifi, etc.), telematics and positional technologies, specialized hardware and software systems, and data analytics [Collado, Edwin, et al., 2019; Beecham Research Limited, 2014] as described in Table I.1.

Table I.1: Six main types of technologies involved in agriculture

Types of technologies	Description	Device/Tool	Citation
Sensing Technologies	It is a technology that uses sensors to acquire information by detecting the physical, chemical, or biological property quantities and convert them into readable data. It is used for gathering data around the clock for an entire field. This information is forwarded to IT systems for tracking and analysis to give an “eye in the field” or “eye in the barn” that makes remote monitoring possible.	Sensor devices i.e. soil moisture sensor, temperature sensor, weather station, etc.	Mukhopadhyay, Subhas Chandra, et al., 2018; Potorti, Francesco, et al., 2020; Beecham Research limited, 2014
Software Applications	It is software that performs specific tasks for an end-user. It also includes the category of mobile apps, including communication apps such as WhatsApp or Line. There are also app versions of common services such as those providing weather or transport information or apps for customers to interact with companies or systems.	Tools/Apps for farm management i.e. FarmLog, AgriWebb, etc.	Pat Research, 2020; alexander sword, 2017
Communication Systems	It is a system which describes the information exchange between two points. The process of transmission and reception of information is called communication. The major elements of communication are the Transmitter of information, Channel or medium of communication and the Receiver of information.	4G, WIFI, Internet of Things (IoTs), etc.	Islam, Nahina, et al., 2021; Atmaja, Ardian Prima, et al., 2021 ; Collado, Edwin, et al., 2019

Types of technologies	Description	Device/Tool	Citation
Telematics and Positional Technologies	It is the technology used to monitor a wide range of information relating to an individual vehicle or an entire fleet. Telematics systems gather data including vehicle location, driver behavior, engine diagnostics and vehicle activity, and visualize this data on software platforms that help fleet operators manage their resources.	GPS, Satellite, drone, etc.	Saiz-Rubio, Verónica, et al., 2020 ; Smartrak, 2021; Arizton, 2018
Hardware and Software Systems	It is a specialized systems and applications for enabling IoT-based solutions, robotics and automation for agriculture.	Internet of Things (IoT), robots, etc.	Sushanth, G., et al., 2018; Beecham Research Limited, 2014; Sharma, Brij Bhushan, et al., 2020; Pat Research, 2020
Data Analytics	It is defined as a process of cleaning, transforming, and modeling data to discover useful information for decision-making and prediction. Data collection is a significant part of smart farming as the quantity of data available from crop yields, soil-mapping, climate change, fertilizer applications, weather data, machinery and animal health continues to escalate. The purpose of Data Analysis is to extract useful information from data and taking the decision based upon the data analysis.	Python, MatLab, SQL, etc.	Muangprathub, Jirapond, et al., 2019; Delgado, Jorge A., et al., 2019 ; Elijah, Olakunle, et al., 2017 ; Elijah, Olakunle, et al., 2018 ; Wolfert, Sjaak, et al., 2017 ; Knierim, Andrea, et al., 2019 ;

I.2.2. Applications of Smart Agriculture Technologies

Current smart agriculture systems are an automatic systems and decision support systems (DSS) that farmers can collect data, monitor, making-decision, and control production via smartphones or computers by using Internet of Things (IoT) technology. The IoT technology or machine to machine (M2M) technology is connection devices such as electronics, sensors, computer, smartphone, etc. together via internet communication that human can monitor or control devices through the internet [Sundresan P., et al., 2015] as illustrated in Figure I.7.

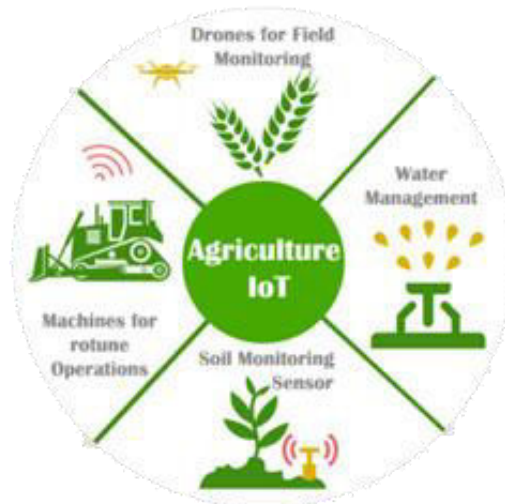

Figure I.7: IoTs in agriculture [Shubhi Mittal, 2020]

Figure I.7 shows the concept of IoT technology in agriculture sector. The application of smart technology includes using sensors, robots, systems of control, and autonomous system. The IoT devices can be of great help in enhancing the production and yield in the agriculture sector since these devices can be used to monitor soil acidity level, temperature, and other variables. Moreover, smart agriculture will help in monitoring productivity and health as well. However, data collected from these IoT devices is the quantitative data which is the numerical values that farmers can use for statistical analysis.

In addition, the potential of IoT agriculture includes an ability to offer for farmers environmentally friendly pesticides. Besides, the introduction of smart technology into agriculture enables proper tracking of the natural factors, like climate change, soil composition, and weather forecast. Application of Internet of Things in agriculture (see Figure I.8) promises previously unavailable efficiency, reduction of resources and cost, automation and data-driven processes, improved product quality. In agriculture, however, these benefits don't act as improvements, but rather the solutions for the whole industry confronting a range of dangerous problems. Therefore, the several cases of IoT are applied in agriculture such as irrigation/water management [R. Venkatesan, et al., 2017; W. Zhao, et al., 2017; S. Saraf and D. Gawali, 2017], agricultural greenhouse management [D. Qi, et al., 2017; Z. Li, et al., 2017], crops management [S. Prathibha, et al, 2017; M. Rajkumar, et al., 2017], etc.

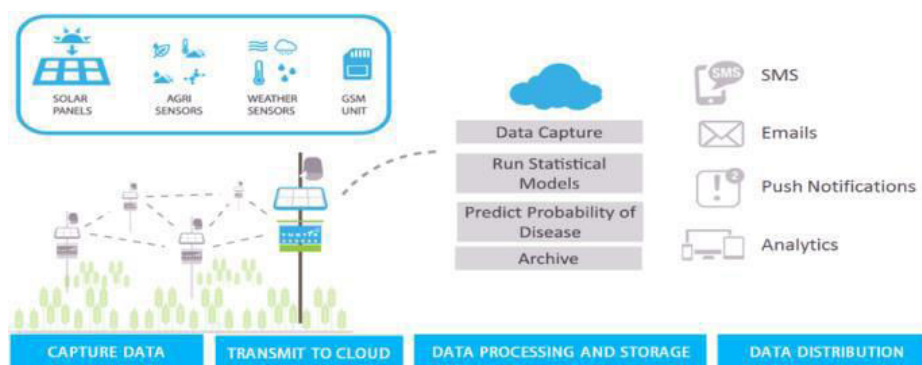

Figure I. 8: Application of IoT in agriculture [P.Anitha, et al., 2007]

Moreover, smart agriculture technologies are applied for the decision making systems (see chapter II) such as expert system (ES), decision support systems (DSS), etc. DSS are software-based systems that gather and analyses data from a variety of sources. Their purpose is to smoothen the decision-making process for management, operations, planning, or optimal solution path recommendation. In the agricultural sector, it helps farmers to solve complex issues related to crop production. As tools for diagnosis, risk assessment and reasoning assistance, DSS use agronomic models and calculations based on water, climate, energy and genetic data but they also take into account other factors such as human and economic inputs. An expert system is a computer program that uses artificial intelligence (AI) technologies to simulate the judgment and behavior of a human or an organization that has expert knowledge and experience in a particular field.

Table I.2: Summary of smart agriculture applications

Application Types		Technologies Used	Data Used	Citation
Monitoring and Automatic Systems	Autonomous Tractors/vehicles	Camera, IoT, GPS	Images, sensing data	Meghan Brown, 2018; Kagan Pittman, 2015; PA Engineer, 2020; Raikwar, Satyam, et al. 2019
	Automatic harvesting of crops	Camera, robots	Images	Yuan Ting, et al. 2009; Zhang Q, et al., 2017; Joseph R. Davidson et al., 2016; Ji Wei et al., 2018
	Monitoring and Automatic irrigation systems	Sensors (soil moisture, weather station, air temperature, light)	Numerical data	Talaviya, Tanha, et al. 2020; Chandavale, Anjali, et al. 2019; Rajalakshmi, P., et al. 2016; Munusamy, Surenthar et al. 2021
Decision Support Systems (DSS)	Water resources management	Sensors, IoT, satellite	Environmental and crops related data	Zhai, Zhaoyu, et al. 2020; Oad, Ramchand, et al. 2009; Navarro-Hellín, Honorio, et al. 2016; Sharma, Yogesh. 2018
	Soil mapping for fertilization	Satellite, drone	Soil images	Debeljak, Marko, et al. 2019; Bouma, Johan, et al. 2012; Van Leeuwen, Jeroen P., et al. 2019; Man, Quang Huy. 2010
	Yield estimation/prediction	Camera, IoT, sensors, sensing technologies	Images, field environmental data	Prasad, Anup K., et al. 2006; Karthikeyan, L., et al. 2020; Ferencz, Cs, et al.

Application Types		Technologies Used	Data Used	Citation
				2004 ; Wang, Qi, et al. 2013 ; Fu, Hongyu, et al. 2021
	Prediction (diseases, insect)	Camera, drone, IoT	Images, field environmental data, diseases/ insect history data	Nilashi, Mehrbakhsh, et al. 2017; Khamparia, Aditya, et al. 2020 ; Pallagani, Vishal, et al. 2019 ; Kumar, SA Ramesh et al. 2015 ; Wani, Hemantkumar, et al. 2017
Expert Systems (ES)	Crops diseases diagnose	Camera, Drone	Images	Sriram, N., et al. 2016; Rani, P. Mercy Nesa, et al. 2011 ; Deepthi, M. B., et al. 2017 : Susanti, Sri, et al. 2020
	Crops insect pests diagnose	Camera, Drone	Images	Rani, P. Mercy Nesa, et l. 2011 ; Mahaman, B. D., et al. 2003 ; Kaloudis, S., et al. 2005 ; Joy, J., et al. 2014
	Crops diseases and pests management	Camera	Knowledge	Joy, J., et al. 2014 ; Susanti, Sri, et al. 2020 ; Deepthi, M. B., et al. 2017

Table I.2 describes the summary of applications of smart agriculture technologies. The smart agriculture technologies are applied in various tasks according to three main application types. Based on these, the automatic systems and DSS mainly use the numerical data and images to analyze for decision-making and control systems. However, the ES mainly use images and knowledge to manage production and diseases pest's management.

I.3. Research problematic and contribution

Smart Agriculture technologies has evolved over time in order to manage crop production. Farmers, on the other hand, must be technologically literate in order to implement agriculture technologies on their farms. As a result, we need to know Thai farmers' backgrounds and technological literacy. According to the 'farmers' smart agriculture literacy survey' (see Appendix A) of the SUNSpAce project, 598748-EPP-1-2018-1-FR-EPPKA2-CBHE-JP (2018-3228/001-001), [Paweena Suebsombut et al., 2020], 260 farmers from Chiang Mai and Khon Kaen provinces in Thailand participated in the survey. According to the characteristics of Thai smart farmers, five aspects (technology usage, digital literacy, agricultural standard, marketing skills, and smart farming practice) were focused on. Based on the survey results, the majority

of farmers use their smartphones for daily activities such as taking photos, communicating, and so on. However, some of them use smartphones to sell their crops through chat applications such as Line, etc. They are all aware of agricultural standards (organic and Good Agriculture Practice, GAP) and some have received agricultural standard certificates. However, due to a lack of smart agriculture technology literacy and practice, the majority of them have never adopted smart agriculture technologies to their farms. They are, however, eager to learn about smart agriculture technologies in order to improve crop production and maintenance.

In addition, as stated in the previous section, the existing decision systems use only data measured by using intelligent sensors and smart systems such as sensors network and technology to predict/control cultivation practices in the whole cycle of cultivation or use only expert's knowledge to suggest the solution or best practices for cultivation and maintenance crops. To maintain crops appropriately based on food safety standard, smart agriculture technology and expert's knowledge are both significant. Consequently, enhancement of functionality of decision making system need to integrate smart agriculture technologies and human expert knowledge for giving an appropriate recommendation to farmers based on data detected from smart sensors and technologies and the judgement of experts. However, to cultivate crops based on food safety standard, smart technology and expert's knowledge are both required. To accomplish this, we considered the Adaptive Decision Support System (Adaptive DSS), which is a system for combining and analyzing expert knowledge and smart agriculture technologies. The concept of adaptive DSS has been applied to other domains such as medical [Wheeler, Steven., 2006], academic resource planning [Franz, Lori Sharp, et al., 1981], industry service [Magnus Holm, et al., 2014], etc. However, in terms of crops maintenance process management, Adaptive DSS is not used in the agriculture domain. As a result, employing the Adaptive DSS for this study is a significant challenge.

As a result, we discovered that smart agriculture literacy is important to farmers in order to improve their crop production process. Furthermore, using only data measured from smart technology or only knowledge alone is not enough for current agriculture production. Consequently, we need to combine the smart technology with the high-level cognitive support and expert decision-making to provide decision-making information for enhancement of functionality of decision support system, especially for complex problem situations. These are our research problems:

1. *What kind of data and knowledge relevant to crops production and maintenance?* The factors, parameters, data and knowledge relevant to crop production and maintenance are revealed in this activity. For data collection, we must define the types of data and the sources of each data.
2. *How to enhance crop maintenance process to meet crop's requirement?* We must manage the maintenance process to give an appropriate way to meet crop's requirements for crops maintaining, such as irrigation, fertilization and so on, because crop's require different maintenance processes at different phases of production. This activity investigates a system for managing crop upkeep that takes into account factors such as relative humidity, temperature, and other environmental factors.

3. *How to aggregate data and expert's knowledge?* This activity studies technique to combine data from sensor and expert's knowledge for the decision-making.
4. *How to provide an appropriate recommendation?* This activity studies the technique to analyze data for the recommendation system. Moreover, we also try to propose the recommendation system to provide an appropriate suggestion to farmers based on aggregation of data from expert's knowledge and sensing technologies which is the main objective of this research.
5. *How to help farmers to access and use the decision-making system conveniently?* Based on the smart technology literacy result of farmers, we need to propose the user friendly interface for easier usage to monitor farm, control, system, and making decision. this activity studies the interface or method to create easy usage of user interface.

CHAPTER II

Literature Review and Related Works

This chapter's content is primarily concerned with the literature, the concepts and related works. In the first section of this chapter, we will go over the concept of crop's life-cycle and maintenance process. In addition, the factors, parameters, and data relevant to crops maintenance process are reviewed and defined including the classification of data type and sources of each data. The second section focuses on the smart agriculture, as well as relevant sensor technologies and Internet of Things (IoT) database technologies. The third section examines the Knowledge Engineering (KE) context and techniques, and the selection of an appropriate technique. The Fourth section of this chapter focuses on the concept, techniques, and application of Decision Support Systems (DSS) and Adaptive Decision Support Systems (ADSS) in the field of smart agriculture. In addition, it goes over machine learning (ML) approaches and techniques including the selection an appropriate technique and approach for this thesis. In the final section, the Chatbot application as the user interface is reviewed and selected. This chapter aims to document the concept of each technology and related works relevant to smart agriculture, as well as to define the gap in existing smart agriculture technology.

II.1. Crop's Cultivation and Maintenance

II.1.1. Crop's Life-cycle

Crop life cycle refers to the sequence of changes and developments that crops go through from the beginning to the end of their lives (William Morgan, 2017). Figure II. 1 depicts the basic crop life cycle.

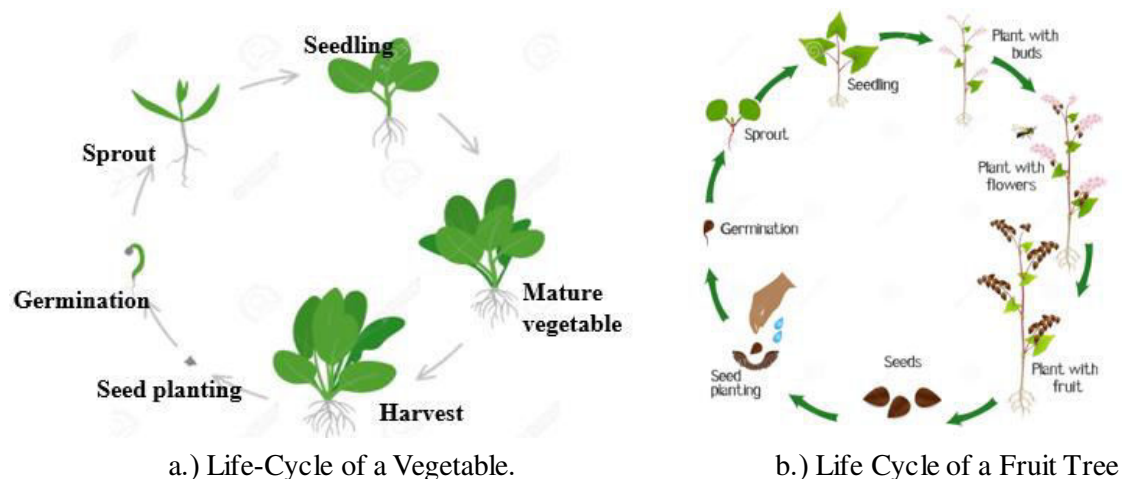

Figure II.1: Crops Life-cycle

The majority of crops grow from seeds. Seeds require soil and light to germinate, depending on the type of seed. The seed will then sprout with its first leaves, and the seedling will be anchored to the soil by its roots. Photosynthesis is a method of seeding that uses light for processing to produce its own food. Then, young trees mature and are able to participate in the flowering process. Finally, mature trees can generate productivity. Water, light, nutrients,

and the growing environment are all important factors in each stage of planting, and they all have an impact on the quality of productivity.

II.1.2. Crop's Production and Maintenance Processes

Crop production refers to crop maintenance or crop raising activities. The crop production cycle consists of seed sowing, crop maintenance during growth and development, harvesting, storage, and distribution. [Madsen, Eugene L., 1995].

Crops maintenance is the process of protecting crop cultivation from issues that affect yields such as weather, diseases, and insects, among others. To meet the purpose of crop cultivation, a variety of cultural treatments may be required. Crop maintenance factors include growth regulators and hormones, soil, nutrients, water, climatic conditions, diseases, insect pests, and weeds. [Sungcom Techawongstien, 2004]. Furthermore, as illustrated in Figure II.2, there are six major methods of crop maintenance: irrigation, fertilizing, pruning, disease control, insect pest control, and weed control [Anucha Chantaraboon, 2010].

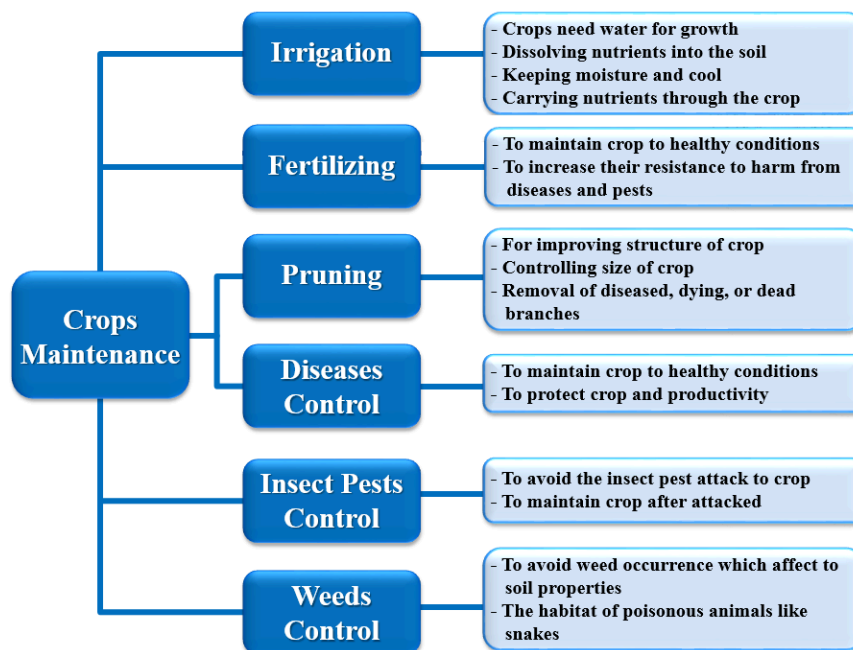

Figure II.2: Crops Maintenance Processes

- **Irrigation:** is one of the most important crop maintenance methods because crops require water for growth, dissolving nutrients into the soil, keeping moisture and cool, and transporting nutrients through the crop, which is relevant to growth regulator and hormone factor, soil factor, water factor, and climatic factor.
- **Fertilization:** is a method for keeping crops healthy and increasing their resistance to disease and pest damage. Growth regulator and hormone, soil nutrient, water, and climatic factors are all relevant fertilizing method factors.
- **Pruning:** is a method for improving crop structure, controlling crop size, or removing diseased, dying, or dead branches. Growth regulators and hormones, diseases, and insect pests are all factors that influence the pruning method.
- **Disease Control:** is a method of crop protection that involves interfering with the crop as little as possible so that forecasting and avoiding the occurrence of diseases, pests, and weeds is the most reliable way of dealing with them. Disease

control factors include growth regulators and hormones, soil, nutrients, water, climatic conditions, and diseases.

- ***Insect Pests Control:*** is a method of preventing insect pest attack on crops, as well as caring for crops that have been attacked. Climate and insect pests are two important factors in insect pest control.
- ***Weeds Control:*** is a method for preventing the occurrence of weeds, which affect soil properties and the habitat of poisonous animals such as snakes. Soil, water, climate, and weeds are all important factors in weed control.

Due to increased consumer demand and an unpredictable environment such as climate change, agricultural crop cultivation must be controlled in order to achieve food safety. As a result of several issues, such as the impact of climate change on crop maintenance processes and the quality of agricultural products, current agricultural practices necessitate the use of smart technology as a supplement. As a result, one way to reduce the risk of highly damaging farming operations based on food safety standards is to implement the Smart Agriculture concept for farm management by closely monitoring farm conditions.

II.1.3. Data relevant to crop production and maintenance

II.1.3.1. Parameters relevant to crop production and maintenance

Plant production factors in cultivation include genetic factors, climatic factors, biological factors, soil factors, nutrient factors, water factors, and agro-economic factors [Sungcom Techawongstien, 2004; Marianne Ames, et al., 2014; D.S. Mingocho, et al., 1998; Archontoulis, Sotirios V., et al., 2016; Onduru, D. D., et al., 2007]. The relevance parameters to factors that impact to plants production and quality of productivity are illustrated in Table II.1.

Table II.1: Relevance parameters to plant's production

Factors	Parameters		
Genetic [8][9][10] [11][12]	- Plants growth - Plants height - Plants canopy - Root initiation - Root growth - Root depth	- Root density - Young leaves development - Leaf area - Fruit setting - Fruit growth and development - Fruit ripening	- Delay senescence - Flower initiation and development - Pruning method - Seed germination
Climatic [8][9][10][11] [13][14][15][16] [21]	- Air temperature - Air humidity - Air pressure - Vapor pressure - Atmospheric pressure - Light intensity	- Light quality or wavelength - Day length or Light duration - Solar radiation - Rainfall - Wind speed - Wind direction	- Wind erosion - Evapotranspiration (ET) - CO ₂ atmospheric concentration - Dissolved oxygen concentration - Atmospheric nitrogen - Natural disasters
Biological [8][10][13]	- Disease occurrence - Disease control - Pest occurrence	- Pest control - Weed occurrence - Weed control	
Soil [8][13][17][18] [19][20][21][22]	- Soil structure - Soil depth - Soil type - Soil texture - Salinity - Soil PH level - Moisture base saturation - Field capacity (FC) - Soil temperature - Soil stress (tension) - Location/Topography of the field - Soil moisture	- Soil water content - Groundwater level - Waterlogging - Sodium of soil - Oxygen concentration - CO ₂ emission - CO ₂ concentration - Soil Erosion - Water holding capacity - Drainage rate - Electrical conductivity (EC) - Evaporation rate - Heat flux	- Soil organic matter (SOM) - Soil organic carbon (SOC) - Soil nutrient balance - Soil nutrient content (N, P, K) - Soil cation exchange capacity - Soil tillage (depth, date, method, number of tillage) - Permeability and infiltration - Wilting point - Rainfall-Runoff rate - Contamination with heavy metals
Nutrient [8][10][12] [23][24][25]	- Types of nutrient - Fertilization application - Nutrient leaching - Fertilizer's type	- Nutrient requirement of plants - Time period to add fertilizer - Suitable amount of fertilizer	
Water [9][13] [18][19][22]	- Nutrient in water - Water PH level - Water salinity - Water sodium - Water Potassium - Water Nitrate - Max/Min irrigation limit	- Water stress - Water temperature - Electrical conductivity (EC) - Water temperature - Evaporation - Water use pattern - Leaf wetness	- Dissolved oxygen - Water requirement of plants - Watering methods - Water allocation - Water resources - Total dissolved solid and sodium adsorption ratio

Agro-economic [25][26][27] [28][29][30][31]	<ul style="list-style-type: none"> - Human resource - Government strategies - Government plan - Taxes - Tariffs - Environmental concern - Education level - Farmer's age - Size of farm - Capacity of manure - Types of productivity - Type of plants - Current market situation - Market share - Income 	<ul style="list-style-type: none"> - Domestic and oversea trade - Gross national income (GNI) - Profitability - Forward market - Sale price - Total production revenue - Current price - Transaction cost - Energy cost - Cost of machinery hiring - Cost of labor hiring - Transportation cost - Production cost - Variable cost of production - Yields 	<ul style="list-style-type: none"> - Investment - Harvest strategy - Planting strategy - Labor allocation - Land occupation - Number of the world population - Gross Domestic Product (GDP) - Diesel fuel usage by farm operation - Input (fertilizers, insecticide, manure, chemical substances, and pesticides) cost - Fixed cost of production - Customer demand - Demand for manure - Price volatility
---	---	---	---

Table II.1 illustrates how factors relevant to cultivation are classified into seven major groups. To begin, genetic factors influence yield growth and quality. Several parameters are relevant to genetic factors, such as plant growth, root growth, fruit growth and development, and so on. Second, climatic factors affect germination, growth, and yield quality because the requirements of weather conditions in each plant type differ, so climate awareness is an important part of cultivation in each arable area. Climate-relevant parameters include air humidity, rainfall, temperature, and so on. Third, biological factors influence the quality of productivity, yields, and plant integrity. Parameters relevant to biology include disease occurrence and control, among other things. Fourth, soil is one of the most important factors influencing plant growth, particularly as an anchor for plant roots and a source of nutrients, so the quality and properties of soil are crucial for cultivation. Soil parameters include moisture, texture, nutrient content, and so on. Fifth, nutrient factor influences plant integrity, productivity quality, and yields. Nutrient factor parameters include time to add fertilizer, plant nutrient requirements, and so on. Sixth, water factor affects plant growth by helping to control soil and plant temperature, dissolve minerals in soil to feed nutrients to crop roots more easily, and increase soil moisture. Water-related parameters include PH, salinity, electrical conductivity, and so on. Finally, agricultural economic or agro-economic factors assist farmers in understanding market trends and customer demand in order to improve the quality of their productivity in order to meet market and customer demand. Agro-economic parameters include market price, market trend, customer demand, and so on.

The cultivation lifecycle is a cycle of plant growth that is divided into three parts: the beginning of life (BOL), the middle of life (MOL), and the end of life (EOL) [William Morgan, 2017; Nikky Tilley, 2018]. The BOL is the first step in cultivation and includes soil preparation, seed/plant preparation, planting stage, and seedling care. The MOL is the care of mature plants until fruit ripening. And the EOL is harvesting yields and maintaining arable land, which includes soil nutrient management, weeding, and pruning in preparation for the next cultivation. Watering, fertilizing, pruning, disease control, pest control, and weed control are the primary methods of plant care [The Morton Arboretum, 2018]. As a result of the results in Table 1, these parameters are relevant to plant care methods, as shown in Table II.2.

Table II.2: Parameters relevance to methods of crop maintenance

Method Factor	Watering	Fertilizing	Pruning	Disease/Pest/Weed control
Genetic	Leaf area, Plants height Plants canopy, Plants growth, Root depth, Root growth, Root density	Plants growth, Plants Integrity, Plants Height, Plants Canopy	Plants Height, Plants Canopy, Plants growth, Plants Integrity, pruning method	Plants Integrity
Climate	Air temperature, Air humidity, Air pressure, Vapor pressure, Atmospheric pressure, Light intensity, Light quality or wavelength, Day length or Light duration, Solar radiation, Rainfall, Wind speed, Wind direction, Wind erosion, Natural disasters, Dissolved oxygen concentration, CO2 atmospheric concentration, Evapotranspiration (ET), Atmospheric nitrogen			Light intensity, Light quality or wavelength, Day length or Light duration, Solar radiation, Air temperature, Air humidity, Rainfall
Biological			Disease occurrence, Disease control, Pest occurrence, Pest control, Weed occurrence, Weed control	Disease occurrence, Disease control, Pest occurrence, Pest control, Weed occurrence, Weed control
Soil	Soil structure, Soil depth, Soil type, Soil texture, Soil water content, Groundwater level, Waterlogging, Location/ Topography of the field, Moisture base saturation, Field capacity (FC), Soil temperature, Water stress in soil, Heat flux, Soil moisture, Rainfall-Runoff rate, Water holding capacity, Drainage rate, Electrical conductivity (EC), Evaporation rate, Wilting Point, Drainage rate, Permeability and infiltration	Sodium in soil, Soil Salinity, Soil organic matter, Soil cation exchange capacity, Soil nutrient balance, Contamination with heavy metals, Soil nutrient content (N, P, K), Soil PH level, Location/Topography of the field, Soil Organic Carbon (SOC)		Soil water content, Soil organic matter, Groundwater level, Waterlogging, Soil nutrient balance, Soil nutrient content (N, P, K), Soil PH level, Soil temperature, Heat flux, Soil moisture Location/Topography of the field
Nutrient		Types of nutrient, Fertilization application, Nutrient leaching, Fertilizer's type, Nutrient requirement of plants, Time period to add fertilizer, Suitable amount of fertilizer		Fertilization application, Fertilizer's type
Water	Water temperature, Water use pattern, Water Runoff rate, Dissolved oxygen, Water requirement of plants, Watering methods, Water allocation, Water resources, Max/Min irrigation limit, Water stress	Nutrients in water, Water PH level, Water salinity, Water sodium, Water Nitrate, Water Potassium		Water use pattern, Water requirement of plants, Watering methods
Agro-economic	Environmental concern, Education level, Human resource, Farmer's age, Size of farm, Type of plants, Cost of labor hiring, Production cost, Planting strategy, Labor allocation, Planting strategy	Human resource, Education level, Environmental concern, Farmer's age, Size of farm, Capacity of manure, Types of productivity, Type of plants, Production cost, Labor allocation, Land occupation, Input (fertilizers, insecticide, manure, chemical substances, and pesticides) cost, Planting strategy	Cost of labor hiring, Education level, Farmer's age, Size of farm, yields, Types of productivity, Type of plants, Planting strategy, Labor allocation	Education level, Farmer's age, Size of farm, Capacity of manure, Types of productivity, Type of plants, Cost of labor hiring, Production cost, Planting strategy, Labor allocation, Land occupation

Table II.2 depicts parameters relevant to plant care methods such as watering, fertilizing, pruning, and disease/pest/weed control. To begin, one of the most important methods of plant care is watering. Plants require water for growth, nutrient dissolution in the soil, moisture retention and cooling, and nutrient transport through the plant. [The Morton Arboretum, 2018; James C. Schmidt, 2018]. The watering-related factors [Scherer, Thomas F., 2010; Hsiao, T., et al., 2011; Kresovic, Branka, et al., 2014; Harun, Ahmad Nizar, et al., 2015; Cottenie, A., 1980] are genetic, climate, soil, water, and agro-economic factors that influence plant height, soil moisture, temperature, plant water requirements, labor allocation, and so on. Second, fertilizing is a method for keeping plants healthy and increasing their resistance to disease and

pest damage [James C. Schmidt, 2018]. Fertilization-related factors [Harun, Ahmad Nizar, et al., 2015; Cottenie, A., 1980; International Fertilizer Industry Association, 2007; Linquist, Bruce A., et al., 2012; Clark, G. A., et al., 1991] are genetic, soil, nutrient, water, and agro-economic factors that influence plant integrity, soil nutrient, nutrient in water, fertilizer application, labor allocation, and so on. Third, pruning is a method for improving plant structure, controlling plant size, or removing diseased, dying, or dead branches [34]. The pruning-related factors [Thomas, Philippe, et al., 2013; Saifuddin, Mohammed, et al., 2010; Goda, Y., et al., 2014; Samsam, Charito I., 2013; Sowley, E. N. K., et al., 2013; Mutawila, Cheusi, 2014; Yeshitela, T., et al., 2003] are genetic, biological, and agro-economic factors with several important parameters such as plant integrity, plant height, disease occurrence and control, labor allocation, labor hiring cost, and so on. Finally, Disease/Pest/Weed control [The Morton Arboretum, 2018] is a method of protecting plants by interfering with them as little as possible, so that forecasting and avoiding the occurrence of diseases, pests, and weeds is the most reliable way to deal with them. The factors that are relevant to Disease/Pest/Weed control [Donatelli, Marcello, et al., 2017; Azfar, Saeed, et al., 2015; Nehnevajova, Erika, et al., 2015; The B. C. Ministry of Agriculture, 2018] are genetic, climate, biological, soil, nutrient, water, and agro-economic, with several relevant parameters such as plant integrity, light, temperature, disease occurrence and control, soil moisture, soil organic matter, fertilizer application, watering method, labor allocation, labor hiring cost, and so on.

Based on the literature, three types of data sources are defined as follows:

- **On-farm data (Quantitative data):** is crop maintenance data such as soil moisture, soil temperature, air humidity/temperature, air pressure, wind speed/direction, and rainfall, among other things. These data are gathered by installing commercially available smart sensors and employing smart technologies such as soil moisture sensors, weather stations, Internet of Things (IoTs), and so on.
- **Off-farm data (Quantitative and Qualitative data):** Data is obtained by gaining access to other open cloud databases (open data sources) that are relevant to crop maintenance, such as weather forecasting, water quality, disease occurrence, and so on.
- **Expert's knowledge (Qualitative data):** Knowledge and best practices are relevant crop maintenance obtained through expert interviews, such as irrigation method, fertilizer method and timing, and so on.

II.1.3.2. Data collected relevance using IoTs technology

As shown in Table II.3, numerous on-farm and off-farm data are now collected using IoT devices and technology such as sensors, satellites, and so on, allowing farmers to precisely and efficiently monitor and control production.

Table II.3: Current data collected using IoTs devices/technology

Factor	Data	IoT devices/ technologies	Lab/ Research	N/A
Genetic [54][55]	- Plants canopy - Leaf area - Plants growth	/		
[56][57] [58][59]	- Plants height - Root growth - Root depth	- Root density - Fruit ripening	- Delay senescence - Seed germination	/
[60]	- Root initiation - Pruning method - Young leaves development	- Fruit setting - Fruit growth and development	- Flower initiation and development	/

Factor	Data			IoT devices/ technologies	Lab/ Research	N/A
Climate [61][62][63]	- Air temperature - Air humidity - Air pressure - Vapor pressure - Atmospheric pressure - Atmospheric nitrogen - Natural disasters	- Light intensity - Light quality or wavelength - Day length or Light duration - Solar radiation - Rainfall - Wind speed - Wind direction	- Wind erosion - Evapotranspiration (ET) - CO ₂ atmospheric concentration - Dissolved oxygen concentration	/		
Biological [64][65][66]	- Disease occurrence - Pest occurrence - Weed occurrence				/	
	- Disease control - Pest control - Weed control					/
Soil [67][68][69] [70][71][7] [73][74][75] [76][77][78] [79][80][81] [82][83]	- Soil Salinity - soil water content - Groundwater level - Waterlogging - Soil PH level	- Location/Topography of the field - Evaporation rate - Drainage rate - Electrical conductivity (EC)	- Soil temperature - Soil heat flux - Soil moisture - Oxygen concentration - CO ₂ emission	/		
	- Soil structure - Soil depth - Soil type - Soil texture - Sodium in soil - Soil organic matter - CO ₂ concentration	- Soil contamination with heavy metals - Soil nutrient balance - Soil nutrient content (N,P,K) - Soil Organic Carbon (SOC) - Permeability and infiltration - Wilting Point	- Moisture saturation - Field capacity (FC) - Water stress in soil - Rainfall-Runoff rate - Soil Erosion - Soil cation exchange capacity		/	
	- Water holding capacity - Soil tillage (depth, date, method, number of tillage)					/
Nutrient	- Types of nutrient - Fertilization application - Nutrient leaching	- Fertilizer's type - Suitable amount of fertilizer - Time period to add fertilizer	- Nutrient requirement of plants			/
Water [84][85] [86][87] [88][89]	- Nutrients in water - Water PH level - Water salinity - Water sodium	- Water Nitrate - Leaf wetness - Water Potassium - Dissolved oxygen	- Water temperature - Evaporation - Electrical conductivity (EC) - Water resources	/		
	- Water runoff rate - Water stress - Total dissolved solid and sodium adsorption ratio				/	
	- Water use pattern - Water requirement of plants - Max/Min irrigation limit - Watering methods - Water allocation					/
Agro-economic	- Human resource - Government strategies - Government plan - Taxes - Tariffs - Environmental concern - Input (fertilizers, insecticide, manure, chemical substances, and pesticides) cost - Fixed cost of production - Customer demand - Demand for manure - Market share - Income - Domestic and oversea trade - Gross national income (GNI)	- Size of farm - Capacity of manure - Types of productivity - Type of plants - Current market situation - Land occupation - Education level - Farmer's age - Number of the world population - Gross Domestic Product (GDP) - Diesel fuel usage by farm operation - Labor allocation - Price volatility	- Forward market - Sale price - Total production revenue - Current price - Transaction cost - Energy cost - Cost of machinery hiring - Cost of labor hiring - Transportation cost - Production cost - Variable cost of production - Yields - Investment - Harvest strategy - Planting strategy - Profitability			/

Table II. 3 displays data on plant cultivation collected with IoTs technology based on seven factors: genetic, climate, biological, soil, water, nutrient, and agro-economic. According to the results in Table 3, there are three cases of data classification: data collected using existing IoTs devices and technologies, data studied in a laboratory or research work, and none collected using new IoTs devices and technologies. To begin, data that is not collected using IoTs technologies is knowledge or information relevant to agriculture, such as watering method, fertilization application, customer demand, and so on. Second, the data are being studied in laboratories or research projects and may be collected using smart devices or technologies in

the future, such as soil nutrient content (N, P, K), run-off rate, seed germination, and so on. Finally, the data are collected using existing IoTs devices and technologies consisting of data relevance to genetic, climate, soil, and water such as plants growth, temperature, light intensity, moisture, PH, etc. These data are primarily collected for cultivation monitoring, automatic control, and prediction. An IoTs devices and technologies [Sreekantha, D. K., et al., 2017; Li, Zhaochan, et al., 2017; Wolfert, Sjaak, Lan Ge, et al., 2017; Suakanto, Sinung, et al., 2016; Popović, Tomo, et al., 2017; Liqiang, Zhao, et al., 2011] Sensors/actuators devices such as weather stations, temperature sensors, soil moisture sensors, PH sensors, light sensors, gas sensors, satellite, camera, robotic with camera, etc. are used to collect these data and transfer and access data via communication layer, such as wireless sensor network (WSN), Wi-Fi network, Bluetooth, 3G/4G technology, and so on, and store data to cloud database.

II.1.3.3. Summary data can be collected.

According to a review of crop production and maintenance data, we obtained a list of factors and parameters relevant to crop maintenance processes, as well as a list of parameters collected using existing smart sensors, as shown in Figure II.3. Furthermore, we can divide the data sources into three types: *on-farm data*, *off-farm data*, and *expert knowledge*.

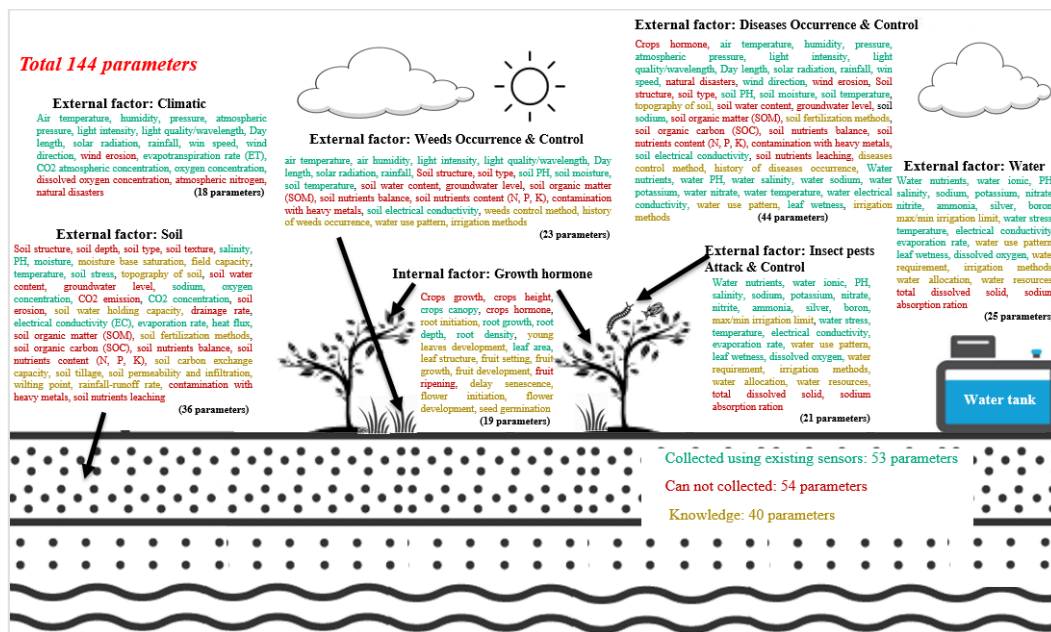

Figure II.3: List of parameters relevant to crops maintenance

Figure II.3 depicts the crop maintenance process parameters. Crop growth regulators and hormones (19 parameters), Climatic (18 parameters), Soil (36 parameters), Water (25 parameters), Diseases (44 parameters), Insect pests (21 parameters), and Weeds (23 parameters) are among the 144 parameters classified based on the factors affecting crop cultivation.

The parameters are relevant to each crops maintenance process comprising;

- **Irrigation:** 65 irrigation-related parameters, 30 of which can be collected using smart sensors
- **Fertilization:** 35 parameters are relevant to fertilization, and 11 of them can be collected using smart sensors.

- **Pruning:** 16 parameters can be pruned for relevance, and 5 parameters can be collected using smart sensors.
- **Diseases control:** There are 43 parameters relevant to disease control, and 25 of them can be collected using smart sensors.
- **Insect pests' control:** There are 25 parameters relevant to insect pest control, 17 of which can be collected using smart sensors.
- **Weeds control:** There are 26 parameters that are relevant to weed, and 18 of them can be collected using smart sensors.

II.2. Smart Agriculture (SA)

II.2.1. Agriculture Sensor Technologies

Sensors are one key factor in IoT success, but these are not conventional types that simply convert physical variables into electrical signals. They have needed to evolve into something more sophisticated to perform a technically and economically viable role within the IoT environment. Sensors have traditionally been functionally simple devices that convert physical variables into electrical signals or changes in electrical properties. While this functionality is an essential starting point, sensors need to add the following properties to perform as IoT components such as low cost, low power consumption, wireless communication, etc. Information from multiple sensors can be combined and correlated to infer conclusions about latent problems. This section looks at the smart sensors that have been developed for IoT applications in smart agriculture systems.

Smart sensors used in smart agriculture are known as agriculture sensors [RF Wireless World, 2012]. These sensors provide data which assist farmers to monitor and optimize crops by adapting to changes in the environmental conditions. These sensors are installed on weather stations, drones and robots used in the agriculture industry. They can be controlled using mobile apps specifically developed for the purpose. Based on wireless connectivity either they can be controlled directly using Wi-Fi or through cellular towers with cellular frequencies with the help of mobile phone applications. Smart sensors are built as IoT components that convert the real-world variable that they're measuring into a digital data stream for transmission to a gateway [sensors [RF Wireless World, 2012]. Figure II.4 shows the application algorithms performed by a built-in microprocessor unit (MPU). These can run filtering, compensation, and any other process-specific signal conditioning tasks. Table II.4 mentions list of agriculture Sensors used for different functions in agricultural industry.

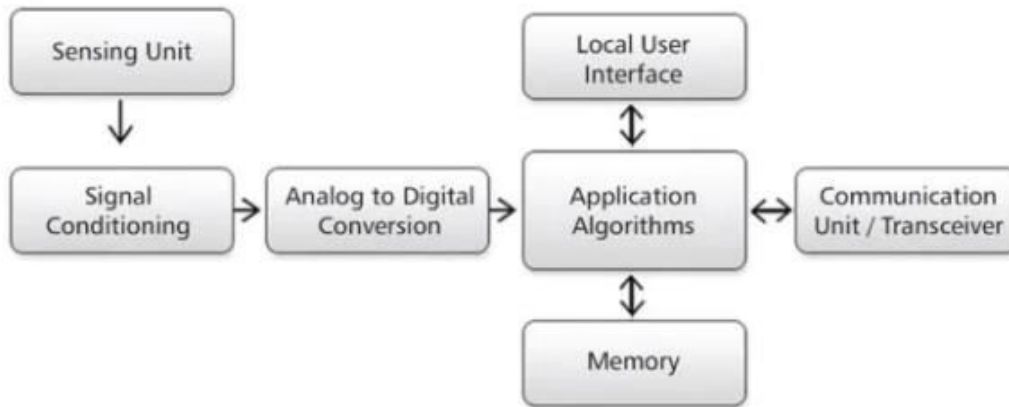

Figure II.4: Basic architectural components of a smart sensor
[Ali, Qutaiba Ibrahim, et al., 2012 ; Fan, Hua, et al., 2017]

Table II.4: List of agriculture sensors [RF Wireless World, 2012]

Agriculture Sensors	Functional description
Location Sensors	These sensors determine latitude, longitude and altitude of any position within required area. They take help of GPS satellites for this purpose.
Optical Sensors	These sensors use light in order to measure properties of the soil. They are installed on satellites, drones or robots to determine clay, organic matter and moisture contents of the soil.
Electro- Chemical Sensors	These sensors help in gathering chemical data of the soils by detecting specific ions in the soil. They provide informations in the form of pH and soil nutrient levels.
Mechanical Sensors	These sensors are used to measure soil compaction or mechanical resistance.
Dielectric Soil Moisture Sensors	These sensors measure moisture levels by measuring dielectric constant of the soil.
Air Flow Sensors	These sensors are used to measure air permeability. They are used in fixed position or in mobile mode.

The most common sensors used in the agriculture domain that capture environmental parameters related to crops [Abbasi, A.Z., et al, 2014; Shafi, Uferah, et al., 2019] are listed in Table II.5.

Table II.5 : List of most common sensors used in the agriculture domain

No.	Sample of Sensor Name	Parameters Captured
1	ECH2O soil moisture sensor	Soil Temperature, Soil Moisture, Conductivity
2	Hydra probe II soil sensor	Soil Temperature, Salinity level, Soil Moisture,

No.	Sample of Sensor Name	Parameters Captured
	Conductivity	
3	MP406 Soil moisture sensor	Soil Temperature, Soil Moisture
4	EC sensor (EC250)	Soil Temperature, Salinity level, Soil Moisture, Conductivity
5	Pogo portable soil sensor	Soil Temperature, Soil Moisture
6	107-L Temperature Sensor	(BetaTherm 100K6A1B Plant Temperature Thermistor)
7	237 leaf wetness sensor	Plant Moisture, Plant Wetness, Plant Temperature
8	SenseH2TM hydrogen sensor	Hydrogen, Plant Wetness, CO ₂ , Plant Temperature
9	Field scout CM1000TM	Photosynthesis
10	YSI 6025 chlorophyll sensor	Photosynthesis
11	LW100, leaf wetness sensor	Plant Moisture, Plant Wetness, Plant Temperature
12	TT4 multi-sensor	thermocouple Plant Moisture, Plant Temperature
13	TPS- 2 portable photosynthesis	Photosynthesis, Plant Moisture, CO ₂ ,
14	LT- 2 M (leaf temperature sensor)	Plant Temperature
15	PTM- 48A photosynthesis monitor	Photosynthesis, Plant Moisture, Plant Wetness, CO ₂ , Plant Temperature
16	CI- 340 hand- held photosynthesis	Photosynthesis, Plant Moisture, Plant Wetness, CO ₂ , Plant Temperature, Hydrogen level in Plant
17	CM- 100 Compact Weather Sensor	Air Temperature, Air Humidity, Wind Speed, Air Pressure
18	HMP45C (Vaisala' s HUMICAP@R H-chip)	Air Temperature, Air Humidity, Air Pressure
19	Met Station One (MSO)	Air Humidity, Air Temperature, Wind Speed, Air Pressure
20	XFAM-115KPASR	Air Temperature, Air Pressure, Air Humidity
21	SHT71, SHT75 (Humidity and temperature sensor)	Humidity and Temperature
22	107- L Temperature Sensor (BetaTherm 100K6A1B thermistor)	Air Temperature

No.	Sample of Sensor Name	Parameters Captured
23	CI- 340 hand-held photosynthesis	Air Temperature, Air Humidity

In this thesis, we focused on the agriculture sensors to detect air parameters, soil parameters, water parameters, and weather conditions such as air temperature, relative humidity, etc. The specific list of agriculture sensors used in this thesis will be described in Chapter 5.

II.2.2. Internet of Things Database

The IoT gateway and wireless communication technologies are used cloud database is widely used to store data collected from agriculture sensors to cloud database. Figure II.5 illustrates the diagram to identify data flow and integration points for typical smart agriculture solution to collect and analyze smart agriculture data from agriculture sensors or IoT sensors.

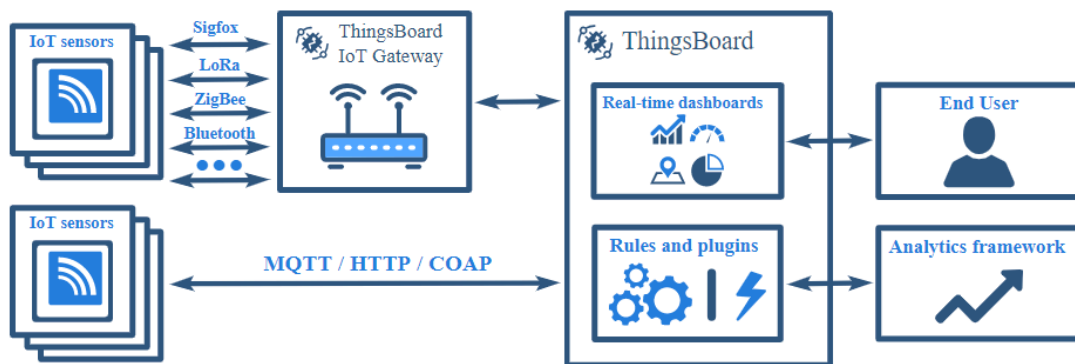

Figure II.5: Sample of diagram to identify data flow and integration for smart agriculture [ThingsBoard, 2021]

An IoT protocol is a solution for enabling IoT communication, usually device-to-device communications or device-to-cloud communications. The protocol is typically a hardware device housing application software that performs essential tasks. At its most basic level, the gateway facilitates the connections between different data sources and destinations [Kang, Byungseok, et al., 2017]. Various IoT protocols have been used presently. The most commonly-used IoT protocols for wireless communication in IoT-based applications in agriculture are:

II.2.2.1. Cellular

Cellular technology is most suitable for applications that require an extraordinary data rate. It can utilize GSM, 3G and 4G cellular communication capabilities by providing reliable high-speed connectivity to the Internet, requiring higher power consumption. It requires infrastructure to be deployed and operation cost and back up staff for it with a centralized managed authority. 4G cellular technology requires more battery power, but cellular technology is a good option in underground wireless sensor networks, such as security systems in smart home projects and agriculture applications [Zhang, X., et al., 2017]. A smart irrigation systems

was presented in [Khelifa, B., et al., 2015], in which several soil moisture sensors were deployed in the field in the ZigBee mesh network. The reading captured from the fields were transmitted over the cloud using the cellular 4G LTE network.

II.2.2.2. ZigBee

ZigBee is a wireless communication widely used in smart agriculture to monitor environmental conditions related to crops' health [Sarode, K., et al., 2018]. It is based on the wireless 802.15.4 standard. Basically, it was developed for personal area networks by the ZigBee alliance [Al-Sarawi, S., et al., 2017]. It has a flexible network structure, long battery life, supports mesh, star and tree topology with multi-hop data transmission, is easily installed and supports large nodes. It has a short range with limited data speed and is less secure compared to Wi-Fi-based systems. ZigBee is very common in smart agriculture applications such as smart green houses and smart irrigation systems [Zhou, Y., et al., 2007]. In [Chikankar, P.B., et al., 2015], a smart irrigation system was presented based on the ZigBee communication protocol. This system consisted of two nodes, i.e., a sensor node and an actuator node. The sensor node was comprised of soil moisture sensors, which monitored the water level in the soil. The actuator module was responsible for taking actions according to the water level of the soil. All communication was carried out by means of ZigBee.

II.2.2.3. RFID

RFID systems consist of a reader and a transponder, which have a very small radio frequency, called the RF tag. This tag is programmed electronically with distinctive information that has a reading characteristic. RFID has two technologies for the tag system the first is the active reader tag system, and the other is the passive reader tag. Active reader tag systems are more expensive, as they utilize more battery power and use high frequencies. However, passive reader tag systems are low powered. Some IoT applications using RFID include smart shopping, healthcare, national security and smart agriculture applications. An IoT-based smart irrigation system based on RFID was presented in [Wasson, T., et al., 2017]. The system was comprised of soil moisture and soil temperature sensors along with a water control system, so it collected the reading of the sensors and sent these readings to the cloud using RFID communication, where the user controlled a water pump based on the water level of the soil.

II.2.2.4. Wi-Fi

Wi-Fi is the most common communication network that enables devices to communicate over a wireless signal. Wi-Fi provides Wireless Local Area Network (WLAN) connectivity to millions of locations, i.e., homes, offices and public locations such as cafes, hotels and airports with high speed. The Wi-Fi supports IEEE 802.11, 802.11a, 802.11b, 802.11g and 802.11n. Wi-Fi is widely used in IoT-based applications including agriculture systems, i.e., smart irrigation, crop health monitoring and greenhouses. In [Liang, M.H., et al., 2018], an infrastructure was presented to monitor environmental parameters inside the greenhouse such as temperature, light intensity and soil moisture level. This platform was comprised of sensors that collected the data related to the environmental variation and sent to

the cloud using Wi-Fi. Similarly, another smart agriculture system based on Wi-Fi communication was presented in [N-USha, 2017]. This last one consisted of a Raspberry Pi connected with multiple sensors, which collected the data. The collected data were further transmitted to the cloud using Wi-Fi communication.

II.2.2.5. LoRaWAN

LoRaWAN operates on the LoRa network. LoRaWAN defines the system architecture and communication of the network, while the physical layer of LoRa enables the link for long-range communication. LoRaWAN manages the frequencies in communication, data rate and power consumption for all devices. LoRaWAN is common in agricultural applications because of its large coverage area and low power consumption [Davcev, D., et al., 2018]. In [Zhou, Y., et al., 2007], a smart irrigation system based on LoRaWAN was presented. Table 3 shows the comparison of all mentioned wireless communication [Al-Sarawi, S., et al., 2017]. Among all wireless communication technologies, 6LoWPAN and ZigBee are considered to be more suitable for PA application because both are based on mesh networking, which makes them suitable to cover large area.

II.2.2.6. Bluetooth

The Bluetooth smart technology is a suitable communication network for IoT applications including agriculture [Xue-fen, W., et al., 2017]. It is particularly designed for low bandwidth, low latency and short range for IoT applications. The main advantages of BLE over typical Bluetooth include lower setup time, lower power consumption and unlimited support for nodes in a star topology. It has a very limited range of 10 meters. However, the drawbacks are that it can only provide communication between two devices, it presents low security, and it can lose connection during communication. In [Tanaka, K., et al., 2018], a BLE-based infrastructure was presented to collect the sensors' data. The proposed system utilized a smart phone to collect the data of sensors using BLE, where sensors were deployed in the plants, i.e., soil moisture sensors and soil temperature sensor.

II.2.2.7. Message Queuing Telemetry Transport

Message Queuing Telemetry Transport (MQTT) is a lightweight messaging protocol that was developed by IBM and first released in 1999 [Daniel Spofford, 2019]. It uses the pub/sub pattern and translates messages between devices, servers, and applications. The MQTT protocol was initially created in order to link sensors on oil pipelines with communications satellites, with an emphasis on minimal battery loss and bandwidth consumption.

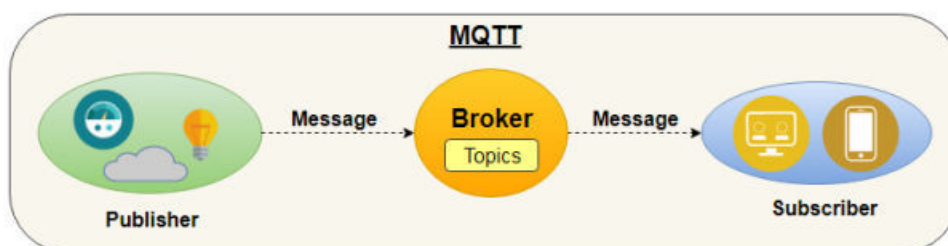

Figure II.6 : MQTT Architecture [Ansari, Danish Bilal, et al., 2018]

Different clients can subscribe to a central broker for accumulating topics created by the devices in MQTT which employs a message exchange model. This message exchange model is resource proficient and does not follow a specific data structure. A client receives a message from the broker, which it subscribed to, about a topic when a message is posted by the device. The purpose of the broker is to confirm message delivery by simplifying management and facilitating IoT devices connected through the network. MQTT is well suited for machine-to-machine communication following a lightweight messaging protocol [Chen, Whei-Jen, et al., 2014]. It also provides security even if the connection breaks off for the transmitted messages by resolving glitches with untrustworthy connections.

II.2.2.8. Node-Red

Node-Red is a programming flow-based tool used for wiring together hardware devices, APIs and online services as a part of Internet of Things. It executes the programs called Flows to implement a server. It consists of built in MQTT client and the nodes contain “topics” and “message payloads” that makes it easy to communicate with the MQTT broker and thus to set up IoT systems [Prolim, 2021].

Table II.6 : IoT Protocols used in Smart Agriculture (SA) [Shafi, Uferah, et al., 2019; Medina-Pérez, Alexandra, et al., 2021]

IOT Protocols	Data Rate	Topology	Standard	Physical Range	Power Consumption
Cellular (2G/3G/4G)	9.6Kb/s(2G) – 100Mb/s (4G)	-	-	-	Medium
ZigBee	250 Kb/s	Star, Mesh Cluster	IEEE 802.15.4	10–100 m	Low
Bluetooth	1–2 Mb/s	Star, Bus	IEEE 802.15.1	30 m	Low
RFID	50 tags/s	P2P	RFID	10–20 cm	Ultra low
LoRa WaAN	27–50 Kb/s	P2P, Star	IEEE 802.11ah	5–10 km	Very low
Wi-Fi	1–54 Mb/s	Star	IEEE 802.11	50 m	Medium
MQTT	-	Star	OASIS	10-100 m	Low
Node-Red	-	Mesh	IEEE	10-100 m	Low

II.2.2.9. Database

The purpose of a database is related to the storage of the sensor information so that the data can be handled with queries and performed when needed. The Database Management Systems (DBMS) allows data storage and user access to modify or edit the database are often used for this purpose. During the design of a database, it is necessary to take into account the structural scheme of the information to be stored as two different models can be used: SQL and NoSQL. The SQL model (Structured Query Language) uses a high-level language where the database is organized into related tables with the assignment of primary or foreign keys. The

primary key provides unique values to the values of the rows in a table and plays the role of identifier against other records; therefore, they cannot be repeated. Meanwhile, the foreign key can be applied in several tables, and the assigned fields are the same because they are related to a primary key of another table.

On the other hand, the NoSQL system is applied in databases whose storage does not follow a defined structure and does not use the SQL language to perform queries. Due to their simplicity, these databases are easy to develop and support large volumes of information because they are not divided into smaller entities. In Figure II.7, some DBMS have been classified to provide some examples, and they are relational (SQL) or non-relational (NoSQL) databases.

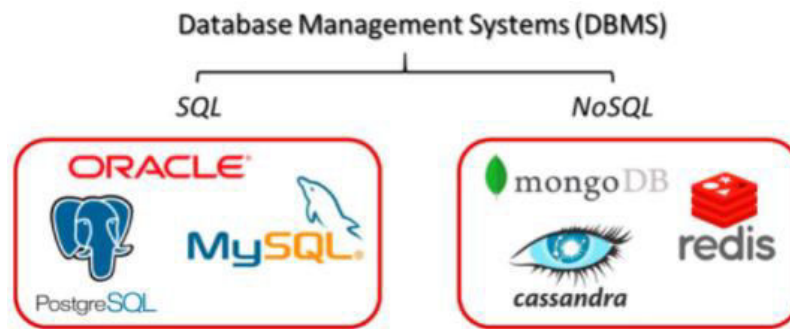

Figure II.7: Classification of the most popular databases considering SQL and NoSQL structure [Medina-Pérez, Alexandra, et al., 2021]

A typical concept of relational databases is the Entity-Relationship Model, and it is the structured design of the information that is implemented in a DBMS. This model is composed of several elements, such as entities and attributes. The entities represent physical objects, and the attributes represent qualities. Consequently, the relationship that links one entity to another is identified by an attribute. It should be noted that there are different types of relationships, which depend on the number of entities involved.

The database is defined based on the aforementioned, plus knowing that there are two types of platforms that offer storage services: local (on-premise) and cloud (remote). A local database is a program where the user is responsible for the security and management of the information, including the infrastructure. Meanwhile, a cloud database does not require local physical storage. The latter is easily accessible compared to a local database, is ubiquitous and has the security of the network. Otherwise, a remote database is based on cloud computing technology (providing service over the Internet).

II.3. Knowledge Engineering (KE)

The design, development, and maintenance of knowledge-based systems in a knowledge management project is referred to as knowledge engineering. It is closely related to software engineering and many computer science domains such as artificial intelligence, databases, data mining, expert systems, and decision support systems. Knowledge engineering is also related to cognitive science and socio-cognitive engineering, in which knowledge is produced by socio-cognitive aggregates (primarily humans) and structured based on our understanding of how human reasoning and logic work [Schreiber 99].

Zhao [Zhao, 2005] defined knowledge engineering as “a process of creating such a semantic system”. Within the methodology, it includes tasks such as scoping, modeling, integration, deployment, and maintenance, which are similar to those found in software development. It emphasizes the formal and methodical process of deductive problem solving and strives for solution optimization. In an inductive process of finding appropriate solutions in the context of conflicting interests and requirements, knowledge modeling is based on guidelines and heuristics tools (e.g., card sorting, mind mapping, etc.).

Knowledge engineering was in a field of artificial intelligence in the past. But since the last decade, knowledge engineers have developed their principles to improve the process of knowledge acquisition [Chua 04]. These principles are used in many real-world environmental issues to apply knowledge engineering. Firstly, there are different types of knowledge which are defined as “know what” and “know how” [Levy 03] or “explicit” and “tacit” knowledge from Nonaka’s definition [Nonaka 95]. Secondly, there are different type of experts and expertise. Thirdly, there are many ways to represent knowledge and use of knowledge. Finally, there is the use of structured method to relate the difference together to perform knowledge oriented activity [Shadbolt 99]. These developed several knowledge engineering techniques to solve various problems in various domains such as bacterial infection diagnosis, mineral exploration advice, electronic circuit design evaluation, and financial analysis. In this study, knowledge engineering methodologies (MOKA, knowledge matrix, and CommonKADS) were reviewed and compared in order to propose a methodology for applying a selected technique in the domain of industry cluster development. The knowledge-based engineering lifecycle (a general model of knowledge engineering) will be analyzed in the following section for benchmarking and selecting a suitable methodology.

II.3.1 Knowledge Engineering Methodology

II.3.2.1. MOKA

MOKA is an acronym that stands for Methodology and Tools Oriented to Knowledge Based Engineering Applications. It aids in the structuring and modeling of engineering design knowledge [Stroke 01]. Furthermore, it provides a standard method of storing knowledge, making re-use and maintenance of knowledge assets more feasible. The MOKA methodology focuses on two types of knowledge representation: informal and formal. These models facilitate the recording of the structure behind the knowledge, which includes not only information about the product and design process, but also the design rationale.

The informal model is made up of five categories of knowledge types that are described on ICARE forms (Illustrations, Constraints, Activities, Rules and Entities). These forms are linked together to provide a comprehensive and simple approach to structuring raw knowledge. This is accomplished by first presenting the knowledge in an appropriate form, based on its type, and then defining the links between the individual knowledge elements. Structure's outputs are informal models that can be saved and used to build the formal model. The formalized step is linked to the formal model. As shown in Figure II.8, this step is made up of two sub-models: the product model and the process model. The product model encompasses five product perspectives: structure, function, behavior, technology, and representation. The process model describes the production activities and tasks. Activities include description,

input, output, constraint, and production method. Tasks are activities that are defined by a set of activities and their sequence.

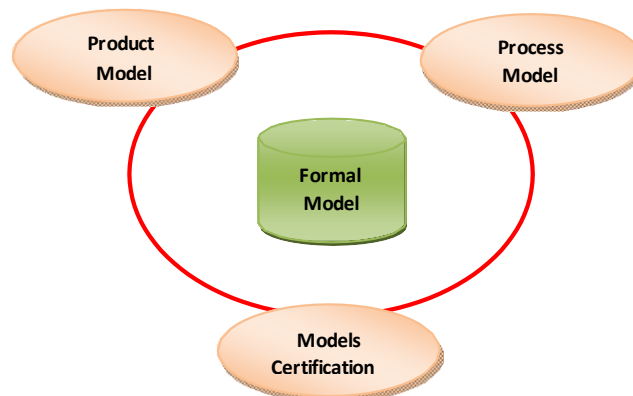

Figure II.8: MOKA formal model

The user can use this tool to create instances of the underlying meta-models. The knowledge stored in the informal model is manually transferred to the formal model, aided by the MOKA tool, until the contents of each ICARE form have been addressed. This method is commonly used in the aerospace and automotive industries. It is one of the most well-known methodologies for acquiring knowledge in the industrial domain. Unlike more generic knowledge acquisition methodologies, the use of ICARE forms in the informal model and the product and design process formal models provides the user with templates specifically suited for the product design process [Stroke 01]. We realized that MOKA is a concrete methodology that is primarily concerned with the manufacturing context. However, they put a high priority on the organization's network and culture.

II.3.2.2. Knowledge Matrix

Knowledge Matrix is a working and innovative tool who help employees and organizations to discover the present stock of knowledge and to develop it continuously by using the transfer of knowledge in order to obtain competitive advantage, to improve individual and organization performance [Valentina, Florea Nicoleta, 2017]. The concept of the Knowledge matrix brings added value in its innovation and training capacity [Blaga, M., et al., 2017]. Moreover, the knowledge matrix is a representation of the internal knowledge of the rule induced neural network [Yeung, Daniel S., et al., 1994]. The knowledge matrix methodology takes explicit data from multiple sources and fuses that data to create the rule based on knowledge extraction and analysis. In some cases, the knowledge matrix method can also capture implicit representations of the quality of the knowledge types that may be associated with a given observation [Pernin, Christopher, et al., 2007]. A knowledge matrix provides symbolic interpretations of the network's response to inputs. Thus, it follows that the network knowledge can be refined based on information stored in the knowledge matrix.

Figure II.9 [Goh, Ong Sing, et al., 2008] shows Domain Knowledge Matrix Model (DKMM) which is sample of knowledge matrix modeling. The data server layer serves as storage for data and knowledge required by the system. This is where AINI's conversational knowledge bases are stored. It is well understood that true intelligent action requires large

quantities of knowledge. Such a reservoir of knowledge can be harvested from the internet and deployed in the domain matrix knowledge bases' architecture. This forms the basis for the construction of large-scale knowledge bases to be used as the engine for intelligent conversation systems. AINI is the mechanism used to manage the knowledge and to provide appropriate answers to the user. The knowledge can be seen as arranged in the vertical columns making up the open-domain or domain-specific knowledge. In addition, specific subjects are shown in the horizontal rows. In summary, the Knowledge Matrix methodology is used with extracting expert's knowledge and matching information in the knowledge matrix.

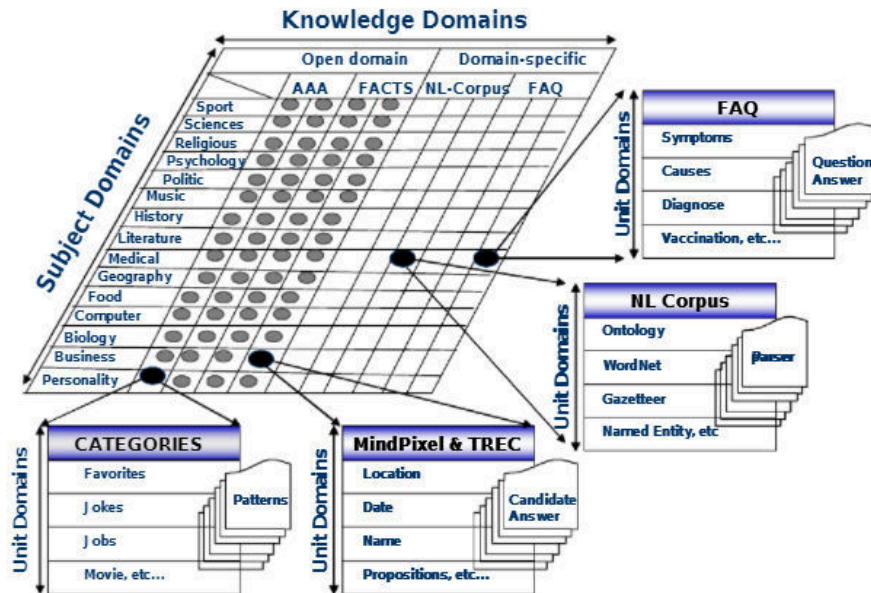

Figure II.9: Domain Knowledge Matrix Model (DKMM)

II.3.2.3. CommonKADS

CommonKADS is an abbreviation for Common Knowledge Acquisition and Design System, the current version of KADS. Since 1984, the method has been developed through two major CEC Esprit-funded research projects. The methodology's goal is to aid in structured knowledge engineering. It identifies organizational opportunities and bottlenecks, distributes and applies knowledge resources, and provides tools for corporate knowledge management. It also includes methods for conducting in-depth analyses of knowledge-intensive tasks and processes. CommonKADS encourages the creation of knowledge systems that support specific aspects of the business process [Schreiber 99].

The CommonKADS methodology provided a structured approach to breaking down and organizing the knowledge engineering process. It provided the CommonKADS model suite for developing knowledge system requirements specifications, as shown in Figure II.10. The method allowed for a top-down approach while also providing handles for quality control and feasibility assessment.

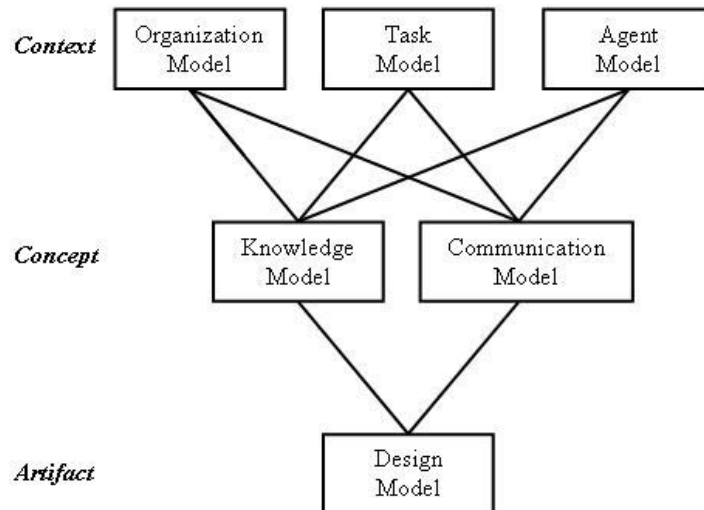

Figure II.10: CommonKADS model suite

- **Context level** analyzes the organizational environment and the critical success factors for a knowledge system
 - **Organization model** supports the analysis of an organization's major features in order to discover problems and opportunities for the knowledge system, establish their feasibility, and assess the impacts of intended knowledge actions on the organization
 - **Task models** are the relevant components of a business process the task model examines the overall task layout, inputs and outputs, preconditions and performance criteria, as well as required resources and skills.
 - **Agent models** are the agents who carry out a task. It describes the characteristics of agents, specifically their competences, authority to act, and constraints in this regard. It also lists the communication links established between agents while performing a task.
- **Concept level** produces a conceptual description of problem-solving functions and data handled and delivered by a knowledge system
 - **Knowledge model** explains in detail the type and structure of knowledge used in performing a task provides a human-understandable implementation-independent description of the role that various knowledge components play in problem-solving.
 - **Communication model** as with the knowledge model, it depicts the transaction between the agents involved in a conceptual and implementation-independent manner.

- *Artifact level* integrates the above levels in the design model to create the requirements specification for the knowledge system
- The design model specifies the technical system architecture, implementation platforms, software modules, representational constructs, and computational mechanisms required to implement the functions defined in the knowledge and communication models.

In terms of knowledge processes, the CommonKADS methodology provides knowledge templates to aid in the knowledge modeling process, which consist of predefined reusable knowledge models that have previously proven to be effective. The next chapter will go over the specifics of knowledge templates. This methodology applies to all knowledge activities, including creation, storage/retrieval, sharing, and representation. However, in this methodology, knowledge sharing methods received a lot of attention. In the context level of the organizational model, the concepts of network and organizational culture are examined. Although this method did not provide a concrete process for dealing with a specific task, it is detailed enough to be applicable to any knowledge-intensive task. This methodology is recommended for KM projects involving intra- and inter-organizational knowledge exchange.

II.3.2.4. Knowledge Engineering Methodology Selection

In order to select the most suitable methodology to be applied to create the rule-based from expert's knowledge acquisition and extraction to solve smart agriculture cluster problem, many well-known knowledge engineering methodologies (i.e. MOKA, knowledge matrix, and CommonKADS) were analyzed. Although, these methodologies were successfully implemented in many domains such as product design, CAD/CAM, or cost/time reduction, there is no empirical study that applied knowledge engineering technique to solve smart agriculture cluster problem.

Each technique has its own advantages and disadvantages. Moreover, the way for applying the technique in the case study is adaptable to the crop, expert's knowledge, and sensing technologies. Thus, in this study, we propose two criteria for comparing and selecting knowledge engineering methodology in the smart agriculture cluster, as follows:

- 1 Coverage of framework for the KM project
- 2 Adaptability of methodology to the case study

In summary, from comparison with two criteria: coverage of framework of KM project, and adaptability of methodology, we agreed that Knowledge Matrix is the suitable methodology for applying in our context. Therefore, the knowledge engineering processes in this study will be based on Knowledge Matrix methodology. However, this methodology cannot be straightforwardly applied to create the rule-based. In chapter IV, we will propose adapted Knowledge Matrix methodology for rule-based creation. The problems and solutions of applying will be discussed.

II.4. Data Analysis Technologies

II.4.1. Decision Support Systems (DSS)

The realm of decision support system (DSS) has grown to include paradigms such as expert systems (ESs), intelligent DSSs, active DSSs, and systems that seek to capitalize on the benefits of integrating DSSs with ESs (Holsapple, Clyde W., 2008). In essence, traditional DSSs use PPK acquired through rote learning (from system developers) to carry out all problem-solving activities (Holsapple, Clyde W., 2008). Based on these considerations, Jacob et al. (1990) define an adaptive DSS class distinguished by a type of unsupervised learning known as learning through observation and discovery or unsupervised inductive learning. (Chuang, Ta-tao., 1998) The concept of adaptive systems has been widely adopted in a variety of applications. The literature on DSS adaptively can be classified into the following: adaptive systems, adaptive help facilities, adaptive user interfaces, adaptive knowledge-based systems, and adaptive problem-solving capabilities in DSS. The goal of adaptation is to "improve the system's suitability for specific tasks; make the system easier to use for specific users, thereby increasing user productivity; optimize workloads, and increase user satisfaction" (Oppermann, 1994a, p. 4). An adaptive system's impact can range from speeding up decision makers' routine tasks to improving understanding of an unstructured problem. Aside from the benefits of using adaptive systems, the flexibility of adaptive systems "makes the user more independent of the designer, and does not force the designer to decide about user-specific optima before the user works with the system" (Oppermann, 1994b, p. 455).

A DSS is a collection of integrated software applications and hardware that serve as the foundation of an organization's decision-making process by utilizing useful information such as data, documents, personal knowledge, and business models to identify and solve problems, EXAMPLES: Systems for product pricing, profit forecasting, and risk analysis, among other things. The goals of DSS are to improve the effectiveness of the manager's decision-making process, to assist the manager in decision-making but not to replace it, and to improve the director's decision-making effectiveness.

Decisions are made at all levels of the organization. Some decisions are extremely common and routine, but they are extremely valuable. IT provides managers with new decision-making tools. Receiving the most current, concrete information and disseminating it to those who need to be aware of it. IT does not directly provide information, but rather gives the user the ability to analyze the decision problem and generate meaningful information for decision-making. DSS refers to a type of system that assists in the decision-making process but does not always

make the decision. Decision Support Systems (DSS) provide computerized assistance in the decision-making process. The data warehouse is actively used by end users. Models are used by end users to represent, understand, and simplify decision situations.

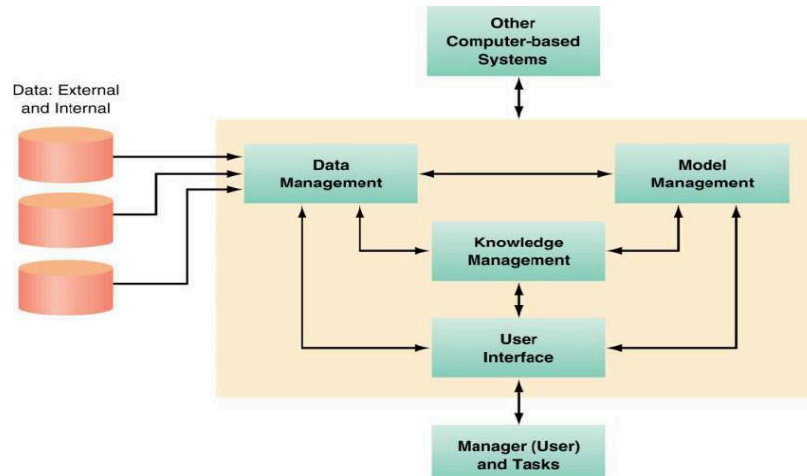

Figure II.11: Components and Structure of DSS (Architecture)

Figure II.11 illustrates the architecture of DSS consisting of:

- **Data Management:** Includes the database(s) containing relevant data for the decision situation
- **User Interface:** Enables the users to communicate with and command the DSS
- **Model Management:** Includes the database(s) containing relevant data for the decision situation
- **Knowledge Management:** Provides knowledge for problem resolution; supports any of the other subsystems or functions as an independent component

II.4.2. Adaptive Decision Support System (Adaptive DSS)

Adaptive Decision Support System (Adaptive DSS) [Fazlollahi, B., et al 1997; Chuang, Ta-Tao, et al., 1998; Al-Qaed, Faisal, 2006; Clyde W. Holsapple et al., 2008] is the DSS with the support of the judgment of human for making decision. It is adapting to meet the needs of users in areas such as cognitive on a high level, task characteristics, and decision contexts. The concept of adaptive systems has been widely adopted in a variety of applications. The literature on DSS adaptively can be categorized as follows: adaptive systems, adaptive help facilities, adaptive user interfaces, adaptive knowledge-based systems, and adaptive problem-solving capabilities in DSS. The primary objective of adaptation is to "improve the system's suitability for specific tasks; make the system easier to use for specific users, thereby increasing user productivity; optimize workloads, and increase user satisfaction." (Oppermann, 1994a, p. 4). An adaptive system's impact can range from speeding up decision makers' routine tasks to increasing understanding of an unstructured problem. Aside from the benefits of using adaptive systems, the flexibility of adaptive systems "makes the user more independent of the designer, and does not force the designer to decide about user-specific optima before the user works with the system." (Oppermann, 1994b, p. 455).

The decision-making process in ADSS will be controlled by the decision-makers, and the process will be monitored by the system to match support to the needs. The needs of decision makers, the characteristics of the decision task, and the contexts of the decision are provided

based on high-level cognitive support that is adapted to the needs [Fazlollahi, B., et al., 1997]. Intelligent technologies are used to define support requirements. Figure II.12 depicts the architecture of ADSS.

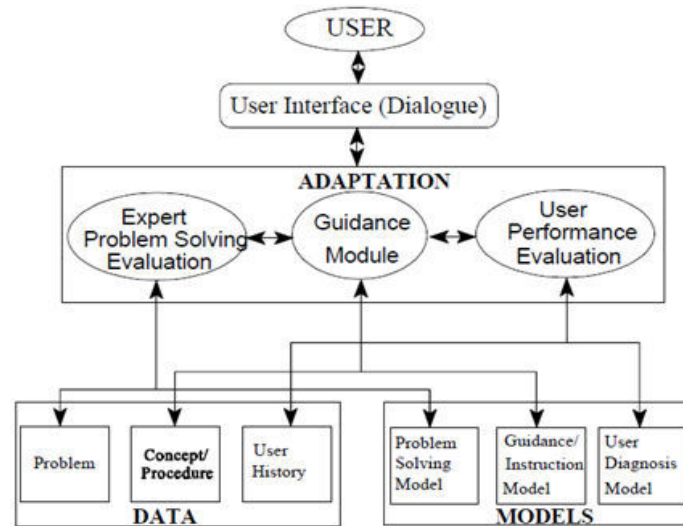

Figure II.12: Architecture of ADSS [R.H. Sprague, et al., 1982]

Figure II.12 depicts the ADSS architecture, which consists of three subsystems: user interface, problem solving, and guidance/ instruction. Each subsystem includes data, an adaptation component, and a model. The system and users will communicate via the user interface subsystem about the user's knowledge and system support. The process, however, is monitored by the system in order to match support to the needs. ADSS is capable of matching the appropriate knowledge to support and create a decision-making strategy based on the motivations and preferences of users.

Adaptive DSS Technologies in Agriculture

According to Holsapple et al. (1993), the DSS can be adaptive in four subsystems: a language subsystem, a presentation subsystem (both components are conventionally referred to as user interfaces), a knowledge subsystem, or a problem processing subsystem. Current ADSS research is examining the feasibility of employing various learning strategies as adaptation-enabling mechanisms in knowledge and problem-solving subsystems. (Accola et al., 1995; Holsapple et al., 1993; Deng, 1993; Jacob et al., 1990; Piramuthu et al., 1993). Similar efforts can be found in knowledge-based systems (Deng, 1994; Deng & Chaudhury, 1992; El-Najdawi & Stylianou, 1993).

The main idea behind adaptive problem processing capability is to provide the problem processing system with an unsupervised inductive learning method that allows it to acquire or refine problem domain knowledge with as little assistance from external agents as possible. (Jacob et al., 1990).

Deng and Chaudhury (1992) propose a conceptual model of adaptive knowledge-based systems by incorporating learning automata into the operational schema of the traditional expert system. This model is made up of four parts: a working memory, a knowledge base, an inference engine, and a critic unit.

Deng (1994) proposes another ADSS model in which an adaptive case-based reasoning model is particularly appropriate for the decision-making context where online interactive feedback is required for incorporating new information into the problem-solving process.

The nearest neighbor algorithm serves as the foundation for this model (Stanfill & Waltz, 1986). Deng's (1994) model, on the other hand, works directly on the data file rather than inducing decision rules from training cases. This model's ability to handle both nominal and quantitative data is a significant feature. Furthermore, by adjusting parameters, the performance of this model can be gradually improved. Holsapple et al. (1993) demonstrate, however, that a genetic algorithm can also be used to gradually refine the solution to a given problem.

The current focus of ADSS research is on investigating the feasibility of automatically acquiring and refining problem domain knowledge. Nonetheless, there are subtle differences between these research efforts. Deng's research (Deng, 1993, 1994; Deng & Chaudhury, 1992) addresses the importance of feedback from environments for the adaptation of adaptive systems, while others (Holsapple et al., 1993; Jacob et al., 1990; Piramuthu et al., 1993) mainly focus on the acquisition of problem domain knowledge and/or the refinement of current knowledge.

A pertinent question in the design of knowledge-based systems is: What knowledge should be retained in the system? This question is related to the previous one: What are the essential components of an adaptive system? Although the question depends on the domain of the problem.

An adaptive help system is a system which adapts "the help facilities to either the task context or to specific user preferences" (Krogsaeter & Thomas, 1994, p. 68). Because the users have different skills, experiences, and expertise, they require different types and amounts of assistance. As a result, adaptive help systems are typically included as part of an adaptive user interface. Both may contain similar components. An adaptive help system's domain can be an online manual that responds passively to a user's request, or an intelligent support system that actively assists the user in making the best use of the main system.

Adaptive user interface systems are a type of adaptive system. Adaptive user interface is possibly the most researched of the three components in the DSS (Holsapple et al., 1993). The fact that "end-users are heterogeneous" is a major reason for designing adaptive user interface systems (Brovme, Norman, & Riches, 1990, p. 21). End-users of systems vary in many ways, including their expertise, experiences, and preferences. Furthermore, the expertise and preferences of individual users may evolve over time. An adaptive interface system can improve decision quality while lowering development costs by avoiding the need to design a new system by adapting to these changes.

Currently, ADSS is not applied in real agriculture sector in terms of crop maintenance but are applied in other domain such as e-commerce system [Al-Qaed, Faisal, et al., 2006], business [Bihl, Trevor J., et al., 2014], financial risk and risk management [Kozhukhivska, O., et al., 2015; C. Cornalba, et al., 2005; Odunola, Akinyemi Bodunde, et al., 2014], medical domain [Wheeler, Steven., 2006], academic resource planning [Franz, Lori Sharp, et al., 1981; Prithviraj Dasgupta, et al., 2005], stock trading [Chiang, Wen-Chyuan, et al., 2016], machine too maintenance strategy [Shagluf, A., et al., 2018], industry service [Magnus Holm, et al., 2014; Deny Raatgever, 2011; Lendermann, Peter, et al., 2015], etc. As a result, it is exceedingly

difficult to apply ADSS in the agriculture sector to assist farmers in improving crop maintenance and agriculture productivity.

II.4.3. Machine Learning (ML) based DSS/ADSS

Machine Learning is a concept that allows computers to learn from examples and experience without being explicitly programmed. Instead of writing code, you feed data to the generic algorithm, which then generates logic based on the data. ML is a data analysis technique that teaches computers to do what humans do naturally: learn from their experiences. The algorithms of machine learning (ML) use computational methods to "learn" information directly from data, rather than relying on a predetermined equation as a model.

II.4.3.1. ML Approach

As shown in Figure II. 13, there are five types of Machine Learning Algorithms: Supervised Learning, Semi-Supervised Learning, Unsupervised Learning, Reinforcement, and Active Learning.

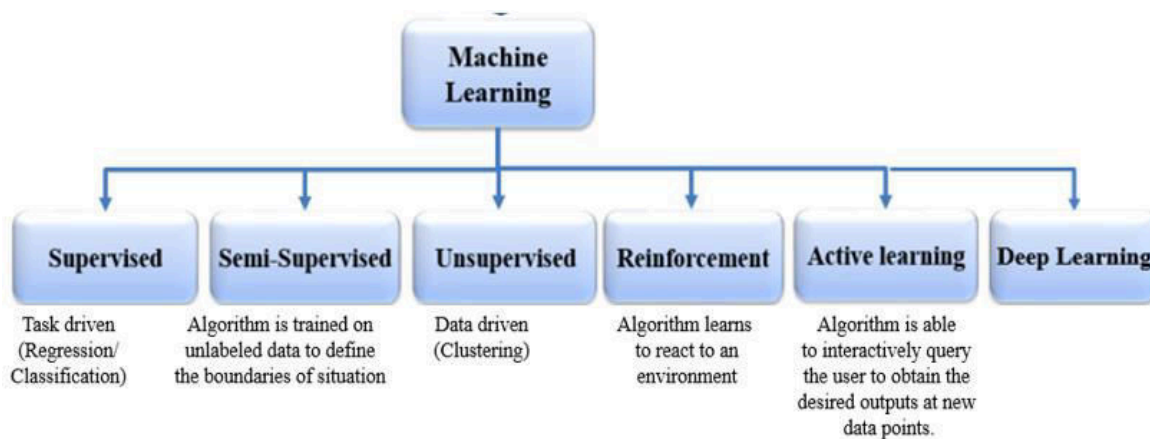

Figure II.13: Machine learning techniques [Mathworks, 2018][Nikki Castle, 2017]

Table II.7: Summary of literature review

Crop maintenance methods	Problem description	Solution/Impact	Methods, technology used	Sources of data	References
Irrigation	How to allocate water for irrigation ?	Development of water allocation model based on weather forecast and meteorological data	Machine learning (ML)	Sensor on farm, weather station, and weather forecast information	Goldstein, Anat, et al., 2018; Khan, Mahmood A., et al., 2011;
		Development of a water demand forecasting	Machine learning (Decision trees)	historical information about water delivery statements, weather forecast	Pulido-Calvo, et al., 2018; Hunsaker, Douglas J., et al., 2007; Khan, Mahmood A., et al., 2011; Yazdi, Amin Bermani, et al., 2013 ; Perea, Rafael González, et al., 2018
		Development of groundwater forecasting model to manage water for irrigation	Machine learning (Back Propagation neural network algorithm)	Historical pumping rate of water wells, historical irrigation return flow and rainfall recharge, weather forecast, weather station	Emamgholizadeh, Samad, et al., 2014; Han, Jmg-Cheng, et al., 2016
		Development of soil water content forecasting to manage water for irrigation	Machine learning (Regression method, Genetic algorithm, Back Propagation (BP) algorithm)	Weather station, soil sensor	Liang, Ruiyu, et al., 2008 ; Haghverdi, Amir, et al., 2015 ; Zou, Ping, et al., 2010
	How to forecast the irrigation scheduling ?	Development of forecasting model to schedule irrigation in future	Machine learning (ML), (Adaptive Neuro Fuzzy Inference Systems (ANFIS))	Weather station,	Navarro-Hellin, et al., 2016; Dimitriadis, Savvas, et al., 2008

Crop maintenance methods	Problem description	Solution/Impact	Methods, technology used	Sources of data	References
	How to optimize irrigation system ?	Development of soil moisture controller able to regulate the moisture level around a desired value	Machine learning (Decision trees)	Soil sensor, soil properties information	Capraro, Flavio, et al., 2008; Dursun, Mahir, et al., 2017
		To develop an optimal irrigation strategy	Machine learning (Fuzzy neural network)	Weather station	Tsang, S. W., et al., 2016 ; Morimoto, T., 2007
Fertilizing	How to mapping soil PH ?	To evaluate the values of soil PH in each area of field for fertilizer application in the future	Statistical analysis	Soil sensor	Schirmann, Michael, et al., 2011
	How to recommend precisely fertilizer application?	Development model to recommend the fertilizer application	GIS, Machine learning (neural fuzzy classification)	Weather data, soil diagnose information, farm location	Snoeck, Didier, et al., 2010
		Development the application to apply fertilizer based on nitrogen value	Statistical analysis, differential GPS	Crop sensor	Ejiri Morimoto, et al.
		Development of recommendation fertilizer application model based on soil diagnostic	Soil diagnostic method	Weather station, soil properties	Snoeck, Didier, et al., 2007
Diseases control	How to forecast diseases occurrence?	Development to predict of crop diseases	Long Short-Term Memory (LSTMs), Machine learning (Recurrent Neural Networks (RNNs)), Decision support system	Historical data on disease occurrence, weather station, historical weather data	Kim, Yangseon, et al., 2017; Lee, Heamin, et al., 2017 ; Tripathy, A. K., et al., 2013
		Development of model to predict weather forecast and then predict the diseases occurrence	Machine learning (Neural network, back propagation, decision trees)	Weather station, soil sensor, historical of diseases occurrence	Wani, Hemantkumar, et al., 2017; Sannakki, S., et al., 2013 ; Clyde Fraisse, et al., 2009
Insect pest control	How to forecasting insect pest occurrence ?	Development of insect pest occurrence forecasting model	Machine learning (BP neural network)	Weather station, historical weather data	Jing, Yang, et al 2017;
		Development early warning system of insect pest attraction	Self-Organizing Maps (SOMs), Machine learning (support vector machine)	Weather station, insect pests count information	Liao, Min-Sheng, et al., 2012
	How to forecast the timing of insect pest attacks ?	Development of simulation model to forecast the timing of insect pest attacks	Linear or Gompertz curves,	Weather station, insect pest monitoring data	Phelps, K., et al., 1993; Collier, Rosemary H., et al., 2001
Weed control	How to predict the weed occurrence ?	Proposed method for weed occurrence	Machine learning (regression analysis)	Soil properties, weather station	Dille, J. Anita, et al., 2002
	How to map the weed occurrence?	Development model to build reliable weed maps and to control weeds in patche	Geostatistical analysis, machine learning (Co-kriging)	Soil sensor, soil diagnostic information, historical of weed occurrence	Heisel, Torben, et al., 1999

There are quantitative and qualitative data based on our input data (on-farm, off-farm, and expert knowledge), and the data are of the time series type. To obtain the output, we can use Long-Short Term Memory (LSTM) to construct the graph based on these three input data points. As a result, we chose the LSTM approach to model our decision model.

II.4.3.2. ML Tools

All following tools will be used in this thesis to create the Adaptive DSS to support smart agriculture system.

II.4.3.2.1. Tensorflow Keras

TensorFlow is an end-to-end open source platform for machine learning. It has a comprehensive, flexible ecosystem of tools, libraries, and community resources that lets researchers push the state-of-the-art in ML and developers easily build and deploy ML-powered applications. TensorFlow was originally developed by researchers and engineers working on the Google Brain team within Google's Machine Intelligence Research organization to conduct machine learning and deep neural networks research. The system is general enough to be applicable in a wide variety of other domains, as well. TensorFlow provides stable Python and C++ APIs, as well as non-guaranteed backward compatible API for other languages. Keras is an official higher-level API on top of TensorFlow. Neptune helps with keeping track of model training metadata. Keras is a deep learning API written in Python, running on top of the machine

learning platform TensorFlow. It was developed with a focus on enabling fast experimentation. Being able to go from idea to result as fast as possible is key to doing good research.

II.4.3.2.2. Python Programming

Python is an interpreted high-level general-purpose programming language. Python's design philosophy emphasizes code readability with its notable use of significant indentation. Its language constructs as well as its object-oriented approach aim to help programmers write clear, logical code for small and large-scale projects [Kuhlman, Dave, 2009]. Python is an object-oriented programming language created by Guido Rossum in 1989 [Guru99, 2021]. It is ideally designed for rapid prototyping of complex applications. It has interfaces to many OS system calls and libraries and is extensible to C or C++. Many large companies use the Python programming language, including NASA, Google, YouTube, BitTorrent, etc. Python programming is widely used in Artificial Intelligence, Natural Language Generation, Neural Networks, and other advanced fields of Computer Science. Moreover, Python is one of the most demanded programming languages in the market, so there are huge job opportunities for candidates having knowledge of Python programming.

II.4.3.2.3. Scikit-Learn

Scikit-learn (formerly scikits.learn and also known as sklearn) is a free software machine learning library for the Python programming language [Fabian Pedregosa, et al., 2011]. It features various classification, regression and clustering algorithms including support vector machines, random forests, gradient boosting, k-means and DBSCAN, and is designed to interoperate with the Python numerical and scientific libraries NumPy and SciPy. Scikit-learn is largely written in Python, and uses NumPy extensively for high-performance linear algebra and array operations. Furthermore, some core algorithms are written in Cython to improve performance. Support vector machines are implemented by a Cython wrapper around LIBSVM; logistic regression and linear support vector machines by a similar wrapper around LIBLINEAR. In such cases, extending these methods with Python may not be possible. Scikit-learn integrates well with many other Python libraries, such as Matplotlib and plotly for plotting, NumPy for array vectorization, Pandas dataframes, SciPy, and many more [Fabian Pedregosa, et al., 2011].

II.4.3.2.4. DialogFlow

Dialogflow is a conversational platform that lets developers design and build Google Actions, chatbots, and conversational. Dialogflow allows chatbots to learn faster, more natural and accurate. Dialogflow can be used to build conversational applications and experiences in various languages and on multiple platforms. The Google-powered product enables developers to create text-based and voice conversation interfaces for responding to customer queries in different languages. Dialogflow is the most common conversational tool used to create functionality for Google Assistant devices. The company was previously called API.AI and acquired by Google in 2016. It was then renamed Dialogflow. Dialogflow can be used for a variety of applications, including:

- Customer service artificial intelligence (AI) agents- Interfaces can be programmed to answer questions, access orders, make appointments and take requests.
- Conversational commerce- Bots can help customers make self-service purchases or schedule deliveries.
- Internet of things (IoT)- Dialogflow can be applied to IoT devices to make them better at understanding context and responding with precision.

Additionally, potential users can view samples to explore how a chat agent can respond to various inquiries on the Dialogflow website. A getting started guide is also available from the company for investigating the types of integrations available and determining if they provide the proper solution. Figure II.14 shows the diagram of the processing flow when interacting with the API.

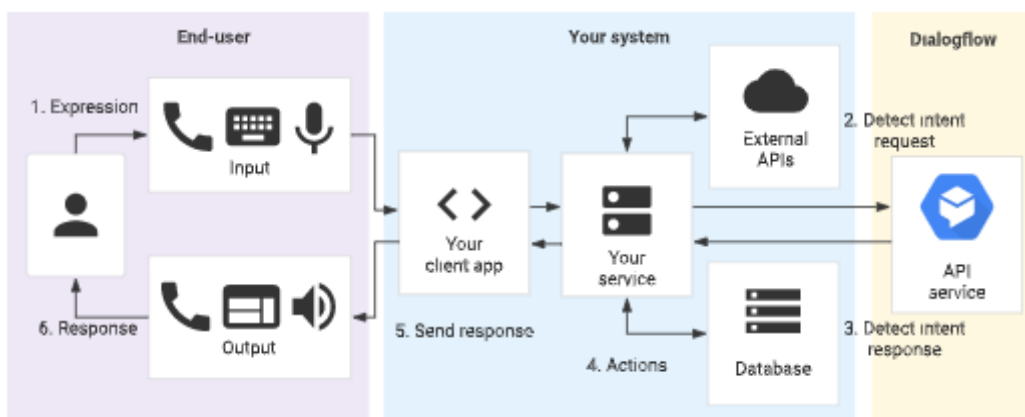

Figure II.14: the processing flow diagram of DialogFlow [Gary Stafford, 2018]

Figure II.14 illustrates the interacting processing flow of DialogFlow. The end-user types or speaks an expression. The system service will send the end-user expression to Dialogflow in a detect intent request message. Dialogflow sends a detect intent response message to your service. This message contains information about the matched intent, the action, the parameters, and the response defined for the intent. The system service performs actions as needed, like database queries or external API calls. The system service sends a response to the end-user. The end-user sees or hears the response.

II.4.3.2.5. PHP Script

A script is a set of programming instructions that is interpreted at runtime. A scripting language is a language that interprets scripts at runtime. Scripts are usually embedded into other software environments. PHP is a general purpose scripting language that is well suited to web development and can be embedded into HTML. PHP scripts can be created using any basic text editor or HTML editing software tool. Each PHP file must be saved with a .php file extension in order to be recognized as a functioning PHP script. When the Apache server has the appropriate settings, PHP code can be recognized also in .html files. This can also be achieved by adding an additional handler in the .htaccess file of a Linux based web server. The PHP language has been especially designed to enable the development of dynamic and interactive web pages. PHP offers excellent connectivity with many databases, among them MySQL,

PostgreSQL and Generic ODBC. The common combination between the PHP v. 4 or the PHP v.5 script and the MySQL database is supported on almost every Linux-based web server.

II.5. User Interface : Chatbot Applications

A chatbot is software that simulates human-like conversations with users via text messages on chat. Its key task is to help users by providing answers to their questions. A chatbot is a computer program that simulates human conversation through voice commands or text chats or both. Chatbot, short for chatterbot, is an artificial intelligence (AI) feature that can be embedded and used through any major messaging applications. Chatbots are used in dialog systems for various purposes including customer service, request routing, or information gathering. While some chatbot applications use extensive word-classification processes, natural language processors, and sophisticated AI, others simply scan for general keywords and generate responses using common phrases obtained from an associated library or database. Most chatbots are accessed on-line via website popups or through virtual assistants. There are various bot platforms used for the chatbot applications:

II.5.1. Slack

Slack launched in 2013 and quickly came to define the team chat space, in no small part because people loved using it. It's not hard to understand why—this is an application designed with the user in mind. Every Slack team has a General channel intended for the entire company, but the bulk of day-to-day chatter happens in channels related to a specific team or project. Users decide which of these channels they want to be in, which means they can avoid being flooded by messages about projects unrelated to them. This sorting goes further: conversations in these channels can be broken down into threads, and users will only be notified of conversations in threads if they participate in the conversation or actively decide to subscribe to them. Team members can tag other users to pull them into channels or threads, which helps balance the need to reduce noise with the need to ensure important conversations are being seen.

Slack also makes it easy for users to find answers using search. You can easily filter by channel, user, date, and more. Collaboration is another key emphasis. Quickly share files by clicking-and-dragging them onto the app, or by linking to them. Most links will unfurl, meaning things like images and videos can be reviewed without leaving the app. Small features, like emoji reactions, make it easy to meaningfully respond to messages in just a couple clicks. Video and audio calls can be started with a single click. And there are thousands of integrations with other applications. All of these small touches might sound overwhelming, but a clever design (alongside friendly UX copy) means that Slack rarely feels confusing or overwhelming. Slack's biggest downside might be its price—particularly given that it doesn't come as part of a broader software bundle. For teams that are serious about workplace chat, however, Slack offers more than enough value to be worthwhile.

II.5.2. WhatsApp

WhatsApp Business is a free to download application that was built with the small business owner in mind. Create a catalog to showcase your products and services. Connect with your customers easily by using tools to automate, sort and quickly respond to messages. WhatsApp can also help medium and large businesses provide customer support and deliver important notifications to customers. WhatsApp from Facebook is a free messaging and video calling app. It's used by over 2B people in more than 180 countries. It's simple, reliable, and private, so you can easily keep in touch with your friends and family. WhatsApp works across mobile and desktop even on slow connections, with no subscription fees.

II.5.3. Line

LINE is a freeware application for instant communications on electronic devices such as smartphones, tablet computers, and personal computers. LINE is the fastest growing mobile messenger app in the world, bringing users closer to their friends and loved ones. Enjoy free messages, voice calls, and video calls anytime, anywhere. LINE is available on smartphones, including iPhones and Android devices, and also PCs and Macs. LINE users exchange texts, images, video and audio, and conduct free VoIP conversations and video conferences. In addition, LINE is a platform providing various services. Line is an application that works on multiple platforms and has access via multiple personal computers (Windows or macOS). The application will also give an option of address book syncing. This application also has a feature to add friends through the use of QR codes, by Line ID, and by shaking phones simultaneously. The application has a direct pop-out message box for reading and replying to make it easy for users to communicate.

According to the survey results of SUNSpACe project [Paweena Suebsombut, 2020], farmers in Thailand mostly use the Line chat application for communication and also selling their crops as shown in Figure II.15.

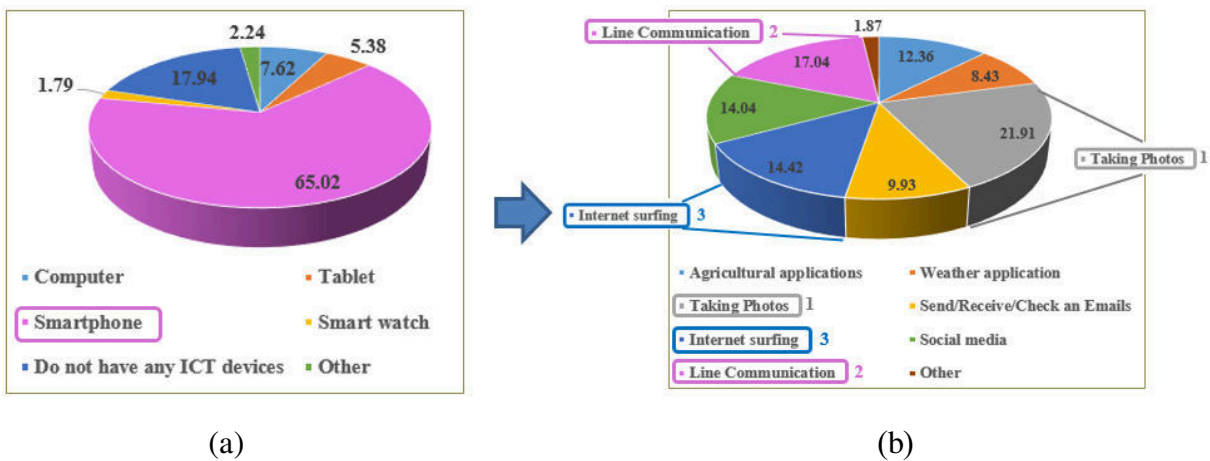

Figure II.15: Survey result of Thai farmer's technology usage
 (a) Technology device Usage
 (b) Reason of using technology device

Figure II. 15 shows that 65% of Thai farmers use smartphone in their daily life (see Figure II. 15(a)). In terms of communication platform, 17% of Thailand farmers use the Line chat application for communication. Consequently, in this thesis, Line Chat application is selected to use as the user interface to communicate between the system and farmers.

In conclusion, 144 parameters related to crop maintenance processes have been identified in the literature. Using existing smart sensors, 53 parameters can be collected. Furthermore, 40 parameters represent an expert's understanding of how to sustain a crop. The Internet of Things (IoT) technology was chosen to send data between sensors and IoT data across a Wi-Fi communication network utilizing MQTT and Node-Red protocols. Expert knowledge is captured using the KE approach. In addition, for rule-base generation, the knowledge matrix is chosen to extract experts' knowledge and to match knowledge and parameters to establish the knowledge dispute among experts. To develop the prediction model for Adaptive DSS, the LSTM technique was chosen. The forecasting model was created using the Python programming tool scikit-learn. To deliver acceptable advice to farmers, the DialogFlow chatbot application was used as a method for communication between the system and farmers.

CHAPTER III

Proposed Methodology

This chapter describes the thesis framework, methodology and architecture. The first section of this chapter discusses the thesis framework as well as the three major components of the thesis work. The methodology is explained in the second section. The final section describes the system architecture, which includes the techniques and technologies used in this thesis. The goal of this chapter is to explain the methods used in each part of this thesis.

III.1. Thesis Framework

Figure III.1 depicts the three parts of the thesis's scientific approach: Knowledge Engineering (KE), Adaptive Decision Support System (Adaptive DSS), and Data Visualization.

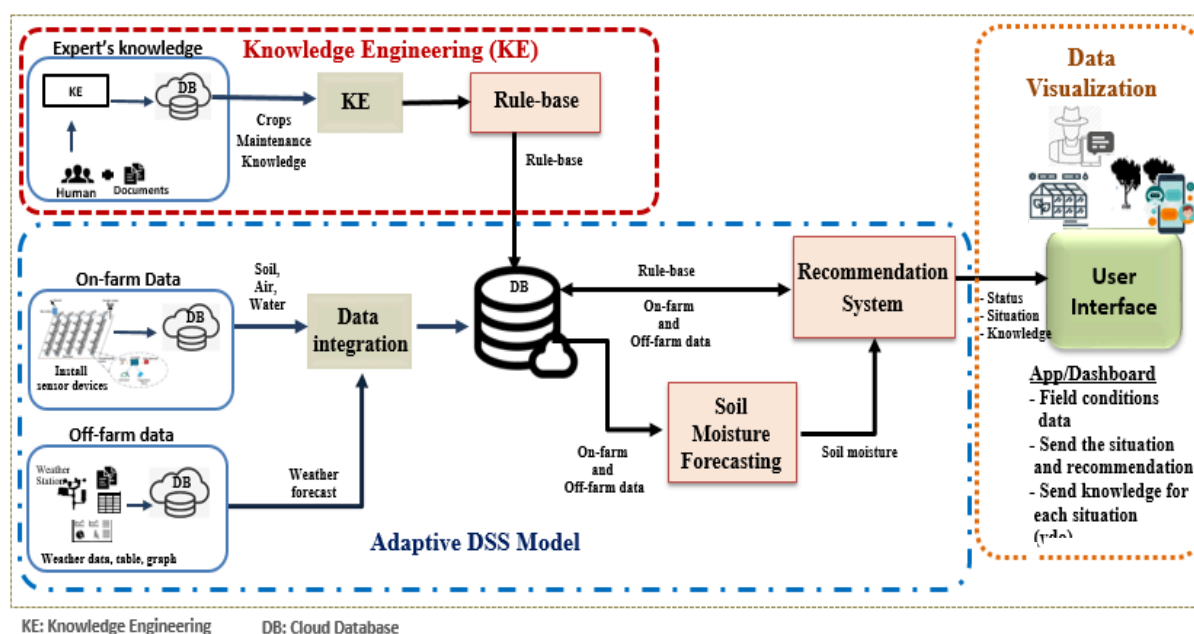

Figure III.1: Thesis framework with three main thesis parts

Figure III.1 illustrates the framework of this thesis consisting three main parts:

- *Knowledge Engineering (KE) part:* The expert's knowledge will be captured and extracted in order to create the rule-base for crop maintenance processes throughout its life cycle.
- *Adaptive DSS part:* Based on the aggregation of data from sensor devices and a rule-base extracted from experts, an appropriate recommendation for crop maintenance will be provided.
- *Data Visualization part:* Interaction with the farmers on some important information such as temperature, humidity, and crop maintenance recommendations for data monitoring and control.

III.2. Thesis Methodology

This section focuses on the methodology description for each of the three parts of the thesis scientific approach. Each section will explain the method for processing and analyzing data using various steps and techniques.

III.2.1. Knowledge Engineering

The Knowledge Engineering (KE) component includes expert knowledge capture, processing, and rule-base creation (see Figure III.2). The Knowledge Engineering technique will be used in this section to capture the expert's knowledge of crop maintenance processes. Furthermore, the captured knowledge will be processed using the knowledge matrix technique to generate the rule-base. Chapter IV will describe the results of the knowledge engineering part.

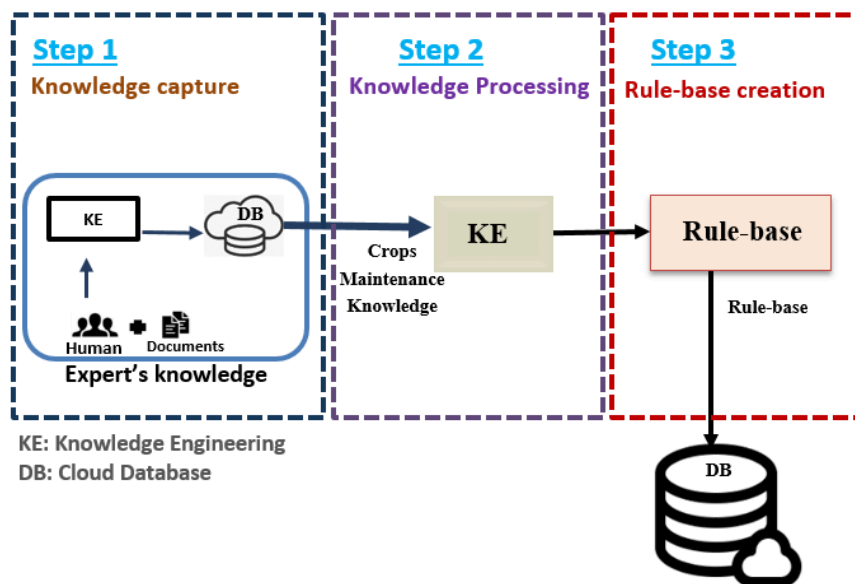

Figure III.2: Methodology of knowledge engineering part

III.2.1.1. Knowledge Capture

Knowledge engineering is used to capture knowledge from experts (see list of expert knowledge relevant to crop maintenance in Chapter II, section II.3). The primary and secondary knowledge sources are the two main sources of information. The primary knowledge is captured by interviewing and studying experts about crop maintenance processes throughout the cultivation period. Secondary awareness can be found in the form of guidelines or books available on the internet. The process of capturing expert knowledge is depicted in Figure III.



Figure III.3: Procedure to capture knowledge from experts

The processes involved in capturing an expert's knowledge and experience are depicted in Figure III.3. The questions are intended for use in interviews with crop maintenance experts who are familiar with crop life cycles and crop maintenance procedures. The criteria for expert selection are then established in order to select the best expert. After that, the appropriate experts are chosen and interviewed. Table III.1 provides a list of questions.

Table III.1: List of questions to interview experts

Crops Maintenance Process	Questions
1. Irrigation	1.1. How to irrigate crop during crop life-cycle or cultivation cycle? 1.2. What is the method used to irrigation crop? 1.3. How much you irrigate crop per day? 1.4. How much/long have you give water to crop during cultivation cycle? 1.5. What is the range of water temperature that suitable for crop irrigation during cultivation cycle?
2. Fertilization	2.1. What is the appropriate pH value to cultivate crop? 2.2. What kind of the organic substances used to give the nutrient to crop during cultivation cycle? 2.3. When we have to give the fertilizer to crop during cultivation cycle? 2.4. How much have you give the fertilizer to crop during cultivation cycle?
3. Weeds Control	3.1. What is the cause of weeds occurrence? 3.2. How it harms to crop? 3.3. How to control weeds during cultivation cycle?
4. Insects Pests Control	4.1. What is the cause of insect's pests' attraction to crop? 4.2. How it harms to crop? 4.3. How do you know when the insect pest's attraction occurs? 4.4. How to control insect pests attraction during cultivation cycle?
5. Diseases Control	5.1. What is the cause of diseases occurrence? 5.2. How it harms to crop? 5.3. How do you know when the diseases occur? 5.4. How to control diseases occurrence during cultivation cycle?
6. Pruning	6.1. When you need to prune your crop? 6.2. What is the cause of crop pruning? 6.3. how to prune crop?

The questions that will be asked of the expert during the interview are listed in Table III.1. The answers to these questions are based on the crop maintenance and life-cycle processes described in Chapter II. These questions are used in question-and-answer interviews with experts. Then, in each phase of crop maintenance, we can capture expert knowledge. We must first select a suitable qualified individual before interviewing experts.

We must define the criteria for selecting an expert person before we can proceed. According to the literature on smart farmer qualification from Thailand's Ministry of Agriculture and Cooperatives and farmer profiles from the SUNSpACe project (see chapter II, section II.4select an appropriate), there are five key expert selection criteria that apply to the assets of our expert farmers as described in Table III.2.

Table III.2: List of criteria to select experts

Criteria	Description
1. Should has experience relevant to crop cultivation at least 5 years	Farmers who are suitable to be an expert need to have crop cultivation experience more than 5 years. This is because they will have experience and best practices in various seasons related to crop cultivation.
2. Has an experience relevant to organic crop cultivation	In this research focuses on organic cultivation. Therefore, we require experts who have experiences relevant to organic crop cultivation.
3. Being trainer or used to train other farmers	The experts should be trainers or at least used to train other farmers so that we can know that they have their own tips, tricks, and experience which they can share to other farmers.
4. Has cultivation certificate (i.e. GAP, organic, etc.)	This certificate will prove that the expert expertise is valuable.
5. Their farm is the demonstration site for training other farmers.	This will prove that the experience of the expert is useable.

Based on the questions and criteria described above, appropriate expert persons will be chosen using the criteria listed in Table III.2 and interviewed using the crop maintenance questions listed in Table III.1.

III.2.1.2. Knowledge Processing

Following the questionnaire, an interview will be held to gather information from the expert. The knowledge will then be processed using the knowledge matrix technique (see Figure III.3), which will match knowledge and parameters based on crop maintenance processes and crop life-cycles. Each matching will be compared among expert knowledge to define the knowledge conflict on crop maintenance processes throughout the crop's life-cycle. The rule-base for crop maintenance will be developed as a result of knowledge conflict among various expert persons.

Figure III.4 depicts the extraction process for the captured expert knowledge. From the captured expert's knowledge, knowledge (K) and parameters (P) applicable to the cultivation and maintenance process will be specified and categorized. As an example,

Expert knowledge (K) = on day 12, during the seedling stage, apply 4-5 cc of fertilizer and check the soil ph. value, which should be between 5.8-6.2 and the water EC value, which should be between 0.6-0.8.

That means, there are 4 parameters relevant to and matching with above knowledge from expert as follow:

- Parameter 1 (P1) = day
- Parameter 2 (P2) = amount of fertilizer
- Parameter 3 (P3) = pH value of soil
- Parameter 4 (P4) = EC value of water

Then, we have to do like this with all cultivation stages, maintenance processes, and all knowledge from experts.

Cycle Stage	Beginning of Life						Middle of Life				End of Life	
	Seed planting		Germination		Sprout		Seedling		Mature		Pre-Harvesting	
Irrigation	K	P	K	P	K	P	K	P	K	P	K	P
	-	-	-	-	-	-	-	-	-	-	-	-
1. Mist	K	P	K	P	K	P	K	P	K	P	K	P
	-	-	-	-	-	-	-	-	-	-	-	-
2. Drip	K	P	K	P	K	P	K	P	K	P	K	P
	-	-	-	-	-	-	-	-	-	-	-	-
Fertilization	K	P	K	P	K	P	K	P	K	P	K	P
	-	-	-	-	-	-	-	-	-	-	-	-
Weeds Control	K	P	K	P	K	P	K	P	K	P	K	P
	-	-	-	-	-	-	-	-	-	-	-	-
Insect Pests Control	K	P	K	P	K	P	K	P	K	P	K	P
	-	-	-	-	-	-	-	-	-	-	-	-
Diseases Control	K	P	K	P	K	P	K	P	K	P	K	P
	-	-	-	-	-	-	-	-	-	-	-	-
Pruning	K	P	K	P	K	P	K	P	K	P	K	P
	-	-	-	-	-	-	-	-	-	-	-	-

Figure III.4: Knowledge Matrix

III.2.1.3. Rule-base Creation

The knowledge conflicts are then identified based on the knowledge extraction results from different experts in order to identify best practices for rule-base creation based on the captured knowledge from experts. The rule-base will be developed after obtaining the best practices based on the validation of knowledge conflict among various experts and knowledge sources. The rule-base will be created using 'IF-THEN' conditions based on parameters relevant to each crop's maintenance processes: irrigation, fertilization, disease control, insect pest control, weed control, and pruning (see Table III.3).

Table III.3: Descriptions of parameters relevant to each crops maintenance processes

Crops Maintenance Process	Relevant Parameters	Description
Irrigation	Soil Moisture	Soil moisture is the amount of water in the active layer of the soil, typically the top 1–2 m. It is extremely important because it is the main source of water for agriculture and natural vegetation.

Crops Maintenance Process	Relevant Parameters	Description
	Soil Temperature	Soil temperature is simply the measurement of the warmth in the soil. It is an important regulator for nutrient transformation and uptake by roots of crops.
	Weather Forecast	Weather forecasting is the application of current technology and science to predict the state of the atmosphere for a future time and a given location.
	Air Temperature	Air temperature is generally used as the temperature when discussing the influence of temperature on crops photosynthesis or respiration.
	Relative Humidity (RH)	The relative humidity (RH) is the ratio of the actual water vapor pressure to the saturation water vapor pressure at the prevailing temperature.
	Light Intensity	Light intensity is the quantity of visible light that is emitted in unit time per unit solid angle.
	Crop's water requirement	Crop's water requirement is amount of water needed of each crops in different cultivation stage of its life-cycle.
	Field Capacity	Field capacity is the amount of soil moisture or water content held in soil after excess water has drained away and the rate of downward movement has materially decreased, which usually takes place within 2–3 days after a rain or irrigation in pervious soils of uniform structure and texture.
	Soil Type	Soil type is the soil indifferent texture and conditions which effects to the crops irrigation and the growth of crops.
	Irrigation Method	Irrigation is the process of applying water to soil, primarily to meet the water needs of growing crop comprising surface, sprinkler, drip, and mist irrigation.
	Water Temperature	Water temperature is a physical property expressing how hot or cold water is. As hot and cold are both arbitrary terms,
	Rainfall/Precipitation	Precipitation is any product of the condensation of atmospheric water vapor that falls under gravitational pull from clouds. The main forms of precipitation include drizzling, rain, sleet, snow, ice pellets, graupel and hail.
Fertilization	Soil pH	Soil pH plays an important role in availability of nutrients essential for plant growth. In general, optimum availability occurs between a soil pH of 6.0 and 7.0.
	Soil Electrical Conductivity (EC)	Soil electrical conductivity (EC) is a measure of the amount of salts in soil (salinity of soil). It is an excellent indicator of nutrient availability and loss, soil texture, and available water capacity.
	Water pH	The pH balance of your water will affect the pH balance of soil, ultimately affecting the growth and health of crops.
	Water EC	Water EC is its ability to conduct an electric current. Salts or other chemicals that dissolve in water can break down into positively and negatively charged ions. These free ions in the water conduct electricity, so the water electrical conductivity depends on the concentration of ions.
	Weather Forecast	Weather forecasting is the application of current technology and science to predict the state of the atmosphere for a future time and a given location.
	Types of Fertilizer	Types of fertilizer effect to amount to apply to crops and crops fertility.
	Fertilization Method	Fertilization method is the process to put fertilizer to crops based on crop's requirement and soil conditions.

Crops Maintenance Process	Relevant Parameters	Description
Diseases Control	Weather Conditions	Weather conditions comprise the state of the atmosphere in terms of temperature and wind and clouds and precipitation.
	Relative Humidity	The relative humidity (RH) is the ratio of the actual water vapor pressure to the saturation water vapor pressure at the prevailing temperature.
	Air Temperature	Air temperature is generally used as the temperature when discussing the influence of temperature on crops photosynthesis or respiration.
	Soil Moisture	Soil moisture is the amount of water in the active layer of the soil, typically the top 1–2 m. It is extremely important because it is the main source of water for agriculture and natural vegetation.
	Soil Temperature	Soil temperature is simply the measurement of the warmth in the soil. It is an important regulator for nutrient transformation and uptake by roots of crops.
	Soil pH	Soil pH plays an important role in availability of nutrients essential for plant growth. In general, optimum availability occurs between a soil pH of 6.0 and 7.0.
	Soil EC	Soil electrical conductivity (EC) is a measure of the amount of salts in soil (salinity of soil). It is an excellent indicator of nutrient availability and loss, soil texture, and available water capacity.
	Light Intensity	Light intensity is the quantity of visible light that is emitted in unit time per unit solid angle.
	UV index	The UV index is an international standard measurement of the strength of sunburn-producing ultraviolet (UV) radiation at a particular place and time.
	Weather Forecast	Weather forecasting is the application of current technology and science to predict the state of the atmosphere for a future time and a given location.
	Rainfall/Precipitation	Precipitation is any product of the condensation of atmospheric water vapor that falls under gravitational pull from clouds. The main forms of precipitation include drizzling, rain, sleet, snow, ice pellets, graupel and hail.
	Methods to control diseases	Methods to control diseases is the process to control the diseases occurrence to crops which impact to crops growth, crops quality, and crops fertility.
Insect Pests Control	Weather Conditions	Weather conditions comprise the state of the atmosphere in terms of temperature and wind and clouds and precipitation.
	Air Temperature	Air temperature is generally used as the temperature when discussing the influence of temperature on crops photosynthesis or respiration.
	Relative Humidity	The relative humidity (RH) is the ratio of the actual water vapor pressure to the saturation water vapor pressure at the prevailing temperature.
	Light Intensity	Light intensity is the quantity of visible light that is emitted in unit time per unit solid angle.
	Day Length	Day length is the time each day from the moment the upper limb of the sun's disk appears above the horizon during sunrise to the moment when the upper limb disappears below the horizon during sunset.
	Methods to control Insect Pests	Methods to control insect pests is the process to control the attack of insect pests to crops which impact to crops growth, crops quality, and crops fertility.

Crops Maintenance Process	Relevant Parameters	Description
Weeds Control	Air Temperature	Air temperature is generally used as the temperature when discussing the influence of temperature on crops photosynthesis or respiration.
	Relative Humidity	Weather conditions comprise the state of the atmosphere in terms of temperature and wind and clouds and precipitation.
	Light Intensity	Light intensity is the quantity of visible light that is emitted in unit time per unit solid angle.
	Soil Moisture	Soil moisture is the amount of water in the active layer of the soil, typically the top 1–2 m. It is extremely important because it is the main source of water for agriculture and natural vegetation.
	Rainfall/Precipitation	Precipitation is any product of the condensation of atmospheric water vapor that falls under gravitational pull from clouds. The main forms of precipitation include drizzling, rain, sleet, snow, ice pellets, graupel and hail.
	Irrigation Method	Irrigation is the process of applying water to soil, primarily to meet the water needs of growing crop comprising surface, sprinkler, drip, and mist irrigation.
	Methods to control weeds	Methods to control weeds is the process to control the weeds growth which effect to crops growth and diseases occurrence.
Pruning	Crop growth	Crop growth is the irreversible increase in size whereas development is the continuous change in plant form and function with characteristic transition phases.
	Crop height	Crop height is valuable for applications such as biomass and yield estimation, or increasing field work efficiency in terms of fertilizing, applying pesticides, irrigation, etc.
	Crop Canopy	Crop canopy likes the branches of crops that grows depending on the suitable weather conditions and crops health.
	Crop Integrity	Crop integrity is to indicate the health of crops.
	Diseases Occurrence	Diseases occurrence is the outbreak situation of crops disease which impact crops fertility, yield, and quality.
	Methods of pruning	Methods of pruning is the process to cut or eliminate unwanted part or branch of crops to form crops structure or to eliminate crops diseases.

Table III.3 identifies the parameters that are important in crop maintenance processes. Based on the relationship between the parameters and the expert's knowledge, these parameters will be used to create the 'If-THEN' rule-base.

Table III.4: Structure to create the rule-base using 'IF-THEN' conditions

Crops Maintenance Process	IF	Situation	THEN
Irrigation	Soil Moisture Value = X AND Soil Temperature Value = X AND Weather Forecast = X AND Air Temperature Value = X AND Relative Humidity (RH) Value = X AND Light Intensity Value = X AND	Crop environment conditions i.e. soil moisture is too dry, rainfall value is too high	Watering based on data, irrigation method and crop's water requirement i.e. irrigate 10 minutes

Crops Maintenance Process	IF	Situation	THEN
	Field Capacity Value = X AND Soil Type Value = X AND Water Temperature Value = X AND Rainfall/Precipitation Value = X		
Fertilization	Soil ph Value = X AND Soil EC Value = X AND Water ph Value = X AND Water EC Value = X AND Weather Forecast = X	Crop environment conditions i.e. soil ph is too high	Apply fertilizer based on value, types of fertilizer, and fertilization Method
Diseases Control	Weather Conditions = X AND Relative Humidity Value = X AND Air Temperature Value = X AND Soil Moisture Value = X AND Soil Temperature Value = X AND Soil ph Value = X AND Soil EC Value = X AND Light Intensity Value = X AND UV index Value = X AND Weather Forecast Value = X AND Rainfall/Precipitation Value = X	Weather conditions impact diseases occurrence	Methods to control diseases
Insect Pests Control	Weather Conditions = X AND Air Temperature Value = X AND Relative Humidity Value = X AND Light Intensity Value = X AND Day Length Value = X	Weather conditions impact insect pests attack	Methods to control Insect Pests
Weeds Control	Air Temperature Value = X AND Relative Humidity Value = X AND Light Intensity Value = X AND Soil Moisture Value = X AND Rainfall/Precipitation Value = X	Weather and irrigation method impact to weed growth	Methods to control weeds
Pruning	Crop growth Value = X AND Crop height Value = X AND Crop Canopy Value = X AND Crop Integrity Value = X AND Diseases Occurrence = disease x occurred	Crop's fertility and diseases occurrence impact the pruning crop	Methods of pruning crop

Table III. 4 depicts the structure used to develop the rule-base for each crop maintenance process. This structure is applicable to both indoor and outdoor crop cultivation. The amount of water used to irrigate crops is affected by soil, water, climatic conditions, and crop water requirements at each stage of the irrigation process. During the fertilization process, the crop requires adequate soil fertility and weather conditions in order to apply the appropriate amount of fertilizer. The appropriate weather and soil conditions influence disease occurrence during the disease control process. The climatic and light conditions have an effect on the attack of insect pests during the insect pest control process. The crop conditions and the occurrence of diseases have an impact on the pruning process. We can define the 'Situation' and the recommendation 'THEN' based on the 'IF' to suggest farmers.

III.2.2. Adaptive Decision Support System

The data analysis part of the Adaptive Decision Support System (Adaptive DSS) is based on an aggregation of data collected from sensors and the rule-base. It is concerned with data

collected both on and off the farm (on-farm data is data collected using smart sensor devices installed in the field and off-farm data is data collected using smart sensor devices installed in the field). Off-farm data refers to information obtained from other open data sources, such as weather forecasts. This dimension includes the following steps: data collection, processing and storage, and data analysis. Figure III.5 illustrates the methodology for this section.

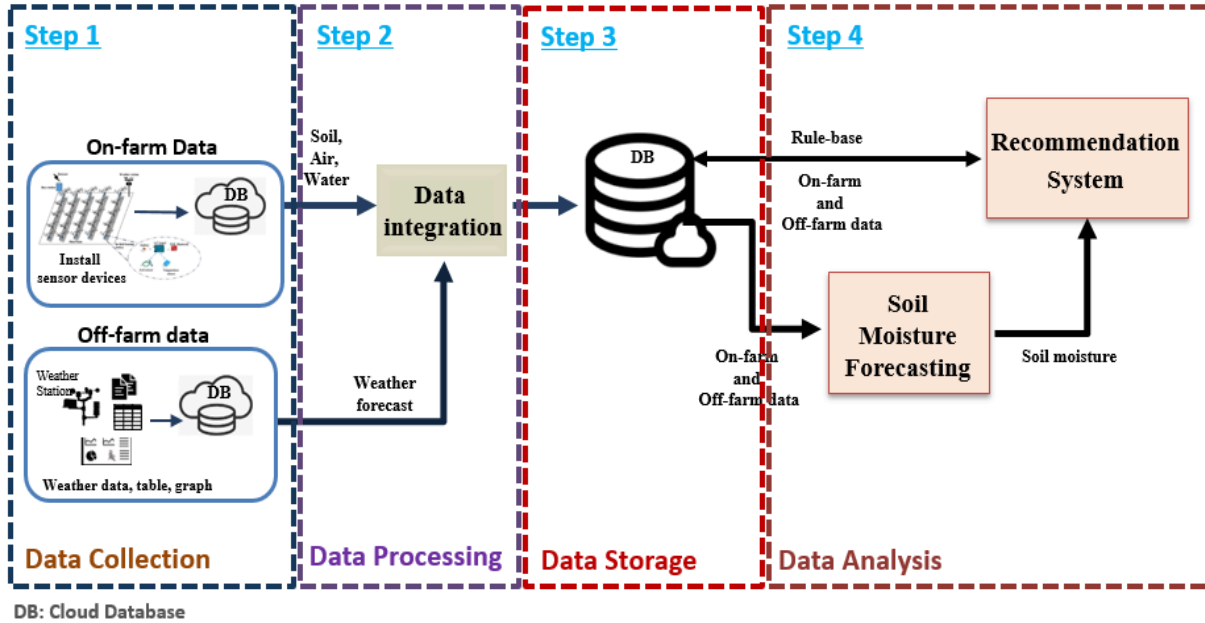

Table III.5: Methodology of Adaptive DSS part

The Adaptive DSS part methodology is depicted in Figure III.5, in which on-farm and off-farm data are collected using smart sensor devices and technologies. The data is then processed by combining and transforming it into the format that will be used to store it in the database. Data is analyzed using the Long-Short Term Memory (LSTM) deep learning technique to provide the expected prediction. On-farm data, off-farm data, and a rule-base are used to provide recommendations for appropriate crop maintenance processes. The proposed Adaptive DSS will be validated in the implementation step by testing it in the field, with the results of the Adaptive DSS part described in Chapter 5.

III.2.2.1. Data Collection

We focus on crop cultivation indoors or in a greenhouse. The relevant sensors are installed in the field to collect on-farm data based on a review of data relevant to crop production and maintenance (see chapter II, section II.4). Furthermore, off-farm data are collected by retrieving data from the API (Application Programming Interface) of a weather forecast website based on the farm location. The sensors, which include a soil sensor, an indoor air sensor, and an outdoor weather station, are installed in the greenhouse (see Figure III.6), and the list of data collected is shown in Table III.5.

Table III.5: List of data collection for Adaptive DSS

Area	Parameters		
	Soil	Water	Air
Inside Greenhouse	- Soil Moisture - Soil Temperature - Soil ph - Soil Electrical Conductivity (EC)		- Air Temperature - Relative Humidity - Light Intensity - UV index - Air CO ₂ Concentration
Outside Greenhouse		- Water ph - Water Temperature - Water EC	- Air Temperature - Relative Humidity - Light Intensity - UV index - Air CO ₂ Concentration - Rainfall/Precipitation - Wind Speed - Wind Direction - Air Pressure

Table III.5 shows all relevant data that we will collect using sensor devices as follow;

- *Soil sensor:* used to monitor real-time soil moisture, soil temperature, soil pH, and soil electrical conductivity (EC), all of which have an impact on crop growth and health.
- *Air indoor sensor:* used to monitor the real-time air temperature, relative humidity, UV index, light intensity, and CO₂ concentration inside the greenhouse, assisting in the control of the crops environment suitable for crop production inside the greenhouse.
- *Outdoor weather station:* used to monitor the weather parameters outside the greenhouse, which include air temperature, relative humidity, UV, light intensity, rainfall or precipitation, and wind speed, all of which have an effect on the environment inside the greenhouse.

**Figure III.6:** Data collection using sensor devices diagram

Figure III.6 depicts a sensor installation diagram for data collection. To collect soil and air indoor data, air indoor and soil sensors will be installed inside the greenhouse. Meanwhile, a weather station will be installed to collect climatic conditions outside the greenhouse so that farmers can monitor the weather for farm management decisions. Furthermore, the water sensor will be installed in the water tank to monitor water conditions for crop maintenance.

III.2.2.2. Data Processing and Storage

Data will be collected every five minutes. The data will then be pre-processed to check for missing data and/or other errors using the function in Python programming. Following that, the cleaned data will be used for data analysis in the Adaptive DSS model.

III.2.2.3. Data Analysis (Adaptive DSS Model)

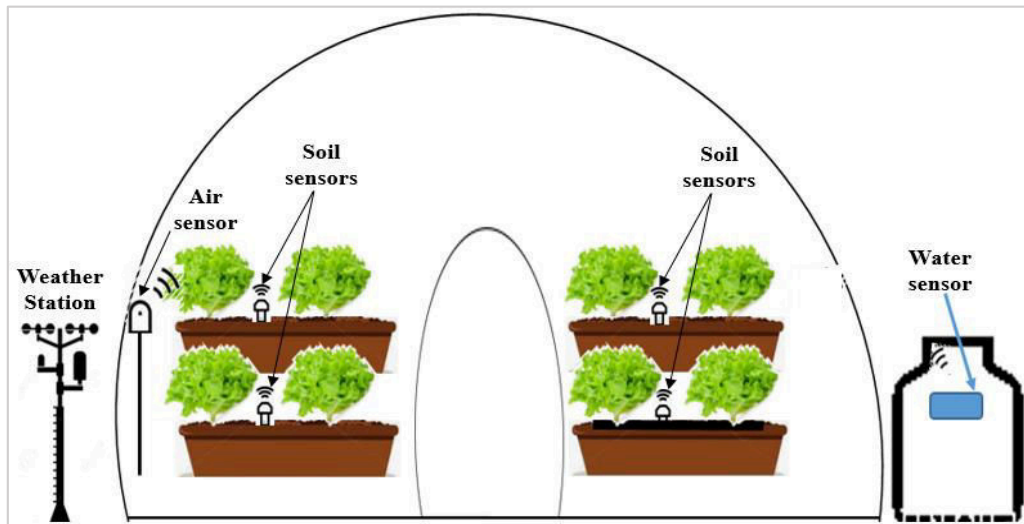
The Adaptive DSS model is divided into two parts: the recommendation system (which will be explained in section III.2.2.3.1) and the soil moisture forecasting model (will explain in section III.2.2.3.2). The soil moisture forecasting model predicts soil moisture values in the future based on weather conditions in order to manage irrigation optimization in the near future. Based on IoT data and a rule-base, the recommendation system suggests appropriate crops maintenance processes to farmers.

III.2.2.3.1. Recommendation system

Figure III.7 depicts the Adaptive DSS diagram, which processes and analyzes data from IoT sensors and weather forecasts using a rule-based script by running an IF-THEN loop for each crop's maintenance process and life-cycle. We focus on only five of the six crop maintenance processes in this thesis: irrigation, fertilizer application, disease control, weed control, and insect pest control. Because we only collect data from sensors, the pruning process is not part of this Adaptive DSS scheme. The pruning method, on the other hand, requires image data for image processing in order to generate a pruning recommendation.

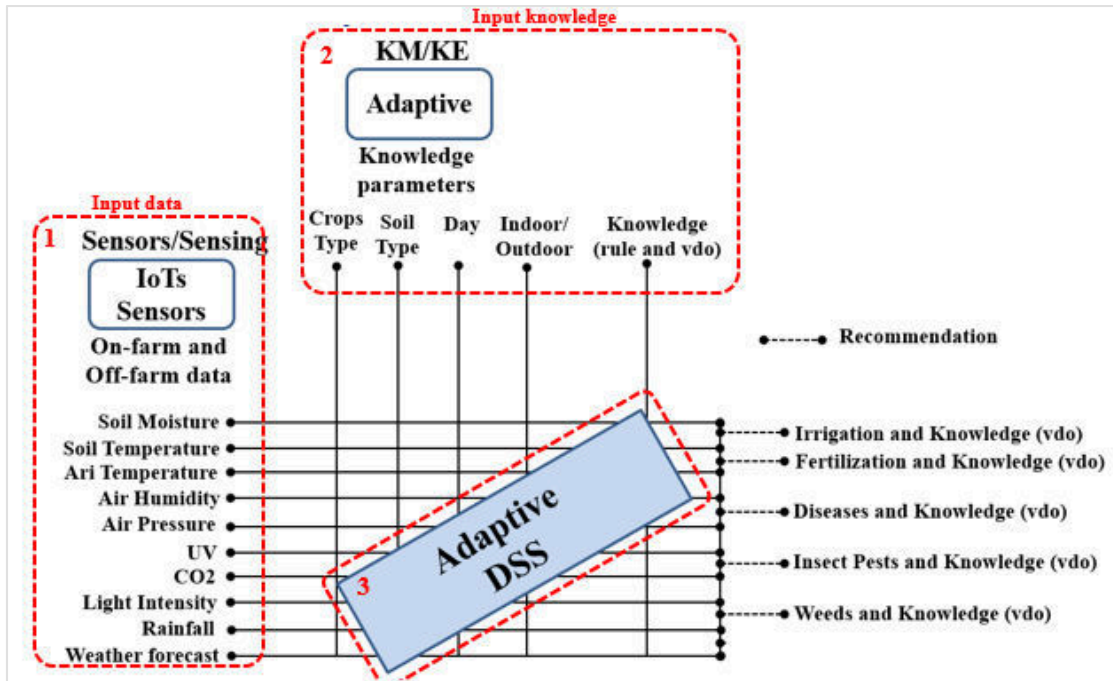

Figure III.7: Adaptive DSS diagram for recommendation system

III.2.2.3.2. Soil Moisture Forecasting Model

The soil moisture forecasting model is one component of the irrigation optimization component that predicts soil moisture value in the near future. Farmers can then properly manage their irrigation. The irrigation optimization (see Figure III.8) is the part that provides an appropriate amount of water to irrigate crop based on calculation and rule-base. Irrigation optimization consists of two primary parts.

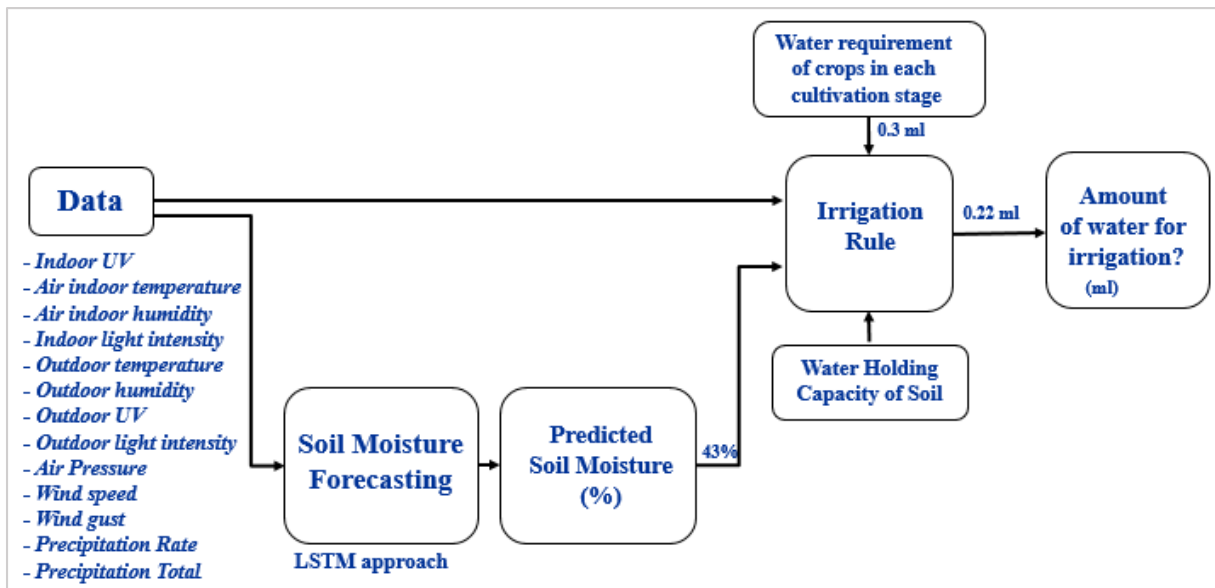

Figure III.8: Irrigation Optimization Diagram

Figure III.8 depicts the irrigation optimization steps. The soil moisture forecasting model is used to predict soil moisture values in field based on meteorology data and provide

farmers with an adequate amount of water. Soil moisture forecasting assists and recognizes farmers in managing water to irrigate crops. The irrigation optimization analyzes data based on irrigation rules, soil water holding capacity, and crop water requirements.

To create a soil moisture forecasting model, we must first clean the relevant IoT data using Python function code, specifically the Imputer class from the scikit-learn module, which will be used to replace the missing value with the mean value of the entire feature column. The soil moisture forecasting model will then be designed using the deep learning approach of Long-Short Term Memory (LSTM). The hyperparameters used to design the soil moisture forecasting model, as well as the model performance, will be discussed in detail in Chapter 5.

III.2.3. Data Virtualization

Following data analysis, recommendations will be sent to farmers via the user interface, which will be used to communicate between the system and the users. To design the data visualization, we must first define the types of data monitoring and user interfaces that will be used to retrieve data from the system. The functions of our data visualization must then be defined. Following that, the user interface is designed and tested using the design methodology depicted in Figure III.9.

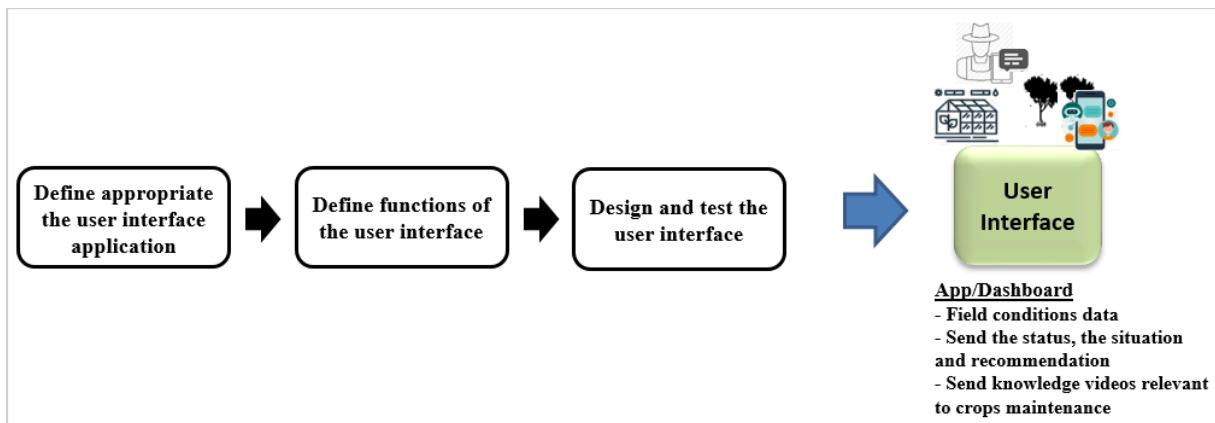

Figure III.9: Design data visualization methodology

III.3. System Architecture

In this section, we will explain the architecture of this research, the methods that will be used for each section, and the scientific approach and literature that will be selected.

III.3.1. Knowledge Engineering architecture

The Expert's knowledge can be obtained from the following sources:

- *Primary expert's knowledge:* collected through expert interviews on crop maintenance processes for the entire cultivation cycle
- *Secondary expert's knowledge:* Searching the internet yielded cultivation guidelines.

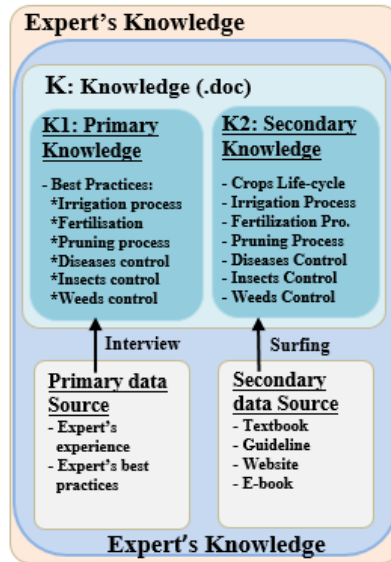

(a)

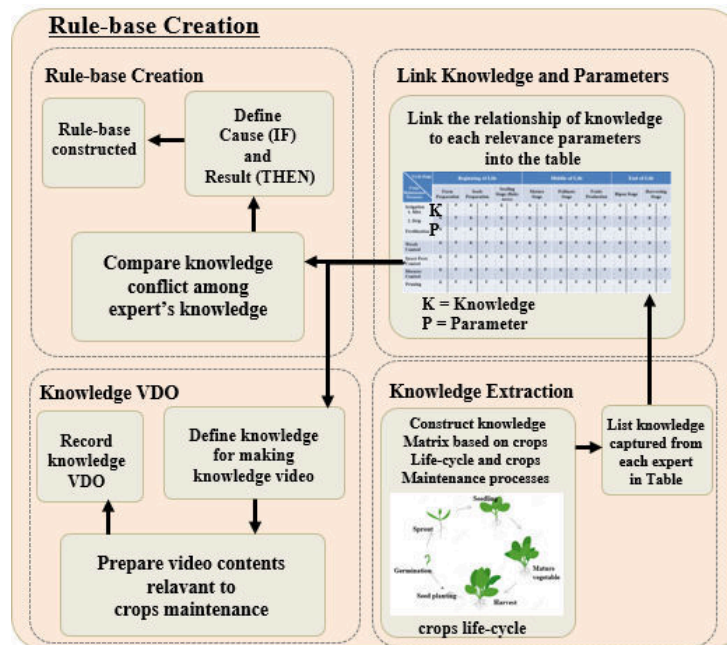

(b)

Figure III.10: Architecture of knowledge engineering part
 (a) Expert's knowledge capture
 (b) Rule-base creation

Figure II.10 depicts a knowledge engineering part architecture. The expert knowledge capturing architecture (shown in Figure III.10(a)) has two primary knowledge sources. After identifying expert sources, knowledge will be gathered through surfing, interviews, and observation.

Following knowledge collection, the captured knowledge must be summarized and identified as the best practice using the knowledge matrix, which is focused on knowledge disagreement from multiple sources. The knowledge and parameters are then specified in order to connect them in order to create the rule-base, and the knowledge video is created based on

the crop cultivation and maintenance processes. Figure 8 depicts the rule-based design architecture.

Figure III.10(b) depicts the knowledge matrix format that will be used to compare knowledge from different knowledge sources and to connect knowledge and parameters to determine the best crop maintenance practice. The rule-based will be constructed by combining knowledge and parameters to create each rule-based situation, and then using a knowledge matrix to create the rule-based. The rule-based system is saved in a Google Sheet.

The rules are based on the parameters relevant to each process of crop maintenance at various stages of the cultivation cycle, which include:

- Cultivation Stage: Is the crop cultivation cycle.
- Maintenance Process: The processes involved in each stage of cultivation.
- Relevance Parameter: The parameters relevant to each stage's processes.
- Crops Maintenance Information: The general information needed to cultivate crops.
- Situation relevant to maintenance processes and parameters
- Recommendation: The advice given to farmers based on the recommendations made based on each process and parameter.

III.3.2. Adaptive DSS architecture

III.3.2.1. On-farm and off-farm data collection

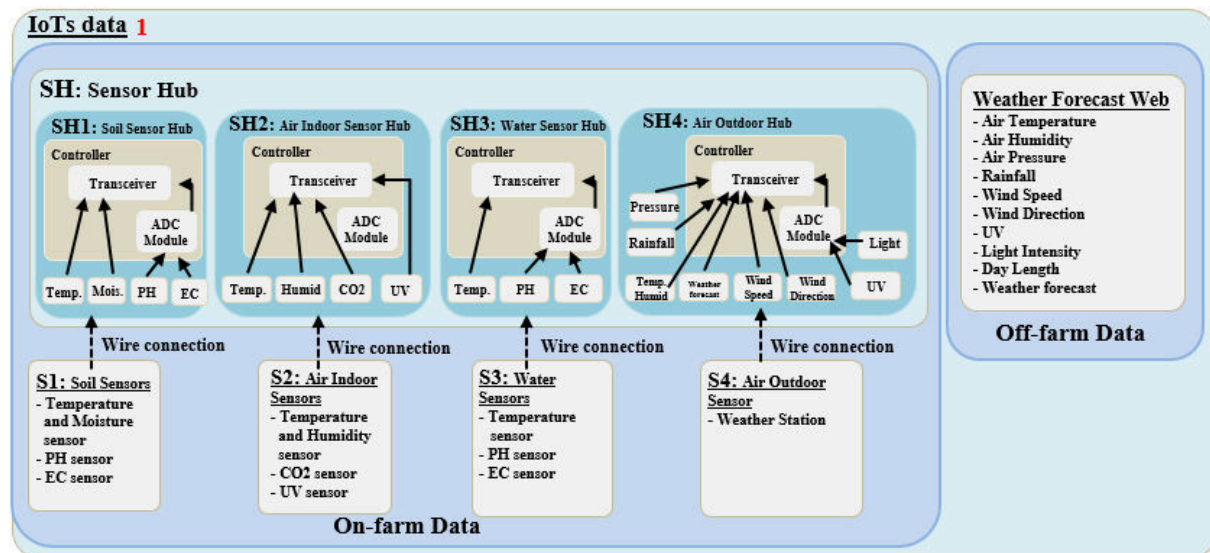

Figure III.11: Architecture of On-farm and off-farm data collection

The architecture of data collection is illustrated in Figure III.11. Transceivers that receive data from sensor probes and send it to data storage include the soil sensor hub, water sensor hub, air indoor sensor hub, and CO₂ sensor hub. The sensor hubs are wired together with the soil sensors, water sensors, air probes, and CO₂ sensor. The sensor hubs send data to data storage using the WiFi network.

Off-farm data are collected by getting data from API of weather forecast website ([http://api.openweathermap.org/data/2.5/weather?lat=". \\$lat. "&lon=". \\$lon." &lang=en&units=metric&APPID=" . \\$apiKey](http://api.openweathermap.org/data/2.5/weather?lat=)). The location is in Mueang Chiang Mai province (18.7452719,98.9781734).

III.3.2.2. Data storage source

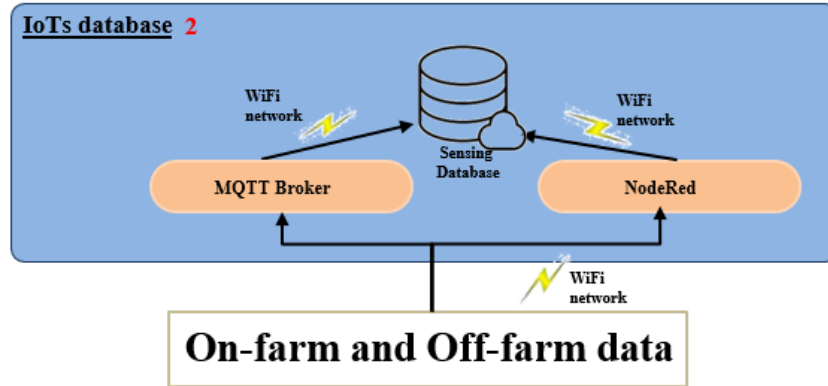

Figure III.12: Architecture of IoTs data storage

Figure III. 12 depicts the IoT data storage architecture, which will store data in a cloud database. Users can monitor sensor data, sensor status, and irrigation control system status via a platform that is linked to the SUNSpAcE project. Using the WiFi communication network, the MQTT broker and NodeRed are used to transfer data from sensors to the cloud database.

III.3.2.3. Proposed Adaptive DSS model

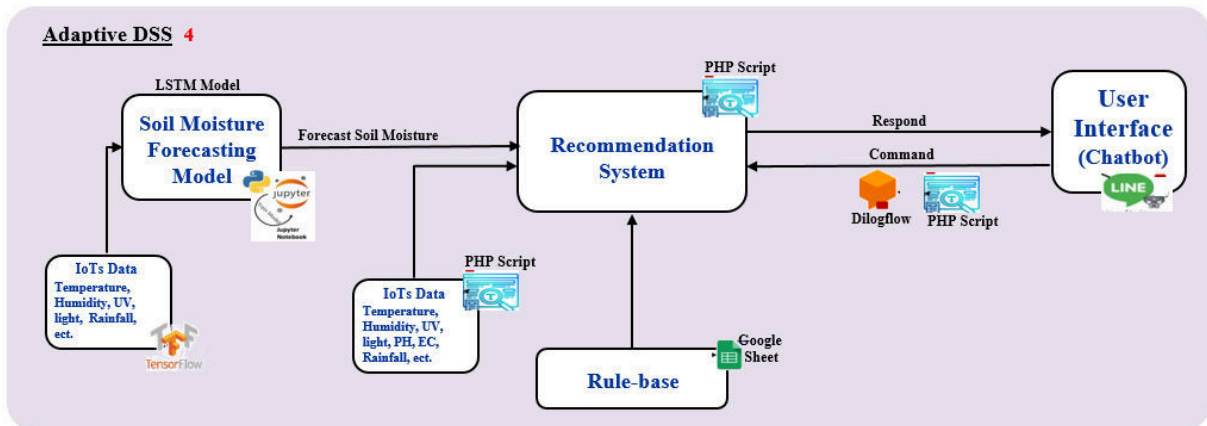

Figure III.13: Architecture of data analyzing (proposed ADSS model)

Figure III. 13 depicts the architecture of the proposed ADSS model, which consists of three major components: a recommendation system, irrigation optimization, and soil moisture forecasting. The architecture of the recommendation system is shown in Figure III. 14. However, the soil moisture forecasting model will be explained in chapter 5.

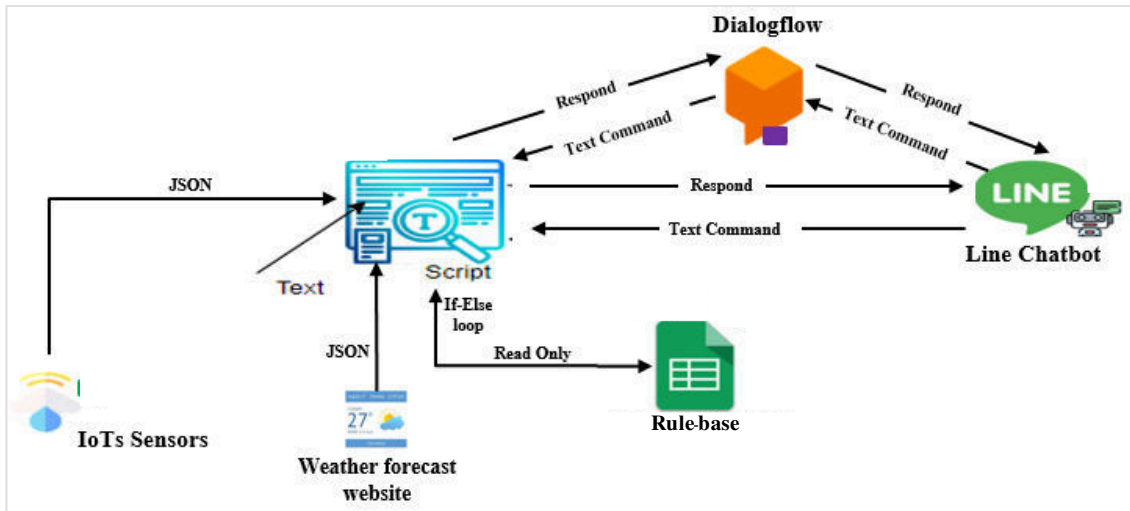
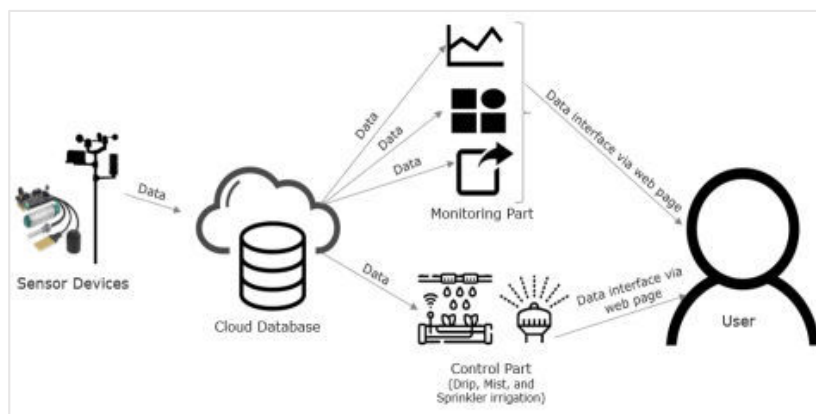

Figure III.14: Recommendation system architecture

The recommendation system (shown in Figure III.14) is the component that processes and analyzes data from IoT sensors and weather forecasts via a script that runs an If-Else loop for each cultivation date. Because Dialogflow has a feature that helps users find the correct word when they type incorrect words, it will be used as the interface between Line chatbots and the system. However, we must interleave training sentences or words in order to train the Dialogflow. Line chatbots are interfaces that are used to interact with users and provide them with knowledge, status, and recommendations automatically.

III.3.3. Data Visualization Part

The visualization process has two parts of data visualization: An IoTs dashboard and a chatbot application, the results of which will be explained in Chapter 6. The IoTs dashboard will be based on the SUNSPACE project dashboard for the Chiang Mai University (CMU) pilot case, as shown in Figure III.15.



(a)

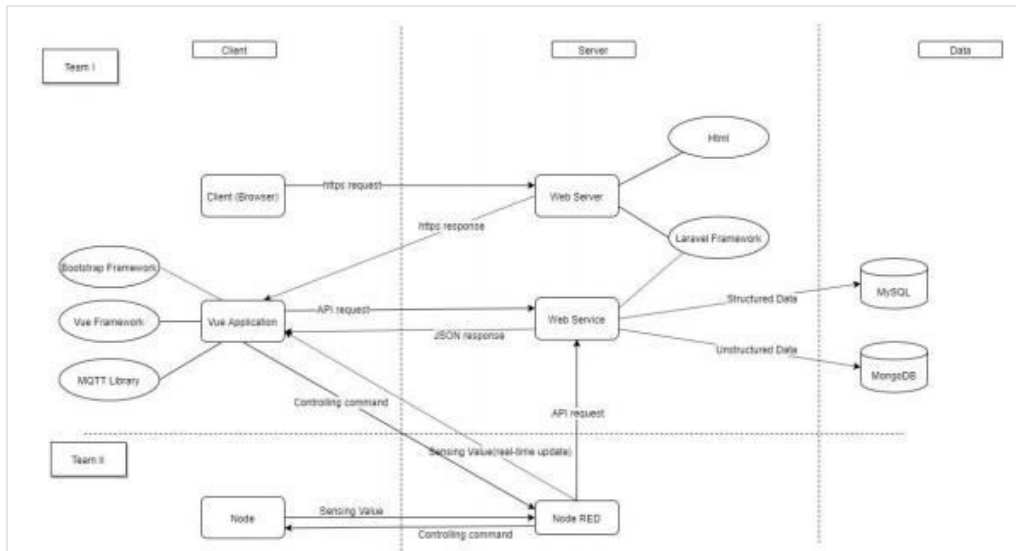

(b)

Figure III.15: IoTs dashboard architecture

The Line chatbots application is used to be the Line “AgriRec” chatbots as the user interface of this system to interface the recommendation provided by analysis of the proposed Adaptive DSS. The user interface is divided into five sections: main page, start menu, monitor page, mist irrigation page, and drip irrigation page.

- *Main page:* The main page is the one that shows the user all of the information. Each feature can be tracked and managed by the user by clicking on it on the main page.
- *Start menu:* This is the function that enables the system to begin operating on the basis of a crop life-cycle. In addition, if the device detects an abnormal condition, the status and recommendation will be sent throughout the day. The following day, the system will automatically submit the user's information, a knowledge video, and a suggestion.
- *Mist irrigation page:* When the device suggests that the mist irrigation be turned on, the user can do so from this page. The chatbot will notify the user of the mist irrigation status, as well as the most recent mist irrigation status. Users can also control the irrigation via the Line chatbot.
- *Drip irrigation page:* When the system suggests that the drip irrigation be turned on, the user can do so from this page. The chatbot will notify the user of the drip irrigation status and will inform the user of the actual drip irrigation status. Users can also use the Line chatbot to control the irrigation.
- *Monitor page:* Users can track the current state of their crop's climate by visiting the monitor page. Following that, the system will submit all relevant data via chatbot. A user can also ask the chatbot for a specific piece of information, and the chatbot will respond with that information.

Figure III. 16 illustrates the overall system architecture that explained above. The IoTs data and Expert’s knowledge is the data collection part to collect data from sensors and capture expert’s knowledge. Part two focuses on the data storage on cloud database. The next part is rule-base creation that is the part to define knowledge conflict to get the best practice for rule-

base creation. The Adaptive DSS part concentrates to recommendation to crops maintenance processes and soil moisture value forecasting model for irrigation optimization. The final part is user interface to communicate between users and system.

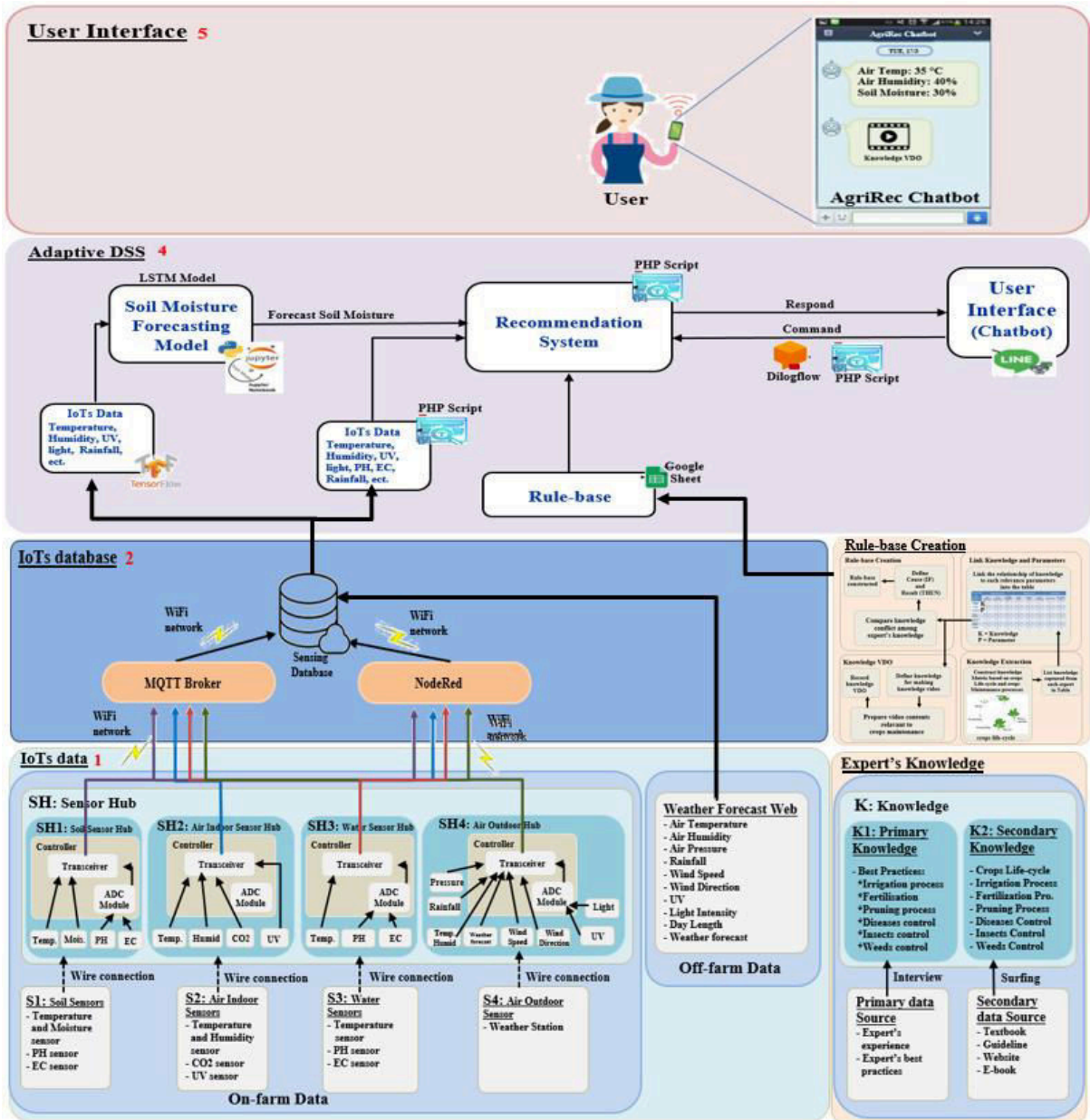

Figure III.16: System Architecture

CHAPTER IV

Rule-base Creation of Crops Recommendation

The objective of this chapter is to explain and to reveal the method and technique used to create the rule-base from diverse knowledge sources (expert's knowledge and experiences captured, and secondary knowledge source) including the list of knowledge videos relevant to smart agriculture for knowledge sharing. As the architecture of rule-base creation is explained in chapter III, section III.2.1. In this chapter, the first part describes about expert's profile selected based on the criteria and the interviewed experts to capture their knowledge. The second section illustrates extracted list of five expert knowledge sources to cultivate and maintain the Lettuce including matching knowledge and parameters relevant to Lettuce cultivation of each knowledge source. The third section reveals the rule-base created based on the best practice results from matching and defining the knowledge conflict among knowledge sources. The final section illustrates the list of knowledge videos relevant to crops maintenance and smart agriculture.

IV.1. Knowledge Capture

This section concentrates on expert's knowledge capturing. In this thesis, we focus on the Lettuce cultivation as our use case because it is high demand in the north of Thailand. According to the knowledge capture procedure described in chapter III (section III.2.1.1), we must first choose an acceptable qualified individual before interviewing experts using the smart farm criteria (see Table III.2). We selected five knowledge sources; four knowledge sources from expert person (primary knowledge source) and one knowledge source from Thailand Ministry of Agriculture and Cooperatives (secondary knowledge source). Table IV.1 describes selected experts' profile. Some experts are smart farmers under 'Young Smart Farmers (YSF)' project of Thailand government and sole experts have a farming and being trainer experience for long time. They have an experience and knowledge relevant to organic crops cultivation including Lettuce.

Table IV.1: List of experts' profile

Expert's ID	Age	Crops cultivation experience (year)	Organic farming experience (year)	Trainer experience (year)	Farm Location
E1	45	20	8	15	Chiang Mai, Thailand (Figure IV.1(a))
E2	38	10	5	5	Chiang Mai, Thailand (Figure IV.1(b))
E3	32	7	7	5	Chiang Mai, Thailand (Figure IV.1(c))
E4	35	8	8	5	Chiang Rai, Thailand (Figure IV.1(d))

After experts selected, we interviewed them according to the questions described in Table III.1 that are relevant to organic Lettuce cultivation and maintenance processes by recording our interviewing. During interview, we also visited their farms to observe their

location (water, soil, organic substances usage and keeping), their practices and management as shown in Figure IV.1.



(a)



(b)



(c)



(d)

Figure IV.1: Farm visiting during interviewing experts

(a) Baeng Pun Organic Farm (b) Ginger Organic Farm

(c) Fresh & Organic Farm (d) Ban Na Kwan Organic Farm

IV.2. Knowledge extraction

The knowledge recorded from each expert person are listed into an excel file as shown sample of knowledge from each expert person in Table IV.2 to Table IV.5. In addition, Table IV.6 shows sample of Lettuce cultivation and maintenance knowledge received from Thailand Ministry of Agriculture and Cooperatives link. In this thesis, we concentrate only five crops maintenance processes: irrigation, fertilization, diseases control, insect pests control, and weeds control because we collect data only from sensor devices.

Table IV.2: Sample of knowledge captured to cultivate Lettuce from expert E1

Crop Maintenance Process	Crop's Life-Cycle					
	Beginning of Life			Middle of Life		End of Life
	Seeding Planting	Germination	Sprout	Seedling	Mature	Pre-Harvesting
Irrigation	Irrigate 2 times every day	Irrigate 2 times every day and can irrigate during the day if the temperature is too high	Irrigate 2 times every day and can irrigate during the day if the temperature is too high	Irrigate 2 times every day and can irrigate during the day if the temperature is too high	Irrigate 2 times every day and can irrigate during the day if the temperature is too high	Irrigate 2 times every day and can irrigate during the day if the temperature is too high
Fertilization	No fertilizer application	No fertilizer application	Apply fertilizer and control EC value between 1.0-1.2 ms/cm	Apply fertilizer and control EC value between 1.2-1.4 ms/cm	Apply fertilizer and control EC value between 1.0-1.1 ms/cm	Stop to apply fertilizer and control EC value lower than 0.5 ms/cm
Weeds Control	Check weeds everyday	Check weeds everyday	Check weeds everyday	Check weeds everyday	Check weeds everyday	Check weeds everyday
Pests Control	No attack from insects	No attack from insects	Might be attack from insects, should cover by the net	Might be attack from insects, should cover by the net	Might be attack from insects, should cover by the net	Might be attack from insects, should cover by the net
Diseases Control	No disease issues	No disease issues	Spray Calcium and Boron 1-2 time/week to protect the Tip burn issue	Spray Calcium and Boron 1-2 time/week to protect the Tip burn issue	Spray Calcium and Boron 1-2 time/week to protect the Tip burn issue	Spray Calcium and Boron 1-2 time/week to protect the Tip burn issue

Table IV.3: Sample of knowledge captured to cultivate Lettuce from expert E2

Crop Maintenance Process	Crop's Life-Cycle					
	Beginning of Life			Middle of Life		End of Life
	Seeding Planting	Germination	Sprout	Seedling	Mature	Pre-Harvesting
Irrigation	Irrigate 2 times every day using sprinkler (30 mins/time)	Irrigate 2 times every day using sprinkler (30 mins/time) and can irrigate during the day if the temperature is too high (20-25 mins)	Irrigate 2 times every day using sprinkler (30 mins/time) and can irrigate during the day if the temperature is too high (20-25 mins)	Irrigate 2 times every day using sprinkler (30 mins/time) and can irrigate during the day if the temperature is too high (20-25 mins)	Irrigate 2 times every day using sprinkler (30 mins/time) and can irrigate during the day if the temperature is too high (20-25 mins)	Irrigate 2 times every day using sprinkler (30 mins/time) and can irrigate during the day if the temperature is too high (20-25 mins)
Fertilization	No fertilizer application	Apply fertilizer buy mixing with water (5ml/water 500ml)	Apply fertilizer and control EC value between 1.0-1.2 ms/cm	Apply fertilizer and control EC value between 1.2-1.4 ms/cm	Apply fertilizer and control EC value between 1.0-1.1 ms/cm	Stop to apply fertilizer and control EC value lower than 0.5 ms/cm
Weeds Control	Check weeds everyday	Check weeds everyday	Check weeds everyday	Check weeds everyday	Check weeds everyday	Check weeds everyday
Pests Control	No attack from insects	Might be attack from insects, should cover by the net	Might be attack from insects, should cover by the net	Might be attack from insects, should cover by the net	Might be attack from insects, should cover by the net	Might be attack from insects, should cover by the net
Diseases Control	No disease issues	Spray Calcium	Spray Calcium and Boron 1-2 time/week to protect the Tip burn issue	Spray Calcium and Boron 1-2 time/week to protect the Tip burn issue	Spray Calcium and Boron 1-2 time/week to protect the Tip burn issue	Spray Calcium and Boron 1-2 time/week to protect the Tip burn issue

Table IV.4: Sample of knowledge captured to cultivate Lettuce from expert E3

Crop Maintenance Process	Crop's Life-Cycle					
	Beginning of Life			Middle of Life		End of Life
	Seeding Planting	Germination	Sprout	Seedling	Mature	Pre-Harvesting
Irrigation	Irrigate 2 times every day using drip (30 mins/time)	Irrigate 2 times every day using drip (30 mins/time) and can irrigate during the day if the temperature is too high (20-25 mins)	Irrigate 2 times every day using drip (30 mins/time) and can irrigate during the day if the temperature is too high (20-25 mins)	Irrigate 2 times every day using drip (30 mins/time) and can irrigate during the day if the temperature is too high (20-25 mins)	Irrigate 2 times every day using drip (30 mins/time) and can irrigate during the day if the temperature is too high (20-25 mins)	Irrigate 2 times every day using drip (30 mins/time) and can irrigate during the day if the temperature is too high (20-25 mins)
Fertilization	No fertilizer application	No fertilizer application	Apply fertilizer and control EC value between 1.0-1.2 ms/cm	Apply fertilizer and control EC value between 1.2-1.4 ms/cm	Apply fertilizer and control EC value between 1.0-1.1 ms/cm	Stop to apply fertilizer and control EC value lower than 0.5 ms/cm
Weeds Control	Check weeds everyday	Check weeds everyday	Check weeds everyday	Check weeds everyday	Check weeds everyday	Check weeds everyday
Pests Control	No attack from insects	No attack from insects	Might be attack from insects, should cover by the net	Might be attack from insects, should cover by the net	Might be attack from insects, should cover by the net	Might be attack from insects, should cover by the net
Diseases Control	No disease issues	No disease issues	Spray Calcium and Boron 1-2 time/week to protect the Tip burn issue	Spray Calcium and Boron 1-2 time/week to protect the Tip burn issue	Spray Calcium and Boron 1-2 time/week to protect the Tip burn issue	Spray Calcium and Boron 1-2 time/week to protect the Tip burn issue

Table IV 5: Sample of knowledge captured to cultivate Lettuce from expert E4

Crop Maintenance Process	Crop's Life-Cycle					
	Beginning of Life			Middle of Life		End of Life
	Seeding Planting	Germination	Sprout	Seedling	Mature	Pre-Harvesting
Irrigation	Irrigate 2 times every day using drip (30 mins/time)	Irrigate 2 times every day using drip (30 mins/time) and can irrigate during the day if the temperature is too high (20-25 mins)	Irrigate 2 times every day using drip (30 mins/time) and can irrigate during the day if the temperature is too high (20-25 mins)	Irrigate 2 times every day using drip (30 mins/time) and can irrigate during the day if the temperature is too high (20-25 mins)	Irrigate 2 times every day using drip (30 mins/time) and can irrigate during the day if the temperature is too high (20-25 mins)	Irrigate 2 times every day using drip (30 mins/time) and can irrigate during the day if the temperature is too high (20-25 mins)
Fertilization	No fertilizer application	Apply fertilizer buy mixing with water (5ml/water 500ml)	Apply fertilizer and control EC value between 1.0-1.2 ms/cm	Apply fertilizer and control EC value between 1.2-1.4 ms/cm	Apply fertilizer and control EC value between 1.0-1.1 ms/cm	Stop to apply fertilizer and control EC value lower than 0.5 ms/cm
Weeds Control	Check weeds everyday	Check weeds everyday	Check weeds everyday	Check weeds everyday	Check weeds everyday	Check weeds everyday
Pests Control	No attack from insects	No attack from insects	Might be attack from insects, should cover by the net	Might be attack from insects, should cover by the net	Might be attack from insects, should cover by the net	Might be attack from insects, should cover by the net
Diseases Control	No disease issues	No disease issues	Spray Calcium and Boron 1-2 time/week to protect the Tip burn issue	Spray Calcium and Boron 1-2 time/week to protect the Tip burn issue	Spray Calcium and Boron 1-2 time/week to protect the Tip burn issue	Spray Calcium and Boron 1-2 time/week to protect the Tip burn issue

Table IV.6: Sample of knowledge captured to cultivate Lettuce from secondary knowledge

Crop Maintenance Process	Crop's Life-Cycle					
	Beginning of Life			Middle of Life		End of Life
	Seeding Planting	Germination	Sprout	Seedling	Mature	Pre-Harvesting
Irrigation	Irrigate 2 times every day	Irrigate 2 times every day and can irrigate during the day if the temperature is too high	Irrigate 2 times every day and can irrigate during the day if the temperature is too high	Irrigate 2 times every day and can irrigate during the day if the temperature is too high	Irrigate 2 times every day and can irrigate during the day if the temperature is too high	Irrigate 2 times every day and can irrigate during the day if the temperature is too high
Fertilization	No fertilizer application	No fertilizer application	Apply fertilizer and control EC value between 1.0-1.2 ms/cm	Apply fertilizer and control EC value between 1.2-1.4 ms/cm	Apply fertilizer and control EC value between 1.0-1.1 ms/cm	Stop to apply fertilizer and control EC value lower than 0.5 ms/cm
Weeds Control	Check weeds everyday	Check weeds everyday	Check weeds everyday	Check weeds everyday	Check weeds everyday	Check weeds everyday
Pests Control	No attack from insects	No attack from insects	Might be attack from insects, should cover by the net	Might be attack from insects, should cover by the net	Might be attack from insects, should cover by the net	Might be attack from insects, should cover by the net
Diseases Control	No disease issues	No disease issues	Spray Calcium and Boron 1-2 time/week to protect the Tip burn issue	Spray Calcium and Boron 1-2 time/week to protect the Tip burn issue	Spray Calcium and Boron 1-2 time/week to protect the Tip burn issue	Spray Calcium and Boron 1-2 time/week to protect the Tip burn issue

Table IV.2 to Table IV.6 show a sample of knowledge gleaned from one of the expert's knowledge sources and secondary knowledge source important to Lettuce's maintenance and life-cycle. Except for the pruning process, which involves image data for image processing, the information collected is applicable to 5 out of 6 crop maintenance processes during the crop's production cycle. This proposed Adaptive DSS, on the other hand, only collects data from sensors and sensing technologies. Following the capture of expert's knowledge, the captured knowledge from various sources is matched between knowledge and parameter relevant to Lettuce cultivation into the knowledge matrix (see chapter III, Figure III.4). Table IV.7 to Table IV.11 illustrate matched of each expert's knowledge into the table of knowledge matrix.

Table IV.7: Sample of knowledge matching matrix of day 1 from the first expert (E1)

Lettuce maintenance process	Beginning of Life (Seeding stage)	
	Knowledge (K)	Parameter (P)
Drip Irrigation	- Water requirement of Lettuce 0.2 ml - Soil moisture value should be between 40-60%	- Amount of water - Soil Moisture
Mist Irrigation	- Require quite humid, Air humidity should be between 60-70% - Appropriate Air Temperature for seeding stage should be between 16-20°C	- Relative Humidity - Air Temperature
Fertilization	- Suitable soil pH should be between 6 – 6.5 - Require normal salinity, the salinity value should be between 0.1 – 0.2	- Soil pH - Soil Electrical Conductivity (EC)
Diseases Control	- This stage needs to control Lettuce's environment to avoid the diseases occurrence so that the soil moisture should not be too moist. - The suitable air temperature should be between 16 – 20°C - The suitable humidity should be between 60 – 70%. - The suitable light should be less than 600 lux.	- Soil Moisture - Air Temperature - Relative Humidity - Light Intensity
Insect Pests Control	- The suitable air temperature should be between 16 – 20°C - The suitable humidity should be between 60 – 70%. - The suitable light should be less than 600 lux.	- Air Temperature - Relative Humidity - Light Intensity
Weeds Control	- This stage needs to control Lettuce's environment to avoid the diseases occurrence so that the soil moisture should not be too moist. - The suitable air temperature should be between 16 – 20°C - The suitable humidity should be between 60 – 70%. - The suitable light should be less than 600 lux.	- Soil Moisture - Air Temperature - Relative Humidity - Light Intensity

Table IV.8: Sample of knowledge matching matrix of day 1 from the second expert (E2),

Lettuce maintenance process	Beginning of Life (Seeding stage)	
	Knowledge (K)	Parameter (P)
Drip Irrigation	- Water requirement of Lettuce 0.2 ml - Soil moisture value should be between 60 - 80%	- Amount of water - Soil Moisture
Mist Irrigation	- Require quite humid, Air humidity should be between 65-80% - Appropriate Air Temperature for seeding stage should be between 15-20°C	- Relative Humidity - Air Temperature

Lettuce maintenance process	Beginning of Life (Seeding stage)	
	Knowledge (K)	Parameter (P)
Fertilization	- Suitable soil pH should between 5.5 – 7 - Require normal salinity, the salinity value should between 0.1 – 0.2	- Soil pH - Soil Electrical Conductivity (EC)
Diseases Control	- This stage needs to control Lettuce's environment to avoid the diseases occurrence so that the soil moisture should not too moist. - The suitable air temperature should between 15-20°C - The suitable humidity should between 60 - 80%. - The suitable light should be less than 800 lux.	- Soil Moisture - Air Temperature - Relative Humidity - Light Intensity
Insect Pests Control	- The suitable air temperature should between 15-20°C - The suitable humidity should between 60 - 80%. - The suitable light should be less than 800 lux.	- Air Temperature - Relative Humidity - Light Intensity
Weeds Control	- This stage needs to control Lettuce's environment to avoid the diseases occurrence so that the soil moisture should not too moist. - The suitable air temperature should between 15-20°C - The suitable humidity should between 60 - 80%. - The suitable light should be less than 800 lux.	- Soil Moisture - Air Temperature - Relative Humidity - Light Intensity

Table IV.9: Sample of knowledge matching matrix of day 1 from the third expert (E3),

Lettuce maintenance process	Beginning of Life (Seeding stage)	
	Knowledge (K)	Parameter (P)
Drip Irrigation	- Water requirement of Lettuce 0.2 ml - Soil moisture value should be between 60 - 80%	- Amount of water - Soil Moisture
Mist Irrigation	- Require quite humid, Air humidity should between 65-80% - Appropriate Air Temperature for seeding stage should between 15-20°C	- Relative Humidity - Air Temperature
Fertilization	- Suitable soil pH should between 6 – 6.5 - Require normal salinity, the salinity value should between 0.1 – 0.2	- Soil pH - Soil Electrical Conductivity (EC)
Diseases Control	- This stage needs to control Lettuce's environment to avoid the diseases occurrence so that the soil moisture should not too moist. - The suitable air temperature should between 15-20°C	- Soil Moisture - Air Temperature

Lettuce maintenance process	Beginning of Life (Seeding stage)	
	Knowledge (K)	Parameter (P)
	<ul style="list-style-type: none"> - The suitable humidity should between 60 - 80%. - The suitable light should between 650 - 800 lux. 	<ul style="list-style-type: none"> - Relative Humidity - Light Intensity
Insect Pests Control	<ul style="list-style-type: none"> - The suitable air temperature should between 15-20°C - The suitable humidity should between 60 - 80%. - The suitable light should between 650 - 800 lux. 	<ul style="list-style-type: none"> - Air Temperature - Relative Humidity - Light Intensity
Weeds Control	<ul style="list-style-type: none"> - This stage needs to control Lettuce's environment to avoid the diseases occurrence so that the soil moisture should not too moist. - The suitable air temperature should between 15-20°C - The suitable humidity should between 60 - 80%. - The suitable light should between 650 - 800 lux. 	<ul style="list-style-type: none"> - Soil Moisture - Air Temperature - Relative Humidity - Light Intensity

Table IV.10: Sample of knowledge matching matrix of day 1 from the fourth expert (E4),

Lettuce maintenance process	Beginning of Life (Seeding stage)	
	Knowledge (K)	Parameter (P)
Drip Irrigation	<ul style="list-style-type: none"> - Water requirement of Lettuce 0.2 ml - Soil moisture value should be between 40 - 70% 	<ul style="list-style-type: none"> - Amount of water - Soil Moisture
Mist Irrigation	<ul style="list-style-type: none"> - Require quite humid, Air humidity should between 65-80% - Appropriate Air Temperature for seeding stage should between 15-20°C 	<ul style="list-style-type: none"> - Relative Humidity - Air Temperature
Fertilization	<ul style="list-style-type: none"> - Suitable soil pH should between 5.5 – 6.5 - Require normal salinity, the salinity value should between 0.1 – 0.15 	<ul style="list-style-type: none"> - Soil pH - Soil Electrical Conductivity (EC)
Diseases Control	<ul style="list-style-type: none"> - This stage needs to control Lettuce's environment to avoid the diseases occurrence so that the soil moisture should not too moist. - The suitable air temperature should between 15-20°C - The suitable humidity should between 40 - 70%. - The suitable light should between 600 - 800 lux. 	<ul style="list-style-type: none"> - Soil Moisture - Air Temperature - Relative Humidity - Light Intensity
Insect Pests Control	<ul style="list-style-type: none"> - The suitable air temperature should between 15-20°C - The suitable humidity should between 40 - 70%. 	<ul style="list-style-type: none"> - Air Temperature - Relative Humidity - Light Intensity

Lettuce maintenance process	Beginning of Life (Seeding stage)	
	Knowledge (K)	Parameter (P)
	- The suitable light should between 600 - 800 lux.	
Weeds Control	- This stage needs to control Lettuce's environment to avoid the diseases occurrence so that the soil moisture should not too moist. - The suitable air temperature should between 15-20°C - The suitable humidity should between 40 - 70%. - The suitable light should between 600 - 800 lux.	- Soil Moisture - Air Temperature - Relative Humidity - Light Intensity

Table IV.11: Sample of knowledge matching matrix of day 1 from the secondary knowledge

Lettuce maintenance process	Beginning of Life (Seeding stage)	
	Knowledge (K)	Parameter (P)
Drip Irrigation	- Water requirement of Lettuce 0.2 ml - Soil moisture value should be between 60 - 80%	- Amount of water - Soil Moisture
Mist Irrigation	- Require quite humid, Air humidity should between 65-80% - Appropriate Air Temperature for seeding stage should between 15-25°C	- Relative Humidity - Air Temperature
Fertilization	- Suitable soil pH should between 5.5 – 7 - Require normal salinity, the salinity value should between 0.1 – 0.2	- Soil pH - Soil Electrical Conductivity (EC)
Diseases Control	- This stage needs to control Lettuce's environment to avoid the diseases occurrence so that the soil moisture should not too moist. - The suitable air temperature should between 15-25°C - The suitable humidity should between 60 - 80%. - The suitable light should be less than 750 lux.	- Soil Moisture - Air Temperature - Relative Humidity - Light Intensity
Insect Pests Control	- The suitable air temperature should between 15-25°C - The suitable humidity should between 60 - 80%. - The suitable light should be less than 750 lux.	- Air Temperature - Relative Humidity - Light Intensity
Weeds Control	- This stage needs to control Lettuce's environment to avoid the diseases occurrence so that the soil moisture should not too moist. - The suitable air temperature should between 15-25°C - The suitable humidity should between 60 - 80%.	- Soil Moisture - Air Temperature - Relative Humidity

Lettuce maintenance process	Beginning of Life (Seeding stage)	
	Knowledge (K)	Parameter (P)
	- The suitable light should be less than 750 lux.	- Light Intensity

Table IV.7 to Table IV.11 illustrate sample of matching results between knowledge and parameters relevant to Lettuce maintenance during its life-cycle of each knowledge sources. Based on matching results, each knowledge sources have some different knowledge and same knowledge. In the same knowledge, we can group them and summary them together. On the other hand, the different knowledge, we need to define the knowledge conflict among expert's knowledge sources. Consequently, the best practices of Lettuce maintenance and its life-cycle are define based on these knowledge conflict and create rule-base.

IV.3. Rule-based Creation

Based on the knowledge conflicts are then identified in order to identify best practices for rule-based creation based on the captured knowledge. The rule-base was created after getting the best practices based on the validation of knowledge conflict by the expert from Faculty of Agriculture, Chiang Mai University, Thailand. According to the cultivation cycle (life-cycle) of Lettuce, the rule-base is set following the life-cycle and the maintenance processes of Lettuce cultivation within 45 days. Hence, the rule-base would cover the 45 days of lettuce production and maintenance. Table IV.12 illustrates a sample of rule-based creation to help Lettuce maintenance processes.

Table IV.12: Sample of rule-based creation (see Appendix)

Maintenance process	IF				THEN
Irrigation	Weather forecast is Sunny	Air Indoor Temperature is 19°C	Air Indoor Humidity lower than 50%	Air Indoor is normal but Air Indoor Humidity is too dry for crop.	Turn ON mist irrigation
	Weather forecast is Sunny	Air Indoor Temperature over than 25°C	Air Indoor Humidity between 50%-80%	Air Indoor is too hot but Air Indoor Humidity is normal for crop.	Turn ON mist irrigation system until air indoor temp is 20°C.
	Soil moisture is 45%	Water Temperature over 25 °C	-	-	Do not apply irrigation and have to decrease water temperature to is 25°C
Fertilizer Application	Soil PH is over than 7	-	-	-	Decrease soil PH by putting

Maintenance process	IF				THEN
	Soil PH lower than 6.5	Water PH lower than 7	Water EC over than 300 us/m2	-	aluminum sulfate in soil increase soil PH by putting aluminum sulfate in soil. and Increase water PH by putting Nutrients in water tank AND Decrease water EC by putting aluminum sulfate in water tank
Insect Pests Control	Soil moisture is 65%	Air indoor Temperature is 18°C	Air Indoor Humidity is 80%	Light Intensity over than 700	See field might be attacked by insects, if occur spray Dimecron (0.05%) and malathion (0.05%)

IV.4. Knowledge Videos

The knowledge videos are recorded to give the knowledge to maintain lettuce to farmers. Figure II. illustrates the list of knowledge videos that will be used in the proposed system. There are 45 knowledge videos will be recorded and some videos are linked to SUNSpACe project. The total number of knowledge video is 28 knowledge videos that are used for knowledge sharing in this thesis.

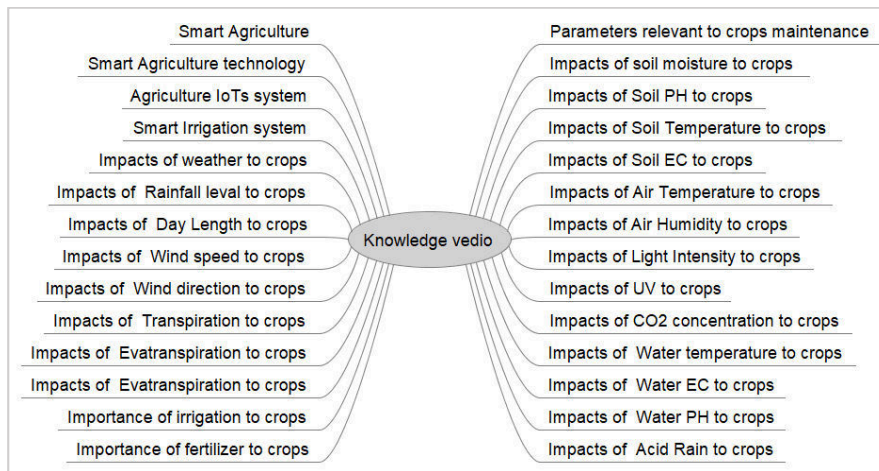

Figure IV.2: List of knowledge video

In summary, the knowledge from five knowledge sources (four expert persons and one secondary knowledge source) have been captured by interview an experts using knowledge engineering technique and surfing from the Thailand department of agriculture link. The experts are selected based on the criteria of smart farmer qualification of Thailand government. The experts' knowledge is extracted and matched to the knowledge matrix to define the knowledge conflict among five knowledge sources. After that, the rule-base is created after getting the best practice based on knowledge from five knowledge sources. The rule-base is relevant to Lettuce cultivation in one cultivation cycle (life-cycle). This rule-base will be integrated with the Adaptive DSS (see chapter V) to provide an appropriate recommendation to farmers. Furthermore, the knowledge relevant to smart agriculture are recorded for using to share knowledge to farmers.

CHAPTER V

Proposed Adaptive Decision Support System

The purpose of this chapter is to show how the rule-base (see Chapter V) and data from sensor devices can be combined to create an Adaptive Decision Support System (Adaptive DSS) model for providing appropriate recommendations and sharing crop maintenance knowledge videos with farmers. The first section describes the data that Adaptive collected for analysis in DSS. The second section describes data preprocessing prior to data analysis, as well as the location for data storage, as well as the technique for preparing data for the proposed forecasting model and Adaptive DSS model. The final section describes the Adaptive DSS model, which consists of two major components. The recommendation system is the component that combines data from sensor devices and a rule-base extracted from experts to provide an appropriate crop maintenance process recommendation. Based on the selection result, the soil moisture forecasting model will predict soil moisture value in the near future using Long-Short Term Memory (LSTM) Deep Learning (DL) approach (see chapter 2). The steps and approach used to build the soil moisture forecasting model are also described. The proposed soil moisture forecasting model's performance results are also addressed. Lettuce cultivation is used as a research and implementation use case in this thesis.

V.1. Data Collection

According to a review of data relevant to crop production and maintenance (see Chapter II, Section II.7), we obtained a list of factors and parameters relevant to crop maintenance processes, as shown in Figure V.1. Furthermore, data sources can be divided into three categories: *on-farm data*, *off-farm data*, and *expert knowledge*.

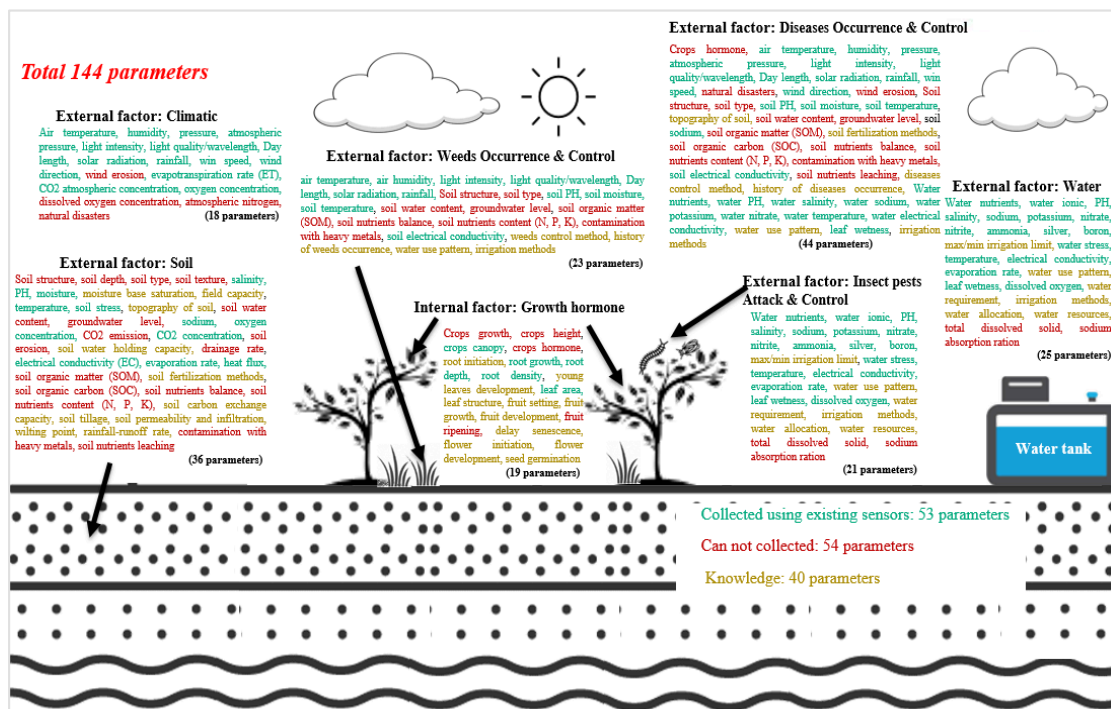

Figure V.1: List of parameters relevant to crops maintenance

Figure V.1 depicts the crop maintenance process parameters. Crop growth regulators and hormones (19 parameters), Climatic (18 parameters), Soil (36 parameters), Water (25 parameters), Diseases (44 parameters), Insect pests (21 parameters), and Weeds are among the 144 parameters classified based on the factors affecting crop cultivation (23 parameters).

The parameters are relevant to each crops maintenance process comprising;

- *Irrigation*: 65 parameters relevance irrigation, 30 parameters can be collected using smart sensors
- *Fertilization*: 35 parameters relevance fertilization, 11 parameters can be collected using smart sensors
- *Pruning*: 16 parameters relevance pruning, 5 parameters can be collected using smart sensors
- *Diseases control*: 43 parameters relevance disease control, 25 parameters can be collected using smart sensors
- *Insect pests control*: 25 parameters relevance insect pests control, 17 parameters can be collected using smart sensors
- *Weeds control*: 26 parameters relevance weed, 18 parameters can be collected using smart sensors

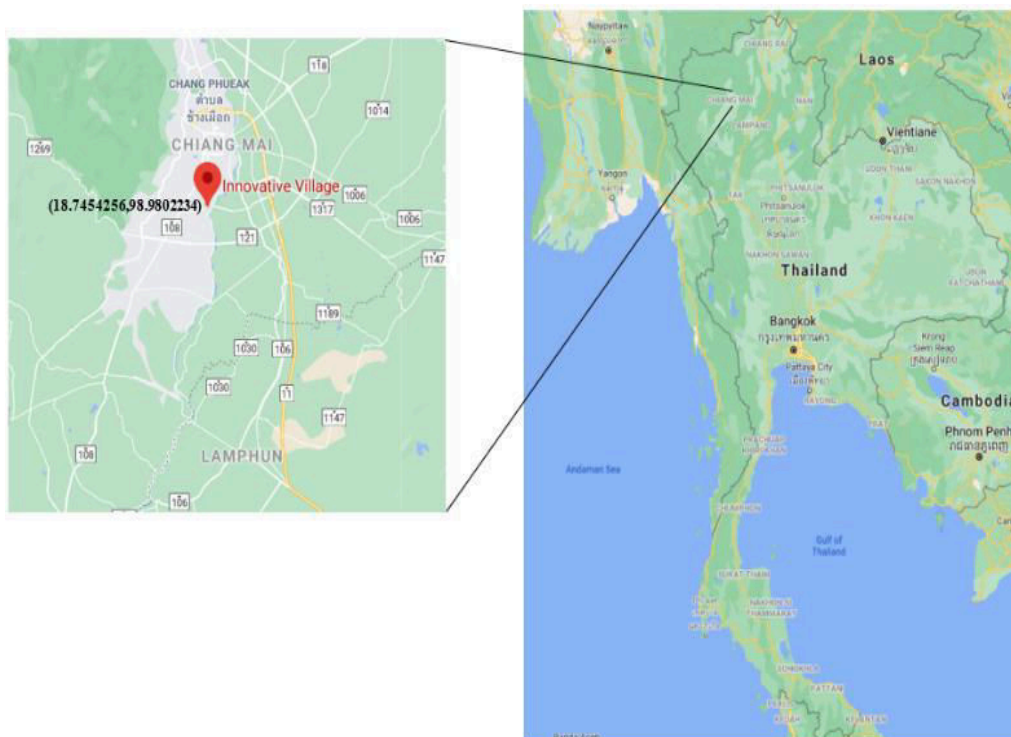

Figure V.2: Data collection location [Website: <https://www.google.co.th/maps>]

To collect on-farm data, the relevant sensors are installed in the Lettuce field. The study area for data collection is located at Innovative Village (18.7453356, 98.9801823) in Pa Daet Sub-district, Mueang Chiang Mai District, Chiang Mai province, Thailand as shown in Figure V.2. The sensors are installed into the greenhouse (see Figure V.3) comprising soil sensor, air indoor sensor, and outdoor weather station that the list and proposes of data collected are

explained in Table V. 1. The data are collected every five minutes and stored on google cloud database. Off-farm data are collected by getting data from API of weather forecast website ([http://api.openweathermap.org/data/2.5/weather?lat=".\\$lat."&lon=".\\$lon."&lang=en&units=metric&APPID=".\\$apiKey](http://api.openweathermap.org/data/2.5/weather?lat=)). The location is in Mueang Chiang Mai province (GPS location: 18.7452719,98.9781734).

Table V.1: List and purposes of data collected

No.	Data field	Purpose
1	Soil Moisture	The historical collected soil moisture value will be used for retraining the proposed forecasting model.
2	Soil Temperature	The historical collected soil temperature value will be used to train/retrain the proposed model. And the real-time soil temperature value will be used to predict the future value of soil moisture.
3	Soil Electrical Conductivity (EC)	The EC value will be tell about the electrical conductivity and soil water content.
4	Soil PH	This value will tell the acidic and alkaline of soil.
5	Indoor: Air Temperature	The air indoor temperature will explain about the air temperature inside the greenhouse that help for making a decision for irrigation.
6	Indoor: Relative Humidity	The indoor relative humidity will explain about the air moisture inside the greenhouse that help for making a decision for irrigation.
7	Indoor: Light Intensity	The indoor light intensity impact to the temperature and relative humidity inside the greenhouse.
8	Indoor: UV index	The UV index value also impact to the temperature and relative humidity inside the greenhouse.
9	Indoor: CO ₂ Concentration	The indoor CO ₂ concentration will help to explain the behavior of crops to understand the water consumption duration of crops.
10	Outdoor: Air Temperature	The air outdoor temperature will explain about the air temperature outside the greenhouse.
11	Outdoor: Relative Humidity	The outdoor relative humidity will explain about the air moisture outside the greenhouse.
12	Outdoor: Light Intensity	The outdoor light intensity impact to the temperature and relative humidity outside the greenhouse.
13	Outdoor: UV index	The UV index value also impact to the temperature and relative humidity outside the greenhouse.
14	Outdoor: Wind Speed	The wind speed value will explain about the speed of wind outside the greenhouse that may impact to the wind flow inside the greenhouse.
15	Outdoor: Wind Direction	The wind direction will explain about the direction of wind outside the greenhouse.

No.	Data field	Purpose
16	Outdoor: Precipitation Rate	The precipitation rate explains the rate of rainfall at that time.
17	Outdoor: Precipitation Total	The precipitation total explains the total amount of rainfall in one day.

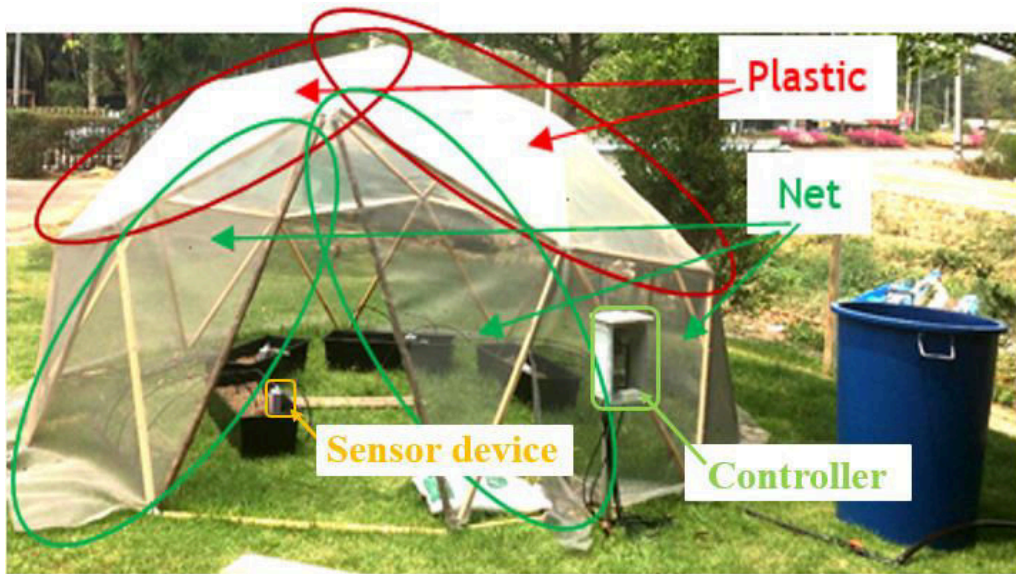

Figure V.3: Multiple sensors installed for data collection (4 soil moisture sensors, (1 air indoor sensor, and 1 weather station)

Figure V.3 depicts a greenhouse dome implementation. The dome was covered with transparent plastic at the top and transparent net at the bottom to allow air to flow and reduce the temperature inside the dome. Inside the dome, four crop pots were installed, and smart sensor devices were installed both inside and outside the dome. Each sensor device contains various sensor types for data collection and data transfer via Wi-Fi communication.

V.2. Data Preprocessing and Storage

Following the collection of data from multiple sensors (see Table V.2), we performed an extensive preprocessing step in which the missing data was cleaned and value scaling for several parameters was performed. The mean imputation technique was used to estimate the missing values from the dataset's other training samples. To replace the missing value with the mean value of the entire feature column, the Imputer class from the scikit-learn module was used.

Table V. 2: Sample of data collected

		Indoor data				Outdoor data							Output		
Date	Date	temp (°C)	humid (%)	uv	lux (light intensity)	temp (°C)	humid (%)	Speed (mph)	Gust (mph)	Pressure (in)	Precip. Rate. (in)	Precip. Accum. (in)	UV	Solar (w/m ²)	Soil moisture (%)
6/3/2020	9:05:30	28.11	37.81	0.36	63	31.39	36	0	0	29.88	0	0	0	0	63.1
6/3/2020	9:06:44	27.92	37.56	0.36	70	31.39	36	0	0	29.89	0	0	0	0	62.2
6/3/2020	9:11:45	27.3	35.38	0.36	10230	31.28	36	0	0	29.89	0	0	0	0	62.7
6/3/2020	9:19:16	28.38	70.19	0.07	1000	31.28	36	0	0	29.89	0	0	0	0	62.6
6/3/2020	9:24:16	32.81	55.13	1.87	35140	31.22	36	0	0	29.89	0	0	0	0	62.2
6/3/2020	9:29:17	34.41	52.34	3.78	54612	31.22	36	0	0	29.89	0	0	0	0	62.2
6/3/2020	9:34:17	34.65	48.95	4.14	54612	31.11	37	0	0	29.89	0	0	0	0	62.3
6/3/2020	9:44:19	35.64	45.96	4.46	54612	31.06	37	0	0	29.89	0	0	0	0	62
6/3/2020	9:49:20	34.79	50.78	1.3	17800	31.00	37	0	0	29.9	0	0	0	0	61.5
6/3/2020	9:54:20	35.54	46.95	1.91	30443	30.94	37	0	0	29.9	0	0	0	0	61.5
6/3/2020	9:59:21	35.16	48.93	1.31	23483	30.89	37	0	0	29.9	0	0	0	0	62.5
6/3/2020	10:04:21	35.52	47.37	1.19	14576	30.78	37	0	0	29.9	0	0	0	0	62.5
6/3/2020	10:09:22	35.93	46.12	1.33	17226	30.78	37	0	0	29.89	0	0	0	0	62.9
6/3/2020	10:14:22	36.13	46.72	1.67	32000	30.72	37	0	0	29.89	0	0	0	0	62.6
6/3/2020	10:19:23	36.38	45.48	2.53	31360	30.67	37	0	0	29.89	0	0	0	0	63
6/3/2020	10:24:23	36.67	45.08	2	24000	30.61	37	0	0	29.89	0	0	0	0	62.7
6/3/2020	10:29:24	36.45	46.15	1.43	16883	30.56	37	0	0	29.89	0	0	0	0	62.7
6/3/2020	10:34:24	36.54	47.52	1.61	21673	30.50	37	0	0	29.89	0	0	0	0	62.6
6/3/2020	10:39:25	36.28	45.84	2.41	29500	30.39	37	0	0	29.89	0	0	0	0	62.4
6/3/2020	10:44:25	36.36	46.36	2.4	37270	30.39	37	0	0	29.89	0	0	0	0	62.8
6/3/2020	10:49:26	36.51	46.17	2.87	29493	30.28	38	0	0	29.88	0	0	0	0	62.3
6/3/2020	10:54:26	37	46.31	3.83	48133	30.22	38	0	0	29.88	0	0	0	0	63.4
6/3/2020	10:59:27	37.05	45.83	2.07	30206	30.22	38	0	0	29.88	0	0	0	0	62.9
6/3/2020	11:04:28	36.73	46.13	3.59	43353	30.11	38	0	0	29.88	0	0	0	0	62.3
6/3/2020	11:09:28	36.54	45.03	3.37	54612	30.11	38	0	0	29.87	0	0	0	0	63
6/3/2020	11:14:28	36.93	44.12	2.66	39270	30.00	38	0	0	29.87	0	0	0	0	62.3
6/3/2020	11:19:29	37.88	43.23	2.18	31096	30.00	38	0	0	29.87	0	0	0	0	62.6
6/3/2020	11:24:30	37.25	43.65	3.14	48990	29.89	38	0	0	29.87	0	0	0	0	63.1

In terms of time, we encoded it using one-hot encoding, dividing a day into four distinct periods (see Table V.3).

Table V. 3: Sample of data processed

	Indoor temp	Indoor humid	Indoor uv	Indoor lux	CO2 indoor	Outdoor temp	Outdoor humid	Outdoor UV	Outdoor Solar	Soil moisture	cos_Times	sin_Times
0	28.11	37.81	0.36	63	599.0	31.39	36	0	0.0	63.1	-0.723871	0.689935
1	27.92	37.56	0.36	70	599.0	31.39	36	0	0.0	62.2	-0.727573	0.686030
2	27.30	35.38	0.36	10230	599.0	31.28	36	0	0.0	62.7	-0.742414	0.669941
3	28.38	70.19	0.07	1000	475.0	31.28	36	0	0.0	62.6	-0.763984	0.645235
4	32.81	55.13	1.87	35140	475.0	31.22	36	0	0.0	62.2	-0.777878	0.628416

V.3. Adaptive Decision Support System (Adaptive DSS) Model

The Adaptive DSS is a device that collects data from IoTs databases, analyzes it using rule-based algorithms, and then sends recommendations to users via the user interface, as described in Chapter 3, Section III.3.2. Furthermore, the system will send the farm's current status as well as a knowledge video every morning. The user interface can be used to inquire about additional information such as air temperature, weather forecast, and so on. A user is

expected to have a basic level of literacy in order to use a system. Our previous paper [Paweena Suebsombut, et al., 2020; Aurelie Charles, et al., 2020] identified literacy levels. Adaptive DSS is comprised of two components: a recommendation system and a soil moisture forecasting model, as described following table.

V.3.1. The Design of Soil Moisture Forecasting Model

V.3.1.1. Soil Moisture Forecasting Designing

We describe the design methodology of our LSTM-based soil moisture forecasting model in this section. Following a trial phase in which we tested different model configuration settings such as layer count, sized, and so on, we established our model, both LSTM and Bi-LSTM design (see Figure V.4).

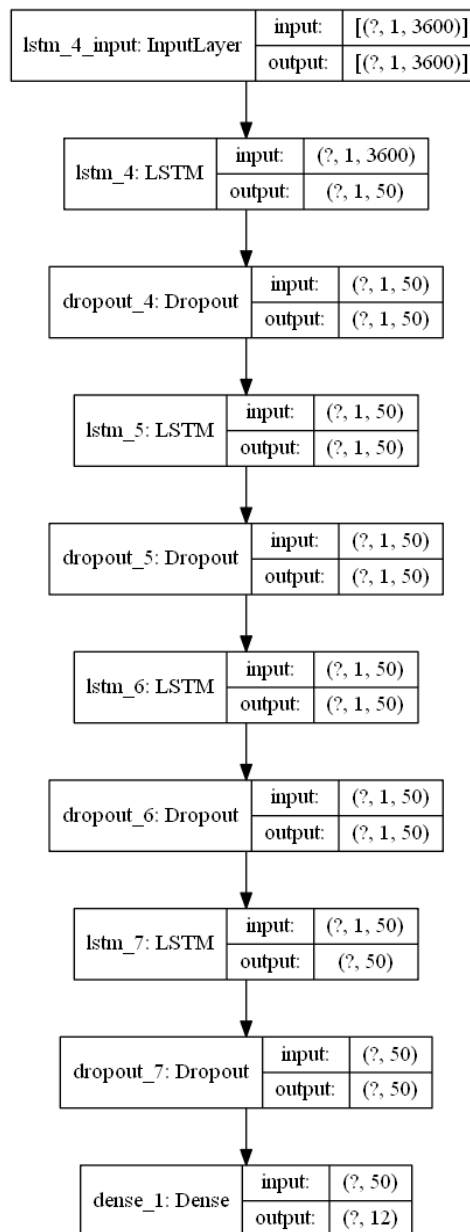

Figure V.4: Proposed model architecture

To create an effective LSTM model, we must fine-tune the hyper parameters, which are the learning rate (lr) and split ratio (rs). In order to achieve the best results in terms of prediction accuracy and error value, we went through an extensive model hyper parameters tuning step for our model. The values of the best hypermeters based on our empirical study are reported in Table V.4.

Table V.4: The best hypermeters based on our empirical study

Hyperparamters	LR	SR	Epoch	Input time steps	Future steps	Batch size
Value	0.01	80% (train) 20% (test)	100	300	12	72
Value	0.001	70% (train) 30% (test)	100	300	12	72
Value	0.0001	80% (train) 20% (test)	100	300	12	72

Based on our empirical findings, the learning rate is a critical hyper parameter that significantly affects model results. As a result, we conducted a more in-depth analysis to determine the best values for this parameter based on different ratios for the training/testing data split.

One of the hyper parameters that controls how much to change the model in response to the estimated error each time the model weights are updated is the learning rate. Choosing the learning rate is difficult because a value too low may result in a long training process that may become stuck, whereas a value too high may result in learning a suboptimal set of weights too quickly or an unstable training process. The split ratio denotes the proportion of the dataset that is divided into training and testing. Table V.5 shows 12 cases with different learning rate and split ratio values to help you choose the best forecast model case.

There are, however, a number of hyper parameters that are important to the performance of the proposed forecasting model. This paper will focus on the learning rate (lr) and the split ratio (sr) in order to improve the performance of the proposed forecasting model.

- *The learning rate (lr)*: is one of the hyper parameters that controls how much the model changes in response to the estimated error each time the model weights are updated. Choosing the learning rate is difficult because a value too small may result in a long training process that may become stuck, whereas a value too large may result in learning a suboptimal set of weights too quickly or an unstable training process.
- *The split ratio (sr)*: is the dataset's split interval for training and testing.

Table V.5 displays the difference learning rates and split ratios for 12 cases. The better results were compared using these various cases. The forecasting model was tested and trained using 17,749 samples from a total of 17 datasets. Split ratios are classified into two types. The first case is the 70% of training data that equals to 12,424 samples of total dataset and the 30% of testing data equals to 5,325 samples of total dataset. The second case is the 80% of training data that equals to 14,200 samples of total dataset and the 20% of testing data equals to 3,549 samples of total dataset.

Table V.5: List of 12 cases of learning rate (α) and split ratio (sr)

Case	Learning Rate (α)	Split ratio (sr)
1	0.1	70% (train), 30% (test)
2	0.1	80% (train), 20% (test)
3	0.01	70% (train), 30% (test)
4	0.01	80% (train), 20% (test)
5	0.001	70% (train), 30% (test)
6	0.001	80% (train), 20% (test)

Case	Learning Rate (α)	Split ratio (sr)
7	0.0001	70% (train), 30% (test)
8	0.0001	80% (train), 20% (test)
9	0.00001	70% (train), 30% (test)
10	0.00001	80% (train), 20% (test)
11	0.000001	70% (train), 30% (test)
12	0.000001	80% (train), 20% (test)

The values of the learning rate and split ratio are shown in Table V.5. To determine the appropriate values of the proposed model's learning rate and split ratio, we must test and compare these cases. The learning rate values range from 0.1 to 0.000001, and they affect the proposed model's training error. Furthermore, the split ratios are divided into two groups: 70% for training and 30% for testing, and 80% for training and 20% for testing. The number of time stems to include in making a prediction and the time steps to predict are the next hyper parameters we tuned.

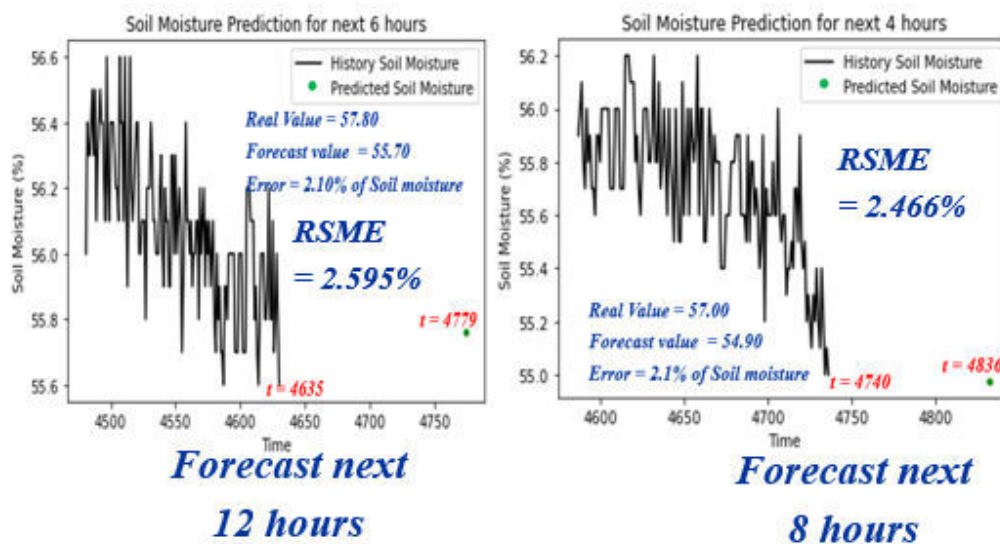

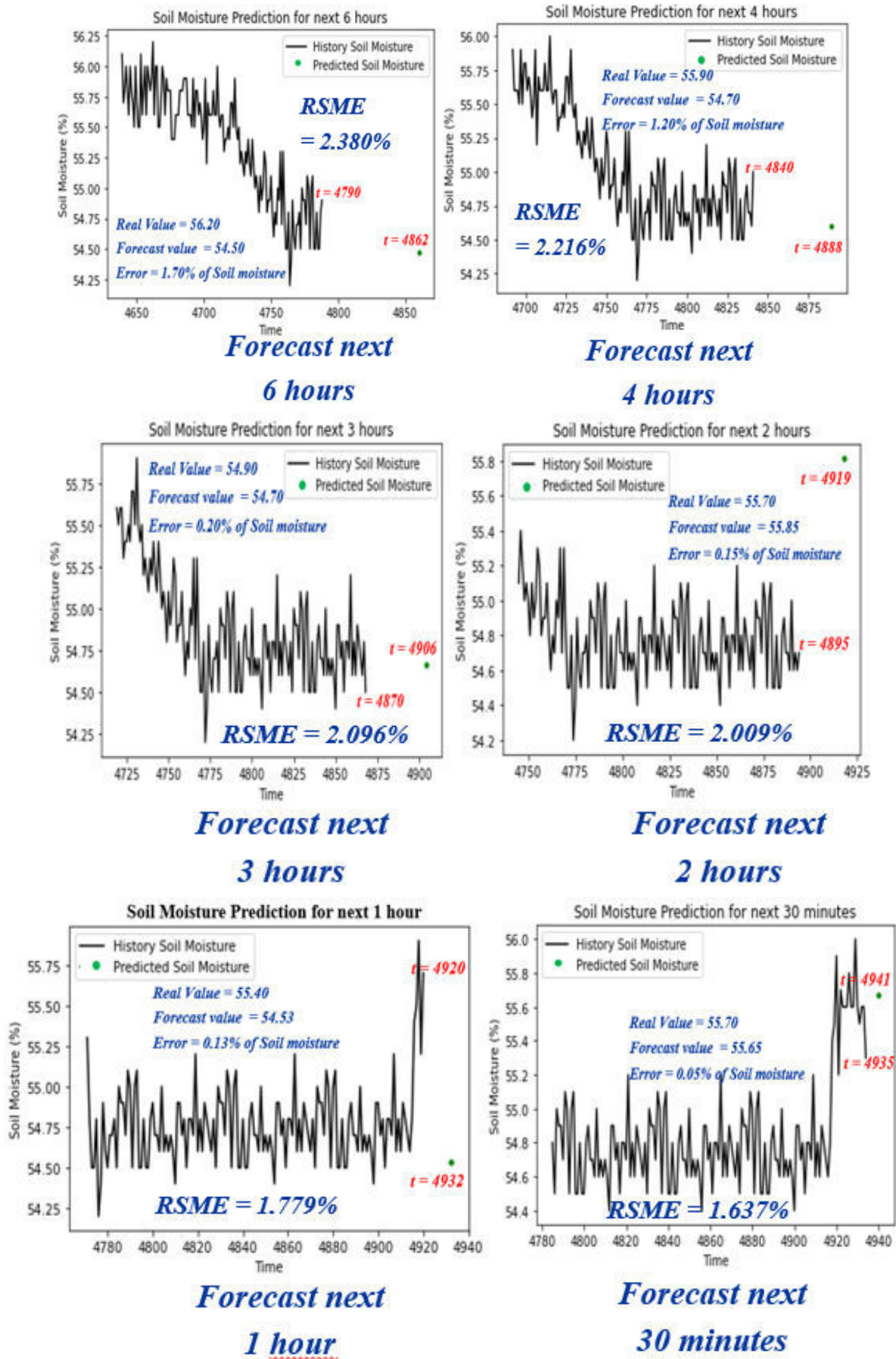

Figure V. 5: Prediction in different time stems and time steps

Figure V. 5 depicts these two values on the soil moisture validation graph. The appropriate time interval for the proposed forecasting is also chosen to define the appropriate time interval for forecasting the next value of soil moisture in the future. The time intervals are divided into eight cases: 12 hours, 8 hours, 6 hours, 4 hours, 3 hours, 2 hours, 1 hour, and 30 minutes, with 144 time steps, 96 time steps, 72 time steps, 48 time steps, 36 time steps, 24 time steps, 12 time steps, and 6 time steps, respectively. So, for the next 12 hours, 8 hours, 6 hours, 4 hours, 3 hours, 2 hours, 1 hour, and 30 minutes, the prediction model with different time interval forecasting is tested and the results are compared to define the appropriate time interval condition.

V.3.1.2. Performance of Proposed Soil Moisture Forecasting Model

To undertake our experiment, we used a machine with an Intel® Core™ i7-6700HQ, CPU 2.60GHz, RAM 16 GB, and GPU Intel® HD Graphics 530. Our model was implemented in Python (Jupyter Notebook 6.0.3 web-based) using the Koras Deep Learning Library with Tensor flow as the backend. The training of our mode for 100 epochs, 0.001 learning rate, split ratio with 70% for training and 30% for testing, and 72 batch size took one hour.

Cross validation is required to resampling procedure used to evaluate machine learning models on a limited data sample in order to increase the reliability of the proposed model. That is, to use a small sample to estimate how the model is expected to perform in general when used to make predictions on data that was not used during the model's training. In this article, K-Fold cross validation is used, which means that the data is divided into 5 subsets using K-Fold coding, and the holdout method is repeated 5 times, with one of the 5 subsets used as the test set and the other 4 subsets combined to form a training set.

Our model's performance was assessed using the Root Mean Square Error (RMSE) and the K-Fold cross validation score. We trained our model with a variety of settings for 100 epochs and hyper parameters. In this section, we present the training and validation results of our forecasting model based on data that we collected and preprocessed. Python programming is used to create the proposed soil moisture forecasting model with the LSTM approach.

After defining the input dataset, the proposed soil moisture forecasting model is created using the Long-Short Term Memory (LSTM) approach because these datasets are time series data collected every five minutes. The difference learning rates and split ratios are divided into 12 cases, as shown in Table 6. The comparison results are illustrated in Figure V.6 and Figure V.7 in different cases (LSTM model and Bi-LSTM model) for comparing the better results.

Figure V.6 depicts a comparison of error results for our LSTM model at various learning rates and split ratios. According to the results, the values of training error, test error, and RSME validation error are quite low in cases 5 to 10 (the red box), indicating that the model performs well. When compared to the other six cases (cases 5–10), case 5 has a lower train error, test error, and RMSE validation, indicating that the proposed model's performance in terms of training is 0.03 % of error, 0.08 % of error, and 1.057 % of RMSE error. As a result, case 5 (the yellow box), with a learning rate of 0.001 and a split ratio of 70% (for training) and 30% (for testing), is selected to be used in the proposed soil moisture forecasting model with LSTM.

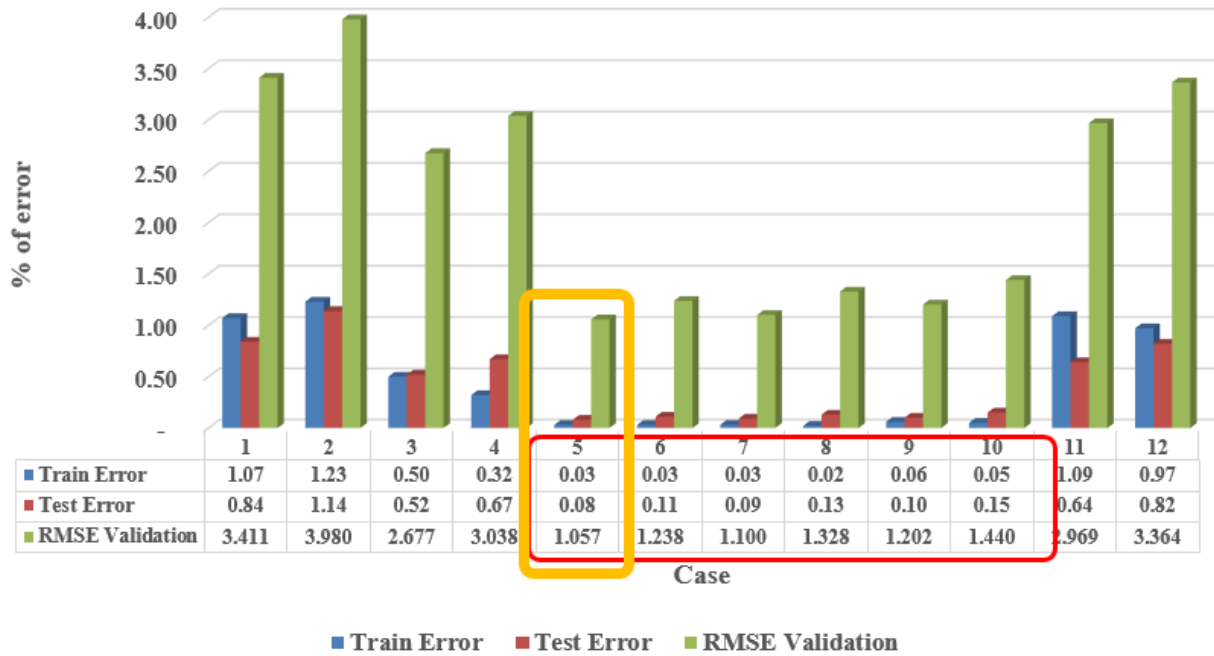

Figure V. 6: Comparison error results of Soil Moisture value forecasting in different cases of learning rate (lr) and split ratio (sr) - LSTM model

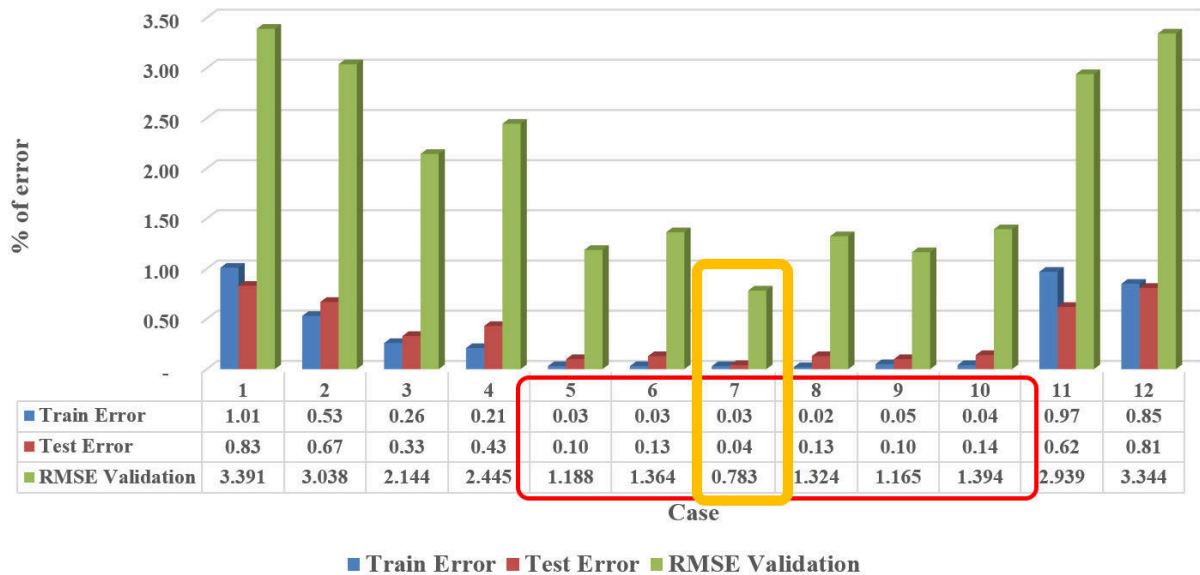

Figure V. 7: Comparison error results of Soil Moisture value forecasting in different cases of learning rate (lr) and split ratio (sr) - Bi-LSTM model

Figure V.7 depicts the error results of different learning rates and split ratios when using the Bi-LSTM. According to the results, the values of train error, test error, and RSME validation errors are quite low in cases 5 to 10 (the red box), indicating good performance. When these 6 cases (cases 5–10) are compared, case 7 (the yellow box) has lower train error, test error, and RMSE validation than the others. That is, the proposed model's training performance is 0.03 % of error, testing performance is 0.04 % of error, and model validation performance is 0.783 % of RMSE error. As a result, case 7, with a learning rate of 0.0001 and a split ratio of 70% (for

training) and 30% (for testing), is chosen to be used in the proposed soil moisture forecasting model with Bi-LSTM.

Following the selection of an appropriate learning rate and split ratio, the prediction model with difference time intervals comprising forecasting for the next 12 hours, 8 hours, 6 hours, 4 hours, 3 hours, 2 hours, 1 hour, and 30 minutes is tested and the error results are compared as shown in Figures V.8 and V.9.

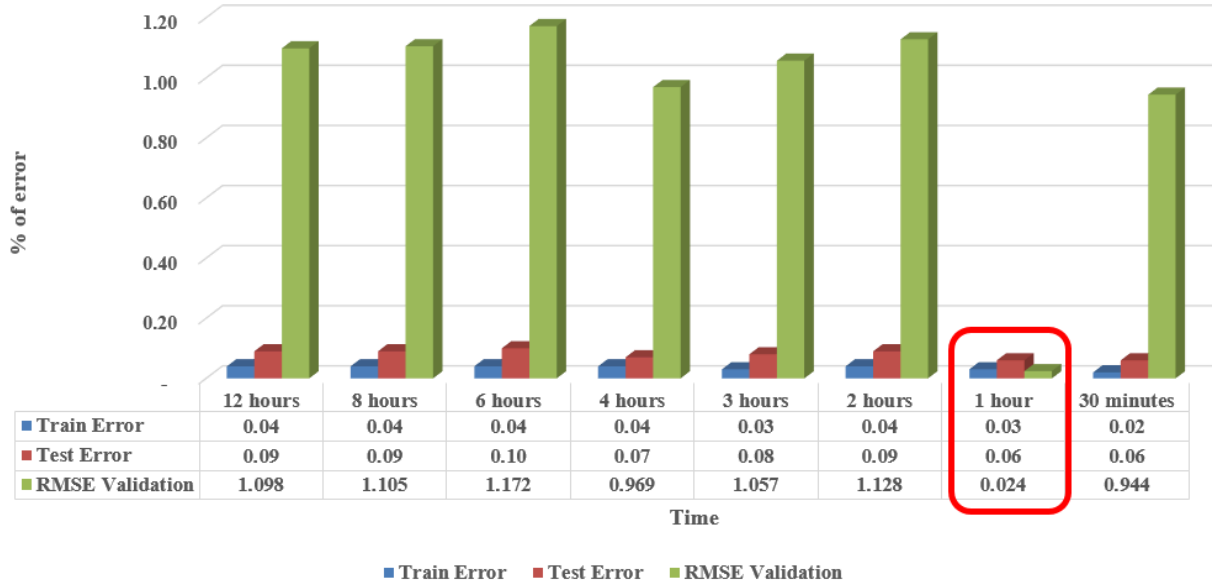

Figure V. 8: Comparison error results of Soil Moisture value forecasting in Different time interval (LSTM model)

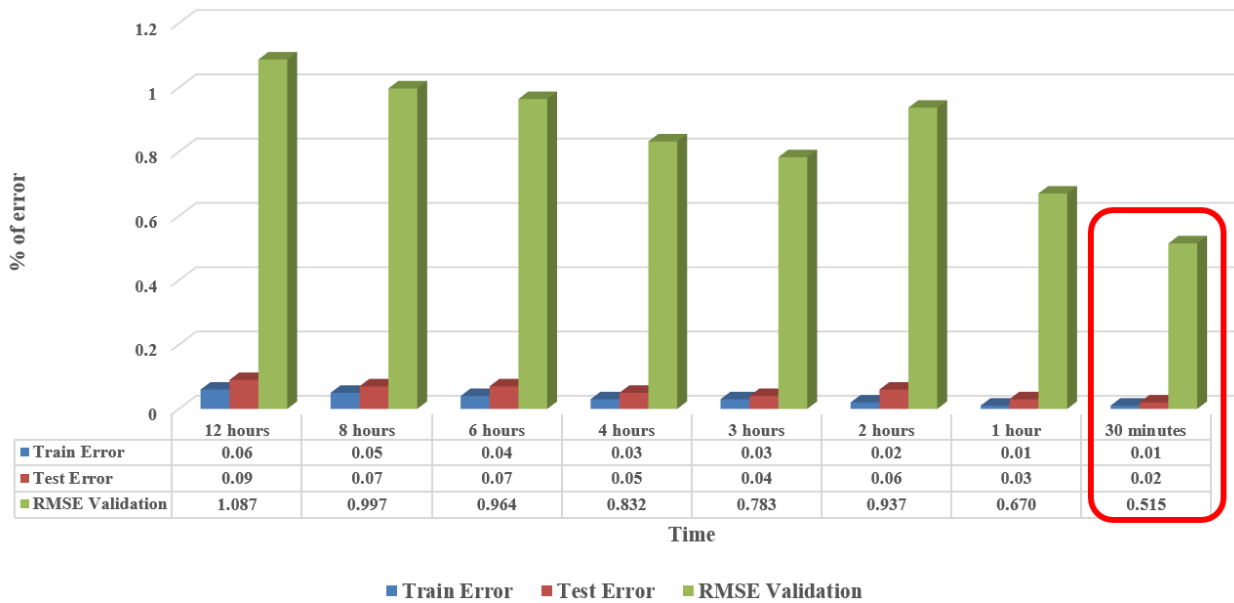
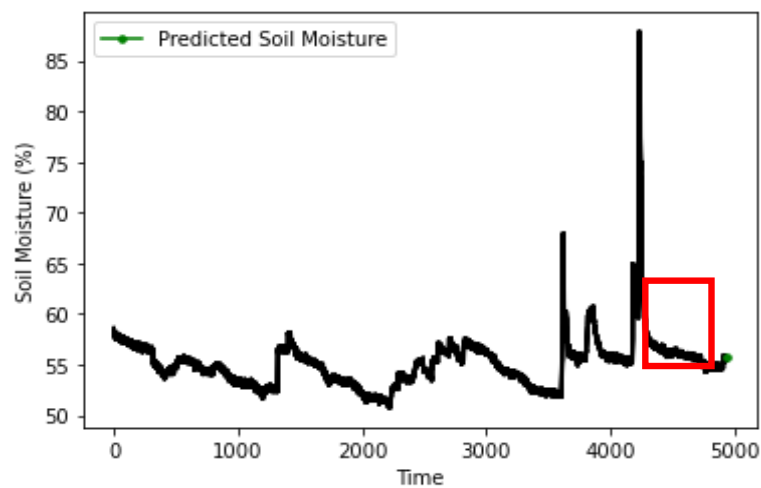

Figure V.9: Comparison error results of Soil Moisture value forecasting in Different time interval (Bi-LSTM model)

Figure V.8 depicts the comparison error results of soil moisture value forecasting using the LSTM model at different time intervals. The error rate among train errors, test errors, and

RMSE validation of the proposed forecasting model in the next 1 hour (the red box) is lower than others, according to the results. This means that the proposed model's performance in forecasting soil moisture value in the next 1 hour in terms of training is 0.03 % of error, 0.06 % of error in testing, and 0.024 % of RMSE error in model validation.

Figure V.9 depicts the error results of forecasting soil moisture values in different time intervals using the Bi-LSTM model. According to the results, the train error, test error, and RMSE validation of the proposed forecasting model in the next 30 minutes (the red box) has a lower error rate than others. That is, the proposed model's performance in forecasting soil moisture value in the next 30 minutes in terms of training is 0.01 % of error, 0.02 % of error in testing, and 0.515 % of RMSE error in model validation. As a result, the soil moisture forecasting for the next 1 hour and 30 minutes are chosen for the forecasting model with LSTM and Bi-LSTM models, as shown in Figures V.10 and V.11.



(a) next 1 hour (LSTM)

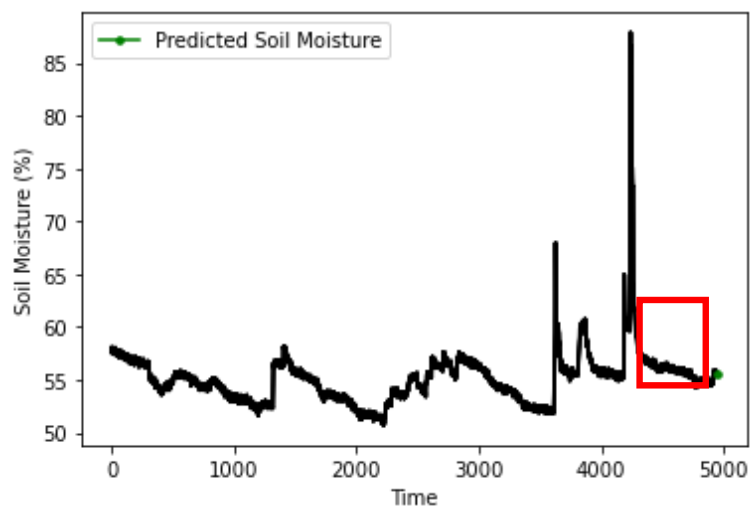

(b) next 30 minutes (Bi-LSTM)

Figure V.10: Result of soil moisture forecasting

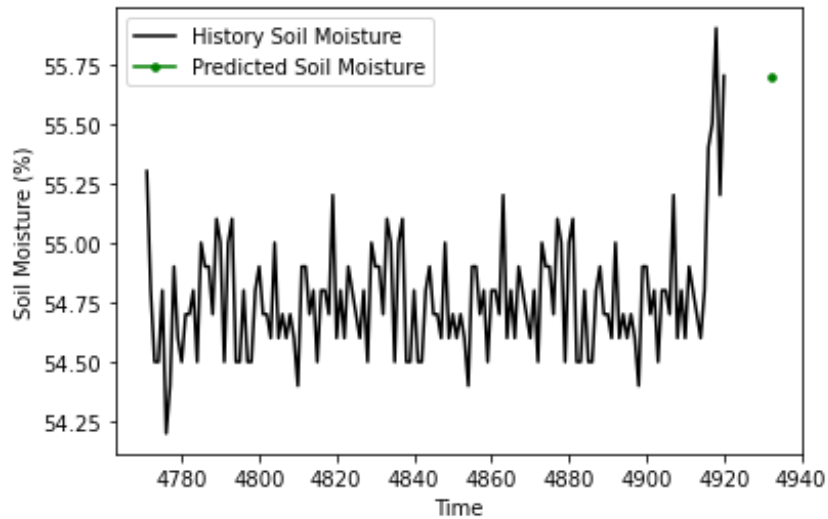

(a) next 1 hour (LSTM)

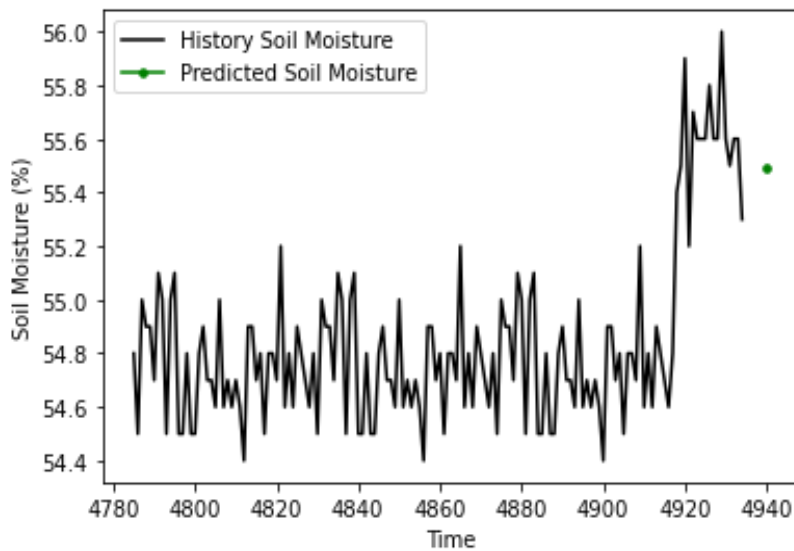

(b) next 30 minutes (Bi-LSTM)

Figure V.11: Zoom in of the red box in (a) Figure 16(a) (b) Figure 16(b)

Figures V.10 and V.11 show the results of soil moisture forecasting for the next 1 hour (LSTM model) and the next 30 minutes (Bi-LSTM approach). The soil moisture forecast value for the next hour is 55.70 % (see Figure V.10(a) and Figure V.11(a)), and the soil moisture forecast value for the next 30 minutes is 55.55 % (see Figure V.10(b) and Figure V.11(b)). The total effectiveness of our model is calculated by averaging the error estimation across all five trials, as shown in Table V.6.

Table V.6: Comparison of cross validation result of soil moisture forecasting model

	Next 1 hour (LSTM)	Next 30 minutes (Bidirectional LSTM)
1. Soil moisture value: Measure	55.64%	55.70%
2. Soil moisture value: Forecast	55.70%	55.55%

	Next 1 hour (LSTM)	Next 30 minutes (Bidirectional LSTM)
3. Cross Validation (CV) results		
3.1. Round 1		
- RSME loss	0.62%	0.62%
- CV loss	0.38%	0.38%
3.2. Round 2		
- RSME loss	0.75%	0.75%
- CV loss	0.56%	0.56%
3.3. Round 3		
- RSME loss	0.78%	0.78%
- CV loss	0.61%	0.61%
3.4. Round 4		
- RSME loss	0.77%	0.77%
- CV loss	0.60%	0.60%
3.5. Round 5		
- RSME loss	0.69%	0.69%
- CV loss	0.48%	0.48%
3. 6. Averaged overall error estimation		
- RSME loss	0.72% (+/- 0.06%)	0.72% (+/- 0.06%)
- CV loss	0.52% (+/- 0.08%)	0.52% (+/- 0.08%)

Table V.6 compares the measured and predicted soil moisture values, as well as the error estimation results obtained using K-Fold cross validation. The error discrepancy between measured and predicted soil moisture values is quite small in both the LSTM and Bi-LSTM approaches, according to the comparison results of soil moisture forecasting models with LSTM and Bi-LSTM models. The Non-Bidirectional LSTM approach, on the other hand, has a lower error between measured and predicted soil moisture values than the Bi-LSTM approach. In terms of cross validation error, both cases have the same results across all 5 trails, with the average overall error estimation being 0.72 % of RMSE error and 0.52 % of cross validation error.

V.3.2. Recommendation System

Figure III.4 depicts the flow of the recommendation system. To begin, the user must first press the "START" button to instruct the system to begin counting the first day of cultivation. The system would then get data from an IoT sensor database and a weather prediction website. The system would then look for an appropriate suggestion by comparing the current state of each day to the rule-base stored on a Google sheet. When the system receives an appropriate recommendation, it will present it to the user via a user interface. Following that,

the system will check the date number until the cycle is completed. Figure V.12 depicts the flow of adaptive DSS to provide recommendations to farmers.

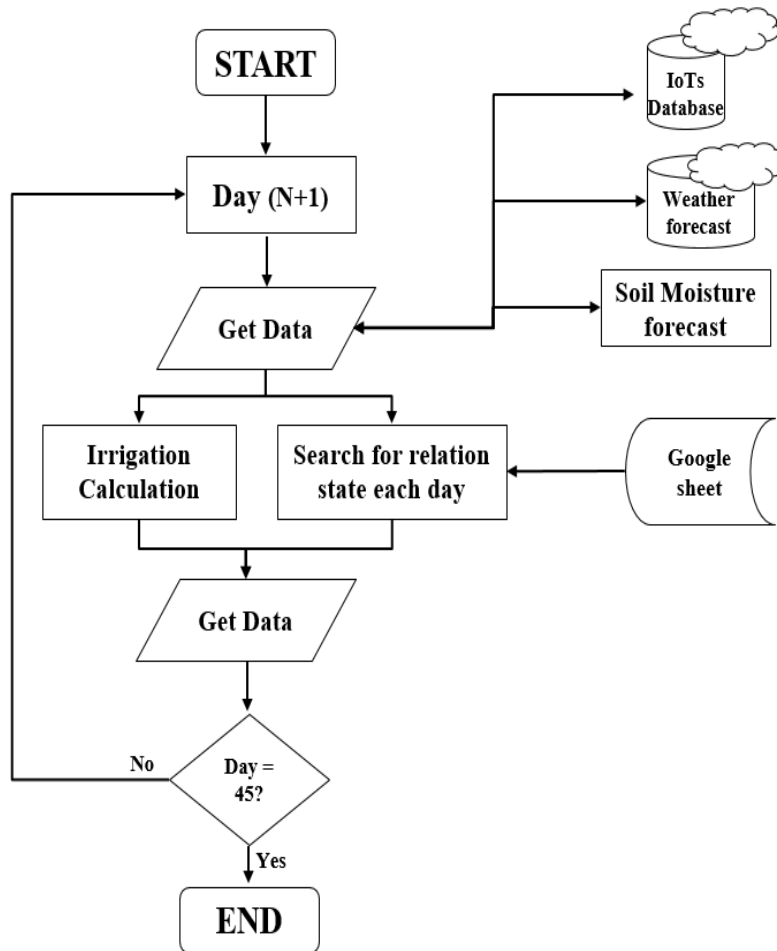

Figure V.12 :Flow of Recommendation System

Figure V.13 demonstrates an example of the proposed Adaptive DSS processing. On the first day, the user must press the 'START' button to begin using the device. The script will then retrieve the water temperature data and use it to search for the day 1 connection state. In this case, the water temperature is less than 20 °C, indicating that it is 'normal.' The script will then automatically submit the water temperature status to the user via the user interface.

The script will then automatically provide the user with the current state of soil moisture as well as a recommendation via Line chatbots. Following receipt of the information and recommendations, the user may begin using the drip irrigation system to irrigate lettuce as directed. After implementing the proposed Adaptive DSS in the real world, the system works very well, and users are very satisfied with it. However, during implementation, there were some internet connection issues that impacted data and information transfer between users and the system.

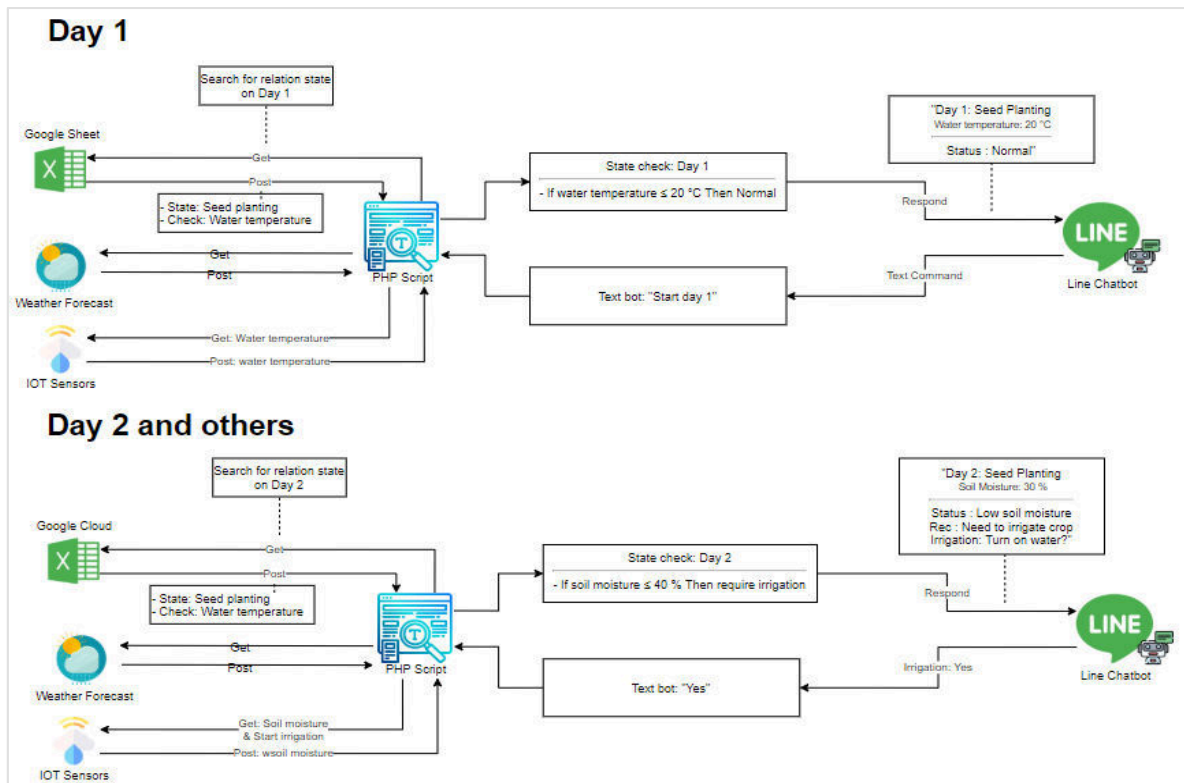

Figure V. 13: Demonstration of data processing using Adaptive DSS on day 1 and 2

In conclusion, this chapter demonstrated how to create a soil moisture forecasting model, as well as the tool/technique used in the system architecture (see chapter III.2). The data gathered by smart sensor technology includes both on-farm and off-farm information. Following the collection of data, the data was prepared to serve as the dataset for the Deep Learning approach by utilizing the correlation of parameters function in Python programming. The proposed soil moisture forecasting model is built using Tensorflow and Keras tools and the Long Short Term Memory (LSTM). The future soil moisture value will be predicted using data collected from real-time sensors. This soil moisture forecasting model will be integrated with the rule-base (see Chapter IV) to provide farmers with an appropriate recommendation.

CHAPTER VI

Data Visualization and System Implementation

The purpose of this chapter is to reveal the data visualization (IoT's platform and Line chatbot application) as well as the results of the proposed Adaptive DSS implementation. The functions of the IoT platform and the Line chatbot app are described in the first section. The final section discusses system implementation methodology, system installation, and user satisfaction.

VI.1. Data visualization

VI.1.1. IoT's platform

Lettuce cultivation is used to demonstrate how the proposed Adaptive DSS can be put into action. The implementation site is Innovative Village (18.7453356, 98.9802234) in Chiang Mai province, Thailand, where our research is being conducted. The area where the project is being implemented has flat terrain and hot and humid weather. We did, however, start growing lettuce indoors (cultivation in greenhouse). The user is expected to have a basic level of literacy in order to use a smartphone. The literacy levels of farmers are identified in the SUNSpACe paper. Sensors (soil, water, indoor air, and weather station) were installed in the greenhouse to collect data. The measured data is saved on a cloud database, and users can access it via a website to track sensor data, sensor status, and irrigation control system status via the modular.io platform. Users can use the platform to access and monitor their own farms. With the platform's functions, the system can control plant irrigation and temperature control in the greenhouse.

- Able to monitor data via graph.
- The platform can be monitored from many locations.
- Users are able to compare data from different sensors from the platform and share their own farm information to others.
- Users are able to control the systems through the platform
- Users are able to monitor the operate status of the sensor and control system.

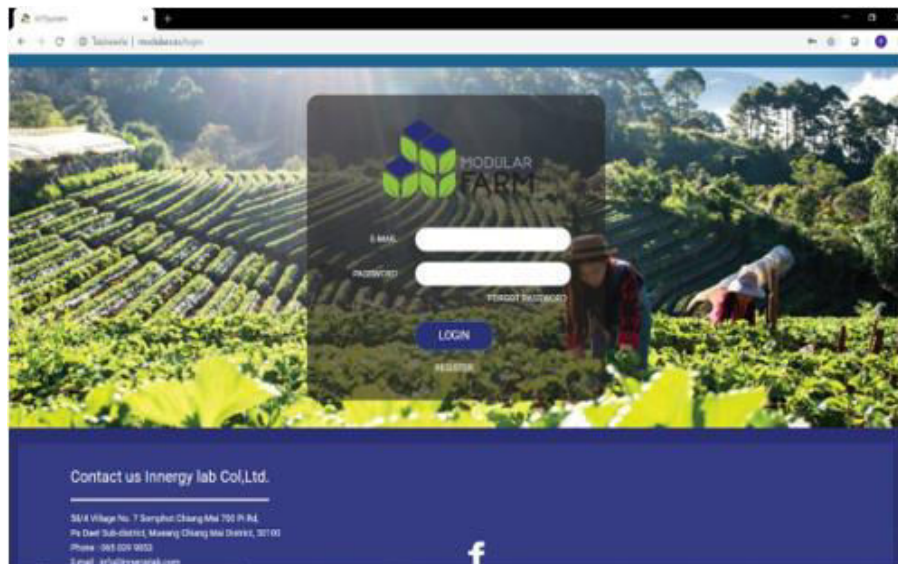

Figure VI.1: Login page of IoT's platform

Figure VI.1 depicts our IoTs platform's login page. Users must register with their own email address and login with their email address and password. The dashboard, as shown in Figure VI.2, allows users to monitor the data obtained from sensors.

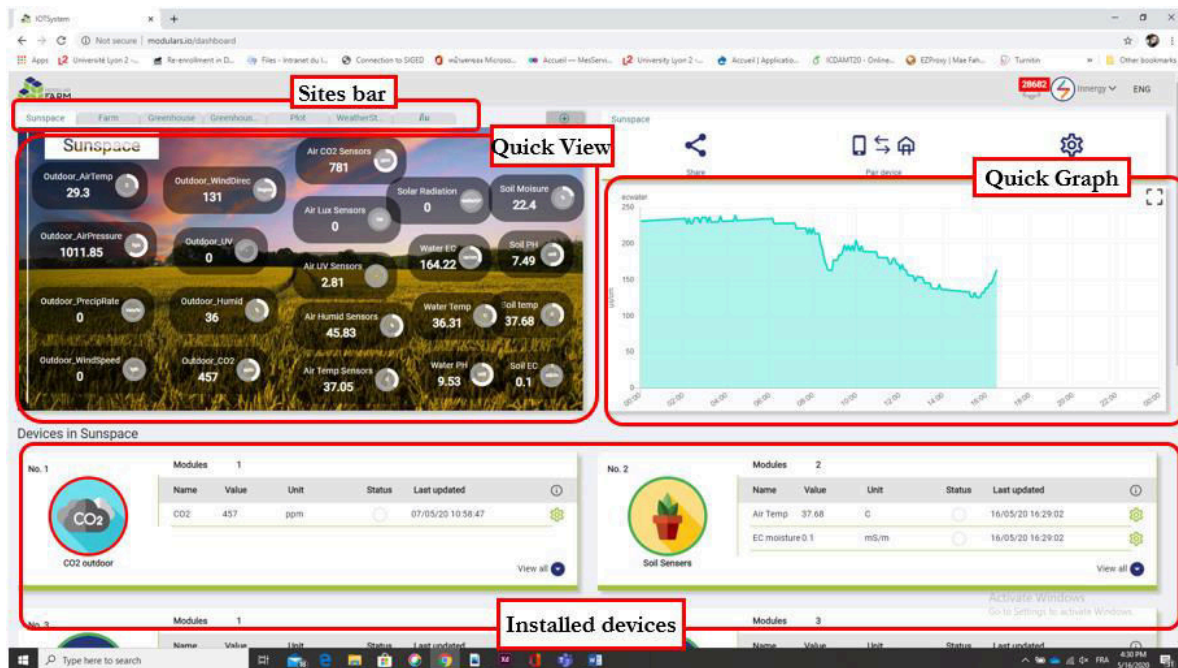

Figure VI.2: Functions of the IoTs Platform

Figure VI.2 shows a dashboard with sensor data that the user can see on both the dashboard and the graph, which includes:

- *Sites Bar*: is a menu bar that contains all farm sites that have been configured in the system.
- *Quick View*: shows data collected from sensors installed in the farm, and the user can choose whether to show only interesting data or all data in the quick view.
- *Quick Graph*: displays the time series data for each day as a graph
- *Installed devices*: shows the status of all devices installed in the farm

VI.1.2. Line Chatbot Application

The 'AgriRec' chatbot application serves as the user interface for communication between Adaptive DSS and farmers. Figure VI.3 depicts the work flow of the 'AgriRec' Line chatbot. It depicts the 'AgriRec' flow of the Line chatbot application. This application has five primary functions:

- *Start menu*: Users must first add a friend to their Line chatbots account by scanning their Line account QR code, then click the start menu to begin using the device. When the user clicks "START," the system starts counting the first day and submits the first day's details, as well as the knowledge video. In addition, if the device detects an abnormal condition, the status and recommendation will be sent throughout the day. The following day, the system will automatically submit the user's information, a knowledge video,

and a suggestion. If the user encounters any problems, they can stop the application by clicking on the 'START/STOP Menu.'

- *Main page:* Users will receive field status and knowledge videos relevant to crop maintenance methods every morning. In addition, by clicking on a feature on the main page, users can track and manage it.
- *Mist irrigation page:* If the mist irrigation control is turned off, the Line chatbot will ask the user to "TURN ON" it. The mist irrigation system will then be activated. If the mist irrigation control is turned on, the chatbots will prompt the user to "TURN OFF." The mist irrigation system would then be turned off.
- *Drip irrigation page:* If the drip irrigation system is turned off, the Line chatbot will ask the user to "TURN ON" it. The drip irrigation system will then be turned on. If the drip irrigation system is turned on, the chatbots will ask the user to "TURN OFF." The drip irrigation system would then be turned off.
- *Monitor page:* Users can request all data collected from sensor devices from the Line chatbot. Furthermore, users can ask the Line chatbot a particular question, such as "weather forecast," and the chatbot will respond with that information.

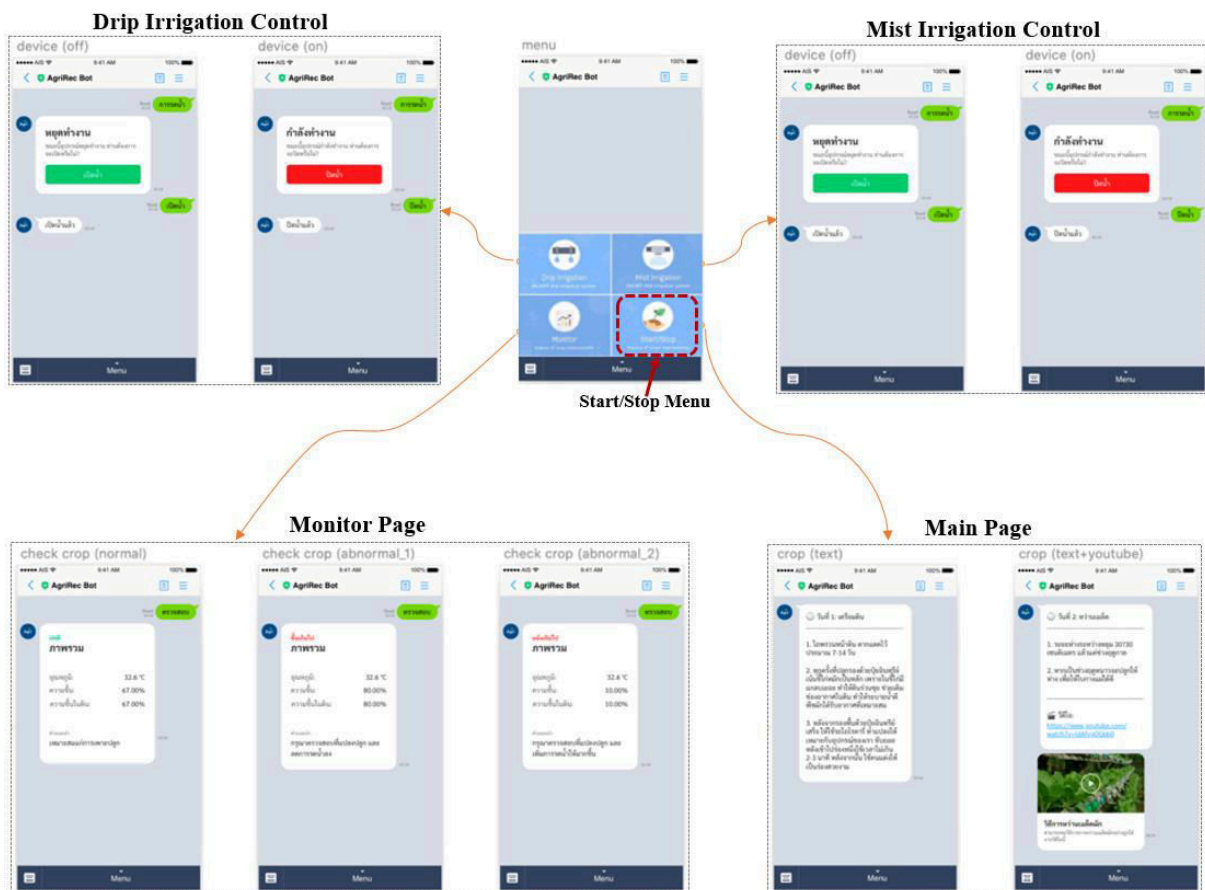

Figure VI.3: Flow of the 'AgriRec' Line chatbot application

VI.2. Software (system) Implementation

The step for implementing the proposed system is depicted in Figure VI.4. It explains how to implement the proposed system. As an example, we used lettuce cultivation. The relevance sensor probes must first be installed. Second, sensors will be linked to the IoTs platform and the Adaptive DSS. Third, the user must download and install the Line chatbot application before using the system. Finally, following use of our proposed Adaptive DSS, users must provide feedback via a satisfaction form (see Table VI. 1). According to the survey results of farmers' literacy levels from the SUNSpACE project [Paweena Suebsombut et al., 2020; Aurelie Charles et al., 2020], the system's target user is people who have the digital literacy skills to use smart devices such as smartphones, tablets, and so on.

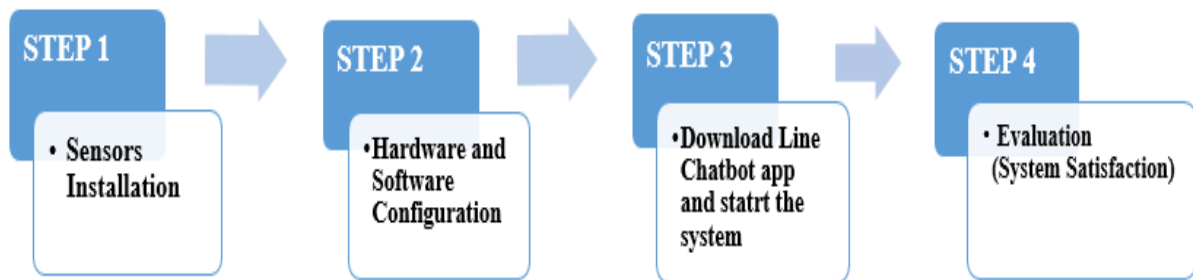

Figure VI.4: Methodology for software (system) implementation

Table VI.1: User satisfaction survey

Questions	Satisfaction Level				
	5	4	3	2	1
1. Interaction ability of system between user and system					
2. User friendly of the system					
3. Usability of the system					
4. Accessibility of system in everywhere and every time					
5. The smoothness of interaction between users and system					
6. Effectiveness of internet connection between user and system					
7. Visibility and clearness of video, text, voice					
8. Ability to support the decision of users for crop maintenance					
9. Ability to support users for crop maintenance more effectively					
10. Ability to response users requirement					

Sensors are installed and configured to the system in order to collect data from them. The implementation site is in Thailand's Mueang Chiang Mai province (GPS location: 18.7452719, 98.9781734). Table V.1 displays the list of installed sensors as well as the data

collected. As shown in Figure VI.5, all of the sensors listed in Table VI.2 are installed in the greenhouse.

Table VI.2: List of sensors installed and data collected (for more information see Appendix)





Sensors	Data	Picture of sensors
Air Indoor Sensor	<ul style="list-style-type: none"> - Air Temperature - Relative Humidity - Air CO₂ concentration - Light Intensity - UV index 	
Weather Station	<ul style="list-style-type: none"> - Air Temperature - Relative Humidity - Air Pressure - Light Intensity - Rainfall/Precipitation - Wind Speed and Direction 	
Water Sensor	<ul style="list-style-type: none"> - Water Temperature - Water pH - Water Electrical Conductivity (EC) 	
Soil Sensor	<ul style="list-style-type: none"> - Soil Moisture - Soil Temperature - Soil pH - Soil Electrical Conductivity (EC) 	

Figure VI.5 depicts the installation of the sensors listed in Table VI.1 for data monitoring and control in a greenhouse. The greenhouse measures 143 cm x 195 cm x 143 cm (Width x Height X Depth). Outside the greenhouse, a water sensor and a weather station are installed. The air sensor and soil sensor are installed inside the greenhouse. Furthermore, we prepared two pots to compare our implementations. Lettuce was grown in pot A using our proposed Adaptive DSS. As shown in Figure VI.6, the soil sensor and drip irrigation are installed in pot A. (a). In the pot B, however, we did not use our proposed Adaptive DSS, as shown in Figure VI.6 (b).



(a)



(b)

Figure VI.5: Dimension of Greenhouse, weather station installation and control box setup



(a)



(b)

Figure VI.6: Comparison of implementation

(a) Pot A: with Adaptive DSS

(b) Pot B: without Adaptive DSS

Users must scan a QR code to connect with the 'AgriRec' Line chatbot application and log in using the chatbot. As shown in Figure VI.7, the QR code was generated by the Line application.



Figure VI.7: QR code to login to AgriRec Line chatbot application

Lettuce is the use case in this thesis, and it takes 45 days to cultivate. As a result, the system can determine whether the current date is day 45. If the date status is 'Yes,' the system will 'END' the process on this day because it is the last day of cultivation. If the date status is 'No,' it means that this day is not the last day of the cultivation period, and the system will increment the day by one to analyze for the recommendation for the next day.

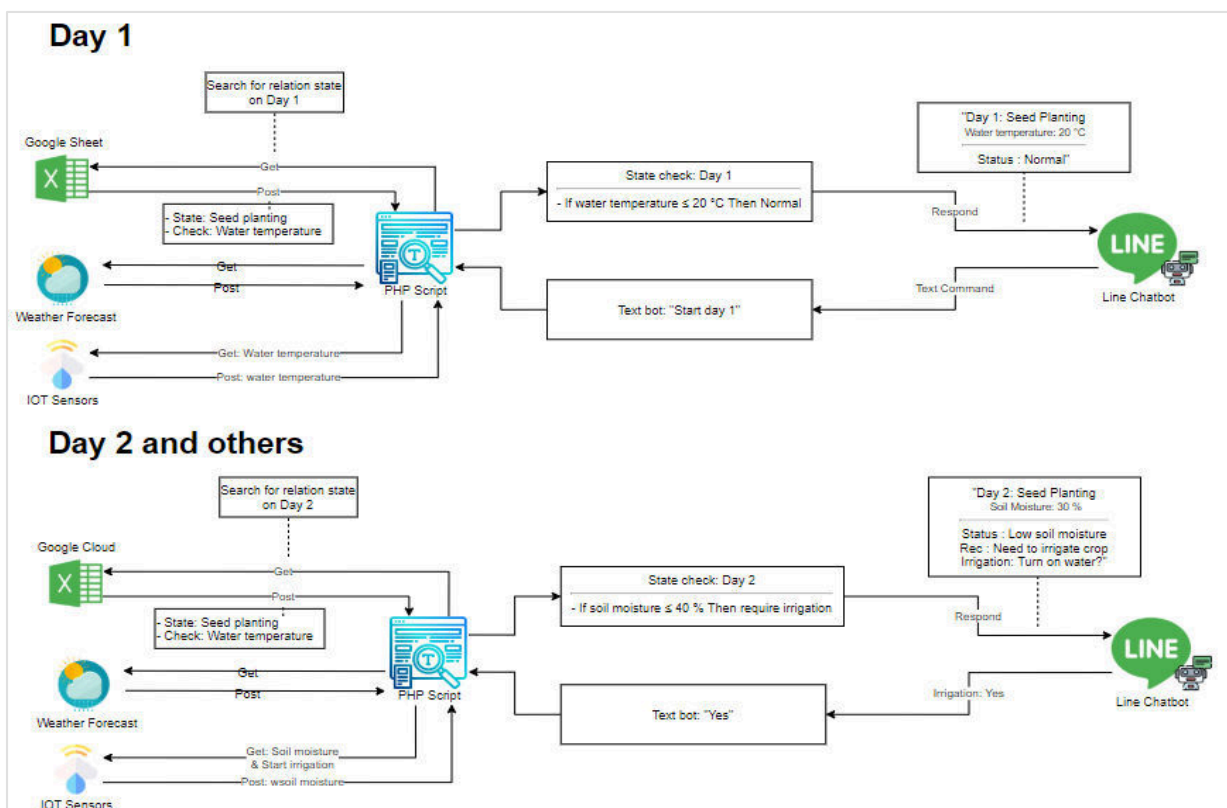

Figure VI.8: Demonstration of data processing sample on day 1 and day 2

Figure VI.8 depicts an example of data processing by the recommendation system for crop irrigation. On the first day, the user must press the 'START' button to begin using the device (see Figure VI.9). Then, as shown in Figure VI.10, users will receive crop maintenance data and a knowledge video for the first day. The php script will then get the water temperature data and use knowledge to look for the day 1 connection state, as shown in the example of irrigation processing demonstration in the preceding figure. In this case, the water temperature

is less than 20 °C, indicating that it is 'Normal.' The php script will then automatically send the water temperature status to the user via Line chatbots.

The php script will automatically collect data from the sensor on day 2 and other days, and use that data to determine the state of the connection on day 2 or other dates. In this case, the soil moisture level is less than 40%, indicating that the soil moisture status is 'abnormal.' The script will then automatically provide the user with the status of soil moisture as well as a recommendation via Line chatbots (see Figure VI.11). Following receipt of the information and recommendations, the user may begin controlling the drip irrigation system to irrigate Lettuce as directed. Furthermore, until day 45, the proposed Adaptive DSS will analyze data every 30 minutes to ensure that the field conditions are suitable for lettuce cultivation. However, the user can always monitor their field via the 'MONITOR' page (see Figure VI.12).

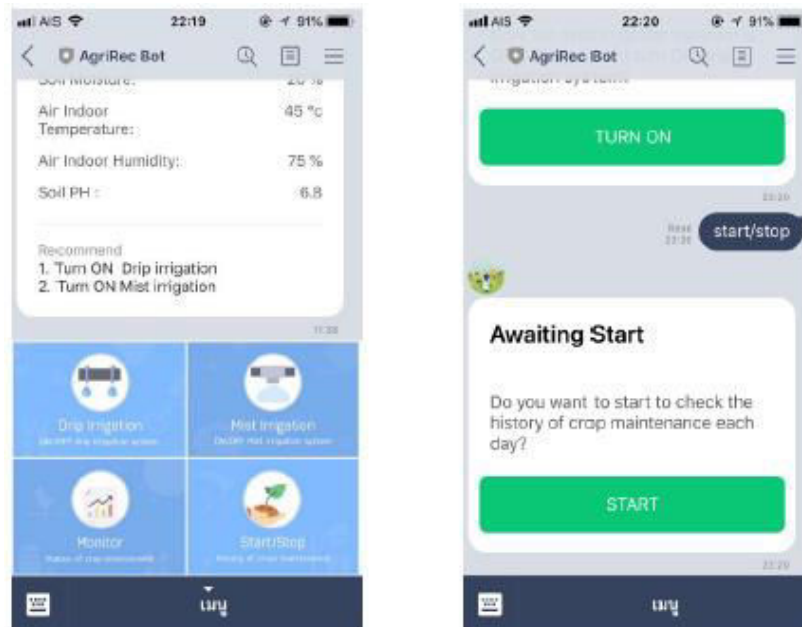

Figure VI.9: Main page and Start menu of Line AgriRec chatbot

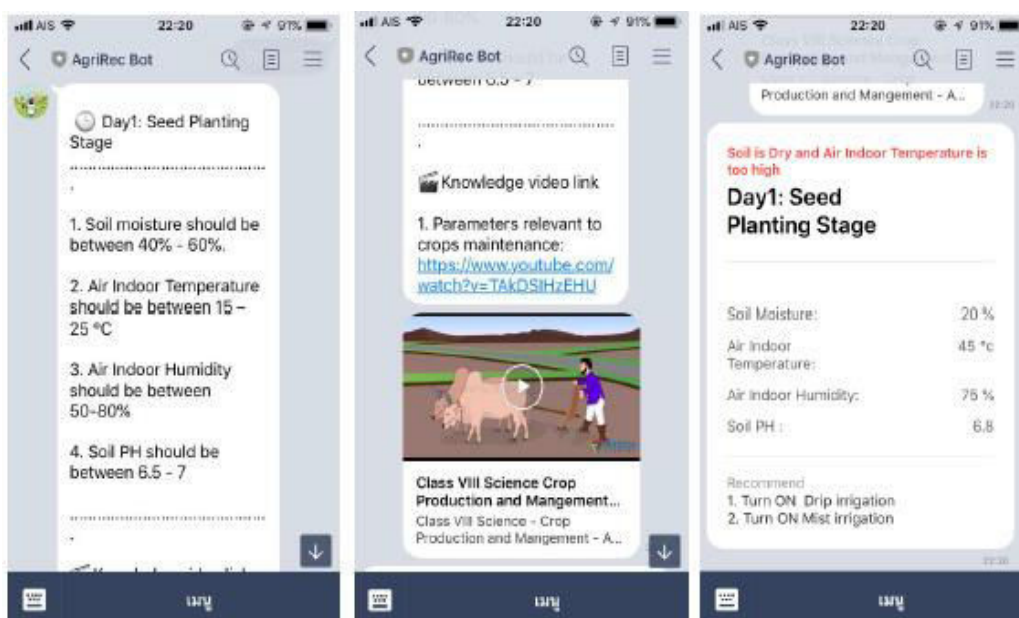

Figure VI.10: Field information, situation, and knowledge video

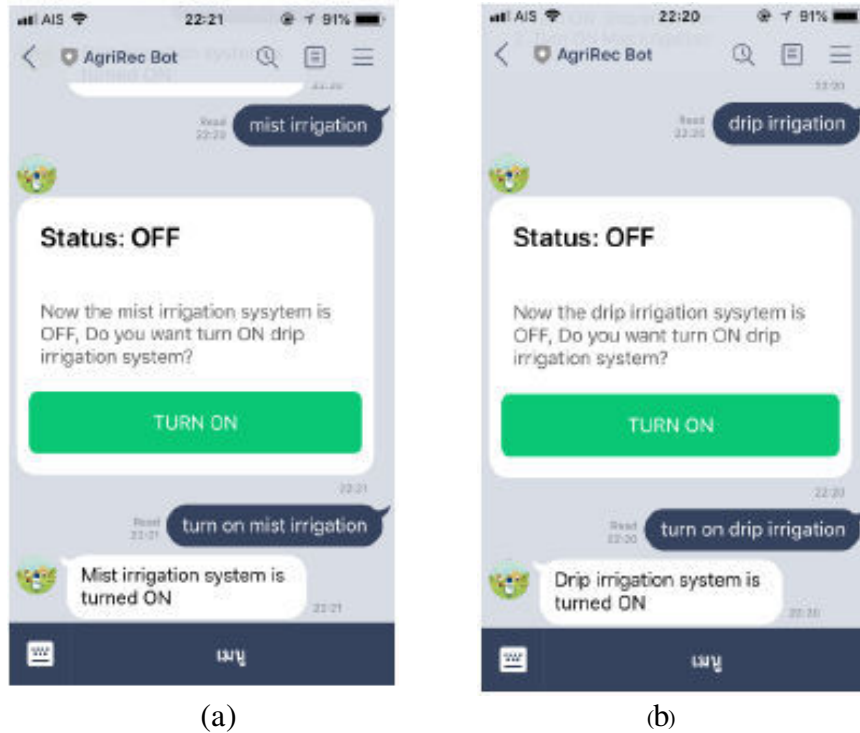

Figure VI.11: Irrigation page (a) Mist Irrigation ; (b) Drip irrigation page

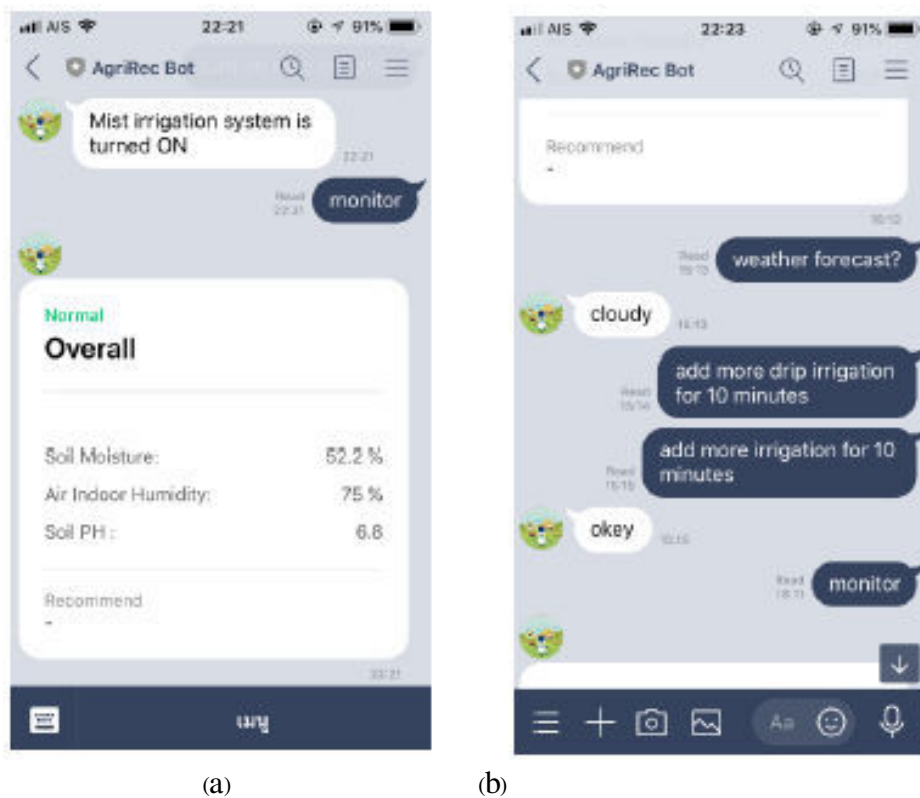

Figure VI.12: Monitor page

The system works very well after implementing the proposed Adaptive DSS in the real world, and users are very satisfied with it. Users are satisfied with the system after using it based on their satisfaction. Table VI.3 shows that the satisfaction rate is 96 percent. However,

there were some internet connection issues during implementation that impacted data and information transfer between user and system.

Table VI.3: Result of satisfaction survey

Questions	Farmers ID			Total	
	FM-001	FM-002	FM-003	Score	%
1. Interaction ability of system between user and system	5	5	5	15	100
2. User friendly of the system	5	5	5	15	100
3. Usability of the system	5	5	5	15	100
4. Accessibility of system in everywhere and every time	5	5	4	14	93.33
5. The smoothness of interaction between users and system	5	5	5	15	100
6. Effectiveness of internet connection between user and system	4	4	5	13	86.67
7. Visibility and clearness of video, text, voice	5	5	4	14	93.33
8. Ability to support the decision of users for crop maintenance	5	5	4	14	93.33
9. Ability to support users for crop maintenance more effectively	5	5	5	15	100
10. Ability to response users requirement	5	5	4	14	93.33
Total (Score)	49	49	46	Grand total score	
Total (%)	98.00	98.00	92.00	144	96.00

In summary, the proposed system combines rule-based and sensing data to provide irrigation optimization and crop maintenance recommendations. The data collected by smart sensors will be analyzed in order to provide appropriate crop maintenance processes such as irrigation, fertilizer application, disease control, insect pest control, and weed control. Furthermore, the appropriate amount of water to irrigate the crop will be calculated using the irrigation rule. Meanwhile, the future soil moisture value is predicted and calculated to help farmers prepare water for crop irrigation in the near future. The Line chatbots application serves as the user interface for communication between the system and the users. Crop maintenance knowledge videos and data are sent to the chatbot to share knowledge and inform farmers about the situation. Based on the proposed system's implementation in Chiang Mai (Thailand), the system can share knowledge videos with farmers every morning for the next 45 days. Farmers can also monitor the situation and practice based on the system's recommendations. Furthermore, users were pleased with the proposed system (96 percent of satisfaction). They can gain more knowledge to properly maintain their crop, and the system is simple for them to use.

Conclusion and Perspectives

The ultimate goal of this research is to improve the functionality of decision support systems by combining smart technologies and the knowledge of human experts. As a result, our research is divided into six chapters. Each chapter focused on a different aspects of the study. The following are the explicit outcomes of each chapter.

Chapter one aims to examine the context of agriculture, the smart agriculture sector and the need for a combination of smart technologies and expert knowledge to aid decision-making in crop production and maintenance. Due to environmental conditions, we discovered that smart technologies and systems are critical for the current crop production and maintenance process. Furthermore, in order to develop intelligent decision-making system support, experts' knowledge and best practices are critical to the development of expert systems. A review of the literature on decision support systems revealed that both smart technologies and expert knowledge are essential for the development of decision-making systems for crop maintenance. However, we discovered that the main impediment to the development of decision-making systems is the existence of separate systems for both elements (smart technologies and expert knowledge). The current decision support system only makes use of data collected by intelligent sensors. That is insufficient for the current crop maintenance decision. As a result, we require high-level cognitive support and expert decision-making to provide decision-making information for improving the functionality of the decision support system, particularly in complex problem situations. Thus, the critical problems of this study are to comprehend the smart agriculture concept and frameworks, issues of decision support systems, and to propose an architecture to aggregate smart technologies and the knowledge of human experts for crop maintenance decision-support systems.

Chapter two focuses on the literature of crop maintenance data and data sources relevant to crop maintenance throughout the crop life-cycle, rule-based, and the applications of Adaptive Decision Support Systems (Adaptive DSS) for crop maintenance process based on Machine Learning (ML) method. We discovered that none of the cases studied used Adaptive DSS to smart agriculture, particularly in the crop maintenance process, based on the combination of smart farm technologies and expert knowledge. As a result, we propose the Adaptive DSS for Smart Agricultural Crop Cultivation to Support Food. For a specific context, the knowledge engineering methodology is used to support knowledge capture, knowledge extraction, and parameter matching. This chapter compares various approaches to knowledge engineering methodology and ML approaches in order to choose an appropriate method to apply in the context of crop maintenance process. The analysis results show that the Knowledge Matrix methodology is best suited for rule-based creation in our case. Furthermore, in terms of soil moisture prediction tasks, the Long-Short Term Memory (LSTM) is appropriate for our case.

Chapter three focuses on the propose of the methodology and architecture to our specific needs. It consists of three parts: Knowledge Engineering (KE), Adaptive DSS, and Data Visualization. KE part consists of expert's knowledge capture, processing and rule-base creation. Knowledge experts are captured using KE technique. The captured knowledge is extracted by matching knowledge and parameters using knowledge matrix to define the knowledge conflict. The best practices for crops maintenance based on knowledge conflict are used to create the rule-base and validated by expertise from Faculty of Agriculture, Chiang Mai University. The Adaptive DSS part composes data collection, data processing and data analysis.

The on-farm and off-farm data are collected using IoT sensors and stored on cloud database. The Adaptive DSS proposes a data analysis phase by providing an appropriate crops maintenance recommendation based on rule-base and data from sensors. The data visualization part is focused on the building of a user interface to communicate between system and farmers via the chatbot application. Farmers will receive data, knowledge, and recommendation via the chatbot application.

Chapter four demonstrates the outcome of applying Knowledge Engineering methodology and architecture to create a rule-base. The Knowledge Engineering section is the focus of this chapter. Smart farmers were chosen as experts based on a combination of the Ministry of Agriculture and Cooperatives' smart farmer criteria and the SUNSpACe project's farmer profile results. Following the format of the interview technique, the knowledge was captured. Before interviewing the experts, we made a list of all pertinent questions. The knowledge captured at the level of knowledge capture is made up of knowledge from five experts in order to keep the lettuce cultivation cycle going. To extract knowledge from experts, match knowledge and parameters, and establish knowledge conflict from diverse experts, the rule-base creation level was constructed utilizing the Knowledge Matrix technique. Following that, experts validated the knowledge dispute. The rule-base was created utilizing expert knowledge that has been validated. This thesis' application case is the rule-base for managing lettuce cultivation.

Chapter five demonstrates the outcomes of Adaptive DSS integration. This chapter focuses on the integration of Adaptive DSS between expert rule-bases, IoTs data, and soil moisture forecasting models, which is part of irrigation optimization to provide an appropriate recommendation for the crop maintenance process, i.e. irrigation, fertilizer application, disease control, insect pest control, and weed control. The php script was used to examine the data by pairing the data's relationships to the rule-base. Furthermore, the Dialogflow was used to help users identify the correct word or term. A soil moisture forecasting model is also related to irrigation optimization. Based on the irrigation rules and predicted soil moisture value, the appropriate amount of water was recommended to users. The soil moisture forecasting model displays the model's output from a Long-Short Term Memory (LSTM) Deep Learning (DL) approach. To collect relevant data, the sensors were installed inside the greenhouse and the weather station was installed outside the greenhouse at Innovative Village in Chiang Mai province, Thailand. The scikit-learn module was used to preprocess the collected data before it was used in the forecasting model. This step results in cleaned and unmissed data in the database. The soil moisture forecasting model was developed in Python using the LSTM approach. As a result of this level, the soil moisture forecasting model performs well in predicting future soil moisture values.

The **sixth chapter** shows the results of data visualization part. The IoT cloud database platform was used for IoT data visualization. The IoT dashboard shows the real-time data collected from sensor devices and also a quick graph to show the historical data. The 'AgriRec' Line chatbot application was used as the user interface to communicate between the system and the user. The implementation scenarios are also presented in this chapter in order to depict how the Adaptive DSS can enhance decision-making support and improve the knowledge of users. According to the findings of the satisfaction survey, users are quite happy with the suggested Adaptive DSS when it is implemented on their farm. Because of the aggregation of smart farm

technology and expert knowledge, it gives superior outcomes in enhancing users' decision-making than a traditional decision support system.

Although this study demonstrated the Adaptive DSS's potential to assist in crop management process decision-making, we believe it might be improved in two ways:

- *Methodological aspect:* Knowledge engineering methodology is the subject of the methodological improvement. The proposed technique is based on the Knowledge Matrix methodology, which is thought to be more appropriate for use in this study than other methods. It does, however, necessitate improvements to the rule-base building process. The rule-base was developed without the use of any software tools in this study, which makes it challenging to create the rule-base. As a result, improving this aspect of our technique will make it easier to generalize the methodology across different domains.
- *The ability to update the rule-base of the system:* The proposed system cannot automatically update the rule-base itself. The rule-base must be validated and updated by the administrative and expertise teams on their own. However, we are interested in automatically updating the system's rule-base, which appears to improve the system's precision and intelligence in making relevant recommendations.
- *The soil moisture forecasting model:* The Learning Rate (LR) and Split Ratio (SR) of the proposed soil moisture forecasting model are selected by testing diverse cases that quite take more time of model building. However, there is other function of scikit-learn for automatic selection of a suitable LR and SR values for the forecasting model.

References

- Aaron O'Neill.** Share of economic sectors in the global gross domestic product from 2008 to 2018. October 2020. Website: <https://www.statista.com/statistics/256563/share-of-economic-sectors-in-the-global-gross-domestic-product/> Retrieved on March 2021.
- Abah J, Ishaq MN, Wada AC** (2010) The role of biotechnology in ensuring food security and sustainable agriculture. *Afr J Biotechnol* 9: 8896–8900.
- AdAP2E project,** 2018, website: <https://adap2e.irstea.fr/contexte-et-objectifs/>, (Retrieved on 10 February 2019)
- Alenyà Ribas, Guillem, Babette Dellen, Sergi Foix Salmerón, and Carme Torras.** "Robotic leaf probing via segmentation of range data into surface patches." In *Proceedings of the 2012 IROS Workshop on Agricultural Robotics: Enabling Safe, Efficient, Affordable Robots for Food Production*, pp. 1-6. 2012.
- Alston, Julian M.,** and Philip G. Pardey. "Agriculture in the global economy." *Journal of Economic Perspectives* 28, no. 1 (2014): 121-46.
- Alliance for Internet of Things Innovation (AIOTI),** ‘Smart Farming and Food Safety Internet of Things Applications – Challenges for Large Scale Implementations AIOTI WG06 – Smart Farming and Food Safety’ 2015
- Anucha Chantaraboon,** “Fruit production.” Faculty of Sciences and Agricultural Technology, Rajamangala University of Technology Lanna (Nan campus), ISBN : 978-616-361-604-3, 2010
- APOLLO project,** 2017, Website: <https://apollo-h2020.eu/> (retrieved on 6 February 2019)
- Beecham Research Ltd.,** “Towards Smart Farm Agricultural Embracing The IoT Vision,” BRL Smart Farming Exclusive Summary, 2014 (<http://beechamresearch.com/>)
- Ben G. Bareja.** " What is Agriculture, Definition of Agriculture." *Cropsreview: Welcome and Let’s Go Crop Farming*, August 2014.
- Blaga, M., R. Harpa, I. R. Radulescu, and Z. Stepjanovic.** "E-learning for textile enterprises innovation improvement." In *IOP Conference Series: Materials Science and Engineering*, vol. 254, no. 22, p. 222001. IOP Publishing, 2017.
- Bongiovanni, Rodolfo,** and Jess Lowenberg-DeBoer. "Precision agriculture and sustainability." *Precision agriculture* 5.4 (2004): 359-387.
- Bulliet RW,** Crossley PK, Headrick DR, Johnson LL, Hirsch SW. *The Earth and Its Peoples: A Global History, Volume I.* Boston, MA: Houghton Mifflin; 2008.
- CARDINAEL Rémi, et al.,** ‘Agroforestry for a climate-smart agriculture – a case study in France,’ *Climate Smart Agriculture Conference, Montpellier, France.* 186 p., March 2015 (hal-01612490)
- Castaneda, Raul,** Dung Doan, David Locke Newhouse, Minh Nguyen, Hiroki Uematsu, and João Pedro Azevedo. "Who are the poor in the developing world?." *World Bank Policy Research Working Paper* 7844 (2016).

- Chapman R**, Slaymaker T (2002) ICTs and rural development: Review of the literature, current interventions and opportunities for action. In: Working Paper 192, Overseas Development Institute, London.
- Collado, Edwin**, Anibal Fossatti, and Yessica Saez. "Smart farming: A potential solution towards a modern and sustainable agriculture in Panama." *AIMS Agriculture and Food* 4, no. 2 (2019): 266-284.
- D. Qi** and G. Lu and X. Dai, "Design of Urban Greening Intelligent Monitoring System Based on Internet of Things Technology," in 9th International Conference on Intelligent Human-Machine Systems and Cybernetics (IHMSC), 2017.
- Desjeux, Yann**, Hervé Guyomard, and Laure Latruffe. "Agricultural policies in France: from EU regulation to national design." PhD diss., IERiGZ-Polish Institute of Agricultural and Food Economics, 2007.
- EIP-AGRI Agriculture and innovation**, "Funding opportunities under Horizon 2020 Calls 2016," 2016
- ENORASIS project**, 2014, website: <http://enorasis.eu/> (retrieved on 6 February 2019)
- Esbrí, Miguel Ángel**. "FOODIE: Farm-Oriented Open Data in Europe." (2014).
- esiFarm Project**, 2014, website: <http://www.famosasrl.com/en/case-study-esifarm/> (Retrieved on May 2017)
- Esther Mietzsch, et al.**, 'Smart Food and Agribusiness: Future Internet for Safe and Healthy Food from Farm to Fork,' Collaborative Project - Large-scale Integrated Project (IP), April 2013
- European Commission**, 'The European Innovation Partnership "Agricultural Productivity and Sustainability", http://europa.eu/rapid/press-release_MEMO-12-147_en.htm?locale=en, retrieved on 27 March 2017.
- Evans, Robert Dwayne**. "Impacts of the Greenbelt Plan on the Agricultural Industry, Case Study: Town of Erin, Wellington County." (2007).
- Farm Europe**, 'A SMART CAP FOR EU PRECISION & SMART FARMING,' <https://www.farm-europe.eu/travaux/a-smart-cap-for-eu-precision-smart-farming/>, 22 DECEMBER 2017 (Retrieved on January 2019)
- Gianluca Zavatta**, "Agriculture Remains Central to the World Economy. 60% of the Population Depends on Agriculture for Survival," United Nations at Expo Milano 2014 [Website: <http://www.expo2015.org/magazine/en/economy/agriculture-remains-central-to-the-world-economy.html>] Retrieved on April 2019
- Gilles Dryancour, et al.**, 'Smart Agriculture for All Farms,' CEMA aisbl - European Agricultural Machinery Industry Association, Brussels, Belgium, November 2017, website: <https://www.cema-agri.org/>

- Goh, Ong Sing**, and Chun Che Fung. "Trust based knowledge acquisition for conversation agents." IAENG International Journal of Computer Science 33, no. 2 (2008): 1-9.
- ITU-T Study Group 20**, 'Overview of Smart Farming based on networks,' International Telecommunication Union, June 2015 [Website: <http://handle.itu.int/11.1002/1000/12520>] (accessed on Jan 2019)
- Josse De Baerdemaeker**, STOA study, Precision agriculture and the future of farming, presentation made at the European Parliament, August 30th, 2017
- Julie Cook** and Elasha Morgan, "Do Plants Need Water?" (accessed on February 15, 2018: <https://www.uen.org/lessonplan/view/2187>)
- Kipps, M.S.**, "Production of field crops. A textbook of agronomy." Production of field crops. A textbook of agronomy., (Edn 6). 1970.
- Kramer, Paul** and Boyer, John, Water Relations of Plants and Soils. Academic Press, San Diego, CA; c1995.
<http://www.fao.org/3/br106e/br106e.pdf>
- Libelium Communication**, 'Precision Farming to control irrigation and improve fertilization strategies on corn crops,' September 28th, 2016, <http://www.libelium.com/precision-farming-to-control-irrigation-and-improve-fertilization-strategies-on-corn-crops/> (Retrieved on May 2017)
- Libelium Communication**, 'Precision Agriculture: Predicting Vineyard Conditions, Preventing Disease,' August 17th, 2015, <http://www.libelium.com/precision-agriculture-predicting-vineyard-conditions-preventing-disease/> (Retrieved on May 2017)
- Lior Doron**, 'Flexible and Precise Irrigation Platform to Improve Farm Scale Water Productivity (FIGARO),' International FIGARO Conference, 19 September 2016, Brussels, Belgium
- Löprich, C.**, 2018. Agriculture in Europe: Greener practices and a brighter future for the sector. EPC Policy Brief, 30 May 2018.
- M. Rajkumar** and S. Abinaya and V. Kumar, "Intelligent irrigation system—An IOT based approach," in International Conference on Innovations in Green Energy and Healthcare Technologies (IGEHT), 2017
- Maarten Elferink**, and Florian Schierhorn, "Global Demand for Food Is Rising. Can We Meet It," Harvard Business Review, 7 April 2016
- Madsen, Eugene L.** "Impacts of agricultural practices on subsurface microbial ecology." Advances in agronomy (USA) (1995).
- MAGESTAN project**, 2016, website: <http://www.franceagrimer.fr/content/download/42859/400654/file/P3A%20-%20fiche%20laur%C3%A9at%20-%20MAGESTAN.pdf>, (Retrieved on 10 February 2019)

- Malavika Bambawale, et al.**, 'EFFICIENT AGRICULTURE, STRONGER ECONOMIES IN ASEAN,' PRIVATE SECTOR PERSPECTIVES FOR POLICY MAKERS, 2020, [Website: https://www.aprilasia.com/images/pdf_files/BCSD/BCSD_white_paper.pdf], Retrieved from February 2021
- Max Roser**, and Hannah Ritchie, "Empirical View: Fertilizer and Pesticides rates," 2015 (online: <https://ourworldindata.org/fertilizer-and-pesticides>] retrieved on April 2019
- Mohseni Moghadam, Maryam.** "Green Belt, a Local Approach For Environmental Challenges." *MANZAR*, the Scientific Journal of landscape 8, no. 37 (2017): 56-65.
- Montgomery D. Dirt:** The Erosion of Civilizations. Berkeley and Los Angeles, California: University of California Press; 2008.
- Morton, Stephen**, David Pencheon, and Neil Squires. "Sustainable Development Goals (SDGs), and their implementation A national global framework for health, development and equity needs a systems approach at every level." *British medical bulletin* (2017): 1-10.
- MousaviSR, Rezaei M** (2011) Nanotechnology in agriculture and food production. *J Appl Environ Biol Sci* 1: 414–419.
- Nino Kakulia**, Davit Zhorzholiani and Pati Mamardashvili, "Organic is the new black," ISET 2018
- Norah Owens**, "Fertilizer and Agriculture," 2017 [online: <https://slideplayer.com/slide/10549424/>] retrieved on April 2019
- ONCHAN, TONGROJ.** "Family Farms and Group Farming in Thailand." *Japanese Journal of Farm Management* 29.3 (1991): 5-12.
- P. Anitha**, T.Chakravarthy, "Application of Internet of Thing (IoT) and Cloud Computing in Agriculture," *International Journal of Innovative Research in Computer and Communication Engineering* (An ISO 3297: 2007 Certified Organization) Vol. 4, Special Issue 5, October 2016
- Pablo J. Zarco-Tejada**, et al., "Directorate-General for Internal Policies Department B: Structural and Cohesion Policies Agriculture and Rural Development Precision Agriculture: an Opportunity for EU Farmers." Potential Support with the CAP 2014-2020 (2014), [online], [http://www.europarl.europa.eu/RegData/etudes/](http://www.europarl.europa.eu/RegData/etudes/note/JOIN/2014/529049/IPOL-AGRI_NT%282014%29529049_EN.pdf)note/JOIN/2014/529049/IPOL-AGRI_NT%282014%29529049_EN.pdf (Retrieved: July 2018)
- Pernin, Christopher**, Louis Moore, and Katherine Comanor. The knowledge matrix approach to intelligence fusion. RAND ARROYO CENTER SANTA MONICA CA, 2007.
- Pivoto, Dieisson**, Paulo Dabdab Waquil, Edson Talamini, Caroline Pauletto Spanhol Finocchio, Vitor Francisco Dalla Corte, and Giana de Vargas Mores. "Scientific development of smart farming technologies and their application in Brazil." *Information processing in agriculture* 5, no. 1 (2018): 21-32.
- Prasad R**, Kumar V, Prasad KS (2014) Nanotechnology in sustainable agriculture: Present concerns and future aspects. *Afr J Biotechnol* 13: 705–713.
- Puntasen, Apichai**, and Paradorn Preedasak. "Agriculture in Thailand at the cross-road." *ASEAN Economic Bulletin* (1998): 90-107.

- Rao, N. Chandrasekhara**, Seema Bathla, Anjani Kumar, and Girish K. Jha. "Agriculture and sustainable development goals: An overview and issues." *Agric. Econ. Res. Rev* 31 (2018): 1-7.
- R. Venkatesan** and A. Tamilvanan, "A sustainable agricultural system using IoT," in *International Conference on Communication and Signal Processing (ICCSP)*, 2017.
- S. Prathibha** and A. Hongal and M. Jyothi, "IOT Based Monitoring System in Smart Agriculture," in *International Conference on Recent Advances in Electronics and Communication Technology (ICRAECT)*, 2017.
- S. Saraf** and D. Gawali, "IoT based smart irrigation monitoring and controlling system," in *2nd IEEE International Conference on Recent Trends in Electronics, Information & Communication Technology (RTEICT)*, 2017.
- Shagun Kapil**. Agri share in GDP hit 20% after 17 years: Economic Survey. 29 January 2021. Website: <https://www.downtoearth.org.in/news/agriculture/agri-share-in-gdp-hit-20-after-17-years-economic-survey-75271> Retrieved on March 2021
- Shubhi Mittal**, (2020). IoT Ecosystem: How the IoT Market will Explode by 2021. [Online: <https://blog.beaconstac.com/2016/03/iot-ecosystem-iot-business-opportunities-and-forecasts-for-the-iot-market/>]. Retrieved on March 2021
- Singhapreecha, Charuk**. "Economy and Agriculture in Thailand." *Asia-Pacific Information Platform on Agricultural Policy (AP)*. Food and Fertilizer Technology Center for the Asian and Pacific Region (2014).
- Smart AKIS: Smart Farming Thematic Network**, 'What is smart farming?', <https://www.smart-akis.com/index.php/network/what-is-smart-farming/>, retrieved on July 2018
- Smart AKIS: Smart Farming Thematic Network**, 'Smart-AKIS Recommendations for mainstreaming Smart Farming in Europe are now public,' <https://www.fedecom.nl/nieuws-list/smart-akis-recommendations-for-mainstreaming-smart-farming-in-europe-are-now-public/>, retrieved on January 2019
- Smart Agriculture System**, 2016, website: <http://cereales-vallee.org/nos-projets/mieux-prevoir-les-rendements-des-cultures-tout-en-repondant-aux-enjeux-environnementaux>, (Retrieved on 10 February 2019)
- Sopon Naruchaikusol**, "Climate Change and its impact in Thailand," *TransRe Fact Sheet No. 2*, June 2016
- Srimongkol, Katin**, and G. G. Marten. "Traditional agriculture in northern Thailand." (1986).
- Sritontip, C., et al**. "The Impact of Climate Changes on Yield of Longan Production in Northern Thailand." *IV International Symposium on Lychee, Longan and Other Sapindaceae Fruits* 1029. 2012.

- Suebsombut, P.**, Sekhari, A., Sureepong, P., Ueasangkomsate, P. and Bouras, A., 2017, March. The using of bibliometric analysis to classify trends and future directions on “smart farm”. In 2017 International Conference on Digital Arts, Media and Technology (ICDAMT) (pp. 136-141). IEEE.
- Suebsombut, P.**, Sekhari, A., Sureepong, P. and Bouras, A., 2017, December. Classification and trends in knowledge research relevance and context for smart farm technology development. In 2017 11th International Conference on Software, Knowledge, Information Management and Applications (SKIMA) (pp. 1-7). IEEE.
- Sun Agri project**, September 2018, website: <https://sunagri.fr/> (Retrieved on 10 February 2019)
- Sundresan P.**, Norita Md N., Valliappan R., (2015). Internet of Things (IoT) digital forensic investigation model: Top-down forensic approach methodology. Fifth International Conference on Digital Information Processing and Communications (ICDIPC).
- Sungcom Techawongstien**, “FACTORS AFFECTING PLANT GROWTH AND DEVELOPMENT,” Faculty of Agriculture, Khon Kaen University, 2004
- The United Nations World Water Development Report**. Wastewater: The Untapped Resource, UNESCO. 2017. Available from: <https://unesdoc.unesco.org/ark:/48223/pf0000247153> [Accessed: February 2020]
- Tongrod N**, Tuantranont A, Kerdcharoen T. "Adoption of precision agriculture in vineyard." In Electrical Engineering/Electronics, Computer, Telecommunications and Information Technology, 2009. ECTI-CON 2009. 6th International Conference on 2009 May 6 (Vol. 2, pp. 735-738). IEEE.
- Trébuil, Guy**, Benchaphum Ekasingh, and Methi Ekasingh. "Agricultural commercialisation, diversification, and conservation of renewable resources in Northern Thailand Highlands." *Moussons. Recherche en sciences humaines sur l'Asie du Sud-Est* 9-10 (2006): 131-155.
- TrimBot2020 project**, 2018, website: <http://trimbot2020.webhosting.rug.nl/> (retrieved on 6 February 2019)
- United Nation**, 2020 website: <https://thailand.un.org/en/103307-thai-agricultural-sector-problems-solutions>
- Valentina, Florea Nicoleta**. "The Tacit Knowledge and the Knowledge Management Processes: Developing a Relationship-Based Knowledge Matrix Using Simulation to Improve Performance." In *Handbook of Research on Tacit Knowledge Management for Organizational Success*, pp. 201-235. IGI Global, 2017.
- W. Zhao** and S. Lin and J. Han and R. Xu and L. Hou, "Design and Implementation of Smart Irrigation System Based on LoRa," in *IEEE Globecom Workshops (GC Wkshps)*, 2017.
- Website**: <http://www.tradingeconomics.com/thailand/gdp-from-agriculture>, Access on October 29, 2016
- Website**: <http://www.fao.org/forestry/11712-0ac469e8b26f5a5558c179493acd1678a.pdf> (access on 24 January 2017)

- Whaley, Kevin J.** "A Knowledge Matrix Modeling of the Intelligence Cycle." (2005).
- WHO (World Health Organization)**, "Food Safety," 31 October 2017 [online: <https://www.who.int/news-room/fact-sheets/detail/food-safety>] Retrieved on April 2019
- William Morgan**, "An Overview of the Plant Lifecycles." *The North American Farmer: Farming+Science+Technology*, 2017 (accessed on July 10, 2017: <https://northamericanfarmer.com/science/life-cycle-of-a-plant/>)
- Wolfert, Sjaak**, Lan Ge, Cor Verdouw, and Marc-Jeroen Bogaardt. "Big data in smart farming—a review." *Agricultural Systems* 153 (2017): 69-80.
- World Bank**, "Agriculture and Food," 2019 [online: <https://www.worldbank.org/en/topic/agriculture/overview>] retrieved on April 2019
- World Bank**. Agriculture and Food. September 30th, 2020 website: <https://www.worldbank.org/en/topic/agriculture/overview> Retrieved on May 2021.
- Yeung, Daniel S.**, and Hank-shun Fong. "Knowledge Matrix-An Explanation and Knowledge Refinement Facility for a Rule Induced Neural Network." In *AAAI*, pp. 889-894. 1994.
- Z. Li** and J. Wang and R. Higgs and L. Zhou and W. Yuan, "Design of an Intelligent Management System for Agricultural Greenhouses Based on the Internet of Things," in *IEEE International Conference on Computational Science and Engineering (CSE) and IEEE International Conference on Embedded and Ubiquitous Computing (EUC)*, 2017.