



HAL
open science

Research perspectives for smart machining based on instantaneous cutting forces in milling and micromilling

Anna Carla Araujo

► **To cite this version:**

Anna Carla Araujo. Research perspectives for smart machining based on instantaneous cutting forces in milling and micromilling. Mechanical engineering [physics.class-ph]. Université de Toulouse, 2022. tel-04149149

HAL Id: tel-04149149

<https://hal.science/tel-04149149v1>

Submitted on 3 Jul 2023

HAL is a multi-disciplinary open access archive for the deposit and dissemination of scientific research documents, whether they are published or not. The documents may come from teaching and research institutions in France or abroad, or from public or private research centers.

L'archive ouverte pluridisciplinaire **HAL**, est destinée au dépôt et à la diffusion de documents scientifiques de niveau recherche, publiés ou non, émanant des établissements d'enseignement et de recherche français ou étrangers, des laboratoires publics ou privés.



HDR Report

En vue de l'obtention de l'
Habilitation à diriger des recherches

Délivré par : *UNIVERSITÉ DE TOULOUSE*

Présentée le *24 juin, 2022* par :

ANNA CARLA MONTEIRO DE ARAUJO

Research perspectives for smart machining based on instantaneous cutting forces in milling and micromilling

Rapporteurs :

Abdelhadi MOUFKI - Professeur d'Université - Université de Lorraine

Irene FASSI - Head of Micro Enabled Devices and Systems - Cons. Naz. delle Ricerche

Mathieu RITOU - Maître de Conférence HDR - Université de Nantes

Examineurs :

Manuel Paredes - Professeur d'Université - INSA Toulouse

Yann Landon - Professeur d'Université - Univ. Paul Sabater (UT3)

Lionel Arnaud - Maître de Conférence HDR - ENI Tarbes (ENIT)

Guillaume Fromentin - Professeur d'Université - ENSAM Cluny

Yang Liu - Biträdande Professor - Linköping University

École doctorale et spécialité :

MEGEP - Génie mécanique, mécanique des matériaux

Unité de Recherche : *Institut Clément Ader (UMR CNRS 5312)*

Acknowledgements

I would like to thanks to:

- my family who are with me in all the moments, near or far;
- music and its effect to my sanity;
- to the good spirituality;
- to all students that I had the opportunity to contribute with, especially my actual and former doctoral students Adriane, Fábio, Gleiton and Sughosh, who are partners of this project;
- the colleagues from Brazil (UFRJ and CEFET) and from ENSAM/Cluny, especially Guillaume Fromentin;
- the colleagues in INSA, especially the manufacturing team: Damien Coutouly, Philippe Seitier, Patrick Gilles and Nicolas Laurien;
- the professors who helped me a lot with discussions about HDR, especially Manuel Paredes, Pierre Lagarrigue, Yann Landon, Jean-Charles Passieux, Fabrice Longere and Lionel Arnauld.

Merci!

Finally, I dedicate this HDR to my mother.

Contents

Introduction	11
--------------	----

I Curriculum Vitae

1	Professional trajectory	15
1.1	Actual position and research indicators	15
1.2	Professional trajectory overview	16
1.3	Beliefs for science and education	18
1.4	Organization of the next chapters in Section I	20
2	Teaching activities	21
2.1	Engineering education system in Brazil and France	21
2.2	Undergraduate courses	24
2.2.1	Introduction to Mechanical Engineering	24
2.2.2	Solid mechanics, mechanical vibrations and reliability	27
2.2.3	General manufacturing processes and forming courses	27
2.2.4	Machining courses	28
2.2.5	Additive manufacturing and the virtual mobility in INSA-Toulouse	29
2.3	Graduate courses	30
2.4	Production of didactic material for manufacturing	30
3	Human resources training for scientific research	33
3.1	Key figures as research advisor	33

3.2	Parallel between Brazil and France for training in research	34
3.3	Detailed description of the research supervision activities	36
3.3.1	Undergraduate students	36
3.3.2	Master of Science students	36
3.3.3	Doctor of Science students	38
3.4	Participation in thesis defense evaluation board	39
4	Published articles in journals and conferences	41
4.1	Publication key figures	41
4.2	Contribution as author in journals	43
4.3	Contribution as author in conferences	45
4.4	Other contributions in conferences and journals	45
4.4.1	Conferences activities (organization, reviewer and chairwoman)	45
4.4.2	Participation in roundtable and as speaker in conferences	46
4.4.3	Acting as reviewer in conferences and journals	47
5	Collective administration and research projects	49
5.1	Administration responsibilities in the department level	49
5.1.1	COLAN in CEFET/RJ: 2007	49
5.1.2	LABUS in CEFET/RJ: 2007	50
5.1.3	LTM in UFRJ: 2011-2012	50
5.1.4	Double degree UFRJ and Paristech	50
5.1.5	Proposition for the participation on Erasmus ASCENT project	50
5.1.6	Incoming students in Mechanical Engineering: 2020-2021	51
5.2	Administration responsibilities in university level	52
5.2.1	Coordination of research in CEFET/RJ	52
5.2.2	International Relations in Engineering at Poli/UFRJ	52
5.2.3	International Affairs Office at COPPE/UFRJ	53
5.3	Application and management of financial resources	55
5.3.1	<i>Recent researcher</i> financial support	55
5.3.2	Individual grant for research from CNPq	55
5.3.3	Emerging Groups FAPERJ in Brazil	56
5.3.4	Internal calls for external financial support for equipment	56
5.3.5	Financial support Defi Diversité in France	57
5.3.6	Financial support for double degree mobility CAPES-CDEFI BRAFITEC	58

5.4	Participation in academic councils	58
5.5	Member of evaluation boards in public tender	59

II Scientific work

6	Scientific work overview	63
7	Monitoring forces in milling for mechanistic models	67
7.1	Mechanistic coefficients on local force approach	69
7.2	Developed research using mechanistic models	70
7.3	Turning and drilling forces: models with constant chip load	71
7.3.1	Mechanistic model for turning smart material alloys	72
7.3.2	Mechanistic model for drilling metals	75
7.4	Modeling milling forces considering rigid tool	79
7.4.1	High feed milling	81
7.4.2	Mechanistic coefficients and produced residual stress in milling	87
7.5	Modeling milling forces with tool deflection	92
7.5.1	Measuring tool tip displacement	93
7.5.2	Experimental identification via Wavelet analysis	94
7.5.3	Predicting chatter regions	97
8	Force milling models applied to helical trajectories	99
8.1	Helical tool trajectory and reference frames	101
8.2	Threads milling process	103
8.2.1	Thread and tool geometries	104
8.2.2	Thread tool modelling	105
8.2.3	Modelling forces in thread milling	108
8.2.4	Cutting continuity of forces	111
8.2.5	Geometric problems related to internal thread milling	112
8.3	Thread milling research applied to industry	116
8.3.1	Analysis of the thrilling process	116
8.3.2	External thread milling in bones	118
8.3.3	Optimization for Industry	118
8.3.4	Thread milling for oil industry	121
8.3.5	Mini-threads in dental implants abutment	125

8.4	Orbital drilling	128
8.5	Smart machining and monitoring helical milling	132
9	New challenges in manufacturing: micromilling and additive manufacturing	137
9.1	Micromilling	137
9.1.1	Micromilling tool geometry	139
9.1.2	Size effect and microstructure	140
9.1.3	Feed per tooth and BUE	143
9.1.4	Feed per tooth and uncut chip thickness	144
9.1.5	Characterization of ploughing and elastic recovery	145
9.1.6	Modelling forces in micromilling	146
9.1.7	Experimental force results and the specific cutting force	148
9.1.8	Burr formation in micromilling	152
9.1.9	Chip morphology in micromilling Titanium alloys	153
9.2	Additive manufacturing research	155

III Research project

10	References	165
-----------	-------------------	------------

Introduction

My professional trajectory is a result of a blend of persistence, audacity and practical challenges along my career. In France, the *Habilitation à diriger des recherches* (HDR) is the highest national diploma of Higher Education and it is required to act as the *Directeur de these*, supervising doctoral students¹, which I already supervised in Brazil. The application includes a summary of the candidate works what takes me to present this report.

It is easier to claim what this text is not: It is not a second thesis; It is not a book; It is not a project (although the last part presents a wide project). It is closer to a state of art of my research and its perspectives. In my opinion, it is more than a report. It is a psychological and strategical challenge.

After these two years after moving to France, I told myself that : "*It is not an easy task, but it is a necessary step to move on*". I should confess that I almost gave up several times in the middle of the writing process. For many reasons as: lack of self esteem due to comparison with other colleagues (mainly the ones with typical trajectories), the reminder of some bad ghosts from the past and the challenge of organizing a lot of work (some that I consider incomplete but important for the research) and new perspectives for future work. But contradictory, the same reasons made me stronger and feed me to complete it.

Finally I was able to connect many fruitful work to a main trunk. It is a very good opportunity to reorganizing priorities on research and also it helps to impulse teaching and administrative activities in free minefield of possibilities. I hope you appreciate this text.

Along the text, an small "P" is added to after the references that I am coauthor. It facilitates to identifying when it is making reference to a developed work from our group or from an external reference. Also, our references are separated from the external references in the bibliography list.

¹HDR is also necessary for positions of *Professeur des Universités* or *Directeur de recherche*.

Section I

Curriculum Vitae

Professional trajectory

This chapter presents an overview of my career, indicators and the organization of this first section about my curriculum vitae.

1.1 Actual position and research indicators

My actual job position is: **Maître de Conference échelon 5** (Assistant Professor, level 5)¹ on Manufacturing Processes at Mechanical Engineering Department in INSA Toulouse, France.

My area of research focuses on manufacturing processes, especially in the process of metal cutting, when the mechanical behavior of the tool is modeled and experimental monitoring is done. In cutting processes, the parameters analysed are mainly: dynamic cutting forces, tool wear, tool life, workpiece machinability and surface quality. The application of study is aeronautic and oil industry (that uses low machinability workpieces) and medical industry (with bio compatible materials). As a summary, it is presented in Table 1.1 some indicators of my research production considering overall publications.

Table 1.1. *Quantitative summary of research indicators*

Bibliometry	Scopus	Web of Science	Google Scholar
H index	7	6	8
Number of citations	175	139	349

In teaching, my focus is on disciplines for undergraduate and graduate courses in manufacturing and experiments as: industrialisation, theory of machining (mechanical cutting and practice activities), additive manufacturing and design of experiments (DOE). Table 1.2 presents

¹The French law allows only the transfer of half of the time on teaching-research experience from non European countries for professional leveling.

some indicator about teaching activities. In chapter 2 the detail of teaching activities and a short report on activities are presented.

Table 1.2. *Quantitative summary of regular teaching courses*

Teaching indicators	Undergraduate* courses	Graduate courses
Hours	2671	765
Number of classes	70	17
Number of different disciplines	20	4

* - Undergraduate : Before Engineering diploma (From 1st - 5th year of Engineering)

On the administrative level, the more relevant considering the working load is connected to International relations for education and mobility, among other activities, described along this text.

1.2 Professional trajectory overview

A trajectory overview is presented in a timeline in Figure 1.1. My trajectory begun in 1993, when I entered in UFRJ² as an undergraduate mechanical Engineering student. UFRJ is the university where I complete the Engineering degree, master and doctoral studies with one year mobility (called Sandwich program) at University of Illinois at Urbana Champaign (UIUC) in USA.

I worked in the industry as a product engineer in a company called *Vesuvius Refractories* and I entered in the academy as a professor in 2006, in CEFET/RJ³. I worked for 10 years in UFRJ as an Associate Professor and my actual position is located in INSA-Toulouse⁴ in France. In 2017, I made a sabbatical research year in ENSAM⁵ in Cluny, France, an School of Engineering with a research laboratory in machining where I did not teach courses.

In order to show my trajectory I do not feel comfortable use the expression "looking back my trajectory" because this unidirectional feeling is far from what I see in my career. I have

²UFRJ - Federal University of Rio de Janeiro: Its history dates back to the beginning of the 19th century and is filled with remarkable scientific, cultural, and artistic accomplishments. It is currently the 3rd best university in Brazil and the 7th best university in Latin America (QS Rankings – 2018)

³CEFET/RJ - Federal Center for Technological Education Celso Suckow da Fonseca had its origin in 1917 as the Normal School of Arts and Crafts and currently, it is a federal teaching institution that understands itself as a public space for human, scientific and technological formation.

⁴INSA-Toulouse: Institut National des Sciences Appliquées of Toulouse, an international, multidisciplinary, state engineering school, recognised for the excellence of its five-year education which attracts students of a high academic level and who have obtained excellent results at the Baccalaureate.

⁵ENSAM: École des Arts et Métiers is established since 1901 at an exceptional location, Cluny Abbey, the Arts et Métiers campus has forged its reputation in three fields of expertise: high-speed machining, the wood industry and digital modelling and virtual imaging.

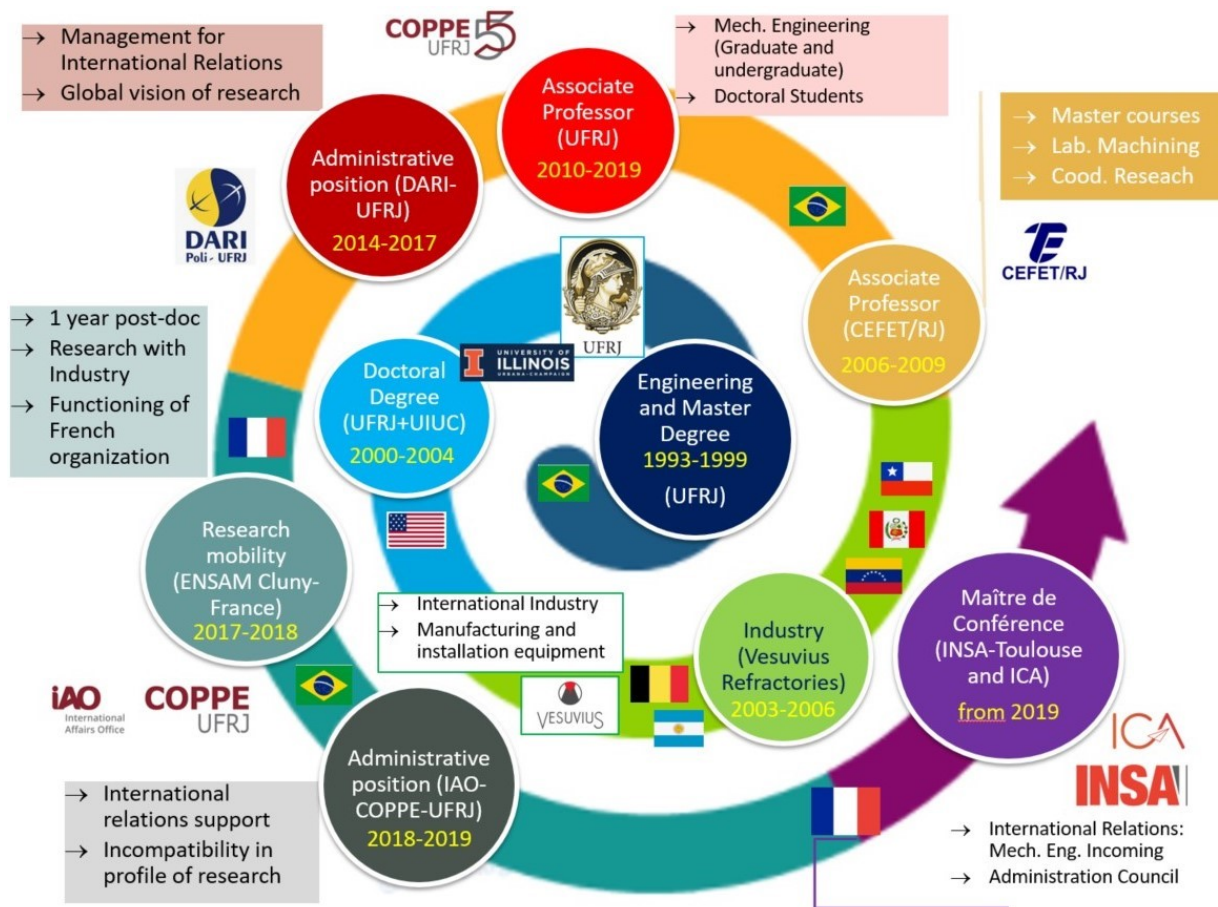

Figure 1.1. Schematic professional trajectory

the feeling that my beliefs guided me in every step I took in my life producing what I call a **conical spiral career** along the time axis. When we look the spiral in the aerial view, it seems that is growing slowly, and coming back to some regions, but it is growing in all dimensions over time. I realize I need these coming backs to reinforce the leanings and to feel the distance to the previous pass and remembers me where I were and who I am.

That is why I thought I was important to present, before detailing the results achieved, my beliefs and my my personal family environment.

1.3 Beliefs for science and education

I was born in Rio de Janeiro city, in the hospital of the State University of Rio de Janeiro (UERJ) where my mother worked as a Mathematician and where I studied in high school⁶. This university, public, free, is located near Maracanã (yes, the stadium) in Vila Isabel, the cradle of Samba, and where my father chose to place his store. His store sold miscellaneous items (really everything) that my father bought at auctions to resell to wholesalers or ordinary clients. Both father and mother had parents that came from different regions in Brazil and both from a poor situation, not too poor to eat and study. My family wealth is study, working hard and finding possibilities wherever it appears, not losing our basis.

I am the older child in a middle class family who lived near to the seashore, some meters away, until I had 15 years old. I loved music. I loved dancing. But I also loved maths. I also enjoyed disassembling and assembling the mechanical items from my father's store. I used to repair my grand mother's telephone. I asked my mother to have a child calculator for Christmas, an apple 2 when older. I asked her to inscribe me in a programming course during weekends in downtown (in a commercial one first and in UFRJ after, for kids). I helped her copying exams on mimeograph. I liked to go to English courses. I liked to follow french courses in school. I liked to sing in the choral, in several languages. I had pen-friends all over the world (I still have some letters). I was brilliant in some classes at school but I was untalented in others, I had also some good and some very bad grades. I was smart when I decided to be. I was focused when I wanted to be. As Sheldon (character from Big Band Theory), "my mother got me tested": I went to some doctors, but I was normal. She never forced me. She never blocked me. I did not know, maybe my mother knew, but I was already the professional I am now.

⁶I studied almost my hole life in public and free schools. CAP-UERJ is a school from UERJ where the public and the UERJ workers child's could study after a hard entry exam. Students in UERJ could do internship as teachers in this school.

My life and story toughed me some principles that I apply on my daily basis, and it guides me. It is the fuel that propelled my professional projects. The ones I share in this report:

- **Language** : Is a one way of communication, not a way of judging. If one wants to send a message and other wants to receive it, both can decide the appropriated language. If one wants to enter in the others world, he should find the language to be part of this world. In research, the chosen language for communication is English, so we should adapt to be inside this research world, despite political history, because it is the reality now. Nowadays, I teach in French for Mechanical Engineering, and it was Portuguese before, the language of school I work. I adapt. I believe that I should be persistent to show that we should make the effort to include English in a research institution (Universities and laboratories) in order to be inclusive, receiving people, exchanging with people from everywhere and to be inside the research community.
- **Diversity and creativity** : The particularity of different cultures, the variety of the problems and the plurality of solutions makes the diversity of the world a source of creativity. Research and innovation needs diversity. Engineering needs peoples ideas. The moment we make a relation between quality and protection of ideas and borders, we are doomed to fail. Global problems requires global solutions. All forms of discrimination, by race, by country, by color, by sex, by sexual option, keep humanity imprisoned in its own cell.
- **Liberty and hierarchy** : Work organization is a way of defining responsibilities and tasks. Hierarchy, especially in research and education institutions, cannot be synonymous with oppression and repression of freedom of expression. People should respect the responsibility of the managers, and its decisions, but also everyone should listen the opinion of everybody. We should be able to agree and disagree, without fear of the retaliation.
- **Team work** : Considering the last topic, it is not possible to have good results only working alone. Academic discussions creates synergy and the knowledge is also created in discussions. I do not believe that the researchers should be kings of their castles. I believe in a network of advisors and students to discuss, help and produce science.

1.4 Organization of the next chapters in Section I

After this chapter of introduction, I present in details my professional career in three dimensions: Teaching, Research and Administration and its combinations, as it is shown in Figure 1.2.

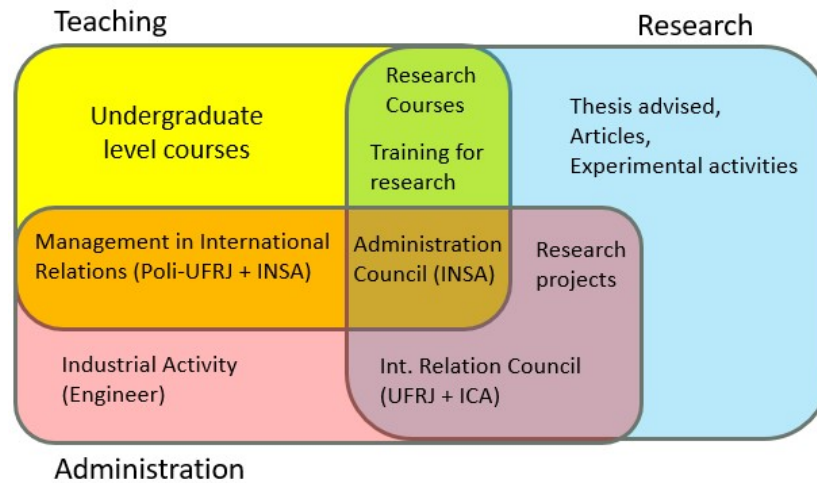

Figure 1.2. *Three set views of a research and education institution and coherence with some key activities*

Chapter 2 presents teaching in undergraduate and also in graduate level, in other words, the courses I taught for Master and Doctoral degree students. These second ones, I considered that is in the green intersection between teaching and research. I present as well some mini-courses out of my home university and the writing of a didactic book.

Chapter 3 presents the advising students in research and the human resources training for scientific activity for all levels: from undergraduate until doctoral degree. I present the participation on evaluation board in final defense of students. It is also in the green region of the map in Figure 1.2.

In chapter 4, the research results is presented : published articles in journals and conferences, pointing out the relation with the students and collaborations. Also the role of reviewer for journals and conferences and participation as chairwoman and speaker in events.

In chapter 5, the administrative activities are presented. In industry the management was not connected to research and education but in an academic institution there is a strong link with both dimensions. In my case, the administrative responsibilities were mainly focused on the management of international relations, some research projects for experimental resources and the participation in university councils.

In the second and third sections of this report, scientific developments in manufacturing is presented and the research project with expectations for the future are exposed.

Teaching activities

As I began my career in Brazil and now I am in a French institution, I considered important to present the differences of structure in research education between both realities first.

2.1 Engineering education system in Brazil and France

In Brazil, the best universities are public and free. It is not easy to be approved in a public university as they have good level and the students do not pay anything. A regular education trajectory for Engineering in Brazil can be observed in Figure 2.1.

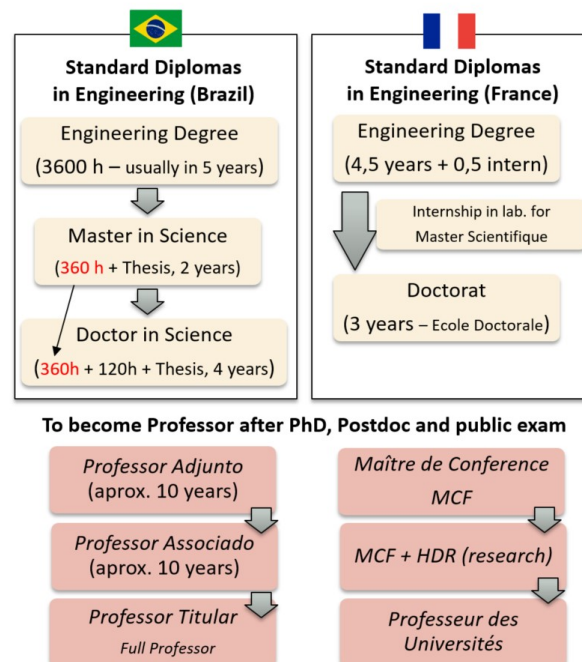

Figure 2.1. Simplified degrees in Engineering and trajectories for a Professor in Brazil and in France

In Brazil, the law determines that the minimum workload in courses to obtain the Engineering degree diploma is 3600 hours and additional hours for extension activities, including internship, and the final Engineering Project. After finishing the Engineering degree, to obtain a master degree diploma, it is necessary to take 360 hours of master courses in the classroom, plus the academic rules of each graduate school. After the master diploma, the doctoral degree diploma is obtained after 480 hours of courses (the 360 hours of master degree are deducted for those who has it). The typical time for completing is 5 years for Engineering degree, 2 years for master of Science and 4 years for doctor of Science. It is common not to finish in the typical time, depends on the approval of the student on the courses or on the completing the thesis, or approval of article.

In my case, I completed Engineering degree, master degree and during doctoral degree, I applied for a scholarship for 9 months in USA to do experimental research in Prof. Shiv Kapoor laboratory. After I came back, I continued my doctoral degree in partial time, without scholarship, and working in Industry. I worked for three years in the steel industry managing the small team of manufacturing, assembly and installation of continuous casting flow equipment in Brazilian and South American companies of the steel industry. I spent one year of research in UFRJ, with a post-doc position, after quitting the industry, in 2005 when I taught three undergraduate courses.

Professors in university should taught for all levels, only depending if they are graded for it. The career of research professor in Brazil is structured in the following progressive stages: "Professor Adjunto" (from 1 to 4 levels), "Professor Associado" (from 1 to 4 levels) and "Professor Titular. Every three years, by submitting a report on the activities of the period if the production is enough for progression, he can advance one level. To become a university professor, it is mandatory to have doctoral degree and the public exam includes writing exam, project exam and didactic exam. I was approved in a public exam and I started my career as a professor as "*Professor Adjunto*" level 1 in CEFET/RJ where I worked for 3 years. I was approved in another public exam in 2009 to work in UFRJ, where I worked for 10 years until the end of "Professora Associada" level 1.

In order to have a numerical idea, UFRJ had in 2020: 52848 undergraduate students, 4533 master students, 5241 doctoral students, 3578 professors¹ in all areas and about 6000 undergraduate² students and 2600 graduate³ students in Engineering. CEFET/RJ, an Engineering school, has 2199 undergraduate students, 180 master students and 442 professors⁴. Both institutions have teaching and research activities and the laboratories are connected to the undergraduate

¹Information available in <https://ufrj.br/>

²<http://www.poli.ufrj.br/>

³<https://www.coppe.ufrj.br/>

⁴Information available in <http://www.cefet-rj.br/>

and graduate departments.

In France, the Engineering degree is also done in five years: 30 ECTS per semester. There are mainly three possible trajectories: (a) students complete the five years in a single institution as in Engineering schools (as in INSA group), (b) students complete bachelor diploma in three years and master diploma in two years in French Universities and (c) students complete two years in a preparatory school for engineering and three years in a School of Engineering (*École d'Ingénieurs*). In the last 6 months, the students should do a full-time internship in Industry or in research laboratory. This internship must be financed, it is illegal to have students for more than two months without a salary (the minimum amount is 3.75 per hour, around 600 euros per month).

The name *Master* has a different meaning in French and Brazilian institutions. In France, this name is only applied in Universities to denote the last two years of Engineering: M1 and M2. Some students follows the last semester (M2) additionally to their studies in a research area. It is called *Master Scientifique*.

In doctoral degree, typically there is no technical courses with exams but some crash courses with low work-load are usual as transverse training program (How to write a scientific paper, mathematics software, career pursuit and integration, entrepreneurship, etc). During the journey, the students have some publication obligations and also they should make regular some presentations about the thesis development. It is important to say that the doctoral students can teach some courses.

It is necessary to be approved in a qualifying of a CNU⁵ section to become a professor (*Enseignant-chercheur*) in France, according to the area of research and teaching. It is evaluated if the candidate has a minimum of research production and teaching hours. After this approval, the professional is able to submit the candidature to an open position of "*Maître de conférences*" (MCF). The statutory teaching obligations per year for MCF are: 128 hours of lessons or 192 hours of tutorial or practical work. After some years in this position, it is possible to candidate for a *Professeur des Universités* (PU) position having the HDR diploma. Another option, it is to evolve internally into a position of *Maître de conférences Hors-classe* and after *classe exceptionnelle*.

In 2018, when I was in ENSAM, I applied and obtained the qualification for section 60 (Mechanical Engineering) and in May 2019, I applied for a MCF position in INSA-Toulouse. In September 2019, I moved to France at this new position.

⁵Conceil National des Universités

2.2 Undergraduate courses

I really like teaching. The areas of my courses are mainly in manufacturing for mechanical, control and naval engineering. I was pleased to have been chosen to be the guest of honor (*paraninfa*) of three graduate classes in UFRJ (2018 and 2016 for Mechanical Engineering and 2014 for Control and Automation Engineering). The following text briefly presents the courses that I have taught in undergraduate level in Brazil and in France.

In UFRJ and CEFET/RJ, there are some mandatory courses and a list of optional courses that the students should choose a certain number to achieve the mandatory number of credits. The flow chart of courses can be found in: [link 1](#) for Mechanical Engineering in CEFET/RJ, [link 2](#) for Mechanical Engineering, [link 3](#) for control and automation, [link 4](#) for Naval Engineering in UFRJ. The number of students in compulsory classes in Mechanical Engineering in UFRJ is around 70-100 students, in Control Engineering is around 40 students and in CEFET/RJ around 50 students. In elective classes depends on their choices.

In INSA, all courses area mandatory from first to forth year and on the last semester (5th year) it is possible to choose three of the optional modules to combine in one course (7 ECTS) that represents around 23% of the semester. The courses can be found in [INSA Toulouse website](#). The number of students in the class in forth and fifth year is around 72 in Mechanical Engineering and 40 in Systems Engineering (a special choice in Mechanical Engineering Department).

In Brazil the course timetable is fixed per week on each semester. Normally one class has 1,5 or 2 hours per day, twice a week, representing in UFRJ 45 or 60 hours per semester and in CEFET 54 and 72 hours, respectively. The complete class is present at the same time except some practical activities as visiting laboratories and following experiments, done in the time preview for classes. In INSA the timetable is adapted depending on each week and the distribution of courses per groups. There are several practical activities for each group, which is very good pedagogically.

The list of courses I taught in undergraduate at CEFET/RJ in table 2.1 (from 2006 to 2009). The undergraduate courses in UFRJ (in 2005 and from 2010-2019) are presented in Table 2.2. The courses I am in charge at INSA-Toulouse are presented in Table 2.3. Note that the column "Hours" indicate the time that I was in charge with the students in class or in the laboratory.

2.2.1 Introduction to Mechanical Engineering

The course "Introduction to Mechanical Engineering" is a mandatory course in the first semester of the course in Brazil having the objective of clarifying the areas and topics in Mechanical Engineering.

Table 2.1. *Courses taught for undergraduate students in CEFET from 2006-2009*

Year	Course Name in English	Hours	Year
1st	Introduction to Mechanical Eng.	30	2007-1
		30	2007-2
		30	2008-1
		30	2008-2
2nd	Solid Mechanics I	72	2006-2
		72	2007-1
		72	2007-2
		72	2008-1
		72	2008-2
		72	2009-1
4rd	Mechanical Vibrations	54	2009-1
5th	Modeling Machining processes (optional)	54	2007-1
		54	2007-2
		54	2008-1
		54	2008-2
5th	Industrial Automation III	54	2006-2
	Total	972	17

In UFRJ (Code: EEK200), when I was responsible for, the main objective of the teacher was to organize seminars in all the areas, the students associations and also information of the Brazilian councils of Engineering (CREA) about the exercise and activities in the professional areas of engineering.

In CEFET (Code: GEDA7800), the course was created in 2007 and I proposed the following structure: (i) to present the structure of the course of Mechanical Engineering, the competition teams and analyzing one final project of CEFET students, (ii) to make the students understand the attributes of a Mechanical Engineer (including a visit to the council CREA/RJ) and finally, (iii) a two-month activity that effectively carried out a very simple Mechanical Project including its conception, sketching, design, one manufacturing (with simple tools) and a project presentation reviewing the difficulties encountered in manufacturing (Figure 2.2(c)).

In this course, we had the opportunity to participate to an international event with students from several institutions to form groups for one week competition in USP (Universidade de São Paulo). The objective was a robot contest with a defined objective related to sugar cane and ethanol transportation (Figures 2.2(a) and 2.2(b)).

In France there is a similar concept divided in modules. I contribute with the practical activity in manufacturing (machining and additive manufacturing) that was prepared by other colleagues and I reproduce with several groups. For each group it is done in two afternoons and the students should do four activities: prepare the machining program in a CAD-CAM software and machine it; produce in lathe a whipping-top; design and manufacture in FDM (3D printing) a small piece and an activity of grooving in a plate to bring as a souvenir. All the students in

Table 2.2. Courses taught for undergraduate students in UFRJ (2005 and from 2010-2019)

Year	Course Name in English	Hours	Year
1st	Introduction to Mech. Eng. ⁶	30 30	2005-2 2006-1
3rd	Manufacturing Processes	60	2010-1 2011-1 2012-1 2013-1 2018-2 2019-1
4th	Additive Manufacturing	45	2016-2
4th	Global Manufacturing (optional in English)	45 45	2015-2 2016-2
4th	Machining I	60 16	2014-1 2015-1 2016-1 2017-1 2019-2
4th	Machining Lab. Practice	20	2011-2 2012-1 2012-2 2013-1 2013-2 2014-1 2014-2 2015-1 2016-1 2017-1 2019-1
5th	Forming processes (optional)	45	2016-2
5th	Jigs and Fixtures for Machining (optional)	45 45 45	2010-2 2011-2 2012-2 2013-2 2018-2
5th	CNC (optional) CNC and 3D Printing (optional)	45 60	2014-2 2019-1
	Total	1406	35



Figure 2.2. Teaching in first year of mechanical engineering

Table 2.3. *Courses taught in INSA Toulouse in 2020-2021*

Year	Course Name in English	Hours	Year
1st	Introduction to Manufacturing Practice	40	2020-1
		30	2021-1
3rd	Machining Practice	30	2020-2
		12	2021-2
3rd	Solid Mechanics	19	2021-2
4rd	Additive Manufacturing Practice	10	2019-2
		8	2020-2
		10	2021-2
5th	Industrialisation	28	2019-2
		28	2020-2
		22	2021-2
	Production Manag.	17	2021-2
5th	Reliability	6	2019-2
		8	2020-2
		12	2021-2
5th	Additive Manufacturing Project (optional) (optional)	7	2019-2
		10	2020-2 ⁷
		5	2021-2
	Total	293	18

INSA, from all the Engineering areas, should participate of this course (Code:I1ANETTI). It is important to have a woman teaching in this type of activity with machine-tools in order to **break the gender stereotype**.

2.2.2 Solid mechanics, mechanical vibrations and reliability

As a mechanical engineer, I also teach some mandatory courses that are related to basic mechanics. In CEFET, I was responsible for “Solid Mechanics I” (Code: GMEC7004) all the semesters that I was teaching in this school. A classic mandatory course of Strength of Materials (concepts of tensor, stress, strain, constitutive relations, Mohr’s circle, traction, torsion and bending) for 2nd year of Mechanical Engineering students using basically a classic book [Hibbeler, 2002], among other similar textbooks. Also in CEFET, I taught Mechanical Vibrations in 2009 (Code: GMEC7508) using a classic bibliography [Rao, 2003] and some practical work in Matlab. In INSA, I am responsible for the theory of the sub-module of Reliability for 5th year Systems Engineering students (course code: I5ISGR22).

2.2.3 General manufacturing processes and forming courses

Some general courses on manufacturing processes and industrialisation are in the list of courses that I taught. The first one was on the 3rd year for Automation and Control Engineering in UFRJ (Code: COM352), which I should include also an introduction of material science as they did not have this course as prerequisites. As I was the first teacher on this course, I defined

the syllabus and planned the course. The first time when I was a Post-doc and after when I became permanent professor. It was usual to do visits as: Volkswagen factory, steel plant and the National Institute of Metrology, Quality and Technology (Inmetro). It was when I proposed the translation of book as it is presented in section 2.5 [Groover, 2014].

In Naval Engineering the discipline (Code: EEK313) was mandatory with prerequisite on material sciences. The course was concentrated in manufacturing process with practical classes. The students could be more focused on the technical calculation of forces and I could cover the complete panorama of manufacturing processes.

As optional course, I proposed a course called "Global Manufacturing" in English for for Brazilian and foreign students. In this course, the focus was to present the international network on manufacturing having a critical analysis of manufacture dependency between nations. It was very interesting to have a mixture of cultures in the class (Brazilians, French, German, Colombian and Italian students).

A more specific elective course that I proposed was "Models for forming processes" for 5th year of Mechanical Engineering. It was interesting to present applied plastic deformation in details with theory and simple computational application [Hosford, 2013]. A small course textbook was produced for the students when I was Post-doc.

2.2.4 Machining courses

Machining courses compose the main part of my teaching activities and it includes: theory of machining, machining practice, CAD, CAM, CNC and fixture design. In UFRJ, I alternated one semester per year the responsibility of the course of "Machining I" (EEK 421) for Mechanical Engineering. A complete theoretical course on machining: from the technical information to the force analysis and tool life. Based on this course, I wrote the book described in section 2.4.

Also I taught several mandatory practice course in machining in UFRJ and INSA every semester using conventional and CNC machines. In UFRJ one module used the dynamometer for force analysis and comparison with prediction. In INSA it is connected to the process itself, and the CAM planning.

In 2007, I created the elective course "Machining Process Modeling" for under graduation in CEFET (5th year of Mechanical Engineering) [Altintas, 2000; Boothroyd, 1965]. It was a proposal to have a connection between research and teaching. In this course, cutting mechanics is presented (Models of force, Chip-Tool Interaction, Wear and friction mechanisms and Surface Integrity). It was possible to develop a more specific work and experiments were carried out to satisfy the students' scientific curiosity. One student produced a student conference paper [Hofmeister et al., 2007]^P on evaluation of the shear angle position. In 2010, I adapted this course to the existing course of "Jigs and Fixtures". I applied the prediction of forces to the

design of fixtures using CAD and CAE. As a result of those courses, some students chose me as advisor in the final engineering project in this area as it is described in Chapter 4.

2.2.5 Additive manufacturing and the virtual mobility in INSA-Toulouse

As I developed a project in additive manufacturing, when the laboratory received the equipment in 2016, I included one small project of practical activity in one class in mechanical engineering in UFRJ. After, I created an elective course "Additive manufacturing" for mechanical engineering and for material science engineering with a colleague from Materials Department. We presented the theory from the design to manufacturing practice in the three process of 3D printing: FDM, SLA and 3DP. Some final projects were also produced as a result of this course.

When I arrived in INSA Toulouse I participated in additive manufacturing classes and in an optional module in this area with 3 other teachers (Patrick Gilles, Philippe Seitier and Damien Coutouly). The program of this module was structured as: a lecture introducing the main additive manufacturing processes, three courses in "conference" format presented by two industrial manufacturers and by a researcher in the field and, then, 7 weeks of supervised projects in groups of 5 students. The last session is devoted to project presentations by all groups, including the presentations related to this project.

In the second time that I participated, I included a special part of virtual mobility with an Italian Institution (Università di Trento in Italy, partner of the ECIU network) through the Open INSA Moodle platform⁹ opening a new collaboration. This module aims to bring together international students in the form of virtual meetings to build a mechanical project and to produce the workpieces on both shop floors. The development of the multicultural skills and the professional communication in English is achieved by the participation of students of different origins. In 2021, we added UFRJ as a third partner and we had 3 students from Material Science Engineering.

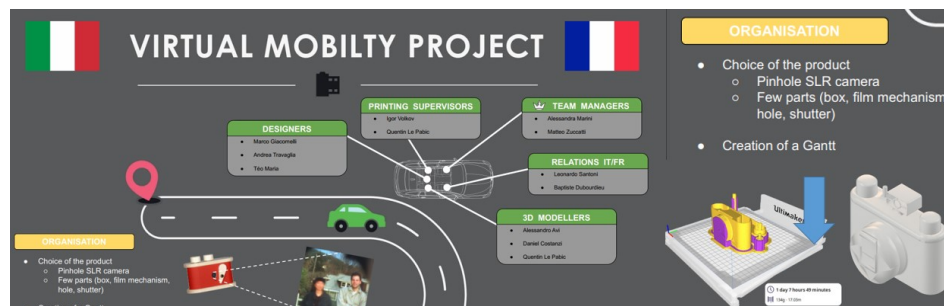

Figure 2.3. Part of one group project for virtual mobility in additive manufacturing course with University of Trento (Italy)

⁹Open INSA: <https://open.insa-toulouse.fr/>

2.3 Graduate courses

As it was described in section 2.1, the students in Master of Science must complete a minimum of 360 hours, that represents 8 courses of 45 hours (during three months), and Doctoral degree students should complete with 4 courses, usually in a higher level themes. The professors from the department should teach courses for the graduate programs as well.

In 2008 the Postgraduate Program in Mechanical Engineering and Materials Technology ((PPEMM) in CEFET was approved by CAPES. I participate on this Program from 2008 to 2011 as a substitute of the department coordinator. Each professor of the new department had to offer new courses and there were three mandatory courses: materials, continuum mechanics and mathematical methods. I took the responsibility of teaching "Mathematical Methods for Engineering" (Code: EMM5014) with a review of Linear algebra, Dual spaces and applications in MATLAB software [Kreyszig, 2006; Strang, 1986], important to guarantee a mathematical level for all the students, coming from different universities.

I proposed a course related to my research activity: "Machining Process Modeling" in order to give proper bases to the students in research in the research group "Machining Modeling and Thermo-Mechanical Conformation", registered in the directory of research groups CNPq. With resources from CEFET, I equipped the LABUS¹⁰ to carry out experiments in machining force dynamometry that was used also for practical classes in this course.

In 2011, after I entered in UFRJ, I was approved to participate on the Post-Graduate Program in Mechanical Engineering in COPPE-UFRJ. In this program I could propose courses on my research area (Models for manufacturing processes, Micro machining and Machining dynamics) and contribute also with the Design of Experiments course for students of areas in the program. The list of all the courses in graduate programs is presented in Table 2.4.

As per my experience in teaching in COPPE, I taught a mini-course in "Design of experiments applied to the cutting of metals" for 3 to 10 December of 2012 in CUJAE (Departamento de Tecnologia de Contruccion de Maquinaria) La Habana, Cuba, under the project CAPES MES "Estados Limites en Mecánica del Solido y su Aplicacion en Biomecanica y Sistemas Mecanicos, Edital 2011".

Another experience in teaching out of my home university was to present a micro-course (4 hours) in "Micromilling" in Federal Fluminense University (UFF-Rio de Janeiro).

2.4 Production of didactic material for manufacturing

I have two main productions in pedagogy: the proposition and coordination for the translation a book in Portuguese in 2014 and the writing of a book from 2018 until 2020. There was

¹⁰LABUS - Small laboratory in machining research, which I founded in CEFET/RJ with Prof. Jose Paulo Vogel in 2007

Table 2.4. Courses taught for Graduate (Master and Doctoral) students in COPPE-UFRJ from 2010-2019

Course Name in English	Hours	Year
Mathematical methods for Engineering	45	2008 -2 2009 -1
Modelling Manufacturing Processes	45	2008-3 2011-2 2012-1 2012-2 2013-3
Research in Metal Cutting (micromilling and other topics)	45	2011-3 2014-3 2016-3
Research in Additive Manufacturing	45	2012-3
Design of Experiments	45	2013-1 2014-2 2015-1 2016-1 2017-1 2019-1
Total	765	17

no actual good textbook complete in Portuguese for teaching manufacturing process. I used a lot an old book for technical words and I had to complete with new articles and personal slides. So, I proposed for four editors for the translation of a selection of four similar books. *Grupo Gen* proposed the translation of [Groover, 2014] that I coordinate and translate some chapters. Now it is a best seller in the area (Figure 2.4(a))¹¹.

The book “*Usinagem para Engenharia – Um curso de mecânica do corte*” (“Machining for Engineering - A course in cutting mechanics”)¹² is a didactic text in Portuguese that I wrote and published in 2020 with my former doctoral students that are associate professors now [Araujo et al., 2020b]^P. It was developed due to the pedagogical need to instigate critical competences for engineering undergraduate students in the course "Machining I" (Table 2.2) on the phenomena that are involved during the mechanical process of cutting materials by machining.

It is a very illustrated, colorful book (Figure 2.4(b)), both through graphic drawings and photos of tools and operators, chosen to be an inclusive book (with women and men, black and white operators). As it is a technical and didactic work, the exercises are presented in each chapter to reinforce the presented concepts. An independent website was created to provide the answers, present videos of the processes and also suggest lesson plans to the teachers ([Website link](#)).

The conceptual approach to the subjects was elaborated in order to be different from the

¹¹<https://www.amazon.com.br/Introdução-Processos-Fabricação-Mikell-Groover/dp/8521625197>

¹²<https://www.amazon.fr/Usinagem-para-Engenharia-Mecânica-Portuguese-ebook/dp/B08NZ2W2RD>

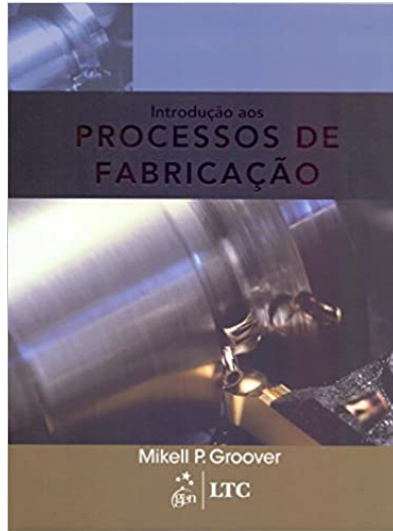

(a) Translation of a Manufacturing Process Textbook



(b) Authorship of a Machining Textbook

Figure 2.4. Didactic material produced

texts of technical level, since the theme in general has a very technological application, which meant that there was a gap in a book that used the knowledge acquired during the diploma. There is a connection with the disciplines of statics, mechanics of solids, mechanical vibrations, heat transfer, metrology and materials. There was also a concern to choose mathematical models to prioritize the fixation of concepts and not to approach a format similar to a bibliographic review of undergraduate studies. However, it is possible to use as an introduction to a postgraduate course.

The content is divided into three parts: (i) **Machining technology** that presents the technical fundamentals of machining with the definition of concepts and presentation of machining processes; (ii) **Cutting mechanics** that shows how the material can be removed by machining, that is, the phenomenology of cutting through the concepts of plasticity, friction and heat generation; and (iii) **Machining process** that presents the result of the phenomena presented in the part, in the tool and in the monitoring of the process. The sequence of chapters expands the concepts little by little, introducing the tool materials and the machines, calculating and evaluating the behavior of forces and cutting power, evaluating the end of the tool's life through wear and carrying out the monitoring of the operation. In the last chapter, about micro-machining, is a relatively new subject in Brazil.

In summary, it is a book for teaching with solid foundations and a strand on industry 4.0 because it connects the monitoring of machining with the planning of experiments, which is not present in any other work in Portuguese.

Human resources training for scientific research

This section presents the dimension of my career that trains people to be researcher in Engineering presenting the numbers of students I have advised in research from the undergraduate until master and doctoral students.

3.1 Key figures as research advisor

Table 3.1 summarize the number of students in ascending order of scientific level.

Considering undergraduate students, I had 22 undergraduate students with scholarship on scientific initiation (IC), I advised 37 engineering projects (final monograph for Engineering degree - EP), in which 24 connected my research activities in Brazil, and two students during master internships in France (one Brazilian student and one Belgian student with Erasmus scholarship). The difference is presented in section 3.3.

In graduate level, I advised 10 master in science students (M.Sc.) in Brazil and 5 doctoral students (D.Sc. and Ph.D.): 3 students finished their Thesis in Brazil (one did not complete for personal reasons) and one is in progress in France. There are two proposals for doctotal students to begin in 2022 (one industrial and one submitted to MEGEP), presented in the research project.

Scientific Init. (IC)	Eng. Project (EP)	Master (M2/France)	M.Science (M.Sc./Brazil)	Doctorate (D.Sc + Ph.D.)
22	24 in research (37 in total)	2 (100%)	10 (640%)	4 (220%) 1 in progress (50%)
Table ??			Section 3.3.2	Section 3.3.3

Table 3.1. Number of advised students in research

3.2 Parallel between Brazil and France for training in research

Completing section 3.1, it is important to present the type of academic projects in research in Brazil and in France. **In Brazil**, there are the following possibilities:

- Advising research projects with undergraduate students:

IC - "Scientific initiation" (*Iniciação científica*): It is a optional research program for students after the third year. The students spend an extra time for doing research in University. The students could receive a scholarship (R\$400 per month¹). This activity receives no grade on the bulletin but it counts inside the hours of extension activities. As the students could be part of a laboratory and work with master and doctoral students, they can be part of the team that the Professor advises.

EP - Engineering final project (*Projeto final de curso*): It is possible to propose a research project for a student in the last year of his degree. The project is done in parallel with the last courses, and each student should have one advisor. It is common that the students that are doing IC uses it to develop this project. It could be in the theme of the researcher or also could be a mechanical project, depending on the advisor proposal and student. In the end of the project, they must produce a textbook having the structure of a thesis and, so the advisor acts as in Master and Doctoral thesis, but in a lower level. Rarely the internship in industry is connected to the project.

- Advising in Master of Science:

The students in Master of Science (**M.Sc.**), after being approved in the master disciplines described on section 2.3 (360 hours, usually 8 courses during the first 10 months), the students prepare a proposal with the advisor with bibliographic review about the master thesis and a seminar. After being approved, the topic of his research is developed until the final thesis defense under the professor's supervision. During the studies, it is possible to have the scholarship from Government (R\$1500,00 per month²). The number of scholarships that the program receives varies and there are some part-time students that are not financed. The scholarship lasts for 2 years and all students have maximum 3 years to complete the master degree.

- Advising in Doctor of Science:

The advisor for Doctor of Science (**D.Sc.**) is in contact with the student before their application to be enrolled in the course. Among the documents for inscription, the students

¹R\$400 in the currency of 14/5/2021 is 62 euros.

²R\$1500,00 in the currency of 14/5/2021 is 233 euros. As a comparison, and the minimum salary in Brazil is R\$1100,00.

should write an academic proposal with their possible advisors. Inside this proposal, there is no financial proposal although the department has some government scholarships (R\$2200 per month and it is not a salary³) available. The ranking of this selection is used to distribute the scholarships. There is the possibility of doing the doctoral degree without scholarship. Some students are part time because they work for the industry or for another academic institution.

After being approved in this selection, the students have two years to complete the courses⁴ and present a half-thesis defense, a qualifying ("*Qualificação*"), in front of jury, as in final defense. The text of this qualifying is almost a thesis: it must include a complete and extended bibliographic review, initial results and time planning until the end of thesis. For the final defense, the student should have an article approved in an international Journal. It is important to say that one objective of the doctoral degree in Brazil is more the human resources training than the actual results of the thesis. So, doctoral degree students can co-advise master students and final projects.

In France, the research students can be formed in these levels:

- During Engineering (UF Recherche (INSA) or in M1/M2 in Universities)

On the last 2 years of the Engineering degree (or an extra-charge on the last year or extra-year after graduation for a *Master Scientifique*). The text is usually lighter comparing to a Brazilian one because the focus is on the results and not on the academic structure of the text. Students can do an internship in the research laboratories for the Master and produce the text based on this scientific internship.

- Doctoral degree (Ph.D)

The standard time to complete in France is in 3 years. There is no academic courses with exams but some training courses for methods in research (one day courses: bibliographic research, publishing in scientific journals, teaching training and ethics). The authorisation for their thesis defence depends on having a minimum of 7 training credits in MEGEP⁵ School. It is really focus on results and the students are treated as professional researchers who receive a regular salary and they have formal vacations. It is mandatory to have one paper in international journal and a thesis report from the jury authoring the defense.

³R\$2200,00 in the currency of 14/5/2021 is 341 euros. The complete table of scholarships can be seen in CNPq website: <https://www.gov.br/cnpq/pt-br/aceso-a-informacao/bolsas-e-auxilios/>

⁴Some schools also do a extra theoretical examination (*Exame de qualificação*).

⁵DOCTORAL SCHOOL of Mechanics, Energetics, Civil & Process Engineering: [link for rules](#)

3.3 Detailed description of the research supervision activities

After presenting the philosophy of the structure in Brazil and France, I present an overview of the students I supervised in research in all the levels.

3.3.1 Undergraduate students

The undergraduate students supervision in research will not be detailed in this text but I need to claim that it is a very important part of the research. Table ?? (Annex A) presents the complete list of students and titles of the Engineering Project I advised, with a selection of the IC students in Brazil. Some students began at this stage and contribute in a level that we can try small objectives and challenges, so certain relevant results are presented in next section.

Considering the different areas, 5 projects were developed in Additive Manufacturing, 5 in drilling, 1 in micromilling, 5 in milling, 8 in thread milling and 5 in turning (9 related to medical applications).

In France, I proposed two "Project documentaire" (2020 and 2021, one per year) that are small project for the first year students. It is only bibliographic review exercise, but relevant for the students. Also, in 2021 I received two internships in ICA: Laurie Kappel in a small project on the measurement of medical threads and Juliana Bastos about the stereotype of woman in mechanical engineering.

3.3.2 Master of Science students

The following list presents the master degree students with the Thesis titles in English, the period of thesis, percentage that I was responsible for the supervision and the publications related to his work, in chronological order. In total, 10 students, 4 M.Sc. in CEFET/RJ, one in collaboration with Universidade Federal do Ceará and 5 M.Sc. in Mechanical Engineering in UFRJ:

- Arthur Wilson Coelho - Title: "Additive manufacturing by binder jet (3D printing): manufacture and evaluation of plaster composites with sisal fibers" (2016-2018) in UFRJ - 50 % - Publications: 1 Journal [Coelho et al., 2019]^P and 1 Conference [Coelho et al., 2017]^P.
- Matheus C. Cosenza - Title: "Turning stability of the Inconel 718 with vibration assistance (VAM)" (2015-2017) in UFRJ - 100 % - Publication: 1 Conference [Coelho Cosenza et al., 2019]^P.
- Gleiton P. Oliveira^(a) - Title: "Influence of the cutting fluid on the generation of residual stresses in the milling process of the Inconel 718" (2014-2016) in UFRJ - 50% - Publication: 1 Conference [Oliveira et al., 2015]^P.

- Fabio O. Campos^(a) - Title: "Experimental Evaluation of Micromilling Aluminum" (2012-2014) in UFRJ - 100 % - Publications: 1 Journal [Campos et al., 2017]^P, 3 Conferences [Araujo et al., 2013b; Campos et al., 2013; Mougo et al., 2013]^P and 1 National journal [Mougo et al., 2015a]^P.
- Cesar G. A. Cabrera - Title: "Vibration Analysis in End Milling using Wavelet " (2012-2014) in UFRJ - 60 % - Publications: 1 Journal [Cabrera et al., 2017]^P and 1 Conference [Cabrera et al., 2015]^P.
- Washington S. Nery - Title: Experimental study of the relationship between cutting forces and surface roughness in external turning (2011-2013) in CEFET/RJ - 50 % - Publications: 3 Conferences [Nery et al., 2012, 2013a; Nery et al., 2013b]^P and 1 National Journal [Nery et al., 2014]^P.
- Sandro P. Mirres - Title: "Experimental Analysis of Cutting Dynamics in End Milling" (2011-2013) in CEFET/RJ - 50 % - Publication: 1 Conference [Mirres et al., 2014]^P.
- Francirlei G. Cardoso - Title: "Thread Milling Force Analysis on API Geometry" (2010-2012) in CEFET/RJ - 100 % - Publications: 1 Journal [Araujo et al., 2015]^P, 2 conferences [Araujo et al., 2012; Cardoso and Araujo, 2013]^P and 1 National Journal [Cardoso and Araujo, 2014]^P.
- Jorge A. C. Santos - Title: "Nanoidentification of Linear Elastic Materials with Finite Thickness" (2008-2010) - UFC - 20 % - Publication: 1 Journal [Santos et al., 2012]^P.
- Etienne B. Friedrich - Title: "Analysis of wear on coated tools and finish in cast iron turning" (2006-2008) - CEFET/RJ - 60 % - Publication: 1 National Journal [Friedrich et al., 2007]^P.

^(a) - students that pursued to Doctoral Degree.

3.3.3 Doctor of Science students

The following list presents the Doctoral degree students, in chronological order with percentage of supervision. It is important to claim that there is no HDR diploma in Brazil and I was able to advise a thesis in 100 % in COPPE/UFRJ and in CEFET/RJ because of my research indicators, which are re-evaluated every two years to allow a professor to be able to advise it.

- Sughosh Deshpande - Title: "A model for cutting power on milling of a layered metallic material for online identification and cutting parameters optimization" (2020-2023) in UPS - 50 % - Publications: 1 submitted to a Journal [Deshpande et al., 2022b]^P and 1 submitted to a conference [Deshpande et al., 2022a]^P.
- Fabio O. Campos⁶ - Title: "Micromilling of titanium alloys: commercial, ECAP and SLM" (2014-2018) in UFRJ - 100 % - Publications: 2 Journals [Campos et al., 2019; Campos et al., 2020]^P, 3 conferences [Campos and Araujo, 2017; Campos et al., 2018a, 2018b]^P and 1 conference published in an International journal [Campos et al., 2016]^P.
- Victor Vizquerra Rojo - Title: "Non-linear model for end milling" (2014-2015) - UFRJ - 50 % - Publications: 1 Conference [Vizquerra-Rojo et al., 2014]^P. (For personal reasons, he immigrated from Brazil.)
- Gleiton P. Oliveira - Title: "Residual stresses and forces in milling of Inconel 718 using cryogenic, MQL and flood" (2013-2017) - UFF - 50 % - Publications: 1 Journal [Oliveira et al., 2017]^P and 2 conferences (one published in an international journal) [Oliveira et al., 2016; de Paula Oliveira et al., 2018]^P.
- Adriane L. Mougo⁶ - Title: "Micromilling of super duplex steel: a comparison with stainless steels (forces and surface)" (2012-2016) - UFRJ 100 % - Publications: 1 Journal [Mougo et al., 2018]^P and 8 conference papers: [Mougo et al., 2014a, 2014b; Mougo et al., 2015c]^P [Mougo et al., 2015b; Mougo et al., 2017b; Pinheiro et al., 2015]^P [Mougo and Araujo, 2017; Mougo et al., 2017a]^P.

Another important difference: in France the thesis objective is defined based on that the financial support and, after, the student is chosen based his skills and adaptation to the project. In Brazil the student applies for the scholarship with a thematic that the supervisor define based on the student skills and the financial support, from the government, is given to the best candidates.

⁶Adriane and Fabio are now-a-days assistant professors and they are co-authors of the book "Usinagem para Engenharia" [Araujo et al., 2020b]^P.

3.4 Participation in thesis defense evaluation board

In research it is very important to be part of committees of evaluation in master and doctoral degrees. I was part in 30 evaluation committees in Brazil: 17 as external member and 13 as internal member. In Brazilian master thesis, the committee is formed by a minimum of 2 internal and one external professors, and for doctoral thesis the board is composed by 3 internals and 2 external members.

Table 3.2. *Participation as evaluating member (jury) in thesis defense*

Year	Candidate	Committee	Institution	Member
2021	Paulo S. Teixeira	D.Sc. Defense	UF Fluminense	External
2020	Renato N. Cunha	M.Sc.	UF Uberlândia	External
2020	Thiago L. L. Oliveira	D.Sc. Qualifying	IFE Itajubá	External
2019	Milla C. Gomes	M.Sc.	UF Uberlândia	External
2019	Eduardo L. Tavares	M.Sc.	UF Fluminense	External
2019	Roseli F. S. Ribeiro	D.Sc. Defense	UF Fluminense	External
2019	Felipe F. Cardoso	D.Sc. Defense	UFRJ (Electrical Eng.)	External
2018	Francisco E. M. Saboya	D.Sc. Qualifying	UF Fluminense	External
2017	Vinicius A. D. Silva	D.Sc. Defense	UNICAMP	External
2017	Marceli N. Conceição	D.Sc. Qualifying	UFRJ	Internal
2016	Daniel F. Cunha	D.Sc. Defense	UF Uberlândia	External
2016	Larissa M. Fonseca	M.Sc.	UFRJ	Internal
2015	Márcio S. Silva	M.Sc.	USP - São Paulo	External
2015	Vandré F. Souza	D.Sc. Qualifying	UFRJ	Internal
2015	Karen J. Q. Cuellar	D.Sc. Qualifying	UFRJ	Internal
2014	Francisco F. R. Pereira	M.Sc.	UF Campina Grande	External
2014	Roseli F. S. Ribeiro	M.Sc.	UF Fluminense	External
2014	Daniel O. Lima	D.Sc. Qualifying	UFRJ	Internal
2014	Filipa J. F. P. Pascoal	D.Sc. Qualifying	UFRJ	Internal
2014	Alexander A. Alvarez	D.Sc. Qualifying	UFRJ	Internal
2013	Marcelo N. Sousa	D.Sc. Defense	UFU - Uberlândia	External
2013	Bruno M. Freitas	M.Sc.	UFRJ	Internal
2013	Jorel L. R. Anjos	M.Sc.	UFRJ	Internal
2013	Mauricio S. Garcia	D.Sc. Qualifying	UFRJ	Internal
2012	Maria C. S. Freitas	D.Sc. Defense	UFF - Fluminense	External
2012	Mariana N. Vasconcellos	M.Sc.	UFRJ	Internal
2011	Francisco D. M. Silva	M.Sc.	UFRJ	Internal
2010	Lauro A. M. T. Silva	M.Sc.	UF Fluminense	External
2010	Vagner C. Rubim	M.Sc.	UFRJ	Internal
2005	Ricardo Alvarez	M.Sc.	UFRJ	External

Table 3.2 presents a list of the candidates evaluated, the year and the Institutions : 7 in doctoral degree (all as an external member), 9 committee of qualifying on doctoral degree (2 external and 7 as internal member), 14 master of science committee (8 external and 6 internal member).

Published articles in journals and conferences

During my undergraduate in engineering degree, in 1996, I worked in a acoustic and vibration laboratory in UFRJ¹ as a "IC" student in two projects: one with the Hopkinson bar for wave propagation in solids and one in anechoic room for sound propagation [Araujo et al., 1996a; Araujo et al., 1996b]^P, [Araujo et al., 1997a; Araujo et al., 1997b]^P. In my master and doctoral degrees, I changed to manufacturing area publishing milling models [Alvarez et al., 2003; Araujo and Silveira, 2001a; Araujo and Silveira, 2001b; Araujo and Silveira, 1999]^P and I specialized in thread milling models [Araujo et al., 2003; Araujo et al., 2004]^P, when I published my first paper in an international journal in 2006 [Araujo et al., 2006]^P. After that, I realize that I wanted to study to publish to be read by overseas researchers.

This chapter presents an overview of the participation as a reviewer and author in journals and conferences.

4.1 Publication key figures

Table 4.1. *Quantitative summary of published articles*

Intern. Journals (ACLI ^a)	National Journals (ACLN ^a)	Intern. Conf. (ACTI ^a)	National Conf. (ACTN ^a)
21 (15 J + 6 JC)	10	29 (15 in COBEM)	33

^a Acronym in France for articles classification.

The quantity of the publications is presented in Table 4.1 classifying per type: international and national journals and conferences . Important to declare that I separated the publications

¹LAVI-UFRJ: Laboratório de Acústica e Vibrações

on International Journals (J) from the ones produced by conferences (JC), detailed in Table ?? (Annex A), also national journals are separated and described on Table ?? (Annex A).

The conference articles include international conferences, national conferences. In international conferences, I identified the number of publications in COBEM², a bianual International Congress of Mechanical Engineering in Brazil. COBEM is the most important conference in mechanical engineering in Brazil with plenaries and communications in English.

Figure 4.1 presents the number of articles related to manufacturing process and also to workpiece material. In both cases, the classification "others" presents the articles that do not fill in other labels. For example, in Figure 4.1a, the articles in additive manufacturing and in the area of "woman in Engineering" are identified as others. In Figure 4.1b, the articles that presents only geometrical analysis, cannot be classified in the selection of materials.

Figure 4.1a shows that 75% of my publications are in milling processes (milling, micromilling, thread milling and orbital drilling) and it is related to the interest of the instantaneous uncut chip thickness variation, that I always found interesting from the dynamic point of view. Considering the workpiece material, 56% of the workpiece materials were metallic refractory materials with lower machinability.

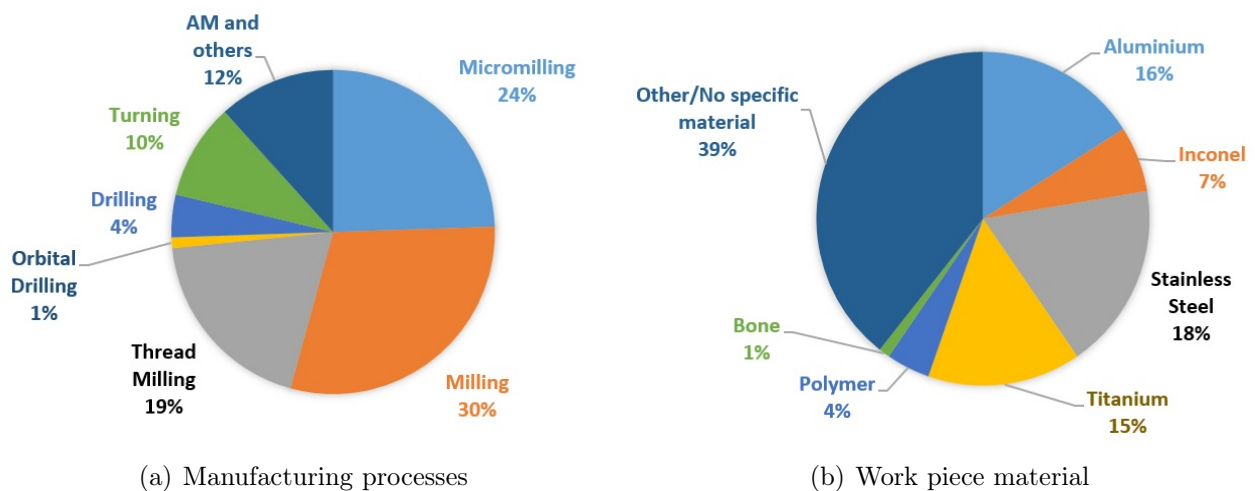

Figure 4.1. *Articles per manufacturing process and workpiece material*

²(COBEM - for more information see: ([Website link](#)))

4.2 Contribution as author in journals

I considered that the most important journals in my area are: International Journal of Machine Tools and Manufacture (Elsevier), Journal of Manufacturing Processes (Elsevier) and The International Journal of Advanced Manufacturing Technology (Springer) where I published respectively: 2 in IJMTEM [Araujo et al., 2006; Araujo et al., 2013a]^P, 3 in JMP [Araujo et al., 2015; Mougo et al., 2018; Wang et al., 2016]^P and 2 articles in IJAMT [Araujo and Fromentin, 2018; Araujo et al., 2020a]^P. Also, I published one article in new Elsevier journal on Additive Manufacturing [Coelho et al., 2019]^P.

The resumed list of articles published in International Journals (ACLI) including direct submission to journal (J), Sort by year (descending), and after the articles published in special edition volume selected from conferences (JC):

- J-15: "Investigation on PCD cutting edge geometry for Ti6Al4V high feed milling [Campos et al., 2020]^P
- J-14: "The influence of additive manufacturing on the micromilling machinability of Ti6Al4V: a comparison of SLM and commercial workpiece" [Campos et al., 2020]^P
- J-13: "Experimental comparison of micromilling pure titanium and Ti6Al4V" [Campos et al., 2019]^P
- J-12: "Manufacturing of gypsum-sisal fiber composites using binder jetting" [Coelho et al., 2019]^P
- J-11: "Investigation of tool deflection during milling of thread in Cr-Co dental implant" [Araujo and Fromentin, 2018]^P
- J-10: "Mechanistic study on micromilling of the super duplex stainless steel UNS S32750" [Mougo et al., 2018]^P
- J-09: "Analysis of residual stress and cutting force in end milling of Inconel 718 using conventional flood cooling and minimum quantity lubrication" [Oliveira et al., 2017]^P
- J-08: "On the wavelet analysis of cutting forces for chatter identification in milling" [Cabrera et al., 2017]^P
- J-07: "Built-up-edge effects on surface deterioration in micromilling processes" [Wang et al., 2016]^P
- J-06: "Study of the cutting forces on micromilling of an aluminum alloy" [Campos et al., 2017]^P
- J-05: "Thread milling as a manufacturing process for API threaded connection: "geometrical and cutting force analysis" [Araujo et al., 2015]^P
- J-04: "Analytical and experimental investigations on thread milling forces" [Araujo et al., 2013a]^P
- J-03: "Thickness-corrected model for nanoindentation of thin films with conical indenters" [Santos et al., 2012]^P
- J-02: "Modeling of the thread milling operation in a combined thread/drilling operation: thrilling" [Jun and Araujo, 2010]^P
- J-01: "A model for thread milling cutting forces" [Araujo et al., 2006]^P
- JC-6: "Smart drilling for aerospace industry: state of art in research and education" [Araujo et al., 2021]^P

- JC-5: "Residual stresses and cutting forces in cryogenic milling of Inconel 718" [[de Paula Oliveira et al., 2018](#)]^P
- JC-4: "Modeling thread milling forces in mini-hole in dental metallic materials" [[Araujo and Fromentin, 2017](#)]^P
- JC-3: "Cutting forces and mechanical resistance of pure titanium processed by equal channel angular pressing" [[Campos et al., 2016](#)]^P
- JC-2: "Dynamics of 2-dof micro-end-milling system considering grain-size variation [[Araujo et al., 2013c](#)]^P
- JC-1: "Effect of the cutting velocity and heat treatment on turning cutting forces of an SMA Cu-Al-Be alloys" [[Pereira da Silva et al., 2013](#)]^P

The following list presents the articles published in National journals (NJ). It was very important to cite them because industrial users gets information thought this journals:

- NJ-10: "Additive manufacturing by stereo lithography: analysis of the part, the influence of position and orientation" [[Coelho et al., 2018](#)]^P
- NJ-09: "Study of the Influence of the radial depth of cut in the Micro-milling of an Aluminum Alloy" [[Mougo et al., 2015a](#)]^P
- NJ-08: "Thread Milling Force Analysis in API Geometry" [[Cardoso and Araujo, 2014](#)]^P
- NJ-07: "Experimental evaluation of the parameterized process by computational optimization" [[Nery et al., 2014](#)]^P
- NJ-06: "Analysis of cutting forces in the drilling process of an austenitic stainless steel alloy" [[Vasconcellos and Araujo, 2012](#)]^P
- NJ-05: "Geometric modeling of thread milling" [[Fromentin et al., 2011a](#)]^P
- NJ-04: "Residual Stresses in Milling Superduplex Steel Samples" [[Barbosa et al., 2010](#)]^P
- NJ-03: "Acoustic Emission used in modeling end milling" [[Araujo and Silveira, 2009](#)]^P
- NJ-02: "Study on the performance of coated tools in turning cast iron" [[Friedrich et al., 2007](#)]^P
- NJ-01: "Force prediction in thread milling" [[Araujo et al., 2004](#)]^P

More information about the articles can be obtained in the reference list and also on Tables ?? and ?? in Annex A. The annex presents additionally columns that identifies the manufacturing process, the material used for experiments or simulation and the students I published with, including the undergraduate students.

4.3 Contribution as author in conferences

In Brazil, the association RBCM³ has been the main promoting agent on Engineering and Mechanical Sciences. One of the mechanisms is the promotion of regular scientific and technical meetings, with publication of all event proceeding. ABCM organize three conferences that involves manufacturing area: COBEM, International Congress of Mechanical Engineering, CONEM, the National Mechanical Engineering conference (*Congresso Nacional de Engenharia Mecânica*) and COBEF, the Brazilian manufacturing conference. Those three are biannual: COBEM and COBEF is the same year, and CONEM in the intervals. In dynamics and computational methods there is DINAME (International Symposium on Dynamic Problems of Mechanics) and CILAMCE that is not organized directly by ABCM.

I promoted these events and I participated several times, so I have: 14 articles in COBEF, 13 articles in CONEM, 15 articles in COBEM, 1 in DINAME and 1 in CILAMCE.

With the same philosophy, I wanted to be faithful to international organizations. I have been in 5 CIRP conferences (1 article published in annals and 4 in Procedia CIRP) and in 5 ICOMM⁴. In the USA and Canada, I published in 4 conferences organized by ASME or Canadian Mechanical Engineering Association.

In Annex A, Table ?? presents the complete list of 62 articles in conferences, excluding the JC references that were presented in the last subsection.

4.4 Other contributions in conferences and journals

Writing articles and presenting your work in conferences reinforce the knowledge and spread the information to other researches. But not less important to the scientist is to organize conferences and be part of the reviewers of journals and conferences. In this section, I cite some contributions that are important to my professional development: as organizer, chairwoman, reviewer and speaker in symposiums.

4.4.1 Conferences activities (organization, reviewer and chairwoman)

The objective of a conference is to enclose researchers from across the world to learn, discuss, to improve the networking and to ignite motivation in science. It is important to participate and to enroll in the organization. Here I present some of these activities:

- Vice president of the organizing comitee of III CREEM (Student conference in Mechanical

³The Brazilian Association of Engineering and Mechanical Sciences – ABCM (Associação Brasileira de Engenharia e Ciências Mecânicas) – is a non-profitable Civil Partnership of cultural and scientific nature. It was founded in 1975 having its head office located in Rio de Janeiro city (<https://abcm.org.br/pb/abcm>)

⁴ICOMM: International Conference in Micro manufacturing that nowadays is called World congress on Micro and Nano Manufacturing (WCMNM)

Engineering) in 1996 with support of ABCM;

- Several participations as chairwoman (COBEM, COBEF, ICOMM, Manufacturing21)
- Proposal and approval for the organization of the ICOMM 2019 in July 2016. As per political difficulties inside UFRJ, in the first steps of the conference organization, I decided to cancel at the beginning of the organization in October 2016. It was finally held in North America, and I presented one article online because I had just arrived in Toulouse;
- Organization of a 3 days mini-course (small symposium) about machining for UFRJ students, inviting external researchers (two Brazilians and one French professors) in 2017;
- Editor of COBEF 2023: I was invited in May 2021 (after COBEF 2021) to participate to the organizing committee of COBEF 2023 (12th Brazilian Congress on Manufacturing Engineering) in Brasília as Editor.
- Organizing comitee ESAFORM 2024: I am part of the organizing committee of 27th International Conference on Material Forming (ESAFORM 2024) that will be organized in Toulouse, France. The conference is organized by Institut Clemend Ader by Fabrice Schmidt and Philippe Olivier.

4.4.2 Participation in roundtable and as speaker in conferences

I just began some participation as speaker in conferences. That is one activity that I want to increase along my career.

- Participation in roundtable about machining in Coloquio de Usinagem 2011 in Universidade Federal de Viçosa (UFV);
- Participation in roundtable about machining in Coloquio de Usinagem 2013 in Universidade Federal de Uberlândia (UFU);
- Lecture in II Engineering week in Universidade Federal Rural de Pernambuco (UFRPE) in 2016 [The industry 4.0](#) with the title "Manufacturing applied to Medicine" (First speech for the students).
- Lecture (mini-course: 3h) in XVI Engineering week in Universidade Federal Fluminense (UFF) in 2016 with the title "Micromachining"
- Participation in the mechanical engineering week roundtable in UFRJ 2019;

- Panelist on one the three event celebrating 100 years of INT (Instituto Nacional de Tecnologia - Brasil) in September 2021. The event has the title: *Seminar New Futures – Strategic Themes for Technological Development* including the themes on Bioeconomy, Health Products and Digital Technologies with two panels: one Scientific-Technological, bringing together researchers and specialists on the subject; and another, strategic, bringing together authorities, industry representatives, researchers and managers. I am participating on the seminar: *New Futures: Health Products* which the main theme is additive manufacturing.

4.4.3 Acting as reviewer in conferences and journals

I am a member of the reviewer committee of some conferences and international journals. Some examples are listed :

- International Journal of Machine Tools and Manufacture
- International Journal of Advanced Manufacturing Technology
- International Journal of Mechanical Sciences
- Journal of Micro-and Nano-Manufacturing
- Journal of Manufacturing Processes
- Journal of the Brazilian Society of Mechanical Sciences and Engineering (Springer)
- Materials Today Communications
- Proceedings of the Institution of Mechanical Engineers, Part B: Journal of Engineering Manufacture
- Revista Matéria (Brazilian Journal edited by UFRJ)
- SN Applied Sciences

Collective administration and research projects

Upon arriving from the Sandwich doctoral period in the USA in 2003, I received a tempting job offer from the industrial sector. There was a need for a professional, specialist in machining with fluent English and availability for technical visits to steel plants in South America. For me, newly arrived from the United States, the proposal really fit perfectly. The function developed was aimed at the nationalization of equipments for continuous casting to reduce the costs of the equipment, which in most cases, was donated to the steel industry under lending, to leverage the company's business: sales of ceramic plates for flow control. This 3 years long industrial experience initiated me in managing employees, planning the delivery of some equipments after assembling and testing for the clients and also several installations in the steel plants. Those activities prepared me to the administration of projects and collective responsibilities in the university, as presented in the next sections.

5.1 Administration responsibilities in the department level

In the department level I contributed with some small collective responsibilities in the laboratories and some international relations activities in all institutions that I worked for, presented in the following subsections.

5.1.1 COLAN in CEFET/RJ: 2007

In 2007, I took over the Coordination of Numerical Analysis Laboratories (COLAN), a small computational laboratory to offer resources to undergraduate and graduate students in CEFET. The coordinator manages the shift of the paid students to make maintenance and the organization of the space, and it is responsible for the public material available in this space. This position has FG-4 bonus function in public institution.

5.1.2 LABUS in CEFET/RJ: 2007

In 2007, I proposed a research line of machining in CEFET and I helped Prof. José Paulo Vogel (an Engineering and teacher with Master degree) to develop and found an small laboratory for research in machining processes. With resources from CEFET and CNPq, I equipped the laboratory to carry out experiments in dynamometry, also used for practical classes.

5.1.3 LTM in UFRJ: 2011-2012

LTM (*Laboratório de Tecnologia Mecânica*) is a Laboratory of manufacturing processes for undergraduate students in UFRJ where the technicians use the manual conventional machines for teaching the processes: machining, forming, welding and foundry. A laboratory in Brazil is not an organization of professors like in France, it is a place of teaching or research, under a responsibility of one employee, normally professor. I managed two years, from march 2011 to December 2012, six employees and the connection between them and the other professors.

5.1.4 Responsible for double degree between UFRJ and Paristech schools: 2011-2019

This academic responsibility of coordinating the double degree between Escola Politécnica degrees and Paristech degrees is related to the program Brafitec (BRasil France Ingénieur TEChnologie, bilateral program between CAPES and CDEFI) with financial support, detailed in section 5.3.5.

This cooperation underneath a framework agreement signed in 2012 providing for the mobility of undergraduate students in engineering as well the cotutela for doctorate in joint supervision. For double degrees in Engineering level, the amendments specified the particular procedures between a French school and Brazilian departments that have been signed between Poli UFRJ and several schools of ParisTech, including Ecole Polytechnique.

The main activity of this responsibility was to organize the selection of students with the French schools, advise the incoming and outgoing students before and during this mobility. It is a transverse activity over some Engineering departments involved in the program.

5.1.5 Proposition for the participation on Erasmus ASCENT project

As international relations representative for Engineering, I was able to propose the Mechanical Engineering to enroll the Internacional project Erasmus Project ASCENT (Competence Centers for Automotive Engineering Sales Management - to increase the positive impact on regional economic development in Argentina, Brazil and Mexico). My contribution was mainly to setting up the project and submitting on the side of the UFRJ in July 2017.

Once the project was approved in 2018, a coordinator took place and I was part of the team from September 2018 to August 2019. During that time, we developed the project thought

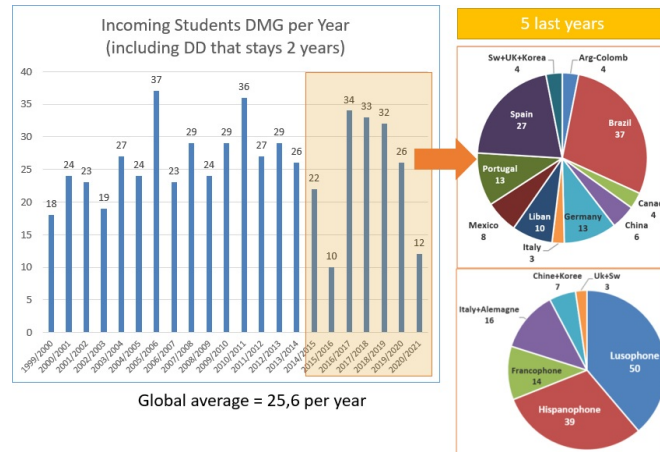

Figure 5.1. *Statistics in incoming mobility in Mechanical Engineering in INSA Toulouse*

bimonthly meetings in universities in Latin America, we organized the workshop in Rio de Janeiro in May 2019 and I offered a conference presentation in June 2019 for the participating students of UFRJ on “Soft skills for the training of the ‘engineer’”.

Some big figures of the project: Funding of the complete project was 992k euros (100k euros for the UFRJ), 10 partner institutions, 3 years of project. The partner universities were: FH JOANNEUM (FHJ), Hochschule Düsseldorf, Universität, Autonoma de Barcelona, Universidad Nacional del Sur (Argentina), Universidad Nacional de La Plata (Argentina), Universidade de São Paulo (USP), UFRJ, Instituto Tecnológico y de estudios superiores de Monterrey (Mexico) and Universidad Iberoamericana AC (Mexico).

5.1.6 Incoming students in Mechanical Engineering: 2020-2021

In the Mechanical Engineering in INSA Toulouse I am now responsible for incoming undergraduate mobility from October 2020. My tasks are to analyze the curriculum of the candidates, to receive the students and follow if they are adapted to our department. I communicate to the academic coordinator for the strategy of the mobility and promote the value added to our institution the opening for external students.

Figure 5.1 shows the statistics of the mechanical department considering only incoming students. It can be seen that 80 % of the students on the last 5 years are Portuguese-speaking, Spanish-speaking or French-speaking. One challenge for this position is to promote having some English courses that could increase the international diversity in class and also to open for more possibilities for outgoing mobility.

5.2 Administration responsibilities in university level

In the university level I was involved in research administration in CEFET/RJ and international relations in UFRJ, presented in the following subsections.

5.2.1 Coordination of research and technological studies in CEFET/RJ: 2008-2009

Due to my involvement in the research and my connection with the students, I was invited to a coordinate COPET in 2008. The Coordination of Research and Technological Studies (COPET) aims to encourage scientific and technological research activities at CEFET/RJ, through the guidance and evaluation of research project proposals presented by the institution's professors and through the Initiation Programs Scientific (IC). In the <http://dippg.cefet-rj.br/index.php/pt/organogramaresearch> board organization chart it was below the director of research in CEFET/RJ.

From the registration of the research project and researchers (professors and students) in its database, COPET monitors and maintains the information based on updates sent by those involved. This activity provides the registration and identification of activities carried out at the institution.

I was the coordinator of COPET from May 2008 to December 2009, managing part-time secretary and my responsibility was to guide the propositions of scientific initiation grants, organize the registration of research projects, supporting scholarships for research students (PIBIC Program - CNPq) and organization of Scientific Initiation (IC) seminars. In 2008, COPET had to manage 65 scholarships in undergraduate level. This position has FG-3 bonus function in public institution.

One example of the abstract book (2008) in the seminars with those IC students is in this [link](#). It can be seen the list of students, the advisors and the abstracts of papers for this specific year. Also, an introduction with the key figures of the research in the institution.

5.2.2 Associate Dean for International Relations in Engineering at Poli/UFRJ (2014-2017)

As I was responsible for double degree between UFRJ and Paristech schools from 2011 and I managed one Brafitec program, I was invited to integrate the directory board of Escola Politécnica when the director Prof. João Carlos dos Santos Basilio took office on March 2017.

Initially, I took the position for coordinating International relations was under the academic associate dean but, as per the augmentation of the mobility and the independence of activities, the director created the *Diretoria Adjunta de Relações Internacionais (DARI-Poli)*¹ and I took the position of Associate Dean of International Relations at the Escola Politécnica da UFRJ until September 2017, when I decided to do my sabbatical year as I dedicated a lot of time for

¹<http://intercambio.poli.ufrj.br/>

administrative activities and I wanted to reinforce the research production.

I manage four people in DARI: the coordinator, two secretaries (one for incoming, one for outgoing) and an internship, and we were responsible for the implementation and development the Internationalization of the Escola Politécnica. Among the activities carried out by DARI are:

- Welcome delegations from visiting Institutions to the School;
- Represent the Poli in activities related to the Internationalization of UFRJ;
- Encourage, support and provide information regarding the international academic mobility of students, professors and staff of Escola Politécnica;
- Promote selection notices for exchange vacancies in foreign universities;
- Receive and guide foreign students in mobility ;
- Provide support for academic exchange activities such as program orientation for students participating in international exchange activities;
- Provide support regarding the waiver of disciplines and study plan for students who participate in international exchange activities;
- Propose new and implement renewals of international agreements;
- In addition to attributions typical of DARI, it should maintains excellent relations with the other units and represents the School in the councils and management meetings of internationalization at the UFRJ and outside.

In the 2014-2017 period: the management managed 1061 students in mobility: 750 outgoing (from Poli-UFRJ) and 311 incoming (to Poli-UFRJ) including 10% in double degree, details can be seen in Figure 5.2. In September 2017 DARI had: 53 active mobility agreements plus 28 in renewal, 19 not renewed (by decision on the one hand), 25 schools with double degree agreements and a semi-automatic degree re validation agreement with FEUP (University of Porto - Portugal) which was done in this period.

5.2.3 Coordination of the International Affairs Office at COPPE/UFRJ (2018-2019)

After I came back from my sabbatical year dedicated fully to research, the academic director of COPPE² asked me to took the position of the coordinator of the International Affairs Office

²Coppe – The Alberto Luiz Coimbra Institute for Graduate Studies and Research in Engineering – is Latin America’s largest center for research and education in engineering. It was founded in 1963 by the engineer Alberto Luiz Coimbra. With Coppe, Coimbra contributed to the introduction of graduate studies in Brazil. The institution has awarded more than 13 thousand masters and doctors’ degrees from its 13 departments.

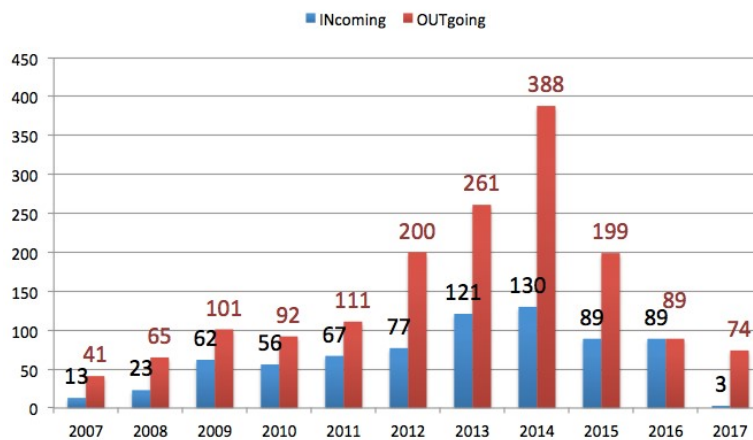

(a) Students in mobility per year (until August 2017)



(b) Folder in the universities

Figure 5.2. Undergraduate mobility in Engineering in UFRJ

([Website link for IAO](#)).

As I was responsible for mobility in the undergraduate level, and I was really recognized for this activity on the university level, taking this place in the graduate level was much more lighter and I could do it with less investment. In this coordination only one administrative employee was enough to do the executive job under my responsibility. I stayed in this function until I was approved in the public tender to come to France, so until July 2019.

The main function of this position was to encourage COPPE's Internationalization by supporting graduate programs and the board of directors and holding events and strategic actions, some examples:

- Articulation of Internationalization actions
- encourage the presence of foreign students and teachers in the classroom and encourage courses in English at COPPE
- encourage the presence of foreign visitors in the laboratories and the mobility of COPPE researchers and technicians in internationally relevant institutions
- encourage the participation of internationally relevant professors in the dissertation and thesis defense boards
- Disseminate public notice opportunities to COPPE researchers
- Accounting for COPPE's Internationalization Results
- Monitoring of International Relations Agreements

- Guidance and preparation of Specific Agreements and Protocols of Intent (MOU)

During the period that I was managing IAO, we signed some agreements as Cotutelle framework agreement with Polytechnic University of Hautes de France, Cotutelle with RWTH, MOU proposals with the University of Nantes, through Polytech Nantes, Savoie Mont Blanc University, through Polytech Annecy-Chambéry. At that time, we had the responsibility to follow 73 international students in research master's and doctorate during the period (the academic responsibility belongs to each Engineering research Program)

5.3 Application and management of financial resources

In this section all the projects that bring financial support to the university or to the laboratories in form of investment in research or scholarships for education.

5.3.1 Recent researcher financial support

In both countries, Brazil and France, it is possible to apply for a special grant for the start of the career. I was able to apply in Brazil in 2006 and in France in 2019.

In Brazil, I applied to this grant in FAPERJ³, the Foundation for Research Support of the State of Rio de Janeiro. It was approved under the number E-26/107/2007 and I could buy my professional computer and printer, and also payed the expenses for traveling to an international conference.

In France, I applied for the project *Toulouse Tech Intégration Jeunes Recrutés 2019/20*. The program support the establishment of new lecturers, recruited in 2019 at INSA, ISAE-SUPAERO, or at Toulouse INP and its associated schools, by awarding them a scholarship that can be used to finance part of their activities during the first months of their career. I received the individual grants of € 3,000, that due to the sanitary crisis I bought some small experimental equipments and financed three months internship for a Brazilian student that produced one article in conference.

5.3.2 Individual grant for research from CNPq

In Brazil, there is an annual calling for individual grant for all areas called "Edital Universal". I applied four times and I had two projects approved: number 15/2007 for two years (2008-2009) and number 481406/2013-1 for 2014-2015. In 2008, the grant approved was R\$12,000 (US\$6,500) and the main investment was for buying computers for the graduate students working under my supervision and tools for machining, and in 2014 the total grant was R\$ 43,400

³Linked to the Secretary of State for Science, Technology and Innovation, the agency aims to encourage activities in the scientific and technological areas and provide extensive support to projects and programs of academic and research institutions headquartered in the State of Rio de Janeiro.

(US\$20,000) and I spent improving the micromachining area (air conditioner, computers, microtools) and also going to micromanufacturing conferences.

5.3.3 Emerging Groups FAPERJ in Brazil

I participated as a member of the call for emerging research groups and the project n.08/2008 was approved with the title "Thermo mechanical Analysis in Materials Processing" (*Análise Termomecânica no Processamento de Materiais*). The team was composed by 5 professors from UFF and myself from CEFET/RJ. The main investment was the acquisition of equipment for manufacturing processing analysis in UFF (total value of approx US\$100,000) that I was able to use as part of the team from 2008-2010.

5.3.4 Internal calls for external financial support for equipment

The following projects had institutional calls for laboratories in CEFET, UFRJ and INSA. I present only the approved financial projects.

1) Acquisition of experimental equipment in CEFET

I wrote an internal project for direct importation, using CNPq support, for the machining laboratory LABUS⁴. Until today the institution produces research with this equipments (total value of approx US\$30,000):

- Piezoelectric Dynamometer 9257BA for measuring machining forces in turning, milling and drilling;
- Lion capacitive displacement sensors and signal acquisition system;

2) Edital Pro-equipamentos CAPES in UFRJ

I wrote a project for calling Application pro-equipment 25/2011 Institutional from CAPES⁵. The project title was "Micro component Manufacturing: analysis of the mechanics of cutting with biomedical applications" and it financed US\$ 124k for the acquisition of those three equipments:

- A CNC micro machine-tool;
- A Kistler 9256C2 quartz mini-dynamometer for measuring the 3 orthogonal components of cutting forces;
- A Taylor Hobson rugosimeter with a 50mm displacement unit to control surface roughness and profile.

⁴<http://dipppg.cefet-rj.br/index.php/pt/component/content/article/57-estrutura/198-labus>

⁵CAPES: Coordination for the Improvement of Higher Education Personnel, a foundation of the Ministry of Education. <https://www.gov.br/capes/>

3) Acquisition of experimental equipment in UFRJ for Additive Manufacturing

I wrote an internal project for acquiring funds from the National Treasury, released through a parliamentary amendment, using COPPE Foundation support, for the manufacturing laboratory CEFCON⁶ in Mechanical Engineering Department.

It financed US\$ 100k for the acquisition of those equipments (It can be seen the news with more detail information and photos in this [link](#)):

- Projet 460 plus - is a full-color 3D powder printer that uses plaster for building the green part and resin for enhancing the mechanical resistance
- 3D Systems ProJet 1200 - a professional desktop 3D printer based on SLA process for producing small metal casting patterns, castable dental wax-ups and dental copings, for example.
- Computers and uninterruptible power supply for additive manufacturing area.

5.3.5 Financial support Defi Diversité in France

I applied for the calling *Appel à Projets Bonus DEFI Diversités 2020* with the project: 3Di Project - Teaching the industry of the future through international monitoring of the FDM additive manufacturing process. The participants of the project were University of Trento (Italy) and INSA Toulouse.

This project aims at virtual international mobility, it involves coordinating three groups of students following lessons taking place in institutions in different countries with a common objective: to produce mechanical parts by Fused Model Deposition (FDM by 3D printing) using the online equipment of the partner institution. This project required multidisciplinary profiles affecting both the field of computer science and that of engineering, with the challenge of communication and evaluation between students showing the intercultural dimension of the training.

I coordinated and managed the expenses with the support of INSA Toulouse. the total of expenses were €4,400 in the academic year 2020-2021 and it was possible the acquisition of those equipments:

- Digital output card (National Instruments);
- FDM extruder for manufacturing composite filaments;
- Computer and electronic devices for online communication for the 3D printers.

⁶CEFCON: Centro de Estudos em Fabricação e Comando Numérico

5.3.6 Financial support for double degree mobility CAPES-CDEFI BRAFITEC

I was responsible for writing the call for two Brafitec projects between UFRJ, UNICAMP and 7 ParisTech Schools: the Brafitec 11/2011 from 2012 to 2015, and Brafitec 203/2015 from 2016 to 2019. Both projects financed for the double degree mobility and a financial support for the coordinator expenses in research. In the first one I was the second coordinator of the project (UNICAMP coordinator was the first) and in the second one I was the first coordinator, who needs to write the general accountability of the project and final report.

The project financed: 44 double degree students and 7 simple mobilities. Out of this total of 51 students, 25 come from UFRJ, 17 from UNICAMP and 9 from France to exchange in the country of destination. Five work missions were carried out for the coordinators of each institution to participated in all the Brafitec forums. During the duration of the project, two international applications were published and during the work missions, 3 articles were presented at congresses.

5.4 Participation in academic councils

- 2017-2018 : member of the **International Relations council of UFRJ** representant of the Technical Center (Centro de Tecnologia - CT ⁷).
- 2017: **Erasmus Mundus SMART 2** - Committee of closure: Participating on the evaluation committee for the end of project at École Supérieure d'Electricité Centrale Supélec. The project was coordinated by Professor Raul de Lacerda, and bring together 18 higher education institutions and 10 European institutions, from 2014 to 2018, with scholarships were limited to Brazilian participants. The project's ambitions were to contribute to the conception of tools and technologies that will help regions in Brazil and in Europe to ensure the social, economic and environmental development of urban ecosystems, and the consolidation of a scientific Euro-Brazilian network on the field of Engineering Technology. An external committee with background competencies in International Relations activities and few or no involvement in the organization of the analyzed Erasmus project in December 2017. The members of the committee are: Paloma Dias Silveira (International Office – UFRGS), Marcio Lobo Netto (Escola Politécnica da USP) and Izabella Gomes (Brazilian Embassy in Paris) and me.

⁷The university is divided in 6 centers: Center for Legal and Economic Sciences (CCJE), Center for Mathematics and Nature Sciences (CCMN), Health Sciences Center (CCS), Center for Philosophy and Human Sciences (CFCH), Center for Arts and Arts (CLA) and Technology Center (CT), formed by 5 faculty units: Escola Politécnica, COPPE, Chemistry school, IMA (Polymers) and NIDES (Interdisciplinary Nucleus for Social Development) - <https://ct.ufrj.br/>

- **2017: University comitee of normative for cotutelles in UFRJ:** Guest member of the normative committee of cotutelles at CPGP (Graduate Studies and Research Committee) in 2017: participation of the discussion team and elaboration of the CEPG resolution - N ° 01/2017 to define the rules for the cotutelle diploma such as the double degree of postgraduate courses *stricto sensu*, the result of a partnership between the Federal University of Rio de Janeiro and a foreign institution, through its graduate programs or equivalent, providing for the issuance of two degrees of equal content.
- **2017: Institutional Council of Administration in INSA Toulouse:** I was elected member of the administration council (CA) of INSA Toulouse in September 2020. The council determines the general policy of the establishment (Articles L. 715-2 and L. 712-3), decides, subject to national regulations, on the five-year establishment contract, on the general organization of studies, as well as on research, scientific and technical information and international cooperation programs. [Details about the *Conseil d'Administration*](#).
- **2021 : Council of Mechanical Engineering Department** I was elected to be part of the council of our the department in INSA Toulouse.

5.5 Member of evaluation boards in public tender

In Brazil, I was part of the evaluation committee of 4 tender exams: 2 for Associate professor, 1 for assistant professor and 1 for Engineering in Research. Note that there is no mandatory quantitative equality of woman and man members in the evaluation committee.

In France, I was internal member on the committee of selection for Associate Professor in INSA Toulouse in 2021 for Mechanical Engineering department. Table 5.1 present those public tender events.

Table 5.1. *Participation as selection committee in public tender exam*

Year	Position	Institution	Member
2021	Maître de Conference	INSA-Toulouse	Internal
2012	Assistant Professor	UFRJ Macaé	Internal
2010	Associate Professor	CEFET/RJ	External
2008	Engineer for Research	CBPF ⁸	External
2007	Associate Professor	CEFET/RJ	Internal

Section II

Scientific work

Scientific work overview

Man discovered the manufacturing processes in the stone age to produce his first tools to guarantee his subsistence. With the development of humanity, the demands for comfort and consumption have progressively increased and the need for higher production makes research applied to manufacturing a constant need. In the last years, the advanced manufacturing is progressing in the direction of the industrial internet of things, reducing the human intervention on the process. It is also impossible to disconnect medicine and high technology, and in manufacturing.

The product from a manufacturing process has well-defined requirements: the final dimensions and geometry, as well as the mechanical and chemical characteristics achieved, necessary for a given application. To ensure quality and repeatability in production, the procedures performed must be well defined and the variability of parameters must be accounted for. But the cost-effective approach to manufacturing is fundamental, as all changes in process steps have an impact on production cost and product quality, which aims to provide greater sales value [Araujo et al., 2020b]^P with a conscious development that protects our planet. The manufacturing of a product is directly connected to the amount of carbon emitted in consuming the electrical energy for that manufacturing process. Research in manufacturing should be aware of this connection: science development, application, cost, product requirements and environmental impact.

Gabriel Colletis states [Colletis, 2012] that *“No country can develop, or remain a developed country, without a scientific development connected to industry production. Ignoring this fact has meant that some nations have gone into crisis in recent years, exporting their productive capacity to other countries”*. That is the main reason I choose manufacturing as my area of research.

Figure 6.1(a) presents a schematic view of approaches that my research is focused. This scheme includes almost every article I published. Even though my teaching experience in manufacturing processes, I focused my research specifically on the modeling and analysis of the machining process, more specifically the milling processes (including micromilling and thread milling), and recently, due to the opportunities and interest, also additive manufacturing using powder based and photo polymerized resin.

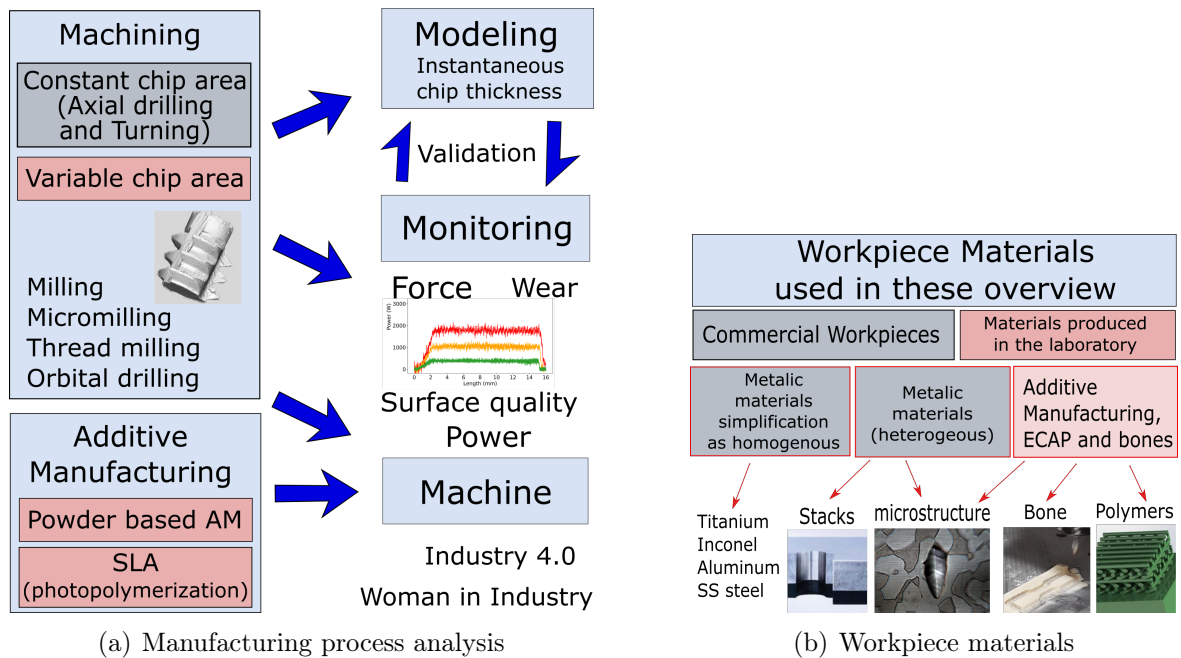

Figure 6.1. General overview of research

I began with force modelling studies and, little by little, I constructed my research connecting physical comprehension of the process and an experimental atmosphere, approaches that I feel challenged and that I enjoyed. It can be noted in the following chapters that "Monitoring" and "Experimental" it was always present: cutting forces, torque, vibration, tool wear, surface quality and its machinability. Recently, with the new challenges in manufacturing, a natural connection is done with "Industry 4.0" adding the connectivity of the machine-tools and the responsiveness for the market.

It also can be observed that, during the development of my research objectives, one application always took my attention was bio manufacturing because it applies my knowledge to an area more directly connected to the improving of human life. That is why I chose titanium alloy and chrome-cobalt for some studies, and also the reason I choose the additive manufacturing equipment to be purchased to the laboratory. In this area, the first articles were focused on the understanding of the process and the equipment, after the quality of the product was analyzed and some effort on the application for bio materials.

The present section presents an overview of the thematic that I developed in the institutions that I worked on: CEFET/RJ, UFRJ and ICA. I identify three axes of research in my past trajectory, detailed in the next chapters:

1. Modeling cutting forces in machining processes with constant and variable uncut chip thickness: chapter 7
2. Analysis of forces in milling with helical tool trajectories (thread milling and orbital drilling): chapter 8
3. Reducing the scale to micro milling and considering size effect and heterogeneity in force models : chapter 9

Transverse to those axes, the materials used were chosen around some applications as oil industry, aeronautic and medical applications: metallic materials, specially with low machinability, as Titanium alloys, Inconel, Stainless steels, Chrome-Cobalt alloys, and some polymers and hard tissues can be found in the literature I produced. Figure 6.1(b) represents the spectrum of materials that can be found in my articles.

Concerning materials, for the models I used, it is important to identify if it is modeled as homogeneous or heterogeneous: in metallic materials it depends on the scale or if it is composite like structure, as stack materials. I also chose to separate commercial materials, defined by standards, from bulk materials that we produce in the laboratories, as by additive manufacturing and equal channel angular pressing, because we can design its properties.

Monitoring forces in milling for mechanistic models

Predicting the forces involved in the machining process is of fundamental importance as it allows the realization of an adequate tooling project and the optimization of cutting parameters in order to increase tool life or improve surface quality. Likewise, calculating the required power a priori ensures that the machine tool has enough energy to perform the operation.

Cutting mechanics is the approach of the machining area that describes the physical phenomena involved to determine the **local** variables, that is, stress, deformation and temperature fields in the region of interest of the part or tool, especially around the cutting edge. For the predictive calculation of **global** parameters such as forces, torque and power, it is necessary to know the laws of mechanical behavior that relate local variables or to use calibration variables that could be used to replace the analytical or numerical model for continuum mechanics.

Those **mechanistic models** are used by many researchers and my research is based on carrying out this relationship, defining these calibration coefficients that helps the understanding of the process and it is influenced by many factors. Furthermore, the error on the prediction to build some of the models, global experimental measures must be used to find the local variables, which makes the process iterative and complex.

Figure 7.1 describes the local approach for prediction of global parameters (forces, torque and power) produced by a cutting process based on the discretization of the cutting edge. The first stage is the description of tool geometry: dimensions and angles that allows the definition of the cutting edge for tool discretization. Using the trajectory defined by the CAM-CNC program and the spindle speed, the local velocities and the chip load are calculated and allow the analysis of the cutting conditions on each element of the cutting edge.

Based on local geometry, the cutting force model in local elements can be defined and, considering the defined limits of integration along the cutting edge in contact to the workpiece, it is possible to integrate the cutting force in one complete cutting edge and predict the contribution of each active cutting edges along the cutting time. That is the **prediction methodology** for

mechanistic models, considering that the model coefficients are known.

The inverse process can be done, from the acquisition of forces and power to the identification of cutting coefficients, the **modelling methodology**, which should consider the dynamic of the machine-tool, the uncertainty of the acquisition system and other variations that could impact the conclusion.

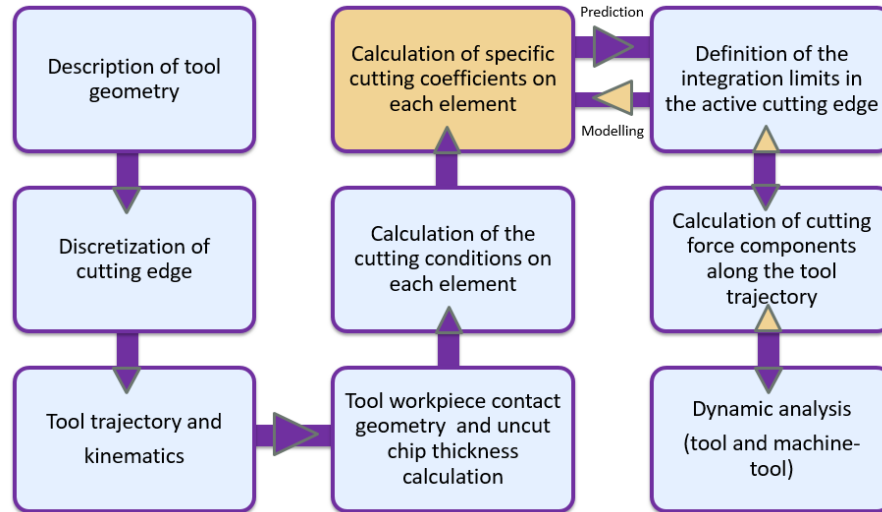

Figure 7.1. Prediction and Modeling machining forces

In this area, a lot have been already done in research and development, although there are still several challenges that could be identified for producing projects and thesis.

Scientific challenges in Mechanistic Models:

- As the cutting coefficients depend on the tool and workpiece material, changes on the machining players (new tool materials or surface coatings, new workpiece materials, changes on the bulk structures and new cutting technologies) represent an open question mark regarding the cutting behavior. In this case, it is a combination of experiment and modeling skills to develop on the research student and in the research.
- The non-mechanical factors that are not directly modeled as the temperature field and the chemical changes during the process impacts the modelling. Even though it is easy to understand and present, very often there is a huge gap between the well known modeling cutting process and the experimental data.
- In the time domain, considering the dynamic of the machine-tool, burr formation phenomena and the error and variation on the acquisition equipment, the instantaneous results are not smooth and precise even considering constant chip load area.

The experimental technology has improved, but it is also related to the nature of data.

- The modeling of machining processes with dynamic uncut chip thickness is, in my opinion, more challenging and interesting to treat. That is why my research is focused in milling and its variations. The chip formation with variable uncut chip thickness includes cyclic thermal and mechanical conditions producing additional influence on tool life, specially for PCD tools.
- The use of prediction modeling in parallel with data acquisition in time domain can be used to feedback changed cutting conditions to the machine-tool. As the CNC machines are not prepared for this closed loop control outside of the machine, this implementation is challenging in research.
- The Industrial Internet of things allows the management of the process thought monitoring and decisions are based on a data-base taken using a range of cutting parameters that should be representative, monitoring and modelling is decisive to achieve this aim.

7.1 Mechanistic coefficients on local force approach

In the mechanistic models [Merchant, 1998] with local approach, also used in the recent articles from other researchers [Anand and Patra, 2017; Ducroux et al., 2021], the machined workpieces are considered as composed of several regions having each one **homogeneous properties** and constant parameters inside each element.

The tool cutting edges are thought divided in segments that faces to one single material at each instant that could change when the reference point \mathbf{P} travels along the workpiece. It is a combination of the basic analytic models of orthogonal and oblique approaches (Figure 7.2) and experimental force coefficients.

The analysis of cutting mechanics in orthogonal cutting, when the cutting speed \vec{V}_c is perpendicular to the cutting edge (inclination angle λ is zero), and oblique cutting if $\lambda \neq 0$, describe the field of stress by a localized plastic region in a shear plane. The plastic stresses are described by a yield law and the forces are calculated based on the continuum mechanics analysis.

In both cases, the geometrical analysis considers the element cutting edge length db (the complete cutting edge is b), a local uncut chip thickness h and the orientation of the edge in relation to the cutting direction. This geometrical chip-tool analysis is used in the **mechanistic models** considering the phenomenology proposed by the analytic models, but not its calcula-

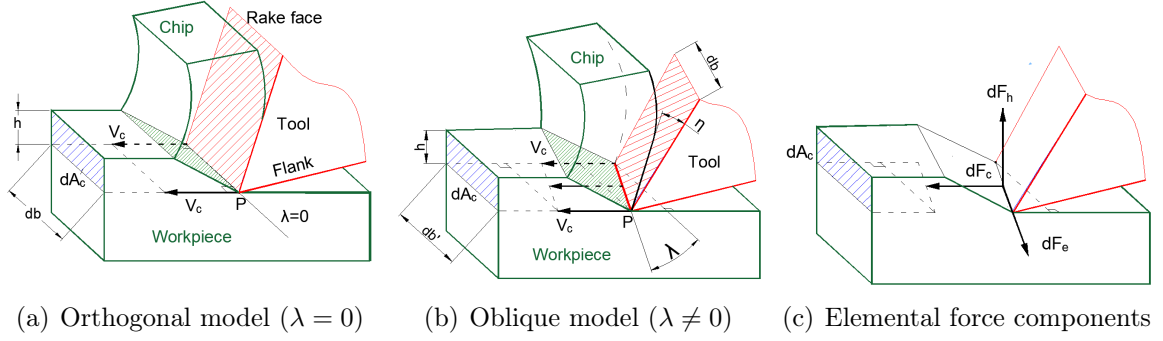

Figure 7.2. Element of the Cutting edge (db) and local forces ($d\vec{F}_m$) considering homogeneous material and shear plan models (Araujo et al., 2020b)^P

tion. Instead, specific force coefficients replace the stress analysis because it could include non modeled parameters.

The local system (**Tool material + workpiece material + Cutting speed + uncut chip thickness**) defines the cutting behavior and consequently the specific coefficients. Although, it is possible to calculate average coefficients in the case a reference is needed.

The machining force $d\vec{F}_m$ is decomposed in the reference frame where the relation between area and force could be considered dependent on this local system, and modeled. That is the case for the cutting direction and its orthogonal directions (c,e,h) as described in Figure 7.2. The specific force coefficients $K.$ and $k.$ are modeled based on calibration experiments Grzesik, 2016.

$$d\vec{F}_m = \begin{bmatrix} dF_c \\ dF_e \\ dF_h \end{bmatrix} = \begin{bmatrix} K_c \\ K_e \\ K_h \end{bmatrix} .h.db + \begin{bmatrix} k_{ce} \\ k_{ee} \\ k_{he} \end{bmatrix} .db \quad (7.1)$$

$$\begin{bmatrix} K. \\ k. \end{bmatrix} = \text{function}(h, \text{Temp}, \text{Materials/coating} \rightarrow \text{replaces } \sigma_Y) \quad (7.2)$$

7.2 Developed research using mechanistic models

When I decided to study with force modelling, the manufacturing laboratory where I worked had no experimental resources for forces or power acquisition [Araujo, 1999]^P. I studied these analytic models to apply to end milling but I used the published papers data acquired from the curves on the articles to compute the modelling. Also, in this master thesis, I constructed a rudimentary piezoelectric sensor using quartz plates and a home made electrical circuit. It was useful only for my young research training and understanding of the principles of dynamometry. Using published data, I was able to publish in national conferences [Araujo and Silveira, 2001a;

[Araujo and Silveira, 2001b](#); [Araujo and Silveira, 1999](#)^P.

In my doctoral degree thesis [[Araujo, 2004](#)]^P, I had to find a laboratory where I could measure forces in order to do real mechanistic model analysis. That is when I applied to work in Kapoor's laboratory in University of Illinois at Urbana-Champaign, where I changed the theme to thread milling mechanistic model and where I met some of the colleagues I collaborate in my career. It was a paradise in dynamometry for me at that time, with several equipment and freedom to research. I was very independent in the data acquisition and treatment. The results are presented in Chapter 7.

After I became a professor in the University, my main goal was to write a project to have a dynamometer because I wanted to continue with this research line. So, when working for CEFET, I bought the Kistler Dynamometer 9257BA and the capacitor sensors for tool run-out (described in 5.3.4). It was the first dynamometer for machining in the state of Rio de Janeiro, because there was no other researcher interested in this type of research. I am glad to open this opportunity to many other thesis that used this equipment after. Years later, I also proposed a complementary dynamometer for UFRJ (Kistler 9272) inside a colleague project who used for friction stir welding and drilling and the project to begin the micromilling research buying the minidynamometer (MiniDyn 9256C2 described in section 5.3.4), that I used in the research presented in Chapter 8.

The conducting wire of my research was guided to the application of dynamometry to machining models. All other research lines are connected to this ground. Even the additive manufacturing research was focused in producing bulk material for further machining.

As example, in this chapter I present some of the results of the research in mechanistic models developed with my collaboration or under my supervision. Exception for the specific research in helical trajectory and in micromilling that it is presented in the next chapters.

7.3 Turning and drilling forces: models with constant chip load

The chip load area in turning and drilling have some similarities: after the transitory period of tool entrance, (a) its value is constant, (b) the cutting edge is continuously in contact with the part, with an impact on the tool temperature, and (c) there is a variation of the local cutting velocity along the edge. In drilling this last characteristic is much more present because as the spindle axis contains part of the cutting edge: so the local velocity varies from zero (no cut at this point, if there it not a pilot hole) until the maximum value at the nominal tool diameter.

In both cases, considering that the tool does not change, and it is necessary to map the cutting coefficient over a range of spindle speed and feed, it is possible to simplify the modeling to an average cutting speed and a uniform specific forces along the edge. This simplification allows a basic analysis with constant chip load area for identification of the calibration parameters.

Using this simplified approach it is possible to focus on the materials analysis during machining, and not on the geometrical analysis. That is why I made some research on turning on Smart material alloys before studying its behavior on thread milling in order to produce smart material screws.

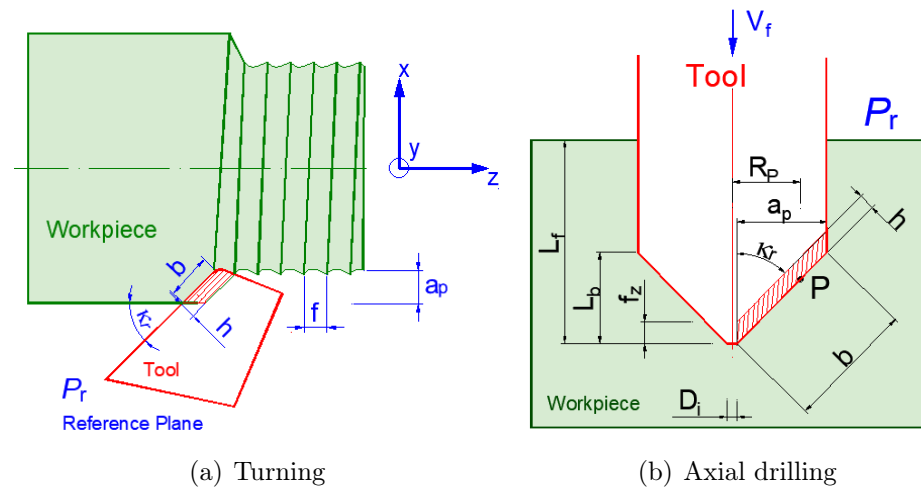

Figure 7.3. Chip load area projected in the reference plane (Araujo et al., 2020b)^P

7.3.1 Mechanistic model for turning smart material alloys

Shape memory alloys (SMA) have unique properties like pseudo elasticity, high resistance, good functional fatigue-strength, and a unique property that is the ability to recover, with the increasing of temperature, its original shape after being subjected to plastic deformation, even after being under the application of high loads, the Shape Memory Effect (SME).

SMA material is commonly used in many fields, such as aerospace, biomedical, composites and structures, communication, and actuators Zhao et al., 2020. For modeling smart materials machining, the interesting point is that the heat changes both: the behavior of pseudo elasticity and also the cutting characteristics.

Copper-based alloys

Several copper-based alloys have the SME, among them the metals Cu-Al-Ni e Cu-Al-Be, manufactured by casting in the collaboration with researchers for machining analysis are presented in two articles: [Pereira da Silva et al., 2013; Pereira Da Silva et al., 2013]^P. Three

alloys were used in this research: (AT) Cu-11.8%Al-0.60%Be (wt%), (BT) Cu-11.8%Al-0.55%Be (wt%) and (CT) Cu- 11.8%Al-0.55%Be-0.50%Nb-0.27%Ni (wt%), in as-cast and heat treated states. It is necessary to perform a heat treatment in order to obtain the shape memory effect, as Cu-Al-Be alloys have no shape memory after casting. The six specimens obtained were then separated in two groups: one group, with three workpieces, was heat-treated and the other group was machined as casted. The start and finish transformation temperatures for the quenched alloy in free stress state are: austenitic $A_s = -28.8^\circ C$ and $A_f = -6.8^\circ C$ and for martensitic $M_s = -33.6^\circ C$ and $M_f = -54.5^\circ C$.

Four cutting velocities were used in the DOE: 135, 140, 145 and 150 m/min (0.5 mm depth of cut, 30 mm nominal diameter and feed is 0.1 mm/rev). Cutting forces were taken using the CEFET dynamometer 9257BA (1kHz acquisition rate) and the resultant force was calculated for all tests and 10 revolutions were analyzed to calculate the average maximum resultant force on each revolution and the average resultant for all cases (results are presented in Figure 7.4).

Table 7.1. Transformation temperatures (deg C) for Quenched alloys

Alloy	wt%	M_f	M_s	A_s	A_f
AT	Cu-11.8%Al-0.6%Be	-87.9	-83.6	-75.7	-57.1
BT	Cu-11.8%Al-0.55%Be	-54.5	-33.6	-28.8	-6.8
CT	Cu-11.8%Al-0.5%Be-0.27%Ni	-74.6	-52.5	-42.9	-22.4

Comparing the three alloys, the (BT) Cu-11.8%Al-0.55%Be requested higher forces for machining and the BeNi alloy (CT) showed higher machinability (considering cutting force as machinability factor). Although, after heat treatment this alloy required higher forces. The refinement of the grains, due to the addition of Niobium, should induce higher resistance and higher machining forces influence is presented in experimental results only in quenched niobium alloy. The resultant forces obtained during machining of quenched samples were higher than those of unquenched workpieces, excepted by alloy (CT), explained by the presence of Shape Memory Effect.

Nickel Titanium alloys

The NiTi alloys, also known as Nitinol, are an important class of SMA because of high ductility, fatigue strength, strong corrosion resistance, excellent strength-to-weight ratio and biocompatibility. As the transformation temperatures and stresses are important factors for those materials in order to properly actuate in systems, I proposed in 2012 and 2013 two final projects about the effects of the machining on those transformation parameters using different cutting velocities. The results were not conclusive enough for a publication at that time, and in 2014 Kaynak et al., 2014 a similar work was published. I did not pursued this work, I present some results we obtained in Figure 7.6.



(a) As cast workpiece

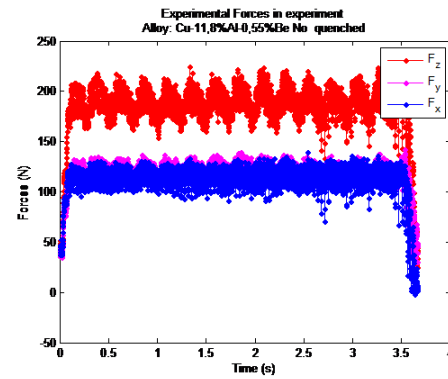
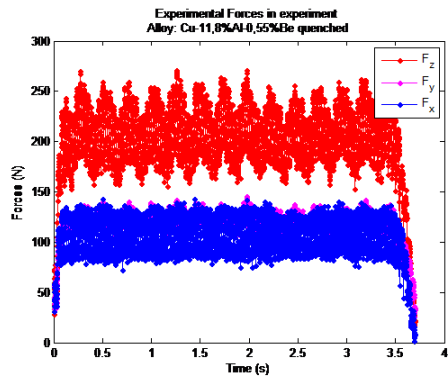

(b) Forces components in turning material B quenched using $V_c = 150$ m/min

(c) Forces components in turning material B unquenched using $V_c = 150$ m/min

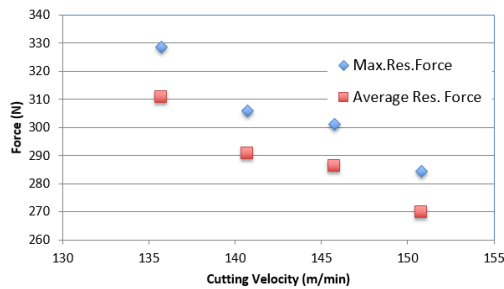

(d) Forces with different velocities

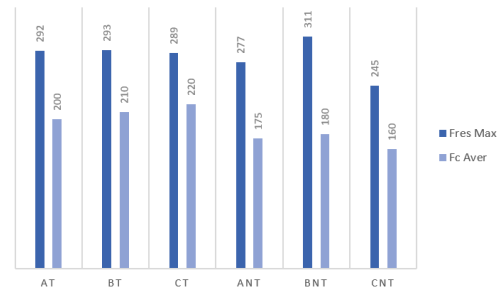

(e) Comparison quenched/no quenched

Figure 7.4. Cutting Forces Generated During Turning Of Quenched And Unquenched Cu-Al-Be Alloys (Pereira da Silva et al., 2013)^P

Radial turning operation was done in a Nitinol bar (57% Ni and 43% Ti and 8 mm nominal diameter) using a fixed cutting velocity for each experiment (Figure 7.6). The cutting parameters were: 0.1 mm/rev for feed and 15m/min, 18m/min e 21m/min for cutting speed with N123G2-0300-0002-CM 1125 insert (the supplier recommended 17 m/min). The cutting speed was constant until 6000rpm without cutting fluid. The workpiece supplier informed that the austenitic transformation was between 9° and 18°C. The resultant chips are analyzed using optical and electrical microscopy and the thermoanalytical technique Differential Scanning Calorimetry (DSC) is used to measure the heat flow to identify the start and end temperature transformations.

The Energy-dispersive X-ray spectroscopy (EDS) enables the chemical characterization and it was performed on the tool coating indicates the possible use of titanium carbide (TiC), titanium carbonitride (TiCN), aluminum oxide (Al₂O₃) and titanium nitride in its composition, favoring the dissemination of material. In one experiment the insert fracture probably occurred due to a possible diffusion of the coating material, generating crater wear, associated with frontal wear, common in the tool clearance surface, leading to a chipping of one of the cutting edges. The DSC result shows that for each heating and cooling the phase changes in different temperatures approximating to the not-machined ones. Different cutting velocity caused variation on those temperatures, as it can be seen in Figure 7.6 and Table 7.2.

V_c (m/min)	M_f	M_s	A_s	A_f
Not machined	-107.8	-83	-35	2.7
15	-106.3	-70.3	-39.4	-21
18	-108.6	-72.1	-40.8	-21.3
21	-114.4	-73.9	-57.8	-20.9

Table 7.2. DSC results using machined samples

After this first study, threads were machined on the NiTi bar with an undergraduate student IC project. Her objective was to produce metric threads using thread milling. Because of the SMA properties, the radial engagement needed to be adapted (higher a_e comparing to the simple geometrical calculation) and a more rigid fixation was adapted to achieve correct thread profile measured in the profilometer [Martins et al., 2014]^P. Using her work, a master degree student from UFCG machined his NiTi workpieces for tensile test [Pereira, 2014]. No further research was developed in this research line.

7.3.2 Mechanistic model for drilling metals

I was also very interested in dynamics and experimental analysis, thus I focused basically on the milling process, but some short work has been done in axial drilling of refractory metals as in austenitic stainless steel [Vasconcellos and Araujo, 2011]^P, Inconel [Rios et al., 2015]^P



(a) NiTi workpiece

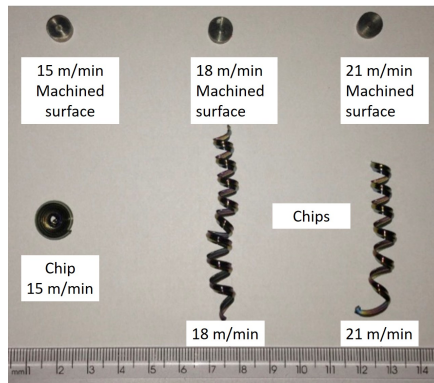

(b) Samples and chips

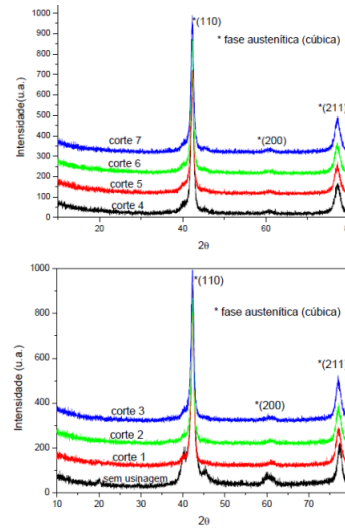

(c) Raman

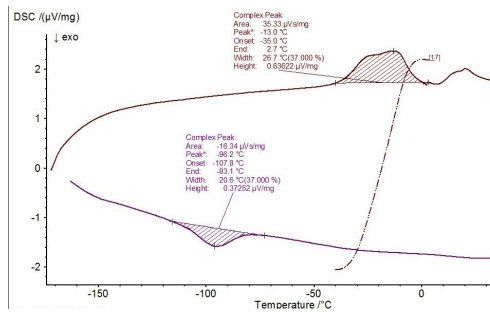

(d) DSC without machining

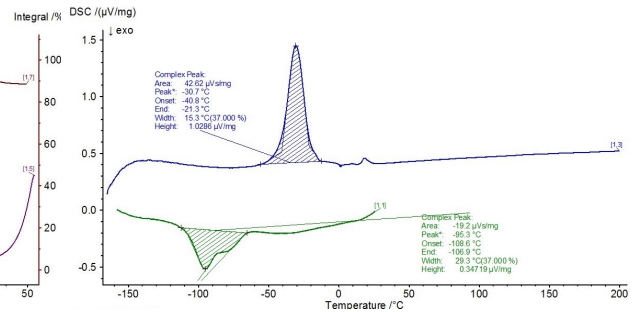

(e) DSC with $V_c = 18$ m/min

Figure 7.5. Machining NiTi Alloys - Final project results (Absi, 2013; Rego, 2013)^P

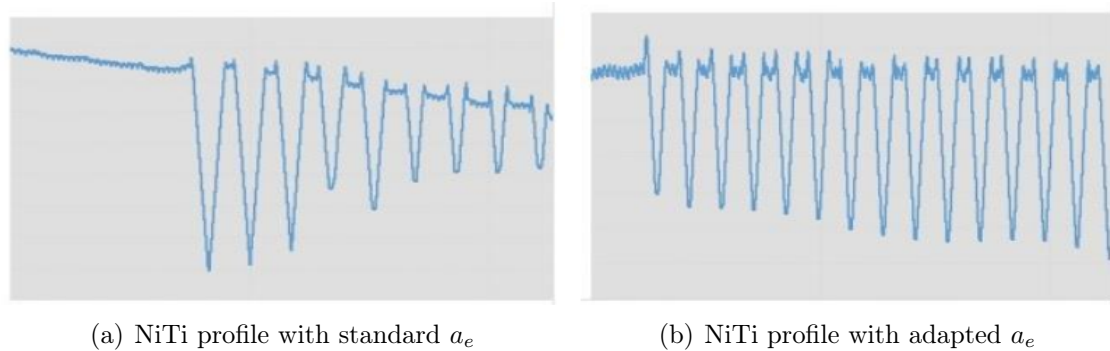

Figure 7.6. Thread profiles of NiTi bar - IC project results (Martins et al., 2014)^P

and titanium alloy [Gonçalves et al., 2021]^P (the last one with the objective of comparing with orbital drilling, a milling process).

The local mechanistic model for drilling should take into account the variation of the rake and relief angle along the cutting edge for the calibration of specific cutting coefficients. Although, if the tool geometry and diameter are fixed, it is possible to calculate and study an average calibration for the tool and that is the case of those three articles. The two first developed in Brazil, using the Kistler dynamometer 9257-BA, the DOE defines the range of calibration and the response map of the specific coefficients is produced.

ASTM B 668 (Sanicro 28), a high-alloy multi-purpose austenitic stainless steel (Steel with Ni-Cr-Mo) for service in highly corrosive conditions. Drilling experiments were conducted with a TiN coated carbide (Corodril Delta C 840) without cutting fluid. The range of calibration was from 15 to 32 m/min (cutting speed) and from 0.03 to 0.06 mm/rev (feed per revolution), recommended by the tool manufacturer. Calibration function was defined as a function of feed, as the cutting velocity has low influence when tool diameter (2 mm) is fixed, and it is presented in Figure 7.7(a), published by the final project student in [Vasconcellos and Araujo, 2011]^P.

The same kind of experiment was done with Inconel 718 by a final project student, who published his results in [Rios et al., 2015]^P. A 10.2 mm diameter high-speed steel (HSS) drill with 5% cobalt with HSS-E heat treatment was used, as indicated by the manufacturer for Inconel. The cutting parameters used were cutting speed equal to 2, 4 and 6 m/min and feed equal to 0.07 mm/rev, with and without pilot hole. The cutting fluid used was Balxedot (Baltar Química), a vegetable-based soluble fluid with ethanol and soybean oil in its composition. Crater wear was observed in the drills, with a rapid evolution of wear through the abrasion mechanism between the first tests and their replicas, generating forces up to 32.6% higher in the repetition of tests. As expected, the most critical region was the maximum cutting speed, on the periphery of the drill, with wear of up to 0.27 mm. The execution of the center hole promoted a reduction of around 20% in this wear. For a better understanding of the variation of the feed force with

the cutting speed, it was considered only the results obtained in the first experiments of full drilling and drilling with pre-drilling, minimizing the influence of wear on the analyzed force values. Results presented in Figure 7.7(b).

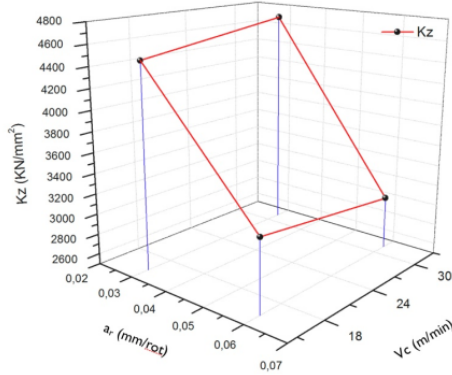

(a) Calibration for Stainless steel [Vasconcellos and Araujo, 2011]^P

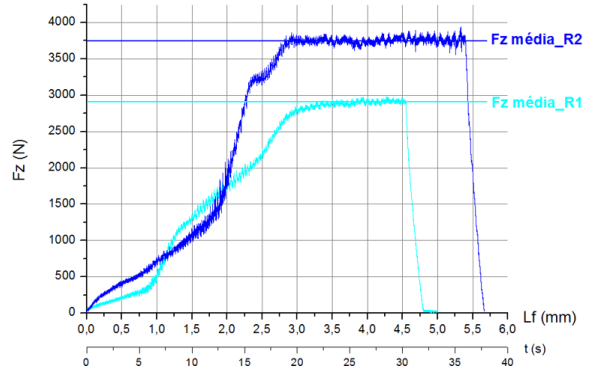

(b) Replicas 1 and 2 with same parameters ($V_c=4m/min$) with pilot hole [Rios et al., 2015]^P

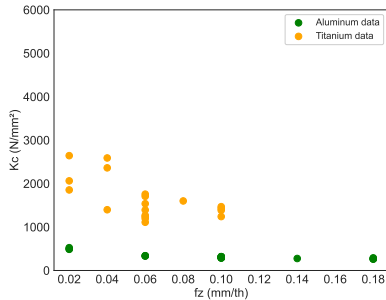

(c) Specific cutting coefficients for Al and Ti [Gonçalves et al., 2021]^P

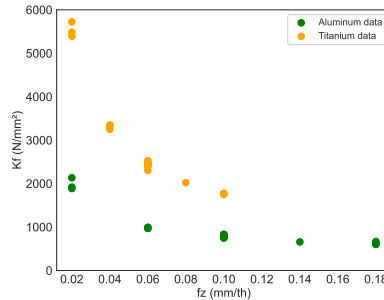

(d) Specific feed coefficients for Al and Ti [Gonçalves et al., 2021]^P

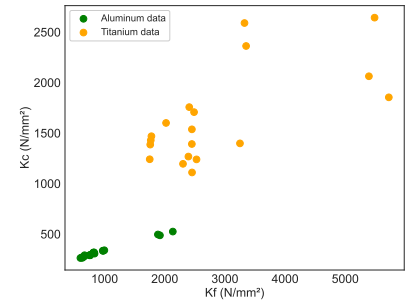

(e) Identification map [Gonçalves et al., 2021]^P

Figure 7.7. Drilling force results from undergraduate projects

These project were important to develop some primary tests before requesting financial support or as a reference data. This is the case of the axial drilling experiments developed in 2020 in ICA, by an internship undergraduate student (Maria Clara Coimbra). In this third case of drilling force results, a database was developed for comparing with orbital drilling results, the research topic of an actual doctoral degree student (Sughosh Deshpande). During the experiments, power and force were measured for drilling two workpiece materials: Aluminum 2017A and Ti6Al4V titanium alloy using a carbide drilling tool (10 mm nominal diameter). The range of cutting parameters is wider than usual because the goal was to compare the Aluminum and Titanium drilling results using the same data input. A full factorial design of experiments was done: for Aluminum $V_c = 20, 60$ and $100 m/min$ and $f_t = 0.04, 0.20$ and $0.36 mm/th$ and for Titanium $V_c = 20, 40$ and $60 m/min$ and $f_t = 0.04, 0.20$ and $0.36 mm/th$.

The K_c and K_f variation with feed is shown in Figure 7.7(c) and (d), where comparisons

between both materials are made (cutting speed had no impact on the results). The behavior of results are similar, considering that the results for titanium are higher. The most important objective of this work is to generate the identification map of K_c and K_f (Figure 7.7(e)). It can be noticed that there is a clear distinction in the range of force and power results for drilling Titanium and Aluminum.

7.4 Modeling milling forces considering rigid tool

In milling, if the tool is considered rigid, the uncut chip thickness depends on the angular position (θ_P) of the reference point P that varies with the tool revolution, and time. The trajectory described by one point P of the cutting edge around its axis if there is no tool displacement, is called **envelop** as it is shown in Figure 7.8(a). The tool envelope is the surface produced considering all points of the cutting edges.

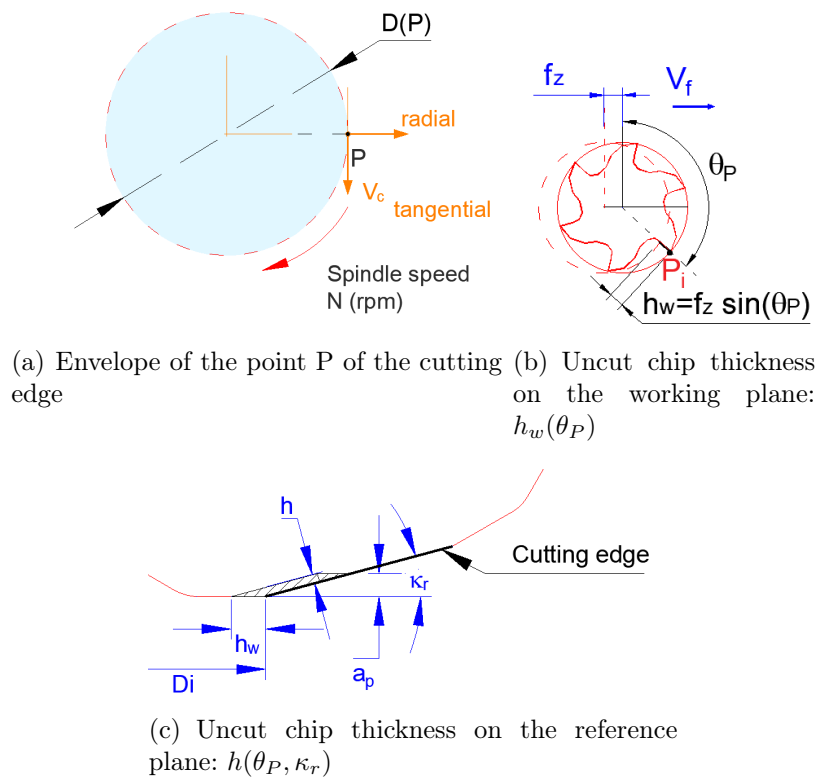

Figure 7.8. Tool envelope and uncut chip thickness

For each P, and its envelop combined with feed velocity, the effective uncut chip thickness h is measured perpendicular to the cutting edge and the cutting velocity V_c (measured on the reference plane). Its projection on the working plane h_w (that contains the cutting velocity and feed velocity) is shown in Figure 7.8(b). Martellotti equation calculates $h_w(\theta_P)$ in milling as

Araujo et al., 2006 where f_z is the feed per tooth:

$$h_w(\theta_P) = f_z \sin(\theta_P) \quad (7.3)$$

If cutting edge angle is equal to zero ($\kappa_r = 0$, cylindrical tool with constant diameter), then $h = h_w$. The uncut chip thickness, considering the cutting edge angle $\kappa_r \neq 0$, is calculated as Araujo et al., 2013a:

$$h(\theta_P, \kappa_r) = f_z \sin(\theta_P) \sin(\kappa_r) \quad (7.4)$$

When there is tool run-out, an additional component should be added to this equation, considering the run-out angle ϵ and the amplitude ρ :

$$h(\theta_P, \kappa_r, \epsilon, \rho) = f_z \sin(\theta_P) \sin(\kappa_r) + \rho(\epsilon, n) \quad (7.5)$$

In rotating tools as in milling, each cutting edge j can be discretized in small portions i with a constant cutting edge length db , located by a location angle $\theta_{P_{ij}}$. When the tool is considered rigid, forces $d\vec{F}_m$ can be written as a function of the $h(\theta_P, \kappa_r)_{ij}$ Dorlin et al., 2015. D_i is the diameter of the circular trajectory described to the inner point of the cutting edge, the diameter of the inner envelope used to define the spindle speed N .

$$d\vec{F}_m(\theta_P, \kappa_r) = \begin{bmatrix} K_c(h(\theta_P, \kappa_r)) \\ K_e(h(\theta_P, \kappa_r)) \\ K_h(h(\theta_P, \kappa_r)) \end{bmatrix} \cdot h(\theta_P, \kappa_r) \cdot db + \begin{bmatrix} k_{ce} \\ k_{ee} \\ k_{he} \end{bmatrix} \cdot db \quad (7.6)$$

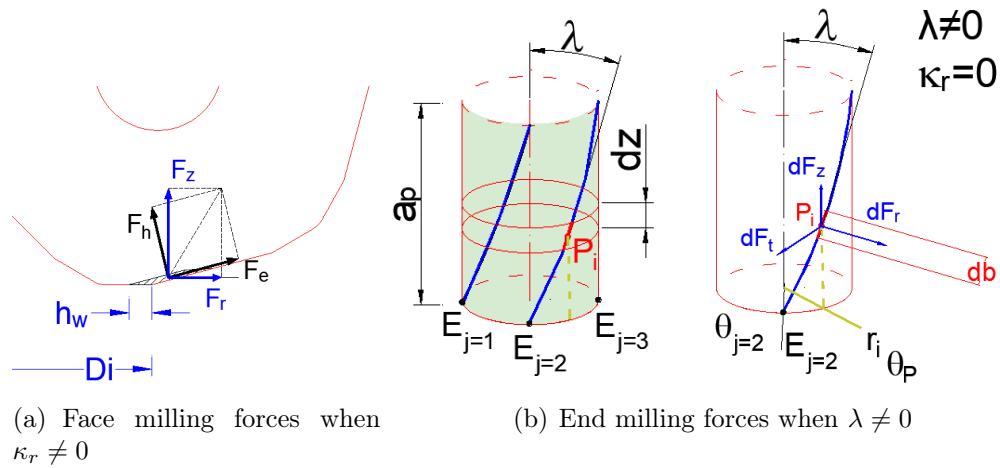

Figure 7.9. End milling analysis

So, the mechanistic model takes into account all n_j flutes and the workpiece-tool contact

in order to define the integration limits to calculate the instantaneous machining forces.

$$\vec{F}_m(t) = \sum_{j=1}^{n_j} \int_{\theta_j}^{\theta_{a_p^{max}}} d\vec{F}_m(\theta_P, \kappa_r) \cdot g(\theta_{P_i}) \quad (7.7)$$

The function $g(\theta_{P_i})$ indicates if the segment of cutting edge is engaged to the workpiece or not. This is accomplished by comparing θ_{P_i} with the entry and exit angles φ_{st} and φ_{ex} .

$$g(\theta_{P_i}) = \begin{cases} 1, & \text{if } \varphi_e < \theta_{P_i} < \varphi_{st} \text{ (Tooth is engaged)} \\ 0, & \text{if } \theta_{P_i} < \varphi_{st} \text{ ou } \theta_{P_i} < \varphi_{ex} \text{ (no contact)} \end{cases} \quad (7.8)$$

It is very important to claim that the integration is done summing components in the same reference frame, in other words, it is not possible to sum the scalar values in radial and tangential components because each segment is oriented in a different radial direction.

Using this approach, many of my articles have been published for milling adapting to each conditions. The next subsections highlight two research projects: (6.4.1) high feed milling with PCD inserts and (6.4.2) the relation between cutting forces in milling and the residual stresses produced in the workpieces.

7.4.1 High feed milling

High-feed milling aims to remove the highest chip rate in the shortest possible time in order to reduce industrial costs without reducing tool life. It is the first choice for machining applications in parts with a large area, for example in mold and die milling applications. It is a process that has existed for some time but the evolution of tool materials has meant that the lifetime of this application has been expanded and machine tools must be stiffer and reach speeds much greater than those typically used. The tool holder positions the inserts in a low position to remove thinner ($\kappa_r < 20^\circ$) and wider chips.

Figure 7.10(a) shows one example of high feed milling published in a conference with a final engineer project student [Henz et al., 2019]^P presenting a theoretical and experimental comparison of cutting forces in Titanium alloy using the same carbide tool. The experiments were developed in ENSAM-Cluny using the insert on two situations: with a high feed tool holder and a regular milling one (Figure 7.10(b)). The objective was to analyse cutting forces and tool life using the same cutting area in both cases verifying if there is an impact related only with κ_r .

The components of the experimental force are oriented by the machine-tool coordinates x, y, z . The coordinate transformation for the cylindrical coordinates t, r, z fixed in the insert used the angular position θ of the insert, which is collected on the analog out-put of the

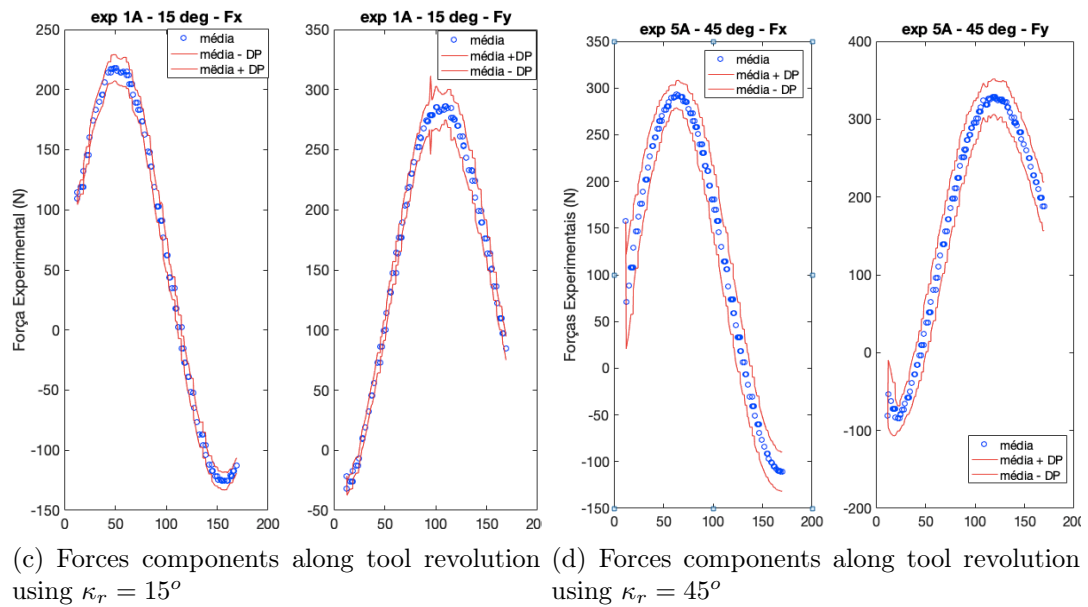
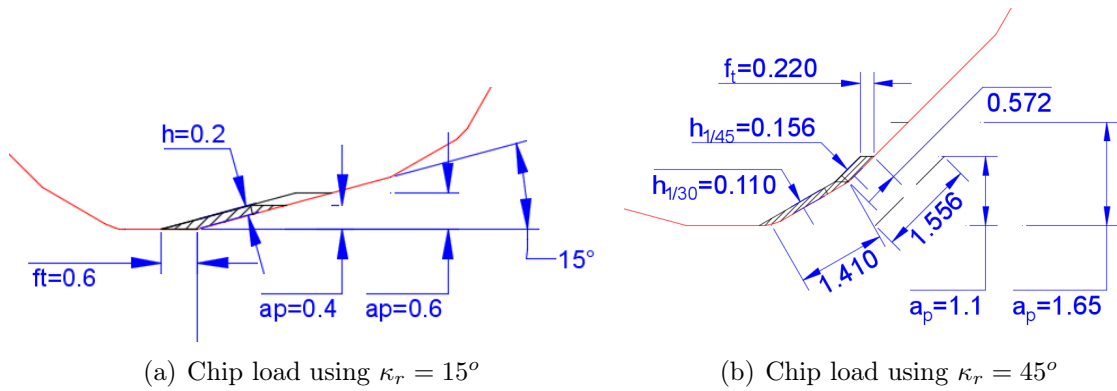

Figure 7.10. High feed milling with Carbide Insert in two κ_r positions

machine-tool.

The design of experiments is done with two levels for feed per tooth and depth of cut, chosen so that the chip thickness and area were the same and could be compared, with constant cutting speed (presented in Table 7.3). Figure 7.10(c) and 7.10(d) presents two examples (one replica of Exp. 1 and Exp. 5) of the force curves as a function of the angular position angle. The dots represent the means of several data taken on the same angular position and the red curve the uncertainty using the standard deviation of these data. Note that the vertical force exhibits a large uncertainty, partly by the drift of the dynamometer, of the order of $0.2N/mm$.

Table 7.3. Design of Experiments using $V_c = 50$ m/min

f_t (mm)	0.3	0.6	0.3	0.6	0.11	0.22	0.11	0.22
a_p (mm)	0.4		0.6		1.1		1.65	
χ_r (deg.)	15				45			
D_i (mm)	32				40			
h (mm)	0.078	0.155	0.078	0.155	0.078	0.155	0.078	0.155
A_c (mm ²)	0.12	0.24	0.18	0.36	0.12	0.24	0.18	0.36

Using the cutting force components, the specific cutting energy obtained proved that the specific cutting and edge energy is independent of the position angle. Using this conclusion, PCD inserts were designed using tool holder having $\kappa_r = 15^\circ$ [Araujo et al., 2020a]^P.

The tool material commonly used for Ti6Al4V alloys is the tungsten carbide (WC-Co) using cutting speed not superior to 60 m/min. For higher cutting speed it is very important to develop advanced tool materials, as Polycrystalline Diamond (PCD) Li et al., 2016. Comparing carbide and diamond, for a similar surface finishing and same removal rate, the recommended cutting speed for uncoated WC-Co inserts stays between 40-80 m/min while using PCD inserts around 120-160 m/min **AMIN2007147**.

Many studies were developed in machining Titanium alloy with PCD specially using different cutting fluid applications. For milling process, the options for the use of cutting fluid are: flood Fang and Wu, 2009, MQL Rao et al., 2018 and cryogenic machining Shokrani et al., 2016, a more expensive installation. In this study it was chosen to focus using flood application as it is the most common in aerospace industry, who is pushing on new tools for reducing the cutting time.

The microstructure of machined material, an $\alpha + \beta$ alloy, consists on equiaxed α phase with average size of $20\mu\text{m}$ (7% Al and 2% V wt. SEM spectrum) in a transformed β phase (5.5% Al and 7.5 % V wt. SEM spectrum). The cutting tool was manufactured by Saint Jean Industries [®]. The PCD element is cut from a blank CMX580 PCD by Element Six [®]. It is characterized by sub-micron grain size, indicated by the supplier as ideal for milling and rough cutting of titanium alloys where extreme chip resistance is required.

The inserts were produced specially for this work doing a pocket in a carbide insert for logging the PCD element. Figure 7.11 shows the commercial carbide insert with the pocket. The set (carbide+PCD) is cut and grind when the chanfer on the cutting edge geometry is produced.

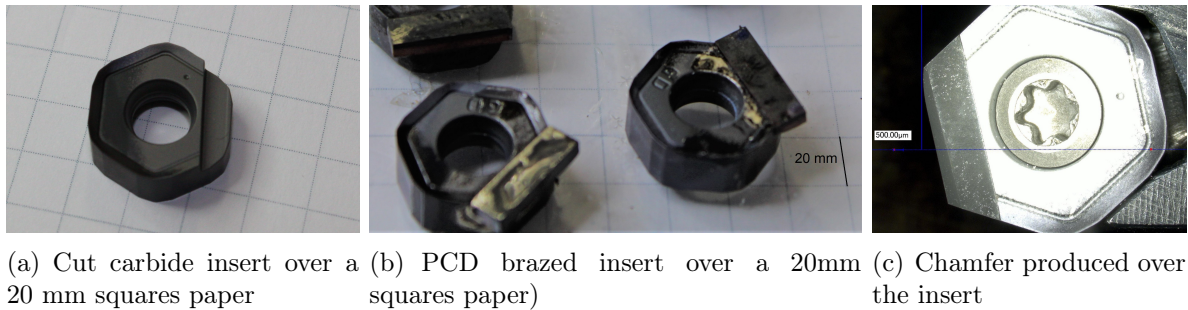
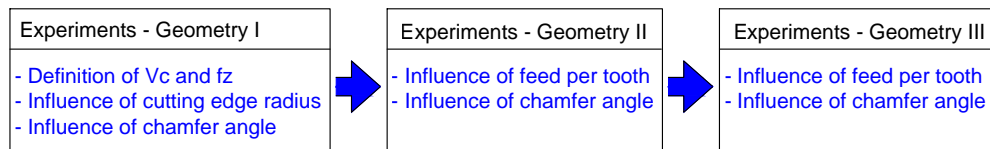

Figure 7.11. PCD insert manufacturing for research in high feed milling

The planning of the experiments evolved over time during the research and three geometries of the cutting edge profile are designed for manufacturing (Figure 7.12), details can be found in the article [Araujo et al., 2020a]^P. In the first experiments, **Geometry I** is designed to produce a straight cutting edge ($\kappa_r = 15^\circ$) with a small flat secondary cutting edge ($\kappa'_r = 0^\circ$) to produce a smooth surface. The first batch of experiments, using geometry I, tested the effect of cutting speed (100-200 m/min), feed per tooth (0.1-0.8 mm/th), the cutting edge radius r_β (4° - 15°) and the rake chamfer angle (0- 20°) on the forces. Cutting power and tool wear was studied. This first geometry presented an upper limit to feed per tooth: when the length of the secondary cutting edge is smaller than the feed per tooth it produces a grooved surface.



(a) Experiments with different Geometries

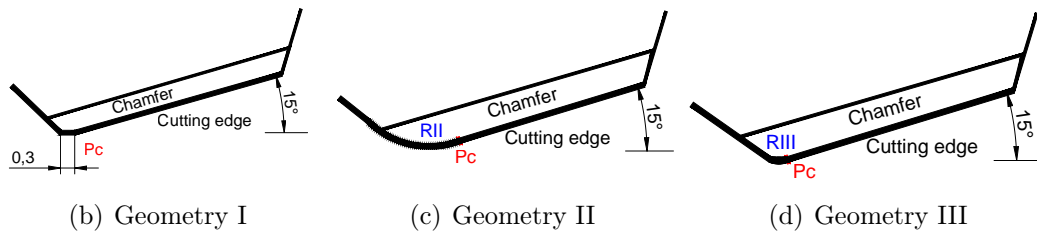

Figure 7.12. Tool Profile Geometries

Table 7.4. Parameters for tool optimization on High feed milling with PCD (slot milling with $\kappa_r = 15^\circ$)

Geometry Cutting edge profile	a_p (mm)	f_z (mm)	V_c (m/min)	γ_n (deg)	r_β (μm)
I	0.50	0.1-0.8	100-200	-5° -15° -25°	5 10 15
II	0.50	0.4-0.8	150	-10° -15° -20°	5
III	0.50 0.75 1.00	0.4	150	-15° -20°	5

Geometry II was designed adding a nose radius r_ϵ to the geometry ($R_{II} \approx 10$ mm) to reduce some crater problems and also to explore a bigger range for rake chamfer angle from 0 - 20° . Using these inserts, the cutting speed was fixed to 150 m/min, varying feed per tooth. Geometry III design has a reduced tool radius ($R_{III} \approx 1$ mm) and only two rake chamfer angles were tested (15° and 20°) as per geometry II results. The third batch of experiments used fixed cutting speed, fixed feed per tooth and three values for depth of cut (Table 7.4 presents the DOE used in this research).

The insert geometry and the chip load area affected drastically tool life, without a regular behavior along the cutting edge. A sharp nose radius (Geometry I) produced a rough surface in workpiece and presented relevant nose wear compared to the small nose radius (Geometry III). The lower PCD cutting edge radius ($5\mu m$) present the lower power and produced the lower specific cutting force comparing to larger radius in the same conditions.

The increasing of the cutting force, and consequently the amplitude for its dynamics, limited drastically the tool life, despite maintaining the specific cutting force constant. Micro-cracks on the rake surface appeared in the cases the cutting force over passed the value of approximately 400 N in average cutting force and 1000 N in maximum cutting force. Raman analysis on wear location did not present typical sp^3 diamond band, indicating the loss of this crystallographic structure and consequently its wear resistance.

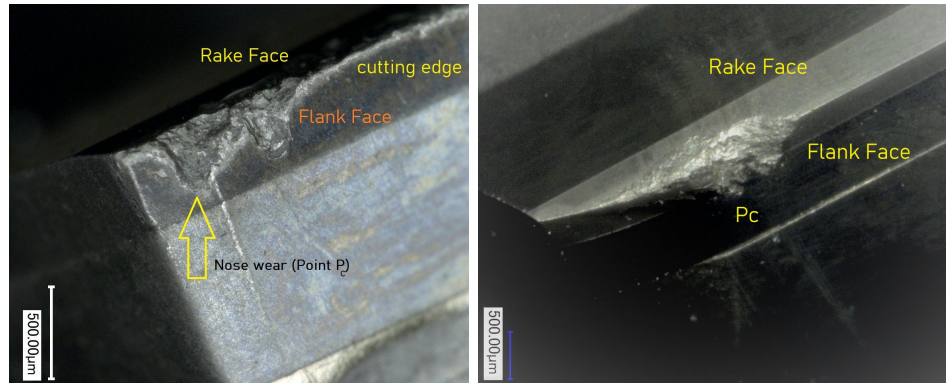

(a) Nose wear using geometry I tools (b) Severe wear located at Pc using Geometry II

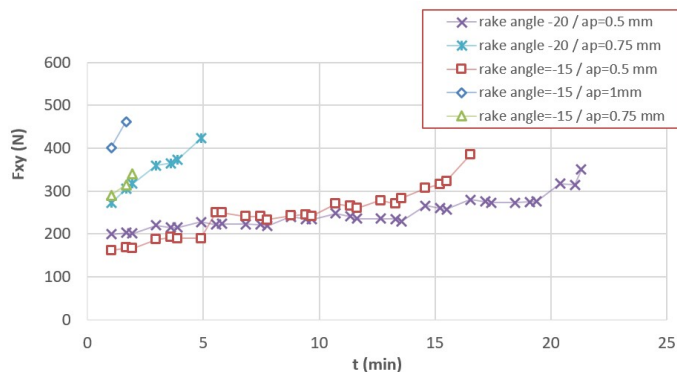

(c) Average force F_{xy} evolution using Geometry III

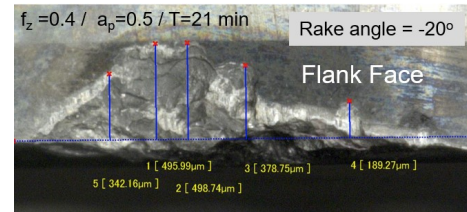

(d) Geometry III, $a_p = 0.5mm$, $t = 21mm$, $\gamma_n = -20^\circ$

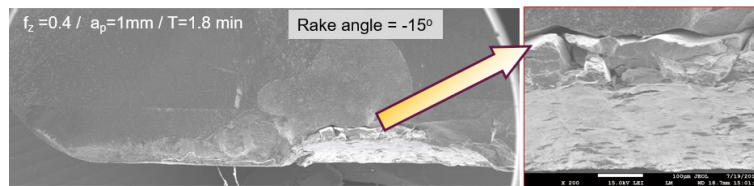

(e) Geometry III, $a_p = 1mm$, $t = 1mm$, $\gamma_n = -15^\circ$

Figure 7.13. Study on the PCD tool geometry for high feed milling

7.4.2 Mechanistic coefficients and produced residual stress in milling

Some effort was done to understand the relation between forces, specific force and residual stresses while milling refractory metals. Some conference papers and journals were developed in collaboration with Universidade Federal Fluminense (UFF) through Prof. Maria Cinda Fonseca, including one thesis. The first work was developed in super duplex machining [Fonseca et al., 2008]^P, after also Inconel [Oliveira et al., 2015]^P and maraging steel [Nascimento et al., 2016]^P were studied. The first two are presented in this report.

Inconel 718

Inconel 718 is a heat-resistant nickel super alloy with excellent mechanical strength at elevated temperatures and high corrosion resistance. Inconel 718 presents good ductility at cryogenic temperatures, and for this reason it is well machined with liquid nitrogen to reduce the high temperatures in the cutting zone caused by the low-conductivity of this material. The research developed by one doctoral degree student includes the experimental analysis of the Inconel 718 end milling on the residual stresses generation, cutting forces, tool wear and surface integrity of the machined workpiece using three types of cutting methods: flood, minimum quantity of minimum quantity of lubricant (MQL) and cryogenic cutting using liquid nitrogen (LN₂).

The surface was flattened and re-machined after all residual stress and surface measurements, when it was needed. The experiments were conducted producing channels in full machining and analyzing the tool wear each 10 mm without removing the tool holder from the machine tool. A carbide insert was used with 1 mm depth of cut in all experiments. The cutting speed and feed per tooth was defined according to previous study as 20 m/min and 0.04 mm/th, respectively.

The analysis of force components is related to transversal and longitudinal residual stresses in all conditions.

Surface residual stresses were analyzed by the X-ray diffraction technique, using the $\sin^2\psi$ method. The measurement used the following set-up: Ni as diffracted material, diffracting plane=(311), $Cr\kappa\beta$ radiation, wavelength of 2.0848 Å, Bragg angle of 157.73° and inclination angle $\psi = 0, 18, 27, 33$ and 45 degrees.

The resulting force levels were similar in both methods flood and MQL using water based cutting fluid, nevertheless using liquid nitrogen about 15% higher increasing in the last experiments. The longitudinal residual stresses generated at the beginning of channels are compressive in all cases and after tool wear, it became tensile except in flood. So, it can be claimed that the tool wear led to higher forces along the cutting length with tensile residual stresses. The correlation between longitudinal residual stresses and machining forces indicated that tensile stress are promoted by the increasing of machining forces. The cryogenic method presented low residual stresses levels and improved workpiece surface roughness compared to flood method, al-

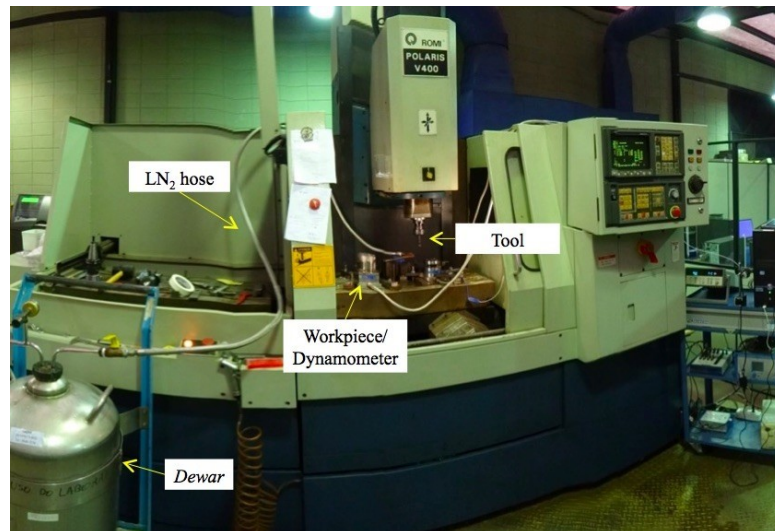

(a) Experiments set-up

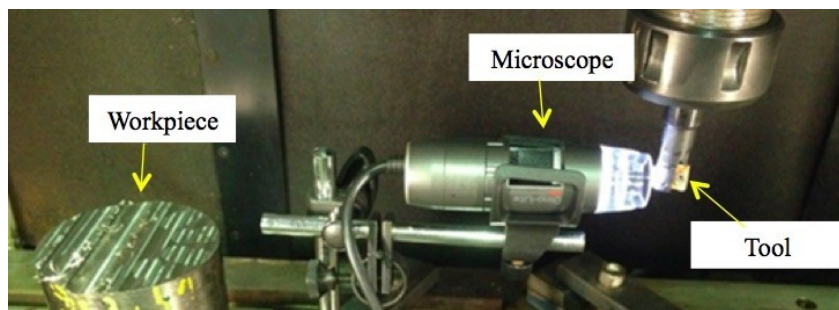

(b) Tool wear images



(c) Residual stress and roughness measurements

Figure 7.14. *Inconel 718 study*

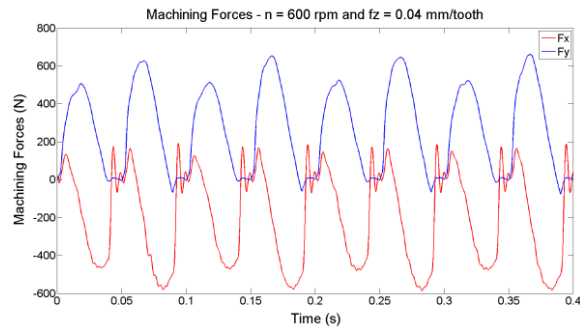

(a) Example of force acquisition

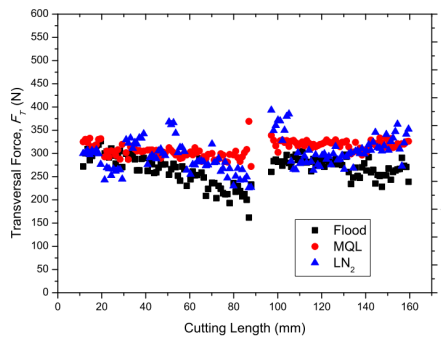

(b) Transversal force and k_c

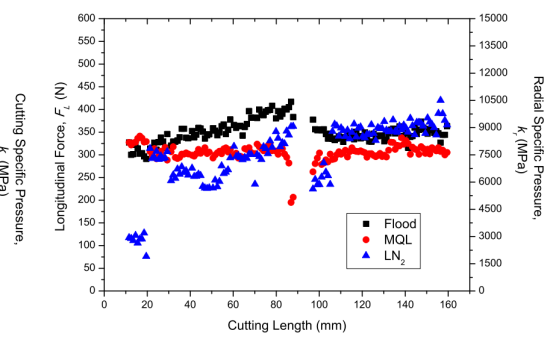

(c) Longitudinal force and k_r

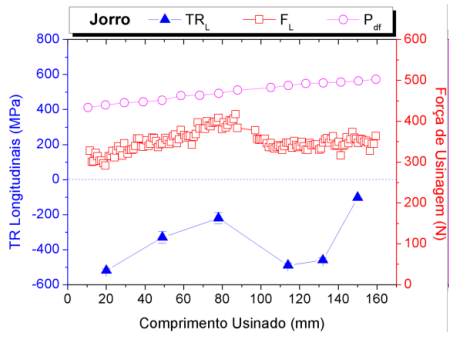

(d) Flood results

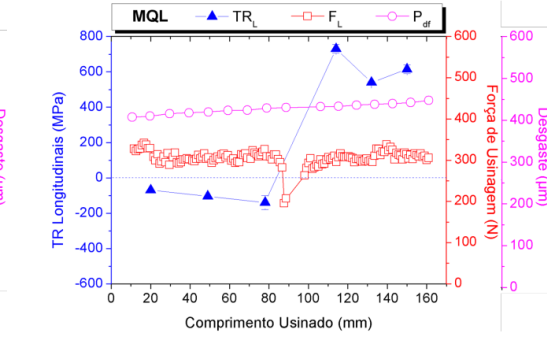

(e) MQL results

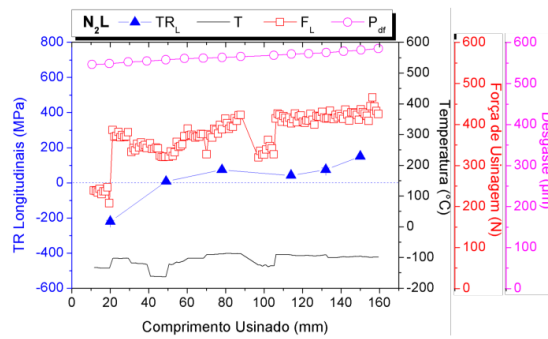

(f) LN2 results

Figure 7.15. Inconel 718 study

though the flood method contributed for compressive residual stresses, which may be beneficial to the service life of the machined component.

Maraging steel

The maraging 300 steel has good ductility with high mechanical strength after aging and it is used in components subject to high stress as in the aeronautical industry, which requires components with a high quality of surface finish and excellent fatigue resistance. The selection of cutting parameters for maraging has a direct impact on the generation of residual stresses and on the surface quality of the mechanical component produced by machining. The article produced in collaboration with UFF [Nascimento et al., 2016]^P studied the influence of cutting parameters on the generation of residual stresses, machining forces and surface quality by end milling of class 300 maraging steel using two levels for depth of cut (0.5 and 1 mm) and three for the cutting speed (25, 35 and 45 m/min). The feed per tooth was 0,03 mm/th using flood for machining and a carbide insert coated with TiN.

Force measurement used the Kister 9257-AB dynamometer (example in Figure 7.16(a)) and residual stresses were analyzed by the X-ray diffraction technique also using $\sin 2\psi$ method, with $Cr\kappa\beta$ radiation, wavelength of 2.29092 Å to diffract the ferrite plane (211) under the Bragg angle of 155.41° .

Longitudinal residual stresses (Figure 7.16(b)) were the most relevant because they are in the forward direction of the milling, and presented more homogeneous results. The surface residual stresses generated were compressive and of high magnitude, that is, the machining is beneficial for this component made of Maraging steel, especially with finishing cut depth. In the transversal direction, the values are homogeneous, as it is shown in 7.16(c).

In my opinion, even though there were some results, I did not want to continue to explore the relation between residual stresses and machining forces with the technical procedure that it was available. The collaboration was very pleasant and fruitful but there was not fine correlation to be done and I wanted more monitoring during machining.

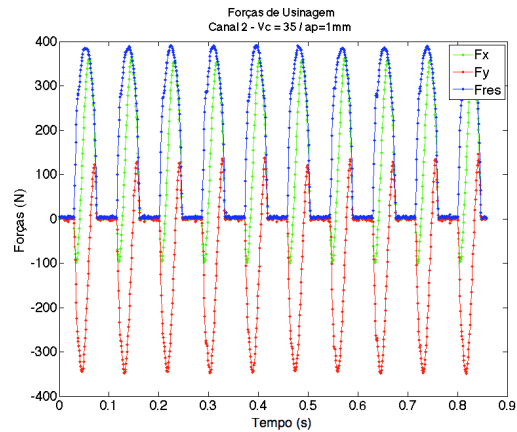

(a) Force components over 10 revolutions ($a_p = 1\text{mm}$ and $V_c = 35\text{ m/min}$)

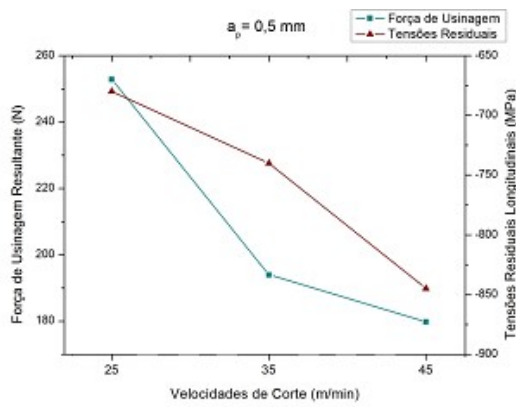

(b) Results with $a_p = 0.5\text{mm}$

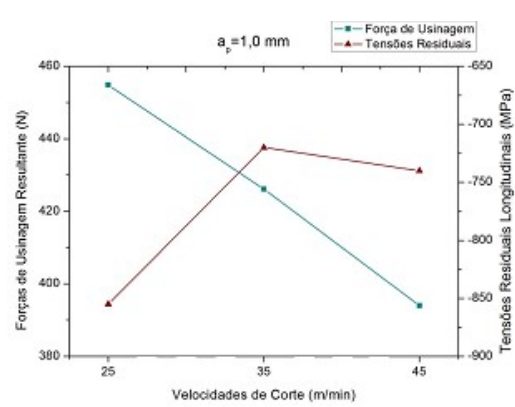

(c) Results with $a_p = 1\text{mm}$

Figure 7.16. Correlation between forces components and residual stress in longitudinal y direction while milling maraging steel (Nascimento et al., 2016)^P

7.5 Modeling milling forces with tool deflection

The presence of vibrations along manufacturing processes has a huge impact on the quality of surface finish and dimensional precision. Additionally, mechanical vibrations also generate tool failures what represent approximately 20% of equipment downtime according to the review article by Kurada and Bradley Kurada and Bradley, 1997.

The dynamics of the system composed by the end milling tool, tool-holder, machine-tool and the workpiece can present complex nonlinear behavior associated to extreme conditions such as chatter, for example. These extreme operational conditions can severely affect the quality of the machined workpiece and therefore the Engineering team should determine the working parameters/conditions to avoid such conditions. In this context, modeling based strategies can be very effective in determining optimal operational parameters. Some articles in my research group were developed measuring tool displacement and also predicting tool vibrations, for example: [Mirres et al., 2014]^P, [Silva et al., 2014]^P, [Vizquerra-Rojo et al., 2014]^P and [Cabrera et al., 2017]^P.

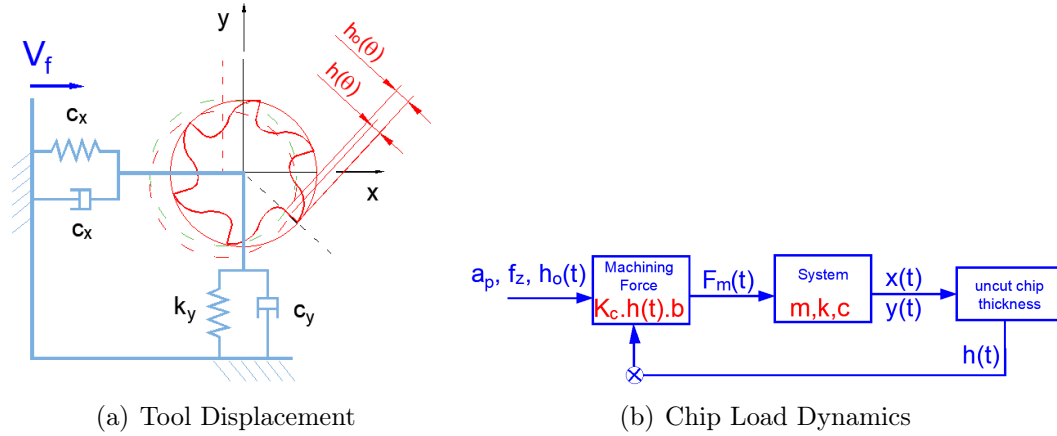

Figure 7.17. Machining force and tool dynamics

The tool tip displacement relatively to the holder ($x(t)$ and $y(t)$), as shown in Figure 7.17(a), is a consequence of the forces applied on the tool-workpiece system in order to produce chips. This movement also changes the uncut chip thickness from the predicted $h(\theta(t))$ to $h_o(x(t), y(t), \theta_j(t))$ that changes the machining force \vec{F}_m when the cutting edge is still in contact to the workpiece. In milling, the passage of the $(j-1)$ cutting edge over-cutting or undercutting (δh_{j-1}) also interfere the uncut chip thickness.

$$h(\theta_j) = (h_o(\theta_j) - \delta h_{j-1} + \Delta_x \sin\theta_j + \Delta_y \cos\theta_j) \cdot g(\theta_j(t)) \quad (7.9)$$

The force components $F_x(t)$ and $F_y(t)$ excite the system and, as a consequence, the dynamic system depends on $x(t)$, $y(t)$, $\dot{y}(t)$ and $\ddot{y}(t)$ as well as the mass, stiffness and damping coefficients m_x , m_y , k_x , k_y , c_x and c_y Altintas, 2000; Budak and Altintas, 1998:

$$m_x \ddot{x}(t) + c_x \dot{x}(t) + k_x x(t) = F_x(t, h_o(t)) \quad (7.10)$$

$$m_y \ddot{y}(t) + c_y \dot{y}(t) + k_y y(t) = F_y(t, h_o(t)) \quad (7.11)$$

This regenerating dynamic system is represented in Figure 7.17(b), called a self-powered system that produces the chatter.

7.5.1 Measuring tool tip displacement

Some experiments were done in milling in order to measure the tool tip deflection and correlate to force measurements. Two capacitive sensors were used to measure the deflection aligned to the directions x and y and fixed to the tool holder as it can be observed in Figure 7.18(a).

Tests were developed using different depth of cut, in order to find chatter situations with fixed radial engagement. The monitoring was done in LABUS, using the equipment we acquired. Forces (Figure 7.18(b)) results and the x-y measurements taken with the capacitive sensor (Figure 7.18(c) and (d)) were measured. The surface roughness were measured and correlated with the time signals.

Some experiments presented chatter effect, characterized by the surface pattern on the workpiece, but it was not possible to identify a pattern of oscillations that characterized the chatter signal using the data obtained in this preliminary study.

Also, it was not conclusive to make a relationship between the signal of displacement and the chatter effect, although the orbits were not smooth and circular in all the chatter cases. Roughness, noise and surface appearance results were more efficient to identify the effect and that is why the following article used a different strategy for this identification.

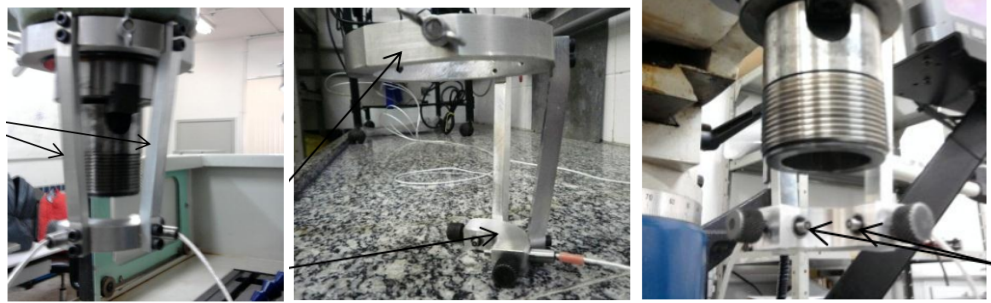

(a) Capacitive sensors holder

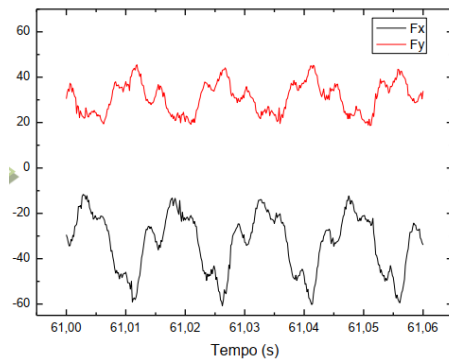

(b) Force components

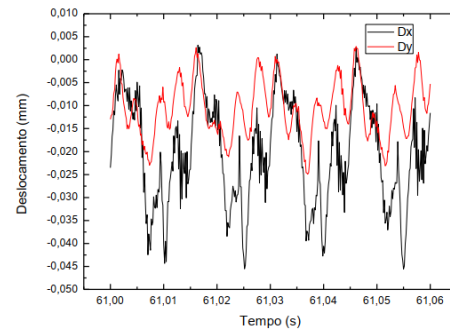

(c) Measured displacements in time

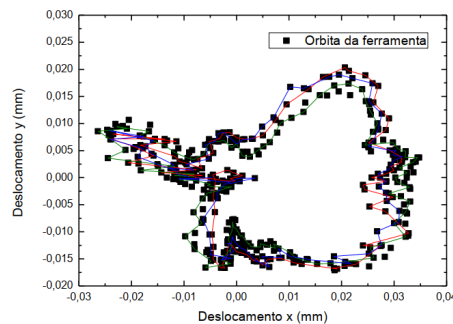

(d) Orbital results

Figure 7.18. Milling tool measurements (displacement and forces) (Mirres et al., 2014)^P

7.5.2 Experimental identification via Wavelet analysis

Aiming at mitigating the presence of mechanical vibrations along manufacturing processes, several studies have been conducted in order to both characterize and model the dynamic behavior of manufacturing tools. As for structural health monitoring strategies applied for the analysis of the tool, several contributions may be found in the literature. In the review article by [Kunpeng et al., 2009], the health monitoring of the tool is considered/classified in five categories: time-frequency analysis of machining data, signal denoising, feature extraction, singularity analysis and Wavelet analysis. Also [Cao et al., 2013] presented an approach to

detect chatter in end milling using wavelet analysis.

So, the master thesis developed by Giovanni Cabrera [Cabrera et al., 2017]^p proposed a strategy to be used for real-time analysis to detect chatter based on wavelet decomposition during milling operations.

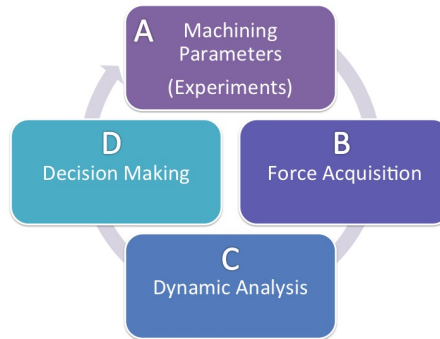

Figure 7.19. Approach for chatter identification (Cabrera et al., 2017)^p

The approach relies on four main steps as shown in Figure (7.19):

- The first step (**A**) consists in determining the cutting parameters judged as appropriate for the end milling as the spindle speed n_f and depth of cut a_p (*a priori* knowledge).
- The second step (**B**) consists in acquiring the forces F_x , F_y and F_z generated by the End Milling Process and computing the magnitude of the resultant force F_m in real time.
- The third step (**C**) corresponds to the analysis of the resultant force $F_m(t)$ using the Discrete Wavelet Transform and the application of a wavelet-based denoising scheme in order to mitigate data pollution that is not associated to the true physical forces.
- The fourth step (**D**) corresponds to the Decision Making: keep parameters or change it.

Step C requires some *a priori* knowledge of the most appropriate characteristics of the Wavelet Transform (WT) based on preliminary experiments in order to get the basic/common features of the cutting force, to use the same characteristics of the WT when considering the End Milling Process of a new set of pieces that are similar to the ones used in the preliminary analysis.

The transformation decomposes the force into an approximation/trend sub-signal and detail sub-signals and recompose it using modified sub-signals in order minimize measurement noise in such a way that the reference peak forces are strengthened. The subsignal modifications are performed by means of the application of a Wavelet based denoising procedure using a hard-thresholding method.

The continuous wavelet transform of the function $s(t)$, denoted here as $\mathbb{W}\{s(t)\} = \tilde{s}(a, b)$, is formally defined as shown in Equation (7.12)

$$\mathbb{W}\{s(t)\} = \tilde{s}(a, b) = \frac{1}{\sqrt{a}} \int_{-\infty}^{+\infty} s(t) \psi^* \left(\frac{t-b}{a} \right) dt \quad (7.12)$$

in which $\psi(t)$ corresponds to the mother wavelet, a corresponds to the dilation parameter and b corresponds to the location parameter. Concerning the profile of the wavelets $\psi(t)$, the Engineer team may choose the Haar, Gaussian wave, Mexican hat, Morlet, Daubechies (Db1, Db2,...) among others Addison, 2002.

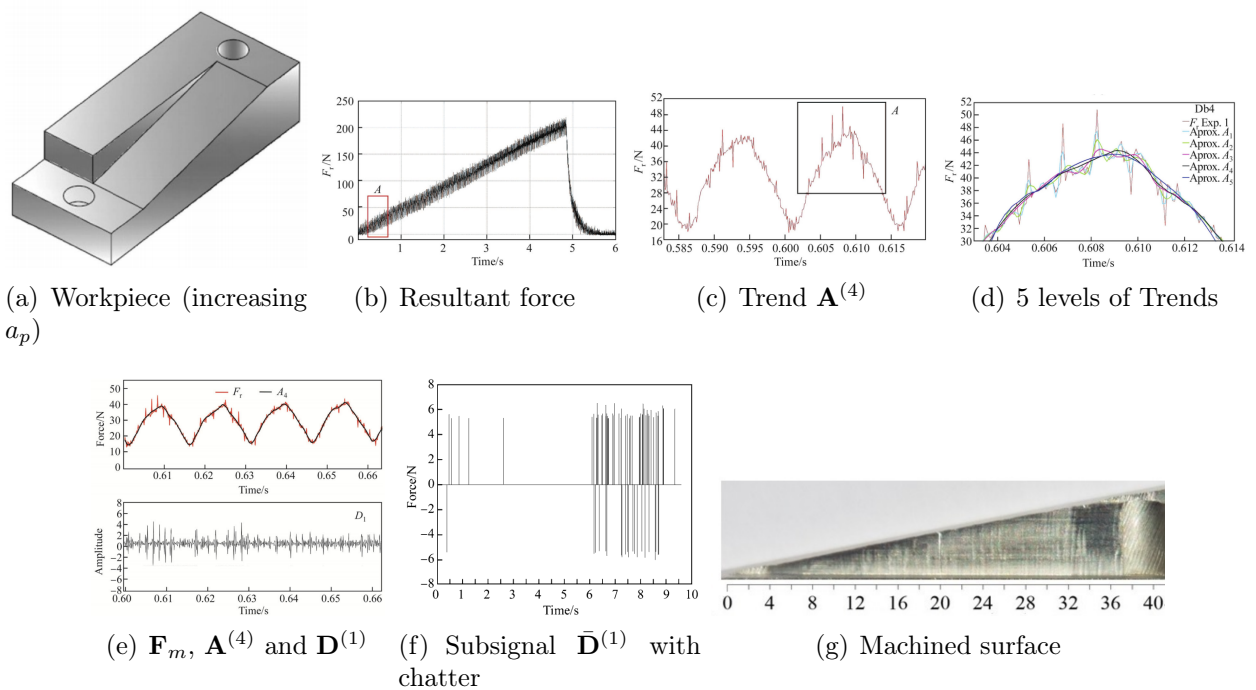

Figure 7.20. Wavelet analysis of the resultant force of using the wavelet Db4 (Cabrera et al., 2017)^P

A specific experimental set-up was properly designed in order to increase the depth of cut along the cutting trajectory and promote the chatter to begin. The general view of the workpiece in shown on the right side of Figure 7.20(a) in which one may observe the ramp that allows for the variable depth of cut. The correlation among the roughness of the machined surfaces, the wavelet analysis of the force signals and the quality of the machined surfaces is performed for four experimental configurations, proving that the proposed procedure recognize the chatter occurrence.

An aluminum SAE 7475-T7 workpiece is used as industry claims that chatter can occur in this application. This material has high mechanical strength and it is widely used in aerospace

industry. It was specifically designed for this research aiming at providing means to have variable depth of cut. The end milling tool (not coated HSS) has a 30° helix angle, a cutting diameter $D_1 = 6$ mm, 4 flutes, a maximum cutting height (L_2) of 13 mm.

The approach proved to be effective for the four different experimental configurations analyzed. It was chosen the wavelet Db4 as presents in Figure 7.20(c), the 4-level approximation/trend subsignal $\mathbf{A}^{(4)}$, and in Figure 7.20(d), showing all 5 trends. The estimates for $\hat{\mathbf{F}}_r^{ref}$ are obtained with $\mathbf{A}^{(4)} \oplus \bar{\mathbf{D}}^{(1)}$ (Figure 7.20(f)) using choice λ_{ah} for the threshold. This choice was made after performing analyses based on the Min-Max threshold during the thesis.

The measurement of the surface profiles allows for performing their correlation with the force signals measured along the end milling process. An important aspect is that the surface measurement was done in cutting length domain (Figure 7.20(g)) and transformed to the time domain for the comparison takes place. It was possible to confirm the signal identification with the chatter marks.

A real-time chatter identification approach as the one proposed here may be viewed as a powerful complement to the model based analysis. It can continuously provide updated information about the status of the system what leads to an increase in the reliability of the system operations. As a contribution, we cite the reinforcement that the peak force density is a compelling and useful feature to be used for chatter identification and also its validation by means of the observation of high levels of correlation between the force peak density and the roughness surface profiles.

7.5.3 Predicting chatter regions

Two undergraduate students worked in Matlab programming using Altintas algorithm [Altintas, 2000] for the prediction of cutting parameters conditions in which chatter will occurs. The first one developed a CAD model for knowing the tool-holder stiffness and produced the lobus diagram, publishing his work in COBEM conference in 2011 [Castilho et al., 2011]^P. And the second one did some case studies (analysing each parameter separately: number of flutes, material, radial depth of cut, ecc), published in COBEM 2013 [Menezes and Araujo, 2013]^P, and also applied a stochastic analysis on lobus diagram in his first year of master in 2014 publishing in CONEM conference [Silva et al., 2014]^P. The computational results presented the importance of considering a stochastic model due to a relevant change on the stable depth of cut. For representation of the new stable zone, a new diagram of lobes with 95% confidence interval was constructed and thus it is checked greater applicability and reliability in its use for the prevention of chatter (Figure 7.21a).

Victor Rojo, the doctoral degree student that worked only one year in COPPE/UFRJ, had a thesis project on non-linear model for end milling. The project was developed in collaboration

with Prof. Marcelo Savi, that is researcher in Chaos and non-linearity. His objective was to apply non-Smooth Models considering contact/non-contact tool-workpiece and dry friction to the regenerative milling problem [Vizquerra-Rojo et al., 2014]^P. The semi-discretization method is a numerical technique of linearized time-delay system based on Floquet theory applied to the governing equation, is used to generate the stability lobes diagram for orthogonal turning process (maximum stable axial depths of cut versus spindle speed). He was developing a the first-order SDM to derive stability regions for orthogonal turning operations and adapting to milling process. He considered the dynamic characteristics on a specific cutting system for different depths of cut and analyzed a steady-state condition in time-domain. His results, the 3D lobus diagrams as the ones presented in Figure 7.21b, were consistent with stability charts confirming the application of the method. Unfortunately, he did not proceed his thesis due to personal reasons.

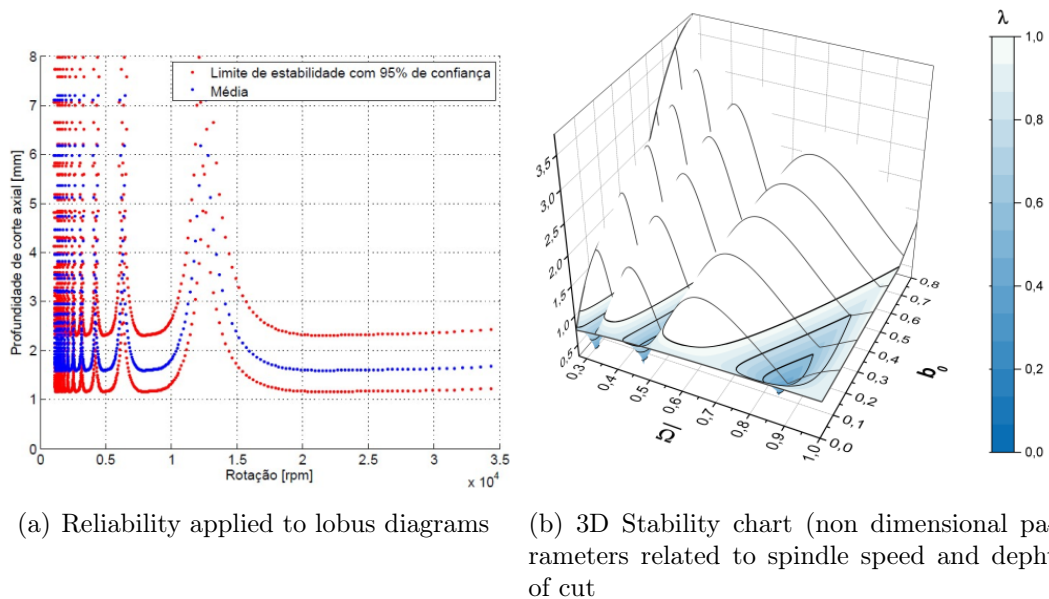

Figure 7.21. Lobus diagrams prediction on milling process

Force milling models applied to helical trajectories

In this chapter, the two helical milling processes are presented: thread milling and orbital drilling (Figure 8.1). In both cases, the machining process uses a milling tool with specific geometry needed to cut perpendicular to its rotation axis having a lower feed in vertical direction to produce the desired envelop geometry.

Originally, my doctoral thesis was expected to be focused on end milling modeling but, after I joined the UIUC laboratory, Prof. Kapoor suggested to develop the first force model for thread milling process: adapting the end milling knowledge to a more complex process in helical trajectory. I felt motivated about the challenge and as a result of the thesis I published the model [Araujo et al., 2006]^P. After finishing my thesis, in this same research line, I was able to collaborate with some colleagues: Martin Jun, from Canada [Jun and Araujo, 2010]^P, and Guillaume Fromentin after 2011 [Araujo et al., 2013a]^P, and also to advice some student's projects.

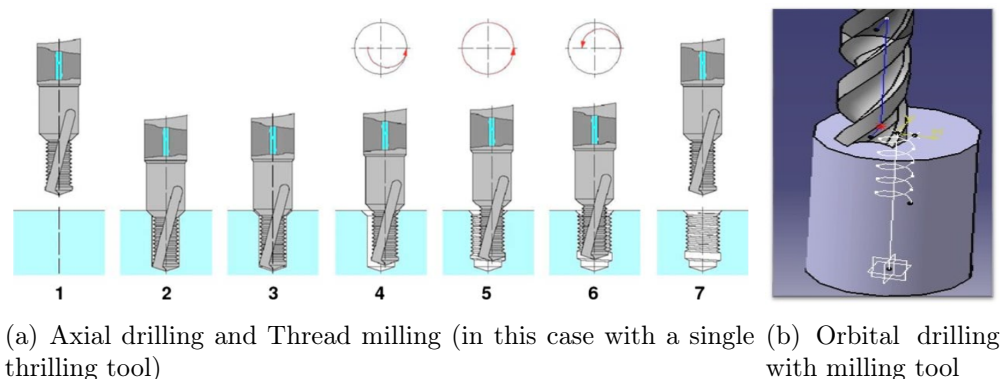

Figure 8.1. *Helical milling processes*

In September 2021, during an updated research in Web of Science, G. Fromentin and myself are still the authors who have more articles about thread milling (14 of the 53 articles, 25% of

the scientific papers). Figure 8.2 shows the number of articles per author and research group the author join, for research groups having more than 1 paper about thread milling.

Authors	Number of articles	% of thread machining	Research group	% of thread machining	Thematic
Fromentin G	10	19%	(1) Fromentin G	19%	Thread milling interference/force
Poulachon G	7	19%			
Brendlen R	2	19%			
Paire Y	2	19%			
Sharma VS	2	19%			
Araujo AC	8	15%	(2) Araujo AC	15%	Thread milling force model
Jun MBG	3	5%			
Cardoso FG	1	2%			
Devor R	1	2%			
Kapoor SG	1	2%			
Silveira JL	1	2%			
Malkov OV	3	6%	(3) Malkov OV	6%	Manufacturing thread tool (2020)
Aoyama E	2	4%	(4) Aoyama E	4%	Smart thread machining (2020)
Hirogaki T	2	4%			
Matsui S	2	4%			
Ozaki N	2	4%			
Yamamoto T	2	4%			
Dong LL	2	4%	(5) Dong LL	4%	Small diameter thread (2020)
Li K	2	4%			
Li T	2	4%			
Wang J	2	4%			
Zhang SW	2	4%			
Hu ZH	2	4%			
Qin CJ	2	4%			
Tang YR	2	4%			
Zhang XD	2	4%			
Lee SW	2	4%	(7) Lee SW	4%	Thread milling forces (2013)
Nestler A	2	4%			
Altintas Y	1	2%	Altintas Y	2%	
Axinte D	1	2%	Axinte D	2%	
Others	1	2%	Others	2%	
			Total articles	53	

Figure 8.2. Authors publications in “thread milling” - Web of Science results in September 2021

Out of our groups, there are 5 relevant research groups with 2, or more, papers. O. V. Malkov (from Bauman Moscow State Technical University) has 3 papers working on the manufacturing of the thready tool [Malkov and Pavlyuchenkov, 2020]. Dong *et al* analyses internal thread milling for small holes [Dong *et al.*, 2021] (similar approach compared to [Araujo and Fromentin, 2018]^p). Hu *et al* work on tool interference on thread milling [Fan *et al.*, 2020] (similar approach as in [Fromentin and Poulachon, 2010c]).

E Aoyama is publishing in servo control and smart manufacturing applied to thread milling [Matsui *et al.*, 2020], near to what is proposed for the doctoral degree student working in orbital drilling in Institut Clement Ader. I contacted this last authors for developing collaboration and we are beginning to have some exchange.

This chapter presents the analysis of the trajectories, the cutting edge geometry, the workpiece-tool geometry and the variable uncut chip thickness calculation. The scientific challenges are described below.

Scientific challenges in helical milling processes:

- Complexity in helical trajectory : the cutting geometry analysis over time is an adaptation from linear description to helical one, which is not trivial;
- Direction of forces, considering fixed referential, and as a consequence tool deflection changes along the trajectory and in time domain analysis, the experimental analysis is particularly interesting;
- Over cutting and under cutting as a consequence of tool deflection should be predicted to avoid scraping the workpiece;
- Cutting tool interference depends on cutting parameters and tool cutting angles and its prediction depends on complex analysis of the tool-workpiece geometries;
- Tool geometry optimization and smart machining depends not only on the cutting velocities but also on thread diameter (and radial depth of cut), so the experimental calibration and validation is difficult.

8.1 Helical tool trajectory and reference frames

The helical trajectory is common between thread milling and orbital drilling. In thread milling, the tool travels inside a drilled hole describing a helical trajectory to manufacture the thread profile with a nominal diameter D and a pitch P . The radial engagement of the tool depends on thread profile and the tool geometry. Usually, there is already a pre-drilled hole (D_1 drilled diameter) that allows the positioning of the tool inside the material before cutting (Stage 3 in Figure 8.1a).

In orbital drilling, presented in Figure 8.1b, the milling tool with diameter D_t also performs a helical trajectory with a vertical pitch P . The combination of tool dimension and trajectory diameter, produces the final machined dimension (D). In this case, as the tool has not a pitch profile along the cutting edge, all parameters can be optimized to low machinability workpieces characteristics.

Remembering that feed per tooth f_z is defined on the trajectory direction, depending on the feed velocity V_f and the number of flutes Z ($f_z = V_f.Z.N$), in helical milling processes, the feed per tooth can be decomposed in two components: feed on the xy plane f_{xy} (calculated by

Martellotti equation 7.3 in linear milling) and an **axial** feed per tooth f_a ¹:

$$\vec{f}_z = \vec{f}_{xy} + f_a \vec{z} \longrightarrow f_z = \sqrt{f_{xy}^2 + f_a^2} \quad (8.1)$$

This vertical feed generates an additional vertical force to the tool, specially important on the secondary cutting edge of orbital milling because there is no pre-drilled hole. The vertical feed is defined based on the pitch of the helical trajectory and its radius R_{tt} . It can be noticed that orbital drilling has more freedom to choose the vertical feed, as there is no connection to the thread geometry (thread pitch).

Three referential frames are important to describe tool and cutting edge position along the machining process: R_0 , the fixed referential located in the center of the machined hole oriented by the machine axis XYZ and two moving referential frames R_1 and R_2 , as shown in Figure 8.3.

The tool trajectory is described by the machine coordinates $(x(t), y(t), z(t))$ in the machine-tool reference frame R_0 . The CNC machine will control the trajectory along those axis and it is possible to have this data from the machine in real time or record it for correlation with other data.

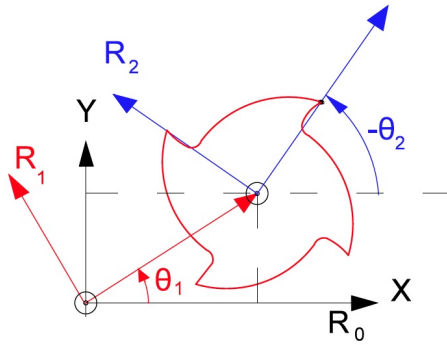

Figure 8.3. Referential Frames R_0 , R_1 and R_2

Along the helical path, the machine coordinates can be replaced by the angle tool $\theta_1(t)$, called tool axis position angle when the trajectory has a constant radius R_{tt} . Using the machine-tool coordinates, $\theta_1(t)$ is calculated by:

$$\theta_1(t) = \arctan \frac{y(t)}{x(t)} \quad (8.2)$$

This angle is important when analysing tool deflection and it defines the perpendicular

¹Note f_z is the feed per tooth along the trajectory, different from feed in the direction z.

direction between tool axis and workpiece. The referential frame R_1 is aligned to the angle $\theta_1(t)$ and it is identified as tangential and radial to the surface direction.

In orbital drilling, the trajectory can be designed in positive direction of $\theta_1(t)$ (down milling if tool cutting edge cuts in clockwise direction) or in negative direction of $\theta_1(t)$ (up milling). In thread milling, $\theta_1(t)$ depends on the thread geometry: right-hand or left-hand thread if the tool moves up or down (positive or negative vertical feed). These geometrical characteristics affect: dynamics of the tool, residual stresses and quality of the produced hole or thread.

The third referential frame R_2 rotates with the tool revolution. It is fixed in one cutting edge tip as in milling processes with linear trajectory. The angle that locates this referential frame is $\theta_2(t)$, the tool revolution angle driven by the spindle speed N :

$$\dot{\theta}_2 = 2\pi N/60 \quad (8.3)$$

In the case of the tool described in Figure 8.3, the tool rotates clockwise, so the tool rotates in the opposite sense of θ_1 , in the case of down milling. In this case, we describe θ_2 positive, but for rotation matrix we should correct the proper position for calculation.

These referential frames are important for the dynamic analysis of the forces on thread milling and orbital drilling.

8.2 Threads milling process

For accuracy on thread geometry the main important processes in industrial scale are: forming and machining. Processes as grinding and electric discharge machining have low material removal rate and are non-productive. Threads produced by plastic deformation are normally stronger, thread forming processes cannot achieve the high accuracy and precision required in many applications. Forming adds higher residual stresses to the workpiece compared to cutting and so brittle materials cannot be produced by plastic working.

Thread milling is thought one of thread cutting manufacturing that produces internal and external thread, which the cutting speed and feed per tooth are independent, and not dependent on thread pitch. This advantage comparing to cut tapping, turning and whirling, allows the use on low machinability materials. While tapping requires the diameter of the tool to be the same as the hole to be threaded, a thread mill can produce internal threads in holes with diameters bigger than the tool.

Another advantage of thread milling is to produce internal and external threads with same process, and in some cases with the same tool. Also, there are more geometry possibilities with thread milling, for example with the same pitch, the tool can produce a range of different diameters.

Machining threads by whirling and turning have the advantage that the tool is in continuous contact with the workpiece. In whirling the inserts are synchronized with the rotation of tool and workpiece displacement to achieve the thread pitch in one revolution. That is the actual process to produce thread in Titanium implants because of the higher production of workpieces with fastest setup, for example Titanium threads for implantable medical screws having the productivity limited by tool wear and low cutting speed limit [Soshi et al., 2018].

The complexities of the thread milling modelling that are presented in this text and thought the published papers are:

- Discretization of the cutting edge with variable diameter
- Discontinuity of rake angles along the cutting edge
- Radial engagement is variable along time (entrance, full machining and radial interference)
- Tool center reference frame difference from the workpiece reference frame (Monitoring complexity)

8.2.1 Thread and tool geometries

The thread profile defines the geometry of tool envelope on thread milling, in other words, the surface produced by the tool revolution defines the machined curve on the workpiece. Some manufacturers produces one single tool for thread geometry profile and others two thread milling tool geometries: one for internal threads and another for external threads. In practice, the difference between internal and external tools are: the maximum diameter for internal threads (detailed in the interference section). As there are a dozen of standardized threads for several different applications, there are several thread tool profiles.

The basis profile for general purpose screw threads there are defined by ISO 68-1, 68-2 and ASME B1.10M-2004² for unified miniature screw threads. For unified inch screw threads the ASME B1.1-2003 is used. Other specific geometries as Acme trapezoidal threads (smoother movement in machines-tables displacement) and buttress inch screw threads with Breech-Lock thread form are defined in ASME B1.5-1997 and ANSI/ASME B1.9-1973. The America Petroleum Institute thread standards are the most commonly used in petroleum industries for drill-stem members which need strong sealing, high torque with abrasive wear and high stresses [Araujo et al., 2015]^P. The failure of the drill pipes occurred mostly in the joint due to continuous changeable load of tension. If it does not desired to introduce additional stresses, thread milling is a good option.

²The last revision of the standards is not specified in this text.

The standard threads in orthopedic and dentistry are slightly different. Dental implants should have the thread shape developed for effective inserting and force transmission as they are inserted into the body (osteotomy site) by manual torque (linear motion through rotation). Thread shapes available for screw-retained implants are: square shape, V-shape, buttress and reverse buttress threads [Ryu et al., 2014]. For orthopedic screws, the buttress geometry is usually used [Kappel, 2021; Lee et al., 2010] with interlocking screw, a non-symmetric thread [Fromentin et al., 2015].

In this HDR report, the articles presented are focused on metric and API threads. For bio-mechanics machining, metric thread tools were used in my research applied to bio-compatible materials having the objective of developing the research. In the future, it is needed to apply to buttress thread in order to be more close to the industry reality even if the methodology does not change.

8.2.2 Thread tool modelling

The thread milling tool can be analyzed as a stack of disks where each disk has dz thickness and diameter $d(z)$ as shown in Figure 8.5a. The diameter $d(z)$ is calculated as a function of the thread pitch P , the nominal tool diameter d_e and, if metric, the thread angle η , as described in [Araujo et al., 2006]^P.

Each disk has a small part of the cutting edge with rake angle that varies along the cutting edge. In the first model developed in 2004, this variation was not taken into account, but in [Fromentin et al., 2010]^P the local rake angle was calculated in based on the curve that defines tool profile $PF(a_z)$ in the range of ($a_z \in [0, P]$), multiplying by the helix angle λ_{sf} and taking into account the orthogonal rake angle γ_{of} , tangential to the cutting velocity, as it is shown in Figure 8.4b.

The calculation of the local rake angle, presented on Figure 8.4c, shows that: on the peaks and valleys of the thread, the local and orthogonal rake angle have the same value; on the lower cutting edge (LCE, between $a_z \approx 0.1 - 0.45P$ for this thread geometry) for zero helix angle the local rake angle is negative and for 15° and 30° , it grows positive; on the upper cutting edge (UCE, between $a_z \approx 0.55 - 0.95P$) the values are all negative, with higher values for higher helix angles. A similar calculation was done for the relief angle is done and presented in 8.4d. A complete description of the mathematics is presented in [Fromentin and Poulachon, 2010a].

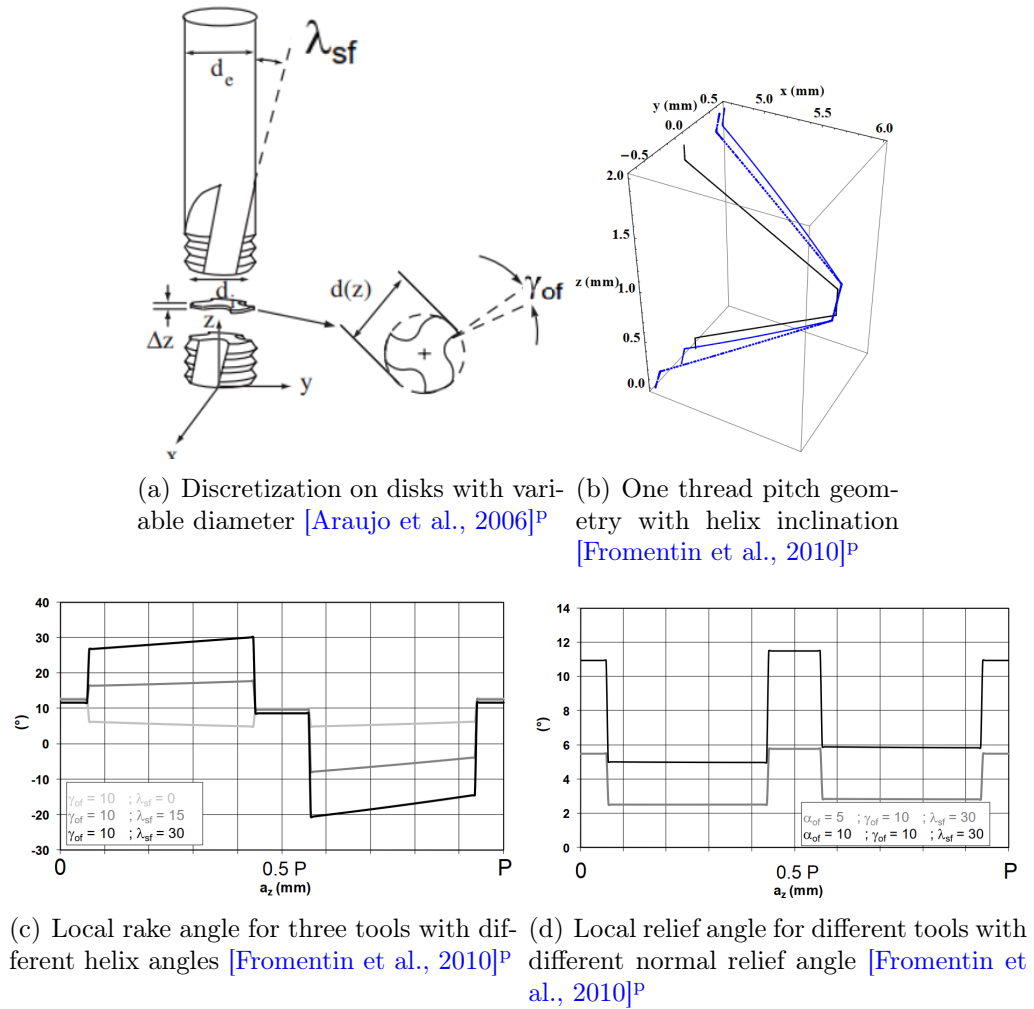
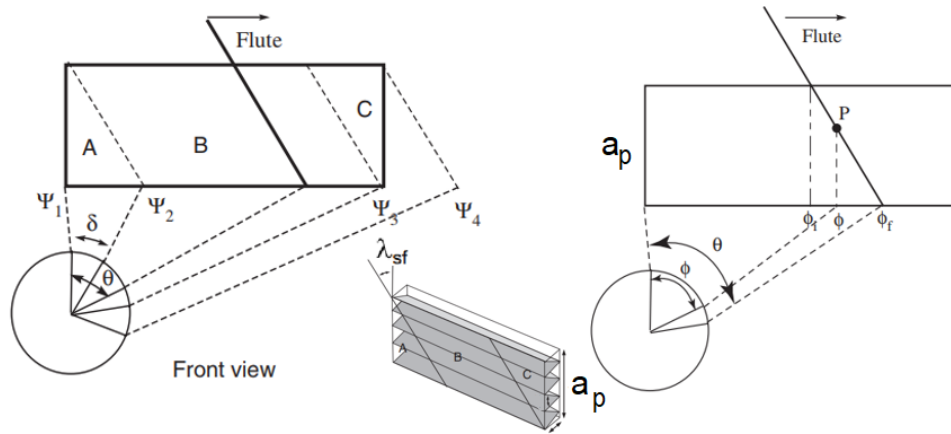

Figure 8.4. Thread tool geometry

In the same disk, Z cutting edge elements are present with an angle delay of $2\pi/Z$. This gap defines the cutting edges in contact to the workpiece. The contribution of each flute, located by the angle Θ should be calculated between the contact angle between the tool and workpiece $[\psi_1, \psi_4]$, as it is presented on Figure 8.5a. For each flute, the calculation of the uncut chip thickness and chip load area is done inside the limits ϕ_i and ϕ_f for a tool located at θ , presented in Figure 8.5b. It can be seen that the flute passes through three regions: A, B and C, the first the cutting edge length grows on each $\Delta\theta$, the second, the length is constant and in the last, it reduces.

The total uncut chip thickness along the flute is calculated by the integral of Martelotti equation (Eq. 7.3 and 7.5, $h(\phi) = f_z \sin \phi + \text{run-out}$) and the total chip load is:

$$A_c = \int_{\phi_i}^{\phi_f} \frac{h(\phi)d(z)}{2 \tan \lambda} d\phi, \quad 0 \leq z \leq a_p. \quad (8.4)$$



(a) Integration limits along the cutting edge

Values of $\phi_i(\theta)$ and $\phi_f(\theta)$ for phases A–C

Phase	Type I		Type II	
	$\phi_i(\theta)$	$\phi_f(\theta)$	$\phi_i(\theta)$	$\phi_f(\theta)$
For $\Psi_1 < \theta \leq \Psi_2$ —Phase A	θ_{en}	θ	θ_{en}	θ
For $\Psi_2 < \theta \leq \Psi_3$ —Phase B	$\theta - \delta$	θ	θ_{en}	θ_{ex}
For $\Psi_3 < \theta \leq \Psi_4$ —Phase C	$\theta - \delta$	θ_{ex}	$\theta - \delta$	θ_{ex}

(b) Values for integration limits

Figure 8.5. Thread milling tool analysis (Araujo et al., 2006)^p

8.2.3 Modelling forces in thread milling

In order to analyse the tools and the machining processes for developing new tools or improving the cutting, it is crucial to know the force behavior. Predicting the forces involved allows the realization of an adequate tooling project and the optimization of cutting parameters. As described in chapter 7, mechanistic or semi-empirical (theoretical-experimental) machining models consider that the machining force is a function of the uncut chip thickness and the analysis of the cutting edge described in the last section. The relationship of the specific force coefficient is done by calibration of the parameter thought experimental cutting forces measured.

For thread milling model, first a mechanistic force model was created from a linear thread cutting experiment just with the development purpose and simplicity of force analysis, as a linear thread does not has industrial application, as presented in Figure 8.6. In linear path, the referential frames are superposed and independent from the tool trajectory, making the analysis easier.

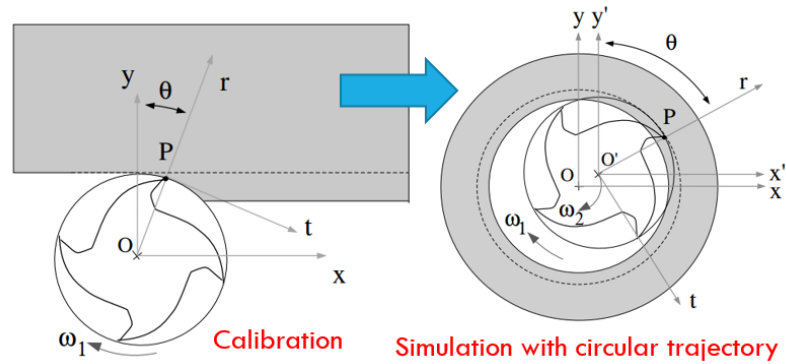

Figure 8.6. Calibrating the model in linear trajectory

In order to find the specific force coefficients using the same tool-workpiece pair of materials, a function depending on the cutting speed and feed per tooth describes the independent range of velocity parameters. In my publications, I concentrated until now on the study of thread milling process using some specific materials (described in Chapter 4) as Titanium alloy, Cr-Co alloys, and Nitinol [Araujo et al., 2015; Araujo and Fromentin, 2017]^P.

The calibration process is based on experimental data on low-high values of the basic input parameters (V_c and f_z), usual in mechanistic models for machining. The equation for calibration is described as a function of the coefficients a_i for K_t and b_i for K_r :

$$\ln(K_t) = a_0 + a_1 \ln(f_z) + a_2 \ln(V_c) \quad (8.5)$$

$$\ln(K_r) = b_0 + b_1 \ln(f_z) + b_2 \ln(V_c) \quad (8.6)$$

The feed velocity in the vertical direction is neglected, so K_z is not calibrated in this

model. After mechanistic calibration, the model is applied in a helical path analysing the tool engagement (vertical and radial) and adapting the contact angles between tool and workpiece. Adding the helical path, the reference frames described in Figure 8.3 for helical milling applies. The calibration is done in the local tool referential, based on measured forces.

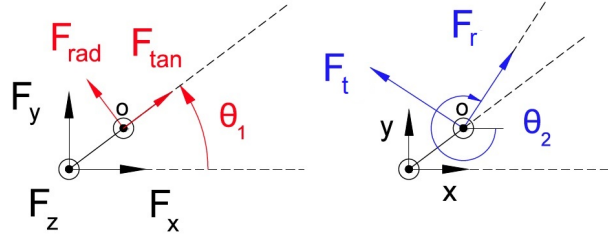

Figure 8.7. Cutting force components in different referential frames.

The prediction of forces is done in local referential R_2 and the experimental forces, if using a table dynamometer, are measured in referential frame R_0 . The resultant machining force F_m is predicted in the referential frame R_2 , fixed in one point of one cutting edge rotating with the tool (the tool rotation angle θ_2 is positive in the clockwise direction, as shown in Figure 8.7). Equation 8.9 is used to transform measured forces in R_2 F_t , F_r and F_z to the machine-tool frame R_0 (F_x , F_y and F_z) considering the tool rotation angle θ_2 :

$$\vec{F}_m = \begin{bmatrix} F_x \\ F_y \\ F_z \end{bmatrix} = \begin{bmatrix} \cos(-\theta_2) & -\sin(-\theta_2) & 0 \\ \sin(-\theta_2) & \cos(-\theta_2) & 0 \\ 0 & 0 & 1 \end{bmatrix} \begin{bmatrix} F_t \\ F_r \\ F_z \end{bmatrix}. \quad (8.7)$$

The total force \vec{F}_m is a sum in the fixed referential of the contribution of all $n = 1..Z$ flutes $\vec{F}_m^{(n)}$:

$$\vec{F}_m = \sum_1^Z \vec{F}_m^{(n)} = \begin{bmatrix} \sum_1^Z F_x^{(n)} \\ \sum_1^Z F_y^{(n)} \\ \sum_1^Z F_z^{(n)} \end{bmatrix} \quad (8.8)$$

Considering the discretization of the flutes, the predicted force for one single flute is:

$$\vec{F}_m^{(n)} = \begin{bmatrix} F_x^{(n)} \\ F_y^{(n)} \\ F_z^{(n)} \end{bmatrix} = \begin{bmatrix} \cos(-\theta_2 + \xi_n) & -\sin(-\theta_2 + \xi_n) & 0 \\ \sin(-\theta_2 + \xi_n) & \cos(-\theta_2 + \xi_n) & 0 \\ 0 & 0 & 1 \end{bmatrix} \begin{bmatrix} K_t \\ K_r \\ K_z \end{bmatrix} \int_{\phi_i}^{\phi_f} \frac{h(\phi)d(z)}{2 \tan \lambda} d\phi, \quad (8.9)$$

where $\xi_n = (n - 1)\frac{2\pi}{Z}$ locates each flute in relation to the fixed referential. Figure 8.8 shows the prediction before specific force calibration and the experimental forces in R_0 including the

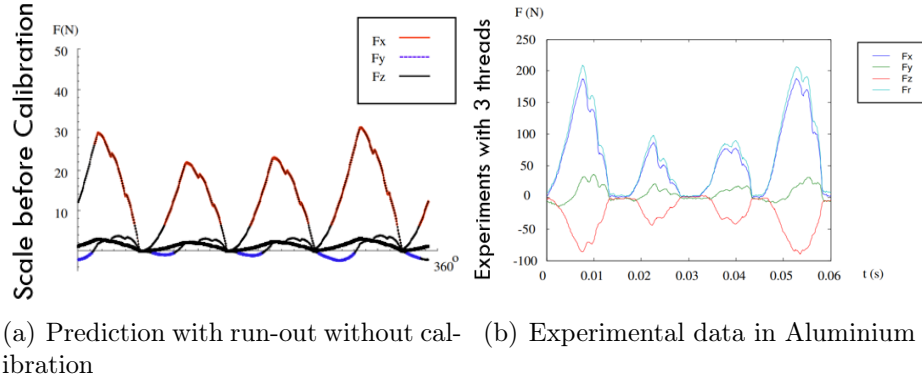

Figure 8.8. Prediction and experiments in thread milling with $\lambda_{sf} = 30^\circ$ for calibration (Araujo, 2004)^P

run-out in the calculation of the chip load area.

Equation 8.10 calculates the force components in R_1 (based on tool axis location θ_1), that allows the analysis of tool flexion and torsion. The local interaction between the tool and the machined surface are described by forces F_{rad} and F_{tan} , radial and tangent to the drilled surface, written in R_1 :

$$\vec{F}_m = \begin{bmatrix} F_{rad} \\ F_{tan} \\ F_z \end{bmatrix} = \begin{bmatrix} \cos(-\theta_1) & -\sin(-\theta_1) & 0 \\ \sin(-\theta_1) & \cos(-\theta_1) & 0 \\ 0 & 0 & 1 \end{bmatrix} \begin{bmatrix} F_x \\ F_y \\ F_z \end{bmatrix}. \quad (8.10)$$

One approximation that can be done to replace the identification of the specific force coefficient using the correlation with the predicted force described as a sum of the local edge segments by an average approach using average resultant force F_{Av} and the average resultant torque T_{Av} . In this case, the average specific forces are calculated by [Araujo et al., 2013a]^P:

$$K_F = \frac{F_{Av}}{f_t a_p} \quad (8.11)$$

$$K_T = \frac{2000\pi}{60} \frac{T_{Av}}{MRR} \quad (8.12)$$

where MRR is the material removal rate calculated using the feed velocity on the center of the material removed and the area of the material removed to form the thread A_{thr} .

It is important to detail that in helical trajectories the feed velocity V_f calculated in the tool axis is not the same as in the periphery V_f^{cg} .

$$MRR = \frac{V_f^{cg}}{60} \cdot \frac{A_{thr} \cdot a_p}{P} \quad (8.13)$$

A second approximation is to identify where the uncut chip thickness is maximum h_{max}

and use the maximum resultant force components [Fromentin and Poulachon, 2010b]:

$$K_r \approx \frac{F_r^{Fmax}}{h_{max} a_p} \quad (8.14)$$

$$K_t \approx \frac{F_t^{Fmax}}{h_{max} a_p} \quad (8.15)$$

$$h_{max} \approx 2f_{xy} \sqrt{\frac{r_{doc}}{D_t} \left(1 - \frac{r_{doc}}{D_t}\right)} \quad (8.16)$$

The choice of the approach depends on the variable of calibration used on the prediction and the precision the user wants to achieve.

8.2.4 Cutting continuity of forces

The helix angle, as in milling, plays an important role in the force distribution, as presented in Figure 8.9 comparing a straight flutes tool and the helical tool [Araujo et al., 2006]^P. This parameter reflects directly on the variation on density of applied force per time, in other words, the impact of the tool when cyclic entering the workpiece: if there is a big gap in a short time or not.

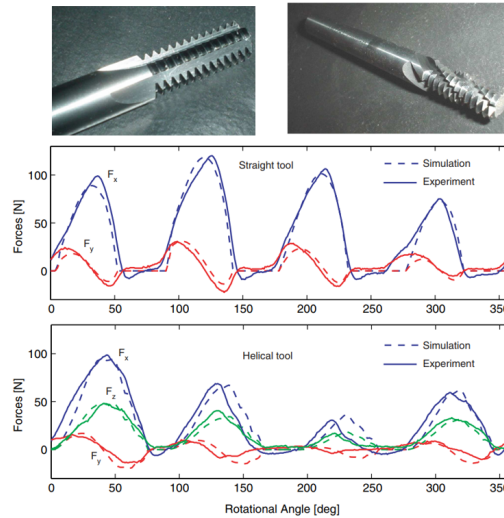

Figure 8.9. Experiments on the first model in thread milling (Araujo et al., 2006)^P

The **cutting continuity** parameter was developed in [Araujo et al., 2013a]^P to describe this time distribution of forces along tool revolution. The cutting continuity $c \geq 1$ means that the tool is always in contact to the workpiece. When $c < 1$, part of the time there is no force on the tool and one cutting edge is alone on the cutting. If $c = 1$ only one cutting edge is in contact at a time and there is always one flute acting on the tool. This evaluation is important to reduce the impact on the entry, consequently tool vibration, or determine calibration experiments, when having only one cutting edge is important.

Cutting continuity is a function of the helix angle but also tool engagement on the hole. In terms of calculation, c makes the ratio between the angle of tool-workpiece in contact $\delta + \theta_{tw}$ with the angle between flutes $\frac{2\pi}{Z}$ [Fromentin et al., 2011b].

In Eq. 8.17 it is clear that there is one part related to vertical engagement (depth of cut) and the second parcel related to the radial engagement of the thread r_{doc} . The tool geometry (helix angle, tool diameter and/or number of flutes) affects both parcels.

$$c = \frac{\delta + \theta_{tw}}{\frac{2\pi}{Z}} = \frac{2a_p \tan(\lambda_{sf})}{D_t} + \arccos\left(\frac{1 - 2r_{doc}}{D_t}\right) \cdot \frac{Z}{2\pi} \quad (8.17)$$

8.2.5 Geometric problems related to internal thread milling

In internal thread milling, the fact that the tool diameter is close to the hole dimension is positive to the continuity of the cutting and the smoothness of the process. In other hand, there are also some elements to be aware related to internal milling:

- **Penetration strategy:** analysis on the entrance trajectory (from the center of the hole to the radial position to machine the nominal thread dimension) in order to reduce the over cutting due to the thread envelop cutting in the positioning of the tool;
- **Influence of penetration on the tool exit:** analysis of the material cut on the tool penetration should be deduced on the forces calculation when the tool completes the trajectory arriving to the xy position affected by tool entrance;
- **Tool deflection:** prediction of the tool deflection is important because if produce undercutting on the deeper threads of deformed tool and also, in very close holes, over cutting on the back of the tool. The smaller the tool diameter in one hand it is positive for more gap to avoid over cutting, in other hand, it allows more deflection for undercutting;
- **Efficiency of coolant and chip removing:** reduction of the space for fluid coolant and chips in addition to the augmentation of the contact time with the workpiece could reduce the advantages of using thread milling in comparison to tapping.

Tool entrance strategies trajectory

The entrance of the tool is a source of interference on the thread produced leading to an over-cut on the thread. There are three penetration strategies: Straight penetration (SP), which the tool does a linear displacement from point O to A in Figure 8.10; half revolution penetration (HRP) strategy, which the tool path from point O to point A is a helical trajectory, semicircle in xy having half of radius compared to the thread milling trajectory; and the quarter revolution penetration (QRP) penetration strategies, in which the tool passes through a point B producing a quarter helix from B to A.

Figure 8.10 also presents also an example of modified path for HRP (mHRP) that passes through a point B in the opposite direction of A to reduce interference. Several possibilities could be proposed and studied. [Fan et al., 2020; Fromentin et al., 2011b; Sharma et al., 2014] studied specifically different penetration strategies and the level of interference produced in order to offer fewer geometrical errors as compared to unmodified strategies.

In HRP, the **radial penetration** increases until the desired radial engagement r_p . The vertical displacement during tool penetration is proportional to the thread pitch: $P/4$. For reference, the time range is defined from 0 to t_1 , and $\theta_1(t)$ in the entrance is $\theta_1(t) = \frac{\pi}{t_1}t - \pi \rightarrow \theta_1(t) \in \{-\pi < \theta_1 < 0\}$ (Figure 8.11).

It is important to claim that SP is not used in the industry for thread milling, but it is common in helical milling and boring with end milling tool (as there is no thread profile to machine).

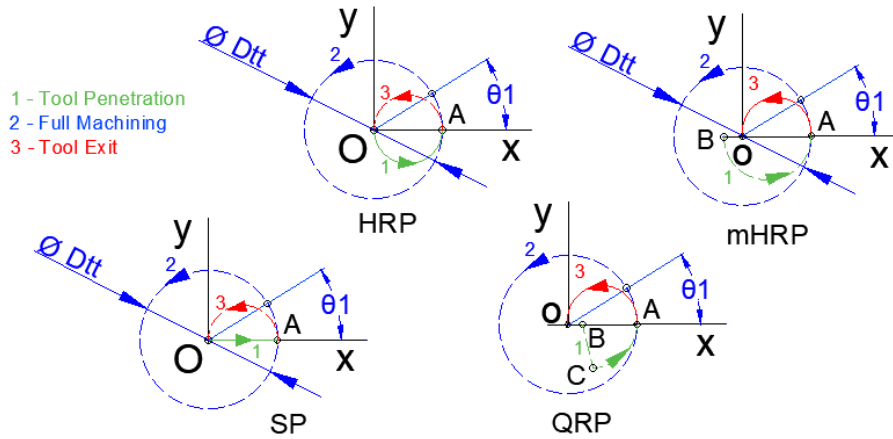

Figure 8.10. Tool path penetration strategies

The trajectory from point A to point A (2 traces in blue in Figure 8.10) in xy coordinates along the circle having D_{tt} diameter produces the threads on the cylindrical surface and the tool vertical displacement is the thread pitch P . It is called "**Full Machining**" and the tool is engaged machining the desired thread profile (Figure 8.11). The nominal radial penetration is constant until there is no influence of tool penetration.

If the number of threads n_P to be machined is higher than the number of threads on the cutting edge n_P^{max} , the tool continues the helical trajectory for more than one pitch until all geometry is machined. In the case $n_P < n_P^{max}$, the depth of cut is described by $a_p(t) = (n_P - \frac{\theta_1(t)}{2\pi})P$ and the time range from t_1 to t_2 . θ_1 in the case is $\theta_1(t) = \frac{2\pi}{(t_2-t_1)} \cdot (t - t_1) \rightarrow \theta_1(t) \in \{0 < \theta_1 < 2\pi\}$.

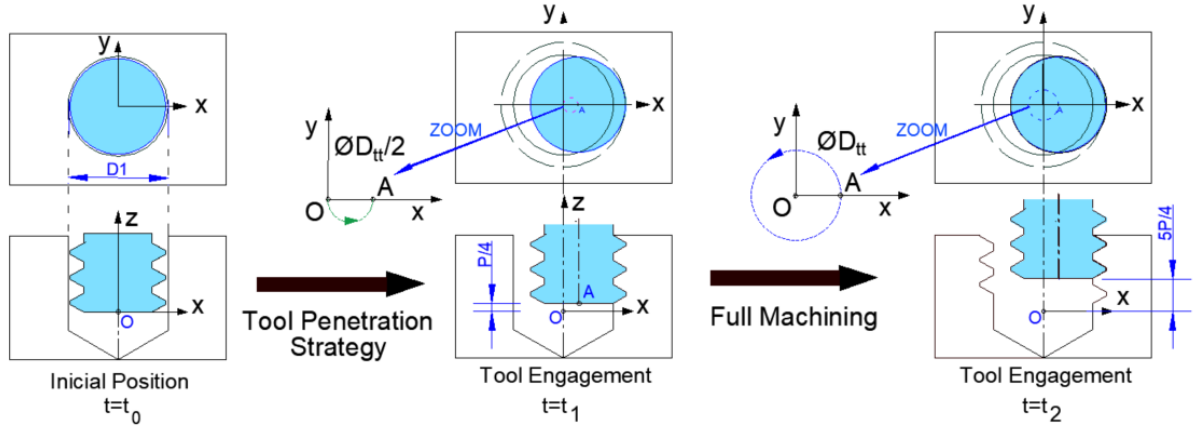

Figure 8.11. Tool paths during thread milling (with HRP)

The **tool exit** is the path which takes the tool out from the thread machined surface back to the center O. The tool goes back to the initial hole axis position as the radial penetration reduces to zero. The vertical displacement is $P/4$. The time range, from t_2 to t_3 , and θ_1 range in tool exit is $\theta_1(t) = \frac{\pi}{(t_3 - t_2 - t_1)} \cdot (t - t_2) \rightarrow \theta_1(t) \in \{0 < \theta_1 < \pi\}$.

Material machined during tool penetration and its reduction in full machining

It is possible to quantify and analyse the material removed during tool penetration trajectory. The material removed during penetration should be considered for the prediction of forces during this first path and also the reduction of forces in the last tool revolutions on full machining, when the tool comes back to point A. As the tool moves vertically one pitch, this influence exists if the $a_p > P$.

The analysis is made considering the tool envelope geometry during penetration, presented in Figure 8.12 [Araujo and Fromentin, 2017]^P. The tool envelope only meet the workpiece surface in point P_2 (Figure 8.12a) when its axis is centered in Q. In this position, if one point the cutting edge is engaged and aligned with the line $\overline{OP_1}$, the first chip is removed.

As an example of the identification of these angles in the analysis, this position is calculated by Eq. 8.18, and so it can be identified the region that is removed by HRP:

$$\theta_1(Q) = \arccos\left(\frac{D_1 - D_t}{D_{tt}}\right) \quad (8.18)$$

After this point, the tool removes material until its axis arrives at A. The area of the material removed during this stage is identified in Figure 8.12b by the limit points P_2 and P_4 . Its influence on thread milling process, it is identified by the angle β between $\overline{OP_1}$ and \overline{OA} (in article the equations are presented).

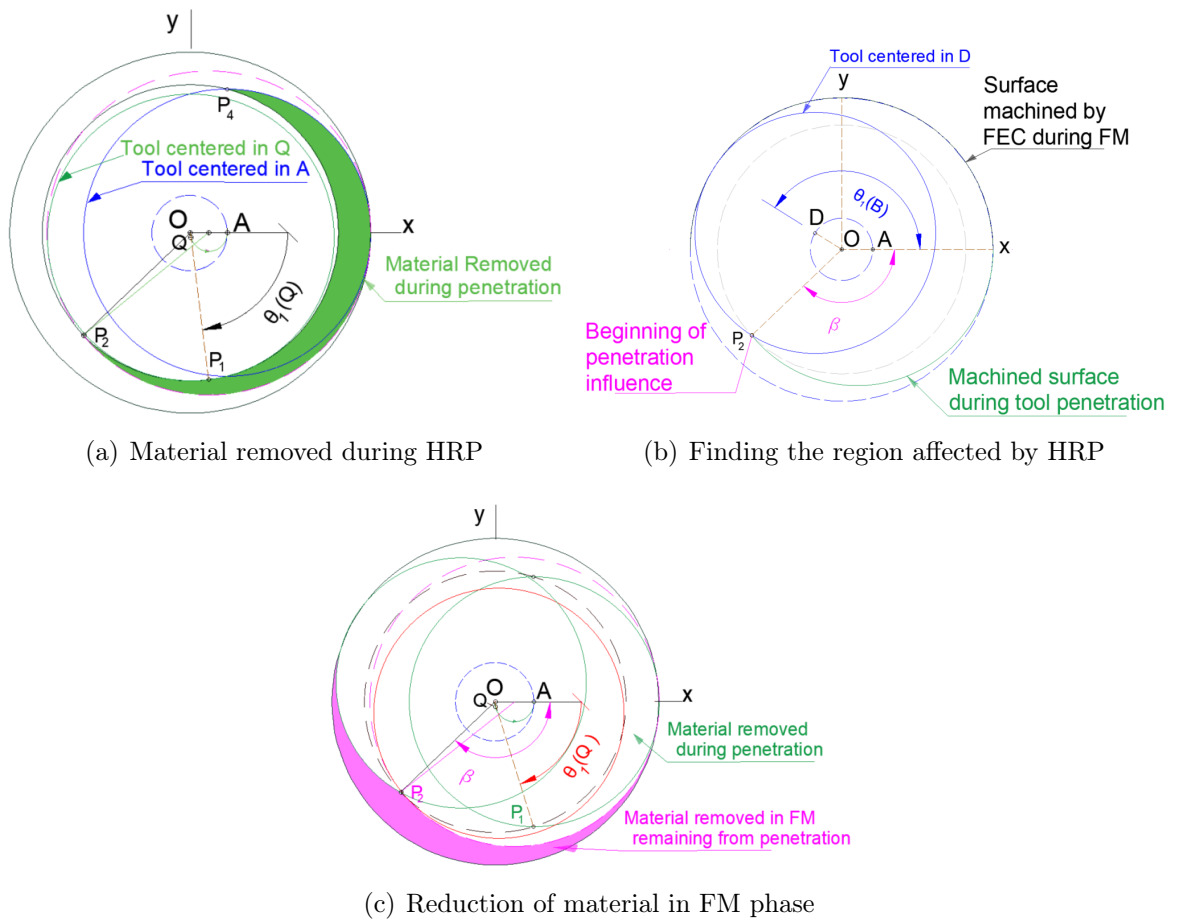

Figure 8.12. *Reduction of removed material*

The tool is in full machining after passing the point A . During this period, it can be identified two regions: in the beginning when the nominal radial penetration is constant without any influence of tool penetration, so called **steady state** (where h_{max} is calculated by thread milling theory), and the region where the material has already been machined by tool penetration, identified in Figure 8.12c and also calculated in this specific article.

8.3 Thread milling research applied to industry

After having developed the knowledge on thread milling geometry and cutting forces in general, some research projects focused specific applications related to industrial questions. It is the case of the thrilling process analysis [Jun and Araujo, 2010]^P, the adaptation of radial engagement for manufacturing of screws by external thread milling on SMA alloy for producing a specimen for traction test [Absi, 2013; Rego, 2013]^P (Section 7.3.2), the optimization of the tool geometry for tool manufacturer [Araujo et al., 2013a]^P, the threads on pipeline connections [Araujo et al., 2015]^P and the mini-threads on the abutment of a dental implant [Araujo and Fromentin, 2018]^P, briefly presented in this section.

8.3.1 Analysis of the thrilling process

The thrilling process is a combination of drilling and thread milling using the same tool, as it is shown in Figure 8.1a. This operation was analysed in [Jun and Araujo, 2010]^P, a product of some experiments developed during a short visit in UIUC some years after the conclusion of my thesis. The preparation for experiments and the analysis was done in collaboration with Martin Jun.

The first stage is a regular drilling, after the tool retracts enough so the cutting edges do not interfere with the thread milling operation. In order to make the thread while rotating at the prescribed rotational speed and retracting the tool half the pitch, the tool moves on radial penetration and finally the full machining. The number of threads generated in this one revolution corresponds to the number of threads engaged in the workpiece. In this process the thread is always machined from down to the bottom (in regular thread milling up to bottom is also an option).

The thriller geometry is composed of a secondary cutting edge and a chisel edge for drilling. The diameter achieved in drilling is bigger than the external diameter of the thready cutting edge, so there is a gap between the hole and tool diameter in thread cutting (as it can be observed in Figure 8.13. That is why there is a small milling cutting edge between the drilling edge and the threaded cutting edge. Although, in this process the gap between both diameters is not very big.

For this application, experiments have been conducted to validate the model for thread

milling and also calibration has been done for drilling part. At that time, the basic thread milling model was used for prediction. Calibration for thread milling used high-low cutting conditions for K_t and K_r as described in Eq. 8.6. The model assumes that the tool and workpiece are rigid and no tool deflection, vibration, and the effect of the run-out are considered in the modeling. The run-out would also have a strong influence on the torque because the radius of the cutting edge with respect to the reference frame varies depending on the magnitude of the run-out. Comparison of the average torque and forces between experiment and simulation results shows that the model predicts the experimental results within 12% error.

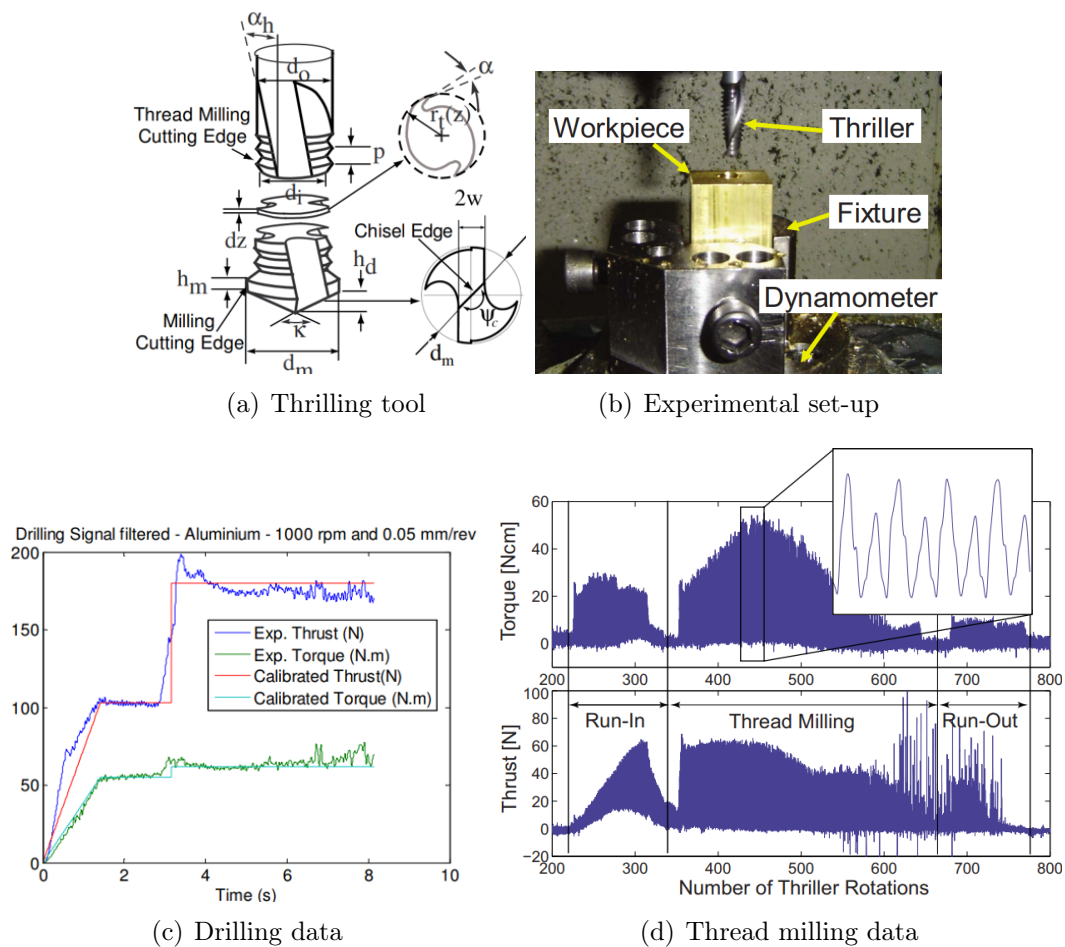

Figure 8.13. Experiments on thrilling (Jun and Araujo, 2010)^P

8.3.2 External thread milling in bones

Threads are used in connection of orthopedic and dental implant elements. In 2010 and 2012, I developed two studies measuring the thread milling forces in bone and in a Polyhydroxybutyrate/Hydroxyapatite composite element.

In 2010, a bovine bone was machined to produce M10 threads and to compare geometry and forces with metallic machined screws. Figure 8.14a presents the bone sample and Figure 8.14b the tangential force in external thread milling [Souza, 2010]^P.

A composite formed by HA (Hydroxyapatite) with PHB (Polyhydroxybutyrate) is used in research in 2012 to study the replacement of Titanium implants by a bio compatible composite with mechanical and biological characteristics similar to the bone [Alves et al., 2011]. The objective of the project developed in [Granato, 2012]^P was to study the machining of a bioabsorbable polyhydroxybutyrate matrix composite with hydroxyapatite particles, making threads in manufactured workpieces (produced by the IMA/UFRJ³), and to compare the results with threads made from bovine bone. For this, it is intended to maintain the same machining conditions used in bovine bone, the same machine tool, the same tool and the same screw dimensions (Figure 8.14c).

The workpieces supported machining with lower forces comparing to bone. Although the produced workpieces composition achieved 1, 2 and 5% HA, low for using in implants. Lower HA compositions did not support machining and broke. Workpieces with 5% HA supported the machining, with forces three times smaller than those used in the machining of bovine bone (Figure 8.14d) and smaller compared some the ones supported by specific bones in the human body. The continuity of this work would be to produce samples with higher concentration of HA, from 20% to 40%, but the production on the laboratory was discontinued.

8.3.3 Optimization for Industry

This application on tool optimization [Araujo et al., 2013a]^P was developed with collaboration with Walter Prototyp Industry, managed by Guillaume Fromentin, and developed during a three months visit in LABOMAP (ENSAM, Cluny). Previous studies focused on geometrical modeling or mechanistic modeling of the thread milling process, and this needed a better understanding of parameter effects on the cutting forces and torque. Special tools with defined parameters were requested to industry in order to complete the design of experiments. This investigation did the analysis on titanium alloy Ti6Al4V and the following parameters are studied: flute angle, rake angle, thread diameter, depth of cut and feed per tooth.

Different designed tools were specially manufactured by Walter Prototyp using two levels for tool orthogonal rake angle γ_{ot} , three levels for flute angle λ_{sf} , same radial clearance angle,

³IMA - Institute of Macromolecules - UFRJ - <https://www.ima.ufrj.br/index.php/pt/>

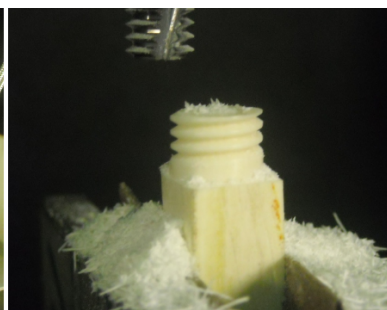
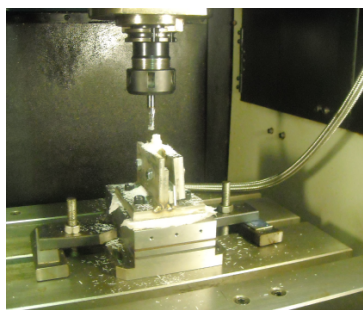

(a) Bone machining

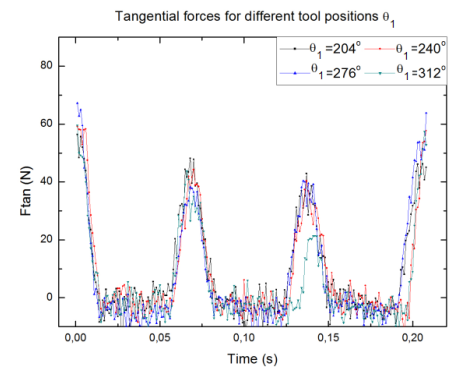

(b) Forces in bone machining

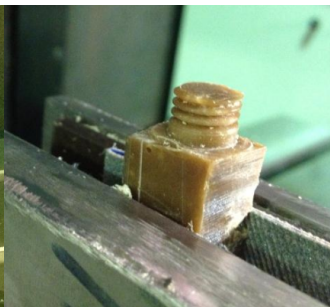
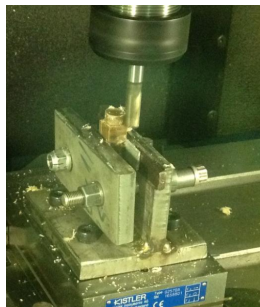

(c) HA+PHB machining

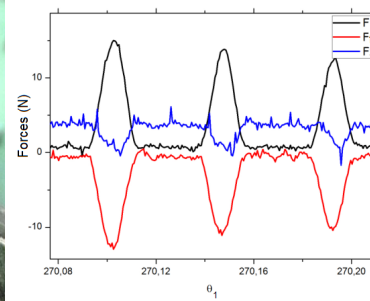

(d) HA+PHB machining forces

Figure 8.14. Bone and HA+PHB external thread milling
(Granato, 2012; Souza, 2010)^P

same tool diameter ($D_t = 10$ mm) and having four flutes. Four different thread geometries were machined: M12x1 and M18x1, with two different axial depth of cut (12 and 18 mm). Drilled diameters and workpiece hardness were controlled to guarantee workpiece homogeneity and the run-out was measured to assure low levels. One replica was used for each experiment. DOE is presented in table 8.1.

A specific experimental set-up was developed for acquiring tool position and triggering acquisition forces with the objective of moving to different referential frames. The specific force coefficients used the approach presented in Eq.8.12.

Table 8.1. *Experimental Cutting Parameters and Levels for analysing effects*

	Basic Factors	Levels
(1)	Rake angle (γ_o)	Low (10°) and High (20°)
(2)	Flute angle (λ_{sf})	10° , 20° and 30°
(3)	Feed per tooth (f_z)	Low (0.1 mm) and High (0.2 mm)
(4)	Axial depth of cut (a_p)	Low (12 mm) and High (18 mm)
(5)	Nominal thread diameter (D)	Low (12 mm) and High (18 mm)
	Composed Factors	Levels
(6)	A_c (function of f_z and a_p)	4 levels (1.2; 1.8; 2.4 and 3.6 mm)
(7)	h_{max} (function of f_z and D)	4 levels (0.06; 0.09; 0.13 and 0.18 mm)
(8)	δ (function of λ_{sf} and a_p)	6 Levels (from 24° to 119°)
(9)	MRR (function of f_t , a_p and D)	8 Levels (from 46 to 348 mm^3/min)
(10)	c (function of λ_{sf} , a_p and D)	12 Levels (from 0.72 to 2.08)

A geometrical analysis and an analysis of variance were employed for determining the influence of the factors and based on the results, it is proposed a physical understanding of the process. From data analysis the article analysis allowed the discussion on tool geometry modification for this material based on the calculated parameters. Force and specific cutting force analysis lead to claim that for this specific case of thread geometry there is an optimization of the flute angle.

The results presented in Figure 8.15 show that the most significant parameter on specific cutting forces are: thread diameter, feed per tooth, axial depth of cut and flute angle. For a specific thread, feed per tooth and axial depth of cut can be easily changed, but the flute angle is defined by the manufacturer.

The effect induced by the rake angle γ_{nt} cannot be concluded from these experiments as per the relation with the uncut chip thickness and the honing radius r_β . Lower peak-to-peak forces reduce vibration and improve thread quality. Even though there is no significant effect of thread diameter on PP forces, the combined effect of flute angle and thread diameter has important effect on the ratio peak-to-peak and average forces. The reduction of radial forces avoid tool bending and it contributes for the precision on the thread dimension.

It can be seen that flute angle has high impact on forces even though it has inverse effect on average and peak-to-peak forces. In the article [Araujo et al., 2013a]^P it is also shown that the flute angle factor presented a negative quadratic effect and positive linear effect on the specific cutting forces. It can be supposed that the lowest flute angle reduces tool stress and higher flute angle increases the global forces, as can be seen from Figure 8.15. Figure 8.16 shows the average value for specific pressure and average forces on the different flute angles, from 10 to 30°. These experiments presented lower force and pressure values for 20° flute angle. The manufacturer changed this design after our study.

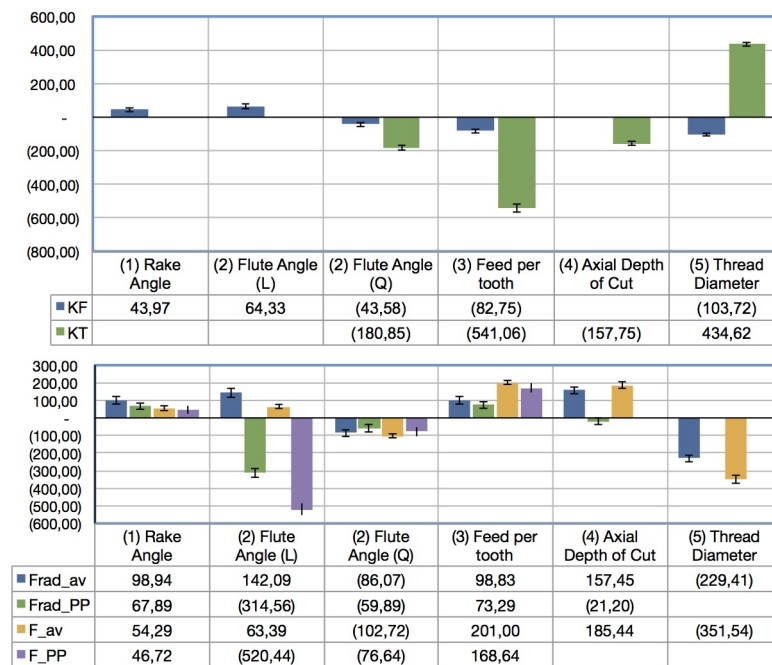

Figure 8.15. Representative Effects of Basic Parameters on Specific Forces (on the upper bars), Radial and Resultant Average Forces, and Radial and Resultant Peak-to-peak Forces (on lower bars) (Araujo et al., 2013a)^P

8.3.4 Thread milling for oil industry

The thread milling model was adapted to inclined thread for oil drilling in [Araujo et al., 2015]^P, because there were not similar studies on American Petroleum Institute (API) thread connection manufacturing. The motivation is that threads localized near the shoulder of the oil rig and near the free end support higher efforts, so the manufacturing process should not add undesired residual stresses especially on those locations. Particularly for drill pipe, strain hardened surface layers and residual stresses affects the service life of the threaded joints Fetullazade et al., 2010. Turning is usually applied but, as the thread pitch connects the feed

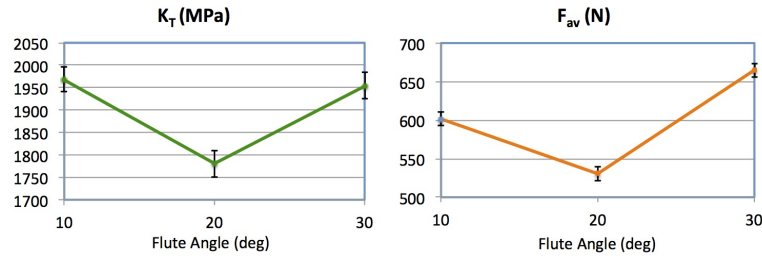

Figure 8.16. Effect of Flute Angle on Specific Cutting Force (MPa) and Average Resultant Forces (N) (Araujo et al., 2013a)^P

velocity and the cutting velocity, residual stresses cannot be reduced by changing the tool feed. This behavior is not expected in thread milling due to much lower feed per tooth and different heat conditions, as described before, that preserves thread roots.

Geometrical chip load analysis, mechanistic model and experimental tests were developed using different feed per tooth in aluminum collars 8.17(a). In the case of API thread milling, the tool trajectory is a conical helix in blue and the red curve is a combination with tool spindle presented in Figure 8.17(b). Considering the insert geometry and the tool-workpiece geometry (Figure 8.17(c), the cutting geometry and the chip load A_c is calculated and presented in Figure 8.17(d).

The specific force coefficient is a function of the cutting velocity and the chip thickness or feed per tooth, calculated based on the experimental data and presented in the curves shown in Figures 8.18(a) and 8.18(b). As an example, experiment using $f_t = 0.34\text{mm}/\text{th}$ is simulated and compared with experimental data for validation as it can be observed in Figure 8.18c. For this case $K_{res} = 1413\text{ MPa}$ and the maximum chip load area is 0.368mm^2 . Surface quality is analyzed and flank and face surfaces did not present different roughness level.

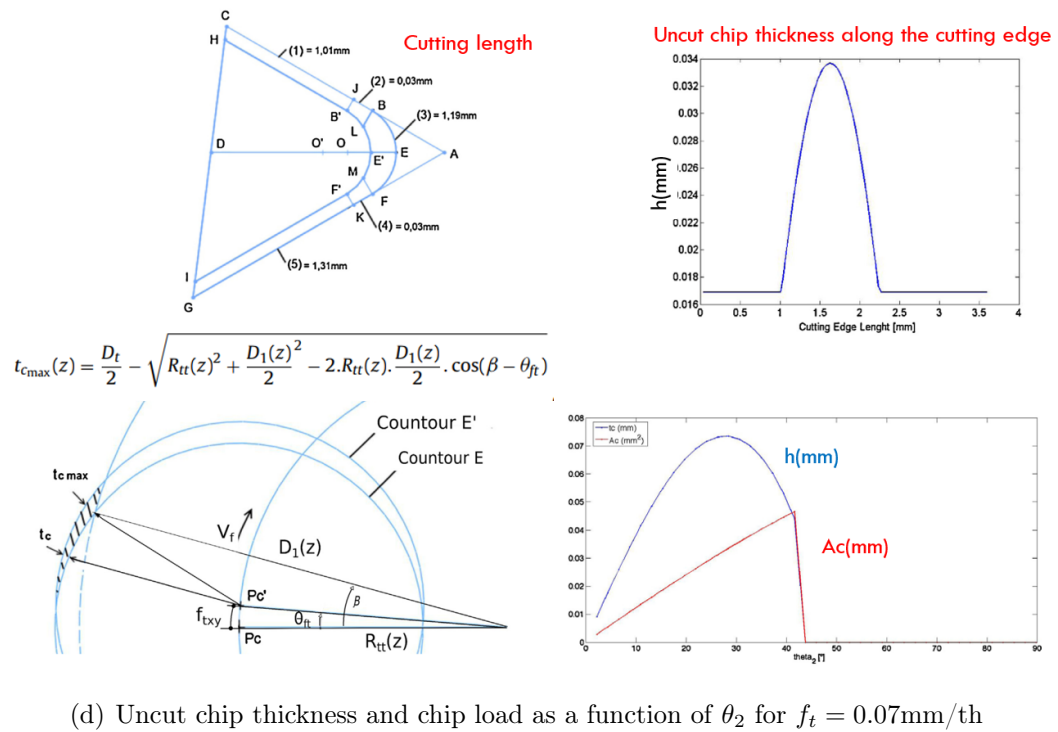
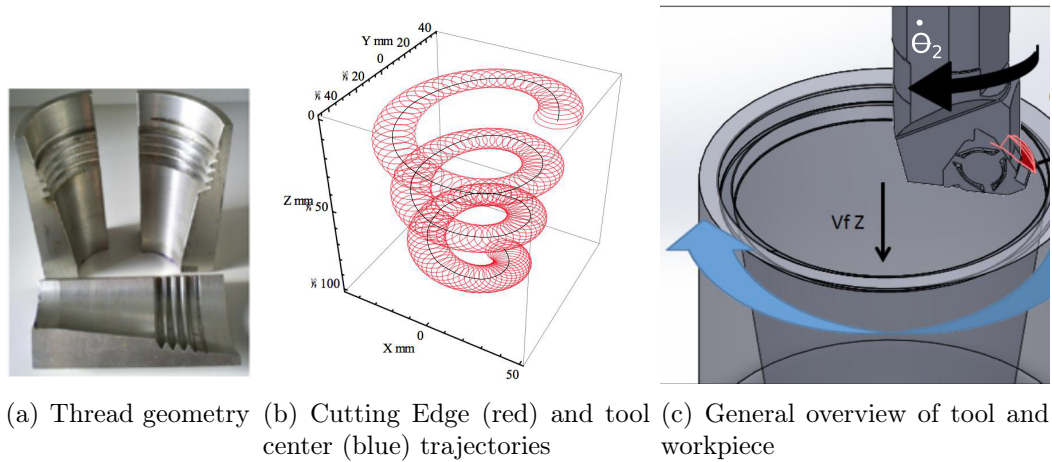
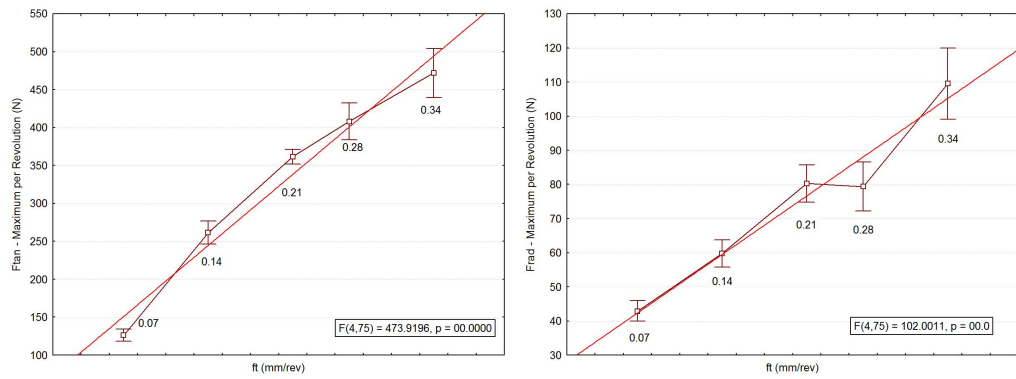
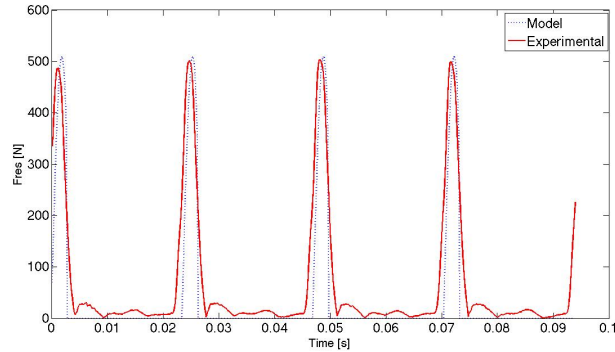

Figure 8.17. Machining API Threads by Milling (Araujo et al., 2015)^P



(a) F_{tan} - Maximum Force Per Revolution (b) F_{rad} - Maximum Force Per Revolution



(c) Resultant Force for Validation - $f_t = 0.34$ mm/th

Figure 8.18. Force results in API threads (Araujo et al., 2015)^p

8.3.5 Mini-threads in dental implants abutment

This work [Araujo and Fromentin, 2017, 2018]^P was developed as an application to dental industry. The aim was to investigate the tool deflection due to cutting forces during milling of thread in Cr-Co dental abutment. This deflection adds imprecision to the machining thread.

The typical thread geometry used for dental abutment is a commercial M2 metric right-hand thread, as the example presented in 8.19a. The analysis of tool penetration, described in subsection 8.2.5, is specially important in the case of mini-threads, in which there is not substantial gap between D_1 and D_t . Figure 8.19b shows the gap of the tool in initial position. The percentage of engagement $e\%$ is higher than regular cases:

$$e\% = \frac{D - D_1}{D - D_t} = 85\%. \quad (8.19)$$

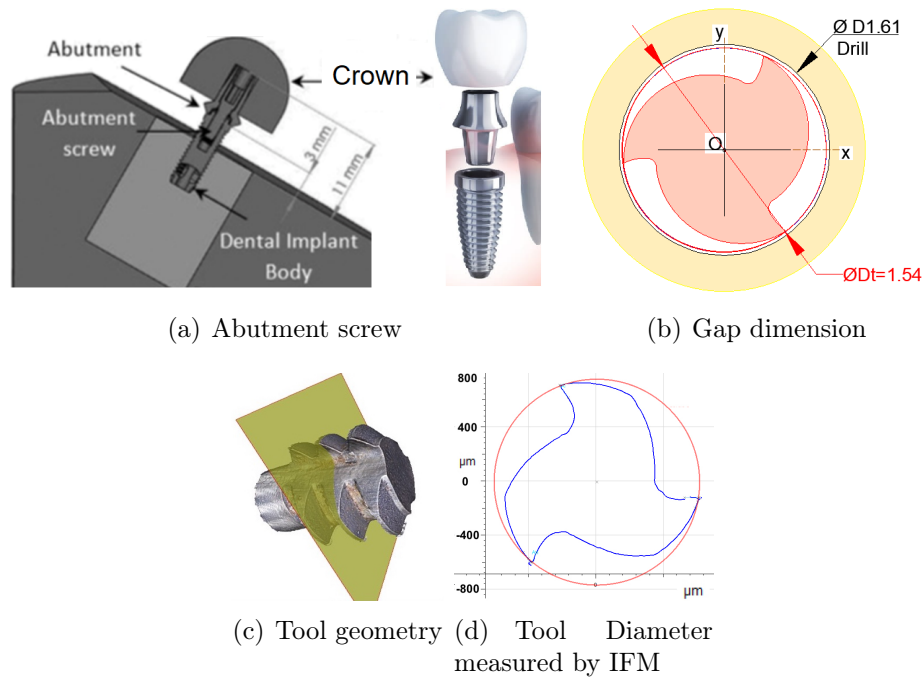

Figure 8.19. Mini-thread geometry analysis (Araujo and Fromentin, 2018)^P

The tool entrance in a small hole can produce over-cutting during tool dislocation before helical cutting then the analysis of engagement was done. The higher the engagement angle was $\delta = 24^\circ$ and cutting continuity near 1, $c = 98\%$, so is no simultaneous cutting flutes which allows a direct experimental force analysis on each flute. The angle for tool entrance is $\beta = 132.1^\circ$ that leads the end of steady state at $\theta_1(B) = 154.3^\circ$.

The experiments are conducted acquiring cutting forces and the three phases of tool penetration, steady state and interference region were identified as shown in Figure 8.20 and tool

axis position in order to estimate tool deflection. Two metallic materials used in dental industry, Ti6Al4V and a CrCo alloy, were exploited in this study.

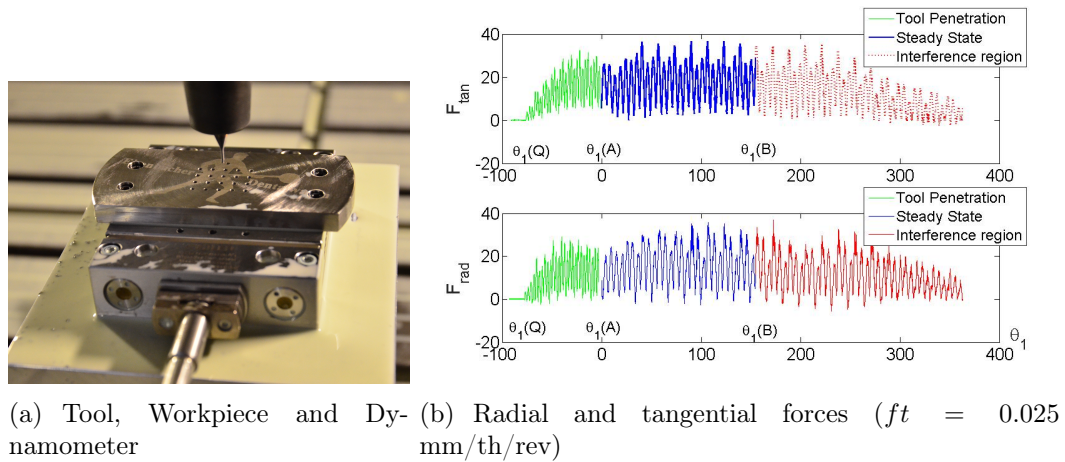

Figure 8.20. *Experimental Set-up and force results with interference region*

In order to calculate the tool tip trajectory considering tool deflection, it is proposed an hybrid procedure, illustrated in Figure 8.21. During the first step, the CNC tool holder position $(x(t), y(t))$ is taken from data file for each experiment (Figure 8.21(a)). The trajectory is verified and θ_1 is calculated.

The second step estimates the tool stiffness by simulation, independent of the experimental results. The tool geometry is read using scanned points (imported using STL file format) taken through a Infinite Focus Measurement (IFM) using an Alicona equipment (as in Figure 8.21(b)). A chosen force is applied on the cutting edge perpendicular to the tool axis. The mechanical properties of Tungsten Carbide are used as input parameter on the software. It is considered the static deflection model, as the natural frequency is not included in harmonics of the experimental forces. Five different values of the applied force are used on the simulations and for each cutting force, the tool tip displacement is registered and the global stiffness.

On the third step, the radial and tangential cutting forces are calculated using acquired cutting forces (F_x, F_y) and θ_1 , based on $(x(t), y(t))$ measurements, for each experiment, as presented in Figure 8.21(c). The last step calculates the tool tip trajectory considering the tool holder position, the forces applied on the tool and the tool stiffness. In real time, the displacement is calculated. The maximum tool deflection per tool revolution is analyzed, as shown in Figure 8.21(d).

The workpiece is cut using wire-EDM process in order to measure the produced thread profiles. Figure 8.22(a) shows the cut workpiece and a image of the IFM measurement aligned with x direction. It was compared ISO 965-1 standard (M2x0.4) and the measured data. It was

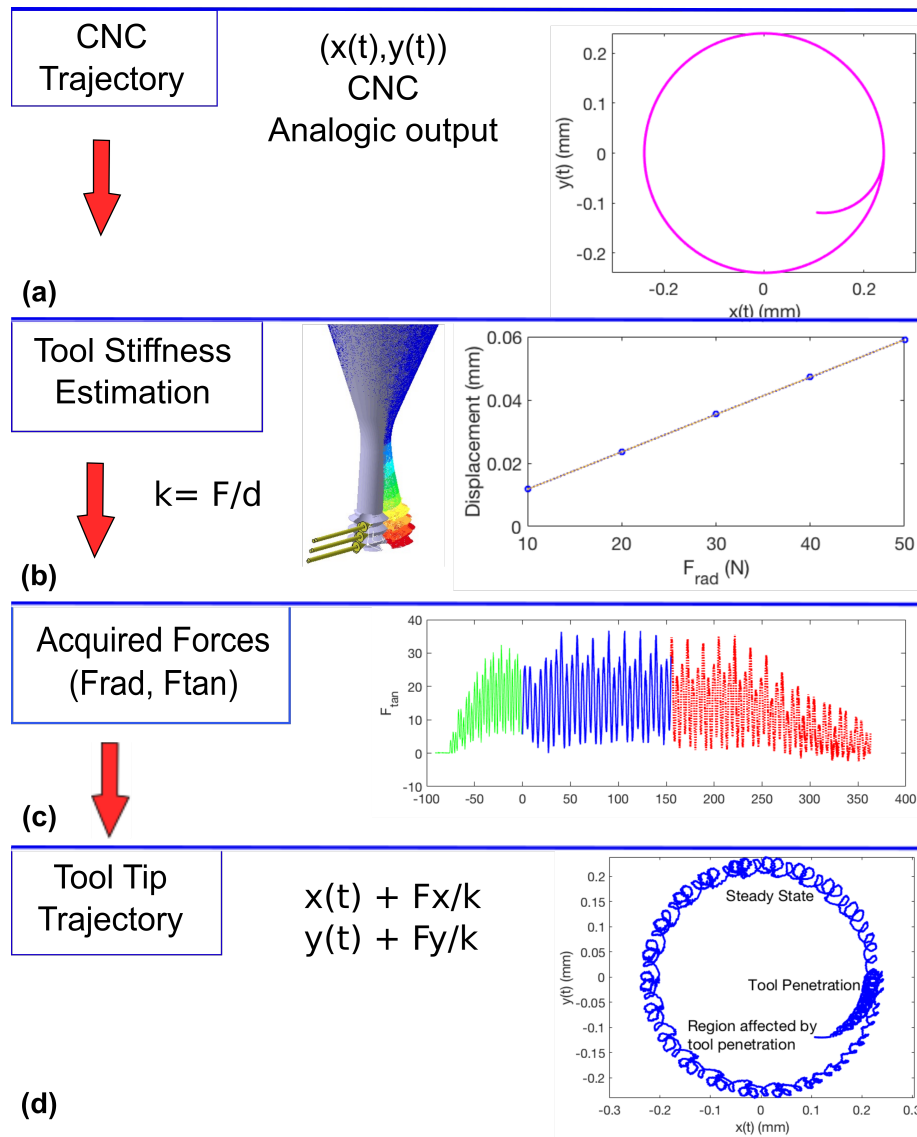
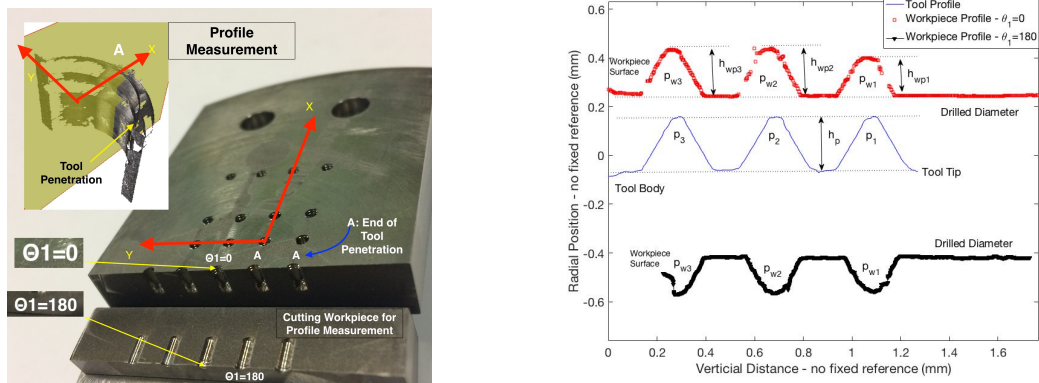

Figure 8.21. Procedure to estimate tool tip trajectory considering tool deflection (Araujo and Fromentin, 2018)^p

noted that in the beginning of full machining, at $\theta_1 = 0$, in the first and second threads (from the top surface, as shown in Figure 8.22(b)).

The difference between the radial penetration and the measured thread height was lower because the tool re-machine the thread surface at this point (see Figure 8.22(c)). Values on the lower thread ($n_P = 3$) were neglected as the screw could not achieve this region as it is not completely machined.



(a) Workpiece thread profile measurement in IFM (b) Workpiece profiles in $\theta_1 = 0$ and $\theta_1 = 180^\circ$ and tool profile for reference

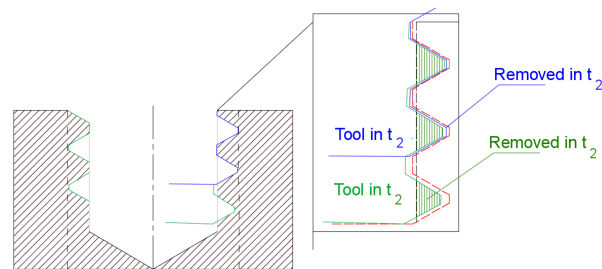

(c) Analysis of removed chip area in $\theta_1 = 0$ (in t_1 and t_2)

Figure 8.22. Analysis of the thread height and deflection (Araujo and Fromentin, 2018)^P

8.4 Orbital drilling

As it was claimed, orbital drilling is an helical milling operation used to produce holes and it used mainly in difficult-to-cut materials, such as Carbon Fiber Reinforced Polymer (CFRP), Ti-alloys, hard materials and other aerospace materials, because it reduces damage and burr comparing to axial drilling [Lacombe et al., 2021]. The helical milling in this case brings potential gains, in terms of quality, but it must be optimized to achieve higher productivity [Araujo et al.,

2021]^P.

The analysis of the variable chip thickness along the cutting edge and cutting time is similar to thread milling analysis, although the radial engagement has different characteristics [Pereira et al., 2017]: there is no pre-drilled hole and its evolution depends on the CNC programming. Entrance strategies could be applied, for example with a variable pitch angle, because the tool envelop is a simple cylinder without the threaded cutting edge, as it is shown in Figure 8.23a from [Denkena et al., 2008]. Unfavorable geometric error [Geng et al., 2018] usually occurs at hole exit in orbital drilling of small-diameter holes and it is useful to predict tool workpiece engagement, chip geometry, cutting forces, chatter stability and hole surface errors simultaneously [Ozturk et al., 2018].

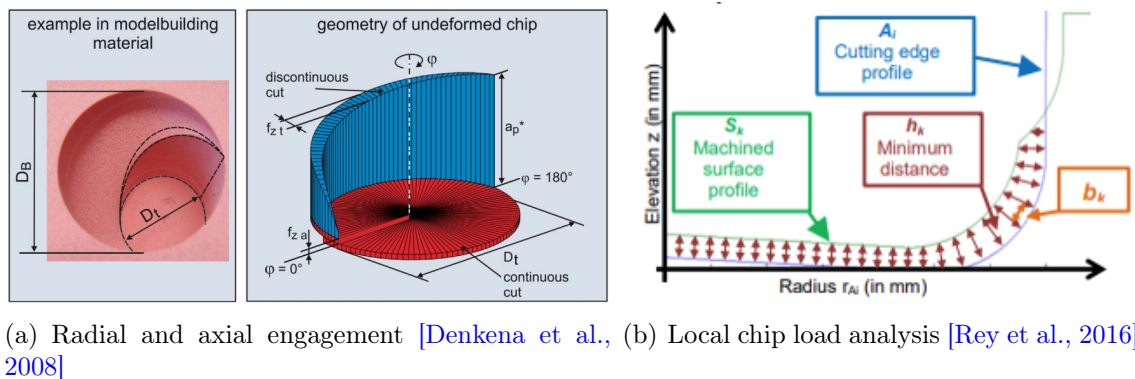

Figure 8.23. Orbital drilling chip geometry analysis

In Institut Clément Ader, three theses were developed in orbital drilling. In the first thesis, [Rey et al., 2016] developed a model for orbital drilling on casted Ti6Al4V alloy depending on the tool geometry and cutting conditions and regarding the final quality of the machined borehole. In this work, it was developed a cutting forces model, based on the instantaneous chip thickness depending on the tool geometry and cutting conditions, in order to control the final quality of the machined borehole.

The second thesis, [Kamgaing Souop et al., 2019] focused on the process optimization in high speed machining in Aluminium for fatigue life enhancement by Orbital Roller burnishing. In his work, an orbital drilling unit, developed by an industrial partner, was integrated on a lightweight industrial robot. The burnishing was used as an innovative mechanical surface treatment to enhance the mechanical behaviour of the system (fatigue and surface hardening). It was developed a comparative study between: axial drilling, orbital drilling and orbital drilling with burnishing, comparing surface roughness, burr height and fatigue life. Performances and quality levels obtained by using orbital drilling (with or without burnishing) were shown to

be significantly different compared to conventional drilling. On open-hole samples, a significantly fatigue life improvement was exhibited using orbital drilling, even more important with burnishing.

[Lacombe et al., 2021] produced the third thesis on orbital drilling in ICA (2017-2020), studied the influence of the hole surface integrity on the fatigue life of aluminium submitted to axial and orbital drilling. The machining was done in up-milling (tool rotation and orbital rotation in the same sense), machined dimension, cutting parameters and tools are chosen to corresponded to industrial applications. Fatigue tests were conducted on open-hole specimens and it was characterized the hole surface integrity (roughness measurements, hardness measurements, metallographic observations, and residual stress analysis).

Sughosh Deshpande is actually doing his thesis in ICA (2020-2023), under my supervision, studying the material identification of aeronautic metallic material based on monitoring the orbital drilling process. Multi stack drilling is one of the major operations in aircraft assemblies and it demands lots of time and resources to achieve high-quality holes.

Usually, Titanium and Aluminium stacked materials are drilled before aircraft assembly and this poses a major challenge in machining due to the different materials machinability. The machining process optimization makes it possible to reduce tool wear, damage and burr controlling trajectory, speed and cutting geometry. In the past, the procedure for optimizing cutting parameters were time disconnected to the manufacturing process.

The objective of his thesis is to develop the bases of indirect identification of the material on the stack based on cutting and power signals on orbital drilling. An experimental model for milling operation is built considering two metallic materials, a large range of input parameters and tool wear. An online changing of cutting parameters is done based on optimization using machine learning.

His first article [Deshpande et al., 2022b]^P, submitted for a journal, the analysis of axial drilling and circular milling processes are developed, for further application in the combination for helical milling. The goal of this paper is to create a data map of specific force coefficients related to each material for both process. The materials used for the experiments were aluminium 2017A and titanium Ti6Al4V, being subjected to a common set of cutting conditions. Based on experimental results, the cutting force models enable estimating the specific cutting coefficients for a different set of variables.

All drilling and milling experiments (see Figure 8.24) were carried out in Institut Clément Ader. The axial drilling tests were developed by a master internship in ICA and published in a Brazilian conference [Gonçalves et al., 2021]^P and he developed the circular milling analysis [Deshpande et al., 2022b]^P.

After acquiring forces, F_t and F_r were calculated (Figure 8.25) and the specific cutting force

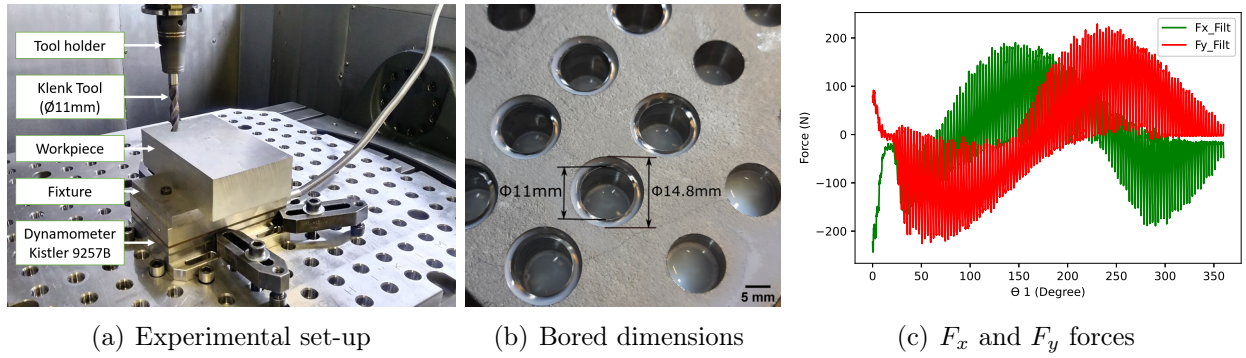

Figure 8.24. Circular milling experiments (Deshpande et al., 2022b)^P

coefficients were estimated. The data includes values calculated at several tool angle positions θ_1 for each specific feed rate and cutting velocity with the objective of having a representative value with larger spectrum of experimental variability and noise. Figure 8.26(a) and 8.26(b) shows K_c and K_r values against feed for Aluminium and Titanium.

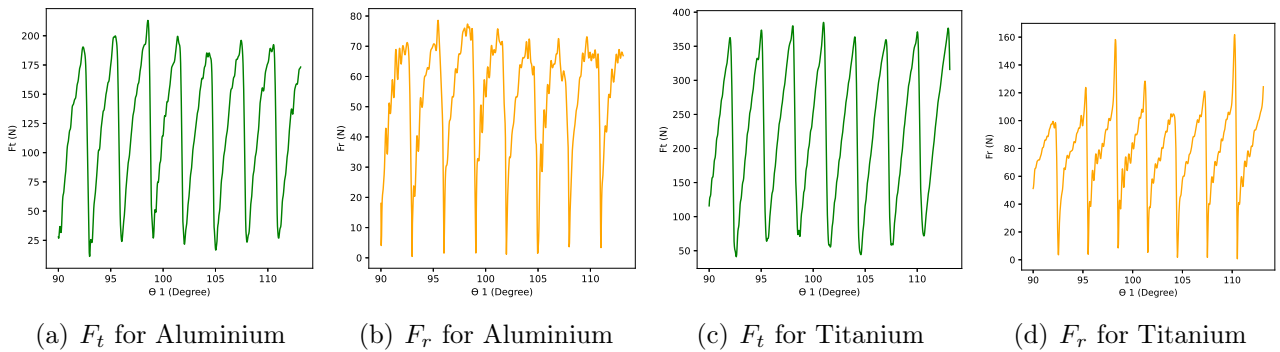

Figure 8.25. F_t and F_r - window on $\theta_1 = [90^\circ - 115^\circ]$ (Deshpande et al., 2022b)^P

A clear distinction between both materials and force coefficient values can be identified in different regions of the map presented in Figure 8.26(c). Thus, the clear distinction between Titanium and Aluminium regions presented in both identification maps, can be further applied for material identification in smart machining processes.

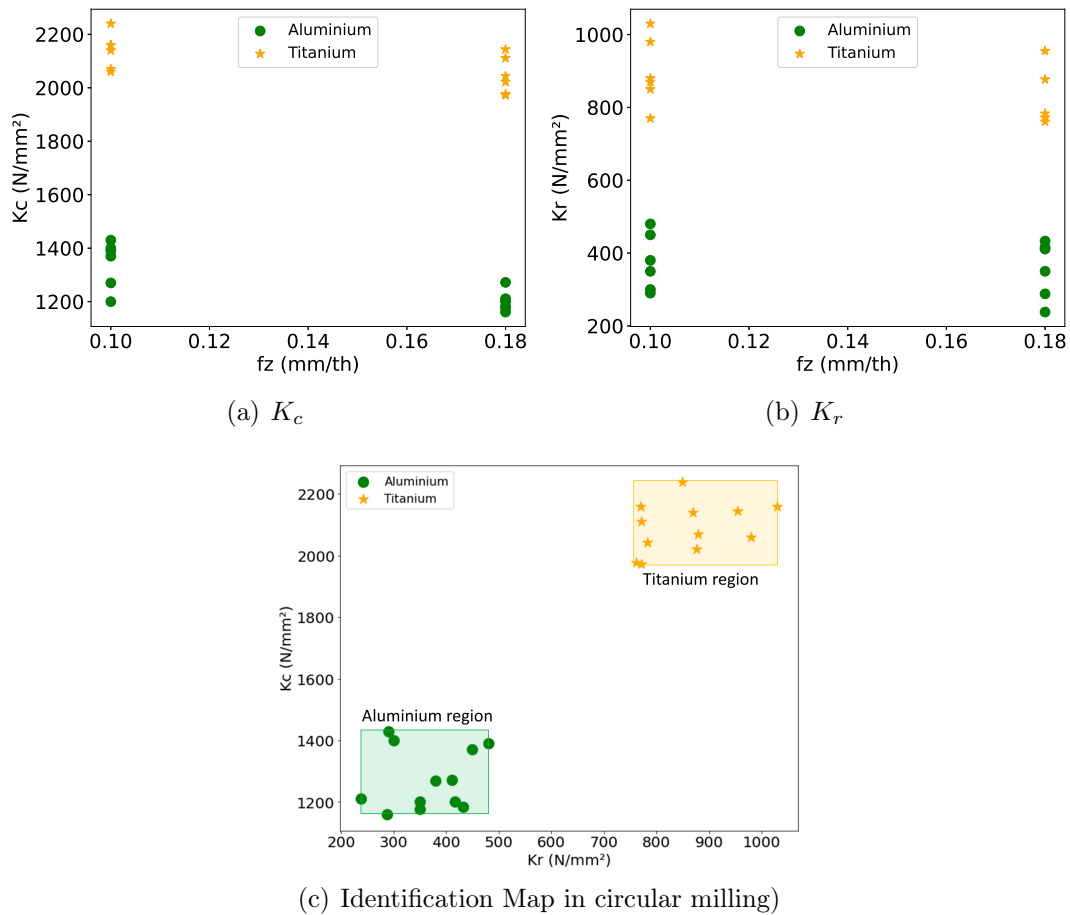

Figure 8.26. Specific force coefficients for Aluminium and Titanium in circular milling (Deshpande et al., 2022b)^P

8.5 Smart machining and monitoring helical milling

In the past, the procedure for optimizing cutting parameters were not done in real-time, but in the new era of Industrial Internet of Things (I-Iot), the identification of parameters can be done during the process [Cheng et al., 2017] using machine-tool signals. This wide approach of monitoring is called smart machining [Chen et al., 2019] claims that there are three stages of evolution on the machine tool: CNC, smart machine-tool and intelligent machine-tool, when there is autonomous sensing and connection, autonomous learning and modeling, autonomous optimization and decision-making, and autonomous control and execution. Our efforts are in the second level due to its close relation with the process understanding. [Cheng et al., 2017] presents some innovative design concepts as smart cutting tools, including a force-based smart cutting tool and smart colets for ultra precision and micro manufacturing purposes, which are included in the HDR project (next section).

Until today, in my research work, smart machining refers to the development of monitoring and the bases of real time adaptation of cutting parameters for process optimization. It involves identifying the material accurately and then adapting the proper cutting parameters, specially in S. Deshpande thesis and some developing collaborations. In my articles, some other monitoring aspects can be identified.

In 2013, a set-up developed by the colleagues in LABOMAP allowed the acquisition of CNC output analog data taken from the machine tool synchronised with cutting force data using a trigger signal to start acquisition in the analog-digital card (Figure 8.27a). In this work, a rotating dynamometer measured the forces in the tool referential frame R_2 and the calculation of R_1 force components is possible with tool position XY (from machine-tool) [Araujo et al., 2013a]^P.

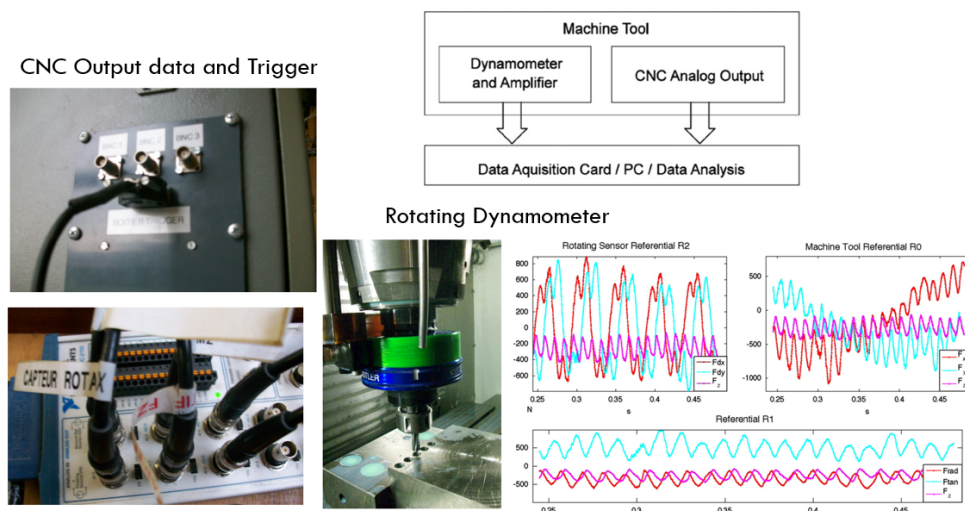

(a) Set-up for synchronous digital acquisition

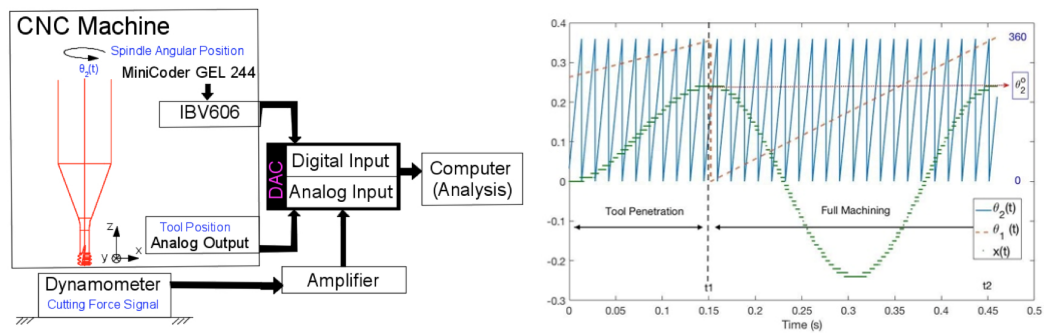

(b) Digital signals of θ_2 from the machine tool (c) Set-up for synchronous analog-digital acquisition

Figure 8.27. Monitoring machining data from machine-tool in ENSAM Cluny (Araujo et al., 2013a)^P

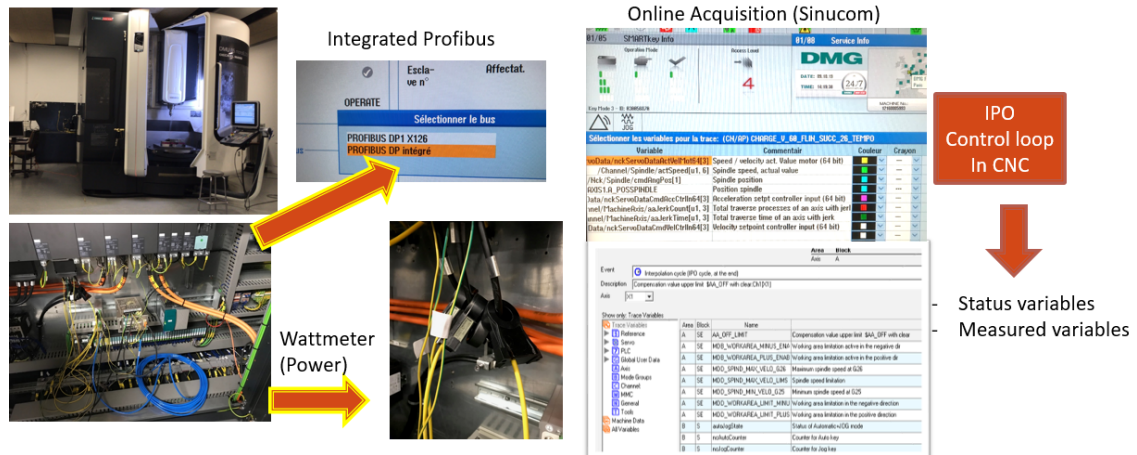

Figure 8.28. Machine-tool acquisition from Profibus port (Araujo et al., 2021)^P

In 2018, in the study of mini-threads, the set-up evolution included the tool angle position acquired digitally using an encoder inside the machine tool, as it can be seen in Figure 8.27(b). The precise information of the tool angle was taken into account to associate θ_1 and θ_2 positions, as it can be seen in Figure 8.27(c).

In 2020, in ICA we collect data from Profibus using Sinucon trace (Siemens software) in order to capture some parameters as: tool coordinates and machine power and torque (Figure 8.28). This discussion is included in the article [Araujo et al., 2021]^P.

In 2021, S. Deshpande used a photo-electronic sensor to measure the cutting edge position in relation to the machine tool encoder reference (presented in Figure 8.29). An article for a conference is submitted presenting this results [Deshpande et al., 2022a]^P.

In summary, we have in ICA today the following possibilities of online monitoring for smart machining:

- ✓ Tool Position and spindle angle (Machine Tool) (in process)
- ✓ Power and torque (Wattmeter and Machine data)
- ✓ Forces and torque (Dynamometer)
- ✓ Tool/Work piece vibration (Accelerometer)
- ✓ Sound (microphones)
- displacement (laser or capacitive sensor)

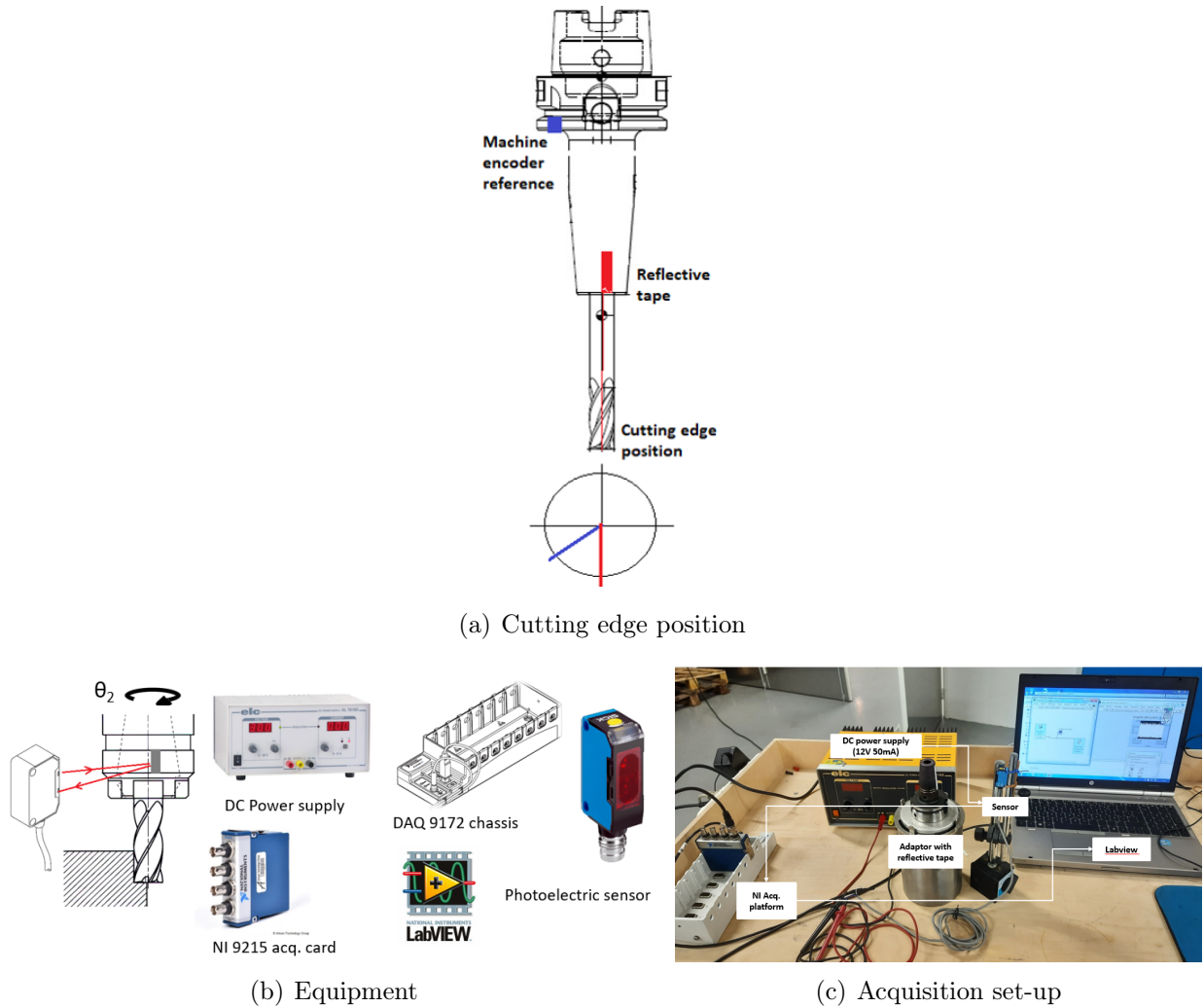

Figure 8.29. Set-up for synchronising θ_2 with force data (Deshpande et al., 2022a)^p

New challenges in manufacturing: micromilling and additive manufacturing

Manufacturing is one of the areas that are changing constantly, specially with the cost reduction on sensors and network connection connected to Industry 4.0. As described in chapter 5, after I joined UFRJ, I was able to write some propositions of grant to acquire new equipment to create new research lines for the mechanical engineering department. After being equipped with a dynamometer for force measurement in machining, two other research lines were developed: first the application of our studies on micromilling, buying a machine-tool capable of producing microchannels and a minidynamometer, and, then, the discovery of new additive manufacturing processes for the university thought the acquisition of two equipments for SLA and 3DP. Even though this second area was not in my priorities when I joined the university, the choice was made because I believe that the best universities should research on the topics we teach. As other laboratories had FDM equipment for producing small prototypes, I chose complementary processes in which the research could be connected to teaching.

In this chapter, I first present the production related to micromilling, including the micro-machining of SLM workpieces produced by metallic additive manufacturing process by partner laboratory, followed by the research developed locally on additive manufacturing.

9.1 Micromilling

The products of micromachining can be components or structures with dimensions located in hundreds of micrometers and with tolerances equal to or below this value [Huo, 2013]. The first mechanical components manufactured on a microscale emerged with the advance of the watch industries in the 1960s. In the following decade, precision and ultra-precision machining were demanded for miniaturization of equipment and devices, providing technological conditions for the development of Microelectromechanical Systems in the USA. After 2000, the need for

the development of new technologies, such as electronic devices, monitoring sensors, biomedical and automotive components, encouraged the growth of the manufacture of products on an increasingly reduced scale.

Despite the scale range, there is no consensus on which cutting conditions a process passes from conventional scale machining to microscale. The main assessments on this issue concern either the dimensions of the cutting tool or the quality of the machined surface or the dimensions of the removed material. The first important difference in scale reduction is the perception of the operation and the cutting conditions. Observing the tool requires optical amplification and contact sensors and it is possible to detect situations of instability and excessive stress on the tool. Thus, it is very difficult to notice damaged cutting edges or even a broken tool, causing the loss of many hours of machining if these flaws are not detected in time [Araujo et al., 2020b]^P.

The research in micromilling started on the 2000s. The first conference on micromanufacturing (ICOMM - International Conference on Micromanufacture), including micromachining, was held in University of Illinois - Urbana-Champaign, USA in 2006. I was visiting the university and I was able to participate. Prof. Kapoor was one of the organizers and he is a leader in this area. Figure 9.1a shows the evolution on numbers of publications worldwide after 2006 (Search done in Clarivate WoS with the keyword "Micromilling" in topic (title, abstract and keywords)).

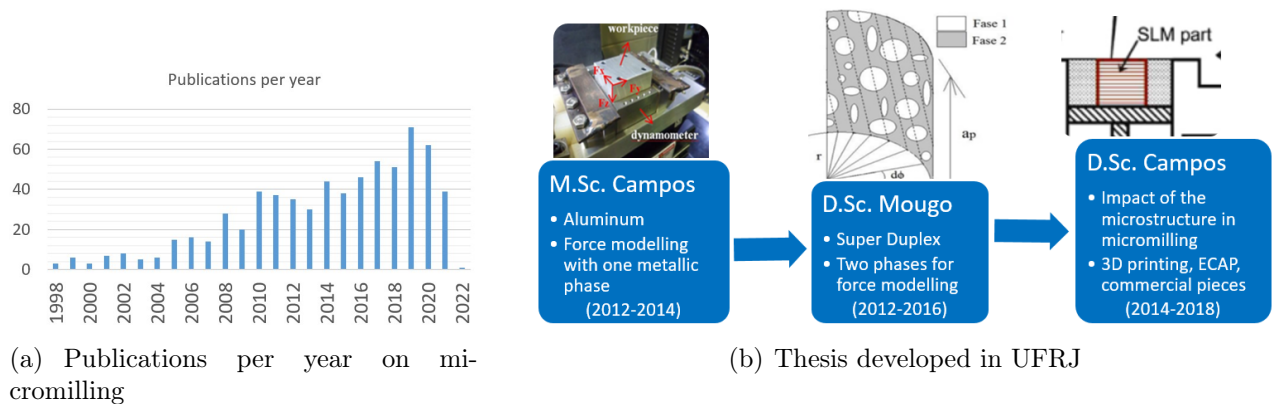

Figure 9.1. *Micromilling research and its relation with the thesis developed*

After my proposition for a grant and the final acquisition of the micromachining equipment in UFRJ, I was able to propose some topics for the students in Master in Science and Doctor in Science linked by the evolution of our knowledge in the field. Figure 9.1(b) presents a scheme with the specificity of the thesis. The first one, a Master thesis, discovered the equipment and applied the available force models. The second and third ones, two doctoral degree theses, were developed with newer models and challenging applications: heterogeneity force model and

application of micromilling in materials with different microstructures.

9.1.1 Micromilling tool geometry

The cutting tools used in micromilling have a different scale in their geometry, because the shank diameter is about 10 times bigger comparing to the cutting diameter. Figure 9.2(a) shows the tool diameter and the shank can be observed in Figure 9.3.

It is important to highlight that the hypothesis that the cutting edge is a sharp corner cannot be considered in micromilling, as it can be observed in Figure 9.2(b). The cutting edge is a rounded surface formed by the filleting between the rake and clearance surfaces, characterized by the cutting edge radius. The cutting edge radius r_e is small, but it cannot be neglected in relation to the feed per tooth. In microtools, r_e is measured by scanning electron microscopy or confocal microscopy.

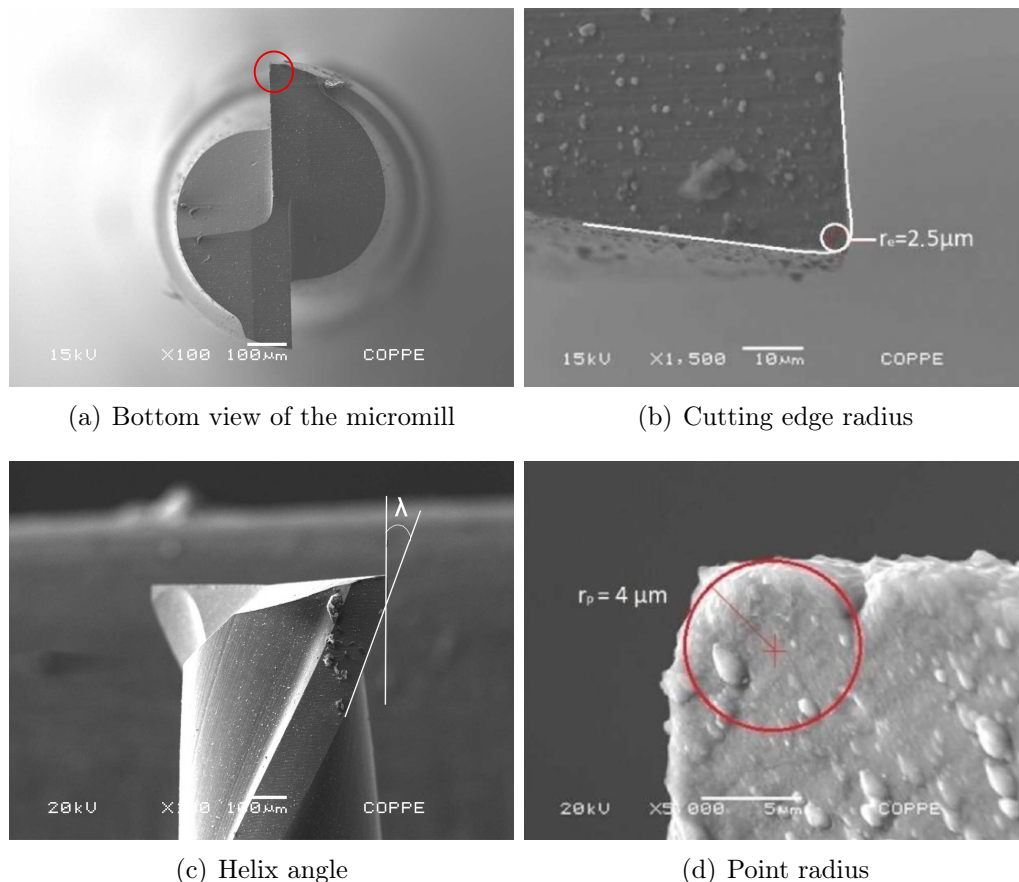

Figure 9.2. Geometry of a carbide micromill with a diameter of 0.8 mm (Mougo, 2016)^P

As it is shown in Figure 9.2(c) and 9.2(d), the helix angle λ and the nose radius r_e are also important elements to measure on the microtool, as shown in [Mougo, 2016]^P. The nose radius

defines the minimum depth of cut to have a proper cutting by the principal cutting edge.

Micromills are commonly made of carbide or diamond. For example, the minimum diameter of a diamond cutter can reach $100\ \mu\text{m}$ with a cutting edge radius of $0.1\ \mu\text{m}$ [Campos, 2018]^P. For carbide cutters, the cutting edge radius can vary from $1\ \mu\text{m}$ to $5\ \mu\text{m}$, limited by the microstructure of the material.

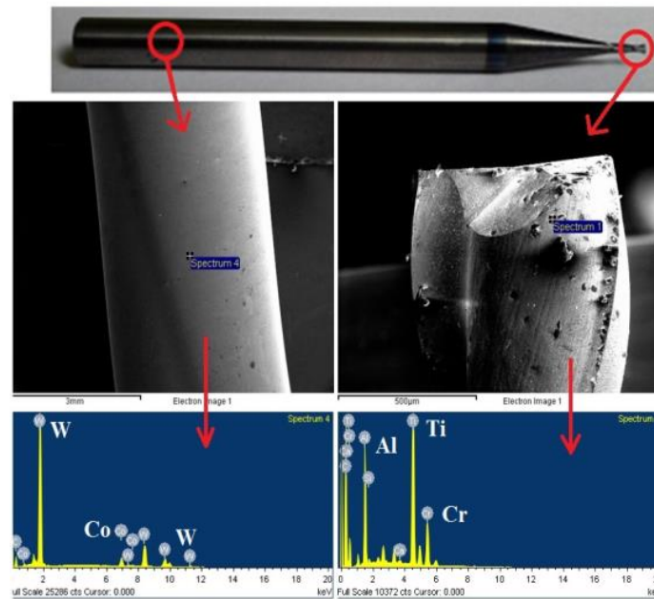

Figure 9.3. Micromilling tool material (Campos et al., 2017)^P

Tungsten carbide cutters take up to 85% of micromilling output, while diamond cutters take up approximately 6%. Among the carbide tools for micromilling, only 30% have some type of coating in the cutting area. The main types of coatings applied to micromills uses titanium aluminum nitride (TiAlN), TiN and hybrid coatings. An example is shown in Figure 9.3. The main advantage of using coatings is the reduction in tool wear but the coating can increase the radius of the cutting edge and consequently there is an increase on the cutting force and the surface quality of the piece changes [Campos, 2018]^P.

9.1.2 Size effect and microstructure

One fundamental concept should be highlighted in micromilling: the **size effect**. The scale effect in machining is a set of phenomena capable of describing the behavior of a material during small-scale manufacturing and deals mainly with the ratio between the rounding radius of the cutting edge (r_e) and the uncut chip thickness (h) and its relations with the grain size of the workpiece material. The grain size represents heterogeneity in the material because the chip size has the same scale: the tool can pass through only some few grains during one feed per tooth.

Special attention must also be given to the microstructure workpiece and the mechanical characterization of different microstructural phases. The presence of soft and hard phases in the same cutting path can cause tool oscillations, change chip dimensions, compromise cutting dynamics and shorten the life of the cutting tool. Another important analysis to be done in microstructure is to verify if the heterogeneous grains have a specific grain orientation. In this case, the cutting direction and the chip geometry can significantly change the cutting behavior as it happens in composite materials in meso scale.

In our research work we studied different workpiece materials, with grain sizes presented in Table 9.1. The tools we used had cutting edge radius were around $2.5\mu m$. In summary, the materials we studied are listed below:

- Aluminium alloy 6351-T6 - the first research, with microstructure that could be considered homogeneous for micromilling. The results are published in [Campos et al., 2017]^P;
- Three stainless steels: AISI 316 (Figure 9.4a) (*in [Wang et al., 2016]^P), AISI 430 (Figure 9.4b) and the super duplex UNS S32750 (Figure 9.4c) having two phases with similar microstructures compared to 316 and 430 - results published in [Mougo et al., 2018]^P;
- and four types of microstructure of Titanium alloys: Pure Titanium (Figure 9.4d), Pure Titanium manufactured from metal powder consolidated by equal channel angular pressing (ECAP) (Figure 9.4e), commercial Ti6Al4V (Figure 9.4f) and Ti6Al4V produced by SLM (Figure 9.4g) - published in [Campos et al., 2019]^P and [Campos et al., 2020]^P.

Material	Average grain size (μm)	f_z ($\mu m/th$)	V_c (m/min)	a_p (μm)
Al 6351T6	115 \approx 3 – 5 grains	2, 4 and 5	24, 30 and 36	100
Super Duplex	30.2 (Austenite) and 21.1 (Ferrite)	1, 2, 3, 5, 7 and 10	30 and 50	100
AISI 430	19.1	1, 5 and 10	30 and 50	100
AISI 316 (BUE analysis)	35.8	1, 5 and 10 0.05 - 1	30 and 50 10 - 60	100 30
Titanium alloys	10-20 (equi-axial α) and 1 (Martensite)	0.5 - 4	38	30

Table 9.1. Cutting parameters used in experiments in micromilling

Other examples of cutting parameters and feed per tooth values in other materials can be seen on the review article [Malayath et al., 2020] that cited recently our publication in Stainless steel.

Some considerations can be done about the cutting parameters in micromilling, based on our experience and the bibliography review: cutting velocities are not the same for micro and

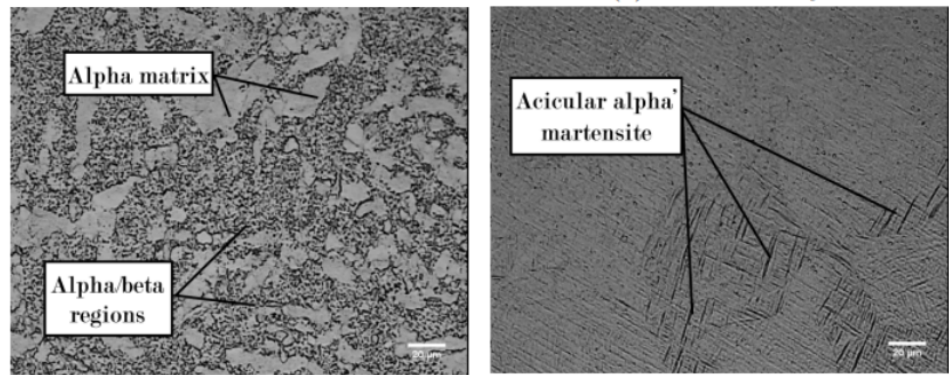
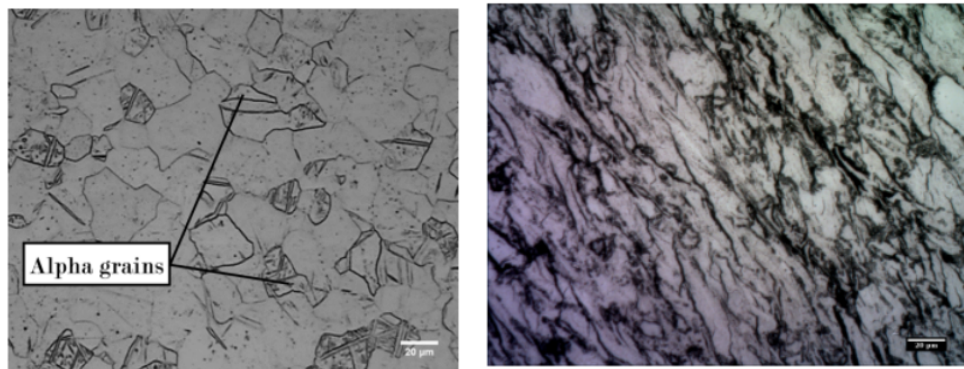
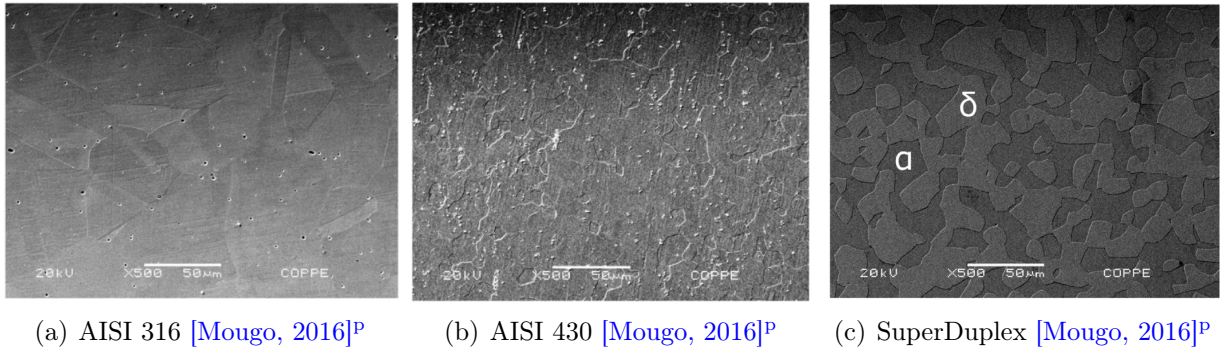

Figure 9.4. Microstructure of micromilling workpieces

mesoscale, although spindle speed is very high due to the small diameter; depth of cut are usually bigger than $a_p > 20\mu\text{m}$, and point radius are around $r_\epsilon \approx 5\mu\text{m}$, the principal cutting edge is mainly used.

9.1.3 Feed per tooth and BUE

Built-up edge (BUE) has been noted as a major cause for surface finish deterioration in micromachining processes because the formation of hardened and brittle structure on the tool edge alters the chip load, creating irregular material flow and deposits on the machined surface. In a collaboration with the University of Texas and the Federal University of Uberlândia, we produced a first experimental investigation of the BUE effects on micromilling. Experiments were conducted in the USA and the discussions were made with some exchanges of the research group.

The surface morphology and BUE formation on tool surfaces were studied via SEM, quantifying the dimension and dispersion of BUE on the surface, as represented in Figure 9.5a.

The experiments produced microchannels on 316L stainless steel using two flutes uncoated tungsten carbide micromills with 0.406 mm diameter and $5\mu\text{m}$ tool edge radius. It was used 16 different cutting conditions were tested: $V_c = 10, 27, 44$ and 60 m/min and $f_z = 0.05, 0.20, 0.50, 1.00$ $\mu\text{m}/\text{tooth}$. The axial depth of cut was $a_p = 30\mu\text{m}$ with a significantly large a_p/r_ϵ ratio.

It can be observed in Figure 9.5b that low feed per tooth results promote higher BUE densities. Also, surface finish were analysed because of the BUE deposits on machined surface. Results suggest that the BUE is the major determinant of surface finish besides the chip load effect in micromilling.

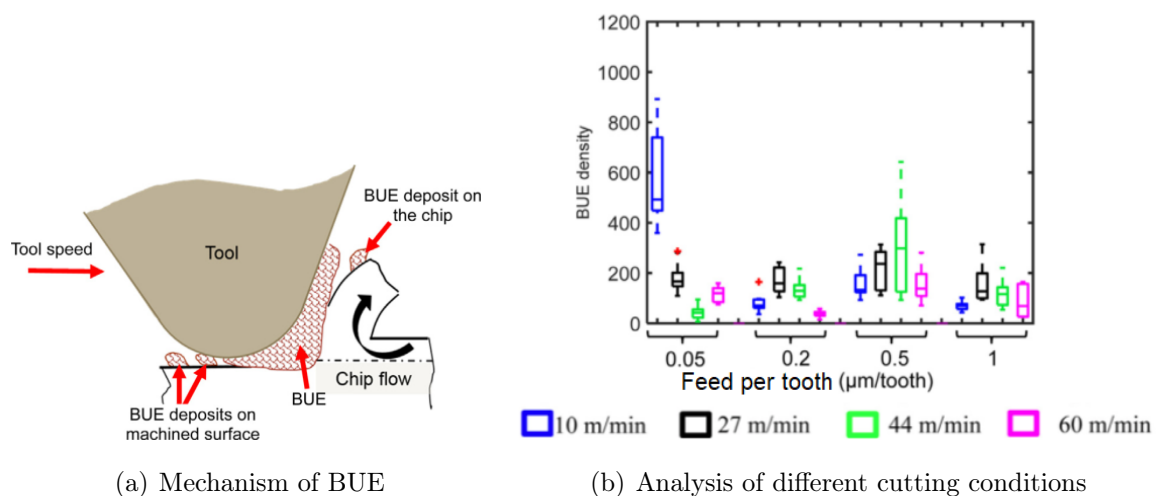

Figure 9.5. Build-up edge analysis in micromilling (Wang et al., 2016)^p

9.1.4 Feed per tooth and uncut chip thickness

In milling, Martellotti equation (Eq. 7.3) described the variation of the projection of uncut chip thickness in the working plane as a function of the position angle ϕ and the feed per tooth. As it can be seen in Table 9.1, the values of the feed per tooth in micromilling are much lower than milling, smaller than $10\mu\text{m}$. In microscale, Martellotti equation is not a good approximation and, among the propositions, Bao equation (Eq. 9.1) is usually used, dependent on the small tool diameter, adding the blue part on Eq. 7.3:

$$h_c(f_z, \phi, D_t) = f_z \sin(\phi) + \frac{N_f}{\pi D_t} f_z^2 \sin(\phi) \cos(\phi) + f_z \cos^2(\phi) \quad (9.1)$$

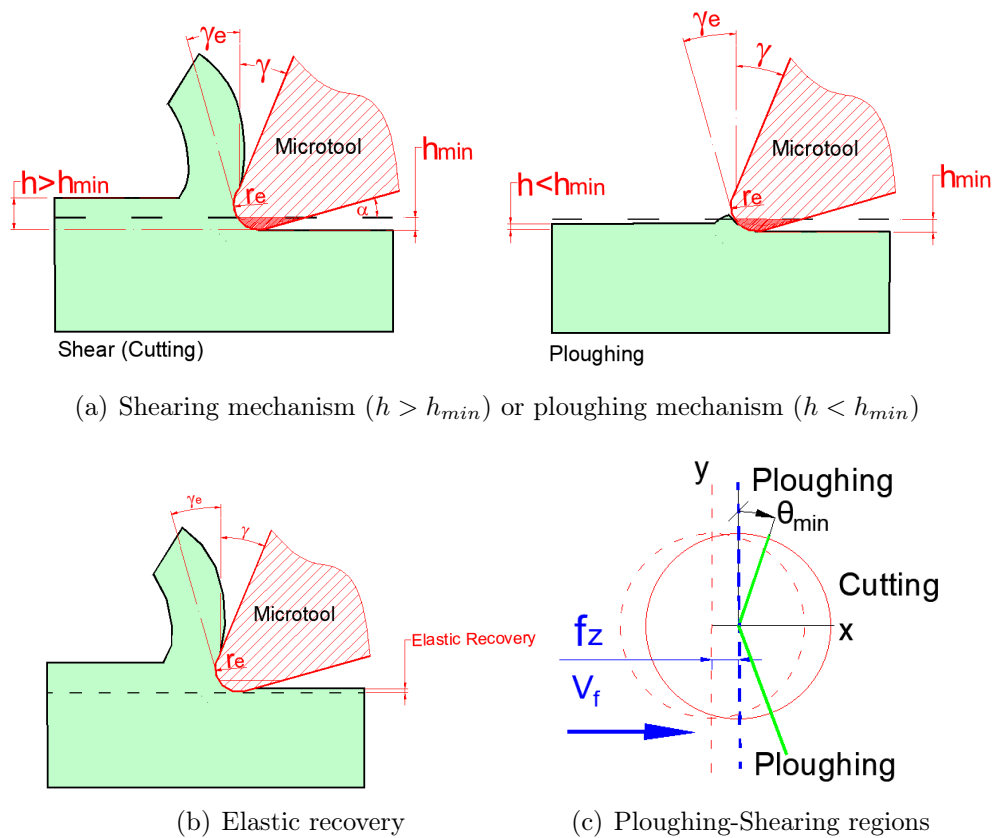

Figure 9.6. Micromilling cutting mechanism (Araujo et al., 2020b)^P

In order for the material to be removed by shear cutting, the uncut chip thickness h must be greater than the minimum thickness for chip formation h_{min} . When the uncut chip thickness is less than h_{min} , the cutting edge deforms the part surface by the **ploughing effect**, shown in Figure 9.6a. It can be noted in this figure that when $h < r_e$, the effective rake angle becomes negative ($\gamma_{ef} < 0$), which can generate excessive efforts during cutting and reduce tool life. In other hand, it could be positive if compression residual stresses are desired.

Elastic recovery is always present in cutting, but in micromachining, this layer is not far from the value of h_{min} , as graphically represented in Figure 9.6b. If $h \ll h_{min}$, the elastic recovery of the surface can compensate ploughing, depending on the elastic material properties of the part. This recovery can generate a rougher or wavy surface.

Analysing Eq. 9.1, it can be identified that in milling there are two regions of cut along ϕ variation (as represented in Figure 9.6c):

- ploughing region when $0 < h_c(f_z, \phi, D_t) < h_{min} \longrightarrow 0 < \phi < \phi_{min}$ or $\pi - \phi_{min} < \phi < \pi$
- and cutting region when $h_{min} < h_c(f_z, \phi, D_t) < f_z, \longrightarrow \phi_{min} < \phi < \pi - \phi_{min}$.

A first estimation of the minimum thickness for some materials is around 0.2-0.5 times r_e , varying with the workpiece material [Mougo, 2016]^P. It can be calculated based on the friction coefficient of nanoscratching test μ using the model developed by [Son et al., 2005]:

$$h_{min} = r_e \left[1 - \cos \left(\frac{\pi}{4} - \frac{\beta}{2} \right) \right] \quad \text{where} \quad \beta = \arccos \frac{1}{\sqrt{1 + \mu^2}} \quad (9.2)$$

9.1.5 Characterization of ploughing and elastic recovery using nanoindenters

As conventional microhardness and scratch testing produce relatively large marks, it becomes difficult to characterize each phase of the same material individually using traditional methods. These tests on the nanometric scale are widely used to verify phase properties such as modulus of elasticity, elastic recovery, coefficient of friction and hardness [Araujo et al., 2020b; Mougo, 2016]^P, described briefly in this subsection. These values can be used in mathematical models to predict the cutting forces.

For the nanoscratch test it is important to determine the displacement and the maximum loading that the diamond tip will reach in the material, to guarantee the analysis in a specific microstructural phase. For this, it is necessary to previously measure the grain diameter or the phase width by metallography and microscopy.

Figure 9.7(a) shows the surface profile during and Figure 9.7(b) after the test (transverse groove). In this last image it is possible to observe the elastic recovery of the material, which can be calculated from the integral of the formed area. From this image and the data provided by the equipment, it is possible to measure the elastic recovery at the base (Δ_h) and compare the volume of material that has flown and accumulated on the side of the tip, the "*pile-up*" (Figure 9.7(c)).

The nanohardness test is configured by the penetration of the diamond tip with a previously selected maximum load P_{max} . As the tip moves inside the material, the depth reached by the indenter h_i is composed of both elastic and plastic deformations. After applying P_{max} , the

indenter is removed and part of the material elastically recovers h_{re} and another part remains as residual deformation h_p . The result of the test is a graph that shows the loading and unloading curves, as shown in Figure 9.7(d).

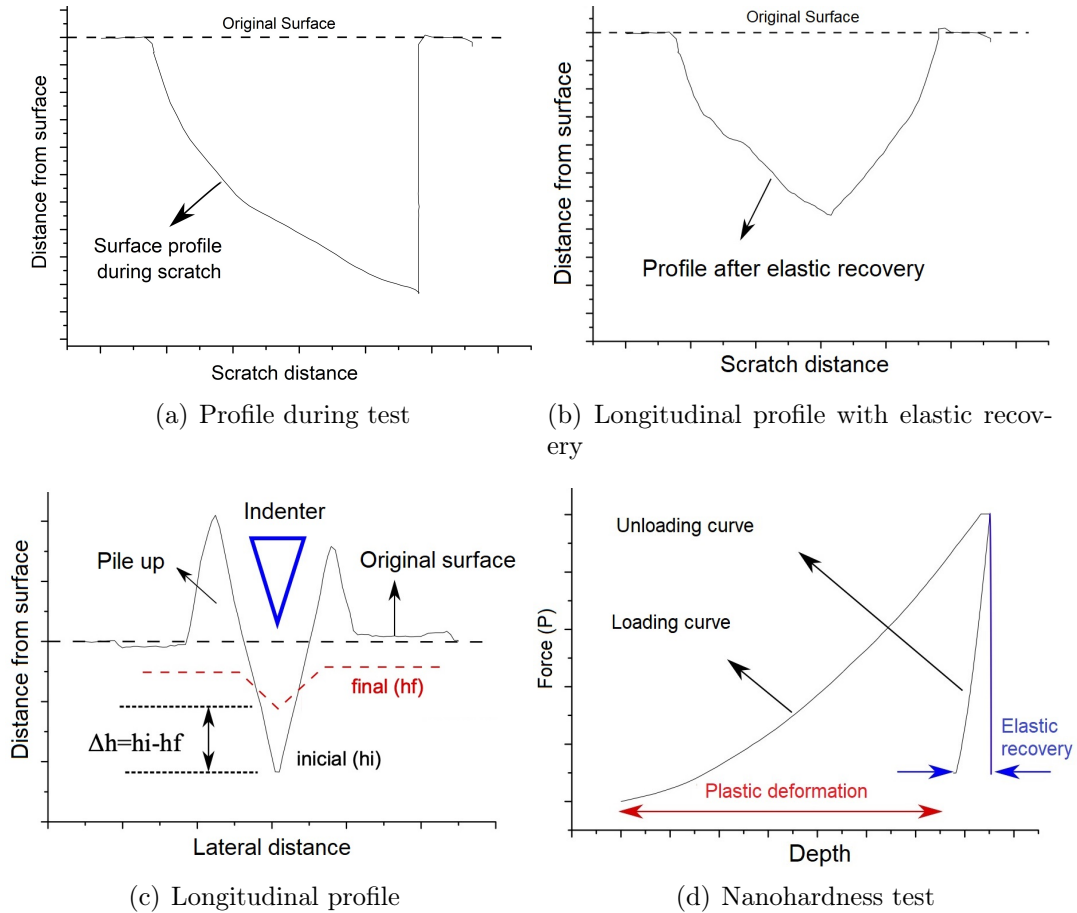

Figure 9.7. Nanoscratch test profiles and nanohardness test (Araujo et al., 2020b; Mougou, 2016)^p

From the results of the nanohardness test (Figure 9.7e) it is possible to calculate the modulus of elasticity E , the local hardness of the piece and the elastic recovery rate ρ_{re} . The elastic recovery thickness h_{re} is a function of the uncut chip thickness h and the elastic recovery rate ρ_{re} .

9.1.6 Modelling forces in micromilling

The micromachining force model is then a combination of shear cutting force dF_c , if $h > h_{min}$ ($p = 0$) and ploughing force dF_p , else if ($p = 1$).

$$\vec{F} = \int_0^b (d\vec{F}_c \cdot (1 - p) + d\vec{F}_p \cdot p) db \quad (9.3)$$

The shear cutting force F_c is calculated similar to milling process, but using Bao equation (Eq. 9.1). F_p is calculated using the ploughing area A_p , a function of the elastic recovery, as described by [Malekian et al., 2012], and the specific ploughing energy K_p :

$$dF_p = K_p A_p \quad (9.4)$$

[Malekian et al., 2012] proposed an elastic recovery height h_{er} for heterogeneous materials as a function of the elastic recovery rate ρ and of uncut chip thickness $h_{er} = \rho_{re} h$. The elastic recovery rate ρ_{re} is calculated using nanoindentation tests, using the maximum indentation force, the stiffness taking on the unloading curve and $h_{i_{max}}$ is the depth achieved at maximum indentation.

In the study of stainless steel, the AISI 430 presented 12% of elastic recovery and AISI 316 9%. The friction coefficient was measured as 0.32 for AISI 316, 0.35 for AISI430 and 0.33 for alpha and beta phases of super Duplex. For the lower feed per tooth ($f_z = 1\mu\text{m}$), the area of ploughing was very different between both materials, what did not happened in the higher value ($f_z = 10\mu\text{m}$).

The model applied for super duplex considered two different phases with different coefficients for each material [Mougo et al., 2018]^p, as shown in Figure 9.8:

$$dF_c = K_{c_i} h d b + k_{c e_i} \quad \text{for phase } i \quad (9.5)$$

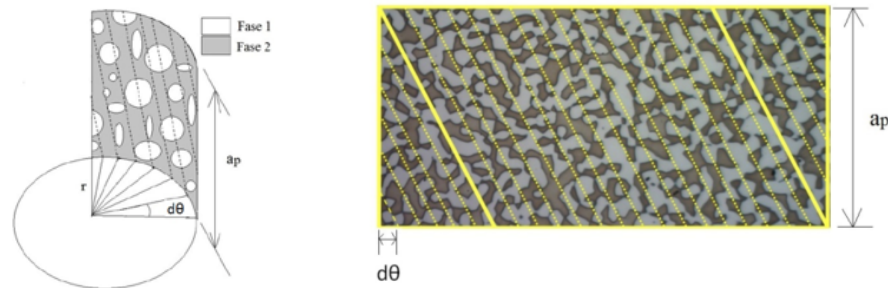

(a) Representation of grains along the micromilling surface (b) Combining microstructure and modelling the micromilling surface

Figure 9.8. Modelling bi-phase material

9.1.7 Experimental force results and the specific cutting force in micromilling

In all studies developed, experimental forces were acquired for model comparison and characterization of the cutting process. The minidynamometer was sensible for measuring forces until 20 N, so it was possible to see that the inertia of the machine was measured with the cutting forces. For the micromilling forces analysis we had to take this movement into account and filter the signal on the corresponding frequencies. Figure 9.9 shows the tool displacement region and the cutting region. After filtering the cutting region, it was possible to identify the expected force behavior.

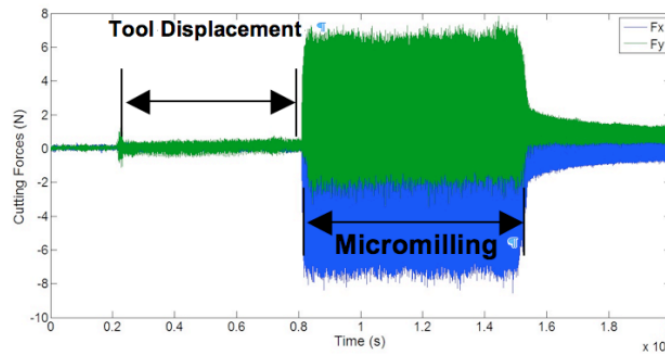

Figure 9.9. Raw signal from minidynamometer

The mechanistic approach considers Eq. 9.6 for calculating F_c for homogeneous workpiece material, calibrating the model using the experimental data to determine the coefficients a_0 , a_1 , a_2 and a_3 :

$$\ln(K_c) = a_0 + a_1 \ln(f_t) + a_2 \ln(V_c) + a_3 \ln(f_t V_c). \quad (9.6)$$

In Aluminium experiments [Campos et al., 2017]^P the force results were taken in the range $V_c = 24, 30$ and 26 m/min. $f_z = 2, 4$ and 5 μm . Figure 9.10a shows one experimental result for one of the calibration points. Using the maximum force data per cutting edge, it was possible to find the calibrated coefficients. The results on all calibration points and the response surface is presented in Figure 9.10b. For radial and vertical forces, it was used the following equation, considering $m_1 = 0.6$ and $m_2 = 0.2$:

$$K_r = m_1 \cdot K_c \quad (9.7)$$

$$K_z = m_2 \cdot K_c \quad (9.8)$$

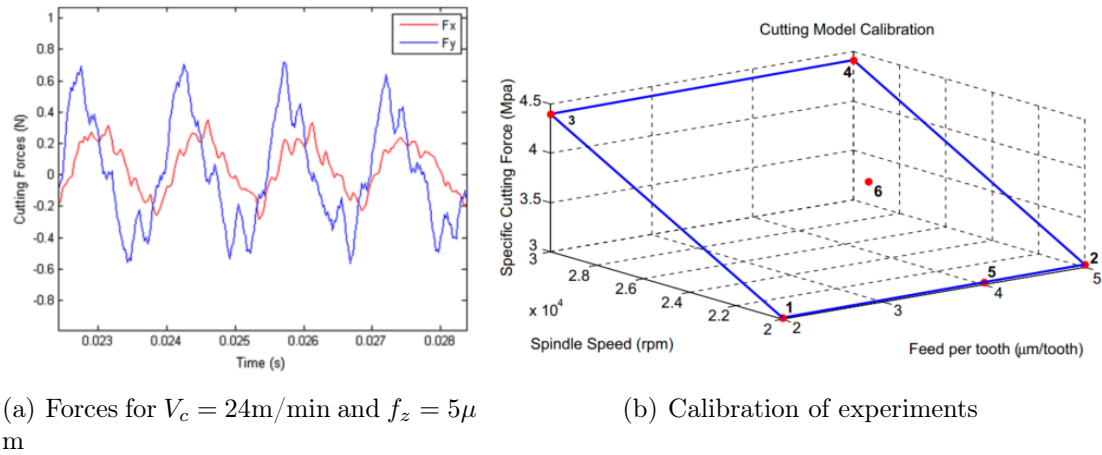

Figure 9.10. Forces and specific cutting calibration for Aluminum workpieces (Campos et al., 2017)^P

The same approach was used for stainless steel, considering all phases separately and combined. A comparison of forces between the different stainless steels is presented in Figure 9.11 using the same cutting conditions of cutting speed and feed per tooth.

Using experimental force data, it was performed the calibration of K_c for all materials and the coefficients are presented in Table 9.2 for each material separately (AISI430, AISI316 and super duplex) [Mougo et al., 2018]^P. Figures 9.12a and b present the calibrated curves of the specific cutting force K_{tc} using the coefficients. It can be seen that specific cutting coefficients of super duplex are located between AISI 316 and AISI 430 values. So, a relation between super duplex specific force K_{tc}^{SD} could be achieved as a combination of $K_{tc}^{AISI430}$ of the ferritic steel and $K_{tc}^{AISI316}$ of the austenitic steel:

$$K_{tc}^{SD} = f(K_{tc}^{AISI430}, K_{tc}^{AISI316}) \quad (9.9)$$

Table 9.2. Calibration coefficients for homogeneous mechanistic force model for stainless steel (Mougo et al., 2018)^P

Coefficient	AISI 430	AISI 316	Super duplex
a_0	6.2028	6.6388	6.7508
a_1	-0.3946	-0.2780	-0.3169
a_2	0.2582	0.0724	0.0846
a_3	-0.1364	-0.2056	-0.2323

Using the experimental data, it was found linear coefficients to relate the specific cutting force of super duplex to the other two materials: 0.4 and 0.6 with very low offset of -0.02. That means that AISI 430 steel contributes with 40% of the cutting force, while AISI 316 with 60%.

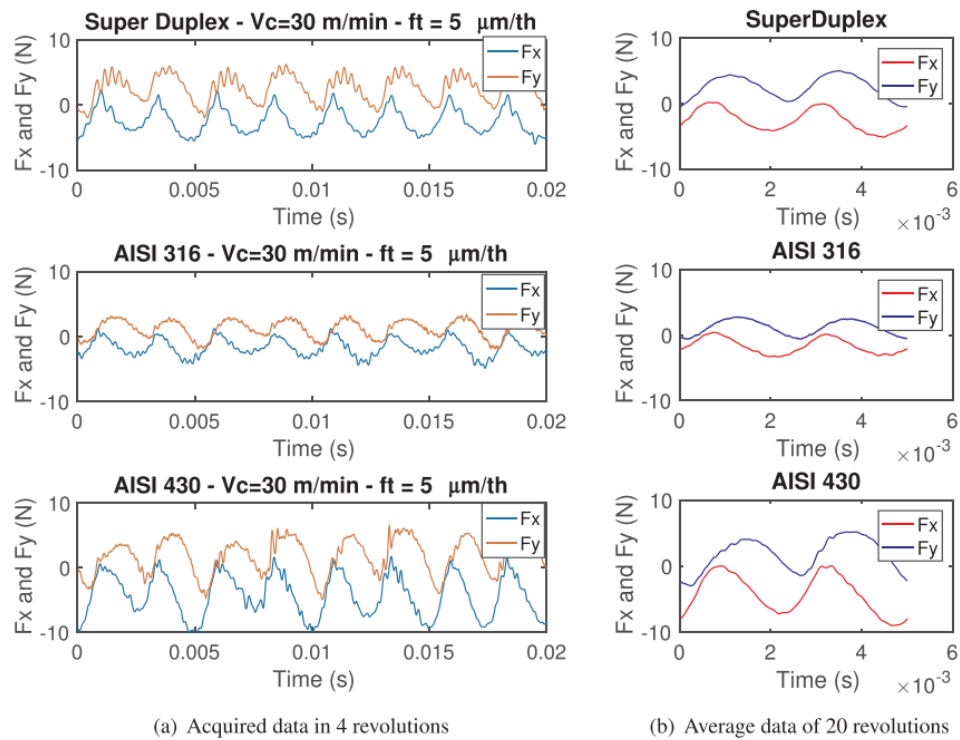
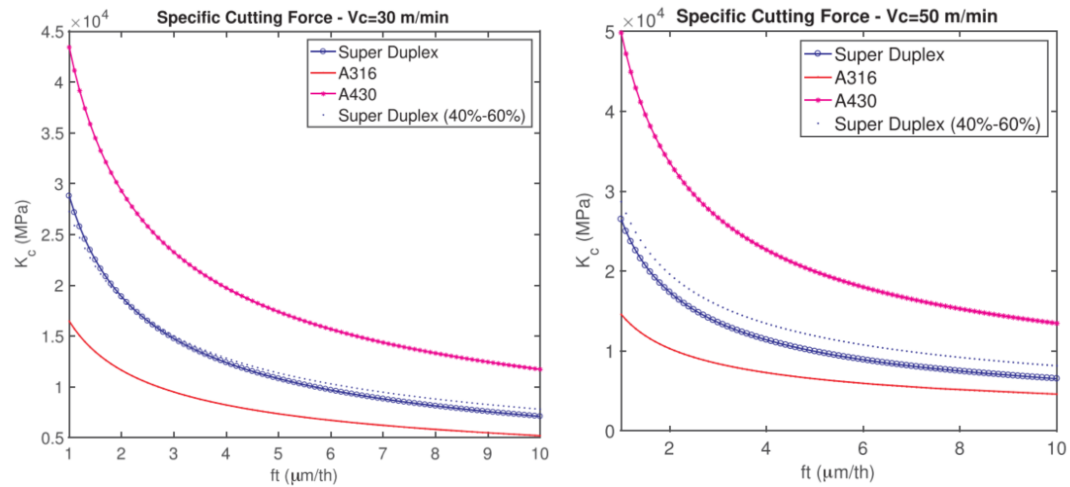

Figure 9.11. Forces during stainless steel experiments (Mougo et al., 2018)^P

It was noticed that it is the same relation between the grain size of each phase found in the structure and it is related to the number of grains that the cutting flute will be face to. The composed specific cutting force (40%-60%) was calculated with the other stainless steels and represented in Fig9.12a and b by a dashed curve, using the relation: $K_c^{SD} = 0.4.K_c^{AISI430} + 0.6.K_c^{AISI316}$. It could be affirmed that it was possible to predict the specific cutting force of the super duplex steel with smaller error, without the need of performing exhaustive experimental tests. Instead, there is the need of knowing the specific cutting force of AISI 430 and AISI 316 steels.

Cutting forces in Titanium alloys were also analysed [Campos, 2018]^P and the specific cutting force calculated for each Titanium alloy. As showed in Figure 9.12c, the comparison between the materials shows that the equal channel angular pressing samples presented higher specific force than the other materials, while commercial pure Ti presented the smaller ones. It can be noted also that SLM alloy sample presented a smaller specific force than the commercial alloy. This means that SLM alloy requires less energy to be cut and that the additive manufacturing changes the machinability of the material.



(a) Specific cutting model with calibrated coefficients in $V_c = 30$ m/min (b) Specific cutting model with calibrated coefficients in $V_c = 50$ m/min

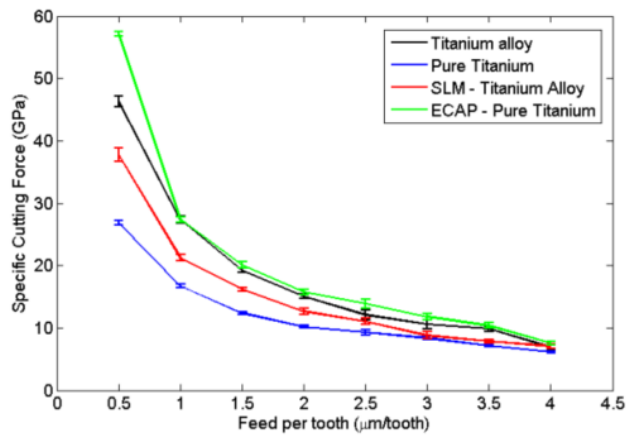

(c) Specific cutting values comparison SLM and commercial

Figure 9.12. Specific cutting values for Stainless steel (Mougo et al., 2018)^P and Titanium workpieces (Campos et al., 2019; Campos et al., 2020)^P

9.1.8 Burr formation in micromilling

Burr formation is an important factor for analyzing surface integrity, specially in micromilling as the procedure for deburring a workpiece machined by micromilling is very complex due to the miniaturized dimensions of the part. Both entrance burr and top burr occurs in micromilling. Although only top burr was quantified in [Mougo, 2016]^P and [Campos, 2018]^P.

In stainless steel experiments it can be seen in Figure 9.13a and b that feed per tooth from $7\mu\text{m}$ to $10\mu\text{m}$ changed the top burr formation. And that it the reason in the research with Titanium this topic was deeper analysed, an example in Figure 9.13c and d.

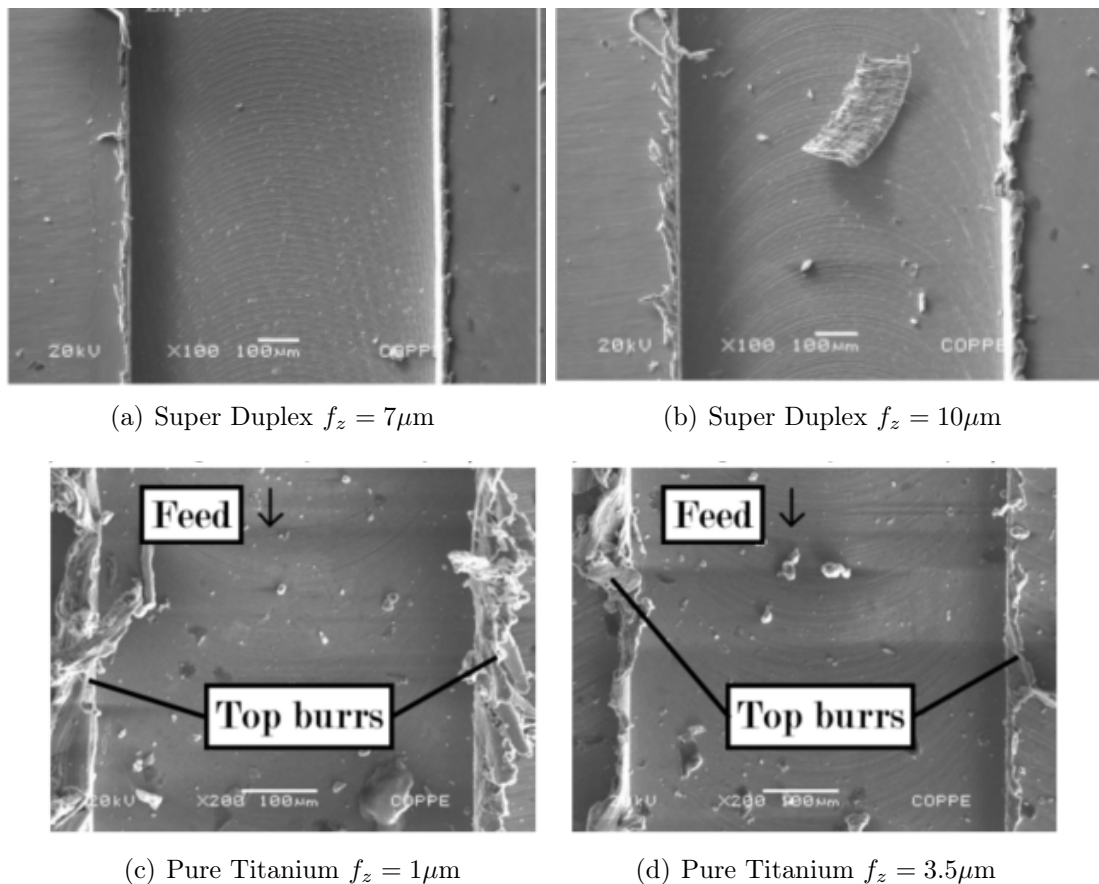

Figure 9.13. *Top burrs in micromilling*

Burr measurement can present expressive variations as there is not a standard procedure for measurement and it can be influenced by several factors. Because of this, burr formation analysis took into consideration both top burr height measurements.

Burr height was measured in all experiments in Titanium thesis [Campos, 2018]^P and a summary of results is presented in Figure 9.14. A general burr formation trend can be identified when varying feed per tooth: it decreases when increasing feed. Although for small feed values this trend is not identifiable, after 2.0 m/tooth , it becomes clear. As feed per tooth gets closer to

the cutting edge radius, shearing of the material starts to be replaced by ploughing mechanism where the material is plastically deformed more than cut off [Campos et al., 2020]^P.

Comparing the commercial sample with the SLM alloy, the SLM presented a better result having less burrs. In addition, despite of presenting less tool wear, the SLM sample also has a more brittle behavior as compared to Ti alloy, which should also contribute to the smaller burr values. The same behavior happened comparing commercial pure Ti and the consolidated powder by ECAP. The results showed that powder manufactured workpieces (SLM and ECAP) presented lower burr formation for all feed velocities and in both .

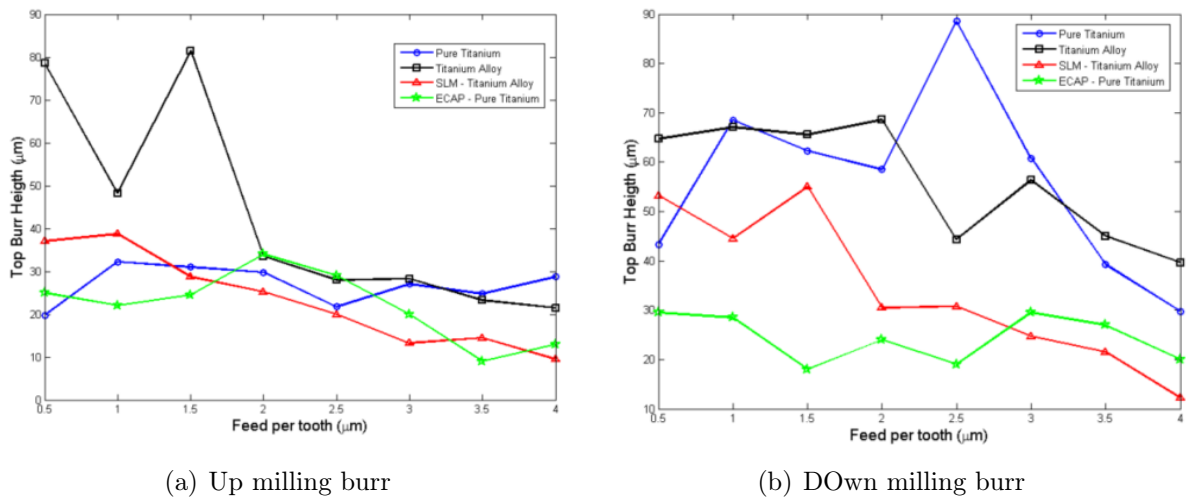

Figure 9.14. Burr height comparison in Titanium channels

9.1.9 Chip morphology in micromilling Titanium alloys

Microchips generated during the experiments in [Campos, 2018]^P were collected and analysed because the morphology of chips shows the transition of the cutting behavior. Analyzing the microchips through all the cutting conditions, it was noted that the microchips for all four material presented the same general behavior. Microchips presented a longer length for small feeds, especially below $1.5 \mu\text{m}/\text{tooth}$. Increasing the feed per tooth made microchips length decreased.

However, the shape of the chips was different when comparing the pure titanium samples (commercial and ECAP) with the Ti-6Al-4V samples (standard and SLM). For higher feeds, the chips for pure titanium went from long snarled chips to loose arc shape, while for the alloy based samples it went from snarled to helical short chips.

Comparing commercial Ti64 with SLM, Figure 9.15 presents microchips generated during the experiments for 0.5 and $4.0 \mu\text{m}/\text{tooth}$. As claimed, comparing lower and higher feed, the chip length is smaller when increasing feed per tooth: chip length for $f_z = 4.0 \mu\text{m}/\text{tooth}$ is $200 \mu\text{m}$

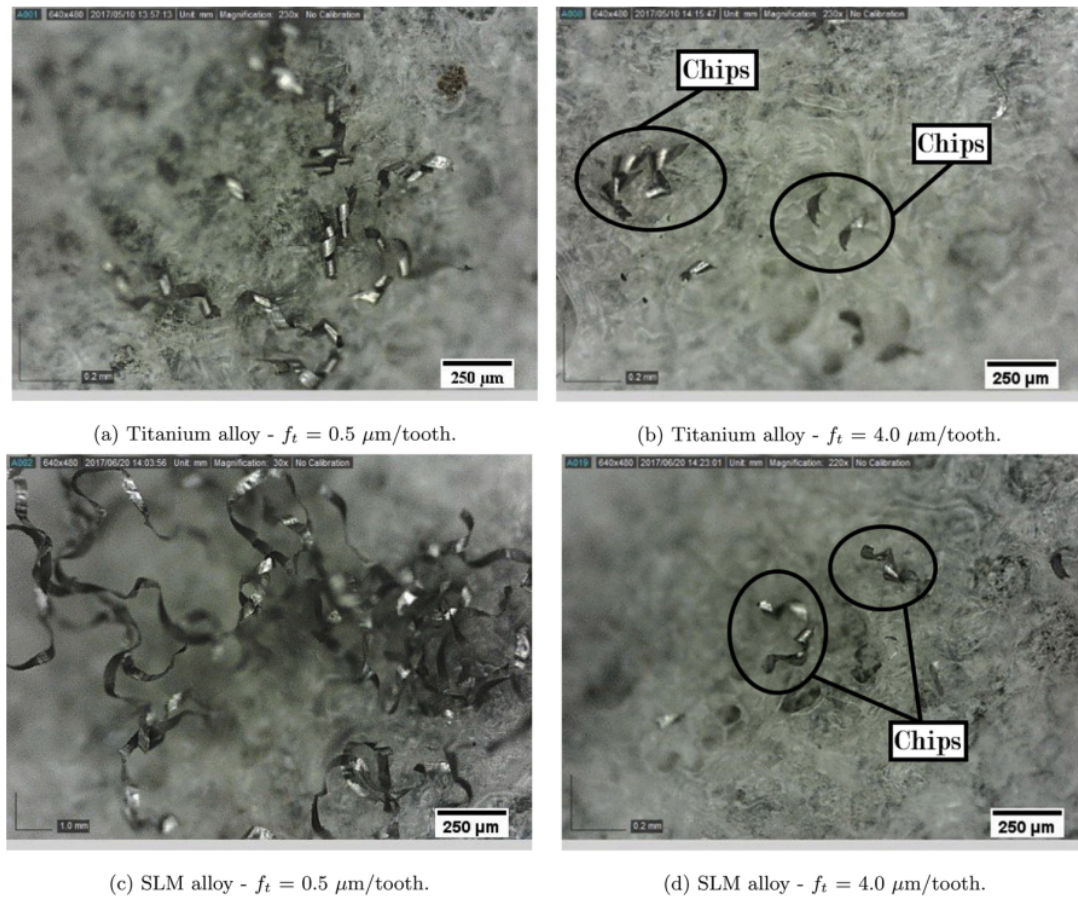

Figure 9.15. *Chips in micromilling*

and the chips taken from $0.5\mu\text{m/tooth}$ have approximately 0.5 mm in commercial workpieces and 2 mm in SLM alloy.

It is important to notice that for the SLM material, small feeds lead chips bigger than the theoretical tool engagement with the workpiece. This can happen when ploughing phenomenon is dominant. As material can accumulate, one flute will remove the material left by the previous flute engagement leading to higher chip length.

9.2 Additive manufacturing research

In addition to the study done with SLM additive manufacturing process in micromilling, I was able to produce research together with the students using the other AM equipment that we acquired for UFRJ: Fused Deposition Modeling (FDM), Stereolithography (SLA) and binder jet printing (BJP), and a collaboration in Selective Laser Sintering (SLS) with INT¹. In this report, it is detailed three studies using these equipments: the production of porous scaffolds and tubes for medical applications [Magaldi et al., 2018]^P, the study of manufacturing a fiber composite by BJP [Coelho et al., 2019]^P, and the production of bone-like material in INT.

Additive manufacturing for medical applications using FDM and SLA

3D printing techniques have been employed in Tissue Engineering to produce scaffolds with complex geometries and controllable porosity because pore geometry and inter connectivity defines its performance. [Magaldi et al., 2018]^P evaluated the structure of the scaffolds produced by FDM and SLA with different geometry configurations.

The geometry was designed to be manufactured by FDM using the filament geometry in order to compare the same geometries, as SLA capacity on bulk geometries is more flexible. Four similar computational models were designed with different filament orientations: 0-90 (A), 0-45-90 (B), 0-60-120 (C) and and 0-45-90-135, represented in Figure 9.16a. The models were transformed in STL files for manufacturing.

It was used 3D Cloner FDM printer using print head extrusion temperature set at 220°C, layer thickness of 0.3 mm and resolution of 0.050 mm. The filament used was poly lactic acid (PLA), on 1.75 mm diameter. SLA equipment is Projet 1200 (3D Systems) using VisiJet FTX Green photo polymerizable resin (Triethylene glycol diacrylate in liquid state ($C_{12}H_{18}O_6$) with phenyl oxide bis photoinitiator).

Figures 9.16b and 9.16c show SEM images of scaffolds produced by FDM and SLA processes with two layer orientations (A and B), respectively, as examples. It can be observed that the scaffolds obtained by FDM were less homogeneous than those obtained by SLA, with respect to the deposition of each printed layer. This fact may be related to the presence of non-projected filaments derived from the process for the production of the parts. In SLA samples some the cylindrical sections in scaffolds were not homogeneous, varying their thicknesses along their length, possibly related to polymer residues that were not removed in the application of isopropyl alcohol and therefore were cured in the post-cure.

It was measured the dimensional errors and the porosity in all samples, comparing the STL model and the produced parts. In spite of using different polymers for each AM process, it was observed that FDM parts presented higher porosity and lower dimensional deviation in

¹INT - National Institute of Technology - <https://www.gov.br/mcti/pt-br/rede-mcti/int/>

relation to digital model then SLA parts for all geometries. However, the quality of deposited filaments was higher for SLA scaffolds. The porosity obtained for scaffolds produced by both techniques is compatible with the use in Tissue Engineering, however the results showed that the parts obtained by SLA, independently of the geometry, presented dimensions with only small variations in relation to the CAD model used [Magaldi et al., 2018]^P.

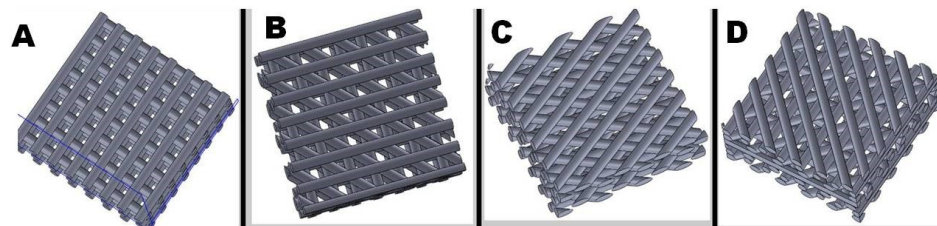

(a) STL geometries with different orientations

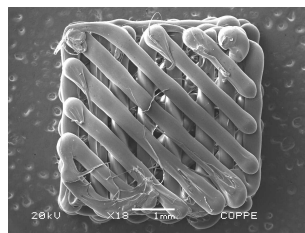
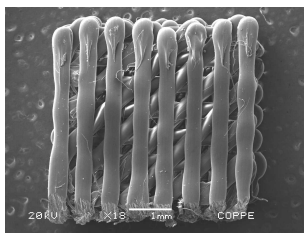

(b) Samples produced by FDM

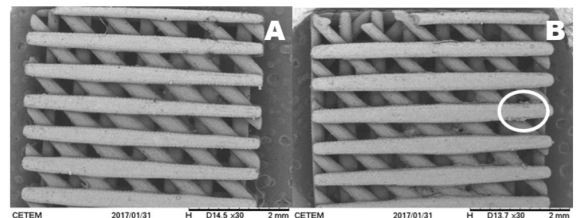

(c) Samples produced by SLA

Figure 9.16. Scaffolds produced in FDM and SLA (Magaldi et al., 2018)^P

In the work of [Gutnik, 2017]^P, a final Engineering project, the same SLA equipment and polymerizable resin was used to evaluate the capability of this process to produce nerve conductors. In this work, it was introduced the concept of this technique of nervous rehabilitation with a bibliographical review regarding recent advances in the use of this technology. Simple tubes (Figure 9.17a) and oblique connectors (Figure 9.17b) were manufactured using different diameters and thicknesses analysing its dimensions and surface defects.

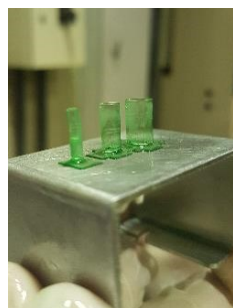

(a) Tubes

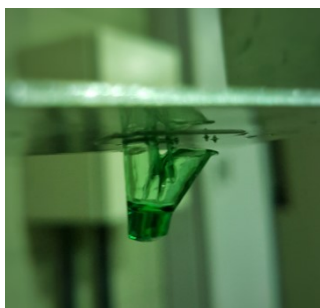

(b) Connectors

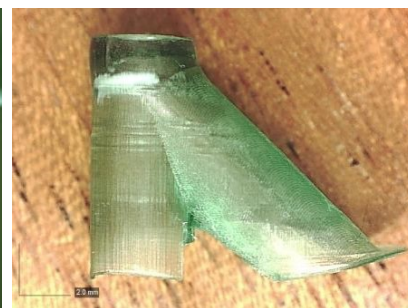

(c) Defects

Figure 9.17. SLA for neurotubes (Gutnik, 2017)^P

The length of the tubes, the most important parameter in the design of conducting nerve, had very satisfactory results, being very close to the ideal dimensions. The diameters deviated slightly from the nominal dimension, although it could be compensated by the contraction factor. The thicknesses were the biggest affected in the manufacture, being necessary bigger adjustments in the drawings to guarantee that they have dimensions for its good functioning. The minimum tube thickness that the manufacturing process was available to produce was 0.20 mm, thinner tubes collapsed due to their own weight. In connectors, the poor cleaning with solvent caused the part to fracture in its removal. It was noted also irregularities of the circular section of the bifurcated tube.

Gypsum–sisal fiber composites using binder jet printing

Binder jetting (BJ) produces workpieces that could be used in a great variety of applications, such as decorative parts, prototypes, foundry molds, bone implants, and consists on a powder deposition process to form the layers, followed by a binding process and a post-processing to enhance mechanical properties. Its building platform is a powder-bed where the printer head deposits the binder at the corresponding workpiece area in each layer. The binder interacts with the powder, causing an agglomeration of the particles, which results in the layer formation. The building platform moves down and the process is repeated until the part is finished (Figure 9.18a). It is a versatile technique as it is possible to make its parts from different powder materials, such as metals, ceramics and some specific composites.

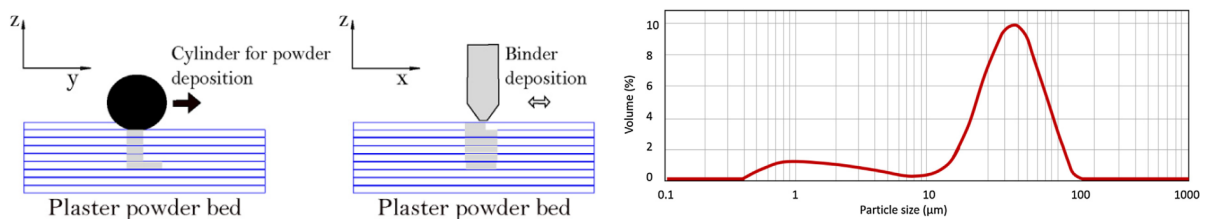

(a) Binder Jetting

(b) Gypsum particle distribution

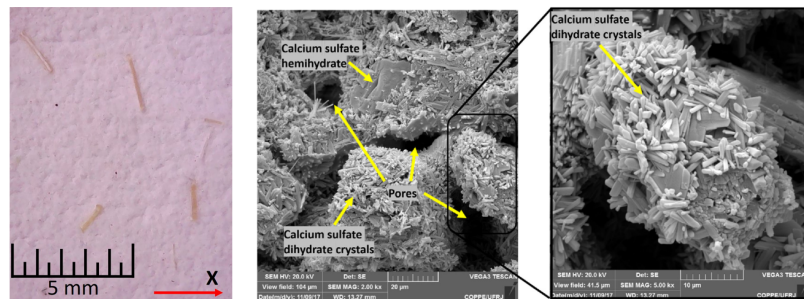

(c) Fibers in the workpiece

(d) SEM of the green part

Figure 9.18. Workpiece material characterization (Coelho et al., 2019)^P

The M.Sc. thesis developed by [Coelho, 2018]^P produced a composite by binder jetting mixing fibers to the traditional raw material in order to enhance its mechanical properties, publishing an article in the main international journal of the area [Coelho et al., 2019]^P.

In Brazil, sisal fibers are abundant and they are considered to be a promising reinforcement in composites because of their low cost, high strength, and lack of risk to human health. As there was no previous study on the application of this fiber in binder jetting, this study proposed the production of gypsum–sisal fiber parts using BJ and the analysis of the effects of some manufacturing parameters, such as the presence of fiber, printing orientation, and post-processing.

The raw materials used were: the gypsum powder (VisiJet PXL Core from 3D Systems) having 80–90% of calcium sulfate hemihydrate ($CaSO_4 \cdot 0.5H_2O$), according to the manufacturer, and a commercial sisal fiber having 3% impurity and 14% humidity. The fibers were cut to achieve lengths of 1-2 mm and mixed to the gypsum powder at the volumetric proportion of 1.5%. Gypsum powder particle size distribution is shown in Figure 9.18b, determined using a laser Malvern Particle Sizer. The binder used was VisiJet PXL Clear (3D systems), a water based liquid containing 1% of 2-Pirrolidone, an organic compound that will prevent the corrosion of the printer head. The infiltrant used was an adhesive compound of ethyl-2-cyanoacrylate with a total curing time of 24 h.

The samples were printed in a ProJet460 Plus binder jetting printer. In this equipment, the powder is spread in the y axis direction across the building platform while the printer head movement of binder deposition is in the x direction. Two types of samples (with and without fibers) and with two different geometries (cubic and prismatic beam) were printed. One image of the surface workpiece with fibers is shown in Figure 9.18(c).

The material characterization was performed on raw materials and printed parts in the form of thermogravimetric analysis (TGA), X-ray diffraction (XRD), and scanning electron microscopy (SEM), as presented in Figure 9.18(d). A complete 24 factorial design for analysis of variance was performed to evaluate the mechanical strength and porosity of the manufactured parts.

The porosity results of each experiment are presented in Figure 9.19a. It can be observed that the 7B experiment (green part reinforced with fiber printed in y direction with its bottom vertical to the platform) has achieved the highest percentage of porosity, while 12B experiment (infiltrated part not reinforced with fiber printed in x direction with its bottom horizontal to the platform) achieved the lowest. The orientation of printing factors contributes to the increase in porosity when the parts are printed in y length direction (B). Each parameter interacts with the sisal fiber reinforcement, so a combination of the parameters had an influence on the porosity, as shows the ANOVA analysis.

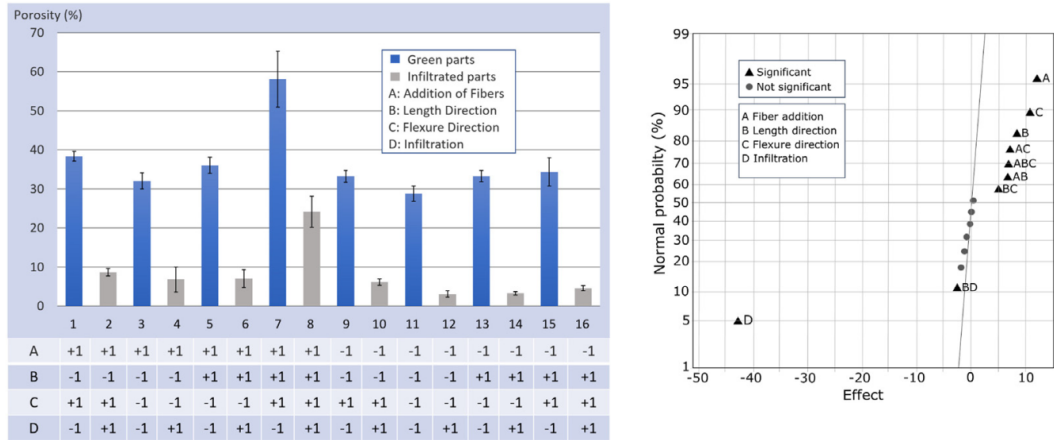

(a) Porosity results

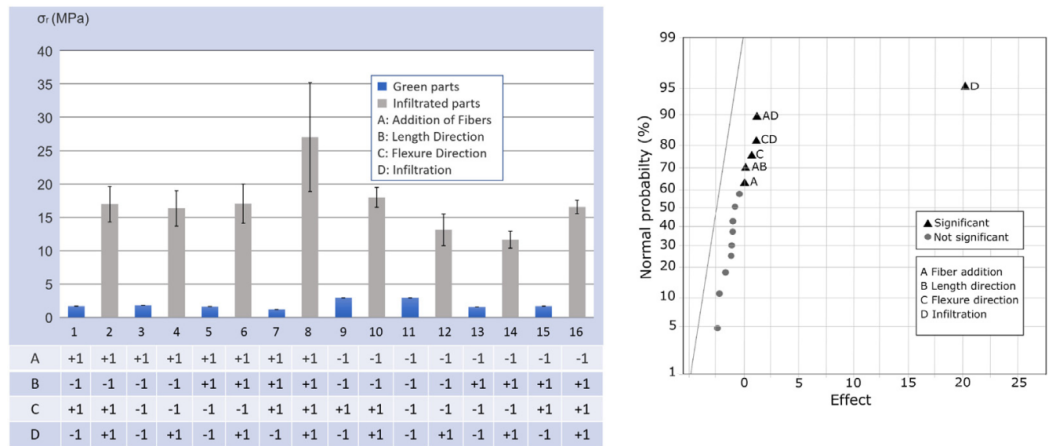

(b) Strength results

Figure 9.19. BJ Results (Coelho et al., 2019)^p

The strength results of each experiment are presented in Figure 9.19b. The 7A experiment (green part reinforced with fiber printed in y direction with its bottom vertical to the platform) has the lowest strength while the 8A experiment (infiltrated part reinforced with fiber printed in y direction with its bottom vertical to the platform) has the highest. It was observed that the fibers had a positive influence on the mechanical strength of the infiltrated parts, but a loss of strength was verified on the green parts. When the post-process of infiltration was applied to the parts, a greater strength was seen for the ones with sisal (41% stronger), which indicates that more resin was capable of entering in the parts with more pores. In addition, the resin may have caused a stronger interface between fiber and matrix, thus enhancing its mechanical properties.

Bone-like specimen produced by SLS

The mechanical properties obtained in bone tissues with different levels of mineralization are fundamental parameters in the study of the development of possible more accurate and economical diagnostic methods of this disease. Tensile tests on cortical bone tissue are often invalidated due to the complex and variable bone geometry and the morphological characteristics of this material.

Two parallel final projects were developed by INT in collaboration with UFRJ: a work that studied the simulation of specimen geometry on mechanical properties obtained by tensile tests (advised by a solid mechanics researcher [de Lima Gonçalves, 2019] and the manufacturing of specimens in ABS (Acrylonitrile Butadiene Styrene) polymer (Figure 9.20(a) and (b)) and also machined from bovine bones [Joaquim, 2019]^P. The second part was done leading several discussions between both universities and the bones were machined in our laboratory in UFRJ (Figure 9.20(c)).



(a) ABS normalized specimen

(b) ABS specimen with scanned bone geometry

(c) Bone normalized specimen produced by machining

Figure 9.20. *SLS and machined specimens (Joaquim, 2019; de Lima Gonçalves, 2019)^P*

Section III

Research project

Personal References, cited in the text as: (name, year)^P

- Araujo, A. C., Silveira, J. L., & Kapoor, S. (2004). Force prediction in thread milling [hal-03226689]. *Journal of the Brazilian Society of Mechanical Sciences and Engineering*, 26, 82–88. http://www.scielo.br/scielo.php?script=sci_arttext&pid=S1678-58782004000100014&nrm=iso
- Araujo, A. C., Silveira, J. L., Jun, M. B., Kapoor, S. G., & DeVor, R. (2006). A model for thread milling cutting forces [hal-03226667]. *International Journal of Machine Tools and Manufacture*, 46(15), 2057–2065. <https://doi.org/https://doi.org/10.1016/j.ijmachtools.2005.12.012>
- Araujo, A. C., & Silveira, J. L. L. (2009). Acoustic Emission used in modeling end milling. *Máquinas e Metais*, 519(p.36 - 51). <https://hal.archives-ouvertes.fr/hal-03226793>
- Araujo, A. C., Fromentin, G., & Poulachon, G. (2013a). Analytical and experimental investigations on thread milling forces in titanium alloy [hal-03226671]. *International Journal of Machine Tools and Manufacture*, 67, 28–34. <https://doi.org/https://doi.org/10.1016/j.ijmachtools.2012.12.005>
- Araujo, A. C., Mougo, A. L., & Campos, F. d. O. Micro milling cutting forces on machining aluminium alloy. In: *ICOMM 2013*. Victoria, Canada, 2013. <https://hal.archives-ouvertes.fr/hal-03214824>
- Araujo, A. C., Savi, M. A., & Calas Lopes Pacheco, P. M. Dynamics of 2-dof micro-end-milling system considering grain-size variation [hal-03226681]. In: *Functional and structural materials ii. 758*. Materials Science Forum. hal-03226681. Trans Tech Publications Ltd, 2013, July, 165–173. <https://doi.org/10.4028/www.scientific.net/MSF.758.165>
- Araujo, A. C., Mello, G. M., & Cardoso, F. G. (2015). Thread milling as a manufacturing process for api threaded connection: Geometrical and cutting force analysis [hal-02971842].
-

- Journal of Manufacturing Processes*, 18, 75–83. <https://doi.org/https://doi.org/10.1016/j.jmapro.2015.01.002>
- Araujo, A. C., & Fromentin, G. (2017). Modeling thread milling forces in mini-hole in dental metallic materials [16th CIRP Conference on Modelling of Machining Operations (16th CIRP CMMO) - hal-03226685]. *Procedia CIRP*, 58, 623–628. <https://doi.org/https://doi.org/10.1016/j.procir.2017.03.228>
- Araujo, A. C., & Fromentin, G. (2018). Investigation of tool deflection during milling of thread in Cr-Co dental implant [hal-02060570]. *The International Journal of Advanced Manufacturing Technology*, 99(1), 531–541. <https://doi.org/10.1007/s00170-018-2520-x>
- Araujo, A. C., Fromentin, G., & Blandenet, P. (2020a). Investigation on PCD cutting edge geometry for Ti6Al4V high-feed milling [hal-02971721]. *The International Journal of Advanced Manufacturing Technology*, 111(5), 1785–1796. <https://doi.org/10.1007/s00170-020-06086-z>
- Araujo, A. C., Mougo, A. L., & Campos, F. d. O. (2020b). *Usinagem para engenharia. um curso de mecânica do corte* (1st edition) [Title in English: Machining for Engineering: A course on cutting mechanics - ISBN: 978-65-8706-504-5 (Printed version) and 978-65-00-08056-8 (E-book)]. Ed. E-papers.
- Araujo, A. C., Landon, Y., & Lagarrigue, P. (2021). Smart drilling for aerospace industry: State of art in research and education [14th CIRP Conference on Intelligent Computation in Manufacturing Engineering, 15-17 July 2020 - hal-03218917]. *Procedia CIRP*, 99, 387–391. <https://doi.org/https://doi.org/10.1016/j.procir.2021.03.105>
- Barbosa, M., Jr., A. M., Pardal, J. M., Bartholo, R., Araujo, A. C., & Fonseca, M. C. (2010). Tensões residuais no fresamento de amostras de aço superduplex. *Máquinas e Metais*, 535, p.46 –61. <https://hal.archives-ouvertes.fr/hal-03226794>
- Cabrera, C. G. A., Castello, D. A., & Araujo, A. C. Detecção de vibrações no processo de fresamento de topo aplicando a transformada wavelet a sinais de força de usinagem. In: *8^o Congresso Brasileiro de Engenharia de Fabricação*. Salvador, Brazil, 2015. <https://hal.archives-ouvertes.fr/hal-03226771>
- Cabrera, C. G., Araujo, A. C., & Castello, D. A. (2017). On the wavelet analysis of cutting forces for chatter identification in milling [hal-02971817]. *Advances in Manufacturing*, 5(2), 130–142. <https://doi.org/10.1007/s40436-017-0179-4>
- Campos, F. d. O., Mougo, A. L., & Araujo, A. C. Modeling micromilling cutting force on machining aluminum alloy. In: *22nd International Congress of Mechanical Engineering (COBEM 2013)*. Ribeirão Preto, Brazil, 2013. <https://hal.archives-ouvertes.fr/hal-03214822>

- Campos, F. d. O., de Castro Monte Schroder, F., Araujo, A. C., de Blas, J. G., & Pereira, L. C. (2016). Cutting forces and mechanical resistance of pure titanium processed by equal channel angular pressing [7th HPC 2016 – CIRP Conference on High Performance Cutting - hal-03226684]. *Procedia CIRP*, 46, 222–225. <https://doi.org/https://doi.org/10.1016/j.procir.2016.04.038>
- Campos, F. d. O., & Araujo, A. C. An experimental comparison regarding burr formation on micromilling of titanium alloy ti-6al-4v using different experimental setups. In: *9^o Congresso Brasileiro de Engenharia de Fabricação*. Joinville, Brazil, 2017. <https://hal.archives-ouvertes.fr/hal-03226786>
- Campos, F. d. O., Mougou, A. L., & Araujo, A. C. (2017). Study of the cutting forces on micromilling of an aluminum alloy [hal-03226672]. *Journal of the Brazilian Society of Mechanical Sciences and Engineering*, 39(4), 1289–1296. <https://doi.org/10.1007/s40430-016-0668-6>
- Campos, F. d. O., Araujo, A. C., & Kapoor, S. G. Experimental Comparison of Micromilling Pure Titanium and Ti-6Al-4V. In: *WCMNM 2018*. Slovenia, Slovenia, 2018, September. <https://hal.archives-ouvertes.fr/hal-02320023>
- Campos, F. d. O., Araujo, A. C., & Kapoor, S. G. Experimental Comparison of Micromilling Pure Titanium and Ti-6Al-4V. In: *WCMNM 2018*. Slovenia, Slovenia, 2018, September. <https://hal.archives-ouvertes.fr/hal-02320023>
- Campos, F. d. O., Araujo, A. C., & Kapoor, S. G. (2019). Experimental Comparison of Micromilling Pure Titanium and Ti-6Al-4V [hal-02320034]. *Journal of Micro and Nano-Manufacturing*, 7(2). <https://doi.org/10.1115/1.4043501>
- Campos, F. d. O., Araujo, A. C., Munhoz, A. L. J., & Kapoor, S. G. (2020). The influence of additive manufacturing on the micromilling machinability of ti6al4v: A comparison of slm and commercial workpieces [hal-02985404]. *Journal of Manufacturing Processes*, 60, 299–307. <https://doi.org/https://doi.org/10.1016/j.jmapro.2020.10.006>
- Cardoso, F. G., & Araujo, A. C. Analise de forças no fresamento de roscas API. In: *7^o Congresso brasileiro de engenharia de fabricação*. Itatiaia, Brazil, 2013, May. <https://hal.archives-ouvertes.fr/hal-03214834>
- Cardoso, F. G., & Araujo, A. C. (2014). Análise de Forças no Fresamento de Roscas API. *Máquinas e Metais*, 582, 18–31. <https://hal.archives-ouvertes.fr/hal-03226824>
- Coelho Cosenza, M., Valério Ribeiro, M., & Araujo, A. C. Stability on turning of Inconel 718 using vibration-assisted machining. In: *DINAME 2019*. Buzios, Brazil, 2019, March. <https://hal.archives-ouvertes.fr/hal-02320012>
- Coelho, A. W. F., Araujo, A. C., & Thiré, R. M. Análise da contração na estereolitografia variando posição e orientação na plataforma de impressão. In: *9^o Congresso Brasileiro de*

- Engenharia de Fabricação*. Joinville, Brazil, 2017. <https://hal.archives-ouvertes.fr/hal-03226785>
- Coelho, A. W. F., Araujo, A. C., & Thiré, R. M. d. S. M. (2018). Manufatura aditiva por estereolitografia: Análise da geometria da peça e da influência da posição e orientação de fabricação. *Matéria (Rio de Janeiro)*, 23(4).
- Coelho, A. W. F., da Silva Moreira Thiré, R. M., & Araujo, A. C. (2019). Manufacturing of gypsum–sisal fiber composites using binder jetting [hal-02971744]. *Additive Manufacturing*, 29, 100789. <https://doi.org/https://doi.org/10.1016/j.addma.2019.100789>
- Deshpande, S., Araujo, A. C., Lagarrigue, P., & Landon, Y. Specific force map for circular milling for online material identification. In: *Esaform 2022 - approved for conference*. Porto, Portugal, 2022.
- Deshpande, S., Gonçalves, M. C. C., Araujo, A. C., Lagarrigue, P., & Landon, Y. (2022b). Specific force map for smart machining applications with rotating tools. *Under submission for Journal*.
- Friedrich, E. B., da Motta Dias, L. M., & Araujo, A. C. (2007). Study on the performance of coated tools in turning cast iron. *Revista Gestão Tecnologia*. <https://hal.archives-ouvertes.fr/hal-03226791>
- Fromentin, G., Araujo, A. C., Poulachon, G., & Paire, Y. (2011a). Modélisation géométrique du filetage à la fraise [Title in English: Geometric modeling of thread milling]. *Mécanique & industries*, 12(6), 469–477.
- Gonçalves, M. C. C., Ferreira Batalha, G., Landon, Y., & Araujo, A. C. Smart drilling: material identification using specific force map. In: *11^o Congresso Brasileiro de Engenharia de Fabricação*. Curitiba, Brazil, 2021, May. <https://hal.archives-ouvertes.fr/hal-03232380>
- Henz, R. O., Campos, F. d. O., Araujo, A. C., & Fromentin, G. Cutting forces in high feed milling. In: *25 International Conference for Mechanical Engineering*. Uberlândia, Brazil, 2019, October. <https://hal.archives-ouvertes.fr/hal-02329834>
- Jun, M. B. G., & Araujo, A. C. (2010). Modeling of the Thread Milling Operation in a Combined Thread/Drilling Operation: Thrilling [hal-03226668]. *Journal of Manufacturing Science and Engineering*, 132(1). <https://doi.org/10.1115/1.4000944>
- Magaldi, B. V., De Oliveira Da Costa, M., Thiré, R. M. D. S., & Araujo, A. C. Comparison of the porosity of scaffolds manufactured by two additive manufacturing technologies: Sla and fdm. In: *24th International Congress of Mechanical Engineering*. Curitiba, Brazil, 2018. <https://hal.archives-ouvertes.fr/hal-03226784>
- Menezes, G. B. D., & Araujo, A. C. Computational algorithm based on altintas model for cutting dynamics of end milling process. In: *22nd International Congress of Mechan-*

- ical Engineering (COBEM 2013)*. Ribeirão Preto, Brazil, 2013. <https://hal.archives-ouvertes.fr/hal-03214832>
- Mirres, S. P., Araujo, A. C., & Aguiar, R. A. A. Análise de diferentes sinais experimentais durante chatter no fresamento de topo. In: *VIII Congresso Nacional de Engenharia Mecânica*. Uberlandia, Brazil, 2014. <https://hal.archives-ouvertes.fr/hal-03219978>
- Mougo, A. L., Campos, F. d. O., & Araujo, A. C. A study of the influence of the width of cut on micro milling aluminum alloy. In: *22nd International Congress of Mechanical Engineering (COBEM 2013)*. Ribeirão Preto, Brazil, 2013, November. <https://hal.archives-ouvertes.fr/hal-03214837>
- Mougo, A. L., Campos, F. d. O., & Araujo, A. C. Experimental Analysis of Micromilling Cutting Forces on Super Duplex Stainless Steel. In: *International Conference on Micro Manufacturing ICOMM 2014*. Singapour, Singapore, 2014. <https://hal.archives-ouvertes.fr/hal-03219974>
- Mougo, A. L., Campos, F. d. O., & Araujo, A. C. Influence of micromilling on the surface integrity of super duplex stainless steel. In: *69° Congresso Anual da ABM*. São Paulo, Brazil, 2014. <https://hal.archives-ouvertes.fr/hal-03219972>
- Mougo, A. L., Campos, F. d. O., & Araujo, A. C. (2015a). Estudo da Influência da Largura de Corte no MicroFresamento de uma Liga de Alumínio. *Máquinas e Metais*, 598, p.50–62. <https://hal.archives-ouvertes.fr/hal-03226825>
- Mougo, A. L., Campos, F. d. O., Pinheiro, V., & Araujo, A. C. Análise das forças de corte e da integridade superficial no microfresamento do aço superduplex 32750. In: *8º Congresso Brasileiro de Engenharia de Fabricação*. Salvador, Brazil, 2015. <https://hal.archives-ouvertes.fr/hal-03226774>
- Mougo, A. L., Campos, F. O., & Araujo, A. C. Experimental Analysis of Micromilling Cutting Forces on Super Duplex Stainless Steel. In: *International Conference on Micro Manufacturing - 4M/ICOMM2015*. Milano, Italy, 2015. <https://hal.archives-ouvertes.fr/hal-03219982>
- Mougo, A. L., & Araujo, A. C. Influência da recuperação elástica na integridade de superfície do aço superduplex. In: *72 ABM Week*. São Paulo, Brazil, 2017. <https://hal.archives-ouvertes.fr/hal-03226782>
- Mougo, A. L., Campos, F. d. O., & Araujo, A. C. Determinação mecanística da pressão específica de corte no micro fresamento do aço superduplex 32750. In: *9º Congresso Brasileiro de Engenharia de Fabricação*. Joinville, Brazil, 2017. <https://hal.archives-ouvertes.fr/hal-03226783>
- Mougo, A. L., Campos, F. d. O., & Araujo, A. C. Modelagem das forças de corte no microfresamento do aço superduplex 32750 considerando a microestrutura heterogênea do

- material. In: *9^o Congresso Brasileiro de Engenharia de Fabricação*. Joinville, Brazil, 2017. <https://hal.archives-ouvertes.fr/hal-03226781>
- Mougo, A. L., Campos, F. d. O., & Araujo, A. C. (2018). Mechanistic study on micromilling of the super duplex stainless steel uns s32750 [hal-02971745]. *Journal of Manufacturing Processes*, *34*, 31–39. <https://doi.org/https://doi.org/10.1016/j.jmapro.2018.05.017>
- Nascimento, C. P., Martins, M. C., Pardal, J. M., Tavares, S. S. M., Araujo, A. C., & Fonseca, M. C. Estudo das tensões residuais, forças de usinagem e qualidade de superfície geradas no fresamento de aço maraging classe 300. In: *IX Congresso Nacional de Engenharia Mecânica*. Fortaleza, Brazil, 2016. <https://hal.archives-ouvertes.fr/hal-03226780>
- Nery, W. S., de Oliveira, J. E. F., & Araujo, A. C. Avaliação experimental de um torneamento cilíndrico externo parametrizado por otimização computacional. In: *VII Congresso Nacional de Engenharia Mecânica*. São Luis, Brazil, 2012. <https://hal.archives-ouvertes.fr/hal-03212877>
- Nery, W. S., de Oliveira, J. E. F., & Araujo, A. C. Avaliação experimental de um torneamento cilíndrico externo parametrizado por otimização computacional. In: *7^o Congresso brasileiro de engenharia de fabricação*. Itatiaia, Brazil, 2013, May. <https://hal.archives-ouvertes.fr/hal-03214833>
- Nery, W. S., Vogel, J. P., & Araujo, A. C. Estudo do efeito do avanço nas forças e no acabamento de um torneamento de aço superduplex. In: *7^o Congresso brasileiro de engenharia de fabricação - COBEF*. Itatiaia, Brazil, 2013. <https://hal.archives-ouvertes.fr/hal-03214830>
- Nery, W., Vogel, J. P., & Araujo, A. C. (2014). Avaliação Experimental do processo parametrizado por otimização computacional. *Máquinas e Metais*, *584*(60-70). <https://hal.archives-ouvertes.fr/hal-03226803>
- Oliveira, G. d. P., Fonseca, M. C., & Araujo, A. C. Effects of cutting speed in forces, surface topography and residual stresses in milling of inconel 718. In: *23rd International Congress of Mechanical Engineering (COBEM 2015)*. Rio de Janeiro, Brazil, 2015. <https://hal.archives-ouvertes.fr/hal-03220001>
- Oliveira, G. P., Fonseca, M. C., & Araujo, A. C. Effects of mql and flooding on residual stresses in an end milling surface. In: *5th international conference on integrity-reliability-failure (irf)*. Porto, Portugal, 2016.
- Oliveira, G. d. P., Fonseca, M. C., & Araujo, A. C. (2017). Analysis of residual stress and cutting force in end milling of Inconel 718 using conventional flood cooling and minimum quantity lubrication [hal-02971823]. *The International Journal of Advanced Manufacturing Technology*, *92*(9), 3265–3272. <https://doi.org/10.1007/s00170-017-0381-3>

- Pereira da Silva, F. V., Vogel, J. P., Gomes, R. M., Melo, T. A. d. A., Araujo, A. C., & de Barros, S. R. Effect of the cutting velocity and heat treatment on turning cutting forces of an sma cu-al-be alloys [hal-03226683]. In: *Functional and structural materials ii. 758*. Materials Science Forum. hal-03226683. Trans Tech Publications Ltd, 2013, July, 157–164. <https://doi.org/10.4028/www.scientific.net/MSF.758.157>.
- Pereira Da Silva, F. V., Vogel, J. P., Gomes, R. M., de Azevedo Melo, T. A., Araujo, A. C., & De Barros, S. Experimental investigation of cutting forces generated during turning of quenched and unquenched cu-al-be alloys. In: *22nd International Congress of Mechanical Engineering (COBEM 2013)*. Ribeirão Preto, Brazil, 2013. <https://hal.archives-ouvertes.fr/hal-03214828>
- Pinheiro, V., Mougo, A. L., & Araujo, A. C. A study of specific cutting force in micromilling of superduplex stainless steel UNS S 32750. In: *23rd International Congress of Mechanical Engineering (COBEM 2015)*. Rio de Janeiro, Brazil, 2015. <https://hal.archives-ouvertes.fr/hal-03226778>
- de Paula Oliveira, G., Fonseca, M. C., & Araujo, A. C. (2018). Residual stresses and cutting forces in cryogenic milling of inconel 718 [8th CIRP Conference on High Performance Cutting (HPC 2018) - hal-02971749]. *Procedia CIRP*, 77, 211–214. <https://doi.org/https://doi.org/10.1016/j.procir.2018.08.289>
- Rios, R. M., Calixto, V., Vogel, J. P., & Araujo, A. C. Análise experimental da força de avanço no processo de furação de liga inconel 718. In: *8º Congresso Brasileiro de Engenharia de Fabricação*. Salvador, Brazil, 2015. <https://hal.archives-ouvertes.fr/hal-03226777>
- Santos, J. A. C., Rebêlo, L. M., Araujo, A. C., Barros, E. B., & de Sousa, J. S. (2012). Thickness-corrected model for nanoindentation of thin films with conical indenters [hal-03226669]. *Soft Matter*, 8, 4441–4448. <https://doi.org/10.1039/C2SM07062F>
- Silva, G. B. M., Thiago, R., & Araujo, A. C. Otimização de parâmetros de corte a partir de abordagem estocástica aplicada a dinâmica do fresamento de topo. In: *VIII Congresso Nacional de Engenharia Mecânica*. Uberlandia, Brazil, 2014, August. <https://hal.archives-ouvertes.fr/hal-03219967>
- Vasconcellos, M. N., & Araujo, A. C. (2012). Analysis of cutting forces in the drilling process of an austenitic stainless steel alloy. *Máquinas e Metais*, 559, 12–20. <https://hal.archives-ouvertes.fr/hal-03226797>
- Vizquerra-Rojo, V., Savi, M. A., & Araujo, A. C. Modelos de dinâmica não linear para usinagem. In: *VIII Congresso Nacional de Engenharia Mecânica*. Uberlandia, Brazil, 2014. <https://hal.archives-ouvertes.fr/hal-03219969>
- Wang, Z., Kovvuri, V., Araujo, A. C., Bacci, M., Hung, W., & Bukkapatnam, S. (2016). Built-up-edge effects on surface deterioration in micromilling processes [hal-02971838]. *Journal*

of *Manufacturing Processes*, 24, 321–327. <https://doi.org/https://doi.org/10.1016/j.jmapro.2016.03.016>

Some thesis and reports under my supervision cited in the text

- Absi, M. Y. B. (2013). *Análise do comportamento termomecânico de uma liga de ni-ti com memória de forma após operação de usinagem* (Engineering projet (undergraduate thesis)) [Analysis of the thermomechanical behavior of a shape memory Ni-Ti alloy after machining operation]. Mechanical Engineering - UFRJ.
- Campos, F. d. O. (2018, February). *Micromilling of Titanium Alloys; A Comparison Between Workpieces Produced by Casting, ECAP and 3D Printing (SLM)* (Doctoral dissertation). Universidade Federal do Rio de Janeiro. <https://hal.archives-ouvertes.fr/tel-03413585>
- Coelho, A. W. F. (2018). *Manufatura aditiva por jato de aglutinante (impressão 3d): Fabricação e avaliação de compósitos de gesso com fibras de sisal* (Master in Science). Universidade Federal do Rio de Janeiro.
- Granato, J. C. (2012). *Comparacao da usinagem de roscas de osso bovino com polimero bioabsorvível* (Engineering projet (undergraduate thesis)) [Comparison of machining of bovine bone threads with bioabsorbable polymer]. Mechanical Engineering - UFRJ.
- Gutnik, A. D. (2017). *Fabricação de protótipo para reabilitação nervosa por manufatura aditiva com base líquida* (Engineering projet (undergraduate thesis)) [Prototype manufacturing for nervous rehabilitation by additive manufacturing on a liquid basis]. Mechanical Engineering - UFRJ.
- Joaquim, T. W. (2019). *Usinagem de corpos de prova em osso bovino (machining of bovine bone samples)* (Engineering projet (undergraduate thesis)) [Advisors: Prof. Anna Carla Araujo and Cristiane Evelise da Silva]. Mechanical Engineering - UFRJ.
- Kappel, L. (2021). *Geometry and mechanical behaviour analysis of medical bone screws* (Internship report (June-July, 2021)). INSA Toulouse.
- Mougo, A. L. (2016, June). *Microfresamento do aço superduplex: Uma comparação mecânica com os aços inoxidáveis austenítico e ferrítico para as forças de usinagem e avaliação da superfície usinada* (Doctoral dissertation). Universidade Federal do Rio de Janeiro. <https://hal.archives-ouvertes.fr/tel-03413588>
- Rego, E. B. (2013). *Usinagem de liga de memoria de forma niti* (Engineering projet (undergraduate thesis)) [Machining of NiTi Shape Memory Alloy]. Mechanical Engineering - UFRJ.
- Souza, P. D. (2010). *Usinagem de rosca em osso bovino* (Engineering projet (undergraduate thesis)) [Thread machining in bovine bone]. Mechanical Engineering - UFRJ.

Other References, cited in the text as: (name, year)

- Addison, P. S. (2002). *The illustrated wavelet transform handbook*. Taylor; Francis.
- Altintas, Y. (2000). *Manufacturing automation* (1a). Cambridge University Press, New York.
- Alves, E. G. L., de Faria Rezende, C. M., Serakides, R., de Magalhães Pereira, M., & Rosado, I. R. (2011). Orthopedic implant of a polyhydroxybutyrate (phb) and hydroxyapatite composite in cats. *Journal of Feline Medicine Surgery*, 13(8), 546–552. <https://doi.org/https://doi.org/10.1016/j.jfms.2011.03.002>
- Anand, R. S., & Patra, K. (2017). Mechanistic cutting force modelling for micro-drilling of cfrp composite laminates. *CIRP Journal of Manufacturing Science and Technology*, 16, 55–63. <https://doi.org/https://doi.org/10.1016/j.cirpj.2016.07.002>
- Boothroyd, G. (1965). *Fundamentals of metal machining*. Edward Arnold Ltd., Inc. London.
- Budak, E., & Altintas, Y. (1998). Analytical prediction of chatter stability in milling part i: General formulation. *Journal of Dynamic Systems, Measurement and Control - Transactions of the ASME*, 120, 22–30.
- Cao, H., Lei, Y., & He, Z. (2013). Chatter identification in end milling process using wavelet packets and hilbert huang transform. *International Journal of Machine Tools and Manufacture*, 69, 11–19.
- Cheng, K., Niu, Z.-C., Wang, R. C., Rakowski, R., & Bateman, R. (2017). Smart cutting tools and smart machining: Development approaches, and their implementation and application perspectives. *Chinese Journal of Mechanical Engineering*, 30(5), 1162–1176. <https://doi.org/10.1007/s10033-017-0183-4>
- Chen, J., Hu, P., Zhou, H., Yang, J., Xie, J., Jiang, Y., Gao, Z., & Zhang, C. (2019). Toward intelligent machine tool. *Engineering*, 5(4), 679–690. <https://doi.org/https://doi.org/10.1016/j.eng.2019.07.018>
- Colletis, G. (2012). *L'urgence industrielle !* (1er édition: 25 janvier 2012). Editions Le Bord de l'eau.
- Denkena, B., Boehnke, D., & Dege, J. (2008). Helical milling of cfrp–titanium layer compounds [High Performance Cutting]. *CIRP Journal of Manufacturing Science and Technology*, 1(2), 64–69. <https://doi.org/https://doi.org/10.1016/j.cirpj.2008.09.009>
- Dong, L., Wang, J., Li, T., Xie, X., Li, K., & Zhang, S. (2021). Study on milling technology of Waspaloy superalloy internal threads with a small diameter. *INTERNATIONAL JOURNAL OF ADVANCED MANUFACTURING TECHNOLOGY*, 113(9-10), 2925–2941. <https://doi.org/{10.1007/s00170-021-06739-7}>
- Dorlin, T., Fromentin, G., & Costes, J.-P. (2015). Analysis and modelling of the contact radius effect on the cutting forces in cylindrical and face turning of Ti6Al4V titanium alloy

- [15th CIRP Conference on Modelling of Machining Operations (15th CMMO)]. *Procedia CIRP*, 31, 185–190.
- Ducroux, E., Fromentin, G., Viprey, F., Prat, D., & D’Acunto, A. (2021). New mechanistic cutting force model for milling additive manufactured inconel 718 considering effects of tool wear evolution and actual tool geometry. *Journal of Manufacturing Processes*, 64, 67–80. <https://doi.org/https://doi.org/10.1016/j.jmapro.2020.12.042>
- Fang, N., & Wu, Q. (2009). A comparative study of the cutting forces in high speed machining of ti-6al-4v and inconel 718 with a round cutting edge tool. *Journal of Materials Processing Technology*, 209(9), 4385–4389.
- Fan, Y., Hu, Z., Tang, Y., Zhang, X., Qin, C., & Chen, X. (2020). Less interference tool-path correction model for half revolution penetration and retraction trajectories in internal straight thread side milling. *INTERNATIONAL JOURNAL OF ADVANCED MANUFACTURING TECHNOLOGY*, 107(3-4), 1605–1624. <https://doi.org/{10.1007/s00170-020-05048-9}>
- Fetullazade, E., Akyildiz, H. K., & Saritas, S. (2010). Effects of the machining conditions on the strain hardening and the residual stresses at the roots of screw threads. *Materials & Design*, 31(4), 2025–2031.
- Fromentin, G., & Poulachon, G. (2010a). Geometrical analysis of thread milling—part 1: Evaluation of tool angles. *The International Journal of Advanced Manufacturing Technology*, 49(1-4), 73–80. <https://doi.org/10.1007/s00170-009-2402-3>
- Fromentin, G., & Poulachon, G. (2010b). Geometrical analysis of thread milling—part 2: Calculation of uncut chip thickness. *The International Journal of Advanced Manufacturing Technology*, 49(1-4), 81–87. <https://doi.org/10.1007/s00170-009-2401-4>
- Fromentin, G., & Poulachon, G. (2010c). Modeling of interferences during thread milling operation. *The International Journal of Advanced Manufacturing Technology*, 49(1-4), 41–51. <https://doi.org/10.1007/s00170-009-2372-5>
- Fromentin, G., Sharma, V. S., Poulachon, G., Paire, Y., & Brendlen, R. (2011b). Effect of Thread Milling Penetration Strategies on the Dimensional Accuracy. *Journal of Manufacturing Science and Engineering*, 133(4), 041014. <https://doi.org/10.1115/1.4004318>
- Fromentin, G., Döbbeler, B., & Lung, D. (2015). Computerized simulation of interference in thread milling of non-symmetric thread profiles [15th CIRP Conference on Modelling of Machining Operations (15th CMMO)]. *Procedia CIRP*, 31, 496–501. <https://doi.org/https://doi.org/10.1016/j.procir.2015.03.018>
- Geng, D., Zhang, D., Teng, Y., & Jiang, X. (2018). An experimental investigation on hole exit geometric error in orbital drilling process [4th CIRP Conference on Surface Integrity

- (CSI 2018)]. *Procedia CIRP*, 71, 128–133. <https://doi.org/https://doi.org/10.1016/j.procir.2018.05.084>
- Groover, M. P. (2014). *Introdução aos processos de fabricação* [Translation for Portuguese - Coordination Anna Carla Araujo - hal-03226694]. LTC, Grupo GEN.
- Grzesik, W. (2016). *Advanced machining processes of metallic materials - theory, modelling and applications*. Elsevier.
- Hibbeler, R. C. (2002). *Mechanics of materials* (5th edition). Prentice Hall College Div.
- Hosford, W. (2013). *Fundamentals of engineering plasticity*. Cambridge University Press. <https://books.google.fr/books?id=neggAwAAQBAJ>
- Huo, D. (2013). *Micro-cutting: Fundamentals and applications*. John Wiley & Sons.
- Kaynak, Y., Tobe, H., Noebe, R., Karaca, H., & Jawahir, I. (2014). The effects of machining on the microstructure and transformation behavior of niti alloy. *Scripta Materialia*, 74, 60–63. <https://doi.org/https://doi.org/10.1016/j.scriptamat.2013.10.023>
- Kreyszig, E. (2006). *Advanced engineering mathematics* (9th ed.). John Wilen; Sons.
- Kamgaing Souop, L. A., Landon, Y., Senatore, J., Daidié, A., & Ritou, M. Orbital Drilling Optimization in High Speed Machining and Fatigue Life Enhancement by Orbital Roller Burnishing: Application to an Aluminum Alloy. In: *SAE International Conference*. Bordeaux, France, 2019, September, 1–13. <https://hal-univ-tlse3.archives-ouvertes.fr/hal-02462039>
- Kunpeng, Z., Sam, W., & Soon, H. (2009). Wavelet analysis of sensor signals for tool condition monitoring: A review and some new results. *International Journal of Machine Tools and Manufacture*, 49, 537–553.
- Kurada, S., & Bradley, C. (1997). A review of machine vision sensors for tool condition monitoring. *Computers in Industry*, 34, 55–72.
- Lacombe, A., Landon, Y., Paredes, M., Texier, D., Chirol, C., & Benaben, A. (2021). Investigations on the impact of the hole surface integrity on the fatigue life of a 2024-T351 aluminum alloy drilled part. *Fatigue and Fracture of Engineering Materials and Structures*, 44(6), 1455–1468. <https://doi.org/10.1111/ffe.13441>
- Lee, C.-C., Lin, S.-C., Kang, M.-J., Wu, S.-W., & Fu, P.-Y. (2010). Effects of implant threads on the contact area and stress distribution of marginal bone. *Journal of Dental Sciences*, 5(3), 156–165. [https://doi.org/https://doi.org/10.1016/S1991-7902\(10\)60023-2](https://doi.org/https://doi.org/10.1016/S1991-7902(10)60023-2)
- de Lima Gonçalves, B. (2019). *O impacto da geometria complexa do tecido cortical ósseo bovino no ensaio de tração: Uma abordagem experimental e computacional* (Engineering projet (undergraduate thesis)) [Advisors: Prof. Fernando Duda and Cristiane Evelise da Silva]. Mechanical Engineering - UFRJ.

- Li, G., Rahim, M. Z., Ding, S., & Sun, S. (2016). Performance and wear analysis of polycrystalline diamond (PCD) tools manufactured with different methods in turning titanium alloy Ti-6Al-4V. *The International Journal of Advanced Manufacturing Technology*, *85*, 825–841.
- Malekian, M., Mostofa, M., Park, S., & Jun, M. (2012). Modeling of minimum uncut chip thickness in micro machining of aluminum. *Journal of Materials Processing Technology*, *212*(3), 553–559.
- Malayath, G., Sidpara, A. M., & Deb, S. (2020). Study of different materials response in micro milling using four edged micro end mill tools. *Journal of Manufacturing Processes*, *56*, 169–179. <https://doi.org/https://doi.org/10.1016/j.jmapro.2020.04.079>
- Malkov, O., V., & Pavlyuchenkov, I. A. Thread Milling Cutter Flute Production Possibility Research by Using Typical Profiles Grinding Wheels (Radionov, AA and Kravchenko, OA and Guzeev, VI and Rozhdestvenskiy, YV, Ed.). In: In *Proceedings of the 5th international conference on industrial engineering, ICIE 2019, VOL II* (Radionov, AA and Kravchenko, OA and Guzeev, VI and Rozhdestvenskiy, YV, Ed.). Ed. by Radionov, AA and Kravchenko, OA and Guzeev, VI and Rozhdestvenskiy, YV. Lecture Notes in Mechanical Engineering. 2020, 1089–1096.
- Matsui, S., Ozaki, N., Hirogaki, T., Aoyama, E., Yamamoto, T., & Shindo, M. (2020). Smart monitoring of helical thread mill process with a wireless tool holder and cnc information. *Advances in Materials and Processing Technologies*, *0*(0), 1–13.
- Merchant, M. E. (1998). An interpretive look at 20th century research on modeling of machining. *Machining Science and Technology*, *2*(2), 157–163. <https://doi.org/10.1080/10940349808945666>
- Ozturk, O., Kilic, Z., & Altintas, Y. (2018). Mechanics and dynamics of orbital drilling operations. *International Journal of Machine Tools and Manufacture*, *129*, 37–47. <https://doi.org/https://doi.org/10.1016/j.ijmachtools.2018.03.001>
- Pereira, F. F. R. (2014). *Fabricação e testes de parafusos de ligas com memória de forma do sistema niti* (Master in Science) [Manufacturing and tests of shape memory alloy bolts from NiTi-systems]. Universidade Federal de Campina Grande. <http://dspace.sti.ufcg.edu.br:8080/jspui/handle/riufcg/504>
- Pereira, R. B. D., Brandão, L. C., de Paiva, A. P., Ferreira, J. R., & Davim, J. P. (2017). A review of helical milling process. *International Journal of Machine Tools and Manufacture*, *120*, 27–48. <https://doi.org/https://doi.org/10.1016/j.ijmachtools.2017.05.002>
- Rao, S. S. (2003). *Mechanical vibrations* (4th edition). Pearson College Div.

- Rao, C. M., Rao, S. S., & Herbert, M. A. (2018). Development of novel cutting tool with a micro-hole pattern on PCD insert in machining of titanium alloy. *Journal of Manufacturing Processes*, *36*, 93–103.
- Rey, P., LeDref, J., Senatore, J., & Landon, Y. (2016). Modelling of cutting forces in orbital drilling of titanium alloy ti-6al-4v. *International Journal of Machine Tools and Manufacture*, *106*, 75–88. <https://doi.org/https://doi.org/10.1016/j.ijmachtools.2016.04.006>
- Ryu, H.-S., Namgung, C., Lee, J.-H., & Lim, Y.-J. (2014). The influence of thread geometry on implant osseointegration under immediate loading: A literature review. *The journal of advanced prosthodontics*, *6*, 547–554. <https://doi.org/https://doi.org/10.4047/jap.2014.6.6.547>
- Sharma, V. S., Fromentin, G., Poulachon, G., & Brendlen, R. (2014). Investigation of tool geometry effect and penetration strategies on cutting forces during thread milling. *The International Journal of Advanced Manufacturing Technology*, *74*, 963–971. <https://doi.org/https://doi.org/10.1007/s00170-014-6040-z>
- Shokrani, A., Dhokia, V., & Newman, S. T. (2016). Investigation of the effects of cryogenic machining on surface integrity in cnc end milling of ti-6al-4v titanium alloy. *Journal of Manufacturing Processes*, *21*, 172–179.
- Son, S. M., Lim, H. S., & Ahn, J. H. (2005). Effects of the friction coefficient on the minimum cutting thickness in micro cutting. *International Journal of Machine Tools and Manufacture*, *45*(4), 529–535. <https://doi.org/https://doi.org/10.1016/j.ijmachtools.2004.09.001>
- Soshi, M., Rigolone, F., Sheffield, J., & Yamazaki, K. (2018). Development of a directly-driven thread whirling unit with advanced tool materials for mass-production of implantable medical parts. *CIRP Annals*, *67*(1), 117–120. <https://doi.org/https://doi.org/10.1016/j.cirp.2018.03.016>
- Strang, G. (1986). *Introduction to applied mathematics*. Wellesley-Cambridge Press.
- Zhao, Y., Li, J., Guo, K., Sivalingam, V., & Sun, J. (2020). Study on chip formation characteristics in turning niti shape memory alloys. *Journal of Manufacturing Processes*, *58*, 787–795. <https://doi.org/https://doi.org/10.1016/j.jmapro.2020.08.072>