



HAL
open science

Microwave and millimeter wave devices

Camilla Kärnfelt

► **To cite this version:**

Camilla Kärnfelt. Microwave and millimeter wave devices. Electronics. Université de Bretagne Occidentale (UBO), Brest, 2022. <tel-04145257>

HAL Id: tel-04145257

<https://hal.science/tel-04145257v1>

Submitted on 29 Jun 2023

HAL is a multi-disciplinary open access archive for the deposit and dissemination of scientific research documents, whether they are published or not. The documents may come from teaching and research institutions in France or abroad, or from public or private research centers.

L'archive ouverte pluridisciplinaire **HAL**, est destinée au dépôt et à la diffusion de documents scientifiques de niveau recherche, publiés ou non, émanant des établissements d'enseignement et de recherche français ou étrangers, des laboratoires publics ou privés.



HAL Authorization

HABILITATION À DIRIGER DES RECHERCHES

L'UNIVERSITE
DE BRETAGNE OCCIDENTALE

ECOLE DOCTORALE N° 601
*Mathématiques et Sciences et Technologies
de l'Information et de la Communication*
Spécialité : Sciences de l'ingénieur
Par

« Camilla KÄRNFELT »

**« Microwave and millimeter wave devices – bridging the gap between
design and production »**

Habilitation à Diriger des Recherches
présentée et soutenue à Brest, le 21 Novembre, 2022
Unité de recherche : UMR CNRS 6285

Rapporteurs avant soutenance :

Anne-Laure Billabert HDR - Maître de conférences, le Conservatoire National des Arts et Métiers – (Le CNAM)
Fabien Ferrero Professeur des universités, Université Côte d'Azur
Dominique Baillargeat Professeur des universités, XLIM, Université de Limoges

Composition du Jury :

Président : Gérard Tanné Professeur des universités, Université de Bretagne Occidentale
Examineurs : Vincent Laur Professeur des universités, Université de Bretagne Occidentale
Anne-Laure Billabert HDR - Maître de conférences, le Conservatoire National des Arts et Métiers
Fabien Ferrero Professeur des universités, Université Côte d'Azur
Dominique Baillargeat Professeur des universités, XLIM, Université de Limoges Dir. de Recherche :
Michel Ney Professeur émérite, IMT Atlantique

Invité

Alain Péden Professeur des universités, IMT Atlantique

Table 1 : Glossary

Abbreviation	Explanation
ACC	Automatic Cruise Control
ADS	Advanced Design System
AGC	Automatic Gain Control
AMC	Advanced Model Composer
ASIG	Auto-catalytic Silver Immersion Gold
CNES	Centre National d'Études Spatiales
CPW	Coplanar waveguides
CTE	Coefficient of Thermal Expansion
CTH	Chalmers Tekniska Högskola / Chalmers University of Technology
DAS	Distributed Antenna System
DBC	Direct Bonded Copper
DEC	Projet Découverte
DGA	Direction Générale de l'Armement
DEMUX	Demultiplexer
DOE	Design of Experiments
DRC	Design Rule Check
EIRP	Equivalent Isotropically Radiated Power
EMW	Ericsson Microwave Systems AB
ESA	European Space Agency
ESL	ElectroScience Laboratory
FC	Flip Chip
FMCW	Frequency Modulated Continuous Waveform
FPA	Faire pour Apprendre (Learning by doing)
FSK	Frequency Shift Keying
GAA	Grid Array Antenna
GaAs	Gallium Arsenide
GLWG	Grooved Laminated WaveGuides
GSG	Ground Signal Ground
GPS	Global Positioning System
HEC	HydroxyEthyl Cellulose
HEMT	High Electronic Mobility Transistor

IAF	Fraunhofer Institute for Applied Solid-State Physics
ICBMS	Institut de Chimie et Biochimie Moléculaires et Supramoléculaires
IETR	Institut d'Électronique et de Télécommunications de Rennes
IGS	Introduction Grands Systèmes
IP3	3rd order intersection point
IVF	Institutet för verstadsteknisk Forskning
Lab-STICC	Laboratoire des Sciences et Techniques de l'information de la Communication et de la Connaissance
LCP	Liquid Crystal Polymer
LFM	Linear Frequency Modulation
LTE	Long Term Evolution
MEL	Microwave Electronics Laboratory
mHEMT	metamorphic High Electronic Mobility Transistor
MIM	Metal Insulator Metal
MMIC	Microwave Monolithic Integrated Circuits
MUX	Multiplexer
NCTU	National Chiao Tung University (Taiwan)
NF	Noise Figure
PA	Power Amplifier
PBL	Project/Problem Based Learning
PCI	Physical Cell identifier
pHEMT	pseudomorphic High Electronic Mobility Transistor
QFN	Quad Flat No-lead Package
QUB	Queen's University of Belfast
RF	Radio Frequency
RoF	Radio over Fiber
RSSI	Receive Signal Strength Indicators
RSRP	Reference Signal Received Power
RSRQ	Reference Signal Received Quality
RX	Receiver
SIW	Substrate Integrated Waveguide
SMD	Surface Mounted Device
SNIR	Signal to Noise Interference Ratio

SNR	Signal to Noise Ratio
SONET/SDH	Synchronous Optical Network/Synchronous Digital Hierarchy.
SSPA	Solid State Power Amplifier
SVM	Sacrificial Volume Materials
TGA	ThermoGravimetric Analysis
TMM	Thermoset Microwave laminates from Rogers
TRX	Combined Transmitter and Receiver
TX	Transmitter
UBO	Université de Bretagne Occidentale
VCO	Voltage Controlled Oscillator
VCSEL	Vertical-Cavity Surface-Emitting Laser
WBIFA	Wide Band Intermittent Frequency Amplifier
WG	WaveGuide
WiFi	Wireless Fidelity
WiMax	Worldwide Interoperability for Microwave Access
WLAN	Wireless Local Area Network

Summary

Introduction.....	10
1. Industrial experience	11
1.1 Technical knowledge	11
1.2 Projects	12
1.3 Managerial knowledge	14
1.4 Startups	14
1.5 Conclusions.....	15
2. Academic credentials	17
2.1 European Industrial Engineer	17
2.2 Master of science of Engineering Physics	17
2.3 Ph.D. degree	17
2.4 Conclusions.....	17
3 Research experience.....	18
3.1 MMIC design	18
3.1.1 60 GHz design	18
3.1.2 LNAs for space applications	19
3.1.3 MMICs for radiometry and security scanners	20
3.1.4 MMIC tape-out coordination.....	21
3.2 Millimeter wave packaging.....	21
3.2.1 Microwave and mm-wave flip chip assembly	21
3.2.2 OPTCOM	29
3.2.3 BRAWO project	30
3.2.4 Collaboration with Omnisys Instruments AB.....	30
3.2.5 Collaboration with SMIT center	31
3.3 Development of a simulation platform for an automatic cruise control radar	31
3.4 Radio over Fiber development	32
3.4.1 CapilR	32
3.4.2 Origin	33
3.4.3 CapilRTram.....	35
3.5 Cell planning - Imaginlab	36
3.6 LTCC design and fabrication.....	37
3.6.1 Packaging solutions for MMIC integration in LTCC technology.....	38

3.6.2	Visiting scientist program: “Packaged antenna in LTCC technology for mm-wave single chip transceivers program”.....	42
3.6.3	CirCKu project.....	45
3.6.4	Antenna collaboration with the Algerian University Mohamed Boudiaf of M’sila	46
3.6.5	Advanced meta-surface-based antennas for millimeter-wave applications.....	47
3.6.6	LTCC quality improvement	50
4.	Ph.D. Co-Supervision.....	51
4.1	Khodor Rida.....	51
4.2	Hexin Liu.....	52
4.3	Malika Tlili	53
4.4	Norbert Parker.....	55
5.	Research community service.....	57
5.1	Scientific paper reviewer	57
5.2	Special issue editor	58
5.3	ANR project reviewer	58
5.4	Ph.D. supervision committee	58
5.5	Ph.D. jury.....	58
5.6	Writing articles for « techniques d’ingenieur ».....	58
5.7	Session chair in a scientific international conference	58
6.	Academic teaching.....	59
6.1	Teaching methodologies	59
6.1.1.	<i>Problem based learning and inverted classroom</i>	59
6.1.2.	<i>Project based learning</i>	59
6.2	Teaching responsibilities.....	60
6.3	Project supervision.....	60
6.3.1	<i>Projects for Generalist engineering students</i>	60
6.3.2	<i>Projects for engineering students alternating school and work</i>	61
6.3.3	<i>Master students’ bibliography project</i>	61
6.4	Master thesis supervision	61
6.5	Extra curriculum teaching.....	62
7.	Future research.....	63
7.1	National collaborations	63
7.2	International collaborations.....	64
	Conclusions.....	66
	Acknowledgments.....	67

Bibliography	68
Appendices	74
Appendix 1 – S2 projects	74
Appendix 2 - Mineur recherche projects	76
Appendix 3 – S4 projects.....	77
Appendix 4 – S5 projects.....	78
Appendix 5 – FIP 3rd year development projects.....	79
Appendix 6 – FIP management projects	80
Appendix 7 – Master students ‘ bibliographical projects	81
Appendix 8 – Master thesis supervision.....	82

Illustrations

Figure 1. The SSPA module intended for the SPOT ₄ satellite	13
Figure 2. The SPOT 4 satellite ³	13
Figure 3. The Optillion 10 Gbps transceivers ⁵	15
Figure 4. The Gotmic logotype	15
Figure 5. Multifunctional RX chip (left) and TX chip (right). The RX chip dimensions are 4 mm × 3 mm while the TX chip dimensions are 3 mm × 2 mm [10] ©2006 IEEE	19
Figure 6. WBIFA five-stage Low Noise Amplifier. The chip dimensions are 3 mm × 1.5 mm	19
Figure 7. Measured gain and noise figure of the five-stage WBIFA LNA	20
Figure 8. 105 to 210 GHz doubler layout designed in the IAF process	21
Figure 9. Chips designed for FC tests: Microstrip chip (MS), CPW chip with ground plane (CPW) and CPW chip on Al ₂ O ₃ without ground plane (CPW_Al ₂ O ₃) are seen from left to right [16]	22
Figure 10. Some of the alumina carrier substrates for FC experiments. Narrow CPW ground lines (upper left), Narrow CPW grounds and resistive layer(upper right), Wide CPW grounds (lower left) and Wide CPW grounds with resistive layer (lower right) [16]	22
Figure 11. Measurement result of the different assemblies for the three chip types on the Wide CPW ground carrier substrate. Left, MS, middle CPW and right CPW_Al ₂ O ₃ -chip. Transmission curves are blue, reflection curves are red [16]	23
Figure 12. Results of FC assembly using the MS and CPW_Al ₂ O ₃ chips with a Wide ground CPW carrier substrate and resistive layer [16].....	23
Figure 13. . Some of the alumina carrier substrates for FC experiments. Narrow CPW ground lines (upper left), Narrow CPW grounds and resistive layer(upper right), Wide CPW grounds (lower left) and Wide CPW grounds with resistive layer (lower right) and Narrow CPW lines with an extra resistance in the drain feed line (center) [18]©2004 IEEE	24
Figure 14. 40-60 GHz PA MMIC based on the doipH process from OMMIC	24
Figure 15. Results of flip chip assembly of the 40-60 GHz power amplifier MMIC. Chip only (black), assembled on Narrow CPW ground line (red), assembled on Wide CPW ground line (blue) and Wide CPW ground line with resistive layer (green).....	25
Figure 16. Stud bump bonds created by the help of VTT Finland for the Hi-Micro project.....	25
Figure 17. Example of our electroplated bumps fabricated in the cleanroom of CTH	26
Figure 18. Hot-via structure as tested in [19] ©2007 IEEE	26
Figure 19. Comparison of insertion loss for a Thru Line, a hot via assembly of a thru line chip (Design I) and an FC assembly (Design II) [19] ©2007 IEEE.....	27
Figure 20. Coaxial flip-chip structure as presented in [21] ©2010 IEEE	27
Figure 21. Comparison of insertion loss for a microstrip line with a flip chipped line connected by the proposed coaxial structure [20] ©2009 IEEE	28
Figure 22. Results of on chip and after FC assembly of the X8 MMIC [21] ©2010 IEEE	28
Figure 23. The OPTCOM MUX package [22]	29
Figure 24. Terminal active antenna with 18dB amplifier MMIC [23] ©2006 IEEE. The antenna gain is 13 dBi and its board size is 5 mm × 10 mm.....	30

Figure 25. A ring resonator used to test the impact of Parylene-C coating (left), frequency shift at 60 GHz for the non-coated (red) as compared to coated resonators by 2 μm (blue) and 5 μm (green) in the graph (right) [26] ©2006 IEEE	31
Figure 26. Ultra-wide band filter in LCP technology [28].....	31
Figure 27. The Adaptive cruise control radar simulation architecture [30]	32
Figure 28. Single antenna power distribution (left), DAS power distribution (right) [33]	33
Figure 29. Origin 60-GHz horn antenna realized in silver painted Rohacell™ foam, produced in-house.....	34
Figure 30. Origin receiver-module under measurements.....	34
Figure 31. Origin’s experimental setup [35].....	35
Figure 32. Origin’s experimental setup with tunnel [35].....	35
Figure 33. Tram stations’ deployment simulations in the center of Brest	36
Figure 34. CapilRTram received bit rate when transmission using Jperfm™ and reception in moving tram by CoverZone™, [33].....	36
Figure 35. Imaginlab received power as simulate over the nearby zone of IMT Atlantique (left) and simulated download data rate (right).....	37
Figure 36. Examples of Grooved Laminated WaveGuides in LTCC [37], V, W and G-band structures (left), U-band structures (right) ©2015 IEEE.....	39
Figure 37. MMIC to GLWG transition as proposed: a) lower metal taper with a metalized via to connect the MMIC signal pas, b) WG top metal with ground pads, c) GSG bumps, d) MMIC chip connection, e) side view [39]	39
Figure 38. FC MMIC to GLWG transition. The WBIFA amplifier is used as MMIC [39].....	40
Figure 39. GLWG to WG transition [39].....	40
Figure 40. The back to back device as fabricated (left), the measurement set up (right) [39].....	41
Figure 41. GLWG to WG back to back transition, simulated results (red), measured results (blue) [39].....	41
Figure 42. The RLC prototype containing MIM and interdigital capacitors, spiral inductances and resistances [40]	42
Figure 43. 145 GHz centered GAA seen from the radiating grid side (left) and feed side (right). Size 12 mm \times 12 mm [41] ©2016 IEEE	42
Figure 44. The QFN package that was designed and fabricated together with the GAA antenna	43
Figure 45. LCP based D-band grid array antenna [42] grid face (left) feed face (right) ©2016 IEEE.....	43
Figure 46. 3D printed metal antennas for the 60 GHz band, conical (top), rectangular (bottom) [43] ©2015 IEEE	44
Figure 47. Comparison of simulated and measured results of the 3D-printed conical horn antenna [43] ©2015 IEEE.....	45
Figure 48. Three different circulators from the CirCKu project: VLF220Q4 and spinel insert (left), all grenat (center), VLF220Q4 and grenat insert (right).....	46
Figure 49. Multicirculator example based on VLF220Q4 with spinel inserts and SMD design.....	46
Figure 50. An LTCC prototype with a set of nine different 60 GHz antennas designed by Djamel Khezzer, PhD student at M’sila University in Algeria	47
Figure 51. After lamination and firing resulting holes 69 μm (left) and 204 μm (right) diameter [47].....	48
Figure 52. Metamaterial design that gives rise to a variation in relative permittivity.	48

Figure 53. Metamaterial realization by holes and patches in and on the LTCC layers	49
Figure 54. The first Lüneburg lens antenna. Some bubbles on its top makes it slightly non-symmetric. The second lens antenna was better in the sense that it had no bubbles.....	49
Figure 55. Luneburg lens antenna measurement, gain variation as a function of feed structure displacement. The gain is also compared to an open waveguide.	50
Figure 56. RF measurement fixture designed by Khodor Rida [53]	51
Figure 57. VCO MMIC installed in an LTCC package, design view (left), photograph (right) [53].	52
Figure 58. AGC loop circuit for an RoF system [54]	53
Figure 59. Interconnexion for the D-band chips as designed by Malika Tlili [55].....	53
Figure 60. Thermal simulations of a 3W chip, attached to a five-layer LTCC module (left), attached to an LTCC-module including a 10-layer heat pipe structure (right) [55].....	54
Figure 61. Heat pipe cross sections from the research work pursued by Malika Tlili [57].....	54
Figure 62. D-band receiver module containing MMICs from Gotmic.....	55
Figure 63. Drawing of a circulator model used in the CirCKu project for simulations.....	56
Figure 64. Measurement validation of one of the proposed circulators in the CirCKu project.	56
Figure 65. Number of reviews per year.	57
Figure 66. Journal reviews.....	58
Figure 67. Arduino based vehicles that are controlled by a smartphone: example (left) and four vehicles on the start line for the end of semester competition (right).	60

Introduction

I have evolved in the microwave world for more than 30 years and given my situation of being an associate professor at IMT Atlantique I think it is time for me to pass my HDR – “Habilitation à Diriger des Recherches”. This document will trace my career in the Microwave field, starting off by ten years at Ericsson Microwave Systems AB (EMW, former Ericsson Radar Electronics and what is today Saab Microwave Systems AB), through my education at Chalmers University of Technology (CTH for Chalmers Tekniska Högskola), one year at a start-up called Optillion, five years as a research engineer at Chalmers and now more than 15 years at IMT Atlantique among which two as a research engineer and thirteen as an associate professor.

The common thread throughout this document is the subject of microwave and millimeter-wave hybrid packaging and design. During all these years, I have been able to build much expertise which is based on prototyping, product development and research where my aim has been to bridge the gap between production engineers and microwave designers, thus, increasing my knowledge in both fields. Normally, production engineers have much knowledge and know-how in production processes, quality management, equipment limitations and such, while they have no or very limited knowledge in the microwave field. Microwave engineers, on the other hand, know a lot about relative permittivity, loss tangent, return loss and so on. However, their optimized choices for the best electrical performance can be challenging and even detrimental for the production to come.

Since 2009, I have had a position as an associate professor, where my background is a source of inspiration in my teaching and serves as reference throughout the projects I propose. Teaching is not an easy task, however at IMT Atlantique teaching is mostly done as a teamwork, which is beneficial to arrive at good solutions for every task. I will treat this subject as one chapter in this document.

This document is arranged as follows: the first chapter retraces my industrial experience, the second my academic credentials, a third chapter is about my research experience, chapter number four on my Ph.D. supervision, then chapter number five is about my service lent to the research community, chapter six on academic teaching and finally chapter seven is on future research plans.

1. Industrial experience

After four years of studies in a technical gymnasium, I started my working career as a trainee engineer at Volvo cars in 1985. I spent nearly two years on the production line as a welder alternatively attending different classes and then 6 months in a material laboratory. At the end of this training period, me and my trainee colleagues were supposed to be transferred to a white-collar job within the company, but this finally wasn't possible due to conjunctural reasons. Thus, I left Volvo and found a job at EMW in a division that designed and fabricated microwave hybrids. I spent ten years at EMW: 1987-1994 as a preproduction engineer and 1994-1997 managing a preproduction engineering group. This is where I acquired the basics of microelectronic packaging as well as my managerial skills.

After getting my master of science degree, at CTH, I also worked in a startup company, Optillion, from 2001 to 2002 as a research engineer responsible of packaging issues of Ethernet transceivers.

Finally, my industrial experience also contains a creation of a startup, Gotmic in 2007, based in Göteborg Sweden. However, my participation in this adventure was very short, since I left Sweden before Gotmic was ready to run.

The common feature for the three above companies (EMW, Optillion and Gotmic) is that they produce microwave and optoelectronic devices where microwave, microelectronics and packaging skills are needed.

Working in industry is quite different from any academic position. In this chapter I will explain what I learnt in industry and how this knowledge has served as a foundation for my career ever after.

1.1 TECHNICAL KNOWLEDGE

As a preproduction engineer, at EMW, I proposed production methods and solutions to the microwave design engineers, I qualified new methods, I did prototype assembly in order to make sure that the product was "buildable". The different methods we used to build hybrids mostly on the S- and X-band, but sometimes at even higher frequencies, are listed below:

1. Substrate soldering methods
 1. Reflow soldering
 2. Fluxless soldering
2. Wire-bonding methods
 1. Ball bonding
 2. Wedge bonding
 3. Ribbon bonding
 4. Heavy Wire-bonding
 5. Beam lead bonding
 6. Parallel Gap Welding
3. Chip assembly methods
 1. Silver epoxy assembly
 2. Silver glass assembly
 3. Fluxless AuSn eutectic soldering
4. Lid closure methods
 1. Fluxless AuSn soldering
 2. Laser soldering

3. Rolled soldering

I also had the opportunity to use different substrate materials such as thick film Alumina (96 % Al₂O₃), thin film Alumina (99 % Al₂O₃), Low Temperature Cofired Ceramics (LTCC), High Temperature Cofired Ceramics (HTCC), Rogers duroïd™, Thermoset Microwave laminates (TMM™) from Rogers and Directs Bonded Copper (DBC).

As a pre-production engineer, I gained some expertise in these production methods over the years, as it was my responsibility to qualify and maintain methods, machines and materials, according to the military standard MIL-STD 883-C.

Developing hybrids for production is quite different from doing research. In production, quality must always be ensured. During my years at EMW I was involved in quite many different projects which, most of them, ran all the way to serial production.

In the mid-1990s, the ISO 9000 certification was globally introduced and we did qualify our complete company at every level of hierarchy. Even though we had great systems to develop our products and we were already used to quality certification, the ISO 9000 also touched people outside the production ranks, which induced more documentation on working methods.

At the same time, we took in Lean production and Just in Time¹ (Kan Ban) influences and worked though the production teams to achieve a better flow. However, these methods were not really fit for this extremely small volume of production. Instead, we learned and implemented the first Six Sigma methods such as Capability measurements and Design of Experiments (DOE)².

1.2 PROJECTS

Our produce can be divided in three categories: defense, telecommunication and space. For the defense systems we mainly developed transmission (TX) modules for S-band and X-band radars. The telecommunication equipment was multiplexer (MUX) and demultiplexer (DEMUX) modules, power amplifiers modules for cell phones as well as base stations, called MiniLink™. The MUX/DEMUX modules is also where we first used LTCC as early as 1990 for a rather high-volume production.

One of the most interesting projects I came across is the space project SPOT 4 funded by the European Space Agency (ESA) and “Centre National d'Études Spatiales” (CNES) with partners as Aerospatial, SAAB Ericsson Space and us. The objective of SPOT4 was to continuously monitor the continental biosphere and crops³ see Figure 2. As it sweeps over earth, the satellite records images over a width of 2250 km. This satellite required an X-band Solid State Power Amplifier (SSPA), which we developed as a subcontractor to Saab Ericsson Space (today named RUAG), Figure 1.

¹ e.g.: <https://www.brighthubpm.com/monitoring-projects/70336-kanban-explained-as-applied-to-jit/>

² e.g.: J. A. Defeo and J. M. Juran, Juran's Quality Handbook: The Complete Guide to Performance Excellence 6/e. McGraw Hill Professional, 2010.

³ “spot4044.gif (Image GIF, 512 × 384 pixels).” http://spot4.cnes.fr/spot4_fr/images/orbite/spot4044.gif (accessed Dec. 27, 2020).



Figure 1. The SSPA module intended for the SPOT₄ satellite

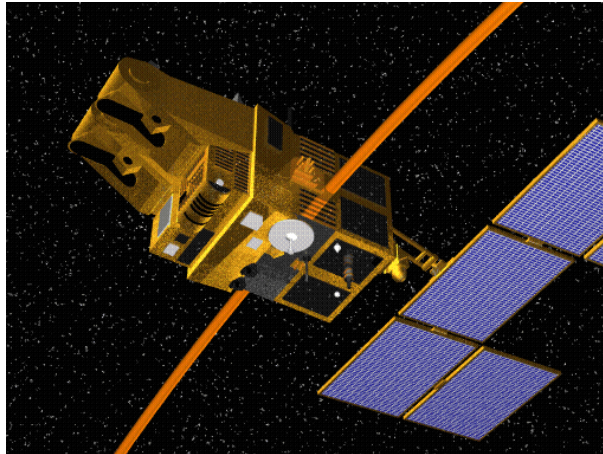

Figure 2. The SPOT 4 satellite³

Throughout this project we upgraded our production to be space qualified. To deliver two functional hybrids, we had to build 25 units. Twenty of those underwent qualification testing, destructive and non-destructive, and they all had to comply. Some of the component qualifications were carried out by CNES.

The SPOT4 satellite was launched March 23rd 1998 by an Ariane 40 launcher and worked successfully many years.

The researchers in Ericsson Research⁴ worked on fiber optical communication in the early 1990s. I helped them packaging a chipset including an 8:1 MUX and a 1:8 DEMUX for the Synchronous Optical Network/Synchronous Digital Hierarchy system (SONET/SDH).

A team at CTH were working on High Electronic Mobility Transistor (HEMT) development and the “Angelov model” in the 1980s. I was given the job to do the assembly and wire-bonding of those transistors. The Angelov model is today implemented in simulators such as Agilent Design Systems (ADS™).

Other than my general contribution, as a preproduction engineer, to make EMW a high quality provider of defense, special and telecommunication microwave hybrids, my contribution in the research projects helped the researchers’ to achieve their goals, and have resulted in several publications, such as [1] and [2] for the SONET/SDH modules and [3], [4], [5] and [6] for the HEMT development.

⁴ Ericsson Research is a research department situated in Göteborg that was at the time part of Ericsson Microwave Systems AB

1.3 MANAGERIAL KNOWLEDGE

After seven years as a pre-production engineer I became the manager of my group. In a first time, I was responsible for the pre-production engineers. Soon, my responsibility grew to include 30 engineers.

The management methods used at EMW at that time were more or less equivalent to what was simultaneously described in quality management literature from Dr. Deming's⁵. Some of the most important points are people related such as:

1. Drive out fear
2. Break down barriers between staff areas
3. Remove barriers and make people proud of their workmanship

All managers at the time at EMW had to follow training programs. The first course was about managing a team where we learned about rewards, escape behavior, managers' most important task and so on. The second was more about team building and decision making, the third was on a personal level to see one's strengths and weaknesses and to set up personal goals. The military course was on team building and finally the assessment center was an evaluation on managerial inherent aptitudes.

The most important personal learning outcome of my managing years is threefold:

1. The managers most important task is to remove obstacles perceived by their staff
2. The best result is obtained when everybody works for the common good, individual interests set aside
3. Everyone involved at the workplace must help make sure that nothing "falls between the chairs".

After three years of management, I missed working on technical issues. This is one of the reasons why I left EMW to improve my level of education at Chalmers University of Technology. However, before going into details about my academic career, I will just mention my startup experiences.

1.4 STARTUPS

In 2001, a new startup called Optillion set up a research department in Göteborg and I got an offer to become a research engineer responsible of packaging solutions for their Ethernet transceivers. In Stockholm, Optillion worked at a 10-Gbps transceiver, Figure 3⁶ while the team in Göteborg was challenged to develop a 40-Gbps solution within a year.

⁵ "Dr. Deming's 14 Points for Management - The W. Edwards Deming Institute," <https://deming.org/>. <https://deming.org/explore/fourteen-points/> (accessed May 16, 2022)

⁶ "Optillion announces 10-Gbit/sec Ethernet long distance XENPAK transceivers," *Lightwave*, Mar. 01, 2002. <https://www.lightwaveonline.com/optical-tech/transmission/article/16652954/optillion-announces-10gbitsec-ethernet-long-distance-xenpak-transceivers> (accessed Dec. 27, 2020).



Figure 3. The Optillion 10 Gbps transceivers⁵

Here, I was mainly focusing on flip chip (FC) assembly which would be needed to pass the signal into and out of the chips. Optillion only lasted for one year. As many other start-ups it was greatly affected by the “Dot com collapse”. So less than 12 months after the start of the research department in Göteborg, it was closed and the staff was laid off, me included.

Fortunately, I instead found a job as a research engineer at CTH which will be discussed in Chapter “Research experience” in this document. However, before I will just briefly describe my experience at Gotmic .

During my time at Chalmers, my colleagues and I created a startup called Gotmic. This company is a spin-off from our 60-GHz Microwave Monolithic Integrated Circuits (MMIC) design activities. We were five engineers who started Gotmic, with the intent to commercialize our MMICs. This was in the period 2006 - 2007. Although, I left early in the development process to go to France for a new career, my colleagues persisted and are still working at this company with about ten additional staff hired on a full-time basis. The Gotmic logo is presented in Figure 4.



Figure 4. The Gotmic logotype

Today, Gotmic is still into MMIC design and have gained a high placed position as a worldwide provider.

1.5 CONCLUSIONS

The industrial experience I have achieved is a rich source of knowledge that has been useful to me ever since. Microwave, microelectronic and optoelectronic packaging is a vast subject where every project and device, production method and qualification has increased my knowhow. At EMW I worked on many different production methods, I learnt quality assurance procedures as well as

management techniques. The Optillion and Gotmic experiences were interesting, but in both cases they lasted rather short time. However, the little time spent added useful experience as well.

As a preproduction engineer at EMW I worked with microwave designers and researchers to help them realize their goals. For the in-house microwave design engineers, in terms of given product specifications and for the researchers in terms of new research achievements. At this time, it became evident to me that what is best for a product electrically-wise, may not be the best solution production-wise and this is the gap I aim to bridge.

2. Academic credentials

After my industrial experience, I will present my academic curriculum. As I have mixed work with educational periods, my career is less straightforward than it is for many of my colleagues. This fact makes the document less easy to follow. This is why three separate education periods follow in this chapter.

2.1 EUROPEAN INDUSTRIAL ENGINEER

From the fall of 1995 to the spring of 1997 I took a half-pace study program entitled “Industrial Economics and Quality Management” at CTH. This program was especially set up for working production engineers after which we received the European Industrial Engineer diploma. I spent two years attending night classes to study matters such as quality engineering, statistical methods, quality management, industrial economy, logistics, English, environmental laws to name a few.

2.2 MASTER OF SCIENCE OF ENGINEERING PHYSICS

I got a temporary leave from EMW in the fall of 1997 to enter the Engineering Physics M.Sc. program at CTH. This is a five-year full-time program where I concentrated my efforts into microwave engineering and material science.

2.3 PH.D. DEGREE

After a few years at IMT Atlantique, I decided that I should finally do a Ph.D. thesis. Among my colleagues, Alain Péden accepted to be my Ph.D. supervisor with Jean-Philippe Coupez and Daniel Bourreau as co-supervisors. The title of my thesis in English is “Packaging solutions for MMIC component integration using the LTCC technology”[7]. This project will be detailed later on in this document. I did this work in parallel with my regular research engineer position. The Ph.D. work started in October 2012 and I defended my thesis in January 2016.

This ends the academic credentials chapter. In the following chapter I will talk about my research experience, based on my five years at CTH and my fifteen years at IMT Atlantique.

2.4 CONCLUSIONS

My academic career has been very “slow” when one compares to others, that may achieve their Ph.D. diploma in their early twenties. I have mixed work and studies and gradually increased my diploma level. However, whether working or pursuing my studies I have always stayed on the same track; design and fabrication of microwave, microelectronic and millimeter wave devices, which is my subject of predilection.

3 Research experience

My research experience is an important part of my professional life. After leaving Optillion, I spent five years at CTH in Göteborg, Sweden. In 2007, I left CTH for an 18-month research engineer position in France in the Microwave department of IMT Atlantique, which was transformed into a tenure position as an associate professor in 2009. My different experiences in research will be detailed hereafter.

3.1 MMIC DESIGN

I worked at the Microwave Electronics Laboratory (MEL) at Chalmers from 2001 to 2007. One large part of my work at MEL focused on millimeter-wave Microwave Monolithic Integrated Circuit (MMIC) design in collaboration with Ph.D. students and research engineers in a design team lead by Professor Herbert Zirath. Most of the time we used external foundries. During the years I spent at Chalmers, I had the opportunity to work on six “tape-outs” using the French foundry OMMIC’s d01mh process, the Taiwanese foundry WIN semiconductor’s 0.15 μm pseudomorphic HEMT (pHEMT) and 0.15 μm metamorphic (mHEMT) processes as well as an mHEMT process from the Fraunhofer Institute for Applied Solid-State Physics (IAF) in Germany.

One of the challenges doing the MMIC design at this time was the circuit models' precision. Actually, above 50 GHz the micro-strip line models provided by ADS™ are no longer accurate since they are based on formulas developed for lower frequencies. As a result, we had to use electromagnetic simulation tools such as Momentum™. We also developed transistor models in-house using the Angelov’s model (Iltcho Angelov was one of our much-appreciated colleagues).

3.1.1 60 GHz design

During the OMMIC and WIN tape-outs we mainly designed chips for a 60-GHz system while the IAF process was used to reach even higher frequencies. During this period, we were world leading in 60-GHz design and our publications have been highly cited throughout the years. The 60-GHz final objective was to achieve multifunctional MMIC Transmission (TX) and Receiver (RX) designs. On the multifunctional chips I realized the multiplier by eight [8] (including X4, X2 and feedback and buffer amplifier), the mixer as well as the DC feed circuit. The first complete RX and TX chips were presented in [9]. At that time, these chips were the most highly integrated MMICs ever reported. The MMICs in mHEMT technology (see [8], [10] and [11]) performed better than the pHEMT ones providing higher output power in the TX chip, higher gain in the RX chip, larger Radio Frequency (RF) and Intermediate Frequency (IF) bandwidths, higher -1dB compression point and IIP3 in the RX chip. Finally, smaller chip areas were obtained and only half of the DC power consumption was required. Micro-photographs of the mHEMT RX and TX MMICs are presented in Figure 5 below. From this work we also published a book chapter [12].

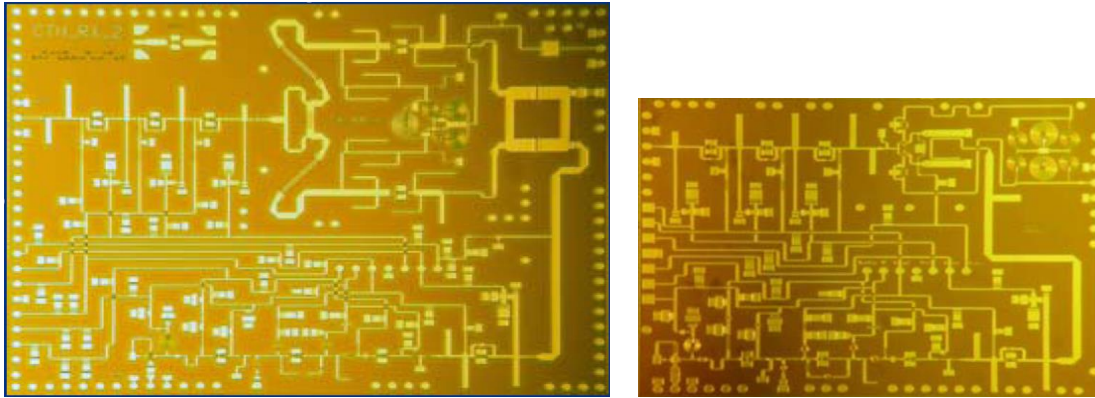

Figure 5. Multifunctional RX chip (left) and TX chip (right). The RX chip dimensions are 4 mm × 3 mm while the TX chip dimensions are 3 mm × 2 mm [10] ©2006 IEEE

3.1.2 LNAs for space applications

One of the projects I was involved in was funded by ESA. It was called Wide Band Intermittent Frequency Amplifier (WBIFA) where the objective was to design LNAs at different frequency bands to amplify the intermittent frequency, i.e. the down-converted frequency, in radio-astronomy systems. I was given the task to realize a 67-87-GHz LNA with a reactive inter-stage matching. This design was made using the WIN foundry mHEMT 0.15 μm process on Gallium Arsenide (GaAs). The chip was designed in several versions, using the Advance Model Composer (AMC) in combination with the Momentum™ simulations. This allowed us to optimize the design without doing a full-design Momentum™ simulation for each iteration. The micro-photograph in Figure 6 shows the five-stage version of this LNA providing over 25-dB gain, as can be seen in Figure 7.

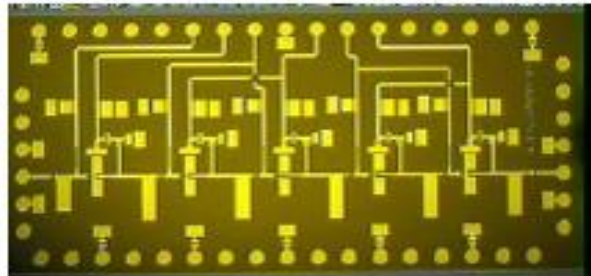

Figure 6. WBIFA five-stage Low Noise Amplifier. The chip dimensions are 3 mm × 1.5 mm

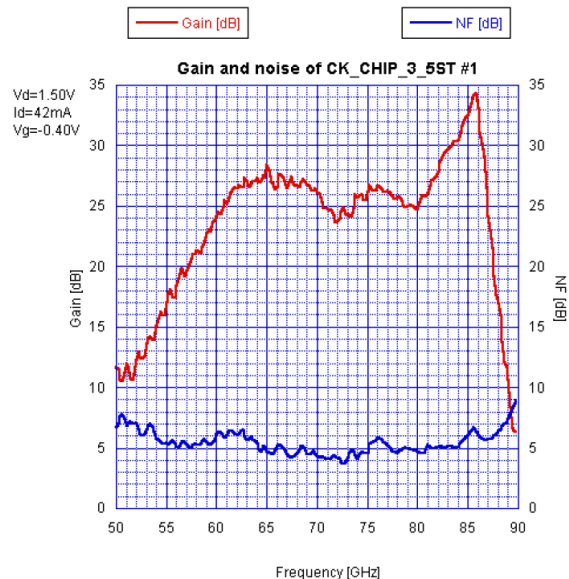

Figure 7. Measured gain and noise figure of the five-stage WBIFA LNA

Unfortunately, the results from the WBIFA project were never published. However, they conveyed new knowledge to our laboratory, especially in terms of simulation techniques and also in packaging since FC experiments were carried out.

3.1.3 MMICs for radiometry and security scanners

My last foundry run at Chalmers was based on an mHEMT process provided by IAF. The 60-GHz project had come to an end and we entered a new chapter where we considered higher frequencies. Consequently, we got closer to the sub-millimeter frequency range. The project was aiming at providing MMICs for radio astronomy systems and security scanners for which a higher frequency provides a better resolution.

I designed a doubler circuit where the input and output frequencies were 105 GHz and 210 GHz. As we had done before, the team developed a design kit to go with this process based on Momentum™ AMC models and transistor models. The doubler was measured after I had left Chalmers and worked as expected. The layout is presented in Figure 8. This doubler was then reused in a multifunctional chip as presented in [13] and [14].

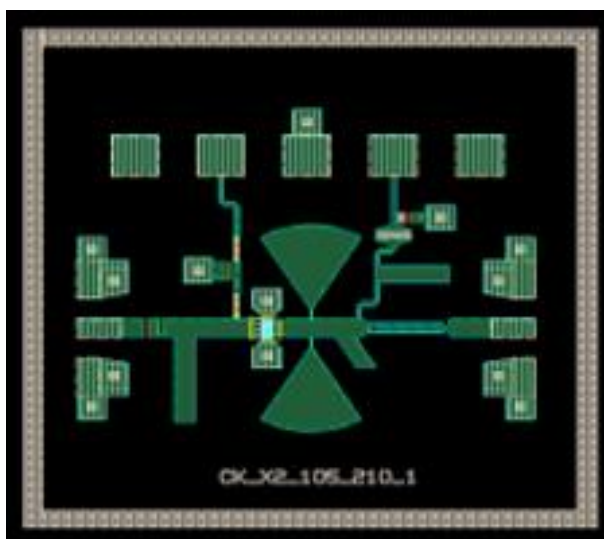

Figure 8. 105 to 210 GHz doubler layout designed in the IAF process

3.1.4 MMIC tape-out coordination

During my five years at MEL, I was responsible for the assembly of all chip layouts on reticles for the foundry. For most of our tape-outs we used four quarters of a wafer with one reticle on each quarter. I was also in charge of the design kit elaboration, since most foundries provide very few components in their proprietary kits. I also performed the Design Rule Check (DRC) before sending it off for fabrication, to avoid the process slow down and minimize the risk of receiving non-functional MMICs. The whole design team consisted of ten researchers and PhD students, each doing his or her designs according to their projects.

3.2 MILLIMETER WAVE PACKAGING

We did not only do MMIC design at MEL, but also took an interest in packaging the MMIC into modules. For the high frequency components, i.e. those working from V-band and above, I was heading this task.

3.2.1 Microwave and mm-wave flip chip assembly

MMICs are often designed with microstrip technology and are generally intended for standard die attach and wire bonding. When one wants to use such chips for FC attach, their surrounding environment changes due to the proximity of the microstrip lines to the supporting substrate. This actually effects the effective permittivity of the circuit and a frequency shift may occur, which can impact the circuits functioning. Furthermore, such microstrip chips are rarely processed to have bumps so these have to be added, either on the chip itself or on the substrate before the FC assembly can take place. Additionally, the bump arrangement forms a more or less closed cage between the chip surface, substrate surface and the bump-rows which may favor resonances to occur during use. Finally, the thermal management of such circuits is not equal to thermal management of a die attached MMIC, since the generated heat has to path through the bumps instead of through the chip to the substrate or carrier board.

These FC inconveniencies were addressed in the HiMicro project, funded by Europe as a Medea+ collaborative project with partners at Acreo in Linköping, Sweden, Epcos in Austria, Robert Bosch in Germany, ST Microelectronics in Italy and EMW and Chalmers also in Göteborg, Sweden. This work resulted in three publications [15], [16] and [17]. FC packaging was also of interest for National Chiao Tung University (NCTU) located in Hsinchu in Taiwan with whom we had a double Ph.D. program. Wei-Cheng (William) Wu, was a Ph.D student who worked together with me during his exchange periods.

To work on this subject, I did simple MMIC designs such as a circuit with two 50 Ω microstrip lines (MS) a Coplanar Waveguide (CPW) circuit using the OMMIC d01mH process [16]. I also designed a CPW chip on alumina as well as carrier substrates on thin film technology. The MS and CPW chips all have Ground Signal Ground (GSG) pads. For the chips, see Figure 9 and for the carrier substrates, see Figure 10. We also had amplifier and mixer chips available for testing and I did the carrier design for those as well.

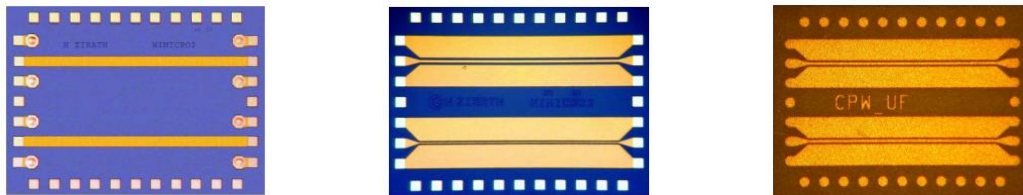

Figure 9. Chips designed for FC tests: Microstrip chip (MS), CPW chip with ground plane (CPW) and CPW chip on Al_2O_3 without ground plane (CPW_ Al_2O_3) are seen from left to right [16]

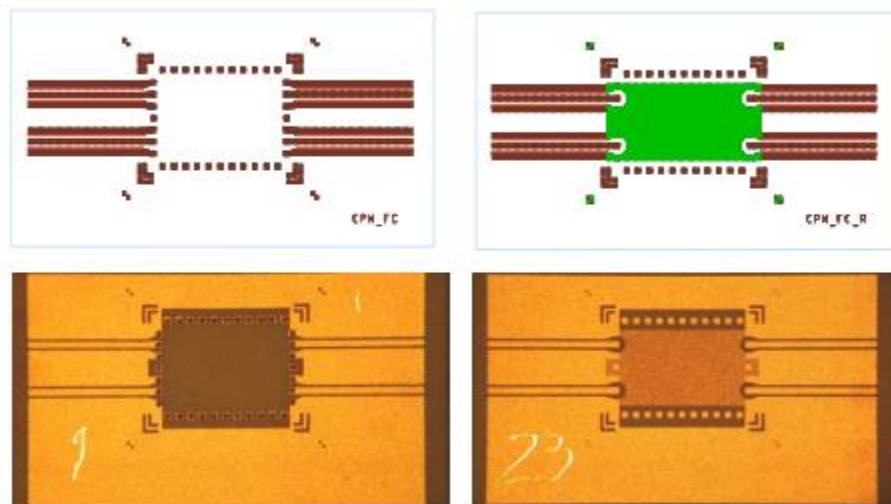

Figure 10. Some of the alumina carrier substrates for FC experiments. Narrow CPW ground lines (upper left), Narrow CPW grounds and resistive layer(upper right), Wide CPW grounds (lower left) and Wide CPW grounds with resistive layer (lower right) [16]

The carrier substrates were all equipped with coplanar lines for the RF in and output. However, the width of the grounds of these CPW lines were varied as to be as narrow as the signal line in some

cases (100 μm), and as wide as the substrate in other cases. I also added a resistive layer underneath the MMIC in order to see if this might help avoid cavity resonances.

The results of the different assemblies, using 50 μm high gold bumps on all pads and the three different chip types, can be seen in Figure 11. Here, the carrier substrate is the lower left one shown in Figure 10. Indeed, the chip type impacts the result strongly. The best results are obtained with the CPW chip without ground plane although unwanted modes impact the result as to be not smooth.

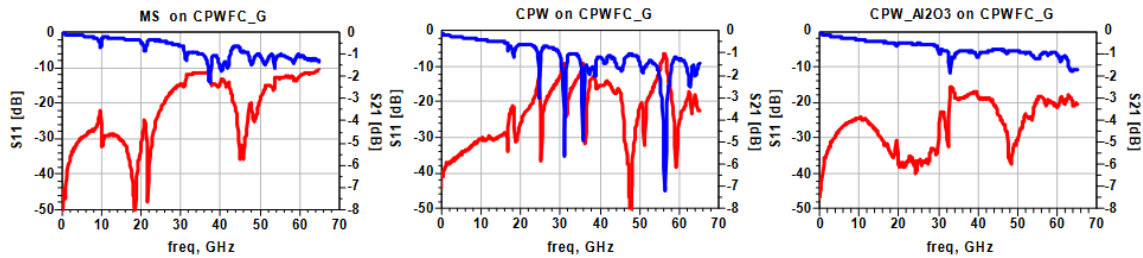

Figure 11. Measurement result of the different assemblies for the three chip types on the Wide CPW ground carrier substrate. Left, MS, middle CPW and right CPW_{Al₂O₃}-chip. Transmission curves are blue, reflection curves are red [16]

For the grounded CPW chip (middle plot on Figure 11) the resonances seen on the transmission result are really deep, so this is the most unfortunate result, while for the microstrip chip (left plot) unwanted modes are present, but less pronounced.

Now, these modes appear both as a result of the chip type but also as a result of the dimensions of the assembly cavity created underneath the chip. Versions of the carrier substrates contained a resistive layer under the chip surface to inhibit the occurrence of these modes, as can be seen in Figure 12 for the MS and CPW_{Al₂O₃}-chip. The suppression of the modes is very convincing; however, the losses are also increased for the whole measurement band. This work was published in [16].

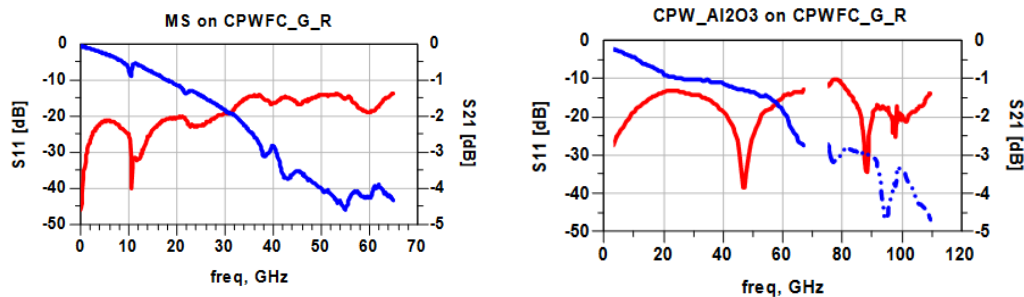

Figure 12. Results of FC assembly using the MS and CPW_{Al₂O₃} chips with a Wide ground CPW carrier substrate and resistive layer [16]

To continue this work, a 40-60 GHz amplifier MMIC (typical microstrip design) was also FC assembled onto carriers with narrow or wide CPW ground lines and with or without a resistive layer underneath the chip, as presented in Figure 13.

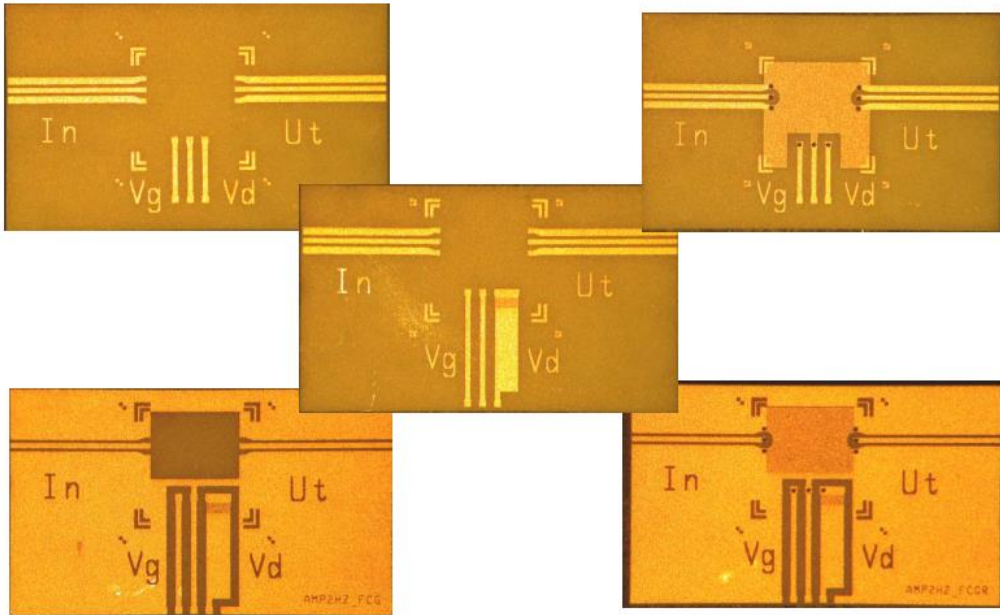

Figure 13. . Some of the alumina carrier substrates for FC experiments. Narrow CPW ground lines (upper left), Narrow CPW grounds and resistive layer(upper right), Wide CPW grounds (lower left) and Wide CPW grounds with resistive layer (lower right) and Narrow CPW lines with an extra resistance in the drain feed line (center) [18]©2004 IEEE

The MMIC was designed by Herbert Zirath using the OMMIC d01pH process. It is shown in Figure 14.

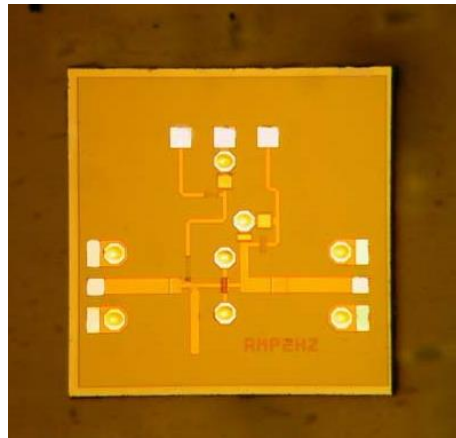

Figure 14. 40-60 GHz PA MMIC based on the d01pH process from OMMIC

The measurement results for three of the substrates after assembly are shown in Figure 15.

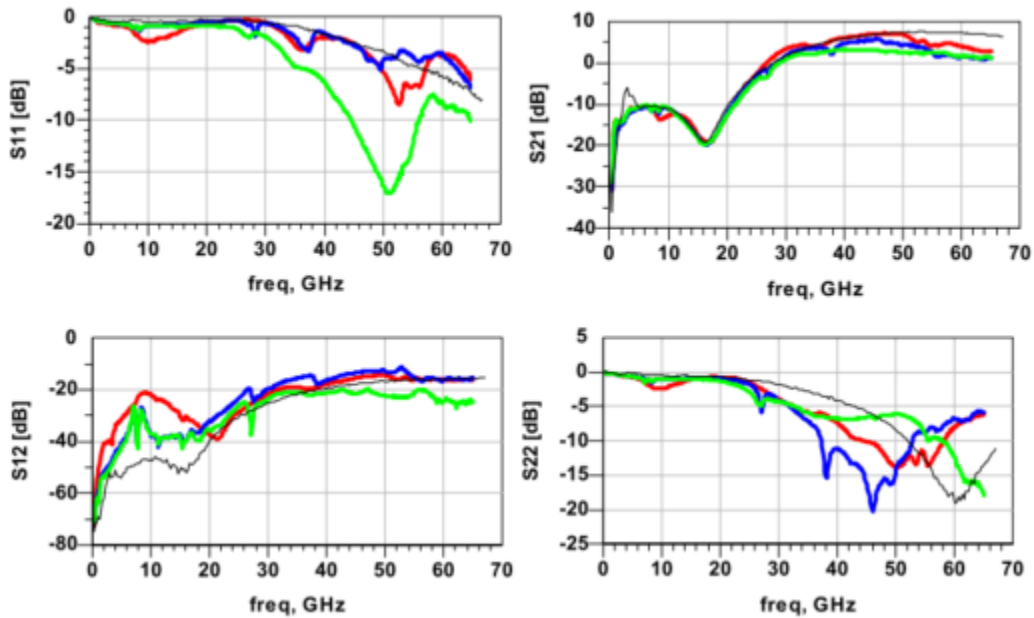

Figure 15. Results of flip chip assembly of the 40-60 GHz power amplifier MMIC. Chip only (black), assembled on Narrow CPW ground line (red), assembled on Wide CPW ground line (blue) and Wide CPW ground line with resistive layer (green)

As was seen before, the best result in terms of suppression of unwanted modes is the sample with a resistive layer deployed underneath the MMICs surface (green curve in Figure 15), however this sample has lost approximately 5 dB of gain as compared to the MMIC itself.

In these previous examples we have used what is called gold stud bumps, created by a ball bonder and then flattened before flip chip assembly, Figure 16. In this case, they were performed by VTT in Finland, who at the time had the necessary equipment for this task.

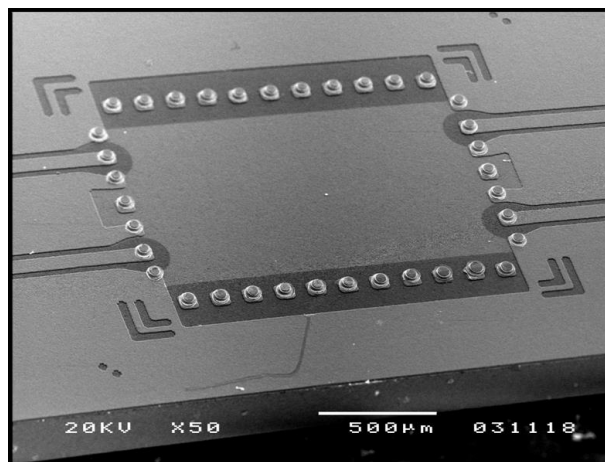

Figure 16. Stud bump bonds created by the help of VTT Finland for the Hi-Micro project.

This is not really an easy task, another way to create these bumps can be done in the clean room. With the cooperation of William Wu, we developed a gold bumping process based on electroplating on a carrier thin film substrate, so that we could flip-chip mount chips that came from the foundry without having bumps. The process steps in simplified form, starting from a substrate where the CPW lines are already present, were:

1. Sputter Ti/Au seed layer
2. Define pattern: Apply photo resist → Mask aligner exposure → Develop
3. Form bumps by electroplating
4. Remove photoresist
5. Etch seed layer

This allowed us to make gold pillars of approximately 50 μm height and 75 μm of diameter, placed exactly where needed. An example is shown in Figure 17.

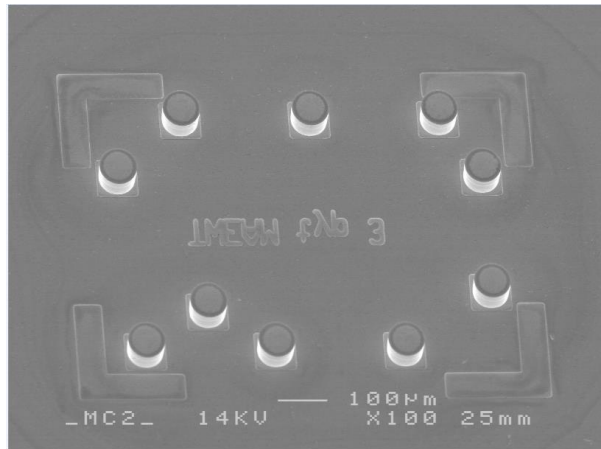

Figure 17. Example of our electroplated bumps fabricated in the cleanroom of CTH

William Wu and I also worked on a hotvia structure, Figure 18. The hotvia assembly was compared to FC and a thru line on an Al_2O_3 substrate and as can be seen on the measured insertion loss graph in Figure 19, the hotvia performs better than the FC version [19]. Compared to the thru line, there are some added losses, but that is normal given that there are two additional transitions.

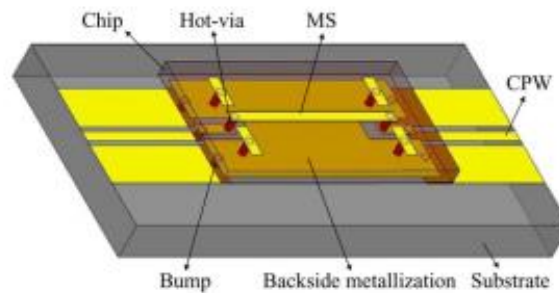

Figure 18. Hot-via structure as tested in [19] ©2007 IEEE

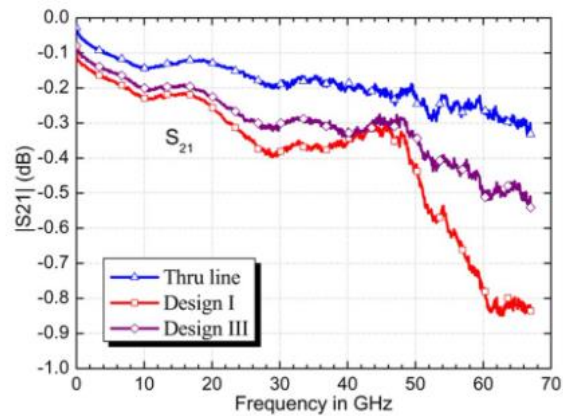

Figure 19. Comparison of insertion loss for a Thru Line, a hot via assembly of a thru line chip (Design I) and an FC assembly (Design II) [19] ©2007 IEEE

The hotvia structure makes life as an RF designer easier, because the chip always stays with its surface upwards and the effective permittivity is the same after assembly as used for the design. However, this type of transition is rarely proposed by the foundries, as it adds backside processing of the chips.

Another part of our collaboration was the measurement validations we did for his a coaxial-like bump structure, Figure 20 [20]. In Figure 21 we can see the measured comparison between an all microstrip-line structure and one with two coaxial transitions. At the most, we have about 0.1 dB more insertion loss for the flip chip structure.

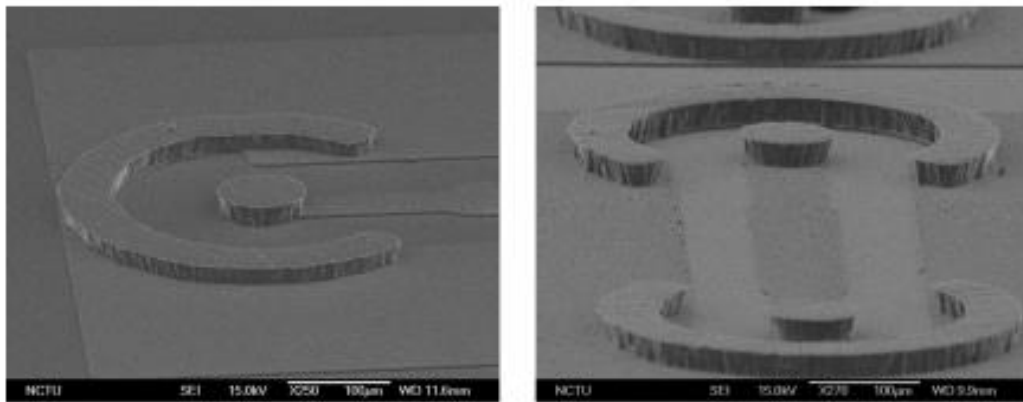

Figure 20. Coaxial flip-chip structure as presented in [21] ©2010 IEEE

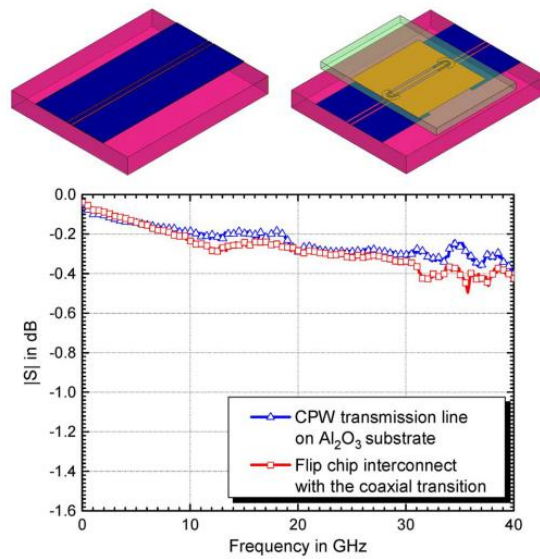

Figure 21. Comparison of insertion loss for a microstrip line with a flip-chipped line connected by the proposed coaxial structure [20] ©2009 IEEE

Thus, from our measurement validation, the coaxial structure is very good in terms of electrical transition, however to do this both the MMIC and the carrier substrate must each have the semi-coaxial transition structure, and that has not yet been implemented in any foundry.

In [21] we tested new transitions by using my X8 MMIC assembled together with a VCO circuit, also designed at MEL. In this work electroplated pillars were used as bumps, and an inductive and capacitive line was introduced in the CPW line of the carrier to compensate for the parasitic elements of the FC assembly. In this work, measurements as presented in Figure 22 show that actually the circuit is more wide-band after assembly than the MMIC itself.

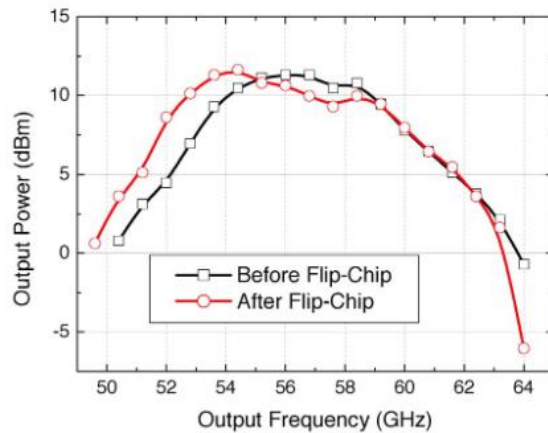

Figure 22. Results of on-chip and after FC assembly of the X8 MMIC [21] ©2010 IEEE

3.2.2 OPTCOM

The overall goal was to build and test a demonstrator system that consisted of a transmitter and a receiver unit with the aim to transmit and receive 100 Gbit/s data over an optical fiber, with transmission distances up to a few tens of km, using only one optical wavelength.

In the OPTCOM demonstrator project, we focused our efforts in the fields of high-speed and high-frequency electronic circuit design, assembly technology, optical components and fiber-optical transmission. In parallel with this, we also had to form test strategies and build a test bench for 100 Gbit/s. The OPTCOM project was a real success with world record data rate transmit and receive chips working up to 165 Gbit/s.

The package designed for the DMUX 1:4 and MUX 4:1 chip is equipped with equal length coplanar transmission lines on an Aluminum Nitride (AlN) substrate. The MUX or DMUX InP chips were FC mounted to minimize interconnection parasitic effects and to avoid losses when the signal is transferred from transmission line to the chip and vice versa. This work was reported in [22]. Figure 23 below shows the final package.

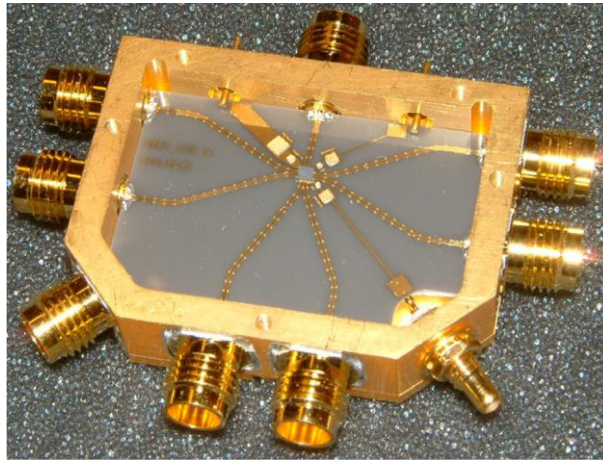

Figure 23. The OPTCOM MUX package [22]

There are more issues with packaging than just the concern regarding the signal: one has to choose the materials not to have a Coefficient of Thermal Expansion (CTE) mismatch. Knowing that InP has a CTE of about 4.75 ppm/K, it is preferable that it is mounted on a substrate material that has a close CTE value. Organic substrates with copper as top and bottom metallization have a CTE around 20, while AlN lies at 4.5. However, since the different substrate materials have other advantages or disadvantages, a tradeoff is often made, for instance, between cost and quality performances.

In addition, one must also be careful regarding material combinations to avoid any electromigration problems. These, as well as the CTE mismatch, are rather long-term problems and must be addressed for products with a required life time of several years (or even decades). However, even if the product is just a prototype for laboratory use, it should be considered with minimum precautions.

The finalized package with all the safety measures taken was presented in [22].

3.2.3 BRAWO project

The Brawo project was a collaboration between MEL and Ericsson Research with the objective to build a complete functional Transmitter and Receiver (TRX) system using our 60-GHz MMICs, i.e. not the multifunctional ones, but the ones designed as single function chips. Ericsson Research was the partner who packaged the chips and built the complete system. During the project, we integrated amplifiers with high-gain antennas for WLAN (Wireless Local Area Network) base stations and terminals. Figure 24 presents one of the proposed structures.

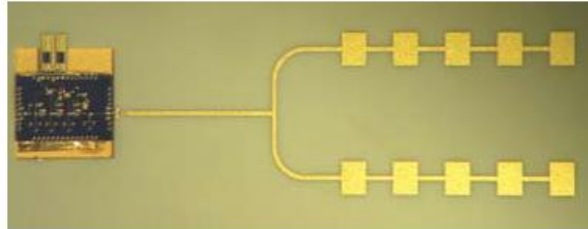

Figure 24. Terminal active antenna with 18dB amplifier MMIC [23] ©2006 IEEE. The antenna gain is 13 dBi and its board size is 5 mm × 10 mm.

This work was reported in [23], [24] and [25] and has been highly cited as a reference for system in package antenna designers thanks to its high gain and very simple integration.

3.2.4 Collaboration with Omnisys Instruments AB

Engineers from Omnisys Instruments AB, a SME that develops components for space applications also collaborated with us on the subject of FC assembly. In a first prototype we used a travelling wave amplifier, that was truly broadband, to evaluate the impact of FC-assembly. From this work we could conclude that we had 1.6 dB loss caused by the two flip chip transitions as compared to a bare chip measurement. A second work on the impact of Parylene-C, used as a protective layer, onto microstrip and coplanar transmission lines and on the FC assembled travelling wave amplifier was carried out and published in [26]. The thin layer of Parylene-C indeed protects the surface but also brings a shift in effective permittivity to the circuit if transmission lines such as microstrip or CPW-lines on the surface layer of the device are used. This is what illustrated on the measured insertion loss obtained by the ring resonator, see Figure 25. For the travelling wave amplifier, we measured an additional gain drop of 0.6 dB at 60 GHz due to this added layer.

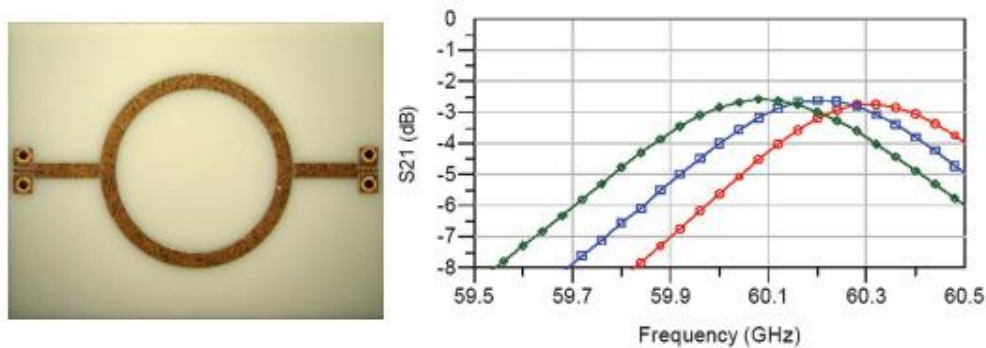

Figure 25. A ring resonator used to test the impact of Parylene-C coating (left), frequency shift at 60 GHz for the non-coated (red) as compared to coated resonators by 2 μm (blue) and 5 μm (green) in the graph (right) [26] ©2006 IEEE

A thermal analysis of the operating amplifiers also showed that the parylene-C layer helped lowering the overall backside temperature of the FC mounted amplifier by as much as 10°C.

3.2.5 Collaboration with SMIT center

I also did some work with a Ph.D. student (Xia Zhang) who pursued a double diploma between the department of Microtechnology and Nanoscience at Chalmers and the SMIT center at Shanghai University of China. She worked on Liquid Crystal Polymer (LCP) substrates, which were new to the RF industry at this time, and designed and manufactured ultra-wide band filters working in the 22 to 29 GHz frequency range [27], [28].

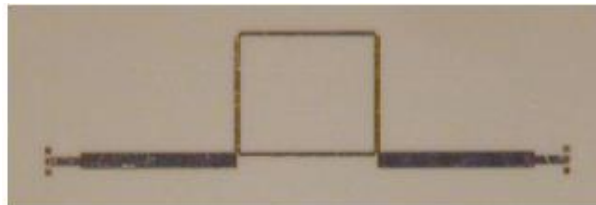

Figure 26. Ultra-wide band filter in LCP technology [28]

During this project, I mainly helped out with measurements even though Xia Zhang's project tasks also considered fabrication procedures to improve the adhesion of the metal to the LCP surface.

This is the last of my packaging project at MEL. The next chapters will treat my research work at IMT Atlantique.

3.3 DEVELOPMENT OF A SIMULATION PLATFORM FOR AN AUTOMATIC CRUISE CONTROL RADAR

During my first time in France, I worked on an ANR / ID4cars financed project on a simulation platform to determine the performance of automotive radars. Before I came, the Frequency Shift Keying (FSK) based radar had already been treated in a Ph.D. project. A simulation platform based on ADS™ was available for the FSK case. However, this one needed to be improved, new waveforms needed to be implemented, and my job also included to develop radar frontend prototypes for testing.

The FSK radars have excellent speed resolution, but the distance resolution is not very good, which makes it difficult to discriminate between two targets with identical relative speed. Also, targets with the same speed as the radar, i.e. a zero-relative speed, are not detected at all. This is why the project was extended to work on Linear Frequency Modulation (LFM) format like the Frequency Modulated Continuous Waveform (FMCW) or the double FMCW that allows the handling of more complex scenarios. This work was done in close collaboration with several partners: the signals and systems department at IMT Atlantique who worked on waveform detection algorithms, the “Institut d'Électronique et de Télécommunications de Rennes” (IETR) who did the antennas together with Satimo (now MVG industries) and Autocruise (now ZF group) a company that develops automotive radars. During this project, we managed to improve the simulation platform so that different fixed scenarios could be tested using diverse architectures, modulation formats as well as detection algorithms. Some articles were published on our work (see for instance [29], and [30]). The publication [29] has been used as the basis for the Matlab Simulink™ example entitled “Automotive Adaptive Cruise Control using FMCW Technology” in their R2019b documentation [31]. An illustration of the simulation platform is presented in Figure 27.

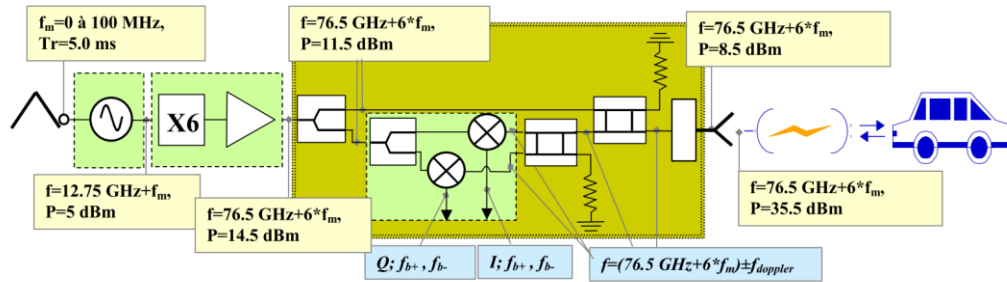

Figure 27. The Adaptive cruise control radar simulation architecture [30]

3.4 RADIO OVER FIBER DEVELOPMENT

The radar project terminated, I had the chance to be employed as a research engineer / associate professor in the microwave department at IMT Atlantique. This is also the moment where I was accepted as a researcher in the Lab-STICC⁷ laboratory which gathers about 500 scientists working on sensors and communication technology. My research engineer position was intended for the development of a new area of research, Radio over Fiber (RoF). RoF projects were developed in collaboration with the optics department where a second research engineer was hired at the same time. During the years 2009 to 2012 we worked intensely on several RoF projects, like CapilR, Origin and CapilRTram, that will be detailed hereafter.

3.4.1 CapilR

CapilR was our first RoF project where we started out learning about these systems. Some investments were done and we were able to deploy a basic RoF system. Our first efforts were in working on the distribution of power using a set of antennas, each transmitting a lower power than regular single antenna systems. In addition to the hardware, we had access to the Winprop™ suite, a radio coverage simulator that allows you to model indoor or outdoor scenarios, using material

⁷ Laboratoire des Sciences et Techniques de l'information de la Communication et de la Connaissance

coefficients for buildings, furniture, trees, walls or whatever is in the area you want to cover. Also, different propagation models can be used to calculate signal propagation and coverage in a 2.5D environment model. We also had measurement equipment to perform measurement campaigns according to different scenarios.

To begin with, we studied the performance of a Distributed Antenna System (DAS) as compared to a standard Wireless Fidelity (WiFi) system, where a single antenna is used. The idea is to distribute the transmitted signal by a fiber network to several departed antennas in the building. This way, the power distribution would be more even and the very high-power level used by the single antenna system can be avoided. The simulation results from an open space office area are presented in Figure 28. In this case we used coaxial cables and power splitters to direct the signal to the four antennas. For the DAS evaluation, the WiFi box (Buffalo Wireless router) was set to transmit 1 dBm, which, after distribution through Radio Frequency (RF) cables and power splitters, meant an Equivalent Isotropically Radiated Power (EIRP) at each antenna of -17 dBm. To achieve the same coverage and bit rate with a single antenna system, the transmitted power from the WiFi box had to be increased to 10 dBm, which resulted in -2 dBm EIRP at the antenna after taking the cable losses into account. As can be seen when comparing both simulations, lowering the EIRP yields a lowered maximum received power level by 15 dB for the DAS setup, while obtaining a better coverage. Using CoveraZone™ we measured and confirmed these results. This work was published in [32].

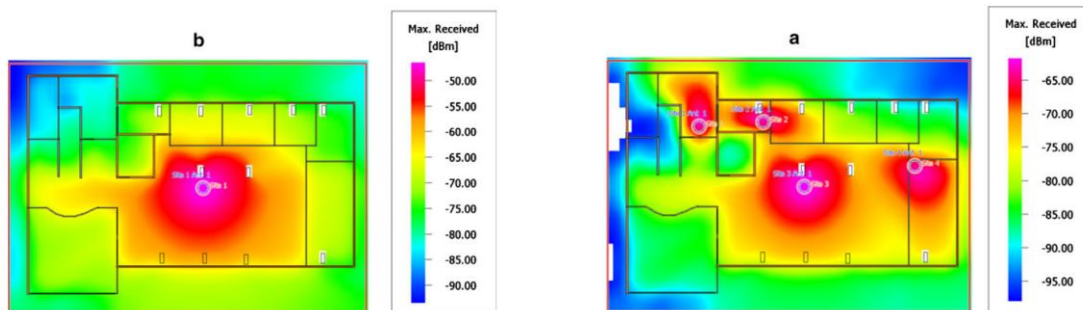

Figure 28. Single antenna power distribution (left), DAS power distribution (right) [33]

During the CapilR project, three Ph.D. projects were initiated with the students Yves Josse, Rabiaa Guemri and Hexin Liu. I co-supervised the latter. Publications, such as [33] and [34], were made during this project.

3.4.2 Origin

ORIGIN (Optical-Radio Infrastructure for Gigabit/s Indoor Networks) project was a FUI8 project with lead by Orange Labs with the following participants: IMT Atlantique, Esycom, IETR (Nantes), Innoptics, Acome, Siradel and Niji. This project concerned an indoor 60-GHz RoF system.

IMT Atlantique / Lab-STICC was responsible of the design and manufacturing of the 60 GHz RX and TX modules and the antennas to go with the system. The RX modules contained a down-converter, so that the signal, once received, could be transformed to a 5-GHz signal, that was transportable over a fibered system in the building. Before transmission, the 5-GHz signal was up-converted in the TX module. IETR designed and manufactured the 5-GHz modules and also the transformation from the electrical to optical domain and from the optical domain to the electrical. Orange Labs worked

on the system design, Easycom provided the photodiodes and Innoptics did the packaging of those and, finally, Siradel provided the radio coverage simulations.

The 60-GHz modules were designed based on MMICs from Gotmic which, at that time, were the only ones covering the needs of our project. The packaging choice was rather basic using Rogers™ duroid substrates integrated on a mechanical base plate, with gold plated copper to enable wire-bonding. Antennas were manufactured in-house using a silver painted foam technology developed by IMT Atlantique / Lab-STICC. A photograph of this antenna fixed in a waveguide structure for measurement is presented in Figure 29. The 60-GHz RX module is presented in Figure 30. The TX and RX modules were successfully integrated with the other components from our colleagues to form a full demonstrator that was installed in the test platform at Orange labs in Lannion.



Figure 29. Origin 60-GHz horn antenna realized in silver painted Rohacell™ foam, produced in-house

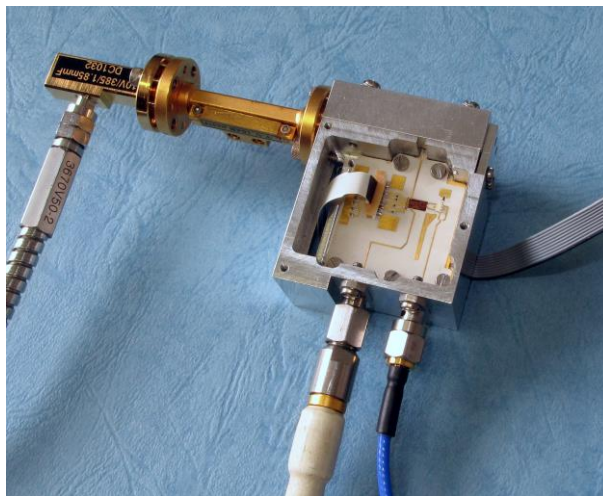

Figure 30. Origin receiver-module under measurements

This work was very fruitful and we managed to build a system that yielded good performance. The experimental setup is presented in [35] from where the illustrations presented in Figure 31 and Figure 32 are taken.

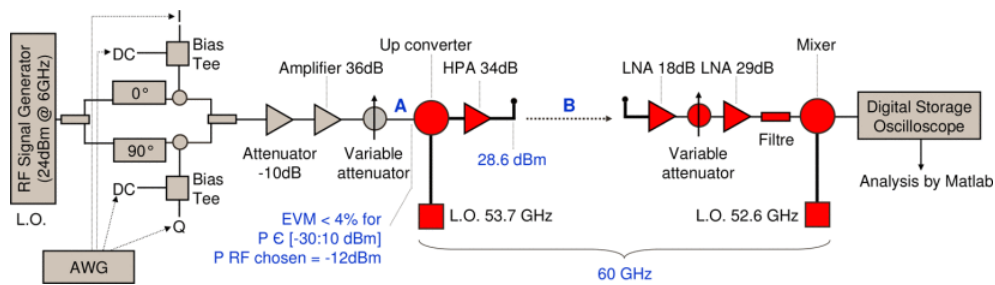

Figure 31. Origin's experimental setup [35]

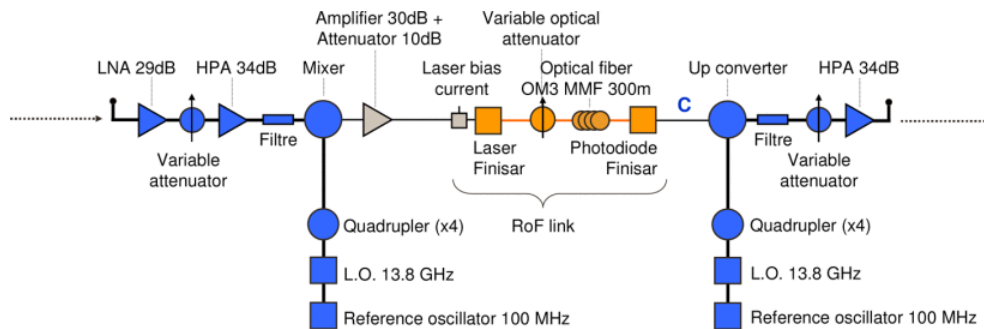

Figure 32. Origin's experimental setup with tunnel [35]

3.4.3 CapilRTram

The CapilRTram project was a project where we analyzed the possibility to use RoF to provide WiFi to the passengers in the newly installed tramway in Brest. The idea was to provide a coverage that included tram-stations as well as inside the tram cars while in circulation. The users would enjoy a “seamless” handover between the city’s WiFi or 4G system and the WiFi system provided by CapilRTram that equipped the tram-stations and the tram cars. This project was funded by Brest Métropole and one of our partners was Kéolis, the tramway service provider.

During this project we also worked with MOXA, a company that delivered the infrastructure equipment, such as WiFi access points working at 2.4 GHz and 5 GHz, Cetelec made the installations on the tramway stations and Kéolis installed some relay equipment in two out of their eighteen tram cars in Brest. Brest Métropole supervised the project and gave necessary authorizations.

Brest Métropole also supplied a complete digital terrain map over Brest, including all urban installations, the city topography, roads, houses, lampposts, trash cans and whatever kind of material that can be found in a city. With the help of this data, we could do propagation and coverage simulation to optimize the site location of the MOXA equipment. In reality, three tram stations were equipped; Liberté, Siam and Recouvrance, for which we could carry out terrain tests. Some of the simulation results is shown in Figure 33. Real-time measured data were collected using different setups, one using a Jperf™ server to transmit data over the system and then Jperf™ and Covera zone™ installed in a laptop was used to evaluate the reception in terms of received bit rate in tram cars. In another setup we used a spectrum analyzer to measure the received power of each channel deployed. Measured bit rate data are presented in Figure 34. This project was finalized the spring 2015 and some publications were made on the subject, e.g. [33].

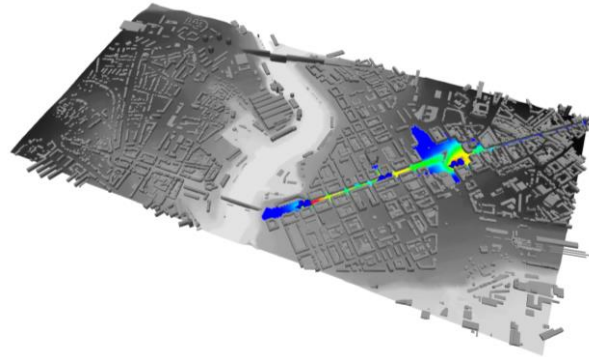

Figure 33. Tram stations' deployment simulations in the center of Brest

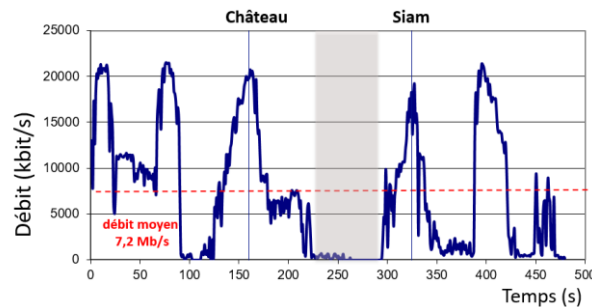

Figure 34. CapilRTram received bit rate when transmission using Jperf™ and reception in moving tram by CoverZone™, [33]

3.5 CELL PLANNING - IMAGINLAB

Imaginlab was a project to launch and test the 4G – Long Term Evolution (LTE) system in Bretagne before its deployment. The intention was to abandon the Worldwide Interoperability for Microwave Access (WiMax) standard and go for 4G – LTE in Brest area and to test Fibre to the Home (FTTH) architecture in Lannion area. A first small-scale deployment of this system was setup with test pilots chosen in the region. In Brest we were mostly involved in the 4G-LTE part for which Alcatel-Lucent provided base stations and antennas. The radio coverage was partly my task and measurements were performed by the Electronics department at IMT Atlantique. During this project we used WinProp™ suite to prognostic the coverage of the four antennas deployed by Alcatel-Lucent.

Using Winprop™ suite, radio propagation previsions were carried out based on files provided by the Brest Metropole Océane GIS service. My personal involvement in this project was to do a cell planning study to optimize the antenna sites' placement. A preliminary study had already been done by Alcatel. This first study, which was performed by students, was done based on clutter data defined by them using Google maps™ to indicate different zones' densities: buildings, agriculture areas, woods, ocean, etc... Different simulation techniques were tested, based on clutter data, and different propagation models, like the Empirical 2-rays model, Okumura-Hata with Knife Edge, and Dominant Path model⁸. Finally, the dominant path model was used.

⁸ "Radio propagation," *Wikipedia*. Feb. 06, 2022. Accessed: May 16, 2022. [Online]. Available: https://en.wikipedia.org/w/index.php?title=Radio_propagation&oldid=1070182857

In a second time, Brest Métropole Océane provided digital terrain elevation data and digital building data which, after some transformations, were possible to use with WinProp™ modeling. Our work resulted in a relocation of one of the antenna sites to better cover the coastline and the “Rade de Brest” as required in the specification. Two simulation results namely, receive power and download maximum data rate, are shown in Figure 35, below.

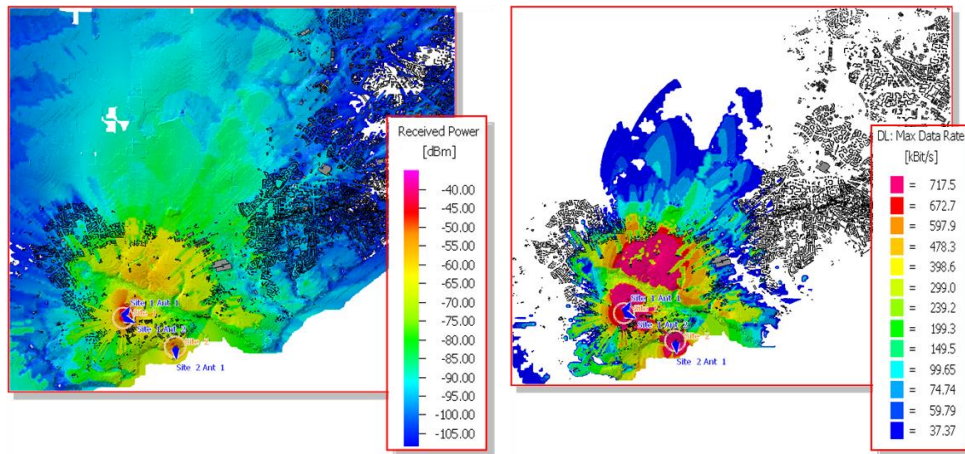

Figure 35. Imaginlab received power as simulate over the nearby zone of IMT Atlantique (left) and simulated download data rate (right)

The Electronics department at IMT Atlantique performed drive tests and measured the received power along several paths and their drive data was compared to the simulated data. The results were quite conformal.

3.6 LTCC DESIGN AND FABRICATION

Throughout my career the microelectronics packaging part has always been among my favorite subjects. I learned a lot as a pre-production engineer at EMW, which has been very useful for the rest of my carrier. I was primarily hired by Optillion thanks to my knowledge in the area. The same applies to when I was hired at Chalmers. When I came to IMT Atlantique / Lab-STICC, this knowledge came to use immediately in the car radar project, as well as in the Origin project where we designed and built 60-GHz packages. Finally, after some years on the car radar and RoF track I was able to reinvest myself in this area when we started the Low Temperature Cofired Ceramics (LTCC) technological platform in our department.

The idea to start an in-house LTCC technology platform was based on the previous experience and the available equipment. My colleagues had been doing thick film circuits with very high quality for many years. They also developed a mixed technology starting with screen printing a gold layer onto a high-quality alumina substrate and then to realize gaps in the gold by etching. In 2008, this technique started to be less interesting and the LTCC was a natural step to enlarge the acquired knowledge. At that time, I proposed a PhD thesis project in collaboration with Chalmers to combine their MMIC design with a LTCC package. Hence, Khodor Rida was hired on this position to initialize the LTCC manufacturing, while I became co-supervisor together with Professor Alain Péden who was the thesis director. Khodor worked with me and the technicians, primarily Guy Chuiton and Pascal Coant, to test and decide on the first fabrication parameters and techniques.

Since 2009 the LTCC platform has been under my responsibility, in all terms from circuit design, manufacturing procedures and parameters, equipment (both the financing and the actual buying, installation and testing), design rules, design kit development and design rule check, quality issues and project proposals. The way we operate is that we can fabricate LTCC circuits for other designers (internal and external). However, they use our design kit with the layer definitions, they comply to our design rules, and they propose their designs in a 1:1 scale. The actual compensation for shrinkage, mask preparation, mask command, screen manufacturing, LTCC manufacturing and validation are carried out by me.

3.6.1 Packaging solutions for MMIC integration in LTCC technology

This LTCC based project is my own Ph.D. project. As the years passed, it became more and more evident that I should pursue a Ph.D. to challenge myself and to reach a higher level of knowledge. I proposed this project by myself, once I had supervised Khodor Rida in his efforts to develop the LTCC technology in our laboratory. When I started my Ph.D. project, the maximum frequency use of LTCC was for car radars, i.e. in the 77-79 GHz band. My objectives in this project was to answer the following four questions:

1. Up to what frequency is LTCC possible to be used, and what LTCC material should be used at the higher frequency end?
2. What transmission-line support should be chosen at higher frequencies?
3. How should the interconnexion between the MMIC chip and the LTCC substrate be designed?
4. How to connect the LTCC substrate to an external waveguide?

3.6.1.1 Grooved Laminated WaveGuides (GLWG)

During this work I was able to realize and measure devices working up to 170 GHz, which was as high as our measurement equipment could operate at that time. The transmission-lines that I chose to work on was the Grooved Laminated WaveGuides (GLWG). The very popular competitor called Substrate Integrated Waveguide (SIW) are according to our calculations, given the design rules, not recommended to use above 150 GHz. This is because there is too much radiation leak between the metallized vias that play the role of the waveguide walls in the substrate. The GLWG is a substrate integrated waveguide with completely closed walls that is possible to realize in LTCC. However, this requires a laser equipment instead of a puncher to create the holes.

We built different GLWGs working from U-band (30-50 GHz) up to the G-band (140-220 GHz) as shown in Figure 36. This work was published in [36] and [37]. Parts of this work (some of the U-band designs) were carried out by my students as a 5th semester project.

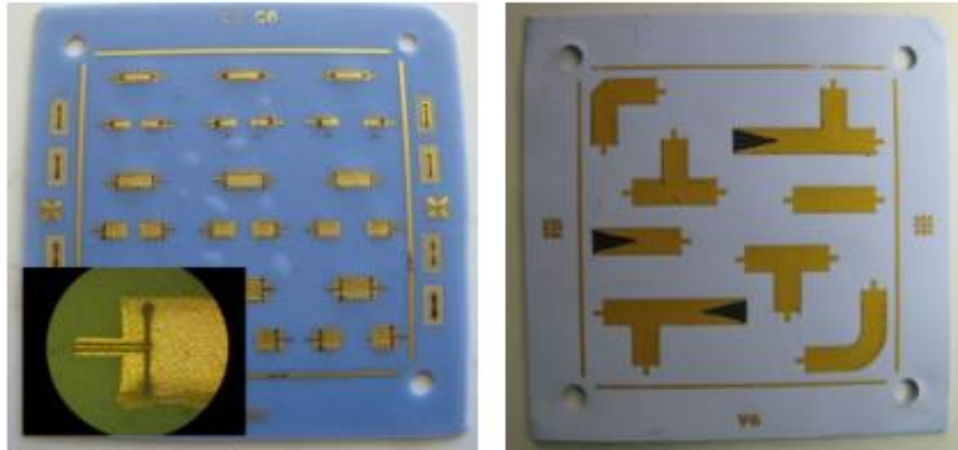

Figure 36. Examples of Grooved Laminated WaveGuides in LTCC [37], V, W and G-band structures (left), U-band structures (right) ©2015 IEEE

Using the ESL41110 tape from ElectroScience Laboratory which has a relative permittivity of 4.11 and a $\tan\delta$ of 0.008, as tested in our quasi-optical test bench [38], we arrived at 0.1 to 0.4 dB/mm loss for these structures.

3.6.1.2 MMIC to LTCC interconnexion

When it comes to the interconnexion between the MMIC chip and the GLWG, several completely new transitions were designed and tested. The one that performed best in simulation is shown in Figure 37, [39].

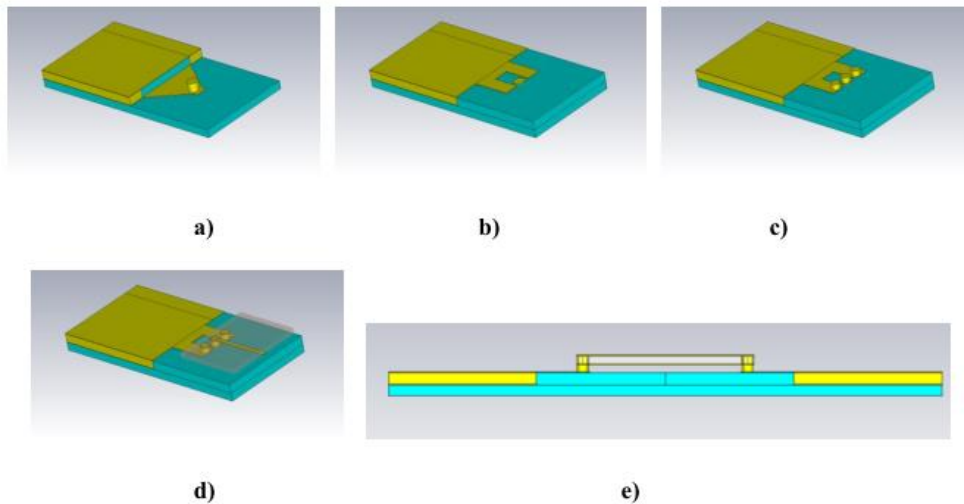

Figure 37. MMIC to GLWG transition as proposed: a) lower metal taper with a metalized via to connect the MMIC signal pas, b) WG top metal with ground pads, c) GSG bumps, d) MMIC chip connection, e) side view [39]

At that time, the above structures were not really easy to fabricate. The gap between the ground and signal pads, as seen in Figure 37 b), had to be cleared by the use of laser ablation. This is one of the techniques that I started to develop during my thesis work.

A first sample was tested with the use of a four stage WBIFA amplifier that I had designed at Chalmers several years before, see Figure 38. The device shown at the top has Metal Insulator Metal (MIM) capacitors made in the same LTCC tape as the GLWGs and the one at the bottom is equipped with MIM inserts of a high-K tape (ESL41060). The two transitions generated a 3 to 4.5-dB gain loss compared to a 3 dB-loss obtained for a five-stage WBIFA amplifier that I had FC assembled onto a coplanar transmission-line at Chalmers. The difference in gain is not surprising since for that assembly, 3 dB were lost by the transitions.

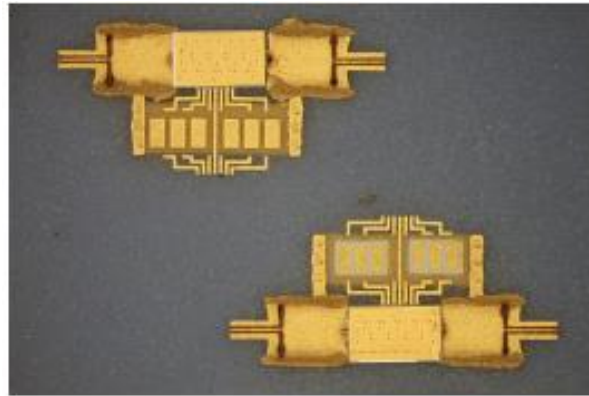

Figure 38. FC MMIC to GLWG transition. The WBIFA amplifier is used as MMIC [39]

3.6.1.3 GLWG to WG transition

The fourth question to be treated was how to connect from the LTCC substrate to an external waveguide. This is also something I tried to tackle during my Ph.D. work.

This transition design was based on the GLWG and should transfer into a waveguide (WG). My idea was to open up the GLWG top metal layer, to gradually remove the dielectric material into air and to gradually build a top case made out of metallized Rohacell™ foam. The illustration in Figure 39 shows the proposed solution and Figure 40 shows the finalized device and the device under test.

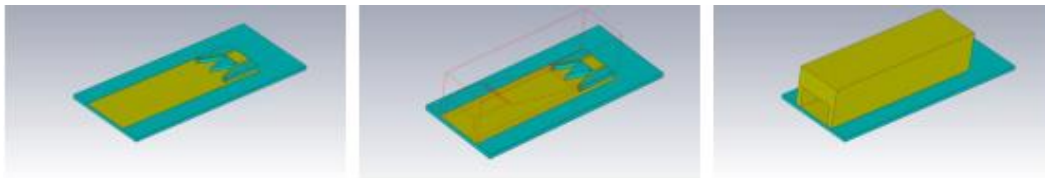

Figure 39. GLWG to WG transition [39]

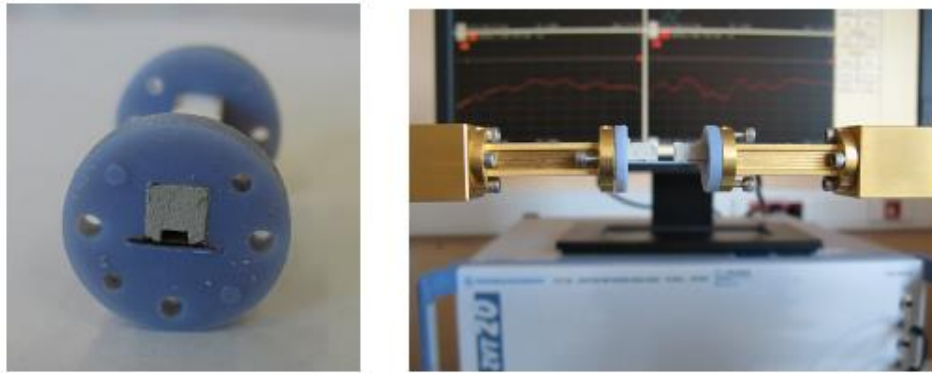

Figure 40. The back to back device as fabricated (left), the measurement set up (right) [39]

The measurements showed important losses. We arrived at more than 20 dB for a back to back device instead of the expected 2 dB. As can be seen in Figure 41, the reflection coefficient is correct, while the transmission losses are huge. Thus, it is possible that we have a bad connection between this device and the waveguides of the measurement system.

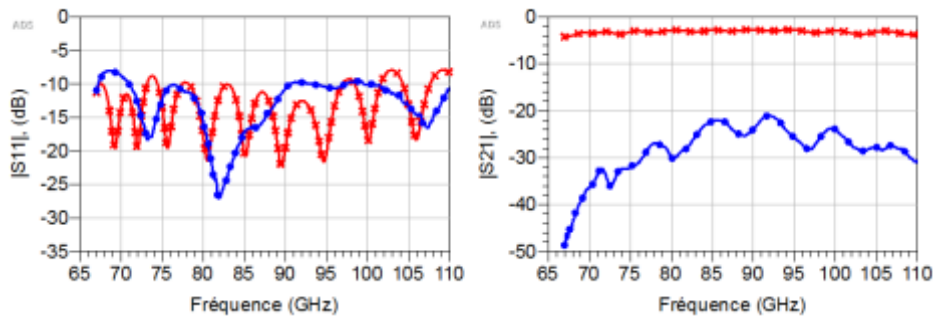

Figure 41. GLWG to WG back to back transition, simulated results (red), measured results (blue) [39]

Even though these proposed solutions didn't work out as desired, they all provides acceptable results to pursue further investigation. Today, it should be interesting to revisit this work a second time, given that we now have more knowledge in the LTCC manufacturing process than we had before.

3.6.1.4 Passive components development

One advantages of the LTCC as compared to organic substrate materials is the possibility to integrate passive components directly into the LTCC. Some MIM capacitors had already been realized first by Khodor Rida and then by me. Nevertheless, more work is necessary to propose the three types of passive elements such as resistances (R), inductances (L) and capacitors (C). A first attempt to tackle this subject was done during my thesis and partly by my students during a 2nd semester project. Together, we developed different MIM and interdigital capacitors, some resistances and some spiral inductors, all on the ESL 41060 material. This material has a relative permittivity of 16-18, which is beneficial to increase the capacitance value, while it has no impact on the inductors or the resistances. The prototype that we realized is shown in Figure 42 below. This work was published in [40].

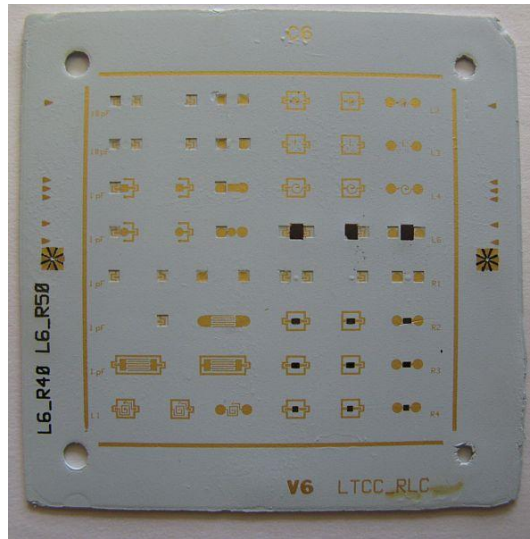

Figure 42. The RLC prototype containing MIM and interdigital capacitors, spiral inductances and resistances [40]

3.6.2 Visiting scientist program: “Packaged antenna in LTCC technology for mm-wave single chip transceivers program”

A first project where the LTCC was used for an external client was a visiting scientist exchange project that was carried out between Chalmers and IMT Atlantique / Lab-STICC. In this project, a postdoc from MEL, Dr Bing Zhang came for two one-month visits at IMT Atlantique / Lab-STICC: a first time for us to collaborate on the designs and a second time to assist during manufacturing and to perform the measurements.

3.6.2.1 Grid Array Antenna project for D-band (110 – 170 GHz)

The first design was a Grid Array Antenna (GAA) for a D-band transceiver application. The antenna can be seen in Figure 43 below. The size is 12 x 12 mm.

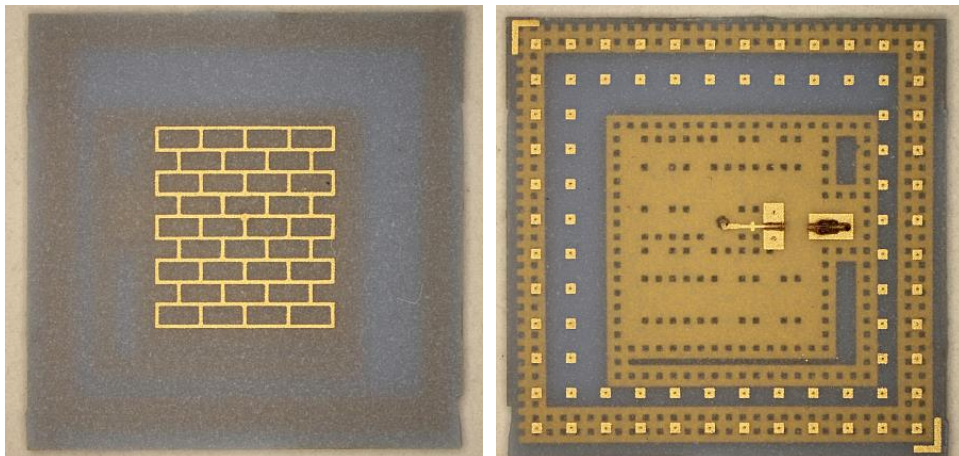

Figure 43. 145 GHz centered GAA seen from the radiating grid side (left) and feed side (right). Size 12 mm × 12 mm [41] ©2016 IEEE

This D-band antenna was designed for ESL41110, a low relative permittivity tape ($\epsilon_r=4.11$). This choice yields a better antenna efficiency as the latter increases as the substrate permittivity decreases. Together with the antenna, a Quad Flat No-lead Package (QFN) was designed (Figure 44) which was also fabricated with the same LTCC material.

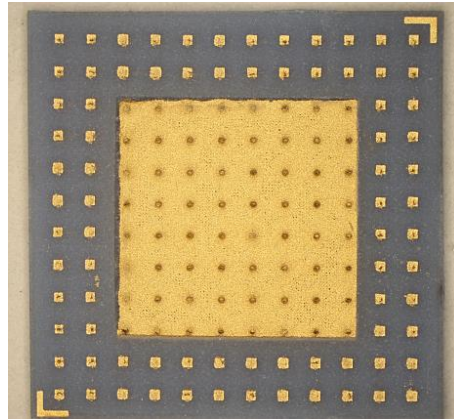

Figure 44. The QFN package that was designed and fabricated together with the GAA antenna

The above package is intended for die-attach of a D-band amplifier MMIC and to provide the interconnection to the antenna. This is done by using gold balls and thermo-compression flip-chip attach. In addition, the package provides heat evacuation and a DC-feed structure. This project was quite successful and we published this work in an international conference [41].

3.6.2.2 Liquid Crystal Polymer D-band (110 – 170 GHz) antenna

To compare the LTCC with organic substrates, Bing Zhang had designed an LCP based grid array antenna that we measured at IMT Atlantique / Lab-STICC during his stay with us. This antenna has a simulated gain of almost 17 dBi at 147 GHz and we reached 14.5 dBi at 145 GHz in measurements [42]. Since LCP (as well as other organic substrates) are clearly harder to control tolerance-wise, we also did an analysis to check the design robustness.

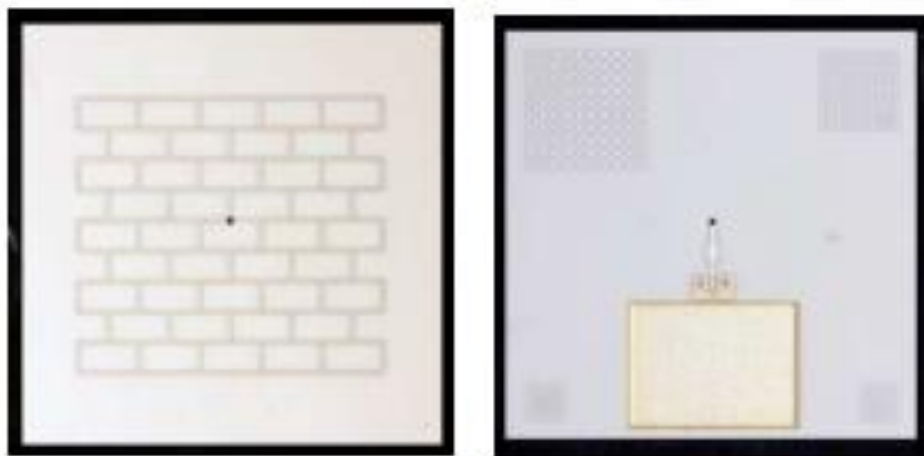

Figure 45. LCP based D-band grid array antenna [42] grid face (left) feed face (right) ©2016 IEEE

Due to the LCP material softness, a copper clad of 0.5 mm had to be inserted between the top and bottom LCP layer. The feed-via connecting the feed CPW with the grid face must then pass through the clad with care, to avoid any short circuit. This is what makes this solution more expensive compared to a regular LCP circuit. Also, in order to connect a chip (a power amplifier, PA for a TX circuit or an LNA for an RX circuit)) to the feed port, the copper metal had to undergo a bondable surface treatment called Auto-catalytic Silver Immersion Gold (ASIG).

Although the lower cost of LCP as compared to LTCC is given in [42], this is not always correct. When considering a fabrication of more than 500 units, the break-even between the LCP and the LTCC materials is reached.

3.6.2.3 Metal printed V-band (50-75 GHz) antennas

3D printing or additive manufacturing is a new technology which has boomed lately. With Bing Zhang, we also did some work on metal printing of horn antennas using 316L stainless steel. For these antennas, the surface roughness mean value was $7.69 \mu\text{m}$ with a standard deviation of $1.32 \mu\text{m}$. Even though this roughness, the measured gain was 21 and 22 dBi for the conical and rectangular antennas respectively [43]. The conical horn antenna's measured data is shown in Figure 47 to give an example.

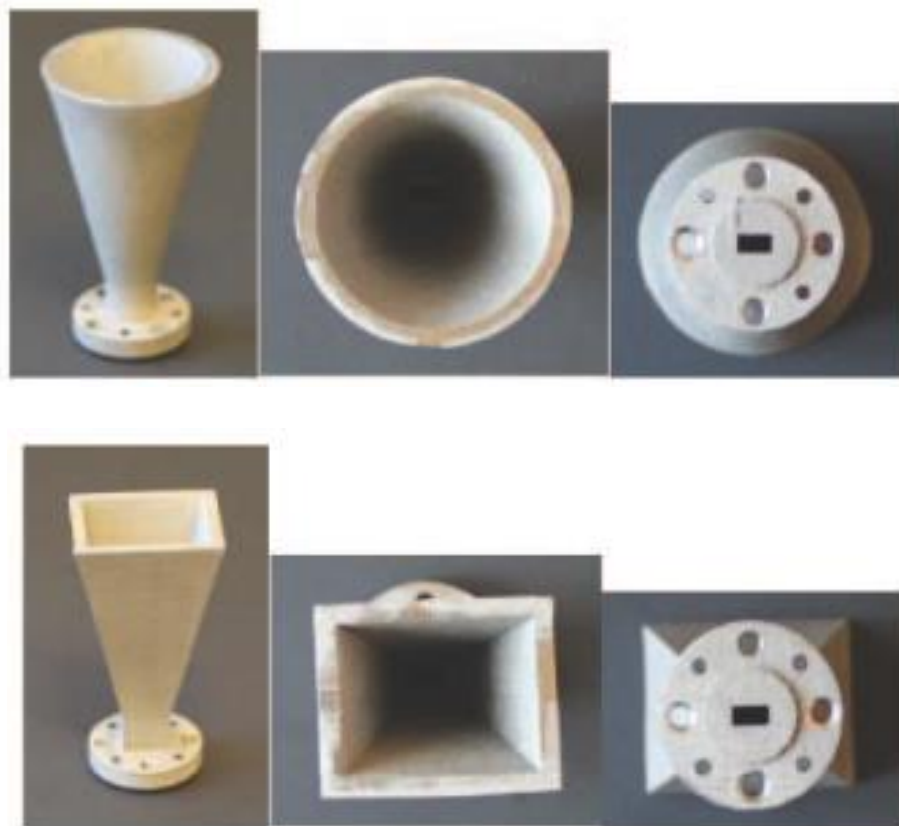

Figure 46. 3D printed metal antennas for the 60 GHz band, conical (top), rectangular (bottom) [43]
©2015 IEEE

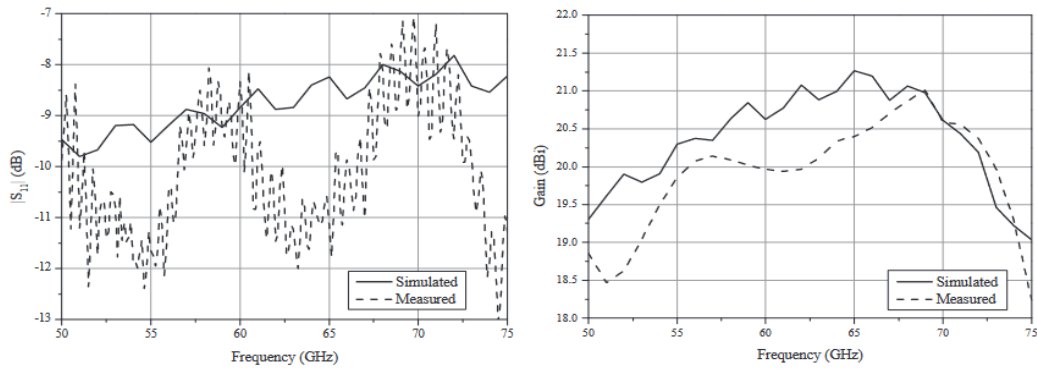

Figure 47. Comparison of simulated and measured results of the 3D-printed conical horn antenna [43]
©2015 IEEE

As can be seen the simulated results are better than the measured, which is quite normal since the surface roughness was not considered in the simulator as well as any dimensional errors.

3.6.3 CirCKu project

Thanks to our knowledge in LTCC manufacturing, we have been able to participate in a very interesting project together with Université de Bretagne Occidentale (UBO) and Thales R&T. The objective was to realize Ku-band circulators on multilayer ceramics using ferrite tapes from Thales R&T according to the design proposed by UBO. The manufacturing part was run by us, where this new material was introduced in our production facility. This project, financed by the Direction Générale d'Armement (DGA) aimed at miniaturizing these devices while improving their performance as compared to commercial ones. This would be beneficial for space and military applications. Quite encouraging results were obtained and a first publication was presented at a conference [44].

In this project we managed to realize circulators for SMD assembly sized 7 mm × 7 mm with a microstrip to coplanar transition through the substrate to the backplane. Soldering was used to attach the circulator to the mother board. These circulators were made up of VLF220Q4 as dielectric with either grenat or spinel inserts or an all grenat version. Finally, a demagnetized spinel was also used with magnetized spinel as inserts. In all of these cases we used silver as metallization. samples are shown in Figure 48.

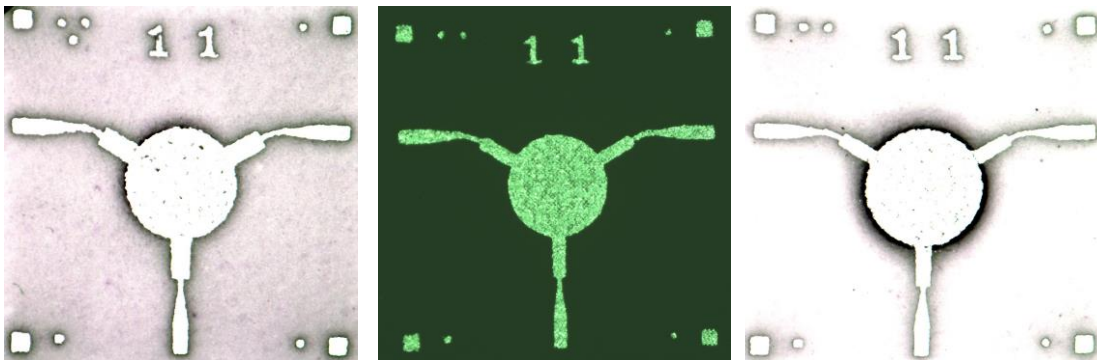

Figure 48. Three different circulators from the CirCKu project: VLF220Q4 and spinel insert (left), all grenat (center), VLF220Q4 and grenat insert (right).

A multi-circulator sample is shown in Figure 49 below. The idea is to produce a number of circulators simultaneously in order to gain time and lower the production cost.

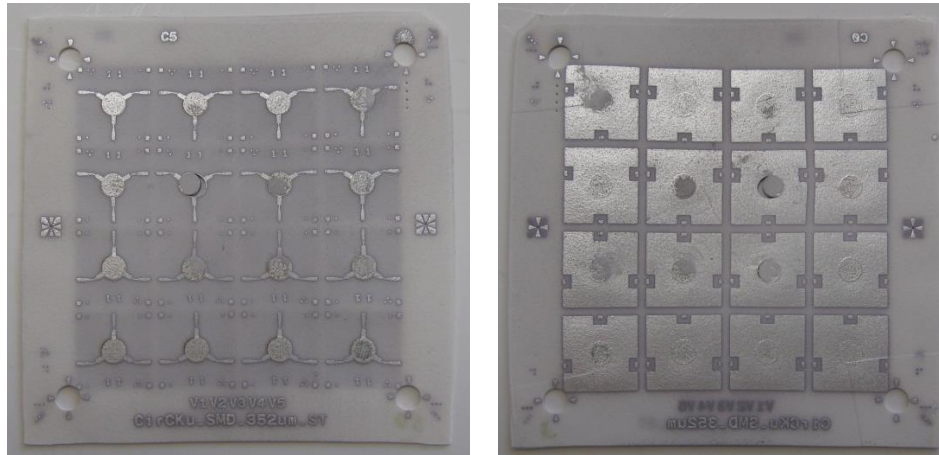

Figure 49. Multicirculator example based on VLF220Q4 with spinel inserts and SMD design.

The cofiring of two different materials is not always evident. The samples with VLF220Q4 as dielectric and grenat or spinel inserts can dissociate at the frontier between both materials. Further on, the silver paste is not really designed for these tape materials which adds some difficulty. The project will hopefully transfer to an ASTRID maturation project where these aspects can be further studied.

From the fabrication point of view, this project was quite challenging. The integration of a ferrite material into the dielectric base material requires a control of all fabrication steps. When stacking the layers, a ferrite disc is inserted in the cut-out hole layer by layer. After having finished the stacking, the stack is laminated. As a result, the ferrite discs completely fill the holes and we have a material continuum. The ground plane and the Y-junction are screen printed onto the stack, before firing the completed module. When firing different materials, they need to shrink in the same way, otherwise deformation will occur. This fabrication method is unique, and, although not perfect at that time, good enough for circulators to fulfill specifications. However, some more work is needed to perfect the process to achieve a good repeatability.

3.6.4 Antenna collaboration with the Algerian University Mohamed Boudiaf of M'sila

Djamel Khezzar, a PhD student at the Mohamed Boudiaf University in Algeria, contacted me to help him produce his 60 GHz LTCC antennas. Mr. Khezzar performed all the design work at his site and I carried out the manufacturing and measurements (together with my colleague Dr. François Gallée) at IMT Atlantique / Lab-STICC. A set of nine different antennas were realized, as can be seen in Figure 50. The outcome are two publications [45]-[46] by which Djamel Khezzar have been able to defend his Ph.D. diploma.

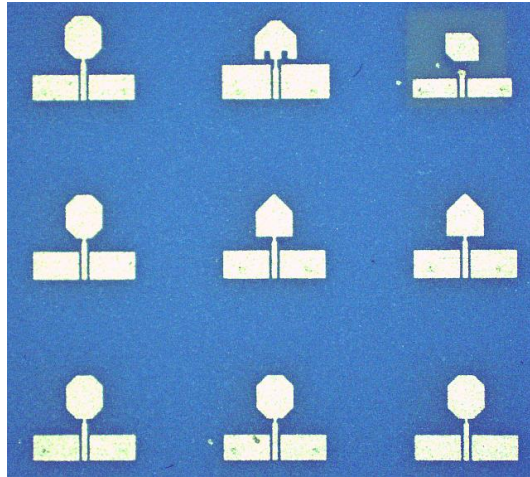

Figure 50. An LTCC prototype with a set of nine different 60 GHz antennas designed by Djamel Khezzer, PhD student at M'sila University in Algeria

3.6.5 Advanced meta-surface-based antennas for millimeter-wave applications

Another interesting project that takes advantage of our LTCC platform is one that we are currently conducting together with Queen's University of Belfast (QUB). This is a project funded by the British research council to open up collaboration between British entities with other countries. A first visit was done by the QUB researchers in October 2019 at IMT Atlantique / Lab-STICC.

3.6.5.1 Sacrificial Volume Material

The work on Sacrificial Volume Materials (SVM) resulted from the need to produce small holes as meta materials to do a Lüneburg antenna. From this work a first common publication for (SVM) applied to realize holes in LTCC material was published together with the QUB team [47]. In Figure 51 we show the holes in a three-layer stack of Ferro A6M-E 5 mil thick tape after lamination and firing. These holes were filled with a 2 wt%⁹ hydroxyethyl cellulose (HEC) at the stacking step. This material fills the holes and protects them during lamination. At the firing step, the HEC burns out and leaves zero residues.

During the editing of this journal publication [47], we came into contact with Dr. Paula Douglas at the Polymer Processing Research Centre of QUB. Dr. Douglas helped us with the Thermogravimetric Analysis (TGA) which were essential to understand the SVM action during lamination and firing. This new contact may be essential in future work, which is also one of the objectives of this kind of funding.

⁹ wt% : weight percentage

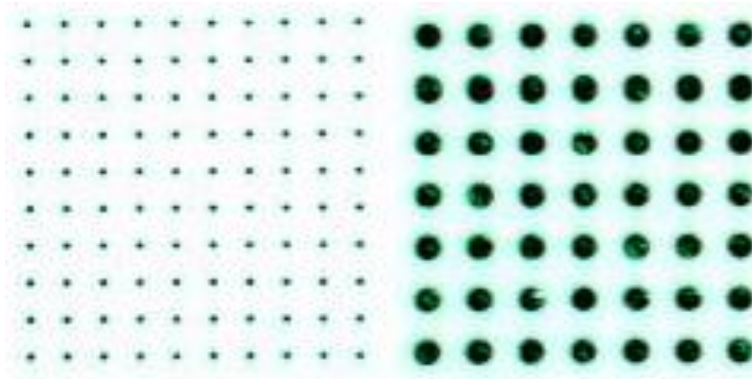

Figure 51. After lamination and firing resulting holes 69 μm (left) and 204 μm (right) diameter [47]

3.6.5.2 Lüneburg Lens Antenna

The possibility to generate holes in the LTCC material enables us to develop a Lüneburg lens antenna. The antenna is made up of 20 layers of Ferro A6M-E 5mil LTCC tape over which is placed a metamaterial with holes and patches of different sizes as can be seen in Figure 53. To achieve a gradually changing relative permittivity (ϵ_r), holes are not identical over each layer and on different layers. Larger and tighter holes correspond to lower ϵ_r starting at 5.7, which is the LTCC tape's relative permittivity, it decreases close to 2 at the antenna edges. The metamaterial patches i.e. squared screen-printed patches which increases in size as they are placed closer to the antenna center, produce an increase in the material's relative permittivity ranging from 5.7 to close to 20 in the center, see Figure 52 and Figure 53. This way, a cylindrical Lüneburg antenna has been realized by the help of transformation optics. The design of this lens antenna was performed by Dr. Dmitry Zelenchuk at QUB, the fabrication by me and the measurements by Dr. François Gallée.

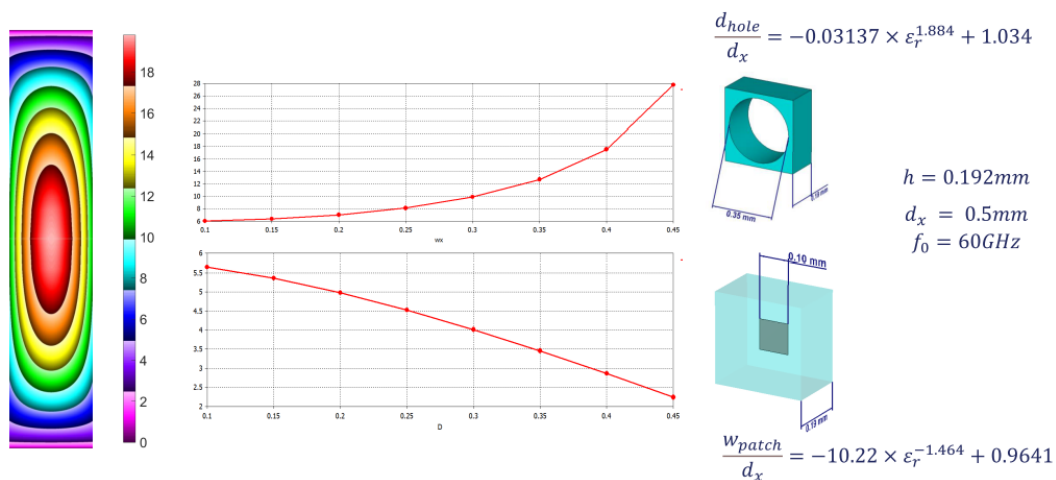

Figure 52. Metamaterial design that gives rise to a variation in relative permittivity.

We realized two samples of this design from which one of the tape layers is presented in Figure 53. The finalized antenna measures approximately 20 mm in diameter, smaller than a 50-cent coin as can be seen in Figure 54.

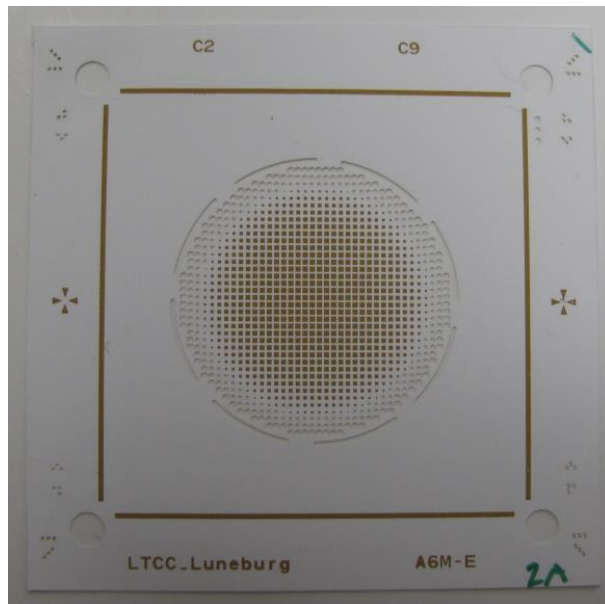

Figure 53. Metamaterial realization by holes and patches in and on the LTCC layers

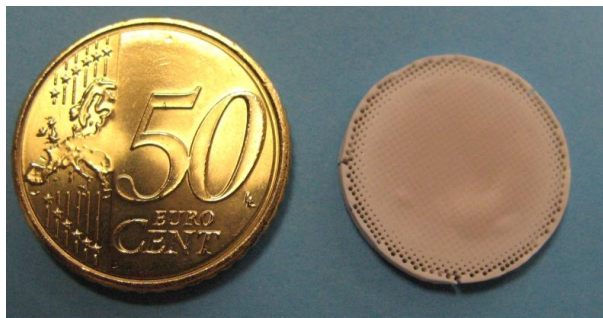

Figure 54. The first Lüneburg lens antenna. Some bubbles on its top makes it slightly non-symmetric. The second lens antenna was better in the sense that it had no bubbles.

The measurements, performed using an antenna measurement robot, showed a gain of approximately 16 dBi. An open waveguide, presented in the same graph, has a gain of 6 dBi as presented in the graph of Figure 55. From simulations and measurements, we had less than 1 dB gain degradation within a $\pm 30^\circ$ angle. Thus, this antenna is a good candidate for 60-GHz hybrid beam forming. The lens antenna was presented at a conference [48] and has been submitted to a journal recently.

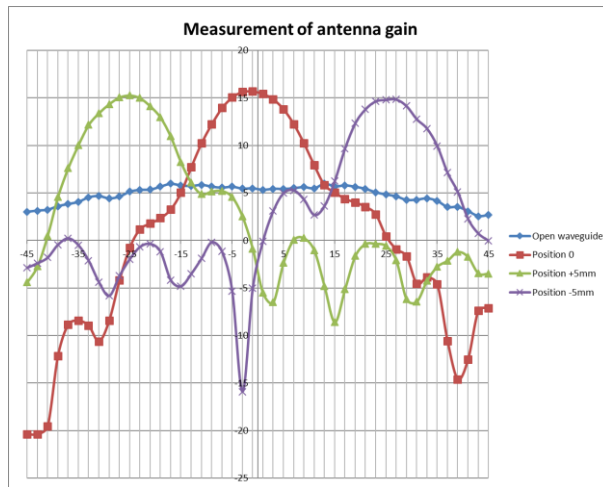

Figure 55. Luneburg lens antenna measurement, gain variation as a function of feed structure displacement. The gain is also compared to an open waveguide.

3.6.6 LTCC quality improvement

Since the installation of our in-house LTCC platform, we have worked hard on quality issues, gradually enhancing our experience on how to fabricate devices. With the fabrication equipment renewal and the change to Ferro LTCC material, we worked on quality improvement. Lately, we worked on the screen-printing quality to achieve 85- μm line width and 75- μm gap size [49]. Yet, another quality issue is connected to the lamination procedure, where we (until now) use a uniaxial press. We found that, depending on different stack size and stack height, we do not achieve the same lamination result, nor the same shrinkage, a crucial factor for LTCC manufacturing. A DOE setup allowed us to implement prevision models, to make design according to estimated shrinkage based on the circuit itself and not only on manufacturer's indication [50]. As a complement to this publication, we started a collaboration with Hochschule Landshut University of Applied Sciences where we iterated the same DOE but by using an isostatic press instead. We presented the results of this collaboration at an international conference in July, 2022, [51].

The work on quality is never ending as one can always improve oneself and this is what I aim to do in my future research. The fact that LTCC can be used for all types of devices (medical, RF, power electronics, satellites etc.) means that new concepts can be developed where we combine and integrate different features. Lately, I was contacted by laboratories or companies, where ideas are thriving but knowledge in packaging and integration is missing. I intend to develop such projects where aiming at even higher frequencies, minimizing the size of low frequency devices, micro-fluidic implementation are only few subjects that will be treated.

As a researcher, we are also called upon supervise younger colleagues pursuing their Ph.D. degree. In my case, I did some supervision already before I had my proper Ph.D. This is the case for Khodor Rida and Hexin Liu. Then, I managed to defend my own thesis before supervising Malika Tlili and Norbert Parker. The four Ph.D. thesis are described in the next chapter.

4. Ph.D. Co-Supervision

Without an HDR diploma, one cannot direct a thesis in France. However, co-supervising is possible and I will detail my contribution hereafter.

I have had the opportunity to co-supervise four Ph.D. students. Three of them worked on LTCC in one way or another, while one worked on a Radio over Fiber project. I will present their work in chronological order.

4.1 KHODOR RIDA

Khodor Rida was the first Ph.D. student I co-supervised with Pr. Alain Péden as director. Khodor's research project aimed at introducing the LTCC manufacturing at IMT Atlantique / Lab-STICC and to work with CTH/MEL to package a Voltage Controlled Oscillator (VCO) MMIC designed by their engineers, i.e. my former colleagues. The global objective of this thesis was the integration of MMICs into LTCC modules to produce high-performance devices. However, to do that, we had to learn how to implement the LTCC technology manufacturing process and to decide on a first set of design rules. To get a good start we first attended a one-week course held at "Institutet för Verkstadsteknisk Forskning" (IVF) in Sweden.

After this, Khodor Rida and the LTCC team started out experimenting the different fabrication steps. We chose to work with ESL (ElectroScience Laboratory) as they provided several tapes with different relative permittivity and the firing profile was feasible in our belt furnace.

After having all material and equipment in place, the manufacturing process was developed. As expected, we encountered different problems during this phase and had to put in much time and efforts to find conformal solutions. This work resulted in a design rule document intended for internal and external use.

Once we knew how to fabricate our prototypes, Khodor Rida concentrated his work on an RF validation, where different microstrip lines, coplanar lines and resonant structures were designed and manufactured. In this work was also included the design of a measurement bench to achieve the interconnections for measurements, see Figure 56, [52].

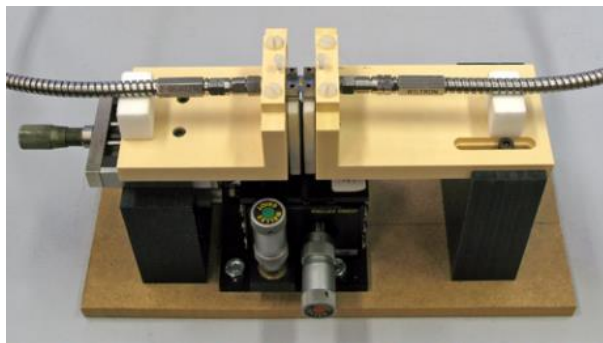

Figure 56. RF measurement fixture designed by Khodor Rida [52]

In the end, Khodor Rida realized an RF package for VCOs as presented in Figure 57 and published in [53].

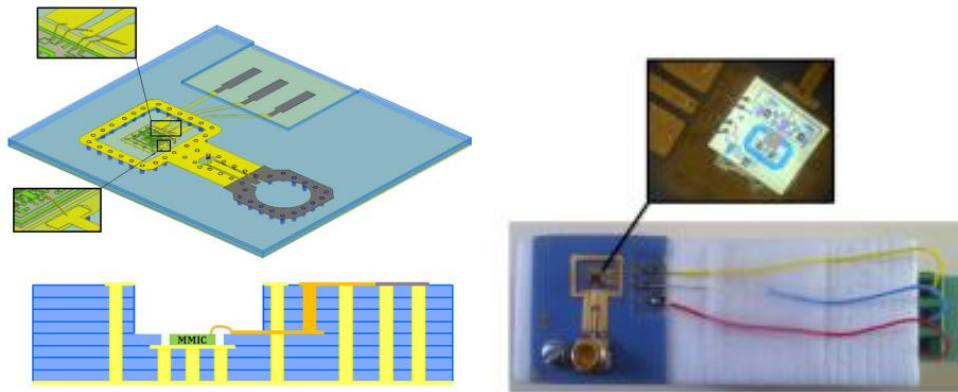

Figure 57. VCO MMIC installed in an LTCC package, design view (left), photograph (right) [53].

The work of Khodor Rida [52] served as a basis for the following projects as he did the basic LTCC manufacturing development of our laboratory.

4.2 HEXIN LIU

Hexin Liu's Ph.D. project [54] had no bearing on the LTCC but was a part of the Radio over Fiber project that we worked on at that time. The director of his Ph.D. was Pr. Michel Ney, while Dr. Daniel Bourreau and I were co-supervisors. The aim was to study and implement a distributed antenna system (DAS) by optical fiber to optimize the radio coverage and to improve the throughput on each pico-cell in the DAS network. The considered radio was the WiFi IEEE 802.11b/g working at 2.45 GHz, which is the system most currently used for indoor or domestic networks.

The main problem in a RoF system is that the signal to noise ratio (SNR) must be respected for all the reception dynamics according to the considered Radio standard while the system linearity must be ensured for the maximum received level. Unfortunately, the laser and photodetector used to convert the signal between the optical and electrical domains, limit the optical link which is generally characterized by a low 3rd order intersection point (IP3) and a high noise figure (NF). To address these problems, Hexin Liu implemented an Automatic Gain Control (AGC) which dynamically ensures an optimal and constant power level at the optical link input to respect linearity while optimizing the SNR linked to the radio standard. With this AGC, he adapted the radio receiver dynamic range to fit the one of the optical devices of the RoF system which is generally very limited. The AGC is a low-cost and low energy-consumption analog component, capable to adapt to any kind of signal. However, other adjustments to the system must also be made to operate correctly. So, the final design contained a two-speed AGC where a capacitor in a low-pass filter could be adjusted according to the signal power given by two RSSIs (Receive signal Strength Indicator).

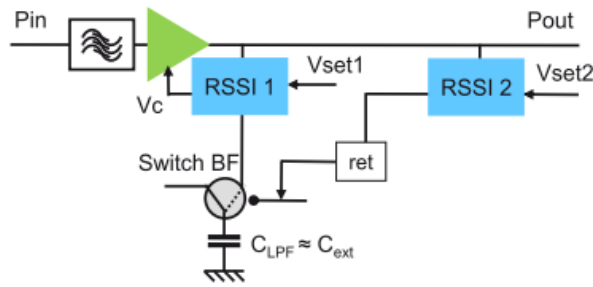

Figure 58. AGC loop circuit for an RoF system [54]

4.3 MALIKA TLILI

The Ph.D. subject of Malika Tlili was more or less a continuation of my own Ph.D. subject. Her director was Pr. Alain Péden and I was co-supervising her work. The intention was to continue to work and resolve problems of MMIC packaging in D-band. We identified four issues to be addressed:

- ✓ thermal management for the future integration of power amplifiers in a LTCC module
- ✓ interconnexion of MMICs to the LTCC
- ✓ a DC-feed system
- ✓ design of a D-band package for the MMICs provided by our partner Gotmic

Regarding the MMIC to LTCC interconnexion, Malika Tlili chose to work with a microstrip line on the LTCC. This is also what is used for MMICs provided by Gotmic. As usual for MMICs, they are equipped with a microstrip to grounded coplanar pad transition at the input and output pads. The reason is that the MMIC needs to be measured in a probe-station with coplanar GSG probes. These MMICs were doubly difficult to interconnect. First, the on-chip pads' size and pitch are smaller than for MMICs that work at lower frequency. Secondly, due to the foundry design rules and the given GSG probe pitch, the impedance of these pads is 34Ω instead of the usual 50Ω . The design as shown in Figure 59 gives an added insertion loss of approximately 1 dB for each transition which is a very good result at D-band frequency [55].

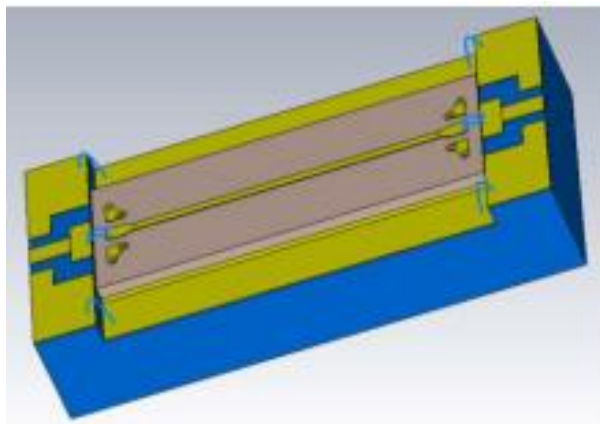

Figure 59. Interconnexion for the D-band chips as designed by Malika Tlili [55]

The thermal management was a subject relatively new to us at that time. The regular LTCC thermal management is made by a grid of thermal vias placed directly under the MMIC that dissipates power. This is a solution that we tested as a backup solution. A more challenging part of the thermal management work was the choice to try to integrate heat pipes internally in the LTCC.

A heat pipe is a passive system where a pipe/tube is partially filled with a liquid and partially filled with vacuum. The pipe is closed to the outer world. One heat pipe end is placed underneath the heating element (the power amplifier in our case) and the other end is where the heat is transferred and evacuated. The PA heats up the liquid underneath it, which transforms into vapor that flows to the other pipe end. There it is cooled down by condensation and returns into liquid form. The liquid droplets are then transferred back to the initial position thanks to a capillary force that is induced by means of a porous wick that covers the heat pipe walls.

For a 3W power amplifier placed on five layers of LTCC without any special precaution to evacuated the dissipated heat, the transistors' gates will heat up to 348°C according to simulations. For the same amplifier placed on a heat pipe, as designed by Malika Tlili, the highest temperature obtained should only reach 75°C as indicated on the plots in Figure 48. The transistors' allowed junction temperature is 175°C.

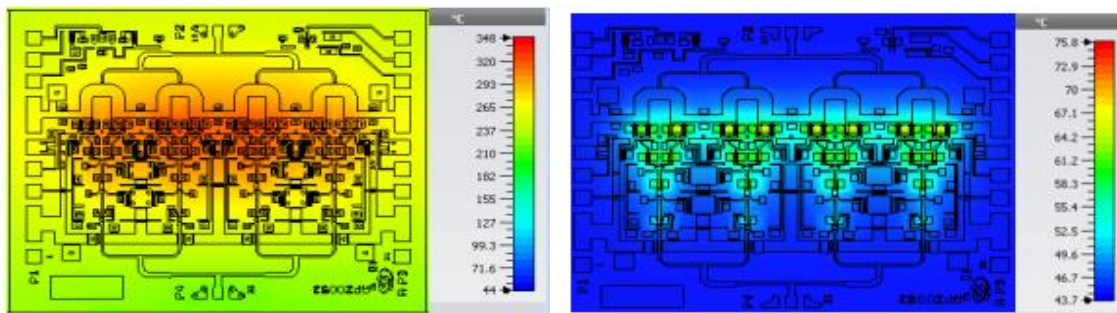

Figure 60. Thermal simulations of a 3W chip, attached to a five-layer LTCC module (left), attached to an LTCC-module including a 10-layer heat pipe structure (right) [55]

The integration of heat pipes in LTCC requires miniaturized dimensions. Much time and effort were invested in the fabrication of these heat pipes. The rectangular shape of a grooved wick and the vapor chamber cross-section was hard to control as illustrated in Figure 61. This work was presented at two international conferences [56] and [57].

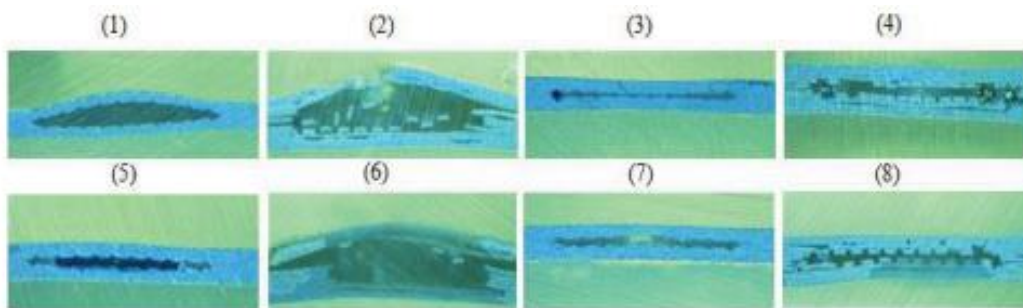

Figure 61. Heat pipe cross sections from the research work pursued by Malika Tlili [57].

Even though the heat pipe's shape was correct to evacuate 1.5 W of power, the procedure to fill it with a microdroplet of water and then to close it under vacuum was not possible to achieve with our equipment. This is, why in the end we tested the thermal vias.

The last part of Malika Tlili's work was the realization of a D-band receiver circuit based on Gotmics chips. A receiver module photograph is presented in Figure 62. This module was unfortunately fabricated during a year where we had no laser, due to the machine broke down. As a consequence, no laser ablation could be done, and Malika had to restrain her design gaps to what could be performed with the screen printer. In order to be connect GSG probes for measurements, we used silver epoxy to diminish the gaps, as can be seen in Figure 62. Even though this is not at all perfect, the module worked fine with 10-15 dB conversion loss as compared to the 12 dB as presented by Gotmic for the mixer chip only.

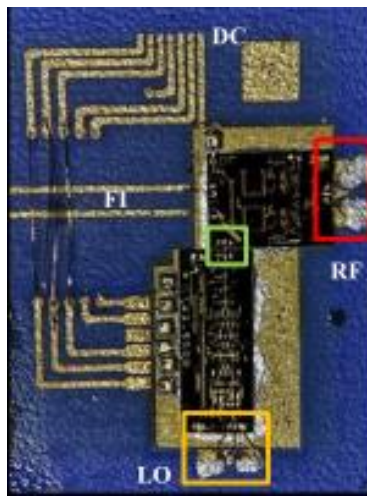

Figure 62. D-band receiver module containing MMICs from Gotmic

4.4 NORBERT PARKER

Nobert Parker worked on the CirCKu project to obtain his Ph.D. He was supervised by Dr. Vincent Laur at UBO and co-supervised by Vincent Castel and myself. In this work, Norbert Parker designed the circulators and also carried out measurements. Thales R & T provided the tape material (dielectric and ferrite versions) while IMT Atlantique / Lab-STICC performed the fabrication. As a co-supervisor of this Ph.D. student, I helped out with the design choices that impacts the fabrication of the LTCC circulators. Norbert Parker presented his thesis in April 2022 [58].

Several circulator designs have been proposed by Mr. Parker, based on the different materials created by Thales R & T. Two different ferritic materials were developed, one based on spinel and the other on grenat. These are the same designs as the ones presented earlier in this document. In Figure 63 we can see a circulator model and in Figure 64 we show some measurement results from one of the realized samples (non-SMD in this case for measurement easiness).

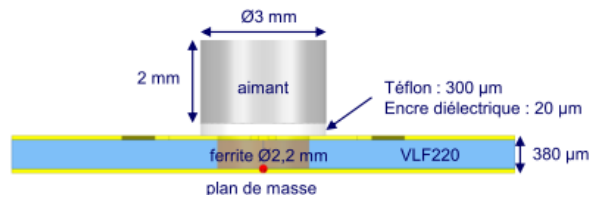

Figure 63. Drawing of a circulator model used in the CirCKu project for simulations.

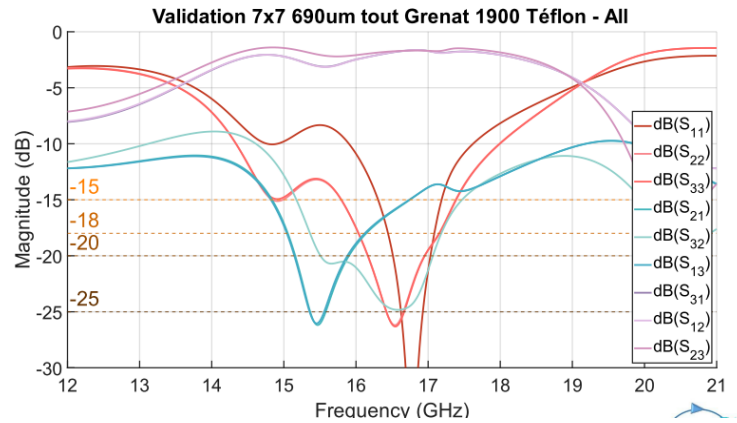

Figure 64. Measurement validation of one of the proposed circulators in the CirCKu project.

This finalizes the research supervision chapter. In the next chapter I will detail the services I provide regularly to the research community, such as for instance paper reviews. This is an important part of my work and it is a valuable contribution to the research community.

5. Research community service

Being a researcher also includes working for the common good for the national and international community. I belong to the Lab-STICC CNRS UMR6285 Laboratory, within the Materials and RF pole (MATRF) and the Microwave Devices team (DH for “Dispositifs hyperfréquence”).

5.1 SCIENTIFIC PAPER REVIEWER

I’ve been a journal paper reviewer since 2010, for IEEE as well as for ETRI and MDPI journals. This is a great opportunity to learn more from other researchers, to help them improve their papers by giving useful comments and to learn what makes a good scientific publication. My review flow until mid-2022 is presented in Figure 65, from the Publons verified review tracking and the different journals are presented in Figure 66.

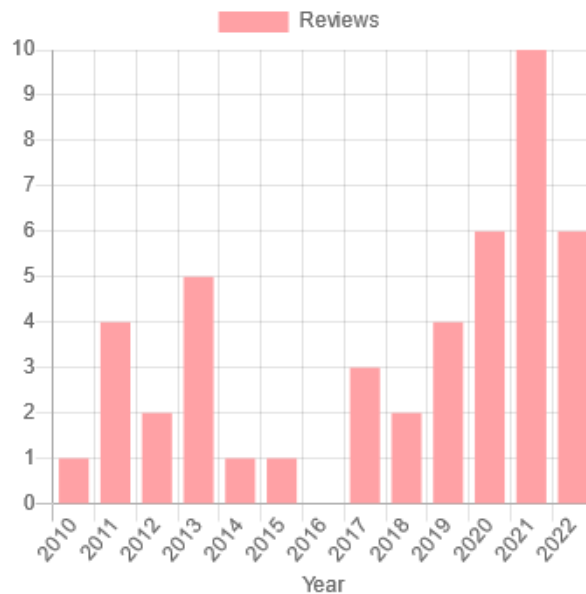

Figure 65. Number of reviews per year.

Verified reviews

























 (11) Sensors 	 (8) Electronics 
 (8) IEEE Transactions on Microwave Theory and ... 	 (4) IEEE Microwave and Wireless Components L... 
 (4) Micromachines 	 (3) ETRI Journal 
 (2) Materials 	 (1) Applied Sciences 
 (1) IEEE Access 	 (1) International Conference on Information Science, Si... 
 (1) International Journal of RF and Microwave C... 	 (1) Nanomaterials 

Figure 66. Journal reviews.

5.2 SPECIAL ISSUE EDITOR

I was guest editor for a special issue of the MDPI journal "Electronics". The special issue title was "LTCC for Space, Imaging, Telecommunication, and Medical Applications"¹⁰. This special issue was published in 2020.

5.3 ANR PROJECT REVIEWER

Since 2021, I've evaluated the second step of four ANR projects. This is useful when proposing our own research projects, as the evaluation criteria will be the same.

5.4 PH.D. SUPERVISION COMMITTEE

Up to date, I have had the opportunity to take part in two Ph.D. supervision committees. The first one was for Tuyen Pham, a joint Ph.D. student between IETR and IMT Atlantique / Lab-STICC who worked on the M5HESTIA project doing antenna design. He was directed by Ronan Sauleau from IETR and co-directed by François Gallée at IMT Atlantique / Lab-STICC.

The second committee is for Hankai Wu, an Optics department Ph.D. student who started his work in the fall of 2020 with Laurent Dupont as director and Cyril Lahuec and Alexandre Khaldi as co-supervisors. Hankai Wu works on the subject of sensors to control indoor air filters.

5.5 PH.D. JURY

Other than being a jury member for my own Ph.D. students, I was invited to participate in a Ph.D. jury in July 2022 at Université Rennes 1. The title was "'Study of Submillimeter-wave Antennas and Associated Technologies'" and the Ph.D. student was Basem Aqlan.

5.6 WRITING ARTICLES FOR « TECHNIQUES D'INGENIEUR »

"Techniques d'ingénieur" is an encyclopedia for every type of user, from students to engineers and politicians as well as any person who wants to know a little bit more on a subject. I've had the chance to update two such articles, concerning different high frequency transmission lines and their fabrication, [59]-[60].

5.7 SESSION CHAIR IN A SCIENTIFIC INTERNATIONAL CONFERENCE

I chaired a session on "Integrated Passive Devices" in an international ceramic conference CICMT2022 (Ceramic Interconnect and Ceramic Microtechnology Systems) held in Vienna in July 2022.

This finalizes the research community part. I will now do a brief presentation of my academic teaching, which is a task that I have done only at IMT Atlantique, since I was hired as an associate professor in 2009.

¹⁰ C. Kärnfelt, "LTCC for Space, Imaging, Telecommunication, and Medical Applications." [Online]. Available: https://www.mdpi.com/journal/electronics/special_issues/ltcc

6. Academic teaching

Since I was hired as an associate professor at IMT Atlantique, I have had lots of opportunities to teach. I have put the emphasis in my teaching in projects with practical work. Also, IMT Atlantique is an engineering school where students do at least one group project every semester. The objective is to work on various disciplines such as intercultural and project management, leadership, planning, writing and presentation skills. These were added to the technical skills that they should simultaneously develop. In many of these projects my colleagues and I have a supervising and motivational role; to keep the groups advancing according to established schedules.

Other than projects, I have intervened in the microwave department's more classical courses dealing with filters, amplifiers, transmission-lines, mixers, radio propagation and cell planning, MMIC design, amplifier and antenna design and manufacturing, car radar simulations, and lately software defined radio projects. I have also taught lab classes, most often on the subject of mixers, up- and down-conversion, and modulation. Measurement and simulation subjects that we propose are excellent opportunities for our students to accumulate some experience on using equipment and software that they may encounter in the industry.

6.1 TEACHING METHODOLOGIES

The teaching methodologies are as many as there are lecturers. However, from the very beginning I have particularly tried to use an alignment strategy between what is actually taught and what is evaluated.

6.1.1. Problem based learning and inverted classroom

At the Catholic University of Loewen, project/problem-based learning (PBL) has been used for several years. The classical lectures have been omitted with the objective to have students do project case studies, to solve problems and learn together, supervised by "tutors". This kind of teaching is based on alignment where the first step is to list what we want to teach in detail and hierarchizing the different learning outcomes. The second step is to see how to evaluate the intended learning outcome and what level of understanding we ask for. It is only at the third step, that we prepare the teaching material in alignment with the evaluation matrix. This is a rather frustrating way to work and it takes much time of preparation. However, we have experimented it on a course on power amplifiers that was really difficult to pass in the standardized format. By the PBL approach mixed with inverted learning we have managed to improve the learning outcomes remarkably. This work was published on a blog on educational innovation [61].

6.1.2. Project based learning

The very first module where I started teaching was the "Introduction de Grands Systèmes" (IGS) project, which was a PBL for all first-year students. The intention was to introduce them to complex systems while at the same time learn how to work in group and to manage cultural differences. In this project framework, I was hired as a tutor to help them manage their groups of eight students. However, after a first year of IGS the project evolved to become "Projet Découverte (DEC)". The idea of DEC was to divide the project into missions, and have a specific team work on each mission. After this reorientation, I found myself responsible for the bibliographical mission. This mission was on a subject of sustainable development, for instance, on the benefits or disadvantages of nano-materials, on electrical cars or on rechargeable batteries. The mission was designed as a research of

scientific papers based on environmental issues. Half of the groups would study the subject's advantages while the other half would study the disadvantages. Arguments should all be based on scientific publications. In the end, they should provide a paper of maximum three pages that summarizes their arguments and gives the list of relevant references. As a final touch, we had the groups to debate on the subject in English in front of a referee who would judge which group best defended their (imposed) point of view. What was really interesting is that the bibliographic mission was used in the English classes before the debate date to improve students' vocabulary. Thus, it was a real transverse mission which concerns search engines, scientific data bases, quality of sources, English language, sustainable development, correct writing, how to reference sources in a document. In addition, it provided some training on how to work in group and best use the different competences of members [62].

6.2 TEACHING RESPONSIBILITIES

After a few years, the DEC project was transformed into FPA ("Faire pour Apprendre", which translates into Learn by doing). The idea to have students solve problems in intercultural groups still applies. However, this time the emphasis is put on a technical development where the goal is to make a complex system work. The system being an Arduino based car driven by a pilot using a smartphone and an Android application (Figure 67). Since several years, I head the FPA team together with two co-pilots and about 12 tutors in the team.



Figure 67. Arduino based vehicles that are controlled by a smartphone: example (left) and four vehicles on the start line for the end of semester competition (right).

When IMT Atlantique was created from the merger of Mines Nantes and Télécom Bretagne, we switched to an evaluation by competences where we use competence matrixes to decide if the student has reached the required level. The project is aligned to these matrixes so all competences are taught and evaluated accordingly.

6.3 PROJECT SUPERVISION

6.3.1 Projects for Generalist engineering students

During my years at IMT Atlantique I have proposed and tutored numerous projects. They are all listed in the appendix at the end of this document. After the first semester project whether named IGS, DEC or FPA, other projects follow.

The 2nd semester project is a project designated for a subject where a technical development is done by groups of three to four students. The idea is to have students solve a problem proposed by a lecturer who supervises the work and acts as the client. Since 2007, I have proposed numerous projects in some cases with a co-supervisor, most of the time in close relation to my on-going research.

This Minor research project is also 2nd semester project, however integrated into a program for students that are curious about how research is done. In these projects one student works more closely together with a researcher or a Ph.D. student. To this date, I have proposed and supervised one such project.

The 4th semester project is co-supervised by internal and external supervisors and is turned towards team management as well as technical development.

The 5th semester project is the last project that is performed within the engineering school. Before the creation of IMT Atlantique this was most often performed by one or two students that worked rather close together with the supervisor on a research project.

The listing of these different projects can be found in Appendix 1 – S2 projects to Appendix 4 – S5 projects.

6.3.2 Projects for engineering students alternating school and work

Telecom Bretagne FIP students normally do two projects during their 3rd year of education namely, a FIP management project which was running in the fall and a development project in the spring.

The development project was the last course to tend to before doing the final Master project in their company. This project was always performed by two students and as the planning was compressed it was rather intensive. I proposed Radio over fiber and cell planning projects for these students, see Appendix 5 – FIP 3rd year development projects.

The management project aimed at challenging the students to manage a large group (approximately 20 students) in a project on a subject outside their specialization, for instance mechanical engineering, soft skills, etc. I took place in the piloting committee of this project for three years. They are listed in Appendix 6 – FIP management projects.

6.3.3 Master students' bibliography project

The Master of science students always do a bibliographical project where, at the end, they are supposed to produce a 5-pages double column scientific paper based on an IEEE model. This is an excellent opportunity to have student work on an interesting subject. I've been proposing one or two projects every year since 2010 (see Appendix 7 – Master students' bibliographical projects). These collaborative projects are carried out in English. The reason is that students are international and do not yet have the French level acquired to operate in French.

6.4 MASTER THESIS SUPERVISION

The Master thesis is the final project for engineering students before they get their diploma. I've had the opportunity to supervise two such projects, both regarding an Automatic Cruise Control (ACC) radar which was my first research project at IMT Atlantique. The first one treated the noise to be added to the simulation platform that we had already developed. The second was on the signal

processing for the same simulation platform. The titles and student names are presented in Appendix 8 – Master thesis supervision.

6.5 EXTRA CURRICULUM TEACHING

As an additional teaching experience, I proposed an intersemester week called “Introduction to the Swedish language and the Swedish culture”. As our students are very interested in the Scandinavian countries, I decided to try to be a language teacher for a week. The proposed program also includes some intercultural training, and a history class presented by my colleagues. I have now been doing this for three years, and since the spring 2022 I animate a language class one hour a week in the “Swedish club” formed by some of the students.

7. Future research

Over the next years, I plan to continue my research on LTCC. Since 2009, when we implemented this technology, I have learned a lot and have a very rich and unique experience in France. Thanks to the different projects I have had to use materials from several manufacturers. As presented, I have realized microwave and millimeter prototypes integrating active components operating at 60 GHz and in the D-band (110-170 GHz). I have worked on circulator fabrication where two distinct materials are combined to form this device, a process that is unique and difficult to master. I have also developed a bio-enzymatic sensor for researchers working on biological analysis and I have some experience on microfluidic and passive components. In fact, the LTCC applies to a lot of different disciplines, and even though I am a microwave engineer, I would like to develop the LTCC in several directions, and combine them if possible. Indeed, LTCC allows integration of microelectronics, microwaves and millimeters, optics, micromechanics and microfluidics. In my future research plan, I want to enlarge the range of possibilities of this technology by integrating all these aspects. Thus, my project for the coming years, is to improve our LTCC manufacturing in order to bring solutions where today the LTCC is not necessarily used. The goal will also be to train students, researchers (i.e. to direct theses) and even industrials on this extended aspect.

A first Ph.D. student who starts his thesis work on October 2022 will develop high frequency packages as a continuation of the work done by Malika Tlili and myself. This time we aim to realize fully integrated RX and TX modules at the W-band that once again treats the obvious challenges of biasing, thermal management, and good RF performance in the context of magnetometry meteorology as a first showcase. A second goal of this project is for the modules to meet space requirements for the case of their integration in cubesats or nanosatellites.

Several types of sensors have been realized on LTCC, such as flow [63], pressure [64], [65] and [66], temperature [67] and [68] and gas sensors [69] to mention a few. Also, heating elements are readily implemented in LTCC as was done in [68] and [70].

Simultaneously, energy harvesting can be integrated into the same module, using radio frequency energy as was done in-house [71] by Kuhn (not based on LTCC). It can be done by using piezo electricity retrieved from movement [72] or by the heat transformation to electricity by the help of thermo electric generators (TEG) (see [73] and [74]). Such energy harvesters are all possible to integrate in the LTCC.

The possibility to build sensors, include energy harvesting, miniaturize circuits and add RF functionality and thermal management, in one single building block is feasible when you have access to design, manufacturing and measurement equipment. If opportunities are vast, lack of time, creativity, manpower or financial means can hinder new devices from being developed. To keep a sufficient success rate, I need to develop my national and international collaborations, where different aspects of the same system are considered. Some of the projects and collaborations in preparation will be given hereafter.

7.1 NATIONAL COLLABORATIONS

A project, currently under discussion, is on the development of an electro-potentiostat to measure glyphosate pollution of water. This project needs almost all the capabilities of LTCC, namely microfluidics, wireless communication, microelectronics and optics. This sensor will directly address the needs of researchers dealing with water analysis and pollution. This project could potentially

include a PhD student at Lab-STICC, as the development task is heavy. At the time being, I propose small parts of this project as student projects to prepare for a project financing application to come. For instance, this year one group worked on the heater element and the thermal measurement (by a thermistor). Parallely, a second group was working on the heater element control to heat precisely a small amount of test liquid and keep the sample at the wanted temperature while the analysis is ongoing.

The Bretagne region has also just positioned itself as a future territory for space applications after the signature of a partnership agreement with the CNES (“Centre National d’Études Spatiales”) in 2019 and the GIS Bretel establishment with a contact person installed at IMT Atlantique. In this field, there are many possibilities to realize devices based on LTCC and I will be ready to bring my expertise together with internal or external collaborators.

Partnerships with French companies is also something that is to be strengthened. At this moment a first collaboration is a CNES R&T project where I partner up with Cobham and Thales R&T to build circulators, different from those developed during the CirCKu project. This project started June 1 2022, for a 16 months-duration.

New cooperations are also coming along. At the moment, discussions are held with Exxelia, a company that makes SMD components such as capacitors in extremely high volumes. They are already experts in tape casting and ceramic manufacturing, however they don’t do complex products such as LTCC ones. We may be able to help each other out.

After a first successful bilateral collaboration between IMT Atlantique / Lab-STICC and WAINVAM-E, we now plan for a second collaboration regarding TX-modules developed in E-band. Here transmitter modules including MMICs based on LTCC are to be designed and fabricated. This is a real challenge and very interesting for both partners Indeed, we have to develop a product according to industrial qualification standards.

I would also like to expand my French academic network. I have had collaborations with XLim and the University of Limoges, the University of Lyon 1, the University of Bretagne Occidentale, the University of Rennes 1, University of Nantes as well as the CNAM and the University Gustave Eiffel, ESIEE Paris. Evidently, much effort will be spent to extend the list to other academic laboratories.

7.2 INTERNATIONAL COLLABORATIONS

I will continue working on very high frequency devices. For two years, we have been collaborating with Queens University of Belfast (QUB) on a project where we have positioned ourselves first at 28 GHz and 60 GHz. The reason is to start at frequencies where we have good measurement means. The next step will naturally be to improve our capabilities to the millimeter-wave range. Also, a new contact taken with Karlsruhe Institute of Technology points to this direction. We aim at developing D-band and J-band TX modules where a thermal management is crucial to obtain power amplifiers to work as expected. In this project we are complementary: KIT will manage the RF part while we will concentrate on the LTCC module implementation and thermal issues. Thus, this is a direct continuation of Malika Tlili’s Ph.D. project where thermal management took up a large part.

This spring, I visited the Center of Micro- and Nanotechnologies at TU Ilmenau¹¹ and this summer one of the researchers from there, Dr. Heike Bartsch, spent a week at IMT Atlantique / Lab-STICC to

¹¹ TU Ilmenau : Technische Universität Ilmenau

work on how we can collaborate on research and how we can exchange Master students and co-supervise PhD projects.

Conclusions

This document describes my career from 1987 to 2022, with work and education done in two countries, engineering positions held in two companies, one startup creation, research engineering positions held in two higher educational institutions and finally a position as associate professor at IMT Atlantique / Lab-STICC. This is mixed with academic education periods also in two countries. I am well aware that my career does not follow the standard flow, and it may be complicated to extract a straightforward path.

Nevertheless, what should be evident to anyone who reads this document is that throughout my whole career, I have always evolved in the microwave engineering and microelectronic packaging field and it is with this background that I apply for my HDR.

Today, IMT Atlantique/Lab-STICC is the only laboratory in France that works on LTCC. The expertise is within the Microwave department and the Lab-STICC DH team. I can claim to have a unique knowledge and experience. In my case it is the bridging of the gap between packaging, LTCC and microwave and millimeter-wave design, which is my strength. Ever since I worked at EMW, I have understood that this gap needs to be filled by engineers and researchers who can apprehend difficulties from both sides. Better research and development can surely be achieved if more people fill the gap between both engineering communities. This is one of my objectives when I propose student and Ph.D. projects. Up to now, I have supervised 38 engineering students and co-supervised three Ph.D. student whose project was related to LTCC.

In my future projects I aim to do this even better going up higher in frequency, miniaturizing lower frequency devices and propose devices for health / space/ telecommunication /automotive / defense or other use. For the LTCC and packaging of electronics there will always be subjects to treat.

Acknowledgments

To end this document, I would like to thank all my colleagues who in one way or another have helped me and motivated me to candidate for an HDR degree. I'd also like to send my appreciation to all colleagues who in one way or the other motivated me to take the next step, during all these years.

Bibliography

- [1] I. Andersson, B. Rudberg, T. Lewin, M. Reed, S. Planer, and S. Sundaram, "Silicon bipolar chipset for SONET/SDH 10 Gbit/s fiber-optic links," in *Proceedings of IEEE Custom Integrated Circuits Conference - CICC '94*, May 1994, pp. 617–620. doi: 10.1109/CICC.1994.379647.
- [2] L. I. Andersson, B. G. R. Rudberg, P. T. Lewin, M. D. Reed, S. M. Planer, and S. L. Sundaram, "Silicon bipolar chipset for SONET/SDH 10 Gb/s fiber-optic communication links," *IEEE Journal of Solid-State Circuits*, vol. 30, no. 3, pp. 210–218, Mar. 1995, doi: 10.1109/4.364434.
- [3] H. Zirath and N. Rorsman, "A Resistive HEMT-Mixer with Very Low LO-Power Requirements and Low Intermodulation," in *1991 21st European Microwave Conference*, Sep. 1991, vol. 2, pp. 1469–1474. doi: 10.1109/EUMA.1991.336552.
- [4] I. Angelov, H. Zirath, and N. Rosman, "A new empirical nonlinear model for HEMT and MESFET devices," *IEEE Transactions on Microwave Theory and Techniques*, vol. 40, no. 12, pp. 2258–2266, Dec. 1992, doi: 10.1109/22.179888.
- [5] I. Angelov, H. Zirath, N. Rorsman, and H. Gronqvist, "A balanced millimeter wave doubler based on pseudomorphic HEMTs," in *1992 IEEE MTT-S Microwave Symposium Digest*, Jun. 1992, pp. 353–356 vol.1. doi: 10.1109/MWSYM.1992.187985.
- [6] H. Zirath, I. Angelov, and N. Rorsman, "A millimeterwave subharmonically pumped resistive mixer based on a heterostructure field effect transistor technology," in *1992 IEEE MTT-S Microwave Symposium Digest*, Jun. 1992, pp. 599–602 vol.2. doi: 10.1109/MWSYM.1992.188053.
- [7] C. Kärnfelt, "Solutions d'intégration en boîtier de puces MMIC via la technologie LTCC," Thèse, Télécom Bretagne ; Université de Bretagne Occidentale, Brest, France, 2016. [Online]. Available: <https://hal.archives-ouvertes.fr/tel-01356199>
- [8] C. Kärnfelt, R. Kozhuharov, H. Zirath, and I. Angelov, "High-purity 60-GHz-band single-chip x8 multipliers in pHEMT and mHEMT technology," *IEEE Trans. Microwave Theory Techn.*, vol. 54, no. 6, Art. no. 6, Jun. 2006, doi: 10.1109/TMTT.2006.875464.
- [9] S. E. Gunnarsson *et al.*, "Highly integrated 60 GHz transmitter and receiver MMICs in a GaAs pHEMT technology," *IEEE J. Solid-State Circuits*, vol. 40, no. 11, Art. no. 11, Nov. 2005, doi: 10.1109/JSSC.2005.857366.
- [10] S. E. Gunnarsson *et al.*, "Single-Chip 60 GHz Transmitter and Receiver MMICs in a GaAs mHEMT Technology," in *2006 IEEE MTT-S International Microwave Symposium Digest*, San Francisco, CA, Jun. 2006, pp. 801–804. doi: 10.1109/MWSYM.2006.249793.
- [11] M. Abbasi *et al.*, "Integrated 60 GHz Circuits and Systems for High-Speed Communications," in *2008 European Microwave Integrated Circuit Conference*, Amsterdam, Netherlands, Oct. 2008, pp. 9–12. doi: 10.1109/EMICC.2008.4772215.
- [12] H. Casier, J. Sevenhans, and AACD Workshop, Eds., *Analog circuit design: sensors, actuators and power drivers; integrated power amplifiers from wireline to RF; very high frequency front ends ; [revised contributions of all speakers of the 16th AACD Workshop, which was organized by Jan Sevenhans of AMI Semiconductor and held in Oostende, Belgium, on March 27-29, 2007]*. Berlin: Springer, 2008.
- [13] M. Abbasi *et al.*, "Single-Chip Frequency Multiplier Chains for Millimeter-Wave Signal Generation," *IEEE Trans. Microwave Theory Techn.*, vol. 57, no. 12, Art. no. 12, Dec. 2009, doi: 10.1109/TMTT.2009.2034344.

- [14] M. Abbasi *et al.*, "A broadband 60-to-120 GHz single-chip MMIC multiplier chain," in *2009 IEEE MTT-S International Microwave Symposium Digest*, Boston, MA, USA, Jun. 2009, pp. 441–444. doi: 10.1109/MWSYM.2009.5165728.
- [15] K. Boustedt and C. Kärnfelt, "GHz flip chip interconnect experiments," in *2004 1st IEEE Consumer Communications and Networking Conference (IEEE Cat. No.04EX745)*, Atlanta, GA, USA, 2004, pp. 267–271. doi: 10.1109/ISAPM.2004.1288025.
- [16] C. Kärnfelt, J. Rudnicki, J. P. Starski, H. Zirath, and K. Boustedt, "GaAs Flip Chip Evaluation in the 3 to 110 GHz Range," Prague, Czech Republic, Jun. 2004, pp. 181–186. Available online: https://www.researchgate.net/profile/Camilla-Kaernfelt/publication/350457764_imaps2004_camillapdf/data/60616dfd92851cd8ce74552c/imaps2004-camilla.pdf
- [17] J. Rudnicki, C. Kärnfelt, and J. P. Starski, "Simulations, measurements and equivalent circuit for a CPW-CPW vertical interconnection," in *15th International Conference on Microwaves, Radar and Wireless Communications (IEEE Cat. No.04EX824)*, Warsaw, Poland, 2004, pp. 682–685. doi: 10.1109/MIKON.2004.1357127.
- [18] C. Kärnfelt, H. Zirath, J. P. Starski, and J. Rudnicki, "Flip chip assembly of a 40–60 GHz GaAs microstrip amplifier," in *34th European Microwave Conference, 2004.*, Amsterdam, Netherlands, Oct. 2004, vol. 1, pp. 89–92. IEEE
- [19] Wei-Cheng Wu *et al.*, "60 GHz Broadband MS-to-CPW Hot-Via Flip Chip Interconnects," *IEEE Microw. Wireless Compon. Lett.*, vol. 17, no. 11, Art. no. 11, Nov. 2007, doi: 10.1109/LMWC.2007.908053.
- [20] Wei-Cheng Wu *et al.*, "Design, Fabrication, and Characterization of Novel Vertical Coaxial Transitions for Flip-Chip Interconnects," *IEEE Trans. Adv. Packag.*, vol. 32, no. 2, Art. no. 2, May 2009, doi: 10.1109/TADVP.2009.2014997.
- [21] L.-H. Hsu *et al.*, "Flip-Chip-Based Multichip Module for Low Phase-Noise ν -Band Frequency Generation," *IEEE Trans. Microwave Theory Techn.*, vol. 58, no. 9, pp. 2408–2419, Sep. 2010, doi: 10.1109/TMTT.2010.2057135.
- [22] C. Kärnfelt, J. Hallin, T. Kjellberg, B. Hansson, and T. Swahn, "Flip-Chip Mounted 1:4 Demultiplexer IC in InP DHBT Technology Operating up to 100 Gb/s," Munich, Germany, Oct. 2007, p. 4. doi: 10.1109/emicc.2007.4412714.
- [23] C. Kärnfelt, P. Hallbjorner, H. Zirath, and A. Alping, "High gain active microstrip antenna for 60-GHz WLAN/WPAN applications," *IEEE Trans. Microwave Theory Techn.*, vol. 54, no. 6, Art. no. 6, Jun. 2006, doi: 10.1109/TMTT.2006.872923.
- [24] C. Kärnfelt, P. Hallbjorner, H. Zirath, P. Ligander, K. Boustedt, and A. Alping, "High gain active microstrip antenna for 60 GHz WLAN," in *2005 European Microwave Conference*, Paris, France, 2005, p. 4 pp. doi: 10.1109/EUMC.2005.1608923.
- [25] I. Angelov and C. Kärnfelt, "Direct Extraction Techniques for Thermal Resistance of MESFET and HEMT Devices," in *2007 IEEE Radio Frequency Integrated Circuits (RFIC) Symposium*, Honolulu, HI, USA, Jun. 2007, pp. 351–354. doi: 10.1109/RFIC.2007.380899.
- [26] C. Kärnfelt, C. Tegnander, J. Rudnicki, J. P. Starski, and A. Emrich, "Investigation of parylene-C on the performance of millimeter-wave circuits," *IEEE Trans. Microwave Theory Techn.*, vol. 54, no. 8, Art. no. 8, Aug. 2006, doi: 10.1109/TMTT.2006.877834.
- [27] X. Zhang *et al.*, "Realization of Ultra Wideband Bandpass Filter based on LCP Substrate for Wireless Application," in *High Density Design Packaging and Microsystem Integration, 2007 International Symposium on*, Jun. 2007, pp. 1–5. doi: 10.1109/HDP.2007.4283655.

- [28] X. Zhang *et al.*, “Millimeter-wave ultra-wideband bandpass filter based on liquid crystal polymer substrates for automotive radar systems,” *Microwave and Optical Technology Letters*, vol. 50, no. 9, pp. 2276–2280, 2008, doi: 10.1002/mop.23634.
- [29] C. Kärnfelt, A. Peden, A. Bazzi, G. El Haj Shhade, M. Abbas, and T. Chonavel, “77 GHz ACC radar simulation platform,” in *2009 9th International Conference on Intelligent Transport Systems Telecommunications, (ITST)*, Lille, Oct. 2009, pp. 209–214. doi: 10.1109/ITST.2009.5399354.
- [30] A. Bazzi, T. Chonavel, C. Kärnfelt, A. Peden, and F. Bodereau, “Strategies for FMCW radars,” in *2009 9th International Conference on Intelligent Transport Systems Telecommunications, (ITST)*, Lille, Oct. 2009, pp. 108–111. doi: 10.1109/ITST.2009.5399375.
- [31] “Automotive Adaptive Cruise Control Using FMCW Technology - MATLAB & Simulink.” <https://www.mathworks.com/help/phased/ug/automotive-adaptive-cruise-control-using-fmcw-technology.html;jsessionid=52daee1a72dce571631ae29e8872> (accessed Dec. 27, 2020).
- [32] T. J. Hall *et al.*, “Radio-over-Fibre access for sustainable Digital Cities,” *Ann. Telecommun.*, vol. 68, no. 1–2, Art. no. 1–2, Feb. 2013, doi: 10.1007/s12243-012-0346-3.
- [33] R. Guemri, H. Liu, I. Jäger, D. Bourreau, C. Kärnfelt, and F. Lucarz, “Radio-over-Fibre Transmission of Multiple Wireless Standards for Digital Cities: Exploiting the New Tramway Infrastructure,” Venice, Italy, Jun. 2012, p. 6. [Online]. Available: <http://citeseerx.ist.psu.edu/viewdoc/download?doi=10.1.1.686.2106&rep=rep1&type=pdf>
- [34] R. Guemri, F. Lucarz, D. Bourreau, C. Kärnfelt, J.-L. de Bougrenet de la Tocnaye, and T. Hall, “Filterless millimetre-wave optical generation using optical phase modulators without DC bias,” in *2014 10th Conference on Ph.D. Research in Microelectronics and Electronics (PRIME)*, Grenoble, Jun. 2014, pp. 1–4. doi: 10.1109/PRIME.2014.6872658.
- [35] J. Guillory *et al.*, “Radio sur Fibre pour un Réseau Local Domestique millimétrique,” Journées Nationales Microondes, JNM 2011, Brest, France, 20 Mai 2011, p. 4. Available online: <https://hal.archives-ouvertes.fr/hal-00799886/file/2011-5.pdf>
- [36] C. Kärnfelt, P. Coant, M. Sinou, J.-P. Coupez, D. Bourreau, and A. Peden, “Grooved Laminated Waveguides in LTCC for mm-wave Packaging,” MiNaPAD 2015: Micro/Nano-electronics Packaging and Assembly, Design and manufacturing Forum. IMAPS, 2015. Grenoble, France, Apr. 2015, p. 6. Available online: <https://hal.archives-ouvertes.fr/hal-01264389/document>
- [37] C. Kärnfelt, P. Coant, M. Sinou, J.-P. Coupez, D. Bourreau, and A. Peden, “Grooved Laminated Waveguide devices for U-, V-, W- and G-band applications,” in *2015 European Microwave Conference (EuMC)*, Paris, France, Sep. 2015, pp. 777–780. doi: 10.1109/EuMC.2015.7345879.
- [38] D. Bourreau, A. Peden, and S. Le Maguer, “A Quasi-Optical Free-Space Measurement Setup Without Time-Domain Gating for Material Characterization in the μ Ws-Band,” *IEEE Trans. Instrum. Meas.*, vol. 55, no. 6, pp. 2022–2028, Dec. 2006, doi: 10.1109/TIM.2006.884283.
- [39] C. Kärnfelt, “Solutions d’intégration en boîtier de puces MMIC via la technologie LTCC,” Thèse, Télécom Bretagne, Université de Bretagne Occidentale, Brest, France, 2016. [Online]. Available: <https://hal.archives-ouvertes.fr/tel-01356199>
- [40] C. Kärnfelt, “Passive component development in LTCC,” in *2017 21st European Microelectronics and Packaging Conference (EMPC) & Exhibition*, Warsaw, Poland, Sep. 2017, pp. 1–4. doi: 10.23919/EMPC.2017.8346838.
- [41] C. Kärnfelt, B. Zhang, and H. Zirath, “A QFN packaged grid array antenna in low dielectric constant LTCC for D-band applications,” in *2016 IEEE MTT-S International Microwave*

Workshop Series on Advanced Materials and Processes for RF and THz Applications (IMWS-AMP), Chengdu, China, Jul. 2016, pp. 1–4. doi: 10.1109/IMWS-AMP.2016.7588410.

- [42] B. Zhang, C. Kärfelt, H. Gulan, T. Zwick, and H. Zirath, “A D-Band Packaged Antenna on Organic Substrate with High Fault Tolerance for Mass Production,” *IEEE Trans. Compon., Packag. Manufact. Technol.*, vol. 6, no. 3, Art. no. 3, Mar. 2016, doi: 10.1109/TCPMT.2016.2519522.
- [43] B. Zhang, P. Linnér, C. Kärfelt, P. L. Tarn, U. Södervall, and H. Zirath, “Attempt of the metallic 3D printing technology for millimeter-wave antenna implementations,” in *2015 Asia-Pacific Microwave Conference (APMC)*, Dec. 2015, vol. 2, pp. 1–3. doi: 10.1109/APMC.2015.7413011.
- [44] N. Parker-Soues *et al.*, “Circulateurs compacts en bande Ku en technologie LTCC,” *JCMM 2020: 16èmes Journées de Caractérisation Microondes et Matériaux*. Toulouse (distance), Nov. 2020, p. 3.
- [45] D. Khezzar, D. Khedrouche, A. Denidni, and C. Kärfelt, “A Low-profile Ultra-wideband LTCC Based Microstrip Antenna for Millimeter-wave Applications under 100 GHz,” *Journal of Nano-and Electronic Physics*, vol. 12, no. 4, p. 04009 (6pp), Aug. 2020, doi: 10.21272/jnep.12(4).04009.
- [46] D. Khezzar, D. Khedrouche, C. Kärfelt, A. T. Denidni, and F. Gallée, “CPW-Fed LTCC Based Broadband Microstrip Antenna for Millimeter-Wave Applications at 60 GHz,” presented at the 19th IEEE International Multi-Conference on Systems, Signals & Devices 2022, On-line (Faculty of Technology, University Ferhat Abbas Setif 1, Algeria), May 2022.
- [47] C. Kärfelt, D. Zelenchuk, M. Sinou, F. Gallée, and P. Douglas, “Sacrificial Volume Materials for Small Hole Generation in Low-Temperature Cofired Ceramics,” *MDPI Electronics*, vol. 9, no. 12, p. 17, 2020, doi: 10.3390/electronics9122168.
- [48] F. Gallée, C. Kärfelt, D. Zelenchuk, I. Munina, M. Sinou, and V. Kirillov, “Antenne lentille de type Lüneburg réalisée en LTCC pour 60 GHz,” presented at the XXII èmes Journées Nationales Microondes, Limoges, France, Jun. 08, 2022. Available online: <https://hal-imt-atlantique.archives-ouvertes.fr/hal-03752358/document>
- [49] C. Kärfelt and N. Ryon, “Screen Printing on Low Temperature Cofired Ceramics,” presented at the 44 th International Microelectronics and Packaging conference, Online, Apr. 18, 2021. Available online: https://www.researchgate.net/publication/351048963_Screen_Printing_on_Low_Temperature_Cofired_Ceramics
- [50] C. Kärfelt and M. Sinou, “Control of Low Temperature Co-fired Ceramic Shrinkage for Unconstrained Sintering,” presented at the 23rd European Microelectronics and Packaging Conference & Exhibition (EMPC), Göteborg, Sweden (online), Sep. 2021. doi: 10.23919/EMPC53418.2021.9584969.
- [51] C. Kärfelt, M. Sinou, and A. Ivanov, “Comparison of Lamination Methods to Control Low Temperature Co-fired Ceramic Shrinkage,” presented at the Ceramic Interconnect and Ceramic Microsystems Technologies, CICMT, Vienna, Austria, Jul. 13, 2022. [Online]. Available: https://www.researchgate.net/publication/362387143_Comparison_of_Lamination_Methods_to_Control_Low_Temperature_Co-fired_Ceramic_Shrinkage
- [52] K. H. Rida, “Packaging of Microwave Integrated Circuits in LTCC Technology,” *Télécom Bretagne, Université de Bretagne Occidentale, Brest, France*, 2013. Accessed: Mar. 04, 2021. [Online]. Available: <https://tel.archives-ouvertes.fr/tel-00908836>
- [53] K. Rida *et al.*, “Conception d’un boîtier multicouche LTCC intégrant un Oscillateur MMIC,” presented at the 18^{ème} Journées Nationales Microondes, JNM 2013, Paris, France, May 2013.

- [54] H. Liu, "Radio sur fibre: réseaux, couvertures radio, architectures et dimensionnements matériels," Télécom Bretagne, Brest, France, 2013. [Online]. Available: <https://hal-imt-atlantique.archives-ouvertes.fr/tel-00823575v1>
- [55] M. Tlili, "Modules intégrés en technologie LTCC pour des applications en bande D (110 - 170 GHz)," Thèse de doctorat. Ecole nationale supérieure Mines-Télécom Atlantique. Brest, France, 2020. Available online: <https://tel.archives-ouvertes.fr/tel-02538427/document>
- [56] M. Tlili, M. Sinou, C. Kärnfelt, D. Bourreau, and A. Peden, "Micro Heat Pipe Design and Fabrication on LTCC," in *2018 7th Electronic System-Integration Technology Conference (ESTC)*, Dresden, Sep. 2018, pp. 1–3. doi: 10.1109/ESTC.2018.8546402.
- [57] M. Tlili, C. Kärnfelt, M. Sinou, and A. Peden, "Cold Chemical Lamination Tests of Grooved Internal Cavities in LTCC for Thermal Management," IMAPS From Nano to Macro Power Electronics and Packaging European Workshop. Tours, France, Nov. 2019, p. 6. Available online: <https://hal.archives-ouvertes.fr/hal-02504765/document>
- [58] N. Parker-Soues, "Développement de circulateurs compacts en bande Ku," These, Brest, 2022. Accessed: Aug. 04, 2022. [Online]. Available: <https://www.theses.fr/s209714>
- [59] M. Ney and C. Kärnfelt, "Structures de guidage hyperfréquences - Propagation et géométrie," *Techniques de l'ingénieur*. Techniques de l'ingénieur, p. 27, 2015. [Online]. Available: DOI : 10.51257/a-v1-e1169
- [60] M. Ney and C. Kärnfelt, "Structures de guidage HF - Technologie et applications," *Techniques de l'ingénieur*. Techniques de l'ingénieur, p. 24, 2016. Available online: <https://www.techniques-ingenieur.fr/base-documentaire/electronique-photonique-th13/electromagnetisme-propagation-42277210/structures-de-guidage-hyperfrequences-e1170/>
- [61] A. Peden, A. Guyomar, C. Karnfelt, and D. Bourreau, "L'alignement pédagogique : objectifs - activités d'apprentissage - évaluations - Innovation Pédagogique," Jan. 07, 2014. <https://www.innovation-pedagogique.fr/article23.html> (accessed Mar. 11, 2021).
- [62] F. Saint-Georges and C. Kärnfelt, "Aide méthodologique à la réalisation d'une bibliographie - Innovation Pédagogique," juin 2014. <https://www.innovation-pedagogique.fr/article71.html> (accessed Mar. 11, 2021).
- [63] M. Węglarski, P. Jankowski-Mihułowicz, G. Pitera, D. Jurków, and M. Dorczyński, "LTCC Flow Sensor with RFID Interface," *Sensors*, vol. 20, no. 1, p. 268, Jan. 2020, doi: 10.3390/s20010268.
- [64] T. Maeder, B. Afra, Y. Fournier, N. Johnner, and P. Ryser, "LTCC ultra high isostatic pressure sensors," in *Proceedings, 16th IMAPS-EMPC*, Oulu, Finland, 2007, pp. 375–380.
- [65] C. Li, Q. Tan, W. Zhang, C. Xue, Y. Li, and J. Xiong, "Microfabrication of a Novel Ceramic Pressure Sensor with High Sensitivity Based on Low-Temperature Co-Fired Ceramic (LTCC) Technology," *Micromachines*, vol. 5, no. 2, pp. 396–407, Jun. 2014, doi: 10.3390/mi5020396.
- [66] J. M. Fernandez-Sanjuan *et al.*, "Ceramic capacitive pressure sensor based on LTCC technology," in *2013 Spanish Conference on Electron Devices*, Valladolid, Spain, Feb. 2013, pp. 111–114. doi: 10.1109/CDE.2013.6481355.
- [67] P. M. Markowski, M. Gierczak, and A. Dziedzic, "Temperature Difference Sensor to Monitor the Temperature Difference in Processor Active Heat Sink Based on Thermopile," *Electronics*, vol. 10, no. 12, p. 1410, Jun. 2021, doi: 10.3390/electronics10121410.
- [68] C. S. Martínez-Cisneros, N. Ibáñez-García, F. Valdés, and J. Alonso, "LTCC microflow analyzers with monolithic integration of thermal control," *Sensors and Actuators A: Physical*, vol. 138, no. 1, pp. 63–70, Jul. 2007, doi: 10.1016/j.sna.2007.04.059.

- [69] M. Ma, Z. Liu, W. Shan, Y. Li, K. Kalantar-zadeh, and W. Wlodarski, "Passive wireless gas sensors based on the LTCC technique," in *2015 IEEE MTT-S International Microwave Workshop Series on Advanced Materials and Processes for RF and THz Applications (IMWS-AMP)*, Jul. 2015, pp. 1–3. doi: 10.1109/IMWS-AMP.2015.7325052.
- [70] D. K. Kharbanda, N. Suri, and P. K. Khanna, "Design, Fabrication and Characterization of Inter-Layer Microheaters Using LTCC Technology," *ECS J. Solid State Sci. Technol.*, vol. 11, no. 3, p. 037002, Mar. 2022, doi: 10.1149/2162-8777/ac5a70.
- [71] V. Kuhn, C. Lahuec, F. Seguin, and C. Person, "A Multi-Band Stacked RF Energy Harvester With RF-to-DC Efficiency Up to 84%," *IEEE Trans. Microwave Theory Techn.*, vol. 63, no. 5, pp. 1768–1778, May 2015, doi: 10.1109/TMTT.2015.2416233.
- [72] M. Sobocinski, M. Leinonen, J. Juuti, and H. Jantunen, "Monomorph piezoelectric wideband energy harvester integrated into LTCC," *Journal of the European Ceramic Society*, vol. 31, no. 5, pp. 789–794, May 2011, doi: 10.1016/j.jeurceramsoc.2010.12.008.
- [73] P. Markowski and A. Dzedzic, "Planar and three-dimensional thick-film thermoelectric microgenerators," *Microelectronics Reliability*, vol. 48, no. 6, pp. 890–896, Jun. 2008, doi: 10.1016/j.microrel.2008.03.008.
- [74] N. Jaziri *et al.*, "Low-temperature co-fired ceramic-based thermoelectric generator with cylindrical grooves for harvesting waste heat from power circuits," *Applied Thermal Engineering*, vol. 184, p. 116367, Feb. 2021, doi: 10.1016/j.applthermaleng.2020.116367.

Appendices

APPENDIX 1 – S2 PROJECTS

Year	Supervisor(s)	Project title	Students
2010-2011	Camilla Kärfelt and Rolland Fleury	Outil logiciel pour analyser des expérimentations avec des variables multiples (A design of experiments (DOE) software)	Antoine Busca, Hélène Dessert and Benoit Coledan
2013-2014	Camilla Kärfelt	Développement d'un kit de conception et un outil de contrôle des règles de conception pour des composants hyperfréquences (A design kit and design rule check tool for microwave component design)	Zakaria El Hassnaout, El Moundir Rohmat and Qian Li
2013-2014	Camilla Kärfelt	Amélioration d'un outil logiciel qui optimise les expérimentations à variables multiples (Improvements of a DOE software)	André Fougeront et Khalid Aitelamine
2014-2015	Camilla Kärfelt	Pilotage d'un laser en mode ablation (Laser ablation management)	Sofien Ben Abdallah, Anas Fennane and Yannis Govinda
2015-2016	Camilla Kärfelt	Réalisation des composants passifs : capacités, résistances et inductances (Design of passive components : capacitors, resistors and inductors)	Iliass Bouchir, Paul Escalle and Narjes Majdoub
2016-2017	Camilla Kärfelt, Maïna Sinou and Malika Tlili	Contrôle thermique de composants électroniques miniaturisés en LTCC (Thermal management of miniaturized LTCC components)	Charles Berti, Hang Zhang and Ibrahim Cherni
2017-2018	Camilla Kärfelt and François Le Pennec	Réalisation d'une antenne cornet intégrée dans le LTCC (Design of an LTCC horn antenna)	Anthony Bibollet, Marco Da Costa and Kushal Bissoondoyal
2017-2018	Camilla Kärfelt and Dmitry Zelenchuk (QUB)	Réalisation des résonateurs en LTCC (LTCC resonator design)	Alexis Guermont, François Xavier Samake and Zine-Eddine Biad
2018-2019	Camilla Kärfelt and Bastien Doumèche Univ. Lyon 1	Fabrication par technologie LTCC d'un connecteur pour des biocapteurs enzymatiques (Fabrication of an LTCC bioenzymatic sensor)	Renata Berwanger Schmidt, Lorraine Lestienne and Mathilde Verlyck
2019-2020	Camilla Kärfelt and Maïna Sinou	Évaluation des poudres pour réaliser des cavités intégrées dans des dispositifs céramiques pour la microélectronique	Romain Tessier, Mohamed

		(Evaluation of powders to realize internal cavities in ceramic microelectronic devices)	Ez-Zarraq and Joanne Khater
2020-2021	Camilla Kärfelt and Maïna Sinou	Réalisation des composants passifs : capacités, résistances et inductances (Design of passive components : capacitors, resistors and inductors)	Maxime Le Parc, Hortense Rozani and Manal Adda
2020-2021	Camilla Kärfelt and Sylvie Kérouedan	Véhicule mobile piloté par smartphone (A vehicle controlled by a smartphone)	Mila Czernichow, Omar Dramé, Nampoina Ravelomanana and Alexandre Azor
2021-2022	Camilla Kärfelt and Maïna Sinou	Améliorations d'un laboratoire bio-enzymatique (Improvement of a bioenzymatic sensor)	Paul Allanore, Vincent Cazenave and Gatien Tiriél
2021-2022	Camilla Kärfelt and Maria Teresa Segarra Montesinos	Création d'un système de contrôle de température (Creation of a thermal management system)	Camille Hervé, Hugo Pereira, Benjamin Karila-Cohen and Paul de Sainte Agathe
2021-2022	Camilla Kärfelt	Plateforme volante (A flying platform)	Salim Sama-Mola, Papa Balla Babou, Ayman Houna and Rida Adardour

APPENDIX 2 - MINEUR RECHERCHE PROJECTS

Year	Supervisor(s)	Project title	Students
2016-2017	Camilla Kärfelt	Modeling using the Design of Experiments Technique: Determining Interdigital Capacitor Value	Joe Bachi

APPENDIX 3 – S4 PROJECTS

Year	Supervisors	Project title	Students
2009-2010	Camilla Kärfelt, Frédéric Lucarz and Daniel Bourreau	Modélisation de composants optoélectroniques pour les transmissions Radio sur fibre (Modeling of optoelectronic Radio over Fibre transmission components)	Rémi Gonzales and David Veillepeau
2010-2011	C. Kärfelt Y. Le Roux J. Menard	Étude de couverture radio d'un système LTE & WiMax sur BMO (Radio cell coverage study for a LTE and WiMax system in BMO)	Cristina Cismas, Tarik Bouizargan, Galliam Bagaya, Mikaël Causard et Felipe Rugeles
2012-2013	Camilla Kärfelt et Jérôme Kerdreux	Intégration des outils libres pour établir la cartographie de la couverture 4G LTE à Brest (Integration of free software to establish the 4G and LTE coverage in Brest)	Paul Mendoza, Joris Le Cossec, Jean-Baptiste Pivert, Jun Ma et Lukasz Siemaszko
2015-2016	Camilla Kärfelt et Isabelle Amigo	Guide vertical pour déficients visuels (Vertical guide for the visually impaired)	Martin Bornes Bchara, Dhouha Fehri, Khadidiatou Ndiaye, Georgina Araly Tiburcio Lara, Valentin Tisseyre

APPENDIX 4 – S₅ PROJECTS

Year	Supervisors	Project title	Students
2011-2012	Frédéric Lucarz, Bruno Fracasso, Patrice Pajusco and Camilla Kärfelt	Étude de l'architecture d'un réseau à fibre optique pour l'accès sans fil dans le tram de Brest (Study of the architecture of a fiber optic network for wireless access in the Brest tramway)	Diana Murcia, Adrian Florez, Loïc Le Ster, Donald Masse
2011-2012	Kristof Cools, Francesco P. Andriulli and Camilla Kärfelt	Double Negative Refractive Index Metamaterials for the Microwave Pendry-Veselago Superlens	Cristina Arenas Buendia, Ruiyi Yang
2012-2013	Francesco P. Andriulli, Camilla Kärfelt and Kristof Cools	Conception et fabrication des métamatériaux pour réaliser une cape d'invisibilité (Design and manufacture of metamaterials to create a cloak of invisibility)	Xabier Ezquerro García, Guillaume Recht
2013-2014	Francesco P. Andriulli and Camilla Kärfelt	Conception d'un fantôme de cerveau humain (Design of a human brain phantom)	Charlotte Bertron, Nicolas Cluzel
2014-2015	Camilla Kärfelt and Alain Peden	Conception de dispositifs passifs pour guides d'ondes sur substrat laminé (Design of passive waveguide devices on laminated substrate)	Benoît Fauré and Lamyae Khibabi
2019-2020	Camilla Kärfelt	Caractérisation et intégration d'une puce MMIC en technologie LTCC (Characterization and integration of a MMIC chip in LTCC technology)	Tobias Baumgartner

APPENDIX 5 – FIP 3RD YEAR DEVELOPMENT PROJECTS

Year	Supervisors	Project title	Students
2008-2009	François Le Pennec and Camilla Kärnfelt	Études Radios dans les contextes intra-bâtiments et véhicules (Radio studies in intra-building and vehicles)	Sami Boulakirba and Florian Jégu
2009-2010	Patrice Pajusco and Camilla Kärnfelt	Étude et déploiement d'un réseau WiFi à antennes distribuées (Study and deployment of a WiFi network with distributed antennas)	Hugo Tanné and Usama Osman Mohamed
2013-2014	Camilla Kärnfelt and Frédéric Lucarz	CapilRTram – radioplanning pour le tramway de Brest (CapilRTram - radioplanning for the Brest tramway)	Manon Blanc, Benjamin Capioux

APPENDIX 6 – FIP MANAGEMENT PROJECTS

Year	Supervisors	Project title	Students
2015-2016	Team supervision	Vidéo promotionnelle pour la formation en alternance (Promotional video for the work-study program)	FIP3A
2017-2018	Team supervision	Proposition d'un défi pour la cohésion entre sites de la nouvelle école IMT Atlantique (Proposal of a challenge for the cohesion between sites of the new ITM Atlantic school)	FIP3A
2018-2019	Team supervision	Gestion et valorisation des déchets sur IMT Atlantique (Waste management and recovery at IMT Atlantique)	FIP3A

APPENDIX 7 – MASTER STUDENTS ‘ BIBLIOGRAPHICAL PROJECTS

Year	Supervisors	Project title	Students
2013	Camilla Kärfelt and Alain Peden	Receiver Technology using Hot Electron Bolometer (HEBs)	Przemyslaw Jasek and Sami Alkabbani
2014	Camilla Kärfelt and Alain Peden	Microwave Stealth Technologies - From Jamming to Metamaterials	Juleixis Guariguata and Mahesh Poudel
2015	Camilla Kärfelt	Exotic wire-bonding metallization	Braulio Antonio Castillo Bautista and Leonard Toshimori
2015	Camilla Kärfelt	Space to Earth Communications: An overview of communication equipment from Vostok 1 to future Mars Explorers	Roberto Jiménez Guerrero and Ahmed Sami Mohamed
2016	Camilla Kärfelt	Bio-inspired miniature robots and energy harvesting using piezo-electric materials	Juana Cordova and Damian Janikowski
2018	Alain Peden and Camilla Kärfelt	Self-driving cars, autonomous vehicles and intelligent transport systems: Goals and Challenges	Gino Montanez
2020	Camilla Kärfelt	Sacrificial Volume Material Options in LTCC	Julian Kopp and Ali Alkathami
2021	Camilla Kärfelt	Energy harvesting for microelectronics devices in Low Temperature Cofired Ceramics	Brittany Coleau
2022	Camilla Kärfelt	An overview of solid liquid interdiffusion bonding	Santiago Guerra Gonzalez and Monserrath Elisabeth Velasco

APPENDIX 8 – MASTER THESIS SUPERVISION

Year	Supervisors	Project title	Student
2008	Alain Peden and Camilla Kärfelt	Plate-forme de simulation système : analyse des performances et des dégradations liées aux bruits dans le cas d'un radar automobile ACC à 77 GHz (System simulation platform: performance and noise degradation analysis for a 77 GHz ACC automotive radar)	Ghayath El Haj Shhade
2009	Alain Peden and Camilla Kärfelt	Traitement des signaux pour radar ACC sous Matlab (Signal processing for ACC radar in Matlab)	Mohammad Abbas

Titre : Dispositifs micro-ondes et millimétriques - combler le gap entre la conception et la production

Mots clés : dispositifs micro-ondes, production, céramique cuite à basse température

Résumé : Ce mémoire présente une synthèse de mes activités de recherche et d'enseignement menées à Chalmers University of Technology et Lab-STICC/IMT Atlantique. Il retrace aussi ma carrière en tant qu'ingénieur de production dans des entreprises du domaine de micro-ondes et optoélectronique, à savoir Ericsson Microwave Electronics et Optillion.

Pour concevoir et fabriquer des dispositifs fonctionnant en très haute fréquence il faut avoir une compréhension des phénomènes physiques, mais il est aussi souhaitable d'avoir une perception des moyens de fabrication, pour ne pas concevoir un dispositif qui ne fonctionne que dans un simulateur. Il est rare que la même personne maîtrise la fabrication et la conception. Ce gap résulte en un rendement de production plus faible que nécessaire.

Lors de mes années en industrie j'ai appris les bases de production micro-électronique. Puis, en tant qu'ingénieur de recherche avec pour mission de concevoir de puces millimétriques et ainsi que leur mise en boîtier, j'ai consolidé mes connaissances de phénomènes micro-ondes. À Lab-STICC/IMT Atlantique j'ai appris comment fonctionnent les radars et les systèmes Radio sur Fibre. Dernièrement, je me suis concentré sur la conception et fabrication des dispositifs de céramique cuite à basse température, appelée LTCC.

À Lab-STICC/IMT Atlantique je m'efforce d'inculquer à mes élèves et aux doctorants ce lien entre la conception et la fabrication, acquis par mon expérience. L'objectif est d'en faire des ingénieurs et des scientifiques appréciés par l'industrie et le milieu de la recherche.

Title : Microwave and millimeter wave devices – bridging the gap between design and production

Keywords : microwave devices, production, low temperature fired ceramic

Abstract : This thesis presents a synthesis of my research and teaching activities at Chalmers University of Technology and Lab-STICC/IMT Atlantique. It also traces my career as a production engineer in companies in the microwave and optoelectronics field, namely Ericsson Microwave Electronics and Optillion.

To design and manufacture devices operating at very high frequencies, it is necessary to understand the physical phenomena. However, it is also desirable to address manufacturing issues to avoid the design of devices that would only work in a simulator. It is rare that the same person masters both manufacturing and design. This gap results in a lower than necessary production yield.

During my years in industry, I learned the basics of microelectronic production. Then, as a research engineer with the mission to design millimeter chips and their packaging, I consolidated my microwave knowledge. At Lab-STICC/IMT Atlantique I learned how radar and Radio-over-Fiber systems work. Lately, I focused on the design and fabrication of low temperature ceramic devices, called LTCC.

At Lab-STICC/IMT Atlantique, my endeavour is to teach my students and graduate students the link between design and production that I have acquired during my career. The objective is to train engineers and scientists who will be appreciated by the industry and the research sector