



HAL
open science

Some aspects of infinite-dimensional Geometry: Theory and Applications

Alice Barbara Tumpach

► **To cite this version:**

Alice Barbara Tumpach. Some aspects of infinite-dimensional Geometry: Theory and Applications. Mathematics [math]. Lille University, 2022. tel-04052429

HAL Id: tel-04052429

<https://hal.science/tel-04052429v1>

Submitted on 30 Mar 2023

HAL is a multi-disciplinary open access archive for the deposit and dissemination of scientific research documents, whether they are published or not. The documents may come from teaching and research institutions in France or abroad, or from public or private research centers.

L'archive ouverte pluridisciplinaire **HAL**, est destinée au dépôt et à la diffusion de documents scientifiques de niveau recherche, publiés ou non, émanant des établissements d'enseignement et de recherche français ou étrangers, des laboratoires publics ou privés.

THÈSE D'HABILITATION

présentée par

Alice Barbara TUMPACH

Spécialité MATHÉMATIQUES

Sujet:

Some aspects of infinite-dimensional Geometry:
Theory and Applications

présentée le 9 décembre 2022,
à l'Université de Lille
devant la commission d'examen composée de:

| | | |
|----|---------------------------|-------------------|
| MM | Juan-Carlos ALVAREZ-PAIVA | Garant |
| | Esteban ANDRUCHOW | Rapporteur |
| | Stephan DE BIÈVRE | Président du jury |
| | Karl-Hermann NEEB | Rapporteur |
| | Cornelia VIZMAN | Examinatrice |
| | Tilmann WURZBACHER | Rapporteur |

Remerciements

Je me dois de remercier avant tout le laboratoire Painlevé ainsi que le CNRS pour leur soutien, et le Wolfgang Pauli Institut de Vienne de m'offrir un cadre de travail idéal qui me permet d'allier mathématiques et vie de famille comme je l'entends. Je remercie également l'agence de la recherche autrichienne FWF (Fonds zur Förderung der wissenschaftlichen Forschung) pour le financement qu'elle m'a accordé et qui permet à mes enfants de poursuivre leur scolarité en Autriche.

Vielen Dank an Karl-Hermann Neeb und Tilmann Wurzbacher dafür, daß sie sich die Zeit genommen haben, einen Bericht über meine Arbeit zu schreiben, und diese Habilitationsverteidigung ermöglicht zu haben. Ich bin auch sehr dankbar dafür, daß Sie beide bei der Habilitationsverteidigung dabei waren.

Agradezco a Esteban Andruchow las molestias que se ha tomado en revisar mi trabajo y sus alentadoras palabras.

Je remercie Juan-Carlos Alvarez-Paiva pour avoir accepté d'être mon garant, et pour s'être acquitté de cette tâche avec enthousiasme, Stephan de Bièvre pour avoir pris le rôle de président du jury in extremis, et pour avoir ainsi sauvé cette soutenance, et, bien sûr Cornelia Vizman pour avoir accepté de faire partie du jury et pour son soutien sans faille.

Je remercie également Patrick Popescu-Pampu, Ludovic Macaire, Alexis Virelizier et tous les membres de l'école doctorale pour leur travail en amont de cette soutenance.

My thanks also goes to all my collaborators for all the fun we had doing mathematics together.

Děkuji své rodině, zvlášt' mojí mamince a mojí tetě, že mě pořád podporovaly. Je remercie ma fille Héloïse pour être ce miroir bienveillant qui me fait grandir chaque jour en tant que mère et en tant qu'être humain, ma fille Constance pour sa constante gentillesse et son infaillible soutien, et mon fils Sébastien pour son cœur si tendre et son imagination sans limite. Je remercie leur père François ainsi que sa famille, en particulier ses parents Veronika et Jean-Yves, pour leur soutien en toutes circonstances.

Je remercie tous ceux, membres du jury, parents, amis, qui, malgré cette date hivernale, ont pris la peine de venir assister à cette soutenance.

À tous ceux que, pour une raison ou une autre, je ne peux nommer ici et qui ont contribué à leur manière à la rédaction de cette thèse d'habilitation, j'exprime ma gratitude.

Finally I would like to thank Steve Preston and Martin Bauer for the impulse they gave me which proved itself crucial in writing these acknowledgements, and my daughter Héloïse for editing them.

If...

(...)

If you can bear to hear the truth you've spoken
Twisted by knaves to make a trap for fools
Or watch the things you gave your life to, broken,
And stoop and build'em up with worn-out tools;

If you can make one heap of all your winnings
And risk it on one turn of pitch-and-toss,
And lose, and start again at your beginnings
And never breathe a word about your loss;
If you can force your heart and nerve and sinew
To serve your turn long after they are gone,
And so hold on when there is nothing in you,
Except the Will which says to them: "Hold on!"

(...)

If you can fill the unforgiving minute
With sixty seconds' worth of distance run,
Yours is the Earth and everything that's in it,
And – which is more – you'll be a man, my son!

Rudyard Kipling¹

¹ Extrait de la plaque commémorative en l'honneur de Raymond Croland (17.05.1913-08.04.1945), agrégé préparateur de zoologie (1938-1944), commandant des forces françaises combattantes, décoré à titre posthume, arrêté par la Gestapo au deuxième étage de l'École normale supérieure de Physique, rue Lhomond, le 14 février 1944, déporté et mort en Allemagne.

Contents

| | |
|--|-----------|
| List of publications | 10 |
| I An introductory tour | 13 |
| 1 | 15 |
| 1.1 The universal Teichmüller space | 15 |
| 1.2 Fingerprint map | 18 |
| 1.3 The restricted Siegel disc | 19 |
| 1.4 The period mapping | 20 |
| 1.5 Isotropic polarizations and complex structures | 21 |
| 1.6 The restricted groups $\mathrm{GL}_{\mathrm{res}}(\mathcal{H})$, $\mathrm{U}_{\mathrm{res}}(\mathcal{H})$, and $\mathrm{Sp}_{\mathrm{res}}(\mathcal{V}, \Omega)$ | 23 |
| 1.7 Restricted Siegel disc and restricted Grassmannian | 24 |
| 1.8 Korteweg-de Vries equation | 26 |
| 1.8.1 Korteweg-de Vries equation as geodesic equation | 26 |
| 1.8.2 KdV hierarchies and infinite-dimensional Grassmannians | 26 |
| 1.9 Banach Poisson–Lie group structure on $\mathrm{U}(\mathcal{H})$ | 28 |
| 1.9.1 Definition of Banach Poisson–Lie groups | 29 |
| 1.9.2 Some subspaces of $\mathfrak{u}^*(\mathcal{H})$ in duality with $\mathfrak{u}(\mathcal{H})$ | 30 |
| 1.9.3 The unitary group $\mathrm{U}(\mathcal{H})$ as a Banach Poisson–Lie group | 33 |
| II Infinite-dimensional Geometry applied to Shape Analysis of Curves and Surfaces | 37 |
| 2 Shape Analysis of curves | 39 |
| 2.1 Introduction | 39 |
| 2.1.1 Unparameterized curves in a homogeneous space | 40 |
| 2.1.2 Quotient space versus section of a fiber bundle | 40 |
| 2.2 The space of curves as an infinite-dimensional manifold | 42 |
| 2.2.1 Rectifiable curves | 42 |
| 2.2.2 Manifolds of based parameterized curves | 43 |
| 2.3 Moving Frames and canonical parameterizations of curves | 48 |
| 2.3.1 Moving frame attached to a curve | 48 |
| 2.3.2 Interpolation of 2D-contours | 49 |
| 2.3.3 Different parameterizations of 2D-shapes | 51 |
| 2.3.4 Basic idea of interpolation using moving frames for curves in \mathbb{R}^3 | 57 |
| 2.4 Examples of Interpolations between 2D-Shapes | 60 |
| 2.4.1 Interpolation between curves in specific parameterization | 60 |
| 2.4.2 Interpolation between curvature functions | 61 |
| 2.5 Quotient elastic metrics on the manifold of arc-length parameterized plane curves | 62 |
| 2.5.1 Quotient elastic metrics on arc-length parameterized plane curves | 64 |
| 2.5.2 Quotient elastic metrics on arc-length parameterized piecewise linear curves | 71 |
| 2.5.3 Two-boundary problem and Energy landscape | 76 |

| | | |
|--|---|------------|
| 3 | Shape Analysis of Surfaces | 83 |
| 3.1 | Introduction | 83 |
| 3.2 | Construction and alignment of spherical surfaces | 85 |
| 3.2.1 | Construction of surfaces using spherical harmonics | 85 |
| 3.2.2 | Alignment of surfaces: removing rotation, translation and scale variability | 85 |
| 3.2.3 | Implementation of Alignment of spherical shapes | 89 |
| 3.2.4 | Fiber bundle structure of pre-shape space | 91 |
| 3.2.5 | Characterization of a shape | 92 |
| 3.3 | Gauge Invariant Framework for surfaces | 93 |
| 3.3.1 | Mathematical Setup | 96 |
| 3.3.2 | Gauge Invariance and Riemannian Metric | 97 |
| 3.3.3 | Geodesic Computation | 103 |
| 3.3.4 | Experimental results | 108 |
| 3.4 | Shape and Pose recognition of Human bodies | 112 |
| 3.4.1 | Mathematical Framework | 112 |
| 3.4.2 | Shape Space as Section of a Fiber Bundle | 113 |
| 3.4.3 | Experiments | 116 |
| 3.4.4 | Application to Pose and Shape Retrieval | 120 |
| III Infinite-dimensional Poisson Geometry | | 123 |
| 4 | Queer Poisson structures | 125 |
| 4.1 | Introduction | 125 |
| 4.2 | Queer operational vector fields | 126 |
| 4.3 | Queer Poisson brackets | 128 |
| 5 | The restricted Grassmannian as a symplectic leave in a Poisson manifold | 131 |
| 5.1 | Introduction | 131 |
| 5.2 | The Banach Lie-Poisson space associated to the universal central extension of $\mathfrak{u}_{\text{res}}$ | 133 |
| 5.3 | Coadjoint orbits of the restricted unitary group | 138 |
| 5.4 | Some smooth adjoint orbits of the restricted unitary group | 141 |
| 5.5 | The Banach Lie-Poisson space associated to the central extension of \mathfrak{u}_2 | 143 |
| 5.6 | Some pathological properties of the restricted algebras | 147 |
| 5.6.1 | Unbounded unitary groups in the restricted algebra | 147 |
| 5.6.2 | The predual of the restricted algebra is not spanned by its positive cone | 148 |
| 5.6.3 | The Cartan subalgebras of $\mathfrak{u}_{\text{res}}$ are not U_{res} -conjugate | 149 |
| 6 | Banach Poisson–Lie groups and related structures | 153 |
| 6.1 | Introduction | 153 |
| 6.2 | Manin triples in the infinite-dimensional setting | 155 |
| 6.2.1 | Duality pairings of Banach spaces | 155 |
| 6.2.2 | Duals and injection of Banach spaces | 157 |
| 6.2.3 | Definition of Banach Manin triples | 158 |
| 6.2.4 | Triangular truncations of operators | 159 |
| 6.2.5 | Example of Iwasawa Manin triples | 160 |
| 6.3 | From Manin triples to 1-cocycles | 161 |
| 6.3.1 | Adjoint and coadjoint actions | 161 |
| 6.3.2 | Coadjoint action on a subspace of the dual | 162 |
| 6.3.3 | Adjoint action on the space of continuous multilinear maps | 162 |
| 6.3.4 | Subspaces of skew-symmetric bilinear maps | 163 |
| 6.3.5 | Definition of 1-cocycles | 163 |
| 6.3.6 | Manin triples and associated 1-cocycles | 163 |
| 6.4 | Generalized Banach Poisson manifolds and related notions | 166 |
| 6.4.1 | Definition of generalized Banach Poisson manifolds | 166 |
| 6.4.2 | Banach Symplectic manifolds | 167 |
| 6.4.3 | Banach Lie–Poisson spaces | 169 |
| 6.5 | Banach Lie bialgebras | 172 |

| | | |
|----------|--|------------|
| 6.5.1 | Definition of Banach Lie bialgebras | 172 |
| 6.5.2 | Banach Lie bialgebras versus Manin triples | 173 |
| 6.6 | Banach Poisson–Lie groups | 176 |
| 6.6.1 | Definition of Banach Poisson–Lie groups | 176 |
| 6.6.2 | Jacobi tensor and local sections | 178 |
| 6.6.3 | Example of Banach Poisson–Lie groups $U_p(\mathcal{H})$ and $B_p^\pm(\mathcal{H})$ for $1 < p \leq 2$ | 180 |
| 6.6.4 | The tangent Banach Lie bialgebra of a Banach Poisson–Lie group | 181 |
| 7 | Poisson–Lie groups and the restricted Grassmannian | 183 |
| 7.1 | Preliminaries | 183 |
| 7.1.1 | Restricted Banach Lie algebra $L_{\text{res}}(\mathcal{H})$ and its predual $L_{1,2}(\mathcal{H})$ | 183 |
| 7.1.2 | Restricted general linear group $GL_{\text{res}}(\mathcal{H})$ and its “predual” $GL_{1,2}(\mathcal{H})$ | 184 |
| 7.1.3 | Unitary Banach Lie algebras $\mathfrak{u}(\mathcal{H})$, $\mathfrak{u}_{\text{res}}(\mathcal{H})$, $\mathfrak{u}_{1,2}(\mathcal{H})$ | 184 |
| 7.1.4 | Restricted unitary group $U_{\text{res}}(\mathcal{H})$ and its “predual” $U_{1,2}(\mathcal{H})$ | 184 |
| 7.1.5 | The restricted Grassmannian $Gr_{\text{res}}(\mathcal{H})$ | 185 |
| 7.1.6 | Triangular Banach Lie subalgebras $\mathfrak{b}_{1,2}^\pm(\mathcal{H})$ and $\mathfrak{b}_{\text{res}}^\pm(\mathcal{H})$ | 185 |
| 7.1.7 | Triangular Banach Lie groups $B_{1,2}^\pm(\mathcal{H})$, and $B_{\text{res}}^\pm(\mathcal{H})$ | 185 |
| 7.2 | Example of Banach Lie bialgebras and Banach Poisson–Lie groups related to the restricted Grassmannian | 185 |
| 7.2.1 | Iwasawa Banach Lie bialgebras | 185 |
| 7.2.2 | Unbounded coadjoint actions | 189 |
| 7.2.3 | The Banach Poisson–Lie groups $B_{\text{res}}^\pm(\mathcal{H})$ and $U_{\text{res}}(\mathcal{H})$ | 191 |
| 7.3 | The restricted Grassmannian as a Poisson manifold | 194 |
| 7.3.1 | A Poisson–Lie subgroup of $U_{\text{res}}(\mathcal{H})$ | 194 |
| 7.3.2 | The restricted Grassmannian as a quotient Poisson homogeneous space | 195 |
| 7.4 | Poisson action of $B_{\text{res}}^+(\mathcal{H})$ on $Gr_{\text{res}}(\mathcal{H})$ and Schubert cells | 197 |
| 7.4.1 | Poisson action of $B_{\text{res}}^\pm(\mathcal{H})$ on $Gr_{\text{res}}(\mathcal{H})$ | 197 |
| 7.4.2 | Schubert cells as symplectic leaves of the restricted Grassmannian | 198 |
| 7.5 | Relation between the restricted Grassmannian and the KdV hierarchy | 200 |

LIST OF PUBLICATIONS OF ALICE BARBORA TUMPACH

In Peer-reviewed Journals

- A.B. Tumpach, *Banach Poisson–Lie groups and Bruhat-Poisson structure of the restricted Grassmannian*, *Commun. Math. Phys.* 373, 795–858 (2020).
<https://doi.org/10.1007/s00220-019-03674-3>
http://math.univ-lille1.fr/~tumpach/Site/research_files/Bruhat_Poisson.pdf
- D. Beltita, T. Golinski, A.B. Tumpach, *Queer Poisson brackets*, *Journal of Geometry and Physics* 132, (2018), 358–362.
<https://doi.org/10.1016/j.geomphys.2018.06.013>
- A.B. Tumpach, S. C. Preston, *Quotient Elastic Metrics on the manifold of arc-length parameterized plane curves*, *Journal of Geometric Mechanics* 9, n°2 (2017), 227–256.
<https://doi.org/10.3934/jgm.2017010>
- A.B. Tumpach, *Gauge Invariance of degenerate Riemannian metrics*, *Notices of American Mathematical Society*, April 2016.
http://math.univ-lille1.fr/~tumpach/Site/research_files/Notices_full.pdf
- A.B. Tumpach, H. Drira, M. Daoudi, A. Srivastava, *Gauge Invariant Framework for Shape Analysis of Surfaces*. *IEEE Transactions on Pattern Analysis and Machine Intelligence*, January 2016, Volume 38, Number 1.
<https://doi.org/10.1109/TPAMI.2015.2430319>
- A. B. Tumpach, *On the classification of infinite-dimensional Hermitian-symmetric affine coadjoint orbits*, *Forum Mathematicum* 21 :3 (May 2009) 375–393.
http://math.univ-lille1.fr/~tumpach/Site/research_files/classification.pdf
- A. B. Tumpach, *Infinite-dimensional hyperkähler manifolds associated with Hermitian-symmetric affine coadjoint orbits*, *Annales de l’Institut Fourier*, Tome 59 (2009) – Fascicule 1, 167–197.
http://math.univ-lille1.fr/~tumpach/Site/research_files/paper3.pdf
- D. Beltita, T. Ratiu, A. B. Tumpach, *The restricted Grassmannian, Banach Lie-Poisson spaces and coadjoint orbits*, *Journal of Functional Analysis*, 247 (2007) 138–168.
http://math.univ-lille1.fr/~tumpach/Site/research_files/grassm_final.pdf
- A. B. Tumpach, *Hyperkähler structures and infinite-dimensional Grassmannians*, *Journal of Functional Analysis*, 243 (2007) 158–206.
<https://doi.org/10.1016/j.jfa.2006.05.019>

In Proceedings

- E. Pierson, M. Daoudi, A.B. Tumpach, *A Riemannian Framework for Analysis of Human Body Surface*, Conference: Winter Conference on Applications of Computer Vision (WACV 2022), <https://www.researchgate.net/publication/355545398>
- A.B. Tumpach, *An Example of Banach and Hilbert manifold : the Universal Teichmüller space*. Proceedings of XXXVI Workshop on Geometric Methods in Physics, 2-8 July 2017, Białowieża, Poland.
- H. Drira, A.B. Tumpach, M. Daoudi, *Gauge Invariant Framework for Trajectories Analysis*, Conference paper in 1st International Workshop on DIFFerential Geometry in Computer Vision for Analysis of Shapes, Images and Trajectories (DIFF-CV), (2015).
- A.B. Tumpach, *Roots Theory of L^* -algebras and Applications*. Oberwolfach Reports, Conference on Infinite Dimensional Lie Theory, 14-20.11.2010, Oberwolfach, Germany

PhD Thesis

- A.B. Tumpach, *Variétés kählériennes et hyperkähleriennes de dimension infinie*, 202 pages, Thèse de doctorat, École polytechnique, soutenue le 26 juillet 2005.
<http://tel.archives-ouvertes.fr/tel-00012012>

Preprints

- A.B. Tumpach and T. Goliński, *The Banach Poisson–Lie group structure of $U(H)$* , to appear in Proceedings of Workshop on Geometric Methods in Physics 2022, <https://arxiv.org/abs/2303.11795>
- A.B. Tumpach, *Mostow’s Decomposition Theorem for L^* -groups and Applications to affine coadjoint orbits and stable manifolds*, <http://fr.arxiv.org/pdf/math-ph/0605039>
- A.B. Tumpach, *On canonical parameterizations of 2D-curves*, <https://arxiv.org/abs/2303.15205>.
- A.B. Tumpach and S.C. Preston, *3 methods to put a Riemannian metric on Shape Space*, <https://arxiv.org/abs/2303.11682>
- A.B. Tumpach and P. Kán, *Temporal Alignment of Human Motion Data: A Geometric Point of View*, <https://arxiv.org/abs/2303.15259>.
- I. Ciuclea, A.B. Tumpach and C. Vizman, *Shape spaces of nonlinear flags*, <https://arxiv.org/abs/2303.15184>.

Part I

An introductory tour

Chapter 1

Introduction

This introduction is mainly based on our publication [214], our paper with T. Goliński [209], and work in progress with F. Gay-Balmaz and T. Ratiu. We explain the relation between the universal Teichmüller space (Section 1.1) and the following infinite-dimensional coadjoint orbits:

- the coadjoint orbit $\text{Diff}(S^1)/\text{PSU}(1,1)$ of the Virasoro group (i.e. of the central extension of the group of diffeomorphisms of the circle)
- the Siegel disc and the restricted Siegel disc as coadjoint orbit of the infinite-dimensional symplectic group and its restricted version;
- the restricted Grassmannian as a coadjoint orbit of the restricted unitary group.

The universal Teichmüller space is closely related to quasi-symmetric homeomorphisms of the circle and their quasi-conformal extensions (see Section 1.1). It injects into the Siegel disc via the period mapping (see Section 1.4), and its connected component (for its Hilbert manifold structure) injects into the restricted Siegel disc, which itself injects holomorphically into the restricted Grassmannian (see Section 1.7)

We will see that the theory of the universal Teichmüller space is linked to applications in pattern recognition and shape analysis via the fingerprint map (see Section 1.2). Some other applications of infinite-dimensional geometry to this field will be given in Part II for curves (see Chapter 2) and surfaces in \mathbb{R}^3 (see Chapter 3).

The Korteweg-de Vries equation arises as the geodesic equation on the Virasoro group, but is also linked to the restricted Grassmannian (Section 1.8). The Poisson geometry of the restricted Grassmannian and its relation to the KdV equation will be explained in details in Chapter 7. A foretaste of the problems arising in this context is given in Section 1.9 where we construct a Poisson structure on the unitary group of an Hilbert space. Some pathologies of Poisson geometry in the infinite-dimensional context are presented in chapters 4, 5 and 6.

1.1 The universal Teichmüller space

H^s -Diffeomorphisms groups of the circle. For $s > 3/2$, the group $\text{Diff}^s(S^1)$ of Sobolev class H^s diffeomorphisms of the circle is a \mathcal{C}^∞ -manifold modeled on the space of H^s -section of the tangent bundle TS^1 ([68]), or equivalently on the space of real H^s -function on S^1 . It is a topological group in the sense that the multiplication $(f, g) \mapsto f \circ g$ is well-defined and continuous, the inverse $f \mapsto f^{-1}$ is continuous, the left translation L_γ by $\gamma \in \text{Diff}^s(S^1)$ applying f to $\eta \circ f$ is continuous, and the right translation R_γ by $\gamma \in \text{Diff}^s(S^1)$ applying f to $f \circ \eta$ is smooth. These results are consequences of the Sobolev Lemma which states that for a compact manifold of dimension n , the space of H^s -sections of a vector bundle E over M is contained, for $s > k + n/2$, in the space of \mathcal{C}^k -sections, and that the injection $H^s(E) \hookrightarrow \mathcal{C}^k(E)$ is continuous. In particular, for $s > 3/2$, $\text{Diff}^s(S^1)$ is the intersection of the space of \mathcal{C}^1 -diffeomorphisms of the circle with the space $H^s(S^1, S^1)$ of H^s maps from S^1 into itself. Hence $\text{Diff}^s(S^1)$ is an open set of $H^s(S^1, S^1)$.

For the same reasons, the subgroup of $\text{Diff}^s(S^1)$ preserving three points in S^1 , say $-1, -i$ and 1 , is, for $s > 3/2$, a \mathcal{C}^∞ manifold and a topological group modeled on the space of H^s -vector fields which vanish on $-1, -i$ and 1 .

One may ask what happens for the critical value $s = 3/2$ and look for a group with some regularity and a manifold structure such that the tangent space at the identity is isomorphic to the space of $H^{\frac{3}{2}}$ -vector fields vanishing at $-1, -i$ and 1 (or equivalently on any codimension 3 subspace of $H^{\frac{3}{2}}$). The universal Teichmüller space $T_0(1)$ defined below will verify these conditions.

Diff $^+(S^1)$ as a group of symplectomorphisms. Consider the Hilbert space $\mathcal{V} = H^{\frac{1}{2}}(S^1, \mathbb{R})/\mathbb{R}$ of real valued $H^{\frac{1}{2}}$ functions with mean-value zero. Each element $u \in \mathcal{V}$ can be written as

$$u(x) = \sum_{n \in \mathbb{Z}} u_n e^{inx} \quad \text{with} \quad u_0 = 0, \quad u_{-n} = \overline{u_n} \quad \text{and} \quad \sum_{n \in \mathbb{Z}} |n| |u_n|^2 < \infty.$$

Endow \mathcal{V} with the symplectic form

$$\Omega(u, v) = \frac{1}{2\pi} \int_{S^1} u(x) \partial_x v(x) dx = -i \sum_{n \in \mathbb{Z}} n u_n \overline{v_n},$$

The group of orientation preserving \mathcal{C}^∞ -diffeomorphisms of the circle acts on \mathcal{V} by

$$\varphi \cdot f = f \circ \varphi - \frac{1}{2\pi} \int_{S^1} f \circ \varphi,$$

preserving the symplectic form Ω . Note that the previous action is well-defined for any orientation preserving homeomorphism of S^1 . Therefore one may ask what is the biggest subgroup of the orientation preserving homeomorphisms of the circle which preserves \mathcal{V} and Ω . The answer is the group of quasimetric homeomorphisms of the circle defined below (Theorem 3.1 and Proposition 4.1 in [146]).

Teichmüller spaces of compact Riemann surfaces. Consider a compact Riemann surface Σ . The Teichmüller space $\mathcal{T}(\Sigma)$ of Σ is defined as the space of complex structures on Σ modulo the action by pull-back of the group of diffeomorphisms which are homotopic to the identity. It can be endowed with a Riemannian metric, called the Weil-Petersson metric, which is not complete. A point beyond which a geodesic can not be continued corresponds to the collapsing of a handle of the Riemann surface ([220]), hence yields to a Riemann surface with lower genus. One can ask for a Riemannian manifold in which all the Teichmüller spaces of compact Riemann surfaces with arbitrary genus inject isometrically. The answer will be the universal Teichmüller space endowed with a Hilbert manifold structure and its Weil-Petersson metric ([201]).

Quasiconformal and quasimetric mappings. Let us give some definitions and basic facts on quasiconformal and quasimetric mappings.

Definition 1.1.1. *An orientation preserving homeomorphism f of an open subset A in \mathbb{C} is called quasiconformal if the following conditions are satisfied.*

- f admits distributional derivatives $\partial_z f, \partial_{\bar{z}} f \in L^1_{loc}(A, \mathbb{C})$;
- there exists $0 \leq k < 1$ such that $|\partial_{\bar{z}} f(z)| \leq k |\partial_z f(z)|$ for every $z \in A$.

Such an homeomorphism is said to be K -quasiconformal, where $K = \frac{1+k}{1-k}$.

Example 1.1.2. *For example, $f(z) = \alpha z + \beta \bar{z}$ with $|\beta| < |\alpha|$ is $\frac{|\alpha|+|\beta|}{|\alpha|-|\beta|}$ -quasiconformal.*

Denote by $L^\infty(A, \mathbb{C})$ the complex Banach space of bounded complex valued functions on an open subset $A \subset \mathbb{C}$.

Theorem 1.1.3 ([129]). *An orientation preserving homeomorphism f defined on an open set $A \subset \mathbb{C}$ is quasiconformal if and only if it admits distributional derivatives $\partial_z f, \partial_{\bar{z}} f \in L^1_{loc}(A, \mathbb{C})$ which satisfy*

$$\partial_{\bar{z}} f(z) = \mu(z) \partial_z f(z), \quad z \in A$$

for some $\mu \in L^\infty(A, \mathbb{C})$ with $\|\mu\|_\infty < 1$.

The function μ appearing in the previous theorem is called the Beltrami coefficient or the complex dilatation of f . Let \mathbb{D} denote the open unit disc in \mathbb{C} .

Theorem 1.1.4 (Ahlfors-Bers). *Given $\mu \in L^\infty(\mathbb{D}, \mathbb{C})$ with $\|\mu\|_\infty < 1$, there exists a unique quasiconformal mapping $\omega_\mu : \mathbb{D} \rightarrow \mathbb{D}$ with Beltrami coefficient μ , extending continuously to $\overline{\mathbb{D}}$, and fixing $1, -1, i$.*

Definition 1.1.5. *An orientation preserving homeomorphism η of the circle S^1 is called quasimetric if there is a constant $M > 0$ such that for every $x \in \mathbb{R}$ and every $|t| \leq \frac{\pi}{2}$*

$$\frac{1}{M} \leq \frac{\tilde{\eta}(x+t) - \tilde{\eta}(x)}{\tilde{\eta}(x) - \tilde{\eta}(x-t)} \leq M,$$

where $\tilde{\eta}$ is the increasing homeomorphism on \mathbb{R} uniquely determined by $0 \leq \tilde{\eta}(0) < 1$, $\tilde{\eta}(x+1) = \tilde{\eta}(x) + 1$, and the condition that it projects onto η .

Theorem 1.1.6 (Beurling-Ahlfors extension Theorem). *Let η be an orientation preserving homeomorphism of S^1 . Then η is quasimetric if and only if it extends to a quasiconformal homeomorphism of the open unit disc \mathbb{D} into itself.*

$T(1)$ as a Banach manifold. One way to construct the universal Teichmüller space is the following. Denote by $L^\infty(\mathbb{D})_1$ the unit ball in $L^\infty(\mathbb{D}, \mathbb{C})$. By Ahlfors-Bers theorem, for any $\mu \in L^\infty(\mathbb{D})_1$, one can consider the unique quasiconformal mapping $w_\mu : \mathbb{D} \rightarrow \mathbb{D}$ which fixes $-1, -i$ and 1 and satisfies the Beltrami equation on \mathbb{D}

$$\frac{\partial}{\partial \bar{z}} \omega_\mu = \mu \frac{\partial}{\partial z} \omega_\mu.$$

Therefore one can define the following equivalence relation on $L^\infty(\mathbb{D})_1$. For $\mu, \nu \in L^\infty(\mathbb{D})_1$, set $\mu \sim \nu$ if $w_\mu|_{S^1} = w_\nu|_{S^1}$. The universal Teichmüller space is defined by the quotient space

$$T(1) = L^\infty(\mathbb{D})_1 / \sim.$$

Theorem 1.1.7 ([129]). *The space $T(1)$ has a unique structure of complex Banach manifold such that the projection map $\Phi : L^\infty(\mathbb{D})_1 \rightarrow T(1)$ is a holomorphic submersion.*

The differential of Φ at the origin $D_0\Phi : L^\infty(\mathbb{D}, \mathbb{C}) \rightarrow T_{[0]}T(1)$ is a complex linear surjection and induces a splitting of $L^\infty(\mathbb{D}, \mathbb{C})$ into ([201]) :

$$L^\infty(\mathbb{D}, \mathbb{C}) = \text{Ker } D_0\Phi \oplus \Omega_\infty(\mathbb{D}),$$

where $\Omega_\infty(\mathbb{D})$ is the Banach space defined by

$$\Omega_\infty(\mathbb{D}) := \left\{ \mu \in L^\infty(\mathbb{D}, \mathbb{C}) \mid \mu(z) = (1 - |z|^2)^2 \overline{\phi(z)}, \quad \phi \text{ holomorphic on } \mathbb{D} \right\}.$$

$T(1)$ as a group. By the Beurling-Ahlfors extension theorem, a quasiconformal mapping on \mathbb{D} extends to a quasimetric homeomorphism on the unit circle. Therefore the following map is a well-defined bijection

$$\begin{aligned} T(1) &\rightarrow \text{QS}(S^1)/PSU(1,1) \\ [\mu] &\mapsto [w_\mu|_{S^1}]. \end{aligned}$$

The coset $\text{QS}(S^1)/PSU(1,1)$ inherits from its identification with $T(1)$ a Banach manifold structure. Moreover the coset $\text{QS}(S^1)/PSU(1,1)$ can be identified with the subgroup of quasimetric homeomorphisms fixing $-1, i$ and 1 . This identification allows to endow the universal Teichmüller space with a group structure. Relative to this differential structure, the right translations in $T(1)$ are biholomorphic mappings, whereas the left translations are not even continuous in general. Consequently $T(1)$ is not a topological group.

The WP-metric and the Hilbert manifold structure on $T(1)$. The Banach manifold $T(1)$ carries a Weil-Petersson metric, which is defined only on a distribution of the tangent bundle ([147]). In order to resolve this problem the idea in [201] is to change the differentiable structure of $T(1)$.

Theorem 1.1.8 ([201]). *The universal Teichmüller space $T(1)$ admits a structure of Hilbert manifold on which the Weil-Petersson metric is a right-invariant strong hermitian metric.*

For this Hilbert manifold structure, the tangent space at $[0]$ in $T(1)$ is isomorphic to

$$\Omega_2(\mathbb{D}) := \left\{ \mu(z) = (1 - |z|^2)^2 \overline{\phi(z)}, \quad \phi \text{ holomorphic on } \mathbb{D}, \quad \|\mu\|_2 < \infty \right\},$$

where $\|\mu\|_2^2 = \int_{\mathbb{D}} |\mu|^2 \rho(z) d^2z$ is the L^2 -norm of μ with respect to the hyperbolic metric of the Poincaré disc $\rho(z) d^2z = 4(1 - |z|^2)^{-2} d^2z$. The Weil-Petersson metric on $T(1)$ is given at the tangent space at $[0] \in T(1)$ by

$$\langle \mu, \nu \rangle_{WP} := \iint_{\mathbb{D}} \mu \bar{\nu} \rho(z) d^2z$$

With respect to this Hilbert manifold structure, $T(1)$ admits uncountably many connected components. For this Hilbert manifold structure, the identity component $T_0(1)$ of $T(1)$ is a topological group. Moreover the pull-back of the Weil-Petersson metric on the quotient space $\text{Diff}_+(S^1)/\text{PSU}(1,1)$ is given at [Id] by

$$h_{WP}([\text{Id}])([u], [v]) = 2\pi \sum_{n=2}^{\infty} n(n^2 - 1) u_n \bar{v}_n.$$

Hence the identity component $T_0(1)$ of $T(1)$ can be seen as the completion of $\text{Diff}_+(S^1)/\text{PSU}(1,1)$ for the $H^{3/2}$ -norm. This metric make $T(1)$ into a strong Kähler-Einstein Hilbert manifold, with respect to the complex structure given at [Id] by the Hilbert transform (see below where the definition of the Hilbert transform is recalled). The tangent space at [Id] consists of Sobolev class $H^{3/2}$ vector fields modulo $\mathfrak{psu}(1,1)$. The associated Riemannian metric is given by

$$g_{WP}([\text{Id}])([u], [v]) = \pi \sum_{n \neq -1, 0, 1} |n|(n^2 - 1) u_n \bar{v}_n,$$

and the imaginary part of the Hermitian metric is the two-form

$$\omega_{WP}([\text{Id}])([u], [v]) = -i\pi \sum_{n \neq -1, 0, 1} n(n^2 - 1) u_n \bar{v}_n.$$

Note that ω_{WP} coincides with the Kirillov-Kostant-Souriau symplectic form obtained on $\text{Diff}_+(S^1)/\text{PSU}(1,1)$ when considered as a coadjoint orbit of the Bott-Virasoro group.

1.2 Fingerprint map

In this section, we make the link between Teichmüller theory presented above and shape analysis presented in next chapter. The link is made through the fingerprint map introduced in [190]. Together with the Weil-Petersson metric, it was used in [190] to compare images in applications to pattern recognition. See also [80] for the interplay with the Hilbert structure of the universal Teichmüller space mentioned in Theorem 1.1.8 and more details on the geometry involved.

Consider a Jordan curve γ in the plane. Denote by \mathcal{O} and \mathcal{O}^* the two connected components of $\mathbb{C} \setminus \gamma$. By the Riemann mapping theorem, there exists two conformal maps $f : \mathbb{D} \rightarrow \mathcal{O}$ and $g : \mathbb{D}^* \rightarrow \mathcal{O}^*$ from the unit disc \mathbb{D} and $\mathbb{D}^* := \{z \in \mathbb{C}, |z| > 1\}$ into \mathcal{O} and \mathcal{O}^* respectively. Both f and g extends to homeomorphisms between the closure of the domains and one can form the **conformal welding**

$$h := g^{-1} \circ f : \mathbb{S}^1 \rightarrow \mathbb{S}^1.$$

There exists homeomorphisms of \mathbb{S}^1 that are not conformal weldings, but any quasi-symmetric homeomorphism h is a conformal welding and the decomposition $h = g^{-1} \circ f$, where $f : \mathbb{D} \rightarrow \mathcal{O}$ and $g : \mathbb{D}^* \rightarrow \mathcal{O}^*$ are conformal, is unique. The Jordan curve $\gamma := f(\mathbb{S}^1) = g(\mathbb{S}^1)$ is called the **quasi-circle** associated to h . Reciprocally, the map that to a quasi-circle associates a quasi-symmetric homeomorphism of \mathbb{S}^1 is called the **fingerprint map** of γ .

Using the fingerprint map, we can pull-back the Weil-Petersson metric of $QS(S^1)/PSU(1,1) = T(1)$ to the set of quasi-circles modulo translations and scaling. The geodesics between quasi-circles for the Weil-Petersson metric furnish interpolations between 2D-contours in the plane. Other interpolation procedures will be presented in the next chapter.

1.3 The restricted Siegel disc

The Siegel disc. Let $\mathcal{V} = H^{\frac{1}{2}}(S^1, \mathbb{R})/\mathbb{R}$ be the Hilbert space of real valued $H^{\frac{1}{2}}$ functions with mean-value zero. The Hilbert inner product on \mathcal{V} is given by

$$\langle u, v \rangle_{\mathcal{V}} = \sum_{n \in \mathbb{Z}} |n| u_n \bar{v}_n.$$

Endow the real Hilbert space \mathcal{V} with the following complex structure (called the Hilbert transform)

$$J \left(\sum_{n \neq 0} u_n e^{inx} \right) = i \sum_{n \neq 0} \text{sgn}(n) u_n e^{inx}.$$

Now $\langle \cdot, \cdot \rangle_{\mathcal{V}}$ and J are compatible in the sense that J is orthogonal with respect to $\langle \cdot, \cdot \rangle_{\mathcal{V}}$. The associated symplectic form is defined by

$$\Omega(u, v) = \langle u, J(v) \rangle_{\mathcal{V}} = \frac{1}{2\pi} \int_{S^1} u(x) \partial_x v(x) dx = -i \sum_{n \in \mathbb{Z}} n u_n \bar{v}_n.$$

Let us consider the **complexified Hilbert space** $\mathcal{H} := H^{1/2}(S^1, \mathbb{C})/\mathbb{C}$ and the complex linear extensions of J and Ω still denoted by the same letters. Each element $u \in \mathcal{H}$ can be written as

$$u(x) = \sum_{n \in \mathbb{Z}} u_n e^{inx} \quad \text{with} \quad u_0 = 0 \quad \text{and} \quad \sum_{n \in \mathbb{Z}} |n| |u_n|^2 < \infty.$$

The eigenspaces \mathcal{H}_+ and \mathcal{H}_- of the operator J are the following subspaces

$$\mathcal{H}_+ = \left\{ u \in \mathcal{H} \mid u(x) = \sum_{n=1}^{\infty} u_n e^{inx} \right\} \quad \text{and} \quad \mathcal{H}_- = \left\{ u \in \mathcal{H} \mid u(x) = \sum_{n=-\infty}^{-1} u_n e^{inx} \right\},$$

and one has the Hilbert decomposition $\mathcal{H} = \mathcal{H}_+ \oplus \mathcal{H}_-$ into the sum of closed orthogonal subspaces. **The Siegel disc** associated with \mathcal{H} is defined by

$$\mathfrak{D}(\mathcal{H}) := \{ Z \in L(\mathcal{H}_-, \mathcal{H}_+) \mid \Omega(Zu, v) = \Omega(Zv, u), \forall u, v \in \mathcal{H}_- \quad \text{and} \quad I - Z\bar{Z} > 0 \},$$

where, for $A \in L(\mathcal{H}_+, \mathcal{H}_+)$, the notation $A > 0$ means $\langle A(u), u \rangle_{\mathcal{H}} > 0$, for all $u \in \mathcal{H}_+, u \neq 0$ and where for $B \in L(\mathcal{H}_-, \mathcal{H}_+)$, define

$$\bar{B}(u) := \overline{B(\bar{u})}, \quad B^T := (\bar{B})^*.$$

It follows easily that $\mathfrak{D}(\mathcal{H})$ can be written as

$$\mathfrak{D}(\mathcal{H}) := \{ Z \in L(\mathcal{H}_-, \mathcal{H}_+) \mid Z^T = Z, \quad \text{and} \quad I - Z\bar{Z} > 0 \}.$$

The restricted Siegel disc associated with \mathcal{H} is by definition

$$\mathfrak{D}_{\text{res}}(\mathcal{H}) := \{ Z \in \mathfrak{D}(\mathcal{H}) \mid Z \in L^2(\mathcal{H}_-, \mathcal{H}_+) \},$$

where $L^2(\mathcal{H}_-, \mathcal{H}_+)$ denotes the space of Hilbert-Schmidt operators from \mathcal{H}_- to \mathcal{H}_+ .

The restricted Siegel disc as a homogeneous space. Consider the symplectic group $\mathrm{Sp}(\mathcal{V}, \Omega)$ of bounded linear maps on \mathcal{V} which preserve the symplectic form Ω

$$\mathrm{Sp}(\mathcal{V}, \Omega) = \{a \in \mathrm{GL}(\mathcal{V}) \mid \Omega(au, av) = \Omega(u, v), \text{ for all } u, v \in \mathcal{V}\}.$$

The restricted symplectic group $\mathrm{Sp}_{\mathrm{res}}(\mathcal{V}, \Omega)$ is by definition the intersection of the symplectic group with the restricted general linear group defined by

$$\mathrm{GL}_{\mathrm{res}}(\mathcal{H}) = \{g \in \mathrm{GL}(\mathcal{H}) \mid [d, g] \in L^2(\mathcal{H})\},$$

where $d := i(p_+ - p_-)$ and p_{\pm} is the orthogonal projection onto \mathcal{H}_{\pm} . Using the block decomposition with respect to the decomposition $\mathcal{H} = \mathcal{H}_+ \oplus \mathcal{H}_-$, one gets

$$\mathrm{Sp}_{\mathrm{res}}(\mathcal{V}, \Omega) := \left\{ \begin{pmatrix} g & h \\ \bar{h} & \bar{g} \end{pmatrix} \in \mathrm{GL}(\mathcal{H}) \mid h \in L^2(\mathcal{H}_-, \mathcal{H}_+), gg^* - hh^* = I, gh^T = hg^T \right\}.$$

Proposition 1.3.1. *The restricted symplectic group acts transitively on the restricted Siegel disc by*

$$\mathrm{Sp}_{\mathrm{res}}(\mathcal{V}, \Omega) \times \mathfrak{D}_{\mathrm{res}}(\mathcal{H}) \longrightarrow \mathfrak{D}_{\mathrm{res}}(\mathcal{H}), \quad \left(\begin{pmatrix} g & h \\ \bar{h} & \bar{g} \end{pmatrix}, Z \right) \longmapsto (gZ + h)(\bar{h}Z + \bar{g})^{-1}.$$

The isotropy group of $0 \in \mathfrak{D}_{\mathrm{res}}(\mathcal{H})$ is the unitary group $\mathrm{U}(\mathcal{H}_+)$ of \mathcal{H}_+ , and the restricted Siegel disc is diffeomorphic as Hilbert manifold to the homogeneous space $\mathrm{Sp}_{\mathrm{res}}(\mathcal{V}, \Omega)/\mathrm{U}(\mathcal{H}_+)$.

On the space $\{A \in L^2(H_-, H_+) \mid A^T = A\}$ consider the following Hermitian inner product

$$\mathrm{Tr}(V^*U) = \mathrm{Tr}(\bar{V}U).$$

Since it is invariant under the isotropy group of $0 \in \mathfrak{D}_{\mathrm{res}}(\mathcal{H})$, it extends to an $\mathrm{Sp}_{\mathrm{res}}(\mathcal{V}, \Omega)$ -invariant Hermitian metric $h_{\mathfrak{D}}$.

Remark 1.3.2. In the construction above, replace \mathcal{V} by \mathbb{R}^2 endowed with its natural symplectic structure. The corresponding Siegel disc is nothing but the open unit disc \mathbb{D} . The action of $\mathrm{Sp}(2, \mathbb{R}) = \mathrm{SL}(2, \mathbb{R})$ is the standard action of $\mathrm{SU}(1, 1)$ on \mathbb{D} given by

$$z \in \mathbb{D} \longmapsto \frac{az + b}{bz + a} \in \mathbb{D}, \quad |a|^2 - |b|^2 = 1,$$

and the Hermitian metric obtained on \mathbb{D} is given by the hyperbolic metric

$$h_{\mathfrak{D}}(z)(u, v) = \frac{1}{(1 - |z|^2)^2} u\bar{v}.$$

Therefore, $\mathfrak{D}_{\mathrm{res}}(\mathcal{H})$ can be seen as an infinite-dimensional generalization of the Poincaré disc.

1.4 The period mapping

The following theorems answer the second question addressed in the first Section.

Theorem 1.4.1 (Theorem 3.1 in [146]). *For ϕ an orientation preserving homeomorphism and any $f \in \mathcal{V}$, set by $V_{\phi}f = f \circ \phi - \frac{1}{2\pi} \int_{S^1} f \circ \phi$. Then V_{ϕ} maps \mathcal{V} into itself iff ϕ is quasisymmetric.*

Theorem 1.4.2 (Proposition 4.1 in [146]). *The group $\mathrm{QS}(S^1)$ of quasisymmetric homeomorphisms of the circle acts on the right by symplectomorphisms on $\mathcal{H} = H^{1/2}(S^1, \mathbb{C})/\mathbb{C}$ by*

$$V_{\phi}f = f \circ \phi - \frac{1}{2\pi} \int_{S^1} f \circ \phi,$$

$\varphi \in \mathrm{QS}(S^1)$, $f \in \mathcal{H}$.

Consequently this action defines a map $\Pi : \mathrm{QS}(S^1) \rightarrow \mathrm{Sp}(\mathcal{V}, \Omega)$. Note that the operator $\Pi(\varphi)$ preserves the subspaces \mathcal{H}_+ and \mathcal{H}_- iff φ belongs to $\mathrm{PSU}(1, 1)$. The resulting map (Theorem 7.1 in [146]) is an injective equivariant holomorphic immersion

$$\Pi : T(1) = \mathrm{QS}(S^1)/\mathrm{PSU}(1, 1) \rightarrow \mathrm{Sp}(\mathcal{V}, \Omega)/\mathrm{U}(H_+) \simeq \mathfrak{D}(\mathcal{H})$$

called the **period mapping** of $T(1)$. The Hilbert version of the period mapping is given by the following

Theorem 1.4.3 ([201]). For $[\mu] \in T(1)$, $\Pi([\mu])$ belongs to the restricted Siegel disc if and only if $[\mu] \in T_0(1)$. Moreover the pull-back of the natural Kähler metric on $\mathfrak{D}_{\text{res}}(\mathcal{H})$ coincides, up to a constant factor, with the Weil-Petersson metric on $T_0(1)$.

1.5 Isotropic polarizations and complex structures

This Section is based on a work in progress with F. Gay-Balmaz and T. Ratiu. Let \mathcal{V} be a real Hilbert space and endow the complexified Hilbert space $\mathcal{H} := \mathcal{V} \otimes \mathbb{C}$ with the induced Hermitian product $\langle \cdot, \cdot \rangle_{\mathcal{H}} := h_{\mathcal{H}}$ defined by

$$\begin{aligned} h_{\mathcal{H}}(u + iv, x + iy) &:= \langle u, x \rangle_{\mathcal{V}} + \langle v, y \rangle_{\mathcal{V}} + i(\langle v, x \rangle_{\mathcal{V}} - \langle u, y \rangle_{\mathcal{V}}) \\ &= \langle u + iv, \overline{x + iy} \rangle_{\mathcal{V}}, \end{aligned} \quad (1.1)$$

where in the last line, the inner product $\langle \cdot, \cdot \rangle_{\mathcal{V}}$ is extended by complex bilinearity to \mathcal{H} . Suppose that \mathcal{V} is endowed with a strong symplectic form Ω . We will still denote by Ω the complex bilinear extension of Ω to \mathcal{H} .

A **polarization** of \mathcal{H} is a complex and closed subspace W of \mathcal{H} such that

$$\mathcal{H} = W \oplus \overline{W},$$

where $\overline{W} = \{\bar{w} \in \mathcal{H} \mid w \in W\}$. We denote by p_W and $p_{\overline{W}}$ the projections associated to this decomposition. Note that, since Ω is extended to \mathcal{H} by complex bilinearity, we have

$$\overline{\Omega(w, z)} = \Omega(\bar{w}, \bar{z}).$$

Therefore

$$\overline{i\Omega(w, \bar{w})} = -i\Omega(\bar{w}, w) = i\Omega(w, \bar{w}).$$

This proves that $i\Omega(w, \bar{w}) \in \mathbb{R}$ and allows us to define a **positive polarization relative to Ω** by the condition

$$i\Omega(w, \bar{w}) > 0, \quad \text{for all } w \in W, w \neq 0.$$

If in addition W is isotropic, we say that the decomposition is an **isotropic polarization**. We denote by $\mathcal{P}ol(\mathcal{H}, \Omega)$ the set of all isotropic polarizations of \mathcal{H} and by $\mathcal{P}ol^+(\mathcal{H}, \Omega)$ the set of all positive and isotropic polarizations of (\mathcal{H}, Ω) .

Remark 1.5.1. Let us show that in an isotropic polarization, both W and \overline{W} are **Lagrangian**, that is, $W = W^{\perp\Omega}$. Since Ω is extended to \mathcal{H} by complex bilinearity, it follows that $W \subset W^{\perp\Omega} \Rightarrow \overline{W} \subset \overline{W^{\perp\Omega}}$, where $W^{\perp\Omega} := \{v \in \mathcal{H} \mid \Omega(v, w) = 0, \forall w \in W\}$. Any $u \in W^{\perp\Omega}$ decomposes as $u = u_1 + u_2$, $u_1 \in W$, $u_2 \in \overline{W}$. Thus, for any $w \in W$, we have $0 = \Omega(u, w) = \Omega(u_1, w) + \Omega(u_2, w) = \Omega(u_2, w)$ since $W \subset W^{\perp\Omega}$. Therefore, $u_2 \in \overline{W} \cap W^{\perp\Omega} \subset \overline{W^{\perp\Omega}} \cap W^{\perp\Omega} = (\overline{W} + W)^{\perp\Omega} = \mathcal{H}^{\perp\Omega} = \{0\}$ because Ω is nondegenerate.

Given a real Hilbert space (\mathcal{V}, Ω) endowed with a strong symplectic form, we denote by $\mathcal{J}(\mathcal{V}, \Omega)$ the set of all **linear complex structures on \mathcal{V} , compatible** with Ω . Here a complex structure $K : \mathcal{V} \rightarrow \mathcal{V}$, $K^2 = -I$ is said to be compatible with Ω if

$$\Omega(Kw, Kz) = \Omega(w, z)$$

for all w, z in \mathcal{V} . Given $K \in \mathcal{J}(\mathcal{V}, \Omega)$ we can form the symmetric and strongly nondegenerate bilinear form on \mathcal{V}

$$g_K(u, v) := \Omega(Ku, v).$$

Note that we have

$$g_K(Ku, Kv) = g_K(u, v) \quad \text{and} \quad \Omega(u, v) = g_K(u, Kv).$$

Since $g_K(u, v) = \langle Au, v \rangle_{\mathcal{V}}$, for a symmetric and isomorphism $A : \mathcal{V} \rightarrow \mathcal{V}$, using Proposition 3.6 in Appendix of [125], we have the equivalence:

$$g_K(u, u) \geq 0, \quad \text{for all } u \in \mathcal{V} \quad \iff \quad g_K(u, u) > 0, \quad \text{for all } u \in \mathcal{V}, u \neq 0.$$

In this case we say that K is **positive**. We denote by $\mathcal{J}^+(\mathcal{V}, \Omega)$ the set of all compatible and positive complex structures on \mathcal{V} . Theorem 3.1.19 in [2] ensures that the set $\mathcal{J}^+(\mathcal{V}, \Omega)$ is non empty.

The associated Hermitian bilinear form on $\mathcal{H} = \mathcal{V} \otimes \mathbb{C}$ is defined by

$$h_K(w, z) := g_K(w, \bar{z}),$$

where g_K is extended by complex bilinearity to \mathcal{H} . Note that h_K is positive definite if and only if g_K is positive definite. If we extend Ω to \mathcal{H} by complex linearity, we have

$$\Omega(w, z) = h_K(w, \overline{Kz}) = h_K(w, K\bar{z}). \quad (1.2)$$

Theorem 1.5.2. *Consider a real Hilbert space \mathcal{V} endowed with a strong symplectic form Ω . Then the map*

$$\mathcal{P}ol(\mathcal{H}, \Omega) \rightarrow \mathcal{J}(\mathcal{V}, \Omega), \quad W \mapsto K_W := i(p_W - p_{\overline{W}})$$

is a bijection. The inverse is

$$\mathcal{J}(\mathcal{V}, \Omega) \rightarrow \mathcal{P}ol(\mathcal{H}, \Omega), \quad K \mapsto W_K := \text{Eig}_i(K).$$

Moreover, for all $W \in \mathcal{P}ol(\mathcal{H}, \Omega)$, we have

$$i\Omega(v, \bar{w}) = h_K(v, w), \quad \text{for all } v, w \in W,$$

where $K = K_W$. Thus the map $W \mapsto K_W$ restricts to a bijection

$$\mathcal{P}ol^+(\mathcal{H}, \Omega) \rightarrow \mathcal{J}^+(\mathcal{V}, \Omega).$$

Proof. We first show that $K_W \in \mathcal{J}(\mathcal{V}, \Omega)$. For $w \in \mathcal{H}$ we have

$$K_W(K_W(w)) = i(p_W - p_{\overline{W}})i(p_W - p_{\overline{W}})(w) = -(p_W + p_{\overline{W}})(w) = -w.$$

Since W and \overline{W} are isotropic, for $w, z \in W$ (or $w, z \in \overline{W}$) we have $\Omega(w, z) = 0$ and

$$\Omega(K_W(w), K_W(z)) = \Omega(iw, iz) = -\Omega(w, z) = 0.$$

For $w \in W$ and $z \in \overline{W}$ we have

$$\Omega(K_W(w), K_W(z)) = \Omega(iw, -iz) = \Omega(w, z).$$

This proves that $\Omega(K_W(w), K_W(z)) = \Omega(w, z)$ for all $w, z \in \mathcal{H}$.

Given $K \in \mathcal{J}(\mathcal{V}, \Omega)$, we now prove that $W_K \in \mathcal{P}ol(\mathcal{H}, \Omega)$. Clearly W_K is isotropic, since for all $w, z \in W_K = \text{Eig}_i(K)$ we have

$$\Omega(w, z) = \Omega(iw, iz) = -\Omega(w, z).$$

Using that $\overline{W_K} = \overline{\text{Eig}_i(K)} = \text{Eig}_{-i}(K)$, we obtain $W_K \cap \overline{W_K} = \{0\}$ and $\mathcal{H} = W_K \oplus \overline{W_K}$. The associate projections are

$$p_{W_K}(w) = \frac{w - iK(w)}{2} \quad \text{and} \quad p_{\overline{W_K}}(w) = \frac{w + iK(w)}{2}.$$

One sees directly that $\text{Eig}_i(K_W) = W$. This proves that $K \mapsto W_K$ is a left inverse of $W \mapsto K_W$, and therefore that $W \mapsto K_W$ is injective. To prove that $W \mapsto K_W$ is surjective it suffices to show that $K \mapsto W_K$ is the right inverse of $W \mapsto K_W$, that is, $K_{W_K} = K$. Using the formulas for p_{W_K} and $p_{\overline{W_K}}$, we have

$$K_{W_K} = i(p_{W_K} - p_{\overline{W_K}}) = K.$$

For all $W \in \mathcal{P}ol(\mathcal{H}, \Omega)$ and $v, w \in W$, we have for $K = K_W$

$$\begin{aligned} i\Omega(v, \bar{w}) &= ig_K(v, K\bar{w}) = ig_K(v, -i\bar{w}) \\ &= g_K(v, \bar{w}) = h_K(v, w). \end{aligned} \quad (1.3)$$

Since the decomposition $\mathcal{H} = W \oplus \overline{W}$ is orthogonal with respect to h_K , we obtain that $i\Omega(w, \bar{w}) > 0$ for all $w \in W$ if and only if h_K is positive definite. ■

1.6 The restricted groups $\mathrm{GL}_{\mathrm{res}}(\mathcal{H})$, $\mathrm{U}_{\mathrm{res}}(\mathcal{H})$, and $\mathrm{Sp}_{\mathrm{res}}(\mathcal{V}, \Omega)$

We now assume that we have a decomposition $\mathcal{H} = \mathcal{H}_+ \oplus \mathcal{H}_-$ into the sum of two closed infinite-dimensional subspaces. The projection onto \mathcal{H}_{\pm} parallel to \mathcal{H}_{\mp} will be denoted by p_{\pm} . We recall from [172], [233] the following facts (see also [149]).

The **restricted general linear group**, relative to the polarization $\mathcal{H} = \mathcal{H}_+ \oplus \mathcal{H}_-$ is defined by

$$\mathrm{GL}_{\mathrm{res}}(\mathcal{H}) = \{a \in \mathrm{GL}(\mathcal{H}) \mid [d, a] \in L^2(\mathcal{H})\},$$

where $d := K_{\mathcal{H}_+} = i(p_+ - p_-) \in \mathfrak{u}(\mathcal{H})$. Note that $g \in \mathrm{GL}(\mathcal{H})$ can be written

$$a = \begin{pmatrix} a_+ & a_{-+} \\ a_{+-} & a_- \end{pmatrix},$$

where $a_+ \in L(\mathcal{H}_+, \mathcal{H}_+)$, $a_{-+} \in L(\mathcal{H}_-, \mathcal{H}_+)$, $a_{+-} \in L(\mathcal{H}_+, \mathcal{H}_-)$ and $a_- \in L(\mathcal{H}_-, \mathcal{H}_-)$. Using this notation, for any $a \in \mathrm{GL}(\mathcal{H})$, we have

$$\begin{aligned} a \in \mathrm{GL}_{\mathrm{res}}(\mathcal{H}) &\Leftrightarrow [d, a] \in L^2(\mathcal{H}) \\ &\Leftrightarrow a_{-+} \in L^2(\mathcal{H}_-, \mathcal{H}_+) \text{ and } a_{+-} \in L^2(\mathcal{H}_+, \mathcal{H}_-). \end{aligned}$$

Using that left and right composition of a bounded operator with a Hilbert-Schmidt operator is Hilbert-Schmidt we have $ab \in \mathrm{GL}_{\mathrm{res}}(\mathcal{H})$ for all $a, b \in \mathrm{GL}_{\mathrm{res}}(\mathcal{H})$.

Since $a \in \mathrm{GL}_{\mathrm{res}}(\mathcal{H})$ is invertible and $a^{-1} \in \mathrm{GL}_{\mathrm{res}}(\mathcal{H})$, we obtain that a_+ and a_- are invertible modulo compact operators, and therefore, that they are Fredholm operators, see Theorem VII.2 in [163]. Moreover we have

$$\mathrm{Ind} a_+ = -\mathrm{Ind} a_-,$$

where $\mathrm{Ind} A$ is the Fredholm index of the operator A , defined by

$$\mathrm{Ind} A := \dim \ker A - \mathrm{codim} \mathrm{range} A.$$

It can be shown that $\mathrm{GL}_{\mathrm{res}}(\mathcal{H})$ is a Banach Lie group and an open subset of the Banach algebra

$$\mathfrak{gl}_{\mathrm{res}}(\mathcal{H}) = \{A \in \mathfrak{gl}(\mathcal{H}) \mid [d, A] \in L^2(\mathcal{H})\}$$

endowed with the norm

$$\|A\|_{\mathrm{res}} := \|A\| + \|[d, A]\|_2.$$

Unlike $\mathrm{GL}(\mathcal{H})$, the restricted general linear group $\mathrm{GL}_{\mathrm{res}}(\mathcal{H})$ has infinitely many connected components. More precisely, a and b are in the same connected component if and only if $\mathrm{Ind} a_+ = \mathrm{Ind} b_+$.

Similar, the **restricted unitary group** and its Lie algebra are given by

$$\begin{aligned} \mathrm{U}_{\mathrm{res}}(\mathcal{H}) &= \{a \in \mathrm{U}(\mathcal{H}) \mid [d, a] \in L^2(\mathcal{H})\} = \mathrm{U}(\mathcal{H}) \cap \mathrm{GL}_{\mathrm{res}}(\mathcal{H}), \text{ and} \\ \mathfrak{u}_{\mathrm{res}}(\mathcal{H}) &= \{A \in \mathfrak{u}(\mathcal{H}) \mid [d, A] \in L^2(\mathcal{H})\} = \mathfrak{u}(\mathcal{H}) \cap \mathfrak{gl}_{\mathrm{res}}(\mathcal{H}). \end{aligned}$$

The group $\mathrm{U}_{\mathrm{res}}(\mathcal{H})$ has also infinitely many connected components. As in the case of $\mathrm{GL}_{\mathrm{res}}(\mathcal{H})$, $a, b \in \mathrm{U}_{\mathrm{res}}(\mathcal{H})$ are in the same connected component if and only if $\mathrm{Ind} a_+ = \mathrm{Ind} b_+$.

Let (\mathcal{V}, Ω) be a real Hilbert space endowed with a strong symplectic form and suppose that the associated operator J is a complex structure compatible with the inner product $\langle \cdot, \cdot \rangle_{\mathcal{V}}$. Recall that when $a \in \mathrm{Sp}(\mathcal{V}, \Omega)$ is seen as acting on $\mathcal{H} := \mathcal{V} \otimes \mathbb{C}$, it reads

$$a = \begin{pmatrix} g & h \\ \bar{h} & \bar{g} \end{pmatrix},$$

relative to the splitting $\mathcal{H} = \mathcal{H}_+ \oplus \mathcal{H}_-$, $\mathcal{H}_{\pm} := \mathrm{Eig}_{\pm}(J)$ with conditions

$$gg^* - hh^* = I, \quad gh^T = hg^T.$$

on g and h . The **restricted symplectic group** is

$$\begin{aligned} \mathrm{Sp}_{\mathrm{res}}(\mathcal{V}, \Omega) &:= \mathrm{Sp}(\mathcal{V}, \Omega) \cap \mathrm{GL}_{\mathrm{res}}(\mathcal{H}) \\ &= \left\{ \begin{pmatrix} g & h \\ \bar{h} & \bar{g} \end{pmatrix} \in \mathrm{Sp}(\mathcal{V}, \Omega) \mid h \in L^2(\mathcal{H}_-, \mathcal{H}_+) \right\}, \end{aligned}$$

and its Lie algebra is given by

$$\mathfrak{sp}_{\text{res}}(\mathcal{V}, \Omega) = \left\{ \begin{pmatrix} A_1 & A_2 \\ \bar{A}_2 & \bar{A}_1 \end{pmatrix} \in \mathfrak{sp}(\mathcal{V}, \Omega) \mid A_2 \in L^2(\mathcal{H}_-, \mathcal{H}_+) \right\}.$$

Using the identities $g^*g = I + h^T\bar{h}$ and $gg^* = I + hh^*$ we obtain that g^*g and gg^* are positive definite and, therefore, injective. This proves that g and g^* are injective. Since g is Fredholm, its range is closed and equals $(\ker g^*)^\perp = \mathcal{H}_+$. This proves that g is a bijection and has Fredholm index zero. Thus, $\text{Sp}_{\text{res}}(\mathcal{V}, \Omega)$ sits in the connected component of the identity of $\text{GL}_{\text{res}}(\mathcal{H})$.

1.7 Restricted Siegel disc and restricted Grassmannian

This Section is based on a work in progress with F. Gay-Balmaz and T. Ratiu. Assume that we have a decomposition $\mathcal{H} = \mathcal{H}_+ \oplus \mathcal{H}_-$ into the orthogonal sum of two closed infinite-dimensional subspaces.

The **restricted Grassmannian** $\text{Gr}_{\text{res}}(\mathcal{H})$ is the set of all closed subspaces W of \mathcal{H} such that

- (i) the orthogonal projection $p_+ : W \rightarrow \mathcal{H}_+$ is a Fredholm operator,
- (ii) the orthogonal projection $p_- : W \rightarrow \mathcal{H}_-$ is a Hilbert-Schmidt operator.

Remark 1.7.1. Equivalently, $W \in \text{Gr}_{\text{res}}(\mathcal{H})$ if and only if W is the image of an operator $w : \mathcal{H}_+ \rightarrow \mathcal{H}$ such that $p_+ \circ w$ is Fredholm and $p_- \circ w$ is Hilbert-Schmidt. Note that if this is the case for w , this will be the case for any operator $w' : \mathcal{H}_+ \rightarrow \mathcal{H}$ such that $w'(\mathcal{H}_+) = W$. Thus

$$W \mapsto a(W),$$

defines a left action of $a \in \text{GL}_{\text{res}}(\mathcal{H}, \mathcal{H}_+)$ on $W \in \text{Gr}_{\text{res}}(\mathcal{H})$.

The following theorem summarizes the principal properties of $\text{Gr}_{\text{res}}(\mathcal{H})$, see [172], Corollary III.4 and Proposition III.5 of [233].

Theorem 1.7.2.

- (i) *The action of $\text{GL}_{\text{res}}(\mathcal{H}, \mathcal{H}_+)$ on $\text{Gr}_{\text{res}}(\mathcal{H})$ is transitive and the isotropy group of \mathcal{H}_+ is*

$$\mathbf{P} := \left\{ \begin{pmatrix} a_+ & a_{-+} \\ 0 & a_- \end{pmatrix} \in \text{GL}_{\text{res}}(\mathcal{H}, \mathcal{H}_+) \right\}$$

whose Lie algebra is

$$\mathfrak{p} = \left\{ \begin{pmatrix} A_+ & A_{-+} \\ 0 & A_- \end{pmatrix} \in \mathfrak{gl}_{\text{res}}(\mathcal{H}, \mathcal{H}_+) \right\}.$$

The action of $\text{U}_{\text{res}}(\mathcal{H}, \mathcal{H}_+)$ on $\text{Gr}_{\text{res}}(\mathcal{H})$ is transitive and the isotropy group of \mathcal{H}_+ is

$$\left\{ \begin{pmatrix} a_+ & 0 \\ 0 & a_- \end{pmatrix} \in \text{U}_{\text{res}}(\mathcal{H}, \mathcal{H}_+) \right\} \simeq \text{U}(\mathcal{H}_+) \times \text{U}(\mathcal{H}_-).$$

- (ii) *$\text{Gr}_{\text{res}}(\mathcal{H})$ can be endowed with a complex Hilbert manifold structure, relative to which the natural map*

$$\mathbf{P} \setminus \text{GL}_{\text{res}}(\mathcal{H}, \mathcal{H}_+) \rightarrow \text{Gr}_{\text{res}}(\mathcal{H})$$

is a diffeomorphism. The tangent map at $[I]_{\mathbf{P}}$ reads

$$\begin{bmatrix} A_+ & A_{-+} \\ A_{+-} & A_- \end{bmatrix}_{\mathfrak{p}} = \begin{bmatrix} 0 & 0 \\ A_{+-} & 0 \end{bmatrix}_{\mathfrak{p}} \mapsto A_{+-} \in L^2(\mathcal{H}_+, \mathcal{H}_-). \quad (1.4)$$

- (iii) *Let W be a closed subspace of \mathcal{H} and p_W the corresponding orthogonal projection. Then $W \in \text{Gr}_{\text{res}}(\mathcal{H})$ if and only if the operator $p_W - p_+$ is Hilbert-Schmidt.*

Consider a real Hilbert space \mathcal{V} endowed with a strong symplectic form Ω . Recall that we have a bijection

$$\mathcal{P}ol^+(\mathcal{H}, \Omega) \rightarrow \mathcal{J}^+(\mathcal{V}, \Omega).$$

Fix a complex structure $J \in \mathcal{J}^+(\mathcal{V}, \Omega)$, the corresponding polarization is $\mathcal{H}_+ := W_J = \text{Eig}_i(J)$. Relative to this choice we define

$$\begin{aligned} \mathcal{P}ol_{\text{res}}^+(\mathcal{H}, \Omega) &:= \mathcal{P}ol^+(\mathcal{H}, \Omega) \cap \text{Gr}_{\text{res}}(\mathcal{H}) \\ \mathcal{J}_{\text{res}}^+(\mathcal{V}, \Omega) &:= \{K \in \mathcal{J}^+(\mathcal{V}, \Omega) \mid K - J \in L^2(\mathcal{V})\}. \end{aligned}$$

Note that $\mathcal{P}ol^+(\mathcal{H}, \Omega)$ and $\mathcal{J}^+(\mathcal{V}, \Omega)$ do not depend on the choice of J , whereas $\mathcal{P}ol_{\text{res}}^+(\mathcal{H}, \Omega)$ and $\mathcal{J}_{\text{res}}^+(\mathcal{V}, \Omega)$ do. The following result shows that the previous definitions are compatible.

Lemma 1.7.3. *The bijection*

$$\mathcal{P}ol^+(\mathcal{H}, \Omega) \rightarrow \mathcal{J}^+(\mathcal{V}, \Omega), \quad W \mapsto K_W,$$

of Theorem 1.5.2 restricts to a bijection

$$\mathcal{P}ol_{\text{res}}^+(\mathcal{H}, \Omega) \rightarrow \mathcal{J}_{\text{res}}^+(\mathcal{V}, \Omega), \quad W \mapsto K_W.$$

Proof. Let $W \in \mathcal{P}ol^+(\mathcal{H}, \Omega)$ and consider the corresponding complex structure $K \in \mathcal{J}^+(\mathcal{V}, \Omega)$. By Theorem 1.7.2 we know that $W \in \mathcal{P}ol_{\text{res}}^+(\mathcal{H}, \Omega)$ if and only if $p_W - p_+$ is Hilbert-Schmidt.

Recall that we have

$$p_W(w) = \frac{w - iKw}{2}.$$

Therefore, we obtain

$$p_W - p_+ = \frac{p_- - p_+ - iK}{2} = \frac{i}{2}(i(p_+ - p_-) - K) = \frac{i}{2}(J - K).$$

This proves that $W \in \mathcal{P}ol_{\text{res}}^+(\mathcal{H}, \Omega)$ if and only if $K \in \mathcal{J}_{\text{res}}^+(\mathcal{V}, \Omega)$. \blacksquare

Theorem 1.7.4. *The action of $\text{GL}_{\text{res}}(\mathcal{H})$ on $\text{Gr}_{\text{res}}(\mathcal{H})$ restricts to a transitive action of $\text{Sp}_{\text{res}}(\mathcal{V}, \Omega)$ on $\mathcal{P}ol_{\text{res}}^+(\mathcal{H}, \Omega)$. The isotropy group of \mathcal{H}_+ is*

$$\left\{ \begin{pmatrix} g & 0 \\ 0 & \bar{g} \end{pmatrix} \in \text{Sp}_{\text{res}}(\mathcal{V}, \Omega) \right\} \simeq \text{U}(\mathcal{H}_+).$$

Proof. Let $W \in \mathcal{P}ol_{\text{res}}^+(\mathcal{H}, \Omega)$. For $a \in \text{Sp}_{\text{res}}(\mathcal{V}, \Omega)$, $a(W)$ is isotropic, $\overline{a(W)} = a(\overline{W})$ and

$$i\Omega(aw, \overline{aw}) = i\Omega(aw, a\bar{w}) = i\Omega(w, \bar{w}) > 0.$$

Since we already know that $a(W) \in \text{Gr}_{\text{res}}(\mathcal{H})$, we obtain that $a(W) \in \mathcal{P}ol_{\text{res}}^+(\mathcal{H}, \Omega)$.

We now show that the action is transitive. Let $W \in \mathcal{P}ol_{\text{res}}^+(\mathcal{H}, \Omega)$, and $K := K_W \in \mathcal{J}_{\text{res}}^+(\mathcal{V}, \Omega)$ be the corresponding complex structure. Let us show that W is in the orbit of \mathcal{H}_+ . For $v, w \in \mathcal{H}_+$ and $v', w' \in W$, we have

$$i\Omega(v, \bar{w}) = h_K(v, w) \quad \text{and} \quad i\Omega(v', \bar{w}') = h_{K'}(v', w'),$$

by (1.3). Consider orthonormal bases (e_j) and (e'_j) of \mathcal{H}_+ and W with respect to the Hermitian product h_J and h_K . Define $f_k := i\bar{e}_k$ and $f'_k := i\bar{e}'_k$, then (e_j, f_k) and (e'_j, f'_k) are symplectic bases of \mathcal{H} , that is,

$$\Omega(e_j, e_k) = 0, \quad \Omega(e_j, f_k) = \delta_{jk} \quad \text{and} \quad \Omega(f_j, f_k) = 0.$$

Define $a \in \text{GL}(\mathcal{H})$ by $ae_j := e'_j$ and $af_k := f'_k$, then a is symplectic and since $a\bar{u} = \overline{au}$, we have $a \in \text{Sp}(\mathcal{V}, \Omega)$. Since $a(\mathcal{H}_+) \in \text{Gr}_{\text{res}}(\mathcal{H})$, the operator $p_- \circ a|_{\mathcal{H}_+}$ is Hilbert-Schmidt hence $a \in \text{Sp}_{\text{res}}(\mathcal{V}, \Omega)$ by Remark 1.7.1. The isotropy group of \mathcal{H}_+ is easily seen to be $\text{U}(\mathcal{H}_+)$. \blacksquare

Remark 1.7.5. The previous Theorem shows that $\mathcal{P}ol_{\text{res}}^+(\mathcal{H}, \Omega)$ can be endowed with the complex Hilbert manifold structure of $\text{U}(\mathcal{H}_+) \backslash \text{Sp}_{\text{res}}(\mathcal{V}, \Omega)$. However, it will be more convenient to choose the conjugate complex manifold structure in order to have the following corollary which shows that this manifold structure is compatible with the complex Hilbert manifold structure of the restricted Grassmannian.

Corollary 1.7.6. Consider a real Hilbert space \mathcal{V} endowed with a strong symplectic form Ω . Fix $J \in \mathcal{J}^+(\mathcal{V}, \Omega)$ and consider the corresponding restricted sets $\mathcal{P}ol_{\text{res}}^+(\mathcal{H}, \Omega)$ and $\mathcal{J}_{\text{res}}^+(\mathcal{V}, \Omega)$. Then $\mathcal{P}ol_{\text{res}}^+(\mathcal{H}, \Omega)$ is a complex Hilbert submanifold of $\text{Gr}_{\text{res}}(\mathcal{H})$, where $\mathcal{H}_+ := \text{Eig}_i(J)$, and

$$T_{\mathcal{H}_+} \mathcal{P}ol_{\text{res}}^+(\mathcal{H}, \Omega) \cong \{A \in L^2(\mathcal{H}_+, \mathcal{H}_-) \mid A^T = A\}.$$

Proof. Recall that $\text{Gr}_{\text{res}}(\mathcal{H})$ is a complex Hilbert manifold complex diffeomorphic to the quotient $\text{P} \backslash \text{GL}_{\text{res}}(\mathcal{H})$. On the other hand, $\mathcal{P}ol_{\text{res}}^+(\mathcal{H}, \Omega)$ is endowed with the conjugate-complex Hilbert manifold structure of the quotient $\text{U}(\mathcal{H}_+) \backslash \text{Sp}_{\text{res}}(\mathcal{V}, \Omega)$, see Remark 1.7.5.

We begin by showing that $\text{U}(\mathcal{H}_+) \backslash \text{Sp}_{\text{res}}(\mathcal{V}, \Omega)$ is a real Banach submanifold of $\text{P} \backslash \text{GL}_{\text{res}}(\mathcal{H}, \mathcal{H}_+)$. Since $\text{Sp}_{\text{res}}(\mathcal{V}, \Omega)$ is a real Banach submanifold of $\text{GL}_{\text{res}}(\mathcal{H}, \mathcal{H}_+)$, and the inclusion is equivariant relative to the actions of $\text{U}(\mathcal{H}_+)$ on $\text{Sp}_{\text{res}}(\mathcal{V}, \Omega)$ and P on $\text{GL}_{\text{res}}(\mathcal{H}, \mathcal{H}_+)$, we obtain that the quotient map is smooth, see Theorem 5.9.6 in [39]. Since $\text{Sp}_{\text{res}}(\mathcal{V}, \Omega) \cap \text{P} = \text{U}(\mathcal{H}_+)$, it is also injective. So it remains to show that this inclusion is an embedding. This follows by noting that the projection maps are open.

The tangent map to the inclusion $\text{U}(\mathcal{H}_+) \backslash \text{Sp}_{\text{res}}(\mathcal{V}, \Omega) \hookrightarrow \text{P} \backslash \text{GL}_{\text{res}}(\mathcal{H}, \mathcal{H}_+)$ reads

$$\begin{aligned} \left[\begin{array}{cc} A & B \\ \bar{B} & \bar{A} \end{array} \right]_{\text{u}(\mathcal{H}_+)} &= \left[\begin{array}{cc} 0 & B \\ \bar{B} & 0 \end{array} \right]_{\text{u}(\mathcal{H}_+)} \in \mathfrak{u}(\mathcal{H}_+) \backslash \mathfrak{sp}_{\text{res}}(\mathcal{V}, \Omega) \\ &\longmapsto \left[\begin{array}{cc} A & B \\ \bar{B} & \bar{A} \end{array} \right]_{\text{p}} = \left[\begin{array}{cc} 0 & 0 \\ \bar{B} & 0 \end{array} \right]_{\text{p}} \in \mathfrak{p} \backslash \mathfrak{gl}_{\text{res}}(\mathcal{H}, \mathcal{H}_+) \end{aligned}$$

and is conjugate-complex linear since the complex structure on the left hand side is given by the identification with $\mathfrak{D}_{\text{res}}(\mathcal{H})$. This proves that the inclusion is antiholomorphic. Since $\mathcal{P}ol_{\text{res}}^+(\mathcal{H}, \Omega)$ is endowed with the conjugate-complex Hilbert manifold of $\text{U}(\mathcal{H}_+) \backslash \text{Sp}_{\text{res}}(\mathcal{V}, \Omega)$, it follows that $\mathcal{P}ol_{\text{res}}^+(\mathcal{H}, \Omega)$ is a complex Hilbert submanifold of $\text{Gr}_{\text{res}}(\mathcal{H})$. Thus the tangent space to $\mathcal{P}ol_{\text{res}}^+(\mathcal{H}, \Omega)$ at \mathcal{H}_+ is the subspace of the tangent space to the Grassmannian at \mathcal{H}_+ given by the stated formula. \blacksquare

Remark 1.7.7. For the complex Hilbert manifold structure on $\mathcal{J}_{\text{res}}^+(\mathcal{V}, \Omega)$ induced by the bijection given in Lemma 1.7.3, the tangent space at J is

$$T_J \mathcal{J}_{\text{res}}^+(\mathcal{V}, \Omega) = \left\{ \left(\begin{array}{cc} 0 & \bar{A} \\ A & 0 \end{array} \right) \middle| A \in L^2(\mathcal{H}_+, \mathcal{H}_-), A^T = A \right\},$$

where the complex structures in $\mathcal{J}_{\text{res}}^+(\mathcal{V}, \Omega)$ are seen as operators acting on $\mathcal{H} := \mathcal{V} \otimes \mathbb{C}$.

1.8 Korteweg-de Vries equation

1.8.1 Korteweg-de Vries equation as geodesic equation

The Korteweg-de Vries equation is the following shallow water equation:

$$u_t + 3u_x u + au_{xxx} = 0.$$

A curve in the Virasoro-Bott group is a geodesic for the right invariant L^2 -metric if and only if its right logarithmic derivative is a solution of the Korteweg-de Vries equation (see [162] and [104]). It was proved in [18] that the geodesic distance, induced by this metric, vanishes. This is a strictly infinite-dimensional phenomenon first uncountered in [142]. Moreover, it was proved in [44] that the corresponding energy functional, when restricted to paths with fixed endpoints, has no local minima. In particular, solutions of KdV do not define locally length-minimizing paths. These pathologies make this equation intriguing. Let me explain how it is related to the restricted Grassmannian.

1.8.2 KdV hierarchies and infinite-dimensional Grassmannians

Definition of the n -th KdV hierarchy

The n -th KdV hierarchy is the hierarchy of equations indexed by $k \in \mathbb{N}$ given in the Lax form by:

$$\frac{\partial L}{\partial t_k} = [(Q^k)_+, L], \quad k \in \mathbb{N}, \quad (1.5)$$

where $D = \frac{\partial}{\partial x}$, and L denotes a differential operator of order n of the form

$$L = D^n + u_{n-2}D^{n-2} + u_{n-3}D^{n-3} + \cdots + u_1D + u_0, \quad (1.6)$$

where Q is the pseudo-differential operator of the form

$$Q = D + \sum_{i=-1}^{-\infty} q_i D^i, \quad (1.7)$$

which satisfies $Q^n = L$, and where $(Q^k)_+$ denotes the projection of (Q^k) on the set of differential operators. In these expressions all coefficients belong to a certain class of functions of infinitely many variables x, t_2, t_3, \dots . Each operator of the form (1.6) belongs to the conjugation class of the operator D^n under the action of the group of pseudo-differential operators

$$G = \left\{ K = 1 + \sum_{i=-1}^{-\infty} a_i D^i \right\}.$$

Since L is conjugate to D^n , Q is conjugate to D , i.e. there exists an operator $K \in G$ such that $K^{-1}QK = D$, uniquely determined modulo right multiplication by a pseudo-differential operator with constant coefficients of the form $1 + \sum_{i=-1}^{-\infty} c_i D^i$.

From pseudo-differential operators to functions

The link with the restricted Grassmannian as explained in [185] is established via the pseudo-differential module

$$M = \left\{ f = e^{(xz+t_2z^2+t_3z^3+\dots)} \left(1 + \sum_{i=-1}^{-\infty} f_i z^i \right) \right\},$$

generated by $e^{(xz+t_2z^2+t_3z^3+\dots)}$. The operator D acts on M by $\frac{\partial}{\partial x}$, and D^{-1} by

$$D^{-1}e^{(xz+t_2z^2+t_3z^3+\dots)} \left(1 + \sum_{i=-1}^{-\infty} f_i z^i \right) := e^{(xz+t_2z^2+t_3z^3+\dots)} (D+z)^{-1} \left(1 + \sum_{i=-1}^{-\infty} f_i z^i \right),$$

where $(D+z)^{-1}$ is the formal series $z^{-1} - Dz^{-2} + \dots$. In particular, one has:

$$De^{(xz+t_2z^2+t_3z^3+\dots)} = ze^{(xz+t_2z^2+t_3z^3+\dots)},$$

and

$$D^{-1}e^{(xz+t_2z^2+t_3z^3+\dots)} = z^{-1}e^{(xz+t_2z^2+t_3z^3+\dots)}.$$

Every element $f \in M$ determines a operator $K \in G$ by the application

$$\begin{aligned} \phi : \quad M &\rightarrow G \\ f = e^{(xz+t_2z^2+t_3z^3+\dots)} \left(1 + \sum_{i=-1}^{-\infty} f_i z^i \right) &\mapsto K = 1 + \sum_{i=-1}^{-\infty} f_i D^i. \end{aligned}$$

The inverse mapping is given by

$$\begin{aligned} \phi^{-1} : \quad G &\rightarrow M \\ K &\mapsto K \left(e^{(xz+t_2z^2+t_3z^3+\dots)} \right). \end{aligned}$$

From $W \in \text{Gr}_{\text{res}}(\mathcal{H})$ to solutions of the KP hierarchy

To each element W of the restricted Grassmannian of a Hilbert space H with decomposition $H = H_+ \oplus H_-$ is associated a function Ψ_W in M , called the Backer function of W , given by the preimage under the orthogonal projection onto H_+ of a given vector of H_+ (the constant function equal to 1 when H is viewed as $L^2(S^1, \mathbb{C})$, and H_+ as the subspace of functions which extend to holomorphic functions in the unit disc). This Backer function determines for each $r \in \mathbb{N}$ a unique differential operator P_r of order r of the form (1.6) that satisfies:

$$\frac{\partial \Psi_W}{\partial t_r} = P_r \Psi_W, \quad r \in \mathbb{N}. \quad (1.8)$$

The operator $K := \phi(\Psi_W)$ in G defines an operator Q of the form (1.7) by:

$$Q = KDK^{-1}. \quad (1.9)$$

The arguments below will show that Q is a solution of the following KP hierarchy:

$$\frac{\partial Q}{\partial t_r} = [(Q^r)_+, Q], \quad r \in \mathbb{N}. \quad (1.10)$$

Indeed differentiating (1.9) with respect to the variable t_r , one gets:

$$\frac{\partial Q}{\partial t_r} = \frac{\partial K}{\partial t_r} DK^{-1} - KDK^{-1} \frac{\partial K}{\partial t_r} K^{-1} = \left[\frac{\partial K}{\partial t_r} K^{-1}, Q \right]. \quad (1.11)$$

Since $K := \phi(\Psi_W)$, one has $\Psi_W = K \left(e^{(xz+t_2z^2+t_3z^3+\dots)} \right)$, and

$$\frac{\partial \Psi_W}{\partial t_r} = \frac{\partial}{\partial t_r} \left(K \left(e^{(xz+t_2z^2+t_3z^3+\dots)} \right) \right) = \frac{\partial K}{\partial t_r} \left(e^{(xz+t_2z^2+t_3z^3+\dots)} \right) + KD^r \left(e^{(xz+t_2z^2+t_3z^3+\dots)} \right).$$

Thus equation (1.8) can be written as:

$$\frac{\partial K}{\partial t_r} \left(e^{(xz+t_2z^2+t_3z^3+\dots)} \right) + KD^r \left(e^{(xz+t_2z^2+t_3z^3+\dots)} \right) = P_r K \left(e^{(xz+t_2z^2+t_3z^3+\dots)} \right),$$

which is equivalent to

$$\frac{\partial K}{\partial t_r} + KD^r = P_r K.$$

In particular, $P_r = (KD^r K^{-1})_+$ and:

$$\frac{\partial K}{\partial t_r} K^{-1} = P_r - KD^r K^{-1} = (Q^r)_+ - Q^r.$$

Since Q and Q^r commute, equation (1.11) is therefore equivalent to equation (1.10).

When W belongs to the sub-Grassmannian $\text{Gr}_{\text{res}}(\mathcal{H})^{(n)}$ consisting of elements $W \in \text{Gr}_{\text{res}}(\mathcal{H})$ stable under the multiplication by z^n , the above defined pseudo-differential operator Q has the property that Q^n is a differential operator of the form (1.6) which gives a solution of the n -th KdV hierarchy. The link between the KdV hierarchy and the Poisson geometry of the restricted Grassmannian will be established in the last chapter. In order to introduce some of the problems arising from the infinite-dimensional setting, we present in the next Section the Poisson structure of the unitary group of an (infinite-dimensional) Hilbert space.

1.9 Banach Poisson–Lie group structure on $U(\mathcal{H})$

This Section is based on a paper under review written in collaboration with T. Goliński. It explains some of the ideas used in chapter 6 and Chapter 7 on the example of the unitary group of an Hilbert space. More precisely, we consider here the Banach Lie group of bounded unitary operators $U(\mathcal{H})$ on a complex separable Hilbert space \mathcal{H} . We denote by $L_\infty(\mathcal{H})$ the Banach space of bounded linear operators on \mathcal{H} , and by $L_1(\mathcal{H})$ the Banach algebra of trace class operators on \mathcal{H} . The Banach Lie algebra of $U(\mathcal{H})$ consisting of skew-hermitian bounded operators will be denoted by $\mathfrak{u}(\mathcal{H})$ and the Banach Lie algebra of trace-class skew-hermitian operators by $\mathfrak{u}_1(\mathcal{H})$.

In the whole Section for a Banach space \mathfrak{b} we will use the notation \mathfrak{b}^* to denote the continuous dual of \mathfrak{b} , i.e. the Banach space of continuous functionals on \mathfrak{b} , and \mathfrak{b}_* for a predual of \mathfrak{b} , i.e. for a Banach space such that $(\mathfrak{b}_*)^* \cong \mathfrak{b}$.

The aim of this section is to define a structure of Banach Poisson–Lie group on $U(\mathcal{H})$ defined on the pre-cotangent bundle $T_*U(\mathcal{H})$, with fibers modeled on the Banach quotient space $L_1(\mathcal{H})/\mathfrak{u}_1(\mathcal{H})$. Notably $L_1(\mathcal{H})/\mathfrak{u}_1(\mathcal{H})$ inherits a Lie algebra structure from this construction.

The notion of Poisson manifold in the context of Banach manifolds was introduced in [156] and generalized in various directions in [46, 166, 152, 32, 24, 29, 213]. The notion of Poisson–Lie group in the finite-dimensional setting goes back to [66, 188, 113, 136]. The notion of Banach Poisson–Lie group was introduced in [213] and examples related to the Korteweg–de Vries hierarchy and restricted Grassmannian [27, 85] were investigated. Some other, more formal approaches to infinite dimensional Poisson–Lie groups can be found e.g. in [88, 238, 106]. The geometry of the unitary groups was studied e.g. in [89, 5, 28].

1.9.1 Definition of Banach Poisson–Lie groups

We recall in this section the generalization of the definition of Banach Poisson manifolds adapted to our considerations. The definition given below was introduced in [213] and called generalized Banach Poisson manifolds. In order to be coherent with the terminology used in [46], we will call this structure Banach sub-Poisson manifold. This notion is a generalization of the notion of Banach Poisson manifolds given in [156] to the case where the Poisson tensor is only defined on a subset of the cotangent bundle (Definition 6.4.5). This subset will be a bundle with possibly different topology and large enough that it is in duality with the tangent bundle (Definition 1.9.1). The definition of Banach Poisson–Lie groups in this context is given in Definition 1.9.8. In the finite-dimensional case, all these definitions become the usual ones.

Definition 1.9.1. *Let M be a Banach manifold. We will say that a Banach bundle \mathbb{F} over M is **in duality** with the tangent bundle to M if, for every $p \in M$, there is a duality pairing (i.e. non-degenerate continuous bilinear map) between the fibers \mathbb{F}_p and T_pM , which depends smoothly on p .*

Remark 1.9.2. Any Banach bundle \mathbb{F} over M in duality with TM injects continuously into T^*M , hence we will identify it sometimes with a subset of T^*M . Such a bundle \mathbb{F} will play the role of **co-characteristic distribution** in the sense of [29]. However in general it may not be a Banach subbundle of T^*M .

We will denote by $\Lambda^2\mathbb{F}^*$ the vector bundle over M whose fiber over $p \in M$ is the Banach space of continuous skew-symmetric bilinear forms on the subspace \mathbb{F}_p .

Definition 1.9.3. *Let M be a Banach manifold and \mathbb{F} a bundle in duality with TM . A smooth section π of $\Lambda^2\mathbb{F}^*$ is called a **Poisson tensor** on M with respect to \mathbb{F} if:*

1. for any closed local sections α, β of \mathbb{F} , the differential $d(\pi(\alpha, \beta))$ is a local section of \mathbb{F} ;
2. (Jacobi) for any closed local sections α, β, γ of \mathbb{F} ,

$$\pi(\alpha, d(\pi(\beta, \gamma))) + \pi(\beta, d(\pi(\gamma, \alpha))) + \pi(\gamma, d(\pi(\alpha, \beta))) = 0. \quad (1.12)$$

The triple (M, \mathbb{F}, π) will be called a **Banach sub-Poisson manifold**.

Remark 1.9.4. Given a Poisson tensor on a Banach manifold M , one can define a Poisson bracket on the space of locally defined functions with differentials in \mathbb{F} by

$$\{f, g\} = \pi(df, dg).$$

Condition 1 in Definition 6.4.5 ensures that the bracket of two such functions is again a function of the same type, and condition 2 is equivalent to the usual Jacobi identity. Consequently, the space of smooth functions on M with differentials in \mathbb{F} forms a Poisson algebra. Note that the existence of Hamiltonian vector fields is not generally assumed.

Remark 1.9.5. The notion of Banach sub-Poisson manifold is adapted to the infinite-dimensional context where:

1. the tangent space of a Banach manifold may be in duality with many different Banach spaces. All these Banach spaces can be identified with subspaces of the cotangent space ;
2. a Banach manifold M may not have partition of unity or bump functions, hence it may not be possible to extend locally defined objects to global ones. This explains why we consider local sections instead of smooth functions on M in order to define a Poisson structure on M .

Definition 1.9.6. *Let $(M_1, \mathbb{F}_1, \pi_1)$ and $(M_2, \mathbb{F}_2, \pi_2)$ be Banach sub-Poisson manifolds and $F : M_1 \rightarrow M_2$ a smooth map. One says that F is a **Poisson map** at $p \in M_1$ if*

1. the tangent map $T_pF : T_pM_1 \rightarrow T_{F(p)}M_2$ satisfies $T_pF^*(\mathbb{F}_2)_{F(p)} \subset (\mathbb{F}_1)_p$ and $T_pF^* : \mathbb{F}_2 \rightarrow \mathbb{F}_1$ is continuous ;
2. $(\pi_1)_p(T_pF^*(\alpha), T_pF^*(\beta)) = (\pi_2)_{F(p)}(\alpha, \beta)$ for any $\alpha, \beta \in (\mathbb{F}_2)_{F(p)}$.

One says that F is a Poisson map if it is a Poisson map at any $p \in M_1$.

Proposition 1.9.7. *Let $(M_1, \mathbb{F}_1, \pi_1)$ and $(M_2, \mathbb{F}_2, \pi_2)$ be Banach sub-Poisson manifolds. Then the product $M_1 \times M_2$ carries a natural Banach sub-Poisson manifold structure $(M_1 \times M_2, \mathbb{F}, \pi)$ where*

1. $M_1 \times M_2$ carries the product Banach manifold structure, in particular $T(M_1 \times M_2) \simeq TM_1 \oplus TM_2$ and $T^*(M_1 \times M_2) \simeq T^*M_1 \oplus T^*M_2$,

2. \mathbb{F} is the subbundle of $T^*M_1 \oplus T^*M_2$ defined as

$$\mathbb{F}_{(p,q)} = (\mathbb{F}_1)_p \oplus (\mathbb{F}_2)_q,$$

3. π is defined on \mathbb{F} by

$$\pi(\alpha_1 + \alpha_2, \beta_1 + \beta_2) = \pi_1(\alpha_1, \beta_1) + \pi_2(\alpha_2, \beta_2), \quad \alpha_1, \beta_1 \in \mathbb{F}_1, \alpha_2, \beta_2 \in \mathbb{F}_2.$$

Definition 1.9.8. *A **Banach Poisson–Lie group** is a Banach Lie group G equipped with a Banach sub-Poisson manifold structure (G, \mathbb{F}, π) such that the group multiplication $m : G \times G \rightarrow G$ is a Poisson map, where $G \times G$ is endowed with the product sub-Poisson structure.*

Remark 1.9.9. Let (G, \mathbb{F}, π) be a Banach Poisson–Lie group with Banach Lie algebra \mathfrak{g} and unit element $e \in G$. According to Proposition 5.6 in [213], the compatibility condition between the Poisson tensor π and the multiplication in G implies that G acts continuously on the fiber $\mathbb{F}_e \subset \mathfrak{g}^*$ by coadjoint action. By derivation, it follows that \mathfrak{g} acts also continuously on \mathbb{F}_e by coadjoint action.

1.9.2 Some subspaces of $\mathfrak{u}^*(\mathcal{H})$ in duality with $\mathfrak{u}(\mathcal{H})$

In order to define a Banach Poisson–Lie group structure on the Banach Lie group $U(\mathcal{H})$, we are looking for subspaces of the dual space $\mathfrak{u}^*(\mathcal{H})$ in duality with $\mathfrak{u}(\mathcal{H})$, on which $U(\mathcal{H})$ acts continuously by coadjoint action (see Remark 1.9.9).

Endow the Hilbert space \mathcal{H} with a Hilbert basis $\{|n\rangle\}_{n \in \mathbb{Z}}$ ordered in decreasing order. We will consider the following Banach Lie algebra of upper triangular trace-class operators:

$$\mathfrak{b}_1^+(\mathcal{H}) := \{\alpha \in L_1(\mathcal{H}) : \alpha|n\rangle \in \text{span}\{|m\rangle, m \geq n\} \text{ and } \langle n|\alpha|n\rangle \in \mathbb{R}, \text{ for } n \in \mathbb{Z}\}.$$

This Section is organized as follows. In Subsection 1.9.2, we show that there is a duality pairing between $\mathfrak{b}_1^+(\mathcal{H})$ and $\mathfrak{u}(\mathcal{H})$ and prove that $\mathfrak{u}(\mathcal{H})$ does not act continuously on $\mathfrak{b}_1^+(\mathcal{H})$ by coadjoint action, hence $\mathfrak{b}_1^+(\mathcal{H})$ cannot be used to define a Poisson–Lie group structure on $U(\mathcal{H})$. In Subsection 1.9.2, we construct a subspace of $\mathfrak{u}^*(\mathcal{H})$ into which $\mathfrak{b}_1^+(\mathcal{H})$ injects as a dense subspace and on which $\mathfrak{u}(\mathcal{H})$ acts continuously.

Duality pairing between $\mathfrak{u}(\mathcal{H})$ and $\mathfrak{b}_1^+(\mathcal{H})$

Proposition 1.9.10. *The continuous bilinear map between $\mathfrak{u}(\mathcal{H})$ and $\mathfrak{b}_1^+(\mathcal{H})$ given by the imaginary part of the trace*

$$\begin{aligned} \mathfrak{u}(\mathcal{H}) \times \mathfrak{b}_1^+(\mathcal{H}) &\rightarrow \mathbb{R} \\ (A, B) &\mapsto \Im \text{Tr } AB \end{aligned}$$

is non-degenerate, hence it defines a duality pairing between $\mathfrak{u}(\mathcal{H})$ and $\mathfrak{b}_1^+(\mathcal{H})$.

Proof. It follows by direct calculation using e.g. operators $E_{nm} := |n\rangle\langle m|$. □

For finite-dimensional \mathcal{H} , this proposition implies that $\mathfrak{b}_1^+(\mathcal{H})$ can be identified with the dual of $\mathfrak{u}(\mathcal{H})$. In the rest of the paper we will assume that \mathcal{H} is infinite-dimensional. In this case $\mathfrak{b}_1^+(\mathcal{H})$ can be identified with a proper subspace of $\mathfrak{u}^*(\mathcal{H})$ using the duality pairing defined in Proposition 1.9.10.

Theorem 1.9.11. *The coadjoint action of $\mathfrak{u}(\mathcal{H})$ is unbounded on the image of $\mathfrak{b}_1^+(\mathcal{H})$ in $\mathfrak{u}^*(\mathcal{H})$.*

Proof. Denote by T_+ (resp. T_{++}) the linear transformation truncating an operator to the upper triangular part (resp. strictly upper triangular part) with respect to the Hilbert basis $\{|n\rangle\}_{n \in \mathbb{Z}}$:

$$\langle m|T_{++}(A)n\rangle := \begin{cases} \langle m|An\rangle & \text{if } m > n \\ 0 & \text{if } m \leq n \end{cases} \quad (1.13)$$

$$\langle m|T_+(A)n\rangle := \begin{cases} \langle m|An\rangle & \text{if } m \geq n \\ 0 & \text{if } m < n \end{cases} \quad (1.14)$$

Recall that T_+ is unbounded on $L_\infty(\mathcal{H})$, as well as on $L_1(\mathcal{H})$ (see [121], [84], [57]), but they are bounded on the space of Hilbert–Schmidt operators $L_2(\mathcal{H})$ since they are just orthogonal projections. Let us denote by T_0 the diagonal truncation defined by $T_0 = T_+ - T_{++}$, which is bounded on $L_\infty(\mathcal{H})$ and $L_1(\mathcal{H})$.

Let us consider the coadjoint action of $\mathfrak{u}(\mathcal{H})$ on the image of $\mathfrak{b}_1^+(\mathcal{H})$ in $\mathfrak{u}^*(\mathcal{H})$. An element $B \in \mathfrak{b}_1^+(\mathcal{H})$ defines a functional $C \mapsto \Im \text{Tr } CB$, $C \in \mathfrak{u}(\mathcal{H})$, on which $A \in \mathfrak{u}(\mathcal{H})$ acts by coadjoint action as:

$$C \mapsto \Im \text{Tr } [A, C]B = -\Im \text{Tr } C[A, B].$$

Since for any $C \in \mathfrak{u}(\mathcal{H})$ and $D \in L_1(\mathcal{H})$,

$$\Im \text{Tr } CD = \Im \text{Tr } C((T_{++} + \frac{1}{2}T_0)(D + D^*)),$$

we have

$$\text{ad}_A^* B = -(T_{++} + \frac{1}{2}T_0)([A, B] + [A, B]^*). \quad (1.15)$$

We show that this coadjoint action is unbounded on $\mathfrak{b}_1^+(\mathcal{H})$. To this end let us decompose the Hilbert space \mathcal{H} into the sum of two orthogonal infinite-dimensional closed subspaces:

$$\mathcal{H} = \mathcal{H}_+ \oplus \mathcal{H}_-,$$

where \mathcal{H}_+ is the Hilbert space generated by $\{|n\rangle\}_{n \in \mathbb{N} \cup \{0\}}$ and \mathcal{H}_- is the Hilbert space generated by $\{|n\rangle\}_{-n \in \mathbb{N} \setminus \{0\}}$. Let us define a unitary operator $u : \mathcal{H}_- \rightarrow \mathcal{H}_+$ by $u| -n\rangle = |n-1\rangle$, $n \in \mathbb{N}$.

From unboundedness of T_+ it follows that there exists a sequence of Hermitian trace class operators K_n on \mathcal{H}_- such that

1. $\|K_n\|_1 \leq 1$,
2. $\lim_{n \rightarrow +\infty} \|T_+(K_n)\|_1 = +\infty$.

The bounded linear operators whose expressions with respect to the decomposition $\mathcal{H} = \mathcal{H}_+ \oplus \mathcal{H}_-$ read

$$B_n := \begin{pmatrix} 0 & uK_n \\ 0 & 0 \end{pmatrix}$$

belong to $\mathfrak{b}_1^+(\mathcal{H})$. The skew-hermitian operator A whose expression with respect to the decomposition $\mathcal{H} = \mathcal{H}_+ \oplus \mathcal{H}_-$ reads

$$A := \begin{pmatrix} 0 & u \\ -u^* & 0 \end{pmatrix}$$

is bounded. Moreover

$$[A, B_n] = \left[\begin{pmatrix} 0 & u \\ -u^* & 0 \end{pmatrix}, \begin{pmatrix} 0 & uK_n \\ 0 & 0 \end{pmatrix} \right] = \begin{pmatrix} uK_n u^* & 0 \\ 0 & -K_n \end{pmatrix}.$$

Since K_n is Hermitian, from (1.15) we get

$$\text{ad}_A^* B_n = -(T_{++} + \frac{1}{2}T_0)([A, B_n]).$$

It follows that $\|\text{ad}_A^* B_n\|_1 \rightarrow \infty$ as $n \rightarrow \infty$ whereas $\|B_n\|_1 = \|K_n\|_1 \leq 1$. \square

We conclude from Remark 1.9.9 the following corollary.

Corollary 1.9.12. *There is no Banach Poisson–Lie group structure $(U(\mathcal{H}), \mathbb{F}, \pi)$ on $U(\mathcal{H})$ with bundle \mathbb{F} such that $\mathbb{F}_e = \mathfrak{b}_1^+(\mathcal{H}) \subset \mathfrak{u}(\mathcal{H})^*$.*

A subspace of $\mathfrak{u}^*(\mathcal{H})$ on which $\mathfrak{u}(\mathcal{H})$ acts continuously by coadjoint action

Consider the continuous linear map $\Phi : L_1(\mathcal{H}) \rightarrow \mathfrak{u}^*(\mathcal{H})$ which maps an operator $a \in L_1(\mathcal{H})$ to the linear functional on $\mathfrak{u}(\mathcal{H})$ given by

$$b \mapsto \Im \operatorname{Tr} ab$$

where $\Im \operatorname{Tr} ab$ is the imaginary part of the trace of $ab \in L_1(\mathcal{H})$.

Proposition 1.9.13. *The kernel of Φ equals $\mathfrak{u}_1(\mathcal{H})$, therefore $L_1(\mathcal{H})/\mathfrak{u}_1(\mathcal{H})$ injects into the dual space $\mathfrak{u}(\mathcal{H})^*$ and can be identified with the predual space $\mathfrak{u}(\mathcal{H})_*$. It is closed and preserved by the coadjoint action of $U(\mathcal{H})$. Moreover functionals given by elements of $\mathfrak{b}_1^+(\mathcal{H})$ form a proper dense subspace.*

Proof.

- It is clear that $\mathfrak{u}_1(\mathcal{H})$ is contained in the kernel of Φ since the product of two skew-hermitian operators has a real trace. Let $a \in L_1(\mathcal{H})$ be such that $\Im \operatorname{Tr} ab = 0$ for any $b \in \mathfrak{u}(\mathcal{H})$. One has for any $b \in \mathfrak{u}(\mathcal{H})$ and $a \in L_1(\mathcal{H})$

$$\Im \operatorname{Tr} ab = \frac{1}{2i} (\operatorname{Tr} ab - \overline{\operatorname{Tr} ab}) = \frac{1}{2i} (\operatorname{Tr} ab + \operatorname{Tr} ba^*) = \frac{1}{2i} (\operatorname{Tr} (a + a^*)b).$$

Consequently,

$$a \in \ker(\Phi) \Rightarrow \operatorname{Tr} (a + a^*)b = 0 \quad \forall b \in \mathfrak{u}(\mathcal{H}).$$

By linearity of the trace, $\operatorname{Tr} (a + a^*)b = 0 \Rightarrow \operatorname{Tr} (a + a^*)ib = 0$. It follows that if $a \in \ker(\Phi)$, $\operatorname{Tr} (a + a^*)\tilde{b} = 0$ for any $\tilde{b} \in L_\infty(\mathcal{H})$. Since the dual of $L_1(\mathcal{H})$ viewed as complex Banach space can be identified with $L_\infty(\mathcal{H})$ using the trace, one has

$$a \in \ker(\Phi) \Rightarrow a + a^* = 0 \in L_1(\mathcal{H}).$$

Hence the kernel of Φ equals $\mathfrak{u}_1(\mathcal{H})$.

- From the previous point, we have an injection

$$L_1(\mathcal{H})/\mathfrak{u}_1(\mathcal{H}) \hookrightarrow \mathfrak{u}(\mathcal{H})^*. \quad (1.16)$$

From the Banach decomposition

$$L_1(\mathcal{H}) = \mathfrak{u}_1(\mathcal{H}) \oplus i\mathfrak{u}_1(\mathcal{H}) \quad (1.17)$$

given by $a \mapsto (\frac{1}{2}(a - a^*) ; \frac{1}{2}(a + a^*))$, it follows that

$$L_1(\mathcal{H})/\mathfrak{u}_1(\mathcal{H}) \simeq i\mathfrak{u}_1(\mathcal{H}). \quad (1.18)$$

It is known that

$$(i\mathfrak{u}_1(\mathcal{H}))^* \simeq \mathfrak{u}(\mathcal{H}),$$

see e.g. [156, Example 7.10]. Thus the injection (1.16) is in fact the natural injection of the Banach space $L_1(\mathcal{H})/\mathfrak{u}_1(\mathcal{H})$ into its bidual

$$(L_1(\mathcal{H})/\mathfrak{u}_1(\mathcal{H}))^{**} \simeq \mathfrak{u}(\mathcal{H})^*.$$

Its image is therefore a closed subspace of $\mathfrak{u}(\mathcal{H})^*$.

- Let us show that the range of Φ is preserved by the coadjoint action of $U(\mathcal{H})$. For $a \in L_1(\mathcal{H})$ and $b \in \mathfrak{u}(\mathcal{H})$, one has

$$\begin{aligned} \operatorname{Ad}_g^*(\Phi(a))(b) &= \Phi(a)(\operatorname{Ad}_g b) = \Im \operatorname{Tr} agbg^{-1} \\ &= \Im \operatorname{Tr} g^{-1}agb = \Phi(g^{-1}ag)(b), \end{aligned}$$

where $g^{-1}ag$ belongs to $L_1(\mathcal{H})$. Note that for $a \in \mathfrak{u}_1(\mathcal{H})$, $g^{-1}ag$ belongs to $\mathfrak{u}_1(\mathcal{H})$ for any $g \in U(\mathcal{H})$. Hence the coadjoint action of $g \in U(\mathcal{H})$ on $L_1(\mathcal{H})/\mathfrak{u}_1(\mathcal{H})$ reads

$$\operatorname{Ad}_g^*[a]_{\mathfrak{u}_1} = [g^{-1}ag]_{\mathfrak{u}_1}, \quad (1.19)$$

where $[a]_{\mathfrak{u}_1}$ denotes the class of $a \in L_1(\mathcal{H})$ modulo $\mathfrak{u}_1(\mathcal{H})$.

- Since $\mathfrak{b}_1^+(\mathcal{H}) \cap \mathfrak{u}_1(\mathcal{H}) = \{0\}$, we have $\mathfrak{b}_1^+(\mathcal{H}) \hookrightarrow L_1(\mathcal{H})/\mathfrak{u}_1(\mathcal{H}) \simeq i\mathfrak{u}_1(\mathcal{H})$. Under this identification an element $b \in \mathfrak{b}_1^+(\mathcal{H})$ is sent to $\frac{1}{2}(b + b^*)$. Hence $\mathfrak{b}_1^+(\mathcal{H})$ corresponds to those elements in $i\mathfrak{u}_1(\mathcal{H})$ that have a triangular truncation in $L_1(\mathcal{H})$. Any functional $a \in \mathfrak{u}(H) \simeq (L_1(\mathcal{H})/\mathfrak{u}_1(\mathcal{H}))^*$ vanishing on $\mathfrak{b}_1^+(\mathcal{H})$ by Proposition 1.9.10 is zero. Hence $\mathfrak{b}_1^+(\mathcal{H})$ is dense in $L_1(\mathcal{H})/\mathfrak{u}_1(\mathcal{H})$.

□

1.9.3 The unitary group $U(\mathcal{H})$ as a Banach Poisson–Lie group

In order to define a Banach Poisson–Lie group structure on $U(\mathcal{H})$ we need to introduce the Lie algebra $\mathfrak{u}_2(\mathcal{H})$ of Hilbert–Schmidt skew-hermitian operators, as well as the Lie algebra $\mathfrak{b}_2^+(\mathcal{H})$ of Hilbert–Schmidt upper triangular operators with real coefficients on the diagonal. Note that we have a direct sum decomposition of the space $L_2(\mathcal{H})$ of Hilbert–Schmidt operators into

$$L_2(\mathcal{H}) = \mathfrak{u}_2(\mathcal{H}) \oplus \mathfrak{b}_2^+(\mathcal{H}).$$

The corresponding projections $p_{\mathfrak{u}_2}$ and $p_{\mathfrak{b}_2^+}$ from $L_2(\mathcal{H})$ onto $\mathfrak{u}_2(\mathcal{H})$ and $\mathfrak{b}_2^+(\mathcal{H})$ respectively are continuous. Since $\mathfrak{u}_2(\mathcal{H})$ is invariant by conjugation by a unitary operator, but $\mathfrak{b}_2^+(\mathcal{H})$ is not, one has for $x \in L_1(\mathcal{H})$ and $g \in U(\mathcal{H})$,

$$p_{\mathfrak{b}_2^+}(g^{-1}xg) = p_{\mathfrak{b}_2^+}(g^{-1}p_{\mathfrak{b}_2^+}(x)g), \quad (1.20)$$

and

$$p_{\mathfrak{u}_2}(g^{-1}xg) = g^{-1}p_{\mathfrak{u}_2}(x)g + p_{\mathfrak{u}_2}(g^{-1}p_{\mathfrak{b}_2^+}(x)g). \quad (1.21)$$

Theorem 1.9.14. *Consider the Banach Lie group $U(\mathcal{H})$ and define*

- the precotangent bundle $\mathbb{F} = T_* U(\mathcal{H}) \subset T^* U(\mathcal{H})$ by right translations

$$\mathbb{F}_g = R_{g^{-1}}^*(L_1(\mathcal{H})/\mathfrak{u}_1(\mathcal{H})) = R_{g^{-1}}^*\mathfrak{u}(\mathcal{H})_*,$$

- the map $\Pi_r : U(\mathcal{H}) \rightarrow \Lambda^2 \mathbb{F}_e^*$ by

$$\Pi_r(g)([x_1]_{\mathfrak{u}_1}, [x_2]_{\mathfrak{u}_1}) = \Im \text{Tr} (g^{-1} p_{\mathfrak{b}_2^+}(x_1) g p_{\mathfrak{u}_2}(g^{-1} p_{\mathfrak{b}_2^+}(x_2) g)), \quad (1.22)$$

- the tensor $\pi \in \Lambda^2 \mathbb{F}^*$ by $\pi(g) = R_g^{**} \Pi_r(g)$.

Then $(U(\mathcal{H}), \mathbb{F}, \pi)$ is a Banach Poisson–Lie group. On the space of smooth functions with differentials in \mathbb{F} , the Poisson bracket reads:

$$\{f, h\}(g) = \Pi_r(g)(R_g^* df_g, R_g^* dh_g) = \Pi_r(g)(df_g \circ R_g, dh_g \circ R_g).$$

Proof. We need to check that π is compatible with the group multiplication and satisfies the Jacobi identity.

1. Using Proposition 5.7 in [213], the compatibility with the group multiplication is equivalent to the fact that Π_r satisfies the following cocycle condition:

$$\Pi_r(gu) = (\text{Ad}_g^*)^* \Pi_r(u) + \Pi_r(g), \quad (1.23)$$

where $(\text{Ad}_g^*)^*$ denotes the natural action of $g \in U(\mathcal{H})$ on $\Lambda^2 \mathbb{F}_e^*$ given explicitly by

$$(\text{Ad}_g^*)^* \Pi_r(u) ([x_1]_{\mathfrak{u}_1}, [x_2]_{\mathfrak{u}_1}) = \Pi_r(u) (\text{Ad}_g^*[x_1]_{\mathfrak{u}_1}, \text{Ad}_g^*[x_2]_{\mathfrak{u}_1}).$$

In order to check that condition, we use (1.19) and (1.22):

$$\begin{aligned} (\text{Ad}_g^*)^* \Pi_r(u) ([x_1]_{\mathfrak{u}_1}, [x_2]_{\mathfrak{u}_1}) &= \Pi_r(u) ([g^{-1}x_1g]_{\mathfrak{u}_1}, [g^{-1}x_2g]_{\mathfrak{u}_1}) \\ &= \Im \text{Tr} (u^{-1} p_{\mathfrak{b}_2^+}(g^{-1}x_1g) u p_{\mathfrak{u}_2}(u^{-1} p_{\mathfrak{b}_2^+}(g^{-1}x_2g) u)). \end{aligned}$$

Using (1.20), this expression can be further expressed as

$$\Im \text{Tr} (u^{-1} p_{\mathfrak{b}_2^+}(g^{-1} p_{\mathfrak{b}_2^+}(x_1) g) u p_{\mathfrak{u}_2}(u^{-1} p_{\mathfrak{b}_2^+}(g^{-1} p_{\mathfrak{b}_2^+}(x_2) g) u)).$$

Using the decomposition

$$p_{\mathfrak{b}_2^+}(g^{-1}p_{\mathfrak{b}_2^+}(x_1)g) = g^{-1}p_{\mathfrak{b}_2^+}(x_1)g - p_{\mathfrak{u}_2}(g^{-1}p_{\mathfrak{b}_2^+}(x_1)g) \quad (1.24)$$

and the fact that $\mathfrak{u}_2(\mathcal{H})$ is isotropic for the imaginary part of the trace, one has

$$\begin{aligned} & (\text{Ad}_g^*)^* \Pi_r(u) ([x_1]_{\mathfrak{u}_1}, [x_2]_{\mathfrak{u}_1}) \\ &= \Im \text{Tr} (u^{-1}g^{-1}p_{\mathfrak{b}_2^+}(x_1)g u p_{\mathfrak{u}_2}(u^{-1}p_{\mathfrak{b}_2^+}(g^{-1}p_{\mathfrak{b}_2^+}(x_2)g)u)). \end{aligned}$$

Using equation (1.24) for x_2 , one finally gets

$$\begin{aligned} & (\text{Ad}_g^*)^* \Pi_r(u) ([x_1]_{\mathfrak{u}_1}, [x_2]_{\mathfrak{u}_1}) \\ &= \Im \text{Tr} (u^{-1}g^{-1}p_{\mathfrak{b}_2^+}(x_1)g u p_{\mathfrak{u}_2}(u^{-1}g^{-1}p_{\mathfrak{b}_2^+}(x_2)g)u) \\ &\quad - \Im \text{Tr} (u^{-1}g^{-1}p_{\mathfrak{b}_2^+}(x_1)g u p_{\mathfrak{u}_2}(u^{-1}p_{\mathfrak{u}_2}(g^{-1}p_{\mathfrak{b}_2^+}(x_2)g)u)), \end{aligned}$$

which, after simplification by u in the last term, gives identity (1.23).

2. Note that by construction the sharp map $\sharp : \mathbb{F} \rightarrow \mathbb{F}^*$, $\alpha \mapsto \pi(\alpha, \cdot)$ takes values in the tangent space of $U(\mathcal{H})$. Therefore, in order to check that π satisfies the Jacobi identity, we can use formula (5.5) from Lemma 5.8 in [213]. We will show that

$$T_g \Pi_r(R_g \iota_{[x_3]_{\mathfrak{u}_1}} \Pi_r(g))([x_1]_{\mathfrak{u}_1}, [x_2]_{\mathfrak{u}_1}) = -\Im \text{Tr} p_{\mathfrak{u}_2}(C) [p_{\mathfrak{b}_2^+}(A), p_{\mathfrak{b}_2^+}(B)] \quad (1.25)$$

$$\langle x_1, [\iota_{[x_3]_{\mathfrak{u}_1}} \Pi_r(g), \iota_{[x_2]_{\mathfrak{u}_1}} \Pi_r(g)] \rangle = -\Im \text{Tr} p_{\mathfrak{u}_2}(C) [p_{\mathfrak{b}_2^+}(A), p_{\mathfrak{u}_2}(B)], \quad (1.26)$$

where $A = g^{-1}p_{\mathfrak{b}_2^+}(x_1)g$, $B = g^{-1}p_{\mathfrak{b}_2^+}(x_2)g$ and $C = g^{-1}p_{\mathfrak{b}_2^+}(x_3)g$. Jacobi identity will then follow by adding the terms obtained by circular permutations of equations (1.25) and (1.26), and remarking that

$$\begin{aligned} & -\Im \text{Tr} p_{\mathfrak{u}_2}(C) [p_{\mathfrak{b}_2^+}(A), p_{\mathfrak{b}_2^+}(B)] - \Im \text{Tr} p_{\mathfrak{u}_2}(C) [p_{\mathfrak{b}_2^+}(A), p_{\mathfrak{u}_2}(B)] \\ & -\Im \text{Tr} p_{\mathfrak{u}_2}(A) [p_{\mathfrak{b}_2^+}(B), p_{\mathfrak{b}_2^+}(C)] - \Im \text{Tr} p_{\mathfrak{u}_2}(A) [p_{\mathfrak{b}_2^+}(B), p_{\mathfrak{u}_2}(C)] \\ & -\Im \text{Tr} p_{\mathfrak{u}_2}(B) [p_{\mathfrak{b}_2^+}(C), p_{\mathfrak{b}_2^+}(A)] - \Im \text{Tr} p_{\mathfrak{u}_2}(B) [p_{\mathfrak{b}_2^+}(C), p_{\mathfrak{u}_2}(A)] \\ &= -\Im \text{Tr} p_{\mathfrak{u}_2}(C) [A, B] - \Im \text{Tr} p_{\mathfrak{b}_2^+}(C) [A, B] \\ &= -\Im \text{Tr} C [A, B] = -\Im \text{Tr} g^{-1}p_{\mathfrak{b}_2^+}(x_3)g [g^{-1}p_{\mathfrak{b}_2^+}(x_1)g, g^{-1}p_{\mathfrak{b}_2^+}(x_2)g] \\ &= -\Im \text{Tr} p_{\mathfrak{b}_2^+}(x_3) [p_{\mathfrak{b}_2^+}(x_1), p_{\mathfrak{b}_2^+}(x_2)] = 0, \end{aligned}$$

where the last equality follows from the fact that $\mathfrak{b}_2^+(\mathcal{H})$ is an isotropic subalgebra. In order to prove equations (1.25) and (1.26), one needs three ingredients:

- (a) The differentiation of the cocycle identity (1.23) with respect to u leads to the following identity

$$T_g \Pi_r(L_g X)([x_1]_{\mathfrak{u}_1}, [x_2]_{\mathfrak{u}_1}) = T_e \Pi_r(X)(\text{Ad}_g^*[x_1]_{\mathfrak{u}_1}, \text{Ad}_g^*[x_2]_{\mathfrak{u}_1}), \quad (1.27)$$

where $X \in \mathfrak{u}(\mathcal{H})$ and $g \in U(\mathcal{H})$.

- (b) The differentiation of equation (1.22) with respect to $g \in U(\mathcal{H})$ gives

$$T_e \Pi_r(Y)([x_1]_{\mathfrak{u}_1}, [x_2]_{\mathfrak{u}_1}) = \Im \text{Tr} Y [p_{\mathfrak{b}_2^+}(x_1), p_{\mathfrak{b}_2^+}(x_2)]. \quad (1.28)$$

- (c) By equation (1.22), the interior product of $\Pi_r(g)$ with $[x_3]_{\mathfrak{u}_1}$ is

$$\iota_{[x_3]_{\mathfrak{u}_1}} \Pi_r(g) = -g p_{\mathfrak{u}_2}(g^{-1}p_{\mathfrak{b}_2^+}(x_3)g)g^{-1} \in \mathfrak{u}(\mathcal{H}). \quad (1.29)$$

From equation (1.27), it follows that

$$\begin{aligned} T_g \Pi_r(R_g X)([x_1]_{\mathfrak{u}_1}, [x_2]_{\mathfrak{u}_1}) &= T_g \Pi_r(L_g \text{Ad}_{g^{-1}}(X))([x_1]_{\mathfrak{u}_1}, [x_2]_{\mathfrak{u}_1}) \\ &= T_e \Pi_r(\text{Ad}_{g^{-1}}(X))(\text{Ad}_g^*[x_1]_{\mathfrak{u}_1}, \text{Ad}_g^*[x_2]_{\mathfrak{u}_1}) \\ &= T_e \Pi_r(\text{Ad}_{g^{-1}}(X))([g^{-1}x_1g]_{\mathfrak{u}_1}, [g^{-1}x_2g]_{\mathfrak{u}_1}) \end{aligned}$$

Using equation (1.28), this simplifies to

$$T_g \Pi_r(R_g X)([x_1]_{\mathfrak{u}_1}, [x_2]_{\mathfrak{u}_1}) = \Im \text{Tr} g^{-1} X g [p_{\mathfrak{b}_2^+}(g^{-1} x_1 g), p_{\mathfrak{b}_2^+}(g^{-1} x_2 g)]. \quad (1.30)$$

Hence for $X = \iota_{[x_3]_{\mathfrak{u}_1}} \Pi_r(g)$, using equation (1.29) one gets

$$\begin{aligned} T_g \Pi_r(R_g \iota_{[x_3]_{\mathfrak{u}_1}} \Pi_r(g))([x_1]_{\mathfrak{u}_1}, [x_2]_{\mathfrak{u}_1}) \\ = -\Im \text{Tr} p_{\mathfrak{u}_2}(g^{-1} p_{\mathfrak{b}_2^+}(x_3) g) [p_{\mathfrak{b}_2^+}(g^{-1} x_1 g), p_{\mathfrak{b}_2^+}(g^{-1} x_2 g)] \end{aligned} \quad (1.31)$$

By equation (1.20) and by the isotropy of \mathfrak{b}_2^+ , one gets

$$\begin{aligned} T_g \Pi_r(R_g \iota_{[x_3]_{\mathfrak{u}_1}} \Pi_r(g))([x_1]_{\mathfrak{u}_1}, [x_2]_{\mathfrak{u}_1}) \\ = -\Im \text{Tr} g^{-1} p_{\mathfrak{b}_2^+}(x_3) g [p_{\mathfrak{b}_2^+}(g^{-1} p_{\mathfrak{b}_2^+}(x_1) g), p_{\mathfrak{b}_2^+}(g^{-1} p_{\mathfrak{b}_2^+}(x_2) g)], \\ = -\Im \text{Tr} p_{\mathfrak{u}_2}(g^{-1} p_{\mathfrak{b}_2^+}(x_3) g) [p_{\mathfrak{b}_2^+}(g^{-1} p_{\mathfrak{b}_2^+}(x_1) g), p_{\mathfrak{b}_2^+}(g^{-1} p_{\mathfrak{b}_2^+}(x_2) g)], \end{aligned} \quad (1.32)$$

which is equation (1.25). On the other hand, by equation (1.29) one gets

$$\begin{aligned} [\iota_{[x_3]_{\mathfrak{u}_1}} \Pi_r(g), \iota_{[x_2]_{\mathfrak{u}_1}} \Pi_r(g)] &= [-g p_{\mathfrak{u}_2}(g^{-1} p_{\mathfrak{b}_2^+}(x_3) g) g^{-1}, -g p_{\mathfrak{u}_2}(g^{-1} p_{\mathfrak{b}_2^+}(x_2) g) g^{-1}] \\ &= g [p_{\mathfrak{u}_2}(g^{-1} p_{\mathfrak{b}_2^+}(x_3) g), p_{\mathfrak{u}_2}(g^{-1} p_{\mathfrak{b}_2^+}(x_2) g)] g^{-1}. \end{aligned}$$

Hence

$$\begin{aligned} \langle x_1, [\iota_{[x_3]_{\mathfrak{u}_1}} \Pi_r(g), \iota_{[x_2]_{\mathfrak{u}_1}} \Pi_r(g)] \rangle \\ = \Im \text{Tr} x_1 g [p_{\mathfrak{u}_2}(g^{-1} p_{\mathfrak{b}_2^+}(x_3) g), p_{\mathfrak{u}_2}(g^{-1} p_{\mathfrak{b}_2^+}(x_2) g)] g^{-1} \\ = \Im \text{Tr} g^{-1} p_{\mathfrak{b}_2^+}(x_1) g [p_{\mathfrak{u}_2}(g^{-1} p_{\mathfrak{b}_2^+}(x_3) g), p_{\mathfrak{u}_2}(g^{-1} p_{\mathfrak{b}_2^+}(x_2) g)] \\ = -\Im \text{Tr} p_{\mathfrak{b}_2^+}(g^{-1} p_{\mathfrak{b}_2^+}(x_1) g) [p_{\mathfrak{u}_2}(g^{-1} p_{\mathfrak{b}_2^+}(x_2) g), p_{\mathfrak{u}_2}(g^{-1} p_{\mathfrak{b}_2^+}(x_3) g)]. \end{aligned} \quad (1.33)$$

By the compatibility of the bracket of operators with the trace ($\text{Tr} A[B, C] = \text{Tr} C[A, B]$), this can be rewritten as

$$\begin{aligned} \langle x_1, [\iota_{[x_3]_{\mathfrak{u}_1}} \Pi_r(g), \iota_{[x_2]_{\mathfrak{u}_1}} \Pi_r(g)] \rangle \\ = -\Im \text{Tr} p_{\mathfrak{u}_2}(g^{-1} p_{\mathfrak{b}_2^+}(x_3) g) [p_{\mathfrak{b}_2^+}(g^{-1} p_{\mathfrak{b}_2^+}(x_1) g), p_{\mathfrak{u}_2}(g^{-1} p_{\mathfrak{b}_2^+}(x_2) g)], \end{aligned} \quad (1.34)$$

which proves equation (1.26). □

Remark 1.9.15. The Lie bracket on $L^1(\mathcal{H})/\mathfrak{u}_1(\mathcal{H}) = \mathfrak{u}_*(\mathcal{H})$ that the Poisson–Lie group structure of $U(\mathcal{H})$ induces by Theorem (5.11) in [213] is given by

$$([x_1]_{\mathfrak{u}_1}, [x_2]_{\mathfrak{u}_1}) \mapsto [p_{\mathfrak{b}_2^+}(x_1), p_{\mathfrak{b}_2^+}(x_2)], \quad (1.35)$$

which is well defined on $L_1(\mathcal{H})/\mathfrak{u}_1(\mathcal{H})$ since $[p_{\mathfrak{b}_2^+}(x_1), p_{\mathfrak{b}_2^+}(x_2)] \in L_1(\mathcal{H})$ for any $x_1, x_2 \in L_1(\mathcal{H})$. Note that this bracket is continuous and extends the natural bracket of $\mathfrak{b}_1^+(\mathcal{H})$. To our knowledge it is an open question whether this Banach Lie algebra structure integrates to a Banach Lie group.

In the last chapter, we construct in a similar way a Poisson structure on the restricted unitary group which descends to a Poisson structure on the restricted Grassmannian, called Bruhat–Poisson structure. The link with the KdV hierarchy is made via the dressing action of the shift and its powers on the restricted Grassmannian.

Part II

Infinite-dimensional Geometry applied to Shape Analysis of Curves and Surfaces

Chapter 2

Shape Analysis of curves

2.1 Introduction

Curves in a homogeneous space appear in many applications: in shape recognition as outline of an object, in radar detection as the signature of a signal, as trajectories of hurricanes or movements of the joints of a tennis player, etc... There are two main features of the curve: the route and the speed profil. In this chapter, we are mainly interested in the route drawn by the curve and we will call it the unparameterized curve. An unparameterized curve can be travelled with many different speed profiles, like a car can travel with different speeds (not necessarily constant) along a given road. The choice of a speed profile is called a parameterization of the curve. It may be physically meaningful or not. For instance, depending on applications, there may not be any relevant parameterization of the contour of the statue of Liberty depicted in Figure 2.4. The set of parameterized curves, called the preshape space, has a natural fiber bundle structure: one can group parameterized curves together when they follow the same route. The set of unparameterized curves is called the shape space. An application which, to any unparameterized curve associates a parameterization of it, is called a section. Sections of fiber bundles are not linear spaces, but, in the case of the fiber bundle of parameterized curves, there is a linear space associated to any given section: the linear space of (generalized) curvature functions. It is a complete set of geometric invariants or descriptors of the unparameterized curves. This means in particular that given a curvature function keeping in mind a given section of the preshape space, one can construct uniquely a curve with this prescribed curvature function and with the parameterization in the chosen section. In Section 2.3 we will use this linear structure to interpolate easily between curves and to measure distances in shape space. We are also able to provide optimal parameterizations or optimal sampling of curves with a fixed number of points.

This chapter is organized as follows: in Section 2.1.1, we give some mathematical definitions of spaces of interest in this chapter. In Section 2.1.2, we stress the distinction between quotient space and section of a fiber bundle. This distinction is analogous to the distinction between a quotient vector space and a complement, and will be crucial in most of our applications. In Section 2.2, we recall the definition of arc-length parameterization, which is well-defined for rectifiable curves, and we show that the spaces of curves we are interested in are Fréchet manifolds (the use of Nash-Moser theorem is necessary in this context of manifolds modeled on Fréchet spaces). In Section 2.3, we show how we can use the moving frames attached to curves in order to define canonical parameterizations of curves and perform shape analysis. In Section 2.5, we consider with more details the canonical parameterization of plane curves given by arc-length, and study the pull-back of a family of Riemannian metrics called quotient elastic metrics on the manifold of arc-length parameterized curves. In this Riemannian context, we give some experimental insights of the energy landscape for the energy whose minimization leads to geodesics between curves. This chapter is based on our collaboration [208], and some of our talks on shape analysis.

2.1.1 Unparameterized curves in a homogeneous space

Roughly speaking, what we will call shape space consists in the set of curves in a homogeneous space. Examples of homogeneous spaces are for instance \mathbb{R}^n , any Lie group, the spheres, the set of positive definite matrices, the Siegel discs, Grassmannians of p -plans in \mathbb{R}^n and so on. The trajectory of a point in a homogeneous space can describe the contour of an organ in medical imagery, the evolution of a hurricane on the Earth, the joints of a tennis player, or the correlation matrix of a radar. There are two principal characteristics of the movement: the velocity of movement and the route. The corresponding mathematical objects are the following: a point-trajectory will be synonymous with a parameterized curve $f : [0, 1] \rightarrow G/H$ where G is a Lie group and H a closed Lie subgroup of G , and the route used by the point $f(t)$ will be synonymous with the shape $[f]$ of the curve f , which is the equivalence class of f modulo the action of the reparameterization group $\text{Diff}^+([0, 1])$. The shape $[f]$ of the parameterized curve f will be also called the unparameterized curve corresponding to f .

Let G be a Lie group, i.e. a smooth manifold which is also a group and such that the natural group operations are smooth. For instance G could be \mathbb{R}^n with group operation being the addition, or G could be the space $\text{GL}(n)$ of invertible n by n matrices with group operation the product of matrices, or G could be $\text{SO}(3)$ the set of all rotations in \mathbb{R}^3 . Let H be a closed subgroup of G and consider the quotient space G/H . An element of G/H is the orbit of $g \in G$ by right multiplication by elements of H . It is the set $gH = \{gh, h \in H\}$. For instance taking $G = \mathbb{R}^n$ and $H = \{0\}$, one obtains $G/H = \mathbb{R}^n$, or taking $G = \text{GL}(n)$ and $H = \text{O}(n)$, one obtains G/H equal to the set of positive definite matrices, or taking $G = \text{SO}(3)$ and $H = \text{SO}(2)$ one has G/H being the 2-sphere. Since H is supposed to be closed, the quotient space G/H is naturally endowed with a manifold structure.

The central object of the present chapter is the set \mathcal{F} of smooth curves f from $[0; 1]$ to G/H . It has a natural (Fréchet) manifold structure (see Section 2.2), for which a tangent vector at f is a vector field along the parameterized curve f in G/H . For instance when G/H is the 2-sphere, then a tangent vector at f is a vector field along the parameterized curve f which is for each value of the parameter tangent to the sphere. The regularity of the curves may depend on the applications.

There is an infinite dimensional group naturally acting on \mathcal{F} : the group of reparameterizations. We will consider only reparameterizations preserving the orientation of the curve, i.e. preserving the start and endpoint. We denote it by $\text{Diff}^+([0; 1])$. An element of $\text{Diff}^+([0; 1])$ is a strictly increasing smooth function from $[0; 1]$ to $[0; 1]$. The group operation in $\text{Diff}^+([0; 1])$ is the composition of applications. The action of $\varphi \in \text{Diff}^+([0; 1])$ on \mathcal{F} is given by $f \mapsto f \circ \varphi$, in particular it preserves the shape of the curve (which is the image of the application f).

The set of shapes of parameterized curves $f : [0; 1] \rightarrow G/H$ is the object of interest in shape analysis of curves. It is the quotient space $\mathcal{S} := \mathcal{F}/\text{Diff}^+([0; 1])$. An element $[f] \in \mathcal{S}$ is the orbit of $f : [0; 1] \rightarrow G/H$ under the action by reparameterization of $\text{Diff}^+([0; 1])$. It is the set of all functions from $[0; 1]$ into G/H which can be written $f \circ \varphi$ with $\varphi \in \text{Diff}^+([0; 1])$. Under mild conditions on the parameterized curves considered, the set \mathcal{S} admits a natural (Fréchet) manifold structure (see Section 2.2). There is a natural projection

$$p : \mathcal{F} \rightarrow \mathcal{S} = \mathcal{F}/\text{Diff}^+([0; 1]),$$

which consists in forgetting the parameterization of the curve f and considering only the route drawn by f in G/H . The triple $(\mathcal{F}, \mathcal{S}, p)$ is called a principal fiber bundle. Note that since we consider only reparameterizations that preserve the orientation, the elements in \mathcal{S} come equipped with a specified start and endpoint.

2.1.2 Quotient space versus section of a fiber bundle

The fiber bundle $p : \mathcal{F} \rightarrow \mathcal{S}$ is a particular example of a general mathematical object attached to a smooth action of a group on a manifold. Another instance of this notion is when \mathbb{R}^2 acts by translations on 2D-curves, or when \mathbb{R}^+ acts on shapes by scaling. If one is interested only in curves modulo translations, i.e. irrespective of their position in space, then one can either consider the quotient space of the manifold of curves modulo the action of \mathbb{R}^2 by translation, or consider only centered curves (see Tabular 2.1). When we specify which procedure we follow to center the curves, one is choosing a representant in each orbit under the action by translation. This preferred choice is called a *section* of the corresponding fiber bundle. Analogously, for the action of \mathbb{R}^+ by scaling,

a section of the manifold of simple closed curves could be the set of length-one curves or the set of curves enclosing an area equal to one. We give in tabular 2.1 examples of group actions on 2D simple closed curves and, for each case, two possible sections.

A global section of the fiber bundle $p : \mathcal{F} \rightarrow \mathcal{S}$ is a smooth application $S : \mathcal{S} \rightarrow \mathcal{F}$, such that $p \circ S([f]) = [f]$ for any $[f] \in \mathcal{S}$. There is one-to-one correspondance between the shape space \mathcal{S} and the range of S . Defining a global section of $p : \mathcal{F} \rightarrow \mathcal{S}$ is in fact defining a way to choose a preferred element in the fiber $p^{-1}([f])$ over $[f]$. It consists of singeling out a preferred parameterization of each oriented shape.







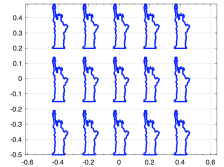

| Group G | Some elements of one orbit under the group G | a preferred element in the orbit | another choice of preferred element in the orbit |
|--|---|--|---|
| \mathbb{R}^3 acting by translation |  |  centered curve : $\int_0^1 \begin{pmatrix} f_1(s) \\ f_2(s) \end{pmatrix} \ f'(s)\ ds = \begin{pmatrix} 0 \\ 0 \end{pmatrix}$. |  curve starting at $\begin{pmatrix} 0 \\ 0 \end{pmatrix}$. |
| $SO(3)$ acting by rotation |  |  axes of approximating ellipse aligned |  tangent vector at starting point horizontal |
| \mathbb{R}^+ acting by scaling |  |  length = 1 |  enclosed area = 1 |
| $\text{Diff}^+([0; 1])$ acting by reparameterization |  |  arc-length parameterization |  curvature proportional parameterization |

Figure 2.1: Examples of group actions on 2D simple closed curves and different choices of sections of the corresponding fiber bundle.

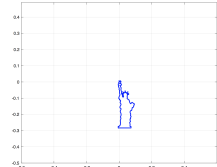
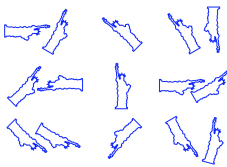
Let us give an example of a canonical section of the fiber bundle $p : \mathcal{F} \rightarrow \mathcal{S}$. Suppose that the homogeneous space G/H is endowed with a Riemannian structure. Then one can measure the norm of the velocity vector of a given curve in G/H , as well as the length of the curve. In this case, *the parameterization proportional to arc-length with parameter $s \in [0; 1]$* is a particularly natural global section of $p : \mathcal{F} \rightarrow \mathcal{S}$. It associates to the oriented shape $[f]$ the parameterization with constant speed such that the curve is travelled for a time parameter ranging in $[0; 1]$. It can be built by hand

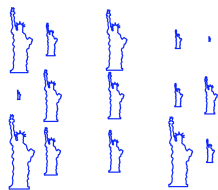
by just measuring the distances in G/H travelled by the curve, but it can be also recovered using *any* parameterization $t \mapsto f(t)$ by the change of parameter $t \mapsto s(t) = \frac{1}{L(f)} \int_0^t \|f'(t)\| dt$, where $L(f) = \int_0^1 \|f'(t)\| dt$ is the length of f . The statue of Liberty figuring in the middle of Fig. 2.4 is an example of a curve reparameterized proportional to arc-length.

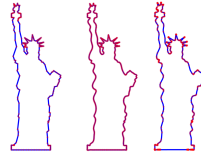
2.2 The space of curves as an infinite-dimensional manifold

2.2.1 Rectifiable curves

In this section we recall some basic facts about rectifiable curves and their approximations by polygonal lines. We refer the reader to [193] for a detailed exposition. Let γ be a curve in the plane parameterized by $\gamma(t) = (x(t), y(t))$, $a \leq t \leq b$, where $x(t)$ and $y(t)$ are continuous real-valued functions on $[a, b]$. The curve γ is called *rectifiable* if there exists $M < \infty$ such that, for any partition $a = t_0 < t_1 < \dots < t_N = b$ of $[a, b]$, one has

$$\sum_{j=1}^N |\gamma(t_j) - \gamma(t_{j-1})| \leq M. \quad (2.1)$$

By definition, the length of a rectifiable curve is well-defined as the supremum over all partitions of $[a, b]$ of the left-hand side in (2.1):

$$L(\gamma) = \sup_{a=t_0 < t_1 < \dots < t_N = b} \sum_{j=1}^N |\gamma(t_j) - \gamma(t_{j-1})|.$$

Note that the quantity $|\gamma(t_i) - \gamma(t_{i-1})|$ is the length of the straight line joining two points on the curve in the plane. Therefore the quantity $L(\gamma)$ is obtained by approximating the curve by polygonal lines and taking the limit of the resulting Euclidian length as the interval $[a, b]$ is partitioned more finely. It is noteworthy that the property of being rectifiable is a property of the curve γ , and does not depend on the parameterization used to define its length.

One says that a real-valued function $u(t)$ on an interval $[a, b]$ is of *bounded variations* if there exist $M < \infty$, such that

$$\sup_{a=t_0 < t_1 < \dots < t_N = b} \sum_{j=1}^N |u(t_j) - u(t_{j-1})| \leq M,$$

where the supremum is taken over all partitions $a = t_0 < t_1 < \dots < t_N = b$ of $[a, b]$. It is not hard to see that a curve γ parameterized by $\gamma(t) = (x(t), y(t))$ is rectifiable if and only if the functions x and y are continuous and of bounded variations. Moreover, a function $u(t)$ of bounded variations on an interval $[a, b]$ is differentiable almost everywhere (see e.g. Theorem 3.4 in [193]). It follows that for any rectifiable curve γ parameterized by $\gamma(t) = (x(t), y(t))$, the following quantity is well-defined

$$\int_a^b (x'(t)^2 + y'(t)^2)^{\frac{1}{2}} dt.$$

However this integral does not match the length of the curve γ in general. To have the equality

$$L(\gamma) = \int_a^b (x'(t)^2 + y'(t)^2)^{\frac{1}{2}} dt,$$

we have to restrict ourselves to functions $\gamma(t) = (x(t), y(t))$ such that $x(t)$ and $y(t)$ are absolutely continuous (see Theorem 4.1 in [193]). By definition, a real-valued function $u(t)$ on an interval $[a, b]$ is *absolutely continuous* if for any $\delta > 0$, there exists $\delta > 0$ such that, for any disjoint intervals (a_k, b_k) of $[a, b]$, one has

$$\sum_{i=1}^N (b_k - a_k) < \delta \Rightarrow \sum_{i=1}^N |u(b_k) - u(a_k)| < \delta.$$

One could think that the set of curves in the plane that can be parameterized by absolutely continuous functions is smaller than the set of rectifiable curves (since there exists functions of bounded variations which are not absolutely continuous). This is not true. In fact, any rectifiable curve can be parameterized by absolutely continuous functions. But more is true. Any rectifiable curve has a unique natural parameterization, the arc-length parameterization. The reason is that the length function $s(t) = L(\gamma|_{[a,t]})$ of the rectifiable curve γ parameterized by $\gamma(t) = (x(t), y(t))$ is a continuous increasing function which maps $[a, b]$ to $[0, L(\gamma)]$. Therefore one can define the *arc-length parameterization* of a rectifiable curve γ by $\tilde{\gamma}(s) = \gamma(s(t))$ for $s \in [0, L(\gamma)]$. Indeed, if $s \in [0, L(\gamma)]$ is such that $s = s(t_1) = s(t_2)$ for $t_1 < t_2$, then in fact $\gamma(t)$ is constant on $[t_1, t_2]$ (since the length of the curve does not vary from t_1 to t_2), therefore $\gamma(s(t_1)) = \gamma(s(t_2))$. We conclude by recalling the following theorem:

Theorem 2.2.1 (Theorem 4.3 in [193]). *Consider a rectifiable curve γ of length L parameterized by its arc-length parameterization $\tilde{\gamma}(t) = (\tilde{x}(t), \tilde{y}(t))$. Then $\tilde{x}(t)$ and $\tilde{y}(t)$ are absolutely continuous functions with $\|\tilde{\gamma}'(t)\| = (\tilde{x}'(t)^2 + \tilde{y}'(t)^2)^{\frac{1}{2}} = 1$ for almost every $s \in [0, L(\gamma)]$ and*

$$L(\gamma) = \int_0^L (\tilde{x}'(t)^2 + \tilde{y}'(t)^2)^{\frac{1}{2}} dt.$$

It follows that the set of rectifiable curves can be identified either with the set of arc-length parameterized absolutely continuous curves, or with the quotient space $AC([0, 1], \mathbb{R}^2)/\sim$ of the space of absolutely continuous maps $AC([0, 1], \mathbb{R}^2)$ under the equivalence relation where $f \sim g$ if and only if f and g have the same constant speed parameterization (where the speed is equal to the length of the curve). Let us denote by $AC_0([0, 1], \mathbb{R}^2)$ the space of absolutely continuous functions γ such that $\gamma(0) = 0$. The quotient space $AC_0([0, 1], \mathbb{R}^2)/\sim$ has been considered in [126] and [43], and, using the square root velocity transform introduced in [192], was endowed with the distance induced by the elastic metric $G^{\frac{1}{4}, 1}$ on $AC_0([0, 1], \mathbb{R}^2)$ (see Section 2.5.1 for the definition of the elastic metrics $G^{a, b}$). In particular, by Lemma 5.6 in [43], $AC_0([0, 1], \mathbb{R}^2)/\sim$ is a complete metric space for the distance induced by $G^{\frac{1}{4}, 1}$. However it is not a manifold, and we will restrict our attention to a smooth part of the quotient $AC([0, 1], \mathbb{R}^2)/\sim$ called the manifold of singular curves in [45] (see Section 2.2.2). Moreover, since we are interested in the shape of curves irrespective of the scale, we will consider only curves of length one.

2.2.2 Manifolds of based parameterized curves

In this section, we define the manifold structure of the set of plane curves that we will consider in this chapter. First some motivation. Roughly speaking, shape space consists of the set of curves in the plane, i.e. one-dimensional manifolds in a two-dimensional vector space. (Sometimes different shapes are identified if they are related to each other by a Euclidean motion). The difficulty is that although this space should be an infinite-dimensional manifold, it does not have convenient coordinate charts. The typical approach is to consider all *parameterized* curves $\gamma: [0, 1] \rightarrow \mathbb{R}^2$ (resp. $\gamma: \mathbb{S}^1 \rightarrow \mathbb{R}^2$ for closed curves), which is a linear space and hence a manifold, then consider the open subset consisting of free immersions or embeddings, then mod out by the group of diffeomorphisms of $[0, 1]$ (resp. \mathbb{S}^1) which represent the reparameterizations of a given curve (all of which correspond to the same shape). Here and in the rest of the paper \mathbb{S}^1 will denote the circle of length one given by

$$\mathbb{S}^1 = \mathbb{R}/\mathbb{Z}.$$

The quotient space of free immersions (and analogously of embeddings) modulo reparameterizations admits a structure of smooth Fréchet manifold (see [140] and [49] for a detailed construction of the coordinate charts in the smooth category), and the set of free immersions (and analogously embeddings) is a principal bundle over this quotient space with structure group the group of diffeomorphisms (see [13] for an overview of the theory). In this paper, we will identify this quotient space with the space of arc-length parameterized curves, which is a nice submanifold of the space of parameterized curves (see Theorem 2.2.4 and Theorem 2.2.9 below). See also Section 3.1. in [45], where an analogous construction is carried out for loops in \mathbb{R}^3 and where the Kähler structure of these loop spaces is explained. Let us stress some choices we made:

- We will work with *based* oriented curves (that is, with a specified start and endpoint) rather than closed curves; the advantage of this is that we have a unique constant-speed parameterization. It is also closer to the implementation, where a curve is replaced by a finite number

of points, which are stored in a matrix and indexed from 1 to n . In our applications later the curves will all happen to be closed, but the analysis will be independent of the choice of base point (i.e., of the ordering of the points).

- We get a further simplification by restricting to those curves of total length one; then we get a *unit*-speed parameterization, and we do not have to carry the length around as an extra parameter.
- We will work with immersions rather than embeddings since the embedding constraint is somewhat tricky to enforce.
- Finally since the Riemannian metrics of interest in this chapter (defined in the next Sections) will depend only on the derivative γ' , we shall identify all curves up to translation, which is of course equivalent with simply working with γ' rather than γ , where γ' has to satisfy $\int_0^1 \gamma'(s) ds = 0$ for closed curves.

In this section, $I = [0, 1]$ (for open curves) or $I = \mathbb{S}^1 = \mathbb{R}/\mathbb{Z}$ (for closed curves).

Curves modulo translations Let $k \in \mathbb{N}$, and define a norm on the vector space $\mathcal{C}^k(I, \mathbb{R}^2)$ of differentiable curves of order k , $\gamma: I \rightarrow \mathbb{R}^2$, by

$$\|\gamma\|_{\mathcal{C}^k} := \sum_{j=1}^k \max_{s \in I} |\gamma^{(j)}(s)|, \quad (2.2)$$

where, for $z \in \mathbb{R}^2$, $|z|$ denotes the norm of z . The purpose of starting the first sum at $j = 1$ instead of $j = 0$ is to reduce to the quotient space by translations $\mathcal{C}^k(I, \mathbb{R}^2)/\mathbb{R}^2$, so that only γ' matters. This corresponds to considering curves in \mathbb{R}^2 irrespective of their positions in comparison to the origin of \mathbb{R}^2 . The quotient vector space $\mathcal{C}^k(I, \mathbb{R}^2)/\mathbb{R}^2$ endowed with the norm induced by (2.2) is a Banach space. We could identify it with any complement to the subspace of constant functions, for instance with the subspace $\mathcal{C}_c^k(I, \mathbb{R}^2)$ of centered curves (i.e., curves whose center of mass lies at the origin of \mathbb{R}^2)

$$\mathcal{C}_c^k(I, \mathbb{R}^2) = \left\{ \gamma \in \mathcal{C}^k(I, \mathbb{R}^2), \int_0^1 \gamma(s) ds = 0 \right\}, \quad (2.3)$$

or with the subspace $\mathcal{C}_0^k(I, \mathbb{R}^2)$ of curves starting at $z = 0$

$$\mathcal{C}_0^k(I, \mathbb{R}^2) = \{ \gamma \in \mathcal{C}^k(I, \mathbb{R}^2), \gamma(0) = 0 \}, \quad (2.4)$$

which are Banach spaces for the norm (2.2) (see Section 2.1.2 for the distinction between quotient space and section of a fiber bundle). Despite the fact that the identification of the quotient space $\mathcal{C}^k(I, \mathbb{R}^2)/\mathbb{R}^2$ with a complement to \mathbb{R}^2 in $\mathcal{C}^k(I, \mathbb{R}^2)$ may seem natural in theory, it introduces unnecessary additional constraints as soon as numerics are involved: indeed restricting ourselves to centered curves implies that the tangent space to a curve contains only centered vector fields, i.e., vector fields Z along the curve which preserve condition (2.3), i.e., such that $\int_0^1 Z(s) ds = 0$, and for curves starting at the origin we get the constraint $Z(0) = 0$. In the numerical applications however it is easier to let the curves evolve in the whole space $\mathcal{C}^k(I, \mathbb{R}^2)$, but considering only their class modulo translations. Moreover, since the elastic metrics introduced in the Section 2.5 are degenerate in the direction of translations, the distance between two curves γ_1 and γ_2 will match the distances between $\gamma_1 + c_1$ and $\gamma_2 + c_2$ for any constants c_1 and c_2 . This degeneracy property implies that in the numerics, we can freely choose how to represent a curves modulo translation. Depending on what we want to emphasize, one may prefer the centered curves or the curves starting at the origin.

Smooth immersions Recall that $\gamma: I \rightarrow \mathbb{R}^2$ is an immersion if and only if $\gamma'(s) \neq 0$ for all $s \in I$. In the topology given by the norm (2.2), the set of all \mathcal{C}^k -immersions is an open subset of the Banach space $\mathcal{C}^k(I, \mathbb{R}^2)/\mathbb{R}^2$, hence a Banach submanifold of $\mathcal{C}^k(I, \mathbb{R}^2)/\mathbb{R}^2$. It is denoted by $\mathcal{C}^k(I)$:

$$\mathcal{C}^k(I) = \{ \gamma \in \mathcal{C}^k(I, \mathbb{R}^2)/\mathbb{R}^2, \gamma'(s) \neq 0, \forall s \in I \}.$$

The vector space $\mathcal{C}^\infty(I, \mathbb{R}^2)/\mathbb{R}^2 = \bigcap_{k=1}^{\infty} \mathcal{C}^k(I, \mathbb{R}^2)/\mathbb{R}^2$ of smooth curves $\gamma: I \rightarrow \mathbb{R}^2$ modulo translations endowed with the family of norms $\|\cdot\|_{\mathcal{C}^k}$ is a graded Fréchet space (see Definition II.1.1.1 in [92]). The space of smooth immersions

$$\mathcal{C}(I) = \bigcap_{k=1}^{\infty} \mathcal{C}^k(I) = \{\gamma \in \mathcal{C}^\infty(I, \mathbb{R}^2)/\mathbb{R}^2, \gamma'(s) \neq 0, \forall s \in I\}. \quad (2.5)$$

is an open set of $\mathcal{C}^\infty(I, \mathbb{R}^2)/\mathbb{R}^2$ for the topology induced by the family of norms $\|\cdot\|_{\mathcal{C}^k}$, hence a Fréchet manifold.

Remark 2.2.2. In the space of smooth immersions $\mathcal{C}([0, 1])$, we can consider the subset of curves γ which are closed, i.e., such that $\gamma(0) = \gamma(1)$, or equivalently such that $\int_0^1 \gamma'(s) ds = 0$. Let us denote it by $\mathcal{C}_c([0, 1])$. Then $\mathcal{C}(\mathbb{S}^1) \subsetneq \mathcal{C}_c([0, 1])$. Indeed a curve $\gamma \in \mathcal{C}(\mathbb{S}^1)$ has all its derivatives matching at 0 and 1, whereas a curve in $\mathcal{C}_c([0, 1])$ may have a failing in smoothness at 0. Note that $\mathcal{C}^\infty(\mathbb{S}^1, \mathbb{R}^2)$ is a closed subset in $\mathcal{C}^\infty([0, 1], \mathbb{R}^2)$ which is not a direct summand (see Example 1.2.2 in [92]). Moreover note that the derivative which maps γ to γ' from $\mathcal{C}^\infty(I, \mathbb{R}^2)/\mathbb{R}^2$ into $\mathcal{C}^\infty(I, \mathbb{R}^2)$ is onto for open curves, but has range equal to the closed subspace $\{f \in \mathcal{C}^\infty(\mathbb{S}^1, \mathbb{R}^2), \int_0^1 f(s) ds = 0\}$ for closed curves.

Length-one curves We denote the subset of length-one immersions modulo translations by

$$\mathcal{C}_1(I) = \{\gamma \in \mathcal{C}(I) : \int_0^1 |\gamma'(s)| ds = 1\}. \quad (2.6)$$

Recall that the implicit function theorem is invalid for general Fréchet manifolds, but is valid in the category of Fréchet manifolds and tame smooth maps, and is known as the implicit function theorem of Nash-Moser (Theorem III.2.3.1 of [92], page 196). Recall that a linear map $A: F_1 \rightarrow F_2$ between graded Fréchet spaces is *tame* if there exists some r and b such that $\|Af\|_n \leq C_n \|f\|_{n+r}$ for each $n \geq b$ and some constants C_n (see Definition II.1.2.1 page 135 in [92]). A Fréchet space is *tame* if it is a tame direct summand in a space $\Sigma(B)$ of exponentially decreasing sequences in some Banach space B . A nonlinear map P from an open set U of a graded Fréchet space F_1 into another graded Fréchet space F_2 is *tame* if it is continuous and if there exists r and b such that

$$\|P(f)\|_n \leq C_n(1 + \|f\|_{n+r})$$

for each $n \geq b$ and some constants C_n (see Definition II.2.1.1. page 140 in [92]). A *tame Fréchet manifold* is a manifold modelled on a tame Fréchet space, such that all transition functions are tame.

Proposition 2.2.3. *The subset $\mathcal{C}_1(I)$ of length-one immersions modulo translations defined by (2.6) is a tame \mathcal{C}^∞ -submanifold of the tame Fréchet manifold $\mathcal{C}(I)$ of immersions modulo translations defined by (2.5) for the Fréchet manifold structure induced by the family of norms given in (2.2).*

Proof. As an open set of $\mathcal{C}^\infty(I, \mathbb{R}^2)/\mathbb{R}^2$, $\mathcal{C}(I)$ is a manifold with only one chart, hence a \mathcal{C}^∞ -manifold. Moreover, $\mathcal{C}(I)$ is a tame Fréchet manifold in the sense of Definition II.2.3 in [92]. To see this, first note that by Theorem II.1.3.6 page 137 in [92], $\mathcal{C}^\infty(I, \mathbb{R})$ is tame since I is compact. Moreover by Lemma II.1.3.4. page 136, the Cartesian product of two tame spaces is tame. It follows that $\mathcal{C}^\infty(I, \mathbb{R}^2)$ is a tame Fréchet space. By Lemma II.1.3.3 in [92], the subspace $\mathcal{C}_0^\infty(I, \mathbb{R}^2)$ is also tame because its complement is one-dimensional and any map from a tame Fréchet space into a finite dimensional space is tame. Since the quotient $\mathcal{C}^\infty(I, \mathbb{R}^2)/\mathbb{R}^2$ is isomorphic as a Fréchet space to $\mathcal{C}_0^\infty(I, \mathbb{R}^2)$, it is also tame. Hence $\mathcal{C}(I)$ is modelled on a tame Fréchet space and since there is only one transition function which is the identity hence tame, $\mathcal{C}(I)$ is a tame Fréchet manifold. Let us endow it with the complete atlas consistent with this \mathcal{C}^∞ tame manifold structure. In particular, the following coordinate charts, as used in [173], belong to the atlas: for each $\gamma \in \mathcal{C}$ we write

$$\gamma'(s) = e^{\sigma(s)} (\cos \theta(s), \sin \theta(s)) = e^{\sigma(s)+i\theta(s)}, \quad (2.7)$$

where $\sigma \in \mathcal{C}^\infty(I, \mathbb{R})$ and $\theta \in \mathcal{C}^\infty(I, \mathbb{R})$. We get a diffeomorphism from the open set

$$\{(\sigma, \theta) \in \mathcal{C}^\infty(I, \mathbb{R}) \times \mathcal{C}^\infty(I, \mathbb{R}), \theta(0) \in]\theta_0 + 2\pi n, \theta_0 + 2\pi(n+1)[\}$$

of the Fréchet space $\mathcal{C}^\infty(I, \mathbb{R}) \times \mathcal{C}^\infty(I, \mathbb{R})$ onto the open subset of $\mathcal{C}(I)$ consisting of those curves such that $\frac{\gamma'(0)}{|\gamma'(0)|} \neq e^{i\theta_0}$. The coordinate transition functions are easily seen to be the identity in the first component (since ρ is uniquely determined) and horizontal translations in the second component, hence are clearly tame.

In (σ, θ) -coordinates the condition (2.6) is described by the condition $L(\sigma) = 1$, where

$$L(\sigma) = \int_0^1 e^{\sigma(s)} ds.$$

Hence $\mathcal{C}_1(I)$ is the inverse image of a real function that is obviously \mathcal{C}^∞ . The derivative of L with respect to (σ, θ) -coordinates may be expressed as

$$DL_{(\sigma, \theta)}(\rho, \phi) = \frac{\partial}{\partial t} \Big|_{t=0} L(\sigma + t\rho, \theta + t\phi) = \int_0^1 \rho(s) e^{\sigma(s)} ds;$$

the kernel of this map splits at any $(\sigma, \theta) \in L^{-1}(1)$ since we can write

$$(\rho, \phi) = (\rho - C, \phi) + (C, 0), \quad C = \int_0^1 \rho(x) e^{\sigma(x)} dx,$$

where $(\rho - C, \phi)$ belongs to the kernel of $DL_{(\sigma, \theta)}$, which is closed, and $(C, 0)$ belongs to a one-dimensional subspace of $\mathcal{C}^\infty(I, \mathbb{R}) \times \mathcal{C}^\infty(I, \mathbb{R})$, which is therefore also closed. Since the image of $(C, 0)$ is obviously C , so the derivative is also surjective.

By the implicit function theorem of Nash-Moser (Theorem III.2.3.1 of [92], page 196), $\mathcal{C}_1(I)$ is a smooth tame submanifold of $\mathcal{C}(I)$. □

Arc-length parameterized curves Now we consider the space $\mathcal{A}_1(I)$ of arc-length parameterized curves from I to \mathbb{R}^2 modulo translations:

$$\mathcal{A}_1(I) = \{\gamma \in \mathcal{C}(I) : |\gamma'(s)| = 1, \forall s \in I\}. \quad (2.8)$$

Obviously $\mathcal{A}_1(I) \subset \mathcal{C}_1(I)$.

Theorem 2.2.4. *The space $\mathcal{A}_1(I)$ of arc-length parameterized curves on I modulo translations defined by (2.8) is a tame \mathcal{C}^∞ -submanifold of $\mathcal{C}(I)$, and thus also of $\mathcal{C}_1(I)$. Its tangent space at a curve γ is*

$$T_\gamma \mathcal{A}_1 = \{w \in \mathcal{C}^\infty(\mathbb{S}^1, \mathbb{R}^2), w'(s) \cdot \gamma'(s) = 0, \quad \forall s \in \mathbb{S}^1\}.$$

Proof. The proof is very simple: the space $\mathcal{A}_1(I)$ is closed and looks, in any (σ, θ) -coordinate chart, like $\{(\sigma, \theta) : \sigma \equiv 0\}$, which is just the definition of a submanifold. Since the (σ, θ) -coordinate charts are tame, $\mathcal{A}_1(I)$ is a tame submanifold of $\mathcal{C}(I)$. The fact that $\mathcal{A}_1(I)$ is also a smooth Fréchet tame submanifold of $\mathcal{C}_1(I)$ follows from the universal mapping property of submanifolds. The expression of the tangent space is straightforward. □

Reparameterizations of curves Reparameterizations of open curves are given by smooth diffeomorphisms $\phi \in \text{Diff}^+([0, 1])$, the plus sign denoting that these diffeomorphisms preserve 0 and 1. For closed curves, we will denote by $\text{Diff}^+(\mathbb{S}^1)$ the group of diffeomorphisms of \mathbb{S}^1 preserving the orientation. In the following we will denote by $\mathcal{G}(I)$ either the group $\text{Diff}^+([0, 1])$ when considering open curves (i.e., when $I = [0, 1]$), or $\text{Diff}^+(\mathbb{S}^1)$ for closed curves (i.e., when $I = \mathbb{S}^1 = \mathbb{R}/\mathbb{Z}$). By Theorem II.2.3.5. page 148 in [92], $\mathcal{G}(I)$ is a tame Fréchet Lie group.

Proposition 2.2.5. *The right action $\Gamma: \mathcal{C}(I) \times \mathcal{G}(I) \rightarrow \mathcal{C}(I)$, $\Gamma(\gamma, \psi) = \gamma \circ \psi$ of the group of reparameterizations $\mathcal{G}(I)$ on the tame Fréchet manifold $\mathcal{C}(I)$ is smooth and tame, and preserves $\mathcal{C}_1(I)$.*

Proof. Note that the action Γ of $\mathcal{G}(I)$ on $\mathcal{C}(I)$ is continuous for the Fréchet manifold structure on $\mathcal{C}(I)$ since

$$\|\gamma_1 \circ \phi - \gamma_2 \circ \phi\|_{\mathcal{C}^k} = \sum_{j=1}^k \max_{s \in I} \left| \frac{d^j}{ds^j} \gamma_1(\phi(s)) - \frac{d^j}{ds^j} \gamma_2(\phi(s)) \right|$$

can be bounded by the chain rule in terms of $\|\gamma_1 - \gamma_2\|_{\mathcal{C}^k}$ and $\|\phi\|_{\mathcal{C}^k}$. It follows that Γ is tame. Moreover the action of $\mathcal{G}(I)$ on $\mathcal{C}(I)$ is differentiable: considering a family $\phi(t, s) \in \mathcal{G}(I)$ and $\gamma(t, s) \in \mathcal{C}(I)$ with $\phi_t(0, s) = \zeta(s)$ in the Lie algebra $\text{Lie}(\mathcal{G}(I))$ of $\mathcal{G}(I)$, and $\gamma_t(0, s) = w(s) \in \mathcal{C}^\infty(I, \mathbb{R}^2)/\mathbb{R}^2$. The derivative of the action $\Gamma := (\gamma, \phi) \mapsto \gamma \circ \phi$ is

$$\begin{aligned} (D\Gamma)_{(\gamma, \phi)}(w, \zeta) &= \left. \frac{\partial}{\partial t} \right|_{t=0} \gamma(t, \phi(t, s)) = \gamma_t(t, \phi(t, s)) + \gamma_s(t, \phi(t, s))\phi_t(t, s) \Big|_{t=0} \\ &= w(\phi(s)) + \gamma'(\phi(s))\zeta(s). \end{aligned} \quad (2.9)$$

Since the map which assigns $\gamma \in \mathcal{C}(I)$ to $\gamma' \in \mathcal{C}(I)$ satisfies $\|\gamma'\|_n \leq \|\gamma\|_{n+1}$, it is a tame linear map (with $r = 1$ and $b = 1$), continuous for the Fréchet manifold structure on $\mathcal{C}(I)$. Hence $D\Gamma$ is continuous as a map from a neighborhood of (γ, ϕ) in $\mathcal{G}(I) \times \mathcal{C}(I)$ times the Fréchet space $\text{Lie}(\mathcal{G}(I)) \times \mathcal{C}^\infty(I, \mathbb{R}^2)/\mathbb{R}^2$ into $\mathcal{C}^\infty(I, \mathbb{R}^2)/\mathbb{R}^2$, and tame. More generally, the k th derivative of the action Γ will involve only a finite number of derivatives of the curve γ , hence will be continuous and tame. \square

Quotient spaces Recall that an immersion $\gamma: I \rightarrow \mathbb{R}^2$ is free if and only if the group of reparameterizations $\mathcal{G}(I)$ acts freely on γ , i.e., the only diffeomorphism ψ satisfying $\gamma \circ \psi = \gamma$ is the identity. By Lemma 1.3 in [49], a diffeomorphism having a fixed point and stabilizing a given immersion is necessarily equal to the identity map. Hence for open curves, every smooth immersion is free, since any diffeomorphism in $\mathcal{D}^+([0, 1])$ fixes 0 and 1. For closed curves, the set of free immersions is an open set in the space of immersions (see [49], Section 1). We will denote it by $\mathcal{C}^f(I)$. Note that since I is compact, any $f \in \mathcal{C}(I)$ is proper. Recall the following theorem in [49]:

Theorem 2.2.6. (Theorem 1.5 in [49]) *The quotient space $\mathcal{C}^f(I)/\mathcal{G}(I)$ of free immersions by the group of diffeomorphisms $\mathcal{G}(I)$ admits a Fréchet manifold structure such that the canonical projection $\pi: \mathcal{C}^f(I) \rightarrow \mathcal{C}^f(I)/\mathcal{G}(I)$ defines a smooth principal bundle with structure group $\mathcal{G}(I)$.*

Remark 2.2.7. Since $\mathcal{G}(I)$ stabilizes the submanifold $\mathcal{C}_1(I)$ of length-one curves, the quotient $\mathcal{C}_1^f(I)/\mathcal{G}(I)$ inherits a Fréchet manifold structure such that $\mathcal{C}_1^f(I)/\mathcal{G}(I)$ is a submanifold of $\mathcal{C}^f(I)/\mathcal{G}(I)$. See also [60] for a new slice theorem in the context of tame Fréchet group actions.

Orbits under the group of reparameterizations The orbit of $\gamma \in \mathcal{C}_1(I)$ with respect to the action by reparameterization will be denoted by

$$\mathcal{O} = \{\gamma \circ \phi \mid \phi \in \mathcal{G}(I)\}.$$

The tangent space to the orbit \mathcal{O} at $\gamma \in \mathcal{C}_1(I)$ is the space of tangent vector fields along γ (preserving the start and endpoints when the curve is open), i.e., the space of vector fields which are, for each value of the parameter $s \in I$, collinear to the unit tangent vector $v(s) = \frac{\gamma'(s)}{|\gamma'(s)|}$. Such a vector field can be written $w(s) = m(s)v(s)$, where m is a real function corresponding to the magnitude of w and such that:

- $m \in \mathcal{C}^\infty([0, 1], \mathbb{R})$ satisfies $m(0) = 0$ and $m(1) = 0$ for open curves,
- $m \in \mathcal{C}^\infty(\mathbb{S}^1, \mathbb{R})$ for closed curves, in particular $m(0) = m(1)$ and $m'(0) = m'(1)$.

Projection on the space of arc-length parameterized curves Any smooth curve in the plane admits a unique reparameterization by its arc-length. This property singles out a preferred parameterized curve in the orbit of a given parameterized curve under the group of reparameterizations.

Theorem 2.2.8. *Given a curve $\gamma \in \mathcal{C}_1(I)$, let $p(\gamma) \in \mathcal{A}_1(I)$ denote its arc-length-reparameterization, so that $p(\gamma) = \gamma \circ \psi$ where*

$$\psi'(s) = \frac{1}{|\gamma'(\psi(s))|}, \quad \psi(0) = 0. \quad (2.10)$$

Then p is a smooth retraction of $\mathcal{C}_1(I)$ onto $\mathcal{A}_1(I)$.

Proof. The definition of ψ comes from the requirement that $|(\gamma \circ \psi)'(s)| = 1$, which translates into $|\gamma'(\psi(s))|\psi'(s) = 1$. The additional requirement $\psi(0) = 0$ gives a unique solution. It is not obvious from here that $\psi(1) = 1$, but this is easier to see if we let ξ be its inverse; then $\xi'(t) = |\gamma'(t)|$, and since γ has length one and $\xi(0) = 0$ we know $\xi(1) = 1$; thus also $\psi(1) = 1$. The image of this map is of course in $\mathcal{A}_1(I)$. Smoothness follows from the fact that ψ depends smoothly on parameters as the solution of an ordinary differential equation, together with smoothness of the right action $\Gamma(\gamma, \psi) = \gamma \circ \psi$. The fact that p is a retraction follows from the obvious fact that if $|\gamma'(s)| \equiv 1$, then the unique solution of (2.10) is $\phi(s) = s$, so that $p|_{\mathcal{A}_1(I)}$ is the identity. \square

Identification of the quotient space with the space of arc-length parameterized curves
The identification of the quotient space $\mathcal{C}_1([0, 1])/\mathcal{G}([0, 1])$ with the space $\mathcal{A}_1([0, 1])$ of arc-length parameterized curves relies on the fact that given a parameterized curve there is a *unique* diffeomorphism fixing the start and endpoints which maps it to an arc-length parameterized curve.

Theorem 2.2.9. $\mathcal{A}_1([0, 1])$ is diffeomorphic to the quotient Fréchet manifold $\mathcal{C}_1([0, 1])/\mathcal{G}([0, 1])$.

Proof. Since $p(\gamma \circ \psi) = p(\gamma)$ for any reparameterization $\psi \in \mathcal{G}([0, 1])$, we get a smooth map

$$\tilde{p}: \mathcal{C}_1([0, 1])/\mathcal{G}([0, 1]) \rightarrow \mathcal{A}_1([0, 1]),$$

which is clearly a bijection, and its inverse is $\pi \circ \iota$ where π is the quotient projection and ι is the smooth inclusion of $\mathcal{A}_1([0, 1])$ into $\mathcal{C}_1([0, 1])$. \square

For closed curves, the subgroup \mathbb{S}^1 of $\mathcal{G}(\mathbb{S}^1)$ acts on a closed curve γ by translating the base point along the curve: $\gamma(s) \mapsto \gamma(s + \tau)$ for $\tau \in \mathbb{S}^1$. One has the following commutative diagram, where the vertical lines are the canonical projections on the quotients spaces.

$$\begin{array}{ccc} p: & \mathcal{C}_1(\mathbb{S}^1) & \longrightarrow & \mathcal{A}_1(\mathbb{S}^1) \\ & \downarrow & & \downarrow \\ & \mathcal{C}_1(\mathbb{S}^1)/\mathcal{G}(\mathbb{S}^1) & \longrightarrow & \mathcal{A}_1(\mathbb{S}^1)/\mathbb{S}^1 \end{array}$$

2.3 Moving Frames and canonical parameterizations of curves

This section is based on the papers [215] and [219].

2.3.1 Moving frame attached to a curve

The general theory of moving frames is the following (see [74]). Suppose you have a curve f in a homogeneous space G/H and that you found a procedure to attached to it a curve \hat{f} in G in a natural way, called a lifting of f . Then using left translation in the group G , this G -valued curve can be encoded by the curve $A := \hat{f}^{-1} \frac{d}{ds} \hat{f}$ with values in the Lie-algebra of G . There are two good properties of this Lie-algebra valued curve:

- The first one is that it remains the same when one replace f by any $g \cdot f$ with $g \in G$. Here the notation $g \cdot f$ means the curve $s \mapsto g \cdot f(s)$ for s in the parameter space (note that g do not depend on s here), where g acts on $f(s)$ by the natural left action of G on G/H . For instance, when $G = \text{SO}(3)$ and $H = \text{SO}(2)$, the action of G on the unit sphere $\mathbb{S}^2 \simeq \text{SO}(3)/\text{SO}(2)$ is by rotation of the sphere, and the corresponding $\mathfrak{so}(3)$ -valued curve will forget the orientation in space of the \mathbb{S}^2 -valued curve, leading to a rigid motion invariant framework.
- The second good property of the Lie-algebra valued curve is that from it one can recover the initial curve f uniquely modulo the action of G . Hence the Lie-algebra valued curve is characteristic of the orbit of f under G , and is a geometric invariant of the G/H -valued curve. For instance, the $\mathfrak{so}(3)$ -valued curve associated to the movement of the joint of a tennis player is characterized by its curvature and torsion functions (see Section 2.3.4). Endowing the space of $\mathfrak{so}(3)$ -valued curves with its natural L^2 -scalar-product (opposite to the Killing form on $\mathfrak{so}(3)$) gives a efficient way to distinguish different actions.

This Section is organized as follows: first we consider the general task of interpolation of 2D-contours (Subsection 2.3.2), then we introduce different parameterizations of 2D-shapes (Subsection 2.3.3) with application in medical imaging, and finally we explain the basic idea of interpolation using moving frames for curves in \mathbb{R}^3 in more details in Subsection 2.3.4. Examples of interpolations are given in Section 2.4.

2.3.2 Interpolation of 2D-contours

When we want to interpolate between two 2D-contours like the two red contours of a ballerina depicted in Figure 2.2, there are a couple of things to keep in mind.

First, one should not take two parameterizations of the contours at random and interpolate linearly between them. This gives usually very bad results, even when one starts the parameterization at points that should correspond. In Figure 2.2, we start the parameterization at the top of the head of the ballerina, travel the contour counterclockwise with a speed profile that is illustrated by the sampling of the curves : on portions of the curve where points accumulate the speed is small, whereas on portions of the curve where points are very far apart, the curve is travelled at high speed (in order to travel between two successive points, the same amount of time is needed). The resulting interpolation is depicted on the first line of Fig. 2.2. One sees that this interpolation procedure does not give good results.

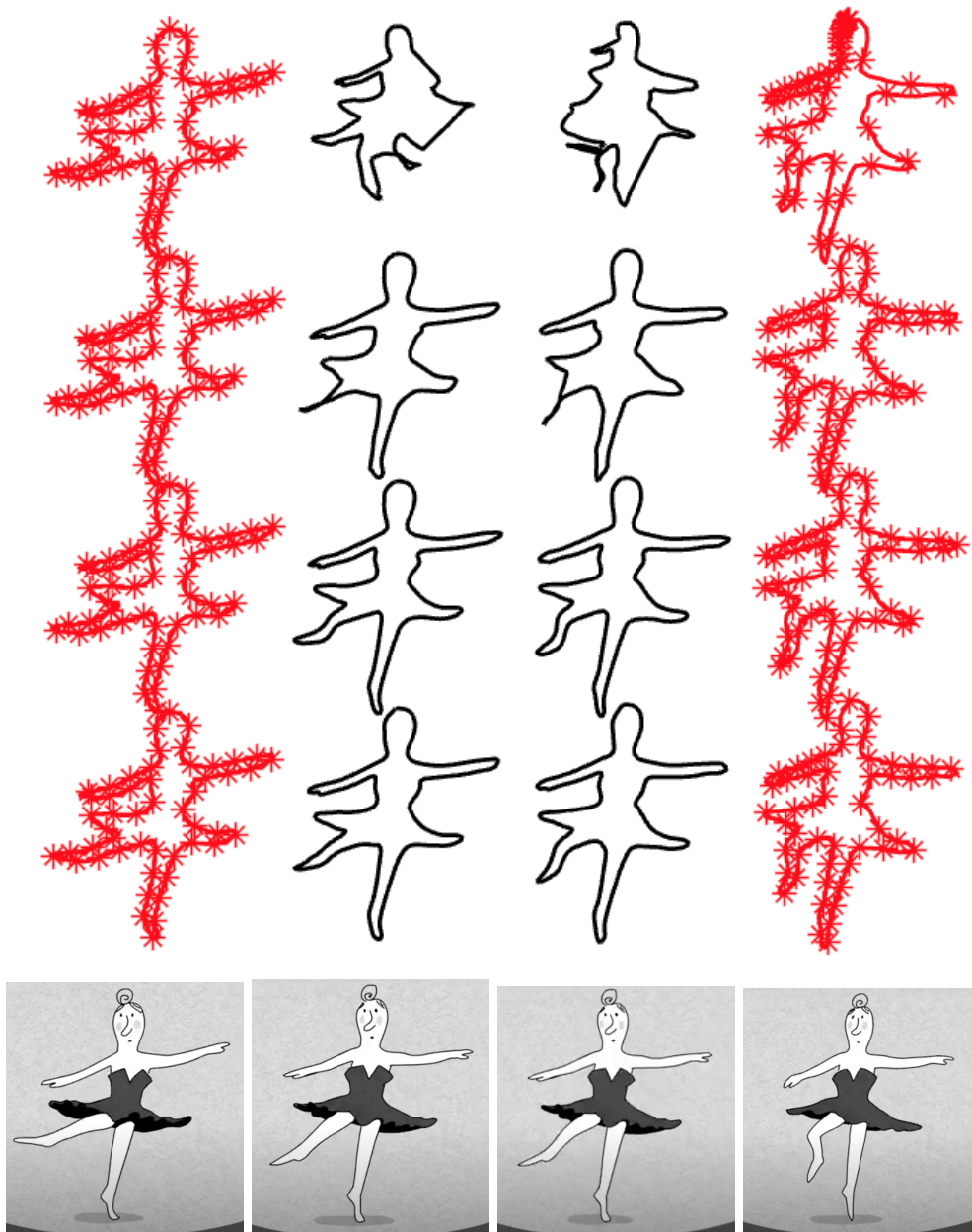

Figure 2.2: First line: linear interpolation between some parameterized ballerinas, second line: linear interpolation between arc-length parameterized ballerinas, third line linear interpolation between two registered ballerinas, fourth line: reference movement taken from [197].

Second, picking up a preferred parameterization of the curves, for instance the arc-length parameterization, and interpolating linearly between the parameterized curves may also lead to bad results. In the second row of Figure 2.2, the two ballerinas are parameterized proportionally to arc-length hence the resulting samplings are uniform. The linear interpolation between the two contours parameterized proportional to arc-length is depicted at the second row in Figure 2.2. One can see that the deformation shrinks the moving leg and therefor appears unnatural. However, in some applications, where the routes to compare are very similar, like the routes of the body of a caterpillar in Figure 2.3, the result may be satisfactory and no fancy shape analysis is needed.

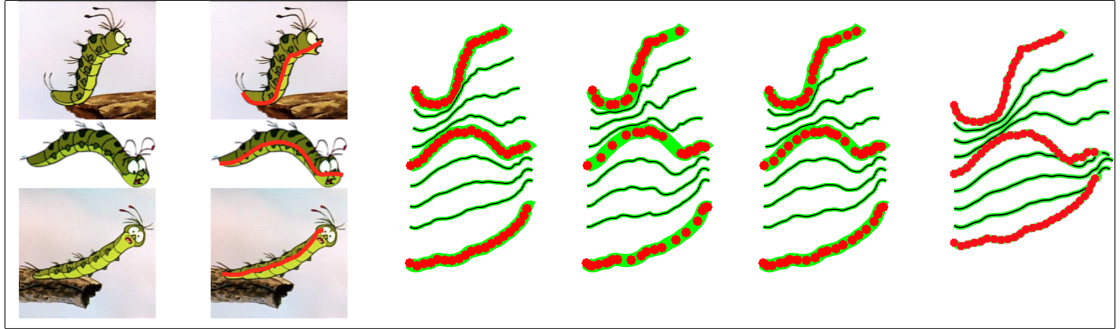

Figure 2.3: First column : 3 positions of the caterpillar from *The Fox and the Hound*, Second column : 3 positions of the caterpillar from *The Fox and the Hound* with extracted curves in red, Third column: linear interpolation between the 3 positions of the caterpillar using arc-length parameterization, Fourth column : linear interpolation between the 3 positions of the caterpillar using curvature-length parameterization, Fifth column : linear interpolation between the 3 positions of the caterpillar using curvarc-length parameterization, Sixth column : geodesic between the unparameterized curves using Qmap (see [102] and [192]). and programs from <http://ssamg.stat.fsu.edu/software>.

One can distinguish two tasks in the comparison of curves :

1. the registration or correspondance, which consists in choosing parameterizations of two curves so that features of the curves that should correspond are associated to the same value of the parameter,
2. the measurement of the discrepancy between the two curves and the generation of a deformation of one curve into the other.

The recent use of differential geometry in shape analysis has allowed to take on these two tasks in the same framework. A traditional strategy to generate deformations between unparameterized curves is the following : the space of parameterized curves is endowed with a parameterization-equivariant Riemannian metric which allows to compute preferred deformations between curves, called geodesics, which are minimal for the corresponding variational problem. Then, given two unparameterized curves, one chooses the parameterization of one curve and, to each parameterization of the second curve, one compute the geodesic (if it exists!) between the two parameterized curves. At last, one has to solve an optimization problem consisting in singeling out the parameterization of the second curve (if it exists!) that achieve the infimum of the cost function among all possible parameterizations of the second curve. The geodesic between the two unparameterized curves is then given by the geodesic between the first curve (with its arbitrarily chosen parameterization) and the second curve with the parameterization minimizing the cost function. The discrepancy between the two curves is measured as the length of this geodesic. This procedure endow the shape space with a Riemannian structure called the quotient Riemannian metric. One can mention the following problems encountered when one pursue this strategy :

- The choice of a Riemannian metric on the space of parameterized curves is usually not easy. As was first highlighted in [142], a badly chosen Riemannian metric can lead to vanishing geodesic distance, ruling out any effort to use geodesic distance to measure discrepancy between curves. For this reason, a large mathematical literature developped in order to propose Riemannian metrics with good mathematical properties: mention Sobolev metrics in [14], curvature weighted metrics in [16], almost local metrics in [15], metrics mesuring the deformations of the interiors of shapes in [76].

- The geodesic between two parameterized curves with respect to a given Riemannian metric are usually hard to compute, and one has to use algorithms like the path-straightening method or the shooting method to approximate them ([65]). These algorithms are time-consuming. To overcome this difficulty and speed up the comparison of curves, some metrics have been proposed where the geodesic on the space of parameterized curves are explicit, like in [236], [237], or [102] and [192]. The framework of [192] has recently been adapted to general manifolds in [127] and homogeneous spaces in [48].
- The optimization problem over all parameterizations of a given curve raise mathematical as well as practical difficulties : first the set of all parameterizations of a given curve is an orbit of an infinite-dimensional Fréchet Lie group, the group of diffeomorphisms, with a lot of pathological properties. There is in general no guarantee that this mathematical problem can be solved. Second, the algorithms used to approximate the solution of this optimization problem are based on dynamical programming (see for instance [143]) with the drawback that in practise only a finite number of reparameterizations distributed mainly around the identity map are considered. For this reason, a gauge invariant framework has been proposed in [205] (see also [212]) in the context of shape analysis of surfaces, where this optimization step is avoided by the use of a Riemannian metric which degenerates along the orbit of the reparameterization group. Another idea to avoid this minimization problem was proposed in [208], where the quotient elastic metric introduced in [192] is expressed as a metric on the section of arc-length parameterized curves. Nevertheless, since the geodesics on shape space are not explicit in any of the previously mentioned works, shape comparison is not really efficient.
- In [126], the optimization step is solved for piecewise linear curves (polygons) under the elastic metric of [192]: the precise matching minimizing the geodesic distance is given between two piecewise linear curves. The only lack in this work is that it relies on the Euclidean geometry of \mathbb{R}^n and may not be adapted to general manifolds or homogeneous spaces.

2.3.3 Different parameterizations of 2D-shapes

We proposed below diverse canonical parameterization of 2D-contours, which are expressed using arc-length and curvature of curves. The curvature-length parameterization and the curvarc-length parameterization are very natural examples, since they corresponds to a constant-speed moving frame in $SO(2)$ and $SE(2)$. We present an application to the problem of point correspondance in medical imaging consisting of labelling automatically keypoints along the contour of bones. We recover an analogous parameterization to the one proposed by Thodberg [203] at real-time speed. Having a two-parameter family of parameterizations at our disposal, a fine-tuning can be applied on top of our results in order to improve the point correspondance further.

Arc-length parameterization and signed curvature

By 2D-shape, we mean the shape drawn by a parameterized curve in the plane. It is the ordered set of points visited by the curve. The shapes of two curves are identical if one can reparameterize one curve into the other (using a continuous increasing function). Any rectifiable planar curve admits a canonical parameterization, its *arc-length parameterization*, which draws the same shape, but with constant unit speed. The set of 2D-shapes can be therefore identified with the set of arc-length parameterized curves, which is not a vector subspace, but rather an infinite-dimensional submanifold of the space of parameterized curves (see [208]).

It may be difficult to compute an explicit formula of the arc-length parameterization of a given rectifiable curve. Fortunately, when working with a computer, one do not need it. One neither need a concrete parameterization of the curve to depict it, a sample of points on the curve suffices. To draw the statue of Liberty as in Figure 2.4, left, one just need a finite ordered set of points (the red stars). The discrete version of an arc-length parameterized curve is a uniformly sampled curve, i.e. an ordered set of equally distant points (for the euclidean metric). Resampling a curve uniformly is immediate using some appropriate interpolation function like the matlab function *spline* (the second picture in Figure 2.4 shows a uniform resampling of the statue of liberty).

Consider the set of 2D simple closed curves, such as the contour of Elie Cartan's head in Figure 2.5. After the choice of a starting point and a direction, there is a unique way to travel the

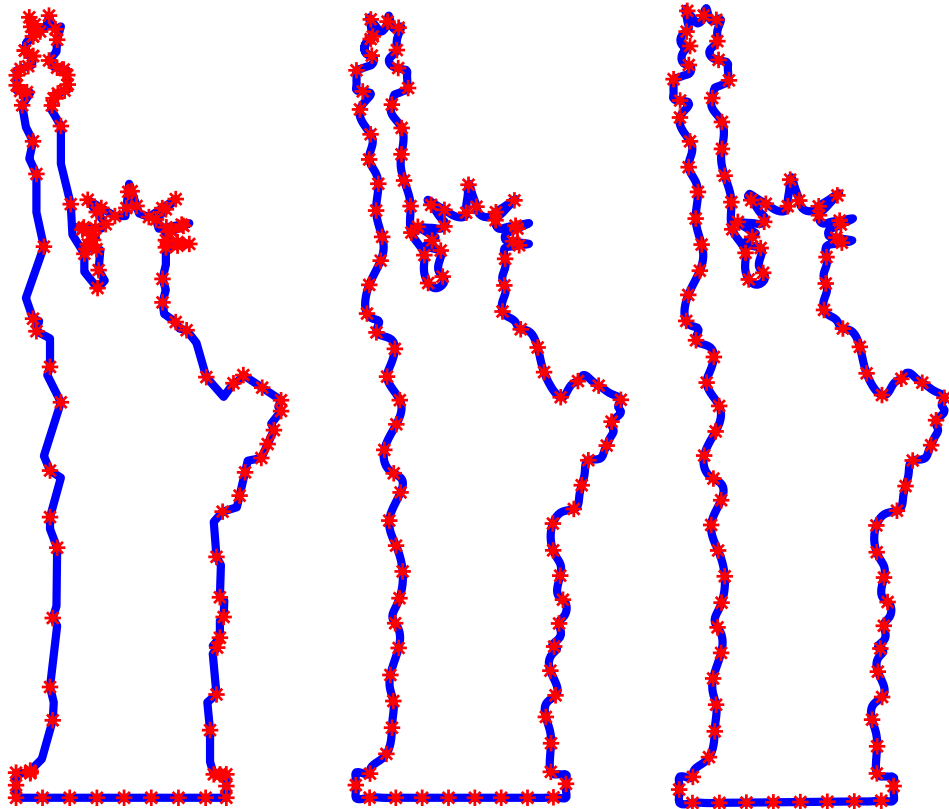

Figure 2.4: The statue of Liberty (left), a uniform resampling using Matlab function spline (middle), a reconstruction of the statue using its discrete curvature (right).

curve at unit speed. In Figure 2.5, we have drawn the velocity vector near the glasses of Elie Cartan, as well as the unit normal vector which is obtained from the unit tangent vector by a rotation of $+\frac{\pi}{2}$. These two vectors form an orthonormal basis, i.e. an element (modulo the choice of a basis of \mathbb{R}^2) of the Lie group $SO(2)$, which is characterized by a rotation angle. The rate of variation of this rotation angle is called the signed curvature of the curve. For instance, when moving along the external outline of the glasses, this curvature equals the inverse of the radius of the glasses.

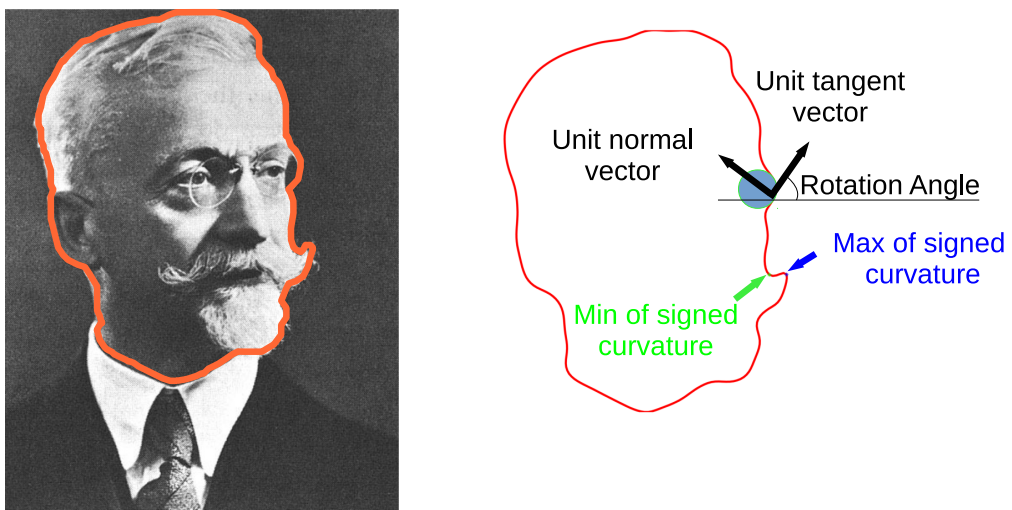

Figure 2.5: Elie Cartan and the moving frame associated to the contour of his head.

There is a little difference in the construction of the moving frame for 2D curves in comparison to the moving frame for 3D curves. Indeed in the 2D case, we don't need the second and third derivative of the curve to construct the frame. Just the first derivative is enough. In fact we are using the knowledge that the curve stays in the plane to construct the normal at each point of the curve. In other words, we are using additional geometric properties of the ambient space (in this case the complex structure of the plane). The consequence of this is that the moving frame can be defined even for 2D curves with flat pieces (zero curvature sections) like the statue of Liberty which has a long flat piece at its base (see Figure 2.4). The corresponding curvature is therefore signed, with positive sign when the moving frame is turning clockwise, negative sign when the moving frame is turning counterclockwise, and zero along flat pieces. We have depicted the curvature function κ of Elie Cartan's head in Figure 2.6, first line, when the parameter $s \in [0; 1]$ on the horizontal axis is proportional to arc-length, and such that the entire contour of Elie Cartan's head is travelled when the parameter reaches 1. Its corresponds to a uniform sampling of the contour.

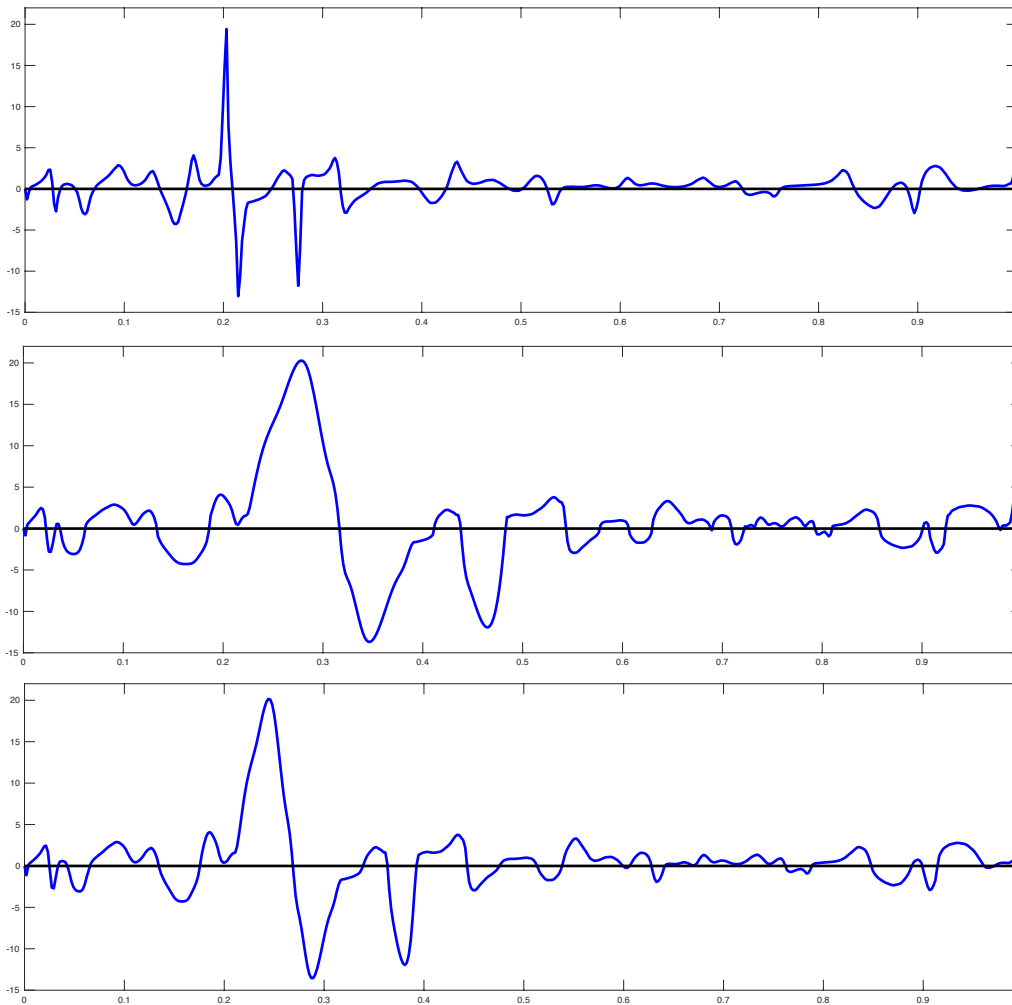

Figure 2.6: Signed curvature of Elie Cartan's head for the parameterization proportional to arc-length (first line), proportional to the curvature-length (second line), and proportional to the curvarc length (third line).

A discrete version of an arc-length parameterized curve is an equilateral polygon. To draw an equilateral polygon, one just need to know the length of the edges, the position of the first edge, and the angles between two successive edges. The sequence of turning-angles is the discrete version of the curvature and defines a equilateral polygon modulo scaling, rotation and translation. In Figure 2.4, right, we have reconstructed the statue of Liberty using the discrete curvature function.

In order to interpolate between two parameterized curves, it is easier when the domains of the parameter coincide. For this reason we will always consider curves parameterized with a parameter in $[0; 1]$. A natural parameterization is then the parameterization proportional to arc-length. It is obtain from the parameterization by arc-length by dividing the arc-length parameter by the

length of the curve L . The corresponding curvature function is also defined on $[0; 1]$ and is obtained from the curvature function parameterized by arc-length by compressing the x -axis by a factor L . To recover the initial curve from the curvature function associated to the parameter $s \in [0; 1]$ proportional to arc-length, one only need to know the length of the curve.

Parameterization proportional to curvature-length

In the same spirit as the scale space of T. Lindeberg ([132]), and the curvature scale space of Mackworth and Farin Mokhtarian ([144]), we now define another very natural parameterization space of 2D curves. Its relies on the fact that the integral of the absolute value of the curvature κ is an increasing function on the interval $[0; 1]$, strictly increasing when there are no flat pieces. In that case the function

$$r(s) = \frac{\int_0^s |\kappa(s)| ds}{\int_0^1 |\kappa(s)| ds} \quad (2.11)$$

(where κ denotes the curvature of the curve) belongs to the group of orientation preserving diffeomorphisms of the parameter space $[0; 1]$, denoted by $\text{Diff}^+([0; 1])$. Note that its inverse $s(r)$ can be computed graphically using the fact that its graph is the symmetric of the graph of $r(s)$ with respect to $y = x$. The contour of Elie Cartan's head can be reparameterized using the parameter $r \in [0; 1]$ instead of the parameter $s \in [0; 1]$. In Figure 2.7 upper left, we have depicted the graph of the function $s \mapsto r(s)$. A uniform sampling with respect to the parameter r is obtain by uniformly sampling the vertical-axis (this is materialized by the green equidistributed horizontal lines) and resampling Elie Cartan's head at the sequence of values of the s -parameter given by the abscissa of the corresponding points on the graph of r (where a green line hits the graph of r a red vertical line materializes the corresponding abscissa). One sees that this reparameterization naturally increases the number of points where the 2D contour is the most curved, and decreases the number of points on nearly flat pieces of the contour. For a given number of points, it gives an optimal way to store the information contained in the contour. The quantity

$$C = L \int_0^1 |\kappa(s)| ds, \quad (2.12)$$

where $s \in [0; 1]$ is proportional to arc-length, is called the *total curvature-length* of the curve. It is the length of the curve drawn in $\text{SO}(2)$ by the moving frame associated with the arc-length parameterized curve. For this reason we call this parameterization the *parameterization proportional to curvature-length*. In the right picture of Figure 2.7, we show the corresponding resampling of the contour of Elie Cartan's head.

This resampling can naturally be adapted in the case of flat pieces resulting in a sampling where there is no points between two points on the curve joint by a straight line. In the left picture of Figure 2.8, we have depicted a sampling of the statue of Liberty proportional to curvature-length. Note that there are no points on the base of the statue. The corresponding parameterization has the advantage of concentrating on the pieces of the contour that are very complex, i.e. where there is a lot of curvature, and not distributing points on the flat pieces which are easy to reconstruct (connecting two points by a straight line is easy, but drawing the moustache of Elie Cartan is harder and needs more information).

As illustrated in Section 2.4.2, it is possible to reconstruct a curve from its curvature function parameterized proportionally to curvature-length, provided that we know the length of the curve L and its total curvature-length C , and provided that there is no flat piece. Indeed, derivating equation (2.11), one obtains $dr = \frac{|\kappa(s)|}{C} L ds$, where $L ds$ is the arc-length measure of the curve.

The drawback of using the parameterization proportional to curvature-length is that one can not reconstruct the flat pieces of a shape without knowing their lengths (remember that the parameterization proportional to curvature-length put no point at all on flat pieces). For this reason we propose a parameterization intermediate between arc-length parameterization and curvature-length parameterization. We call it *curvarc-length parameterization*.

Curvarc-length parameterization

In order to define the curvarc-length parameterization, we consider the triple $(P(s), \vec{v}(s), \vec{n}(s))$, where $P(s)$ is the point of the shape parameterized proportionally to arc-length with $s \in [0; 1]$, $\vec{v}(s)$

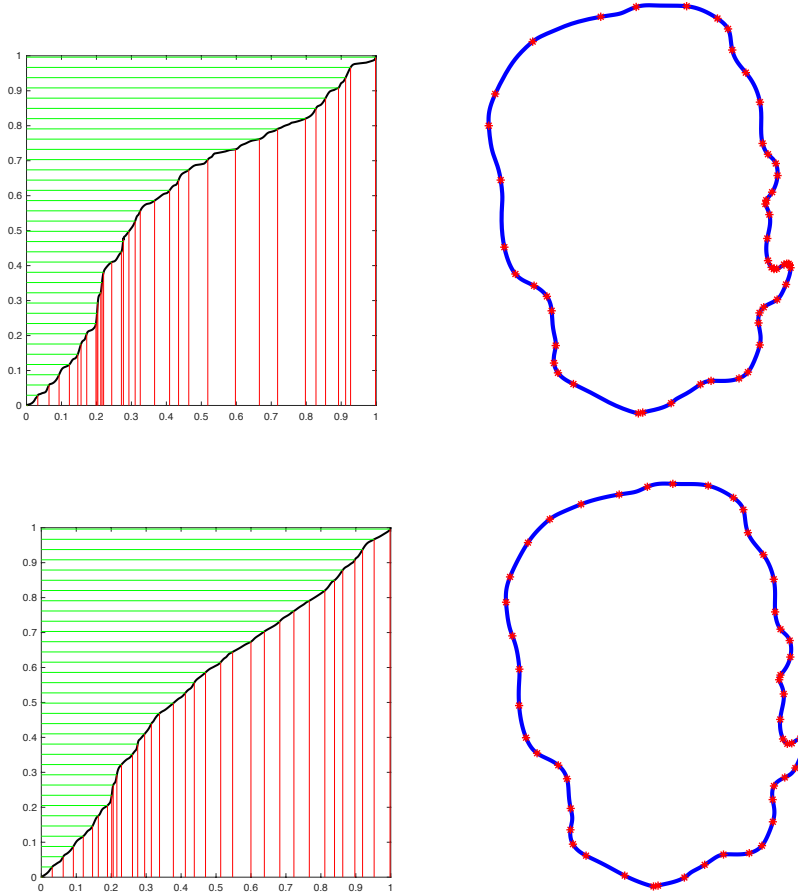

Figure 2.7: First line : Integral of the (renormalized) absolute value of the curvature (left), and corresponding resampling of Elie's Cartan head (right). Second line : Integral of the (renormalized) curvarc length (left), and corresponding resampling of Elie's Cartan head (right).

and $\vec{n}(s)$ the corresponding unit tangent vector and unit normal vector respectively. It defines an element of the group of rigid motions of \mathbb{R}^2 , called the special Euclidean group and denoted by $SE(2) := \mathbb{R}^2 \rtimes SO(2)$. The point $P(s)$ corresponds to the translation part of the rigid motion, it is the vector of translation needed to move the origin to the point of the curve corresponding to the parameter value s . The moving frame $O(s)$ defined by $\vec{v}(s)$ and $\vec{n}(s)$ is the rotation part of the rigid motion. One has the following equations :

$$\frac{dP}{ds} = L\vec{v}(s) \quad \text{and} \quad O(s)^{-1} \frac{d}{ds} O(s) = \begin{pmatrix} 0 & -\kappa(s) \\ \kappa(s) & 0 \end{pmatrix}, \quad (2.13)$$

where L is the length of the curve. Endow $SE(2) := \mathbb{R}^2 \rtimes SO(2)$ with the structure of a Riemannian manifold, product of the plane and the Lie group $SO(2) \simeq S^1$. Then the norm of the tangent vector to the curve $s \mapsto (P(s), \vec{v}(s), \vec{n}(s))$ is $L + |\kappa(s)|$. Therefore the length of the $SE(2)$ -valued curve is $L + \int_0^1 |\kappa(s)| ds = L + \frac{C}{L}$. We call it the total curvarc-length. It follows that the following function

$$u(s) = \frac{\int_0^s (L + |\kappa(s)|) ds}{\int_0^1 (L + |\kappa(s)|) ds}$$

defines a reparameterization of $[0; 1]$. The arc-length parameter of the initial shape is related to the parameter u by

$$Lds = \frac{L^2 + C}{L + |\kappa(u)|} du.$$

Parameterization proportional to the integral of $\lambda +$ curvature

With the same idea as before, one can reparameterize a curve using the integral of a constant λ plus the curvature function. In Fig. 2.8, the statue of Liberty is resampled with (from left to right)

$\lambda = 0; \lambda = 0.3; \lambda = 1; \lambda = 2; \lambda = 100.$

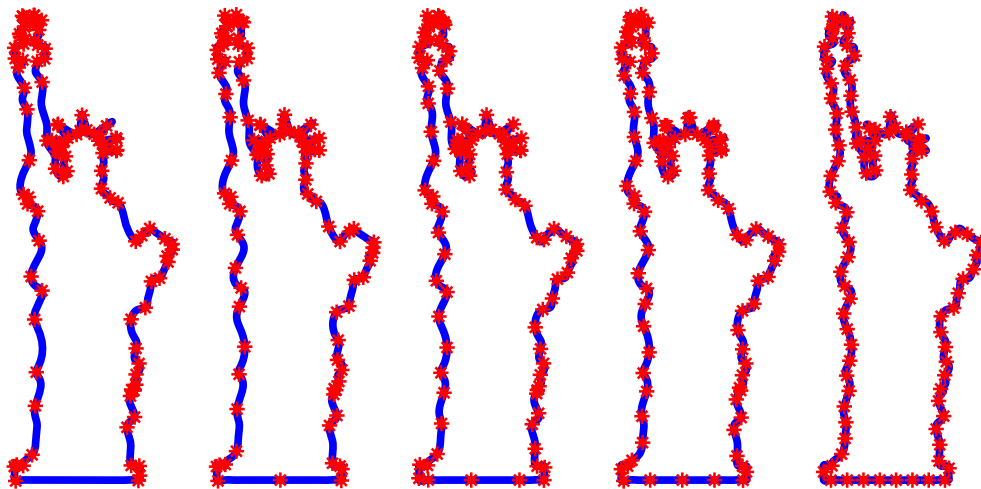

Figure 2.8: Resampling of the statue of Liberty proportional to the integral of $\lambda + \text{curvature}$, for (from left to right) $\lambda = 0; \lambda = 0.3; \lambda = 1; \lambda = 2; \lambda = 100.$

Application to medical imaging : parameterization of bones

In the analysis of diseases like Rheumatoid Arthritis, one uses X-ray scans to evaluate how the disease affects the bones. One effect of Rheumatoid Arthritis is erosion of bones, another is joint shrinking. In order to measure joint space, one has to solve a point correspondance problem. For this, one uses landmarks along the contours of bones. These landmarks have to be placed at the same anatomical positions for every patient. Below they are placed using a method by Hans Henrik Thodberg ([203]), based on minimum description length which minimizes the description of a PCA model capturing the variability of the landmark positions. For instance in Figure 2.9 left, the landmark number 56 should always be in the middle of the head of the bone because it is used to measure the width between two adjacent bones in order to detect rheumatoid arthritis.

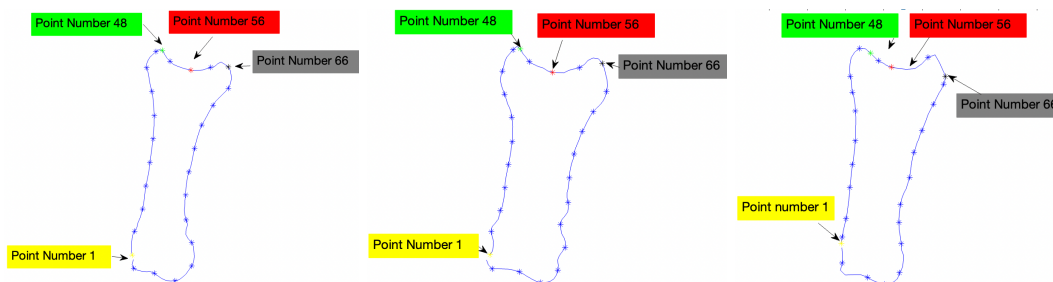

Figure 2.9: Point correspondance on 3 different bones using the method of [203]

Although the method by Hans Henrik Thodberg gives good results, it is computationally expensive. In this paper we propose to recover similar results with a quicker algorithm. It is based on the fact that any geometrically meaningful parameterization of a contour can be expressed using the arc-length measure and the curvature of the contour, which are the only geometric invariants of a 2D-curve (modulo translation and rotation). It follows that the parameterization calculated by Thodberg's algorithm should be recovered as a parameterization expressed using arc-length and curvature. We investigate a 2 parameter family of parameterizations defined by

$$u(s) = \frac{\int_0^s (c * L + |\kappa(s)|^\lambda) ds}{\int_0^1 (c * L + |\kappa(s)|^\lambda) ds} \quad (2.14)$$

where c and λ are positive parameters and where L is the length of the curve and κ its curvature function. We recover an analogous parameterization to the one given by Thodberg's algorithm with $c = 1$ and $\lambda = 7$ at real time speed.

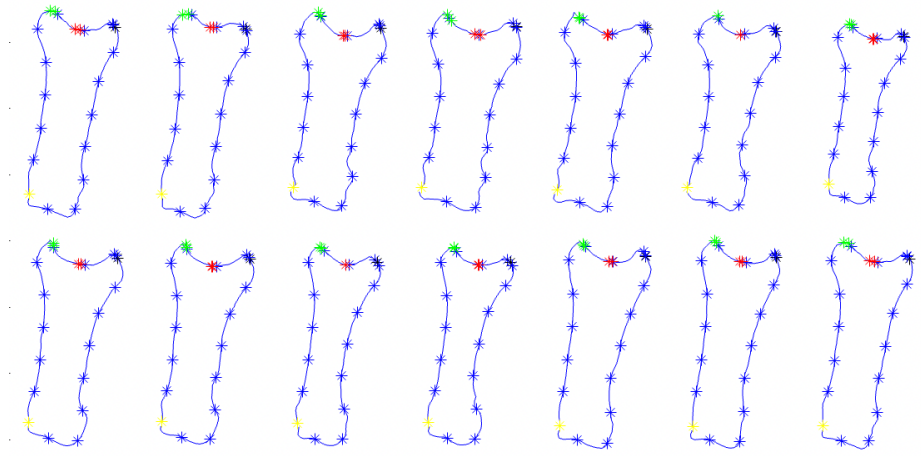

Figure 2.10: 14 bones parameterized by Thodberg's algorithm on one hand and the parameterization defined by (7.6) with $c = 1$ and $\lambda = 7$ on the other hand (the two parameterizations are superposed). The colored points corresponds to points labelled 1, 48, 56, 66. They overlap for the two methods.

2.3.4 Basic idea of interpolation using moving frames for curves in \mathbb{R}^3

The method of moving frames was first developed by Jean Frédéric Frenet and Joseph Alfred Serret for curves in \mathbb{R}^3 and later generalized by Gaston Darboux and Elie Cartan for more general submanifolds and spaces. For 3D curves, it consists in associating a natural frame to each point of a curve, i.e. a set of three vectors which are “moving” with the point of the curve (see Figure 2.3.4 right). The three vectors are naturally defined using the arc-length-parametrization f_0 of the curve and its derivatives f'_0 , f''_0 and f'''_0 . The first vector is the unit tangent vector of the curve

$$\vec{v}(s) = f'_0(s),$$

the second vector is the unit normal vector, which, using arc-length parametrization, is defined by

$$\vec{n}(s) = \frac{f''_0(s)}{\|f''_0(s)\|},$$

and the third vector is the unit bi-normal to the curve, which reads

$$\vec{b}(s) = \vec{v}(s) \wedge \vec{n}(s).$$

It is important to understand that the frame $\{\vec{v}, \vec{n}, \vec{b}\}$ is a geometric feature of the unparameterized curve, or equivalently of a class of parameterized curves modulo reparameterization. In the example of an aircraft trajectory as in Figure 2.3.4 left, this means that the Frenet-Serret frame depends only on the track of the airplane and not on the speed profile along the track. If we start with an arbitrary parameterization f of the same curve, one has $f(t) = f_0(s(t))$ where $s(t) = \int_0^t \|f'(t)\| dt$, i.e. the point $f(t)$ of the curve is equal, as point in \mathbb{R}^3 , to the point $f_0(s(t))$ with arc-length parameter $s(t)$. As function of t , the frame $\{\vec{v}(s(t)), \vec{n}(s(t)), \vec{b}(s(t))\}$ attached to the point $f(t) = f_0(s(t))$ on the curve could be defined directly using f and its derivatives by the following formulas:

$$\vec{v}(s(t)) = \frac{f'(t)}{\|f'(t)\|}, \quad \vec{b}(s(t)) = \frac{f'(t) \wedge f''(t)}{\|f'(t) \wedge f''(t)\|},$$

and

$$\vec{n}(s(t)) = \vec{b}(t) \wedge \vec{v}(t).$$

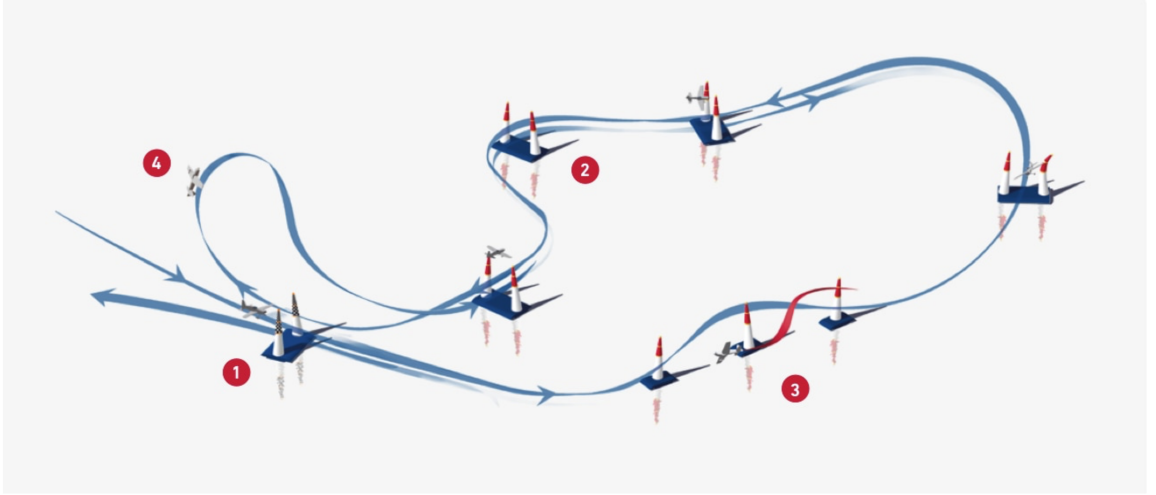

Figure 2.11: Air Track of Red Bull Air Race World Championship (<https://airrace.redbull.com/en/section/track>) Aircraft trajectory (Picture taken from <https://www.fsd.lrg.tum.de/research/trajectory-optimization/>) and Frenet-Serret frame of a space curve (Picture taken from <https://en.wikipedia.org/wiki/Moving-frame>)

Using the arc-length derivative of a function $h \in \mathcal{C}^\infty([0; 1], \mathbb{R}^3)$ given by

$$D_s h(t) := \frac{h'(t)}{\|f'(t)\|},$$

one has the following Frenet-Serret equations:

$$\begin{cases} D_s \vec{v} = \kappa \vec{n} \\ D_s \vec{n} = -\kappa \vec{v} + \tau \vec{b} \\ D_s \vec{b} = -\tau \vec{n}, \end{cases} \quad (2.15)$$

where κ and τ are called the *curvature* and the *torsion* of the curve respectively. In fact, it is not necessary to specify a parameterization to compute the curvature and torsion of a curve at a given point. One says that these are geometric features of the curve. They encode how much the curve is turning and moving away from a plane curve. The important point is that these two functions characterize the curve uniquely modulo translation and rotation. One says that they form a complete set of geometric invariants of the \mathbb{R}^3 -curve. In particular it is possible to reconstruct the curve from its curvature and torsion (modulo translation and rotation).

Writting the vectors \vec{v} , \vec{n} and \vec{b} in coordinates, one obtain an orthogonal matrix

$$O(s) = \begin{pmatrix} \vec{v}(s) & \vec{n}(s) & \vec{b}(s) \end{pmatrix}$$

depending on the arc-length parameter s , i.e. a curve on the Lie-group $\text{SO}(3)$. The derivative $\frac{d}{ds}O(s)$ of this curve at $O(s)$ is a tangent vector to $\text{SO}(3)$ at $O(s)$, which can be send to the Lie-algebra $\mathfrak{so}(3)$ of $\text{SO}(3)$ by left-translation. The Frenet-Serret formulas (2.15) are equivalent to the fact that the corresponding curve on the Lie-algebra as the following form:

$$O(s)^{-1} \frac{d}{ds} O(s) = \begin{pmatrix} 0 & -\kappa(s) & 0 \\ \kappa(s) & 0 & -\tau(s) \\ 0 & \tau(s) & 0 \end{pmatrix} \in \mathfrak{so}(3), \quad (2.16)$$

where the functions κ and τ are the curvature and torsion functions of the curve.

In this paper we propose different ways to interpolate between curves. One of these interpolation procedures is the linear interpolation in the space of geometric invariants. In the case of curves in \mathbb{R}^3 , the geometric invariants are the curvature and torsion functions, or using the matrix notation introduced in equation (2.16), curves with values in the Lie-algebra $\mathfrak{so}(3)$ with vanishing coefficients at the upper-right and lower-left corners. Since the Lie-algebra $\mathfrak{so}(3)$ is a finite-dimensional linear space naturally endowed with a scalar product (proportional to the Killing-form) given by:

$$\langle A, B \rangle = -\frac{1}{2} \text{Tr}(AB), \quad (2.17)$$

where $A, B \in \mathfrak{so}(3)$ and where Tr denotes the trace of a matrix, one can use this Euclidean structure to measure the discrepancy between two curves and interpolate between them. It corresponds to endowing the space $\mathcal{C}^\infty([0; 1], \mathfrak{so}(3))$ with the L^2 metric given by

$$\langle\langle A, B \rangle\rangle = -\frac{1}{2} \int_0^1 \text{Tr}(A(s)B(s))ds.$$

Note that the *parameterization proportional to arc-length* is used here to interpolate the two curves, hence it relies on the fact that an oriented curve has a unique parameterization proportional to arc-length with parameter in $[0; 1]$. In particular we used the fact that the parameter space of the two curves is the same. In other words, the space of (oriented) curves can be identified with the space of parameterized curves proportionally to arc-length with parameter in $[0; 1]$. Mathematically, the space of curves is the quotient space of the space of parameterized curves modulo the group of diffeomorphisms of $[0; 1]$, and the space of curves parameterized proportional to arc-length is a global section of the corresponding fiber bundle. One could use another section of this fiber bundle in order to interpolate in the space of curvatures and torsions.

Next we propose a very natural section which is the *parameterization proportional to curvature-length*. It involves the fact that the Killing form on $\mathfrak{so}(3)$ defines a natural Riemannian structure on the Lie group $\text{SO}(3)$, which is invariant by left and right translations. This means that there is a natural way to measure the speed of a curve on $\text{SO}(3)$. In particular, given a curve in \mathbb{R}^3 parameterized proportionally to arc-length, the speed of the corresponding moving frame $s \mapsto O(s)$ with respect to the scalar product given in (2.17) is $\sqrt{\kappa(s)^2 + \tau(s)^2}$ (apply formula (2.17) to the matrix given in (2.16)). Now the parameterization of the 3D curve proportional to curvature-length corresponds to parameterization proportional to arc-length of the corresponding moving frame. The corresponding parameter is

$$r(s) = \frac{\int_0^s \sqrt{\kappa(s)^2 + \tau(s)^2} ds}{\int_0^1 \sqrt{\kappa(s)^2 + \tau(s)^2} ds}.$$

Given two curves $f_1(r)$ and $f_2(r)$ parameterized proportional to the curvature-length with parameter $r \in [0; 1]$, one can consider the straight line in the space of curvatures and torsions connecting the curvature and torsion $(\kappa_1(r), \tau_1(r))$ at $f_1(r)$ to the curvature and torsion $(\kappa_2(r), \tau_2(r))$ at $f_2(r)$. As we will explain in this paper, from the curvature and torsion $(1-\lambda)(\kappa_1(r), \tau_1(r)) + \lambda(\kappa_2(r), \tau_2(r))$ one can reconstruct uniquely (modulo translation and rotation) a curve $F_\lambda(r)$ parameterized proportionally to curvature-length knowing its total length or its total curvature. The interpolation $\lambda \mapsto F_\lambda$ between the curves f_1 and f_2 differs from the interpolation $\lambda \mapsto f_\lambda$ constructed before, but share with it the rapidity of computation. We call it the *linear interpolation in the space of geometric invariants with respect to the parameterization proportional to curvature-length*. Mathematically the only difference is in the choice of a global section of the fiber bundle of the space of parameterized curves over the shape space.

One should note that any global section of the aforementioned fiber bundle gives theoretically a way to interpolate rapidly between two shapes. The two sections we considered here, namely the parameterization proportional to arc-length on one side and the parameterization proportional to curvature-length on the other, are both very natural and lead to easy computations. But the possibilities are infinite: any strictly increasing function having a geometric meaning with respect to what the shapes materialize will lead to a preferred parameterization of the shapes, and to a distance on shape space that stress this geometric quantity.

Let us mentionned also that for many applications, the step consisting in reconstructing the curve deformation from the curvature and torsion is unnecessary. Like in the case of the body of a caterpillar in Figure 2.3, linear interpolation between pertinent parameterizations of the routes may lead to very good results. In the fourth line of Figure 2.2, we have registered the second ballerina in an optimal way, and depicted the linear interpolation between the first ballerina with arc-length parameterization and the registered second ballerina. The result is the best that we have been able to obtain so far, in particular the stretching of the pointes (so important in ballet!) is very well depicted. For this reason, we will systematically compare the linear interpolation between curves parameterized with respect to a given section with the reconstruction from the linear interpolation of the geometric invariants. We will see for instance that linear interpolation between curvature-length parameterizations behave in many applications very well.

2.4 Examples of Interpolations between 2D-Shapes

2.4.1 Interpolation between curves in specific parameterization

Consider two 2D shapes S_1 and S_2 in a canonical parameterization (like arc-length, curvature-length, curvarc-length, etc...). We can interpolate between them by drawing the 2D shapes S_λ defined by $S_\lambda = (1 - \lambda)S_1 + \lambda S_2$, for $\lambda \in [0; 1]$. As mentioned before, this procedure may give very bad results when the parameterization is not well-choosen, as in the case of the ballerinas given in Figure 2.2. However in a lot of situations, linear interpolations between preferred parameterization gives very good results for a very low computational cost. In Figure 2.3, we have depicted the interpolation between three positions of the caterpillar from the movie *The Fox and the Hound* in different parameterizations : arc-length, curvature-length and curvarc-length. As a comparaison, we have also depicted the geodesics between the three positions of the caterpillar obtained using a method known in the litterature as the Square Root Velocity Transform (SRVT) or Qmap (see [102] and [192]). One can see that the last case is very similar to the arc-length interpolation. In Fig. 2.14, we have depicted different linear interpolations between parameterized curves:

1. Linear interpolation using parameterization as graphs of functions,
2. Linear interpolation using arc-length parameterization,
3. Linear interpolation using curvature-length parameterization,
4. Linear interpolation using curvarc-length parameterization.
5. Using q-map on preshape space (see <http://ssamg.stat.fsu.edu/software>).
6. Using q-map on shape space (see <http://ssamg.stat.fsu.edu/software>).

For each specific parameterization, we depict

- a) first parameterized curve,
- b) second parameterized curve
- c) Linear interpolation between the parameterized curves
- d) Corresponding points trajectories
- e) Resampling of each curve in the path with the specific parameterization
- f) Diffeomorphism defining the parameterization of curve 1
- g) Diffeomorphism defining the parameterization of curve 2
- h) Evolution of the primitive of the curvature during interpolation
- i) Evolution of the total curvature during interpolation
- j) Evolution of the total length during interpolation

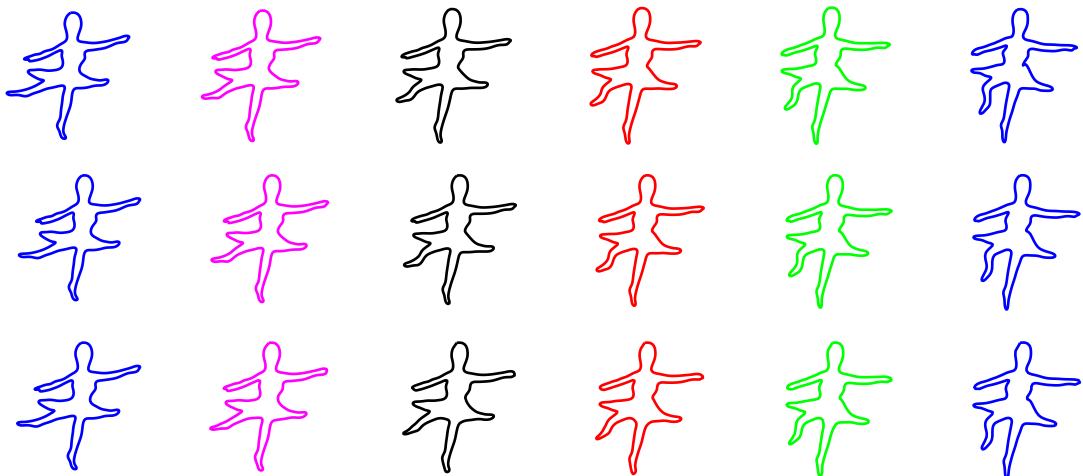

Figure 2.12: First line: Geodesic between some parameterized ballerinas with 300 points using Qmap : execution time = 561.75 s. The algorithms used for generating these geodesics are part of [102], and [192], and are available for free download at <http://ssamg.stat.fsu.edu/software>. The first and last shapes were taken from [197]. Second line: linear interpolation between the first blue ballerina and the last blue ballerina after registration using Qmap : execution time = 561.49 s. Third Line : Linear interpolation between the initial blue ballerina and the last one with a parameterization given by a function of arclength and curvature : execution time : 0.15 s.

2.4.2 Interpolation between curvature functions

2D-Shape interpolation using arc-length

Consider two 2D shapes S_1 and S_2 parameterized proportional to arc-length with length L_1 and L_2 respectively. One can compute the curvature functions κ_1 and κ_2 associated to their parameterization proportional to arc-length with parameter $s \in [0; 1]$, and consider the linear interpolation of these curvatures

$$\lambda \mapsto \kappa_\lambda(s) := (1 - \lambda)\kappa_1(s) + \lambda\kappa_2(s), \quad s \in [0; 1],$$

as well as the linear interpolation of their lengths

$$\lambda \mapsto L_\lambda := (1 - \lambda)L_1 + \lambda L_2.$$

For each value of the interpolating parameter $\lambda \in [0; 1]$, one can reconstruct the curve with length L_λ and curvature function κ_λ .

Denoting by \mathcal{K} the space of curvatures functions of 2D-curves

$$\mathcal{K} = \mathcal{C}^2([0, 1], \mathbb{R}),$$

the previously mentioned interpolation of curves consists in using the representation $f \mapsto \kappa$ and pulling-back the flat L^2 -metric on \mathcal{K} to the shape-space \mathcal{S} . The resulting scalar product at the class of an arc-length-parametrized curve f_0 reads:

$$\langle h_1, h_2 \rangle_{f_0} = \int_0^1 (\delta\kappa_1(s) \cdot \delta\kappa_2(s)) ds, \quad (2.18)$$

where h_1 and h_2 are tangent vectors to the space of arc-length parameterized curves at f_0 and $\delta\kappa_i$ the infinitesimal variations of the curvature function induced by h_i , $i = 1, 2$. Recall that the curvature of a curve f_0 parametrized by arc-length satisfies

$$|\kappa(s)| = \|f_0''(s)\|, \quad (2.19)$$

hence the variation of the curvature induced by a tangent vector h reads

$$\delta\kappa(s) = \frac{\langle f_0''(s), h''(s) \rangle}{\|f_0''(s)\|}.$$

It follows that the Riemannian metric used to compare curves in this section reads

$$G(h, h) = \int_0^1 \langle h''(s), \vec{n}(s) \rangle^2 ds, \quad (2.20)$$

where h is tangent to the space of arc-length parameterized curves.

2D-Shape interpolation using curvature-length

The scheme for interpolating between two 2D shapes S_1 and S_2 using the curvature-length is analogous to the one in Section 2.3.3 : given two 2D shapes S_1 and S_2 parameterized proportional to curvature-length with total curvature-length C_1 and C_2 respectively, one compute the curvature functions κ_1 and κ_2 associated to their parameterization proportional to curvature-length with parameter $r \in [0; 1]$, and consider the linear interpolation of these curvatures

$$\lambda \mapsto \kappa_\lambda(r) := (1 - \lambda)\kappa_1(r) + \lambda\kappa_2(r), \quad r \in [0; 1],$$

as well as the linear interpolation of their total curvature-length:

$$\lambda \mapsto C_\lambda := (1 - \lambda)C_1 + \lambda C_2.$$

For each value of the interpolating parameter $\lambda \in [0; 1]$, one can reconstruct the curve with total curvature-length C_λ and curvature function $\kappa_\lambda(r)$.

Visualization

In Fig.2.13, we have depicted the interpolation between a blue curve and a red curve obtain by the linear interpolation of their curvatures functions when the curves are first parameterized by arc-length, and second by curvature-length.

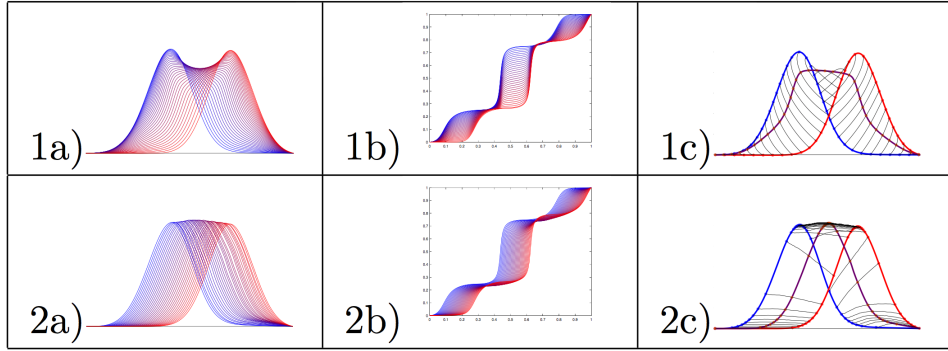

Figure 2.13: 1a) Path of curves constructed from the linear interpolation of the curvature functions of the blue and red curves parameterized by arc-length, 1b) Evolution of the integrals of the curvature functions parameterized by arc-length, 1c) Points trajectories for the path of curves constructed from the linear interpolation of the curvature functions parameterized by arc-length, 2a) Path of curves constructed from the linear interpolation of the curvature functions of the blue and red curves parameterized by curvature-length, 2b) Evolution of the integrals of the curvature functions parameterized by curvature-length, 2c) Points trajectories for the path of curves constructed from the linear interpolation of the curvature functions parameterized by curvature-length

2.5 Quotient elastic metrics on the manifold of arc-length parameterized plane curves

The authors of [143] introduced a 2-parameter family of Riemannian metrics $G^{a,b}$ on the space of plane curves that penalizes bending as well as stretching. The metrics within this family are now called elastic metrics. In [192], it was shown that, for a certain relation between the parameters, the resulting metric is flat on parameterized open curves, whereas the space of length-one curves is the unit sphere in an Hilbert space, and the space of parameterized closed curves a codimension 2 submanifold of a flat space. A similar method for simplifying the analysis of plane curves was introduced in [237]. These results have been generalized in [12], where the authors introduced another family of metrics, including the elastic metrics as well as the metric of [237], and studied in which cases these metrics can be described using the restrictions of flat metrics to submanifolds. In particular they showed that, for arbitrary values of the parameters a and b , the elastic metrics $G^{a,b}$ are flat metrics on the space of parameterized open curves, and the space of parameterized closed curves a codimension 2 submanifold of a flat space. These results have important consequences for shape comparison and form recognition since the comparison of parameterized curves becomes a trivial task and the comparison of unparameterized curves is greatly simplified. In this strategy, the space of unparameterized curves, also called *shape space*, is presented as a quotient space of the space of parameterized curves, where two parameterized curves are identified when they differ by a reparameterization. The elastic metrics induce Riemannian metrics on shape space, called quotient elastic metrics. The remaining difficult task in comparing two unparameterized curves under the quotient elastic metrics is to find a matching between the two curves that minimizes the distance between the corresponding reparameterization-orbits. Given this matching, computing a geodesic between two shapes is again an easy task using the flatness of the metrics.

In [126], a mathematically rigorous development of the quotient elastic metric used in [192] is given (i.e., with the parameters $a = \frac{1}{4}$ and $b = 1$), including a careful analysis of the quotient procedure by the reparameterization semi-group. The authors of [126] also showed that a minimizing geodesic always exists between two curves, when at least one of them is piecewise linear. Moreover, when both curves are piecewise linear, the minimizing geodesic can be represented by a straight line between two piecewise linear curves in the corresponding orbits. In other words the space of piecewise linear curves is a geodesically convex subset of the space of curves for the quotient elastic metric $G^{\frac{1}{4},1}$. Finally, in the same paper, a precise algorithm for the matching problem of piecewise linear curves is implemented, giving a tool to compare shapes in an efficient as well as accurate manner.

In [43], it was shown that, in the same context, a minimizing geodesic for the quotient elastic metric $G^{\frac{1}{4},1}$ always exists between two \mathcal{C}^1 -curves γ_1 and γ_2 , meaning that there exists two elements ϕ_1 and ϕ_2 in the reparameterization semi-group such that the straight line between $\gamma_1 \circ \phi_1$ and $\gamma_2 \circ \phi_2$ minimizes the geodesic distance between the orbits of γ_1 and γ_2 . However, the reparameterizations

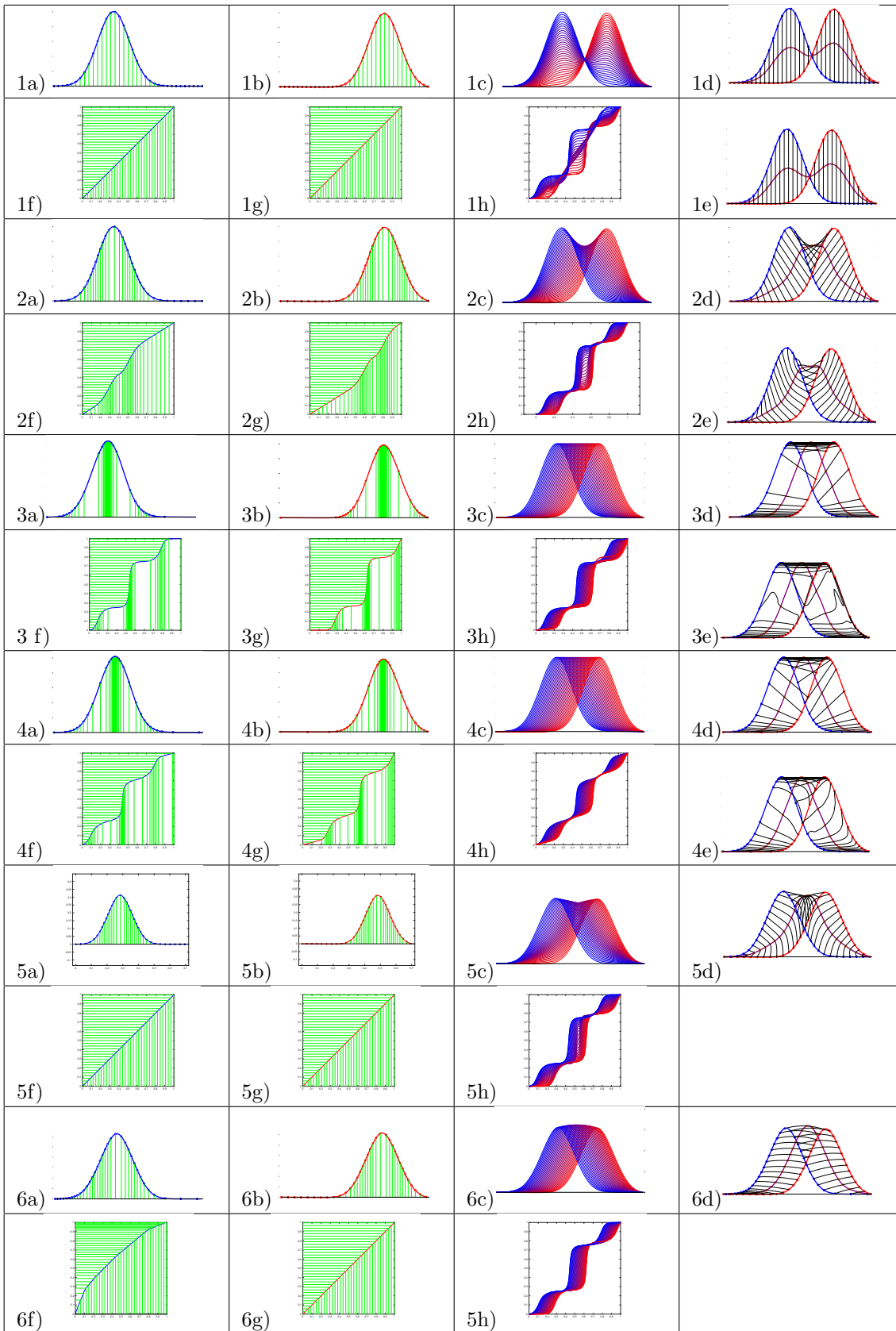

Figure 2.14: Examples of interpolations between curves: 1. Linear interpolation using parameterization as graphs of functions, 2. Linear interpolation using arc-length parameterization, 3. Linear interpolation using curvature-length parameterization, 4. Linear interpolation using curvarc-length parameterization. 5. Using q-map on preshape space (see <http://ssamg.stat.fsu.edu/software>). 6. Using q-map on shape space (see <http://ssamg.stat.fsu.edu/software>). For each specific parameterization: a) first parameterized curve, b) second parameterized curve c) Linear interpolation between the parameterized curves d) Corresponding points trajectories e) Resampling of each curve in the path with the specific parameterization f) Diffeomorphism defining the parameterization of curve 1 g) Diffeomorphism defining the parameterization of curve 2 h) Evolution of the primitive of the curvature during interpolation i) Evolution of the total curvature during interpolation j) Evolution of the total length during interpolation

ϕ_1 and ϕ_2 being a priori only absolutely continuous, it is not clear whether $\gamma_1 \circ \phi_1$ and $\gamma_2 \circ \phi_2$ can be chosen to be \mathcal{C}^1 . In other words, it is (to our knowledge) not known whether the subset of \mathcal{C}^1 -curves is geodesically convex. In addition, two Lipschitz-curves in the plane are constructed in [43] for which no optimal reparameterizations exist.

In the present Section, we want to present another strategy for understanding the quotient elastic metrics on shape space. Indeed, instead of identifying the shape space of unparameterized curves with a quotient space, we identify it with the space of arc-length parameterized curves. Given a shape in the plane, this consists in endowing it with the preferred parameterization by its arc-length, leading to a uniformly sampled curve. Note that any Riemannian metric on shape space can be understood as a Riemannian metric on the space of arc-length parameterized curves. In this section, we endow the space of arc-length parameterized curves with the quotient elastic metrics. In [110], the manifold of arc-length parameterized curves was also studied, but the metrics used there are not the elastic ones. The present Section is organized as follows. In Section 2.5.1, we concentrate on the smooth case, and compute the gradient of the energy functional associated to the quotient elastic metrics $G^{a,b}$. In Section 2.5.2, we consider a discretization of the smooth case. This is an unavoidable step towards implementation, where each smooth curve is approximated by polygonal lines, and each smooth parameterized curve is approximated by a piecewise linear curve. Finally, in Subsection 2.5.3, an algorithm for the two-boundary problem is presented, and some properties of the energy landscape depending on the parameters are studied.

2.5.1 Quotient elastic metrics on arc-length parameterized plane curves

Definition of the elastic metrics

For $I = [0, 1]$ or $I = \mathbb{S}^1 = \mathbb{R}/\mathbb{Z}$, we will consider the following 2-parameter family of metrics on the space $\mathcal{C}_1(I)$ of plane curves:

$$G^{a,b}(w, w) = \int_0^1 \left(a (D_s w \cdot v)^2 + b (D_s w \cdot n)^2 \right) |\gamma'(t)| dt, \quad (2.21)$$

where a and b are positive constants, γ is any parameterized curve in $\mathcal{C}_1(I)$, w is any element of the tangent space $T_\gamma \mathcal{C}_1(I)$, with $D_s w = \frac{w'}{|\gamma'|}$ denoting the arc-length derivative of w , $v = \gamma'/|\gamma'|$ and $n = v^\perp$. These metrics have been introduced in [143], and are now called elastic metrics. They have been also studied in [12] with another convention for the coefficients (a in [143] equals b^2 in [12], and b in [143] equals a^2 in [12]). For w_1 and w_2 two tangent vectors at $\gamma \in \mathcal{C}_1(I)$, the corresponding inner product reads:

$$G^{a,b}(w_1, w_2) = \int_0^1 \left(a (D_s w_1 \cdot v)(D_s w_2 \cdot v) + b (D_s w_1 \cdot n)(D_s w_2 \cdot n) \right) |\gamma'(t)| dt. \quad (2.22)$$

The metric $G^{a,b}$ is invariant with respect to the action of the reparameterization group $\mathcal{G}(I)$ on $\mathcal{C}_1(I)$ and therefore it defines a metric on the quotient space $\mathcal{C}_1^f(I)/\mathcal{G}(I)$, which we will refer to as the *quotient elastic metric*.

Horizontal space for the elastic metrics

Let us now consider an initial curve γ located on the submanifold $\mathcal{A}_1(I)$ of curves parameterized by arc-length and of length 1. Recall that in this case, one has $|\gamma'(s)| = 1$ and $D_s = \frac{d}{ds}$. Any tangent vector $u \in T_\gamma \mathcal{C}_1(I)$ at $\gamma \in \mathcal{A}_1(I)$ can be written as $u(t) = m(t)v(t)$ where $m \in \mathcal{C}^\infty([0, 1], \mathbb{R})$ satisfies $m(0) = 0$ and $m(1) = 0$ for open curves and $m \in \mathcal{C}^\infty(\mathbb{S}^1, \mathbb{R})$ for closed curves. The orthogonal space to $T_\gamma \mathcal{C}_1(I)$ for the elastic metric $G^{a,b}$ on $\mathcal{C}_1(I)$ is called the *horizontal space* at γ .

Proposition 2.5.1. *The horizontal space Hor at $\gamma \in \mathcal{A}_1(I)$ is*

$$Hor_\gamma = \left\{ w \in T_\gamma \mathcal{C}_1(I), (w' \cdot v)' = \frac{b}{a} \kappa (w' \cdot n) \right\}. \quad (2.23)$$

Proof. Let $u = m v \in T_\gamma \mathcal{C}_1(I)$. One has:

$$u' \cdot v = m'(s), \quad u' \cdot n = m(s)\kappa(s).$$

The horizontal space at γ consists of vector fields $w \in T_\gamma \mathcal{C}_1(I)$ such that for any function $m \in \mathcal{C}^\infty(I, \mathbb{R})$ (with $m(0) = m(1) = 0$ for open curves), the following quantity vanishes:

$$0 = G^{a,b}(w, m \mathbf{v}) = \int_0^1 (am'(s) (w'(s) \cdot \mathbf{v}(s)) + bm(s)\kappa(s) (w'(s) \cdot \mathbf{n}(s))) ds.$$

After integrating the first term by parts, one obtains the following condition on w , which has to be satisfied for any real function $m \in \mathcal{C}^\infty(I, \mathbb{R})$ (with $m(0) = 0$ and $m(1) = 0$ for open curves):

$$0 = \int_0^1 m (-a (w' \cdot \mathbf{v})' + b\kappa (w' \cdot \mathbf{n})) ds.$$

Using the density of such functions m in $L^2(I, \mathbb{R})$, this implies that the equation defining the horizontal space of the elastic metric at γ is

$$(w' \cdot \mathbf{v})' = \frac{b}{a} \kappa (w' \cdot \mathbf{n}). \quad (2.24)$$

□

Quotient elastic metrics

Since the reparameterization group preserves the elastic metric $G^{a,b}$, it defines a quotient elastic metric on the quotient space $\mathcal{C}_1([0, 1])/\mathcal{G}([0, 1])$, which we will denote by $\overline{G}^{a,b}$. By Theorem 2.2.9, this quotient space is identified with the submanifold $\mathcal{A}_1([0, 1])$, and we can pull back the quotient elastic metric $\overline{G}^{a,b}$ on $\mathcal{A}_1([0, 1])$. We will denote the corresponding metric on $\mathcal{A}_1([0, 1])$ by $\tilde{G}^{a,b}$. The value of the metric $\tilde{G}^{a,b}$ on a tangent vector $w \in T_\gamma \mathcal{A}_1([0, 1])$ is the value of $\overline{G}^{a,b}([w], [w])$, where $[w]$ denotes the equivalence class of w in the quotient space $T_\gamma \mathcal{C}_1([0, 1])/T_\gamma \mathcal{O}$. By definition of the quotient metric,

$$\overline{G}^{a,b}([w], [w]) = \inf_{u \in T_\gamma \mathcal{O}} G^{a,b}(w + u, w + u)$$

where u ranges over all tangent vectors in $T_\gamma \mathcal{O}$. If $T_\gamma \mathcal{C}_1([0, 1])$ decomposes as $T_\gamma \mathcal{C}_1([0, 1]) = T_\gamma \mathcal{O} \oplus \text{Hor}_\gamma$, this minimum is achieved by the unique vector $P_h(w) \in [w]$ belonging to the horizontal space Hor_γ at γ . In this case:

$$\tilde{G}^{a,b}(w, w) = G^{a,b}(P_h(w), P_h(w)), \quad (2.25)$$

where $P_h(w) \in T_\gamma \mathcal{C}_1([0, 1])$ is the projection of w onto the horizontal space, i.e., is the unique horizontal vector such that $w = P_h(w) + u$ with $u \in T_\gamma \mathcal{O}$.

Proposition 2.5.2. *Let w be a tangent vector to the manifold $\mathcal{A}_1([0, 1])$ at γ and write $w' = \Phi \mathbf{n}$, where Φ is a real function in $\mathcal{C}^\infty([0, 1], \mathbb{R})$. Then the projection $P_h(w)$ of $w \in T_\gamma \mathcal{A}_1([0, 1])$ onto the horizontal space Hor_γ reads $P_h(w) = w - m \mathbf{v}$ where $m \in \mathcal{C}^\infty([0, 1], \mathbb{R})$ is the unique solution of*

$$-\frac{a}{b} m'' + \kappa^2 m = \kappa \Phi, \quad m(0) = 0, \quad m(1) = 0. \quad (2.26)$$

where κ is the curvature function of γ .

Proof. Recall that a tangent vector w to the manifold $\mathcal{A}_1([0, 1])$ at γ satisfies $w' \cdot \mathbf{v} = 0$, where \mathbf{v} is the unit tangent vector field of the curve γ . Hence, for any $w \in T_\gamma \mathcal{A}_1([0, 1])$, the derivative w' of w with respect to the arc-length parameter reads $w' = \Phi \mathbf{n}$, where Φ is a real function in $\mathcal{C}^\infty([0, 1], \mathbb{R})$. One has

$$P_h(w)' = \Phi \mathbf{n} - m' \mathbf{v} - m \kappa \mathbf{n}, \quad (2.27)$$

hence $P_h(w)' \cdot \mathbf{v} = -m'$ and $P_h(w)' \cdot \mathbf{n} = (\Phi - m\kappa)$. The condition (2.24) for $P_h(w)$ to be horizontal is therefore (2.26). Equation (2.26) is a particular case of Sturm-Liouville equation $-(pm')' + qm = f$ with homogeneous boundary condition $m(0) = 0$ and $m(1) = 0$. Here $p = \frac{a}{b} > 0$ and $q = \kappa^2 \geq 0$. The fact that equation (2.26) has a unique solution follows from Lax-Milgram Theorem (see Section 8.4 in [40]). □

For closed curves, the tangent space to $\mathcal{A}_1^f(\mathbb{S}^1)$ at γ contains the vector space of vector fields of the form $c \mathbf{v}$ where c is a constant and $\mathbf{v} = \gamma'$. These vector fields generate the translation of base point, which is the natural action of the subgroup \mathbb{S}^1 of $\mathcal{G}(\mathbb{S}^1)$. One has

$$T_\gamma \mathcal{A}_1^f(\mathbb{S}^1) \cap T_\gamma \mathcal{O} = T_\gamma (\mathbb{S}^1 \cdot \gamma),$$

where $\mathbb{S}^1 \cdot \gamma = \{s \mapsto \gamma(s + \tau), \tau \in \mathbb{S}^1\}$. Therefore one can consider the horizontal projection $P_h: T_{[\gamma]}\mathcal{A}_1^f(\mathbb{S}^1)/\mathbb{S}^1 \rightarrow \text{Hor}_\gamma$, where $[\gamma]$ denotes the projection of γ on the quotient space $\mathcal{A}_1(\mathbb{S}^1)/\mathbb{S}^1$. We will denote by $[w]$ the projection of $w \in T_\gamma\mathcal{A}_1(\mathbb{S}^1)$ on the tangent space $T_{[\gamma]}\mathcal{A}_1(\mathbb{S}^1)/\mathbb{S}^1$. Note that $[w] = \{w + cv, c \in \mathbb{R}\}$ and that $\int_0^1 w'(s)ds = 0$.

Proposition 2.5.3. *Let w be a tangent vector to the manifold $\mathcal{A}_1(\mathbb{S}^1)$ at γ and write $w' = \Phi \mathbf{n}$, where Φ is a real function in $\mathcal{C}^\infty(\mathbb{S}^1, \mathbb{R})$ such that $\int_0^1 \Phi(s) \mathbf{n}(s) ds = 0$. Then the horizontal projection $P_h([w])$ of $[w]$ onto the horizontal space reads $P_h([w]) = [w - mv]$ where $m \in \mathcal{C}^\infty(\mathbb{S}^1, \mathbb{R})$ is the unique periodic solution of*

$$-\frac{a}{b}m'' + \kappa^2 m = \kappa\Phi. \quad (2.28)$$

Proof. As before the condition for $w - mv$ to be horizontal is (2.26). The question is whether there exists a periodic solution m of the equation for given periodic functions $\kappa(x)$ and $\Phi(x)$. Since $\kappa(s+1) = \kappa(s)$ and $\Phi(s+1) = \Phi(s)$, we would like to satisfy $m'(1) = m'(0)$ and $m(1) = m(0)$. By the equation satisfied by m , it will imply that m is a smooth periodic function on \mathbb{S}^1 . Let $y_1(s)$ and $y_2(s)$ be solutions of the equation $y''(s) - \kappa(s)^2 y(s) = 0$, with initial conditions $y_1(0) = 1, y_1'(0) = 0$, $y_2(0) = 0$, and $y_2'(0) = 1$. Then Abel's formula implies that the Wronskian is

$$W(s) = y_1(s)y_2'(s) - y_2(s)y_1'(s) \equiv 1.$$

And variation of parameters gives us the solution

$$m(x) = c_1 y_1(x) + c_2 y_2(x) - y_1(x) \int_0^x \kappa(x)\Phi(x)y_2(x) dx + y_2(x) \int_0^x \kappa(x)\Phi(x)y_1(x) dx,$$

where $c_1 = m(0)$ and $c_2 = m'(0)$.

The question is how to choose c_1 and c_2 so that $m(1) = c_1$ and $m'(1) = c_2$. We clearly end up with the system

$$\begin{aligned} c_1[y_1(1) - 1] + c_2 y_2(1) &= B y_1(1) - A y_2(1) \\ c_2 y_1'(1) + c_2[y_2'(1) - 1] &= B y_1'(1) - A y_2'(1), \end{aligned}$$

where

$$A = \int_0^1 \kappa(x)\Phi(x)y_1(x) dx \quad \text{and} \quad B = \int_0^1 \kappa(x)\Phi(x)y_2(x) dx.$$

This has a solution if and only if the determinant

$$\delta = [y_1(1) - 1][y_2'(1) - 1] - y_2(1)y_1'(1)$$

is nonzero. Note that since the Wronskian is constant, we can write $\delta = 2 - y_2'(1) - y_1(1)$.

To further see what's happening, we now use the reduction of order trick to write $y_2(s) = \phi(s)y_1(s)$, where

$$\phi(s) = \int_0^s \frac{dx}{y_1(x)^2}.$$

It is obvious from the initial condition and the fact that $\kappa(s)^2$ is positive that $y_1(s)$ is strictly increasing for $s > 0$, and $y_1'(s)$ is nonnegative for $s \geq 0$. Thus ϕ is always well-defined. We now have $y_2'(1) = \phi'(1)y_1(1) + \phi(1)y_1'(1)$, and thus our formula is

$$\begin{aligned} \delta &= 2 - \frac{1}{y_1(1)} - y_1'(1) \int_0^1 \frac{dx}{y_1(x)^2} - y_1(1) \\ &= -[y_1(1) - 1/y_1(1)]^2 - y_1'(1) \int_0^1 \frac{dx}{y_1(x)^2}. \end{aligned}$$

We see that the only way this can be zero is if $y_1'(1) = 0$ and $y_1(1) = y_1(1)$, and both these conditions are equivalent to $y_1(s)$ actually being constant, which only happens if $\kappa(s)$ is identically equal to zero on $[0, 1]$. Hence unless the curve is a straight line, one can always solve the differential equation and get a unique periodic solution m . Since γ is a closed curve, γ cannot be a straight line. \square

Denote by \mathbb{G} the Green function associated to equation (2.26). By definition, the solution of

$$-\frac{a}{b}m'' + \kappa^2 m = \varphi, \quad (2.29)$$

where φ is any right-hand side, is

$$m(s) = \int_0^1 \mathbb{G}(s, x)\varphi(x)dx,$$

where m satisfies the additional condition:

- $m(0) = 0$ and $m(1) = 0$ for open curves,
- m is periodic for closed curves.

Remark 2.5.4. Using (2.27), observe that for any tangent vector $w \in T_\gamma \mathcal{A}_1(I)$ with $w' = \Phi \mathbf{n}$, one has

$$\tilde{G}^{a,b}(w, w) = \int_0^1 (a(m')^2 + b(\Phi - m\kappa)^2) ds, \quad (2.30)$$

where m satisfies (2.26) for open curves and (2.28) for closed curves.

We will also need the following expression of the quotient elastic metric on $\mathcal{A}_1([0, 1])$.

Theorem 2.5.5. *Let w and z be two tangent vectors in $T_\gamma \mathcal{A}_1([0, 1])$ with $w' = \Phi \mathbf{n}$ and $z' = \Psi \mathbf{n}$, where $\Phi, \Psi \in \mathcal{C}^\infty([0, 1], \mathbb{R})$. Write $P_h(z) = z - p \mathbf{v}$, where p satisfies $-ap'' + b\kappa^2 p = b\kappa \Psi$ with $p(0) = p(1) = 0$. Then the scalar product of w and z with respect to the quotient elastic metric $\tilde{G}^{a,b}$ on the space of arc-length parameterized curves $\mathcal{A}_1([0, 1])$ reads*

$$\tilde{G}^{a,b}(w, z) = \int_0^1 b\Phi(\Psi - \kappa p) ds. \quad (2.31)$$

Proof. Denote respectively by $P_h(w)$ and $P_h(z)$ the projections of w and z on the horizontal space, and define $m, p \in \mathcal{C}^\infty([0, 1], \mathbb{R})$ by $P_h(w) = w - m \mathbf{v}$ and $P_h(z) = z - p \mathbf{v}$. Since the horizontal space is the orthogonal space to $T_\gamma \mathcal{O}$ for the elastic metric $G^{a,b}$, one has

$$G^{a,b}(w, z) = G^{a,b}(P_h(w) - m \mathbf{v}, P_h(z) - p \mathbf{v}) = G^{a,b}(P_h(w), P_h(z)) + G^{a,b}(m \mathbf{v}, p \mathbf{v}).$$

It follows that

$$\begin{aligned} \tilde{G}^{a,b}(w, z) &= G^{a,b}(P_h(w), P_h(z)) = G^{a,b}(w, z) - G^{a,b}(m \mathbf{v}, p \mathbf{v}) \\ &= \int_0^1 (b\Phi\Psi - am'p' - b\kappa^2 mp) ds. \end{aligned}$$

After integrating the second term by parts, one has

$$\tilde{G}^{a,b}(w, z) = \int_0^1 (b\Phi\Psi + p(am'' - b\kappa^2 m)) ds.$$

Using the differential equation (2.26) satisfied by the function m , we obtain (2.31). \square

For closed curves, the same construction gives a Riemannian metric on the quotient space $\mathcal{A}_1^f(\mathbb{S}^1)/\mathbb{S}^1$. We can extend the definition of this metric to the space $\mathcal{A}_1(\mathbb{S}^1)/\mathbb{S}^1$ by the same formula. We get the following result:

Theorem 2.5.6. *Let w and z be two tangent vectors in $T_\gamma \mathcal{A}_1(\mathbb{S}^1)$ with $w' = \Phi \mathbf{n}$ and $z' = \Psi \mathbf{n}$, where $\Phi, \Psi \in \mathcal{C}^\infty(\mathbb{S}^1, \mathbb{R})$. Write $P_h([z]) = [z - p \mathbf{v}]$, where p satisfies $-ap'' + b\kappa^2 p = b\kappa \Psi$ with periodic boundary conditions. Then the scalar product of $[w]$ and $[z]$ with respect to the quotient elastic metric $\tilde{G}^{a,b}$ on the space of arc-length parameterized curves $\mathcal{A}_1(\mathbb{S}^1)/\mathbb{S}^1$ reads*

$$\tilde{G}^{a,b}([w], [z]) = \int_0^1 b\Phi(\Psi - \kappa p) ds. \quad (2.32)$$

Proof. Let us check that the expression of $\tilde{G}^{a,b}([w], [z])$ does not depend on the representative of $[w]$ and $[z]$ chosen. Set $z_2 = z + c \mathbf{v}$ for some constant $c \in \mathbb{R}$. Then $z_2' = z' + c \mathbf{n} = (\Psi + c\kappa) \mathbf{n}$. Denote by p_2 the solution of $-ap_2'' + b\kappa^2 p_2 = b\kappa(\Psi + c\kappa)$ with periodic boundary conditions. Then $-a(p_2 - c)'' + b\kappa^2(p_2 - c) = b\kappa\Psi$. By uniqueness of the solution of equation $-ap'' + b\kappa^2 p = b\kappa\Psi$, one has $p = p_2 - c$. Therefore

$$\int_0^1 b\Phi((\Psi + c) - \kappa p_2) ds = \int_0^1 b\Phi(\Psi - \kappa p) ds.$$

By symmetry, one also has the independence with respect to the representative of $[w]$. \square

For closed curves, this Riemannian metric can be lifted in a unique way to a degenerate metric on $\mathcal{A}_1(\mathbb{S}^1)$ with only degeneracy along the fibers of the projection $\mathcal{A}_1(\mathbb{S}^1) \rightarrow \mathcal{A}_1(\mathbb{S}^1)/\mathbb{S}^1$. The advantage of the degenerate lift is that it allows to compare closed curve irrespective of the position of the base point. This situation is analogous to the one encountered in Section 2.2.2, where the degeneracy of the metric was along the orbits by space translations. See also [205] where this idea is used in the context of 2-dimensional shapes.

Definition and derivative of the energy functional

In this section we will determine the gradient of the energy functional corresponding to the metric $\tilde{G}^{a,b}$ on the spaces $\mathcal{A}_1([0, 1])$ and $\mathcal{A}_1(\mathbb{S}^1)/\mathbb{S}^1$ of arc-length parameterized curves. We will use the following conventions:

- the arc-length parameter of curves in $\mathcal{A}_1(I)$ will be denoted by $s \in I$,
- the time parameter of a path in $\mathcal{A}_1(I)$ will be denoted by $t \in [0, T]$,
- the parameter $\varepsilon \in (-\delta, +\delta)$ will be the parameter of deformation of a path in $\mathcal{A}_1(I)$.

Consider a variation $\gamma: (-\delta, +\delta) \times [0, T] \times I \rightarrow \mathbb{R}^2$ of a smooth path in $\mathcal{A}_1(I)$. In general in the following Sections we will denote partial derivatives by subscripted index notations. Note that, since any curve in $\mathcal{A}_1(I)$ is parameterized by arc-length, the arc-length derivative γ_s of γ is a unit vector in the plane for any values of the parameters (ε, t, s) , previously denoted by v . For this reason, we will write it as

$$\gamma_s(\varepsilon, t, s) = (\cos \theta(\varepsilon, t, s), \sin \theta(\varepsilon, t, s)), \quad (2.33)$$

where $\theta(\varepsilon, t, s)$ denotes a smooth lift of the angle between the x -axis and the unit vector $v(\varepsilon, t, s) = \gamma_s(\varepsilon, t, s)$. In particular for closed curves, $\theta(\cdot, \cdot, 0) = 2\pi R + \theta(\cdot, \cdot, 1)$ where R is the rotation number of the curve.

Definition 2.5.7. For any $\varepsilon \in (-\delta, +\delta)$, the function $t \mapsto \gamma(\varepsilon, t, \cdot)$ is a path in $\mathcal{A}_1(I)$, whose energy is defined as

$$E(\varepsilon) = \frac{1}{2} \int_0^T \tilde{G}^{a,b}(\gamma_t, \gamma_t) dt,$$

where γ_t is the tangent vector to the path $t \mapsto \gamma(\varepsilon, t, \cdot) \in \mathcal{A}_1(I)$.

Theorem 2.5.8. Consider a variation $\gamma: (-\delta, +\delta) \times [0, T] \times I \rightarrow \mathbb{R}^2$ of a smooth path in $\mathcal{A}_1(I)$, with $\gamma_s(\varepsilon, t, s) = (\cos \theta(\varepsilon, t, s), \sin \theta(\varepsilon, t, s))$ for some angle $\theta(\varepsilon, t, s)$. Then the energy as a function of ε is given by

$$E(\varepsilon) = \frac{1}{2} \int_0^T \int_0^1 (am_s^2 + b(\theta_t - \theta_s m)^2) ds dt, \quad (2.34)$$

where m is uniquely determined by the condition

$$-am_{ss} + b\theta_s^2 m = b\theta_s \theta_t, \quad (2.35)$$

with $m(0) = m(1) = 0$ for $I = [0, 1]$ and periodic boundary conditions for $I = \mathbb{S}^1 = \mathbb{R}/\mathbb{Z}$. The derivative of the energy functional is given by

$$\frac{dE}{d\varepsilon}(0) = \int_0^T \int_0^1 \theta_\varepsilon(t, s) \xi(t, s) ds dt, \quad (2.36)$$

where

$$\frac{1}{b} \xi = -\theta_{tt} + \partial_t(\theta_s m) + \partial_s(\theta_t m) - \partial_s(\theta_s m^2). \quad (2.37)$$

Proof. Equation (2.33) implies in particular that

$$\gamma_{ss}(\varepsilon, t, s) = \theta_s(\varepsilon, t, s) (-\sin \theta(\varepsilon, t, s), \cos \theta(\varepsilon, t, s)) = \theta_s(\varepsilon, t, s) n(\varepsilon, t, s),$$

where $s \mapsto n(\varepsilon, t, s) = (-\sin \theta(\varepsilon, t, s), \cos \theta(\varepsilon, t, s))$ is the normal vector field n along the parameterized curve $s \mapsto \gamma(\varepsilon, t, s)$. In particular, the curvature $\kappa(\varepsilon, t, s)$ of the curve $s \mapsto \gamma(\varepsilon, t, s)$ at $\gamma(\varepsilon, t, s)$ reads

$$\kappa(\varepsilon, t, s) = \theta_s(\varepsilon, t, s).$$

For closed curves, one has $\theta_s(\varepsilon, t, s) = \theta_s(\varepsilon, t, s+1)$ since the curvature is a feature of the curve. Furthermore the arc-length derivative of the tangent vector γ_t along the path $t \mapsto \gamma(\varepsilon, t, s)$ reads

$$\gamma_{ts}(\varepsilon, t, s) = \gamma_{st}(\varepsilon, t, s) = \theta_t(\varepsilon, t, s) \mathbf{n}(\varepsilon, t, s).$$

For $I = \mathbb{S}^1$, since γ is a path of closed curves, $\gamma_t(\varepsilon, t, s) = \gamma_t(\varepsilon, t, s+1)$ and $\theta_t(\varepsilon, t, s) = \theta_t(\varepsilon, t, s+1)$. Denote by $m \in \mathcal{C}^\infty([0, T] \times I, \mathbb{R})$ the solution, for each fixed t , of

$$-\frac{a}{b} m_{ss}(t, s) + \theta_s^2(t, s) m(t, s) = \theta_s(t, s) \theta_t(t, s), \quad (2.38)$$

with $m(t, 0) = m(t, 1) = 0$ for $I = [0, 1]$ and periodic boundary conditions for $I = \mathbb{S}^1$, i.e.,

$$m(t, s) = \int_0^1 \mathbb{G}(t; s, x) \theta_x(t, x) \theta_t(t, x) dx, \quad (2.39)$$

where \mathbb{G} is the (time-dependent) Green function associated to equation (2.29) (we have omitted the dependency on ε here in order to improve readability). Using the expression of the metric $\tilde{G}^{a,b}$ given in (2.30) with $\Phi = \theta_t$ and $\kappa = \theta_s$, one has

$$E(\varepsilon) = \frac{1}{2} \int_0^T \int_0^1 (am_s^2 + b(\theta_t - \theta_s m)^2) ds dt.$$

Note that the ε -derivative γ_ε at $\varepsilon = 0$ is a vector field along the path $t \mapsto \gamma(0, t, s)$. Hence for any fixed parameter $t \in [0, T]$, $s \mapsto \gamma_\varepsilon(0, t, s)$ is an element of the tangent space $T_{\gamma(0, t, \cdot)} \mathcal{A}_1(I)$ whose arc-length derivative reads

$$\gamma_{\varepsilon s}(0, t, s) = \theta_\varepsilon(0, t, s) \mathbf{n}(0, t, s). \quad (2.40)$$

The derivative of the energy functional with respect to the parameter ε is therefore

$$\frac{dE}{d\varepsilon}(0) = \int_0^T \int_0^1 am_s m_{s\varepsilon} + b(\theta_t - \theta_s m)(\theta_{t\varepsilon} - \theta_{s\varepsilon} m - \theta_s m_\varepsilon) ds dt.$$

Integrate the first term by parts in s , and we obtain

$$\frac{dE}{d\varepsilon}(0) = \int_0^T \int_0^1 b(\theta_t - \theta_s m)(\theta_{t\varepsilon} - m\theta_{s\varepsilon}) ds dt + \int_0^T \int_0^1 m_\varepsilon(-am_{ss} - b\theta_t\theta_s + b\theta_s^2 m) ds dt,$$

and the last term vanishes by equation (2.35). Integrating by parts in s and t to isolate θ_ε , we obtain (2.36)–(2.37) \square

Gradient of the energy functional

In Theorem 2.5.8, the derivative of the energy functional is expressed as the integral of an L^2 -product, i.e., as a 1-form. In order to obtain the gradient of the energy functional, we need to find the vector corresponding to this 1-form via the quotient elastic metric $\tilde{G}^{a,b}$ on $\mathcal{A}_1(I)$. In other words, the aim is to rewrite the derivative of the energy functional, given by (2.36)–(2.37), as

$$\frac{dE}{d\varepsilon}(0) = \int_0^T \tilde{G}^{a,b}(\gamma_\varepsilon, \nabla E(\gamma)) dt, \quad (2.41)$$

for some vector field $\nabla E(\gamma)$ along the path γ in $\mathcal{A}_1(I)$. Deforming the path γ in the opposite direction of $\nabla E(\gamma)$ will then give us an efficient way to minimise the path-energy of γ , and a path-straightening algorithm will allow us to find approximations of geodesics.

Based on equations (2.31) and (2.32), finding this Riemannian gradient now reduces to solving the following problem for each fixed time: given functions $\kappa(s)$ and $\xi(s)$, find a function $\beta(s)$ such that

$$\beta(s) - \kappa(s)h(s) = \xi(s), \quad \text{where } ah''(s) - b\kappa(s)^2 h(s) = -b\kappa(s)\beta(s), \quad (2.42)$$

with boundary conditions $h(0) = h(1) = 0$ for open curves, $h(0) = h(1)$ and $h'(0) = h'(1)$ for closed curves. At first glance this problem seems rather tricky, since in terms of the Green function \mathbb{G} defined by (2.29), we have $h = \mathbb{G} \star (\kappa\beta)$, and so (2.42) appears to become $h - \kappa\mathbb{G} \star (\kappa h) = \xi$, which would require inverting the operator $I - M_\kappa K M_\kappa$, where K is the operator $h \mapsto \mathbb{G} \star h$ and M_κ is the operator of multiplication by κ . What is remarkable in the following theorem is that this computation actually ends up being a lot simpler than expected due to some nice cancellations.

Theorem 2.5.9. Consider a variation $\gamma: (-\delta, +\delta) \times [0, T] \times I \rightarrow \mathbb{R}^2$ of a smooth path in $\mathcal{A}_1(I)$, with $\gamma_s(\varepsilon, t, s) = (\cos \theta(\varepsilon, t, s), \sin \theta(\varepsilon, t, s))$ for some angle $\theta(\varepsilon, t, s)$. Then the gradient ∇E determined by formula (2.41) satisfies $(\nabla E)_s(0, t, s) = \beta(t, s) \mathbf{n}(t, s)$ with

$$\beta(0, t, s) = \frac{1}{b} \xi(0, t, s) - \frac{1}{a} \theta_s(0, t, s) \int_0^s \left(\int_0^x \theta_s(0, t, y) \xi(0, t, y) dy \right) dx + \frac{1}{a} \kappa(s) s \int_0^1 \left(\int_0^x \kappa(y) \xi(y) dy \right) dx, \quad (2.43)$$

or equivalently

$$\begin{aligned} \beta(t, s) = & \frac{1}{b} \xi(t, s) - \theta_s(t, s) m_t(t, s) - \frac{b}{2a} C(t) s \theta_s(t, s) \\ & + \frac{1}{2} \theta_s(t, s) \int_0^s (m_x(t, x)^2 + \frac{b}{a} \theta_x(t, x)^2 m(t, x)^2 - \frac{b}{a} \theta_t(t, x)^2) dx, \end{aligned} \quad (2.44)$$

where ξ is given by (2.37), m satisfies (2.38), and $C(t)$ is given by

$$C(t) = \int_0^1 \theta_s(t, s) \theta_t(t, s) m(t, s) ds - \int_0^1 \theta_t(t, s)^2 ds. \quad (2.45)$$

Proof. By Theorem 2.5.8, the derivative of the energy functional is the integral of $\langle \theta_\varepsilon, \xi \rangle$ where ξ is given by (2.37). Recall that θ_ε is related to the derivative γ_ε by $\gamma_{\varepsilon s} = \theta_\varepsilon \mathbf{n}$. Comparing with the expression of the quotient elastic metric (2.31), it follows that

$$\langle \theta_\varepsilon, \xi \rangle = \tilde{G}^{a,b}(\gamma_\varepsilon, \nabla E),$$

where $\xi = b(\beta - \kappa h)$, and where β and h are related to ∇E by $(\nabla E)_s = \beta \mathbf{n}$ and $-ah'' + b\kappa^2 h = b\kappa\beta$. Note that ξ determine the functions β and h since the relation $b\beta = \xi + b\kappa h$ implies

$$-ah'' = \kappa\xi.$$

A first integration gives

$$h'(x) = -\frac{1}{a} \int_0^x \kappa(y) \xi(y) dy + c_1,$$

for some constants c_1 and a second integration gives

$$h(s) = -\frac{1}{a} \int_0^s \left(\int_0^x \kappa(y) \xi(y) dy \right) dx + c_1 s + c_2, \quad (2.46)$$

for some other constant c_2 .

For open curves, using the condition $h(0) = h(1) = 0$, we obtain $c_2 = 0$ and $c_1 = \frac{1}{a} \int_0^1 \left(\int_0^x \kappa(y) \xi(y) dy \right) dx$. Therefore

$$h(s) = \frac{1}{a} \int_0^s \left(\int_0^x -\kappa(y) \xi(y) dy \right) dx + \frac{1}{a} s \int_0^1 \left(\int_0^x \kappa(y) \xi(y) dy \right) dx,$$

and

$$\beta(s) = \frac{1}{b} \xi(s) - \frac{1}{a} \kappa(s) \int_0^s \int_0^x \kappa(y) \xi(y) dy dx + \frac{1}{a} \kappa(s) s \int_0^1 \left(\int_0^x \kappa(y) \xi(y) dy \right) dx.$$

Substituting $\kappa = \theta_s$ gives (2.43).

Moreover by formula (2.37) we have

$$\kappa\xi = -\theta_s \theta_{tt} + 2\theta_s \theta_{ts} m + \theta_s^2 m_t + \theta_t \theta_s m_s - \theta_{ss} \theta_s m^2 - 2\theta_s^2 m m_s. \quad (2.47)$$

But also differentiating (2.38) in time gives

$$a m_{sst} - b \theta_s^2 m_t = 2b \theta_s \theta_{st} m - b \theta_{st} \theta_t - b \theta_s \theta_{tt},$$

and eliminating $\theta_s \theta_{tt}$ in (2.47) gives the equation

$$\kappa\xi = \frac{a}{b} m_{sst} + \theta_{st} \theta_t + \theta_s \theta_t m_s - \theta_{ss} \theta_s m^2 - 2\theta_s^2 m m_s.$$

Now substitute from (2.38) the relation $\theta_s \theta_t = \theta_s^2 m - \frac{a}{b} m_{ss}$, and we obtain

$$-\frac{a}{b} h_{ss} = \kappa\xi = \frac{a}{b} m_{sst} + \theta_{st} \theta_t - \frac{a}{b} m_s m_{ss} - \theta_{ss} \theta_s m^2 - \theta_s^2 m m_s.$$

The right side is now easy to integrate in s , and we get

$$-ah_s = am_{st} + \frac{1}{2}b\theta_t^2 - \frac{1}{2}am_s^2 - \frac{1}{2}b\theta_s^2m^2 + \frac{b}{2a}C, \quad (2.48)$$

where the constant C is chosen so that both sides integrate to zero between $s = 0$ and $s = 1$ (since $h(0) = h(1) = 0$). Multiplying both sides of (2.38) by m and integrating from $s = 0$ to $s = 1$, we conclude that $C(t)$ satisfies (2.45). Another integration in s gives the formula

$$h(t, s) = -m_t(t, s) + \frac{1}{2} \int_0^s m_x(t, x)^2 dx + \frac{b}{2a} \int_0^s \theta_x(t, x)^2 m(t, x)^2 - \theta_t(t, x)^2 dx - \frac{b}{2a} C(t)s. \quad (2.49)$$

Since $m(t, 0) = m(t, 1) = 0$ for all t , this clearly vanishes at $s = 0$ as it should; furthermore it is easy to check that it also vanishes at $s = 1$ by definition of C . Plugging h given by (2.49) into the formula $\beta = \frac{1}{b}\xi + \kappa h$, we obtain (2.44) as desired.

For closed curves, using the conditions $h(0) = h(1)$ and $h'(0) = h'(1)$ in (2.46), we obtain $c_1 = \frac{1}{a} \int_0^1 \left(\int_0^x \kappa(y)\xi(y)dy \right) dx$ and the condition $\int_0^1 \kappa(s)\xi(s) ds = 0$, which is satisfied by (2.48) since the right hand side is periodic. Note that there is no condition on c_2 as expected. We take $c_2 = 0$ in order to match the formula for open curves. \square

Remark 2.5.10. Given the derivative of the gradient flow $(\nabla E)_s(0, t, s) = \beta(t, s)\mathbf{n}(t, s)$ with $\beta(t, s)$ given by (2.43) or (2.44), we have flexibility in the choice of the constant of integration to obtain ∇E . This is related to the fact that the curves are considered modulo translations (see Section 2.2.2). In the numerics we used the condition $\nabla E(0) = 0$, which corresponds to representing curves modulo translations as curves starting at the origin. Furthermore, there is no guarantee that $\int_0^1 \beta(t, s)\mathbf{n}(t, s) = 0$, in other words the gradient may not preserve the closedness condition. Since the space of closed curves is a codimension 2 submanifold of the vector space of open curves, we have to project the gradient of the energy functional to the tangent space of the space of closed curves. This projection is given by $\nabla E(s) \mapsto \nabla E(s) - s \int_0^1 \nabla E(x) dx$.

2.5.2 Quotient elastic metrics on arc-length parameterized piecewise linear curves

Notation

Let us consider a “chain” given by points joined by rigid rods of length $1/n$. We denote the points by γ_k for $1 \leq k \leq n$, and periodicity is enforced by requiring $\gamma_{n+1} = \gamma_1$ and $\gamma_0 = \gamma_n$. We let

$$\mathbf{v}_k = n(\gamma_{k+1} - \gamma_k)$$

denote the unit vectors along the rods, and θ_k be the angle between the x -axis and \mathbf{v}_k , so that

$$\mathbf{v}_k = (\cos \theta_k, \sin \theta_k).$$

The unit normal vectors are defined by

$$\mathbf{n}_k = (-\sin \theta_k, \cos \theta_k).$$

We will also introduce the variation of the angles θ_k :

$$\Delta_k = \theta_k - \theta_{k-1}.$$

Vector fields along a chain are denoted by sequences $w = (w_k : 1 \leq k \leq n)$. A vector field w preserves the arc-length parameterization if and only if

$$\frac{d}{dt} \Big|_{t=0} |\gamma_{k+1}(t) - \gamma_k(t)|^2 = \frac{2}{n} \langle w_{k+1} - w_k, \mathbf{v}_k \rangle = 0,$$

for any k , where $\gamma_k(t)$ is any variation of γ_k satisfying $w_k = \gamma_k'(0)$. In particular, any vector field preserving the arc-length parameterization satisfies

$$w_{k+1} - w_k = \frac{1}{n} \phi_k \mathbf{n}_k,$$

for some sequence $\phi = (\phi_k : 1 \leq k \leq n)$.

Discrete version of the elastic metrics

The discrete elastic metric is given by

$$G^{a,b}(w, w) = n \sum_{k=1}^n (a \langle w_{k+1} - w_k, \mathbf{v}_k \rangle^2 + b \langle w_{k+1} - w_k, \mathbf{n}_k \rangle^2), \quad (2.50)$$

which clearly agrees with (2.21) in the limit as $n \rightarrow \infty$ using $w(k/n) = w_k$. In addition this metric has the same property as (2.21) in that the a term disappears when w is a field that preserves the arc-length parameterization. For two vector fields w and z , the expression of their $G^{a,b}$ scalar product reads

$$G^{a,b}(w, z) = n \sum_{k=1}^n (a \langle w_{k+1} - w_k, \mathbf{v}_k \rangle \langle z_{k+1} - z_k, \mathbf{v}_k \rangle + b \langle w_{k+1} - w_k, \mathbf{n}_k \rangle \langle z_{k+1} - z_k, \mathbf{n}_k \rangle). \quad (2.51)$$

For further use note that if w preserves the arc-length parameterization and z is arbitrary,

$$G^{a,b}(w, z) = n \sum_{k=1}^n b \langle w_{k+1} - w_k, \mathbf{n}_k \rangle \langle z_{k+1} - z_k, \mathbf{n}_k \rangle. \quad (2.52)$$

Horizontal space for the discrete elastic metrics

Assume now that w preserves the arc-length parameterization, and write $n(w_{k+1} - w_k) = \phi_k \mathbf{n}_k$ for some numbers ϕ_k . The ‘‘vertical vectors’’ will still be all those of the form $u_k = g_k \mathbf{v}_k$ for some numbers g_k , although it is not clear in the discrete context if these actually represent the nullspace of a projection as in the smooth case. Let us show the following:

Theorem 2.5.11. *If $(w_k : 1 \leq k \leq n)$ satisfies $n(w_{k+1} - w_k) = \phi_k \mathbf{n}_k$, then its projection onto the orthogonal space to the space spanned by vectors of the form $u_k = g_k \mathbf{v}_k$, with respect to the discrete elastic metric (2.50) is*

$$P_h(w) = w_k - m_k \mathbf{v}_k \quad (2.53)$$

where the numbers m_k satisfy

$$\frac{b}{n} \sin \Delta_k \phi_{k-1} = (a + a \cos^2 \Delta_k + b \sin^2 \Delta_k) m_k - a \cos \Delta_k m_{k-1} - a \cos \Delta_{k+1} m_{k+1} \quad (2.54)$$

with $\mathbf{v}_k = (\cos \theta_k, \sin \theta_k)$ and $\Delta_k = \theta_k - \theta_{k-1}$.

Proof. For every vertical vector $(g_k \mathbf{v}_k)$ for any numbers g_k , we want to see $G^{a,b}(w - m\mathbf{v}, g\mathbf{v}) = 0$. We therefore get

$$\begin{aligned} 0 &= \sum_{k=1}^n a \langle w_{k+1} - w_k - m_{k+1} \mathbf{v}_{k+1} + m_k \mathbf{v}_k, \mathbf{v}_k \rangle \langle g_{k+1} \mathbf{v}_{k+1} - g_k \mathbf{v}_k, \mathbf{v}_k \rangle \\ &\quad + b \langle w_{k+1} - w_k - m_{k+1} \mathbf{v}_{k+1} + m_k \mathbf{v}_k, \mathbf{n}_k \rangle \langle g_{k+1} \mathbf{v}_{k+1} - g_k \mathbf{v}_k, \mathbf{n}_k \rangle \\ &= \sum_{k=1}^n a (m_k - m_{k+1} \langle \mathbf{v}_{k+1}, \mathbf{v}_k \rangle) (g_{k+1} \langle \mathbf{v}_{k+1}, \mathbf{v}_k \rangle - g_k) \\ &\quad + b \left(\frac{1}{n} \phi_k - m_{k+1} \langle \mathbf{v}_{k+1}, \mathbf{n}_k \rangle \right) g_{k+1} \langle \mathbf{v}_{k+1}, \mathbf{n}_k \rangle. \end{aligned}$$

Using the identities

$$\langle \mathbf{v}_{k+1}, \mathbf{v}_k \rangle = \cos \theta_{k+1} \cos \theta_k + \sin \theta_{k+1} \sin \theta_k = \cos \Delta_{k+1},$$

and

$$\langle \mathbf{v}_{k+1}, \mathbf{n}_k \rangle = -\cos \theta_{k+1} \sin \theta_k + \sin \theta_{k+1} \cos \theta_k = \sin \Delta_{k+1},$$

one gets

$$\begin{aligned} 0 &= \sum_{k=1}^n g_k \left[a (m_{k-1} - m_k \cos \Delta_k) \cos \Delta_k - a (m_k - m_{k+1} \cos \Delta_{k+1}) \right. \\ &\quad \left. + \frac{1}{n} b \phi_{k-1} \sin \Delta_k - b m_k \sin^2 \Delta_k \right], \end{aligned}$$

after reindexing. Since this must be true for every choice of g_k , we obtain (2.54). \square

Remark 2.5.12. It is easy to check that (2.54) is a discretization of (2.35), as expected. Note that equation (2.54) can be rewritten as

$$\frac{b}{n} \begin{pmatrix} \sin \Delta_1 \phi_n \\ \sin \Delta_2 \phi_1 \\ \sin \Delta_3 \phi_2 \\ \vdots \\ \sin \Delta_{n-1} \phi_{n-2} \\ \sin \Delta_n \phi_{n-1} \end{pmatrix} = \mathbb{T} \begin{pmatrix} m_1 \\ m_2 \\ m_3 \\ \vdots \\ m_{n-1} \\ m_n \end{pmatrix}$$

where \mathbb{T} is a cyclic tridiagonal matrix of the form

$$\mathbb{T} = \begin{pmatrix} d_1 & \tau_2 & 0 & 0 & \cdots & 0 & 0 & \tau_1 \\ \tau_2 & d_2 & \tau_3 & 0 & \cdots & 0 & 0 & 0 \\ 0 & \tau_3 & d_3 & \tau_4 & \cdots & 0 & 0 & 0 \\ \vdots & \vdots & \vdots & \vdots & \cdots & \vdots & \vdots & \vdots \\ 0 & 0 & 0 & 0 & \cdots & \tau_{n-1} & d_{n-1} & \tau_n \\ \tau_1 & 0 & 0 & 0 & \cdots & 0 & \tau_n & d_n \end{pmatrix} \quad (2.55)$$

with $d_k = a + a \cos^2 \Delta_k + b \sin^2 \Delta_k$ and $\tau_k = -a \cos \Delta_k$. Note that \mathbb{T} is a small deformation of a tridiagonal matrix which can be inverted in $O(n)$ operations using Thomas algorithm. Observe that $d_k > \tau_k + \tau_{k+1}$ as soon as $\cos \Delta_{k+1} > -\frac{3}{4}$, hence the matrix \mathbb{T} is strictly dominant as soon as the angles between two successive rods are small enough, and this can be easily achieved by raising the number of points. This implies that Thomas algorithm is numerically stable ([97]). See [67] where algorithms are presented to invert cyclic tridiagonal matrices. Other algorithms for the solution of cyclic tridiagonal systems are given for example in [202].

Definition and derivative of the energy functional in the discrete case

Consider a path $t \mapsto \gamma_k(t)$, $0 \leq t \leq T$, preserving the arc-length parameterization (i.e., the length of the rods) and connecting two positions of the chain $\gamma_{1,k}$ and $\gamma_{2,k}$. Write

$$\gamma_{k+1}(t) - \gamma_k(t) = \frac{1}{n} \mathbf{v}_k(t) = \frac{1}{n} (\cos \theta_k(t), \sin \theta_k(t)).$$

We will use a dot for the differentiation with respect to the parameter t along the path. In particular $w = \dot{\gamma}$ is a vector field along the chain γ satisfying

$$w_{k+1}(t) - w_k(t) = \frac{1}{n} \dot{\theta}_k(t) \mathbf{n}_k(t).$$

Let $\Delta_k(t) = \theta_k(t) - \theta_{k-1}(t)$. Given a variation $\varepsilon \mapsto \gamma_k(\varepsilon, t)$, $\varepsilon \in (-\delta, \delta)$, of the path $\gamma_k(0, t) = \gamma_k(t)$ preserving the arc-length parameterization, let us compute the energy functional for the discrete elastic metrics and its derivative at $\varepsilon = 0$. We will use a subscript ε for the differentiation with respect to ε , in particular we will use the notation

$$\frac{d}{d\varepsilon} \Big|_{\varepsilon=0} (\gamma_{k+1}(\varepsilon, t) - \gamma_k(\varepsilon, t)) = \frac{1}{n} \theta_{\varepsilon,k} \mathbf{n}_k(0, t).$$

Theorem 2.5.13. *Suppose we have a family of curves $\gamma_k(\varepsilon, t)$ depending on time and joining fixed curves $\gamma_{1,k}$ and $\gamma_{2,k}$ (which is to say that $\gamma_k(\varepsilon, 0) = \gamma_{1,k}$ and $\gamma_k(\varepsilon, T) = \gamma_{2,k}$ for all ε and k). Then the energy as a function of ε is*

$$E(\varepsilon) = \frac{n}{2} \int_0^T \sum_{k=1}^n \left(a(m_k - m_{k+1} \cos \Delta_{k+1})^2 + b \left(\frac{1}{n} \dot{\theta}_k - m_{k+1} \sin \Delta_{k+1} \right)^2 \right) dt, \quad (2.56)$$

where m satisfies (2.54) with $\phi_k = \dot{\theta}_k$. Its derivative at $\varepsilon = 0$ is given by

$$\frac{dE}{d\varepsilon}(0) = \int_0^T \frac{1}{n} \sum_{k=1}^n \theta_{\varepsilon,k}(0, t) \xi_k(t) dt,$$

where ξ_k is given by

$$\begin{aligned} \xi_k = & -b \ddot{\theta}_k + bn(\dot{m}_{k+1} \sin \Delta_{k+1} + m_{k+1} \cos \Delta_{k+1} \dot{\theta}_{k+1} - m_k \cos \Delta_k \dot{\theta}_{k-1}) \\ & + n^2(b-a)(m_k^2 \sin \Delta_k \cos \Delta_k - m_{k+1}^2 \sin \Delta_{k+1} \cos \Delta_{k+1}) \\ & + an^2 m_k (m_{k-1} \sin \Delta_k - m_{k+1} \sin \Delta_{k+1}). \end{aligned} \quad (2.57)$$

Proof. By Theorem 2.5.11, the horizontal projection of the velocity vector $w = \dot{\gamma}$ is given by $P_h(w) = w_k - m_k \nu_k$ where m satisfies (2.54) with $\phi_k = \dot{\theta}_k$. Hence the energy is

$$E(\varepsilon) = \frac{n}{2} \int_0^T \sum_{k=1}^n a \langle w_{k+1} - w_k - m_{k+1} \nu_{k+1} + m_k \nu_k, \nu_k \rangle^2 + b \langle w_{k+1} - w_k - m_{k+1} \nu_{k+1} + m_k \nu_k, \mathfrak{n}_k \rangle^2 dt, \quad (2.58)$$

which reduces to (2.56).

To compute the derivative of the energy functional, we first simplify (2.56) by expanding and reindexing to obtain

$$E(\varepsilon) = \frac{n}{2} \sum_{k=1}^n \int_0^T \left(\frac{b}{n^2} \dot{\theta}_{k-1}^2 - 2 \frac{b}{n} m_k \dot{\theta}_{k-1} \sin \Delta_k + b m_k^2 \sin^2 \Delta_k + a m_k^2 - 2 a m_{k-1} m_k \cos \Delta_k + a m_k^2 \cos^2 \Delta_k \right) dt.$$

Now let $\psi_k = \frac{\partial \theta_k}{\partial \varepsilon} |_{\varepsilon=0}$, $\nu_k = \psi_k - \psi_{k-1}$, and $g_k = \frac{\partial m_k}{\partial \varepsilon} |_{\varepsilon=0}$. We then get

$$\begin{aligned} \frac{dE}{d\varepsilon}(0) &= n \sum_{k=1}^n \int_0^T \left(\frac{b}{n^2} \dot{\theta}_{k-1} \dot{\psi}_{k-1} - \frac{b}{n} m_k \dot{\psi}_{k-1} \sin \Delta_k - \frac{b}{n} m_k \dot{\theta}_{k-1} \cos \Delta_k \nu_k \right. \\ &\quad \left. + (b-a) m_k^2 \sin \Delta_k \cos \Delta_k \nu_k + a m_{k-1} m_k \sin \Delta_k \nu_k \right) dt \\ &\quad + n \sum_{k=1}^n \int_0^T g_k \left(- \frac{b}{n} \dot{\theta}_{k-1} \sin \Delta_k + b m_k \sin^2 \Delta_k + a m_k \right. \\ &\quad \left. - a m_{k-1} \cos \Delta_k - a m_{k+1} \cos \Delta_{k+1} + a m_k \cos^2 \Delta_k \right) dt. \end{aligned}$$

But notice that the term multiplied by g_k vanishes since m_k satisfies (2.54); hence it is not necessary to compute the variation g_k . All that remains is to express every term in $\frac{dE}{d\varepsilon}(0)$ in terms of ψ_k either by reindexing or integrating by parts in time, which is straightforward and leads to (2.57). \square

Gradient of the discrete energy functional

Let us compute the gradient of the discrete energy functional with respect to the quotient elastic metric $G^{a,b}$. Considering equation (2.57), let us first compute \dot{m}_k .

Lemma 2.5.14. *Let \mathbb{G} denote the inverse matrix of the matrix \mathbb{T} in (2.55), so that*

$$m_j = \sum_{k=1}^n \mathbb{G}_{jk} \frac{b}{n} \phi_{k-1} \sin \Delta_k \quad \text{for all } j, \quad (2.59)$$

where $\Delta_k = \theta_k - \theta_{k-1}$ for some angles θ_k . If $\theta_k(t)$ depends on time and $\phi_k(t) = \dot{\theta}_k(t)$, then we have the formula

$$\begin{aligned} \dot{m}_j &= \sum_{k=1}^n \mathbb{G}_{jk} \left(\frac{b}{n} \sin \Delta_k \ddot{\theta}_{k-1} + \frac{b}{n} \cos \Delta_k \dot{\theta}_{k-1} \dot{\Delta}_k + 2(a-b) \sin \Delta_k \cos \Delta_k m_k \dot{\Delta}_k \right. \\ &\quad \left. - a \sin \Delta_k m_{k-1} \dot{\Delta}_k - a \sin \Delta_{k+1} m_{k+1} \dot{\Delta}_{k+1} \right). \quad (2.60) \end{aligned}$$

Proof. We just compute the time derivative of each term of equation (2.54) and notice that the terms involving \dot{m}_k are

$$b \sin^2 \Delta_k \dot{m}_k + a \dot{m}_k + a \cos^2 \Delta_k \dot{m}_k - a \cos \Delta_k \dot{m}_{k-1} - a \cos \Delta_{k+1} \dot{m}_{k+1}.$$

Hence we need to invert the same matrix \mathbb{T} to solve for \dot{m}_k as we do to solve for m_k . The remainder is straightforward. \square

Finally let us rewrite the l^2 -product in (2.57) as an $G^{a,b}$ -inner product, analogously to Theorem 2.5.9.

Proposition 2.5.15. Let w and z be two vector fields along γ with $n(w_{k+1} - w_k) = \alpha_k \mathfrak{n}_k$ and $n(z_{k+1} - z_k) = \beta_k \mathfrak{n}_k$ for some numbers α_k and β_k . Consider the equation

$$G^{a,b}(P_h(w), P_h(z)) = \sum_{k=1}^n \frac{1}{n} \alpha_k \xi_k \quad (2.61)$$

for some numbers ξ_k . Then

$$\beta_k = \frac{1}{b} \xi_k + nh_{k+1} \sin \Delta_{k+1}, \quad (2.62)$$

where the sequence h_k satisfies

$$\frac{1}{n} \xi_{k-1} \sin \Delta_k = (a + a \cos^2 \Delta_k) h_k - a \cos \Delta_k h_{k-1} - a \cos \Delta_{k+1} h_{k+1}. \quad (2.63)$$

Remark 2.5.16. Note that equation (2.63) can be written as

$$\frac{1}{a} \begin{pmatrix} \sin \Delta_1 \xi_n \\ \sin \Delta_2 \xi_1 \\ \sin \Delta_3 \xi_2 \\ \vdots \\ \sin \Delta_{n-2} \xi_{n-3} \\ \sin \Delta_{n-1} \xi_{n-2} \\ \sin \Delta_n \xi_{n-1} \end{pmatrix} = M \begin{pmatrix} h_1 \\ h_2 \\ h_3 \\ \vdots \\ h_{n-2} \\ h_{n-1} \\ h_n \end{pmatrix},$$

where M is the following cyclic tridiagonal matrix

$$M = n \begin{pmatrix} \delta_1 & t_2 & 0 & \cdots & 0 & 0 & t_1 \\ t_2 & \delta_2 & t_3 & \cdots & 0 & 0 & 0 \\ 0 & t_3 & \delta_3 & \cdots & 0 & 0 & 0 \\ \vdots & \vdots & \vdots & \cdots & \vdots & \vdots & \vdots \\ 0 & 0 & 0 & \cdots & t_{n-1} & \delta_{n-1} & t_n \\ t_1 & 0 & 0 & \cdots & 0 & t_n & \delta_n \end{pmatrix}. \quad (2.64)$$

where $\delta_k = 1 + \cos^2(\Delta_k)$ and where $t_k = -\cos(\Delta_k)$. Note that again, M is strictly dominant as soon as $-\frac{3}{4} < \cos \Delta_{k+1}$ (see remark 2.5.12).

Proof. First of all, we have $G^{a,b}(P_h(w), P_h(z)) = G^{a,b}(w, P_h(z))$, since the projection P_h is orthogonal with respect to $G^{a,b}$. Since the vector field z satisfies $n(z_{k+1} - z_k) = \beta_k \mathfrak{n}_k$, by Theorem 2.5.11, its horizontal projection reads

$$P_h(z) = z_k - h_k \mathfrak{v}_k,$$

where h_k is the solution of

$$\frac{b}{n} \beta_{k-1} \sin \Delta_k - bh_k \sin^2 \Delta_k = a(h_k + \cos^2 \Delta_k h_k - \cos \Delta_k h_{k-1} - \cos \Delta_{k+1} h_{k+1}). \quad (2.65)$$

Using the expression of the $G^{a,b}$ -inner product given in (2.52), it follows that

$$\begin{aligned} G^{a,b}(w, P_h(z)) &= n \sum_{k=1}^n \frac{b}{n} \alpha_k \langle (z_{k+1} - h_{k+1} \mathfrak{v}_{k+1}) - (z_k - h_k \mathfrak{v}_k), \mathfrak{n}_k \rangle \\ &= n \sum_{k=1}^n b \frac{\alpha_k}{n} \left(\frac{\beta_k}{n} - h_{k+1} \sin \Delta_{k+1} \right), \end{aligned}$$

where we have used $n(z_{k+1} - z_k) = \beta_k \mathfrak{n}_k$ and $\langle \mathfrak{v}_{k+1}, \mathfrak{n}_k \rangle = \sin \Delta_{k+1}$. Comparing with equation (2.61), it follows that

$$\frac{1}{n} \xi_k = \frac{b}{n} (\beta_k - nh_{k+1} \sin \Delta_{k+1}).$$

Therefore equation (2.65) reads

$$\frac{1}{n} \sin \Delta_k \xi_{k-1} = a(h_k + \cos^2 \Delta_k h_k - \cos \Delta_k h_{k-1} - \cos \Delta_{k+1} h_{k+1}).$$

□

Let us summarize the previous results in the following Theorem.

Theorem 2.5.17. *Suppose we have a family of curves $\gamma_k(\varepsilon, t)$ depending on time and joining fixed curves $\gamma_{1,k}$ and $\gamma_{2,k}$ (which is to say that $\gamma_k(\varepsilon, 0) = \gamma_{1,k}$ and $\gamma_k(\varepsilon, T) = \gamma_{2,k}$ for all ε and k). Then the derivative of the energy functional E associated with the quotient elastic metric $G^{a,b}$ reads*

$$\frac{dE}{d\varepsilon}(0) = \int_0^T G^{a,b}(\gamma_\varepsilon, \nabla E(\gamma)) dt,$$

where $\nabla E(\gamma) = (z_k : 1 \leq k \leq n)$ is the solution of $n(z_{k+1} - z_k) = \beta_k \mathbf{n}_k$ with β_k solving (2.62) for ξ_k defined by (2.57). Since we consider curves modulo translation, we can take $z_0 = 0$. The projection of $\nabla E(\gamma)$ on the manifold of closed curves reads

$$\left(z_k - \frac{1}{n} \sum_{k=1}^n \beta_k \mathbf{n}_k : 1 \leq k \leq n \right).$$

2.5.3 Two-boundary problem and Energy landscape

Algorithms for the two-boundary problem

Given two shapes in the plane, solving the two-boundary problem consists in finding a geodesic (if it exists!) having these shapes as endpoints. A geodesic is a path that is locally length-minimizing. Using the exact expression of the gradient of the energy functional, we can obtain approximations of geodesics by a path-straightening method. This method relates to the fact that critical points of the energy are geodesics, and it consists of straightening an initial path between two given shapes in the plane by following the opposite of the gradient flow of the energy functional (see Algorithm 1). The algorithm for the computation of the gradient of the energy functional, based on the computation given in previous Sections, is given below (see Algorithm 2). Of course the efficiency of the path-straightening method depends greatly on the landscape created by the energy functional on the space of paths connecting two shapes, and this landscape in turns varies with the parameters a and b of the elastic metric. In Section 2.5.3, we illustrate some aspects of this dependence. In all the numerics presented in [208] we used 100 points for each curve.

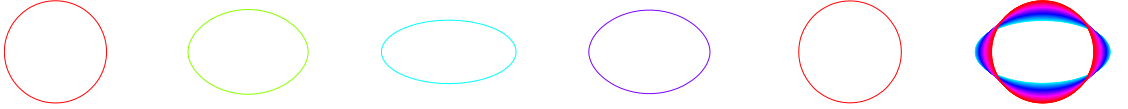

Figure 2.15: Toy example: initial path joining a circle to the same circle via an ellipse. The 5 first shapes at the left correspond to the path at time $t = 0$, $t = 0.25$, $t = 0.5$, $t = 0.75$ and $t = 1$. The right picture shows the entire path, with color varying from red ($t = 0$) to blue ($t = 0.5$) to red again ($t = 1$).

Algorithm 1: Algorithm for the path-straightening method

Input:

1. An initial shape γ_1 given by the positions $\gamma_{k,1}, 1 \leq k \leq n$ of n points in \mathbb{R}^2 ,
2. A final shape γ_2 given by the positions $\gamma_{k,2}, 1 \leq k \leq n$ of n points in \mathbb{R}^2 .

Output: An (approximation of a) geodesic between γ_1 and γ_2 under the quotient elastic metric $G^{a,b}$, given by the positions $\gamma_k(t), 1 \leq k \leq n$ of n points in \mathbb{R}^2 , with $\gamma_k(0) = \gamma_{k,1}$ and $\gamma_k(1) = \gamma_{k,2}$.

Algorithm 1: Initialize $\gamma_k(t)$ by a path connecting γ_1 to γ_2 .

1. compute $\nabla E(\gamma)$ using Algorithm 2.
 2. while $\nabla E(\gamma) < 10^{-3}$ do
 - (a) $\gamma_k(t) \leftarrow \gamma_k(t) - \delta \nabla E(\gamma)$ where δ is a small parameter to be adjusted (we used $\delta = 10^{-9}$).
 - (b) Compute the length $L(\gamma)$ of $\gamma_k(t)$ and do $\gamma_k(t) \leftarrow \gamma_k(t)/L(\gamma)$.
-

Algorithm 2: Algorithm for the computation of the gradient of the energy functional

Input: positions $\gamma_k(t)$, $1 \leq k \leq n$ of n points in \mathbb{R}^2 depending on time $t \in I$.

Output: n vectors $z_k = \nabla E_k(t)$, $1 \leq k \leq n$ in \mathbb{R}^3 , depending on time $t \in I$, corresponding to the values of the gradient of the $G^{a,b}$ -energy of $\gamma_k(t)$.

Algorithm 2:

1. compute $(\cos \theta_k(t), \sin \theta_k(t)) = n(\gamma_{k+1}(t) - \gamma_k(t)) / |\gamma_{k+1}(t) - \gamma_k(t)|$, θ_k , $\dot{\theta}_k$ and $\Delta_k = \theta_{k+1} - \theta_k$.

2. define T as in equation (2.55) and compute $(m_k, 1 \leq k \leq n)$ defined by: $T \begin{pmatrix} m_1 \\ m_2 \\ m_3 \\ \vdots \\ m_{n-1} \\ m_n \end{pmatrix} = \frac{b}{n} \begin{pmatrix} \dot{\theta}_n \sin \Delta_1 \\ \dot{\theta}_1 \sin \Delta_2 \\ \dot{\theta}_2 \sin \Delta_3 \\ \vdots \\ \dot{\theta}_{n-2} \sin \Delta_{n-1} \\ \dot{\theta}_{n-1} \sin \Delta_n \end{pmatrix}$.

3. compute $\ddot{\theta}_k$ and $\dot{\Delta}_k$ as well as

$$R_k = \left(\frac{b}{n} \sin \Delta_k \ddot{\theta}_{k-1} + \frac{b}{n} \cos \Delta_k \dot{\theta}_{k-1} \dot{\Delta}_k + 2(a-b) \sin \Delta_k \cos \Delta_k m_k \dot{\Delta}_k - a \sin \Delta_k m_{k-1} \dot{\Delta}_k - a \sin \Delta_{k+1} m_{k+1} \dot{\Delta}_{k+1} \right).$$

4. compute \dot{m}_k defined by equation (2.60): $T \dot{m} = R$.

5. compute ξ_k defined by equation (2.57):

$$\begin{aligned} \xi_k = & -b\ddot{\theta}_k + bn(m_{k+1} \sin \Delta_{k+1} + m_{k+1} \cos \Delta_{k+1} \dot{\theta}_{k+1} - m_k \cos \Delta_k \dot{\theta}_{k-1}) \\ & + n^2(b-a)(m_k^2 \sin \Delta_k \cos \Delta_k - m_{k+1}^2 \sin \Delta_{k+1} \cos \Delta_{k+1}) \\ & + an^2 m_k (m_{k-1} \sin \Delta_k - m_{k+1} \sin \Delta_{k+1}). \end{aligned}$$

6. define matrix M by equation (2.64) and compute h_k defined by: $M \begin{pmatrix} h_1 \\ h_2 \\ h_3 \\ \vdots \\ h_{n-2} \\ h_{n-1} \\ h_n \end{pmatrix} = \frac{1}{a} \begin{pmatrix} \sin \Delta_1 \xi_n \\ \sin \Delta_2 \xi_1 \\ \sin \Delta_3 \xi_2 \\ \vdots \\ \sin \Delta_{n-2} \xi_{n-3} \\ \sin \Delta_{n-1} \xi_{n-2} \\ \sin \Delta_n \xi_{n-1} \end{pmatrix}$.

7. compute β_k defined by equation (2.62): $\beta_k = \frac{1}{b} \xi_k + n h_{k+1} \sin \Delta_{k+1}$.

8. compute z_k defined by $z_1 = 0$ and $z_{k+1} = z_k + \frac{1}{n} \beta_k \mathbf{v}_k - \frac{1}{n} \sum_{k=1}^n \beta_k \mathbf{v}_k$.
-

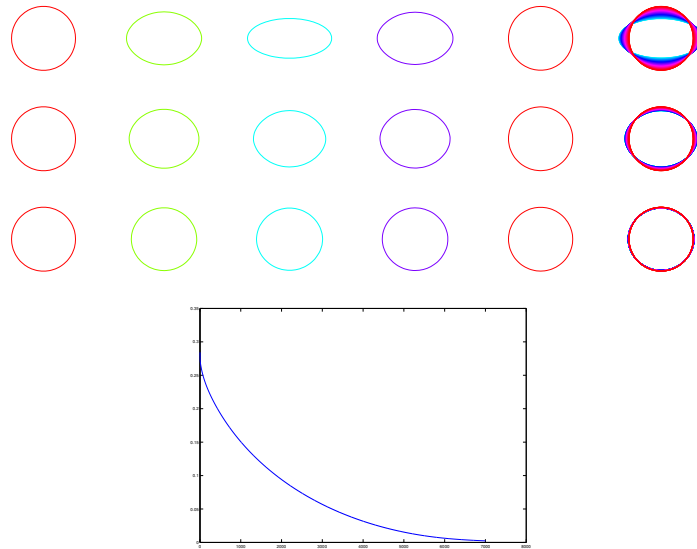

Figure 2.16: Straightening of the path illustrated in Fig. 2.15, with $a = 100$ and $b = 1$. The first line corresponds to the initial path, the second line to the path after 3500 iterations, and the third line corresponds to the path after 7000 iterations. At the right the evolution of the energy with respect to the number of iterations is depicted.

Energy landscape

In order to experience the range of convergence of the path-straightening algorithm, we first start with a toy example, namely we start with an initial path joining a circle to the same circle but passing by an ellipse in the middle of the path. This path is illustrated in Fig. 2.15, where the middle ellipse may be replaced by an ellipse with different eccentricity. Starting with this initial path, we expect the path-straightening method to straighten it into the constant path containing only circles, which is a geodesic. However, this will happen only if the initial path is in the attraction basin of the constant path, in the sense of dynamical systems, i.e., if the initial path is close enough to the constant geodesic. This in turn will depend on the value of the parameter a/b of the elastic metric. In particular the same path can be in the attraction basin of the constant path for some value of a/b and outside of it for some other value of the parameter. In order to have a better idea when

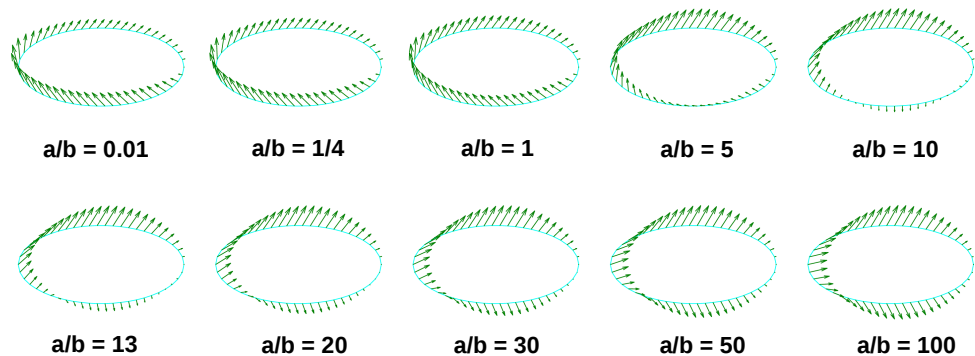

Figure 2.17: Gradient of the energy functional at the middle of the path depicted in Fig. 2.15 for $b = 1$ and different values of the parameter a/b .

the path-straightening method will converge, we plot in Fig. 2.17 the opposite of the gradient of the energy functional at the middle of the path for different values of the parameter a/b . In this figure, the magnitude of the gradient is rescaled, hence the only important information is the directions taken by the vector field. For $a/b = 100$, the opposite of the gradient is the vector field that one expects for turning the ellipse into a circle. On the contrary, for $a/b = 0.01$, the opposite of the gradient is not bowing the ellipse. In other words, one can conjecture that the initial path depicted in Fig. 2.15 is in the attraction basin of the constant path for $a/b = 100$, but not for $a/b = 0.01$.

This is indeed what is happening, the path-straightening algorithm applied to the path of Fig. 2.15 converges for $a/b = 100$ (see Fig. 2.16) but diverge for $a/b = 0.01$.

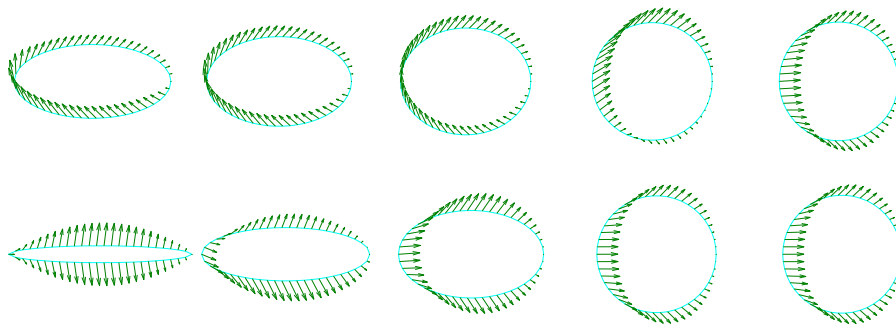

Figure 2.18: Gradient of the energy functional at the middle of the path connecting a circle to the same circle via an ellipse for different values of the eccentricity of the middle ellipse. The first line corresponds to the values of parameters $a = 0.01$ and $b = 1$. The second line corresponds to $a = 100$ and $b = 1$.

To have an idea of the attraction basin of the constant geodesic for $a/b = 0.01$, one can vary the eccentricity of the middle ellipse in the initial path. Recall that the ellipse eccentricity is defined as $e = \sqrt{1 - c^2/d^2}$ with c the semi-minor axis and d the semi-major axis. In Fig. 2.18, we have depicted the gradient of the energy functional at the middle of the initial path for different values of the middle ellipse's eccentricity. The first line corresponds to $a/b = 0.01$. From left to right the eccentricity of the ellipse at the middle of the path takes the values 0.8844, 0.7882, 0.5750, 0.1980 and 0.0632. One sees a change in the vector field between the third and fourth picture: only when the middle ellipse is nearly a circle will the path-straightening algorithm converge for the value $a/b = 0.01$. In comparison, the second line corresponds to $a/b = 100$. From left to right the eccentricity of the ellipse at the middle of the path takes the values 0.9963, 0.95, 0.8, 0.1980 and 0.0632. In this case, the opposite of the gradient is bowing the ellipse even if the ellipse is very far from a circle.

Another aspect of the gradient in this toy example is that it is localized at the middle shape as is illustrated in Fig. 2.19. In this picture the gradient is scaled uniformly. One sees that the gradient is nearly zero except at the middle shape. This is clearly a disadvantage for the path-straightening method since after one iteration of algorithm 1, only the middle shape is significantly changed. This localization of the gradient imposes a small step size in order to avoid discontinuities in the path around the middle shape.

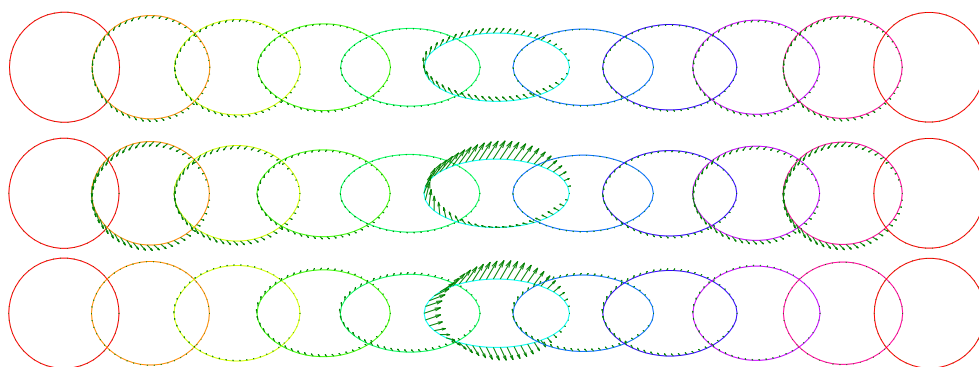

Figure 2.19: Gradient of the energy functional along the path depicted in Fig. 2.15 for $a = 1$ (upper line), $a = 5$ (middle line) and $a = 50$ (lower line) and $b = 1$.

In Fig. 2.20, we show a 2-parameter family of variations of a circle. The middle horizontal line corresponds to the deformation of the circle into an ellipse, and can be thought of as stretching the circle by pulling or pushing it to opposite circle points. In comparison, the middle vertical column corresponds to the deformation of the circle into a square and can be thought of as bending the circle at four corners. We built a 2-parameter family of deformations of the constant path connecting a circle to itself by interpolating smoothly from the circle to one of these shapes at the middle of

the path and back to the circle. In Fig. 2.21, the energy plots of the 2-parameter family of paths obtained this way are depicted for $a = 0.01, b = 1$ (left upper picture and nearly flat piece in the lower picture), and for $a = 100, b = 1$ (right upper picture, and curved piece in the lower picture). One sees that, for the elastic metric with $a = 0.01, b = 1$, both directions of deformation - turning a circle into an ellipse and turning a circle into a square - have the same energy amplitude. On the contrary, for the elastic metric with $a = 100$ and $b = 1$, one needs a lot more energy to deform a circle into an ellipse than to deform a circle into a square, i.e., stretching is predominant.

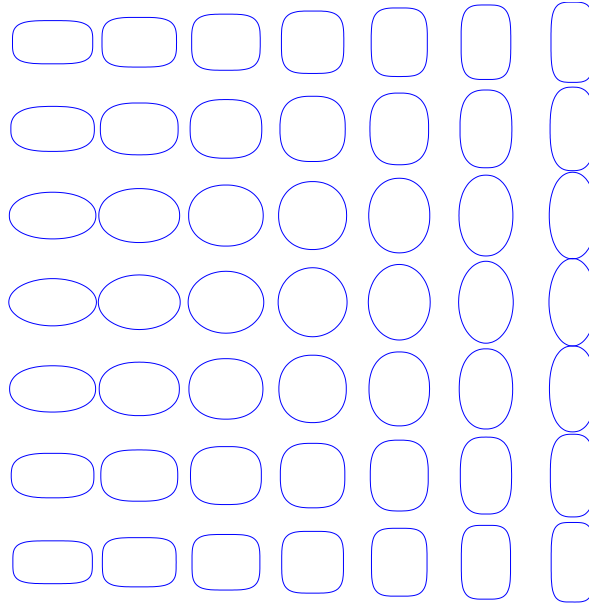

Figure 2.20: 2-parameter family of variations of the middle shape of a path connecting a circle to the same circle

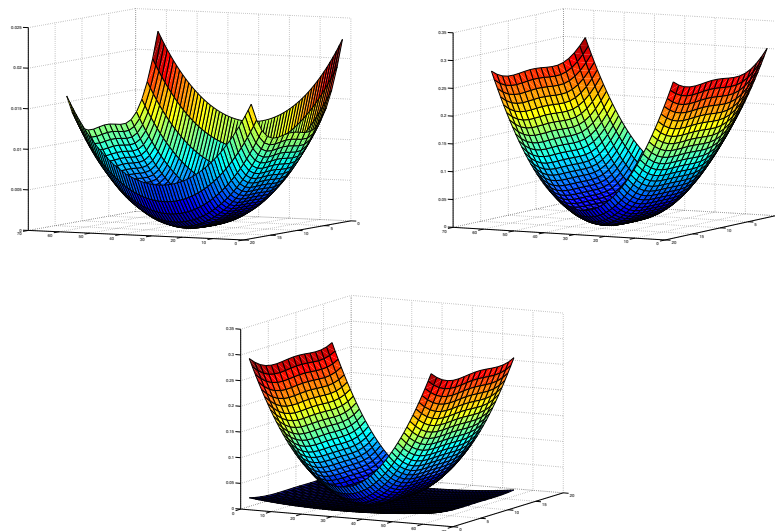

Figure 2.21: Energy functional for the 2-parameter family of paths whose middle shape is one of the shapes depicted in Fig. 2.20. The left upper picture corresponds to $a = 0.01, b = 1$ and the right upper picture to $a = 100, b = 1$. The lower picture shows the plots of both energy functionals with equal axis.

Finally we consider in Fig. 2.22 the problem of finding a geodesic from a Mickey Mouse hand to the same hand with a finger missing. The first line is obtained by taking the linear interpolation of the hands, when both hands are parameterized by arc-length. The second line is obtained by first taking the linear interpolation of the hands and then parameterizing each shape of the path by arc-length. The second path serves as initial path for the path-straightening method. The third

| parameter values | linear interpolation 1 | linear interpolation 2 | path 3 | path 4 | path 5 |
|-------------------|------------------------|------------------------|---------|---------|---------|
| $a = 0.01, b = 1$ | 32.3749 | 27.45 | 25.3975 | 26.2504 | 28.3768 |
| $a = 0.25, b = 1$ | 63.1326 | 52.4110 | 47.8818 | 47.5037 | 48.2284 |
| $a = 100, b = 1$ | 77.6407 | 66.6800 | 63.4840 | 60.9704 | 57.4557 |

Table 2.1: Energy of the paths depicted in Fig. 2.22.

line (resp. the fourth line, resp. the last line) corresponds to the path of minimal energy that we were able to find for $a = 0.01, b = 1$ (resp. $a = 0.25, b = 1$, resp. $a = 100, b = 1$), but the path-straightening algorithm is struggling in all cases. Note the different shapes of the growing finger when the parameters are changed. The energy of all these paths, for the different values of the parameters, is given in Tab. 2.1.

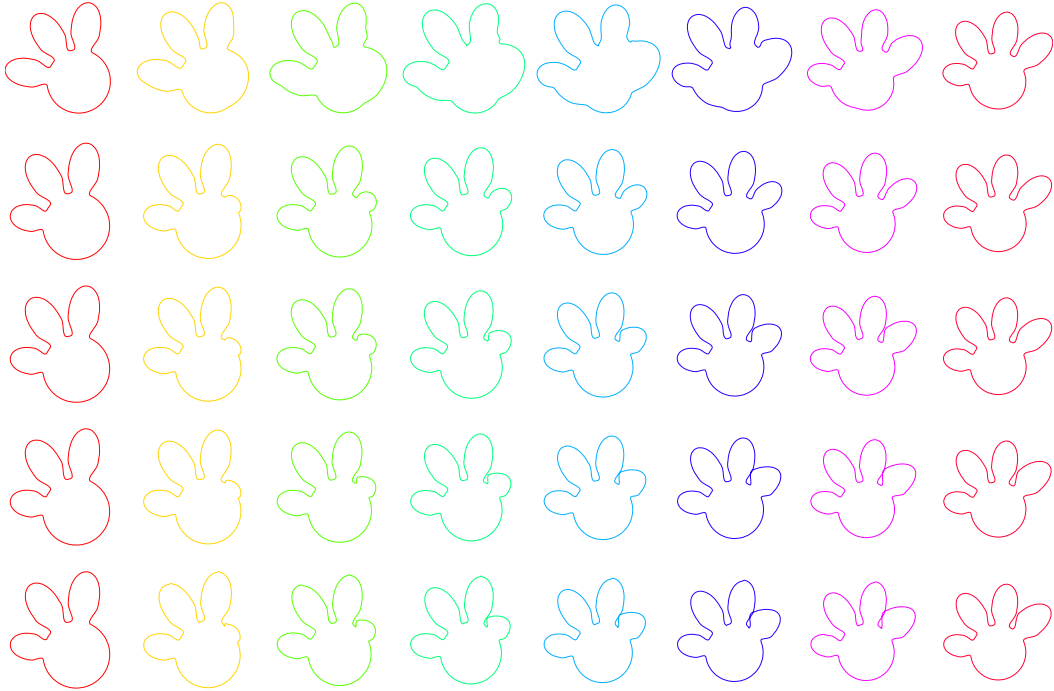

Figure 2.22: Different paths connecting a Mickey Mouse hand to the same hand with a missing finger.

Conclusion

In this section, we presented the study of the pull-back of the quotient elastic metrics to the space of arc-length parameterized plane curves of fixed length. We computed, for all values of the parameters, the exact energy functional as well as its gradient. These computations allowed us to illustrate how these metrics behave with respect to stretching and bending. In particular, we showed that even for small values of a/b , stretching and bending have contributions of the same order of magnitude to the energy, a fact that may be surprising in regard to the expression of the elastic metric on parameterized curves. On the other hand, for large values of a/b , stretching has a predominant cost to the energy, as expected. This implies that the energy landscape is steeper for big values of a/b in the sense that some deformations are preferred, a property that facilitates convergence of a path-straightening algorithm.

Chapter 3

Shape Analysis of Surfaces

3.1 Introduction

This chapter is based on our publication [212] and our collaborations [205], [169]. It is organized as follows. In Section 3.2, we first explain how spherical surfaces (i.e. surfaces of genus 0) can be implemented on a computer using spherical harmonics. Then we explain how a spherical surface can be aligned in order to have its center of mass at the origin, its inner volume equal to one and its principal axes along a preferred frame. These steps are usually needed in order to work independently of rotation, scaling and translation. Mathematically the alignment procedure is equivalent to the projection of a spherical surface of interest onto a preferred section of the fiber bundle of surfaces modulo translation, rotation and scaling. The remaining variability is given by the action of the group of diffeomorphisms of \mathbb{S}^2 which acts on a parameterized surface $f : \mathbb{S}^2 \rightarrow \mathbb{R}^3$ by reparameterizations $f \mapsto f \circ \gamma$, for $\gamma \in \text{Diff}(\mathbb{S}^2)$. Contrary to the group $\text{Diff}([0, 1])$ of reparameterizations of compact curves which can be dealt with dynamic programming, the group $\text{Diff}(\mathbb{S}^2)$ is more difficult to handle directly. As already mentioned in Part I, a canonical parameterization of spherical shapes exists modulo $\text{PSL}(2, \mathbb{C})$, given by the uniformization map. However it is difficult to implement in general. For this reason, we propose two different ways to deal with parameterization variability:

- In Section 3.3, we propose a gauge invariant framework (publication [205]) for shape analysis of spherical surfaces, which allows to define a Riemannian metric directly on the quotient of parameterized surfaces modulo diffeomorphisms without having to optimize over the group of diffeomorphisms of \mathbb{S}^2 . In this setting the length of a metamorphosis between two surfaces depends neither on the parameterizations of starting and ending shapes, nor on the parameterizations of shapes along the path of deformations connecting them. This framework is directly inspired from gauge theories in mathematical physics, and can be applied to the set of all spherical surfaces. As an example of this setting, the two paths of parameterized surfaces depicted in Fig 3.1, projecting onto the same deformation of shapes, have the same length.
- In Section 3.4, based on our collaboration [169], we specialize the set of surfaces under consideration to be the set of human bodies with different morphologies and poses. In this case, a local section of the fiber bundle of parameterized surfaces modulo reparameterization is provided by surfaces aligned with a SMPL template (see Fig 3.2b). In this case, a Riemannian metric is defined on the section of human bodies aligned with the template. Notably we proposed an optimization procedure for computing geodesics between aligned human bodies that preserved this section by constructing a family of deformations out of a database of plausible poses and morphologies. This idea of creating an adapted deformation basis from the surfaces under consideration (as opposed to general deformation basis build with spherical harmonics, see Section 3.2.1) appears to lead to very efficient algorithms. Mathematically, this corresponds to the choice of a finite-dimensional subspace of the tangent space to the manifold of surfaces, that is relevant for the current application and general enough to provide all plausible deformations. Moreover it improves the stability of the algorithm since the preferred section of aligned human bodies is by construction preserved by perturbations coming from this adapted basis of deformations. Fig. 3.2a shows some examples of human shapes from FAUST dataset [34] and Fig. 3.2b shows the SMPL template \mathcal{T} used in [169].

The fiber bundle structure of the space of parameterized spherical surfaces is explained in more details in Section 3.2.4. In Section 3.2.5, we explain what characterizes a spherical surface modulo reparameterization, namely its first and second fundamental forms. In Section 3.3, we will use this characterization to define a Riemannian metric on the space of shapes and, using Section 3.2.4, implement it in a way that is independent of the parameterizations ([205]). The Riemannian metrics introduced in this section are reused in a different way in Section 3.4 ([169]).

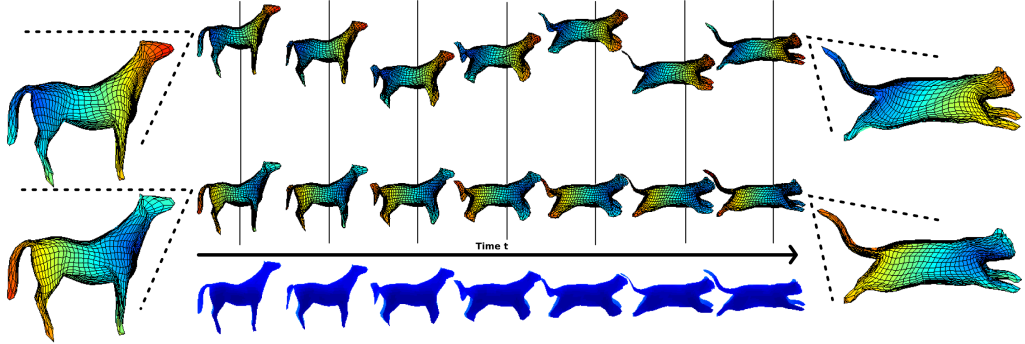
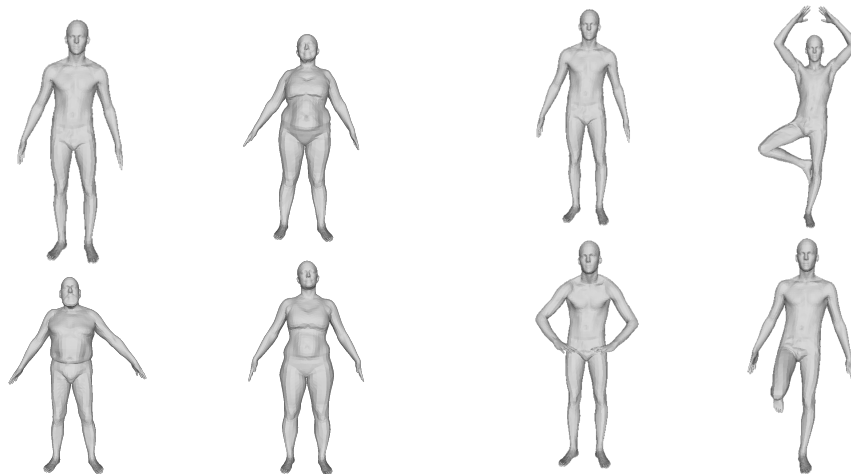
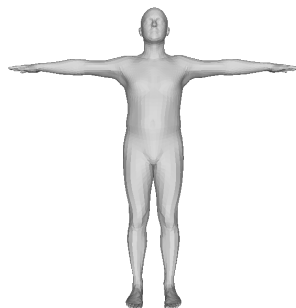

Figure 3.1: Two paths of parameterized surfaces with the same sequence of shapes but with different parameterizations of the corresponding shapes.



(a) Human shapes from the FAUST dataset.



(b) SMPL template used in [169].

3.2 Construction and alignment of spherical surfaces

3.2.1 Construction of surfaces using spherical harmonics

In order to represent surfaces on a computer, we start with a basis $\mathcal{B}_1 = \{Y_l^m, 1 \leq l \leq N, -l \leq m \leq l\}$ of spherical harmonics of degree less than N , available in Matlab as function SPHARM (see [56] for more information on spherical harmonics). We make three copies of this basis of \mathbb{R} -valued functions in order to obtain a basis \mathcal{B}_2 of the space $L^2(\mathbb{S}^2, \mathbb{R}^3)$ of \mathbb{R}^3 -valued functions. Any spherical surface can be constructed or reconstructed using the resulting basis. The convergence of the reconstruction process, as the degree of the spherical harmonics grows, is demonstrated in Fig. 3.3.

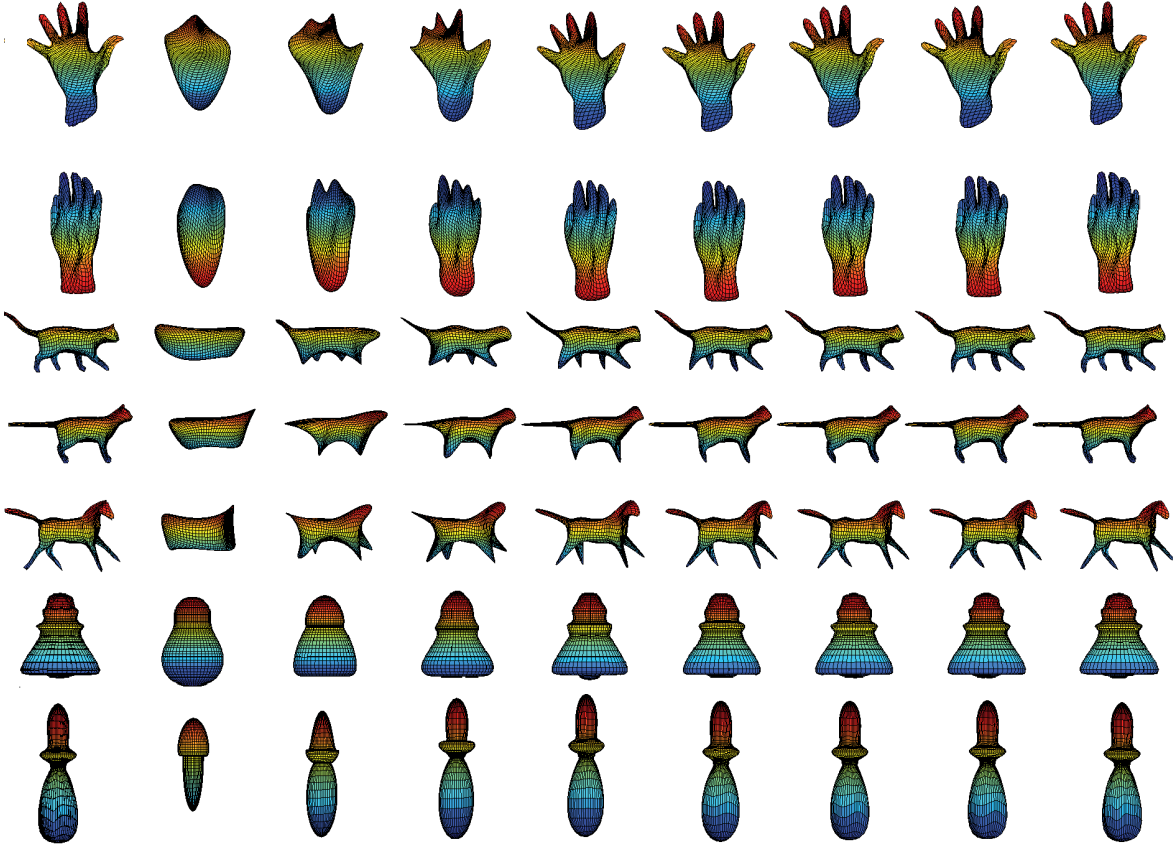

Figure 3.3: Reconstruction of several surfaces with different degree of spherical harmonics. From left to right is depicted the initial surface and its approximation using spherical harmonics with maximal degree $l = 3$, $l = 5$, $l = 7$, $l = 11$, $l = 15$, $l = 18$, $l = 20$ and $l = 28$ respectively.

3.2.2 Alignment of surfaces: removing rotation, translation and scale variability

If we want to compare shapes in \mathbb{R}^3 , the first thing to do is to state clearly what is relevant in the shape, and what is not. Depending on our situation, one may for instance think of a shape as a surface *modulo rotation* and/or *modulo translation* and/or *modulo scaling*. Before comparing two surfaces, one may therefore want to align them properly first, and do so in a way that does not depend on the parameterizations. In the next Section, we explain how the first and second moments of the surface can help us do that. In most situations, it makes sense to think of our spherical surfaces as boundaries of 3D-volumes (the surface of a cat has a meaning for us, precisely because it encloses a cat). In order to scale a given surface, we will therefore compute the enclosed volume V and divide each coordinate of surface points by $V^{1/3}$. Accordingly, to center a surface, we will compute the center of mass of the enclosed volume and subtract it from the coordinates

of surfaces points. The center of mass, whose coordinates are the *first moments* of the surface, is defined by the following integral over the enclosed volume:

$$C = \int \begin{pmatrix} x \\ y \\ z \end{pmatrix} d\text{Vol}.$$

In order to rotationally align our spherical surface, we will compute the best ellipsoid that approximates the enclosed volume, and apply to the surface points the rotation that maps the axes of the ellipsoid (with decreasing lengths) to the reference axes. This rotation is uniquely defined if the approximating ellipsoid is triaxial (i.e. the lengths of its principal axes are distinct). As an example, Fig. 3.4 shows two hands that have different orientations in space, the corresponding ellipsoids, and the hands after rotation (with a gap to separates them in order to facilitate visualization).

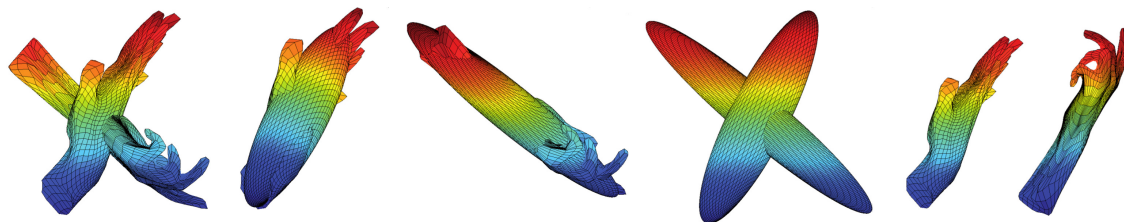

Figure 3.4: Rotational alignment: two hands before and after the alignment, respectively at the left and at the right. Each hand is approximated by an ellipsoid. The rotation used apply the axis of one ellipsoid to the axis of the other.

What we expect from the approximation of a surface by an ellipsoid is at least that, if we start with an ellipsoid, then it returns the ellipsoid itself. We expect also that if we change the parameterization of the surface, the ellipsoid's shape does not change. To fulfill both conditions, we will need the *second moments* of the surface defined as the following integral over the enclosed volume

$$M = \int \begin{pmatrix} x^2 & xy & xz \\ xy & y^2 & yz \\ xz & xy & z^2 \end{pmatrix} d\text{vol}.$$

The resulting matrix is a symmetric real matrix, hence can be diagonalized in an orthonormal basis. Its eigenvectors define the rotation we are looking for (more precisely its inverse). To illustrate this robustness we show in Fig. 3.5 different parameterizations of a horse (middle row) obtained by pre-composing a given parameterization by a diffeomorphism of the sphere (bottom row) and the resulting ellipsoid (top row). The diffeomorphisms used in this experiment are (from left to right) $\varphi_1 = \text{identity}$, $\varphi_2 = \text{rotation of } -3\pi/4 \text{ around } x\text{-axis}$, $\varphi_3 = \text{Möbius transformation that maps } z \in \mathbb{S}^2 \simeq \mathbb{C} \cup \{\infty\} \text{ to } \phi_3(z) = 0.4z + 0.5$, $\varphi_4 = \text{rotation of } -\pi/2 \text{ around } x\text{-axis composed with } \varphi_3$.

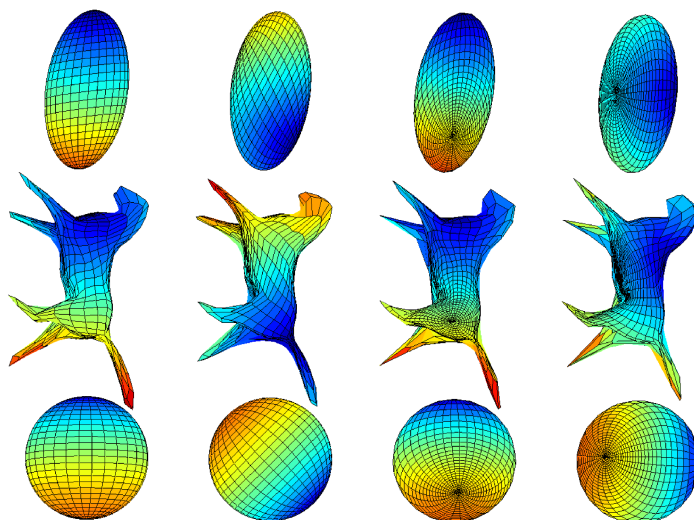

Figure 3.5: Robustness of the approximating ellipsoid of a surface with respect to reparameterizations.

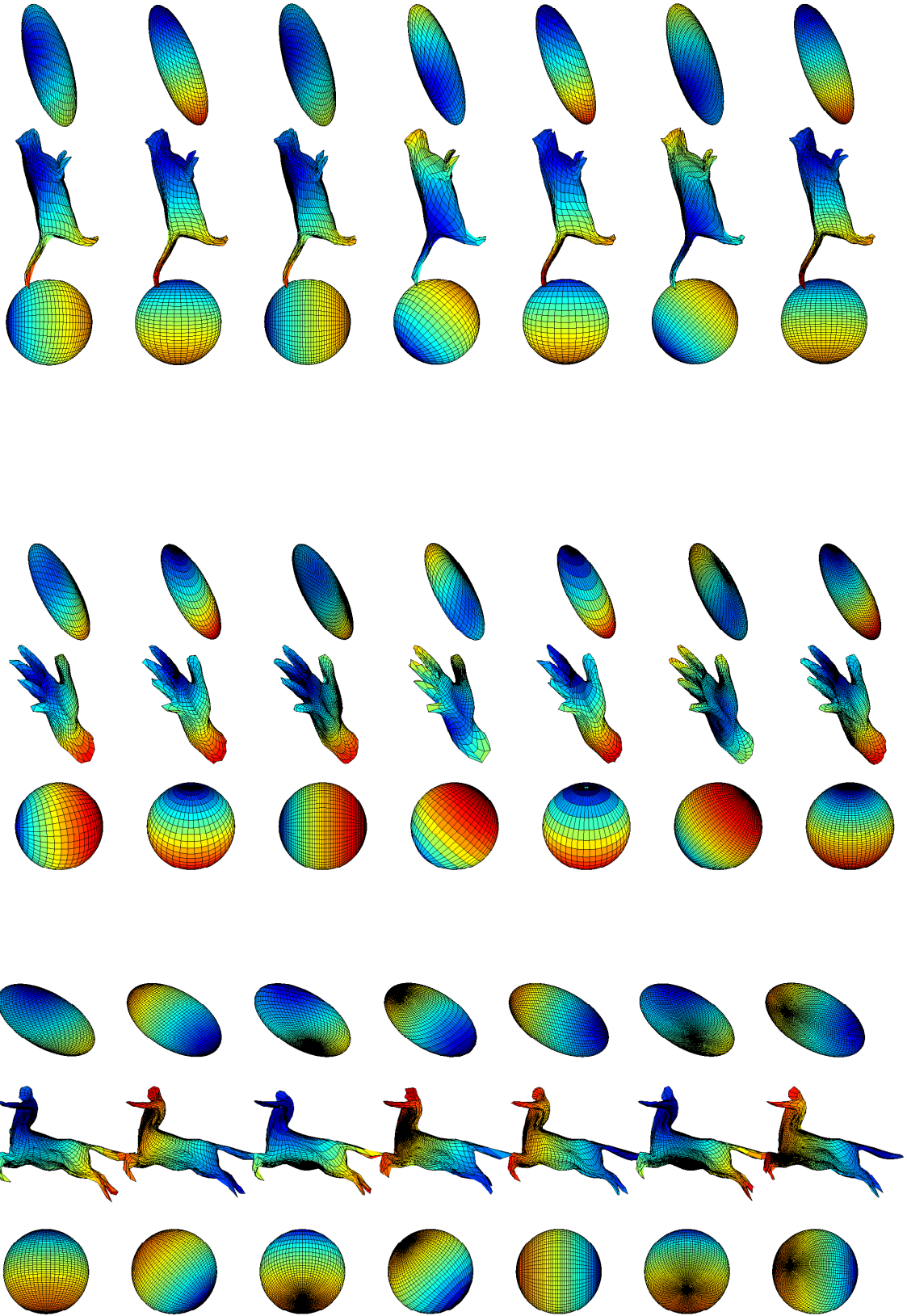

Figure 3.6: Lower rows: different re-parametrizations of the sphere; Middle rows: corresponding re-parametrizations of a shape; Upper rows: corresponding approximating ellipsoids.

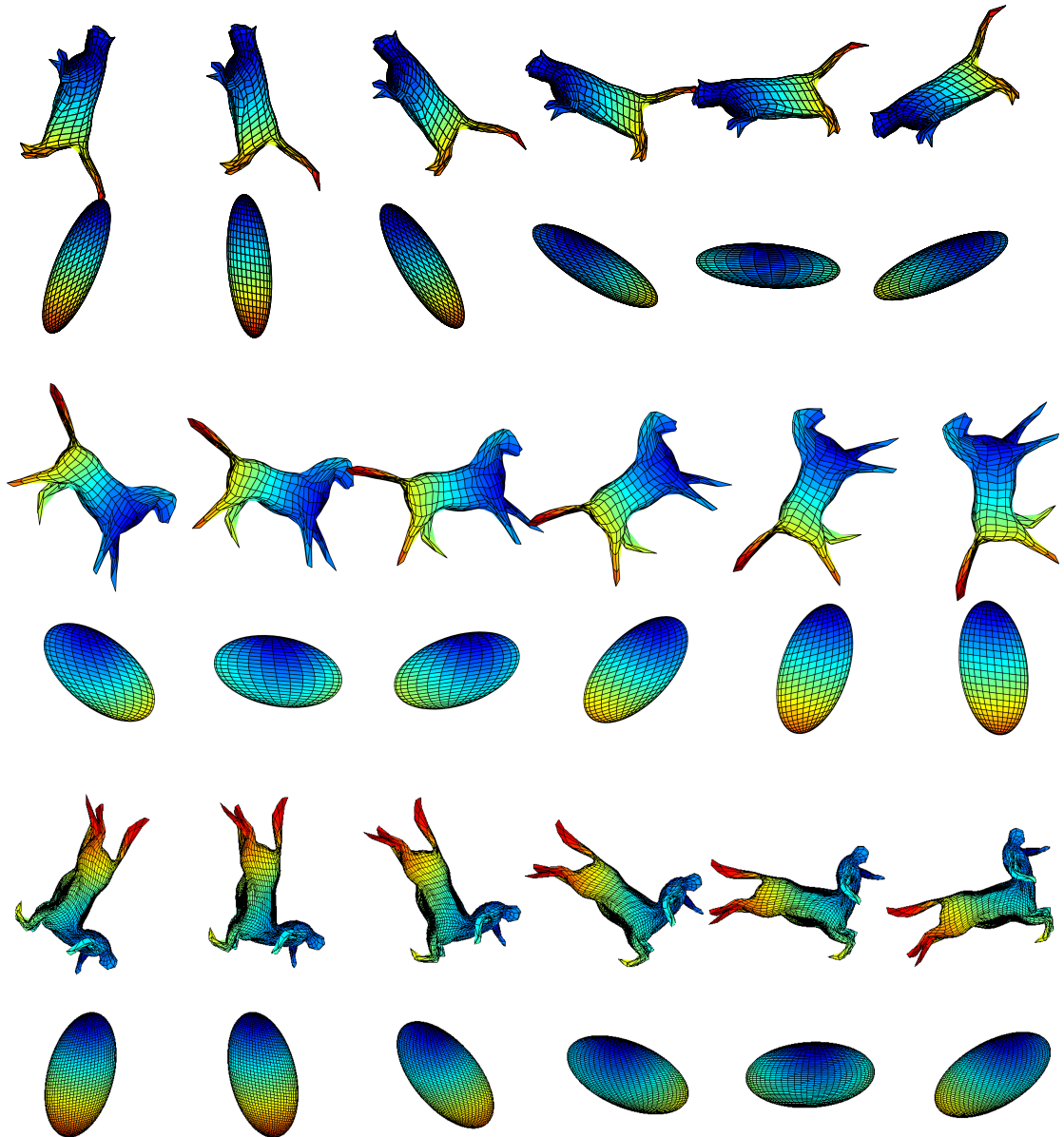

Figure 3.7: Dependence of the approximating ellipsoid with respect to rotation of the shape.

Recall that, given a spherical surface, we do not have any formula for a parameterization of it. Moreover we have only a finite number of points on the surface. The integration procedure is therefore replaced by the sum over the oriented tetrahedra defined by two edges on the surface, and a surface point (see Fig. 3.8). Recall that the volume of a tetrahedron built on three vectors v_1, v_2 and v_3 reads $\frac{1}{6} \det(v_1, v_2, v_3)$. It is important to keep track of the orientation of the surface (in Fig. 3.8, the volume of the red tetrahedron is coming with a + sign, whereas the volume of the blue one is coming with a - sign). The value of the integral of a polynomial function on a tetrahedron can be expressed (exactly) using just the values taken by the polynomial at a finite number of points on the tetrahedron. For instance, the integral of x^2 over the tetrahedron with vertices $0, v_1 = (x_1, y_1, z_1), v_2 = (x_2, y_2, z_2)$, and $v_3 = (x_3, y_3, z_3)$ is the volume of the tetrahedron multiplied by $\frac{1}{20} \times [(x_1 + x_2)^2 + (x_2 + x_3)^2 + (x_1 + x_3)^2]$.

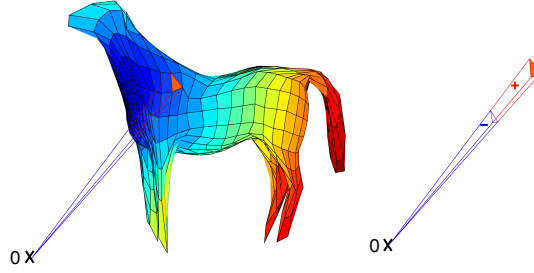

Figure 3.8: Integration over a triangulated surface.

3.2.3 Implementation of Alignment of spherical shapes

In this section we provide the details of the alignment program (Algorithm 6) described in the previous Section. The center of mass of the inscribed volume in a surface f is computed using Algorithm 3. The inscribed volume in a surface f is computed using Algorithm 4. The computation of the second moments is implemented using Algorithm 5. To find the best ellipsoid that approximates a surface S and the corresponding rotation U , one can use a singular value decomposition of $S^T S$. However, in the case where the surface is the boundary of a 3D-volume, it is more accurate to compute the mean of $S^T S$ over the inscribed volume. It also has a more physical meaning since the resulting ellipsoid is equivariant with respect to affine transformations (see previous Section). Moreover, the estimation of ellipsoid for an inscribed volume is more stable under reparameterizations. More pictures illustrating the robustness of the approximating ellipsoid when the parametrization of the initial surface is changed are given in Fig. 3.6. The dependence of the approximating ellipsoid with respect to a rotation of the surface is illustrated in Fig.3.7.

Algorithm 3: Computation of center of mass

Input:

1. 3D-parametrized surface f of size $a \times b \times 3$
2. Inscribed volume Vol in surface f
3. volume $\text{vol1}(i, j)$ of infinitesimal tetrahedron with vertices $0, f(i, j, :), f(i + 1, j), f(i, j + 1)$
4. volume $\text{vol2}(i, j)$ of infinitesimal tetrahedron with vertices $0, f(i + 1, j + 1, :), f(i + 1, j), f(i, j + 1)$.

Output: Center of mass of inscribed volume in surface f .

Algorithm: Initialize Center = (0, 0, 0). **for** $i \leftarrow 1$ **to** $\text{size}(f, 1)$ **do**
 for $j \leftarrow 1$ **to** $\text{size}(f, 2)$ **do**
 1- $m1 = \frac{1}{4}(f(i, j, :) + f(i + 1, j, :) + f(i, j + 1, :))$
 2- $m2 = \frac{1}{4}(f(i + 1, j + 1, :) + f(i + 1, j, :) + f(i, j + 1, :))$
 3- Center \leftarrow Center + $\text{vol1}(i, j) \times m1 + \text{vol2}(i, j) \times m2$

Algorithm 4: Computation of inscribed volume

Input: 3D-parametrized surface f of size $a \times b \times 3$.

Output:

1. Inscribed volume Vol in surface f
2. volume vol1(i, j) of infinitesimal tetrahedron with vertices $0, f(i, j, :), f(i+1, j), f(i, j+1)$;
3. volume vol2(i, j) of infinitesimal tetrahedron with vertices $0, f(i+1, j+1, :), f(i+1, j), f(i, j+1)$.

Algorithm: Initialize Vol = 0.

for $i \leftarrow 1$ **to** $size(f, 1)$ **do**

for $j \leftarrow 1$ **to** $size(f, 2)$ **do**

1- Set

$$edge(1) = f(i+1, j, :) - f(i, j, :)$$

$$edge(2) = f(i, j+1, :) - f(i, j, :)$$

$$edge(3) = f(i, j+1, :) - f(i+1, j+1, :)$$

$$edge(4) = f(i+1, j, :) - f(i+1, j+1, :)$$

2- Set

$$vol1(i, j) = \frac{1}{6} \text{Det}(edge(1), edge(2), -f(i, j, :))$$

$$vol2(i, j) = \frac{1}{6} \text{Det}(edge(3), edge(4), -f(i+1, j+1, :))$$

3- Vol \leftarrow Vol + vol(1) + vol(2).

Algorithm 5: Computation of second moments

Input:

1. 3D-parametrized surface f of size $a \times b \times 3$
2. Inscribed volume Vol in surface f
3. volume vol1(i, j) of infinitesimal tetrahedron with vertices $0, f(i, j, :), f(i+1, j), f(i, j+1)$
4. volume vol2(i, j) of infinitesimal tetrahedron with vertices $0, f(i+1, j+1, :), f(i+1, j), f(i, j+1)$.

Output: second moments of surface f defined as the following integral over the inscribed volume

$$M = \int \begin{pmatrix} x^2 & xy & xz \\ xy & y^2 & yz \\ xz & xy & z^2 \end{pmatrix} dvol$$

Algorithm: Initialize $M = \text{zeros}(3, 3)$.

for $i \leftarrow 1$ **to** $size(f, 1)$ **do**

for $j \leftarrow 1$ **to** $size(f, 2)$ **do**

for $k \leftarrow 1$ **to** 3 **do**

for $l \leftarrow 1$ **to** 3 **do**

$$s1 = (f(i, j, k) + f(i, j+1, k)) * (f(i, j, l) + f(i, j+1, l)),$$

$$s2 = (f(i, j, k) + f(i+1, j, k)) * (f(i, j, l) + f(i+1, j, l)),$$

$$s3 = (f(i+1, j, k) + f(i, j+1, k)) * (f(i+1, j, l) + f(i, j+1, l)).$$

$$m1 = \frac{1}{20} * (s1 + s2 + s3).$$

$$s4 = (f(i+1, j, k) + f(i, j+1, k)) * (f(i+1, j, l) + f(i, j+1, l)).$$

$$s5 = (f(i+1, j+1, k) + f(i+1, j, k)) * (f(i+1, j+1, l) + f(i+1, j, l)),$$

$$s6 = (f(i+1, j+1, k) + f(i, j+1, k)) * (f(i+1, j+1, l) + f(i, j+1, l)).$$

$$m2 = \frac{1}{20} * (s4 + s5 + s6).$$

$$M(k, l) \leftarrow M(k, l) + vol1(i, j) * m1 + vol2(i, j) * m2.$$

Algorithm 6: Alignement of 3D-shapes

Input:

1. a grid of $n \times n$ points on the unit sphere, i.e. for each index $(i, j) \in [1, n] \times [1, n]$, a value of polar angle $\theta(i, j)$ and of azimuthal angle $\phi(i, j)$,
2. a parametrized surface f_1 , i.e. for each index $(i, j) \in [1, n] \times [1, n]$, a point $f_1(i, j)$ in \mathbb{R}^3 corresponding to the image of the point on the sphere with spherical coordinates $(\theta(i, j), \phi(i, j))$ by the map f_1 ,
3. a parametrized surface f_2 , i.e. for each index $(i, j) \in [1, n] \times [1, n]$, a point $f_2(i, j)$ in \mathbb{R}^3 corresponding to the image of the point on the sphere with spherical coordinates $(\theta(i, j), \phi(i, j))$ by the map f_2 .

Output:

1. a centered and scaled surface F_1 having the same shape as f_1 , with center of mass at the origin and inscribed volume 1,
2. a centered, scaled and rotated surface F_2 having the same shape as f_2 , with center of mass at the origin, inscribed volume 1 and principal axes aligned with the principal axes of F_1 .
3. For $k = 1, 2$, an approximating ellipse E_k of F_k .

Algorithm:

- 1- For $k = 1, 2$, use algorithm 4 to compute the volume Vol_k inscribed in the surface f_k .
- 2- For $k = 1, 2$, $f_k \leftarrow f_k / (Vol_k)^{1/3}$.
- 3- For $k = 1, 2$, use algorithm 3 to compute the center of mass $Center_k$ of the inscribed volume in surface f_k .
- 4- For $k = 1, 2$, $f_k \leftarrow f_k - Center_k$.
- 5- For $k = 1, 2$, use algorithm 5 to compute the second moments M_k of surface f_k .
- 6- For $k = 1, 2$, compute $[U_k, S_k, V_k] = \text{svd}(M_k)$.
- 7- Set $F_1 = f_1$ and $F_2 = U_2 \times U_1' \times f_2$.
- 8- For $k = 1, 2$, compute

$$A_k = \left(\frac{4\pi}{15}\right)^{\frac{1}{5}} \det(M_k)^{-\frac{1}{10}} U_k \times \sqrt{S_k} \times U_k'.$$

- 9- Set $E_k = A_k \times \text{sphere}$, $k = 1, 2$.
-

3.2.4 Fiber bundle structure of pre-shape space

In this section, we stressed the distinction between the set of all (aligned) *parameterized* spherical surfaces, called *pre-shape space*, and the set of all (aligned) spherical surfaces, called *shape space*. Recall that the group $\text{Diff}^+(\mathbb{S}^2)$ of (orientation preserving) diffeomorphisms of the unit sphere acts on the pre-shape space simply by reparameterization. It is noteworthy that two parameterized surfaces correspond to the same surface if and only if one can pre-compose the first parameterization by a diffeomorphism of the sphere to obtain the second parameterization. One can therefore put an equivalence relation on the pre-shape space, by saying that two parameterized surfaces are equivalent if and only if they can be related by an element of the group $\text{Diff}^+(\mathbb{S}^2)$, i.e. if and only if they represent the same surface. The equivalence classes are also called the *orbits* of the group $\text{Diff}^+(\mathbb{S}^2)$ acting on pre-shape space. Note that two distinct orbits do not intersect, therefore the set of orbits fibers the pre-shape space in a nice way. There is a one to one correspondence between the set of orbits and the shape space. One says that the shape space is the *quotient space* of the pre-shape space by the action of the group of diffeomorphisms of the sphere. In Fig. 3.1, we have illustrated this *fiber bundle structure*: the blue surfaces at the bottom line are elements in the shape space (no parameterization), and the vertical lines above them symbolize the corresponding fibers in pre-shape space. Two elements in each fiber are depicted, for instance in the first left fiber one can see two parameterized horses which correspond to the same shape.

The pre-shape space is a smooth (Fréchet) manifold, meaning that locally it looks like a vector space, in the same sense that the earth looks locally like a plane. In fact, the pre-shape space is an open set in the vector space $\mathcal{C}^\infty(\mathbb{S}^2, \mathbb{R}^3)$ of smooth maps from the unit sphere into \mathbb{R}^3 . Moreover, the fiber bundle structure described above is a smooth one, meaning in particular that the tangent space at some pre-shape point (which can be identified with $\mathcal{C}^\infty(\mathbb{S}^2, \mathbb{R}^3)$ itself) can be decomposed into the tangent space to the fiber passing through this point and some complement. Since we are dealing with surfaces embedded in \mathbb{R}^3 , there is a natural complement to the tangent space of the fibers (in mathematical terminology, there is a natural *connection* on this fiber bundle). Indeed, let us describe the tangent space of the fiber at some pre-shape point, for instance at the parameterization of the cat depicted in Fig. 3.9. By definition, a tangent vector to the fiber passing

through this parameterized cat is the velocity vector at $t = 0$ of a smooth curve drawn in the fiber whose initial point at $t = 0$ is precisely the parameterized cat we are considering. Such a smooth curve is depicted at the bottom line of Fig. 3.9, and is obtained by the action on the parameterized cat of a smooth curve in the diffeomorphism group of \mathbb{S}^2 starting at the identity (upper line of Fig. 3.9). Hence the tangent space to the fiber passing through the parameterized cat is the space of *tangent* vector fields to the surface of the cat. A natural complement to this tangent space in $\mathcal{C}^\infty(\mathbb{S}^2, \mathbb{R}^3)$ (which can be identified with the space of \mathbb{R}^3 -valued vector fields on the cat using the parameterization at hand) is the space of vector fields which are *orthogonal* to the surface of the cat, for the scalar product of the Euclidean space \mathbb{R}^3 . In Fig. 3.10, we have depicted the decomposition of an element in $\mathcal{C}^\infty(\mathbb{S}^2, \mathbb{R}^3)$ into the sum of a vector field tangent to the cat and a vector field orthogonal to the cat. In Section 3.3.2 we give more details about the invariance of the subbundle of orthogonal vector fields under the action of the group of diffeomorphism of \mathbb{S}^2 .

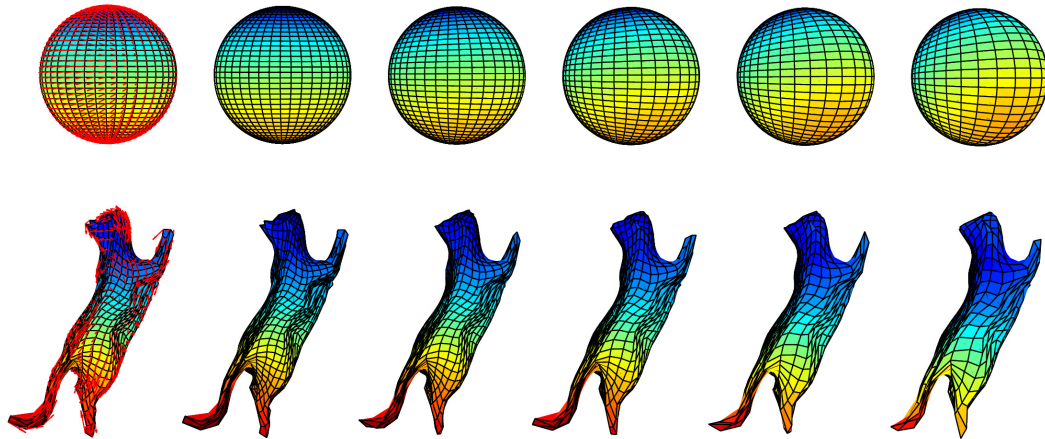

Figure 3.9: A vector field on the sphere (upper left), and a path of diffeomorphisms having this vector field as velocity at $t = 0$ (5 other spheres). Bottom line : action of this path of diffeomorphisms on a cat and corresponding vector field.

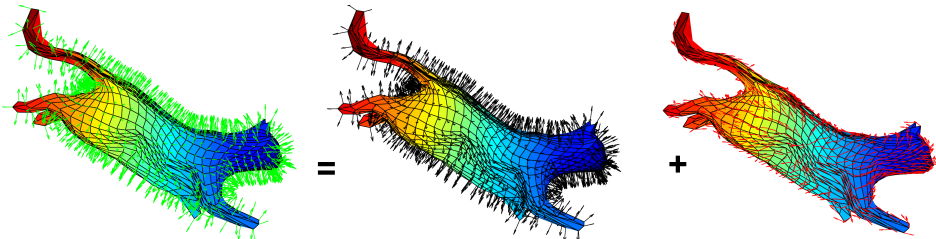

Figure 3.10: Decomposition of a vector field on the cat (green) into a vector field orthogonal to the cat (black) and a vector field tangent to the cat (red).

3.2.5 Characterization of a shape

If we want to compare shapes, as opposed to parameterized surfaces, one has to understand what is characteristic of the shape, i.e. what is independent of the parameterization. Recall that on a spherical surface one can measure distances, and angles, just because the surface is sitting in the Euclidean 3-dimensional space. This is encoded by the Riemannian metric on the spherical surface obtained by restricting the Euclidean metric of \mathbb{R}^3 , and is called the *first fundamental form* of the surface. The *second fundamental form* is encoding how the surface is embedded into \mathbb{R}^3 , and combine with the first fundamental form to define the *Shape operator* of the surface, which tells us how the surface is bent in \mathbb{R}^3 . The shape operator is related to the differential of the normal vector field seen as an application, called *Gauss map*, from the surface into the unit sphere, assigning to each point of the surface the unit normal vector to the surface at this point (identified with an element of the unit sphere). The eigenvalues of the Shape operator at a given point, called *principal curvatures*, are the minimal and maximal curvatures that a curve, obtained as intersection of a

plane containing the normal at this point with the surface, can have. For instance, the principal curvatures at any point of a plane are both 0, whereas the principal curvatures at any point of a sphere of radius R are both $1/R$. It is a remarkable fact observed by Gauss that the product of the principal curvatures (called *Gauss curvature* nowadays) depends only on the first fundamental form (Theorema Egregium). The half sum of the principal curvatures is the *mean curvature* and is what is relevant in the formation of soap films.

To compute the principal curvatures κ_1 and κ_2 at a given point of a surface, e.g. at the tip of the index finger of the hand depicted in Fig. 3.11, we first compute the normal at this point by averaging the normals of the facets having this point as vertex. A tangent plane is then defined as the plane orthogonal to the normal passing through the point under consideration. A neighborhood of the point is isolated from the surface (we use a 3-neighborhood, see second drawing in Fig. 3.11). We then apply a rigid transformation to center the point at the origin and to align the tangent plane with the xy -plane (see third drawing, and a closeup in the fourth drawing). After that, we compute the second order polynomial $P(x, y) = a_1x^2 + a_2y^2 + a_3xy + a_4x + a_5y + a_6$, which minimizes the sum $\sum_i (z_i - P(x_i, y_i))^2$ over the points of the centered and rotated neighborhood. Then, the Gauss curvature at that point is approximated by $K = 4a_1a_2 - a_3^2$, the mean curvature by $H = a_1 + a_2$, and the principal curvatures by $\kappa_1 = a_1 + a_2 + \sqrt{((a_1 - a_2)^2 + a_3^2)}$ and $\kappa_2 = a_1 + a_2 - \sqrt{((a_1 - a_2)^2 + a_3^2)}$.

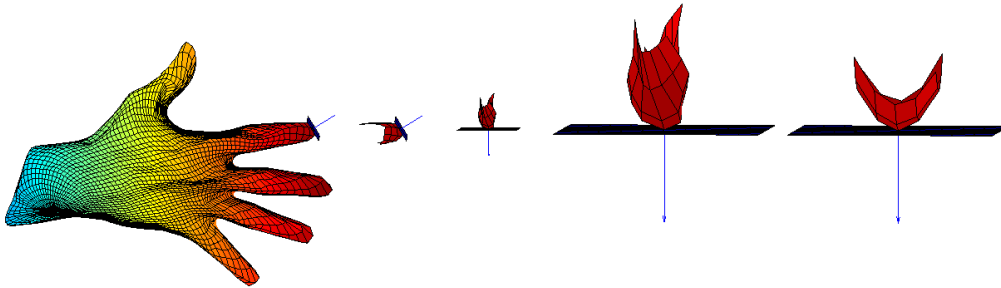

Figure 3.11: From left to right: A hand with the tangent plane and normal at the tip of the index finger; 3-neighborhood of the tip of the index finger; tip of the index finger after rotation; a closeup; approximating second order polynomial.

It follows from the fundamental theorem of surface theory that two parameterized (smooth) surfaces f_1 and f_2 having the same first and second fundamental forms differ at most by a translation and a rotation. Therefore, in order to characterize an aligned surface, one can use its first and second fundamental forms, or better, its first fundamental form g and its Gauss map n .

3.3 Gauge Invariant Framework for surfaces

In this section, we will explain a framework for analysing shapes of 3D objects that are bounded by a spherical surface. While there have been many efforts in shape analysis of 3D objects, the problem is far from solved and the current solutions face many technical and practical issues. For instance, many general techniques for shape analysis rely on quantifying shape differences by spatially matching geometric features across objects. Therefore, it becomes important to establish a correspondence of parts between objects, i.e. which part in one object corresponds to which part in the other? Some Riemannian frameworks have been used in shape analysis of parameterized surfaces and treat the problem of shape comparison as the problem of computing geodesic paths in shape spaces under a chosen metric coming from a Riemannian metric on a *pre-shape space* \mathcal{F} consisting of embeddings or immersions of a model manifold (like the sphere, or the disc) into the 3D Euclidean space \mathbb{R}^3 . Two embeddings correspond to the same shape in \mathbb{R}^3 if and only if they differ by an element of a shape-preserving transformation group, such as rigid motion, scaling, and reparameterization. The shape space is therefore the quotient space of the pre-shape space by these shape-preserving groups. If the Riemannian metric on the pre-shape space is preserved by the action of the shape-preserving group then it induces a Riemannian metric on the quotient space. The construction of geodesics in shape space provide optimal deformations between surfaces and

is a very important tool in *statistical* analysis of shapes. Interestingly, the problem of registration is handled using parameterizations of surfaces such that the points denoting the same parameter values on two objects are considered registered.

Let us stress here a big difference between the case of surface in comparison to the case of curves studied in previous chapter. The main difficulty in comparing shapes of surfaces is that there is no preferred parameterization that we could easily implement for general shapes, that can be used for registering and comparing features across surfaces. To be more precise, a canonical parameterization of a genus 0 surface sitting in the 3-dimensional Euclidean space exists, but it is hard to implement. Indeed, from the embedding into \mathbb{R}^3 , it follows that each tangent space at a given point of a spherical surface (for example at the tip of the middle finger depicted in Fig. 3.12) can be identified with a 2-dimensional vector subspace of \mathbb{R}^3 to which the Euclidean scalar product of \mathbb{R}^3 can be restricted. The smoothness of the surface then ensures that these 2-dimensional scalar products on the tangent spaces vary smoothly along the surface, defining what is called a *Riemannian metric* on the surface. It follows that, on a spherical surface, one is able to measure angles between two tangent vectors anchored at the same surface point: this angle is exactly the angle between these tangent vectors seen as vectors in \mathbb{R}^3 (see Fig. 3.12). One can also measure distances, in the same way we are measuring distances on earth, by measuring the shortest path drawn on earth's surface (and not inside!) joining two given points. In this context, saying that a

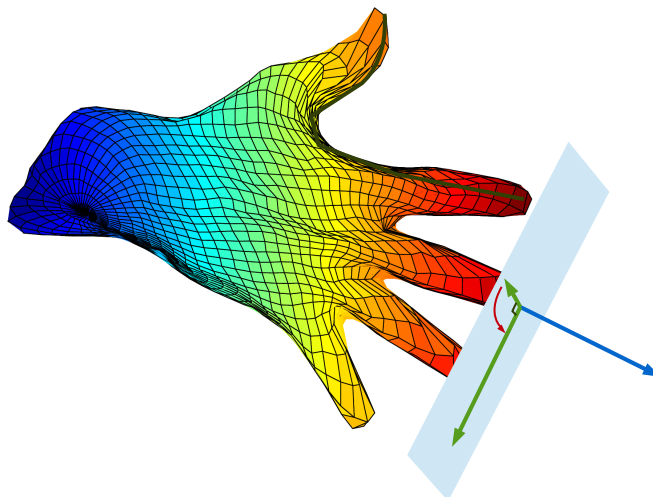

Figure 3.12: Scalar product on the tangent plan to the tip of the middle finger of a hand, and shortest path from the tip of the index finger to the tip of the thumb.

spherical surface is orientable means exactly that one can define on the surface a unit normal vector field pointing outside the surface. This is enough to ensure that the surface is naturally endowed with a complex structure, the complex structure in a given tangent space being nothing but the rotation of Euclidean angle $+\pi/2$ around the normal (the orientability helps defining the direction of rotation in a coherent way, see Fig. 3.12). In other words, the surfaces we are considering are *Riemann surfaces*. Since they are compact and simply connected, the Uniformization Theorem says that they are conformally equivalent to the unit sphere. This means that, given a spherical surface, there exists a homeomorphism, called the *uniformization map*, which preserves the angles and transforms the unit sphere into the surface. In particular, the uniformization map transforms the coordinate grid into a grid which also has the property of orthogonal intersections (for the orthogonality of vectors in \mathbb{R}^3). Note that the parameterization of the hand given in Fig. ?? is *not conformal* since it does not preserve the orthogonality of the grid. In fact, given a spherical surface, there are many conformal maps from the unit sphere to it, as many as elements in $PSL(2, \mathbb{C})$. This may sound a lot since there are infinitely many complex 2-by-2-matrices with determinant 1 (and the P in $PSL(2, \mathbb{C})$ only divides this amount by 2), but $PSL(2, \mathbb{C})$ is *just* a 3-dimensional complex Lie group, as opposed to the infinite-dimensional Fréchet Lie group $\text{Diff}^+(\mathbb{S}^2)$. Hence, to the question if there exists a preferred parameterization of a spherical surface, one can answer, modulo $PSL(2, \mathbb{C})$, there is a unique one, however the Algorithms approximating the uniformization maps are computationally heavy and can not be applied for our purposes.

Furthermore, we are not only interested in the comparison and matching of two shapes, but also in the deformation processes that may transform one shape into another, i.e. metamorphosis. To be physically meaningful, the evolution from one shape to another should be independent of the way surfaces may be parameterized. Our approach to shape analysis presented in [205] was therefore initiated by the following question: *What is the natural framework where one can measure deformations of shapes independently of the way shapes are parameterized?* As a motivating example, the sequence of shapes displayed in Fig. 3.1 (bottom) denotes a path where a horse is transformed into a jumping cat. During the transformation process, only the change of shape, drawn in the bottom line as a sequence of blue surfaces, is relevant to us. How the surfaces may be parameterized during the metamorphosis has no importance in our context. To emphasize this idea, two paths of parameterized surfaces corresponding to the same transformation process are displayed in the top two rows. We would like a framework where the physical quantities measured on the path of shapes, such as its length or its energy, are independent of the parameterizations of surfaces along the transformation process. In particular, in Fig. 3.1, the two paths of parameterized surfaces corresponding to the same transformation process should have the same length. Note that the surfaces along the second path are obtained by applying a *different reparameterization at each time step* to the surfaces along the first path.

Let us emphasize that we are not only interested in how *far* the horse and the jumping cat are from each other, in other words in a quantity like a distance measuring the minimal cost needed to deform the horse into a cat. But, given a metamorphosis between these two shapes, we are also interested in measuring its *length* on one hand, and its *energy* on the other hand, independently of the parameterizations of the transformation process that may have been used to create this metamorphosis.

What should be a good Riemannian metric on shape space ? A good Riemannian metric on shape space should be such that: (1) it induces a positive distance function on shape space, i.e. the infimum of the lengths of paths connecting two different shapes should be non-zero ; (2) the distance between two shapes should be independent of the way the two shapes are parameterized ; and, (3) the length of a path of shapes should be independent of the way shapes along the path are parameterized. The last point should be thought of as the natural generalization of the fact that, on a finite-dimensional Riemannian manifold, the length of a curve is independent of the way the curve is parameterized. It should be true for any path (not only for geodesics), and is called *gauge invariance*. Indeed the use of parameterized surfaces in order to measure the deformation of a shape can be compared to the use of a gauge. Let us comment on Fig. 3.1 in order to illustrate this idea. Each column depicts an orbit under the reparameterization group for the corresponding surface, the surfaces in a given orbit correspond to the same shape but with different parameterizations. A path of shapes can be lifted in many ways to a path of parameterized surfaces. In Fig. 3.1 two lifts of the bottom line path are depicted. The first path connects parameterized surfaces with different “heights” in the fibers. This is made to emphasize that the variations of the “height” (i.e. of the parameterization) in the fibers should not influence the value of the length of the path of shapes.

The framework of this section achieves the following:

- The proposed method achieves gauge invariance, i.e. the lengths of paths (geodesics or otherwise) measured under this metric are invariant to arbitrary reparameterizations of shapes along these paths (in particular, the two paths in Fig.3.1 have the same length).
- It uses an elastic metric that accounts for any deformation of patches to define and compute geodesic paths between given objects in the shape space, and it presents a geometric interpretation of the different terms involved in this metric.
- By defining a metric directly in the shape space, it avoids the optimization step over the reparameterization group and difficult mathematical issues arising from inheriting a metric from pre-shape space.

Note that the third point leads to more efficient Algorithms in cases where one only needs a shape geodesic and not the optimal registration between surfaces. It provides the same geodesic path despite arbitrary initial parameterizations (or registrations) of given surfaces, and saves the computational cost of finding a registration. This fact is also a source of limitation in the situation where one needs a registration. If one wants to use geodesic lengths for comparing shapes, then a registration is not needed. However, if one wants to study statistical summaries of deformation fields, then a registration will be needed.

The rest of this section is organized as follows. Subsection 3.3.1 describes the mathematical representation of embedded surfaces and establishes mathematical setup. Subsection 3.3.2 is devoted to the description of gauge invariance and to the definition of the Riemannian metric involved in this (and next) Section. The geodesic computation is described in Subsection 3.3.3 and the final Subsection presents experimental results.

3.3.1 Mathematical Setup

We will represent a shape S with an embedding $f : \mathbb{S}^2 \rightarrow \mathbb{R}^3$ such that the image $f(\mathbb{S}^2)$ is S . The function f is also called a *parameterization* of the surface S .

We will use local coordinates (u, v) on the sphere. For the theoretical framework, any coordinates on the sphere are suitable, but in the application we use spherical coordinates: u stands for the polar angle and ranges from 0 to π , and v denotes azimuthal angle and ranges from 0 to 2π .

Recall that a map $f : \mathbb{S}^2 \rightarrow \mathbb{R}^3$ is an *embedding* when: for any point $(u, v) \in \mathbb{S}^2$, (1) f is smooth, in particular the derivatives f_u and f_v of f with respect to u and v are well-defined, (2) f is an immersion, i.e. the cross product $f_u \times f_v$ never vanishes and allows us to define the normal (resp. tangent) space to the surface $f(\mathbb{S}^2)$ at a point $f(u, v)$ as the subspace of \mathbb{R}^3 which is generated by (resp. orthogonal to) $f_u \times f_v$, and (3) f is a homeomorphism onto its image, i.e. points on $f(\mathbb{S}^2)$ that look close in \mathbb{R}^3 are images of close points in \mathbb{S}^2 . If f is an embedding, then the surface $f(\mathbb{S}^2)$ is naturally oriented by the frame $\{f_u, f_v\}$, or equivalently by the normal vector field $f_u \times f_v$.

We define the space of all such surfaces as

$$\mathcal{F} := \{f : \mathbb{S}^2 \rightarrow \mathbb{R}^3, f \text{ is an embedding}\}.$$

It is often called the *pre-shape space* since objects with same shape but different orientations or parameterizations may correspond to different points in \mathcal{F} . The set \mathcal{F} is itself a manifold, as an open subset of the linear space $\mathcal{C}^\infty(\mathbb{S}^2, \mathbb{R}^3)$ of smooth functions from \mathbb{S}^2 to \mathbb{R}^3 (see Theorem 3.1 in [13] and the references therein). The tangent space to \mathcal{F} at f , denoted by $T_f\mathcal{F}$, is therefore just $\mathcal{C}^\infty(\mathbb{S}^2, \mathbb{R}^3)$.

The shape-preserving transformations of 3D object can be expressed as group actions on \mathcal{F} . The group \mathbb{R}^+ with multiplication operation acts on \mathcal{F} by *scaling*: $(\beta, f) \mapsto \beta f$, for $\beta \in \mathbb{R}^+$ and $f \in \mathcal{F}$. The group \mathbb{R}^3 with addition as group operation acts on \mathcal{F} , by *translations*: $(v, f) \mapsto f + v$, for $v \in \mathbb{R}^3$ and $f \in \mathcal{F}$. The group $\text{SO}(3)$ with matrix multiplication as group operation acts on \mathcal{F} , by *rotations*: $(O, f) \mapsto Of$, for $O \in \text{SO}(3)$ and $f \in \mathcal{F}$. Finally, the group $\Gamma := \text{Diff}^+(\mathbb{S}^2)$ consisting of diffeomorphisms which preserve the orientation of \mathbb{S}^2 acts also on \mathcal{F} , by *reparameterization*: $(\gamma, f) \mapsto f \circ \gamma^{-1}$, for $\gamma \in \text{Diff}^+(\mathbb{S}^2)$ and $f \in \mathcal{F}$. The use of γ^{-1} , instead of γ , ensures that the action is from left and, since the action of $\text{SO}(3)$ is also from left, one can form a joint action of $G := \text{Diff}^+(\mathbb{S}^2) \times \text{SO}(3) \times \mathbb{R}^3$ on \mathcal{F} . In our setting, the translation group is taken care of by using a translation-independant metric (the elastic metric) and, when needed, the scaling is taken care of by rescaling the surfaces to have unit surface area. Therefore, in the following we will focus only on the reparameterization group Γ and on the rotation group $\text{SO}(3)$.

Shape Space as quotient space

Since we are only interested in shapes of surfaces, we would like to identify surfaces that can be related through a shape-preserving transformation. This is accomplished using the notion of group action and orbits under those group actions.

Given a group G acting on \mathcal{F} , the elements in \mathcal{F} obtained by following a fix parameterized surface $f \in \mathcal{F}$ when acted on by all elements of G is called the *G-orbit* of f or the *equivalence class* of f under the action of G , and will be denoted by $[f]$. In particular, when G is the reparameterization group, the orbit of $f \in \mathcal{F}$ is characterized by the surface $f(\mathbb{S}^2) = S$, i.e. the elements in $[f] = \{f \circ \gamma^{-1} \text{ for } \gamma \in \Gamma\}$ are all possible parameterizations of S . For instance in Fig. 3.1, the first column contains some parameterized horses that are elements of the same orbit. The set of orbits of \mathcal{F} under a group G is called the *quotient space* and will be denoted by \mathcal{F}/G . The quotient space of interest here is the *shape space* defined as follows.

Definition 3.3.1. The *shape space* \mathcal{S} is the set of oriented surfaces in \mathbb{R}^3 , which are diffeomorphic to \mathbb{S}^2 , modulo translation and rotation. It is isomorphic to the quotient space of the pre-shape space \mathcal{F} by the shape-preserving group $G := \text{Diff}^+(\mathbb{S}^2) \times \text{SO}(3) \times \mathbb{R}^3$: $\mathcal{S} = \mathcal{F}/G$.

It is important to note that the shape space $\mathcal{S} = \mathcal{F}/G$ is a smooth manifold and the canonical projection $\Pi : \mathcal{F} \rightarrow \mathcal{F}/G, f \mapsto [f]$ is a submersion (see for instance [33] and [141]). This submersion is useful in establishing the notion of a vertical space that will be needed a little later. By definition, the vertical space of a submersion is the kernel space of its differential. When the submersion is a quotient map by a group action, the vertical space is the tangent space to the orbit (the terminology comes from the fact that the orbits are usually depicted as vertical fibers over a base manifold which is the quotient space, see Fig.3.1). In the case of the submersion $\tilde{\Pi} : \mathcal{F} \mapsto \mathcal{F}/\text{Diff}^+(\mathbb{S}^2)$, the vertical space takes a very natural, intuitive form.

Proposition 3.3.2. *The vertical space $Ver(f)$ of $\tilde{\Pi}$ at some embedding $f \in \mathcal{F}$ is the space of vector fields which are tangent to the shape $f(\mathbb{S}^2)$, or equivalently the space of vector fields such that the dot product with the unit normal vector field $n_f := \frac{f_u \times f_v}{\|f_u \times f_v\|} : \mathbb{S}^2 \rightarrow \mathbb{R}^3$ vanishes:*

$$Ver(f) = \{\delta f : \mathbb{S}^2 \rightarrow \mathbb{R}^3 \mid \delta f(s) \cdot n_f(s) = 0, \forall s \in \mathbb{S}^2\}.$$

Remark 3.3.3. *A canonical complement to this vertical space (consisting of tangent vector fields) is given by the space of vector fields normal to the surface $f(\mathbb{S}^2)$ denoted by Nor . This is the sub-bundle of the tangent bundle $T\mathcal{F}$ defined by*

$$Nor(f) = \{\delta f : \mathbb{S}^2 \rightarrow \mathbb{R}^3 \mid \delta f(s) \times n_f(s) = 0, \forall s \in \mathbb{S}^2\}.$$

Any tangent vector $\delta f \in T_f\mathcal{F}$ admits a unique decomposition $\delta f = \delta f^T + \delta f^\perp$ into its tangential part $\delta f^T \in Ver(f)$ and its normal part $\delta f^\perp \in Nor(f)$. Specifically, the normal part is given by:

$$\delta f^\perp = (\delta f \cdot n_f) n_f. \quad (3.1)$$

See Fig. 3.13 for an illustration of this decomposition. Generally speaking, one has $T\mathcal{F} = Ver \oplus Nor$ as a direct sum of smooth fiber bundles over \mathcal{F} . This decomposition is preserved by the action of the reparameterization group Γ , i.e. $(\delta f \circ \gamma)^T = \delta f^T \circ \gamma$ and $(\delta f \circ \gamma)^\perp = \delta f^\perp \circ \gamma$ (for a proof of this statement, see Section 1 of the Supplementary Material).

The interest in splitting a perturbation δf into its normal and vertical components comes from the fact that the vertical component $\delta f^T \in Ver(f)$ can only lead to a shape-preserving transformations of the surface $f(\mathbb{S}^2)$. Thus, in the process of deforming one shape into another (for instance along a geodesic path) and quantifying shape differences between them using geodesic lengths, we are not interested in measuring deformations that are in $Ver(f)$. An important novelty of our approach is that the eventual Riemannian metric is imposed only on the δf^\perp components of the perturbations, and that the δf^T components have a zero contribution to the metric.

3.3.2 Gauge Invariance and Riemannian Metric

In this subsection, we first provide a precise definition gauge invariance and then motivate its use in shape analysis.

Defining Gauge Invariance

The gauge invariance relates to the parameterization of surfaces along a path in \mathcal{F} and, thus, the mathematical objects of importance in this subsection are paths $\Psi : [0, 1] \mapsto \mathcal{F}$. The set of such paths is the smooth manifold $\mathcal{P} := \mathcal{C}^\infty([0, 1], \mathcal{F})$.

An element of \mathcal{P} can be thought of as a metamorphosis from the initial shape to the final shape. For instance, Fig. 3.1 shows two elements in \mathcal{P} as two different deformations from a parameterized horse to a parameterized cat. To have a picture in mind, consider the upper path $\Psi : t \mapsto \Psi(t)$ in \mathcal{P} : at each time step $t \in [0, 1]$, $\Psi(t)$ is a parameterized shape, i.e. a map from our model manifold \mathbb{S}^2 into \mathbb{R}^3 . The map $\Psi(0)$ is the parameterization of our initial parameterized shape chosen to be a horse and $\Psi(1)$ is the parameterization of our final parameterized shape which, in this case, is a cat.

The definition of length of the path $t \mapsto \Psi(t)$ requires specification of a metric on \mathcal{F} . Given such a metric $(\langle \cdot, \cdot \rangle)$, one can define the length as:

$$L[\Psi] = \int_0^1 (\langle \Psi_t(t), \Psi_t(t) \rangle)_{\Psi(t)}^{\frac{1}{2}} dt, \quad (3.2)$$

where $\Psi_t(t) = \frac{d\Psi}{dt}(t)$ is the velocity vector of the path $t \mapsto \Psi(t)$, i.e. an infinitesimal deformation of the parameterized shape $\Psi(t)$. The geodesic distance between two shapes f_1 and f_2 is then defined by

$$d(f_1, f_2) = \inf_{\Psi: [0,1] \rightarrow \mathcal{F} | \Psi(0)=f_1, \Psi(1)=f_2} L[\Psi], \quad (3.3)$$

where the infimum is taken over all paths connecting shape f_1 and shape f_2 .

We would like the length $L[\Psi]$, for any path Ψ , to match the length of the path $t \mapsto \Psi(t) \circ \gamma(t)$, where $t \mapsto \gamma(t) \in \Gamma$ is any time-dependent reparameterization of \mathbb{S}^2 :

$$L[\Psi] = L[\tilde{\Psi}], \quad \text{where } \tilde{\Psi}(t) = \Psi(t) \circ \gamma(t). \quad (3.4)$$

More formally, set $\Gamma = \text{Diff}^+(\mathbb{S}^2)$ and define the group $\mathcal{G} := \mathcal{C}^\infty([0,1], \Gamma)$, of time-dependant reparameterizations that acts on \mathcal{P} according to

$$\begin{aligned} \mathcal{G} \times \mathcal{P} &\longrightarrow \mathcal{P} \\ (t \mapsto \gamma(t), t \mapsto \Psi(t)) &\longmapsto (t \mapsto \Psi(t) \circ \gamma(t)). \end{aligned}$$

The group \mathcal{G} is called the *gauge group*, and one says that \mathcal{G} acts by *gauge transformations*. We are looking for a framework where the length of a path is *invariant to gauge transformations*, i.e. satisfies Eqn. (3.4). One should distinguish these transformations from *temporal* reparameterizations of the path Ψ itself. A gauge transformation changes spatial reparameterization of surfaces, while preserving shapes, along the path, while a temporal reparameterization changes the time it takes to reach each shape along the path.

To build a gauge invariant framework, the basic idea is as follows: take any Γ -invariant Riemannian metric $\langle\langle \cdot, \cdot \rangle\rangle$ on the pre-shape space, and *ignore* the direction tangent to the reparameterization orbit. (An example of Γ -invariant Riemannian metric is the elastic metric defined in Eqn. (3.7) as is shown in Section 2 of the Supplementary Material). More precisely, let $\langle\langle \cdot, \cdot \rangle\rangle$ be a Riemannian metric on pre-shape space \mathcal{F} which is preserved by the action of the group of reparameterizations Γ , that is:

$$\langle\langle \delta f_1 \circ \gamma, \delta f_2 \circ \gamma \rangle\rangle_{f \circ \gamma} = \langle\langle \delta f_1, \delta f_2 \rangle\rangle_f, \quad (3.5)$$

for any $f \in \mathcal{F}$, for any $\delta f_1, \delta f_2 \in T_f \mathcal{F}$ and any $\gamma \in \Gamma$. Given a Γ -invariant sub-bundle H of $T\mathcal{F}$ such that

$$H(f) \oplus \text{Ver}(f) = T_f \mathcal{F}, \quad (3.6)$$

denote by $p_H : T_f \mathcal{F} \rightarrow H(f)$ the projection onto $H(f)$ with respect to the direct sum decomposition given in Eqn. (3.6). This means that any element $\delta f \in T_f \mathcal{F}$ admits a unique decomposition into

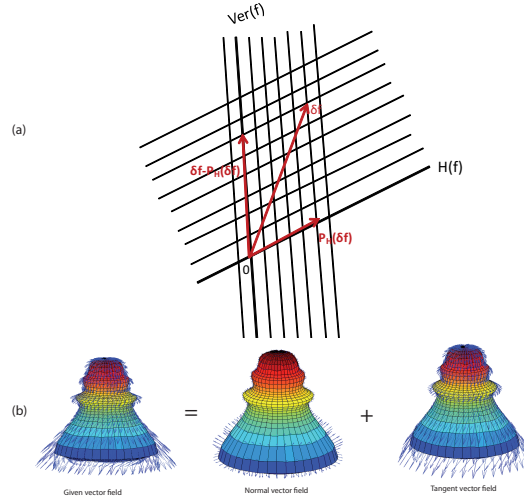

Figure 3.13: a. Direct sum decomposition $H(f) \oplus \text{Ver}(f) = T_f \mathcal{F}$. b. Vector field decomposition into tangent and normal directions

the sum of an element $p_H(\delta f)$ in $H(f)$ and an element in $\text{Ver}(f)$. We illustrate this decomposition of vector spaces in Fig. 3.13.a, while the particular case when H is the space of normal vector fields Nor is shown in Fig. 3.13.b.

Proposition 3.3.4. *The non-negative semi-definite inner product on pre-shape space defined by*

$$((\delta f_1, \delta f_2))_f := \langle\langle p_H(\delta f_1), p_H(\delta f_2) \rangle\rangle_f$$

satisfies the gauge-invariance condition given in Eqn. (3.4) and induces a Riemannian metric on quotient space \mathcal{S} such that the quotient map is an isometry between $H(f)$ and the tangent space $T_{[f]}\mathcal{S}$.

Distinction between Gauge Invariant Framework and Quotient Riemannian Framework

In practice the subbundle H has to be chosen in order to make the implementation easy. A natural choice of subbundle H is the normal bundle Nor which is preserved by the action of the reparameterization group $\Gamma = \text{Diff}^+(\mathbb{S}^2)$ (see below). We have used this subbundle in the paper [205]. Another requirement is that the chosen Riemannian metric has to be Γ -invariant. This is the case for the elastic metric defined below. We will therefore apply the idea of gauge invariance to the concrete example of the elastic metric and the normal bundle Nor . It is worth noting that the Riemannian metric on shape space obtained by restricting a Riemannian metric on preshape space to the normal bundle Nor differs in general from the quotient Riemannian metric. In fact, the quotient metric coincides with the restriction to the subbundle Nor if and only if the *Horizontal* subbundle defined by $Hor(f) = \text{Ker}(d\pi)^\perp$ is the normal bundle. This is not the case for the elastic metric. We also remark that the present gauge invariant framework has been used implicitly in [16], Section 6, and [15], Section 11, in the case where the horizontal bundle coincides with the normal bundle.

The Subbundle of normal vector fields is Γ -invariant

In this subsection, we provide the proof of the fact that the subbundle of normal vector fields is a Γ -invariant complement to the subbundle of tangent vector fields.

Proposition 3.3.5. *Denote by Nor the subbundle of the tangent bundle $T\mathcal{F}$ consisting of normal vector fields which is the space of vector fields such that the cross product with the normal $n_f : \mathbb{S}^2 \rightarrow \mathbb{R}^3$ to the shape $f(\mathbb{S}^2)$ vanishes:*

$$Nor(f) = \{\delta f : \mathbb{S}^2 \rightarrow \mathbb{R}^3, \text{ such that } \delta f \times n_f = 0\}.$$

Any tangent vector $\delta f \in T_f\mathcal{F}$ admits a unique decomposition

$$\delta f = \delta f^T + \delta f^\perp$$

into its tangential part $\delta f^T \in Ver(f)$ and its normal part $\delta f^\perp \in Nor(f)$. In other words one as

$$T\mathcal{F} = Ver \oplus Nor$$

as a direct sum of smooth fiber bundles over \mathcal{F} . Moreover this decomposition is preserved by the action of the re-parametrization group Γ , i.e. $(\delta f \circ \gamma)^T = \delta f^T \circ \gamma$ and $(\delta f \circ \gamma)^\perp = \delta f^\perp \circ \gamma$.

Proof. The uniqueness of the decomposition into tangential and normal direction comes from the uniqueness of the decomposition of a vector in \mathbb{R}^3 into a tangent vector and normal vector to the surface. The smoothness of the decomposition is a consequence of the smoothness of the tangent and normal bundles. To see that Γ preserves the normal bundle, note that if $\gamma \in \Gamma$ reads $\gamma = (\gamma_1(u, v), \gamma_2(u, v))$ in a chart, then $(f \circ \gamma)_u = f_u \circ \gamma \frac{\partial \gamma_1}{\partial u} + f_v \circ \gamma \frac{\partial \gamma_2}{\partial u}$ and $(f \circ \gamma)_v = f_u \circ \gamma \frac{\partial \gamma_1}{\partial v} + f_v \circ \gamma \frac{\partial \gamma_2}{\partial v}$, therefore

$$(f \circ \gamma)_u \times (f \circ \gamma)_v = f_u \circ \gamma \times f_v \circ \gamma \left(\frac{\partial \gamma_1}{\partial u} \frac{\partial \gamma_2}{\partial v} - \frac{\partial \gamma_2}{\partial u} \frac{\partial \gamma_1}{\partial v} \right).$$

It follows that the unit normal vector field to the parametrized surface $f \circ \gamma$ reads

$$\begin{aligned} & \frac{(f \circ \gamma)_u \times (f \circ \gamma)_v}{\|(f \circ \gamma)_u \times (f \circ \gamma)_v\|} \\ &= \frac{f_u \circ \gamma \times f_v \circ \gamma}{\|f_u \circ \gamma \times f_v \circ \gamma\|} \cdot \frac{\left(\frac{\partial \gamma_1}{\partial u} \frac{\partial \gamma_2}{\partial v} - \frac{\partial \gamma_2}{\partial u} \frac{\partial \gamma_1}{\partial v} \right)}{\left| \frac{\partial \gamma_1}{\partial u} \frac{\partial \gamma_2}{\partial v} - \frac{\partial \gamma_2}{\partial u} \frac{\partial \gamma_1}{\partial v} \right|} = n \circ \gamma, \end{aligned}$$

where in the last equality we have used that γ preserves the orientation of \mathbb{S}^2 . Therefore $\delta f \circ \gamma = (\delta f^T + \delta f^\perp) \circ \gamma = \delta f^T \circ \gamma + \delta f^\perp \circ \gamma$ with $\delta f^T \circ \gamma \in Ver(f \circ \gamma)$ and $\delta f^\perp \circ \gamma \in Nor(f \circ \gamma)$. The uniqueness of the decomposition then implies $\delta f^T \circ \gamma = (\delta f \circ \gamma)^T$ and $(\delta f \circ \gamma)^\perp = \delta f^\perp \circ \gamma$. \square

Elastic Riemannian Metric

Next, we will choose a Riemannian metric on \mathcal{F} that will enable a gauge-invariant analysis as stated above. We will use the elastic Riemannian metric proposed in [101] and given in Eqns. (3.7) and (3.8). However, before we use this metric we motivate its use by making a connection between the space of parameterized surfaces \mathcal{F} and the space of metrics on a domain, and we will provide some geometrical interpretation of terms in that elastic metric. The space of positive-definite Riemannian metrics on \mathbb{S}^2 will be denoted by $\text{Met}(\mathbb{S}^2)$. Consider a parameterized surface $f : \mathbb{S}^2 \rightarrow \mathbb{R}^3$. Denote by $g = f^*\bar{g}$ the pull-back of the Euclidian metric \bar{g} of \mathbb{R}^3 and by n_f the unit normal vector field (Gauss map) on $S = f(\mathbb{S}^2)$.

The metric g and the normal vector field n_f are defined using derivatives of f according to:

$$\begin{aligned} g &= \begin{pmatrix} f_u \cdot f_u & f_u \cdot f_v \\ f_v \cdot f_u & f_v \cdot f_v \end{pmatrix} = \text{Jac}(f)^T \text{Jac}(f), \\ &= \begin{pmatrix} E & F \\ F & G \end{pmatrix}, \quad \text{Jac}(f) = [f_u \ f_v], \quad \text{and} \\ n_f &= \frac{f_u \times f_v}{\|f_u \times f_v\|}, \quad \|f_u \times f_v\| = \sqrt{\det g} = |g|^{\frac{1}{2}}, \end{aligned}$$

where f_u and f_v are the derivatives of f with respect to the local coordinates (u, v) on the sphere. We consider the following relationship between parameterized surfaces on one hand and the product space of metrics and normals on the other:

$$\begin{aligned} \Phi : \mathcal{F} &\longrightarrow \text{Met}(\mathbb{S}^2) \times \mathcal{C}^\infty(\mathbb{S}^2, \mathbb{S}^2) \\ f &\longmapsto (g, n_f). \end{aligned}$$

It follows from the fundamental theorem of surface theory (see Bonnet's Theorem in [62] for the local result, Theorem 3.8.8 in [111] or Theorem 2.8-1 in [53] for the global result) that two parameterized surfaces f_1 and f_2 having the same representation (g, n) differ at most by a translation and rotation. This is an important result, and implies that we can represent a surface by its induced metric $g = f^*\bar{g}$ and the unit normal field $n = n_f$, for the purpose of analyzing its shape. We will not lose any information about the shape of a surface f if we represent it by the pair (g, n) . Let $\delta f_1, \delta f_2$ denote two perturbations of a surface f , and let $(\delta g_1, \delta n_1) = \Phi_*(\delta f_1)$, $(\delta g_2, \delta n_2) = \Phi_*(\delta f_2)$ denote the corresponding perturbations in (g, n) of f . The expression for Φ_* is given by:

$$\begin{aligned} \delta g &= \text{Jac}(f)^T \text{Jac}(\delta f) + (\text{Jac}(\delta f))^T \text{Jac}(f) \\ &= \begin{pmatrix} 2f_u \cdot \delta f_u & f_u \cdot \delta f_v + f_v \cdot \delta f_u \\ f_u \cdot \delta f_v + f_v \cdot \delta f_u & 2f_v \cdot \delta f_v \end{pmatrix}, \\ \delta n &= -\frac{1}{2} \text{Tr}(g^{-1} \delta g) n + \frac{1}{|g|^{\frac{1}{2}}} (\delta f_u \times f_v + f_u \times \delta f_v). \end{aligned}$$

Then, by definition, the metric on \mathcal{F} used in the present considerations measures these perturbations using the expression

$$\begin{aligned} \langle\langle \delta f_1, \delta f_2 \rangle\rangle_f &= \int_{\mathbb{S}^2} ds |g|^{\frac{1}{2}} \{ a \text{Tr}(g^{-1} \delta g_1 g^{-1} \delta g_2) \\ &\quad + \frac{\lambda}{2} \text{Tr}(g^{-1} \delta g_1) \text{Tr}(g^{-1} \delta g_2) + c \delta n_1 \cdot \delta n_2 \}. \end{aligned} \quad (3.7)$$

The same metric (with $a = 1$) was introduced in [101], Eqn. (2), and called ‘‘elastic metric’’. A related metric measuring the elastic deformation of the interiors of shapes was used in [76] (see Eqn. (4) in [76]). The metric given in Eqn. (3.7) can be decomposed into three parts

$$\begin{aligned} \langle\langle \delta f_1, \delta f_2 \rangle\rangle_f &= \int_{\mathbb{S}^2} ds |g|^{\frac{1}{2}} \{ a \text{Tr}((g^{-1} \delta g_1)_0 (g^{-1} \delta g_2)_0) \\ &\quad + b \text{Tr}(g^{-1} \delta g_1) \text{Tr}(g^{-1} \delta g_2) + c \delta n_1 \cdot \delta n_2 \}, \end{aligned} \quad (3.8)$$

where $b = \frac{\lambda+a}{2}$ and where A_0 is the traceless part of a 2×2 -matrix A defined as $A_0 = A - \frac{\text{Tr}(A)}{2} I_{2 \times 2}$. The term multiplied by a measures area-preserving changes in the induced metric g , the term multiplied by b measures changes in the area of patches, and the last term measures bending. Note that only the relative weights b/a and c/a are meaningful.

Now we consider a key property of this metric that relates to reparameterization of surfaces. Recall that $\Gamma := \text{Diff}^+(\mathbb{S}^2)$ denotes the subgroup of $\text{Diff}(\mathbb{S}^2)$ consisting of diffeomorphisms γ which preserve the orientation of \mathbb{S}^2 , i.e. such that $\det \text{Jac}(\gamma) > 0$. (Note that for a diffeomorphism $\gamma \in \text{Diff}(\mathbb{S}^2)$, since $\text{Jac}(\gamma)$ is invertible, the determinant of $\text{Jac}(\gamma)$ never vanishes. It follows that either $\det \text{Jac}(\gamma)(s) > 0$ for all $s \in \mathbb{S}^2$, or $\det \text{Jac}(\gamma)(s) < 0$ for all $s \in \mathbb{S}^2$.) It will be called the group of orientation-preserving reparameterizations. The group $\Gamma = \text{Diff}^+(\mathbb{S}^2)$ acts on $\text{Maps}(\mathbb{S}^2, \mathbb{R}^3)$ by pre-composition. That is, a surface f is reparameterized by a $\gamma \in \text{Diff}^+(\mathbb{S}^2)$ according to $f \mapsto f \circ \gamma^{-1}$. How does the metric-normal representation (g, n) of that surface change due to reparameterization? This representation of the reparameterized surface is given by $(\gamma^{-1*}g, n \circ \gamma^{-1})$. This representation is Γ -equivariant for the actions introduced, i.e. if we reparameterize a surface and then compute its (g, n) representation, or if we compute (g, n) representation of a surface and then reparameterize them according to $(\gamma^*g, n \circ \gamma)$, we get the same result.

Proposition 3.3.6. *The elastic metric is invariant to the action of $\text{Diff}^+(\mathbb{S}^2)$.*

Proof. Now we will prove the fact that the elastic metric is invariant by the group of orientation-preserving re-parametrizations $\Gamma = \text{Diff}^+(\mathbb{S}^2)$. This means that

$$\langle\langle h \circ \gamma, k \circ \gamma \rangle\rangle_{f \circ \gamma} = \langle\langle h, k \rangle\rangle_f.$$

for $\gamma \in \Gamma$ and any tangent vectors h, k at $f \in \mathcal{F}$.

Denote by $\tilde{f} := f \circ \gamma$. Set $(g, n_f) := \Phi(f)$, and $(\tilde{g}, \tilde{n}_{\tilde{f}}) := \Phi(\tilde{f})$. Define $\tilde{h} := h \circ \gamma$ and $\tilde{k} := k \circ \gamma$. Let us compute the volume form of the metric \tilde{g} . For any $s \in \mathbb{S}^2$, one has $\text{Jac } \tilde{f}(s) = \text{Jac}(f \circ \gamma)(s) = (\text{Jac } f)(\gamma(s)) \cdot \text{Jac } \gamma(s)$, and $\tilde{g}(s) = (\text{Jac } \gamma)^T g(\gamma(s)) (\text{Jac } \gamma)$. Therefore

$$\begin{aligned} \det \tilde{g}(s) &= \det(\text{Jac } \gamma)^T \det g(\gamma(s)) \det \text{Jac } \gamma \\ &= (\det \text{Jac } \gamma)^2 \det g(\gamma(s)), \end{aligned}$$

and

$$\begin{aligned} |\tilde{g}(s)|^{\frac{1}{2}} &= \sqrt{\det \tilde{g}(s)} = \sqrt{(\det \text{Jac } \gamma)^2 \det g(\gamma(s))} \\ &= |\det \text{Jac } \gamma| |g(\gamma(s))|^{\frac{1}{2}}. \end{aligned}$$

Let us now compute the first two terms of the elastic metric. Since

$$\tilde{g}(s)^{-1} = (\text{Jac } \gamma)^{-1} g(\gamma(s))^{-1} (\text{Jac } \gamma^T)^{-1},$$

and

$$\tilde{\delta g}(s) = (\text{Jac } \gamma)^T \delta g(\gamma(s)) \text{Jac } \gamma,$$

one has

$$\begin{aligned} \text{Tr } \tilde{g}^{-1} \tilde{\delta g}(s) &= \\ \text{Tr } \left[\text{Jac } \gamma^{-1} g(\gamma(s))^{-1} (\text{Jac } \gamma^{-1})^T (\text{Jac } \gamma)^T \delta g(\gamma(s)) \text{Jac } \gamma \right] &= \\ = \text{Tr} \left[(\text{Jac } \gamma)^{-1} g(\gamma(s))^{-1} \delta g(\gamma(s)) \text{Jac } \gamma \right] &= \\ = \text{Tr } g^{-1} \delta g(\gamma(s)). \end{aligned}$$

Therefore, if one denotes by $(\tilde{\delta g}_1, \tilde{\delta n}_1)$ (resp. $(\tilde{\delta g}_2, \tilde{\delta n}_2)$) the infinitesimal variation of the pull-back metric \tilde{g} and the normal vector field $n_{f \circ \gamma}$ induced by the tangent vector $\tilde{h} \in T_{f \circ \gamma} \mathcal{F}$ (resp. $\tilde{k} \in T_{f \circ \gamma} \mathcal{F}$), and $(\delta g_1, \delta n_1)$ (resp. $(\delta g_2, \delta n_2)$) the infinitesimal variation of the pull-back metric g and the normal vector field n_f induced by the tangent vector $h \in T_f \mathcal{F}$ (resp. $k \in T_f \mathcal{F}$), one has

$$\begin{aligned} \text{Tr } \tilde{g}^{-1} \tilde{\delta g}_1 \tilde{g}^{-1} \tilde{\delta g}_2(s) &= \\ \text{Tr} \left[(\text{Jac } \gamma)^{-1} g^{-1} \delta g_1 (\text{Jac } \gamma) (\text{Jac } \gamma)^{-1} g^{-1} \delta g_2 \text{Jac } \gamma \right] &= \\ = \text{Tr } g^{-1} \delta g_1 g^{-1} \delta g_2(\gamma(s)). \end{aligned}$$

For the last term of the metric, since γ acts by re-parametrization on the normal vector field, one has $\tilde{\delta n}_1(s) = \delta n_1(\gamma(s))$ and $\tilde{\delta n}_2(s) = \delta n_2(\gamma(s))$. The invariance by re-parametrization of the elastic metrics then follows by a simple change of variables in the integral defining it. \square

Although this elastic metric has been introduced in [101], it has not been used completely for shape analysis of surfaces. Furthermore, we are going to use it in a novel way – by restricting its evaluation only to the normal vector fields on a surface (see next section for a geometric expression of the resulting metric on shape space).

Definition 3.3.7. For any two perturbations $\delta f_1, \delta f_2 \in T_f \mathcal{F}$ define the pairing

$$((\delta f_1, \delta f_2))_f = \langle\langle \delta f_1^\perp, \delta f_2^\perp \rangle\rangle_f ,$$

where δf_i^\perp is the normal component of δf_i as defined in Eqn. (3.1) and where $\langle\langle \cdot, \cdot \rangle\rangle_f$ is as given in Eqn. (3.8).

Remark 3.3.8. It follows from proposition 3.3.4, that $((\cdot, \cdot))$ satisfies the gauge-invariant condition $L[\Psi] = L[\tilde{\Psi}]$, where Ψ is any path of shapes, $\tilde{\Psi}(t) = \Psi(t) \circ \gamma(t)$ with $t \mapsto \gamma(t)$ any time-dependant reparameterization, and $L[\Psi]$ is as specified in Eqn. (3.2).

Geometric expression of the elastic metric in the normal direction

In this section, we will give some geometric interpretation of the restriction of the elastic metric on the space of normal vector fields introduced in the previous section. Given a surface f parameterized by (u, v) , we will consider normal variations: $f_\varepsilon(u, v) = f(u, v) + \varepsilon h(u, v)n(u, v)$, where $(u, v) \in \mathbb{S}^2$, $\varepsilon > 0$, $n(u, v) = n_f(u, v)$ is the unit normal to the surface $f(\mathbb{S}^2)$ at $f(u, v)$, and $h : \mathbb{S}^2 \rightarrow \mathbb{R}$ is a real function corresponding to the amplitude of the normal vector field $h n_f$. Let us compute the first fundamental form g_ε of the surface parameterized by f_ε , i.e. the metric induced on the parameterized surface f_ε by the Euclidian metric of \mathbb{R}^3 . We obtain

$$\begin{aligned} f_{\varepsilon,u} &:= \frac{\partial f_\varepsilon}{\partial u} = f_u + \varepsilon h n_u + \varepsilon h_u n, \\ f_{\varepsilon,v} &:= \frac{\partial f_\varepsilon}{\partial v} = f_v + \varepsilon h n_v + \varepsilon h_v n. \end{aligned} \tag{3.9}$$

Therefore

$$f_{\varepsilon,u} \cdot f_{\varepsilon,u} = f_u \cdot f_u + 2\varepsilon h n_u \cdot f_u + \varepsilon^2 (h^2 n_u \cdot n_u + h_u^2),$$

where we have used that $n \cdot f_u = 0$ and $n_u \cdot n = 0$ since $n \cdot n = 1$. Similarly

$$f_{\varepsilon,v} \cdot f_{\varepsilon,v} = f_v \cdot f_v + 2\varepsilon h n_v \cdot f_v + \varepsilon^2 (h^2 n_v \cdot n_v + h_v^2),$$

and

$$f_{\varepsilon,u} \cdot f_{\varepsilon,v} = f_u \cdot f_v + \varepsilon h (n_u \cdot f_v + f_u \cdot n_v) + \varepsilon^2 (h^2 n_u \cdot n_v + h_u h_v).$$

It follows that

$$\begin{aligned} g_\varepsilon = & g + 2\varepsilon h \begin{pmatrix} n_u \cdot f_u & n_u \cdot f_v \\ n_v \cdot f_u & n_v \cdot f_v \end{pmatrix} \\ & + \varepsilon^2 h^2 \begin{pmatrix} n_u \cdot n_u & n_u \cdot n_v \\ n_v \cdot n_u & n_v \cdot n_v \end{pmatrix} + \varepsilon^2 \begin{pmatrix} h_u^2 & h_u h_v \\ h_u h_v & h_v^2 \end{pmatrix}. \end{aligned}$$

Using the definition of the second fundamental form \mathbf{II} of the surface $f(\mathbb{S}^2)$, we obtain

$$g_\varepsilon = g - 2\varepsilon h \mathbf{II} + \varepsilon^2 h^2 \mathbf{II} g^{-1} \mathbf{II} + \varepsilon^2 \begin{pmatrix} h_u & h_v \end{pmatrix}^T \begin{pmatrix} h_u & h_v \end{pmatrix}.$$

It follows that

$$g^{-1} \delta g = -2h g^{-1} \mathbf{II} = -2h \mathbf{L}, \tag{3.10}$$

where \mathbf{L} is called the *shape operator*. Recall that the eigenvalues of \mathbf{L} are the principal curvatures of the surface $f(\mathbb{S}^2)$, denoted by κ_1 and κ_2 , which provide local information about the surface: at a given point on the surface, they measure the greatest and smallest possible curvatures of a curve drawn on the surface passing through this point. For instance, the vanishing of the principal curvatures at one point of the surface tells that the surface is flat near this point (i.e. looks like a plane). The equality $\kappa_1 = \kappa_2 = 1/R$ at one point tells that the surface looks like a sphere of radius R near this point. In other words, κ_1 and κ_2 are functions on the surface that characterize how the surface is locally curved.

On the other hand, the variation δn of the normal vector field satisfies $\delta n \cdot n = 0$ since the norm of n remains constant. Moreover $n \cdot f_u = n \cdot f_v = 0$, therefore $\delta n \cdot f_u = -n \cdot \delta f_u$ and $\delta n \cdot f_v = -n \cdot \delta f_v$. By Eqn. (3.9), $\delta f_u = h n_u + h_u n$, hence $\delta n \cdot f_u = -h_u$ and similarly $\delta n \cdot f_v = -h_v$. Consequently $\delta n = \alpha f_u + \beta f_v$ where $\begin{pmatrix} \alpha \\ \beta \end{pmatrix} = -g^{-1} \begin{pmatrix} h_u \\ h_v \end{pmatrix}$. It follows that for two normal vector fields hn and kn with $h, k \in \mathcal{C}^\infty(\mathbb{S}^2, \mathbb{R})$, one has

$$\delta n_1 \cdot \delta n_2 = (h_u \ h_v) g^{-1} \begin{pmatrix} k_u \\ k_v \end{pmatrix}. \quad (3.11)$$

Using Eqn. (3.10) and Eqn. (3.11) the elastic metric restricted to these normal fields is given by:

$$\begin{aligned} ((hn, kn))_f &= \int_{\mathbb{S}^2} ds |g|^{\frac{1}{2}} \{ hk (2a(\kappa_1 - \kappa_2)^2 \\ &\quad + 4b(\kappa_1 + \kappa_2)^2) + c (h_u \ h_v) g^{-1} \begin{pmatrix} k_u \\ k_v \end{pmatrix} \}. \end{aligned} \quad (3.12)$$

This is the form used to define and compute geodesic paths in the shape space \mathcal{S} in this section. The difference $\kappa_1 - \kappa_2$ in the first term has been called the normal deformation of the surface in [100]. The sum $\kappa_1 + \kappa_2$ is twice the mean curvature which measures variations of the area of local patches. These two terms are related to the shape index $\text{idx} = \frac{2}{\pi} \arctan \frac{\kappa_1 + \kappa_2}{\kappa_1 - \kappa_2}$ [112]. The last term in Eqn. (3.12) measures variations of the normal vector field, i.e. bending.

3.3.3 Geodesic Computation

Finding geodesics between two surfaces f_1 and f_2 under invariant Riemannian metrics is a difficult problem. In the present case, analytical solutions are not known and we will use a path-straightening approach to find geodesics. This method has been used for instance in [120] and [101]. The basic idea here is to connect f_1 and f_2 by any initial path and then iteratively straighten it until it becomes a geodesic. The update is performed using the gradient of an energy function. As mentioned earlier, this method only achieves a local minimum of the energy function, resulting in a geodesic path that may not be the shortest geodesic.

Computations of the energy

Let $\Psi : [0, 1] \rightarrow \mathcal{F}$. The energy of the path Ψ is defined to be:

$$\mathcal{E}(\Psi(t)) = \int_0^1 \langle \Psi_t^\perp, \Psi_t^\perp \rangle_{\Psi(t)} dt = \int_0^1 ((\Psi_t, \Psi_t))_{\Psi(t)} dt,$$

where $\langle \cdot, \cdot \rangle$ is the elastic metric given in Eqn. (3.8), $\Psi_t^\perp = (\Psi_t \cdot n) n$ is the normal component of the deformation, and $((\cdot, \cdot))$ is the inner product presented in Eqn. (3.12). We will present several numerical strategies for approximating this energy and will compare their computational costs in Table 3.1. This evaluation uses a linear path connecting two concentric spheres of radius $R_1 = 1$ and $R_2 = 2.5$, with constants $a = 1$, $\lambda = 0.125$ and $c = 0$ for defining energy (see Fig. 3.14). The theoretical value of the energy in this case is given by $E_{th} = 32\pi(a + \lambda)(R_2 - R_1)^2$ and measures exclusively the cost of changing the area of the spheres (the first and third term of the metric given in Eqn. (3.8) vanish in this experiment). We expect that improvement in accuracy comes at an increased computational cost, and this is indeed the case in the results presented in the Table. Note that a time-dependent rotation is applied on the path of spheres, but the values of the energy is independant of this rotation.

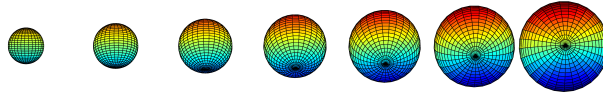

Figure 3.14: Path connecting two concentric spheres used for computations in Table 3.1.

One way to compute the energy of a path Ψ of shapes is to express it using the coefficients of the first fundamental form. Consider the mapping $\Psi : \mathbb{S}^2 \times \mathbb{R} \rightarrow \mathbb{R}^3$ and define

$$E = \Psi_u \cdot \Psi_u, F = \Psi_u \cdot \Psi_v, G = \Psi_v \cdot \Psi_v, \quad (3.13)$$

and their time derivatives

$$\dot{E} = 2\Psi_{tu}^\perp \cdot \Psi_u, \dot{F} = \Psi_{tu}^\perp \cdot \Psi_v + \Psi_u \cdot \Psi_{tv}^\perp, \dot{G} = 2\Psi_{tv}^\perp \cdot \Psi_v,$$

as well as the unit normal field $n := n_f = \frac{f_u \times f_v}{\|f_u \times f_v\|}$ and the vector field $w = \Psi_{tu}^\perp \times \Psi_v + \Psi_u \times \Psi_{tv}^\perp$. Then, the energy of a path Ψ decomposes into the sum of four terms: $\mathcal{E}(\Psi(t)) = \mathcal{E}_1 + \mathcal{E}_2 + \mathcal{E}_3 + \mathcal{E}_4$, where

$$\begin{aligned} \mathcal{E}_1 &= a \int_0^1 \int_{\mathbb{S}^2} (EG - F^2)^{-3/2} B \, du \, dv \, dt \\ &\quad \text{with } B = G^2 \dot{E}^2 + 2(EG + F^2) \dot{F}^2 + E^2 \dot{G}^2 \\ &\quad \quad - 4FG \dot{E} \dot{F} + 2F^2 \dot{E} \dot{G} - 4EF \dot{F} \dot{G}, \\ \mathcal{E}_2 &= \left(\frac{\lambda}{2} + \frac{c}{4}\right) \int_0^1 \int_{\mathbb{S}^2} (EG - F^2)^{-\frac{3}{2}} (G \dot{E} - 2F \dot{F} + E \dot{G})^2 \, du \, dv \, dt, \\ \mathcal{E}_3 &= -c \int_0^1 \int_{\mathbb{S}^2} (G \dot{E} - 2F \dot{F} + E \dot{G}) (n \cdot w) \, du \, dv \, dt, \\ \mathcal{E}_4 &= c \int_0^1 \int_{\mathbb{S}^2} (EG - F^2)^{-\frac{1}{2}} (w \cdot w) \, du \, dv \, dt. \end{aligned}$$

In the implementation of these formulas, we can reach singularities on the boundary of the integration domain, which we can ignore. In the example involving two concentric spheres, the total energy computed by this method is labelled $E_{I\&II}$ in Table 3.1.

Another way to compute the energy is based on Eqn. (3.12) that expresses the elastic metric in terms of principal curvatures. In terms of the coefficients of the first fundamental form given in Eqn. (3.13) and of the second fundamental given by

$$\begin{aligned} e &= \Psi_{uu} \cdot n = -\Psi_u \cdot n_u, \\ f &= \Psi_{uv} \cdot n = -\Psi_u \cdot n_v = -\Psi_v \cdot n_u, \\ g &= \Psi_{vv} \cdot n = -\Psi_v \cdot n_v, \end{aligned}$$

the Gauss curvature K and the mean curvature H have the following expressions

$$K = \frac{eg - f^2}{EG - F^2}, \quad H = \frac{1}{2} \frac{eG + gE - 2fF}{EG - F^2},$$

and the principal curvatures are given by

$$\kappa_1 = H + \sqrt{H^2 - K}, \quad \kappa_2 = H - \sqrt{H^2 - K}.$$

Again, in the implementation of these formulas, we can get singularities for curvatures on the boundary, but we can ignore them in computing the integral given in Eqn. (3.12). This corresponds to removing a small disc on the parameterized surface around the images of the north and south poles.

In the example of the two concentric spheres, the theoretical values of κ_1 and κ_2 is the constant function equal to $1/R$ where $R = R_1 + t(R_2 - R_1)$ is the radius of the sphere along the path interpolating linearly the sphere of radius $R_1 = 1$ to the sphere of radius $R_2 = 2.5$. The total energy computed by this method is labelled $E_{k_1 k_2}$ in Table 3.1.

To improve the computation of the curvatures and therefore also of the energy, we can use polynomial approximations of the surfaces. This procedure, leading to the computation of the principal curvatures, is illustrated in Fig. 3.11. To compute the principal curvatures at a given point of a surface, e.g. at the tip of the index finger of the hand depicted in Fig. 3.11, we first compute the normal at this point by averaging the normals of the facets having this point as vertex. A tangent plane is then defined as the plane orthogonal to the normal passing through the point under consideration. A neighborhood of the point is isolated from the surface (we use a 3-neighborhood, see second drawing in Fig. 3.11). We then apply a rigid transformation to center the point at the origin and to align the tangent plan with the xy-plane (see third drawing, and a closeup in the fourth drawing). After that, we use Algorithm 7 to compute the second order polynomial $P(x, y) = a_1 x^2 + a_2 y^2 + a_3 xy + a_4 x + a_5 y + a_6$, which minimizes the sum $\sum_i (z_i - P(x_i, y_i))^2$ over the points of the centered and rotated neighborhood. Then, the Gauss curvature at that point is given by $K = 4a_1 a_2 - a_3^2$, the mean curvature by $H = a_1 + a_2$, and the principal curvatures by $\kappa_1 = a_1 + a_2 + \sqrt{((a_1 - a_2)^2 + a_3^2)}$ and $\kappa_2 = a_1 + a_2 - \sqrt{((a_1 - a_2)^2 + a_3^2)}$. In the example of the two concentric spheres, the total energy computed using the principal curvatures obtained by this method is labelled E_P in Table 3.1.

In order to show that the energy function of a path of shapes is independent of the way the objects are parameterized, we replace the integration over the domain of parameterization by the

Algorithm 7: Computation of second order approximation of a surface at a given point.

Input: a surface passing through the origin, tangent to the xy -plane at the origin

Output: coefficients $A = (a_1, a_2, a_3, a_4, a_5, a_6)$ of the second order polynomial

$P(x, y) = a_1x^2 + a_2y^2 + a_3xy + a_4x + a_5y + a_6$, which minimize the sum $\sum_i (z_i - P(x_i, y_i))^2$ over the points (x_i, y_i, z_i) of the surface

Algorithm: Initialize $z_B = \text{zeros}(1, 6)$, $B = \text{zeros}(1, 6)$, $B2 = \text{zeros}(6, 6)$.

for $i \leftarrow 1$ **to** *number of points* **do**

- 1- $z_B(1) \leftarrow z_B(1) + z_i x_i^2;$
 $z_B(2) \leftarrow z_B(2) + z_i y_i^2;$
 $z_B(3) \leftarrow z_B(3) + z_i x_i y_i;$
 $z_B(4) \leftarrow z_B(4) + z_i x_i;$
 $z_B(5) \leftarrow z_B(5) + z_i y_i;$
 $z_B(6) \leftarrow z_B(6) + z_i;$
- 2- $B(1) \leftarrow x_i^2;$
 $B(2) \leftarrow y_i^2;$
 $B(3) \leftarrow x_i y_i;$
 $B(4) \leftarrow x_i;$
 $B(5) \leftarrow y_i;$
 $B(6) \leftarrow 1;$
- 3- $B2 \leftarrow B2 + B' * B;$

$A = \text{inv}(B2) * z'_B.$

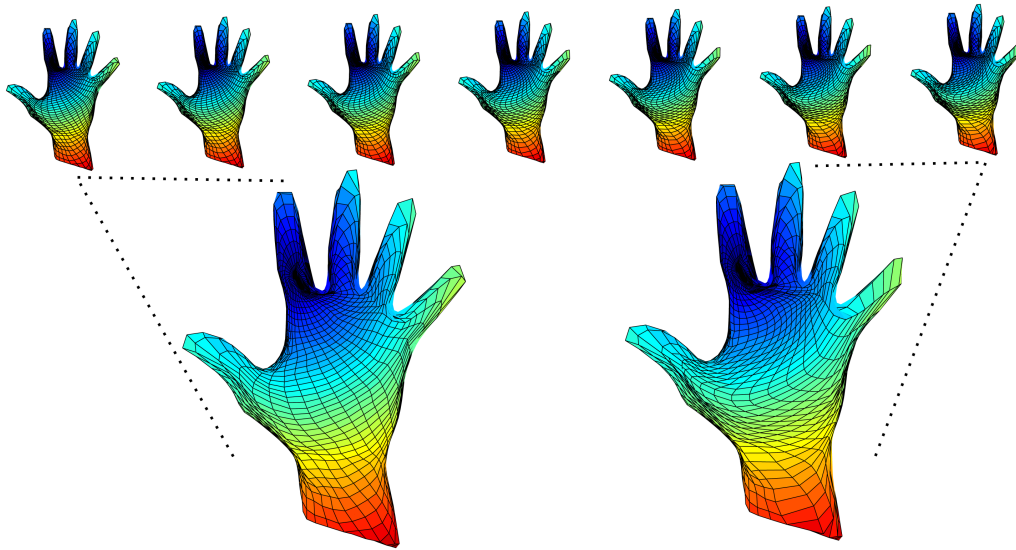

Figure 3.15: A path of zero energy connecting a hand and the same hand with another parameterization.

integration over the triangulated surfaces. This means that we approximate the area elements of the surfaces by the area of triangles whose vertices are given by the parameterization. In this way, the parameterization of surfaces is only used to define the surfaces, but plays no role at all in the computation of the energy function. In the example of the two concentric spheres, the total energy computed by this method is labelled E_Δ and given in Table 3.1. In Fig. 3.15, a path connecting a hand to the same hand, but with a different parameterization, is shown. The energy of this path, computed with the constants $a = 1$, $\lambda = c = 0.125$, reads $E_\Delta = 0.4824$, hence is close to 0. Now returning to Fig. 3.1, the energy of the lower path from a horse to a cat computed with the same constants is $E_\Delta = 227.4049$, its length is $L[\Psi] = 14.9099$, whereas the upper path (obtained from the lower path by applying a different reparameterization at each time step) has an energy equal to $E_\Delta = 225.5249$ and a length of $L[\Psi] = 14.8802$. Note that in this example, the colors refer to the Euclidean distance to the point on the surface corresponding to the image of the north pole of

| Energy, 10^4 points per object | Elapsed time for 10^4 points |
|-----------------------------------|---|
| $E_{I\&II} = 246.2854$ | 0.221726 seconds |
| $E_{k_1 k_2} = 249.1969$ | 0.862376 seconds |
| $E_P = 255.8288$ | 1.238354 seconds |
| $E_\Delta = 255.9043$ | 9.738431 seconds |
| Energy for 4×10^4 points | Elapsed time for 4×10^4 points |
| $E_{I\&II} = 249.1503$ | 0.978828 seconds |
| $E_{k_1 k_2} = 251.8494$ | 3.45599 seconds |
| $E_P = 254.7646$ | 4.906798 seconds |
| $E_\Delta = 254.7832$ | 39.011899 seconds |

Table 3.1: Computation of the energy of a path connecting two concentric spheres (Fig. 3.14) using different methods, and time needed for the computations. The theoretical value of the energy is $E_{th} = 254.4690$. Here $R_1 = 1$, $R_2 = 2.5$, $\lambda = 0.125$ and $c = 0$.

the sphere (cold colors for small distances versus hot colors for large distances).

Independance of the Energy function with respect to reparametrization

From the theory it is clear that the energy function defined above is independant of the way shapes are parametrized along a path. To provide numerical examples to illustrate this fact was however a difficult task. One has to mention here that the parametrization has to be changed *smoothly* in order to provide a *smooth* path in the pre-shape space. Therefore only parametrizations that are closed to the initial parametrization can be used in these experiments.

In Figure 3.16, we give examples of zero-energy paths, projecting to a point in shape space. The energy, as computed by our program, is closed to zero for each of them.

In Figure 3.17, we are interested in two different lifts of the same path in Shape space. The rows go by pairs: the upper two rows show a metamorphosis from a horse to a jumping cat, but with two different parametrizations. Theoretically the energy of the two upper paths should be the same. Numerically we obtain an energy $E_\Delta = 225.3565$ for the upper path, and $E_\Delta = 225.3216$ for the second one. For the third and fourth paths, showing a metamorphosis from a jumping cat to a standing cat, the energy computed by our program is $E_\Delta = 180.8444$ and $E_\Delta = 176.8673$ respectively. For the fifth and sixth paths, from a standing cat to a standing horse, the computed energies are $E_\Delta = 243.1812$ and $E_\Delta = 239.5410$ respectively. These energies were computed with the parameters $a = 1$, $\lambda = 0.125$, $c = 0$, 50^2 numbers of points and using 6-neighborhoods for the computation of principal curvatures.

Orthonormal Basis of Deformations

In this subsection, we define bases for representing perturbations of a path of surfaces. These basis elements form possible directions for use in path-straightening in the next subsection.

We construct a basis of perturbations of a path connecting two parameterized surfaces f_1 and f_2 . In order to apply the path-straightening method as described below, we want the perturbations to vanish at $t = 0$ and $t = 1$ so that f_1 and f_2 remain fixed. Therefore, we want a basis of $L^2(\mathbb{S}^2 \times [0, 1], \mathbb{R}^3)$ with elements that have this property. To ensure this, each element of \mathcal{B}_2 is multiplied by a basis element of $L^2([0, 1], \mathbb{R})$ of the form $P_j(t) = \frac{1}{4} \sin(\pi j t)$, $1 \leq j \leq J$. Unfortunately a major limitation of the resulting L^2 basis is that slowly- and rapidly-oscillating harmonics have comparable amplitudes. In the implementation of the path-straightening method, this implies that the updated path can go out of the open set of immersions.

One possible way to counter this effect is to orthonormalize the L^2 -basis with respect to an H^1 -type scalar product (i.e. that measures also the variation of the derivatives). For this kind of scalar product, an orthonormal basis consists of functions which have controlled derivatives (hence can not oscillate too much). This approach was also used in [120] where the L^2 -basis is orthonormalized using the Gram-Schmidt procedure with respect to the following scalar product

$$(B^1, B^2) = \int_0^1 \int_{\mathbb{S}^2} (B^1 \cdot B^2 + B_t^1 \cdot B_t^2 + B_u^1 \cdot B_u^2 + B_v^1 \cdot B_v^2 + B_{t,u}^1 \cdot B_{t,u}^2 + B_{t,v}^1 \cdot B_{t,v}^2) ds dt.$$

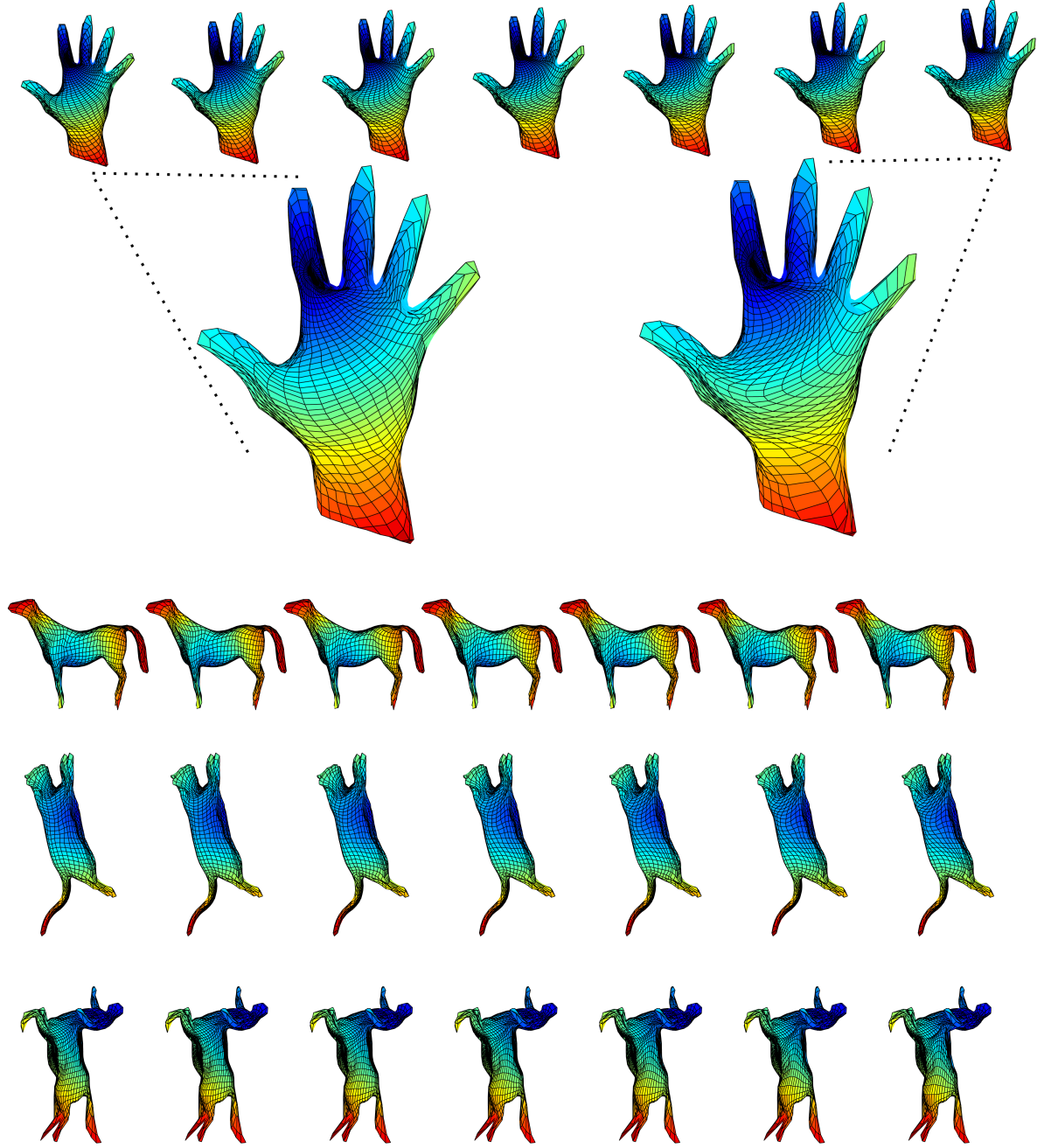

Figure 3.16: Four Paths connecting the same shape but with a parametrization depending smoothly on time. The energy computed by our program is respectively $E_{\Delta} = 0$ for the path of hands, $E_{\Delta} = 0.1113$ for the path of horses, $E_{\Delta} = 0$ for the path of cats, and $E_{\Delta} = 0.0014$ for the path of Centaurs.

However, when increasing the degree of spherical harmonics, the computational cost of generation of an orthonormal basis using this scalar product is very high. Therefore, we first orthonormalize the basis \mathcal{B}_2 with respect to the following inner product

$$(B^1, B^2) = \int_{\mathbb{S}^2} (B^1 \cdot B^2 + B_u^1 \cdot B_u^2 + B_v^1 \cdot B_v^2) ds, \quad (3.14)$$

and then we multiply the resulting basis by the time-dependant components $P_j(t) = \frac{1}{4} \sin(\pi j t)$, $1 \leq j \leq J$. The advantage of this method is that the Gram-Schmidt procedure is applied to matrices of lower dimensions (without the time dimension) and on a smaller number of elements

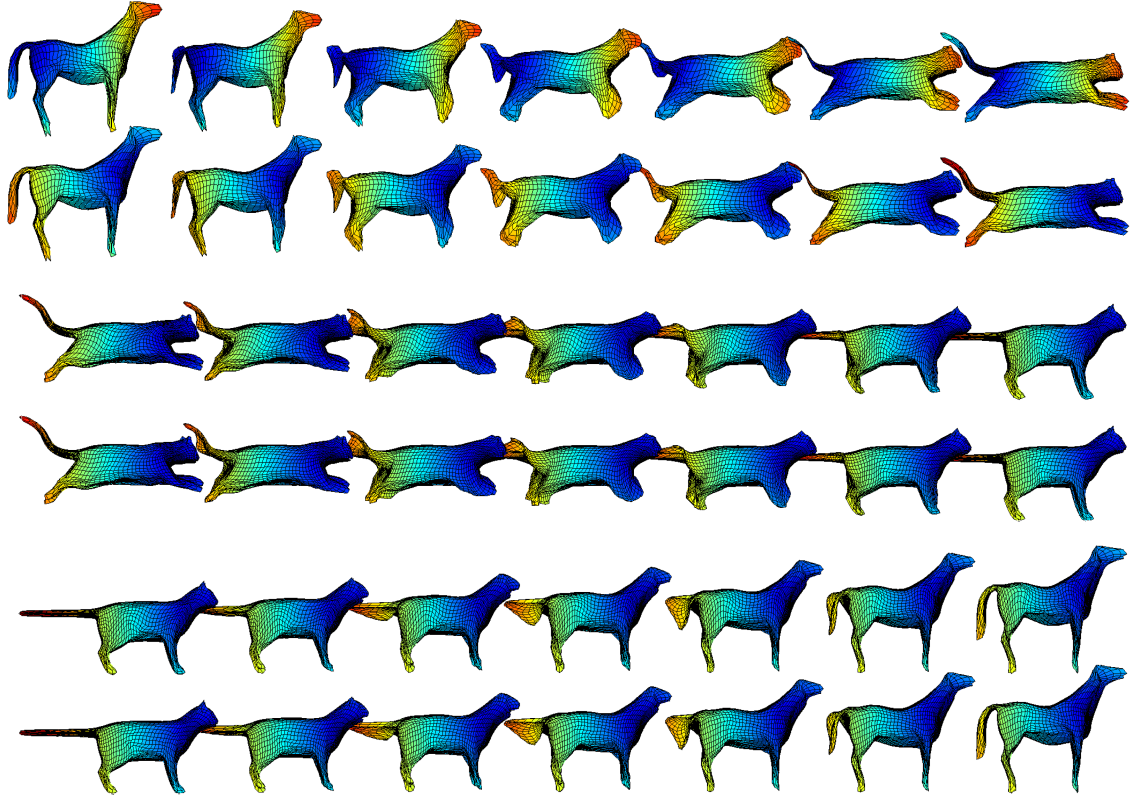

Figure 3.17: Pairs of paths projecting to the same path in Shape space, but with different parametrizations. The energies of these paths, as computed by our program, are respectively (from the upper row to the lower row): $E_{\Delta} = 225.3565$, $E_{\Delta} = 225.3216$, $E_{\Delta} = 180.8444$, $E_{\Delta} = 176.8673$, $E_{\Delta} = 243.1812$ and $E_{\Delta} = 239.5410$.

(by a factor J). The spatial oscillations of the resulting basis elements are well controlled by the presence of the spatial derivatives B_u and B_v in the inner product given in Eqn. (3.14).

Path-straightening method

The path-straightening method is used to find critical points of the energy functional. Starting with an arbitrary path, the method consists of iteratively deforming (or “straightening”) the path in the opposite direction of the gradient, until the path converges to a geodesic. The gradient of the path energy is approximated using a basis \mathcal{B} of possible perturbations of a path of surfaces Ψ , as constructed in the previous section. We first compute the directional derivatives $\nabla \mathcal{E}_{\Psi}(b) = \frac{d}{d\epsilon}(\mathcal{E}(\Psi + \epsilon b))|_{\epsilon=0}$ where b ranges over \mathcal{B} . This is done by fixing a small ϵ_1 and approximating the directional derivative by $\nabla \mathcal{E}_{\Psi}(b) \simeq (\mathcal{E}(\Psi + \epsilon_1 b) - \mathcal{E}(\Psi))\epsilon_1^{-1}$. Using the finite orthonormal basis \mathcal{B} , we obtain a numerical approximation of the gradient: $\nabla \mathcal{E}_{\Psi} = \sum_{b \in \mathcal{B}} \nabla \mathcal{E}_{\Psi}(b) b$. In particular, the norm of the gradient is approximately given by $\|\nabla \mathcal{E}_{\Psi}\|^2 = \sum_{b \in \mathcal{B}} \nabla \mathcal{E}_{\Psi}(b)^2$. The update of the path is done by replacing Ψ by $\Psi - \epsilon_2 \nabla \mathcal{E}_{\Psi}$, where ϵ_2 is a small parameter that has to be adjusted empirically. The method is detailed in Algorithm 8 below.

3.3.4 Experimental results

The 3D realistic models used in our experiments are part of the TOSCA [41] dataset. Their spherical parameterizations were initially implemented in [118].

Examples of geodesics obtained by path-straightening

First we apply the path-straightening method to the case where the surfaces at the extremes of the initial path have the same shape, but different parameterizations. More precisely, we consider the special case where $\Psi_0(0) = f_1$, $\Psi_0(1) = f_1 \circ \gamma$ for some diffeomorphism γ and where we initialize

Algorithm 8: Path-straightening method.

Input:

1. A path Ψ between two parameterized surfaces f_1 and f_2 ,
2. a basis of perturbation \mathcal{B} .

Output:

1. The minimal energy needed to deform f_1 into f_2 given by the value of the cost function E ,
2. the geodesic path between f_1 and f_2 .

Set $\|\nabla E\|^2 = 1$.

while $\|\nabla E\|^2 > 10^{-3}$ **do**
2- Compute the energy E of the path Ψ according to Eqn.(3.8) or Eqn. (3.12).

3- Set $\Psi_{\text{upd}} = 0$ and $\|\nabla E\|^2 = 0$.

for $i \leftarrow 1$ **to** $\text{size}(\mathcal{B})$ **do**
4- Add a perturbation to the current path Ψ : define $\Psi(i) = \Psi + \epsilon_1 \mathcal{B}(i)$, where $\mathcal{B}(i)$ is the element of the perturbation basis \mathcal{B} of index i and $\epsilon_1 > 0$ is small.

5- Compute the energy $E(i)$ of the perturbed path $\Psi(i)$.

6- Compute the gradient of energy $\nabla E(i)$ in the direction $\mathcal{B}(i)$ using the approximation $\nabla E(i) \sim \frac{E(i)-E}{\epsilon_1}$.

7- Compute the updating path: $\Psi_{\text{upd}} \leftarrow \Psi_{\text{upd}} + \nabla E(i) \cdot \mathcal{B}(i)$.

8- Compute the squared norm of the gradient of energy at path Ψ : $\|\nabla E\|^2 \leftarrow \|\nabla E\|^2 + (\nabla E(i))^2$.

10- Update the path: $\Psi = \Psi - \epsilon_2 \Psi_{\text{upd}}$

the path with piecewise linear interpolation to a different surface f_3 in the middle of the path, i.e. $\Psi_0(\frac{t}{2}) = f_3$. This situation is illustrated in Fig. 3.18. The proposed gauge-invariant approach is expected to reach a path with constant shape as a geodesic, despite the different shapes appearing in the initial path and the different parameterization of shapes at the end points of the path (to emphasize the differences in parameterization, zoom-ins of these surfaces are also shown). Once we have the geodesic path Ψ between the given surfaces, the distance in the shape space between f_1 and $f_1 \circ \gamma$, $d_\Psi(f_1, f_2)$, is the length of Ψ as specified in Eqn. (3.2). As expected, the resulting geodesic path, shown in Fig. 3.18, is constant with the same shape as the either end, and with $d_\Psi(f_1, f_2) = 0$. Using path-straightening, we obtain a 99.28% decrease in the energy function from the initial path to the final path.

In Fig. 3.19 we consider more challenging shapes. The top-two rows display the case where we have $\Psi_0(0) = f_1$, $\Psi_0(1) = f_1$ (a cat) and where we initialize the path with piecewise linear interpolation to a horse in the middle of the path. The upper row shows the initial path and the second row the geodesic path. We can see that the geodesic path has a constant shape throughout, as expected. We also plot the evolution of the path energy on the right during path-straightening. We can see that the energy decreases until it reaches a relatively small value; the theoretical minimum is, of course, zero for a constant path. In the last two rows of Fig. 3.19, we consider the case of two hands. We initialize the path with linear interpolation (third row in Fig. 3.19), and the resulting path is shown in the last rows of Fig. 3.19. The energy evolution is shown on the right and we can see the energy decreasing until it reaches a constant value; thus, the final path is a geodesic. It can be seen that the deformation along the geodesic path is more natural than the original path.

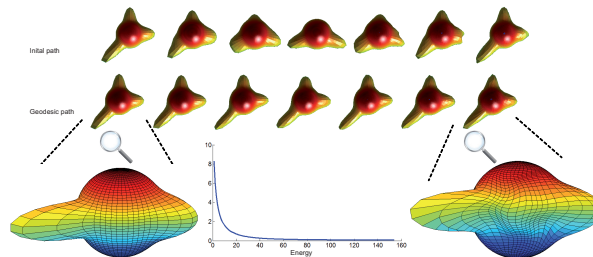

Figure 3.18: Illustration of initial path (upper row) and geodesic path in shape space (middle row). The energy is reported in the bottom row. The surfaces at the end points of the path have different parameterizations.

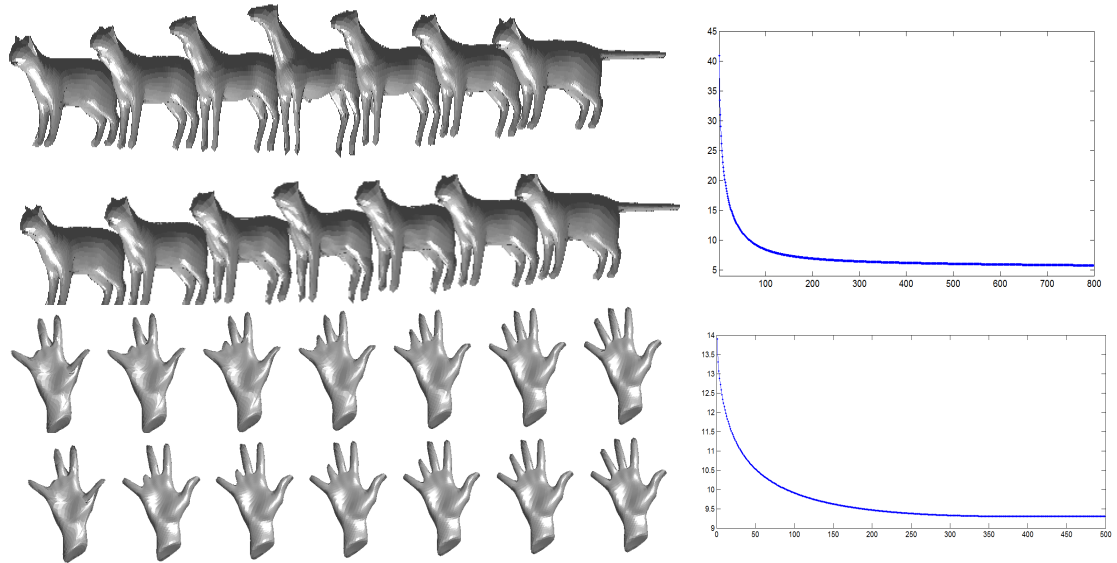

Figure 3.19: The top row shows an initial path formed by linear interpolation between a cat to a horse and back to the cat. The second row illustrates the geodesic obtained after 800 iterations of path-straightening. The corresponding evolution of the energy is shown on the right. Similarly, the third row shows a linear path between two hands with bad correspondence and the last row shows the final geodesic, with the corresponding energy is shown on the right.

Classification of 3D shapes

As mentioned earlier, the geodesic paths provide us with tools for comparing, and deforming parameterized surfaces. We suggest a comparison of shapes of 3D objects using geodesic distances between their boundary surfaces in the shape space. This section presents a specific application to illustrate that idea. In this section, we study several shapes belonging to four classes: horses, hands, cats and centaurs.

We begin by computing the pairwise geodesic distances between corresponding 3D surfaces. The distance matrix and the classification dendrogram are shown in Fig. 3.20. In the distance matrix, we can easily distinguish four classes corresponding to four blue boxes. Actually the cold colors in the illustrated matrix correspond to small values of distances versus hot colors that correspond to greater distances. The clustering obtained using the *dendrogram* (command in matlab) can be interpreted by slicing the top of the dendrogram by a horizontal line to split the shapes into the desired number of classes, and then sliding the horizontal line to the bottom in order to refine the classification. The coarsest classification results by slicing the dendrogram into two classes (by a horizontal line close to the top), the shapes 4, 5 and 6 (the hands) forms a first class and the remaining (horses, cats and centaurs) are grouped together as a second class. The next level in classification distinguishes the shapes 1, 2, and 3 (the horses) and 12, 13 (the centaurs) from the shapes 7, 8, 9, 10, 11 (the cats). The finest level separates the horses and the centaurs in different classes and results in four classes. Thus, we argue that the proposed framework provides a powerful tool for shape classification.

The effect of number of basis elements

In this section, we study the effect of the number of basis elements, used in path-straightening, on the resulting geodesic path. Given two parameterized surfaces f_1 and f_2 , we again initialize the path with the linear interpolation to a different surface f_3 in the middle of the path. This initial path is shown in the upper row of Fig 3.21. Then, we compute the geodesic path using different number of basis elements. We show the geodesic paths that use 52, 432 and 1728 basis elements, respectively. We can see that the larger the number of basis elements, the better the final result is. We also provide the trade-off between the number of basis elements and the minimum energy value obtained. The trade-off confirms our assertion. At the bottom of the figure, we show the geodesic path obtained when the path-straightening Algorithm is initialized with the linear interpolation

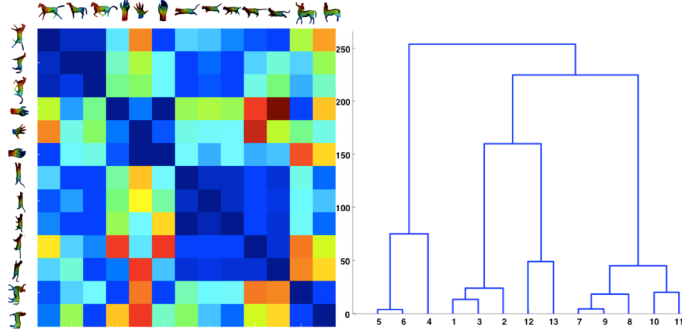

Figure 3.20: Classification performance; left: the distance matrix. right: the dendrogram.

between f_1 and f_2 . This path is also calculated using the number of basis elements corresponding to the lowest energy. This path can be seen as ground truth to visually interpret the previous geodesics (with more complicated initial conditions and fewer basis elements).

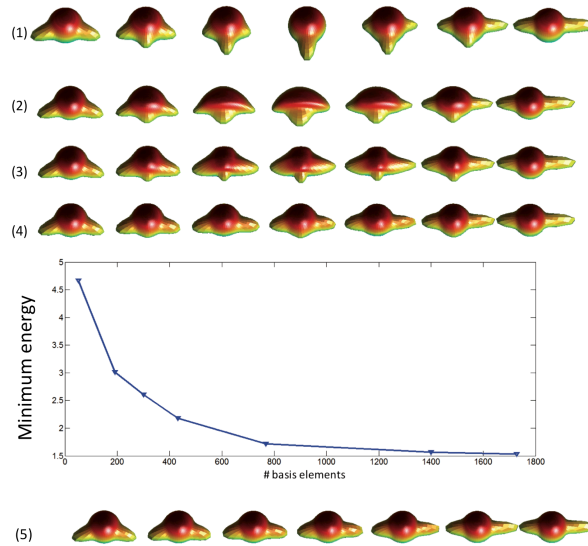

Figure 3.21: The effect of the number of basis elements, (1) initial path, (2) geodesic path using 52 basis elements, (3) geodesic path using 432 basis elements, (4) geodesic path using 1728 basis elements, (5) geodesic path using 1728 basis elements after linear interpolation initialization.

Conclusion

In our collaboration [205], we have proposed a novel Riemannian framework for computing geodesic paths between shapes of parameterized surfaces. These geodesics are invariant to rigid motion, scaling and most importantly reparameterization of individual surfaces. The novelty lies in defining a Riemannian metric directly on the quotient (shape) space, rather than inheriting it from pre-shape space, and in using it to formulate a path energy that measures only the normal components of velocities along the path. The geodesic computation is based on a path-straightening technique that iteratively corrects paths between surfaces until geodesics are achieved. We have presented some examples of geodesics between surfaces in shape spaces and utilized the distances between surfaces for classification of some 3D shapes. However, the computational costs of our programs are deemed high and convergence should be accelerated in order to be able to apply this framework in realistic practical scenarios such as, for instance, human body action recognition.

3.4 Shape and Pose recognition of Human bodies

In this section, we present the work that appeared in our collaboration [169]. Human shape analysis is an important area of research with a wide applications in vision, graphics, virtual reality, product design and avatar creation. While 3D human shapes are usually represented as 3D surfaces, human bodies vary significantly across two important properties: shape (or subjects identity) and body postures (or body pose). These variations make human body shape analysis a challenging problem. In this section, we seek a framework for human shape analysis which provides: (i) a shape metric to quantify shape and pose differences (ii) a full pipeline for generating deformations and shape interpolation; and (iii) a shape summary, a compact representation of human shapes in terms of the center (mean of human shapes).

The main tasks in human shape analysis can be divided into representing, comparing, deforming and summarizing human shapes. A common theme in the literature has been to represent human surfaces by certain geometrical features, such as HKS [198], WKS [8] and ShapeDNA [177]. The readers can refer to recent surveys [168, 131] for an extensive review and comparison of such descriptors. Their structure does not allow for more complex tasks such as interpolation or statistical shape analysis. Recent deep learning approaches try to tackle this problem. They use a deep neural networks to build "disentangled" latent spaces [9, 239]. However those approaches requires training data, while our approach is using purely geometric information. Most of the approaches use a spherical parameterization of 3D objects, while we propose to use a human template as a parametrization, and take some advantages of the recent developments of static and dynamic human datasets such as SMPL and FAUST.

In this section, we present a comprehensive Riemannian framework for analyzing human bodies, in the process of dealing with the change in shape and pose. Unlike some past works, instead of using a general parameterization of human body surfaces, we propose to use a human template and to align the human surfaces to this template. The human body surface is represented by the normal and the induced surface metric. Using the metric on the space of normals and the Ebin metric on the space of Riemannian metrics, a family of metrics is proposed to compare shapes and poses of a human body. We present an efficient framework to compute geodesic between given human body surfaces under the chosen metric. We provide some basic tools for statistical shape analysis of human body surfaces. These tools help us to compute an average human body. To evaluate our approach, we conduct extensive experiments on multiple datasets. The experimental results show that the proposed family of Riemannian metrics classifies correctly the shapes and the poses. The experimental results show also that our proposed framework provides better geodesics than the state-of-the-art Riemannian framework.

3.4.1 Mathematical Framework

Given a reference human being \mathcal{T} (also called a template in the sequel), we will represent a human shape S with an embedding $f : \mathcal{T} \rightarrow \mathbb{R}^3$ such that the image $f(\mathcal{T})$ equals S . The map f is an embedding onto a human shape $f(\mathcal{T})$. The function f is also called a *correspondence* between the template \mathcal{T} and the human shape $f(\mathcal{T})$.

Recall that a map $f : \mathcal{T} \rightarrow \mathbb{R}^3$ is an *embedding* when: (1) f is smooth, in particular small variations on the template \mathcal{T} correspond to small variations on the human shape $f(\mathcal{T})$ (2) f is an immersion, i.e. at each point of the human shape $f(\mathcal{T})$ one can define the normal (resp. tangent) space to the surface of the human body as subspace of \mathbb{R}^3 , and (3) f is a homeomorphism onto its image, i.e. points on $f(\mathcal{T})$ that look close in \mathbb{R}^3 are images of close points in \mathcal{T} . We define the space of all registered human shapes as

$$\mathcal{H} := \{f : \mathcal{T} \rightarrow \mathbb{R}^3, f \text{ is an embedding}\}.$$

It is often called the *pre-shape space* since human bodies with the same shape but different correspondences with the template may correspond to different points in \mathcal{H} . The set \mathcal{H} is a manifold, as an open subset of the linear space $\mathcal{C}^\infty(\mathcal{T}, \mathbb{R}^3)$ of smooth functions from \mathcal{T} to \mathbb{R}^3 . The tangent space to \mathcal{H} at f , denoted by $T_f\mathcal{H}$, is therefore just $\mathcal{C}^\infty(\mathcal{T}, \mathbb{R}^3)$.

The shape preserving transformations can be expressed as group actions on \mathcal{H} . The group \mathbb{R}^3 with addition as group operation acts on \mathcal{H} , by *translations*: $(v, f) \mapsto f + v$, for $v \in \mathbb{R}^3$ and $f \in \mathcal{H}$. The group $\text{SO}(3)$ with matrix multiplication as group operation acts on \mathcal{H} , by *rotations*: $(O, f) \mapsto Of$, for $O \in \text{SO}(3)$ and $f \in \mathcal{H}$. Finally, the group $\Gamma := \text{Diff}^+(\mathcal{T})$ consisting

of diffeomorphisms which preserve the orientation of \mathcal{T} acts also on \mathcal{H} , by *reparameterization*: $(\gamma, f) \mapsto f \circ \gamma^{-1}$, for $\gamma \in \text{Diff}^+(\mathcal{T})$ and $f \in \mathcal{H}$. The use of γ^{-1} , instead of γ , ensures that the action is from left and, since the action of $\text{SO}(3)$ is also from left, one can form a joint action of $G := \text{Diff}^+(\mathcal{T}) \times \text{SO}(3)$ on \mathcal{H} . In this section, the translation group is taken care of by using a translation-independent metric. Therefore, in the following we will focus only on the reparameterization group Γ and on the rotation group $\text{SO}(3)$.

Shape Space of aligned Human bodies

Given a group G acting on \mathcal{H} , the elements in \mathcal{H} obtained by following a fix registered human body $f \in \mathcal{H}$ when acted on by all elements of G is called the *equivalence class* of f under the action of G , and will be denoted by $[f]$. In particular, when G is the reparameterization group $\Gamma := \text{Diff}^+(\mathcal{T})$, the orbit of $f \in \mathcal{H}$ is characterized by the human shape $f(\mathcal{T}) = S$, i.e. the elements in $[f] = \{f \circ \gamma^{-1} \text{ for } \gamma \in \Gamma\}$ are all possible registrations of S . The quotient space \mathcal{H}/G is called *shape space* and is defined as follows.

Definition 3.4.1. *The shape space \mathcal{S} is the set of (oriented) human bodies in \mathbb{R}^3 , which are diffeomorphic to \mathcal{T} , modulo rotation. It is isomorphic to the quotient space of the pre-shape space \mathcal{H} by the human motion-preserving group $G := \text{Diff}^+(\mathcal{T}) \times \text{SO}(3)$: $\mathcal{S} = \mathcal{H}/G$.*

In this section, each human body surface is aligned to a given template \mathcal{T} . This means that for any equivalence class $[f] \in \mathcal{H}/G$ a preferred correspondence with the template is chosen. This alignment is anatomically meaningful (for instance the finger tips of the template correspond to the finger tips of the other human bodies (See Figure 3.22). The set of aligned human bodies will be denoted by \mathcal{S}_0 and is the space of interest in for the application we have in mind. Since the correspondence with the template is chosen in a smooth way, the shape space \mathcal{S} is diffeomorphic to the manifold of aligned human bodies \mathcal{S}_0 . Mathematically this alignment is called a section \mathcal{S}_0 of the fiber bundle $\Pi : \mathcal{H} \rightarrow \mathcal{H}/G$.

3.4.2 Shape Space as Section of a Fiber Bundle

Recall that each human body surface is aligned to a given human template (SMPL template). As illustrated in Figure 3.22, the geometric features of the template are aligned with geometric feature of the human surface (for instance, the finger tips of the template correspond to the finger tips of the other humans bodies).

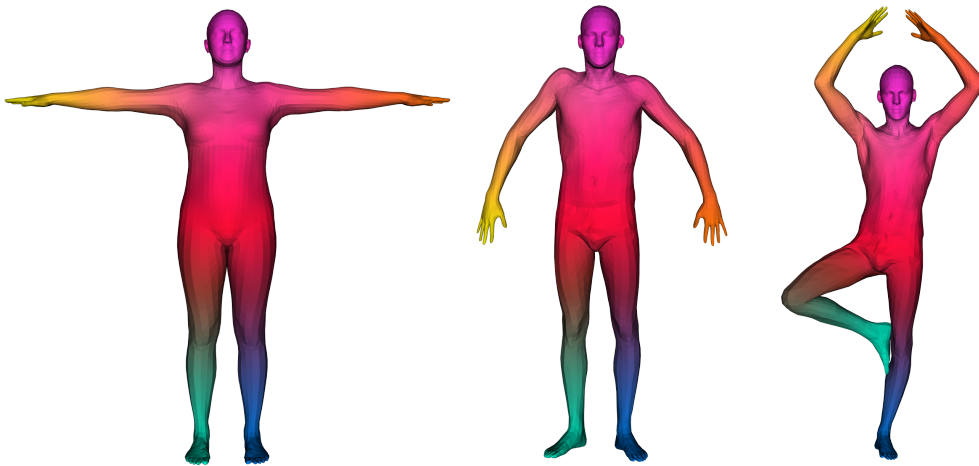

Figure 3.22: Alignment with the template: The 3 meshes in different poses are displayed with different color on extremities. This validate the choice to work on this particular section of the fiber bundle $\Pi : \mathcal{H} \rightarrow \mathcal{H}/G$

Mathematically the choice of a preferred alignment with the template is called a section \mathcal{S}_0 of the fiber bundle $\Pi : \mathcal{H} \rightarrow \mathcal{H}/G$. A section of Π is a (smooth) map assigning to each equivalence class $[f_0] \in \mathcal{H}/G$ a representative $f_0 \in \mathcal{H}$ in this class, i.e. such that $\Pi(f_0) = [f_0]$. This notion is illustrated in Figure 3.23. The section we are using, i.e. the correspondence with the template, is smooth, thanks to the geometric alignment as explained above.

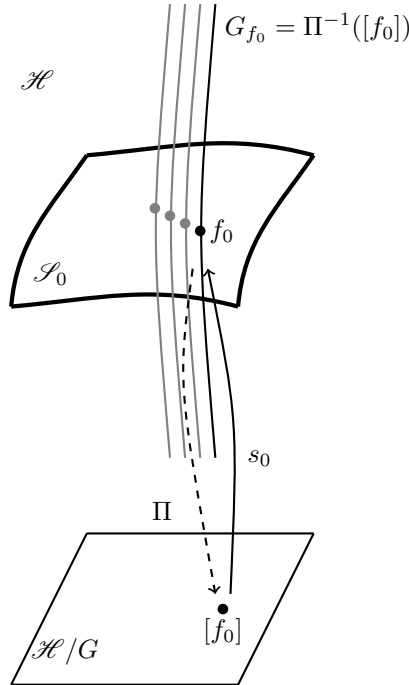

Figure 3.23: Section of the fiber bundle $\Pi : \mathcal{H} \rightarrow \mathcal{H}/G$: the one-to-one correspondance with the template mesh allows us to work on the corresponding section \mathcal{S}_0 as a shape space. The correspondance initially gives the section for $\text{Diff}^+(\mathcal{T})$, but with Procrustes analysis, the section for $\text{SO}(3)$ comes straightforwardly.

Elastic Riemannian Metric

Consider a parameterized surface $f : \mathcal{T} \rightarrow \mathbb{R}^3$. Denote by g the pull-back of the Euclidian metric of \mathbb{R}^3 and by n the unit normal vector field (Gauss map) on $S = f(\mathcal{T})$. We consider the following map between parameterized surfaces on one hand and the product space of metrics and normals on the other:

$$\begin{aligned} \Phi : \mathcal{S}_0 &\longrightarrow \text{Met}(\mathcal{T}) \times \mathcal{C}^\infty(\mathcal{T}, \mathbb{S}^2) \\ f &\longmapsto (g, n). \end{aligned} \tag{3.15}$$

It follows from the fundamental theorem of surface theory (see Bonnet's Theorem in [62] for the local result, Theorem 3.8.8 in [111] or Theorem 2.8-1 in [53] for the global result) that two parameterized surfaces f_1 and f_2 having the same representation (g, n) differ at most by a translation (and rotation for g). This theorem implies that we can represent a surface by its induced metric g and the unit normal field n , for the purpose of analyzing its shape. We will not loose any information about the shape of a surface f if we represent it by the pair (g, n) . The induced metric g captures the intrinsic shape, while the normal n captures the extrinsic geometry of shape.

The Manifold of Metrics on \mathcal{T} and its Geodesic Distance

The space of positive-definite Riemannian metrics on \mathcal{T} will be denoted by $\text{Met}(\mathcal{T})$. Once we have selected a Riemannian metric for a human body, it is a point in the infinite-dimensional manifold $\text{Met}(\mathcal{T})$. We will equip the infinite-dimensional space of all Riemannian metrics with a diffeomorphism-invariant Riemannian metric, called the Ebin (or DeWitt) metric [68, 59], as

suggested by [195]. The Riemannian metric on the tangent space is defined by:

$$((\delta g, \delta g))_g = \int_{\mathcal{S}} \text{Tr}(g^{-1}\delta g_0 g^{-1}\delta g_0) + \lambda \text{Tr}(g^{-1}\delta g)^2 \mu_g \quad (3.16)$$

where $\delta g_0 = \delta g - \frac{1}{2}\text{Tr}(g^{-1}\delta g)g$ is called the traceless part of δg , and where μ_g denotes the volume form defined by g . In this section, we endow the shape space with the following elastic metric and pull it back on the preferred section \mathcal{S}_0 given by the correspondence with the template:

$$\begin{aligned} (((\delta g, \delta n), (\delta g, \delta n)))_{g,n} = \\ a \left(\int_{\mathcal{S}} \text{Tr}(g^{-1}\delta g_0 g^{-1}\delta g_0) + \lambda \text{Tr}(g^{-1}\delta g)^2 \mu_g \right) \\ + c \int_{\mathcal{S}} \langle \delta n, \delta n \rangle dx \end{aligned} \quad (3.17)$$

Here a , λ , and b are constants that will be adjusted empirically depending on the applications.

Computation of Geodesics

As mentioned above, an important advantage of our Riemannian approach is its ability to compute not only the distance between two human surfaces but also the geodesics or the deformations between shapes. The computation of geodesics requires the minimization of an energy. In [205], the path-straightening method is used to find critical points of the energy functional. Starting with an arbitrary path, the method consists of iteratively deforming (or “straightening”) the path in the opposite direction of the gradient, until the path converges to a geodesic. In [169], we used another approach: after choosing a time step $\frac{1}{T}, T \in \mathbb{N}$, the path is set to the linear path (initialization) on which we add a sum of deformations:

$$\begin{aligned} f(t_0) &= f_0, & f(t_T) &= f_1 \\ f(t_i) &= (1 - t_i) f_0 + t_i f_1 + \sum_j \alpha_{ij} \mathcal{D}_j, \end{aligned} \quad (3.18)$$

where \mathcal{D}_j is an orthogonal basis of $N_{\mathcal{D}}$ plausible deformations gathered beforehand. The computation of the geodesic requires the minimization of the energy functional $E(\alpha)$, defined by:

$$E(\alpha) = \int_0^1 \left(\left(\frac{d\Phi(f(t))}{dt}, \frac{d\Phi(f(t))}{dt} \right) \right)_{\Phi(f(t))} dt \quad (3.19)$$

with $\alpha \in \mathbb{R}^{(T-2)*N_{\mathcal{D}}}$ the vector containing all α_{ij} presented in equation 3.18, and $((\cdot, \cdot))_{\Phi(f(t))}$ being the pullback by Φ of the Riemannian metric (3.17) on $\text{Met}(\mathcal{S}) \times C^\infty(\mathcal{S}, \mathcal{S}^2)$. To find the optimal coefficients α , similar to [196], we employ the Broyden-Fletcher-Goldfarb-Shanno (BFGS) method [73], implemented in the SciPy library [225] where we calculate the gradient using the automatic differentiation feature of PyTorch library [165].

Basis Deformations

In [120], [122], [195], [205], spherically parameterization of 3D objects is used and spherical harmonics are computed to define the set of deformations. However, human surfaces will require a large number of basis elements to achieve high accuracy and capture all the human surface details. In addition, in the case of human shapes, we are using a human template as a parametrization and there are several publicly available dynamic human shapes that can be used to build a PCA basis of deformations.

In our case to build such real deformations, we use the publicly Dynamic FAUST dataset [34], which contains motions registered to the template \mathcal{S} . 10 individuals (5 males, 5 females) perform 14 different motions, sampled at the rate of 60 frame per second. Given a set of motions, we collect deformations by gathering differences from the sequences. Let $(m_1, \dots, m_T) \in \mathcal{S}_0$ be a motion available in the dataset. We define the small deformations that we collect from the motions as the family $(m_{n\tau+\tau} - m_{n\tau})_n$, with τ being a time interval chosen manually, fixed to 10 frames ($\simeq 160$ ms). Thus, given a set of training samples, we can compute its PCA basis. In our experiments, the number of PCA basis elements required is of the order of 100.

Note that, by construction, adding a deformations of the basis of deformation to a aligned human shape will not destroy the alignment with the template.

Algorithm 9: Computation of Geodesics

Input: the source and target surfaces f_1 and f_2 , a, λ, c the parameter of the elastic metric

Output: f_{geo} : the geodesic connecting f_1 and f_2

- 1: Initialize $\alpha_{ij} = 0$ and $f(t_i)$ by linear path;
 - 2: Define the energy functional $E(\alpha)$ in an automatic differentiation framework (PyTorch here), that computes the gradient value $\nabla_{\alpha}E$ along the functional value;
 - 3: Minimize E with respect to α with a BFGS implementation (SciPy *BFGS* or *L-BFGS-B*), that uses the gradient $\nabla_{\alpha}E$;
 - 4: Set the geodesic to be: $f_{\text{geo}}(t_i) = t_i f_0 + (1 - t_i) f_1 + \sum_j \alpha_{ij} \mathcal{D}_j$;
 - 5: **return** the final geodesic f_{geo}
-

3.4.3 Experiments

Assessment of the Family of Elastic Metrics

To further assess the pertinence of the family of elastic distances defined in Equation ?? in human shape and pose analysis, we measured pairwise distances of the metric on the registrations present in the FAUST dataset [34]. It contains 10 individuals (5 males, 5 females) in 10 different poses. We present in Figure 3.24 and 3.25 2D visualizations of the dataset using the t-Distributed Stochastic Neighbor Embedding (t-SNE) algorithm [221].

The Figure 3.24 clearly evidences that the 3D human with similar poses belong to very close distributions. These results show the assumption that given $a = 0, \lambda = 0, c = 1$ (normal field L_2 metric), the metric is preserved under shape change, and could be used in pose and motion analysis application [137, 223]. The figure 3.25 shows that 3D human with similar shape belong to very close distribution. These results states the assumption that given $a = 1, \lambda = 0.0001, c = 0$, the metric is preserved under pose change, and could be used in many shape analysis application approaches [168] and [131].

Geodesic paths

We performed a number of experiments using human surfaces of same and different persons under a variety of pose and shape, and studied the resulting geodesic paths.

Figure 3.26 shows the geodesic path between f_1 (shown in far left) and f_2 (shown in far right). Drawn in between are human surfaces denoting equally spaced points along the geodesic path. In terms of the Riemannian metric chosen, these paths denote the optimal deformations in going from the first human body to the second and the path lengths quantify the amount of deformations. For this experiment, we also provide a curve of the energy, available right to the paths, which shows that the energy decreases smoothly with time. For the first path, the change in the pose induces small changes in shape. We thus want to minimize the shape change along the path, which would set the extrinsic parameters $c = 0$. We find that $a = 1, \lambda = 1$ gives the best visual results. The second path is a path with change in shape. We thus want to minimize the pose change along the path, which would set parameters $a = \lambda = 0$, and the normal parameter $c = 1$.

We also compare the results obtained with our method to the results using linear geodesic path, SRNF and SMPL descriptors.

1. The linear geodesic path between the initial and final embeddings.
2. The SRNF geodesic path is also visualized. This representation has been used to analyze human shapes with interesting results [122, 196]. The SRNF is a pointwise representation based on $q = \sqrt{A}n$, where $A = \|f_u \times f_v\|$ is the area, and n the normal field. We compute the geodesic for the *SRNF* representation with the same method as presented in this section.

As shown in Figures 3.27(a) and (b), the linear interpolation and SRNF lead to unnatural deformations for human paths. The deformation between surfaces contains many artifacts and degeneracies.

3. SMPL body model [134] : The SMPL model is a human blend shape model. The human shape is presented as a function of β, θ , with θ being the parameters of human body pose, as

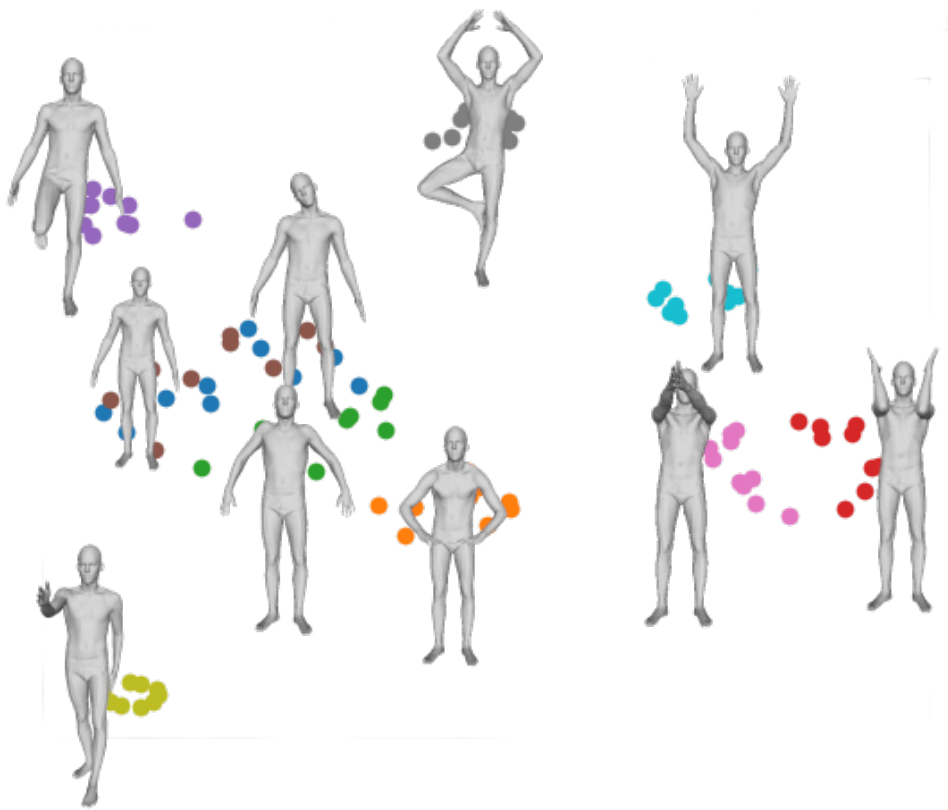

Figure 3.24: 2D visualization of the FAUST dataset by our method using t-SNE algorithm. The metric parameters are set to $a = 1, \lambda = 0.0001, c = 0$. Each color represents a class of pose and a class representative is also displayed.

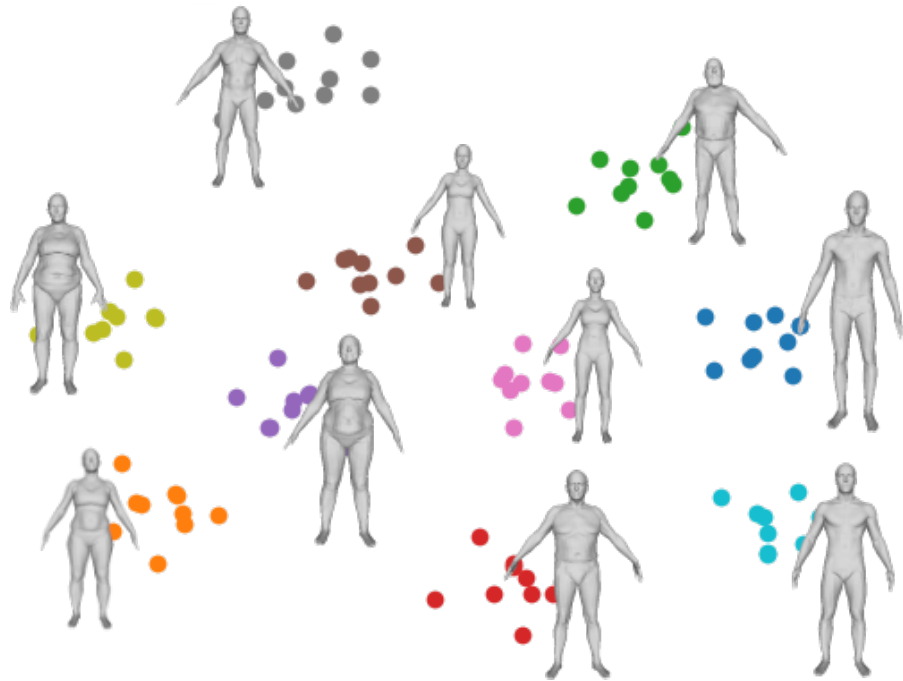

Figure 3.25: 2D visualization of the FAUST dataset by our method using t-SNE algorithm. The metric parameters are set to $a = 0, \lambda = 0, c = 1$. Each color represents a class of shape and a class representative is also displayed.

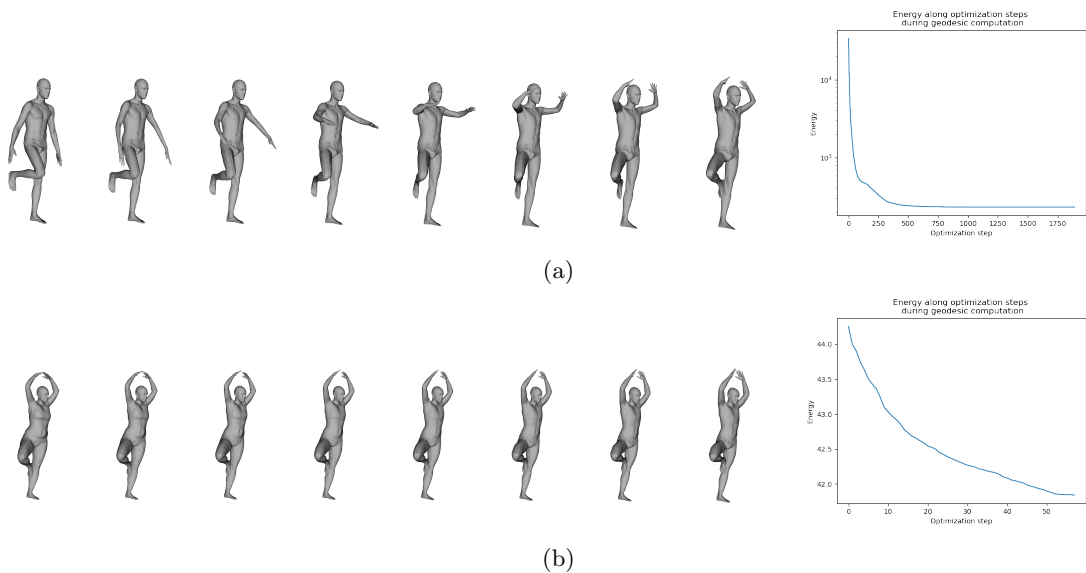
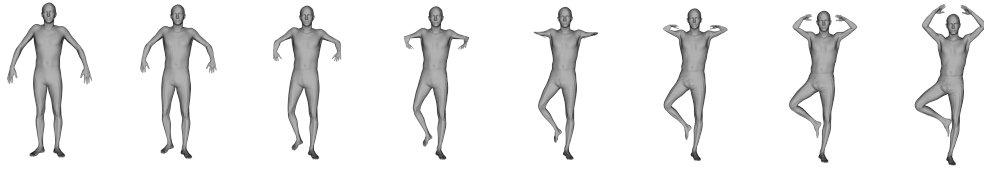
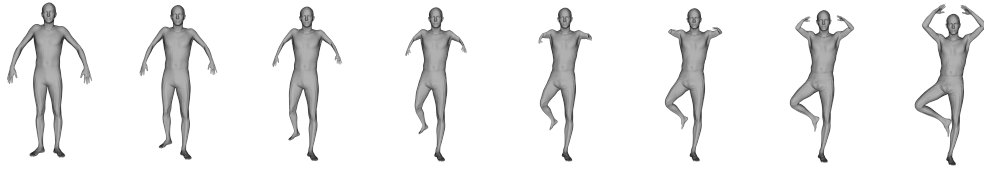

Figure 3.26: Examples of geodesic path between f_1 and far left and f_2 far right: (a) with metric parameters ($a=1, \lambda = 1, c=0$), (b) with metric parameters ($a=0, \lambda = 0, c=1$). The corresponding energy evolution during optimization are displayed on the right. Computation time was respectively 3min31s and 10.6s.



(a) Linear geodesic path



(b) Geodesic computed with SRNF

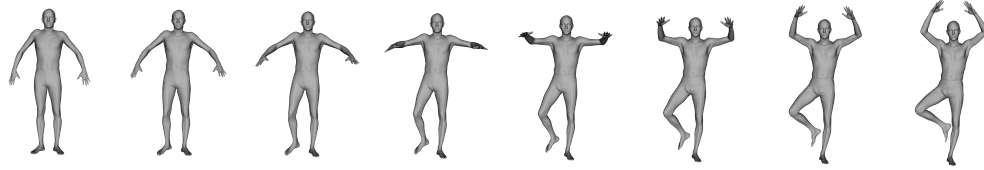

(c) Geodesic computed in SMPL space

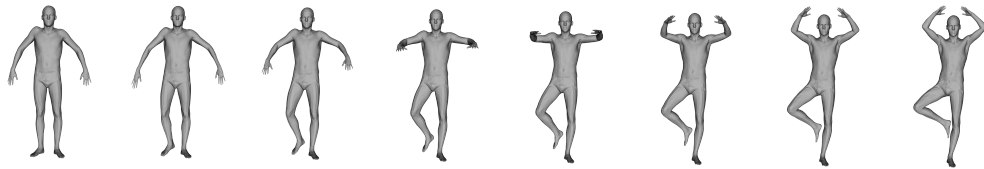

(d) Geodesic computed with our approach, metric parameters are set to $a = 1, \lambda = 1, c = 0$. Computation time was 3min10s.

Figure 3.27: Comparison of our approach with different frameworks.

| Repr. | NN | FT | ST |
|------------------------|------------|-------------|-------------|
| GDVAE intrinsic [9] | 27 | 24.8 | 46.2 |
| Zhou et al. shape[239] | 42 | 24.8 | 42.8 |
| SMPL shape vector | 98 | 72.4 | 86.7 |
| APT [81] | 96 | 86.5 | 96.2 |
| Metric (1, 0.0001, 0) | 100 | 94.8 | 97.1 |

Table 3.2: FAUST dataset results for shape retrieval

a cartesian product of axis angle rotation of skeletal joints (21 joints), in axis-angle representation, which lives in $\mathbb{R}^{21*3} = \mathbb{R}^{63}$. β are the parameters of the human body shape being the coefficients of linear combination of Principal Component Analysis (PCA) shape decomposition (10 components). After fitting SMPL model to the FAUST dataset, we can compute the corresponding geodesic, using the resulting shapes of the linear path in the SMPL parameter space, see Figure 3.27. While the deformation propose by the SMPL body model is in some way plausible, we first argue that the pose deformation proposed by SMPL does not bend enough the elbow: this is due to the linear interpolation of the elbow joint angle. In addition, one can observe that the target and sources shapes are slightly different than for our shapes. This is due to the fitting step of SMPL: the resulting shape is the closest shape with plausible SMPL parameters, not exactly the input shape.

3.4.4 Application to Pose and Shape Retrieval

We tested the usefulness of the family of metrics given by equation (3.17) in 3D human shape and pose retrieval. We use Nearest neighbor (NN), First-tier (FT), Second-tier (ST) as evaluations criteria. We propose to compare other methods of shape and/or pose retrieval with our method.

1. The first method GDVAE [9] is a point cloud variational autoencoder which is trained to disentangle the intrinsic and extrinsic informations of a given shape in the latent space, and propose a latent vector that decomposes in an intrinsic and extrinsic part. We used the FAUST meshes as input of their available trained network and gathered their extrinsic latent vectors, which lives in \mathbb{R}^{12} , along with their intrinsic latent vectors, which were for human pose retrieval and shape retrieval respectively. The network has been trained on the SURREAL dataset [222].
2. The second method proposed by Zhou et al. [239] is a mesh autoencoder based on Neural3DMM [38] graph neural network structure. They disentangle the shape and pose in the latent space. We apply the FAUST meshes on their available network, trained on AMASS dataset, and use the pose latent vector, which lives in \mathbb{R}^{112} as a descriptor for comparison.
3. For human shape, the Area Projection Transform [81] which won the human shape retrieval challenge [168] is presented. It has been designed for a different goal here, since it is parameterization invariant.
4. We also compare to the SRNF distance that showed reliable results for pose retrieval.
5. Finally we use both shape and pose representation from the SMPL body model for the respective retrieval tasks.

We perform evaluations of our method in FAUST dataset. We evaluate on pose and shape retrieval. The evaluation results in Table 3.2 demonstrate that our method outperforms the previous state of the art shape retrieval methods in term of NN criteria. The Table 3.3 shows that the proposed approach provides the best results on pose retrieval in term of FT and ST criteria. We also find that for shape retrieval, the best parameters are $a = 1, \lambda \ll a$. The computation times for each pairwise distance were $\simeq 70$ ms and $\simeq 80$ ms for pose and shape retrieval respectively.

| Repr. | NN | FT | ST |
|-----------------------|-----------|-------------|-------------|
| GDVAE extrinsic [9] | 60 | 38.0 | 54.2 |
| Zhou et al. pose[239] | 82 | 69.2 | 83.4 |
| SMPL pose vector | 80 | 84.4 | 95.2 |
| SRNF | 73 | 77.7 | 94.4 |
| Metric (0, 0, 1) | 85 | 88.3 | 97.6 |

Table 3.3: FAUST dataset results for pose retrieval

Part III

**Infinite-dimensional Poisson
Geometry**

Chapter 4

Queer Poisson structures

4.1 Introduction

This chapter is based on the publication [24]. We give a method to construct Poisson brackets $\{\cdot, \cdot\}$ on Banach manifolds M , for which the value of $\{f, g\}$ at some point $m \in M$ may depend on higher order derivatives of the smooth functions $f, g: M \rightarrow \mathbb{R}$, and not only on the first-order derivatives, as it is the case on all finite-dimensional manifolds. We discuss specific examples in this connection, as well as the impact on the earlier research on Poisson geometry of Banach manifolds. Those brackets are counterexamples to the claim that the Leibniz property for any Poisson bracket on a Banach manifold would imply the existence of a Poisson tensor for that bracket.

The Poisson brackets in infinite-dimensional setting have played for a long time a significant role in various areas of mathematics including (classical and quantum) mechanics and integrable systems theory (see e.g. [70, 31, 1, 51]). However the rigorous approach to the notion of Poisson manifold in the context of Banach space is relatively recent (see [156]). It is known that the Poisson brackets on infinite-dimensional manifolds lack some of the properties known from the finite-dimensional case. It was shown for instance in [156] that the existence of Hamiltonian vector fields requires an additional condition on the Poisson tensor in the case of manifolds modelled on a non-reflexive Banach space (i.e. a Banach space E that is not canonically isomorphic to its second dual $E \subsetneq E^{**}$, where E^* denotes the topological dual of a Banach space). Another example of a new behaviour can be found in [61] — a Poisson bracket defined only on a certain space of smooth functions might lead to an unbounded Poisson tensor. Moreover on some manifolds, Poisson brackets need not be local although as far as we know a counterexample is not known yet, see a related discussion in [46].

The aim of this chapter is to prove by example still another phenomenon that is specific to Poisson geometry on an infinite dimensional manifold M , namely the existence of Poisson brackets of higher order. That is, Leibniz property does not ensure that the bracket depends only on the first-order derivatives of functions. The constructed Poisson brackets serve as a counterexample to the statements given in the literature (see [156] or subsequently [99]), where it was claimed that the existence of a Poisson tensor Π follows from Leibniz property and skew symmetry of the Poisson bracket $\{\cdot, \cdot\}$, in particular for every $m \in M$ one could find a bounded bilinear functional $\Pi_m: T_m^*M \times T_m^*M \rightarrow \mathbb{R}$ satisfying

$$\{f, g\}(m) = \Pi_m(f'_m, g'_m)$$

where $f'_m, g'_m \in T_m^*M$ are the differentials of $f, g \in C^\infty(M)$ at point $m \in M$. There is a related fact in [1, Thm. 4.2.16], but we show that it is not applicable here (see Proposition 4.2.6).

We prove the existence of Poisson brackets not given by Poisson tensors on the family of Banach sequence spaces l^p for $1 \leq p \leq 2$ and present an explicit example for $p = 2$. Such Poisson brackets are pathological and do not lead to the dynamics in the usual way, thus from the point of view of applications in physics one should explicitly assume the existence of Poisson tensor in the definition of Poisson Banach manifold.

In Section 4.2 we investigate "queer operational tangent vectors", that is, derivations which are differential operators of order higher than 1 on spaces of smooth functions on the manifold. This notion was introduced with several results on their existence (including the examples on the Hilbert space) in [117]. We explore the case of queer vectors of order 2 on the family of Banach sequence spaces l^p for $1 \leq p < \infty$.

Section 4.3 contains the main result of this chapter, which shows a way to construct higher order Poisson brackets out of queer vector fields, and we illustrate the general result by a specific example on the Hilbert space. We conclude this chapter with a version of the definition of Banach Poisson manifold which clarifies the one introduced in [156]

All the Banach and Hilbert spaces considered in this chapter are real. By manifold we will always mean a smooth real manifold modelled on a Banach space.

4.2 Queer operational vector fields

There are two major approaches to tangent vectors, namely the kinematic one and the operational one. These approaches lead to the same notion for finite-dimensional manifolds, but this is no longer the case in infinite dimensions. A kinematic tangent vector to a Banach manifold M at a point $m \in M$ is an equivalence class of curves passing through that point (for precise definition see e.g. [1]). On the other hand, an operational tangent vector is defined as a derivation acting in the space of germs of functions (see [117], [46]).

For any $m \in M$ we consider the set of all functions $f: U \rightarrow \mathbb{R}$ defined on an open neighborhood U of m . We define an equivalence relation in that set in the following way: two functions $f_1: U_1 \rightarrow \mathbb{R}$ and $f_2: U_2 \rightarrow \mathbb{R}$ are equivalent if there exists an open neighborhood $U \subset U_1 \cap U_2$ of m for which the restrictions of f_1 and f_2 to U coincide. Any equivalence class $[f]$ defined in this way is called a germ at the point $m \in M$. We denote the set of germs of all smooth functions at m by $C_m^\infty(M)$. We will drop the brackets in the notation of germ when there is no risk of confusion.

Definition 4.2.1. An *operational tangent vector* at point $m \in M$ is a linear map $\delta: C_m^\infty(M) \rightarrow \mathbb{R}$ satisfying Leibniz rule:

$$\delta(fg) = \delta f g(m) + f(m) \delta g. \quad (4.1)$$

An *operational vector field* on M is a collection of maps $\delta_U: C^\infty(U) \rightarrow C^\infty(U)$ for each open set $U \subset M$, compatible with restrictions to open subsets and defining an operational tangent vector at every $m \in M$.

Let us denote by $L_k(T_m M; \mathbb{R})$ the space of bounded k -linear maps on $T_m M$ with values in \mathbb{R} and let $f_m^{(k)} \in L_k(T_m M; \mathbb{R})$ be the k -th differential of a function f at $m \in M$.

Definition 4.2.2. The operational tangent vector δ is of **order** n if it can be expressed in the form

$$\delta f = \sum_{k=1}^n \ell_k(f_m^{(k)}), \quad (4.2)$$

with $\ell_k: L_k(T_m M; \mathbb{R}) \rightarrow \mathbb{R}$, and ℓ_n does not vanish identically on the subspace of symmetric n -linear maps in $L_k(T_m M; \mathbb{R})$. Otherwise the order of δ is infinite. If only one term is present in the sum (4.2), δ is called homogeneous. The operational tangent vectors of order at least 2 are called **queer**.

The operational vector field δ is of **order at most** n if there exists a family of smooth sections ℓ_k of the bundle $\bigsqcup_{m \in M} (L_k(T_m M; \mathbb{R}))^*$ satisfying (4.2) at each $m \in M$.

The Leibniz rule (4.1) satisfied by δ implies certain algebraic conditions on functionals ℓ_k , see [117, 28.2].

By definition, operational tangent vectors of order n depend only on the n^{th} jet of functions. The existence of infinite order operational tangent vectors is an open problem as far as we know.

Remark 4.2.3. Any kinematic tangent vector defines an operational tangent vector of order 1. On the other hand in the case of manifolds modelled on non-reflexive Banach spaces, operational tangent vectors of order 1 are given by elements of $T^{**}M$ which is larger than the (kinematic) tangent bundle TM . Thus in the case of Banach manifolds (even the ones having a global chart, as for instance Banach spaces), the notions of kinematic tangent vector and operational tangent vector do not coincide in general.

There are examples of Banach spaces possessing queer operational tangent vectors even in the reflexive case. A construction of homogeneous second order operational tangent vectors on Hilbert spaces was given in [117] and we explore it below for a class of Banach spaces. Let E be a Banach space and consider the natural inclusion of $E^* \times E^*$ into $L_2(E; \mathbb{R})$ by:

$$\begin{aligned} E^* \times E^* &\rightarrow L_2(E; \mathbb{R}) \\ (f, g) &\mapsto (f \otimes g : (v, w) \mapsto f(v)g(w)). \end{aligned} \quad (4.3)$$

In general (contrary to the finite-dimensional case) the linear span of its image may not be dense. A functional $\ell \in (L_2(E; \mathbb{R}))^*$ defines an operational tangent vector of order 2 at any $a \in E$ by

$$\delta_\ell f = \ell(f''_a) \quad (4.4)$$

if and only if it vanishes on $E^* \times E^*$ regarded as a subspace of $L_2(E; \mathbb{R})$ via (4.3). We also recall here that we can identify $L_2(E; \mathbb{R})$ with $L(E; E^*)$.

Proposition 4.2.4. *There are no operational tangent vectors of the second order on the Banach space l^p of p -summable sequences for $2 < p < \infty$. On the other hand, if $1 \leq p \leq 2$ there are non-trivial operational tangent vectors of the second order.*

Proof. The existence of operational tangent vectors of the second order follows from [117, Rem. 28.8]. Namely according to Pitt's theorem, every map from l^p to $(l^p)^*$ is compact if $2 < p < \infty$, see e.g. [170], [179, Thm. 4.23], [71, Prop 6.25]. Moreover since all $(l^p)^*$ spaces have the approximation property, the closure of linear span of $(l^p)^* \times (l^p)^*$ coincides with the space of compact operators from l^p to $(l^p)^*$ [179, Ch. 4]. So, the only functional ℓ which would vanish on $E^* \times E^*$ is the zero functional. Thus there are no non-zero operational tangent vectors of the second order on l^p for $2 < p < \infty$.

In the case $1 \leq p \leq 2$, the inclusion map $\iota : l^p \hookrightarrow (l^p)^*$ is not compact, so using Hahn–Banach theorem it is possible to define a non-zero functional ℓ on $L_2(E; \mathbb{R})$ that vanishes on the image of the map (4.3). This implies the existence of non-zero operational tangent vectors of the second order on l^p for $1 \leq p \leq 2$. \square

In particular for $p = 2$ we obtain an operational tangent vector of the second order on the separable Hilbert space \mathcal{H} . We will present this case more explicitly.

Example 4.2.5 (concrete queer operational vector on a Hilbert space). *The Banach space $L_2(\mathcal{H}; \mathbb{R})$ can be identified with the Banach space of bounded operators $L^\infty(\mathcal{H})$. This identification maps a bilinear map B to the operator A defined by*

$$B(v, w) = \langle Av, w \rangle \quad (4.5)$$

using Riesz theorem. The closure of the linear span of $\mathcal{H}^ \times \mathcal{H}^*$ considered as a subspace of $L_2(\mathcal{H}; \mathbb{R}) \simeq L^\infty(\mathcal{H})$ by inclusion (4.3) is the ideal of compact operators on \mathcal{H} . One can now obtain ℓ with required properties by putting e.g. $\ell(\mathbb{K}) = 1$ where \mathbb{K} denotes the identity map, and $\ell(K) = 0$ for any compact operator $K \in L^\infty(\mathcal{H})$ and extend ℓ to the whole $L^\infty(\mathcal{H})$ by means of Hahn–Banach theorem.*

Let us now demonstrate explicitly that the operational tangent vector δ_ℓ given by (4.4) with ℓ defined as above is not a kinematic tangent vector. Without loss of generality we fix the point $a = 0$. Taking for example the function

$$\rho(v) = \langle v, v \rangle \quad (4.6)$$

for $v \in \mathcal{H}$, we get $\rho''_v = 2\mathbb{K}$, where we have used the identification $L_2(\mathcal{H}; \mathbb{R}) \simeq L^\infty(\mathcal{H})$ given by (4.5). From definition it follows that $\delta_\ell(\rho) = 2$. On the other hand, any kinematic tangent vector to \mathcal{H} at 0 can be identified with some $w \in \mathcal{H}$ and

$$w \cdot \rho = \langle w, 0 \rangle + \langle 0, w \rangle = 0.$$

Thus δ_ℓ is in fact a queer tangent vector. One can extend δ_ℓ to a queer constant operational vector field on \mathcal{H} , which we will denote by the same symbol.

Let us show that existence of δ_ℓ in Example 4.2.5 is not a contradiction with [1, Thm. 4.2.16] stating that for manifolds M modelled on Banach spaces with norm smooth away from the origin, a certain space of derivations is isomorphic to the vector space of kinematic vector fields on M . In this reference, a derivation \mathbf{D} on the Banach manifold M is a collection of linear maps $C^\infty(M, F) \rightarrow C^\infty(M, F)$ for all Banach spaces F , such that for any $f \in C^\infty(M, F)$, $g \in C^\infty(M, G)$, and any bilinear map $B : F \times G \rightarrow H$, the following Leibniz rule holds

$$\mathbf{D}(B(f, g)) = B(\mathbf{D}f, g) + B(f, \mathbf{D}g), \quad (4.7)$$

where F , G , and H are Banach spaces. An example of such a derivation is the Lie derivative. However the operational vector field δ_ℓ cannot be extended to a derivation in the sense of [1].

Proposition 4.2.6. *The queer operational vector field δ_ℓ constructed in Example 4.2.5 cannot be extended to a derivation on all $C^\infty(\mathcal{H}, F)$ spaces, where F is any Banach space.*

Proof. Let us assume that there exists an extension \mathbf{D}_ℓ of δ_ℓ . Let B be the natural duality pairing between \mathcal{H}^* and \mathcal{H} . Consider the maps $f : \mathcal{H} \rightarrow \mathcal{H}^*$, $v \mapsto \langle v, \cdot \rangle$ and g equal to the identity map on \mathcal{H} . Then $B(f, g)(v) = \langle v, v \rangle = \rho(v)$, and

$$\mathbf{D}_\ell(B(f, g))(v) = \delta_\ell(\rho)(v) = \ell(2\mathbb{1}) = 2.$$

On the other hand,

$$B(\mathbf{D}_\ell f, g)(v) + B(f, \mathbf{D}_\ell g)(v) = B(\mathbf{D}_\ell f(v), v) + \langle v, \mathbf{D}_\ell g(v) \rangle.$$

This expression vanishes for $v = 0$, hence (4.7) cannot be satisfied for any extension of δ_ℓ . \square

Proposition 4.2.7. *Let δ be an operational vector field of finite order on a manifold M . Then the set of points at which it is queer is open while the set of points at which it is kinematic is closed in M .*

Proof. Let n be the order of δ . The set of points at which δ is not queer is the intersection $\bigcap_{k=2}^n \ell_k^{-1}(0)$ of level sets of zero sections of coefficients $\ell_k : M \rightarrow \bigsqcup_{m \in M} (L_k(T_m M; \mathbb{R}))^*$ of δ . Since ℓ_k are continuous, the above intersection is a closed set.

The set of points at which δ is kinematic is $\bigcap_{k=2}^n \ell_k^{-1}(0) \cap \ell_1^{-1}(TM)$, where we regard TM as a subbundle of $\bigsqcup_{m \in M} (L_1(T_m M; \mathbb{R}))^* = T^{**}M$. It is straightforward to check that TM is a closed subset of $T^{**}M$ using local trivialization. \square

4.3 Queer Poisson brackets

In this section we will construct Poisson brackets which are localizable in the sense of the following definition:

Definition 4.3.1. A **Poisson bracket** on a manifold M is a bilinear operation $\{ \cdot, \cdot \} : C^\infty(M) \times C^\infty(M) \rightarrow C^\infty(M)$ satisfying

- (i) skew-symmetry: $\{f, g\} = -\{g, f\}$;
- (ii) Jacobi identity: $\{\{f, g\}, h\} + \{\{g, h\}, f\} + \{\{h, f\}, g\} = 0$;
- (iii) Leibniz rule: $\{f, gh\} = \{f, g\}h + g\{f, h\}$;

for all $f, g, h \in C^\infty(M)$.

A Poisson bracket $\{ \cdot, \cdot \}$ on M is called **localizable** if it has a **localization**, that is, a family consisting of a Poisson bracket $\{ \cdot, \cdot \}_U$ on every open subset $U \subseteq M$, which satisfy $\{ \cdot, \cdot \}_M = \{ \cdot, \cdot \}$ and are compatible with restrictions, i.e., if $U \subseteq V$ and $f, g \in C^\infty(V)$ then $\{f, g\}_V|_U = \{f|_U, g|_U\}_U$. If this is the case, then for any function $h \in C^\infty(M)$, its corresponding **Hamiltonian vector field** is the operational vector field given by

$$X_h(f)(m) := \{h|_U, f\}_U(m) \quad (4.8)$$

for all $f \in C^\infty(U)$ and $m \in U$, for every open subset $U \subseteq M$.

Remark 4.3.2. A version of Peetre's theorem on a Banach space E was proved in [230], to the effect that if a linear map $T : C^\infty(E) \rightarrow C^\infty(E)$ is local in the sense that $\text{supp } Tf \subset \text{supp } f$ for all $f \in C^\infty(E)$, then T is a differential operator of locally finite order provided that E satisfies the condition of B^∞ smoothness (existence of bump functions with Lipschitz property for all derivatives). This condition is satisfied for Hilbert spaces, but e.g. not for the Banach space of real sequences that are convergent to zero.

From compatibility with restrictions it follows that operational vector fields (including Hamiltonian vector fields) are local in this sense. Thus in the case of B^∞ smooth Banach spaces they are differential operators of locally finite order.

In the following we denote by $\bigwedge^2 T^{**}M$ the bundle of skew-symmetric bilinear functions on the fibers of T^*M , for any Banach manifold M .

Definition 4.3.3. A Poisson bracket $\{\cdot, \cdot\}$ on M is of **order one** at $m \in M$ if there exists a skew-symmetric bounded bilinear functional $\Pi_m : T_m^*M \times T_m^*M \rightarrow \mathbb{R}$ with

$$\{f, g\}(m) = \Pi_m(f'_m, g'_m) \quad (4.9)$$

for all $f, g \in C^\infty(M)$. Otherwise we say that $\{\cdot, \cdot\}$ is **queer** at $m \in M$.

If there exists a smooth section Π of the bundle $\bigwedge^2 T^{**}M$ satisfying (4.9) at every point $m \in M$, then we say that Π is the **Poisson tensor** of the Poisson bracket $\{\cdot, \cdot\}$.

Remark 4.3.4. In the above definition, if the Poisson bracket is of order one at some point $m \in M$ then it is not clear that there exists only one functional Π_m satisfying (4.9), as the differentials of globally defined functions at a given point m might not span the whole T_m^*M . However this is certainly the case if for instance Poisson bracket is localizable or M has a global chart.

Theorem 4.3.5. Let δ_1 and δ_2 be two commuting operational vector fields on a Banach manifold M , and define

$$\{f_1, f_2\}_U := (\delta_1)_U(f_1) (\delta_2)_U(f_2) - (\delta_2)_U(f_1) (\delta_1)_U(f_2),$$

for all $f_1, f_2 \in C^\infty(U)$, for every open subset $U \subseteq M$. Then $\{\cdot, \cdot\} := \{\cdot, \cdot\}_M$ is a localizable Poisson bracket with a localization consisting of the brackets $\{\cdot, \cdot\}_U$. If moreover δ_1 and δ_2 are linearly independent at some point $m \in M$, then the Poisson bracket $\{\cdot, \cdot\}$ is queer at the point m if and only if at least one the operational vector field δ_1 and δ_2 is queer at m .

Proof. Bilinearity and skew-symmetry of $\{\cdot, \cdot\}$ are obvious. Jacobi identity follows from the commutativity of δ_1 and δ_2 just like in the case of canonical Poisson bracket on \mathbb{R}^2 . This can also be seen e.g. as the special case $n = 2$ of [72, Prop. 2]. The Leibniz rule for $\{\cdot, \cdot\}$ follows easily from (4.1). Compatibility with restrictions follows from the definition of operational vector fields.

Now assume that δ_1 and δ_2 are linearly independent at $m \in M$. If none of δ_1 and δ_2 is queer at m , then it follows by Remark 4.2.3 that their values at m satisfy $(\delta_1)_m, (\delta_2)_m \in T_m^{**}M$. Then (4.9) is satisfied if we define $\Pi_m : T_m^*M \times T_m^*M \rightarrow \mathbb{R}$ by

$$\Pi_m(\mu, \nu) = (\delta_1)_m(\mu) (\delta_2)_m(\nu) - (\delta_2)_m(\mu) (\delta_1)_m(\nu) \text{ for all } \mu, \nu \in T_m^*M,$$

hence $\{\cdot, \cdot\}$ is not queer at $m \in M$.

Conversely, assume that $\{\cdot, \cdot\}$ is not queer at $m \in M$, hence we have (4.9). Since the linear functionals $(\delta_1)_m, (\delta_2)_m : C_m^\infty(M) \rightarrow \mathbb{R}$ are linearly independent by hypothesis, there exists a germ $[f_1] \in C_m^\infty(M)$ with $\delta_1(f_1) = 0$ and $\delta_2(f_1) \neq 0$. Then for every $f \in C^\infty(U)$ we obtain $\{f_1, f\}_U(m) = \delta_2(f_1)(m) \delta_1(f)(m)$, hence by (4.9)

$$\delta_1(f)(m) = \frac{1}{\delta_2(f_1)(m)} \Pi_m((f_1)'_m, f'_m)$$

and this shows that the operational tangent vector $(\delta_1)_m$ has order 1 at m . One can similarly prove that the operational tangent vector $(\delta_2)_m$ has order 1 at m and this completes the proof. \square

One can use Theorem 4.3.5 and Proposition 4.2.4 to construct queer Poisson brackets on l^p spaces for $1 \leq p \leq 2$. Again we will present the case $p = 2$ in more detail.

Example 4.3.6 (concrete queer Poisson bracket). Now let us take $M = \mathcal{H} \times \mathbb{R}$. Denote points of M as (v, x) . As the first operational vector field let us take δ_ℓ from Example 4.2.5 acting in v variable, and for the second — $\frac{\partial}{\partial x}$. They commute and thus by Theorem 4.3.5 define a queer Poisson bracket on $\mathcal{H} \times \mathbb{R}$:

$$\{f, g\}(v, x) := \delta_\ell(v)f(\cdot, x)\frac{\partial g}{\partial x}(v, x) - \frac{\partial f}{\partial x}(v, x)\delta_\ell(v)g(\cdot, x).$$

Note that this Poisson bracket has pathological properties: it does not allow Hamiltonian formalism in the usual sense since its corresponding Hamiltonian vector fields are in general only operational vector fields, e.g. for the function $h(v, x) = -x$ is

$$X_h := \{h, \cdot\} = \delta_\ell.$$

Thus it is not a section of TM . Since in the constructed example δ_ℓ was a differential operator of the second order, it will not lead to an evolution flow on M . Note that the system of Hamilton equations

$$\frac{d}{dt}f(v(t), x(t)) = (X_h f)(v(t), x(t))$$

for $f \in C^\infty(M)$ is not even a well posed problem. Namely for the function ρ given by (4.6) we get

$$\frac{d}{dt}\rho(v(t)) = 2. \tag{4.10}$$

Now consider the function $f(v, x) = \langle v, w \rangle$ for a fixed vector $w \in \mathcal{H}$. One sees that $f'' = 0$ and thus $X_h f = 0$. Since the vector w was arbitrary, it follows that $\frac{d}{dt}v(t) = 0$.

As demonstrated a queer Poisson bracket does not lead to the dynamics in the usual way. However it may be possible to consider the dynamics not on the initial manifold but on some jet bundle or higher (co)-tangent bundle, see e.g. [42] and references therein.

Taking this into account, from the point of view of applications in physics (including classical mechanics) one should explicitly assume the existence of Poisson tensor in the definition of Poisson Banach manifold. This also ensures the existence of the map $\sharp : T^*M \rightarrow T^{**}M$ defined by

$$\sharp(\mu_m) = \Pi_m(\mu_m, \cdot), \quad \mu_m \in T_m^*M. \tag{4.11}$$

Definition 4.3.7. A Banach Poisson manifold $(M, \{\cdot, \cdot\})$ is a Banach manifold M equipped with a localizable Poisson bracket $\{\cdot, \cdot\}$ for which there exists a Poisson tensor and the corresponding \sharp map satisfies

$$\sharp(T^*M) \subset TM. \tag{4.12}$$

This definition is a clarification of the definition of Banach Poisson manifolds given in [156, Def. 2.1], where the localizability property and the existence of Poisson tensor or \sharp map were not explicitly assumed, but were assumed implicitly. In consequence all Banach Poisson manifolds considered there (including Banach Lie–Poisson spaces) do satisfy the corrected definition. Moreover, the Poisson tensor of every Banach Lie–Poisson space is uniquely determined. (See Remark 4.3.4.)

The condition (4.12) on the map \sharp was introduced in [156] and guarantees that Hamiltonian vector fields are kinematic and it is equivalent to the bilinear functional $\Pi_m : T^*M \times T^*M \rightarrow \mathbb{R}$ being separately weak*-continuous.

Chapter 5

The restricted Grassmannian as a symplectic leaf in a Poisson manifold

5.1 Introduction

The present chapter is devoted to an investigation of the relationship between the restricted Grassmannian and the theory of Banach Lie–Poisson spaces. It is based on publication [27].

The restricted Grassmannian (whose definition is recalled after Proposition 5.2.11 below) is a quite remarkable infinite-dimensional *Kähler* manifold that plays an important role in many areas of mathematics and physics. There are many interesting objects related to the restricted Grassmannian, such as: loop groups (see Proposition 8.3.3 in [172]), the coadjoint orbits $\text{Diff}^+(S^1)/S^1$ and $\text{Diff}^+(S^1)/\text{PSU}(1, 1)$ of the group of orientation-preserving diffeomorphisms of the circle (Proposition 6.8.2 in [172] and Proposition 5.3 in [182]). It is related to the integrable system defined by the KP hierarchy (see [185]) and to the fermionic second quantization (see [233]). On the other hand, the notion of a Banach Lie–Poisson space was recently introduced in [156] and is an infinite-dimensional version of the Lie–Poisson spaces, that is, the Poisson manifolds provided by dual spaces of finite-dimensional Lie algebras (see for instance [161] for the finite-dimensional theory). Specifically, a *Banach Lie–Poisson space* is a Banach space \mathfrak{b} whose topological dual \mathfrak{b}^* is endowed with a structure of Banach Lie algebra such that the subspace \mathfrak{b} of $(\mathfrak{b}^*)^*$ is invariant under the corresponding coadjoint action. Equivalently, the Lie bracket of \mathfrak{b}^* is separately weak*-continuous. This new class of infinite-dimensional linear Poisson manifolds is remarkable in several respects: it includes all the preduals of W^* -algebras, thus establishing a bridge between Poisson geometry and the theory of operator algebras, and hence it provides links with algebraic quantum theories; it interacts in a fruitful way with the theory of extensions of Lie algebras (see [157]); and finally, there exist large classes of Banach Lie–Poisson spaces which share with the finite-dimensional Poisson manifolds the fundamental property that the characteristic distribution is integrable, the corresponding integral manifolds being in addition Poisson submanifolds which are symplectic and, in several important situations, are even *Kähler* manifolds (see [26]).

We have mentioned here two types of infinite-dimensional *Kähler* manifolds: the restricted Grassmannian and certain symplectic leaves in infinite-dimensional Lie–Poisson spaces introduced in [156]. This brings us to the first question addressed:

Question 5.1.1. *Is the restricted Grassmannian a symplectic leaf in a Banach Lie–Poisson space?*

The main result of our collaboration [27] shows that the answer to this question is essentially affirmative; see Section 5.5 for the precise statements and a detailed discussion of this problem. Specifically, we shall employ the method of central extensions to construct a certain Banach Lie–Poisson space $\tilde{\mathfrak{u}}_2$ whose characteristic distribution is integrable (Theorem 5.5.1) and one of the integral manifolds of this distribution is symplectomorphic to the connected component Gr_{res}^0 of the restricted Grassmannian (Theorem 5.5.3). Using a similar method, we realize the restricted Grassmannian as a symplectic leaf in yet another Banach Lie–Poisson space, which is the predual

to a 1-dimensional central extension of the restricted Lie algebra $\mathfrak{u}_{\text{res}}$. See Section 5.2 for a detailed discussion of the Poisson geometry of this new Banach Lie-Poisson space $(\tilde{\mathfrak{u}}_{\text{res}})_*$.

This second construction is closely related to another area where the theory of restricted groups interacts with the theory initiated in [156]. Specifically, we also address the following question on the predual $(\mathfrak{u}_{\text{res}})_*$ of the restricted Lie algebra:

Question 5.1.2. *Does the real Banach space $(\mathfrak{u}_{\text{res}})_*$ have a natural structure of Banach Lie-Poisson space and is its characteristic distribution integrable?*

By the very construction of the Banach Lie-Poisson space $(\tilde{\mathfrak{u}}_{\text{res}})_*$, the predual $(\mathfrak{u}_{\text{res}})_*$ appears as a Poisson submanifold of $(\tilde{\mathfrak{u}}_{\text{res}})_*$ and carries a natural structure of Banach Lie-Poisson space. Nonetheless, the answer to the second part of Question 5.1.2 turns out to be much more difficult to give than the one to Question 5.1.1 inasmuch as the restricted algebra \mathcal{B}_{res} (see Notation 5.1.3 below) is a dual Banach $*$ -algebra with many pathological properties (summarized in Section 5.6): its unitary group is unbounded, its natural predual is not spanned by its positive cone, and a conjugation theorem for its maximal Abelian $*$ -subalgebras fails to be true. Despite these unpleasant properties, we show that the characteristic distribution of $(\mathfrak{u}_{\text{res}})_*$ has numerous smooth integral manifolds, which are, in particular, *smooth* coadjoint orbits of the restricted unitary group U_{res} (see Section 5.3). For the sake of completeness, a short section (Section 5.4) is devoted to investigating smoothness of adjoint orbits of U_{res} .

Notation 5.1.3. We conclude this Introduction by setting up some notation to be used throughout this chapter. In the following, \mathcal{H} will denote a complex Hilbert space, endowed with a decomposition $\mathcal{H} = \mathcal{H}_+ \oplus \mathcal{H}_-$ into the orthogonal sum of two closed subspaces.

It will follow implicitly from the hypotheses of various statements when additional conditions on the Hilbert space \mathcal{H} are imposed. For example, Corollary 5.3.7 requests the existence of a certain *countable* orthonormal basis, so \mathcal{H} needs to be separable. Also, sometimes it is assumed that both \mathcal{H}_{\pm} are infinite-dimensional. This is the case in Section 5.6 where we need operators that do *not* belong to the restricted algebra \mathcal{B}_{res} .

The orthogonal projection onto \mathcal{H}_{\pm} will be denoted by p_{\pm} . The Banach ideal of trace class operators on \mathcal{H} will be denoted by $L_1(\mathcal{H})$ and $L_2(\mathcal{H})$ will denote the Hilbert ideal of Hilbert-Schmidt operators on \mathcal{H} . We let $\mathcal{B}(\mathcal{H})$ be the algebra of all bounded linear operators on \mathcal{H} . We shall also need the Banach Lie group of unitary operators on \mathcal{H} ,

$$U(\mathcal{H}) = \{u \in \mathcal{B}(\mathcal{H}) \mid u^*u = uu^* = \text{id}\},$$

whose Lie algebra is

$$\mathfrak{u}(\mathcal{H}) = \{a \in \mathcal{B}(\mathcal{H}) \mid a^* = -a\}.$$

Now let us define the following skew-Hermitian element:

$$d := i(p_+ - p_-) \in \mathfrak{u}(\mathcal{H}).$$

The restricted Banach algebra and the restricted unitary group are respectively defined as follows:

$$\begin{aligned} \mathcal{B}_{\text{res}} &= \{a \in \mathcal{B}(\mathcal{H}) \mid [d, a] \in L_2(\mathcal{H})\} = \{a \in \mathcal{B}(\mathcal{H}) \mid \|a\|_{\text{res}} := \|a\| + \|[d, a]\|_2 < \infty\}, \text{ and} \\ U_{\text{res}} &= \{u \in U(\mathcal{H}) \mid [d, u] \in L_2(\mathcal{H})\} = U(\mathcal{H}) \cap \mathcal{B}_{\text{res}}. \end{aligned}$$

The Lie algebra of U_{res} is the following Banach Lie algebra:

$$\mathfrak{u}_{\text{res}} = \{a \in \mathfrak{u}(\mathcal{H}) \mid [d, a] \in L_2(\mathcal{H})\} = \mathfrak{u}(\mathcal{H}) \cap \mathcal{B}_{\text{res}}.$$

Let us define the following Banach Lie algebra:

$$(\mathfrak{u}_{\text{res}})_* = \{\rho \in \mathfrak{u}(\mathcal{H}) \mid [d, \rho] \in L_2(\mathcal{H}), p_{\pm}\rho|_{\mathcal{H}_{\pm}} \in L_1(\mathcal{H}_{\pm})\}.$$

A connected Banach Lie group with Lie algebra $(\mathfrak{u}_{\text{res}})_*$ is

$$U_{1,2} = \{a \in U(\mathcal{H}) \mid a - \text{id} \in L_2(\mathcal{H}), p_{\pm}a|_{\mathcal{H}_{\pm}} \in \text{id} + L_1(\mathcal{H}_{\pm})\}.$$

The group U_1 and its Lie algebra \mathfrak{u}_1 are defined as follows:

$$\begin{aligned} U_1 &= \{a \in U(\mathcal{H}) \mid a - \text{id} \in L_1(\mathcal{H})\}, \text{ and} \\ \mathfrak{u}_1 &= \mathfrak{u}(\mathcal{H}) \cap L_1(\mathcal{H}). \end{aligned}$$

Finally, the Hilbert-Lie group U_2 and its Lie algebra \mathfrak{u}_2 are defined by :

$$\begin{aligned} U_2 &= \{a \in U(\mathcal{H}) \mid a - \text{id} \in L_2(\mathcal{H})\}, \text{ and} \\ \mathfrak{u}_2 &= \mathfrak{u}(\mathcal{H}) \cap L_2(\mathcal{H}). \end{aligned}$$

5.2 The Banach Lie-Poisson space associated to the universal central extension of $\mathfrak{u}_{\text{res}}$

In this section we construct a Banach Lie-Poisson space $(\tilde{\mathfrak{u}}_{\text{res}})_*$ whose dual is the universal central extension of the restricted algebra $\mathfrak{u}_{\text{res}}$. (See [150] for the definition of universal central extension and Proposition 5.2.4 below for the justification of this fact.) The Poisson structure of $(\tilde{\mathfrak{u}}_{\text{res}})_*$ is defined by (5.8) in Proposition 5.2.5. Let us first justify the suggestive notation $(\mathfrak{u}_{\text{res}})_*$.

Proposition 5.2.1. *The Lie algebra $(\mathfrak{u}_{\text{res}})_*$ is a predual of the unitary restricted algebra $\mathfrak{u}_{\text{res}}$, the duality pairing $\langle \cdot, \cdot \rangle$ being given by*

$$\langle \cdot, \cdot \rangle : (\mathfrak{u}_{\text{res}})_* \times \mathfrak{u}_{\text{res}} \rightarrow \mathbb{R}, \quad (b, c) \mapsto \text{Tr}(bc). \quad (5.1)$$

Proof. Consider two arbitrary elements

$$a = \begin{pmatrix} a_{++} & a_{+-} \\ -a_{+-}^* & a_{--} \end{pmatrix} \in \mathfrak{u}_{\text{res}} \quad \text{and} \quad \rho = \begin{pmatrix} \rho_{++} & -\rho_{-+}^* \\ \rho_{-+} & \rho_{--} \end{pmatrix} \in (\mathfrak{u}_{\text{res}})_*.$$

Then

$$a\rho = \begin{pmatrix} a_{++}\rho_{++} + a_{+-}\rho_{-+} & -a_{++}\rho_{-+}^* + a_{+-}\rho_{--} \\ -a_{+-}^*\rho_{++} + a_{--}\rho_{-+} & a_{+-}^*\rho_{-+}^* + a_{--}\rho_{--} \end{pmatrix}, \quad (5.2)$$

hence

$$\text{Tr}(a\rho) = \text{Tr}(a_{++}\rho_{++}) + 2\Re\text{Tr}(a_{+-}\rho_{-+}) + \text{Tr}(a_{--}\rho_{--}), \quad (5.3)$$

where $\Re z$ denotes the real part of the complex number z . Recall that the bilinear functional

$$\mathcal{B}(\mathcal{H}_{\pm}) \times L_1(\mathcal{H}_{\pm}) \rightarrow \mathbb{C}, \quad (b, c) \mapsto \text{Tr}(bc),$$

induces a topological isomorphism of complex Banach spaces $(L_1(\mathcal{H}_{\pm}))^* \simeq \mathcal{B}(\mathcal{H}_{\pm})$. It follows that the trace induces a topological isomorphism of real Banach spaces

$$(\mathfrak{u}(\mathcal{H}_{\pm}) \cap L_1(\mathcal{H}_{\pm}))^* \simeq \mathfrak{u}(\mathcal{H}_{\pm}). \quad (5.4)$$

Indeed, the \mathbb{C} -linearity of the trace implies that for $b \in \mathcal{B}(\mathcal{H}_{\pm})$ the following conditions are equivalent:

$$(\forall c \in \mathfrak{u}(\mathcal{H}_{\pm}) \cap L_1(\mathcal{H}_{\pm})) \quad \text{Tr}(bc) = 0 \iff (\forall c \in L_1(\mathcal{H}_{\pm})) \quad \text{Tr}(bc) = 0.$$

Moreover the condition

$$(\forall c \in \mathfrak{u}(\mathcal{H}_{\pm}) \cap L_1(\mathcal{H}_{\pm})) \quad \text{Tr}(bc) \in \mathbb{R}$$

implies

$$(\forall c \in \mathfrak{u}(\mathcal{H}_{\pm}) \cap L_1(\mathcal{H}_{\pm})) \quad \text{Tr}(b + b^*)c = 0,$$

hence b belongs to $\mathfrak{u}(\mathcal{H}_{\pm})$. On the other hand, the duality pairing of complex Hilbert spaces

$$L_2(\mathcal{H}_-, \mathcal{H}_+) \times L_2(\mathcal{H}_+, \mathcal{H}_-) \rightarrow \mathbb{C}, \quad (b, c) \mapsto \text{Tr}(bc),$$

induces a duality pairing of the underlying real Hilbert spaces by

$$L_2(\mathcal{H}_-, \mathcal{H}_+) \times L_2(\mathcal{H}_+, \mathcal{H}_-) \rightarrow \mathbb{R}, \quad (b, c) \mapsto \Re \text{Tr}(bc). \quad (5.5)$$

In view of formula (5.3), we conclude that the trace induces a topological isomorphism of real Banach spaces

$$((\mathfrak{u}_{\text{res}})_*)^* \simeq \mathfrak{u}_{\text{res}}.$$

That is, $(\mathfrak{u}_{\text{res}})_*$ is indeed a predual to $\mathfrak{u}_{\text{res}}$, the duality pairing being induced by (5.4) and (5.5). \square

Definition 5.2.2. We define the Banach Lie algebra $\tilde{\mathfrak{u}}_{\text{res}}$ as the central extension of $\mathfrak{u}_{\text{res}}$ with continuous two-cocycle s given by

$$s(A, B) := \text{Tr}(A[d, B]), \quad (5.6)$$

for all $A, B \in \mathfrak{u}_{\text{res}}$. That is, $\tilde{\mathfrak{u}}_{\text{res}}$ is the Banach Lie algebra $\mathfrak{u}_{\text{res}} \oplus \mathbb{R}$ endowed with the bracket $[\cdot, \cdot]_d$ defined by

$$[(A, a), (B, b)]_d = ([A, B], s(A, B)). \quad (5.7)$$

Remark 5.2.3. Note that by the very definition of $\mathfrak{u}_{\text{res}}$, one has $[d, \mathfrak{u}_{\text{res}}] \subset (\mathfrak{u}_{\text{res}})_*$. It follows from the duality pairing (5.1), that s is well-defined by (5.6). To see that s defines a two-cocycle on $\mathfrak{u}_{\text{res}}$, let us remark that s is (2i)-times the Schwinger term of [233]. It follows from Corollary II.12 in the aforementioned work that s defines a non-trivial element in the second continuous Lie algebra cohomology space $H^2(\mathfrak{u}_{\text{res}}, \mathbb{R})$. The corresponding $U(1)$ -extension of the unitary restricted group U_{res} is isomorphic to the $U(1)$ -extensions U_{res}^\sim and \widehat{U}_{res} of U_{res} constructed in [233].

Proposition 5.2.4. *The cohomology class $[s]$ is a generator of the continuous Lie algebra cohomology space $H^2(\mathfrak{u}_{\text{res}}, \mathbb{R})$.*

Proof. According to Proposition I.11 in [149], the second continuous Lie algebra cohomology space $H^2(\mathcal{B}_{\text{res}}, \mathbb{C})$ of the restricted Lie algebra \mathcal{B}_{res} is 1-dimensional. Note that a continuous \mathbb{R} -valued 2-cocycle v on $\mathfrak{u}_{\text{res}}$ extends by \mathbb{C} -linearity to a continuous \mathbb{C} -valued 2-cocycle $v^{\mathbb{C}}$ on the complex Lie algebra \mathcal{B}_{res} . The cocycle $v^{\mathbb{C}}$ is a coboundary if and only if there exists a continuous linear map $\alpha: \mathcal{B}_{\text{res}} \rightarrow \mathbb{C}$ such that $v^{\mathbb{C}}(x, y) = \alpha([x, y])$ for every $x, y \in \mathcal{B}_{\text{res}}$. But since $v^{\mathbb{C}}$ restricts to the \mathbb{R} -valued 2-cocycle v on $\mathfrak{u}_{\text{res}}$, this is the case if and only if there exists $\beta := \Re\alpha: \mathfrak{u}_{\text{res}} \rightarrow \mathbb{R}$ such that $v(x, y) = \beta([x, y])$ for every $x, y \in \mathfrak{u}_{\text{res}}$. It follows that the extension $v^{\mathbb{C}}$ is a coboundary on \mathcal{B}_{res} if and only if v is a coboundary on $\mathfrak{u}_{\text{res}}$. Consequently, there is a natural linear injection of $H^2(\mathfrak{u}_{\text{res}}, \mathbb{R})$ into $H^2(\mathcal{B}_{\text{res}}, \mathbb{C})$. Since s defines a non-trivial element in $H^2(\mathfrak{u}_{\text{res}}, \mathbb{R})$ (see Remark 5.2.3) and $\dim_{\mathbb{C}} H^2(\mathcal{B}_{\text{res}}, \mathbb{C}) = 1$, it follows that $\dim_{\mathbb{R}} H^2(\mathfrak{u}_{\text{res}}, \mathbb{R}) = 1$ and thus $H^2(\mathfrak{u}_{\text{res}}, \mathbb{R})$ is generated by s . \square

Proposition 5.2.5. *The Banach space $(\tilde{\mathfrak{u}}_{\text{res}})_*$ is a Banach Lie-Poisson space for the Poisson bracket*

$$\{f, g\}_d(\mu, \gamma) := \langle \mu, [D_\mu f(\mu), D_\mu g(\mu)] \rangle + \gamma s(D_\mu f, D_\mu g) \quad (5.8)$$

where $f, g \in \mathcal{C}^\infty((\tilde{\mathfrak{u}}_{\text{res}})_*)$, (μ, γ) is an arbitrary element in $(\tilde{\mathfrak{u}}_{\text{res}})_*$, and D_μ denotes the partial Fréchet derivative with respect to $\mu \in (\mathfrak{u}_{\text{res}})_*$.

The pairing in equation (5.8) is the duality pairing defined by (5.1). We will denote by $\langle \cdot, \cdot \rangle_d$ the duality pairing between $(\tilde{\mathfrak{u}}_{\text{res}})_* = (\mathfrak{u}_{\text{res}})_* \oplus \mathbb{R}$ and $\tilde{\mathfrak{u}}_{\text{res}} = \mathfrak{u}_{\text{res}} \oplus \mathbb{R}$ given by

$$\langle (\mu, \gamma), (A, a) \rangle_d = \langle \mu, A \rangle + \gamma a.$$

Proof of Proposition 5.2.5. By Theorem 4.2 in [156], the Banach space $(\tilde{\mathfrak{u}}_{\text{res}})_*$ is a Banach Lie-Poisson space if and only if its dual $\tilde{\mathfrak{u}}_{\text{res}}$ is a Banach Lie algebra satisfying $\text{ad}_x^*(\tilde{\mathfrak{u}}_{\text{res}})_* \subset (\tilde{\mathfrak{u}}_{\text{res}})_*$ for all $x \in \tilde{\mathfrak{u}}_{\text{res}}$. The fact that $\tilde{\mathfrak{u}}_{\text{res}}$ is a Banach Lie algebra follows directly from the continuity of s and from the 2-cocycle identity which implies the Jacobi identity of $[\cdot, \cdot]_d$. To see that the coadjoint action of $\tilde{\mathfrak{u}}_{\text{res}}$ preserves the predual $(\tilde{\mathfrak{u}}_{\text{res}})_*$, note that for every $(A, a), (B, b) \in \tilde{\mathfrak{u}}_{\text{res}}$ and every $(\mu, \gamma) \in (\tilde{\mathfrak{u}}_{\text{res}})_*$, one has

$$\begin{aligned} \langle -\text{ad}_{(A,a)}^*(\mu, \gamma), (B, b) \rangle_d &:= \langle (\mu, \gamma), -\text{ad}_{(A,a)}(B, b) \rangle_d = \langle (\mu, \gamma), -[(A, a), (B, b)]_d \rangle_d \\ &= \langle (\mu, \gamma), (-[A, B], -s(A, B)) \rangle_d = -\text{Tr } \mu[A, B] - \gamma \text{Tr } A[d, B] \\ &= -\text{Tr } \mu[A, B] - \gamma \text{Tr } [A, d]B = \langle (-\text{ad}_A^*(\mu) - \gamma[A, d], 0), (B, b) \rangle_d. \end{aligned} \quad (5.9)$$

Since

$$[(\mathfrak{u}_{\text{res}})_*, \mathfrak{u}_{\text{res}}] \subseteq (\mathfrak{u}_{\text{res}})_*, \quad \text{and} \quad [d, \mathfrak{u}_{\text{res}}] \subset (\mathfrak{u}_{\text{res}})_*,$$

we conclude that $-\text{ad}^*(A)(\mu) - \gamma[A, d]$ belongs to $(\mathfrak{u}_{\text{res}})_*$ for every $A \in \mathfrak{u}_{\text{res}}$. Hence the predual $(\tilde{\mathfrak{u}}_{\text{res}})_*$ is preserved by the coadjoint action. Referring again to Theorem 4.2 in [156], it follows that the Poisson bracket of $f, g \in \mathcal{C}^\infty((\tilde{\mathfrak{u}}_{\text{res}})_*)$ is given by

$$\{f, g\}_d(\mu, \gamma) = \langle (\mu, \gamma), [Df(\mu, \gamma), Dg(\mu, \gamma)]_d \rangle_d.$$

Denoting respectively by D_μ and D_γ the partial Fréchet derivatives with respect to $\mu \in (\mathfrak{u}_{\text{res}})_*$ and $\gamma \in \mathbb{R}$, one has

$$\begin{aligned} \{f, g\}_d(\mu, \gamma) &= \langle (\mu, \gamma), [(D_\mu f, D_\gamma f), (D_\mu g, D_\gamma g)]_d \rangle_d \\ &= \langle (\mu, \gamma), ([D_\mu f, D_\mu g], s(D_\mu f, D_\mu g)) \rangle_d \\ &= \langle \mu, [D_\mu f, D_\mu g] \rangle + \gamma s(D_\mu f, D_\mu g), \end{aligned}$$

and this ends the proof. \square

Remark 5.2.6. By Theorem 4.2 in [156], it follows that the Hamiltonian vector field associated to a smooth function h on $(\mathbf{u}_{\text{res}})_*$ is given by

$$X_h(\mu, \gamma) = -\text{ad}_{(D_\mu h, D_\gamma h)}^*(\mu, \gamma) = (-\text{ad}_{D_\mu h}^* \mu - \gamma[D_\mu h, d], 0). \quad (5.10)$$

Remark 5.2.7. Note that, for each $\gamma \in \mathbb{R}$, $(\mathbf{u}_{\text{res}})_* \oplus \{\gamma\}$ is a Poisson submanifold of $(\tilde{\mathbf{u}}_{\text{res}})_*$ for the following Poisson bracket on the first factor

$$\{f, g\}_{d, \gamma}(\mu) := \langle \mu, [D_\mu f(\mu), D_\mu g(\mu)] \rangle + \gamma s(D_\mu f, D_\mu g).$$

Remark 5.2.8. The central extension $(\tilde{\mathbf{u}}_{\text{res}})_*$ of the Banach Lie-Poisson space $(\mathbf{u}_{\text{res}})_*$ is a particular example of the extensions of Banach Lie-Poisson spaces constructed in [157]. Indeed formula (5.8) for the bracket of two functions on $(\tilde{\mathbf{u}}_{\text{res}})_*$ can be alternatively deduced from the general formula (5.6) in Theorem 5.2 of [157], with $\mathfrak{c} = \mathbb{R}$, $\mathfrak{a} = (\mathbf{u}_{\text{res}})_*$, $\varphi = 0$ and $\omega = s$. The pairing in the second term of the right hand side of (5.6), Theorem 5.2, [157], is, in this special case, just the pairing between the real line and its dual given by multiplication of real numbers (the element $c \in \mathfrak{c}$ is γ), and the bracket of partial derivatives of the functions f and g with respect to c vanishes since \mathbb{R} is commutative.

Proposition 5.2.9. *The unitary group U_{res} acts on the Poisson manifold $(\mathbf{u}_{\text{res}})_* \oplus \{\gamma\} \subset (\tilde{\mathbf{u}}_{\text{res}})_*$ by the affine coadjoint action as follows. For $g \in U_{\text{res}}$,*

$$g \cdot (\mu, \gamma) := (\text{Ad}^*(g^{-1})(\mu) - \gamma\sigma(g), \gamma)$$

where $\mu \in (\mathbf{u}_{\text{res}})_*$, $\gamma \in \mathbb{R}$, and where

$$\begin{aligned} \sigma: U_{\text{res}} &\rightarrow (\mathbf{u}_{\text{res}})_*, \\ g &\mapsto gdg^{-1} - d. \end{aligned}$$

Proof. Let us verify that for every $g \in U_{\text{res}}$ we have $gdg^{-1} - d \in (\mathbf{u}_{\text{res}})_*$. Consider the block decomposition of g with respect to the direct sum $\mathcal{H} = \mathcal{H}_+ \oplus \mathcal{H}_-$

$$g = \begin{pmatrix} g_{++} & g_{+-} \\ g_{-+} & g_{--} \end{pmatrix} \in U_{\text{res}}.$$

One has

$$\begin{pmatrix} g_{++} & g_{+-} \\ g_{-+} & g_{--} \end{pmatrix} \begin{pmatrix} \mathbf{i} & 0 \\ 0 & -\mathbf{i} \end{pmatrix} \begin{pmatrix} g_{++}^* & g_{+-}^* \\ g_{-+}^* & g_{--}^* \end{pmatrix} = \begin{pmatrix} \mathbf{i}g_{++}g_{++}^* - \mathbf{i}g_{+-}g_{+-}^* & \mathbf{i}g_{++}g_{-+}^* - \mathbf{i}g_{+-}g_{--}^* \\ \mathbf{i}g_{-+}g_{++}^* - \mathbf{i}g_{--}g_{-+}^* & \mathbf{i}g_{-+}g_{-+}^* - \mathbf{i}g_{--}g_{--}^* \end{pmatrix} \quad (5.11)$$

Since $g_{\pm\mp}$ belongs to $L_2(\mathcal{H}_\mp, \mathcal{H}_\pm)$, the off-diagonal blocks of the right hand side are in $L_2(\mathcal{H}_\pm, \mathcal{H}_\mp)$. Further, since

$$\begin{pmatrix} g_{++} & g_{+-} \\ g_{-+} & g_{--} \end{pmatrix} \begin{pmatrix} g_{++}^* & g_{+-}^* \\ g_{-+}^* & g_{--}^* \end{pmatrix} = \begin{pmatrix} g_{++}g_{++}^* + g_{+-}g_{-+}^* & g_{++}g_{-+}^* + g_{+-}g_{--}^* \\ g_{-+}g_{++}^* + g_{--}g_{-+}^* & g_{-+}g_{-+}^* + g_{--}g_{--}^* \end{pmatrix} = \begin{pmatrix} \text{id} & 0 \\ 0 & \text{id} \end{pmatrix},$$

and since $L_2 \cdot L_2 \subset L_1$, one has

$$g_{++}g_{++}^* = \text{id} - g_{+-}g_{-+}^* \in \text{id} + L_1(\mathcal{H}_+)$$

and

$$g_{--}g_{--}^* = \text{id} - g_{-+}g_{-+}^* \in \text{id} + L_1(\mathcal{H}_-).$$

Consequently,

$$g_{++}g_{-+}^* - g_{+-}g_{-+}^* \in \text{id} + L_1(\mathcal{H}_+)$$

and

$$g_{-+}g_{-+}^* - g_{--}g_{-+}^* \in -\text{id} + L_1(\mathcal{H}_-).$$

Moreover, it is clear that the result of the multiplication (5.11) is skew-symmetric. Hence for all $g \in U_{\text{res}}$ we have $gdg^{-1} - d \in (\mathbf{u}_{\text{res}})_*$.

Denoting by $\text{Aff}((\mathfrak{u}_{\text{res}})_* \oplus \{\gamma\})$ the affine group of transformations of $(\mathfrak{u}_{\text{res}})_* \oplus \{\gamma\}$, it remains to show that

$$\begin{aligned} (\text{Ad}^*, -\gamma\sigma): \text{U}_{\text{res}} &\rightarrow \text{Aff}((\mathfrak{u}_{\text{res}})_* \oplus \{\gamma\}) = \text{GL}((\mathfrak{u}_{\text{res}})_* \oplus \{\gamma\}) \times (\mathfrak{u}_{\text{res}})_* \\ g &\mapsto (\text{Ad}^*(g^{-1}), -\gamma\sigma(g)) \end{aligned}$$

is a group homomorphism. For this, we have to check that $\sigma(g_1g_2) = \text{Ad}^*(g_1^{-1})\sigma(g_2) + \sigma(g_1)$ for all g_1, g_2 in U_{res} (see [148]). In fact

$$\begin{aligned} \sigma(g_1g_2) &= g_1g_2 d g_2^{-1} g_1^{-1} - d = g_1 (g_2 d g_2^{-1} - d) g_1^{-1} + (g_1 d g_1^{-1} - d) \\ &= \text{Ad}^*(g_1^{-1})(\sigma(g_2)) + \sigma(g_1), \end{aligned}$$

and this ends the proof. \square

Proposition 5.2.10. *The isotropy group of $(0, \gamma) \in (\mathfrak{u}_{\text{res}})_* \oplus \{\gamma\}$ for the U_{res} -affine coadjoint action is a Lie subgroup of U_{res} .*

Proof. An element X in the Lie algebra $\mathfrak{u}_{\text{res}}$ of U_{res} induces by the infinitesimal affine coadjoint action on $(\mathfrak{u}_{\text{res}})_* \oplus \{\gamma\}$ the following vector field

$$\begin{aligned} X \cdot (\mu, \gamma) &:= \frac{d}{dt} [\exp(tX) \cdot (\mu, \gamma)]_{t=0} \\ &= \left(\frac{d}{dt} [\text{Ad}^*(\exp(-tX))(\mu) - \gamma\sigma(\exp(tX))]_{t=0}, 0 \right) \\ &= (-\text{ad}_X^*(\mu) - \gamma[X, d], 0). \end{aligned}$$

By definition, the Lie algebra of the isotropy group of (μ, γ) is

$$\mathfrak{u}_{(\mu, \gamma)} := \{X \in \mathfrak{u}_{\text{res}} \mid -\text{ad}_X^*(\mu) - \gamma[X, d] = 0\}$$

The proposition is trivial when μ and γ vanish. For $\mu = 0$ and $\gamma \neq 0$, the Lie algebra $\mathfrak{u}_{(0, \gamma)}$ consist of all elements of $\mathfrak{u}_{\text{res}}$ which commute with d . Hence, for $\gamma \neq 0$, $\mathfrak{u}_{(0, \gamma)} = \mathfrak{u}(\mathcal{H}_+) \oplus \mathfrak{u}(\mathcal{H}_-)$. A topological complement to $\mathfrak{u}_{(0, \gamma)}$ in $\mathfrak{u}_{\text{res}}$ is $\mathfrak{m} := \mathfrak{u}(\mathcal{H}) \cap (\text{L}_2(\mathcal{H}_+, \mathcal{H}_-) \oplus \text{L}_2(\mathcal{H}_-, \mathcal{H}_+))$. \square

Proposition 5.2.11. *The affine coadjoint orbits of U_{res} that are smooth are tangent to the characteristic distribution of the Poisson manifold $(\tilde{\mathfrak{u}}_{\text{res}})_*$.*

Proof. By the proof of Proposition 5.2.10, the image of the differential of the orbit map is

$$\mathfrak{u}_{\text{res}} \cdot (\mu, \gamma) = \{(-\text{ad}_X^*(\mu) - \gamma[X, d], 0) \mid X \in \mathfrak{u}_{\text{res}}\}.$$

By Remark 5.2.6, the characteristic space at $(\mu, \gamma) \in (\tilde{\mathfrak{u}}_{\text{res}})_*$ is

$$P(\mu, \gamma) = \{X_h(\mu) = (-\text{ad}_{D_\mu h}^* \mu - \gamma[D_\mu h, d], 0) \mid h \in \mathcal{C}^\infty((\mathfrak{u}_{\text{res}})_*)\} = \{(-\text{ad}_X^* \mu - \gamma[X, d], 0) \mid X \in \mathfrak{u}_{\text{res}}\}.$$

Thus the assertion follows. \square

The *restricted Grassmannian* Gr_{res} is defined as the set of subspaces W of the Hilbert space \mathcal{H} such that the orthogonal projection from W to \mathcal{H}_+ (respectively to \mathcal{H}_-) is a Fredholm operator (respectively a Hilbert-Schmidt operator). It follows from Propositions 7.1.2 and 7.1.3 in [172] that Gr_{res} is a Hilbert manifold and a homogeneous space under the natural action of U_{res} . According to Proposition II.2 in [233], the connected components of U_{res} are the sets

$$\text{U}_{\text{res}}^k = \left\{ \begin{pmatrix} U_{++} & U_{+-} \\ U_{-+} & U_{--} \end{pmatrix} \in \text{U}_{\text{res}} \mid \text{index}(U_{++}) = k \right\} \quad \text{for } k \in \mathbb{Z}.$$

The pairwise disjoint sets

$$\text{Gr}_{\text{res}}^k = \{W \in \text{Gr}_{\text{res}} \mid \text{index}(p_+|_W: W \rightarrow H_+) = k\}, \quad k \in \mathbb{Z}$$

are the images of the connected components of U_{res} by the continuous projection $\text{U}_{\text{res}} \rightarrow \text{Gr}_{\text{res}} = \text{U}_{\text{res}} / (\text{U}(\mathcal{H}_+) \times \text{U}(\mathcal{H}_-))$, and thus they are the connected components of Gr_{res} . In particular, the connected component of Gr_{res} containing \mathcal{H}_+ is Gr_{res}^0 . The Kähler structure of the restricted

Grassmannian is defined in [172], Section 7.8. According to the convention in [172], the Kähler form ω_{Gr} of Gr_{res} is the U_{res} -invariant 2-form whose value at \mathcal{H}_+ is given by

$$\omega_{\text{Gr}}(X, Y) = 2\Im \text{Tr}(X^*Y), \quad (5.12)$$

where $X, Y \in L_2(\mathcal{H}_+, \mathcal{H}_-) \simeq T_{\mathcal{H}_+} \text{Gr}_{\text{res}}$ and $\Im z$ denotes the imaginary part of $z \in \mathbb{C}$. Equivalently, ω_{Gr} is the quotient of the following real-valued anti-symmetric bilinear form Ω_{Gr} on $\mathfrak{u}_{\text{res}}$ which vanishes on $\mathfrak{u}(\mathcal{H}_+) \oplus \mathfrak{u}(\mathcal{H}_-)$ and is invariant under the $U(\mathcal{H}_+) \times U(\mathcal{H}_-)$ -action (see Corollary III.8 in [233]):

$$\Omega_{\text{Gr}}(A, B) = -\frac{1}{2}s(A, B) \quad (5.13)$$

where A and B belong to $\mathfrak{u}_{\text{res}}$. In this correspondence, an element $A = \begin{pmatrix} A_{++} & -A_{-+}^* \\ A_{-+} & A_{--} \end{pmatrix}$ in $\mathfrak{u}_{\text{res}}$ is identified with the vector $X = A_{-+}$ in $L_2(\mathcal{H}_+, \mathcal{H}_-) \simeq T_{\mathcal{H}_+}(\text{Gr}_{\text{res}})$.

Proposition 5.2.12. *For every $\gamma \neq 0$, the connected components of the U_{res} -affine coadjoint orbit $\mathcal{O}_{(0,\gamma)}$ of $(0, \gamma) \in (\mathfrak{u}_{\text{res}})_* \oplus \{\gamma\}$ are strong symplectic leaves in the Banach Lie-Poisson space $(\tilde{\mathfrak{u}}_{\text{res}})_*$.*

Proof. We recall from Proposition 5.2.5 that $(\tilde{\mathfrak{u}}_{\text{res}})_*$ is a Banach Lie-Poisson space. By Proposition 5.2.10, the isotropy group $U_{(0,\gamma)}$ of $(0, \gamma)$ for the U_{res} -affine coadjoint action is a Banach Lie subgroup of U_{res} since its Lie algebra $\mathfrak{u}_{(0,\gamma)}$ is complemented in $\mathfrak{u}_{\text{res}}$. Let us denote by \tilde{U}_{res} the central extension of U_{res} with Lie algebra $\tilde{\mathfrak{u}}_{\text{res}}$ and by $p : \tilde{U}_{\text{res}} \rightarrow U_{\text{res}}$ the projection map in the exact sequence $1 \rightarrow S^1 \rightarrow \tilde{U}_{\text{res}} \rightarrow U_{\text{res}} \rightarrow 1$. The group \tilde{U}_{res} is isomorphic to the unitary subgroup of $\text{GL}_{\tilde{\mathfrak{u}}_{\text{res}}}$, the central extension of the group of invertible elements in \mathcal{B}_{res} constructed in [172], Section 6.6 (see also Section II.3 in [233]). The usual coadjoint action of \tilde{U}_{res} on the dual of its Lie algebra leaves the predual $(\tilde{\mathfrak{u}}_{\text{res}})_*$ invariant since by equation (5.9) and the arguments in the proof of Proposition 5.2.5 following it, one has

$$-\text{ad}_{(A,a)}^*(\mu, \gamma) = (-\text{ad}_A^*(\mu) - \gamma[A, d], 0) \in (\tilde{\mathfrak{u}}_{\text{res}})_*. \quad (5.14)$$

The isotropy group $\tilde{U}_{(0,\gamma)}$ of $(0, \gamma) \in (\tilde{\mathfrak{u}}_{\text{res}})_*$ for the usual coadjoint action of \tilde{U}_{res} is a Banach Lie subgroup of \tilde{U}_{res} since its Lie algebra

$$\tilde{\mathfrak{u}}_{(0,\gamma)} := \{(A, a) \in \mathfrak{u}_{\text{res}} \mid -\text{ad}_{(A,a)}^*(0, \gamma) = 0\} = \mathfrak{u}_{(0,\gamma)} \oplus \mathbb{R}$$

is complemented in $\tilde{\mathfrak{u}}_{\text{res}}$. It follows from Theorem 7.3 in [156] that the homogeneous space $\tilde{U}_{\text{res}}/\tilde{U}_{(0,\gamma)}$, which admits a unique smooth Banach manifold structure making the canonical projection $\tilde{\pi} : \tilde{U}_{\text{res}} \rightarrow \tilde{U}_{\text{res}}/\tilde{U}_{(0,\gamma)}$ a surjective submersion, carries a weak symplectic two-form $\omega_{(0,\gamma)}$ given by

$$\omega_{(0,\gamma)}([\tilde{g}]) (T_{\tilde{g}}\tilde{\pi}(T_e L_{\tilde{g}}\xi), T_{\tilde{g}}\tilde{\pi}(T_e L_{\tilde{g}}\eta)) := \langle (0, \gamma), [\xi, \eta]_d \rangle_d, \quad (5.15)$$

where $\xi, \eta \in \tilde{\mathfrak{u}}_{\text{res}}$, $\tilde{g} \in \tilde{U}_{\text{res}}$, $[\tilde{g}] := \tilde{\pi}(\tilde{g})$. The usual coadjoint action of \tilde{U}_{res} on the predual $(\tilde{\mathfrak{u}}_{\text{res}})_*$ and the affine coadjoint action of U_{res} on $(\tilde{\mathfrak{u}}_{\text{res}})_*$ defined in Proposition 5.2.9 are related by

$$\text{Ad}^*(\tilde{g}^{-1})(\mu, \gamma) = p(\tilde{g}) \cdot (\mu, \gamma), \quad (5.16)$$

where $(\mu, \gamma) \in (\tilde{\mathfrak{u}}_{\text{res}})_*$. To see this, note that the coadjoint action of the center of the extended group is trivial. Therefore the corresponding action descends to an action of the restricted unitary group. The tangent maps of the group homomorphisms $\tilde{U}_{\text{res}} \rightarrow \text{GL}((\tilde{\mathfrak{u}}_{\text{res}})_*)$ defined by the left and right hand sides of (5.16) coincide by equation (5.14), hence equation (5.16) holds for \tilde{g} in the connected component of the unit in \tilde{U}_{res} which is simply connected by Proposition IV.9(i) in [149]. The general case follows by verifying formula (5.16) for the shift operator since by the remark following Definition and Proposition II.23 and Proposition II.27 in [233], we have $\tilde{U}_{\text{res}} = \tilde{U}_{\text{res}}^0 \rtimes \mathbb{Z}$ where the action of $1 \in \mathbb{Z}$ on \tilde{U}_{res}^0 projects to the conjugation by the shift on U_{res}^0 . Consequently, the U_{res} -affine coadjoint orbit $\mathcal{O}_{(0,\gamma)}$ is the coadjoint orbit of $(0, \gamma)$ for the usual coadjoint action of \tilde{U}_{res} . It follows from Theorem 7.4 in [156] that the map

$$\iota : [\tilde{g}] \in \tilde{U}_{\text{res}}/\tilde{U}_{(0,\gamma)} \mapsto \text{Ad}_{\tilde{g}^{-1}}^*(0, \gamma) \in (\tilde{\mathfrak{u}}_{\text{res}})_* \quad (5.17)$$

is an injective weak immersion of the quotient manifold $\tilde{U}_{\text{res}}/\tilde{U}_{(0,\gamma)}$ into the predual space $(\tilde{\mathfrak{u}}_{\text{res}})_*$, and that the connected component of the affine coadjoint orbit $\mathcal{O}_{(0,\gamma)}$ endowed with the smooth manifold structure making ι into a diffeomorphism and the symplectic form given by $\iota_*(\omega_{(0,\gamma)})$ are symplectic leaves of the Banach Lie-Poisson space $(\tilde{\mathfrak{u}}_{\text{res}})_*$. By Theorem 7.5 in [156], this symplectic form is in fact strong. \square

Theorem 5.2.13. *The connected components of the restricted Grassmannian are strong symplectic leaves in the Banach Lie-Poisson space $(\tilde{\mathfrak{u}}_{\text{res}})_*$. More precisely, for every $\gamma \neq 0$, the U_{res} -affine coadjoint orbit $\mathcal{O}_{(0,\gamma)}$ of $(0, \gamma) \in (\mathfrak{u}_{\text{res}})_* \oplus \{\gamma\}$ is isomorphic to the restricted Grassmannian Gr_{res} via the map*

$$\begin{aligned} \Phi_\gamma: \text{Gr}_{\text{res}} &\rightarrow \mathcal{O}_{(0,\gamma)} \\ W &\mapsto 2i\gamma(p_W - p_+), \end{aligned}$$

where p_W denotes the orthogonal projection on W . The pull-back by Φ_γ of the symplectic form on $\mathcal{O}_{(0,\gamma)}$ is (-2γ) -times the symplectic form ω_{Gr} on Gr_{res} .

Proof. An element in the affine coadjoint orbit $\mathcal{O}_{(0,\gamma)}$ of $(0, \gamma)$ is of the form (ρ, γ) with

$$\rho = \gamma(g d g^{-1} - d) = 2i\gamma(g p_+ g^{-1} - p_+),$$

for some $g \in U_{\text{res}}$ (where we have used the identity $p_- = \text{id} - p_+$ to simplify the formula for the affine coadjoint action given in Proposition 5.2.9). By Corollary III.4 ii) in [233], Φ_γ is bijective for $\gamma \neq 0$. Since the manifold structure of the orbit $\mathcal{O}_{(0,\gamma)}$ is induced by the identification $\mathcal{O}_{(0,\gamma)} = U_{\text{res}}/(U(\mathcal{H}_+) \times U(\mathcal{H}_-))$, it follows from Corollary III.4 i) in [233] that Φ_γ is a diffeomorphism. The symplectic form $\omega_\mathcal{O}$ on $\mathcal{O}_{(0,\gamma)}$ is the U_{res} -invariant symplectic form whose value at $(0, \gamma) \in \mathcal{O}_{(0,\gamma)}$ is the given by

$$\omega_\mathcal{O}(0, \gamma)(X_f(0, \gamma), X_g(0, \gamma)) = \{f, g\}_d(0, \gamma),$$

where f and g are any smooth functions on $(\mathfrak{u}_{\text{res}})_*$. Using formulas (5.10) and (5.8), it then follows that

$$\omega_\mathcal{O}(0, \gamma)(\gamma[D_\mu f, d], \gamma[D_\mu g, d]) = \gamma s(D_\mu f, D_\mu g).$$

Hence for every $A, B \in \mathfrak{u}_{\text{res}}$, one has

$$\omega_\mathcal{O}(0, \gamma)(\gamma[A, d], \gamma[B, d]) = \gamma s(A, B) = -2\gamma\Omega_{\text{Gr}}(A, B).$$

It follows that the real-valued anti-symmetric bilinear form on $\mathfrak{u}_{\text{res}}$ corresponding to the symplectic form $\omega_\mathcal{O}$ on $\mathcal{O}_{(0,\gamma)} = U_{\text{res}}/(U(\mathcal{H}_+) \times U(\mathcal{H}_-))$ equals $-2\gamma\Omega_{\text{Gr}}$ (where the latter identification is given by the orbit map), and this ends the proof. \square

Remark 5.2.14. We refer to the paper [157] for additional information on the relationship between the Banach Lie-Poisson spaces and the theory of Lie algebra extensions.

5.3 Coadjoint orbits of the restricted unitary group

This section includes some partial answers to Question 5.1.2. The main difficulty is to show that the isotropy group of an element in the predual $(\mathfrak{u}_{\text{res}})_*$ is a Lie subgroup of U_{res} , or equivalently that its Lie algebra is complemented in $\mathfrak{u}_{\text{res}}$. Using the averaging method developed in [19] and [22] for constructing closed complements, we will be able to show that the U_{res} -coadjoint orbit of every element $\rho \in (\mathfrak{u}_{\text{res}})_*$ which commutes with d is a smooth manifold and that its connected components are symplectic leaves of the characteristic distribution (see Proposition 5.3.3). It follows that the same conclusion holds for every element $\rho \in (\mathfrak{u}_{\text{res}})_*$ which is U_{res} -conjugate to an element commuting with d , or equivalently to a diagonal operator with respect to a Hilbert basis compatible with the eigenspaces of d . The set of elements with the latter property is not equal to the whole $(\mathfrak{u}_{\text{res}})_*$; however, it is dense (for more details see the proof of Corollary 5.3.5). Recall that in finite dimensions, every element in the Lie algebra $\mathfrak{u}(n)$ of the unitary group $U(n)$ is $U(n)$ -conjugate to a diagonal matrix with respect to a given basis of \mathbb{C}^n , or, in other words, $U(n)$ acts transitively on the set of Cartan subalgebras of $\mathfrak{u}(n)$. This is no longer true in the infinite-dimensional case (see Subsection 5.6.3). It is a difficult question to decide whether a given operator ρ in $(\mathfrak{u}_{\text{res}})_*$ or $\mathfrak{u}_{\text{res}}$ has the good property of being U_{res} -conjugate to a diagonal operator with respect to a basis adapted to the decomposition $\mathcal{H} = \mathcal{H}_+ \oplus \mathcal{H}_-$. In Propositions 5.3.5 and 5.3.7, we give some concrete criteria to check that property.

Conjecture 5.3.1. *The real Banach space $(\mathbf{u}_{\text{res}})_*$ has a natural structure of Banach Lie-Poisson space and its characteristic distribution is integrable.*

We refer to [155] for a discussion of integrable distributions on Banach manifolds. The meaning of the integrability of the characteristic distribution in Conjecture 5.3.1 is that for every $\mu_0 \in (\mathbf{u}_{\text{res}})_*$ there exist a connected Banach manifold M and a smooth injective mapping $\psi: M \rightarrow (\mathbf{u}_{\text{res}})_*$ such that $\mu_0 \in \psi(M)$ and for every $x \in M$ the tangent map $T_x\psi: T_xM \rightarrow T_{\psi(x)}((\mathbf{u}_{\text{res}})_*)$ is also injective and its range is equal to the fiber of the characteristic distribution at the point $\psi(x) \in (\mathbf{u}_{\text{res}})_*$. Such a pair (M, ψ) (or just the manifold M , for the sake of simplicity) is said to be an integral manifold of the characteristic distribution of $(\mathbf{u}_{\text{res}})_*$ through the point μ_0 .

Remark 5.3.2. It is clear that

$$(\mathbf{u}_{\text{res}})_* \hookrightarrow \mathbf{u}_{\text{res}}$$

with a continuous inclusion map. On the other hand, it follows at once by the multiplication formula (5.2) that

$$[(\mathbf{u}_{\text{res}})_*, \mathbf{u}_{\text{res}}] \subseteq (\mathbf{u}_{\text{res}})_*, \quad (5.18)$$

which implies that the predual $(\mathbf{u}_{\text{res}})_*$ is left invariant by the coadjoint representation of the Banach Lie algebra \mathbf{u}_{res} . Now the results of [156] imply the following two facts:

- The predual Banach space $(\mathbf{u}_{\text{res}})_*$ has a natural structure of Banach Lie-Poisson space.
- If $\rho \in (\mathbf{u}_{\text{res}})_*$ has the property that the corresponding isotropy group

$$U_{\text{res},\rho} := \{u \in U_{\text{res}} \mid u\rho u^{-1} = \rho\}$$

is a Banach Lie subgroup of U_{res} , then the coadjoint orbit \mathcal{O}_ρ is an integral manifold of the characteristic distribution of $(\mathbf{u}_{\text{res}})_*$. Moreover, \mathcal{O}_ρ is a weakly symplectic manifold when equipped with the orbit symplectic structure.

Thus, the desired conclusion will follow as soon as we prove that the isotropy group $U_{\text{res},\rho}$ of any $\rho \in (\mathbf{u}_{\text{res}})_*$ is a Banach Lie subgroup of U_{res} . Throughout the present chapter, by *Banach Lie subgroup* we mean the same notion as in [37] or [156]: a subgroup of a Banach Lie group which has a structure of Banach Lie group of its own with respect to the relative topology and has the additional property that the corresponding Lie subalgebra has a closed complement in the Lie algebra of the ambient Banach Lie group.

As an easy consequence of the Harris-Kaup theorem (see for instance Theorem 4.13 in [20]) the isotropy group $U_{\text{res},\rho}$ of any $\rho \in (\mathbf{u}_{\text{res}})_*$ does have a structure of Banach Lie group of its own with respect to the relative topology, so the only point that remains to be settled is the existence of a closed complement of the isotropy Lie algebra. The Lie algebra of $U_{\text{res},\rho}$ is given by

$$\mathbf{u}_{\text{res},\rho} = \{a \in \mathbf{u}_{\text{res}} \mid a\rho = \rho a\} = \{a \in \mathbf{u}_{\text{res}} \mid (\forall t \in \mathbb{R}) \quad \alpha_t(a) = a\},$$

where

$$\alpha: \mathbb{R} \rightarrow \mathcal{B}(\mathbf{u}_{\text{res}}), \quad \alpha(t)b := \alpha_t(b) := \exp(t\rho) \cdot b \cdot \exp(-t\rho).$$

It is clear that α is a group homomorphism. Moreover, since $\rho \in (\mathbf{u}_{\text{res}})_* \subseteq \mathbf{u}_{\text{res}}$ and the adjoint action of the Banach Lie group U_{res} is continuous, it follows that $\alpha: \mathbb{R} \rightarrow \mathcal{B}(\mathbf{u}_{\text{res}})$ is norm continuous.

On the other hand, it follows by (5.18) that

$$(\forall t \in \mathbb{R}) \quad \alpha_t((\mathbf{u}_{\text{res}})_*) \subseteq (\mathbf{u}_{\text{res}})_*, \quad (5.19)$$

since $\rho \in (\mathbf{u}_{\text{res}})_*$. Then the concrete form of the duality pairing between $(\mathbf{u}_{\text{res}})_*$ and \mathbf{u}_{res} (see (5.3)) shows that

$$(\forall t \in \mathbb{R}) \quad (\alpha_t|_{(\mathbf{u}_{\text{res}})_*})^* = \alpha_{-t}, \quad (5.20)$$

and in particular each operator $\alpha_t: \mathbf{u}_{\text{res}} \rightarrow \mathbf{u}_{\text{res}}$ is weak*-continuous.

Now a complement to $\mathbf{u}_{\text{res},\rho}$ in \mathbf{u}_{res} can be constructed by the averaging technique over the amenable group $(\mathbb{R}, +)$ provided one has $\sup_{t \in \mathbb{R}} \|\alpha_t\| < \infty$. (Some references for the aforementioned averaging technique are [19], the proof of Proposition 3.4 in [26], and [22].)

Additionally we note that since for every operator $T: X \rightarrow Y$ between the Banach spaces X and Y the norm of T equals the norm of its dual T^* , it is enough to estimate uniformly the norm of α_t restricted to the predual $(\mathbf{u}_{\text{res}})_*$. This restriction is an adjoint action of the group corresponding to the predual.

Proposition 5.3.3. *If $\rho \in (\mathfrak{u}_{\text{res}})_*$ and $[d, \rho] = 0$, then the coadjoint isotropy group of ρ is a Banach Lie subgroup of U_{res} and the connected components of the corresponding U_{res} -coadjoint orbit \mathcal{O}_ρ are smooth leaves of the characteristic distribution of $(\mathfrak{u}_{\text{res}})_*$.*

Proof. According to Remark 5.3.2 it suffices to show that $\sup_{t \in \mathbb{R}} \|\alpha_t\| < \infty$. The hypothesis $[d, \rho] = 0$ shows that ρ preserves \mathcal{H}_+ and \mathcal{H}_- , that is

$$\rho = \begin{pmatrix} \rho_{++} & 0 \\ 0 & \rho_{--} \end{pmatrix} \in (\mathfrak{u}_{\text{res}})_*.$$

An element $b \in (\mathfrak{u}_{\text{res}})_*$ with block decomposition with respect to the direct sum $\mathcal{H} = \mathcal{H}_+ \oplus \mathcal{H}_-$

$$b = \begin{pmatrix} b_{++} & b_{+-} \\ b_{-+} & b_{--} \end{pmatrix}$$

is the sum of an element

$$b_1 = \begin{pmatrix} b_{++} & 0 \\ 0 & b_{--} \end{pmatrix}$$

in the Lie algebra $\mathfrak{u}_0 := \mathfrak{u}_1 \cap (\mathfrak{u}(\mathcal{H}_+) \times \mathfrak{u}(\mathcal{H}_-))$ and an element

$$b_2 = \begin{pmatrix} 0 & b_{+-} \\ b_{-+} & 0 \end{pmatrix}$$

in the topological complement $\mathfrak{m} = \mathfrak{u}(\mathcal{H}) \cap (\mathbb{L}_2(\mathcal{H}_+, \mathcal{H}_-) \oplus \mathbb{L}_2(\mathcal{H}_-, \mathcal{H}_+))$ of \mathfrak{u}_0 in $(\mathfrak{u}_{\text{res}})_*$. Accordingly,

$$\begin{aligned} \|\alpha_t(b)\|_{(\mathfrak{u}_{\text{res}})_*} &= \|\exp(t\rho)b\exp(-t\rho)\|_{(\mathfrak{u}_{\text{res}})_*} \\ &= \|\exp(t\rho)b_1\exp(-t\rho) + \exp(t\rho)b_2\exp(-t\rho)\|_{(\mathfrak{u}_{\text{res}})_*} \\ &= \|e^{\text{ad}(t\rho)}(b_1) + e^{\text{ad}(t\rho)}(b_2)\|_{(\mathfrak{u}_{\text{res}})_*}. \end{aligned}$$

Since $\text{ad}(t\rho)$ preserves both \mathfrak{u}_0 and \mathfrak{m} , it follows that

$$e^{\text{ad}(t\rho)}(b_1) \in \mathfrak{u}_0 \quad \text{and} \quad e^{\text{ad}(t\rho)}(b_2) \in \mathfrak{m}.$$

By the very definition of the norm $\|\cdot\|_{(\mathfrak{u}_{\text{res}})_*}$, one has

$$\|\alpha_t(b)\|_{(\mathfrak{u}_{\text{res}})_*} = \|e^{\text{ad}(t\rho)}(b_1)\|_1 + \|e^{\text{ad}(t\rho)}(b_2)\|_2,$$

where $\|\cdot\|_1$ (respectively $\|\cdot\|_2$) is the usual norm in L_1 (respectively L_2). Since the conjugation by a unitary element preserves both $\|\cdot\|_1$ and $\|\cdot\|_2$, it follows that α_t acts by isometries on $(\mathfrak{u}_{\text{res}})_*$, in particular $\sup_{t \in \mathbb{R}} \|\alpha_t\| < \infty$. \square

Remark 5.3.4. The calculation in the proof of Proposition 5.3.3 actually shows that for every $u \in U_{\text{res}}$ satisfying $[d, u] = 0$ we have $\|ubu^{-1}\|_{\text{res}} = \|b\|_{\text{res}}$ whenever $b \in \mathcal{B}_{\text{res}}$. In fact

$$\|ubu^{-1}\|_{\text{res}} = \|ubu^{-1}\| + \|[d, ubu^{-1}]\|_2 = \|b\| + \|u[d, b]u^{-1}\|_2 = \|b\| + \|[d, b]\|_2 = \|b\|_{\text{res}}$$

where the second equality follows since $[d, u] = 0$. Note also that

$$\|ab\|_{\text{res}} = \|ab\| + \|[d, a]b + a[d, b]\|_2 \leq \|a\|\|b\| + \|[d, a]\|_2\|b\| + \|a\|\|[d, b]\|_2 \leq \|a\|_{\text{res}}\|b\|_{\text{res}}.$$

Corollary 5.3.5. *If $\rho \in (\mathfrak{u}_{\text{res}})_*$ is a finite-rank operator, then the coadjoint isotropy group of ρ is a Banach Lie subgroup of U_{res} and the connected components of the corresponding U_{res} -coadjoint orbit \mathcal{O}_ρ are smooth leaves of the characteristic distribution of $(\mathfrak{u}_{\text{res}})_*$.*

Proof. The set of finite-rank operators \mathcal{F} is a dense subset of the predual $(\mathfrak{u}_{\text{res}})_*$. For every skew-symmetric finite-rank operator F there exists a unitary operator $u \in \mathbb{1} + \mathcal{F}$, such that uFu^{-1} leaves both \mathcal{H}_- and \mathcal{H}_+ invariant. (This follows since any two finite-rank operators are contained in a certain finite-dimensional Lie algebra of finite-rank operators; see for instance Lemma 1 in Chapter I of [90] or Proposition 3.1 in [194].) Note that $u \in U_{\text{res}}$, and the isotropy groups of the elements F and uFu^{-1} are conjugated by the element u . Hence the isotropy group at any finite-rank operator is a Banach Lie subgroup of U_{res} , and this shows that the conclusion of Proposition 5.3.3 is satisfied if we replace the hypothesis $[d, \rho] = 0$ by the condition that ρ is a finite-rank operator. \square

Remark 5.3.6. An alternative way to prove Corollary 5.3.5 is to pick a $*$ -invariant d -invariant subalgebra containing the skew-symmetric finite-rank operator F and thus to reduce things to the finite-dimensional setting.

Corollary 5.3.7. *Assume that $\rho \in (\mathfrak{u}_{\text{res}})_*$ and that there exist an orthonormal basis $\{e_n\}_{n \geq 1}$ of the Hilbert space \mathcal{H} and the real numbers $t \in (0, 1)$ and $s \in (0, 3(1-t)/100]$ such that the following conditions are satisfied:*

- (i) *We have $\{e_n \mid n \geq 1\} \subseteq \mathcal{H}_+ \cup \mathcal{H}_-$.*
- (ii) *The matrix $(\rho_{mn})_{m,n \geq 1}$ of ρ with respect to the basis $\{e_n\}_{n \geq 1}$ has the properties*

$$|\rho_{m+1,n+1}| \leq t|\rho_{m,n}| \text{ whenever } m, n \geq 1,$$

and

$$|\rho_{m,n}|^2 \leq \frac{s^2}{(mn)^2} |\rho_{mm}\rho_{nn}| \text{ whenever } m, n \geq 1 \text{ and } m \neq n.$$

Then the coadjoint isotropy group of ρ is a Banach Lie subgroup of \mathbf{U}_{res} and the connected components of the corresponding \mathbf{U}_{res} -coadjoint orbit \mathcal{O}_ρ are smooth leaves of the characteristic distribution of $(\mathfrak{u}_{\text{res}})_$.*

Proof. It follows at once by Theorem 1 in [98] that there exists an operator $a = -a^* \in \mathbf{L}_2(\mathcal{H})$ such that the operator $u\rho u^{-1}$ is diagonal with respect to the basis $\{e_n\}_{n \geq 1}$, where $u = \exp a$. In particular we have $u \in \mathbf{U}_2 \subseteq \mathbf{U}_{\text{res}}$ and $[d, u\rho u^{-1}] = 0$, so that we can use Proposition 5.3.3 to get the desired conclusion. \square

Remark 5.3.8. Let $\rho \in \mathcal{B}(\mathcal{H})$. In addition to the applications of Proposition 5.3.3 in the proofs of Corollaries 5.3.5 and 5.3.7, we note that each of the following two conditions is equivalent to the existence of an unitary operator $u \in \mathbf{U}_{\text{res}}$ such that $[d, u\rho u^{-1}] = 0$:

- (i) There exists $p \in \mathcal{B}(\mathcal{H})$ such that $p = p^* = p^2$, $p - p_+ \in \mathbf{L}_2(\mathcal{H})$, and $\rho p = p\rho$.
- (ii) There exists an element $\mathcal{W} \in \text{Gr}_{\text{res}}$ such that $\rho(\mathcal{W}) \subseteq \mathcal{W}$.

In fact, our assertion concerning (i) follows at once since

$$\{p \in \mathcal{B}(\mathcal{H}) \mid p = p^* = p^2 \text{ and } p - p_+ \in \mathbf{L}_2(\mathcal{H})\} = \{up_+u^{-1} \mid u \in \mathbf{U}_{\text{res}}\}$$

according to Lemma 3.1 in [47].

On the other hand, the assertion on condition (ii) holds since by Proposition 7.1.3 in [172] we have

$$\text{Gr}_{\text{res}} = \{u(\mathcal{H}_+) \mid u \in \mathbf{U}_{\text{res}}\}$$

and, in addition, if $p \in \mathcal{B}(\mathcal{H})$ is the orthogonal projection onto some closed subspace $\mathcal{W} \subseteq \mathcal{H}$ then $\rho(\mathcal{W}) \subseteq \mathcal{W}$ if and only if $[p, \rho] = 0$. To see this, recall that $\rho^* = -\rho$, hence $\rho(\mathcal{W}) \subseteq \mathcal{W}$ if and only if $\rho(\mathcal{W}^\perp) \subseteq \mathcal{W}^\perp$.

5.4 Some smooth adjoint orbits of the restricted unitary group

We are going to investigate in this section the smoothness of adjoint orbits of the restricted unitary group and derive some consequences about the smoothness of affine coadjoint orbits of the restricted unitary group. In particular, we shall find sufficiently many smooth adjoint orbits of \mathbf{U}_{res} to fill an open subset of the Lie algebra $\mathfrak{u}_{\text{res}}$ (see Proposition 5.4.2), as well as sufficiently many smooth affine coadjoint orbits of \mathbf{U}_{res} to fill an open subset of the Lie algebra $(\mathfrak{u}_{\text{res}})_*$ (see Corollary 5.4.4).

Lemma 5.4.1. *Assume that the element*

$$\rho = \begin{pmatrix} \rho_{++} & \rho_{+-} \\ \rho_{-+} & \rho_{--} \end{pmatrix} \in \mathfrak{u}_{\text{res}}$$

satisfies the conditions

$$\sigma(\rho_{++}) \cap \sigma(\rho_{--}) = \emptyset, \quad (5.21)$$

(where $\sigma(\rho_{\pm\pm})$ denotes the spectrum of $\rho_{\pm\pm}$) and

$$\|\rho_{+-}\|_2 < \frac{1}{2} \text{dist}(\sigma(\rho_{++}), \sigma(\rho_{--})). \quad (5.22)$$

Then there exists $u \in \mathbf{U}_{\text{res}}$ such that $[d, u^{-1}\rho u] = 0$.

Proof. The hypotheses (5.21) and (5.22) imply that there exists a Hilbert-Schmidt operator $k: \mathcal{H}_+ \rightarrow \mathcal{H}_-$ satisfying the operator Riccati equation

$$k\rho_{+-}k + k\rho_{++} - \rho_{--}k = \rho_{-+}.$$

(This result was obtained in [145]; see also Theorem 4.6 and Remark 4.7 in [3], as well as [4].) Then the operator

$$g = \begin{pmatrix} \text{id}_{\mathcal{H}_+} & k^* \\ k & -\text{id}_{\mathcal{H}_-} \end{pmatrix}$$

is invertible and has the properties $[d, g] \in \mathbf{L}_2(\mathcal{H})$, $g = g^*$, $[d, g^2] = 0$ and

$$[d, g^{-1}\rho g] = 0 \quad (5.23)$$

(see Subsection 2.3 in [3]). Now let $g = us$ be the polar decomposition of the invertible operator $g \in \mathcal{B}(\mathcal{H})$, where $u \in \mathcal{B}(\mathcal{H})$ is unitary and $s = (g^*g)^{1/2}$.

On the other hand, since $d^* = -d$, it follows that the commutant $\{d\}'$ is a von Neumann algebra of operators on \mathcal{H} . Thus, since $g = g^*$ and $g^*g = g^2 \in \{d\}'$, it is straightforward to deduce that $(g^*g)^{1/2} \in \{d\}'$, that is, $[d, s] = 0$. Now recall that $[d, g] \in \mathbf{L}_2(\mathcal{H})$ to deduce that the unitary operator $u = gs^{-1}$ satisfies $[d, u] \in \mathbf{L}_2(\mathcal{H})$, that is, $u \in \mathbf{U}_{\text{res}}$.

Moreover by (5.23) we have

$$0 = [d, g^{-1}\rho g] = [d, s^{-1}u^{-1}\rho us] = s^{-1}[d, u^{-1}\rho u]s,$$

where the latter equality follows since we have seen that $[d, s] = 0$. Now we get $[d, u^{-1}\rho u] = 0$, as desired. \square

Proposition 5.4.2. *For any $\gamma \in \mathbb{R} \setminus \{0\}$, there exists an open \mathbf{U}_{res} -invariant neighborhood V of $\gamma d \in \mathbf{u}_{\text{res}}$ such that V is a union of smooth adjoint orbits of the Banach Lie group \mathbf{U}_{res} .*

Proof. Denote by V_γ the set of all elements

$$\rho = \begin{pmatrix} \rho_{++} & \rho_{+-} \\ \rho_{-+} & \rho_{--} \end{pmatrix} \in \mathbf{u}_{\text{res}}$$

satisfying conditions

$$\sigma(\rho_{\pm\pm}) \subseteq \{y \in \mathbb{R} \mid |y \mp \gamma i| < 1/3\}$$

and

$$\|\rho_{\pm\mp}\|_2 < \frac{2}{3}.$$

Recall that $\rho_{\pm\pm} \mp \gamma i$ is skew-Hermitian, hence its spectral radius equals its operator norm and the condition $\sigma(\rho_{\pm\pm}) \subseteq \{y \in \mathbb{R} \mid |y \mp \gamma i| < 1/3\}$ is equivalent to $\|\rho_{\pm\pm} \mp \gamma i\| < 1/3$. Note that

$$\begin{pmatrix} \rho_{++} & 0 \\ 0 & \rho_{--} \end{pmatrix} = \rho - \frac{1}{2i}[d, \rho],$$

hence the condition on the spectrum of $\rho_{\pm\pm}$ defines an open subset of \mathbf{u}_{res} . On the other hand, the condition $\|\rho_{\pm\mp}\|_2 < 2/3$ is equivalent to $\|[d, \rho]\|_{\text{res}} < 2\sqrt{2}/3$ (since $\rho_{\pm\mp}^* = \rho_{\mp\pm}$) hence it also describes an open subset of \mathbf{u}_{res} . It follows that V_γ is an open neighborhood of $\gamma d \in \mathbf{u}_{\text{res}}$. We are going to show that the set

$$V := \bigcup_{u \in \mathbf{U}_{\text{res}}} \text{Ad}_{\mathbf{U}_{\text{res}}}(u)V_\gamma \subseteq \mathbf{u}_{\text{res}}$$

has the desired properties.

Indeed, V is clearly invariant under the adjoint action of U_{res} , it is a union of open sets, and one of these open sets contains γd . Moreover, it follows by Lemma 5.4.1 along with the construction of V that for every $\rho \in V$ there exists $u \in U_{\text{res}}$ such that $[d, u^{-1}\rho u] = 0$. Next denote $\tilde{\rho} = u^{-1}\rho u$, so that $\exp(t\rho) = u \exp(t\tilde{\rho}) u^{-1}$ for all $t \in \mathbb{R}$. Then for all $t \in \mathbb{R}$ and $b \in \mathfrak{u}_{\text{res}}$ it follows by means of Remark 5.3.4 that

$$\begin{aligned} \|\exp(t\rho)b\exp(-t\rho)\|_{\text{res}} &= \|u \exp(t\tilde{\rho})u^{-1}bu \exp(-t\tilde{\rho})u^{-1}\|_{\text{res}} \\ &\leq \|u\|_{\text{res}} \|\exp(t\tilde{\rho})u^{-1}bu \exp(-t\tilde{\rho})\|_{\text{res}} \|u^{-1}\|_{\text{res}} \\ &= \|u\|_{\text{res}} \|u^{-1}bu\|_{\text{res}} \|u^{-1}\|_{\text{res}} \\ &\leq \|u\|_{\text{res}}^2 \|u^{-1}\|_{\text{res}}^2 \|b\|_{\text{res}}. \end{aligned}$$

Consequently the 1-parameter group

$$\alpha: \mathbb{R} \rightarrow \mathcal{B}(\mathfrak{u}_{\text{res}}), \quad \alpha_t(b) = \exp(t\rho)b\exp(-t\rho)$$

satisfies

$$\sup_{t \in \mathbb{R}} \|\alpha_t\| \leq \|u\|_{\text{res}}^2 \|u^{-1}\|_{\text{res}}^2.$$

Now the arguments in Remark 5.3.2 show that the adjoint isotropy group of ρ is a Lie subgroup of U_{res} , and thus the adjoint orbit of ρ is smooth. \square

An alternative way to see that the set V_γ in the previous proof is open follows by the well known upper continuity of the spectrum as a function of the operator (see, e.g. [154, 91, 55]). We also note that a shorter argument for the fact that the adjoint isotropy group of ρ is a Lie subgroup of U_{res} consists in an application of Proposition 5.3.3 for $u^{-1}\rho u$ along with the fact that the stabilizer of $u^{-1}\rho u$ is conjugate to the stabilizer of ρ .

Corollary 5.4.3. *For any $\gamma \in \mathbb{R} \setminus \{0\}$, there exists an open $U_{1,2}$ -invariant neighborhood V of $\gamma d \in \mathfrak{u}_{\text{res}} = \mathfrak{u}_{1,2}^*$ such that V is a union of smooth coadjoint orbits of the Banach Lie group $U_{1,2}$.*

Proof. Apply Proposition 5.4.2 along with the fact that $U_{1,2} \hookrightarrow U_{\text{res}}$ and the adjoint action of U_{res} restricts to the coadjoint action of $U_{1,2}$. \square

Corollary 5.4.4. *For any $\gamma \in \mathbb{R} \setminus \{0\}$, there exists an open U_{res} -invariant neighborhood W of $(0, \gamma) \in (\tilde{\mathfrak{u}}_{\text{res}})_*$ such that W is a union of smooth affine coadjoint orbits of the Banach Lie group U_{res} .*

Proof. For any $(\mu, \lambda) \in (\tilde{\mathfrak{u}}_{\text{res}})_*$, the operator $\rho = \mu - \lambda d$ belongs to $\mathfrak{u}_{\text{res}}$ and

$$\|\mu - \lambda d\|_{\text{res}} \leq |\lambda| + \|\mu\|_{(\tilde{\mathfrak{u}}_{\text{res}})_*}$$

which implies that the linear map $\theta: (\mu, \lambda) \in (\tilde{\mathfrak{u}}_{\text{res}})_* \mapsto \mu - \lambda d \in \mathfrak{u}_{\text{res}}$ is continuous. With the notation introduced in the proof of Proposition 5.4.2, let $W_\gamma := \{(\mu, \lambda) \in (\tilde{\mathfrak{u}}_{\text{res}})_* \mid \mu - \lambda d \in V_{-\gamma}\}$, that is, $W_\gamma = \theta^{-1}(V_{-\gamma})$ and hence W_γ is open in $(\tilde{\mathfrak{u}}_{\text{res}})_*$. Note that $(0, \gamma) \in W_\gamma$. Moreover since

$$g \cdot (\mu, \lambda) = (\mu, \lambda) \iff g\mu g^{-1} - \lambda(gdg^{-1} - d) = \mu,$$

the isotropy group of any (μ, λ) for the affine coadjoint action of U_{res} equals the isotropy group of $\mu - \lambda d$ for the adjoint action of U_{res} , hence is a Banach Lie subgroup of U_{res} by Proposition 5.4.2. Now

$$W := \bigcup_{u \in U_{\text{res}}} u \cdot W_\gamma \subseteq (\tilde{\mathfrak{u}}_{\text{res}})_*$$

has the desired properties. \square

5.5 The Banach Lie-Poisson space associated to the central extension of \mathfrak{u}_2

Denote by $\tilde{\mathfrak{u}}_2 := \mathfrak{u}_2 \oplus \mathbb{R}$ the central extension of \mathfrak{u}_2 defined by the restriction of s to $\mathfrak{u}_2 \times \mathfrak{u}_2$, where s is the two-cocycle defined in (5.6). The natural isomorphism $(\tilde{\mathfrak{u}}_2)^* \simeq \tilde{\mathfrak{u}}_2$ implies that $\tilde{\mathfrak{u}}_2$ is a Banach Lie-Poisson space, for the Poisson bracket given by

$$\{f, g\}_d(\mu, \gamma) := \langle \mu, [D_\mu f(\mu), D_\mu g(\mu)] \rangle + \gamma s(D_\mu f, D_\mu g)$$

where $f, g \in \mathcal{C}^\infty(\tilde{\mathfrak{u}}_2)$, (μ, γ) is an arbitrary element in $\tilde{\mathfrak{u}}_2$, and D_μ denotes the partial Fréchet derivative with respect to $\mu \in \mathfrak{u}_2$.

Theorem 5.5.1. *The characteristic distribution of the Banach Lie-Poisson space $\tilde{\mathfrak{u}}_2$ is integrable.*

Proof. In order to prove that the characteristic distribution is integrable, it suffices to check that all of the affine coadjoint isotropy groups are Lie subgroups of the Hilbert Lie group U_2 . For this purpose we note that, for arbitrary $(\mu, \gamma) \in \tilde{\mathfrak{u}}_2$, the corresponding isotropy group of the affine coadjoint action of U_2 on $\tilde{\mathfrak{u}}_2$ is

$$(U_2)_{(\mu, \gamma)} = \{g \in U_2 \mid \mu = g\mu g^{-1} - \gamma g d g^{-1} + \gamma d\},$$

according to the explicit expression of the affine coadjoint action in Proposition 5.2.9. The previous equality implies that

$$(U_2)_{(\mu, \gamma)} = \{g \in \mathbb{C}\mathbb{1} + L_2(\mathcal{H}) \mid g^*g = gg^* = 1 \text{ and } \mu = g\mu g^{-1} - \gamma g d g^{-1} + \gamma d\},$$

and now it is clear that $(U_2)_{(\mu, \gamma)}$ is an algebraic subgroup of degree ≤ 2 of the group of invertible elements in the unital Banach algebra $\mathbb{C}\mathbb{1} + L_2(\mathcal{H})$. Then the Harris-Kaup theorem (see for instance Theorem 4.13 in [20]) implies that $(U_2)_{(\mu, \gamma)}$ is a Lie group with respect to the topology inherited from $\mathbb{C}\mathbb{1} + L_2(\mathcal{H})$. In particular, this topology coincides with the one inherited from U_2 . Since U_2 is a Hilbert Lie group, hence the Lie algebra of $(U_2)_{(\mu, \gamma)}$ has a complement in the Lie algebra of U_2 , it then follows that $(U_2)_{(\mu, \gamma)}$ is a Banach Lie subgroup of U_2 , and this concludes the proof. (Compare Remark 5.3.2.) \square

The transitivity of the action of the Lie group U_2 on the connected component Gr_{res}^0 of the restricted Grassmannian has been established in Theorem 3.5 in [47], and Proposition V.7 in [149]. That the action of the subgroup $U_{1,2}$ of U_2 on Gr_{res}^0 is transitive has been proved in Section 1.3.4 of [206] with the help of the canonical basis defined in Section 7.3 of [172] and associated to any element of the restricted Grassmannian. Below we give a shorter and geometrical proof of the latter fact.

Proposition 5.5.2. *The connected component Gr_{res}^0 of the restricted Grassmannian is a homogeneous space under the unitary group $U_{1,2} \subset U_2$.*

Proof. The restricted Grassmannian is a symmetric space of the restricted unitary group U_{res} . It follows from the description of geodesics in Proposition 8.8 in [7] (see also [160] and [50] or its infinite-dimensional version as given in Example 3.9 in [151], or Proposition 1.9 in [207]) that each geodesic of Gr_{res}^0 starting at $W \in \text{Gr}_{\text{res}}^0$ is given by

$$\beta(t) = (\exp tX) \cdot \mathcal{H}_+, \quad X \in \mathfrak{m}_W, \quad (5.24)$$

where \mathfrak{m}_W is the orthogonal in $\mathfrak{u}_{\text{res}}$ to the Lie algebra of the isotropy group of W . For $W = \mathcal{H}_+$ we have $\mathfrak{m} = \mathfrak{u}(\mathcal{H}) \cap (L_2(\mathcal{H}_+, \mathcal{H}_-) \oplus L_2(\mathcal{H}_-, \mathcal{H}_+))$, and for $W = g \cdot \mathcal{H}_+$ with $g \in U_{\text{res}}$, we have $\mathfrak{m}_W = g\mathfrak{m}g^{-1}$. Note that for $X \in \mathfrak{m}$, $\exp tX$ belongs to $U_{1,2} \subset U_2$. Since the Hopf-Rinow Theorem is no longer true in the infinite dimensional case, it is not clear whether every two elements in the complete connected manifold Gr_{res}^0 can be joined by a geodesic. Nevertheless Theorem B in [69] asserts that, for every $W \in \text{Gr}_{\text{res}}^0$, the set of elements which can be joined to W by a unique minimal geodesic contains a dense G_δ set. Moreover from the properties of the Riemannian exponential map, there exists a neighborhood \mathcal{V} of \mathcal{H}_+ in Gr_{res}^0 such that every element in \mathcal{V} can be joined to \mathcal{H}_+ by a (minimal) geodesic. Hence an arbitrary element $W \in \text{Gr}_{\text{res}}^0$ can be joined to an element $W' \in \mathcal{V}$ by a geodesic

$$\beta_1(t) = (\exp tX_1) \cdot W', \quad X_1 \in \mathfrak{m}_{W'}, \quad t \in [0, 1],$$

and W' can be joined to \mathcal{H}_+ by a geodesic

$$\beta_2(t) = (\exp tX_2) \cdot \mathcal{H}_+, \quad X_2 \in \mathfrak{m}, \quad t \in [0, 1].$$

Consequently

$$W = \beta_1(1) = (\exp X_1) \cdot W' = (\exp X_1)(\exp X_2) \cdot \mathcal{H}_+.$$

But X_1 belongs to $\mathfrak{m}_{W'} = \exp(X_2)\mathfrak{m}\exp(-X_2)$, hence

$$W = (\exp X_2 \exp X_3) \cdot \mathcal{H}_+$$

where $X_3 = \text{Ad}(\exp(-X_2))(X_1)$ belongs to \mathfrak{m} . Since $\exp X_3$ and $\exp X_2$ are elements of the unitary group $U_{1,2}$, it follows that their product belongs to $U_{1,2}$. Thus $U_{1,2}$ acts transitively on Gr_{res}^0 . \square

Theorem 5.5.3. *The connected component Gr_{res}^0 of the restricted Grassmannian is a strong symplectic leaf in the Banach Lie-Poisson space $\tilde{\mathfrak{u}}_2$. More precisely, for every $\gamma \neq 0$, the U_2 -affine coadjoint orbit $\tilde{\mathcal{O}}_{(0,\gamma)}$ of $(0, \gamma) \in \tilde{\mathfrak{u}}_2$ is diffeomorphic to Gr_{res}^0 via the application*

$$\begin{aligned} \Phi_\gamma : \text{Gr}_{\text{res}}^0 &\rightarrow \tilde{\mathcal{O}}_{(0,\gamma)} \\ W &\mapsto 2i\gamma(p_W - p_+), \end{aligned}$$

where p_W denotes the orthogonal projection on W . The pull-back by Φ_γ of the symplectic form on $\tilde{\mathcal{O}}_{(0,\gamma)}$ is (-2γ) -times the symplectic form ω_{Gr} on Gr_{res}^0 .

Proof. The assertion follows by the method of proof of Theorem 5.2.13, since Gr_{res}^0 is transitively acted upon by the group U_2 according to Proposition 5.5.2. \square

Next we shall investigate the existence of invariant complex structures on certain covering spaces of the symplectic leaves of $\tilde{\mathfrak{u}}_2$ (Corollary 5.5.6 below). To this end we need two facts holding in a more general setting. In connection with the first of these statements, we note that invariant complex structures on certain homogeneous spaces related to derivations of L^* -algebras have been previously obtained by a different method in Theorem IV.5 in [148].

Proposition 5.5.4. *Let \mathfrak{X} be a real Hilbert Lie algebra with a scalar product denoted by $(\cdot | \cdot)$. Assume that there exists a connected Hilbert Lie group $\text{U}_{\mathfrak{X}}$ whose Lie algebra is \mathfrak{X} ; we write $\mathbf{L}(\text{U}_{\mathfrak{X}}) = \mathfrak{X}$.*

Now let $D: \mathfrak{X} \rightarrow \mathfrak{X}$ be a bounded linear derivation such that

$$(\forall x, y \in \mathfrak{X}) \quad (Dx | y) = -(x | Dy). \quad (5.25)$$

Consider the closed subalgebra $\mathfrak{h}_0 := \text{Ker } D$ of \mathfrak{X} and define

$$H_0 := \langle \exp_{\text{U}_{\mathfrak{X}}}(\mathfrak{h}_0) \rangle,$$

that is, the subgroup of $\text{U}_{\mathfrak{X}}$ generated by the image of \mathfrak{h}_0 by the exponential map.

If it happens that H_0 has a structure of Banach Lie group with respect to the topology inherited from $\text{U}_{\mathfrak{X}}$, then it is actually a Banach Lie subgroup of $\text{U}_{\mathfrak{X}}$ and the smooth homogeneous space $\text{U}_{\mathfrak{X}}/H_0$ has an invariant complex structure.

Proof. Denote $\mathfrak{L} := \mathfrak{X}_{\mathbb{C}}$, that is, the complex Hilbert Lie algebra which is the complexification of \mathfrak{X} and is endowed with the complex scalar product $(\cdot | \cdot)$ extending the scalar product of \mathfrak{X} . We denote the complex linear extension of D to \mathfrak{L} again by D .

Then $D^* = -D$ as operators on the complex Hilbert space \mathfrak{L} , so that $-iD \in \mathcal{B}(\mathfrak{L})$ is a self-adjoint operator. Let us denote its spectral measure by $\delta \mapsto E(\delta)$. Thus $E(\cdot)$ is a spectral measure on \mathbb{R} and we have

$$D = i \int_{\mathbb{R}} t dE(t).$$

Also denote $S = (-\infty, 0]$, which is a closed subsemigroup of \mathbb{R} , and

$$\mathfrak{k} := \text{Ran } E(-S) = \text{Ran } E([0, \infty)) \subseteq \mathfrak{L}.$$

Then \mathfrak{k} is a closed subspace of \mathfrak{L} since it is the range of an idempotent continuous map. In addition, since D is a derivation of the Hilbert Lie algebra \mathfrak{X} and S is a closed semigroup, it follows by Proposition 6.4 in [20] that \mathfrak{k} is a complex subalgebra of \mathfrak{L} with the following properties:

- (i) $[\mathfrak{h}_0, \mathfrak{k}] \subseteq \mathfrak{k}$,
- (ii) $\mathfrak{k} \cap \bar{\mathfrak{k}} = \mathfrak{h}_0 + i\mathfrak{h}_0 (= \text{Ker } D)$, and
- (iii) $\mathfrak{k} + \bar{\mathfrak{k}} = \mathfrak{L}$.

Moreover, for every $y \in \mathfrak{h}_0$ and all $x \in \mathfrak{X}$ we have

$$D[y, x] = [Dy, x] + [y, Dx] = [y, Dx]$$

since $Dy = 0$. Therefore, we have $D \circ \text{ad}_{\mathfrak{X}} y = \text{ad}_{\mathfrak{X}} y \circ D$ for each $y \in \mathfrak{h}_0$. According to the definition of H_0 , it then follows that for arbitrary $h \in H_0$ we have $\text{Ad}_{\text{U}_{\mathfrak{X}}} h \circ D = D \circ \text{Ad}_{\text{U}_{\mathfrak{X}}} h$ on \mathfrak{X} . Then the latter equality holds throughout \mathfrak{L} , and it then follows that the operator $\text{Ad}_{\text{U}_{\mathfrak{X}}} h: \mathfrak{L} \rightarrow \mathfrak{L}$ commutes with every value of the spectral measure $E(\cdot)$. In particular we have $\text{Ad}_{\text{U}_{\mathfrak{X}}}(h) \circ E(-S) = E(-S) \circ \text{Ad}_{\text{U}_{\mathfrak{X}}}(h)$, whence

$$(i') \quad (\forall h \in H_0) \quad \text{Ad}_{U_x}(h)\mathfrak{k} \subseteq \mathfrak{k}.$$

Now Theorem 6.1 in [20] shows that the smooth homogeneous space U_x/H_0 has an invariant complex structure. \square

Proposition 5.5.5. *Let \mathcal{H} be an infinite-dimensional complex Hilbert space and let $a \in \mathcal{B}(\mathcal{H})$ such that $a^* = -a$. Denote by*

$$D = \text{ad}_{\mathfrak{u}_2} a: \mathfrak{u}_2 \rightarrow \mathfrak{u}_2, \quad x \mapsto [a, x]$$

the derivation of the compact L^* -algebra \mathfrak{u}_2 defined by a , and denote

$$\mathfrak{h}_0 := \text{Ker } D = \{x \in \mathfrak{u}_2 \mid [a, x] = 0\}.$$

Next denote

$$H := \{u \in U_2 \mid uau^{-1} = a\}$$

and in addition define

$$H_0 := \langle \exp(\mathfrak{h}_0) \rangle.$$

That is, H_0 is the subgroup of U_2 generated by the image of \mathfrak{h}_0 by the exponential map. Then the following assertions hold:

- (j) Both H and H_0 are Banach Lie subgroups of U_2 .
- (jj) The subgroup H_0 is the connected component of $\mathbb{1} \in H$.
- (jjj) The natural map

$$U_2/H_0 \rightarrow U_2/H, \quad uH_0 \mapsto uH,$$

is an U_2 -equivariant smooth covering map.

Proof. Consider the Banach algebra $\mathcal{A} := \mathbb{C}\mathbb{1} + L_2(\mathcal{H})$ and denote by $\varphi: \mathcal{A} \rightarrow \mathbb{C}$ the continuous linear functional uniquely defined by the conditions $\varphi(\mathbb{1}) = 1$ and $\text{Ker } \varphi = L_2(\mathcal{H})$. Then we have

$$H = \{u \in \mathcal{A}^\times \mid u^*u = uu^* = \mathbb{1}, ua = au, \text{ and } \varphi(u) = 1\}$$

hence, by the Harris-Kaup theorem (see for instance Theorem 4.13 in [20]), H is a subgroup of \mathcal{A}^\times that carries a Banach Lie group structure of its own. In addition, the Lie algebra

$$\mathbf{L}(H) = \{x \in \mathcal{A} \mid x^* = -x \text{ and } xa = ax\} = \mathfrak{h}_0,$$

of H has a closed complement in \mathfrak{u}_2 since the latter is a real Hilbert space. Thus H is a Banach Lie subgroup of U_2 .

On the other hand, H_0 has the structure of connected Lie group such that the inclusion map $H_0 \hookrightarrow U_2$ is an immersion and $\mathbf{L}(H_0) = \mathfrak{h}_0$. (See for instance Theorem 3.5 in [20] and its proof.) Since $H_0 \subseteq H$ and $\mathbf{L}(H_0) = \mathbf{L}(H) = \mathfrak{h}_0$, it then follows that H_0 is the connected component of $\mathbb{1} \in H$. This can be seen directly by Lie theoretic methods; specifically, one just has to use the fact that the exponential map of any Banach Lie group is a local diffeomorphism at 0. An alternative approach is to use the proof of Lie's second theorem by means of the Frobenius theorem (see for instance Theorem 5.4 in Chapter VI of [124]). According to that proof, the connected group H_0 is the integral manifold through $\mathbb{1}$ corresponding to a smooth left-invariant integrable distribution on U_2 whose fiber at $\mathbb{1}$ is (the complemented closed Lie subalgebra) \mathfrak{h}_0 . Now recall the universality property of the integral leaves of integrable distributions according to Theorem 4.2 in Chapter VI of [124] or, more generally, Theorem 4(iii) in [155], which implies that the inclusion map $H_0 \hookrightarrow H$ is smooth. Then the wished-for property that H_0 is open in H follows since H_0 and H have the same tangent space at $\mathbb{1} \in H_0 \subseteq H$.

By either of these methods it follows that H_0 is an open subgroup of the Banach Lie subgroup H of U_2 , and then H_0 is in turn a Lie subgroup of U_2 . Thus assertions (j) and (jj) are proved. Assertion (jjj) follows since the natural map $U_2/H_0 \rightarrow U_2/H$ is clearly an U_2 -equivariant map whose tangent map at every point is an isomorphism. \square

In the following statement we need the notion of symplectic leaf in a Banach Lie-Poisson space. Let G be a Banach Lie group with Lie algebra \mathfrak{g} . Assume that \mathfrak{g} admits a predual \mathfrak{g}_* such that the coadjoint action of G on \mathfrak{g}_* preserves the predual space \mathfrak{g}_* . Then, for any $\rho \in \mathfrak{g}_*$ such that the isotropy subgroup $G_\rho := \{g \in G \mid \text{Ad}_g^* \rho = \rho\}$ is a Banach Lie subgroup of G , the coadjoint orbit $\mathcal{O} := \{\text{Ad}_g^* \rho \mid g \in G\} \subset \mathfrak{g}_*$ is a Banach manifold diffeomorphic to the quotient G/G_ρ , weakly immersed in \mathfrak{g}_* , and the Banach Lie-Poisson structure of \mathfrak{g}_* induces on \mathcal{O} a weak symplectic form given by the usual formula (see [156], Theorems 7.3 and 7.4). Weak immersion means that the derivative of the inclusion is only injective without any assumption on the closedness of the range, let alone splitting assumptions. This statement was also used in Remark 5.3.2 for $G = \text{U}_{\text{res}}$. See also the comments preceding it regarding integrable distributions on Banach manifolds. Several classes of Banach Lie-Poisson spaces that are unions of smooth symplectic leaves are given in [26]. In the corollary below the situation is simpler because we are dealing with a Hilbert Lie-Poisson space.

Corollary 5.5.6. *Every symplectic leaf of the Hilbert Lie-Poisson space $\tilde{\mathfrak{u}}_2$ is transitively acted on by U_2 by means of the affine coadjoint action and is U_2 -equivariantly covered by some complex homogeneous space of U_2 .*

Proof. Let $(\mu, \gamma) \in \tilde{\mathfrak{u}}_2$ arbitrary and denote $a := \mu - \gamma d \in \mathcal{B}(\mathcal{H})$. With the notation of Proposition 5.5.5, it is clear that H is equal to the isotropy group of the affine coadjoint action of U_2 . Thus the symplectic leaf $\tilde{\mathcal{O}}_{(\mu, \gamma)}$ through (μ, γ) is U_2 -equivariantly diffeomorphic to U_2/H . Now the conclusion follows since U_2/H is U_2 -equivariantly covered by the complex homogeneous space U_2/H_0 , according to Propositions 5.5.4 and 5.5.5. \square

Remark 5.5.7. It follows by Corollary 5.5.6 that every simply connected symplectic leaf of the Banach Lie-Poisson space $\tilde{\mathfrak{u}}_2$ has an U_2 -invariant complex structure. For instance, this is the case for the connected component Gr_{res}^0 of the restricted Grassmannian viewed as a symplectic leaf of $\tilde{\mathfrak{u}}_2$ by means of Theorem 5.5.3.

5.6 Some pathological properties of the restricted algebras

5.6.1 Unbounded unitary groups in the restricted algebra

We are going to point out a property that provides a good illustration for the difference between the Banach $*$ -algebra \mathcal{B}_{res} and a C^* -algebra (Proposition 5.6.2 below).

Lemma 5.6.1. *Let $a \in \mathcal{B}(\mathcal{H}_-, \mathcal{H}_+)$ and assume that $a = v|a|$ and $a^* = w|a^*|$ are the polar decompositions of a and a^* , where $|a| \in \mathcal{B}(\mathcal{H}_-)$ and $|a^*| \in \mathcal{B}(\mathcal{H}_+)$, while $v: \mathcal{H}_- \rightarrow \mathcal{H}_+$ and $w: \mathcal{H}_+ \rightarrow \mathcal{H}_-$ are partial isometries. Next, denote*

$$\rho = \begin{pmatrix} 0 & a \\ -a^* & 0 \end{pmatrix} \in \mathcal{B}(\mathcal{H}).$$

Then

$$\exp \rho = \begin{pmatrix} \cos |a^*| & v \sin |a| \\ -w \sin |a^*| & \cos |a| \end{pmatrix}.$$

Proof. We have

$$\rho^2 = \begin{pmatrix} -aa^* & 0 \\ 0 & -a^*a \end{pmatrix} = - \begin{pmatrix} |a^*|^2 & 0 \\ 0 & |a|^2 \end{pmatrix}$$

hence

$$(\forall n \geq 0) \quad \rho^{2n} = (-1)^n \begin{pmatrix} |a^*|^{2n} & 0 \\ 0 & |a|^{2n} \end{pmatrix}.$$

This implies that for every $n \geq 0$ we have

$$\rho^{2n+1} = \rho \cdot \rho^{2n} = (-1)^n \begin{pmatrix} 0 & v|a| \\ -w|a^*| & 0 \end{pmatrix} \begin{pmatrix} |a^*|^{2n} & 0 \\ 0 & |a|^{2n} \end{pmatrix} = (-1)^n \begin{pmatrix} 0 & v|a|^{2n+1} \\ -w|a^*|^{2n+1} & 0 \end{pmatrix}.$$

Consequently

$$\exp \rho = \sum_{n=0}^{\infty} \left(\frac{1}{(2n)!} \rho^{2n} + \frac{1}{(2n+1)!} \rho^{2n+1} \right) = \begin{pmatrix} \cos |a^*| & v \sin |a| \\ -w \sin |a^*| & \cos |a| \end{pmatrix}$$

which concludes the proof. \square

Proposition 5.6.2. *All of the unitary groups $(\mathbb{1} + \mathcal{F}) \cap \mathbf{U}(\mathcal{H})$, $\mathbf{U}_{1,2}$, and \mathbf{U}_{res} are unbounded subsets of the unital associative Banach algebra \mathcal{B}_{res} .*

Proof. We have

$$(\mathbb{1} + \mathcal{F}) \cap \mathbf{U}(\mathcal{H}) \subseteq \mathbf{U}_{1,2} \subseteq \mathbf{U}_{\text{res}}$$

so it suffices to show that

$$\sup\{\|u\|_{\text{res}} \mid u \in (\mathbb{1} + \mathcal{F}) \cap \mathbf{U}(\mathcal{H})\} = \infty. \quad (5.26)$$

To this end let $n \geq 1$ be an arbitrary positive integer, pick a projection $q_n = q_n^* = q_n^2 \in \mathcal{B}(\mathcal{H}_-)$ with $\dim(\text{Ran } q_n) = n$ and define $a_n := v_n((\pi/2)q_n) = (\pi/2)v_n \in \mathcal{B}(\mathcal{H}_-, \mathcal{H}_+)$, where $v_n: \mathcal{H}_- \rightarrow \mathcal{H}_+$ is an arbitrary partial isometry such that $v_n^*v_n = q_n$. Then $|a_n| = (\pi/2)q_n$, so that $\sin |a_n| = q_n$ and then $\|(\sin |a_n|)\|_2 = \sqrt{\dim(\text{Ran } q_n)} = \sqrt{n}$. Now Lemma 5.6.1 shows that the element

$$\rho_n = \begin{pmatrix} 0 & a_n \\ -a_n^* & 0 \end{pmatrix} \in \mathfrak{u}(\mathcal{H}) \cap \mathcal{F}$$

satisfies

$$\|\exp(\rho_n)\|_{\text{res}} \geq \|(\sin |a_n|)\|_2 = \sqrt{n}.$$

Now the desired conclusion (5.26) follows since $\exp(\rho_n) \in (\mathbb{1} + \mathcal{F}) \cap \mathbf{U}(\mathcal{H})$ and $n \geq 1$ is arbitrary. \square

5.6.2 The predual of the restricted algebra is not spanned by its positive cone

It is well known that every self-adjoint normal functional in the predual of a W^* -algebra can be written as the difference of two positive normal functionals. It is also well known and easy to see that a similar property holds for the preduals of numerous operator ideals. More precisely, if \mathfrak{J} and \mathfrak{B} are Banach operator ideals such that the trace pairing

$$(\mathfrak{B}, \mathfrak{J}) \rightarrow \mathbb{C}, \quad (T, S) \mapsto \text{Tr}(TS)$$

is well defined and induces a topological isomorphism of the topological dual \mathfrak{B}^* onto \mathfrak{J} , then for every $T = T^* \in \mathfrak{B}$ there exist $T_1, T_2 \in \mathfrak{B}$ such that $T_1 \geq 0$, $T_2 \geq 0$ and $T = T_1 - T_2$. In fact, we can take $T_1 = (|T| + T)/2$ and $T_2 = (|T| - T)/2$, and we have $T_1, T_2 \in \mathfrak{B}$ since $|T| \in \mathfrak{B}$. (The latter property follows since if $T = W|T|$ is the polar decomposition of T , then $|T| = W^*T \in \mathfrak{B}$.)

We shall see in Proposition 5.6.4 below that the predual $(\mathfrak{u}_{\text{res}})_*$ of the restricted Lie algebra fails to have the similar property of being spanned by its elements ρ with $i\rho \geq 0$. In fact, the linear span of these elements turns out to be the proper subspace \mathfrak{u}_1 of $(\mathfrak{u}_{\text{res}})_*$.

Lemma 5.6.3. *Let \mathcal{H}_{\pm} be two complex separable Hilbert spaces, $\mathcal{H} = \mathcal{H}_+ \oplus \mathcal{H}_-$, $0 \leq a_{\pm} \in \mathcal{B}(\mathcal{H}_{\pm})$, and $t \in \mathcal{B}(\mathcal{H}_-, \mathcal{H}_+)$. Also denote*

$$a = \begin{pmatrix} a_+ & t \\ t^* & a_- \end{pmatrix} \in \mathcal{B}(\mathcal{H}).$$

Then the following assertions hold:

- (i) *We have $a \geq 0$ if and only if the inequality*

$$|\langle \xi, t\eta \rangle|^2 \leq \langle \xi, a_+\xi \rangle \cdot \langle \eta, a_-\eta \rangle \quad (5.27)$$

holds for all $\xi \in \mathcal{H}_+$ and $\eta \in \mathcal{H}_-$.

- (ii) *If $a \geq 0$ and in addition $a_{\pm} \in \mathbf{L}_1(\mathcal{H}_{\pm})$ and $t \in \mathbf{L}_2(\mathcal{H}_-, \mathcal{H}_+)$, then*

$$\|t\|_2 \leq (\text{Tr } a)/\sqrt{2}. \quad (5.28)$$

Proof. For assertion (i) see Exercise 3.2 at the end of Chapter 3 in [164].

Next, let $\{\xi_i\}_{i \geq 1}$ and $\{\eta_j\}_{j \geq 1}$ be orthonormal bases in the Hilbert spaces \mathcal{H}_+ and \mathcal{H}_- , respectively. Then (5.27) shows that

$$(\forall i, j \geq 1) \quad |\langle \xi_i, t\eta_j \rangle|^2 \leq \langle \xi_i, a_+\xi_i \rangle \cdot \langle \eta_j, a_-\eta_j \rangle.$$

Now recall that $(\|t\|_2)^2 = \sum_{i,j \geq 1} |\langle \xi_i, t\eta_j \rangle|^2$, $\text{Tr } a_+ = \sum_{i \geq 1} \langle \xi_i, a_+\xi_i \rangle$, and $\text{Tr } a_- = \sum_{j \geq 1} \langle \eta_j, a_-\eta_j \rangle$. Thus, adding the above inequalities, we get

$$(\|t\|_2)^2 \leq (\text{Tr } a_+) \cdot (\text{Tr } a_-) \leq (\text{Tr } a_+ + \text{Tr } a_-)^2/2 = (\text{Tr } a)^2/2$$

and assertion (ii) follows. \square

Proposition 5.6.4. *The following assertions hold:*

(i) *If $a \in (\mathfrak{u}_{\text{res}})_*$ and $ia \geq 0$, then $a \in L_1(\mathcal{H})$ and $\|a\|_1 \leq \|a\|_{(\mathfrak{u}_{\text{res}})_*} \leq (1 + \sqrt{2})\|a\|_1$.*

(ii) *If $\rho \in (\mathfrak{u}_{\text{res}})_* \setminus \mathfrak{u}_1$ then there exist no $\rho_1, \rho_2 \in (\mathfrak{u}_{\text{res}})_*$ such that $i\rho_1 \geq 0$, $i\rho_2 \geq 0$, and $\rho = \rho_1 - \rho_2$.*

Proof. (i) Let $a \in (\mathfrak{u}_{\text{res}})_*$ such that $ia \geq 0$, and denote $ia =: \begin{pmatrix} a_+ & t \\ t^* & a_- \end{pmatrix}$. Then

$$\begin{aligned} \|a\|_1 &= \|ia\|_1 = \text{Tr}(ia) = \text{Tr } a_+ + \text{Tr } a_- = \|a_+\|_1 + \|a_-\|_1 \\ &\leq \|ia\|_{(\mathfrak{u}_{\text{res}})_*} = \|a_+\|_1 + \|a_-\|_1 + 2\|t\|_2 \\ &\leq \|a_+\|_1 + \|a_-\|_1 + \sqrt{2} \cdot \text{Tr}(ia) = (1 + \sqrt{2})\|ia\|_1 = (1 + \sqrt{2})\|a\|_1, \end{aligned}$$

where the second inequality follows by Lemma 5.27(ii). Consequently, for all $a \in (\mathfrak{u}_{\text{res}})_*$ with $ia \geq 0$ we have $\|a\|_1 \leq \|a\|_{(\mathfrak{u}_{\text{res}})_*} \leq (1 + \sqrt{2})\|a\|_1$.

(ii) Let $\rho \in (\mathfrak{u}_{\text{res}})_* \setminus \mathfrak{u}_1$ and assume that there exist elements $\rho_1, \rho_2 \in (\mathfrak{u}_{\text{res}})_*$ such that $i\rho_1 \geq 0$, $i\rho_2 \geq 0$, and $\rho = \rho_1 - \rho_2$. Then $i\rho_1, i\rho_2 \in L_1(\mathcal{H})$ according to the assertion (i), which we have already proved. Consequently, $\rho_1, \rho_2 \in \mathfrak{u}_1$, whence $\rho = \rho_1 - \rho_2 \in \mathfrak{u}_1$. This is a contradiction with the assumption on ρ , which concludes the proof. \square

5.6.3 The Cartan subalgebras of $\mathfrak{u}_{\text{res}}$ are not U_{res} -conjugate

For a (finite-dimensional) compact connected semi-simple Lie subgroup G of the unitary group $U(n)$, every element X of the Lie algebra \mathfrak{g} of G is conjugate to a diagonal element with respect to a given basis \mathcal{B} of \mathbb{C}^n by an element of G . This can be seen as follows (see [95] chap. V Theorem 6.4 for more general results). Take a diagonal element $H \in \mathfrak{g}$ with respect to \mathcal{B} such that the one-parameter subgroup $\exp tH$ is dense in the torus whose Lie algebra is the set of diagonal matrices belonging to \mathfrak{g} . On G , consider the continuous function $g \mapsto B(H, \text{Ad}(g)(X))$, where B denotes the Killing form of G . By compactness, this function takes a minimum at some g_0 , and for every element Y in \mathfrak{g} one has

$$\frac{d}{dt} B(H, \text{Ad}(\exp tY)\text{Ad}(g_0)(X))|_{t=0} = 0,$$

i.e. $B(H, [Y, \text{Ad}(g_0)(X)]) = 0$. Since the Killing form is $\text{Ad}(G)$ -invariant, one has

$$B(H, [Y, \text{Ad}(g_0)(X)]) = B([\text{Ad}(g_0)(X), H], Y).$$

The non-degeneracy of the Killing form then implies that $[\text{Ad}(g_0)(X), H] = 0$. But H has been chosen such that the centralizer of H is the set of diagonal matrices with respect to \mathcal{B} belonging to \mathfrak{g} . Consequently $\text{Ad}(g_0)(X)$ is a diagonal element in \mathfrak{g} . It follows that the maximal Abelian subalgebras, called *Cartan subalgebras*, of \mathfrak{g} are conjugate under G .

This proof cannot be extended to the infinite dimensional case since the minimization argument above uses in a crucial manner the compactness of the group. We shall prove below that the conjugacy statement itself does not hold, in general. More precisely, we shall show that not all Cartan subalgebras of $(\mathfrak{u}_{\text{res}})_* \hookrightarrow \mathfrak{u}_{\text{res}}$ are U_{res} -conjugate.

We note that a related fact follows from results in the paper [30]. Specifically, let $\rho_0 \in (\mathfrak{u}_{\text{res}})_*$ such that $[d, \rho_0] = 0$, $\text{Ker } \rho_0 = \{0\}$, and each eigenvalue of ρ_0 has multiplicity 1. Next denote by \mathcal{O}_{ρ_0} the coadjoint U_{res} -orbit of ρ_0 , let $\rho \in (\mathfrak{u}_{\text{res}})_*$, and define

$$f_\rho: \mathcal{O}_{\rho_0} \rightarrow (0, \infty), \quad f_\rho(b) = \|\rho - b\|_2.$$

If the function f_ρ happens to have a critical point $\rho_1 \in \mathcal{O}_{\rho_0}$, then $[\rho_1, \rho] = 0$ according to [30]. Since $\rho_1 \in \mathcal{O}_{\rho_0}$, there exists $u \in \mathbf{U}_{\text{res}}$ such that $\rho_1 = u\rho_0u^{-1}$, and then $[\rho_0, u^{-1}\rho u] = 0$. The latter equality implies that $u^{-1}\rho u$ commutes with all of the spectral projections of ρ_0 . Hence $[d, u^{-1}\rho u] = 0$ in view of the spectral assumptions on ρ_0 , and then Proposition 5.3.3 applied to $u^{-1}\rho u$ shows that the coadjoint isotropy group of ρ is a Banach Lie subgroup of \mathbf{U}_{res} and the corresponding \mathbf{U}_{res} -coadjoint orbit \mathcal{O}_ρ is a smooth leaf of the characteristic distribution of $(\mathbf{u}_{\text{res}})_*$.

Proposition 5.6.5. *The unitary group \mathbf{U}_{res} does not act transitively on the set of Cartan subalgebras of its Lie algebra.*

Proof. Endow the Hilbert space \mathcal{H} with an orthonormal basis $\mathcal{B} = \{e_n\}_{n \in \mathbb{Z} \setminus \{0\}}$, such that $\{e_{-n}\}_{n \in \mathbb{N} \setminus \{0\}}$ is an orthonormal basis of \mathcal{H}_+ and $\{e_n\}_{n \in \mathbb{N} \setminus \{0\}}$ an orthonormal basis of \mathcal{H}_- . The set \mathcal{D} of skew-Hermitian bounded diagonal operators with respect to \mathcal{B} form a Cartan subalgebra of \mathbf{u}_{res} . Now consider the following subset of the set of anti-diagonal elements in \mathbf{u}_{res} :

$$\mathcal{J} = \{J \in \mathbf{u}_{\text{res}} \mid J(e_n) \in \mathbb{R}e_{-n} \quad \forall n \in \mathbb{Z} \setminus \{0\}\}.$$

Since the coefficients $J_{-k,k}$, $k \in \mathbb{Z} \setminus \{0\}$, of $J \in \mathcal{J}$ satisfy $J_{-k,k} = -J_{k,-k}$, it follows from an easy computation that \mathcal{J} is Abelian. An element $B = (B_{i,j}) \in \mathbf{u}_{\text{res}}$ commutes with every element $J = (J_{i,j})$ in \mathcal{J} if and only if

$$([B, J]_{i,-k}) = (B_{i,k}J_{k,-k} - J_{i,-i}B_{-i,-k}) \quad (5.29)$$

vanishes for every $J \in \mathcal{J}$. This implies the following conditions:

$$\begin{aligned} B_{i,k} &= 0 \quad \text{for } i \notin \{k, -k\}; \\ B_{k,k} &= B_{-k,-k} \quad \text{for } k \in \mathbb{Z} \setminus \{0\}; \\ B_{-k,k} &= -B_{k,-k} \quad \text{for } k \in \mathbb{Z} \setminus \{0\}. \end{aligned}$$

It follows that the maximal Abelian subalgebra \mathcal{C} of \mathbf{u}_{res} which contains \mathcal{J} is $\mathcal{J} + \mathcal{D}_+$, where

$$\mathcal{D}_+ = \{D = (D_{i,j}) \in \mathcal{D} \mid D_{-k,-k} = D_{k,k} \quad \forall k \in \mathbb{Z} \setminus \{0\}\}.$$

Let us prove by contradiction that the Cartan subalgebras \mathcal{C} and \mathcal{D} are not conjugate under \mathbf{U}_{res} . Suppose that there exists a unitary operator

$$g = \begin{pmatrix} g_{++} & g_{+-} \\ g_{-+} & g_{--} \end{pmatrix} \in \mathbf{U}_{\text{res}}$$

such that $g\mathcal{J}g^{-1} \subseteq \mathcal{D}$. Consider an element

$$J = \begin{pmatrix} 0 & J_{+-} \\ J_{-+} & 0 \end{pmatrix} \in \mathcal{J}$$

which is a Hilbert-Schmidt operator that is not trace class. One has

$$\begin{aligned} gJg^{-1} &= \begin{pmatrix} g_{++} & g_{+-} \\ g_{-+} & g_{--} \end{pmatrix} \begin{pmatrix} 0 & J_{+-} \\ J_{-+} & 0 \end{pmatrix} \begin{pmatrix} g_{++}^* & g_{+-}^* \\ g_{-+}^* & g_{--}^* \end{pmatrix} \\ &= \begin{pmatrix} g_{+-}J_{-+}g_{++}^* + g_{++}J_{+-}g_{-+}^* & g_{+-}J_{-+}g_{-+}^* + g_{++}J_{+-}g_{--}^* \\ g_{--}J_{-+}g_{++}^* + g_{-+}J_{+-}g_{-+}^* & g_{--}J_{-+}g_{-+}^* + g_{-+}J_{+-}g_{--}^* \end{pmatrix}. \end{aligned}$$

By hypothesis, gJg^{-1} is a diagonal operator

$$D = \begin{pmatrix} D_{++} & 0 \\ 0 & D_{--} \end{pmatrix}$$

with $D_{++} = g_{+-}J_{-+}g_{++}^* + g_{++}J_{+-}g_{-+}^*$ and $D_{--} = g_{--}J_{-+}g_{-+}^* + g_{-+}J_{+-}g_{--}^*$. Now, since g belongs to \mathbf{U}_{res} , g_{+-} and g_{-+} are Hilbert-Schmidt. Since J belongs to $\mathbf{L}_2(\mathcal{H})$, J_{+-} and J_{-+} are Hilbert-Schmidt as well. From the relation $\mathbf{L}_2 \cdot \mathbf{L}_2 \subset \mathbf{L}_1$, it follows that D_{++} and D_{--} are trace class, hence D belongs to $\mathbf{L}_1(\mathcal{H})$. But this implies that $J = g^{-1}Dg$ is also trace class, since $\mathbf{L}_1(\mathcal{H})$ is an ideal of $\mathcal{B}(\mathcal{H})$. This leads to a contradiction by the choice of $J \in \mathcal{J}$. It follows that elements in $\mathcal{J} \setminus \mathbf{L}_1(\mathcal{H})$ are not \mathbf{U}_{res} -conjugate to diagonal elements with respect to \mathcal{B} . Consequently, the Cartan subalgebra \mathcal{C} and \mathcal{D} are not \mathbf{U}_{res} -conjugate. \square

Remark 5.6.6. The proof of Proposition 5.6.5 implies that the unitary group U_{res} does not act transitively on the set of Cartan subalgebras of $(\mathfrak{u}_{\text{res}})_*$. Since every compact skew-Hermitian operator admits an orthonormal basis of eigenvectors, the set of conjugacy classes of Cartan subalgebras in $(\mathfrak{u}_{\text{res}})_*$ is in bijection with $U(\mathcal{H})/U_{\text{res}}$ and is infinite. The conjugacy classes of Cartan subalgebras are related to the conjugacy classes of maximal tori. An infinite number of conjugacy classes of maximal tori has already been encountered in the case of some groups of contactomorphisms (see [128]). Examples of maximal tori of different dimensions were provided in [94] in some groups of symplectomorphisms.

Chapter 6

Banach Poisson–Lie groups and related structures

6.1 Introduction

This chapter is based on our publication [213]. Poisson–Lie groups and Lie bialgebras were introduced by Drinfel’d in [66]. From this starting point, these notions and their relations to integrable systems were extensively studied. We refer the readers to the very well documented papers [115], [189], [135] and the references therein. For a more algebraic approach to Poisson–Lie groups and their relation to quantum groups we refer to [36]. For more details about dual pairs of Poisson manifolds we refer to [226], applications to the study of equations coming from fluid dynamics were given in [77], [78] and [79], and applications to geometric quantization can be found in [10]. The motivation to write the paper [213] comes mainly from the reading of [136], [185] and [172]. In [136], the Bruhat-Poisson structure of finite-dimensional Grassmannians were studied. In [185], the relation between the infinite-dimensional restricted Grassmannian and equations of the KdV hierarchy was established. In [172], the Schubert cells of the restricted Grassmannian were shown to be homogeneous spaces with respect to the natural action of some triangular group, which appears to contain the group that generates the KdV hierarchy in [185]. It is therefore natural to ask the following questions:

Question 6.1.1. *Does the restricted Grassmannian carry a Bruhat-Poisson structure? Can the KdV hierarchy be related to a Poisson action of a Poisson–Lie group on the restricted Grassmannian?*

The difficulties to answer these questions come mainly from the following facts

- taking the upper triangular part of some infinite-dimensional matrix does not preserve the Banach space of bounded operators, nor the Banach space of trace-class operators.
- Iwasawa decompositions may not exist in the context of infinite-dimensional Banach Lie groups (see however [21] and [25] where some Iwasawa type factorisations were established).

Related papers on Poisson geometry in the infinite-dimensional setting are [32], [152], [156] and [238] (see Section 3). Let us mention that a hierarchy of commuting Hamiltonian equations related to the restricted Grassmannian was described in [85]. In the aforementioned paper, the method of F. Magri was used to generate the integrals of motions. It would be interesting to explore the link between equations studied in [85] and the Bruhat-Poisson structure of the restricted Grassmannian introduced in [213]. Some integrable systems on subspaces of Hilbert-Schmidt operators were also introduced in [63]. There, the coinduction method suggested in [159] was used to construct Banach Lie–Poisson spaces obtained from the ideal of real Hilbert-Schmidt operators, and Hamiltonian systems related to the k -diagonal Toda lattice were presented. Last but not least, the relation between the Bruhat-Poisson structure on the restricted Grassmannian constructed in [213] and the Poisson–Lie group of Pseudo-Differential symbols considered in [106] in relation to the Korteweg-de Vries hierarchy needs further study, and the link with the Poisson–Lie Grassmannian introduced in [238] has to be clarified.

The present chapter just approaches some aspects of the theory of Banach Poisson–Lie groups, and a more systematic study of the infinite-dimensional theory would be interesting. It is written to be as self-contained as possible, and we hope that our exposition enables functional-analysts, geometers and physicists to read it. However the notions of Banach manifold and fiber bundles over Banach manifolds will not be recalled and we refer the readers to [124] for more introductory exposition.

This chapter is devoted to the general theory of Banach Poisson–Lie groups and related structures. The exposition goes in the opposite direction of the usual exposition in the finite-dimensional setting, where the notion of finite-dimensional Poisson–Lie groups is introduced first, followed by the notion of Lie bialgebra (which is the structure that a Lie algebra of a Poisson–Lie group inherits), and at last the notion of Manin triples. Here we start with the notion of Banach Manin triples in Section 6.2, since it is a notion of linear algebra that is easy to adapted to the Banach context, and which provides a good entry point into the theory of (Banach) Poisson–Lie groups. This point of view allows us to introduce little by little notation and notions that are fundamental for our considerations: the notion of duality pairing is recalled in Section 6.2.1, the notion of coadjoint action on bounded multilinear maps on subspaces of the dual is defined in Section 6.3.3, and the notion of 1-cocycles on a Banach Lie group or a Banach Lie algebra is explained in Section 6.3.5. Generalized Banach Poisson manifolds are defined in Section 6.4.1. In Section 6.4.2 we show that weak symplectic Banach manifolds are examples of generalized Banach Poisson manifolds. In Section 6.4.3, we adapt the notion of Banach Lie–Poisson spaces introduced in [156] to the case of an arbitrary duality pairing between two Banach Lie algebras, and show that they are generalized Banach Poisson manifolds (Theorem 6.4.14). The notion of Banach Lie bialgebras is introduced in Section 6.5, and its relation to the notion of Banach Manin triples is given by the following Theorem:

Theorem 6.1.2 (Theorem 6.5.9). *Consider two Banach Lie algebras $(\mathfrak{g}_+, [\cdot, \cdot]_{\mathfrak{g}_+})$ and $(\mathfrak{g}_-, [\cdot, \cdot]_{\mathfrak{g}_-})$ in duality. Denote by \mathfrak{g} the Banach space $\mathfrak{g} = \mathfrak{g}_+ \oplus \mathfrak{g}_-$ with norm $\|\cdot\|_{\mathfrak{g}} = \|\cdot\|_{\mathfrak{g}_+} + \|\cdot\|_{\mathfrak{g}_-}$. The following assertions are equivalent.*

- (1) \mathfrak{g}_+ is a Banach Lie–Poisson space and a Banach Lie bialgebra with respect to \mathfrak{g}_- ;
- (2) $(\mathfrak{g}, \mathfrak{g}_+, \mathfrak{g}_-)$ is a Banach Manin triple for the non-degenerate symmetric bilinear map given by

$$\begin{aligned} \langle \cdot, \cdot \rangle_{\mathfrak{g}} : \quad \mathfrak{g} \times \mathfrak{g} &\rightarrow \mathbb{K} \\ (x, \alpha) \times (y, \beta) &\mapsto \langle x, \beta \rangle_{\mathfrak{g}_+, \mathfrak{g}_-} + \langle y, \alpha \rangle_{\mathfrak{g}_+, \mathfrak{g}_-}. \end{aligned}$$

Finally Section 6.6 is devoted to the notion of Banach Poisson–Lie groups. Basic examples are given in Section 6.6.3. In Section 6.6.4, we prove that the Lie algebra \mathfrak{g} of a Banach Poisson–Lie group (G, \mathbb{F}, π) carries a natural structure of Banach Lie bialgebra with respect to \mathbb{F}_e , and, with an additional condition on the Poisson tensor, is a Banach Lie–Poisson space with respect to \mathbb{F}_e .

The generalized notion of Banach Poisson manifolds introduced in this chapter is adapted to the particular examples of Poisson–Lie groups we present in Chapter 7. Examples of Banach Poisson–Lie group in our sense include the restricted unitary group $U_{\text{res}}(\mathcal{H})$ and the restricted triangular group $B_{\text{res}}^+(\mathcal{H})$, which are modelled on non-reflexive Banach spaces (see Section 7.2.3). In Section 7.4, we show that the restricted Grassmannian viewed as homogeneous space under $U_{\text{res}}(\mathcal{H})$ inherits a Poisson structure in analogy to the finite-dimensional picture developed in [136] and called Bruhat–Poisson structure. Moreover, the natural action of the Poisson–Lie group $B_{\text{res}}^+(\mathcal{H})$ on the restricted Grassmannian is a Poisson map, and its orbits are the Schubert cells described in [172]. These results are summarized in the following Theorem (see Theorem 7.3.3, Theorem 7.4.1, and Theorem 7.4.5).

Theorem 6.1.3. *The restricted Grassmannian*

$$\text{Gr}_{\text{res}}(\mathcal{H}) = U_{\text{res}}(\mathcal{H})/U(\mathcal{H}_+) \times U(\mathcal{H}_-) = \text{GL}_{\text{res}}(\mathcal{H})/\text{P}_{\text{res}}(\mathcal{H})$$

carries a natural Poisson structure such that:

1. *the canonical projection $p : U_{\text{res}}(\mathcal{H}) \rightarrow \text{Gr}_{\text{res}}(\mathcal{H})$ is a Poisson map,*
2. *the natural action of $U_{\text{res}}(\mathcal{H})$ on $\text{Gr}_{\text{res}}(\mathcal{H})$ by left translations is a Poisson map,*

3. the following right action of $B_{\text{res}}^+(\mathcal{H})$ on $\text{Gr}_{\text{res}}(\mathcal{H}) = \text{GL}_{\text{res}}(\mathcal{H})/\text{P}_{\text{res}}(\mathcal{H})$ is a Poisson map:

$$\begin{aligned} \text{Gr}_{\text{res}}(\mathcal{H}) \times B_{\text{res}}^+(\mathcal{H}) &\rightarrow \text{Gr}_{\text{res}}(\mathcal{H}) \\ (g \text{P}_{\text{res}}(\mathcal{H}), b) &\mapsto (b^{-1}g) \text{P}_{\text{res}}(\mathcal{H}). \end{aligned}$$

4. the symplectic leaves of $\text{Gr}_{\text{res}}(\mathcal{H})$ are the Schubert cells and are the orbits of $B_{\text{res}}^+(\mathcal{H})$.

Let us mention that the infinite-dimensional abelian subgroup of $B_{\text{res}}^+(\mathcal{H})$ generated by the shift induces the KdV hierarchy as explained in [185].

6.2 Manin triples in the infinite-dimensional setting

We start in this section with the easiest notion related to Poisson–Lie groups, namely the notion of Manin triples. It will allow us to set up some notation used in [213], and recall the notion of duality pairing, which is crucial for the following Sections. The unboundedness of the triangular truncation on the space of trace class operators and on the space of bounded operators (see Section 6.2.4) will have important consequences in Section 7.2.2. Examples of Banach Manin triples coming from Iwasawa decompositions are given in Section 6.2.5. In particular, the Manin triple $(L_2(\mathcal{H}), \mathfrak{u}_2(\mathcal{H}), \mathfrak{b}_2^+(\mathcal{H}))$ of Hilbert-Schmidt operators will have a key rôle in the proofs of most Theorems in Chapter 7.

6.2.1 Duality pairings of Banach spaces

In this chapter, we will consider real or complex Banach spaces, and we will denote by $\mathbb{K} \in \{\mathbb{R}, \mathbb{C}\}$ the scalar field. The dual \mathfrak{g}^* of a Banach space \mathfrak{g} will mean the continuous dual, i.e. the Banach space of bounded linear forms with values in \mathbb{K} . In a lot of applications, the dual of a Banach space \mathfrak{g} is too big to work with, and one uses proper subspaces of \mathfrak{g}^* . A duality pairing between two Banach spaces allows to identify one Banach space with a subspace of the dual of the other. Additional structures on one of the Banach spaces (like a Lie bracket for instance) give rise to additional structures on the other Banach space via duality.

Definition of strong and weak duality pairings

Let us recall the notion of duality pairing in the infinite-dimensional setting (see [1], supplement 2.4.C).

Definition 6.2.1. Let \mathfrak{g}_1 and \mathfrak{g}_2 be two normed vector spaces over the same field $\mathbb{K} \in \{\mathbb{R}, \mathbb{C}\}$, and let

$$\langle \cdot, \cdot \rangle_{\mathfrak{g}_1, \mathfrak{g}_2} : \mathfrak{g}_1 \times \mathfrak{g}_2 \rightarrow \mathbb{K}$$

be a continuous bilinear map. One says that the map $\langle \cdot, \cdot \rangle_{\mathfrak{g}_1, \mathfrak{g}_2}$ is a **duality pairing** between \mathfrak{g}_1 and \mathfrak{g}_2 if and only if it is **non-degenerate**, i.e. if the following two conditions hold:

$$\langle x, y \rangle_{\mathfrak{g}_1, \mathfrak{g}_2} = 0, \quad \forall x \in \mathfrak{g}_1 \Rightarrow y = 0 \quad \text{and} \quad \langle x, y \rangle_{\mathfrak{g}_1, \mathfrak{g}_2} = 0, \quad \forall y \in \mathfrak{g}_2 \Rightarrow x = 0.$$

Definition 6.2.2. A duality pairing $\langle \cdot, \cdot \rangle_{\mathfrak{g}_1, \mathfrak{g}_2}$ is a **strong duality pairing** between \mathfrak{g}_1 and \mathfrak{g}_2 if and only if the two continuous linear maps

$$\begin{aligned} \mathfrak{g}_1 &\longrightarrow \mathfrak{g}_2^* \\ x &\longmapsto \langle x, \cdot \rangle_{\mathfrak{g}_1, \mathfrak{g}_2} \end{aligned} \quad \text{and} \quad \begin{aligned} \mathfrak{g}_2 &\longrightarrow \mathfrak{g}_1^* \\ y &\longmapsto \langle \cdot, y \rangle_{\mathfrak{g}_1, \mathfrak{g}_2} \end{aligned} \tag{6.1}$$

are isomorphisms. In all other cases, the duality pairing is called **weak**.

The non-degenerate condition of a duality pairing implies that the maps (6.1) are injective. In other words, the existence of a duality pairing between \mathfrak{g}_1 and \mathfrak{g}_2 allows to identify \mathfrak{g}_1 with a subspace (not necessarily closed!) of the continuous dual \mathfrak{g}_2^* of \mathfrak{g}_2 , and \mathfrak{g}_2 with a subspace of \mathfrak{g}_1^* , whereas a strong duality pairing gives isomorphisms $\mathfrak{g}_1 \simeq \mathfrak{g}_2^*$ and $\mathfrak{g}_2 \simeq \mathfrak{g}_1^*$. Therefore the existence of a strong duality pairing between \mathfrak{g}_1 and \mathfrak{g}_2 implies that \mathfrak{g}_1 and \mathfrak{g}_2 are reflexive Banach spaces. Note that in the finite-dimensional case, a count of the dimensions shows that any duality pairing is a strong duality pairing.

Remark 6.2.3. By Hahn-Banach Theorem, the natural pairing between a Banach space \mathfrak{g} and its continuous dual \mathfrak{g}^* is a duality pairing. It is a strong duality pairing in the reflexive case $\mathfrak{g}^{**} = \mathfrak{g}$.

Notation and Examples

In order to give examples of duality pairings, let us introduce some notation used in the present chapter. The letter \mathcal{H} will refer to a general complex separable infinite-dimensional Hilbert space. The inner product in \mathcal{H} will be denoted by $\langle \cdot | \cdot \rangle : \mathcal{H} \times \mathcal{H} \rightarrow \mathbb{C}$ and will be complex-linear in the second variable, and conjugate-linear in the first variable.

Banach algebra $L_\infty(\mathcal{H})$ of bounded operators over a Hilbert space \mathcal{H}

Denote by $L_\infty(\mathcal{H})$ the space of bounded linear maps from \mathcal{H} into itself. It is a Banach space for the norm of operators $\|A\|_\infty := \sup_{\|x\| \leq 1} \|Ax\|$ and a Banach Lie algebra for the bracket given by the commutator of operators: $[A, B] = A \circ B - B \circ A$, for $A, B \in L_\infty(\mathcal{H})$. In the following, we will denote the composition $A \circ B$ of the operators A and B simply by AB .

Hilbert algebra $L_2(\mathcal{H})$ of Hilbert-Schmidt operators

A bounded operator A admits an adjoint A^* which is the bounded linear operator defined by $\langle A^*x|y \rangle = \langle x|Ay \rangle$. A positive operator is a bounded operator such that $\langle \varphi|A\varphi \rangle \geq 0$ for any $\varphi \in \mathcal{H}$. By polarization, if A is positive then $A^* = A$. The trace of a positive operator A is defined as

$$\text{Tr } A := \sum_{n=1}^{+\infty} \langle \varphi_n | A \varphi_n \rangle \in [0, +\infty],$$

where φ_n is any orthonormal basis of \mathcal{H} (the right hand side does not depend on the choice of orthonormal basis, see Theorem 2.1 in [191]). The Schatten class $L_2(\mathcal{H})$ of Hilbert-Schmidt operators is the subspace of $L_\infty(\mathcal{H})$ consisting of bounded operators A such that $\|A\|_2 := (\text{Tr}(A^*A))^{\frac{1}{2}}$ is finite. It is a Banach Lie algebra for $\|\cdot\|_2$ and for the bracket given by the commutator of operators. It is also an ideal of $L_\infty(\mathcal{H})$ in the sense that for any $A \in L_2(\mathcal{H})$ and any $B \in L_\infty(\mathcal{H})$, one has $AB \in L_2(\mathcal{H})$ and $BA \in L_2(\mathcal{H})$.

Banach algebra $L_1(\mathcal{H})$ of trace-class operators

For a bounded linear operator A , the square root of A^*A is well defined, and denoted by $(A^*A)^{\frac{1}{2}}$ (see Theorem VI.9 in [174]). The Schatten class $L_1(\mathcal{H})$ of trace class operators is the subspace of $L_\infty(\mathcal{H})$ consisting of bounded operators A such that $\|A\|_1 := \text{Tr}(A^*A)^{\frac{1}{2}}$ is finite. It is a Banach Lie algebra for $\|\cdot\|_1$ and for the bracket given by the commutator of operators. We recall that for any $A \in L_1(\mathcal{H})$ (not necessarily positive), the trace of A is defined as

$$\text{Tr } A := \sum_{n=1}^{\infty} \langle \varphi_n | A \varphi_n \rangle,$$

where $\{\varphi_n\}$ is any orthonormal basis of \mathcal{H} (the right hand side does not depend on the orthonormal basis, see Theorem 3.1 in [191]) and that we have

$$|\text{Tr } A| \leq \|A\|_1.$$

Moreover $L_1(\mathcal{H})$ is an ideal of $L_\infty(\mathcal{H})$, i.e. for any $A \in L_1(\mathcal{H})$ and any $B \in L_\infty(\mathcal{H})$, $AB \in L_1(\mathcal{H})$ and $BA \in L_1(\mathcal{H})$, and furthermore $\text{Tr } AB = \text{Tr } BA$. Finally for A and B in $L_2(\mathcal{H})$, one has $AB \in L_1(\mathcal{H})$, $BA \in L_1(\mathcal{H})$, and $\text{Tr } AB = \text{Tr } BA$ (see Corollary 3.8 in [191]).

Banach algebras $L_p(\mathcal{H})$

For any $1 < p < \infty$, the Schatten class $L_p(\mathcal{H})$ is the subspace of $L_\infty(\mathcal{H})$ consisting of bounded operators A such that

$$\|A\|_p := \left(\text{Tr}(A^*A)^{\frac{p}{2}} \right)^{\frac{1}{p}}$$

is finite. It is a Banach algebra for the norm $\|\cdot\|_p$ and for the bracket given by the commutator of operators. Moreover $L_p(\mathcal{H})$ is an ideal of $L_\infty(\mathcal{H})$: for any $A \in L_p(\mathcal{H})$ and any $B \in L_\infty(\mathcal{H})$, $AB \in L_p(\mathcal{H})$ and $BA \in L_p(\mathcal{H})$.

Remark 6.2.4. For $1 < p < 2 < q < \infty$, one has

$$L_1(\mathcal{H}) \hookrightarrow L_p(\mathcal{H}) \hookrightarrow L_2(\mathcal{H}) \hookrightarrow L_q(\mathcal{H}) \hookrightarrow L_\infty(\mathcal{H}),$$

where each injection is a continuous map between Banach spaces. In the following, we will repeatedly use these inclusions.

Let us now give some examples of duality pairings.

Example 6.2.5. The trace of the product of two operators $(A, B) \mapsto \text{Tr } AB$ is a strong duality pairing between $L_2(\mathcal{H})$ and itself.

Example 6.2.6. Since $L_1(\mathcal{H})$ is a dense subspace of $L_2(\mathcal{H})$, one obtains a weak duality pairing between $L_1(\mathcal{H})$ and $L_2(\mathcal{H})$ by considering the bilinear map $(A, B) \mapsto \text{Tr } AB$ with $A \in L_1(\mathcal{H})$ and $B \in L_2(\mathcal{H})$.

Example 6.2.7. Since the dual of $L_1(\mathcal{H})$ can be identified with $L_\infty(\mathcal{H})$ using the trace, one has a weak duality pairing between $L_1(\mathcal{H})$ and $L_\infty(\mathcal{H})$ by considering the bilinear map $(A, B) \mapsto \text{Tr } AB$ with $A \in L_1(\mathcal{H})$ and $B \in L_\infty(\mathcal{H})$. Note that the dual space of $L_\infty(\mathcal{H})$ strictly contains $L_1(\mathcal{H})$ as a closed subspace.

Example 6.2.8. For $1 < p < \infty$, define $1 < q < \infty$ by the relation $\frac{1}{p} + \frac{1}{q} = 1$. For any $A \in L_p(\mathcal{H})$ and any $B \in L_q(\mathcal{H})$, $AB \in L_1(\mathcal{H})$ and $BA \in L_1(\mathcal{H})$ with

$$\|AB\|_1 \leq \|A\|_p \|B\|_q \quad \text{and} \quad \|BA\|_1 \leq \|A\|_p \|B\|_q,$$

(see Proposition 5, page 41 in [175]) and furthermore $\text{Tr } AB = \text{Tr } BA$. Moreover the trace of the product of two operators $(A, B) \mapsto \text{Tr } AB$ is a strong duality pairing between $L_p(\mathcal{H})$ and $L_q(\mathcal{H})$ and gives rise to the following identifications (see Proposition 7, page 43 in [175] and Theorem VI.26, page 212 in [174]):

$$(L_p(\mathcal{H}))^* \simeq L_q(\mathcal{H}) \quad \text{and} \quad (L_q(\mathcal{H}))^* \simeq L_p(\mathcal{H})$$

6.2.2 Duals and injection of Banach spaces

Suppose that \mathfrak{h} is a Banach space that injects continuously into another Banach space \mathfrak{g} , i.e. one has a continuous injection $\iota : \mathfrak{h} \hookrightarrow \mathfrak{g}$. Then one can consider two different dual spaces : the dual space \mathfrak{h}^* which consists of linear forms on the Banach space \mathfrak{h} which are continuous with respect to the operator norm associated to the Banach norm $\|\cdot\|_{\mathfrak{h}}$ on \mathfrak{h} , and the norm dual $\iota(\mathfrak{h})^*$ of the subspace $\iota(\mathfrak{h}) \subset \mathfrak{g}$ endowed with the norm $\|\cdot\|_{\mathfrak{g}}$ of \mathfrak{g} , consisting of continuous linear forms on the normed vector space $(\iota(\mathfrak{h}), \|\cdot\|_{\mathfrak{g}})$. Note that, since \mathbb{R} is complete, $\iota(\mathfrak{h})^*$ is complete even if $\iota(\mathfrak{h})$ is not closed in \mathfrak{g} (see for instance [40] Section 1.1). Let us compare these two duals : \mathfrak{h}^* on one hand and $\iota(\mathfrak{h})^*$ on the other hand. First note that one gets a well-defined map

$$\begin{aligned} \iota^* : \mathfrak{g}^* &\rightarrow \mathfrak{h}^* \\ f &\mapsto f \circ \iota \end{aligned}$$

since $f \circ \iota$ is continuous for the operator norm induced by the norm of \mathfrak{h} whenever f is continuous for the operator norm induced by the norm on \mathfrak{g} . Note that ι^* is surjective if and only if any continuous form on \mathfrak{h} can be extended to a continuous form on \mathfrak{g} . On the other hand, ι^* is injective if and only if the only continuous form on \mathfrak{g} that vanishes on $\iota(\mathfrak{h})$ is the zero form.

Suppose that the range of $\iota : \mathfrak{h} \hookrightarrow \mathfrak{g}$ is closed. Then $\iota(\mathfrak{h})$ endowed with the norm of \mathfrak{g} is a Banach space. It follows that ι is a continuous bijection from the Banach space \mathfrak{h} onto the Banach space $\iota(\mathfrak{h})$, therefore by the open mapping theorem, it is an isomorphism of Banach spaces (see for instance Corollary 2.7 in [40]). In this case, any continuous form on \mathfrak{h} is continuous for the norm of \mathfrak{g} i.e. one has $\mathfrak{h}^* = \iota(\mathfrak{h})^*$. By Hahn-Banach theorem, any continuous form on $\iota(\mathfrak{h})$ can be extended to a continuous form on \mathfrak{g} with the same norm (see Corollary 1.2 in [40]). Therefore the dual map $\iota^* : \mathfrak{g}^* \rightarrow \mathfrak{h}^*$ is surjective. Its kernel is the annihilator $\iota(\mathfrak{h})^0$ of $\iota(\mathfrak{h})$ and \mathfrak{h}^* is isomorphic to the quotient space $\mathfrak{g}^*/\iota(\mathfrak{h})^0$.

Example 6.2.9. The injection of the Banach space of compact operators $\mathcal{K}(\mathcal{H})$ on a separable Hilbert space \mathcal{H} into the Banach space of bounded operators $L_\infty(\mathcal{H})$ is closed. The dual map $\iota^* : L_\infty(\mathcal{H})^* \rightarrow \mathcal{K}(\mathcal{H})^*$ is surjective and $\mathcal{K}(\mathcal{H})^*$ can be identified with the space $L_1(\mathcal{H})$ of trace class operators on \mathcal{H} using the trace. Therefore $L_1(\mathcal{H})$ is isomorphic to the quotient space $L_\infty(\mathcal{H})^*/\mathcal{K}(\mathcal{H})^0$.

Suppose now that the range of $\iota : \mathfrak{h} \hookrightarrow \mathfrak{g}$ is dense in \mathfrak{g} . In this case, any continuous form on $\iota(\mathfrak{h})$ extends in a unique way to a continuous form on \mathfrak{g} with the same norm i.e. $\iota(\mathfrak{h})^* = \mathfrak{g}^*$. The kernel of ι^* consists of continuous maps on \mathfrak{g} that vanish on the dense subspace $\iota(\mathfrak{h})$, hence is reduced to 0. In other words $\iota^* : \mathfrak{g}^* \rightarrow \mathfrak{h}^*$ is injective (see also Corollary 1.8 in [40]).

Example 6.2.10. Consider the inclusion $\iota : L_1(\mathcal{H}) \hookrightarrow L_2(\mathcal{H})$ of the space of trace-class operators into the space of Hilbert-Schmidt operators on \mathcal{H} . Then the range of ι is dense. This leads to the injection $\iota^* : L_2(\mathcal{H})^* = L_2(\mathcal{H}) \hookrightarrow L_1(\mathcal{H})^* = L_\infty(\mathcal{H})$.

6.2.3 Definition of Banach Manin triples

The notion of Manin triple is a notion of linear algebra that can be adapted in a straightforward way to the Banach context.

Definition 6.2.11. A Banach Manin triple consists of a triple of Banach Lie algebras $(\mathfrak{g}, \mathfrak{g}_+, \mathfrak{g}_-)$ over a field \mathbb{K} and a **non-degenerate symmetric bilinear** continuous map $\langle \cdot, \cdot \rangle_{\mathfrak{g}}$ on \mathfrak{g} such that

1. the bilinear map $\langle \cdot, \cdot \rangle_{\mathfrak{g}}$ is invariant with respect to the bracket $[\cdot, \cdot]_{\mathfrak{g}}$ of \mathfrak{g} , i.e.

$$\langle [x, y]_{\mathfrak{g}}, z \rangle_{\mathfrak{g}} + \langle y, [x, z]_{\mathfrak{g}} \rangle_{\mathfrak{g}} = 0, \quad \forall x, y, z \in \mathfrak{g}; \quad (6.2)$$

2. $\mathfrak{g} = \mathfrak{g}_+ \oplus \mathfrak{g}_-$ as Banach spaces;
3. both \mathfrak{g}_+ and \mathfrak{g}_- are Banach Lie subalgebras of \mathfrak{g} ;
4. both \mathfrak{g}_+ and \mathfrak{g}_- are isotropic with respect to the bilinear map $\langle \cdot, \cdot \rangle_{\mathfrak{g}}$.

Note that in the Banach context, it is important to ask for the continuity of the bilinear map $\langle \cdot, \cdot \rangle_{\mathfrak{g}}$, as well as for a decomposition $\mathfrak{g} = \mathfrak{g}_+ \oplus \mathfrak{g}_-$ of \mathfrak{g} into the sum of two closed Banach subspaces. Let us make some remarks which are simple consequences of the definition of a Manin triple.

Remark 6.2.12. Given a Manin triple $(\mathfrak{g}, \mathfrak{g}_+, \mathfrak{g}_-)$, condition (2) implies that any continuous linear form α on \mathfrak{g} decomposes in a continuous way as

$$\alpha = \alpha \circ p_{\mathfrak{g}_+} + \alpha \circ p_{\mathfrak{g}_-},$$

where $p_{\mathfrak{g}_+}$ (resp. $p_{\mathfrak{g}_-}$) is the continuous projection onto \mathfrak{g}_+ (resp. \mathfrak{g}_-) with respect to the decomposition $\mathfrak{g} = \mathfrak{g}_+ \oplus \mathfrak{g}_-$. In other words, one has a decomposition of the continuous dual \mathfrak{g}^* of \mathfrak{g} as

$$\mathfrak{g}^* = \mathfrak{g}_-^0 \oplus \mathfrak{g}_+^0,$$

where \mathfrak{g}_\pm^0 is the annihilator of \mathfrak{g}_\pm , i.e.

$$\mathfrak{g}_\pm^0 := \{\alpha \in \mathfrak{g}^* : \alpha(x) = 0, \quad \forall x \in \mathfrak{g}_\pm\}.$$

Moreover any continuous linear form β on \mathfrak{g}_+ can be extended in a unique way to a continuous linear form on \mathfrak{g} belonging to \mathfrak{g}_-^0 by $\beta \mapsto \beta \circ p_+$. It follows that one has an isomorphism

$$\mathfrak{g}_+^* \simeq \mathfrak{g}_-^0,$$

and similarly

$$\mathfrak{g}_-^* \simeq \mathfrak{g}_+^0.$$

Remark 6.2.13. Given a Manin triple $(\mathfrak{g}, \mathfrak{g}_+, \mathfrak{g}_-)$ where $\langle \cdot, \cdot \rangle_{\mathfrak{g}}$ is a **strong** duality pairing, any continuous linear form on \mathfrak{g} can be written as $\langle x, \cdot \rangle_{\mathfrak{g}}$ for some $x \in \mathfrak{g}$. In particular, for any subspace $\mathfrak{h} \subset \mathfrak{g}$, one has

$$\mathfrak{h}^0 \simeq \mathfrak{h}^\perp,$$

where

$$\mathfrak{h}^\perp := \{x \in \mathfrak{g} : \langle x, y \rangle_{\mathfrak{g}} = 0, \forall y \in \mathfrak{h}\}.$$

Moreover, any continuous linear form β on \mathfrak{g}_+ can be represented as $\beta(x) = \langle x, y \rangle_{\mathfrak{g}}$ for a unique element $y \in \mathfrak{g}_-$. Therefore, in this case,

$$\mathfrak{g}_- \simeq \mathfrak{g}_+^*$$

and similarly

$$\mathfrak{g}_+ \simeq \mathfrak{g}_-^*.$$

6.2.4 Triangular truncations of operators

Endow the separable complex Hilbert space \mathcal{H} with an orthonormal basis $\{|n\rangle\}_{n \in \mathbb{Z}}$ ordered according to decreasing values of n . For $1 \leq p \leq \infty$, consider the following Banach Lie subalgebras of $L_p(\mathcal{H})$

$$\begin{aligned} L_p(\mathcal{H})_- &:= \{x \in L_p(\mathcal{H}) : x|n\rangle \in \text{span}\{|m\rangle, m \leq n\}\} \\ &\quad \text{(lower triangular operators)} \end{aligned} \tag{6.3}$$

$$\begin{aligned} L_p(\mathcal{H})_{++} &:= \{x \in L_p(\mathcal{H}) : x|n\rangle \in \text{span}\{|m\rangle, m > n\}\} \\ &\quad \text{(strictly upper triangular operators)}. \end{aligned}$$

and

$$\begin{aligned} L_p(\mathcal{H})_+ &:= \{\alpha \in L_p(\mathcal{H}) : \alpha|n\rangle \in \text{span}\{|m\rangle, m \geq n\}\} \\ &\quad \text{(upper triangular operators)} \end{aligned} \tag{6.4}$$

$$\begin{aligned} L_p(\mathcal{H})_{--} &:= \{\alpha \in L_p(\mathcal{H}) : \alpha|n\rangle \in \text{span}\{|m\rangle, m < n\}\} \\ &\quad \text{(strictly lower triangular operators)}. \end{aligned}$$

The linear transformation T_- consisting in taking the lower triangular part of an operator with respect to the orthonormal basis $\{|n\rangle\}_{n \in \mathbb{Z}}$ of \mathcal{H} is called a triangular truncation or triangular projection (see [6]) and is defined as follows:

$$\langle m|T_-(A)n\rangle := \begin{cases} \langle m|An\rangle & \text{if } m \leq n \\ 0 & \text{if } m > n \end{cases} \tag{6.5}$$

Similarly, the linear transformation T_{++} consisting in taking the strictly upper triangular part of an operator with respect to $\{|n\rangle\}_{n \in \mathbb{Z}}$ is defined as follows:

$$\langle m|T_{++}(A)n\rangle := \begin{cases} \langle m|An\rangle & \text{if } m > n \\ 0 & \text{if } m \leq n \end{cases} \tag{6.6}$$

The linear transformation D consisting in taking the diagonal part of a linear operator is defined by

$$\langle m|D(A)n\rangle := \begin{cases} \langle m|An\rangle & \text{if } n = m \\ 0 & \text{if } n \neq m \end{cases} \tag{6.7}$$

Remark 6.2.14. The triangular truncations T_- and T_{++} are unbounded on $L_\infty(\mathcal{H})$ and on $L_1(\mathcal{H})$, but are bounded on $L_p(\mathcal{H})$ for $1 < p < \infty$ (see [138], [121], [84] as well as Proposition 4.2 in [6] for the proof and more detail on the subject). See also [57] for an example of bounded operator whose triangular truncation is unbounded (Hilbert matrix). As far as we know the existence and construction of a trace class operator whose triangular projection is not trace class is an open problem. We refer the reader to [23] for related functional-analytic issues in the theory of Banach Lie groups.

Denote by $T_+ = T_{++} + D$ (resp. $T_{--} = T_- - D$) the linear transformation consisting in taking the upper triangular part (resp. strictly lower triangular part) of an operator. One has for $1 < p < \infty$,

$$L_p(\mathcal{H}) = L_p(\mathcal{H})_+ \oplus L_p(\mathcal{H})_{--}, \tag{6.8}$$

and

$$L_p(\mathcal{H}) = L_p(\mathcal{H})_- \oplus L_p(\mathcal{H})_{++}. \tag{6.9}$$

6.2.5 Example of Iwasawa Manin triples

The Iwasawa decomposition of a finite-dimensional semi-simple Lie group is a generalization of the decomposition of $GL(n, \mathbb{C})$ as the product of $SU(n) \times A \times N$, where A is the abelian group of diagonal matrices with positive real coefficients, and N is the group of triangular matrices whose diagonal entries are all equal to 1. The product $A \times N$ is often denoted by B for Borel subgroup. At the level of Lie algebras, the Iwasawa decomposition gives rise to the decomposition $M(n, \mathbb{C}) = \mathfrak{u}(n) \oplus \mathfrak{b}(n)$, where $\mathfrak{b}(n)$ is the Lie algebra of complex triangular matrices with real coefficients on the diagonal. Since the triangular truncation defined in Section 6.2.4 is bounded on $L^p(\mathcal{H})$ for $1 < p < \infty$, we can generalize this decomposition to the Banach context (see Lemma 6.2.15). As explained in [136], $(M(n, \mathbb{C}), \mathfrak{u}(n), \mathfrak{b}(n))$ is an example of Manin triple, where the duality pairing is given by the imaginary part of the trace. This duality pairing can be defined on $L^p(\mathcal{H})$ for $1 < p \leq 2$ because in this case $L^p(\mathcal{H})$ injects into its dual. This gives rise to Banach Manin triples, that we will call Iwasawa Manin triples (see Proposition 6.2.16 below).

We will use the following notation. The real Banach Lie algebra $\mathfrak{u}_p(\mathcal{H})$ is the Lie algebra of skew-Hermitian operators in $L_p(\mathcal{H})$:

$$\mathfrak{u}_p(\mathcal{H}) := \{A \in L_p(\mathcal{H}) : A^* = -A\}. \quad (6.10)$$

The real Banach subalgebras $\mathfrak{b}_p^+(\mathcal{H})$ and $\mathfrak{b}_p^-(\mathcal{H})$ of $L_p(\mathcal{H})$ are the triangular Banach algebras defined as follows:

$$\begin{aligned} \mathfrak{b}_p^+(\mathcal{H}) &:= \{\alpha \in L_p(\mathcal{H}) : \alpha|_n \in \text{span}\{|m\rangle, m \geq n\} \text{ and } \langle n|\alpha|n\rangle \in \mathbb{R}, \text{ for } n \in \mathbb{Z}\}, \\ \mathfrak{b}_p^-(\mathcal{H}) &:= \{\alpha \in L_p(\mathcal{H}) : \alpha|_n \in \text{span}\{|m\rangle, m \leq n\} \text{ and } \langle n|\alpha|n\rangle \in \mathbb{R}, \text{ for } n \in \mathbb{Z}\}. \end{aligned} \quad (6.11)$$

Lemma 6.2.15. *For $1 < p < \infty$, one has the following direct sum decompositions of $L_p(\mathcal{H})$ into the sum of closed subalgebras*

$$L_p(\mathcal{H}) = \mathfrak{u}_p(\mathcal{H}) \oplus \mathfrak{b}_p^+(\mathcal{H}), \quad (6.12)$$

and

$$L_p(\mathcal{H}) = \mathfrak{u}_p(\mathcal{H}) \oplus \mathfrak{b}_p^-(\mathcal{H}). \quad (6.13)$$

The projection $p_{\mathfrak{u}_p, +}$ onto $\mathfrak{u}_p(\mathcal{H})$ with respect to the decomposition (6.12) reads

$$p_{\mathfrak{u}_p, +}(A) = T_{--}(A) - T_{--}(A)^* + \frac{1}{2}[D(A) - D(A)^*], \quad \text{where } A \in L_p(\mathcal{H}). \quad (6.14)$$

Similarly, the projection $p_{\mathfrak{u}_p, -}$ onto $\mathfrak{u}_p(\mathcal{H})$ with respect to the decomposition (6.13) reads:

$$p_{\mathfrak{u}_p, -}(A) = T_{++}(A) - T_{++}(A)^* + \frac{1}{2}[D(A) - D(A)^*], \quad \text{where } A \in L_p(\mathcal{H}). \quad (6.15)$$

Proof. Since the triangular truncations $T_+ : L_p(\mathcal{H}) \rightarrow L_p(\mathcal{H})$ and $T_{++} : L_p(\mathcal{H}) \rightarrow L_p(\mathcal{H})$ are bounded for $1 < p < \infty$ (see remark 6.2.14), the same is true for the operator $D = T_+ - T_{++}$. The Lemma follows as in the finite-dimensional case. \square

Proposition 6.2.16. *For $1 < p \leq 2$, the triples of Banach Lie algebras $(L_p(\mathcal{H}), \mathfrak{u}_p(\mathcal{H}), \mathfrak{b}_p^+(\mathcal{H}))$ and $(L_p(\mathcal{H}), \mathfrak{u}_p(\mathcal{H}), \mathfrak{b}_p^-(\mathcal{H}))$ are real Banach Manin triples with respect to the pairing given by the imaginary part of the trace*

$$\begin{aligned} \langle \cdot, \cdot \rangle_{\mathbb{R}} : L_p(\mathcal{H}) \times L_p(\mathcal{H}) &\longrightarrow \mathbb{R} \\ (x, y) &\longmapsto \Im \text{Tr}(xy). \end{aligned} \quad (6.16)$$

Proof. • Let us show that the bilinear form on $L_p(\mathcal{H})$ given by the imaginary part of the trace is invariant with respect to the bracket given by the commutator. Set $q := \frac{p}{p-1}$. Then $1 < p \leq 2 \leq q < \infty$. For any $x, y, z \in L_p(\mathcal{H})$, recall that $L_p(\mathcal{H}) \cdot L_p(\mathcal{H}) \subset L_p(\mathcal{H})$, $L_p(\mathcal{H}) \subset L_q(\mathcal{H})$, and $L_p(\mathcal{H}) \cdot L_q(\mathcal{H}) \subset L_1(\mathcal{H})$. Therefore one has

$$\begin{aligned} \text{Tr}([x, y]z) &= \text{Tr}(xyz - yxz) = \text{Tr}(xyz) - \text{Tr}(yxz) \\ &= \text{Tr}(yzx) - \text{Tr}(yxz) = -\text{Tr}y[x, z], \end{aligned}$$

where the second equality follows from the fact that both xyz and yxz are in $L_1(\mathcal{H})$, and the third is justified since yz belongs to $L_1(\mathcal{H})$ and x is bounded. Taking the imaginary part of the trace preserves this invariance. Hence $\langle \cdot, \cdot \rangle_{\mathbb{R}}$ is invariant with respect to the Lie bracket of $L_p(\mathcal{H})$.

- By Lemma 6.2.15, one has the direct sum decompositions

$$L_p(\mathcal{H}) = \mathfrak{u}_p(\mathcal{H}) \oplus \mathfrak{b}_p^\pm(\mathcal{H}).$$

- Note that $\langle \cdot, \cdot \rangle_{\mathbb{R}}$ is well-defined because $L_p(\mathcal{H}) \subset L_q(\mathcal{H})$ for $1 < p \leq 2$. It is clearly symmetric and continuous. Let us show that $\langle \cdot, \cdot \rangle_{\mathbb{R}}$ is a non-degenerate bilinear form on $L_p(\mathcal{H})$. Denote by $\mathcal{H}_{\mathbb{R}}$ the real Hilbert space generated by $\{|n\rangle\}_{n \in \mathbb{Z}}$. Any bounded linear operator A on the complex Hilbert space $\mathcal{H} = \mathcal{H}_{\mathbb{R}} + i\mathcal{H}_{\mathbb{R}}$ can be written in blocks as

$$A = \begin{pmatrix} \Re A & -\Im A \\ \Im A & \Re A \end{pmatrix}.$$

where $\Re A : \mathcal{H}_{\mathbb{R}} \rightarrow \mathcal{H}_{\mathbb{R}}$ and $\Im A : \mathcal{H}_{\mathbb{R}} \rightarrow i\mathcal{H}_{\mathbb{R}}$. In particular, $A \in L_p(\mathcal{H})$ is the \mathbb{C} -linear extension of $\Re A + i\Im A$ (note that this is not the decomposition of A into its symmetric and skew-symmetric parts). Therefore, for any $A, B \in L_p(\mathcal{H})$,

$$\Im \text{Tr}(AB) = \text{Tr}(\Re A \Im B + \Im A \Re B).$$

Suppose that $\Im \text{Tr}(AB) = 0$ for any $B \in L_p(\mathcal{H})$. Since $L_p(\mathcal{H})$ is dense in $L_2(\mathcal{H})$, this implies that $\text{Tr} \Re A \cdot C = 0$ for any operator $C \in L_2(\mathcal{H}_{\mathbb{R}})$, and $\text{Tr} \Im A \cdot D = 0$ for any $D \in L_2(\mathcal{H}_{\mathbb{R}})$. It follows that $\Re A = 0$ and $\Im A = 0$ because the trace is a strong duality pairing between $L_2(\mathcal{H}_{\mathbb{R}})$ and itself.

- It is easy to show that $\mathfrak{u}_p(\mathcal{H}) \subset (\mathfrak{u}_p(\mathcal{H}))^\perp$, $\mathfrak{b}_p^+(\mathcal{H}) \subset (\mathfrak{b}_p^+(\mathcal{H}))^\perp$ and $\mathfrak{b}_p^-(\mathcal{H}) \subset (\mathfrak{b}_p^-(\mathcal{H}))^\perp$, in other words $\mathfrak{u}_p(\mathcal{H})$, $\mathfrak{b}_p^+(\mathcal{H})$ and $\mathfrak{b}_p^-(\mathcal{H})$ are isotropic subspaces with respect to the pairing $\langle \cdot, \cdot \rangle_{\mathbb{R}}$. □

Remark 6.2.17. In the previous Proposition, the condition $1 < p \leq 2$ is necessary in order to define the trace of the product of two elements in $L_p(\mathcal{H})$ ($L_p(\mathcal{H})$ is contained in its dual $L_q(\mathcal{H})$ for $1 < p \leq 2$).

6.3 From Manin triples to 1-cocycles

The existence of a Lie bracket on a Banach space \mathfrak{g}_+ has consequences on any Banach space \mathfrak{g}_- in duality with \mathfrak{g}_+ . Under some stability and continuity conditions (see Section 6.3.2), \mathfrak{g}_+ will act on \mathfrak{g}_- by coadjoint action, as well as on the space of bounded multilinear maps on \mathfrak{g}_- (see Section 6.3.3). When \mathfrak{g}_+ and \mathfrak{g}_- form a Banach Manin triple, a natural 1-cocycle with respect to the action of \mathfrak{g}_+ on the space of skew-symmetric bilinear maps on \mathfrak{g}_- can be defined (see Section 6.3.6).

6.3.1 Adjoint and coadjoint actions

Recall that a Banach Lie algebra \mathfrak{g}_+ acts on itself, its continuous dual \mathfrak{g}_+^* and bidual \mathfrak{g}_+^{**} by the adjoint and coadjoint actions:

$$\begin{aligned} \text{ad} : \mathfrak{g}_+ \times \mathfrak{g}_+ &\longrightarrow \mathfrak{g}_+ \\ (x, y) &\longmapsto \text{ad}_x y := [x, y], \end{aligned}$$

$$\begin{aligned} -\text{ad}^* : \mathfrak{g}_+ \times \mathfrak{g}_+^* &\longrightarrow \mathfrak{g}_+^* \\ (x, \alpha) &\longmapsto -\text{ad}_x^* \alpha := -\alpha \circ \text{ad}_x, \end{aligned}$$

and

$$\begin{aligned} \text{ad}^{**} : \mathfrak{g}_+ \times \mathfrak{g}_+^{**} &\longrightarrow \mathfrak{g}_+^{**} \\ (x, \mathcal{F}) &\longmapsto \text{ad}_x^{**} \mathcal{F} := \mathcal{F} \circ \text{ad}_x^*. \end{aligned}$$

Here the notation $\text{ad}_x^* : \mathfrak{g}_+^* \rightarrow \mathfrak{g}_+^*$ means the dual map of $\text{ad}_x : \mathfrak{g}_+ \rightarrow \mathfrak{g}_+$. Remark that the actions ad and ad^{**} coincide on the subspace \mathfrak{g}_+ of \mathfrak{g}_+^{**} . These actions extend in a natural way to spaces of bounded multilinear maps from any Banach product of copies of \mathfrak{g}_+ and \mathfrak{g}_+^* . For Banach spaces $\mathfrak{g}_1, \dots, \mathfrak{g}_k$ and \mathfrak{h} , we will use the notation $L(\mathfrak{g}_1, \mathfrak{g}_2, \dots, \mathfrak{g}_k; \mathfrak{h})$ to denote the **Banach space of continuous k -multilinear maps** from the product Banach space $\mathfrak{g}_1 \times \dots \times \mathfrak{g}_k$ to the Banach

space \mathfrak{h} (note the semi-colon separating the initial Banach spaces from the final one). Let us recall (see Proposition 2.2.9 in [1]) that one has the following isometric isomorphisms of Banach spaces

$$L(\mathfrak{g}_+^*; L(\mathfrak{g}_+, \mathfrak{g}_+; \mathbb{K})) \simeq L(\mathfrak{g}_+^*, \mathfrak{g}_+, \mathfrak{g}_+; \mathbb{K}) \simeq L(\mathfrak{g}_+, \mathfrak{g}_+^*; L(\mathfrak{g}_+; \mathbb{K})) \simeq L(\mathfrak{g}_+, \mathfrak{g}_+^*; \mathfrak{g}_+^*). \quad (6.17)$$

In particular, since the map $\text{ad} : \mathfrak{g}_+ \times \mathfrak{g}_+ \rightarrow \mathfrak{g}_+$ is bilinear and continuous, its dual map ad^* is continuous as a map from \mathfrak{g}_+^* to $L(\mathfrak{g}_+, \mathfrak{g}_+; \mathbb{K})$ and, following the sequence of isomorphisms in (6.17), it follows that $\text{ad}^* : \mathfrak{g}_+ \times \mathfrak{g}_+^* \rightarrow \mathfrak{g}_+^*$ is continuous. Similarly, using the following isometric isomorphisms of Banach spaces

$$L(\mathfrak{g}_+^{**}; L(\mathfrak{g}_+, \mathfrak{g}_+^*; \mathbb{K})) \simeq L(\mathfrak{g}_+^{**}, \mathfrak{g}_+, \mathfrak{g}_+^*; \mathbb{K}) \simeq L(\mathfrak{g}_+, \mathfrak{g}_+^{**}; L(\mathfrak{g}_+^*; \mathbb{K})) \simeq L(\mathfrak{g}_+, \mathfrak{g}_+^{**}; \mathfrak{g}_+^{**}),$$

it follows that $\text{ad}^{**} : \mathfrak{g}_+ \times \mathfrak{g}_+^{**} \rightarrow \mathfrak{g}_+^{**}$ is continuous.

6.3.2 Coadjoint action on a subspace of the dual

Suppose that we have a continuous injection from a Banach space \mathfrak{g}_- into the dual space \mathfrak{g}_+^* of a Banach Lie algebra \mathfrak{g}_+ , in such a way that \mathfrak{g}_- is stable by the coadjoint action of \mathfrak{g}_+ on its dual, i.e. is such that

$$\text{ad}_x^* \alpha \in \mathfrak{g}_-, \quad \forall x \in \mathfrak{g}_+, \forall \alpha \in \mathfrak{g}_-. \quad (6.18)$$

Then the coadjoint action $-\text{ad}^* : \mathfrak{g}_+ \times \mathfrak{g}_+^* \rightarrow \mathfrak{g}_+^*$ restricts to a continuous bilinear map $-\text{ad}_{|\mathfrak{g}_-}^* : \mathfrak{g}_+ \times \mathfrak{g}_- \rightarrow \mathfrak{g}_+^*$, where $\mathfrak{g}_+ \times \mathfrak{g}_-$ is endowed with the Banach structure of the product of Banach spaces \mathfrak{g}_+ and \mathfrak{g}_- . In other words

$$-\text{ad}_{|\mathfrak{g}_-}^* \in L(\mathfrak{g}_+, \mathfrak{g}_-; \mathfrak{g}_+^*) \simeq L(\mathfrak{g}_+; L(\mathfrak{g}_-; \mathfrak{g}_+^*)).$$

Moreover, condition (6.18) implies that $-\text{ad}^*$ takes values in \mathfrak{g}_- , i.e. that one gets a well-defined action

$$\begin{aligned} -\text{ad}_{|\mathfrak{g}_-}^* : \mathfrak{g}_+ \times \mathfrak{g}_- &\longrightarrow \mathfrak{g}_- \\ (x, \alpha) &\longmapsto -\text{ad}_x^* \alpha := -\alpha \circ \text{ad}_x. \end{aligned}$$

However, this action will in general not be continuous if one endows the target space with its Banach space topology. Nevertheless it is continuous if the target space is equipped with the topology induced from \mathfrak{g}_+^* . Under the additional assumption that $-\text{ad}_{|\mathfrak{g}_-}^* : \mathfrak{g}_+ \times \mathfrak{g}_- \rightarrow \mathfrak{g}_-$ is continuous with respect to the Banach space topologies of \mathfrak{g}_+ and \mathfrak{g}_- (for instance in the case where \mathfrak{g}_- is a closed subspace of the dual \mathfrak{g}_+^*), \mathfrak{g}_+ acts also continuously on \mathfrak{g}_- by

$$\begin{aligned} (\text{ad}_{|\mathfrak{g}_-}^*)^* : \mathfrak{g}_+ \times \mathfrak{g}_-^* &\longrightarrow \mathfrak{g}_-^* \\ (x, \mathcal{F}) &\longmapsto \mathcal{F} \circ \text{ad}_x^*. \end{aligned}$$

6.3.3 Adjoint action on the space of continuous multilinear maps

Suppose that we have a continuous injection from a Banach space \mathfrak{g}_- into the dual space \mathfrak{g}_+^* of a Banach Lie algebra \mathfrak{g}_+ and that \mathfrak{g}_+ acts continuously on \mathfrak{g}_- by coadjoint action, i.e. suppose that $-\text{ad}_{|\mathfrak{g}_-}^*$ takes values in \mathfrak{g}_- and that $-\text{ad}_{|\mathfrak{g}_-}^* : \mathfrak{g}_+ \times \mathfrak{g}_- \rightarrow \mathfrak{g}_-$ is continuous. In order to simplify notation, we will write just ad^* for $\text{ad}_{|\mathfrak{g}_-}^*$ and ad^{**} for $(\text{ad}_{|\mathfrak{g}_-}^*)^*$. In order to compactify notations, let us denote by $L^{r,s}(\mathfrak{g}_-, \mathfrak{g}_+; \mathbb{K})$ the **Banach space of continuous multilinear maps** from $\mathfrak{g}_- \times \cdots \times \mathfrak{g}_- \times \mathfrak{g}_+ \times \cdots \times \mathfrak{g}_+$ to \mathbb{K} , where \mathfrak{g}_- is repeated r -times and \mathfrak{g}_+ is repeated s -times. Since \mathfrak{g}_+ acts continuously by adjoint action on itself and by coadjoint action on \mathfrak{g}_- , one can define a continuous linear action of \mathfrak{g}_+ on $L^{r,s}(\mathfrak{g}_-, \mathfrak{g}_+; \mathbb{K})$, also called adjoint action, by

$$\begin{aligned} \text{ad}_x^{(r,s)} \mathbf{t}(\alpha_1, \dots, \alpha_r, x_1, \dots, x_s) &= \sum_{i=1}^r \mathbf{t}(\alpha_1, \dots, \text{ad}_x^* \alpha_i, \dots, \alpha_r, x_1, \dots, x_s) \\ &\quad - \sum_{i=1}^s \mathbf{t}(\alpha_1, \dots, \alpha_r, x_1, \dots, \text{ad}_x x_i, \dots, x_s), \end{aligned}$$

where $\mathbf{t} \in L^{r,s}(\mathfrak{g}_-, \mathfrak{g}_+; \mathbb{K})$, for $i \in \{1, \dots, r\}$, $\alpha_i \in \mathfrak{g}_-$, and for $i \in \{1, \dots, s\}$, $x_i \in \mathfrak{g}_+$. In particular, the adjoint action of \mathfrak{g}_+ on $L^{2,0}(\mathfrak{g}_-, \mathfrak{g}_+; \mathbb{K}) := L(\mathfrak{g}_-, \mathfrak{g}_-; \mathbb{K})$ reads:

$$\text{ad}_x^{(2,0)} \mathbf{t}(\alpha_1, \alpha_2) = \mathbf{t}(\text{ad}_x^* \alpha_1, \alpha_2) + \mathbf{t}(\alpha_1, \text{ad}_x^* \alpha_2). \quad (6.19)$$

6.3.4 Subspaces of skew-symmetric bilinear maps

Note that the adjoint action $\text{ad}^{(2,0)}$ defined in (6.19) preserves the subspace of skew-symmetric continuous bilinear maps on \mathfrak{g}_- , denoted by $\Lambda^2 \mathfrak{g}_-^*$:

$$\Lambda^2 \mathfrak{g}_-^* := \{ \mathbf{t} \in L(\mathfrak{g}_-, \mathfrak{g}_-; \mathbb{K}) : \forall e_1, e_2 \in \mathfrak{g}_-, \mathbf{t}(e_1, e_2) = -\mathbf{t}(e_2, e_1) \}.$$

For any subspace $\mathfrak{g}_+ \subset \mathfrak{g}_-^*$, the subspace $\Lambda^2 \mathfrak{g}_+ \subset \Lambda^2 \mathfrak{g}_-^*$ refers to the subspace consisting of elements $\mathbf{t} \in \Lambda^2 \mathfrak{g}_-^*$ such that, for $\alpha \in \mathfrak{g}_-$, the maps $\alpha \mapsto \mathbf{t}(e_1, \alpha)$ belong to $\mathfrak{g}_+ \subset \mathfrak{g}_-^*$ for any $e_1 \in \mathfrak{g}_-$.

$$\Lambda^2 \mathfrak{g}_+ := \{ \mathbf{t} \in \Lambda^2 \mathfrak{g}_-^* : \forall e_1 \in \mathfrak{g}_-, \mathbf{t}(e_1, \cdot) \in \mathfrak{g}_+ \}.$$

6.3.5 Definition of 1-cocycles

Let us recall the notion of 1-cocycle. Let G be a Banach Lie group, and consider an affine action of G on a Banach space V , i.e. a group morphism Φ of G into the Affine group $\text{Aff}(V)$ of transformations of V . Using the isomorphism $\text{Aff}(V) = \text{GL}(V) \rtimes V$, Φ decomposes into (φ, Θ) where $\varphi : G \rightarrow \text{GL}(V)$ and $\Theta : G \rightarrow V$. The condition that Φ is a group morphism implies that φ is a group morphism and that Θ satisfies:

$$\Theta(gh) = \Theta(g) + \varphi(g)(\Theta(h)), \quad (6.20)$$

where $g, h \in G$. One says that Θ is a **1-cocycle on G relative to φ** . The derivative $d\Phi$ of Φ at the unit element of G is a Lie algebra morphism of the Lie algebra \mathfrak{g} of G into the Lie algebra $\text{aff}(V)$ of $\text{Aff}(V)$. By the isomorphism $\text{aff}(V) = \mathfrak{gl}(V) \rtimes V$, $d\Phi$ decomposes into $(d\varphi, d\Theta)$ where $d\varphi : \mathfrak{g} \rightarrow \mathfrak{gl}(V)$ is the Lie algebra morphism induced by φ and $d\Theta : \mathfrak{g} \rightarrow V$ satisfies:

$$d\Theta([x, y]) = d\varphi(x)(d\Theta(y)) - d\varphi(y)(d\Theta(x)), \quad (6.21)$$

for $x, y \in \mathfrak{g}$. One says that $d\Theta$ is a **1-cocycle on \mathfrak{g} relative to $d\varphi$** .

Example 6.3.1. Let us consider in particular the Banach space $V = L(\mathfrak{g}_-, \mathfrak{g}_-; \mathbb{K})$ of bilinear maps on \mathfrak{g}_- , where \mathfrak{g}_- is a Banach space that injects continuously in the dual space \mathfrak{g}_+^* of a Banach Lie algebra \mathfrak{g}_+ , is stable under the coadjoint action of \mathfrak{g}_+ , and such that the coadjoint action of \mathfrak{g}_+ on \mathfrak{g}_- is continuous. A 1-cocycle θ on \mathfrak{g}_+ relative to the natural action $\text{ad}^{(2,0)}$ of \mathfrak{g}_+ on $L(\mathfrak{g}_-, \mathfrak{g}_-; \mathbb{K})$ given by (6.19) is a map $\theta : \mathfrak{g}_+ \rightarrow L(\mathfrak{g}_-, \mathfrak{g}_-; \mathbb{K})$ which satisfies:

$$\theta([x, y]) = \text{ad}_x^{(2,0)}(\theta(y)) - \text{ad}_y^{(2,0)}(\theta(x))$$

where $x, y \in \mathfrak{g}_+$. For α and β in \mathfrak{g}_- , previous condition reads

$$\theta([x, y])(\alpha, \beta) = \theta(y)(\text{ad}_x^* \alpha, \beta) + \theta(y)(\alpha, \text{ad}_x^* \beta) - \theta(x)(\text{ad}_y^* \alpha, \beta) - \theta(x)(\alpha, \text{ad}_y^* \beta). \quad (6.22)$$

Remark 6.3.2. A continuous map $\theta : \mathfrak{g}_+ \rightarrow L(\mathfrak{g}_-, \mathfrak{g}_-; \mathbb{K})$ from a Banach Lie algebra \mathfrak{g}_+ to the Banach space of bilinear maps on \mathfrak{g}_- satisfying equation (6.22) defines an affine action of \mathfrak{g}_+ on $L(\mathfrak{g}_-, \mathfrak{g}_-; \mathbb{K})$ whose linear part is the adjoint action $\text{ad}^{(2,0)}$ given by equation (6.19).

6.3.6 Manin triples and associated 1-cocycles

The following proposition enable to define 1-cocycles naturally associated to a Manin triple.

Theorem 6.3.3. *Let $(\mathfrak{g}, \mathfrak{g}_+, \mathfrak{g}_-)$ be a Manin triple for a non-degenerate symmetric bilinear continuous map $\langle \cdot, \cdot \rangle_{\mathfrak{g}} : \mathfrak{g} \times \mathfrak{g} \rightarrow \mathbb{K}$. Then*

1. *The map $\langle \cdot, \cdot \rangle_{\mathfrak{g}}$ restricts to a duality pairing $\langle \cdot, \cdot \rangle_{\mathfrak{g}_+, \mathfrak{g}_-} : \mathfrak{g}_+ \times \mathfrak{g}_- \rightarrow \mathbb{K}$.*
2. *The subspace $\mathfrak{g}_+ \hookrightarrow \mathfrak{g}_-^*$ is stable under the coadjoint action of \mathfrak{g}_- on \mathfrak{g}_-^* and*

$$\text{ad}_\alpha^*(x) = -p_{\mathfrak{g}_+}([\alpha, x]_{\mathfrak{g}})$$

for any $x \in \mathfrak{g}_+$ and $\alpha \in \mathfrak{g}_-$. In particular, the map

$$\begin{aligned} \text{ad}_{\mathfrak{g}_-}^* : \mathfrak{g}_- \times \mathfrak{g}_+ &\rightarrow \mathfrak{g}_+ \\ (\alpha, x) &\mapsto -p_{\mathfrak{g}_+}([\alpha, x]_{\mathfrak{g}}) \end{aligned}$$

is continuous.

3. The subspace $\mathfrak{g}_- \hookrightarrow \mathfrak{g}_+^*$ is stable under the coadjoint action of \mathfrak{g}_+ on \mathfrak{g}_+^* and

$$\mathrm{ad}_x^*(\alpha) = -p_{\mathfrak{g}_-}([x, \alpha]_{\mathfrak{g}})$$

for any $x \in \mathfrak{g}_+$ and $\alpha \in \mathfrak{g}_-$. In particular, the map

$$\begin{aligned} \mathrm{ad}_{\mathfrak{g}_+}^* : \mathfrak{g}_+ \times \mathfrak{g}_- &\rightarrow \mathfrak{g}_- \\ (x, \alpha) &\mapsto -p_{\mathfrak{g}_-}([x, \alpha]_{\mathfrak{g}}) \end{aligned}$$

is continuous.

4. The dual map to the bracket $[\cdot, \cdot]_{\mathfrak{g}_-}$ restricts to a 1-cocycle $\theta_+ : \mathfrak{g}_+ \rightarrow \Lambda^2 \mathfrak{g}_+$ with respect to the adjoint action $\mathrm{ad}^{(2,0)}$ of \mathfrak{g}_+ on $\Lambda^2 \mathfrak{g}_+ \subset \Lambda^2 \mathfrak{g}_+^*$.

5. The dual map to the bracket $[\cdot, \cdot]_{\mathfrak{g}_+}$ restricts to a 1-cocycle $\theta_- : \mathfrak{g}_- \rightarrow \Lambda^2 \mathfrak{g}_-$ with respect to the adjoint action $\mathrm{ad}^{(2,0)}$ of \mathfrak{g}_- on $\Lambda^2 \mathfrak{g}_- \subset \Lambda^2 \mathfrak{g}_+^*$.

Proof. 1. Let us show that the restriction of the non-degenerate bilinear form $\langle \cdot, \cdot \rangle_{\mathfrak{g}} : \mathfrak{g} \times \mathfrak{g} \rightarrow \mathbb{K}$ to $\mathfrak{g}_+ \times \mathfrak{g}_-$ denoted by

$$\langle \cdot, \cdot \rangle_{\mathfrak{g}_+, \mathfrak{g}_-} : \mathfrak{g}_+ \times \mathfrak{g}_- \rightarrow \mathbb{K}$$

is a non-degenerate duality pairing between \mathfrak{g}_+ and \mathfrak{g}_- . Suppose that there exists $x \in \mathfrak{g}_+$ such that $\langle x, \alpha \rangle_{\mathfrak{g}_+, \mathfrak{g}_-} = 0$ for all $\alpha \in \mathfrak{g}_-$. Then, since \mathfrak{g}_+ is isotropic for $\langle \cdot, \cdot \rangle_{\mathfrak{g}}$, one has $\langle x, y \rangle_{\mathfrak{g}} = 0$ for all $y \in \mathfrak{g}$, and the non-degeneracy of $\langle \cdot, \cdot \rangle_{\mathfrak{g}}$ implies that $x = 0$. The same argument apply interchanging \mathfrak{g}_+ and \mathfrak{g}_- , thus $\langle \cdot, \cdot \rangle_{\mathfrak{g}_+, \mathfrak{g}_-}$ is non-degenerate. As a consequence, one obtains two continuous injections

$$\begin{aligned} \mathfrak{g}_- &\hookrightarrow \mathfrak{g}_+^* & \text{and} & & \mathfrak{g}_+ &\hookrightarrow \mathfrak{g}_-^* \\ \alpha &\mapsto \langle \cdot, \alpha \rangle_{\mathfrak{g}_+, \mathfrak{g}_-}, & & & x &\mapsto \langle x, \cdot \rangle_{\mathfrak{g}_+, \mathfrak{g}_-}. \end{aligned}$$

(2)-(3) Let us show that both

$$\mathfrak{g}_+ \subset \mathfrak{g}_-^*$$

and

$$\mathfrak{g}_- \subset \mathfrak{g}_+^*$$

are stable under the coadjoint action of \mathfrak{g}_- on \mathfrak{g}_-^* and \mathfrak{g}_+ on \mathfrak{g}_+^* respectively. Indeed, the invariance of the bilinear form $\langle \cdot, \cdot \rangle_{\mathfrak{g}}$ with respect to the bracket $[\cdot, \cdot]_{\mathfrak{g}}$ implies that for any $x \in \mathfrak{g}_+$ and $\alpha \in \mathfrak{g}_-$,

$$\langle x, [\alpha, \cdot]_{\mathfrak{g}} \rangle_{\mathfrak{g}} = -\langle [\alpha, x]_{\mathfrak{g}}, \cdot \rangle_{\mathfrak{g}}.$$

Hence, since \mathfrak{g}_- is isotropic,

$$\langle x, [\alpha, \cdot]_{\mathfrak{g}} \rangle_{\mathfrak{g}_+, \mathfrak{g}_-} = -\langle p_{\mathfrak{g}_+}([\alpha, x]_{\mathfrak{g}}), \cdot \rangle_{\mathfrak{g}_+, \mathfrak{g}_-},$$

for any $x \in \mathfrak{g}_+$ and any $\alpha \in \mathfrak{g}_-$. It follows that

$$\mathrm{ad}_\alpha^*(x) = -p_{\mathfrak{g}_+}([\alpha, x]_{\mathfrak{g}})$$

and similarly

$$\mathrm{ad}_x^*(\alpha) = -p_{\mathfrak{g}_-}([\alpha, x]_{\mathfrak{g}})$$

for any $x \in \mathfrak{g}_+$ and $\alpha \in \mathfrak{g}_-$. The continuity of the corresponding adjoint maps follows from the continuity of the bracket $[\cdot, \cdot]_{\mathfrak{g}}$ and of the projections $p_{\mathfrak{g}_+}$ and $p_{\mathfrak{g}_-}$.

(4)-(5) Let us prove that the dual map of the Lie bracket on \mathfrak{g}_- restricts to a 1-cocycle with respect to the adjoint action of \mathfrak{g}_+ on $\Lambda^2 \mathfrak{g}_+$. The dual map

$$[\cdot, \cdot]_{\mathfrak{g}_-}^* : \mathfrak{g}_-^* \rightarrow L(\mathfrak{g}_-, \mathfrak{g}_-; \mathbb{K})$$

to the bilinear map $[\cdot, \cdot]_{\mathfrak{g}_-}$ assigns to $\mathcal{F}(\cdot) \in \mathfrak{g}_-^*$ the bilinear form $\mathcal{F}([\cdot, \cdot]_{\mathfrak{g}_-})$ and takes values in $\Lambda^2 \mathfrak{g}_-^*$. Since by (2), $\mathfrak{g}_- \subset \mathfrak{g}_+^*$ is stable under the coadjoint action of \mathfrak{g}_+ and since the coadjoint action $\mathrm{ad}^* : \mathfrak{g}_+ \times \mathfrak{g}_- \rightarrow \mathfrak{g}_-$ is continuous, one can consider the adjoint action of \mathfrak{g}_+ on $\Lambda^2 \mathfrak{g}_-^*$ defined by (6.19). Since the duality pairing $\langle \cdot, \cdot \rangle_{\mathfrak{g}_+, \mathfrak{g}_-}$ induces a continuous injection

$\mathfrak{g}_+ \hookrightarrow \mathfrak{g}_-^*$, one can consider the subspace $\Lambda^2 \mathfrak{g}_+$ of $\Lambda^2 \mathfrak{g}_-^*$ defined in Section 6.3.4. Denote by $\theta_+ : \mathfrak{g}_+ \rightarrow L(\mathfrak{g}_-, \mathfrak{g}_-; \mathbb{K})$ the restriction of $[\cdot, \cdot]_{\mathfrak{g}_-}^*$ to the subspace $\mathfrak{g}_+ \subset \mathfrak{g}_-^*$:

$$\theta_+(x) = \langle x, [\cdot, \cdot]_{\mathfrak{g}_-} \rangle_{\mathfrak{g}_+, \mathfrak{g}_-}.$$

Using the identification $L(\mathfrak{g}_-, \mathfrak{g}_-; \mathbb{K}) \simeq L(\mathfrak{g}_-; \mathfrak{g}_-^*)$, one has

$$\theta_+(x)(\alpha) = \langle x, [\alpha, \cdot]_{\mathfrak{g}_-} \rangle_{\mathfrak{g}_+, \mathfrak{g}_-} = \text{ad}_\alpha^* x(\cdot).$$

One sees immediately that the map θ_+ takes values in $\Lambda^2 \mathfrak{g}_+$ if and only if $\text{ad}_\alpha^* x \in \mathfrak{g}_+$ for any $\alpha \in \mathfrak{g}_-$ and for any $x \in \mathfrak{g}_+$, which is verified by (2). Using the fact that the duality pairing $\langle \cdot, \cdot \rangle_{\mathfrak{g}_+, \mathfrak{g}_-}$ is the restriction of $\langle \cdot, \cdot \rangle_{\mathfrak{g}}$ and that $\langle \cdot, \cdot \rangle_{\mathfrak{g}}$ is invariant with respect to the bracket $[\cdot, \cdot]_{\mathfrak{g}}$, one has

$$\langle [x, y], [\alpha, \beta] \rangle_{\mathfrak{g}_-, \mathfrak{g}_+} = -\langle [\alpha, [x, y]], \beta \rangle_{\mathfrak{g}},$$

and the Jacobi identity verified by $[\cdot, \cdot]_{\mathfrak{g}}$ implies

$$\langle [x, y], [\alpha, \beta] \rangle_{\mathfrak{g}_-, \mathfrak{g}_+} = -\langle [[\alpha, x], y], \beta \rangle_{\mathfrak{g}} - \langle [x, [\alpha, y]], \beta \rangle_{\mathfrak{g}}.$$

Using the decomposition

$$-[\alpha, x] = -p_{\mathfrak{g}_-}[\alpha, x] - p_{\mathfrak{g}_+}[\alpha, x] = -\text{ad}_x^* \alpha + \text{ad}_\alpha^* x,$$

and similarly

$$-[\alpha, y] = -p_{\mathfrak{g}_-}[\alpha, y] - p_{\mathfrak{g}_+}[\alpha, y] = -\text{ad}_y^* \alpha + \text{ad}_\alpha^* y,$$

one gets

$$\langle [x, y], [\alpha, \beta] \rangle_{\mathfrak{g}_+, \mathfrak{g}_-} = \langle [\text{ad}_\alpha^* x - \text{ad}_x^* \alpha, y], \beta \rangle_{\mathfrak{g}} + \langle [x, \text{ad}_\alpha^* y - \text{ad}_y^* \alpha], \beta \rangle_{\mathfrak{g}},$$

hence

$$\begin{aligned} \langle [x, y], [\alpha, \beta] \rangle_{\mathfrak{g}_+, \mathfrak{g}_-} &= \langle [\text{ad}_\alpha^* x, y], \beta \rangle_{\mathfrak{g}} + \langle [x, \text{ad}_\alpha^* y], \beta \rangle_{\mathfrak{g}} \\ &\quad + \langle y, [\text{ad}_x^* \alpha, \beta] \rangle_{\mathfrak{g}} - \langle x, [\text{ad}_y^* \alpha, \beta] \rangle_{\mathfrak{g}}. \end{aligned} \quad (6.23)$$

It follows that

$$\text{ad}_\alpha^* [x, y] = [\text{ad}_\alpha^* x, y] + [x, \text{ad}_\alpha^* y] + \text{ad}_{\text{ad}_x^* \alpha}^* y - \text{ad}_{\text{ad}_y^* \alpha}^* x.$$

On the other hand, the condition (6.22) that θ_+ is a 1-cocycle reads:

$$\begin{aligned} \langle [x, y], [\alpha, \beta] \rangle_{\mathfrak{g}_+, \mathfrak{g}_-} &= \langle y, [\text{ad}_x^* \alpha, \beta] \rangle_{\mathfrak{g}_+, \mathfrak{g}_-} + \langle y, [\alpha, \text{ad}_x^* \beta] \rangle_{\mathfrak{g}_+, \mathfrak{g}_-} \\ &\quad - \langle x, [\text{ad}_y^* \alpha, \beta] \rangle_{\mathfrak{g}_+, \mathfrak{g}_-} - \langle x, [\alpha, \text{ad}_y^* \beta] \rangle_{\mathfrak{g}_+, \mathfrak{g}_-}. \end{aligned} \quad (6.24)$$

The first and third terms in the RHS of (6.24) equal the last two terms in the RHS of (6.23). Using the invariance (6.2) of the bilinear form $\langle \cdot, \cdot \rangle_{\mathfrak{g}}$ with respect to the bracket $[\cdot, \cdot]_{\mathfrak{g}}$, the last term in the RHS of (6.24) reads

$$\begin{aligned} -\langle x, [\alpha, \text{ad}_y^* \beta] \rangle_{\mathfrak{g}_+, \mathfrak{g}_-} &= \langle [\alpha, x], \text{ad}_y^* \beta \rangle_{\mathfrak{g}} = \langle p_{\mathfrak{g}_+}([\alpha, x]), \text{ad}_y^* \beta \rangle_{\mathfrak{g}_+, \mathfrak{g}_-} \\ &= -\langle \text{ad}_\alpha^* x, \text{ad}_y^* \beta \rangle_{\mathfrak{g}_+, \mathfrak{g}_-} = -\langle [y, \text{ad}_\alpha^* x], \beta \rangle_{\mathfrak{g}_+, \mathfrak{g}_-}, \end{aligned}$$

and similarly the second term in the RHS of (6.24) reads

$$\langle y, [\alpha, \text{ad}_x^* \beta] \rangle_{\mathfrak{g}_+, \mathfrak{g}_-} = \langle [x, \text{ad}_\alpha^* y], \beta \rangle_{\mathfrak{g}_+, \mathfrak{g}_-}.$$

Hence the equivalence between (6.24) and (6.23) follows. By interchanging the roles of \mathfrak{g}_+ and \mathfrak{g}_- , one proves (5) in a similar way. \square

In the proof of Theorem 6.3.3, we have showed the following:

Proposition 6.3.4. *Let $\mathfrak{g} = \mathfrak{g}_+ \oplus \mathfrak{g}_-$ be a decomposition of a Banach Lie algebra \mathfrak{g} into the direct sum of two Banach Lie subalgebras, and suppose that \mathfrak{g} is endowed with a non-degenerate symmetric bilinear map $\langle \cdot, \cdot \rangle_{\mathfrak{g}}$, invariant with respect to the Lie bracket in \mathfrak{g} . Then the cocycle condition (6.22) for the restriction θ_+ of $[\cdot, \cdot]_{\mathfrak{g}_-}^* : \mathfrak{g}_- \rightarrow \Lambda^2 \mathfrak{g}_-^*$ to the subspace $\mathfrak{g}_+ \subset \mathfrak{g}_-^*$ reads*

$$\text{ad}_\alpha^* [x, y] = [\text{ad}_\alpha^* x, y] + [x, \text{ad}_\alpha^* y] + \text{ad}_{\text{ad}_x^* \alpha}^* y - \text{ad}_{\text{ad}_y^* \alpha}^* x, \quad (6.25)$$

where $x, y \in \mathfrak{g}_+$ and $\alpha \in \mathfrak{g}_-$.

Remark 6.3.5. Equation (6.25) is exactly the formula given in [136] page 507, but with the opposite sign convention for the coadjoint map ad^* .

6.4 Generalized Banach Poisson manifolds and related notions

In this section, we generalize the definition of Poisson manifolds to the Banach context (Section 6.4.1). Example of generalized Banach Poisson manifolds are Banach symplectic manifolds (Section 6.4.2) and Banach Lie–Poisson spaces (Section 6.4.2).

6.4.1 Definition of generalized Banach Poisson manifolds

The notions of Banach Poisson manifolds and Banach Lie–Poisson spaces were introduced in [156]. The notion of sub Poisson structures in the Banach context was introduced in [46]. In the case of locally convex spaces, an analogous definition of weak Poisson manifold structure was defined in [152]. In the symplectic case, related notions were introduced in [32] enabling the study of the orbital stability of some Hamiltonian PDE’s. In the present chapter, we restrict ourselves to the Banach setting but generalize slightly these notions to the case where an arbitrary duality pairing is considered, and where the existence of Hamiltonian vector fields is not assumed (this last point is assumed in [152] and [46]). Moreover, instead of working with subalgebras of the space of smooth functions $\mathcal{C}^\infty(M)$ on a Banach manifold M , we will work with subbundles of the cotangent bundle (see Remark 6.4.2 below).

Definition 6.4.1. *Consider a unital subalgebra $\mathcal{A} \subset \mathcal{C}^\infty(M)$ of smooth functions on a Banach manifold M , i.e. \mathcal{A} is a vector subspace of $\mathcal{C}^\infty(M)$ containing the constants and stable under pointwise multiplication. An \mathbb{R} -bilinear operation $\{\cdot, \cdot\} : \mathcal{A} \times \mathcal{A} \rightarrow \mathcal{A}$ is called a **Poisson bracket** on M if it satisfies:*

- (i) *anti-symmetry* : $\{f, g\} = -\{g, f\}$;
- (ii) *Jacobi identity*: $\{\{f, g\}, h\} + \{\{g, h\}, f\} + \{\{h, f\}, g\} = 0$;
- (iii) *Leibniz formula*: $\{f, gh\} = \{f, g\}h + g\{f, h\}$;

Remark 6.4.2. 1. Note that the Leibniz rule implies that for any $f \in \mathcal{A}$, $\{f, \cdot\}$ acts by derivations on the subalgebra $\mathcal{A} \subset \mathcal{C}^\infty(M)$. When M is finite-dimensional and $\mathcal{A} = \mathcal{C}^\infty(M)$, this condition implies that $\{f, \cdot\}$ is a smooth vector field X_f on M , called the Hamiltonian vector field associated to f , uniquely defined by its action on $\mathcal{C}^\infty(M)$:

$$X_f(h) = dh(X_f) = \{f, h\}.$$

It is worth noting that on an infinite-dimensional Hilbert space, there exists derivations of order greater than 1, i.e. that do not depend only on the differentials of functions (see Lemma 28.4 in [117], chapter VI). It follows that, contrary to the finite-dimensional case, one may not be able to associate a Poisson tensor (see Definition 6.4.5 below) to a given Poisson bracket. Examples of Poisson brackets not given by Poisson tensors were constructed in [24].

2. Given a covector $\xi \in T_p^*M$, it is always possible to extend it to a locally defined 1-form α with $\alpha_p = \xi$ (for instance by setting α equal to a constant in a chart around $p \in M$). However, it may not be possible to extend it to a smooth 1-form on M . It may therefore not be possible to find a smooth real function on M whose differential equals ξ at $p \in M$. The difficulty resides in defining smooth bump functions, which are, in the finite dimensional Euclidean case, usually constructed using the differentiability of the norm. In [176], it was shown that a Banach space admits a \mathcal{C}^1 -norm away from the origin if and only if its dual is separable. Remark that $L_\infty(\mathcal{H})$ is not separable (since it contains the nonseparable Banach space l_∞ as the space of diagonal operators). It follows that the dual of $L_\infty(\mathcal{H})$ is nonseparable (since by Theorem III.7 in [174], if the dual of a Banach space is separable, so is the Banach space itself). Therefore working with unital subalgebras of smooth functions on a Banach manifold modelled on $L_\infty(\mathcal{H})$ (or on $L_{\text{res}}(\mathcal{H})$ and $\mathfrak{u}_{\text{res}}(\mathcal{H})$ defined below) may lead to unexpected difficulties. For this reason, we will adapt the definition of Banach Poisson manifold and work with local sections of subbundles of the cotangent bundle. The link between unital subalgebras of $\mathcal{C}^\infty(M)$ and subbundles of the cotangent bundle is given by next definition.

Definition 6.4.3. Let M be a Banach manifold and \mathcal{A} be a unital subalgebra of $\mathcal{C}^\infty(M)$. The first jet of \mathcal{A} , denoted by $J^1(\mathcal{A})$ is the subbundle of the cotangent bundle T^*M whose fiber over $p \in M$ is the space of differentials of functions in \mathcal{A} ,

$$J^1(\mathcal{A})_p = \{df_p : f \in \mathcal{A}\}.$$

Definition 6.4.4. We will say that \mathbb{F} is a subbundle of T^*M **in duality** with the tangent bundle to M if, for every $p \in M$,

1. \mathbb{F}_p is an injected Banach space of T_p^*M , i.e. \mathbb{F}_p admits a Banach space structure such that the injection $\mathbb{F}_p \hookrightarrow T_p^*M$ is continuous,
2. the natural duality pairing between T_p^*M and T_pM restricts to a duality pairing between \mathbb{F}_p and T_pM , i.e. \mathbb{F}_p separates points in T_pM .

We will denote by $\Lambda^2\mathbb{F}^*$ the vector bundle over M whose fiber over p is the Banach space of continuous skew-symmetric bilinear maps on the subspace \mathbb{F}_p of T_p^*M .

Definition 6.4.5. Let M be a Banach manifold and \mathbb{F} a subbundle of T^*M in duality with TM . A smooth section π of $\Lambda^2\mathbb{F}^*$ is called a **Poisson tensor** on M with respect to \mathbb{F} if:

1. for any closed local sections α, β of \mathbb{F} , the differential $d(\pi(\alpha, \beta))$ is a local section of \mathbb{F} ;
2. (Jacobi) for any closed local sections α, β, γ of \mathbb{F} ,

$$\pi(\alpha, d(\pi(\beta, \gamma))) + \pi(\beta, d(\pi(\gamma, \alpha))) + \pi(\gamma, d(\pi(\alpha, \beta))) = 0. \quad (6.26)$$

Remark 6.4.6. 1. The first condition in Definition 6.4.5 is necessary in order to make sense of equation (6.26) since the Poisson tensor is defined only on local sections of \mathbb{F} .

2. Consider a unital subalgebra \mathcal{A} of $\mathcal{C}^\infty(M)$ and set $\mathbb{F} = J^1(\mathcal{A})$ the first jet of functions in \mathcal{A} . Then equation (6.26) for a Poisson tensor π on M with respect to \mathbb{F} is equivalent to the Jacobi identity for the Poisson bracket defined for $f, g \in \mathcal{A}$ by $\{f, g\} = \pi(df, dg)$.

Definition 6.4.7. A **generalized Banach Poisson manifold** is a triple (M, \mathbb{F}, π) consisting of a smooth Banach manifold M , a subbundle \mathbb{F} of the cotangent bundle T^*M in duality with TM , and a Poisson tensor π on M with respect to \mathbb{F} .

Remark 6.4.8. Let us make the link between our definition of generalized Banach Poisson manifold and related notions in the literature. Consider a unital subalgebra \mathcal{A} of $\mathcal{C}^\infty(M)$, set $\mathbb{F} = J^1(\mathcal{A})$ the first jet of functions in \mathcal{A} , and consider a Poisson bracket on \mathcal{A} given by a Poisson tensor: $\{f, g\} = \pi(df, dg)$. Our definition of generalized Banach Poisson manifold differs from the one given in [152] and the definition of sub Poisson manifold given in [46] by the fact that we do not assume the existence of Hamiltonian vector fields associated to functions $f \in \mathcal{A}$ (condition P3 in Definition 2.1 in [152] and condition $P : T^bM \rightarrow TM$ in [46]). In other words, for $f \in \mathcal{A}$, $\{f, \cdot\}$ is a derivation on $\mathcal{A} \subset \mathcal{C}^\infty(M)$ that may not –with our definition of Poisson manifold– be given by a smooth vector field on M . However, since the Poisson bracket is given by a smooth Poisson tensor, $\{f, \cdot\}$ is a smooth section of the bundle $J^1(\mathcal{A})^*$ whose fiber over $p \in M$ is the dual Banach space to $J^1(\mathcal{A})_p$. Moreover, in order to stay in the Banach context, we suppose that \mathbb{F}_p has a structure of Banach space.

6.4.2 Banach Symplectic manifolds

An important class of finite-dimensional Poisson manifolds is provided by symplectic manifolds. As we will see below, this is also the case in the Banach setting, i.e. general Banach symplectic manifolds (not necessarily strong symplectic) are particular examples of generalized Banach Poisson manifolds. Let us recall the following definitions. The exterior derivative d associates to a n -form on a Banach manifold M a $(n+1)$ -form on M . In particular, for any 2-form ω on a Banach manifold M , the exterior derivative of ω is the 3-form $d\omega$ defined by:

$$\begin{aligned} d\omega_p(X, Y, Z) = & -\omega_p([\tilde{X}, \tilde{Y}], \tilde{Z}) + \omega_p([\tilde{X}, \tilde{Z}], \tilde{Y}) - \omega_p([\tilde{Y}, \tilde{Z}], \tilde{X}) + \left\langle d_p \left(\omega(\tilde{Y}, \tilde{Z}) \right), \tilde{X} \right\rangle_{T_p^*M, T_pM} \\ & - \left\langle d_p \left(\omega(\tilde{X}, \tilde{Z}) \right), \tilde{Y} \right\rangle_{T_p^*M, T_pM} + \left\langle d_p \left(\omega(\tilde{X}, \tilde{Y}) \right), \tilde{Z} \right\rangle_{T_p^*M, T_pM}, \end{aligned}$$

where $\tilde{X}, \tilde{Y}, \tilde{Z}$ are any smooth extensions of X, Y and $Z \in T_p M$ around $p \in M$. An expression of this formula in a chart shows that it does not depend on the extensions $\tilde{X}, \tilde{Y}, \tilde{Z}$, but only on the values of these vector fields at $p \in M$, i.e. it defines a tensor (see Proposition 3.2, Chapter V in [124]). The contraction or interior product $i_X \omega$ of a n -form ω with a vector field X is the $(n-1)$ -form defined by

$$i_X \omega(Y_1, \dots, Y_{n-1}) := \omega(X, Y_1, \dots, Y_{n-1}).$$

The Lie derivative \mathcal{L}_X with respect to a vector field X can be defined using the Cartan formula

$$\mathcal{L}_X = i_X d + d i_X. \quad (6.27)$$

The Lie derivative, the bracket $[X, Y]$ of two vector fields X and Y , and the interior product satisfy the following relation (see Proposition 5.3, Chapter V in [124]):

$$i_{[X, Y]} = \mathcal{L}_X i_Y - i_Y \mathcal{L}_X. \quad (6.28)$$

Let us recall the definition of a Banach (weak) symplectic manifold.

Definition 6.4.9. A **Banach symplectic manifold** is a Banach manifold M endowed with a 2-form $\omega \in \Gamma(\Lambda^2 T^* M)$ such that

1. ω is non-degenerate: $\omega_p^\sharp : T_p M \rightarrow T_p^* M, X \mapsto i_X \omega := \omega(X, \cdot)$ is injective $\forall p \in M$;
2. ω is closed: $d\omega = 0$.

Lemma 6.4.10. Let (M, ω) be a Banach symplectic manifold. Consider α and β two closed local sections of $\omega^\sharp(TM)$, i.e. $d\alpha = d\beta = 0, \alpha = \omega(X_\alpha, \cdot)$ and $\beta = \omega(X_\beta, \cdot)$ for some local vector fields X_α and X_β . Then

1. X_α and X_β are symplectic vector fields: $\mathcal{L}_{X_\alpha} \omega = 0 = \mathcal{L}_{X_\beta} \omega$
2. $i_{[X_\alpha, X_\beta]} \omega = -d(\omega(X_\alpha, X_\beta))$.

Proof. 1. Using the Cartan formula (6.27), one has $\mathcal{L}_{X_\alpha} \omega = i_{X_\alpha} d\omega + d i_{X_\alpha} \omega = d i_{X_\alpha} \omega$, since ω is closed. But by definition $i_{X_\alpha} \omega = \alpha$ is closed. Using $d \circ d = 0$ (see Supplement 6.4A in [1] for a proof of this identity in the Banach context), it follows that $\mathcal{L}_{X_\alpha} \omega = 0$. Similarly $\mathcal{L}_{X_\beta} \omega = 0$.

2. By relation (6.28), one has

$$i_{[X_\alpha, X_\beta]} \omega = \mathcal{L}_{X_\alpha} i_{X_\beta} \omega - i_{X_\beta} \mathcal{L}_{X_\alpha} \omega,$$

where the second term in the RHS vanishes by (1). Using Cartan formula, one gets

$$i_{[X_\alpha, X_\beta]} \omega = d i_{X_\alpha} i_{X_\beta} \omega + i_{X_\alpha} d(i_{X_\beta} \omega) = d i_{X_\alpha} i_{X_\beta} \omega = d(\omega(X_\beta, X_\alpha)) = -d(\omega(X_\alpha, X_\beta)),$$

where we have used that $i_{X_\beta} \omega = \beta$ is closed. □

Proposition 6.4.11. Any Banach symplectic manifold (M, ω) is naturally a generalized Banach Poisson manifold (M, \mathbb{F}, π) with

1. $\mathbb{F} = \omega^\sharp(TM)$;
2. $\pi : \omega^\sharp(TM) \times \omega^\sharp(TM) \rightarrow \mathbb{R}$ defined by $(\alpha, \beta) \mapsto \omega(X_\alpha, X_\beta)$ where X_α and X_β are uniquely defined by $\alpha = \omega(X_\alpha, \cdot)$ and $\beta = \omega(X_\beta, \cdot)$.

Proof. 1. By Lemma 6.4.10, for any closed local sections α and β of \mathbb{F} , with $\alpha = \omega(X_\alpha, \cdot)$ and $\beta = \omega(X_\beta, \cdot)$, one has

$$d(\pi(\alpha, \beta)) := d(\omega(X_\alpha, X_\beta)) = -i_{[X_\alpha, X_\beta]} \omega,$$

hence is a local section of $\mathbb{F} = \omega^\sharp(TM)$.

2. Let us show that π satisfies the Jacobi identity (6.26). Consider closed local sections α, β and γ of \mathbb{F} and define the local vector fields X_α, X_β and X_γ by $\alpha = i_{X_\alpha} \omega, \beta = i_{X_\beta} \omega$ and $\gamma = i_{X_\gamma} \omega$. Using Lemma 6.4.10, the differential of ω satisfies

$$\begin{aligned} d\omega(X_\alpha, X_\beta, X_\gamma) &= 2(-\omega([X_\alpha, X_\beta], X_\gamma) + \omega([X_\alpha, X_\gamma], X_\beta) - \omega([X_\beta, X_\gamma], X_\alpha)) \\ &= 2(\pi(d(\pi(\alpha, \beta), \gamma))) + \pi(d(\pi(\gamma, \alpha)), \beta) + \pi(d(\pi(\beta, \gamma)), \alpha). \end{aligned}$$

Since ω is closed, the Jacobi identity (6.26) is satisfied. □

6.4.3 Banach Lie–Poisson spaces

Banach Lie–Poisson spaces were introduced in [156]. Here we extend this notion to an arbitrary duality pairing.

Definition 6.4.12. Consider a duality pairing $\langle \cdot, \cdot \rangle_{\mathfrak{g}_+, \mathfrak{g}_-} : \mathfrak{g}_+ \times \mathfrak{g}_- \rightarrow \mathbb{K}$ between two Banach spaces. We will say that \mathfrak{g}_+ is a **Banach Lie–Poisson space with respect to \mathfrak{g}_-** if \mathfrak{g}_- is a Banach Lie algebra $(\mathfrak{g}_-, [\cdot, \cdot]_{\mathfrak{g}_-})$ which acts continuously on $\mathfrak{g}_+ \hookrightarrow \mathfrak{g}_-^*$ by coadjoint action, i.e.

$$\mathrm{ad}_\alpha^* x \in \mathfrak{g}_+,$$

for all $x \in \mathfrak{g}_+$ and $\alpha \in \mathfrak{g}_-$, and $\mathrm{ad}^* : \mathfrak{g}_- \times \mathfrak{g}_+ \rightarrow \mathfrak{g}_+$ is continuous.

Remark 6.4.13. A Banach Lie–Poisson space \mathfrak{g}_+ with respect to its continuous dual space \mathfrak{g}_+^* is a Banach Lie–Poisson space in the sense of Definition 4.1 in [156].

The following Theorem is a generalization of Theorem 4.2 in [156] to the case of an arbitrary duality pairing between two Banach spaces \mathfrak{g}_+ and \mathfrak{g}_- . See also Corollary 2.11 in [152] for an analogous statement. We will include the proof for sake of completeness.

Theorem 6.4.14. Consider a duality pairing $\langle \cdot, \cdot \rangle_{\mathfrak{g}_+, \mathfrak{g}_-} : \mathfrak{g}_+ \times \mathfrak{g}_- \rightarrow \mathbb{K}$ between two Banach spaces, and suppose that \mathfrak{g}_+ is a **Banach Lie–Poisson space with respect to \mathfrak{g}_-** .

Denote by \mathbb{F} the subbundle of $T^*\mathfrak{g}_+ \simeq \mathfrak{g}_+ \times \mathfrak{g}_+^*$ whose fiber at $x \in \mathfrak{g}_+$ is given by

$$\mathbb{F}_x = \{x\} \times \mathfrak{g}_- \subset \{x\} \times \mathfrak{g}_+^* \simeq T_x^*\mathfrak{g}_+.$$

For α and β any two local sections of \mathbb{F} , define a tensor $\pi \in \Lambda^2\mathbb{F}^*$ by:

$$\pi_x(\alpha, \beta) := \langle x, [\alpha(x), \beta(x)]_{\mathfrak{g}_-} \rangle_{\mathfrak{g}_+, \mathfrak{g}_-}.$$

Then $(\mathfrak{g}_+, \mathbb{F}, \pi)$ is a generalized Banach Poisson manifold, and π takes values in $\Lambda^2\mathfrak{g}_+ \subset \Lambda^2\mathbb{F}^*$.

Let \mathcal{A} be the unital subalgebra of $\mathcal{C}^\infty(\mathfrak{g}_+)$ consisting of all functions with differentials in \mathfrak{g}_- :

$$\mathcal{A} := \{f \in \mathcal{C}^\infty(\mathfrak{g}_+) : d_x f \in \mathfrak{g}_- \subset \mathfrak{g}_+^* \text{ for any } x \in \mathfrak{g}_+\}.$$

Define the bracket of two functions f, h in \mathcal{A} by

$$\{f, h\}(x) := \pi_x(df_x, dh_x) = \langle x, [df_x, dh_x]_{\mathfrak{g}_-} \rangle_{\mathfrak{g}_+, \mathfrak{g}_-}, \quad (6.29)$$

where $x \in \mathfrak{g}_+$, and df and dh denote the Fréchet derivatives of f and h respectively. Then $\{\cdot, \cdot\} : \mathcal{A} \times \mathcal{A} \rightarrow \mathcal{A}$ is a Poisson bracket on \mathfrak{g}_+ . If h is a smooth function on \mathfrak{g}_+ belonging to \mathcal{A} , the associated Hamiltonian vector field is given by

$$X_h(x) = -\mathrm{ad}_{dh_x}^* x \in \mathfrak{g}_+.$$

Proof. Let α and β be any closed local sections of \mathbb{F} . Then α and β are functions from \mathfrak{g}_+ to \mathfrak{g}_- , and we will denote by $T_x\alpha : T_x\mathfrak{g}_+ \simeq \mathfrak{g}_+ \rightarrow \mathfrak{g}_- \simeq T_{\alpha(x)}\mathfrak{g}_-$ and similarly $T_x\beta : \mathfrak{g}_+ \rightarrow \mathfrak{g}_-$ their derivatives at $x \in \mathfrak{g}_+$. For any tangent vector $X \in T_x\mathfrak{g}_+ \simeq \mathfrak{g}_+$, one has

$$\begin{aligned} d_x\pi(\alpha, \beta)(X) &= \langle X, [\alpha(x), \beta(x)]_{\mathfrak{g}_-} \rangle_{\mathfrak{g}_+, \mathfrak{g}_-} + \langle x, [T_x\alpha(X), \beta]_{\mathfrak{g}_-} \rangle_{\mathfrak{g}_+, \mathfrak{g}_-} + \langle x, [\alpha, T_x\beta(X)]_{\mathfrak{g}_-} \rangle_{\mathfrak{g}_+, \mathfrak{g}_-} \\ &= \langle X, [\alpha(x), \beta(x)]_{\mathfrak{g}_-} \rangle_{\mathfrak{g}_+, \mathfrak{g}_-} - \langle \mathrm{ad}_\beta^* x, T_x\alpha(X) \rangle_{\mathfrak{g}_+, \mathfrak{g}_-} + \langle \mathrm{ad}_\alpha^* x, T_x\beta(X) \rangle_{\mathfrak{g}_+, \mathfrak{g}_-} \end{aligned}$$

Since α and β are closed local sections of $\mathbb{F} \subset T^*\mathfrak{g}_+$, by Poincaré Lemma (see Theorem 4.1 in [123]), there exist locally real valued smooth functions f and g on \mathfrak{g}_+ such that $\alpha = df$ and $\beta = dg$. It follows that $T_x\alpha \in L(\mathfrak{g}_+; L(\mathfrak{g}_+, \mathbb{R})) \simeq L^2(\mathfrak{g}_+; \mathbb{R})$ is the second derivative $d_x^2 f$ of f at $x \in \mathfrak{g}_+$ and is symmetric (see Proposition 3.3 in [123]). Similarly $T_x\beta = d_x^2 g$ is a symmetric bilinear map on \mathfrak{g}_+ . Consequently

$$-\langle \mathrm{ad}_\beta^* x, T_x\alpha(X) \rangle_{\mathfrak{g}_+, \mathfrak{g}_-} = -\langle X, T_x\alpha(\mathrm{ad}_\beta^* x) \rangle_{\mathfrak{g}_+, \mathfrak{g}_-}$$

and

$$\langle \mathrm{ad}_\alpha^* x, T_x\beta(X) \rangle_{\mathfrak{g}_+, \mathfrak{g}_-} = \langle X, T_x\beta(\mathrm{ad}_\alpha^* x) \rangle_{\mathfrak{g}_+, \mathfrak{g}_-}.$$

Therefore, for any closed local section α and β of \mathbb{F} , and any $x \in \mathfrak{g}_+$,

$$d_x \pi(\alpha, \beta) = [\alpha(x), \beta(x)]_{\mathfrak{g}_-} - T_x \alpha(\text{ad}_\beta^* x) + T_x \beta(\text{ad}_\alpha^* x) \quad (6.30)$$

belongs to \mathfrak{g}_- . It follows that $d\pi(\alpha, \beta)$ a local section of \mathbb{F} . Let us show that π satisfies the Jacobi identity (6.26). One has

$$\begin{aligned} \pi_x(\alpha, d(\pi(\beta, \gamma))) &= \langle x, [\alpha(x), [\beta(x), \gamma(x)]_{\mathfrak{g}_-}]_{\mathfrak{g}_-} \rangle_{\mathfrak{g}_+, \mathfrak{g}_-} - \langle \text{ad}_\alpha^* x, T_x \beta(\text{ad}_\gamma^* x) \rangle_{\mathfrak{g}_+, \mathfrak{g}_-} \\ &\quad + \langle \text{ad}_\alpha^* x, T_x \gamma(\text{ad}_\beta^* x) \rangle_{\mathfrak{g}_+, \mathfrak{g}_-} \end{aligned}$$

By the Jacobi identity for the Lie bracket $[\cdot, \cdot]_{\mathfrak{g}_-}$ and by the symmetry of $T_x \alpha$, $T_x \beta$ and $T_x \gamma$, the Jacobi identity for π is satisfied. Moreover, for any local section α of \mathbb{F} , $\pi_x(\alpha, \cdot) = \text{ad}_\alpha^* x$ belongs to \mathfrak{g}_+ since \mathfrak{g}_+ is a Banach Lie–Poisson space with respect to \mathfrak{g}_- . Therefore $\pi \in \Lambda^2 \mathfrak{g}_+ \subset \Lambda^2 \mathbb{F}^*$.

The bracket (6.29) of two functions $f, g \in \mathcal{A}$ takes values in \mathcal{A} because, by equation (6.30), $d_x \{f, g\}$ belongs to \mathfrak{g}_- . By definition $\{\cdot, \cdot\}$ is skew-symmetric and satisfies the Leibniz rule. The Jacobi identity for $\{\cdot, \cdot\}$ follows from the Jacobi identity for π . The expression of the hamiltonian vector field associated to $h \in \mathcal{A}$ is straightforward. \square

We give below some examples of Banach Lie–Poisson spaces (see [156], [158], and [27] for more information on these spaces).

Example 6.4.15. *Dual Banach Lie algebras of operators.* Let p and q be such that $1 < p \leq q < \infty$ and $\frac{1}{p} + \frac{1}{q} = 1$. Then $L_p(\mathcal{H})^* \simeq L_q(\mathcal{H})$ and $L_q(\mathcal{H})^* \simeq L_p(\mathcal{H})$ where the duality pairing is given by the trace (see example 6.2.8). Moreover

$$\text{ad}_\alpha^* x(\beta) = \text{Tr}(x[\alpha, \beta]_{L_q(\mathcal{H})}) = \text{Tr}(x\alpha\beta - x\beta\alpha) = \text{Tr}(x\alpha\beta - \alpha x\beta) = \text{Tr}([x, \alpha]\beta),$$

where the first bracket is the Lie bracket of the dual space $L_q(\mathcal{H})$, and the second is the commutator of the bounded linear operators $x \in L_p(\mathcal{H})$ and $\alpha \in L_q(\mathcal{H})$. Since $L_p(\mathcal{H})$ is an ideal of $L_\infty(\mathcal{H})$, $[x, \alpha] \in L_p(\mathcal{H})$, and the pairing given by the trace being non-degenerate, one has

$$\text{ad}_\alpha^* x = [x, \alpha] \in L_p(\mathcal{H})$$

for any $x \in L_p(\mathcal{H})$ and any $\alpha \in L_q(\mathcal{H})$. Therefore $L_p(\mathcal{H})$ is a Banach Lie–Poisson space with respect to $L_q(\mathcal{H})$. In the same manner, one has for any $x \in L_p(\mathcal{H})$ and any $\alpha \in L_q(\mathcal{H})$

$$\text{ad}_x^* \alpha = [\alpha, x] \in L_q(\mathcal{H}),$$

hence $L_q(\mathcal{H})$ is a Banach Lie–Poisson space with respect to $L_p(\mathcal{H})$.

Example 6.4.16. *Trace class operators and bounded operators.* For the same reasons as in the previous example, the Banach Lie algebra $L_1(\mathcal{H})$ is a Banach Lie–Poisson space with respect to $L_\infty(\mathcal{H})$ and $L_\infty(\mathcal{H})$ is a Banach Lie–Poisson space with respect to $L_1(\mathcal{H})$, the (weak) duality pairing being given by the trace.

Example 6.4.17. *Trace class operators and Hilbert–Schmidt operators.* Since the trace is a weak duality pairing between $L_1(\mathcal{H})$ and $L_2(\mathcal{H}) \subset L_\infty(\mathcal{H})$ (see Example 6.2.6), one can consider the coadjoint action of $L_1(\mathcal{H})$ on $L_2(\mathcal{H})$ and vice-versa. For any $x \in L_1(\mathcal{H})$ and any $\alpha \in L_2(\mathcal{H})$, one has

$$\text{ad}_x^* \alpha = -\text{ad}_\alpha^* x = [\alpha, x] \in L_1(\mathcal{H}) \cap L_2(\mathcal{H}),$$

therefore $L_1(\mathcal{H})$ is Banach Lie–Poisson space with respect to $L_2(\mathcal{H})$, and $L_2(\mathcal{H})$ is a Banach Lie–Poisson space with respect to $L_1(\mathcal{H})$. Using (6.29), one obtains a Poisson bracket on $L_1(\mathcal{H})$ defined on the algebra of functions on $L_1(\mathcal{H})$ with differentials in $L_2(\mathcal{H}) \subset L_\infty(\mathcal{H})$, as well as a Poisson bracket on $L_2(\mathcal{H})$ defined on those functions on $L_2(\mathcal{H})$ which have their differential in $L_1(\mathcal{H}) \subset L_2(\mathcal{H})$.

Example 6.4.18. *Banach Lie algebras of upper and lower triangular operators.* For $1 < p < \infty$, consider the Banach algebra $L_p(\mathcal{H})_-$ of lower triangular operators in $L_p(\mathcal{H})$ defined by (6.4) and its complement $L_p(\mathcal{H})_{++}$ consisting in strictly upper triangular operators in $L_p(\mathcal{H})$. One can identify $L_p(\mathcal{H})_-^*$ with $L_p(\mathcal{H})^* / (L_p(\mathcal{H})_-)^0$ where

$$(L_p(\mathcal{H})_-)^0 := \{\alpha \in L_q(\mathcal{H}), \text{Tr}(\alpha x) = 0, \quad \forall x \in L_p(\mathcal{H})_-\}$$

Recall that $L_p(\mathcal{H})^* \simeq L_q(\mathcal{H})$ where $\frac{1}{p} + \frac{1}{q} = 1$, the duality pairing being given by the trace. It is easy to see that $(L_p(\mathcal{H})_-)^0$ is isomorphic to the Banach space $L_q(\mathcal{H})_{--}$ of strictly lower triangular operators in $L_q(\mathcal{H})$. Therefore, by the direct sum decomposition (6.8), one has

$$L_p(\mathcal{H})_-^* \simeq L_q(\mathcal{H})_+.$$

The coadjoint action of an element $\alpha \in L_q(\mathcal{H})_+$ on $x \in L_p(\mathcal{H})_- \subset (L_p(\mathcal{H})_-)^{**}$ reads

$$\text{ad}_\alpha^* x(\beta) = \text{Tr} (x[\alpha, \beta]_{L_q(\mathcal{H})_+}) = \text{Tr} ([x, \alpha]\beta),$$

where β is an arbitrary element in $L_q(\mathcal{H})_+$. Since $L_p(\mathcal{H})$ and $L_q(\mathcal{H})$ are ideals in $L_\infty(\mathcal{H})$, one has

$$[x, \alpha] \in [L_p(\mathcal{H}), L_q(\mathcal{H})] \subset L_p(\mathcal{H}) \cap L_q(\mathcal{H}).$$

The relation $L_p(\mathcal{H})_{++} \subset (L_q(\mathcal{H})_+)^0$ then implies

$$\text{ad}_\alpha^* x(\beta) = \text{Tr} (p_{L_p(\mathcal{H})_-}([x, \alpha])\beta), \quad \forall \beta \in L_q(\mathcal{H})_+,$$

where $p_{L_p(\mathcal{H})_-}$ is the projection onto $L_p(\mathcal{H})_-$ with respect to the direct sum decomposition (6.9). From $L_p(\mathcal{H})_- \subset (L_q(\mathcal{H})_{--})^0$ and from the direct sum decomposition (6.8), it follows that

$$\text{ad}_\alpha^* x = p_{L_p(\mathcal{H})_-}([x, \alpha]).$$

In particular, $\text{ad}_\alpha^* x \in L_p(\mathcal{H})_-$ for any $x \in L_p(\mathcal{H})_-$ and any $\alpha \in L_q(\mathcal{H})_+$. Therefore $L_p(\mathcal{H})_-$ is a Banach Lie–Poisson space with respect to $L_q(\mathcal{H})_+$. Similarly one has

$$\text{ad}_x^* \alpha = p_{L_q(\mathcal{H})_+}([\alpha, x]),$$

for any $x \in L_p(\mathcal{H})_-$ and any $\alpha \in L_q(\mathcal{H})_+$. Therefore $L_q(\mathcal{H})_+$ is a Banach Lie–Poisson space with respect to $L_p(\mathcal{H})_-$. Note that the existence of the projections $p_{L_p(\mathcal{H})_-}$ and $p_{L_q(\mathcal{H})_+}$ is crucial in this example. This is the reason why we have excluded the case $p = 1$ and $q = \infty$.

Example 6.4.19. *Iwasawa Banach Lie algebras.* For $1 < p < \infty$, consider the unitary algebra $\mathfrak{u}_p(\mathcal{H})$ defined by (6.10), and its complement $\mathfrak{b}_p^+(\mathcal{H})$ defined by (6.11). For $q := \frac{p}{p-1}$, let us denote by $\langle \cdot, \cdot \rangle_{\mathbb{R}}$ the continuous bilinear map given by the imaginary part of the trace:

$$\begin{aligned} \langle \cdot, \cdot \rangle_{\mathbb{R}} : L_p(\mathcal{H}) \times L_q(\mathcal{H}) &\longrightarrow \mathbb{R} \\ (x, \alpha) &\longmapsto \Im \text{Tr} (x\alpha). \end{aligned}$$

It is a strong duality pairing between $L_p(\mathcal{H})$ and $L_q(\mathcal{H})$ viewed as real Banach spaces. By Lemma 6.2.15, one has the direct sum decomposition

$$L_p(\mathcal{H}) = \mathfrak{u}_p(\mathcal{H}) \oplus \mathfrak{b}_p^+(\mathcal{H}).$$

Since $(\mathfrak{u}_p(\mathcal{H}))^0 \simeq \mathfrak{u}_q(\mathcal{H})$ and $(\mathfrak{b}_p^+(\mathcal{H}))^0 \simeq \mathfrak{b}_q^+(\mathcal{H})$, one has

$$\mathfrak{u}_p(\mathcal{H})^* \simeq L_q(\mathcal{H}) / (\mathfrak{u}_p(\mathcal{H}))^0 \simeq L_q(\mathcal{H}) / \mathfrak{u}_q(\mathcal{H}) \simeq \mathfrak{b}_q^+(\mathcal{H})$$

and similarly

$$\mathfrak{b}_p^+(\mathcal{H})^* = \mathfrak{u}_q(\mathcal{H}).$$

Consider the coadjoint action of an element $\alpha \in \mathfrak{b}_q^+(\mathcal{H})$ on an element $x \in \mathfrak{u}_p(\mathcal{H}) \subset \mathfrak{u}_p(\mathcal{H})^{**}$

$$\text{ad}_\alpha^* x(\beta) = \langle x, [\alpha, \beta] \rangle_{L^p, L^q} = \Im \text{Tr} (x[\alpha, \beta]_{\mathfrak{b}_q}) = \Im \text{Tr} ([x, \alpha]\beta),$$

where β is an arbitrary element in $\mathfrak{b}_q^+(\mathcal{H})$. Since $\mathfrak{b}_p^+(\mathcal{H}) \subset (\mathfrak{b}_q^+(\mathcal{H}))^0$ and $[L_p(\mathcal{H}), L_q(\mathcal{H})] \in L_p(\mathcal{H}) \cap L_q(\mathcal{H})$, one has

$$\text{ad}_\alpha^* x(\beta) = \Im \text{Tr} (p_{\mathfrak{u}_p, +}([x, \alpha])\beta) = \langle p_{\mathfrak{u}_p, +}([x, \alpha]), \beta \rangle_{L^p, L^q}, \quad \forall \beta \in \mathfrak{b}_q^+(\mathcal{H}),$$

where $p_{\mathfrak{u}_p, +}$ is the projection onto $\mathfrak{u}_p(\mathcal{H})$ defined by (6.14). Therefore

$$\text{ad}_\alpha^* x = p_{\mathfrak{u}_p, +}([x, \alpha]).$$

Analogously one has

$$\text{ad}_x^* \alpha = p_{\mathfrak{b}_q^+}([\alpha, x]),$$

for any $x \in \mathfrak{u}_p(\mathcal{H})$ and any $\alpha \in \mathfrak{b}_q^+(\mathcal{H})$. Consequently $\mathfrak{u}_p(\mathcal{H})$ and $\mathfrak{b}_q^+(\mathcal{H})$ are dual Banach Lie–Poisson spaces. Similarly $\mathfrak{u}_p(\mathcal{H})$ and $\mathfrak{b}_q^-(\mathcal{H})$ are dual Banach Lie–Poisson spaces.

6.5 Banach Lie bialgebras

In the finite dimensional case, a couple $(\mathfrak{g}, \mathfrak{g}^*)$ of Lie algebras is a Lie bialgebra if and only if the triple of Lie algebras $(\mathfrak{g} \oplus \mathfrak{g}^*, \mathfrak{g}, \mathfrak{g}^*)$ form a Manin triple. In that case, $(\mathfrak{g}^*, \mathfrak{g})$ is also a Lie bialgebra. The symmetry of the situation comes from the fact that $\mathfrak{g}^{**} = \mathfrak{g}$ for finite dimensional spaces. In Section 6.5.1, we introduce the notion of Banach Lie bialgebra with respect to an arbitrary duality pairing. In Section 6.5.2, we show that a Banach Lie bialgebra \mathfrak{g}_+ with respect to a Banach Lie algebra \mathfrak{g}_- gives rise to a Manin triple $(\mathfrak{g}_+ \oplus \mathfrak{g}_-, \mathfrak{g}_+, \mathfrak{g}_-)$ if and only if \mathfrak{g}_+ is also a Banach Lie–Poisson space with respect to \mathfrak{g}_- (see Theorem 6.5.9).

6.5.1 Definition of Banach Lie bialgebras

Let us introduce the notion of Banach Lie bialgebras. We refer the reader to [136] for the corresponding notion in the finite-dimensional case.

Definition 6.5.1. *Let \mathfrak{g}_+ be a Banach Lie algebra over the field $\mathbb{K} \in \{\mathbb{R}, \mathbb{C}\}$, and consider a duality pairing $\langle \cdot, \cdot \rangle_{\mathfrak{g}_+, \mathfrak{g}_-}$ between \mathfrak{g}_+ and a Banach space \mathfrak{g}_- . One says that \mathfrak{g}_+ is a **Banach Lie bialgebra with respect to \mathfrak{g}_-** if*

1. \mathfrak{g}_+ acts continuously by coadjoint action on $\mathfrak{g}_- \subset \mathfrak{g}_+^*$;
2. there is given a Banach Lie algebra structure on \mathfrak{g}_- such that the dual map of the Lie bracket $[\cdot, \cdot]_{\mathfrak{g}_-} : \mathfrak{g}_- \times \mathfrak{g}_- \rightarrow \mathfrak{g}_-$ restricts to a 1-cocycle $\theta : \mathfrak{g}_+ \rightarrow \Lambda^2 \mathfrak{g}_-^*$ with respect to the adjoint action $\text{ad}^{(2,0)}$ of \mathfrak{g}_+ on $\Lambda^2 \mathfrak{g}_-^*$ (recall that \mathfrak{g}_+ can be viewed as a subspace of \mathfrak{g}_-^*).

Remark 6.5.2. A finite-dimensional Lie bialgebra $(\mathfrak{g}, \mathfrak{g}^*)$ (see Definition 1.7 in [136]) is a Banach Lie bialgebra \mathfrak{g} with respect to its dual space \mathfrak{g}^* , where the duality pairing is the natural pairing between \mathfrak{g} and \mathfrak{g}^* .

Remark 6.5.3. 1. The first condition in Definition 6.5.1 means that \mathfrak{g}_- is preserved by the coadjoint action of \mathfrak{g}_+ , i.e

$$\text{ad}_x^* \mathfrak{g}_- \subset \mathfrak{g}_- \subset \mathfrak{g}_+^*$$

for any $x \in \mathfrak{g}_+$, and that the action map

$$\begin{aligned} \mathfrak{g}_+ \times \mathfrak{g}_- &\rightarrow \mathfrak{g}_- \\ (x, \alpha) &\mapsto \text{ad}_x^* \alpha \end{aligned}$$

is continuous. This condition is necessary in order to define the action of \mathfrak{g}_+ on the space $\Lambda^2 \mathfrak{g}_-^*$ of continuous skew-symmetric maps on \mathfrak{g}_- by (6.19).

2. The map θ is a 1-cocycle on \mathfrak{g}_+ if it satisfies:

$$\theta([x, y]) = \text{ad}_x^{(2,0)}(\theta(y)) - \text{ad}_y^{(2,0)}(\theta(x))$$

where $x, y \in \mathfrak{g}_+$. The second condition in Definition 6.5.1 means therefore that (see Section 6.3.5)

$$\theta([x, y])(\alpha, \beta) = \theta(y)(\text{ad}_x^* \alpha, \beta) + \theta(y)(\alpha, \text{ad}_x^* \beta) - \theta(x)(\text{ad}_y^* \alpha, \beta) - \theta(x)(\alpha, \text{ad}_y^* \beta), \quad (6.31)$$

for any x, y in \mathfrak{g}_+ and any α, β in \mathfrak{g}_- . In a more explicit form, the cocycle condition reads

$$\begin{aligned} \langle [x, y]_{\mathfrak{g}_+}, [\alpha, \beta]_{\mathfrak{g}_-} \rangle_{\mathfrak{g}_+, \mathfrak{g}_-} &= \langle y, [\text{ad}_x^* \alpha, \beta]_{\mathfrak{g}_-} \rangle_{\mathfrak{g}_+, \mathfrak{g}_-} + \langle y, [\alpha, \text{ad}_x^* \beta]_{\mathfrak{g}_-} \rangle_{\mathfrak{g}_+, \mathfrak{g}_-} \\ &\quad - \langle x, [\text{ad}_y^* \alpha, \beta]_{\mathfrak{g}_-} \rangle_{\mathfrak{g}_+, \mathfrak{g}_-} - \langle x, [\alpha, \text{ad}_y^* \beta]_{\mathfrak{g}_-} \rangle_{\mathfrak{g}_+, \mathfrak{g}_-}, \end{aligned} \quad (6.32)$$

for any x, y in \mathfrak{g}_+ and any α, β in \mathfrak{g}_- .

3. Let us remark that we do not assume that the cocycle θ takes values in the subspace $\Lambda^2 \mathfrak{g}_+^*$ of $\Lambda^2 \mathfrak{g}_-^*$. This is related to the generalized notion of Poisson manifolds given in Definition 6.4.7.

Let us first give examples of Banach Lie algebras which are Banach Lie–Poisson spaces (see Section 6.4.3) but **not** Banach Lie bialgebras.

Example 6.5.4. For $1 \leq p \leq \infty$, consider $\mathfrak{g}_+ := L_p(\mathcal{H})$ and its dual space $\mathfrak{g}_- := L_q(\mathcal{H})$, the duality pairing $\langle \cdot, \cdot \rangle_{\mathfrak{g}_+, \mathfrak{g}_-}$ being given by the trace. By example 6.4.15, $L_p(\mathcal{H})$ is a Banach Lie–Poisson space with respect to $L_q(\mathcal{H})$. For $x \in L_p(\mathcal{H})$ and $\alpha \in L_q(\mathcal{H})$, one has $\text{ad}_\alpha^* x = [x, \alpha] \in L_p(\mathcal{H})$ and $\text{ad}_x^* \alpha = [\alpha, x] \in L_q(\mathcal{H})$. Therefore, for any $\alpha, \beta \in L_q(\mathcal{H})$ and $x, y \in L_p(\mathcal{H})$, one has

$$\begin{aligned} & \langle y, [\text{ad}_x^* \alpha, \beta]_{\mathfrak{g}_-} \rangle_{\mathfrak{g}_+, \mathfrak{g}_-} + \langle y, [\alpha, \text{ad}_x^* \beta]_{\mathfrak{g}_-} \rangle_{\mathfrak{g}_+, \mathfrak{g}_-} - \langle x, [\text{ad}_y^* \alpha, \beta]_{\mathfrak{g}_-} \rangle_{\mathfrak{g}_+, \mathfrak{g}_-} - \langle x, [\alpha, \text{ad}_y^* \beta]_{\mathfrak{g}_-} \rangle_{\mathfrak{g}_+, \mathfrak{g}_-} \\ &= 2 \langle \text{ad}_\alpha^* [x, y], \beta \rangle_{\mathfrak{g}_+, \mathfrak{g}_-}. \end{aligned} \tag{6.33}$$

This implies that $L_p(\mathcal{H})$ is not a Banach Lie bialgebra with respect to $L_q(\mathcal{H})$ (compare with the cocycle condition (6.32)).

Example 6.5.5. By example 6.4.16, $L_1(\mathcal{H})$ is a Banach Lie–Poisson space with respect to $L_\infty(\mathcal{H})$. A computation analogous as in previous example shows that $L_1(\mathcal{H})$ is not a Banach Lie bialgebra with respect to $L_\infty(\mathcal{H})$.

Example 6.5.6. By example 6.4.17, $L_1(\mathcal{H})$ is a Banach Lie–Poisson space with respect to $L_2(\mathcal{H})$. It is easy to see that equation (6.33) is satisfied for any $\alpha, \beta \in L_2(\mathcal{H})$ and $x, y \in L_1(\mathcal{H})$, hence $L_1(\mathcal{H})$ is not a Banach Lie bialgebra with respect to $L_2(\mathcal{H})$.

Let us now give examples of Banach Lie–Poisson spaces which are also Banach Lie bialgebras. In Example 6.5.7 and Example 6.5.8, the cocycle condition can be checked by hand using the expression of the coadjoint actions.

Example 6.5.7. *Banach Lie bialgebra of upper and lower triangular operators.* For $1 < p < \infty$, consider the Banach algebra $L_p(\mathcal{H})_-$ of lower triangular operators in $L_p(\mathcal{H})$ defined by (6.4) and its dual space $L_q(\mathcal{H})_+$, where $\frac{1}{p} + \frac{1}{q} = 1$ and where the duality pairing is given by the trace. Then $L_p(\mathcal{H})_-$ is a Banach Lie bialgebra with respect to $L_q(\mathcal{H})_+$.

Example 6.5.8. *Iwasawa Banach Lie bialgebras.* Let p and q be such that $1 < p < \infty$, $1 < q < \infty$ and $\frac{1}{p} + \frac{1}{q} = 1$. Consider the Banach Lie algebra $\mathfrak{u}_p(\mathcal{H})$ and its dual Banach space $\mathfrak{b}_q^+(\mathcal{H})$, endowed with its natural Banach Lie algebra structure, which makes $\mathfrak{u}_p(\mathcal{H})$ into a Banach Lie–Poisson space (see example 6.4.19). In this case the duality pairing is given by the imaginary part of the trace. Then $\mathfrak{u}_p(\mathcal{H})$ is a Banach Lie bialgebra with respect to $\mathfrak{b}_q^+(\mathcal{H})$.

6.5.2 Banach Lie bialgebras versus Manin triples

In the finite-dimensional case, the notion of Lie bialgebra is equivalent to the notion of Manin triple (see [66] or Section 1.6 in [115]). In the infinite-dimensional case the notion of Banach Lie–Poisson space comes into play.

Theorem 6.5.9. *Consider two Banach Lie algebras $(\mathfrak{g}_+, [\cdot, \cdot]_{\mathfrak{g}_+})$ and $(\mathfrak{g}_-, [\cdot, \cdot]_{\mathfrak{g}_-})$ in duality. Denote by \mathfrak{g} the Banach space $\mathfrak{g} = \mathfrak{g}_+ \oplus \mathfrak{g}_-$ with norm $\|\cdot\|_{\mathfrak{g}} = \|\cdot\|_{\mathfrak{g}_+} + \|\cdot\|_{\mathfrak{g}_-}$. The following assertions are equivalent.*

- (1) \mathfrak{g}_+ is a Banach Lie–Poisson space and a Banach Lie bialgebra with respect to \mathfrak{g}_- with cocycle $\theta_+ := [\cdot, \cdot]_{\mathfrak{g}_-}^* : \mathfrak{g}_+ \rightarrow \Lambda^2 \mathfrak{g}_-^*$;
- (2) $(\mathfrak{g}, \mathfrak{g}_+, \mathfrak{g}_-)$ is a Manin triple for the natural non-degenerate symmetric bilinear map

$$\begin{aligned} \langle \cdot, \cdot \rangle_{\mathfrak{g}} : \quad & \mathfrak{g} \times \mathfrak{g} && \rightarrow \mathbb{K} \\ (x, \alpha) \times (y, \beta) & \mapsto && \langle x, \beta \rangle_{\mathfrak{g}_+, \mathfrak{g}_-} + \langle y, \alpha \rangle_{\mathfrak{g}_+, \mathfrak{g}_-} \end{aligned}$$

with bracket given by

$$\begin{aligned} [\cdot, \cdot]_{\mathfrak{g}} : \quad & \mathfrak{g} \times \mathfrak{g} && \rightarrow \mathfrak{g} = \mathfrak{g}_+ \oplus \mathfrak{g}_- \\ (x, \alpha) \times (y, \beta) & \mapsto && ([x, y]_{\mathfrak{g}_+} + \text{ad}_\beta^* x - \text{ad}_\alpha^* y, \quad [\alpha, \beta]_{\mathfrak{g}_-} + \text{ad}_y^* \alpha - \text{ad}_x^* \beta). \end{aligned} \tag{6.34}$$

- (3) \mathfrak{g}_- is a Banach Lie–Poisson space and a Banach Lie bialgebra with respect to \mathfrak{g}_+ with cocycle $\theta_- := [\cdot, \cdot]_{\mathfrak{g}_+}^* : \mathfrak{g}_- \rightarrow \Lambda^2 \mathfrak{g}_+^*$;

Proof. (2) \Rightarrow (1) follows from Theorem 6.3.3. Let us prove (1) \Rightarrow (2).

- Since \mathfrak{g}_+ is a Banach Lie–Poisson space with respect to \mathfrak{g}_- , \mathfrak{g}_- is a Banach Lie algebra $(\mathfrak{g}_-, [\cdot, \cdot]_{\mathfrak{g}_-})$ such that the coadjoint action of \mathfrak{g}_- on \mathfrak{g}_-^* preserves the subspace $\mathfrak{g}_+ \subset \mathfrak{g}_-^*$ and the map

$$\begin{aligned} \text{ad}_{\mathfrak{g}_-}^* : \mathfrak{g}_- \times \mathfrak{g}_+ &\rightarrow \mathfrak{g}_+ \\ (\alpha, x) &\mapsto \text{ad}_{\alpha}^* x, \end{aligned}$$

is continuous. Since \mathfrak{g}_+ is a Banach Lie bialgebra, the coadjoint action of \mathfrak{g}_+ on \mathfrak{g}_+^* preserves the subspace $\mathfrak{g}_- \subset \mathfrak{g}_+^*$ and the map

$$\begin{aligned} \text{ad}_{\mathfrak{g}_+}^* : \mathfrak{g}_+ \times \mathfrak{g}_- &\rightarrow \mathfrak{g}_- \\ (x, \alpha) &\mapsto \text{ad}_x^* \alpha, \end{aligned}$$

is continuous. Therefore bracket (6.34) is continuous on $\mathfrak{g} = \mathfrak{g}_+ \oplus \mathfrak{g}_-$.

- Let us show that the symmetric non-degenerate pairing $\langle \cdot, \cdot \rangle_{\mathfrak{g}}$ is invariant with respect to the bracket $[\cdot, \cdot]_{\mathfrak{g}}$. For this, we will use the fact that \mathfrak{g}_+ and \mathfrak{g}_- are isotropic subspaces for $\langle \cdot, \cdot \rangle_{\mathfrak{g}}$. For $x \in \mathfrak{g}_+$ and $\alpha \in \mathfrak{g}_-$, one has

$$[x, \alpha]_{\mathfrak{g}} = (\text{ad}_{\alpha}^* x, -\text{ad}_x^* \alpha). \quad (6.35)$$

Therefore, for any $x \in \mathfrak{g}_+$ and any $\alpha, \beta \in \mathfrak{g}_-$, one has

$$\begin{aligned} \langle [x, \alpha]_{\mathfrak{g}}, \beta \rangle_{\mathfrak{g}} &= \langle \text{ad}_{\alpha}^* x, \beta \rangle_{\mathfrak{g}} = \langle x, \text{ad}_{\alpha} \beta \rangle_{\mathfrak{g}} = \langle x, [\alpha, \beta]_{\mathfrak{g}} \rangle_{\mathfrak{g}} \\ &= -\langle x, [\beta, \alpha]_{\mathfrak{g}} \rangle_{\mathfrak{g}} = -\langle \text{ad}_{\beta}^* x, \alpha \rangle_{\mathfrak{g}} = \langle [\beta, x]_{\mathfrak{g}}, \alpha \rangle_{\mathfrak{g}}. \end{aligned}$$

Similarly, for any $x, y \in \mathfrak{g}_+$ and any $\beta \in \mathfrak{g}_-$, one has

$$\langle [x, y]_{\mathfrak{g}}, \beta \rangle_{\mathfrak{g}} = \langle y, \text{ad}_x^* \beta \rangle_{\mathfrak{g}} = \langle y, [\beta, x]_{\mathfrak{g}} \rangle_{\mathfrak{g}} = -\langle \text{ad}_y^* \beta, x \rangle_{\mathfrak{g}} = \langle [y, \beta]_{\mathfrak{g}}, x \rangle_{\mathfrak{g}}.$$

By linearity, it follows that $\langle \cdot, \cdot \rangle_{\mathfrak{g}}$ is invariant with respect to $[\cdot, \cdot]_{\mathfrak{g}}$.

- It remains to verify that $[\cdot, \cdot]_{\mathfrak{g}}$ satisfies the Jacobi identity. Let us first show that for any $x, y \in \mathfrak{g}_+$ and any $\alpha \in \mathfrak{g}_-$,

$$[\alpha, [x, y]] = [[\alpha, x], y] + [x, [\alpha, y]].$$

The dual map $[\cdot, \cdot]_{\mathfrak{g}_-}^* : \mathfrak{g}_-^* \rightarrow \Lambda^2 \mathfrak{g}_-^*$ of the bilinear map $[\cdot, \cdot]_{\mathfrak{g}_-} : \Lambda^2 \mathfrak{g}_- \rightarrow \mathfrak{g}_-$ is

$$[\cdot, \cdot]_{\mathfrak{g}_-}^* (\mathcal{F}) = \mathcal{F}([\cdot, \cdot]_{\mathfrak{g}_-}).$$

In particular, its restriction $\theta_+ : \mathfrak{g}_+ \rightarrow \Lambda^2 \mathfrak{g}_-^*$ to $\mathfrak{g}_+ \subset \mathfrak{g}_-^*$ reads

$$\theta(x)(\alpha, \beta) = \langle x, [\alpha, \beta]_{\mathfrak{g}_-} \rangle_{\mathfrak{g}} = \langle [x, \alpha]_{\mathfrak{g}}, \beta \rangle_{\mathfrak{g}} = \langle \text{ad}_{\alpha}^* x, \beta \rangle_{\mathfrak{g}}.$$

Since \mathfrak{g}_+ is a Banach Lie–Poisson space, the cocycle $\theta_+ = [\cdot, \cdot]_{\mathfrak{g}_-}^*$ restricted to $\mathfrak{g}_+ \subset \mathfrak{g}_-^*$ takes values in $\Lambda^2 \mathfrak{g}_+$. The cocycle condition (6.31) reads

$$\begin{aligned} \langle [x, y], [\alpha, \beta] \rangle_{\mathfrak{g}_+, \mathfrak{g}_-} &= +\langle y, [\text{ad}_x^* \alpha, \beta] \rangle_{\mathfrak{g}_+, \mathfrak{g}_-} + \langle y, [\alpha, \text{ad}_x^* \beta] \rangle_{\mathfrak{g}_+, \mathfrak{g}_-} \\ &\quad - \langle x, [\text{ad}_y^* \alpha, \beta] \rangle_{\mathfrak{g}_+, \mathfrak{g}_-} - \langle x, [\alpha, \text{ad}_y^* \beta] \rangle_{\mathfrak{g}_+, \mathfrak{g}_-}, \end{aligned} \quad (6.36)$$

where $x, y \in \mathfrak{g}_+$ and $\alpha, \beta \in \mathfrak{g}_-$. Using the definition of the bracket $\langle \cdot, \cdot \rangle_{\mathfrak{g}}$ and its invariance with respect to $[\cdot, \cdot]_{\mathfrak{g}}$, this is equivalent to

$$\begin{aligned} -\langle [\alpha, [x, y]], \beta \rangle_{\mathfrak{g}} &= -\langle [\text{ad}_x^* \alpha, y], \beta \rangle_{\mathfrak{g}} - \langle [\alpha, y], \text{ad}_x^* \beta \rangle_{\mathfrak{g}} \\ &\quad + \langle [\text{ad}_y^* \alpha, x], \beta \rangle_{\mathfrak{g}} + \langle [\alpha, x], \text{ad}_y^* \beta \rangle_{\mathfrak{g}}. \end{aligned}$$

Using the fact that \mathfrak{g}_+ and \mathfrak{g}_- are isotropic subspaces for $\langle \cdot, \cdot \rangle_{\mathfrak{g}}$ and relation (6.35), one gets

$$\begin{aligned} -\langle [\alpha, [x, y]], \beta \rangle_{\mathfrak{g}} &= -\langle [\text{ad}_x^* \alpha, y], \beta \rangle_{\mathfrak{g}} + \langle \text{ad}_{\alpha}^* y, \text{ad}_x^* \beta \rangle_{\mathfrak{g}_+, \mathfrak{g}_-} \\ &\quad + \langle [\text{ad}_y^* \alpha, x], \beta \rangle_{\mathfrak{g}} - \langle \text{ad}_{\alpha}^* x, \text{ad}_y^* \beta \rangle_{\mathfrak{g}_+, \mathfrak{g}_-}. \end{aligned}$$

Using the definition of the coadjoint actions, one obtains

$$\begin{aligned} -\langle [\alpha, [x, y]], \beta \rangle_{\mathfrak{g}} &= -\langle [\text{ad}_x^* \alpha, y], \beta \rangle_{\mathfrak{g}} + \langle [x, \text{ad}_{\alpha}^* y], \beta \rangle_{\mathfrak{g}_+, \mathfrak{g}_-} \\ &\quad + \langle [\text{ad}_y^* \alpha, x], \beta \rangle_{\mathfrak{g}} - \langle [y, \text{ad}_{\alpha}^* x], \beta \rangle_{\mathfrak{g}_+, \mathfrak{g}_-}, \end{aligned}$$

or, in a more compact manner,

$$-\langle [\alpha, [x, y]], \beta \rangle_{\mathfrak{g}} = \langle [\text{ad}_\alpha^* x - \text{ad}_x^* \alpha, y], \beta \rangle_{\mathfrak{g}} + \langle [x, \text{ad}_\alpha^* y - \text{ad}_y^* \alpha], \beta \rangle_{\mathfrak{g}}.$$

Using $[x, \alpha]_{\mathfrak{g}} = \text{ad}_\alpha^* x - \text{ad}_x^* \alpha$, and $[y, \alpha]_{\mathfrak{g}} = \text{ad}_\alpha^* y - \text{ad}_y^* \alpha$, one eventually gets

$$-\langle [\alpha, [x, y]], \beta \rangle_{\mathfrak{g}} = -\langle [[\alpha, x], y], \beta \rangle_{\mathfrak{g}} - \langle [x, [\alpha, y]], \beta \rangle_{\mathfrak{g}}, \quad (6.37)$$

for any $x, y \in \mathfrak{g}_+$ and any $\alpha, \beta \in \mathfrak{g}_-$. Since $\langle \cdot, \cdot \rangle_{\mathfrak{g}}$ restricts to the duality pairing between \mathfrak{g}_+ and \mathfrak{g}_- , it follows that

$$p_{\mathfrak{g}_+} [\alpha, [x, y]] = p_{\mathfrak{g}_+} [[\alpha, x], y] + p_{\mathfrak{g}_+} [x, [\alpha, y]], \quad (6.38)$$

for any $x, y \in \mathfrak{g}_+$ and any $\alpha \in \mathfrak{g}_-$. On the other hand, considering the projection on \mathfrak{g}_- one has

$$p_{\mathfrak{g}_-} [\alpha, [x, y]] = \text{ad}_{[x, y]}^* \alpha,$$

as well as

$$p_{\mathfrak{g}_-} [[\alpha, x], y] = \text{ad}_y^* \text{ad}_x^* \alpha,$$

and

$$p_{\mathfrak{g}_-} [x, [\alpha, y]] = -\text{ad}_x^* \text{ad}_y^* \alpha.$$

Since the bracket in \mathfrak{g}_+ satisfied Jacobi identity, it follows that

$$\langle \alpha, [[x, y], z] \rangle_{\mathfrak{g}_+, \mathfrak{g}_-} = \langle \alpha, [x, [y, z]] \rangle_{\mathfrak{g}_+, \mathfrak{g}_-} - \langle \alpha, [y, [x, z]] \rangle_{\mathfrak{g}_+, \mathfrak{g}_-},$$

therefore

$$p_{\mathfrak{g}_-} [\alpha, [x, y]] = p_{\mathfrak{g}_-} [[\alpha, x], y] + p_{\mathfrak{g}_-} [x, [\alpha, y]], \quad (6.39)$$

for any $x, y \in \mathfrak{g}_+$ and any $\alpha \in \mathfrak{g}_-$. Combining (6.38) and (6.39), it follows that

$$[\alpha, [x, y]] = [[\alpha, x], y] + [x, [\alpha, y]],$$

for any $x, y \in \mathfrak{g}_+$ and any $\alpha \in \mathfrak{g}_-$.

- It remains to show that for any $x \in \mathfrak{g}_+$ and any $\alpha, \beta \in \mathfrak{g}_-$,

$$[x, [\alpha, \beta]] = [[x, \alpha], \beta] + [\alpha, [x, \beta]].$$

Since the bracket in \mathfrak{g}_- satisfies Jacobi identity, similarly to (6.39) replacing \mathfrak{g}_- by \mathfrak{g}_+ , one has

$$p_{\mathfrak{g}_+} [x, [\alpha, \beta]] = p_{\mathfrak{g}_+} [[x, \alpha], \beta] + p_{\mathfrak{g}_+} [\alpha, [x, \beta]]. \quad (6.40)$$

Let us show that

$$p_{\mathfrak{g}_-} [x, [\alpha, \beta]] = p_{\mathfrak{g}_-} [[x, \alpha], \beta] + p_{\mathfrak{g}_-} [\alpha, [x, \beta]],$$

for any $x \in \mathfrak{g}_+$ and any $\alpha, \beta \in \mathfrak{g}_-$. For any $x, y \in \mathfrak{g}_+$ and any $\alpha, \beta \in \mathfrak{g}_-$, one has

$$\langle y, p_{\mathfrak{g}_-} [x, [\alpha, \beta]] \rangle_{\mathfrak{g}_+, \mathfrak{g}_-} = -\langle y, \text{ad}_x^* [\alpha, \beta] \rangle_{\mathfrak{g}_+, \mathfrak{g}_-} = -\langle [x, y], [\alpha, \beta] \rangle_{\mathfrak{g}_+, \mathfrak{g}_-} = \langle [\alpha, [x, y]], \beta \rangle_{\mathfrak{g}}.$$

On the other hand, for any $x, y \in \mathfrak{g}_+$ and any $\alpha, \beta \in \mathfrak{g}_-$, one has

$$\langle y, p_{\mathfrak{g}_-} [[x, \alpha], \beta] \rangle_{\mathfrak{g}_+, \mathfrak{g}_-} = \langle y, [[x, \alpha], \beta] \rangle_{\mathfrak{g}} = \langle [[\alpha, x], y], \beta \rangle_{\mathfrak{g}},$$

and

$$\langle y, p_{\mathfrak{g}_-} [\alpha, [x, \beta]] \rangle_{\mathfrak{g}_+, \mathfrak{g}_-} = \langle y, [\alpha, [x, \beta]] \rangle_{\mathfrak{g}} = \langle [x, [\alpha, y]], \beta \rangle_{\mathfrak{g}}.$$

By (6.37), it follows that

$$p_{\mathfrak{g}_-} [x, [\alpha, \beta]] = p_{\mathfrak{g}_-} [[x, \alpha], \beta] + p_{\mathfrak{g}_-} [\alpha, [x, \beta]]. \quad (6.41)$$

Combining (6.40) and (6.41), it follows that

$$[x, [\alpha, \beta]] = [[x, \alpha], \beta] + [\alpha, [x, \beta]],$$

for any $x \in \mathfrak{g}_+$ and any $\alpha, \beta \in \mathfrak{g}_-$. This ends the proof of (1) \Rightarrow (2). The equivalence with (3) follows by symmetry of (2) with respect to exchange of \mathfrak{g}_+ into \mathfrak{g}_- .

□

Remark 6.5.10. It is noteworthy that the cocycle condition needs only to be verified for one of the Banach Lie algebra \mathfrak{g}_+ or \mathfrak{g}_- . The following Corollary is therefore a direct consequence of the proof of Theorem 6.5.9.

Corollary 6.5.11. *Consider two Banach Lie algebras $(\mathfrak{g}_+, [\cdot, \cdot]_{\mathfrak{g}_+})$ and $(\mathfrak{g}_-, [\cdot, \cdot]_{\mathfrak{g}_-})$ in duality. If \mathfrak{g}_+ is a Banach Lie–Poisson space and a Banach Lie bialgebra with respect to \mathfrak{g}_- , then \mathfrak{g}_- is a Banach Lie–Poisson space and a Banach Lie bialgebra with respect to \mathfrak{g}_+ .*

Example 6.5.12. By Proposition 6.2.16, the triple $(L_p(\mathcal{H}), \mathfrak{u}_p(\mathcal{H}), \mathfrak{b}_p^+(\mathcal{H}))$ is a Banach Manin triple for $1 < p \leq 2$. Under this condition on p , it follows from Theorem 6.5.9 that $\mathfrak{u}_p(\mathcal{H})$ is a Banach Lie–Poisson space and a Banach Lie bialgebra with respect to $\mathfrak{b}_p^+(\mathcal{H})$, and $\mathfrak{b}_p^+(\mathcal{H})$ is a Banach Lie–Poisson space and a Banach Lie bialgebra with respect to $\mathfrak{u}_p(\mathcal{H})$.

Example 6.5.13. For $1 < p < \infty$, by Example 6.4.19, $\mathfrak{u}_p(\mathcal{H})$ is a Banach Lie–Poisson space with respect to $\mathfrak{b}_q^+(\mathcal{H})$, where $\frac{1}{p} + \frac{1}{q} = 1$. By Example 6.5.8, $\mathfrak{u}_p(\mathcal{H})$ is a Banach Lie bialgebra with respect to $\mathfrak{b}_q^+(\mathcal{H})$. We deduce from Theorem 6.5.9 that $(\mathfrak{u}_p(\mathcal{H}) \oplus \mathfrak{b}_q^+(\mathcal{H}), \mathfrak{u}_p(\mathcal{H}), \mathfrak{b}_q^+(\mathcal{H}))$ form a Banach Manin triple, and that $\mathfrak{b}_q^+(\mathcal{H})$ is a Banach Lie bialgebra with respect to $\mathfrak{u}_p(\mathcal{H})$.

Example 6.5.14. From Example 6.4.18, we know that $L_p(\mathcal{H})_-$ is a Banach Lie–Poisson space with respect to $L_q(\mathcal{H})_+$. By Example 6.5.7, $L_p(\mathcal{H})_-$ is a Banach Lie bialgebra with respect to $L_q(\mathcal{H})_+$. By Theorem 6.5.9, the triple of Banach Lie algebras $(L_p(\mathcal{H})_- \oplus L_q(\mathcal{H})_+, L_p(\mathcal{H})_-, L_q(\mathcal{H})_+)$ is a Banach Manin triple. By corollary 6.5.11, $L_q(\mathcal{H})_+$ is a Banach Lie bialgebra with respect to $L_p(\mathcal{H})_-$.

6.6 Banach Poisson–Lie groups

This Section is devoted to the notion of Banach Poisson–Lie groups in the general framework of generalized Banach Poisson manifolds (see Section 6.4.1). We start in Section 6.6.1 with the definition, and show that the compatibility condition between the Poisson tensor and the multiplication on the group gives rise to a 1-cocycle on the group. In Section 6.6.2, we use the triviality of the tangent and cotangent bundles in order to write the Jacobi identity for a Poisson tensor on a group at the level of the Lie algebra (Theorem 6.6.8). This allows us to give examples of Banach Poisson–Lie groups in Section 6.6.3. Finally, in Section 6.6.4, we prove that the tangent space at the unit element e of a Banach Poisson–Lie group (G, \mathbb{F}, π) admits a natural Banach Lie algebra structure with respect to \mathbb{F}_e , and, in the case when the Poisson tensor π is a section of $\Lambda^2 TG$, is also a Banach Lie–Poisson space. The integrability problem of a Banach Lie bialgebra into a Banach Poisson–Lie group remains open.

6.6.1 Definition of Banach Poisson–Lie groups

In order to be able to define the notion of Banach Poisson–Lie groups, we need to recall the construction of a Poisson structure on the product of two Poisson manifolds. The following Proposition is straightforward.

Proposition 6.6.1. *Let $(M_1, \mathbb{F}_1, \pi_1)$ and $(M_2, \mathbb{F}_2, \pi_2)$ be two generalized Banach Poisson manifolds. Then the product $M_1 \times M_2$ carries a natural generalized Banach Poisson manifold structure $(M_1 \times M_2, \mathbb{F}, \pi)$ where*

1. $M_1 \times M_2$ carries the product Banach manifold structure, in particular the tangent bundle of $M_1 \times M_2$ is isomorphic to the direct sum $TM_1 \oplus TM_2$ of the vector bundles TM_1 and TM_2 and the cotangent bundle of $M_1 \times M_2$ is isomorphic to $T^*M_1 \oplus T^*M_2$,
2. \mathbb{F} is the subbundle of $T^*M_1 \oplus T^*M_2$ defined as

$$\mathbb{F}_{(p,q)} = (\mathbb{F}_1)_p \oplus (\mathbb{F}_2)_q,$$

3. π is defined on \mathbb{F} by

$$\pi(\alpha_1 + \alpha_2, \beta_1 + \beta_2) = \pi_1(\alpha_1, \beta_1) + \pi_2(\alpha_2, \beta_2), \quad \alpha_1, \beta_1 \in \mathbb{F}_1, \alpha_2, \beta_2 \in \mathbb{F}_2.$$

Recall the following definition.

Definition 6.6.2. Let $(M_1, \mathbb{F}_1, \pi_1)$ and $(M_2, \mathbb{F}_2, \pi_2)$ be two generalized Banach Poisson manifolds and $F : M_1 \rightarrow M_2$ a smooth map. One says that F is a **Poisson map** at $p \in M_1$ if

1. the tangent map $T_p F : T_p M_1 \rightarrow T_{F(p)} M_2$ satisfies $T_p F^*(\mathbb{F}_2)_{F(p)} \subset (\mathbb{F}_1)_p$ and $T_p F^* : \mathbb{F}_2 \rightarrow \mathbb{F}_1$ is continuous ;
2. $(\pi_1)_p(\alpha \circ T_p F, \beta \circ T_p F) = (\pi_2)_{F(p)}(\alpha, \beta)$ for any $\alpha, \beta \in (\mathbb{F}_2)_{F(p)}$.

One says that F is a Poisson map if it is a Poisson map at any $p \in M_1$.

Definition 6.6.3. A **Banach Poisson–Lie group** G is a Banach Lie group equipped with a generalized Banach Poisson manifold structure such that the group multiplication $m : G \times G \rightarrow G$ is a Poisson map, where $G \times G$ is endowed with the product Poisson structure.

The compatibility condition between the multiplication in the group and the Poisson tensor can be checked at the level of the Lie algebra. To see this, let us introduce some notation. Denote by $L_g : G \rightarrow G$ and $R_g : G \rightarrow G$ the left and right translations by $g \in G$. By abuse of notation, we will also denote by L_g and R_g the induced actions of $g \in G$ on the tangent bundle TG . The induced actions on the cotangent bundle T^*G will be denoted by L_g^* and R_g^* , and on the dual $T^{**}G$ of the cotangent bundle by L_g^{**} and R_g^{**} . In particular, for $g \in G$ and $\alpha \in T_u^*G$, $L_g^* \alpha \in T_{g^{-1}u}^*G$ is defined by $L_g^* \alpha(X) := \alpha(L_g X)$. The smooth adjoint action of G on its Lie algebra \mathfrak{g} will be denoted by $\text{Ad}_g = L_g \circ R_g^{-1}$, the induced smooth coadjoint action of G on the dual space \mathfrak{g}^* by $\text{Ad}_g^* = L_g^* \circ R_{g^{-1}}^*$, and the induced smooth action of G on the bidual space \mathfrak{g}^{**} by $\text{Ad}_g^{**} = L_g^{**} \circ R_{g^{-1}}^{**}$. Suppose that the restriction of the coadjoint action of G to an invariant subspace $\mathfrak{g}_- \subset \mathfrak{g}^*$ is continuous for the topology of \mathfrak{g}_- . Then one can define the coadjoint action $\text{Ad}^{**}(g)$ of $g \in G$ on $\Lambda^2 \mathfrak{g}_-$ by

$$\text{Ad}^{**}(g)\mathfrak{t} := \mathfrak{t}(\text{Ad}(g)^*, \text{Ad}(g)^*), \quad \text{for } \mathfrak{t} \in \Lambda^2 \mathfrak{g}_-.$$

By abuse of notation, we will also denote by L_g^{**} the action of $g \in G$ on a section π of $\Lambda^2 T^{**}G$:

$$L_g^{**} \pi_u(\alpha, \beta) = \pi_u(L_g^* \alpha, L_g^* \beta), \quad \text{with } \alpha, \beta \in T_{gu}^*G.$$

Similarly, one defines

$$R_u^{**} \pi_g(\alpha, \beta) = \pi_g(R_u^* \alpha, R_u^* \beta), \quad \text{with } \alpha, \beta \in T_{gu}^*G.$$

Proposition 6.6.4. A Banach Lie group G equipped with a generalized Banach Poisson structure (G, \mathbb{F}, π) is a Banach Poisson–Lie group if and only if

1. G acts continuously on \mathbb{F} by left and right translations ;
2. the Poisson tensor π is a section of $\Lambda^2 \mathbb{F}^*$ satisfying

$$\pi_{gu} = L_g^{**} \pi_u + R_u^{**} \pi_g, \quad \forall g, u \in G. \quad (6.42)$$

Proof. The tangent map $T_{(g,u)}m : T_g G \oplus T_u G \rightarrow T_{gu} G$ to the multiplication m in G maps (X_g, X_u) to $T_g R_u(X_g) + T_u L_g(X_u)$. The first condition in definition 6.6.2 is equivalent to the fact that for any $\alpha \in \mathbb{F}_{gu}$, the covector $\alpha \circ T_u L_g$ belongs to $\mathbb{F}_u \subset T_u^*G$ and the covector $\alpha \circ T_g R_u$ belongs to $\mathbb{F}_g \subset T_g^*G$, and the maps $T_u L_g^* : \mathbb{F}_{gu} \rightarrow \mathbb{F}_u$ and $T_g R_u^* : \mathbb{F}_{gu} \rightarrow \mathbb{F}_g$ are continuous. This is in turn equivalent to the fact that G acts continuously on \mathbb{F} by left and right translations.

The second condition in definition 6.6.2 reads

$$\pi_{G \times G}(\alpha \circ T_{(g,u)}m, \beta \circ T_{(g,u)}m) = \pi_{gu}(\alpha, \beta),$$

for any α and β in \mathbb{F}_{gu} . By definition of the Poisson structure on the product manifold $G \times G$, one has:

$$\pi_{G \times G}(\alpha \circ T_{(g,u)}m, \beta \circ T_{(g,u)}m) = \pi_u(\alpha \circ T_u L_g, \beta \circ T_u L_g) + \pi_g(\alpha \circ T_g R_u, \beta \circ T_g R_u),$$

hence m is a Poisson map if and only if (6.42) is satisfied. \square

Corollary 6.6.5. *The Poisson tensor π of a Banach Poisson–Lie group vanishes at the unit element.*

Proof. By equation (6.42), one has $\pi_e = \pi_e + \pi_e$, hence $\pi_e = 0$. \square

Proposition 6.6.6. *Let (G, \mathbb{F}, π) be a Banach Poisson–Lie group. Then G acts continuously by coadjoint action on the fiber $\mathbb{F}_e \subset T_e^*G$ over the unit element $e \in G$.*

Proof. Suppose that (G, \mathbb{F}, π) is a Banach Poisson–Lie group. The invariance of \mathbb{F} by left translations implies that for any $\alpha \in \mathbb{F}_e$ and any $g \in G$, the covector $L_g^*\alpha := \alpha \circ T_{g^{-1}}L_g$ belongs to $\mathbb{F}_{g^{-1}} \subset T_{g^{-1}}^*G$. The invariance of \mathbb{F} by right translations then implies that the covector $\text{Ad}^*(g)\alpha := R_{g^{-1}}^* \circ L_g^*\alpha = \alpha \circ T_{g^{-1}}L_g \circ T_e R_{g^{-1}}$ belongs to $\mathbb{F}_e \subset T_e^*G$. Hence \mathbb{F}_e is stable by the coadjoint action of G . Moreover, by Proposition 6.6.4, G acts continuously on \mathbb{F} by left and right translations. It follows that the coadjoint action of G on $\mathbb{F}_e \subset T_e^*G$ is continuous. \square

In next Proposition, we introduce a 1-cocycle naturally associated to a generalized Banach Poisson–Lie group (see Theorem 1.2 in [136] for the finite-dimensional case).

Proposition 6.6.7. *A Banach Lie group G equipped with a generalized Banach Poisson structure (G, \mathbb{F}, π) is a Banach Poisson–Lie group if and only if*

1. G acts continuously on \mathbb{F} by left and right translations ;
2. the map $\Pi_r : G \rightarrow \Lambda^2\mathbb{F}_e^*$ defined by $g \mapsto \Pi_r(g) := R_{g^{-1}}^{**}\pi_g$ is a 1-cocycle on G with respect to the coadjoint action Ad^{**} of G on $\Lambda^2\mathbb{F}_e^*$, i.e. for any $g, u \in G$,

$$\Pi_r(gu) = \text{Ad}(g)^{**}\Pi_r(u) + \Pi_r(g). \quad (6.43)$$

Proof. Using the relation $R_{(gu)^{-1}}^{**} = R_{g^{-1}}^{**} \circ R_{u^{-1}}^{**}$, the condition $\pi_{gu} = L_g^{**}\pi_u + R_u^{**}\pi_g$ for all $g, u \in G$ is equivalent to

$$R_{(gu)^{-1}}^{**}\pi_{gu} = R_{g^{-1}}^{**} \circ R_{u^{-1}}^{**} \circ L_g^{**}\pi_u + R_{g^{-1}}^{**} \circ R_{u^{-1}}^{**} \circ R_u^{**}\pi_g.$$

Since $R_{u^{-1}}^{**}$ and L_g^{**} commutes, the previous equality simplifies to give

$$\Pi_r(gu) = R_{g^{-1}}^{**} \circ L_g^{**}\Pi_r(u) + \Pi_r(g) = \text{Ad}(g)^{**}\Pi_r(u) + \Pi_r(g),$$

which is the cocycle condition (see Section 6.3.5). \square

6.6.2 Jacobi tensor and local sections

The following Lemma will be used in Section 6.6.3 and Section 7.2.3 in order to check the Jacobi identity for Poisson–Lie groups in the Banach setting.

Lemma 6.6.8. *Let G be a Banach Lie group with Lie algebra \mathfrak{g} , \mathbb{F} a subbundle of T^*G in duality with TG , invariant by left and right translations by elements in G , and π a smooth section of $\Lambda^2\mathbb{F}^*$. Then*

1. Any closed local section α of \mathbb{F} in a neighborhood \mathcal{V}_g of $g \in G$ is of the form $\alpha(u) = R_{u^{-1}}^*\alpha_0(u)$, where $\alpha_0 : \mathcal{V}_g \rightarrow \mathbb{F}_e \subset \mathfrak{g}^*$ satisfies:

$$\langle \alpha_0(g), [X_0, Y_0] \rangle = \langle T_g\alpha_0(R_g Y_0), X_0 \rangle - \langle T_g\alpha_0(R_g X_0), Y_0 \rangle, \quad (6.44)$$

with $T_g\alpha_0 : T_g G \rightarrow \mathfrak{g}^*$ the tangent map of α_0 at $g \in \mathcal{V}_g$, and X_0, Y_0 any elements in \mathfrak{g} .

2. Let $\Pi_r : G \rightarrow \Lambda^2\mathbb{F}_e^*$ be defined by $\Pi_r(g) := R_{g^{-1}}^{**}\pi(g)$. Then for any closed local sections α, β of \mathbb{F} around $g \in G$, the differential $d(\pi(\alpha, \beta))$ at g reads

$$d(\pi(\alpha, \beta))(X_g) = T_g\Pi_r(X_g)(\alpha_0(g), \beta_0(g)) + \Pi_r(g)(T_g\alpha_0(X_g), \beta_0(g)) + \Pi_r(g)(\alpha_0(g), T_g\beta_0(X_g)), \quad (6.45)$$

where $X_g \in T_g G$, $T_g\Pi_r : T_g G \rightarrow \Lambda^2\mathbb{F}_e^*$ is the tangent map of Π_r at g , $\alpha = R_{g^{-1}}^*\alpha_0$ and $\beta = R_{g^{-1}}^*\beta_0$.

3. Suppose that $i_{\alpha_0}\Pi_r(g) \in \mathfrak{g} \subset \mathbb{F}^*$ for any $\alpha = R_g^*\alpha_0 \in \mathbb{F}$. Then for any closed local sections α, β, γ of \mathbb{F} ,

$$\begin{aligned} & \pi(\alpha, d(\pi(\beta, \gamma))) + \pi(\beta, d(\pi(\gamma, \alpha))) + \pi(\gamma, d(\pi(\alpha, \beta))) = \\ & T_g\Pi_r(R_g i_{\alpha_0}\Pi_r(g))(\beta_0(g), \gamma_0(g)) + \langle \alpha_0(g), [i_{\gamma_0(g)}\Pi_r(g), i_{\beta_0(g)}\Pi_r(g)] \rangle \\ & + T_g\Pi_r(R_g i_{\beta_0}\Pi_r(g))(\gamma_0(g), \alpha_0(g)) + \langle \beta_0(g), [i_{\alpha_0(g)}\Pi_r(g), i_{\gamma_0(g)}\Pi_r(g)] \rangle \\ & + T_g\Pi_r(R_g i_{\gamma_0}\Pi_r(g))(\alpha_0(g), \beta_0(g)) + \langle \gamma_0(g), [i_{\beta_0(g)}\Pi_r(g), i_{\alpha_0(g)}\Pi_r(g)] \rangle \end{aligned} \quad (6.46)$$

where $\alpha = R_{g^{-1}}^*\alpha_0$, $\beta = R_{g^{-1}}^*\beta_0$, and $\gamma = R_{g^{-1}}^*\gamma_0$. In particular the left hand side of equation (6.46) defines a tensor.

Proof. 1. Since α is closed, one has:

$$d\alpha(X, Y) = \mathcal{L}_X\alpha(Y) - \mathcal{L}_Y\alpha(X) - \alpha([X, Y]) = 0$$

for any local vector fields X and Y around $g \in \mathcal{Y}_g$. But since $d\alpha$ is a tensor (see Proposition 3.2, Chapter V in [124]), the previous identity depends only on the values of X and Y at g . In other words, α is closed if and only if the previous identity is satisfied for any right invariant vector fields X and Y . Set $X_g = R_g X_0$ and $Y_g = R_g Y_0$ for $X_0, Y_0 \in \mathfrak{g}$. One has

$$\begin{aligned} d\alpha(X, Y) &= \mathcal{L}_X\alpha_0(g)(R_{g^{-1}}Y_g) - \mathcal{L}_Y\alpha_0(g)(R_{g^{-1}}X_g) - \alpha_0(g)(R_{g^{-1}}[X, Y]_g) \\ &= \mathcal{L}_X\alpha_0(g)(Y_0) - \mathcal{L}_Y\alpha_0(g)(X_0) + \alpha_0(g)([X_0, Y_0]_{\mathfrak{g}}) \end{aligned}$$

Denote by $f : \mathcal{Y}_g \rightarrow \mathbb{R}$ the function defined by $f(g) = \alpha_0(g)(Y_0) = \langle \alpha_0(g), Y_0 \rangle$, where the bracket denotes the natural pairing between \mathfrak{g}^* and \mathfrak{g} . Then

$$df_g(X_g) = \langle T_g\alpha_0(R_g X_0), Y_0 \rangle.$$

It follows that

$$d\alpha(X, Y) = \langle T_g\alpha_0(R_g X_0), Y_0 \rangle - \langle T_g\alpha_0(R_g Y_0), X_0 \rangle + \langle \alpha_0(g), [X_0, Y_0]_{\mathfrak{g}} \rangle.$$

Therefore $d\alpha(X, Y) = 0$ for any X and Y if and only if

$$\langle \alpha_0(g), [X_0, Y_0]_{\mathfrak{g}} \rangle = \langle T_g\alpha_0(R_g Y_0), X_0 \rangle - \langle T_g\alpha_0(R_g X_0), Y_0 \rangle,$$

for any X_0 and Y_0 in \mathfrak{g} .

2. This is a straightforward application of the chain rule.

3. In the case where $i_{\alpha_0}\Pi_r(g)$ belongs to \mathfrak{g} , one has the following expression of the differential of π :

$$d(\pi(\beta, \gamma))(X_g) = T_g\Pi_r(X_g)(\beta_0(g), \gamma_0(g)) - \langle T_g\beta_0(X_g), i_{\gamma_0(g)}\Pi_r(g) \rangle + \langle T_g\gamma_0(X_g), i_{\beta_0(g)}\Pi_r(g) \rangle,$$

where $\langle \cdot, \cdot \rangle$ denotes the duality pairing between \mathfrak{g}^* and \mathfrak{g} . Therefore

$$\begin{aligned} \pi(\alpha, d(\pi(\beta, \gamma))) &= \Pi_r(g)(\alpha_0(g), R_g^*d(\pi(\beta, \gamma))) = d(\pi(\beta, \gamma))(R_g i_{\alpha_0(g)}\Pi_r(g)) \\ &= T_g\Pi_r(R_g i_{\alpha_0(g)}\Pi_r(g))(\beta_0(g), \gamma_0(g)) \\ &\quad - \langle T_g\beta_0(R_g i_{\alpha_0(g)}\Pi_r(g)), i_{\gamma_0(g)}\Pi_r(g) \rangle \\ &\quad + \langle T_g\gamma_0(R_g i_{\alpha_0(g)}\Pi_r(g)), i_{\beta_0(g)}\Pi_r(g) \rangle. \end{aligned}$$

It follows that

$$\begin{aligned} & \pi(\alpha, d(\pi(\beta, \gamma))) + \pi(\beta, d(\pi(\gamma, \alpha))) + \pi(\gamma, d(\pi(\alpha, \beta))) \\ &= -\langle T_g\beta_0(R_g i_{\alpha_0(g)}\Pi_r(g)), i_{\gamma_0(g)}\Pi_r(g) \rangle + \langle T_g\gamma_0(R_g i_{\alpha_0(g)}\Pi_r(g)), i_{\beta_0(g)}\Pi_r(g) \rangle \\ &\quad - \langle T_g\gamma_0(R_g i_{\beta_0(g)}\Pi_r(g)), i_{\alpha_0(g)}\Pi_r(g) \rangle + \langle T_g\alpha_0(R_g i_{\beta_0(g)}\Pi_r(g)), i_{\gamma_0(g)}\Pi_r(g) \rangle \\ &\quad - \langle T_g\alpha_0(R_g i_{\gamma_0(g)}\Pi_r(g)), i_{\beta_0(g)}\Pi_r(g) \rangle + \langle T_g\beta_0(R_g i_{\gamma_0(g)}\Pi_r(g)), i_{\alpha_0(g)}\Pi_r(g) \rangle \\ &\quad + T_g\Pi_r(R_g i_{\alpha_0}\Pi_r(g))(\beta_0(g), \gamma_0(g)) + T_g\Pi_r(R_g i_{\beta_0}\Pi_r(g))(\gamma_0(g), \alpha_0(g)) \\ &\quad + T_g\Pi_r(R_g i_{\gamma_0}\Pi_r(g))(\alpha_0(g), \beta_0(g)) \end{aligned}$$

Using (6.44), the previous equation simplifies to (6.46). □

6.6.3 Example of Banach Poisson–Lie groups $U_p(\mathcal{H})$ and $B_p^\pm(\mathcal{H})$ for $1 < p \leq 2$

Let us give some examples of Banach Poisson–Lie groups. We will need to introduce classical Banach Lie groups of operators.

General linear group $GL(\mathcal{H})$.

The general linear group of \mathcal{H} , denoted by $GL(\mathcal{H})$ is the group consisting of bounded operators A on \mathcal{H} which admit a bounded inverse, i.e. for which there exists a bounded operator A^{-1} satisfying $AA^{-1} = A^{-1}A = \text{Id}$, where $\text{Id} : \mathcal{H} \rightarrow \mathcal{H}$ denotes the identity operator $x \mapsto x$.

General linear group $GL_p(\mathcal{H})$.

The Banach Lie algebra $L_p(\mathcal{H})$ is the Banach Lie algebra of the following Banach Lie group:

$$GL_p(\mathcal{H}) := GL(\mathcal{H}) \cap \{\text{Id} + A : A \in L_p(\mathcal{H})\}. \quad (6.47)$$

Unitary group $U(\mathcal{H})$.

The unitary group of \mathcal{H} is defined as the subgroup of $GL(\mathcal{H})$ consisting of operators A such that $A^{-1} = A^*$ and is denoted by $U(\mathcal{H})$.

Unitary groups $U_p(\mathcal{H})$.

The Banach Lie algebra $\mathfrak{u}_p(\mathcal{H})$ defined by (6.10) is the Banach Lie algebra of the following Banach Lie group

$$U_p(\mathcal{H}) := U(\mathcal{H}) \cap \{\text{Id} + A : A \in L_p(\mathcal{H})\}. \quad (6.48)$$

Triangular groups $B_p^\pm(\mathcal{H})$.

To the Banach Lie algebra $\mathfrak{b}_p^\pm(\mathcal{H})$ defined by (6.11) is associated the following Banach Lie group:

$$B_p^\pm(\mathcal{H}) := \{\alpha \in GL(\mathcal{H}) \cap (\text{Id} + \mathfrak{b}_p^\pm(\mathcal{H})) : \alpha^{-1} \in \text{Id} + \mathfrak{b}_p^\pm(\mathcal{H}) \text{ and } \langle n|\alpha|n \rangle \in \mathbb{R}^{+*}, \text{ for } n \in \mathbb{Z}\},$$

where \mathbb{R}^{+*} is the group of strictly positive real numbers.

Let us now give some examples of Banach Poisson–Lie groups. Similar results will be proved in the more involved restricted case in Section 7.2.3. Recall that the orthogonal projections $p_{\mathfrak{u}_p,+}$ and $p_{\mathfrak{u}_p,-}$ are defined by (6.14) and (6.15) respectively.

Proposition 6.6.9. *For $1 < p \leq 2$, consider the Banach Lie group $B_p^\pm(\mathcal{H})$ with Banach Lie algebra $\mathfrak{b}_p^\pm(\mathcal{H})$, and the duality pairing $\langle \cdot, \cdot \rangle_{\mathbb{R}} : \mathfrak{b}_p^\pm(\mathcal{H}) \times \mathfrak{u}_p(\mathcal{H}) \rightarrow \mathbb{R}$ given by the imaginary part of the trace (6.16). Consider*

$$1. \mathbb{B}_b := R_{b^{-1}}^* \mathfrak{u}_p(\mathcal{H}) \subset T_b^* B_p^\pm(\mathcal{H}), \quad b \in B_p^\pm(\mathcal{H}).$$

$$2. \Pi_r^{\mathfrak{B}_p^\pm} : B_p^\pm(\mathcal{H}) \rightarrow \Lambda^2 \mathfrak{u}_p(\mathcal{H})^* \text{ defined by}$$

$$\Pi_r^{\mathfrak{B}_p^\pm}(b)(x_1, x_2) := \Im \text{Tr } p_{\mathfrak{b}_p^\pm}(b^{-1}x_1b) [p_{\mathfrak{u}_p,\pm}(b^{-1}x_2b)], \quad (6.49)$$

where $b \in B_p^\pm(\mathcal{H})$ and $x_1, x_2 \in \mathfrak{u}_p(\mathcal{H})$.

$$3. \pi^{\mathfrak{B}_p^\pm} : B_p^\pm \rightarrow \Lambda^2 T B_p^\pm(\mathcal{H}) \text{ given by } \pi^{\mathfrak{B}_p^\pm}(b) := R_b^{**} \Pi_r^{\mathfrak{B}_p^\pm}(b).$$

Then $(B_p^\pm(\mathcal{H}), \mathbb{B}, \pi^{\mathfrak{B}_p^\pm})$ is a Banach Poisson–Lie group.

Proof. The expression of the Poisson tensor makes sense because $L_p(\mathcal{H}) \subset L_q(\mathcal{H})$ for $1 < p \leq 2$ with $\frac{1}{p} + \frac{1}{q} = 1$. The Jacobi identity is a consequence of equation (6.46). The compatibility of the Poisson tensor and the multiplication of the group can be checked using equation (6.43). \square

Similarly one has:

Proposition 6.6.10. For $1 < p \leq 2$, consider the Banach Lie group $U_p(\mathcal{H})$ with Banach Lie algebra $\mathfrak{u}_p(\mathcal{H})$ and the duality pairing $\langle \cdot, \cdot \rangle_{\mathbb{R}} : \mathfrak{b}_p^{\pm}(\mathcal{H}) \times \mathfrak{u}_p(\mathcal{H}) \rightarrow \mathbb{R}$ given by the imaginary part of the trace (6.16). Consider

1. $\mathbb{U}_u := R_{u^{-1}}^* \mathfrak{b}_p^{\pm}(\mathcal{H}) \subset T_u^* U_p(\mathcal{H})$, $u \in U_p(\mathcal{H})$,

2. $\Pi_r^{\mathbb{U}_p^{\pm}} : U_p(\mathcal{H}) \rightarrow \Lambda^2 \mathfrak{b}_p^{\pm}(\mathcal{H})^*$ defined by

$$\Pi_r^{\mathbb{U}_p^{\pm}}(u)(b_1, b_2) := \Im \text{Tr } p_{\mathfrak{u}_p, \pm}(u^{-1} b_1 u) \left[p_{\mathfrak{b}_p^{\pm}}(u^{-1} b_2 u) \right], \quad (6.50)$$

where $u \in U_p(\mathcal{H})$ and $b_1, b_2 \in \mathfrak{b}_p^{\pm}(\mathcal{H})$.

3. $\pi^{\mathbb{U}_p^{\pm}} : U_p(\mathcal{H}) \rightarrow \Lambda^2 T U_p(\mathcal{H})$ given by $\pi^{\mathbb{U}_p^{\pm}}(g) := R_g^{**} \Pi_r^{\mathbb{U}_p^{\pm}}(g)$.

Then $(U_p(\mathcal{H}), \mathbb{U}, \pi^{\mathbb{U}_p^{\pm}})$ is a Banach Poisson–Lie group.

6.6.4 The tangent Banach Lie bialgebra of a Banach Poisson–Lie group

In this section, we show that the Banach Lie algebra \mathfrak{g} of any Banach Poisson–Lie group (G, \mathbb{F}, π) carries an natural Banach Lie bialgebra structure with respect to \mathbb{F}_e (see Theorem 6.6.11 below). Moreover, when the Poisson tensor is a section of $\Lambda^2 TG \subset \Lambda^2 T^{**}G$, then \mathfrak{g} is a Banach Lie–Poisson space with respect to \mathbb{F}_e (see Theorem 6.6.13).

Theorem 6.6.11. Let (G_+, \mathbb{F}, π) be a Banach Poisson–Lie group. Then \mathfrak{g}_+ is a Banach Lie bialgebra with respect to \mathfrak{g}_- . The Lie bracket in \mathfrak{g}_- is given by

$$[\alpha_1, \beta_1]_{\mathfrak{g}_-} := T_e \Pi_r(\cdot)(\alpha_1, \beta_1) \in \mathfrak{g}_- \subset \mathfrak{g}_+^*, \quad \alpha_1, \beta_1 \in \mathfrak{g}_- \subset \mathfrak{g}_+^*, \quad (6.51)$$

where $\Pi_r := R_{g^{-1}}^{**} \pi : G_+ \rightarrow \Lambda^2 \mathfrak{g}_+^*$, and $T_e \Pi_r : \mathfrak{g}_+ \rightarrow \Lambda^2 \mathfrak{g}_+^*$ denotes the differential of Π_r at the unit element $e \in G_+$.

Proof. • Let us show that the dual map $T_e \Pi_r^* : (\Lambda^2 \mathfrak{g}_+^*)^* \rightarrow \mathfrak{g}_+^*$ defines a skew-symmetric bilinear map $[\cdot, \cdot]_{\mathfrak{g}_-}$ on \mathfrak{g}_- with values in $\mathfrak{g}_- \subset \mathfrak{g}_+^*$. Let α and β be any local sections of \mathbb{F} in a neighborhood \mathcal{V}_e of the unit element $e \in G_+$. Define $\alpha_0 : \mathcal{V}_e \rightarrow \mathfrak{g}_-$ and $\beta_0 : \mathcal{V}_e \rightarrow \mathfrak{g}_-$ by $\alpha_0(u) := R_u^* \alpha(u)$ and $\beta_0(u) := R_u^* \beta(u)$. It follows from equation (6.45), that for any $X \in \mathfrak{g}_+$,

$$d_e(\pi(\alpha, \beta))(X) = T_e \Pi_r(X)(\alpha_0(e), \beta_0(e)) + \Pi_r(e)(T_e \alpha_0(X), \beta_0(e)) + \Pi_r(e)(\alpha_0(e), T_e \beta_0(X)).$$

By Corollary 6.6.5, $\Pi_r(e) = 0$. Hence

$$d_e(\pi(\alpha, \beta))(X) = T_e \Pi_r(X)(\alpha_0(e), \beta_0(e)). \quad (6.52)$$

By the first condition in the definition of a Poisson tensor, $d(\pi(\alpha, \beta))$ is a local section of \mathbb{F} , therefore $d_e(\pi(\alpha, \beta))$ belongs to $\mathbb{F}_e = \mathfrak{g}_-$. It follows that the formula

$$[\alpha_1, \beta_1]_{\mathfrak{g}_-} := T_e \Pi_r(\cdot)(\alpha_1, \beta_1)$$

defines a bracket on \mathfrak{g}_- . The skew-symmetry of $[\cdot, \cdot]_{\mathfrak{g}_-}$ is clear.

- Let us show that $[\cdot, \cdot]_{\mathfrak{g}_-}$ satisfies the Jacobi identity, hence is a Lie algebra structure on \mathfrak{g}_- . Consider any closed local sections α, β, γ of \mathbb{F} defined in a neighborhood of $e \in G_+$. Since π is a Poisson tensor, one has

$$\pi(\alpha, d(\pi(\beta, \gamma))) + \pi(\beta, d(\pi(\gamma, \alpha))) + \pi(\gamma, d(\pi(\alpha, \beta))) = 0.$$

Differentiating the above identity at $e \in G_+$, one gets

$$d_e(\pi(\alpha, d\pi(\beta, \gamma))) + d_e(\pi(\beta, d\pi(\gamma, \alpha))) + d_e(\pi(\gamma, d\pi(\alpha, \beta))) = 0. \quad (6.53)$$

Define $\alpha_0(u) := R_u^* \alpha(u)$, and $\delta_0(u) := R_u^* d_u(\pi(\beta, \gamma))$. Note that $\alpha_0(e) = \alpha(e)$ and $\delta_0(e) = d_e(\pi(\beta, \gamma))$. Hence, by equation (6.52) and (6.51), for any $X \in \mathfrak{g}_+$,

$$\begin{aligned} d_e(\pi(\alpha, d\pi(\beta, \gamma)))(X) &= T_e \Pi_r(X)(\alpha_0(e), \delta_0(e)) = T_e \Pi_r(X)(\alpha(e), d_e(\pi(\beta, \gamma))) \\ &= T_e \Pi_r(X)(\alpha(e), T_e \Pi_r(\cdot)(\beta(e), \gamma(e))) \\ &= [\alpha(e), [\beta(e), \gamma(e)]_{\mathfrak{g}_-}]_{\mathfrak{g}_-}(X). \end{aligned}$$

It follows that equation (6.53) can be rewritten as

$$[\alpha(e), [\beta(e), \gamma(e)]_{\mathfrak{g}_-}]_{\mathfrak{g}_-} + [\beta(e), [\gamma(e), \alpha(e)]_{\mathfrak{g}_-}]_{\mathfrak{g}_-} + [\gamma(e), [\alpha(e), \beta(e)]_{\mathfrak{g}_-}]_{\mathfrak{g}_-} = 0.$$

To show that the bracket $[\cdot, \cdot]_{\mathfrak{g}_-}$ satisfies Jacobi identity, it remains to prove that any element $\alpha_1 \in \mathfrak{g}_-$ can be extended to a closed local section α of \mathbb{F} such that $\alpha(e) = \alpha_1$. For this, it suffices to find a scalar function f defined in a neighborhood \mathcal{V}_e of $e \in G_+$ such that $d_g f \in \mathbb{F}_g$ for any $g \in \mathcal{V}_e$ and $d_e f = \alpha_1$. This can be done using a chart around $e \in G_+$ and a local trivialisation of \mathbb{F} . Then $\alpha := df$ is a closed local section of \mathbb{F} such that $\alpha_1 = \alpha(e)$.

- Let us show that \mathfrak{g}_+ acts continuously on $\mathfrak{g}_- \subset \mathfrak{g}_+^*$ by coadjoint action. By Proposition 6.6.6, G_+ acts continuously on $\mathfrak{g}_- := \mathbb{F}_e$ by the coadjoint action. By differentiation, $\mathfrak{g}_- \subset \mathfrak{g}_+^*$ is stable by the coadjoint action of \mathfrak{g}_+ on \mathfrak{g}_+^* and this action is continuous.
- Let us show that the dual map of the bracket $[\cdot, \cdot]_{\mathfrak{g}_-}$ restricts to a 1-cocycle $\theta : \mathfrak{g}_+ \rightarrow \Lambda^2 \mathfrak{g}_-^*$ with respect to the adjoint action $\text{ad}^{(2,0)}$ of \mathfrak{g}_+ on $\Lambda^2 \mathfrak{g}_-^*$. By definition of the bracket (6.51), $\theta = T_e \Pi_r$. By Proposition 6.6.7, Π_r is a 1-cocycle on G_+ with respect to the coadjoint action Ad^{**} of G_+ on $\Lambda^2 \mathfrak{g}_-^*$. Hence $T_e \Pi_r$ is a 1-cocycle on \mathfrak{g}_+ with respect to the adjoint action $\text{ad}^{(2,0)}$ of \mathfrak{g}_+ on $\Lambda^2 \mathfrak{g}_-^*$ (see Section 6.3.5). □

Example 6.6.12. The tangent bialgebras of the Banach Poisson–Lie groups $B_p^\pm(\mathcal{H})$ and $U_p(\mathcal{H})$ defined in Proposition 6.6.9 and Proposition 6.6.10, are the Banach Lie bialgebra $\mathfrak{b}_p^\pm(\mathcal{H})$ and $\mathfrak{u}_p(\mathcal{H})$ in duality, which combine into the Manin triple $(L_p(\mathcal{H}), \mathfrak{u}_p(\mathcal{H}), \mathfrak{b}_p^\pm(\mathcal{H}))$ given in Proposition 6.2.16. Indeed, the derivative at the unit element e of $\Pi_r^{\text{U}^\pm} : U_p(\mathcal{H}) \rightarrow \Lambda^2 \mathfrak{b}_p^\pm(\mathcal{H})^*$ defined by equation (6.50) reads:

$$\begin{aligned} d_e \Pi_r^{\text{U}^\pm}(x)(b_1, b_2) &= \mathfrak{S}\text{Tr} \left(p_{\mathfrak{u}_p, \pm}([x, b_1]) p_{\mathfrak{b}_p^\pm}(b_2) \right) + \mathfrak{S}\text{Tr} \left(p_{\mathfrak{u}_p, \pm}(b_1) p_{\mathfrak{b}_p^\pm}([x, b_2]) \right), \\ &= \mathfrak{S}\text{Tr} \left(p_{\mathfrak{u}_p, \pm}([x, b_1]) b_2 \right) = \mathfrak{S}\text{Tr} [x, b_1] b_2 = \mathfrak{S}\text{Tr} x [b_1, b_2]_{\mathfrak{b}_p^\pm}, \end{aligned}$$

with $x \in \mathfrak{u}_p(\mathcal{H})$ and $b_1, b_2 \in \mathfrak{b}_p^\pm(\mathcal{H})$, where we have used that $\mathfrak{b}_p^\pm(\mathcal{H})$ is an isotropic subspace. It follows that $d_e \Pi_r^{\text{U}^\pm}(\cdot)(b_1, b_2) = [b_1, b_2]_{\mathfrak{b}_p^\pm} \in \mathfrak{b}_p^\pm(\mathcal{H}) \subset \mathfrak{u}_p(\mathcal{H})^*$. Similarly, the derivative of $\Pi_r^{\text{B}^\pm}$ defined by equation (6.49) is given by

$$d_e \Pi_r^{\text{B}^\pm}(b)(x_1, x_2) = \mathfrak{S}\text{Tr} b [x_1, x_2]_{\mathfrak{u}_p}, \quad b \in \mathfrak{b}_p^\pm(\mathcal{H}), x_1, x_2 \in \mathfrak{u}_p(\mathcal{H}),$$

and is the dual map of the bracket $[\cdot, \cdot]_{\mathfrak{u}_p}$.

Theorem 6.6.13. *Let (G_+, \mathbb{F}, π) be a Banach Poisson–Lie group. If the map $\pi^\sharp : \mathbb{F} \rightarrow \mathbb{F}^*$ defined by $\pi^\sharp(\alpha) := \pi(\alpha, \cdot)$ takes values in $TG_+ \subset \mathbb{F}^*$, then \mathfrak{g}_+ is a Banach Lie–Poisson space with respect to $\mathfrak{g}_- := \mathbb{F}_e$.*

Proof. Let $\alpha_1 \in \mathfrak{g}_-$ and define $\alpha(g) = R_{g^{-1}}^*(\alpha_1) \in \mathbb{F}_g$. Then $\pi(R_{g^{-1}}^* \alpha_1, \cdot) = \pi(\alpha, \cdot)$ takes values in $T_g G_+ \subset \mathbb{F}_g^*$, and $\Pi_r(g)(\alpha_1, \cdot) = \pi(R_{g^{-1}}^* \alpha_1, R_{g^{-1}}^* \cdot)$ takes values in $\mathfrak{g}_+ \subset \mathfrak{g}_-^*$. It follows that Π_r takes values in $\Lambda^2 \mathfrak{g}_+ \subset \Lambda^2 \mathfrak{g}_-^*$. By differentiation, it follows that $T_e \Pi_r$ takes also values in $\Lambda^2 \mathfrak{g}_+$. Using equation (6.51) for the bracket in \mathfrak{g}_- , one has

$$\langle \text{ad}_{\alpha_1}^* X, \beta_1 \rangle_{\mathfrak{g}_+, \mathfrak{g}_-} := \langle X, [\alpha_1, \beta_1]_{\mathfrak{g}_-} \rangle_{\mathfrak{g}_+, \mathfrak{g}_-} = T_e \Pi_r(X)(\alpha_1, \beta_1). \quad (6.54)$$

where $X \in \mathfrak{g}_+$ and $\alpha_1, \beta_1 \in \mathfrak{g}_-$. Hence $\text{ad}_{\alpha_1}^* X = T_e \Pi_r(X)(\alpha_1, \cdot)$, therefore $\text{ad}_{\alpha_1}^* X$ belongs to \mathfrak{g}_+ for any $\alpha_1 \in \mathfrak{g}_-$. Since $\mathfrak{g}_- = \mathbb{F}_e$ injects continuously in \mathfrak{g}_+^* (see definition 6.4.4) and since \mathfrak{g}_+ is Banach subspace of \mathfrak{g}_+^* , the map $\text{ad}^* : \mathfrak{g}_- \times \mathfrak{g}_+ \rightarrow \mathfrak{g}_+$ is continuous as composition of the continuous injection $\mathfrak{g}_- \subset \mathfrak{g}_+^*$ with the continuous map $\text{ad}^* : \mathfrak{g}_+^* \times \mathfrak{g}_+^* \rightarrow \mathfrak{g}_+^*$. Consequently \mathfrak{g}_+ is a Banach Lie–Poisson space with respect to \mathfrak{g}_- . □

Remark 6.6.14. In the finite-dimensional case, any Lie bialgebra can be integrated to a connected simply-connected Poisson–Lie group. The Banach situation is more complicated, since not every Banach Lie algebra can be integrated into a Banach Lie group (see [153] for a survey on the problem of integrability of Banach Lie algebras and on Lie theory in the more general framework of locally convex spaces). Even in the case when a Banach Lie bialgebra is a Lie algebra of a connected and simply-connect Banach Lie group, it is still an open problem to determine if the bialgebra structure can be integrated into a Poisson–Lie group structure on the group.

Chapter 7

Poisson–Lie groups and the restricted Grassmannian

In this chapter we use the notions introduced in chapter 6 in order to construct Banach Poisson–Lie group structures on the restricted unitary group $U_{\text{res}}(\mathcal{H})$ and on the triangular group $B_{\text{res}}^{\pm}(\mathcal{H})$, and a generalized Banach Poisson manifold structure on the restricted Grassmannian such that both actions of $U_{\text{res}}(\mathcal{H})$ and $B_{\text{res}}^{\pm}(\mathcal{H})$ on the restricted Grassmannian are Poisson.

In Section 7.1, we set the notation. In Section 7.2.1, we introduce weak duality pairings between the Banach Lie algebras $\mathfrak{u}_{\text{res}}(\mathcal{H})$ and $\mathfrak{b}_{1,2}^{\pm}(\mathcal{H})$, and between $\mathfrak{b}_{\text{res}}^{\pm}(\mathcal{H})$ and $\mathfrak{u}_{1,2}(\mathcal{H})$. In Section 7.2.2 we use the unboundedness of the triangular truncation on the space of trace class operators to show that $\mathfrak{b}_{1,2}^{\pm}(\mathcal{H})$ is not a Banach Lie–Poisson space with respect to $\mathfrak{u}_{\text{res}}(\mathcal{H})$. Similarly $\mathfrak{u}_{1,2}(\mathcal{H})$ is not a Banach Lie–Poisson space with respect to $\mathfrak{b}_{\text{res}}^{\pm}(\mathcal{H})$. This implies in particular that there is no Banach Poisson–Lie group structure on $B_{\text{res}}^{\pm}(\mathcal{H})$ defined on the translation invariant subbundle whose fiber at the unit element is $\mathfrak{u}_{1,2}(\mathcal{H}) \subset \mathfrak{b}_{\text{res}}^{\pm}(\mathcal{H})^*$ (otherwise, by Proposition 6.6.6, the coadjoint action of $\mathfrak{b}_{\text{res}}^{\pm}(\mathcal{H})$ on $\mathfrak{u}_{1,2}(\mathcal{H})$ would be continuous). In Section 7.2.3 we overcome this difficulty by replacing $\mathfrak{u}_{1,2}(\mathcal{H})$ by the quotient Banach space $L_{1,2}(\mathcal{H})/\mathfrak{b}_{1,2}^{\pm}(\mathcal{H})$, and construct a Banach Poisson–Lie group structure on $B_{\text{res}}^{\pm}(\mathcal{H})$. The Banach Poisson–Lie group structure of $U_{\text{res}}(\mathcal{H})$ can be constructed in a similar way. In Section 7.4, we show that the restricted Grassmannian is a quotient Poisson homogeneous space of $U_{\text{res}}(\mathcal{H})$, the stabilizer H of a point being a Banach Poisson–Lie subgroup of $U_{\text{res}}(\mathcal{H})$. In Section 7.4.1, we show that the action of $B_{\text{res}}^{\pm}(\mathcal{H})$ on the restricted Grassmannian is Poisson. In Section 7.4.2, we show that the symplectic leaves of the Poisson structure of the restricted Grassmannian are the orbits of $B_{\text{res}}^{\pm}(\mathcal{H})$ and coincides with Schubert cells. At last, we mention that the action of the subgroup Γ^+ of $B_{\text{res}}^{\pm}(\mathcal{H})$ generated by the shift gives rise to the KdV hierarchy.

7.1 Preliminaries

Let us introduce some notation. If not stated otherwise, the Banach Lie algebras and related notions are over the field of real numbers. Endow the infinite-dimensional separable complex Hilbert space \mathcal{H} with orthonormal basis $\{|n\rangle, n \in \mathbb{Z}\}$ ordered with respect to decreasing values of n , and consider the decomposition $\mathcal{H} = \mathcal{H}_+ \oplus \mathcal{H}_-$, where $\mathcal{H}_+ := \text{span}\{|n\rangle : n \geq 0\}$ and $\mathcal{H}_- := \text{span}\{|n\rangle : n < 0\}$. Denote by p_+ (resp. p_-) the orthogonal projection onto \mathcal{H}_+ (resp. \mathcal{H}_-), and set $d = i(p_+ - p_-) \in L_{\infty}(\mathcal{H})$.

7.1.1 Restricted Banach Lie algebra $L_{\text{res}}(\mathcal{H})$ and its predual $L_{1,2}(\mathcal{H})$

The restricted Banach Lie algebra is the Banach Lie algebra

$$L_{\text{res}}(\mathcal{H}) = \{A \in L_{\infty}(\mathcal{H}) : [d, A] \in L_2(\mathcal{H})\} \quad (7.1)$$

for the norm $\|A\|_{\text{res}} = \|A\|_{\infty} + \|[d, A]\|_2$ and the bracket given by the commutator of operators. A predual of L_{res} is

$$L_{1,2}(\mathcal{H}) := \{A \in L_{\infty}(\mathcal{H}) : [d, A] \in L_2(\mathcal{H}), p_{\pm}A|_{\mathcal{H}_{\pm}} \in L_1(\mathcal{H}_{\pm})\}. \quad (7.2)$$

It is a Banach Lie algebra for the norm given by

$$\|A\|_{1,2} = \|p_+A|_{\mathcal{H}_+}\|_1 + \|p_-A|_{\mathcal{H}_-}\|_1 + \|[d, A]\|_2.$$

The duality pairing between $L_{1,2}(\mathcal{H})$ and $L_{\text{res}}(\mathcal{H})$ is given by

$$\begin{aligned} \langle \cdot, \cdot \rangle_{L_{\text{res}}, L_{1,2}} : L_{\text{res}}(\mathcal{H}) \times L_{1,2}(\mathcal{H}) &\rightarrow \mathbb{C} \\ (A, B) &\mapsto \text{Tr}_{\text{res}}(AB), \end{aligned}$$

where the restricted trace Tr_{res} (see [85]) is defined on $L_{1,2}(\mathcal{H})$ by

$$\text{Tr}_{\text{res}}A = \text{Tr } p_+A|_{\mathcal{H}_+} + \text{Tr } p_-A|_{\mathcal{H}_-}. \quad (7.3)$$

According to Proposition 2.1 in [85], one has $\text{Tr}_{\text{res}}AB = \text{Tr}_{\text{res}}BA$ for any $A \in L_{1,2}(\mathcal{H})$ and any $B \in L_{\text{res}}(\mathcal{H})$.

7.1.2 Restricted general linear group $\text{GL}_{\text{res}}(\mathcal{H})$ and its “predual” $\text{GL}_{1,2}(\mathcal{H})$

The restricted general linear group, denoted by $\text{GL}_{\text{res}}(\mathcal{H})$ is defined as

$$\text{GL}_{\text{res}}(\mathcal{H}) := \text{GL}(\mathcal{H}) \cap L_{\text{res}}(\mathcal{H}). \quad (7.4)$$

It is an open subset of $L_{\text{res}}(\mathcal{H})$ hence carries a natural Banach Lie group structure with Banach Lie algebra $L_{\text{res}}(\mathcal{H})$. It is not difficult to show that $\text{GL}_{\text{res}}(\mathcal{H})$ is closed under the operation that takes an operator $A \in \text{GL}_{\text{res}}(\mathcal{H})$ to its inverse $A^{-1} \in \text{GL}(\mathcal{H})$. It follows that $\text{GL}_{\text{res}}(\mathcal{H})$ is a Banach Lie group.

The Banach Lie algebra $L_{1,2}(\mathcal{H})$, predual to $L_{\text{res}}(\mathcal{H})$, is the Banach Lie algebra of the following Banach Lie group

$$\text{GL}_{1,2}(\mathcal{H}) := \text{GL}(\mathcal{H}) \cap \{\text{Id} + A : A \in L_{1,2}(\mathcal{H})\}. \quad (7.5)$$

7.1.3 Unitary Banach Lie algebras $\mathfrak{u}(\mathcal{H})$, $\mathfrak{u}_{\text{res}}(\mathcal{H})$, $\mathfrak{u}_{1,2}(\mathcal{H})$

The subspace

$$\mathfrak{u}(\mathcal{H}) := \{A \in L_{\infty}(\mathcal{H}) : A^* = -A\} \quad (7.6)$$

of skew-Hermitian bounded operators is a real Banach Lie subalgebra of $L_{\infty}(\mathcal{H})$ considered as a real Banach space. The unitary restricted algebra $\mathfrak{u}_{\text{res}}(\mathcal{H})$ is the real Banach Lie subalgebra of $L_{\text{res}}(\mathcal{H})$ consisting of skew-Hermitian operators:

$$\mathfrak{u}_{\text{res}}(\mathcal{H}) := \{A \in \mathfrak{u}(\mathcal{H}) : [d, A] \in L_2(\mathcal{H})\} = L_{\text{res}}(\mathcal{H}) \cap \mathfrak{u}(\mathcal{H}). \quad (7.7)$$

By Proposition 2.1 in [27], a predual of the unitary restricted algebra $\mathfrak{u}_{\text{res}}(\mathcal{H})$ is the subalgebra $\mathfrak{u}_{1,2}(\mathcal{H})$ of $L_{\text{res}}(\mathcal{H})$ consisting of skew-Hermitian operators (see also Remark 7.2.2 below):

$$\mathfrak{u}_{1,2}(\mathcal{H}) := \{A \in L_{1,2}(\mathcal{H}) : A^* = -A\}. \quad (7.8)$$

Remark 7.1.1. It follows from Proposition 2.5 in [27] with $\gamma = 0$ that $\mathfrak{u}_{1,2}(\mathcal{H})$ is a Banach Lie–Poisson space with respect to $\mathfrak{u}_{\text{res}}(\mathcal{H})$. A direct computation shows that $\mathfrak{u}_{1,2}(\mathcal{H})$ is not a Banach Lie bialgebra with respect to $\mathfrak{u}_{\text{res}}(\mathcal{H})$.

7.1.4 Restricted unitary group $U_{\text{res}}(\mathcal{H})$ and its “predual” $U_{1,2}(\mathcal{H})$

The restricted unitary group is defined as

$$U_{\text{res}}(\mathcal{H}) := \text{GL}_{\text{res}}(\mathcal{H}) \cap U(\mathcal{H}). \quad (7.9)$$

It has a natural structure of Banach Lie group with Banach Lie algebra $\mathfrak{u}_{\text{res}}(\mathcal{H})$. The Banach Lie algebra $\mathfrak{u}_{1,2}(\mathcal{H})$, predual to $\mathfrak{u}_{\text{res}}(\mathcal{H})$, is the Banach Lie algebra of the following Banach Lie group

$$U_{1,2}(\mathcal{H}) := U(\mathcal{H}) \cap \{\text{Id} + A : A \in L_{1,2}(\mathcal{H})\}. \quad (7.10)$$

7.1.5 The restricted Grassmannian $\text{Gr}_{\text{res}}(\mathcal{H})$

In the present chapter, the restricted Grassmannian $\text{Gr}_{\text{res}}(\mathcal{H})$ denotes the set of all closed subspaces W of \mathcal{H} such that the orthogonal projection $p_- : W \rightarrow \mathcal{H}_-$ is a Hilbert-Schmidt operator. The restricted Grassmannian is a homogeneous space under the restricted unitary group (see [172]),

$$\text{Gr}_{\text{res}}(\mathcal{H}) = \text{U}_{\text{res}}(\mathcal{H}) / (\text{U}(\mathcal{H}_+) \times \text{U}(\mathcal{H}_-)),$$

and under the restricted general linear group $\text{GL}_{\text{res}}(\mathcal{H})$,

$$\text{Gr}_{\text{res}}(\mathcal{H}) = \text{GL}_{\text{res}}(\mathcal{H}) / \text{P}_{\text{res}}(\mathcal{H}),$$

where

$$\text{P}_{\text{res}}(\mathcal{H}) = \{A \in \text{GL}_{\text{res}}(\mathcal{H}) : p_- A|_{\mathcal{H}_+} = 0\}. \quad (7.11)$$

It follows that $\text{Gr}_{\text{res}}(\mathcal{H})$ is a homogeneous Kähler manifold (see [233], [27], [210], [211] for more informations on the geometry of the restricted Grassmannian).

7.1.6 Triangular Banach Lie subalgebras $\mathfrak{b}_{1,2}^{\pm}(\mathcal{H})$ and $\mathfrak{b}_{\text{res}}^{\pm}(\mathcal{H})$

Let us define the following triangular subalgebras of $\text{L}_{1,2}(\mathcal{H})$ and $\text{L}_{\text{res}}(\mathcal{H})$:

$$\mathfrak{b}_{1,2}^+(\mathcal{H}) := \{\alpha \in \text{L}_{1,2}(\mathcal{H}) : \alpha(|n\rangle) \in \text{span}\{|m\rangle, m \geq n\} \text{ and } \langle n|\alpha|n\rangle \in \mathbb{R}, \text{ for } n \in \mathbb{Z}\}.$$

$$\mathfrak{b}_{1,2}^-(\mathcal{H}) := \{\alpha \in \text{L}_{1,2}(\mathcal{H}) : \alpha(|n\rangle) \in \text{span}\{|m\rangle, m \leq n\} \text{ and } \langle n|\alpha|n\rangle \in \mathbb{R}, \text{ for } n \in \mathbb{Z}\},$$

$$\mathfrak{b}_{\text{res}}^+(\mathcal{H}) := \{\alpha \in \text{L}_{\text{res}}(\mathcal{H}) : \alpha(|n\rangle) \in \text{span}\{|m\rangle, m \geq n\} \text{ and } \langle n|\alpha|n\rangle \in \mathbb{R}, \text{ for } n \in \mathbb{Z}\}.$$

$$\mathfrak{b}_{\text{res}}^-(\mathcal{H}) := \{\alpha \in \text{L}_{\text{res}}(\mathcal{H}) : \alpha(|n\rangle) \in \text{span}\{|m\rangle, m \leq n\} \text{ and } \langle n|\alpha|n\rangle \in \mathbb{R}, \text{ for } n \in \mathbb{Z}\}.$$

7.1.7 Triangular Banach Lie groups $\text{B}_{1,2}^{\pm}(\mathcal{H})$, and $\text{B}_{\text{res}}^{\pm}(\mathcal{H})$

Consider

$$\text{B}_{1,2}^{\pm}(\mathcal{H}) := \{\alpha \in \text{GL}(\mathcal{H}) \cap (\text{Id} + \mathfrak{b}_{1,2}^{\pm}(\mathcal{H})) : \alpha^{-1} \in \text{Id} + \mathfrak{b}_{1,2}^{\pm}(\mathcal{H}), \forall n \in \mathbb{Z}, \langle n|\alpha|n\rangle \in \mathbb{R}^{+*}\}.$$

For any $A \in \mathfrak{b}_{1,2}^{\pm}(\mathcal{H})$ with $\|A\|_{1,2} < 1$, and any $\alpha \in \text{B}_{1,2}^{\pm}(\mathcal{H})$, the operator $\alpha - \alpha A$ belongs to $\text{B}_{1,2}^{\pm}(\mathcal{H})$, since

$$(\alpha - \alpha A)^{-1} = (\text{Id} - A)^{-1} \alpha^{-1},$$

and $(\text{Id} - A)^{-1} = \sum_{n=0}^{\infty} A^n$ is a convergent series in $(\text{Id} + \mathfrak{b}_{1,2}^{\pm}(\mathcal{H}))$, whose limit admits strictly positive diagonal coefficients. Hence $\text{B}_{1,2}^{\pm}(\mathcal{H})$ is an open subset of $(\text{Id} + \mathfrak{b}_{1,2}^{\pm}(\mathcal{H}))$, stable under group multiplication and inversion. It follows that $\text{B}_{1,2}^{\pm}(\mathcal{H})$ is a Banach Lie group with Banach Lie algebra $\mathfrak{b}_{1,2}^{\pm}(\mathcal{H})$.

Similarly define the following Banach Lie groups of triangular operators:

$$\text{B}_{\text{res}}^{\pm}(\mathcal{H}) := \{\alpha \in \text{GL}_{\text{res}}(\mathcal{H}) \cap \mathfrak{b}_{\text{res}}^{\pm}(\mathcal{H}) : \alpha^{-1} \in \text{GL}_{\text{res}}(\mathcal{H}) \cap \mathfrak{b}_{\text{res}}^{\pm}(\mathcal{H}) \text{ and } \forall n \in \mathbb{Z}, \langle n|\alpha|n\rangle \in \mathbb{R}^{+*}\}.$$

Remark 7.1.2. Remark that $\text{B}_{\text{res}}^+(\mathcal{H})$ does not contain the shift operator $S : \mathcal{H} \rightarrow \mathcal{H}$, $|n\rangle \mapsto |n+1\rangle$ since the diagonal coefficients of any element in $\text{B}_{\text{res}}^+(\mathcal{H})$ are non-zero. However S belongs to the Lie algebra $\mathfrak{b}_{\text{res}}^+(\mathcal{H})$, whereas S^{-1} belongs to $\mathfrak{b}_{\text{res}}^-(\mathcal{H})$.

7.2 Example of Banach Lie bialgebras and Banach Poisson–Lie groups related to the restricted Grassmannian

7.2.1 Iwasawa Banach Lie bialgebras

Recall that $\langle \cdot, \cdot \rangle_{\text{L}_{\text{res}}, \text{L}_{1,2}}$ denote the continuous bilinear map given by the imaginary part of the restricted trace (see equation (7.3)):

$$\begin{aligned} \langle \cdot, \cdot \rangle_{\text{L}_{\text{res}}, \text{L}_{1,2}} : \text{L}_{\text{res}}(\mathcal{H}) \times \text{L}_{1,2}(\mathcal{H}) &\longrightarrow \mathbb{R} \\ (x, y) &\longmapsto \Im \text{Tr}_{\text{res}}(xy). \end{aligned}$$

Proposition 7.2.1. *The continuous bilinear map $\langle \cdot, \cdot \rangle_{L_{\text{res}}, L_{1,2}}$ restricts to a weak duality pairing between $\mathfrak{u}_{\text{res}}(\mathcal{H})$ and $\mathfrak{b}_{1,2}^{\pm}(\mathcal{H})$ denoted by*

$$\begin{aligned} \langle \cdot, \cdot \rangle_{\mathfrak{u}_{\text{res}}, \mathfrak{b}_{1,2}^{\pm}} : \mathfrak{u}_{\text{res}}(\mathcal{H}) \times \mathfrak{b}_{1,2}^{\pm}(\mathcal{H}) &\longrightarrow \mathbb{R} \\ (x, y) &\longmapsto \Im \text{Tr}_{\text{res}}(xy). \end{aligned}$$

Similarly the continuous bilinear map $\langle \cdot, \cdot \rangle_{L_{\text{res}}, L_{1,2}}$ restricts to a weak duality pairing between $\mathfrak{b}_{\text{res}}^{\pm}(\mathcal{H})$ and $\mathfrak{u}_{1,2}(\mathcal{H})$ denoted by

$$\begin{aligned} \langle \cdot, \cdot \rangle_{\mathfrak{b}_{\text{res}}^{\pm}, \mathfrak{u}_{1,2}} : \mathfrak{b}_{\text{res}}^{\pm}(\mathcal{H}) \times \mathfrak{u}_{1,2}(\mathcal{H}) &\longrightarrow \mathbb{R} \\ (x, y) &\longmapsto \Im \text{Tr}_{\text{res}}(xy). \end{aligned}$$

Proof. Let us show that the map $(a, b) \mapsto \Im \text{Tr}_{\text{res}} ab$ is non-degenerate for $a \in \mathfrak{u}_{\text{res}}(\mathcal{H})$ and $b \in \mathfrak{b}_{1,2}^+(\mathcal{H})$.

Suppose that $a \in \mathfrak{u}_{\text{res}}(\mathcal{H})$ is such that $\Im \text{Tr}_{\text{res}} ab = 0$ for any $b \in \mathfrak{b}_{1,2}^+(\mathcal{H})$ and let us show that a necessarily vanishes. Since $\{|n\rangle\}_{n \in \mathbb{Z}}$ is an orthonormal basis of \mathcal{H} and a is bounded, it is sufficient to show that for any $n, m \in \mathbb{Z}$, $\langle m|an\rangle = 0$. In fact, since a is skew-symmetric, it is enough to show that $\langle m|an\rangle = 0$ for $m \leq n$. For $n \geq m$, the operator $E_{nm} = |n\rangle\langle m|$ of rank one given by $x \mapsto \langle m, x\rangle|n\rangle$ belongs to $\mathfrak{b}_{1,2}^+(\mathcal{H})$. Hence for $n \geq m$, one has

$$\Im \text{Tr}_{\text{res}} a E_{nm} = \Im \left(\sum_{j \in \mathbb{Z}} \langle j|m\rangle \langle j|an\rangle \right) = \Im \langle m|an\rangle = 0.$$

In particular, for $m = n$, since $\langle n|an\rangle$ is purely imaginary, one has $\langle n|an\rangle = 0$, $\forall n \in \mathbb{Z}$. For $n > m$, the operator iE_{nm} belongs also to $\mathfrak{b}_{1,2}^+(\mathcal{H})$ and

$$\Im \text{Tr}_{\text{res}} a i E_{nm} = \Im \left(\sum_{j \in \mathbb{Z}} i \langle j|m\rangle \langle j|an\rangle \right) = \Re \langle m|an\rangle = 0.$$

This allows to conclude that $\langle m|an\rangle = 0$ for any $n, m \in \mathbb{Z}$, hence $a = 0 \in \mathfrak{u}_{\text{res}}(\mathcal{H})$.

On the other hand, consider an element $b \in \mathfrak{b}_{1,2}^+(\mathcal{H})$ such that $\Im \text{Tr}_{\text{res}} ab = 0$ for any $a \in \mathfrak{u}_{\text{res}}(\mathcal{H})$. We will show that $\langle n|bm\rangle = 0$ for any $n, m \in \mathbb{Z}$ such that $n \geq m$. For $n > m$, the operator $E_{mn} - E_{nm}$ belongs to $\mathfrak{u}_{\text{res}}(\mathcal{H})$, and for $n \geq m$, $iE_{mn} + iE_{nm} \in \mathfrak{u}_{\text{res}}(\mathcal{H})$. Therefore for $n > m$, one has

$$\Im \text{Tr}_{\text{res}} (E_{mn} - E_{nm}) b = \Im (\langle n|bm\rangle - \langle m|bn\rangle) = \Im \langle n|bm\rangle = 0,$$

and for $n \geq m$, one has

$$\Im \text{Tr}_{\text{res}} (iE_{mn} + iE_{nm}) b = \Im (i \langle n|bm\rangle + i \langle m|bn\rangle) = \Re \langle n|bm\rangle = 0.$$

It follows that $\langle n|bm\rangle = 0$ for all $n, m \in \mathbb{Z}$ such that $n > m$. Moreover, since $\langle n|bn\rangle \in \mathbb{R}$ for any $n \in \mathbb{Z}$, one also has $\langle n|bn\rangle = 0$, $\forall n \in \mathbb{Z}$. Consequently $b = 0$.

It follows that $\langle \cdot, \cdot \rangle_{\mathfrak{u}_{\text{res}}, \mathfrak{b}_{1,2}^{\pm}} : \mathfrak{u}_{\text{res}}(\mathcal{H}) \times \mathfrak{b}_{1,2}^{\pm}(\mathcal{H}) \rightarrow \mathbb{R}$, $(x, y) \mapsto \Im \text{Tr}_{\text{res}} xy$, is non-degenerate and defines a duality pairing between $\mathfrak{u}_{\text{res}}(\mathcal{H})$ and $\mathfrak{b}_{1,2}^+(\mathcal{H})$. One shows in a similar way that $\langle \cdot, \cdot \rangle_{L_{\text{res}}, L_{1,2}}$ induces a duality pairing between $\mathfrak{u}_{\text{res}}(\mathcal{H})$ and $\mathfrak{b}_{1,2}^-(\mathcal{H})$, between $\mathfrak{u}_{1,2}(\mathcal{H})$ and $\mathfrak{b}_{\text{res}}^+(\mathcal{H})$, and between $\mathfrak{u}_{1,2}(\mathcal{H})$ and $\mathfrak{b}_{\text{res}}^-(\mathcal{H})$. \square

Remark 7.2.2. Recall that by Proposition 2.1 in [27], the dual space $\mathfrak{u}_{1,2}(\mathcal{H})^*$ can be identified with $\mathfrak{u}_{\text{res}}(\mathcal{H})$, the duality pairing being given by $(a, b) \mapsto \text{Tr}_{\text{res}}(ab)$. By previous Proposition, one has a continuous injection from $\mathfrak{b}_{\text{res}}^+(\mathcal{H})$ into $\mathfrak{u}_{1,2}(\mathcal{H})^*$ by $a \mapsto (b \mapsto \Im \text{Tr}_{\text{res}}(ab))$. The corresponding injection from $\mathfrak{b}_{\text{res}}^+(\mathcal{H})$ into $\mathfrak{u}_{\text{res}}(\mathcal{H}) \simeq \mathfrak{u}_{1,2}(\mathcal{H})^*$ reads:

$$\begin{aligned} \iota : \mathfrak{b}_{\text{res}}^+(\mathcal{H}) &\hookrightarrow \mathfrak{u}_{\text{res}}(\mathcal{H}) \\ b &\longmapsto -\frac{i}{2}(b + b^*). \end{aligned}$$

The range of ι is the subspace of $\mathfrak{u}_{\text{res}}(\mathcal{H})$ consisting of those $x \in \mathfrak{u}_{\text{res}}(\mathcal{H})$ such that the triangular truncation $T_-(x)$ is bounded. Recall that T_- is unbounded on $L_{\infty}(\mathcal{H})$, as well as on $L_1(\mathcal{H})$ (see [138], [121], [84]), and that there exists skew-symmetric bounded operators whose triangular truncation is not bounded (see [57]). Therefore ι is not surjective.

Theorem 7.2.3. *The Banach Lie algebra $\mathfrak{b}_{1,2}^\pm(\mathcal{H})$ is a Banach Lie bialgebra with respect to $\mathfrak{u}_{\text{res}}(\mathcal{H})$. Similarly the Banach Lie algebra $\mathfrak{u}_{1,2}(\mathcal{H})$ is a Banach Lie bialgebra with respect to $\mathfrak{b}_{\text{res}}^\pm(\mathcal{H})$.*

Proof. Let us show that the Lie algebra structure $[\cdot, \cdot]_{\mathfrak{u}_{\text{res}}}$ on $\mathfrak{u}_{\text{res}}(\mathcal{H})$ is such that

1. $\mathfrak{b}_{1,2}^\pm(\mathcal{H})$ acts continuously by coadjoint action on $\mathfrak{u}_{\text{res}}(\mathcal{H})$;
 2. the dual map $[\cdot, \cdot]_{\mathfrak{u}_{\text{res}}}^* : \mathfrak{u}_{\text{res}}^*(\mathcal{H}) \rightarrow \Lambda^2 \mathfrak{u}_{\text{res}}^*(\mathcal{H})$ to the Lie bracket $[\cdot, \cdot]_{\mathfrak{u}_{\text{res}}} : \mathfrak{u}_{\text{res}}(\mathcal{H}) \times \mathfrak{u}_{\text{res}}(\mathcal{H}) \rightarrow \mathfrak{u}_{\text{res}}(\mathcal{H})$ restricts to a 1-cocycle $\theta : \mathfrak{b}_{1,2}^\pm(\mathcal{H}) \rightarrow \Lambda^2 \mathfrak{u}_{\text{res}}^*(\mathcal{H})$ with respect to the adjoint action $\text{ad}^{(2,0)}$ of $\mathfrak{b}_{1,2}^\pm(\mathcal{H})$ on $\Lambda^2 \mathfrak{u}_{\text{res}}^*(\mathcal{H})$.
- Let us first prove (1). Since by Proposition 7.2.1, $\langle \cdot, \cdot \rangle_{\mathfrak{b}_{1,2}^\pm, \mathfrak{u}_{\text{res}}}$ is a duality pairing between $\mathfrak{u}_{\text{res}}(\mathcal{H})$ and $\mathfrak{b}_{1,2}^\pm(\mathcal{H})$, the Banach space $\mathfrak{u}_{\text{res}}(\mathcal{H})$ is a subspace of the continuous dual of $\mathfrak{b}_{1,2}^\pm(\mathcal{H})$. Recall that the coadjoint action of $\mathfrak{b}_{1,2}^\pm(\mathcal{H})$ on its dual reads

$$\begin{aligned} -\text{ad}^* : \mathfrak{b}_{1,2}^\pm(\mathcal{H}) \times \mathfrak{b}_{1,2}^\pm(\mathcal{H})^* &\longrightarrow \mathfrak{b}_{1,2}^\pm(\mathcal{H})^* \\ (x, \alpha) &\longmapsto -\text{ad}_x^* \alpha := -\alpha \circ \text{ad}_x. \end{aligned}$$

Let us show that $\mathfrak{u}_{\text{res}}(\mathcal{H})$ is invariant under coadjoint action. This means that when α is given by $\alpha(y) = \Im \text{Tr}_{\text{res}} ay$ for some $a \in \mathfrak{u}_{\text{res}}(\mathcal{H})$, then, for any $x \in \mathfrak{b}_{1,2}^\pm(\mathcal{H})$, the one form $\beta = -\text{ad}_x^* \alpha$ reads $\beta(y) = \Im \text{Tr}_{\text{res}} \tilde{a}y$ for some $\tilde{a} \in \mathfrak{u}_{\text{res}}(\mathcal{H})$. One has

$$\begin{aligned} \beta(y) &= -\text{ad}_x^* \alpha(y) = -\alpha(\text{ad}_x y) = -\alpha([x, y]) \\ &= -\Im \text{Tr}_{\text{res}} a[x, y] = -\Im \text{Tr}_{\text{res}} (axy - ayx), \end{aligned}$$

where $a \in \mathfrak{u}_{\text{res}}(\mathcal{H})$, $x, y \in \mathfrak{b}_{1,2}^\pm(\mathcal{H})$. Since ay and x belong to $L_2(\mathcal{H})$, axy and xay belong to $L_1(\mathcal{H})$ and $\text{Tr}_{\text{res}}(axy) = \text{Tr}(axy) = \text{Tr}(xay)$. Since axy belongs also to $L_1(\mathcal{H})$, one has

$$\beta(y) = -\Im \text{Tr}(axy) + \Im \text{Tr}(ayx) = -\Im \text{Tr}(axy) + \Im \text{Tr}(xay) = -\Im \text{Tr}([a, x]y).$$

Note that $[a, x]$ belongs to $L_2(\mathcal{H})$. Recall that by Proposition 6.2.16, the triples of Hilbert Lie algebras $(L_2(\mathcal{H}), \mathfrak{u}_2(\mathcal{H}), \mathfrak{b}_2^+(\mathcal{H}))$ and $(L_2(\mathcal{H}), \mathfrak{u}_2(\mathcal{H}), \mathfrak{b}_2^-(\mathcal{H}))$ are real Hilbert Manin triples with respect to the pairing $\langle \cdot, \cdot \rangle_{\mathbb{R}}$ given by the imaginary part of the trace. Using the decomposition $L_2(\mathcal{H}) = \mathfrak{u}_2(\mathcal{H}) \oplus \mathfrak{b}_2^\pm(\mathcal{H})$, and the continuous projection $p_{\mathfrak{u}_2^\pm} : L_2(\mathcal{H}) \rightarrow \mathfrak{u}_2(\mathcal{H})$ with kernel $\mathfrak{b}_2^\pm(\mathcal{H})$, one therefore has

$$\beta(y) = -\Im \text{Tr} p_{\mathfrak{u}_2^\pm}([a, x])y,$$

since $y \in \mathfrak{b}_{1,2}^\pm(\mathcal{H}) \subset \mathfrak{b}_2^\pm(\mathcal{H})$ and $\mathfrak{b}_2^\pm(\mathcal{H})$ is isotropic. It follows that $\beta(y) = \Im \text{Tr} \tilde{a}y$ with

$$\tilde{a} = -p_{\mathfrak{u}_2^\pm}([a, x]) \in \mathfrak{u}_2(\mathcal{H}) \subset \mathfrak{u}_{\text{res}}(\mathcal{H}).$$

In other words, the coadjoint action of $x \in \mathfrak{b}_{1,2}^\pm(\mathcal{H})$ maps $a \in \mathfrak{u}_{\text{res}}(\mathcal{H})$ to $-\text{ad}_x^* a = -p_{\mathfrak{u}_2^\pm}([a, x]) \in \mathfrak{u}_{\text{res}}(\mathcal{H})$. The continuity of the map

$$\begin{aligned} -\text{ad}^* : \mathfrak{b}_{1,2}^\pm(\mathcal{H}) \times \mathfrak{u}_{\text{res}}(\mathcal{H}) &\longrightarrow \mathfrak{u}_{\text{res}}(\mathcal{H}) \\ (x, a) &\longmapsto -\text{ad}_x^* a = -p_{\mathfrak{u}_2^\pm}([a, x]) \end{aligned}$$

follows from the continuity of the product

$$\begin{aligned} \mathfrak{b}_{1,2}^\pm(\mathcal{H}) \times \mathfrak{u}_{\text{res}}(\mathcal{H}) &\longrightarrow L_1(\mathcal{H}) \\ (x, a) &\longmapsto ax, \end{aligned}$$

from the continuity of the projection $p_{\mathfrak{u}_2^\pm}$ and from the continuity of the injections $L_1(\mathcal{H}) \subset L_2(\mathcal{H})$ and $\mathfrak{u}_2(\mathcal{H}) \subset \mathfrak{u}_{\text{res}}(\mathcal{H})$.

- Let us now prove (2). The dual map of the bilinear map $[\cdot, \cdot]_{\mathfrak{u}_{\text{res}}}$ is given by

$$\begin{aligned} [\cdot, \cdot]_{\mathfrak{u}_{\text{res}}}^* : \mathfrak{u}_{\text{res}}^*(\mathcal{H}) &\longrightarrow L(\mathfrak{u}_{\text{res}}(\mathcal{H}), \mathfrak{u}_{\text{res}}(\mathcal{H}); \mathbb{K}) \simeq L(\mathfrak{u}_{\text{res}}(\mathcal{H}); \mathfrak{u}_{\text{res}}^*(\mathcal{H})) \\ \mathcal{F}(\cdot) &\longmapsto \mathcal{F}([\cdot, \cdot]_{\mathfrak{u}_{\text{res}}}) \longmapsto (\alpha \mapsto \mathcal{F}([\alpha, \cdot]_{\mathfrak{u}_{\text{res}}}) = \text{ad}_\alpha^* \mathcal{F}(\cdot)), \end{aligned}$$

and takes values in $\Lambda^2 \mathfrak{u}_{\text{res}}^*(\mathcal{H})$. Since by (1), $\mathfrak{u}_{\text{res}}(\mathcal{H}) \subset \mathfrak{b}_{1,2}^\pm(\mathcal{H})^*$ is stable under the coadjoint action of $\mathfrak{b}_{1,2}^\pm(\mathcal{H})$ and the coadjoint action $\text{ad}^* : \mathfrak{b}_{1,2}^\pm(\mathcal{H}) \times \mathfrak{u}_{\text{res}}(\mathcal{H}) \rightarrow \mathfrak{u}_{\text{res}}(\mathcal{H})$ is continuous, one can consider the adjoint action of $\mathfrak{b}_{1,2}^\pm(\mathcal{H})$ on $\Lambda^2 \mathfrak{u}_{\text{res}}^*(\mathcal{H})$ defined by (6.19). Denote by θ the restriction of $[\cdot, \cdot]_{\mathfrak{u}_{\text{res}}}^*$ to the subspace $\mathfrak{b}_{1,2}^\pm(\mathcal{H}) \subset \mathfrak{u}_{\text{res}}(\mathcal{H})^*$:

$$\begin{aligned} \theta : \mathfrak{b}_{1,2}^\pm(\mathcal{H}) &\longrightarrow L(\mathfrak{u}_{\text{res}}(\mathcal{H}), \mathfrak{u}_{\text{res}}(\mathcal{H}); \mathbb{K}) \simeq L(\mathfrak{u}_{\text{res}}(\mathcal{H}); \mathfrak{u}_{\text{res}}(\mathcal{H})^*) \\ x &\longmapsto \langle x, [\cdot, \cdot]_{\mathfrak{u}_{\text{res}}} \rangle_{\mathfrak{b}_{1,2}^\pm, \mathfrak{u}_{\text{res}}} \mapsto \left(\alpha \mapsto \langle x, [\alpha, \cdot]_{\mathfrak{u}_{\text{res}}} \rangle_{\mathfrak{b}_{1,2}^\pm, \mathfrak{u}_{\text{res}}} = \text{ad}_\alpha^* x(\cdot) \right). \end{aligned}$$

The condition (6.31) expressing that θ is a 1-cocycle reads:

$$\begin{aligned} \langle [\alpha, \beta], [x, y] \rangle_{\mathfrak{b}_{1,2}^\pm, \mathfrak{u}_{\text{res}}} &= \langle y, [\text{ad}_x^* \alpha, \beta] \rangle_{\mathfrak{b}_{1,2}^\pm, \mathfrak{u}_{\text{res}}} + \langle y, [\alpha, \text{ad}_x^* \beta] \rangle_{\mathfrak{b}_{1,2}^\pm, \mathfrak{u}_{\text{res}}} \\ &\quad - \langle x, [\text{ad}_y^* \alpha, \beta] \rangle_{\mathfrak{b}_{1,2}^\pm, \mathfrak{u}_{\text{res}}} - \langle x, [\alpha, \text{ad}_y^* \beta] \rangle_{\mathfrak{b}_{1,2}^\pm, \mathfrak{u}_{\text{res}}}. \end{aligned} \quad (7.12)$$

The first term in the RHS reads

$$+\langle y, [\text{ad}_x^* \alpha, \beta] \rangle_{\mathfrak{b}_{1,2}^\pm, \mathfrak{u}_{\text{res}}} = \Im \text{Tr } y p_{\mathfrak{u}_2^\pm}([\alpha, x], \beta) = \Im \text{Tr } [\beta, y] p_{\mathfrak{u}_2^\pm}([\alpha, x]).$$

Using the fact that $[\beta, y] \in L_2(\mathcal{H})$, and that $\mathfrak{u}_2(\mathcal{H}) \subset L_2(\mathcal{H})$ and $\mathfrak{b}_2^\pm(\mathcal{H}) \subset L_2(\mathcal{H})$ are isotropic subspaces with respect to the pairing given by the imaginary part of the trace, one has

$$+\langle y, [\text{ad}_x^* \alpha, \beta] \rangle_{\mathfrak{b}_{1,2}^\pm, \mathfrak{u}_{\text{res}}} = \Im \text{Tr } p_{\mathfrak{b}_2^\pm}([\beta, y]) p_{\mathfrak{u}_2^\pm}([\alpha, x]).$$

Similarly the second, third and last term in the RHS of equation (7.12) read respectively

$$\begin{aligned} +\langle y, [\alpha, \text{ad}_x^* \beta] \rangle_{\mathfrak{b}_{1,2}^\pm, \mathfrak{u}_{\text{res}}} &= \Im \text{Tr } p_{\mathfrak{b}_2^\pm}([y, \alpha]) p_{\mathfrak{u}_2^\pm}([\beta, x]), \\ -\langle x, [\text{ad}_y^* \alpha, \beta] \rangle_{\mathfrak{b}_{1,2}^\pm, \mathfrak{u}_{\text{res}}} &= -\Im \text{Tr } p_{\mathfrak{b}_2^\pm}([\beta, x]) p_{\mathfrak{u}_2^\pm}([\alpha, y]), \\ -\langle x, [\alpha, \text{ad}_y^* \beta] \rangle_{\mathfrak{b}_{1,2}^\pm, \mathfrak{u}_{\text{res}}} &= -\Im \text{Tr } p_{\mathfrak{b}_2^\pm}([x, \alpha]) p_{\mathfrak{u}_2^\pm}([\beta, y]). \end{aligned}$$

Using once more the fact that $\mathfrak{u}_2(\mathcal{H}) \subset L_2(\mathcal{H})$ and $\mathfrak{b}_2^\pm(\mathcal{H}) \subset L_2(\mathcal{H})$ are isotropic subspaces with respect to the pairing given by the imaginary part of the trace, it follows that the first and last term in the RHS of equation (7.12) sum up to give

$$+\langle y, [\text{ad}_x^* \alpha, \beta] \rangle_{\mathfrak{b}_{1,2}^\pm, \mathfrak{u}_{\text{res}}} - \langle x, [\alpha, \text{ad}_y^* \beta] \rangle_{\mathfrak{b}_{1,2}^\pm, \mathfrak{u}_{\text{res}}} = -\Im \text{Tr } [\beta, y][x, \alpha],$$

and the second and third term in equation (7.12) simplify to

$$+\langle y, [\alpha, \text{ad}_x^* \beta] \rangle_{\mathfrak{b}_{1,2}^\pm, \mathfrak{u}_{\text{res}}} - \langle x, [\text{ad}_y^* \alpha, \beta] \rangle_{\mathfrak{b}_{1,2}^\pm, \mathfrak{u}_{\text{res}}} = -\Im \text{Tr } [\beta, x][\alpha, y].$$

Developping the brackets and using that, for A and B bounded such that AB and BA are trace class, one has $\text{Tr } AB = \text{Tr } BA$, the RHS of equation (7.12) becomes

$$\begin{aligned} \Im \text{Tr } [\beta, y][x, \alpha] + \Im \text{Tr } [\beta, x][\alpha, y] &= \Im \text{Tr } (-\beta y x \alpha - y \beta \alpha x + \beta x y \alpha + x \beta \alpha y) \\ &= \Im \text{Tr } (x y \alpha \beta - x y \beta \alpha - y x \alpha \beta + y x \beta \alpha) \\ &= \Im \text{Tr } [x, y][\alpha, \beta] \\ &= \langle [x, y], [\alpha, \beta] \rangle_{\mathfrak{b}_{1,2}^\pm, \mathfrak{u}_{\text{res}}}, \end{aligned}$$

hence θ satisfies the cocycle condition.

One can show in a similar way that the Lie algebra structure $[\cdot, \cdot]_{\mathfrak{b}_{\text{res}}^\pm}$ on $\mathfrak{b}_{\text{res}}^\pm(\mathcal{H})$ is such that

1. $\mathfrak{u}_{1,2}(\mathcal{H})$ acts continuously by coadjoint action on $\mathfrak{b}_{\text{res}}^\pm(\mathcal{H})$;
2. the dual map $[\cdot, \cdot]_{\mathfrak{b}_{\text{res}}^\pm}^* : \mathfrak{b}_{\text{res}}^\pm(\mathcal{H})^* \rightarrow \Lambda^2 \mathfrak{b}_{\text{res}}^\pm(\mathcal{H})^*$ to the Lie bracket $[\cdot, \cdot]_{\mathfrak{b}_{\text{res}}^\pm} : \mathfrak{b}_{\text{res}}^\pm(\mathcal{H}) \times \mathfrak{b}_{\text{res}}^\pm(\mathcal{H}) \rightarrow \mathfrak{b}_{\text{res}}^\pm(\mathcal{H})$ restricts to a 1-cocycle $\theta : \mathfrak{u}_{1,2}(\mathcal{H}) \rightarrow \Lambda^2 \mathfrak{b}_{\text{res}}^\pm(\mathcal{H})^*$ with respect to the adjoint action $\text{ad}^{(2,0)}$ of $\mathfrak{u}_{1,2}(\mathcal{H})$ on $\Lambda^2 \mathfrak{b}_{\text{res}}^\pm(\mathcal{H})^*$.

□

7.2.2 Unbounded coadjoint actions

Recall that for $1 < p < \infty$ and $q := \frac{p}{p-1}$, $\mathfrak{u}_p(\mathcal{H})$ and $\mathfrak{b}_q^\pm(\mathcal{H})$ are dual Banach Lie–Poisson spaces (see Example 6.4.19), and that the coadjoint actions are given by

$$\mathrm{ad}_\alpha^* x = p_{\mathfrak{u}_p, \pm}([x, \alpha]) \quad \text{and} \quad \mathrm{ad}_x^* \alpha = p_{\mathfrak{b}_q^\pm}([\alpha, x]),$$

where $x \in \mathfrak{u}_p(\mathcal{H})$ and $\alpha \in \mathfrak{b}_q^\pm(\mathcal{H})$. In this example, the continuity of the triangular truncation T_+ on $L_p(\mathcal{H})$ and $L_q(\mathcal{H})$ (see Section 6.2.4) is crucial in order to define the orthogonal projections $p_{\mathfrak{u}_p, \pm}$ and $p_{\mathfrak{b}_q^\pm}$ using equations (6.14) and (6.15).

The situation is different for the Banach Lie algebras $\mathfrak{u}_{1,2}(\mathcal{H})$ and $\mathfrak{b}_{\mathrm{res}}^\pm(\mathcal{H})$. We will show that $\mathfrak{u}_{1,2}(\mathcal{H})$ is not a Banach Lie–Poisson space with respect to $\mathfrak{b}_{\mathrm{res}}^\pm(\mathcal{H})$ since the coadjoint action of $\mathfrak{b}_{\mathrm{res}}^\pm(\mathcal{H})$ on $\mathfrak{u}_{1,2}(\mathcal{H})$ is unbounded. To prove this result, we will use the fact that the triangular truncation is unbounded on the space of trace class operators. In a similar way, the coadjoint action of $\mathfrak{u}_{\mathrm{res}}(\mathcal{H})$ on $\mathfrak{b}_{1,2}^+(\mathcal{H})$ is unbounded (see also [209]). Using Theorem 6.5.9, we conclude that there is no Banach Manin triple associated to the pair $(\mathfrak{u}_{1,2}(\mathcal{H}), \mathfrak{b}_{\mathrm{res}}^\pm(\mathcal{H}))$ nor to the pair $(\mathfrak{b}_{1,2}^+(\mathcal{H}), \mathfrak{u}_{\mathrm{res}}(\mathcal{H}))$ for the duality pairing given by the imaginary part of the restricted trace (see Theorem 7.2.7 below).

Proposition 7.2.4. *There exist a bounded sequence of elements $x_n \in \mathfrak{u}_{1,2}(\mathcal{H})$ and an element $y \in \mathfrak{b}_{\mathrm{res}}^\pm(\mathcal{H})$ such that*

$$\|T_+([x_n, y]|_{\mathcal{H}_+})\|_1 \rightarrow +\infty.$$

Proof. Consider the Hilbert space $\mathcal{H} = \mathcal{H}_+ \oplus \mathcal{H}_-$, with orthonormal basis $\{|n\rangle, n \in \mathbb{Z}\}$ ordered with respect to decreasing values of n , where $\mathcal{H}_+ = \mathrm{span}\{|n\rangle, n > 0\}$ and $\mathcal{H}_- = \mathrm{span}\{|n\rangle, n \leq 0\}$. Furthermore decompose \mathcal{H}_+ into the Hilbert sum of $\mathcal{H}_+^{\mathrm{even}} := \mathrm{span}\{|2n+2\rangle, n \in \mathbb{N}\}$ and $\mathcal{H}_+^{\mathrm{odd}} := \mathrm{span}\{|2n+1\rangle, n \in \mathbb{N}\}$. We will denote by $u : \mathcal{H}_+^{\mathrm{odd}} \rightarrow \mathcal{H}_+^{\mathrm{even}}$ the unitary operator defined by $u|2n+1\rangle = |2n+2\rangle$.

Since the triangular truncation is not bounded on the Banach space of trace class operators, there exists a sequence $K_n \in L_1(\mathcal{H}_+^{\mathrm{odd}})$ such that $\|K_n\|_1 \leq 1$ and $\|T_+(K_n)\|_1 > n$ for all $n \in \mathbb{N}$. It follows that either $\|T_+(K_n + K_n^*)/2\|_1 > n/2$ or $\|T_+(K_n - K_n^*)/2\|_1 > n/2$. Modulo the extraction of a subsequence, we can suppose that K_n is either Hermitian $K_n = K_n^*$ or skew-Hermitian $K_n = -K_n^*$. Moreover, since the triangular truncation is complex linear, the existence of a sequence of skew-Hermitian operators such that $\|K_n\|_1 \leq 1$ and $\|T_+(K_n)\|_1 > n/2$ implies that the sequence iK_n is a sequence of Hermitian operators such that $\|iK_n\|_1 \leq 1$ and $\|T_+(iK_n)\|_1 > n/2$. Therefore without loss of generality we can suppose that K_n are Hermitian.

Consider the bounded operators x_n defined by 0 on \mathcal{H}_- , preserving \mathcal{H}_+ and whose expression with respect to the decomposition $\mathcal{H}_+ = \mathcal{H}_+^{\mathrm{even}} \oplus \mathcal{H}_+^{\mathrm{odd}}$ reads

$$x_n|_{\mathcal{H}_+} = \begin{pmatrix} 0 & uK_n \\ -K_n^*u^* & 0 \end{pmatrix}. \quad (7.13)$$

By construction, x_n is skew-Hermitian. The restriction of $x_n^*x_n$ to \mathcal{H}_+ decomposes as follows with respect to $\mathcal{H}_+ = \mathcal{H}_+^{\mathrm{even}} \oplus \mathcal{H}_+^{\mathrm{odd}}$,

$$x_n^*x_n|_{\mathcal{H}_+} = \begin{pmatrix} uK_n^*K_nu^* & 0 \\ 0 & K_n^*K_n \end{pmatrix},$$

therefore x_n belongs to $\mathfrak{u}_{1,2}(\mathcal{H})$ since the singular values of x_n are the singular values of K_n but with doubled multiplicities. Moreover $\|x_n\|_1 \leq 2$.

Now let $y : \mathcal{H} \rightarrow \mathcal{H}$ be the bounded linear operator defined by 0 on $\mathcal{H}_+^{\mathrm{even}}$, by 0 on \mathcal{H}_- , and by $y = u$ on $\mathcal{H}_+^{\mathrm{odd}}$. Remark that y belongs to $\mathfrak{b}_{\mathrm{res}}^+(\mathcal{H})$. Since x_n and y vanish on \mathcal{H}_- and preserve \mathcal{H}_+ , one has

$$[x_n, y] = \begin{pmatrix} [x_n, y]|_{\mathcal{H}_+} & 0 \\ 0 & 0 \end{pmatrix},$$

where the operators $[x_n, y]|_{\mathcal{H}_+}$ have the following expression with respect to the decomposition $\mathcal{H}_+ = \mathcal{H}_+^{\mathrm{even}} \oplus \mathcal{H}_+^{\mathrm{odd}}$,

$$[x_n, y]|_{\mathcal{H}_+} = \begin{pmatrix} uK_n^*u^* & 0 \\ 0 & -K_n^* \end{pmatrix}.$$

It follows that

$$\|T_+([x_n, y]|_{\mathcal{H}_+})\|_1 = 2\|T_+(K_n)\|_1 \geq n, \quad (7.14)$$

hence $\|T_+([x_n, y]|_{\mathcal{H}_+})\|_1 \rightarrow +\infty$. \square

Lemma 7.2.5. *Let $x_n \in \mathfrak{u}_{1,2}(\mathcal{H})$ and $y \in \mathfrak{b}_{\text{res}}^+(\mathcal{H})$ be as in the proof of Proposition 7.2.4. Then $\|x_n\|_{\mathfrak{u}_{1,2}} \leq 2$ but $\|\text{ad}_y^* x_n\|_{\mathfrak{u}_{1,2}} \rightarrow +\infty$. Consequently the coadjoint action of $\mathfrak{b}_{\text{res}}^+(\mathcal{H})$ on $\mathfrak{u}_{1,2}(\mathcal{H})$ is unbounded.*

Proof. Consider the linear forms α_n on $\mathfrak{b}_{\text{res}}^+(\mathcal{H})$ given by $\alpha_n(A) = \Im \text{Tr } x_n A$ for $x_n \in \mathfrak{u}_{1,2}(\mathcal{H})$ defined by (7.13). Then the linear forms $\beta_n = -\text{ad}_y^* \alpha_n$ read

$$\beta_n(A) = -\text{ad}_y^* \alpha_n(A) = -\alpha_n(\text{ad}_y A) = -\alpha_n([y, A]) = -\Im \text{Tr } x[y, A] = -\Im \text{Tr } (xyA - xAy).$$

According to Proposition 2.1 in [85], one has $\text{Tr } xAy = \text{Tr } yxA$, therefore

$$\beta_n(A) = -\Im \text{Tr } [x_n, y]A.$$

The unique skew-symmetric operator T_n such that $-\Im \text{Tr } T_n A = -\Im \text{Tr } [x_n, y]A$ for any A in the subspace $\mathfrak{b}_2^+(\mathcal{H})$ of $\mathfrak{b}_{\text{res}}^+(\mathcal{H})$ is

$$T_n = p_{\mathfrak{u}_2^+}([x_n, y]) = T_{--}([x_n, y]) - T_{--}([x_n, y])^* + \frac{1}{2}(D([x_n, y]) - D([x_n, y])^*)$$

Since K_n are Hermitian, $[x_n, y]|_{\mathcal{H}_+}$ are Hermitian and we get

$$T_n = [x_n, y] - 2T_+([x_n, y]) + D([x_n, y]).$$

In particular,

$$2T_+([x_n, y]) = T_n - [x_n, y] - D([x_n, y]).$$

By equation (7.14), $2T_+([x_n, y]) \geq 2n$. Therefore

$$\|T_n\|_{\mathfrak{u}_{1,2}} + \|[x_n, y]\|_{\mathfrak{u}_{1,2}} + \|D([x_n, y])\|_{\mathfrak{u}_{1,2}} \geq \|T_n - [x_n, y] - D([x_n, y])\|_{\mathfrak{u}_{1,2}} \geq 2n,$$

for all $n \in \mathbb{N}$, and

$$\|T_n\|_{\mathfrak{u}_{1,2}} \geq 2n - 2 - \|D([x_n, y])\|_{\mathfrak{u}_{1,2}}.$$

The operator D consisting in taking the diagonal is bounded in $L_1(\mathcal{H})$ with operator norm less than 1 (see Theorem 1.19 in [191] or [84] page 134), therefore

$$\|T_n\|_{\mathfrak{u}_{1,2}} > 2n - 4.$$

It follows that $\|-\text{ad}_y^* \alpha_n\|_{\mathfrak{u}_{1,2}} = \|T_n\|_{\mathfrak{u}_{1,2}} \rightarrow +\infty$. \square

Using the same kind of arguments (see also [209]), we have:

Lemma 7.2.6. *The coadjoint action of $\mathfrak{u}_{\text{res}}(\mathcal{H})$ on $\mathfrak{b}_{1,2}^+(\mathcal{H})$ is unbounded.*

From the previous discussion, we obtain the following theorems.

Theorem 7.2.7. *The Banach Lie algebra $\mathfrak{u}_{1,2}(\mathcal{H})$ is not a Banach Lie–Poisson space with respect to $\mathfrak{b}_{\text{res}}^\pm(\mathcal{H})$. Consequently there is no Banach Manin triple structure on the triple of Banach Lie algebras $(\mathfrak{b}_{\text{res}}^\pm(\mathcal{H}) \oplus \mathfrak{u}_{1,2}(\mathcal{H}), \mathfrak{b}_{\text{res}}^\pm(\mathcal{H}), \mathfrak{u}_{1,2}(\mathcal{H}))$ for the duality pairing defined in Proposition 7.2.1.*

Proof. The Banach space $\mathfrak{u}_{1,2}(\mathcal{H})$ is not a Banach Lie–Poisson space with respect to $\mathfrak{b}_{\text{res}}^\pm(\mathcal{H})$ as a consequence of Lemma 7.2.5. By Theorem 6.5.9, there is no Banach Manin triple structure on the Banach Lie algebras $(\mathfrak{u}_{1,2}(\mathcal{H}) \oplus \mathfrak{b}_{\text{res}}^\pm(\mathcal{H}), \mathfrak{u}_{1,2}(\mathcal{H}), \mathfrak{b}_{\text{res}}^\pm(\mathcal{H}))$ for the duality pairing given by the imaginary part of the restricted trace. \square

Along the same lines, we have the analogous Theorem:

Theorem 7.2.8. *The Banach Lie algebra $\mathfrak{b}_{1,2}^\pm(\mathcal{H})$ is not a Banach Lie–Poisson space with respect to $\mathfrak{u}_{\text{res}}(\mathcal{H})$. Consequently there is no Banach Manin triple structure on the triple of Banach Lie algebras $(\mathfrak{b}_{1,2}^\pm(\mathcal{H}) \oplus \mathfrak{u}_{\text{res}}(\mathcal{H}), \mathfrak{b}_{1,2}^\pm(\mathcal{H}), \mathfrak{u}_{\text{res}}(\mathcal{H}))$ for the duality pairing defined in Proposition 7.2.1.*

7.2.3 The Banach Poisson–Lie groups $B_{\text{res}}^{\pm}(\mathcal{H})$ and $U_{\text{res}}(\mathcal{H})$

In this section we will construct a Banach Poisson–Lie group structure on the Banach Lie group $B_{\text{res}}^+(\mathcal{H})$. A similar construction can be of course carried out for the Banach Lie group $B_{\text{res}}^-(\mathcal{H})$ instead. Recall that the coadjoint action of $B_{\text{res}}^+(\mathcal{H})$ is unbounded on $\mathfrak{u}_{1,2}(\mathcal{H})$ (see Section 7.2.2, in particular Lemma 7.2.5). Therefore, in order to construct a Poisson–Lie group structure on $B_{\text{res}}^+(\mathcal{H})$, we need a larger subspace of the dual $\mathfrak{b}_{\text{res}}^+(\mathcal{H})^*$ which will play the role of $\mathfrak{g}_- := \mathbb{F}_e$ (compare with Theorem 6.6.4). Consider the following map:

$$F : \begin{array}{ll} L_{1,2}(\mathcal{H}) & \rightarrow \mathfrak{b}_{\text{res}}^+(\mathcal{H})^* \\ a & \mapsto (b \mapsto \Im \text{Tr } ab). \end{array}$$

Proposition 7.2.9. *The kernel of F equals $\mathfrak{b}_{1,2}^+(\mathcal{H})$, therefore $L_{1,2}(\mathcal{H})/\mathfrak{b}_{1,2}^+(\mathcal{H})$ injects into the dual space $\mathfrak{b}_{\text{res}}^+(\mathcal{H})^*$. Moreover $L_{1,2}(\mathcal{H})/\mathfrak{b}_{1,2}^+(\mathcal{H})$ is preserved by the continuous coadjoint action of $B_{\text{res}}^+(\mathcal{H})$ and strictly contains $\mathfrak{u}_{1,2}(\mathcal{H})$ as a dense subspace.*

Proof. In order to show that the kernel of F is $\mathfrak{b}_{1,2}^+(\mathcal{H})$, consider, for $n \geq m$, the operator $E_{nm} = |n\rangle\langle m| \in \mathfrak{b}_{\text{res}}^+(\mathcal{H})$ given by $x \mapsto \langle m|x\rangle|n\rangle$ and, for $n > m$, the operator $iE_{nm} \in \mathfrak{b}_{\text{res}}^+(\mathcal{H})$. As in the proof of Proposition 7.2.1, an element $a \in L_{1,2}(\mathcal{H})$ satisfying $F(a)(E_{nm}) = 0$ and $F(a)(iE_{nm}) = 0$ is such that $\langle m|an\rangle = 0$ for $n > m$ and $\langle n|an\rangle \in \mathbb{R}$ for $n \in \mathbb{Z}$, i.e. belongs to $\mathfrak{b}_{1,2}^+(\mathcal{H})$. Let us show that the range of F is preserved by the coadjoint action of $B_{\text{res}}^+(\mathcal{H})$. Let $g \in B_{\text{res}}^+(\mathcal{H})$ and $a \in L_{1,2}(\mathcal{H})$. For any $b \in \mathfrak{b}_{\text{res}}^+(\mathcal{H})$, one has:

$$\begin{aligned} \text{Ad}^*(g)F(a)(b) &= F(a)(\text{Ad}(g)(b)) = F(a)(gbg^{-1}) \\ &= \Im \text{Tr } agbg^{-1} = \Im \text{Tr } g^{-1}agb = F(g^{-1}ag)(b), \end{aligned}$$

where, in the fourth equality, we have used Proposition 2.1 in [85] (since the product agb belongs to $L_{1,2}(\mathcal{H})$ and b to $L_{\text{res}}(\mathcal{H})$). In fact, $B_{\text{res}}^+(\mathcal{H})$ acts continuously on the right on $L_{1,2}(\mathcal{H})$ by

$$a \cdot g = g^{-1}ag.$$

Then one has the equivariance property

$$F(a \cdot g) = \text{Ad}^*(g)F(a).$$

Moreover the subalgebra $\mathfrak{b}_{1,2}^+(\mathcal{H})$ is preserved by the right action of $B_{\text{res}}^+(\mathcal{H})$ on $L_{1,2}(\mathcal{H})$. It follows that there is a well-defined continuous right action of $B_{\text{res}}^+(\mathcal{H})$ on the quotient space $L_{1,2}(\mathcal{H})/\mathfrak{b}_{1,2}^+(\mathcal{H})$ defined by

$$[a] \cdot g = [a \cdot g],$$

where $[a]$ denotes the class of $a \in L_{1,2}(\mathcal{H})$ modulo $\mathfrak{b}_{1,2}^+(\mathcal{H})$.

Let us show that $\mathfrak{u}_{1,2}(\mathcal{H}) \oplus \mathfrak{b}_{1,2}^+(\mathcal{H})$ is dense in $L_{1,2}(\mathcal{H})$. To do this, we will show that any continuous linear form on $L_{1,2}(\mathcal{H})$ which vanishes on $\mathfrak{u}_{1,2}(\mathcal{H}) \oplus \mathfrak{b}_{1,2}^+(\mathcal{H})$ is equal to the zero form. Recall that the dual space of $L_{1,2}(\mathcal{H})$ is $L_{\text{res}}(\mathcal{H})$, the duality pairing being given by the restricted trace. Consider $X \in L_{\text{res}}(\mathcal{H})$ such that $\text{Tr } Xa = 0$ and $\text{Tr } Xb = 0$ for any $a \in \mathfrak{u}_{1,2}(\mathcal{H})$ and any $b \in \mathfrak{b}_{1,2}^+(\mathcal{H})$. Letting $b = E_{nm}$ with $n \geq m$, we get $\langle m|Xn\rangle = 0$ for $n \geq m$. Letting $a = E_{nm} - E_{mn} \in \mathfrak{u}_{1,2}(\mathcal{H})$, we get $\langle m|Xn\rangle - \langle n|Xm\rangle = 0$ for $n \geq m$. It follows that $\langle m|Xn\rangle = 0$ for any $m, n \in \mathbb{Z}$, which implies that the bounded linear operator X vanishes, hence $\mathfrak{u}_{1,2}(\mathcal{H}) \oplus \mathfrak{b}_{1,2}^+(\mathcal{H})$ is dense in $L_{1,2}(\mathcal{H})$. It follows from Section 7.2.2, that $\mathfrak{u}_{1,2}(\mathcal{H}) \oplus \mathfrak{b}_{1,2}^+(\mathcal{H})$ is strictly contained in $L_{1,2}(\mathcal{H})$.

Let us show that $\mathfrak{u}_{1,2}(\mathcal{H})$ is dense in $L_{1,2}(\mathcal{H})/\mathfrak{b}_{1,2}^+(\mathcal{H})$. Consider a class $[a] \in L_{1,2}(\mathcal{H})/\mathfrak{b}_{1,2}^+(\mathcal{H})$, where a is any element in $L_{1,2}(\mathcal{H})$. Since $\mathfrak{u}_{1,2}(\mathcal{H}) \oplus \mathfrak{b}_{1,2}^+(\mathcal{H})$ is dense in $L_{1,2}(\mathcal{H})$, there is a sequence $u_i \in \mathfrak{u}_{1,2}(\mathcal{H})$ and a sequence $b_i \in \mathfrak{b}_{1,2}^+(\mathcal{H})$ such that $u_i + b_i$ converge to a in $L_{1,2}(\mathcal{H})$. It follows that $[u_i + b_i] = [u_i]$ converge to $[a]$ in $L_{1,2}(\mathcal{H})/\mathfrak{b}_{1,2}^+(\mathcal{H})$. \square

Now we are able to state the following Theorem. The proof uses Lemma 6.6.8.

Theorem 7.2.10. *Consider the Banach Lie group $B_{\text{res}}^+(\mathcal{H})$, and*

1. $\mathfrak{g}_- := L_{1,2}(\mathcal{H})/\mathfrak{b}_{1,2}^+(\mathcal{H}) \subset \mathfrak{b}_{\text{res}}^+(\mathcal{H})^*$,

2. $\mathbb{B} \subset T^* \mathbb{B}_{\text{res}}^+(\mathcal{H})$, $\mathbb{B}_b := R_{b^{-1}}^* \mathfrak{g}_-$,

3. $\Pi_r^{B^+} : \mathbb{B}_{\text{res}}^+(\mathcal{H}) \rightarrow \Lambda^2 \mathfrak{g}_^*$ defined by

$$\Pi_r^{B^+}(b)([x_1]_{\mathfrak{b}_{1,2}^+}, [x_2]_{\mathfrak{b}_{1,2}^+}) = \Im \text{Tr} (b^{-1} p_{\mathfrak{u}_2^+}(x_1) b) \left[p_{\mathfrak{b}_2^+}(b^{-1} p_{\mathfrak{u}_2^+}(x_2) b) \right],$$

4. $\pi^{B^+}(b) = R_b^* \Pi_r^{B^+}(b)$.

Then $(\mathbb{B}_{\text{res}}^+(\mathcal{H}), \mathbb{B}, \pi^{B^+})$ is a Banach Poisson-Lie group.

Proof. • Let us show that $\Pi_r^{B^+}$ satisfies the cocycle condition.

$$\begin{aligned} \Pi_r^{B^+}(u) \left(\text{Ad}^*(g)[x_1]_{\mathfrak{b}_{1,2}^+}, \text{Ad}^*(g)[x_2]_{\mathfrak{b}_{1,2}^+} \right) &= \Pi_r^{B^+}(u) \left([g^{-1} x_1 g]_{\mathfrak{b}_{1,2}^+}, [g^{-1} x_2 g]_{\mathfrak{b}_{1,2}^+} \right) \\ &= \Im \text{Tr} (u^{-1} p_{\mathfrak{u}_2^+}(g^{-1} x_1 g) u) \left[p_{\mathfrak{b}_2^+}(u^{-1} p_{\mathfrak{u}_2^+}(g^{-1} x_2 g) u) \right] \end{aligned}$$

Using the decomposition $p_{\mathfrak{u}_2^+}(g^{-1} x_1 g) = g^{-1} x_1 g - p_{\mathfrak{b}_2^+}(g^{-1} x_1 g)$, the fact that \mathfrak{b}_2^+ is preserved by conjugation by elements in $\mathbb{B}_{\text{res}}^+(\mathcal{H})$, and the fact that \mathfrak{b}_2^+ is isotropic, one has:

$$\begin{aligned} \Pi_r^{B^+}(u) \left(\text{Ad}^*(g)[x_1]_{\mathfrak{b}_{1,2}^+}, \text{Ad}^*(g)[x_2]_{\mathfrak{b}_{1,2}^+} \right) &= \Im \text{Tr} (u^{-1} g^{-1} x_1 g u) \left[p_{\mathfrak{b}_2^+}(u^{-1} p_{\mathfrak{u}_2^+}(g^{-1} x_2 g) u) \right] \\ &= \Im \text{Tr} (u^{-1} g^{-1} x_1 g u) \left[p_{\mathfrak{b}_2^+}(u^{-1} g^{-1} x_2 g u) \right] - \Im \text{Tr} (u^{-1} g^{-1} x_1 g u) \left[p_{\mathfrak{b}_2^+}(u^{-1} p_{\mathfrak{b}_2^+}(g^{-1} x_2 g) u) \right] \\ &= \Im \text{Tr} (u^{-1} g^{-1} x_1 g u) \left[p_{\mathfrak{b}_2^+}(u^{-1} g^{-1} x_2 g u) \right] - \Im \text{Tr} g^{-1} x_1 g p_{\mathfrak{b}_2^+}(g^{-1} x_2 g) \end{aligned}$$

Using the decompositions $x_1 = p_{\mathfrak{u}_2^+}(x_1) + p_{\mathfrak{b}_2^+}(x_1)$ and $x_2 = p_{\mathfrak{u}_2^+}(x_2) + p_{\mathfrak{b}_2^+}(x_2)$, one gets 8 terms but 4 of them vanish since \mathfrak{b}_2^+ is isotropic. The remaining terms are:

$$\begin{aligned} \Pi_r^{B^+}(u) \left(\text{Ad}^*(g)[x_1]_{\mathfrak{b}_{1,2}^+}, \text{Ad}^*(g)[x_2]_{\mathfrak{b}_{1,2}^+} \right) &= \Im \text{Tr} (u^{-1} g^{-1} p_{\mathfrak{u}_2^+}(x_1) g u) \left[p_{\mathfrak{b}_2^+}(u^{-1} g^{-1} p_{\mathfrak{u}_2^+}(x_2) g u) \right] \\ &\quad + \Im \text{Tr} (u^{-1} g^{-1} p_{\mathfrak{u}_2^+}(x_1) g u) \left[p_{\mathfrak{b}_2^+}(u^{-1} g^{-1} p_{\mathfrak{b}_2^+}(x_2) g u) \right] \\ &\quad - \Im \text{Tr} g^{-1} p_{\mathfrak{u}_2^+}(x_1) g p_{\mathfrak{b}_2^+}(g^{-1} p_{\mathfrak{u}_2^+}(x_2) g) \\ &\quad - \Im \text{Tr} g^{-1} p_{\mathfrak{u}_2^+}(x_1) g p_{\mathfrak{b}_2^+}(g^{-1} p_{\mathfrak{b}_2^+}(x_2) g) \end{aligned}$$

The first term in the right hand side equals $\Pi_r^{B^+}(gu)([x_1]_{\mathfrak{b}_{1,2}^+}, [x_2]_{\mathfrak{b}_{1,2}^+})$, the third term equals $-\Pi_r^{B^+}(g)([x_1]_{\mathfrak{b}_{1,2}^+}, [x_2]_{\mathfrak{b}_{1,2}^+})$, whereas the second term equals $+\Im \text{Tr} (p_{\mathfrak{u}_2^+}(x_1) p_{\mathfrak{b}_2^+}(x_2))$, and the last terms equals $-\Im \text{Tr} (p_{\mathfrak{u}_2^+}(x_1) p_{\mathfrak{b}_2^+}(x_2))$.

- It remains to check that π^{B^+} satisfies the Jacobi identity (6.26). We will use Lemma 6.6.8. Using the cocycle identity, one has for any X in $\mathfrak{b}_{\text{res}}^+(\mathcal{H})$ and $g \in \mathbb{B}_{\text{res}}^+$,

$$T_g \Pi_r^{B^+}(L_g X)([x_1], [x_2]) = T_e \Pi_r^{B^+}(X)(\text{Ad}^*(g)[x_1], \text{Ad}^*(g)[x_2]),$$

in particular,

$$\begin{aligned} T_g \Pi_r^{B^+}(R_g X)([x_1], [x_2]) &= T_g \Pi_r^{B^+}(L_g \text{Ad}(g^{-1})(X))([x_1], [x_2]) \\ &= T_e \Pi_r^{B^+}(\text{Ad}(g^{-1})(X))(\text{Ad}^*(g)[x_1], \text{Ad}^*(g)[x_2]) \\ &= T_e \Pi_r^{B^+}(\text{Ad}(g^{-1})(X))([g^{-1} x_1 g], [g^{-1} x_2 g]) \end{aligned}$$

On the other hand

$$\begin{aligned} T_e \Pi_r^{B^+}(Y)([x_1], [x_2]) &= -\Im \text{Tr} [Y, p_{\mathfrak{u}_2^+}(x_1)] p_{\mathfrak{b}_2^+}(p_{\mathfrak{u}_2^+}(x_2)) - \Im \text{Tr} p_{\mathfrak{u}_2^+}(x_1) p_{\mathfrak{b}_2^+}([Y, p_{\mathfrak{u}_2^+}(x_2)]) \\ &= -\Im \text{Tr} p_{\mathfrak{u}_2^+}(x_1) [Y, p_{\mathfrak{u}_2^+}(x_2)] = \Im \text{Tr} Y [p_{\mathfrak{u}_2^+}(x_1), p_{\mathfrak{u}_2^+}(x_2)]. \end{aligned}$$

It follows that

$$T_g \Pi_r^{B^+}(R_g X)([x_1], [x_2]) = \Im \text{Tr} g^{-1} X g [p_{\mathfrak{u}_2^+}(g^{-1} x_1 g), p_{\mathfrak{u}_2^+}(g^{-1} x_2 g)]. \quad (7.15)$$

In particular, for any x_1 and x_2 in $L_{1,2}(\mathcal{H})$, the 1-form on $\mathfrak{b}_{\text{res}}^+$ given by

$$X \mapsto T_g \Pi_r^{B^+_{\text{res}}}(L_g X)([x_1], [x_2])$$

belongs to $\mathfrak{u}_{1,2}(\mathcal{H})$ and is given by

$$T_g \Pi_r^{B^+_{\text{res}}}(L_g(\cdot))([x_1], [x_2]) = [p_{\mathfrak{u}_2^+}(g^{-1} x_1 g), p_{\mathfrak{u}_2^+}(g^{-1} x_2 g)]$$

Moreover for $g \in B_{\text{res}}^+(\mathcal{H})$, $x_3 \in L_{1,2}(\mathcal{H})$ and $y \in L_{1,2}(\mathcal{H})$, one has

$$\begin{aligned} \Pi_r^{B^+_{\text{res}}}(g)([x_3], [y]) &= \Im \text{Tr}(g^{-1} p_{\mathfrak{u}_2^+}(x_3) g) p_{\mathfrak{b}_2^+}(g^{-1} p_{\mathfrak{u}_2^+}(y) g) \\ &= \Im \text{Tr} p_{\mathfrak{u}_2^+}(g^{-1} p_{\mathfrak{u}_2^+}(x_3) g) p_{\mathfrak{b}_2^+}(g^{-1} p_{\mathfrak{u}_2^+}(y) g) \\ &= -\Im \text{Tr} p_{\mathfrak{b}_2^+}(g^{-1} p_{\mathfrak{u}_2^+}(x_3) g) p_{\mathfrak{u}_2^+}(g^{-1} p_{\mathfrak{u}_2^+}(y) g) \\ &= -\Im \text{Tr} g p_{\mathfrak{b}_2^+}(g^{-1} p_{\mathfrak{u}_2^+}(x_3) g) g^{-1} p_{\mathfrak{u}_2^+}(y) \\ &= -\Im \text{Tr} g p_{\mathfrak{b}_2^+}(g^{-1} p_{\mathfrak{u}_2^+}(x_3) g) g^{-1}(y) \end{aligned}$$

In particular $i_{[x_3]} \Pi_r^{B^+_{\text{res}}}(g) = -g p_{\mathfrak{b}_2^+}(g^{-1} p_{\mathfrak{u}_2^+}(x_3) g) g^{-1}$ belongs to $\mathfrak{b}_2^+(\mathcal{H}) \subset \mathfrak{b}_{\text{res}}^+(\mathcal{H})$. Using (7.15), it follows that

$$\begin{aligned} T_g \Pi_r^{B^+_{\text{res}}}(R_g i_{[x_3]} \Pi_r^{B^+_{\text{res}}}(g))([x_1], [x_2]) &= -\Im \text{Tr} p_{\mathfrak{b}_2^+}(g^{-1} p_{\mathfrak{u}_2^+}(x_3) g) [p_{\mathfrak{u}_2^+}(g^{-1} x_1 g), p_{\mathfrak{u}_2^+}(g^{-1} x_2 g)] \\ &= -\Im \text{Tr} p_{\mathfrak{b}_2^+}(g^{-1} p_{\mathfrak{u}_2^+}(x_3) g) [p_{\mathfrak{u}_2^+}(g^{-1} p_{\mathfrak{u}_2^+}(x_1) g), p_{\mathfrak{u}_2^+}(g^{-1} p_{\mathfrak{u}_2^+}(x_2) g)], \end{aligned} \tag{7.16}$$

where we have used that $g^{-1} p_{\mathfrak{b}_2^+}(x_i) g \in \mathfrak{b}_2^+$ for any $x_i \in L_{1,2}(\mathcal{H})$ and any $g \in B_{\text{res}}^+(\mathcal{H})$.

Moreover

$$\begin{aligned} \langle x_1, [i_{[x_3]} \Pi_r^{B^+_{\text{res}}}(g), i_{[x_2]} \Pi_r^{B^+_{\text{res}}}(g)] \rangle &= \Im \text{Tr} x_1 [g p_{\mathfrak{b}_2^+}(g^{-1} p_{\mathfrak{u}_2^+}(x_3) g) g^{-1}, g p_{\mathfrak{b}_2^+}(g^{-1} p_{\mathfrak{u}_2^+}(x_2) g) g^{-1}] \\ &= \Im \text{Tr} p_{\mathfrak{u}_2^+}(x_1) [g p_{\mathfrak{b}_2^+}(g^{-1} p_{\mathfrak{u}_2^+}(x_3) g) g^{-1}, g p_{\mathfrak{b}_2^+}(g^{-1} p_{\mathfrak{u}_2^+}(x_2) g) g^{-1}] \\ &= \Im \text{Tr} g^{-1} p_{\mathfrak{u}_2^+}(x_1) g [p_{\mathfrak{b}_2^+}(g^{-1} p_{\mathfrak{u}_2^+}(x_3) g), p_{\mathfrak{b}_2^+}(g^{-1} p_{\mathfrak{u}_2^+}(x_2) g)] \\ &= \Im \text{Tr} p_{\mathfrak{u}_2^+}(g^{-1} p_{\mathfrak{u}_2^+}(x_1) g) [p_{\mathfrak{b}_2^+}(g^{-1} p_{\mathfrak{u}_2^+}(x_3) g), p_{\mathfrak{b}_2^+}(g^{-1} p_{\mathfrak{u}_2^+}(x_2) g)] \\ &= -\Im \text{Tr} p_{\mathfrak{u}_2^+}(g^{-1} p_{\mathfrak{u}_2^+}(x_1) g) [p_{\mathfrak{b}_2^+}(g^{-1} p_{\mathfrak{u}_2^+}(x_2) g), p_{\mathfrak{b}_2^+}(g^{-1} p_{\mathfrak{u}_2^+}(x_3) g)] \end{aligned} \tag{7.17}$$

Consider $\alpha = R_{g^{-1}}^*[x_1] \in (T_g B_{\text{res}}^+)^*$, $\beta = R_{g^{-1}}^*[x_2] \in (T_g B_{\text{res}}^+)^*$ and $\gamma = R_{g^{-1}}^*[x_3] \in (T_g B_{\text{res}}^+)^*$, for x_1, x_2 and x_3 in $L_{1,2}(\mathcal{H})$. Injecting (7.16) and (7.17) into (6.46) and using the fact that the left hand side of (6.46) defines a tensor, one gets :

$$\begin{aligned} &\pi(\alpha, d(\pi(\beta, \gamma))) + \pi(\beta, d(\pi(\gamma, \alpha))) + \pi(\gamma, d(\pi(\alpha, \beta))) \\ &= -\Im \text{Tr} p_{\mathfrak{b}_2^+}(g^{-1} p_{\mathfrak{u}_2^+}(x_3) g) [p_{\mathfrak{u}_2^+}(g^{-1} p_{\mathfrak{u}_2^+}(x_1) g), p_{\mathfrak{u}_2^+}(g^{-1} p_{\mathfrak{u}_2^+}(x_2) g)] \\ &\quad -\Im \text{Tr} p_{\mathfrak{u}_2^+}(g^{-1} p_{\mathfrak{u}_2^+}(x_1) g) [p_{\mathfrak{b}_2^+}(g^{-1} p_{\mathfrak{u}_2^+}(x_2) g), p_{\mathfrak{b}_2^+}(g^{-1} p_{\mathfrak{u}_2^+}(x_3) g)] \\ &\quad -\Im \text{Tr} p_{\mathfrak{b}_2^+}(g^{-1} p_{\mathfrak{u}_2^+}(x_1) g) [p_{\mathfrak{u}_2^+}(g^{-1} p_{\mathfrak{u}_2^+}(x_2) g), p_{\mathfrak{u}_2^+}(g^{-1} p_{\mathfrak{u}_2^+}(x_3) g)] \\ &\quad -\Im \text{Tr} p_{\mathfrak{u}_2^+}(g^{-1} p_{\mathfrak{u}_2^+}(x_2) g) [p_{\mathfrak{b}_2^+}(g^{-1} p_{\mathfrak{u}_2^+}(x_3) g), p_{\mathfrak{b}_2^+}(g^{-1} p_{\mathfrak{u}_2^+}(x_1) g)] \\ &\quad -\Im \text{Tr} p_{\mathfrak{b}_2^+}(g^{-1} p_{\mathfrak{u}_2^+}(x_2) g) [p_{\mathfrak{u}_2^+}(g^{-1} p_{\mathfrak{u}_2^+}(x_3) g), p_{\mathfrak{u}_2^+}(g^{-1} p_{\mathfrak{u}_2^+}(x_1) g)] \\ &\quad -\Im \text{Tr} p_{\mathfrak{u}_2^+}(g^{-1} p_{\mathfrak{u}_2^+}(x_3) g) [p_{\mathfrak{b}_2^+}(g^{-1} p_{\mathfrak{u}_2^+}(x_1) g), p_{\mathfrak{b}_2^+}(g^{-1} p_{\mathfrak{u}_2^+}(x_2) g)] \\ &= -\Im \text{Tr} p_{\mathfrak{b}_2^+}(g^{-1} p_{\mathfrak{u}_2^+}(x_3) g) [p_{\mathfrak{u}_2^+}(g^{-1} p_{\mathfrak{u}_2^+}(x_1) g), p_{\mathfrak{u}_2^+}(g^{-1} p_{\mathfrak{u}_2^+}(x_2) g)] \\ &\quad -\Im \text{Tr} p_{\mathfrak{b}_2^+}(g^{-1} p_{\mathfrak{u}_2^+}(x_3) g) [p_{\mathfrak{u}_2^+}(g^{-1} p_{\mathfrak{u}_2^+}(x_1) g), p_{\mathfrak{b}_2^+}(g^{-1} p_{\mathfrak{u}_2^+}(x_2) g)] \\ &\quad -\Im \text{Tr} p_{\mathfrak{u}_2^+}(g^{-1} p_{\mathfrak{u}_2^+}(x_3) g) [p_{\mathfrak{b}_2^+}(g^{-1} p_{\mathfrak{u}_2^+}(x_1) g), p_{\mathfrak{u}_2^+}(g^{-1} p_{\mathfrak{u}_2^+}(x_2) g)] \\ &\quad -\Im \text{Tr} p_{\mathfrak{b}_2^+}(g^{-1} p_{\mathfrak{u}_2^+}(x_3) g) [p_{\mathfrak{b}_2^+}(g^{-1} p_{\mathfrak{u}_2^+}(x_1) g), p_{\mathfrak{u}_2^+}(g^{-1} p_{\mathfrak{u}_2^+}(x_2) g)] \\ &\quad -\Im \text{Tr} p_{\mathfrak{u}_2^+}(g^{-1} p_{\mathfrak{u}_2^+}(x_3) g) [p_{\mathfrak{u}_2^+}(g^{-1} p_{\mathfrak{u}_2^+}(x_1) g), p_{\mathfrak{b}_2^+}(g^{-1} p_{\mathfrak{u}_2^+}(x_2) g)] \\ &\quad -\Im \text{Tr} p_{\mathfrak{b}_2^+}(g^{-1} p_{\mathfrak{u}_2^+}(x_3) g) [p_{\mathfrak{b}_2^+}(g^{-1} p_{\mathfrak{u}_2^+}(x_1) g), p_{\mathfrak{b}_2^+}(g^{-1} p_{\mathfrak{u}_2^+}(x_2) g)] \\ &= -\Im \text{Tr} g^{-1} p_{\mathfrak{u}_2^+}(x_3) g [g^{-1} p_{\mathfrak{u}_2^+}(x_1) g, g^{-1} p_{\mathfrak{u}_2^+}(x_2) g] \\ &= -\Im \text{Tr} g^{-1} p_{\mathfrak{u}_2^+}(x_3) [p_{\mathfrak{u}_2^+}(x_1), p_{\mathfrak{u}_2^+}(x_2)] g \\ &= -\Im \text{Tr} p_{\mathfrak{u}_2^+}(x_3) [p_{\mathfrak{u}_2^+}(x_1), p_{\mathfrak{u}_2^+}(x_2)] \\ &= 0, \end{aligned}$$

hence π is a Poisson tensor. □

Remark 7.2.11. In the proof of the previous Theorem, we have established that

$$T_e \Pi_r^{B^+ \text{res}}(Y)([x_1]_{\mathfrak{b}_{1,2}^+}, [x_2]_{\mathfrak{b}_{1,2}^+}) = \Im \text{Tr} Y [p_{\mathfrak{u}_2^+}(x_1), p_{\mathfrak{u}_2^+}(x_2)],$$

where $x_1, x_2 \in L_{1,2}(\mathcal{H})$ and $Y \in \mathfrak{b}_{\text{res}}^+(\mathcal{H})$. It follows that $T_e \Pi_r^{B^+ \text{res}}$ is the dual map of

$$\begin{aligned} L_{1,2}(\mathcal{H})/\mathfrak{b}_{1,2}^+(\mathcal{H}) \times L_{1,2}(\mathcal{H})/\mathfrak{b}_{1,2}^+(\mathcal{H}) &\rightarrow L_{1,2}(\mathcal{H})/\mathfrak{b}_{1,2}^+(\mathcal{H}) \\ ([x_1]_{\mathfrak{b}_{1,2}^+}, [x_2]_{\mathfrak{b}_{1,2}^+}) &\mapsto [p_{\mathfrak{u}_2^+}(x_1), p_{\mathfrak{u}_2^+}(x_2)], \end{aligned} \quad (7.18)$$

which is well defined on $L_{1,2}(\mathcal{H})/\mathfrak{b}_{1,2}^+(\mathcal{H})$ since $[p_{\mathfrak{u}_2^+}(x_1), p_{\mathfrak{u}_2^+}(x_2)] \in L_1(\mathcal{H})$ for any $x_1, x_2 \in L_{1,2}(\mathcal{H})$. Note that this bracket is continuous and extends the natural bracket of $\mathfrak{u}_{1,2}(\mathcal{H})$.

Along the same lines (see also [209]), we obtain the following Theorem:

Theorem 7.2.12. Consider the Banach Lie group $U_{\text{res}}(\mathcal{H})$, and

1. $\mathfrak{g}_+ := L_{1,2}(\mathcal{H})/\mathfrak{u}_{1,2}(\mathcal{H}) \subset \mathfrak{u}_{\text{res}}^*(\mathcal{H})$,
2. $\mathbb{U} \subset T^* U_{\text{res}}(\mathcal{H})$, $\mathbb{U}_g = R_{g^{-1}}^* \mathfrak{g}_+$,
3. $\Pi_r^{\text{Ures}} : U_{\text{res}}(\mathcal{H}) \rightarrow \Lambda^2 \mathfrak{g}_+^*$ defined by

$$\Pi_r^{\text{Ures}}(g)([x_1]_{\mathfrak{u}_{1,2}}, [x_2]_{\mathfrak{u}_{1,2}}) = \Im \text{Tr} (g^{-1} p_{\mathfrak{b}_2^+}(x_1) g) [p_{\mathfrak{u}_2}(g^{-1} p_{\mathfrak{b}_2^+}(x_2) g)],$$

4. $\pi^{\text{Ures}}(g) = R_g^{**} \Pi_r^{\text{Ures}}(g)$.

Then $(U_{\text{res}}(\mathcal{H}), \mathbb{U}, \pi^{\text{Ures}})$ is a Banach Poisson–Lie group.

7.3 The restricted Grassmannian as a Poisson manifold

In this section, we construct a generalized Banach Poisson structure on the restricted Grassmannian, and called it Bruhat–Poisson structure by reference to the finite-dimensional picture developed in [136].

7.3.1 A Poisson–Lie subgroup of $U_{\text{res}}(\mathcal{H})$

The following definition is identical to the definition in the finite-dimensional case.

Definition 7.3.1. A Banach Lie subgroup H of a Banach Poisson–Lie group G is called a **Banach Poisson–Lie subgroup** if it is a Banach Poisson submanifold of G , i.e. if it carries a Poisson structure such that the inclusion map $\iota : H \hookrightarrow G$ is a Poisson map.

Let us show the following Proposition.

Proposition 7.3.2. The Banach Lie group $H := U(\mathcal{H}_+) \times U(\mathcal{H}_-)$ is a Poisson–Lie subgroup of $U_{\text{res}}(\mathcal{H})$.

Proof. Denote by $\iota : H \hookrightarrow U_{\text{res}}(\mathcal{H})$ the inclusion map. It is clear that H is a Banach submanifold of $U_{\text{res}}(\mathcal{H})$. Denote by \mathfrak{h} its Lie algebra. Recall that \mathbb{U} is the subbundle of $T^* U_{\text{res}}(\mathcal{H})$ given by $\mathbb{U}_g = R_{g^{-1}}^* \mathfrak{g}_+$ where $\mathfrak{g}_+ := L_{1,2}(\mathcal{H})/\mathfrak{u}_{1,2}(\mathcal{H})$. Denote by $\langle \cdot, \cdot \rangle_{\mathfrak{u}_{\text{res}}}$ the duality pairing between \mathfrak{g}_+ and $\mathfrak{u}_{\text{res}}(\mathcal{H})$, and by \mathfrak{h}^0 the closed subspace of \mathfrak{g}_+ consisting of those covectors in \mathfrak{g}_+ which vanish on the closed subspace \mathfrak{h} of $\mathfrak{u}_{\text{res}}(\mathcal{H})$. For any covector $\alpha \in \iota^* \mathfrak{g}_+$ acting on \mathfrak{h} , and any vector $X \in \mathfrak{h}$, denote by $[\alpha]_{\mathfrak{h}^0}$ the class of $\alpha \in \iota^* \mathfrak{g}_+$ in $\iota^* \mathfrak{g}_+/\mathfrak{h}^0$. Then the formula

$$\langle [\alpha]_{\mathfrak{h}^0}, X \rangle_{\mathfrak{h}} := \langle \alpha, X \rangle_{\mathfrak{u}_{\text{res}}},$$

defines a duality pairing between $\mathbb{H}_e := \iota^* \mathfrak{g}_+/\mathfrak{h}^0$ and \mathfrak{h} . It follows that $\mathbb{H} := \iota^* \mathbb{U}/(TH)^0$ is a subbundle of $T^* H$ in duality with TH . Recall that the Poisson tensor on $U_{\text{res}}(\mathcal{H})$ is defined as follows

$$\Pi_r^{\text{Ures}}(h)(\alpha, \beta) = \Im \text{Tr} (h^{-1} p_{\mathfrak{b}_2^+}(x_1) h) [p_{\mathfrak{u}_2^+}(h^{-1} p_{\mathfrak{b}_2^+}(x_2) h)]$$

where $\alpha, \beta \in \mathfrak{g}_+ = L_{1,2}(\mathcal{H})/\mathfrak{u}_{1,2}$ and $x_1, x_2 \in L_{1,2}(\mathcal{H})$ are such that $\alpha = [x_1]_{\mathfrak{u}_{1,2}}$ and $\beta = [x_2]_{\mathfrak{u}_{1,2}}$. Note that an element $x_2 = \begin{pmatrix} A & B \\ C & D \end{pmatrix} \in L_{1,2}(\mathcal{H})$ belongs to \mathfrak{h}^0 if and only if $A \in \mathfrak{u}_1(\mathcal{H})$ and $D \in \mathfrak{u}_1(\mathcal{H})$. In that case, one has

$$x_2 = \begin{pmatrix} A & -C^* \\ C & D \end{pmatrix} + \begin{pmatrix} 0 & B+C^* \\ 0 & 0 \end{pmatrix},$$

with $p_{\mathfrak{u}_2^+}(x_2) = \begin{pmatrix} A & -C^* \\ C & D \end{pmatrix}$ and $p_{\mathfrak{b}_2^+}(x_2) = \begin{pmatrix} 0 & B+C^* \\ 0 & 0 \end{pmatrix}$. Note also that for any $h = \begin{pmatrix} h_1 & 0 \\ 0 & h_2 \end{pmatrix} \in \mathrm{U}(\mathcal{H}_+) \times \mathrm{U}(\mathcal{H}_-)$, one has

$$h^{-1}p_{\mathfrak{b}_2^+}(x_2)h = \begin{pmatrix} 0 & h_1^{-1}(B+C^*)h_2 \\ 0 & 0 \end{pmatrix} \in \mathfrak{b}_2^+(\mathcal{H}).$$

It follows that $\Pi_r^{\mathrm{U}_{\mathrm{res}}}(h)(\cdot, \beta) = 0$ whenever $\beta \in \mathfrak{h}^0$. By skew-symmetry of $\Pi_r^{\mathrm{U}_{\mathrm{res}}}$, one also has $\Pi_r^{\mathrm{U}_{\mathrm{res}}}(h)(\alpha, \cdot) = 0$ whenever $\alpha \in \mathfrak{h}^0$. This allows to define the following map

$$\Pi_r^H : H \rightarrow \Lambda^2 \mathbb{H}_e^*$$

by

$$\Pi_r^H(h)([\alpha]_{\mathfrak{h}^0}, [\beta]_{\mathfrak{h}^0}) := \Pi_r^{\mathrm{U}_{\mathrm{res}}}(h)(\alpha, \beta)$$

for $\alpha, \beta \in \mathfrak{g}_+ = L_{1,2}(\mathcal{H})/\mathfrak{u}_{1,2}$. Set $\pi_g^H := R_g^{**}\Pi_r^H$. The Jacobi identity for π^H follows from the Jacobi identity for $\pi^{\mathrm{U}_{\mathrm{res}}}$. By construction, the injection $\iota : H \hookrightarrow \mathrm{U}_{\mathrm{res}}(\mathcal{H})$ is a Poisson map. \square

7.3.2 The restricted Grassmannian as a quotient Poisson homogeneous space

Theorem 7.3.3. *The restricted Grassmannian $\mathrm{Gr}_{\mathrm{res}}(\mathcal{H}) = \mathrm{U}_{\mathrm{res}}(\mathcal{H})/\mathrm{U}(\mathcal{H}_+) \times \mathrm{U}(\mathcal{H}_-)$ carries a natural Poisson structure $(\mathrm{Gr}_{\mathrm{res}}(\mathcal{H}), T^*\mathrm{Gr}_{\mathrm{res}}(\mathcal{H}), \pi^{\mathrm{Gr}_{\mathrm{res}}})$ such that:*

1. *the canonical projection $p : \mathrm{U}_{\mathrm{res}}(\mathcal{H}) \rightarrow \mathrm{Gr}_{\mathrm{res}}(\mathcal{H})$ is a Poisson map,*
2. *the natural action $\mathrm{U}_{\mathrm{res}}(\mathcal{H}) \times \mathrm{Gr}_{\mathrm{res}}(\mathcal{H}) \rightarrow \mathrm{Gr}_{\mathrm{res}}(\mathcal{H})$ by left translations is a Poisson map.*

Proof. 1. The tangent space at $eH \in \mathrm{Gr}_{\mathrm{res}}(\mathcal{H}) = \mathrm{U}_{\mathrm{res}}(\mathcal{H})/\mathrm{U}(\mathcal{H}_+) \times \mathrm{U}(\mathcal{H}_-)$ can be identified with the quotient Banach space $\mathfrak{u}_{\mathrm{res}}(\mathcal{H})/(\mathfrak{u}(\mathcal{H}_+) \oplus \mathfrak{u}(\mathcal{H}_-))$ which is isomorphic to the Hilbert space

$$\mathfrak{m} := \left\{ \begin{pmatrix} 0 & A \\ -A^* & 0 \end{pmatrix} \in \mathfrak{u}_2(\mathcal{H}) \right\}.$$

The duality pairing between $\mathfrak{u}_{\mathrm{res}}(\mathcal{H})$ and $\mathfrak{g}_+ = L_{1,2}(\mathcal{H})/\mathfrak{u}_{1,2}(\mathcal{H})$ induces a strong duality pairing between the quotient space $\mathfrak{u}_{\mathrm{res}}(\mathcal{H})/(\mathfrak{u}(\mathcal{H}_+) \oplus \mathfrak{u}(\mathcal{H}_-)) = \mathfrak{m}$ and $\mathfrak{h}^0 \subset \mathfrak{g}_+$. For $\alpha, \beta \in T_{gH}^*\mathrm{Gr}_{\mathrm{res}}(\mathcal{H})$, identify $p^*\alpha \in T_g^*\mathrm{U}_{\mathrm{res}}(\mathcal{H})$ with an element $L_{g^{-1}x_1}^*$ in $L_{g^{-1}}^*\mathfrak{h}^0$, and $p^*\beta$ with $L_{g^{-1}x_2}^*$ in $L_{g^{-1}}^*\mathfrak{h}^0$. Define

$$\pi_{gH}^{\mathrm{Gr}_{\mathrm{res}}}(\alpha, \beta) = \pi_g^{\mathrm{U}_{\mathrm{res}}}(p^*\alpha, p^*\beta).$$

We have to check that the right hand side is invariant by the natural right action of H on $\mathrm{U}_{\mathrm{res}}(\mathcal{H})$, which induces an action of H on forms in $T_g^*\mathrm{U}_{\mathrm{res}}(\mathcal{H})$ by $\gamma \rightarrow R_{h^{-1}}^*\gamma \in T_{gh}^*\mathrm{U}_{\mathrm{res}}(\mathcal{H})$. In other words, we have to check that

$$\pi_g^{\mathrm{U}_{\mathrm{res}}}((p^*\alpha)_g, (p^*\beta)_g) = \pi_{gh}^{\mathrm{U}_{\mathrm{res}}}(R_{h^{-1}}^*(p^*\alpha)_g, R_{h^{-1}}^*(p^*\beta)_g) \quad (7.19)$$

$$\Leftrightarrow \pi_g^{\mathrm{U}_{\mathrm{res}}}(L_{g^{-1}x_1}^*, L_{g^{-1}x_2}^*) = \pi_{gh}^{\mathrm{U}_{\mathrm{res}}}(R_{h^{-1}}^*L_{g^{-1}x_1}^*, R_{h^{-1}}^*L_{g^{-1}x_2}^*)$$

$$\Leftrightarrow \Pi_r^{\mathrm{U}_{\mathrm{res}}}(g)(\mathrm{Ad}_{g^{-1}}^*x_1, \mathrm{Ad}_{g^{-1}}^*x_2) = \Pi_r^{\mathrm{U}_{\mathrm{res}}}(gh)(R_{gh}^*R_{h^{-1}}^*L_{g^{-1}x_1}^*, R_{gh}^*R_{h^{-1}}^*L_{g^{-1}x_2}^*)$$

Note that $R_{gh}^*\gamma(X) = \gamma(R_{gh}X) = \gamma(Xgh) = R_h^*\gamma(Xg) = R_g^*R_h^*\gamma(X)$. Therefore $R_{gh}^* = R_g^*R_h^*$. It follows that (7.19) is equivalent to

$$\Pi_r^{\mathrm{U}_{\mathrm{res}}}(g)(\mathrm{Ad}_{g^{-1}}^*x_1, \mathrm{Ad}_{g^{-1}}^*x_2) = \Pi_r^{\mathrm{U}_{\mathrm{res}}}(gh)(\mathrm{Ad}_{g^{-1}}^*x_1, \mathrm{Ad}_{g^{-1}}^*x_2)$$

By the cocycle identity $\Pi_r^{\mathrm{U}_{\mathrm{res}}}(gh) = \mathrm{Ad}(g)^*\Pi_r^{\mathrm{U}_{\mathrm{res}}}(h) + \Pi_r^{\mathrm{U}_{\mathrm{res}}}(g)$, one has

$$\begin{aligned} \Pi_r^{\mathrm{U}_{\mathrm{res}}}(gh)(\mathrm{Ad}_{g^{-1}}^*x_1, \mathrm{Ad}_{g^{-1}}^*x_2) &= \Pi_r^{\mathrm{U}_{\mathrm{res}}}(h)(\mathrm{Ad}_g^*\mathrm{Ad}_{g^{-1}}^*x_1, \mathrm{Ad}_g^*\mathrm{Ad}_{g^{-1}}^*x_2) \\ &\quad + \Pi_r^{\mathrm{U}_{\mathrm{res}}}(g)(\mathrm{Ad}_{g^{-1}}^*x_1, \mathrm{Ad}_{g^{-1}}^*x_2) \end{aligned}$$

Since $\Pi_r^{\text{Ures}}(h)$ vanishes on \mathfrak{h}^0 , one has

$$\Pi_r^{\text{Ures}}(h)(\text{Ad}_{h^{-1}}^*x_1, \text{Ad}_{h^{-1}}^*x_2) = 0,$$

therefore equation (7.19) is satisfied. The Jacobi identity for $\pi^{Gr_{\text{res}}}$ follows from the Jacobi identity for π^{Ures} . Moreover p is a Poisson map by construction.

2. Consider the action

$$\begin{aligned} a_U : \text{Ures}(\mathcal{H}) \times \text{Gr}_{\text{res}}(\mathcal{H}) &\rightarrow \text{Gr}_{\text{res}}(\mathcal{H}) \\ (g_1, gH) &\mapsto g_1gH \end{aligned}$$

by left translations. Note that the tangent map to a_U is given by

$$\begin{aligned} T_{(g_1, gH)}a_U : T_{g_1}\text{Ures}(\mathcal{H}) \oplus T_{gH}\text{Gr}_{\text{res}}(\mathcal{H}) &\rightarrow T_{g_1gH}\text{Gr}_{\text{res}}^0(\mathcal{H}) \\ (X_{g_1}, X_{gH}) &\mapsto p_*[(R_g)_*X_{g_1}] + (L_{g_1})_*X_{gH}. \end{aligned}$$

Therefore, for any $\alpha \in T_{g_1gH}^*\text{Gr}_{\text{res}}(\mathcal{H})$,

$$\begin{aligned} \alpha \circ T_{(g_1, gH)}a_U(X_{g_1}, X_{gH}) &= \alpha(p_*[(R_g)_*X_{g_1}]) + \alpha((L_{g_1})_*X_{gH}) \\ &= R_g^*p^*\alpha(X_{g_1}) + L_{g_1}^*\alpha(X_{gH}). \end{aligned}$$

In other words

$$\alpha \circ T_{(g_1, gH)}a_U = R_g^*p^*\alpha + L_{g_1}^*\alpha,$$

where $R_g^*p^*\alpha \in T_{g_1}\text{Ures}(\mathcal{H})$ and $L_{g_1}^*\alpha \in T_{gH}\text{Gr}_{\text{res}}(\mathcal{H})$. In order to show that a_U is a Poisson map, we have to show that

(a) for any $\alpha \in T_{g_1gH}^*\text{Gr}_{\text{res}}(\mathcal{H})$, the covector $R_g^*p^*\alpha$ belongs to

$$\mathbb{U}_{g_1} = R_{(g_1)^{-1}}^*L_{1,2}(\mathcal{H})/\mathfrak{u}_{1,2}(\mathcal{H}),$$

(b) the Poisson tensors π^{Ures} and $\pi^{Gr_{\text{res}}}$ are related by

$$\pi_{g_1gH}^{Gr_{\text{res}}}(\alpha, \beta) = \pi_{g_1}^{\text{Ures}}(R_g^*p^*\alpha, R_g^*p^*\beta) + \pi_{gH}^{Gr_{\text{res}}}(L_{g_1}^*\alpha, L_{g_1}^*\beta).$$

For point (a), let us show that for $\alpha \in T_{g_1gH}^*\text{Gr}_{\text{res}}(\mathcal{H})$, and $g_1, g \in \text{Ures}(\mathcal{H})$, one has $R_{g_1}^*R_g^*p^*\alpha \in L_{1,2}(\mathcal{H})/\mathfrak{u}_{1,2}(\mathcal{H})$. Recall that $p^*\alpha$ can be identified with an element $L_{(g_1g)^{-1}}^*x_1$ where $x_1 \in \mathfrak{h}^0$. Therefore $R_{g_1}^*R_g^*p^*\alpha = \text{Ad}_{(g_1g)^{-1}}^*x_1$. For $X \in T_e\text{Ures}(\mathcal{H})$, one has

$$\begin{aligned} R_{g_1}^*R_g^*p^*\alpha(X) &= \mathfrak{S}\text{Tr } x_1 \text{Ad}_{(g_1g)^{-1}}(X) = \mathfrak{S}\text{Tr } x_1 (g_1g)^{-1} X g_1g \\ &= \mathfrak{S}\text{Tr } g_1g x_1 (g_1g)^{-1} X. \end{aligned}$$

Since $g_1g x_1 (g_1g)^{-1} \in L_{1,2}(\mathcal{H})$ for any $g_1, g \in \text{Ures}(\mathcal{H})$ and $x_1 \in L_{1,2}(\mathcal{H})$, it follows that $R_{g_1}^*R_g^*p^*\alpha \in L_{1,2}(\mathcal{H})/\mathfrak{u}_{1,2}(\mathcal{H})$.

In order to prove (b), we will use the cocycle identity. Note that for $\alpha, \beta \in T_{g_1gH}^*\text{Gr}_{\text{res}}(\mathcal{H})$, one has

$$\begin{aligned} \pi_{g_1gH}^{Gr_{\text{res}}}(\alpha, \beta) &= \pi_{g_1g}^{\text{Ures}}(p^*\alpha, p^*\beta) = \Pi_r^{\text{Ures}}(g_1g)(R_{g_1g}^*p^*\alpha, R_{g_1g}^*p^*\beta) \\ &= \text{Ad}(g_1)^*\Pi_r^{\text{Ures}}(g)(R_{g_1g}^*p^*\alpha, R_{g_1g}^*p^*\beta) + \Pi_r^{\text{Ures}}(g_1)(R_{g_1g}^*p^*\alpha, R_{g_1g}^*p^*\beta) \\ &= \Pi_r^{\text{Ures}}(g)(L_{g_1}^*R_g^*p^*\alpha, L_{g_1}^*R_g^*p^*\beta) + \Pi_r^{\text{Ures}}(g_1)(R_{g_1}^*R_g^*p^*\alpha, R_{g_1}^*R_g^*p^*\beta) \\ &= \pi_g^{\text{Ures}}(L_{g_1}^*p^*\alpha, L_{g_1}^*p^*\beta) + \pi_{g_1}^{\text{Ures}}(R_g^*p^*\alpha, R_g^*p^*\beta) \\ &= \pi_g^{\text{Ures}}(p^*L_{g_1}^*\alpha, p^*L_{g_1}^*\beta) + \pi_{g_1}^{\text{Ures}}(R_g^*p^*\alpha, R_g^*p^*\beta) \\ &= \pi_{gH}^{Gr_{\text{res}}}(L_{g_1}^*\alpha, L_{g_1}^*\beta) + \pi_{g_1}^{\text{Ures}}(R_g^*p^*\alpha, R_g^*p^*\beta). \end{aligned}$$

Hence the left action of $\text{Ures}(\mathcal{H})$ on $\text{Gr}_{\text{res}}(\mathcal{H})$ is a Poisson map. \square

7.4 Poisson action of $B_{\text{res}}^+(\mathcal{H})$ on $\text{Gr}_{\text{res}}(\mathcal{H})$ and Schubert cells

7.4.1 Poisson action of $B_{\text{res}}^\pm(\mathcal{H})$ on $\text{Gr}_{\text{res}}(\mathcal{H})$

The next Theorem shows that the action of $B_{\text{res}}^\pm(\mathcal{H})$ on $\text{Gr}_{\text{res}}(\mathcal{H})$ is a Poisson map, where $B_{\text{res}}^\pm(\mathcal{H})$ is endowed with the Banach Poisson–Lie group structure defined in Section 7.2, and where $\text{Gr}_{\text{res}}(\mathcal{H})$ is endowed with the Bruhat–Poisson structure defined in Section 7.3.

Theorem 7.4.1. *The following right action of $B_{\text{res}}^\pm(\mathcal{H})$ on $\text{Gr}_{\text{res}}(\mathcal{H}) = \text{GL}_{\text{res}}(\mathcal{H})/P_{\text{res}}(\mathcal{H})$ is a Poisson map:*

$$a_B : \text{Gr}_{\text{res}}(\mathcal{H}) \times B_{\text{res}}^\pm(\mathcal{H}) \rightarrow \text{Gr}_{\text{res}}(\mathcal{H}) \\ (gP_{\text{res}}(\mathcal{H}), b) \mapsto (b^{-1}g)P_{\text{res}}(\mathcal{H}).$$

Proof. The tangent map to the action a_B reads

$$T_{(gH,b)}a_B : T_{gH}\text{Gr}_{\text{res}}(\mathcal{H}) \oplus T_b B_{\text{res}}^\pm(\mathcal{H}) \rightarrow T_{b^{-1}gP_{\text{res}}}\text{Gr}_{\text{res}}(\mathcal{H}) \\ (X_{gH}, X_b) \mapsto (L_{(b^{-1})})*X_{gH} - p_*(R_g)_*(b^{-1}X_b b^{-1}).$$

Therefore, for any $\alpha \in T_{b^{-1}gP_{\text{res}}}\text{Gr}_{\text{res}}(\mathcal{H})$,

$$\alpha \circ T_{(gH,b)}a_B(X_{gH}, X_b) = \alpha((L_{(b^{-1})})*X_{gH}) - \alpha(p_*(R_g)_*b^{-1}X_b b^{-1}) \\ = L_{b^{-1}}^*\alpha(X_{gH}) - R_{b^{-1}}^*L_{b^{-1}}^*R_g^*p^*\alpha(X_b),$$

and

$$\alpha \circ T_{(gH,b)}a_B = L_{b^{-1}}^*\alpha - R_{b^{-1}}^*L_{b^{-1}}^*R_g^*p^*\alpha,$$

where $L_{b^{-1}}^*\alpha \in T_{gH}\text{Gr}_{\text{res}}(\mathcal{H})$ and $R_{b^{-1}}^*L_{b^{-1}}^*R_g^*p^*\alpha \in T_b B_{\text{res}}^\pm(\mathcal{H})$.

- (a) Let us show that for any $\alpha \in T_{b^{-1}gP_{\text{res}}}\text{Gr}_{\text{res}}(\mathcal{H})$ and any $b \in B_{\text{res}}^\pm(\mathcal{H})$, the form $R_{b^{-1}}^*L_{b^{-1}}^*R_g^*p^*\alpha$ belongs to $\mathbb{B}_b = R_{b^{-1}}^*L_{1,2}(\mathcal{H})/\mathfrak{b}_{1,2}(\mathcal{H})$. Recall that α can be identified with an element $L_{(b^{-1}g)^{-1}}^*x_1$ where $x_1 \in \mathfrak{h}^0$. For $X \in T_e B_{\text{res}}^\pm(\mathcal{H})$, one has

$$L_{b^{-1}}^*R_g^*p^*\alpha(X) = \alpha(p_*R_{g^*}(L_{b^{-1}})_*X) = \Im\text{Tr } x_1(L_{g^{-1}b})_*p_*R_{g^*}(L_{b^{-1}})_*X \\ = \Im\text{Tr } x_1p_*(\text{Ad}(g^{-1})X) = \Im\text{Tr } p_{\mathfrak{b}_2^+}(x_1)g^{-1}Xg \\ = \Im\text{Tr } gp_{\mathfrak{b}_2^+}(x_1)g^{-1}X.$$

Recall that for $x_1 = \begin{pmatrix} A & B \\ C & D \end{pmatrix} \in \mathfrak{h}^0$, $p_{\mathfrak{b}_2^+}(x_1) = \begin{pmatrix} 0 & B+C^* \\ 0 & 0 \end{pmatrix}$. Since for any $g \in GL_{\text{res}}(\mathcal{H})$ and any $x_1 \in \mathfrak{h}^0$, $gp_{\mathfrak{b}_2^+}(x_1)g^{-1} \in L_{1,2}(\mathcal{H})$, the form $R_{b^{-1}}^*L_{b^{-1}}^*R_g^*p^*\alpha$ belongs to \mathbb{B}_b .

- (b) Let us show that the Poisson tensors $\pi_{B_{\text{res}}^+}$ and $\pi_{Gr_{\text{res}}}$ are related by

$$\pi_{b^{-1}gP_{\text{res}}}^{Gr_{\text{res}}}(\alpha, \beta) = \pi_{gH}^{Gr_{\text{res}}}(L_{b^{-1}}^*\alpha, L_{b^{-1}}^*\beta) + \pi_b^{B_{\text{res}}^+}(R_{b^{-1}}^*L_{b^{-1}}^*R_g^*p^*\alpha, R_{b^{-1}}^*L_{b^{-1}}^*R_g^*p^*\beta).$$

One has

$$\pi_b^{B_{\text{res}}^+}(R_{b^{-1}}^*L_{b^{-1}}^*R_g^*p^*\alpha, R_{b^{-1}}^*L_{b^{-1}}^*R_g^*p^*\beta) = \Pi_r^{B_{\text{res}}^+}(b)([gp_{\mathfrak{b}_2^+}(x_1)g^{-1}]_{\mathfrak{b}_{1,2}^+}, [gp_{\mathfrak{b}_2^+}(x_2)g^{-1}]_{\mathfrak{b}_{1,2}^+}) \\ = \Im\text{Tr} \left(b^{-1}p_{\mathfrak{u}_2^+}(gp_{\mathfrak{b}_2^+}(x_1)g^{-1})b \right) \left[p_{\mathfrak{b}_2^+}(b^{-1}p_{\mathfrak{u}_2^+}(gp_{\mathfrak{b}_2^+}(x_2)g^{-1})b) \right] \\ = \Im\text{Tr } p_{\mathfrak{u}_2^+}(gp_{\mathfrak{b}_2^+}(x_1)g^{-1})b \left[p_{\mathfrak{b}_2^+}(b^{-1}p_{\mathfrak{u}_2^+}(gp_{\mathfrak{b}_2^+}(x_2)g^{-1})b) \right] b^{-1} \\ = \Im\text{Tr} (b^{-1}gp_{\mathfrak{b}_2^+}(x_1)g^{-1}b) \left[p_{\mathfrak{b}_2^+}(b^{-1}p_{\mathfrak{u}_2^+}(gp_{\mathfrak{b}_2^+}(x_2)g^{-1})b) \right] \\ = \Im\text{Tr} (b^{-1}gp_{\mathfrak{b}_2^+}(x_1)g^{-1}b) \left[p_{\mathfrak{b}_2^+}(b^{-1}gp_{\mathfrak{b}_2^+}(x_2)g^{-1}b) \right] \\ - \Im\text{Tr} (b^{-1}gp_{\mathfrak{b}_2^+}(x_1)g^{-1}b) \left[p_{\mathfrak{b}_2^+}(b^{-1}p_{\mathfrak{b}_2^+}(gp_{\mathfrak{b}_2^+}(x_2)g^{-1})b) \right]$$

Therefore

$$\pi_b^{B_{\text{res}}^+}(R_{b^{-1}}^*L_{b^{-1}}^*R_g^*p^*\alpha, R_{b^{-1}}^*L_{b^{-1}}^*R_g^*p^*\beta) = \\ \Im\text{Tr} (b^{-1}gp_{\mathfrak{b}_2^+}(x_1)g^{-1}b) \left[p_{\mathfrak{b}_2^+}(b^{-1}gp_{\mathfrak{b}_2^+}(x_2)g^{-1}b) \right] - \Im\text{Tr} (gp_{\mathfrak{b}_2^+}(x_1)g^{-1}) \left[p_{\mathfrak{b}_2^+}(gp_{\mathfrak{b}_2^+}(x_2)g^{-1}) \right]. \quad (7.20)$$

On the other hand

$$\begin{aligned}
\pi_{gH}^{Gr_{\text{res}}}(L_{b^{-1}}^* \alpha, L_{b^{-1}}^* \beta) &= \Pi_r^{\text{U}_{\text{res}}}(g)([gp_{\mathfrak{b}_2^+}(x_1)g^{-1}], [gp_{\mathfrak{b}_2^+}(x_2)g^{-1}]) \\
&= \Im \text{Tr}(g^{-1}p_{\mathfrak{b}_2^+}(gp_{\mathfrak{b}_2^+}(x_1)g^{-1})g) \left[p_{\mathfrak{u}_2^+}(g^{-1}p_{\mathfrak{b}_2^+}(gp_{\mathfrak{b}_2^+}(x_1)g^{-1})g) \right] \\
&= \Im \text{Tr} p_{\mathfrak{b}_2^+}(x_1) \left[p_{\mathfrak{u}_2^+}(g^{-1}p_{\mathfrak{b}_2^+}(gp_{\mathfrak{b}_2^+}(x_1)g^{-1})g) \right] \\
&= \Im \text{Tr} p_{\mathfrak{b}_2^+}(x_1)(g^{-1}p_{\mathfrak{b}_2^+}(gp_{\mathfrak{b}_2^+}(x_1)g^{-1})g) \\
&= \Im \text{Tr} gp_{\mathfrak{b}_2^+}(x_1)g^{-1}p_{\mathfrak{b}_2^+}(gp_{\mathfrak{b}_2^+}(x_1)g^{-1})
\end{aligned}$$

which is the second term in the right hand side of equation (7.20) with the opposite sign. Moreover, since

$$\text{Gr}_{\text{res}}(\mathcal{H}) = \text{GL}_{\text{res}}(\mathcal{H}) / P_{\text{res}}(\mathcal{H}) = \text{U}_{\text{res}}(\mathcal{H}) / (\text{U}(\mathcal{H}_+) \times \text{U}(\mathcal{H}_-))$$

there exist $g_1 \in \text{U}_{\text{res}}(\mathcal{H})$ and $p_1 \in P_{\text{res}}(\mathcal{H})$ such that $b^{-1}g = g_1p_1$. In fact, the pair (g_1, p_1) is defined modulo the right action by H given by $(g_1, p_1) \cdot h = (g_1h, h^{-1}p_1)$. It follows that the first term in the right hand side of equation (7.20) reads

$$\begin{aligned}
&\Im \text{Tr}(b^{-1}gp_{\mathfrak{b}_2^+}(x_1)g^{-1}b) \left[p_{\mathfrak{b}_2^+}(b^{-1}gp_{\mathfrak{b}_2^+}(x_2)g^{-1}b) \right] \\
&= \Im \text{Tr}(g_1p_1p_{\mathfrak{b}_2^+}(x_1)p_1^{-1}g_1^{-1}) \left[p_{\mathfrak{b}_2^+}(g_1p_1p_{\mathfrak{b}_2^+}(x_2)p_1^{-1}g_1^{-1}) \right]
\end{aligned}$$

Recall that for any $x_1 = \begin{pmatrix} A & B \\ C & D \end{pmatrix} \in \mathfrak{h}^0$, one has

$$x_1 = \begin{pmatrix} A & -C^* \\ C & D \end{pmatrix} + \begin{pmatrix} 0 & B+C^* \\ 0 & 0 \end{pmatrix},$$

with $p_{\mathfrak{u}_2^+}(x_1) = \begin{pmatrix} A & -C^* \\ C & D \end{pmatrix}$ and $p_{\mathfrak{b}_2^+}(x_1) = \begin{pmatrix} 0 & B+C^* \\ 0 & 0 \end{pmatrix}$. Note that for any $p_1 = \begin{pmatrix} P_1 & P_2 \\ 0 & P_3 \end{pmatrix} \in P_{\text{res}}(\mathcal{H})$, one has

$$p_1^{-1} = \begin{pmatrix} P_1^{-1} & -P_1^{-1}P_2P_3^{-1} \\ 0 & P_3^{-1} \end{pmatrix} \in P_{\text{res}}(\mathcal{H}),$$

and

$$p_1p_{\mathfrak{b}_2^+}(x_1)p_1^{-1} = \begin{pmatrix} 0 & P_1(B+C^*)P_3^{-1} \\ 0 & 0 \end{pmatrix} \in \mathfrak{b}_2^+(\mathcal{H}).$$

Therefore

$$\begin{aligned}
&\Im \text{Tr}(b^{-1}gp_{\mathfrak{b}_2^+}(x_1)g^{-1}b) \left[p_{\mathfrak{b}_2^+}(b^{-1}gp_{\mathfrak{b}_2^+}(x_2)g^{-1}b) \right] \\
&= \Im \text{Tr}(g_1p_1p_{\mathfrak{b}_2^+}(x_1)p_1^{-1}g_1^{-1}) \left[p_{\mathfrak{b}_2^+}(g_1p_1p_{\mathfrak{b}_2^+}(x_2)p_1^{-1}g_1^{-1}) \right] \\
&= \Pi_r^{\text{U}_{\text{res}}}(g_1)([g_1p_1p_{\mathfrak{b}_2^+}(x_1)p_1^{-1}g_1^{-1}], [g_1p_1p_{\mathfrak{b}_2^+}(x_2)p_1^{-1}g_1^{-1}]) \\
&= \Pi_r^{\text{U}_{\text{res}}}(g_1)([b^{-1}gp_{\mathfrak{b}_2^+}(x_1)g^{-1}b], [b^{-1}gp_{\mathfrak{b}_2^+}(x_2)g^{-1}b]) \\
&= \pi_{g_1H}^{Gr_{\text{res}}}(\alpha, \beta) = \pi_{b^{-1}gP_{\text{res}}}^{Gr_{\text{res}}}(\alpha, \beta).
\end{aligned}$$

It follows that the right action of $B_{\text{res}}^+(\mathcal{H})$ on $\text{Gr}_{\text{res}}(\mathcal{H})$ is a Poisson map. \square

7.4.2 Schubert cells as symplectic leaves of the restricted Grassmannian

In this section, \mathcal{H} will be specified to be the space $L^2(\mathbb{S}^1, \mathbb{C})$ of complex square-integrable functions defined almost everywhere on the unit circle $\mathbb{S}^1 = \{z \in \mathbb{C}, |z| = 1\}$ modulo the equivalence relation that identifies two functions that are equal almost everywhere. In that case, the inner product of two elements f and g in $L^2(\mathbb{S}^1, \mathbb{C})$ reads $\langle f, g \rangle = \int_{\mathbb{S}^1} \overline{f(z)}g(z)d\mu(z)$, where $d\mu(z)$ denotes the Lebesgue measure on the circle. Let us recall some geometric facts about the restricted Grassmannian that were established in [172], Chapter 7. Set $\mathcal{H}_+ = \text{span}\{z^n, n \geq 0\}$ and $\mathcal{H}_- = \text{span}\{z^n, n < 0\}$.

The restricted Grassmannian admits a stratification $\{\Sigma_S, S \in \mathcal{S}\}$ as well as a decomposition into Schubert cells $\{\mathcal{C}_S, S \in \mathcal{S}\}$, which are dual to each other in the following sense:

- (i) the same set \mathcal{S} indexes the cells $\{\mathcal{C}_S\}$ and the strata $\{\Sigma_S\}$;
- (ii) the dimension of \mathcal{C}_S is the codimension of Σ_S ;
- (iii) \mathcal{C}_S meets Σ_S transversally in a single point, and meets no other stratum of the same codimension.

A element S of the set \mathcal{S} is a subset of \mathbb{Z} , which is bounded from below and contains all sufficiently large integers. Given $S \in \mathcal{S}$, define the subspace \mathcal{H}_S of the restricted Grassmannian $\text{Gr}_{\text{res}}(\mathcal{H})$ by:

$$\mathcal{H}_S = \overline{\text{span}\{z^s, s \in S\}}.$$

Recall the following Proposition:

Proposition 7.4.2 (Proposition 7.1.6 in [172]). *For any $W \in \text{Gr}_{\text{res}}(\mathcal{H})$ there is a set $S \in \mathcal{S}$ such that the orthogonal projection $W \rightarrow \mathcal{H}_S$ is an isomorphism. In other words the sets $\{\mathcal{U}_S, S \in \mathcal{S}\}$, where*

$$\mathcal{U}_S = \{W \in \text{Gr}_{\text{res}}(\mathcal{H}), \text{ the orthogonal projection } W \rightarrow \mathcal{H}_S \text{ is an isomorphism}\},$$

form an open covering of $\text{Gr}_{\text{res}}(\mathcal{H})$.

Following [172], let us introduce the Banach Lie groups $N_{\text{res}}^+(\mathcal{H})$ and $N_{\text{res}}^-(\mathcal{H})$:

$$N_{\text{res}}^+(\mathcal{H}) = \{A \in \text{GL}_{\text{res}}(\mathcal{H}), A(z^k \mathcal{H}_+) = z^k \mathcal{H}_+ \text{ and } (A - \text{Id})(z^k \mathcal{H}_+) \subset z^{k+1} \mathcal{H}_+, \forall k \in \mathbb{Z}\},$$

$$N_{\text{res}}^-(\mathcal{H}) = \{A \in \text{GL}_{\text{res}}(\mathcal{H}), A(z^k \mathcal{H}_-) = z^k \mathcal{H}_- \text{ and } (A - \text{Id})(z^k \mathcal{H}_-) \subset z^{k+1} \mathcal{H}_-, \forall k \in \mathbb{Z}\}.$$

In other words, the group $N_{\text{res}}^\pm(\mathcal{H})$ is the subgroup of $B_{\text{res}}^\pm(\mathcal{H})$ consisting of the triangular operators with respect to the basis $\{|n\rangle := z^n, n \in \mathbb{Z}\}$ which have only 1's on the diagonal.

Proposition 7.4.3. *The Banach Lie group $N_{\text{res}}^\pm(\mathcal{H})$ is a normal subgroup of $B_{\text{res}}^\pm(\mathcal{H})$ and the quotient group $B_{\text{res}}^\pm(\mathcal{H})/N_{\text{res}}^\pm(\mathcal{H})$ is isomorphic to the group of bounded linear positive definite operators which are diagonal with respect to the orthonormal basis $\{|z^k\rangle, k \in \mathbb{Z}\}$.*

Proof. For a triangular operator $g \in B_{\text{res}}^\pm(\mathcal{H})$, the diagonal coefficients of g and g^{-1} are inverses of each other: $\langle n|g^{-1}n\rangle = \langle n|gn\rangle^{-1}, \forall n \in \mathbb{Z}$. Therefore, for any element $h \in N_{\text{res}}^\pm(\mathcal{H})$, the composed operator ghg^{-1} has only 1's on it's diagonal and belong to $N_{\text{res}}^\pm(\mathcal{H})$. This implies that $N_{\text{res}}^\pm(\mathcal{H})$ is a normal subgroup of $B_{\text{res}}^\pm(\mathcal{H})$. Recall that D denotes the linear transformation consisting in taking the diagonal part of a linear operator (see equation (6.7)). Since $|\langle n|D(A)m\rangle| \leq \|A\|$ and $D(A)$ is diagonal, the linear transformation D maps bounded operators to bounded operators. By the definition of $B_{\text{res}}^\pm(\mathcal{H})$, the range of $D : B_{\text{res}}^\pm(\mathcal{H}) \rightarrow L_\infty(\mathcal{H})$ is the group of bounded linear positive definite operators which are diagonal with respect to the orthonormal basis $\{|z^k\rangle : k \in \mathbb{Z}\}$. Moreover, the kernel of $D : B_{\text{res}}^\pm(\mathcal{H}) \rightarrow L_\infty(\mathcal{H})$ is exactly $N_{\text{res}}^\pm(\mathcal{H})$. \square

Proposition 7.4.4. (i) *The cell \mathcal{C}_S is the orbit of \mathcal{H}_S under $B_{\text{res}}^+(\mathcal{H})$.*

(ii) *The stratum Σ_S is the orbit of \mathcal{H}_S under $B_{\text{res}}^-(\mathcal{H})$.*

Proof. It follows from Proposition 7.4.1 in [172], that the cell \mathcal{C}_S is the orbit of \mathcal{H}_S under $N_{\text{res}}^+(\mathcal{H})$. Symmetrically, it follows from Proposition 7.3.3 in [172], that the stratum Σ_S is the orbit of \mathcal{H}_S under $N_{\text{res}}^-(\mathcal{H})$. Since the diagonal part of an operator in $B_{\text{res}}^\pm(\mathcal{H})$ acts trivially, one gets the same result replacing $N_{\text{res}}^\pm(\mathcal{H})$ by $B_{\text{res}}^\pm(\mathcal{H})$. \square

Recall that the restricted Grassmannian is a Hilbert manifold endowed with the Poisson structure constructed in Theorem 7.3.3. In this Hilbert context, the Poisson tensor $\pi^{Gr_{\text{res}}}$ defines a bundle map $(\pi^{Gr_{\text{res}}})^\sharp : T^* \text{Gr}_{\text{res}}(\mathcal{H}) \rightarrow T \text{Gr}_{\text{res}}(\mathcal{H})$. The range of this map is called the **characteristic distribution** of the Poisson structure, and the maximal integral submanifolds of this distribution are called **symplectic leaves** (see [156] Section 7 for a general discussion on characteristic distributions and symplectic leaves in the Banach context).

Theorem 7.4.5. *The Schubert cells $\{\mathcal{C}_S, S \in \mathcal{S}\}$ are the symplectic leaves of $\text{Gr}_{\text{res}}(\mathcal{H})$.*

Proof. The integrability of the characteristic distribution follows from Theorem 6 in [167], since $\text{Gr}_{\text{res}}(\mathcal{H})$ is a Hilbert manifold. The fact that the symplectic leaves are the orbits of $B_{\text{res}}^\pm(\mathcal{H})$ follows from the construction as in the finite-dimensional case (see Theorem 4.6 (3) in [136]). It follows from Proposition 7.4.4 that the orbits of $B_{\text{res}}^\pm(\mathcal{H})$ coincide with the Schubert cells $\{\mathcal{C}_S, S \in \mathcal{S}\}$. \square

7.5 Relation between the restricted Grassmannian and the KdV hierarchy

Let us recall the construction of G. Segal and G. Wilson explained in [185] which gives a correspondence between some elements of the restricted Grassmannian $\text{Gr}_{\text{res}}(\mathcal{H})$ and solutions of the KdV hierarchy.

Let Γ^+ be the group of real-analytic functions $g : \mathbb{S}^1 \rightarrow \mathbb{C}^*$, which extend to holomorphic functions g from the unit disc $\mathbb{D} = \{z \in \mathbb{C} : |z| \leq 1\}$ to \mathbb{C}^* , satisfying $g(0) = 1$. Any such function $g \in \Gamma^+$ can be written $g = e^f$, where f is a holomorphic function on \mathbb{D} such that $f(0) = 0$.

Proposition 7.5.1. *The group Γ^+ acts by multiplication operators on \mathcal{H} and $\Gamma^+ \subset \text{B}_{\text{res}}^+(\mathcal{H})$. Consequently Γ^+ acts on the restricted Grassmannian.*

Proof. By Proposition 2.3 in [185], $\Gamma^+ \subset \text{GL}_{\text{res}}(\mathcal{H}) := \text{GL}(\mathcal{H}) \cap \text{L}_{\text{res}}(\mathcal{H})$. Since $g \in \Gamma^+$ is holomorphic in \mathbb{D} and satisfies $g(0) = 1$, the Fourier decomposition of g reads $g(z) = 1 + \sum_{k>0} g_k z^k$. Therefore $g(z) \cdot z^n = z^n + \sum_{k>0} g_k z^{k+n}$. It follows that the multiplication operator by g is an upper triangular operator $M_g \in \text{B}_{\text{res}}^+(\mathcal{H})$, with diagonal elements equal to 1. \square

Following [185] (see Proposition 5.13), we will see that the action of Γ^+ on (some subgrassmannians of) $\text{Gr}_{\text{res}}(\mathcal{H})$ generates the KdV hierarchy. Denote by $\text{Gr}^{(n)}$ the subset of the restricted Grassmannian $\text{Gr}_{\text{res}}(\mathcal{H})$ given by

$$\text{Gr}^{(n)} = \{W \in \text{Gr}_{\text{res}}(\mathcal{H}) : z^n W \subset W\}.$$

Moreover, given a subspace $W \in \text{Gr}_{\text{res}}(\mathcal{H})$, we set

$$\Gamma_W^+ = \{g \in \Gamma^+ : g^{-1}W \cap \mathcal{H}_- = \{0\}\}.$$

Let us now recall the following Proposition (see [58] for more informations on Baker functions).

Proposition 7.5.2 (Proposition 5.1 in [185]). *For each $W \in \text{Gr}_{\text{res}}(\mathcal{H})$, there is a unique function $\Phi_W(g, z)$ called the Baker function of W , defined for $g \in \Gamma_W^+$ and $z \in \mathbb{S}^1$, such that*

- (i) $\Phi_W(g, \cdot) \in W$ for each fixed $g \in \Gamma_W^+$
- (ii) Φ_W has the form

$$\Phi_W = g(z) \left(1 + \sum_1^\infty a_i(g) z^{-i} \right).$$

The coefficients a_i are analytic functions on Γ_W^+ and extend to meromorphic functions on the whole of Γ^+ .

Since any $g \in \Gamma^+$ can be written uniquely as $g(z) = \exp(xz + t_2 z^2 + t_3 z^3 + \dots)$, the Baker function of $W \in \text{Gr}_{\text{res}}(\mathcal{H})$ as the following expression:

$$\Phi_W = \exp(xz + t_2 z^2 + t_3 z^3 + \dots) \left(1 + \sum_1^\infty a_i(g) z^{-i} \right).$$

Now the following Proposition assigns to $W \in \text{Gr}_{\text{res}}(\mathcal{H})$ a hierarchy of differential operators P_r :

Proposition 7.5.3 (Proposition 5.5 in [185]). *Set $D = \frac{\partial}{\partial x}$. For each integer $r \geq 2$, there is a unique differential operator P_r of the form*

$$P_r = D^r + p_{r,2} D^{r-2} + \dots + p_{r,r-1} D + p_{rr}$$

such that

$$\frac{\partial \Phi_W}{\partial t_r} = P_r \Phi_W.$$

Denote by $\mathcal{C}^{(n)}$ the space of all operators P_n associated to subspaces W in $\text{Gr}^{(n)}$ and evaluated at $t_2 = t_3 = \dots = 0$. Then

Proposition 7.5.4 (Proposition 5.13 in [185]). *The action of Γ^+ on $\text{Gr}^{(n)}$ induces an action on the space $\mathcal{C}^{(n)}$. For $r \geq 1$, the flow $W \mapsto \exp(t_r z^r) W$ on $\text{Gr}^{(n)}$ induces the r -th KdV flow on $\mathcal{C}^{(n)}$.*

Bibliography

- [1] R. Abraham, J.E. Marsden, T. Ratiu, *Manifolds, Tensor Analysis, and Applications* (second edition), Applied Mathematical Sciences 75, Springer-Verlag, New York, 1988.
- [2] Abraham, R. and J. E. Marsden [1978], *Foundations of Mechanics*. Benjamin-Cummings Publ. Co, Updated 1985 version, reprinted by Perseus Publishing, second edition.
- [3] V. Adamjan, H. Langer, C. Tretter, Existence and uniqueness of contractive solutions of some Riccati equations, *J. Funct. Anal.* **179** (2001), no. 2, 448–473.
- [4] S. Albeverio, K.A. Makarov, A.K. Motovilov, Graph subspaces and the spectral shift function, *Canad. J. Math.* **55** (2003), no. 3, 449–503.
- [5] Andruchow, E., Larotonda, G., Recht, L.: Finsler geometry and actions of the p -Schatten unitary groups. *Trans. Amer. Math. Soc.* **362**(1), 319–344 (2010)
- [6] J. Arazy, *Some remarks on interpolation theorems and the boundness of the triangular projection in unitary matrix spaces*, *Integral Equations and Operator Theory*, Vol. 1/4, (1978), 453–495.
- [7] A. Arvanitoyeorgos, *An Introduction to Lie Groups and the Geometry of Homogeneous Spaces*, Student Math. Library no. 22, American Math. Society, Providence, R.I., 2003.
- [8] Mathieu Aubry, Ulrich Schlickewei, and Daniel Cremers. The wave kernel signature: A quantum mechanical approach to shape analysis. In *2011 IEEE International Conference on Computer Vision Workshops (ICCV Workshops)*, pages 1626–1633, 2011.
- [9] Tristan Aumentado-Armstrong, Stavros Tsogkas, Allan Jepson, and Sven Dickinson. Geometric disentanglement for generative latent shape models. In *Proceedings of the IEEE/CVF International Conference on Computer Vision (ICCV)*, October 2019.
- [10] C. Balleier, T. Wurzbacher, *On the geometry and quantization of symplectic Howe pairs*, *Mathematische Zeitschrift*, Vol. 271 (2012), no. 1, 577–591.
- [11] M. Bauer, M. Bruveris, P. Harms, and P. W. Michor. Sobolev metrics on shape space, ii: Weighted sobolev metrics and almost local metrics. 2012.
- [12] M. Bauer, M. Bruveris, and P. W. Michor. Constructing reparametrization invariant metrics on spaces of plane curves. *Differential Geometry and its Applications*, 34:139–165, 2014.
- [13] M. Bauer, M. Bruveris, and P. W. Michor. Overview of the geometries of shape spaces and diffeomorphism groups. *Journal of Mathematical Imaging and Vision*, 50(1-2):60–97, 2014.
- [14] M. Bauer, P. Harms, and P. W. Michor. Sobolev metrics on shape space of surfaces. *Journal of Geometric Mechanics*, 3(4):389–438, 2011.
- [15] M. Bauer, P. Harms, and P. W. Michor. Almost local metrics on shape space of hypersurfaces in n -space. *SIAM J. Img. Sci.*, 5(1):244–310, March 2012.
- [16] M. Bauer, P. Harms, and P. W. Michor. Curvature weighted metrics on shape space of hypersurfaces in n -space. *Differential Geom. Appl.*, 30:33–41, 2012.
- [17] M. Bauer, P. Harms, and P. W. Michor. Sobolev metrics on the manifold of all Riemannian metrics. *Journal of Differential Geometry*, 94(2):187–208, 2013.

- [18] M. Bauer, M. Bruveris, P. Harms, and P. W. Michor, *Vanishing geodesic distance for the Riemann metric with geodesic equation the KdV equation*, *Ann. Glob. Anal. Geom.* 41, 4 (2012) 461-472.
- [19] A.G. Baskakov, Diagonalization of operators and complementability of subspaces of Banach spaces, *Ukrain. Mat. Zh.* **42** (1990), no. 7, 867–873; translation in *Ukrainian Math. J.* **42** (1990), no. 7, 763–768 (1991).
- [20] D. Beltiță, *Smooth Homogeneous Structures in Operator Theory*, Chapman & Hall/CRC Monographs and Surveys in Pure and Applied Mathematics, 137. Chapman & Hall/CRC Press, Boca Raton-London-New York-Singapore, 2006.
- [21] D. Beltiță, *Iwasawa decompositions of some infinite-dimensional Lie groups*, *Trans. Amer. Math. Soc.* 361 (2009), no. 12, 6613–6644.
- [22] D. Beltiță, B. Prunaru, Amenability, completely bounded projections, dynamical systems and smooth orbits, *Integral Equations Operator Theory* **57** (2007), no. 1, 1–17.
- [23] D. Beltiță, *Functional analytic background for a theory of infinite-dimensional reductive Lie groups*, *Developments and trends in infinite-dimensional Lie theory*, 367–392, *Progr. Math.*, 288, Birkhäuser Boston, Inc., Boston, MA, 2011.
- [24] D. Beltiță, T. Golinski, A.B. Tumpach, *Queer Poisson brackets*, *Journal of Geometry and Physics*, Vol. 132 (2018), 358–362.
- [25] D. Beltiță, K.-H. Neeb, *Geometric characterization of Hermitian algebras with continuous inversion*, *Bull. Aust. Math. Soc.* 81 (2010), no. 1, 96–113.
- [26] D. Beltiță, T.S. Ratiu, Symplectic leaves in real Banach Lie-Poisson spaces, *Geom. Funct. Analysis* **15** (2005), no. 4, 753–779.
- [27] D. Beltiță, T.S. Ratiu, A.B. Tumpach, *The restricted Grassmannian, Banach Lie-Poisson spaces and coadjoint orbits*, *J. Funct. Anal.* 247 (2007), no.1, 138–168.
- [28] Beltiță, D., Larotonda, G.: Unitary group orbits versus groupoid orbits of normal operators. arXiv:2111.04238 (2021)
- [29] Beltiță, D., Odziejewicz, A.: Poisson geometrical aspects of the Tomita–Takesaki modular theory. arXiv:1910.14466 (2019)
- [30] R. Bhatia, P. Šemrl, Distance between Hermitian operators in Schatten classes, *Proc. Edinburgh Math. Soc. (2)* **39** (1996), no. 2, 377–380.
- [31] P. Bóna: Extended quantum mechanics. *Acta Physica Slovaca*, **50**:1–198, 2000.
- [32] S. de Bièvre, F. Genoud, S. Rota Nodari, *Orbital stability: Analysis meets Geometry*, Nonlinear optical and atomic systems, 147–273, *Lecture Notes in Math.*, 2146, CEMPI Ser., Springer, Cham, 2015.
- [33] Ernst Binz and Hans R. Fischer. The manifold of embeddings of a closed manifold. In *Proc. Differential geometric methods in theoretical physics, Clausthal 1978*, volume Springer Lecture Notes in Physics 139, 1981.
- [34] Federica Bogo, Javier Romero, Matthew Loper, and Michael J. Black. FAUST: Dataset and evaluation for 3D mesh registration. In *Proceedings IEEE Conf. on Computer Vision and Pattern Recognition (CVPR)*, Piscataway, NJ, USA, June 2014. IEEE.
- [35] Federica Bogo, Javier Romero, Gerard Pons-Moll, and Michael J. Black. Dynamic FAUST: Registering Human Bodies in Motion. In *2017 IEEE Conference on Computer Vision and Pattern Recognition (CVPR)*, pages 5573–5582, Honolulu, HI, July 2017. IEEE.
- [36] R. Borchers, M. Haiman, N. Reshetikhin, V. Serganova, *Berkeley Lectures on Lie Groups and Quantum Groups*, edited by A. Geraschenko and T. Johnson-Freyd, <http://math.berkeley.edu/theojf/LieQuantumGroups.pdf>.

- [37] N. Bourbaki, *Groupes et Algèbres de Lie*, Hermann, Paris, 1972.
- [38] Giorgos Bouritsas, Sergiy Bokhnyak, Stylianos Ploumpis, Michael Bronstein, and Stefanos Zafeiriou. Neural 3D Morphable Models: Spiral Convolutional Networks for 3D Shape Representation Learning and Generation. *arXiv:1905.02876 [cs]*, August 2019. arXiv: 1905.02876.
- [39] Bourbaki, N. *Variétés différentielles et analytiques, fascicule de résultats*. Herman, Paris, (1971).
- [40] H. Bre10, *Functional Analysis, Sobolev Spaces and Partial Differential Equations*, Springer (2010).
- [41] A. Bronstein, M. Bronstein, and R. Kimmel. *Numerical Geometry of Non-Rigid Shapes*. Springer, 2008.
- [42] A. J. Bruce, K. Grabowska, J. Grabowski: Higher order mechanics on graded bundles. *Journal of Physics A: Mathematical and Theoretical*, **48**(20):205203, 2015.
- [43] M. Bruveris, “Optimal reparametrizations in the square root velocity framework,” *J. Math. Anal.*, 2016.
- [44] M. Bruveris, *The energy functional on the Virasoro-Bott group with the L^2 -metric has no local minima*, Annals of Global Analysis and Geometry volume 43, pages 385–395 (2013)
- [45] J. Brylinski, *Loop Spaces, Characteristic Classes and Geometric Quantization*. Modern Birkhäuser Classics, 1993.
- [46] P. Cabau and F. Pelletier, *Almost Lie structures on an anchored Banach bundle*, J. Geom. Phys. 62 (2012), no. 11, 2147–2169.
- [47] A.L. Carey, Some homogeneous spaces and representations of the Hilbert Lie group $\mathcal{U}(H)_2$, *Rev. Roumaine Math. Pures Appl.* **30** (1985), no. 7, 505–520.
- [48] E. Celledoni, S. Eidnes, and A. Schmeding, “Shape analysis on homogeneous spaces,” 2017. [Online]. Available: [arXiv:1704.01471v1](https://arxiv.org/abs/1704.01471v1)
- [49] V. Cervera, F. Mascaró, and P. W. Michor, “The action of the diffeomorphism group on the space of immersions,” *Differential Geom. Appl.*, vol. 1, no. 4, pp. 391–401, 1991.
- [50] J. Cheeger, D.G. Ebin, *Comparison Theorems in Riemannian Geometry*, North-Holland, Amsterdam, 1975.
- [51] P. R. Chernoff, J. E. Marsden: Properties of Infinite Dimensional Hamiltonian Systems, *Lecture Notes in Mathematics*, volume 425. Springer Verlag, 1974.
- [52] Chow. The ricci flow on the 2-sphere. *J. Diff. Geom.*, 33:325–334, 1991.
- [53] P. G. Ciarlet. *An Introduction to Differential Geometry with Applications to Elasticity*, volume 78-79. Kluwer Academic Publishers, 2005.
- [54] B. Clarke. The metric geometry of the manifold of Riemannian metrics over a closed manifold. *Calculus of Variations and Partial Differential Equations*, 39:533–545, 2010.
- [55] J.B. Conway, B.B. Morrel, Operators that are points of spectral continuity, *Integral Equations Operator Theory* **2** (1979), no. 2, 174–198.
- [56] Richard Courant and David Hilbert. *Methods of Mathematical Physics*, volume Volume I. Wiley-Interscience, 1962.
- [57] K. R. Davidson, *Nest algebras*, Pitman Research Notes in Mathematics Series, vol. 191, Longman Scientific and Technical Pub. Co., New York, 1988.
- [58] L. A. Dickey, *Soliton Equations and Hamiltonian Systems*, Second edition. Advanced Series in Mathematical Physics, 26. World Scientific Publishing Co., Inc., River Edge, NJ, 2003.

- [59] Bryce S. DeWitt. Quantum theory of gravity. i. the canonical theory. *Phys. Rev.*, 160:1113–1148, Aug 1967.
- [60] T. Diez, “Slice theorem for fréchet group actions and covariant symplectic field theory,” 2014. [Online]. Available: [arXiv:1405.2249](https://arxiv.org/abs/1405.2249)
- [61] G. Dito: Deformation quantization on a Hilbert space. In *Noncommutative Geometry and Physics* (edited by Y. Maeda, *et al.*), pages 139–157. World Scientific, Singapore, 2005.
- [62] M. P. do Carmo. *An Introduction to Differential Geometry with Applications to Elasticity*. Prentice-Hall, Inc., Englewood Cliffs, New Jersey, 1976.
- [63] A. Dobrogowska, A. Odziejewicz, *Integrable Hamiltonian systems related to the Hilbert-Schmidt ideal*, *J. Geom. Phys.* 61 (2011), no. 8, 1426–1445.
- [64] Hassen Drira, Ben Amor Boulbaba, Srivastava Anuj, Mohamed Daoudi, and Rim Slama. 3D Face Recognition Under Expressions, Occlusions and Pose Variations. *IEEE Transactions on Pattern Analysis and Machine Intelligence*, 2013. To appear.
- [65] H. Drira, A. Tumpach, and M. Daoudi, “Gauge invariant framework for trajectories analysis,” in *Proceedings of the 1st International Workshop on DIFFerential Geometry in Computer Vision for Analysis of Shapes, Images and Trajectories*, 2015.
- [66] V. G. Drinfel’d, *Hamiltonian structures on Lie groups, Lie bialgebras and the geometric meaning of the classical Yang-Baxter equations*, *Soviet Math. Dokl.*, Vol 27 (1983), no. 1, 68–71.
- [67] F. Dubeau and J. Savoie, “A remark on cyclic tridiagonal matrices,” *Zastosowania Matematyki Applicationes Mathematicae*, vol. 21, no. 2, pp. 253–256, 1991.
- [68] D. G. Ebin. The manifold of Riemannian metrics. *Global Analysis (Proc. Sympos. Pure Math., Vol. XV, Berkeley, Calif., 1968)*, pages 11–40, 1970.
- [69] I. Ekeland, The Hopf-Rinow Theorem in infinite dimension, *J. Differential Geometry* **13** (1978), 287–301.
- [70] L. D. Fadeev: Hamiltonian interpretation of inverse-scattering method. In *Solitons* (edited by R. K. Bullough, P. J. Caudrey). Springer-Verlag, 1980.
- [71] M. Fabian, P. Habala, P. Hájek, V. M. Santalucía, J. Pelant, V. Zizler: *Functional analysis and infinite-dimensional geometry*. Springer Science & Business Media, 2001.
- [72] V. Filippov: n -Lie algebras. *Sibirsk. Mat. J.*, **26**(6):879–891, 1985.
- [73] R. (Roger) Fletcher. *Practical methods of optimization*. Chichester ; New York : Wiley, 1987.
- [74] A.S. Fokas, I.M. Gelfand, J.-C. Alvarez Paiva, *surfaces on Lie Groups, on Lie Algebras and their Integrability*, *Commun. Math. Phys.* 177, 203–220 (1996).
- [75] D. S. Freed and D. Groisser. The basic geometry of the manifold of Riemannian metrics and of its quotient by the diffeomorphism group. *Michigan Math. J.*, 1989.
- [76] M. Fuchs, B. Jüttler, O. Scherzer, and H. Yang. Shape metrics based on elastic deformations. *J. Math. Imaging Vis.*, 35(1):86–102, 2009.
- [77] F. Gay-Balmaz, C. Vizman, *Dual pairs in fluid dynamics*, *Annals of Global Analysis and Geometry*, Vol. 41 (2012), no. 1, 1–24.
- [78] F. Gay-Balmaz, C. Vizman, *A dual pair for free boundary fluids*, *Int. J. Geom. Methods Mod. Phys.* 12 (2015), no. 7.
- [79] F. Gay-Balmaz, C. Vizman, *Dual pairs for non-abelian fluids*, *Geometry, mechanics, and dynamics*, *Fields Inst. Commun.* 73, 107–135, Springer, New-York (2015).
- [80] F. Gay-Balmaz, T. Ratiu, *The geometry of the universal Teichmüller space and the Euler-Weil-Petersson equation*, *Advances in Mathematics* 279 (2015) 717–778.

- [81] A. Giachetti and C. Lovato. Radial Symmetry Detection and Shape Characterization with the Multiscale Area Projection Transform. *Computer Graphics Forum*, 31(5):1669–1678, 2012.
- [82] O. Gil-Medrano and Peter W. Michor. The Riemannian manifold of all Riemannian metrics. *Quarterly J. Math. Oxford*, 2:183–202, 1991.
- [83] Giorgi Daniela, Biasotti Silvia, and Paraboschi Laura. Shape retrieval contest 2007: Watertight models track, 2007.
- [84] I.C. Gohberg, M.G. Krein, *Theory and Applications of Volterra operators on Hilbert spaces*, Translations of Mathematical Monographs (2nd ed.), Vol. 24, Amer. Math. Soc, Providence, RI (1970).
- [85] T. Goliński, A. Odziejewicz, *Hierarchy of Hamiltonian equations on Banach Lie–Poisson spaces related to restricted Grassmannian*, Journal of Functional Analysis 258 (2010), 3266–3294.
- [86] R. Goldman. Curvature formulas for implicit curves and surfaces. *Computer Aided Geometric Design*, 22:632–658, 2005.
- [87] E. Grinspun, Y. Gingold, J. Reisman, and D. Zorin. Computing discrete shape operators on general meshes. *Eurographics*, 25(3), 2006.
- [88] Grabowski, J.: A Poisson–Lie structure on the diffeomorphism group of a circle. *Lett. Math. Phys.* **32**(4), 307–313 (1994)
- [89] Grabowski, J., Kuś, M., Marmo, G.: Geometry of quantum systems: density states and entanglement. *J. Phys. A: Math. Gen.* **38**(47), 10217 (2005)
- [90] P. de la Harpe, *Classical Banach Lie Algebras and Banach Lie Groups of Operators in Hilbert Space*. Lecture Notes in Mathematics, Vol. 285, Springer-Verlag, Berlin-New York, 1972.
- [91] P.R. Halmos, *A Hilbert Space Problem Book*. Van Nostrand Co. Inc., Princeton, NJ, 1967.
- [92] R. S. Hamilton, “The inverse function theorem of nash moser,” *Bulletin (New series) of the American Mathematical Society*, vol. 7, no. 1, pp. 65–222, 1982.
- [93] R. Hamilton. Ricci flow on surfaces. *Mathematics and General Relativity, Contemporary Mathematics*, 71:237–261, 1988.
- [94] J.-C. Hausmann, S. Tolman, Maximal Hamiltonian tori for polygon spaces, *Ann. Inst. Fourier (Grenoble)* **53** (2003), no. 6, 1925–1939.
- [95] S. Helgason, *Differential Geometry and Symmetric Spaces*, Academic Press, New York, 1962.
- [96] B. Heeren, M. Rumpf, M. Wardetzky, and B. Wirth. Time-discrete geodesics in the space of shells. *Comp. Graph. Forum*, 31(5):1755–1764, August 2012.
- [97] N. J. Higham, *Accuracy and Stability in Numerical Algorithms:second edition*. Siam, 2002.
- [98] A. Hinkkanen, On the diagonalization of a certain class of operators, *Michigan Math. J.* **32** (1985), no. 3, 349–359.
- [99] C. Ida, Lichnerowicz–Poisson cohomology and Banach Lie algebroids. *Ann. Funct. Anal*, **2**(2):130–137, 2011.
- [100] I. Ivanova-Karatopraklieva and I. Kh. Sabitov. Surface deformation. i. *Journal of Mathematical Sciences*, 70(2):1685–1716, 1994.
- [101] Ian H. Jermyn, Sebastian Kurtek, Eric Klassen, and Anuj Srivastava. Elastic shape matching of parameterized surfaces using square root normal fields. In *ECCV (5)*, pages 804–817, 2012.
- [102] S. H. Joshi, A. Srivastava, E. Klassen, and I. Jermyn, “A novel representation for computing geodesics between n-dimensional elastic curves,” in *IEEE Conference on computer Vision and Pattern Recognition (CVPR)*, 2007.

- [103] Kac, V.G. *Infinite Dimensional Lie Algebras*, Progress in Mathematics, Edited by J.Coates and S.Helgason, Birkhäuser, 1983.
- [104] Khesin, B. A. and Misiolek, G. *Euler equations on homogeneous spaces and Virasoro orbits* Advances in Math. 176 (2003), pp 116-144.
- [105] Khesin, B. A. *Poisson-Lie group of pseudo-differential symbols and fractional KP-KdV Hierarchies* arXiv.
- [106] B. Khesin, I. Zakharevich, *Poisson-Lie group of pseudodifferential symbols*, Comm. Math. Phys., Vol. 171, no. 3, (1995), 475–530.
- [107] Martin Kilian, Niloy J. Mitra, and Helmut Pottmann. Geometric modeling in shape space. *ACM Trans. Graphics*, 26(3), 2007. Proc. SIGGRAPH.
- [108] Kirillov, A. A *Infinite Dimensional Lie Groups ; their orbits, invariants and representations. The Geometry of Moments*. Lectures notes in Math, Springer-Verlag 970 (1982) p 101-123.
- [109] A. A. Kirillov, *Merits and Demerits of the orbit method*, Bulletin (New Series) of the American Mathematical Society, Vol. 36, no. 4, 433–488.
- [110] E. Klassen, A. Srivastava, W. Mio, and S. H. Joshi, “Analysis of planar shapes using geodesic paths on shape spaces,” *IEEE Trans. PAMI*, vol. 26, no. 3, pp. 372–383, 2004.
- [111] W. Klingenberg. *Eine Vorlesung in Differentialgeometrie*. Springer Verlag, Berlin, 1973.
- [112] J.J. Koenderink. *Solid Shape*. Mit Press, 1990.
- [113] Y. Kosmann-Schwarzbach, F. Magri, *Poisson-Lie groups and complete integrability*, Ann. Inst. Henri Poincaré, Vol. 49, no. 4, (1988), 433–460.
- [114] Y. Kosmann-Schwarzbach, *Poisson-Lie groups and beyond*, Journal of Mathematical Sciences, Vol. 82, no. 6, (1996), 3807–3813.
- [115] Y. Kosmann-Schwarzbach, *Lie bialgebras, Poisson Lie groups and dressing transformations*, Integrability of Nonlinear Systems, Second edition, Lectures Notes in Physics 638, Springer-Verlag, 2004, 107–173.
- [116] Y. Kosmann-Schwarzbach, F. Magri, Lax-Nijenhuis operators for integrable systems, Journal Math. Phys. 37 (12), (1996), 6173–6197.
- [117] A. Kriegl, P. W. Michor, *The convenient setting of global analysis*, Mathematical surveys and Monographs, American Mathematical Society, Vol. 53, (1997).
- [118] S. Kurtek, A. Srivastava, E. Klassen, and H. Laga. Landmark-guided elastic shape analysis of spherically-parameterized surfaces. *Eurographics*, 32(2), 2013.
- [119] Sebastian Kurtek, Eric Klassen, Zhaohua Ding, and Anuj Srivastava. A novel Riemannian framework for shape analysis of 3d objects. In *CVPR*, pages 1625–1632, 2010.
- [120] Sebastian Kurtek, Eric Klassen, John C. Gore, Zhaohua Ding, and Anuj Srivastava. Elastic geodesic paths in shape space of parameterized surfaces. *IEEE Trans. Pattern Anal. Mach. Intell.*, 34(9):1717–1730, 2012.
- [121] S. Kwapien, A. Pelczynski, *The main triangle projection in matrix spaces and its applications*, Studia Math. 34 (1970), 43–68.
- [122] Hamid Laga, Qian Xie, Ian H. Jermyn, and Anuj Srivastava. Numerical inversion of SRNF maps for elastic shape analysis of genus-zero surfaces. *IEEE Trans. Pattern Anal. Mach. Intell.*, 39(12):2451–2464, 2017.
- [123] S. Lang, *Differential and Riemannian manifolds*, Graduate texts in mathematics, vol. 160, Springer-Verlag, New York, 1995.
- [124] S. Lang, *Fundamentals of Differential Geometry* (corrected second printing), Graduate texts in mathematics, vol. 191, Springer-Verlag, New York, 2001.

- [125] S. Lang, *Fundamentals of differential geometry*, Springer-Verlag, graduate texts in math **191**, 1999.
- [126] Sayani Lahiri, Danial Robinson, and Erik Klassen. Precise matching of PL curves in \mathbb{R}^N in the square root velocity framework. 2015.
- [127] A. Le Brigant, “Computing distances and geodesics between manifold-valued curves in the srv framework,” 2017. [Online]. Available: [arXiv:1601.02358v4](https://arxiv.org/abs/1601.02358v4)
- [128] E. Lerman, Contact cuts, *Israel J. Math.* **124** (2001), 77–92.
- [129] Lehto, O. , *Univalent functions and Teichmüller spaces*, Springer-Verlag, New-York, 1987.
- [130] Bruno Lévy. *Géométrie Numérique*. Habilitation à diriger des recherches, Institut National Polytechnique de Lorraine - INPL, February 2008.
- [131] Zhouhui Lian, Afzal Godil, Benjamin Bustos, Mohamed Daoudi, Jeroen Hermans, Shun Kawamura, Yukinori Kurita, Guillaume Lavoué, Hien Van Nguyen, Ryutarou Ohbuchi, Yuki Ohkita, Yuya Ohishi, Fatih Porikli, Martin Reuter, Ivan Sipiran, Dirk Smeets, Paul Suetens, Hedi Tabia, and Dirk Vandermeulen. A comparison of methods for non-rigid 3d shape retrieval. *Pattern Recognit.*, 46(1):449–461, 2013.
- [132] T. Lindeberg, “Image matching using generalized scale-space interest points,” *Journal of Mathematical Imaging and Vision*, vol. 52, no. 1, pp. 3–36, 2015.
- [133] N. Litke, M. Droske, M. Rumpf, and P. Schröder. An image processing approach to surface matching. In *Proceedings of the Third Eurographics Symposium on Geometry Processing*, SGP ’05, pages 207–216, 2005.
- [134] Matthew Loper, Naureen Mahmood, Javier Romero, Gerard Pons-Moll, and Michael J. Black. SMPL: A skinned multi-person linear model. *ACM Trans. Graphics (Proc. SIGGRAPH Asia)*, 34(6):248:1–248:16, October 2015.
- [135] J.-H. Lu, *Multiplicative and Affine Poisson Structures on Lie groups*, Ph.D. thesis, UC Berkeley, 1991.
- [136] J.-H. Lu, A. Weinstein, Poisson Lie groups, dressing transformations, and Bruhat decompositions, *J. Differential Geom.* 31 (1990), no. 2, 501–526.
- [137] Guoliang Luo, Frederic Cordier, and Hyewon Seo. Spatio-temporal segmentation for the similarity measurement of deforming meshes. *The Visual Computer*, 32(2):243–256, February 2016.
- [138] V.I. Macaev, *Volterra operators produced by perturbation of self adjoint operators*, Soviet Math. Dokl. 2 (1961), 1013–1016.
- [139] C.-M. Marle, Introduction aux groupes de Lie–Poisson. In: A.S. Alves, F.J. Craveiro de Carvalho and J.A. Pereira da Silva, ed., *Geometria, Fisica-Matemática e Outros Ensaio*, Departamento de Matemática, Universidad de Coimbra, 1998, pp. 149–170
- [140] A. C. G. Mennucci, “Neighborhoods and manifolds of immersed curves,” *International Journal of Mathematics and Mathematical Sciences*, 2021, cvgmt preprint. [Online]. Available: <http://cvgmt.sns.it/paper/5355/>
- [141] Peter W. Michor. *Manifolds of differentiable mappings*. Shiva Publishing Ltd., Nantwich, 1980.
- [142] Peter W. Michor and David Mumford. Vanishing geodesic distance on spaces of submanifolds and diffeomorphisms. *Doc. Math.*, 10:217–245, 2005.
- [143] W. Mio, A. Srivastava, and S. H. Joshi, “On shape of plane elastic curves,” *International Journal of Computer Vision*, vol. 73, no. 3, pp. 307–324, 2007.

- [144] F. Mokhtarian and A. K. Mackworth, “A theory of multiscale, curvature-based shape representation for planar curves,” *IEEE Transactions on Pattern Analysis and Machine Intelligence*, vol. 14, no. 8, pp. 789–805, 1992.
- [145] A.K. Motovilov, Removal of the resolvent-like energy dependence from interactions and invariant subspaces of a total Hamiltonian, *J. Math. Phys.* **36** (1995), no. 12, 6647–6664.
- [146] Nag, S. and D. Sullivan [1995], Teichmüller theory and the universal period mapping via quantum calculus and the $H^{1/2}$ space on the circle, *Osaka J. Math.*, **32**, no. 1, 1–34.
- [147] Nag, S. and A. Verjovsky [1990], $\text{Diff}(S^1)$ and the Teichmüller Spaces, *Comm. Math. Phys.*, **130**, no. 1, 123–138.
- [148] K.-H. Neeb, Highest weight representations and infinite-dimensional Kähler manifolds. In: *Recent Advances in Lie Theory (Vigo, 2000)*, Res. Exp. Math., 25, Heldermann, Lemgo, 2002, 367–392.
- [149] K.-H. Neeb, Classical Hilbert-Lie groups, their extensions and their homotopy groups. In: *Geometry and Analysis on Finite- and Infinite-dimensional Lie Groups (Będlewo, 2000)*, Banach Center Publ., 55, Polish Acad. Sci., Warsaw, 2002, 87–151.
- [150] K.-H. Neeb, Universal central extensions of Lie groups. *Acta Appl. Math.* **73** (2002), no. 1-2, 175–219.
- [151] K.-H. Neeb, A Cartan-Hadamard theorem for Banach-Finsler manifolds, *Geom. Dedicata* **95** (2002), 115–156.
- [152] K.-H. Neeb, H. Sahlmann, T. Thiemann, *Weak Poisson structures on infinite dimensional manifolds and Hamiltonian actions*, Lie Theory and Its Applications in Physics, Varna, Bulgaria, June 2013, Springer Proceedings in Mathematics and Statistics, Vol. 111, 105–135, Springer, Tokyo, 2014.
- [153] K.-H. Neeb, *Towards a Lie theory of locally convex groups*, Japanese Journal of Mathematics, Vol. 1, Issue 2, 291–468, 2006.
- [154] J.D. Newburgh, The variation of spectra, *Duke Math. J.* **18** (1951), 165–176.
- [155] F. Nübel, On integral manifolds for vector space distributions, *Math. Ann.* **294** (1992), no. 1, 1–17.
- [156] A. Odziejewicz, T.S. Ratiu, *Banach Lie–Poisson spaces and reduction*, Comm. Math. Phys. **243** (2003), no. 1, 1–54.
- [157] A. Odziejewicz, T.S. Ratiu, Extensions of Banach Lie-Poisson spaces, *J. Funct. Anal.* **217** (2004) no. 1, 103–125.
- [158] A. Odziejewicz, T.S. Ratiu, *Induction for weak symplectic Banach manifolds*, Journal of Geometry and Physics, Volume 58, Issue 6, 701–719, 2008.
- [159] A. Odziejewicz, T.S. Ratiu, *Induced and coinduced Lie–Poisson spaces and integrability*, J. Funct. Anal., 255, Issue 5, 1225–1272, 2008.
- [160] B. O’Neill, *Semi-Riemannian Geometry with Applications to Relativity*, Academic Press, United Kingdom, 1983.
- [O] Ottesen, J. T. *Infinite Dimensional Groups and Algebras in Quantum Physics*, Lectures notes in Physics, Serie m 27, Springer.
- [161] J.-P. Ortega, T.S. Ratiu, *Momentum Maps and Hamiltonian Reduction*, Progress in Mathematics, 222. Birkhäuser Boston, Inc., Boston, MA, 2004.
- [162] V.Y. Ovsienko and B.A. Khesin. Korteweg-de Vries superequations as an Euler equation. *Funct. Anal. Appl.*, 21 (1987), 329–331.

- [163] Palais, R. S., *Seminar on the Atiyah-Singer Index Theorem*, Princeton Univ. Press, Princeton, N. J., 1963.
- [164] V. Paulsen, *Completely Bounded Maps and Operator Algebras*. Cambridge Studies in Advanced Mathematics, 78. Cambridge University Press, Cambridge, 2002.
- [165] Adam Paszke, Sam Gross, Francisco Massa, Adam Lerer, James Bradbury, Gregory Chanan, Trevor Killeen, Zeming Lin, Natalia Gimelshein, Luca Antiga, Alban Desmaison, Andreas Kopf, Edward Yang, Zachary DeVito, Martin Raison, Alykhan Tejani, Sasank Chilamkurthy, Benoit Steiner, Lu Fang, Junjie Bai, and Soumith Chintala. Pytorch: An imperative style, high-performance deep learning library. In H. Wallach, H. Larochelle, A. Beygelzimer, F. d. Alché-Buc, E. Fox, and R. Garnett, editors, *Advances in Neural Information Processing Systems 32*, pages 8024–8035. Curran Associates, Inc., 2019.
- [166] Pelletier, F., Cabau, P.: Convenient partial Poisson manifolds. *J. Geom. Phys.* **136**, 173–194 (2019)
- [167] F. Pelletier, *Integrability of weak distributions on Banach manifolds*, *Indag. Math. (N.S.)* 23 (2012), no. 3, 214–242.
- [168] D. Pickup, X. Sun, P. L. Rosin, R. R. Martin, Z. Cheng, Z. Lian, M. Aono, A. Ben Hamza, A. Bronstein, M. Bronstein, S. Bu, U. Castellani, S. Cheng, V. Garro, A. Giachetti, A. Godil, L. Isaia, J. Han, H. Johan, L. Lai, B. Li, C. Li, H. Li, R. Litman, X. Liu, Z. Liu, Y. Lu, L. Sun, G. Tam, A. Tatsuma, and J. Ye. Shape Retrieval of Non-rigid 3D Human Models. *International Journal of Computer Vision*, 120(2):169–193, 2016.
- [169] E. Pierson, M. Daoudi, A.B. Tumpach, *A Riemannian Framework for Analysis of Human Body Surface*, Conference: Winter Conference on Applications of Computer Vision (WACV 2022)
- [170] H. Pitt: A note on bilinear forms. *Journal of the London Mathematical Society*, 1(3):174–180, 1936.
- [171] A. Pressley, *Loop Groups, Grassmannians and KdV equations*, Infinite-dimensional groups with applications, *Publ. Math. Sci. Res. Inst.* 4, 285–306 (1985).
- [172] A. Pressley, G. Segal, *Loop Groups*, Oxford Mathematical Monographs. Oxford Science Publications. The Clarendon Press, Oxford University Press, Oxford, 1990.
- [173] S. C. Preston, “The geometry of whips,” *Ann. Global Anal. Geom.*, vol. 41, no. 3, pp. 281–305, 2012.
- [174] M. Reed, B. Simon, *Functional Analysis (Methods of Modern Mathematical Physics Vol. I)*, Academic Press, (1980).
- [175] M. Reed, B. Simon, *Fourier analysis, self-adjointness (Methods of Mathematical Physics Vol. II)*, Academic Press, (1975).
- [176] G. Restrepo, *Differentiable norms in Banach spaces*, *Bull. Am. Math. Soc.* 70, 413–414, (1964).
- [177] Martin Reuter, Franz-Erich Wolter, and Niklas Peinecke. Laplace-beltrami spectra as ‘shapedna’ of surfaces and solids. *Comput. Aided Des.*, 38(4):342–366, 2006.
- [178] A.G. Reyman, M.A. Semenov-Tian-Shansky, *Reduction of Hamiltonian systems, affine Lie algebras and Lax equations*, *Inventiones Math.* 54, (1979), 81–100.
- [179] R. A. Ryan: Introduction to tensor products of Banach spaces. Springer Science & Business Media, 2002.
- [180] M. Sato, Y. Sato, *Soliton equations as dynamical systems on infinite-dimensional Grassmann manifold*, Nonlinear partial differential equations in applied science, *Proc. U.S. - Jap. Semin.*, Tokyo 1982, North-Holland Math. Stud. 81, (1983), 259–271.
- [181] R. Schatten, *A theory of cross spaces*, *Annals of Mathematical Studies* 26, Princeton, N.J. (1950).

- [182] G. Segal, *Unitary Representations of some Infinite Dimensional Groups*, Comm. Math. Phys 80, n° 3, (1981), 301–342.
- [183] G. Segal, *Loop groups and harmonic maps*, Advances in homotopy theory, Proc. Conf. in Honour of I. M. James, Cortona/Italy 1988, Lond. Math. Soc. Lect. Note Ser. 139, (1989), 153–164.
- [184] G. Segal, *The geometry of the KdV equation*, Int. J. Mod. Phys. A 6, n° 16, (1991), 2859–2869.
- [185] G. Segal, G. Wilson, *Loop Groups and equations of KdV type*, Pub. Math. I.H.E.S., 61 (1985), 5–65.
- [186] M. A. Semenov-Tian-Shansky, *What is a classical r -matrix?*, Funct. Anal. Appl. 17, no. 4, (1983), 259–272.
- [187] M. A. Semenov-Tian-Shansky, *Dressing transformations and Poisson group actions*, Publ. RIMS (Kyoto) 21, (1985), 1237–1260.
- [188] Semenov-Tian-Shansky, M.A.: Classical r -matrices, Lax equations, Poisson Lie groups and dressing transformations. In: Field Theory, Quantum Gravity and Strings II, pp. 174–214. Springer (1987)
- [189] M. A. Semenov-Tian-Shansky, *Lectures on R -matrices, Poisson–Lie groups and integrable systems*, in Lectures on Integrable Systems, In Memory of J.-L. Verdier, Proc. of the CIMPA School on Integrable systems, Nice (France) 1991, O.Babelon, P. Cartier, Y. Kosmann-Schwarzbach, eds., World Scientific 1994, 269–317.
- [190] E. Sharon, D. Mumford, 2D-shape analysis using conformal mapping, Int. J. Comput. Vis. 70 (1) (2006) 55–75
- [191] B. Simon, *Trace ideals and their applications*, Cambridge University Press, Cambridge, (1979).
- [192] Anuj Srivastava, Eric Klassen, Shantanu H. Joshi, and Ian H. Jermyn. Shape analysis of elastic curves in euclidean spaces. *IEEE Trans. Pattern Anal. Mach. Intell.*, 33(7):1415–1428, 2011.
- [193] E. Stein and R. Shakarchi, *Real Analysis : Measure Theory, Integration, and Hilbert Spaces*. Princeton University Press, 2005.
- [194] I. Stewart, *Lie Algebras Generated by Finite-dimensional Ideals*. Research Notes in Mathematics, Vol. 2, Pitman Publishing, London-San Francisco, Calif.-Melbourne, 1975.
- [195] Zhe Su, Martin Bauer, Eric Klassen, and Kyle Gallivan. Simplifying transformations for a family of elastic metrics on the space of surfaces. In *Proceedings of the IEEE/CVF Conference on Computer Vision and Pattern Recognition (CVPR) Workshops*, June 2020.
- [196] Zhe Su, Martin Bauer, Stephen C. Preston, Hamid Laga, and Eric Klassen. Shape Analysis of Surfaces Using General Elastic Metrics. *arXiv:1910.02045 [math]*, October 2019. arXiv: 1910.02045.
- [197] A. Sugano, “The physics of the hardest move in ballet,” 2017. [Online]. Available: <http://ed.ted.com/lessons/the-physics-of-the-hardest-move-in-ballet-arleen-sugano>
- [198] Jian Sun, Maks Ovsjanikov, and Leonidas J. Guibas. A concise and provably informative multi-scale signature based on heat diffusion. *Comput. Graph. Forum*, 28(5):1383–1392, 2009.
- [199] Takhtajan, L.A and Teo L-P. *Weil-Petersson metric on the universal Teichmüller space I. Curvature properties and Chern forms* arXiv:math.CV/0312172v2, 10 december 2003.
- [200] Takhtajan, L.A and Teo L-P. *Weil-Petersson metric on the universal Teichmüller space II. Kähler potential and period mapping* arXiv:math.CV/0406408v1, 21 june 2004.
- [201] Takhtajan, L. and L.-P. Teo [2004], Weil-Petersson metric on the universal Teichmüller space, *Mem. Amer. Math. Soc.*, **183**, no.861, viii+119pp.

- [202] C. Temperton, “Algorithms for the solution of cyclic tridiagonal systems,” *Journal of computational physics*, vol. 19, pp. 317–323, 1975.
- [203] H. Thodberg, “Minimum description length shape and appearance models,” *Proceedings of Information Processing in Medical Imaging (IPMI 2003)*, 2003.
- [204] W. Thurston. *The geometry and topology of three manifolds*. Princeton University Press, 1997.
- [205] A.B. Tumpach, H. Drira, M. Daoudi, and A. Srivastava. Gauge Invariant Framework for Shape Analysis of Surfaces. *IEEE Transactions on Pattern Analysis and Machine Intelligence*, 38(1):46–59, January 2016. arXiv: 1506.03065.
- [206] A.B. Tumpach, *Variétés Kählériennes et Hyperkählériennes de Dimension Infinie*, Ph.D Thesis, École Polytechnique, Paris, 2005.
- [207] A.B. Tumpach, Mostow Decomposition Theorem for a L^* -group and applications to affine coadjoint orbits and stable manifolds, *preprint math-ph/0605039* (May 2006).
- [208] A.B. Tumpach, S. C. Preston, *Quotient Elastic Metrics on the manifold of arc-length parameterized plane curves*, *Journal of Geometric Mechanics* 9, n°2 (2017), 227–256.
- [209] A. B. Tumpach, T. Goliński, *Banach Poisson–Lie group structure on $U(\mathcal{H})$* , to appear in *Proceedings of Workshop on Geometric Methods in Physics 2022*.
- [210] A. B. Tumpach, *Variétés kählériennes et hyperkählériennes de dimension infinie*, Thèse de doctorat, École polytechnique, Palaiseau, France, (2005).
- [211] A. B. Tumpach, *Hyperkähler structures and infinite-dimensional Grassmannians*, *J. Funct. Anal.* 243 (2007), 158–206.
- [212] A. B. Tumpach, “Gauge invariance of degenerate riemannian metrics,” *Notices of the American Mathematical Society*, vol. 63, no. 4, pp. 342–350, 2016.
- [213] A. B. Tumpach, *Banach Poisson–Lie groups and Bruhat–Poisson structure of the restricted Grassmannian*, *Comm. Math. Phys.* **373**(3), 795–858 (2020)
- [214] A.B. Tumpach, *An Example of Banach and Hilbert manifold : the Universal Teichmüller space*. *Proceedings of XXXVI Workshop on Geometric Methods in Physics, 2-8 July 2017, Białowieża, Poland*.
- [215] A.B. Tumpach, *On canonical parameterizations of 2D-curves*, <https://arxiv.org/abs/2303.15205>
- [216] A.B. Tumpach and S.C. Preston, *3 methods to put a Riemannian metric on Shape Space*, <https://arxiv.org/abs/2303.11682>.
- [217] A.B. Tumpach and P. Kán, *Temporal Alignment: A Geometric Point of View*, <https://arxiv.org/abs/2303.15259>.
- [218] I. Ciuclea, A.B. Tumpach and C. Vizman, *Shape spaces of nonlinear flags*, <https://arxiv.org/abs/2303.15184>.
- [219] A.B. Tumpach, *Moving Frames and canonical parameterizations of curves*, in preparation.
- [220] Tromba, A. J. [1992], *Teichmüller theory in Riemannian geometry*, *Lectures in Mathematics*, ETH Zürich, Birkhäuser.
- [221] Laurens van der Maaten and Geoffrey Hinton. Visualizing data using t-SNE. *JMLR*, 9(86):2579–2605, 2008.
- [222] Gül Varol, Javier Romero, Xavier Martin, Naureen Mahmood, Michael J. Black, Ivan Laptev, and Cordelia Schmid. Learning from synthetic humans. In *CVPR*, 2017.

- [223] Christos Veinidis, Antonios Danelakis, Ioannis Pratikakis, and Theoharis Theoharis. Effective descriptors for human action retrieval from 3d mesh sequences. *Int. J. Image Graph.*, 19(3):1950018:1–1950018:34, 2019.
- [224] Christos Veinidis, Ioannis Pratikakis, and Theoharis Theoharis. On the retrieval of 3d mesh sequences of human actions. *Multimedia Tools and Applications*, 76(2):2059–2085, 2017.
- [225] Pauli Virtanen, Ralf Gommers, Travis E. Oliphant, Matt Haberland, Tyler Reddy, David Cournapeau, Evgeni Burovski, Pearu Peterson, Warren Weckesser, Jonathan Bright, Stéfan J. van der Walt, Matthew Brett, Joshua Wilson, K. Jarrod Millman, Nikolay Mayorov, Andrew R. J. Nelson, Eric Jones, Robert Kern, Eric Larson, C J Carey, İlhan Polat, Yu Feng, Eric W. Moore, Jake VanderPlas, Denis Laxalde, Josef Perktold, Robert Cimrman, Ian Henriksen, E. A. Quintero, Charles R. Harris, Anne M. Archibald, Antônio H. Ribeiro, Fabian Pedregosa, Paul van Mulbregt, and SciPy 1.0 Contributors. SciPy 1.0: Fundamental Algorithms for Scientific Computing in Python. *Nature Methods*, 17:261–272, 2020.
- [226] A. Weinstein, *The local structure of Poisson manifolds*, J. Diff. Geom. 18, 523–557 (1983).
- [227] A. Weinstein, *Symplectic groupoids and Poisson manifolds*, Bulletin (New Series) of the American Mathematical Society, Vol. 16, no. 1, (1987), 101–104.
- [228] A. Weinstein, *Some remarks on dressing transformations*, J. Fac. Sci. Univ. Tokyo Sect. IA Math. 35 (1988), no. 1, 163–167.
- [229] A. Weinstein, *Poisson Geometry*, Differential Geometry and its Applications 9 (1998), 213–238.
- [230] J. C. Wells, C. R. DePrima: Local automorphisms are differential operators on some Banach spaces. *Proceedings of the American Mathematical Society*, 40(2):453–457, 1973.
- [231] Thomas Windheuser, Ulrich Schlickewei, Frank R. Schmidt, and Daniel Cremers. Geometrically consistent elastic matching of 3d shapes: A linear programming solution. In *Proceedings of the 2011 International Conference on Computer Vision, ICCV '11*, pages 2134–2141, 2011.
- [232] Wirth B., Bar L., Rumpf M., and Shapiro G. A continuum mechanical approach to geodesics in shape space. *IJCV*, 93(3):293–318, 2011.
- [233] T. Wurzbacher, *Fermionic Second Quantization and the Geometry of the Restricted Grassmannian*, Infinite Dimensional Kähler Manifolds, DMV Seminar, Band 31, Birkhäuser, 2001.
- [234] Qian Xie, Sebastian Kurtek, Huiling Le, and Anuj Srivastava. Parallel transport of deformations in shape space of elastic surfaces. In *Proceedings of the 2013 International Conference on Computer Vision, ICCV '13*, 2013.
- [235] H. Yamada, *The Virasoro Algebra and the KP Hierarchy*, Infinite Dimensional Groups with applications, Edited by Kac, Springer-Verlag, 1985.
- [236] Laurent Younes. Computable elastic distances between shapes. *SIAM J. of Applied Math.*, pages 565–586, 1998.
- [237] L. Younes, P. W. Michor, J. Shah, and D. Mumford, “A metric on shape space with explicit geodesics.” *Matematica E Applicazioni*, no. 19, pp. 25–57, 2008.
- [238] I. Zakharevich, *The second Gelfand-Dickey Bracket as a Bracket on a Poisson-Lie Grassmannian*, Gelfand Seminar, Amer. Math. Soc, 1993, 179–208, Commun. Math. Phys. 159 (1994), 93–119.
- [239] Keyang Zhou, Bharat Lal Bhatnagar, and Gerard Pons-Moll. Unsupervised shape and pose disentanglement for 3d meshes. In *European Conference on Computer Vision (ECCV)*, August 2020.