



**HAL**  
open science

# Imprégnation de la faune sauvage par les micropolluants : Causes et conséquences sur les individus et les populations

Aurélie Goutte

► **To cite this version:**

Aurélie Goutte. Imprégnation de la faune sauvage par les micropolluants : Causes et conséquences sur les individus et les populations. Ecotoxicologie. Ecole Pratique des Hautes Etudes Paris, 2019. tel-04013681

**HAL Id: tel-04013681**

**<https://hal.science/tel-04013681>**

Submitted on 3 Mar 2023

**HAL** is a multi-disciplinary open access archive for the deposit and dissemination of scientific research documents, whether they are published or not. The documents may come from teaching and research institutions in France or abroad, or from public or private research centers.

L'archive ouverte pluridisciplinaire **HAL**, est destinée au dépôt et à la diffusion de documents scientifiques de niveau recherche, publiés ou non, émanant des établissements d'enseignement et de recherche français ou étrangers, des laboratoires publics ou privés.



École Pratique des Hautes Études

Ecole doctorale EPHE 472  
Mention Systèmes intégrés, environnement et biodiversité

Mémoire présenté en vue de l'obtention de  
l'Habilitation à Diriger des Recherches

par

Aurélie Goutte  
Maître de conférences EPHE  
UMR 7619 METIS, Sorbonne Université/CNRS/EPHE

---

**Imprégnation de la faune sauvage par les micropolluants :**  
**Causes et conséquences sur les individus et les populations**

---

Soutenu le 16 mai 2019 devant la commission d'examen :

Sylvie Derenne (Directrice de recherche, CNRS, DECU EPHE).....Directeur HDR  
Stéphane Betoulle Professeur des universités.....Rapporteur  
Renaud Scheifler Maître de Conférences HDR.....Rapporteur  
Julien Gasparini Professeur des universités.....Examineur  
Sandrine Meylan Professeure des universités.....Examineur



## Avant-propos

Les résultats présentés dans ce mémoire HDR sont, pour leur grande majorité, issus de mon deuxième post-doctorat et des travaux effectués depuis mon recrutement en tant que maître de conférences EPHE. Ce choix répond à une cohérence thématique sur le devenir des micropolluants dans les réseaux trophiques et leurs effets à différentes échelles d'organisation biologique. Certains résultats ont aussi été obtenus à partir d'échantillons collectés durant ma thèse et mon premier post-doctorat qui ont été revisités par la suite dans une approche écotoxicologique.

Pour retracer brièvement mon parcours, le premier contact avec l'écotoxicologie s'est fait en école d'ingénieur agronome à Montpellier. Nous devions traiter d'un projet de controverses sociotechniques et avons choisi le sujet médiatisé des insecticides systémiques et du déclin des abeilles.

Passionnée depuis toujours par les milieux polaires, je suis partie faire une partie de mes études au sein de l'université la plus septentrionale au monde, au Svalbard, de janvier à août 2006. Ce semestre Erasmus dans l'Arctique norvégien était avant tout un rêve d'enfant : la nuit polaire et les aurores boréales, la banquise et les glaciers, le retour du soleil et de la vie si foisonnante après un hiver feutré. Les cours étaient tout aussi enrichissants et j'ai poursuivi l'aventure par un stage sur l'écologie trophique des mergules nains en lien avec la distribution et l'abondance en zooplancton.

De retour en France, j'ai effectué ma dernière année d'école d'ingénieur à l'Université de Montpellier, en suivant un master recherche en Biologie de l'Evolution et Ecologie, avec la ferme intention de repartir dans les régions polaires. J'ai eu la chance de réaliser mon stage de master 2 sous la direction d'Olivier Chastel, au Centre d'Etudes Biologiques de Chizé, sur les liens entre la corticostérone, une hormone dite de stress et la mortalité, chez les mouettes tridactyles au Svalbard. J'ai poursuivi par une thèse de 2007 à 2010, visant à étudier les mécanismes endocriniens impliqués dans l'orchestration de la phénologie de la reproduction chez les oiseaux marins polaires. Ce projet a été une formidable formation à la recherche. Bien qu'il n'y ait pas de polluants au programme, j'ai réussi à en greffer lors d'un séjour d'un mois à l'Institut Polaire Norvégien à Tromsø.

Mon premier post-doctorat (2010-2012) a été mené au LOCEAN, avec Guillaume Massé. Le sujet exploratoire et innovant m'a tout de suite plu : l'idée était de transposer des marqueurs de banquise développés en paléoclimatologie, les isoprénoïdes hautement ramifiés, à des problématiques d'écologie trophique. Nous avons ainsi pu montrer que ces marqueurs synthétisés par des diatomées associées à la banquise, étaient transmis des proies aux prédateurs, et reflétaient la contribution relative de cette production primaire cryopélagique aux organismes marins antarctiques. En parallèle, j'ai initié une collaboration avec Marc Chevreuil de l'UMR Sisyphe (qui deviendra l'UMR METIS) et Paco Bustamante (LIENSs) pour analyser le devenir des polluants organiques persistants et des éléments traces métalliques dans les écosystèmes pélagiques et benthiques en Antarctique.

Dans le cadre de l'ANR POLARTOP portée par Olivier Chastel, je suis retournée dans mon laboratoire de thèse pour mon deuxième post-doctorat (2012-2014), qui consistait à évaluer et à prédire les effets des polluants organiques et métalliques sur les taux de survie, les performances de reproduction et la dynamique de populations d'oiseaux marins polaires. Ce sont mes premiers travaux officiels en écotoxicologie, ils ont attiré une bonne couverture médiatique et je leur consacre la première partie de ce mémoire HDR.

En octobre 2014, j'ai été recrutée comme maître de conférences à l'Ecole Pratique des Hautes Etudes. Après avoir consacré 8 ans aux milieux polaires, territoires éloignés de presque toutes activités humaines, mes travaux s'inscrivent désormais dans l'anthropo-hydro-écosystème de la



Seine, c'est-à-dire sur les communautés biologiques des cours d'eau qui ont co-évolué avec les sociétés humaines. Je m'intéresse toujours aux contaminants historiques et persistants, mais aussi à ceux actuellement émis dans l'environnement ainsi qu'à leurs produits de dégradation. Avec des financements de l'Agence de l'Eau Seine Normandie et du PIREN-Seine, j'étudie le devenir de ces polluants et de leurs métabolites dans les réseaux trophiques de rivières urbanisées, ainsi que les facteurs d'imprégnation des poissons d'eau douce et les dommages potentiels à différentes échelles biologiques. Ces travaux font l'objet de la deuxième partie de ce mémoire HDR. J'ai eu la chance d'encadrer des étudiants brillants, comme Claire Fourgous, qui a publié ses résultats de stage M2 et Noëlie Molbert, qui poursuit en thèse avec un financement de l'Institut de Transition Environnementale de Sorbonne Université.

Ce changement de cadre a aussi refaçonné ma conception du métier de chercheur. Le premier point d'inflexion vers des questionnements plus appliqués s'est fait lors de mon arrivée dans l'UMR 7619 METIS, dont l'une des spécificités est de répondre à des grands défis sociétaux liés à l'eau et aux territoires. En parallèle, je suis membre du Conseil National de la Protection de la Nature depuis 2017, ce qui me permet d'apporter une contribution concrète, aussi modeste soit-elle, à la conservation des espèces et des espaces protégés.

Pour finir, si l'exercice de rédaction de l'HDR se prête à une certaine introspection, je ne pense pas être de ces brillants chercheurs qui gardent le cap dans leurs questionnements scientifiques et repoussent les limites des connaissances dans un domaine précis. J'ai plutôt l'impression de naviguer entre différentes disciplines, d'explorer les passerelles entre les champs thématiques, d'essayer d'emboîter les pièces entre elles. Je suis loin d'y arriver, j'apprends, je désapprends, mais je vais tenter de dresser le bilan de mes travaux et les directions vers lesquelles je souhaite m'orienter.

*Contrairement à Villon qui stagnait dans le ruisseau  
j'ai la chance d'habiter en plein Paris une maison qui donne sur un petit jardin.  
Quelle joie chaque matin d'ouvrir les volets pour entendre tousser les oiseaux.*

Pierre Desproges

*« Le papier, lui avait un jour expliqué un gars volubile, la rédaction, le procès-verbal est à la naissance de toute Idée. Pas de papier, pas d'idée. Le verbe hisse l'idée comme l'humus hisse le petit pois. Un acte sans papier, et c'est un petit pois de plus qui meurt dans le monde. »  
Bien, il avait donc dû faire mourir des camions de petits pois depuis qu'il était flic.  
Mais il avait souvent senti émerger des pensées intrigantes à l'issue de ses déambulations.  
Pensées qui ressemblaient plus à des paquets d'algues qu'à des petits pois, sans doute, mais le végétal reste le végétal et l'idée reste l'idée, et nul ne vous demande une fois que vous l'avez énoncée si vous l'avez cueillie dans un champ labouré ou ramassée sur un bourbier.*

Fred Vargas

## Remerciements

Ces résultats sont le fruit d'un travail d'équipe, de rencontres déterminantes et de discussions passionnantes.

Je remercie les membres du jury, Stéphane Betoulle, Julien Gasparini, Sandrine Meylan, Renaud Scheifler, ainsi que Suzanne Mills d'avoir accepté d'évaluer ce travail.

A Sylvie Derenne, responsable du département Biogéochimie de l'UMR METIS pour m'avoir fait l'honneur d'être ma directrice d'habilitation, malgré nos domaines relativement éloignés.

A Jean-Marie Mouchel, directeur de l'UMR METIS, pour ses conseils avisés.

Aux membres de l'UMR METIS et tout particulièrement aux collègues EPHE, Fabrice Alliot, Hélène Blanchoud, Annie Desportes, Elodie Guigon, Thomas Thiebault pour rendre notre environnement de travail si bienveillant et convivial.

Aux étudiants que j'ai eu le plaisir d'encadrer et qui ont largement contribué à l'acquisition et à la valorisation de ces résultats.

Aux collaborateurs nationaux et internationaux, avec qui j'espère pouvoir continuer à travailler.

Aux membres du Conseil National de la Protection de la Nature pour leur vision inspirante et leur engagement pour la nature.

Aux institutions et organisations qui m'ont fait confiance, en m'accordant un financement ou un appui logistique et technique.

À mes amis et ma famille, et tout particulièrement à mes parents, Jean-Pierre et Tristan pour leur précieux soutien.

Merci.

## Liste des figures

Figure 1 : Exemple d'effets synergiques pouvant amplifier le risque d'extinction des populations ....	17
Figure 2 : Facteurs d'imprégnation des poissons par les micropolluants organiques. ....	20
Figure 3 : Voies de métabolisation des micropolluants .....	21
Figure 4 : Grands axes thématiques de mes travaux de recherche .....	23
Figure 5 : Capture d'organismes marins en Terre Adélie, Antarctique, comme ce dragon nu ( <i>Gymnodraco acuticeps</i> ) de la famille des Bathydraconidés, à l'aide de nasses, filets sous la banquise, et pêches à la ligne .....	24
Figure 6 : Imprégnation des organismes marins Antarctiques (A) au PCBs et (B) et au mercure.....	25
Figure 7 : Espèces étudiées (de gauche à droite, de haut en bas) : grand albatros ( <i>Diomedea exulans</i> ) à Crozet, mouette tridactyle ( <i>Rissa tridactyla</i> ) au Spitzberg, skua antarctique ( <i>Catharacta maccormicki</i> ) en Terre Adélie et skua subantarctique ( <i>Catharacta lonnbergi</i> ) à Kerguelen .....	26
Figure 8: Effets des taux de mercure dans le sang (moyenne $\pm$ erreur type) sur le taux de survie, la probabilité et le succès de reproduction sur le long-terme chez les 4 espèces d'oiseaux marins .....	28
Figure 9 : Effets des taux de POPs dans le sang sur le taux de survie, la probabilité et le succès de reproduction sur le long-terme chez les 3 espèces d'oiseaux marins .....	31
Figure 10 : Modèles matriciels de populations qui révèlent un déclin des populations de grands albatros avec les taux de mercure et de POPs .....	33
Figure 11 : Dilution trophique des HAPs (A) et des phtalates (C). Bioamplification trophique des métabolites de phtalates (D), des PCBs (E) et des pesticides organochlorés (F). Absence de corrélation entre les teneurs en métabolites de HAPs et le niveau trophique (B), déterminé par la signature isotopique en azote. Les ronds représentent les producteurs primaires (biofilm, feuilles mortes, fausse renouée du japon), les triangles, les macro-invertébrés (gammare, limnées, corbicules, sangsues), les croix, les poissons (tanches, chabots, goujons, gardons, perches communes, perches soleils, poissons chats) .....	35
Figure 12 : Pêche électrique en rivière et prélèvement sanguin sur un chevesne .....	37
Figure 13 : Répartition des matrices environnementales (eau, phase dissoute (PD), préleveurs passifs, sédiment, biofilm) et biologiques (muscle et foie de chevesnes) en fonction des micropolluants (phtalates, HAP, pesticides pyréthrinoides, PCB, pesticides organochlorés (OC)) .....	37
Figure 14 : Diminution des teneurs musculaires en phtalates (A) et en métabolites de phtalates (B) avec la longueur totale des chevesnes.....	38
Figure 15 : Teneurs musculaires en pesticides organochlorés (ng/g dw) significativement plus faibles chez les chevesnes parasités d'acanthocéphales que chez les non-parasités.....	40
Figure 16 : Diminution de la capacité anti-oxydante (OXY) avec les teneurs hépatiques (A) en métabolites de phtalates et (B) en métabolites totaux .....	41
Figure 17 : Diminution du stress oxydant chez les chevesnes avec (A) la longueur et (B) la présence de parasites acanthocéphales.....	42
Figure 18 : (A) diminution de la longueur des télomères avec la taille des chevesnes, (B) : Diminution de la longueur des télomères corrigée par la taille en fonction des teneurs musculaires en pesticides organochlorés (POC).....	43
Figure 19 : Design expérimental utilisé pour tester les effets croisés du parasitisme et de l'exposition aux HAPs sur les chevesnes.....	46
Figure 20 : Prédiction sur la (A) variation des taux de corticostérone et (B) du temps passé recroqueviller dans la carapace en fonction de l'âge et des niveaux d'imprégnation des cistudes par les micropolluants .....	50

## Table des matières

Avant-propos.....	3
Remerciements .....	5
Liste des figures.....	6
I. Curriculum Vitae.....	8
II. Contexte et concepts.....	17
1. Causes multifactorielles du déclin des espèces et des populations.....	17
2. Identification des verrous limitant la compréhension des risques écotoxicologiques en milieux naturels.....	18
2.1 Un défi analytique : la caractérisation des micropolluants et de leurs métabolites.....	18
2.2. Des divergences conceptuelles entre écologues et écotoxicologues .....	19
2.3 Le devenir incertain des polluants dans les organismes et les écosystèmes.....	20
2.4 La diversité des effets toxiques en conditions naturelles .....	21
3. Positionnement thématique .....	22
III. Résultats marquants.....	24
1. Polluants organiques persistants et mercure chez les organismes marins polaires.....	24
1.1 Importance du niveau trophique et de l'habitat.....	24
1.2 Effets des polluants sur la survie et la reproduction à long-terme .....	26
1.3 Scénarios prédictifs en terme de dynamique des populations .....	32
2. Polluants métabolisables et leurs métabolites chez les poissons de rivières urbanisées.....	34
2.1 Devenir des polluants métabolisables dans les réseaux trophiques lotiques.....	34
2.2 Facteurs d'imprégnation des poissons d'eau douce .....	36
2.3 Dommages potentiels .....	41
IV. Conclusion et perspectives de recherche.....	45
1. Coûts et bénéfices du parasitisme en milieu pollué: une approche expérimentale.....	45
2. Les poissons d'eau douce comme réservoir d'antibiorésistance.....	47
3. Dynamique temporelle des marqueurs écotoxicologiques chez les chabots en lien avec la contamination en pesticides .....	48
4. Bioaccumulation et impact des micropolluants chez les Cistudes en Camargue .....	49
5. L'horizon des possibles.....	50
Références bibliographiques .....	52
Annexe.....	60

## I. Curriculum Vitae

Prénom et nom : Aurélie Goutte  
Age : 34 ans  
Nationalité : Française  
Situation familiale : Pacsée, 1 enfant

Contact : ✉ Sorbonne Université, campus Pierre et Marie Curie  
UMR METIS 7619, EPHE/CNRS/SU, Case courrier 105,  
4 place Jussieu  
75252 Paris Cedex 05  
☎ +33 (0)1 44 27 63 20  
💻 [aurelie.goutte@upmc.fr](mailto:aurelie.goutte@upmc.fr) ou [aurelie.goutte@ephe.sorbonne.fr](mailto:aurelie.goutte@ephe.sorbonne.fr)  
Site web : [aureliegoutte.webs.com](http://aureliegoutte.webs.com)

### PARCOURS PROFESSIONNEL

---

- 2017 Membre nommé au Conseil National de la Protection de la Nature (CNPN)
- Membre titulaire de la commission « Espèces et Communautés Biologiques »
  - Membre suppléant de la commission « Espaces Protégés »
  - Rapporteur de dossiers de demande de dérogation espèces protégées
- 2014 Maître de conférences à l'Ecole Pratique des Hautes Etudes (EPHE)  
Basé à Sorbonne Université, campus Pierre et Marie Curie, UMR 7619 METIS
- 2012 - 14 Post-doctorat, CNRS, Centre d'Etudes Biologiques de Chizé, UMR 7372  
*Effets des polluants sur la survie, la reproduction et la dynamique des populations d'oiseaux marins dans les Terres Australes et Antarctiques Françaises*  
(ANR PolarTop, PI : Olivier Chastel)
- 2010 - 2012 Post-doctorat, Laboratoire d'Océanographie et du Climat : Expérimentations et Approches Numériques (LOCEAN), UMR 7159  
*Développement de nouveaux marqueurs de glace dans les écosystèmes marins antarctiques* (ERC IceProxy, PI : Guillaume Massé)

### DIPLOMES, TITRES UNIVERSITAIRES ET CURSUS

---

- 2012 Qualification aux fonctions de Maître de Conférences, section 67
- 2007-2010 Doctorat en écologie, Centre d'Etudes Biologiques de Chizé, CNRS UPR 1934  
*Mécanismes hormonaux impliqués dans la phénologie de la reproduction chez les oiseaux marins polaires* (directeur de thèse : Olivier Chastel, bourse de docteur ingénieur, CNRS-Région Poitou Charentes)
- 2007 Master 2 en Biologie Évolutive et Écologie, Université de Montpellier II  
2004-2007 Ecole d'Ingénieur Agronome de Montpellier SupAgro
- 2002-2004 Classes Préparatoires BCPST, Lycée Hoche, Versailles  
2002 Baccalauréat, S, mention bien

## RECHERCHE : RESPONSABILITES DANS LA GESTION ET L'ANIMATION DE PROJETS

### *Gestion de contrats de recherche et autres financements*

<b>Période</b>	<b>Financier</b>	<b>Programme</b>
2018	UMR 7619 METIS (4k€, responsable)	Effet croisé du parasitisme et de l'exposition aux HAPs sur le microbiote intestinal des poissons
2018	Ecole Pratique des Hautes Etudes (4k€, responsable)	Infestation expérimentale de chevesnes par les acanthocéphales
2017 - 2020	Institut de la Transition Environnementale (co-resp. J-M Mouchel)	Transfert hôte-parasites de micropolluants métabolisables (Bourse doctorale Noëlie Molbert)
2017	Syndicat interdépartemental pour l'assainissement de l'agglomération parisienne (13 k€, responsable)	Comparaison de l'ADN environnemental et des pêches électriques pour les inventaires piscicoles au sein de l'agglomération parisienne
2015 - 2018	Agence de l'Eau Seine Normandie (182 k€, co.resp M. Chevreuil)	Métabolisation des polluants organiques par les poissons et effets à plusieurs échelles biologiques
2016 - 2019	PIREN-Seine phase VII (63 k€, co-resp. P. Labadie)	Dynamique de transfert des polluants organiques dans les réseaux trophiques lotiques
2016 - 2019	Agence de l'Eau Adour-Garonne (140 k€, PI : L. Jacquin)	Réponses physiologiques à la pollution et conséquences sur les interactions hôtes-parasites chez les poissons
2015	Fédération Ile-de-France de Recherche en Environnement (3.5 k€, responsable)	Métabolites de phtalates et stress oxydant chez l'anguille (Gratification de M2, Claire Fourgous)

### *Animation de la recherche*

2015 - 2019 Membre du comité de direction du PIREN-Seine phase VII (Programme Interdisciplinaire de Recherche sur l'Environnement de la Seine)  
Animatrice du bloc « Contaminants » (budget total de 450 k€)

2015 - 2018 Co-responsable des séminaires scientifiques hebdomadaires, UMR 7619 METIS

### *Expertise comme referee pour des publications scientifiques*

Proceeding of the Royal Society B, Ecological Application, Nature Scientific Report, PLOS ONE, Hormones and Behaviour, General and Comparative Endocrinology, Marine Ecology Progress Series, Comparative Biochemistry and Physiology, Science of the Total Environment, Environmental Pollution, Chemosphere, Environmental Research, Journal of Ornithology, Oecologia, Avian conservation and Ecology, Journal of Avian Biology, Journal of Experimental Marine Biology and Ecology, Ardeola, Environmental Sciences Group, Revue d'Ecologie (Terre et Vie), Bulletin de Veille Scientifique ANSES

## Rapporteur pour des projets scientifiques

2014 : Institut Paul Emile Victor (IPEV)

## Evaluation des établissements d'enseignement supérieur et de recherche

2017 : Membre du comité HCERES de l'entité BELCA (Ecotoxicologie et Bioindication des Milieux Aquatiques), tutelle de l'IRSTEA

## ENCADREMENT ET CO-ENCADREMENT DE STAGES ET DE THESE

---

Au total : 1 thèse, 5 stages de master 2, 2 de master 1, 1 de l'ENS, 2 de licence 3, 1 de DUT

Année	Type	Candidat, sujet et co-encadrement
2019	L3	Marwa Khabou. Transfert hôte-parasite de HAPs : une approche expérimentale
2019	M2	Etienne Marchand. Les peuplements piscicoles comme réservoir d'antibiorésistance en lien avec la pression antibiotique ( <i>co-encadrement F. Petit et T. Berthe, UMR 6143 M2C</i> )
2019	M2	Louisiane Burkart. Bioaccumulation et impact des contaminants aquatiques chez la cistude d'Europe dans une zone humide ( <i>co-encadrement A. Olivier et M. Vittecoq, Tour du Valat, O. Lourdais, CEBC</i> )
2018	L3	Garance Despréaux. Comparaison de l'ADNe et des pêches électriques pour les inventaires piscicoles
2018	M1	Andrea Adequin. Évaluation des teneurs en glyphosate et AMPA dans un poisson d'eau douce, le chevesne ( <i>co-encadrement H. Blanchoud</i> )
2017 – 2020	Thèse	Noëlie Molbert. Transfert hôte-parasites de micropolluants métabolisables ( <i>directeur de thèse : J-M Mouchel</i> ) → Publication (article <b>26</b> ), présentations orales et posters
2017	M2	Victor Lachaux. Dynamique trophique des polluants dans un écosystème aquatique soumis à une forte pression chimique
2017	M2	Noëlie Molbert. Imprégnation des poissons d'eau douce par les micropolluants organiques en fonction des composantes environnementales et individuelles.
2015	M2	Claire Fourgous. Les plastifiants chez l'anguille européenne : variations spatio-temporelles et effets potentiels sur le stress oxydant → Publication (article <b>23</b> ) et présentation orale à un congrès
2011	M1	Sara Labrousse. Transfert de polluants organiques persistants dans les organismes marins antarctiques
2011	DUT	Floriane Cargouët. Analyse de marqueurs de glace dans les organismes marins antarctiques
2009	ENS	Françoise Amélineau. Effect of age and reproductive experience on the timing of breeding in a long-lived bird: the snow petrel in Adélie Land. ( <i>co-encadrement O. Chastel</i> )

## PARTICIPATION A DES JURYS ET COMITES DE PILOTAGE

---

### Participation à des jurys de thèse

(à venir) 11/09/ 2019 : Rapporteur de la thèse de Norith Eckbo. *The influence of contaminants in the life history of polar seabirds*. Université d'Oslo, Norvège

- 2018 : Examinatrice de la thèse de doctorat de Pierre Blévin. *Polluants organiques émergents en Arctique : effets des composés perfluorés sur les oiseaux marins*. UMR 7372 Centre d'Etudes Biologiques de Chizé CNRS – Université de la Rochelle
- 2017 : Examinatrice de la thèse de doctorat d'Héloïse Guillot. *L'herpétofaune, sentinelle de l'accumulation et des effets des contaminants environnementaux ?* UMR 7372 Centre d'Etudes Biologiques de Chizé CNRS – Université de la Rochelle

#### *Participation à des comités de pilotage de thèse*

- 2017 et 2019 : Quentin Petitjean. *Réponses aux stress multiples chez les poissons d'eau douce*. UMR 5245 Ecolab, Université Toulouse III
- 2016 : Héloïse Guillot. *Herpétofaune et contaminants environnementaux*. UMR 7372 Centre d'Etudes Biologiques de Chizé CNRS – Université de la Rochelle

#### *Participation à des jurys de fin de formation*

- 2019 : Présidente du jury de diplôme EPHE d'Alexandre Crégu. *Ecologie et chorologie d'une famille de lépidoptères méconnue, les Sesiidae*.
- 2018 : Membre du jury de diplôme - Ecole Spéciale d'Architecture. Axel Ganivet. *S'adapter à la montée des eaux – de terrien à merrien. Étude prospective sur les phénomènes de submersions maritimes en Nouvelle-Calédonie, qu'ils soient temporaires ou définitifs*

### **RESPONSABILITES PEDAGOGIQUES ET ACTIVITES D'ENSEIGNEMENT**

---

#### *Création et co-responsabilité d'Unités d'Enseignements (UE)*

- Ecologie aquatique
- Services et gestion écosystémiques
- Acquisition et traitement statistique des données. Niveau 2

#### *Activités d'enseignement dans d'autres UE :*

- Acquisition et traitement statistique des données. Niveau 1
- Fondamentaux d'écologie : Dynamique des populations
- Qualité des Milieux : Impacts des changements climatiques
- Perturbations Anthropiques : risques écotoxicologiques
- Techniques de terrain en environnement aquatique
- Effets des perturbateurs endocriniens sur les organismes aquatiques
- Processus chimiques dans l'environnement

#### *Tutorat pédagogique à l'EPHE*

- 2018- en cours : Pascaline Belle Chifflet (diplôme EPHE)  
2018 et 2019 : Manal Belhoucine (M1 et M2 EPHE)  
2016 : Louise Jullien (M2 Pro EPHE)



## PUBLICATIONS SCIENTIFIQUES (APRES LE DOCTORAT)

---

### *En révision ou en relecture par les co-auteurs (soumission dans les 2 mois)*

30. Simonnet-Laprade C, Budzinski H., Maciejewski K, Le Menach K, Santos R, Alliot F, **Goutte A**, Labadie P (in prep for *Environmental Science and Technology*). Contribution of targeted and unknown precursors to the apparent biomagnification of perfluoroalkyl acids (PFAAs) in the food web of an urban river
29. Carré C, Meybeck M, Garnier J, Chong N, Deroubaix J-F, Flipo N, Gob F, **Goutte A**, Le Pichon C, Seguin L, Tournebize J (in prep for *the Handbook of Environmental Chemistry*). River basin vision: tools and approaches, from yesterday to tomorrow
28. Bonnard M, Barjhoux I, Dedourge-Geffard O, **Goutte A**, Oziol L, Palos-Ladeiro M, Geffard A (in prep for *the Handbook of Environmental Chemistry*). Thirty years of ecotoxicity studies in the Seine River and its drainage basin.
27. **Goutte A**, Alliot F, C. Budzinski H, Simonnet-Laprade C, Santos R, Labadie P (in prep for *Environmental Science and Technology*). Trophic transfer of PAH, phthalates, and their metabolites in an urban river food web.
26. Molbert N, Alliot F, Santos R, Chevreuril M, Mouchel J-M, **Goutte A** (in revision in *Environmental Toxicology and Chemistry*). Multi-residue methods for the determination of organic micropollutants and their metabolites in fish tissues from the Marne hydrographic network (France).

### *Publiés*

25. Aviles A., Boulogne I, Durand N, Maria A, Cordeiro A, Bozzolan F, **Goutte A**, Alliot F, Dacher F, Renault D, Maibeche M, Siaussat D. (2019) Effects of DEHP on post-embryonic development, nuclear receptor expression, metabolites and ecdysteroids concentrations of *S. littoralis*, *Chemosphere* 215, 725-738.
24. **Goutte A**, Meillère A, Barbraud C, Budzinski H, Labadie P, Peluhet L, Weimerskirch H, Delord K, Chastel O (2018) Demographic, endocrine and behavioral responses to mirex in the South polar skua. *The Science of the Total Environment* 631-632, 317-325
23. Fourgous C, Chevreuril M, Alliot F, Amilhat E, Faliex E, Paris-Palacios S, Teil MJ, **Goutte A** (2016) Phthalate metabolites in the European eel (*Anguilla anguilla*) from Mediterranean coastal lagoons. *The Science of the Total Environment* 569-570, 1053–1059
22. Bustamante P, Carravieri A, **Goutte A**, Barbraud C, Delord K, Chastel O, Weimerskirch H, Cherel Y (2016) High feather mercury concentrations in the wandering albatross are related to sex, breeding status and trophic ecology with no demographic consequences. *Environmental Research* 144, 1-10
21. **Goutte A**, Cherel Y, Churlaud C, Ponthus JP, Massé G, Bustamante P (2015) Trace elements in Antarctic fish species and the influence of foraging habitats and dietary habits on mercury levels. *The Science of the Total Environment* 538, 743–749
20. Costantini D, **Goutte A**, Barbraud C, Faivre B, Sorci G, Weimerskirch H, Delord K, Chastel O (2015) Demographic responses to oxidative stress and inflammation in the wandering albatross (*Diomedea exulans*). *PLOS ONE*, 10(8): e0133967
19. **Goutte A**, Barbraud C, Herzke D, Bustamante P, Angelier F, Tartu S, Clément-Chastel C, Moe B, Bech C, Gabrielsen GW, Bustnes JO, Chastel O (2015) Survival rate and breeding outputs in a

high Arctic seabird exposed to legacy persistent organic pollutants and mercury. *Environmental Pollution* 200, 1-9

18. **Goutte A**, Charrassin JB, Cherel Y, Carravieri A, De Grissac S, Massé G (2014) Importance of ice algal production for top predators: new insights using sea ice biomarkers. *Marine Ecology Progress Series* 513, 269-275
17. Tartu S, Bustamante P, **Goutte A**, Bustnes JO, Cherel Y, Weimerskirch H, Chastel O (2014) Age related mercury contamination and endocrine disruption in a long-lived Antarctic bird, the snow petrel. *PLOS ONE* 9(7): e103642
16. **Goutte A**, Barbraud C, Meillère A, Carravieri A, Bustamante P, Labadie P, Budzinski H, Delord K, Cherel Y, Weimerskirch H, Chastel O (2014) Demographic consequences of heavy metals and persistent organic pollutants in a vulnerable long-lived bird, the wandering albatross. *Proceedings of the Royal Society B* 281, 20133313
15. **Goutte A**, Cherel Y, Ozouf-Crosta C, Robineau C, Lanshere J, Massé G (2014) Seasonal contribution of sea ice organic matter in the diet of Antarctic fishes: a diatom-specific Highly Branched Isoprenoid approach. *Polar Biology* 37, 903-910
14. **Goutte A**, Angelier F, Bech C, Clément-Chastel C, Dell'Omo G, Gabrielsen GW, Lendvai ÁZ, Moe B, Noreen E, Pinaud D, Tartu S, Chastel O (2014) Annual variation in the timing of breeding, pre-breeding foraging areas and corticosterone levels in an Arctic population of black-legged kittiwakes. *Marine Ecology Progress Series* 496, 233-247
13. Jaeger A, **Goutte A**, Lecomte VJ, Richard P, Chastel O, Barbraud C, Weimerskirch H, Cherel Y (2014) Age, sex and breeding status shape a complex foraging pattern in an extremely long-lived seabird. *Ecology* 95, 2324-2333
12. **Goutte A**, Bustamante P, Barbraud C, Delord K, Weimerskirch H, Chastel O (2014) Demographic responses to mercury exposure in two closely-related Antarctic top predators. *Ecology* 95, 1075-1086
11. **Goutte A**, Chevreuril M, Alliot F, Eléaume M, Chastel O, Cherel Y, Massé G (2013) Persistent organic pollutants in benthic and pelagic organisms off Adélie Land, Antarctica. *Marine Pollution Bulletin* 77, 82-89
10. Tartu S, **Goutte A**, Angelier F, Clément-Chastel C, Moe B, Bech C, Gabrielsen GW, Bustnes JO, Bustamante P, Chastel O (2013) To breed or not to breed: endocrine response to mercury contamination by an Arctic seabird. *Biology Letters* 9(4):20130317
9. **Goutte A**, Cherel Y, Houssais MN, Klein V, Ozouf-Costaz C, Raccurt M, Robineau C, Massé G (2013) Diatom specific highly branched isoprenoids as biomarkers in Antarctic consumers. *PLOS ONE* e56504

## **PUBLICATIONS SCIENTIFIQUES (LIEES AU DOCTORAT ET AU MASTER 2)**

---

8. Nordstad T, Moe B, Bustnes JO, Bech C, Chastel O, **Goutte A**, Trouvé C, Herzke D, Gabrielsen GW (2012) POPs and baseline corticosterone levels in kittiwakes during three periods of the breeding season. *Environmental Pollution* 164, 219-226
7. Frederiksen M, et al (2012) Multi-colony tracking reveals the non-breeding distribution of a pelagic seabird on an ocean basin scale. *Diversity and Distributions* 18, 530-542
6. **Goutte A**, Kriloff M, Weimerskirch H, Chastel O (2011) Why do some adult birds skip breeding? A hormonal investigation in a long-lived bird. *Biology Letters* 7, 790-792
5. **Goutte A**, Antoine E, Chastel O (2011) Experimentally delayed hatching triggers a magnified stress response in a long-lived bird. *Hormones and Behavior* 59, 167-173

4. **Goutte A**, Clément-Chastel C, Bech C, Gabrielsen GW, Chastel O (2011) Experimentally reduced corticosterone release promotes early breeding in Black-legged kittiwakes *Journal of Experimental Biology* 214, 2005-2013
3. **Goutte A**, Antoine E, Weimerskirch H, Chastel O (2010) Age and the timing of breeding in a long-lived bird: a role for stress hormones? *Functional Ecology* 24, 1007-1016
2. **Goutte A**, Angelier F, Welcker J, Moe B, Clément-Chastel C, Gabrielsen GW, Bech C, Chastel O (2010) Long-term survival effect of corticosterone manipulation in Black-legged kittiwakes. *General and Comparative Endocrinology* 167, 246-251
1. **Goutte A**, Angelier F, Clément-Chastel C, Trouvé C, Moe B, Bech C, Gabrielsen GW, Chastel O (2010) Stress and the timing of breeding: glucocorticoids- luteinizing hormone relationships in an arctic seabird. *General and Comparative Endocrinology* 169, 108-116

## RAPPORTS TECHNIQUES

---

- Goutte, A.**, Alliot, F., Azimi, S., Guérin S., Molbert, N., Rocher, V. (2018) Influence du niveau trophique sur l'imprégnation des chevesnes par les micropolluants organiques en agglomération parisienne. Rapport PIREN-Seine
- Goutte, A.** (2018) Métabolisation des micropolluants: Imprégnation et dommages potentiels chez les poissons d'eau douce de la Marne et de ses affluents. Rapport final pour l'Agence de l'Eau Seine Normandie
- Labadie, P., Simonnet-Laprade C., Maciejewski K., Lachaux, V., Le Menach, K., Budzinski, H., Alliot, F., Chevreuil, M., Santos, R., **Goutte, A.** (2017) Transferts de micropolluants dans les réseaux trophiques lotiques : exemple de l'Orge. Rapport PIREN-Seine

## CHAPITRES D'OUVRAGES

---

- *Antarctique: une explosion de vie*, 2012, Museum of Natural History, Le Havre, MkF éditions, ISBN-13: 979-1092305012
- *Mondes polaires : Hommes et biodiversités. Des défis pour la science*, 2012, ed. Le Cherche Midi, ISBN-10: 2749123666

## COMMUNICATIONS ORALES ET POSTERS

---

### *Oraux*

- Molbert N**, Alliot F, Médoc V, Mouchel J M, **Goutte A** (2018) Insights from chub – acanthocephalan system in polluted environments: towards a host decontamination? 9th Acanthocephalan Workshop, Stará Lesná, Slovaquie
- Goutte A**, Alliot F, Molbert N, Chevreuil M. (2018) Métabolisation des micropolluants organiques: Imprégnation et dommages potentiels chez les chevesnes (*Squalius cephalus*). Société Française d'Ecotoxicologie Fondamentale et Appliquée, 27-28 juin 2018, Montpellier, France
- Goutte A**, Alliot F, Santos R, Teil M-J, Chevreuil M. (2017). Environmental pollutants and their metabolites in freshwater fish: integrating effects across multiple biological levels. Symposium for European Freshwater Sciences, 2-7/07/2017, Olomouc, République Tchèque
- Santos R, Besnard A, **Goutte A**, Bony S, Sanchez W, Devaux A. (2017). Monitoring of ecological risks of river contamination for fish populations. Symposium for European Freshwater Sciences, 2-7/07/2017, Olomouc, République Tchèque

Molbert N, Alliot F, Santos R, Chevreuil M, **Goutte A** (2017) Meeting of (France): Levels of several organic micropollutants and their metabolites in the European chub from the Marne hydrographic network. Ecology & Behaviour, Chizé

Labadie P & **Goutte A**. (2017) Transferts de micropolluants dans les réseaux trophiques lotiques: exemple de l'Orge. Colloque du PIREN Seine, 5-6/10/2017, Paris, France

Fourgous C, Teil M J, Alliot F, Chevreuil M, Paris-Palacios S, Amilhat E, Faliex E, **Goutte A**. (2015) Phtalates et métabolites chez l'anguille européenne : relations avec les marqueurs de stress oxydant. Colloque d'EcoPhysiologie Animale, La Rochelle

**Goutte A**, Barbraud C., Bustamante P, Budzinski H, Labadie P, Gabrielsen G W, Weimeskirch H, Chastel O. (2015) L'exposition chronique aux polluants organiques et métalliques peuvent-ils causer un déclin démographique chez les prédateurs supérieurs ? Colloque d'EcoPhysiologie Animale, La Rochelle

**Goutte A**, Bustamante P, Barbraud C, Delord K, Weimeskirch H, Chastel O. (2013) Demographic responses to mercury exposure in two closely-related Antarctic top predators. Colloque d'EcoPhysiologie Animale, Lyon

**Goutte A**, Bustamante P, Barbraud C, Meillere A, Weimeskirch H, Chastel O. (2013) Fitness consequences of mercury exposure in Antarctic top predators, 9th "Ecology & Behaviour" scientific meeting, Strasbourg

**Goutte A**, Clement-Chastel C, Moe B, Bech C, Gabrielsen G W, Chastel O. (2010). Breeding phenology of Black-legged kittiwakes under environmental stress: a role for stress hormones? Field Ornithology EGI Conference, Oxford

**Goutte A**, Clement-Chastel C, Moe B, Bech C, Gabrielsen G W, Chastel O. (2010). Breeding phenology of arctic seabirds under environmental stress. Arctic Frontiers Conference 2010, Tromsø

**Goutte A**, Antoine E, Weimerskirch H, Chastel O. (2009). Age-specific timing of breeding in a long-lived bird: are young birds more sensitive to stress? European Ornithologists' Union (EOU), Zurich

**Goutte A**, Angelier F, Chastel O (2008). Effects of experimentally increased stress hormones levels on breeding success and survival in a long-lived bird: the Black-legged kittiwake, European Conference on Behavioural Biology (ECBB), Dijon

**Goutte A**, Angelier F, Chastel O (2008). Effects of experimentally increased stress hormones levels on breeding success and survival in a long-lived bird: the Black-legged kittiwake, 20th International Congress of Zoology (ICZ), Paris

### *Posters*

Molbert N, Guérin S, Rocher V, **Goutte A** (2018) Comparaison entre pêche d'inventaire et ADN environnemental pour appréhender la diversité piscicole sur la Seine et de la Marne en région parisienne. Journées Information Eaux, Poitiers

**Goutte A**, Alliot F, Budzinski H, Chevreuil M, Santos R, Labadie P. (2018) Fate of PAH, phthalates and their metabolites in an urban river food web. SETAC ROME, 13-17/05/2018, Rome, Italie

Molbert N F, Chevreuil M, Alliot F, Santos R, Mouchel J, **Goutte A**. (2018) Impregnation factors of freshwater fish by organic micropollutants in the Marne Hydrographic network, SETAC ROME, 13-17/05/2018, Rome, Italie

Blanchoud H, Ferreux T, Alliot F, **Goutte A**. (2018) Determination of glyphosate and AMPA in fish bile from the Marne River, France. SETAC ROME, 13-17/05/2018, Rome, Italie

Alliot F, Chevreuil M, **Goutte A.** (2018) Application of a silicone rubber passive sampling technique for monitoring dissolved phase concentrations of Semi Volatile Organic Compounds in the water of the Marne River basin, France. SETAC ROME, 13-17/05/2018, Rome, Italie

Simonnet-Laprade C, Budzinski H, Maciejewski K, Le Menach K, Santos R, Alliot F, **Goutte A**, Labadie P. (2018) Potential contribution of targeted and unknown precursors to the apparent biomagnification of perfluoroalkyl acids (PFAA) in the food web of an urban river. SETAC ROME, 13-17/05/2018, Rome, Italie

Labadie P, **Goutte A**, Maciejewski K, Simonnet-Laprade, C, Le Menach K, Alliot F, Santos R, Budzinski H. (2018). Comparative trophodynamics of polychlorinated biphenyls and chlorinated paraffins in an urban river SETAC ROME, 13-17/05/2018, Rome, Italie

**Goutte A**, Angelier F, Chastel O (2008). Stress and Survival in Black-legged Kittiwakes. SERL, Rencontres Scientifiques Ecologie et Comportement, Toulouse

## SEMINAIRES INVITES

---

- Séminaire invité à la Tour du Valat, 2018. *Imprégnation de la faune sauvage par les micropolluants*
- Séminaire invité iEES-Paris, 2015. *Transfert trophique des micropolluants organiques et effets sur la faune*
- Séminaire invité, Université Toulouse Paul Sabatier, 2014. *Demographic consequences of heavy metals and persistent organic pollutants in polar seabirds*

## DISSEMINATION SCIENTIFIQUE

---

- 2018 : médiatisation des résultats sur les réponses endocriniennes, comportementales et démographiques des skuas antarctiques exposés aux polluants organiques persistants :  
<https://www.cnrs.fr/inee/communication/brevs/b363.html>  
<https://www.actu-environnement.com/ae/news/pesticides-interdits-persistants-contamination-oiseaux-marins-antarctique-31315.php4>
- 2016-2017 : Programme éducatif “*Les Savanturiers – École de la recherche*”. Parrainage d’une classe de 6<sup>ème</sup> au collège F. Dolto, Paris
- 2014 : Conférence scientifique grand public au Museum d’Histoire Naturelle du Havre *Changement climatique et pollution, quels effets sur les oiseaux de l’Antarctique ?*
- 2009 : Parrainage d’une classe de terminale au lycée J. Desfontaines, à Melle

## II. Contexte et concepts

### 1. Causes multifactorielles du déclin des espèces et des populations

Erosion, effondrement, crise de la biodiversité, défaunation, sixième extinction de masse... les termes ne manquent pas pour décrire le déclin des populations et de l'extinction des espèces. Cette profusion lexicale, à la hauteur de l'étiologie de la biodiversité, s'appuie sur une littérature scientifique toute aussi foisonnante, notamment chez les Vertébrés (Ceballos et al 2015). Il convient toutefois de noter que ce sujet très actuel s'avère être un phénomène bien plus ancien. Il y a 132 000 ans, la migration des Hominines (e.g. *Homo erectus*, *H. neanderthalensis*, *H. sapiens*), alors chasseurs-cueilleurs, aurait causé l'extinction de la mégafaune terrestre du Pléistocène (Sandom et al. 2014 ; Smith et al. 2018). Cette thèse est toutefois à nuancer avec d'autres études : il y a 4-5 millions d'années, les changements climatiques liés à une baisse du taux de CO<sub>2</sub> atmosphérique auraient favorisé un changement de végétation dans la vallée du rift africain, passant de milieux forestiers vers des paysages de savane, avec des répercussions sur les grands herbivores, et par ricochet, sur les prédateurs supérieurs (Faith et al. 2018).

Pour expliquer le déclin actuel de la biodiversité, l'hypothèse multifactorielle est souvent privilégiée (Vitousek et al. 1997) : surexploitation des espèces (Pauly et al. 1998), dégradation, homogénéisation, fragmentation et perte d'habitats (Brooks et al. 2002), changements climatiques (Thomas et al. 2004), pollution de l'air, de l'eau et des sols (Beketov et al. 2013 ; Köhler and Triebkorn 2013), espèces exotiques envahissantes (Gurevitch and Padilla 2004), et maladies émergentes (Daszak et al. 2001). Ces pressions anthropiques sont difficilement hiérarchisables (Sala et al. 2000), d'autant plus qu'elles agissent de façon synergique (Brook et al. 2008 ; Blaustein and Kiesecker 2002). Pour l'illustrer schématiquement (Figure 1), prenons l'exemple de l'atrazine, un herbicide connu pour son potentiel perturbateur endocrinien chez les amphibiens adultes et létal à faible dose chez les têtards (Storrs and Kieseckers 2004). Un milieu fragmenté diminue les possibilités de fuite vers des milieux moins exposés à l'atrazine, ce qui *in fine* peut réduire le potentiel adaptatif des populations exposées. De plus, les effets immunosuppresseurs de l'atrazine amplifient la virulence de pathogènes, comme les infections à Ranavirus (Forson and Storfer 2006).

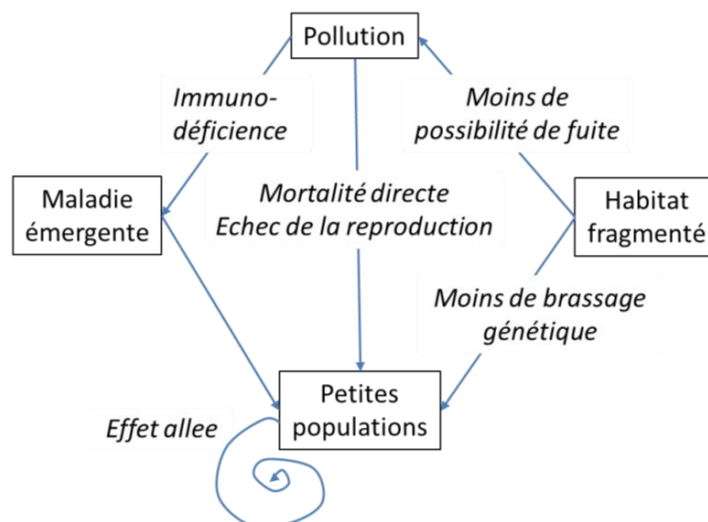


Figure 1 : Exemple d'effets synergiques pouvant amplifier le risque d'extinction des populations



Alors que les effets démographiques des changements climatiques ont suscité un engouement sans précédent chez les écologues (Jenouvrier et al. 2013), peu d'études se sont attachées à mesurer, comprendre et prédire l'impact des polluants sur les populations animales. De plus, elles se sont souvent limitées aux pollutions aiguës, qui provoquent des symptômes rapides et sévères. L'exemple historique qui a marqué le réveil des consciences est l'effet du DDT (dichlorodiphényltrichloroéthane), un insecticide organochloré, et de son métabolite, le DDE, sur la mortalité des oiseaux et sur le faible succès d'éclosion des œufs, dû à l'amincissement de leur coquille (Ratcliffe 1967). Malgré l'évolution de la législation, les cas d'intoxication aiguë restent toujours d'actualité : on peut citer les cas d'empoisonnement secondaire des rapaces, renards et mustélidés par le bromadiolone, un rodenticide anticoagulant (Coeurdassier et al. 2012 ; Rattner et al. 2014). De même, l'effondrement vertigineux -à plus de 90%- des populations de vautours chagoun (*Gyps bengalensis*) en Inde, Népal et Pakistan depuis 1997 est attribué au diclofénac, un anti-inflammatoire non stéroïdien et antalgique. Les vautours s'étant nourris sur les carcasses de bétail préalablement traité au diclofénac souffrent d'insuffisances rénales et meurent dans les 24 heures (Oaks et al. 2004).

La faune sauvage est par ailleurs exposée à une multitude de polluants de façon chronique, c'est-à-dire à faibles doses et sur le long-terme. On estime que plus de 100 000 composés de synthèse sont potentiellement émis dans l'environnement (Bettelheim et al. 2010). Appréhender correctement les impacts cumulés sur les espèces non-cibles représente un défi de taille, dans la mesure où les dysfonctionnements sont subtils (à l'échelle moléculaire et physiologique), différés dans le temps (baisse de la probabilité de survie à long-terme), parfois indirects (baisse du nombre et de la qualité des proies disponibles dans l'environnement, Nocera et al. 2012) et peuvent s'exprimer lors de la survenue d'autres stress environnementaux (e.g. pathogènes, événement climatique extrême, Forson and Storfer 2006 ; Bustnes et al. 2005, 2015).

## **2. Identification des verrous limitant la compréhension des risques écotoxicologiques en milieux naturels**

### **2.1 Un défi analytique : la caractérisation des micropolluants et de leurs métabolites**

Le premier défi est analytique, au vu du nombre et de la diversité des molécules et de leur présence à l'état de trace, et ce, malgré les récents progrès techniques qui permettent leur détection dans des matrices biologiques complexes. Concernant le choix des molécules les plus préoccupantes, la priorité a historiquement été donnée aux polluants organiques persistants (POPs), en raison de leur persistance (P) dans l'environnement, de leur fort potentiel de bioaccumulation (B) et de toxicité (T) (Howard and Muir 2010). Parmi ces POPs, les PCB (polychlorobiphényles) et les pesticides organochlorés (POC) sont toujours détectés dans l'environnement, malgré une chute des émissions depuis leur interdiction dans les années 1990. Un fait marquant des POPs est leur présence à des niveaux extrêmement élevés en Arctique, en raison de leur circulation globale *via* les courants atmosphériques et océaniques et de leur « piégeage » dans les zones les plus froides (Wania and Mackay 1996). La première partie de ce mémoire HDR concerne le transfert des POPs dans les écosystèmes marins en Antarctique, ainsi que leurs effets sur les traits d'histoires de vie et les dynamiques de population chez les oiseaux marins polaires.

Cette approche PBT présente toutefois des limites pour les molécules facilement dégradables et métabolisables, donc non-persistantes dans l'environnement et peu bioaccumulables dans les organismes. Leur forte production, leur utilisation continue et à large échelle et leur rejet parfois très localisé aboutissent à une exposition chronique pour les organismes dulçaquicoles (Dudgeon et al.

2006 ; Schwarzenbach et al. 2006). De plus, les produits de dégradation peuvent s'avérer plus toxiques que les composés parents, mais sont pourtant rarement caractérisés. C'est le cas par exemple des Hydrocarbures Aromatiques Polycycliques (HAPs, Varanasi 1989), des phtalates (Barron et al. 1995) et des pesticides pyréthrinoïdes (Demoute 1989).

Les HAPs sont les substances les plus déclassantes (i.e. qui ne respectent pas les Normes de Qualité Environnementale (NQE)) de l'état chimique des cours d'eau français. Les époxydes et dérivés hydroxylés qui sont générés par la métabolisation des HAPs peuvent se lier à des macromolécules fondamentales au sein des cellules (ADN, ARN, protéines) et provoquer des dysfonctionnements importants. Les diesters de phtalates, utilisés massivement en tant que plastifiants, ont été classés en 2017, pour 4 d'entre eux, comme substances extrêmement préoccupantes au titre du règlement REACH (Registration, Evaluation, Authorization and Restriction of Chemicals). Les pesticides pyréthrinoïdes ont représenté une alternative aux pesticides organochlorés en raison de leur faible persistance dans l'environnement et font actuellement partie des insecticides les plus utilisés dans la protection des cultures, élevages animaux, constructions, établissements publics de santé et en milieu domestique. La deuxième partie des résultats présentés dans ce mémoire HDR se focalise sur la dynamique de ces micropolluants et leurs métabolites dans les réseaux trophiques de rivières, sur les facteurs d'imprégnation des poissons et les effets potentiels à différentes échelles biologiques. Le défi analytique est donc important pour la quantification des micropolluants métabolisables et de leurs métabolites qui sont faiblement bioaccumulables et d'une structure physico-chimique plus instable que les POPs.

## 2.2. Des divergences conceptuelles entre écologues et écotoxicologues

Le second verrou est conceptuel, en raison de la divergence de langages et des approches méthodologiques entre écotoxicologues et écologues, et ce, malgré les progrès depuis plusieurs années pour concilier les points de vue (Chapman 2002 ; Relyea and Hoverman 2006). Les tests écotoxicologiques sont indispensables pour établir des relations de causalité entre l'exposition à un polluant à concentrations croissantes et les effets à différentes échelles, des mécanismes moléculaires et physiologiques jusqu'à la mortalité. Le point fort des tests est incontestablement leur réplicabilité, mais ils sont difficilement extrapolables à la réalité environnementale et à la complexité des processus écologiques. Ils reposent sur des manipulations en laboratoire, sous conditions contrôlées et constantes, de courtes durées d'exposition (jours, semaines), en utilisant un nombre réduit de modèles d'étude, choisis pour leur facilité d'élevage et non pour leur pertinence écologique (espèce non locale, cycle de vie rapide), des individus homogènes, sans la variabilité caractéristique des populations naturelles (sexe, âge, condition corporelle, qualité individuelle), et sans interactions biotiques. Les processus micro-évolutifs et la plasticité phénotypique sont par ailleurs négligés dans cette démarche standardisée.

Dans le cadre de mes travaux de recherche, j'étudie les niveaux d'imprégnation et les effets écotoxicologiques sur des individus capturés *in situ*, en prenant en considération les variations interindividuelles, les interactions interspécifiques (en particulier proie-prédateur et hôte-parasite), et les variations environnementales. J'ai choisi d'utiliser le terme d'imprégnation, plus employé en médecine et toxicologie humaine, qui peut être vu comme une photographie à un temps donné, des niveaux de polluants dans un tissu ou un organisme, et qui englobe les dynamiques d'assimilation, circulation, accumulation, transformation et élimination de ces polluants et de leurs métabolites au sein des organismes.



## 2.3 Le devenir incertain des polluants dans les organismes et les écosystèmes

L'évaluation du risque écotoxicologique se heurte à la complexité des processus qui gouvernent le devenir des polluants dans les organismes, tels que les différentes voies d'exposition (cutanée, branchiale/pulmonaire, ingestion), la bioaccumulation au cours de la vie, le stockage différentiel en fonction des tissus, la circulation et la remobilisation de polluants stockés pendant une période de jeûne, la métabolisation des polluants et le devenir des métabolites ainsi formés, les voies d'excrétion (Figure 2).

La plupart des études d'écodynamique des contaminants se sont focalisées sur les POPs qui, en raison de leur très faible biodégradabilité, s'accumulent au cours de la croissance des individus (par exemple chez la truite commune *Salmo trutta*, Vives et al. 2005). Des proies aux prédateurs, on assiste à une bioamplification trophique des POPs (Kelly et al. 2007). Au sein d'une même espèce, les teneurs en POP peuvent augmenter avec le niveau trophique des individus, mesuré à partir de leur signature isotopique (Olsson et al. 2000) ou, au contraire, ne pas y être corrélés (Dufour et al. 2001).

Certains processus permettent l'élimination de ces polluants lipophiles (Figure 2) : les POPs peuvent être transférés de la mère vers les œufs, ce qui résulte en une moindre contamination des femelles par rapport aux mâles (Miller 1993). Enfin, une voie de détoxification potentielle est le transfert de polluants des poissons-hôtes vers leurs parasites. Ce phénomène a été bien décrit pour les chevesnes *Squalius cephalus* infectés de parasites intestinaux, les acanthocéphales (*Pomphorhynchus laevis*), qui se sont révélés moins contaminés en plomb que les individus non parasités (Sures et al. 2003).

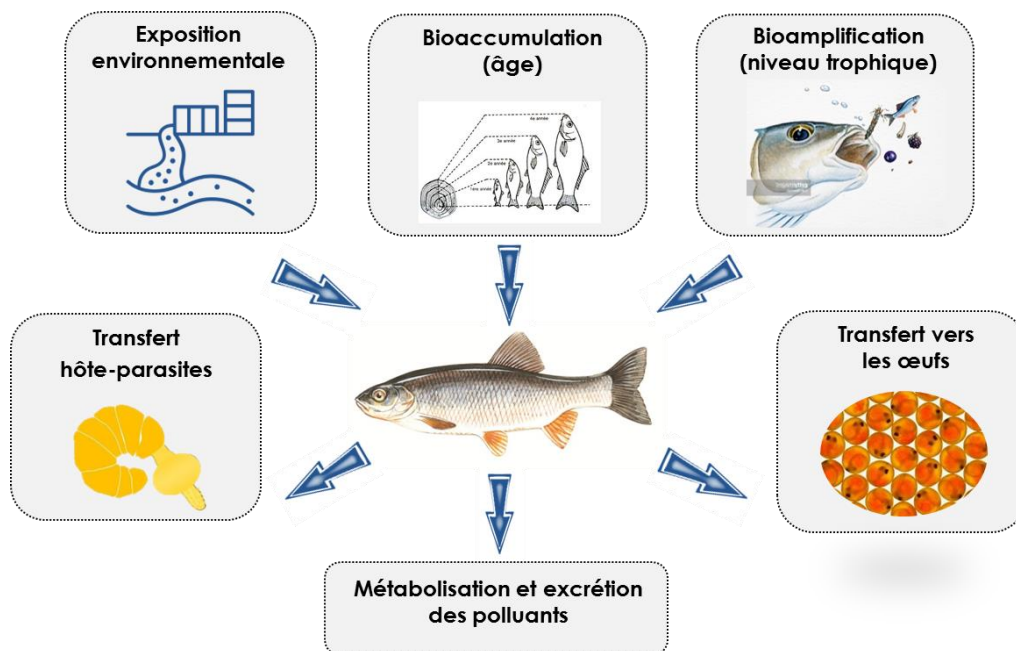


Figure 2 : Facteurs d'imprégnation des poissons par les micropolluants organiques.

La métabolisation des micropolluants organiques se déroule en trois étapes (Figure 3), principalement au niveau du foie. Lorsqu'un polluant hydrophobe pénètre dans une cellule, il est rapidement pris en charge par des enzymes du métabolisme des xénobiotiques. La phase I, dite de fonctionnalisation, consiste en une réaction d'oxydation souvent réalisée par des enzymes

appartenant aux cytochromes P-450 (CYP 450) et conduit à la formation d'intermédiaires électrophiles hautement réactifs. Ils sont alors pris en charge par les enzymes de conjugaison, comme la glutathion-S- ou glucuro-transférase (GST, phase II) et sont greffés à des groupements hydrophiles, les rendant inactifs et plus facilement exportables hors de la cellule, grâce à des protéines de transport (phase III). L'excrétion des métabolites intermédiaires et conjugués se fait par voies biliaire et urinaire.

La métabolisation facilite donc la détoxification des organismes et limite les processus de bioaccumulation au cours de la croissance des individus. Les prédateurs sont moins contaminés que leurs proies en HAPs (Wan et al. 2007) et en phtalates (Mackintosh et al. 2004) dans les écosystèmes marins. Chez l'Homme, ce sont les métabolites de polluants et non les composés parents qui sont analysés dans le plasma ou les urines (e.g. pour les phtalates, Ferguson et al. 2011). Une telle surveillance des métabolites de polluants dans les organismes aquatiques en milieux naturels reste rare (Wessel et al. 2010 ; Valton et al. 2014), en raison du défi analytique que pose la caractérisation de ces métabolites de micropolluants.

Mes travaux de recherche se basent sur une comparaison entre POPs historiques et polluants métabolisables d'intérêt émergent (phtalates, HAPs, pesticides pyréthrinoïdes), en prenant en compte les métabolites de ces micropolluants, afin d'acquérir une vision exhaustive de la contamination des individus.

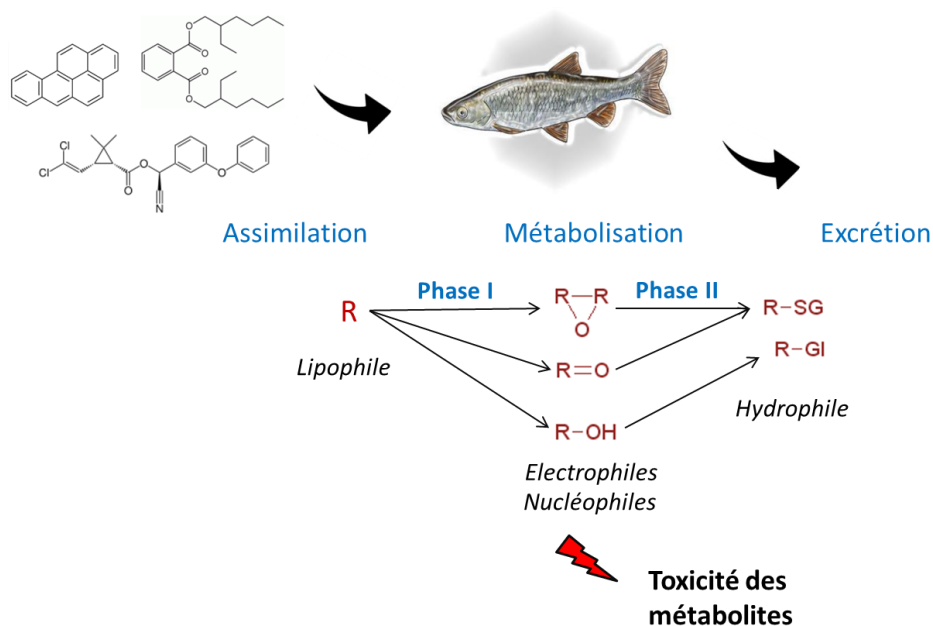


Figure 3 : Voies de métabolisation des micropolluants

## 2.4 La diversité des effets toxiques en conditions naturelles

L'exposition chronique aux micropolluants peut provoquer des effets néfastes à différentes échelles biologiques. Les dommages à l'ADN, le stress oxydatif, les troubles neurologiques, immunitaires, hormonaux, comportementaux, l'altération du microbiote intestinal peuvent se traduire par une baisse de la valeur sélective des individus (faible taux de survie et échec de la reproduction), un déclin des populations, un changement de structure et de fonctionnement des communautés

biologiques. Ces effets peuvent être synergiques avec les autres polluants (effet cocktail, Relyea 2009), les autres perturbations environnementales (Holmstrup et al. 2010) et les interactions avec d'autres organismes (compétition, symbiose, prédation, parasitisme, Clements and Rohr 2009). Mes projets de recherche sont basés sur une approche intégrant plusieurs échelles biologiques, des effets moléculaires jusqu'aux communautés.

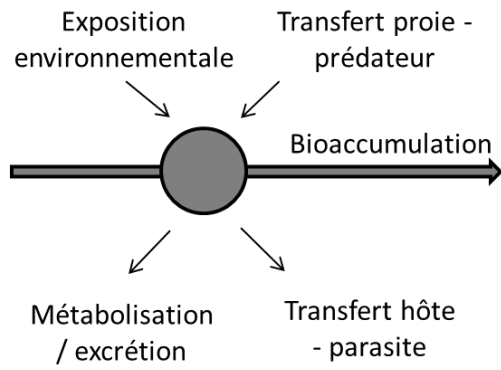
De plus, l'écotoxicologie doit être considérée à la lumière des processus évolutifs (Medina et al. 2007 ; Monosson 2012). La synthèse de molécules toxiques n'est pas imputée à l'Homme. A titre d'exemple, les plantes produisent de nombreuses substances qui sont nocives pour les herbivores. On peut citer la synthèse de pyréthrine par les fleurs de pyrèthe de Dalmatie et de chrysanthèmes de Perse, qui agit comme répulsif contre les insectes et dont la découverte inspira par la suite la production et l'utilisation d'insecticides pyréthrinoïdes, comme la deltaméthrine, par l'Homme. Les mécanismes co-évolutifs ont jalonné ces stress toxiques d'origine naturelle et anthropique, avec des mécanismes de résistance à la deltaméthrine bien documentés chez les insectes (Bouvier et al. 2001). Les populations présentes dans des sites contaminés de façon chronique peuvent donc présenter des phénotypes différents dus aux processus microévolutifs. C'est le cas du poulamon atlantique (*Microgadus tomcod*), dans la rivière Hudson aux Etats-Unis, qui a été le réceptacle de rejets de PCBs pendant 3 décennies. 99% des poulamons portent la forme mutée d'un allèle, codant les récepteurs des hydrocarbures aromatiques, ce qui rend difficile la fixation des PCBs et réduit leur toxicité (Wirgin et al. 2011). La proportion de poulamons portant cet allèle muté décroît rapidement avec l'éloignement de la rivière Hudson (Wirgin et al. 2011). De même, les processus microévolutifs rapides suite à la pollution environnementale ont été bien étudiés chez des populations de choquemorts (*Fundulus heteroclitus*) qui persistent dans des estuaires extrêmement contaminés aux Etats-Unis (Whitehead et al. 2017). Enfin, l'exposition de la mère à un polluant pourrait modifier le phénotype des descendants, favorisant notamment leur capacité à se disperser et donc à prospecter des environnements plus favorables, au détriment de performances futures. Ces aspects trans-générationnels restent peu étudiés, on peut citer une étude expérimentale sur les bryozoaires *Bugula neritina* exposés au cuivre (Marshall 2008).

### 3. Positionnement thématique

Dans ce cadre, mes travaux de recherche visent à décrire les causes et les conséquences de l'imprégnation de la faune sauvage par les micropolluants. Il s'agit d'une part de comprendre le devenir des polluants dans les réseaux trophiques et dans les organismes (Figure 4), en tenant compte des voies d'exposition environnementale, du facteur temporel (bioaccumulation ou biodilution au cours de la vie des organismes), des processus de métabolisation et d'excrétion des micropolluants, et des dynamiques de transfert interspécifique des proies aux prédateurs, mais aussi des hôtes aux parasites.

D'autre part, l'objectif est d'évaluer et de prédire les effets potentiels en intégrant plusieurs échelles biologiques, avec la volonté d'une approche multi-stress (conditions environnementales, parasitisme, coût des épisodes de reproduction passés) et à la lumière des processus évolutifs (Figure 4). Mes travaux se positionnent ainsi à l'interface entre chimie environnementale, écotoxicologie, physiologie et écologie évolutive.

## Devenir des polluants dans le biote



## Effets potentiels

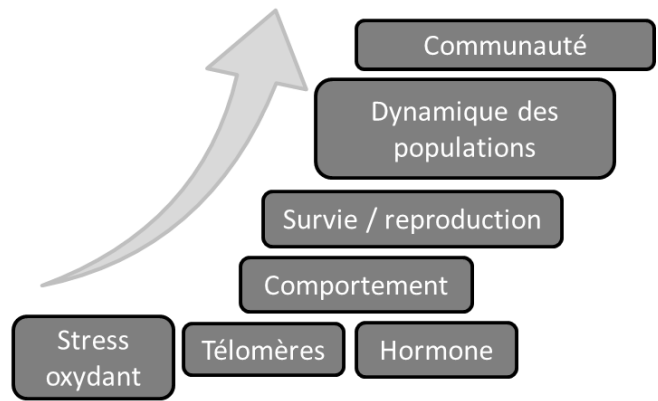


Figure 4 : Grands axes thématiques de mes travaux de recherche

### III. Résultats marquants

#### 1. Polluants organiques persistants et mercure chez les organismes marins polaires

##### 1.1 Importance du niveau trophique et de l'habitat

Eloignés des activités humaines, excepté des bases scientifiques et du tourisme croissant, les milieux polaires ont longtemps été considérés comme exempts de toute pollution (Hale et al. 2008 ; Nash 2011). Or, les niveaux de mercure et de POPs en Arctique excèdent souvent ceux de régions industrialisées, en raison des transports atmosphériques et océaniques sur de longues distances, (Wania and MacKay 1993). Ces polluants se bioaccumulent dans le tissu adipeux des organismes arctiques et se bioamplifient d'un maillon trophique à l'autre (Atwell et al. 1998 ; Borgå et al. 2001). En Antarctique, les études sont plus rares et restent incomplètes: elles ne couvrent pas plusieurs groupes taxonomiques, plusieurs maillons trophiques ou plusieurs niches écologiques (Bargagli et al. 1998 ; Corsolini 2009).

Les résultats présentés dans ce chapitre sont issus d'un projet mené en parallèle de mon premier post-doctorat, pendant lequel j'ai collecté des organismes benthiques, pélagiques et cryopélagiques (i.e. associés à la banquise), ainsi que des œufs non-viables de pétrels des neiges (*Pagodroma nivea*) et de manchots Adélie (*Pygoscelis adeliae*) en Terre Adélie, Antarctique de novembre 2011 à janvier 2012 (Figure 5). Grâce à des collaborations avec Marc Chevreuil (UMR 7619 METIS, anciennement Sysiphe) et Paco Bustamante (UMR 7266 LIENSs), j'ai pu analyser les teneurs en POPs et en éléments traces métalliques dans ces organismes marins polaires (articles 11 et 21<sup>1</sup>).



Figure 5 : Capture d'organismes marins en Terre Adélie, Antarctique, comme ce dragon nu (*Gymnodraco acuticeps*) de la famille des Bathyracónidés, à l'aide de nasses, filets sous la banquise, et pêches à la ligne

<sup>1</sup> Le numéro des articles renvoie au curriculum vitae

Le mercure et les POPs étant bioamplifiables (Fisk et al. 2001 ; Kelly et al. 2007 ; Borgå et al. 2012), les organismes prédateurs sont suspectés être plus contaminés que leurs proies. De même, ces polluants étant piégés dans les sédiments (Wania and Mackay 1996) et dans la banquise (Fuoco et al. 1991), une imprégnation plus élevée était attendue chez les organismes benthiques et cryopélagiques par rapport aux organismes pélagiques. Les signatures isotopiques ( $\delta^{13}\text{C}$  et  $\delta^{15}\text{N}$ ) et les marqueurs de banquise développés lors de mon post-doctorat (isoprénoïdes hautement ramifiés, HBIs) m'ont permis de vérifier ces hypothèses.

Pour les POPs (PCBs, pesticides organochlorés, polybromodiphényléthers (PBDEs)), j'ai pu valider que les organismes sur-imprégnés sont les pétrels des neiges, une espèce pagophilique, se nourrissant principalement de krill et de poissons associés à la banquise. Les organismes benthiques prédateurs (poissons démersaux *Notothenia coriiceps*) et détrivores (oursins *Sterechinus neumayeri*) sont aussi très contaminés, en raison de la sédimentation des POPs (article 11). Les organismes occupant des maillons trophiques plus bas, qu'ils soient benthiques comme les ascidies (*Synoicum sp.*), pélagiques comme le krill antarctique (*Euphausia superba*) ou cryopélagiques comme le krill des glaces (*Euphausia crystallophias*) ou le poisson des glaces (*Pagothenia borchgrevinki*) sont les moins imprégnés en POPs (Figure 6A).

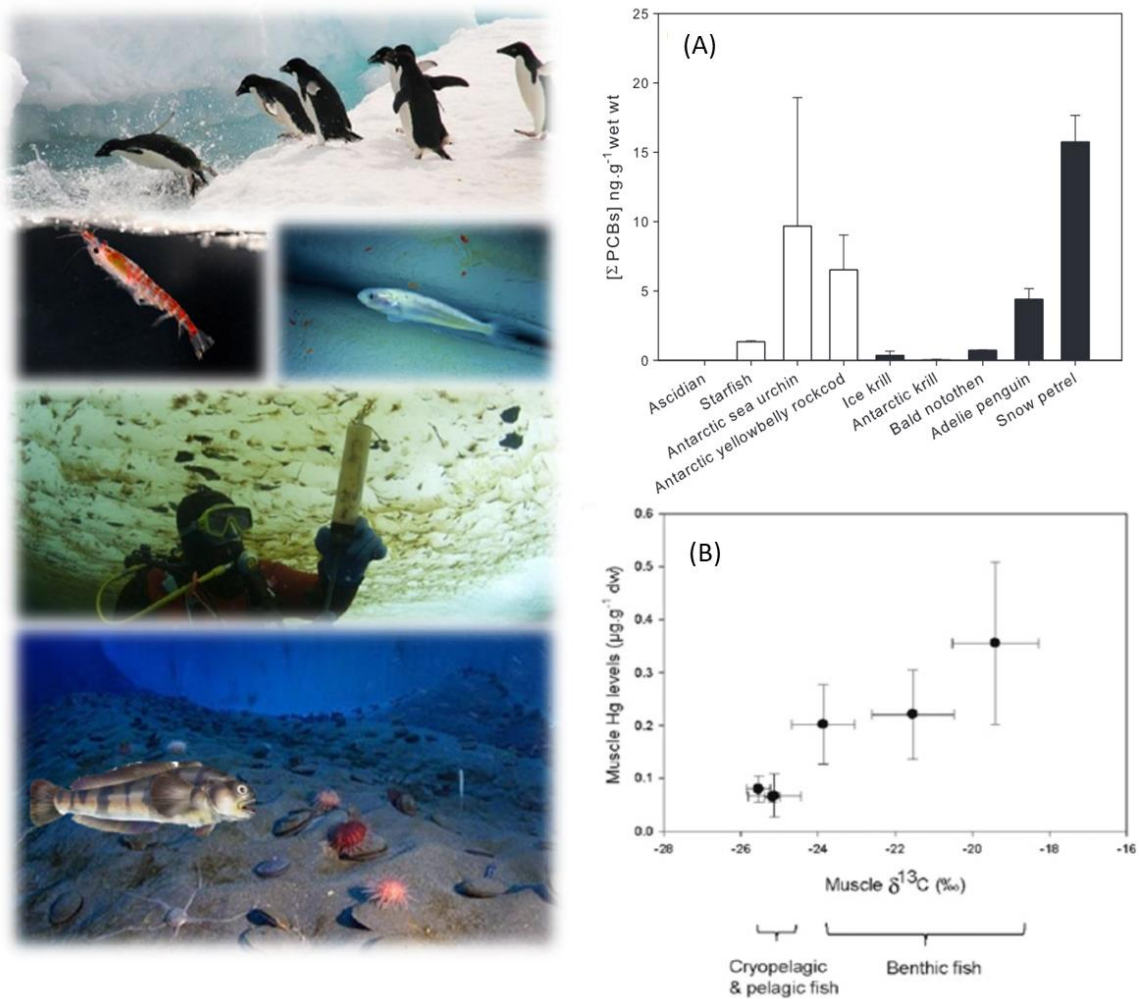


Figure 6 : Imprégnation des organismes marins Antarctiques (A) au PCBs et (B) et au mercure



Concernant les éléments traces métalliques dans l'ichtyofaune antarctique (Figure 6B), l'habitat est le principal facteur d'imprégnation, les poissons benthiques étant plus contaminés en mercure que les poissons pélagiques et cryopélagiques (article **21**), probablement en raison de la méthylation du mercure dans les sédiments côtiers et la photodéméthylation dans les eaux de surface. Le niveau trophique des poissons joue peu dans la charge en mercure, suggérant que l'exposition par ingestion de proies est moindre par rapport aux autres voies d'exposition (diffusion branchiale, cutanée, ingestion de particules de sédiments, article **21**).

## 1.2 Effets des polluants sur la survie et la reproduction à long-terme

Les résultats présentés dans ce chapitre sont issus de mon deuxième post-doctorat (2012-2014), dans le cadre de l'ANR POLARTOP en collaboration avec Olivier Chastel et Christophe Barbraud (UMR 7372 CEBC), Paco Bustamante (UMR 7266 LIENSs), Hélène Budzinski et Pierre Labadie (UMR 5805 EPOC) et Børge Moe, Jan Ove Bustnes (NINA, Norvège), Claus Bech (Norwegian University of Science and Technology), Geir Gabrielsen (Norwegian Polar Institute).

Des analyses de type capture-marquage-recapture ont permis d'évaluer les conséquences démographiques des POPs et du mercure chez 4 espèces d'oiseaux marins polaires (Figure 7, articles n° **12, 16, 19, 22, 24**).



Figure 7 : Espèces étudiées (de gauche à droite, de haut en bas) : grand albatros (*Diomedea exulans*) à Crozet, mouette tridactyle (*Rissa tridactyla*) au Spitzberg, skua antarctique (*Catharacta maccormicki*) en Terre Adélie et skua subantarctique (*Catharacta lonnbergi*) à Kerguelen

Les oiseaux marins polaires présentent des avantages indéniables pour ce type d'étude. En tant que prédateurs supérieurs extrêmement longévifs (espérance de vie > 50 ans), ils sont particulièrement contaminés (Rowe 2008). Les colonies abritent plusieurs centaines d'individus,

reproducteurs et non-reproducteurs, qui peuvent être échantillonnés en déployant des méthodes peu invasives (prélèvements sanguins et de plumes de couverture). Espèces philopatrices (i.e. qui reviennent sur leur lieu de naissance) et très fidèles au nid, les taux de détection sont élevés et les taux d'émigration faibles. Les individus sont bagués poussins à l'aide de bague métal et plastique, ce qui permet de connaître précisément leur âge et leur histoire de vie en les observant sans dérangement : chaque année est noté le retour à la colonie, la tentative de reproduction (ponte), le succès à l'éclosion, le succès du (des) poussin(s) à l'envol. Le grand albatros ne se reproduit généralement qu'une année sur deux et ne pond qu'un œuf, sans remplacement. Les mouettes tridactyles et les deux espèces de skuas se reproduisent tous les ans, mais peuvent sauter un épisode de reproduction, notamment lorsque les conditions individuelles ou environnementales sont défavorables ; ils pondent respectivement 1 à 3 œufs, et 2 œufs. Ce sont des « parents prudents » qui ont tendance à se désengager de la reproduction lorsque leur propre survie est menacée (Bokony et al. 2009). Ces larges jeux de données sur le long-terme ont été acquis sur les oiseaux marins des Terres Australes et Antarctiques Françaises par le Centre d'Etudes Biologiques de Chizé, ainsi que sur les mouettes tridactyles au Spitzberg par une collaboration franco-norvégienne.

Des modèles de capture-recapture multi-états m'ont permis de tester si les individus les plus imprégnés en POPs ou en mercure présentaient un taux de survie réduit, une moindre probabilité de reproduction et/ou un plus faible succès reproducteur sur le long terme, avec un effectif conséquent. Ce genre d'analyses à l'échelle individuelle, reliant les niveaux de polluants et les taux vitaux n'avait jamais été conduite auparavant, excepté une étude sur le Goéland bourgmestre (*Larus hyperboreus*, Erikstad et al. 2013), mais cette dernière considérait seulement le taux de survie et non les performances reproductrices futures. Par ailleurs, j'ai pu prendre en considération l'hétérogénéité individuelle, et notamment l'effet de l'âge ou de l'expérience antérieure de reproduction, les différences mâles / femelles, la qualité individuelle et les effets de reports (« carry over effect », Harrison et al. 2011), notamment l'état reproducteur (échec/succès) à l'année t sur la reproduction future. J'ai aussi testé des différences interannuelles et interspécifiques. Les éventuels effets confondants ont été pris en considération autant que possible, notamment les effets de l'âge, de l'expérience antérieure de reproduction sont discutés dans l'article **12**, et les effets de l'écologie trophique dans l'article **13**. Les effets des polluants étaient prépondérants par rapport à ces facteurs individuels.

Les articles ont, pour la plupart, été publiés séparément pour chaque espèce ; je profite de ce mémoire HDR pour en faire une synthèse et une comparaison interspécifique. Il faut toutefois souligner que les prises de sang ont été réalisées à des périodes différentes du cycle de reproduction en fonction des espèces, ce qui peut biaiser les comparaisons. En effet, les niveaux de polluants circulant varient au cours du temps, en fonction des zones de nourrissage et des périodes de jeûne, associées à la mobilisation des réserves énergétiques et au relargage des polluants stockés dans le tissu adipeux. De plus, si l'échantillonnage se fait tard dans la saison de reproduction, les individus non-reproducteurs ou en échec sont moins présents à la colonie et seront peu échantillonnés.

### *Cas du mercure*

Les liens entre les niveaux sanguins de mercure et les taux vitaux ont été testés sur les quatre espèces d'oiseaux marins (articles **12**, **16** et **19**). Nous avons par ailleurs exploré chez le grand albatros, le lien entre les taux vitaux et les taux de mercure dans les plumes, principale voie d'excrétion durant la mue (article **22**) ; contrairement au mercure dans le sang chez cette espèce, le mercure dans les plumes n'est pas lié aux performances de reproduction, ce qui suggère que les plumes, même si elles intègrent l'imprégnation sur une longue période, ne reflètent pas le potentiel toxique durant une période énergétiquement élevée.



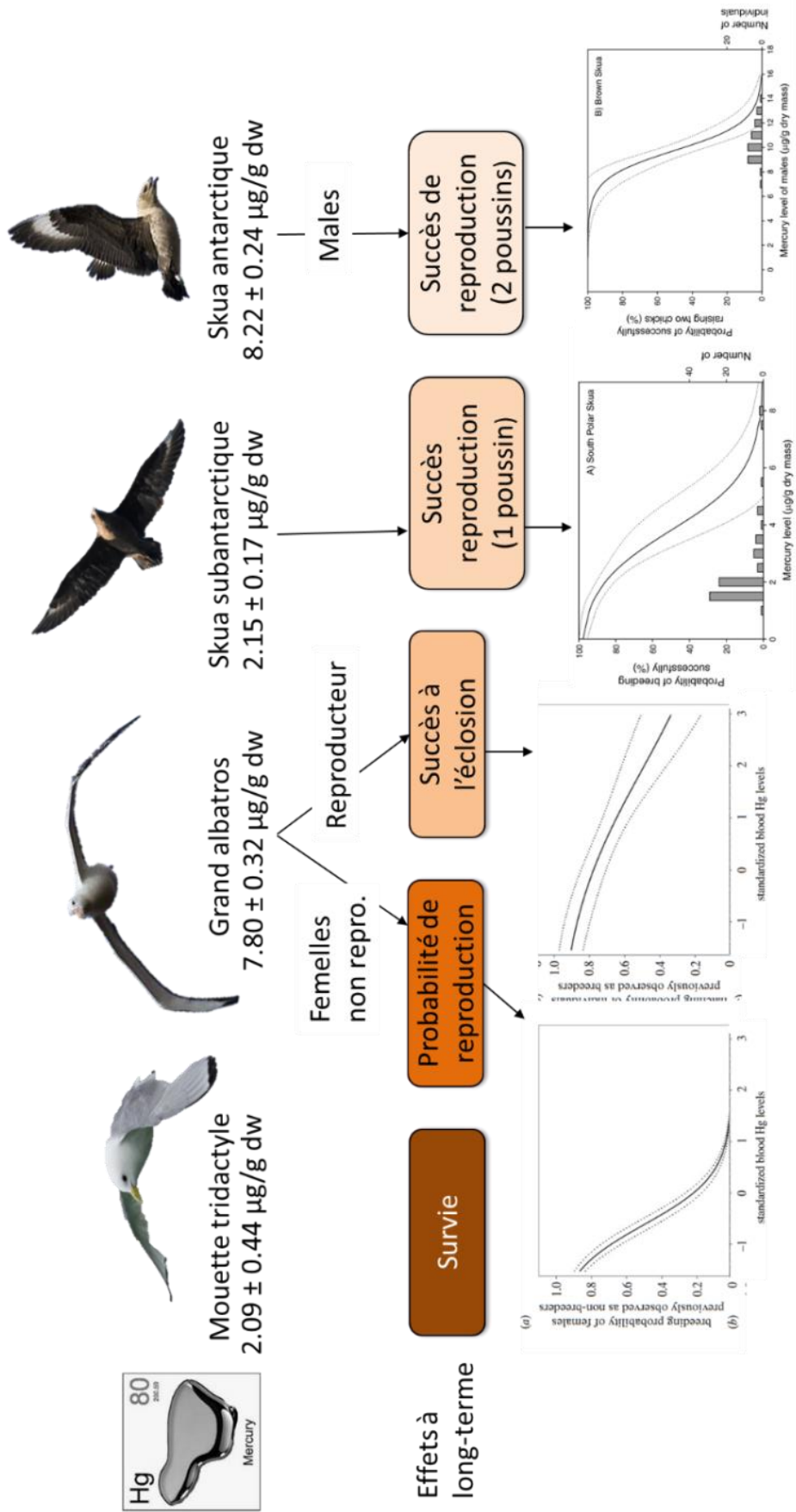


Figure 8: Effets des taux de mercure dans le sang (moyenne ± erreur type) sur le taux de survie, la probabilité et le succès de reproduction sur le long-terme chez les 4 espèces d'oiseaux marins

La synthèse des résultats pour le mercure dans le sang est présentée sur la Figure 8. Le taux de survie n'est jamais corrélé aux taux de mercure individuel, ce qui rejoint de précédentes études (Wayland et al. 2008; Hallinger et al. 2011). Pour les mouettes tridactyles, malgré les effets du mercure sur la probabilité de reproduction l'année en cours, nous n'avons pas trouvé d'effets sur les performances de reproductions futures (article 19). Ce résultat peut s'expliquer par les niveaux de mercure les plus bas chez les mouettes par rapport aux 3 autres espèces. Pour les grands albatros, de nombreux effets du mercure ont été détectés sur la fertilité et la fécondité sur le long terme, ce qui peut s'expliquer par les niveaux élevés de mercure dans le sang. Les femelles avec des niveaux élevés de mercure ont une moindre probabilité de se reproduire les années suivantes (article 16). Le fait que cet effet ne soit détecté que chez les femelles non-reproductrices à  $t_0$  (année de la prise de sang) suggère que l'effet délétère du mercure sur la fertilité soit exacerbé chez les femelles de « mauvaise qualité individuelle ». De plus, toujours chez le grand albatros, les reproducteurs avec des niveaux élevés de mercure, qu'ils aient réussi ou échoué leur reproduction à  $t_0$ , endurent un plus fort échec d'éclosion les années suivantes (article 16). On peut aussi supposer, pour les femelles du moins, que le transfert de mercure maternel vers les œufs affecte la position de l'embryon dans l'œuf, comme cela a été montré chez des limicoles et des Laridés (Herring et al. 2010). Pour les deux espèces de skuas, le mercure n'affecte pas la probabilité de reproduction mais diminue le succès reproducteur l'année suivante. L'impact est plus marqué chez les skuas antarctiques que chez les skuas subantarctiques, malgré des taux de mercure 4 fois moins élevés (article 12). Il est surprenant de constater de telles différences pour des espèces phylogénétiquement proches, avec des cas d'hybridation fréquemment décrits entre ces deux espèces. Il est aussi possible que cette différence soit due à des interactions avec d'autres stress, les effets du mercure pouvant être exacerbés par des conditions environnementales rudes.

Concernant les mécanismes proximaux, nous avons étudié le lien entre les niveaux de mercure en période prénuptiale et l'hormone lutéinisante (LH), qui est impliquée dans le début de la reproduction. La sécrétion de LH diminue avec l'augmentation des concentrations de mercure dans le sang, ce qui provoque un désengagement de l'épisode de reproduction en cours (articles 10 et 17).

### *Cas des POPs*

Les niveaux de POPs n'ont pas été mesurés chez les skuas subantarctiques, limitant à 3 espèces cette analyse comparative. En raison des contraintes inhérentes à chaque jeu de données, les teneurs en POPs ont été traitées soit en additionnant tous les composés, ce qui limite la multiplication des analyses statistiques, soit en les considérant par familles de polluants, qui permet d'identifier les composés particulièrement néfastes.

Les taux de survie du grand albatros et du skua antarctique ne sont pas affectés par les niveaux de polluants des individus. Chez les mouettes tridactyles, les taux de survie sont compromis chez les femelles chargées en HCB (hexachlorobenzène) et chez les mâles et femelles chargés en chlordane ( $C_{10}H_6Cl_8$ , article 19, Figure 9). Ces résultats viennent conforter l'effet de l'oxychlordane ( $C_{10}H_4Cl_8O$ ), un métabolite du chlordane sur le taux de survie des goélands bourgmestre, notamment des femelles, de l'île aux ours -Bjørnøya- dans l'Arctique norvégien (Erikstad et al. 2013).

La théorie de la canalisation environnementale prédit que le (ou les) trait(s) d'histoire de vie (taux de survie, reproduction) qui contribue(nt) le plus à la valeur sélective (i.e. forte élasticité) doi(ven)t être le(s) moins sensible(s) aux fluctuations environnementales (Gaillard and Yoccoz 2003). A l'inverse, les traits qui répondent le plus aux polluants sont ceux qui affectent le moins la croissance démographique (Forbes et al. 2010). Chez les espèces longévives, le taux de survie est déterminant pour la valeur sélective et la dynamique des populations (Sæther and Bakke 2000).

Cette théorie avait été vérifiée jusqu'à présent dans nos jeux de données, puisque le taux de survie des adultes n'était pas compromis par l'imprégnation en mercure et en POPs, mais il semble que les niveaux de certains pesticides organochlorés très toxiques, comme le chlordane et l'oxychlordane, dépassent un seuil de toxicité chez les oiseaux marins arctiques (Erikstad et al. 2013). De façon surprenante, chez les mouettes tridactyles, les traits avec la plus forte élasticité (taux de survie et probabilité de reproduction à long-terme) sont les plus affectés par les POPs, tandis que le succès reproducteur, avec une élasticité plus faible, n'est pas sensible aux polluants. Les populations de mouettes tridactyles au Spitzberg semblent être particulièrement vulnérables à la pollution historique. Parmi les mécanismes proximaux possibles, la longueur des télomères chez les femelles de la même population de mouettes tridactyles est négativement corrélée aux niveaux d'oxychlordane (Blévin et al. 2016), ce qui peut expliquer le déclin des taux de survie détecté (article **19**). Les télomères sont des séquences non-codantes de l'ADN situées à l'extrémité des chromosomes, qui assurent le maintien de l'intégrité du génome (Monaghan and Haussmann, 2006). A chaque mitose, les derniers nucléotides ne sont pas répliqués, entraînant un raccourcissement de la longueur des télomères (Monaghan & Haussmann 2006). En deçà d'une longueur de télomère critique, une division cellulaire risque d'endommager l'ADN codant, ce qui provoque une apoptose ou une sénescence cellulaire. Il a été montré que la longueur des télomères est un bon proxy de l'espérance de vie chez l'Homme et la faune sauvage (Bize et al. 2009 ; Heidinger et al. 2012 ; Barrett et al. 2013) et un bon marqueur du risque d'extinction des populations (Dupoué et al. 2017). Ces résultats convergent donc vers des effets létaux sur le long-terme du chlordane chez les mouettes tridactyles.

Concernant la probabilité de reproduction sur le long-terme, on observe un déclin chez les albatros femelles chargées de POPs, et non-reproductrices à  $t_0$  (année de la prise de sang, article **16**), ainsi qu'un déclin chez les mouettes tridactyles mâles avec des taux élevés de chlordane et de HCB, mais seulement chez les reproducteurs à  $t_0$  (article **19**), ce qui peut suggérer des effets de report du coût de la reproduction en cours (Figure 9). Il est intéressant de constater que seuls les mâles de mouettes contaminés ne se reproduisent pas les années suivantes, ce qui peut être expliqué par des effets de pesticides organochlorés sur les anomalies spermatiques, les gamètes mâles étant plus sensibles aux polluants que les gamètes femelles, en raison de l'absence de synthèse de réparation de l'ADN et de molécules anti-oxydantes (Santos et al. 2013). On peut aussi supposer une perturbation des parades nuptiales, qui sont énergétiquement coûteuses chez les Laridés mâles (construction et défense du nid, offrandes de nourriture au partenaire). Il est possible que les mâles chargés de pesticides organochlorés soient moins efficaces et accèdent donc moins à la reproduction. Dans la même veine, il a été montré que les POPs altèrent la coloration du tégument chez cette population de mouettes tridactyles (Blévin et al. 2014) et altèrent potentiellement la qualité des signaux sexuels secondaires.

Aucun lien n'a été détecté entre les niveaux de POPs chez les femelles des 3 espèces (Figure 9) et le succès à l'éclosion, contrairement aux précédents travaux sur le transfert des POPs vers les œufs et la viabilité réduite, *via* l'amincissement de la coquille des œufs par le DDT par exemple (Porter and Wiemeyer, 1969).

La somme des POPs circulant est corrélée à un plus faible succès à l'envol chez les albatros reproducteurs à  $t_0$  (article **16**). Des taux élevés de mirex ( $C_{10}Cl_{12}$ ) chez le skua antarctique sont corrélés à un faible succès de la reproduction à long-terme (article **24**), mais seulement les années contraignantes (i.e. avec des niveaux de glucocorticoïdes élevés), ce qui suggère une exacerbation des effets toxiques lorsque les conditions environnementales sont défavorables. De tels effets synergiques entre POPs et stress énergétique (raréfaction et éloignement de la ressource alimentaire) avaient été mis en évidence dans de précédentes études sur des oiseaux marins (Bustnes et al. 2005, 2015).

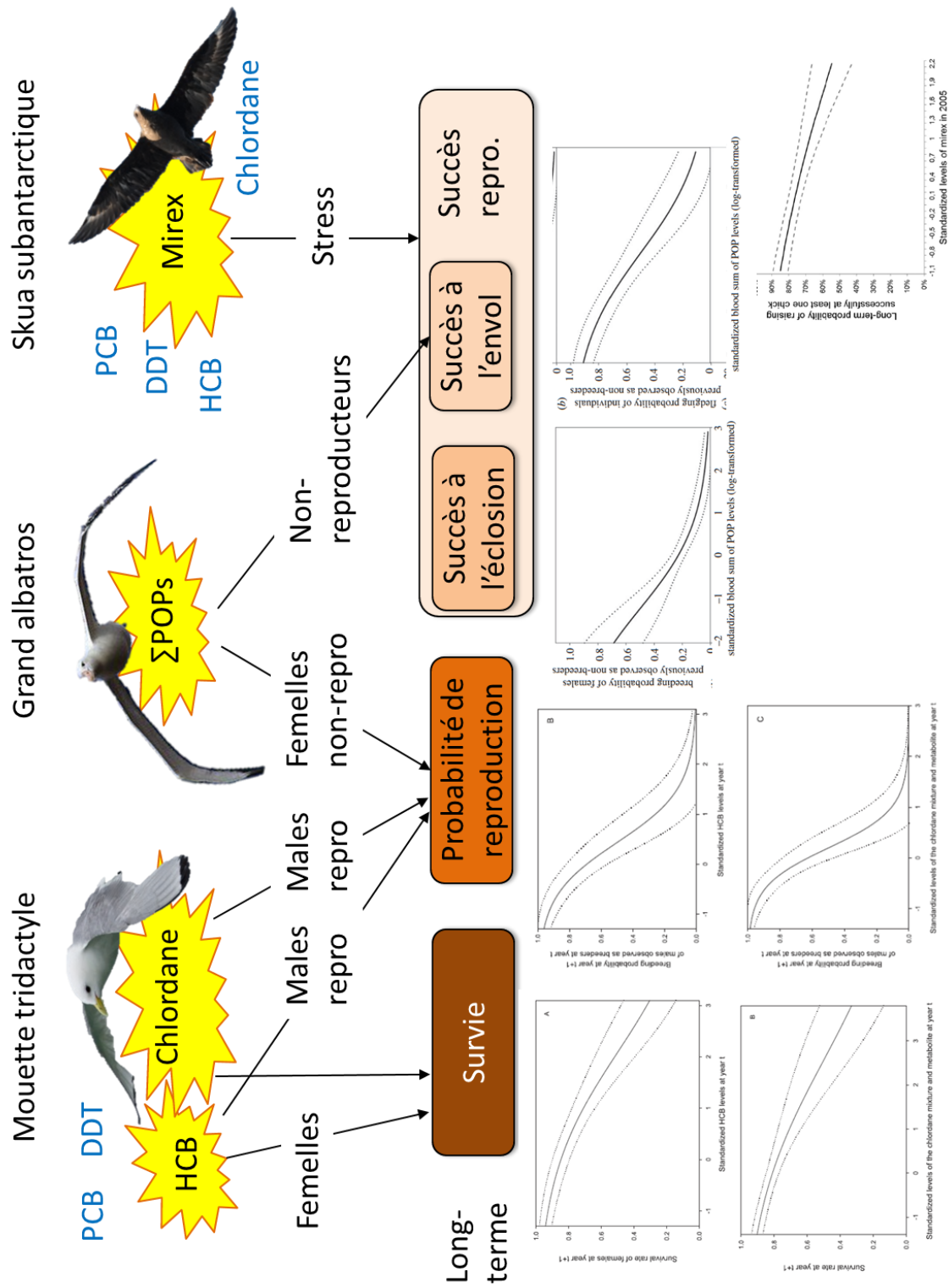


Figure 9 : Effets des taux de POPs dans le sang sur le taux de survie, la probabilité et le succès de reproduction sur le long-terme chez les 3 espèces d'oiseaux marins

Chez le skua antarctique, nous nous sommes aussi intéressés aux mécanismes hormonaux et comportementaux (article **24**). Les hormones sont sécrétées en réponse aux fluctuations externes et internes et orchestrent des actions pléiotropiques (i.e. activent et inhibent plusieurs fonctions simultanément), ce qui en fait d'excellents médiateurs des compromis adaptatifs entre traits d'histoire de vie (Ricklefs and Wikelski 2002). Chez les Vertébrés, la sécrétion accrue de glucocorticoïdes (corticotérostéone chez les oiseaux) suite à un épisode de stress déclenche la mobilisation des réserves énergétiques, en adoptant des comportements de recherche alimentaire ou de fuite, et en supprimant toutes fonctions non vitales, comme la reproduction (Wingfield and Sapolsky 2003). Cette réponse au stress est considérée comme adaptative puisqu'elle optimise la valeur sélective des individus en redirigeant les réserves énergétiques vers la survie immédiate au détriment de la reproduction. Nous n'avons pas identifié de lien entre les différentes familles de POPs et les taux basaux de corticotérostéone chez les skuas antarctiques (article **24**). Par ailleurs, la prolactine est une hormone impliquée dans les soins parentaux. Chez les skuas antarctiques incubant ou élevant leurs poussins, nous n'avons pas identifié de liens entre les niveaux de prolactine et les teneurs en POPs (article **24**), conformément à une autre étude sur les pétrels des neiges (Tartu et al. 2015). Concernant l'activité comportementale, les skuas présentant des niveaux élevés de mirex sont moins enclins à défendre leur nid des intrus, ce qui pourrait expliquer la baisse du succès reproducteur à long-terme observé chez les skuas sur-imprégnés en mirex (article **24**).

Pour conclure, cette approche en milieu naturel et à l'échelle des populations est innovante et originale, puisque la plupart des études écotoxicologiques se consacrent aux effets moléculaires et cellulaires dans des conditions expérimentales et contrôlées, et ne translatent pas les conséquences à l'échelle des individus et des populations. La grande majorité des traits d'histoire de vie a été explorée. On peut simplement regretter que les effets trans-générationnels des polluants n'aient pas pu être inclus : Le sex-ratio des poussins est-il biaisé ? Qu'advient-il des poussins de parents contaminés après avoir quitté le nid ? Survivent-ils au premier hiver en mer ? Atteignent-ils la maturité sexuelle plus tardivement ? Se dispersent-ils vers d'autres colonies ? Il est cependant difficile de répondre à ces questions, dans la mesure où ces espèces passent leurs premières années en mer, sans retour à la colonie et donc sans possibilité de récupérer l'information.

### 1.3 Scénarios prédictifs en terme de dynamique des populations

Les projections démographiques présentées dans cette sous-partie sont la continuité des travaux de mon post-doctorat : après avoir identifié quels traits d'histoires de vie étaient sensibles aux polluants, ces relations ont été intégrées à des modèles de population (matrices de Leslie), afin de prédire les dynamiques de population dans des scénarios de diminution et d'augmentation des taux de mercure et de POPs, dans une fourchette de contamination observée actuellement au sein de la population étudiée. Des projections démographiques avaient été faites chez une espèce de poisson pour un perturbateur endocrinien (Miller and Ankley 2004), d'amphibien pour le mercure (Willson et al. 2012), de reptile pour les PCBs (Salice et al. 2014) et d'oiseau pour le DDT (Nakamaru et al. 2003), mais en utilisant des relations dose-réponses établies en conditions contrôlées de laboratoire, et non sur les traits d'histoire de vie observés en milieu naturel. Un déclin démographique a été projeté dans chaque cas d'augmentation des niveaux de mercure et/ou de POPs (Figure 10, articles **12**, **16** et **24**), avec des différences interspécifiques marquées même pour les espèces phylogénétiquement proches (article **12**).

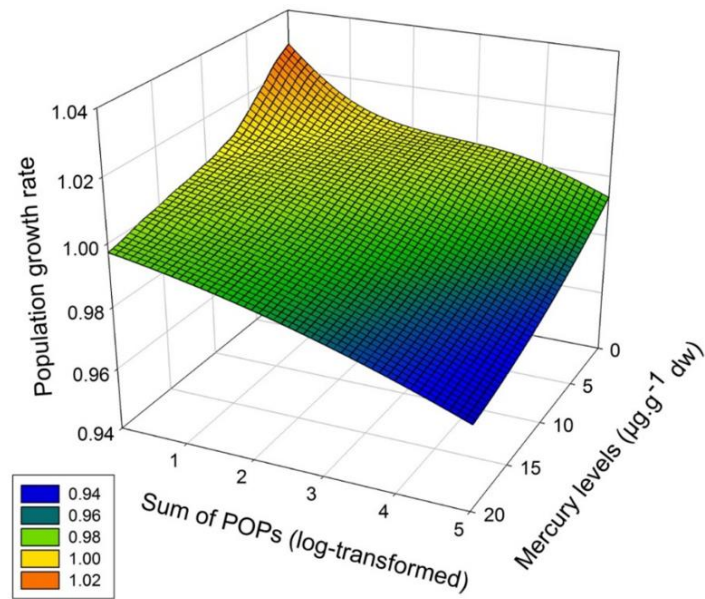


Figure 10 : Modèles matriciels de populations qui révèlent un déclin des populations de grands albatros avec les taux de mercure et de POPs

Ce type de modélisation avait été conduit précédemment pour projeter les effets des changements climatiques et des pêcheries (Barbaud et al. 2012). La prochaine étape serait de mieux comprendre les effets synergiques avec ces autres stress pour les inclure dans les modélisations. Rappelons aussi que ces études ont été réalisés sur le mercure et sur les POPs historiques, interdits depuis plusieurs décennies et dont les niveaux sont en déclin dans le monde, y compris dans les régions polaires (Hung et al. 2016). Les effets démographiques de polluants d'intérêt émergents pourraient être aussi évalués et comparés aux effets des POPs historiques.

## 2. Polluants métabolisables et leurs métabolites chez les poissons de rivières urbanisées

Cette deuxième partie concerne les travaux de recherche que je mène depuis mon recrutement comme maître de conférences à l'EPHE. Elle repose sur les articles **23, 26, 27, 28, 29, 30** ainsi que sur des rapports PIREN-Seine et Agence de l'Eau Seine Normandie.

### 2.1 Devenir des polluants métabolisables dans les réseaux trophiques lotiques

Les écosystèmes de rivière, contrairement aux marins, n'ont pas fait l'objet d'études approfondies sur les dynamiques de transfert trophique de polluants, malgré les connexions directes avec les sources (station d'épuration, ruissellement et lixiviation), une moindre dilution des polluants par rapport aux océans, et des chaînes trophiques plus courtes et instables (Hette-Tronquart 2012). Les HAPs et les phtalates sont des substances fréquemment responsables du déclassement des cours d'eau pour le bon état chimique. Ces deux familles de polluants présentent la particularité d'être soumises à des mécanismes de métabolisation, principalement dans le foie des vertébrés (Barron et al. 1995), puis d'élimination par voies urinaire et biliaire. Pour les composés facilement métabolisables, le patron de transfert trophique est très différent des POPs : au lieu d'une bioamplification, on observe une biodilution trophique, c'est-à-dire une moindre contamination des prédateurs par rapport à leurs proies (Trophic Magnification Factor, TMF <1, Walters et al. 2016). C'est le cas des HAPs (Wan et al. 2007) et des phtalates (Mackintosh et al. 2004) en milieu marin. Cependant le comportement des métabolites de HAPs et de phtalates dans les réseaux trophiques est largement ignoré. Ces métabolites s'avèrent, dans certains cas, plus toxiques que leurs composés parents (Van der Oost et al. 2003), car ils se lient de façon covalente à l'ADN, l'ARN, les protéines (Schuler et al. 2004). Les adduits ainsi formés rendent les métabolites disponibles et assimilables par les prédateurs, de telle sorte qu'en condition de laboratoire, il a été montré un transfert de métabolites de benzo(a)pyrène, de pyrène et de fluoranthène, des proies aux prédateurs (Palmqvist et al. 2006; Carrasco Navarro et al. 2012; 2013)

Dans le cadre de la phase VII du PIREN-Seine (2015-2019), nous avons analysé les PCBs, pesticides organochlorés, HAPs et phtalates parents, ainsi que leurs métabolites dans des organismes à différents maillons trophiques d'une rivière fortement urbanisée, l'Orge, à proximité de la confluence avec la Seine. La bioamplification trophique a bien été confirmée dans les réseaux trophiques de rivière pour les PCBs et les pesticides organochlorés (Figure 11 E,F, article **27**). Pour les polluants métabolisables, on observe une dilution trophique, avec des pentes bien plus faibles pour les HAPs que pour les phtalates (Figure 11 A,C, article **27**). Quant aux produits de métabolisation, aucun patron trophique n'est détecté pour les métabolites de HAPs, tandis qu'une bioamplification trophique est mise en évidence pour les métabolites de phtalates (Figure 11 B,D, article **27**). Les mécanismes de métabolisation et d'élimination semblent donc être plus performants pour les HAPs que pour les phtalates. Les métabolites de phtalates ne sont pas rapidement excrétés et pourraient être transférés des proies aux prédateurs.

D'autres micropolluants ont été analysés sur les mêmes échantillons par l'équipe de Pierre Labadie (UMR 5805 EPOC) : les chloroalcanes, le PFOS (acide perfluorooctane sulfonique) et les composés perfluoroalkylés (PFAS) (article **30**).



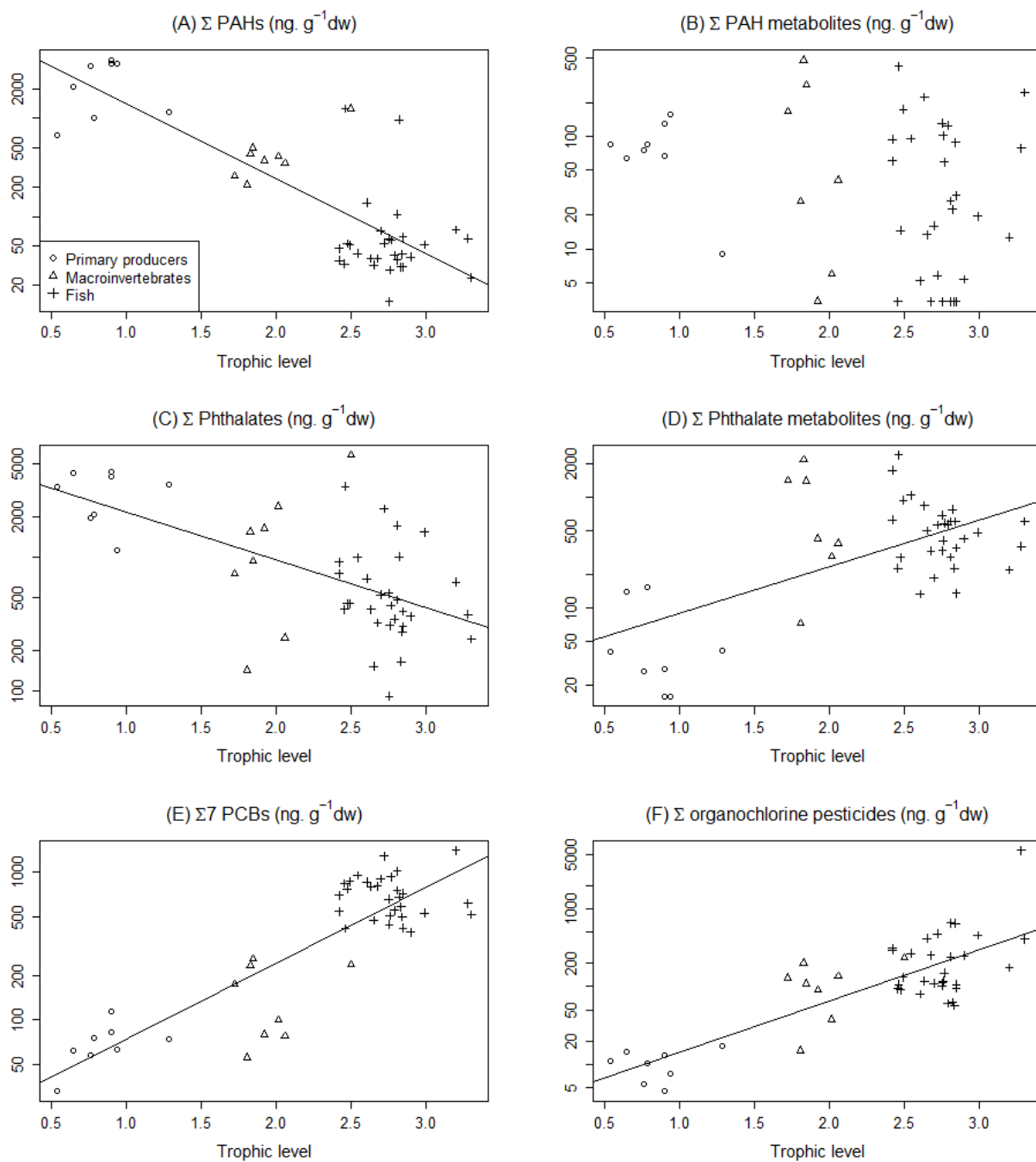


Figure 11 : Dilution trophique des HAPs (A) et des phtalates (C). Bioamplification trophique des métabolites de phtalates (D), des PCBs (E) et des pesticides organochlorés (F). Absence de corrélation entre les teneurs en métabolites de HAPs et le niveau trophique (B), déterminé par la signature isotopique en azote. Les ronds représentent les producteurs primaires (biofilm, feuilles mortes, fausse renouée du japon), les triangles, les macro-invertébrés (gammare, limnées, corbicules, sangsues), les croix, les poissons (tanches, chabots, goujons, gardons, perches communes, perches soleils, poissons chats)



## 2.2 Facteurs d'imprégnation des poissons d'eau douce

La biosurveillance des polluants dans les milieux aquatiques constitue un défi de taille. D'un point de vue réglementaire, la directive-fille « Substances » de la Directive Cadre sur l'Eau (DCE 2013/39/UE) et le Guide relatif à l'évaluation de l'état des eaux de surface (2016) imposent aux états-membres de compléter l'évaluation de l'état chimique des eaux par la surveillance des micropolluants dans les organismes aquatiques, en appliquant en priorité les Normes de Qualité Environnementale (NQE) sur le biote. Les poissons, car ils occupent les maillons trophiques supérieurs et intègrent les pressions environnementales sur le long-terme, sont considérés comme des indicateurs pertinents de la pollution des hydrosystèmes (Sanchez and Porcher 2009).

Ces travaux ont été menés dans le cadre d'un programme de recherche financé par l'Agence de l'Eau Seine Normandie que j'ai porté (2015-2018). Plusieurs personnes se sont fortement impliquées dans ces travaux. Fabrice Alliot, ingénieur d'étude EPHE a développé les méthodes multi-résidus pour les analyses de micropolluants et de leurs métabolites. Noëlie Molbert (METIS, en stage de master 2 au premier semestre 2017 sur le projet, puis doctorante depuis octobre 2017, avec une bourse de l'Institut de Transition Energétique, Sorbonne Université SU-ITE) a effectué les analyses de micropolluants et de marqueurs écotoxicologiques. Raphaël Santos (Haute École du Paysage, d'Ingénierie et d'Architecture de Genève) et Clotilde Biard (iEES-Paris) ont contribué aux analyses de stress oxydant ; Lisa Jacquin (EDB, Université de Toulouse) aux analyses de marqueurs immunitaires ; Frédéric Angelier (Centre d'Etude Biologiques de Chizé) aux analyses de télomères, Vincent Médoc (iEES-Paris et actuellement Université Jean Monnet, Saint-Etienne) aux interactions hôte-parasites. La richesse de ces collaborations a contribué à apporter à ce projet des aspects pluridisciplinaires et innovants, et a permis d'adopter une approche intégrée pour évaluer les effets potentiels de la contamination des milieux aquatiques sur les chevesnes.

Un des aspects innovants des résultats est la double caractérisation des micropolluants (HAPs, phtalates, pesticides pyréthrinoides, PCBs, PBDEs et pesticides organochlorés) et de leurs métabolites dans différents tissus d'un poisson d'eau douce, le chevesne, ainsi que dans son milieu (eau, sédiment, biofilm). Huit stations du bassin versant de la Marne ont été prospectées pendant le mois de septembre 2016 par pêche électrique pour la capture et l'échantillonnage de chevesnes (Figure 12).

### *Exposition environnementale*

Ces micropolluants étant présents à l'état de trace dans l'environnement, le prélèvement ponctuel d'eau, technique classiquement utilisée, peut présenter des limites de quantification. En parallèle des analyses dans les phases dissoute et particulaire de l'eau, nous avons déployé des préleveurs passifs de type membranes en silicone pour améliorer la sensibilité analytique en concentrant les polluants présents dans l'eau et en intégrant les variations de contamination sur la durée du déploiement, selon le protocole de Smedes et Booij (2012). Par ailleurs, les sédiments et le biofilm ont été analysés sur chaque site et complètent l'image globale de la pollution environnementale.

Concernant les tissus biologiques, il n'est pas envisageable d'analyser le poisson entier. Le muscle est classiquement privilégié, en raison de son abondance relative, mais d'autres organes et fluides biologiques apportent une information singulière, en raison de leur exposition directe par diffusion (branchies) et par absorption (contenu stomacal), de leur propriété de stockage et de métabolisation (foie), ou de leur rôle dans la circulation (plasma) et l'excrétion (bile) des polluants et de leurs métabolites. Dans ce mémoire HDR, je ne présente que les résultats pour le muscle et le

foie, mais la comparaison de profil des micropolluants et des métabolites dans tous les tissus et liquides biologiques des chevesnes a fait l'objet de l'article 26.



Figure 12 : Pêche électrique en rivière et prélèvement sanguin sur un chevesne

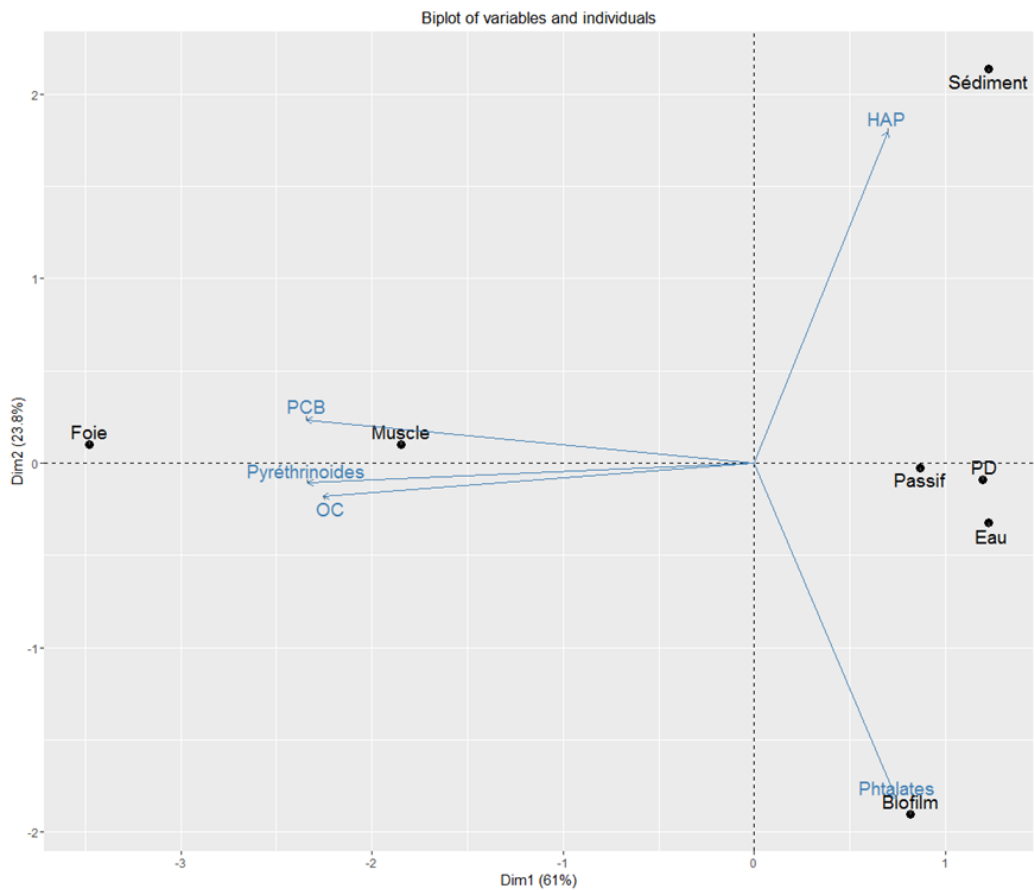


Figure 13 : Répartition des matrices environnementales (eau, phase dissoute (PD), préleveurs passifs, sédiment, biofilm) et biologiques (muscle et foie de chevesnes) en fonction des micropolluants (phtalates, HAP, pesticides pyréthrinoides, PCB, pesticides organochlorés (OC))

Nos résultats montrent une nette opposition entre les matrices environnementales (eau, phase dissoute, prélèvements passifs, sédiments, biofilm) et les tissus de chevesnes (muscles et foie) en termes de profil de micropolluants, avec une concentration relative des PCBs, pesticides

organochlorés POCs et pesticides pyréthrinoïdes plus importante dans les chevesnes (Figure 13). Les sédiments sont dominés par les HAPs lourds (Figure 13), ce qui est cohérent avec leur hydrophobicité et leur tendance à sédimenter rapidement (Notar et al. 2001). La sensibilité des préleveurs passifs est jusqu'à 15000 fois supérieure à la phase dissoute pour la quantification des micropolluants et en particulier des pesticides pyréthrinoides.

Entre les sites échantillonnés sur le réseau hydrographique de la Marne, les niveaux de micropolluants et de leurs métabolites mesurés dans les matrices environnementales sont bien corrélés aux niveaux dans le muscle ou le foie des chevesnes pour les POPs : plus les sédiments et biofilm d'un site sont chargés en PCBs, plus le foie de chevesne en est imprégné. Par contre, ce type de corrélation est absent ou faible pour les polluants métabolisables : des chevesnes pêchés sur un site très contaminé en phtalates, HAPs ou pesticides pyréthrinoides ne sont pas sur-imprégnés par rapport à ceux issus d'un site peu contaminé, et ce quelle que soit la matrice environnementale ou le tissu biologique analysé. Ainsi il apparaît difficile d'extrapoler au biote les valeurs de micropolluants métabolisables et de leurs métabolites mesurés sur un site donné, probablement en raison des variations temporelles liées aux émissions de polluants. L'exposition des poissons englobent aussi une dimension spatiale, bien que les chevesnes soient relativement peu mobiles (< 1.2 km, Allouche et al. 1999). Enfin comme discuté précédemment, la détectabilité des polluants dépend de leurs caractéristiques physico-chimiques, ils se partitionnent dans les différentes matrices en fonction de leur caractère hydrophile/lipophile, leur aptitude à être adsorbé sur la matière organique, leur potentiel de bioaccumulation et de bioamplification dans les organismes et leur conversion métabolique.

### Effet de l'âge / de la taille

Parmi les traits individuels pouvant expliquer l'imprégnation des poissons par les micropolluants, nous nous sommes intéressés à l'âge (estimé par scalimétrie, *via* la lecture des marques de croissance hivernales), la taille, l'écologie trophique (estimée par la signature isotopique en azote et en carbone) et à la présence de parasites intestinaux, les acanthocéphales. Les résultats ont été acquis dans le cadre du projet financé par l'Agence de l'Eau Seine Normandie, ainsi que *via* la réexposition d'échantillons de muscle d'anguilles, prélevés dans le cadre de l'ANR CIEL, lors du stage de Master 2 de Claire Fourgous en 2015 (article n°23).

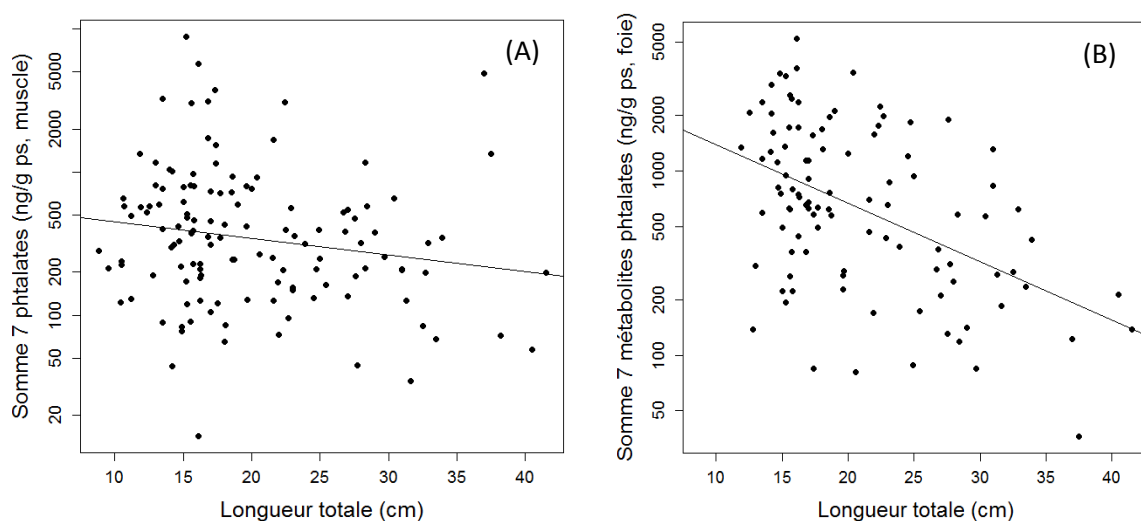


Figure 14 : Diminution des teneurs musculaires en phtalates (A) et en métabolites de phtalates (B) avec la longueur totale des chevesnes

Chez l'anguille européenne de lagunes méditerranéennes, les teneurs musculaires en métabolites de phtalates ne sont pas corrélées à l'âge (article n°23). Sur les chevesnes, nous n'avons pas détecté de bioaccumulation des PCBs et des pesticides organochlorés avec l'âge ou la taille, contrairement à de précédentes études, par exemple chez la truite commune *Salmo trutta* (Vives et al. 2005). Les teneurs en phtalates parents dans les muscles et en métabolites de phtalates dans le foie diminuent avec l'âge des chevesnes (Figure 14 A,B), probablement en raison de l'augmentation de l'activité métabolique et de l'efficacité à métaboliser les polluants avec l'âge. Dans la mesure où cette étude est transversale (comparaison d'individus d'âge différent à un temps donné) et non longitudinale (suivi répété d'un même groupe d'individu sur une longue période de temps), on peut aussi avancer l'hypothèse d'une élimination progressive dans le milieu des individus les moins efficaces à métaboliser les polluants.

### *Effet du niveau trophique*

Il était prédit que les chevesnes fourrageant des proies à des niveaux trophiques plus élevés (déterminé par la signature isotopique en azote) étaient les plus imprégnés par les POPs, en raison des phénomènes de bioamplification trophique. Cette hypothèse n'est pas vérifiée par nos résultats avec une absence de corrélation significative entre les teneurs musculaires en PCBs et en POC et les isotopes stables de l'azote, conformément à d'autres études sur les truites de lac *Salvelinus namaycush* au Canada (Kiriluk et al. 1995) et l'omble chevalier *Salvelinus alpinus* (Dufour et al. 2001). Une augmentation des teneurs en POPs avait été liée au niveau trophique des perches communes *Perca fluviatilis* mais seulement pour les individus de plus de 20 cm (Olsson et al. 2000).

### *Effet du parasitisme*

Il est communément admis une synergie des effets entre parasitisme et pollution, dans la mesure où la pollution induit un stress physiologique et un déficit immunitaire, favorisant une infection parasitaire (Poulin 1992 ; Marcogliese and Pietrock 2011 ; Gasparini et al. 2014). Cependant l'idée d'un possible effet antagoniste entre parasitisme et pollution a émergé du constat de la bioaccumulation de polluants par les parasites, aboutissant à une détoxification de leur hôte. Ainsi, les poissons parasités par les ectoparasites intestinaux, les acanthocéphales sont moins contaminés que des poissons non parasités en plomb chez les chevesnes (Sures et al. 2003) et en PCBs chez les perches communes (Brázová et al. 2012).

Dans notre étude, 57,4% des chevesnes étaient infectés par les acanthocéphales et ils étaient moins imprégnés par les pesticides organochlorés que les non-parasités (Figure 15). Plusieurs explications mutuellement non-exclusives peuvent être envisagées pour expliquer ces résultats : (i) Il est possible que l'effet conjugué de la pollution et du parasitisme soit très néfaste pour les chevesnes, au point que les individus parasités et très contaminés soient dans un état sub-létal et n'aient pas été échantillonnés. Cependant, cette explication est peu plausible, dans la mesure où la présence d'acanthocéphales n'est pas liée à des dommages physiologiques chez leur hôte. (ii) Les parasites peuvent modifier le comportement alimentaire de leurs hôtes, engendrant ainsi une moindre exposition aux polluants. Cependant, la signature isotopique des chevesnes n'est pas significativement différente entre individus parasités et non-parasités. (iii) Les micropolluants peuvent être toxiques pour les parasites (Carreras-Aubets et al. 2012), si bien que la probabilité d'infestation par les parasites diminue avec la charge en polluants des hôtes (Sures 2003). Un écosystème sain est d'ailleurs considéré être riche en parasites (Marcogliese 2005 ; Hudson et al. 2006). (iv) Les parasites intestinaux accumulent les polluants ingérés par les hôtes, comme cela a été

montré pour le plomb avec des teneurs 1000 fois supérieures chez les parasites acanthocéphales que chez leur hôte (Sures et Siddall 1999).

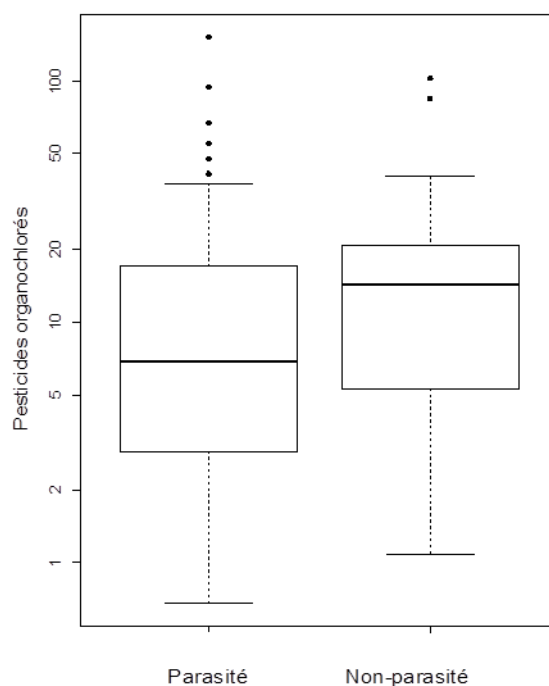


Figure 15 : Teneurs musculaires en pesticides organochlorés (ng/g dw) significativement plus faibles chez les chevesnes parasités d'acanthocéphales que chez les non-parasités

Afin de tester l'hypothèse de bioaccumulation des polluants par les parasites acanthocéphales, nous avons comparé les niveaux de contamination entre les parasites et leur hôte, à travers le rapport entre les teneurs en polluants organiques mesurées dans les parasites et celles mesurées dans les muscles de l'hôte (Ratio  $C_{[acanthocéphale]} / C_{[tissus\ de\ chevesne\ parasité]}$ ). Ce rapport est significativement supérieur à 1 pour toutes les sommes de micropolluants (persistants ou métabolisables), excepté les pyréthriinoïdes parents dans le muscle et le foie (Tableau 1), ce qui conforte l'hypothèse d'une bioaccumulation et/ou d'une moindre capacité à métaboliser les polluants par les acanthocéphales. Les métabolites de phtalates, HAPs et pyréthriinoïdes n'ont pas été analysés dans les parasites par manque de matériel biologique suffisant.

Tableau 1 : Rapport (moyenne et écart type) entre les niveaux en micropolluants organiques mesurés dans les parasites acanthocéphales et ceux mesurés dans les tissus (muscle, foie, intestin) de leur hôte. Rapports significativement différents de 1 d'après les tests de Student ou de Wilcoxon : \* ( $p < 0,05$ ), \*\* ( $p < 0,01$ ), \*\*\* ( $p < 0,001$ )

Compound	Muscle (n = 19)		Liver (n = 8)		Intestin (n = 10)	
	Ratio	± SD	Ratio	± SD	Ratio	± SD
Σ7 Phthalates	22.82***	12.24	7.91*	6.98	11.13*	25.13
Σ16 PAHs	211.45***	187.50	99.13**	146.32	3.03***	1.16
Σ7 Pyrethroids	1.48	2.14	2.84	3.90	1.54	2.81
Σ4 OCPs	6.23***	5.74	2.40*	1.37	0.40	0.66
Σ7 PCBs	3.06***	1.86	2.06*	1.56	1.72	1.59
Σ6 PBDEs	3.39***	2.44	2.39*	2.12	0.88	0.71

## 2.3 Dommages potentiels

### Stress oxydant

Le stress oxydant résulte des dommages engendrés par les radicaux libres et d'espèces réactives non radicales de l'oxygène (qui font référence aux ROS pour reactive oxygen species), qui ne sont pas contrebalancées par des mécanismes de défenses anti-oxydantes enzymatiques et non enzymatiques. Chez l'Homme, les concentrations urinaires en métabolites de phtalates sont positivement liées à des marqueurs sanguins de stress oxydant (Ferguson et al. 2011, 2014). Chez les poissons, les liens entre stress oxydant et polluants environnementaux sont moins évidents (Wessel et al. 2010 ; Benedetti et al. 2015 ; Ling et al. 2016). Les phtalates et les HAPs pourraient entraîner une stimulation de la formation directe ou indirecte des ROS qui échappent aux défenses antioxydantes, mais aussi diminuer l'efficacité des défenses anti-oxydantes (Livingstone 2003 ; Valavanidis et al. 2006). Un déséquilibre entre la génération et l'élimination de ROS induit un stress oxydant susceptible d'engendrer des dysfonctionnements cellulaires.

Chez l'anguille européenne, les partenaires de l'ANR CIEL avaient mesuré l'expression des gènes (ARNm) et le produit l'expression des gènes (activité enzymatique) de plusieurs marqueurs du stress oxydant (catalase, glutathion-S-transférase, glutathion, glutathion réductase). Peu de corrélations significatives (positives et négatives) ont été retrouvées entre ces biomarqueurs de stress oxydant et les métabolites de phtalates à l'échelle individuelle. Chez les chevesnes, la capacité anti-oxydante plasmatique mesurée par le test OXY-adsorbent diminue significativement avec les teneurs en métabolites (Figure 16). Il a été démontré que les phtalates sont capables d'altérer non seulement l'activité des enzymes anti-oxydantes mais aussi leur expression (Qu et al. 2013). Les métabolites réactifs à l'oxygène mesurés par le test d-ROMs dans le plasma ne sont pas expliqués par les teneurs en micropolluants et en leurs métabolites.

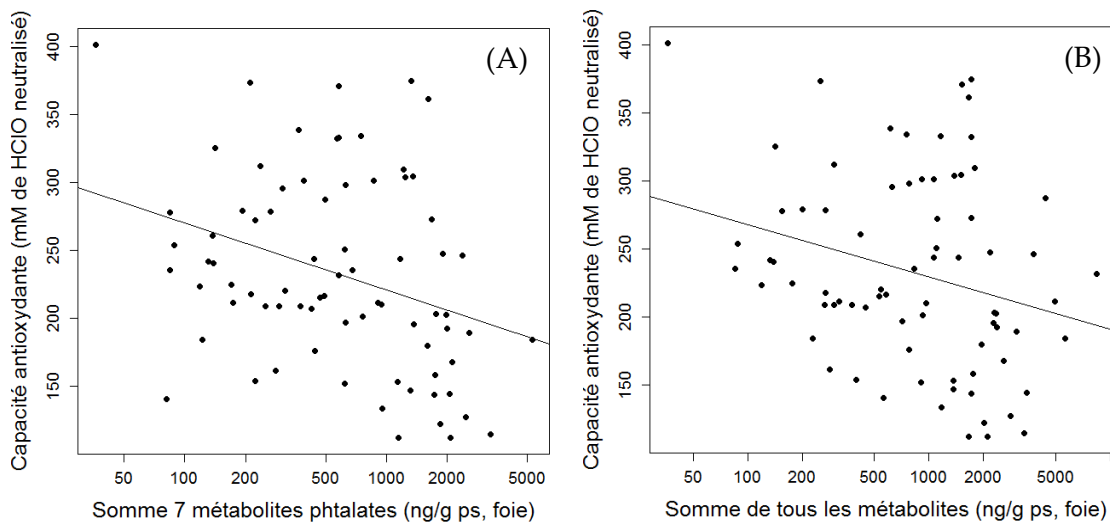


Figure 16 : Diminution de la capacité anti-oxydante (OXY) avec les teneurs hépatiques (A) en métabolites de phtalates et (B) en métabolites totaux

Le stress oxydant diminue avec la taille des chevesnes et est plus bas chez les parasités par les acanthocéphales que chez les non-parasités (Figure 17), ce qui étaye l'hypothèse d'un bénéfice à être parasité en milieu pollué, *via* l'accumulation de micropolluants par les parasites acanthocéphales et la détoxification de leur hôte. Un possible effet antagoniste entre parasitisme et

pollution a été formulé par une récente étude : la présence de cestodes diminue le taux de mortalité induit par l'arsenic chez leur hôte intermédiaire, les artémies (*Artemia parthenogenetica*) et augmente la capacité anti-oxydante des artémies (Sanchez et al. 2016). Il serait intéressant de tester ce potentiel bénéfique des parasites en milieux pollués, pour des hôtes définitifs.

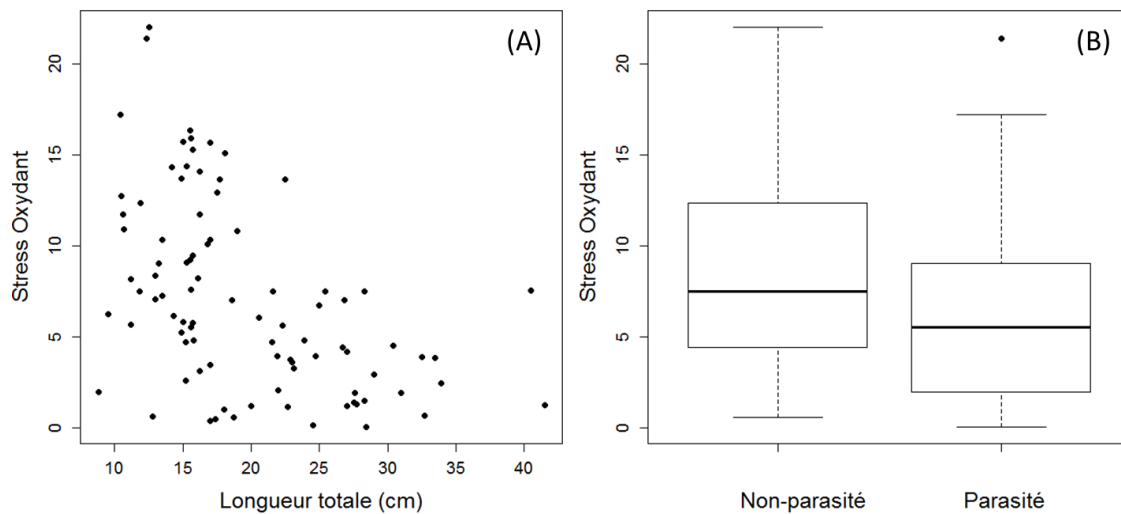


Figure 17 : Diminution du stress oxydant chez les chevesnes avec (A) la longueur et (B) la présence de parasites acanthocéphales

### Défenses immunitaires

Des marqueurs immunitaires (peroxydase et lysozyme) couramment utilisés comme marqueurs d'immunité innée (Abreu et al. 2009) ont été analysés au laboratoire Bordeaux Sciences Agro, en collaboration avec Lisa Jacquin sur du plasma de chevesnes. La peroxydase appartient à une large famille d'enzymes étudiées pour leur activité anti-oxydative et leur activité immunitaire comme agent anti-bactérien naturel, comme mécanisme de détoxification et de défense contre les pathogènes. La mesure de la peroxydase sanguine est souvent utilisée comme un indicateur de l'activation des leucocytes circulants (Esteban et al. 2013). Le lysozyme est une enzyme lytique d'origine leucocytaire qui joue un rôle dans l'immunité innée des Vertébrés et la lutte contre plusieurs types de bactéries et de parasites. Ces marqueurs immunitaires ne sont pas corrélés aux teneurs en micropolluants ou en métabolites, ni à la présence de parasites acanthocéphales chez les chevesnes.

### Longueur des télomères

Les perturbations environnementales et les dommages oxydatifs peuvent accélérer le raccourcissement des télomères (Angelier et al. 2013), mais les effets des micropolluants sur la dynamique des télomères restent encore peu explorés chez la faune sauvage (Blévin et al. 2016 ; 2017). La longueur des télomères diminue significativement avec la taille (ou l'âge) des chevesnes (Figure 18A) et la longueur des télomères corrigée par la taille diminue significativement avec les teneurs en pesticides organochlorés (Figure 18B). Malgré leurs relativement faibles teneurs dans les muscles de chevesnes et dans le milieu (eau, sédiment) par rapport aux autres polluants, les niveaux de pesticides organochlorés sont corrélés à une diminution de la longueur des télomères corrigée par



la taille et donc à une accélération du vieillissement des individus. Ces résultats rejoignent ceux déjà discutés sur les femelles de mouettes tridactyles présentant des taux sanguins élevés d'oxychlordan, un métabolite de pesticide organochloré (Blévin et al. 2016).

Les relations entre polluants et télomères chez l'Homme sont plus étayées et révèlent des effets contrastés en fonction des polluants : l'exposition aux éléments traces métalliques, au benzène et au toluène notamment chez les agents de la circulation est associée à des télomères courts (Hoxha et al. 2009). De façon surprenante, l'exposition aux POPs les plus toxiques sont associés à des télomères plus longs (Mitro et al. 2016), possiblement *via* l'activation par les dioxines de la télomérase (Sarkar et al. 2006), une enzyme qui ajoute de nouvelles séquences aux extrémités de l'ADN lors des réplifications, permettant de conserver voire d'allonger la longueur des télomères.

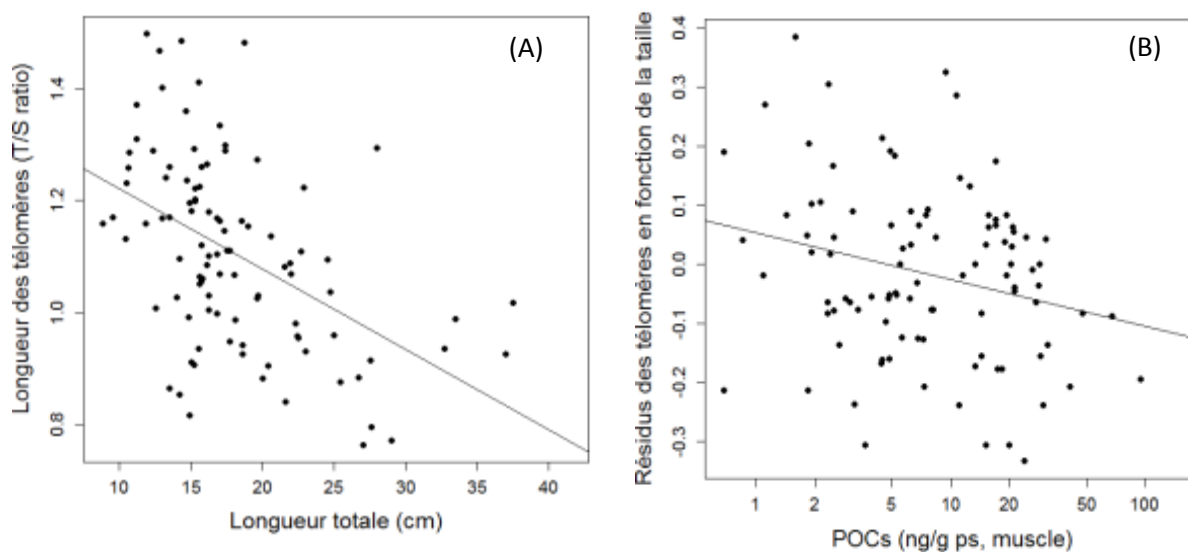


Figure 18 : (A) diminution de la longueur des télomères avec la taille des chevesnes, (B) : Diminution de la longueur des télomères corrigée par la taille en fonction des teneurs musculaires en pesticides organochlorés (POC)

### *Indice hépato-somatique et lésions hépatiques*

Dans le cas d'une importante exposition aux polluants, il a été constaté une hypertrophie du foie chez les chevesnes (Larno et al. 2001). Nous avons mesuré l'indice hépato-somatique (IHS), le rapport de la masse de l'hépatopancréas par rapport à la masse totale de l'organisme. Malgré les variations connues en fonction des activités de détoxification (Bolger & Connolly 1989), nous n'avons pas trouvé de liens entre l'indice hépato-somatique et les teneurs en micropolluants et en métabolites de micropolluants.

Enfin, nous nous sommes intéressés au lien entre les lésions histo-pathologiques dans le foie et les teneurs en métabolites de phtalates chez les anguilles de deux lagunes méditerranéennes dans le cadre du stage de master 2 de Claire Fourgous qui a abouti à l'article **23**. Les principales altérations du tissu hépatique des anguilles, constatées par Séverine Paris-Palacios (UMR-I 02 Stress Environnementaux et BIOSurveillance des milieux aquatiques, SEBIO), dans le cadre de l'ANR CIEL, étaient des nécroses des cellules hépatiques et des lyses parenchymateuses, une hyperplasie cellulaire associée à une vacuolisation lipidique et des fibroses. Chez les anguilles jaunes, ces troubles sont symptomatiques d'un dysfonctionnement métabolique, dans la mesure où leur foie ne stocke pas de lipides. Nous avons montré que plus les lésions du tissu hépatique étaient sévères, plus les teneurs en métabolites de phtalates étaient faibles (article **23**), ce qui corrobore l'hypothèse d'une altération des fonctions de métabolisation des xénobiotiques (Vandemiale et al. 2001).



## *Diversité piscicole*

Les dommages observés chez les chevesnes, une espèce dite polluo-tolérante, peuvent potentiellement se répercuter à l'échelle des communautés piscicoles, avec l'absence d'espèces particulièrement sensibles à la pollution. Une telle perte de biodiversité due à l'exposition aux micropolluants a d'ailleurs été décrite pour les invertébrés dulçaquicoles (Beketov *et al.* 2013). L'ADN environnemental (ADNe) est un outil novateur pour estimer la diversité des espèces présentes sur chaque site (Thomsen *et al.* 2012) et est particulièrement performant pour détecter des espèces rares dans un milieu donné (Valentini *et al.* 2016). Sur la cinquantaine d'espèces connues sur l'ensemble du bassin de la Seine, 33 espèces ou assemblages d'espèces ont été inventoriées sur nos sites de la Marne et ses affluents, ainsi que sur des sites de la Seine (projet financé par le SIAAP) grâce à l'ADNe analysé par SpyGen®. Les sites les plus pollués, avec les chevesnes les plus imprégnés ou avec le plus de dommages écotoxicologiques ne sont pas les plus pauvres en espèces piscicoles et ne souffrent pas de l'absence des espèces dites polluo-sensibles. Ces résultats ne confirment pas une perte de diversité spécifique dans les sites pollués à l'échelle des bassins versants de la Seine et de la Marne. Il convient de rappeler que la diversité des communautés piscicoles est la résultante de plusieurs facteurs naturels (gradient amont-aval, géomorphologie, habitats) et anthropiques (ouvrages, chenalisation, perte des zones de frayères, gestion des débits, qualité physico-chimique de l'eau, notamment oxygène dissous), la pollution n'étant qu'un facteur parmi d'autres.

Des études de capture-marquage-recapture seraient nécessaires pour estimer et prédire la dynamique des populations en lien avec les variations de contamination environnementale, afin d'accéder au niveau biologique intermédiaire. Il serait aussi enthousiasmant de comparer les tolérances et résistances aux micropolluants entre sites plus ou moins pollués, ce qui pourrait expliquer la présence de plusieurs espèces piscicoles malgré de forts niveaux de contamination.

## IV. Conclusion et perspectives de recherche

Les travaux présentés dans ce mémoire ont permis de :

(1) décrire les transferts de polluants métalliques et organiques, ainsi que leurs métabolites des proies aux prédateurs mais aussi, de façon originale, des hôtes aux parasites dans des écosystèmes marins polaires et dulçaquicoles tempérés,

(2) évaluer les effets de l'âge, du niveau trophique, du parasitisme sur la variabilité inter-individuelle d'imprégnation en micropolluants,

(3) identifier les conséquences de cette imprégnation sur le stress oxydant, la longueur des télomères, les niveaux hormonaux et les comportements reproducteurs,

(4) évaluer et prédire les conséquences de ces polluants sur les traits démographiques et les dynamiques de population de la faune sauvage, grâce à de suivis longitudinaux sur plusieurs années.

La diversité des modèles d'étude offre une opportunité unique pour les comparaisons interspécifiques et a révélé de fortes disparités dans la réponse aux polluants entre espèces phylogénétiquement proches (e.g. les deux espèces de skuas). Ceci remet en question les tests écotoxicologiques menés sur un nombre restreint d'espèces modèles et extrapolés à des groupes taxonomiques très larges. Des différences mâles/femelles dans les réponses aux polluants ont aussi mises en évidence, ainsi que des effets de qualité individuelle et de report du coût de reproduction antérieure sur les performances de reproductions futures. Par ailleurs, le large panel des micropolluants considérés a permis d'identifier les composés les plus néfastes, qui ne sont pas forcément les plus abondants. C'est le cas du HCB et du chlordane, dont les teneurs dans le sang des mouettes tridactyles sont corrélées à un plus faible taux de survie, malgré leurs faibles contributions par rapport à d'autres POPs. Les skuas semblent, quant à eux, particulièrement sensibles au mirex. Les pesticides organochlorés, malgré leur relativement faible contribution dans l'imprégnation des chevesnes sont les seuls polluants à expliquer un raccourcissement des télomères. Enfin, l'importance des stress multiples, difficile à évaluer en milieu naturel, a été pris en compte. D'une part, il a été suggéré une synergie entre l'imprégnation aux polluants et les perturbations environnementales, caractérisées par des taux de corticostérone élevés. D'autre part, le parasitisme et la pollution semblent induire des interactions antagonistes, avec une possible détoxification de l'hôte et des bénéfices en termes de stress oxydant. Cette approche multi-stress est enthousiasmante et c'est dans la continuité de ces travaux que je souhaite inscrire mes futurs projets de recherche.

### 1. Coûts et bénéfices du parasitisme en milieu pollué: une approche expérimentale

Dans le cadre de la thèse de Noëlie Molbert (2017-2020) sur les transferts hôte-parasites de micropolluants, nous avons donc montré, en milieu naturel, une bioaccumulation d'une grande majorité de micropolluants chez les acanthocéphales par rapport au poisson hôte, ainsi qu'un plus faible stress oxydant chez les chevesnes parasités par rapport aux non-parasités. Nous avons émis l'hypothèse d'un bénéfice à être infesté d'acanthocéphales pour les chevesnes exposés aux micropolluants. Afin de tester cette hypothèse, nous réalisons une manipulation expérimentale, visant à infester des chevesnes et à les exposer à des HAPs, afin de tester (1) une détoxification par rapport aux individus non-parasités et (2) les coûts et bénéfices du parasitisme couplé à la pollution.

Pour réaliser cette expérience, 200 chevesnes âgés d'environ 2 ans et capturés *in natura* par pêche électrique en janvier 2019 sont hébergés au CEREEP-Ecotron jusqu'en fin avril 2019. Après trois semaines d'acclimatation, les 150 chevesnes seront exposés pendant cinq semaines à trois traitements aux HAPs (doses faibles, moyennes ou élevés, N = 50 pour chaque groupe). Le taux d'infestation des chevesnes sur ce site (la Semoigne à Verneuil) était de 50% en septembre 2016. On s'attend donc à environ 25 chevesnes naturellement parasités par les acanthocéphales pour chaque lot de 50 individus.

Plusieurs paramètres seront suivis pour évaluer les effets croisés du parasitisme et de l'exposition aux HAPs : la survie des chevesnes, la condition corporelle (taille et poids), les effets physiologiques et moléculaires (stress oxydant, marqueurs de défenses immunitaires, dynamique de raccourcissement des télomères). Après euthanasie, les chevesnes seront disséqués et la présence de parasites acanthocéphales sera activement recherchée sur le tractus intestinal. Le muscle sera prélevé pour analyser les teneurs en HAPs parents, et le foie, pour les métabolites de HAPs. Les parasites acanthocéphales seront comptés et analysés pour les teneurs en HAPs et métabolites de HAPs. Enfin, un lot supplémentaire de chevesnes exposés à des niveaux moyens de HAPs (N = 50) servira à estimer la cinétique d'imprégnation en HAPs dans les poissons et les parasites, ainsi que l'évolution des marqueurs physiologiques et moléculaires au cours du temps, en sacrifiant 10 poissons chaque semaine pendant les 5 semaines d'exposition. La Figure 19 présente le design expérimental.

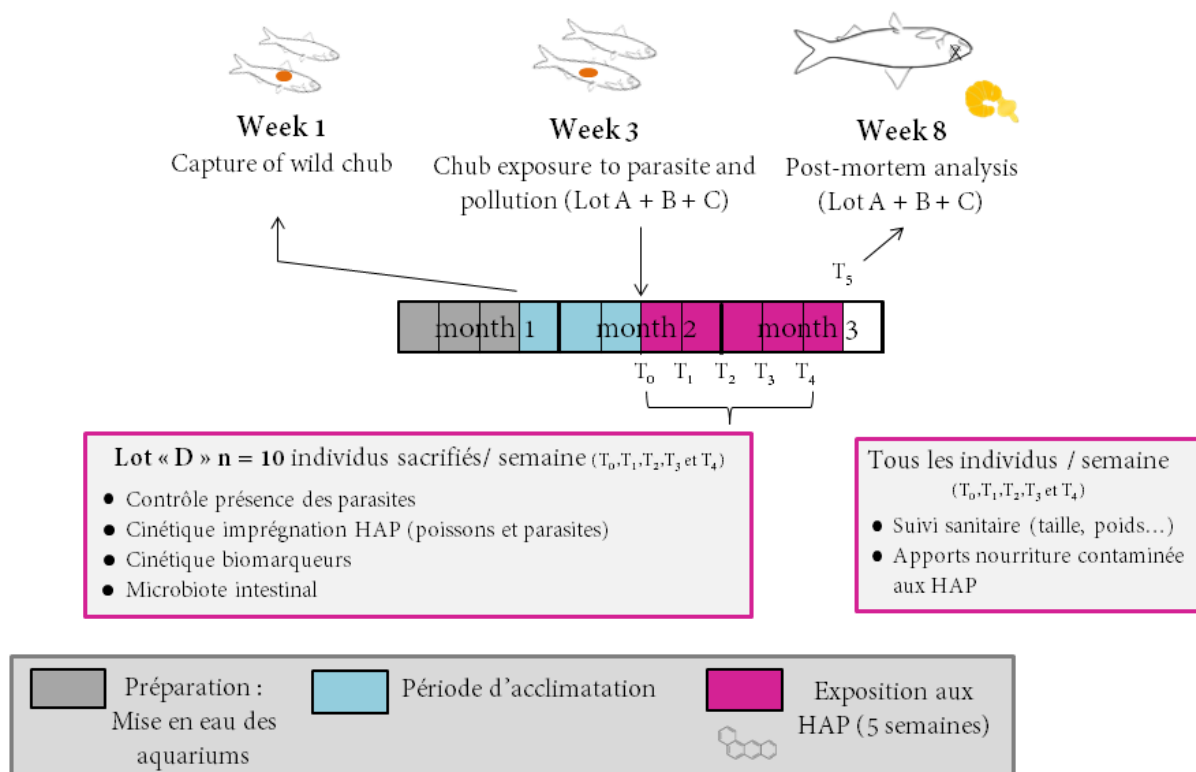


Figure 19 : Design expérimental utilisé pour tester les effets croisés du parasitisme et de l'exposition aux HAPs sur les chevesnes

Enfin, en collaboration avec Sylvie Collin (UMR 7619 METIS), Fabienne Petit et Thierry Berthe (UMR 6143 M2C, CNRS Université de Rouen), la diversité phylogénétique (bactéries et archées) du microbiote intestinal et son évolution seront suivis chez les chevesnes parasités ou non-parasités, exposés aux HAPs, afin d'apporter une vision complémentaire et intégrée sur l'état de santé des

poissons. Le microbiote intestinal participe à la digestion et à la transformation des xénobiotiques (Claus et al. 2016), mais sa composition, son fonctionnement et sa dynamique peuvent être déséquilibrés par l'exposition aux polluants environnementaux. Une récente étude a montré que l'exposition au glyphosate ralentit la croissance et compromet la survie du microbiote intestinal des Tortues vertes *Chelonia mydas* (Kittle et al. 2018). Un tel déséquilibre des communautés bactériennes est susceptible d'engendrer des répercussions fonctionnelles majeures sur les organismes, et affecter notamment leur capacité à métaboliser des xénobiotiques ainsi que leur susceptibilité aux agents pathogènes. Les objectifs du suivi du microbiote intestinal des chevesnes sont multiples : 1) tester si l'exposition croissante aux HAPs s'accompagne d'une modification de la diversité spécifique des communautés, y compris les communautés métaboliquement actives, du microbiote intestinal des poissons (archées et bactéries) ; 2) *via* le suivi des métabolites de HAPs, tester si une efficacité réduite de métabolisation des HAPs peut être associée à une modification de la diversité des communautés bactériennes et 3) tester si un potentiel effet bénéfique des parasites accumulateurs de polluants chez le poisson se traduit par une réponse modérée du microbiote intestinal à cette exposition.

Cette manipulation expérimentale bénéficie de deux financements (appels internes EPHE et UMR 7619 METIS, 8000 €).

## 2. Les poissons d'eau douce comme réservoir d'antibiorésistance

Du fait de leur connexion directe aux rejets urbains, les milieux aquatiques jouent un rôle majeur dans les flux d'antibiotiques et dans les échanges de bactéries porteuses de gènes d'antibiorésistance entre humains, animaux domestiques, aquaculture et faune sauvage (Baquero et al. 2008 ; Vittecoq et al. 2016). L'antibiorésistance, enjeu sanitaire actuel et majeur, explose dans les environnements les plus anthropisés. La faune sauvage constitue un réservoir important de bactéries résistantes aux antibiotiques, notamment les espèces omnivores et carnivores (Vittecoq et al. 2016), mais aussi les poissons d'élevage (Shah et al. 2012) et sauvages (Marti et al. 2017).

Dans ce contexte et en collaboration avec Elodie Guigon et Sylvie Collin (UMR 7619 METIS), ainsi que Fabienne Petit et Thierry Berthe (UMR 6143 M2C, CNRS Université de Rouen), nous avons récemment monté un projet visant à évaluer le lien entre les teneurs en antibiotiques dans les poissons dulçaquicoles et l'occurrence et la diversité des gènes d'antibiorésistance (intégrons) dans le microbiote intestinal et cutané des poissons. Quatre-vingt-dix poissons ont été pêchés les 30, 31 mai et 1er juin 2018 sur 3 sites de l'Orge, un affluent de la Seine, le long d'un gradient d'urbanisation, d'un site amont forestier à un site aval fortement urbanisé. Des échantillons de muscle et de foie ont été prélevés sur différentes espèces de poissons pour les analyses d'un large panel d'antibiotiques et leurs résidus. Les gènes d'antibiorésistance seront recherchés dans le microbiote du mucus et du tractus intestinal. Dans le cadre d'un projet PANDORE financé par l'ANSES, les teneurs en antibiotiques et l'antibiorésistance sont aussi analysées sur le biofilm et les sédiments sur les mêmes sites de l'Orge, dont un prélèvement aux mêmes dates que les pêches effectuées. Ces travaux s'inscrivent dans la vision « One Health », une santé connectée au sein de la triade homme-animal-environnement.

Ce projet fait l'objet d'un stage de master 2 (Etienne Marchand, janvier-juin 2019).

### 3. Dynamique temporelle des marqueurs écotoxicologiques chez les chabots en lien avec la contamination en pesticides

Les résultats présentés aux paragraphes III.2.2 et III.2.3 donnent une photographie à un temps donné de la contamination du milieu et des dommages écotoxicologiques chez les chevesnes à l'échelle d'un bassin versant. Il semble nécessaire de poursuivre dans cette voie en y intégrant la dynamique temporelle des processus à travers un suivi fréquent et à long-terme du milieu et des individus marqués.

Le bassin versant de l'Orgeval (bassin agricole amont en Seine et Marne) fait l'objet d'un suivi sur le long-terme dans le cadre du PIREN Seine et de l'observatoire ORACLE, géré par l'IRSTEA depuis 60 ans. Il est en outre intégré au sein de plusieurs réseaux de suivi des effets de la contamination agricole : RECOTOX au niveau national et le projet H2020 GHPest (An integrated assessment tool-set for Global Health and Pesticide use in agricultural systems prévu pour 2019) au niveau international. La contamination mensuelle par les pesticides (échantillons continus mensuels asservis au débit) est maintenant suivie depuis 2008 à la station des Avenelles par Hélène Blanchoud (UMR 7619 METIS). Les fluctuations mensuelles de teneurs en herbicides (atrazine, isoproturon, chlortoluron ou S-Métolachlor) et leurs métabolites sont comprises entre 1 et 1000 ng/L (Blanchoud et al. 2018), avec d'importantes variations saisonnières en lien avec le calendrier d'application des agriculteurs. Les substances actives étant rapidement dégradables et faiblement bioaccumulables, tout l'enjeu réside dans l'évaluation des teneurs en pesticides et de leurs produits de métabolisation.

Nous proposons d'aborder les effets de ces herbicides sur les communautés piscicoles sous le prisme des dynamiques saisonnières. Le modèle d'étude choisi est le chabot commun (*Cottus gobio*), un petit prédateur qui fréquente les parties supérieures des cours d'eau. Poisson territorial sédentaire, sa faible mobilité fait de lui un très bon indicateur des conditions locales. Environ 500 chabots seront pêchés dans le ru des Avenelles, marqués individuellement par PIT-TAG et recapturés tous les deux mois par pêche électrique d'avril à novembre 2020 et 2021. Le taux de recapture des chabots marqués oscille entre 50 et 70% (Knaepkens et al. 2005). Des mesures biométriques et des prélèvements sanguins seront ainsi effectués tous les 2 mois, afin de suivre la condition corporelle, le stress oxydant, le raccourcissement de la longueur des télomères, et autres marqueurs physiologiques et écotoxicologiques, en lien avec les variations mensuelles de pesticides dans l'eau.

Si les effectifs de chabots marqués et les taux de recapture nous le permettent, des analyses démographiques seront menées pour estimer les taux de survie et les taux de détection des individus au cours des deux années et en lien avec l'exposition aux pesticides. Enfin, à l'échelle des communautés piscicoles, la diversité des espèces piscicoles sera suivie à pas de temps régulier par ADNe, dans la continuité des études débutées en 2016 dans le cadre du PIREN-Seine (Tallec et al. 2018). Il sera ainsi possible d'évaluer les effets écotoxicologiques des variations mensuelles en pesticides à l'échelle individuelle et en intégrant plusieurs niveaux biologiques.

Ce projet fait l'objet de plusieurs demandes de financements (Plan ECOPHYTO II et PIREN-Seine phase VIII, PI : Hélène Blanchoud), en collaboration avec Gaëlle Tallec (IRSTEA), Frédéric Angelier (CEBC) et Maxime Le Simple (Fédération de Pêche de Seine et Marne).

Une fois cette dynamique temporelle de réponses écotoxicologiques établie, l'étape suivante serait d'étudier les mécanismes microévolutifs qui pourraient expliquer la persistance de populations de poissons (vairons, chabots, loches franches) dans ce cours d'eau particulièrement exposé aux rejets de multiples herbicides à de fortes concentrations. Ainsi une approche expérimentale pourrait être envisagée en exposant aux herbicides des poissons issus de sites plus ou moins contaminés dans le bassin versant de l'Orgeval, afin de tester une éventuelle résistance et adaptation aux substances anciennement et actuellement utilisées en agriculture et rapidement métabolisables. De tels travaux

ont été menés chez les amphibiens, montrant par exemple que la résistance aux pesticides augmente avec la proximité de zones agricoles chez les grenouilles des bois (*Lithobates sylvaticus*) et ceci d'autant plus pour les anciens pesticides par rapport à ceux récemment mis sur le marché (Hua et al. 2015).

#### 4. Bioaccumulation et impact des micropolluants chez les Cistudes en Camargue

Avec Olivier Lourdais (Centre d'Etudes Biologiques de Chizé), Marion Vittecoq et Anthony Olivier (Tour du Valat), nous montons un projet sur la Cistude d'Europe *Emys orbicularis*, une espèce de tortue d'eau douce longévive (espérance de vie > 30-40 ans) et prédatrice, qui fait face à un déclin important du fait de multiples pressions anthropiques. Les reptiles sont peu étudiés en écotoxicologie, bien qu'ils constituent d'excellents intégrateurs de la qualité écologique des milieux à une échelle locale, en raison de leurs domaines vitaux restreints, de leur position comme prédateurs supérieurs et de leur longévité (Hopkins 2000 ; Campbell and Campbell 2002). La Tour du Valat suit par capture-marquage-recapture (CMR) près de 1300 individus depuis plus de 20 ans - les premiers marquages ayant débuté en 1976 - en Camargue (Olivier et al. 2010 ; Ficheux et al. 2014).

La Camargue est une mosaïque de zones humides hébergeant une grande biodiversité dont les différentes composantes reçoivent des cocktails de micropolluants, selon qu'elles sont alimentées seulement par les précipitations et la nappe phréatique, par le Rhône ou par des eaux ayant circulé dans les parcelles agricoles traitées. Tout d'abord, le projet se base sur une comparaison de trois noyaux de populations de cistudes issus d'habitats exposés à différents micropolluants : (1) des canaux de drainage du bassin du Fumemorte et des marais irrigués par ces canaux, contaminés par un cortège d'herbicides et insecticides employés en riziculture (e.g. glyphosate, métolachlore, oxadiazon, cycloxydime), (2) une zone de marais et de canaux d'irrigation dont l'eau est pompée depuis le Rhône avec une contamination historique par les PCBs et les POCs, et (3) une zone peu contaminée en Camargue gardoise, caractérisée par des mares forestières alimentées en eau par les précipitations et la nappe phréatique. En plus de la comparaison entre différents habitats, le sexe et l'âge (entre 5 et 40 ans) des cistudes seront pris en compte pour interpréter les variations individuelles d'imprégnation des cistudes par les micropolluants. Enfin, les effets potentiels de ces micropolluants seront étudiés à différentes échelles biologiques : stress oxydant, raccourcissement de la longueur des télomères, taux de corticostérone, sensibilité aux parasites sanguins, morphologie et coloration, comportement anti-prédateur, traits d'histoire de vie *via* les taux de recapture durant au moins 3 années consécutives.

Percevoir la présence d'un prédateur déclenche des stratégies comportementales, telles que (1) la fuite active vers un refuge, (2) des comportements défensifs ou (3) l'immobilité. Chez les tortues, la carapace offre une protection immédiate mais incomplète. Ainsi les individus recroquevillés restent vigilants et dès que le risque diminue, ils adoptent un comportement de fuite et se cachent dans un refuge plus approprié (Martin, Marcos and Lopez 2005). L'ajustement de stratégies anti-prédation varie au cours de la vie : les jeunes tortues d'Hermann *Testudo hermanni* passent ainsi très peu de temps recroquevillées dans la carapace, dont l'ossification est incomplète et la rigidité ne suffit pas à décourager le prédateur (Golubovic 2015).

Cet ajustement comportemental face à la perception du risque peut être régulé par la sécrétion accrue de corticostérone, comme c'est le cas chez les lézards *Urosaurus ornatus* (Thaker et al. 2009). Notre prédiction est que les jeunes cistudes sont plus susceptibles au stress, présentent des taux de corticostérone plus élevés et adoptent une stratégie active de fuite face au prédateur, tandis que les individus plus âgés atténuent la sécrétion de corticostérone et restent cachés dans leur

carapace plus longtemps (Figure 20). Il est possible que la réponse au stress s'accroisse à nouveau chez les individus les plus âgés en raison d'une altération des risques perçus ou d'une carapace plus fracturée, la rendant moins efficace contre les prédateurs. Il est prédit que l'imprégnation par les micropolluants inhibent la sécrétion de corticostérone et retardant l'adoption d'un comportement de fuite active (Figure 20). Ces perturbations endocriniennes et comportementales pourraient être plus prononcées chez les individus les plus âgés, en raison d'une plus forte imprégnation en micropolluants (Rowe 2008).

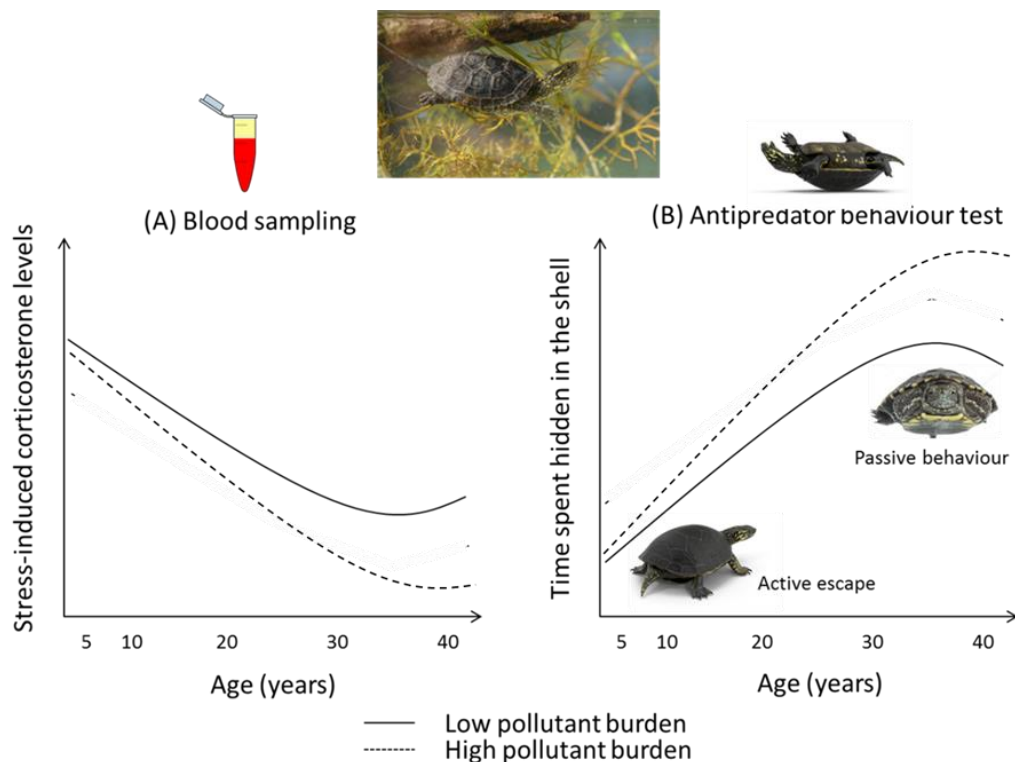


Figure 20 : Prédications sur la (A) variation des taux de corticostérone et (B) du temps passé recroqueviller dans la carapace en fonction de l'âge et des niveaux d'imprégnation des cistudes par les micropolluants

Ce projet a obtenu un soutien financier de 57 643 € par l'Agence de l'Eau Rhône Méditerranée Corse et fait l'objet d'autres demandes de financement. En 2018, des prises de sang ont été réalisées sur 180 cistudes, dont 66 d'âge connu. Les analyses de PCBs et de POCs en lien avec l'habitat, l'âge et le sexe font l'objet du stage M2 de Louisiane Burkart (janvier-juin 2019). La campagne de terrain d'avril à août 2019 sera dédiée à l'évaluation des effets des micropolluants sur le comportement anti-prédateur et la sécrétion de corticostérone des cistudes d'âge connu.

## 5. L'horizon des possibles

A ce stade de la rédaction de l'HDR, la définition d'une trajectoire sur le long-terme me paraît être un exercice quelque peu vertigineux, dès lors que chaque projet renvoie à ses propres limites et débouche sur une multitude de questions, que la réalisation de nouveaux projets est conditionnée par l'obtention de financements, eux-mêmes dépendants d'orientations nationales ou

internationales, et que certaines rencontres contribuent très largement à la maturation des idées. Je me suis jusqu'ici contentée de développer les perspectives concrètes de recherche à court et moyen terme, en laissant en jachère toutes les autres idées qui ne demandent qu'un climat plus propice et le temps nécessaire pour éclore.

Quoiqu'il en soit, les échanges récents avec divers acteurs m'ont convaincue de m'orienter vers une recherche plus appliquée. Le projet financé par l'Agence de l'Eau Seine Normandie a par exemple nourri les discussions actuelles sur l'application des Normes de Qualité environnementale sur biote. De même, des pistes de recherche ont émergé suite à des échanges au sein du Conseil National de la Protection de la Nature, sur la possibilité de compenser la perte nette de biodiversité lors de projets éoliens en contexte agricole, par la réduction de l'utilisation d'herbicides ou insecticides. Les projets envisagés sur les chabots et sur les cistudes, en lien avec l'utilisation de pesticides s'inscrivent dans cette démarche.

Pour conclure, il m'apparaît fondamental de tisser et consolider les liens entre chimie environnementale, écologie trophique, interactions hôte-parasite, écophysiologie évolutive, dynamique des populations, biologie de la conservation, santé humaine et sciences sociales pour relever les grands défis de l'écotoxicologie, d'autant plus en ces temps de crises et de transition qui requièrent d'aborder les problèmes dans toute leur complexité.



## Références bibliographiques

- Abreu, J. S., C. M. Marzocchi-Machado, A. C. Urbaczek, L. M. Fonseca, and Elisabeth Criscuolo Urbinati. "Leukocytes Respiratory Burst and Lysozyme Level in Pacu (*Piaractus Mesopotamicus* Holmberg, 1887)." *Brazilian Journal of Biology* 69, no. 4 (2009): 1133–1139
- Allouche, S., Thévenet, A., Gaudin, P. (1999). Habitat use by chub (*Leuciscus cephalus* L. 1766) in a large river, the French Upper Rhone, as determined by radiotelemetry. *Archiv für Hydrobiologie*, 219-236
- Angelier, F., Vleck, C. M., Holberton, R. L., & Marra, P. P. (2013). Telomere length, non-breeding habitat and return rate in male American redstarts. *Functional Ecology*, 27(2), 342-350.
- Atwell, L., Hobson, K.A., Welch, H.E. (1998). Biomagnification and bioaccumulation of mercury in an arctic marine food web : insights from stable nitrogen isotope analysis. *Canadian journal of fisheries and aquatic sciences* 55, 1114–1121.
- Baquero, F., Martínez, J. L., Cantón, R. (2008). Antibiotics and antibiotic resistance in water environments. *Current opinion in biotechnology*, 19 (3), 260-265
- Barbraud, C., Rolland, V., Jenouvrier, S., Nevoux, M., Delord, K., Weimerskirch, H. (2012). Effects of climate change and fisheries bycatch on Southern Ocean seabirds: a review. *Marine Ecology Progress Series*, 454, 285-307.
- Bargagli, R., Monaci, F., Sanchez Hernandez, J.C., Cateni, D. (1998) Biomagnification of mercury in an Antarctic marine coastal food web. *Marine Ecology Progress Series*, 169, 65-76
- Barrett, E. L., Burke, T. A., Hammers, M., Komdeur, J., Richardson, D. S. (2013). Telomere length and dynamics predict mortality in a wild longitudinal study. *Molecular ecology*, 22(1), 249-259.
- Barron, M. G., Albro, P. W., Hayton, W. L. (1995). Biotransformation of di (2-ethylhexyl) phthalate by rainbow trout. *Environmental Toxicology and Chemistry*, 14(5), 873-876.
- Beketov, M. A., Kefford, B. J., Schäfer, R. B., Liess, M. (2013). Pesticides reduce regional biodiversity of stream invertebrates. *Proceedings of the National Academy of Sciences*, 110(27), 11039-11043.
- Benedetti, M., Giuliani, M. E., Regoli, F. (2015). Oxidative metabolism of chemical pollutants in marine organisms: molecular and biochemical biomarkers in environmental toxicology. *Annals of the New York Academy of Sciences*, 1340(1), 8-19.
- Bettelheim, F.A., Brown, W.H., Campbell, M.K., Farrell, S.O., (2010). Introduction to General, Organic, and Biochemistry, 9th Edition. Brooks/Cole Cengage Learning, Belmont.
- Bize, P., Criscuolo, F., Metcalfe, N. B., Nasir, L., Monaghan, P. (2009). Telomere dynamics rather than age predict life expectancy in the wild. *Proceedings of the Royal Society of London B: Biological Sciences*, 276(1662), 1679-1683.
- Blanchoud H., Tallec G., Desportes A., Ansart P. (2018) Suivi à long terme des pesticides pour la compréhension de leurs processus de transfert à l'échelle du bassin versant, PIREN-Seine phase VII - rapport 2018, 9p.
- Blaustein, A. R., Kiesecker, J. M. (2002). Complexity in conservation: lessons from the global decline of amphibian populations. *Ecology letters*, 5(4), 597-608.
- Blévin, P., Tartu, S., Angelier, F., Leclaire, S., Bustnes, J. O., Moe, B., ... Chastel, O. (2014). Integument colouration in relation to persistent organic pollutants and body condition in arctic breeding black-legged kittiwakes (*Rissa tridactyla*). *Science of the Total Environment*, 470, 248-254.
- Blévin, P., Angelier, F., Tartu, S., Ruault, S., Bustamante, P., Herzke, D., Moe, B., Bech, C., Gabrielsen, G.W., Bustnes, J.O., Chastel, O. (2016). Exposure to oxychlordan is associated with shorter telomeres in arctic breeding kittiwakes. *Science of the Total Environment* 563, 125–130.
- Blévin, P., Angelier, F., Tartu, S., Bustamante, P., Herzke, D., Moe, B., Bech, C., Gabrielsen, G.W., Bustnes, J.O., Chastel, O. (2017). Perfluorinated substances and telomeres in an Arctic

- seabird: Cross-sectional and longitudinal approaches. *Environmental Pollution* 230, 360-367.
- Bokony, V., Lendvai, A. Z., Liker, A., Angelier, F., Wingfield, J. C., Chastel, O. (2009). Stress response and the value of reproduction: are birds prudent parents?. *The American Naturalist*, 173(5), 589-598.
- Bolger, T., Connolly, P. L. (1989): The selection of suitable indices for the measurement and analysis of fish condition. *Journal of Fish Biology.*, 34: 171-182
- Borgå, K., Gabrielsen, G., Skaare, J. (2001) Biomagnification of organochlorines along a Barents Sea food chain. *Environmental Pollution* 113, 187-198
- Borgå, K., Kidd, K. A., Muir, D. C., Berglund, O., Conder, J. M., Gobas, F. A., ... Powell, D. E. (2012). Trophic magnification factors: considerations of ecology, ecosystems, and study design. *Integrated environmental assessment and management* 8, 64-84.
- Bouvier, J. C., Buès, R., Boivin, T., Boudinhon, L., Beslay, D., & Sauphanor, B. (2001). Deltamethrin resistance in the codling moth (Lepidoptera: Tortricidae): inheritance and number of genes involved. *Heredity* 87(4), 456.
- Brázová, T., Torres, J., Eira, C., Hanzelová, V., Miklisová, D., Šalamún, P. (2012). Perch and its parasites as heavy metal biomonitors in a freshwater environment: the case study of the Ružín water reservoir, Slovakia. *Sensors* 12(3), 3068-3081.
- Brook, B. W., Navjot S. Sodhi and Corey J. A. Bradshaw (2008) "Synergies among extinction drivers under global change." *Trends in ecology & evolution* 23 8 : 453-60.
- Brooks, T. M., Mittermeier, R. A., Mittermeier, C. G., Da Fonseca, G. A., Rylands, A. B., Konstant, W. R., ... Hilton-Taylor, C. (2002). Habitat loss and extinction in the hotspots of biodiversity. *Conservation biology*, 16(4), 909-923
- Bustnes, J. O., Miland, Ø., Fjeld, M., Erikstad, K. E., & Skaare, J. U. (2005). Relationships between ecological variables and four organochlorine pollutants in an arctic glaucous gull (*Larus hyperboreus*) population. *Environmental Pollution*, 136(1), 175-185
- Bustnes, J. O., Bourgeon, S., Leat, E. H., Magnúsdóttir, E., Strøm, H., Hanssen, S. A., ... Furness, R. W. (2015). Multiple stressors in a top predator seabird: potential ecological consequences of environmental contaminants, population health and breeding conditions. *PloS one*, 10(7), e0131769.
- Campbell, K. R., Campbell, T. S. (2002). A logical starting point for developing priorities for lizard and snake ecotoxicology: a review of available data. *Environmental Toxicology and Chemistry*, 21(5), 894-898.
- Carreras-Aubets, M., Montero, F. E., Kostadinova, A., Carrassón, M. (2012). Parasite communities in the red mullet, *Mullus barbatus* L., respond to small-scale variation in the levels of polychlorinated biphenyls in the Western Mediterranean. *Marine pollution bulletin*, 64(9), 1853-1860.
- Ceballos, G., Ehrlich, P. R., Barnosky, A. D., García, A., Pringle, R. M., & Palmer, T. M. (2015). Accelerated modern human-induced species losses: Entering the sixth mass extinction. *Science advances*, 1(5), e1400253
- Chapman, P. M. (2002). Integrating toxicology and ecology: putting the "eco" into ecotoxicology. *Marine pollution bulletin*, 44(1), 7-15
- Claus P.S., Guillou H. & Ellero-Simatós S. (2016) The gut microbiota: a major player in the toxicity of environmental pollutants? *npj Biofilms and Microbiomes*, 2 : 16003.
- Clements, W. H., & Rohr, J. R. (2009). Community responses to contaminants: using basic ecological principles to predict ecotoxicological effects. *Environmental toxicology and chemistry*, 28(9), 1789-1800
- Coeurdassier, M., Poirson, C., PAUL, J. P., Rieffel, D., Michelat, D., Reymond, D., ... & Scheifler, R. (2012). The diet of migrant Red Kites *Milvus milvus* during a Water Vole *Arvicola terrestris* outbreak in eastern France and the associated risk of secondary poisoning by the rodenticide bromadiolone. *Ibis*, 154(1), 136-146.
- Corsolini, S. (2009). Industrial contaminants in Antarctic biota. *J. Chromatogr. A* 1216 (3), 598e612.

- Daszak, P., Cunningham, A. A., & Hyatt, A. D. (2001). Anthropogenic environmental change and the emergence of infectious diseases in wildlife. *Acta tropica*, 78(2), 103-116.
- Demoute, J. P. (1989). A brief review of the environmental fate and metabolism of pyrethroids. *Pesticide Science*, 27(4), 375-385
- Dudgeon, D., Arthington, A. H., Gessner, M. O., Kawabata, Z. I., Knowler, D. J., Lévêque, C., ... & Sullivan, C. A. (2006). Freshwater biodiversity: importance, threats, status and conservation challenges. *Biological reviews*, 81(2), 163-182.
- Dupoué, A., Rutschmann, A., Le Galliard, J.F., Clobert, J., Angelier, F., Marciaud, C., Ruault, S., Miles, D., Meylan, S., (2017). Shorter telomeres precede population extinction in wild lizards. *Scientific reports* 7, 16976.
- Dufour, E., Gerdeaux, D., Corvi, C., Khim-Heang, S., & Mariotti, A. (2001). Assessment of the contaminant concentration variability among Lake Geneva Arctic char using stable isotopic composition ( $\delta^{15}\text{N}$  and  $\delta^{13}\text{C}$ ). *Environmental Toxicology: An International Journal*, 16(2), 185-191
- Erikstad, K. E., Sandvik, H., Reiertsen, T. K., Bustnes, J. O., Strøm, H. (2013). Persistent organic pollution in a high-Arctic top predator: sex-dependent thresholds in adult survival. *Proceedings of the Royal Society of London B: Biological Sciences*, 280(1769), 20131483
- Esteban, M. A., Cuesta, A., Chaves-Pozo, E., Meseguer J. (2013). "Influence of Melatonin on the Immune System of Fish : a Review." *International Journal of Molecular Sciences* 14, 4, 7979–99
- Faith, J. T., Rowan, J., Du, A., Koch, P. L. (2018). Plio-Pleistocene decline of African megaherbivores: No evidence for ancient hominin impacts. *Science*, 362(6417), 938-941.
- Ferguson, K. K., Loch-Carusio, R., Meeker, J. D. (2011). Urinary phthalate metabolites in relation to biomarkers of inflammation and oxidative stress: NHANES 1999–2006. *Environmental research*, 111(5), 718-726.
- Ferguson, K. K., McElrath, T. F., Chen, Y. H., Mukherjee, B., Meeker, J. D. (2014). Urinary phthalate metabolites and biomarkers of oxidative stress in pregnant women: a repeated measures analysis. *Environmental health perspectives*, 123(3), 210-216
- Ficheux, S., Olivier, A., Fay, R., Crivelli, A., Besnard, A., Béchet, A. (2014). Rapid response of a long-lived species to improved water and grazing management: The case of the European pond turtle (*Emys orbicularis*) in the Camargue, France. *Journal for nature conservation*, 22(4), 342-348.
- Fisk, A. T., Hobson, K. A., Norstrom, R. J. (2001). Influence of chemical and biological factors on trophic transfer of persistent organic pollutants in the Northwater Polynya marine food web. *Environmental Science & Technology*, 35(4), 732-738.
- Forbes, V. E., Olsen, M., Palmqvist, A., Calow, P. (2010). Environmentally sensitive life-cycle traits have low elasticity: implications for theory and practice. *Ecological Applications*, 20(5), 1449-1455.
- Forson, D. D., Storfer, A. (2006). Atrazine increases ranavirus susceptibility in the tiger salamander, *Ambystoma tigrinum*. *Ecological Applications*, 16(6), 2325-2332.
- Fuoco R., Colombini, M.P., Abete, C. (1991). Evaluation of pack melting effect on polychlorobiphenyl content in sea water samples from Terra Nova Bay - Ross Sea (Antarctica). *Annali di Chimica (Società Chimica Italiana)* 81: 383-394.
- Gaillard, J. M., Yoccoz, N. G. (2003). Temporal variation in survival of mammals: a case of environmental canalization? *Ecology*, 84(12), 3294-3306.
- Gasparini, J., Jacquin, L., Laroucau, K., Vorimore, F., Aubry, E., Castrec-Rouëlle, M., & Frantz, A. (2014). Relationships between metals exposure and epidemiological parameters of two pathogens in urban pigeons. *Bulletin of environmental contamination and toxicology*, 92(2), 208-212.
- Golubović, A. (2015). Ontogenetic shift of antipredator behaviour in Hermann's tortoises. *Behavioral ecology and sociobiology*, 69(7), 1201-1208.

- Gurevitch, J., Padilla, D. K. (2004). Are invasive species a major cause of extinctions?. *Trends in ecology & evolution*, 19(9), 470-474.
- Hale, R. C., Kim, S. L., Harvey, E., La Guardia, M. J., Mainor, T. M., Bush, E. O., Jacobs, E. M. (2008). Antarctic research bases: local sources of polybrominated diphenyl ether (PBDE) flame retardants. *Environmental science & technology*, 42(5), 1452-1457
- Hallinger K. K., Cornell, K. L., Brasso, R. L., Cristol, D. A. (2011) Mercury exposure and survival in free-living tree swallows (*Tachycineta bicolor*). *Ecotoxicology* 20, 39–46.
- Harrison, X. A., Blount, J. D., Inger, R., Norris, D. R., Bearhop, S. (2011). Carry-over effects as drivers of fitness differences in animals. *Journal of Animal Ecology*, 80(1), 4-18.
- Heidinger, B. J., Blount, J. D., Boner, W., Griffiths, K., Metcalfe, N. B., Monaghan, P. (2012). Telomere length in early life predicts lifespan. *Proceedings of the National Academy of Sciences*, 109(5), 1743-1748.
- Herring, G., Ackerman, J. T., Eagles-Smith, C. A. (2010). Embryo malposition as a potential mechanism for mercury-induced hatching failure in bird eggs. *Environmental toxicology and chemistry*, 29(8), 1788-1794.
- Hette-Tronquart, N. (2012). Organisation trophique des peuplements piscicoles des cours d'eau, approche par l'analyse des isotopes stables (thèse, MNHN).
- Holmstrup, M., Bindsbøl, A. M., Oostingh, G. J., Duschl, A., Scheil, V., Köhler, H. R., ... Gerhardt, A. (2010). Interactions between effects of environmental chemicals and natural stressors: a review. *Science of the Total Environment*, 408(18), 3746-3762
- Hopkins W.A. (2000). Reptile toxicology: challenges and opportunities on the last frontier in vertebrate ecotoxicology. *Environmental Toxicology and Chemistry* 19,2391-2393.
- Howard, P.H., Muir, D.C.G., (2010). Identifying New Persistent and Bioaccumulative Organics Among Chemicals in Commerce. *Environmental Science & Technology* 44, 2277-2285
- Hoxha, M., Dioni, L., Bonzini, M., Pesatori, A. C., Fustinoni, S., Cavallo, D., ... Bertazzi, P. A. (2009). Association between leukocyte telomere shortening and exposure to traffic pollution: a cross sectional study on traffic officers and indoor office workers. *Environmental Health*, 8(1), 41.
- Hua, J., Jones, D. K., Mattes, B. M., Cothran, R. D., Relyea, R. A., & Hoverman, J. T. (2015). Evolved pesticide tolerance in amphibians: predicting mechanisms based on pesticide novelty and mode of action. *Environmental Pollution*, 206, 56-63.
- Hudson, P. J., Dobson, A. P., Lafferty, K. D. (2006). Is a healthy ecosystem one that is rich in parasites?. *Trends in ecology & evolution*, 21(7), 381-385.
- Hung, H., Katsoyiannis, A. A., Brorström-Lundén, E., Olafsdottir, K., Aas, W., Breivik, K., ... Skov, H. (2016). Temporal trends of Persistent Organic Pollutants (POPs) in arctic air: 20 years of monitoring under the Arctic Monitoring and Assessment Programme (AMAP). *Environmental Pollution*, 217, 52-61.
- Jenouvrier, S. (2013). Impacts of climate change on avian populations. *Global Change Biology*, 19(7), 2036-2057
- Kelly, B. C., Ikonomou, M. G., Blair, J. D., Morin, A. E., Gobas, F. A. (2007). Food web-specific biomagnification of persistent organic pollutants. *Science*, 317(5835), 236-239.
- Kiriluk, R. M., Servos, M. R., Whittle, D. M., Cabana, G., Rasmussen, J. B. (1995). Using ratios of stable nitrogen and carbon isotopes to characterize the biomagnification of DDE, mirex, and PCB in a Lake Ontario pelagic food web. *Canadian Journal of Fisheries and Aquatic Sciences*, 52(12), 2660-2674.
- Kittle R.P., McDermid K.J., Muehlstein L., Balazs J.H. (2018) Effects of glyphosate herbicide on the gastrointestinal microflora of Hawaiian green turtles (*Chelonia mydas*) Linnaeus. *Marine Pollution Bulletin*, 127 : 170–174.
- Knaepkens, G., Baekelandt, K., & Eens, M. (2005). Assessment of the movement behaviour of the bullhead (*Cottus gobio*), an endangered European freshwater fish. *Animal Biology*, 55(3), 219-226.

- Köhler, H. R., Triebkorn, R. (2013). Wildlife ecotoxicology of pesticides: can we track effects to the population level and beyond?. *Science*, 341(6147), 759-765.
- Larno, V., Laroche, J., Launey, S., Flammarion, P., Devaux, A. (2001). Responses of chub (*Leuciscus cephalus*) populations to chemical stress, assessed by genetic markers, DNA damage and cytochrome P4501A induction. *Ecotoxicology*, 10(3), 145-158.
- Ling, X., Zhang, G., Chen, Q., Yang, H., Sun, L., Zhou, N., ... Liu, J. (2016). Shorter sperm telomere length in association with exposure to polycyclic aromatic hydrocarbons: Results from the MARHCS cohort study in Chongqing, China and in vivo animal experiments. *Environment international*, 95, 79-85.
- Livingstone, D. R. (2003). Oxidative stress in aquatic organisms in relation to pollution and aquaculture. *Revue de Medecine Veterinaire*, 154(6), 427-430.
- Mackintosh, C. E., Maldonado, J., Hongwu, J., Hoover, N., Chong, A., Ikonomou, M. G., Gobas, F. A. (2004). Distribution of phthalate esters in a marine aquatic food web: comparison to polychlorinated biphenyls. *Environmental science & technology*, 38(7), 2011-2020.
- Marcogliese, D. J., Pietrock, M. (2011). Combined effects of parasites and contaminants on animal health: parasites do matter. *Trends in parasitology*, 27(3), 123-130.
- Marcogliese, D. J. (2005). Parasites of the superorganism: are they indicators of ecosystem health?. *International journal for parasitology*, 35(7), 705-716.
- Marshall, D. J. (2008). Transgenerational plasticity in the sea: context-dependent maternal effects across the life history. *Ecology*, 89(2), 418-427.
- Marti, E., Huerta, B., Rodríguez-Mozaz, S., Barceló, D., Marcé, R., Balcázar, J. L. (2018). Abundance of antibiotic resistance genes and bacterial community composition in wild freshwater fish species. *Chemosphere*, 196, 115-119.
- Martín, J., Marcos, I., López, P. (2005). When to come out from your own shell: risk-sensitive hiding decisions in terrapins. *Behavioral Ecology and Sociobiology*, 57(5), 405-411.
- Medina, M. H., Correa, J. A., Barata, C. (2007). Micro-evolution due to pollution: possible consequences for ecosystem responses to toxic stress. *Chemosphere*, 67(11), 2105-2114.
- Miller, M. A. (1993). Maternal transfer of organochlorine compounds in salmonines to their eggs. *Canadian Journal of Fisheries and Aquatic Sciences*, 50(7), 1405-1413
- Miller, D. H., Ankley, G. T. (2004). Modeling impacts on populations: fathead minnow (*Pimephales promelas*) exposure to the endocrine disruptor 17 $\beta$ -trenbolone as a case study. *Ecotoxicology and environmental safety*, 59(1), 1-9.
- Mitro, S. D., Birnbaum, L. S., Needham, B. L., Zota, A. R. (2016). Cross-sectional associations between exposure to persistent organic pollutants and leukocyte telomere length among US adults in NHANES, 2001–2002. *Environmental Health Perspectives*, 124(5), 651.
- Monaghan, P., Haussmann, M. F. (2006). Do telomere dynamics link lifestyle and lifespan?. *Trends in Ecology & Evolution*, 21(1), 47-53.
- Monosson, E. (2012) Evolution in a toxic world: how life responds to chemical threats. Island Press, Washington, DC
- Nakamaru, M., Iwasa, Y., Nakanishi, J. (2003). Extinction risk to bird populations caused by DDT exposure. *Chemosphere*, 53(4), 377-387.
- Nash, S. B. (2011). Persistent organic pollutants in Antarctica: current and future research priorities. *Journal of Environmental Monitoring*, 13(3), 497-504.
- Navarro, V. C., Leppänen, M. T., Honkanen, J. O., Kukkonen, J. V. K. (2012). Trophic transfer of pyrene metabolites and nonextractable fraction from Oligochaete (*Lumbriculus variegatus*) to juvenile brown trout (*Salmo trutta*). *Chemosphere*, 88(1), 55-61.
- Navarro, V. C., Leppänen, M. T., Kukkonen, J. V. K., Olmos, S. G. (2013). Trophic transfer of pyrene metabolites between aquatic invertebrates. *Environmental pollution*, 173, 61-67.
- Nocera, J. J., Blais, J. M., Beresford, D. V., Finity, L. K., Grooms, C., Kimpe, L. E., ... & Smol, J. P. (2012). Historical pesticide applications coincided with an altered diet of aerially foraging insectivorous chimney swifts. *Proceedings of the Royal Society of London B: Biological Sciences*, rspb20120445.

- Notar, M., Leskovšek, H., Faganeli, J. (2001). Composition, distribution and sources of polycyclic aromatic hydrocarbons in sediments of the Gulf of Trieste, Northern Adriatic Sea. *Marine Pollution Bulletin*, 42(1), 36-44.
- Oaks, J. L., Gilbert, M., Virani, M. Z., Watson, R. T., Meteyer, C. U., Rideout, B. A., ... Mahmood, S. (2004). Diclofenac residues as the cause of vulture population decline in Pakistan. *Nature*, 427(6975), 630.
- Olivier, A., Barbraud, C., Rosecchi, E., Germain, C., Cheylan, M. (2010). Assessing spatial and temporal population dynamics of cryptic species: an example with the European pond turtle. *Ecological Applications*, 20(4), 993-1004
- Olsson, A., Valters, K., Burreau, S. (2000). Concentrations of organochlorine substances in relation to fish size and trophic position: a study on perch (*Perca fluviatilis* L.). *Environmental science & technology*, 34(23), 4878-4886.
- Palmqvist, A., Rasmussen, L. J., Forbes, V. E. (2006). Influence of biotransformation on trophic transfer of the PAH, fluoranthene. *Aquatic toxicology*, 80(3), 309-319.
- Pauly, D., Christensen, V., Dalsgaard, J., Froese, R., Torres Jr., F. (1998). Fishing down marine food webs. *Science*, 279, 5352, 860-863
- Porter, R. D., Wiemeyer, S. N. (1969). Dieldrin and DDT: effects on sparrow hawk eggshells and reproduction. *Science*, 165(3889), 199-200
- Poulin, R. (1992). Toxic pollution and parasitism in freshwater fish. *Parasitology Today*, 8(2), 58-61
- Qu, R., Feng, M., Sun, P., Wang, Z. (2015). A comparative study on antioxidant status combined with integrated biomarker response in *Carassius auratus* fish exposed to nine phthalates. *Environmental toxicology*, 30(10), 1125-1134.
- Quade, M. J., Roth, J. A. (1997). A rapid, direct assay to measure degranulation of bovine neutrophil primary granules. *Veterinary Immunology and Immunopathology*, 58(3-4), 239-248.
- Ratcliffe, D. A. (1967) Decrease in eggshell weight in certain birds of prey. *Nature* 215:208–210
- Rattner, B. A., Lazarus, R. S., Elliott, J. E., Shore, R. F., van den Brink, N. (2014). Adverse outcome pathway and risks of anticoagulant rodenticides to predatory wildlife. *Environmental science & technology*, 48(15), 8433-8445.
- Relyea, R. A. (2009). A cocktail of contaminants: how mixtures of pesticides at low concentrations affect aquatic communities. *Oecologia*, 159(2), 363-376
- Relyea, R., Hoverman, J. (2006). Assessing the ecology in ecotoxicology: a review and synthesis in freshwater systems. *Ecology Letters*, 9(10), 1157-1171.
- Ricklefs, R. E., Wikelski, M. (2002). The physiology/life-history nexus. *Trends in ecology & evolution*, 17(10), 462-468.
- Rowe, C. L. (2008). "The calamity of so long life": life histories, contaminants, and potential emerging threats to long-lived vertebrates. *AIBS Bulletin*, 58(7), 623-631.
- Relyea, R. A. (2009). A cocktail of contaminants: how mixtures of pesticides at low concentrations affect aquatic communities. *Oecologia*, 159(2), 363-376
- Relyea, R., Hoverman, J. (2006). Assessing the ecology in ecotoxicology: a review and synthesis in freshwater systems. *Ecology Letters*, 9(10), 1157-1171.
- Sæther, B. E., Bakke, Ø. (2000). Avian life history variation and contribution of demographic traits to the population growth rate. *Ecology*, 81(3), 642-653.
- Sala, O. E., Chapin, F. S., Armesto, J. J., Berlow, E., Bloomfield, J., Dirzo, R., ... Leemans, R. (2000). Global biodiversity scenarios for the year 2100. *Science*, 287(5459), 1770-1774.
- Salice, C. J., Rowe, C. L., Eisenreich, K. M. (2014). Integrative demographic modeling reveals population level impacts of PCB toxicity to juvenile snapping turtles. *Environmental pollution*, 184, 154-160.
- Sanchez, W., Porcher, J. M. (2009). Fish biomarkers for environmental monitoring within the Water Framework Directive of the European Union. *Trends in Analytical Chemistry*, 28(2), 150-158
- Sánchez, M. I., Pons, I., Martínez-Haro, M., Taggart, M. A., Lenormand, T., Green, A. J. (2016). When parasites are good for health: cestode parasitism increases resistance to arsenic in brine shrimps. *PLoS Pathogens*, 12(3), e1005459.

- Sarkar P, Shiizaki K, Yonemoto J, Sone H. Activation of telomerase in BeWo cells by estrogen and 2,3,7,8-tetrachlorodibenzo-p-dioxin in co-operation with c-Myc. *Int J Oncol.* 2006;28:43–51.
- Schuler, L. J., Landrum, P. F., Lydy, M. J. (2004). Time-dependent toxicity of fluoranthene to freshwater invertebrates and the role of biotransformation on lethal body residues. *Environmental science & technology*, 38(23), 6247-6255.
- Schwarzenbach, R. P., Escher, B. I., Fenner, K., Hofstetter, T. B., Johnson, C. A., Von Gunten, U., Wehrli, B. (2006). The challenge of micropollutants in aquatic systems. *Science*, 313(5790), 1072-1077
- Shah, S. Q., Colquhoun, D. J., Nikuli, H. L., Sørnum, H. (2012). Prevalence of antibiotic resistance genes in the bacterial flora of integrated fish farming environments of Pakistan and Tanzania. *Environmental science & technology*, 46(16), 8672-8679.
- Smedes, F., Booij, K. (2012). Guidelines for passive sampling of hydrophobic contaminants in water using silicone rubber samplers. International Council for the Exploration of the Sea.
- Smith, F. A., Smith, R. E. E., Lyons, S. K., Payne, J. L. (2018). Body size downgrading of mammals over the late Quaternary. *Science*, 360(6386), 310-313.
- Storrs, S. I., Kiesecker, J. M. (2004). Survivorship patterns of larval amphibians exposed to low concentrations of atrazine. *Environmental Health Perspectives*, 112(10), 1054.
- Sures, B., Siddall, R. (1999). Pomphorhynchus laevis: the intestinal acanthocephalan as a lead sink for its fish host, chub (*Leuciscus cephalus*). *Experimental Parasitology*, 93(2), 66-72.
- Sures, B., Dezfuli, B. S., Krug, H. F. (2003). The intestinal parasite Pomphorhynchus laevis (Acanthocephala) interferes with the uptake and accumulation of lead (210Pb) in its fish host chub (*Leuciscus cephalus*). *International Journal for Parasitology*, 33(14), 1617-1622.
- Sures, B. (2003). Accumulation of heavy metals by intestinal helminths in fish: an overview and perspective. *Parasitology*, 126(7), S53-S60
- Talleg, G., Tales, E., Flinck, A., Zham, A., Belliard, J., Le Pichon, C. (2018) Variations temporelles de l'ADN environnemental pour l'évaluation des espèces piscicoles sur le bassin versant de l'Orgeval. PIREN-Seine phase VII - rapport 2018, 13p
- Tartu, S., Angelier, F., Wingfield, J. C., Bustamante, P., Labadie, P., Budzinski, H., ... Chastel, O. (2015). Corticosterone, prolactin and egg neglect behavior in relation to mercury and legacy POPs in a long-lived Antarctic bird. *Science of the Total Environment*, 505, 180-188.
- Thaker, M., Lima, S. L., Hews, D. K. (2009). Acute corticosterone elevation enhances antipredator behaviors in male tree lizard morphs. *Hormones and Behavior*, 56(1), 51-57.
- Thomas, C.D., Cameron, A., Green, R.E., Bakkenes, M., Beaumont, L.J., Collingham, Y.C., Erasmus, B.F.N., de Siqueira, M.F., Grainger, A., Hannah, L., Hughes, L., Huntley, B., van Jaarsveld, A.S., Midgley, G.F., Miles, L., Ortega-Huerta, M.A., Peterson, A.T., Phillips, O.L., Williams, S.E. (2004). Extinction risk from climate change. *Nature*, 427(6970), 145-148,
- Thomsen, P. F., Kielgast, J. O. S., Iversen, L. L., Wiuf, C., Rasmussen, M., Gilbert, M. T. P., ... & Willerslev, E. (2012). Monitoring endangered freshwater biodiversity using environmental DNA. *Molecular ecology*, 21(11), 2565-2573
- Valentini, A., Taberlet, P., Miaud, C., Civade, R., Herder, J., Thomsen, P. F., ... & Gaboriaud, C. (2016). Next-generation monitoring of aquatic biodiversity using environmental DNA metabarcoding. *Molecular Ecology*, 25(4), 929-942
- Valavanidis, A., Vlahogianni, T., Dassenakis, M., Scoullou, M. (2006). Molecular biomarkers of oxidative stress in aquatic organisms in relation to toxic environmental pollutants. *Ecotoxicology and environmental safety*, 64(2), 178-189.
- Valton, A. S., Serre-Dagnat, C., Blanchard, M., Alliot, F., Chevreuril, M. (2014). Determination of phthalates and their by-products in tissues of roach (*Rutilus rutilus*) from the Orge river (France). *Environmental Science and Pollution Research*, 21(22), 12723-12730.
- Van der Oost, R., Beyer, J., Vermeulen, N. P. (2003). Fish bioaccumulation and biomarkers in environmental risk assessment: a review. *Environmental toxicology and pharmacology*, 13(2), 57-149

- Vandemiale, U., Graffagiano, I., Cafaceni, P., Caraccio, G., Domenicali, M., Dall'Agata, M., Trévisani, F., Guerrieri, F., Bernardi, M., Altomre, E. (2001) Mitochondrial oxidative injury and energy metabolism alteration in rat fatty liver: effect of the nutritional status. *Hepatology* 33, 808-815
- Varanasi, U. (1989). Metabolism of polycyclic aromatic hydrocarbons in the aquatic environment. CRC Press
- Vitousek, P. M., Mooney, H. A., Lubchenco, J., Melillo, J. M. (1997). Human domination of Earth's ecosystems. *Science*, 277(5325), 494-499.
- Vittecoq M., Godreuil S., Prugnotte F., Durand P., Brazier L., Renaud N., Arnal A., Aberkane S., Jean-Pierre H., Gauthier-Clerc M., Thomas F., Renaud F. 2016. Review: Antimicrobial resistance in wildlife. *Journal of Applied Ecology* 53: 519-529.
- Vives, I., Grimalt, J. O., Ventura, M., Catalán, J., & Rosseland, B. O. (2005). Age dependence of the accumulation of organochlorine pollutants in brown trout (*Salmo trutta*) from a remote high mountain lake (Redo, Pyrenees). *Environmental Pollution*, 133(2), 343-350.
- Walters, D. M., Jardine, T. D., Cade, B. S., Kidd, K. A., Muir, D. C. G., Leipzig-Scott, P. (2016). Trophic magnification of organic chemicals: A global synthesis. *Environmental science & technology*, 50(9), 4650-4658.
- Wan, Y., Jin, X., Hu, J., Jin, F. (2007). Trophic dilution of polycyclic aromatic hydrocarbons (PAHs) in a marine food web from Bohai Bay, North China. *Environmental science & technology*, 41(9), 3109-3114.
- Wayland, M., Drake, K.L., Alisauskas, R.T., Kellett, D. K., Traylor, J., Swoboda, C., Mehl, K. (2008) Survival rates and blood metal concentrations in two species of free-ranging North American sea ducks. *Environmental Toxicology and Chemistry* 27,698–704
- Wessel, N., Santos, R., Menard, D., Le Menach, K., Buchet, V., Lebayon, N., ... Akcha, F. (2010). Relationship between PAH biotransformation as measured by biliary metabolites and EROD activity, and genotoxicity in juveniles of sole (*Solea solea*). *Marine environmental research*, 69, S71-S73.
- Wania, F., Mackay, D. (1996). Peer reviewed: tracking the distribution of persistent organic pollutants. *Environmental science & technology*, 30(9), 390A-396A
- Willson, J. D., Hopkins, W. A., Bergeron, C. M., Todd, B. D. (2012). Making leaps in amphibian ecotoxicology: translating individual-level effects of contaminants to population viability. *Ecological Applications*, 22(6), 1791-1802.
- Wingfield, J. C., Sapolsky, R. M. (2003) Reproduction and Resistance to Stress When and How. *Journal of Neuroendocrinology*, 15, 711-724.
- Wirgin, I., Roy, N. K., Loftus, M., Chambers, R. C., Franks, D. G., Hahn, M. E. (2011). Mechanistic basis of resistance to PCBs in Atlantic tomcod from the Hudson River. *Science*, 331(6022), 1322-1325.
- Whitehead, A., Clark, B. W., Reid, N. M., Hahn, M. E., & Nacci, D. (2017). When evolution is the solution to pollution: Key principles, and lessons from rapid repeated adaptation of killifish (*Fundulus heteroclitus*) populations. *Evolutionary applications*, 10(8), 762-783.



## **Annexe**

Sélection de 6 articles étayant les résultats marquants présentés dans la section III.

# Demographic responses to mercury exposure in two closely related Antarctic top predators

A. GOUTTE,<sup>1,3</sup> P. BUSTAMANTE,<sup>2</sup> C. BARBRAUD,<sup>1</sup> K. DELORD,<sup>1</sup> H. WEIMERSKIRCH,<sup>1</sup> AND O. CHASTEL<sup>1</sup>

<sup>1</sup>Centre d'Etudes Biologiques de Chizé (CEBC), UMR 7372, CNRS–Université de la Rochelle, Villiers en Bois F-79360 France

<sup>2</sup>Littoral Environnement et Sociétés (LIENSs), UMR 7266, CNRS–Université de La Rochelle, 2 rue Olympe de Gouges, La Rochelle F-17000 France

**Abstract.** Although toxic chemicals constitute a major threat for wildlife, their effects have been mainly assessed at the individual level and under laboratory conditions. Predicting population-level responses to pollutants in natural conditions is a major and ultimate task in ecological and ecotoxicological research. The present study aims to estimate the effect of mercury (Hg) levels on future apparent survival rates and breeding performances. We used a long-term data set (~10 years) and recently developed methodological tools on two closely related Antarctic top predators, the South Polar Skua *Catharacta maccormicki* from Adélie Land and the Brown Skua *C. lonnbergi* from the Kerguelen Archipelago. Adult survival rates and breeding probabilities were not affected by Hg levels, but breeding success in the following year decreased with increasing Hg levels. Although South Polar Skuas exhibited much lower Hg levels than Brown Skuas, they suffered from higher Hg-induced breeding failure. This species difference could be attributed to an interaction between Hg and other environmental perturbations, including climate change and a complex cocktail of pollutants. By including Hg-dependent demographic parameters in population models, we showed a weak population decline in response to increasing Hg levels. This demographic decline was more pronounced in South Polar Skuas than in Brown Skuas. Hence, Hg exposure differently affects closely related species. The wide range of environmental perturbations in Antarctic regions could exacerbate the demographic responses to Hg levels. In that respect, we urge future population modeling to take into account the coupled effects of climate change and anthropogenic pollution to estimate population projections.

**Key words:** Brown Skua; capture–recapture; *Catharacta lonnbergi*; *Catharacta maccormicki*; heavy metals; pollution; population dynamics; population projections; reproductive performance; South Polar Skua; Southern Ocean; survival.

## INTRODUCTION

A major challenge in ecological research is to assess and predict the ecological impact of environmental changes on demographic traits and on population dynamics. In that respect, many studies have evidenced steep population declines and high extinction risks in response to ongoing climate change (Frederiksen et al. 2004, Thomas et al. 2004, Jenouvrier et al. 2009, Barbraud et al. 2011). In the case of toxic chemicals, organic and metallic pollutants constitute another major threat for wildlife. However, their toxic effects have been assessed mainly at the individual and the cellular levels, under laboratory conditions. Translating these individual-level effects to population-level processes is an ultimate goal in ecotoxicology and conservation biology (e.g., Forbes and Calow 2002, Tanaka 2003). However, this population-level approach has been poorly applied in free-living species and some toxic effects have been estimated from controlled laboratory conditions and

using closely related species (Nakamaru et al. 2003, Miller and Ankley 2004, Willson et al. 2012).

Mercury (Hg), a heavy metal of both natural and anthropogenic releases, is a globally distributed contaminant of particular concern for aquatic biota (Wolfe et al. 1998, Scheuhammer et al. 2009). Toxic effects of Hg have been extensively studied in vertebrates and may include developmental, neurological, immune, behavioral, and physiological impairments (Wolfe et al. 1998, Heath and Frederick 2005, Tan et al. 2009, Frederick and Jayasena 2010). Hence, one may predict strong fitness consequences in terms of mortality and lifetime reproductive success. Furthermore, the expected increase of anthropogenic Hg emissions in the next decades (Streets et al. 2009) raises serious environmental concerns, including population declines and extinction risks.

In that context, previous studies have investigated the effect of Hg levels on survival rate. There is no evidence of Hg-induced effects on return rate in adult Great Skuas *Catharacta skua* (Thompson et al. 1991), or on apparent adult survival rates of Common Loons *Gavia immer* (Mitro et al. 2008), King Eiders *Somateria*

Manuscript received 27 June 2013; accepted 12 September 2013. Corresponding Editor: D. R. Strong.

<sup>3</sup> E-mail: agoutte@gmail.com

*spectabilis*, and White-winged Scoter *Melanitta fusca* (Wayland et al. 2008), using capture–mark–recapture (CMR) studies. Only a 1% difference in adult survival rates was detected in Tree Swallows *Tachycineta bicolor* between Hg-contaminated and reference sites (Hallinger et al. 2011). Regarding reproductive performance, the most Hg-contaminated individuals were less likely to breed successfully during the current reproductive attempt (Brasso and Cristol 2008, Burgess and Meyer 2008, Frederick and Jayasena 2010, Jackson et al. 2011). Moreover, individuals that skipped the immediate breeding attempt had the highest Hg levels during the pre-breeding period (Tartu et al. 2013). Long-term data sets and recent and robust methodological approaches may be useful to estimate the effects of Hg on multiple life history traits, including survival rate, breeding probability, and breeding success in the following year.

The present study focuses on two Antarctic top predators: the South Polar Skua, *Catharacta macrorhynchos* and the Brown Skua *C. lonnbergi* breeding in Antarctica and on subantarctic islands, respectively. These two *Catharacta* skua species are closely related, with frequent cases of hybridization (Ritz et al. 2008). Hence, we expected that Hg effects on demographic parameters and on population dynamics would not significantly differ between the two skua species. Top predators are expected to be the most contaminated among the organisms of food webs, because of Hg biomagnification with increasing trophic level (Bargagli et al. 1998). In the Southern Ocean, Hg may reach some of the highest concentrations so far observed in surface waters of open oceans (Cossa et al. 2011). However, Hg levels have been poorly described in southern hemisphere seabird populations (Bocher et al. 2003, Blévin et al. 2013), and historical increases have been slower than in northern hemisphere seabirds (Thompson et al. 1993). The first aim of this study was to detect whether demographic traits (survival, breeding decision, probability of successfully raising at least one chick, and probability of successfully raising two chicks in the following year) are affected by Hg levels in both species, using long-term (~10-year) data sets, individual Hg blood concentrations, and multistate mark–recapture (MSMR) models (Lebreton and Pradel 2002). The second aim of this study was to assess population-level responses to an increase in Hg levels. This was done by establishing a life cycle for the two skua species by constructing corresponding matrix population models (Caswell 2001) and by including Hg-dependent and Hg-independent demographic traits in the models.

## METHODS

### *Study species and sites*

The study was carried out at two sites in the French Southern Territories. The South Polar Skua (see Plate 1) was studied on the Pointe Géologie Archipelago, Adélie Land, Antarctica (66°40' S, 140°01' E), where ~50 breeding pairs have been monitored annually since 1964/

1965 (named the 1964 breeding season). This annual breeder forages on fish and Adélie Penguin (*Pygoscelis adeliae*) eggs and chicks during the breeding season from October to early April (Le Morvan et al. 1967). The Brown Skua was studied in Mayes Island (48°28' S, 69°57' E), a subantarctic island of 2.3 km<sup>2</sup> within the Morbihan Gulf of the Kerguelen Archipelago, where ~50 breeding pairs have been monitored annually since the 1990 breeding season. This annual breeder feeds on small burrowing petrels during the breeding season from October to March (Mougeot et al. 1998). Both species are loosely colonial and highly territorial and lay two eggs (Furness 1996). Site tenacity and mate fidelity are high (Ainley et al. 1990, Pietz and Parmelee 1993).

Monitoring procedures for banding and resighting were similar for the two species: all individuals were ringed with a stainless steel band and a plastic band engraved with a unique alphanumeric code. This allowed individual identification at a distance with binoculars. Every year, each partner of a breeding pair was identified at the time of the visits (four to eight) to the nests and territories during egg laying, incubation, and chick-rearing (from early November to early February). Groups of nonbreeding individuals occurring at both sites were also checked regularly for individual identification of ringed birds. Breeding performances were determined by checking the nest sites for the presence of eggs or young chicks, and nest surroundings for the presence of chicks. Chicks were ringed just before fledging. New individuals (breeders and nonbreeders) found in the territories and their surroundings were ringed each year.

### *Blood sampling*

Skuas were captured using a nylon snare on the end of a fishing rod or using remote-controlled noose traps. South Polar Skuas ( $n = 76$ ) were captured from 5 January to 7 February 2003 (32 males and 27 females), and from 17 December 2004 to 19 January 2005 (7 males and 10 females). In total, 13 were nonbreeders, 8 were incubating, and 55 were brooding. Brown Skuas (31 males and 37 females) were handled from 17 November to 9 December 2001. Among them, 11 were nonbreeders, 33 were incubating, and 24 were brooding. Among nonbreeders, 4 were not ringed and were thus not included in the CMR analyses.

Blood samples (1 mL) were taken immediately after capture from the alar vein with a heparinized 5-mL syringe and a 25-gauge needle. After centrifugation, plasma and blood cells were separated and stored at -20°C until assayed. In Great Skuas, blood is a good indicator of mercury intake during the breeding season (Bearhop et al. 2000).

### *Analysis of Hg concentrations and molecular sexing*

Total Hg was measured at the laboratory Littoral ENvironnement et Sociétés (LIENSs) from lyophilized red blood cells in an Advanced Mercury Analyzer

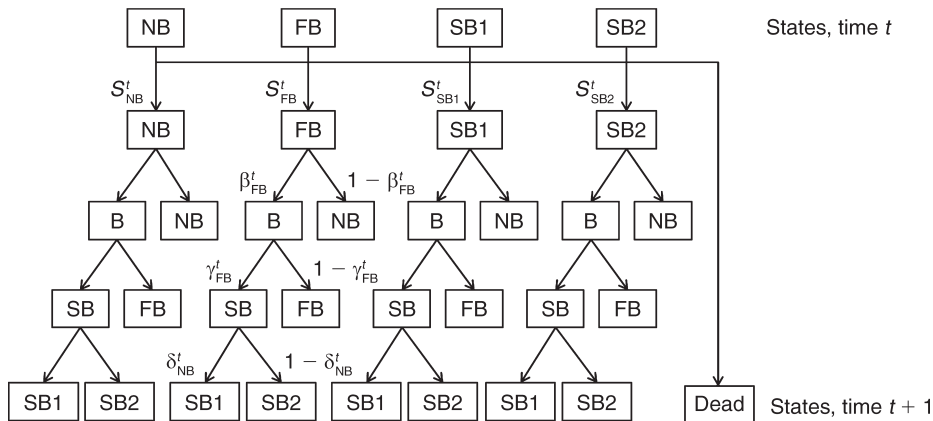


FIG. 1. A multinomial tree diagram describing the probability structure for multistate observations. Solid boxes indicate the states alive in state NB (nonbreeder), FB (failed breeder), B (breeder), SB1 (successful breeder with one chick), SB2 (successful breeder with two chicks), or dead. State transition probabilities were decomposed in a four-step process. The state transitions are  $S$ , apparent survival rate;  $\beta$ , breeding probability;  $\gamma$ , breeding success; and  $\delta$ , probability of successfully brooding two chicks; states are defined in the *Methods* section.

spectrophotometer (Altec AMA 254, LECO, St. Joseph, Michigan, USA). At least two aliquots ranging from 5 to 10 mg dry mass were analyzed for each individual, and measurement quality was certified by reference material, as described by Bustamante et al. (2006). Molecular sexing was determined at the Centre d'Etudes Biologiques de Chizé (CEBC), by polymerase chain reaction (PCR) amplification of part of two highly conserved genes (CHD) present on the sex chromosomes, as detailed in Weimerskirch et al. (2005).

We used R software (R Development Core Team 2012) and generalized linear models (GLMs) with quasi-Poisson error distribution and a log-link function to test whether Hg levels were linked to current breeding status (nonbreeding, incubating, brooding), sex, and the interaction effect between breeding status and sex.

*Estimating the effect of Hg on demographic parameters*

We evaluated the effects of Hg concentrations on the demographic parameters through the capture–recapture data of sampled individuals from 2002 to 2011 for the South Polar Skua, and from 2001 to 2011 for the Brown Skua. We constructed a MSMR model common to both species. This model distinguished five states: nonbreeder (NB, defined as an individual that was not observed with an egg); failed breeder (FB, defined as an individual that was observed with one or two eggs, or one or two chicks but that failed to fledged a chick); successful breeder with one chick (SB1, defined as an individual that fledged one chick); successful breeder with two chicks (SB2, defined as an individual that fledged two chicks); and dead. The state “dead” was an absorbing state representing death or permanent emigration from the study areas. Models were parameterized in terms of the probability of survival ( $S$ ), the probability of breeding ( $\beta$ ), the probability of breeding successfully ( $\gamma$ ), the probability of successfully raising two chicks ( $\delta$ ), and the

detection probability ( $p$ ). Transition probabilities between states were thus modeled with a four-step procedure where  $S$ ,  $\beta$ ,  $\gamma$ , and  $\delta$  were considered as four successive steps in transition matrices. Fig. 1 presents a multinomial tree diagram describing the probability structure for multistate observations, and parameters of the model are defined in Table 1. We chose a MSMR approach because this allows taking into account the probability of detecting individuals given their return to the study sites. It also allows taking into account the previous breeding state of individuals, which might be important for obtaining unbiased estimates of demographic parameters (Lebreton and Pradel 2002).

Several constraints were made to ensure that the parameters of the model were estimable. Because the dead state was explicitly included in the model but was never encountered, transition probabilities from the dead state were fixed to 0 and capture probability was fixed to 0 (Pradel 2005, Choquet et al. 2009a). Our capture–recapture analyses relied on a limited number of individual capture histories (South Polar Skua,  $n = 76$ ; Brown Skua,  $n = 64$ ); thus parameters  $S$ ,  $\beta$ ,  $\gamma$ , and  $\delta$  were constrained to be constant over time but state dependent. With this constraint, the initial model was full rank. Detection probability was time and state dependent to allow taking into account variations in detectability. Note that we ran a model where all demographic parameters were time and state dependent, but this model was highly rank deficient.

This MSMR model was parameterized by the survival–transition probabilities matrix:

	NB	FB	SB1	SB2	Dead
NB	$S(1 - \beta)$	$S\beta(1 - \gamma)$	$S\beta\gamma(1 - \delta)$	$S\beta\gamma\delta$	*
FB	$S(1 - \beta)$	$S\beta(1 - \gamma)$	$S\beta\gamma(1 - \delta)$	$S\beta\gamma\delta$	*
SB1	$S(1 - \beta)$	$S\beta(1 - \gamma)$	$S\beta\gamma(1 - \delta)$	$S\beta\gamma\delta$	*
SB2	$S(1 - \beta)$	$S\beta(1 - \gamma)$	$S\beta\gamma(1 - \delta)$	$S\beta\gamma\delta$	*
Dead	–	–	–	–	*

TABLE 1. Definition of parameters used in the multistate mark–recapture model.

Parameter	Definition
$S'_s$	Probability that an individual in state $s$ at time $t$ survives to time $t + 1$ and does not permanently emigrate from the study area.
$\beta'_s$	Probability that an individual in state $s$ at time $t$ breeds at time $t + 1$ , given that it survives to $t + 1$ .
$\gamma'_s$	Probability that an individual in state $s$ at time $t$ breeds successfully at time $t + 1$ , given that it survives to and breeds at time $t + 1$ .
$\delta'_s$	Probability that an individual in state $s$ at time $t$ raises successfully two chicks at time $t + 1$ , given that it survives to and breeds successfully at time $t + 1$ .
$p'_s$	Probability that an individual in state $s$ at time $t$ is encountered at time $t + 1$ .

Asterisks in the column for dead birds represent the complementary parameter (complement of the sum of positive row entries).

Because we were interested in testing for sex-specific effects of Hg on demographic parameters, we started from an initial model including an effect of sex ( $g$ ) on each parameter. Model selection was first performed on detection probability by testing state dependency (difference between all states, between breeders and nonbreeders, or no difference) and time dependency. We then tested for state dependency (difference between all states, difference between breeders and nonbreeders, or no difference) for  $S$ ,  $\beta$ ,  $\gamma$ , and  $\delta$ . Once we identified the best model structure for all parameters, we tested for an effect of breeding experience (number of previous breeding attempts) for South Polar Skuas on the demographic parameters ( $S$ ,  $\beta$ ,  $\gamma$ , or  $\delta$ ). Breeding experience data were not available for Brown Skuas. Then we tested for a linear or a quadratic effect of Hg on demographic parameters in the following year to test the hypothesis that contamination levels in one breeding season may influence the survival and breeding success of an individual in the following season. We did not test for an effect of Hg on current breeding success, because capture and blood sampling were mainly conducted during the chick-rearing period. We built MSMR models where each demographic parameter  $\theta$  was modeled as a function of Hg using a logit link function:  $\text{logit}(\theta) = a + b \times \text{Hg}_i$ , where  $a$  is an intercept,  $b$  is a slope, and  $\text{Hg}_i$  is the Hg concentration for individual  $i$ . When  $b < 0$ , or  $b > 0$ , the covariate Hg has a negative or positive effect, respectively, on the demographic parameter. Individual covariates, breeding experience, and Hg were standardized. We tested the goodness of fit (GOF) of the time-dependent MSMR model using U-CARE (Choquet et al. 2009b).

Model selection was based on Akaike's information criterion corrected for small sample size,  $\text{AIC}_c$  (Burnham and Anderson 2002), and all models were run under program E-SURGE 1.8.5, allowing the splitting of transition probabilities between states (Choquet et al. 2009a).

#### Modeling population dynamics

To evaluate the population-level effects of Hg, we constructed population models using pre-breeding ma-

trices (Caswell 2001) structured by age and reproductive status classes (Fig. 2). For South Polar Skuas, we built a female-only age- and stage-classified matrix population model, because Hg similarly affected the same demographic parameters of both sexes (see *Results*). Based on results from a detailed demographic study on South Polar Skuas (Ainley et al. 1990), the model consists of four immature (juvenile) age classes (first-year  $J_1$ , second-year  $J_2$ , third-year  $J_3$ , fourth-year  $J_4$ ); five pre-breeder classes (from  $PB_5$  to  $PB_9$ ; individuals in this class are able to start breeding and are thus considered as pre-breeders); and two stage classes: breeder (B) and nonbreeder (NB). Parameters entering the model were adult survival rate of breeders and nonbreeders ( $S_{AB}$  and  $S_{ANB}$ ); survival during the second and the third year ( $S_1$  and  $S_2$ ); the proportion of juveniles attempting to breed ( $pb_5$  to  $pb_9$ ), breeding probability of breeders and nonbreeders ( $\beta_B$  and  $\beta_{NB}$ ), fecundity, and the proportion of immigrants ( $m$ ). Fecundity was calculated as the product of clutch size (2), breeding success probability ( $\gamma$ ), the probability of successfully raising two chicks ( $\delta$ ), the survival probability during the first year at sea ( $S_0$ ), and assuming a 1:1 sex ratio.

For the Brown Skua, we built a two-sex age- and stage-classified matrix population model (Caswell 2001), because Hg concentrations affected the demographic parameters of males only (see *Results*). We used the same life cycle as the one used for South Polar Skuas, because Brown Skuas and South Polar Skuas are similar in size and other life history traits (Furness 1996). Moreover, to the best of our knowledge, there is no detailed demographic study on Brown Skuas. The two-sex model was thus parameterized with the same parameters as for the South Polar Skua, except for fecundity, which included the harmonic fertility function  $n_{(f,m)}/(n_f + n_m)$ , where  $n_f$  and  $n_m$  are the number of breeding females and males, respectively.

We first built deterministic matrix models with no stochasticity, which included the mean values of the demographic rates. Mean estimates of the demographic parameters used in the deterministic model ( $S_0$ ,  $S_1$ ,  $S_2$ ,  $pb_5$  to  $pb_9$ , and  $m$ ) were obtained from Ainley et al. (1990) and from our MSMR model results ( $S_{AB}$ ,  $S_{ANB}$ ,  $\beta_B$ ,  $\beta_{NB}$ ,  $\gamma$ , and  $\delta$ ). From these matrix analyses, we estimated the deterministic growth rate ( $\lambda$ ) and the sensitivities of  $\lambda$  to variations in demographic rates  $\theta$



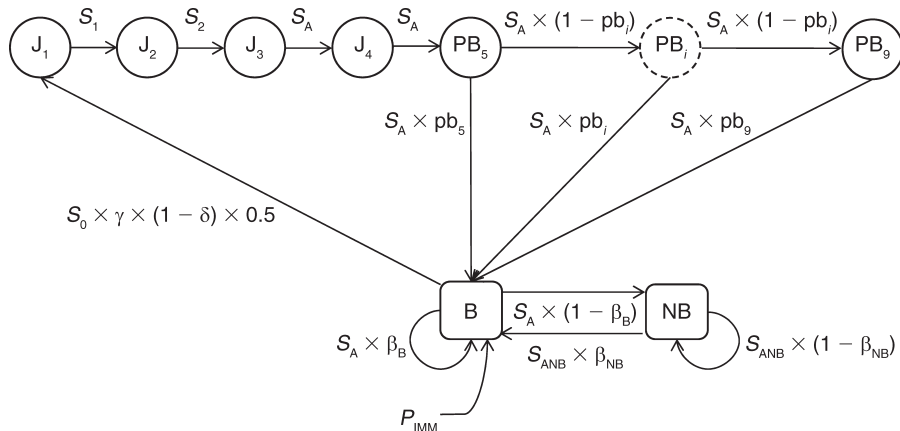


FIG. 2. Lifetime cycle graph for the Brown Skua and the South Polar Skua.  $J_i$ , juvenile of age class  $i$ ;  $PB_i$ , pre-breeder of age class  $i$ ; B, adult breeder; NB, adult nonbreeder;  $S_0$ , survival during the first year at sea;  $S_i$ , survival probability of age class  $i$ ;  $S_A$ , adult breeder survival probability;  $S_{ANB}$ , adult nonbreeder survival probability;  $pb_i$ , proportion of pre-breeders of age class  $i$  attempting to breed for the first time;  $\beta_B$ , breeding probability of breeders;  $\beta_{NB}$ , breeding probability of nonbreeders;  $\gamma$ , probability of successfully raising two chicks;  $\delta$ , probability of successfully raising two chicks;  $P_{IMM}$ , immigration rate.

( $\partial\lambda/\partial\theta$ ) (Caswell 2001). We then focused on stochastic matrix models to estimate the stochastic growth rate  $\lambda_{sto}$ . Environmental stochasticity was included in two different ways. When a vital rate had no significant relationship with Hg levels, its yearly values were sampled from a beta distribution (Morris and Doak 2002), with mean and variance equal to those estimated from the MSMR model selected or taken from Ainley et al. (1990). When a vital rate had a significant relationship with Hg levels, its value at year  $t$  ( $\theta^t$ ) was modeled as  $\theta^t = \text{logit}^{-1}(a + b \times \text{Hg}^t)$ , where  $\text{Hg}^t$  represents the mean Hg value. Hg values were sampled from a lognormal distribution for all individuals sampled. To assess the population-level effects of Hg concentrations, we estimated stochastic population growth rates according to changes in mean Hg levels within the range of observed Hg values.

We assessed the fit of our deterministic and stochastic population models by comparing the observed annual population growth rate ( $\lambda_{obs}$ ) calculated as  $(N_t/N_0)^{(1/t)}$  (Caughley 1977), based on the counts of the number of breeding pairs. The matrix population models were analyzed by Monte Carlo simulations (10 000 iterations) using package *popbio* (Stubben and Milligan 2007) implemented in program R (R Development Core Team 2012).

RESULTS

*Effects of sex, current breeding status, breeding experience, and body conditions on Hg levels*

Hg levels were around four times higher in Brown Skuas ( $8.22 \pm 0.24 \mu\text{g/g}$  dry mass, mean  $\pm$  SE) than in South Polar Skuas ( $2.15 \pm 0.17 \mu\text{g/g}$  dry mass;  $F_{1,140} = 381.07, P < 0.001$ ), even when considering only breeders ( $F_{1,116} = 1162.00, P < 0.001$ ). Nonbreeders bore higher Hg levels than incubating and chick-rearing South Polar Skuas, without sex difference (Fig. 3A, Table 2).

Nonbreeders had lower previous breeding experience than incubating and chick-rearing birds ( $F_{2,68} = 4.908, P = 0.010$ ), and Hg levels decreased with increasing breeding experience in South Polar Skuas (Table 2). In

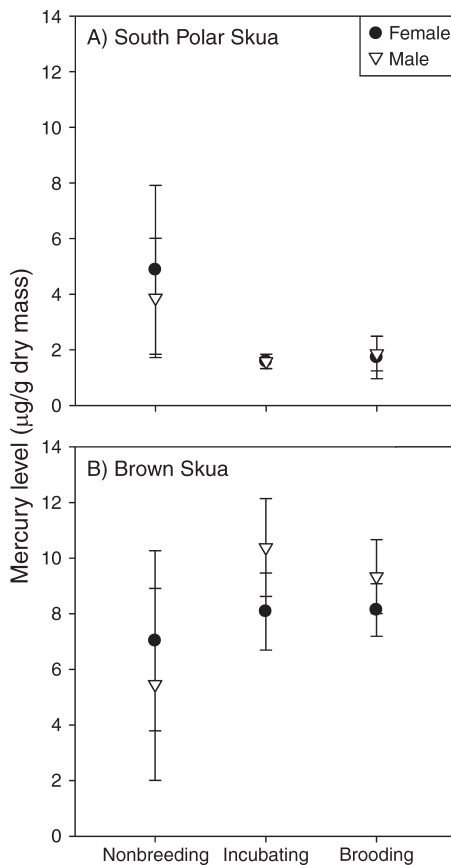


FIG. 3. Mercury (Hg) levels (mean  $\pm$  SD) in nonbreeding, incubating, and brooding South Polar Skuas and Brown Skuas, by sex.

TABLE 2. Mercury (Hg) levels as a function of breeding status, sex, the interaction between breeding status and sex, and breeding experience in South Polar Skuas and Brown Skuas.

Independent variables (Hg is dependent)	South Polar Skua			Brown Skua		
	df	F	P	df	F	P
Breeding status	2, 71	30.986	<0.001	2, 65	8.612	0.001
Sex	1, 69	0.006	0.938	1, 64	7.760	0.007
Breeding status $\times$ sex	2, 67	0.280	0.757	2, 62	3.821	0.027
Breeding experience	1, 67	10.107	0.002			

Notes: Analysis was done using GLMs (quasi-Poisson error distribution and a log-link function). Breeding status (nonbreeding, incubating, brooding) was assessed in the year of blood sampling; breeding experience was prior to the year of blood sampling.

Brown Skuas, nonbreeding males had lower Hg levels than incubating and chick-rearing males, whereas Hg levels did not differ among females' breeding status (Fig. 3B, Table 2).

#### Long-term fitness consequences of Hg exposure

The GOF of the MSMR model was overall not significant for South Polar Skuas (males,  $\chi^2 = 15.31$ ,  $df = 47$ ,  $P = 1.0$ ; females,  $\chi^2 = 19.85$ ,  $df = 50$ ,  $P = 1.0$ ) and for Brown Skuas (males,  $\chi^2 = 13.48$ ,  $df = 35$ ,  $P = 1.0$ ; females,  $\chi^2 = 19.99$ ,  $df = 43$ ,  $P = 0.99$ ). For the two skua species, the best model according to  $AIC_c$  (model 9, Appendix) states that in year  $t + 1$ , individuals captured as breeders in year  $t$  had higher apparent survival rates, higher breeding probabilities, and higher detection probabilities than nonbreeders captured in year  $t$ , but did not differ in breeding success probabilities (Appendix and Table 3).

In South Polar Skuas, model 12 (Table 4A) was the best model according to  $AIC_c$ ; it suggested an effect of previous breeding experience on breeding probability. However, the parameter value ( $-0.05$ ) and its wide confidence interval including 0 suggested that the effect was very weak. For the two species, Hg levels had no effect on apparent survival rate and breeding probability in the following year (Table 4A, B: models 15–18). In South Polar Skuas, increasing Hg levels were linked to decreasing breeding success in the following year (model 19, Table 4A, Fig. 4A), but not to the probability of successfully raising two chicks in the following year (models 21 and 22, Table 4A). In Brown Skuas, breeding success in the following year was not related to Hg levels (models 19 and 20, Table 4B), but the probability of successfully fledging two chicks in the following year

decreased with increasing Hg levels (Models 21–23, Table 4B). Specifically, model 23 suggested that the probability of successfully raising two chicks in the following year decreased with increasing Hg levels in male Brown Skuas (Fig. 4B). Model 23 had the lowest  $AIC_c$  and the confidence interval for the slope parameter did not contain 0 (Table 4B).

#### Hg and population growth rate

The deterministic population growth rate was 1.002 and 1.020 for South Polar Skuas and Brown Skuas, respectively, and the respective generation times were 19.4 and 23.5 years. Sensitivity analyses suggested that changes in adult survival of breeders will have the greatest effect on the population growth rate for both species, followed by changes in the probability of breeding, the probability of adult survival of nonbreeders, and the probability of juvenile survival in the South Polar Skua, and by changes in the probability of breeding, the probability of juvenile survival, and the probability of breeding successfully in the Brown Skua. In both species, changes in the probability of breeding successfully will have a greater effect on the population growth rate than will changes in the probability of fledging two chicks (ratio of elasticities 4.6 to 4.7).

Our stochastic population model predicted an increase in the numbers of breeding pairs of South Polar Skua ( $\lambda_{sto} = 1.001$ ) and Brown Skua ( $\lambda_{sto} = 1.009$ ), which were similar to the mean annual population growth rate observed from 2003 to 2012 ( $\lambda_{obs} = 1.015$ ) for South Polar Skuas and from 2001 to 2011 ( $\lambda_{obs} = 1.008$ ) for Brown Skuas. Population growth rates accounting for Hg effects from MSMR analyses were similar to the purely stochastic growth rate regardless of Hg effects

TABLE 3. Estimation of parameters (mean with 95% CI; all values are percentages) calculated from the best model (model 9) for South Polar Skuas and Brown Skuas.

Parameter	South Polar Skuas		Brown Skuas	
	Nonbreeders	Breeders	Nonbreeders	Breeders
$S$ , apparent survival rate	83 [72–91]	93 [89–95]	80 [66–89]	95 [90–97]
$\beta$ , breeding probability	60 [48–71]	85 [81–89]	37 [25–50]	87 [82–90]
$\gamma$ , breeding success	74 [68–78]	74 [68–78]	84 [79–88]	84 [79–88]
$\delta$ , probability of successfully brooding two chicks	28 [23–34]	28 [23–34]	28 [23–34]	28 [23–34]
$p$ , detection probability	59 [46–70]	100 [100–100]	41 [29–55]	100 [100–100]



TABLE 4. Modeling the effects of experience, Hg levels, and sex on demographic parameters of South Polar Skuas, and of Hg levels and sex on demographic parameters on Brown Skuas; effects are arranged from lowest to highest  $\Delta AIC_c$  for each species.

Hypothesis, by species	Model no.	Rank	Deviance	$\Delta AIC_c$	Slope [95% CI]
<b>A) South Polar Skua</b>					
Experience					
Effect on $\beta$	12	13	1537.71	0	-0.05 [-0.34, 0.24]
No effect on $S, \beta, \gamma, \delta$	9	11	1543.36	1.42	
Effect on $\gamma$	13	12	1542.97	3.14	
Effect on $\delta$	14	12	1543.34	3.51	
Effect on $S$	11	13	1549.40	11.69	
Mercury, Hg					
Effect (lin) on $\gamma$	19	13	1530.89	0	-1.92 [-3.40, -0.45]
Effect (quad) on $\gamma$	27	14	1530.26	1.51	
Effect (lin) on $\gamma$ with Hg $\times$ sex effect	20	15	1530.39	3.77	
Effect (lin) on $\delta$	21	13	1537.81	6.93	
Effect (quad) on $\gamma$ with Hg $\times$ sex effect	28	17	1529.56	7.26	
No effect on $S, \beta, \gamma, \delta$	9	11	1543.36	8.24	
Effect (lin) on $\delta$	29	14	1537.12	8.37	
Effect (lin) on $S$ with Hg $\times$ sex effect	16	18	1528.70	8.57	
Effect (lin) on $\delta$ with Hg $\times$ sex effect	22	15	1536.32	9.70	
Effect (quad) on $\delta$ with Hg $\times$ sex effect	30	17	1532.10	9.80	
Effect (quad) on $\beta$	25	17	1532.33	10.03	
Effect (quad) on $\beta$ with Hg $\times$ sex effect	26	23	1521.53	12.42	
Effect (lin) on $S$	15	14	1541.22	12.47	
Effect (lin) on $\beta$ with Hg $\times$ sex effect	18	18	1532.61	12.48	
Effect (lin) on $\beta$	17	14	1541.85	13.10	
Effect (quad) on $S$ with Hg $\times$ sex effect	24	23	1524.11	14.99	
Effect (quad) on $S$	23	17	1539.27	16.97	
<b>B) Brown Skua</b>					
Mercury, Hg					
Effect (lin) of males on $\delta$	23	14	1332.10	0	-1.70 [-3.34, -0.06]
Effect (lin) on $\delta$	21	13	1335.54	1.29	-0.58 [-1.36, 0.20]
Effect (lin) on $\delta$ with Hg $\times$ sex effect	22	15	1331.74	1.80	males -1.70 [-3.33, -0.06]; females -0.40 [-1.72, 0.93]
Effect (quad) on $\delta$	31	14	1335.50	3.40	
Effect (lin) of females on $\delta$	24	14	1337.40	5.30	
No effect on $S, \beta, \gamma, \delta$	9	11	1344.80	6.29	
Effect (quad) on $S$	25	17	1334.28	8.70	
Effect (quad) on $\delta$ with Hg $\times$ sex effect	32	17	1335.42	10.62	
Effect (quad) on $\gamma$	29	14	1343.00	10.90	
Effect (quad) on $\beta$	27	17	1337.01	11.42	
Effect (lin) on $S$	15	15	1342.40	12.46	
Effect (lin) on $\gamma$ with Hg $\times$ sex effect	20	15	1343.69	13.75	
Effect (quad) on $\gamma$ with Hg $\times$ sex effect	30	17	1340.57	14.98	
Effect (lin) on $\beta$ with Hg $\times$ sex effect	18	19	1337.53	16.34	
Effect (lin) on $S$ with Hg $\times$ sex effect	16	19	1338.52	17.33	
Effect (lin) on $\gamma$	19	13	1351.22	16.98	
Effect (quad) on $S$ with Hg $\times$ sex effect	26	23	1330.83	18.57	
Effect (quad) on $\beta$ with Hg $\times$ sex effect	28	23	1336.18	23.92	
Effect (lin) on $\beta$	17	15	1479.61	149.67	

Notes: The effects of standardized breeding experience were tested on each parameter. The effects of standardized Hg levels (lin, linear relationship; quad, quadratic relationship) were then tested on each parameter in the following year, with or without an interaction effect between Hg and sex.

(South Polar Skua,  $\lambda = 1.006$ ; Brown Skua,  $\lambda = 1.020$ ). According to our population modeling, Hg negatively affects population growth rate. Demographic decline ( $\lambda < 1$ ) was predicted for mean Hg levels exceeding 2.8  $\mu\text{g/g}$  dry mass in the South Polar Skua and 12  $\mu\text{g/g}$  dry mass in the Brown Skua (Fig. 5).

DISCUSSION

Using long-term data sets and MSMR models, the present study indicates no effect of Hg accumulation on adult survival rate and breeding probability in the following year. However, Hg exposure decreased the

probability of successfully raising at least one or two chicks, respectively, in the following year in the South Polar Skua and the Brown Skua. At the population level, this study suggested a slight demographic decline in response to increasing Hg levels.

*Hg levels in Brown Skuas and South Polar Skuas*

Hg levels found in adult Brown Skuas and South Polar Skuas were within the range of those measured in the blood of adult Great Skuas at northeast Atlantic colonies (from  $3.49 \pm 1.83$  to  $6.71 \pm 3.08$   $\mu\text{g/g}$  dry mass, mean  $\pm$  SE; Bearhop et al. 2000). South Polar Skuas

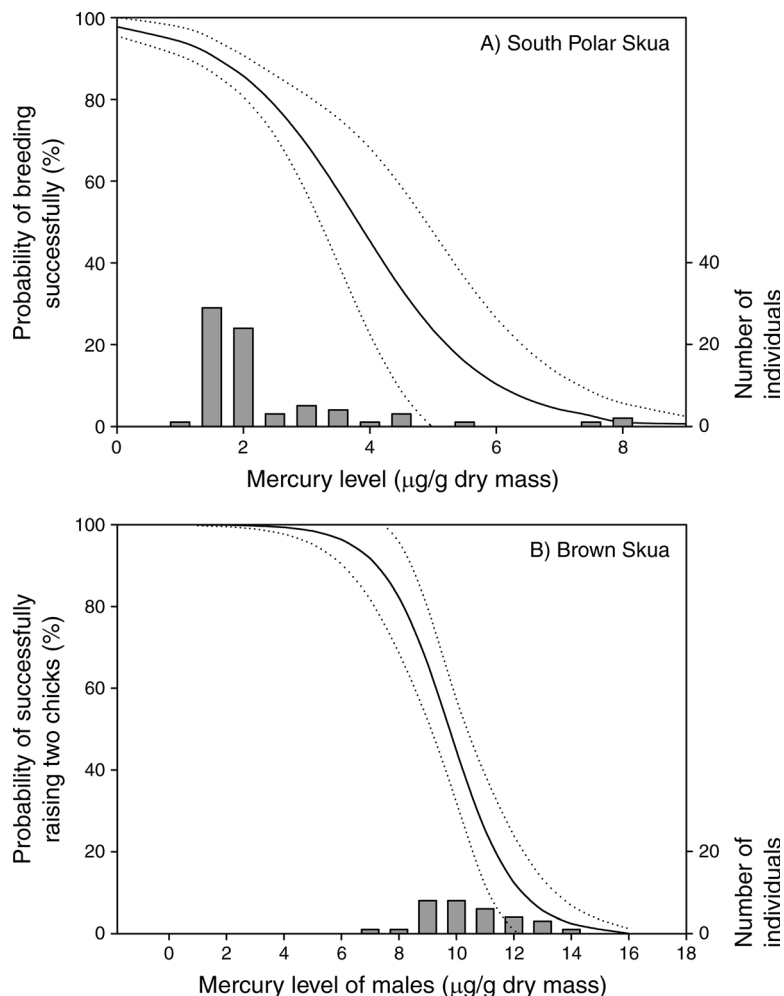


FIG. 4. Effects of Hg on (A) the probability of breeding successfully in the following year in South Polar Skuas (Table 4A: model 19) and (B) the probability of raising two chicks in the following year in Brown Skuas (Table 4A: model 23). The solid line is the mean probability; the dotted lines represent 95% confidence intervals estimated using the delta method (Seber 1982). Histograms represent the measured Hg levels in the sampled individuals (right axis).

were less contaminated than Brown Skuas, which could be attributed to a species-specific difference in diet and trophic level during the breeding season and/or during the wintering period. On the one hand, Brown Skuas breeding in the Kerguelen Islands feed primarily on adult Blue Petrels *Halobaena caerulea* (Mougeot et al. 1998), long-lived highly piscivorous seabirds (Cherel et al. 2002). On the other hand, South Polar Skuas breeding in Adélie Land rely on fish, as well as eggs and chicks of the Adélie Penguin *Pygoscelis adeliae*, a krill-eating seabird (Young 1963). The two species also differ in their migration pattern and wintering areas, with South Polar Skuas migrating farther north to Japan (CEBC [Centre d'Etudes Biologiques de Chizé], unpublished data) and the northern Atlantic and the northern Pacific Oceans (Kopp et al. 2011) than Brown Skuas, which migrate to Australia (CEBC, unpublished data) and between the Antarctic Polar Front and the Northern Subtropical Front (Phillips et al. 2007).

Moreover, Hg levels decreased with previous breeding experience, and differed between breeders and non-breeders in a species-specific manner. This could be due to a difference in foraging ecology between breeders and nonbreeders. Little is known about the foraging ecology of nonbreeders. Although it is conceivable that the most contaminated individuals were not functionally able to breed (Tartu et al. 2013), this was not supported by our MSMR analysis.

#### Long-term fitness consequences of Hg exposure

In the two skua species, adult survival rates of breeders were high and similar to those previously estimated for South Polar Skuas (89–96%; Ainley et al. 1990, Pietz and Parmelee 1993) and for Great Skuas (82–93%; Ratcliffe et al. 2002). Breeding probability was low in individuals previously observed as nonbreeders (37–60%) and high in breeders (~86%), as previously estimated (72–100% for mature South Polar Skuas;

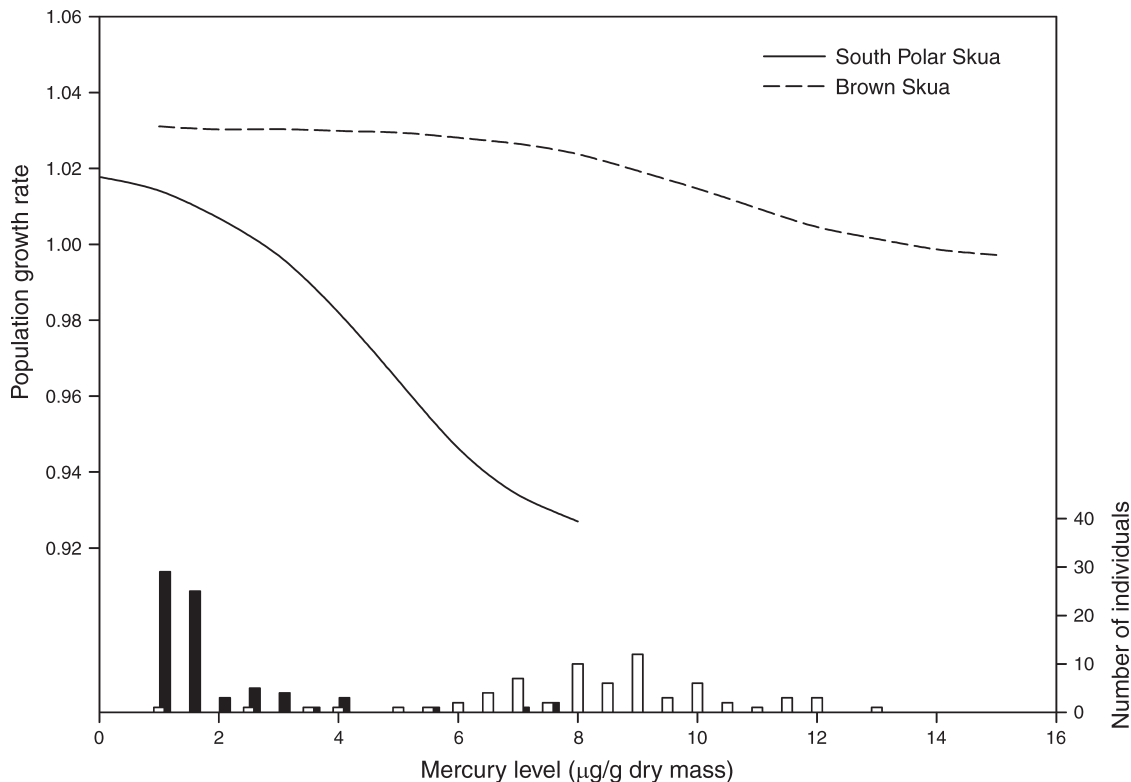


FIG. 5. Modeled population-level growth rate responses (curves) to an increase in mean Hg levels in South Polar Skuas and Brown Skuas. Histograms of the observed range of Hg levels in the sampled individuals (right axis) are given for South Polar Skuas (black bars) and for Brown Skuas (open bars).

Ainley et al. 1990). The probability of breeding successfully was higher in Brown Skuas (83.8%) than in South Polar Skuas (73.5%). The probability of successfully raising two chicks was low in the two skua species (~28%). Although experienced seabirds are known to breed more frequently than inexperienced ones (Desprez et al. 2011), we did not detect any strong effect of previous breeding experience on breeding parameters. This could be due to our relatively low sample size and/or to an effect of experience being restricted to the first reproductive attempts (Nevoux et al. 2007).

According to life history theory, environmental stressors should have the strongest effects on life history traits with the lowest sensitivity, e.g., traits with the lowest importance for population growth (Gaillard et al. 2000, Forbes et al. 2010). In long-lived species, adult survival rate has the highest elasticity and should be the least affected by environmental stressors, whereas breeding success has the lowest elasticity and should be the most sensitive to stressors (Gaillard et al. 2000, Gaillard and Yoccoz 2003), including toxic chemicals (Forbes et al. 2010). Our results partly supported this theoretical framework, because Hg burden did not jeopardize adult survival in the two skua species (which had the highest elasticity by far), thereby corroborating previous studies (Thompson et al. 1991, Mitro et al.

2008, Wayland et al. 2008, Hallinger et al. 2011). Moreover, the probability of remaining a breeder in the following year was not affected by Hg levels. In contrast, high Hg levels induced detrimental effects on the probability of successfully fledgling one or two chicks in the following year. The probability of successfully fledgling at least one chick had a higher elasticity than the probability of raising two chicks. This Hg-induced breeding failure was previously demonstrated in the current breeding attempt (Brasso and Cristol 2008, Burgess and Meyer 2008, Frederick and Jayasena 2010, Jackson et al. 2011), but not in the following year.

Although Brown Skuas exhibited much higher Hg levels than South Polar Skuas, Hg-induced effects in the following year were much stronger in the South Polar Skua and were only detected in male Brown Skuas. This study clearly highlights that closely related species did not respond similarly to toxic chemicals under natural conditions. This species difference could be attributed to environmental conditions, such as harsh weather, food availability, and/or the interaction with other pollutants. All of these environmental fluctuations may exacerbate or attenuate the Hg-induced effects on breeding success. Testing the combined effects of multiple stressors on survival and lifetime breeding performances is a challenging task that would require very large data sets.



PLATE 1. South Polar Skua *Catharacta maccormicki* displaying, Pointe Géologie Archipelago, Adélie Land, Antarctica. This individual is ringed with a stainless steel band and a plastic band engraved with unique alphanumeric code (H24). Photo credit: A. Goutte.

#### *Hg and population growth rate*

Anthropogenic Hg emissions are expected to rise worldwide in the next decades (Streets et al. 2009), probably resulting in growing Hg accumulation in Antarctic top predators. Our population models predicted that an increase of 1  $\mu\text{g/g}$  dry mass in mean Hg levels would slightly decelerate the population growth rate of 1.51% in the South Polar Skua and 0.46% in the Brown Skua. An Hg increase of 0.6  $\mu\text{g/g}$  dry mass in the South Polar Skua and of 3.8  $\mu\text{g/g}$  dry mass in the Brown Skua would be enough to cause population declines. Hence, the South Polar Skua from Adélie Land appears to be more exposed to population decline in response to Hg contamination than is the Brown Skua from Kerguelen Island. These predictions could undoubtedly be worsened by other environmental perturbations. For instance, climate change is known to affect Hg distribution and exposure in polar ecosystems (Stern et al. 2012), and to trigger steep population declines in seabirds (Frederiksen et al. 2004, Jenouvrier et al. 2009, Barbraud et al. 2011). An additional harmful factor is the high levels of persistent organic pollutants (POPs: PCBs, pesticides) found in South Polar Skuas (Bustnes et al. 2007). In Glaucous Gulls *Larus hyperboreus*, the local survival rate was negatively affected by organochlorines and was only apparent among individuals with the highest levels of contamination (Erikstad et al. 2013). Hence, we urge future population modeling to take into account the coupled effects of climate change and anthropogenic pollution (heavy metal and POPs) to

predict population-level responses to a wider range of environmental perturbations.

Translating individual-level effects of toxic chemicals to population-level processes is a crucial and ultimate goal of modern ecological research. By using recent and robust methodological approaches and long-term data sets, we showed a negative effect of Hg on breeding success in the following year in free-living top predators. An increase of Hg levels may result in a slight demographic decline, as highlighted by matrix population models.

#### ACKNOWLEDGMENTS

This project was supported by the French Polar Institute (IPEV, program 109, H. Weimerskirch), Agence Nationale de la Recherche (ANR PolarTop, O. Chastel), Terres Australes et Antarctiques Françaises, Zone Atelier de Recherches sur l'Environnement Antarctique et Subantarctique (CNRS-IN-EE). Field procedures and blood sampling were authorized by the Ethics Committee of IPEV and by the Comité de l'Environnement Polaire. The authors thank G. Bouteloup, R. Bernard, F. Angelier, B. Moe, and all the wintering fieldworkers involved in the long-term monitoring programs for their help on the field, and D. Besson for managing the long-term data base.

#### LITERATURE CITED

- Ainley, D. G., C. A. Ribic, and R. C. Wood. 1990. A demographic study of the South Polar Skua *Catharacta maccormicki* at Cape Crozier. *Journal of Animal Ecology* 59: 1–20.
- Barbraud, C., P. Rivalan, P. Inchausti, M. Nevoux, V. Rolland, and H. Weimerskirch. 2011. Contrasted demographic responses facing future climate change in Southern Ocean seabirds. *Journal of Animal Ecology* 80:89–100.



- Bargagli, R., F. Monaci, J. C. Sanchez-Hernandez, and D. Cateni. 1998. Biomagnification of mercury in an Antarctic marine coastal food web. *Marine Ecology Progress Series* 169:65–76.
- Bearhop, S., R. A. Phillips, D. R. Thompson, S. Waldron, and R. W. Furness. 2000. Variability in mercury concentrations of great skuas *Catharacta skua*: the influence of colony, diet and trophic status inferred from stable isotope signatures. *Marine Ecology Progress Series* 195:261–268.
- Blévin, P., A. Carravieri, A. Jaeger, O. Chastel, P. Bustamante, and Y. Cherel. 2013. Wide range of mercury contamination in chicks of Southern Ocean seabirds. *PLoS ONE* 8(1): e54508.
- Bocher, P., F. Caurant, P. Miramand, Y. Cherel, and P. Bustamante. 2003. Influence of the diet on the bioaccumulation of heavy metals in zooplankton-eating petrels at Kerguelen Archipelago, Southern Indian Ocean. *Polar Biology* 26:759–767.
- Brasso, R. L., and D. A. Cristol. 2008. Effects of mercury exposure on reproductive success of tree swallows (*Tachycineta bicolor*). *Ecotoxicology* 17:133–141.
- Burgess, N. M., and M. W. Meyer. 2008. Methylmercury exposure associated with reduced productivity in common loons. *Ecotoxicology* 17:83–91.
- Burnham, K. P., and D. R. Anderson. 2002. Model selection and multimodel inference: a practical information-theoretic approach. Springer, New York, New York, USA.
- Bustamante, P., V. Lahaye, C. Durnez, C. Churlaud, and F. Caurant. 2006. Total and organic Hg concentrations in cephalopods from the North East Atlantic waters: influence of geographical origin and feeding ecology. *Science of the Total Environment* 368:585–596.
- Bustnes, J. O., T. Tveraa, Ø. Varpe, J. A. Henden, and J. U. Skaare. 2007. Reproductive performance and organochlorine pollutants in an Antarctic marine top predator: the south polar skua. *Environment International* 33:911–918.
- Caswell, H. 2001. Matrix population models: constructions, analysis and interpretation. Second edition. Sinauer Associates, Sunderland, Massachusetts, USA.
- Caughley, G. 1977. Analysis of vertebrate populations. John Wiley, New York, New York, USA.
- Cherel, Y., P. Bocher, C. Trouvé, and H. Weimerskirch. 2002. Diet and feeding ecology of blue petrels *Halobaena caerulea* at Iles Kerguelen, Southern Indian Ocean. *Marine Ecology Progress Series* 228:283–299.
- Choquet, R., J. D. Lebreton, O. Gimenez, A. M. Reboulet, and R. Pradel. 2009b. U-CARE: Utilities for performing goodness of fit tests and manipulating CApture-REcapture data. *Ecography* 32:1071–1074.
- Choquet, R., L. Rouan, and R. Pradel. 2009a. Program E-SURGE: a software application for fitting multievent models. Pages 845–865 in D. L. Thomson, E. G. Cooch, and M. J. Conroy, editors. Modeling demographic processes in marked populations. Springer, New York, New York, USA.
- Cossa, D., L. E. Heimburger, D. Lannuzel, S. R. Rintoul, C. V. Butler, A. R. Bowie, B. Averty, R. J. Watson, and T. Remenyi. 2011. Mercury in the Southern Ocean. *Geochimica Cosmochimica Acta* 75:4037–4052.
- Desprez, M., R. Pradel, E. Cam, J. Y. Monnat, and O. Gimenez. 2011. Now you see him, now you don't: experience, not age, is related to reproduction in kittiwakes. *Proceedings of the Royal Society B* 278:3060–3066.
- Erikstad, K. E., H. Sandvik, T. K. Reiertsen, J. O. Bustnes, and H. Strøm. 2013. Persistent organic pollution in a high-Arctic top predator: sex-dependent thresholds in adult survival. *Proceedings of the Royal Society B* 280:20131483.
- Forbes, V. E., and P. Calow. 2002. Population growth rate as a basis for ecological risk assessment of toxic chemicals. *Philosophical Transactions of the Royal Society B* 357: 1299–1306.
- Forbes, V. E., M. Olsen, A. Palmqvist, and P. Calow. 2010. Environmentally sensitive life-cycle traits have low elasticity: implications for theory and practice. *Ecological Applications* 20:1449–1455.
- Frederick, P., and N. Jayasena. 2010. Altered pairing behaviour and reproductive success in white ibises exposed to environmentally relevant concentrations of methylmercury. *Proceedings of the Royal Society B* 278:1851–1857.
- Frederiksen, M., S. Wanless, M. P. Harris, P. Rothery, and L. J. Wilson. 2004. The role of industrial fisheries and oceanographic change in the decline of North Sea black-legged kittiwakes. *Journal of Applied Ecology* 41:1129–1139.
- Furness, R. W. 1996. Family Stercorariidae (Skuas). Pages 556–571 in J. del Hoyo, A. Elliott, and J. Sargatal, editors. *Handbook of the birds of the world. Volume 3: Hoatzin to auks*. Lynx Editions, Barcelona, Spain.
- Gaillard, J. M., M. Festa-Bianchet, N. G. Yoccoz, A. Loison, and C. Toigo. 2000. Temporal variation in fitness components and population dynamics of large herbivores. *Annual Review of Ecology and Systematics* 31:367–393.
- Gaillard, J. M., and N. G. Yoccoz. 2003. Temporal variation in survival of mammals: a case of environmental canalization? *Ecology* 84:3294–3306.
- Hallinger, K. K., K. L. Cornell, R. L. Brasso, and D. A. Cristol. 2011. Mercury exposure and survival in free-living tree swallows (*Tachycineta bicolor*). *Ecotoxicology* 20:39–46.
- Heath, J. A., and P. C. Frederick. 2005. Relationships among mercury concentrations, hormones, and nesting effort of White Ibises (*Eudocimus albus*) in the Florida Everglades. *Auk* 122:255–267.
- Jackson, A. J., D. C. Evers, M. A. Etterson, A. M. Condon, S. B. Folsom, J. Detweiler, J. Schmerfeld, and D. A. Cristol. 2011. Mercury exposure affects the reproductive success of a free-living terrestrial songbird, the Carolina Wren (*Thryothorus ludovicianus*). *Auk* 128:759–769.
- Jenouvrier, S., H. Caswell, C. Barbraud, M. Holland, J. Stroeve, and H. Weimerskirch. 2009. Demographic models and IPCC climate projections predict the decline of an emperor penguin population. *Proceedings of the National Academy of Sciences USA* 106:1844–1847.
- Kopp, M., H.-U. Peter, O. Mustafa, S. Lisovski, M. S. Ritz, R. A. Phillips, and S. Hahn. 2011. South polar skuas from a single breeding population overwinter in different oceans though show similar migration patterns. *Marine Ecology Progress Series* 435:263–267.
- Le Morvan, P., J. L. Mougin, and J. Prévost. 1967. Ecologie du skua antarctique (*Stercorarius skua maccormicki*) dans l'archipel de Pointe Géologie (Terre Adélie). *L'Oiseau RFO* 37:193–220.
- Lebreton, J.-D., and R. Pradel. 2002. Multistate recapture models: modelling incomplete individual histories. *Journal of Applied Statistics* 29:353–369.
- Miller, D. H., and G. T. Ankley. 2004. Modeling impacts on populations: fathead minnow (*Pimephales promelas*) exposure to the endocrine disruptor 17-B trenbolone as a case study. *Ecotoxicology and Environmental Safety* 59:1–9.
- Mitro, M. G., D. C. Evers, M. W. Meyer, and W. H. Piper. 2008. Common loon survival rates and mercury in New England and Wisconsin. *Journal of Wildlife Management* 72: 665–673.
- Morris, W. F., and D. F. Doak. 2002. Quantitative conservation biology: the theory and practice of population viability analysis. Sinauer Associates, Sunderland, Massachusetts, USA.
- Mougeot, F., F. Genevois, and V. Bretagnolle. 1998. Predation on burrowing petrels by the brown skua (*Catharacta skua lonnbergi*) at Mayes Island, Kerguelen. *Journal of Zoology* 244:429–438.
- Nakamaru, M., Y. Iwasa, and J. Nakanishi. 2003. Extinction risk to bird populations caused by DDT exposure. *Chemosphere* 53:377–387.

- Nevoux, M., H. Weimerskirch, and C. Barbraud. 2007. Environmental variation and experience-related differences in the demography of the long-lived black-browed albatross. *Journal of Animal Ecology* 76:159–167.
- Phillips, R. A., P. Catry, J. R. D. Silk, S. Bearhop, R. McGill, V. Afanasyev, and I. J. Strange. 2007. Movements, winter distribution and activity patterns of Falkland and brown skuas: insights from loggers and isotopes. *Marine Ecology Progress Series* 345:281–291.
- Pietz, P. J., and D. F. Parmelee. 1993. Survival, site and mate fidelity in South Polar Skuas *Catharacta maccormicki* at Anvers Island, Antarctica. *Ibis* 135:32–38.
- Pradel, R. 2005. Multievent: An extension of multistate capture–recapture models to uncertain states. *Biometrics* 61:442–447.
- R Development Core Team. 2012. R: A language and environment for statistical computing. R Foundation for Statistical Computing, Vienna, Austria. <http://www.R-project.org/>
- Ratcliffe, N., P. Catry, K. C. Hamer, N. I. Klomp, and R. W. Furness. 2002. The effect of age and year on the survival of breeding adult Great Skuas *Catharacta skua* in Shetland. *Ibis* 144:384–392.
- Ritz, M. S., C. Millar, G. D. Miller, R. A. Phillips, P. Ryan, V. Sternkopf, D. Liebers-Helbig, and H.-U. Peter. 2008. Phylogeography of the southern skua complex—rapid colonization of the southern hemisphere during a glacial period and reticulate evolution. *Molecular Phylogenetics and Evolution* 49:292–303.
- Scheuhammer, A. M., M. W. Meyer, M. B. Sandheinrich, and M. W. Murray. 2009. Effects of environmental methylmercury on the health of wild birds, mammals, and fish. *AMBIO: a Journal of the Human Environment* 36:12–19.
- Seber, G. A. F. 1982. The estimation of animal abundance and related parameters. MacMillan, New York, New York, USA.
- Stern, G. A., et al. 2012. How does climate change influence arctic mercury? *Science of the Total Environment* 414:22–42.
- Streets, D. G., Q. Zhang, and Y. Wu. 2009. Projections of global mercury emissions in 2050. *Environmental Science and Technology* 43:2983–2988.
- Stubben, C., and B. Milligan. 2007. Estimating and analyzing demographic models using the popbio package in R. *Journal of Statistical Software* 22(11). <http://www.jstatsoft.org/v22/i11/paper>
- Tan, S. W., J. C. Meiller, and K. R. Mahaffey. 2009. The endocrine effects of mercury in humans and wildlife. *Critical Reviews in Toxicology* 39:228–269.
- Tanaka, Y. 2003. Ecological risk assessment of pollutant chemicals: extinction risk based on population-level effects. *Chemosphere* 53:421–425.
- Tartu, S., A. Goutte, P. Bustamante, F. Angelier, B. Moe, C. Clément-Chastel, C. Bech, G. W. Gabrielsen, J. O. Bustnes, and O. Chastel. 2013. To breed or not to breed: endocrine response to mercury contamination by an arctic seabird. *Biology Letters* 9:20130317.
- Thomas, C. D., et al. 2004. Extinction risk from climate change. *Nature* 427:145–148.
- Thompson, D. R., R. W. Furness, and S. A. Lewis. 1993. Temporal and spatial variation in mercury concentrations in some albatrosses and petrels from the sub-Antarctic. *Polar Biology* 13:239–244.
- Thompson, D. R., K. C. Hamer, and R. W. Furness. 1991. Mercury accumulation in great skuas *Catharacta skua* of known age and sex, and its effects upon breeding and survival. *Journal of Applied Ecology* 28:672–684.
- Wayland, M., K. L. Drake, R. T. Alisauskas, D. K. Kellett, J. Traylor, C. Swoboda, and K. Mehl. 2008. Survival rates and blood metal concentrations in two species of free-ranging North American sea ducks. *Environmental Toxicology and Chemistry* 27:698–704.
- Weimerskirch, H., J. Lallemand, and J. Martin. 2005. Population sex ratio variation in a monogamous long-lived bird, the wandering albatross. *Journal of Animal Ecology* 74: 285–291.
- Willson, J. D., W. A. Hopkins, C. M. Bergeron, and B. D. Todd. 2012. Making leaps in amphibian ecotoxicology: translating individual-level effects of contaminants to population viability. *Ecological Applications* 22:1791–1802.
- Wolfe, M. F., S. Schwarzbach, and R. A. Sulaiman. 1998. Effects of mercury on wildlife: a comprehensive review. *Environmental Toxicology and Chemistry* 17:146–160.
- Young, E. C. 1963. Feeding habits of the South Polar Skua *Catharacta maccormicki*. *Ibis* 105:301–318.

## SUPPLEMENTAL MATERIAL

### Appendix

Table presenting the effects of time and state on detection probability ( $p$ ), and of state on the probabilities of survival ( $S$ ), breeding ( $\beta$ ), breeding successfully ( $\gamma$ ), and successfully raising two chicks ( $\delta$ ) in South Polar Skuas and Brown Skuas ([Ecological Archives E095-091-A1](#)).

## Demographic consequences of heavy metals and persistent organic pollutants in a vulnerable long-lived bird, the wandering albatross

Aurélie Goutte, Christophe Barbraud, Alizée Meillère, Alice Carravieri, Paco Bustamante, Pierre Labadie, Hélène Budzinski, Karine Delord, Yves Cherel, Henri Weimerskirch and Olivier Chastel

*Proc. R. Soc. B* 2014 **281**, 20133313, published 11 June 2014

---

### Supplementary data

["Data Supplement"](#)

<http://rspb.royalsocietypublishing.org/content/suppl/2014/06/06/rspb.2013.3313.DC1.html>

### References

[This article cites 33 articles, 3 of which can be accessed free](#)

<http://rspb.royalsocietypublishing.org/content/281/1787/20133313.full.html#ref-list-1>

### Subject collections

Articles on similar topics can be found in the following collections

[ecology](#) (1672 articles)

[environmental science](#) (273 articles)

### Email alerting service

Receive free email alerts when new articles cite this article - sign up in the box at the top right-hand corner of the article or click [here](#)



## Research

**Cite this article:** Goutte A *et al.* 2014 Demographic consequences of heavy metals and persistent organic pollutants in a vulnerable long-lived bird, the wandering albatross. *Proc. R. Soc. B* **281**: 20133313. <http://dx.doi.org/10.1098/rspb.2013.3313>

Received: 19 December 2013

Accepted: 15 May 2014

### Subject Areas:

ecology, environmental science

### Keywords:

capture–recapture, *Diomedea exulans*, mercury, polybrominated diphenyl ethers (PBDE), polychlorinated biphenyl, pesticides

### Author for correspondence:

Aurélie Goutte

e-mail: [agoutte@gmail.com](mailto:agoutte@gmail.com)

Electronic supplementary material is available at <http://dx.doi.org/10.1098/rspb.2013.3313> or via <http://rsps.royalsocietypublishing.org>.

# Demographic consequences of heavy metals and persistent organic pollutants in a vulnerable long-lived bird, the wandering albatross

Aurélie Goutte<sup>1,2</sup>, Christophe Barbraud<sup>1</sup>, Alizée Meillère<sup>1</sup>, Alice Carravieri<sup>1</sup>, Paco Bustamante<sup>2</sup>, Pierre Labadie<sup>3</sup>, Hélène Budzinski<sup>3</sup>, Karine Delord<sup>1</sup>, Yves Cherel<sup>1</sup>, Henri Weimerskirch<sup>1</sup> and Olivier Chastel<sup>1</sup>

<sup>1</sup>Centre d'Etudes Biologiques de Chizé (CEBC), UMR 7372, CNRS-Université de La Rochelle, Villiers-en-Bois 79360, France

<sup>2</sup>Littoral Environnement et Sociétés (LIENSs), UMR 7266, CNRS-Université de La Rochelle, 2 rue Olympe de Gouges, La Rochelle 17000, France

<sup>3</sup>UMR 5805 EPOC-LPTC, Université Bordeaux, 351 Cours de la Libération, Talence Cedex 33405, France

Seabirds are top predators of the marine environment that accumulate contaminants over a long life-span. Chronic exposure to pollutants is thought to compromise survival rate and long-term reproductive outputs in these long-lived organisms, thus inducing population decline. However, the demographic consequences of contaminant exposure are largely theoretical because of the dearth of long-term datasets. This study aims to test whether adult survival rate, return to the colony and long-term breeding performance were related to blood mercury (Hg), cadmium (Cd) and persistent organic pollutants (POPs), by using a capture–mark–recapture dataset on the vulnerable wandering albatross *Diomedea exulans*. We did not find evidence for any effect of contaminants on adult survival probability. However, blood Hg and POPs negatively impacted long-term breeding probability, hatching and fledging probabilities. The proximate mechanisms underlying these deleterious effects are likely multifaceted, through physiological perturbations and interactions with reproductive costs. Using matrix population models, we projected a demographic decline in response to an increase in Hg or POPs concentrations. This decline in population growth rate could be exacerbated by other anthropogenic perturbations, such as climate change, disease and fishery bycatch. This study gives a new dimension to the overall picture of environmental threats to wildlife populations.

## 1. Introduction

Free-living animal populations are affected by a wide range of anthropogenic pressures. Chronic exposure to metallic and organic pollutants may compromise survival and long-term fecundity, thereby leading to population decline. For instance, mercury (Hg) is a globally distributed heavy metal of particular concern for aquatic biota, because of the harmful effects of its organic form (methyl-Hg) on embryo development, neurology, immune system, physiology and behaviour [1–3]. Another ubiquitous heavy metal, cadmium (Cd), causes irreversible renal tubular damage, leading to reduced skeletal calcium content [4]. Persistent organic pollutants (POPs), such as organochlorine pesticides (HCB, HCH, DDE, DDD and DDT), polychlorinated biphenyls (PCBs) and brominated diphenyl ethers (BDEs), can persist in the environment for decades and trigger a suite of detrimental effects in vertebrates, including endocrine disruption, immunotoxicity, embryo mortality and behavioural impairments [5–7].

Although toxic effects of heavy metals and POPs have been well described at the individual level and under controlled laboratory conditions, their population-level effects have been virtually neglected in free-living vertebrates because of the



dearth of long-term datasets. In aquatic birds, there is no evidence of an impact of heavy metals on adult mortality [8,9]. In two *Catharacta skua* species, breeding failure in the following year, but not adult survival rate, was positively related to Hg exposure [10], as highlighted by the use of long-term datasets and multi-state mark–recapture models (MSMR [11]). Concerning POPs, very high concentrations of organochlorine compounds were related to increased mortality in the glaucous gull *Larus hyperboreus* [12], but their effects on long-term fecundity were not explored in that study.

The present study aimed to relate demographic parameters to pollutants in wandering albatrosses *Diomedea exulans*. The effects of Hg and Cd in red blood cells and  $\Sigma$  POPs in plasma on apparent probabilities of adult survival, return to the breeding colony, breeding, hatching and fledgling, were investigated by using a MSMR approach. According to recent studies on long-lived seabirds [10,12], a deleterious effect of Hg was expected on long-term breeding performances and a possible lethal effect of POPs was expected in the most contaminated wandering albatrosses. Then, population-level responses to an increase in Hg and POPs levels were assessed by establishing a life cycle for the wandering albatross and by including Hg- or POP-dependent demographic traits in the matrix population models [13].

Despite high pollution burdens in albatrosses [14–16], the effects of contaminants on demographic parameters and population growth rate are unknown. Albatrosses are among the most highly endangered of the world's birds, with 18 of 22 species considered as threatened and the remaining four species considered as near threatened [17]. In this population of wandering albatrosses, population growth rate remained relatively stable during the 1960s (about 850 breeding pairs), before a first decline between the early 1970s and 1986, and a second decline since 2003 down to 380 breeding pairs [18]. Causes of decline in albatross populations have been attributed to fishery bycatch, climate change and disease [19]. This study thus gives a new dimension to the overall picture of environmental threats in albatross populations.

## 2. Material and methods

### (a) Study area and species

The study was conducted at Ile de la Possession in the Crozet Archipelago (46° S, 52° E), Southern Indian Ocean, where 300–400 pairs of wandering albatrosses nest each year. Adults return to their breeding grounds in December and females lay a single egg in late December–early January. Both parents incubate alternately until hatching in March and most young are fledged in November. Up to 6% of the birds that fledged a chick bred again in the following year, and the wandering albatross is considered to be a quasi-biennial breeding species [20]. Approximately 80% of birds that failed to breed in the previous year engage in another breeding attempt in the following year. All wandering albatrosses had been ringed and sexed as part of a long-term mark–recapture programme [21]. In December, pre-breeding adults are controlled over the whole island. From mid-January to mid-February, at least three visits are carried out every 10 days at each nest to determine the identity and breeding status (egg laid/egg hatched) of each individual. In mid-April, June and August, all nests are checked to monitor the chicks' survival.

### (b) Blood sampling

From 21 December 2007 to 04 March 2008, 147 sexually mature adults (i.e. observed as incubating or chick-rearing at least once before or during the current breeding season) were captured.

A sample of venous blood was taken from the tarsus with a 1-ml heparinized syringe and a 25-gauge needle. Only one bird was sampled per nest. The volume of the blood draws never exceeded 0.05% of the bird's body mass (8–12 kg).

### (c) Laboratory analyses

Hg and Cd were analysed in red blood cells at the Littoral Environnement et Sociétés (LIENSs), La Rochelle, France. POPs (PCBs: CB-28, -52, -101, -118, -138, -153 and -180; organochlorine pesticides: HCB (hexachlorobenzene), Gamma HCH (hexachlorocyclohexane), Heptachlore, 2,4' DDE (dichlorodiphenyldichloroethylene), Cis-chlordane, trans-nonachlor, 4,4' DDD (dichlorodiphenyldichloroethane), 2,4' DDT (dichlorodiphenyltrichloroethane), 4,4' DDT, Mirex; and BDE-47) were analysed in plasma at the EPOC-LPTC, Bordeaux, France. Further details about analyses are reported in the electronic supplementary material.

### (d) Estimating the effects of blood heavy metals and persistent organic pollutants on breeding output during the year of sampling

Generalized linear models (GLMs) with binomial error distribution and a logit link function were used to test whether breeding success in 2007–2008 was linked to blood Hg, Cd or POP levels in individuals sampled as breeders in 2007–2008. Breeding success was coded as 1 for birds that successfully fledged a chick, and as 0 for those that failed at the egg or chick stage. Analyses were performed using R [22].

### (e) Estimating the effects of blood heavy metals and persistent organic pollutants on demographic parameters

The capture–recapture data of sampled individuals from 2008 to 2012 were used to evaluate the effects of blood Hg, Cd and POPs on demographic parameters.<sup>1</sup> A MSMR model was constructed, as developed by Pardo *et al.* [23,24], and included eight states: dead, failed breeder on egg (FBE, defined as an individual that was observed with one egg that failed to hatch), failed breeder on chick (FBC, defined as an individual that was observed with one chick but that failed to fledge the chick), successful breeder (SB, defined as an individual that fledged one chick), observable non-breeder (ONB, defined as an individual that was observed at the colony but that was not observed with an egg or a chick) and three unobservable states (UNB) consisting of non-breeders that were observed at the colony during the previous breeding attempt (PONB), non-breeders whose previous breeding attempt failed (PFB) and non-breeders whose previous breeding attempt was successful (PSB). The state coded as 'dead' (†) absorbed all those individuals that had either died or permanently emigrated from the study areas. The UNBs account for temporary absence, corresponding to birds that skip breeding in one year after breeding unsuccessfully or successfully during the previous year.

Models were parametrized in terms of the probability of survival ( $s$ ), the probability of returning to the colony given survival ( $r$ ), the probability of breeding given return to the colony ( $\beta$ ), the probability of successful hatching given breeding ( $\omega$ ), the probability of successful fledgling given hatching ( $\gamma$ ) and the detection probability ( $p$ ). Transition probabilities between states were thus modelled with a five-step procedure where  $s$ ,  $r$ ,  $\beta$ ,  $\omega$  and  $\gamma$  were considered as five successive steps in transition matrices. Parameters of the model are defined in the electronic

supplementary material. We chose a MSMR approach as this allows us to take into account the probability of detecting individuals given their return to the study site, as well as the

previous breeding state of individuals in order to obtain unbiased estimates of demographic parameters [11].

This MSMR model was parametrized by the survival-transition probabilities matrix

	FBE	FBC	SB	ONB	PFB	PSB	PONB	†
FBE	$sr\beta(1-\omega)$	$sr\beta\omega(1-\gamma)$	$sr\beta\omega\gamma$	$sr(1-\beta)$	$s(1-r)$	---	---	*
FBC	$sr\beta(1-\omega)$	$sr\beta\omega(1-\gamma)$	$sr\beta\omega\gamma$	$sr(1-\beta)$	$s(1-r)$	---	---	*
SB	$sr\beta(1-\omega)$	$sr\beta\omega(1-\gamma)$	$sr\beta\omega\gamma$	$sr(1-\beta)$	---	$s(1-r)$	---	*
ONB	$sr\beta(1-\omega)$	$sr\beta\omega(1-\gamma)$	$sr\beta\omega\gamma$	$sr(1-\beta)$	---	---	$s(1-r)$	*
PFB	$sr\beta(1-\omega)$	$sr\beta\omega(1-\gamma)$	$sr\beta\omega\gamma$	$sr(1-\beta)$	---	---	---	*
PSB	$sr\beta(1-\omega)$	$sr\beta\omega(1-\gamma)$	$sr\beta\omega\gamma$	$sr(1-\beta)$	---	---	---	*
PONB	$sr\beta(1-\omega)$	$sr\beta\omega(1-\gamma)$	$sr\beta\omega\gamma$	$sr(1-\beta)$	---	---	---	*
†	$sr\beta(1-\omega)$	$sr\beta\omega(1-\gamma)$	$sr\beta\omega\gamma$	$sr(1-\beta)$	---	---	---	*

Several constraints were made to ensure that the parameters of the model were estimable. The state 'dead' being explicitly included in the model but never being encountered, initial state probability was fixed at 0, transition probabilities from the state 'dead' to the other states were fixed at 0 and capture probability was fixed at 0 [25,26]. The probability of seeing individuals in UNBs and transitions between UNBs was constrained to 0. Since some individuals were observed breeding in the year consecutive to a successful breeding event [20],  $\beta_{SB}$  was not constrained to 0. To limit redundancy in survival parameters, models where survival probabilities all varied separately were not considered [27]. Because of the limited number of individual capture histories, the limited number of recapture occasions and the relatively large number of UNBs, we constrained (i) all parameters to be constant over time, (ii)  $r$  to be identical for ONB, PFB, PSB and PONB and (iii)  $\beta$  to be identical for PFB, PSB and PONB. With these constraints, the initial model was full-rank. Note that the model where all demographic parameters were time- and state-dependent was highly rank deficient.

Once the best model structure was identified (Model 21, electronic supplementary material), effects of blood Hg, Cd and POPs were tested on demographic parameters to investigate whether contamination levels in one breeding season may influence the long-term survival and breeding outputs of an individual over the four following years. MSMR models were built where each demographic parameter  $\theta$  was modelled as a function of an individual covariate  $C$  (standardized level of Hg, Cd or sum of POPs (log-transformed)) using a logit link function:  $\text{logit}(\theta) = a + b \times C_i$ , where  $a$  is an intercept,  $b$  is a slope and  $C_i$  is the covariate for individual  $i$ . When  $b < 0$ , or  $b > 0$ ,  $C$  has a negative or positive effect on  $\theta$ , respectively.

The effect of  $C$  was first tested on each demographic parameter separately and for different states. Because some parameters were estimated as 100% [100–100%] (electronic supplementary material), we did not test the effects of  $C$  on the return probability of males previously observed as (FBE and FBC) or as (ONB, PFB, PSB and PONB), and on the breeding probability of unobservable non-breeders. The 95% confidence interval (CI) of the slope parameters was used, as well as Akaike's information criterion corrected (AICc) for small sample size [28] for inference. We considered a contaminant's effect to be statistically supported when 0 was outside the 95% CI of the mean of the slope of the relationship [29]. A composite model was then constructed by combining all the covariates that were detected to have an effect on demographic parameters. Composite models were constructed for heavy metals and POPs separately, as sample sizes differed. In composite models, an effect was not supported if the 95% CI of the slope parameter included 0 [29].

We tested the goodness-of-fit (GOF) of the time-dependent MSMR model using U-CARE [30]. All models were run under program E-SURGE 1.8.5 allowing splitting transition probabilities

between states [26]. To avoid estimating parameters at a local minimum of the likelihood function, each model was run five times with random initial values.

### (f) Modelling population dynamics

To evaluate the population-level effects of contaminants, we constructed population models using pre-breeding matrices [13] structured by age and reproductive status classes. We built a two-sex age- and stage-classified matrix population model [13], because Hg and POPs concentrations affected the demographic parameters of males and females differently (see §3). Based on a detailed demographic study on wandering albatrosses [31], the model consists of five juvenile age classes, one pre-breeder class and seven stage-classes according to the breeding status (SB, FBE, FBC, ONB, PSB, PFB and PONB). Parameters entering the model were the recruitment probability,  $s$  of adult males, females and juveniles,  $r$  of SB and other states,  $\beta$  of SB, FB, ONB and UNB for males and females separately,  $\omega$  and  $\gamma$  of breeders and non-breeders. We assumed a 1:1 sex ratio.

We first built a deterministic matrix model with no stochasticity, which included the mean estimates of the demographic parameters from our MSMR model results and from Barbraud *et al.* [31] for juvenile survival and recruitment probability. From these matrix analyses, we estimated the deterministic population growth rate [13]. We then focused on stochastic matrix models to estimate the stochastic growth rate. Environmental stochasticity was included in two different ways. When a vital rate had no significant relationship with levels of contaminant ( $C$ ), its yearly values were sampled from a beta distribution [32], with mean and variance equal to those estimated from the MSMR model selected. When a vital rate had a significant relationship with  $C$  levels, its value was modelled as  $\theta = \text{logit}^{-1}(a + b \times \bar{C})$ , where  $\bar{C}$  is the mean value of the contaminant levels for all individuals.  $C$  values were sampled from a log-normal distribution for all individuals sampled. The values of  $a$  and  $b$  were recalculated for non-standardized  $C$  values representing the absolute values for Hg and log-transformed values for  $\Sigma$  POPs. To assess the population-level effects of  $C$ , we estimated stochastic population growth rates according to changes in mean  $C$  levels within the range of observed  $C$  values. The matrix population models were analysed by Monte Carlo simulations (10 000 iterations) using package popbio [33] implemented in R [22].

## 3. Results

### (a) Effects of blood heavy metal and persistent organic pollutants on current breeding output

Blood levels of contaminants are given in the electronic supplementary material. When considering only breeders in 2008,

**Table 1.** Modelling the effects of standardized blood heavy metals levels (*a*, Hg; *b*, Cd; and *c*, composite model) on demographic parameters ( $N = 147$  individuals). The estimated slope and 95% CIs for models with a lower AICc than the intercept model (Hg0 and Cd0) are given.

hypothesis	model	rank	deviance	$\Delta$ AICc	slope (CI−; CI+)
<b>(a) effect of blood Hg on demographic parameters</b>					
breeding probability of females previously in state ONB	Hg10	24	1442.026	0	−2.141 (−4.267; −0.014)
hatching probability of individuals previously in states FB or SB	Hg3	24	1444.431	2.405	−0.659 (−1.271; −0.047)
fledging probability of individuals previously in states FB or SB	Hg1	24	1444.560	2.533	−0.844 (−1.659; −0.029)
breeding probability of males previously in states FBE or FBC	Hg5	24	1446.133	4.107	1.569 (−0.307; 3.445)
intercept model: no effect	Hg0	23	1449.217	4.946	
breeding probability of females previously in states FBE or FBC	Hg6	24	1448.236	6.210	
breeding probability of females previously in state SB	Hg8	24	1448.881	6.854	
return probability of individuals previously in state SB	Hg12	24	1448.955	6.929	
hatching probability of individuals previously in states ONB or UNB	Hg4	24	1449.035	7.009	
breeding probability of males previously in state SB	Hg7	24	1449.159	7.133	
fledging probability of individuals previously in states ONB or UNB	Hg2	24	1449.208	7.182	
survival rate of females	Hg14	24	1449.209	7.183	
breeding probability of males previously in state ONB	Hg9	24	1449.215	7.189	
survival rate of males	Hg13	24	1449.216	7.190	
breeding probability of females previously in states PFB, PSB or PONB	Hg11	24	1449.217	7.191	
<b>(b) effect of blood Cd on demographic parameters</b>					
return probability of individuals previously in state SB	Cd12	24	1445.909	0	−0.350 (−0.758; 0.058)
hatching probability of individuals previously in states ONB or UNB	Cd4	24	1446.645	0.735	0.520 (−0.204; 1.243)
intercept model: no effect	Cd0	23	1449.217	1.063	
fledging probability of individuals previously in states ONB or UNB	Cd2	24	1447.314	1.405	
breeding probability of females previously in state ONB	Cd10	24	1447.905	1.996	
breeding probability of females previously in state SB	Cd8	24	1448.247	2.338	
breeding probability of females previously in states FBE or FBC	Cd6	24	1448.730	2.820	
hatching probability of individuals previously in states FB or SB	Cd3	24	1448.744	2.835	
survival rate of females	Cd14	24	1448.794	2.885	
survival rate of males	Cd13	24	1449.048	3.139	
probability of males previously in states FBE or FBC	Cd5	24	1449.054	3.145	
fledging probability of individuals previously in states FB or SB	Cd1	24	1449.129	3.220	
breeding probability of males previously in state SB	Cd7	24	1449.159	3.250	
breeding probability of males previously in state ONB	Cd9	24	1449.215	3.306	
breeding probability of females previously in states PFB, PSB or PONB	Cd11	24	1449.217	3.307	
<b>(c) effect of blood heavy metals on demographic parameters</b>					
composite model (Hg10, Hg3, Hg1)	Hg15	26	1433.319	0	(cf. S3(b))
intercept model: no effect	Hg0	23	1449.217	9.131	

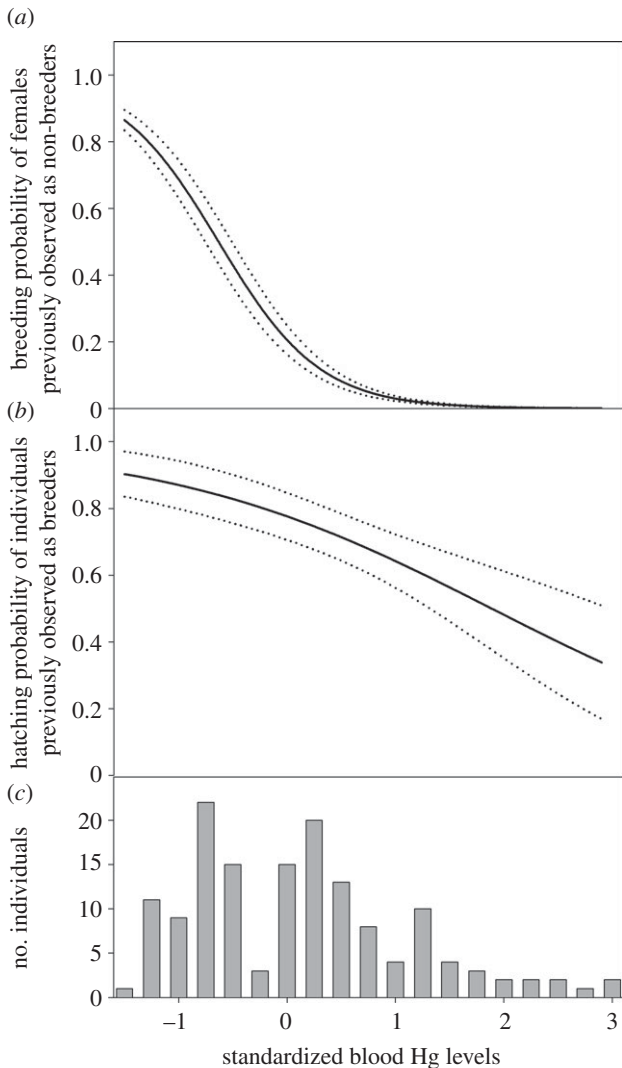
current breeding success was not related to Hg (d.f. = 1,105,  $\chi^2 = 0.126$ ,  $p = 0.723$ ), Cd (d.f. = 1,105,  $\chi^2 = 0.008$ ,  $p = 0.929$ ) or  $\Sigma$  POPs concentrations (d.f. = 1,81,  $\chi^2 < 0.001$ ,  $p = 0.993$ ).

### (b) Demographic consequences of blood heavy metal levels

The GOF of the MSMR model was overall not significant (males:  $\chi^2 = 16.327$ , d.f. = 22,  $p = 0.799$  and females:  $\chi^2 = 7.078$ , d.f. = 16,  $p = 0.972$ ). The effects of sex and states on demographic parameters and the estimation of parameters are detailed in the electronic supplementary material.

Model selection and slope estimates suggested negative effects of Hg on the breeding probability of females previously in state ONB, and on hatching probability and fledging probability of individuals previously in states FB and SB (table 1*a*). There was no detectable effect of Cd on demographic parameters (table 1*b*). Slope estimates obtained from the composite model (table 1*c*) were −2.114 (95% CI: (−4.213; −0.015)), −0.620 (−1.234; −0.005) and −0.807 (−1.645; 0.032) for the effects of Hg on breeding probability of females previously in state ONB (figure 1*a,c*), hatching probability of individuals previously in states FB and SB (figure 1*b,c*) and fledging probability of individuals previously in states FB





**Figure 1.** Effect of standardized blood Hg levels on (a) breeding probability of females previously observable as non-breeders (ONB), and (b) hatching probability of individuals previously observed as breeders. Dotted lines represent 95% CIs estimated using the delta method [34]. Histograms represent the measured blood Hg levels (c).

and SB, respectively. The last effect was not supported, because 95% CI included 0 in the composite model.

### (c) Demographic consequences of blood $\Sigma$ POP levels

Model selection and slope estimates suggested a negative effect of  $\Sigma$  POPs on fledging probability of individuals previously in states ONB or UNB and on breeding probability of females previously in state ONB (table 2). Other models were not supported, because 95% CI of slope parameter values included 0 (table 2). Slope estimates obtained from the composite model were  $-0.976$  ( $-1.917$ ;  $-0.035$ ) and  $-0.812$  ( $-1.551$ ;  $-0.072$ ) for the effects of  $\Sigma$  POPs on breeding probability of females previously in state ONB (figure 2a,c) and on fledging probability of individuals previously in states ONB or UNB (figure 2b,c), respectively.

### (d) Modelling population dynamics

The deterministic population growth rate was 1.038, and the respective generation time was 23.8. The stochastic population growth rates were 1.008 when accounting for mean Hg effects from MSMR analyses, 1.002 when accounting for mean POPs

effects and 0.991 when accounting for both mean Hg and POPs effects (figure 3). A doubling in mean Hg concentration would decelerate the population growth rate of 0.68%. A doubling in mean  $\Sigma$  POPs concentration would decelerate the population growth rate of 0.11%. Doublings in mean Hg and  $\Sigma$  POPs concentrations would decelerate the population growth rate of 1.31% (figure 3).

## 4. Discussion

Using a unique long-term dataset and MSMR models, this study explores the demographic effects of both metallic and organic pollutants in a wild vertebrate population. Contaminant levels were associated with a lower breeding probability, a higher hatching failure and a higher fledgling failure, but not with adult survival rate in the wandering albatross. At the population level, a demographic decline was projected in response to increasing Hg and  $\Sigma$  POP levels.

### (a) Effects of contaminants on current breeding output

Contrary to previous studies [1,2,5,7], no negative effect of blood Hg, Cd and  $\Sigma$  POPs was detected on breeding success at the year of sampling. The lack of relationship is probably due to the sampling protocol, since blood sampling was mainly conducted during the incubating period. Some effect of contaminants on early nest desertion and skipped breeding [3] may have been missed.

### (b) Survival and contaminants

Estimated demographic parameters were similar to those previously estimated in the same population using all ringed individuals [20,24]. The survival rate of wandering albatrosses was not jeopardized by Hg, Cd and POPs. An effect of POPs was detected on survival rate in one of the most polluted seabirds, the glaucous gull breeding in the Norwegian Arctic, but only the most contaminated individuals had lower survival [12]. Concerning heavy metals, these findings corroborate previous studies that did not evidence an effect of Hg and Cd on adult mortality in birds [8–10]. However, our study did not exclude the possibility that contaminants could jeopardize the survival rate of immature wandering albatrosses, as they have a higher pollution burden [16] and a lower survival rate [31] than sexually mature adults.

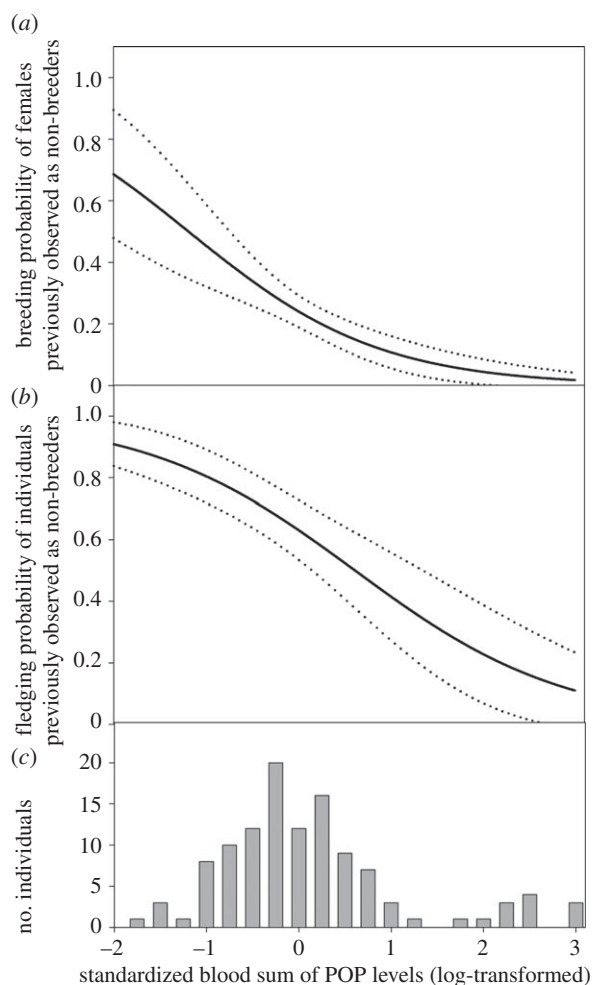
### (c) Long-term fecundity and heavy metals

A negative effect of blood Hg was detected on breeding probability of females observed as non-breeders. Concerning the proximate mechanisms, Hg, in its methylated form, is known to disrupt reproductive hormones [1] such as the luteinizing hormone, a key pituitary hormone for the onset of breeding [3].

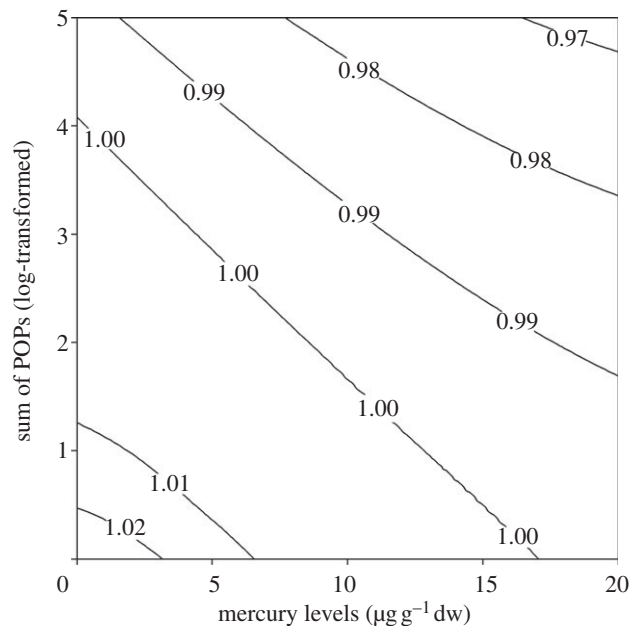
As found in two southern *Catharacta skua* species [10], Hg negatively impacted hatching probability of albatrosses, but only in individuals previously observed as breeders. Energetic and time-dependent costs of reproduction may have downstream consequences for reproductive investment during the following breeding season (carry-over effect [35]). Hence, Hg load may have exacerbated these carry-over effects in individuals that previously bred. Concerning the possible proximate mechanisms, Hg may have caused long-term endocrine disruption of the reproductive system and behavioural

**Table 2.** Modelling the effects of blood  $\Sigma$  POP levels (log-transformed and standardized) on demographic parameters ( $N = 115$  individuals). The estimated slope and 95% CIs for models with a lower AICc than the intercept model (POP0) are given.

hypothesis	model	rank	deviance	$\Delta$ AICc	slope (CI-; CI+)
breeding probability of females previously in state SB	POP8	24	1129.266	0	2.763 (-0.205; 5.731)
composite model (POP2, POP10)	POP15	25	1127.642	0.716	(cf. S3(c))
fledging probability of individuals previously in states ONB or UNB	POP2	24	1130.764	1.498	-0.878 (-1.641; -0.114)
hatching probability of individuals previously in states ONB or UNB	POP4	24	1131.111	1.845	0.841 (-0.036; 1.719)
fledging probability of individuals previously in states FB and SB	POP1	24	1131.312	2.046	1.226 (-0.075; 2.527)
hatching probability of individuals previously in states FB and SB	POP3	24	1131.434	2.168	1.006 (-0.116; 2.127)
breeding probability of females previously in state ONB	POP10	24	1131.826	2.560	-0.964 (-1.870; -0.058)
intercept model: no effect	POP0	23	1135.079	3.488	
breeding probability of females previously in states PFB, PSB or PONB	POP11	24	1133.513	4.247	
breeding probability of males previously in state SB	POP7	24	1133.847	4.581	
breeding probability of males previously in states FBE or FBC	POP5	24	1134.095	4.829	
survival rate of males	POP13	24	1134.313	5.047	
breeding probability of females previously in states FBE or FBC	POP6	24	1134.808	5.542	
return rate of individuals previously in state SB	POP12	24	1135.034	5.768	
survival rate of females	POP14	24	1135.035	5.769	
breeding probability of males previously in state ONB	POP9	24	1135.093	5.827	



**Figure 2.** Effect of standardized blood  $\Sigma$  POPs (log-transformed) on (a) breeding probability of females previously observed as non-breeders, and (b) fledging probability of individuals previously observed as non-breeders or unobserved. Dotted lines represent 95% CIs estimated using the delta method [34]. Histograms represent the measured blood  $\Sigma$  POP levels (c).



**Figure 3.** Isoclines of population growth rate in wandering albatrosses as projected with the population models, which included the responses to blood Hg levels and blood  $\Sigma$  POPs (log-transformed) within the range of observed Hg and  $\Sigma$  POP levels.

impairments [1,2]. In addition, the maternal transfer of Hg into the egg may have altered embryo development [36].

#### (d) Long-term fecundity and $\Sigma$ POPs

POP burdens reduced the long-term breeding probability of females previously observed as non-breeders and fledging probability of individuals that were previously non-breeders. Interestingly, POPs appeared to mostly affect albatrosses that skipped the preceding breeding attempt, suggesting a possible

segregation of foraging areas between breeders and non-breeders. Alternatively, non-breeding females may suffer from higher deleterious effects of POPs on long-term fecundity, because their loads of POPs were not eliminated through the egg.

During the incubating and chick-rearing periods, POPs may weaken the secretion of prolactin, a hormone closely involved in the mediation of parental care, as shown in glaucous gulls [37]. In turn, a durable Hg-induced attenuation of prolactin release may result in fledgling failure.

The link between contaminants and reduced fecundity could be a by-product of age-dependant mechanisms. However, in this population, fecundity declined in the oldest individuals (35+ years old [24,38]), while Hg levels tended to decrease with age [16] and POP levels were unrelated to age (data not shown). Moreover, age (6–48+ years old) did not affect humoral immunity, oxidative stress, antioxidant defences or hormone levels in wandering albatrosses [38]. Hence, it is unlikely that age was a confounding factor in the correlation between contaminants and physiological mechanisms underlying breeding performance.

### (e) Modelling population dynamics

Translating individual-level effects of contaminants to population-level processes is a crucial and ultimate goal of modern ecological research. Our population models suggested that the actual Hg and POPs levels could decelerate the population growth rate (0.991), whereas the population growth rate would increase (1.027) with zero concentrations of blood Hg and POPs. In addition, doublings in mean blood Hg and POPs levels would decelerate the growth rate of this wandering

albatross population by 1.31%. These predictions could undoubtedly be worsened by other anthropogenic perturbations. For instance, climate change can impact transport, distribution, bioavailability, bioaccumulation and effects of pollutants [39–41] and triggers steep population declines in albatrosses [19]. In that respect, a future avenue for ecotoxicological and conservation research could be dedicated to evaluating and predicting the coupled effects of climatic and chemical perturbations on wildlife population viability.

Field procedures and blood sampling were authorized by the Ethics Committee of IPEV and by the Comité de l'Environnement Polaire.

**Acknowledgements.** The authors thank V. Lecomte and A. Jaeger for data collection; H. Maheo and M. Berlinecourt for their assistance in the field and all the wintering fieldworkers involved in the long-term monitoring programmes; C. Churlaud and S. Tartu for their help in laboratory analyses; D. Besson for managing the long-term database; and the reviewers for their constructive and helpful comments.

**Funding statement.** This project was supported by l'Agence Nationale de la Recherche (ANR PolarTop, O.C.), the French Polar Institute (IPEV, program 109, H.W.), the Terres Australes et Antarctiques Françaises and the Zone Atelier de Recherches sur l'Environnement Antarctique et Subantarctique (CNRS-INEE).

### Endnote

<sup>1</sup>Dataset: demographic consequences of heavy metals and POPs in a vulnerable long-lived bird, the wandering albatross. Aurelie Goutte, Christophe Barbraud, Alizée Meillère, Alice Carravieri, Paco Bustamante, Pierre Labadie, Hélène Budzinski, Karine Delord, Yves Chereh, Henri Weimerskirch, Olivier Chastel. figshare (<http://dx.doi.org/10.6084/m9.figshare.947689>).

## References

1. Tan SW, Meiller JC, Mahaffey KR. 2009 The endocrine effects of mercury in humans and wildlife. *Crit. Rev. Toxicol.* **39**, 228–269. (doi:10.1080/10408440802233259)
2. Frederick P, Jayasena N. 2010 Altered pairing behaviour and reproductive success in white ibises exposed to environmentally relevant concentrations of methylmercury. *Proc. R. Soc. B* **278**, 1851–1857. (doi:10.1098/rspb.2010.2189)
3. Tartu S *et al.* 2013 To breed or not to breed: endocrine response to mercury contamination by an arctic seabird. *Biol. Lett.* **9**, 20130317. (doi:10.1098/rsbl.2013.0317)
4. Larison JR, Likens GE, Fitzpatrick JW, Crock JG. 2000 Cadmium toxicity among wildlife in the Colorado Rocky Mountains. *Nature* **406**, 181–183. (doi:10.1038/35018068)
5. Barron MG, Galbraith H, Beltman D. 1995 Comparative reproductive and developmental toxicology of PCBs in birds. *Comp. Biochem. Physiol.* **112**, 1–14. (doi:10.1016/0742-8413(95)00074-7)
6. Vos JG, Dybing E, Greim HA, Ladefoged O, Lambré C, Tarazona JV, Brandt I, Vethaak AD. 2000 Health effects of endocrine-disrupting chemicals on wildlife, with special reference to the European situation. *Crit. Rev. Toxicol.* **30**, 71–133. (doi:10.1080/10408440091159176)
7. Bustnes JO, Erikstad KE, Skaare JU, Bakken V, Mehlum F. 2003 Ecological effects of organochlorine pollutants in the Arctic: a study of the glaucous gull. *Ecol. Appl.* **13**, 504–515. (doi:10.1890/1051-0761(2003)013[0504:EEOPI]2.0.CO;2)
8. Wayland M, Drake KL, Alisauskas RT, Kellett DK, Traylor J, Swoboda C, Mehl K. 2008 Survival rates and blood metal concentrations in two species of free-ranging North American sea ducks. *Environ. Toxicol. Chem.* **27**, 698–704. (doi:10.1897/07-321.1)
9. Hallinger KK, Cornell KL, Brasso RL, Cristol DA. 2011 Mercury exposure and survival in free-living tree swallows (*Tachycineta bicolor*). *Ecotoxicology* **20**, 39–46. (doi:10.1007/s10646-010-0554-4)
10. Goutte A, Bustamante P, Barbraud C, Delord K, Weimerskirch H, Chastel O. 2014 Demographic responses to mercury exposure in two closely-related Antarctic top predators. *Ecology* **95**, 1075–1086. (doi:10.1890/13-1229.1)
11. Lebreton J-D, Pradel R. 2002 Multistate recapture models: modelling incomplete individual histories. *J. Appl. Stat.* **29**, 353–369. (doi:10.1080/02664760120108638)
12. Erikstad KE, Sandvik H, Reiertsen TK, Bustnes JO, Strøm H. 2013 Persistent organic pollution in a high-Arctic top predator: sex-dependent thresholds in adult survival. *Proc. R. Soc. B* **280**, 20131483. (doi:10.1098/rspb.2013.1483)
13. Caswell H. 2001 *Matrix population models: constructions, analysis and interpretation*, 2nd edn. Sunderland, MA: Sinauer Associates.
14. Finkelstein M, Keitt BS, Croll DA, Tershy B, Jarman WM, Rodriguez-Pastor S, Anderson DJ, Sievert PR, Smith DR. 2006 Albatross species demonstrate regional differences in North Pacific marine contamination. *Ecol. Appl.* **16**, 678–686. (doi:10.1890/1051-0761(2006)016[0678:ASDRD]2.0.CO;2)
15. Anderson ORJ, Phillips RA, Shore RF, McGill RAR, McDonald RA, Bearhop S. 2010 Element patterns in albatrosses and petrels: influence of trophic position, foraging range and prey type. *Environ. Pollut.* **158**, 98–107. (doi:10.1016/j.envpol.2009.07.040)
16. Tavares S, Xavier JC, Phillips RA, Pereira ME, Pardo MA. 2013 Influence of age, sex and breeding status on mercury accumulation patterns in the wandering albatross *Diomedea exulans*. *Environ. Pollut.* **181**, 315–320. (doi:10.1016/j.envpol.2013.06.032)
17. IUCN (2009). 2009 *IUCN Red List of threatened species*. See <http://www.iucnredlist.org>.
18. Delord K, Besson D, Barbraud C, Weimerskirch H. 2008 Population trends in a community of large Procellariiforms of Indian Ocean: potential effects of environment and fisheries interactions. *Biol.*

- Conserv.* **141**, 1840–1856. (doi:10.1016/j.biocon.2008.05.001)
19. Barbraud C, Rolland V, Jenouvrier S, Nevoux M, Delord K, Weimerskirch H. 2012 Effects of climate change and fisheries bycatch on Southern Ocean seabirds: a review. *Mar. Ecol. Prog. Ser.* **454**, 285–307. (doi:10.3354/meps09616)
  20. Barbraud C, Weimerskirch H. 2012 Estimating survival and reproduction in a quasi-biennially breeding seabird with uncertain and unobservable states. *J. Ornithol.* **152**, 605–615. (doi:10.1007/s10336-011-0686-1)
  21. Weimerskirch H, Brothers N, Jouventin P. 1997 Population dynamics of wandering albatross *Diomedea exulans* and Amsterdam albatross *D. amsterdamensis* in the Indian Ocean and their relationships with long-line fisheries: conservation implications. *Biol. Conserv.* **79**, 257–270. (doi:10.1016/S0006-3207(96)00084-5)
  22. R Core Team., and 2012 *R: a language and environment for statistical computing*. Vienna, Austria: R Foundation for Statistical Computing. See <http://www.R-project.org/>.
  23. Pardo D, Weimerskirch H, Barbraud C. 2013 When celibacy matters: incorporating non-breeders improves demographic parameter estimates. *PLoS ONE* **8**, e60389. (doi:10.1371/journal.pone.0060389)
  24. Pardo D, Weimerskirch H, Barbraud C. 2013 Females better face senescence in the wandering albatross. *Oecologia* **173**, 1283–1294. (doi:10.1007/s00442-013-2704-x)
  25. Pradel R. 2005 Multievent: an extension of multistate capture–recapture models to uncertain states. *Biometrics* **61**, 442–447. (doi:10.1111/j.1541-0420.2005.00318.x)
  26. Choquet R, Rouan L, Pradel R. 2009 Program E-SURGE: a software application for fitting multievent models. In *Modeling demographic processes in marked populations* (eds DL Thomson, EG Cooch, MJ Conroy), pp. 845–865. New York, NY: Springer.
  27. Hunter CM, Caswell H. 2009 Rank and redundancy of multistate mark-recapture models for seabird populations with unobservable states. In *Modeling demographic processes in marked populations* (eds DL Thomson, EG Cooch, MJ Conroy), pp. 797–825. New York, NY: Springer.
  28. Burnham KP, Anderson DR. 2002 *Model selection and multimodel inference: a practical information-theoretic approach*. New York, NY: Springer.
  29. Grosbois V, Gimenez O, Gaillard J-M, Pradel R, Barbraud C, Clobert J, Møller AP, Weimerskirch H. 2008 Assessing the impact of climate variation on survival in vertebrate populations. *Biol. Rev.* **83**, 357–399. (doi:10.1111/j.1469-185X.2008.00047.x)
  30. Choquet R, Lebreton J-D, Gimenez O, Reboulet AM, Pradel R. 2009 U-CARE: utilities for performing goodness of fit tests and manipulating capture–recapture data. *Ecography* **32**, 1071–1074. (doi:10.1111/j.1600-0587.2009.05968.x)
  31. Barbraud C, Tuck GN, Thomson R, Delord K, Weimerskirch H. 2013 Fisheries bycatch as an inadvertent human-induced evolutionary mechanism. *PLoS ONE* **8**, e60353. (doi:10.1371/journal.pone.0060353)
  32. Morris WF, Doak DF. 2002 *Quantitative conservation biology: the theory and practice of population viability analysis*. Sunderland, MA: Sinauer Associates.
  33. Stubbén C, Milligan B. 2007 Estimating and analyzing demographic models using the popbio package in R. *J. Stat. Softw.* **22**, 1–23. See <http://www.jstatsoft.org/v22/i11/paper>.
  34. Seber GAF. 1982 *The estimation of animal abundance and related parameters*. New York, NY: MacMillan.
  35. Catry P, Dias MP, Anthony Phillips R, Granadeiro J. 2013 Carry-over effects from breeding modulate the annual cycle of a long-distance migrant: an experimental demonstration. *Ecology* **94**, 1230–1235. (doi:10.1890/12-2177.1)
  36. Kenow KP, Meyer MW, Rossmann R, Gendron-Fitzpatrick A, Gray BR. 2011 Effects of injected methylmercury on the hatching of common loon (*Gavia immer*) eggs. *Ecotoxicology* **20**, 1684–1693. (doi:10.1007/s10646-011-0743-9)
  37. Verreault J, Verboven N, Gabrielsen GW, Letcher RJ, Chastel O. 2008 Changes in prolactin in a highly organohalogen contaminated Arctic top predator seabird, the glaucous gull. *Gen. Comp. Endocrinol.* **156**, 569–576. (doi:10.1016/j.ygcen.2008.02.013)
  38. Lecomte VJ *et al.* 2010 Patterns of aging in the long-lived wandering albatross. *Proc. Natl Acad. Sci. USA* **107**, 6370–6375. (doi:10.1073/pnas.0911181107)
  39. Noyes PD, McElwee MK, Miller HD, Clark BW, Van Tiem LA, Walcott KC, Erwin KN, Levin ED. 2009 The toxicology of climate change: environmental contaminants in a warming world. *Environ. Int.* **35**, 971–986. (doi:10.1016/j.envint.2009.02.006)
  40. Stern GA *et al.* 2012 How does climate change influence arctic mercury? *Sci. Total Environ.* **414**, 22–42. (doi:10.1016/j.scitotenv.2011.10.039)
  41. Cossa D. 2013 Marine biogeochemistry: methylmercury manufacture. *Nat. Geosci.* **6**, 810–811. (doi:10.1038/ngeo1967)





## Survival rate and breeding outputs in a high Arctic seabird exposed to legacy persistent organic pollutants and mercury



Aurélie Goutte <sup>a, b, \*</sup>, Christophe Barbraud <sup>b</sup>, Dorte Herzke <sup>c</sup>, Paco Bustamante <sup>d</sup>, Frédéric Angelier <sup>b</sup>, Sabrina Tartu <sup>b</sup>, Céline Clément-Chastel <sup>b</sup>, Børge Moe <sup>e</sup>, Claus Bech <sup>g</sup>, Geir W. Gabrielsen <sup>f</sup>, Jan Ove Bustnes <sup>e</sup>, Olivier Chastel <sup>b</sup>

<sup>a</sup> École Pratique des Hautes Études (EPHE), SPL, UPMC Univ Paris 06, UMR 7619, METIS, F-75005 Paris, France

<sup>b</sup> Centre d'Études Biologiques de Chizé, UMR 7372 CNRS-Université de La Rochelle, BP 14, 79360 Villiers-en-Bois, France

<sup>c</sup> NILU – Norwegian Institute for Air Research, FRAM, High North Research Centre on Climate and the Environment, N-9296 Tromsø, Norway

<sup>d</sup> Littoral Environnement et Sociétés (LIENSs), UMR 7266 CNRS-Université de La Rochelle, 2 rue Olympe de Gouges, 17000 La Rochelle, France

<sup>e</sup> Norwegian Institute for Nature Research, FRAM, High North Research Centre on Climate and the Environment, N-9296 Tromsø, Norway

<sup>f</sup> Norwegian Polar Research Institute, FRAM Centre High North Research on Climate and the Environment, N-9296 Tromsø, Norway

<sup>g</sup> Department of Biology, Norwegian University of Science and Technology, NO-7491 Trondheim, Norway

### ARTICLE INFO

#### Article history:

Received 4 November 2014

Received in revised form

23 January 2015

Accepted 25 January 2015

Available online

#### Keywords:

Heavy metals

Kittiwake

Population

Pesticides

PCBs

### ABSTRACT

Chronic exposure to pollutants may represent a threat for wildlife. We tested whether adult survival rate, breeding probability and breeding success the year of sampling and the following year were affected by blood levels of mercury or persistent organic pollutants in Svalbard black-legged kittiwake *Rissa tridactyla*, by using capture–mark–recapture models over a five-year period. Survival rate was negatively linked to HCB levels in females, to chlordane mixture and oxychlordane, tended to decrease with increasing PCBs or DDE levels, but was unrelated to mercury. Breeding probability decreased with increasing mercury levels during the sampling year and with increasing CHL or HCB levels during the following year, especially in males observed as breeders. Surprisingly, the probability of raising two chicks increased with increasing HCB levels. Although levels of these legacy pollutants are expected to decline, they represent a potential threat for adult survival rate and breeding probability, possibly affecting kittiwake population dynamics.

© 2015 Elsevier Ltd. All rights reserved.

## 1. Introduction

Contaminants, such as mercury (Hg) and persistent organic pollutants (hereafter POPs) may represent a threat for wildlife, because of their detrimental effects on developmental, neurological, physiological, endocrine and immune functions (Barron et al., 1995; Bustnes et al., 2003a; Tan et al., 2009; Letcher et al., 2010). Despite a growing environmental concern during the last decades, the demographic consequences of pollution remain poorly evaluated in free-living vertebrates. Only a few long-term monitoring studies have addressed the consequences of environmental pollutants on survival rate and long-term reproductive outputs. Hg or POP levels were negatively related to long-term breeding

probability and success in the wandering albatross *Diomedea exulans* and in two *Catharacta skua* species (Goutte et al., 2014a,b). Apparent survival rate was lower in glaucous gulls *Larus hyperboreus*, bearing the highest levels of oxychlordane, a metabolite of the chlordane mixture, which is regarded as one of the most toxic POPs (Erikstad et al., 2013). However, adult survival rate was not related to POPs or Hg in tree swallows (*Tachycineta bicolor*), king eiders (*Somateria spectabilis*), white-winged scoters (*Melanitta fusca*), wandering albatrosses and two *Catharacta skua* species (Wayland et al., 2008; Hallinger et al., 2011; Goutte et al., 2014a,b).

Some seabird species appear as ideal models for assessing the demographic consequences of environmental pollution. Firstly, individual detection probabilities of seabirds at breeding colonies are generally high because of high overall site fidelity (e.g. Gauthier et al., 2012). Secondly, large sample sizes and accurate measures of breeding outputs are relatively easy to obtain in seabird's colonies. Thirdly, these long-lived top predators are particularly exposed to contaminants, because of bioaccumulation process and

\* Corresponding author. Centre d'Études Biologiques de Chizé, UMR 7372 CNRS-Université de La Rochelle, BP 14, 79360 Villiers-en-Bois, France.

E-mail address: [aurelie.goutte@ephe.sorbonne.fr](mailto:aurelie.goutte@ephe.sorbonne.fr) (A. Goutte).

biomagnification along the trophic web (Rowe, 2008; Letcher et al., 2010).

The present study focusses on black-legged kittiwakes *Rissa tridactyla* breeding in Svalbard, a Norwegian archipelago in the north-western part of the Barents Sea. The Norwegian Arctic is recognized as a final sink for organic and metallic pollutants, which are transported by atmospheric and oceanic currents and by large rivers (Gabrielsen and Henriksen, 2001). Previous studies in this population of Svalbard kittiwakes have reported deleterious effects of Hg and POPs on endocrine mechanisms (Nordstad et al., 2012; Tartu et al., 2013, 2014). The estimated number of breeding pairs in the Svalbard archipelago is 270 000 in 215 colonies (Strøm, 2006). The status of black-legged kittiwakes is near threatened, with a pronounced population decline from 1995 to 2002 and a slight increase from 2002 to 2012 (Barrett et al., 2012). This study aims at detecting whether breeding probability the year of sampling and demographic traits the following year (apparent adult survival rate, breeding probability, probability of successfully raising at least one chick and probability of successfully raising two chicks) were correlated with individual blood levels of Hg or POPs. According to the few available long-term studies on polar seabird species (Erikstad et al., 2013; Goutte et al., 2014a,b), we predicted deleterious effects of Hg or POPs on breeding probability and breeding success during the year of sampling and during the following year and deleterious effects of the chlordane mixture and metabolites on survival rate in black legged kittiwakes.

## 2. Materials and methods

### 2.1. Study area and birds

Our study was conducted in a colony of black legged kittiwakes at Kongsfjorden, Svalbard (78°54'N, 12°13'E), seven kilometers southeast of Ny-Ålesund, Norway. Kittiwakes are colonial seabirds that breed on cliffs throughout the northern parts of the Pacific and Atlantic, including the Barents Sea region up to the Svalbard Archipelago (Anker-Nilssen et al., 2000). Kittiwakes were studied in one plot of around 150 pairs breeding on cliff ledges at heights of 5–10 m. Male and female kittiwakes were sampled once, between 2007 and 2010 years, during the pre-laying stage (arrival, nest building, courtship and mating period) from 23rd of April to 16th of

June. Table 1 summarizes sampling information: a total of 105 kittiwakes were sampled for measurement of Hg and 138 kittiwakes for POPs. We chose to focus our study on the pre-laying period, because sampling kittiwakes during the incubating or chick-rearing period would have biased our demographic study towards good-quality birds (breeders) and would have missed possible effects in non-breeders.

### 2.2. Capture and blood sampling

Male and female kittiwakes were caught on the nests with a noose at the end of a 5 m fishing rod. Blood samples were collected from the alar vein with a 2 ml heparinized syringe and a 23-gauge needle. Kittiwakes were individually marked with metal rings and PVC plastic bands engraved with a three-digit code and fixed to the bird's tarsus for identification from a distance without perturbation.

### 2.3. Laboratory analyses

Blood samples were centrifuged. Plasma and red blood cells were separated and stored at  $-20\text{ }^{\circ}\text{C}$ . Molecular sexing was performed on red blood cells as detailed in Weimerskirch et al. (2005). Total Hg was measured at the laboratory Littoral Environnement et Sociétés (LIENSs) from lyophilized red blood cells with an Advanced Mercury Analyzer spectrophotometer (Altec AMA 254). At least two aliquots ranging from 5 to 10 mg dry weight were analyzed for each individual until having a relative standard deviation  $< 5\%$ . As described by Bustamante et al. (2006), accuracy was checked using a certified reference material (CRM, Tort-2 Lobster Hepatopancreas, NRC, Canada; certified Hg concentration:  $0.27 \pm 0.06\text{ }\mu\text{g g}^{-1}$  dry mass; with recoveries of 98–102%). Mass of CRM was adjusted to represent the same amount of Hg introduced in the AMA compared to that in blood samples. Blanks were analyzed at the beginning of each set of samples and the detection limit of the method was  $0.005\text{ }\mu\text{g g}^{-1}$  dry mass. Mean values of replicates were used in statistical analyses.

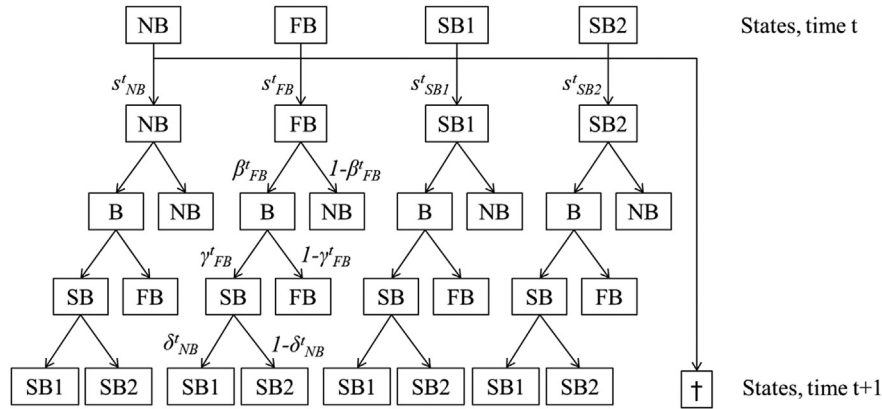
POPs were analyzed from whole blood samples at the Norwegian Institute for Air Research (NILU) in Tromsø. The following compounds were analyzed: polychlorinated biphenyl (CB, -99, -118, -138, -153, -180, -183 and -187) hereafter referred as  $\sum$  PCBs, p,p'-DDE (p,p'-dichlorodiphenyldichloroethylene), HCB (hexachlorobenzene), and the chlordane mixture (trans-chlordane, trans-, cis-nonachlor) and metabolites (oxy-chlordane), hereafter referred as CHL. To a blood sample of 0.5–1.5 ml, an internal standard solution was added (13C-labeled compounds from Cambridge Isotope Laboratories: Woburn, MA, USA). The sample was extracted twice with 6 ml of *n*-hexane, after denaturation with ethanol and a saturated solution of ammonium sulfate in water. Matrix removal on florisil columns, separation on an Agilent Technology 7890 GC and detection on an Agilent Technology 5975C MSD were performed as described by Herzke et al. (2009). The limit for detection was threefold the signal-to-noise ratio, and for the compounds investigated the limit ranged from 0.4 to 122  $\text{pg.g}^{-1}$  wet weights (ww). For quality assurance, blanks (clean and empty glass tubes treated like a sample) were run for every 10 samples similar to standard reference material (1589 a human serum from NIST). The accuracy of the method was within the 70 and 108% range.

### 2.4. Life history traits

From 2007 to 2012, individuals were individually identified, through PVC plastic bands reading. Using a mirror at the end of an 8 m fishing rod, we checked the whole plot (about 120 nests) every

**Table 1**  
Levels (mean  $\pm$  SD) of  $\sum$  PCBs (CB, -99, -118, -138, -153, -180, -183 and -187), p,p'-DDE, HCB, CHL (transchlordane, trans-, cis-nonachlor, oxychlordane) and Hg (mercury) in blood of male and female kittiwakes sampled during the pre-laying period.

	Year	Males	Females
$\sum$ PCBs ( $\text{pg.g}^{-1}$ ww)	2007	14,700 $\pm$ 9630	12,640 $\pm$ 6421
	2008	14,896 $\pm$ 11,029	13,399 $\pm$ 9197
	2009	9282 $\pm$ 7915	10,375 $\pm$ 4705
	2010	12,786 $\pm$ 10,966	21,168 $\pm$ 14,390
DDE ( $\text{pg.g}^{-1}$ ww)	2007	3622 $\pm$ 1730	3152 $\pm$ 1422
	2008	4025 $\pm$ 2642	4189 $\pm$ 3490
	2009	2618 $\pm$ 1660	2184 $\pm$ 890
	2010	3249 $\pm$ 2739	4725 $\pm$ 3584
HCB ( $\text{pg.g}^{-1}$ ww)	2007	1616 $\pm$ 966	1600 $\pm$ 407
	2008	1616 $\pm$ 444	1691 $\pm$ 697
	2009	2416 $\pm$ 1493	2699 $\pm$ 451
	2010	2670 $\pm$ 877	3487 $\pm$ 1288
CHL ( $\text{pg.g}^{-1}$ ww)	2007	1352 $\pm$ 782	1329 $\pm$ 508
	2008	1237 $\pm$ 510	1275 $\pm$ 765
	2009	1344 $\pm$ 1155	1353 $\pm$ 403
	2010	1766 $\pm$ 650	2482 $\pm$ 1602
Hg ( $\mu\text{g.g}^{-1}$ dw)	2008	2.06 $\pm$ 0.44	1.97 $\pm$ 0.44
	2009	2.33 $\pm$ 0.55	2.01 $\pm$ 0.41



**Fig. 1.** A multinomial tree diagram describing the probability structure for multistate observations. Solid boxes indicate the states alive in state NB (non-breeder), FB (failed breeder), SB1 (successful breeder with one chick), SB2 (successful breeder with two chicks) dead. State transition probabilities were decomposed in a four-step process. The state transitions ( $S, \beta, \gamma, \delta$ ) are defined in Table 2 and states in the Methods section.

**Table 2**  
Definition of parameters used in the multistate mark–recapture model.

Parameter	Definition
$S_s^t$	Probability that an individual in state $s$ at time $t$ survives to time $t + 1$ and does not permanently emigrate from the study area
$\beta_s^t$	Probability that an individual in state $s$ at time $t$ breeds at time $t + 1$ given that it survives to $t + 1$
$\gamma_s^t$	Probability that an individual in state $s$ at time $t$ breeds successfully at time $t + 1$ given that it survives to and breeds at time $t + 1$
$\delta_s^t$	Probability that an individual in state $s$ at time $t$ raises successfully two chicks at time $t + 1$ given that it survives to and breeds successfully at time $t + 1$
$p_s^t$	Probability that an individual in state $s$ at time $t$ is encountered at time $t + 1$

two days to monitor breeding status (at least one egg is laid or no egg laid). Then, we checked the nest content every 2 or 3 days to monitor the number of chicks that reached at least 12 days of age per nest.

2.5. Statistical analyses

We used R software (R Development Core Team, 2012) and generalized linear models (GLMs) with normal distribution and a link function to test whether log-transformed Hg,  $\Sigma$  PCBs, DDE, HCB or CHL levels were linked to sex, year and the interaction sex  $\times$  year. GLMs with binomial error distribution and a logit link function were then used to test whether breeding probability (will breed or will skip) the year of sampling was linked to pre-laying Hg,  $\Sigma$  PCBs, DDE, HCB or CHL levels.

2.6. Estimating the effect of Hg and POPs on demographic parameters

The effects of Hg and POPs concentrations on the demographic parameters were evaluated through the capture–recapture data of sampled kittiwakes. A MSMR (Multi-State Mark Recapture, Lebreton and Pradel, 2002) model was constructed by distinguishing five states: non-breeder (NB, defined as an individual that was not observed with an egg), failed breeder (FB, defined as an individual that was observed with one or two eggs, or one or two chicks but that failed to raise a chick), successful breeder with one chick (SB1, defined as an individual that raised one chick), successful breeder with two chicks (SB2, defined as an individual that raised two chicks), and dead. The state dead ( $\dagger$ ) was an absorbing

state representing death or permanent emigration from the study area. Kittiwakes that were ringed and observed the years before sampling for Hg or POPs were considered as non-observed, in order to test the effect of contaminants (at year  $t$ ) on future (year  $t + 1$ ) survival and breeding performances. Models were parameterized in terms of the probability of survival ( $S$ ), the probability of breeding ( $\beta$ ), the probability of breeding successfully ( $\gamma$ ), the probability of successfully raising two chicks ( $\delta$ ), and the detection probability ( $p$ ). Transition probabilities between states were thus modeled with a four-step procedure where  $S, \beta, \gamma$  and  $\delta$  were considered as four successive steps in transition matrices. Fig. 1 presents a multinomial tree diagram describing the probability structure for multistate observations, and parameters of the model are defined in Table 2. We chose an MSMR approach since this allows taking into account the probability of detecting individuals given their return to the study sites. It also allows taking into account the previous breeding state of individuals which might be important to obtain unbiased estimates of demographic parameters (Lebreton and Pradel, 2002).

Several constraints were made to ensure that the parameters of the model were estimable. The state “dead” being explicitly included in the model but being never encountered, transition probabilities from the state dead were fixed to 0 and capture probability was fixed to 0 (Pradel, 2005; Choquet et al., 2009a). Because our capture–recapture analyses relied on a limited number of individual capture histories, parameters  $S, \beta, \gamma, \delta$  and  $p$  were constrained to be constant over time but state and sex dependent. With this constraint the initial model was full-rank. Note that we ran a model where all demographic parameters were time, sex and state dependent but this model was highly rank deficient.

This MSMR model was parameterized by the survival–transition probabilities matrix:

$$\begin{matrix}
 & \text{NB} & \text{FB} & \text{SB1} & \text{SB2} & \dagger \\
 \text{NB} & \left[ \begin{matrix} S(1 - \beta) & S\beta(1 - \gamma) & S\beta\gamma(1 - \delta) & S\beta\gamma\delta & * \\ S(1 - \beta) & S\beta(1 - \gamma) & S\beta\gamma(1 - \delta) & S\beta\gamma\delta & * \\ S(1 - \beta) & S\beta(1 - \gamma) & S\beta\gamma(1 - \delta) & S\beta\gamma\delta & * \\ S(1 - \beta) & S\beta(1 - \gamma) & S\beta\gamma(1 - \delta) & S\beta\gamma\delta & * \\ - & - & - & - & * \end{matrix} \right. \\
 \text{FB} & \\
 \text{SB1} & \\
 \text{SB2} & \\
 \dagger & 
 \end{matrix}$$

Because we were interested to test for sex-specific effects of Hg and POPs on demographic parameters we started from an initial model including an effect of sex ( $g$ ) on each parameter. Model selection was first performed on detection probability by testing state-dependency (difference between all states, between breeders

**Table 3**  
Estimation of parameters (mean and CI) calculated from the best model (model 16, Appendix 3) for breeders and non-breeders.

	Non-breeders	Breeders
S: apparent survival rate (%)	85 [82; 88]	85 [82; 88]
$\beta$ : Breeding probability (%)	47 [41; 53]	82 [78; 86]
$\gamma$ : Breeding success (%)	75 [71; 79]	75 [71; 79]
$\delta$ : Probability of raising 2 chicks (%)	40 [35; 45]	40 [35; 45]
p: Detection probability (%)	78 [67; 85]	98 [90; 99]

and non-breeders, or no difference). We then tested for sex difference and state-dependency (difference between all states, difference between breeders and non-breeders or no difference) for S,  $\beta$ ,  $\gamma$  and  $\delta$ . We tested for an effect of Hg,  $\Sigma$  PCBs, DDE, HCB, or CHL on demographic parameters the following year to test the hypothesis that contamination levels in one breeding season may influence the survival and breeding success of an individual in the following season. We built MSMR models where each demographic parameter  $\theta$  was modeled as a function of contaminant C using a logit link function:  $\text{logit}(\theta) = a + b \times C_i$ , where  $a$  is an intercept,  $b$  is a slope and  $C_i$  is Hg or POPs concentration for individual  $i$ . The 95% confidence interval (CI) of the slope parameters  $b$  was used, as well as Akaike's Information Criterion corrected for small sample size (AICc, Burnham and Anderson, 2002) for inference. We considered an effect of contaminant as statistically supported when 0 was outside the 95% CI of the mean of the slope of the relationship (Grosbois et al., 2008). When  $b < 0$ , or  $b > 0$ , the covariate C has a negative or positive effect on the demographic parameter, respectively. We tested the goodness-of-fit (GOF) of the time dependent MSMR model using U-CARE (Choquet et al., 2009b). All models were run under program E-SU RGE 1.8.5 allowing splitting transition probabilities between states (Choquet et al., 2009a).

### 3. Results

#### 3.1. Associations between Hg or POPs and breeding probability in year of blood sampling

Table 1 summarizes the values of Hg,  $\Sigma$  PCBs, DDE, HCB and CHL in males and females. Appendix 1 gives the concentrations of each POP congener and appendix 2 presents the relationships between levels of Hg,  $\Sigma$  PCBs, DDE, HCB and CHL.

Hg levels were significantly higher in males than in females ( $F_{1,103} = 3.993$ ,  $p = 0.048$ ), but did not differ between the two sampling years (year:  $F_{1,102} = 3.339$ ,  $p = 0.071$ ; sex  $\times$  year:  $F_{1,101} = 1.102$ ,  $p = 0.296$ ). Breeding probability during the sampling year was influenced by Hg levels ( $df = 103$ ,  $\chi^2 = 12.983$ ,  $p < 0.001$ ): kittiwakes that would skip (mean  $\pm$  SD:  $2.284 \pm 0.417 \mu\text{g g}^{-1}$ ) had higher pre-laying Hg levels than kittiwakes that would breed

**Table 4**  
Modeling the effects of Hg levels and sex on demographic parameters of *Rissa tridactyla* ( $N = 105$ ). Models are arranged from lowest to highest  $\Delta\text{AICc}$ . The estimated slope and 95% confidence intervals (CI) are given for the model (Hg3) that has a lower AICc than the intercept model.

Hypothesis	<sup>a</sup> Model	Rank	Deviance	$\Delta\text{AICc}$	Slope	95% CI
Effect of Hg on $\gamma$	Hg3	12	1194.84	0	0.29	-0.84; 1.43 <sup>a</sup>
Intercept model	Hg0	10	1201.22	2.10		
Effect of Hg on $\delta$	Hg1	12	1197.40	2.56		
Effect of Hg and sex on $\gamma$	Hg4	14	1193.67	3.18		
Effect of Hg and sex on $\delta$	Hg2	14	1194.82	4.33		
Effect of Hg on S	Hg7	12	1201.11	6.28		
Effect of Hg on $\beta$	Hg5	14	1197.90	7.41		
Effect of Hg and sex on $\beta$	Hg6	18	1190.66	9.03		
Effect of Hg and sex on S	Hg8	14	1200.50	10.01		

<sup>a</sup> This effect is not supported because the 95% confidence intervals of the mean of the slope of the relationship included zero.

( $1.962 \pm 0.470 \mu\text{g g}^{-1}$ ).

Levels of  $\Sigma$  PCBs, DDE, HCB, or CHL did not differ between males and females (sex:  $p > 0.07$  for all tests; sex  $\times$  year:  $p > 0.09$  for all tests). Levels of  $\Sigma$  PCBs ( $F_{3,134} = 4.935$ ,  $p = 0.003$ ), HCB ( $F_{3,134} = 37.035$ ,  $p < 0.001$ ),  $\Sigma$  CHL ( $F_{3,134} = 12.818$ ,  $p < 0.001$ ), but not DDE ( $F_{3,134} = 2.519$ ,  $p = 0.061$ ) differed among years. Breeding probability was not influenced by levels of  $\Sigma$  PCBs, DDE, HCB, or CHL during the sampling year ( $p > 0.61$  for all tests).

#### 3.2. Associations between Hg and demographic parameters in year after blood sampling

The GOF of the MSMR model was overall not significant (males:  $\chi^2 = 48.913$ ,  $df = 69$ ,  $p = 0.968$  and females:  $\chi^2 = 47.435$ ,  $df = 71$ ,  $p = 0.986$ ). The best model according to AICc (model 16, Appendix 3) indicated that breeders in the previous year had higher breeding probabilities and detection probabilities than non-breeders in the previous year. However birds captured as breeders or non-breeders did not differ in survival rate, probabilities of successfully raising one or two chicks (Appendix 3 and Table 3). Demographic parameters did not differ between males and females (Appendix 3 and Table 3).

Model selection and slope estimates suggested no effect of Hg on demographic parameters. Model Hg3 had a  $\Delta\text{AICc}$  lower than 2 compared to the null model, but the effect of Hg on breeding probability the following year was not supported, since the 95% CI of the slope parameter included 0 (Table 4).

#### 3.3. Associations between POPs and demographic parameters in year after blood sampling

Model selection was based on  $\Delta\text{AICc}$  higher than 2 compared to the intercept model and the 95% CI of the slope of the relationship that did not include zero. Hence, in spite of good AICc, several models suggesting an effect of  $\Sigma$  PCBs, DDE, HCB or CHL on demographic parameters were not retained. Only six models met these requirements (Table 5). Models HCB5 and HCB6 suggested a negative effect of HCB on breeding probability the following year for individuals and especially males observed as breeders (Figs. 2A, B). Model CHL6 suggested a negative effect of CHL on breeding probability the following year for males observed as breeders (Fig. 2C). Model HCB1 suggested a positive effect of HCB on the probability of successfully raising two chicks the following year (Fig. 3). Model HCB8 suggested a negative effect of HCB on survival rate of females (Fig. 4A). Model CHL7 suggested a negative effect of CHL on survival rate (Fig. 4B). We could also notice a tendency towards a negative effect between survival rates and levels of  $\Sigma$  PCBs (model PCB7,  $\Delta\text{AICc} = 1.24$ , mean slope and 95% CI =  $-0.44$  [ $-0.82$ ;  $-0.03$ ]), DDE (Model: DDE7,  $\Delta\text{AICc} = 0.88$ , slope =  $-0.42$  [ $-0.82$ ;  $-0.01$ ]), HCB for males and females (Model HCB7,  $\Delta\text{AICc} = 1.73$ , slope =  $-0.47$  [ $-0.88$ ;  $-0.06$ ]), or CHL for females only (Model CHL8,  $\Delta\text{AICc} = 1.50$ , slope =  $-0.73$  [ $-1.29$ ;  $-0.17$ ]).

### 4. Discussion

Using a long-term data set and MSMR models, this study explores the demographic effects of Hg or families of legacy POPs (7 PCB congeners, p-p' DDE, HCB, and the chlordane mixture and metabolites (trans-chlordane, trans-, cis-nonachlor, oxychlordane)) in a free-living Arctic seabird species. It should be noticed that differences in toxicity among POP congeners were not taken into account in these analyses, because toxic equivalent factors (TEFs) were only available for PCB-105 and PCB-118. Moreover interactions among families of pollutants may occur within an organism to induce synergistic effects, but they are difficult to demonstrate within a field study.



**Table 5**

Modeling the effects of  $\Sigma$  PCBs, p,p'-DDE, HCB and CHL levels and sex on demographic parameters of *Rissa tridactyla* (N = 138). Models are arranged from lowest to highest  $\Delta$ AICc. The estimated slopes and 95% confidence intervals (CI) are given for models that have a lower AICc than the intercept model (NB: non-breeders, B: breeders).

Hypothesis	# Model	Rank	Deviance	$\Delta$ AICc	Slope	95% CI	
Effect of $\Sigma$ PCBs on $\beta$	PCB5	14	1351.03	0	NB: -0.62 B: -0.14	-1.48; 0.23 -0.82; 0.53	# #
Effect of $\Sigma$ PCBs and sex on $\beta$	PCB6	18	1344.22	1.90	Male NB: -0.36 Male B: -1.10 Female NB: -0.87 Female B: 0.83	-1.50; 0.78 -2.43; 0.22 -2.21; 0.46 -0.38; 2.06	# # # #
Effect of $\Sigma$ PCBs on S	PCB7	12	1366.07	10.75	-0.44	-0.82; -0.03	###
Effect of $\Sigma$ PCBs on $\delta$	PCB1	12	1367.05	11.74	0.47	-0.36; 1.31	###
Intercept model	PCB0	10	1371.55	11.99			
Effect of $\Sigma$ PCBs and sex on $\delta$	PCB2	14	1364.06	13.03			
Effect of $\Sigma$ PCBs and sex on S	PCB8	14	1364.33	13.30			
Effect of $\Sigma$ PCBs on $\gamma$	PCB3	12	1368.92	13.61			
Effect of $\Sigma$ PCBs and sex on $\gamma$	PCB4	14	1368.69	17.66			
Effect of DDE and sex on $\beta$	DDE6	18	1339.67	0	Male NB: -0.26 Male B: -1.17 Female NB: -1.82 Female B: 0.69	-1.78; 1.26 -2.44; 0.10 -3.79; 0.14 -0.64; 2.01	# # # #
Effect of DDE on $\beta$	DDE5	14	1349.00	0.61	NB: -1.00 B: -0.14	-2.08; 0.08 -0.70; 0.42	# #
Effect of DDE on S	DDE7	12	1366.43	13.76	-0.42	-0.82; -0.01	##
Intercept model	DDE0	10	1371.55	14.64			
Effect of DDE on $\delta$	DDE1	12	1367.91	15.24			
Effect of DDE on $\gamma$	DDE3	12	1368.85	16.18			
Effect of DDE and sex on S	DDE8	14	1365.94	17.56			
Effect of DDE and sex on $\delta$	DDE2	14	1366.73	18.35			
Effect of DDE and sex on $\gamma$	DDE4	14	1368.19	19.80			
Effect of HCB and sex on $\beta$	HCB6	18	1339.36	0	Male NB: -1.50 Male B: -1.86 Female NB: -0.02 Female B: 0.08	-4.24; 1.25 -3.38; -0.34 -0.87; 0.92 -0.74; 0.90	# # # #
Effect of HCB on $\beta$	HCB5	14	1349.44	1.37	NB: -0.28 B: -0.53	-1.06; 0.50 -1.04; -0.01	# #
Effect of HCB and sex on $\delta$	HCB2	14	1357.05	8.98	NB: -0.18 B: -2.27	-0.57; 0.21 -0.15; 4.69	# #
Effect of HCB on $\delta$	HCB1	12	1362.22	9.86	0.94	0.10; 1.79	
Effect of HCB and sex on S	HCB8	14	1360.54	12.47	Male: 0.41 Female: -0.82	-0.75; 1.57 -1.39; -0.25	# #
Effect of HCB on S	HCB7	12	1365.58	13.22	-0.47	-0.88; -0.06	##
Intercept model	HCB0	10	1371.55	14.95			
Effect of HCB on $\gamma$	HCB3	12	1369.19	16.83			
Effect of HCB and sex on $\gamma$	HCB4	14	1367.08	19.01			
Effect of CHL and sex on $\beta$	CHL6	18	1338.80	0	Male NB: -0.59 Male B: -2.64 Female NB: -0.73 Female B: -0.07	-2.95; 1.77 -5.09; -0.18 -1.98; 0.51 -0.85; 0.70	# # # #
Effect of CHL on $\beta$	CHL5	14	1347.61	0.10	NB: -0.73 B: -0.59	-1.81; 0.34 -1.20; 0.01	# #
Effect of CHL on S	CHL7	12	1363.00	11.20	-0.57	-1.00; -0.13	
Effect of CHL and sex on $\delta$	CHL2	14	1359.59	12.08	NB: 1.46 B: 1.85	-1.23; 4.15 -0.23; 3.93	# #
Effect of CHL on $\delta$	CHL1	12	1363.83	12.03	1.05	-0.15; 2.24	#
Effect of CHL and sex on S	CHL8	14	1361.52	14.01	Male: -0.04 Female: -0.73	-1.12; 1.04 -1.29; -0.17	### ##
Intercept model	CHL0	10	1371.55	15.51			
Effect of CHL on $\gamma$	CHL3	12	1368.41	16.61			
Effect of CHL and sex on $\gamma$	CHL4	14	1368.38	20.87			

# This effect is not supported, because the 95% CI of the mean of the slope of the relationship included zero.

## This effect is not supported, because the model has a  $\Delta$ AICc <2 compared to the intercept model.

### This effect is not supported, because the 95% CI of the mean of the slope of the relationship included zero and the model has a  $\Delta$ AICc <2 compared to the intercept model.

#### 4.1. Survival and contaminants

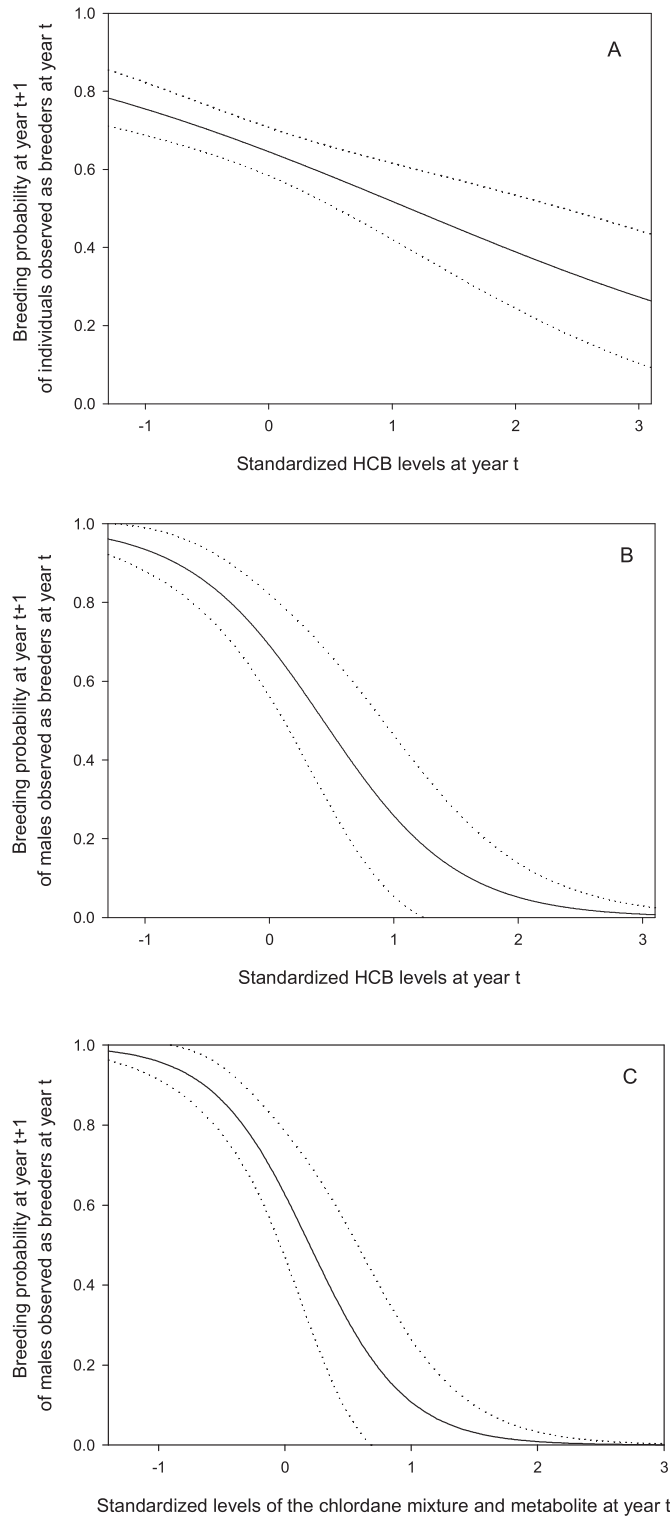
Estimated demographic parameters were similar to those previously estimated in other populations of black legged kittiwakes (Frederiksen et al., 2005). Adult survival rate in this study (85% [82–88%]) was within the range of estimated survival rates in north Atlantic populations (80–92%, Danchin and Monnat, 1992; Erikstad et al., 1995; Oro and Furness, 2002; Frederiksen et al., 2005).

The adult survival rate of kittiwakes was not jeopardized by Hg, which corroborates most of the previous studies in free-living birds

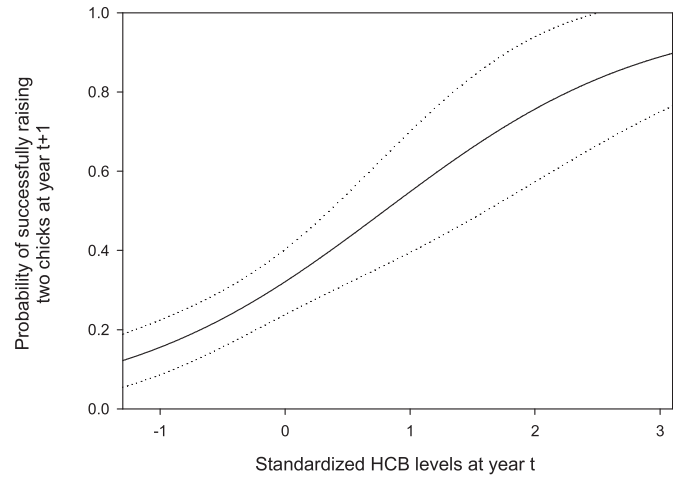
(Wayland et al., 2008; Hallinger et al., 2011; Goutte et al., 2014a,b). Apparent survival rate was negatively linked to HCB levels in females, to mixture of chlordane and oxychlordane, and tended to be negatively correlated with  $\Sigma$  PCBs or DDE levels. Only one study (Erikstad et al., 2013) highlighted a negative effect of oxychlordane on adult survival rate in the glaucous gull breeding in the Bjørnøya Island (blood levels of oxychlordane: 1.3–128.8 ng.g<sup>-1</sup> wet weight, median: 13.2 ng.g<sup>-1</sup> ww) and this effect was the most pronounced among the most contaminated females. Even if kittiwakes were more than 10-time less contaminated than glaucous gull (blood

levels of oxychlordan: 0.007–6.0 ng.g<sup>-1</sup> wet weight), this study reveals that high levels of the chlordan mixture and metabolites or HCB could negatively affect adult survival rate, and especially in female kittiwakes.

The correlation between POP levels and survival rate could be a

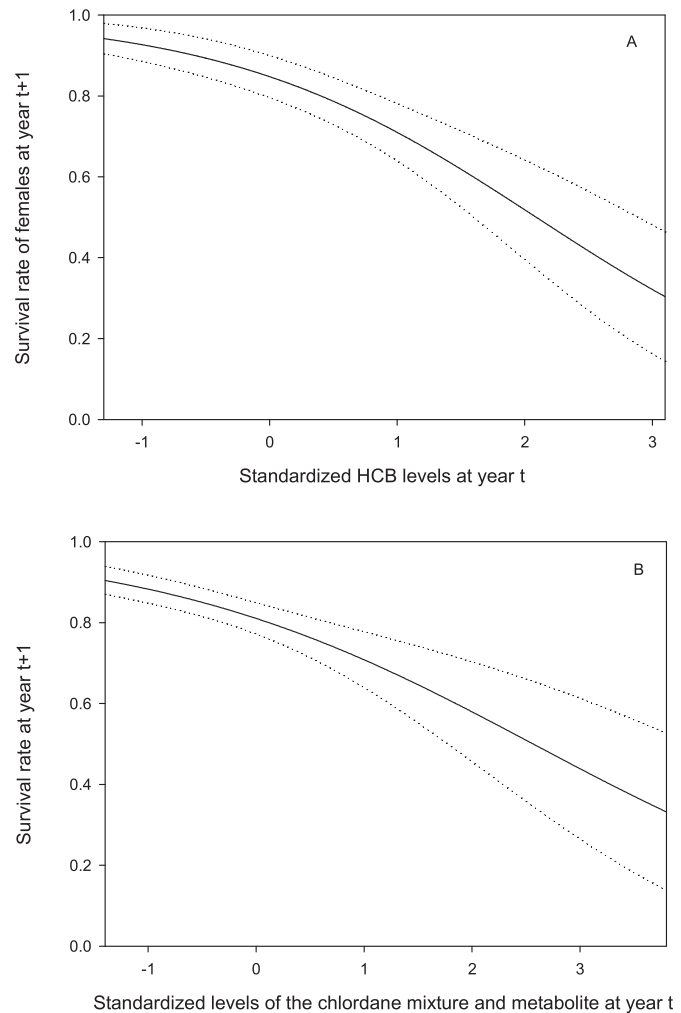


**Fig. 2.** Relationship between breeding probability at year t + 1 in black-legged kittiwakes and (A) standardized HCB levels in individuals observed as breeders at year t, (B) standardized HCB levels in males observed as breeders at year t and (C) standardized levels of the chlordan mixture and metabolites in males observed as breeders at year t. Dotted lines represent 95% CI.



**Fig. 3.** Relationship between probability of successfully raising two chicks at year t + 1 in black-legged kittiwakes and standardized HCB levels at year t.

by-product of age-dependent mechanisms, with older kittiwakes having the highest POP burden and the lowest survival probability. Age of kittiwakes was unknown in this study and we could not control for age. However, blood levels of PCB-153, p,p'-DDE, HCB,



**Fig. 4.** Relationship between survival rate at year t + 1 in black-legged kittiwakes and (A) standardized HCB levels in females at year t, (B) standardized levels of the chlordan mixture and metabolites at year t.

and oxychlordanes were unrelated to age in glaucous gulls (Bustnes et al., 2003b). Similarly, blood levels of PCBs or organochlorine pesticides (HCB, lindane, chlordane mixture, mirex, DDT and metabolites) were unrelated to age in wandering albatrosses (Carravieri et al., 2014). Therefore, it seems unlikely that age was a confounding factor in the correlation between POP levels and survival rate. In addition, as we did not monitor long-distance dispersal, our findings on apparent survival rate could also include the effects of POPs on long-term emigration of the most polluted birds.

This study suggests that HCB or the chlordane mixture and metabolites may weaken the general health of kittiwakes and may increase their vulnerability to harsh environmental pressures in the Arctic (Letcher et al., 2010). In that context, it is conceivable that the effect of POPs on survival rate is only detected during harsh environmental events. Because our sample size did not allow taking into account an effect of years, we could not have tested whether harsh environmental conditions during a specific year would exacerbate the effects of pollutants on demographic parameters the following year.

#### 4.2. Long-term fecundity and contaminants

A previous study on this population of kittiwakes has highlighted that total blood Hg load during the pre-laying period predicted the likelihood of breeding, with non-breeders having higher Hg levels than breeders, but not the timing of breeding, clutch size, and breeding success (Tartu et al., 2013). Moreover experimentally elevated Hg levels (total Hg in blood, mean  $\pm$  SD: from  $0.73 \pm 0.09$  to  $3.95 \pm 0.68$  mg.kg<sup>-1</sup> fresh weight) led to an altered pairing behavior in white ibises *Eudocimus albus* (Frederick and Jayasena, 2010). In the present study, Hg levels were higher in kittiwakes that would skip breeding than in birds that would breed, as previously shown (Tartu et al., 2013). Hg levels did not affect breeding probability and breeding success the following year, which differed from previous studies in the south polar skua *Catharacta macrorhynchos* (Hg levels in blood: mean  $\pm$  SE:  $2.15 \pm 0.17$   $\mu$ g g<sup>-1</sup> dry mass), in the brown skua *C. lonnbergi* ( $8.22 \pm 0.24$   $\mu$ g g<sup>-1</sup> dry mass) and in the wandering albatross ( $7.7 \pm 3.6$   $\mu$ g g<sup>-1</sup> dry mass) (Goutte et al., 2014a,b). However, Hg levels in these species were measured during the incubation and the chick-rearing period, while Hg levels in the present study were measured in pre-laying kittiwakes. Furthermore, breeding success was monitored on chicks that reached at least 12 days of age and did not allow testing an effect of contaminants on late developmental stage.

POPs burden did not influence the breeding probability the year of sampling, which was consistent with a previous study on the same population of kittiwakes (Tartu et al., 2014). Breeding probability the following years was reduced by high HCB levels in breeders and especially in males, or by high levels of the chlordane mixture and metabolites in male breeders. A negative correlation between POP levels and breeding probabilities the following year has been highlighted in the wandering albatross (Goutte et al., 2014b). Male breeders seemed to be the most sensitive to POPs. Energetic and time-dependent costs of reproduction have been shown to induce downstream consequences on reproductive investment during the following breeding season (carry over effect, Catry et al., 2013). One may suggest that POPs burden may intensify these carry over effects, but studies are needed to either rebut or confirm this hypothesis.

Levels of  $\sum$  PCB, DDE, HCB, and the chlordane mixture and metabolites did not influence the probability of successfully raising one chick the following year, which was consistent with a previous study on the same population of kittiwakes and during the year of sampling (Tartu et al., 2014). We detected a positive relationship

between the probability of successfully raising two chicks the following year and HCB levels, but not PCBs, DDE or the chlordane mixture. This positive relationship between HCB and breeding performance appears surprising, as contaminants are believed to induce deleterious effects on reproductive traits. Previous studies have pointed out that female kittiwakes and gulls with higher levels of organochlorine pesticides laid their eggs earlier in the season (Bustnes et al., 2008; Tartu et al., 2014). As laying early is related to high breeding success (Lack, 1968), this could explain the positive relationship between HCB and the probability of successfully raising two chicks. In another hand, this relationship may not be causal and may be enhanced by confounding factors: for instance, kittiwakes succeeding in raising two chicks may be of higher quality, rely on higher trophic level organisms and hence be more exposed to pollutant.

It appears that some families of POPs may be more prone to trigger damaging effects the following year. Specifically, high levels of HCB or the chlordane mixture and metabolites were correlated to lower survival rate and lower probability to breed the following year. These findings corroborate a previous study: despite their lower concentrations, HCB and oxychlordanes tended to be more often related to adverse effects than PCB and DDE in glaucous gull (Bustnes, 2006). Although levels of these “legacy” POPs are expected to decline, as shown in Canadian Arctic seabirds from the 1970s to the late 1990s (Braune et al., 2005), they appear to represent a potential threat for adult survival rate and thus for population dynamics.

#### Acknowledgments

The study was funded by the Institut Paul-Émile Victor (IPEV Programme 330, O Chastel), Agence Nationale de la Recherche (ANR PolarTop, O. Chastel), COPOL (G.W. Gabrielsen & J.O. Bustnes) and AVITOX (J. O. Bustnes). This study was approved by the French and Norwegian Ethic committees and by the Governor of Svalbard. The authors thank the numerous fieldworkers who helped with blood sampling and ring-reading: A. Lendvai, E. Noreen, T. Nordstad, K. Sagerup, S.A. Hanssen, C. Trouvé, and J. Welcker. At the LIENSS, the authors thank M. Brault-Favrou from the Plateforme Analyses Elementaires for her excellent technical assistance in laboratory analyses. AMA was funded by the CPER (Contrat de Projet Etat Région).

#### Appendix 1. Concentrations (mean, median and standard deviation SD, in pg.g<sup>-1</sup> ww) measured for each POP congener in 138 black-legged kittiwakes during the pre-laying period.

Congener	Mean	Median	SD
PCB-99	1069	800	869
PCB-118	1638	1313	1217
PCB-138	4104	2856	3463
PCB-153	5498	4159	3979
PCB-180	1888	1513	1832
PCB-183	537	354	591
PCB-187	932	680	867
p,p' DDE	3892	2978	2900
HCB	2418	2026	1262
Transchlordanes	322	217	346
Oxychlordanes	1002	818	786
Cisnonachlor	173	158	100
Transnonachlor	216	196	142



## Appendix 2. Relationships between Hg, $\Sigma$ PCBs, DDE, HCB, and CHL levels

$\Sigma$ PCB	DDE	HCB	CHL
DDE $F_{1,136} = 180$ , $p < 0.001$			
HCB $F_{1,136} = 63$ , $p < 0.001$	$F_{1,136} = 41$ , $p < 0.001$		
CHL $F_{1,136} = 129$ , $p < 0.001$	$F_{1,136} = 104$ , $p < 0.001$	$F_{1,136} = 201$ , $p < 0.001$	
Hg $F_{1,35} < 0.01$ $p = 0.983$	$F_{1,35} = 0.04$ $p = 0.839$	$F_{1,35} = 2.77$ $p = 0.105$	$F_{1,35} = 1.33$ $p = 0.136$

## Appendix 3. Initial model (Model1) considers sex-difference and state-difference on $S$ , $\beta$ , $\gamma$ , $\delta$ , and $p$ . A. Modelling the effect of states on $p$ . B. Modelling the effect of sex on $s$ , $\beta$ , $\gamma$ and $\delta$ , with $p$ being different between breeders and non-breeders. C. Modelling the effect of states on $s$ , $\beta$ , $\gamma$ and $\delta$ ( $\delta$ is necessarily constant).

A. Hypothesis	# Model	Rank	Deviance	$\Delta$ AICc
<b><math>p</math> differs between NB and B</b>	<b>Model2</b>	<b>31</b>	<b>3630.77</b>	<b>0</b>
$p$ is state-dependent	Model1	33	3630.23	3.73
$p$ is constant	Model3	30	3642.96	10.06
B. Hypothesis	# Model	Rank	Deviance	$\Delta$ AICc
<b>No sex difference on <math>S</math>, <math>\beta</math>, <math>\gamma</math> and <math>\delta</math></b>	<b>Model8</b>	<b>18</b>	<b>3636.86</b>	<b>0</b>
Sex difference on $S$ , $\beta$ and $\delta$	Model5	27	3632.09	14.08
Sex difference on $S$ , $\gamma$ and $\delta$	Model6	27	3632.90	14.88
Sex difference on $\beta$ , $\gamma$ and $\delta$	Model7	27	3633.21	15.19
Sex difference on $S$ , $\beta$ and $\gamma$	Model4	30	3630.77	19.11
Sex difference on $S$ , $\beta$ , $\gamma$ and $\delta$	Model2	31	3630.77	21.24
C. Hypothesis	# Model	Rank	Deviance	$\Delta$ AICc
$S$ and $\gamma$ are constant; $\beta$ is state-dependent	Model15	12	3640.14	0
<b><math>S</math> and <math>\gamma</math> are constant; <math>\beta</math> differs between NB and B</b>	<b>Model16</b>	<b>10</b>	<b>3644.82</b>	<b>0.59</b>
$S$ , $\beta$ and $\gamma$ are constant	Model17	11	3644.79	2.61
$\gamma$ is constant; $S$ and $\beta$ are state-dependent	Model10	15	3638.35	4.38
$S$ is constant; $\beta$ and $\gamma$ are state-dependent	Model14	15	3638.68	4.72
$S$ differs between NB and B; $\beta$ and $\gamma$ are state-dependent	Model13	16	3637.55	5.64
$S$ , $\beta$ and $\gamma$ are state-dependent	Model8	18	3636.86	9.10
$\beta$ differs between NB and B; $S$ and $\gamma$ are state-dependent	Model11	16	3641.59	9.69
$\gamma$ differs between NB and B; $S$ and $\beta$ are state-dependent	Model9	16	3678.02	46.12
$\beta$ is constant; $S$ and $\gamma$ are state-dependent	Model12	15	3725.68	91.71

## References

Anker-Nilssen, T., Bakken, V., Strøm, H., Golovkin, A.N., Bianki, V.V., Tatarinkova, I.P., 2000. The Status of Marine Birds Breeding in the Barents Sea Region. Norwegian Polar Institute, Tromsø, pp. 1–213.

Barrett, R.T., Anker-Nilssen, T., Bustnes, J.O., Christensen-Dalgaard, S., Descamps, S., Erikstad, K.-E., Lorentsen, S.-H., Strøm, H., Systad, G.H., 2012. Key-site Monitoring in Norway 2011. SEAPOP. Short Report 1–2012: 16 pp.

Barron, M.G., Galbraith, H., Beltman, D., 1995. Comparative reproductive and developmental toxicology of PCB in birds. *Comp. Biochem. Physiol.* 112, 1–14.

Braune, B.M., Outridge, P.M., Fisk, A.T., Muir, D.C.G., Helm, P.A., Hobbs, K., Hoekstra, P.F., Kuziy, Z.A., Kwan, M., Letcher, R.J., Lockhart, W.L., Norstrom, R.J., Stern, G.A., Stirling, I., 2005. Persistent organic pollutants and mercury in marine biota of the Canadian Arctic: an overview of spatial and temporal trends. *Sci. Total Environ.* 351, 4–56.

Burnham, K.P., Anderson, D.R., 2002. Model Selection and Multimodel Inference: a Practical Information-theoretic Approach. Springer-Verlag, New York, NY.

Bustamante, P., Lahaye, V., Durnez, C., Churlaud, C., Caurant, F., 2006. Total and organic Hg concentrations in cephalopods from the North East Atlantic waters:

influence of geographical origin and feeding ecology. *Sci. Total Environ.* 368, 585–596.

Bustnes, J.O., Erikstad, K.E., Skaare, J.U., Bakken, V., Mehlum, F., 2003a. Ecological effects of organochlorine pollutants in the Arctic: a study of the glaucous gull. *Ecol. Appl.* 13, 504–515.

Bustnes, J.O., Bakken, V., Skaare, J.U., Erikstad, K.E., 2003b. Age and accumulation of persistent organochlorines: a study of arctic-breeding glaucous gulls (*Larus hyperboreus*). *Environ. Toxicol. Chem.* 22, 2173–2179.

Bustnes, J.O., Fauchald, P., Tveraa, T., Helberg, M., Skaare, J.U., 2008. The potential impact of environmental variation on the concentrations and ecological effects of pollutants in a marine avian top predator. *Environ. Int.* 34, 193–201.

Bustnes, J.O., 2006. Pinpointing potential causative agents in mixtures of persistent organic pollutants in observational field studies: a review of glaucous gull studies. *J. Toxicol. Environ. Health A* 69, 97–108.

Carravieri, A., Bustamante, P., Tartu, S., Meillère, A., Labadie, P., Budzinski, H., Peluhet, L., Barbraud, C., Weimerskirch, H., Chastel, O., Cherel, Y., 2014. Wandering albatrosses document latitudinal variations in the transfer of persistent organic pollutants and mercury to Southern Ocean predators. *Environ. Sci. Technol.* 48 (24), 14746–14755. <http://dx.doi.org/10.1021/es504601m>.

Catry, P., Dias, M.P., Anthony Phillips, R., Granadeiro, J., 2013. Carry-over effects from breeding modulate the annual cycle of a long-distance migrant: an experimental demonstration. *Ecology* 94, 1230–1235. <http://dx.doi.org/10.1890/12-2177.1>.

Choquet, R., Rouan, L., Pradel, R., 2009a. Program ESURGE: a software application for fitting multi event models. In: Thomson, D.L., Cooch, E.G., Conroy, M.J. (Eds.), *Modeling Demographic Processes in Marked Populations*. Springer, New York, NY, pp. 845–865.

Choquet, R., Lebreton, J.-D., Gimenez, O., Reboulet, A.M., Pradel, R., 2009b. U-CARE: utilities for performing goodness of fit tests and manipulating capture–recapture data. *Ecography* 32, 1071–1074. <http://dx.doi.org/10.1111/j.1600-0587.2009.05968.x>.

Danchin, E., Monnat, J.-Y., 1992. Population dynamics modelling of two neighbouring kittiwake *Rissa tridactyla* colonies. *Ardea* 80, 171–180.

Erikstad, K.E., Tveraa, T., Barrett, R.T., 1995. Adult survival and chick production in long-lived seabirds: a 5-year study of the kittiwake *Rissa tridactyla*. In: Skjoldal, H.R., Hopkins, C., Erikstad, K.E., et al. (Eds.), *Ecology of Fjords and Coastal Waters*. Elsevier, pp. 471–477.

Erikstad, K.E., Sandvik, H., Reiertsen, T.K., Bustnes, J.O., Strøm, H., 2013. Persistent organic pollution in a high-Arctic top predator: sex-dependent thresholds in adult survival. *Proc. R. Soc. B* 280, 20131483. <http://dx.doi.org/10.1098/rspb.2013.1483>.

Frederick, P., Jayasena, N., 2010. Altered pairing behaviour and reproductive success in white ibises exposed to environmentally relevant concentrations of methylmercury. *Proc. R. Soc. B* 278, 1851–1857. <http://dx.doi.org/10.1098/rspb.2010.2189>.

Frederiksen, M., Harris, M.P., Wanless, S., 2005. Inter-population variation in demographic parameters: a neglected subject? *Oikos* 111, 209–214.

Gabrielsen, G.W., Henriksen, E., 2001. Persistent organic pollutants in Arctic animals in the Barents Sea area and at Svalbard: levels and effects. *Mem. Natl. Inst. Polar Res.* 54, 349–364. Spec. Issue.

Gauthier, G., Milot, E., Weimerskirch, H., 2012. Estimating dispersal, recruitment and survival in a biennially-breeding species, the wandering albatross. *J. Ornithol.* 152, S457–S467.

Goutte, A., Bustamante, P., Barbraud, C., Delord, K., Weimerskirch, H., Chastel, O., 2014a. Demographic responses to mercury exposure in two closely related Antarctic top predators. *Ecology* 95, 1075–1086. <http://dx.doi.org/10.1890/13-1229.1>.

Goutte, A., Barbraud, C., Meillère, A., Carravieri, A., Bustamante, P., Labadie, P., Budzinski, H., Delord, K., Cherel, Y., Weimerskirch, H., Chastel, O., 2014b. Demographic consequences of heavy metals and persistent organic pollutants in a vulnerable long-lived bird, the wandering albatross. *Proc. R. Soc. B* 281, 20133313. <http://dx.doi.org/10.1098/rspb.2013.3313>.

Grosbois, V., Gimenez, O., Gaillard, J.-M., Pradel, R., Barbraud, C., Clobert, J., Møller, A.P., Weimerskirch, H., 2008. Assessing the impact of climate variation on survival in vertebrate populations. *Biol. Rev.* 83, 357–399. <http://dx.doi.org/10.1111/j.1469-185X.2008.00047.x>.

Hallinger, K.K., Cornell, K.L., Brasso, R.L., Cristol, D.A., 2011. Mercury exposure and survival in free-living tree swallows (*Tachycineta bicolor*). *Ecotoxicology* 20, 39–46. <http://dx.doi.org/10.1007/s10646-010-0554-4>.

Herzke, D., Nygård, T., Berger, U., Huber, S., Røv, N., 2009. Perfluorinated and other persistent halogenated organic compounds in European shag (*Phalacrocorax aristotelis*) and common eider (*Somateria mollissima*) from Norway: a suburban to remote pollutant gradient. *Sci. Total Environ.* 408, 340–348.

Lack, D., 1968. *Ecological Adaptations for Breeding in Birds*. Methuen, London.

Lebreton, J.-D., Pradel, R., 2002. Multistate recapture models: modelling incomplete individual histories. *J. Appl. Stat.* 29, 353–369. <http://dx.doi.org/10.1080/02664760120108638>.

Letcher, R.J., Bustnes, J.O., Dietz, R., Jenssen, B.M., Jørgensen, E.H., Sonne, C., Verreault, J., Vijayan, M.M., Gabrielsen, G.W., 2010. Exposure and effects assessment of persistent organohalogen contaminants in arctic wildlife and fish. *Sci. Total Environ.* 408, 2995–3043.

Nordstad, T., Moe, B., Bustnes, J.O., Bech, C., Chastel, O., Goutte, A., Trouvé, C., Herzke, D., Gabrielsen, G.W., 2012. Relationships between POPs and baseline corticosterone levels in black-legged kittiwakes (*Rissa tridactyla*) across their breeding cycle. *Environ. Pollut.* 164, 219–226.

- Oro, D., Furness, R.W., 2002. Influences of food availability and predation on survival of kittiwakes. *Ecology* 83, 2516–2528.
- Pradel, R., 2005. Multievent: an extension of multistate capture–recapture models to uncertain states. *Biometrics* 61, 442–447. <http://dx.doi.org/10.1111/j.1541-0420.2005.00318.x>.
- R Core Team, 2012. R: a Language and Environment for Statistical Computing. R Foundation for Statistical Computing, Vienna, Austria. <http://www.R-project.org/>.
- Rowe, C.L., 2008. “The calamity of so long life:” life histories, contaminants, and potential emerging threats to long-lived vertebrates. *Bioscience* 58, 623–631.
- Strøm, H., 2006. Birds of svalbard. In: Kovacs, K.M., Lydersen, C. (Eds.), *Birds and Mammals of Svalbard*. Norwegian Polar Institute, pp. 86–191.
- Tan, S.W., Meiller, J.C., Mahaffey, K.R., 2009. The endocrine effects of mercury in humans and wildlife. *Crit. Rev. Toxicol.* 39, 228–269. <http://dx.doi.org/10.1080/10408440802233259>.
- Tartu, S., Goutte, A., Bustamante, P., Angelier, F., Moe, B., Clément-Chastel, C., Bech, C., Gabrielsen, G.W., Bustnes, J.O., Chastel, O., 2013. To breed or not to breed: endocrine response to mercury contamination by an arctic seabird. *Biol. Lett.* 9 <http://dx.doi.org/10.1098/rsbl.2013.0317>, 20130317.
- Tartu, S., Angelier, F., Herzke, D., Moe, B., Bech, C., Gabrielsen, G.W., Bustnes, J.O., Chastel, O., 2014. The stress of being contaminated? Adrenocortical function and reproduction in relation to persistent organic pollutants in female Black-legged kittiwakes. *Sci. Total Environ.* 476–477, 553–560.
- Weimerskirch, H., Lallemand, J., Martin, J., 2005. Population sex ratio variation in a monogamous long-lived bird, the wandering albatross. *J. Anim. Ecol.* 74, 285–291.
- Wayland, M., Drake, K.L., Alisauskas, R.T., Kellett, D.K., Traylor, J., Swoboda, C., Mehl, K., 2008. Survival rates and blood metal concentrations in two species of free-ranging North American sea ducks. *Environ. Toxicol. Chem.* 27, 698–704. <http://dx.doi.org/10.1897/07-321.1>.



## Demographic, endocrine and behavioral responses to mirex in the South polar skua

A. Goutte<sup>a,b,\*</sup>, A. Meillère<sup>a</sup>, C. Barbraud<sup>a</sup>, H. Budzinski<sup>c</sup>, P. Labadie<sup>c</sup>, L. Peluhet<sup>c</sup>, H. Weimerskirch<sup>a</sup>, K. Delord<sup>a</sup>, O. Chastel<sup>a</sup>

<sup>a</sup> Centre d'Etudes Biologiques de Chizé (CEBC), UMR 7372 CNRS, Université de La Rochelle, F-79360, France

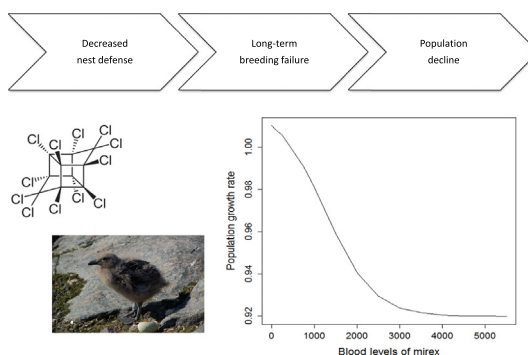
<sup>b</sup> EPHE, PSL Research University, UMR 7619 Sorbonne University, F-75005, 4 place Jussieu, Paris, France

<sup>c</sup> UMR 5805 EPOC-LPTC, Université Bordeaux, 351 Cours de la Libération, Talence Cedex 33405, France

### HIGHLIGHTS

- Blood levels of POPs did not affect survival rate nor long-term breeding probability.
- Long-term breeding success decreased with increasing mirex and stress levels.
- Stress and parental care hormones were not affected by POP burden.
- Nest defense behavior was weakened in breeders bearing high mirex levels.
- Demographic responses to POP burden were projected using matrix population models.

### GRAPHICAL ABSTRACT



### ARTICLE INFO

#### Article history:

Received 13 November 2017

Received in revised form 30 January 2018

Accepted 27 February 2018

Available online xxxx

Editor: Adrian Covaci

#### Keywords:

Capture–mark–recapture

*Catharacta maccormicki*

Ecotoxicology

Vital rates

Population dynamics

### ABSTRACT

Population consequences of chronic exposure to multiple pollutants at low environmental doses remain speculative, because of the lack of appropriate long-term monitoring surveys. This study integrates proximate and ultimate aspects of persistent organic pollutants (POP) burden in free-living vertebrates, by coupling hormonal and behavioral endpoints, life-history traits, and population dynamics. Blood samples ( $N = 70$ ) were collected in South polar skuas during two breeding periods, in 2003 and 2005, and individuals were annually monitored until 2011. Multi-state mark recapture models were used to test the effects of POP levels on demographic traits. Survival rate and long-term breeding probability were not related to individual POP levels, whereas long-term breeding success significantly decreased with increasing blood levels of mirex, an organochlorine insecticide. At the proximate level, corticosterone (stress hormone) and prolactin (parental care hormone) levels were not linked to individual POP burden. Nest defense in 2005 was significantly less intensive in chick-rearing skuas bearing higher mirex levels, suggesting reproductive behavioral impairment. Matrix population models were then built to project the rate of population decline according to increasing mirex burden. Although mirex levels were 2.8 times higher in 2003 than in 2005, the population-level effect of mirex was only detected in 2005, the year of higher corticosterone levels. The combination of endocrine traits with demographic analysis thereby enables to provide new support of synergistic interactions between pollutants and stress levels on long-term breeding outputs and population dynamics.

© 2018 Published by Elsevier B.V.

\* Corresponding author at: Centre d'Etudes Biologiques de Chizé (CEBC), UMR 7372 CNRS, Université de La Rochelle, F-79360, France.  
E-mail address: [aurelie.goutte@ephe.sorbonne.fr](mailto:aurelie.goutte@ephe.sorbonne.fr) (A. Goutte).

## 1. Introduction

Environmental chemicals may contribute to wildlife population vulnerabilities, by altering biochemical, genetic, immune, neurological, hormonal and behavioral functions (e.g. Vos et al., 2000). First reports of wildlife population collapses following acute chemical pollution were documented in the late 19th century, after large and intensive spraying of organochlorine pesticides, such as DDT (dichlorodiphenylthichloroethane, Wurster et al., 1965). Poisoning disasters still resonate today, with for instance, the high mortality and population collapses of three Gyps vultures' species in South Asia, due to scavenging of domestic livestock carcasses that had been treated with diclofenac (Oaks et al., 2004). Besides these spectacular cases of acute intoxication, wild animals are chronically exposed to complex mixtures of chemical substances at sublethal levels. A large scale experimental manipulation (Kidd et al., 2007) has demonstrated that low doses of a synthetic estrogen, 17 $\alpha$ -ethynylestradiol, may decimate free-living fathead minnow populations *Pimephales promelas*. Long-term effects of such chronic pollution in natural conditions are less readily measurable and remain mainly speculative, because of the dearth of large and longitudinal monitoring data.

Capture-mark-recapture models have shed new light on potential relationships between individuals' pollutant burdens and fitness-related traits. Specifically, recent studies on seabirds have pointed out a decrease in long-term reproductive performances with increasing persistent organic pollutants (POPs) and trace metal elements, such as mercury (Hg) levels in the Brown skua *Catharacta lonnbergi* from the Kerguelen Islands and the South polar skua *C. maccormicki* from Adélie Land, Antarctica (Goutte et al., 2014a) and in the Wandering albatross *Diomedea exulans* in the Crozet Archipelago (Goutte et al., 2014b). A decrease in adult survival rate has been linked to high levels of oxychlorane in the Glaucous gull *Larus hyperboreus* (Erikstad et al., 2013), and to high levels of HCB (hexachlorobenzene) and the chlor-dane mixture in the Black-legged kittiwakes *Rissa tridactyla* (Goutte et al., 2015). Matrix population models have been built to project demographic responses to pollutant levels in fish species (Miller and Ankley, 2004), amphibians (Willson et al., 2012), reptiles (Salice et al., 2011) and birds (Nakamaru et al., 2003; Goutte et al., 2014a, 2014b). These works support the assumption that pollutant exposure even at low environmental levels may lead to wildlife population decline, by compromising fitness-related traits. Complex issues have also been raised, including species-differences, interrelationships between POP and individual parameters (e.g. sex, previous reproductive state, age, breeding experience and body condition) or environmental factors (e.g. parasite load, food availability, habitat loss; Bustnes et al., 2006a, 2015; Salice et al., 2011).

Proximate mechanisms may help understand and better predict the impact of chronic pollution on wildlife population dynamics. Hormone levels play a major role in regulating reproductive phenology and behavior, acquisition and allocation of resources and life-history trade-offs (Kitaysky et al., 2007; Angelier and Chastel, 2009). Hg and POPs can interfere with hormones that trigger the onset of breeding (e.g. luteinizing hormone, sex steroids), the hormone that regulate parental care (prolactin, hereafter referred as PRL; Verreault et al., 2008; Angelier et al., 2016), and with stress hormones (glucocorticoids, such as corticosterone or cortisol, hereafter referred as CORT) (Tyler et al., 1998; Tartu et al., 2015a, 2015b, 2015c, 2016). Such endocrine disruption may result in behavioral impairments during the breeding period. For instance, nest temperature decreased with increasing blood POP levels in incubating Glaucous gulls (Verboven et al., 2009). In female South polar skuas with high blood POP levels, egg hatching was delayed and chicks were in poor body condition (Bustnes et al., 2007).

This study investigates the endocrine, behavioral and demographic consequences of POP burden in a South polar skua population breeding in Antarctica. We are revisiting a long-term data set that was previously used to assess the effect of Hg on vital rates and population dynamics in

this skuas population (Goutte et al., 2014a). In addition, proximate end-points were explored by considering hormone levels and nest defense behavior. The South polar skua is an ideal model for several reasons: (1) polar apex predators are predicted to be highly contaminated, because Arctic and to a lesser extent Antarctic environments are considered as 'sinks' for POPs and because biomagnification of POPs occurs across trophic levels (Bustnes et al., 2006b; Bargagli, 2008), (2) life-history traits could be acquired annually and at the individual level in this long-lived species with high nest fidelity, (3) nest defense behavior is particularly pronounced. The first aim of this study was to investigate whether demographic traits (adult survival rate, breeding probability, probability of raising one or two chicks the following years) are linked with individual POP levels. To do so, we used a 10 year longitudinal monitoring survey and multi-state mark recapture models (MSMR; Lebreton and Pradel, 2002). Because breeding success of long-lived animals has a low elasticity (i.e. has a low importance for population growth rate), we hypothesized that skua with high POP levels will fail to raise their fledglings the following years, as validated for Hg levels in the same skua population (Goutte et al., 2014a). The second goal was to explore whether endocrine and behavioral traits (CORT, PRL and nest defense intensity) the same year were negatively affected by high individual POP levels. The third objective was to project population-level consequences to increasing POP levels, through matrix population modeling (Caswell, 2001).

## 2. Materials and methods

### 2.1. Site and species

South polar skuas were studied in Antarctica, Adélie Land, on the Pointe Géologie Archipelago (66°40' S, 148°01' E), where ~50 pairs of breeders have been checked every year since 1964/1965. This long-lived species reproduces in loose colonies in Antarctica and is highly territorial during breeding with strong site tenacity and mate fidelity (Young, 1963; Jouventin and Guillotin, 1979; Pietz and Parmelee, 1993). Pair formation starts in October, and usually 2 eggs are laid in intervals of 2–4 days in mid-November, hatching of the eggs occurs in late-December and chicks fledge 50 days after (Young, 1963). Parents feed their chicks until they leave the nesting territory between late March and mid-April (Le Morvan et al., 1967). First reproduction can occur at 3-year old at the earliest, but most females start breeding between 5 and 7 years, and a little later for males (Ainley et al., 1990). After the breeding season, adults from Pointe Géologie migrate directly and winter off at the East of Japan (Weimerskirch et al., 2015). Once arrived on the breeding grounds in October, South polar skuas feed regularly on dead Emperor penguin (*Aptenodytes forsteri*) chicks that are available at the surface of sea-ice occupied by the penguin colony (Pryor, 1968). At Pointe Géologie, South polar skuas have been observed feeding on dead chicks of Emperor penguins daily, from their arrival in October until sea-ice breaks up in January or February (C. Barbraud, personal observation). From mid-November until the end of the breeding season South polar skuas feed mainly on eggs and chicks of Adélie penguins (*Pygoscelis adeliae*, Jouventin and Guillotin, 1979; Weimerskirch et al., 2015). All studied skuas were ringed with a stainless steel ring, as well as a plastic ring engraved with a unique alphanumeric code for identification without recapture. Every year, from early November to early February, each individual was identified on its nest or territory during the pre-laying period, incubation, and the chick-rearing period. In addition, groups of non-breeders were observed and ringed birds were identified. Nests and surroundings were monitored for the presence of one or two eggs or chicks.

Skull (head and bill) length was measured using a caliper (nearest 0.5 mm) and weight was measured using a spring balance (nearest 2 g). As female skuas are significantly larger than males, we calculated body condition (BC) from a least squares linear regression of weight against skull length for males and females separately.



## 2.2. Blood sampling and analyses

Skuas were captured in 2003, from 5 January to 7 February (18 males and 18 females, stage: 4 non-breeders, 4 incubating and 28 chick-rearing birds), and in 2004/2005 from 17 December to 19 January (14 males and 20 females, stage: 8 non-breeders, 3 incubating, 23 chick-rearing birds). Among them, nine individuals were sampled during both years. Since POP levels strongly differed between the two years (see Results section), all analyses were conducted for the two years separately. Less than 3 min after capture (Romero and Reed, 2005), blood samples (1 mL) were collected from the alar vein with a 25-gauge needle and a heparinized 5-mL syringe. Blood samples were centrifuged within 3 h (7000 rpm, 6 min at 4 °C). Blood cells were stored at –20 °C until assayed for sex determination as described in Goutte et al. (2014a). Plasmas were used to determine baseline concentrations of CORT and PRL at Chizé laboratory, as described in Lormée et al. (2003) and Angelier and Chastel (2009) respectively. Intra-assay variations (7.4% for CORT and 8.4% for PRL) were measured by including 10 times 4 reference samples. Minimal detection levels were 0.52 ng·mL<sup>-1</sup> for CORT and 19.26 ng·mL<sup>-1</sup> for PRL.

## 2.3. POPs determination

Levels of polychlorinated biphenyls (PCB) and organochlorine pesticides were determined in 150 µL of plasma at the EPOC/LPTC laboratory, Bordeaux, France as described in Goutte et al. (2014b). In particular, five families of POPs were quantified, using gas chromatography coupled with micro electron capture detector (GC-µECD): ΣPCB congeners (CB- 28, -52, -101, -118, -138, -153 and -180), ΣDDT (2,4' dichlorodiphenyldichloroethylene (DDE), 2,4' dichlorodiphenyltrichloroethane (DDT), 4,4' dichlorodiphenyldichloroethane (DDD), 4,4' DDT, 4,4'-DDE), chlordane mixture (hereafter CHL including cis-chlordane, trans-nonachlor, heptachlore), hexachlorobenzene (HCB) and mirex.

Quality control consisted in the analysis of procedural blanks (clean and empty glass tubes treated like a sample, one blank for 8 samples) and of standard solutions (Standard Reference Material: NIST SRM 2261 and SRM 2262). The most abundant analytes in procedural blanks were PCB-105, -118 and -153. When applicable, analyte levels were blank corrected. Recoveries of compounds for the standard solutions (n = 4) ranged from 80 to 114% with standard deviations lower than 14%. For each analyte, the limit of detection (LoD) was defined as the concentration with a signal to noise ratio of 3. Overall, LoDs ranged from 0.02 to 0.11 ng·g<sup>-1</sup> wet weight. The recovery rates of internal standards were acceptable and were as follows: CB-30: 88 ± 32%, CB-103: 63 ± 12%, CB-155: 72 ± 20%, CB-198: 71 ± 20%; 4,4'-DDT D8: 65 ± 19%. The percentage of total lipids (Table SM1 in Supplementary Material) was measured in 10 µL of plasma by the sulfophosphovanillin (SPV) method for colorimetric determination (Frings et al., 1972). POP results are given in lipid weight (ng·g<sup>-1</sup> lw).

## 2.4. Territorial behavior

During the breeding season, skuas are highly territorial and emit long calls to advertise territorial ownership (Furness, 1987). Skuas also defend their nests and territory, by flying up above the intruder, and then swooping down at it. In December 2004/January 2005, these two behavioral traits (number of swoops and long calls) were recorded during the intrusion into the territory for captures and blood sampling of incubating and chick-rearing skuas. Behavioral monitoring lasted 10 ± 1 min (mean ± SE) and traits were time corrected (number of swoops per minute and number of long calls per minute).

## 2.5. Estimating the effects of POPs on hormones, behavior and current breeding success

Circulating levels of POP families (ΣPCB, ΣDDT, CHL, HCB and Mirex) were compared between the two sampling years (2002/2003 and 2004/2005) using Welch's *t*-tests. Because POP levels strongly differed between the two years (see Results section and Table S1, SI), we conducted subsequent analyses, by considering the two years separately. Ln-transformed variables were used if necessary to meet the assumptions of parametric statistical tests. Since stage (non-breeding, incubating, chick-rearing) and sampling date were correlated, they were not included in the same model. The additive effects of sex, sampling date (or stage) and body condition (BC) on the levels of POP families (ln-transformed) or baseline CORT (ln-transformed) were tested using GLMs (general linear models) with an identity link function and a normal error distribution. Similarly, effects of sex, sampling date, BC and brood size on baseline PRL levels and on nest defense behaviors (number of long calls and swoops per minute) were tested in chick-rearing skuas. After model selection, the effects of ln-transformed levels of ΣPCB, ΣDDT, CHL, HCB or Mirex on ln-transformed levels of CORT, PRL, number of long calls per minute and number of swoops per minute were tested using GLMs with normal error distribution and an identity link function. Success of the current reproductive attempt was coded as 1 and failure as 0. The effects of ln-transformed levels of each POP family on current breeding success were tested using GLMs with a logit link function and binomial error distribution. Akaike's Information Criterion adjusted for small sample sized (AICc) was used for model selection through the R package 'AICcmodavg' (Mazerolle, 2017; R Development Core Team, 2015).

## 2.6. Estimating the effect of POP families on demographic parameters

We used the same MSMR model that was previously described in Goutte et al. (2014a) to evaluate the demographic consequences of blood POP concentrations in skuas that were sampled in 2003 or 2005 and annually monitored until 2011. Five states were defined: nonbreeder (NB); failed breeder (FB); successful breeder with one chick (SB1); successful breeder with two chicks (SB2); and dead. This last state refers to permanent emigration from the study site or death. Demographic parameters were the probability of survival (*S*), the probability of breeding (*β*), the probability of breeding successfully (*γ*), the probability of successfully raising two chicks (*δ*), and the detection probability (*p*). This MSMR model was parameterized by the survival-transition probabilities matrix:

$$\begin{array}{c} \text{NB} \\ \text{FB} \\ \text{SB1} \\ \text{SB2} \\ \dagger \end{array} \begin{bmatrix} S(1-\beta) & S\beta(1-\gamma) & S\beta\gamma(1-\delta) & S\beta\gamma\delta & * \\ S(1-\beta) & S\beta(1-\gamma) & S\beta\gamma(1-\delta) & S\beta\gamma\delta & * \\ S(1-\beta) & S\beta(1-\gamma) & S\beta\gamma(1-\delta) & S\beta\gamma\delta & * \\ S(1-\beta) & S\beta(1-\gamma) & S\beta\gamma(1-\delta) & S\beta\gamma\delta & * \\ - & - & - & - & * \end{bmatrix}$$

Asterisks in the column for dead birds represent the complementary parameter (complement of the sum of positive row entries). Further details are provided in Goutte et al. (2014a). We used the same initial model than the one validated in Goutte et al. (2014a): apparent survival rates, breeding probabilities, and detection probabilities the following years were higher in individuals captured as breeders in year *t* than non-breeders, and breeding success probabilities did not differ between individual previously observed as breeder or as non-breeders. An effect of POP families (ΣPCB, ΣDDT, CHL, HCB, Mirex), with or without an interaction with sex was tested separately on each demographic parameter (*S*, *β*, *γ*, *δ*). Levels of each POP family were standardized for 2003 and 2005 separately. Each demographic

parameter ( $\theta$ ) was included in the MSMR models as a function of  $POP_i$  that was the standardized concentration of a POP family for individual  $i$ :  $\text{logit}(\theta) = a + b \times POP_i$ , with the intercept  $a$  and the slope  $b$ . A demographic effect of  $POP_i$  was validated, when the 95% Confidence Interval (CI) of the mean of  $b$  did not contain 0 (Grosbois et al., 2008). The goodness of fit was tested using U-CARE (Choquet et al., 2009a) and models were run under E-SURGE 1.8.5 (Choquet et al., 2009b).

### 2.7. Matrix population models

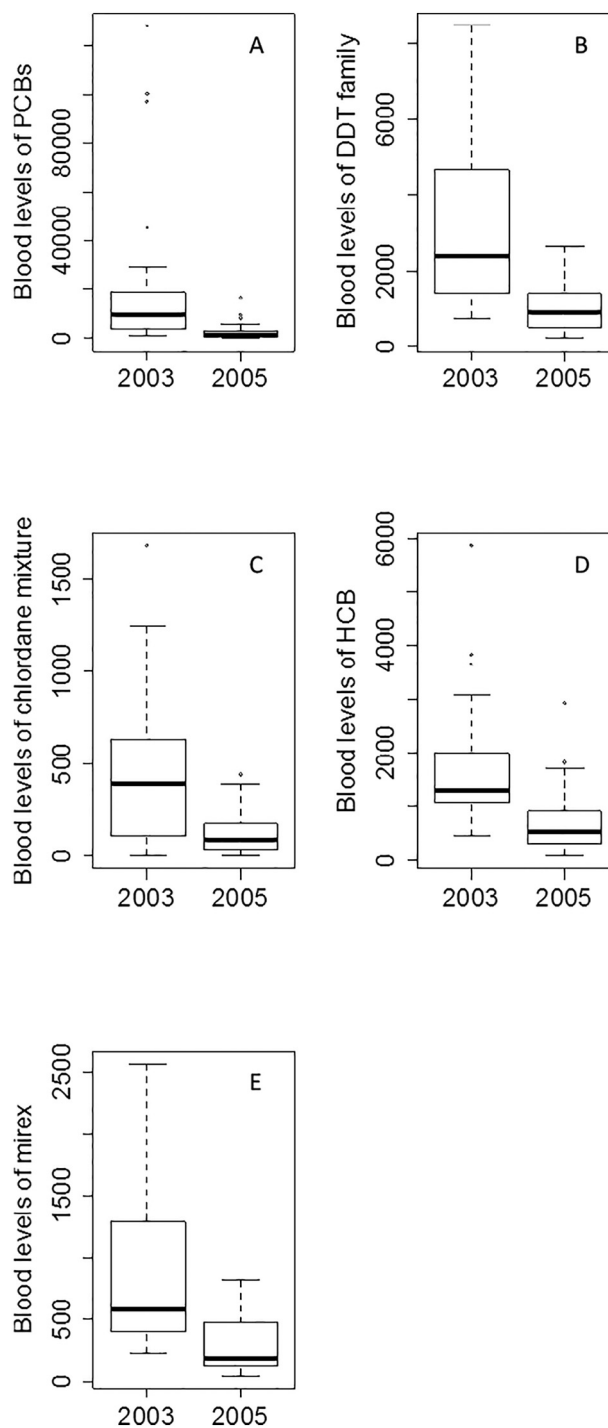
To assess the population-level effects of POP, specifically of mirex in 2005 (see Results section), population models were built through pre-breeding matrices that were structured by reproductive status classes and age (Caswell, 2001) as previously described in Goutte et al. (2014a) for the same population of South polar skuas. This model is structured into 9 classes, including 4 sexually-immature age classes; 5 pre-breeder classes and 2 stage classes (breeder and non-breeder). Model parameters were survival rate of adult breeders and non-breeders; survival rate of immatures during the 2nd and the 3rd year; the proportion of juveniles trying to breed for the first time, breeding probability of breeders and non-breeders, the proportion of immigrants and fecundity (i.e. the product of clutch size (2), the probability of successfully breeding, the probability of successfully raising two chicks, the survival probability during the first year). The deterministic growth rate ( $\lambda$ , Caswell, 2001) was calculated with deterministic models without stochasticity (Goutte et al., 2014a). The stochastic growth rate  $\lambda_{sto}$  was then estimated using stochastic matrix models. The yearly value of a vital rate that was not correlated with POP levels was sampled from a beta distribution (Morris and Doak, 2002) with variance and mean estimated from the selected MSMR model (Goutte et al., 2014a) or from Ainley et al. (1990). The value at year  $t$  of a vital rate that was significantly correlated with POP levels ( $\theta^t$ ) was calculated as  $\theta^t = \text{logit}^{-1}(a + b \times POP^t)$  with  $POP^t$ : the mean POP value sampled from a lognormal distribution. Population-level consequences of mirex concentrations (see Results section) were evaluated by changing mirex levels within the range of observed values (from 0 to 5000  $\text{ng} \cdot \text{g}^{-1}$  lw) and by estimating the corresponding  $\lambda_{sto}$  through Monte Carlo simulations (R-package *popbio*, Stubben and Milligan, 2007, R Development Core Team, 2015).

## 3. Results

### 3.1. Levels of POP families in the South polar skua

The two years strongly differed in the plasma levels of POP in skuas, with POP levels 5.5 times higher in 2003 compared to 2005 (from 2.3 times for HCB to 8.3 times for PCB, all Welch's  $t$ -tests,  $p < 0.001$ , Fig. 1, Table SM1 in Supplementary Material). These changes are also observed at the individual level for the nine skuas that were sampled in 2003 and in 2005 (Fig. SM1 in Supplementary Material).

Ln-transformed blood levels of  $\Sigma$ PCB were unrelated to sex, BC, stage or sampling date in 2003 (Table SM2A in Supplementary Material), whereas they decreased with sampling date (slope estimate  $\pm$  SE:  $-0.09 \pm 0.04$ ) in 2005, tended to be higher in males than in females and to be related to BC, but the 95% CI of the mean of the slope contains 0 [ $-0.87$ ;  $0.55$ ] (Table SM2B in Supplementary Material). Ln-transformed  $\Sigma$ DDT levels were unrelated to sex, BC, stage or sampling date in 2005, whereas they increased with date in 2003 ( $0.04 \pm 0.01$ ) and were slightly higher in males than in females (Table SM2 in Supplementary Material). CHL levels decreased with BC in 2003 ( $-0.41 \pm 0.31$ ) and with sampling date in 2005 ( $-0.08 \pm 0.02$ , Table SM2 in Supplementary Material). HCB levels were higher in males than in females in 2003. The relationship between HCB and date in 2005 was not supported by the 95% CI of the mean of the slope that contains 0 [ $-0.38$ ;  $0.20$ ] (Table SM2 in Supplementary



**Fig. 1.** Blood levels of POP families (A:  $\Sigma$ PCB (sum of chlorinated biphenyl - 28, -52, -101, -118, -138, -153 and -180), B:  $\Sigma$ DDT (sum of 2,4'-DDE (dichlorodiphenyldichloroethylene), 2,4'-DDT (dichlorodiphenyltrichloroethane), 4,4'-DDD (dichlorodiphenyldichloroethane), 4,4'-DDT, 4,4'-DDE), C: CHL (sum of cis-chlordane, trans-nonachlor, heptachlore), D: HCB (hexachlorobenzene), E: Mirex,  $\text{ng} \cdot \text{g}^{-1}$  lw) in 2003 and 2005 in South polar skuas.

Material). Mirex levels in 2003 were higher in males than in females. The negative relationship between mirex levels in 2003 and date was not supported by the 95% CI of the mean of the slope that contains 0 [ $-0.00$ ;  $0.05$ ]. Mirex levels were unrelated to individual parameters in 2005 (Table SM2 in Supplementary Material).

3.2. Relationships between POP levels and demographic traits

Current reproduction success of breeders did not significantly differ between 2003 (84.4%) and 2005 (96.2%,  $p = 0.209$ ) and was not correlated to POP levels in any year (Table SM3 in Supplementary Material).

The goodness of fit was overall not significant in 2003 (males:  $df = 26$ ,  $\chi^2 = 8.26$ ,  $p = 1$ , females:  $df = 24$ ,  $\chi^2 = 4.22$ ,  $p = 1$ ) nor in 2005 (males:  $df = 14$ ,  $\chi^2 = 3.74$ ,  $p = 1$ , females:  $df = 20$ ,  $\chi^2 = 3.76$ ,  $p = 1$ ). Of the set of candidate models describing demographic parameters, the selected model ( $\Delta AICc < 2$ ) was the effect of high mirex levels in 2005 on long-term reproductive failure (Table 1B, Fig. 2). The levels of other POP families in 2003 or in 2005 were not related to adult survival rate, the long-term probability of breeding, and of raising one or two chicks (Table 1A, B). For the effect of CHL levels in 2005 on adult survival rate, although the model was supported by the  $\Delta AICc$  (Table 1B), the model was not approved since 0 was included in the confidence interval  $[-0.72; 0.96]$ . The effect of HCB levels in 2003 on survival rate of adult

skuas was not supported by the  $\Delta AICc$  lower than 2 for the intercept model (Table 1A).

3.3. Relationships between POP levels, hormones and territorial behavior

Baseline CORT levels were lower in 2003 (mean  $\pm$  SE:  $8.91 \pm 1.10$  ng·mL<sup>-1</sup>) than in 2005 ( $15.16 \pm 1.49$  ng·mL<sup>-1</sup>,  $W = 318$ ,  $p = 0.001$ ) for all skuas and for breeders only ( $W = 270$ ,  $p = 0.022$ ). Males tended to exhibit higher CORT levels compared to female skuas in 2003 (Tables SM1 and SM4 in Supplementary Material). CORT levels were higher in incubating skuas and tended to decrease with increasing BC in 2005, although the 95% CI contains 0  $[-0.43; 0.04]$  (Table SM4 in Supplementary Material). No correlation was found between ln-transformed levels of baseline CORT and POP families during both years (Tables SM6A and B in Supplementary Material).

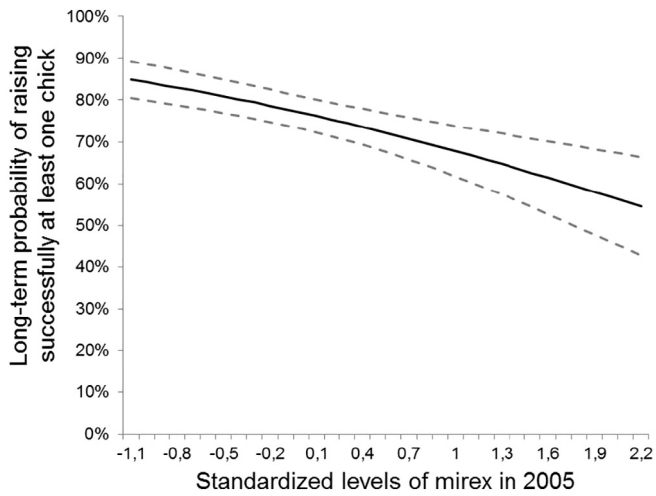
PRL levels in 2003 did not differ between chick-rearing males and females, between skuas brooding one or two chicks, and were unrelated

Table 1

Modeling the effects of standardized blood levels of  $\Sigma$ PCB (sum of chlorinated biphenyl - 28, -52, -101, -118, -138, -153 and -180),  $\Sigma$ DDT (sum of 2,4'-DDE (dichlorodiphenyldichloroethylene), 2,4'-DDT (dichlorodiphenyltrichloroethane), 4,4'-DDD (dichlorodiphenyldichloroethane), 4,4'-DDT, 4,4'-DDE), CHL (sum of cis-chlordane, trans-nonachlor, heptachlore), HCB (hexachlorobenzene), Mirex in 2003 (A) and 2005 (B) on demographic parameters ( $S$ : probability of survival,  $\beta$ : the probability of breeding,  $\gamma$ : the probability of breeding successfully,  $\delta$ : the probability of successfully raising two chicks), of South Polar Skuas; effects are ranked from lowest to highest  $\Delta AICc$ .  $\Delta AICc$  is the difference in AICc (Akaike's Information Criteria adjusted for small sample-sizes) between the current and the most appropriate model.

A. 2003				B. 2005			
Hypothesis	Rank	Deviance	$\Delta AICc$	Model	# Id. par.	Deviance	$\Delta AICc$
Intercept model	11	762.542	0	Intercept model	11	576.258	0
Effect of [ $\Sigma$ PCBs] on $\gamma$	12	762.275	1.976	Effect of [ $\Sigma$ PCBs] on $S$	13	572.836	1.215
Effect of [ $\Sigma$ PCBs] on $\delta$	12	762.485	2.186	Effect of [ $\Sigma$ PCBs] on $\delta$	12	575.213	1.259
Effect of [ $\Sigma$ PCBs] on $S$	13	760.505	2.471	Effect of [ $\Sigma$ PCBs] and sex on $\delta$	14	571.575	2.316
Effect of [ $\Sigma$ PCBs] on $\beta$	13	761.673	3.639	Effect of [ $\Sigma$ PCBs] on $\gamma$	12	576.235	2.281
Effect of [ $\Sigma$ PCBs] and sex on $\gamma$	14	760.278	4.531	Effect of [ $\Sigma$ PCBs] on $\beta$	13	575.653	4.032
Effect of [ $\Sigma$ PCBs] and sex on $\delta$	14	761.985	6.239	Effect of [ $\Sigma$ PCBs] and sex on $\gamma$	14	573.839	4.579
Effect of [ $\Sigma$ PCBs] and sex on $S$	17	758.170	9.424	Effect of [ $\Sigma$ PCBs] and sex on $S$	17	569.034	7.039
Effect of [ $\Sigma$ PCBs] and sex on $\beta$	17	759.726	10.980	Effect of [ $\Sigma$ PCBs] and sex on $\beta$	17	571.284	9.289
Effect of [ $\Sigma$ DDT] on $\beta$	13	758.889	0.855	Effect of [ $\Sigma$ DDT] and sex on $\gamma$	14	570.093	0.833
Effect of [ $\Sigma$ DDT] on $\gamma$	12	761.476	1.176	Effect of [ $\Sigma$ DDT] on $\delta$	12	576.126	2.172
Effect of [ $\Sigma$ DDT] on $\delta$	12	762.521	2.222	Effect of [ $\Sigma$ DDT] on $\gamma$	12	576.257	2.303
Effect of [ $\Sigma$ DDT] on $S$	13	760.905	2.870	Effect of [ $\Sigma$ DDT] on $S$	13	574.791	3.170
Effect of [ $\Sigma$ DDT] and sex on $\gamma$	14	759.911	4.164	Effect of [ $\Sigma$ DDT] on $\beta$	13	575.484	3.862
Effect of [ $\Sigma$ DDT] and sex on $\delta$	17	755.583	6.837	Effect of [ $\Sigma$ DDT] and sex on $\delta$	14	574.884	5.625
Effect of [ $\Sigma$ DDT] and sex on $\beta$	14	762.294	6.548	Effect of [ $\Sigma$ DDT] and sex on $\beta$	17	569.111	7.116
Effect of [ $\Sigma$ DDT] and sex on $S$	17	758.969	10.224	Effect of [ $\Sigma$ DDT] and sex on $S$	17	571.102	9.107
Intercept model	11	762.542	0	Effect of [CHL] on $S$	13	569.411	0
Effect of [CHL] on $\delta$	12	761.904	1.605	Intercept model	11	576.258	2.210
Effect of [CHL] on $\gamma$	12	762.507	2.207	Effect of [CHL] on $\gamma$	12	575.081	3.337
Effect of [CHL] and sex on $\delta$	14	758.858	3.111	Effect of [CHL] on $\delta$	12	575.539	3.795
Effect of [CHL] on $\beta$	13	761.162	3.128	Effect of [CHL] and sex on $S$	17	566.041	6.256
Effect of [CHL] on $S$	13	761.316	3.281	Effect of [CHL] on $\beta$	13	575.118	5.707
Effect of [CHL] and sex on $\gamma$	14	761.862	6.116	Effect of [CHL] and sex on $\gamma$	14	573.734	6.685
Effect of [CHL] and sex on $\beta$	17	758.200	9.454	Effect of [CHL] and sex on $\delta$	14	574.811	7.762
Effect of [CHL] and sex on $S$	17	759.072	10.326	Effect of [CHL] and sex on $\beta$	17	569.857	10.072
Effect of [HCB] on $S$	13	757.825	0	Intercept model	11	576.258	0
Intercept model	11	762.542	0.209	Effect of [HCB] on $\beta$	13	572.314	0.693
Effect of [HCB] and sex on $\gamma$	14	757.499	1.962	Effect of [HCB] on $\gamma$	12	575.628	1.674
Effect of [HCB] on $\gamma$	12	762.004	1.914	Effect of [HCB] and sex on $\gamma$	14	571.993	2.733
Effect of [HCB] on $\delta$	12	762.492	2.402	Effect of [HCB] on $\delta$	12	576.088	2.134
Effect of [HCB] on $\beta$	13	760.615	2.790	Effect of [HCB] on $S$	13	576.197	4.576
Effect of [HCB] and sex on $\delta$	14	762.125	6.588	Effect of [HCB] and sex on $\beta$	17	568.597	6.602
Effect of [HCB] and sex on $S$	17	756.252	7.716	Effect of [HCB] and sex on $\delta$	14	575.070	5.811
Effect of [HCB] and sex on $\beta$	17	757.089	8.553	Effect of [HCB] and sex on $S$	17	570.515	8.520
Intercept model	11	762.542	0	Effect of [Mirex] on $\gamma$	12	571.264	0
Effect of [Mirex] on $\beta$	13	759.539	1.505	Effect of [Mirex] and sex on $\gamma$	14	569.236	2.666
Effect of [Mirex] on $S$	13	760.015	1.981	Intercept model	11	576.258	2.690
Effect of [Mirex] on $\gamma$	12	762.126	1.827	Effect of [Mirex] and sex on $S$	17	564.398	5.093
Effect of [Mirex] on $\delta$	12	762.530	2.231	Effect of [Mirex] on $\delta$	12	575.643	4.378
Effect of [Mirex] and sex on $\gamma$	14	759.831	4.084	Effect of [Mirex] on $S$	13	574.545	5.613
Effect of [Mirex] and sex on $\beta$	17	754.524	5.779	Effect of [Mirex] and sex on $\delta$	14	572.840	6.270
Effect of [CHL] and sex on $\delta$	14	761.884	6.138	Effect of [Mirex] on $\beta$	13	574.982	6.051
Effect of [Mirex] and sex on $S$	17	758.277	9.532	Effect of [Mirex] and sex on $\beta$	17	571.434	12.129





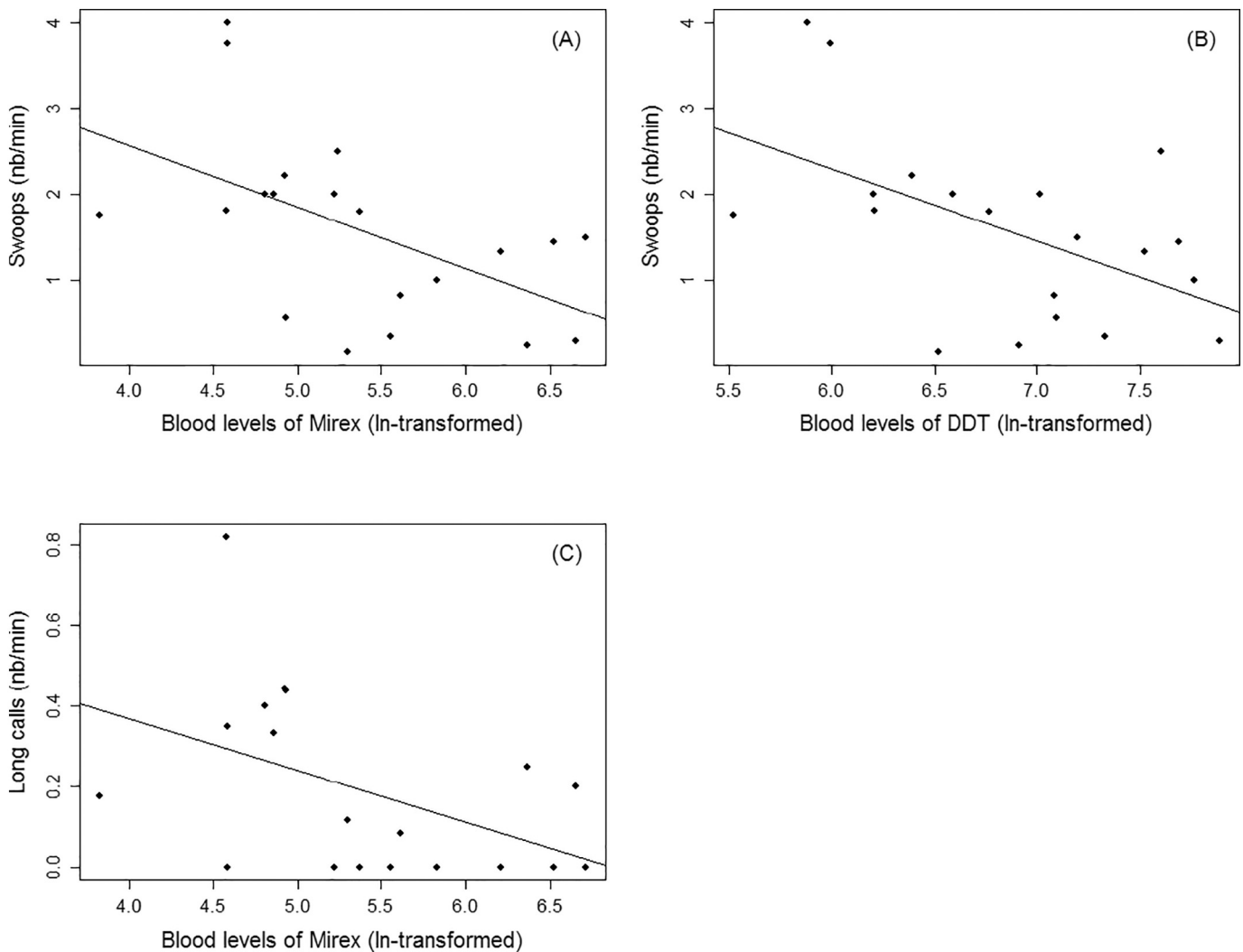
**Fig. 2.** Effects of blood standardized levels of mirex in 2005 on the long-term probability of raising successfully at least one chick in South polar skuas. The solid line is the mean probability; the dotted lines represent the 95% confidence intervals estimated using the delta method (Seber, 1982).

to BC or sampling date (Tables SM5 in Supplementary Material). No correlation was found between ln-transformed levels of PRL and POP families (Tables SM6C in Supplementary Material).

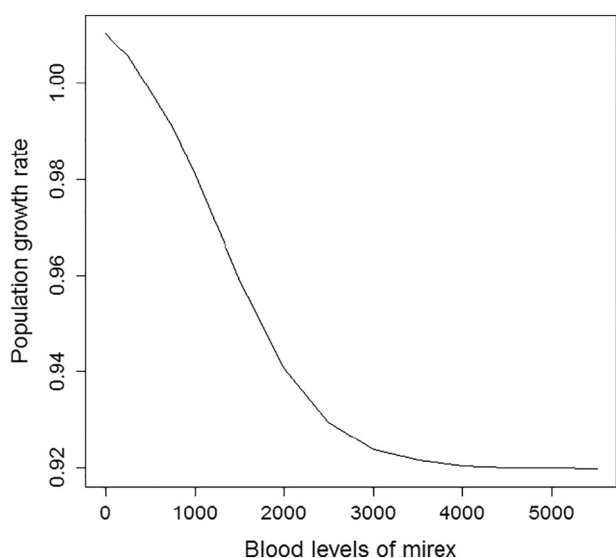
Nest defense behaviors in 2005 did not differ between females and males, were unrelated to BC and sampling date and tended to be higher in skuas rearing one chick compared to skuas rearing two chicks (Tables SM7A and B in Supplementary Material). The highest rank model was a decrease of number of long calls per minute with increasing ln-transformed levels of mirex (Fig. 3, Table SM8A in Supplementary Material). Similarly, number of swoops per minute decreased with increasing blood levels of Mirex and  $\Sigma$ DDT (Fig. 3, Table SM8B in Supplementary Material).

### 3.4. POP levels and population growth rate

Mirex negatively impacted population growth rate under a scenario with stress levels similar to those in 2005 (Fig. 4), with a steep decline ( $\lambda = 0.93$ ) until mirex levels reach approximately  $2.5 \mu\text{g}\cdot\text{g}^{-1}$  lw, and then a stabilization ( $\lambda = 0.92$ ). Population growth rate will increase ( $\lambda = 1.01$ ) with zero concentrations of mirex. Under a scenario with stress levels similar to those in 2003, blood levels of mirex did not impact vital rates according to the MSMR analyses, so that population



**Fig. 3.** Nest defense behaviour in 2005 in South polar skuas: number of swoops per minute according to ln-transformed blood levels of (A) mirex ( $\text{ng}\cdot\text{g}^{-1}$  lw) and (B)  $\Sigma$ DDT (sum of 2,4'-DDE (dichlorodiphenyldichloroethylene), 2,4'-DDT (dichlorodiphenyltrichloroethane), 4,4'-DDD (dichlorodiphenyldichloroethane), 4,4'-DDT, 4,4'-DDE), and (C) number of long calls per minute according to ln-transformed blood levels of mirex ( $\text{ng}\cdot\text{g}^{-1}$  lw).



**Fig. 4.** Modeled population-level growth rate response to an increase in mean mirex blood levels ( $\text{ng}\cdot\text{g}^{-1}\text{ lw}$ ) in South polar skuas under a scenario with environmental conditions similar to those in 2005.

growth rate will remain stable ( $\lambda = 1.001$ ) with an increase of mirex levels in the range of observed values (0 to  $5000\text{ ng}\cdot\text{g}^{-1}\text{ lw}$ ).

## 4. Discussion

### 4.1. POP levels in South polar skuas and inter-annual differences

The distribution of POP families in South polar skuas sampled in 2003 and 2005 at the Pointe Géologie Archipelago, Adélie Land (AL) followed the pattern  $\Sigma\text{PCB} > \Sigma\text{DDT} > \text{HCB} > \text{Mirex} > \text{CHL}$ . These chemicals are ubiquitous in the Antarctic, despite its isolation from direct sources of chemical pollution (Corsolini, 2009). POP inputs derive mainly from long-distance atmospheric transport. POPs are highly persistent, especially in Polar Regions, because they can be entrapped in ice over long time-periods and low temperatures limit their biodegradation. After being deposited to surface waters, POPs are incorporated in trophic webs and reached high levels in top predators (Bargagli, 2008; Corsolini, 2009). Plasma levels of POPs were comparable to those previously described in the same species and sampled during 2001 and 2002 at Svarthamaren, Dronning Maud Land (DML), Antarctica (mean  $\pm$  SE in  $\mu\text{g}\cdot\text{g}^{-1}\text{ lw}$  for DML/AL, *trans*-nonachlor:  $0.1 \pm <0.1/0.14 \pm 0.02$ ; 4,4'-DDE:  $2.0 \pm 0.1/1.65 \pm 0.17$ ; Bustnes et al., 2006b). HCB and especially mirex levels were higher in DML than in AL (HCB:  $2.3 \pm 0.1/1.22 \pm 0.12$ ; mirex:  $6.5 \pm 0.4/0.59 \pm 0.64$ , respectively). The insecticide mirex belongs to the “dirty dozen” listed under the Stockholm Convention in 2001 and was commonly used in the southern hemisphere, against ants and termites until it was banned in the late 70's (Kaiser, 1978).

In our study, much lower POP levels were observed in 2005 compared to 2003. Since blood samples were collected approximately two weeks earlier in 2005 compared to 2003, one possible explanation is that blood POP levels greatly varied daily and weekly, thus explaining the annual difference. However this hypothesis is not supported by the lack of significant relationships or negative correlation between POP levels and sampling date, during the one-month sampling period. Large inter-annual variations in circulating concentrations of PCBs and organochlorine pesticides were also observed in other seabird species, such as Black legged kittiwakes (Bustnes et al., 2017). One possible explanation of such variations could be changes in migratory routes and foraging ecology. Skuas breeding in Adélie Land perform wide-ranging migration to the north Pacific and stay during winter east of Japan (Weimerskirch et al., 2015). They are therefore exposed to POPs on

their breeding territories and foraging ranges, migratory routes as well as wintering areas. Inter-annual differences in ice conditions around the breeding areas or in atmospheric emissions in migratory and wintering grounds could then result in different exposures to organic micropollutants.

### 4.2. POP burden and demographic traits

High POP burden did not jeopardize adult apparent rate of survival and long-term probability of reproduction in South polar skuas. To our knowledge, only two studies have detected an effect of POPs on mortality in seabirds: one on adult Glaucous gulls bearing high levels of oxychlordane, a metabolite of the chlordane mixture (Erikstad et al., 2013) and another on Black-legged kittiwakes with elevated levels of HCB and of the chlordane mixture (Goutte et al., 2015). The current study pointed out a decline in long-term breeding success with increasing levels of mirex.

Surprisingly, the effect of mirex on long-term breeding failure was detected in 2005 only, although skuas had lower circulating levels of POPs compared to 2003. This result suggests that the expression of a deleterious effect could be modulated by environmental conditions. In 2005, skuas exhibited higher baseline CORT levels compared to 2003, whereas breeding success and body condition were not significantly different between the two years. Since CORT is a good proxy of environmental stress, including food availability (e.g. Kitaysky et al., 2007) and foraging activities (e.g. Angelier et al., 2007), skuas were likely more energetically-challenged in 2005 than in 2003. Hence, the effect of mirex on long-term breeding outputs in 2005 may have been triggered by food scarcity and/or sustained energy expenditure. This result supports the assumption of synergistic interactions between pollution and stress. Accordingly, experimentally-improved feeding conditions removed adverse impacts of POPs on daily growth rate of chicks in Great skua *Stercorarius skua* (Bustnes et al., 2015). Similarly, the negative effect of food restriction on reproductive performance was enhanced in Ringed turtle *Streptopelia risoria* that were exposed to DDE (Keith and Mitchell, 1993). Finally, negative effects of maternal POP levels on chick growth rate were detected in Glaucous gulls undertaking long foraging trips, but not in those feeding near the colony (Bustnes et al., 2005).

### 4.3. Relationships between POP levels, hormones and territorial behavior

Potential endocrine and behavioral mechanisms were explored to better understand how POP levels may impair reproductive outputs. Modulations of CORT and PRL releases are known to mediate parental effort and reproductive success in seabirds (Angelier and Chastel, 2009; Angelier et al., 2016). CORT reached higher levels in 2005 than in 2003, while POP levels followed the opposite trend. Skuas were blood sampled approximately two weeks earlier in 2005 compared to 2003, which could also explain the inter-annual difference in CORT levels. At the individual level, circulating POP levels were not related to CORT or PRL levels, suggesting that POPs did not disrupt these endocrine axes in skuas at the reported concentrations. Stress-induced CORT and PRL levels were not measured. Several individual and environmental factors may influence these baseline hormone levels, making relationships between POPs and CORT or PRL appear complex in seabirds (Tartu et al., 2015a, 2015b; Verreault et al., 2008).

Moreover, the intensity of nest defense is considered to be a good proxy of parental investment (Montgomerie and Weatherhead, 1988). The blood levels of mirex and DDT family, but not other POP compounds, were negatively associated with the number of swoops and long calls in 2005, which was in line with the observed effect of mirex on long-term breeding failure. Weaker nest defense could be due to reproductive impairment, although no disruption of CORT or PRL release was detected in 2003 and no data for PRL levels was available in 2005. Parental disinvestment could also be linked to lower brood value,

since chicks' development may be impacted by high POP levels in female South polar skuas (Bustnes et al., 2007). Despite the negative effect of mirex on nest defense behavior, no direct consequences were detected on current breeding attempt. This could be due to the late blood sampling and behavioral monitoring, so that early reproductive failure, such as non-viable eggs and egg predation were not taken into consideration in the current study.

#### 4.4. POP burden and population growth rate

Predicting population vulnerability as a consequence of contamination is a challenging task in ecotoxicology. As previously projected for increasing Hg levels in the same skua population (Goutte et al., 2014a), we modeled a deceleration of population growth rate until 0.920 in response to an increase in mirex exposure, because of its effect on long-term breeding failure. Considering a mirex level of 858.7 ng·g<sup>-1</sup> lw (similar to the mean blood level measured in 2003), population size of skuas is expected to decline ( $\lambda = 0.986$ ). More favorable environmental conditions, such as those observed in 2003, would mask the population-level effect of pollutant burden at least in the range of observed POP levels in the current study.

## 5. Conclusion

The study shows for the first time an impact of the insecticide mirex on long-term reproductive success and population dynamics in a free-living vertebrate, through long-term mark-recapture survey. This effect may be due to behavioral impairment, since skuas with high mirex levels were less active in defending their chicks against intruders. Surprisingly the demographic effect of mirex was detected during 2005, the year of lower pollutants levels compared to 2003. One possible explanation is the synergistic interactions between pollutant burden and environmental stress on fitness-related traits, since baseline corticosterone levels were higher in 2003. The combination of proximate and ultimate approaches may thus offer new insight into population vulnerability of free-living vertebrates exposed to chemical and environmental stress.

## Acknowledgments

This study was funded by the Agence Nationale de la Recherche (ANR PolarTop, ANR-10-CESA-0016, O Chastel), the French Polar Institute (109 ORNITHOECO, H Weimerskirch). Authorizations were obtained from the ethics committee of the French Polar Institute and from the French polar environment committee. We thank the numerous fieldworkers and Dominique Besson for the data base management.

## Appendix A. Supplementary data

Supplementary data to this article can be found online at <https://doi.org/10.1016/j.scitotenv.2018.02.326>.

## References

Ainley, D.G., Ribic, C.A., Wood, R.C., 1990. A demographic study of the South Polar Skua *Catharacta maccormicki* at Cape Crozier. *J. Anim. Ecol.* 59, 1–20.

Angelier, F., Chastel, O., 2009. Stress, prolactin and parental investment in birds: a review. *Gen. Comp. Endocrinol.* 163 (1), 142–148.

Angelier, F., Clément-Chastel, C., Gabrielsen, G.W., Chastel, O., 2007. Corticosterone and time-activity budget: an experiment with black-legged kittiwakes. *Horm. Behav.* 52 (4), 482–491.

Angelier, F., Wingfield, J.C., Tartu, S., Chastel, O., 2016. Does prolactin mediate parental and life-history decisions in response to environmental conditions in birds? A review. *Horm. Behav.* 77, 18–29.

Bargagli, R., 2008. Environmental contamination in Antarctic ecosystems. *Sci. Total Environ.* 400 (1), 212–226.

Bustnes, J.O., Miland, Ø.O., Fjeld, M., Erikstad, K.E., Skaare, J.U., 2005. Relationships between ecological variables and four organochlorine pollutants in an arctic glaucous gull (*Larus hyperboreus*) population. *Environ. Pollut.* 136, 175–185.

Bustnes, J.O., Erikstad, K.E., Hanssen, S.A., Tveraa, T., Folstad, I., Skaare, J.U., 2006a. Anti-parasite treatment removes negative effects of environmental pollutants on reproduction in an Arctic seabird. *Proc. R. Soc. Lond. B Biol. Sci.* 273 (1605), 3117–3122.

Bustnes, J.O., Tveraa, T., Henden, J.A., Varpe, Ø., Janssen, K., Skaare, J.U., 2006b. Organochlorines in antarctic and arctic avian top predators: a comparison between the South Polar skua and two species of northern hemisphere gulls. *Environ. Sci. Technol.* 40 (8), 2826–2831.

Bustnes, J.O., Tveraa, T., Varpe, O., Henden, J.A., Skaare, J.U., 2007. Reproductive performance and organochlorine pollutants in an Antarctic marine top predator: the south polar skua. *Environ. Int.* 33, 911–918.

Bustnes, J.O., Bourgeon, S., Leat, E.H., Magnúsdóttir, E., Strøm, H., Hanssen, S.A., Petersen, A., Olafsdóttir, K., Borgå, K., Gabrielsen, G.W., Furness, R.W., 2015. Multiple stressors in a top predator seabird: potential ecological consequences of environmental contaminants, population health and breeding conditions. *PLoS One* 10 (7), e0131769.

Bustnes, J.O., Bårdsen, B.J., Moe, B., Herzke, D., Hanssen, S.A., Sagerup, K., Bech, C., Nordstad, T., Chastel, O., Tartu, S., Gabrielsen, G.W., 2017. Temporal variation in circulating concentrations of organochlorine pollutants in a pelagic seabird breeding in the high Arctic. *Environ. Toxicol. Chem.* 36 (2), 442–448.

Caswell, H., 2001. *Matrix Population Models: Constructions, Analysis and Interpretation*. Second edition. Sinauer Associates, Sunderland, Massachusetts, USA.

Choquet, R., Lebreton, J.D., Gimenez, O., Reboulet, A.M., Pradel, R., 2009a. U-CARE: utilities for performing goodness of fit tests and manipulating C-Apture-REcapture data. *Ecography* 32, 1071–1074.

Choquet, R., Rouan, L., Pradel, R., 2009b. Program ESURGE: a software application for fitting multievent models. In: Thomson, D.L., Cooch, E.G., Conroy, M.J. (Eds.), *Modeling Demographic Processes in Marked Populations*. Springer, New York, New York, USA, pp. 845–865.

Corsolini, S., 2009. Industrial contaminants in Antarctic biota. *J. Chromatogr. A* 1216 (3), 598–612.

Erikstad, K.E., Sandvik, H., Reiertsen, T.K., Bustnes, J.O., Strom, H., 2013. Persistent organic pollution in a high-Arctic top predator: sex-dependent thresholds in adult survival. *Proc. R. Soc. B* 280, 20131483.

Frings, C.S., Fendley, T.W., Dunn, R.T., Queen, C.A., 1972. Improved determination of total serum lipids by the sulfo-phosphovanillin reaction. *Clin. Chem.* 18, 673–674.

Furness, R.W., 1987. *The Skuas*. T. & A. D. Poyser, Calton.

Goutte, A., Bustamante, P., Barbraud, C., Delord, K., Weimerskirch, H., Chastel, O., 2014a. Demographic responses to mercury exposure in two closely related Antarctic top predators. *Ecology* 95 (4), 1075–1086.

Goutte, A., Barbraud, C., Meillère, A., Carravieri, A., Bustamante, P., Labadie, P., Budzinski, H., Delord, K., Cherel, Y., Weimerskirch, H., Chastel, O., 2014b. Demographic consequences of heavy metals and persistent organic pollutants in a vulnerable long-lived bird, the wandering albatross. *Proc. R. Soc. Lond. B Biol. Sci.* 281 (1787), 20133313.

Goutte, A., Barbraud, C., Herzke, D., Bustamante, P., Angelier, F., Tartu, S., Clément-Chastel, C., Moe, B., Bech, C., Gabrielsen, G.W., Bustnes, J.O., Chastel, O., 2015. Survival rate and breeding outputs in a high Arctic seabird exposed to legacy persistent organic pollutants and mercury. *Environ. Pollut.* 200, 1–9.

Grosbois, V., Gimenez, O., Gaillard, J.-M., Pradel, R., Barbraud, C., Clobert, J., Møller, A.P., Weimerskirch, H., 2008. Assessing the impact of climate variation on survival in vertebrate populations. *Biol. Rev.* 83:357–399. <https://doi.org/10.1111/j.1469-185X.2008.00047.x>.

Jouventin, P., Guillotin, M., 1979. Socio-écologie du Skua Antarctique à Pointe Géologie. *Revue d'Ecologie Terre et Vie* 33, 109–127.

Kaiser, K.L.E., 1978. Pesticide report: the rise and fall of Mirex. *Environ. Sci. Technol.* 12 (5), 520–528.

Keith, J.O., Mitchell, C.A., 1993. Effects of DDE and food stress on reproduction and body condition of ringed turtle doves. *Arch. Environ. Contam. Toxicol.* 25, 192–203 1993.

Kidd, K.A., Blanchfield, P.J., Mills, K.H., Palace, V.P., Evans, R.E., Lazorchak, J.M., Flick, R.W., 2007. Collapse of a fish population after exposure to a synthetic estrogen. *Proc. Natl. Acad. Sci.* 104 (21), 8897–8901.

Kitaysky, A.S., Piatt, J.F., Wingfield, J.C., 2007. Stress hormones link food availability and population processes in seabirds. *Mar. Ecol. Prog. Ser.* 352, 245–258.

Le Morvan, P., Mouglin, J.L., Prevost, J., 1967. *Ecologie du Skua antarctique (Stercorarius skua maccormicki) dans l'archipel de Pointe Géologie (Terre Adélie)*. L'Oiseau et R.F.O. 37, 193–220.

Lebreton, J.-D., Pradel, R., 2002. Multistate recapture models: modelling incomplete individual histories. *J. Appl. Stat.* 29, 353–369.

Lormée, H., Jouventin, P., Trouve, C., Chastel, O., 2003. Sex-specific patterns in baseline corticosterone and body condition changes in breeding Red-footed Boobies *Sula sula*. *Ibis* 145, 212–219.

Mazerolle, Marc J., 2017. AICcmmodavg: Model Selection and Multimodel Inference Based on (Q)AIC(c). R package Version 2.1-1. <https://cran.r-project.org/package=AICcmmodavg>.

Miller, D.H., Ankley, G.T., 2004. Modeling impacts on populations: fathead minnow (*Pimephales promelas*) exposure to the endocrine disruptor 17 beta-trenbolone as a case study. *Ecotoxicol. Environ. Saf.* 59, 1–9.

Montgomerie, R.D., Weatherhead, P.J., 1988. Risks and rewards of nest defence by parent birds. *Q. Rev. Biol.* 63 (2), 167–187.

Morris, W.F., Doak, D.F., 2002. *Quantitative Conservation Biology: The Theory and Practice of Population Viability Analysis*. Sinauer Associates, Sunderland, Massachusetts, USA.

Nakamaru, M., Iwasa, Y., Nakanishi, J., 2003. Extinction risk to bird populations caused by DDT exposure. *Chemosphere* 53, 377–387.

Oaks, J.L., Gilbert, M., Virani, M.Z., Watson, R.T., Meteyer, C.U., Rideout, B.A., Shivaprasad, H., Ahmed, S., Chaudhry, M.J.L., Arshad, M., Khan, A.A., 2004. Diclofenac residues as the cause of vulture population decline in Pakistan. *Nature* 427 (6975), 630–633.

Pietz, P.J., Parmelee, D.F., 1993. Survival, site and mate fidelity in South Polar Skuas *Catharacta maccormicki* at Anvers Island, Antarctica. *Ibis* 135, 32–38.

- Pryor, M.E., 1968. The avifauna of Haswell Island, Antarctica. In: Austin, O.L. (Ed.), *Antarctic Bird Studies*. Antarctic Research Series. 12. Am. Geophys. Union, Washington, D.C., pp. 57–82.
- R Core Team, 2015. R: A Language and Environment for Statistical Computing. R Foundation for Statistical Computing, Vienna, Austria <http://www.R-project.org/>.
- Romero, L.M., Reed, J.M., 2005. Collecting baseline corticosterone samples in the field: is under 3 min good enough? *Comp. Biochem. Physiol. A Mol. Integr. Physiol.* 140, 73–79.
- Salice, C.J., Rowe, C.L., Pechmann, J.H.K., Hopkins, W.A., 2011. Multiple stressors and complex life cycles: insights from a population-level assessment of breeding site contamination and terrestrial habitat loss in an amphibian. *Environ. Toxicol. Chem.* 30, 2874–2882.
- Seber, G.A.F., 1982. *The Estimation of Animal Abundance and Related Parameters*. MacMillan, New York, New York, USA.
- Stubben, C., Milligan, B., 2007. Estimating and analyzing demographic models using the popbio package in R. *J. Stat. Softw.* 22 (11). <http://www.jstatsoft.org/v22/i11/paper>.
- Tartu, S., Angelier, F., Bustnes, J.O., Moe, B., Hanssen, S.A., Herzke, D., Gabrielsen, G.W., Verboven, N., Verreault, J., Labadie, P., Budzinski, H., Wingfield, J.C., Chastel, O., 2015a. Polychlorinated biphenyl exposure and corticosterone levels in seven polar seabird species. *Environ. Pollut.* 197, 173–180.
- Tartu, S., Angelier, F., Wingfield, J.C., Bustamante, P., Labadie, P., Budzinski, H., Weimerskirch, H., Bustnes, J.O., Chastel, O., 2015b. Corticosterone, prolactin and egg neglect behavior in relation to mercury and legacy POPs in a long-lived Antarctic bird. *Sci. Total Environ.* 505, 180–188.
- Tartu, S., Lendvai, Á.Z., Blévin, P., Herzke, D., Bustamante, P., Moe, B., Gabrielsen, G.W., Bustnes, J.O., Chastel, O., 2015c. Increased adrenal responsiveness and delayed hatching date in relation to polychlorinated biphenyl exposure in Arctic-breeding black-legged kittiwakes (*Rissa tridactyla*). *Gen. Comp. Endocrinol.* 219, 165–172.
- Tartu, S., Bustamante, P., Angelier, F., Lendvai, Á.Z., Moe, B., Blévin, P., Bech, C., Gabrielsen, G.W., Bustnes, J.O., Chastel, O., 2016. Mercury exposure, stress and prolactin secretion in an Arctic seabird: an experimental study. *Funct. Ecol.* 30, 596–604.
- Tyler, C., Jobling, S., Sumpter, J.P., 1998. Endocrine disruption in wildlife: a critical review of the evidence. *Crit. Rev. Toxicol.* 28 (4), 319–361.
- Verboven, N., Verreault, J., Letcher, R.J., Gabrielsen, G.W., Evans, N.P., 2009. Nest temperature and parental behaviour of Arctic-breeding glaucous gulls exposed to persistent organic pollutants. *Anim. Behav.* 77 (2), 411–418.
- Verreault, J., Verboven, N., Gabrielsen, G.W., Letcher, R.J., Chastel, O., 2008. Changes in prolactin in a highly organohalogen contaminated Arctic top predator seabird, the glaucous gull. *Gen. Comp. Endocrinol.* 156:569–576. <https://doi.org/10.1016/j.ygcen.2008.02.013>.
- Vos, J.G., Dybing, E., Greim, H.A., Ladefoged, O., Lambré, C., Tarazona, J.V., Brandt, I., Vethaak, A.D., 2000. Health effects of endocrine-disrupting chemicals on wildlife, with special reference to the European situation. *CRC Crit. Rev. Toxicol.* 30 (1), 71–133.
- Weimerskirch, H., Tarroux, A., Chastel, O., Delord, K., Cherel, Y., Descamps, S., 2015. Population-specific wintering distributions of adult south polar skuas over three oceans. *Mar. Ecol. Prog. Ser.* 538, 229–237.
- Willson, J.D., Hopkins, W.A., Bergeron, C.M., Todd, B.D., 2012. Making leaps in amphibian ecotoxicology: translating individual-level effects of contaminants to population viability. *Ecol. Appl.* 22, 1791–1802.
- Wurster, D.H., Wurster Jr., C.F., Strickland, W.N., 1965. Bird mortality following DDT spray for Dutch elm disease. *Ecology* 488–499.
- Young, E.C., 1963. The breeding behaviour of the south polar skua *Catharacta maccormicki*. *Ibis* 105 (2), 203–233.





Contents lists available at ScienceDirect

Science of the Total Environment

journal homepage: [www.elsevier.com/locate/scitotenv](http://www.elsevier.com/locate/scitotenv)

## Phthalate metabolites in the European eel (*Anguilla anguilla*) from Mediterranean coastal lagoons

C. Fourgous<sup>a</sup>, M. Chevreuril<sup>a</sup>, F. Alliot<sup>a</sup>, E. Amilhat<sup>b,c</sup>, E. Faliex<sup>b,c</sup>, S. Paris-Palacios<sup>d</sup>, M.J. Teil<sup>a</sup>, A. Goutte<sup>a,\*</sup>

<sup>a</sup> École Pratique des Hautes Études (EPHE), SPL, UPMC Univ Paris 06, UMR 7619 METIS, F-75005, 4 Place Jussieu, Paris, France

<sup>b</sup> Univ. Perpignan Via Domitia, Centre de Formation et de Recherche sur les Environnements Méditerranéens, UMR 5110, F-66860 Perpignan, France

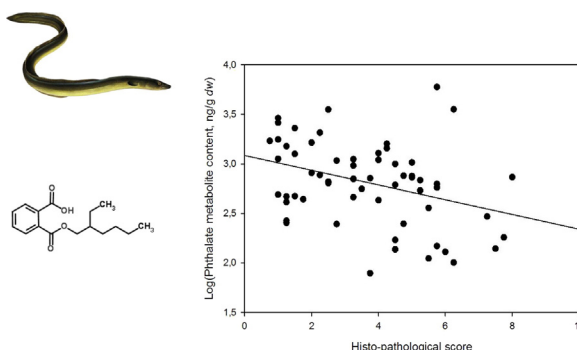
<sup>c</sup> CNRS, Centre de Formation et de Recherche sur les Environnements Méditerranéens, UMR 5110, F-66860 Perpignan, France

<sup>d</sup> Université de Reims Champagne Ardenne, UMR-I 02, Stress Environnementaux et BIOSurveillance des milieux aquatiques (SEBIO), CNRS, Reims, France

### HIGHLIGHTS

- Phthalate metabolites were characterized in 117 European eels' muscle samples.
- Phthalate metabolites' levels were higher in March/June than in October.
- Body condition, length and age did not explain variations in metabolites' levels.
- Phthalate metabolites' levels declined with increasing lesions in the liver tissue.

### GRAPHICAL ABSTRACT



### ARTICLE INFO

#### Article history:

Received 11 January 2016

Received in revised form 26 May 2016

Accepted 20 June 2016

Available online xxxx

Editor: Adrian Covaci

#### Keywords:

Phthalate monoesters

Plasticizers

By-product

Fish

### ABSTRACT

The levels and fate of phthalate metabolites have been poorly evaluated in fish, despite their potential ecotoxicological impacts. The present study aims to characterize the levels of phthalate metabolites in muscle tissue of yellow eels (*Anguilla anguilla*) from two coastal Mediterranean lagoons, during three sampling periods. Nine phthalate metabolites were detected in >70% of the samples. Slightly higher levels of phthalate metabolites were detected in March and June compared to October, suggesting possible seasonal variations in environmental release and/or phthalate metabolization process by eels. The large sample size (N = 117) made it possible to explore correlations between phthalate metabolites' levels and individual parameters, such as body length, age, body condition and hepatic histo-pathologies. Body length and estimated age poorly correlated with phthalate metabolites, suggesting that eels did not accumulate phthalates during growth, contrary to persistent compounds. Eels presented different grades of hepatic fibrosis and lipidoses. A negative correlation was found between the severity of these pathologies in the liver and the sum of phthalate metabolites levels, supporting the hypothesis that eels with damaged liver are less able to metabolize xenobiotics.

© 2016 Elsevier B.V. All rights reserved.

### 1. Introduction

Some synthesized chemicals are rapidly transformed through photodegradation, bacterial degradation and metabolization, which may limit the bioaccumulation and biomagnification of the parent

\* Corresponding author.

E-mail address: [aurelie.goutte@ephe.sorbonne.fr](mailto:aurelie.goutte@ephe.sorbonne.fr) (A. Goutte).

**Table 1**  
Mean  $\pm$  standard deviation (SD) of phthalate metabolites in eel muscles ( $\text{ng}\cdot\text{g}^{-1}\text{ dw}$ ,  $N = 117$ ). % represents the percentage for each metabolites with respect to the sum of phthalate metabolites (MPA).

	MPA	MMP	MEP	MiBP	MnBP	MBzP	MnOP	MEHP	MEHHP	MEOHP
Mean	913	5.7	33	206	174	2.0	82	282	94	34
SD	885	6.0	108	280	333	4.1	162	403	206	94
%		0.6%	3.6%	23%	19%	0.2%	9%	31%	10%	3.7%

compound (Mackintosh et al., 2004). Because of the intensive and continuous release of these degradable pollutants into the environment, some of their products of transformation may pose a significant environmental concern. Hence, a recent challenging task in ecotoxicology has focused on the evaluation of the fate and impacts of these biodegradable chemicals and their metabolites upon wildlife.

Phthalates have been extensively synthesized since the 1930s and used as plasticizers mainly for polyvinyl chloride (PVC), but also as solubilizing or stabilizing agents. Their worldwide production was estimated to reach 8.1 million tons per year (Crinnion, 2010). Phthalate are omnipresent in all environmental compartments (Mankidy et al., 2013), and induce deleterious effects, including endocrine disruption (Oehlmann et al., 2009). They are easily metabolized and excreted in vertebrates, such as fish (Barron et al., 1995). However, phthalate toxicokinetics and interspecific differences remain poorly described. Phthalate diesters are degraded by hydrolysis in the digestive lumen, which leads to a monoester. Then, hydroxylation (phase I) occurs in liver and kidney through the cytochrome P-450 system. At last, oxidized monoesters are conjugated (phase II, generally by glucuronidation), which enhances the solubility of the compounds and facilitates their urinary excretion. Monoester can also be directly conjugated (Silva et al., 2003). Erkekoglu et al. (2010) reported that the monoesters might display the same toxic potencies as the parent compounds, or even greater, as for mono-ethyl-hexyl phthalate (MEHP, Zhai et al., 2014). Despite the potential ecotoxicological impacts, the occurrence and levels of phthalate metabolites have been poorly investigated in free-living fish (Blair et al., 2009; Valton et al., 2014). Moreover, little is known about the extrinsic and intrinsic factors that drive their accumulation, metabolization and excretion in wildlife.

The present study investigates the occurrence of phthalate metabolites in the European eel (*Anguilla anguilla*), according to environmental and individual parameters. European eel has been listed in 2010 on the IUCN red list as a species under critical danger of extinction, after the catastrophic stock decline since the 1970s. Yellow eel is used as a sentinel species for monitoring the chemical status of surface waters with respect to hazardous substances because of its life cycle (benthic, predatory, long-lived and semelparous fatty species, Belpaire and Goemans, 2007; Geeraerts and Belpaire, 2010). To date, the levels and effects of PCBs, pesticides and trace metals have been extensively studied in European eels (Geeraerts and Belpaire, 2010; Amilhat et al., 2014), while the levels of phthalate parents and metabolites have been virtually neglected. Moreover, eel represents a targeted species in the important economic activity of fisheries and the accumulation of hazardous substances in eels may raise important public health issues. In this study, eels were collected in two Mediterranean lagoons that host an important fishing activity (37 tons for Bages-Sigean and 10 tons for Canet-Saint Nazaire in 2009, Vouvé et al., 2014) and that have to deal with increasing agricultural, industrial, urban and recreational pressures. This study attempts to explain individual variations of nine phthalate metabolites' levels in eels muscles ( $N = 117$ ) according to sampling sites and periods, as well as age, length, body condition, and histological abnormalities in the liver.

## 2. Materials and methods

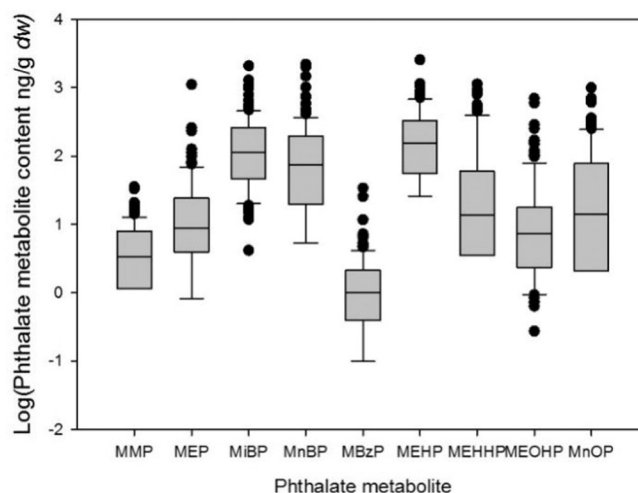
### 2.1. Study area, species and sample collection

Eels were collected from two lagoons on the south-western French Mediterranean coast of the Gulf of Lions (Languedoc-Roussillon). The

Canet-St Nazaire lagoon ( $42^{\circ}39'42.28''\text{N}$ - $3^{\circ}1'27.51''\text{E}$ ) has an area of  $4.9\text{ km}^2$  and average depth is 0.4 m (maximum: 1.0 m), with a proportionally extended catchment area of  $260\text{ km}^2$ . Bages-Sigean lagoon ( $43^{\circ}4'24.81''\text{N}$ - $2^{\circ}59'49.98''\text{E}$ ) covers  $38\text{ km}^2$  with an average depth of 1.5 m (maximum: 3.75 m) and a catchment area of  $443\text{ km}^2$ .

Yellow eels (juveniles of *A. anguilla*) were collected at two locations in the north (BN), and in the south (BS), of the Bages-Sigean lagoon as well as in one station in the Canet-St Nazaire lagoon. The collection campaigns were conducted during three periods in 2010: beginning of March ( $N = 60$ ), June ( $N = 60$ ) and October ( $N = 60$ ), using passive fyke-nets. Among the 180 sampled eels, 117 muscle samples were analyzed for levels of phthalate metabolites. Eels were transported to the laboratory in containers with aerated sampling site water. Eels were anesthetized by speed freezing (5 min,  $4-6^{\circ}\text{C}$ ) and immediately decapitated. The total length (Lt) was recorded to the nearest millimeter and the total weight (W) to the nearest g. A portion (10–20 g) of fillet muscle was removed from between the pectoral fin and anus then stored at  $-20^{\circ}\text{C}$  until further analysis. Length varied among the three sites (ANOVA:  $F_{2,177} = 9.9$ ,  $p < 0.001$ ), with longer eels in BN and BS (mean  $\pm$  SD:  $36.1 \pm 3.3\text{ cm}$ ) compared to Canet ( $33.9 \pm 3.7\text{ cm}$ , Tukey post hoc tests:  $p < 0.001$ ).

The condition of each eel was estimated using Fulton's condition factor  $K = 100 \cdot W(\text{g})/\text{Lt}(\text{cm})^3$  (Ricker, 1975). Body condition did not differ among the three sampling sites ( $F_{2,177} = 2.25$ ,  $p = 0.11$ ). Body condition significantly differed among sampling periods ( $F_{2,177} = 28.2$ ,  $p < 0.001$ ), with greater body condition in June ( $1.8 \pm 0.2$ ) compared to March ( $1.5 \pm 0.2$ , Tukey post hoc test:  $p < 0.001$ ) and October ( $1.6 \pm 0.2$ , Tukey post hoc test:  $p < 0.001$ ). The age was estimated by analyzing the sagittal otoliths. Otoliths were removed from the head of each eel and cleaned with distilled water. Small otoliths (young eels) were examined in toto in camomile oil under stereomicroscope. For older eels ( $>4$  years old) and when the reading was not clear, the otolith was embedded in resin and ground to the sagittal plane and polished until the nucleus was exposed. After using an EDTA solution, otoliths were stained with toluidine blue prior to microscopic examination.



**Fig. 1.** Distribution of phthalate metabolites content (log-transformed) in muscle ( $\text{ng}\cdot\text{g}^{-1}\text{ dw}$ ) in 117 eels specimens.

**Table 2**

Pearson or Spearman correlation matrix between phthalate metabolites levels in eel muscles (N = 117, \*p &lt; 0.05, \*\*p &lt; 0.01, \*\*\*p &lt; 0.001).

	MEP	MiBP	MnBP	MBzP	MEHP	MEHHP	MEOHP	MnOP
MMP	0.1	0.03	−0.15	0.05	0.2**	0.2**	0.1	0.11
MEP		0.3**	0.1	0.15	0.1	0.2	0.2	0.08
MiBP			0.7***	0.4***	−0.02	0.1	0.15	0.01
MnBP				0.2**	−0.02	−0.2*	0.2	0.2*
MBzP					0.2*	0.2	0.2*	0.02
MEHP						0.5***	0.4***	0.2*
MEHHP							0.5***	−0.009
MEOHP								0.5***

The age of each individual was estimated by counting the winter rings (Lecomte-Finiger, 1985; ICES, 2009). The estimated age varied between 1 and 6 years. The eels from BS were significantly older (mean ± SD: 3.1 ± 1.0) than those from BN (2.5 ± 1.0) and Canet (2.2 ± 0.9) (Kruskal Wallis test and Bonferroni post hoc test: p < 0.001).

## 2.2. Chemicals and reagents

Solvents for cleaning and extraction purposes of ultrapure quality and free from phthalate residues were supplied by Merck-Chimie (Fontenay-sous-Bois, France). Oasis HLB cartridges (6 mL/200 mg) were provided by Waters (Guyancourt, France). Mobile phase for high performance liquid chromatography with tandem mass spectrometry (LC-MS/MS) was prepared with acetonitrile (liquid chromatography – mass spectrometry quality solvent; Merck), formic acid (Carlo-Erba for analysis) and ultrapure water from a Milli-Q system. Seven phthalate monoesters: mono-methyl phthalate (MMP), mono-ethyl phthalate (MEP), mono-isobutyl phthalate (MiBP), mono-nbutyl phthalate (MnBP), mono-benzyl phthalate (MBzP), mono-n-octyl phthalate (MnOP), MEHP and two oxidized by-products, mono (2-ethyl-5-oxohexyl) phthalate (MEOHP) and mono (2-ethyl-5-hydroxyhexyl) phthalate (MEHHP) were purchased from Cambridge Isotope Laboratories, Inc. (UK). A mixture of four surrogates (from Cambridge Isotope Laboratories, purity >95%), 4-methylumbelliferone-<sup>13</sup>C<sub>12</sub> (4-MU-<sup>13</sup>C<sub>12</sub>), MnBP-<sup>13</sup>C<sub>12</sub>, MEHP-<sup>13</sup>C<sub>12</sub> and MiNP-<sup>13</sup>C<sub>12</sub>, each one at 25 ng.μL<sup>−1</sup> in acetonitrile (ACN) was prepared and used as 10 μL per sample. β-Glucuronidase from Escherichia coli K12, 200 units·mL<sup>−1</sup> was provided by Roche Biomedical (France). Basic buffer (pH of 11) was prepared with NH<sub>4</sub>OH/ACN/H<sub>2</sub>O (0.5:50:50, v/v/v). Acid buffer (pH of 2.8) was prepared with NaH<sub>2</sub>PO<sub>4</sub> (1.93 g for 100 mL) in H<sub>3</sub>PO<sub>4</sub> (85%)/H<sub>2</sub>O (1:99, v/v).

## 2.3. Phthalate monoesters extraction and purification

In order to avoid sample contamination by phthalates the equipment used (flask, pipet, tubes) was glassware or polycarbonate tubes for storage. After washing twice with acetone and with n-hexane, the glassware (except for volumetric material) was baked at 400 °C in a furnace, for 4 h and stored with glass stoppers in aluminum foils. For micro-volumes, automated analytical glass syringes (Thermo Fisher Scientific, UK) were used. Moreover laboratory blanks were performed every 20 samples, following the same treatment steps than the samples.

Prior to analysis, tissues were freeze-dried for 48 h and then ground to obtain a fine powder. Surrogates were added to the muscle

samples, prior to their extraction. Concentrations of seven monoesters (MMP, MEP, MiBP, MnBP, MBzP, MnOP and MEHP) and two phase I metabolites of DEHP (MEOHP and MEHHP) were determined in eel muscles (N = 117).

First, 500 mg of freeze-dried muscle tissue were spiked with surrogates in a 25 mL polycarbonate tube and crushed with an Ultra-Turrax in 4 mL of ammonium acetate (1 M). Then, a deconjugation step was used (90 min, 37 °C) with β-glucuronidase from *E. coli* K 12 (25 μL) free from any detectable esterase activity upon phthalate diesters (Blount et al., 2000). The glucuronide conjugate of 4-MU, the 4-methylumbelliferyl-β-D-glucuronide, was used (140 mg by incubation) for controlling the deconjugation reaction. Thus, for each parent phthalate, total metabolites were quantified including deconjugated compounds.

After deconjugation and centrifugation (4500 RPM, 10 min), the supernatants were collected into a 15 mL glass tube and 3 mL of ammonium acetate (1 M) were added to the deconjugated sample and homogenized with an Ultra-Turrax, centrifuged and the supernatants collected (step repeated with 2 mL of ammonium acetate (1 M)). The combined supernatants were extracted twice on SPE (solid phase extraction) cartridges (Oasis HLB 6 mL/200 mg) for purification. Prior to the first elution, the cartridge were conditioned with 3 mL of ACN and 6 mL of basic buffer. After loading, the samples were cleaned-up (twice) with 2 mL of ammonium acetate (1 M) and eluted with 6 mL of basic buffer, and collected in a 22 mL glass tube with 10 mL of acid buffer. The acidified sample was then purified through a second conditioned SPE cartridge (1 mL of ACN then 1 mL of H<sub>2</sub>O and 2 mL of acid buffer) and washed (twice) with 2 mL of acid buffer then 2 mL of H<sub>2</sub>O. The analytes were eluted with 10 mL of ACN then, 10 mL of ethyl acetate. The purified eluate was evaporated under nitrogen stream in a thermostatic bath (65 °C), until dry. The residue was resuspended in 0.5 mL of ACN, filtered under centrifugation (6000 RPM, 5 min) and transferred in vial. This procedure was repeated three times. Finally, the filtrated samples were combined and concentrated under nitrogen stream (65 °C) at 500 μL before analysis. Concentrations (ng·g<sup>−1</sup> dry weight, dw) are given for individual phthalate metabolites as well as the sum of all nine metabolites (MPA). Water content in eel muscles was 40.2 ± 6.1%.

## 2.4. LC-MS/MS analysis

Phthalate monoesters were quantified by liquid chromatography (1200 series - Agilent Technologies, Massy, France) – tandem mass spectrometry (6410-triple quadrupole MS, in negative ion mode for

**Table 3**

Spatial and temporal differences in the levels of phthalate metabolites in eel muscles, using ANOVA or Kruskal Wallis (\*p &lt; 0.05, \*\*p &lt; 0.01, \*\*\*p &lt; 0.001). When the difference was statistically significant within sites or periods, a Tukey or Bonferroni post hoc test was realized.

	MPA	MMP	MEP	MiBP	MnBP	MBzP	MEHP	MEHHP	MEOHP	MnOP
Periods	F <sub>2,114</sub> = 3.3*	X <sup>2</sup> = 4.4**	X <sup>2</sup> = 18.1***	F <sub>2,114</sub> = 1.4	X <sup>2</sup> = 2.2	X <sup>2</sup> = 2.7	X <sup>2</sup> = 5.1	X <sup>2</sup> = 7.6*	F <sub>2,114</sub> = 8.7***	X <sup>2</sup> = 1.6
Post-hoc			Oct < Jun** Oct < Mar***					Oct < Jun*	Mar < Jun* Oct < Jun***	
Sites	F <sub>2,114</sub> = 0.3	X <sup>2</sup> = 0.9	X <sup>2</sup> = 1.3	F <sub>2,114</sub> = 1.8	X <sup>2</sup> = 5.6	X <sup>2</sup> = 2	X <sup>2</sup> = 0.6	X <sup>2</sup> = 0.08	F <sub>2,114</sub> = 0.3	X <sup>2</sup> = 1



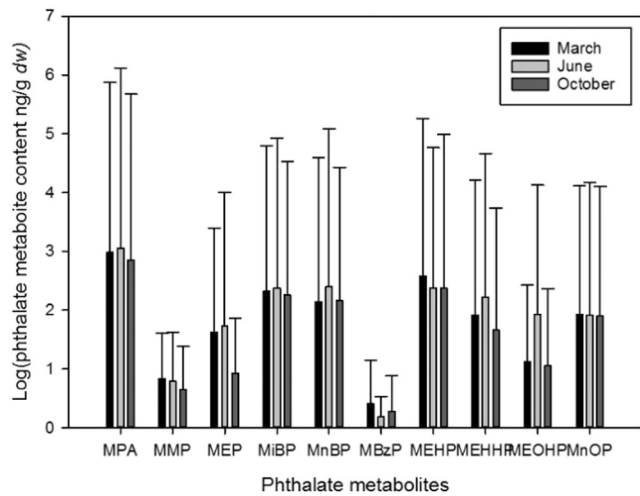


Fig. 2. Seasonal distribution of phthalate metabolites content (log-transformed) in 117 muscle samples (ng·g<sup>-1</sup> dw).

the electrospray source - Agilent Technologies (LC-MS/MS)), equipped with a silice upsi-prep strategy column (100 Å, C18-2, 2 × 100 mm, 2.2 µm - Interchim) heated at 40 °C. The source was in ESI negative mode (N2: 350 °C; gas flow: 660 L/h; capillary: 4000 V) and the injected sample volumes were 10 µL. The LC gradient flow, the MRM parameters for LC-MS/MS and limits of quantification (LOQs) are indicated in the Supplementary material (Table SM.1, 2, 3 and 5).

2.5. Method validation

The analytical method performance was determined by evaluating the linearity, recovery rates, instrument detection limits (IDLs), limits of detection (LODs) and limits of quantification (LOQs). Performance in terms of linearity and dynamic range was checked by injecting reference standard solutions in duplicate. The range tested was 0.3–10 ng on column for phthalate metabolites and 0.002–2 ng for 4-MU.

Recovery experiments were performed on eel muscle samples (N = 3) spiked at high concentration levels, i.e. at least 10 times higher than the mean concentrations of each endogenous phthalate metabolite in eel muscle samples (Table SM.4, Supplementary material).

IDLs were determined using the less concentrated surrogate as a signal/noise ratio of 3 peak to peak.

Eight procedural blanks that underwent all the sample extraction and purification, were analyzed every 20 samples. All samples were blank-corrected by subtracting the mean phthalate metabolite concentration in the batch blanks from each sample, prior to recovery correction. The LOD was calculated as the mean value plus three standard deviations of the analyte in blank samples, and LOQ was calculated as the mean value plus ten standard deviations of the analyte in blank samples.

2.6. Histological approach

Small pieces of liver from 62 eels were fixed with Bouin Hollande's solution, dehydrated with graded series of ethanol, placed in butanol-

1 for at least 24 h and then embedded in paraffin wax. Liver sections (6 µm) were stained with nuclear fast red (NR) and picro-indigo-carmin (PIC). Microphotographies were taken with a light microscope (Laborlux S - Leitz Wetzlar Germany) equipped with a digital camera (ImagingSource) and analysis were realized with the Archimed software (Version 5.6.0.). Three different liver areas (25 mm<sup>2</sup>) randomly selected on different sections were analyzed for each eel. Scoring notes for 5 hepatic parameters: lysis-necrosis, lipidosis, fibrosis, melano-macrophage (MMC) aggregates and nuclear alterations, were established and an individual global score was calculated as the mean value of the different scores (Jaffal et al., 2015). The normal histological state of the eel liver (score 0) corresponding to healthy uncontaminated yellow eels was established according to studies realized 30 to 20 years before, when it was possible to collect eels that were not exposed to phthalates (Barni et al., 1985; Affandi and Biagiatti, 1987; Lemaire-Gony and Lemaire, 1992). The higher scores of histopathological alterations were established taking into account the grade of alterations reported in literature for eel but also for different fish species (Affandi and Biagiatti, 1987; Braunbeck et al., 1990; Costa et al., 2011; Jaffal et al., 2011). The global histopathological score (on 10 grade) was calculated with the formula:

$$\text{Global score} = [\text{score}_{\text{lysis-necrosis}} + \text{score}_{\text{MMC}} + \text{score}_{\text{fibrosis}} + \text{score}_{\text{nucleus}} + \text{score}_{\text{lipid}}] / 5.$$

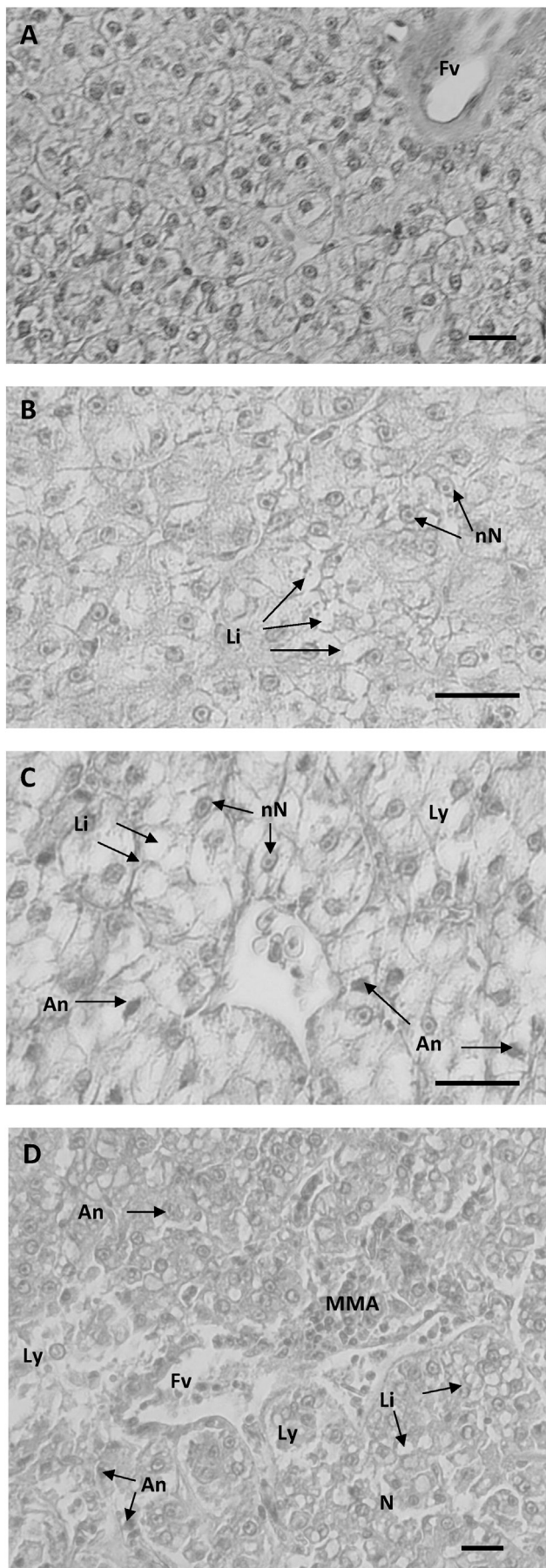
Lysis-necrosis score was established as follow: 0 = <10%, 2.5 = 10 to 25%; 5 = 25 to 50%; 7.5 = 50 to 75%, 10 = >75% of death hepatocytes in the parenchyma. To establish the nuclear alterations score, the quantity of altered nucleus among 40 randomly observed was converted in a score on 10 points. The lipid score was established on the size and the amount of the lipid droplets observed in hepatocytes: 0 = no lipid droplet; 2.5 = few little lipid droplets; 5 = lipid droplets present in 25 to 50% of the hepatocyte; 7.5 = >50% of the hepatocytes presented large lipid droplets and have a double sized; 10 = all hepatocytes were filled with huge lipid droplets and have at least a double size. The fibrosis score was determined by observation of the collagen deposits localization in liver: 0 = only big blood vessel (portal section) had collagen deposits, 2.5 = some blood vessel and bile duct presented collagen deposit, 5 = the majority of the blood vessel and bile duct presented collagen deposit, 7.5 = abnormal large collagen deposits were observable around sinusoids, veins, small bile ducts and some hepatocytes, 10 = collagen deposit present throughout all the parenchyma, particularly between hepatocytes. Melano macrophage aggregate (MMA) were counted and the score was the quantity of MMA per area with a maximum of 10 (score10 = 10 or more MMC observed on each of the three areas).

2.7. Statistical analyses

All statistical tests were performed using R software version 3.2.2 (R Core Team, 2015). Data were log-transformed to make the data fit the normal distribution. Significant differences among groups (i.e. sampling periods or sampling sites) were evaluated by ANOVA (or Kruskal-Wallis tests for non-parametric data), followed by post hoc Tukey test (or Bonferroni tests for non-parametric data) if ANOVA indicated a significant difference between groups. Correlations between phthalate metabolites and individual parameters (age, body condition, body length,

Table 4 Pearson or Spearman correlation matrix between the levels of phthalate metabolites in eel muscles and individual parameters (age, length, body condition and the score of histological abnormalities in the liver (histo), \*p < 0.05, \*\*p < 0.01, \*\*\*p < 0.001).

	MPA	MMP	MEP	MiBP	MnBP	MBzP	MEHP	MEHHP	MEOHP	MnOP
Age	-0.02	-0.1	-0.08	-0.05	-0.2*	-0.07	0.08	0.15	0.2	0.05
L	-0.07	0.04	-0.03	-0.02	-0.25**	-0.2	0.01	0.1	0.2*	-0.02
K	-0.08	-0.09	-0.1	-0.09	-0.1	-0.1	-0.03	0.05	0.1	0.07
Histo	-0.4**	-0.1	-0.3**	-0.3*	-0.2	-0.2	-0.07	-0.05	-0.01	-0.3*



score of histological abnormalities in liver) were expressed by Pearson (or Spearman for non-parametric data) correlation coefficient.

### 3. Results

#### 3.1. Method performance

The column separation obtained for the LC-MS/MS method was consistent with accurate quantification. The Multiple Reaction Monitoring mode (MRM) separates masses in two stages, making the instrument significantly more selective and sensitive than a single quadrupole system. As a result, compounds can be easily identified and quantified in the presence of complex matrices using MRM. Quantification of phthalate metabolites was carried out by calculating the response factor for each compound relative to the corresponding surrogate and concentrations were obtained using a linear regression analysis of the peak area versus the concentration ratio.

The results for linearity were satisfactory with an  $R^2$  ranging from 0.997 to 0.999 (Table SM.3, Supplementary material). Recoveries for the overall extraction procedure displayed satisfactory results (74%–102%) for MiBP, MEHHP, MnBP, MEOHP, average score for MEHP and MBzP (46%–61%) and poor results (12%–32%) for MMP, MEP, MnOP (Table SM.4, Supplementary material). Low recovery rates for these phthalate metabolites could be due to the long lasting protocol, and especially the deconjugation step. IDLs ranged from 0.3 to 6 pg (Table SM.2, Supplementary material). The nine phthalate metabolites were detected in the 8 blanks (Table SM.5, Supplementary material) and were consistent with compound determinations. The LODs and LOQs were compatible with fish concentrations and allowed quantification of all compounds (Table SM.5, Supplementary material).

#### 3.2. Phthalate metabolites in eel muscles

All the phthalate metabolites were detected in >70% of the muscle samples analyzed. Large inter-individual variations were detected (Table 1, Fig. 1). The most abundant phthalate metabolites were MEHP, followed by MiBP and MnBP, whereas the less abundant was MBzP (Table 1, Fig. 1). Positive correlations were detected between MiBP and MnBP (DBP metabolites), between MEHP, MEHHP and MEOHP (DEHP metabolites), and between MEOHP and MnOP (Table 2). A negative correlation was detected between MEHHP and MnBP (Table 2).

#### 3.3. Sampling sites and periods

The levels of each phthalate metabolite and of the sum of all nine metabolites in eel muscle did not significantly differ among the sites Canet, South and North of Bages-Sigean (Table 3). Concerning the sampling periods, levels of MEP, MEHHP and MEOHP were higher in March and June than in October (Table 3, Fig. 2), whereas the other phthalate metabolites did not show significant differences among the three periods (Table 3).

#### 3.4. Age, length, body condition

Muscular levels of phthalate metabolites in eels were not correlated to age, body length and body condition (Table 4), except a negative

**Fig. 3.** Micrographies of eel liver showing contrasted grade of hepatic alterations: [A] low perturbations in liver of an eel from BN in March (score 1/10); [B] moderate grade of alterations in the liver of an eel from BN in June with a beginning of lipidosis (score 3/10); [C] steatosis in liver of eel from BS in October (score 5/10) and [D] high grade of alterations in liver of an eel from C in October undergoing lipid degeneration with lipidosis, fibrosis and frequent necrosis and lysis (score 7/10). Bar = 20  $\mu$ m, AN: altered nucleus, FV: fibrotic vessel, MMA: melanomacrophage aggregate, nN: normal nucleus, N: necrosis, Ly: lysis, Li: lipidic droplet, V: vessel.

correlation between MnBP levels and age, between MnBP levels and length and a positive correlation between MEOHP levels and length.

### 3.5. Histological abnormalities

Histological abnormalities were detected in the liver of eels collected at the three stations. The main liver alterations were hepatocytic lysis or necrosis, nuclear abnormalities, lipid accumulation, fibrosis and presence of melano-macrophage aggregates. The score of histopathological perturbations in eels revealed clear liver pathologies in most of the individuals. The higher grade of hepatic alterations were related to important accumulation of lipid forming large lipid droplets in enlarged hepatocyte and paralleled with nuclear alteration, fibrosis and necrosis and lysis which characterize the lipid degeneration (also called fatty liver) (Fig. 3). Muscular levels of MPA, MEP, MiBP and MnOP significantly decreased with increasing number of hepatic abnormalities (Table 4, Fig. 4).

## 4. Discussion

### 4.1. Muscular levels of phthalate metabolites

The detection of phthalate metabolites in eel muscle suggested that eels were directly exposed to phthalate metabolites from the water or the sediment, since phthalate parents can be transformed by microorganisms, or that eels were exposed to phthalate parents and were able to incorporate and metabolize them. MEHP, MiBP and MnBP were the major phthalate metabolites. Results obtained in this study and using a new method are consistent with previous studies that reported similar muscle contents of phthalate metabolites in fish collected in an urbanized marine inlet, in Vancouver: the juvenile Shiner Perch *Cymatogaster aggregata* (geometric mean ranged from  $0.54 \text{ ng} \cdot \text{g}^{-1} \text{ ww}$  for MBzP to  $82 \text{ ng} \cdot \text{g}^{-1} \text{ ww}$  for MnBP, McConnell, 2007) and the white spotted greenling *Hexagrammos stelleri* ( $0.24\text{--}1.1 \text{ ng} \cdot \text{g}^{-1} \text{ ww}$  for MEHP,  $6.63\text{--}60.9 \text{ ng} \cdot \text{g}^{-1} \text{ ww}$  for MnBP, Blair et al., 2009), as well as in marine fish from the Yangtze River Delta sea area (China,  $1.2$  to  $20.4 \text{ ng} \cdot \text{g}^{-1} \text{ ww}$ , Gu et al., 2014). It should be noted that much higher levels of phthalates metabolites were found in liver samples (mean ranged from  $7.1 \pm 2.6$  (MEOHP) to  $1607 \pm 2706$  (MiBP)  $\text{ng} \cdot \text{g}^{-1} \text{ dw}$ ) of roaches fished in the Seine river, France (Valton et al., 2014), which is coherent with the metabolization of phthalates in liver.

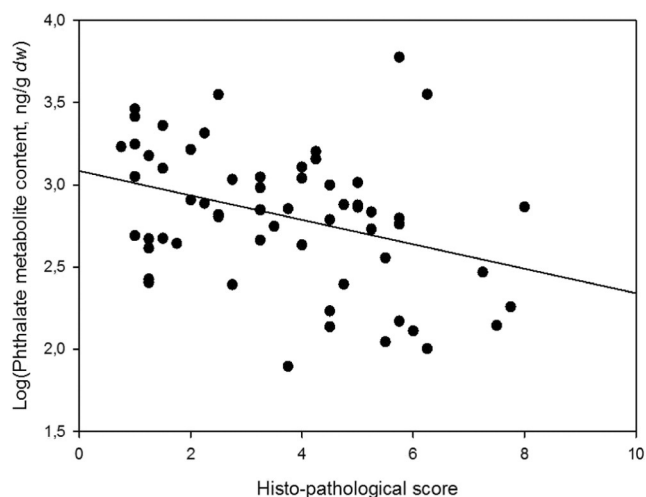


Fig. 4. Correlations between the sum of all the phthalate metabolites (MPA) content in muscle (log-transformed,  $\text{ng} \cdot \text{g}^{-1} \text{ dw}$ ) and the individuals' histo-pathological score.

### 4.2. Seasonal and spatial variations

Lagoons are known to be characterized by great spatial and seasonal variabilities in environmental conditions (e.g. temperature, Viaroli et al., 2007). In the present study no significant differences of phthalate metabolite levels were observed among the three sites. This lack of spatial difference could be due to the geographical proximity of Canet and Bages Sigean lagoons and the absence of direct discharge of urban wastewater into these lagoons. The levels of PCBs and PBDEs were also relatively low in the sediment and eels muscles from these two lagoons (Labadie et al., 2010; Vouvé et al., 2014). Analyses of phthalate concentrations in water and sediments should be necessary to confirm this lack of spatial variation.

A temporal variation was detected, especially for MEP, MEOHP and MEHHP, whose levels were higher in March/June than in October 2010. This could be due to a seasonal change in exposure to phthalate, in abiotic factors (e.g. temperature, precipitation, salinity, oxygen rate) and thus in the hepatic enzymatic activities involved in detoxification processes in fish (Förlin et al., 1995). Moreover, March/June corresponds to the intense recreational activity, and potentially to an increasing release of plasticizers into the lagoons. Additional data are needed, however, to confirm this seasonal trend.

### 4.3. Age, length, body condition

The large sample size of eel muscles ( $N = 117$ ) made it possible to explore correlations between phthalate metabolites' levels and individual parameters. Age was not correlated to phthalate metabolites' levels, except for MnBP, whose levels decreased with age. Similarly body length was not correlated to muscular levels of phthalate metabolites, except for MnBP whose levels decreased with length and for MEOHP whose levels increase with length. These results suggest that eels did not accumulate phthalates during growth, contrary to persistent compounds. For instance, levels of polychlorobiphenyls (PCBs) and polybrominated diphenyl-ethers (PBDEs) increased with length and age from glass eels to silver eels (Tapie et al., 2011). Similarly, PCBs, hexachlorocyclohexanes (HCHs), hexachlorobenzene (HCB), dichlorodiphenyltrichloroethane (DDT) and dichlorodiphenyldichloroethylene (DDE) accumulated with age in the muscle of brown trout (*Salmo trutta*, Vives et al., 2005). It should also be noted that range of age and length were limited in our data set, which may have restricted patterns of accumulation or dilution with growth. At last, eels could have been exposed to phthalate intermittently throughout their lives.

No correlation was found between muscular levels of phthalate metabolites and body condition, suggesting that metabolization efficiency is not linked to the individual body condition.

### 4.4. Histological abnormalities

An original and innovative objective of this study was to explore whether individuals with hepatic lesions had lower metabolites' levels, because of a less efficiency of their liver to metabolize phthalate parents. The prevalent histopathological characteristics identified in eel from Mediterranean lagoons were hepatocellular necrosis and parenchymal lysis, cellular hyperplasia associated to lipid vacuolization and fibrosis who are interpreted as nonspecific responses to stress as they have been described in fish exposed to a wide spectrum of pollutants (Hinton et al., 1992). The lipid degeneration (fatty liver) is one of the major changes observed here. In yellow eel, this change is symptomatic of a metabolic dysfunction since their liver does not usually store lipids. Lipid droplets may sequester fat-soluble pollutants and may reduce the metabolic capacity of that tissue. Moderate lipidosis is commonly regarded as an unspecific alteration with multiple potential causes and lipid degeneration indicates a severe alteration of fish health (Costa et al., 2011). Lipid degeneration is linked to an high rate of



hepatic alteration and fatty liver probably take place with impairment of their function (Vandemiale et al., 2001).

Muscular levels of the sum of phthalate metabolites were negatively correlated with the score of histological abnormalities in the liver. This negative correlation supports the hypothesis that individuals with numerous hepatic lesions are less efficient to metabolize xenobiotics. Such hepatic alteration of the metabolic function would imply an accumulation of phthalate parents.

## 5. Conclusion

Nine phthalate metabolites were characterized in muscle tissue of 117 European eels. No difference was found between the two lagoons, and a weak temporal variation was detected with higher contamination in March/June than in October. Body condition, length and age did not explain individual variations in muscular levels of phthalate metabolites suggesting that eels did not accumulate phthalates during growth, contrary to persistent compounds. Individuals with numerous histological abnormalities in liver bore lower levels of phthalates metabolites, suggesting that they were less efficient to metabolize xenobiotics. Further ecotoxicological research should be conducted to improve understanding of the links between fish physiology and ecology and the metabolization of phthalates.

## Acknowledgments

This collaborative work was funded by the project ANR CIEL CESA 00501 2008. We would like to thank Gaël Simon for his help in sample collection, as well as Annie Desportes and Catherine Bourges for their technical assistance for chemical analyses.

## Appendix A. Supplementary data

Supplementary data to this article can be found online at <http://dx.doi.org/10.1016/j.scitotenv.2016.06.159>.

## References

- Affandi, R., Biagiatti, S., 1987. A study of the liver of eels kept in captivity: disturbances induced to hepatocytes by artificial diets. *Aquaculture* 67, 226–228.
- Amilhat, E., Fazio, G., Simon, G., Manetti, M., Paris, S., Delahaut, L., Faliex, E., 2014. Silver European eels health in Mediterranean habitats. *Ecol. Freshw. Fish* 23 (1), 49–64. <http://dx.doi.org/10.1111/eff.12077>.
- Barni, S., Bernocchi, G., Gerzeli, G., 1985. Morphohistochemical changes in hepatocytes during the eel life cycle of the European eel. *Tissue Cell* 17 (1), 97–109.
- Barron, M.G., Albro, P.W., Haytons, W.L., 1995. Biotransformation of di(2-ethylhexyl)phthalate by rainbow trout. *Environ. Toxicol. Chem.* 14 (5), 873–876.
- Belpaire, C., Goemans, G., 2007. The European eel *Anguilla anguilla*, a rapporteur of the chemical status for the water framework directive? *Vie Milieu* 57 (4), 235–252.
- Blair, J.D., Ikonoumou, M.G., Kelly, B.C., Surridge, B., Gobas, F.A., 2009. Ultra-trace determination of phthalate ester metabolites in seawater, sediments, and biota from an urbanized marine inlet by LC/ESI-MS/MS. *Environ. Sci. Technol.* 43 (16), 6262–6268.
- Blount, B.C., Silva, M.J., Caudill, S.P., Needham, L.L., Pirkle, J.L., Sampson, E.J., Lucier, G.W., Jackson, R.J., Brock, J.W., 2000. Levels of seven urinary phthalate metabolites in a human reference population. *Environmental health perspectives* 108 (10), 979.
- Braunbeck, T., Gorge, G., Storch, V., Nagel, R., 1990. Hepatic steatosis in zebra fish (*Brachydanio rerio*) induced by long-term exposure to  $\gamma$ -hexachlorocyclohexane. *Ecotoxicol. Environ. Saf.* 19 (3), 355–374.
- Costa, P.M., Caeriro, S., Lobo, J., Martins, M., Ferreira, A.M., Caetano, M., Vale, C., DeValls, T.A., Costa, M.H., 2011. Estuarine ecological risk based on hepatic histological indices from laboratory and in situ tested fish. *Mar. Pollut. Bull.* 62, 55–65.
- Crinnion, W.J., 2010. Toxic effects of the easily avoidable phthalates and parabens. *Alternat. Med. Rev.* 15 (3), 190–196.
- Erkekoglu, P., Rachidi, W., Yuzugullu, O.G., Giray, B., Favier, A., Ozturk, M., Hincal, F., 2010. Evaluation of cytotoxicity and oxidative DNA damaging effects of di(2-ethylhexyl)-phthalate (DEHP) and mono(2-ethylhexyl)-phthalate (MEHP) on MA-10 Leydig cells and protection by selenium. *Toxicol. Appl. Pharmacol.* 248 (1), 52–62.
- Förlin, L., Lemaire, P., Livingstone, D., 1995. Comparative studies of hepatic xenobiotic metabolizing and antioxidant enzymes in different fish species. *Mar. Environ. Res.* 39, 201–204.
- Geeraerts, C., Belpaire, C., 2010. The effects of contaminants in European eel: a review. *Ecotoxicology* 19 (2), 239–266.
- Gu, Y.Y., Yu, X.J., Peng, J.F., Chen, S.B., Zhong, Y.Y., Yin, D.Q., Hu, X.L., 2014. Simultaneous solid phase extraction coupled with liquid chromatography tandem mass spectrometry and gas chromatography tandem mass spectrometry for the highly sensitive determination of 15 endocrine disrupting chemicals in seafood. *J. Chromatogr. B* 965, 164–172.
- Hinton, D.E., Baumann, P.C., Gardner, G.C., Hawkins, W.E., Hendricks, J.D., Murchelano, R.A., Okihiro, M.S., 1992. Histopathologic biomarkers. In: Huggett, R.J., Kimerly, R.A., Mehrle Jr., P.M., Bergman, H.L. (Eds.), *Biomarkers: Biochemical, Physiological and Histological Markers of Anthropogenic Stress*. Lewis Publishers, Chelsea, MI, USA, pp. 155–210.
- ICES, 2009. *Workshop on Age Reading of European and American Eel (WKAREA)*, 20–24 April 2009, Bordeaux, France. No. ICES CM 2009/ACOM 48 (66 pp.).
- Jaffal, A., Paris-Palacios, S., Jolly, S., Thailly, A.F., Delahaut, L., Beall, E., Roche, H., Biagiatti-Risbourg, S., Betoulle, S., 2011. Cadmium and copper contents in a freshwater fish species (brook trout, *Salvelinus fontinalis*) from the subantarctic Kerguelen Islands. *Polar Biol.* 34 (3), 397–409.
- Jaffal, A., Betoulle, S., Biagiatti-Risbourg, S., Terreau, A., Sanchez, W., Paris-Palacios, S., 2015. Heavy metal contamination and hepatic toxicological responses in brown trout (*Salmo trutta*) from the Kerguelen Islands. *Polar Res.* 34.
- Labadie, P., Alliot, F., Bourges, C., Desportes, A., Chevreuil, M., 2010. Determination of polybrominated diphenyl ethers in fish tissues by matrix solid-phase dispersion and gas chromatography coupled to triple quadrupole mass spectrometry: case study on European eel (*Anguilla anguilla*) from Mediterranean coastal lagoons. *Anal. Chim. Acta* 675 (2), 97–105.
- Lecomte-Finiger, R., 1985. L'âge de l'anguille européenne (*Anguilla anguilla* L., 1758), état actuel des connaissances et recherches nouvelles en Méditerranée. *J. Appl. Ichthyol.* 1, 178–192.
- Lemaire-Gony, S., Lemaire, P., 1992. Interactive effects of cadmium and benzo(a)pyrene on cellular structure and biotransformation enzymes of the liver of the European eel *Anguilla anguilla*. *Aquat. Toxicol.* 22, 145–160.
- Mackintosh, C.E., Maldonado, J., Hongwu, J., Hoover, N., Chong, A., Ikonoumou, M.G., Gobas, F.A.P.C., 2004. Distribution of phthalate esters in a marine aquatic food web: comparison to polychlorinated biphenyls. *Environ. Sci. Technol.* 38 (7), 2011–2020.
- Mankidy, R., Wiseman, S., Ma, H., Giesy, J.P., 2013. Biological impact of phthalates. *Toxicol. Lett.* 217 (1), 50–58.
- McConnell, M.L., 2007. *Distribution of phthalate monoesters in an aquatic food web. Master Report No. 426*. School of Resource and Environmental Management, Simon Fraser University.
- Oehlmann, J., Schulte-Oehlmann, U., Kloas, W., Jagnytsch, O., Lutz, I., Kusk, K.O., Tyler, C.R., 2009. A critical analysis of the biological impacts of plasticizers on wildlife. *Philos. Trans. R. Soc. B Biol. Sci.* 364 (1526), 2047–2062.
- R Core Team, 2015. *R: A language and environment for statistical computing*. R Foundation for Statistical Computing, Vienna, Austria URL <http://www.R-project.org/>.
- Ricker, W.E., 1975. Computation and interpretation of biological statistics of fish populations. *Bull. Fish. Res. Board Can.* 191, 1–382.
- Silva, M.J., Barr, D.B., Reidy, J.A., Kato, K., Malek, N.A., Hodge, C.C., Brock, J.W., 2003. Glucuronidation patterns of common urinary and serum monoester phthalate metabolites. *Arch. Toxicol.* 77 (10), 561–567. <http://dx.doi.org/10.1007/s00204-003-0486-3>.
- Tapie, N., Le Menach, K., Pasquaud, S., Elie, P., Devier, M.H., Budzinski, H., 2011. PBDE and PCB contamination of eels from the Gironde estuary: from glass eels to silver eels. *Chemosphere* 83 (2), 175–185.
- Valton, A.S., Serre-Dargnat, C., Blanchard, M., Alliot, F., Chevreuil, M., 2014. Determination of phthalates and their by-products in tissues of roach (*Rutilus rutilus*) from the Orge river (France). *Environ. Sci. Pollut. Res.* 21 (22), 12723–12730.
- Vandemiale, U., Graffagiano, I., Cafaceni, P., Caraccio, G., Domenicali, M., Dall'Agata, M., Trévisani, F., Guerrieri, F., Bernardi, M., Altomre, E., 2001. Mitochondrial oxidative injury and energy metabolism alteration in rat fatty liver: effect of the nutritional status. *Hepatology* 33, 808–815.
- Viaroli, P., Lasserre, P., Camprostrini, P., 2007. Lagoons and coastal wetlands. *Hydrobiologia* 577, 1–3.
- Vives, I., Grimalt, J.O., Ventura, M., Catalan, J., Rosseland, B.O., 2005. Age dependence of the accumulation of organochlorine pollutants in brown trout (*Salmo trutta*) from a remote high mountain lake (Redo, Pyrenees). *Environ. Pollut.* 133 (2), 343–350.
- Vouvé, F., Buscaill, R., Aubert, D., Labadie, P., Chevreuil, M., Canal, C., Biagiatti-Risbourg, S., 2014. Bages-Sigean and Canet-St Nazaire lagoons (France): physico-chemical characteristics and contaminant concentrations (Cu, Cd, PCBs and PBDEs) as environmental quality of water and sediment. *Environ. Sci. Pollut. Res.* 21 (4), 3005–3020.
- Zhai, W., Huang, Z., Chen, L., Feng, C., Li, B., Li, T., 2014. Thyroid endocrine disruption in zebrafish larvae after exposure to mono-(2-ethylhexyl) phthalate (MEHP). *PLoS One* 9 (3), e92465.



## Persistent organic pollutants in benthic and pelagic organisms off Adélie Land, Antarctica



A. Goutte<sup>a,c,\*</sup>, M. Chevreuil<sup>b</sup>, F. Alliot<sup>b</sup>, O. Chastel<sup>c</sup>, Y. Cherel<sup>c</sup>, M. Eléaume<sup>d</sup>, G. Massé<sup>a,e</sup>

<sup>a</sup> LOCEAN/IPSL, UMR7159, Université Pierre et Marie Curie, 75005 Paris, France

<sup>b</sup> Laboratoire Hydrologie Environnement, Ecole Pratique Des Hautes Etudes, UMR Sisyphé, Université Pierre et Marie Curie, 75005 Paris, France

<sup>c</sup> Centre d'Etudes Biologiques de Chizé, CNRS UPR 1934, 79360 Villiers-en-Bois, France

<sup>d</sup> Muséum National d'Histoire Naturelle, Département Milieux et Peuplements Aquatiques, UMR 7208 BOREA, CP26, 57 Rue Cuvier, 75231 Paris Cedex 05, France

<sup>e</sup> TAKUVIK, UMI3376 CNRS, Université Laval, G1V0A6 Québec, Canada

### ARTICLE INFO

#### Keywords:

Polar ecosystem  
Persistent organic pollutants  
Echinoderm  
Fish  
Krill  
Seabird

### ABSTRACT

The concentrations of polychlorinated biphenyls (PCB), hexachlorobenzene (HCB), pentachlorobenzene (PeCB) and polybrominated diphenylethers (PBDE) were described in benthic and pelagic species collected off Adélie Land, Antarctica. Strong differences were observed among species, with reduced PeCB and HCB levels in benthic species, and elevated PCB levels in the Antarctic yellowbelly rockcod, the Antarctic sea urchin and the snow petrel. Lower-chlorinated congeners were predominant in krill; penta-PCBs in benthic organisms; hexa- and hepta-PCBs in seabirds and cryopelagic fish. This segregation may result from sedimentation process, specific accumulation and excretion, and/or biotransformation processes. The presence of PBDEs in Antarctic coastal organisms may originate from atmospheric transport and partly from a contamination by local sources. Although POP levels in Antarctic marine organisms were substantially lower than in Arctic and temperate organisms, very little is known about their toxic effects on these cold-adapted species, with high degree of endemism.

© 2013 Elsevier Ltd. All rights reserved.

### 1. Introduction

The remote Antarctic continent has long been considered to be pristine until contamination by persistent organic pollutants (POPs) was first documented in the 1970s (Risebrough et al., 1976). Polar areas are now considered as final sinks for pesticides and industrial chemicals, due to long-range atmospheric transport and cold-condensation (Simonich and Hites, 1995). Moreover, polar scientific stations as well as growing touristic activities represent an additional source of contamination (e.g. Negri et al., 2006; Hale et al., 2008). Eco-toxicological studies have been extensively conducted in the Arctic, especially on apex predators, and have shown a broad spectrum of detrimental effects, ranging from endocrine disruption, immune dysfunctions, impaired fertility and ultimately high mortality (e.g. Letcher et al., 2010). Cold-adapted species are particularly vulnerable to toxic chemicals, because of their long life-span, low detoxifying activity and seasonal lipid accumulation followed by fasting period, which influence the toxicokinetics of organic pollutants (Clarke, 1983; Bright et al., 1995; Corsolini, 2009; Letcher et al., 2010). In Antarctic biota, only a few studies have reported the presence of polychlorinated biphenyls (PCB), dichloro-diphenyl-trichloroethane (DDT),

hexachlorobenzene (HCB) and pentachlorobenzene (PeCB), and most of them focused on a restricted number of taxa (Kennicutt et al., 1995; Goerke et al., 2004; Negri et al., 2006; Corsolini, 2009; Cipro et al., 2010; van den Brink et al., 2011). Global policy measures have led to the reduction of PCBs and DDT releases since the 1970s in the United States and Europe and since 1993 in Russia (Breivik et al., 2004). In turn, this has caused a reduction of POPs levels in Antarctic pelagic fish and seabirds but not in benthic fish (van den Brink et al., 2011). Thus, the dynamics of POP persistence in Antarctic biota over time may differ between the pelagic and benthic zones. To better understand such trends, there is an urgent need to investigate POP levels in a large spectrum of species and trophic levels, differentiating between benthic and pelagic organisms in order to give a broader overview of POP burden in Antarctic marine ecosystems.

Among emerging toxicological compounds, other halogenated contaminants like polybrominated diphenylethers (PBDEs) are widely used as flame retardants in electronics and textiles since the 1970s. They present high environmental stability and persistence (Birnbaum and Staskal, 2004), as well as bioaccumulation and biomagnification properties through marine food webs, as demonstrated in zooplankton, fish, seabirds and seals (de Wit, 2002; Sørmo et al., 2006; Shaw et al., 2009). PBDEs have aroused growing scientific concerns since 2000, because of their exponential increase in many ecosystems including polar regions

\* Corresponding author. Tel.: +33 549093514.

E-mail address: [goutte@cebc.cnrs.fr](mailto:goutte@cebc.cnrs.fr) (A. Goutte).

(e.g. Ikonomou et al., 2002; Hale et al., 2003). Their toxic effects have been mainly described on vertebrates: specifically, PBDEs cause developmental neurotoxicity in rats (reviewed by Costa and Giordano, 2007), disrupt thyroid functions because of their structural similarities with thyroxine (Zhou et al., 2002), and act as estrogen-receptor agonists (Meerts et al., 2001). In that context, production of the penta- and octa-PBDE formulations ceased in the European Union and North America in 2004, but deca-PBDE is still produced and used. Few studies have recently described PBDEs levels in Antarctic fish, seabirds and benthic organisms (Borghesi et al., 2008, 2009; Corsolini et al., 2006; Hale et al., 2008; Yogui and Sericano, 2009; van den Brink et al., 2011), and the current state of knowledge remains scarce in the Antarctic region.

The present study aims to describe the occurrence and levels of HCB, PeCB, PCBs and PBDEs in a broad spectrum of Antarctic organisms, collected off the coast of Adélie Land. The Pointe Géologie archipelago contains a highly diverse marine community, including epibenthic organisms, pelagic fish and seabirds (Micol and Jouventin, 2001; Gutt et al., 2007). However the distribution and abundance of POP in this rich ecosystem have never been explored. In the present study, we searched for the presence of PCBs, HCB, PeCB and PBDEs in euphausiids, ascidian, sea urchin, starfish, teleost fish and eggs of seabirds. Then, we investigated whether POP levels and classes of isomers differ between benthic and pelagic compartments, and among trophic levels.

## 2. Materials and methods

### 2.1. Study species and field procedures

The study was carried out near the Dumont D'Urville French station, in the Pointe Géologie Archipelago, Adélie Land, Antarctica (66°40'S, 140°01'E, Fig. 1). Table 1 summarizes information on specimen collection, including their habitats and feeding habits.

Antarctic krill *Euphausia superba* (Dana, 1850) and ice krill *Euphausia crystallorophias* (Holt and Tattersall, 1906) are mainly grazers and were collected using an Isaacs-Kidd Midwater Trawl (IKMT) in January 2011. Bald notothen *Pagothenia borchgrevinkii* (Boulenger, 1902) were fished under the sea ice using a fishing rod in November 2010 ( $N = 3$ ). This common cryopelagic fish feeds on sympagic zooplankton (La Mesa et al., 2004). Three abandoned eggs of Adélie penguins *Pygoscelis adeliae* (Wagler, 1832) and six abandoned eggs of snow petrels *Pagodroma nivea* (Forster, 1777) were collected in December 2007 and 2010. Adélie penguins prey upon krill and to a lesser extent fish, while snow petrels mainly feed on fish, thus occupying a higher trophic level than Adélie penguins (Ridoux and Offredo, 1989; Rau et al., 1992). Eggs are useful non-destructive samples to determine POP levels, because of the transfer of contaminants from mother to eggs (Verreault et al., 2006). For ethical reasons, only abandoned eggs were collected, although they may be more contaminated than viable eggs from successful breeders. A colony of the filter-feeder ascidian *Synoicum* sp. was collected using a trawl in January 2011 at 130-meter deep. Two specimens of the Antarctic sea urchin *Sterechinus neumayeri* (Meissner, 1900) and two specimens of the starfish *Saliasterias brachiata* (Koehler, 1920) were collected at ca. 35-meters deep by divers in January 2010 and using a beam trawl in January 2011, respectively. The urchin *Sterechinus neumayeri* is omnivorous, while the starfish *Saliasterias brachiata* is necrophagous (McClintock, 1994). Five specimens of the opportunistic demersal fish Antarctic yellowbelly rockcod *Notothenia coriiceps* (Richardson, 1844) were sampled on the seabed (35-meter deep) using a fishing rod, in the Pointe Géologie Archipelago in April 2010 and in December 2010.

All samples were frozen at  $-20^{\circ}\text{C}$  until they were assayed. POPs were analyzed in whole seabird eggs, fish muscle and the whole

body of krill, ascidian, urchin and starfish. Krill samples were pooled due to their low wet weight. Ethical approval for all procedures was granted by the ethics committee of the Ministère de l'Environnement and the French Polar Research Institute (IPEV). The experiments conformed to the code of ethics of animal experimentation in the Antarctic.

### 2.2. Chemical analyses

Biological samples were freeze-dried for 48 h and were then ground to obtain a fine powder. The wet weight/dry weight ratio was determined (Table 1). Samples were extracted for the determination of pentachlorobenzene (PeCB), hexachlorobenzene (HCB), polychlorinated biphenyls (PCBs) and polybrominated diphenyl ethers (PBDEs) according to Labadie et al. (2010) and Teil et al. (2012). Briefly, label internal standard ( $^{13}\text{C}$ -BDE -47, -153, -181, -209, and PCB -30, -107) were added to the samples (approximately 3 g dry weight) prior to extraction, and thoroughly dispersed with silica gel and acidic silica. Samples were then extracted with hexane/dichloromethane (1:1) in a sonication bath and centrifuged. This procedure was repeated twice and then the supernatant was concentrated and treated with  $\text{H}_2\text{SO}_4$ . After centrifugation and the removal of the acid layer, extracts were purified on a multilayer column (from top to bottom: acidic silica, 1 g, activated silica gel, 1 g and neutral activated alumina, 1 g). After sample loading, the first fraction was eluted with hexane (20 mL) and the second one was eluted with hexane/dichloromethane (8:2, 15 mL). External standards  $^{13}\text{C}$  CB-209 and BB-209 were added to the second fraction previously transferred to an injection vial for PBDEs analyses. The PBDE-congeners analyzed in this study were: BDE-28, -47, -99, -100, -153, -154, -183 and -209. The external standard  $^{13}\text{C}$  PCB-194 was added to the first fraction which was combined with the first one for PCB, PeCB and HCB analyses, with a GC-QQQ-MS/MS (EI, 70 eV). PCB-congeners with the following IU-PAC numbers were analyzed: 28, 52, 77, 81, 101, 105, 110, 114, 118, 123, 126, 138, 153, 156, 157, 167, 169, 180 and 189. Analyses were carried out using a 7890 A gas chromatograph GC coupled to a 7000 A mass spectrometer (MS; Agilent Technologies, Massy, France). Analytical conditions for GC-MSMS are detailed in the Supplementary file. Identification of analytes was performed by comparing retention times with those determined with standard solutions. Quantification was performed by calculating the response factor for each analyte relative to its corresponding internal standards, and concentrations were obtained using a linear regression analysis of the peak area ratio versus the concentration ratio. MRM parameters for PCBs, HCB and PeCB are detailed in the Supplementary file. Class of isomer patterns was calculated as the percentage of each isomer class with respect to total PCBs.

### 2.3. Quality assurance and controls

For quality assurance, procedural blanks were analyzed in triplicate for each of the 10 samples and all data were blank corrected. Recovery experiments were performed on samples ( $N = 3$  for each tissue type) spiked at 20 ng (Antarctic krill), 50 ng (urchin and muscle of Antarctic yellowbelly rockcod) and 100 ng (eggs of Adélie penguin) for PCBs, at 20 ng for tri-hepta BDE (all samples) and 200 ng for BDE-209 (all samples). Internal standards were added at the very last step of the procedure, directly in the injection vials, so as to assess overall procedure PeCB, HCB, PCB and PBDE recoveries. Spiked matrices were recovered within the acceptance ranges (i.e. 50–130% for 90% of the spiked analytes) suggested by Wade and Cantillo (1994). Method quantification limits (MQLs) for PeCB, HCB, PCBs and PBDEs were determined for Antarctic krill, urchin, muscle of Antarctic yellowbelly rockcod and egg of Adélie

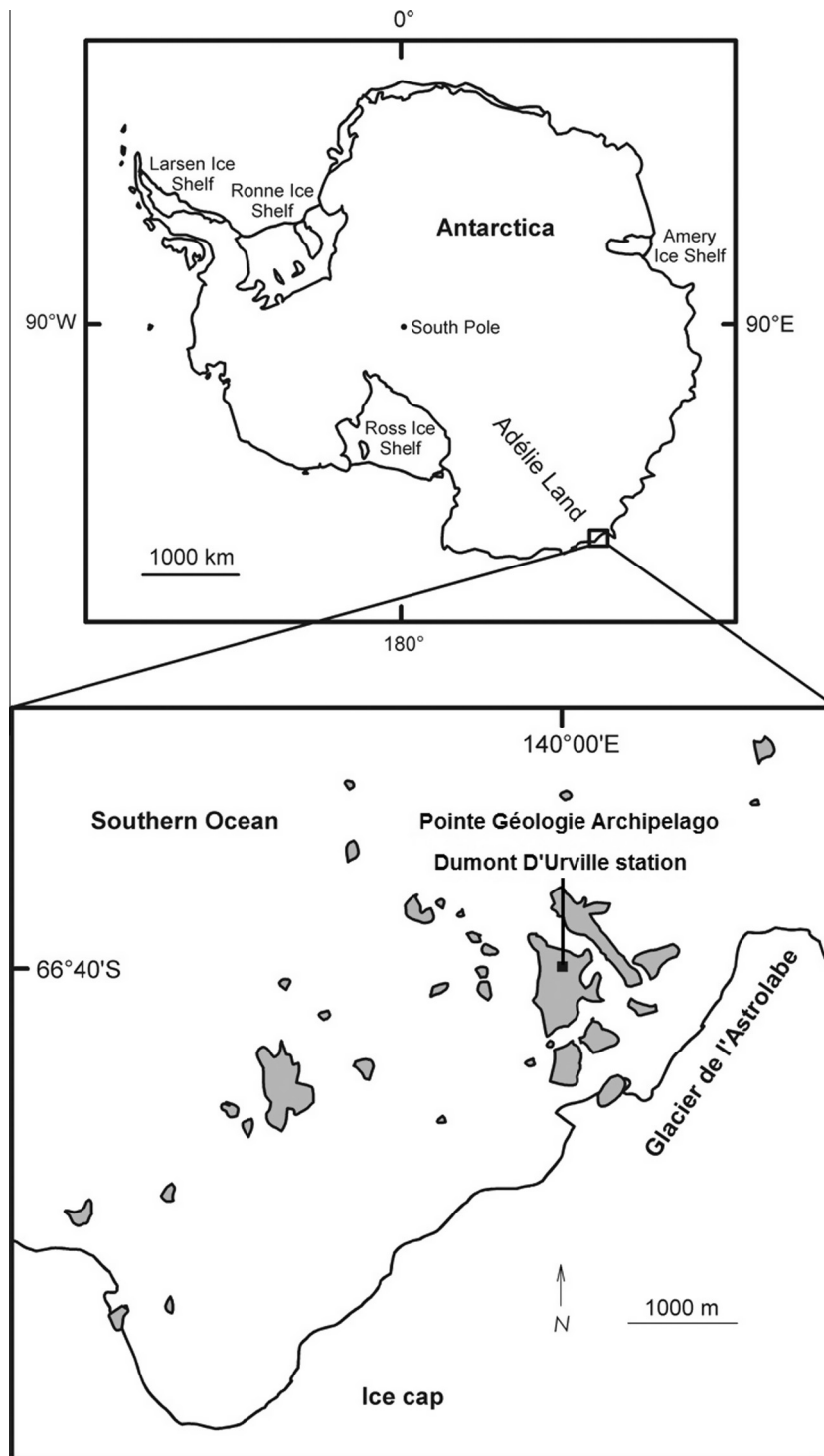


Fig. 1. Map indicating the location of Adélie Land in Antarctica. Biological samples were collected at the Pointe Géologie Archipelago, near the Dumont d'Urville research station.

penguins ( $N = 3$  for each tissue type) as 10 times the concentration of spiked samples divided by the signal to noise ratio.

#### 2.4. Statistical analyses

All statistical analyses were performed using R 2.14.2 (R development Core Team 2012). We used Kruskal–Wallis tests and Wilcoxon rank sum tests to compare POP levels (PeCB, HCB,  $\sum$  PCBs and  $\sum$  PBDEs in  $\text{ng g}^{-1}$  wet wt) among species, between closed

species (the two krill species, the two fish species and the two sea-bird species) and between benthic and pelagic organisms.

### 3. Results

#### 3.1. Differential POPs distribution between benthic and pelagic species

POP levels significantly differed between species (PeCB: Kruskal–Wallis  $\chi^2 = 20.434$ ,  $df = 8$ ,  $p = 0.009$ ; HCB: Kruskal–Wallis



**Table 1**

Studied species with name, group, habitat (benthic or pelagic), feeding habit, tissue, sample size (N), and water content.

Latin name	Common name	Group	Habitat	Feeding habit	Tissue	N	% water content
<i>Euphausia crytallorophias</i>	Ice krill	Krill	Pelagic	Grazer	Whole body	6	73.4
<i>Euphausia superba</i>	Antarctic krill	Krill	Pelagic	Grazer	Whole body	2	73.4
<i>Pagothenia borchgrevinki</i>	Bald notothen	Fish	Pelagic	Zooplanktivorous	Muscle	3	64.2
<i>Pygoscelis adeliae</i>	Adélie penguin	Seabird	Pelagic	Krill eater, piscivorous	Egg	3	63.8
<i>Pagodroma nivea</i>	Snow petrel	Seabird	Pelagic	Piscivorous, krill eater	Egg	6	63.8
<i>Synicum sp.</i>	Ascidian	Ascidian	Benthic	Filter feeder	Whole body	1	88.4
<i>Saliasterias brachiata</i>	Starfish	Starfish	Benthic	Necrophagous	Whole body	2	69.9
<i>Sterechinus neumayeri</i>	Antarctic sea urchin	Urchin	Benthic	Omnivorous	Whole body	2	78.4
<i>Notothenia coriiceps</i>	Antarctic yellowbelly rockcod	Fish	Benthic	Omnivorous	Muscle	5	75.7

$\chi^2 = 21.742$ ,  $df = 8$ ,  $p = 0.005$ ;  $\sum$  PCBs: Kruskal–Wallis  $\chi^2 = 24.467$ ,  $df = 8$ ,  $p = 0.002$ , except for  $\sum$  PBDEs (Kruskal–Wallis  $\chi^2 = 13.577$ ,  $df = 8$ ,  $p = 0.093$ ). This species-difference was partly explained by difference between benthic and pelagic species for PeCB ( $W = 155$ ,  $p = 0.006$ , Fig. 2A) and for HCB ( $W = 155$ ,  $p = 0.016$ , Fig. 2B). PeCB and HCB levels were much higher in pelagic than in benthic organisms, especially in bald notothen's muscles (for PeCB) and in seabirds' eggs (for HCB). Concentrations of  $\sum$  PCBs did not differ between pelagic and benthic species ( $W = 81$ ,  $p = 0.422$ , Fig. 2C). PBDEs were detected in 9 of the 30 analyzed biological samples: in starfish, Antarctic yellowbelly rockcod, Antarctic krill, egg of snow petrel, and bald notothen. Concentrations of  $\sum$  PBDEs did not differ between benthic and pelagic species ( $W = 72$ ,  $p = 0.136$ , Fig. 2D).

The ascidian was the least contaminated organisms in this study. The two krill species presented the lowest concentrations of POPs among pelagic species and the two krill species had no significantly different POPs concentrations (PeCB:  $W = 5$ ,  $p = 0.773$ ; HCB:  $W = 6$ ,  $p = 1$ ;  $\sum$  PCBs:  $W = 9$ ,  $p = 0.429$ ) except significantly higher concentration of  $\sum$  PBDEs in Antarctic krill ( $W = 12$ ,  $p$ -value = 0.016). Bald notothen's muscle had higher PeCB concentration ( $W = 15$ ,  $p$ -value = 0.017), higher HCB concentration ( $W = 10$ ,  $p = 0.571$ ), lower  $\sum$  PCBs concentration ( $W = 0$ ,  $p$ -value = 0.036) and not significantly different  $\sum$  PBDEs concentration ( $W = 6$ ,  $p = 0.760$ ). Snow petrels' eggs were more than 3 times more contaminated by PCBs than Adélie penguins' eggs ( $W = 18$ ,  $p = 0.024$ ). This difference between the two seabird species was not detected for PeCB concentrations ( $W = 7$ ,  $p = 0.697$ ), HCB concentrations ( $W = 11$ ,  $p = 0.714$ ), and  $\sum$  PBDEs ( $W = 10.5$ ,  $p$ -value = 0.637).

### 3.2. Isomer class patterns

Among PCBs, low-chlorinated isomers (tri- and tetra-CBs) were dominant in ice krill and Antarctic krill, penta- and hexa-CBs were dominant in benthic species, while high-chlorinated isomers (hexa- and hepta-CBs) were dominant in the bald notothen, and in eggs of Adélie penguin and snow petrel (Fig. 3). Among PBDEs, only four congeners were detected: BDE-47 (tetra-BDE), –99, –100 (penta-BDE) and –209 (deca-BDE). The proportion of each congener varied between species (Fig. 4), with a predominance of deca-BDE in bald notothen and the starfish *Saliasterias brachiata*, of tetra-BDE in Antarctic yellowbelly rockcod and snow petrel, and of penta-BDE in Antarctic krill.

## 4. Discussion

### 4.1. POP levels in species from Adélie Land: comparison with other areas

In this study we present for first time the distribution and abundances of POPs in some species of the rich ecosystems of the pointe Géologie Archipelago, Adélie Land, Antarctica. It has to be

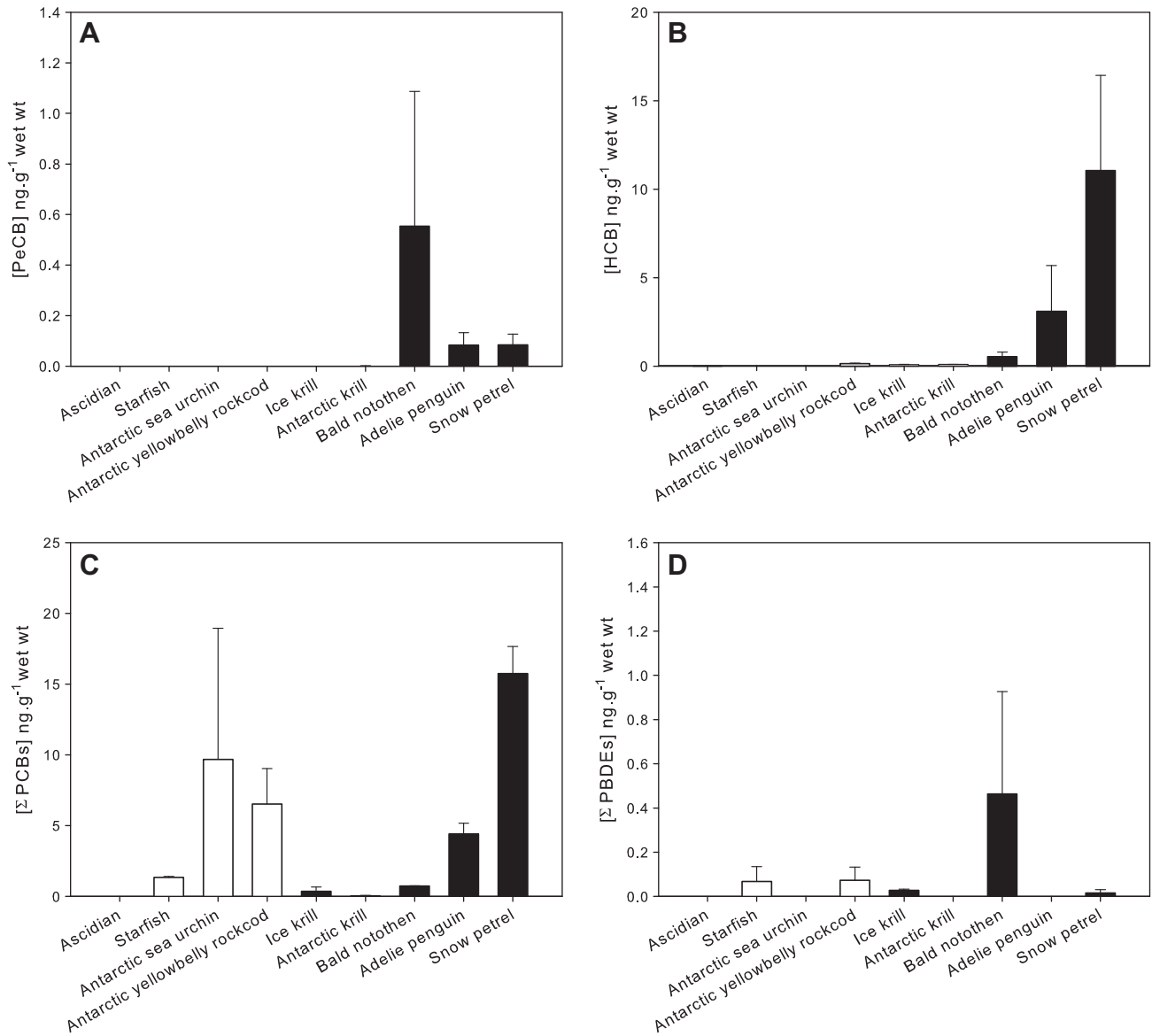
noticed that the high density of seabirds in Adélie Land (Micol and Jouventin, 2001) may have contributed to a local import and concentration of persistent organic pollutants, through excretion, as previously described at Hop island (Roosens et al., 2007). Comparing POP burden with other results from polar and temperate areas remains difficult due to large differences in analytical methods, number of analyzed PCB and PBDE congeners and units among studies. Moreover, the sample size for each species was small, which is characteristic of opportunistic sampling studies in remote environments. When focusing on HCB levels, our results were similar to studies conducted in the Ross Sea on Antarctic krill, eggs of Adélie penguin and eggs of snow petrel (Corsolini et al., 2003, 2011). When focusing on PCB-153, a commonly found congener, the Antarctic yellowbelly rockcod and the starfish were less contaminated than benthic species and starfish species from the Belgian North Sea (Voorspoels et al. 2004). Hence POP levels in species off Adélie Land appear to be relatively low compared to temperate trophic webs.

### 4.2. Species difference in POPs levels

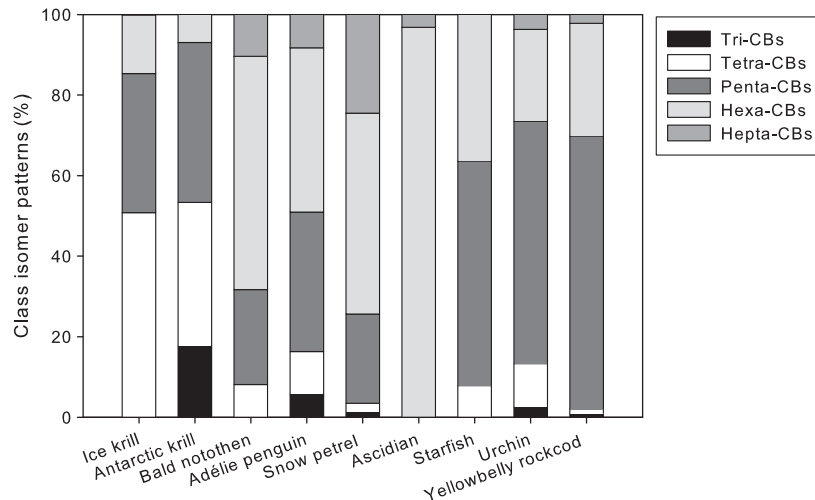
The present study highlights difference in POPs levels among Antarctic marine organisms off the Pointe Géologie Archipelago, Adélie Land. It has to be noticed that our statistical analyses were limited, because of the small sample size for each species. As a consequence, some results indicating species differences in POPs levels may actually be false positive (type I error).

POP bioaccumulation and biomagnification across polar marine food webs may partly explain species differences in POPs levels (e.g. Fisk et al., 2001; Goerke et al., 2004). Among the pelagic trophic food web, ice krill and Antarctic krill had the lowest POP levels, since they occupy a low trophic level. Moreover, concentrations of PCBs in eggs were higher in snow petrels than in Adélie penguins. It is known that concentrations of PCBs in seabirds' eggs are positively correlated to concentrations in plasma of the laying females (Verreault et al., 2006). This difference among the two seabirds' species could be due to their higher trophic level (Rau et al., 1992; Cherel, 2008), as Adélie penguin feeds mainly on krill, while snow petrel is predominantly piscivorous. Benthic species had no PeCB and reduced HCB levels compared to pelagic organisms. The filter feeder ascidian was the least contaminated in the present study, as it occupies the lowest trophic level. The sea urchins *Sterechinus neumayeri* and the benthic fish *Notothenia coriiceps* had the highest PCBs levels among benthic species, which could be attributed to their omnivorous feeding habit (McClintock, 1994), and/or to their potentially weak efficiency to metabolize contaminants (Brockington and Peck, 2001).

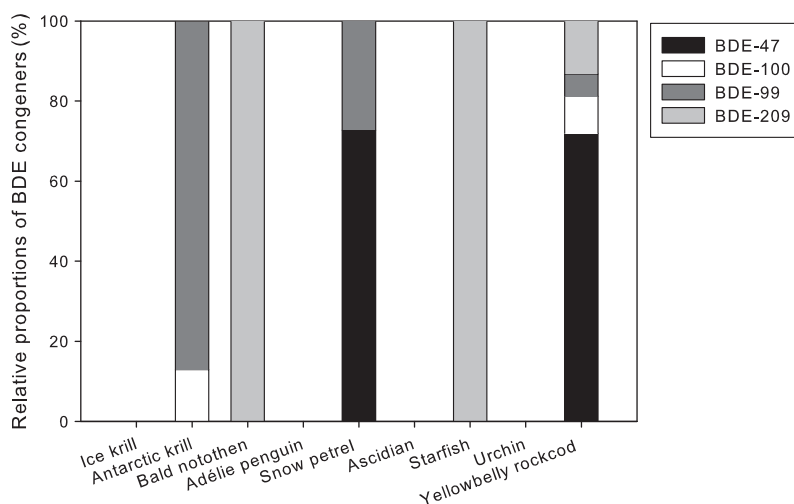
Difference in POP levels between pelagic and benthic species could be due to seasonal ice-dynamics and sedimentation process. Since large blooms of lipid-rich ice algae incorporate the hydrophobic POPs compounds (see Table 2 for Octanol–Water partition coefficient, hereafter log Kow), they are transported from the



**Fig. 2.** POP levels in Antarctic marine organisms. Concentrations (mean and SE,  $\text{ng.g}^{-1}$  wet wt) of PeCB (A), HCB (B),  $\Sigma$  PCBs (C), and  $\Sigma$  PBDEs (D) in ice krill ( $N = 6$ ), Antarctic krill ( $N = 2$ ), bald notothen ( $N = 3$ ), eggs of Adélie penguin ( $N = 3$ ), eggs of snow petrel ( $N = 6$ ), ascidian ( $N = 1$ ), starfish ( $N = 2$ ), urchin ( $N = 2$ ) and Antarctic yellowbelly rockcod ( $N = 5$ ). Pelagic species are represented in black and benthic species are presented in white.



**Fig. 3.** Class PCB isomer patterns. Relative proportion of tri, tetra, penta, hexa and hepta-PCBs in ice krill ( $N = 6$ ), Antarctic krill ( $N = 2$ ), bald notothen ( $N = 3$ ), eggs of Adélie penguin ( $N = 3$ ), eggs of snow petrel ( $N = 6$ ), ascidian ( $N = 1$ ), starfish ( $N = 2$ ), urchin ( $N = 2$ ) and Antarctic yellowbelly rockcod ( $N = 5$ ).



**Fig. 4.** Relative proportions of BDE congeners. Relative proportions of the detected BDE congeners (BDE-47, –100, –99, 209). PBDEs were found in only two Antarctic krill, one bald notothen, one snow petrel's egg, one starfish, and four Antarctic yellowbelly rockcod.

surface to the seabed through short but intense sedimentation (Wania and Daly, 2002; Dachs et al., 2002). Such effects of sea ice on sedimentation of PCBs have been put forward to explain the increase of PCBs levels in benthic fish during the last decades, in spite of a decrease in PCBs levels reported in pelagic seabirds and fish (Goerke et al., 2004; van den Brink et al., 2011). Furthermore, bio-deposition by filter-feeding organisms, such as blue mussels *Mytilus edulis*, has been shown to significantly increase the downward transport of PCBs from the water column to the bottom in a Baltic coastal ecosystem (Bjöerk et al., 2000). The low HCB levels and the absence of PeCB in benthic species could have resulted from the lower hydrophobicity of these compounds (see Table 2 for log Kow), so that they would be less incorporated into profuse blooms of lipid-rich algae and poorly transported to benthic organisms by sedimentation (Fahl and Kattner, 1993).

#### 4.3. Isomer class patterns

Low-chlorinated PCBs (tri and tetra-CBs) were relatively abundant in the two euphausiids, while high-chlorinated PCBs (hexa and hepta-CBs) were relatively abundant in cryopelagic fish and seabird eggs, as previously noted (Corsolini et al., 2003). These results could have arisen from selective uptake of high-chlorinated PCBs and/or excretion of lower chlorinated congeners by higher-trophic level organisms, the longer lifespan of fish and seabirds compared to krill, and thus longer exposure time, and/or biotransformation process, such as enzymatic efficiency. It is important to note that differences may exist in PCB congener concentrations between eggs and plasma of the laying females (Verreault et al., 2006). Among benthic species, penta-PCBs were predominant, probably due to their high incorporation into ice algae compared to tri- and tetra-CBs (see Table 2 for log Kow).

#### 4.4. PBDE exposure in Antarctic marine ecosystems

In spite of growing scientific interest worldwide, PBDEs exposure has been poorly studied in Antarctic biota (Borghesi et al., 2008, 2009; Corsolini et al., 2006; Hale et al., 2008; Yogui and Sericano, 2009; van den Brink et al., 2011). A recent cruise carried out from Southeast Asia toward Antarctica has confirmed the long-range atmospheric transport of PBDEs (Möller et al., 2012). In the present study, PBDEs were detected in less than a third of the biological samples. No clear differences in PBDE levels were observed

between benthic and pelagic compartments. However, given our reduced sample size, we could not exclude an effect of sea ice dynamics and sedimentation on PBDE distributions.

Although previous studies have described the bioaccumulation and biomagnification of PBDEs with increasing trophic level (e.g. de Wit, 2002), our analyses did not reveal any accumulation across the food web. This may be attributed to our low sample size and to the low concentrations of PBDEs. The ability of PBDEs to bioaccumulate in organisms has been shown to increase with decreasing degree of bromination (de Boer et al., 2000). Accordingly, BDE-47, a tetra-brominated congener, was predominant in two upper trophic level species, the snow petrel and the Antarctic yellowbelly rockcod. BDE-209 was the main congener present in this study, as previously noted in some Antarctic organisms (Hale et al., 2008;

**Table 2**

Octanol–Water partition coefficient (Log Kow) for the studied compounds.

	Log Kow	Reference
PeCB	5.17	
HCB	5.5	
PCB28	5.60	Ballschmitter et al. (2005)
PCB52	5.88	Ballschmitter et al. (2005)
PCB101	6.32	Ballschmitter et al. (2005)
PCB110	6.18	Ballschmitter et al. (2005)
PCB77	6.29	Ballschmitter et al. (2005)
PCB81	6.27	Ballschmitter et al. (2005)
PCB123	6.60	Ballschmitter et al. (2005)
PCB118	6.63	Ballschmitter et al. (2005)
PCB114	6.72	Ballschmitter et al. (2005)
PCB153	6.76	Ballschmitter et al. (2005)
PCB105	6.60	Ballschmitter et al. (2005)
PCB138	6.75	Ballschmitter et al. (2005)
PCB126	6.93	Ballschmitter et al. (2005)
PCB167	7.11	Ballschmitter et al. (2005)
PCB156	7.25	Ballschmitter et al. (2005)
PCB157	7.10	Ballschmitter et al. (2005)
PCB180	7.28	Ballschmitter et al. (2005)
PCB169	7.59	Ballschmitter et al. (2005)
PCB189	7.77	Ballschmitter et al. (2005)
PBDE28	5.94	Braekeveldt et al. (2003)
PBDE47	6.81	Braekeveldt et al. (2003)
PBDE100	7.24	Braekeveldt et al. (2003)
PBDE99	7.32	Braekeveldt et al. (2003)
PBDE154	7.82	Braekeveldt et al. (2003)
PBDE153	7.90	Braekeveldt et al. (2003)
PBDE183	8.27	Braekeveldt et al. (2003)
PBDE209	12.61	Hardy (2002)

van den Brink et al., 2011). The presence of PBDEs in Antarctica may originate from atmospheric transport and partly from a contamination by local sources such as touristic or research activities. Indeed, import of personal and professional goods (e.g. plastics, fabrics, electronic equipment) to Antarctic research stations, like McMurdo station might enhance the local release of this deca-brominated congener (Hale et al., 2008). In the present study, local input of BDE-209 is supposed to be relatively low, since less than 100 inhabitants are present in the Dumont D'Urville station during summer and less than 30 during winter. Although BDE-209 is thought to be of reduced toxicity, there is growing evidence that birds and fish are able to debrominate this congener into more toxic lower-brominated congeners (Luross et al., 2002; de Wit, 2002; Kuo et al., 2010; Stapleton et al., 2004; Tomy et al., 2004). As very little is known about the toxic consequences of PBDEs accumulation on Antarctic marine organisms, there is an urgent need to assess the combined effects of POP burden on these cold-adapted species with high degree of endemism.

## 5. Conclusion

The present study provides a new contribution to the scarce data on POPs levels, including PCBs and PBDEs levels in Antarctic marine species, especially in the highly diverse marine community of the Adélie Land coast. Our data showed differences in POP distribution among species in accordance with their trophic levels and benthic–pelagic coupling.

## Acknowledgments

The authors thank the European Research Council (ERC StG 203441, G. Massé), the French Polar Institute (Research Programs No. 1010, G. Massé; No. 1124: G. Lecointre; No. 1039: J.Y. Toullec and No. 109: H. Weimerskirch) and the ANR project POLARTOP (ANR-10-CESA-0016, O. Chastel). We thank S. de Grissac and C. Robineau for their help in collecting biological samples, as well as A. Desportes and S. Labrousse for their excellent technical assistance in chemical analyses.

## Appendix A. Supplementary data

Supplementary data associated with this article can be found, in the online version, at <http://dx.doi.org/10.1016/j.marpolbul.2013.10.027>.

## References

- Ballschmiter, K., Klingler, D., Ellinger, S., Hackenberg, R., 2005. High-resolution gas chromatography retention data as a basis for estimation of the octanol–water distribution coefficients (Kow) of PCB: the effect of experimental conditions. *Anal. Bioanal. Chem.* 382, 1859–1870.
- Birnbaum, L.S., Staskal, D.F., 2004. Brominated flame retardants: cause for concern? *Environ. Health Perspect.* 112, 9–17.
- Björck, M., Gilek, M., Kautsky, N., Naef, C., 2000. In situ determination of PCB biodeposition by *Mytilus edulis* in a Baltic coastal ecosystem. *Mar. Ecol. Prog. Ser.* 194, 193–201.
- Borghesi, N., Corsolini, S., Focardi, S., 2008. Levels of polybrominated diphenyl ethers (PBDEs) and organochlorine pollutants in two species of Antarctic fish (*Chionodraco hamatus* and *Trematomus bernacchii*). *Chemosphere* 73, 155–160.
- Borghesi, N., Corsolini, S., Leonards, P., Brandsma, S., de Boer, J., Focardi, S., 2009. Polybrominated diphenyl ether contamination levels in fish from the Antarctic and the Mediterranean Sea. *Chemosphere* 77, 693–698.
- Braekveldt, E., Tittlemier, S.A., Tomy, G.T., 2003. Direct measurement of octanol–water partition coefficients of some environmentally relevant brominated diphenyl ether congeners. *Chemosphere* 51, 563–567.
- Brevik, K., Alcock, R., Li, Y.F., Bailey, R.E., Fiedley, H., Pacyna, J.M., 2004. Primary sources of selected POPs: regional and global scale emission inventories. *Environ. Pollut.* 128, 3–16.
- Bright, D.A., Grundy, S.L., Reimer, K.J., 1995. Differential bioaccumulation of non-ortho-substituted and other PCB congeners in coastal Arctic invertebrates and fish. *Environ. Sci. Technol.* 29, 2504–2512.
- Brockington, S., Peck, L.S., 2001. Seasonality of respiration and ammonium excretion in the Antarctic echinoid *Sterechnus neumayeri*. *Mar. Ecol. Prog. Ser.* 219, 159–168.
- Cipro, C.V.Z., Taniguchi, S., Montone, R.C., 2010. Occurrence of organochlorine compounds in *Euphausia superba* and unhatched eggs of *Pygoscelis* genus penguins from admiralty bay (King George Island, Antarctica) and estimation of biomagnification factors. *Chemosphere* 78, 767–771.
- Cherel, Y., 2008. Isotopic niches of emperor and Adélie penguins in Adélie Land, Antarctica. *Mar. Biol.* 154, 813–821.
- Clarke, A., 1983. Life in cold water: the physiological ecology of polar marine ectotherms. *Oceanography Biol.: Ann. Rev.* 21, 341–453.
- Corsolini, S., 2009. Industrial contaminants in Antarctic biota. *J. Chromatogr. A* 1216, 598–612.
- Corsolini, S., Ademollo, N., Romeo, T., Olmastroni, S., Focardi, S., 2003. Persistent organic pollutants in some species of a Ross Sea pelagic trophic web. *Antarct. Sci.* 15, 95–104.
- Corsolini, S., Borghesi, N., Ademollo, N., Focardi, S., 2011. Chlorinated biphenyls and pesticides in migrating and resident seabirds from East and West Antarctica. *Environ. Int.* 37, 1329–1335.
- Corsolini, S., Covaci, A., Ademollo, N., Focardi, S., Schepens, P., 2006. Occurrence of organochlorine pesticides (OCPs) and their enantiomeric signatures, and concentrations of polybrominated diphenyl ethers (PBDEs) in the Adélie penguin food web, Antarctica. *Environ. Pollut.* 140, 371–382.
- Costa, L.G., Giordano, G., 2007. Developmental neurotoxicity of polybrominated diphenyl ether (PBDE) flame retardants. *Neurotoxicology* 28, 1047–1067.
- Dachs, J., Lohmann, R., Ockenden, W.A., Méjanelle, L., Eisenreich, S.J., Jones, K.C., 2002. Oceanic biogeochemical controls on global dynamics of persistent organic pollutants. *Environ. Sci. Technol.* 36, 4229–4237.
- de Boer, J., de Boer, K., Boon, J.P., 2000. In: Paasavirta (Ed.), *The Handbook of Environmental Chemistry, New Types of Persistent Halogenated Compounds*. Springer-Verlag, Heidelberg, Germany, pp. 61–95.
- de Wit, C.A., 2002. An overview of brominated flame retardants in the environment. *Chemosphere* 46, 583–624.
- Fahl, K., Kattner, G., 1993. Lipid content and fatty acid composition of algal communities in sea-ice and water from the Weddell sea (Antarctica). *Polar Biol.* 13, 405–409.
- Fisk, A.T., Hobson, K.A., Norstrom, R.J., 2001. Influence of chemical and biological factors on trophic transfer of persistent organic pollutants in the Northwater Polynya food web. *Environ. Sci. Technol.* 35, 732–738.
- Goerke, H., Weber, K., Bornemann, H., Ramdohr, S., Ploetz, J., 2004. Increasing levels and biomagnification of persistent organic pollutants (POPs) in Antarctic biota. *Mar. Pollut. Bull.* 48, 295–302.
- Gutt, J., Koubbi, P., Eléaume, M., 2007. Mega-epibenthic diversity off Terre Adélie (Antarctica) in relation to disturbance. *Polar Biol.* 30, 1323–1329.
- Hale, R.C., Alaei, M., Manchester-Neesvig, J.B., Stapleton, H.M., Ikonou, M.G., 2003. Polybrominated diphenyl ether flame retardants in the North American environment. *Environ. Int.* 29, 771–779.
- Hale, R.C., Kim, S.L., Harvey, E., La Guardia, M.J., Mainor, T.M., Bush, E.O., Jacobs, E.M., 2008. Antarctic research bases: local sources of polybrominated diphenyl ether (PBDE) flame retardants. *Environ. Sci. Technol.* 42, 1452–1457.
- Hardy, M.L., 2002. A comparison of the properties of the major commercial PBDE/ PBDE product to those of major PBB and PCB products. *Chemosphere* 46, 717–728.
- Ikonou, M.G., Rayne, S., Addison, R.F., 2002. Exponential increases of the brominated flame retardants, polybrominated diphenyl ethers, in the Canadian arctic from 1981 to 2000. *Environ. Sci. Technol.* 36, 1886–1892.
- Kennicutt II, M.C., McDonald, S.J., Sericano, J.L., Boothem, P., Oliver, J., Safe, S., Presley, B.J., Liu, H., Wolfe, D., Wade, T.L., Crockett, A., Bockus, D., 1995. Human contamination of the marine environment: Arthur harbour and McMurdo sound, Antarctica. *Environ. Sci. Technol.* 29, 1279–1287.
- Kuo, Y.M., Sepulveda, M.S., Sutton, T.M., Ochoa-Acuna, H.G., Muir, A.M., Miller, B., Hua, I., 2010. Bioaccumulation and biotransformation of decabromodiphenyl ether and effects on daily growth in juvenile lake whitefish (*Coregonus clupeaformis*). *Ecotoxicology* 19, 751–760.
- La Mesa, M., Eastman, J.T., Vacchi, M., 2004. The role of notothenioid fish in the food web of the Ross Sea shelf waters: a review. *Polar Biol.* 27, 321–338.
- Labadie, P., Alliot, F., Bourges, C., Desportes, A., Chevreuil, M., 2010. Determination of polybrominated diphenyl ethers in fish tissues by matrix solid-phase dispersion and gas chromatography coupled to triple quadrupole mass spectrometry: case study on European eel (*Anguilla anguilla*) from Mediterranean coastal lagoons. *Anal. Chim. Acta* 675, 97–105.
- Letcher, R.J., Bustnes, J.O., Dietz, R., Jenssen, B.M., Jørgensen, E.V., Sonne, C., Verreault, J., Vijayan, M.M., Gabrielsen, G.W., 2010. Exposure and effects assessment of persistent organohalogen contaminants in arctic wildlife and fish. *Sci. Total Environ.* 408, 2995–3043.
- Luross, J.M., Alaei, M., Sergeant, D.B., Cannon, C.M., Whittle, D.M., Solomon, K.R., Muir, D.C.G., 2002. Spatial distribution of polybrominated diphenyl ethers and polybrominated biphenyls in lake trout from the Laurentian great lakes. *Chemosphere* 46, 665–672.
- McClintock, J.B., 1994. Trophic biology of shallow water antarctic echinoderms. *Mar. Ecol. Prog. Ser.* 111, 191–202.
- Meerts, I.A.T.M., Letcher, R.J., Hoving, S., Marsh, G., Bergman, A., Lemmen, J.G., van der Burg, B., Brouwer, A., 2001. In vitro estrogenicity of polybrominated diphenyl ethers, hydroxylated PBDEs, and polybrominated bisphenol A compounds. *Environ. Health Perspect.* 109, 399–407.

- Micol, T., Jouventin, P., 2001. Long term population trends in seven Antarctic seabirds at Pointe Géologie Terre Adélie. *Polar Biol.* 24, 175–185.
- Möller, A., Xie, Z., Cai, M., Sturm, R., Ebinghaus, R., 2012. Brominated flame retardants and dechlorane plus in the marine atmosphere from southeast Asia toward Antarctica. *Environ. Sci. Technol.* 46, 3141–3148.
- Negri, A., Burns, K., Boyle, S., Brinkman, D., Webster, N., 2006. Contamination in sediments, bivalves and sponges of McMurdo sound, Antarctica. *Environ. Pollut.* 143, 456–467.
- Rau, G.H., Ainley, D.G., Bengtson, J.L., Torres, J.J., Hopkins, T.L., 1992.  $^{15}\text{N}/^{14}\text{N}$  and  $^{13}\text{C}/^{12}\text{C}$  in Weddell seabirds, seals, and fish: implications for diet and trophic structure. *Mar. Ecol. Prog. Ser.* 84, 1–8.
- Ridoux, V., Offredo, C., 1989. The diets of five summer breeding seabirds in Adélie Land, Antarctica. *Polar Biol.* 9, 137–145.
- Risebrough, R.W., Walker II, W., Schimdt, T.T., deLappe, D.W., Connors, C.W., 1976. Transfer of chlorinated biphenyls to Antarctica. *Nature* 264, 738–739.
- Roosens, L., Van Den Brink, N., Riddle, M., Blust, R., Neels, H., Covaci, A., 2007. Penguin colonies as secondary sources of contamination with persistent organic pollutants. *J. Environ. Monit.* 9, 822–825.
- Shaw, S.D., Berger, M.L., Brenner, D., Kannan, K., Lohmann, N., Päpke, O., 2009. Bioaccumulation of polybrominated diphenyl ethers and hexabromocyclododecane in the northwest Atlantic marine food web. *Sci. Total Environ.* 407, 3323–3329.
- Simonich, S.L., Hites, R.A., 1995. Global distribution of persistent organochlorine compounds. *Science* 269, 1851–1854.
- Sørmo, E.G., Salmer, M.P., Jenssen, B.M., Hop, H., Bæk, K., Kovacs, K.M., Lydersen, C., Falk-Petersen, S., Gabrielsen, G.W., Lie, E., Skaare, J.U., 2006. Biomagnification of polybrominated diphenyl ether and hexabromocyclododecane flame retardants in the polar bear food chain in Svalbard, Norway. *Environ. Toxicol. Chem.* 25, 2502–2511.
- Stapleton, H.M., Alaee, M., Letcher, R.J., Baker, J.E., 2004. Debromination of the flame retardant decabromodiphenyl ether by juvenile carp (*Cyprinus carpio*) following dietary exposure. *Environ. Sci. Technol.* 38, 112–119.
- Teil, M.J., Tlili, K., Blanchard, M., Chevreuil, M., Alliot, F., Labadie, P., 2012. Occurrence of polybrominated diphenyl ethers, polychlorinated biphenyls, and phthalates in freshwater fish from the Orge river (Ile-de France). *Arch. Environ. Contam. Toxicol.* 63, 101–113.
- Tomy, G.T., Palace, V.P., Halldorsson, T., Braekevelt, E., Danell, R., Wautier, K., Evans, B., Brinkworth, L., Fisk, A.T., 2004. Bioaccumulation, biotransformation and biochemical effects of brominated diphenyl ethers in juvenile lake trout (*Salvelinus namaycush*). *Environ. Sci. Technol.* 38, 1496–1504.
- van den Brink, N.W., Riddle, M.J., van den Heuvel-Greve, M., van Franeker, J.A., 2011. Contrasting time trends of organic contaminants in Antarctic pelagic and benthic food webs. *Mar. Pollut. Bull.* 62, 128–132.
- Verreault, J., Villa, R.A., Gabrielsen, G.W., Skaare, J.U., Letcher, R.J., 2006. Maternal transfer of organohalogen contaminants and metabolites to eggs of Arctic-breeding glaucous gulls. *Environ. Pollut.* 144, 1053–1060.
- Voorspoels, S., Covaci, A., Maervoet, J., De Meester, I., Schepens, P., 2004. Distribution of PCBs/OCs in benthic organisms and fish from the North Sea Continental Shelf and Scheldt estuary. *Mar. Pollut. Bull.* 49, 393–404.
- Wade, T.L., Cantillo, A.Y., 1994. Use of Standards and Reference Materials in the Measurement of Chlorinated Hydrocarbon Residues. Chemistry Workbook. NOAA Technical Memorandum NOS ORCA 77. Silver, Spring, Maryland.
- Wania, F., Daly, G.L., 2002. Estimating the contribution of degradation in air and deposition to the deep sea to the global loss of PCBs. *Atmos. Environ.* 36, 5581–5593.
- Yogui, G.T., d Sericano, J.L., 2009. Levels and pattern of polybrominated diphenyl ethers in eggs of Antarctic seabirds: endemic versus migratory species. *Environ. Pollut.* 157, 975–980.
- Zhou, T., Taylor, M.M., DeVito, M.J., Crofton, K.M., 2002. Developmental exposure to brominated diphenyl ethers results in thyroid hormone disruption. *Toxicol. Sci.* 66, 105–116.





## Résumé

L'exposition à de multiples polluants constitue l'une des pressions anthropiques qui menacent la biodiversité. Appréhender l'imprégnation de la faune sauvage et les dommages potentiels est un défi majeur en écotoxicologie, en raison de la complexité des processus qui gouvernent le devenir et les effets des polluants dans les organismes. Mes travaux de recherche visent, d'une part, à mieux caractériser les transferts de micropolluants (mercure, Polychlorobiphényles (PCBs), pesticides organochlorés, Hydrocarbures Aromatiques Polycycliques (HAPs), phtalates, insecticides pyréthrinoïdes), ainsi que leurs métabolites dans les réseaux trophiques marins polaires et dulçaquicoles tempérés, des proies aux prédateurs, mais aussi des hôtes aux parasites. Les voies d'exposition environnementale et les processus de métabolisation ont été explorés, ainsi que les effets de l'âge, de l'habitat, de l'écologie trophique et du parasitisme sur les niveaux de contamination des poissons. D'autre part, les effets des micropolluants et de leurs métabolites ont été évalués à différentes échelles biologiques. Au niveau physiologique, seuls quelques composés, malgré leurs niveaux relativement faibles, accélèrent le vieillissement des individus et perturbent la sécrétion d'hormones et l'expression de comportement reproducteur. En ce qui concerne les traits d'histoire de vie, l'utilisation de jeux de données à long-terme et de modèles de capture-marquage-recapture ont permis de montrer que les taux élevés de mercure, PCBs et pesticides organochlorés, en particulier l'oxychlordan et le mirex, peuvent compromettre les performances de reproduction à long terme des oiseaux marins en Arctique et en Antarctique, voire même diminuer les taux de survie des adultes. Ces résultats illustrent notamment de fortes disparités entre espèces phylogénétiquement proches et entre mâles et femelles. A l'échelle des populations, il a été possible de projeter des déclin démographiques avec une exposition croissante aux micropolluants. Dans un contexte de stress multiples, ces travaux soulignent que certaines perturbations environnementales amplifient ou au contraire, atténuent les effets des polluants, réitérant l'importance de conduire des études écotoxicologiques en milieux naturels.