



**HAL**  
open science

## Operads in algebraic combinatorics

Samuele Giraudo

► **To cite this version:**

Samuele Giraudo. Operads in algebraic combinatorics. Combinatorics [math.CO]. Université Paris-Est Marne-la-Vallée, 2017. tel-03615171

**HAL Id: tel-03615171**

**<https://hal.science/tel-03615171v1>**

Submitted on 21 Mar 2022

**HAL** is a multi-disciplinary open access archive for the deposit and dissemination of scientific research documents, whether they are published or not. The documents may come from teaching and research institutions in France or abroad, or from public or private research centers.

L'archive ouverte pluridisciplinaire **HAL**, est destinée au dépôt et à la diffusion de documents scientifiques de niveau recherche, publiés ou non, émanant des établissements d'enseignement et de recherche français ou étrangers, des laboratoires publics ou privés.

# HABILITATION À DIRIGER DES RECHERCHES

Spécialité Informatique

*Présentée le 4 décembre 2017 par*

**Samuele Giraud**

Université Paris-Est Marne-la-Vallée

## **Operads in algebraic combinatorics**

Opérades en combinatoire algébrique

*Devant le jury composé par*

Frédéric Chapoton	Président du jury
Jean-Yves Thibon	Garant d'habilitation
Pierre-Louis Curien	Rapporteur
Loïc Foissy	Rapporteur
Dominique Manchon	Rapporteur
Alessandra Frabetti	Examineur
Florent Hivert	Examineur
Jean-Gabriel Luque	Examineur



# Samuele Girardo

UNIVERSITÉ PARIS-EST, LIGM (UMR 8049), CNRS, ENPC, ESIEE PARIS, UPEM, F-77454, MARNE-LA-VALLÉE, FRANCE

*E-mail address:* `samuele.girardo@u-pem.fr`

2010 *Mathematics Subject Classification.* 05A15, 05C05, 05E15, 16T05, 18D50, 68Q42.

*Key words and phrases.* Algebraic combinatorics; Computer science; Formal power series; Tree; Rewrite system; Poset; Operad; Colored operad; Hopf bialgebra; Pro.

ABSTRACT. This habilitation thesis fits in the fields of algebraic and enumerative combinatorics, with connections with computer science. The main ideas developed in this work consist in endowing combinatorial objects (words, permutations, trees, integer partitions, Young tableaux, *etc.*) with operations in order to construct algebraic structures. This process allows, by studying algebraically the structures thus obtained (changes of bases, generating sets, presentations by generators and relations, morphisms, representations), to collect combinatorial information about the underlying objects. The algebraic structures the most encountered here are magmas, posets, associative algebras, dendriform algebras, Hopf bialgebras, operads, and pros.

This work explores the aforementioned research direction and provides many (functorial or not) constructions having the particularity to build algebraic structures on combinatorial objects. We develop for instance a functor from nonsymmetric colored operads to nonsymmetric operads, from monoids to operads, from unitary magmas to nonsymmetric operads, from finite posets to nonsymmetric operads, from stiff pros to Hopf bialgebras, and from precompositions to nonsymmetric operads. These constructions bring alternative ways to describe already known structures and provide new ones, as for instance, some of the deformations of the noncommutative Faà di Bruno Hopf bialgebra of Foissy and a generalization of the dendriform operad of Loday.

We also use algebraic structures to obtain enumerative results. In particular, nonsymmetric colored operads are promising devices to define formal series generalizing the usual ones. These series come with several products (for instance a pre-Lie product, an associative product, and their Kleene stars) enriching the usual ones on classical power series. This provides a framework and a toolbox to strike combinatorial questions in an original way.

The text is organized as follows. The first two chapters pose the elementary notions of combinatorics and algebraic combinatorics used in the whole work. The last ten chapters contain our original research results fitting the context presented above.

## Remerciements

Même si sur le papier je figure comme unique auteur de ce document, ce travail n'a pu s'épanouir que grâce aux personnes que j'ai côtoyées. Leurs apports, qu'ils soient scientifiques, culturels, spirituels ou amicaux, sont tous à mes yeux d'une grande valeur. C'est à vous tous que ces lignes sont dédiées.

Je souhaite tout d'abord remercier Jean-Yves Thibon d'avoir accepté ce rôle de garant d'habilitation. Je le connais depuis que j'ai commencé mon doctorat il y a huit ans. L'expérience montre qu'absolument tous ses conseils et avis sont d'une importance capitale. L'étendue et la profondeur de ses connaissances, ainsi que sa bienveillance, font que l'avoir comme chef de l'équipe de combinatoire au LIGM est une chance inestimable.

J'adresse maintenant mes plus sincères remerciements à l'ensemble des rapporteurs. Je suis conscient du très lourd travail que représente simplement la lecture de ce long manuscrit. Avoir un avis dessus et l'évaluer est un travail encore plus exigeant. C'est donc à la fois un honneur et une faveur immense qui m'est faite. J'ai rencontré Pierre-Louis Curien en 2016 lors d'une conférence sur les opérades et les systèmes de réécriture. Nous avons eu à cette occasion une très agréable discussion à propos des opérades et des liens que cette théorie entretient avec l'informatique théorique et les modèles de calcul. Je suis très reconnaissant du travail de relecture attentif de Pierre-Louis. Ses remarques ont beaucoup amélioré le texte. Les travaux de Loïc Foissy sur les opérades, les structures dendrifformes et les bigèbres de toutes sortes m'ont beaucoup inspiré et vont sans aucun doute le continuer pendant un très long moment. Je profite aussi de cette opportunité pour le remercier pour ses réponses aux questions que j'ai pu lui poser ces dernières années, que ce soit pendant les conférences ou bien par courrier. J'ai assisté à un cours de Dominique Manchon à Benasque en début 2010 sur les bigèbres de Hopf combinatoires et les opérades. Je ne me doutais pas encore à ce moment là que ces objets allaient être aussi importants pour moi. La pédagogie et le soin avec lesquels il a présenté son cours ont beaucoup contribué à ma passion alors naissante pour ces objets. Merci aussi à Dominique pour ses remarques qui ont rendu ce document meilleur.

Je souhaite remercier maintenant l'ensemble des membres du jury. Vous me faites un immense honneur par votre présence et le temps que vous avez investi à cette fin. J'ai travaillé avec Frédéric Chapoton à propos de constructions mêlant opérades et configurations de diagonales dans les polygones. Cette expérience a été très bénéfique puisque j'ai pu profiter de son point de vue très précis sur ces objets. Je profite de cette occasion pour remercier Frédéric pour ses réponses patientes et complètes à mes questions régulières. Ses contributions m'ont tellement inspiré que sans elles, ma recherche serait aujourd'hui totalement différente.

Les articles d’Alessandra Frabetti m’ont appris beaucoup, surtout ceux traitant des séries sur opérades ensemblistes. Je suis très content de la compter dans mon jury, car, même si nous travaillons sur des domaines assez différents, leur intersection contient au moins la théorie des opérades et des bigèbres de Hopf. Florent Hivert a co-encadré ma thèse et m’a transmis énormément de choses. Je l’ai connu alors que j’étais étudiant à l’université de Rouen où j’ai été frappé par sa passion très vive et communicante de la combinatoire. Je lui dois tant de choses que ces quelques lignes ne pourraient le signifier. Que mon respect le plus profond lui soit témoigné. J’ai collaboré avec Jean-Gabriel Luque au sujet d’opérades émergeant d’opérateurs en théorie des langages. Sa capacité à mélanger plusieurs concepts différents et de manière cohérente est très enrichissante. Je le remercie aussi pour ses invitations multiples et très agréables aux séminaires à Rouen.

Les collaborations en recherche sont des pratiques très épanouissantes. Je remercie tous mes coauteurs et plus particulièrement (sans renommer ceux déjà cités plus haut) Jean-Paul Bultel et Stéphane Vialette. J’ai pris beaucoup de plaisir à travailler avec vous et j’espère bien que cela va continuer.

Le LIGM est depuis quelques années dirigé de manière extraordinaire par Cyril Nicaud. Je le remercie pour tout ce qu’il fait et la simplicité qu’il y a installée. Je remercie les membres de l’équipe, Philippe Biane, Nicolas Borie<sup>a</sup>, Olivier Bouillot, Cyrille Chenavier, Christophe Cordero<sup>b</sup>, Matthieu Josuat-Vergès, Arthur Nunge<sup>c</sup> et Luca Randazzo, Le groupe de travail du vendredi matin est incontournable. Merci aussi à tout ceux qui ont fait partie de l’équipe ou qui en sont plus ou moins proches : Adrien Boussicault, Grégory Châtel<sup>d</sup>, Zakaria Chemli, Ali Chouria, Bérénice Delcroix-Oger, Gérard Duchamp, Valentin Féray, Thibault Manneville, Gia-Thuy Pham<sup>e</sup>, Vincent Penelle, Vincent Pilaud, Viviane Pons, Adrian Tanasa, Nicolas Thiéry, Christophe Tollu et Vincent Vong. L’équipe administrative du laboratoire fait un travail remarquable : celui, entre autres, de simplifier de manière miraculeuse les tâches qui paraissent insurmontables et complexes. Je remercie à ce sujet Séverine Giboz, Patrice Hérault, Corinne Palessandolo, Nathalie Rousseau et Pascale Souliez. Par ailleurs, on peut facilement observer que l’équipe pédagogique du laboratoire tourne bien, ce qui implique beaucoup de temps de gagné et du plaisir en plus. Mes remerciements vont à ce sujet à tous ceux avec qui j’ai pu collaborer pédagogiquement de près ou de loin, incluant Marie-Pierre Béal, Claire David, Etienne Duris, Isabelle Fagnot, Rémi Forax, Xavier Goac, Anthony Larbarre, Stéphane Lohier, Antoine Meyer, Serge Midonnet, Dominique Perrin, Carine Pivoteau, Dominique Revuz, Giuseppina Rindone, Johan Thapper et Marc Zipstein.

Je saisis l’occasion pour témoigner toute ma gratitude envers Jean-Christophe Novelli. Depuis que je le connais, il est toujours disponible pour aider les autres, avec franchise, rigueur et diplomatie. Il n’a cessé de me prodiguer des conseils précieux de tout ordre et de me consacrer beaucoup de temps. Je lui témoigne ici mon respect le plus sincère.

---

<sup>a</sup>Grand inventeur de la Borification et du concept controversé du « un Giraudal / des Giraudos ».

<sup>b</sup>Mieux connu sous le nom de... Ah non, je ne peux pas dire !

<sup>c</sup>Mieux connu sous le nom de Sire.

<sup>d</sup>Qui a, sans que personne ne sache comment, de manière continue des thèmes et idées fascinants à partager.

<sup>e</sup>Qui me laisse généreusement gagner beaucoup de parties d’échecs.

J'exprime tous mes remerciements envers mes amis (sans renommer ceux déjà cités plus haut). En particulier, merci à Cédric, Jocelyn, Marie, Christine et Simone.

Mes plus tendres remerciements sont destinés à Camille<sup>f</sup>. Merci de m'avoir soutenu depuis le début<sup>g</sup>. Je suis heureux, comblé et bien plus que cela encore de t'avoir à mes côtés. Merci enfin à toute ma famille, Papa, Maman, mes frères Carlo et Davide, et ma sœur Chiara<sup>h</sup>. Je sais que je peux compter sur vous en toutes circonstances<sup>i</sup>. Je vous aime.

À tout ceux qui cherchent et ne voient pas leur nom : mon insuffisance est impardonnable. Si c'est le cas, ne cherchez plus, vous méritez d'y être ; si vous n'êtes pas sous ma plume ce soir, vous êtes et resterez dans mon cœur.

---

<sup>f</sup>Combe mais sans « s ».

<sup>g</sup>Et de m'avoir fait — bien — découvrir le concept de pauses multiples en voyage.

<sup>h</sup>Se prononce « Chiara » et non pas « Chiara ».

<sup>i</sup>Et réciproquement. Bip bip bip bip ! Je promets d'essayer de progresser en informatique !





# Contents

<b>List of Figures</b>	xv
<b>List of Tables</b>	xvii
<b>Introduction</b>	1
<b>Part 1. Algebraic combinatorics</b>	<b>21</b>
<b>Chapter 1. Combinatorics</b>	<b>23</b>
1. Structured collections	24
1.1. Collections	24
1.2. Main collections	29
1.3. Posets on collections	33
1.4. Rewrite systems on collections	37
2. Collections of trees	40
2.1. Planar rooted trees	40
2.2. Subcollections of planar rooted trees	44
2.3. Syntax trees	46
2.4. Syntax tree patterns and rewrite systems	48
3. Combinatorial objects	54
3.1. Other kinds of trees	54
3.2. Configurations of chords	56
3.3. Prographs	58
3.4. Alternating sign matrices	60
<b>Chapter 2. Algebraic combinatorics</b>	<b>63</b>
1. Polynomial spaces	64
1.1. Series and polynomials on collections	64
1.2. Operations over graded polynomial spaces	68
1.3. Changes of basis and posets	70
2. Bialgebras	72
2.1. Biproducts and duality	72

2.2. Polynomial bialgebras	75
2.3. Types of polynomial bialgebras	77
3. Hopf bialgebras in combinatorics	83
3.1. Hopf bialgebras	83
3.2. Main Hopf bialgebras in combinatorics	84
4. Operads in combinatorics	90
4.1. Operads	90
4.2. Main operads in combinatorics	101
5. Pros in combinatorics	105
5.1. Pros	105
5.2. Main pros in combinatorics	107
<b>Part 2. Combinatorial operads</b>	<b>109</b>
<b>Chapter 3. Enveloping operads of colored operads</b>	<b>111</b>
Introduction	111
1. Enveloping operads of colored operads	112
1.1. The construction	112
1.2. Bubble decompositions of operads and consequences	115
2. The operad of bicolored noncrossing configurations	116
2.1. Bicolored noncrossing configurations	116
2.2. The colored operad of bubbles	117
2.3. Properties of the operad of bicolored noncrossing configurations	120
3. Suboperads of the operad of bicolored noncrossing configurations	122
3.1. Overview of the obtained suboperads	122
3.2. Suboperads generated by two elements of arity 2	123
Concluding remarks	130
<b>Chapter 4. From monoids to operads</b>	<b>131</b>
Introduction	131
1. A functor from monoids to operads	132
1.1. The operad of a monoid	132
1.2. Main properties of the construction	133
2. Concrete constructions	134
2.1. Operads from the additive monoid	135
2.2. Operads from the max monoid	150
Concluding remarks	151

<b>Chapter 5. Pluriassociative and polydendriform operads</b>	<b>153</b>
Introduction	153
1. Pluriassociative operads	155
1.1. Construction and first properties	155
1.2. Additional properties	156
2. Pluriassociative algebras	161
2.1. Category of pluriassociative algebras and free objects	161
2.2. Bar and wire-units	161
2.3. Construction of pluriassociative algebras	162
3. Pluritriassociative operads	166
3.1. Construction and first properties	166
3.2. Additional properties	167
4. Polydendriform operads	169
4.1. Construction and properties	170
4.2. Category of polydendriform algebras and free objects	173
5. Multiassociative operads	175
5.1. Two generalizations of the associative operad	175
5.2. A diagram of operads	179
6. Further generalizations	180
6.1. Duplicial operad	180
6.2. Polytridendriform operads	183
6.3. Operads of the operadic butterfly	184
Concluding remarks	186
<b>Chapter 6. From posets to operads</b>	<b>189</b>
Introduction	189
1. From posets to operads	190
1.1. Construction	190
1.2. General properties	192
1.3. Algebras over poset associative operads	193
2. Forest posets, Koszul duality, and Koszulity	194
2.1. Koszulity and Poincaré-Birkhoff-Witt bases	194
2.2. Dimensions and realization	196
2.3. Koszul dual	201
3. Thin forest posets and Koszul duality	204
3.1. Thin forest posets	204
3.2. Koszul duality and poset duality	206

Concluding remarks	209
<b>Chapter 7. Operads of decorated cliques</b>	<b>211</b>
Introduction	211
1. From unitary magmas to operads	214
1.1. Unitary magmas, decorated cliques, and operads	214
1.2. General properties	216
2. Quotients and suboperads	221
2.1. Main substructures	221
2.2. Secondary substructures	226
2.3. Relations between substructures	228
3. Operads of noncrossing decorated cliques	229
3.1. General properties	230
3.2. Presentation and Koszulity	234
3.3. Suboperads generated by bubbles	236
3.4. Algebras over the noncrossing clique operads	238
3.5. Koszul dual	243
4. Concrete constructions	245
4.1. Rational functions and related operads	245
4.2. Operad of bicolored noncrossing configurations	246
4.3. Operads from language theory	247
4.4. Gravity operad	248
Concluding remarks	249
<b>Part 3. Combinatorial Hopf bialgebras</b>	<b>251</b>
<b>Chapter 8. Hopf bialgebra of packed square matrices</b>	<b>253</b>
Introduction	253
1. Hopf algebra of packed matrices	254
1.1. Packed matrices	254
1.2. Enumeration	256
1.3. Hopf bialgebra structure	257
2. Algebraic properties	259
2.1. Multiplicative bases and freeness	259
2.2. Self-duality	262
2.3. Bidendriform bialgebra structure	263
3. Related Hopf bialgebras	265
3.1. Links with known bialgebras	265

3.2. Equivalence relations and Hopf sub-bialgebras	268
4. Alternating sign matrices	270
4.1. Hopf bialgebra structure	271
4.2. Algebraic interpretation of statistics on ASMs	273
Concluding remarks	276
<b>Chapter 9. From pros to Hopf bialgebras</b>	<b>277</b>
Introduction	277
1. Hopf bialgebras and the natural Hopf bialgebra of an operad	278
1.1. Combinatorial Hopf algebras	278
1.2. The natural Hopf bialgebra of an operad	280
2. From pros to combinatorial Hopf algebras	280
2.1. The Hopf bialgebra of a free pro	281
2.2. Properties of the construction	281
2.3. The Hopf bialgebra of a stiff pro	284
2.4. Related constructions	287
3. Examples of application of the construction	288
3.1. Hopf bialgebra of forests	288
3.2. Faà di Bruno Hopf bialgebra and its deformations	290
3.3. Hopf bialgebra of forests of bitrees	292
3.4. Hopf bialgebra of heaps of pieces	293
3.5. Hopf bialgebra of heaps of friable pieces	295
Concluding remarks	297
<b>Part 4. Combinatorics and algorithms</b>	<b>299</b>
<b>Chapter 10. Shuffle of permutations</b>	<b>301</b>
Introduction	301
1. Square elements, shuffles, and words	302
1.1. Square elements with respect to a product	302
1.2. Square words for the shuffle product	303
2. Supershuffle of permutations	304
2.1. Unshuffling coalgebra and square permutations	304
2.2. Square binary words and permutations	306
2.3. Algebraic properties	306
3. Algorithmic aspects of square permutations	308
3.1. Directed perfect matchings on permutations	308
3.2. Hardness of recognizing square permutations	310

Concluding remarks	310
<b>Chapter 11. Bud generating systems</b>	<b>313</b>
Introduction	313
1. Colored operads and formal power series	315
1.1. Bud operads	315
1.2. The space of series on colored operads	316
1.3. Pre-Lie product on series	321
1.4. Composition product on series	323
2. Bud generating systems and combinatorial generation	326
2.1. Bud generating systems	326
2.2. First properties	329
2.3. Links with other generating systems	329
3. Series on colored operads and bud generating systems	332
3.1. General definitions	332
3.2. Hook generating series	333
3.3. Syntactic generating series	336
3.4. Synchronous generating series	338
Concluding remarks	341
<b>Chapter 12. Operads and regular languages</b>	<b>343</b>
Introduction	343
1. Breaking operads via precompositions	344
1.1. Monoids of infinite matrices	344
1.2. Precompositions and operads	346
2. Constructing operads from precompositions	348
2.1. Alternative constructions	348
2.2. New operads	350
3. Links with language theory	351
3.1. Action of multi-tildes and double multi-tildes	352
3.2. Action of pseudo-transitive double multi-tildes	354
Concluding remarks	356
<b>Conclusion</b>	<b>357</b>
<b>Bibliography</b>	<b>359</b>

## List of Figures

0.1	Diagram of the dependences between the chapters.	16
1.1	The cube poset of order 4.	35
1.2	The Tamari poset of order 5.	36
1.3	The right weak poset of order 4.	37
1.4	An ASM and a six-vertex configuration in correspondence.	61
2.1	The sylvester equivalence class of the permutation 15423.	88
3.1	Reduction of syntax trees on colored operads.	112
3.2	Partial composition of anticolored syntax trees.	113
3.3	A bicolored noncrossing configuration.	117
3.4	The complementary and the returned of a bubble.	119
3.5	A bicolored noncrossing configuration and its dual tree.	121
4.1	The diagram of ns suboperads and quotients of the operad $\mathcal{TN}$ .	135
4.2	A planar rooted tree of the ns operad $\mathcal{PRT}$ .	138
4.3	A partial composition of two planar rooted trees of $\mathcal{PRT}$ .	138
4.4	A 3-ary tree of the ns operad $\mathcal{FCat}^{(2)}$ .	139
4.5	A partial composition of two 3-ary trees of $\mathcal{FCat}^{(2)}$ .	140
4.6	A Schröder tree of the ns operad $\mathcal{Schr}$ .	142
4.7	A partial composition of two Schröder trees of $\mathcal{Schr}$ .	142
4.8	A Motzkin path of the ns operad $\mathcal{Motz}$ .	144
4.9	A partial composition of two Motzkin paths of $\mathcal{Motz}$ .	144
4.10	A ribbon diagram of the ns operad $\mathcal{Comp}$ .	146
4.11	Two partial compositions of ribbon diagrams of $\mathcal{Comp}$ .	146
4.12	A directed animal.	148
4.13	A ribbon diagram of the ns operad $\mathcal{SComp}$ .	149
4.14	The diagram of ns suboperads and quotients of the operad $\mathcal{TM}$ .	150
5.1	A syntax tree on $\mathcal{G}_{\text{Dias}_\gamma}$ and its evaluation.	157
5.2	A syntax tree on $\mathcal{G}_{\text{Trias}_\gamma}$ and its evaluation.	168



5.3	A 4-edge valued binary tree of the ns operad $\text{Dendr}_4(10)$ .	171
5.4	A 3-alternating Schröder tree of the ns operad $\text{DAs}_3(14)$ .	178
5.5	A 4-edge valued Schröder of the ns operad $\text{TDendr}_4(16)$ .	184
6.1	A thin forest poset and a standard thin forest poset.	204
6.2	A forest poset.	205
7.1	The partial composition of $\mathcal{M}$ -cliques.	215
7.2	The diagram of the main suboperads and quotients of the ns operad $\mathcal{CM}$ .	228
7.3	The diagram of the secondary suboperads and quotients of $\mathcal{CM}$ .	229
7.4	The partial composition of the ns operad $\text{NC}\mathcal{M}$ in terms of $\mathcal{M}$ -Schröder trees.	233
8.1	The covering relation of the poset of packed matrices.	260
8.2	An interval of the poset of packed matrices.	260
8.3	The covering relation of the poset of matrices.	267
8.4	An interval of the poset of matrices.	267
8.5	The diagram of Hopf bialgebras of packed matrices and related structures.	268
8.6	Two equivalence classes of packed matrices.	269
9.1	A diagram of pros involving combinatorial objects.	288
9.2	A diagram of Hopf bialgebras constructed from pros.	289
10.1	A perfect matching on the word bababbcc.	303
10.2	Two perfect matchings on words.	304
10.3	A directed perfect matching on the permutation 41328576.	309
10.4	A directed perfect matching on the square permutation 35867241.	310
11.1	Derivations in a bud generating system on Motzkin paths.	327
11.2	The derivation graph of a bud generating system of Motzkin paths.	327
11.3	Derivations in a bud generating system on binary trees.	328
12.1	A diagram of operads having links with language theory.	348

## List of Tables

1.1	Properties of $I$ -collections.	25
1.2	Six-vertex configurations and statistics on ASMs.	61
3.1	Data about the binary suboperads of the ns operad BNC.	123
3.2	Data about the binary suboperads of the ns colored operad Bubble.	124
4.1	Data about ns suboperads and quotients of the operad $\mathbb{T}\mathbb{N}$ .	136
4.2	Data about ns suboperads of the ns operad $\mathbb{T}\mathbb{M}$ .	150
5.1	Data about operads related to the ns operads Dias and Dendr.	155
6.1	Properties of $\mathcal{Q}$ -associative operads.	189
7.1	Data about operads related to the ns operad $\mathcal{C}\mathcal{M}$ .	213
8.1	First cardinalities of sets of packed matrices.	257
8.2	First dimensions of Hopf sub-bialgebras of packed matrices.	271



## Introduction

This dissertation contains the main research results developed since our PhD, defended about six years ago. Our research fits in the fields of combinatorics and algebraic combinatorics, with solid connections with computer science. The purpose of this first part of the text is to progressively contextualize the presented work and to provide a preview of its main results.

### Context

Combinatorics is a subfield of both mathematics and computer science. It is somewhat hard to provide a global and concise definition of this field. For our part, we think that one of the best definitions of combinatorics is that it is the science of the construction plans. A construction plan is a list of rules expressed in a rigorous language, whose goal is to define objects. Unlike construction plans of houses, bridges, or space shuttles, a single construction plan in combinatorics offers the possibility to build not only one object but many similar ones. Indeed, a certain degree of freedom is contained in such construction plans. All the objects thus described form a set, named a combinatorial set. Given a construction plan, it is natural to collect as many properties as possible of the objects of their combinatorial set.

One of the simplest examples of construction plans is the one describing permutations. A permutation is a sequence of  $n \in \mathbb{N}$  symbols taken in the set  $\{1, \dots, n\}$ , each one appearing exactly once. From this plan, the smallest objects are

$$\epsilon, 1, 12, 21, 123, 132, 213, 231, 312, 321, \tag{0.0.1}$$

where  $\epsilon$  is the unique sequence of  $n = 0$  symbols. A slightly more elaborate example is the one of Motzkin paths. This construction plan specifies that a Motzkin path is a possibly empty sequence of steps of three kinds: a stationary step  $\circ\circ$ , a rising step  $\circ\circ$  (with the second  $\circ$  higher), or a descending step  $\circ\circ$  (with the second  $\circ$  lower), with the constraint that the path ends at the same level as its starting point and never goes below its starting point. From this plan, we can build among others the following Motzkin paths:

$$\circ, \circ\circ, \circ\circ\circ, \begin{array}{c} \circ \\ \diagup \quad \diagdown \\ \circ \quad \circ \end{array}, \circ\circ\circ\circ, \begin{array}{c} \circ \\ \diagup \quad \diagdown \\ \circ \quad \circ \end{array} \begin{array}{c} \circ \\ \diagup \quad \diagdown \\ \circ \quad \circ \end{array}, \begin{array}{c} \circ \\ \diagup \quad \diagdown \\ \circ \quad \circ \end{array} \begin{array}{c} \circ \\ \diagup \quad \diagdown \\ \circ \quad \circ \end{array}, \begin{array}{c} \circ \\ \diagup \quad \diagdown \\ \circ \quad \circ \end{array} \begin{array}{c} \circ \\ \diagup \quad \diagdown \\ \circ \quad \circ \end{array}, \circ\circ\circ\circ\circ, \tag{0.0.2}$$

where  $\circ$  is the unique sequence of 0 steps.

There are several flavors of combinatorics. Each of them depends on the point of view on construction plans. Here follow the main ones related with our work. To continue the metaphor with construction plans of buildings, let us express the point of view of the architect, of the workman, and of the electrician.

**General combinatorics.** The role of the architect consists primarily in designing new construction plans. The final aim is to use construction plans and combinatorial sets as tools to solve precise problems or explain some phenomena.

For instance, we can study all the possible ways to bracket an expression involving  $n + 1$  occurrences of a variable  $x$  and  $n$  occurrences of a binary operation  $\star$  satisfying *a priori* no relations. For instance,

$$((x \star x) \star ((x \star x) \star x)) \tag{0.0.3}$$

is one of these. A combinatorial modelization of this problem amounts to seeing such expressions through their syntax trees. Since  $\star$  is binary, one can encode an expression with  $n$  occurrences of  $\star$  by a binary tree with  $n$  internal nodes. The previous expression is encoded in this way by the binary tree



$$\tag{0.0.4}$$

Now, the original problem is translated into a more combinatorial language consisting in studying such binary trees. The construction plan of binary trees is recursive: a binary tree is either a leaf  $\blacksquare$  or two binary trees attached to an internal node  $\circ$ . The first ones are



$$\tag{0.0.5}$$

From this translation, it is possible to enumerate the underlying expressions of the trees for each size  $n$ . Moreover, this translation helps to discover some properties of the expressions such as their height, this statistics being the usual height of the binary trees.

Another illustration of the work of the combinatorial architect consists in designing combinatorial objects being the bases of some algebraic structures. A classical example relies on free Lie algebras [Reu93] and the description of their bases. Indeed, the combinatorial set of the Lyndon words on a totally ordered alphabet  $A$  is a basis of the free Lie algebra generated by  $A$ . A Lyndon word on  $A$  is a sequence  $u$  of  $n \in \mathbb{N}$  symbols of  $A$  such that all strict suffixes of  $u$  are greater than  $u$  for the lexicographic order induced by the total order on  $A$ . By knowing this property, the study of free Lie algebras can be transferred on the combinatorial study of Lyndon words. A more modern example in the same vein consists in describing the bases of free pre-Lie algebras [Vin63, Ger63, Man11] generated by a set  $\mathcal{G}$ . In this context, the right construction plan is the one of the rooted trees on  $\mathcal{G}$ , that are connected acyclic graphs whose vertices are labeled on  $\mathcal{G}$  and admitting a distinguished vertex, the root [CL01].

The usual work in the field of general combinatorics consists hence in modelizing a problem or a phenomenon coming from close domains such as computer science, algebra, or physics, by combinatorial objects with the hope of a better understanding.

**Enumerative combinatorics.** The role of the workman, benefiting of the knowledge of a lot of construction plans and of their internal functioning, is to understand how does a construction plan work and to discover relations between a bunch of them. The combinatorial workman asks in most cases the question to count, given a construction plan, the

combinatorial objects we can build of a given size  $n \in \mathbb{N}$ . The notion of counting is primary in enumerative combinatorics and is somewhat fuzzy. Counting may mean that we expect a closed formula, a recurrence formula, a generating function, or even a functional equation for a generating series. Generating series are series of the form

$$\mathcal{G}(t) = \sum_{n \in \mathbb{N}} a_n t^n \quad (0.0.6)$$

where  $a_n$  is the number of objects of size  $n$  for each  $n \in \mathbb{N}$ . They form a very important concept in enumerative combinatorics.

For instance, by defining the size of a binary tree as its number  $n$  of internal nodes, it is possible to show that the generating series  $\mathcal{G}(t)$  of binary trees satisfies the algebraic equation

$$\mathcal{G}(t) = 1 + t\mathcal{G}(t)^2, \quad (0.0.7)$$

and expresses thus as a generating function by

$$\mathcal{G}(t) = \frac{1 - \sqrt{1 - 4t}}{2t}. \quad (0.0.8)$$

One can deduce from this that the number  $a_n$  of binary trees with  $n \in \mathbb{N}$  internal nodes satisfies

$$a_n = \frac{1}{n+1} \binom{2n}{n}. \quad (0.0.9)$$

On the other hand, counting integer partitions is not so easy. An integer partition of size  $n \in \mathbb{N}$  is a multiset  $[\lambda_1, \dots, \lambda_\ell]$  of integers such that  $\lambda_1 + \dots + \lambda_\ell = n$ . The generating series  $\mathcal{G}(t)$  of these objects satisfies

$$\mathcal{G}(t) = \prod_{k \in \mathbb{N}_{\geq 1}} \frac{1}{1 - t^k}. \quad (0.0.10)$$

The situation here is less fruitful than in the case of binary trees since there is no known closed formula for integer partitions similar to (0.0.9).

Besides, as mentioned above, one of the roles of the combinatorial workman consists in establishing links between different combinatorial sets. Consider for instance the combinatorial set of Dyck paths, that are Motzkin paths discussed before, but without horizontal steps  $\circ\circ$ . Then, there is a bijection between the set of all binary trees with  $n$  internal nodes and the set of all Dyck paths having  $n$  rising steps  $\circ\uparrow$ . This bijection can be computed by induction, but there is a direct interpretation of it consisting in computing a Dyck path in correspondence with a binary tree  $t$  by performing a left to right depth-first traversal of  $t$  and outputting a step  $\circ\uparrow$  when an internal node is visited and a step  $\downarrow\circ$  when a leaf is visited, without considering the last leaf. For instance, the Dyck path in correspondence with the binary tree appearing in (0.0.4) is



$$\quad (0.0.11)$$

Moreover, not only bijections between combinatorial sets are interesting. Indeed, surjections or injections between combinatorial sets are susceptible to establish interesting links between such sets. For example, the algorithm of insertion of an element in a binary search tree [Knu98] provides a surjection from the set of all permutations of  $n$  elements to the set of all binary trees with  $n$  internal nodes. A binary search tree is a binary tree where all

internal nodes are labeled by integers with some extra conditions. The insertion of a letter  $a$  in a binary search tree  $t$  consists in following the path starting from the root of  $t$  to one of its leaves by going into the right subtree if  $a$  is greater than the label of the considered internal node and into the left one otherwise. For instance, the insertion from left to right of the letters of the permutation  $\sigma := 451326$  gives the binary search tree



and, by forgetting the labels of the nodes, we obtain the binary tree image of  $\sigma$ . This surjection has also several algebraic properties [LR98, HNT05].

A last important part of enumerative combinatorics includes algorithms generating all the objects of a given size of a combinatorial set [Rus04]. The efficiency of these algorithms is a highly important feature, so that constant amortized time algorithms are the most sought. One can cite in this context the algorithm of Proskurowski and Ruskey for binary trees [PR85], and the Steinhaus–Johnson–Trotter algorithm for permutations [Tro62, Joh63, Ste64].

**Algebraic combinatorics.** The role of the electrician consists in endowing an edifice with a network of electric wires, making it capable to perform additional functions. Given a construction plan, the combinatorial electrician tries to define operations on its combinatorial objects. Operations on combinatorial objects allow to assemble several of these to obtain bigger ones, or, contrariwise, allow to disassemble a single object into smaller pieces. In this last case, it is more accurate to speak of co-operations. This point of view draws a bridge between combinatorics and algebra, creating interactions in both ways between these two fields.

For instance, operations on Motzkin paths offer an interesting way to describe their generating series  $\mathcal{G}(t)$ , counting them with respect to their number of steps. For this, consider the monoid  $(\mathcal{P}, \cdot)$  of all paths consisting in steps  $\circ\circ$ ,  $\circ\circ$ , and  $\circ\circ$  (here we relax the conditions about the levels of the starting and ending points of the paths), where  $\cdot$  is the concatenation of paths (obtained by superimposing the ending point of the first path and the starting point of the second). For instance,

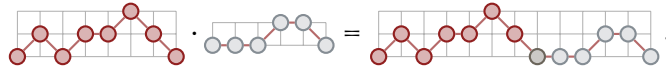

Now, let  $\mathbf{g}$  be the formal series defined as the formal sum of all Motzkin paths. Hence,

$$\mathbf{g} = \circ + \circ\circ + \circ\circ\circ + \circ\circ\circ + \circ\circ\circ + \circ\circ\circ + \circ\circ\circ + \circ\circ\circ + \circ\circ\circ\circ + \dots \quad (0.0.13)$$

By nearly elementary properties of Motzkin paths about their unambiguous decomposition, and by extending  $\cdot$  linearly on series,  $\mathbf{g}$  can be expressed as

$$\mathbf{g} = \circ + \circ\circ \cdot \mathbf{g} + \circ\circ \cdot \mathbf{g} \cdot \circ\circ + \mathbf{g} \cdot \circ\circ \cdot \mathbf{g} \quad (0.0.14)$$

By observing that  $\mathcal{G}(t)$  is the series obtained by specializing each Motzkin path of size  $n$  by  $t^n$  in  $\mathbf{g}$ , we deduce from (0.0.14) that  $\mathcal{G}(t)$  satisfies

$$\mathcal{G}(t) = 1 + t\mathcal{G}(t) + t^2\mathcal{G}(t)^2. \quad (0.0.15)$$

From this algebraic equation, it is possible to obtain a generating function of  $\mathcal{G}(t)$  or a closed formula for its coefficients, like in the case of binary trees presented above.

On the other hand, endowing combinatorial sets with operations allows to highlight some of their properties. Consider in this context the monoid  $(\mathfrak{S}, /)$  where  $\mathfrak{S}$  is the combinatorial set of all permutations and  $/$  is the shifted concatenation of permutations: given two permutations  $\sigma$  and  $\nu$ ,  $\sigma/\nu$  is the permutation obtained by concatenating  $\sigma$  with the word obtained by incrementing each letter of  $\nu$  by the size of  $\sigma$ . For instance,  $312/21 = 31254$ . The minimal generating set of this monoid is the set of all connected permutations, that are the nonempty permutations  $\sigma$  having no proper prefixes that are permutations [Com72]. For instance, the first connected permutations are

$$\begin{aligned} &1, \quad 21, \quad 231, \quad 312, \quad 321, \\ &2341, \quad 2413, \quad 2431, \quad 3142, \quad 3241, \quad 3412, \quad 3421, \quad 4123, \quad 4132, \quad 4213, \quad 4231, \quad 4312, \quad 4321. \end{aligned} \quad (0.0.16)$$

From this very natural question about finding a minimal generating set of an algebraic structure, we obtain the description of new natural combinatorial objects. Moreover, since  $(\mathfrak{S}, /)$  is free as a monoid, the generating series  $\mathcal{G}_{\mathfrak{S}}(t)$  of connected permutations and the generating series  $\mathcal{G}_{\mathfrak{S}}(t)$  of permutations are related by

$$\mathcal{G}_{\mathfrak{S}}(t) = \frac{1}{1 - \mathcal{G}_{\mathfrak{S}}(t)} = \sum_{n \in \mathbb{N}} n! t^n. \quad (0.0.17)$$

Connected permutations have several properties. For instance, the Hopf bialgebra of free quasi-symmetric functions (also known as the Malvenuto-Reutenauer Hopf bialgebra [MR95]) is, as an associative algebra, freely generated by the connected permutations [DHT02].

Let us consider another example consisting in a unary operation on binary trees. As said before, binary trees are in one-to-one correspondence with expressions involving variables  $x$  and operations  $\star$ . Now, assume that  $\star$  is associative. This leads to allow the relation

$$(\dots(u_1 \star u_2) \star u_3 \dots) = (\dots u_1 \star (u_2 \star u_3) \dots), \quad (0.0.18)$$

where  $u_1$ ,  $u_2$ , and  $u_3$  are expressions. In terms of binary trees (0.0.18) translates as the identification

$$\begin{array}{c} \circ \\ / \quad \backslash \\ \circ \quad \circ \\ / \quad \backslash \\ t_1 \quad t_2 \end{array} \star t_3 = t_1 \star \begin{array}{c} \circ \\ / \quad \backslash \\ \circ \quad \circ \\ / \quad \backslash \\ t_2 \quad t_3 \end{array}, \quad (0.0.19)$$

where  $t_1$ ,  $t_2$ , and  $t_3$  are binary trees. This identification can be performed anywhere in the binary trees and not only at their roots. One can see this identification as an operation consisting in taking a binary tree and one of its edges oriented to the left (like the left member of (0.0.19)) and changing it into an edge oriented to right (like the right member of (0.0.19)). This operation is known as a right rotation [Knu98]. Now, it is possible to show



by induction on the number of internal nodes of the binary trees that all binary trees with  $n$  internal nodes can be identified with the right comb tree of size  $n$ , that is the binary tree such that the left child of each internal node is a leaf. This provides a (quite complicated) proof of the well-known fact that all parenthesizings of an expression involving  $n$  occurrences of an associative operation  $\star$  are equal.

Finally, as mentioned before, interpreting an algebraic structure by means of combinatorial objects endowed with operations—like free Lie algebras in terms of Lyndon words, free pre-Lie algebras in terms of rooted trees, free dendriform algebras [Lod01] in terms of binary trees, or even free monoids in terms of words—brings a good understanding of it. These interpretations of algebraic structures are known as combinatorial realizations. In algebraic combinatorics, we endow combinatorial sets, or more generally spaces whose bases are indexed by combinatorial sets, with several algebraic structures. These can be simply monoids or groups, but in some cases posets, lattices, associative algebras, dendriform algebras, pre-Lie algebras, duplicial algebras [Lod08], *etc.* In this work, Hopf bialgebras, operads, and pros are the structures encountered the most.

**Other flavors of combinatorics.** In addition to enumerative and algebraic combinatorics, there are other important flavors of combinatorics. Among these is analytic combinatorics [FS09] wherein techniques coming from complex analysis are employed at the level of generating series. This field studies also the asymptotic behavior and the general form of combinatorial objects. Probabilistic combinatorics is close to analytic combinatorics. This domain uses methods coming from probability theory to design algorithms randomly generating objects of a given combinatorial set (see for instance [Ré85] for an algorithm generating uniformly binary trees). Moreover, probabilistic combinatorics is useful to show, within a given combinatorial set, that there is at least one object satisfying a given property [AJ08]. This point of view was initiated by Erdős and has links with the Ramsey theory [Soi10]. As a last flavor mentioned here, one can cite geometric combinatorics wherein geometric realizations of polytopes are designed, including the realizations of the permutohedron and of the associahedron [CSZ15].

Let us now dive a little more deeply into algebraic combinatorics and explain our point of view about it and the context of our contributions.

### Point of view

Historically, algebraic combinatorics was concerned with questions related to representation theory [GL01]. This field consists in studying algebraic structures (like monoids, groups, associative algebras, Lie algebras, *etc.*) by regarding their elements as linear maps. In an equivalent way, this amounts to letting the structure act on a vector space in a reasonable way. One of the benefits of this process rests upon the fact that algebraic problems are translated into linear algebra questions. The underlying algorithmic of linear algebra (like Gaussian elimination, matrix inversion, matrix reduction, *etc.*) offers strategies coming from computer science and combinatorics to explore these problems.

In particular, representations of the symmetric groups  $\mathfrak{S}_n$  of permutations of size  $n \in \mathbb{N}$  have a special status in algebraic combinatorics. Indeed, the irreducible representations of  $\mathfrak{S}_n$

are indexed by integer partitions of size  $n$  [FH91]. Schur functions are symmetric functions indexed by integer partitions that appear in this context of representation theory. They have the particularity to admit a lot of very different but equivalent definitions [Las84, Sta99, Lot02]. The set of all symmetric functions is naturally endowed with the structure of an associative algebra  $Sym$  [Mac15] and the set of all Schur functions is one of its bases. Many other bases of  $Sym$  have been discovered, like the monomial, elementary, complete homogeneous, and power sum functions. The changes of bases between these different families of functions express most of the time by simple and nice combinatorial algorithms.

This work is distant from these classical questions about representation theory and symmetric functions. Our point of view about algebraic combinatorics is somewhat unrelated to these considerations but, instead, related to the study of operations and algebraic structures on combinatorial sets. Nevertheless, like in all these research areas, we work most of the time with finite structures that can be encoded by the computer. For this reason, we can use the computer to perform large computations or to make experiments. These are very powerful tools to establish conjectures and to collect as much information as possible about a given research subject.

**Objects, operations, and algebraic structures.** In accordance to what we have explained above, defining and studying operations on combinatorial sets has several advantages. More precisely, in this context, we try to progress in both of the following axes:

- (A) Endowing combinatorial sets with algebraic structures by defining operations or co-operations;
- (B) Given a type of algebraic structure, searching a realization of it in terms of combinatorial objects endowed with operations.

Let us explain in more details these two directions.

Point (A) consists, starting with a combinatorial set  $C$ , in defining operations or co-operations on  $C$ . In practice, we work rather on  $\mathbb{K}\langle C \rangle$ , the linear span of  $C$  where  $\mathbb{K}$  is a field. To highlight some statistics on the objects,  $\mathbb{K}$  is often the field  $\mathbb{K}(q_0, q_1, \dots)$  of rational functions on the parameters  $q_i$ ,  $i \in \mathbb{N}$ . The linear structure of  $\mathbb{K}\langle C \rangle$  implies that we inherit the techniques coming from linear algebra to perform its study. When the (co)operations defined on  $\mathbb{K}\langle C \rangle$  endow it with a certain algebraic structure (like an associative algebra, a dendriform algebra, a pre-Lie algebra, or even a coalgebra), we can ask all the algebraic questions related to the structure and we can hope to harvest information about the objects of  $C$ .

Among the classical questions, the first one consists in expressing new bases of  $\mathbb{K}\langle C \rangle$  and observing how its operations behave on these. Frequently, changes of bases are triangular and are defined through partial orders on  $C$  by considering sums of elements minored by other ones. It is time to study an example. Let us endow  $\mathbb{K}\langle \mathfrak{S} \rangle$  with the linear binary product  $\sqcup$ , where for any permutations  $\sigma$  and  $\nu$ ,  $\sigma \sqcup \nu$  is the sum of all the permutations that can be obtained by interleaving the letters of  $\sigma$  with the ones of the word obtained by incrementing by the size of  $\sigma$  the letters of  $\nu$ . For instance,

$$12 \sqcup 21 = 1243 + 1423 + 1432 + 4123 + 4132 + 4312. \quad (0.0.20)$$

This product is known as the shifted shuffle product of permutations. Consider now the partial order  $\preceq$  on  $\mathfrak{S}$  being the reflexive and transitive closure of the relation  $\mathcal{R}$  such that for any permutations  $\sigma$  and  $\nu$ ,  $\sigma \mathcal{R} \nu$  if  $\nu$  can be obtained from  $\sigma$  by exchanging two adjacent letters  $\sigma(i)$  and  $\sigma(i+1)$  such that  $\sigma(i) < \sigma(i+1)$ . This order is known as the right weak order on permutations [GR63, YO69]. Let the family  $\{E_\sigma : \sigma \in \mathfrak{S}\}$  of elements of  $\mathbb{K}\langle\mathfrak{S}\rangle$  defined by

$$E_\sigma := \sum_{\substack{\nu \in \mathfrak{S} \\ \sigma \preceq \nu}} \nu. \quad (0.0.21)$$

For instance,

$$E_{2341} = 2341 + 2431 + 3241 + 3421 + 4231 + 4321. \quad (0.0.22)$$

By triangularity, this family forms a basis of  $\mathbb{K}\langle\mathfrak{S}\rangle$  and it appears that the product  $\sqcup$  on this E-basis satisfies, for all permutations  $\sigma$  and  $\nu$ ,

$$E_\sigma \sqcup E_\nu = E_{\sigma/\nu}, \quad (0.0.23)$$

where  $/$  is the shifted concatenation of permutations encountered before. This provides an example of a rather complicated product when considered in a given basis that becomes very simple in another one. Moreover, proving that (0.0.23) holds provides an interesting proof of the associativity of  $\sqcup$  since  $/$  is clearly associative.

A second question almost as much immediate as the first one is to find minimal generating sets of  $\mathbb{K}\langle C \rangle$ , whose elements can be interpreted as base blocks to build any object of  $C$ . This is even more interesting when  $\mathbb{K}\langle C \rangle$  has some freeness properties; in this case, any element decomposes in a unique way in a certain sense. As a consequence, obtaining minimal generating sets of  $\mathbb{K}\langle C \rangle$  leads to expressions for the Hilbert series

$$\mathcal{H}_{\mathbb{K}\langle C \rangle}(t) = \sum_{n \in \mathbb{N}} \dim \mathbb{K}\langle C(n) \rangle t^n \quad (0.0.24)$$

of  $\mathbb{K}\langle C \rangle$ , where  $C(n)$  is the set of the objects of size  $n \in \mathbb{N}$  of  $C$ . Since as generating series  $\mathcal{H}_{\mathbb{K}\langle C \rangle}(t)$  is the generating series  $\mathcal{G}_C(t)$  of  $C$ , this may offer an alternative way to enumerate the objects of  $C$ . To continue the example we started,  $(\mathbb{K}\langle\mathfrak{S}\rangle, \sqcup)$  admits as a minimal generating set the set  $\{E_\sigma : \sigma \in \mathcal{B}\}$  where  $\mathcal{B}$  is the set all connected permutations, and is freely generated by this set as an associative algebra (for details see [DHT02]).

Besides, to complete the study of  $\mathbb{K}\langle C \rangle$ , it is natural to study morphisms (with respect to the algebraic structure equipping  $\mathbb{K}\langle C \rangle$ ) involving it. Automorphisms of  $\mathbb{K}\langle C \rangle$  lead potentially to the discovery of more or less hidden symmetries between the objects of  $C$ . Morphisms between  $\mathbb{K}\langle C \rangle$  and other known structures  $\mathbb{K}\langle D \rangle$  lead to establish connections between the objects of  $C$  and the ones of  $D$ . This also includes the study of substructures and quotients of  $\mathbb{K}\langle C \rangle$ . It is worth observing that most of such morphisms use algorithms coming from computer science in an unexpected way. For instance, the associative algebra  $(\mathbb{K}\langle\mathfrak{S}\rangle, \sqcup)$  admits several substructures involving a large range of combinatorial objects. Some of these can be constructed by considering a family  $\{P_x : x \in D\}$  of elements of  $\mathbb{K}\langle\mathfrak{S}\rangle$  defined by

$$P_x := \sum_{\substack{\sigma \in \mathfrak{S} \\ \text{alg}(\sigma) = x}} \sigma, \quad (0.0.25)$$

where  $D$  is a certain combinatorial set and  $\text{alg}$  is an algorithm transforming a permutation into an object of  $D$ . When  $\text{alg}$  satisfies some precise properties (see [Hiv99, HN07, Gir11, NT14]), the  $\mathbb{P}$ -family spans an associative subalgebra of  $(\mathbb{K}\langle \mathfrak{S} \rangle, \overline{\sqcup})$ . For instance,  $D$  can be the set of binary trees and  $\text{alg}$ , the algorithm of insertion in a binary tree exposed above. In this case, one has for instance

$$\mathbb{P} \begin{array}{c} \circ \\ / \quad \backslash \\ \circ \quad \circ \\ / \quad \backslash \quad / \quad \backslash \\ \square \quad \square \quad \square \quad \square \end{array} = 2143 + 2413 + 2431. \quad (0.0.26)$$

Besides,  $D$  can be the set of the standard Young tableaux and  $\text{alg}$ , the algorithm consisting in inserting the letters of a permutation into a standard Young tableau using the Schensted algorithm [Sch61, Lot02]. In this case, one has for instance

$$\mathbb{P} \begin{array}{|c|c|c|} \hline 1 & 2 & 4 \\ \hline 3 & & \\ \hline \end{array} = 1324 + 1342 + 3124. \quad (0.0.27)$$

These mechanisms, coming from algebraic combinatorics, can also be used to conjecture properties and to obtain results in enumerative combinatorics. Indeed, assume that  $C$  and  $D$  are two combinatorial sets and that we look for a bijection between them. A tool to discover a bijection consists in endowing  $\mathbb{K}\langle C \rangle$  and  $\mathbb{K}\langle D \rangle$  with algebraic structures satisfying similar properties. More explicitly, when these structures admit minimal generating sets clearly in bijection, and when the objects of  $C$  and  $D$  decompose in the same way on the generators, one obtains a computable bijection between  $C$  and  $D$ .

In summary, Direction (A) uses algebra to obtain results in combinatorics and in computer science.

Conversely, Direction (B) employs mechanisms and techniques coming from combinatorics to solve algebraic questions. Given a type of algebra, that is a set of (co)operation symbols together with axioms they have to satisfy, the knowledge of the free structure on a set  $\mathfrak{G}$  of generators brings a lot of information. In many cases, the description of these structures is combinatorial, in the sense that their bases are indexed by combinatorial objects labeled in an adequate way by elements of  $\mathfrak{G}$ . As mentioned before, examples are abundant in the literature. They include pre-Lie algebras using rooted trees and operations of grafting of trees [CL01], Zinbiel algebras using words and half-shuffle operations [Lod95], dendriform algebras using binary trees and operations of shuffling of trees [Lod01], operads using planar rooted trees and grafting operations, and pros using prographs and operations of compositions [Mar08]. Several of these combinatorial realizations of algebraic structures can be established by orienting their axioms to obtain rewrite rules [BN98]. When the obtained rewrite rules satisfy some properties like termination and confluence, the normal forms of the rewrite rules can be seen as the elements of the structure.

Another classical example of use of combinatorial methods for algebra is provided by the Littlewood-Richardson rule [LR34]. This rule offers a way to compute the structure coefficients of the algebra of symmetric functions  $\text{Sym}$  in the basis of the Schur functions. A simple and enlightening proof [DHT02, HNT05] of this rule is provided by the combinatorics of Young tableaux and of the plactic monoid [LS81, Lot02].

Let us now provide details about the main structures appearing here. During our research, we work particularly with three types of algebraic structures: Hopf bialgebras, operads, and pros. We now present some of their features and why they are interesting and adapted structures in the field of algebraic combinatorics.

**Hopf bialgebras.** Hopf bialgebras are vector spaces endowed with an associative product  $\star$  and a coassociative coproduct  $\Delta$ . These (co)operations satisfy the relation

$$\Delta(x \star y) = \Delta(x)\Delta(y) \tag{0.0.28}$$

for any elements  $x$  and  $y$ . If we see  $\star$  as a product assembling two elements to build another one, and  $\Delta$  as a coproduct breaking an element into two smaller parts, Equation (0.0.28) says that assembling two elements and then breaking the result is the same as assembling the results obtained by breaking them before. This kind of commutation between  $\star$  and  $\Delta$  is thus very natural. Hopf bialgebras  $\mathbb{K}\langle C \rangle$  where  $C$  is a combinatorial set with exactly one element of size 0 and where  $\star$  (resp.  $\Delta$ ) is graded (resp. cograded) are the most encountered ones in algebraic combinatorics. These structures are known as combinatorial Hopf bialgebras. Main references about these structures are [Car07] and [GR16].

The prototypical example of a Hopf bialgebra is the symmetric functions  $Sym$ . Indeed, it is possible to add a coproduct on  $Sym$  to turn it into a Hopf bialgebra. Most of other Hopf bialgebras are generalizations of  $Sym$  in the sense that they contain it as a quotient or as a Hopf sub-bialgebra. A famous full diagram of Hopf bialgebras includes the Malvenuto-Reutenauer Hopf bialgebra [MR95], also known as FQSym [DHT02]. This structure is the space  $\mathbb{K}\langle \mathfrak{S} \rangle$  endowed with the shifted shuffle product and a deconcatenation coproduct of permutations. The Malvenuto-Reutenauer Hopf bialgebra contains the Poirier-Reutenauer Hopf bialgebra of tableaux [PR95], also known as the Hopf bialgebra of free symmetric functions FSym [DHT02, HNT05] and involves standard Young tableaux. The Loday-Ronco Hopf bialgebra [LR98], also known as the Hopf bialgebra of binary search trees PBT [HNT05] involves binary trees and is a Hopf sub-bialgebra of FQSym. Moreover, a noncommutative version  $Sym$  [GKL<sup>+</sup>95] of  $Sym$  exists as a Hopf sub-bialgebra of FQSym known as the Hopf bialgebra of noncommutative symmetric functions. This structure involves integer compositions and provides noncommutative versions of Schur functions. Furthermore, a lot of Hopf bialgebras involving various sorts of trees with links with renormalization theory like the Connes-Kreimer Hopf bialgebra CK [CK98] have been introduced. Several variations of this structure exist [Foi02a, Foi02b] (see also [FNT14]).

One of the main striking facts shared by most of these constructions is that they establish links between combinatorial objects through combinatorial algorithms, lead to the definition of monoids (like the plactic [LS81, Lot02], sylvester [HNT05], and hypoplactic [KT97, KT99] monoids), and use partial orders (the right weak order on permutations [GR63, YO69], the Tamari order on binary trees [Tam62], and the refinement order on integer compositions).

Besides Hopf bialgebras that are structures allowing, as explained, to assemble or disassemble objects, operads are other ones manipulating combinatorial objects. These last work by composing objects together rather than assembling them.

**Operads.** Operads are algebraic structures introduced in the context of algebraic topology [May72, BV73]. These structures provide an abstraction of the notion of operators (of any arities) and of their compositions. This theory has somewhat been neglected during almost the first two decades after its discovery. In the 1990s, the theory of operads enjoyed a renaissance raised by Loday [Lod96] and, since the 2000s, many links between the theory of operads and combinatorics have been developed. A large survey of this theory can be found in [Mar08, LV12, Mé15].

The modern treatment of operads in algebraic combinatorics consists in regarding combinatorial objects like operators endowed with gluing operations mimicking the composition (see for instance [Cha08]). From an intuitive point of view, an operad is a set (or a space) of abstract operators with several inputs and one output that can be composed in many ways. More precisely, if  $x$  is an operator with  $n$  inputs and  $y$  is an operator with  $m$  inputs,  $x \circ_i y$  denotes the operator with  $n + m - 1$  inputs obtained by gluing the output of  $y$  to the  $i$ th input of  $x$ . Pictorially,

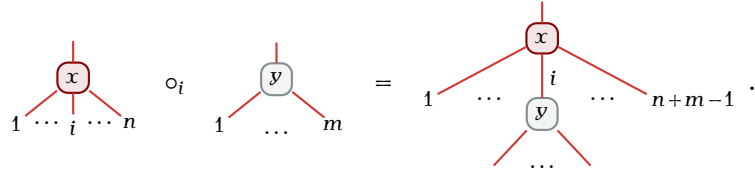

$$\begin{array}{c} \textcircled{x} \\ \vdots \\ 1 \cdots i \cdots n \end{array} \circ_i \begin{array}{c} \textcircled{y} \\ \vdots \\ 1 \cdots m \end{array} = \begin{array}{c} \textcircled{x} \\ \vdots \\ 1 \cdots i \cdots n+m-1 \\ \vdots \\ \textcircled{y} \\ \vdots \\ \dots \end{array} \cdot \quad (0.0.29)$$

There is also an action  $\cdot$  of the symmetric group  $\mathfrak{S}_n$  on the elements of arity  $n$  letting to permute their inputs. Operads are algebraic structures related to trees in the same way as monoids are algebraic structures related to words (by their free objects). There are numerous variations and enrichments of operads, like cyclic operads [GK95], colored operads [BV73, Yau16], and nonsymmetric operads. In this dissertation, we work mainly with nonsymmetric operads (also called ns operads or pre-Lie systems).

A large number of interactions between operads and combinatorics exist. Let us explain four of these. Koszul duality of operads is an important part of the theory. This kind of duality has been introduced by Ginzburg and Kapranov [GK94] as an extension of the analogous duality for quadratic associative algebras. An operad is by definition Koszul if its Koszul complex is acyclic [GK94]. When  $\mathcal{O}$  is a Koszul operad, its Hilbert series  $\mathcal{H}_{\mathcal{O}}(t)$  and the one  $\mathcal{H}_{\mathcal{O}^!}(t)$  of its Koszul dual  $\mathcal{O}^!$  are related by

$$\mathcal{H}_{\mathcal{O}}(-\mathcal{H}_{\mathcal{O}^!}(-t)) = t. \quad (0.0.30)$$

Hence, from the knowledge of  $\mathcal{H}_{\mathcal{O}}(t)$ , one can hope to compute the coefficients of  $\mathcal{H}_{\mathcal{O}^!}(t)$ . Moreover, the Koszulity property for operads is strongly related to the theory of rewrite rules on trees, this last theory providing a sufficient combinatorial condition to prove the Koszulity of an operad [Hof10, DK10, LV12]. Besides, another strategy to prove that an operad is Koszul consists in constructing a family of posets from an operad [MY91], so that the Koszulity of the considered operad is a consequence of a combinatorial property of these posets [Val07]. Operads lead also to generalized versions of generating series, enriching the usual techniques for enumeration. Given an operad  $\mathcal{O}$ , one can consider formal series of the

form

$$\mathbf{f} = \sum_{x \in \mathcal{O}} \lambda_x x, \quad (0.0.31)$$

where the  $\lambda_x$  are coefficients in  $\mathbb{K}$ . From the partial compositions of  $\mathcal{O}$ , we can endow the set  $\mathbb{K}\langle\langle\mathcal{O}\rangle\rangle$  of all series on  $\mathcal{O}$  with a monoid structure. Chapoton studied some of these for many usual operads [Cha02, Cha08, Cha09]. Some other authors consider such series as e.g., van der Laan [vdL04], Frabetti [Fra08], and Loday and Nikolov [LN13].

Let us provide a simple example involving series on operads. The set of all Motzkin paths forms a structure of a ns operad  $\text{Motz}$  where, given two Motzkin paths  $u$  and  $v$ ,  $u \circ_i v$  is the path obtained by replacing the  $i$ th point of  $u$  (indexed from left to right) by  $v$ . For example,

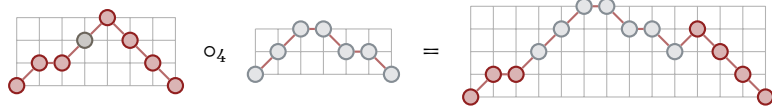

$$\text{Motzkin path 1} \circ_4 \text{Motzkin path 2} = \text{Motzkin path 3}. \quad (0.0.32)$$

In this operad, a Motzkin path of  $n - 1$  steps is seen as an operator of arity  $n$ . Now, by denoting by  $\mathbf{g} \in \mathbb{K}\langle\langle\text{Motz}\rangle\rangle$  the formal sum of all the elements of  $\text{Motz}$ , one obtains the relation

$$\mathbf{g} = \circ + \circ \circ [\circ, \mathbf{g}] + \circ \circ \circ [\circ, \mathbf{g}, \mathbf{g}], \quad (0.0.33)$$

where  $\circ$  is the complete composition map of  $\text{Motz}$  extended on series on  $\text{Motz}$ . Of course, this expression for  $\mathbf{g}$  is very similar to the one provided by (0.0.13) but (0.0.33) admits at least two major advantages. First, contrariwise to (0.0.13) which relies on the monoid  $(\mathcal{P}, \cdot)$  of all paths (because  $\circ$  and  $\circ \circ$  are not Motzkin paths), (0.0.33) only uses elements of  $\text{Motz}$ . Second, the fact that (0.0.33) holds is a consequence of a presentation by generators and relations of  $\text{Motz}$ . Indeed, one can show that  $\{\circ, \circ \circ, \circ \circ \circ\}$  is a minimal generating set of  $\text{Motz}$  and that there is a convergent orientation of the nontrivial relations between these generators so that the normal forms are precisely the terms of the form  $\circ, \circ \circ \circ [\circ, u]$ , or  $\circ \circ \circ \circ [\circ, u, v]$ , where  $u$  and  $v$  are Motzkin paths. This combinatorial property is a consequence of the Koszulity of  $\text{Motz}$ . All this provides another example of combinatorial properties encapsulated into suitable algebraic structures.

Let us provide now a little more elaborate example concerning the enumeration of balanced binary trees. These trees were introduced in an algorithmic context [AVL62] as efficient data structures to represent dynamic finite sets. A binary tree  $t$  is balanced if for any of its internal node  $u$ , the height of the right and left subtrees of  $u$  differ by at most 1. For example,



$$\text{Balanced binary tree} \quad (0.0.34)$$

is a balanced binary tree. The generating series  $\mathcal{G}(t)$  of these trees, enumerating them with respect to their number of leaves, satisfies  $\mathcal{G}(t) = F(t, 0)$  where  $F(x, y)$  is the bivariate series satisfying the functional equation

$$F(x, y) = x + F(x^2 + 2xy, x). \quad (0.0.35)$$

The coefficients of  $\mathcal{G}(t)$  can hence been computed by iteration. This way of enumerating balanced binary trees is presented in [BLL88, BLL98, Knu98]. By using colored operads, it is possible to obtain a better description for the coefficients of  $\mathcal{G}(t)$ . For this purpose, let  $\text{CMag}$  be the colored operad on the set of all binary trees such that each leaf and the root has a color in  $\{1, 2\}$ . The partial composition  $\mathfrak{s} \circ_i \mathfrak{t}$  of two such trees is defined if the output color of  $\mathfrak{t}$  is the same as the color of the  $i$ th input of  $\mathfrak{s}$  and is the tree obtained by grafting the root of  $\mathfrak{t}$  onto the  $i$ th leaf of  $\mathfrak{s}$ . For example,

$$(0.0.36)$$

In this operad, a binary tree having  $n$  leaves is seen as an operator of arity  $n$ . Now, Let  $\mathbf{g} \in \mathbb{K}\langle\langle \text{CMag} \rangle\rangle$  be the formal series defined as the formal sum of all the balanced binary trees, seen as elements of  $\text{CMag}$  where all colors are equal to 1. Hence,

$$(0.0.37)$$

We obtain the relation

$$(0.0.38)$$

where  $\odot$  is an associative product on series on  $\text{CMag}$  obtained from its partial compositions maps and  $\odot_*$  is the Kleene star of  $\odot$ . One can deduce from (0.0.38) and from the properties of the operations  $\odot$  and  $\odot_*$  the recurrence

$$g(n, m) = \begin{cases} 1 & \text{if } (n, m) = (1, 0), \\ \sum_{\substack{\ell_1, \ell_2 \in \mathbb{N} \\ n=2\ell_1+\ell_2+m}} \binom{\ell_1+m}{\ell_1} 2^m g(\ell_1 + m, \ell_2) & \text{otherwise} \end{cases} \quad (0.0.39)$$

for the number  $g(n, 0)$  of balanced binary trees with  $n$  leaves.

These two examples show that the formalization of combinatorial problems in terms of operads offer tools for enumerative questions. Contrariwise, operads on combinatorial objects may lead to algebraic observations. Indeed, any operad  $\mathcal{O}$  defines a category of algebras called  $\mathcal{O}$ -algebras. Any  $\mathcal{O}$ -algebra can be seen as a representation of  $\mathcal{O}$  in the sense that  $\mathcal{O}$  acts on any  $\mathcal{O}$ -algebra. For instance, there is an operad  $\text{Lie}$  describing the category of all Lie algebras, an operad  $\text{As}$  describing the category of all associative algebras, and an operad  $\text{Dendr}$  describing the category of all dendriform algebras [Lod01]. Morphisms  $\phi : \mathcal{O}_1 \rightarrow \mathcal{O}_2$  between two operads  $\mathcal{O}_1$  and  $\mathcal{O}_2$  give rise to functors from the category of  $\mathcal{O}_2$ -algebras to the one of  $\mathcal{O}_1$ -algebras. For instance,  $\text{Lie}$  is a suboperad of  $\text{As}$  so that there is



an injective morphism  $\phi : \text{Lie} \rightarrow \text{As}$ . This morphism translates into the well-known functor from associative algebras to Lie algebras consisting in considering the commutator of an associative algebra as a Lie bracket.

**Pros.** A natural generalization of operads consists in authorizing multiple outputs for its elements instead of a single one. This leads to the theory of pros (this term is an abbreviation of product category). These algebraic structures have been introduced by Mac Lane [ML65]. Intuitively, a pro  $\mathcal{P}$  is a set (or a space) of operators together with two operations: an horizontal composition  $*$  and a vertical composition  $\circ$ . The first operation takes two operators  $x$  and  $y$  of  $\mathcal{P}$  and builds a new one whose inputs (resp. outputs) are, from left to right, those of  $x$  and then those of  $y$ . The second operation takes two operators  $x$  and  $y$  of  $\mathcal{P}$  and produces a new one obtained by plugging the outputs of  $y$  onto the inputs of  $x$ . Basic and modern references about pros are [Lei04] and [Mar08].

Like operads, pros can describe categories of algebras. Nevertheless, in this case, pros can handle coproducts and can hence describe categories of bialgebras. Consider the pro generated by the following three operations:

$$\begin{array}{c} \square \\ | \\ \textcircled{*} \\ / \quad \backslash \\ \square \quad \square \end{array}, \quad \begin{array}{c} \square \quad \square \\ | \quad | \\ \textcircled{\Delta} \\ | \\ \square \end{array}, \quad \begin{array}{c} \square \quad \square \\ / \quad \backslash \\ \textcircled{\omega} \\ \backslash \quad / \\ \square \quad \square \end{array}, \quad (0.0.40)$$

subjected to the following three relations:

$$\begin{array}{c} \square \\ | \\ \textcircled{*} \\ / \quad \backslash \\ \textcircled{*} \quad \square \\ / \quad \backslash \\ \square \quad \square \end{array} = \begin{array}{c} \square \\ | \\ \textcircled{*} \\ / \quad \backslash \\ \square \quad \textcircled{*} \\ / \quad \backslash \\ \square \quad \square \end{array}, \quad \begin{array}{c} \square \quad \square \\ | \quad | \\ \textcircled{\Delta} \\ / \quad \backslash \\ \square \quad \textcircled{\Delta} \\ | \quad | \\ \square \quad \square \end{array} = \begin{array}{c} \square \quad \square \\ / \quad \backslash \\ \textcircled{\Delta} \\ | \\ \square \end{array}, \quad \begin{array}{c} \square \quad \square \\ / \quad \backslash \\ \textcircled{\Delta} \\ | \\ \textcircled{*} \\ / \quad \backslash \\ \textcircled{\omega} \quad \textcircled{*} \\ / \quad \backslash \\ \textcircled{\Delta} \quad \textcircled{\Delta} \\ | \quad | \\ \square \quad \square \end{array}. \quad (0.0.41)$$

The first (resp. second) one says that  $*$  (resp.  $\Delta$ ) is associative (resp. coassociative). By seeing the operator  $\omega$  as a map transposing its two inputs, the last one models Relation (0.0.28). Hence, this pro describes the category of Hopf bialgebras.

Another interaction between the theory of pros and combinatorics happens when we consider presentations by generators and relations of pros (see for instance [Laf11]). Recall that the symmetric group  $\mathfrak{S}_n$  is presented in the following way. It is generated by symbols  $\{s_i : 1 \leq i \leq n-1\}$  whose elements are called elementary transpositions. These generators are subjected to the relations

$$s_i^2 = 1, \quad 1 \leq i \leq n-1, \quad (0.0.42a)$$

$$s_i s_j = s_j s_i, \quad 1 \leq i, j \leq n-1 \text{ and } |i-j| \geq 2, \quad (0.0.42b)$$

$$s_i s_{i+1} s_i = s_i s_{i+1} s_i, \quad 1 \leq i \leq n-2. \quad (0.0.42c)$$

It is rather technical to show that  $\mathfrak{S}_n$  admits the stated presentation or, by going in the opposite direction, to show that the group admitting the stated presentation is realized by  $\mathfrak{S}_n$ . It is worth noting that there is a pro  $\mathbb{K}\langle \text{Per} \rangle$  of permutations offering a comfortable way to prove these facts. Each permutation  $\sigma$  of size  $n \in \mathbb{N}$  is seen as an operator with  $n$  inputs

and  $n$  outputs, connecting each  $i$ th input to the  $\sigma(i)$ th output. For instance, the permutation 42153 is seen as the element

$$\begin{array}{c}
 1 \ 2 \ 3 \ 4 \ 5 \\
 \square \ \square \ \square \ \square \ \square \\
 \text{---} \text{---} \text{---} \text{---} \text{---} \\
 \text{---} \text{---} \text{---} \text{---} \text{---} \\
 \square \ \square \ \square \ \square \ \square \\
 1 \ 2 \ 3 \ 4 \ 5
 \end{array}
 \tag{0.0.43}$$

of  $\mathbb{K}\langle \text{Per} \rangle$ . The operations of pros, that are the horizontal and vertical compositions, translate on permutations respectively as the shifted concatenation  $\diagdown$  of permutations and as the composition  $\circ$  of permutations. Therefore,  $\mathbb{K}\langle \text{Per} \rangle$  contains all the symmetric groups  $\mathfrak{S}_n$ ,  $n \in \mathbb{N}$ . Now, one can ask about natural algebraic questions as finding a minimal generating set of  $\mathbb{K}\langle \text{Per} \rangle$ . It is easy to show that the singleton

$$\mathfrak{G} := \left\{ \begin{array}{c} 1 \ 2 \\ \square \ \square \\ \text{---} \text{---} \\ \text{---} \text{---} \\ \square \ \square \\ 1 \ 2 \end{array} \right\}
 \tag{0.0.44}$$

is a minimal generating set of  $\mathbb{K}\langle \text{Per} \rangle$ . The unique element  $\mathfrak{s}$  of  $\mathfrak{G}$  encodes the permutation 21. Now, by finding the nontrivial relations satisfied by  $\mathfrak{s}$  [Laf03], one obtains the analogous relations of (0.0.42a), (0.0.42b), and (0.0.42c), stated in the language of pros. As a side remark, let us mention that the analogous relation of (0.0.42c) is axiomatic for pros. This provides a nice strategy to establish the presentation of the symmetric groups. Note that similar ideas work for establishing presentations or realizations of other Coxeter groups.

## Contributions

Let us now present our contributions and the main results contained in this dissertation. Before that, let us say a few words about the organization of the text.

**Global overview.** This text is divided into twelve chapters, the first two containing preliminary notions, and the last ten containing original results coming from published or submitted works. Figure 0.1 shows the diagram of dependences between the chapters and the references to our work on which each chapter relies. Our results fall into three categories: algebraic combinatorics, enumerative combinatorics, and computer science.

What follows is not a chapter-by-chapter summary. We follow the idea to organize and present our contributions into the three categories cited above. For this reason, a same chapter may appear several times in the sequel.

**Algebraic combinatorics.** Our main contributions in the field of algebraic combinatorics rely on constructions, taking as input some algebraic structures, and outputting other ones. Most of them are functorial and endow combinatorial sets with (co)operations. We have presented above our point of view about the advantages to endow objects with algebraic structures. Here, our philosophy consists in designing general ways to achieve these goals. For this reason, we create metatools (functorial constructions) whose aim is to create tools (algebraic structures on combinatorial objects). Let us list the main results, chapter by chapter, belonging to this field.

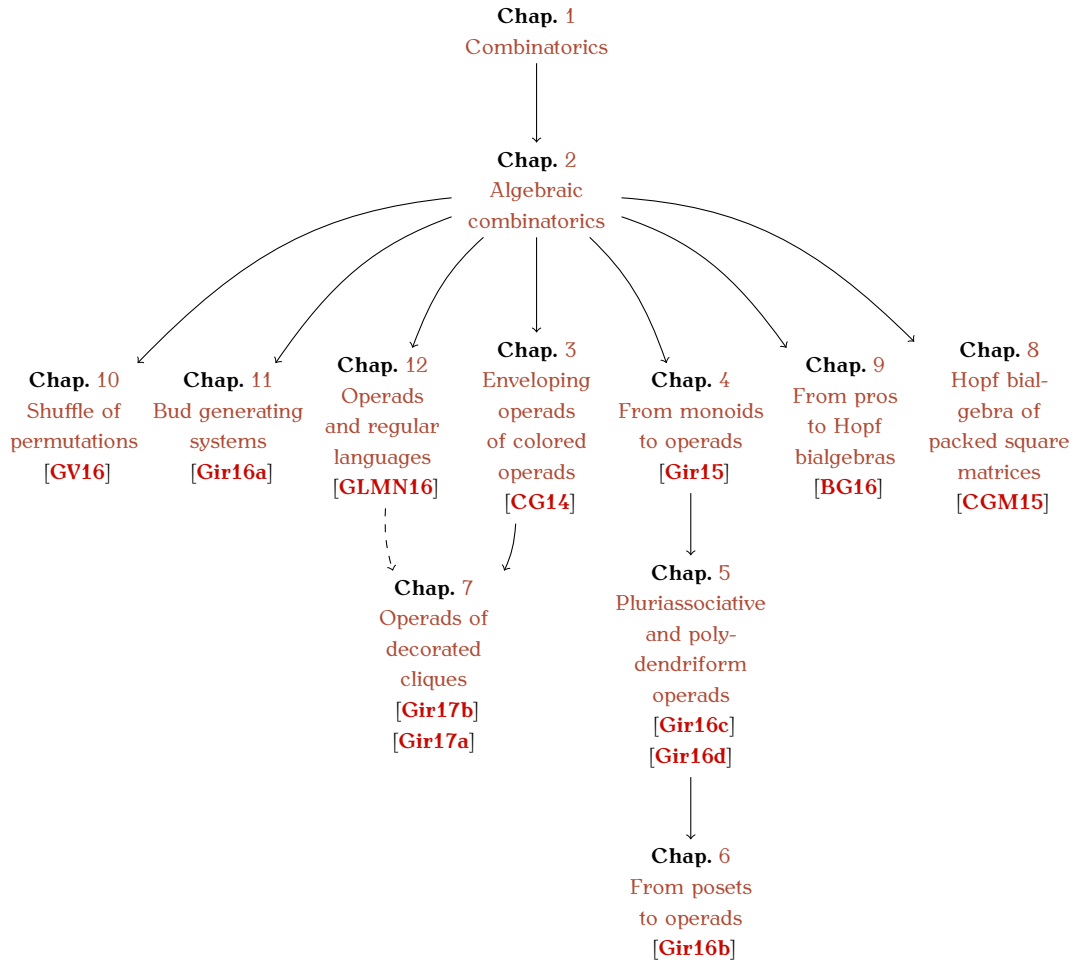

FIGURE 0.1. Diagram of the dependences between the chapters. Each arrow  $a \rightarrow b$  means that  $b$  need some notions contained in  $a$ . The dashed arrow means an optional dependence.

In **Chapter 3**, we introduce a tool to facilitate the study of ns operads. This tool is a functor **Hull** from the category of ns colored operads to the category of ns noncolored operads. It sends a ns colored operad  $\mathcal{C}$  to the smallest ns noncolored operad containing the elements of arities greater than 1 of  $\mathcal{C}$ . The ns operad  $\mathbf{Hull}(\mathcal{C})$  is realized in terms of anticolored syntax trees labeled on  $\mathcal{C}$ , that are particular syntax trees satisfying some conditions involving the colors of  $\mathcal{C}$ . This construction is used to collect properties of ns operads in the following way. Given a ns operad  $\mathcal{O}$ , finding a ns colored operad  $\mathcal{C}$  such that  $\mathbf{Hull}(\mathcal{C}) = \mathcal{O}$  brings information on  $\mathcal{O}$ . Indeed, some properties of  $\mathcal{O}$  are implied by properties of  $\mathcal{C}$ , such as the Hilbert series, the description of suboperads and quotients, and presentations by generators and relations. Due to the fact that a ns colored operad is a more constrained structure than a noncolored one, it is in practice easier to collect properties on  $\mathcal{C}$  rather than on  $\mathcal{O}$ . These techniques are illustrated to perform the study

of the operad of bicolored noncrossing configurations BNC, an operad on some sorts of noncrossing configurations [FN99], introduced as a generalization of the operads NCT of noncrossing trees and NCP of noncrossing plants [Cha07].

The main contribution of **Chapter 4** is a functor  $T$  from the category of monoids to the category of operads. Given a monoid  $\mathcal{M}$ ,  $T\mathcal{M}$  is an operad of words on  $\mathcal{M}$  seen as an alphabet. The definitions of the partial compositions of  $T\mathcal{M}$  follow from the monoidal product of  $\mathcal{M}$ , and the symmetric groups act on  $T\mathcal{M}$  by permuting the letters of the words. This functor is rich from a combinatorial point of view since it leads to the construction of several (ns) operads on combinatorial objects. Among others,  $T$  allows to construct operads on endofunctions, parking functions, packed words, permutations, and ns operads on planar rooted trees,  $k$ -ary trees (and thus,  $k$ -Dyck paths, see [LPRR15] for some structures on these), Motzkin paths (the operad *Motz* appearing above is constructed in this chapter), integer compositions, directed animals, and segmented compositions. This construction  $T$  provides also alternative ways to obtain the diassociative operad *Dias* [Lod01] and the triassociative operad *Trias* [LR04]. By using rewriting techniques, presentations of these operads are provided. We think that there are a lot of other operads to be constructed through  $T$  on many other families of combinatorial objects.

We use in **Chapter 5** the functor  $T$  to define generalizations of the diassociative operad depending on an integer  $\gamma \in \mathbb{N}$ . These ns operads  $\text{Dias}_\gamma$  are realized in terms of certain words on the alphabet  $\{0, 1, \dots, \gamma\}$ . Since the diassociative operad is the Koszul dual of the dendriform operad *Dendr* [Lod01], we obtain by Koszul duality the ns operads  $\text{Dendr}_\gamma$ ,  $\gamma \in \mathbb{N}$ , each one being the Koszul dual of  $\text{Dias}_\gamma$ . These operads  $\text{Dendr}_\gamma$  are realized in terms of binary trees with labeled edges endowed with tree shuffling operations. The original motivation for this research direction is the following. Dendriform algebras are algebraic structures consisting in two operations  $<$  and  $>$  satisfying some axioms. As a consequence of these axioms, the operation  $< + >$  is associative. This provides hence a framework to study associative algebras by studying them as dendriform algebras through the definition of two dendriform products such that their sum is the original product of the algebra. The category of algebras described by  $\text{Dendr}_\gamma$  leads to a generalization of this method and forms a new device to study associative algebras.

In **Chapter 6**, we provide a functorial construction associating with any finite poset  $\mathcal{Q}$  a ns operad  $\text{As}(\mathcal{Q})$ . Under some conditions on  $\mathcal{Q}$ ,  $\text{As}(\mathcal{Q})$  can be realized in terms of Schröder trees labeled on  $\mathcal{Q}$  satisfying some conditions. The original motivation for the introduction of this construction comes from the previous chapter where two operads  $\text{As}_\gamma$  and  $\text{DAs}_\gamma$  were introduced. Both of these operads can be constructed as degenerate cases of the construction  $\text{As}$  (by considering respectively trivial orders and total orders). The question to study the operads  $\text{As}(\mathcal{Q})$  when  $\mathcal{Q}$  is nondegenerate is natural, and this leads to unexpected results involving Koszul duality of ns operads. Indeed, the main result here states that if  $\mathcal{Q}$  is a thin forest poset (a poset whose Hasse diagram satisfies a certain property), the Koszul dual of  $\text{As}(\mathcal{Q})$  is isomorphic to the ns operad  $\text{As}(\mathcal{Q}^\perp)$  where  $^\perp$  is an involution on thin forest posets. The main contributions of this chapter are of two kinds. First, new links between the theory of operads, posets, and Koszul duality are developed (some different links between

these theories are included in [MY91, Val07, FFM16]). Second, this work provides definitions of several algebraic structures (as  $\text{As}(\mathcal{O})$ -algebras) having many associative operations and generalizing associative algebras.

Another functorial construction  $\mathbf{C}$  is introduced in **Chapter 7**. It is defined from the category of unitary magmas to the one of ns operads. Given a unitary magma  $\mathcal{M}$ ,  $\mathbf{C}\mathcal{M}$  is a ns operad of regular polygons endowed with configurations of arcs labeled on  $\mathcal{M}$ . The definitions of the partial compositions of  $\mathbf{C}\mathcal{M}$  follow from the magmatic product of  $\mathcal{M}$ . This construction too is very rich from a combinatorial point of view since it endows several families of configurations with ns operad structures, as for instance, noncrossing configurations, Motzkin configurations, Lucas configurations, and diagrams of involutions. This leads to a new diagram of operads, each one realized in terms of combinatorial objects. Moreover, the construction  $\mathbf{C}$  allows to define a large number of known operads in a unified way. For instance, one can construct from  $\mathbf{C}$  the operad BNC (and all its suboperads as NCT, NCP, the dipterous operad [LR03, Zin12], and the 2-associative operad [LR06, Zin12]), the suboperad  $\mathcal{FF}_4$  of the operad of formal fractions  $\mathcal{FF}$  [CHN16], the operad of multi-tildes MT [LMN13], the operad of double multi-tildes DMT (see Chapter 12), and a ns version of the gravity operad Grav [Get94, AP15].

**Chapter 8** is concerned with Hopf bialgebras and more precisely with the definition of a Hopf bialgebra on packed square matrices  $\text{PM}_k$  depending on an integer parameter  $k \in \mathbb{N}$ . This Hopf bialgebra is a generalization of  $\text{FQSym}$  [DHT02] since the subspace of  $\text{PM}_k$  restricted to permutation matrices is isomorphic to  $\text{FQSym}$ . It contains also the Hopf bialgebra of uniform block permutations UBP [AO08]. Among the most notable facts,  $\text{PM}_k$  contains a Hopf sub-bialgebra ASM involving alternating sign matrices [MRR83]. This chapter provides also an algebraic point of view of some statistics of alternating sign matrices by using the associative algebra structure of ASM.

Like the previous one, **Chapter 9** deals with constructions of Hopf bialgebras. We introduce here a construction  $\mathbf{H}$  from stiff pros to Hopf bialgebras. A stiff pro is a quotient of a free pro by a pro congruence satisfying some precise properties. This construction is a generalization of the construction  $H$  associating with an operad its natural Hopf bialgebra [vdL04, CL07, ML14]. Indeed, given an operad  $\mathcal{O}$ , one can construct a stiff pro  $\mathbf{R}(\mathcal{O})$  [Mar08] such that  $H(\mathcal{O})$  is isomorphic to the abelianization of  $\mathbf{H}(\mathbf{R}(\mathcal{O}))$ . In addition to creating a link between the theories of pros and of Hopf bialgebras, the construction  $\mathbf{H}$  brings several new Hopf bialgebras on objects like forests of trees with a fixed arity and heaps of pieces [Vie86]. It allows also to construct some of the deformations of the noncommutative version of the Fàa di Bruno Hopf bialgebra [BFK06] introduced by Foissy [Foi08].

The main algebraic contribution of **Chapter 12** concerns the introduction of a new category of algebraic objects, the precompositions. These objects are used as inputs of a functorial construction  $\mathbf{PO}$  producing ns operads. This construction is used to provide alternative definitions of the operads MT and Poset introduced in [LMN13] in the context of language theory and the study of multi-tildes [CCM11], and to construct new operads DMT and Qoset as respective extensions of the last two.

**Enumerative combinatorics.** As explained before, defining algebraic structures on combinatorial objects leads to discover combinatorial properties on them. This form a large part of our philosophy. We list here the main results, chapter by chapter, in this context.

As said above, **Chapter 3** presents a way to study a ns operad  $\mathcal{O}$  through a ns colored operad  $\mathcal{C}$  satisfying  $\text{Hull}(\mathcal{C}) = \mathcal{O}$ . We highlight the fact that the Hilbert series of  $\mathcal{O}$  can be computed from the colored Hilbert series of  $\mathcal{C}$  by solving a system of equations, and, as the developed examples show, the colored Hilbert series of  $\mathcal{C}$  are simpler (rational) than the Hilbert series of  $\mathcal{O}$  (algebraic). Since the Hilbert series of a ns operad and the generating series of its elements are the same series, this offers a tool for enumeration. In this chapter, we enumerate bicolored noncrossing configurations by using this technique.

In **Chapter 11**, we work with formal power series on ns colored operads to develop enumerative tools. We introduce a new kind of formal grammar (see [Har78, HMU06]) generalizing both context-free grammars of words and regular tree grammars [CDG<sup>+</sup>07]. These grammars, called bud generating systems, allow to generate elements of a ground ns colored operad. To enumerate the elements generated by a bud generating system  $\mathcal{B}$ , we introduce three formal series on ns colored operads: the hook generating series  $\text{hook}(\mathcal{B})$ , the syntactic generating series  $\text{synt}(\mathcal{B})$ , and the synchronous generating series  $\text{sync}(\mathcal{B})$ . Each of these provide a different enumeration of the elements generated by  $\mathcal{B}$ . For instance,  $\text{hook}(\mathcal{B})$  is a series whose coefficients provide analogs of the hook-length statistics for binary trees [Knu98]. Moreover, these series are defined through operations on series: a pre-Lie product  $\curvearrowright$  and an associative product  $\odot$ . The example treated above about the enumeration of balanced binary trees uses tools developed in this chapter.

**Computer science.** In this research some contributions to computer science and, more precisely, to formal language theory and to computational complexity theory have been developed. Let us summarize them.

In **Chapter 10**, we consider the supershuffle  $\bullet$  of permutations introduced by Vargas [Var14]. This operation is different from the shifted shuffle of permutations and can be seen as an extension of the usual shuffle product  $\sqcup$  on words [EML53]. A classical question in algorithmic consists in evaluating the complexity of recognizing words that are squares for this operation. In other words, the problem amounts to decide if, given a word  $u$ , there exists a word  $v$  such that  $u$  appears in  $v \sqcup v$ . It is known from [RV13, BS14] that this problem is NP-complete. We ask in this chapter the analogous question for the recognition of square permutations with respect to  $\bullet$  and show that this problem is also NP-complete.

We have explained that **Chapter 11** contains enumerative results. In addition to this, the chapter introduces bud generating systems as new kinds of grammars capable to generate any type of combinatorial objects. Some elementary results about these grammars are developed.

As said before, **Chapter 12** provides algebraic results. Nevertheless, the operads constructed here are intended to be tools in formal language theory. A common research axis in this field is to define a family of operations to express formal languages with the smallest spatial complexity as possible. Multi-fildes [CCM11] have been designed in this way. Here,

we introduce an extension of multi-tildes, namely the double multi-tildes, increasing their expressive power. An operad DMT of double multi-tildes is constructed and its action on languages is described. One of the main results of the chapter is that every regular language can be expressed by the action of a double multi-tilde seen as an operator of arity  $n$  on  $n$  languages  $\alpha_i$ ,  $1 \leq i \leq n$ , such that each  $\alpha_i$  is empty or contains one unique word of length 1. However, this action is not faithful, in the sense that there are different multi-tildes of DMT that act similarly on languages. For this reason, we introduce a quotient Qoset of DMT such that elements are quasiorders. We show that the action of Qoset on regular languages is faithful. This establishes an unexpected link between quasiorders and regular languages.

**Part 1**

**Algebraic combinatorics**





## CHAPTER 1

# Combinatorics

In combinatorics, counting how many objects a given family contains is one of the most common, hard, and stimulating activities. Nevertheless, even before trying to answer this kind of question, an important preliminary and basic work consists in classifying the objects of a family according to some of their particularities. The size of the objects is, of course, one of these, but also, if we take the example of permutations, the number of inversions and recoils are other features which may be considered.

Combinatorial collections are structures designed to work with such structured sets of combinatorial objects. Roughly speaking, a combinatorial collection is a set expressible by a disjoint union of finite sets, indexed by a particular set  $I$ . Depending on  $I$ , these collections are designed to represent various kinds of sets of objects. For instance, when the indexing set  $I$  is  $\mathbb{N}$ , one obtains graded collections. These are sets endowed with a size function, a concept fully developed in [FS09] under the name of combinatorial classes. When the indexing set is  $\mathbb{N}^2$ , one obtains bigraded collections. These collections provide a suitable framework to work with prographs and pros (see Section 3.3 of this chapter and Section 5.1 of Chapter 2) since the elements of these algebraic structures have an input and an output arity. Moreover, when the indexing set is a set of words on a given alphabet, one obtains colored collections. These collections provide a suitable framework to work with colored syntax trees and colored operads (see Section 3.1.2 of this chapter and Section 4.1.10 of Chapter 2) since the elements of these algebraic structures have input and output colors.

There are other sensible tools to encode combinatorial collections. One can cite species of structures introduced by Joyal [Joy81] that allow to work with labeled objects. This theory has been developed by the Quebec school of combinatorics [BLL98, BLL13]. Species of structures are very good candidates to work with symmetric operads [Mé15] since the action of the symmetric group of a symmetric operad is encapsulated into the action of the symmetric group on an underlying species of structure. Another interesting way to describe combinatorial objects passes through polynomial functors [Koc09].

This machinery of combinatorial collections is applied in this work mainly to rigorously define several families of trees. Let us remark that this concept of tree encompasses a large range of quite different combinatorial objects. For instance, in graph theory, trees are connected acyclic graphs while in combinatorics, one encounters mostly rooted trees. Among rooted trees, some of these can be planar (the order of the children of a node is relevant) or not. In addition to this, the internal nodes, the leaves, or the edges of the trees can be labeled, and some conditions for the arities of their nodes can be imposed. One of the first occurrences of the concept of tree came from the work of Cayley [Cay57]. Nowadays, trees

appear among other in computer science as data structures [Knu98, CLRS09], in combinatorics in relation with enumeration questions and Lagrange inversion [Lab81, FS09], and in algebraic combinatorics, where several families of trees are endowed with algebraic structures [LR98, HNT05, Cha08]. In our context, the most important families of trees are the syntax trees, which are kind of labeled planar rooted trees. These trees are central objects in the study of operads.

This chapter is devoted to set the main definitions and notations about combinatorics. In Section 1, we introduce combinatorial collections and structured combinatorial collections, including the notion of posets and rewrite systems. Trees and syntax trees are considered in Section 2. We describe here several families of trees and rewrite systems on syntax trees. Finally, Section 3 contains a list of definitions of combinatorial objects met afterwards in this dissertation.

## 1. Structured collections

We introduce here the general notion of collection. Then, we consider very usual concepts as magmas, monoids, posets, rewrite systems under this context of collections.

**1.1. Collections.** After defining collections, combinatorial collections, (multi)graded collections, and colored collections, a bunch of operations on graded collections are reviewed.

1.1.1. *General collections.* Let  $I$  be a nonempty set called *index*. An  *$I$ -collection* is a set  $C$  expressible as a disjoint union

$$C = \bigsqcup_{i \in I} C(i) \tag{1.1.1}$$

where all  $C(i)$ ,  $i \in I$ , are sets. All the elements of  $C$  (resp.  $C(i)$  for an  $i \in I$ ) are called *objects* (resp.  *$i$ -objects*) of  $C$ . If  $x$  is an  $i$ -object of  $C$ , we say that the *index*  $\text{ind}(x)$  of  $x$  is  $i$ . When for all  $i \in I$ , all  $C(i)$  are finite sets,  $C$  is *combinatorial*. Besides,  $C$  is *finite* if  $C$  is finite as a set. The *empty  $I$ -collection* is the set  $\emptyset$ . When  $I$  is a singleton,  $C$  is *simple*. Any set can thus be seen as a simple collection and conversely.

A *relation* on  $C$  is a binary relation  $\mathcal{R}$  on  $C$  such that for any objects  $x$  and  $y$  of  $C$  satisfying  $x \mathcal{R} y$ ,  $x$  and  $y$  have the same index. Let  $C_1$  and  $C_2$  be two  $I$ -collections. A map  $\phi : C_1 \rightarrow C_2$  is an  *$I$ -collection morphism* if, for all  $x \in C_1$ ,  $\text{ind}(x) = \text{ind}(\phi(x))$ . We express by  $C_1 \simeq C_2$  the fact that there exists an isomorphism between  $C_1$  and  $C_2$ . Besides, if for all  $i \in I$ ,  $C_1(i) \subseteq C_2(i)$ ,  $C_1$  is a *subcollection* of  $C_2$ . For any  $i \in I$ , we can regard each  $C(i)$  as a subcollection of  $C$  consisting in all its  $i$ -objects.

Let us now consider particular  $I$ -collections for precise sets  $I$ . Table 1.1 contains an overview of the properties that such collections can satisfy.

<b>Collections</b>			
<i>Combinatorial</i>		<i>Finite</i>	<i>Simple</i>
<b><i>k</i>-graded</b>			<b>Colored</b>
<b>1-graded</b>			
<i>Connected</i>	<i>Augmented</i>	<i>Monatomic</i>	<i>Monochrome</i>

TABLE 1.1. The most common  $I$ -collections (in bold) and the properties (in italic) they can satisfy. The inclusions relations between these collections read from bottom to top. For instance, 1-graded collections are particular  $k$ -graded collections which are particular collections.

1.1.2. *Graded collections.* An  $\mathbb{N}$ -collection is called a *graded collection*. If  $C$  is a graded collection, for any object  $x$  of  $C$ , the *size*  $|x|$  of  $x$  is the integer  $\text{ind}(x)$ . The map  $|-| : C \rightarrow \mathbb{N}$  is the *size function* of  $C$ .

Let us from now on assume that  $C$  is a combinatorial graded collection. The *generating series* of  $C$  is the series

$$\mathcal{G}_C(t) := \sum_{n \in \mathbb{N}} \#C(n)t^n, \quad (1.1.2)$$

where  $\#S$  denotes the cardinality of any finite set  $S$ . This formal power series encodes the *sequence of integers* associated with  $C$ , that is the sequence  $(\#C(n))_{n \in \mathbb{N}}$ . Observe that if  $C_1$  and  $C_2$  are two combinatorial graded collections,  $C_1 \simeq C_2$  holds if and only if  $\mathcal{G}_{C_1}(t) = \mathcal{G}_{C_2}(t)$ .

We say that  $C$  is *connected* if  $C(0)$  is a singleton, and that  $C$  is *augmented* if  $C(0) = \emptyset$ . Moreover,  $C$  is *monatomic* if it is augmented and  $C(1)$  is a singleton. We denote by  $\{\epsilon\}$  the graded collection such that  $\epsilon$  is an object satisfying  $|\epsilon| = 0$ . This collection is called the *unit collection*. Observe that  $\{\epsilon\}$  is connected, and that  $C$  is connected if and only if there is a unique collection morphism from  $\{\epsilon\}$  to  $C$ . We denote by  $\{\bullet\}$  the collection such that  $\bullet$  is an *atom*, that is an object satisfying  $|\bullet| = 1$ . This collection is called the *neutral collection*. Observe that  $\{\bullet\}$  is monatomic, and that  $C$  is monatomic if and only if  $C$  is augmented and there is a unique collection morphism from  $\{\bullet\}$  to  $C$ .

1.1.3. *Statistics and multigraded collections.* Let  $C$  be a collection. A *statistics* on  $C$  is a map  $s : C \rightarrow \mathbb{N}$ , associating a nonnegative integer value with any object of  $C$ . A  *$k$ -graded collection* (also called *multigraded collection*) is an  $\mathbb{N}^k$ -collection for an integer  $k \geq 1$ . To not overload the notation, we denote by  $C(n_1, \dots, n_k)$  the subset  $C((n_1, \dots, n_k))$  of any  $k$ -graded collection  $C$ . These collections are useful to work with objects endowed with many statistics. Indeed, if  $x$  is an  $(n_1, \dots, n_k)$ -object, one sets  $s_i(x) := n_i$  for each  $1 \leq i \leq k$ . This defines in this way  $k$  statistics  $s_i : C \rightarrow \mathbb{N}$ ,  $1 \leq i \leq k$ . Besides, the *generating series* of a combinatorial  $k$ -graded  $\mathbb{N}^k$ -collection  $C$  is the series

$$\mathcal{G}_C(t_1, \dots, t_k) := \sum_{(n_1, \dots, n_k) \in \mathbb{N}^k} \#C(n_1, \dots, n_k) t_1^{n_1} \dots t_k^{n_k}. \quad (1.1.3)$$

Of course, (1.1.2) is a particular case of (1.1.3) when  $k = 1$ .

1.1.4. *Colored collections.* Let  $\mathfrak{C}$  be a finite set, called *set of colors*. A  $\mathfrak{C}$ -colored collection  $C$  is an  $I$ -collection such that

$$I := \{(a, u) : a \in \mathfrak{C} \text{ and } u \in \mathfrak{C}^\ell \text{ for an } \ell \geq 1\}. \quad (1.1.4)$$

In other terms, any object  $x$  of  $C$  has an index  $(a, u)$ . By setting that the *size* of  $x$  is the length  $|u|$  of  $u$  (that is the integer  $\ell$  such that  $u \in \mathfrak{C}^\ell$ ), we can see  $C$  as an augmented graded collection. Moreover, the *output color* of  $x$  is  $\mathbf{out}(x) := a$ , and the *word of input colors* of  $x$  is  $\mathbf{in}(x) := u$ . The  *$i$ th input color* of  $x$  is the  $i$ th letter of  $\mathbf{in}(x)$ , denoted by  $\mathbf{in}_i(x)$ . We say that  $C$  is *monochrome* if  $\mathfrak{C}$  is a singleton. For any nonnegative integer  $k$ , a  *$k$ -colored collection* is a  $\mathfrak{C}$ -colored collection where  $\mathfrak{C}$  is the set of integers  $\{1, \dots, k\}$ . Assume now that  $\mathfrak{C} = \{a_1, \dots, a_k\}$  and let  $\mathbb{X}_{\mathfrak{C}} := \{x_{a_1}, \dots, x_{a_k}\}$  and  $\mathbb{Y}_{\mathfrak{C}} := \{y_{a_1}, \dots, y_{a_k}\}$  be two alphabets of commutative letters. The *generating series* of  $C$  is the series

$$\mathcal{G}_C(x_{a_1}, \dots, x_{a_k}, y_{a_1}, \dots, y_{a_k}) := \sum_{x \in C} x_{\mathbf{out}(x)} \prod_{1 \leq i \leq |\mathbf{in}(x)|} y_{\mathbf{in}_i(x)}. \quad (1.1.5)$$

Observe that when  $C$  is monochrome, the specialization  $\mathcal{G}_C(1, t)$  is the generating series of  $C$  seen as a graded collection.

1.1.5. *Products in collections.* Let  $C$  be an  $I$ -collection. A *product* on  $C$  is a partial map

$$\star : C^p \rightarrow C \quad (1.1.6)$$

where  $p \in \mathbb{N} \setminus \{0\}$ . The *arity* of  $\star$  is  $p$ . Any product of arity  $p$  can be seen as an operation taking  $p$  elements of  $C$  as input and outputting one element of  $C$ . When, for any  $i \in I$  and any objects  $x_1, \dots, x_p$  of  $C(i)$  such that  $\star(x_1, \dots, x_p)$  is defined,  $\star(x_1, \dots, x_p) \in C(i)$  holds, we say that  $\star$  is *internal*.

When  $I$  is endowed with an associative binary product  $\dot{+}$ , if for any objects  $x_1, \dots, x_p$  of  $C$  such that  $\star(x_1, \dots, x_p)$  is defined,

$$\mathbf{ind}(\star(x_1, \dots, x_p)) = \mathbf{ind}(x_1) \dot{+} \dots \dot{+} \mathbf{ind}(x_p), \quad (1.1.7)$$

we say that  $\star$  is  *$\dot{+}$ -compatible*. In the particular case where  $C$  is a graded collection and  $\star$  is  $+$ -compatible,  $\star$  is *graded*.

Let us now assume that  $C$  is a simple collection endowed with a binary and total product  $\star$ . In this case,  $C$  is a *magma*. We say that  $C$  is *right cancellable* if for any  $x, y, z \in C$ , the relation  $y \star x = z \star x$  implies  $y = z$ . An element  $\mathbb{1}$  of  $C$  is a *unit* for  $\star$  if for all  $x \in C$ ,  $x \star \mathbb{1} = x = \mathbb{1} \star x$ . When  $\star$  admits a unit,  $C$  is a *unitary magma*. If, additionally, the product  $\star$  is associative,  $C$  is a *monoid*.

1.1.6. *Operations over graded collections.* We list here the most important operations that take as input graded collections and output new ones. Most of these are binary or unary, and under some precise conditions, they produce combinatorial collections. In what follows,  $C, C_1, C_2$ , and  $C_3$  are four graded collections.

*Suspension and augmentation.* For any  $k \in \mathbb{Z}$ , the *k-suspension* of  $C$  is the graded collection  $\text{Sus}_k(C)$  defined for all  $n \in \mathbb{N}$  by

$$(\text{Sus}_k(C))(n) := \begin{cases} C(n-k) & \text{if } n-k \geq 0, \\ \emptyset & \text{otherwise.} \end{cases} \quad (1.1.8)$$

Observe that  $\text{Sus}_1(\text{Sus}_{-1}(C))$  is the subcollection  $C \setminus C(0)$  of  $C$ , that is the augmented collection having the objects of  $C$  without its objects of size 0. We call this collection the *augmentation* of  $C$  and we denote it by  $\text{Aug}(C)$ .

*Sum.* The *sum* of  $C_1$  and  $C_2$  is the graded collection  $C_1 + C_2$  such that, for all  $n \in \mathbb{N}$ ,

$$(C_1 + C_2)(n) := C_1(n) \sqcup C_2(n). \quad (1.1.9)$$

In other words, each object of size  $n$  of  $C_1 + C_2$  is either an object of size  $n$  of  $C_1$  or an object of size  $n$  of  $C_2$ . Since the sum operation (1.1.9) is defined through a disjoint union, when the sets  $C_1(n)$  and  $C_2(n)$  are not disjoint, there are in  $(C_1 + C_2)(n)$  two copies of each element belonging to the intersection  $C_1(n) \cap C_2(n)$ , one coming from  $C_1(n)$ , the other from  $C_2(n)$ . Moreover, when  $C_1$  and  $C_2$  are combinatorial,  $C_1 + C_2$  is also combinatorial and its generating series satisfies

$$\mathcal{G}_{C_1+C_2}(t) = \mathcal{G}_{C_1}(t) + \mathcal{G}_{C_2}(t). \quad (1.1.10)$$

The iterated version of the operation  $+$  is denoted by  $\sqcup$  in the sequel.

*Product.* The *product* of  $C_1$  and  $C_2$  is the graded collection  $C_1 \times C_2$  such that, for all  $n \in \mathbb{N}$ ,

$$(C_1 \times C_2)(n) := \{(x_1, x_2) : x_1 \in C_1, x_2 \in C_2, \text{ and } |x_1| + |x_2| = n\}. \quad (1.1.11)$$

In other words, each object of size  $n$  of  $C_1 \times C_2$  is an ordered pair  $(x_1, x_2)$  such that  $x_1$  (resp.  $x_2$ ) is an object of  $C_1$  (resp.  $C_2$ ) and the sum of the sizes of  $x_1$  and  $x_2$  is  $n$ . Moreover, when  $C_1$  and  $C_2$  are combinatorial,  $C_1 \times C_2$  is also combinatorial and its generating series satisfies

$$\mathcal{G}_{C_1 \times C_2}(t) = \mathcal{G}_{C_1}(t)\mathcal{G}_{C_2}(t). \quad (1.1.12)$$

*Hadamard product.* The *Hadamard product* of  $C_1$  and  $C_2$  is the graded collection  $C_1 \boxtimes C_2$  such that, for all  $n \in \mathbb{N}$ ,

$$(C_1 \boxtimes C_2)(n) := C_1(n) \times C_2(n). \quad (1.1.13)$$

In other words, each object of size  $n$  of  $C_1 \boxtimes C_2$  is an ordered pair  $(x_1, x_2)$  such that  $x_1$  (resp.  $x_2$ ) is an object of size  $n$  of  $C_1$  (resp.  $C_2$ ). Moreover, when  $C_1$  and  $C_2$  are combinatorial,  $C_1 \boxtimes C_2$  is also combinatorial and its generating series satisfies

$$\mathcal{G}_{C_1 \boxtimes C_2}(t) = \mathcal{G}_{C_1}(t) \boxtimes \mathcal{G}_{C_2}(t) = \sum_{n \in \mathbb{N}} \#C_1(n) \#C_2(n) t^n. \quad (1.1.14)$$

*List operation.* For any  $k \geq 0$ , the *k-list operation* applied to  $C$  produces the graded collection  $T_k(C)$  such that, for all  $n \in \mathbb{N}$ ,

$$(T_k(C))(n) := \{(x_1, \dots, x_k) : x_1, \dots, x_k \in C, \text{ and } |x_1| + \dots + |x_k| = n\}. \quad (1.1.15)$$

In other words, each object of size  $n$  of  $T_k(C)$  is a tuple  $(x_1, \dots, x_k)$  of objects of  $C$  such that the sum of the sizes of  $x_1, \dots, x_k$  is  $n$ . When  $C$  is combinatorial,  $T_k(C)$  is also combinatorial and its generating series satisfies

$$\mathcal{G}_{T_k(C)}(t) = \mathcal{G}_C(t)^k. \quad (1.1.16)$$

The *list operation* applied to  $C$  produces the graded collection  $T(C)$  defined by

$$T(C) := \bigsqcup_{k \in \mathbb{N}} T_k(C). \quad (1.1.17)$$

Moreover, when  $C$  is combinatorial and augmented,  $T(C)$  is also combinatorial (but not augmented) and its generating series satisfies

$$\mathcal{G}_{T(C)}(t) = \frac{1}{1 - \mathcal{G}_C(t)}. \quad (1.1.18)$$

Besides, for any  $k \in \mathbb{N}$ , we denote by  $T_{\geq k}(C)$  the graded collection defined by

$$T_{\geq k}(C) := \bigsqcup_{\substack{\ell \in \mathbb{N} \\ \ell \geq k}} T_\ell(C). \quad (1.1.19)$$

This notation “ $T$ ” comes from tensor algebras (see Section 1.2.3 of Chapter 2).

*Multiset operation.* For any  $k \geq 0$ , the *k-multiset operation* applied to  $C$  produces the graded collection  $S_k(C)$  such that, for all  $n \in \mathbb{N}$ ,

$$(S_k(C))(n) := \{[x_1, \dots, x_k] : x_1, \dots, x_k \in C, \text{ and } |x_1| + \dots + |x_k| = n\}. \quad (1.1.20)$$

In other words, each object of size  $n$  of  $S_k(C)$  is a multiset  $[x_1, \dots, x_k]$  of objects of  $C$  such that the sum of the sizes of  $x_1, \dots, x_k$  is  $n$ . The *multiset operation* applied to  $C$  produces the graded collection  $S(C)$  defined by

$$S(C) := \bigsqcup_{k \in \mathbb{N}} S_k(C). \quad (1.1.21)$$

Moreover, when  $C$  is combinatorial and augmented,  $S(C)$  is also combinatorial (but not augmented) and its generating series satisfies

$$\mathcal{G}_{S(C)}(t) = \prod_{n \in \mathbb{N} \setminus \{0\}} \left( \frac{1}{1 - t^n} \right)^{\#C(n)}. \quad (1.1.22)$$

This notation “ $S$ ” comes from symmetric algebras (see Section 1.2.4 of Chapter 2).

*Set operation.* For any  $k \geq 0$ , the *k-set operation* applied to  $C$  produces the graded collection  $E_k(C)$  such that, for all  $n \in \mathbb{N}$ ,

$$(E_k(C))(n) := \{\{x_1, \dots, x_k\} \subseteq C : |x_1| + \dots + |x_k| = n\}. \quad (1.1.23)$$

In other words, each object of size  $n$  of  $E_k(C)$  is a set  $\{x_1, \dots, x_k\}$  of objects of  $C$  such that the sum of the sizes of  $x_1, \dots, x_k$  is  $n$ . The *set operation* applied to  $C$  produces the graded collection  $E(C)$  defined by

$$E(C) := \bigsqcup_{k \in \mathbb{N}} E_k(C). \quad (1.1.24)$$

Moreover, when  $C$  is combinatorial,  $E(C)$  is also combinatorial and its generating series satisfies

$$\mathcal{G}_{E(C)}(t) = \prod_{n \in \mathbb{N} \setminus \{0\}} (1 + t^n)^{\#C(n)}. \quad (1.1.25)$$

Unlike the cases of the list and multiset operations,  $E(C)$  is a combinatorial collection without requiring that  $C$  is augmented. This notation “E” comes from exterior algebras (see Section 1.2.5 of Chapter 2).

*Composition product.* For any  $k \geq 0$  and graded collections  $C_1, \dots, C_k$ , the *homogeneous composition* of  $C$  with  $C_1, \dots, C_k$  is the graded collection  $C \circ [C_1, \dots, C_k]$  such that, for all  $n \in \mathbb{N}$ ,

$$(C \circ [C_1, \dots, C_k])(n) := \bigsqcup_{x \in C(k)} \{(x, (y_1, \dots, y_k)) : y_i \in C_i, 1 \leq i \leq k, \text{ and } |y_1| + \dots + |y_k| = n\}. \quad (1.1.26)$$

In other words, each object of size  $n$  of  $C \circ [C_1, \dots, C_k]$  is an ordered pair  $(x, (y_1, \dots, y_k))$  where  $x$  is an object of  $C$  of size  $k$ , and  $(y_1, \dots, y_k)$  is a tuple such that each  $y_i$  is an object of  $C_i$ ,  $1 \leq i \leq k$ , and the sum of the sizes of these objects  $y_i$  is  $n$ . The *composition* of  $C_1$  and  $C_2$  is the graded collection  $C_1 \circ C_2$  such that, for all  $n \in \mathbb{N}$ ,

$$(C_1 \circ C_2)(n) := \bigsqcup_{k \in \mathbb{N}} C_1 \circ \underbrace{[C_2, \dots, C_2]}_{k \text{ terms}}. \quad (1.1.27)$$

Moreover, when  $C_1$  and  $C_2$  are both combinatorial and  $C_2$  is augmented,  $C_1 \circ C_2$  is also combinatorial (but not necessarily augmented) and its generating series satisfies

$$\mathcal{G}_{C_1 \circ C_2}(t) = \mathcal{G}_{C_1}(\mathcal{G}_{C_2}(t)). \quad (1.1.28)$$

**1.2. Main collections.** We define, in some cases by using the operations of Section 1.1.6, some usual graded combinatorial collections. At the same time, we set here our main notations and definitions about their objects.

**1.2.1. Natural numbers.** We can regard the set  $\mathbb{N}$  as the graded collection satisfying  $\mathbb{N}(n) := \{n\}$  for all  $n \in \mathbb{N}$ . Hence,  $T(\{\bullet\}) \simeq \mathbb{N}$  for an atom  $\bullet$ . Moreover, for any  $k \in \mathbb{N}$ , let  $\mathbb{N}_{\geq k}$  be the graded collection defined by

$$\mathbb{N}_{\geq k} := \text{Sus}_k(\text{Sus}_{-k}(\mathbb{N})). \quad (1.2.1)$$



By definition of the suspension operation over graded collections,  $\mathbb{N}_{\geq k}$  is the set of all integers greater than or equal to  $k$ . Observe that  $\mathbb{N}_{\geq 1} = \text{Aug}(\mathbb{N})$ . The generating series of  $\mathbb{N}_{\geq k}$  satisfies

$$\mathcal{G}_{\mathbb{N}_{\geq k}}(t) = \frac{t^k}{1-t} = t^k + t^{k+1} + t^{k+2} + \dots \quad (1.2.2)$$

Observe also that the list operation over graded collections can be expressed as a composition involving  $\mathbb{N}$  since

$$T(C) \simeq \mathbb{N} \circ C \quad (1.2.3)$$

for any augmented combinatorial graded collection  $C$ . Let also, for any  $x, z \in \mathbb{N}$ , the subcollection  $[x, z] := \{y \in \mathbb{N} : x \leq y \leq z\}$ , and  $[x] := [1, x]$ . These examples of graded collections are among the simplest nontrivial ones.

It is time to provide some notations about natural numbers. For any multiset  $S := \{s_1, \dots, s_n\}$  of elements of  $\mathbb{N}$ , we denote by  $\sum S$  the sum  $s_1 + \dots + s_n$  of its elements. We moreover denote by  $S!$  the *multinomial coefficient*

$$S! := \binom{\sum S}{s_1, \dots, s_n} = \frac{(s_1 + \dots + s_n)!}{s_1! \dots s_n!} \quad (1.2.4)$$

**1.2.2. Words.** Let  $A$  be an *alphabet*, that is a set whose elements are called *letters*. One can see  $A$  as a graded collection wherein all letters are atoms. In this case, we denote by  $A^*$  the graded collection  $T(A)$ . By definition, the objects of  $A^*$  are finite sequences of elements of  $A$ . We call *words* on  $A$  these objects. When  $A$  is finite,  $A^*$  is combinatorial and it follows from (1.1.18) that the generating series of  $A^*$  is

$$\mathcal{G}_{A^*}(t) = \sum_{n \in \mathbb{N}} m^n t^n = 1 + mt + m^2 t^2 + m^3 t^3 + \dots, \quad (1.2.5)$$

where  $m := \#A$ . If  $u := (a_1, \dots, a_n)$  is a word on  $A$ , it follows from the definition of  $A^*$  that the size  $|u|$  of  $u$  is  $n$ . The  *$i$ th letter* of  $u$  is  $a_i$  and is denoted by  $u(i)$  (and also denoted by  $u_i$  in some contexts). For any letter  $b \in A$ , the *number of occurrences*  $|u|_b$  of  $b$  in  $u$  is the cardinality of the set  $\{i \in [|u|] : u(i) = b\}$ . The unique word on  $A$  of size 0 is denoted by  $\epsilon$  and is called *empty word*. The subcollection  $A^+ := \text{Aug}(A^*)$  of  $A^*$  contains all nonempty words on  $A$ . For any  $n \in \mathbb{N}$ ,  $A^n$  denote the subcollection  $A^*(n)$  of  $A^*$ . When  $A$  is endowed with a total order  $\preceq$  and  $u$  is nonempty,  $\max_{\preceq}(u)$  is the greatest letter appearing in  $u$  with respect to  $\preceq$ . Moreover, an *inversion* of  $u$  is a pair  $(i, j)$  such that  $i < j$ ,  $u(i) \neq u(j)$ , and  $u(j) \preceq u(i)$ . Given two words  $u$  and  $v$  on  $A$ , the *concatenation* of  $u$  and  $v$  is the word  $u \cdot v$  containing from left to right the letters of  $u$  and then the ones of  $v$ . If  $u$  can be expressed as  $u = u_1 \cdot u_2 \cdot u_3$  where  $u_1, u_2, u_3 \in A^*$ , we say that  $u_1$  (resp.  $u_3, u_2$ ) is a *prefix* (resp. *suffix, factor*) of  $u$ . We denote by  $u \leq_{\text{pref}} v$  (resp.  $u \leq_{\text{suff}} v, u \leq_{\text{fact}} v$ ) the fact that  $u$  is a prefix (resp. suffix, factor) of  $v$ . For any subset  $P := \{p_1 \leq \dots \leq p_k\}$  of  $[|u|]$ ,  $u|_P$  is the word  $u(p_1) \dots u(p_k)$ . Moreover, when  $v$  is a word such that there exists  $P \subseteq [|u|]$  satisfying  $v = u|_P$ ,  $v$  is a *subword* of  $u$ . The *commutative image* of  $u$  is the multiset  $\{u(i) : i \in [|u|]\}$ . Given two words  $u$  and  $v$  of the same size  $n$ , the *Hamming distance*  $\text{ham}(u, v)$  between  $u$  and  $v$  is the number of integers  $i \in [n]$  such that  $u(i) \neq v(i)$ . A *language* on  $A$  is subcollection of  $A^*$ . A language  $\mathcal{L}$  on  $A$  is *prefix* if for all  $u \in \mathcal{L}$  and  $v \in A^*$ ,  $v \leq_{\text{pref}} u$  implies  $v \in \mathcal{L}$ .

1.2.3. *Integer compositions.* By regarding the set  $\mathbb{N}$  as a graded collection as explained in Section 1.2.1, let  $\text{Comp}$  be the combinatorial graded collection  $\mathbb{T}(\mathbb{N}_{\geq 1})$ . It follows from (1.1.18) and (1.2.2) that the generating series of  $\text{Comp}$  is

$$\mathcal{G}_{\text{Comp}}(t) = \frac{1-t}{1-2t} = 1 + \sum_{n \geq 1} 2^{n-1} t^n = 1 + t + 2t^2 + 4t^3 + 8t^4 + 16t^5 + 32t^6 + 64t^7 + \dots \quad (1.2.6)$$

By definition, the objects of  $\text{Comp}$  are finite sequences of positive numbers. We call *integer compositions* (or, for short, *compositions*) these objects. If  $\lambda := (\lambda_1, \dots, \lambda_k)$  is a composition, it follows from the definition of  $\text{Comp}$  that the size  $|\lambda|$  of  $\lambda$  is  $\lambda_1 + \dots + \lambda_k$ . The *length*  $\ell(\lambda)$  of  $\lambda$  is  $k$ , and for any  $i \in [\ell(\lambda)]$ , the  *$i$ th part* of  $\lambda$  is  $\lambda_i$ . The unique composition of size 0 is denoted by  $\epsilon$  and is called *empty composition* (even if  $\epsilon$  is already used to express the empty word, this overloading of notation is not a problem in practice).

The *descents set* of  $\lambda$  is the set

$$\text{Des}(\lambda) := \{\lambda_1, \lambda_1 + \lambda_2, \dots, \lambda_1 + \lambda_2 + \dots + \lambda_{k-1}\}. \quad (1.2.7)$$

For instance,  $\text{Des}(4131) = \{4, 5, 8\}$ . Moreover, for any word  $u$  defined on an alphabet  $A$  equipped with a total order  $\preceq$ , the *composition*  $\text{cmp}(u)$  of  $u$  is the composition of size  $|u|$  defined by

$$\text{cmp}(u) := (|u_1|, \dots, |u_k|), \quad (1.2.8)$$

where  $u = u_1 \dots u_k$  is the factorization of  $u$  in longest nondecreasing factors (with respect to the order  $\preceq$ ). For instance, if  $u := a_2 a_2 a_3 a_1 a_3 a_2 a_1 a_2$  is a word on the alphabet  $A := \{a_1, a_2, a_3\}$  ordered by  $a_1 \preceq a_2 \preceq a_3$ ,  $\text{cmp}(u) = 3212$ . When  $\#A \geq 2$ , this map  $\text{cmp}$  is a surjective collection morphism from  $A^*$  to  $\text{Comp}$ .

Integer compositions are drawn as *ribbon diagrams* in the following way. For each part  $\lambda_i$  of  $\lambda$ , we draw a horizontal line of  $\lambda_i$  boxes. These lines are organized so that the line for the first part of  $\lambda$  is the uppermost, and the first box of the line of the part  $\lambda_{i+1}$  is glued below the last box of the line of the part  $\lambda_i$ , for all  $i \in [\ell(\lambda) - 1]$ . For instance, the ribbon diagram of the composition 4131 is



$$(1.2.9)$$

1.2.4. *Integer partitions.* Again by regarding the set  $\mathbb{N}$  as a graded collection as considered in Section 1.2.1, let  $\text{Part}$  be the graded combinatorial collection  $\mathbb{S}(\mathbb{N}_{\geq 1})$ . Since  $\#\mathbb{N}_{\geq 1}(n) = 1$  for all  $n \geq 1$ , it follows from (1.1.22) that the generating series of  $\text{Part}$  is

$$\mathcal{G}_{\text{Part}}(t) = \prod_{n \geq 1} \frac{1}{1-t^n} = 1 + t + 2t^2 + 3t^3 + 5t^4 + 7t^5 + 11t^6 + 15t^7 + 22t^8 + \dots \quad (1.2.10)$$

By definition, the objects of  $\text{Part}$  are finite multisets of positive integers. We call *integer partitions* (or, for short, *partitions*) these objects. As a consequence of the definition of  $\text{Part}$ , the size  $|\lambda|$  of any partition  $\lambda$  is the sum of the integers appearing in the multiset  $\lambda$ . Due to the definition of partitions as multisets, we can present a partition as an ordered sequence of positive integers with respect to any total order on  $\mathbb{N}_{\geq 1}$ . For this reason, we denote any partition  $\lambda$  by a nondecreasing sequence  $(\lambda_1, \dots, \lambda_k)$  of positive integers (that is,

$\lambda_i \geq \lambda_{i+1}$  for all  $i \in [k-1]$ ). Under this convention, the *length*  $\ell(\lambda)$  of  $\lambda$  is  $k$ , and for any  $i \in [\ell(\lambda)]$ , the *ith part* of  $\lambda$  is  $\lambda_i$ .

1.2.5. *Permutations and colored permutations.* A *permutation* of *size*  $n$  is a bijection  $\sigma$  from  $[n]$  to  $[n]$ . The combinatorial graded collection of all permutations is denoted by  $\mathfrak{S}$ . The generating series of  $\mathfrak{S}$  is

$$\mathcal{G}_{\mathfrak{S}}(t) = \sum_{n \in \mathbb{N}} n! t^n = 1 + t + 2t^2 + 6t^3 + 24t^4 + 120t^5 + 720t^6 + 5040t^7 + 40320t^8 + \dots \quad (1.2.11)$$

Any permutation  $\sigma$  of  $\mathfrak{S}(n)$  is denoted as a word  $\sigma(1) \dots \sigma(n)$  on  $\mathbb{N}_{\geq 1}$ . Under this convention, a permutation of size  $n$  is a word on the alphabet  $[n]$  with exactly one occurrence of each letter of  $[n]$ . The composition operation  $\circ$  of maps forms a binary internal operation on  $\mathfrak{S}$ .

A *descent* of  $\sigma$  is a position  $i \in [|\sigma| - 1]$  such that  $\sigma(i) > \sigma(i+1)$ . The set of all descents of  $\sigma$  is denoted by  $\text{Des}(\sigma)$ . A *coinversion* of  $\sigma$  is an ordered pair of letters  $(a, b)$  occurring in  $\sigma$  such that  $a < b$  and the position of  $a$  is greater than the position of  $b$  in  $\sigma$ . The set of all coinversions of  $\sigma$  is denoted by  $\text{Civ}(\sigma)$ . For any word  $u$  defined on an alphabet  $A$  equipped with a total order  $\preceq$ , the *standardized*  $\text{std}(u)$  of  $u$  is the permutation of size  $|u|$  having the same inversions as the ones of  $u$ . In other terms  $\text{std}(u)$  has its letters in the same relative order as those of  $u$ , with respect to  $\preceq$ , where equal letters of  $u$  are ordered from left to right as the smallest to the greatest. For example, by considering the alphabet  $\mathbb{N}$  equipped with the natural order of integers,  $\text{std}(211241) = 412563$ . This map  $\text{std}$  is a surjective collection morphism from  $\mathbb{N}^*$  to  $\mathfrak{S}$ .

This collection  $\mathfrak{S}$  admits the following straightforward generalization. For any  $\ell \geq 1$ , let  $\mathfrak{S}^{(\ell)}$  be the set of all pairs  $(\sigma, u)$  where  $\sigma$  is a permutation and  $u$  is a word of  $[\ell]^{|\sigma|}$ . We call this object an  *$\ell$ -colored permutation*. The *size* of  $(\sigma, u)$  in  $\mathfrak{S}^{(\ell)}$  is the size of  $\sigma$  in  $\mathfrak{S}$ .

1.2.6. *Binary trees.* Let  $\text{BT}_{\perp}$  be the combinatorial graded collection satisfying the relation

$$\text{BT}_{\perp} = \{\perp\} + \{\bullet\} \times \text{BT}_{\perp}^2, \quad (1.2.12)$$

where  $\perp$  is an atomic object called *leaf* and  $\bullet$  is an object of size 0 called *internal node*. We call *binary tree* each object of  $\text{BT}_{\perp}$ . By definition, a binary tree  $t$  is either the leaf  $\perp$  or an ordered pair  $(\bullet, (t_1, t_2))$  where  $t_1$  and  $t_2$  are binary trees. Observe that this description of binary trees is recursive. For instance,

$$\perp, \quad (\bullet, (\perp, \perp)), \quad (\bullet, ((\bullet, (\perp, \perp)), \perp)), \quad (\bullet, (\perp, (\bullet, (\perp, \perp))))), \quad (\bullet, ((\bullet, (\perp, \perp)), (\bullet, (\perp, \perp))))), \quad (1.2.13)$$

are binary trees. If  $t$  is a binary tree different from the leaf, by definition,  $t$  can be expressed as  $t = (\bullet, (t_1, t_2))$  where  $t_1$  and  $t_2$  are two binary trees. In this case,  $t_1$  (resp.  $t_2$ ) is the *left subtree* (resp. *right subtree*) of  $t$ . By drawing each leaf by  $\sqcup$  and each binary tree with at least one internal node by an internal node  $\circ$  attached below it, from left to right, to its left and right subtrees by means of edges  $-$ , the binary trees of (1.2.13) are depicted by

$$\sqcup, \quad \begin{array}{c} \circ \\ / \quad \backslash \\ \sqcup \quad \sqcup \end{array}, \quad \begin{array}{c} \circ \\ / \quad \backslash \\ \circ \quad \sqcup \\ / \quad \backslash \\ \sqcup \quad \sqcup \end{array}, \quad \begin{array}{c} \circ \\ / \quad \backslash \\ \circ \quad \circ \\ / \quad \backslash \quad / \quad \backslash \\ \sqcup \quad \sqcup \quad \sqcup \quad \sqcup \end{array}, \quad \begin{array}{c} \circ \\ / \quad \backslash \\ \circ \quad \circ \\ / \quad \backslash \quad / \quad \backslash \\ \sqcup \quad \sqcup \quad \sqcup \quad \sqcup \end{array}. \quad (1.2.14)$$

By definition of the sum and the product operations over graded collections, the size of a binary tree  $t$  satisfies

$$|t| = \begin{cases} 1 & \text{if } t = \perp, \\ |t_1| + |t_2| & \text{otherwise } (t = (\bullet, (t_1, t_2))). \end{cases} \quad (1.2.15)$$

In other words, the size of  $t$  is the number of occurrences of  $\perp$  it contains. Since  $\mathcal{G}_{\{\perp\}}(t) = t$  and  $\mathcal{G}_{\{\bullet\}}(t) = 1$ , it follows from (1.1.10) and (1.1.12) that the generating series of  $\text{BT}_\perp$  satisfies the quadratic algebraic equation

$$t - \mathcal{G}_{\text{BT}_\perp}(t) + \mathcal{G}_{\text{BT}_\perp}(t)^2 = 0. \quad (1.2.16)$$

The unique solution having a combinatorial meaning of (1.2.16) is

$$\mathcal{G}_{\text{BT}_\perp}(t) = \frac{1 - \sqrt{1 - 4t}}{2} = \sum_{n \in \mathbb{N}_{\geq 1}} \frac{1}{n} \binom{2n-2}{n-1} t^n \quad (1.2.17)$$

The sequence of integers associated with  $\text{BT}_\perp$  begins by

$$1, 1, 2, 5, 14, 42, 132, 429, \quad (1.2.18)$$

and is Sequence A000108 of [Slo]. These numbers are known as *Catalan numbers*.

**1.3. Posets on collections.** We consider now collections endowed with partial order relations compatible with their indexations. Such structures are important in combinatorics since they lead for instance to the construction of alternative bases of combinatorial spaces (see Section 1.3 of Chapter 2). We provide general definitions about posets and consider as examples three important ones: the cube, Tamari, and right weak order posets.

**1.3.1. Elementary definitions.** An *I-poset* is a pair  $(Q, \preceq_Q)$  where  $Q$  is an  $I$ -collection and  $\preceq_Q$  is both a relation on  $Q$  (recall that relations on collections preserve the indices) and a partial order relation. For any property  $P$  of collections, we say that  $(Q, \preceq)$  *satisfies the property  $P$*  if, as a collection,  $Q$  satisfies  $P$ . Observe in particular that our terminology concerning graded posets differs from the classical one [Sta11] (where a poset is graded when all its maximal chains have the same length). Moreover, simple posets are usual posets (that are sets endowed with partial order relations, without extra structure).

The *strict order relation* of  $\preceq$  is the binary relation  $<$  on  $Q$  satisfying, for all  $x, y \in Q$ ,  $x < y$  if  $x \preceq y$  and  $x \neq y$ . The *interval* between two objects  $x$  and  $z$  of  $Q$  is the set  $[x, z] := \{y \in Q : x \preceq_Q y \preceq_Q z\}$ . When all intervals of  $Q$  are finite,  $Q$  is *locally finite*. Observe that when  $Q$  is combinatorial,  $Q$  is locally finite. When  $Q$  is finite, the number of intervals of  $Q$  is finite and is denoted by  $\text{int}(Q)$ . For any  $i \in I$ , an object  $x$  of  $Q(i)$  is a *greatest* (resp. *least*) *element* if for all  $y \in Q(i)$ ,  $y \preceq_Q x$  (resp.  $x \preceq_Q y$ ). Moreover, for any  $i \in I$ , an object  $x$  of  $Q(i)$  is a *maximal* (resp. *minimal*) *element* if for all  $y \in Q(i)$ ,  $x \preceq_Q y$  (resp.  $y \preceq_Q x$ ) implies  $x = y$ . The partial binary operation  $\min$  (resp.  $\max$ ) with respect to the order  $\preceq_Q$  is denoted by  $\uparrow_Q$  (resp.  $\downarrow_Q$ ). If  $x$  and  $y$  are two objects of  $Q$ ,  $y$  *covers*  $x$  if  $x \preceq_Q y$  and  $[x, y] = \{x, y\}$ . Two objects  $x$  and  $y$  are *comparable* (resp. *incomparable*) in  $Q$  if  $x \preceq_Q y$  or  $y \preceq_Q x$  (resp. neither  $x \preceq_Q y$  nor  $y \preceq_Q x$  holds). If for any  $i \in I$  and any  $i$ -objects  $x$  and  $y$  of  $Q$ ,  $x$  and  $y$  are comparable,  $Q$  is a *total order*. A *chain* of  $Q$  is a sequence  $(x_1, \dots, x_k)$  such that  $x_j \preceq_Q x_{j+1}$

for all  $j \in [k - 1]$ . An *antichain* of  $\mathcal{Q}$  is a subset of pairwise incomparable elements of  $\mathcal{Q}$ . A *linear extension* of  $\mathcal{Q}$  is an  $I$ -poset  $(\mathcal{Q}', \preceq'_\mathcal{Q})$  being a total order and such that  $\preceq'_\mathcal{Q}$  contains  $\preceq_\mathcal{Q}$  as a relation. An *order filter* of  $\mathcal{Q}$  is a subset  $\mathcal{F}$  of  $\mathcal{Q}$  such that for all  $x \in \mathcal{F}$  and all  $y \in \mathcal{Q}$  satisfying  $x \preceq_\mathcal{Q} y$ ,  $y$  is in  $\mathcal{F}$ . For any  $i \in I$ , the  *$i$ -subset* of  $\mathcal{Q}$  is the poset obtained by restricting  $\preceq_\mathcal{Q}$  on  $\mathcal{Q}(i)$ . The *Hasse diagram* of  $(\mathcal{Q}, \preceq_\mathcal{Q})$  is the directed graph having  $\mathcal{Q}$  as set of vertices and all the pairs  $(x, y)$  where  $y$  covers  $x$  as set of arcs.

We shall define posets  $\mathcal{Q}$  by drawing Hasse diagrams, where minimal elements are drawn uppermost and vertices are labeled by the elements of  $\mathcal{Q}$ . For instance, the Hasse diagram



denotes the simple poset  $([6], \preceq)$  satisfying among others  $3 \preceq 5$  and  $2 \preceq 6$ .

The *dual* of  $\mathcal{Q}$  is the poset  $(\mathcal{Q}, \overleftarrow{\preceq}_\mathcal{Q})$  such that  $x \overleftarrow{\preceq}_\mathcal{Q} y$  holds whenever  $y \preceq_\mathcal{Q} x$  for any  $x, y \in \mathcal{Q}$ . Besides, if  $(\mathcal{Q}_1, \preceq_{\mathcal{Q}_1})$  and  $(\mathcal{Q}_2, \preceq_{\mathcal{Q}_2})$  are two posets, a map  $\phi : \mathcal{Q}_1 \rightarrow \mathcal{Q}_2$  is a *poset morphism* if  $\phi$  is a collection morphism and for all  $x, y \in \mathcal{Q}_1$  such that  $x \preceq_{\mathcal{Q}_1} y$ ,  $\phi(x) \preceq_{\mathcal{Q}_2} \phi(y)$ . Besides,  $\mathcal{Q}_2$  is a *subset* of  $\mathcal{Q}_1$  if  $\mathcal{Q}_2$  is a subcollection of  $\mathcal{Q}_1$  and  $\preceq_{\mathcal{Q}_2}$  is the restriction of  $\preceq_{\mathcal{Q}_1}$  on  $\mathcal{Q}_2$ .

Let us state the following easy lemma, used for instance in Chapter 6.

LEMMA 1.3.1. *Let  $\mathcal{Q}_1$  and  $\mathcal{Q}_2$  be two posets and  $\phi : \mathcal{Q}_1 \rightarrow \mathcal{Q}_2$  be a morphism of posets. Then, for all comparable objects  $x$  and  $y$  of  $\mathcal{Q}_1$ ,*

$$\phi(x \uparrow_{\mathcal{Q}_1} y) = \phi(x) \uparrow_{\mathcal{Q}_2} \phi(y). \quad (1.3.2)$$

1.3.2. *Patterns.* Let  $(\mathcal{Q}_1, \preceq_{\mathcal{Q}_1})$  and  $(\mathcal{Q}_2, \preceq_{\mathcal{Q}_2})$  be two posets. We say that  $\mathcal{Q}_1$  admits an *occurrence* of (the *pattern*)  $\mathcal{Q}_2$  if there is an isomorphism of posets  $\phi : \mathcal{Q}'_1 \rightarrow \mathcal{Q}_2$  where  $\mathcal{Q}'_1$  is a subset of  $\mathcal{Q}_1$ . Conversely, we say that  $\mathcal{Q}_1$  *avoids*  $\mathcal{Q}_2$  if there is no occurrence of  $\mathcal{Q}_2$  in  $\mathcal{Q}_1$ . Since only the isomorphism class of a pattern is important to decide if a poset admits an occurrence of it, we shall draw unlabeled Hasse diagrams to specify patterns. For instance, the simple poset



admits two occurrences of the simple pattern



a first one since  $1 \preceq_\mathcal{Q} 2$ ,  $1 \preceq_\mathcal{Q} 4$ ,  $2 \preceq_\mathcal{Q} 5$ , and  $4 \preceq_\mathcal{Q} 5$ , and a second one since  $1 \preceq_\mathcal{Q} 3$ ,  $1 \preceq_\mathcal{Q} 4$ ,  $3 \preceq_\mathcal{Q} 5$ , and  $4 \preceq_\mathcal{Q} 5$ . Moreover,  $\mathcal{Q}$  avoids the simple pattern



since  $\mathcal{Q}$  has no antichain of cardinality 3.

We call *forest poset* any finite simple poset avoiding the pattern . In other words, a forest poset is a poset for which its Hasse diagram is a forest of rooted trees (where roots are the minimal elements).

LEMMA 1.3.2. Let  $\mathcal{Q}$  be a forest poset and  $x, y$ , and  $z$  be three elements of  $\mathcal{Q}$  such that  $x$  and  $y$  are comparable and  $y$  and  $z$  are comparable. Then,  $x \uparrow_{\mathcal{Q}} y \uparrow_{\mathcal{Q}} z$  is a well-defined element of  $\mathcal{Q}$ .

1.3.3. *Examples.* We consider here three well-known combinatorial posets.

*The cube poset.* Let  $\leq$  be the partial order relation on the combinatorial collection  $\text{Comp}$  of compositions generated by the covering relation  $\mathcal{R}$  defined, for any composition  $\lambda$  of length  $k$ , by

$$(\lambda_1, \dots, \lambda_{i-1}, \lambda_i, \lambda_{i+1}, \lambda_{i+2}, \dots, \lambda_k) \mathcal{R} (\lambda_1, \dots, \lambda_{i-1}, \lambda_i + \lambda_{i+1}, \lambda_{i+2}, \dots, \lambda_k). \quad (1.3.6)$$

For instance,  $2123 \leq 215$  and  $2123 \leq 8$ . This order is the *refinement order* of compositions. The Hasse diagram of  $(\text{Comp}, \leq)$  restricted on  $\text{Comp}(4)$  is shown in Figure 1.1.

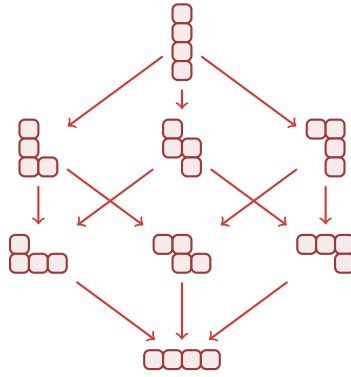

FIGURE 1.1. The Hasse diagram of the refinement order of compositions of size 4, where each composition is represented through its ribbon diagram.

Observe that for all compositions  $\lambda$  and  $\mu$ ,  $\lambda \leq \mu$  if and only if  $\text{Des}(\mu) \subseteq \text{Des}(\lambda)$ . Each  $n$ -subset of the refinement order of compositions is known as the *cube poset* of dimension  $n - 1$ . Moreover, the cube poset of dimension  $n - 1$  is isomorphic to the dual of the poset of all subsets of  $[n - 1]$  ordered by set inclusion. An isomorphism is provided by the map  $\text{Des}$  sending a composition of size  $n$  to a subset of  $[n - 1]$ .

*The Tamari order on binary trees.* Let  $\preceq$  be the partial order relation on the combinatorial collection  $\text{BT}_{\perp}$  of binary trees generated by the covering relation  $\mathcal{R}$  defined by

$$(\dots (\bullet, ((\bullet, (\tau_1, \tau_2)), \tau_3)) \dots) \mathcal{R} (\dots (\bullet, (\tau_1, (\bullet, (\tau_2, \tau_3)))) \dots), \quad (1.3.7)$$

where  $\tau_1, \tau_2$ , and  $\tau_3$  are any binary trees. We call  $\mathcal{R}$  the *right rotation* relation. At this moment, the definition of this relation on binary trees is informal, but, in Section 2.4, we shall develop precise tools to define and handle such operations on binary trees and more generally on syntax trees. The order  $\preceq$  is the *Tamari order* on binary trees. The Hasse diagram of  $(\text{BT}_{\perp}, \preceq)$  restricted on  $\text{BT}_{\perp}(5)$  is shown in Figure 1.2.

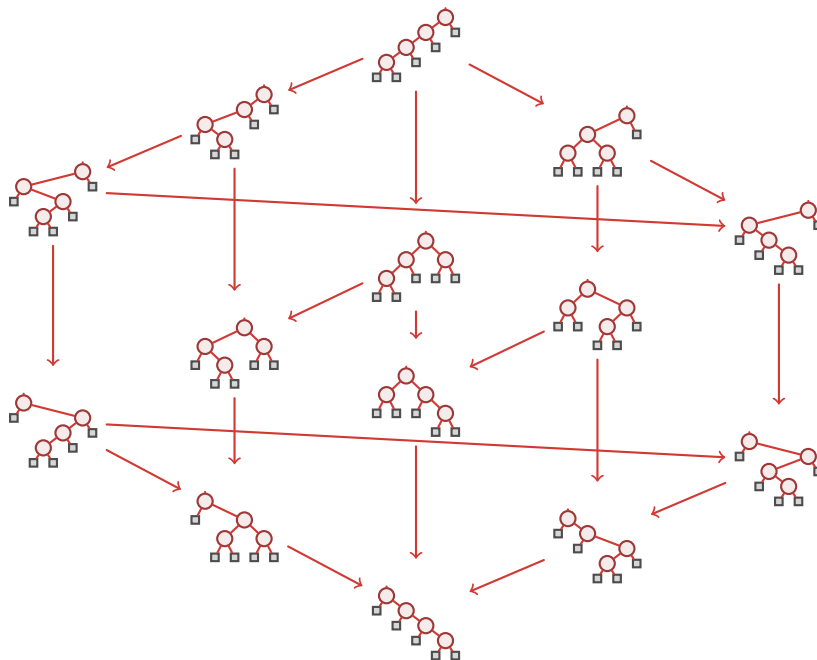

FIGURE 1.2. The Hasse diagram of the Tamari poset of binary trees of size 5.

The Tamari poset is a combinatorial poset on binary trees introduced in the study of nonassociative operations [Tam62]. Indeed, the covering relation generating this poset can be thought as a way to move brackets in expressions where a nonassociative product intervenes. Moreover, seen on binary trees, this operation translates as a right rotation, a fundamental operation on binary search trees, used in an algorithmic context [Knu98]. This operation is used to maintain binary trees with a small height in order to access efficiently, from the roots, to their internal nodes. Some of these trees are known as balanced binary trees [AVL62] and form efficient structures to represent dynamic sets (sets supporting the addition and the suppression of elements). A lot of properties of the Tamari poset are known, like the number of intervals of each of its  $n$ -subposets [Cha06] (equivalently, this is the number of pairs of comparable trees enumerated by their size), and the fact that these posets are lattices [HT72], for all  $n \in \mathbb{N}_{\geq 1}$ . Generalizations of this poset have been introduced by Bergeron and Préville-Ratelle [BPR12] under the name of  $m$ -Tamari poset. This poset is defined on the combinatorial collection of all  $m+1$ -ary trees (see Section 2.2.2). The number of intervals of each of its  $n$ -subposets, and the fact that these posets are lattices are known from [BMFPR11], for all  $n \in \mathbb{N}_{\geq 1}$ .

*The right weak order on permutations.* Let  $\preceq$  be the partial order relation on the combinatorial collection  $\mathfrak{S}$  of permutations generated by the covering relation  $\mathcal{R}$  defined by

$$uabv \mathcal{R} ubav, \quad (1.3.8)$$

where  $u$  and  $v$  are words on  $\mathbb{N}_{\geq 1}$ , and  $a$  and  $b$  are letters such that  $a < b$ . This order is the *right weak order* of permutations. The Hasse diagram of  $(\mathfrak{S}, \preceq)$  restricted on  $\mathfrak{S}(4)$  is shown in Figure 1.3.

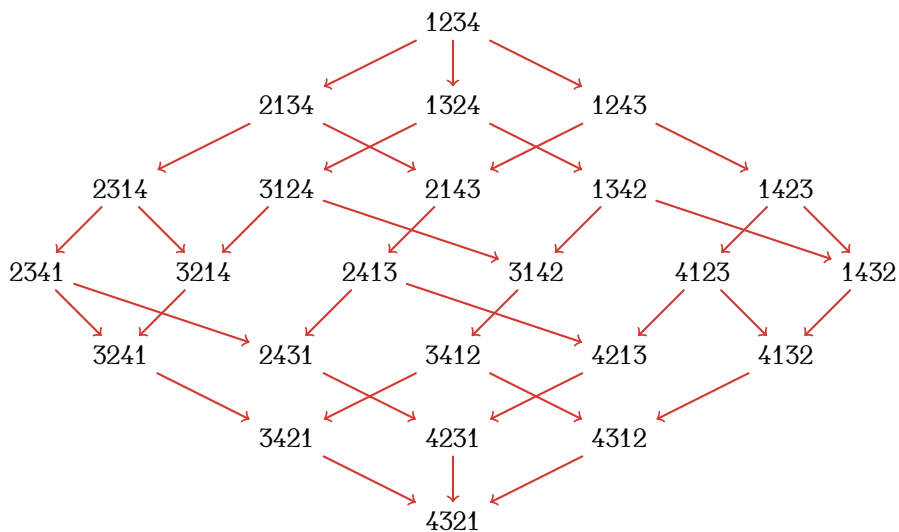

FIGURE 1.3. The Hasse diagram of the right weak poset of permutations of size 4.

The right weak poset of permutations is also a lattice [GR63, YO69]. In a surprising way, despite its apparent simplicity, there is no known description of the number of intervals of each  $n$ -subposet,  $n \in \mathbb{N}$ , of the right weak poset. Some other combinatorial poset structures exist on  $\mathfrak{S}$  like the Bruhat order, whose generating relation is similar to the one of the right weak poset. The definition of the Bruhat order on permutations comes from the general notion of Bruhat order [Bjö84] in Coxeter groups [Cox34].

As a last noteworthy fact, the cube, the Tamari, and the right weak posets are linked through surjective morphisms of combinatorial posets [LR02]. Indeed, a map between the right weak poset to the Tamari poset is based upon the binary search tree insertion algorithm [Knu98, HNT05]. This algorithm consists in inserting the letters of a permutation to form step by step a binary tree. Moreover, a map between the Tamari poset to the cube poset uses the canopies [LR98] of the binary trees. The canopy of a binary tree is a binary word encoding the orientations (to the left or to the right) of its leaves.

**1.4. Rewrite systems on collections.** A rewrite rule describes a process whose goal is to transform iteratively a combinatorial object into another one. We consider rewrite rules on  $I$ -collections, so that an  $i$ -object,  $i \in I$ , can be transformed only into  $i$ -objects. As we shall see, rewrite rules and posets have some close connections because it is possible, in some cases, to construct posets from rewrite systems. A general reference about rewrite rules and rewrite systems is [BN98].



Two properties of rewrite systems are fundamental: the termination and the confluence. We provide strategies to prove that a given rewrite system satisfies one or the other.

1.4.1. *Elementary definitions.* Let  $C$  be an  $I$ -collection. An  *$I$ -rewrite system* is a pair  $(C, \Rightarrow)$  where  $C$  is an  $I$ -collection and  $\Rightarrow$  is a relation on  $C$ . We call  $\Rightarrow$  a *rewrite rule*. For any property  $P$  of collections, we say that  $(C, \Rightarrow)$  *satisfies the property  $P$*  if, as a collection,  $C$  satisfies  $P$ . If  $x, y_1, \dots, y_k$ , and  $x'$  are objects of  $C$  such that  $k \in \mathbb{N}$  and

$$x \Rightarrow y_1 \Rightarrow \dots \Rightarrow y_k \Rightarrow x', \quad (1.4.1)$$

we say that  $x$  is *rewritable* by  $\Rightarrow$  into  $x'$  in  $k + 1$  steps. The reflexive and transitive closure of  $\Rightarrow$  is denoted by  $\Rightarrow^*$ . The directed graph  $(C, \Rightarrow)$  consisting in  $C$  as set of vertices and  $\Rightarrow$  as set of arcs is the *rewriting graph* of  $(C, \Rightarrow)$ .

1.4.2. *Termination.* When there is no infinite chain

$$x_1 \Rightarrow x_2 \Rightarrow x_3 \Rightarrow \dots \quad (1.4.2)$$

where all  $x_j \in C$ ,  $j \in \mathbb{N}_{\geq 1}$ ,  $(C, \Rightarrow)$  is *terminating*. Observe that, if  $C$  is combinatorial, due to the fact that for any  $i \in I$ , each set  $C(i)$  is finite and the fact that the rewriting relation preserves the indices, if an infinite chain (1.4.2) exists, then it is of the form

$$x_1 \Rightarrow \dots \Rightarrow x_j \Rightarrow \dots \Rightarrow x_j \Rightarrow \dots, \quad (1.4.3)$$

for a  $j \in \mathbb{N}_{\geq 1}$ . A *normal form* of  $(C, \Rightarrow)$  is an object  $x$  of  $C$  such that for all  $x' \in C$ ,  $x \Rightarrow^* x'$  imply  $x' = x$ . In other words, a normal form of  $(C, \Rightarrow)$  is an object which is not rewritable by  $\Rightarrow$ . This set of objects, which is a subcollection of  $C$ , is denoted by  $\mathcal{F}_{(C, \Rightarrow)}$ . The following result provides a tool in the aim to show that a rewrite system is terminating.

LEMMA 1.4.1. *Let  $(C, \Rightarrow)$  be a combinatorial rewrite system. Then,  $(C, \Rightarrow)$  is terminating if and only if the binary relation  $\Rightarrow^*$  is an order relation and endows  $C$  with a structure of a combinatorial poset.*

In practice, Lemma 1.4.1 is used as follows. To show that a combinatorial rewrite system  $(C, \Rightarrow)$  is terminating, we construct a map  $\theta : C \rightarrow Q$  where  $(Q, \preceq)$  is an  $I$ -poset such that for any  $x, x' \in C$ ,  $x \Rightarrow x'$  implies  $\theta(x) < \theta(x')$ . Such a map  $\theta$  is a *termination invariant*. Indeed, since each  $C(i)$ ,  $i \in I$ , is finite, this property leads to the fact that there is no infinite chain of the form (1.4.3). In most cases,  $Q$  is a set of tuples of integers of a fixed length, and  $\preceq$  is the lexicographic order on these tuples.

In [BN98], a general method using maps called measure functions to show that (not necessarily combinatorial) rewrite systems are terminating is presented.

When  $C$  is combinatorial and  $\Rightarrow$  is terminating, by Lemma 1.4.1,  $(C, \Rightarrow^*)$  is a combinatorial poset and we call it the *poset generated* by  $\Rightarrow$ .

1.4.3. *Confluence.* When for any objects  $x, y_1,$  and  $y_2$  of  $C$  such that  $x \xRightarrow{*} y_1$  and  $x \xRightarrow{*} y_2,$  there exists an object  $x'$  of  $C$  such that  $y_1 \xRightarrow{*} x'$  and  $y_2 \xRightarrow{*} x',$  the rewrite system  $(C, \Rightarrow)$  is *confluent*. An object  $x$  of  $C$  is a *branching* object if there exist two different objects  $y_1$  and  $y_2$  satisfying  $x \Rightarrow y_1$  and  $x \Rightarrow y_2.$  In this case, the pair  $\{y_1, y_2\}$  is a *branching pair* for  $x.$  We say that a branching pair  $\{y_1, y_2\}$  is *joinable* if there exists an object  $z$  of  $C$  such that  $y_1 \xRightarrow{*} z$  and  $y_2 \xRightarrow{*} z.$  In practice, showing that a terminating rewrite system is confluent is made simple thanks to the following result, known as the *diamond lemma*.

LEMMA 1.4.2. *Let  $(C, \Rightarrow)$  be a rewrite system. If  $(C, \Rightarrow)$  is terminating and all of its branching pairs are joinable,  $(C, \Rightarrow)$  is confluent.*

Lemma 1.4.2 is a highly important result in the theory of rewrite systems and is due to Newman [New42]. There are some additional useful tools in this theory like the Knuth-Bendix completion algorithm [KB70]. This semi-algorithm takes as input a non-confluent rewrite system and outputs, if possible, a confluent one having the same reflexive, symmetric, and transitive closures.

When  $\Rightarrow$  is both terminating and confluent,  $\Rightarrow$  is *convergent*.

1.4.4. *Closures.* Let  $(C, \Rightarrow)$  be an  $I$ -rewrite system and assume that  $C$  is endowed with a set  $\mathcal{P}$  of  $\dagger$ -compatible products, where  $\dagger$  is an associative binary product on  $I.$  Then, let  $(C, \Rightarrow_{\mathcal{P}})$  be the rewrite system such that  $\Rightarrow_{\mathcal{P}}$  contains  $\Rightarrow$  (as a binary relation) and satisfies

$$\star(x_1, \dots, x_{j-1}, y, x_{j+1}, \dots, x_p) \Rightarrow_{\mathcal{P}} \star(x_1, \dots, x_{j-1}, y', x_{j+1}, \dots, x_p) \quad (1.4.4)$$

for any product  $\star$  of arity  $p$  of  $\mathcal{P}, j \in [p], x_{\ell} \in C, \ell \in [p] \setminus \{j\}, y, y' \in C$  such that  $y \Rightarrow y',$  and when both members of (1.4.4) are defined (because the products of  $\mathcal{P}$  can be partial, see Section 1.1.5). The fact that all products  $\star$  of  $\mathcal{P}$  are  $\dagger$ -compatible ensures that  $(C, \Rightarrow_{\mathcal{P}})$  is a rewrite system. We call  $(C, \Rightarrow_{\mathcal{P}})$  the  *$\mathcal{P}$ -closure* of  $(C, \Rightarrow).$  Such closures provide convenient and concise ways to define rewrite systems.

1.4.5. *Examples.* Let us review some examples of rewrite systems on various combinatorial sets.

*A rewrite rule on words.* Let  $A := \{a, b\}$  be an alphabet, and consider the rewrite system  $(A^*, \Rightarrow)$  defined by

$$u(1) \dots u(n-1)u(n) \Rightarrow u(n)u(1) \dots u(n-1) \quad (1.4.5)$$

for any  $u \in A^n$  and  $n \in \mathbb{N}_{\geq 2}.$  We have for instance

$$aaba \Rightarrow aaab \Rightarrow baaa \Rightarrow abaa \Rightarrow aaba. \quad (1.4.6)$$

This rewrite system is not terminating but, since for each word  $u \in A^*$  there is at most a word  $v \in A^*$  satisfying  $u \Rightarrow v,$   $(A^*, \Rightarrow)$  is confluent.

Let also be the rewrite system  $(A^*, \Rightarrow)$  defined by  $aba \Rightarrow bab.$  Consider the ternary product  $\star$  on  $A^*$  defined by  $\star(u, v, w) := u \cdot v \cdot w$  where  $\cdot$  is the concatenation product of words. Let  $(A^*, \Rightarrow_{\mathcal{P}})$  be the  $\mathcal{P}$ -closure of  $(A^*, \Rightarrow)$  where  $\mathcal{P} := \{\star\}.$  By definition of closures,  $\Rightarrow_{\mathcal{P}}$  satisfies

$$aba \Rightarrow_{\mathcal{P}} bab, \quad (1.4.7a)$$

$$\text{aba} \cdot v \cdot w \Rightarrow_{\mathcal{G}} \text{bab} \cdot v \cdot w, \quad (1.4.7b)$$

$$u \cdot \text{aba} \cdot w \Rightarrow_{\mathcal{G}} u \cdot \text{bab} \cdot w, \quad (1.4.7c)$$

$$u \cdot v \cdot \text{aba} \Rightarrow_{\mathcal{G}} u \cdot v \cdot \text{bab}, \quad (1.4.7d)$$

for any words  $u$ ,  $v$ , and  $w$  on  $A$ . All this is equivalent to the fact that  $\Rightarrow_{\mathcal{G}}$  is the rewrite rule satisfying

$$u \cdot \text{aba} \cdot w \Rightarrow_{\mathcal{G}} u \cdot \text{bab} \cdot w, \quad (1.4.8)$$

for any words  $u$  and  $w$  on  $A$ . The rewrite system  $(A^*, \Rightarrow_{\mathcal{G}})$  is terminating since, for any words  $u$  and  $v$  on  $A$ , if  $u \Rightarrow_{\mathcal{G}} v$ , then  $|v|_b = |u|_b + 1$ . Hence, the map  $\theta : A^n \rightarrow [0, n]$  defined for any  $n \in \mathbb{N}$  and  $u \in A^n$  by  $\theta(u) := |u|_b$  is a termination invariant. The normal forms of  $(A^*, \Rightarrow_{\mathcal{G}})$  are the words that do not admit  $\text{aba}$  as factor. Moreover,  $(A^*, \Rightarrow_{\mathcal{G}})$  is not confluent since  $\text{ababa} \Rightarrow_{\mathcal{G}} \text{babba}$  and  $\text{ababa} \Rightarrow_{\mathcal{G}} \text{abbab}$ , and  $\{\text{babba}, \text{abbab}\}$  is a non-joinable branching pair for  $\text{ababa}$  (since these two elements are normal forms).

## 2. Collections of trees

This section is devoted mainly to set all basic definitions about trees used in this work. We define here the collection of planar rooted trees and present some of its properties. We then consider enrichments of planar rooted trees, namely the syntax trees. These are one of the most important objects in this work since bases of free operads are indexed by syntax trees. Moreover, rewrite systems on syntax trees are reviewed. These rewrite systems are a major tool to study operads since they allow to establish presentation by generators and relations, or the Koszulity of an operad.

**2.1. Planar rooted trees.** The graded combinatorial collection of the planar rooted trees can be defined concisely in a recursive way by using some operations over graded combinatorial collections (see Section 1.1.6). However, to define rigorously the usual notions of internal node, leaf, child, father, path, subtree, *etc.*, we need the notion of language associated with a tree. Indeed, a planar rooted tree is in fact a finite language satisfying some properties. Therefore, in this section, we shall adopt the point of view of defining most of the properties of a planar rooted tree through its language.

**2.1.1. Collection of planar rooted trees.** Let PRT be the graded combinatorial collection satisfying the relation

$$\text{PRT} = \{\bullet\} \times \text{T}(\text{PRT}) \quad (2.1.1)$$

where  $\bullet$  is an atomic object called *node*. We call *planar rooted tree* each object of PRT. By definition, a planar rooted tree  $t$  is an ordered pair  $(\bullet, (t_1, \dots, t_k))$  where  $(t_1, \dots, t_k)$  is a (possibly empty) tuple of planar rooted trees. This definition is recursive. By convention, the planar rooted tree  $(\bullet, ())$  is denoted by  $\perp$  and is called the *leaf*. Observe that the leaf is of size 1. For instance,

$$\perp, \quad (\bullet, (\perp)), \quad (\bullet, (\perp, \perp)), \quad (\bullet, (\perp, (\bullet, (\perp))))), \quad (\bullet, ((\bullet, ((\bullet, (\perp, \perp))))), \perp, (\bullet, (\perp, \perp)))) \quad (2.1.2)$$

are planar rooted trees. The *root arity* of a planar rooted tree  $t := (\bullet, (t_1, \dots, t_k))$  is  $k$ . If  $t$  is a planar rooted tree different from the leaf, by definition,  $t$  can be expressed as  $t = (\bullet, (t_1, \dots, t_k))$  where  $k \geq 1$  and all  $t_i$ ,  $i \in [k]$ , are planar rooted trees. In this case, for any

$i \in [k]$ ,  $t_i$  is the  *$i$ th suffix subtree* of  $t$ . Planar rooted trees are depicted by drawing each leaf by  $\sqcup$  and each planar rooted tree different from the leaf by a node  $\circ$  attached below it, from left to right, to its suffix subtrees  $t_1, \dots, t_k$  by means of edges  $-$ . For instance, the planar rooted trees of (2.1.2) are depicted by



By definition of the product and the list operations over graded collections (see Section 1.1.6), the size of a planar rooted tree  $t$  having a root arity of  $k$  satisfies

$$|t| = 1 + \sum_{i \in [k]} |t_i|. \quad (2.1.4)$$

In other words, the size of  $t$  is the number of occurrences of  $\bullet$  it contains. We also deduce from (2.1.1) that the generating series of PRT satisfies

$$\mathcal{G}_{\text{PRT}}(t) = \frac{t}{1 - \mathcal{G}_{\text{PRT}}(t)} \quad (2.1.5)$$

so that it satisfies the quadratic algebraic equation

$$t - \mathcal{G}_{\text{PRT}}(t) + \mathcal{G}_{\text{PRT}}(t)^2 = 0. \quad (2.1.6)$$

**2.1.2. Induction and structural induction.** One among the most obvious techniques to prove that all the planar rooted trees of a subcollection  $C$  of PRT satisfy a predicate  $P$  consists in performing a proof by induction on the size of the trees of  $C$ .

There is another method which is in some cases much more elegant than this approach, called *structural induction* on trees. A subcollection  $C$  of PRT is *inductive* if  $C$  is nonempty and, if  $t \in C$ , all suffix subtrees  $t_i$  of  $t$  belong to  $C$ . Observe in particular that  $\perp$  belongs to any inductive subcollection of PRT.

**THEOREM 2.1.1.** *Let  $C$  be an inductive subcollection of PRT and  $P$  be a predicate on  $C$ . If*

- (i) *the leaf  $\perp$  satisfies  $P$ ;*
- (ii) *for any  $t_1, \dots, t_k \in C$  such that  $t := (\bullet, (t_1, \dots, t_k))$  belongs to  $C$ , the fact that all  $P(t_i)$ ,  $i \in [k]$ , hold implies that  $P(t)$  holds;*

*then, all objects of  $C$  satisfy  $P$ .*

Theorem 2.1.1 provides a powerful tool to prove properties  $P$  of planar rooted trees belonging to inductive combinatorial subsets  $C$ . In practice, to perform a structural induction in order to show that all objects  $t$  of  $C$  satisfy  $P$ , we check that  $C$  is inductive and that Properties (i) and (ii) of Theorem 2.1.1 hold.

2.1.3. *Links with binary trees.* As a consequence of (2.1.6), we observe that the generating series of PRT satisfies the same algebraic relation as the one of the graded collection  $BT_{\perp}$  of binary trees where the size of a binary tree is its number of leaves (defined in Section 1.2.6). Therefore, PRT and  $BT_{\perp}$  are isomorphic as graded collections. Let us describe an explicit isomorphism between these two collections. Let  $\phi : \text{PRT} \rightarrow BT_{\perp}$  be the map recursively defined, for any planar rooted tree  $t$ , by

$$\phi(t) := \begin{cases} \perp \in BT_{\perp} & \text{if } t = \perp, \\ (\bullet, (\phi(t_1), \phi((\bullet, (t_2, \dots, t_k)))))) & \text{otherwise } (t = (\bullet, (t_1, t_2, \dots, t_k)) \text{ with } k \geq 1). \end{cases} \quad (2.1.7)$$

One has for instance

$$\phi \left( \begin{array}{c} \text{ } \\ \diagup \quad \diagdown \\ \text{ } \end{array} \right) = \begin{array}{c} \text{ } \\ \diagup \quad \diagdown \\ \text{ } \end{array}, \quad (2.1.8a)$$

$$\phi \left( \begin{array}{c} \text{ } \\ \diagup \quad \diagdown \\ \text{ } \end{array} \right) = \begin{array}{c} \text{ } \\ \diagup \quad \diagdown \\ \text{ } \end{array}. \quad (2.1.8b)$$

PROPOSITION 2.1.2. *The graded combinatorial collections PRT and  $BT_{\perp}$  are isomorphic. The map  $\phi$  defined by (2.1.7) is an isomorphism between these two collections.*

This bijection is known as the rotation correspondence and is due to Knuth [Knu97]. It offers a means to encode a planar rooted tree by a binary tree and admits applications in algebraic combinatorics [NT13, EFM14].

2.1.4. *Tree languages.* To rigorously specify nodes in planar rooted trees, we shall use a useful interpretation of planar rooted trees as special languages on the alphabet  $\mathbb{N}_{\geq 1}$ . Recall that a right monoid action of a monoid  $A^*$  of words (endowed with the concatenation product) on a set  $S$  is a map  $\cdot : S \times A^* \rightarrow S$  satisfying  $x \cdot \epsilon = x$  and  $x \cdot ua = (x \cdot u) \cdot a$ , for all  $x \in S$ ,  $u \in A^*$ , and  $a \in A$ . Let

$$\cdot : \text{PRT} \times \mathbb{N}_{\geq 1}^* \rightarrow \text{PRT} \quad (2.1.9)$$

be the right partial monoid action defined recursively by

$$(\bullet, (t_1, \dots, t_k)) \cdot u := \begin{cases} (\bullet, (t_1, \dots, t_k)) & \text{if } u = \epsilon, \\ t_i \cdot v & \text{otherwise } (u = iv \text{ where } v \in \mathbb{N}_{\geq 1}^* \text{ and } i \in \mathbb{N}_{\geq 1}), \end{cases} \quad (2.1.10)$$

for any  $(\bullet, (t_1, \dots, t_k)) \in \text{PRT}$  and  $u \in \mathbb{N}_{\geq 1}^*$ . Observe that this action is partial since each  $t_i$  in (2.1.10) is well-defined only if  $i$  is no greater than the root arity of  $t$ . The *tree language*  $\mathcal{N}(t)$  of  $t$  is the finite language on  $\mathbb{N}_{\geq 1}$  of all the words  $u$  such that  $t \cdot u$  is a well-defined planar rooted tree.

For instance, by setting

$$t := \begin{array}{c} \square \\ \diagup \quad \diagdown \\ \square \quad \square \\ \diagup \quad \diagdown \quad \diagup \quad \diagdown \\ \square \quad \square \quad \square \quad \square \\ \diagup \quad \diagdown \quad \diagup \quad \diagdown \\ \square \quad \square \quad \square \quad \square \end{array}, \quad (2.1.11)$$

we have

$$t \cdot 1 = \square, \quad t \cdot 231 = \square, \quad t \cdot 3 = \square, \quad t \cdot 21 = \begin{array}{c} \square \\ \diagup \quad \diagdown \\ \square \quad \square \end{array}, \quad t \cdot 23 = \begin{array}{c} \square \\ \diagup \quad \diagdown \\ \square \quad \square \end{array}, \quad (2.1.12)$$

and, among others, the actions of the words 11, 24, and 2321 on  $t$  are all undefined. Moreover, the tree language of  $t$  is

$$\mathcal{N}(t) = \{\epsilon, 1, 2, 21, 211, 2111, 2112, 22, 23, 231, 232, 3\}. \quad (2.1.13)$$

Let  $\mathcal{L}_{\text{PRT}}$  be the graded combinatorial collection of all finite and nonempty prefix languages  $\mathcal{L}$  on  $\mathbb{N}_{\geq 1}$  such that if  $ui \in \mathcal{L}$  where  $u \in \mathbb{N}_{\geq 1}^*$  and  $i \in \mathbb{N}_{\geq 2}$ ,  $ui' \in \mathcal{L}$  where  $i' := i - 1$ . The size of such a language is its cardinality. For instance, the set  $\mathcal{N}(t)$  of (2.1.13) is an object of size 12 of  $\mathcal{L}_{\text{PRT}}$ , and  $\{\epsilon, 1, 11, 12, 2\}$  is an object of size 5.

**PROPOSITION 2.1.3.** *The graded combinatorial collections PRT and  $\mathcal{L}_{\text{PRT}}$  are isomorphic. Seen as a morphism of combinatorial collections  $\mathcal{N} : \text{PRT} \rightarrow \mathcal{L}_{\text{PRT}}$ ,  $\mathcal{N}$  is an isomorphism between these two collections.*

Proposition 2.1.3 is used in practice to define planar rooted trees through their languages. This will be useful later when operations on planar rooted trees will be described.

**2.1.5. Additional definitions.** Let  $t$  be a planar rooted tree. We say that each word of  $\mathcal{N}(t)$  is a **node** of  $t$ . A node  $u$  of  $t$  is an **internal node** if there is an  $i \in \mathbb{N}_{\geq 1}$  such that  $ui$  is a node of  $t$ . A node  $u$  of  $t$  which is not an internal node is a **leaf**. The set of all internal nodes (resp. leaves) of  $t$  is denoted by  $\mathcal{N}_{\bullet}(t)$  (resp.  $\mathcal{N}_{\perp}(t)$ ). The **root** of  $t$  is the node  $\epsilon$  (which can be either an internal node or a leaf). The **degree**  $\text{deg}(t)$  of  $t$  is  $\#\mathcal{N}_{\bullet}(t)$  and the **arity**  $\text{ari}(t)$  of  $t$  is  $\#\mathcal{N}_{\perp}(t)$ . A node  $u$  of  $t$  is an **ancestor** of a node  $v$  of  $t$  if  $u \neq v$  and  $u \leq_{\text{pref}} v$ . Moreover,  $v$  is the  **$i$ th child** of  $u$  if  $v = ui$  for an  $i \in \mathbb{N}_{\geq 1}$ . In this case,  $u$  is the (unique) **father** of  $v$ . The **arity** of a node is the number of children it has. Two nodes  $v$  and  $v'$  of  $t$  are **brothers** if there exist a node  $u$  of  $t$  and  $i \neq i' \in \mathbb{N}_{\geq 1}$  such that  $v$  is the  $i$ th child of  $u$  and  $v'$  is the  $i'$ th child of  $u$ . The lexicographic order on the words of  $\mathcal{N}(t)$  induces a total order on the nodes of  $t$  called **depth-first order**. The  **$i$ th leaf** of  $t$  is the  $i$ th leaf encountered by considering the nodes of  $t$  according to the depth-first order. A **sector** of  $t$  is an ordered pair  $(u_i, u_{i+1})$  of leaves of  $t$  such that  $u_i$  (resp.  $u_{i+1}$ ) is the  $i$ th (resp.  $i+1$ st) leaf of  $t$ . The **number of sectors** of  $t$  is denoted by  $\wedge(t)$  and is equal to  $\text{ari}(t) - 1$ . A **path** in  $t$  is a sequence  $(u_1, \dots, u_k)$  of nodes of  $t$  such that for any  $j \in [k-1]$ ,  $u_j$  is the father of  $u_{j+1}$ . Such a path is **maximal** if  $u_1$  is the root of  $t$  and  $u_k$  is a leaf. The **length** of a path is the number of nodes it contains. The **height**  $\text{ht}(t)$  of  $t$  is the maximal length of its maximal paths minus 1. This is also the length of a longest word of  $\mathcal{N}(t)$  minus 1. When all maximal paths of  $t$  have the same length,  $t$  is **perfect**. For any node  $u$  of  $t$ , the planar rooted tree  $t \cdot u$  is the **suffix subtree** of  $t$  rooted at  $u$ . By extension, the  **$i$ th suffix subtree** of  $u$  is the planar rooted tree  $t \cdot ui$  when  $i$  is no greater than the arity of  $u$ . A planar rooted tree  $s$  is a **prefix subtree** of  $t$  if  $\mathcal{N}(s) \subseteq \mathcal{N}(t)$ . A

planar rooted tree  $\mathfrak{s}$  is a *factor subtree* of  $\mathfrak{t}$  rooted at a node  $u$  if  $\mathfrak{s}$  is a prefix subtree of a suffix subtree of  $\mathfrak{t}$  rooted at  $u$ . The *poset* induced by  $\mathfrak{t}$  is the poset  $(Q_{\mathfrak{t}}, \preceq_{\mathfrak{t}})$  where  $Q_{\mathfrak{t}} := \mathcal{N}_{\bullet}(\mathfrak{t})$  and  $\preceq_{\mathfrak{t}}$  is the prefix order relation  $\leq_{\text{pref}}$  on words. In other terms, the poset induced by  $\mathfrak{t}$  is a poset on the internal nodes of  $\mathfrak{t}$  where  $\mathfrak{t}$  is its Hasse diagram wherein the root is the least element.

Let us provide some examples for these notions. Consider the planar rooted tree  $\mathfrak{t}$  of (2.1.11). Then,

$$\mathcal{N}_{\bullet}(\mathfrak{t}) = \{\epsilon, 2, 21, 211, 23\}, \quad (2.1.14a)$$

$$\mathcal{N}_{\perp}(\mathfrak{t}) = \{1, 2111, 2112, 22, 231, 232, 3\}, \quad (2.1.14b)$$

so that  $\text{deg}(\mathfrak{t}) = 5$  and  $\text{ari}(\mathfrak{t}) = 7$ . Besides, the sequences  $(\epsilon, 2, 21)$  and  $(\epsilon, 2, 23)$  are nonmaximal paths in  $\mathfrak{t}$ , and on the contrary, the paths  $(\epsilon, 1)$ ,  $(\epsilon, 2, 21, 211, 2112)$ , and  $(\epsilon, 2, 22)$  are maximal. The maximal path  $(\epsilon, 2, 21, 211, 2112)$  have a maximal length among all maximal paths of  $\mathfrak{t}$  and hence, the height of  $\mathfrak{t}$  is 4. In the poset induced by  $\mathfrak{t}$ , one has  $\epsilon \preceq_{\mathfrak{t}} 2 \preceq_{\mathfrak{t}} 21 \preceq_{\mathfrak{t}} 211$  and  $\epsilon \preceq_{\mathfrak{t}} 2 \preceq_{\mathfrak{t}} 23$ . Finally, the planar rooted tree

$$\mathfrak{s} := \begin{array}{c} \circ \\ / \quad \backslash \\ \square \quad \circ \\ \quad / \quad \backslash \\ \quad \circ \quad \square \\ \quad \quad | \\ \quad \quad \square \end{array} \quad (2.1.15)$$

is a prefix subtree of  $\mathfrak{t}$ , and, the planar rooted tree

$$\mathfrak{r} := \begin{array}{c} \circ \\ / \quad \backslash \\ \circ \quad \square \\ | \quad \quad | \\ \square \quad \square \end{array}, \quad (2.1.16)$$

being a suffix subtree of  $\mathfrak{s}$  rooted at the node 2, is a factor subtree of  $\mathfrak{t}$  rooted at 2.

**2.2. Subcollections of planar rooted trees.** By basically restraining the possible arities of the internal nodes of planar rooted trees, we obtain several subcollections of PRT. We review here the families formed by ladders, corollas,  $k$ -ary trees, and Schröder trees. Besides, among these families, some admit alternative size functions.

**2.2.1. Ladders and corollas.** A *ladder* is a planar rooted tree of arity 1. The first ladders are

$$\square, \quad \begin{array}{c} \circ \\ | \\ \square \end{array}, \quad \begin{array}{c} \circ \\ / \quad \backslash \\ \square \quad \square \\ | \quad \quad | \\ \square \quad \square \end{array}, \quad \begin{array}{c} \circ \\ / \quad \backslash \\ \square \quad \square \\ | \quad \quad | \\ \square \quad \square \\ | \quad \quad | \\ \square \quad \square \end{array}, \quad \begin{array}{c} \circ \\ / \quad \backslash \\ \square \quad \square \\ | \quad \quad | \\ \square \quad \square \\ | \quad \quad | \\ \square \quad \square \\ | \quad \quad | \\ \square \quad \square \end{array}. \quad (2.2.1)$$

This set of ladders forms a subcollection  $\text{Lad}$  of PRT. Besides, a *corolla* is a planar rooted tree of degree 1. The first corollas are

$$\begin{array}{c} \circ \\ | \\ \square \end{array}, \quad \begin{array}{c} \circ \\ / \quad \backslash \\ \square \quad \square \\ | \quad \quad | \\ \square \quad \square \end{array}, \quad \begin{array}{c} \circ \\ / \quad \backslash \\ \square \quad \square \\ | \quad \quad | \\ \square \quad \square \\ | \quad \quad | \\ \square \quad \square \end{array}, \quad \begin{array}{c} \circ \\ / \quad \backslash \\ \square \quad \square \\ | \quad \quad | \\ \square \quad \square \\ | \quad \quad | \\ \square \quad \square \end{array}. \quad (2.2.2)$$

This set of corollas forms a subcollection  $\text{Cor}$  of PRT. Observe that  $(\bullet, (\perp))$  is the only planar rooted that is both a ladder and a corolla.

2.2.2. *k*-ary trees. Let  $k \in \mathbb{N}_{\geq 1}$ . A *k*-ary tree is a planar rooted tree  $t$  such that all internal nodes are of arity  $k$ . For instance, the first 3-ary trees are

$$\perp, \quad \begin{array}{c} \circ \\ / \quad \backslash \\ \square \quad \square \end{array}, \quad \begin{array}{c} \circ \\ / \quad \backslash \quad \backslash \\ \square \quad \square \quad \square \end{array}, \quad \begin{array}{c} \circ \\ / \quad \backslash \quad \backslash \quad \backslash \\ \square \quad \square \quad \square \quad \square \end{array}, \quad \begin{array}{c} \circ \\ / \quad \backslash \quad \backslash \quad \backslash \quad \backslash \\ \square \quad \square \quad \square \quad \square \quad \square \end{array}. \quad (2.2.3)$$

This set of *k*-ary trees forms a subcollection  $\text{Ary}^{(k)}$  of PRT expressing recursively as

$$\text{Ary}^{(k)} = \{\perp\} + \{\bullet\} \times \text{Ary}^{(k)k}, \quad (2.2.4)$$

where  $\perp$  and  $\bullet$  are both atomic. One can immediately observe that  $\text{Ary}^{(1)} = \text{Lad}$ .

By structural induction (see Theorem 2.1.1) on  $\text{Ary}^{(k)}$  (which is an inductive subcollection of PRT), it follows that for any *k*-ary tree  $t$ , the arity and the degree of  $t$  are related by

$$\text{ari}(t) - \text{deg}(t)(k - 1) = 1. \quad (2.2.5)$$

This implies that a *k*-ary tree of a given arity has an imposed degree and conversely, a *k*-ary tree of a given degree has an imposed arity. Hence, since the size of a *k*-ary tree  $t$  is  $\text{ari}(t) + \text{deg}(t)$  and there are finitely many planar rooted trees of a fixed size, there are finitely many *k*-ary trees of a fixed arity, and there are finitely many *k*-ary trees of a fixed degree. As a consequence, the graded collections  $\text{Ary}_{\perp}^{(k)}$  and  $\text{Ary}_{\bullet}^{(k)}$  of all *k*-ary trees such that the size of a tree of  $\text{Ary}_{\perp}^{(k)}$  is its arity and the size of a tree of  $\text{Ary}_{\bullet}^{(k)}$  is its degree are combinatorial. Observe that  $\text{Ary}_{\perp}^{(2)} \simeq \text{BT}_{\perp}$  where  $\text{BT}_{\perp}$  is defined in Section 1.2.6. Moreover, the generating series of  $\text{Ary}_{\bullet}^{(k)}$  satisfies the algebraic equation

$$1 - \mathcal{G}_{\text{Ary}_{\bullet}^{(k)}}(t) + t\mathcal{G}_{\text{Ary}_{\bullet}^{(k)}}(t)^k = 0. \quad (2.2.6)$$

and it is known [DM47] that

$$\#\text{Ary}_{\bullet}^{(k)}(n) = \frac{1}{(k-1)n+1} \binom{kn}{n}. \quad (2.2.7)$$

For instance, the sequences of integers associated with  $\text{Ary}_{\bullet}^{(k)}$  begin with

$$1, 1, 1, 1, 1, 1, 1, \quad k = 1, \quad (2.2.8a)$$

$$1, 1, 2, 5, 14, 42, 132, 429, 1430, \quad k = 2, \quad (2.2.8b)$$

$$1, 1, 3, 12, 55, 273, 1428, 7752, 43263, \quad k = 3, \quad (2.2.8c)$$

$$1, 1, 4, 22, 140, 969, 7084, 53820, 420732, \quad k = 4. \quad (2.2.8d)$$

The second, third, and fourth sequences are respectively Sequences A000108, A001764, and A002293 of [Slo]. These are known as the Fuss-Catalan numbers.

From now on, we call *binary tree* any 2-ary tree. If  $t$  is a binary tree and  $u$  is an internal node of  $t$ ,  $u1$  and  $u2$  are nodes of  $t$ . We call  $u1$  (resp.  $u2$ ) the *left* (resp. *right*) *child* of  $u$ , and  $t \cdot u1$  (resp.  $t \cdot u2$ ) the *left* (resp. *right*) *subtree* of  $u$  in  $t$ . The left (resp. right) subtree of  $t$  is the *left* (resp. *right*) *subtree* of the root of  $t$ . Besides, a *left* (resp. *right*) *comb tree* is a binary tree  $t$  such that for all internal nodes  $u$  of  $t$ , all right (resp. left) subtrees of  $u$  are leaves. The *infix order* induced by  $t$  is the total order on the set of its internal nodes defined recursively by setting that all the internal nodes of  $t \cdot 1$  are smaller than the root of  $t$ , and that the root of  $t$  is smaller than all the internal nodes of  $t \cdot 2$ .



2.2.3. *Schröder trees.* A *Schröder tree* is a planar rooted tree such that all internal nodes are of arities 2 or more. Some among the first Schröder trees are

$$(2.2.9)$$

This set of Schröder trees forms a subcollection  $\text{Sch}$  of PRT expressing recursively as

$$\text{Sch} = \{\perp\} + \{\bullet\} \times T_{\geq 2}(\text{Sch}), \quad (2.2.10)$$

where  $\perp$  and  $\bullet$  are both atomic.

By structural induction on  $\text{Sch}$  (which is an inductive subcollection of PRT), it follows that there are finitely many Schröder trees of a given arity  $n$ . For this reason, the graded collection  $\text{Sch}_{\perp}$  of all the Schröder trees such that the size of a tree of  $\text{Sch}_{\perp}$  is its arity is combinatorial. Conversely, considering the degrees of the trees for their sizes does not form a combinatorial graded collection since there are infinitely many Schröder trees of degree 1 (the corollas). The generating series of  $\text{Sch}_{\perp}$  satisfies the algebraic quadratic equation

$$t - (1 + t)\mathcal{G}_{\text{Sch}_{\perp}}(t) + 2\mathcal{G}_{\text{Sch}_{\perp}}(t)^2 = 0. \quad (2.2.11)$$

Let  $\text{nar}(n, k)$  be the number of binary trees of arity  $n$  having exactly  $k$  internal nodes having an internal node as a left child. Then, for all  $0 \leq k \leq n - 2$ , it is known [Nar55] that

$$\text{nar}(n, k) = \frac{1}{k+1} \binom{n-2}{k} \binom{n-1}{k}. \quad (2.2.12)$$

These are *Narayana numbers*. The cardinalities of the sets  $\text{Sch}_{\perp}(n)$  hence express by

$$\#\text{Sch}_{\perp}(n) = \sum_{k \in [0, n-2]} 2^k \text{nar}(n, k), \quad (2.2.13)$$

for all  $n \in \mathbb{N}_{\geq 2}$ . The sequence of integers associated with  $\text{Sch}_{\perp}$  begins by

$$1, 1, 3, 11, 45, 197, 903, 4279, \quad (2.2.14)$$

and forms Sequence A001003 of [Slo].

2.3. *Syntax trees.* We are now in position to introduce syntax trees. Such trees are, roughly speaking, planar rooted trees where internal nodes are labeled by objects of a fixed graded collection. These trees can be endowed with two size functions (where the size is the degree or the arity), leading to the definition of two graded collections of syntax trees.

2.3.1. *Collections of syntax trees.* Let  $C$  be an augmented graded collection. A *syntax tree* on  $C$  (or, for short, a *C-syntax tree*) is a planar rooted tree  $t$  endowed with a map  $\omega_t : \mathcal{N}_{\bullet}(t) \rightarrow C$  sending each internal node  $u$  of  $t$  of arity  $k$  to an element of size  $k$  of  $C$ . This map  $\omega_t$  is the *labeling map* of  $t$ . We say that an internal node  $u$  of  $t$  is *labeled* by  $x \in C$  if  $\omega_t(u) = x$ . The collection  $C$  is the *labeling collection* of  $t$ . The *underlying planar rooted tree* of  $t$  is the planar rooted tree obtained by forgetting the map  $\omega_t$ . For any  $x \in C$ , the *corolla* labeled by  $x$  is the  $C$ -syntax tree  $\odot(x)$  having exactly one internal node labeled by  $x$  and with  $|x|$  leaves as children. All the notions about planar rooted trees defined in Sections 2.1 and 2.2 apply to  $C$ -syntax trees as well. More precisely, for any property  $P$  on planar rooted trees, we say that  $t$  satisfies the property  $P$  if the underlying planar rooted

tree of  $t$  satisfies  $P$ . Moreover, the notions of suffix, prefix, and factor subtrees of planar rooted trees naturally extend on  $C$ -syntax trees by taking into account the labeling maps. In graphical representations of a  $C$ -syntax tree  $t$ , instead of drawing each internal node  $u$  of  $t$  by  $\circ$ , we draw  $u$  by its label  $\omega_t(u)$ .

For instance, consider the labeling collection  $C := C(1) \sqcup C(2) \sqcup C(3)$  where  $C(1) := \{a, b\}$ ,  $C(2) := \{c\}$ , and  $C(3) := \{d, e\}$ , and the planar rooted tree



By endowing  $t$  with the labeling map defined by  $\omega_t(\epsilon) := e$ ,  $\omega_t(2) := d$ ,  $\omega_t(21) := a$ ,  $\omega_t(211) := c$ , and  $\omega_t(23) := c$ ,  $t$  is a  $C$ -syntax tree. This  $C$ -syntax tree is depicted more concisely as



We denote by  $\text{PRT}^C$  the graded collection of all the  $C$ -syntax trees, where the size of a  $C$ -syntax tree  $t$  is the size of its underlying planar rooted tree in  $\text{PRT}$ . When  $C$  is additionally combinatorial, by structural induction on planar rooted trees, it follows that for any  $t \in \text{PRT}$ , there are finitely many labeling maps  $\omega_t$  for  $t$ . For this reason,  $\text{PRT}^C$  is in this case combinatorial. Besides, let  $\text{Lad}^C$ ,  $\text{Cor}^C$ ,  $\text{Ary}^{(k),C}$ , and  $\text{Sch}^C$  be respectively the subcollections of  $\text{PRT}^C$  consisting in the  $C$ -syntax trees whose underlying planar rooted trees are ladders, corollas,  $k$ -ary trees, and Schröder trees. The concepts of inductive subcollections of  $\text{PRT}^C$  and of structural induction presented in Section 2.1.2 extend obviously on  $C$ -syntax trees.

2.3.2. *Alternative definition and generating series.* The graded collection  $\text{PRT}^C$  can be described as follows. Let  $\mathcal{S}^C$  be the graded collection satisfying the relation

$$\mathcal{S}^C = \{\perp\} + \{\bullet\} \times (C \circ \mathcal{S}^C) \quad (2.3.3)$$

where both  $\perp$  and  $\bullet$  are atomic, and  $\circ$  is the composition product over combinatorial collections defined in Section 1.1.5. Then, the combinatorial collections  $\text{PRT}^C$  and  $\mathcal{S}^C$  are isomorphic through the map  $\phi : \text{PRT}^C \rightarrow \mathcal{S}^C$  of combinatorial collections recursively defined, for any  $t \in \text{PRT}^C$  of root arity  $k$ , by

$$\phi(t) := \begin{cases} \perp \in \mathcal{S}^C & \text{if } t = \perp, \\ (\bullet, (\omega_t(\epsilon), (\phi(t_1), \dots, \phi(t_k)))) & \text{otherwise.} \end{cases} \quad (2.3.4)$$

From this equivalence and (2.3.3), we obtain, when  $C$  is combinatorial, that the generating series of  $\text{PRT}^C$  satisfies

$$\mathcal{G}_{\text{PRT}^C}(t) = t + t \mathcal{G}_C(\mathcal{G}_{\text{PRT}^C}(t)), \quad (2.3.5)$$

where  $\mathcal{G}_C(t)$  is the generating series of  $C$ . For instance, by considering the combinatorial collection  $C$  defined above, we have  $\mathcal{G}_C(t) = 2t + t^2 + 2t^3$ , so that

$$t + (2t - 1)\mathcal{G}_{\text{PRT}^C}(t) + t\mathcal{G}_{\text{PRT}^C}(t)^2 + 2t\mathcal{G}_{\text{PRT}^C}(t)^3 = 0. \quad (2.3.6)$$

**2.3.3. Subcollections of syntax trees.** For well-chosen augmented combinatorial collections  $C$ , it is possible to recover a large part of the families of planar rooted trees described in Section 2.2. Indeed, one has  $\text{PRT}^{\mathbb{N}_{\geq 1}} \simeq \text{PRT}$ ,  $\text{PRT}^{\mathbb{N}_{\geq 2}} \simeq \text{Sch}$ , and, when  $\bullet_k$  is an object of size  $k \in \mathbb{N}_{\geq 1}$ ,  $\text{PRT}^{\{\bullet_k\}} \simeq \text{Ary}^{(k)}$ .

**2.3.4. Alternative sizes.** Let  $\text{PRT}_{\perp}^C$  be the graded collection of all the  $C$ -syntax trees such that the size of a tree is its arity. One has  $\text{PRT}_{\perp}^C \simeq \mathcal{S}^C$  where  $\mathcal{S}^C$  is the graded collection defined in (2.3.3) wherein  $\perp$  is atomic and  $\bullet$  is of size 0. When  $C$  is combinatorial, augmented, and has no object of size 1, we can show by structural induction on  $\text{PRT}_{\perp}^C$  that there are finitely many  $C$ -syntax trees of a given arity  $n$ . For this reason,  $\text{PRT}_{\perp}^C$  is combinatorial. In this case, the generating series of  $\text{PRT}_{\perp}^C$  satisfies

$$\mathcal{G}_{\text{PRT}_{\perp}^C}(t) = t + \mathcal{G}_C\left(\mathcal{G}_{\text{PRT}_{\perp}^C}(t)\right). \quad (2.3.7)$$

Let also  $\text{PRT}_{\bullet}^C$  be the graded collection of all the  $C$ -syntax trees such that the size of a tree is its degree. One has  $\text{PRT}_{\bullet}^C \simeq \mathcal{S}^C$  where  $\mathcal{S}^C$  is the graded collection defined in (2.3.3) wherein  $\bullet$  is atomic and  $\perp$  is of size 0. When  $C$  is augmented and is finite, we can show by structural induction on  $\text{PRT}_{\bullet}^C$  that there are finitely many  $C$ -syntax trees of a given degree  $n$ . For this reason,  $\text{PRT}_{\bullet}^C$  is combinatorial. In this case, the generating series of  $\text{PRT}_{\bullet}^C$  satisfies

$$\mathcal{G}_{\text{PRT}_{\bullet}^C}(t) = 1 + t \mathcal{G}_C\left(\mathcal{G}_{\text{PRT}_{\bullet}^C}(t)\right). \quad (2.3.8)$$

Observe that  $\text{PRT}_{\bullet}^C$  is not an augmented graded collection.

**2.4. Syntax tree patterns and rewrite systems.** We focus now the theory of rewrite systems on the particular case of syntax trees. Intuitively, a rewrite rule on syntax trees works by replacing factor subtrees in a syntax tree by other ones. We explain techniques to prove termination and confluence of these particular rewrite systems.

**2.4.1. Occurrence and avoidance of patterns.** Let  $C$  be an augmented graded collection, and  $s$  and  $t$  be two  $C$ -syntax trees. For any node  $u$  of  $t$ ,  $s$  *occurs* at position  $u$  in  $t$  if  $s$  is a factor subtree of  $t$  rooted at  $u$ . In this case, we say that  $t$  *admits an occurrence* of the *pattern*  $s$ . Conversely,  $t$  *avoids*  $s$  if there is no occurrence of  $s$  in  $t$ . By extension,  $t$  avoids a set  $P$  of  $C$ -syntax trees if  $t$  avoids all the patterns of  $P$ . For instance, consider the combinatorial collection  $C := C(2) \sqcup C(3)$  where  $C(2) := \{a, b\}$  and  $C(3) := \{c\}$ , and the  $C$ -syntax tree

$$t := \begin{array}{c} \text{b} \\ \swarrow \quad \searrow \\ \text{c} \quad \text{b} \\ \swarrow \quad \searrow \quad \swarrow \quad \searrow \\ \text{a} \quad \text{b} \quad \text{a} \quad \text{c} \\ \swarrow \quad \searrow \quad \swarrow \quad \searrow \\ \text{b} \end{array} . \quad (2.4.1)$$

Then,  $t$  admits an occurrence of

$$\begin{array}{c} | \\ c \\ / \quad \backslash \\ a \quad b \\ / \quad \backslash \end{array} \quad (2.4.2)$$

at position 1 and two occurrences of

$$\begin{array}{c} | \\ a \\ / \quad \backslash \end{array} \quad (2.4.3)$$

at positions 11 and 21.

**2.4.2. Grafting of syntax trees.** Let  $t$  be a  $C$ -syntax tree of arity  $n$ ,  $i \in [n]$ , and  $s$  be a  $C$ -syntax tree. The *grafting* of  $s$  onto the  $i$ th leaf  $u$  of  $t$  is the  $C$ -syntax tree  $\tau := t \circ_i s$  defined as follows. The underlying planar rooted tree of  $\tau$  admits the tree language

$$\mathcal{N}(\tau) := (\mathcal{N}(t) \setminus \{u\}) \cup \{uv : v \in \mathcal{N}(s)\}, \quad (2.4.4)$$

and the labeling map of  $\tau$  satisfies, for any  $w \in \mathcal{N}_\bullet(\tau)$ ,

$$\omega_\tau(w) := \begin{cases} \omega_t(w) & \text{if } w \in \mathcal{N}_\bullet(t), \\ \omega_s(v) & \text{otherwise } (w = uv \text{ and } v \in \mathcal{N}_\bullet(s)). \end{cases} \quad (2.4.5)$$

Observe that by Proposition 2.1.3,  $\tau$  is wholly specified by its tree language  $\mathcal{N}(\tau)$  defined in (2.4.4). In more intuitive terms, the tree  $\tau$  is obtained by connecting the root of  $s$  onto the  $i$ th leaf of  $t$ . For instance, by considering the same labeling collection  $C$  as above,

$$\begin{array}{c} | \\ c \\ / \quad \backslash \\ a \quad \end{array} \circ_3 \begin{array}{c} | \\ b \\ / \quad \backslash \\ a \quad c \\ / \quad \backslash \end{array} = \begin{array}{c} | \\ c \\ / \quad \backslash \\ a \quad \begin{array}{c} | \\ b \\ / \quad \backslash \\ a \quad c \\ / \quad \backslash \end{array} \end{array}. \quad (2.4.6)$$

The operations  $\circ_i$  thus defined are binary products

$$\circ_i : \text{PRT}_\perp^C \times \text{PRT}_\perp^C \rightarrow \text{PRT}_\perp^C \quad (2.4.7)$$

on  $\text{PRT}_\perp^C$ , in the sense of Section 1.1.5. We call each  $\circ_i$  a *grafting operation*. Since, for any  $C$ -syntax trees  $t$  and  $s$ , and  $i \in [\text{ari}(t)]$ ,

$$\text{ari}(t \circ_i s) = \text{ari}(t) + \text{ari}(s) - 1, \quad (2.4.8)$$

these operations are  $\dot{+}$ -compatible for the product  $\dot{+}$  defined by  $n \dot{+} m := n + m - 1$  for all  $n, m \in \mathbb{N}_{\geq 1}$ .

**2.4.3. Complete grafting of syntax trees.** Let  $t$  be a  $C$ -syntax tree of arity  $n$ , and let  $s_1, \dots, s_n$  be  $C$ -syntax trees. The *complete grafting* of  $s_1, \dots, s_n$  onto  $t$  is the  $C$ -syntax tree  $\circ^{(n)}(t, s_1, \dots, s_n)$  defined by

$$\circ^{(n)}(t, s_1, \dots, s_n) := (\dots((t \circ_n s_n) \circ_{n-1} s_{n-1}) \dots) \circ_1 s_1. \quad (2.4.9)$$

In more intuitive terms, the tree  $o^{(n)}(t, s_1, \dots, s_n)$  is obtained by connecting the root of each  $s_i$  onto the  $i$ th leaf of  $t$ . For instance, by considering the same labeling collection  $C$  as before,

$$o^{(4)} \left( \begin{array}{c} \text{c} \\ / \quad \backslash \\ \text{a} \quad \text{c} \\ / \quad \backslash \\ \text{a} \quad \text{c} \end{array}, \begin{array}{c} \text{a} \\ / \quad \backslash \\ \text{a} \quad \text{c} \end{array}, \begin{array}{c} \text{c} \\ / \quad \backslash \\ \text{a} \quad \text{c} \end{array}, \begin{array}{c} \text{b} \\ / \quad \backslash \\ \text{a} \quad \text{c} \end{array} \right) = \begin{array}{c} \text{c} \\ / \quad \backslash \\ \text{a} \quad \text{c} \\ / \quad \backslash \\ \text{a} \quad \text{c} \end{array}. \quad (2.4.10)$$

The operations  $o^{(n)}$  thus defined are products

$$o^{(n)} : \text{PRT}_{\perp}^C \times \left( \text{PRT}_{\perp}^C \right)^n \rightarrow \text{PRT}_{\perp}^C \quad (2.4.11)$$

of arity  $n + 1$  on  $\text{PRT}_{\perp}^C$ . We call each  $o^{(n)}$  a *complete grafting operation*. Since, for any  $C$ -syntax trees  $t, s_1, \dots, s_n$  such that  $n = \text{ari}(t)$ ,

$$\text{ari} \left( o^{(n)}(t, s_1, \dots, s_n) \right) = \text{ari}(t) + \text{ari}(s_1) + \dots + \text{ari}(s_n) - n, \quad (2.4.12)$$

these operations are  $\dagger$ -compatible for the product  $\dagger$  defined in Section 2.4.2. Moreover, to gain concision, we shall denote by  $t \circ [s_1, \dots, s_n]$  the  $C$ -syntax tree  $o^{(n)}(t, s_1, \dots, s_n)$ .

2.4.4. *Rewrite systems.* Let for any  $m, i \in \mathbb{N}_{\geq 1}$  the operation  $\ominus_i^{(m)}$  defined as follows. For any  $C$ -syntax trees  $t, \tau, s_1, \dots, s_m$  where  $t$  is of arity  $n \geq i$ , we set

$$\ominus_i^{(m)}(t, \tau, s_1, \dots, s_m) := t \circ_i (\tau \circ [s_1, \dots, s_m]). \quad (2.4.13)$$

These operations  $\ominus_i^{(m)}$  thus defined are products

$$\ominus_i^{(m)} : \text{PRT}_{\perp}^C \times \text{PRT}_{\perp}^C \times \left( \text{PRT}_{\perp}^C \right)^m \rightarrow \text{PRT}_{\perp}^C \quad (2.4.14)$$

of arity  $m + 2$  on  $\text{PRT}_{\perp}^C$ . It is easy to see that  $\ominus_i^{(m)}$  is  $\dagger$ -compatible for the product  $\dagger$  considered in Sections 2.4.2 and 2.4.3.

Let  $(\text{PRT}_{\perp}^C, \Rightarrow)$  be a rewrite system. We denote by  $(\text{PRT}_{\perp}^C, \rightsquigarrow)$  the  $\mathcal{P}$ -closure of  $(\text{PRT}_{\perp}^C, \Rightarrow)$ , where

$$\mathcal{P} := \left\{ \ominus_i^{(m)} : m, i \in \mathbb{N}_{\geq 1} \right\}. \quad (2.4.15)$$

We call  $(\text{PRT}_{\perp}^C, \rightsquigarrow)$  the *closure* of  $(\text{PRT}_{\perp}^C, \Rightarrow)$ . In other terms,  $\rightsquigarrow$  is the rewrite rule satisfying

$$t \circ_i (\tau \circ [s_1, \dots, s_m]) \rightsquigarrow t \circ_i (\tau' \circ [s_1, \dots, s_m]) \quad (2.4.16)$$

for any  $C$ -syntax trees  $t, \tau, \tau', s_1, \dots, s_m$  where  $t$  of arity  $n$ ,  $i \in [n]$ , and  $\tau \Rightarrow \tau'$ . In intuitive terms, one has  $q \rightsquigarrow q'$  for two  $C$ -syntax trees  $q$  and  $q'$  if there are two  $C$ -syntax trees  $\tau$  and  $\tau'$  such that  $\tau \Rightarrow \tau'$  and, by replacing an occurrence of  $\tau$  by  $\tau'$  in  $q$ , we obtain  $q'$ . For instance, by considering the same labeling set  $C$  as before, let  $(\text{PRT}_{\perp}^C, \Rightarrow)$  be the rewrite system defined by

$$\begin{array}{c} \text{c} \\ / \quad \backslash \\ \text{a} \quad \text{c} \end{array} \Rightarrow \begin{array}{c} \text{a} \\ / \quad \backslash \\ \text{a} \quad \text{c} \end{array}, \quad \begin{array}{c} \text{b} \\ / \quad \backslash \\ \text{a} \quad \text{c} \end{array} \Rightarrow \begin{array}{c} \text{a} \\ / \quad \backslash \\ \text{a} \quad \text{b} \end{array}. \quad (2.4.17)$$

One has the following chain of rewritings

$$(2.4.18)$$

Observe by the way that the right rotation operation on binary trees considered in Section 1.3.3 (see (1.3.7)) can be expressed as the closure of the rewrite system  $(\text{PRT}_{\perp}^B, \Rightarrow)$  such that  $B := B(2) := \{b\}$  defined by

$$(2.4.19)$$

In this dissertation, we shall mainly consider rewrite systems  $(\text{PRT}_{\perp}^C, \rightsquigarrow)$  defined as closures of rewrite systems  $(\text{PRT}_{\perp}^C, \Rightarrow)$  such that the number of pairs  $(t, t')$  satisfying  $t \Rightarrow t'$  is finite. We say in this case that  $(\text{PRT}_{\perp}^C, \rightsquigarrow)$  is of *finite type*. In this context, the *degree* of  $(\text{PRT}_{\perp}^C, \rightsquigarrow)$  is the maximal degree among the  $C$ -syntax trees appearing as left members of  $\Rightarrow$ . The *arity* of  $(\text{PRT}_{\perp}^C, \rightsquigarrow)$  is the maximal arity among the  $C$ -syntax trees appearing as left (or right) members of  $\Rightarrow$ .

**2.4.5. Proving termination.** We have observed in Section 1.4.2 that termination invariants provide tools to show that a combinatorial rewrites system is terminating. This idea extends on rewrite systems on syntax trees defined as closures of other ones in the following way.

Let  $(\text{PRT}_{\perp}^C, \Rightarrow)$  be a combinatorial rewrite system and  $(\text{PRT}_{\perp}^C, \rightsquigarrow)$  its closure. Assume that  $\theta : \text{PRT}_{\perp}^C \rightarrow \mathcal{Q}$  is a termination invariant for  $(\text{PRT}_{\perp}^C, \Rightarrow)$ , where  $(\mathcal{Q}, \preceq)$  is a poset. We say that  $\theta$  is *compatible with the closure* if, for any  $C$ -syntax trees  $\tau$  and  $\tau'$  such that  $\tau \Rightarrow \tau'$ , the inequality

$$\theta(\mathfrak{s} \circ_i (\tau \circ [q_1, \dots, q_k])) < \theta(\mathfrak{s} \circ_i (\tau' \circ [q_1, \dots, q_k])) \quad (2.4.20)$$

holds for all  $C$ -syntax trees  $\mathfrak{s}, q_1, \dots, q_k$ , where  $k := \text{ari}(\tau) = \text{ari}(\tau')$ . Now, as a consequence of (2.4.16) and Lemma 1.4.1, one has the following result.

**PROPOSITION 2.4.1.** *Let  $C$  be an augmented combinatorial collection without object of size 1,  $(\text{PRT}_{\perp}^C, \Rightarrow)$  be a rewrite system, and  $(\text{PRT}_{\perp}^C, \rightsquigarrow)$  be the closure of  $(\text{PRT}_{\perp}^C, \Rightarrow)$ . If  $\theta : \text{PRT}_{\perp}^C \rightarrow \mathcal{Q}$  is a termination invariant for  $(\text{PRT}_{\perp}^C, \Rightarrow)$  and  $\theta$  is compatible with the closure,  $(\text{PRT}_{\perp}^C, \rightsquigarrow)$  is terminating.*

Consider for instance the rewrite rule  $(\text{PRT}_{\perp}^C, \Rightarrow)$  defined by (2.4.17). By setting  $\mathcal{Q} := \mathbb{N}^2$  and  $\preceq$  as the lexicographic order on  $\mathbb{N}^2$ , let us define the map  $\theta : \text{PRT}_{\perp}^C \rightarrow \mathcal{Q}$ , for any  $C$ -syntax tree  $t$ , by  $\theta(t) := (\text{deg}(t), \text{tam}(t))$ , where

$$\text{tam}(t) := \sum_{\substack{u \in \mathcal{N}_*^2(t) \\ u \text{ of arity } 2}} \text{deg}(t \cdot u2). \quad (2.4.21)$$

In other words,  $\text{tam}(t)$  is the sum, for all internal and binary nodes  $u$  of  $t$ , of the number of internal nodes appearing in the 2nd suffix subtrees of  $u$ . One can check that  $\theta(t) < \theta(t')$  for all the  $C$ -syntax trees  $t$  and  $t'$  such that  $t \Rightarrow t'$ . Indeed,

$$\theta \left( \begin{array}{c} \text{c} \\ / \quad \backslash \\ \text{a} \quad \text{a} \end{array} \right) = (1, 0) < (2, 0) = \theta \left( \begin{array}{c} \text{a} \\ / \quad \backslash \\ \text{a} \quad \text{a} \end{array} \right), \quad (2.4.22)$$

and

$$\theta \left( \begin{array}{c} \text{b} \\ / \quad \backslash \\ \text{a} \quad \text{a} \end{array} \right) = (2, 0) < (2, 1) = \theta \left( \begin{array}{c} \text{a} \\ / \quad \backslash \\ \text{a} \quad \text{b} \end{array} \right). \quad (2.4.23)$$

Moreover, the fact that  $\theta$  is compatible with the closure is a straightforward verification. Therefore, the closure  $(\text{PRT}_{\perp}^C, \rightsquigarrow)$  of  $(\text{PRT}_{\perp}^C, \Rightarrow)$  is terminating.

**2.4.6. Proving confluence.** In the same way as the tool to show that a rewrite system on  $C$ -syntax trees is terminating presented in Section 2.4.5, we present here a tool to prove that rewrite systems on syntax trees defined as closures of other ones are confluent. This criterion requires now some precise properties.

**PROPOSITION 2.4.2.** *Let  $C$  be an augmented combinatorial collection without object of size 1,  $(\text{PRT}_{\perp}^C, \Rightarrow)$  be a rewrite system, and  $(\text{PRT}_{\perp}^C, \rightsquigarrow)$  be the closure of  $(\text{PRT}_{\perp}^C, \Rightarrow)$ . If  $(\text{PRT}_{\perp}^C, \rightsquigarrow)$  is terminating, is of finite type, has  $\ell \geq 0$  as degree, and all branching pairs of  $(\text{PRT}_{\perp}^C, \rightsquigarrow)$  consisting in trees with  $2\ell - 1$  internal nodes or less are joinable, then  $(\text{PRT}_{\perp}^C, \rightsquigarrow)$  is confluent.*

**PROOF.** Assume that all the hypotheses of the statement hold. Let  $t$  be a branching tree of  $(\text{PRT}_{\perp}^C, \rightsquigarrow)$  and  $\{r_1, r_2\}$  be a branching pair for  $t$ . We have thus  $t \rightsquigarrow r_1$  and  $t \rightsquigarrow r_2$ . By definition of  $\rightsquigarrow$ , there are four  $C$ -syntax trees  $t'_1, r'_1, t'_2,$  and  $r'_2$  such that  $t'_1 \Rightarrow r'_1, t'_2 \Rightarrow r'_2$ , and  $r_1$  (resp.  $r_2$ ) is obtained by replacing an occurrence of  $t'_1$  (resp.  $t'_2$ ) rooted at a node  $u_1$  (resp.  $u_2$ ) by  $r'_1$  (resp.  $r'_2$ ) in  $t$ . We have now two cases to consider, depending on the positions of the nodes  $u_1$  and  $u_2$  in  $t$ .

*Case 1.* Assume first that the occurrences of  $t'_1$  and  $t'_2$  at positions  $u_1$  and  $u_2$  in  $t$  do not share any internal node of  $t$ . Then,  $r_1$  (resp.  $r_2$ ) admits an occurrence of  $t'_2$  (resp.  $t'_1$ ) at a position  $u'_2$  (resp.  $u'_1$ ). These positions  $u'_1$  and  $u'_2$  are obtained from the original positions  $u_1$  and  $u_2$  of the occurrences of  $t'_1$  and  $t'_2$  in  $t$ . Now, let  $t'$  be the tree obtained by replacing the occurrence of  $t'_2$  at position  $u'_2$  by  $r'_2$  in  $r_1$ . Equivalently, due to the above assumption,  $t'$  is the tree obtained by replacing the occurrence of  $t'_1$  at position  $u'_1$  by  $r'_1$  in  $r_2$ . Thereby, we have  $r_1 \rightsquigarrow t'$  and  $r_2 \rightsquigarrow t'$ , showing that the branching pair  $\{r_1, r_2\}$  is joinable.

*Case 2.* Otherwise, the occurrences of  $t'_1$  and  $t'_2$  at positions  $u_1$  and  $u_2$  in  $t$  share at least one internal node of  $t$ . Denote by  $s$  the factor subtree of  $t$ , rooted at a node  $v$ , of the smallest degree and whose internal nodes come from the internal nodes of  $t$  involved in the occurrences of  $t'_1$  and  $t'_2$  at positions  $u_1$  and  $u_2$ . Observe that  $v = u_1$  or  $v = u_2$ . Let us denote by  $v_1$  (resp.  $v_2$ ) the position of the occurrence of  $t'_1$  (resp.  $t'_2$ ) in  $s$ . Let  $s_1$  (resp.  $s_2$ ) be the tree obtained by replacing the occurrence of  $t'_1$  (resp.  $t'_2$ ) at position  $v_1$  (resp.  $v_2$ ) by  $r'_1$  (resp.  $r'_2$ ) in  $s$ . Now, due to the above assumption, by the minimality of the degree of  $s$ ,  $s$  has at most

$2\ell - 1$  internal nodes. Now, since we have  $s \rightsquigarrow s_1$  and  $s \rightsquigarrow s_2$ ,  $s$  is a branching tree for  $\rightsquigarrow$  and  $\{s_1, s_2\}$  is a branching pair for  $s$ . By hypothesis,  $\{s_1, s_2\}$  is joinable, so that there is a tree  $s'$  such that  $s_1 \rightsquigarrow^* s'$  and  $s_2 \rightsquigarrow^* s'$ . By setting  $t'$  as the tree obtained by replacing the occurrence of  $s$  at position  $v$  by  $s'$  in  $t$ , we finally have  $\tau_1 \rightsquigarrow^* t'$  and  $\tau_2 \rightsquigarrow^* t'$ , showing that  $\{\tau_1, \tau_2\}$  is joinable. We have shown that all branching pairs of  $\rightsquigarrow$  are joinable. Since  $(\text{PRT}_{\perp}^C, \rightsquigarrow)$  is terminating, this implies by the diamond lemma (Lemma 1.4.2) that  $(\text{PRT}_{\perp}^C, \rightsquigarrow)$  is confluent.  $\square$

Proposition 2.4.2 leads to an algorithmic way to check if a terminating rewrite system  $(\text{PRT}_{\perp}^C, \rightsquigarrow)$  defined as the closure of an other one  $(\text{PRT}_{\perp}^C, \Rightarrow)$  is confluent by enumerating all the  $C$ -syntax trees  $t$  of degrees at most  $2\ell - 1$  (where  $\ell$  is the degree of  $(\text{PRT}_{\perp}^C, \rightsquigarrow)$ ) and by computing the parts  $G_t$  of the rewriting graphs of  $(\text{PRT}_{\perp}^C, \rightsquigarrow)$  consisting in the trees reachable from  $t$ . If each  $G_t$  contains exactly one normal form (which correspond to a vertex with no outgoing edge in  $G_t$ ),  $(\text{PRT}_{\perp}^C, \rightsquigarrow)$  is confluent.

For instance, by considering the same labeling set  $C$  as above, let  $(\text{PRT}_{\perp}^C, \Rightarrow)$  be the rewrite system defined by

$$\begin{array}{c} \text{a} \\ | \\ \text{b} \text{---} \text{a} \end{array} \Rightarrow \begin{array}{c} \text{b} \\ | \\ \text{a} \end{array}, \quad \begin{array}{c} \text{a} \\ | \\ \text{a} \end{array} \Rightarrow \begin{array}{c} \text{b} \\ | \\ \text{b} \end{array}. \quad (2.4.24)$$

The degree of the closure  $(\text{PRT}_{\perp}^C, \rightsquigarrow)$  of  $(\text{PRT}_{\perp}^C, \Rightarrow)$  is  $\ell := 2$  and it is possible to show that  $(\text{PRT}_{\perp}^C, \rightsquigarrow)$  is terminating. Consider

$$t := \begin{array}{c} \text{a} \\ | \\ \text{a} \\ | \\ \text{b} \end{array}, \quad (2.4.25)$$

which is a  $C$ -syntax tree of degree  $2\ell - 1 = 3$ . The graph  $G_t$  associated with  $t$  is of the form

$$\begin{array}{c} \text{b} \\ | \\ \text{a} \\ | \\ \text{a} \end{array} \begin{array}{l} \xrightarrow{\text{a}} \\ \xrightarrow{\text{b}} \end{array} \begin{array}{c} \text{b} \\ | \\ \text{b} \\ | \\ \text{b} \end{array}, \quad (2.4.26)$$

$$\begin{array}{c} \text{b} \\ | \\ \text{a} \\ | \\ \text{a} \end{array} \xrightarrow{\text{a}} \begin{array}{c} \text{a} \\ | \\ \text{a} \end{array} \xrightarrow{\text{b}} \begin{array}{c} \text{b} \\ | \\ \text{b} \end{array}$$

and shows that  $(\text{PRT}_{\perp}^C, \rightsquigarrow)$  is not confluent. Indeed,  $t$  is a non-joinable branching tree. On the other hand, consider the rewrite system  $(\text{PRT}_{\perp}^C, \Rightarrow)$  defined by

$$\begin{array}{c} \text{a} \\ | \\ \text{a} \end{array} \Rightarrow \begin{array}{c} \text{a} \\ | \\ \text{a} \end{array}, \quad \begin{array}{c} \text{b} \\ | \\ \text{a} \end{array} \Rightarrow \begin{array}{c} \text{a} \\ | \\ \text{b} \end{array}, \quad \begin{array}{c} \text{b} \\ | \\ \text{b} \end{array} \Rightarrow \begin{array}{c} \text{b} \\ | \\ \text{a} \end{array}. \quad (2.4.27)$$



The degree of the closure  $(\text{PRT}_{\perp}^C, \rightsquigarrow)$  of  $(\text{PRT}_{\perp}^C, \Rightarrow)$  is  $\ell := 2$  and here also, it is possible to show that  $(\text{PRT}_{\perp}^C, \rightsquigarrow)$  is terminating. Consider

$$t := \begin{array}{c} \cdot \\ \text{b} \\ \cdot \\ \text{a} \quad \text{b} \\ \cdot \\ \text{a} \end{array}, \quad (2.4.28)$$

a  $C$ -syntax tree of degree  $2\ell - 1 = 3$ . The graph  $G_t$  associated with  $t$  is of the form

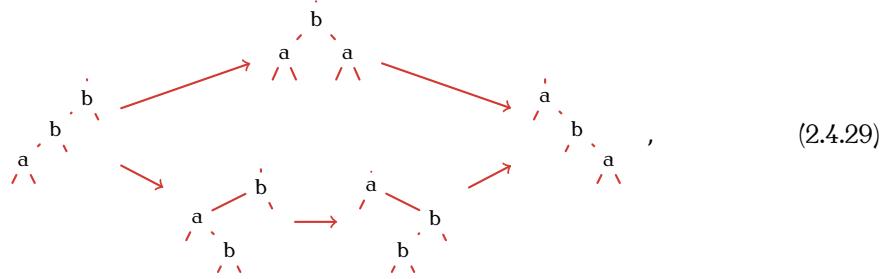

This graph satisfies the required property stated above, and, as a systematic study of cases shows, all other graphs  $G_s$  where  $s$  is a  $C$ -syntax tree of degree 3 or less, also. For this reason,  $(\text{PRT}_{\perp}^C, \rightsquigarrow)$  is confluent.

### 3. Combinatorial objects

This last section of the chapter contains a list of definitions about combinatorial objects appearing in some next chapters.

**3.1. Other kinds of trees.** Let us set some definitions about two other kinds of trees: rooted trees and colored syntax trees.

3.1.1. *Rooted trees.* Let  $\text{RT}$  be the graded collection satisfying the relation

$$\text{RT} = \{\bullet\} \times \text{S}(\text{RT}). \quad (3.1.1)$$

where  $\bullet$  is an atomic object called *node*. We call *rooted tree* each object of  $\text{RT}$ . By definition, a rooted tree  $t$  is an ordered pair  $(\bullet, \{t_1, \dots, t_k\})$  where  $\{t_1, \dots, t_k\}$  is a multiset of rooted trees. Like the case of planar rooted trees, this definition is recursive. For instance,

$$(\bullet, \emptyset), \quad (\bullet, \{\bullet, \emptyset\}), \quad (\bullet, \{\bullet, \emptyset, (\bullet, \emptyset)\}), \quad (\bullet, \{\bullet, \emptyset, (\bullet, \emptyset), (\bullet, \emptyset)\}), \quad (\bullet, \{\bullet, \{\bullet, \emptyset, (\bullet, \emptyset)\}\}), \quad (3.1.2)$$

are rooted trees. If  $t = (\bullet, \{t_1, \dots, t_k\})$  is a rooted tree, each  $t_i$ ,  $i \in [k]$ , is a *suffix subtree* of  $t$ .

Rooted trees are different kinds of trees than planar rooted trees presented in Section 2. The difference is due to the fact that rooted trees are defined by using multisets of rooted trees, while planar rooted trees are defined by using lists of planar rooted trees. Hence, the order of the suffix subtrees of a rooted tree is not significant.

By drawing each rooted tree by a node  $\circ$  attached below it to its subtrees by means of edges  $-$ , the rooted trees of (3.1.2) are depicted by

$$\circ, \circ, \circ, \circ, \circ. \quad (3.1.3)$$

By definition of the product and multiset operations over combinatorial collections, the size of a rooted tree  $t$  satisfies

$$|t| := 1 + \sum_{i \in [k]} |t_i|. \quad (3.1.4)$$

The sequence of integers associated with RT begins by

$$1, 1, 2, 4, 9, 20, 48, 115, \quad (3.1.5)$$

and forms Sequence A000081 of [Slo].

**3.1.2. Colored syntax trees.** Let  $\mathcal{C}$  be a set of colors and  $C$  be a  $\mathcal{C}$ -colored collection (see Section 1.1.4). A  $\mathcal{C}$ -colored  $C$ -syntax tree is a triple  $(a, t, u)$  where  $t$  is a  $C$ -syntax tree,  $a \in \mathcal{C}$ ,  $u \in \mathcal{C}^{\text{ari}(t)}$ , and for any internal nodes  $u$  and  $v$  of  $t$  such that  $v$  is the  $i$ th child of  $u$ ,  $\text{out}(y) = \text{in}_i(x)$  where  $x$  (resp.  $y$ ) is the label of  $u$  (resp.  $v$ ). The set of all  $\mathcal{C}$ -colored  $C$ -syntax trees is denoted by  $\text{CPRT}^{\mathcal{C}}$ . This set is a  $\mathcal{C}$ -colored collection by setting that  $\text{out}((a, t, u)) := a$  and  $\text{in}((a, t, u)) := u$  for all  $(a, t, u) \in \text{CPRT}^{\mathcal{C}}$ . By a slight abuse of notation, if  $u$  is an internal node of  $t$ , we denote by  $\text{out}(u)$  (resp.  $\text{in}(u)$ ) the color  $\text{out}(x)$  (resp. word of colors  $\text{in}(x)$ ) where  $x$  is the label of  $u$ . We say that a  $\mathcal{C}$ -colored  $C$ -syntax tree  $t$  is *monochrome* if  $C$  is a monochrome colored collection. In graphical representations of a  $\mathcal{C}$ -colored  $C$ -syntax tree  $(a, t, u)$ , we draw  $t$  together with its output color above its root and its input color  $u(i)$  below its  $i$ th leaf for any  $i \in [|u|]$ .

For instance, consider the set of colors  $\mathcal{C} := \{1, 2\}$  and the  $\mathcal{C}$ -colored collection  $C$  defined by  $C := C(2) \sqcup C(3)$  with  $C(2) := \{a, b\}$ ,  $C(3) := \{c\}$ ,  $\text{out}(a) := 1$ ,  $\text{out}(b) := 2$ ,  $\text{out}(c) := 1$ ,  $\text{in}(a) := 11$ ,  $\text{in}(b) := 21$ , and  $\text{in}(c) := 221$ . The tree

$$\begin{array}{c} 1 \\ | \\ c \\ / \quad | \quad \backslash \\ b \quad 2 \quad a \\ / \quad \backslash \quad / \quad \backslash \\ 2 \quad 1 \quad c \quad a \\ \quad \quad \quad / \quad \backslash \quad / \quad \backslash \\ \quad \quad \quad 2 \quad 2 \quad 1 \quad 1 \quad 1 \end{array} \quad (3.1.6)$$

is a  $\mathcal{C}$ -colored  $C$ -syntax tree. Its degree is 5, its arity is 8, and its height is 3. Moreover, its output color is 1 and its word of input colors is 21222111. Besides,  $(1, \perp, 1)$  and  $(1, \perp, 2)$  are two  $\mathcal{C}$ -colored  $C$ -syntax trees of degree 0 and arity 1.

Let  $(a, t, u)$  and  $(b, s, v)$  be two  $\mathcal{C}$ -colored  $C$ -syntax trees and  $i \in [| \text{ari}(t) |]$ . If  $b = u(i)$ , the *grafting* on  $s$  onto the  $i$ th leaf of  $t$  is defined by

$$(a, t, u) \circ_i (b, s, v) := (a, t \circ_i s, u \leftarrow_i v), \quad (3.1.7)$$

where  $u \leftarrow_i v$  is the word obtained by replacing the  $i$ th letter of  $u$  by  $v$ , and the second occurrence of  $\circ_i$  in (3.1.7) is the grafting of syntax trees defined in Section 2.4.2. For instance,



is a polygon of size 5. Its set of all diagonals is

$$\mathcal{D}_p = \{(1, 3), (1, 4), (1, 5), (2, 4), (2, 5), (2, 6), (3, 5), (3, 6), (4, 6)\}, \quad (3.2.2)$$

its set of all edges is

$$\mathcal{E}_p = \{(1, 2), (2, 3), (3, 4), (4, 5), (5, 6)\}, \quad (3.2.3)$$

and its set of all arcs is

$$\mathcal{A}_p = \mathcal{D}_p \sqcup \mathcal{E}_p \sqcup \{(1, 6)\}. \quad (3.2.4)$$

**3.2.2. Configurations.** For any set  $S$ , an  $S$ -*configuration* (or a *configuration* when  $S$  is known without ambiguity) is a polygon  $c$  endowed with a partial function

$$\phi_c : \mathcal{A}_c \rightarrow S. \quad (3.2.5)$$

When  $\phi_c((x, y))$  is defined, we say that the arc  $(x, y)$  is *labeled* and we denote it by  $c(x, y)$ . When the base of  $c$  is labeled, we denote it by  $c_0$ , and when the  $i$ th edge of  $c$  is labeled, we denote it by  $c_i$ .

In our graphical representations, we shall represent any  $S$ -configuration  $c$  by drawing a polygon of the same size as the one of  $c$  following the conventions explained before, and by labeling its arcs accordingly. For instance



is an  $\{a, b, c\}$ -configuration. The arcs  $(1, 2)$  and  $(1, 4)$  of  $c$  are labeled by  $a$ , the arcs  $(2, 5)$  and  $(4, 5)$  are labeled by  $b$ , and the other arcs are unlabeled.

**3.2.3. Additional definitions.** Let us now provide some definitions and statistics on configurations. Let  $c$  be a configuration of size  $n$ . The *skeleton* of  $c$  is the undirected graph  $\text{skel}(c)$  on the set of vertices  $[n + 1]$  and such that for any  $x < y \in [n + 1]$ , there is an arc  $\{x, y\}$  in  $\text{skel}(c)$  if  $(x, y)$  is labeled in  $c$ . The *degree* of a vertex  $x$  of  $c$  is the number of vertices adjacent to  $x$  in  $\text{skel}(c)$ . The *degree*  $\text{degr}(c)$  of  $c$  is the maximal degree among its vertices. Two (non-necessarily labeled) diagonals  $(x, y)$  and  $(x', y')$  of  $c$  are *crossing* if  $x < x' < y < y'$  or  $x' < x < y' < y$ . The *crossing* of a labeled diagonal  $(x, y)$  of  $c$  is the number of labeled diagonals  $(x', y')$  such that  $(x, y)$  and  $(x', y')$  are crossing. The *crossing*  $\text{cros}(c)$  of  $c$  is the maximal crossing among its labeled diagonals. When  $\text{cros}(c) = 0$ , there are no crossing diagonals in  $c$  and in this case,  $c$  is *noncrossing*. A (non-necessarily labeled) arc  $(x', y')$  is *nested* in a (non-necessarily labeled) arc  $(x, y)$  of  $c$  if  $x \leq x' < y' \leq y$ . We say that  $c$  is *nesting-free* if for any labeled arcs  $(x, y)$  and  $(x', y')$  of  $c$  such that  $(x', y')$  is nested in  $(x, y)$ ,  $(x, y) = (x', y')$ . Besides,  $c$  is *acyclic* if  $\text{skel}(c)$  is acyclic. When  $c$  has no labeled edges nor labeled base,  $c$  is *white*. If  $c$  has no labeled diagonals,  $c$  is a *bubble*. A *triangle* is a configuration of size 2. Obviously, all triangles are bubbles, and all bubbles are noncrossing.

**3.3. Prographs.** We present here prographs, that are combinatorial objects modeling operations with several inputs and several outputs. These objects are elements of free pros (see Section 5.1 of Chapter 2) and admit many different definitions. A first one consists in defining prographs (called in this context diagrams) through an equivalence relation [Laf11]. A second one consists in defining prographs (called in this context directed  $(m, n)$ -graphs) by graphs satisfying some conditions [Mar08]. We chose to define these objects by using the tools offered by the theory of bigraded collections. Our approach is however similar to the one of [Laf11].

For all bigraded collections  $C$  considered in this section, if  $x$  is an object of index  $(p, q) \in \mathbb{N}^2$ , the *input* (resp. *output*) *arity* of  $x$  is  $|x|_{\uparrow} := p$  (resp.  $|x|_{\downarrow} := q$ ).

3.3.1. *Sequences of wires.* Let  $\text{Wir}$  be the bigraded collection satisfying

$$\text{Wir}(p, q) := \begin{cases} \{\mathbb{1}_p\} & \text{if } p = q, \\ \emptyset & \text{otherwise.} \end{cases} \quad (3.3.1)$$

We call  $\mathbb{1}_1$  the *wire* and each element  $\mathbb{1}_p$  the *sequence of wires* of arity  $p$ . Each  $\mathbb{1}_p$  is depicted by  $p$  vertical lines. For instance,  $\mathbb{1}_5$  is depicted as

$$\begin{array}{c} \square \square \square \square \square \\ | | | | | \\ \square \square \square \square \square \end{array} . \quad (3.3.2)$$

3.3.2. *Preprographs.* From now on,  $C$  is a bigraded collection such that  $C(p, q) = \emptyset$  if  $p = 0$  or  $q = 0$ .

An *elementary prograph*  $x$  on  $C$  (or, for short, an *elementary C-prograph*) is an object  $a$  of  $C(p, q)$ . We represent  $x$  as a rectangle labeled by  $a$  with  $p$  incoming edges (below the rectangle) and  $q$  outgoing edges (above the rectangle). For instance, if  $a \in C(2, 3)$ , the elementary prograph  $a$  is depicted as

$$\begin{array}{c} 1 \ 2 \ 3 \\ \square \ \square \ \square \\ \circlearrowleft \ a \ \circlearrowright \\ \square \ \square \\ 1 \ 2 \end{array} . \quad (3.3.3)$$

An *enriched elementary prograph*  $x$  on  $C$  (or, for short, an *enriched elementary C-prograph*) is a triple  $(k, a, \ell)$  where  $k, \ell \in \mathbb{N}$ , and  $a$  is an elementary  $C$ -prograph. These objects form a bigraded collection where the index of  $(k, a, \ell)$  is  $(k + |a|_{\uparrow} + \ell, k + |a|_{\downarrow} + \ell)$ . We represent  $x$  by drawing from left to right  $\mathbb{1}_k$ ,  $a$ , and  $\mathbb{1}_{\ell}$ . For instance, the enriched elementary prograph  $(1, a, 2)$  where  $a \in C(2, 3)$  is depicted as

$$\begin{array}{c} \square \ \square \ \square \ \square \ \square \\ | \ \square \ \square \ | \\ \square \ \square \ \square \ \square \ \square \\ \circlearrowleft \ a \ \circlearrowright \\ \square \ \square \ \square \ \square \ \square \\ | \ \square \ \square \ | \\ \square \ \square \ \square \ \square \ \square \end{array} . \quad (3.3.4)$$

A *preprograph*  $x$  on  $C$  (or, for short, a *C-preprograph*) is a sequence  $(x_1, \dots, x_k)$  of enriched elementary  $C$ -prographs such that  $|x_i|_{\uparrow} = |x_{i+1}|_{\downarrow}$  for any  $i \in [k-1]$ . These objects form a bigraded collection  $\text{PPrg}^C$  where the index of  $x$  is  $(|x_k|_{\uparrow}, |x_1|_{\downarrow})$ . We represent  $x$  by drawing each enriched elementary prograph  $x_i$ ,  $i \in [k]$ , vertically, where  $x_1$  is at the top and

$x_k$  is at the bottom. We moreover draw dashed lines for all  $i \in [k - 1]$  between  $x_i$  and  $x_{i+1}$ . For instance, the  $C$ -preprograph

$$x := ((1, a, 5), (5, b, 2), (7, a, 1)) \tag{3.3.5}$$

where  $a \in C(2, 2)$  and  $b \in C(3, 1)$  is depicted as

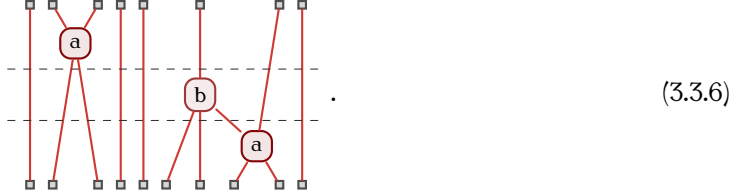

3.3.3. *Prographs.* Let  $(\text{PPr}g^C, \Rightarrow)$  be the rewrite system satisfying

$$((k_1, a, k_2 + |b|_{\downarrow} + k_3), (k_1 + |a|_{\uparrow} + k_2, b, k_3)) \Rightarrow ((k_1 + |a|_{\downarrow} + k_2, b, k_3), (k_1, a, k_2 + |b|_{\uparrow} + k_3)) \tag{3.3.7}$$

where  $a$  and  $b$  are elementary  $C$ -prographs and  $k_1, k_2, k_3 \geq 0$ . Pictorially,

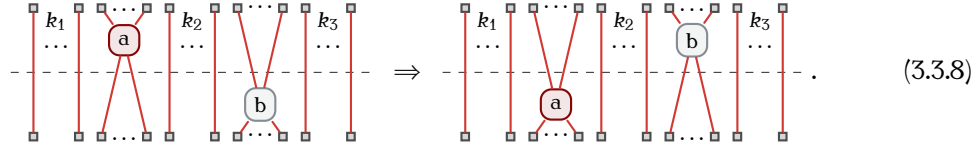

If  $x := (x_1, \dots, x_k)$  and  $y := (y_1, \dots, y_\ell)$  are two  $C$ -preprographs such that  $|x|_{\uparrow} = |y|_{\downarrow}$ , we denote by  $x \circ y$  the  $C$ -preprograph  $(x_1, \dots, x_k, y_1, \dots, y_\ell)$ . Let also  $\star$  be the ternary product on  $\text{PPr}g^C$  defined by  $\star(x, y, z) := x \circ y \circ z$  where  $x, y$ , and  $z$  are three  $C$ -preprographs satisfying  $|x|_{\uparrow} = |y|_{\downarrow}$  and  $|y|_{\uparrow} = |z|_{\downarrow}$ .

Let  $(\text{PPr}g^C, \Rightarrow_\star)$  be the  $\{\star\}$ -closure of  $(\text{PPr}g^C, \Rightarrow)$  (it is possible to define a product  $\dagger$  on  $\mathbb{N}^2$  so that  $\star$  is  $\dagger$ -compatible) and  $\leftrightarrow$  be the reflexive, symmetric, and transitive closure of  $\Rightarrow_\star$ . Let the bigraded collection  $\text{Pr}g^C$  defined by

$$\text{Pr}g^C := \text{PPr}g^C /_{\leftrightarrow} + \text{Wir}. \tag{3.3.9}$$

We call *prograph* on  $C$  (or, for short, a  *$C$ -prograph*) any element  $x$  of  $\text{Pr}g^C$ . When  $x$  is an object of  $\text{PPr}g^C /_{\leftrightarrow}$ , we represent  $x$  by considering the drawing of any preprograph of the  $\leftrightarrow$ -equivalence class of  $x$  and by letting the elementary prographs constituting  $x$  to move vertically along the edges. When  $x$  is an object of  $\text{Wir}$ , we represent  $x$  as explained in Section 3.3.1. For instance, the prograph having the preprograph of (3.3.6) in its  $\leftrightarrow$ -equivalence class is depicted as

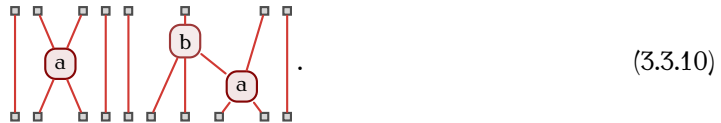

The *degree*  $\text{deg}(x)$  of a prograph  $x$  is defined in the following way. When  $x$  is an object of  $\text{PPr}g^C /_{\leftrightarrow}$ ,  $\text{deg}(x)$  is the length of  $x'$  where  $x'$  is any preprograph of the  $\leftrightarrow$ -equivalence class  $x$ . In other terms,  $\text{deg}(x)$  is the number of elementary prographs constituting  $x$ . When  $x$  is an object of  $\text{Wir}$ ,  $\text{deg}(x) := 0$ . For instance, the prograph of (3.3.10) has 3 as degree, and each sequence of wires  $1_p$ ,  $p \in \mathbb{N}$ , has 0 as degree.

**3.3.4. Operations on prographs.** Let  $x$  and  $y$  be two  $C$ -prographs such that  $|x|_{\uparrow} = |y|_{\downarrow}$ . The **vertical composition**  $x \circ y$  of  $x$  and  $y$  is defined as follows. When  $x$  (resp.  $y$ ) is a sequence of wires,  $x \circ y$  is equal to  $y$  (resp.  $x$ ). Otherwise,  $x$  and  $y$  are not sequences of wires, and  $x \circ y$  is the  $C$ -prograph  $[x' \circ y']_{\leftrightarrow}$  where  $x'$  and  $y'$  are respectively any elements of the  $\leftrightarrow$ -equivalence classes  $x$  and  $y$ , and  $\circ$  is the operation on preprographs defined in Section 3.3.3. For instance,

$$(3.3.11)$$

Let  $x$  and  $y$  be two  $C$ -prographs. The **horizontal composition**  $x * y$  of  $x$  and  $y$  is defined as follows. If  $x$  and  $y$  are both the sequences of wires  $\mathbb{1}_p$  and  $\mathbb{1}_q$  for some  $p, q \in \mathbb{N}$ ,

$$\mathbb{1}_p * \mathbb{1}_q := \mathbb{1}_{p+q}. \quad (3.3.12)$$

If  $x$  is the sequence of wires  $\mathbb{1}_p$  for a  $p \in \mathbb{N}$  and  $y$  is an object of  $\text{PPrg}^C /_{\leftrightarrow}$ ,

$$\mathbb{1}_p * y := [((p + k_1, a_1, \ell_1), \dots, (p + k_r, a_r, \ell_r))]_{\leftrightarrow}, \quad (3.3.13)$$

where  $((k_1, a_1, \ell_1), \dots, (k_r, a_r, \ell_r))$  is any preprograph in the  $\leftrightarrow$ -equivalence class  $y$ . Similarly, if  $x$  is an object of  $\text{PPrg}^C /_{\leftrightarrow}$  and  $y$  is the sequence of wires  $\mathbb{1}_p$ ,  $p \in \mathbb{N}$ ,

$$x * \mathbb{1}_p := [((k_1, a_1, \ell_1 + p), \dots, (k_r, a_r, \ell_r + p))]_{\leftrightarrow}, \quad (3.3.14)$$

where  $((k_1, a_1, \ell_1), \dots, (k_r, a_r, \ell_r))$  is any preprograph in the  $\leftrightarrow$ -equivalence class  $x$ . Finally, when  $x$  and  $y$  are both objects of  $\text{PPrg}^C /_{\leftrightarrow}$ ,  $x * y$  is defined, by using the particular cases for the horizontal composition explained above and the vertical composition, by

$$x * y := (x * \mathbb{1}_{|y|_{\downarrow}}) \circ (\mathbb{1}_{|x|_{\uparrow}} * y). \quad (3.3.15)$$

For instance,

$$(3.3.16)$$

**3.4. Alternating sign matrices.** We recall here some definitions about alternating sign matrices and usual statistics on them.

**3.4.1. Alternating sign matrices and six-vertex configurations.** An **alternating sign matrix** [MRR83], or an **ASM** for short, of size  $n$  is a square matrix of order  $n$  with entries in the alphabet  $\{0, +, -\}$  such that every row and column starts and ends by 0 or by  $+$  and in every row and column, the  $+$  and the  $-$  alternate. For instance,

$$\delta := \begin{bmatrix} 0 & + & 0 & 0 & 0 \\ 0 & 0 & + & 0 & 0 \\ + & - & 0 & 0 & + \\ 0 & + & - & + & 0 \\ 0 & 0 & + & 0 & 0 \end{bmatrix} \quad (3.4.1)$$

is an ASM of size 5. The number  $a_n$  of these objects of size  $n$  satisfies

$$a_n = \prod_{0 \leq i \leq n-1} \frac{(3i+1)!}{(n+i)!}, \quad (3.4.2)$$

a formula conjectured in [MRR83] and proven independently by Zeilberger [Zei96] and Kuperberg [Kup96].

A *six-vertex configuration* of size  $n$  is an  $n \times n$  square grid with oriented edges so that each vertex has two incoming and two outgoing edges. There are six possible configurations for each vertex, whence the name. A six-vertex configuration satisfies the *domain wall boundary condition* if all its horizontal (resp. vertical) edges on the boundary are oriented inwardly (resp. outwardly). Figure 1.4b shows an example of such an object. In what follows, we shall exclusively and implicitly consider six-vertex configurations satisfying the domain wall boundary condition.

Six-vertex configurations of size  $n$  are in one-to-one correspondence with ASMs of the same size. To compute the ASM in correspondence with a six-vertex configuration, we replace each of its vertices by a symbol 0, +, or - according to the rules described in Table 1.2. Reciprocally, to recover a six-vertex configuration from an ASM  $\delta$ , we first replace each

Statistics	ne	sw	se	nw	oi	io
ASM entry	0	0	0	0	+	-
Six-vertex-configuration						

TABLE 1.2. Correspondence between entries of ASMs, vertices of six-vertex configurations, and statistics on six-vertex-configurations.

nonzero entry of  $\delta$  by the corresponding vertex configuration (see the last two columns of Table 1.2). Then, for each zero entry of  $\delta$ , we look at the sum  $\ell$  (resp.  $a$ ) of the entries ( $a +$  counts as 1 and  $a -$  counts as  $-1$ ) to the left (resp. above) of it and in the same row (resp. column). By the alternating property of the ASMs,  $\ell$  and  $a$  belong to  $\{0, 1\}$ . Now, set in  $\delta$  the configuration  $\leftarrow$  (resp.  $\rightarrow$ ) if  $\ell = 1$  (resp.  $\ell = 0$ ) together with the configuration  $\downarrow$  (resp.  $\uparrow$ ) if  $a = 1$  (resp.  $a = 0$ ). Figure 1.4 shows an example.

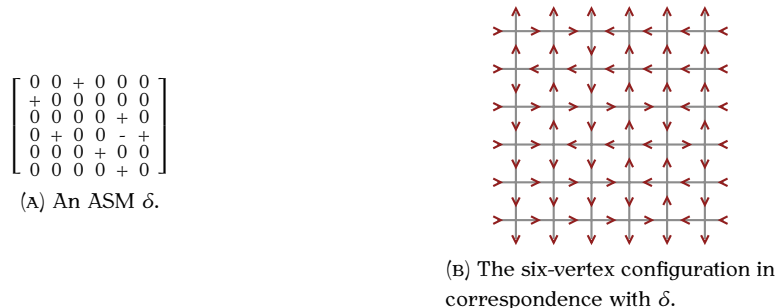

FIGURE 1.4. An ASM and a six-vertex configuration in correspondence.



3.4.2. *Statistics on alternating sign matrices.* It is possible to define several statistics on ASMs by counting how many entries of an ASM play a special role, seen as vertices of the six-vertex configurations in correspondence.

Let us denote by  $ne(\delta)$  (resp.  $sw(\delta)$ ,  $se(\delta)$ ,  $nw(\delta)$ ,  $oi(\delta)$ ,  $io(\delta)$ ) the number of vertices  $ne$  (resp.  $sw$ ,  $se$ ,  $nw$ ,  $oi$ ,  $io$ ) in the six-vertex configuration in bijection with the ASM  $\delta$  (see Table 1.2). Let  $\mathfrak{Z} := \{se, nw, sw, ne\}$  be the set of the statistics counting the four configurations of 0 and  $\mathfrak{N} := \{io, oi\}$  be the set of the statistics counting the two nonzero configurations.

Let us end this section on ASMs by stating the following result establishing some symmetries satisfied by these statistics.

PROPOSITION 3.4.1. *Let  $\delta$  be an ASM of size  $n$ . Then,*

$$se(\delta) = nw(\delta), \quad ne(\delta) = sw(\delta), \quad oi(\delta) = io(\delta) + n. \quad (3.4.3)$$

## Algebraic combinatorics

One of the main activities in algebraic combinatorics consists in developing interactions between combinatorics (enumerative combinatorics and even computer science) and algebra. The benefits are twofold: one obtains combinatorial properties and results by seeing combinatorial objects under an algebraic framework, and studying algebraic structures with the help of combinatorics leads to general algebraic results.

The first direction consists in endowing collections of combinatorial objects with operations. This provides a framework to collect combinatorial and enumerative properties on the objects by exploring natural and usual algebraic questions on the obtained algebraic structures. To be a little more precise, let  $C$  be a collection and  $\mathbb{K}\langle C \rangle$  be the linear span of  $C$  where  $\mathbb{K}$  is any field. To get a better understanding of properties of the objects of  $C$ , we endow  $\mathbb{K}\langle C \rangle$  with operations or co-operations. In this way, we can ask about the behavior of these operations under different bases of  $\mathbb{K}\langle C \rangle$  (leading to discovering links between different products, for instance, the shifted shuffle product and the shifted concatenation products of permutations are the same ones [DHT02, DHNT11]), minimal generating sets of  $\mathbb{K}\langle C \rangle$  (leading to describe the objects of  $C$  as assemblies of elementary building blocks), morphisms involving  $\mathbb{K}\langle C \rangle$  and other linear spans of collections (leading to discover symmetries of  $C$ —useful for enumeration problems—, or establishing links between  $C$  and other collections [LR98, DHT02, HNT05]).

The second direction consists, on the contrary, in seeing abstract algebraic structures as linear spans of combinatorial objects endowed with operations. This process is known as a combinatorial realization of an algebraic structure. To be more concrete, given a category of algebras defined by the relations their (co)operations have to satisfy, the problem consists in understanding the free object on a set  $\mathcal{G}$  of generators. This reinforces the understanding of the category since all other ones are, in most cases, quotients or substructures of free ones. The literature contains a lot of such constructions. For instance, free Lie algebras are realized in terms of Lyndon words and concatenation operations [Reu93], free pre-Lie algebras in terms of rooted trees and grafting operations [CL01], free dendriform algebras in terms of binary trees and shuffling operations [Lod01], free duplial algebras in terms of binary trees and over and under operations [Lod08], and free Zinbiel algebras using words and half-shuffle operations [Lod95].

Additionally to very classical algebraic structures like magmas, monoids, groups, posets, and associative algebras, in our work we consider Hopf bialgebras [Car07, GR16], operads [Mar08, LV12, Mé15], and pros [Lei04, Mar08]. The purpose of this chapter is to present a unified approach to work with these structures. We introduce in this way the notion of

polynomial spaces and of biproducts, that are operations working with several inputs and several outputs. All the aforementioned algebraic structures can be seen as particular cases of these objects.

This chapter begins in Section 1 by defining polynomial and series spaces on collections. Then, in Section 2, we introduce biproducts, bialgebras, and list some examples of such algebraic structures. Finally, in Sections 3, 4, and 5, we provide the mains definitions and properties of Hopf bialgebras, operads, and pros used in the next chapters.

## 1. Polynomial spaces

We introduce here the notion of polynomial spaces and series spaces. All the algebraic structures considered in this dissertation are polynomial or series spaces endowed with some operations or co-operations. A set of operations, analogous to the operations on graded collections of Section 1.1.5 of Chapter 1, over graded polynomial spaces are considered. We also review some links between changes of bases of polynomial spaces, posets, and incidence algebras.

**1.1. Series and polynomials on collections.** Intuitively, a series (resp. polynomial) on a collection  $C$  is a formal sum (resp. finite formal sum) of objects of the  $C$  with coefficients in a field  $\mathbb{K}$ . In what follows,  $\mathbb{K}$  can be any field of characteristic 0.

**1.1.1. Rational functions.** In a combinatorial context, it is nevertheless convenient to set  $\mathbb{K}$  as the space  $\mathbb{Q}(q_0, q_1, \dots)$  of *rational functions* on the formal parameters  $q_i$ ,  $i \in \mathbb{N}$ . Let us recall some classical notations. For any  $i \in \mathbb{N}$ ,

$$(n)_{q_i} := 1 + q_i + q_i^2 + \dots + q_i^{n-1}, \quad n \in \mathbb{N}_{\geq 1}, \quad (1.1.1a)$$

$$(n)_{q_i}! := \begin{cases} 1 & \text{if } n = 0, \\ (n)_{q_i} ((n-1)_{q_i})! & \text{otherwise } (n \in \mathbb{N}_{\geq 1}), \end{cases} \quad (1.1.1b)$$

$$\binom{n_1 + n_2}{n_1, n_2}_{q_i} := \frac{(n_1 + n_2)_{q_i}!}{(n_1)_{q_i}! (n_2)_{q_i}!}, \quad n_1, n_2 \in \mathbb{N}. \quad (1.1.1c)$$

Elements (1.1.1a) are known as *q-analogs* of integers. Indeed, the specialization  $q_i := 1$  in  $(n)_{q_i}$  is equal to  $n$ . Elements (1.1.1b) are *q-factorials* and (1.1.1c) are *q-binomials*.

**1.1.2. Series and polynomials.** Let  $C$  be an  $I$ -collection. A *series* on  $C$  (or, for short, a *C-series*) is a map  $f : C \rightarrow \mathbb{K}$ . The *coefficient*  $f(x)$  of  $x \in C$  in  $f$  is denoted by  $\langle x, f \rangle$ . The *support* of  $f$  is the set

$$\text{Supp}(f) := \{x \in C : \langle x, f \rangle \neq 0\}, \quad (1.1.2)$$

where the symbol 0 of (1.1.2) is the zero of  $\mathbb{K}$ . A *polynomial* on  $C$  (or, for short, a *C-polynomial*) is a  $C$ -series having a finite support. A  $C$ -series  $f$  is a *C-monomial* if  $\text{Supp}(f)$  is a singleton. We say that  $f$  is *homogeneous* if there is an  $i \in I$  such that  $\text{Supp}(f) \subseteq C(i)$ . For any subset  $X$  of  $C$ , the *characteristic series* of  $X$  is the  $C$ -series  $\text{ch}(X)$  defined, for any  $x \in C$ , by

$$\langle x, \text{ch}(X) \rangle := \begin{cases} 1 \in \mathbb{K} & \text{if } x \in X, \\ 0 \in \mathbb{K} & \text{otherwise.} \end{cases} \quad (1.1.3)$$

Given two  $C$ -series  $f$  and  $g$ , the *scalar product* of  $f$  and  $g$  is the scalar

$$\langle f, g \rangle := \sum_{x \in C} \langle x, f \rangle \langle x, g \rangle \quad (1.1.4)$$

of  $\mathbb{K}$ . Of course, when  $f$  or  $g$  are  $C$ -polynomials,  $\langle f, g \rangle$  is well-defined. When  $f$  and  $g$  are both  $C$ -series,  $\langle f, g \rangle$  may not. This notation for the scalar product of  $C$ -series is consistent with the notation  $\langle x, f \rangle$  for the coefficient of  $x$  in  $f$  because by (1.1.4), the coefficient  $\langle x, f \rangle$  and the scalar product  $\langle \text{ch}(\{x\}), f \rangle$  are equal.

When  $C$  is a graded collection and  $f$  is a  $C$ -polynomial, the *degree*  $\deg(f)$  of  $f$  is undefined if  $\text{Supp}(f) = \emptyset$  and is otherwise the greatest size of an object appearing in  $\text{Supp}(f)$ .

1.1.3. *Polynomial spaces.* The  *$C$ -polynomial space* is the set  $\mathbb{K}\langle C \rangle$  of all the  $C$ -polynomials. We say that  $C$  is the *underlying collection* of  $\mathbb{K}\langle C \rangle$ . For any property  $P$  of collections (see Section 1 of Chapter 1), we say that  $\mathbb{K}\langle C \rangle$  *satisfies the property  $P$*  if  $C$  satisfies  $P$ . This set  $\mathbb{K}\langle C \rangle$  is endowed with the following two operations. First, the *addition*

$$+ : \mathbb{K}\langle C \rangle \times \mathbb{K}\langle C \rangle \rightarrow \mathbb{K}\langle C \rangle \quad (1.1.5)$$

is defined, for any  $f_1, f_2 \in \mathbb{K}\langle C \rangle$  and  $x \in C$ , by

$$\langle x, f_1 + f_2 \rangle := \langle x, f_1 \rangle + \langle x, f_2 \rangle. \quad (1.1.6)$$

Second, the *multiplication by a scalar*

$$\cdot : \mathbb{K} \times \mathbb{K}\langle C \rangle \rightarrow \mathbb{K}\langle C \rangle \quad (1.1.7)$$

is defined, for any  $f \in \mathbb{K}\langle C \rangle$ ,  $\lambda \in \mathbb{K}$ , and  $x \in C$ , by

$$\langle x, \lambda \cdot f \rangle = \lambda \langle x, f \rangle. \quad (1.1.8)$$

Endowed with these two operations,  $\mathbb{K}\langle C \rangle$  is a  $\mathbb{K}$ -vector space. Moreover,  $\mathbb{K}\langle C \rangle$  decomposes as a direct sum

$$\mathbb{K}\langle C \rangle = \bigoplus_{i \in I} \mathbb{K}\langle C(i) \rangle. \quad (1.1.9)$$

We call each  $\mathbb{K}\langle C(i) \rangle$  the  *$i$ -homogeneous component* of  $\mathbb{K}\langle C \rangle$ . In the sequel, we shall also write  $\mathbb{K}\langle C \rangle(i)$  for  $\mathbb{K}\langle C(i) \rangle$ .

Besides, by using the linear structure of  $\mathbb{K}\langle C \rangle$ , any  $C$ -polynomial  $f$  can be expressed as the finite sum of  $C$ -monomials

$$f = \sum_{x \in C} \langle x, f \rangle \cdot \text{ch}(\{x\}), \quad (1.1.10)$$

which is denoted, by a slight abuse of notation, by

$$f = \sum_{x \in C} \langle x, f \rangle x. \quad (1.1.11)$$

The notation (1.1.11) for  $f$  as a linear combination of objects of  $C$  is the *sum notation* of  $C$ -polynomials. By using this notation, it appears that the set  $\{\text{ch}(\{x\}) : x \in C\}$  forms a basis of  $\mathbb{K}\langle C \rangle$ . This basis is called *fundamental basis* of  $\mathbb{K}\langle C \rangle$ , and, by a slight but convenient abuse of notations, each basis element  $\text{ch}(\{x\})$ ,  $x \in C$ , is simply denoted by  $x$ .

We would like to emphasize the fact a polynomial space  $\mathbb{K}\langle C \rangle$  is always seen through its explicit basis  $C$  (contrarily to working with a vector space  $\mathcal{V}$  without explicit basis). In the sequel, we shall define (co-)operations on  $C$  which extend by linearity on  $\mathbb{K}\langle C \rangle$ . Properties of such (co-)operations (like associativity or commutativity) can be defined and checked only on  $C$ .

Besides, we are sometimes led to consider several bases of  $\mathbb{K}\langle C \rangle$  and work with many of them at the same time. In this case, to distinguish elements expressed on different bases, we denote them by putting elements of  $C$  as indices of a letter naming the basis. For instance, the elements of the B-basis of  $\mathbb{K}\langle C \rangle$  are denoted by  $B_x$ ,  $x \in C$ .

Let  $\mathbb{K}\langle C_1 \rangle$  and  $\mathbb{K}\langle C_2 \rangle$  be two polynomial spaces such that  $C_1$  and  $C_2$  are both  $I$ -collections. A linear map

$$\phi : \mathbb{K}\langle C_1 \rangle \rightarrow \mathbb{K}\langle C_2 \rangle \quad (1.1.12)$$

is a *polynomial space morphism* if for all  $i \in I$  and all  $x \in C_1(i)$ ,  $\phi(x) \in \mathbb{K}\langle C_2(i) \rangle$ . Observe that any combinatorial collection morphism  $\psi : C_1 \rightarrow C_2$  gives rise to a polynomial space morphism  $\phi : \mathbb{K}\langle C_1 \rangle \rightarrow \mathbb{K}\langle C_2 \rangle$  obtained by extending  $\psi$  linearly. Besides, we say that  $\mathbb{K}\langle C_2 \rangle$  is a *subspace* of  $\mathbb{K}\langle C_1 \rangle$  if there is an injective polynomial space morphism from  $\mathbb{K}\langle C_2 \rangle$  to  $\mathbb{K}\langle C_1 \rangle$ .

**1.1.4. Graded combinatorial polynomial spaces.** When  $C$  is a graded combinatorial collection, as a particular case of (1.1.9),  $\mathbb{K}\langle C \rangle$  decomposes as a direct sum

$$\mathbb{K}\langle C \rangle = \bigoplus_{n \in \mathbb{N}} \mathbb{K}\langle C \rangle(n). \quad (1.1.13)$$

Moreover, since  $C$  is combinatorial, each  $\mathbb{K}\langle C(n) \rangle$ ,  $n \in \mathbb{N}$ , is finite dimensional. For this reason, the *Hilbert series* of  $\mathbb{K}\langle C \rangle$ , defined by

$$\mathcal{H}_{\mathbb{K}\langle C \rangle}(t) = \sum_{n \in \mathbb{N}} \dim \mathbb{K}\langle C \rangle(n) t^n, \quad (1.1.14)$$

is a well-defined series. We can observe that the Hilbert series  $\mathcal{H}_{\mathbb{K}\langle C \rangle}(t)$  of  $\mathbb{K}\langle C \rangle$  and the generating series  $\mathcal{G}_C(t)$  of  $C$  are the same power series.

**1.1.5. Duality.** The *dual* of  $\mathbb{K}\langle C \rangle$  is the  $\mathbb{K}$ -vector space  $\mathbb{K}\langle C \rangle^*$  defined by

$$\mathbb{K}\langle C \rangle^* := \bigoplus_{i \in I} \mathbb{K}\langle C \rangle(i)^*, \quad (1.1.15)$$

where for any  $i \in I$ ,  $\mathbb{K}\langle C \rangle(i)^*$  is the dual space of  $\mathbb{K}\langle C \rangle(i)$ . If  $C$  is combinatorial, all  $\mathbb{K}\langle C \rangle(i)$  are finite dimensional spaces, so that  $\mathbb{K}\langle C \rangle(i)^* \simeq \mathbb{K}\langle C \rangle(i)$ , and hence,

$$\mathbb{K}\langle C \rangle^* \simeq \mathbb{K}\langle C \rangle. \quad (1.1.16)$$

For this reason, we shall identify  $\mathbb{K}\langle C \rangle$  and  $\mathbb{K}\langle C \rangle^*$  in this work once  $C$  is combinatorial. The *duality bracket* between  $\mathbb{K}\langle C \rangle$  and  $\mathbb{K}\langle C \rangle^*$  is the linear map

$$\langle -, - \rangle : \mathbb{K}\langle C \rangle \otimes \mathbb{K}\langle C \rangle^* \rightarrow \mathbb{K} \quad (1.1.17)$$

defined, for all  $x, x' \in C$ , by

$$\langle x, x' \rangle := \begin{cases} 1 & \text{if } x = x', \\ 0 & \text{otherwise.} \end{cases} \quad (1.1.18)$$

If  $\mathcal{V}$  is a  $\mathbb{K}$ -vector space,  $\mathcal{V}^{\otimes k}$  denotes the space of all tensors on  $\mathcal{V}$  of order  $k \in \mathbb{N}$ . The duality bracket extends for any  $k \in \mathbb{N}$  on  $\mathbb{K}\langle C \rangle^{\otimes k} \otimes \mathbb{K}\langle C \rangle^{*\otimes k}$  linearly by

$$\langle x_1 \otimes \cdots \otimes x_k, x'_1 \otimes \cdots \otimes x'_k \rangle := \prod_{i \in [k]} \langle x_i, x'_i \rangle \quad (1.1.19)$$

for any  $x_i, x'_i \in C$ ,  $i \in [k]$ .

**1.1.6. Rewrite systems and quotient spaces.** Any rewrite system  $(C, \Rightarrow)$  gives rise to a subspace  $\mathcal{R}_{(C, \Rightarrow)}$  of  $\mathbb{K}\langle C \rangle$  generated by all the  $C$ -polynomials  $x' - x$  whenever  $x$  and  $x'$  are two objects of  $C$  such that  $x \Rightarrow x'$ . We call  $\mathcal{R}_{(C, \Rightarrow)}$  the *space induced* by  $(C, \Rightarrow)$ . Conversely, when  $\mathcal{R}$  is a subspace of  $\mathbb{K}\langle C \rangle$  such that there exists a rewrite system  $(C, \Rightarrow)$  such that  $\mathcal{R}$  and  $\mathcal{R}_{(C, \Rightarrow)}$  are isomorphic, we say that  $(C, \Rightarrow)$  is an *orientation* of  $\mathcal{R}$ . When  $(C, \Rightarrow)$  is convergent, one has a concrete description of the quotient space  $\mathbb{K}\langle C \rangle /_{\mathcal{R}_{(C, \Rightarrow)}}$  provided by the following result.

**PROPOSITION 1.1.1.** *Let  $(C, \Rightarrow)$  be a convergent rewrite system. Then, as spaces*

$$\mathbb{K}\langle C \rangle /_{\mathcal{R}_{(C, \Rightarrow)}} \simeq \mathbb{K}\langle \mathcal{F}_{(C, \Rightarrow)} \rangle. \quad (1.1.20)$$

**PROOF.** First, observe that since  $(C, \Rightarrow)$  is convergent,  $(C, \Rightarrow)$  is terminating and admits a set  $\mathcal{F}_{(C, \Rightarrow)}$  of normal forms. Moreover, since  $(C, \Rightarrow)$  is confluent, for any object  $x$  of  $C$ , there is a unique normal form  $\eta(x)$  such that  $x \xrightarrow{*} \eta(x)$ . Let  $\mathcal{V}$  be the subspace of  $\mathbb{K}\langle C \rangle$  generated by all the  $C$ -polynomials  $\eta(x) - x$  such that  $x \in C$ , and let us show that  $\mathcal{R}_{(C, \Rightarrow)}$  is isomorphic to  $\mathcal{V}$ . Let  $y - x$  be an element of  $\mathcal{R}_{(C, \Rightarrow)}$  such that  $x, y \in C$  and  $x \Rightarrow y$ . Then,  $\eta(y) - y$  and  $\eta(x) - x$  are elements of  $\mathcal{V}$ . Now, since  $x \Rightarrow y$  and  $(C, \Rightarrow)$  is confluent, the two normal forms  $\eta(x)$  and  $\eta(y)$  are equal. This implies that  $\eta(x) - x - (\eta(y) - y) = y - x$ , showing that  $y - x \in \mathcal{V}$ . By linearity, this implies that  $\mathcal{R}_{(C, \Rightarrow)}$  is a subspace of  $\mathcal{V}$ . Conversely, let  $\eta(x) - x$  be a nonzero element of  $\mathcal{V}$  where  $x \in C$ . By definition, there is a chain  $x \Rightarrow y_1 \Rightarrow \cdots \Rightarrow y_k \Rightarrow \eta(x)$  with  $k \in \mathbb{N}$  and  $y_i \in C$ ,  $i \in [k]$ . Hence, the  $C$ -polynomials  $\eta(x) - y_k, y_k - y_{k-1}, \dots, y_2 - y_1, y_1 - x$  belong to  $\mathcal{R}_{(C, \Rightarrow)}$ . By summing all these  $C$ -polynomials, we obtain that  $\eta(x) - x$  belongs to  $\mathcal{R}_{(C, \Rightarrow)}$ . By linearity, this implies that  $\mathcal{V}$  is a subspace of  $\mathcal{R}_{(C, \Rightarrow)}$ . Now, let  $B$  be the family of all the  $C$ -polynomials of the form  $\eta(x) - x$  where  $x$  is an object of  $C$  which is not a normal form for  $(C, \Rightarrow)$  (otherwise, the polynomial would be zero). Since all the elements of  $B$  are linearly independent,  $B$  is a basis of  $\mathcal{V}$ . Hence, the linear map  $\phi : \mathcal{V} \rightarrow \mathcal{V}$  satisfying  $\phi(\eta(x) - x) := x$  for all  $x \in C \setminus \mathcal{F}_{(C, \Rightarrow)}$  is an isomorphism. This shows that  $\mathcal{R}_{(C, \Rightarrow)}$  is isomorphic to  $\mathbb{K}\langle C \setminus \mathcal{F}_{(C, \Rightarrow)} \rangle$ . The statement of the proposition follows.  $\square$

**1.1.7. Series spaces.** The *C-series space* is the set  $\mathbb{K}\langle\langle C \rangle\rangle$  of all  $C$ -series. Most of the definitions concerning  $C$ -polynomials and  $C$ -polynomial spaces developed in Section 1.1.3 remain valid in the context of  $C$ -series. For instance,  $\mathbb{K}\langle\langle C \rangle\rangle$  is a vector space (for the similar operations of addition and multiplication by a scalar as the ones of  $C$ -polynomials) and each element of  $\mathbb{K}\langle\langle C \rangle\rangle$  can be expressed by a sum notation (1.1.11), which is possibly infinite. One of the main differences of features between  $\mathbb{K}\langle C \rangle$  and  $\mathbb{K}\langle\langle C \rangle\rangle$  is that the first one admits  $C$  as a basis, while the second does not.

Observe that a generating series of a combinatorial graded collection is an element of  $\mathbb{K}\langle\langle S(\{t\})\rangle\rangle$ , where  $\{t\}$  is the graded collection wherein  $t$  is an atomic object and  $S$  is multiset operation over graded collections (see Sections 1.1.2 and 1.1.6 of Chapter 1). Since the introduction of formal power series, a lot of generalizations were proposed in order to extend the range of enumerative problems they can help to solve.

The most obvious ones are multivariate series allowing to count objects not only with respect to their sizes but also with respect to various other statistics. This encompasses the case of the generating series of combinatorial multigraded collections (see Section 1.1.3 of Chapter 1). Such series are elements of  $\mathbb{K}\langle\langle S(\{t_1, \dots, t_k\})\rangle\rangle$  where all the  $t_i$ ,  $i \in [k]$ , are atomic objects. Another one consists in considering noncommutative series on words [Eil74, SS78, BR10] (and hence, elements of  $\mathbb{K}\langle\langle A^*\rangle\rangle$ , where  $A$  is an alphabet), or even, pushing the generalization one step further, on elements of a monoid [Sak09] (and hence, elements of  $\mathbb{K}\langle\langle \mathcal{M}\rangle\rangle$  where  $\mathcal{M}$  is a monoid). Besides, as another generalization, series on trees have been considered [BR82, Boz01]. Series on operads (see Section 4.1 about these algebraic structures) increase the list of these generalizations. Chapoton is the first to have considered such series on operads [Cha02, Cha08, Cha09]. Several authors have contributed to this field by considering slight variations in the definitions of these series. Among these, one can cite van der Laan [vdL04], Frabetti [Fra08], and Loday and Nikolov [LN13].

**1.2. Operations over graded polynomial spaces.** In the same way as operations over graded collections allow to create new graded collections from already existing ones, there exist operations over graded polynomial spaces. Some of these are consequences of the definitions of operations over graded collections. We present here the main ones. In what follows,  $\mathbb{K}\langle C \rangle$ ,  $\mathbb{K}\langle C_1 \rangle$  and  $\mathbb{K}\langle C_2 \rangle$  are three graded polynomial spaces.

**1.2.1. Direct sum.** The sum of two graded collections translates as the direct sum of the associated graded polynomial spaces. Indeed,

$$\mathbb{K}\langle C_1 + C_2 \rangle \simeq \mathbb{K}\langle C_1 \rangle \oplus \mathbb{K}\langle C_2 \rangle. \quad (1.2.1)$$

An isomorphism between the two spaces of (1.2.1) is provided by the map  $\phi : \mathbb{K}\langle C_1 + C_2 \rangle \rightarrow \mathbb{K}\langle C_1 \rangle \oplus \mathbb{K}\langle C_2 \rangle$ , linearly defined for any  $x \in C_1 + C_2$  by

$$\phi(x) := \begin{cases} x \in \mathbb{K}\langle C_1 \rangle & \text{if } x \in C_1, \\ x \in \mathbb{K}\langle C_2 \rangle & \text{otherwise } (x \in C_2). \end{cases} \quad (1.2.2)$$

**1.2.2. Tensor product.** The product of two graded collections translates as the tensor product of the associated graded polynomial spaces. Indeed

$$\mathbb{K}\langle C_1 \times C_2 \rangle \simeq \mathbb{K}\langle C_1 \rangle \otimes \mathbb{K}\langle C_2 \rangle. \quad (1.2.3)$$

An isomorphism between the two spaces of (1.2.3) is provided by the map  $\phi : \mathbb{K}\langle C_1 \times C_2 \rangle \rightarrow \mathbb{K}\langle C_1 \rangle \otimes \mathbb{K}\langle C_2 \rangle$ , linearly defined for any  $(x_1, x_2) \in C_1 \times C_2$  by

$$\phi((x_1, x_2)) := x_1 \otimes x_2. \quad (1.2.4)$$

1.2.3. *Tensor algebras.* If  $\mathcal{V}$  is a  $\mathbb{K}$ -vector space, the *tensor algebra* of  $\mathcal{V}$  is the space  $T\mathcal{V}$  defined by

$$T\mathcal{V} := \bigoplus_{k \in \mathbb{N}} \mathcal{V}^{\otimes k}. \quad (1.2.5)$$

A basis of  $T\mathcal{V}$  is formed by all tensors on any basis of  $\mathcal{V}$ . The list operation applied to a graded collection translates as the tensor algebra of the associated graded polynomial space. Indeed, for any  $k \geq 0$ ,

$$\mathbb{K}\langle T_k(C) \rangle \simeq \mathbb{K}\langle C \rangle^{\otimes k} \quad (1.2.6)$$

and

$$\mathbb{K}\langle T(C) \rangle \simeq T\mathbb{K}\langle C \rangle. \quad (1.2.7)$$

An isomorphism between the two spaces of (1.2.7) is provided by the map  $\phi : \mathbb{K}\langle T(C) \rangle \rightarrow T\mathbb{K}\langle C \rangle$ , linearly defined for any  $(x_1, \dots, x_k) \in T(C)$  by

$$\phi((x_1, \dots, x_k)) := x_1 \otimes \cdots \otimes x_k. \quad (1.2.8)$$

1.2.4. *Symmetric algebras.* If  $\mathcal{V}$  is a  $\mathbb{K}$ -vector space, the *symmetric algebra* of  $\mathcal{V}$  is the space  $S\mathcal{V}$  defined by

$$S\mathcal{V} := T\mathcal{V}/\mathcal{V}_S, \quad (1.2.9)$$

where  $\mathcal{V}_S$  is the subspace of  $T\mathbb{K}\langle C \rangle$  consisting in all the tensors

$$u \otimes x_1 \otimes x_2 \otimes v - u \otimes x_2 \otimes x_1 \otimes v, \quad (1.2.10)$$

where  $u, v \in T\mathcal{V}$  and  $x_1, x_2 \in \mathcal{V}$ . A basis of  $S\mathcal{V}$  is formed by all monomials on any basis of  $\mathcal{V}$ . The multiset operation applied to a graded collection translates as the symmetric algebra of the associated graded polynomial space. Indeed,

$$\mathbb{K}\langle S(C) \rangle \simeq S\mathbb{K}\langle C \rangle. \quad (1.2.11)$$

An isomorphism between the two spaces of (1.2.11) is provided by the map  $\phi : \mathbb{K}\langle S(C) \rangle \rightarrow S\mathbb{K}\langle C \rangle$ , linearly defined for any  $\{x_1, \dots, x_k\} \in S(C)$  by

$$\phi(\{x_1, \dots, x_k\}) := y_1^{\alpha_1} \cdots y_\ell^{\alpha_\ell}, \quad (1.2.12)$$

where  $\ell$  is the number of distinct elements of  $\{x_1, \dots, x_k\}$  and each  $\alpha_i$ ,  $i \in [\ell]$ , denotes the multiplicity of  $y_i$  in  $\{x_1, \dots, x_k\}$ .

1.2.5. *Exterior algebras.* If  $\mathcal{V}$  is a  $\mathbb{K}$ -vector space, the *exterior algebra* of  $\mathcal{V}$  is the space  $E\mathcal{V}$  defined by

$$E\mathcal{V} := T\mathcal{V}/\mathcal{V}_E, \quad (1.2.13)$$

where  $\mathcal{V}_E$  is the subspace of  $T\mathcal{V}$  consisting in all the tensors

$$u \otimes x_1 \otimes x_2 \otimes v + u \otimes x_2 \otimes x_1 \otimes v, \quad (1.2.14)$$

where  $u, v \in T\mathcal{V}$  and  $x_1, x_2 \in \mathcal{V}$ . A basis of  $E\mathcal{V}$  is formed by all monomials on a basis of  $\mathcal{V}$  without repeated variables. The set operation applied to a graded collection translates as the exterior algebra of the associated graded polynomial space. Indeed,

$$\mathbb{K}\langle E(C) \rangle \simeq E\mathbb{K}\langle C \rangle. \quad (1.2.15)$$



An isomorphism between the two spaces of (1.2.15) is provided by the map  $\phi : \mathbb{K}\langle E(C) \rangle \rightarrow \mathbb{E}\mathbb{K}\langle C \rangle$ , linearly defined for any  $\{x_1, \dots, x_k\} \in E(C)$  by

$$\phi(\{x_1, \dots, x_k\}) := x_1 \dots x_k. \quad (1.2.16)$$

**1.3. Changes of basis and posets.** It is very usual, given a polynomial space  $\mathbb{K}\langle C \rangle$ , to consider a poset structure on  $C$  to define new bases of  $\mathbb{K}\langle C \rangle$ . Indeed, such new bases are defined by considering sums of elements greater (or smaller) than other ones. In this context, incidence algebras of posets and their Möbius functions play an important role. We expose here these concepts.

**1.3.1. Incidence algebras.** One of the first apparitions of incidence algebras in combinatorics is due to Rota [Rot64]. These structures, associated with any locally finite poset, provide an abstraction of the principle of inclusion-exclusion [Sta11] through their Möbius functions. Indeed, the usual inclusion-exclusion principle comes from the Möbius function of the cube poset.

Let  $(Q, \preceq)$  be a locally finite  $I$ -poset and  $\mathcal{G}^Q$  be the  $I$ -collection of all the ordered pairs  $(x, y)$  of objects of  $Q$  such that  $x \preceq y$ , called *pairs of comparable objects*. The index of  $(x, y)$  is the index of  $x$  in  $Q$  (or equivalently, the index of  $y$  in  $Q$ ). The *incidence algebra* of  $(Q, \preceq)$  is the polynomial space  $\mathbb{K}\langle \mathcal{G}^Q \rangle$  endowed with the linear binary product  $\star$  (the notion of products in polynomial spaces is presented in the following Section 2 but here, only elementary notions about these are needed) defined, for any objects  $(x, y)$  and  $(x', y')$  of  $\mathcal{G}^Q$  by

$$(x, y) \star (x', y') := \begin{cases} (x, y') & \text{if } y = x', \\ 0 & \text{otherwise.} \end{cases} \quad (1.3.1)$$

This product is obviously associative. Moreover, on each  $i$ -homogeneous component of  $\mathbb{K}\langle \mathcal{G}^Q \rangle$ ,  $i \in I$ , the  $\mathcal{G}^Q$ -polynomial

$$\mathbb{1}_i := \sum_{x \in C(i)} (x, x) \quad (1.3.2)$$

plays the role of a unit, that is,  $f \star \mathbb{1}_i = f = \mathbb{1}_i \star f$  for all  $f \in \mathbb{K}\langle \mathcal{G}^Q \rangle(i)$ . Let for any  $i \in I$  the  $\mathcal{G}^Q$ -polynomial  $\zeta_i$ , called  *$i$ -zeta polynomial* of  $(Q, \preceq)$ , defined by

$$\zeta_i := \sum_{\substack{x, y \in C(i) \\ x \preceq y}} (x, y). \quad (1.3.3)$$

This  $\mathcal{G}^Q$ -polynomial encodes some properties of the order  $\preceq$ . For instance, the coefficient in  $\zeta_i \star \zeta_i$  of each  $(x, y) \in \mathcal{G}^Q(i)$  is the cardinality of the interval  $[x, y]$  in  $(Q, \preceq)$ . The  *$i$ -Möbius polynomial* of  $(Q, \preceq)$  is the  $\mathcal{G}^Q$ -polynomial  $\mu_i$  satisfying

$$\mu_i \star \zeta_i = \mathbb{1}_i = \zeta_i \star \mu_i. \quad (1.3.4)$$

In other words,  $\mu_i$  is the inverse of  $\zeta_i$  with respect to the product  $\star$ . Recall that, as exposed in Section 1.1.2, polynomials on collections are functions associating a coefficient with any object. For this reason,  $\zeta_i$  and  $\mu_i$  are functions associating a coefficient with any pair of comparable objects of  $Q$ . We have presented the elements of incidence algebras as polynomials of pairs of comparable elements, but in the literature [Sta11], it is most common to see these elements as maps associating a coefficient with each pair of comparable elements. These

two points of view are therefore equivalent but the definition of the product of incidence algebras in terms of polynomials is simpler.

**THEOREM 1.3.1.** *Let  $(Q, \preceq)$  be a locally finite  $I$ -poset. Then, the  $i$ -Möbius polynomial  $\mu_i$ ,  $i \in I$ , of  $(Q, \preceq)$  is a well-defined element of  $\mathbb{K}\langle \mathcal{G}^Q \rangle$  and its coefficients satisfy  $\langle (x, x), \mu_i \rangle = 1$  for all  $x \in Q(i)$ , and*

$$\langle (x, z), \mu_i \rangle = - \sum_{\substack{y \in Q(i) \\ x \preceq y \prec z}} \langle (x, y), \mu_i \rangle \quad (1.3.5)$$

for all  $x, z \in C(i)$  such that  $x \neq z$ .

**PROOF.** Let  $f$  be a  $\mathcal{G}^Q$ -polynomial satisfying  $f \star \zeta_i = 1_i$ . By using the definitions of  $\star$  and of  $\zeta_i$ , we obtain

$$\sum_{\substack{x, y, z \in Q(i) \\ x \preceq y \preceq z}} \langle (x, y), f \rangle \langle (x, z) = \sum_{x \in Q(i)} \langle (x, x) \rangle. \quad (1.3.6)$$

This leads to the fact that  $\langle (x, x), f \rangle = 1$  for all  $x \in Q(i)$ , and, for all  $x, z \in Q(i)$  such that  $x \neq z$ ,

$$\sum_{\substack{y \in Q(i) \\ x \preceq y \prec z}} \langle (x, y), f \rangle = 0. \quad (1.3.7)$$

Then, (1.3.7) rewrites as

$$\langle (x, z), f \rangle + \sum_{\substack{y \in Q(i) \\ x \preceq y \prec z}} \langle (x, y), f \rangle = 0. \quad (1.3.8)$$

Moreover, in the same way, one can prove that if  $f'$  is a  $\mathcal{G}^Q$ -polynomial satisfying  $\zeta_i \star f' = 1_i$ , the coefficients of  $f'$  satisfy the same relations as the ones of  $f$ . Recall now that in any algebraic structure endowed with a unitary and associative product, if an element has an inverse, it is unique. For this reason,  $\mu_i = f$ . Hence, (1.3.8) implies that the coefficients of  $\mu_i$  satisfy (1.3.5). Finally, since all coefficients appearing in  $\mu_i$  are well-defined,  $\mu_i$  is a well-defined  $\mathcal{G}^Q$ -polynomial.  $\square$

Theorem 1.3.1 provides a recursive way to compute the coefficients of  $\mu_i$ ,  $i \in I$ , as a consequence of the finiteness of each interval of  $Q(i)$ .

**1.3.2. Changes of basis.** Let  $C$  be a combinatorial  $I$ -collection and  $\preceq$  be a partial order relation on  $C$  such that  $(C, \preceq)$  is an  $I$ -poset. Consider the family

$$\{B_x^{\preceq}, x \in C\} \quad (1.3.9)$$

of elements of  $\mathbb{K}\langle C \rangle$  defined, from the fundamental basis of  $\mathbb{K}\langle C \rangle$ , by

$$B_x^{\preceq} := \sum_{\substack{y \in C \\ x \preceq y}} y. \quad (1.3.10)$$

Observe that since  $C$  is combinatorial and  $\preceq$  preserves the indices of the objects of  $C$ , each  $B_x^{\preceq}$  is a homogeneous  $C$ -polynomial. We call the family (1.3.9) the  **$B^{\preceq}$ -family** of  $\mathbb{K}\langle C \rangle$ .

PROPOSITION 1.3.2. Let  $(C, \preccurlyeq)$  be a combinatorial  $I$ -poset. The  $B^{\preccurlyeq}$ -family forms a basis of  $\mathbb{K}\langle C \rangle$  and

$$x = \sum_{\substack{y \in C \\ x \preccurlyeq y}} \langle (x, y), \mu_i \rangle B_y^{\preccurlyeq} \quad (1.3.11)$$

for all  $x \in C(i)$ ,  $i \in I$ , where  $\mu_i$  is the  $i$ -Möbius polynomial of  $(C, \preccurlyeq)$ .

PROOF. Let us compute the right member of (1.3.11) by using (1.3.10). Then, for any  $x \in C(i)$ ,  $i \in I$ , by using the relations satisfied by the coefficients of  $\mu_i$  provided by Theorem 1.3.1, we obtain

$$\begin{aligned} \sum_{\substack{y \in C \\ x \preccurlyeq y}} \langle (x, y), \mu_i \rangle B_y^{\preccurlyeq} &= \sum_{\substack{y \in C \\ x \preccurlyeq y}} \langle (x, y), \mu_i \rangle \sum_{\substack{z \in C \\ y \preccurlyeq z}} z \\ &= \sum_{\substack{z \in C \\ x \preccurlyeq z}} \left( \sum_{\substack{y \in C \\ x \preccurlyeq y \preccurlyeq z}} \langle (x, y), \mu_i \rangle \right) z \\ &= \langle (x, x), \mu_i \rangle x + \sum_{\substack{z \in C \\ x \prec z}} \left( \sum_{\substack{y \in C \\ x \preccurlyeq y \preccurlyeq z}} \langle (x, y), \mu_i \rangle \right) z \\ &= x + 0. \end{aligned} \quad (1.3.12)$$

Therefore, (1.3.11) holds. Finally, since  $C$  is a basis of  $\mathbb{K}\langle C \rangle$  and, as we have shown, any  $x \in C$  can be expressed as a linear combination of elements of the  $B^{\preccurlyeq}$ -family, this family is a basis of  $\mathbb{K}\langle C \rangle$ .  $\square$

## 2. Bialgebras

Bialgebras are polynomial spaces endowed with operations. These operations are very general in the sense that they can have several inputs and outputs. These structures encompass all the algebraic structures seen in this work.

**2.1. Biproducts and duality.** Polynomial spaces are rather poor algebraic structures. It is usual in combinatorics to handle spaces endowed with several products. When the products are compatible with the sizes of the underlying combinatorial objects, all this form a graded algebra. This notion is detailed here, as well as the concepts of coproduct, duality, and coalgebras and bialgebras.

2.1.1. *Biproducts.* Let  $C$  be an  $I$ -collection. A *biproduct* on  $\mathbb{K}\langle C \rangle$  is a linear map

$$\square : \mathbb{K}\langle C \rangle^{\otimes p} \rightarrow \mathbb{K}\langle C \rangle^{\otimes q} \quad (2.1.1)$$

where  $p, q \in \mathbb{N}$ . The *arity* (resp. *coarity*) of  $\square$  is  $p$  (resp.  $q$ ). Any biproduct of arity  $p$  and coarity  $q$  can be seen as an operation taking  $p$  elements of  $\mathbb{K}\langle C \rangle$  as input and outputting

$q$  elements of  $\mathbb{K}\langle C \rangle$ . This biproduct is depicted by a rectangle labeled by its name, with  $p$  incoming edges (below the rectangle) and  $q$  outgoing edges (above the rectangle) as

$$\begin{array}{c} \dots \\ \diagup \quad \diagdown \\ \square \\ \diagdown \quad \diagup \\ \dots \end{array} \cdot \quad (2.1.2)$$

Under a concrete point of view, given any objects  $x_1, \dots, x_p$  of  $C$ ,

$$\square(x_1 \otimes \dots \otimes x_p) = \sum_{y_1, \dots, y_q \in C} \xi_{\square}^{(x_1 \otimes \dots \otimes x_p, y_1 \otimes \dots \otimes y_q)} y_1 \otimes \dots \otimes y_q, \quad (2.1.3)$$

where the  $\xi_{\square}^{(x_1 \otimes \dots \otimes x_p, y_1 \otimes \dots \otimes y_q)}$  are coefficients of  $\mathbb{K}$ . These coefficients are called *structure coefficients* of  $\square$  and wholly determine the behavior of  $\square$ . We say that  $\square$  is *degenerate* if all its structure coefficients are zero.

The set of all the biproducts of arity  $p$  and coarity  $q$  on  $\mathbb{K}\langle C \rangle$  has a structure of a  $\mathbb{K}$ -vector space. Indeed, if  $\square_1$  and  $\square_2$  are two such biproducts, the *addition* of  $\square_1$  and  $\square_2$  is the biproduct  $\square_1 + \square_2$  defined by

$$(\square_1 + \square_2)(x_1 \otimes \dots \otimes x_p) := \square_1(x_1 \otimes \dots \otimes x_p) + \square_2(x_1 \otimes \dots \otimes x_p) \quad (2.1.4)$$

for any objects  $x_1, \dots, x_p$  of  $C$ . Moreover, for any coefficient  $\lambda \in \mathbb{K}$ , if  $\square$  is such a biproduct, the *multiplication by a scalar* of  $\square$  by  $\lambda$  is the biproduct  $\lambda\square$  defined by

$$(\lambda\square)(x_1 \otimes \dots \otimes x_p) := \lambda\square(x_1 \otimes \dots \otimes x_p) \quad (2.1.5)$$

for any objects  $x_1, \dots, x_p$  of  $C$ .

**2.1.2. Dual biproducts.** Assume that  $C$  is combinatorial so that we can identify  $\mathbb{K}\langle C \rangle$  with its dual  $\mathbb{K}\langle C \rangle^*$  as mentioned in Section 1.1.5. Given a biproduct  $\square$  on  $\mathbb{K}\langle C \rangle$  of arity  $p$  and coarity  $q$ , the *dual biproduct* of  $\square$  is the biproduct

$$\square^* : \mathbb{K}\langle C \rangle^{*\otimes q} \rightarrow \mathbb{K}\langle C \rangle^{*\otimes p} \quad (2.1.6)$$

of arity  $q$  and coarity  $p$ , linearly defined, for all  $y_1, \dots, y_q \in C$ , by

$$\square_*(y_1 \otimes \dots \otimes y_q) := \sum_{x_1, \dots, x_p \in C} \langle \square(x_1 \otimes \dots \otimes x_p), y_1 \otimes \dots \otimes y_q \rangle x_1 \otimes \dots \otimes x_p. \quad (2.1.7)$$

Let us observe that in (2.1.7), the coefficient  $\langle \square(x_1 \otimes \dots \otimes x_p), y_1 \otimes \dots \otimes y_q \rangle$  is the structure coefficient  $\xi_{\square}^{(x_1 \otimes \dots \otimes x_p, y_1 \otimes \dots \otimes y_q)}$  of  $\square$ . Hence, if one sees the structure coefficients of  $\square$  as a matrix whose rows are indexed by the  $x_1 \otimes \dots \otimes x_p$  and the columns by the  $y_1 \otimes \dots \otimes y_q$ , the structure coefficients of  $\square^*$  is the transpose of this matrix.

2.1.3. *Products.* A **product** is a biproduct of coarity 1. In this section,  $\star$  is a product of arity  $p \in \mathbb{N}$ .

For any  $\ell \geq 1$ , let  $T_\ell(\star)$  be the biproduct

$$T_\ell(\star) : (\mathbb{K}\langle C \rangle^{\otimes \ell})^{\otimes p} \simeq \mathbb{K}\langle C \rangle^{\otimes \ell p} \rightarrow \mathbb{K}\langle C \rangle^{\otimes \ell} \quad (2.1.8)$$

defined linearly by

$$\begin{aligned} T_\ell(\star) (x_{1,1} \otimes \cdots \otimes x_{\ell,1} \otimes x_{1,2} \otimes \cdots \otimes x_{\ell,2} \otimes \cdots \otimes x_{1,p} \otimes \cdots \otimes x_{\ell,p}) \\ := \star(x_{1,1} \otimes \cdots \otimes x_{1,p}) \otimes \star(x_{2,1} \otimes \cdots \otimes x_{2,p}) \otimes \cdots \otimes \star(x_{\ell,1} \otimes \cdots \otimes x_{\ell,p}), \end{aligned} \quad (2.1.9)$$

for any  $x_{1,1}, \dots, x_{1,p}, x_{2,1}, \dots, x_{2,p}, \dots, x_{\ell,1}, \dots, x_{\ell,p} \in C$ . Graphically,  $T_\ell(\star)$  is the biproduct

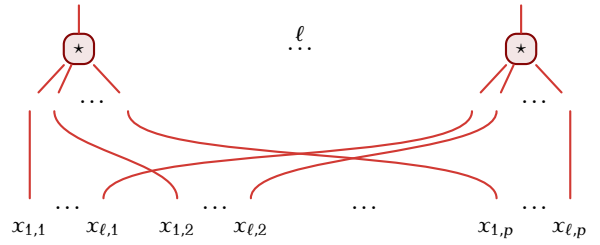

$$(2.1.10)$$

This product  $T_\ell(\star)$  can be seen as the  $\ell$ th-tensor power of  $\star$  seen as a linear map. For this reason,  $T_\ell(\star)$  is called the  **$\ell$ th tensor power** of  $\star$ . For instance, when  $\star$  is a binary product, one has

$$T_2(\star) : \mathbb{K}\langle C \rangle^{\otimes 2 \times 2} \rightarrow \mathbb{K}\langle C \rangle^{\otimes 2} \quad (2.1.11)$$

and

$$(x_{1,1} \otimes x_{2,1}) T_2(\star) (x_{1,2} \otimes x_{2,2}) = (x_{1,1} \star x_{1,2}) \otimes (x_{2,1} \star x_{2,2}) \quad (2.1.12)$$

for all  $x_{1,1}, x_{2,1}, x_{1,2}, x_{2,2} \in C$ . In (2.1.12), since  $\star$  and  $T_2(\star)$  are binary products, we denote them in infix way. We follow this convention in all this text. Graphically,  $T_2(\star)$  is the biproduct



$$(2.1.13)$$

Let us now list some properties a product can satisfy.

When  $I$  is endowed with an associative binary product  $\dot{+}$ , if for any  $x_1, \dots, x_p \in C$  one has

$$\star(x_1 \otimes \cdots \otimes x_p) \in \mathbb{K}\langle C \rangle(\text{ind}(x_1) \dot{+} \cdots \dot{+} \text{ind}(x_p)), \quad (2.1.14)$$

we say that  $\star$  is  **$\dot{+}$ -compatible**. In the particular case where  $C$  is a graded collection and  $\star$  is  $\dot{+}$ -compatible,  $\star$  is **graded**. If  $\{B_x : x \in C\}$  is a basis of  $\mathbb{K}\langle C \rangle$  such that, for any objects  $x_1, \dots, x_p$  of  $C$  there is an  $x \in C$  satisfying

$$\star(B_{x_1} \otimes \cdots \otimes B_{x_p}) = B_x, \quad (2.1.15)$$

we say that the B-basis of  $\mathbb{K}\langle C \rangle$  is a **set-basis** (or a **multiplicative basis**) with respect to  $\star$ .

Assume now that  $\star$  is of arity 2. The *associator* of  $\star$  is the ternary product

$$(-, -, -)_\star : \mathbb{K}\langle C \rangle \otimes \mathbb{K}\langle C \rangle \otimes \mathbb{K}\langle C \rangle \rightarrow \mathbb{K}\langle C \rangle \quad (2.1.16)$$

defined linearly for all  $x_1, x_2, x_3 \in C$  by

$$(x_1, x_2, x_3)_\star := (x_1 \star x_2) \star x_3 - x_1 \star (x_2 \star x_3). \quad (2.1.17)$$

When for all  $x_1, x_2, x_3 \in C$ ,

$$(x_1, x_2, x_3)_\star = 0, \quad (2.1.18)$$

we say that  $\star$  is *associative*. The *commutator* of  $\star$  is the binary product

$$[-, -]_\star : \mathbb{K}\langle C \rangle \otimes \mathbb{K}\langle C \rangle \rightarrow \mathbb{K}\langle C \rangle \quad (2.1.19)$$

defined linearly for all  $x_1, x_2 \in C$  by

$$[x_1, x_2]_\star := x_1 \star x_2 - x_2 \star x_1. \quad (2.1.20)$$

When for all  $x_1, x_2 \in C$ ,

$$[x_1, x_2]_\star = 0, \quad (2.1.21)$$

the product  $\star$  is *commutative*. When there is an element  $\mathbb{1}_\star$  of  $\mathbb{K}\langle C \rangle$  such that, for all  $x \in C$ ,

$$x \star \mathbb{1}_\star = x = \mathbb{1}_\star \star x, \quad (2.1.22)$$

we say that  $\star$  is *unitary* and that  $\mathbb{1}_\star$  is the *unit* of  $\star$ . This element  $\mathbb{1}_\star$  of  $\mathbb{K}\langle C \rangle$  can be seen as a product of arity 0, that is  $\mathbb{1}_\star : (\mathbb{K}\langle C \rangle)^{\otimes 0} = \mathbb{K} \rightarrow \mathbb{K}\langle C \rangle$  is the map sending linearly the multiplicative unit of  $\mathbb{K}$  to the element  $\mathbb{1}_\star$  of  $\mathbb{K}\langle C \rangle$ . Observe that if  $\mathbb{1}_\star$  is a graded product,  $\mathbb{1}_\star$  is necessarily of degree 0.

Finally, any product  $\star$  on  $C$  of arity  $p$  gives rise to a product  $\bar{\star}$  on  $\mathbb{K}\langle C \rangle$  defined linearly, for any objects  $x_1, \dots, x_p$  of  $C$ , by

$$\bar{\star}(x_1 \otimes \dots \otimes x_p) := \begin{cases} \star(x_1, \dots, x_p) & \text{if } \star(x_1, \dots, x_p) \text{ is well-defined,} \\ 0 & \text{otherwise.} \end{cases} \quad (2.1.23)$$

This product  $\bar{\star}$  is the *linearization* of  $\star$ .

**2.1.4. Coproducts.** A *coproduct* is a biproduct of arity 1. Let  $\Delta$  be a product of coarity  $q \in \mathbb{N}$ . Observe that the dual of a coproduct is a product and conversely.

All the properties of products defined in Section 2.1.3 hold for coproducts in the following way. For any property  $P$  on products, we say that  $\Delta$  *satisfies the property "coP"* if the dual product  $\star_\Delta$  of  $\Delta$  satisfies  $P$ . For instance,  $\Delta$  is *cograded* if  $\star_\Delta$  is graded, and  $\Delta$  is *coassociative* if  $\star_\Delta$  is associative.

**2.2. Polynomial bialgebras.** We now consider polynomial spaces endowed with a set of biproducts. The main definitions and properties of these structures are listed.

2.2.1. *Elementary definitions.* A **polynomial bialgebra** is a pair  $(\mathbb{K}\langle C \rangle, \mathcal{B})$  where  $\mathbb{K}\langle C \rangle$  is a polynomial space endowed with a (possibly infinite) set  $\mathcal{B}$  of biproducts. Let  $(\mathbb{K}\langle C_1 \rangle, \mathcal{B}_1)$  and  $(\mathbb{K}\langle C_2 \rangle, \mathcal{B}_2)$  be two polynomial bialgebras. These algebras are  **$\mu$ -compatible** if there exists a bijective map  $\mu : \mathcal{B}_1 \rightarrow \mathcal{B}_2$  that sends any biproduct of  $\mathcal{B}_1$  to a biproduct of  $\mathcal{B}_2$  of the same arity and coarity. When  $(\mathbb{K}\langle C_1 \rangle, \mathcal{B}_1)$  and  $(\mathbb{K}\langle C_2 \rangle, \mathcal{B}_2)$  are  $\mu$ -compatible, a  **$\mu$ -polynomial bialgebra morphism** (or simply a **polynomial bialgebra morphism** when there is no ambiguity) from  $\mathbb{K}\langle C_1 \rangle$  to  $\mathbb{K}\langle C_2 \rangle$  is a polynomial space morphism  $\phi : \mathbb{K}\langle C_1 \rangle \rightarrow \mathbb{K}\langle C_2 \rangle$  such that

$$(\phi^{\otimes q})(\square(x_1 \otimes \cdots \otimes x_p)) = (\mu(\square))(\phi(x_1) \otimes \cdots \otimes \phi(x_p)) \quad (2.2.1)$$

for all biproducts  $\square$  of arity  $p$  and coarity  $q$  of  $\mathcal{B}_1$ , and  $x_1, \dots, x_p \in C_1$ , where  $\phi^{\otimes q}$  is the  $q$ th tensor power  $T_q(\phi)$  of  $\phi$ . Graphically, (2.2.1) reads as

$$(2.2.2)$$

Besides, when  $(\mathbb{K}\langle C_1 \rangle, \mathcal{B}_1)$  and  $(\mathbb{K}\langle C_2 \rangle, \mathcal{B}_2)$  are  $\mu$ -compatible,  $(\mathbb{K}\langle C_2 \rangle, \mathcal{B}_2)$  is a **sub-bialgebra** of  $(\mathbb{K}\langle C_1 \rangle, \mathcal{B}_1)$  if there is an injective  $\mu$ -polynomial bialgebra morphism from  $\mathbb{K}\langle C_2 \rangle$  to  $\mathbb{K}\langle C_1 \rangle$ . Let  $(\mathbb{K}\langle C \rangle, \mathcal{B})$  be a polynomial bialgebra. For any subset  $\mathcal{G}$  of  $\mathbb{K}\langle C \rangle$ , the **bialgebra generated** by  $\mathcal{G}$  is the smallest sub-bialgebra  $\mathbb{K}\langle C \rangle^{\mathcal{G}}$  of  $\mathbb{K}\langle C \rangle$  containing  $\mathcal{G}$ . When  $\mathbb{K}\langle C \rangle^{\mathcal{G}} = \mathbb{K}\langle C \rangle$  and  $\mathcal{G}$  is minimal with respect to the inclusion among the subsets of  $\mathcal{G}$  satisfying this property,  $\mathcal{G}$  is a **minimal generating set** of  $\mathbb{K}\langle C \rangle$ . A **polynomial bialgebra ideal** of  $\mathbb{K}\langle C \rangle$  is a subspace  $\mathcal{V}$  of  $\mathbb{K}\langle C \rangle$  such that

$$\square(x_1 \otimes \cdots \otimes x_{i-1} \otimes f \otimes x_{i+1} \otimes \cdots \otimes x_p) \in \bigoplus_{j \in [q]} \mathbb{K}\langle C \rangle^{\otimes j-1} \otimes \mathcal{V} \otimes \mathbb{K}\langle C \rangle^{\otimes q-j} \quad (2.2.3)$$

for all biproducts  $\square$  of  $\mathcal{B}$  of arity  $p$  and coarity  $q$ ,  $i \in [p]$ ,  $f \in \mathcal{V}$ , and  $x_r \in C$  where  $r \in [p] \setminus \{i\}$ . Given a polynomial bialgebra ideal  $\mathcal{V}$  of  $\mathbb{K}\langle C \rangle$ , the **quotient bialgebra**  $\mathbb{K}\langle C \rangle /_{\mathcal{V}}$  of  $\mathbb{K}\langle C \rangle$  by  $\mathcal{V}$  is defined in the usual way.

When  $\mathcal{B}$  contains only products (resp. coproducts),  $(\mathbb{K}\langle C \rangle, \mathcal{B})$  is a **polynomial algebra** (resp. **polynomial coalgebra**).

2.2.2. *Combinatorial polynomial bialgebras.* In practice, and even more so in this dissertation, most of the encountered polynomial bialgebras are of the form  $(\mathbb{K}\langle C \rangle, \mathcal{B})$  where  $C$  is a combinatorial  $I$ -collection and  $\mathcal{B}$  contains only products and coproducts. When all products (resp. coproducts) of  $\mathcal{B}$  are  $\dagger$ -compatible (resp.  $\dagger$ -cocompatible) for some associative binary products  $\dagger$  on  $I$ , we say that  $\mathbb{K}\langle C \rangle$  is a **combinatorial bialgebra**. In most practical cases,  $C$  is a graded, a bigraded, or a colored combinatorial collection.

Let us assume that  $(\mathbb{K}\langle C \rangle, \mathcal{B})$  is a combinatorial bialgebra. The *dual bialgebra* of  $\mathbb{K}\langle C \rangle$  is the bialgebra  $(\mathbb{K}\langle C \rangle^*, \mathcal{B}^*)$  where  $\mathcal{B}^*$  is the set of the dual biproducts of the biproducts of  $\mathcal{B}$ .

It is very common, given a combinatorial bialgebra  $(\mathbb{K}\langle C \rangle, \mathcal{B})$ , to endow  $C$  with a structure of a combinatorial poset  $(C, \preceq)$  in order to construct  $B^\preceq$ -families (see Section 1.3.2). For instance, when a biproduct  $\square$  has complicated structure coefficients, considering an adequate partial order relation  $\preceq$  on  $C$  such that the  $B^\preceq$ -family is a set-basis with respect to  $\square$  allows to infer properties of  $\square$  (such as generating sets of  $\mathbb{K}\langle C \rangle$ , a description of the nontrivial relations satisfied by these generators, or even freeness properties).

**2.2.3. Set-theoretic algebras.** When  $(\mathbb{K}\langle C \rangle, \mathcal{P})$  is a polynomial algebra such that its fundamental basis is a set-basis with respect to all the products of  $\mathcal{P}$ , each product  $\bar{\star}$  of  $\mathcal{P}$  is the linearization of a product  $\star$  on  $C$ . In this case, it is possible to forget the linear structure of  $\mathbb{K}\langle C \rangle$  and work only with  $C$  and its set of products  $\mathcal{P}' := \{\star : \bar{\star} \in \mathcal{P}\}$ . We say in this case that  $C$  is a *set-theoretic algebra*.

A large part of the concepts presented above about bialgebras work for the particular case of set-theoretic algebras with some adjustments. For instance, to define quotients of a set-theoretic algebra  $(C, \mathcal{P}')$ , we do not work with polynomial algebra ideals but with congruences of set-theoretic algebras. To be a little more precise, a *set-theoretic algebra congruence* is a relation  $\equiv$  on  $C$  which is an equivalence relation satisfying

$$\star(x_1, \dots, x_{i-1}, x_i, x_{i+1}, \dots, x_p) \equiv \star(x_1, \dots, x_{i-1}, x'_i, x_{i+1}, \dots, x_p) \quad (2.2.4)$$

for all products  $\star$  of arities  $p$ ,  $i \in [p]$ ,  $x_i, x'_i \in C$ ,  $x_j \in C$ ,  $j \in [p] \setminus \{i\}$ , whenever  $x_i \equiv x'_i$ .

In the sequel, if “ $N$ ” is the name of an algebraic structure, we call “set- $N$ ” the corresponding set-theoretic structure. For instance, a set-theoretic unitary associative algebra is a monoid. We shall further encounter in this way set-operads, colored set-operads, and set-pros.

**2.3. Types of polynomial bialgebras.** A *type of polynomial bialgebra* is specified by biproduct symbols together with their arities and coarities, and the possible relations between them (like, for instance, associativity, commutativity, cocommutativity, or distributivity). In this section, we list some of the very ordinary types of polynomial bialgebras in combinatorics, and give concrete examples for each of them. Hopf bialgebras are other very important types of polynomial bialgebras and are presented in Section 3.

**2.3.1. Associative algebras.** An *associative algebra* is a polynomial space endowed with an associative binary product. An associative algebra is *unitary* if its product is unitary. Besides, an associative algebra is *commutative* if its product is commutative. To perfectly fit to the definition of types of bialgebras given above, the type of unitary associative and commutative algebras is made of a product symbol  $\star$  of arity 2 and a product symbol  $\mathbb{1}$  of arity 0 together with the relations  $(f_1, f_2, f_3)_\star = 0$ ,  $[f_1, f_2]_\star = 0$ ,  $f \star \mathbb{1}(\lambda) = \lambda f = \mathbb{1}(\lambda) \star f$ , where  $\lambda$  is any coefficient of  $\mathbb{K}$ , and  $f_1, f_2$ , and  $f_3$  are any elements of the space.



*Concatenation algebra.* Let  $A := \{a_1, \dots, a_\ell\}$  be an alphabet. The *concatenation product* is the binary product  $\cdot$  on  $\mathbb{K}\langle A^* \rangle$  defined as the linearization of the concatenation product on  $A^*$ . Since  $\cdot$  is graded and all  $\mathbb{K}\langle A^n \rangle$  are finite dimensional for all  $n \in \mathbb{N}$ ,  $(\mathbb{K}\langle A^* \rangle, \cdot)$  is a combinatorial algebra. Moreover,  $\cdot$  is associative, noncommutative, and admits the empty word  $\epsilon$  as unit so that  $(\mathbb{K}\langle A^* \rangle, \cdot)$  is a unitary noncommutative associative algebra.

*Shuffle algebra.* The *shuffle product* is the binary product  $\sqcup$  on  $\mathbb{K}\langle A^* \rangle$  linearly and recursively defined by

$$u \sqcup \epsilon := u =: \epsilon \sqcup u, \quad (2.3.1a)$$

$$ua \sqcup vb := (u \sqcup vb) \cdot a + (ua \sqcup v) \cdot b \quad (2.3.1b)$$

for any  $u, v \in A^*$  and  $a, b \in A$ , where  $\cdot$  is the concatenation product of words. Intuitively,  $\sqcup$  consists in summing in all the ways of interlacing the two operands. For instance,

$$\begin{aligned} a_1 a_2 \sqcup a_2 a_1 a_1 &= a_1 a_2 a_2 a_1 a_1 + a_1 a_2 a_2 a_1 a_1 + a_1 a_2 a_1 a_2 a_1 + a_1 a_2 a_1 a_1 a_2 \\ &\quad + a_2 a_1 a_2 a_1 a_1 + a_2 a_1 a_1 a_2 a_1 + a_2 a_1 a_1 a_1 a_2 + a_2 a_1 a_1 a_2 a_1 \\ &\quad + a_2 a_1 a_1 a_1 a_2 + a_2 a_1 a_1 a_1 a_2 \\ &= 2a_1 a_2 a_2 a_1 a_1 + a_1 a_2 a_1 a_2 a_1 + a_1 a_2 a_1 a_1 a_2 + a_2 a_1 a_2 a_1 a_1 \\ &\quad + 2a_2 a_1 a_1 a_2 a_1 + 3a_2 a_1 a_1 a_1 a_2. \end{aligned} \quad (2.3.2)$$

Since  $\sqcup$  is graded and all  $\mathbb{K}\langle A^n \rangle$  are finite dimensional for all  $n \in \mathbb{N}$ ,  $(\mathbb{K}\langle A^* \rangle, \sqcup)$  is a combinatorial algebra. Moreover,  $\sqcup$  is associative, commutative, and admits  $\epsilon$  as unit so that  $(\mathbb{K}\langle A^* \rangle, \sqcup)$  is a unitary commutative associative algebra.

**2.3.2. Coassociative coalgebras.** A *coassociative coalgebra* is a polynomial space endowed with a coassociative coproduct. A coassociative coalgebra is *counitary* if its coproduct is counitary. Besides, a coassociative coalgebra is *cocommutative* if its coproduct is cocommutative.

*Deconcatenation coalgebra.* let  $\Delta_\cdot$  be the dual coproduct of the concatenation product  $\cdot$  of  $\mathbb{K}\langle A^* \rangle$  considered in Section 2.3.1. By (2.1.7), for all  $u \in A^*$ ,

$$\Delta_\cdot(u) = \sum_{v, w \in A^*} \langle v \cdot w, u \rangle v \otimes w = \sum_{\substack{v, w \in A^* \\ v \cdot w = u}} v \otimes w. \quad (2.3.3)$$

For instance,

$$\Delta_\cdot(a_1 a_1 a_2) = \epsilon \otimes a_1 a_1 a_2 + a_1 \otimes a_1 a_2 + a_1 a_1 \otimes a_2 + a_1 a_1 a_2 \otimes \epsilon. \quad (2.3.4)$$

This coproduct is known as the *deconcatenation coproduct* and endows  $\mathbb{K}\langle A^* \rangle$  with a structure of a counitary coassociative noncocommutative coalgebra.

*Unshuffle coalgebra.* Let  $\Delta_\sqcup$  be the dual coproduct of the shuffle product  $\sqcup$  of  $\mathbb{K}\langle A^* \rangle$ . Again by (2.1.7), for all  $u \in A^*$ ,

$$\Delta_\sqcup(u) = \sum_{v, w \in A^*} \langle v \sqcup w, u \rangle v \otimes w. \quad (2.3.5)$$

The coefficient  $\langle v \sqcup w, u \rangle$  counts the number of ways to decompose  $u$  as two disjoint subwords  $v$  and  $w$ , and thus,

$$\Delta_{\sqcup}(u) = \sum_{\substack{P_1, P_2 \subseteq [u] \\ P_1 \sqcup P_2 = [u]}} u_{|P_1} \otimes u_{|P_2}. \quad (2.3.6)$$

This coproduct can also be expressed by

$$\Delta_{\sqcup}(a) = \epsilon \otimes a + a \otimes \epsilon \quad (2.3.7)$$

for any  $a \in A$ , and

$$\Delta_{\sqcup}(u) = \prod_{i \in [u]} \Delta(u_i) \quad (2.3.8)$$

for any  $u \in A^*$ , where the product of (2.3.8) denotes the iterated version of the 2nd tensor power  $T_2(\cdot)$  of the concatenation product  $\cdot$ . This product  $T_2(\cdot)$  is associative due to the fact that  $\cdot$  is associative, and hence, its iterated version is well-defined. For instance,

$$\begin{aligned} \Delta_{\sqcup}(a_1 a_1 a_2) &= (\epsilon \otimes a_1 + a_1 \otimes \epsilon) T_2(\cdot) (\epsilon \otimes a_1 + a_1 \otimes \epsilon) T_2(\cdot) (\epsilon \otimes a_2 + a_2 \otimes \epsilon) \\ &= \epsilon \otimes a_1 a_1 a_2 + a_2 \otimes a_1 a_1 + a_1 \otimes a_1 a_2 + a_1 a_2 \otimes a_1 \\ &\quad + a_1 \otimes a_1 a_2 + a_1 a_2 \otimes a_1 + a_1 a_1 \otimes a_2 + a_1 a_1 a_2 \otimes \epsilon \\ &= \epsilon \otimes a_1 a_1 a_2 + a_2 \otimes a_1 a_1 + 2a_1 \otimes a_1 a_2 \\ &\quad + 2a_1 a_2 \otimes a_1 + a_1 a_1 \otimes a_2 + a_1 a_1 a_2 \otimes \epsilon. \end{aligned} \quad (2.3.9)$$

This coproduct is known as the *unshuffling coproduct* and endows  $\mathbb{K}\langle A^* \rangle$  with a structure of a counitary coassociative cocommutative coalgebra.

**2.3.3. Dendriform algebras.** A *dendriform algebra* [Lod01] is a polynomial space  $\mathbb{K}\langle C \rangle$  endowed with two binary products  $<$  and  $>$  satisfying

$$(f_1 < f_2) < f_3 = f_1 < (f_2 < f_3) + f_1 < (f_2 > f_3), \quad (2.3.10a)$$

$$(f_1 > f_2) < f_3 = f_1 > (f_2 < f_3), \quad (2.3.10b)$$

$$(f_1 < f_2) > f_3 + (f_1 > f_2) > f_3 = f_1 > (f_2 > f_3), \quad (2.3.10c)$$

for all  $f_1, f_2, f_3 \in \mathbb{K}\langle C \rangle$ .

*Dendriform algebra structure.* A polynomial algebra  $(\mathbb{K}\langle C \rangle, \star)$ , where  $\star$  is a binary product, admits a *dendriform algebra structure* if its product can be split into two operations

$$\star = < + >, \quad (2.3.11)$$

where  $<$  and  $>$  are two non-degenerate binary products such that  $(\mathbb{K}\langle C \rangle, <, >)$  is a dendriform algebra. Observe that if  $(\mathbb{K}\langle C \rangle, \star)$  admits a dendriform algebra structure,  $\star$  is associative. The associativity of  $< + >$  is a consequence of Relations (2.3.10a), (2.3.10b), and (2.3.10c) of dendriform algebras.

*Codendriform coalgebra structure.* By dualizing the notion of dendriform algebra structure, one obtains the notion of *codendriform coalgebras* [Foi07]. More precisely, a codendriform coalgebra is a polynomial space  $\mathbb{K}\langle C \rangle$  endowed with two binary coproducts  $\Delta_{<}$  and  $\Delta_{>}$  such that the dual products  $<$  and  $>$  of respectively  $\Delta_{<}$  and  $\Delta_{>}$  endow  $\mathbb{K}\langle C \rangle$  with a dendriform algebra structure.

In the same way as above, we say that a polynomial coalgebra  $(\mathbb{K}\langle C \rangle, \Delta)$ , where  $\Delta$  is a binary coproduct, admits a *codendriform algebra structure* if its coproduct can be split into two operations

$$\Delta = \Delta_{<} + \Delta_{>}, \quad (2.3.12)$$

where  $\Delta_{<}$  and  $\Delta_{>}$  are two non-degenerate binary coproducts such that  $(\mathbb{K}\langle C \rangle, \Delta_{<}, \Delta_{>})$  is a codendriform coalgebra.

*Bidendriform bialgebra structure.* A bialgebra  $(\mathbb{K}\langle C \rangle, *, \Delta)$ , where  $*$  is a binary product and  $\Delta$  is a binary coproduct, admits a *bidendriform bialgebra structure* [Foi07] if  $\mathbb{K}\langle C \rangle$  admits both a dendriform algebra  $(\mathbb{K}\langle C \rangle, <, >)$  and a codendriform coalgebra  $(\mathbb{K}\langle C \rangle, \Delta_{<}, \Delta_{>})$  structure with some extra compatibility relations between the products  $<$  and  $>$  and the coproducts  $\Delta_{<}$  and  $\Delta_{>}$ .

One among the main benefits of showing that  $\mathbb{K}\langle C \rangle$  admits a bidendriform bialgebra structure relies a rigidity theorem [Foi07] implying several properties of  $\mathbb{K}\langle C \rangle$ . For instance, when  $\mathbb{K}\langle C \rangle$  is a Hopf bialgebra (see Section 3), the fact that  $\mathbb{K}\langle C \rangle$  admits a bidendriform bialgebra structure implies its self-duality, its freeness as an associative algebra, and its freeness as a coassociative coalgebra.

*Remarks and generalizations.* We invite the reader to take a look at [LR98, Agu00, Lod02, Foi07, EFMP08, EFM09, LV12] for a supplementary review of properties of dendriform algebras.

Besides, in the recent years, a lot of generalizations of dendriform algebras and their dual notions were introduced, each of them splitting an associative product in different ways and in more than two pieces. Tridendriform algebras [LR04], quadri-algebras [AL04], ennea-algebras [Ler04],  $m$ -dendriform algebras of Leroux [Ler07],  $m$ -dendriform algebras of Novelli [Nov14], and polydendriform algebras (see Chapter 5) are examples of such structures.

*Shuffle dendriform algebra.* Consider on  $\mathbb{K}\langle A^* \rangle$  the binary products  $<$  and  $>$  defined linearly and recursively by

$$u < \epsilon := u =: \epsilon > u, \quad (2.3.13a)$$

$$w > \epsilon =: 0 =: \epsilon < w, \quad (2.3.13b)$$

$$ua < v := (u \sqcup v) \cdot a, \quad (2.3.13c)$$

$$u > vb := (u \sqcup v) \cdot b \quad (2.3.13d)$$

for any  $u, v \in A^*$ ,  $w \in A^+$ , and  $a, b \in A$ , where  $\cdot$  is the concatenation product of words. In other words,  $u < v$  (resp.  $u > v$ ) is the sum of all the words  $w$  obtained by shuffling  $u$  and  $v$  such that the last letter of  $w$  comes from  $u$  (resp.  $v$ ). For example,

$$\begin{aligned} a_1 a_2 < a_2 a_1 a_1 &= a_1 a_2 a_1 a_1 a_2 + a_2 a_1 a_1 a_1 a_2 + a_2 a_1 a_1 a_1 a_2 + a_2 a_1 a_1 a_1 a_2 \\ &= a_1 a_2 a_1 a_1 a_2 + 3a_2 a_1 a_1 a_1 a_2, \end{aligned} \quad (2.3.14a)$$

$$\begin{aligned}
\mathbf{a}_1 \mathbf{a}_2 \succ \mathbf{a}_2 \mathbf{a}_1 \mathbf{a}_1 &= \mathbf{a}_1 \mathbf{a}_2 \mathbf{a}_2 \mathbf{a}_1 \mathbf{a}_1 + \mathbf{a}_1 \mathbf{a}_2 \mathbf{a}_2 \mathbf{a}_1 \mathbf{a}_1 + \mathbf{a}_1 \mathbf{a}_2 \mathbf{a}_1 \mathbf{a}_2 \mathbf{a}_1 + \mathbf{a}_2 \mathbf{a}_1 \mathbf{a}_2 \mathbf{a}_1 \mathbf{a}_1 \\
&\quad + \mathbf{a}_2 \mathbf{a}_1 \mathbf{a}_1 \mathbf{a}_2 \mathbf{a}_1 + \mathbf{a}_2 \mathbf{a}_1 \mathbf{a}_1 \mathbf{a}_2 \mathbf{a}_1 \\
&= 2\mathbf{a}_1 \mathbf{a}_2 \mathbf{a}_2 \mathbf{a}_1 \mathbf{a}_1 + \mathbf{a}_1 \mathbf{a}_2 \mathbf{a}_1 \mathbf{a}_2 \mathbf{a}_1 + \mathbf{a}_2 \mathbf{a}_1 \mathbf{a}_2 \mathbf{a}_1 \mathbf{a}_1 + 2\mathbf{a}_2 \mathbf{a}_1 \mathbf{a}_1 \mathbf{a}_2 \mathbf{a}_1.
\end{aligned} \tag{2.3.14b}$$

These two products endow  $\mathbb{K}\langle A^* \rangle$  with a structure of a dendriform algebra. Moreover, the products  $\prec$  and  $\succ$  divide the shuffle product into two parts in the sense that

$$\mathbf{u} \sqcup \mathbf{v} = \mathbf{u} \prec \mathbf{v} + \mathbf{u} \succ \mathbf{v} \tag{2.3.15}$$

for all  $\mathbf{u}, \mathbf{v} \in A^*$ . This shows that  $(\mathbb{K}\langle A^* \rangle, \sqcup)$  admits a dendriform algebra structure and offers a way to recover the recursive definition (see (2.3.1a) and (2.3.1b)) of  $\sqcup$ . This recursive description of the shuffle product was known since Ree [Ree58].

*Max dendriform algebra.* Assume here that  $A$  is a totally ordered alphabet by  $a_i \leq a_j$  if  $i \leq j$ . Consider on  $\mathbb{K}\langle A^+ \rangle$  the binary products  $\prec$  and  $\succ$  defined linearly by

$$\mathbf{u} \prec \mathbf{v} := \begin{cases} \mathbf{u} \cdot \mathbf{v} & \text{if } \max_{\leq}(\mathbf{u}) \geq \max_{\leq}(\mathbf{v}) \\ 0 & \text{otherwise,} \end{cases} \tag{2.3.16a}$$

$$\mathbf{u} \succ \mathbf{v} := \begin{cases} \mathbf{u} \cdot \mathbf{v} & \text{if } \max_{\leq}(\mathbf{u}) < \max_{\leq}(\mathbf{v}) \\ 0 & \text{otherwise,} \end{cases} \tag{2.3.16b}$$

for all  $\mathbf{u}, \mathbf{v} \in A^+$ , where  $\cdot$  is the concatenation product of words. These two products endow  $\mathbb{K}\langle A^+ \rangle$  with a structure of a dendriform algebra. Moreover, we have here  $\cdot = \prec + \succ$  where  $\cdot$  is the associative algebra product of concatenation of  $\mathbb{K}\langle A^+ \rangle$ .

**2.3.4. Pre-Lie algebras.** A *pre-Lie algebra* is a polynomial space  $\mathbb{K}\langle C \rangle$  endowed with a binary product  $\frown$  satisfying

$$(\mathbf{f}_1 \frown \mathbf{f}_2) \frown \mathbf{f}_3 - \mathbf{f}_1 \frown (\mathbf{f}_2 \frown \mathbf{f}_3) = (\mathbf{f}_1 \frown \mathbf{f}_3) \frown \mathbf{f}_2 - \mathbf{f}_1 \frown (\mathbf{f}_3 \frown \mathbf{f}_2) \tag{2.3.17}$$

for all  $\mathbf{f}_1, \mathbf{f}_2, \mathbf{f}_3 \in \mathbb{K}\langle C \rangle$ . This relation (2.3.17) of pre-Lie algebras says that the associator  $(-, -, -)_{\frown}$  is symmetric in its two last entries.

Pre-Lie algebras were introduced by Vinberg [Vin63] and Gerstenhaber [Ger63] independently. These structures appear under different names in the literature, for instance as Vinberg algebras, left-symmetric algebras, or chronological algebras. The appellation pre-Lie algebra is now very natural since, given a pre-Lie algebra  $(\mathbb{K}\langle C \rangle, \frown)$ , the commutator of  $\frown$  endows  $\mathbb{K}\langle C \rangle$  with a structure of a Lie algebra. In the context of combinatorics, several pre-Lie products are defined on combinatorial spaces by summing over all the ways to compose (in a certain sense) two combinatorial objects. For this reason, in an intuitive way, pre-Lie algebras encode the combinatorics of the composition of combinatorial objects in all possible ways [Cha08]. For more details on pre-Lie algebras, see [Man11].

*Pre-Lie algebras from associative algebras.* When  $(\mathbb{K}\langle C \rangle, \star)$  is an associative algebra,  $\star$  satisfies in particular (2.3.17) since both left and right members are equal to zero. For this reason,  $(\mathbb{K}\langle C \rangle, \star)$  is a pre-Lie algebra.

*Pre-Lie algebra of rooted trees.* Recall that  $\text{RT}$  is the graded combinatorial collection of all rooted trees (see Section 3.1.1 of Chapter 1). Consider now on  $\mathbb{K}\langle\text{RT}\rangle$  the products  $\wedge^{(k)} : \mathbb{K}\langle\text{RT}\rangle^{\otimes k} \rightarrow \mathbb{K}\langle\text{RT}\rangle$  defined linearly for all  $k \geq 1$  and all rooted trees  $t_1, \dots, t_k$  by

$$\wedge^{(k)}(t_1 \otimes \cdots \otimes t_k) := (\bullet, [t_1, \dots, t_k]). \quad (2.3.18)$$

Intuitively,  $\wedge^{(k)}$  consists in grafting all the trees  $t_1, \dots, t_k$  onto a common root. This product is symmetric with respect to all its inputs. Now, let  $\curvearrowright$  be the binary product on  $\mathbb{K}\langle\text{RT}\rangle$  defined linearly and recursively by

$$s \curvearrowright t := \wedge^{(k+1)}(s_1 \otimes \cdots \otimes s_k \otimes t) + \sum_{i \in [k]} \wedge^{(k)}(s_1 \otimes \cdots \otimes s_{i-1} \otimes (s_i \curvearrowright t) \otimes s_{i+1} \otimes \cdots \otimes s_k) \quad (2.3.19)$$

for any  $s, t \in \text{RT}$  where  $s = (\bullet, [s_1, \dots, s_k])$ . Intuitively,  $\curvearrowright$  consists in summing all the ways of connecting the root of the second operand on a node of the first. For example,

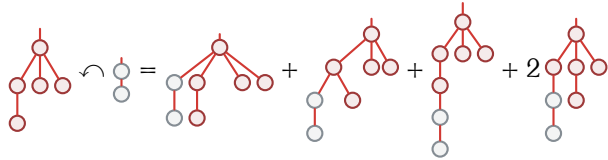

$$\quad (2.3.20)$$

This product endows  $\mathbb{K}\langle\text{RT}\rangle$  with a structure of a pre-Lie algebra.

The free objects in the category of pre-Lie algebras have been described by Chapoton and Livernet [CL01]. They have shown that the free pre-Lie algebra generated by a set  $\mathfrak{G}$  is the combinatorial space of all rooted trees whose nodes are labeled on  $\mathfrak{G}$ , and the product of two such rooted trees is the sum of all the ways to connect the root of the second tree to a node of the first. Thereby, the pre-Lie algebra  $(\mathbb{K}\langle\text{RT}\rangle, \curvearrowright)$  is the free pre-Lie algebra generated by a singleton.

2.3.5. *About bialgebras.* In the field of algebraic combinatorics, many types of bialgebras have emerged recently. As previously mentioned, bidendriform bialgebras [Foi07] are one of these. In [Lod08], Loday defined the notion of triples of operads, leading to the constructions of various kinds of bialgebras and analogs of the Poincaré-Birkhoff-Witt and Cartier-Milnor-Moore theorems (see also [Cha02]). He defined, among others, infinitesimal bialgebras, forming an example of combinatorial bialgebras having one associative binary product and one coassociative binary coproduct satisfying a compatibility relation. Moreover, in [Foi12], Foissy considered algebraic structures, named Dup-Dendr bialgebras, having two binary products satisfying the duplicial relations [BF03, Lod08], two binary coproducts such that their dual products satisfy the dendriform relations, and such that these four (co)products satisfy several compatibility relations. These structures lead to rigidity theorems, in the sense that any Dup-Dendr bialgebra is free as a duplicial algebra. In the same way, Foissy introduced also in [Foi15] structures named Com-PreLie bialgebras, that are spaces with an associative and commutative binary product, a pre-Lie product, and a binary coproduct that satisfy compatibility relations.

### 3. Hopf bialgebras in combinatorics

Hopf bialgebras are polynomial spaces endowed with an associative product  $\star$  and a coassociative coproduct  $\Delta$  satisfying a kind of commutativity relation very natural in combinatorics. We list the basic concepts related with these structures and provide some examples.

**3.1. Hopf bialgebras.** A *Hopf bialgebra* is a polynomial space  $\mathbb{K}\langle C \rangle$  endowed with a binary product  $\star$  and a binary coproduct  $\Delta$  such that  $(\mathbb{K}\langle C \rangle, \star)$  is a unitary associative algebra,  $(\mathbb{K}\langle C \rangle, \Delta)$  is a counitary coassociative coalgebra, and, for all  $f_1, f_2 \in \mathbb{K}\langle C \rangle$ ,

$$\Delta(f_1 \star f_2) = \Delta(f_1) T_2(\star) \Delta(f_2). \quad (3.1.1)$$

The dual bialgebra of a Hopf bialgebra is still a Hopf bialgebra.

Let us now provide some classical definitions about Hopf bialgebras.

**3.1.1. Primitive and group-like elements.** An element  $f$  of  $\mathbb{K}\langle C \rangle$  is *primitive* if  $\Delta(f) = 1 \otimes f + f \otimes 1$ . The set  $\mathcal{P}_{\mathbb{K}\langle C \rangle}$  of all primitive elements of  $\mathbb{K}\langle C \rangle$  forms a subspace of  $\mathbb{K}\langle C \rangle$  and the commutator  $[-, -]_\star$  endows  $\mathcal{P}_{\mathbb{K}\langle C \rangle}$  with a structure of a Lie algebra. Besides, an element  $f$  of  $\mathbb{K}\langle C \rangle$  is *group-like* if  $\Delta(f) = f \otimes f$ .

**3.1.2. Convolution product and antipode.** Given two Hopf bialgebras  $(\mathbb{K}\langle C_1 \rangle, \star_1, \Delta_1)$  and  $(\mathbb{K}\langle C_2 \rangle, \star_2, \Delta_2)$ , if  $\omega$  and  $\omega'$  are two Hopf bialgebra morphisms from  $\mathbb{K}\langle C_1 \rangle$  to  $\mathbb{K}\langle C_2 \rangle$ , the *convolution* of  $\omega$  and  $\omega'$  is the map

$$\omega * \omega' : \mathbb{K}\langle C_1 \rangle \rightarrow \mathbb{K}\langle C_2 \rangle \quad (3.1.2)$$

defined linearly, for any  $x \in C_1$ , by

$$(\omega * \omega')(x) := \sum_{y_1, y_2 \in C_1} \xi_{\Delta_1}^{(x, y_1 \otimes y_2)} \omega(y_1) \star_2 \omega'(y_2), \quad (3.1.3)$$

where the  $\xi_{\Delta_1}^{(-, -)}$  are the structure coefficients of  $\Delta_1$ . This convolution product is associative, as a consequence of the fact that  $\Delta_1$  is coassociative and  $\star_2$  is associative.

Now, let  $(\mathbb{K}\langle C \rangle, \star, \Delta)$  be a Hopf bialgebra. Let  $\nu : \mathbb{K}\langle C \rangle \rightarrow \mathbb{K}\langle C \rangle$  be the linear map defined as the inverse of the identity map  $\text{Id}_{\mathbb{K}\langle C \rangle}$  on  $\mathbb{K}\langle C \rangle$ . This map  $\nu$  is the *antipode* of  $\mathbb{K}\langle C \rangle$  and it can be undefined in certain cases.

**3.1.3. Combinatorial Hopf bialgebras.** In algebraic combinatorics, one encounters very particular Hopf bialgebras. A *combinatorial Hopf bialgebra* is a Hopf bialgebra  $(\mathbb{K}\langle C \rangle, \star, \Delta)$  which is graded and combinatorial (that is  $\mathbb{K}\langle C \rangle$  is a graded combinatorial space, and  $\star$  and  $\Delta$  are respectively graded and cograded) and such that  $C$  is connected as a graded collection (as a consequence,  $\mathbb{K}\langle C \rangle(0)$  is of dimension 1 and can be identified with  $\mathbb{K}$ ).

All combinatorial Hopf bialgebras admit a unique well-defined antipode  $\nu$ . Indeed, consider a combinatorial Hopf bialgebra  $(\mathbb{K}\langle C \rangle, \star, \Delta)$  and let us denote by  $\mathbb{1}$  its unique element of  $C(0)$ . We can consider, without loss of generality that  $\mathbb{1}$  is the unit of  $\star$ . The antipode  $\nu$  must satisfy

$$(\nu * \text{Id}_{\mathbb{K}\langle C \rangle})(x) = \begin{cases} \mathbb{1} & \text{if } x = \mathbb{1}, \\ 0 & \text{otherwise.} \end{cases} \quad (3.1.4)$$

Hence, we obtain

$$\sum_{y_1, y_2 \in C} \xi_{\Delta}^{(x, y_1 \otimes y_2)} v(y_1) \star y_2 = \begin{cases} \mathbb{1} & \text{if } x = \mathbb{1}, \\ 0 & \text{otherwise.} \end{cases} \quad (3.1.5)$$

Now, by using the fact that  $\Delta$  is counitary and cograded, we obtain

$$v(\mathbb{1}) = \mathbb{1}, \quad (3.1.6)$$

and, for any  $x \in \text{Aug}(C)$ ,

$$v(x) = - \sum_{\substack{y_1, y_2 \in C \\ y_2 \neq \mathbb{1}}} \xi_{\Delta}^{(x, y_1 \otimes y_2)} v(y_1) \star y_2. \quad (3.1.7)$$

Therefore, (3.1.6) and (3.1.7) imply that the antipode of  $\mathbb{K}\langle C \rangle$  is well-defined can be computed by induction.

**3.2. Main Hopf bialgebras in combinatorics.** Hopf bialgebras are a heavily studied subject. In the last years, many Hopf bialgebras have been introduced involving a very wide range of combinatorial spaces. Let us review the main examples.

**3.2.1. Shuffle deconcatenation Hopf bialgebra.** Let  $A := \{a_1, \dots, a_\ell\}$  be an alphabet. The concatenation product  $\cdot$  and the unshuffling coproduct  $\Delta_{\sqcup}$  (see Section 2.3.2) endow  $\mathbb{K}\langle A^* \rangle$  with a structure of a combinatorial Hopf bialgebra  $(\mathbb{K}\langle A^* \rangle, \cdot, \Delta_{\sqcup})$ . Its dual bialgebra is the Hopf bialgebra  $(\mathbb{K}\langle A^* \rangle, \sqcup, \Delta)$  where  $\sqcup$  is the shuffle product and  $\Delta$  is the deconcatenation coproduct (see again Section 2.3.2).

**3.2.2. Noncommutative symmetric functions.** Consider the graded combinatorial polynomial space  $\text{Sym} := \mathbb{K}\langle \text{Comp} \rangle$  of the compositions. Let  $\{S_{\lambda} : \lambda \in \text{Comp}\}$  be the basis of the *complete noncommutative symmetric functions* of  $\text{Sym}$  and  $\star$  be the binary product defined linearly, for any  $\lambda, \mu \in \text{Comp}$ , by

$$S_{\lambda} \star S_{\mu} := S_{\lambda \cdot \mu}, \quad (3.2.1)$$

where  $\lambda \cdot \mu$  is the concatenation of the compositions (seen as words of integers). Moreover, let  $\Delta$  be the binary coproduct defined linearly, for any  $\lambda \in \text{Comp}$ , by

$$\Delta(S_{\lambda}) := \prod_{j \in [\ell(\lambda)]} \left( \sum_{\substack{n, m \in \mathbb{N} \\ n+m=\lambda_j}} S_{(n)} \otimes S_{(m)} \right), \quad (3.2.2)$$

where the product of (3.2.2) denotes the iterated version of 2nd tensor power  $T_2(\star)$  of  $\star$ , and for any  $n \geq 1$ ,  $S_{(n)}$  is the basis element indexed by the composition of length 1 whose only part is  $n$ , and  $S_{(0)}$  is identified with the unit 1 of  $\mathbb{K}$ . For instance,

$$\begin{aligned} \Delta(S_{121}) &= (1 \otimes S_1 + S_1 \otimes 1) T_2(\star) (1 \otimes S_2 + S_1 \otimes S_1 + S_2 \otimes 1) T_2(\star) (1 \otimes S_1 + S_1 \otimes 1) \\ &= 1 \otimes S_{121} + S_1 \otimes S_{111} + S_1 \otimes S_{12} + S_1 \otimes S_{21} + 2S_{11} \otimes S_{11} + S_{11} \otimes S_2 \\ &\quad + S_2 \otimes S_{11} + S_{111} \otimes S_1 + S_{12} \otimes S_1 + S_{21} \otimes S_1 + S_{121} \otimes 1. \end{aligned} \quad (3.2.3)$$

The product  $\star$  and the coproduct  $\Delta$  endow  $\text{Sym}$  with a structure of a combinatorial Hopf bialgebra.

Moreover, let  $\{R_\lambda : \lambda \in \text{Comp}\}$  be the family defined by

$$R_\lambda := \sum_{\substack{\mu \in \text{Comp} \\ \lambda \leq \mu}} (-1)^{\ell(\lambda) - \ell(\mu)} S_\mu, \quad (3.2.4)$$

where  $\leq$  is the refinement order of compositions. For instance,

$$R_{212} = S_{212} - S_{23} - S_{32} + S_5. \quad (3.2.5)$$

By triangularity, this family forms a basis of  $\text{Sym}$  and is known as the basis of *ribbon noncommutative symmetric functions*. On this basis, one has, for any  $\lambda, \mu \in \text{Comp}$ ,

$$R_\lambda \star R_\mu := R_{\lambda \star \mu} + R_{\lambda \triangleright \mu}, \quad (3.2.6)$$

for any  $\lambda, \mu \in \text{Comp}$ , where  $\lambda \cdot \mu$  is the concatenation of the compositions and

$$\lambda \triangleright \mu := (\lambda_1, \dots, \lambda_{\ell(\lambda)-1}, \lambda_{\ell(\lambda)} + \mu_1, \mu_2, \dots, \mu_{\ell(\mu)}). \quad (3.2.7)$$

For instance,

$$R_{3112} \star R_{142} = R_{3112142} + R_{311342}. \quad (3.2.8)$$

This Hopf bialgebra  $\text{Sym}$  is usually known as the *Hopf bialgebra of noncommutative symmetric functions*. To explain this name, consider a totally ordered alphabet  $A := \{a_1, a_2, \dots\}$  where  $1 \leq i \leq j$  implies  $a_i \preceq a_j$ . Now, let the series

$$R_\lambda(A) := \sum_{\substack{u \in A^* \\ \text{cmp}(u) = \lambda}} u, \quad (3.2.9)$$

of  $\mathbb{K}\langle\langle A^* \rangle\rangle$  defined for all  $\lambda \in \text{Comp}$ , where  $\text{cmp}$  is defined in Section 1.2.3 of Chapter 1. Observe that all  $R_\lambda(A)$  are polynomials when  $A$  is finite, but are series in the other case. For instance,

$$R_{31}(\{a_1, a_2\}) = a_1 a_1 a_2 a_1 + a_1 a_2 a_2 a_1 + a_2 a_2 a_2 a_1, \quad (3.2.10a)$$

$$\begin{aligned} R_{21}(\{a_1, a_2, a_3\}) &= a_1 a_2 a_1 + a_1 a_3 a_1 + a_1 a_3 a_2 + a_2 a_2 a_1 \\ &\quad + a_2 a_3 a_1 + a_2 a_3 a_2 + a_3 a_3 a_1 + a_3 a_3 a_2, \end{aligned} \quad (3.2.10b)$$

$$\begin{aligned} R_{121}(\{a_1, a_2, a_3\}) &= a_2 a_1 a_2 a_1 + a_2 a_1 a_3 a_1 + a_2 a_1 a_3 a_2 + a_3 a_1 a_2 a_1 + a_3 a_1 a_3 a_1 \\ &\quad + a_3 a_1 a_3 a_2 + a_3 a_2 a_2 a_1 + a_3 a_2 a_3 a_1 + a_3 a_2 a_3 a_2. \end{aligned} \quad (3.2.10c)$$

The linear span of all the  $R_\lambda(A)$ ,  $\lambda \in \text{Comp}$ , is the space of noncommutative symmetric functions on  $A$ . The associative algebra structure of  $\text{Sym}$  is compatible with these series in the sense that

$$R_\lambda(A) \cdot R_\mu(A) = (R_\lambda \star R_\mu)(A) \quad (3.2.11)$$

for all  $\lambda, \mu \in \text{Comp}$ , where the product  $\cdot$  of the left member of (3.2.11) is the usual product of noncommutative series of  $\mathbb{K}\langle\langle A^* \rangle\rangle$ .

This Hopf bialgebra has been introduced in [GKL<sup>+</sup>95] as a generalization of the usual symmetric functions [Mac15]. This generalization is a consequence of the fact that there is a surjective morphism from  $\text{Sym}$  to the algebra of symmetric functions.



3.2.3. *Free quasi-symmetric noncommutative symmetric functions.* Consider the graded combinatorial polynomial space  $\text{FQSym} := \mathbb{K}\langle \mathfrak{S} \rangle$  of the permutations. Let  $\{F_\sigma : \sigma \in \mathfrak{S}\}$  be the basis of the *fundamental free quasi-symmetric functions* of  $\text{FQSym}$  and  $\star$  be the binary product defined linearly, for any  $\sigma, \nu \in \mathfrak{S}$ , by

$$F_\sigma \star F_\nu := \sum_{\pi \in \mathfrak{S}} \langle \pi, \sigma \sqcup \bar{\nu} \rangle F_\pi, \quad (3.2.12)$$

where  $\bar{\nu}$  is the word obtained by incrementing each letter of  $\nu$  by  $|\sigma|$ , and  $\sqcup$  is the shuffle product of words defined in Section 2.3.1. For instance

$$F_{21} \star F_{12} = F_{2134} + F_{2314} + F_{2341} + F_{3214} + F_{3241} + F_{3421}. \quad (3.2.13)$$

This product is known as the *shifted shuffle product*. Let also  $\Delta$  be the binary coproduct defined linearly, for any  $\pi \in \mathfrak{S}$ , by

$$\Delta(F_\pi) := \sum_{0 \leq i \leq |\pi|} F_{\text{std}(\pi(1)\dots\pi(i))} \otimes F_{\text{std}(\pi(i+1)\dots\pi(|\pi|))}, \quad (3.2.14)$$

where  $\text{std}$  is defined in Section 1.2.5 of Chapter 1. For instance

$$\Delta(F_{42513}) = 1 \otimes F_{42513} + F_1 \otimes F_{2413} + F_{21} \otimes F_{312} + F_{213} \otimes F_{12} + F_{3241} \otimes F_1 + F_{42513} \otimes 1. \quad (3.2.15)$$

The product  $\star$  and the coproduct  $\Delta$  endow  $\text{FQSym}$  with a structure of a combinatorial Hopf bialgebra.

This Hopf bialgebra  $\text{FQSym}$  is usually known as the *Hopf bialgebra of free quasi-symmetric functions*. Indeed, as for  $\text{Sym}$ , there is a way to see the elements of  $\text{FQSym}$  as noncommutative series. For this, consider a totally ordered alphabet  $A := \{a_1, a_2, \dots\}$  where  $1 \leq i \leq j$  implies  $a_i \preceq a_j$ . Let the series

$$F_\sigma(A) := \sum_{\substack{u \in A^* \\ \text{std}(u) = \sigma^{-1}}} u, \quad (3.2.16)$$

of  $\mathbb{K}\langle\langle A^* \rangle\rangle$  defined for all  $\sigma \in \mathfrak{S}$ . For instance

$$F_{312}(\{a_1, a_2, a_3\}) = a_2 a_2 a_1 + a_2 a_3 a_1 + a_3 a_3 a_1 + a_3 a_3 a_2, \quad (3.2.17a)$$

$$F_{132}(\{a_1, a_2, a_3\}) = a_1 a_2 a_1 + a_1 a_3 a_1 + a_1 a_3 a_2 + a_2 a_3 a_2. \quad (3.2.17b)$$

Furthermore, the Hopf bialgebras  $\text{FQSym}$  and  $\text{Sym}$  are related through the injective morphism of Hopf bialgebras  $\phi : \text{Sym} \rightarrow \text{FQSym}$  defined linearly by

$$\phi(R_\lambda) := \sum_{\substack{\sigma \in \mathfrak{S} \\ \text{Des}(\sigma^{-1}) = \text{Des}(\lambda)}} F_\sigma \quad (3.2.18)$$

for all  $\lambda \in \text{Comp}$ . For instance,

$$\phi(R_{21}) = F_{312} + F_{132}. \quad (3.2.19)$$

Observe, with the help of (3.2.10b), (3.2.17a), and (3.2.17b), in particular that (3.2.19) holds on the noncommutative series associated with the elements of  $\text{Sym}$  and  $\text{FQSym}$ , that is,  $R_{21}(A) = F_{312}(A) + F_{132}(A)$ .

This Hopf bialgebra has been introduced by Malvenuto and Reutenauer [MR95] and is sometimes called the Malvenuto-Reutenauer algebra. Due to its interpretation [DHT02] as an algebra of noncommutative series  $F_\sigma(A)$ , it is also called the algebra of free quasi-symmetric functions. Other classical examples include the Poirier-Reutenauer Hopf bialgebra of tableaux [PR95], also known as the Hopf bialgebra of free symmetric functions FSym [DHT02, HNT05]. This Hopf bialgebra is defined on the combinatorial space of all standard Young tableaux. The Loday-Ronco Hopf bialgebra [LR98], also known as the Hopf bialgebra of binary search trees PBT [HNT05] is defined on the combinatorial space of all binary trees. As other modern examples of combinatorial spaces endowed with a Hopf bialgebra structure, one can cite WQSym [Hiv99] involving packed words, PQSym [NT07] involving parking functions, Bell [Rey07] involving set partitions, Baxter [LR12, Gir12a] involving ordered pairs of twin binary trees, and Camb [CP17] involving Cambrian trees. The study of all these structures uses a large set of tools. Indeed, it relies on algorithms transforming words into combinatorial objects, congruences of free monoids, partial orders structures and lattices, and polytopes and their geometric realizations. Besides, a polynomial realization of a combinatorial Hopf bialgebra  $\mathbb{K}\langle C \rangle$  consists in seeing  $\mathbb{K}\langle C \rangle$  as an algebra of noncommutative series so that its product is the usual product of series and its coproduct is obtained by alphabet doubling (see for instance [Hiv03]). In this text, only the polynomial realizations of Sym and FQSym have been detailed, but all the Hopf bialgebras discussed here have polynomial realizations.

3.2.4. *Congruences and Hopf sub-bialgebras of FQSym.* It is worth to note that some of the structures discussed above (and many other ones) can be constructed through congruences of the free monoid  $A^*$  where  $A := \{a_1, a_2, \dots\}$ . Indeed, if  $\equiv$  is a congruence of  $A^*$ , one can construct a family  $\{P_{[\sigma]_\equiv} : \sigma \in \mathfrak{S}\}$  where  $[\sigma]_\equiv$  is the  $\equiv$ -equivalence class of the permutation  $\sigma$  seen as a word on  $A$  by identifying each letter  $i$  of  $\sigma$  with the letter  $a_i$  of  $A$ , and, for any  $\sigma \in \mathfrak{S}$ ,

$$P_{[\sigma]_\equiv} := \sum_{\sigma \in [\sigma]_\equiv} F_\sigma. \quad (3.2.20)$$

Of course, the elements (3.2.20) do not form a Hopf sub-bialgebra of FQSym without precise properties on  $\equiv$ . Let us state them. First, we consider that  $A$  is totally ordered by the relation  $\preccurlyeq$  satisfying  $a_i \preccurlyeq a_j$  if  $i \leq j$ . For any interval  $J$  of  $A$  and any word  $u$  on  $A$ , we denote by  $u|_J$  the subword of  $u$  consisting in the letters belonging to  $J$ . We say that  $\equiv$  is *compatible with the restriction of alphabet intervals* if, for any interval  $J$  of  $A$  and any  $u, v \in A^*$ ,  $u \equiv v$  implies  $u|_J \equiv v|_J$ . We say that  $\equiv$  is *compatible with the destandardization process* if, for any  $u, v \in A^*$ ,  $u \equiv v$  if and only if  $\text{std}(u) \equiv \text{std}(v)$  and  $u$  and  $v$  have the same commutative image.

**THEOREM 3.2.1.** *Let  $\equiv$  be a monoid congruence of  $A^*$  compatible with the restriction of alphabet intervals and with the destandardization process. Then, the elements (3.2.20) form a combinatorial Hopf sub-bialgebra of FQSym whose bases are index by the  $\equiv$ -equivalence classes of permutations.*

This way to construct combinatorial Hopf sub-bialgebras of  $\text{FQSym}$  has been introduced in [HN07]. One can see also [Hiv99, Gir11, NT14] where properties of this construction are studied.

Let us now provide some examples of congruences satisfying the requirements of Theorem 3.2.1.

*Sylvester congruence.* The *sylvester congruence* [HNT05] is the finest monoid congruence  $\equiv$  of  $A^*$  satisfying, for any  $u \in A^*$  and  $a, b, c \in A$ ,

$$acub \equiv caub, \quad a \preccurlyeq b < c. \quad (3.2.21)$$

For example, the  $\equiv$ -equivalence class of the permutation 15423 (see Figure 2.1) is

$$\{12543, 15243, 15423, 51243, 51423, 54123\}. \quad (3.2.22)$$

The set of all  $\equiv$ -equivalence classes of permutations of size  $n$  are in one-to-one correspon-

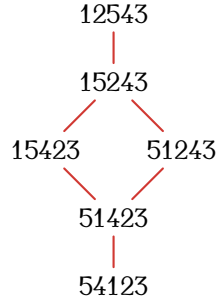

FIGURE 2.1. The sylvester equivalence class of the permutation 15423.

dence with the set of all binary trees with  $n$  internal nodes. A possible bijection between these two sets is furnished by the binary search tree insertion algorithm [Knu98].

*Plactic congruence.* The *plactic congruence* [LS81, Lot02] is the finest monoid congruence  $\equiv$  of  $A^*$  satisfying, for any  $a, b, c \in A$ ,

$$acb \equiv cab, \quad a \preccurlyeq b < c, \quad (3.2.23a)$$

$$bac \equiv bca, \quad a < b \preccurlyeq c. \quad (3.2.23b)$$

The set of all  $\equiv$ -equivalence classes of permutations of size  $n$  are in one-to-one correspondence with the set of all standard Young tableaux [LS81, Fu197]. A possible bijection between these two sets is furnished by the Robinson-Schensted correspondence [Sch61].

*Baxter congruence.* The *Baxter congruence* [Gir12b] (see also [Rea05, LR12]) is the finest monoid congruence  $\equiv$  of  $A^*$  satisfying, for any  $u, v \in A^*$  and  $a, b, c, d \in A$ ,

$$cuadvb \equiv cudavb, \quad a \preccurlyeq b < c \preccurlyeq d, \quad (3.2.24a)$$

$$budavc \equiv buadvc, \quad a < b \preccurlyeq c < d. \quad (3.2.24b)$$

The set of all  $\equiv$ -equivalence classes of permutations of size  $n$  are in one-to-one correspondence with the set of all ordered pairs of twin binary trees, objects introduced in [DG94].

A possible bijection between these two sets uses the classical binary search tree insertion algorithm together with a variant of it where the last inserted node becomes the root of the tree [Gir12b].

*Bell congruence.* The *Bell congruence* [Rey07] is the finest monoid congruence  $\equiv$  of  $A^*$  satisfying, for any  $u \in A^*$  and  $a, b, c \in A$ ,

$$acub \equiv caub, \quad a \preccurlyeq b < c \text{ and for all letters } d \text{ of } u, c \preccurlyeq d. \quad (3.2.25)$$

The set of all  $\equiv$ -equivalence classes of permutations of size  $n$  are in one-to-one correspondence with the set of all set partitions of  $[n]$ . A possible bijection between these two sets uses a variant of the patience sorting algorithm [Rey07].

*Hypoplactic congruence.* The *hypoplactic congruence* [KT97,KT99] is the finest monoid congruence  $\equiv$  of  $A^*$  satisfying, for any  $u \in A^*$  and  $a, b, c \in A$ ,

$$acub \equiv caub, \quad a \preccurlyeq b < c, \quad (3.2.26a)$$

$$buca \equiv buac, \quad a < b \preccurlyeq c. \quad (3.2.26b)$$

The set of all  $\equiv$ -equivalence classes of permutations of size  $n$  are in one-to-one correspondence with the set of all compositions of size  $n$ .

*Total congruence.* The *total congruence* is the monoid congruence  $\equiv$  satisfying  $u \equiv v$  if  $u$  and  $v$  have the same commutative image. There is exactly one  $\equiv$ -equivalence class of permutations of size  $n$ .

**3.2.5. Hopf bialgebra of colored permutations.** Let, for any  $\ell \geq 1$ , the graded combinatorial polynomial space  $\text{FQSym}^{(\ell)} := \mathbb{K} \langle \mathfrak{S}^{(\ell)} \rangle$  of the  $\ell$ -colored permutations. Let  $\{F_{(\sigma,u)} : (\sigma, u) \in \mathfrak{S}^{(\ell)}\}$  be the basis of the *fundamental  $\ell$ -free quasi-symmetric functions* of  $\text{FQSym}^{(\ell)}$ . The space  $\text{FQSym}^{(\ell)}$  is endowed with a binary product  $\star$  similar to the product of  $\text{FQSym}$  (see (3.2.12)) wherein the letters of the permutations and their colors are shuffled. For instance, in  $\text{FQSym}^{(5)}$ ,

$$F_{(12,43)} \star F_{(1,5)} = F_{(123,435)} + F_{(132,453)} + F_{(312,543)}. \quad (3.2.27)$$

Let also  $\Delta$  be the binary coproduct defined in  $\text{FQSym}^{(\ell)}$  in a similar way as the coproduct of  $\text{FQSym}$  (see (3.2.14)). Again in this case, the colors follow the letters of the permutations. For instance, in  $\text{FQSym}^{(4)}$ ,

$$F_{(312,411)} = 1 \otimes F_{(312,411)} + F_{(1,4)} \otimes F_{(12,11)} + F_{(21,41)} \otimes F_{(1,1)} + F_{(312,411)} \otimes 1. \quad (3.2.28)$$

The product  $\star$  and the coproduct  $\Delta$  endow  $\text{FQSym}^{(\ell)}$  with a structure of a combinatorial Hopf bialgebra.

These Hopf bialgebras have been introduced in [NT10]. Obviously, they provide a generalization of  $\text{FQSym}$  since  $\text{FQSym} = \text{FQSym}^{(1)}$  and, for any  $\ell \geq 1$ ,  $\text{FQSym}^{(\ell)}$  is a Hopf sub-bialgebra of  $\text{FQSym}^{(\ell+1)}$ .

3.2.6. *Hopf bialgebra of uniform block permutations.* A **uniform block permutation** (or a **UBP** for short) of size  $n$  is a bijection  $\pi : \pi^d \rightarrow \pi^c$  where  $\pi^d$  and  $\pi^c$  are set partitions of  $[n]$ , and, for any  $e \in \pi^d$ ,  $\#e = \#\pi(e)$ . These objects are obvious generalizations of permutations since a permutation is a UBP where  $\pi^d$  and  $\pi^c$  are sets of singletons. For instance, the map  $\pi$  defined by

$$\pi(\{1, 4, 5\}) := \{2, 5, 6\}, \quad \pi(\{2\}) := \{1\}, \quad \pi(\{3, 6\}) := \{3, 4\} \quad (3.2.29)$$

is a UBP of size 6. We denote by **UBP** the graded combinatorial collection of all UBPs. The sequence of integers associated with **UBP** starts by

$$1, 1, 3, 16, 131, 1496, 22482, 426833, \quad (3.2.30)$$

and is Sequence **A023998** of **[Slo]**.

The graded combinatorial polynomial space  $\mathbf{UBP} := \mathbb{K}\langle \mathbf{UBP} \rangle$  admits a combinatorial Hopf bialgebra structure defined through its basis  $\{F_\pi : \pi \in \mathbf{UBP}\}$  (see **[AO08]**). This Hopf bialgebra contains **FQSym**.

3.2.7. *Hopf bialgebra of matrix quasi-symmetric functions.* A **packed matrix** is a matrix with entries in  $\mathbb{N}$  such that each row and each column contains at least one nonzero entry. We denote by **M** the graded combinatorial collection of all packed matrices, where the size of a packed matrix is the sum of its entries.

The graded combinatorial polynomial space  $\mathbf{MQSym} := \mathbb{K}\langle \mathbf{M} \rangle$  admits a combinatorial Hopf bialgebra structure defined through its basis  $\{M_M : M \in \mathbf{M}\}$  of the **quasi-multiword functions**. Let  $\star$  be the binary product defined linearly, for any  $M_1, M_2 \in \mathbf{M}$  in the following way. The product  $M_{M_1} \star M_{M_2}$  is the sum of all the  $M_M$  such that the packed matrix  $M$  is obtained by horizontally concatenating  $N_1$  and  $N_2$  where  $N_1$  (resp.  $N_2$ ) is obtained from  $M_1$  (resp.  $M_2$ ) by inserting some null rows, and so that  $N_1$  and  $N_2$  have both a same number of rows. For example,

$$M_{\begin{bmatrix} 2 & 1 \\ 0 & 1 \end{bmatrix}} \star M_{\begin{bmatrix} 1 & 3 \end{bmatrix}} = M_{\begin{bmatrix} 2 & 1 & 0 & 0 \\ 0 & 1 & 0 & 0 \\ 0 & 0 & 1 & 3 \end{bmatrix}} + M_{\begin{bmatrix} 2 & 1 & 0 & 0 \\ 0 & 1 & 1 & 3 \end{bmatrix}} + M_{\begin{bmatrix} 2 & 1 & 0 & 0 \\ 0 & 0 & 1 & 3 \\ 0 & 1 & 0 & 0 \end{bmatrix}} + M_{\begin{bmatrix} 2 & 1 & 1 & 3 \\ 0 & 1 & 0 & 0 \end{bmatrix}} + M_{\begin{bmatrix} 0 & 0 & 1 & 3 \\ 2 & 1 & 0 & 0 \\ 0 & 1 & 0 & 0 \end{bmatrix}}. \quad (3.2.31)$$

There is also a binary coproduct  $\Delta$  defined on **MQSym** that, on the basis of quasi-multiword functions, splits the packed matrices horizontally and delete the columns of zeros.

This Hopf bialgebra has been introduced in **[Hiv99]** (see also **[DHT02]**).

## 4. Operads in combinatorics

We regard here operads as polynomial algebras and provide the main definitions used in the following chapters. We also give examples of some usual operads.

**4.1. Operads.** Operads have been introduced in the field of algebraic topology **[May72, BV73]**. Here we see operads under a combinatorial point of view. The notions of operads, nonsymmetric operads, free operads, presentations by generators and relations, Koszul duality, and algebras over operads are reviewed.

4.1.1. *Nonsymmetric operads.* A *nonsymmetric operad* (or a *ns operad* for short) is a graded augmented polynomial space  $\mathbb{K}\langle C \rangle$  endowed with a set of binary linear products  $\{\circ_i : i \in \mathbb{N}_{\geq 1}\}$ . These products have to satisfy several relations. First, when  $x \in C(n)$  and  $i \geq n + 1$ , for any  $y \in C$ ,

$$x \circ_i y = 0. \tag{4.1.1}$$

Moreover, the products  $\circ_i, i \in \mathbb{N}_{\geq 1}$ , satisfy

$$\circ_i : \mathbb{K}\langle C \rangle(n) \otimes \mathbb{K}\langle C \rangle(m) \rightarrow \mathbb{K}\langle C \rangle(n + m - 1), \quad n, m \in \mathbb{N}_{\geq 1}, i \in [n]. \tag{4.1.2}$$

This is equivalent to the fact that if  $x \in C(n), y \in C(m)$ , and  $i \in [n], x \circ_i y \in \mathbb{K}\langle C \rangle(n + m - 1)$ . For any  $x \in C(n), y \in C(m)$ , and  $z \in C(k)$ , one must have

$$(x \circ_i y) \circ_{i+j-1} z = x \circ_i (y \circ_j z), \quad i \in [n], j \in [m], \tag{4.1.3a}$$

$$(x \circ_i y) \circ_{j+m-1} z = (x \circ_j z) \circ_i y, \quad i < j \in [n], \tag{4.1.3b}$$

Finally, we demand the existence of an element  $\mathbb{1}$  of  $\mathbb{K}\langle C \rangle(1)$  satisfying, for any  $x \in C(n)$ ,

$$\mathbb{1} \circ_i x = x = x \circ_i \mathbb{1}, \quad i \in [n]. \tag{4.1.4}$$

Let us now provide an intuitive meaning of these relations. Any element  $f$  of  $\mathbb{K}\langle C \rangle(n)$  is seen as a product of arity  $n$ , depicted as



and where the inputs are indexed from 1 to  $n$  from left to right. The  $\circ_i$  act by composing these products: for any  $f \in \mathbb{K}\langle C \rangle(n), g \in \mathbb{K}\langle C \rangle(m)$ , and  $i \in [n], f \circ_i g$  is the product obtained by plugging the output of  $g$  onto the  $i$ th input of  $f$ . This is depicted as

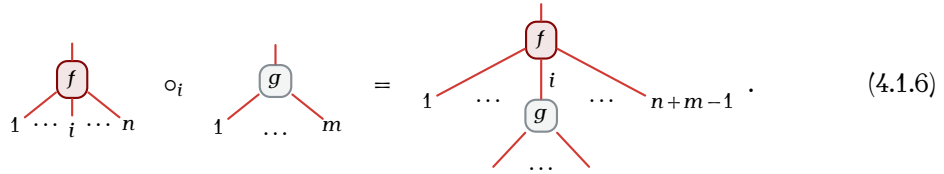

Under this formalism, Relation (4.1.3a) says that the product



can be formed by two ways: by starting by composing  $f$  and  $g$ , and the result with  $h$ , or by starting by composing  $g$  and  $h$ , and the result with  $f$ . Relation (4.1.3b) says that the product

$$(4.1.8)$$

can be formed by two ways: by starting by composing  $f$  and  $g$ , and the result with  $h$ , or by starting by composing  $f$  and  $h$ , and the result with  $g$ . Finally, Relation (4.1.4) says that  $\mathbb{1}$  behaves as an identity product, so that

$$(4.1.9)$$

Let us fix some vocabulary. Each element  $f$  of  $\mathbb{K}\langle C \rangle(n)$  is of *arity*  $n$ . The arity of  $f$  is denoted by  $|f|$ . The maps  $\circ_i$ ,  $i \geq 1$ , are *partial composition maps*. Relation (4.1.3a) is the *series associativity relation*, while (4.1.3b) is the *parallel associativity relation*. The element  $\mathbb{1}$  of arity 1 satisfying (4.1.4) is the *unit* of  $\mathbb{K}\langle C \rangle$ . This element is unique.

Since a ns operad is a particular polynomial algebra, all the properties and definitions about polynomial algebras exposed in Section 2.2 remain valid for ns operads (like ns operad morphisms, ns suboperads, generating sets, operad ideals and quotients, etc.). Observe also, from (4.1.2) that the  $\circ_i$ ,  $i \in \mathbb{N}_{\geq 1}$ , are not graded products. Nevertheless, these partial composition maps are  $\dot{+}$ -compatible products where  $\dot{+}$  is the operation satisfying  $n \dot{+} m := n + m - 1$  for any  $n, m \in \mathbb{N}_{\geq 1}$ . As a side remark, since  $C$  augmented, one can see the partial composition maps as graded products on the space  $\mathbb{K}\langle \text{Sus}_{-1}(C) \rangle$ . In this way, when  $C$  is combinatorial, one can see  $\mathbb{K}\langle C \rangle$  as a particular combinatorial algebra (see Section 2.2.2).

**4.1.2. Additional definitions.** Given a ns operad  $\mathbb{K}\langle C \rangle$ , the *complete composition maps* of  $\mathbb{K}\langle C \rangle$  are, the linear maps  $\circ^{(n)}$ ,  $n \in \mathbb{N}_{\geq 1}$ , satisfying

$$\circ^{(n)} : \mathbb{K}\langle C \rangle(n) \otimes \mathbb{K}\langle C \rangle(m_1) \otimes \cdots \otimes \mathbb{K}\langle C \rangle(m_n) \rightarrow \mathbb{K}\langle C \rangle(m_1 + \cdots + m_n) \quad (4.1.10)$$

defined linearly, for any  $x \in C(n)$  and  $y_1, \dots, y_n \in C$ , by

$$\circ^{(n)}(x \otimes y_1 \otimes \cdots \otimes y_n) := (\dots((x \circ_n y_n) \circ_{n-1} y_{n-1}) \dots) \circ_1 y_1. \quad (4.1.11)$$

To gain concision, we shall denote by  $f \circ [g_1, \dots, g_n]$  the element  $\circ^{(n)}(f \otimes g_1 \otimes \cdots \otimes g_n)$  of  $\mathbb{K}\langle C \rangle$ , for all  $f \in \mathbb{K}\langle C \rangle(n)$  and  $g_1, \dots, g_n \in \mathbb{K}\langle C \rangle$ . Under this notation, we call  $\circ$  the *complete composition map* of  $\mathbb{K}\langle C \rangle$ .

Let us now provide some particular definitions about ns operads that do not come from the general ones of polynomial algebras of Section 2.2.

An element  $f$  of arity 2 of  $\mathbb{K}\langle C \rangle$  is *associative* if  $f \circ_1 f = f \circ_2 f$ . If  $\mathbb{K}\langle C_1 \rangle$  and  $\mathbb{K}\langle C_2 \rangle$  are two ns operads, a *ns operad antimorphism* is a graded polynomial space morphism  $\phi : \mathbb{K}\langle C_1 \rangle \rightarrow \mathbb{K}\langle C_2 \rangle$  such that  $\phi(f \circ_i g) = \phi(f) \circ_{n-i+1} \phi(g)$  for any element  $f$  of arity  $n$  of  $\mathbb{K}\langle C_1 \rangle$ , any  $g \in \mathbb{K}\langle C_1 \rangle$ , and  $i \in [n]$ . A *symmetry* of  $\mathbb{K}\langle C \rangle$  is either a ns operad automorphism or a ns operad antiautomorphism of  $\mathbb{K}\langle C \rangle$ . The set of all symmetries of  $\mathbb{K}\langle C \rangle$  forms a group for the map composition, called *group of symmetries* of  $\mathbb{K}\langle C \rangle$ .

Given two ns operads  $\mathbb{K}\langle C_1 \rangle$  and  $\mathbb{K}\langle C_2 \rangle$ , the *Hadamard product* of  $\mathbb{K}\langle C_1 \rangle$  and  $\mathbb{K}\langle C_2 \rangle$  is the ns operad denoted by  $\mathbb{K}\langle C_1 \rangle \boxtimes \mathbb{K}\langle C_2 \rangle$  and defined on the polynomial space  $\mathbb{K}\langle C_1 \boxtimes C_2 \rangle$  where  $\boxtimes$  is the Hadamard product of graded collections (see Section 1.1.5 of Chapter 1). The partial compositions  $\circ_i$ ,  $i \in \mathbb{N}_{\geq 1}$ , are defined linearly by

$$(x_1, x_2) \circ_i (y_1, y_2) := (x_1 \circ_i y_1, x_2 \circ_i y_2), \quad (4.1.12)$$

for any  $(x_1, x_2) \in (C_1 \boxtimes C_2)(n)$ ,  $(y_1, y_2) \in C_1 \boxtimes C_2$ ,  $i \in [n]$ , where the second (resp. third) occurrence of  $\circ_i$  in (4.1.12) is a partial composition map of  $\mathbb{K}\langle C_1 \rangle$  (resp.  $\mathbb{K}\langle C_2 \rangle$ ).

4.1.3. *Free ns operads.* Let  $\mathfrak{G}$  be an augmented graded collection. The *free ns operad* over  $\mathfrak{G}$  is the ns operad

$$\mathbf{FO}(\mathfrak{G}) := \mathbb{K}\langle \mathbf{PRT}_{\perp}^{\mathfrak{G}} \rangle, \quad (4.1.13)$$

where  $\mathbf{PRT}_{\perp}^{\mathfrak{G}}$  is the graded collection of all the  $\mathfrak{G}$ -syntax trees (see Section 2.3 of Chapter 1). The space  $\mathbf{FO}(\mathfrak{G})$  is endowed with the linearizations of the grafting operations  $\circ_i$ ,  $i \in \mathbb{N}_{\geq 1}$ , defined in Section 2.4.2 of Chapter 1. The unit of  $\mathbf{FO}(\mathfrak{G})$  is the only  $\mathfrak{G}$ -syntax tree  $\perp$  of arity 1.

Let also

$$\odot : \mathfrak{G} \rightarrow \mathbf{FO}(\mathfrak{G}) \quad (4.1.14)$$

be the *inclusion map*, that is the map sending any  $x \in \mathfrak{G}$  to the corolla  $\odot(x)$  (see Section 2.3.1 of Chapter 1).

4.1.4. *Evaluations and treelike expressions.* Let now  $\mathbb{K}\langle C \rangle$  be a ns operad. Since  $C$  is a graded augmented collection, one can consider the free ns operad  $\mathbf{FO}(C)$  of the  $C$ -syntax trees. The *evaluation map* of  $\mathbb{K}\langle C \rangle$  is the map

$$\mathbf{ev} : \mathbf{FO}(C) \rightarrow \mathbb{K}\langle C \rangle \quad (4.1.15)$$

defined linearly by induction, for any  $C$ -syntax tree  $t$ , by

$$\mathbf{ev}(t) := \begin{cases} 1 \in \mathbb{K}\langle C \rangle & \text{if } t = \perp, \\ \omega_t(\epsilon) \circ [\mathbf{ev}(t_1), \dots, \mathbf{ev}(t_k)] & \text{otherwise,} \end{cases} \quad (4.1.16)$$

where  $\circ$  is the complete composition map of  $\mathbb{K}\langle C \rangle$ ,  $\omega_t(\epsilon)$  is the label of the root of  $t$ , and  $k$  is the root arity of  $t$ . This map  $\mathbf{ev}$  is the unique surjective ns operad morphism from  $\mathbf{FO}(C)$  to  $\mathbb{K}\langle C \rangle$  satisfying  $\mathbf{ev}(\odot(x)) = x$  for all  $x \in C$ .

For any subset  $S$  of  $C$ , an *S-treelike expression* of an element  $f$  of  $\mathbb{K}\langle C \rangle$  is an element  $g$  of  $\mathbf{FO}(S)$  such that  $\mathbf{ev}(g) = f$ . A treelike expression can be thought as a factorization in a ns operad.



4.1.5. *Presentations by generators and relations.* A **presentation** of a ns operad  $\mathbb{K}\langle C \rangle$  consists in a pair  $(\mathfrak{G}, \mathfrak{R})$  such that  $\mathfrak{G}$  is an augmented graded collection,  $\mathfrak{R}$  is a subspace of  $\mathbf{FO}(\mathfrak{G})$  and

$$\mathbb{K}\langle C \rangle \simeq \mathbf{FO}(\mathfrak{G})/\langle \mathfrak{R} \rangle \quad (4.1.17)$$

where  $\langle \mathfrak{R} \rangle$  is the ns operad ideal of  $\mathbf{FO}(\mathfrak{G})$  generated by  $\mathfrak{R}$ . We call  $\mathfrak{G}$  the **set of generators** and  $\mathfrak{R}$  the **space of relations** of  $\mathbb{K}\langle C \rangle$ .

We say that a presentation  $(\mathfrak{G}, \mathfrak{R})$  of  $\mathbb{K}\langle C \rangle$  is **quadratic** if  $\mathfrak{R}$  is a homogeneous subspace of  $\mathbf{FO}(\mathfrak{G})$  consisting in syntax trees of degree 2. Besides, we say that  $(\mathfrak{G}, \mathfrak{R})$  is **binary** if  $\mathfrak{G}$  has only elements of size 2. By extension, we say also that  $\mathbb{K}\langle C \rangle$  is **quadratic** (resp. **binary**) if it admits a quadratic (resp. binary) presentation.

In practice, to establish presentations of ns operads, we use rewrite systems on syntax trees (see Section 2.4 of Chapter 1).

**THEOREM 4.1.1.** *Let  $\mathbb{K}\langle C \rangle$  be a ns operad,  $\mathfrak{G}$  be a subcollection of  $C$ , and  $\mathfrak{R}$  be a subspace of  $\mathbf{FO}(\mathfrak{G})$  of syntax trees of degrees 2 or more. If*

- (i) *the collection  $\mathfrak{G}$  is a generating set of  $\mathbb{K}\langle C \rangle$ ;*
- (ii) *for any  $f \in \mathfrak{R}$ ,  $\text{ev}(f) = 0$ ;*
- (iii) *there exists a rewrite system  $(\text{PRT}_{\perp}^{\mathfrak{G}}, \Rightarrow)$  being an orientation of  $\mathfrak{R}$ , such that its closure  $(\text{PRT}_{\perp}^{\mathfrak{G}}, \rightsquigarrow)$  is convergent, and its set of normal forms  $\mathcal{F}_{(\text{PRT}_{\perp}^{\mathfrak{G}}, \rightsquigarrow)}$  is isomorphic to  $C$ ,*

*then  $(\mathfrak{G}, \mathfrak{R})$  is a presentation of  $\mathbb{K}\langle C \rangle$ .*

**PROOF.** By definition of the evaluation map  $\text{ev} : \mathbf{FO}(C) \rightarrow \mathbb{K}\langle C \rangle$  and by (ii), the map

$$\phi : \mathbf{FO}(\mathfrak{G})/\langle \mathfrak{R} \rangle \rightarrow \mathbb{K}\langle C \rangle \quad (4.1.18)$$

defined linearly for any  $x \in C$  by  $\phi([x]) := \text{ev}(x)$ , where  $[x]$  is the image of  $x$  through the canonical surjection from  $\mathbf{FO}(C)$  to  $\mathbf{FO}(C)/\langle \mathfrak{R} \rangle$ , is a ns operad morphism. Moreover, by (i), and since  $\mathfrak{R}$  has no element of degree 0 or 1,  $\phi([g]) = g$  for all  $g \in \mathfrak{G}$ . This implies that  $\phi$  is surjective.

Besides, (iii) and Proposition 1.1.1 imply, as spaces, the isomorphisms

$$\mathbf{FO}(\mathfrak{G})/\langle \mathfrak{R} \rangle \simeq \mathbb{K}\langle \mathcal{F}_{(\text{PRT}_{\perp}^{\mathfrak{G}}, \rightsquigarrow)} \rangle \simeq \mathbb{K}\langle C \rangle \quad (4.1.19)$$

This, together with the fact that  $\phi$  is surjective implies that  $\phi$  is a ns operad isomorphism. Hence,  $\mathbb{K}\langle C \rangle$  admits the claimed presentation.  $\square$

In practice, there are at least two ways to use Theorem 4.1.1 to establish a presentation of a ns operad  $\mathbb{K}\langle C \rangle$ . The first one is the most obvious: it consists first in finding a generating set  $\mathfrak{G}$  of  $\mathbb{K}\langle C \rangle$ , then conjecturing a space of relations  $\mathfrak{R}$  and a rewrite system  $(\text{PRT}_{\perp}^{\mathfrak{G}}, \Rightarrow)$  such that all conditions (i), (ii), and (iii) are satisfied. This can be technical (especially to prove that the closure  $(\text{PRT}_{\perp}^{\mathfrak{G}}, \rightsquigarrow)$  is convergent), and relies heavily on computer exploration. The second way requires as a prerequisite that  $\mathbb{K}\langle C \rangle$  is combinatorial (and hence, all its homogeneous components are finite dimensional). In this case, we need here also to find a generating set  $\mathfrak{G}$  of  $\mathbb{K}\langle C \rangle$ , a space of relations  $\mathfrak{R}$  and a rewrite system  $(\text{PRT}_{\perp}^{\mathfrak{G}}, \Rightarrow)$  such

that (i), (ii) hold. The difference with the first way occurs for (iii): it is now sufficient to prove  $(\text{PRT}_{\perp}^{\mathfrak{G}}, \rightsquigarrow)$  is terminating (and not necessarily convergent). Indeed, if  $(\text{PRT}_{\perp}^{\mathfrak{G}}, \rightsquigarrow)$  is terminating, since  $\mathbb{K}\langle C \rangle$  is combinatorial,

$$\dim \mathbb{K}\langle C(n) \rangle = \#\mathcal{F}_{(\text{PRT}_{\perp}^{\mathfrak{G}}, \rightsquigarrow)}(n) \geq \dim \text{FO}(\mathfrak{G}(n)) / \langle \mathfrak{R} \rangle \quad (4.1.20)$$

for all  $n \geq 1$ . The inequality of (4.1.20) comes from the fact that, since we do not know if  $(\text{PRT}_{\perp}^{\mathfrak{G}}, \rightsquigarrow)$  is confluent, it can have more normal forms of arity  $n$  than the dimension of  $\text{FO}(\mathfrak{G}) / \langle \mathfrak{R} \rangle$  in arity  $n$ . It follows from (4.1.20), by using similar arguments as the ones used in the proof of Theorem 4.1.1, that there is a ns operad isomorphism from  $\text{FO}(\mathfrak{G}) / \langle \mathfrak{R} \rangle$  to  $\mathbb{K}\langle C \rangle$ .

**4.1.6. Koszulity and Koszul duality.** In [GK94], Ginzburg and Kapranov extended the notion of Koszul duality of quadratic associative algebras to quadratic ns operads. Starting with a ns operad  $\mathbb{K}\langle C \rangle$  admitting a binary and quadratic presentation  $(\mathfrak{G}, \mathfrak{R})$  where  $\mathfrak{G}$  is finite, the *Koszul dual* of  $\mathbb{K}\langle C \rangle$  is the ns operad  $\mathbb{K}\langle C \rangle^!$ , isomorphic to the ns operad admitting the presentation  $(\mathfrak{G}, \mathfrak{R}^{\perp})$  where  $\mathfrak{R}^{\perp}$  is the annihilator of  $\mathfrak{R}$  in  $\text{FO}(\mathfrak{G})$  with respect to the scalar product

$$\langle -, - \rangle : \text{FO}(\mathfrak{G})(3) \otimes \text{FO}(\mathfrak{G})(3) \rightarrow \mathbb{K} \quad (4.1.21)$$

linearly defined, for all  $x, x', y, y' \in \mathfrak{G}(2)$ , by

$$\langle \odot(x) \circ_i \odot(y), \odot(x') \circ_{i'} \odot(y') \rangle := \begin{cases} 1 & \text{if } x = x', y = y', \text{ and } i = i' = 1, \\ -1 & \text{if } x = x', y = y', \text{ and } i = i' = 2, \\ 0 & \text{otherwise.} \end{cases} \quad (4.1.22)$$

Then, with knowledge of a presentation of  $\mathbb{K}\langle C \rangle$ , one can compute a presentation of  $\mathbb{K}\langle C \rangle^!$ .

A quadratic ns operad  $\mathbb{K}\langle C \rangle$  is *Koszul* if its Koszul complex is acyclic [GK94, LV12]. Furthermore, when  $\mathbb{K}\langle C \rangle$  is Koszul and admits an Hilbert series, the Hilbert series of  $\mathbb{K}\langle C \rangle$  and of its Koszul dual  $\mathbb{K}\langle C \rangle^!$  are related [GK94] by

$$\mathcal{H}_{\mathbb{K}\langle C \rangle} \left( -\mathcal{H}_{\mathbb{K}\langle C \rangle^!}(-t) \right) = t. \quad (4.1.23)$$

Relation (4.1.23) can be used either to prove that a ns operad is not Koszul (it is the case when the coefficients of the hypothetical Hilbert series of the Koszul dual admits coefficients that are not nonnegative integers) or to compute the Hilbert series of the Koszul dual of a Koszul operad.

In all this work, to prove the Koszulity of a ns operad  $\mathbb{K}\langle C \rangle$ , we shall make use of a tool introduced by Dotsenko and Khoroshkin [DK10] in the context of Gröbner bases for operads, which reformulates in our context, by using rewrite rules on syntax trees, in the following way.

**LEMMA 4.1.2.** *Let  $\mathbb{K}\langle C \rangle$  be a ns operad admitting a quadratic presentation  $(\mathfrak{G}, \mathfrak{R})$ . If there exists an orientation  $(\text{PRT}_{\perp}^{\mathfrak{G}}, \Rightarrow)$  of  $\mathfrak{R}$  such that its closure  $(\text{PRT}_{\perp}^{\mathfrak{G}}, \rightsquigarrow)$  is a convergent rewrite system, then  $\mathbb{K}\langle C \rangle$  is Koszul.*

When  $(\text{PRT}_{\perp}^{\mathfrak{G}}, \sim)$  satisfies the conditions contained in the statement of Lemma 4.1.2, the set of  $\mathfrak{G}$ -syntax trees that are normal forms  $\mathcal{F}_{(\text{PRT}_{\perp}^{\mathfrak{G}}, \sim)}$  forms a basis of  $\text{FO}(\mathfrak{G})/\langle \mathcal{R} \rangle$ , called *Poincaré-Birkhoff-Witt basis*. These bases arise from the work of Hoffbeck [Hof10] (see also [LV12]).

4.1.7. *Algebras over ns operads.* Any ns operad  $\mathbb{K}\langle C \rangle$  encodes a type of graded polynomial algebras, called *algebras over  $\mathbb{K}\langle C \rangle$*  (or, for short,  *$\mathbb{K}\langle C \rangle$ -algebras*). A  $\mathbb{K}\langle C \rangle$ -algebra is a graded polynomial space  $\mathbb{K}\langle D \rangle$ , where  $D$  is a graded collection, and endowed with a linear left action

$$\cdot : \mathbb{K}\langle C \rangle(n) \otimes \mathbb{K}\langle D \rangle^{\otimes n} \rightarrow \mathbb{K}\langle D \rangle, \quad n \geq 1, \quad (4.1.24)$$

satisfying the relations imposed by the structure of a ns operad of  $\mathbb{K}\langle C \rangle$ , that are

$$(f \circ_i g) \cdot (a_1 \otimes \cdots \otimes a_{n+m-1}) = f \cdot (a_1 \otimes \cdots \otimes a_{i-1} \otimes g \cdot (a_i \otimes \cdots \otimes a_{i+m-1}) \otimes a_{i+m} \otimes \cdots \otimes a_{n+m-1}), \quad (4.1.25)$$

for all  $f \in \mathbb{K}\langle C \rangle(n)$ ,  $g \in \mathbb{K}\langle C \rangle(m)$ ,  $i \in [n]$ , and  $a_1 \otimes \cdots \otimes a_{n+m-1} \in \mathbb{K}\langle D \rangle^{\otimes n+m-1}$ . In other words, any element  $f$  of  $\mathbb{K}\langle C \rangle$  of arity  $n$  plays the role of a linear operation

$$f : \mathbb{K}\langle D \rangle^{\otimes n} \rightarrow \mathbb{K}\langle D \rangle, \quad (4.1.26)$$

taking  $n$  elements of  $\mathbb{K}\langle D \rangle$  as inputs and computing an element of  $\mathbb{K}\langle D \rangle$ . Under this point of view, Relation (4.1.25) reads as

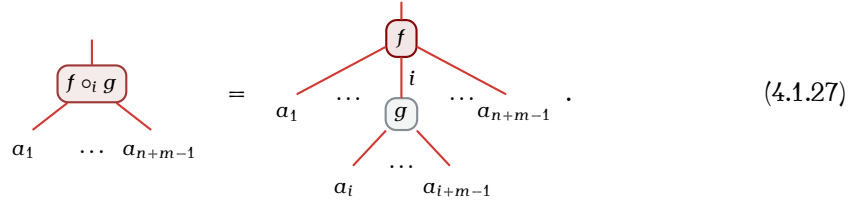

$$(4.1.27)$$

Notice that, by (4.1.25), if  $\mathfrak{G}$  is a generating set of  $\mathbb{K}\langle C \rangle$ , it is enough to define the action of each  $x \in \mathfrak{G}$  on  $\mathbb{K}\langle D \rangle^{\otimes |x|}$  to wholly define  $\cdot$ .

By a slight but convenient abuse of notation, for any  $f \in \mathbb{K}\langle C \rangle(n)$ , we shall denote by  $f(a_1, \dots, a_n)$ , or by  $a_1 f a_2$  if  $f$  has arity 2, the element  $f \cdot (a_1 \otimes \cdots \otimes a_n)$  of  $\mathbb{K}\langle D \rangle$ , for any  $a_1 \otimes \cdots \otimes a_n \in \mathbb{K}\langle D \rangle^{\otimes n}$ . Observe that by (4.1.25), any associative element of  $\mathbb{K}\langle C \rangle$  gives rise to an associative operation on  $\mathbb{K}\langle D \rangle$ .

The class of all the  $\mathbb{K}\langle C \rangle$ -algebras forms a category, called *category of  $\mathbb{K}\langle C \rangle$ -algebras*, wherein morphisms

$$\phi : \mathbb{K}\langle D_1 \rangle \rightarrow \mathbb{K}\langle D_2 \rangle \quad (4.1.28)$$

between two  $\mathbb{K}\langle C \rangle$ -algebras  $\mathbb{K}\langle D_1 \rangle$  and  $\mathbb{K}\langle D_2 \rangle$  are  *$\mathbb{K}\langle C \rangle$ -algebra morphisms*, that are graded polynomial algebra morphisms satisfying

$$\phi(f(a_1, \dots, a_n)) = f(\phi(a_1), \dots, \phi(a_n)) \quad (4.1.29)$$

for all  $a_1, \dots, a_n \in \mathbb{K}\langle D_1 \rangle$  and  $f \in \mathbb{K}\langle C \rangle(n)$ ,  $n \in \mathbb{N}_{\geq 1}$ .

4.1.8. *Set-operads.* Following Section 2.2.3, in a ns set-operad  $\mathbb{K}\langle C \rangle$ , any partial composition of two elements of  $C$  belongs to  $C$ . We say in this case that the fundamental basis of  $\mathbb{K}\langle C \rangle$  is a *set-operad basis*. Besides, by extension, if  $\mathbb{K}\langle C \rangle$  is a ns operad admitting a basis  $C'$  which is a set-operad basis, we say that  $\mathbb{K}\langle C \rangle$  is a *set-operad*. To study a set-operad  $\mathbb{K}\langle C \rangle$ , it is in some cases convenient to forget about its linear structure and see it as a graded collection  $C$  endowed with partial composition maps  $\circ_i$ ,  $i \in \mathbb{N}_{\geq 1}$ . We will follow this idea multiple times in the sequel. In the context of set-operads, a  $\mathbb{K}\langle C \rangle$ -algebra is called a *C-monoid*.

We now state some useful lemmas and notions about ns set-operads.

LEMMA 4.1.3. *Let  $C$  be a ns set-operad generated by a set  $\mathfrak{G}$  of generators. Then any object  $x$  of  $C$  different from the unit can be written as  $x = y \circ_i g$ , where  $y \in C(n)$ ,  $n \in \mathbb{N}_{\geq 1}$ ,  $g \in \mathfrak{G}$ , and  $i \in [n]$ .*

Lemma 4.1.3 is a consequence of the fact that, since  $\mathfrak{G}$  is a generating set of  $C$ , any object of  $C$  admits a treelike expression being a  $\mathfrak{G}$ -syntax tree.

Now, let  $C$  be a ns set-operad. Given a subset  $S$  of  $C$ , the *S-degree* of an object  $x$  of  $C$  is defined by

$$\deg_S(x) := \max \{ \deg(t) : t \in \mathbf{FO}(S) \text{ and } \text{ev}(t) = x \}. \quad (4.1.30)$$

Of course, the set appearing in (4.1.30) could be empty or infinite, so that some elements of  $C$  could have no  $S$ -degree.

4.1.9. *Left expressions in ns set-operads and hook-length formula.* Let  $C$  be a ns set-operad,  $S$  be a subset of  $C$ , and  $x$  be an object of  $C$ . An *S-left expression* of  $x$  is an expression for  $x$  of the form

$$x = (\dots (s_1 \circ_{i_1} s_2) \circ_{i_2} \dots) \circ_{i_{\ell-1}} s_\ell \quad (4.1.31)$$

where  $s_1, \dots, s_\ell \in S$  and  $i_1, \dots, i_{\ell-1} \in \mathbb{N}_{\geq 1}$ .

A *linear extension* of a syntax tree  $t$  is a linear extension of the poset  $\mathcal{Q}_t$  induced by  $t$  (see Section 2.1.5 of Chapter 1). Left expressions and linear extensions of treelike expressions in ns set-operads are related, as shown by the following lemma.

LEMMA 4.1.4. *Let  $C$  be a combinatorial ns operad and  $S$  be a subset of  $C$ . Then, for any object  $x$  of  $C$ , the set of all the  $S$ -left expressions of  $x$  is in one-to-one correspondence with the set of all pairs  $(t, u)$  where  $t$  is an  $S$ -treelike expression of  $x$  and  $u$  is a linear extension of  $t$ .*

A famous result of Knuth [Knu98], known as the *hook-length formula for trees*, stated here in our setting, says that given a syntax tree  $t$ , the number of linear extensions of the poset induced by  $t$  is

$$\text{hk}(t) := \frac{\deg(t)!}{\prod_{v \in \mathcal{N}_*(t)} \deg(t_v)}. \quad (4.1.32)$$

A subset  $S$  of  $C$  *finitely factorizes*  $C(1)$  if any element of  $C(1)$  admits finitely many factorizations on  $S$  with respect to the operation  $\circ_1$ .

When  $S$  finitely factorizes  $C(1)$ , the number of  $S$ -treelike expressions for any object  $x$  of  $C$  is finite. Hence, in this case, we deduce from Lemma 4.1.4 and (4.1.32) that the number of  $S$ -left expressions of  $x$  is

$$\sum_{\substack{t \in \mathbf{FO}(S) \\ \text{ev}(t)=x}} \text{hk}(t). \quad (4.1.33)$$

4.1.10. *Colored operads.* Let  $\mathcal{C}$  be a set of colors. A *nonsymmetric  $\mathcal{C}$ -colored operad* (or a *ns  $\mathcal{C}$ -colored operad* for short) is a polynomial space  $\mathbb{K}\langle C \rangle$  where  $C$  is a  $\mathcal{C}$ -colored collection and  $\mathbb{K}\langle C \rangle$  is endowed with a set of partially defined binary linear products  $\{\circ_i : i \in \mathbb{N}_{\geq 1}\}$  of the form (4.1.2). The following conditions have to hold. First, the partial composition  $x \circ_i y$  is defined if and only  $\mathbf{out}(y) = \mathbf{in}_i(x)$  for any  $x \in C(n)$ ,  $y \in C(m)$ , and  $i \in [n]$ . Moreover, when they are well-defined, Relations (4.1.2), (4.1.3a), and (4.1.3b) have to hold. Finally, we demand the existence of a set of elements  $\{\mathbb{1}_a : a \in \mathcal{C}\}$  of arity 1 satisfying

$$\mathbf{out}(\mathbb{1}_a) = a = \mathbf{in}(\mathbb{1}_a), \quad a \in \mathcal{C}, \quad (4.1.34a)$$

$$\mathbb{1}_a \circ_i x = x = x \circ_i \mathbb{1}_b, \quad x \in C(n), a, b \in \mathcal{C}, i \in [n], n \in \mathbb{N}_{\geq 1}, \quad (4.1.34b)$$

whenever  $\mathbf{out}(x) = a$  and  $\mathbf{in}_i(x) = b$ . We call each  $\mathbb{1}_a$ ,  $a \in \mathcal{C}$ , the *unit of color  $a$* . For any nonnegative integer  $k$ , a *ns  $k$ -colored operad* is a ns  $\mathcal{C}$ -colored operad where  $\mathcal{C}$  is a  $k$ -colored collection. A *ns monochrome operad* is a ns  $\mathcal{C}$ -colored operad where  $\mathcal{C}$  is monochrome.

To describe free ns colored operads, we need the notion of  $\mathcal{C}$ -colored syntax trees (see Section 3.1.2 of Chapter 1). Let  $\mathcal{G}$  be a  $\mathcal{C}$ -colored graded collection. The *free ns  $\mathcal{C}$ -colored operad* over  $\mathcal{G}$  is the ns  $\mathcal{C}$ -colored operad

$$\mathbf{FCO}(\mathcal{G}) := \mathbb{K}\langle \mathbf{CPRT}^{\mathcal{G}} \rangle, \quad (4.1.35)$$

where  $\mathbf{CPRT}^{\mathcal{G}}$  is the  $\mathcal{C}$ -colored collection of all the  $\mathcal{C}$ -colored  $\mathcal{G}$ -syntax trees. The space  $\mathbf{FCO}(\mathcal{G})$  is endowed with the linearizations of the grafting operations  $\circ_i$ ,  $i \in \mathbb{N}_{\geq 1}$ , defined in Section 3.1.2 of Chapter 1. The units of color  $a$ ,  $a \in \mathcal{C}$ , are the trees of degree 0 and arity 1 with output and input colors equal to  $a$ .

LEMMA 4.1.5. *Let  $C$  be a combinatorial ns  $\mathcal{C}$ -colored set-operad and  $S$  be a subset of  $C$  such that  $S$  finitely factorizes  $C(1)$ . Then, any element of  $C$  admits finitely many  $S$ -treelike expressions.*

All the notions developed in the above sections about ns operads extends on ns colored operads by taking colors into account. Classical references about colored operads are [BV73, Yau16].

4.1.11. *Categorical point of view.* In the same way as a monoid  $\mathcal{M}$  can be seen as a category with exactly one object  $x$  (the elements of  $\mathcal{M}$  are interpreted as morphisms  $\phi : x \rightarrow x$ ), a ns operad  $\mathcal{O}$  can be seen as a multicategory with exactly one object  $x$ . In this case, the elements of  $\mathcal{O}$  of arity  $n \in \mathbb{N}_{\geq 1}$  are interpreted as multimorphisms  $\phi : x^n \rightarrow x$ . The complete composition maps of  $\mathcal{O}$  translate as the composition of multimorphisms.

In a similar way, a ns  $\mathcal{C}$ -colored operad  $\mathcal{B}$  can be seen as a multicategory having  $\mathcal{C}$  as set of objects (see [Cur12]). In this case, the elements of  $\mathcal{B}$  having  $u_1 \dots u_n \in \mathcal{C}^n$  as word of input colors and  $a \in \mathcal{C}$  as output color are interpreted as multimorphisms  $\phi : u_1 \times \dots \times u_n \rightarrow a$ . The complete composition maps of  $\mathcal{B}$  translate as the composition of multimorphisms, where the constraints imposed by the colors in  $\mathcal{B}$  become constraints imposed by the domains and codomains of multimorphisms.

4.1.12. *Enrichments.* Ns operads can have some additional structure. Let us now describe some usual enrichments of operads. In what follows,  $\mathbb{K}\langle C \rangle$  is a ns operad.

*Basic ns set-operads.* When  $\mathbb{K}\langle C \rangle$  is a ns set-operad, let for any  $y \in C(m)$  the maps

$$\circ_i^y : C(n) \rightarrow C(n + m - 1), \quad n \in \mathbb{N}_{\geq 1}, i \in [n], \quad (4.1.36)$$

defined by

$$\circ_i^y(x) := x \circ_i y \quad (4.1.37)$$

for all  $x \in C$ . When all the maps  $\circ_i^y$ ,  $y \in C$ , are injective,  $\mathbb{K}\langle C \rangle$  is a *basic ns set-operad* and  $C$  is a *basic ns set-operad basis* of  $\mathbb{K}\langle C \rangle$ . This notion is a slightly modified version of the original notion of basic set-operads introduced by Vallette [Val07].

*Rooted ns operads.* The ns operad  $\mathbb{K}\langle C \rangle$  is *rooted* if there is a map

$$\text{root} : C(n) \rightarrow [n], \quad n \in \mathbb{N}_{\geq 1}, \quad (4.1.38)$$

satisfying, for all  $x \in C(n)$ ,  $y \in C(m)$ , and  $i \in [n]$ ,

$$\text{root}(x \circ_i y) = \begin{cases} \text{root}(x) + m - 1 & \text{if } i \leq \text{root}(x) - 1, \\ \text{root}(x) + \text{root}(y) - 1 & \text{if } i = \text{root}(x), \\ \text{root}(x) & \text{otherwise } (i \geq \text{root}(x) + 1). \end{cases} \quad (4.1.39)$$

We call such a map a *root map*. More intuitively, the root map of a rooted ns operad associates a particular input with any of its basis elements and this input is preserved by partial compositions. It is immediate that any ns operad  $\mathbb{K}\langle C \rangle$  is rooted for both the root maps  $\text{root}_L$  and  $\text{root}_R$  which send respectively all objects  $x$  of  $C$  of arity  $n$  to 1 or to  $n$ . For this reason, we say that  $\mathbb{K}\langle C \rangle$  is *nontrivially rooted* if it can be endowed with a root map different from  $\text{root}_L$  and  $\text{root}_R$ . These notions are slight variations of ones introduced first in [Cha14].

*Cyclic ns operads.* Finally,  $\mathbb{K}\langle C \rangle$  is *cyclic* if there is a map

$$\rho : \mathbb{K}\langle C \rangle(n) \rightarrow \mathbb{K}\langle C \rangle(n), \quad n \in \mathbb{N}_{\geq 1}, \quad (4.1.40)$$

satisfying, for all  $f \in \mathbb{K}\langle C \rangle(n)$ ,  $g \in \mathbb{K}\langle C \rangle(m)$ , and  $i \in [n]$ ,

$$\rho(\mathbb{1}) = \mathbb{1}, \quad (4.1.41a)$$

$$\rho^{n+1}(f) = f, \quad (4.1.41b)$$

$$\rho(f \circ_i g) = \begin{cases} \rho(g) \circ_m \rho(f) & \text{if } i = 1, \\ \rho(f) \circ_{i-1} g & \text{otherwise.} \end{cases} \quad (4.1.41c)$$

We call such a map  $\rho$  a *rotation map*. Intuitively, a rotation map in a ns operad acts by transforming its 1st input of an element  $f$  in an output, its 2nd input in a 1st input, its 3rd

input in a 2nd input, and so on, and its output in a last input. This notion has been introduced in [GK95].

4.1.13. *Symmetric operads.* Let  $\text{Per}$  be the ns operad defined by  $\text{Per} := \mathbb{K}\langle \text{Aug}(\mathfrak{S}) \rangle$  with the partial compositions defined as follow. For all  $\sigma \in \mathfrak{S}(n)$ ,  $\nu \in \mathfrak{S}(m)$ , and  $i \in [n]$ ,

$$\sigma \circ_i \nu := \sigma'(1) \dots \sigma'(i-1) \nu'(1) \dots \nu'(m) \sigma'(i+1) \dots \sigma'(n), \quad (4.1.42)$$

where, for any  $j \in [m]$ ,

$$\nu'(j) := \nu(j) + \sigma(i) - 1, \quad (4.1.43)$$

and, or any  $j \in [n]$ ,

$$\sigma'_j := \begin{cases} \sigma_j & \text{if } \sigma_j < \sigma_i, \\ \sigma_j + m - 1 & \text{otherwise.} \end{cases} \quad (4.1.44)$$

For instance, here are two examples of compositions in  $\text{Per}$ :

$$123 \circ_2 12 = 1234, \quad (4.1.45a)$$

$$7415623 \circ_4 231 = 941675823. \quad (4.1.45b)$$

This ns operad is known as the *associative noncommutative operad* or more prosaically, the *operad of permutations*.

A *symmetric operad*, or an *operad* for short, is a ns operad  $\mathbb{K}\langle C \rangle$  together with linear maps

$$\cdot : \mathbb{K}\langle C \rangle(n) \otimes \text{Per}(n) \rightarrow \mathbb{K}\langle C \rangle(n), \quad n \geq 1, \quad (4.1.46)$$

satisfying, for any  $x \in C(n)$ ,  $y \in C(m)$ ,  $\sigma \in \mathfrak{S}(n)$ ,  $\nu \in \mathfrak{S}(m)$ , and  $i \in [n]$ ,

$$(x \cdot \sigma) \circ_i (y \cdot \nu) = (x \circ_{\sigma_i} y) \cdot (\sigma \circ_i \nu), \quad (4.1.47)$$

and in such a way that  $\cdot$  also is a symmetric group action. Note that any operad  $\mathbb{K}\langle C \rangle$  is also (and thus can be seen as) a ns operad by forgetting its action of  $\text{Per}$ .

A *simple permutation* is a permutation  $\sigma$  such that for all factors  $u$  of  $\sigma$ , if the letters of  $u$  form an interval of  $\mathbb{N}$  then  $|u| = 1$  or  $|u| = |\sigma|$ . For instance, the permutation 624135 is not simple since the letters of the factor  $u := 2413$  form an interval of  $\mathbb{N}$ . On the other hand, the permutation 5137462 is simple.

PROPOSITION 4.1.6. *As a ns operad,  $\text{Per}$  is minimally generated by the set of all simple permutations of sizes 2 or more.*

One of the simplest examples of symmetric operads is the *commutative associative operad*  $\text{Com}$ . This operad is defined as  $\text{Com} := \mathbb{K}\langle C \rangle$  where  $C$  is the augmented graded collection satisfying  $C(n) := \{a_n\}$  for all  $n \in \mathbb{N}_{\geq 1}$ , its partial compositions satisfy

$$a_n \circ_i a_m := a_{n+m-1}, \quad (4.1.48)$$

for any  $n, m \in \mathbb{N}_{\geq 1}$  and  $i \in [n]$ , and  $\text{Per}$  acts trivially on  $\text{Com}$ .

There is also a notion of algebras over symmetric operads. An *algebra over  $\mathbb{K}\langle C \rangle$*  (or, short, a  $\mathbb{K}\langle C \rangle$ -algebra) is an algebra  $\mathbb{K}\langle D \rangle$  over  $\mathbb{K}\langle C \rangle$  seen as a ns operad. We ask additionally that the relation

$$(f \cdot \sigma)(a_1, \dots, a_n) = f(a_{\sigma^{-1}(1)}, \dots, a_{\sigma^{-1}(n)}) \tag{4.1.49}$$

holds for any  $f \in \mathbb{K}\langle C \rangle(n)$ ,  $\sigma \in \mathfrak{S}(n)$ ,  $a_1, \dots, a_n \in \mathbb{K}\langle D \rangle$ ,  $n \in \mathbb{N}_{\geq 1}$ .

**4.2. Main operads in combinatorics.** This section contains a list of common ns operads studied or encountered in the sequel. A classical text containing a list of definitions of operads is [Zin12].

4.2.1. *Associative operad.* The *associative operad*  $\text{As}$  is defined as the operad  $\text{Com}$  seen as a nonsymmetric one (see Section 4.1.13).

The ns operad  $\text{As}$  is a set-operad and its Hilbert series satisfies

$$\mathcal{H}_{\text{As}}(t) = \frac{t}{1-t}. \tag{4.2.1}$$

Moreover,  $\text{As}$  admits the presentation  $(\mathfrak{G}, \mathcal{R})$  where  $\mathfrak{G} := \{a_2\}$  and  $\mathcal{R}$  is the space generated by

$$\odot(a_2) \circ_1 \odot(a_2) - \odot(a_2) \circ_2 \odot(a_2). \tag{4.2.2}$$

Any algebra over  $\text{As}$  is a space  $\mathbb{K}\langle D \rangle$  endowed with a binary associative operation.

4.2.2. *Magmatic operad.* Let  $\text{Mag} := \mathbb{K}\langle \text{Ary}_{\perp}^{(2)} \rangle$  be the ns operad where for any binary trees  $t$  and  $s$ , the partial composition  $t \circ_i s$  is the grafting of  $s$  onto the  $i$ th leaf of  $t$ , seen as syntax trees. In other terms,  $\text{Mag}$  is the operad  $\text{FO}(C)$  where  $C := C(2) := \{a\}$ . This ns operad is the *magmatic operad*.

The ns operad  $\text{Mag}$  is a set-operad and its Hilbert series satisfies

$$\mathcal{H}_{\text{Mag}}(t) = \frac{1 - \sqrt{1 - 4t}}{2}. \tag{4.2.3}$$

Moreover,  $\text{Mag}$  admits the presentation  $(\mathfrak{G}, \mathcal{R})$  where

$$\mathfrak{G} := \left\{ \begin{array}{c} \circ \\ \diagup \quad \diagdown \\ \square \quad \square \end{array} \right\} \tag{4.2.4}$$

and  $\mathcal{R}$  is the trivial space. Any algebra over  $\text{Mag}$  is a space  $\mathbb{K}\langle D \rangle$  endowed with a binary operation which do satisfy any required relation.

4.2.3. *Duplicial operad.* Let  $\text{Dup} := \mathbb{K}\langle \text{Aug}(\text{Ary}_{\bullet}^{(2)}) \rangle$  be the ns operad where for any nonempty binary trees  $t$  and  $s$ , the partial composition  $t \circ_i s$  consists in replacing the  $i$ th (with respect to the infix order) internal node  $u$  of  $t$  by a copy of  $s$ , and by grafting the left subtree of  $u$  to the first leaf of the copy, and the right subtree of  $u$  to the last leaf of the copy. For instance,

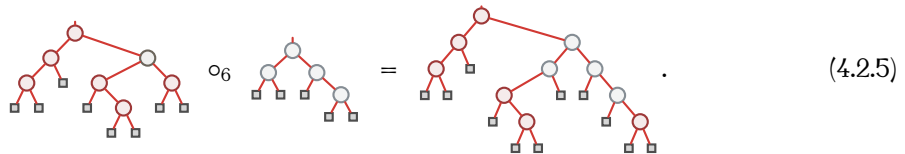



This ns operad is the *duplicial operad* [Lod08].

The ns operad Dup is a set-operad and its Hilbert series satisfies

$$\mathcal{H}_{\text{Dup}}(t) = \frac{1 - 2t - \sqrt{1 - 4t}}{2t}. \quad (4.2.6)$$

Moreover, Dup admits the presentation  $(\mathfrak{G}, \mathfrak{R})$  where

$$\mathfrak{G} := \left\{ \begin{array}{c} \text{Diagram 1} \\ \text{Diagram 2} \end{array} \right\} \quad (4.2.7)$$

and  $\mathfrak{R}$  is the space generated by, by denoting by  $\ll$  (resp.  $\gg$ ) the first (resp. second) tree of (4.2.7),

$$\odot(\ll) \circ_1 \odot(\ll) - \odot(\ll) \circ_2 \odot(\ll), \quad (4.2.8a)$$

$$\odot(\gg) \circ_1 \odot(\ll) - \odot(\ll) \circ_2 \odot(\gg), \quad (4.2.8b)$$

$$\odot(\gg) \circ_1 \odot(\gg) - \odot(\gg) \circ_2 \odot(\gg). \quad (4.2.8c)$$

Any algebra over Dup is a space  $\mathbb{K}\langle D \rangle$  endowed with two binary relations  $\ll$  and  $\gg$  such that both  $\ll$  and  $\gg$  are associative (as consequences of (4.2.8a) and (4.2.8b)), and, for any  $x, y, z \in D$ ,

$$(x \ll y) \gg z = x \ll (y \gg z). \quad (4.2.9)$$

These structures are called *duplicial algebras*.

**4.2.4. Operad of rational functions.** The graded vector space of all commutative rational functions  $\mathbb{K}\langle \mathbb{U} \rangle$ , where  $\mathbb{U}$  is the infinite commutative alphabet  $\{u_1, u_2, \dots\}$ , has the structure of a ns operad RatFct introduced by Loday [Lod10] and defined as follows. Let  $\text{RatFct}(n)$  be the subspace  $\mathbb{K}\langle u_1, \dots, u_n \rangle$  of  $\mathbb{K}\langle \mathbb{U} \rangle$  and

$$\text{RatFct} := \bigoplus_{n \geq 1} \text{RatFct}(n). \quad (4.2.10)$$

Observe that since RatFct is a graded space, each rational function has an arity. Hence, by setting  $f_1(u_1) := 1$  and  $f_2(u_1, u_2) := 1$ ,  $f_1$  is of arity 1 while  $f_2$  is of arity 2, so that  $f_1$  and  $f_2$  are considered as different rational functions. The partial composition of two rational functions  $f \in \text{RatFct}(n)$  and  $g \in \text{RatFct}(m)$  satisfies, for any  $i \in [n]$ ,

$$f \circ_i g := f(u_1, \dots, u_{i-1}, u_i + \dots + u_{i+m-1}, u_{i+m}, \dots, u_{n+m-1}) g(u_i, \dots, u_{i+m-1}). \quad (4.2.11)$$

This ns operad is the *operad of rational functions*. The rational function  $f$  of  $\text{RatFct}(1)$  defined by  $f(u_1) := 1$  is the unit of RatFct. As shown by Loday, this operad is (nontrivially) isomorphic to the operad Mould introduced by Chapoton [Cha07].

**4.2.5. Diassociative operad.** Let the operad Dias :=  $\mathbb{K}\langle C \rangle$  where  $C$  is the augmented graded collection satisfying  $C(n) := \{\epsilon_{n,k} : k \in [n]\}$  for all  $n \in \mathbb{N}_{\geq 1}$ . The partial compositions of Dias are defined by

$$\epsilon_{n,k} \circ_i \epsilon_{m,\ell} = \begin{cases} \epsilon_{n+m-1, k+m-1} & \text{if } i < k, \\ \epsilon_{n+m-1, k+\ell-1} & \text{if } i = k, \\ \epsilon_{n+m-1, k} & \text{otherwise } (i > k), \end{cases} \quad (4.2.12)$$

for all  $n, m \in \mathbb{N}_{\geq 1}$ ,  $k \in [n]$ ,  $\ell \in [m]$ , and  $i \in [n]$ . This operad is the *diassociative operad*.

The ns operad Dias is a set-operad and its Hilbert series satisfies

$$\mathcal{H}_{\text{Dias}}(t) = \frac{t}{(1-t)^2}. \quad (4.2.13)$$

Moreover, Dias admits the presentation  $(\mathfrak{G}, \mathfrak{R})$  where

$$\mathfrak{G} := \{\epsilon_{2,1}, \epsilon_{2,2}\} \quad (4.2.14)$$

and  $\mathfrak{R}$  is the space generated by, by denoting by  $\dashv$  (resp.  $\vdash$ ) the first (resp. second) element of (4.2.14),

$$\odot(\dashv) \circ_1 \odot(\dashv) - \odot(\dashv) \circ_2 \odot(\dashv), \quad \odot(\dashv) \circ_1 \odot(\dashv) - \odot(\dashv) \circ_2 \odot(\vdash), \quad (4.2.15a)$$

$$\odot(\dashv) \circ_1 \odot(\vdash) - \odot(\vdash) \circ_2 \odot(\dashv), \quad (4.2.15b)$$

$$\odot(\vdash) \circ_1 \odot(\dashv) - \odot(\vdash) \circ_2 \odot(\vdash), \quad \odot(\vdash) \circ_1 \odot(\vdash) - \odot(\vdash) \circ_2 \odot(\vdash). \quad (4.2.15c)$$

This operad, by its presentation by generators and relations, has been introduced in [Lod01]. Its realization in terms of the elements  $\epsilon_{n,k}$  and the partial compositions maps (4.2.12) appears in [Cha05]. Any algebra over Dias is a space  $\mathbb{K}\langle D \rangle$  endowed with two binary relations  $\dashv$  and  $\vdash$  such that both  $\dashv$  and  $\vdash$  are associative (as particular consequences of (4.2.15a) and (4.2.15c)), and, for any  $x, y, z \in D$ ,

$$(x \dashv y) \dashv z = x \dashv (y \vdash z), \quad (4.2.16a)$$

$$(x \vdash y) \dashv z = x \vdash (y \dashv z), \quad (4.2.16b)$$

$$(x \dashv y) \vdash z = x \vdash (y \vdash z). \quad (4.2.16c)$$

These structures are called *diassociative algebras*.

4.2.6. *Dendriform operad.* The *dendriform operad* Dendr is the ns suboperad of RatFct generated by the set  $\left\{ \frac{1}{u_1}, \frac{1}{u_2} \right\}$  [Lod10]. This operad admits the presentation  $(\mathfrak{G}, \mathfrak{R})$  where

$$\mathfrak{G} := \mathfrak{G}(2) := \{<, >\} \quad (4.2.17)$$

and  $\mathfrak{R}$  is the space generated by

$$\odot(<) \circ_1 \odot(<) - \odot(<) \circ_2 \odot(<) - \odot(<) \circ_2 \odot(>), \quad (4.2.18a)$$

$$\odot(<) \circ_1 \odot(>) - \odot(>) \circ_2 \odot(<), \quad (4.2.18b)$$

$$\odot(>) \circ_1 \odot(<) + \odot(>) \circ_1 \odot(>) - \odot(>) \circ_2 \odot(>). \quad (4.2.18c)$$

This operad, by its presentation by generators and relations, has been introduced in [Lod01]. It is shown here that Dendr is the Koszul dual of Dias and that these operads are Koszul operads. Hence, the Hilbert series  $\mathcal{H}_{\text{Dendr}}(t)$  of Dendr satisfies, by (4.1.23),

$$\mathcal{H}_{\text{Dendr}}(t) = \frac{1 - 2t - \sqrt{1 - 4t}}{2t}. \quad (4.2.19)$$

This shows that Dendr is, as a combinatorial polynomial space, the space  $\mathbb{K}\langle \text{Aug}(\text{Ary}^{\bullet(2)}) \rangle$ . Moreover, the operads Dias and Dendr are Koszul dual one of the other. Finally, any algebra of Dendr is a dendriform algebra (see Section 2.3.3).

The free dendriform algebra over one generator is the space  $\text{Dendr}$ , that is the linear span of all nonempty binary trees, endowed with the linear operations

$$\langle, \rangle: \text{Dendr} \otimes \text{Dendr} \rightarrow \text{Dendr}, \tag{4.2.20}$$

defined recursively, for any nonempty tree  $s$ , and binary trees  $t_1$  and  $t_2$  by

$$s \langle \square := s =: \square \rangle s, \tag{4.2.21a}$$

$$\square \langle s := 0 =: s \rangle \square, \tag{4.2.21b}$$

$$t_1 \begin{array}{c} \circ \\ / \quad \backslash \\ t_1 \quad t_2 \end{array} \langle s := \begin{array}{c} \circ \\ / \quad \backslash \\ t_1 \quad t_2 \end{array} \langle s + \begin{array}{c} \circ \\ / \quad \backslash \\ t_1 \quad t_2 \end{array} \rangle s, \tag{4.2.21c}$$

$$s \rangle \begin{array}{c} \circ \\ / \quad \backslash \\ t_1 \quad t_2 \end{array} := \begin{array}{c} \circ \\ / \quad \backslash \\ s \rangle t_1 \quad t_2 \end{array} + \begin{array}{c} \circ \\ / \quad \backslash \\ s \langle t_1 \quad t_2 \end{array}. \tag{4.2.21d}$$

Note that neither  $\square \langle \square$  nor  $\square \rangle \square$  are defined. We have for instance,

$$\begin{array}{c} \circ \\ / \quad \backslash \\ \circ \quad \circ \\ / \quad \backslash \quad / \quad \backslash \\ \square \quad \square \quad \square \quad \square \end{array} \langle \begin{array}{c} \circ \\ / \quad \backslash \\ \circ \quad \circ \\ / \quad \backslash \quad / \quad \backslash \\ \square \quad \square \quad \square \quad \square \end{array} = \begin{array}{c} \circ \\ / \quad \backslash \\ \circ \quad \circ \\ / \quad \backslash \quad / \quad \backslash \\ \square \quad \square \quad \square \quad \square \end{array} + \begin{array}{c} \circ \\ / \quad \backslash \\ \circ \quad \circ \\ / \quad \backslash \quad / \quad \backslash \\ \square \quad \square \quad \square \quad \square \end{array} + \begin{array}{c} \circ \\ / \quad \backslash \\ \circ \quad \circ \\ / \quad \backslash \quad / \quad \backslash \\ \square \quad \square \quad \square \quad \square \end{array}, \tag{4.2.22a}$$

$$\begin{array}{c} \circ \\ / \quad \backslash \\ \circ \quad \circ \\ / \quad \backslash \quad / \quad \backslash \\ \square \quad \square \quad \square \quad \square \end{array} \rangle \begin{array}{c} \circ \\ / \quad \backslash \\ \circ \quad \circ \\ / \quad \backslash \quad / \quad \backslash \\ \square \quad \square \quad \square \quad \square \end{array} = \begin{array}{c} \circ \\ / \quad \backslash \\ \circ \quad \circ \\ / \quad \backslash \quad / \quad \backslash \\ \square \quad \square \quad \square \quad \square \end{array} + \begin{array}{c} \circ \\ / \quad \backslash \\ \circ \quad \circ \\ / \quad \backslash \quad / \quad \backslash \\ \square \quad \square \quad \square \quad \square \end{array} + \begin{array}{c} \circ \\ / \quad \backslash \\ \circ \quad \circ \\ / \quad \backslash \quad / \quad \backslash \\ \square \quad \square \quad \square \quad \square \end{array}. \tag{4.2.22b}$$

4.2.7. *Operad of gravity chord diagrams.* The *operad of gravity chord diagrams*  $\text{Grav}$  is an operad defined in [AP15]. This operad is the nonsymmetric version of the gravity operad, a symmetric operad introduced by Getzler [Get94]. Let us describe this operad.

A *gravity chord diagram* is a configuration  $c$  (see Section 3.2 of Chapter 1) where each arc can be *blue* (drawn as a thick line) and that satisfies the following conditions. By denoting by  $n$  the size of  $c$ , all the edges and the base of  $c$  are blue, and if  $(x, y)$  and  $(x', y')$  are two blue crossing diagonals of  $c$  such that  $x < x'$ , the arc  $(x', y)$  is not labeled. In other words, the quadrilateral formed by the vertices  $x, x', y,$  and  $y'$  of  $c$  is such that its side  $(x', y)$  is not labeled. For instance,



is a gravity chord diagram of arity 7 having four blue diagonals (observe in particular that, as required, the arc  $(3, 5)$  is not labeled). For any  $n \geq 2$ ,  $\text{Grav}(n)$  is the linear span of all gravity chord diagrams of size  $n$ . Moreover,  $\text{Grav}(1)$  is the linear span of the singleton containing the only polygon of arity 1 where its only arc is not labeled. The partial composition of  $\text{Grav}$  is defined, in a geometric way, as follows. For any gravity chord diagrams  $c$  and  $d$  of

respective arities  $n$  and  $m$ , and  $i \in [n]$ , the gravity chord diagram  $c \circ_i d$  is obtained by gluing the base of  $d$  onto the  $i$ th edge of  $c$ , so that the arc  $(i, i + m)$  of  $c \circ_i d$  is blue. For example,

$$(4.2.24)$$

### 5. Pros in combinatorics

We regard here pros as polynomial algebras and provide the main definitions used in the following chapters. We also give examples of some usual pros.

**5.1. Pros.** Pros can be thought as variations of operads allowing multiple outputs for some elements. Surprisingly, pros appeared earlier than operads in the work of Mac Lane [ML65]. Intuitively, a pro is a space  $\mathbb{K}\langle C \rangle$  wherein elements are biproducts (see Section 2.1.1) and is endowed with two operations: an horizontal composition and a vertical composition. The first operation takes two operators  $x$  and  $y$  of  $\mathbb{K}\langle C \rangle$  and builds a new one whose inputs (resp. outputs) are, from left to right, those of  $x$  and then those of  $y$ . The second operation takes two operators  $x$  and  $y$  of  $\mathbb{K}\langle C \rangle$  and produces a new one obtained by plugging the outputs of  $y$  onto the inputs of  $x$ . Basic and modern references about pros are [Lei04] and [Mar08].

5.1.1. *Categorical definition.* A **product category** (or, for short, a **pro**) is a category  $\mathcal{P}$  endowed with a associative bifunctor  $*$  :  $\mathcal{P} \times \mathcal{P} \rightarrow \mathcal{P}$  such that the objects of  $\mathcal{P}$  are the elements of  $\mathbb{N}$  and  $x * y := x + y$  for all  $x, y \in \mathbb{N}$ .

This formal definition of pros is not combinatorial. Let us provide in the next section a more concrete one.

5.1.2. *Axioms of pros.* A **pro** is a bigraded polynomial space  $\mathbb{K}\langle C \rangle$  endowed with a binary linear product

$$* : \mathbb{K}\langle C \rangle(p, q) \times \mathbb{K}\langle C \rangle(p', q') \rightarrow \mathbb{K}\langle C \rangle(p + p', q + q'), \quad p, p', q, q' \geq 0, \quad (5.1.1)$$

called **horizontal composition** and a binary linear product  $\circ$  is a map of the form

$$\circ : \mathbb{K}\langle C \rangle(q, r) \times \mathbb{K}\langle C \rangle(p, q) \rightarrow \mathbb{K}\langle C \rangle(p, r), \quad p, q, r \geq 0, \quad (5.1.2)$$

called **vertical composition**. We demand, for any  $p \in \mathbb{N}$ , the existence of an element  $\mathbb{1}_p$  of  $\mathbb{K}\langle C \rangle(p, p)$  called **unit of arity  $p$** . The **input** (resp. **output**) **arity** of  $f \in \mathbb{K}\langle C \rangle(p, q)$  is  $|f|_{\uparrow} := p$  (resp.  $|x|_{\downarrow} := q$ ).

These data have to satisfy for all  $x, y, z, x', y' \in C$  the six relations

$$(x * y) * z = x * (y * z), \quad (5.1.3)$$

$$(x \circ y) \circ z = x \circ (y \circ z), \quad |x|_{\uparrow} = |y|_{\downarrow}, |y|_{\uparrow} = |z|_{\downarrow}, \quad (5.1.4)$$

$$(x \circ y) * (x' \circ y') = (x * x') \circ (y * y'), \quad \text{if } |x|_{\uparrow} = |y|_{\downarrow}, |x'|_{\uparrow} = |y'|_{\downarrow}, \quad (5.1.5)$$

$$\mathbb{1}_p * \mathbb{1}_q = \mathbb{1}_{p+q}, \quad p, q \geq 0, \quad (5.1.6)$$

$$x * \mathbb{1}_0 = x = \mathbb{1}_0 * x, \quad (5.1.7)$$

$$x \circ \mathbb{1}_p = x = \mathbb{1}_q \circ x, \quad p, q \geq 0, \text{ if } |x|_{\uparrow} = p, |x|_{\downarrow} = q. \quad (5.1.8)$$

Since a pro is a particular polynomial algebra, all the properties and definitions about polynomial algebras exposed in Section 2.2 remain valid for pros (like pros morphisms, sub-pros, generating sets, pro ideals and quotients, etc.).

5.1.3. *Free pros.* Let  $\mathfrak{G}$  be a bigraded collection such that  $\mathfrak{G}(p, q) = \emptyset$  if  $p = 0$  or  $q = 0$ . The *free pro* over  $\mathfrak{G}$  is the pro

$$\mathbf{FP}(\mathfrak{G}) := \mathbb{K}\langle \text{Prg}^{\mathfrak{G}} \rangle, \quad (5.1.9)$$

where  $\text{Prg}^{\mathfrak{G}}$  is the bigraded collection of all the  $\mathfrak{G}$ -prographs (see Section 3.3 of Chapter 1). The space  $\mathbf{FP}(\mathfrak{G})$  is endowed with linearizations of the horizontal composition of prographs and of the vertical composition of prographs (see Section 3.3.4 of Chapter 1). The unit of arity  $p$ ,  $p \geq 0$ , is the sequence of wires  $\mathbb{1}_p$ . Notice that by the above assumption on  $\mathfrak{G}$ , there is no elementary  $\mathfrak{G}$ -prograph in  $\mathbf{FP}(\mathfrak{G})$  with a null input or output arity. Therefore,  $\mathbb{1}_0$  is the only element of  $\mathbf{FP}(\mathfrak{G})$  with a null input (resp. output) arity. In this dissertation, we consider only free pros satisfying this property.

Let us now state some definitions and properties about free pros.

Let  $\mathbf{FP}(\mathfrak{G})$  be a free pro. Since  $\mathbf{FP}(\mathfrak{G})$  is free (and, by convention,  $\mathfrak{G}$  has no generator of input or output arity 0), any  $\mathfrak{G}$ -prograph  $x$  can be uniquely written as

$$x = x_1 * \cdots * x_{\ell} \quad (5.1.10)$$

where the  $x_i$  are  $\mathfrak{G}$ -prographs different from  $\mathbb{1}_0$ , and  $\ell \geq 0$  is maximal. We call the word  $\text{dec}(x) := (x_1, \dots, x_{\ell})$  the *maximal decomposition* of  $x$  and the  $x_i$  the *factors* of  $x$ . Notice that the maximal decomposition of  $\mathbb{1}_0$  is the empty word. We have in  $\mathbf{FP}(\mathfrak{G})$ , for instance, by setting  $\mathfrak{G}$  as the bigraded collection defined by  $\mathfrak{G} := \mathfrak{G}(2, 2) \sqcup \mathfrak{G}(3, 1)$  where  $\mathfrak{G}(2, 2) := \{a\}$  and  $\mathfrak{G}(3, 1) := \{b\}$ ,

$$\text{dec} \left( \begin{array}{c} \square \quad \square \quad \square \quad \square \\ \diagdown \quad \diagup \quad \diagdown \quad \diagup \\ \text{a} \quad \text{b} \quad \text{a} \\ \diagup \quad \diagdown \quad \diagup \quad \diagdown \\ \square \quad \square \quad \square \quad \square \end{array} \right) = \left( \begin{array}{c} \square \quad \square \\ \diagdown \quad \diagup \\ \text{a} \\ \diagup \quad \diagdown \\ \square \quad \square \end{array}, \begin{array}{c} \square \quad \square \quad \square \\ \diagdown \quad \diagup \quad \diagdown \\ \text{b} \quad \text{a} \\ \diagup \quad \diagdown \\ \square \quad \square \end{array}, \begin{array}{c} \square \\ \square \\ \square \end{array} \right). \quad (5.1.11)$$

An  $\mathfrak{G}$ -prograph  $x$  is *reduced* if all its factors are different from  $\mathbb{1}_1$ . For any  $\mathfrak{G}$ -prograph  $x$ , we denote by  $\text{red}(x)$  the reduced  $\mathfrak{G}$ -prograph admitting as maximal decomposition the longest subword of  $\text{dec}(x)$  consisting in factors different from  $\mathbb{1}_1$ . We have in  $\mathbf{FP}(\mathfrak{G})$ , for instance,

$$\text{red} \left( \begin{array}{c} \square \quad \square \quad \square \quad \square \quad \square \quad \square \\ \diagdown \quad \diagup \quad \diagdown \quad \diagup \quad \diagdown \quad \diagup \\ \text{a} \quad \text{b} \quad \text{a} \\ \diagup \quad \diagdown \quad \diagup \quad \diagdown \\ \square \quad \square \quad \square \quad \square \end{array} \right) = \begin{array}{c} \square \quad \square \\ \diagdown \quad \diagup \\ \text{a} \\ \diagup \quad \diagdown \\ \square \quad \square \end{array} \begin{array}{c} \square \quad \square \quad \square \\ \diagdown \quad \diagup \quad \diagdown \\ \text{b} \quad \text{a} \\ \diagup \quad \diagdown \\ \square \quad \square \end{array}. \quad (5.1.12)$$

By extension, we denote by  $\text{red}(\mathbf{FP}(\mathfrak{G}))$  the set of all the reduced  $\mathfrak{G}$ -prographs. Note that  $\mathbb{1}_0$  belongs to  $\text{red}(\mathbf{FP}(\mathfrak{G}))$ .

Besides, we say that a  $\mathfrak{G}$ -prograph is *indecomposable* if its maximal decomposition consists in exactly one factor. Note that  $\mathbb{1}_0$  is not indecomposable while  $\mathbb{1}_1$  is.

LEMMA 5.1.1. *Let  $x$  and  $y$  be two  $\mathfrak{G}$ -prographs such that  $x = \text{red}(y)$ . Then, by denoting by  $(x_1, \dots, x_\ell)$  the maximal decomposition of  $x$ , there exists a unique sequence of nonnegative integers  $p_1, \dots, p_\ell, p_{\ell+1}$  such that*

$$y = \mathbb{1}_{p_1} * x_1 * \mathbb{1}_{p_2} * x_2 * \dots * x_\ell * \mathbb{1}_{p_{\ell+1}}. \tag{5.1.13}$$

LEMMA 5.1.2. *Let  $x, y, z$ , and  $t$  be four  $\mathfrak{G}$ -prographs such that  $x * y = z \circ t$ . Then, there exist four unique elements  $x_1, x_2, y_1, y_2$  of  $\mathcal{P}$  such that  $x = x_1 \circ x_2, y = y_1 \circ y_2, z = x_1 * y_1$ , and  $t = x_2 * y_2$ .*

**5.2. Main pros in combinatorics.** This section contains a short list of common pros (see [Laf03, Laf11] for many examples of pros).

5.2.1. *Pro of maps.* Let  $\text{Map}$  be the bigraded collection wherein for any  $p, q \in \mathbb{N}$ ,  $\text{Map}(p, q)$  is the set of maps from  $[p]$  to  $[q]$ . We endow  $\mathbb{K}\langle \text{Map} \rangle$  with an horizontal composition  $*$  defined linearly, for any maps  $f \in \text{Map}(p_1, q_1), g \in \text{Map}(p_2, q_2)$ , and  $x \in [p_1 + q_1]$ , by

$$(f * g)(x) := \begin{cases} f(x) & \text{if } x \in [|f|_\uparrow], \\ g(x) + |f|_\downarrow & \text{otherwise.} \end{cases} \tag{5.2.1}$$

We endow the polynomial space  $\mathbb{K}\langle \text{Map} \rangle$  with a vertical composition  $\circ$  defined linearly, for any maps  $f \in \text{Map}(p_1, q_1), g \in \text{Map}(p_2, p_1)$ , and  $x \in [p_2]$ , by

$$(f \circ g)(x) = f(g(x)). \tag{5.2.2}$$

The unit  $\mathbb{1}_p$  of arity  $p \in \mathbb{N}$  is the identity map on  $[p]$ .

For instance, by denoting maps of  $\text{Map}$  by words (the  $i$ th letters of the words being the images of  $i$ ), one has

$$3115 * 133 = 3115799, \quad 3115 \in \text{Map}(4, 6), 133 \in \text{Map}(3, 5), \tag{5.2.3a}$$

$$1224244 \circ 3312 = 2212, \quad 1224244 \in \text{Map}(7, 6), 3312 \in \text{Map}(4, 7). \tag{5.2.3b}$$

By seeing each map  $f \in \text{Map}(p, q)$  as an operator with  $p$  inputs and  $q$  outputs where each  $i$ th input is connected to the  $f(i)$ th output, (5.2.3a) and (5.2.3b) read respectively as

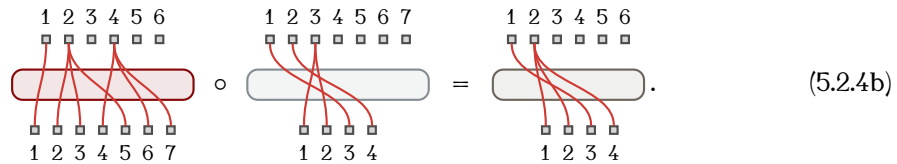
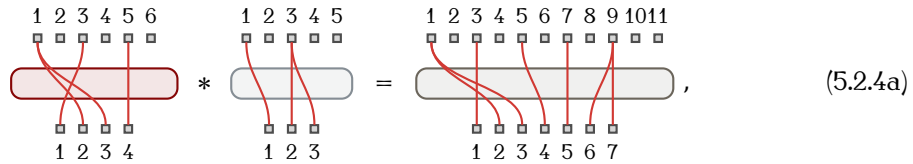

Observe hence that the horizontal composition of  $\mathbb{K}\langle \text{Map} \rangle$  is a shifted concatenation of words and that the vertical composition of  $\mathbb{K}\langle \text{Map} \rangle$  is a functional composition. We call  $\mathbb{K}\langle \text{Map} \rangle$  the *pro of maps*.

5.2.2. *Pro of increasing maps.* Let  $\text{NMap}$  be the bigraded collection wherein for any  $p, q \in \mathbb{N}$ ,  $\text{NMap}(p, q)$  is the set of nondecreasing maps from  $[p]$  to  $[q]$ , that is the maps  $f$  such that  $i \leq j$  implies  $f(i) \leq f(j)$ . Since the operations  $*$  and  $\circ$  of  $\mathbb{K}\langle \text{Map} \rangle$  are stable in  $\mathbb{K}\langle \text{NMap} \rangle$  and the identity maps  $\mathbb{1}_p$ ,  $p \in \mathbb{N}$ , are nondecreasing maps,  $\mathbb{K}\langle \text{NMap} \rangle$  is a sub-pro of  $\mathbb{K}\langle \text{Map} \rangle$ . In particular, we call  $\mathbb{K}\langle \text{NMap} \rangle$  the *pro of nondecreasing maps*.

5.2.3. *Pro of permutations and props.* Let  $\text{Per}$  be the bigraded subcollection of  $\text{Map}$  consisting in all bijective maps. Hence,  $\text{Per}(p, q) = \emptyset$  when  $p \neq q$ . Since the operations  $*$  and  $\circ$  of  $\mathbb{K}\langle \text{Map} \rangle$  are stable in  $\mathbb{K}\langle \text{Per} \rangle$  and the identity maps  $\mathbb{1}_p$ ,  $p \in \mathbb{N}$ , are bijections,  $\mathbb{K}\langle \text{Per} \rangle$  is a sub-pro of  $\mathbb{K}\langle \text{Map} \rangle$ . It is moreover possible to show that the singleton  $\mathcal{O} := \{21\} \subseteq \text{Per}(2, 2)$  is a minimal generating set of  $\mathbb{K}\langle \text{Per} \rangle$ . We call  $\mathbb{K}\langle \text{Per} \rangle$  the *pro of permutations*.

A *prop* is a pro  $\mathbb{K}\langle C \rangle$  containing  $\mathbb{K}\langle \text{Per} \rangle$  as a sub-pro.

## **Part 2**

# **Combinatorial operads**





## Enveloping operads of colored operads

The content of this chapter comes from [CG14] and is a joint work with Frédéric Chapoton. We include here some new results that do not appear in the aforementioned publication like the Koszulity of some of the constructed operads.

### Introduction

In [Cha07], Chapoton considered a ns operad structure on the objects called noncrossing trees and noncrossing plants. These objects can be depicted as simple graphs inside regular polygons, and are some kinds of noncrossing configurations that are well-known combinatorial objects [FN99, FS09]. The partial compositions of these ns operads have very simple graphical descriptions and it is tempting and easy to generalize this composition as much as possible, by removing some constraints on the objects. This leads to a very big ns operad of noncrossing configurations. This research initially started as a study of this ns operad, with possible aim the description of its suboperads.

This study has led us to the following results. First, we introduce a general functorial construction from ns colored operads to ns operads, which is called the enveloping operad. This can be compared to the amalgamated product of groups, in the sense that it takes a compound object to build a unified object in the simplest possible way, by imposing as few relations as possible. The main interest of this construction relies on the fact that a lot of properties of an enveloping operad (as *e.g.*, its Hilbert series and a presentation by generators and relations) can be obtained from its underlying ns colored operad.

Next, we consider the ns operad BNC of bicolored noncrossing configurations, defined by a simple graphical composition, and show that it admits a description as the enveloping operad of a very simple ns colored operad on two colors called Bubble. We also obtain a presentation by generators and relations of the ns colored operad Bubble.

Then this understanding of the operad BNC is used to describe in details some of its suboperads, namely those generated by two chosen generators among the binary generators of BNC. This already gives an interesting family of operads, where one can recognize some known ones: the operad of based noncrossing trees NCT [Cha07], the operad of noncrossing plants NCP [Cha07], the dipterous operad [LR03, Zin12], and the 2-associative operad [LR06, Zin12]. Our main results here are a presentation by generators and relations for all these suboperads except one, and also the description of all the generating series. It should be noted that the presentations are obtained in a case-by-case fashion, using similar techniques involving rewrite rules on syntax trees (see Section 2.4 of Chapter 1).

This chapter is organized as follows. In Section 1, the general construction of enveloping operads is given and its properties described. Next, in Section 2, we introduce the operad BNC and prove that this operad is isomorphic to an enveloping operad. Finally, in Section 3, several suboperads of BNC are considered, in a more or less detailed way.

*Note.* This chapter deals only with ns set-operads and ns colored set-operads. For this reason, “operad” means “ns set-operad”. Moreover, we consider only colored operads  $\mathcal{B}$  such that  $\mathcal{B}(1)$  is trivial, that is  $\mathcal{B}(1) = \{1_c : c \in [k]\}$ . Moreover, all considered colored operads are  $k$ -colored operads (see Section 4.1.10 of Chapter 2).

### 1. Enveloping operads of colored operads

The aim of this section is twofold. We begin by introducing the main object of this chapter: the construction which associates an operad with a colored one, namely its enveloping operad. We finally justify the benefits of seeing an operad  $\mathcal{O}$  as an enveloping operad of a colored one  $\mathcal{B}$  by reviewing some properties of  $\mathcal{O}$  that can be deduced from the ones of  $\mathcal{B}$ .

**1.1. The construction.** Let us now introduce the construction associating a (noncolored) operad with a colored one. We begin by giving the formal definition of what enveloping operads of colored operads are, and then, give a combinatorial interpretation of the construction in terms of anticolored syntax trees.

**1.1.1. Enveloping operads.** Let  $\mathcal{B}$  be a  $k$ -colored operad. Recall that  $\text{Aug}(\mathcal{B})$  is the set  $\mathcal{B} \setminus \mathcal{B}(1)$ . The *enveloping operad*  $\text{Hull}(\mathcal{B})$  of  $\mathcal{B}$  is the smallest (noncolored) operad containing  $\text{Aug}(\mathcal{B})$ . In other terms,

$$\text{Hull}(\mathcal{B}) := \text{FO}(\text{Aug}(\mathcal{B})) / \equiv, \quad (1.1.1)$$

where  $\equiv$  is the smallest operad congruence of  $\text{FO}(\text{Aug}(\mathcal{B}))$  satisfying

$$\odot(x) \circ_i \odot(y) \equiv \odot(x \circ_i y), \quad (1.1.2)$$

for all  $x, y \in \text{Aug}(\mathcal{B})$  such that  $x \circ_i y$  are well-defined in  $\mathcal{B}$ . Observe that in (1.1.1),  $\text{FO}(\text{Aug}(\mathcal{B}))$  is the free noncolored operad generated by  $\text{Aug}(\mathcal{B})$ , where  $\text{Aug}(\mathcal{B})$  is here a combinatorial graded collection whose input and output colors are forgotten.

**1.1.2. Reductions.** Let  $t$  be a syntax tree of  $\text{FO}(\text{Aug}(\mathcal{B}))$  and  $e$  be an edge of  $t$  connecting two internal nodes  $r$  and  $s$  respectively labeled by  $x$  and  $y$ , such that  $s$  is the  $i$ th child of  $r$  and, as elements of  $\mathcal{B}$ ,  $\text{in}_i(x) = \text{out}(y)$ . Then, the *reduction* of  $t$  with respect to  $e$  is the tree obtained by replacing  $r$  and  $s$  by an internal node labeled by  $x \circ_i y$  (see Figure 3.1). This tree is an element of  $\text{FO}(\text{Aug}(\mathcal{B}))$ .

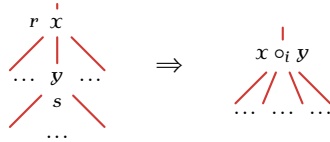

FIGURE 3.1. The reduction of syntax trees. The internal node  $s$  is the  $i$ th child of  $r$ .

1.1.3. *Anticolored syntax trees.* Let  $C$  be a  $k$ -colored collection. A  *$k$ -anticolored syntax tree* on  $C$  (or for short, a  *$k$ -anticolored  $C$ -syntax tree*) is a (noncolored)  $C$ -syntax tree  $t$  such that for any internal nodes  $r$  and  $s$  of  $t$  such that  $s$  is the  $i$ th child of  $r$ , we have  $\mathbf{in}_i(x) \neq \mathbf{out}(y)$  where  $x$  (resp.  $y$ ) is the label of  $r$  (resp.  $s$ ). The set of all  $k$ -anticolored  $C$ -syntax trees is denoted by  $\mathbf{Anti}(C)$ . Observe that the leaf  $\perp$  is a  $k$ -anticolored syntax tree. Since anticolored syntax trees are particular syntax trees, the usual terminology and tools about them applies (see Section 2 of Chapter 1).

1.1.4. *The operad of anticolored syntax trees.* For any  $k$ -colored operad  $\mathcal{G}$ , the set  $\mathbf{Anti}(\mathbf{Aug}(\mathcal{G}))$  is endowed with an operad structure for the partial composition defined as follows. Let  $s$  and  $t$  be two anticolored syntax trees on  $\mathbf{Aug}(\mathcal{G})$ . If  $\mathbf{out}(t) \neq \mathbf{in}_i(s)$ ,  $s \circ_i t$  is the anticolored syntax tree obtained by grafting the root of  $t$  on the  $i$ th leaf of  $s$ . Otherwise, when  $\mathbf{out}(t) = \mathbf{in}_i(s)$ ,  $s \circ_i t$  is the anticolored syntax tree obtained by grafting the root of  $t$  on the  $i$ th leaf of  $s$  and then, by reducing the obtained tree with respect to the edge connecting the nodes  $r$  and  $s$ , where  $r$  is the parent of the  $i$ th leaf of  $s$  and  $s$  is the root of  $t$  (see Figure 3.2).

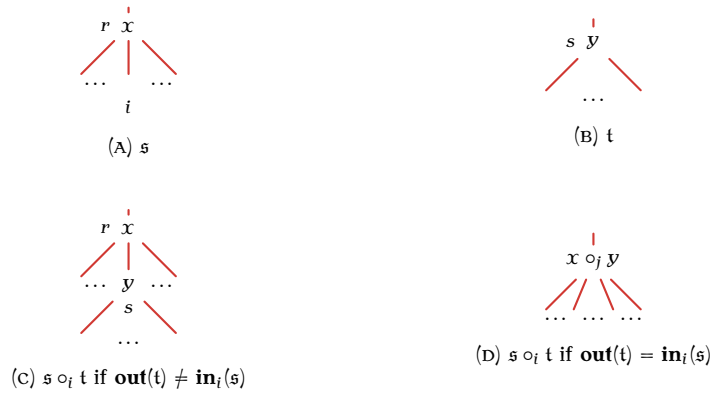

FIGURE 3.2. The two cases for the partial composition of two anticolored trees  $s$  and  $t$ . In (d),  $j$  is the index of the  $i$ th leaf of  $s$  among the children of the internal node  $r$ .

PROPOSITION 1.1.1. *For any colored operad  $\mathcal{G}$ , the operads  $\mathbf{Hull}(\mathcal{G})$  and  $\mathbf{Anti}(\mathbf{Aug}(\mathcal{G}))$  are isomorphic.*

PROOF. Let  $\phi : \mathbf{Hull}(\mathcal{G}) \rightarrow \mathbf{Anti}(\mathbf{Aug}(\mathcal{G}))$  be the map associating with any  $\equiv$ -equivalence class of syntax trees on  $\mathbf{Aug}(\mathcal{G})$ , the only anticolored  $\mathbf{Aug}(\mathcal{G})$ -syntax tree on belonging to it. To prove the statement, let us show that  $\phi$  is a well-defined operad isomorphism.

For that, let  $\sim$  be the closure of the rewrite relation  $\Rightarrow$  of reduction with respect to the partial compositions operations of trees. The axioms of operads ensure that  $\sim$  is confluent, and since any rewriting decreases the degrees of the trees,  $\sim$  is terminating. The normal forms of  $\sim$  are the trees that cannot be reduced, and thus, are anticolored  $\mathbf{Aug}(\mathcal{G})$ -syntax

trees. Since by definition of  $\equiv$ ,  $s \rightsquigarrow t$  implies  $s \equiv t$ , the application  $\phi$  is well-defined and is a bijection.

Finally, let  $[s]_{\equiv}, [t]_{\equiv} \in \mathbf{Hull}(\mathcal{G})$ ,  $s := \phi([s]_{\equiv})$ , and  $t := \phi([t]_{\equiv})$ . The only anticolored syntax tree in  $[s \circ_i t]_{\equiv}$  is obtained by grafting  $s$  and  $t$  together and performing, if possible, a reduction with respect to the edge linking them. Since the obtained tree is also the anticolored syntax tree  $s \circ_i t$  of  $\mathbf{Anti}(\mathbf{Aug}(\mathcal{G}))$ ,  $\phi$  is an operad morphism.  $\square$

Proposition 1.1.1 implies that the elements of  $\mathbf{Hull}(\mathcal{G})$  can be regarded as anticolored trees, endowed with their partial composition defined above. We shall maintain this point of view in the rest of this chapter by setting  $\mathbf{Hull}(\mathcal{G}) := \mathbf{Anti}(\mathbf{Aug}(\mathcal{G}))$ .

1.1.5. *Functoriality.* Let  $\mathcal{G}_1$  and  $\mathcal{G}_2$  be two  $k$ -colored operads. Given  $\phi : \mathcal{G}_1 \rightarrow \mathcal{G}_2$  a colored operad morphism, let the map  $\mathbf{Hull}(\phi) : \mathbf{Hull}(\mathcal{G}_1) \rightarrow \mathbf{Hull}(\mathcal{G}_2)$  be the unique operad morphism satisfying

$$\mathbf{Hull}(\phi) (\odot (x)) := \odot (\phi(x)) \quad (1.1.3)$$

for any  $x \in \mathcal{G}_1$ .

**THEOREM 1.1.2.** *The construction  $\mathbf{Hull}$  is a functor from the category of colored operads to the category of operads that preserves injections and surjections.*

**PROOF.** For any colored operad  $\mathcal{G}$ ,  $\mathbf{Hull}(\mathcal{G})$  is by definition an operad on anticolored syntax trees on  $\mathbf{Aug}(\mathcal{G})$ . Moreover, by induction on the number of internal nodes of the anticolored syntax trees, it follows that for any colored operad morphism  $\phi$ ,  $\mathbf{Hull}(\phi)$  is a well-defined operad morphism.

Since  $\mathbf{Hull}$  is compatible with map composition and sends the identity colored operad morphism to the identity operad morphism,  $\mathbf{Hull}$  is a functor. It is moreover plain that if  $\phi$  is an injective (resp. surjective) colored operad morphism, then  $\mathbf{Hull}(\phi)$  is an injective (resp. surjective) operad morphism.  $\square$

Theorem 1.1.2 is rich in consequences: Propositions 1.2.2, 1.2.3, 1.2.5, 1.2.4 of next section directly rely on it.

Notice that  $\mathbf{Hull}$  is a surjective functor. Indeed, since an anticolored syntax tree on a 1-colored collection is necessarily a corolla, for any operad  $\mathcal{O}$ ,  $\mathbf{Hull}(\mathcal{O})$  contains only corollas labeled on  $\mathbf{Aug}(\mathcal{O})$  and it is therefore isomorphic to  $\mathcal{O}$ .

Notice also that  $\mathbf{Hull}$  is not an injective functor. Let us exhibit two 2-colored operads not themselves isomorphic that produce by  $\mathbf{Hull}$  two isomorphic operads. Let  $\mathcal{G}$  be the 2-colored operad where  $\mathcal{G}(2) := \{a_2\}$  with  $\mathbf{out}(a_2) := 1$  and  $\mathbf{in}_1(a_2) := \mathbf{in}_2(a_2) := 2$ , and for all  $n \geq 3$ ,  $\mathcal{G}(n) := \emptyset$ . Due to the output and input colors of  $a_2$ , there is no nontrivial partial composition in  $\mathcal{G}$ . On the other hand, let FAs be the 2-colored operad where, for all  $n \geq 2$ ,  $\mathbf{FAs}(n) := \{b_n\}$  with  $\mathbf{out}(b_n) := 1$ ,  $\mathbf{in}_1(b_n) := 1$ , and  $\mathbf{in}_i(b_n) := 2$  for all  $2 \leq i \leq n$ . Nontrivial partial compositions of FAs are only defined for the first position by  $b_n \circ_1 b_m := b_{n+m-1}$ , for any  $n, m \geq 2$ . One observes that  $\mathbf{Hull}(\mathcal{G})$  and  $\mathbf{Hull}(\mathbf{FAs})$  are both the free operad generated by one element of arity 2 with no nontrivial relations, and hence, are isomorphic. The isomorphism between  $\mathbf{Hull}(\mathcal{G})$  and  $\mathbf{Hull}(\mathbf{FAs})$  can be described by a left-child right-sibling bijection [CLRS09] between binary trees and planar rooted trees.



### 1.2.2. Suboperads and quotients.

PROPOSITION 1.2.2. *Let  $\mathcal{C}$  be a colored operad and  $\mathcal{C}'$  be one of its colored suboperads (resp. quotients). Then, the enveloping operad of  $\mathcal{C}'$  is a suboperad (resp. quotient) of the enveloping operad of  $\mathcal{C}$ .*

### 1.2.3. Generating sets.

PROPOSITION 1.2.3. *Let  $\mathcal{C}$  be a colored operad admitting  $\mathfrak{G}$  as a generating set. Then, the enveloping operad of  $\mathcal{C}$  is generated by*

$$\mathbf{Hull}(\mathfrak{G}) := \{\odot(g) : g \in \mathfrak{G}\}. \quad (1.2.3)$$

### 1.2.4. Symmetries.

PROPOSITION 1.2.4. *Let  $\mathcal{C}$  be a colored operad and  $\mathcal{G}$  its group of symmetries. Then, the group of symmetries of the enveloping operad of  $\mathcal{C}$  is  $\mathbf{Hull}(\mathcal{G})$  where*

$$\mathbf{Hull}(\mathcal{G}) := \{\mathbf{Hull}(\phi) : \phi \in \mathcal{G}\}. \quad (1.2.4)$$

### 1.2.5. Presentations by generators and relations.

PROPOSITION 1.2.5. *Let  $\mathcal{C}$  be a colored operad admitting a presentation  $(\mathfrak{G}, \leftrightarrow)$ . Then, the enveloping operad of  $\mathcal{C}$  admits the presentation  $(\mathbf{Hull}(\mathfrak{G}), \leftrightarrow')$ , where  $\leftrightarrow'$  is the equivalence relation satisfying*

$$s' \leftrightarrow' t' \quad \text{if and only if} \quad s \leftrightarrow t, \quad (1.2.5)$$

where  $s'$  (resp.  $t'$ ) is the  $\mathbf{Hull}(\mathfrak{G})$ -colored syntax tree obtained by replacing any node labeled by  $x$  of  $s$  (resp.  $t$ ) by  $\odot(x)$ .

## 2. The operad of bicolored noncrossing configurations

In this section, we shall define an operad over a new kind of noncrossing configurations. In order to study it and apply the results of Section 1, we shall see this operad as an enveloping operad of a colored one.

**2.1. Bicolored noncrossing configurations.** Let us start by introducing our new combinatorial object, some of its properties, and its operad structure.

2.1.1. *Bicolored noncrossing configurations.* A **bicolored noncrossing configuration** (or, for short, a **BNC**) is a noncrossing configuration (see Section 3.2 of Chapter 1) where each arc can be either **blue** (drawn as a thick line) or **red** (drawn as a dotted line) and such that all red arcs are diagonals. We say that  $c$  is **based** if its base is blue and **nonbased** otherwise. Besides, we impose by definition that there is only one BNC of size 1: the segment consisting in one blue arc. Figure 3.3 shows a BNC.

When the size of  $c$  is not smaller than 2, the **border** of  $c$  is the word  $\text{bor}(c)$  of length  $n$  such that, for any  $i \in [n]$ ,  $\text{bor}(c)_i := 1$  if the  $i$ th edge of  $c$  is uncolored and  $\text{bor}(c)_i := 2$  otherwise. See Figure 3.3 for an example.

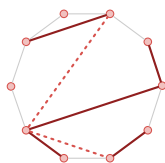

FIGURE 3.3. A nonbased BNC of size 9. Blue arcs are  $(1, 2)$ ,  $(2, 8)$ ,  $(4, 6)$ ,  $(7, 8)$ , and  $(9, 10)$ , and red arcs are  $(2, 6)$  and  $(2, 10)$ . All other arcs are uncolored. The border of this BNC is 211111212.

2.1.2. *Operad structure.* From now on, the *arity*  $|c|$  of a BNC  $c$  is its size. Let  $c$  and  $\partial$  be two BNCs of respective arities  $n$  and  $m$ , and  $i \in [n]$ . The partial composition  $c \circ_i \partial =: \epsilon$  is obtained by gluing the base of  $\partial$  onto the  $i$ th edge of  $c$ , and then,

- (1) if the base of  $\partial$  and the  $i$ th edge of  $c$  are both uncolored, the arc  $(i, i + m)$  of  $\epsilon$  becomes red;
- (2) if the base of  $\partial$  and the  $i$ th edge of  $c$  are both blue, the arc  $(i, i + m)$  of  $\epsilon$  becomes blue;
- (3) otherwise, the base of  $\partial$  and the  $i$ th edge of  $c$  have different colors; in this case, the arc  $(i, i + m)$  of  $\epsilon$  is uncolored.

For aesthetic reasons, the resulting shape is reshaped to form a regular polygon. For instance,

(2.1.1a)

(2.1.1b)

(2.1.1c)

(2.1.1d)

are partial compositions in BNC.

PROPOSITION 2.1.1. *The set of all the BNCs, together with the partial composition maps  $\circ_i$  and the BNC of arity 1 as unit form an operad, denoted by BNC.*

2.2. **The colored operad of bubbles.** We now define a colored operad involving particular BNCs and perform a complete study of it.



2.2.1. *Bubbles.* A **bubble** is a BNC of size no smaller than 2 with no diagonal (hence the name). For instance,



is a bubble of size 6 and whose border is 111221.

2.2.2. *Colored operad structure.* Let  $\mathfrak{b}$  be a bubble of arity  $n$ . Let us assign input and output colors to  $\mathfrak{b}$  in the following way. The output color  $\mathbf{out}(\mathfrak{b})$  of  $\mathfrak{b}$  is 1 if  $\mathfrak{b}$  is based and 2 otherwise, and the color  $\mathbf{in}_i(\mathfrak{b})$  of the  $i$ th input of  $\mathfrak{b}$  is the  $i$ th letter of the border of  $\mathfrak{b}$ .

Let us denote by  $\mathbb{1}_1$  and  $\mathbb{1}_2$  two virtual bubbles of arity 1 such that  $\mathbf{out}(\mathbb{1}_1) := \mathbf{in}_1(\mathbb{1}_1) := 1$  and  $\mathbf{out}(\mathbb{1}_2) := \mathbf{in}_1(\mathbb{1}_2) := 2$ .

PROPOSITION 2.2.1. *The set of all the bubbles, together with the partial composition map  $\circ_3$  of BNC and the units  $\mathbb{1}_1$  and  $\mathbb{1}_2$  form a 2-colored operad, denoted by Bubble.*

Notice that any bubble  $\mathfrak{b}$  is wholly encoded by the pair  $(\mathbf{out}(\mathfrak{b}), (\mathbf{in}_i(\mathfrak{b}))_{i \in [|\mathfrak{b}|]})$ . Therefore, Bubble is a very simple colored operad: for any  $n$ , the set of elements of arity  $n \geq 2$  is  $[2] \times [2]^n$  and the partial composition, when defined, is a substitution in words. For instance, the partial composition

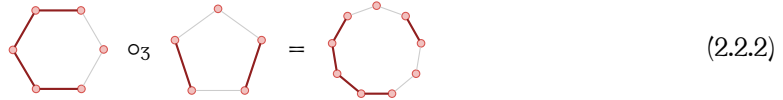

of Bubble can be expressed concisely as

$$(1, 22211) \circ_3 (2, 21112) = (1, 22211211). \tag{2.2.3}$$

2.2.3. *Colored Hilbert series.* Since Bubble contains by definition all the bubbles, the colored Hilbert series of Bubble satisfies

$$B_1(z_1, z_2) = B_2(z_1, z_2) = \sum_{n \geq 2} (z_1 + z_2)^n = \frac{(z_1 + z_2)^2}{1 - z_1 - z_2}. \tag{2.2.4}$$

2.2.4. *Generating set.*

PROPOSITION 2.2.2. *The set*

$$\mathfrak{G}_{\text{Bubble}} := \{ \text{diagram 1}, \text{diagram 2}, \text{diagram 3}, \text{diagram 4}, \text{diagram 5}, \text{diagram 6}, \text{diagram 7}, \text{diagram 8} \} \tag{2.2.5}$$

of bubbles of arity 2 is the unique minimal generating set of Bubble.

2.2.5. *Symmetries.* The **complementary**  $\mathbf{cpl}(\mathfrak{b})$  of a bubble  $\mathfrak{b}$  is the bubble obtained by swapping the colors of the edges of  $\mathfrak{b}$  (blue edges become uncolored and conversely). The **returned**  $\mathbf{ret}(\mathfrak{b})$  of  $\mathfrak{b}$  is the bubble obtained by applying to  $\mathfrak{b}$  the reflection through the vertical line passing by its base. Figure 3.4 shows examples of these symmetries.

PROPOSITION 2.2.3. *The group of symmetries of Bubble is generated by  $\mathbf{cpl}$  and  $\mathbf{ret}$  and satisfies the relations*

$$\mathbf{ret} = \mathbf{ret}^{-1}, \quad \mathbf{cpl} = \mathbf{cpl}^{-1}, \quad \mathbf{ret} \mathbf{cpl} = \mathbf{cpl} \mathbf{ret}. \tag{2.2.6}$$



Let us now prove that  $\phi$  is a bijection. For that, let us orient the relation  $\leftrightarrow$  by means of the rewrite rule  $\Rightarrow$  on the colored syntax trees on  $\mathfrak{G}_{\text{Bubble}}$  satisfying  $s \Rightarrow t$  if  $s \leftrightarrow t$  and  $t$  is one of the following sixteen target trees

$$\begin{aligned}
& \odot \left( \begin{array}{c} \circ \\ \circ \end{array} \right) \circ_1 \odot \left( \begin{array}{c} \circ \\ \circ \end{array} \right), \odot \left( \begin{array}{c} \circ \\ \circ \end{array} \right) \circ_1 \odot \left( \begin{array}{c} \circ \\ \circ \end{array} \right), \odot \left( \begin{array}{c} \circ \\ \circ \end{array} \right) \circ_1 \odot \left( \begin{array}{c} \circ \\ \circ \end{array} \right), \odot \left( \begin{array}{c} \circ \\ \circ \end{array} \right) \circ_1 \odot \left( \begin{array}{c} \circ \\ \circ \end{array} \right), \\
& \odot \left( \begin{array}{c} \circ \\ \circ \end{array} \right) \circ_1 \odot \left( \begin{array}{c} \circ \\ \circ \end{array} \right), \odot \left( \begin{array}{c} \circ \\ \circ \end{array} \right) \circ_1 \odot \left( \begin{array}{c} \circ \\ \circ \end{array} \right), \odot \left( \begin{array}{c} \circ \\ \circ \end{array} \right) \circ_1 \odot \left( \begin{array}{c} \circ \\ \circ \end{array} \right), \odot \left( \begin{array}{c} \circ \\ \circ \end{array} \right) \circ_1 \odot \left( \begin{array}{c} \circ \\ \circ \end{array} \right), \\
& \odot \left( \begin{array}{c} \circ \\ \circ \end{array} \right) \circ_1 \odot \left( \begin{array}{c} \circ \\ \circ \end{array} \right), \odot \left( \begin{array}{c} \circ \\ \circ \end{array} \right) \circ_1 \odot \left( \begin{array}{c} \circ \\ \circ \end{array} \right), \odot \left( \begin{array}{c} \circ \\ \circ \end{array} \right) \circ_1 \odot \left( \begin{array}{c} \circ \\ \circ \end{array} \right), \odot \left( \begin{array}{c} \circ \\ \circ \end{array} \right) \circ_1 \odot \left( \begin{array}{c} \circ \\ \circ \end{array} \right), \\
& \odot \left( \begin{array}{c} \circ \\ \circ \end{array} \right) \circ_1 \odot \left( \begin{array}{c} \circ \\ \circ \end{array} \right), \odot \left( \begin{array}{c} \circ \\ \circ \end{array} \right) \circ_1 \odot \left( \begin{array}{c} \circ \\ \circ \end{array} \right), \odot \left( \begin{array}{c} \circ \\ \circ \end{array} \right) \circ_1 \odot \left( \begin{array}{c} \circ \\ \circ \end{array} \right), \odot \left( \begin{array}{c} \circ \\ \circ \end{array} \right) \circ_1 \odot \left( \begin{array}{c} \circ \\ \circ \end{array} \right).
\end{aligned} \tag{2.2.8}$$

The target trees of  $\Rightarrow$  are the only left comb trees appearing in each  $\leftrightarrow$ -equivalence class of the statement such that the color of the first input of the root is the same as the color of the first input of its child.

Let  $\sim$  be the closure of  $\Rightarrow$  and let us prove that  $\sim$  is terminating. Let  $\psi$  be the map associating the pair  $(\text{tam}(t), \text{In}(t))$  with a colored syntax tree  $t$ , where  $\text{tam}$  is defined by (2.4.21) in Chapter 1, and  $\text{In}(t)$  is the number of internal nodes labeled by  $x$  of  $t$  having an internal node labeled by  $y$  as left child such that  $\mathbf{in}_1(x) \neq \mathbf{in}_1(y)$ . We observe that, for any trees  $t_0$  and  $t_1$  such that  $t_0 \sim t_1$ ,  $\psi(t_1)$  is lexicographically smaller than  $\psi(t_0)$ . Hence,  $\sim$  is terminating.

The normal forms of  $\sim$  are the colored  $\mathfrak{G}_{\text{Bubble}}$ -syntax trees avoiding the trees  $s$  appearing as a left members of  $\Rightarrow$ . These are left comb trees  $t$  such that for all internal nodes  $x$  and  $y$  of  $t$ ,  $\mathbf{in}_1(x) = \mathbf{in}_1(y)$ . Pictorially,  $t$  is of the form

$$t = \begin{array}{c} \phantom{c} \\ \phantom{x_{n-1}} \\ \phantom{d_1} \phantom{d_n} \\ \phantom{x_1} \\ \phantom{d_1} \phantom{d_2} \\ \phantom{\square} \phantom{\square} \end{array} \tag{2.2.9}$$

where  $c \in [2]$ ,  $d_i \in [2]$  for all  $i \in [n]$ , and  $x_j \in \mathfrak{G}_{\text{Bubble}}$  for all  $j \in [n-1]$ . Since  $t$  is a colored syntax tree, given  $c$  and the  $d_i$ , there is exactly one possibility for all the  $x_j$ . Therefore, there are  $f_c(n) := 2^n$  normal forms of  $\sim$  of arity  $n$  with  $c$  as output color. This imply that  $\mathbf{FCO}(\mathfrak{G}_{\text{Bubble}})/\equiv$  contains at most  $f_c(n)$  elements of arity  $n$  and  $c$  as output color. Then, since  $f_c(n)$  is also the number of elements of Bubble with arity  $n$  and  $c$  as output color (see Section 2.2.3),  $\phi$  is a bijection.

Finally, since  $\Rightarrow$  is an orientation of  $\leftrightarrow$  and the normal forms of  $\sim$  are the colored  $\mathfrak{G}_{\text{Bubble}}$ -syntax trees avoiding the trees appearing as second, third or fourth members of Relations (2.2.7a)—(2.2.7p) (see (2.2.8)), the last part of the statement follows.  $\square$

**2.3. Properties of the operad of bicolored noncrossing configurations.** Let us come back to the study of the operad BNC. We show here that BNC is the enveloping operad of Bubble and then, by using the results of Section 2.2 together with the ones of Section 1.2, give some of its properties.

2.3.1. *Bubble decomposition.* Let  $c$  be a BNC. An *area* of  $c$  is a maximal component of  $c$  without colored diagonals and bounded by colored arcs or by uncolored edges. Any area  $a$  of  $c$  defines a bubble  $b$  consisting in the edges of  $a$ . The base of  $b$  is the only edge of  $a$  that splits  $c$  in two parts where one contains the base of  $c$  and the other contains  $a$ . Blue edges of  $a$  remain blue edges in  $b$  and red edges of  $a$  become uncolored edges in  $b$ .

The *dual tree* of  $c$  is the planar rooted tree labeled by bubbles defined as follows. If  $c$  is of size 1, its dual tree is the leaf. Otherwise, put an internal node in each area of  $c$  and connect any pair of nodes that are in adjacent areas. Put also leaves outside  $c$ , one for each edge, except the base, and connect these with the internal nodes of their adjacent areas. This forms a tree rooted at the node of the area containing the base of  $c$ . Finally, label each internal node of the tree by the bubble associated with the area containing it. Figure 3.5 shows an example of a BNC and its dual tree.

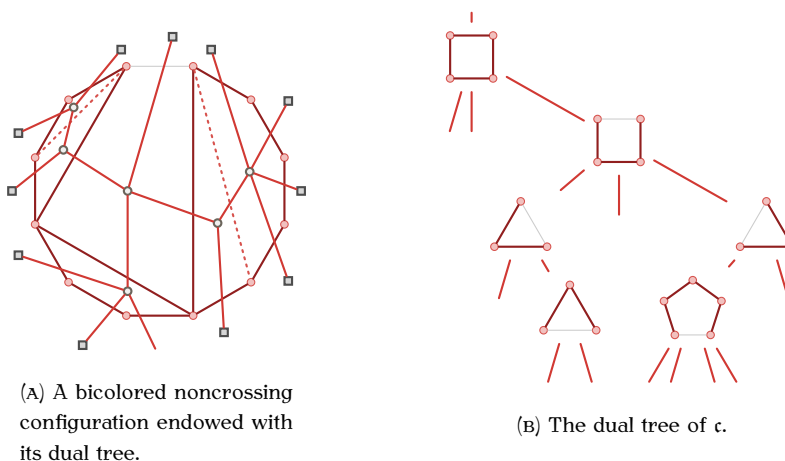

FIGURE 3.5. A bicolored noncrossing configuration and its dual tree.

**THEOREM 2.3.1.** *The 2-colored operad Bubble is a 2-bubble decomposition of the operad BNC.*

2.3.2. *Enumeration of the bicolored noncrossing configurations.* By using the fact that, by Theorem 2.3.1, Bubble is a 2-bubble decomposition of BNC, together with Proposition 1.2.1 and the colored Hilbert series (2.2.4) of Bubble, we obtain the following algebraic equation for the generating series of the BNCs.

**PROPOSITION 2.3.2.** *The Hilbert series  $\mathcal{H}(t)$  of BNC satisfies*

$$-t - t^2 + (1 - 4t)\mathcal{H}(t) - 3\mathcal{H}(t)^2 = 0. \tag{2.3.1}$$

First numbers of BNCs by size are

$$1, 8, 80, 992, 13760, 204416, 3180800, 51176960, 844467200. \tag{2.3.2}$$

This forms Sequence A234596 of [Slo].

2.3.3. *Other consequences.* Since Bubble is, by Theorem 2.3.1, a 2-bubble decomposition of BNC, we can use the results of Section 1.2 to obtain the generating set, the group of symmetries, and the presentation by generators and relations of BNC. Thus, by Propositions 1.2.3 and 2.2.2, the generating set of BNC is the set of the eight BNCs of arity 2. By Propositions 1.2.4 and 2.2.3, the group of symmetries of BNC is generated by the maps  $\text{cpl}' := \mathbf{Hull}(\text{cpl})$  and  $\text{ret}' := \mathbf{Hull}(\text{ret})$ . For any BNC  $c$ ,  $\text{cpl}'(c)$  is the BNC obtained by swapping the colors of the red and blue diagonals of  $c$ , and by swapping the colors of the edges of  $c$ . Moreover, for any BNC  $c$ ,  $\text{ret}'(c)$  is the BNC obtained by applying to  $c$  the reflection through the vertical line passing by its base. Finally, by Proposition 1.2.5 and Theorem 2.2.4, BNC admits the presentation by generators and relations of the statement of Theorem 2.2.4.

### 3. Suboperads of the operad of bicolored noncrossing configurations

We now study some of the suboperads of BNC generated by various sets of BNCs. We shall mainly focus on the suboperads generated by sets of two BNCs of arity 2.

3.1. **Overview of the obtained suboperads.** In what follows, we denote by  $\langle \mathfrak{G} \rangle$  the suboperad of BNC generated by a set  $\mathfrak{G}$  of BNCs, and when  $\mathfrak{G}$  is a set of bubbles, by  $\langle\langle \mathfrak{G} \rangle\rangle$  the colored suboperad of Bubble generated by  $\mathfrak{G}$ .

3.1.1. *Orbits of suboperads.* There are  $2^8 = 256$  suboperads of BNC generated by elements of arity 2. The symmetries provided by the group of symmetries of BNC (see Proposition 2.2.3) allow to gather some of these together. Indeed, if  $\mathfrak{G}_1$  and  $\mathfrak{G}_2$  are two sets of BNCs and  $\phi$  is a map of the group of symmetries of BNC such that  $\phi(\mathfrak{G}_1) = \mathfrak{G}_2$ , the suboperads  $\langle \mathfrak{G}_1 \rangle$  and  $\langle \mathfrak{G}_2 \rangle$  would be isomorphic or antiisomorphic. We say in this case that these two operads are *equivalent*. There are in this way only 88 orbits of suboperads that are pairwise nonequivalent.

3.1.2. *Suboperads on one generator.* There are three orbits of suboperads of BNC generated by one generator of arity 2. The first contains  $\langle \triangle \rangle$ . By induction on the arity, one can show that this operad contains all the triangulations and that it is free. The second one contains  $\langle \triangleleft \rangle$ . By using similar arguments, one can show that this operad is also free and isomorphic to the latter. The third orbit contains  $\langle \circ \rangle$ . This operad contains exactly one element of any arity, and hence, is the associative operad.

3.1.3. *Operads of noncrossing trees and plants.* Chapoton defined in [Cha07] an operad NCT involving based noncrossing trees and an operad NCP involving noncrossing plants. As follows directly from the definition, these operads are the suboperads  $\langle \triangleleft, \triangle \rangle$  and  $\langle \triangleleft, \triangle, \triangle \rangle$  of BNC respectively. The operad NCT governs L-algebras, a sort of algebras introduced by Leroux [Ler11].

3.1.4. *Suboperads on two generators.* The  $\binom{8}{2} = 28$  suboperads of BNC generated by two BNCs of arity 2 form eleven orbits. Table 3.1 summarizes some information about these. Some of these operads are well-known operads: the free operad  $\langle \triangle, \triangle \rangle$  on two generators of arity 2, the operad of noncrossing trees [Cha07, Ler11]  $\langle \triangleleft, \triangle \rangle$ , the dipterous operad [LR03, Zin12]  $\langle \triangleleft, \triangle \rangle$ , and the 2-associative operad [LR06, Zin12]  $\langle \circ, \triangle \rangle$ . All the

Operad	Dimensions	Presentation
$\langle \triangle, \triangle \rangle$	1, 2, 8, 40, 224, 1344, 8448, 54912	free
$\langle \triangle, \triangle \rangle$	1, 2, 8, 40, 216, 1246, 7516, 46838	quartic or more
$\langle \triangle, \triangle \rangle$	1, 2, 8, 38, 200, 1124, 6608, 40142	cubic
$\langle \triangle, \triangle \rangle$		
$\langle \triangle, \triangle \rangle$		
$\langle \triangle, \triangle \rangle$	1, 2, 7, 31, 154, 820, 4575, 26398	quadratic
$\langle \triangle, \triangle \rangle$	1, 2, 7, 30, 143, 728, 3876, 21318	quadratic
$\langle \triangle, \triangle \rangle$	1, 2, 6, 22, 90, 394, 1806, 8558	quadratic
$\langle \triangle, \triangle \rangle$		
$\langle \triangle, \triangle \rangle$		
$\langle \triangle, \triangle \rangle$		

TABLE 3.1. The eleven orbits of suboperads of BNC generated by two generators of arity 2, their dimensions and the degrees of nontrivial relations between their generators.

Hilbert series of the eleven operads are algebraic, with the genus of the associated algebraic curve being 0. The sequences of the dimensions of the operads of Table 3.1 are respectively Sequences A052701, A234938, A234939, A007863, A006013, and A006318 of [Slo].

3.1.5. *Suboperads on more than two generators.* Some suboperads of BNC generated by more than two generators are very complicated to study. For instance, the operad  $\langle \triangle, \triangle, \triangle \rangle$  has two equivalence classes of nontrivial relations in degree 2, three in degree 3, ten in degree 4 and seems to have no nontrivial relations in higher degree (this has been checked until degree 6). The operad  $\langle \triangle, \triangle, \triangle, \triangle \rangle$  is also complicated since it has four equivalence classes of nontrivial relations in degree 2, sixteen in degree 3 and seems to have no nontrivial relations in higher degree (this has been checked until degree 6).

**3.2. Suboperads generated by two elements of arity 2.** For any of the eleven nonequivalent suboperads of BNC generated by two elements of arity 2, we compute its dimensions and provide a presentation by generators and relations by passing through a bubble decomposition of it.

3.2.1. *Outline of the study.* Let  $\langle \mathcal{G} \rangle$  be one of these suboperads. Since, by Theorem 2.3.1, Bubble is a bubble decomposition of BNC and  $\langle \mathcal{G} \rangle$  is generated by bubbles,  $\langle\langle \mathcal{G} \rangle\rangle$  is a bubble decomposition of  $\langle \mathcal{G} \rangle$ . We shall compute the dimensions and establish the presentation by generators and relations of  $\langle\langle \mathcal{G} \rangle\rangle$  to obtain in return, by Propositions 1.2.1 and 1.2.5, the dimensions and the presentation by generators and relations of  $\langle \mathcal{G} \rangle$ . To compute the

dimensions of  $\langle\langle G \rangle\rangle$ , we shall furnish a description of its elements and then deduce from the description its colored Hilbert series. Table 3.2 shows the first coefficients of the colored Hilbert series of the eleven colored suboperads. All of these series are rational. To establish

colored operad	Based bubbles	Nonbased bubbles
$\langle\langle \text{triangle}_1, \text{triangle}_2 \rangle\rangle$	2, 2, 2, 2, 2, 2, 2	0, 0, 0, 0, 0, 0, 0
$\langle\langle \text{triangle}_1, \text{triangle}_2 \rangle\rangle$	1, 2, 5, 10, 21, 42, 85	1, 2, 5, 10, 21, 42, 85
$\langle\langle \text{triangle}_1, \text{triangle}_2 \rangle\rangle$	1, 2, 4, 8, 16, 32, 64	1, 2, 4, 8, 16, 32, 64
$\langle\langle \text{triangle}_1, \text{triangle}_2 \rangle\rangle$		
$\langle\langle \text{triangle}_1, \text{triangle}_2 \rangle\rangle$		
$\langle\langle \text{triangle}_1, \text{triangle}_2 \rangle\rangle$	2, 3, 5, 8, 13, 21, 34	0, 0, 0, 0, 0, 0, 0
$\langle\langle \text{triangle}_1, \text{triangle}_2 \rangle\rangle$	2, 3, 4, 5, 6, 7, 8	0, 0, 0, 0, 0, 0, 0
$\langle\langle \text{triangle}_1, \text{triangle}_2 \rangle\rangle$	2, 4, 8, 16, 32, 64, 128	0, 0, 0, 0, 0, 0, 0
$\langle\langle \text{triangle}_1, \text{triangle}_2 \rangle\rangle$	1, 1, 1, 1, 1, 1, 1	1, 1, 1, 1, 1, 1, 1
$\langle\langle \text{triangle}_1, \text{triangle}_2 \rangle\rangle$		
$\langle\langle \text{triangle}_1, \text{triangle}_2 \rangle\rangle$		

TABLE 3.2. The eleven orbits of 2-colored suboperads of Bubble generated by two generators of arity 2 and the number of their bubbles, based and nonbased.

the presentation of  $\langle\langle \mathfrak{G} \rangle\rangle$ , we shall use the same strategy as the one used for the proof of the presentation of Bubble (see the proof of Theorem 2.2.4). Recall that this consists in exhibiting an orientation  $\Rightarrow$  of the presentation we want to prove such that its closure  $\rightsquigarrow$  is a terminating rewrite rule on colored syntax trees and its normal forms are in bijection with the elements of  $\langle\langle \mathfrak{G} \rangle\rangle$ .

3.2.2. *First orbit.* This orbit consists of the operads  $\langle \text{triangle}_1, \text{triangle}_2 \rangle$ ,  $\langle \text{triangle}_1, \text{triangle}_2 \rangle$ ,  $\langle \text{triangle}_1, \text{triangle}_2 \rangle$ , and  $\langle \text{triangle}_1, \text{triangle}_2 \rangle$ . We choose  $\langle \text{triangle}_1, \text{triangle}_2 \rangle$  as a representative of the orbit.

PROPOSITION 3.2.1. *The set of bubbles of  $\langle\langle \text{triangle}_1, \text{triangle}_2 \rangle\rangle$  is the set of based bubbles such that all edges of the border except possibly the last one are blue. Moreover, the colored Hilbert series of  $\langle\langle \text{triangle}_1, \text{triangle}_2 \rangle\rangle$  satisfy*

$$B_1(z_1, z_2) = \frac{z_1 z_2 + z_2^2}{1 - z_2} \quad \text{and} \quad B_2(z_1, z_2) = 0. \quad (3.2.1)$$

PROPOSITION 3.2.2. *The Hilbert series  $\mathcal{H}(t)$  of  $\langle \text{triangle}_1, \text{triangle}_2 \rangle$  satisfies*

$$t - \mathcal{H}(t) + 2\mathcal{H}(t)^2 = 0. \quad (3.2.2)$$

**THEOREM 3.2.3.** *The operad  $\langle \triangle, \circ \rangle$  is the free operad generated by two generators of arity 2.*

3.2.3. *Second orbit.* This orbit consists of the operad  $\langle \triangle, \circ \rangle$ .

**PROPOSITION 3.2.4.** *The set of based (resp. nonbased) bubbles of  $\langle \triangle, \circ \rangle$  of arity  $n$  is the set of based (resp. nonbased) bubbles having at least two consecutive edges of the border of a same color and the number of blue (resp. uncolored) edges of the border is congruent to  $1 - n$  modulo 3. Moreover, the colored Hilbert series of  $\langle \triangle, \circ \rangle$  satisfy*

$$B_1(z_1, z_2) = \frac{z_1 + z_2^2}{1 - 3z_1z_2 - z_1^3 - z_2^3} - \frac{z_1}{1 - z_1z_2} \quad (3.2.3a)$$

and

$$B_2(z_1, z_2) = \frac{z_2 + z_1^2}{1 - 3z_1z_2 - z_1^3 - z_2^3} - \frac{z_2}{1 - z_1z_2}. \quad (3.2.3b)$$

**PROPOSITION 3.2.5.** *The Hilbert series  $\mathcal{H}(t)$  of  $\langle \triangle, \circ \rangle$  satisfies*

$$4t - 2t^2 - t^3 + t^4 + (-4 + 4t - t^2 + 2t^3)\mathcal{H}(t) + (6 + t)\mathcal{H}(t)^2 + (1 - 2t)\mathcal{H}(t)^3 - \mathcal{H}(t)^4 = 0. \quad (3.2.4)$$

**PROPOSITION 3.2.6.** *The operad  $\langle \triangle, \circ \rangle$  does not admit nontrivial relations between its generators in degree two, three, five and six. It admits the following non trivial relations between its generators in degree four:*

$$((\triangle \circ_2 \circ) \circ_3 \triangle) \circ_3 \circ = ((\triangle \circ_1 \circ) \circ_1 \triangle) \circ_2 \circ, \quad (3.2.5a)$$

$$((\triangle \circ_2 \circ) \circ_2 \triangle) \circ_4 \triangle = ((\triangle \circ_1 \circ) \circ_1 \triangle) \circ_3 \triangle, \quad (3.2.5b)$$

$$((\triangle \circ_2 \circ) \circ_2 \triangle) \circ_3 \circ = ((\triangle \circ_1 \circ) \circ_1 \triangle) \circ_4 \circ, \quad (3.2.5c)$$

$$((\triangle \circ_1 \circ) \circ_3 \circ) \circ_4 \triangle = ((\triangle \circ_1 \circ) \circ_2 \triangle) \circ_2 \circ, \quad (3.2.5d)$$

$$((\circ \circ_2 \triangle) \circ_3 \circ) \circ_3 \triangle = ((\circ \circ_1 \triangle) \circ_1 \circ) \circ_2 \triangle, \quad (3.2.5e)$$

$$((\circ \circ_2 \triangle) \circ_2 \circ) \circ_4 \circ = ((\circ \circ_1 \triangle) \circ_1 \circ) \circ_3 \circ, \quad (3.2.5f)$$

$$((\circ \circ_2 \triangle) \circ_2 \circ) \circ_3 \triangle = ((\circ \circ_1 \triangle) \circ_1 \circ) \circ_4 \triangle, \quad (3.2.5g)$$

$$((\circ \circ_1 \triangle) \circ_3 \triangle) \circ_4 \circ = ((\circ \circ_1 \triangle) \circ_2 \circ) \circ_2 \triangle. \quad (3.2.5h)$$

**PROOF.** This statement is proven with the help of the computer. All partial compositions between the generators  $\triangle$  and  $\circ$  are computed up to degree six and relations thus established.  $\square$

Proposition 3.2.6 does not provide a presentation by generators and relations of  $\langle \triangle, \circ \rangle$ . The methods employed in this chapter fail to establish the presentation of  $\langle \triangle, \circ \rangle$  because it is not possible to define an orientation  $\Rightarrow$  of the relations of the statement of Proposition 3.2.6. Indeed, in degree six, all the closures  $\sim$  of  $\Rightarrow$  have no less than 7518 normal forms whereas they should be 7516. Nevertheless, these relations seem to be the only nontrivial ones; this may be proved by using the Knuth-Bendix completion algorithm (see [KB70, BN98]) over an appropriate orientation of the relations.



3.2.4. *Third orbit.* This orbit consists of the operads  $\langle \triangleleft, \triangleright \rangle$ ,  $\langle \triangleleft, \triangleright \rangle$ ,  $\langle \triangleleft, \triangleright \rangle$ , and  $\langle \triangleleft, \triangleright \rangle$ . We choose  $\langle \triangleleft, \triangleright \rangle$  as a representative of the orbit.

PROPOSITION 3.2.7. *The set of based (resp. nonbased) bubbles of  $\langle \triangleleft, \triangleright \rangle$  of arity  $n$  is the set of based (resp. nonbased) bubbles such that first edge is blue and the number of uncolored edges of the border is congruent to  $n$  (resp.  $n + 1$ ) modulo 2. Moreover, the colored Hilbert series of  $\langle \triangleleft, \triangleright \rangle$  satisfy*

$$B_1(z_1, z_2) = \frac{z_2^2}{1 - 2z_1 + z_1^2 - z_2^2} \quad \text{and} \quad B_2(z_1, z_2) = \frac{z_1 z_2 - z_1^2 z_2 + z_2^3}{1 - 2z_1 + z_1^2 - z_2^2}. \quad (3.2.6)$$

PROPOSITION 3.2.8. *The Hilbert series  $\mathcal{H}(t)$  of  $\langle \triangleleft, \triangleright \rangle$  satisfies*

$$2t - t^2 + (2t - 2)\mathcal{H}(t) + 3\mathcal{H}(t)^2 = 0. \quad (3.2.7)$$

THEOREM 3.2.9. *The operad  $\langle \triangleleft, \triangleright \rangle$  admits the presentation  $(\{\triangleleft, \triangleright\}, \leftrightarrow)$  where  $\leftrightarrow$  is the equivalence relation satisfying*

$$(\odot (\triangleleft) \circ_2 \odot (\triangleleft)) \circ_3 \odot (\triangleright) \leftrightarrow (\odot (\triangleright) \circ_1 \odot (\triangleright)) \circ_2 \odot (\triangleleft), \quad (3.2.8a)$$

$$(\odot (\triangleleft) \circ_2 \odot (\triangleright)) \circ_3 \odot (\triangleleft) \leftrightarrow (\odot (\triangleleft) \circ_1 \odot (\triangleright)) \circ_2 \odot (\triangleleft). \quad (3.2.8b)$$

Moreover, the set of the  $\{\triangleleft, \triangleright\}$ -syntax trees avoiding the trees  $(\odot (\triangleright) \circ_1 \odot (\triangleright)) \circ_2 \odot (\triangleleft)$  and  $(\odot (\triangleleft) \circ_2 \odot (\triangleright)) \circ_3 \odot (\triangleleft)$  is a Poincaré-Birkhoff-Witt basis of  $\langle \triangleleft, \triangleright \rangle$ .

3.2.5. *Fourth orbit.* This orbit consists of the operads  $\langle \triangleleft, \triangleright \rangle$  and  $\langle \triangleleft, \triangleright \rangle$ . We choose  $\langle \triangleleft, \triangleright \rangle$  as a representative of the orbit.

PROPOSITION 3.2.10. *The set of bubbles of  $\langle \triangleleft, \triangleright \rangle$  is the set of bubbles such that first edge is blue and last edge uncolored. Moreover, the colored Hilbert series of  $\langle \triangleleft, \triangleright \rangle$  satisfy*

$$B_1(z_1, z_2) = \frac{z_1 z_2}{1 - z_1 - z_2} \quad \text{and} \quad B_2(z_1, z_2) = \frac{z_1 z_2}{1 - z_1 - z_2}. \quad (3.2.9)$$

PROPOSITION 3.2.11. *The Hilbert series  $\mathcal{H}(t)$  of  $\langle \triangleleft, \triangleright \rangle$  satisfies*

$$2t - t^2 + (2t - 2)\mathcal{H}(t) + 3\mathcal{H}(t)^2 = 0. \quad (3.2.10)$$

THEOREM 3.2.12. *The operad  $\langle \triangleleft, \triangleright \rangle$  admits the presentation  $(\{\triangleleft, \triangleright\}, \leftrightarrow)$  where  $\leftrightarrow$  is the equivalence relation satisfying*

$$(\odot (\triangleleft) \circ_2 \odot (\triangleleft)) \circ_2 \odot (\triangleright) \leftrightarrow (\odot (\triangleright) \circ_1 \odot (\triangleright)) \circ_2 \odot (\triangleleft), \quad (3.2.11a)$$

$$(\odot (\triangleleft) \circ_2 \odot (\triangleright)) \circ_2 \odot (\triangleleft) \leftrightarrow (\odot (\triangleleft) \circ_1 \odot (\triangleright)) \circ_2 \odot (\triangleleft). \quad (3.2.11b)$$

Moreover, the set of the  $\{\triangleleft, \triangleright\}$ -syntax trees avoiding the trees  $(\odot (\triangleright) \circ_2 \odot (\triangleleft)) \circ_2 \odot (\triangleright)$  and  $(\odot (\triangleleft) \circ_2 \odot (\triangleright)) \circ_2 \odot (\triangleleft)$  is a Poincaré-Birkhoff-Witt basis of  $\langle \triangleleft, \triangleright \rangle$ .

3.2.6. *Fifth orbit.* This orbit consists of the operads  $\langle \text{triangle with blue edge}, \text{triangle with red edge} \rangle$  and  $\langle \text{triangle with red edge}, \text{triangle with blue edge} \rangle$ . We choose  $\langle \text{triangle with blue edge}, \text{triangle with red edge} \rangle$  as a representative of the orbit.

PROPOSITION 3.2.13. *The set of based (resp. nonbased) bubbles of  $\langle \text{triangle with blue edge}, \text{triangle with red edge} \rangle$  is the set of based (resp. nonbased) bubbles such that penultimate edge is blue (resp. uncolored) and the last edge is uncolored (resp. blue). Moreover, the colored Hilbert series of  $\langle \text{triangle with blue edge}, \text{triangle with red edge} \rangle$  satisfy*

$$B_1(z_1, z_2) = \frac{z_1 z_2}{1 - z_1 - z_2} \quad \text{and} \quad B_2(z_1, z_2) = \frac{z_1 z_2}{1 - z_1 - z_2}. \quad (3.2.12)$$

PROPOSITION 3.2.14. *The Hilbert series  $\mathcal{H}(t)$  of  $\langle \text{triangle with blue edge}, \text{triangle with red edge} \rangle$  satisfies*

$$2t - t^2 + (2t - 2)\mathcal{H}(t) + 3\mathcal{H}(t)^2 = 0. \quad (3.2.13)$$

THEOREM 3.2.15. *The operad  $\langle \text{triangle with blue edge}, \text{triangle with red edge} \rangle$  admits the presentation  $(\{\text{triangle with blue edge}, \text{triangle with red edge}\}, \leftrightarrow)$  where  $\leftrightarrow$  is the equivalence relation satisfying*

$$(\odot (\text{triangle with blue edge}) \circ_2 \odot (\text{triangle with blue edge})) \circ_2 \odot (\text{triangle with red edge}) \leftrightarrow (\odot (\text{triangle with blue edge}) \circ_1 \odot (\text{triangle with red edge})) \circ_1 \odot (\text{triangle with blue edge}), \quad (3.2.14)$$

$$(\odot (\text{triangle with red edge}) \circ_2 \odot (\text{triangle with red edge})) \circ_2 \odot (\text{triangle with blue edge}) \leftrightarrow (\odot (\text{triangle with red edge}) \circ_1 \odot (\text{triangle with blue edge})) \circ_1 \odot (\text{triangle with red edge}). \quad (3.2.15)$$

Moreover, the set of the  $\{\text{triangle with blue edge}, \text{triangle with red edge}\}$ -syntax trees avoiding the trees  $(\odot (\text{triangle with blue edge}) \circ_2 \odot (\text{triangle with blue edge})) \circ_2 \odot (\text{triangle with red edge})$  and  $(\odot (\text{triangle with red edge}) \circ_2 \odot (\text{triangle with red edge})) \circ_2 \odot (\text{triangle with blue edge})$  is a Poincaré-Birkhoff-Witt basis of  $\langle \text{triangle with blue edge}, \text{triangle with red edge} \rangle$ .

3.2.7. *Sixth orbit.* This orbit consists of the operads  $\langle \text{triangle with blue edge}, \text{triangle with blue edge} \rangle$  and  $\langle \text{triangle with red edge}, \text{triangle with red edge} \rangle$ . We choose  $\langle \text{triangle with blue edge}, \text{triangle with blue edge} \rangle$  as a representative of the orbit.

PROPOSITION 3.2.16. *The set of bubbles of  $\langle \text{triangle with blue edge}, \text{triangle with blue edge} \rangle$  is the set of based bubbles such that maximal sequences of blues edges of the border have even length. Moreover, the colored Hilbert series of  $\langle \text{triangle with blue edge}, \text{triangle with blue edge} \rangle$  satisfy*

$$B_1(z_1, z_2) = \frac{z_1^2 + z_2^2 + z_1 z_2^2}{1 - z_1 - z_2^2} \quad \text{and} \quad B_2(z_1, z_2) = 0. \quad (3.2.16)$$

PROPOSITION 3.2.17. *The Hilbert series  $\mathcal{H}(t)$  of  $\langle \text{triangle with blue edge}, \text{triangle with blue edge} \rangle$  satisfies*

$$t + (t - 1)\mathcal{H}(t) + \mathcal{H}(t)^2 + \mathcal{H}(t)^3 = 0. \quad (3.2.17)$$

THEOREM 3.2.18. *The operad  $\langle \text{triangle with blue edge}, \text{triangle with blue edge} \rangle$  admits the presentation  $(\{\text{triangle with blue edge}, \text{triangle with blue edge}\}, \leftrightarrow)$  where  $\leftrightarrow$  is the equivalence relation satisfying*

$$\odot (\text{triangle with blue edge}) \circ_1 \odot (\text{triangle with blue edge}) \leftrightarrow \odot (\text{triangle with blue edge}) \circ_2 \odot (\text{triangle with blue edge}). \quad (3.2.18)$$

Moreover,  $\langle \text{triangle with blue edge}, \text{triangle with blue edge} \rangle$  is Koszul and the set of the  $\{\text{triangle with blue edge}, \text{triangle with blue edge}\}$ -syntax trees avoiding the tree  $\odot (\text{triangle with blue edge}) \circ_2 \odot (\text{triangle with blue edge})$  is a Poincaré-Birkhoff-Witt basis of  $\langle \text{triangle with blue edge}, \text{triangle with blue edge} \rangle$ .

3.2.8. *Seventh orbit.* This orbit consists of the operads  $\langle \text{triangle}_1, \text{triangle}_2 \rangle$  and  $\langle \text{triangle}_2, \text{triangle}_1 \rangle$ . We choose  $\langle \text{triangle}_1, \text{triangle}_2 \rangle$  as a representative of the orbit.

PROPOSITION 3.2.19. *The set of bubbles of  $\langle \langle \text{triangle}_1, \text{triangle}_2 \rangle \rangle$  is the set of based bubbles having exactly one uncolored edge in the border. Moreover, the colored Hilbert series of  $\langle \langle \text{triangle}_1, \text{triangle}_2 \rangle \rangle$  satisfy*

$$B_1(z_1, z_2) = \frac{2z_1z_2 - z_1z_2^2}{(1 - z_2)^2} \quad \text{and} \quad B_2(z_1, z_2) = 0. \quad (3.2.19)$$

PROPOSITION 3.2.20. *The Hilbert series  $\mathcal{H}(t)$  of  $\langle \text{triangle}_1, \text{triangle}_2 \rangle$  satisfies*

$$t - \mathcal{H}(t) + 2\mathcal{H}(t)^2 - \mathcal{H}(t)^3 = 0. \quad (3.2.20)$$

THEOREM 3.2.21. *The operad  $\langle \text{triangle}_1, \text{triangle}_2 \rangle$  admits the presentation  $(\{\text{triangle}_1, \text{triangle}_2\}, \leftrightarrow)$  where  $\leftrightarrow$  is the equivalence relation satisfying*

$$\odot(\text{triangle}_1) \circ_1 \odot(\text{triangle}_2) \leftrightarrow \odot(\text{triangle}_1) \circ_2 \odot(\text{triangle}_2). \quad (3.2.21)$$

Moreover,  $\langle \text{triangle}_1, \text{triangle}_2 \rangle$  is Koszul and the set of the  $\{\text{triangle}_1, \text{triangle}_2\}$ -syntax trees avoiding the tree  $\odot(\text{triangle}_1) \circ_2 \odot(\text{triangle}_2)$  is a Poincaré-Birkhoff-Witt basis of  $\langle \text{triangle}_1, \text{triangle}_2 \rangle$ .

The above presentation shows that  $\langle \text{triangle}_1, \text{triangle}_2 \rangle$  is the operad of based noncrossing trees NCT.

3.2.9. *Eighth orbit.* This orbit consists of the operads  $\langle \text{triangle}_1, \text{triangle}_2 \rangle$ ,  $\langle \text{triangle}_2, \text{triangle}_1 \rangle$ ,  $\langle \text{triangle}_1, \text{triangle}_1 \rangle$ , and  $\langle \text{triangle}_2, \text{triangle}_2 \rangle$ . We choose  $\langle \text{triangle}_1, \text{triangle}_2 \rangle$  as a representative of the orbit.

PROPOSITION 3.2.22. *The set of bubbles of  $\langle \langle \text{triangle}_1, \text{triangle}_2 \rangle \rangle$  is the set of based bubbles such that last edge is uncolored. Moreover, the colored Hilbert series of  $\langle \langle \text{triangle}_1, \text{triangle}_2 \rangle \rangle$  satisfy*

$$B_1(z_1, z_2) = \frac{z_1^2 + z_1z_2}{1 - z_1 - z_2} \quad \text{and} \quad B_2(z_1, z_2) = 0. \quad (3.2.22)$$

PROPOSITION 3.2.23. *The Hilbert series  $\mathcal{H}(t)$  of  $\langle \text{triangle}_1, \text{triangle}_2 \rangle$  satisfies*

$$t - (1 - t)\mathcal{H}(t) + \mathcal{H}(t)^2 = 0. \quad (3.2.23)$$

THEOREM 3.2.24. *The operad  $\langle \text{triangle}_1, \text{triangle}_2 \rangle$  admits the presentation  $(\{\text{triangle}_1, \text{triangle}_2\}, \leftrightarrow)$  where  $\leftrightarrow$  is the equivalence relation satisfying*

$$\odot(\text{triangle}_1) \circ_1 \odot(\text{triangle}_2) \leftrightarrow \odot(\text{triangle}_2) \circ_2 \odot(\text{triangle}_1), \quad (3.2.24)$$

$$\odot(\text{triangle}_1) \circ_1 \odot(\text{triangle}_1) \leftrightarrow \odot(\text{triangle}_1) \circ_2 \odot(\text{triangle}_1). \quad (3.2.25)$$

Moreover,  $\langle \text{triangle}_1, \text{triangle}_2 \rangle$  is Koszul and the set of the  $\{\text{triangle}_1, \text{triangle}_2\}$ -syntax trees avoiding the trees  $\odot(\text{triangle}_1) \circ_1 \odot(\text{triangle}_2)$  and  $\odot(\text{triangle}_1) \circ_1 \odot(\text{triangle}_1)$  is a Poincaré-Birkhoff-Witt basis of  $\langle \text{triangle}_1, \text{triangle}_2 \rangle$ .

This operad  $\langle \text{triangle}_1, \text{triangle}_2 \rangle$  is similar to the duplicial operad [Lod08, Zin12] with the difference that  $\text{triangle}_1$  is not associative in  $\langle \text{triangle}_1, \text{triangle}_2 \rangle$ .

3.2.10. *Ninth orbit.* This orbit consists of the operads  $\langle \triangleleft, \triangleleft \rangle$  and  $\langle \triangleleft, \triangleleft \rangle$ . We choose  $\langle \triangleleft, \triangleleft \rangle$  as a representative of the orbit.

PROPOSITION 3.2.25. *The set of bubbles of  $\langle \triangleleft, \triangleleft \rangle$  is the set of bubbles such that all edges of the border are blue. Moreover, the colored Hilbert series of  $\langle \triangleleft, \triangleleft \rangle$  satisfy*

$$B_1(z_1, z_2) = \frac{z_2^2}{1 - z_2} \quad \text{and} \quad B_2(z_1, z_2) = \frac{z_2^2}{1 - z_2}. \quad (3.2.26)$$

PROPOSITION 3.2.26. *The Hilbert series  $\mathcal{H}(t)$  of  $\langle \triangleleft, \triangleleft \rangle$  satisfies*

$$t - (1 - t)\mathcal{H}(t) + \mathcal{H}(t)^2 = 0. \quad (3.2.27)$$

THEOREM 3.2.27. *The operad  $\langle \triangleleft, \triangleleft \rangle$  admits the presentation  $(\{\triangleleft, \triangleleft\}, \leftrightarrow)$  where  $\leftrightarrow$  is the equivalence relation satisfying*

$$\odot(\triangleleft) \circ_1 \odot(\triangleleft) \leftrightarrow \odot(\triangleleft) \circ_2 \odot(\triangleleft), \quad (3.2.28)$$

$$\odot(\triangleleft) \circ_1 \odot(\triangleleft) \leftrightarrow \odot(\triangleleft) \circ_2 \odot(\triangleleft). \quad (3.2.29)$$

Moreover,  $\langle \triangleleft, \triangleleft \rangle$  is Koszul and the set of the  $\{\triangleleft, \triangleleft\}$ -syntax trees avoiding the trees  $\odot(\triangleleft) \circ_2 \odot(\triangleleft)$  and  $\odot(\triangleleft) \circ_2 \odot(\triangleleft)$  is a Poincaré-Birkhoff-Witt basis of  $\langle \triangleleft, \triangleleft \rangle$ .

3.2.11. *Tenth orbit.* This orbit consists of the operads  $\langle \triangleleft, \triangleleft \rangle$ ,  $\langle \triangleleft, \triangleleft \rangle$ ,  $\langle \triangleleft, \triangleleft \rangle$ , and  $\langle \triangleleft, \triangleleft \rangle$ . We choose  $\langle \triangleleft, \triangleleft \rangle$  as a representative of the orbit.

PROPOSITION 3.2.28. *The set of based (resp. nonbased) bubbles of  $\langle \triangleleft, \triangleleft \rangle$  is the set of based (resp. nonbased) bubbles such that first edge is uncolored (resp. blue) and the other edges of the border are blue. Moreover, the colored Hilbert series of  $\langle \triangleleft, \triangleleft \rangle$  satisfy*

$$B_1(z_1, z_2) = \frac{z_1 z_2}{1 - z_2} \quad \text{and} \quad B_2(z_1, z_2) = \frac{z_2^2}{1 - z_2}. \quad (3.2.30)$$

PROPOSITION 3.2.29. *The Hilbert series  $\mathcal{H}(t)$  of  $\langle \triangleleft, \triangleleft \rangle$  satisfies*

$$t - (1 - t)\mathcal{H}(t) + \mathcal{H}(t)^2 = 0. \quad (3.2.31)$$

THEOREM 3.2.30. *The operad  $\langle \triangleleft, \triangleleft \rangle$  admits the presentation  $(\{\triangleleft, \triangleleft\}, \leftrightarrow)$  where  $\leftrightarrow$  is the equivalence relation satisfying*

$$\odot(\triangleleft) \circ_1 \odot(\triangleleft) \leftrightarrow \odot(\triangleleft) \circ_2 \odot(\triangleleft), \quad (3.2.32)$$

$$\odot(\triangleleft) \circ_1 \odot(\triangleleft) \leftrightarrow \odot(\triangleleft) \circ_2 \odot(\triangleleft). \quad (3.2.33)$$

Moreover,  $\langle \triangleleft, \triangleleft \rangle$  is Koszul and the set of the  $\{\triangleleft, \triangleleft\}$ -syntax trees avoiding the trees  $\odot(\triangleleft) \circ_1 \odot(\triangleleft)$  and  $\odot(\triangleleft) \circ_1 \odot(\triangleleft)$  is a Poincaré-Birkhoff-Witt basis of  $\langle \triangleleft, \triangleleft \rangle$ .

This operad  $\langle \triangleleft, \triangleleft \rangle$  is hence the operad governing dipterous algebras [LR03, Zin12].

3.2.12. *Eleventh orbit.* This orbit consists of the operad  $\langle \text{bubble}_1, \text{bubble}_2 \rangle$ .

PROPOSITION 3.2.31. *The set of based (resp. nonbased) bubbles of  $\langle \text{bubble}_1, \text{bubble}_2 \rangle$  is the set of based (resp. nonbased) bubbles such that all edges of the border are uncolored (resp. blue). Moreover, the colored Hilbert series of  $\langle \text{bubble}_1, \text{bubble}_2 \rangle$  satisfy*

$$B_1(z_1, z_2) = \frac{z_1^2}{1 - z_1} \quad \text{and} \quad B_2(z_1, z_2) = \frac{z_2^2}{1 - z_2}. \quad (3.2.34)$$

PROPOSITION 3.2.32. *The Hilbert series  $\mathcal{H}(t)$  of  $\langle \text{bubble}_1, \text{bubble}_2 \rangle$  satisfies*

$$t - (1 - t)\mathcal{H}(t) + \mathcal{H}(t)^2 = 0. \quad (3.2.35)$$

THEOREM 3.2.33. *The operad  $\langle \text{bubble}_1, \text{bubble}_2 \rangle$  admits the presentation  $(\{\text{bubble}_1, \text{bubble}_2\}, \leftrightarrow)$  where  $\leftrightarrow$  is the equivalence relation satisfying*

$$\odot(\text{bubble}_1) \circ_1 \odot(\text{bubble}_1) \leftrightarrow \odot(\text{bubble}_1) \circ_2 \odot(\text{bubble}_1), \quad (3.2.36)$$

$$\odot(\text{bubble}_1) \circ_1 \odot(\text{bubble}_2) \leftrightarrow \odot(\text{bubble}_1) \circ_2 \odot(\text{bubble}_2). \quad (3.2.37)$$

Moreover,  $\langle \text{bubble}_1, \text{bubble}_2 \rangle$  is Koszul and the set of the  $\{\text{bubble}_1, \text{bubble}_2\}$ -syntax trees avoiding the trees  $\odot(\text{bubble}_1) \circ_2 \odot(\text{bubble}_1)$  and  $\odot(\text{bubble}_1) \circ_2 \odot(\text{bubble}_2)$  is a Poincaré-Birkhoff-Witt basis of  $\langle \text{bubble}_1, \text{bubble}_2 \rangle$ .

This operad  $\langle \text{bubble}_1, \text{bubble}_2 \rangle$  is hence the operad governing two-associative algebras [LR06, Zin12].

### Concluding remarks

We have developed in this chapter a tool to study a noncolored operad  $\mathcal{O}$  by considering one of its bubble decompositions  $\mathcal{G}$ . As explained, most of the properties of  $\mathcal{O}$  come from properties of  $\mathcal{G}$ . This, together with the fact that a colored operad is a more constrained structure than a noncolored one, leads to easier proofs for most of their properties (for instance to establish a presentation by generators and relations, a bubble decomposition reduces the number of orientations of relations to consider). This framework has been applied to the operad BNC of bicolored noncrossing configurations and on some of its suboperads. As an additional remark, this chapter considers only colored or uncolored set-operads but the notion of enveloping operads and bubble decompositions also work for linear operads.

## From monoids to operads

The content of this chapter comes from [Gir12c, Gir12d, Gir15]. A very preliminary version of the results presented here was sketched in [Gir11] while the work was still in progress. We include here some new results that do not appear in the aforementioned publications like the Koszulity and presentations of the Koszul duals of some of the constructed ns operads.

### Introduction

We propose here a new generic method to build combinatorial operads. The starting point is to pick a monoid  $\mathcal{M}$ . We then consider the set of words whose letters are elements of  $\mathcal{M}$ . The arity of such words are their length, the composition of two words is expressed from the product of  $\mathcal{M}$ , and permutations act on words by permuting letters. In this way, we associate an operad denoted by  $T\mathcal{M}$  with any monoid  $\mathcal{M}$ . This construction is rich from a combinatorial point of view since it allows us, by considering suboperads and quotients of  $T\mathcal{M}$ , to get new (symmetric or not) operads on various combinatorial objects. Our construction is related to two previous ones.

The first one is a construction of Méndez and Nava [MN93] emerging from the context of the species theory [Joy81]. Roughly speaking, a species is a combinatorial construction  $U$  which takes an underlying finite set  $E$  as input and produces a set  $U[E]$  of objects by adding some structure on the elements of  $E$  (see [BLL98]). This theory has many links with the theory of operads since an operad is a monoid with respect to the operation of substitution of species. In [MN93], the authors defined the plethystic species, that are species taking as input sets where any element has a color picked from a fixed monoid  $\mathcal{M}$ . This monoid has to satisfy some precise conditions (as to be left cancellable and without proper divisor of the unit, and such that any element has finitely many factorizations). It appears that the elements of the so-called uniform plethystic species can be seen as words of colors and hence, as elements of  $T\mathcal{M}$ . Moreover, the composition of this operad is the one of  $T\mathcal{M}$ . The main difference between the construction of Méndez and Nava and ours lies in the fact that the construction  $T$  can be applied to any monoid.

The second one, introduced by Berger and Moerdijk [BM03], is a construction which allows to obtain, from a commutative bialgebra  $\mathcal{B}$ , a cooperad  $\bar{T}\mathcal{B}$ . Our construction  $T$  and the construction  $\bar{T}$  of these two authors are different but coincide in many cases. For instance, when  $(\mathcal{M}, \star)$  is a monoid such that for any  $x \in \mathcal{M}$ , the set of pairs  $(y, z) \in \mathcal{M}^2$  satisfying  $y \star z = x$  is finite, the operad  $T\mathcal{M}$  is the dual of the cooperad  $\bar{T}\mathcal{B}$  where  $\mathcal{B}$  is the dual bialgebra of  $\mathbb{K}\langle \mathcal{M} \rangle$  endowed with the diagonal coproduct. On the other hand, there are

operads that we can build by the construction  $T$  but not by the construction  $\bar{T}$ , and conversely. For example, the operad  $T\mathbb{Z}$ , where  $\mathbb{Z}$  is the additive monoid of integers, cannot be obtained as the dual of a cooperad built by the construction  $\bar{T}$  of Berger and Moerdijk.

Furthermore, the operads  $T\mathcal{M}$  are defined directly on set-theoretic bases. Hence, these operads are well-defined in the category of sets and the computations are explicit. It is therefore possible given a monoid  $\mathcal{M}$ , to make experiments on the operad  $T\mathcal{M}$ , using if necessary a computer. In this chapter, we study many applications of the construction  $T$  focusing on its combinatorial aspect. More precisely, we define, by starting from very simple monoids like the additive or max monoids of integers, or cyclic monoids, various nonsymmetric operads involving well-known combinatorial objects.

This chapter is organized as follows. We begin, in Section 1, by defining the construction  $T$  associating an operad with a monoid and establishing its first properties. We show that this construction is a functor from the category of monoids to the category of operads which preserves injections and surjections. We then apply this construction in Section 2 to various monoids and obtain several new (symmetric or not) operads. We construct in this way some operads on combinatorial objects which were not provided with such a structure: planar rooted trees with a fixed arity, Motzkin words, integer compositions, directed animals, and segmented integer compositions. We also obtain new operads on objects which are already provided with such a structure: endofunctions, parking functions, packed words, permutations, planar rooted trees, and Schröder trees. By using the construction  $T$ , we also give an alternative construction for the diassociative operad [Lod01] and for the triassociative operad [LR04].

*Note.* In this chapter, “operad” means “symmetric operad”. To refer to a nonsymmetric operad, we shall write “ns operad”.

## 1. A functor from monoids to operads

We describe in this section the main ingredient of this chapter, namely the *construction*  $T$ .

**1.1. The operad of a monoid.** We explain here how the construction  $T$  associates an operad  $T\mathcal{M}$  with any monoid  $\mathcal{M}$  and an operad morphism  $T\theta : T\mathcal{M}_1 \rightarrow T\mathcal{M}_2$  with any monoid morphism  $\theta : \mathcal{M}_1 \rightarrow \mathcal{M}_2$ . We also review some of the main properties of  $T$ .

Let  $\mathcal{M}$  be a monoid with an associative product  $\star$  admitting a unit  $1_{\mathcal{M}}$ . We denote by  $T\mathcal{M}$  the space

$$T\mathcal{M} := \bigoplus_{n \geq 1} T\mathcal{M}(n) \quad (1.1.1)$$

where for all  $n \geq 1$ ,  $T\mathcal{M}(n) := \mathbb{K}\langle \mathcal{M}^n \rangle$ . The set  $\mathcal{M}^+$  forms hence a basis of  $T\mathcal{M}$  called *fundamental basis*. We endow  $T\mathcal{M}$  with the partial composition maps

$$\circ_i : T\mathcal{M}(n) \otimes T\mathcal{M}(m) \rightarrow T\mathcal{M}(n + m - 1), \quad n, m \geq 1, i \in [n], \quad (1.1.2)$$

defined linearly, over the fundamental basis, for any words  $u \in \mathcal{M}^n$  and  $v \in \mathcal{M}^m$  by

$$u \circ_i v := u_1 \dots u_{i-1} (u_i \star v_1) \dots (u_i \star v_m) u_{i+1} \dots u_n, \quad i \in [n]. \quad (1.1.3)$$

Moreover, we endow  $\mathbb{T}\mathcal{M}$  with right actions

$$\cdot : \mathbb{T}\mathcal{M}(n) \otimes \text{Per}(n) \rightarrow \mathbb{T}\mathcal{M}(n), \quad n \geq 1, \quad (1.1.4)$$

defined linearly, for any permutation  $\sigma \in \mathfrak{S}(n)$  and word  $u \in \mathcal{M}^n$  by

$$u \cdot \sigma := u_{\sigma_1} \dots u_{\sigma_n}. \quad (1.1.5)$$

In other words,  $\mathbb{T}\mathcal{M}$  is the vector space of the words on  $\mathcal{M}$  seen as an alphabet, the partial composition returns to insert a word  $v$  onto the  $i$ th letter  $u_i$  of a word  $u$  together with a left multiplication by  $u_i$ , and permutations act by permuting the letters of the words. The arity  $|u|$  of an element  $u$  of  $\mathbb{T}\mathcal{M}(n)$  is  $n$ .

Now, let  $\mathcal{M}_1$  and  $\mathcal{M}_2$  be two monoids and  $\theta : \mathcal{M}_1 \rightarrow \mathcal{M}_2$  be a monoid morphism. Let us denote by  $\mathbb{T}\theta$  the map  $\mathbb{T}\theta : \mathbb{T}\mathcal{M}_1 \rightarrow \mathbb{T}\mathcal{M}_2$ , defined for all  $u_1 \dots u_n \in \mathbb{T}\mathcal{M}(n)$  by  $\mathbb{T}\theta(u_1 \dots u_n) := \theta(u_1) \dots \theta(u_n)$ .

**THEOREM 1.1.1.** *The construction  $\mathbb{T}$  is a functor from the category of monoids with monoid morphisms to the category of operads with operad morphisms. Moreover,  $\mathbb{T}$  preserves injections and surjections.*

Observe that the word  $\mathbb{1}_{\mathcal{M}} \in \mathbb{T}\mathcal{M}(1)$  is the unit of  $\mathbb{T}\mathcal{M}$ .

Let us consider an example. Let  $\mathcal{M} := \{a, b\}^*$  be a free monoid. Then,  $\mathbb{T}\mathcal{M}$  is the space of all words whose letters are words on  $\{a, b\}$ . We call such element *multiwords*. For instance,  $(aa, ba, b, \epsilon, a)$  is an element of arity 5 of  $\mathbb{T}\mathcal{M}$  and

$$(aa, ba, b, \epsilon, a) \circ_3 (ab, \epsilon, a) = (aa, ba, bab, b, ba, \epsilon, a) \quad (1.1.6)$$

and

$$(aa, ba, b, \epsilon, a) \cdot 41352 = (\epsilon, aa, b, a, ba). \quad (1.1.7)$$

Moreover, if  $\theta : \mathcal{M} \rightarrow \mathbb{N}$  is the monoid morphism defined by  $\theta(u) := |u|$ , where  $\mathbb{N}$  is the additive monoid of natural numbers, one has

$$\theta((aa, ba, b, \epsilon, a)) = 22101. \quad (1.1.8)$$

**1.2. Main properties of the construction.** Let us review the main properties of the construction  $\mathbb{T}$ .

**PROPOSITION 1.2.1.** *Let  $\mathcal{M}$  be a monoid. The fundamental basis of  $\mathbb{T}\mathcal{M}$  is a basic set-operad basis if and only if  $\mathcal{M}$  is a right cancellable monoid.*

**PROPOSITION 1.2.2.** *Let  $\mathcal{M}$  be a monoid. Then, the set  $\mathfrak{G}_{\mathcal{M}} := \mathcal{M} \sqcup \{a_2\}$ , is a generating set of  $\mathbb{T}\mathcal{M}$  as a  $n$ s operad, where  $a_2 := \mathbb{1}_{\mathcal{M}}\mathbb{1}_{\mathcal{M}}$  and the elements of  $\mathcal{M}$  are seen as elements of arity 1 of  $\mathbb{T}\mathcal{M}$ .*

**PROPOSITION 1.2.3.** *Let  $\mathcal{M}$  be a monoid. The  $n$ s operad  $\mathbb{T}\mathcal{M}$  admits the presentation  $(\mathfrak{G}_{\mathcal{M}}, \mathfrak{R}_{\mathcal{M}})$  where  $\mathfrak{R}_{\mathcal{M}}$  is the subspace of  $\mathbf{FO}(\mathfrak{G}_{\mathcal{M}})$  generated by the elements*

$$\odot(a_2) \circ_1 \odot(a_2) - \odot(a_2) \circ_2 \odot(a_2), \quad (1.2.1a)$$

$$\odot(x) \circ_1 \odot(y) - \odot(x \star y), \quad x, y \in \mathcal{M}, \quad (1.2.1b)$$

$$\odot(a_2) \circ [\odot(x) \otimes \odot(x)] - \odot(x) \circ_1 \odot(a_2), \quad x \in \mathcal{M}. \quad (1.2.1c)$$



The proof of Proposition 1.2.3 relies on a orientation  $\Rightarrow$  of  $\mathcal{R}_{\mathcal{M}}$  satisfying

$$\begin{array}{c} \text{a}_2 \\ \diagup \quad \diagdown \\ \text{a}_2 \end{array} \Rightarrow \begin{array}{c} \text{a}_2 \\ \diagdown \quad \diagup \\ \text{a}_2 \end{array}, \quad (1.2.2a)$$

$$\begin{array}{c} x \\ | \\ y \end{array} \Rightarrow \begin{array}{c} x \\ * \\ y \end{array}, \quad x, y \in \mathcal{M}, \quad (1.2.2b)$$

$$\begin{array}{c} x \\ | \\ \text{a}_2 \\ \diagup \quad \diagdown \end{array} \Rightarrow \begin{array}{c} \text{a}_2 \\ \diagup \quad \diagdown \\ x \quad x \end{array}, \quad x \in \mathcal{M}. \quad (1.2.2c)$$

The closure  $\sim$  of  $\Rightarrow$  is a convergent rewrite rule and its normal forms of arity  $n$  are in one-to-one correspondence with the set of the words of arity  $n$  of  $T\mathcal{M}$ .

Let  $\mathcal{A}$  be an associative algebra with associative product denoted by  $\cdot$ , and

$$\uparrow_x: \mathcal{A} \rightarrow \mathcal{A}, \quad x \in \mathcal{M}, \quad (1.2.3)$$

be a family of associative algebra morphisms satisfying

$$\uparrow_x \circ \uparrow_y = \uparrow_{x*y}, \quad (1.2.4)$$

for all  $x, y \in \mathcal{M}$ . Observe that (1.2.4) implies in particular that  $\uparrow_{1_{\mathcal{M}}} = \text{Id}_{\mathcal{A}}$  where  $\text{Id}_{\mathcal{A}}$  is the identity map on  $\mathcal{A}$ . We call  *$\mathcal{M}$ -compatible algebra* such an algebra.

**THEOREM 1.2.4.** *Let  $\mathcal{M}$  be a monoid and  $\mathcal{A}$  be an  $\mathcal{M}$ -compatible algebra. Then,  $\mathcal{A}$  is an algebra on  $T\mathcal{M}$ .*

Theorem 1.2.4 is a consequence of the presentation of  $T\mathcal{M}$  provided by Proposition 1.2.3. Indeed, the associative product  $\cdot$  comes from the generator  $\text{a}_2$  of  $T\mathcal{M}$ , and each map  $\uparrow_x$ ,  $x \in \mathcal{M}$ , comes from the generator  $x \in \mathcal{M}$  of  $T\mathcal{M}$ .

For instance, by Theorem 1.2.4, the space  $\mathbb{K}\langle \mathcal{M}^* \rangle$  of noncommutative polynomials on  $\mathcal{M}$ , endowed with the associative product  $\cdot$  of concatenation of words of  $\mathcal{M}^*$  and with the maps  $\uparrow_x$ ,  $x \in \mathcal{M}$ , defined linearly for all words  $u$  on  $\mathcal{M}$  by

$$\uparrow_x(u) := (x * u_1) \dots (x * u_{|u|}) \quad (1.2.5)$$

is an algebra on  $T\mathcal{M}$ .

## 2. Concrete constructions

Through this section, we consider examples of applications of the functor  $T$ . We shall mainly consider, given a monoid  $\mathcal{M}$ , some suboperads of  $T\mathcal{M}$ , symmetric or not, which have for all  $n \geq 1$  finitely many elements of arity  $n$ . For the most part of the constructed operads  $\mathcal{O}$ , we shall establish isomorphisms of combinatorial spaces  $\phi: \mathcal{O} \rightarrow \mathbb{K}\langle C \rangle$  where the  $C$  are well-chosen combinatorial sets. To this aim, we shall consider bijections between the basis elements of  $\mathcal{O}(n)$  and the elements of size  $n$  of  $C$ , for all  $n \geq 1$ . Interpreting the partial compositions of  $\mathcal{O}$  on  $\mathbb{K}\langle C \rangle$  amounts to endow  $\mathbb{K}\langle C \rangle$  with the structure of an operad, and

thus to the construction of an operad on the objects of  $C$ . Moreover, we shall also establish presentations by generators and relations of the constructed ns operads by using tools from rewrite theory on syntax trees (see Section 2.4 of Chapter 1).

**2.1. Operads from the additive monoid.** Let us denote by  $\mathbb{N}$  the additive monoid of natural numbers, and for all  $\ell \geq 1$ , by  $\mathbb{N}_\ell$  the cyclic additive monoid on  $\mathbb{Z}/\ell\mathbb{Z}$ . Note that since, by Theorem 1.1.1,  $T$  is a functor which preserves surjective maps,  $T\mathbb{N}_\ell$  is a quotient operad of  $T\mathbb{N}$ . Besides, since the monoids  $\mathbb{N}$  and  $\mathbb{N}_\ell$  are right cancellable, by Proposition 1.2.1, the fundamental bases of the operads  $T\mathbb{N}$  and  $T\mathbb{N}_\ell$  are basic set-operad bases. As a consequence, the fundamental bases of all the suboperads of  $T\mathbb{N}$  and  $T\mathbb{N}_\ell$  constructed in this section are basic set-operad bases. All these operads fit into the diagram of ns operads represented by Figure 4.1. Table 4.1 summarizes some information about these ns operads.

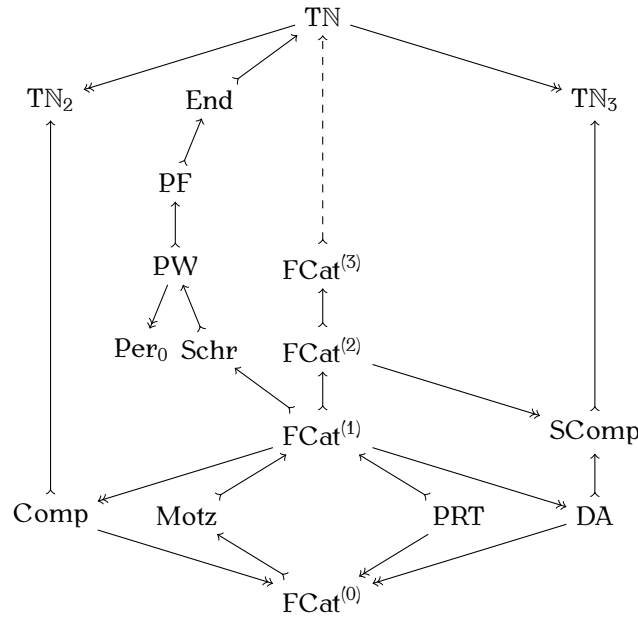

FIGURE 4.1. The diagram of ns suboperads and quotients of  $T\mathbb{N}$ . Arrows  $\hookrightarrow$  (resp.  $\twoheadrightarrow$ ) are injective (resp. surjective) ns operad morphisms.

**2.1.1. Operads on endofunctions, parking functions, packed words, and permutations.** Recall that an *endofunction* of size  $n$  is a word  $u$  of length  $n$  on the alphabet  $\{1, \dots, n\}$ . A *parking function* of size  $n$  is an endofunction  $u$  of size  $n$  such that the nondecreasing rearrangement  $v$  of  $u$  satisfies  $v_i \leq i$  for all  $i \in [n]$ . A *packed word* of size  $n$  is an endofunction  $u$  of size  $n$  such that for any letter  $u_i \geq 2$  of  $u$ , there is in  $u$  a letter  $u_j = u_i - 1$ . Note that neither the set of endofunctions, of parking functions, of packed words, nor of permutations are suboperads of  $T\mathbb{N}$ . Indeed, one has the following counterexample:

$$12 \circ_2 12 = 134, \tag{2.1.1}$$

showing that, even if  $12$  is a permutation,  $134$  is not an endofunction.

Monoid	Ns operad	Generators	First dimensions	Combinatorial objects
$\mathbb{N}$	End	—	1, 4, 27, 256, 3125	Endofunctions
	PF	—	1, 3, 16, 125, 1296	Parking functions
	PW	—	1, 3, 13, 75, 541	Packed words
	$\text{Per}_0$	—	1, 2, 6, 24, 120	Permutations
	PRT	01	1, 1, 2, 5, 14, 42	Planar rooted trees
	$\text{FCat}^{(k)}$	00, 01, ..., 0k	Fuß-Catalan numbers	$k$ -ary trees
	Schr	00, 01, 10	1, 3, 11, 45, 197	Schröder trees
	Motz	00, 010	1, 1, 2, 4, 9, 21, 51	Motzkin words
$\mathbb{N}_2$	Comp	00, 01	1, 2, 4, 8, 16, 32	Compositions
$\mathbb{N}_3$	DA	00, 01	1, 2, 5, 13, 35, 96	Directed animals
	SComp	00, 01, 02	1, 3, 27, 81, 243	Seg. compositions

TABLE 4.1. Ground monoids, generators, first dimensions, and combinatorial objects involved in the ns suboperads and quotients of  $\mathbb{TN}$ .

As a consequence of this observation, let us call a word  $u$  a *twisted* endofunction (resp. parking function, packed word, permutation) if the word  $(u_1 + 1)(u_2 + 1) \dots (u_n + 1)$  is an endofunction (resp. parking function, packed word, permutation). For example, the word 2300 is a twisted endofunction since 3411 is an endofunction. Let us denote by End (resp. PF, PW,  $\text{Per}_0$ ) the linear span of all twisted endofunctions (resp. parking functions, packed words, permutations). Under this reformulation, one has the following result:

PROPOSITION 2.1.1. *The spaces End, PF, and PW form suboperads of  $\mathbb{TN}$ .*

For example, we have in End the partial composition

$$2123 \circ_2 30313 = 24142423, \quad (2.1.2)$$

and the action  $\cdot$  of a permutation

$$11210 \cdot 23514 = 12011. \quad (2.1.3)$$

Note that End is not a finitely generated operad. Indeed, the twisted endofunctions  $u$  of size  $n$  satisfying  $u_i := n - 1$  for all  $i \in [n]$  cannot be obtained by partial compositions involving elements of End of arity smaller than  $n$ . Similarly, PF is not a finitely generated operad since the twisted parking functions  $u$  of size  $n$  satisfying  $u_i := 0$  for all  $i \in [n - 1]$  and  $u_n := n - 1$  cannot be obtained by partial compositions involving elements of PF of arity smaller than  $n$ . However, the operad PW is a finitely generated operad:

PROPOSITION 2.1.2. *The operad PW is the suboperad of  $\mathbb{TN}$  generated by  $\{00, 01\}$ .*

Let  $\mathcal{V}$  be the linear span of all twisted packed words having multiple occurrences of a same letter.

PROPOSITION 2.1.3. *The space  $\mathcal{V}$  is an operad ideal of PW. Moreover, the quotient operad  $\text{PW}/\mathcal{V}$  is the space  $\text{Per}_0$  of twisted permutations. Finally, for all twisted permutations  $u$  and  $v$ , the partial composition map in  $\text{Per}_0$  can be expressed as*

$$u \circ_i v = \begin{cases} u \circ_i v & \text{if } u_i = |u| - 1, \\ 0_{\mathbb{K}} & \text{otherwise,} \end{cases} \quad (2.1.4)$$

where  $0_{\mathbb{K}}$  is the null vector of  $\text{Per}_0$  and the partial composition map  $\circ_i$  in the right member of (2.1.4) is the partial composition map of PW.

Here are two examples of compositions in  $\text{Per}_0$ :

$$20431 \circ_1 102 = 0_{\mathbb{K}}, \quad (2.1.5a)$$

$$20431 \circ_3 102 = 2054631. \quad (2.1.5b)$$

Let us recall that any minimal generating set of  $\text{Per}$  (seen as a ns operad) has no element of arity 3 (see Section 4.1.13 of Chapter 2). Moreover, since the homogeneous component of arity 3 of  $\text{Per}_0^{(01,10)}$  is only of dimension 4, any minimal generating set of  $\text{Per}_0$  has two elements of arity 3. Therefore,  $\text{Per}_0$  and  $\text{Per}$  are not isomorphic as ns operads.

2.1.2. *A ns operad on planar rooted trees.* Let  $\text{PRT}$  be the ns suboperad of  $\text{TN}$  generated by  $\mathfrak{G}_{\text{PRT}} := \{01\}$ .

PROPOSITION 2.1.4. *The fundamental basis of PRT is the set of all the words  $u$  on the alphabet  $\mathbb{N}$  satisfying  $u_1 = 0$  and  $1 \leq u_{i+1} \leq u_i + 1$  for all  $i \in [|u| - 1]$ .*

Let us consider the combinatorial graded collection of all planar rooted trees where the size of such a tree is its number of nodes (this is the collection  $\text{PRT}$  defined in Section 2.1.1 of Chapter 1). There is a bijection  $\phi_{\text{PRT}}$  between the words of  $\text{PRT}$  of arity  $n$  and planar rooted trees of size  $n$ . To compute  $\phi_{\text{PRT}}(u)$  where  $u$  is a word of  $\text{PRT}$ , iteratively insert the letters of  $u$  from left to right according to the following procedure. If  $|u| = 1$ , then  $u = 0$  and  $\phi_{\text{PRT}}(0)$  is the only planar rooted tree with one node. Otherwise, the insertion of a letter  $a \geq 1$  into a planar rooted tree  $t$  consists in grafting in  $t$  a new node as the rightmost child of the last node of depth  $a - 1$  for the depth-first traversal of  $t$ . The inverse bijection is computed as follows. Given a planar rooted tree  $t$  of size  $n$ , one computes a word of  $\text{PRT}$  of arity  $n$  by labeling each node of  $t$  by its depth and then, by reading its labels following a depth-first traversal of  $t$ . Since the words of  $\text{PRT}$  satisfy Proposition 2.1.4,  $\phi_{\text{PRT}}$  is well-defined. Hence, we can regard the words of arity  $n$  of  $\text{PRT}$  as planar rooted trees with  $n$  nodes. Figure 4.2 shows an example of this bijection.

Hence, the Hilbert series of  $\text{PRT}$  satisfies

$$\mathcal{H}_{\text{PRT}}(t) = \sum_{n \geq 1} \frac{1}{n} \binom{2n-2}{n-1} t^n, \quad (2.1.6)$$

so that its dimensions are the Catalan numbers.

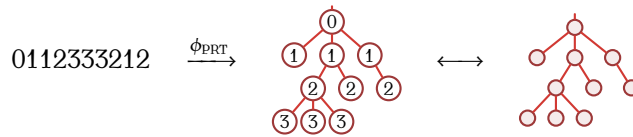

FIGURE 4.2. Interpretation of a word of the ns operad PRT in terms of a planar rooted tree via the bijection  $\phi_{\text{PRT}}$ . The nodes of the planar rooted tree in the middle are labeled by their depth.

In terms of planar rooted trees, the partial composition of PRT can be expressed as follows:

PROPOSITION 2.1.5. *Let  $s$  and  $t$  be two planar rooted trees and  $s$  be the  $i$ th node for the depth-first traversal of  $s$ . The composition  $s \circ_i t$  in PRT amounts to replace  $s$  by the root of  $t$  and graft the children of  $s$  as rightmost sons of the root of  $t$ .*

Figure 4.3 shows an example of a partial composition in PRT.

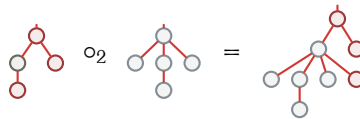

FIGURE 4.3. Interpretation of a partial composition in the ns operad PRT in terms of planar rooted trees.

PROPOSITION 2.1.6. *The ns operad PRT is isomorphic to the free ns operad generated by one element of arity 2.*

Proposition 2.1.6 also says that PRT is isomorphic to the ns magmatic operad and hence, that PRT is a realization of the magmatic operad. This result is already known since in [MY91], Méndez and Yang point out that the species of parenthesizations (binary trees) and the species of planar rooted trees are isomorphic. This isomorphism implies that these species are also isomorphic as ns operads. Moreover, PRT can be seen as a planar version of the *non-associative permutative operad* NAP [MY91] (see also [Liv06]) seen as a ns operad, which is an operad involving labeled non-planar rooted trees.

2.1.3. *A ns operad on  $k$ -ary trees.* Let  $k \geq 0$  be an integer and  $\text{FCat}^{(k)}$  be the ns suboperad of TN generated by  $\mathfrak{G}_{\text{FCat}^{(k)}} := \{00, 01, \dots, 0k\}$ . It is immediate from the definition of  $\text{FCat}^{(k)}$  that for any  $k \geq 0$ ,  $\text{FCat}^{(k)}$  is a ns suboperad of  $\text{FCat}^{(k+1)}$ . Hence, the ns operads  $\text{FCat}^{(k)}$  form an increasing sequence (for the inclusion) of ns operads. Note that  $\text{FCat}^{(0)}$  is isomorphic to the ns associative operad  $\text{As}$ . Note also that since  $\text{FCat}^{(1)}$  is generated by 00 and 01 and since PRT is generated by 01, PRT is a ns suboperad of  $\text{FCat}^{(1)}$ .

PROPOSITION 2.1.7. For any  $k \geq 0$ , the fundamental basis of  $\text{FCat}^{(k)}$  is the set of all the words  $u$  on the alphabet  $\mathbb{N}$  satisfying  $u_1 = 0$  and  $0 \leq u_{i+1} \leq u_i + k$  for all  $i \in [|u| - 1]$ .

Let us consider the combinatorial graded collection of the  $k + 1$ -ary trees where the size of such a tree is its number of internal nodes (this is the collection  $\text{Ary}_{\bullet}^{(k+1)}$  defined in Section 2.2.2 of Chapter 1). Let  $t$  be a  $k + 1$ -ary tree of size  $n$ . We say that an internal node  $x$  of  $t$  is *smaller* than an internal node  $y$  if, in the depth-first traversal of  $t$ ,  $x$  appears before  $y$ . We also say that a  $k + 1$ -ary tree  $t$  is *well-labeled* if its root is labeled by 0, and, for each internal node  $x$  of  $t$  labeled by  $a$ , the children of  $x$  which are not leaves are labeled, from left to right, by  $a + k, \dots, a + 1, a$ . There is a unique way to label a  $k + 1$ -ary tree so that it is well-labeled. There is a bijection  $\phi_{\text{FCat}}^{(k)}$  between the words of  $\text{FCat}^{(k)}$  of arity  $n$  and well-labeled  $k + 1$ -ary trees of size  $n$ . To compute  $\phi_{\text{FCat}}^{(k)}(u)$  where  $u$  is a word of  $\text{FCat}^{(k)}$ , iteratively insert the letters of  $u$  from left to right according to the following procedure. If  $|u| = 1$ , then  $u = 0$  and  $\phi_{\text{FCat}}^{(k)}(u)$  is the only well-labeled  $k + 1$ -ary tree of size 1. Otherwise, the insertion of a letter  $a \geq 0$  into a well-labeled  $k + 1$ -ary tree  $t$  consists in replacing a leaf of  $t$  by the  $k + 1$ -ary tree  $s$  of size 1 labeled by  $a$  so that  $s$  is the child of the greatest internal node such that the obtained  $k + 1$ -ary tree is still well-labeled. The inverse bijection is computed as follows. Given a well-labeled  $k + 1$ -ary tree  $t$ , one computes a word of  $\text{FCat}^{(k)}$  of arity  $n$  by reading its labels following a depth-first traversal of  $t$ . Since the words of  $\text{FCat}^{(k)}$  satisfy Proposition 2.1.7,  $\phi_{\text{FCat}}^{(k)}$  is well-defined. Hence, we can regard the words of arity  $n$  of  $\text{FCat}^{(k)}$  as  $k + 1$ -ary trees of size  $n$ . Figure 4.4 shows an example of this bijection.

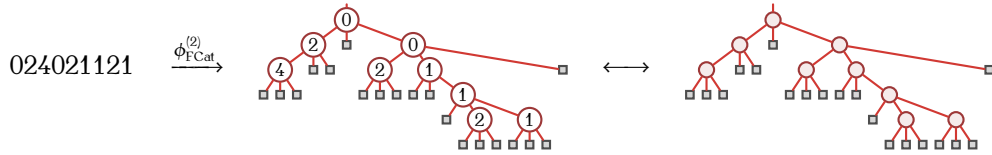

FIGURE 4.4. Interpretation of a word of the ns operad  $\text{FCat}^{(2)}$  in terms of 3-ary trees via the bijection  $\phi_{\text{FCat}}^{(2)}$ . The 3-ary tree in the middle is well-labeled.

Hence, the Hilbert series of  $\text{FCat}^{(k)}$  satisfies the algebraic relation

$$1 - \mathcal{H}_{\text{FCat}^{(k)}}(t) + t\mathcal{H}_{\text{FCat}^{(k)}}(t)^{k+1} = 0, \tag{2.1.7}$$

so that

$$\mathcal{H}_{\text{FCat}^{(k)}}(t) = \sum_{n \geq 1} \frac{1}{kn + 1} \binom{kn + n}{n} t^n. \tag{2.1.8}$$

In terms of  $k + 1$ -ary trees, the partial composition of  $\text{FCat}^{(k)}$  can be expressed as follows:

PROPOSITION 2.1.8. Let  $s$  and  $t$  be two  $k + 1$ -ary trees and  $s$  be the  $i$ th internal node for the depth-first traversal of  $s$ . The composition  $s \circ_i t$  in  $\text{FCat}^{(k)}$  amounts to replace  $s$  by the root of  $t$  and graft the children of  $s$  from right to left on the rightmost leaves of  $t$ .

Figure 4.5 shows an example of composition in  $\text{FCat}^{(2)}$ .



FIGURE 4.5. Interpretation of the partial composition map of the ns operad  $\text{FCat}^{(2)}$  in terms of 3-ary trees.

**THEOREM 2.1.9.** *For any  $k \geq 0$ , the ns operad  $\text{FCat}^{(k)}$  admits the presentation  $(\mathfrak{G}_{\text{FCat}^{(k)}}, \mathcal{R})$  where  $\mathcal{R}$  is the subspace of  $\text{FO}(\mathfrak{G}_{\text{FCat}^{(k)}})$  generated by the elements*

$$\odot(0(a+b)) \circ_1 \odot(0a) - \odot(0a) \circ_2 \odot(0b), \quad a, b \geq 0, a+b \leq k. \quad (2.1.9)$$

Moreover,  $\text{FCat}^{(k)}$  is a Koszul operad and the set of the  $\mathfrak{G}_{\text{FCat}^{(k)}}$ -syntax trees avoiding the trees  $\odot(0(a+b)) \circ_1 \odot(0a)$  for all  $a, b \geq 0$  and  $a+b \leq k$  is a Poincaré-Birkhoff-Witt basis of  $\text{FCat}^{(k)}$ .

It is now natural to ask if  $\text{FCat}^{(1)}$  is isomorphic to the dendriform operad  $\text{Dendr}$  or to the duplicial operad  $\text{Dup}$  since all these ns operads share the same dimensions. Let us show that  $\text{FCat}^{(1)}$  is not isomorphic to  $\text{Dup}$  nor to  $\text{Dendr}$ . Assume first that  $\phi: \text{Dup} \rightarrow \text{FCat}^{(1)}$  is an operad morphism so that  $\phi(\ll) = \lambda_1 00 + \lambda_2 01$  and  $\phi(\gg) = \lambda_3 00 + \lambda_4 01$  for some coefficients  $\lambda_1, \lambda_2, \lambda_3$ , and  $\lambda_4$  of  $\mathbb{K}$ . Now, Relation (4.2.8a) of Section 4.2.3 of Chapter 2 of the presentation of  $\text{Dup}$  leads to

$$\phi(\ll) \circ_1 \phi(\ll) - \phi(\ll) \circ_2 \phi(\ll) = 0, \quad (2.1.10)$$

so that

$$\lambda_1^2 000 + \lambda_1 \lambda_2 010 + \lambda_1 \lambda_2 001 + \lambda_2^2 011 - \lambda_1^2 000 - \lambda_1 \lambda_2 001 - \lambda_1 \lambda_2 011 - \lambda_2^2 012 = 0, \quad (2.1.11)$$

implying that  $\lambda_2 = 0$ . Similarly, Relation (4.2.8c) of the presentation of  $\text{Dup}$  implies that  $\lambda_4 = 0$ . Therefore, we obtain  $\phi(\ll) = \lambda_1 00$  and  $\phi(\gg) = \lambda_3 00$ , showing that  $\phi$  is not an isomorphism. Assume now that  $\phi: \text{Dendr} \rightarrow \text{FCat}^{(0)}$  is an operad morphism so that  $\phi(\ll) = \lambda_1 00 + \lambda_2 01$  and  $\phi(\gg) = \lambda_3 00 + \lambda_4 01$  for some coefficients  $\lambda_1, \lambda_2, \lambda_3$ , and  $\lambda_4$  of  $\mathbb{K}$ . Relation (4.2.18b) of Section 4.2.6 of Chapter 2 of the presentation of  $\text{Dendr}$  leads to

$$\phi(\gg) \circ_1 \phi(\ll) - \phi(\ll) \circ_2 \phi(\gg) = 0, \quad (2.1.12)$$

so that

$$\lambda_1 \lambda_3 000 + \lambda_2 \lambda_3 010 + \lambda_1 \lambda_4 001 + \lambda_2 \lambda_4 011 - \lambda_1 \lambda_3 000 - \lambda_1 \lambda_4 001 - \lambda_2 \lambda_3 011 - \lambda_2 \lambda_4 012 = 0, \quad (2.1.13)$$

implying that  $\lambda_2 = 0$ , or  $\lambda_3 = 0 = \lambda_4$ . When  $\lambda_2 = 0$ , one has  $\phi(\ll) = \lambda_1 00$  and, since  $\lambda_1 00$  is associative in  $\text{FCat}^{(1)}$  but  $\ll$  is not associative in  $\text{Dendr}$ ,  $\phi$  cannot be an isomorphism. Moreover, when  $\lambda_3 = 0 = \lambda_4$ , the kernel of  $\phi$  is nontrivial, showing that  $\phi$  is not an isomorphism.

Since by Theorem 2.1.9,  $\text{FCat}^{(k)}$  is binary and quadratic, this ns operad admits a Koszul dual. Let  $\text{FCat}^{(k)\dagger}$  be the Koszul dual of  $\text{FCat}^{(k)}$ .

PROPOSITION 2.1.10. *For any  $k \geq 0$ , the ns operad  $\text{FCat}^{(k)^\dagger}$  admits the presentation  $(\mathfrak{G}_{\text{FCat}^{(k)}}, \mathcal{R})$  where  $\mathcal{R}$  is the subspace of  $\text{FO}(\mathfrak{G}_{\text{FCat}^{(k)}})$  generated by the elements*

$$\odot(0(a+b)) \circ_1 \odot(0a) - \odot(0a) \circ_2 \odot(0b), \quad a, b \geq 0, a+b \leq k, \quad (2.1.14a)$$

$$\odot(0a) \circ_1 \odot(0(a+b+1)), \quad 0 \leq a \leq k, 0 \leq b \leq k-1, a+b+1 \leq k, \quad (2.1.14b)$$

$$\odot(0a) \circ_2 \odot(0b), \quad 0 \leq a \leq k, 0 \leq b \leq k, a+b \geq k+1. \quad (2.1.14c)$$

PROPOSITION 2.1.11. *For any  $k \geq 0$ , the Hilbert series of the ns operad  $\text{FCat}^{(k)^\dagger}$  can be expressed as*

$$\mathcal{H}_{\text{FCat}^{(k)^\dagger}}(t) = \frac{t}{(1-t)^{k+1}}. \quad (2.1.15)$$

We deduce from Proposition 2.1.11 that

$$\mathcal{H}_{\text{FCat}^{(k)^\dagger}}(t) = \sum_{n \geq 1} \binom{n+k-1}{k} t^n. \quad (2.1.16)$$

2.1.4. *A ns operad on Schröder trees.* Let  $\text{Schr}$  be the ns suboperad of  $\text{TN}$  generated by  $\mathfrak{G}_{\text{Schr}} := \{00, 01, 10\}$ . Since  $\mathfrak{G}_{\text{FCat}}^{(1)} \subseteq \mathfrak{G}_{\text{Schr}}$ ,  $\text{FCat}^{(1)}$  is a ns suboperad of  $\text{Schr}$ . Moreover, since  $\text{PW}$  is, by Proposition 2.1.2, generated as an operad by  $\{00, 01\}$ ,  $\text{Schr}$  is a ns suboperad of  $\text{PW}$ .

PROPOSITION 2.1.12. *The fundamental basis of  $\text{Schr}$  is the set of all the words  $u$  on the alphabet  $\mathbb{N}$  having at least one occurrence of 0 and, for all letter  $b \geq 1$  of  $u$ , there exists a letter  $a := b-1$  such that  $u$  has a factor  $avb$  or  $bva$  where  $v$  is a word consisting in letters  $c$  satisfying  $c \geq b$ .*

Let us consider the combinatorial graded collection of the Schröder trees where the size of such a tree is its number of sectors (this is the collection  $\text{Sus}_{-1}(\text{Sch}_\perp)$  where  $\text{Sch}_\perp$  is the collection defined in Section 2.2.3 of Chapter 1). There is a bijection  $\phi_{\text{Schr}}$  between the words of  $\text{Schr}$  of arity  $n$  and Schröder trees of size  $n$ . To compute  $\phi_{\text{Schr}}(u)$  where  $u$  is a word of  $\text{Schr}$ , factorize  $u$  as  $u = u^{(1)}a \dots au^{(\ell)}$  where  $a$  is the smallest letter occurring in  $u$  and the  $u^{(i)}$ ,  $i \in [\ell]$ , are factors of  $u$  without  $a$ . Then, set

$$\phi_{\text{Schr}}(u) := \begin{cases} \mathfrak{e} & \text{if } u = \epsilon, \\ \lambda(\phi_{\text{Schr}}(u^{(1)}), \dots, \phi_{\text{Schr}}(u^{(\ell)})) & \text{otherwise,} \end{cases} \quad (2.1.17)$$

where  $\epsilon$  denotes the empty word and  $\lambda(t_1, \dots, t_\ell)$  is the Schröder tree consisting in a root that has  $t_1, \dots, t_\ell$  as subtrees from left to right. The inverse bijection is computed as follows. Given a Schröder tree  $t$ , one computes a word of  $\text{Schr}$  by assigning to each sector  $(x_i, x_{i+1})$  of  $t$  the maximal depth of the common ancestors to the leaves  $x_i$  and  $x_{i+1}$ . The word of  $\text{Schr}$  is obtained by reading the labels from left to right. Since the words of  $\text{Schr}$  satisfy Proposition 2.1.12,  $\phi_{\text{Schr}}$  is well-defined. Figure 4.6 shows an example of this bijection.

Hence, the Hilbert series of  $\text{Schr}$  satisfies the algebraic relation

$$t + (3t-1)\mathcal{H}_{\text{Schr}}(t) + 2t\mathcal{H}_{\text{Schr}}(t)^2 = 0 \quad (2.1.18)$$



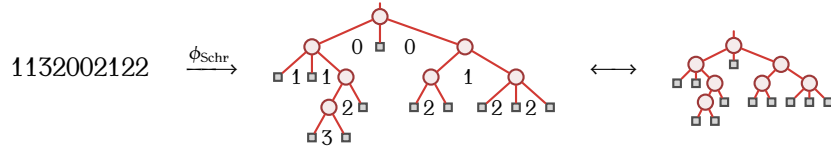

FIGURE 4.6. Interpretation of a word of the ns operad Schr in terms of Schröder trees via the bijection  $\phi_{\text{Schr}}$ .

so that its first dimensions are

$$1, 3, 11, 45, 197, 903, 4279, 20793, \tag{2.1.19}$$

forming Sequence A001003 of [Slo].

It is possible to use the bijection  $\phi_{\text{Schr}}$  to express the partial composition of Schr in terms of Schröder trees. We shall not describe it here but Figure 4.7 shows an example of such a composition.



FIGURE 4.7. Interpretation of the partial composition map of the ns operad Schr in terms of Schröder trees.

**THEOREM 2.1.13.** *The ns operad Schr admits the presentation  $(\mathfrak{G}_{\text{Schr}}, \mathcal{R})$  where  $\mathcal{R}$  is the subspace of  $\text{FO}(\mathfrak{G}_{\text{Schr}})$  generated by the elements*

$$\odot(00) \circ_1 \odot(00) - \odot(00) \circ_2 \odot(00), \tag{2.1.20a}$$

$$\odot(01) \circ_1 \odot(10) - \odot(10) \circ_2 \odot(01), \tag{2.1.20b}$$

$$\odot(00) \circ_1 \odot(01) - \odot(00) \circ_2 \odot(10), \tag{2.1.20c}$$

$$\odot(01) \circ_1 \odot(00) - \odot(00) \circ_2 \odot(01), \tag{2.1.20d}$$

$$\odot(00) \circ_1 \odot(10) - \odot(10) \circ_2 \odot(00), \tag{2.1.20e}$$

$$\odot(01) \circ_1 \odot(01) - \odot(01) \circ_2 \odot(00), \tag{2.1.20f}$$

$$\odot(10) \circ_1 \odot(00) - \odot(10) \circ_2 \odot(10). \tag{2.1.20g}$$

Moreover, Schr is a Koszul operad and the set of the  $\mathfrak{G}_{\text{Schr}}$ -syntax trees avoiding the trees  $\odot(00) \circ_1 \odot(00)$ ,  $\odot(01) \circ_1 \odot(10)$ ,  $\odot(00) \circ_1 \odot(01)$ ,  $\odot(01) \circ_1 \odot(00)$ ,  $\odot(00) \circ_1 \odot(10)$ ,  $\odot(01) \circ_1 \odot(01)$ , and  $\odot(10) \circ_2 \odot(10)$  is a Poincaré-Birkhoff-Witt basis of Schr.

Since by Theorem 2.1.13, Schr is binary and quadratic, this ns operad admits a Koszul dual. Let  $\text{Schr}^\dagger$  be the Koszul dual of Schr.

PROPOSITION 2.1.14. *The ns operad  $\text{Schr}^1$  admits the presentation  $(\mathfrak{G}_{\text{Schr}}, \mathcal{R})$  where  $\mathcal{R}$  is the subspace of  $\mathbf{FO}(\mathfrak{G}_{\text{Schr}})$  generated by the elements*

$$\odot(00) \circ_1 \odot(00) - \odot(00) \circ_2 \odot(00), \quad (2.1.21a)$$

$$\odot(01) \circ_1 \odot(10) - \odot(10) \circ_2 \odot(01), \quad (2.1.21b)$$

$$\odot(00) \circ_1 \odot(01) - \odot(00) \circ_2 \odot(10), \quad (2.1.21c)$$

$$\odot(01) \circ_1 \odot(00) - \odot(00) \circ_2 \odot(01), \quad (2.1.21d)$$

$$\odot(00) \circ_1 \odot(10) - \odot(10) \circ_2 \odot(00), \quad (2.1.21e)$$

$$\odot(01) \circ_1 \odot(01) - \odot(01) \circ_2 \odot(00), \quad (2.1.21f)$$

$$\odot(10) \circ_1 \odot(00) - \odot(10) \circ_2 \odot(10), \quad (2.1.21g)$$

$$\odot(10) \circ_1 \odot(01), \quad (2.1.21h)$$

$$\odot(10) \circ_1 \odot(10), \quad (2.1.21i)$$

$$\odot(01) \circ_2 \odot(01), \quad (2.1.21j)$$

$$\odot(01) \circ_2 \odot(10). \quad (2.1.21k)$$

PROPOSITION 2.1.15. *For any  $k \geq 0$ , the Hilbert series of the ns operad  $\text{Schr}^1$  can be expressed as*

$$\mathcal{H}_{\text{Schr}^1}(t) = \frac{t}{(1-t)(1-2t)}. \quad (2.1.22)$$

We deduce from Proposition 2.1.15 that

$$\mathcal{H}_{\text{Schr}^1}(t) = \sum_{n \geq 1} (2^n - 1)t^n. \quad (2.1.23)$$

2.1.5. *A ns operad on Motzkin words.* Let  $\text{Motz}$  be the ns suboperad of  $\mathbf{TN}$  generated by  $\mathfrak{G}_{\text{Motz}} := \{00, 010\}$ . Since 00 and 010 are elements of  $\text{FCat}^{(1)}$ ,  $\text{Motz}$  is a ns suboperad of  $\text{FCat}^{(1)}$ . Moreover, since  $\mathfrak{G}_{\text{FCat}}^{(0)} \subseteq \mathfrak{G}_{\text{Motz}}$ ,  $\text{FCat}^{(0)}$  is a ns suboperad of  $\text{Motz}$ .

PROPOSITION 2.1.16. *The fundamental basis of  $\text{Motz}$  is the set of all the words  $u$  on the alphabet  $\mathbb{N}$  beginning and starting by 0 and such that  $|u_i - u_{i+1}| \leq 1$  for all  $i \in [|u| - 1]$ .*

A *Motzkin word* is a word  $u$  on the alphabet  $\{-1, 0, 1\}$  such that the sum of all letters of  $u$  is 0 and, for any prefix  $u'$  of  $u$ , the sum of all letters of  $u'$  is a nonnegative integer. The size  $|u|$  of a Motzkin word  $u$  is its length plus 1. In the sequel, we shall denote by  $\bar{1}$  the letter  $-1$ . We can represent a Motzkin word  $u$  graphically by a *Motzkin path* that is the path in  $\mathbb{N}^2$  connecting the points  $(0, 0)$  and  $(n, 0)$  obtained by drawing a step  $(1, -1)$  (resp.  $(1, 0)$ ,  $(1, 1)$ ) for each letter  $\bar{1}$  (resp.  $0$ ,  $1$ ) of  $u$ . There is a bijection  $\phi_{\text{Motz}}$  between the words of  $\text{Motz}$  of arity  $n$  and Motzkin words of size  $n$ . To compute  $\phi_{\text{Motz}}(u)$  where  $u$  is a word of  $\text{Motz}(n)$ , build the word  $v$  of length  $n - 1$  satisfying  $v_i := u_{i+1} - u_i$  for all  $i \in [n - 1]$ . The inverse bijection is computed as follows. The word of  $\text{Motz}$  in bijection with a Motzkin word  $v$  is the word  $u$  such that  $u_i$  is the sum of the letters of the prefix  $v_1 \dots v_{i-1}$  of  $v$ , for all  $i \in [n]$ . Since the words of  $\text{Motz}$  satisfy Proposition 2.1.16,  $\phi_{\text{Motz}}$  is well-defined. Figure 4.8 shows an example of this bijection.

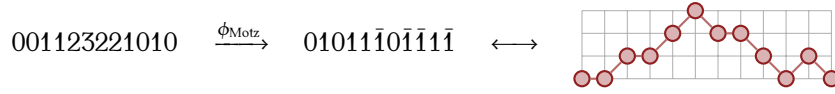

FIGURE 4.8. Interpretation of a word of the ns operad Motz in terms of Motzkin words and Motzkin paths via the bijection  $\phi_{\text{Motz}}$ .

Hence, the Hilbert series of Motz satisfies the algebraic relation

$$t + (t - 1)\mathcal{H}_{\text{Motz}}(t) + t\mathcal{H}_{\text{Motz}}(t)^2 = 0 \tag{2.1.24}$$

so that its first dimensions are

$$1, 1, 2, 4, 9, 21, 51, 127, \tag{2.1.25}$$

forming Sequence **A001006**.

In terms of Motzkin words, the partial composition of Motz can be expressed as follows:

PROPOSITION 2.1.17. *Let  $u$  and  $v$  be two Motzkin words where  $u$  is of size  $n$ , and  $i \in [n]$  be an integer. Then the composition  $u \circ_i v$  in Motz amounts to insert  $v$  at the  $i$ th position into  $u$ .*

Figure 4.9 shows an example of composition in Motz.

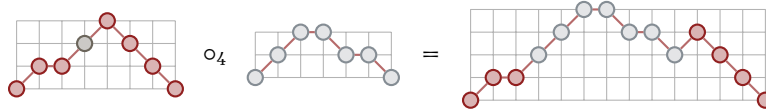

FIGURE 4.9. Interpretation of the partial composition map of the ns operad Motz in terms of Motzkin paths.

THEOREM 2.1.18. *The ns operad Motz admits the presentation  $(\mathfrak{G}_{\text{Motz}}, \mathcal{R})$  where  $\mathcal{R}$  is the subspace of  $\mathbf{FO}(\mathfrak{G}_{\text{Motz}})$  generated by the elements*

$$\odot(00) \circ_1 \odot(00) - \odot(00) \circ_2 \odot(00), \tag{2.1.26a}$$

$$\odot(010) \circ_1 \odot(00) - \odot(00) \circ_2 \odot(010), \tag{2.1.26b}$$

$$\odot(00) \circ_1 \odot(010) - \odot(010) \circ_3 \odot(00), \tag{2.1.26c}$$

$$\odot(010) \circ_1 \odot(010) - \odot(010) \circ_3 \odot(010). \tag{2.1.26d}$$

Moreover, Motz is a Koszul operad and the set of the  $\mathfrak{G}_{\text{Motz}}$ -syntax trees avoiding the trees  $\odot(00) \circ_1 \odot(00)$ ,  $\odot(010) \circ_1 \odot(00)$ ,  $\odot(00) \circ_1 \odot(010)$ , and  $\odot(010) \circ_1 \odot(010)$  is a Poincaré-Birkhoff-Witt basis of Motz.

2.1.6. *A ns operad on compositions.* Let  $\text{Comp}$  be the ns suboperad of  $\text{TN}_2$  generated by  $\mathfrak{G}_{\text{Comp}} := \{00, 01\}$ . Since  $\text{FCat}^{(1)}$  is the ns suboperad of  $\text{TN}$  generated by  $\mathfrak{G}_{\text{FCat}}^{(1)} = \{00, 01\}$ , and since  $\text{TN}_2$  is a quotient of  $\text{TN}$ ,  $\text{Comp}$  is a quotient of  $\text{FCat}^{(1)}$ .

PROPOSITION 2.1.19. *The fundamental basis of  $\text{Comp}$  is the set of all the words on the alphabet  $\{0, 1\}$  beginning by 0.*

PROOF. It is immediate, from the definition of  $\text{Comp}$  and Lemma 4.1.3 of Chapter 2, that any element of this ns operad starts by 0 since its generators 00 and 01 all start by 0.

Let us now show by induction on the length of the words that  $\text{Comp}$  contains any word  $u$  satisfying the statement. This is true when  $|u| = 1$ . When  $n := |u| \geq 2$ , let us observe that if  $u$  only consists in letters 0,  $\text{Comp}$  contains  $u$  because  $u$  can be obtained by composing the generator 00 with itself. Otherwise,  $u$  has at least one occurrence of 1. Since its first letter is 0, there is in  $u$  a factor  $u_i u_{i+1} = 01$ . By setting  $v := u_1 \dots u_i u_{i+2} \dots u_n$ , we have  $u = v \circ_i 01$ . Since  $v$  satisfies the statement, by induction hypothesis  $\text{Comp}$  contains  $v$ . Hence,  $\text{Comp}$  also contains  $u$ .  $\square$

Let us consider the combinatorial graded collection of the compositions where the size of such a composition is the sum of its parts (this is the collection  $\text{Comp}$  defined in Section 1.2.3 of Chapter 1. The *ith box* of a ribbon diagram of a composition  $\lambda$  is the  $i$ th encountered box by traversing  $\lambda$  column by column from left to right and from top to bottom. The *transpose* of  $\lambda$  is the ribbon diagram obtained by applying to  $\lambda$  the reflection through the line passing by its first and its last boxes. There is a bijection  $\phi_{\text{Comp}}$  between the words of  $\text{Comp}$  of arity  $n$  and ribbon diagrams of compositions of size  $n$ . To compute  $\phi_{\text{Comp}}(u)$  where  $u$  is a word of  $\text{Comp}$ , iteratively insert the letters of  $u$  from left to right according to the following procedure. If  $|u| = 1$ , then  $u = 0$  and  $\phi_{\text{Comp}}(0)$  is the only ribbon diagram consisting in one box. Otherwise, the insertion of a letter  $a$  into  $\lambda$  consists in adding a new box below (resp. to the right of) the right bottommost box of  $\lambda$  if  $a = 1$  (resp.  $a = 0$ ). The inverse bijection is computed as follows. Given a ribbon diagram  $\lambda$  of a composition of size  $n$ , one computes a word of  $\text{Comp}$  of arity  $n$  by labeling the first box of  $\lambda$  by 0 and the  $i$ th box  $b$  by 0 if the  $(i - 1)$ st box is on the left of  $b$  or by 1 otherwise, for any  $1 \leq i \leq n$ . The corresponding word of  $\text{Comp}$  is obtained by reading the labels of  $\lambda$  from top to bottom and left to right. Since the words of  $\text{Comp}$  satisfy Proposition 2.1.19,  $\phi_{\text{Comp}}$  is well-defined. Hence, we can regard the words of arity  $n$  of  $\text{Comp}$  as ribbon diagrams with  $n$  boxes. Figure 4.10 shows an example of this bijection.

Hence, the Hilbert series of  $\text{Comp}$  satisfies

$$\mathcal{H}_{\text{Comp}}(t) = \sum_{n \geq 1} 2^{n-1} t^n. \quad (2.1.27)$$

In terms of ribbon diagrams, the partial composition of  $\text{Comp}$  can be expressed as follows:

PROPOSITION 2.1.20. *Let  $\lambda$  and  $\mu$  be two ribbon diagrams,  $i$  be an integer, and  $c$  be the  $i$ th box of  $\lambda$ . Then, the composition  $\lambda \circ_i \mu$  in  $\text{Comp}$  amounts to replace  $c$  by  $\mu$  if  $c$  is the upper box of its column, or to replace  $c$  by the transpose ribbon diagram of  $\mu$  otherwise.*

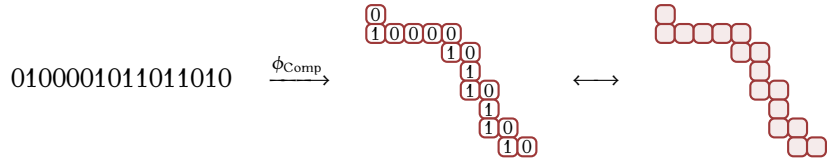
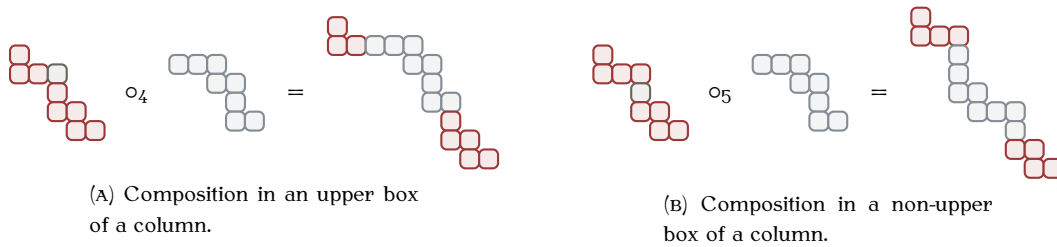

FIGURE 4.10. Interpretation of a word of the  $ns$  operad  $\text{Comp}$  in terms of compositions via the bijection  $\phi_{\text{Comp}}$ . Boxes of the ribbon diagram in the middle are labeled.

Figure 4.11 shows two examples of compositions in  $\text{Comp}$ .



(A) Composition in an upper box of a column.

(B) Composition in a non-upper box of a column.

FIGURE 4.11. Interpretation of the partial composition map of the  $ns$  operad  $\text{Comp}$  in terms of ribbon diagrams.

**THEOREM 2.1.21.** *The  $ns$  operad  $\text{Comp}$  admits the presentation  $(\mathfrak{G}_{\text{Comp}}, \mathcal{R})$  where  $\mathcal{R}$  is the subspace of  $\text{FO}(\mathfrak{G}_{\text{Comp}})$  generated by the elements*

$$\odot(00) \circ_1 \odot(00) - \odot(00) \circ_2 \odot(00), \tag{2.1.28a}$$

$$\odot(01) \circ_1 \odot(00) - \odot(00) \circ_2 \odot(01), \tag{2.1.28b}$$

$$\odot(01) \circ_1 \odot(01) - \odot(01) \circ_2 \odot(00), \tag{2.1.28c}$$

$$\odot(00) \circ_1 \odot(01) - \odot(01) \circ_2 \odot(01). \tag{2.1.28d}$$

Moreover,  $\text{Comp}$  is a Koszul operad and the set of the  $\mathfrak{G}_{\text{Comp}}$ -syntax trees avoiding the trees  $\odot(00) \circ_1 \odot(00)$ ,  $\odot(01) \circ_1 \odot(00)$ ,  $\odot(01) \circ_1 \odot(01)$ , and  $\odot(00) \circ_1 \odot(01)$  is a Poincaré-Birkhoff-Witt basis of  $\text{Comp}$ .

**PROOF.** Observe first that since the evaluations of all the elements (2.1.28a)–(2.1.28d) are 0, for all element  $x$  of  $\mathcal{R}$ ,  $\text{ev}(x) = 0$ . Let now  $\Rightarrow$  be the rewrite rule, being an orientation of  $\mathcal{R}$ , defined by

$$\begin{array}{c} \cdot \\ \text{00} \\ \cdot \end{array} \begin{array}{c} \cdot \\ \text{00} \\ \cdot \end{array} \Rightarrow \begin{array}{c} \cdot \\ \text{00} \\ \cdot \end{array} \begin{array}{c} \cdot \\ \text{00} \\ \cdot \end{array}, \tag{2.1.29a}$$

$$\begin{array}{c} \cdot \\ \text{01} \\ \cdot \end{array} \begin{array}{c} \cdot \\ \text{00} \\ \cdot \end{array} \Rightarrow \begin{array}{c} \cdot \\ \text{00} \\ \cdot \end{array} \begin{array}{c} \cdot \\ \text{01} \\ \cdot \end{array}, \tag{2.1.29b}$$

$$\begin{array}{c} \cdot \\ | \\ 01 \\ / \quad \backslash \\ \cdot \quad \cdot \\ | \quad | \\ 01 \quad 00 \end{array} \Rightarrow \begin{array}{c} \cdot \\ | \\ 01 \\ / \quad \backslash \\ \cdot \quad \cdot \\ | \quad | \\ 01 \quad 00 \end{array}, \quad (2.1.29c)$$

$$\begin{array}{c} \cdot \\ | \\ 00 \\ / \quad \backslash \\ \cdot \quad \cdot \\ | \quad | \\ 01 \quad 01 \end{array} \Rightarrow \begin{array}{c} \cdot \\ | \\ 01 \\ / \quad \backslash \\ \cdot \quad \cdot \\ | \quad | \\ 01 \quad 01 \end{array}. \quad (2.1.29d)$$

Let  $\sim$  be the closure of  $\Rightarrow$ . It is immediate that the map  $\text{tam}$  (see (2.4.21) of Chapter 1) is a termination invariant for  $\sim$  so that  $\sim$  is terminating. Moreover, the normal forms of  $\sim$  are the  $\mathfrak{G}_{\text{Comp}}$ -syntax trees which have no internal node with an internal node as left child. Hence, the generating series  $\mathcal{G}_{\mathfrak{F}_{\sim}}(t)$  of the normal forms of  $\sim$  satisfies

$$\mathcal{G}_{\mathfrak{F}_{\sim}}(t) = \sum_{n \geq 1} 2^{n-1} t^n. \quad (2.1.30)$$

By Proposition 2.1.19,  $\mathcal{G}_{\mathfrak{F}_{\sim}}(t)$  also is the Hilbert series of  $\text{Comp}$ . Hence, by Theorem 4.1.1 of Chapter 2,  $\text{Comp}$  admits the claimed presentation.  $\square$

Since by Theorem 2.1.21,  $\text{Comp}$  is binary and quadratic, this ns operad admits a Koszul dual. Let  $\text{Comp}^\dagger$  be the Koszul dual of  $\text{Comp}$ .

PROPOSITION 2.1.22. *The ns operad  $\text{Comp}$  is self-dual, that is  $\text{Comp} \simeq \text{Comp}^\dagger$ .*

2.1.7. *A ns operad on directed animals.* Let  $\text{DA}$  be the ns suboperad of  $\text{TN}_3$  generated by  $\mathfrak{G}_{\text{DA}} := \{00, 01\}$ . Since  $\text{FCat}^{(1)}$  is the ns suboperad of  $\text{TN}$  generated by  $\mathfrak{G}_{\text{FCat}^{(1)}} = \{00, 01\}$ , and since  $\text{TN}_3$  is a quotient of  $\text{TN}$ ,  $\text{DA}$  is a quotient of  $\text{FCat}^{(1)}$ . We denote here by  $\bar{1}$  the representative of the equivalence class of 2 in  $\mathbb{N}_3$ .

PROPOSITION 2.1.23. *Let, for any  $n \geq 1$ ,  $\mathcal{B}(n)$  be the set of the words of forming the fundamental basis of  $\text{DA}(n)$  and let  $\phi_{\text{DA}} : \mathcal{B}(n) \rightarrow \{\bar{1}, 0, 1\}^{n-1}$  be the map defined for any word  $u$  of arity  $n$  of  $\text{DA}$  by*

$$\phi_{\text{DA}}(u) := (u_1 * u_2) (u_2 * u_3) \dots (u_{n-1} * u_n), \quad (2.1.31)$$

where  $u_i * u_{i+1} := u_{i+1} - u_i \pmod 3$  for all  $i \in [n-1]$ . Then,  $\phi_{\text{DA}}$  is a bijection between the words of arity  $n$  of  $\text{DA}$  and prefixes of Motzkin words of length  $n-1$ .

Here are two examples of images by  $\phi_{\text{DA}}$  of words of  $\text{DA}$ :

$$\phi_{\text{DA}}(011\bar{1}\bar{1}0\bar{1}01) = 10101\bar{1}11, \quad (2.1.32a)$$

$$\phi_{\text{DA}}(010010101\bar{1}\bar{1}) = \bar{1}\bar{1}01\bar{1}\bar{1}\bar{1}\bar{1}\bar{1}. \quad (2.1.32b)$$

A *directed animal* is a subset  $A$  of  $\mathbb{N}^2$  such that  $(0,0) \in A$  and  $(i,j) \in A$  with  $i \geq 1$  or  $j \geq 1$  implies  $(i-1,j) \in A$  or  $(i,j-1) \in A$ . The size of a directed animal  $A$  is its cardinality. Figure 4.12 shows a directed animal.

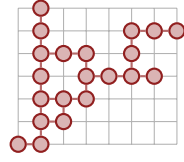

FIGURE 4.12. A directed animal of size 21. The point  $(0,0)$  is the lowest and leftmost point.

According to [GBV88], there is a bijection  $\alpha$  between the set of prefixes of Motzkin words of length  $n - 1$  and the set of directed animals of size  $n$ . Hence, by Proposition 2.1.23, the map  $\alpha \circ \phi_{\text{DA}}$  is a bijection between the words of DA of arity  $n$  and directed animals of size  $n$ . Therefore, DA can be seen as a ns operad on directed animals.

Hence, the Hilbert series of DA satisfies the algebraic relation

$$t + (3t - 1)\mathcal{H}_{\text{DA}}(t) + (3t - 1)\mathcal{H}_{\text{DA}}(t)^2 = 0 \quad (2.1.33)$$

so that its first dimensions are

$$1, 2, 5, 13, 35, 96, 267, 750, 2123, \quad (2.1.34)$$

forming Sequence A005773 of [Slo].

**THEOREM 2.1.24.** *The ns operad DA admits the presentation  $(\mathfrak{G}_{\text{DA}}, \mathcal{R})$  where  $\mathcal{R}$  is the subspace of  $\text{FO}(\mathfrak{G}_{\text{DA}})$  generated by the elements*

$$\odot(00) \circ_1 \odot(00) - \odot(00) \circ_2 \odot(00), \quad (2.1.35a)$$

$$\odot(01) \circ_1 \odot(00) - \odot(00) \circ_2 \odot(01), \quad (2.1.35b)$$

$$\odot(01) \circ_1 \odot(01) - \odot(01) \circ_2 \odot(00), \quad (2.1.35c)$$

$$(\odot(00) \circ_1 \odot(01)) \circ_2 \odot(01) - (\odot(01) \circ_2 \odot(01)) \circ_3 \odot(01). \quad (2.1.35d)$$

Moreover, the set of the  $\mathfrak{G}_{\text{DA}}$ -syntax trees avoiding the trees  $\odot(00) \circ_1 \odot(00)$ ,  $\odot(01) \circ_1 \odot(00)$ ,  $\odot(01) \circ_2 \odot(00)$ ,  $(\odot(01) \circ_2 \odot(01)) \circ_3 \odot(01)$  is a Poincaré-Birkhoff-Witt basis of DA.

Since the nontrivial relation (2.1.35d) has degree 3, the presentation of DA exhibited by Theorem 2.1.24 is not quadratic.

**2.1.8. A ns operad on segmented compositions.** Let SComp be the ns suboperad of  $\text{TN}_3$  generated by  $\mathfrak{G}_{\text{SComp}} := \{00, 01, 02\}$ . Since  $\text{FCat}^{(2)}$  is the ns suboperad of  $\text{TN}$  generated by  $\mathfrak{G}_{\text{FCat}}^{(2)} = \{00, 01, 02\}$ , and since  $\text{TN}_3$  is a quotient of  $\text{TN}$ , SComp is a quotient of  $\text{FCat}^{(2)}$ . Moreover, since DA is generated by  $\mathfrak{G}_{\text{DA}} \subseteq \mathfrak{G}_{\text{SComp}}$ , DA is a ns suboperad of SComp.

**PROPOSITION 2.1.25.** *The fundamental basis of SComp is the set of all the words on the alphabet  $\{0, 1, 2\}$  beginning by 0.*

A *segmented composition* is a sequence  $(\lambda_1, \dots, \lambda_\ell)$  of compositions  $\lambda_i$ ,  $i \in [\ell]$ . The size of a segmented composition is the sum of the sizes of the compositions constituting it. We shall represent a segmented composition  $\lambda$  by a *ribbon diagram*, that is the diagram consisting in the sequence of the ribbon diagrams of the compositions that constitute  $\lambda$ . There is a bijection between the words of SComp of arity  $n$  and ribbon diagrams of segmented compositions of size  $n$ . To compute  $\phi_{\text{SComp}}(u)$  where  $u$  is a word of SComp, factorize  $u$  as  $x = 0u^{(1)} \dots 0u^{(\ell)}$  such that for any  $i \in [\ell]$ , the factor  $u^{(i)}$  has no occurrence of 0, and compute the sequence  $(\phi_{\text{Comp}}(0\bar{u}^{(1)}), \dots, \phi_{\text{Comp}}(0\bar{u}^{(\ell)}))$ , where for any  $i \in [\ell]$ ,  $\bar{u}^{(i)}$  is the word obtained from  $u^{(i)}$  by decreasing all letters. The inverse bijection is computed as follows. Given a ribbon diagram  $\lambda := (\lambda_1, \dots, \lambda_\ell)$  of a segmented composition of size  $n$ , one computes a word of SComp of arity  $n$  by computing the sequence  $(u^{(1)}, \dots, u^{(\ell)})$  where for any  $i \in [[\ell]]$ ,  $u^{(i)}$  is the word of Comp obtained by applying the inverse bijection of  $\phi_{\text{Comp}}$  to  $\lambda_i$ , then by incrementing in each  $u^{(i)}$  all letters, excepted the first one, and finally by concatenating the words of the sequence together. Since the words of SComp satisfy Proposition 2.1.25,  $\phi_{\text{SComp}}$  is well-defined. Figure 4.13 shows an example of this bijection.

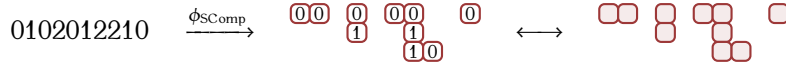

FIGURE 4.13. Interpretation of a word of the operad SComp in terms of a segmented composition via the bijection  $\phi_{\text{SComp}}$ . Boxes of the ribbon diagram in the middle are labeled.

Hence, the Hilbert of SComp satisfies

$$\mathcal{H}_{\text{SComp}}(t) = \sum_{n \geq 1} 3^{n-1} t^n. \quad (2.1.36)$$

In terms of ribbon diagrams, the partial composition of SComp can be expressed as follows:

**THEOREM 2.1.26.** *The  $ns$  operad SComp admits the presentation  $(\mathfrak{G}_{\text{SComp}}, \mathcal{R})$  where  $\mathcal{R}$  is the subspace of  $\mathbf{FO}(\mathfrak{G}_{\text{SComp}})$  generated by the elements*

$$\odot(00) \circ_1 \odot(00) - \odot(00) \circ_2 \odot(00), \quad (2.1.37a)$$

$$\odot(01) \circ_1 \odot(00) - \odot(00) \circ_2 \odot(01), \quad (2.1.37b)$$

$$\odot(01) \circ_1 \odot(01) - \odot(01) \circ_2 \odot(00), \quad (2.1.37c)$$

$$\odot(00) \circ_1 \odot(01) - \odot(01) \circ_2 \odot(02), \quad (2.1.37d)$$

$$\odot(01) \circ_1 \odot(02) - \odot(02) \circ_2 \odot(02), \quad (2.1.37e)$$

$$\odot(00) \circ_1 \odot(02) - \odot(02) \circ_2 \odot(01), \quad (2.1.37f)$$

$$\odot(02) \circ_1 \odot(00) - \odot(00) \circ_2 \odot(02), \quad (2.1.37g)$$

$$\odot(02) \circ_1 \odot(01) - \odot(01) \circ_2 \odot(01), \quad (2.1.37h)$$

$$\odot(02) \circ_1 \odot(02) - \odot(02) \circ_2 \odot(00). \quad (2.1.37i)$$



Moreover,  $SComp$  is a Koszul operad and the set of the  $\mathfrak{G}_{SComp}$ -syntax trees avoiding the trees  $\odot(00)_{\circ_1} \odot(00)$ ,  $\odot(01)_{\circ_1} \odot(00)$ ,  $\odot(01)_{\circ_1} \odot(01)$ ,  $\odot(00)_{\circ_1} \odot(01)$ ,  $\odot(01)_{\circ_1} \odot(02)$ ,  $\odot(00)_{\circ_1} \odot(02)$ ,  $\odot(02)_{\circ_1} \odot(00)$ ,  $\odot(02)_{\circ_1} \odot(01)$ , and  $\odot(02)_{\circ_1} \odot(02)$  is a Poincaré-Birkhoff-Witt basis of  $SComp$ .

Since by Theorem 2.1.26,  $SComp$  is binary and quadratic, this ns operad admits a Koszul dual. Let  $SComp^!$  be the Koszul dual of  $SComp$ .

PROPOSITION 2.1.27. *The ns operad  $SComp$  is self-dual, that is  $SComp \simeq SComp^!$ .*

**2.2. Operads from the max monoid.** We shall denote by  $\mathbb{M}$  the monoid  $\mathbb{N}$  with the binary operation  $\max$  as product. Note that the ns suboperad of  $\mathbb{T}\mathbb{M}$  generated by  $\{aa\}$  where  $a \in \mathbb{M}$  are all isomorphic to the ns associative operad  $As$ . The operads constructed in this section fit into the diagram of ns operads represented by Figure 4.14. Table 4.2 summarizes some information about these ns operads.



FIGURE 4.14. The diagram of ns suboperads and quotients of  $\mathbb{T}\mathbb{M}$ . Arrows  $\rightarrow$  (resp.  $\twoheadrightarrow$ ) are injective (resp. surjective) ns operad morphisms.

Monoid	Ns operad	Generators	First dimensions	Combinatorial objects
$\mathbb{M}$	Di	01, 10	1, 2, 3, 4, 5	Binary words with exactly one 0
	Tr	00, 01, 10	1, 3, 7, 15, 31	Binary words with at least one 0

TABLE 4.2. Ground monoids, generators, first dimensions, and combinatorial objects involved in the ns suboperads of  $\mathbb{T}\mathbb{M}$ .

2.2.1. *The diassociative operad.* Let  $Di$  be the ns suboperad of  $\mathbb{T}\mathbb{M}$  generated by  $\mathfrak{G}_{Di} := \{01, 10\}$ .

PROPOSITION 2.2.1. *The fundamental basis of  $Di$  is the set of all the words on the alphabet  $\{0, 1\}$  containing exactly one 0.*

The diassociative operad  $Dias$  [Lod01] is a ns operad whose definition is recalled in Section 4.2.5 of Chapter 2.

PROPOSITION 2.2.2. *The ns operad  $\text{Di}$  and the ns diassociative operad  $\text{Dias}$  are isomorphic and the map*

$$\phi : \text{Dias} \rightarrow \text{Di} \quad (2.2.1)$$

*satisfying  $\phi(-) = 01$  and  $\phi(+ ) = 10$  is an isomorphism of operads.*

Proposition 2.2.2 also shows that  $\text{Di}$  is a realization of the ns diassociative operad.

2.2.2. *The triassociative operad.* Let  $\text{Tr}$  be the ns suboperad of  $\text{TM}$  generated by  $\mathfrak{G}_{\text{Tr}} := \{00, 01, 10\}$ . Since  $\mathfrak{G}_{\text{Di}} \subseteq \mathfrak{G}_{\text{Tr}}$ ,  $\text{Di}$  is a ns suboperad of  $\text{Tr}$ .

PROPOSITION 2.2.3. *The fundamental basis of  $\text{Tr}$  is the set of all the words on the alphabet  $\{0, 1\}$  containing at least one 0.*

The triassociative operad  $\text{Trias}$  is a ns operad introduced in [LR04].

PROPOSITION 2.2.4. *The ns operad  $\text{Tr}$  and the ns triassociative operad  $\text{Trias}$  are isomorphic and the map*

$$\phi : \text{Trias} \rightarrow \text{Tr} \quad (2.2.2)$$

*satisfying  $\phi(-) = 01$ ,  $\phi(+ ) = 10$ , and  $\phi(\perp) = 00$  is an isomorphism.*

Proposition 2.2.4 also shows that  $\text{Tr}$  is a realization of the ns triassociative operad.

### Concluding remarks

We have presented here the functorial construction  $T$  producing an operad given a monoid. As we have seen, this construction is very rich from a combinatorial point of view since most of the obtained operads coming from usual monoids involve a wide range of combinatorial objects. There are various ways to continue this work. Let us address here the main directions.

In the first place, it appears that we have somewhat neglected the fact that  $T$  is a functor to operads and not only to ns ones. Indeed, except for the operads  $\text{End}$ ,  $\text{PF}$ ,  $\text{PW}$ , and  $\text{Per}_0$ , we only have regarded the obtained operads as ns ones. Computer experiments let us think that the dimensions of the operads  $\text{PRT}$ ,  $\text{FCat}^{(2)}$ ,  $\text{Moz}$ ,  $\text{DA}$  and  $\text{SComp}$  seen as symmetric ones are, respectively, Sequences A052882, A050351, A032181, A101052, and A001047 of [Slo]. Bijections between elements of these operads and combinatorial objects enumerated by these sequences, together with presentations by generators and relations in this symmetric context, would be worth studying.

Another line of research is the following. It is well-known that the Koszul dual of the operads  $\text{Dias}$  and  $\text{Trias}$  are respectively the dendriform  $\text{Dendr}$  [Lod01] and the tridendriform  $\text{TDendr}$  [LR04] operads. Since the operads  $\text{Di}$  and  $\text{Tr}$ , obtained from the  $T$  construction, are respectively isomorphic to the operads  $\text{Dias}$  and  $\text{Trias}$ , we can ask if there are generalizations of  $\text{Di}$  and  $\text{Tr}$  so that their Koszul duals provide generalizations of the operads  $\text{Dendr}$  and  $\text{TDendr}$ . It turns out that it is the case and Chapter 5 contains our research and results about this subject.



## Pluriassociative and polydendriform operads

The content of this chapter comes from [Gir16c] and [Gir16d].

### Introduction

Associative algebras play an obvious and primary role in algebraic combinatorics. Let us cite for instance the algebra of symmetric functions [Mac15] involving integer partitions, the algebra of noncommutative symmetric functions [GKL<sup>+</sup>95] involving integer compositions, the Malvenuto-Reutenauer algebra of free quasi-symmetric functions [MR95] (see also [DHT02]) involving permutations, the Loday-Ronco Hopf algebra of binary trees [LR98] (see also [HNT05]), and the Connes-Kreimer Hopf algebra of forests of rooted trees [CK98]. There are several ways to understand and to gather information about such structures and their associative operations. A very fruitful strategy consists in splitting an associative product  $\star$  into two separate operations  $<$  and  $>$  in such a way that  $\star$  turns to be the sum of  $<$  and  $>$  (see Section 2.1.1 of Chapter 2 about the sum of operations). One of the most obvious example occurs by considering the shuffle product on words (see Section 2.3.1 of Chapter 2). Indeed, this product can be separated into two operations according to the origin (first or second operand) of the last letter of the words appearing in the result [Ree58]. Other main examples include the split of the shifted shuffle product of permutations of the Malvenuto-Reutenauer Hopf algebra and of the product of binary trees of the Loday-Ronco Hopf algebra [Foi07]. The original formalization and the germs of generalization of these notions, due to Loday [Lod01], lead to the introduction of dendriform algebras. Dendriform algebras are vector spaces endowed with two operations  $<$  and  $>$  so that  $< + >$  is associative and satisfy some few other relations. Since any dendriform algebra is a quotient of a certain free dendriform algebra, the study of free dendriform algebras is worth considering. Besides, the description of free dendriform algebras has a nice combinatorial interpretation involving binary trees and shuffle of binary trees.

In recent years, several generalizations of dendriform algebras were introduced and studied. Among these, one can cite tridendriform algebras [LR04], quadri-algebras [AL04], ennea-algebras [Ler04],  $m$ -dendriform algebras of Leroux [Ler07], and  $m$ -dendriform algebras of Novelli [Nov14], all providing new ways to split associative products into more than two pieces. Besides, free objects in the corresponding categories of these algebras can be described by relatively complex combinatorial objects and more or less tricky operations on these. For instance, free tridendriform algebras involve Schröder trees, free quadri-algebras

involve noncrossing connected graphs on a circle, and free  $m$ -dendriform algebras of Leroux and free  $m$ -dendriform algebras of Novelli involve planar rooted trees where internal nodes have a constant number of children.

The first goal of this chapter is to define and justify a new generalization of dendriform algebras, using the point of view offered by the theory of operads. Our long term primary objective is to develop new implements to split associative products in smaller pieces. We use the approach consisting in considering the diassociative operad  $\text{Dias}$  [Lod01], the Koszul dual of the dendriform operad  $\text{Dendr}$ , rather than focusing on  $\text{Dendr}$ . Since  $\text{Dias}$  admits a description far simpler than  $\text{Dendr}$ , starting by constructing a generalization of  $\text{Dias}$  to obtain a generalization of  $\text{Dendr}$  by Koszul duality is a convenient path to explore. To obtain a generalization of the diassociative operad, we exploit the general functorial construction  $T$  producing an operad from any monoid (see Chapter 4). We show here that this functor  $T$  provides an original construction for the diassociative operad. In the present chapter, we rely on  $T$  to construct the operads  $\text{Dias}_\gamma$ , where  $\gamma$  is a nonnegative integer, in such a way that  $\text{Dias}_1 = \text{Dias}$ .

The operads  $\text{Dias}_\gamma$ , called  $\gamma$ -pluriassociative operads, are operads defined on the linear span of some words on the alphabet  $\{0\} \sqcup [\gamma]$ . By computing the Koszul dual of  $\text{Dias}_\gamma$ , we obtain the operads  $\text{Dendr}_\gamma$ , satisfying  $\text{Dendr}_1 = \text{Dendr}$ . The operads  $\text{Dendr}_\gamma$  govern the category of the so-called  $\gamma$ -polydendriform algebras, that are algebras with  $2\gamma$  operations  $\leftarrow_a, \rightarrow_a, a \in [\gamma]$ , satisfying some relations. Free algebras in these categories involve binary trees where all edges connecting two internal nodes are labeled on  $[\gamma]$ . These algebras are endowed with  $2\gamma$  products described by induction and can be seen as kinds of shuffle of trees, generalizing the shuffle of trees introduced by Loday [Lod01] intervening in the construction of free dendriform algebras. Moreover, the introduction of  $\gamma$ -polydendriform algebras offers to split an associative product  $\star$  by

$$\star = \leftarrow_1 + \rightarrow_1 + \cdots + \leftarrow_\gamma + \rightarrow_\gamma, \quad (0.0.1)$$

with, among others, the stiffening conditions that all partial sums

$$\leftarrow_1 + \rightarrow_1 + \cdots + \leftarrow_a + \rightarrow_a \quad (0.0.2)$$

are associative for all  $a \in [\gamma]$ . Besides, this work naturally leads to the consideration and the definition of numerous operads. Table 5.1 summarizes some information about these.

This work is organized as follows. Section 1 is devoted to the introduction and the complete study of the operads  $\text{Dias}_\gamma$ , and in Section 2, algebras over  $\text{Dias}_\gamma$  are studied. In Section 3 we present an analogous generalization  $\text{Trias}_\gamma$  of the triassociative operad [LR04]. The study of  $\text{Dendr}_\gamma$  is performed in Section 4, where we provide several presentations of this operad and a construction of free  $\gamma$ -polydendriform algebras. Section 5 extends a part of the operadic butterfly [Lod01, Lod06]. This extension contains the operads  $\text{Dias}_\gamma$ ,  $\text{Dendr}_\gamma$ , and two generalizations  $\text{As}_\gamma$  and  $\text{DAs}_\gamma$  of the associative operad, Koszul duals one of the other. Finally, in Section 6, we sustain our previous ideas to propose still new generalizations of some more operads like the operad  $\text{Dup}_\gamma$  generalizing the duplicial operad [Lod08] and the operad  $\text{TDendr}_\gamma$  generalizing the tridendriform operad. We also then define the operads

Operad	Bases	Dimensions	Symmetric
$\text{Dias}_\gamma$	Some words on $\{0\} \sqcup [\gamma]$	$n\gamma^{n-1}$	No
$\text{Dendr}_\gamma$	$\gamma$ -edge valued binary trees	$\gamma^{n-1} \text{cat}(n)$	No
$\text{As}_\gamma$	$\gamma$ -corollas	$\gamma$	No
$\text{DAs}_\gamma$	$\gamma$ -alternating Schröder trees	$\sum_{k=0}^{n-2} \gamma^{k+1} (\gamma-1)^{n-k-2} \text{nar}(n, k)$	No
$\text{Dup}_\gamma$	$\gamma$ -edge valued binary trees	$\gamma^{n-1} \text{cat}(n)$	No
$\text{Trias}_\gamma$	Some words on $\{0\} \sqcup [\gamma]$	$(\gamma+1)^n - \gamma^n$	No
$\text{TDendr}_\gamma$	$\gamma$ -edge valued Schröder trees	$\sum_{k=0}^{n-1} (\gamma+1)^k \gamma^{n-k-1} \text{nar}(n+1, k)$	No
$\text{Com}_\gamma$	—	—	Yes
$\text{Zin}_\gamma$	—	—	Yes

TABLE 5.1. The main operads constructed in this chapter. All these depend on a nonnegative integer parameter  $\gamma$ . The shown dimensions are the ones of their homogeneous components of arities  $n \geq 2$ .

$\text{Com}_\gamma$ ,  $\text{Lie}_\gamma$ ,  $\text{Zin}_\gamma$ , and  $\text{Leib}_\gamma$ , that are respective generalizations of the commutative operad, the Lie operad, the Zinbiel operad [Lod95] and the Leibniz operad [Lod93].

*Note.* This chapter deals mostly with ns operads. For this reason, “operad” means “ns operad”.

## 1. Pluriassociative operads

We define here one of the main object of this chapter: a generalization on a nonnegative integer parameter  $\gamma$  of the diassociative operad (see [Lod01] or Section 4.2.6 of Chapter 2). We provide a complete study of this new operad.

**1.1. Construction and first properties.** Our generalization of the diassociative operad passes through the functor  $T$  (see Section 1.1 of Chapter 4). We begin here by describing a basis and by establishing the Hilbert series of our generalization.

1.1.1. *Construction.* For any integer  $\gamma \geq 0$ , let  $\mathbb{M}_\gamma$  be the monoid  $\{0\} \sqcup [\gamma]$  with the binary operation  $\max$  as product, denoted by  $\downarrow$ . We define the  $\gamma$ -pluriassociative operad  $\text{Dias}_\gamma$  as the suboperad of  $\text{TM}_\gamma$  generated by

$$\mathfrak{G}_{\text{Dias}_\gamma} := \{0a, a0 : a \in [\gamma]\}. \quad (1.1.1)$$

By definition,  $\text{Dias}_\gamma$  is the linear span of all the words that can be obtained by partial compositions of words of  $\mathfrak{G}_{\text{Dias}_\gamma}$ . We have, for instance,

$$\text{Dias}_2(1) = \mathbb{K} \langle \{0\} \rangle, \quad (1.1.2a)$$

$$\text{Dias}_2(2) = \mathbb{K} \langle \{01, 02, 10, 20\} \rangle, \quad (1.1.2b)$$

$$\text{Dias}_2(3) = \mathbb{K} \langle \{011, 012, 021, 022, 101, 102, 201, 202, 110, 120, 210, 220\} \rangle, \quad (1.1.2c)$$

and, as examples of partial compositions in  $\text{Dias}_3$ ,

$$211201 \circ_4 31103 = 2113222301, \quad (1.1.3a)$$

$$111101 \circ_3 20 = 1121101, \quad (1.1.3b)$$

$$1013 \circ_2 210 = 121013. \quad (1.1.3c)$$

**1.1.2. First properties.** In the first place, observe that  $\text{Dias}_1$  is the operad  $\text{Di}$  defined in Chapter 4. For this reason,  $\text{Dias}_1$  is the diassociative operad  $\text{Dias}$ . Moreover, observe that  $\text{Dias}_0$  is the trivial operad and that  $\text{Dias}_\gamma$  is a suboperad of  $\text{Dias}_{\gamma+1}$ . Then, for all integers  $\gamma \geq 0$ , the operads  $\text{Dias}_\gamma$  are generalizations of the diassociative operad. Besides, it follows immediately from the definition of  $\text{Dias}_\gamma$  as a suboperad of  $\text{TM}_\gamma$  that its fundamental basis is a set-operad basis. Indeed, any partial composition of two basis elements of  $\text{Dias}_\gamma$  gives rises to exactly one basis element.

### 1.1.3. Elements and dimensions.

**PROPOSITION 1.1.1.** *For any integer  $\gamma \geq 0$ , the fundamental basis of  $\text{Dias}_\gamma$  is the set of all the words on the alphabet  $\{0\} \sqcup [\gamma]$  containing exactly one occurrence of 0.*

We deduce from Proposition 1.1.1 that the Hilbert series of  $\text{Dias}_\gamma$  satisfies

$$\mathcal{H}_{\text{Dias}_\gamma}(t) = \frac{t}{(1 - \gamma t)^2} \quad (1.1.4)$$

and that for all  $n \geq 1$ ,  $\dim \text{Dias}_\gamma(n) = n\gamma^{n-1}$ . For instance, the first dimensions of  $\text{Dias}_1$ ,  $\text{Dias}_2$ ,  $\text{Dias}_3$ , and  $\text{Dias}_4$  are respectively

$$1, 2, 3, 4, 5, 6, 7, 8, 9, 10, 11, \quad (1.1.5a)$$

$$1, 4, 12, 32, 80, 192, 448, 1024, 2304, 5120, 11264, \quad (1.1.5b)$$

$$1, 6, 27, 108, 405, 1458, 5103, 17496, 59049, 196830, 649539, \quad (1.1.5c)$$

$$1, 8, 48, 256, 1280, 6144, 28672, 131072, 589824, 2621440, 11534336. \quad (1.1.5d)$$

The second one is Sequence [A001787](#), the third one is Sequence [A027471](#), and the last one is Sequence [A002697](#) of [[Slo](#)].

**1.2. Additional properties.** We exhibit here, among others, two presentations of  $\text{Dias}_\gamma$  and establish the fact that it is a Koszul operad.

1.2.1. *Presentation by generators and relations.* For any  $a \in [\gamma]$ , let us denote by  $\neg_a$  (resp.  $\vdash_a$ ) the generator  $0a$  (resp.  $a0$ ) of  $\text{Dias}_\gamma$ .

**THEOREM 1.2.1.** *For any integer  $\gamma \geq 0$ , the operad  $\text{Dias}_\gamma$  admits the presentation  $(\mathfrak{G}_{\text{Dias}_\gamma}, \mathcal{R}_{\text{Dias}_\gamma})$  where  $\mathcal{R}_{\text{Dias}_\gamma}$  is the space induced by the equivalence relation  $\leftrightarrow_\gamma$  satisfying*

$$\odot(\neg_a) \circ_1 \odot(\vdash_{a'}) \leftrightarrow_\gamma \odot(\vdash_{a'}) \circ_2 \odot(\neg_a), \quad a, a' \in [\gamma], \quad (1.2.1a)$$

$$\odot(\neg_a) \circ_1 \odot(\neg_b) \leftrightarrow_\gamma \odot(\neg_a) \circ_2 \odot(\vdash_b), \quad a < b \in [\gamma], \quad (1.2.1b)$$

$$\odot(\vdash_a) \circ_1 \odot(\neg_b) \leftrightarrow_\gamma \odot(\vdash_a) \circ_2 \odot(\vdash_b), \quad a < b \in [\gamma], \quad (1.2.1c)$$

$$\odot(\neg_b) \circ_1 \odot(\neg_a) \leftrightarrow_\gamma \odot(\neg_a) \circ_2 \odot(\neg_b), \quad a < b \in [\gamma], \quad (1.2.1d)$$

$$\odot(\vdash_a) \circ_1 \odot(\vdash_b) \leftrightarrow_\gamma \odot(\vdash_b) \circ_2 \odot(\vdash_a), \quad a < b \in [\gamma], \quad (1.2.1e)$$

$$\odot(\neg_d) \circ_1 \odot(\neg_d) \leftrightarrow_\gamma \odot(\neg_d) \circ_2 \odot(\neg_c) \leftrightarrow_\gamma \odot(\neg_d) \circ_2 \odot(\vdash_c), \quad c \leq d \in [\gamma], \quad (1.2.1f)$$

$$\odot(\vdash_d) \circ_1 \odot(\neg_c) \leftrightarrow_\gamma \odot(\vdash_d) \circ_1 \odot(\vdash_c) \leftrightarrow_\gamma \odot(\vdash_d) \circ_2 \odot(\vdash_d), \quad c \leq d \in [\gamma]. \quad (1.2.1g)$$

Our proof of Theorem 1.2.1 does not follow the usual technique consisting in providing a convergent orientation  $\Rightarrow_\gamma$  of  $\leftrightarrow_\gamma$  and proving that its closure  $\sim_\gamma$  admits as many normal forms of arity  $n$  as basis words of  $\text{Dias}_\gamma(n)$  (as for instance in Chapter 4). Instead, we consider the evaluation morphism

$$\text{ev} : \text{FO}(\mathfrak{G}_{\text{Dias}_\gamma}) \rightarrow \text{Dias}_\gamma, \quad (1.2.2)$$

and show that its kernel is generated by  $\mathcal{R}_{\text{Dias}_\gamma}$ . This strategy uses the noteworthy fact that the image of a  $\mathfrak{G}_{\text{Dias}_\gamma}$ -syntax tree  $t$  can be computed as follows. We say that an integer  $a \in \{0\} \sqcup [\gamma]$  is *eligible* for a leaf  $x$  of  $t$  if  $a = 0$  or there is an ancestor  $y$  of  $x$  labeled by  $\neg_a$  (resp.  $\vdash_a$ ) and  $x$  is in the right (resp. left) subtree of  $y$ . The *image* of  $x$  is its greatest eligible integer. Now,  $\text{ev}(t)$  is the word obtained by considering, from left to right, the images of the leaves of  $t$  (see Figure 5.1).

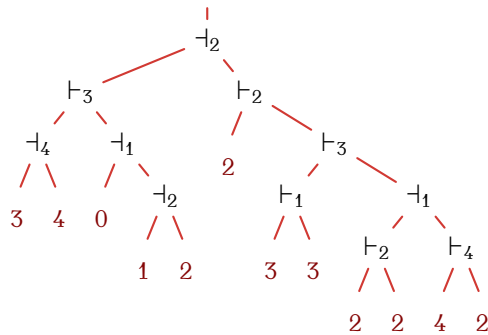

FIGURE 5.1. A  $\mathfrak{G}_{\text{Dias}_\gamma}$ -syntax tree  $t$  where the images of its leaves are shown. This tree satisfies  $\text{ev}(t) = 340122332242$ .



The space of relations  $\mathcal{R}_{\text{Dias}_\gamma}$  of  $\text{Dias}_\gamma$  exhibited by Theorem 1.2.1 can be rephrased in a more compact way as the space generated by

$$\odot (\neg a) \circ_1 \odot (\neg a') - \odot (\neg a') \circ_2 \odot (\neg a), \quad a, a' \in [\gamma], \quad (1.2.3a)$$

$$\odot (\neg a) \circ_1 \odot (\neg a \downarrow a') - \odot (\neg a) \circ_2 \odot (\neg a'), \quad a, a' \in [\gamma], \quad (1.2.3b)$$

$$\odot (\neg a) \circ_1 \odot (\neg a') - \odot (\neg a) \circ_2 \odot (\neg a \downarrow a'), \quad a, a' \in [\gamma], \quad (1.2.3c)$$

$$\odot (\neg a \downarrow a') \circ_1 \odot (\neg a) - \odot (\neg a) \circ_2 \odot (\neg a'), \quad a, a' \in [\gamma], \quad (1.2.3d)$$

$$\odot (\neg a) \circ_1 \odot (\neg a') - \odot (\neg a \downarrow a') \circ_2 \odot (\neg a), \quad a, a' \in [\gamma]. \quad (1.2.3e)$$

### 1.2.2. Koszulity.

**THEOREM 1.2.2.** *For any integer  $\gamma \geq 0$ ,  $\text{Dias}_\gamma$  is a Koszul operad and the set of the  $\mathcal{G}_{\text{Dias}_\gamma}$ -syntax trees avoiding the trees*

$$\odot (\neg a') \circ_2 \odot (\neg a), \quad a, a' \in [\gamma], \quad (1.2.4a)$$

$$\odot (\neg a) \circ_2 \odot (\neg a'), \quad a, a' \in [\gamma], \quad (1.2.4b)$$

$$\odot (\neg a) \circ_1 \odot (\neg a'), \quad a, a' \in [\gamma], \quad (1.2.4c)$$

$$\odot (\neg a) \circ_2 \odot (\neg a'), \quad a, a' \in [\gamma], \quad (1.2.4d)$$

$$\odot (\neg a) \circ_1 \odot (\neg a'), \quad a, a' \in [\gamma], \quad (1.2.4e)$$

is a Poincaré-Birkhoff-Witt basis of  $\text{Dias}_\gamma$ .

**1.2.3. Miscellaneous properties.** We list some secondary properties of  $\text{Dias}_\gamma$ . The definitions of these properties can be found in Section 4.1 of Chapter 2.

**PROPOSITION 1.2.3.** *For any integer  $\gamma \geq 0$ , the group of symmetries of  $\text{Dias}_\gamma$  contains the linear map sending any word of  $\text{Dias}_\gamma$  to its mirror image.*

**PROPOSITION 1.2.4.** *For any integer  $\gamma \geq 0$ , the fundamental basis of  $\text{Dias}_\gamma$  is a basic set-operad basis.*

**PROPOSITION 1.2.5.** *For any integer  $\gamma \geq 0$ ,  $\text{Dias}_\gamma$  is a nontrivially rooted operad for the root map sending any word of  $\text{Dias}_\gamma$  to the position of its 0.*

**1.2.4. Alternative basis.** Let  $\preccurlyeq_\gamma$  be the order relation on the underlying set of  $\text{Dias}_\gamma(n)$ ,  $n \geq 1$ , where for all words  $x$  and  $y$  of  $\text{Dias}_\gamma$  of a same arity  $n$ , we have

$$x \preccurlyeq_\gamma y \quad \text{if } x_i \leq y_i \text{ for all } i \in [n]. \quad (1.2.5)$$

This order relation allows to define for all words  $x$  of  $\text{Dias}_\gamma$  the elements

$$K_x^{(\gamma)} := \sum_{x \preccurlyeq_\gamma x'} \mu_\gamma(x, x') x', \quad (1.2.6)$$

where  $\mu_\gamma$  is the Möbius function of the poset defined by  $\preccurlyeq_\gamma$ . For instance,

$$K_{102}^{(2)} = 102 - 202, \quad (1.2.7a)$$

$$K_{102}^{(3)} = K_{102}^{(4)} = 102 - 103 - 202 + 203, \quad (1.2.7b)$$

$$K_{23102}^{(3)} = 23102 - 23103 - 23202 + 23203 - 33102 + 33103 + 33202 - 33203. \quad (1.2.7c)$$

Since, by Möbius inversion (see Proposition 1.3.2 of Chapter 2), for any word  $x$  of  $\text{Dias}_\gamma$  one has

$$x = \sum_{x \prec_\gamma x'} K_{x'}^{(\gamma)}, \quad (1.2.8)$$

the family of all  $K_x^{(\gamma)}$ , where the  $x$  are words of  $\text{Dias}_\gamma$ , forms by triangularity a basis of  $\text{Dias}_\gamma$ , called the *K-basis*.

Recall that  $\text{ham}(u, v)$  denotes the Hamming distance between the words  $u$  and  $v$  of the same length. For any word  $x$  of  $\text{Dias}_\gamma$  of length  $n$ , we denote by  $\text{Incr}_\gamma(x)$  the set of all words obtained by incrementing by 1 some letters of  $x$  smaller than  $\gamma$  and greater than 0. Proposition 1.1.1 ensures that  $\text{Incr}_\gamma(x)$  is a set of words of  $\text{Dias}_\gamma$ .

PROPOSITION 1.2.6. *For any integer  $\gamma \geq 0$  and any word  $x$  of  $\text{Dias}_\gamma$ ,*

$$K_x^{(\gamma)} = \sum_{x' \in \text{Incr}_\gamma(x)} (-1)^{\text{ham}(x, x')} x'. \quad (1.2.9)$$

To compute a direct expression for the partial composition of  $\text{Dias}_\gamma$  over the K-basis, we have to introduce two notations. If  $x$  is a word of  $\text{Dias}_\gamma$  of length nons maller than 2, we denote by  $\min(x)$  the smallest letter of  $x$  among its letters different from 0. Proposition 1.1.1 ensures that  $\min(x)$  is well-defined. Moreover, for all words  $x$  and  $y$  of  $\text{Dias}_\gamma$ , a position  $i$  such that  $x_i \neq 0$ , and  $\alpha \in [\gamma]$ , we denote by  $x \circ_{\alpha, i} y$  the word  $x \circ_i y$  in which the 0 coming from  $y$  is replaced by  $\alpha$  instead of  $x_i$ .

THEOREM 1.2.7. *For any integer  $\gamma \geq 0$ , the partial composition of  $\text{Dias}_\gamma$  over the K-basis satisfies, for all words  $x$  and  $y$  of  $\text{Dias}_\gamma$  of arities non smaller than 2,*

$$K_x^{(\gamma)} \circ_i K_y^{(\gamma)} = \begin{cases} K_{x \circ_i y}^{(\gamma)} & \text{if } \min(y) > x_i, \\ \sum_{\alpha \in [x_i, \gamma]} K_{x \circ_{\alpha, i} y}^{(\gamma)} & \text{if } \min(y) = x_i, \\ 0 & \text{otherwise } (\min(y) < x_i). \end{cases} \quad (1.2.10)$$

We have for instance

$$K_{20413}^{(5)} \circ_1 K_{304}^{(5)} = K_{3240413}^{(5)}, \quad (1.2.11a)$$

$$K_{20413}^{(5)} \circ_2 K_{304}^{(5)} = K_{2304413}^{(5)}, \quad (1.2.11b)$$

$$K_{20413}^{(5)} \circ_3 K_{304}^{(5)} = 0, \quad (1.2.11c)$$

$$K_{20413}^{(5)} \circ_4 K_{304}^{(5)} = K_{2043143}^{(5)}, \quad (1.2.11d)$$

$$K_{20413}^{(5)} \circ_5 K_{304}^{(5)} = K_{2041334}^{(5)} + K_{2041344}^{(5)} + K_{2041354}^{(5)}. \quad (1.2.11e)$$

Theorem 1.2.7 implies in particular that the structure coefficients of the partial composition of  $\text{Dias}_\gamma$  over the K-basis are 0 or 1. It is possible to define another bases of  $\text{Dias}_\gamma$  by reversing in (1.2.6) the relation  $\prec_\gamma$  and by suppressing or keeping the Möbius function  $\mu_\gamma$ . This gives obviously rise to three other bases. It is worth to note that, as small computations reveal, over all these additional bases, the structure coefficients of the partial composition of  $\text{Dias}_\gamma$  can be negative or different from 1. This observation makes the K-basis even more particular and interesting. It has some other properties, as next section will show.

1.2.5. *Alternative presentation.* The  $K$ -basis introduced in the previous section leads to state a new presentation for  $\text{Dias}_\gamma$  in the following way. For any  $a \in [\gamma]$ , let us denote by  $\dashv_a$  (resp.  $\Vdash_a$ ) the element  $K_{0a}$  (resp.  $K_{a0}$ ) of  $\text{Dias}_\gamma$ . Then, for all  $a \in [\gamma]$  we have

$$\dashv_a = \sum_{a \leq b \in [\gamma]} \dashv_b \quad (1.2.12a)$$

and

$$\Vdash_a = \sum_{a \leq b \in [\gamma]} \Vdash_b, \quad (1.2.12b)$$

and by triangularity, the family

$$\mathfrak{G}'_{\text{Dias}_\gamma} := \{\dashv_a, \Vdash_a : a \in [\gamma]\} \quad (1.2.13)$$

is a generating set of  $\text{Dias}_\gamma$ .

PROPOSITION 1.2.8. *For any integer  $\gamma \geq 0$ , the operad  $\text{Dias}_\gamma$  admits the presentation  $(\mathfrak{G}'_{\text{Dias}_\gamma}, \mathcal{R}'_{\text{Dias}_\gamma})$  where  $\mathcal{R}'_{\text{Dias}_\gamma}$  is the space generated by*

$$\odot (\dashv_a) \circ_1 \odot (\Vdash_{a'}) - \odot (\Vdash_{a'}) \circ_2 \odot (\dashv_a), \quad a, a' \in [\gamma], \quad (1.2.14a)$$

$$\odot (\Vdash_b) \circ_1 \odot (\Vdash_a), \quad a < b \in [\gamma], \quad (1.2.14b)$$

$$\odot (\dashv_b) \circ_2 \odot (\dashv_a), \quad a < b \in [\gamma], \quad (1.2.14c)$$

$$\odot (\Vdash_b) \circ_1 \odot (\dashv_a), \quad a < b \in [\gamma], \quad (1.2.14d)$$

$$\odot (\dashv_b) \circ_2 \odot (\Vdash_a), \quad a < b \in [\gamma], \quad (1.2.14e)$$

$$\odot (\Vdash_a) \circ_1 \odot (\Vdash_b) - \odot (\Vdash_b) \circ_2 \odot (\Vdash_a), \quad a < b \in [\gamma], \quad (1.2.14f)$$

$$\odot (\dashv_b) \circ_1 \odot (\dashv_a) - \odot (\dashv_a) \circ_2 \odot (\dashv_b), \quad a < b \in [\gamma], \quad (1.2.14g)$$

$$\odot (\Vdash_a) \circ_1 \odot (\dashv_b) - \odot (\Vdash_a) \circ_2 \odot (\Vdash_b), \quad a < b \in [\gamma], \quad (1.2.14h)$$

$$\odot (\dashv_a) \circ_1 \odot (\dashv_b) - \odot (\dashv_a) \circ_2 \odot (\Vdash_b), \quad a < b \in [\gamma], \quad (1.2.14i)$$

$$\odot (\Vdash_a) \circ_1 \odot (\Vdash_a) - \left( \sum_{a \leq b \in [\gamma]} \odot (\Vdash_a) \circ_2 \odot (\Vdash_b) \right), \quad a \in [\gamma], \quad (1.2.14j)$$

$$\left( \sum_{a \leq b \in [\gamma]} \odot (\dashv_a) \circ_1 \odot (\dashv_b) \right) - \odot (\dashv_a) \circ_2 \odot (\dashv_a), \quad a \in [\gamma], \quad (1.2.14k)$$

$$\odot (\Vdash_a) \circ_1 \odot (\dashv_a) - \left( \sum_{a \leq b \in [\gamma]} \odot (\Vdash_b) \circ_2 \odot (\Vdash_a) \right), \quad a \in [\gamma], \quad (1.2.14l)$$

$$\left( \sum_{a \leq b \in [\gamma]} \odot (\dashv_b) \circ_1 \odot (\dashv_a) \right) - \odot (\dashv_a) \circ_2 \odot (\Vdash_a), \quad a \in [\gamma]. \quad (1.2.14m)$$

Despite the apparent complexity of the presentation of  $\text{Dias}_\gamma$  exhibited by Proposition 1.2.8, as we will see in Section 4, the Koszul dual of  $\text{Dias}_\gamma$  computed from this presentation has a very simple and manageable expression.

## 2. Pluriassociative algebras

We now focus on algebras over  $\gamma$ -pluriassociative operads. For this purpose, we construct free  $\text{Dias}_\gamma$ -algebras over one generator, and define and study two notions of units for  $\text{Dias}_\gamma$ -algebras. We end this section by introducing a convenient way to define  $\text{Dias}_\gamma$ -algebras and give several examples of such algebras.

**2.1. Category of pluriassociative algebras and free objects.** Let us study the category of  $\text{Dias}_\gamma$ -algebras and the units for algebras in this category.

**2.1.1. Pluriassociative algebras.** We call  *$\gamma$ -pluriassociative algebra* any  $\text{Dias}_\gamma$ -algebra. From the presentation of  $\text{Dias}_\gamma$  provided by Theorem 1.2.1, any  $\gamma$ -pluriassociative algebra is a vector space endowed with linear operations  $\dashv_a, \vdash_a, a \in [\gamma]$ , satisfying the relations encoded by (1.2.3a)—(1.2.3e).

**2.1.2. General definitions.** Let  $\mathcal{P}$  be a  $\gamma$ -pluriassociative algebra. We say that  $\mathcal{P}$  is *commutative* if for all  $x, y \in \mathcal{P}$  and  $a \in [\gamma]$ ,  $x \dashv_a y = y \vdash_a x$ . Besides,  $\mathcal{P}$  is *pure* for all  $a, a' \in [\gamma]$ ,  $a \neq a'$  implies  $\dashv_a \neq \dashv_{a'}$  and  $\vdash_a \neq \vdash_{a'}$ .

Given a subset  $C$  of  $[\gamma]$ , one can keep on the vector space  $\mathcal{P}$  only the operations  $\dashv_a$  and  $\vdash_a$  such that  $a \in C$ . By renumbering the indices of these operations from 1 to  $\#C$  by respecting their former relative numbering, we obtain a  $\#C$ -pluriassociative algebra. We call it the  *$\#C$ -pluriassociative subalgebra induced by  $C$*  of  $\mathcal{P}$ .

**2.1.3. Free pluriassociative algebras.** Recall that  $\mathcal{F}_{\text{Dias}_\gamma}$  denotes the free  $\text{Dias}_\gamma$ -algebra over one generator. By definition,  $\mathcal{F}_{\text{Dias}_\gamma}$  is the linear span of the set of the words on  $\{0\} \sqcup [\gamma]$  with exactly one occurrence of 0. Let us endow this space with the linear operations

$$\dashv_a, \vdash_a: \mathcal{F}_{\text{Dias}_\gamma} \otimes \mathcal{F}_{\text{Dias}_\gamma} \rightarrow \mathcal{F}_{\text{Dias}_\gamma}, \quad a \in [\gamma], \quad (2.1.1)$$

satisfying, for any such words  $u$  and  $v$ ,

$$u \dashv_a v := u h_a(v) \quad (2.1.2a)$$

and

$$u \vdash_a v := h_a(u) v, \quad (2.1.2b)$$

where  $h_a(u)$  (resp.  $h_a(v)$ ) is the word obtained by replacing in  $u$  (resp.  $v$ ) any occurrence of a letter smaller than  $a$  by  $a$ .

**PROPOSITION 2.1.1.** *For any integer  $\gamma \geq 0$ , the vector space  $\mathcal{F}_{\text{Dias}_\gamma}$  of all nonempty words on  $\{0\} \sqcup [\gamma]$  containing exactly one occurrence of 0 endowed with the operations  $\dashv_a, \vdash_a, a \in [\gamma]$ , is the free  $\gamma$ -pluriassociative algebra over one generator.*

One has for instance in  $\mathcal{F}_{\text{Dias}_4}$ ,

$$101241 \dashv_2 203 = 101241223, \quad (2.1.3a)$$

$$101241 \vdash_3 203 = 333343203. \quad (2.1.3b)$$

**2.2. Bar and wire-units.** Loday has defined in [Lod01] some notions of units in diassociative algebras. We generalize here these definitions to the context of  $\gamma$ -pluriassociative algebras.

2.2.1. *Bar-units.* Let  $\mathcal{P}$  be a  $\gamma$ -pluriassociative algebra and  $a \in [\gamma]$ . We say that an element  $e$  of  $\mathcal{P}$  is an  *$a$ -bar-unit*, or simply a *bar-unit* when taking into account the value of  $a$  is not necessary, of  $\mathcal{P}$  if for all  $x \in \mathcal{P}$ ,

$$x \dashv_a e = x = e \vdash_a x. \quad (2.2.1)$$

As we shall see below, a  $\gamma$ -pluriassociative algebra can have, for a given  $a \in [\gamma]$ , several  $a$ -bar-units. The  *$a$ -halo* of  $\mathcal{P}$ , denoted by  $\text{Halo}_a(\mathcal{P})$ , is the set of the  $a$ -bar-units of  $\mathcal{P}$ .

2.2.2. *Wire-units.* Let  $\mathcal{P}$  be a  $\gamma$ -pluriassociative algebra and  $a \in [\gamma]$ . We say that an element  $e$  of  $\mathcal{P}$  is an  *$a$ -wire-unit*, or simply a *wire-unit* when taking into account the value of  $a$  is not necessary, of  $\mathcal{P}$  if for all  $x \in \mathcal{P}$ ,

$$e \dashv_a x = x = x \vdash_a e. \quad (2.2.2)$$

As the following proposition shows, the presence of a wire-unit in  $\mathcal{P}$  has some implications.

**PROPOSITION 2.2.1.** *Let  $\gamma \geq 0$  be an integer and  $\mathcal{P}$  be a  $\gamma$ -pluriassociative algebra admitting a  $b$ -wire-unit  $e$  for a  $b \in [\gamma]$ . Then*

- (i) *for all  $a \in [b]$ , the operations  $\dashv_a$ ,  $\vdash_b$ ,  $\vdash_a$ , and  $\dashv_b$  of  $\mathcal{P}$  are equal;*
- (ii)  *$e$  is also an  $a$ -wire-unit for all  $a \in [b]$ ;*
- (iii)  *$e$  is the only wire-unit of  $\mathcal{P}$ ;*
- (iv) *if  $e'$  is an  $a$ -bar unit for a  $a \in [b]$ , then  $e' = e$ .*

Relying on Proposition 2.2.1, we define the *height* of a  $\gamma$ -pluriassociative algebra  $\mathcal{P}$  as 0 if  $\mathcal{P}$  has no wire-unit, otherwise as the greatest integer  $h \in [\gamma]$  such that the unique wire-unit  $e$  of  $\mathcal{P}$  is a  $h$ -wire-unit. Observe that any pure  $\gamma$ -pluriassociative algebra has height 0 or 1.

**2.3. Construction of pluriassociative algebras.** We now present a general way to construct  $\gamma$ -pluriassociative algebras. Our construction is a natural generalization of some constructions introduced by Loday [Lod01] in the context of diassociative algebras. In this section, we introduce new algebraic structures, the so-called  $\gamma$ -multiprojection algebras, which are inputs of our construction.

2.3.1. *Multiaassociative algebras.* For any integer  $\gamma \geq 0$ , a  *$\gamma$ -multiaassociative algebra* is a vector space  $\mathcal{M}$  endowed with linear operations

$$\star_a : \mathcal{M} \otimes \mathcal{M} \rightarrow \mathcal{M}, \quad a \in [\gamma], \quad (2.3.1)$$

satisfying, for all  $x, y, z \in \mathcal{M}$ , the relations

$$(x \star_a y) \star_b z = (x \star_b y) \star_{a'} z = x \star_{a''} (y \star_b z) = x \star_b (y \star_{a'''} z), \quad a, a', a'', a''' \leq b \in [\gamma]. \quad (2.3.2)$$

These algebras are obvious generalizations of associative algebras since all of its operations are associative. Observe that by (2.3.2), all bracketings of an expression involving elements of a  $\gamma$ -multiaassociative algebra and some of its operations are equal. Then, since the bracketings

of such expressions are not significant, we shall denote these without parenthesis. In upcoming Section 5, we will study the underlying operads of the category of  $\gamma$ -multiassociative algebras, called  $\text{As}_\gamma$ , for a very specific purpose.

If  $\mathcal{M}_1$  and  $\mathcal{M}_2$  are two  $\gamma$ -multiassociative algebras, a linear map  $\phi : \mathcal{M}_1 \rightarrow \mathcal{M}_2$  is a  **$\gamma$ -multiassociative algebra morphism** if it commutes with the operations of  $\mathcal{M}_1$  and  $\mathcal{M}_2$ . We say that  $\mathcal{M}$  is **commutative** when all operations of  $\mathcal{M}$  are commutative. Besides, for an  $a \in [\gamma]$ , an element  $\mathbb{1}$  of  $\mathcal{M}$  is an  **$a$ -unit**, or simply a **unit** when taking into account the value of  $a$  is not necessary, of  $\mathcal{M}$  if for all  $x \in \mathcal{M}$ ,  $\mathbb{1} \star_a x = x = x \star_a \mathbb{1}$ . When  $\mathcal{M}$  admits a unit, we say that  $\mathcal{M}$  is **unital**. As the following proposition shows, the presence of a unit in  $\mathcal{M}$  has some implications.

**PROPOSITION 2.3.1.** *Let  $\gamma \geq 0$  be an integer and  $\mathcal{M}$  be a  $\gamma$ -multiassociative algebra admitting a  $b$ -unit  $\mathbb{1}$  for a  $b \in [\gamma]$ . Then*

- (i) *for all  $a \in [b]$ , the operations  $\star_a$  and  $\star_b$  of  $\mathcal{M}$  are equal;*
- (ii)  *$\mathbb{1}$  is also an  $a$ -unit for all  $a \in [b]$ ;*
- (iii)  *$\mathbb{1}$  is the only unit of  $\mathcal{M}$ .*

Relying on Proposition 2.3.1, similarly to the case of  $\gamma$ -pluriassociative algebras, we define the **height** of a  $\gamma$ -multiassociative algebra  $\mathcal{M}$  as zero if  $\mathcal{M}$  has no unit, otherwise as the greatest integer  $h \in [\gamma]$  such that the unit  $\mathbb{1}$  of  $\mathcal{M}$  is an  $h$ -unit.

**2.3.2. Multiprojection algebras.** A  **$\gamma$ -multiprojection algebra** is a  $\gamma$ -multiassociative algebra  $\mathcal{M}$  endowed with endomorphisms

$$\pi_a : \mathcal{M} \rightarrow \mathcal{M}, \quad a \in [\gamma], \quad (2.3.3)$$

satisfying

$$\pi_a \circ \pi_{a'} = \pi_{a \downarrow a'}, \quad a, a' \in [\gamma]. \quad (2.3.4)$$

By extension, the **height** of  $\mathcal{M}$  is its height as a  $\gamma$ -multiassociative algebra. We say that  $\mathcal{M}$  is **unital** as a  $\gamma$ -multiprojection algebra if  $\mathcal{M}$  is unital as a  $\gamma$ -multiassociative algebra and its only, by Proposition 2.3.1, unit  $\mathbb{1}$  satisfies  $\pi_a(\mathbb{1}) = \mathbb{1}$  for all  $a \in [h]$  where  $h$  is the height of  $\mathcal{M}$ .

**2.3.3. From multiprojection algebras to pluriassociative algebras.** The next result describes how to construct  $\gamma$ -pluriassociative algebras from  $\gamma$ -multiprojection algebras.

**THEOREM 2.3.2.** *For any integer  $\gamma \geq 0$  and any  $\gamma$ -multiprojection algebra  $\mathcal{M}$ , the vector space  $\mathcal{M}$  endowed with binary linear operations  $\dashv_a, \vdash_a$ ,  $a \in [\gamma]$ , defined for all  $x, y \in \mathcal{M}$  by*

$$x \dashv_a y := x \star_a \pi_a(y) \quad (2.3.5a)$$

and

$$x \vdash_a y := \pi_a(x) \star_a y, \quad (2.3.5b)$$

where the  $\star_a$ ,  $a \in [\gamma]$ , are the operations of  $\mathcal{M}$  and the  $\pi_a$ ,  $a \in [\gamma]$ , are its endomorphisms, is a  $\gamma$ -pluriassociative algebra, denoted by  $M(\mathcal{M})$ .

PROOF. This is a verification of the relations of  $\gamma$ -pluriassociative algebras in  $M(\mathcal{M})$ . Let  $x, y$ , and  $z$  be three elements of  $M(\mathcal{M})$  and  $a, a' \in [\gamma]$ .

By (2.3.2), we have

$$(x \vdash_{a'} y) \dashv_a z = \pi_{a'}(x) \star_{a'} y \star_a \pi_a(z) = x \vdash_{a'} (y \dashv_a z), \quad (2.3.6)$$

showing that (1.2.3a) is satisfied in  $M(\mathcal{M})$ .

Moreover, by (2.3.2) and (2.3.4), we have

$$\begin{aligned} x \dashv_a (y \vdash_{a'} z) &= x \star_a \pi_a(\pi_{a'}(y) \star_{a'} z) \\ &= x \star_a \pi_{a \downarrow a'}(y) \star_{a'} \pi_a(z) \\ &= x \star_{a \downarrow a'} \pi_{a \downarrow a'}(y) \star_a \pi_a(z) \\ &= (x \dashv_{a \downarrow a'} y) \dashv_a z, \end{aligned} \quad (2.3.7)$$

so that (1.2.3b), and for the same reasons (1.2.3c), check out in  $M(\mathcal{M})$ .

Finally, again by (2.3.2) and (2.3.4), we have

$$\begin{aligned} x \dashv_a (y \dashv_{a'} z) &= x \star_a \pi_a(y \star_{a'} \pi_{a'}(z)) \\ &= x \star_a \pi_a(y) \star_{a'} \pi_{a \downarrow a'}(z) \\ &= x \star_a \pi_a(y) \star_{a \downarrow a'} \pi_{a \downarrow a'}(z) \\ &= (x \dashv_a y) \dashv_{a \downarrow a'} z, \end{aligned} \quad (2.3.8)$$

showing that (1.2.3d), and for the same reasons (1.2.3e), are satisfied in  $M(\mathcal{M})$ .  $\square$

When  $\mathcal{M}$  is commutative, since for all  $x, y \in M(\mathcal{M})$  and  $a \in [\gamma]$ ,

$$x \dashv_a y = x \star_a \pi_a(y) = \pi_a(y) \star_a x = y \vdash_a x, \quad (2.3.9)$$

it appears that  $M(\mathcal{M})$  is a commutative  $\gamma$ -pluriassociative algebra.

When  $\mathcal{M}$  is unital,  $M(\mathcal{M})$  has several properties, summarized in the next proposition.

PROPOSITION 2.3.3. *Let  $\gamma \geq 0$  be an integer,  $\mathcal{M}$  be a unital  $\gamma$ -multiprojection algebra of height  $h$ . Then, by denoting by  $\mathbb{1}$  the unit of  $\mathcal{M}$  and by  $\pi_a, a \in [\gamma]$ , its endomorphisms,*

- (i) *for any  $a \in [h]$ ,  $\mathbb{1}$  is an  $a$ -bar-unit of  $M(\mathcal{M})$ ;*
- (ii) *for any  $a \leq b \in [h]$ ,  $\text{Halo}_a(M(\mathcal{M}))$  is a subset of  $\text{Halo}_b(M(\mathcal{M}))$ ;*
- (iii) *for any  $a \in [h]$ , the linear span of  $\text{Halo}_a(M(\mathcal{M}))$  forms an  $h-a+1$ -pluriassociative subalgebra of the  $h-a+1$ -pluriassociative subalgebra of  $M(\mathcal{M})$  induced by  $[a, h]$ ;*
- (iv) *for any  $a \in [h]$ ,  $\pi_a$  is the identity map if and only if  $\mathbb{1}$  is an  $a$ -wire-unit of  $M(\mathcal{M})$ .*

2.3.4. *Examples of constructions of pluriassociative algebras.* The construction  $M$  of Theorem 2.3.2 allows to build several  $\gamma$ -pluriassociative algebras. A few examples follow.

*The  $\gamma$ -pluriassociative algebra of positive integers.* Let  $\gamma \geq 1$  be an integer and consider the vector space Pos spanned by positive integers, endowed with the operations  $\star_a, a \in [\gamma]$ , all equal to the operation  $\downarrow$  extended by linearity and with the endomorphisms  $\pi_a, a \in [\gamma]$ , linearly defined for any positive integer  $x$  by  $\pi_a(x) := a \downarrow x$ . Then, Pos is a non-unital  $\gamma$ -multiprojection algebra. By Theorem 2.3.2,  $M(\text{Pos})$  is a  $\gamma$ -pluriassociative algebra. We have for instance

$$2 \dashv_3 5 = 5, \quad (2.3.10a)$$

$$1 \vdash_3 2 = 3. \quad (2.3.10b)$$

We can observe that  $M(\text{Pos})$  is commutative, pure, and its 1-halo is  $\{1\}$ . Moreover, when  $\gamma \geq 2$ ,  $M(\text{Pos})$  has no wire-unit and no  $a$ -bar-unit for  $a \geq 2 \in [\gamma]$ . This example is important because it provides a counterexample for (ii) of Proposition 2.3.3 in the case when the construction  $M$  is applied to a non-unital  $\gamma$ -multiprojection algebra.

*The  $\gamma$ -pluriassociative algebra of finite sets.* Let  $\gamma \geq 1$  be an integer and consider the vector space Sets of finite sets of positive integers, endowed with the operations  $\star_a, a \in [\gamma]$ , all equal to the union operation  $\cup$  extended by linearity and with the endomorphisms  $\pi_a, a \in [\gamma]$ , linearly defined for any finite set of positive integers  $x$  by  $\pi_a(x) := x \cap [a, \gamma]$ . Then, Sets is a  $\gamma$ -multiprojection algebra. By Theorem 2.3.2,  $M(\text{Sets})$  is a  $\gamma$ -pluriassociative algebra. We have for instance

$$\{2, 4\} \dashv_3 \{1, 3, 5\} = \{2, 3, 4, 5\}, \quad (2.3.11a)$$

$$\{1, 2, 4\} \vdash_3 \{1, 3, 5\} = \{1, 3, 4, 5\}. \quad (2.3.11b)$$

We can observe that  $M(\text{Sets})$  is commutative and pure. Moreover,  $\emptyset$  is a 1-wire-unit of  $M(\text{Sets})$  and, by Proposition 2.2.1, it is its only wire-unit. Therefore,  $M(\text{Sets})$  has height 1. Observe that for any  $a \in [\gamma]$ , the  $a$ -halo of  $M(\text{Sets})$  consists in the subsets of  $[a - 1]$ . Besides, since Sets is a unital  $\gamma$ -multiprojection algebra,  $M(\text{Sets})$  satisfies all properties exhibited by Proposition 2.3.3.

*The  $\gamma$ -pluriassociative algebra of words.* Let  $\gamma \geq 1$  be an integer and consider the vector space Words of the words of positive integers. Let us endow Words with the operations  $\star_a, a \in [\gamma]$ , all equal to the concatenation operation extended by linearity and with the endomorphisms  $\pi_a, a \in [\gamma]$ , where for any word  $x$  of positive integers,  $\pi_a(x)$  is the longest subword of  $x$  consisting in letters greater than or equal to  $a$ . Then, Words is a  $\gamma$ -multiprojection algebra. By Theorem 2.3.2,  $M(\text{Words})$  is a  $\gamma$ -pluriassociative algebra. We have for instance

$$412 \dashv_3 14231 = 41243, \quad (2.3.12a)$$

$$11 \vdash_2 323 = 323. \quad (2.3.12b)$$

We can observe that  $M(\text{Words})$  is not commutative and is pure. Moreover,  $\epsilon$  is a 1-wire-unit of  $M(\text{Words})$  and by Proposition 2.2.1, it is its only wire-unit. Therefore,  $M(\text{Words})$  has height 1. Observe that for any  $a \in [\gamma]$ , the  $a$ -halo of  $M(\text{Words})$  consists in the words on the alphabet  $[a - 1]$ . Besides, since Words is a unital  $\gamma$ -multiprojection algebra,  $M(\text{Words})$  satisfies all properties exhibited by Proposition 2.3.3.



The  $\gamma$ -pluriassociative algebras  $M(\text{Sets})$  and  $M(\text{Words})$  are related in the following way. Let  $I_{\text{com}}$  be the subspace of  $M(\text{Words})$  generated by the  $x - x'$  where  $x$  and  $x'$  are words of positive integers and have the same commutative image. Since  $I_{\text{com}}$  is a  $\gamma$ -pluriassociative algebra ideal of  $M(\text{Words})$ , one can consider the quotient  $\gamma$ -pluriassociative algebra  $\text{CWords} := M(\text{Words})/I_{\text{com}}$ . Its elements can be seen as commutative words of positive integers.

Moreover, let  $I_{\text{occ}}$  be the subspace of  $M(\text{CWords})$  generated by the  $x - x'$  where  $x$  and  $x'$  are commutative words of positive integers and for any letter  $a \in [\gamma]$ ,  $a$  appears in  $x$  if and only if  $a$  appears in  $x'$ . Since  $I_{\text{occ}}$  is a  $\gamma$ -pluriassociative algebra ideal of  $M(\text{CWords})$ , one can consider the quotient  $\gamma$ -pluriassociative algebra  $M(\text{CWords})/I_{\text{occ}}$ . Its elements can be seen as finite subsets of positive integers and we observe that  $M(\text{CWords})/I_{\text{occ}} = M(\text{Sets})$ .

*The  $\gamma$ -pluriassociative algebra of marked words.* Let  $\gamma \geq 1$  be an integer and consider the vector space  $M\text{Words}$  of the words of positive integers where letters can be marked or not, with at least one occurrence of a marked letter. We denote by  $\bar{a}$  any *marked letter*  $a$  and we say that the *value* of  $\bar{a}$  is  $a$ . Let us endow  $M\text{Words}$  with the linear operations  $\star_a$ ,  $a \in [\gamma]$ , where for all words  $u$  and  $v$  of  $M\text{Words}$ ,  $u \star_a v$  is obtained by concatenating  $u$  and  $v$ , and by replacing therein all marked letters by  $\bar{c}$  where  $c := \max(u) \downarrow a \downarrow \max(v)$  where  $\max(u)$  (resp.  $\max(v)$ ) denotes the greatest value among the marked letters of  $u$  (resp.  $v$ ). For instance,

$$2\bar{1}3\bar{1}\bar{3} \star_2 3\bar{4}\bar{1}2\bar{1} = 2\bar{4}3\bar{1}\bar{4}3\bar{4}\bar{4}2\bar{1}, \quad (2.3.13a)$$

$$\bar{2}1\bar{1}\bar{1} \star_3 34\bar{2} = \bar{3}1\bar{1}\bar{3}34\bar{3}. \quad (2.3.13b)$$

We also endow  $M\text{Words}$  with the endomorphisms  $\pi_a$ ,  $a \in [\gamma]$ , where for any word  $u$  of  $M\text{Words}$ ,  $\pi_a(u)$  is obtained by replacing in  $u$  any occurrence of a nonmarked letter smaller than  $a$  by  $a$ . For instance,

$$\pi_3 \left( 2\bar{2}14\bar{4}3\bar{5} \right) = 3\bar{2}34\bar{4}3\bar{5}. \quad (2.3.14)$$

One can show without difficulty that  $M\text{Words}$  is a  $\gamma$ -multiprojection algebra. By Theorem 2.3.2,  $M(M\text{Words})$  is a  $\gamma$ -pluriassociative algebra. We have for instance

$$3\bar{2}5 \vdash_3 4\bar{4}1 = 3\bar{4}54\bar{4}3, \quad (2.3.15a)$$

$$1\bar{3}4\bar{1}\bar{3} \vdash_2 31\bar{2}3\bar{1}1 = 2\bar{3}4\bar{3}331\bar{3}3\bar{3}1. \quad (2.3.15b)$$

We can observe that  $M(M\text{Words})$  is not commutative, pure, and has no wire-units neither bar-units.

*The free  $\gamma$ -pluriassociative algebra over one generator.* Let  $\gamma \geq 0$  be an integer. We give here a construction of the free  $\gamma$ -pluriassociative algebra  $\mathcal{F}_{\text{Dias}_\gamma}$  over one generator described in Section 2.1.3 passing through the following  $\gamma$ -multiprojection algebra and the construction  $M$ . Consider the vector space of nonempty words on the alphabet  $\{0\} \sqcup [\gamma]$  with exactly one occurrence of 0, endowed with the operations  $\star_a$ ,  $a \in [\gamma]$ , all equal to the concatenation operation extended by linearity and with the endomorphisms  $h_a$ ,  $a \in [\gamma]$ , defined in Section 2.1.3. This vector space is a  $\gamma$ -multiprojection algebra. Therefore, by Theorem 2.3.2, it gives rise by the construction  $M$  to a  $\gamma$ -pluriassociative algebra and it appears that it is  $\mathcal{F}_{\text{Dias}_\gamma}$ . Besides, we can now observe that  $\mathcal{F}_{\text{Dias}_\gamma}$  is not commutative, pure, and has no wire-units neither bar-units.

### 3. Pluritriassociative operads

We describe in this section a generalization on a nonnegative integer parameter  $\gamma$  of the triassociative operad [LR04].

**3.1. Construction and first properties.** Our original idea of using the T construction (see Section 1.1.1) to obtain a generalization of the diassociative operad admits an analogue in the context of the triassociative operad. Let us describe it.

3.1.1. *Construction.* For any integer  $\gamma \geq 0$ , we define the  $\gamma$ -*pluritriassociative operad*  $\text{Trias}_\gamma$  as the suboperad of  $\text{TML}_\gamma$  generated by

$$\mathfrak{G}_{\text{Trias}_\gamma} := \{0a, 00, a0 : a \in [\gamma]\}. \quad (3.1.1)$$

By definition,  $\text{Trias}_\gamma$  is the vector space of words that can be obtained by partial compositions of words of  $\mathfrak{G}_{\text{Trias}_\gamma}$ . We have, for instance,

$$\text{Trias}_2(1) = \mathbb{K} \langle \{0\} \rangle, \quad (3.1.2a)$$

$$\text{Trias}_2(2) = \mathbb{K} \langle \{00, 01, 02, 10, 20\} \rangle, \quad (3.1.2b)$$

$$\begin{aligned} \text{Trias}_2(3) = \mathbb{K} \langle \{000, 001, 002, 010, 011, 012, 020, 021, \\ 022, 100, 101, 102, 110, 120, 200, 201, 202, 210, 220\} \rangle, \end{aligned} \quad (3.1.2c)$$

3.1.2. *First properties.* In the first place, observe that  $\text{Trias}_1$  is the operad  $\text{Tr}$  defined in Chapter 4. For this reason,  $\text{Trias}_1$  is the triassociative operad  $\text{Trias}$ . Moreover, observe that  $\text{Trias}_0$  is the trivial operad and that  $\text{Trias}_\gamma$  is a suboperad of  $\text{Trias}_{\gamma+1}$ . Then, for all integers  $\gamma \geq 0$ , the operads  $\text{Trias}_\gamma$  are generalizations of the triassociative operad. Observe that since  $\mathfrak{G}_{\text{Trias}_\gamma} = \mathfrak{G}_{\text{Dias}_\gamma} \sqcup \{00\}$ ,  $\text{Dias}_\gamma$  is a suboperad of  $\text{Trias}_\gamma$ . Finally, remark that the fundamental basis of  $\text{Trias}_\gamma$  is a set-operad basis.

3.1.3. *Elements and dimensions.*

PROPOSITION 3.1.1. *For any integer  $\gamma \geq 0$ , the fundamental basis of  $\text{Trias}_\gamma$  is the set of all the words on the alphabet  $\{0\} \sqcup [\gamma]$  containing at least one occurrence of 0.*

We deduce from Proposition 3.1.1 that the Hilbert series of  $\text{Trias}_\gamma$  satisfies

$$\mathcal{H}_{\text{Trias}_\gamma}(t) = \frac{t}{(1 - \gamma t)(1 - \gamma t - t)} \quad (3.1.3)$$

and that for all  $n \geq 1$ ,  $\dim \text{Trias}_\gamma(n) = (\gamma + 1)^n - \gamma^n$ . For instance, the first dimensions of  $\text{Trias}_1$ ,  $\text{Trias}_2$ ,  $\text{Trias}_3$ , and  $\text{Trias}_4$  are respectively

$$1, 3, 7, 15, 31, 63, 127, 255, 511, 1023, 2047, \quad (3.1.4a)$$

$$1, 5, 19, 65, 211, 665, 2059, 6305, 19171, 58025, 175099, \quad (3.1.4b)$$

$$1, 7, 37, 175, 781, 3367, 14197, 58975, 242461, 989527, 4017157, \quad (3.1.4c)$$

$$1, 9, 61, 369, 2101, 11529, 61741, 325089, 1690981, 8717049, 44633821. \quad (3.1.4d)$$

These sequences are respectively Sequences A000225, A001047, A005061, and A005060 of [Slo].

**3.2. Additional properties.** We exhibit here a presentation of  $\text{Trias}_\gamma$  and establish the fact that it is a Koszul operad.

3.2.1. *Presentation by generators and relations.* For any  $a \in [\gamma]$ , let us denote by  $\neg a$  (resp.  $\vdash_a, \perp$ ) the generator  $0a$  (resp.  $a0, 00$ ) of  $\text{Trias}_\gamma$ .

**THEOREM 3.2.1.** *For any integer  $\gamma \geq 0$ , the operad  $\text{Trias}_\gamma$  admits the presentation  $(\mathfrak{G}_{\text{Trias}_\gamma}, \mathfrak{R}_{\text{Trias}_\gamma})$  where  $\mathfrak{R}_{\text{Trias}_\gamma}$  is the space induced by the equivalence relation  $\leftrightarrow_\gamma$  satisfying*

$$\begin{aligned} \circlearrowleft(\perp) \circ_1 \circlearrowleft(\perp) &\leftrightarrow_\gamma \circlearrowleft(\perp) \circ_2 \circlearrowleft(\perp), & (3.2.1a) \\ \circlearrowleft(\neg a) \circ_1 \circlearrowleft(\perp) &\leftrightarrow_\gamma \circlearrowleft(\perp) \circ_2 \circlearrowleft(\neg a), & a \in [\gamma], & (3.2.1b) \\ \circlearrowleft(\perp) \circ_1 \circlearrowleft(\vdash_a) &\leftrightarrow_\gamma \circlearrowleft(\vdash_a) \circ_2 \circlearrowleft(\perp), & a \in [\gamma], & (3.2.1c) \\ \circlearrowleft(\perp) \circ_1 \circlearrowleft(\neg a) &\leftrightarrow_\gamma \circlearrowleft(\perp) \circ_2 \circlearrowleft(\vdash_a), & a \in [\gamma], & (3.2.1d) \\ \circlearrowleft(\neg a) \circ_1 \circlearrowleft(\vdash_{a'}) &\leftrightarrow_\gamma \circlearrowleft(\vdash_{a'}) \circ_2 \circlearrowleft(\neg a), & a, a' \in [\gamma], & (3.2.1e) \\ \circlearrowleft(\neg a) \circ_1 \circlearrowleft(\neg b) &\leftrightarrow_\gamma \circlearrowleft(\neg a) \circ_2 \circlearrowleft(\vdash_b), & a < b \in [\gamma], & (3.2.1f) \\ \circlearrowleft(\vdash_a) \circ_1 \circlearrowleft(\neg b) &\leftrightarrow_\gamma \circlearrowleft(\vdash_a) \circ_2 \circlearrowleft(\vdash_b), & a < b \in [\gamma], & (3.2.1g) \\ \circlearrowleft(\neg b) \circ_1 \circlearrowleft(\neg a) &\leftrightarrow_\gamma \circlearrowleft(\neg a) \circ_2 \circlearrowleft(\neg b), & a < b \in [\gamma], & (3.2.1h) \\ \circlearrowleft(\vdash_a) \circ_1 \circlearrowleft(\vdash_b) &\leftrightarrow_\gamma \circlearrowleft(\vdash_b) \circ_2 \circlearrowleft(\vdash_a), & a < b \in [\gamma], & (3.2.1i) \\ \circlearrowleft(\neg d) \circ_1 \circlearrowleft(\neg d) &\leftrightarrow_\gamma \circlearrowleft(\neg d) \circ_2 \circlearrowleft(\perp) \leftrightarrow_\gamma \circlearrowleft(\neg d) \circ_2 \circlearrowleft(\neg c) \leftrightarrow_\gamma \circlearrowleft(\neg d) \circ_2 \circlearrowleft(\vdash_c), & c \leq d \in [\gamma], & (3.2.1j) \\ \circlearrowleft(\vdash_d) \circ_1 \circlearrowleft(\neg c) &\leftrightarrow_\gamma \circlearrowleft(\vdash_d) \circ_1 \circlearrowleft(\vdash_c) \leftrightarrow_\gamma \circlearrowleft(\vdash_d) \circ_1 \circlearrowleft(\perp) \leftrightarrow_\gamma \circlearrowleft(\vdash_d) \circ_2 \circlearrowleft(\vdash_d), & c \leq d \in [\gamma]. & (3.2.1k) \end{aligned}$$

In the same fashion as we have done for Theorem 1.2.1, our proof of Theorem 3.2.1 is based upon the computation of the kernel of the evaluation morphism

$$\text{ev} : \text{FO}(\mathfrak{G}_{\text{Trias}_\gamma}) \rightarrow \text{Trias}_\gamma. \tag{3.2.2}$$

In this case, the image of a  $\mathfrak{G}_{\text{Trias}_\gamma}$ -syntax tree  $t$  can be computed in the same way as in the case of  $\mathfrak{G}_{\text{Dias}_\gamma}$ -syntax trees (see Section 1.2.1). The internal nodes of  $t$  labeled by  $\perp$  do not play any role in this computation (see Figure 5.2).

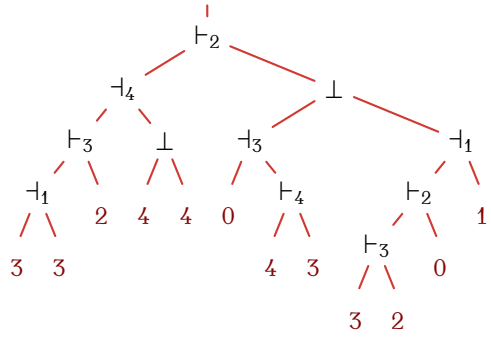

FIGURE 5.2. A  $\mathfrak{G}_{\text{Trias}_\gamma}$ -syntax tree  $t$  where the images of its leaves are shown. This tree satisfies  $\text{ev}(t) = 332440433201$ .

The space of relations  $\mathcal{R}_{\text{Trias}_\gamma}$  of  $\text{Trias}_\gamma$  exhibited by Theorem 3.2.1 can be rephrased a bit more concisely as the space generated by

$$\odot(\perp) \circ_1 \odot(\perp) - \odot(\perp) \circ_2 \odot(\perp), \quad (3.2.3a)$$

$$\odot(\neg a) \circ_1 \odot(\perp) - \odot(\perp) \circ_2 \odot(\neg a), \quad a \in [\gamma], \quad (3.2.3b)$$

$$\odot(\perp) \circ_1 \odot(\vdash a) - \odot(\vdash a) \circ_2 \odot(\perp), \quad a \in [\gamma], \quad (3.2.3c)$$

$$\odot(\perp) \circ_1 \odot(\neg a) - \odot(\perp) \circ_2 \odot(\vdash a), \quad a \in [\gamma], \quad (3.2.3d)$$

$$\odot(\neg a) \circ_1 \odot(\vdash a') - \odot(\vdash a') \circ_2 \odot(\neg a), \quad a, a' \in [\gamma], \quad (3.2.3e)$$

$$\odot(\neg a) \circ_1 \odot(\neg a \downarrow a') - \odot(\neg a) \circ_2 \odot(\vdash a'), \quad a, a' \in [\gamma], \quad (3.2.3f)$$

$$\odot(\vdash a) \circ_1 \odot(\neg a') - \odot(\vdash a) \circ_2 \odot(\vdash a \downarrow a'), \quad a, a' \in [\gamma], \quad (3.2.3g)$$

$$\odot(\neg a \downarrow a') \circ_1 \odot(\neg a) - \odot(\neg a) \circ_2 \odot(\neg a'), \quad a, a' \in [\gamma], \quad (3.2.3h)$$

$$\odot(\vdash a) \circ_1 \odot(\vdash a') - \odot(\vdash a \downarrow a') \circ_2 \odot(\vdash a), \quad a, a' \in [\gamma], \quad (3.2.3i)$$

$$\odot(\neg a) \circ_1 \odot(\neg a) - \odot(\neg a) \circ_2 \odot(\perp), \quad a \in [\gamma], \quad (3.2.3j)$$

$$\odot(\vdash a) \circ_2 \odot(\vdash a) - \odot(\vdash a) \circ_1 \odot(\perp). \quad a \in [\gamma]. \quad (3.2.3k)$$

### 3.2.2. Koszulity.

**THEOREM 3.2.2.** *For any integer  $\gamma \geq 0$ ,  $\text{Trias}_\gamma$  is a Koszul operad and the set of the  $\mathfrak{G}_{\text{Trias}_\gamma}$ -syntax trees avoiding the trees*

$$\odot(\perp) \circ_2 \odot(\perp), \quad (3.2.4a)$$

$$\odot(\neg a) \circ_1 \odot(\perp) \quad a \in [\gamma], \quad (3.2.4b)$$

$$\odot(\vdash a) \circ_2 \odot(\perp), \quad a \in [\gamma], \quad (3.2.4c)$$

$$\odot(\perp) \circ_2 \odot(\vdash a), \quad a \in [\gamma], \quad (3.2.4d)$$

$$\odot(\vdash a') \circ_2 \odot(\neg a), \quad a, a' \in [\gamma], \quad (3.2.4e)$$

$$\odot(\neg a) \circ_2 \odot(\vdash a'), \quad a, a' \in [\gamma], \quad (3.2.4f)$$

$$\odot(\vdash a) \circ_1 \odot(\neg a'), \quad a, a' \in [\gamma], \quad (3.2.4g)$$

$$\odot(\neg a) \circ_2 \odot(\neg a'), \quad a, a' \in [\gamma], \quad (3.2.4h)$$

$$\odot(\vdash a) \circ_1 \odot(\vdash a'), \quad a, a' \in [\gamma], \quad (3.2.4i)$$

$$\odot(\neg a) \circ_2 \odot(\perp), \quad a \in [\gamma], \quad (3.2.4j)$$

$$\odot(\vdash a) \circ_1 \odot(\perp), \quad a \in [\gamma]. \quad (3.2.4k)$$

is a Poincaré-Birkhoff-Witt basis of  $\text{Trias}_\gamma$ .

## 4. Polydendriform operads

We introduce at this point our generalization on a nonnegative integer parameter  $\gamma$  of the dendriform operad and dendriform algebras. We first construct this operad, compute its dimensions, and give then two presentations by generators and relations. This section ends by a description of free algebras over one generator in the category encoded by our generalization.

**4.1. Construction and properties.** Theorem 1.2.1, by exhibiting a presentation of  $\text{Dias}_\gamma$ , shows that this operad is binary and quadratic. It then admits a Koszul dual, denoted by  $\text{Dendr}_\gamma$  and called  *$\gamma$ -polydendriform operad*.

4.1.1. *Definition and presentation.* A description of  $\text{Dendr}_\gamma$  is provided by the following presentation by generators and relations.

**THEOREM 4.1.1.** *For any integer  $\gamma \geq 0$ , the operad  $\text{Dendr}_\gamma$  admits the presentation  $(\mathfrak{G}_{\text{Dendr}_\gamma}, \mathfrak{R}_{\text{Dendr}_\gamma})$  where  $\mathfrak{G}_{\text{Dendr}_\gamma} := \mathfrak{G}_{\text{Dendr}_\gamma}(2) := \{\leftarrow_a, \rightarrow_a : a \in [\gamma]\}$  and  $\mathfrak{R}_{\text{Dendr}_\gamma}$  is the space generated by*

$$\circledast (\leftarrow_a) \circ_1 \circledast (\rightarrow_{a'}) - \circledast (\rightarrow_{a'}) \circ_2 \circledast (\leftarrow_a), \quad a, a' \in [\gamma], \quad (4.1.1a)$$

$$\circledast (\leftarrow_a) \circ_1 \circledast (\leftarrow_b) - \circledast (\leftarrow_a) \circ_2 \circledast (\rightarrow_b), \quad a < b \in [\gamma], \quad (4.1.1b)$$

$$\circledast (\rightarrow_a) \circ_1 \circledast (\leftarrow_b) - \circledast (\rightarrow_a) \circ_2 \circledast (\rightarrow_b), \quad a < b \in [\gamma], \quad (4.1.1c)$$

$$\circledast (\leftarrow_a) \circ_1 \circledast (\leftarrow_b) - \circledast (\leftarrow_a) \circ_2 \circledast (\leftarrow_b), \quad a < b \in [\gamma], \quad (4.1.1d)$$

$$\circledast (\rightarrow_a) \circ_1 \circledast (\rightarrow_b) - \circledast (\rightarrow_a) \circ_2 \circledast (\rightarrow_b), \quad a < b \in [\gamma], \quad (4.1.1e)$$

$$\circledast (\leftarrow_d) \circ_1 \circledast (\leftarrow_d) - \left( \sum_{c \in [d]} \circledast (\leftarrow_d) \circ_2 \circledast (\leftarrow_c) + \circledast (\leftarrow_d) \circ_2 \circledast (\rightarrow_c) \right), \quad d \in [\gamma], \quad (4.1.1f)$$

$$\left( \sum_{c \in [d]} \circledast (\rightarrow_d) \circ_1 \circledast (\rightarrow_c) + \circledast (\rightarrow_d) \circ_1 \circledast (\leftarrow_c) \right) - \circledast (\rightarrow_d) \circ_2 \circledast (\rightarrow_d), \quad d \in [\gamma]. \quad (4.1.1g)$$

Theorem 4.1.1 provides a quite complicated presentation of  $\text{Dendr}_\gamma$ . We shall define below a more convenient basis for the space of relations of  $\text{Dendr}_\gamma$ .

4.1.2. *Elements and dimensions.*

**PROPOSITION 4.1.2.** *For any integer  $\gamma \geq 0$ , the Hilbert series  $\mathcal{H}_{\text{Dendr}_\gamma}(t)$  of the operad  $\text{Dendr}_\gamma$  satisfies*

$$t + (2\gamma t - 1) \mathcal{H}_{\text{Dendr}_\gamma}(t) + \gamma^2 t \mathcal{H}_{\text{Dendr}_\gamma}(t)^2 = 0. \quad (4.1.2)$$

**PROOF.** Let  $G(t)$  be the generating series such that  $G(-t)$  satisfies (4.1.2). Therefore,  $G(t)$  satisfies

$$t = \frac{-G(t)}{(1 + \gamma G(t))^2}. \quad (4.1.3)$$

Moreover, by setting  $F(t) := \mathcal{H}_{\text{Dias}_\gamma}(-t)$ , where  $\mathcal{H}_{\text{Dias}_\gamma}(t)$  is the Hilbert series of  $\text{Dias}_\gamma$  defined by (1.1.4), we have

$$F(G(t)) = \frac{-G(t)}{(1 + \gamma G(t))^2} = t, \quad (4.1.4)$$

showing that  $F(t)$  and  $G(t)$  are the inverses for each other for series composition.

Now, since by Theorem 1.2.2 and Proposition 1.1.1,  $\text{Dias}_\gamma$  is a Koszul operad and its Hilbert series is  $\mathcal{H}_{\text{Dias}_\gamma}(t)$ , and since  $\text{Dendr}_\gamma$  is by definition the Koszul dual of  $\text{Dias}_\gamma$ , the Hilbert series of these two operads satisfy Relation (4.1.23) of Chapter 2. Therefore, (4.1.4) implies that the Hilbert series of  $\text{Dendr}_\gamma$  is  $\mathcal{H}_{\text{Dendr}_\gamma}(t)$ .  $\square$

By examining the expression for  $\mathcal{H}_{\text{Dendr}_\gamma}(t)$  of the statement of Proposition 4.1.2, we observe that for any  $n \geq 1$ ,  $\text{Dendr}_\gamma(n)$  can be seen as the vector space  $\mathcal{F}_{\text{Dendr}_\gamma}(n)$  of all binary trees with  $n$  internal nodes wherein its  $n - 1$  edges connecting two internal nodes are labeled on  $[\gamma]$ . We call these trees  *$\gamma$ -edge valued binary trees*. In our graphical representations of  $\gamma$ -edge valued binary trees, any edge label is drawn into a hexagon located half the edge (see Figure 5.3).

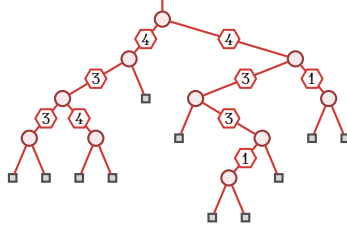

FIGURE 5.3. A 4-edge valued binary tree of arity 10. This tree is a basis element of  $\text{Dendr}_4(10)$ .

We deduce from Proposition 4.1.2 that the Hilbert series of  $\text{Dendr}_\gamma$  satisfies

$$\mathcal{H}_{\text{Dendr}_\gamma}(t) = \frac{1 - \sqrt{1 - 4\gamma t} - 2\gamma t}{2\gamma^2 t}, \tag{4.1.5}$$

and we also obtain that for all  $n \geq 1$ ,  $\dim \text{Dendr}_\gamma(n) = \gamma^{n-1} \text{cat}(n)$  where  $\text{cat}(n)$  is the number  $\frac{1}{n+1} \binom{2n}{n}$  of binary trees with  $n$  internal nodes. For instance, the first dimensions of  $\text{Dendr}_1$ ,  $\text{Dendr}_2$ ,  $\text{Dendr}_3$ , and  $\text{Dendr}_4$  are respectively

$$1, 2, 5, 14, 42, 132, 429, 1430, 4862, 16796, 58786, \tag{4.1.6a}$$

$$1, 4, 20, 112, 672, 4224, 27456, 183040, 1244672, 8599552, 60196864, \tag{4.1.6b}$$

$$1, 6, 45, 378, 3402, 32076, 312741, 3127410, 31899582, 330595668, 3471254514, \tag{4.1.6c}$$

$$1, 8, 80, 896, 10752, 135168, 1757184, 23429120, 318636032, 4402970624, 61641588736. \tag{4.1.6d}$$

These sequences are respectively Sequences **A000108**, **A003645**, **A101600**, and **A269796** of **[Slo]**.

4.1.3. *Associative operations.* In the same manner as in the dendriform operad the sum of its two operations produces an associative operation, in the  $\gamma$ -dendriform operad there is a way to build associative operations, as the next statement shows.

PROPOSITION 4.1.3. *For any integers  $\gamma \geq 0$  and  $b \in [\gamma]$ , the element*

$$\bullet_b := \sum_{a \in [b]} \leftarrow_a + \rightarrow_a \tag{4.1.7}$$

*of  $\text{Dendr}_\gamma$  is associative.*

4.1.4. *Alternative presentation.* For any integer  $\gamma \geq 0$ , let  $\leftarrow_b$  and  $\rightarrow_b$ ,  $b \in [\gamma]$ , be the elements of  $\text{Dendr}_\gamma$  defined by

$$\leftarrow_b := \sum_{a \in [b]} \leftarrow_a, \quad (4.1.8a)$$

and

$$\rightarrow_b := \sum_{a \in [b]} \rightarrow_a. \quad (4.1.8b)$$

Then, since for all  $b \in [\gamma]$  we have

$$\leftarrow_b = \begin{cases} \leftarrow_1 & \text{if } b = 1, \\ \leftarrow_b - \leftarrow_{b-1} & \text{otherwise,} \end{cases} \quad (4.1.9a)$$

and

$$\rightarrow_b = \begin{cases} \rightarrow_1 & \text{if } b = 1, \\ \rightarrow_b - \rightarrow_{b-1} & \text{otherwise,} \end{cases} \quad (4.1.9b)$$

by triangularity, the family

$$\mathfrak{G}'_{\text{Dendr}_\gamma} := \{\leftarrow_b, \rightarrow_b : b \in [\gamma]\} \quad (4.1.10)$$

is a generating set of  $\text{Dendr}_\gamma$ . Remark that this change of basis from is similar to the change of basis of  $\text{Dias}_\gamma$  considered in Section 1.2.5. Let us now express a presentation of  $\text{Dendr}_\gamma$  through the family  $\mathfrak{G}'_{\text{Dendr}_\gamma}$ .

**THEOREM 4.1.4.** *For any integer  $\gamma \geq 0$ , the operad  $\text{Dendr}_\gamma$  admits the presentation  $(\mathfrak{G}'_{\text{Dendr}_\gamma}, \mathcal{R}'_{\text{Dendr}_\gamma})$  where  $\mathcal{R}'_{\text{Dendr}_\gamma}$  is the space generated by*

$$\odot(\leftarrow_a) \circ_1 \odot(\rightarrow_{a'}) - \odot(\rightarrow_{a'}) \circ_2 \odot(\leftarrow_a), \quad a, a' \in [\gamma], \quad (4.1.11a)$$

$$\odot(\leftarrow_a) \circ_1 \odot(\leftarrow_b) - \odot(\leftarrow_a) \circ_2 \odot(\rightarrow_b) - \odot(\leftarrow_a) \circ_2 \odot(\leftarrow_a), \quad a < b \in [\gamma], \quad (4.1.11b)$$

$$\odot(\rightarrow_a) \circ_1 \odot(\rightarrow_a) + \odot(\rightarrow_a) \circ_1 \odot(\leftarrow_b) - \odot(\rightarrow_a) \circ_2 \odot(\rightarrow_b), \quad a < b \in [\gamma], \quad (4.1.11c)$$

$$\odot(\leftarrow_b) \circ_1 \odot(\leftarrow_a) - \odot(\leftarrow_a) \circ_2 \odot(\leftarrow_b) - \odot(\leftarrow_a) \circ_2 \odot(\rightarrow_a), \quad a < b \in [\gamma], \quad (4.1.11d)$$

$$\odot(\rightarrow_a) \circ_1 \odot(\leftarrow_a) + \odot(\rightarrow_a) \circ_1 \odot(\rightarrow_b) - \odot(\rightarrow_b) \circ_2 \odot(\rightarrow_a), \quad a < b \in [\gamma], \quad (4.1.11e)$$

$$\odot(\leftarrow_a) \circ_1 \odot(\leftarrow_a) - \odot(\leftarrow_a) \circ_2 \odot(\rightarrow_a) - \odot(\leftarrow_a) \circ_2 \odot(\leftarrow_a), \quad a \in [\gamma], \quad (4.1.11f)$$

$$\odot(\rightarrow_a) \circ_1 \odot(\rightarrow_a) + \odot(\rightarrow_a) \circ_1 \odot(\leftarrow_a) - \odot(\rightarrow_a) \circ_2 \odot(\rightarrow_a), \quad a \in [\gamma]. \quad (4.1.11g)$$

**PROOF.** Let us show that  $\mathcal{R}'_{\text{Dendr}_\gamma}$  is equal to the space of relations  $\mathcal{R}_{\text{Dendr}_\gamma}$  of  $\text{Dendr}_\gamma$  defined in the statement of Theorem 4.1.1. By this last theorem, for any  $x \in \text{FO}(\mathfrak{G}_{\text{Dendr}_\gamma})(3)$ ,  $x$  is in  $\mathcal{R}_{\text{Dendr}_\gamma}$  if and only if  $\text{ev}(x) = 0$ . By straightforward computations, by expanding any element  $x$  of (4.1.11a)—(4.1.11g) over the elements  $\leftarrow_a, \rightarrow_a$ ,  $a \in [\gamma]$ , by using (4.1.8a) and (4.1.8b) we obtain that  $x$  can be expressed as a sum of elements of  $\mathcal{R}_{\text{Dendr}_\gamma}$ . This implies that  $\text{ev}(x) = 0$  and hence that  $\mathcal{R}'_{\text{Dendr}_\gamma}$  is a subspace of  $\mathcal{R}_{\text{Dendr}_\gamma}$ . Now, one can observe that elements (4.1.11a)—(4.1.11f) are linearly independent. Then,  $\mathcal{R}'_{\text{Dendr}_\gamma}$  has dimension  $3\gamma^2$  which is also, by Theorem 4.1.1, the dimension of  $\mathcal{R}_{\text{Dendr}_\gamma}$ . The statement of the theorem follows.  $\square$

The presentation of  $\text{Dendr}_\gamma$  provided by Theorem 4.1.4 is easier to handle than the one provided by Theorem 4.1.1. The main reason is that Relations (4.1.1f) and (4.1.1g) of the first presentation involve a nonconstant number of terms, while all relations of this second presentation always involve only two or three terms. As a very remarkable fact, it is worthwhile to note that the presentation of  $\text{Dendr}_\gamma$  provided by Theorem 4.1.4 can be directly obtained by considering the Koszul dual of  $\text{Dias}_\gamma$  over the  $K$ -basis (see Sections 1.2.4 and 1.2.5). Therefore, an alternative way to establish this presentation consists in computing the Koszul dual of  $\text{Dias}_\gamma$  seen through the presentation having  $\mathcal{R}'_{\text{Dendr}_\gamma}$  as space of relations, which is made of the relations of  $\text{Dias}_\gamma$  expressed over the  $K$ -basis (see Proposition 1.2.8).

From now on,  $\uparrow$  denotes the operation min on integers. Using this notation, the space of relations  $\mathcal{R}'_{\text{Dendr}_\gamma}$  of  $\text{Dendr}_\gamma$  exhibited by Theorem 4.1.4 can be rephrased in a more compact way as the space generated by

$$\odot(\prec_a) \circ_1 \odot(\succ_{a'}) - \odot(\succ_{a'}) \circ_2 \odot(\prec_a), \quad a, a' \in [\gamma], \quad (4.1.12a)$$

$$\odot(\prec_a) \circ_1 \odot(\prec_{a'}) - \odot(\prec_{a\uparrow a'}) \circ_2 \odot(\prec_a) - \odot(\prec_{a\uparrow a'}) \circ_2 \odot(\succ_{a'}), \quad a, a' \in [\gamma], \quad (4.1.12b)$$

$$\odot(\succ_{a\uparrow a'}) \circ_1 \odot(\prec_{a'}) + \odot(\succ_{a\uparrow a'}) \circ_1 \odot(\succ_a) - \odot(\succ_a) \circ_2 \odot(\succ_{a'}), \quad a, a' \in [\gamma]. \quad (4.1.12c)$$

Over the family  $\mathcal{G}'_{\text{Dendr}_\gamma}$ , one can build associative operations in  $\text{Dendr}_\gamma$  in the following way.

**PROPOSITION 4.1.5.** *For any integers  $\gamma \geq 0$  and  $b \in [\gamma]$ , the element*

$$\odot_b := \prec_b + \succ_b \quad (4.1.13)$$

*of  $\text{Dendr}_\gamma$  is associative. Moreover, any associative element of  $\text{Dendr}_\gamma$  is proportional to  $\odot_b$  for  $a, b \in [\gamma]$ .*

**4.2. Category of polydendriform algebras and free objects.** The aim of this section is to describe the category of  $\text{Dendr}_\gamma$ -algebras and more particularly the free  $\text{Dendr}_\gamma$ -algebra over one generator.

**4.2.1. Polydendriform algebras.** We call  *$\gamma$ -polydendriform algebra* any  $\text{Dendr}_\gamma$ -algebra. From the presentation of  $\text{Dendr}_\gamma$  provided by Theorem 4.1.1, any  $\gamma$ -polydendriform algebra is a vector space endowed with linear operations  $\prec_a, \rightarrow_a, a \in [\gamma]$ , satisfying the relations encoded by (4.1.1a)–(4.1.1g). By considering the presentation of  $\text{Dendr}_\gamma$  exhibited by Theorem 4.1.4, any  $\gamma$ -polydendriform algebra is a vector space endowed with linear operations  $\prec_a, \succ_a, a \in [\gamma]$ , satisfying the relations encoded by (4.1.12a)–(4.1.12c).

**4.2.2. Two ways to split associativity.** Like dendriform algebras, which offer a way to split an associative operation into two parts,  $\gamma$ -polydendriform algebras propose two ways to split associativity depending on its chosen presentation.

On the one hand, in a  $\gamma$ -polydendriform algebra  $\mathcal{D}$  over the operations  $\prec_a, \rightarrow_a, a \in [\gamma]$ , by Proposition 4.1.3, an associative operation  $\bullet$  is split into the  $2\gamma$  operations  $\prec_a, \rightarrow_a, a \in [\gamma]$ , so that for all  $x, y \in \mathcal{D}$ ,

$$x \bullet y = \sum_{a \in [\gamma]} x \prec_a y + x \rightarrow_a y, \quad (4.2.1)$$





For example, we have

(4.2.6a)

(4.2.6b)

**THEOREM 4.2.1.** *For any integer  $\gamma \geq 0$ , the vector space  $\mathcal{F}_{\text{Dendr}_\gamma}$  of all  $\gamma$ -edge valued binary trees endowed with the operations  $\langle_a, \rangle_a, a \in [\gamma]$ , is the free  $\gamma$ -polydendriform algebra over one generator.*

### 5. Multiassociative operads

There is a well-known diagram, whose definition is recalled below, gathering the diasociative, associative, and dendriform operads. The main goal of this section is to define a generalization on a nonnegative integer parameter of the associative operad to obtain a new version of this diagram, suited to the context of pluriassociative and polydendriform operads.

**5.1. Two generalizations of the associative operad.** The associative operad is generated by one binary element. This operad admits two different generalizations generated by  $\gamma$  binary elements with the particularity that one is the Koszul dual of the other. In this section, we introduce and study these two operads.

5.1.1. *Multiassociative operads.* For any integer  $\gamma \geq 0$ , we define the  $\gamma$ -multiassociative operad  $\text{As}_\gamma$  as the operad admitting the presentation  $(\mathfrak{G}_{\text{As}_\gamma}, \mathfrak{R}_{\text{As}_\gamma})$ , where

$$\mathfrak{G}_{\text{As}_\gamma} := \mathfrak{G}_{\text{As}_\gamma}(2) := \{\star_a : a \in [\gamma]\} \tag{5.1.1}$$

and  $\mathfrak{R}_{\text{As}_\gamma}$  is generated by

$$\odot(\star_a) \circ_1 \odot(\star_b) - \odot(\star_b) \circ_2 \odot(\star_a), \quad a \leq b \in [\gamma], \tag{5.1.2a}$$

$$\odot(\star_b) \circ_1 \odot(\star_a) - \odot(\star_b) \circ_2 \odot(\star_a), \quad a < b \in [\gamma], \tag{5.1.2b}$$

$$\odot(\star_a) \circ_2 \odot(\star_b) - \odot(\star_b) \circ_2 \odot(\star_a), \quad a < b \in [\gamma], \tag{5.1.2c}$$

$$\odot(\star_b) \circ_2 \odot(\star_a) - \odot(\star_b) \circ_2 \odot(\star_b), \quad a < b \in [\gamma]. \tag{5.1.2d}$$

This space of relations can be rephrased in a more compact way as the space generated by

$$\odot(\star_a) \circ_1 \odot(\star_{a'}) - \odot(\star_{a \downarrow a'}) \circ_2 \odot(\star_{a \downarrow a'}), \quad a, a' \in [\gamma], \tag{5.1.3a}$$

$$\odot(\star_a) \circ_2 \odot(\star_{a'}) - \odot(\star_{a \downarrow a'}) \circ_2 \odot(\star_{a \downarrow a'}), \quad a, a' \in [\gamma]. \tag{5.1.3b}$$

It follows immediately that  $\text{As}_\gamma$  is well-defined as a set-operad. Moreover, since  $\text{As}_1$  is isomorphic to the associative operad  $\text{As}$  and  $\text{As}_\gamma$  is a suboperad of  $\text{As}_{\gamma+1}$ , for all integers  $\gamma \geq 0$ , the operads  $\text{As}_\gamma$  are generalizations of the associative operad. Observe that the algebras over  $\text{As}_\gamma$  are the  $\gamma$ -multiassociative algebras introduced in Section 2.3.1.

Let us now provide a realization of  $\text{As}_\gamma$ . A  $\gamma$ -corolla is a rooted tree with at most one internal node labeled on  $[\gamma]$ . Denote by  $\mathcal{F}_{\text{As}_\gamma}$  the graded vector space of all  $\gamma$ -corollas where the arity of a  $\gamma$ -corolla is its arity, and let

$$\star : \mathcal{F}_{\text{As}_\gamma} \otimes \mathcal{F}_{\text{As}_\gamma} \rightarrow \mathcal{F}_{\text{As}_\gamma} \tag{5.1.4}$$

be the linear operation where, for any  $\gamma$ -corollas  $c_1$  and  $c_2$ ,  $c_1 \star c_2$  is the  $\gamma$ -corolla with  $n + m - 1$  leaves and labeled by  $a \downarrow a'$  where  $n$  (resp.  $m$ ) is the number of leaves of  $c_1$  (resp.  $c_2$ ) and  $a$  (resp.  $a'$ ) is the label of  $c_1$  (resp.  $c_2$ ).

PROPOSITION 5.1.1. *For any integer  $\gamma \geq 0$ , the operad  $\text{As}_\gamma$  is the vector space  $\mathcal{F}_{\text{As}_\gamma}$  of  $\gamma$ -corollas and its partial compositions satisfy, for any  $\gamma$ -corollas  $c_1$  and  $c_2$ ,  $c_1 \circ_i c_2 = c_1 \star c_2$  for all valid integer  $i$ . Besides,  $\text{As}_\gamma$  is a Koszul operad and the set of right comb  $\mathfrak{G}_{\text{As}_\gamma}$ -syntax trees where all internal nodes have the same label forms a Poincaré-Birkhoff-Witt basis of  $\text{As}_\gamma$ .*

We have for instance in  $\text{As}_3$ ,

$$\begin{array}{c} \textcircled{2} \\ \diagup \quad \diagdown \\ \square \quad \square \end{array} \circ_1 \begin{array}{c} \textcircled{1} \\ \diagup \quad \diagdown \\ \square \quad \square \end{array} = \begin{array}{c} \textcircled{2} \\ \diagup \quad \diagdown \\ \square \quad \square \end{array}, \tag{5.1.5a}$$

$$\begin{array}{c} \textcircled{2} \\ \diagup \quad \diagdown \\ \square \quad \square \end{array} \circ_2 \begin{array}{c} \textcircled{3} \\ \diagup \quad \diagdown \\ \square \quad \square \end{array} = \begin{array}{c} \textcircled{3} \\ \diagup \quad \diagdown \\ \square \quad \square \end{array}. \tag{5.1.5b}$$

We deduce from Proposition 5.1.1 that the Hilbert series of  $\text{As}_\gamma$  satisfies

$$\mathcal{H}_{\text{As}_\gamma}(t) = \frac{t + (\gamma - 1)t^2}{1 - t}. \tag{5.1.6}$$

and that for all  $n \geq 2$ ,  $\dim \text{As}_\gamma(n) = \gamma$ .

5.1.2. *Dual multiassociative operads.* Since  $\text{As}_\gamma$  is a binary and quadratic operad, it admits a Koszul dual, denoted by  $\text{DAs}_\gamma$  and called  *$\gamma$ -dual multiassociative operad*. The presentation of this operad is provided by the next result.

PROPOSITION 5.1.2. *For any integer  $\gamma \geq 0$ , the operad  $\text{DAs}_\gamma$  admits the following presentation  $(\mathfrak{G}_{\text{DAs}_\gamma}, \mathfrak{R}_{\text{DAs}_\gamma})$  where  $\mathfrak{G}_{\text{DAs}_\gamma} := \mathfrak{G}_{\text{DAs}_\gamma}(2) := \{\sqcup_a : a \in [\gamma]\}$  and  $\mathfrak{R}_{\text{DAs}_\gamma}$  is the space generated by*

$$\left( \sum_{a < b} \odot(\sqcup_a) \circ_1 \odot(\sqcup_b) + \odot(\sqcup_b) \circ_1 \odot(\sqcup_a) - \odot(\sqcup_a) \circ_2 \odot(\sqcup_b) - \odot(\sqcup_b) \circ_2 \odot(\sqcup_a) \right) \\ + \odot(\sqcup_b) \circ_1 \odot(\sqcup_b) - \odot(\sqcup_b) \circ_2 \odot(\sqcup_b), \quad \mathbf{b} \in [\gamma]. \quad (5.1.7)$$

For any integer  $\gamma \geq 0$ , let  $\diamond_b, \mathbf{b} \in [\gamma]$ , the elements of  $\text{DAs}$  defined by

$$\diamond_b := \sum_{a \in [\mathbf{b}]} \sqcup_a. \quad (5.1.8)$$

Then, since for all  $\mathbf{b} \in [\gamma]$  we have

$$\sqcup_{\mathbf{b}} = \begin{cases} \diamond_1 & \text{if } \mathbf{b} = 1, \\ \diamond_{\mathbf{b}} - \diamond_{\mathbf{b}-1} & \text{otherwise,} \end{cases} \quad (5.1.9)$$

by triangularity, the family

$$\mathfrak{G}'_{\text{DAs}_\gamma} := \{\diamond_b : \mathbf{b} \in [\gamma]\} \quad (5.1.10)$$

is a generating set of  $\text{DAs}_\gamma$ . Let us now express a presentation of  $\text{DAs}_\gamma$  through the family  $\mathfrak{G}'_{\text{DAs}_\gamma}$ .

PROPOSITION 5.1.3. *For any integer  $\gamma \geq 0$ , the operad  $\text{DAs}_\gamma$  admits the presentation  $(\mathfrak{G}'_{\text{DAs}_\gamma}, \mathfrak{R}'_{\text{DAs}_\gamma})$  where  $\mathfrak{R}'_{\text{DAs}_\gamma}$  is the space generated by*

$$\odot(\diamond_a) \circ_1 \odot(\diamond_a) - \odot(\diamond_a) \circ_2 \odot(\diamond_a), \quad a \in [\gamma]. \quad (5.1.11)$$

Observe, from the presentation provided by Proposition 5.1.3 of  $\text{DAs}_\gamma$ , that  $\text{DAs}_2$  is the operad denoted by  $2\text{as}$  in [LR06].

Notice that the presentation of the Koszul dual of  $\text{DAs}_\gamma$  computed from the presentation  $(\mathfrak{G}'_{\text{DAs}_\gamma}, \mathfrak{R}'_{\text{DAs}_\gamma})$  of Proposition 5.1.3 gives rise to the following presentation for  $\text{As}_\gamma$ . This last operad admits the presentation  $(\mathfrak{G}'_{\text{As}_\gamma}, \mathfrak{R}'_{\text{As}_\gamma})$  where

$$\mathfrak{G}'_{\text{As}_\gamma} := \mathfrak{G}'_{\text{As}_\gamma}(2) := \{\Delta_a : a \in [\gamma]\} \quad (5.1.12)$$

and  $\mathfrak{R}'_{\text{As}_\gamma}$  is the space generated by

$$\odot(\Delta_a) \circ_1 \odot(\Delta_{a'}), \quad a \neq a' \in [\gamma], \quad (5.1.13a)$$

$$\odot(\Delta_a) \circ_2 \odot(\Delta_{a'}), \quad a \neq a' \in [\gamma], \quad (5.1.13b)$$

$$\odot(\Delta_a) \circ_1 \odot(\Delta_a) - \odot(\Delta_a) \circ_2 \odot(\Delta_a), \quad a \in [\gamma]. \quad (5.1.13c)$$

Indeed,  $\mathcal{R}'_{\text{DAs}_\gamma}$  is the space  $\mathcal{R}_{\text{DAs}_\gamma}$  through the identification

$$\Delta_a = \begin{cases} \star_\gamma & \text{if } a = \gamma, \\ \star_a - \star_{a+1} & \text{otherwise.} \end{cases} \tag{5.1.14}$$

PROPOSITION 5.1.4. *For any integer  $\gamma \geq 0$ , the Hilbert series  $\mathcal{H}_{\text{DAs}_\gamma}(t)$  of the operad  $\text{DAs}_\gamma$  satisfies*

$$t + (t - 1) \mathcal{H}_{\text{DAs}_\gamma}(t) + (\gamma - 1) \mathcal{H}_{\text{DAs}_\gamma}(t)^2 = 0. \tag{5.1.15}$$

By examining the expression for  $\mathcal{H}_{\text{DAs}_\gamma}(t)$  of the statement of Proposition 5.1.4, we observe that for any  $n \geq 1$ ,  $\text{DAs}_\gamma(n)$  can be seen as the vector space  $\mathcal{F}_{\text{DAs}_\gamma}(n)$  of all Schröder trees of arity  $n$ , all labeled on  $[\gamma]$  such that the label of an internal node is different from the labels of its children that are internal nodes (see Figure 5.4). We call these trees  $\gamma$ -

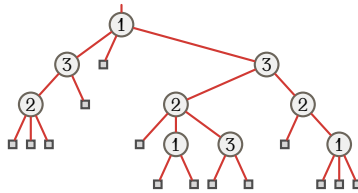

FIGURE 5.4. A 3-alternating Schröder tree of size 14. This tree is a basis element of  $\text{DAs}_3(14)$ .

*alternating Schröder trees.* Let us also denote by  $\mathcal{F}_{\text{DAs}_\gamma}$  the graded vector space of all  $\gamma$ -alternating Schröder trees.

We deduce also from Proposition 5.1.4 that

$$\mathcal{H}_{\text{DAs}_\gamma}(t) = \frac{1 - \sqrt{1 - (4\gamma - 2)t + t^2} - t}{2(\gamma - 1)}. \tag{5.1.16}$$

PROPOSITION 5.1.5. *For any integer  $\gamma \geq 0$ , the dimensions of the operad  $\text{DAs}_\gamma$  satisfy, for all  $n \geq 2$ ,*

$$\dim \text{DAs}_\gamma(n) = \sum_{k=0}^{n-2} \gamma^{k+1} (\gamma - 1)^{n-k-2} \text{nar}(n, k). \tag{5.1.17}$$

In the statement of Proposition 5.1.5,  $\text{nar}(n, k)$  is a Narayana number whose definition is recalled in Section 2.2.12 of Chapter 1. For instance, the first dimensions of  $\text{DAs}_1$ ,  $\text{DAs}_2$ ,  $\text{DAs}_3$ , and  $\text{DAs}_4$  are respectively

$$1, 1, 1, 1, 1, 1, 1, 1, 1, 1, \tag{5.1.18a}$$

$$1, 2, 6, 22, 90, 394, 1806, 8558, 41586, 206098, 1037718, \tag{5.1.18b}$$

$$1, 3, 15, 93, 645, 4791, 37275, 299865, 2474025, 20819307, 178003815, \tag{5.1.18c}$$

$$1, 4, 28, 244, 2380, 24868, 272188, 3080596, 35758828, 423373636, 5092965724. \tag{5.1.18d}$$

The second one is Sequence A006318, the third one is Sequence A103210, and the last one is Sequence A103211 of [Slo].

Let us now establish a realization of  $\text{DAs}_\gamma$ .

**PROPOSITION 5.1.6.** *For any nonnegative integer  $\gamma$ , the operad  $\text{DAs}_\gamma$  is the vector space  $\mathcal{F}_{\text{DAs}_\gamma}$  of  $\gamma$ -alternating Schröder trees. Moreover, for any  $\gamma$ -alternating Schröder trees  $s$  and  $t$ ,  $s \circ_i t$  is the  $\gamma$ -alternating Schröder tree obtained by grafting the root of  $t$  on the  $i$ th leaf  $x$  of  $s$  and then, if the father  $y$  of  $x$  and the root  $z$  of  $t$  have a same label, by contracting the edge connecting  $y$  and  $z$ .*

We have for instance in  $\text{DAs}_3$ ,

(5.1.19a)

(5.1.19b)

**5.2. A diagram of operads.** We now define morphisms between the operads  $\text{Dias}_\gamma$ ,  $\text{As}_\gamma$ ,  $\text{DAs}_\gamma$ , and  $\text{Dendr}_\gamma$  to obtain a generalization of a classical diagram involving the diassociative, associative, and dendriform operads.

5.2.1. *Relating the diassociative and dendriform operads.* The diagram

$$\begin{array}{ccc}
 & \text{!} & \\
 & \text{!} & \\
 \text{Dendr} & \xleftarrow{\zeta} & \text{As} \xleftarrow{\eta} \text{Dias} \\
 & \text{!} & \\
 & \text{!} & 
 \end{array}
 \tag{5.2.1}$$

is a well-known diagram of operads, being a part of the so-called operadic butterfly [Lod01, Lod06] and summarizing in a nice way the links between the dendriform, associative, and diassociative operads. The operad  $\text{As}$ , being at the center of the diagram, is its own Koszul dual, while  $\text{Dias}$  and  $\text{Dendr}$  are Koszul dual one of the other.

The operad morphisms  $\eta : \text{Dias} \rightarrow \text{As}$  and  $\zeta : \text{As} \rightarrow \text{Dendr}$  are linearly defined through the realizations of  $\text{Dias}$  and  $\text{Dendr}$  recalled respectively in Sections 4.2.5 and 4.2.6 of Chapter 2 by

$$\eta(\epsilon_{2,1}) := \begin{array}{c} \text{!} \\ \text{!} \\ \square \end{array} =: \eta(\epsilon_{2,2}), \tag{5.2.2}$$

and

$$\zeta \left( \begin{array}{c} \text{!} \\ \text{!} \\ \square \end{array} \right) := \begin{array}{c} \text{!} \\ \text{!} \\ \square \end{array} + \begin{array}{c} \text{!} \\ \text{!} \\ \square \end{array}. \tag{5.2.3}$$

Since  $\text{Dias}$  is generated by  $\epsilon_{2,1}$  and  $\epsilon_{2,2}$ , and since  $\text{As}$  is generated by  $\begin{array}{c} \text{!} \\ \text{!} \\ \square \end{array}$ ,  $\eta$  and  $\zeta$  are wholly defined.

5.2.2. Relating the pluriassociative and polydendriform operads.

PROPOSITION 5.2.1. For any integer  $\gamma \geq 0$ , the map  $\eta_\gamma : \text{Dias}_\gamma \rightarrow \text{As}_\gamma$  satisfying

$$\eta_\gamma(0a) = \begin{array}{c} \textcircled{a} \\ \diagup \quad \diagdown \\ \square \quad \square \end{array} = \eta_\gamma(a0), \quad a \in [\gamma], \tag{5.2.4}$$

extends in a unique way into an operad morphism. Moreover, this morphism is surjective.

By Proposition 5.2.1, the map  $\eta_\gamma$ , whose definition is only given in arity 2, defines an operad morphism. Nevertheless, by induction on the arity, one can prove that for any word  $x$  of  $\text{Dias}_\gamma$ ,  $\eta_\gamma(x)$  is the  $\gamma$ -corolla of arity  $|x|$  labeled by the greatest letter of  $x$ .

PROPOSITION 5.2.2. For any integer  $\gamma \geq 0$ , the map  $\zeta_\gamma : \text{DAs}_\gamma \rightarrow \text{Dendr}_\gamma$  satisfying

$$\zeta_\gamma \left( \begin{array}{c} \textcircled{a} \\ \diagup \quad \diagdown \\ \square \quad \square \end{array} \right) = \begin{array}{c} \textcircled{a} \\ \diagup \quad \diagdown \\ \textcircled{a} \quad \square \\ \diagup \quad \diagdown \\ \square \quad \square \end{array} + \begin{array}{c} \textcircled{a} \\ \diagup \quad \diagdown \\ \square \quad \textcircled{a} \\ \diagup \quad \diagdown \\ \square \quad \square \end{array}, \quad a \in [\gamma], \tag{5.2.5}$$

extends in a unique way into an operad morphism.

We have to observe that the morphism  $\zeta_\gamma$  defined in the statement of Proposition 5.2.2 is injective only for  $\gamma \leq 1$ . Indeed, when  $\gamma \geq 2$ , we have the relation

$$\zeta_2 \left( \begin{array}{c} \textcircled{1} \\ \diagup \quad \diagdown \\ \textcircled{2} \quad \square \\ \diagup \quad \diagdown \\ \textcircled{1} \quad \square \end{array} \right) + \zeta_2 \left( \begin{array}{c} \textcircled{1} \\ \diagup \quad \diagdown \\ \square \quad \textcircled{2} \\ \diagup \quad \diagdown \\ \square \quad \textcircled{1} \end{array} \right) = \zeta_2 \left( \begin{array}{c} \textcircled{1} \\ \diagup \quad \diagdown \\ \textcircled{2} \quad \square \end{array} \right) + \zeta_2 \left( \begin{array}{c} \textcircled{2} \\ \diagup \quad \diagdown \\ \textcircled{1} \quad \square \end{array} \right). \tag{5.2.6}$$

THEOREM 5.2.3. For any integer  $\gamma \geq 0$ , the operads  $\text{Dias}_\gamma$ ,  $\text{Dendr}_\gamma$ ,  $\text{As}_\gamma$ , and  $\text{DAs}_\gamma$  fit into the diagram

$$\begin{array}{c} \text{!} \\ \text{Dendr}_\gamma \xleftarrow{\zeta_\gamma} \text{DAs}_\gamma \xleftarrow{\text{!}} \text{As}_\gamma \xleftarrow{\eta_\gamma} \text{Dias}_\gamma \end{array}, \tag{5.2.7}$$

where  $\eta_\gamma$  is the surjection defined in the statement of Proposition 5.2.1 and  $\zeta_\gamma$  is the operad morphism defined in the statement of Proposition 5.2.2.

Diagram (5.2.7) is a generalization of (5.2.1) in which the associative operad splits into operads  $\text{As}_\gamma$  and  $\text{DAs}_\gamma$ .

6. Further generalizations

In this last section of this chapter, we propose some generalizations on a nonnegative integer parameter of well-known operads. For this, we use similar tools as the ones used in the first sections of the chapter.

**6.1. Duplicial operad.** We construct here a generalization on a nonnegative integer parameter of the duplicial operad and describe the free algebras over one generator in the category encoded by this generalization.

6.1.1. *Multiplicial operads.* It is well-known [LV12] that the dendriform operad and the duplicial operad Dup [Lod08] are both specializations of a same operad  $D_q$  with one parameter  $q \in \mathbb{K}$ . This operad admits the presentation  $(\mathfrak{G}_{D_q}, \mathfrak{R}_{D_q})$ , where  $\mathfrak{G}_{D_q} := \mathfrak{G}_{\text{Dendr}}$  and  $\mathfrak{R}_{D_q}$  is the space generated by

$$\odot (<) \circ_1 \odot (>) - \odot (>) \circ_2 \odot (<), \quad (6.1.1a)$$

$$\odot (<) \circ_1 \odot (<) - \odot (<) \circ_2 \odot (<) - q \odot (<) \circ_2 \odot (>), \quad (6.1.1b)$$

$$q \odot (>) \circ_1 \odot (<) + \odot (>) \circ_1 \odot (>) - \odot (>) \circ_2 \odot (>). \quad (6.1.1c)$$

One can observe that  $D_1$  is the dendriform operad and that  $D_0$  is the duplicial operad.

On the basis of this observation, from the presentation of  $\text{Dendr}_\gamma$  provided by Theorem 4.1.4 and its concise form provided by Relations (4.1.12a), (4.1.12b), and (4.1.12c) for its space of relations, we define the operad  $D_{q,\gamma}$  with two parameters, an integer  $\gamma \geq 0$  and  $q \in \mathbb{K}$ , in the following way. We set  $D_{q,\gamma}$  as the operad admitting the presentation  $(\mathfrak{G}_{D_{q,\gamma}}, \mathfrak{R}_{D_{q,\gamma}})$ , where  $\mathfrak{G}_{D_{q,\gamma}} := \mathfrak{G}'_{\text{Dendr}_\gamma}$  and  $\mathfrak{R}_{D_{q,\gamma}}$  is the space generated by

$$\odot (<_a) \circ_1 \odot (>_{a'}) - \odot (>_{a'}) \circ_2 \odot (<_a), \quad a, a' \in [\gamma], \quad (6.1.2a)$$

$$\odot (<_a) \circ_1 \odot (<_{a'}) - \odot (<_{a \uparrow a'}) \circ_2 \odot (<_a) - q \odot (<_{a \uparrow a'}) \circ_2 \odot (>_{a'}), \quad a, a' \in [\gamma], \quad (6.1.2b)$$

$$q \odot (>_{a \uparrow a'}) \circ_1 \odot (<_{a'}) + \odot (>_{a \uparrow a'}) \circ_1 \odot (>_a) - \odot (>_a) \circ_2 \odot (>_{a'}), \quad a, a' \in [\gamma]. \quad (6.1.2c)$$

One can observe that  $D_{1,\gamma}$  is the operad  $\text{Dendr}_\gamma$ .

Let us define the operad the  *$\gamma$ -multiplicial operad*  $\text{Dup}_\gamma$  as the operad  $D_{0,\gamma}$ . By using respectively the symbols  $\ll_a$  and  $\gg_a$  instead of  $<_a$  and  $>_a$  for all  $a \in [\gamma]$ , we obtain that the space of relations  $\mathfrak{R}_{\text{Dup}_\gamma}$  of  $\text{Dup}_\gamma$  is generated by

$$\ll_a \circ_1 \gg_{a'} - \gg_{a'} \circ_2 \ll_a, \quad a, a' \in [\gamma], \quad (6.1.3a)$$

$$\ll_a \circ_1 \ll_{a'} - \ll_{a \uparrow a'} \circ_2 \ll_a, \quad a, a' \in [\gamma], \quad (6.1.3b)$$

$$\gg_{a \uparrow a'} \circ_1 \gg_a - \gg_a \circ_2 \gg_{a'}, \quad a, a' \in [\gamma]. \quad (6.1.3c)$$

We denote by  $\mathfrak{G}_{\text{Dup}_\gamma}$  the generating set  $\{\ll_a, \gg_a; a \in [\gamma]\}$  of  $\text{Dup}_\gamma$ .

PROPOSITION 6.1.1. *For any integer  $\gamma \geq 0$ , the operad  $\text{Dup}_\gamma$  is Koszul and for any integer  $n \geq 1$ ,  $\text{Dup}_\gamma(n)$  is the vector space of  $\gamma$ -edge valued binary trees with  $n$  internal nodes.*

Since Proposition 6.1.1 shows that the operads  $\text{Dup}_\gamma$  and  $\text{Dendr}_\gamma$  have the same underlying vector space, asking if these two operads are isomorphic is natural. The next result implies that this is not the case.

PROPOSITION 6.1.2. *For any integer  $\gamma \geq 0$ , any associative element of  $\text{Dup}_\gamma$  is proportional to  $\ll_a$  or to  $\gg_a$  for an  $a \in [\gamma]$ .*

By Proposition 6.1.2 there are exactly  $2\gamma$  nonproportional associative operations in  $\text{Dup}_\gamma$  while, by Proposition 4.1.5 there are exactly  $\gamma$  such operations in  $\text{Dendr}_\gamma$ . Therefore,  $\text{Dup}_\gamma$  and  $\text{Dendr}_\gamma$  are not isomorphic.



6.1.2. *Free multiplicial algebras.* A  $\gamma$ -multiplicial algebra is a  $\text{Dup}_\gamma$ -algebra. From the definition of  $\text{Dup}_\gamma$ , any  $\gamma$ -multiplicial algebra is a vector space endowed with linear operations  $\ll_a, \gg_a, a \in [\gamma]$ , satisfying the relations encoded by (6.1.3a)—(6.1.3c).

In order to simplify and make uniform next definitions, we consider that in any  $\gamma$ -edge valued binary tree  $t$ , all edges connecting internal nodes of  $t$  with leaves are labeled by  $\infty$ . By convention, for all  $a \in [\gamma]$ , we have  $a \uparrow \infty = a = \infty \uparrow a$ .

Let us endow the vector space  $\mathcal{F}_{\text{Dup}_\gamma}$  of  $\gamma$ -edge valued binary trees with linear operations

$$\ll_a, \gg_a: \mathcal{F}_{\text{Dup}_\gamma} \otimes \mathcal{F}_{\text{Dup}_\gamma} \rightarrow \mathcal{F}_{\text{Dup}_\gamma}, \quad a \in [\gamma], \tag{6.1.4}$$

recursively defined, for any  $\gamma$ -edge valued binary tree  $s$  and any  $\gamma$ -edge valued binary trees or leaves  $t_1$  and  $t_2$  by

$$s \ll_a \downarrow := s := \downarrow \gg_a s, \tag{6.1.5a}$$

$$\downarrow \ll_a s := 0 := s \gg_a \downarrow, \tag{6.1.5b}$$

$$\begin{array}{c} \begin{array}{c} \circ \\ / \quad \backslash \\ \boxed{x} \quad \boxed{y} \\ t_1 \quad t_2 \end{array} \ll_a s := \begin{array}{c} \circ \\ / \quad \backslash \\ \boxed{x} \quad \boxed{z} \\ t_1 \quad t_2 \ll_a s \end{array}, \quad z := a \uparrow y, \end{array} \tag{6.1.5c}$$

$$s \gg_a \begin{array}{c} \circ \\ / \quad \backslash \\ \boxed{x} \quad \boxed{y} \\ t_1 \quad t_2 \end{array} := \begin{array}{c} \circ \\ / \quad \backslash \\ \boxed{z} \quad \boxed{y} \\ s \gg_a t_1 \quad t_2 \end{array}, \quad z := a \uparrow x. \tag{6.1.5d}$$

Note that neither  $\downarrow \ll_a \downarrow$  nor  $\downarrow \gg_a \downarrow$  are defined.

These recursive definitions for the operations  $\ll_a, \gg_a, a \in [\gamma]$ , lead to the following direct reformulations. If  $s$  and  $t$  are two  $\gamma$ -edge valued binary trees,  $t \ll_a s$  (resp.  $s \gg_a t$ ) is obtained by replacing each label  $y$  (resp.  $x$ ) of any edge in the rightmost (resp. leftmost) path of  $t$  by  $a \uparrow y$  (resp.  $a \uparrow x$ ) to obtain a tree  $t'$ , and by grafting the root of  $s$  on the rightmost (resp. leftmost) leaf of  $t'$ . These two operations are respective generalizations of the operations under and over on binary trees introduced by Loday and Ronco [LR02].

For example, we have

$$\begin{array}{c} \begin{array}{c} \circ \\ / \quad \backslash \\ \boxed{1} \quad \boxed{3} \\ / \quad \backslash \\ \circ \quad \circ \\ / \quad \backslash \\ \square \quad \square \end{array} \ll_2 \begin{array}{c} \circ \\ / \quad \backslash \\ \boxed{1} \quad \boxed{2} \\ / \quad \backslash \\ \circ \quad \circ \\ / \quad \backslash \\ \square \quad \square \end{array} = \begin{array}{c} \circ \\ / \quad \backslash \\ \boxed{1} \quad \boxed{2} \\ / \quad \backslash \\ \circ \quad \circ \\ / \quad \backslash \\ \square \quad \square \end{array} \begin{array}{c} \circ \\ / \quad \backslash \\ \boxed{1} \quad \boxed{2} \\ / \quad \backslash \\ \circ \quad \circ \\ / \quad \backslash \\ \square \quad \square \end{array}, \end{array} \tag{6.1.6a}$$

$$\begin{array}{c} \begin{array}{c} \circ \\ / \quad \backslash \\ \boxed{1} \quad \boxed{3} \\ / \quad \backslash \\ \circ \quad \circ \\ / \quad \backslash \\ \square \quad \square \end{array} \gg_2 \begin{array}{c} \circ \\ / \quad \backslash \\ \boxed{1} \quad \boxed{2} \\ / \quad \backslash \\ \circ \quad \circ \\ / \quad \backslash \\ \square \quad \square \end{array} = \begin{array}{c} \circ \\ / \quad \backslash \\ \boxed{1} \quad \boxed{2} \\ / \quad \backslash \\ \circ \quad \circ \\ / \quad \backslash \\ \square \quad \square \end{array} \begin{array}{c} \circ \\ / \quad \backslash \\ \boxed{1} \quad \boxed{3} \\ / \quad \backslash \\ \circ \quad \circ \\ / \quad \backslash \\ \square \quad \square \end{array}. \end{array} \tag{6.1.6b}$$

**THEOREM 6.1.3.** *For any integer  $\gamma \geq 0$ , the vector space  $\mathcal{F}_{\text{Dup}_\gamma}$  of all  $\gamma$ -edge valued binary trees endowed with the operations  $\ll_a, \gg_a, a \in [\gamma]$ , is the free  $\gamma$ -multiplicial algebra over one generator.*

**6.2. Polytridendriform operads.** We propose here a generalization  $\text{TDendr}_\gamma$  on a non-negative integer parameter  $\gamma$  of the tridendriform operad [LR04]. This last operad is the Koszul dual of the triassociative operad. We proceed by using an analogous strategy as the one used to define the operads  $\text{Dendr}_\gamma$  as Koszul duals of  $\text{Dias}_\gamma$ . Indeed, we define  $\text{TDendr}_\gamma$  as the Koszul dual of the operad  $\text{Trias}_\gamma$ , called  $\gamma$ -pluritriassociative operad, a generalization of the triassociative operad defined in Section 3.

Theorem 3.2.1, by exhibiting a presentation of  $\text{Trias}_\gamma$ , shows that this operad is binary and quadratic. It then admits a Koszul dual, denoted by  $\text{TDendr}_\gamma$  and called  $\gamma$ -polytridendriform operad.

**THEOREM 6.2.1.** *For any integer  $\gamma \geq 0$ , the operad  $\text{TDendr}_\gamma$  admits the presentation  $(\mathfrak{G}_{\text{TDendr}_\gamma}, \mathcal{R}_{\text{TDendr}_\gamma})$  where  $\mathfrak{G}_{\text{TDendr}_\gamma} := \mathfrak{G}_{\text{TDendr}_\gamma}(2) := \{\leftarrow_a, \wedge, \rightarrow_a : a \in [\gamma]\}$  and  $\mathcal{R}_{\text{TDendr}_\gamma}$  is the space generated by*

$$\odot(\wedge) \circ_1 \odot(\wedge) - \odot(\wedge) \circ_2 \odot(\wedge), \quad (6.2.1a)$$

$$\odot(\leftarrow_a) \circ_1 \odot(\wedge) - \odot(\wedge) \circ_2 \odot(\leftarrow_a), \quad a \in [\gamma], \quad (6.2.1b)$$

$$\odot(\wedge) \circ_1 \odot(\rightarrow_a) - \odot(\rightarrow_a) \circ_2 \odot(\wedge), \quad a \in [\gamma], \quad (6.2.1c)$$

$$\odot(\wedge) \circ_1 \odot(\leftarrow_a) - \odot(\wedge) \circ_2 \odot(\rightarrow_a), \quad a \in [\gamma], \quad (6.2.1d)$$

$$\odot(\leftarrow_a) \circ_1 \odot(\rightarrow_{a'}) - \odot(\rightarrow_{a'}) \circ_2 \odot(\leftarrow_a), \quad a, a' \in [\gamma], \quad (6.2.1e)$$

$$\odot(\leftarrow_a) \circ_1 \odot(\leftarrow_b) - \odot(\leftarrow_a) \circ_2 \odot(\rightarrow_b), \quad a < b \in [\gamma], \quad (6.2.1f)$$

$$\odot(\rightarrow_a) \circ_1 \odot(\leftarrow_b) - \odot(\rightarrow_a) \circ_2 \odot(\rightarrow_b), \quad a < b \in [\gamma], \quad (6.2.1g)$$

$$\odot(\leftarrow_b) \circ_1 \odot(\leftarrow_a) - \odot(\leftarrow_a) \circ_2 \odot(\leftarrow_b), \quad a < b \in [\gamma], \quad (6.2.1h)$$

$$\odot(\rightarrow_a) \circ_1 \odot(\rightarrow_b) - \odot(\rightarrow_b) \circ_2 \odot(\rightarrow_a), \quad a < b \in [\gamma], \quad (6.2.1i)$$

$$\odot(\leftarrow_d) \circ_1 \odot(\leftarrow_d) - \odot(\leftarrow_d) \circ_2 \odot(\wedge) - \left( \sum_{c \in [d]} \odot(\leftarrow_d) \circ_2 \odot(\leftarrow_c) + \odot(\leftarrow_d) \circ_2 \odot(\rightarrow_c) \right), \quad d \in [\gamma], \quad (6.2.1j)$$

$$\left( \sum_{c \in [d]} \odot(\rightarrow_d) \circ_1 \odot(\leftarrow_c) + \odot(\rightarrow_d) \circ_1 \odot(\rightarrow_c) \right) + \odot(\rightarrow_d) \circ_1 \odot(\wedge) - \odot(\rightarrow_d) \circ_2 \odot(\rightarrow_d), \quad d \in [\gamma]. \quad (6.2.1k)$$

**PROPOSITION 6.2.2.** *For any integer  $\gamma \geq 0$ , the Hilbert series  $\mathcal{H}_{\text{TDendr}_\gamma}(t)$  of the operad  $\text{TDendr}_\gamma$  satisfies*

$$t + ((2\gamma + 1)t - 1) \mathcal{H}_{\text{TDendr}_\gamma}(t) + \gamma(\gamma + 1)t \mathcal{H}_{\text{TDendr}_\gamma}(t)^2 = 0. \quad (6.2.2)$$

By examining the expression for  $\mathcal{H}_{\text{TDendr}_\gamma}(t)$  of the statement of Proposition 6.2.2, we observe that for any  $n \geq 1$ ,  $\text{TDendr}(n)$  can be seen as the vector space  $\mathcal{F}_{\text{TDendr}_\gamma}(n)$  of Schröder trees with  $n$  sectors wherein its edges connecting two internal nodes are labeled on  $[\gamma]$ . We call these trees  *$\gamma$ -edge valued Schröder trees*. In our graphical representations of  $\gamma$ -edge valued Schröder trees, any edge label is drawn into a hexagon located half the edge (see Figure 5.5).

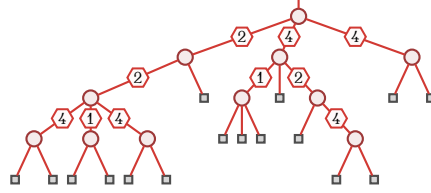

FIGURE 5.5. A 4-edge valued Schröder tree of arity 16. This tree is a basis element of  $\text{TDendr}_4(16)$ .

We deduce from Proposition 6.2.2 that

$$\mathcal{H}_{\text{TDendr}_\gamma}(t) = \frac{1 - \sqrt{1 - (4\gamma + 2)t + t^2} - (2\gamma + 1)t}{2(\gamma + \gamma^2)t}. \tag{6.2.3}$$

PROPOSITION 6.2.3. For any integer  $\gamma \geq 0$ , the dimensions of the operad  $\text{TDendr}_\gamma$  satisfy, for all  $n \geq 1$ ,

$$\dim \text{TDendr}_\gamma(n) = \sum_{k=0}^{n-1} (\gamma + 1)^k \gamma^{n-k-1} \text{nar}(n + 1, k). \tag{6.2.4}$$

For instance, the first dimensions of  $\text{TDendr}_1$ ,  $\text{TDendr}_2$ ,  $\text{TDendr}_3$ , and  $\text{TDendr}_4$  are respectively

$$1, 3, 11, 45, 197, 903, 4279, 20793, 103049, 518859, 2646723, \tag{6.2.5a}$$

$$1, 5, 31, 215, 1597, 12425, 99955, 824675, 6939769, 59334605, 513972967, \tag{6.2.5b}$$

$$1, 7, 61, 595, 6217, 68047, 770149, 8939707, 105843409, 1273241431, 15517824973, \tag{6.2.5c}$$

$$1, 9, 101, 1269, 17081, 240849, 3511741, 52515549, 801029681, 12414177369, 194922521301. \tag{6.2.5d}$$

These sequences are respectively Sequences **A001003**, **A269730**, **A269731**, and **A269732** of [Slo].

**6.3. Operads of the operadic butterfly.** In what follows, we shall work with algebraic structures satisfying relations involving possibly permutations of some inputs. For simplicity, instead of working with symmetric operads, we shall just work with types of algebras (see Section 4.1.13 of Chapter 2).

6.3.1. *A generalization of the operadic butterfly.* Let us consider the diagram of symmetric operads

$$\begin{array}{ccccc}
 & & \text{Dendr}_\gamma & \xleftrightarrow{\quad ! \quad} & \text{Dias}_\gamma & & \\
 & \swarrow & & & & \searrow & \\
 \text{Zin}_\gamma & & & & & & \text{Leib}_\gamma \\
 & \swarrow & \text{DAs}_\gamma & \xleftrightarrow{\quad ! \quad} & \text{As}_\gamma & \searrow & \\
 & & & & & & \\
 & \swarrow & & & & \searrow & \\
 & \text{Com}_\gamma & \xleftrightarrow{\quad ! \quad} & \text{Lie}_\gamma & & & 
 \end{array} \tag{6.3.1}$$

where  $\text{DAs}_\gamma$  is the  $\gamma$ -dual multiassociative operad defined in Section 5.1.2 and  $\text{Com}_\gamma$ ,  $\text{Lie}_\gamma$ ,  $\text{Zin}_\gamma$ , and  $\text{Leib}_\gamma$ , respectively are generalizations on a nonnegative integer parameter  $\gamma$  of the operads  $\text{Com}$ ,  $\text{Lie}$ ,  $\text{Zin}$ , and  $\text{Leib}$ . Let us now define these operads.

6.3.2. *Commutative and Lie operads.* Observe that the commutative operad  $\text{Com}$  is a commutative version of  $\text{As} = \text{DAs}_1$  (see Section 4.1.13 of Chapter 2). We define the symmetric operad  $\text{Com}_\gamma$  by using the same idea of being a commutative version of  $\text{DAs}_\gamma$ . Therefore,  $\text{Com}_\gamma$  is the symmetric operad describing the category of algebras  $\mathcal{C}$  with binary operations  $\diamond_a$ ,  $a \in [\gamma]$ , subjected for any elements  $x$ ,  $y$ , and  $z$  of  $\mathcal{C}$  to the two sorts of relations

$$x \diamond_a y = y \diamond_a x, \quad a \in [\gamma], \tag{6.3.2a}$$

$$(x \diamond_a y) \diamond_a z = x \diamond_a (y \diamond_a z), \quad a \in [\gamma]. \tag{6.3.2b}$$

Moreover, we define the symmetric operad  $\text{Lie}_\gamma$  as the Koszul dual of  $\text{Com}_\gamma$ .

6.3.3. *Zinbiel and Leibniz operads.* It is well-known that the Zinbiel operad  $\text{Zin}$  [Lod95] is a commutative version of  $\text{Dendr} = \text{Dendr}_1$  [Lod01]. We define the symmetric operad  $\text{Zin}_\gamma$  by using the same idea of having the property to be a commutative version of  $\text{Dendr}_\gamma$ . Therefore,  $\text{Zin}_\gamma$  is the symmetric operad describing the category of algebras  $\mathcal{L}$  with binary operations  $\sqcup_a$ ,  $a \in [\gamma]$ , subjected for any elements  $x$ ,  $y$ , and  $z$  of  $\mathcal{L}$  to the relation

$$(x \sqcup_{a'} y) \sqcup_a z = x \sqcup_{a \uparrow a'} (y \sqcup_a z) + x \sqcup_{a \uparrow a'} (z \sqcup_{a'} y), \quad a, a' \in [\gamma]. \tag{6.3.3}$$

Relation (6.3.3) is obtained from Relations (4.1.12a), (4.1.12b), and (4.1.12c) of  $\gamma$ -polydendri-form algebras with the condition that for any elements  $x$  and  $y$  and  $a \in [\gamma]$ ,  $x \prec_a y = y \succ_a x$ , and by setting  $x \sqcup_a y := x \prec_a y$ . Moreover, we define the symmetric operad  $\text{Leib}_\gamma$  as the Koszul dual of  $\text{Zin}_\gamma$ .

**PROPOSITION 6.3.1.** *For any integer  $\gamma \geq 0$  and any  $\text{Zin}_\gamma$ -algebra  $\mathcal{L}$ , the binary operations  $\diamond_a$ ,  $a \in [\gamma]$ , defined for all elements  $x$  and  $y$  of  $\mathcal{L}$  by*

$$x \diamond_a y := x \sqcup_a y + y \sqcup_a x, \quad a \in [\gamma], \tag{6.3.4}$$

*endow  $\mathcal{L}$  with a  $\text{Com}_\gamma$ -algebra structure.*

**PROOF.** Since for all  $a \in [\gamma]$  and all elements  $x$  and  $y$  of  $\mathcal{L}$ , by (6.3.3), we have

$$x \diamond_a y - y \diamond_a x = x \sqcup_a y + y \sqcup_a x - y \sqcup_a x - x \sqcup_a y = 0, \tag{6.3.5}$$

the operations  $\diamond_a$  satisfy Relation (6.3.2a) of  $\text{Com}_\gamma$ -algebras. Moreover, since for all  $a \in [\gamma]$  and all elements  $x, y$ , and  $z$  of  $\mathcal{L}$ , by (6.3.3), we have

$$\begin{aligned}
& (x \diamond_a y) \diamond_a z - x \diamond_a (y \diamond_a z) \\
&= (x \sqcup_a y + y \sqcup_a x) \sqcup_a z + z \sqcup_a (x \sqcup_a y + y \sqcup_a x) \\
&\quad - x \sqcup_a (y \sqcup_a z + z \sqcup_a y) - (y \sqcup_a z + z \sqcup_a y) \sqcup_a x \\
&= (x \sqcup_a y) \sqcup_a z + (y \sqcup_a x) \sqcup_a z + z \sqcup_a (x \sqcup_a y) + z \sqcup_a (y \sqcup_a x) \\
&\quad - x \sqcup_a (y \sqcup_a z) - x \sqcup_a (z \sqcup_a y) - (y \sqcup_a z) \sqcup_a x - (z \sqcup_a y) \sqcup_a x \\
&= (y \sqcup_a x) \sqcup_a z - (y \sqcup_a z) \sqcup_a x \\
&= y \sqcup_a (x \sqcup_a z) + y \sqcup_a (z \sqcup_a x) - y \sqcup_a (z \sqcup_a x) - y \sqcup_a (x \sqcup_a z) \\
&= 0,
\end{aligned} \tag{6.3.6}$$

the operations  $\diamond_a$  satisfy Relation (6.3.2b) of  $\text{Com}_\gamma$ -algebras. Hence,  $\mathcal{L}$  is a  $\text{Com}_\gamma$ -algebra.  $\square$

**PROPOSITION 6.3.2.** *For any integer  $\gamma \geq 0$ , and any  $\text{Zin}_\gamma$ -algebra  $\mathcal{L}$ , the binary operations  $\prec_a, \succ_a, a \in [\gamma]$  defined for all elements  $x$  and  $y$  of  $\mathcal{L}$  by*

$$x \prec_a y := x \sqcup_a y, \quad a \in [\gamma], \tag{6.3.7}$$

and

$$x \succ_a y := y \sqcup_a x, \quad a \in [\gamma], \tag{6.3.8}$$

endow  $\mathcal{L}$  with a  $\gamma$ -polydendriform algebra structure.

The constructions stated by Propositions 6.3.1 and 6.3.2 producing from a  $\text{Zin}_\gamma$ -algebra respectively a  $\text{Com}_\gamma$ -algebra and a  $\gamma$ -polydendriform algebra are functors from the category of  $\text{Zin}_\gamma$ -algebras respectively to the category of  $\text{Com}_\gamma$ -algebras and the category of  $\gamma$ -polydendriform algebras. These functors respectively translate into symmetric operad morphisms from  $\text{Com}_\gamma$  to  $\text{Zin}_\gamma$  and from  $\text{Dendr}_\gamma$  to  $\text{Zin}_\gamma$ . These morphisms are generalizations of known morphisms between  $\text{Com}$ ,  $\text{Dendr}$ , and  $\text{Zin}$  of the operadic butterfly (see [Lod01, Lod06, Zin12]).

### Concluding remarks

In this chapter, we have defined a new generalization  $\text{Dendr}_\gamma$  of the dendriform operad and also several ones of related operads. Among its most important features,  $\text{Dendr}_\gamma$  encodes the notion of splitting an associative product in several pieces. Moreover, as illustrated, the underlying combinatorics of this operad involves a new kind of combinatorial objects, which are binary trees with labeled edges. A natural question about these trees consists in investigating whether some particular subfamilies of these form suboperads of  $\text{Dendr}_\gamma$ . Moreover, like the dendriform operad which admits a realization in term of rational functions [Lod10] (see also Section 4.2.4 of Chapter 2), we can ask whether  $\text{Dendr}_\gamma$  admits a similar realization.

Besides, a complete study of the operads  $\text{Com}_\gamma$ ,  $\text{Lie}_\gamma$ ,  $\text{Zin}_\gamma$ , and  $\text{Leib}_\gamma$  (like computing their presentations and providing realizations), and suitable definitions for all the morphisms intervening in our generalization of the operadic butterfly (6.3.1) is worth to interest for future works.

Finally, one of our generalizations of the associative operad, namely the multiassociative operad  $As_\gamma$ , admits a direct generalization  $As(\mathcal{Q})$  wherein its presentation is parametrized by a finite poset  $\mathcal{Q}$ . These operads and their Koszul duals have nice combinatorial properties and will be studied in Chapter 6.



## From posets to operads

The content of this chapter comes from [Gir16b].

### Introduction

This chapter is devoted to enrich connections between operads and combinatorics by establishing a new link between posets and operads by means of a construction associating a operad  $\text{As}(\mathcal{Q})$ , called  $\mathcal{Q}$ -associative operad, with any finite poset  $\mathcal{Q}$ . This construction is a functor  $\text{As}$  from the category of finite posets to the category of binary and quadratic operads. The will to generalize two families of operads Koszul dual to each other, constructed in Chapter 5, is the first impetus of this work. The operads of these families are the multiassociative operads  $\text{As}_\gamma$  and the dual multiassociative operads  $\text{DAs}_\gamma$  (see Section 5 of Chapter 5). In this present work, we retrieve  $\text{As}_\gamma$  by applying the construction  $\text{As}$  to the total order on a set of  $\gamma$  elements and we retrieve  $\text{DAs}_\gamma$  by applying the construction  $\text{As}$  to the trivial order on the same set. Note that different constructions of operads involving posets [FFM16], and not directly related constructions involving posets and operads [MY91, Val07] have been considered in the literature.

Let us describe some main properties of  $\text{As}$ . First, each operad obtained by our construction provides a generalization of the associative operad since all its generating operations are associative. Besides, many combinatorial properties of the starting poset  $\mathcal{Q}$  lead to algebraic properties for  $\text{As}(\mathcal{Q})$  (see Table 6.1). For instance, when  $\mathcal{Q}$  is a forest (with the meaning

Properties of the poset $\mathcal{Q}$	Properties of the operad $\text{As}(\mathcal{Q})$	Statement
None	Binary and quadratic	Definition, Section 1.1.1
Forest	Koszul	Theorem 2.1.5
Thin forest	Closed under Koszul duality	Theorem 3.2.2
Trivial	Basic set-operad basis	Proposition 1.2.3

TABLE 6.1. Summary of the properties satisfied by a poset  $\mathcal{Q}$  implying properties for the operad  $\text{As}(\mathcal{Q})$ . Note that any trivial poset is also a thin forest poset, and that a thin forest poset is also a forest poset. In particular, if  $\mathcal{Q}$  is a trivial poset,  $\text{As}(\mathcal{Q})$  has all properties mentioned in the middle column.

that no element of  $\mathcal{Q}$  covers two different elements),  $\text{As}(\mathcal{Q})$  is a Koszul operad. Moreover,



when  $\mathcal{Q}$  is not a trivial poset, the fundamental basis of  $\text{As}(\mathcal{Q})$  is not a basic set-operad basis. This last property seems to be interesting since almost all set-operad bases of common operads are basic, such as the associative operad or the diassociative operad [Lod01] (see additionally [Zin12]). This gives to our construction a very unique flavor.

The further study of the operads obtained by the construction  $\text{As}$  is driven by computer exploration. Indeed, computer experiments bring us the observation that some operads obtained by the construction  $\text{As}$  are Koszul duals to each other. This observation raises several questions. The first one consists in describing a family of posets, called thin forest posets, such that the construction  $\text{As}$  restricted to this family is closed under Koszul duality. The second one consists in defining an operation  $^\perp$  on this family of posets such that for any of these posets  $\mathcal{Q}$ ,  $\text{As}(\mathcal{Q}^\perp)$  is isomorphic to the Koszul dual  $\text{As}(\mathcal{Q})^\perp$  of  $\text{As}(\mathcal{Q})$ . The last one relies on an expression of an explicit isomorphism between  $\text{As}(\mathcal{Q})^\perp$  and  $\text{As}(\mathcal{Q}^\perp)$ . We answer all these questions in this work, forming its main results. As additional results, we provide a complete study of the operads  $\text{As}(\mathcal{Q})$ , including, when  $\mathcal{Q}$  satisfies some precise properties, an expression for its Hilbert series and a realization involving labeled Schröder trees.

This chapter is organized as follows. Section 1 is concerned with the description of the construction  $\text{As}$  and the first general properties of the obtained operads. In Section 2, we focus on the case where the poset  $\mathcal{Q}$  at input of the construction  $\text{As}$  is a forest poset. We show that in this case,  $\text{As}(\mathcal{Q})$  is a Koszul operad and derive some consequences. This chapter ends by introducing in Section 3 the class of thin forest posets. The construction  $\text{As}$  restricted to this class of posets has the property to be closed under Koszul duality.

*Note.* In this chapter all posets are finite. For this reason, “poset” means “finite poset”. Moreover, since this chapter deals only with ns operads, “operad” means “ns operad”. If  $\star$  is a generator of an operad  $\mathcal{O}$ , we denote by  $\bar{\star}$  the associated generator in the Koszul dual of  $\mathcal{O}$ .

## 1. From posets to operads

This section is devoted to the introduction of our construction producing an operad from a poset. We also establish here some of its first general properties. We end this section by presenting algebras over our operads and some of their properties.

**1.1. Construction.** Let us describe the construction  $\text{As}$ , associating with any poset a binary and quadratic operad presentation, and prove that it is functorial.

**1.1.1. Operad presentations from posets.** For any poset  $(\mathcal{Q}, \preceq_{\mathcal{Q}})$ , we define the  *$\mathcal{Q}$ -associative operad*  $\text{As}(\mathcal{Q})$  as the operad admitting the presentation  $(\mathfrak{G}_{\mathcal{Q}}^*, \mathfrak{R}_{\mathcal{Q}}^*)$  where  $\mathfrak{G}_{\mathcal{Q}}^*$  is the set of generators

$$\mathfrak{G}_{\mathcal{Q}}^* := \mathfrak{G}_{\mathcal{Q}}^*(2) := \{\star_a : a \in \mathcal{Q}\}, \quad (1.1.1)$$

and  $\mathfrak{R}_{\mathcal{Q}}^*$  is the space of relations generated by

$$\odot(\star_a) \circ_1 \odot(\star_b) - \odot(\star_{a \uparrow_{\mathcal{Q}} b}) \circ_2 \odot(\star_{a \uparrow_{\mathcal{Q}} b}), \quad a, b \in \mathcal{Q} \text{ and } (a \preceq_{\mathcal{Q}} b \text{ or } b \preceq_{\mathcal{Q}} a), \quad (1.1.2a)$$

$$\odot(\star_{a \uparrow_{\mathcal{Q}} b}) \circ_1 \odot(\star_{a \uparrow_{\mathcal{Q}} b}) - \odot(\star_a) \circ_2 \odot(\star_b), \quad a, b \in \mathcal{Q} \text{ and } (a \preceq_{\mathcal{Q}} b \text{ or } b \preceq_{\mathcal{Q}} a). \quad (1.1.2b)$$

By definition,  $\text{As}(\mathcal{Q})$  is a binary and quadratic operad. The *fundamental basis* of  $\text{As}(\mathcal{Q})$  is the basis induced by  $\mathfrak{G}_{\mathcal{Q}}^*$ . Moreover, since Relations (1.1.2a) and (1.1.2b) are of the form  $\mathfrak{s} - \mathfrak{t}$  where  $\mathfrak{s}$  and  $\mathfrak{t}$  are  $\mathfrak{G}_{\mathcal{Q}}^*$ -syntax trees,  $\text{As}(\mathcal{Q})$  is well-defined in the category of sets.

LEMMA 1.1.1. *Let  $\mathcal{Q}$  be a poset. For any  $a \in \mathcal{Q}$ , let  $R_a$  be the set*

$$R_a := \{\odot(\star_a) \circ_1 \odot(\star_b), \odot(\star_b) \circ_1 \odot(\star_a), \\ \odot(\star_b) \circ_2 \odot(\star_a), \odot(\star_a) \circ_2 \odot(\star_b) : b \in \mathcal{Q} \text{ and } a \preceq_{\mathcal{Q}} b\}. \quad (1.1.3)$$

Then, for all  $\mathfrak{s}, \mathfrak{t} \in R_a$ ,  $\mathfrak{s} - \mathfrak{t}$  is an element of the space of relations  $\mathcal{R}_{\mathcal{Q}}^*$  of  $\text{As}(\mathcal{Q})$ .

By Lemma 1.1.1, we observe that all  $\star_a$ ,  $a \in \mathcal{Q}$ , are associative. For this reason,  $\text{As}(\mathcal{Q})$  is a generalization of the associative operad on several binary generating operations. As we will see in the sequel, this very simple way to produce operads has many combinatorial and algebraic properties.

1.1.2. *Functoriality.* For any morphism of posets  $\phi : \mathcal{Q}_1 \rightarrow \mathcal{Q}_2$ , we denote by  $\text{As}(\phi)$  the map

$$\text{As}(\phi) : \text{As}(\mathcal{Q}_1)(2) \rightarrow \text{As}(\mathcal{Q}_2)(2) \quad (1.1.4)$$

defined by

$$\text{As}(\phi)(\star_x) := \star_{\phi(x)} \quad (1.1.5)$$

for all  $x \in \mathcal{Q}_1$ .

LEMMA 1.1.2. *Let  $\mathcal{Q}_1$  and  $\mathcal{Q}_2$  be two posets and  $\phi : \mathcal{Q}_1 \rightarrow \mathcal{Q}_2$  be a morphism of posets. Then, the map  $\text{As}(\phi)$  uniquely extends into an operad morphism from  $\text{As}(\mathcal{Q}_1)$  to  $\text{As}(\mathcal{Q}_2)$ .*

THEOREM 1.1.3. *The construction  $\text{As}$  is a functor from the category of posets to the category of binary and quadratic operads.*

1.1.3. *First examples.* Let us use Theorem 1.1.3 to exhibit some examples of constructions of binary and quadratic operads from posets.

From the poset

$$\mathcal{Q} := \begin{array}{c} \textcircled{1} \quad \textcircled{2} \\ \diagdown \quad \diagup \\ \textcircled{3} \quad \textcircled{4} \end{array}, \quad (1.1.6)$$

the operad  $\text{As}(\mathcal{Q})$  is binary and quadratic, generated by the set  $\mathfrak{G}_{\mathcal{Q}}^* = \{\star_1, \star_2, \star_3, \star_4\}$ , and, by Lemma 1.1.1, subjected to the relations

$$\star_1 \circ_1 \star_1 = \star_1 \circ_1 \star_3 = \star_3 \circ_1 \star_1 = \star_3 \circ_2 \star_1 = \star_1 \circ_2 \star_3 = \star_1 \circ_2 \star_1, \quad (1.1.7a)$$

$$\star_2 \circ_1 \star_2 = \star_2 \circ_1 \star_3 = \star_2 \circ_1 \star_4 = \star_3 \circ_1 \star_2 = \star_4 \circ_1 \star_2 \quad (1.1.7b)$$

$$= \star_4 \circ_2 \star_2 = \star_3 \circ_2 \star_2 = \star_2 \circ_2 \star_4 = \star_2 \circ_2 \star_3 = \star_2 \circ_2 \star_2,$$

$$\star_3 \circ_1 \star_3 = \star_3 \circ_2 \star_3, \quad (1.1.7c)$$

$$\star_4 \circ_1 \star_4 = \star_4 \circ_2 \star_4. \quad (1.1.7d)$$

Besides, when  $\mathcal{Q}$  is the trivial poset on the set  $[\ell]$ ,  $\ell \geq 0$ , the operad  $\text{As}(\mathcal{Q})$  is generated by the set  $\mathfrak{G}_{\mathcal{Q}}^* = \{\star_1, \dots, \star_\ell\}$  and, by Lemma 1.1.1, subjected to the relations

$$\star_a \circ_1 \star_a = \star_a \circ_2 \star_a, \quad a \in [\ell]. \quad (1.1.8)$$

In particular, when  $\ell = 0$ ,  $\text{As}(\mathcal{Q})$  is the trivial operad, when  $\ell = 1$ ,  $\text{As}(\mathcal{Q})$  is the associative operad, and when  $\ell = 2$ ,  $\text{As}(\mathcal{Q})$  is the operad  $2\text{as}$  [LR06]. These operads, for a generic  $\ell \geq 0$ , are the dual multiassociative operads  $\text{DAs}_\ell$ , introduced in Section 5 of Chapter 5. These operads can be realized using Schröder trees endowed with labels satisfying some conditions. In Section 2.2.2, we shall describe a generalized version of this realization.

Furthermore, when  $\mathcal{Q}$  is the total order on the set  $[\ell]$ ,  $\ell \geq 0$ , the operad  $\text{As}(\mathcal{Q})$  is generated by the set  $\mathfrak{G}_{\mathcal{Q}}^* = \{\star_1, \dots, \star_\ell\}$  and, by Lemma 1.1.1, subjected to the relations

$$\star_a \circ_1 \star_a = \star_a \circ_1 \star_b = \star_b \circ_1 \star_a = \star_b \circ_2 \star_a = \star_a \circ_2 \star_b = \star_a \circ_2 \star_a, \quad a \leq b \in [\ell]. \quad (1.1.9)$$

In particular, when  $\ell = 0$ ,  $\text{As}(\mathcal{Q})$  is the trivial operad and when  $\ell = 1$ ,  $\text{As}(\mathcal{Q})$  is the associative operad. These operads, for a generic  $\ell \geq 0$ , are the multiassociative operads  $\text{As}_\ell$ , introduced in Section 5 of Chapter 5. They have the particularity to have stationary dimensions since  $\dim \text{As}(\mathcal{Q})(1) = 1$  and  $\dim \text{As}(\mathcal{Q})(n) = \ell$  for all  $n \geq 2$ .

**1.2. General properties.** Let us now list some general properties of the operad  $\text{As}(\mathcal{Q})$  where  $\mathcal{Q}$  is a poset without particular requirements. We provide the dimension of the space of relations of  $\text{As}(\mathcal{Q})$ , describe its associative elements, and give a necessary and sufficient condition for the fact that its fundamental basis is a basic set-operad basis.

### 1.2.1. Space of relations dimensions.

PROPOSITION 1.2.1. *Let  $\mathcal{Q}$  be a poset. Then, the dimension of the space  $\mathcal{R}_{\mathcal{Q}}^*$  of relations of  $\text{As}(\mathcal{Q})$  satisfies*

$$\dim \mathcal{R}_{\mathcal{Q}}^* = 4 \text{int}(\mathcal{Q}) - 3 \#\mathcal{Q}. \quad (1.2.1)$$

Recall that  $\text{int}(\mathcal{Q})$  denotes the number of intervals of  $\mathcal{Q}$  (see Section 1.3.1 of Chapter 1).

### 1.2.2. Associative elements.

PROPOSITION 1.2.2. *Let  $\mathcal{Q}$  be a poset and  $C := \{c_1 <_{\mathcal{Q}} \dots <_{\mathcal{Q}} c_\ell\}$  be a chain of  $\mathcal{Q}$ . Then,  $\mathbb{K}\langle C \rangle$  contains only associative elements of  $\text{As}(\mathcal{Q})$ . Conversely, any associative element of  $\text{As}(\mathcal{Q})$  is an element of  $\mathbb{K}\langle C \rangle$  for a chain  $C$  of  $\mathcal{Q}$ .*

### 1.2.3. Basicity.

PROPOSITION 1.2.3. *Let  $\mathcal{Q}$  be a poset. The fundamental basis of  $\text{As}(\mathcal{Q})$  is a basic set-operad basis if and only if  $\mathcal{Q}$  is a trivial poset.*

**1.3. Algebras over poset associative operads.** Let  $\mathcal{Q}$  be a poset. From the presentation  $(\mathcal{G}_{\mathcal{Q}}^*, \mathcal{R}_{\mathcal{Q}}^*)$  of the operad  $\text{As}(\mathcal{Q})$  provided by its definition in Section 1.1.1, an  $\text{As}(\mathcal{Q})$ -algebra is a vector space  $\mathcal{A}$  endowed with linear operations

$$\star_a : \mathcal{A} \otimes \mathcal{A} \rightarrow \mathcal{A}, \quad a \in \mathcal{Q}, \quad (1.3.1)$$

satisfying, for all  $x, y, z \in \mathcal{A}$ , the relations

$$(x \star_a y) \star_b z = x \star_a (y \star_b z) = (x \star_c y) \star_a z = x \star_c (y \star_a z), \quad a, b, c \in \mathcal{Q} \text{ and } a \preceq_{\mathcal{Q}} b \text{ and } a \preceq_{\mathcal{Q}} c. \quad (1.3.2)$$

We call  *$\mathcal{Q}$ -associative algebra* any  $\text{As}(\mathcal{Q})$ -algebra.

We shall exhibit two examples of  $\mathcal{Q}$ -associative algebras in the sequel: in Section 2.2.3, free  $\mathcal{Q}$ -associative algebras over one generator when  $\mathcal{Q}$  is a forest poset and in Section 1.3.2,  $\mathcal{Q}$ -associative algebras involving the antichains of the poset  $\mathcal{Q}$ .

**1.3.1. Units.** Let  $\mathcal{Q}$  be a poset and  $\mathcal{A}$  be a  $\mathcal{Q}$ -associative algebra. An  *$a$ -unit*,  $a \in \mathcal{Q}$ , of  $\mathcal{A}$  is an element  $\mathbb{1}_a$  of  $\mathcal{A}$  satisfying

$$\mathbb{1}_a \star_a x = x = x \star_a \mathbb{1}_a \quad (1.3.3)$$

for all  $x \in \mathcal{A}$ . Obviously, for any  $a \in \mathcal{Q}$  there is at most one  $a$ -unit in  $\mathcal{A}$ .

Besides, for any element  $x$  of  $\mathcal{A}$ , we denote by  $\mathcal{E}_{\mathcal{A}}(x)$  the set of elements  $a$  of  $\mathcal{Q}$  such that  $x$  is an  $a$ -unit of  $\mathcal{A}$ . Obviously, if  $\mathbb{1}_a$  is an  $a$ -unit of  $\mathcal{A}$ ,  $a \in \mathcal{E}_{\mathcal{A}}(\mathbb{1}_a)$ .

**PROPOSITION 1.3.1.** *Let  $\mathcal{Q}$  be a poset and  $\mathcal{A}$  be a  $\mathcal{Q}$ -associative algebra. Then:*

- (i) *for any element  $x$  of  $\mathcal{A}$ ,  $\mathcal{E}_{\mathcal{A}}(x)$  is an order filter of  $\mathcal{Q}$ ;*
- (ii) *for all elements  $x$  and  $y$  of  $\mathcal{A}$  such that  $x \neq y$ , the sets  $\mathcal{E}_{\mathcal{A}}(x)$  and  $\mathcal{E}_{\mathcal{A}}(y)$  are disjoint.*

Proposition 1.3.1 implies that the sets  $\mathcal{E}_{\mathcal{A}}(x)$ ,  $x \in \mathcal{A}$ , form a partition of an order filter of  $\mathcal{Q}$  where each part is itself an order filter of  $\mathcal{Q}$ .

**1.3.2. Antichains algebra.** Let  $\mathcal{Q}$  be a poset and set  $\mathbb{X}_{\mathcal{Q}} := \{x_a : a \in \mathcal{Q}\}$  as a set of commutative parameters and consider the commutative and associative polynomial algebra  $\mathbb{K}[\mathbb{X}_{\mathcal{Q}}]/\mathcal{F}_{\mathcal{Q}}$ , where  $\mathcal{F}_{\mathcal{Q}}$  is the ideal of  $\mathbb{K}[\mathbb{X}_{\mathcal{Q}}]$  generated by

$$x_a x_b - x_a, \quad a \preceq_{\mathcal{Q}} b \in \mathcal{Q}. \quad (1.3.4)$$

Then, one observes that  $x_{a_1} \dots x_{a_k}$  is a reduced monomial of  $\mathbb{K}[\mathbb{X}_{\mathcal{Q}}]/\mathcal{F}_{\mathcal{Q}}$  if and only if the set  $\{a_1, \dots, a_k\}$  is an antichain of  $\mathcal{Q}$  of size  $k$ .

We endow  $\mathbb{K}[\mathbb{X}_{\mathcal{Q}}]/\mathcal{F}_{\mathcal{Q}}$  with linear operations

$$\star_a : \mathbb{K}[\mathbb{X}_{\mathcal{Q}}]/\mathcal{F}_{\mathcal{Q}} \otimes \mathbb{K}[\mathbb{X}_{\mathcal{Q}}]/\mathcal{F}_{\mathcal{Q}} \rightarrow \mathbb{K}[\mathbb{X}_{\mathcal{Q}}]/\mathcal{F}_{\mathcal{Q}}, \quad a \in \mathcal{Q}, \quad (1.3.5)$$

defined, for all reduced monomials  $x_{b_1} \dots x_{b_k}$  and  $x_{c_1} \dots x_{c_\ell}$  of  $\mathbb{K}[\mathbb{X}_{\mathcal{Q}}]/\mathcal{F}_{\mathcal{Q}}$ , by

$$x_{b_1} \dots x_{b_k} \star_a x_{c_1} \dots x_{c_\ell} := \pi(x_{b_1} \dots x_{b_k} x_a x_{c_1} \dots x_{c_\ell}), \quad (1.3.6)$$

where  $\pi : \mathbb{K}[\mathbb{X}_{\mathcal{Q}}] \rightarrow \mathbb{K}[\mathbb{X}_{\mathcal{Q}}]/\mathcal{F}_{\mathcal{Q}}$  is the canonical projection. These operations  $\star_a$ ,  $a \in \mathcal{Q}$ , endow  $\mathbb{K}[\mathbb{X}_{\mathcal{Q}}]/\mathcal{F}_{\mathcal{Q}}$  with a structure of a  $\mathcal{Q}$ -associative algebra.

Consider for instance the poset

$$\mathbb{Q} := \begin{array}{c} \textcircled{1} \\ \textcircled{2} \textcircled{3} \textcircled{4} \\ \textcircled{5} \end{array}. \quad (1.3.7)$$

The space  $\mathbb{K}[\mathbb{X}_{\mathbb{Q}}]/\mathcal{I}_{\mathbb{Q}}$  is the linear span of the reduced monomials

$$x_1, x_2, x_3, x_4, x_5, x_2x_3, x_2x_4, x_3x_4, x_3x_5, x_2x_3x_4, \quad (1.3.8)$$

and one has for instance

$$x_2 \star_3 x_4 = x_2x_3x_4, \quad (1.3.9a)$$

$$x_2x_3 \star_1 x_4 = x_1, \quad (1.3.9b)$$

$$x_2x_3 \star_5 x_4 = x_2x_3x_4. \quad (1.3.9c)$$

## 2. Forest posets, Koszul duality, and Koszulity

Here, we focus on the construction  $\text{As}$  when the input poset  $\mathbb{Q}$  of the construction is a forest poset. In this case, we show that  $\text{As}(\mathbb{Q})$  is Koszul, we provide a realization of  $\text{As}(\mathbb{Q})$ , and we obtain a functional equation for its Hilbert series. We end this section by computing presentations of the Koszul dual of  $\text{As}(\mathbb{Q})$ .

**2.1. Koszulity and Poincaré-Birkhoff-Witt bases.** We prove here that when  $\mathbb{Q}$  is a forest poset,  $\text{As}(\mathbb{Q})$  is Koszul. For that, we consider an orientation of the space of relations  $\mathcal{R}_{\mathbb{Q}}^*$  of  $\text{As}(\mathbb{Q})$  and show that this orientation is a convergent rewrite rule. As a consequence, the Koszulity of  $\text{As}(\mathbb{Q})$  follows (see Lemma 4.1.2 of Chapter 2).

**2.1.1. Forest posets.** We call *forest poset* any poset avoiding the pattern  (see Section 1.3.2 of Chapter 1 for the definition of pattern avoidance in posets). In other words, a forest poset is a poset for which its Hasse diagram is a forest of rooted trees (where roots are minimal elements). Figure 6.2 shows an example of a forest poset.

**2.1.2. Orientation of the space of relations.** Let  $\mathbb{Q}$  be a poset (not necessarily a forest poset just now) and  $\Rightarrow_{\mathbb{Q}}$  be the rewrite rule on  $\mathcal{G}_{\mathbb{Q}}^*$ -syntax trees satisfying

$$\odot(\star_a) \circ_1 \odot(\star_b) \Rightarrow_{\mathbb{Q}} \odot(\star_{a \uparrow_{\mathbb{Q}} b}) \circ_2 \odot(\star_{a \uparrow_{\mathbb{Q}} b}), \quad a, b \in \mathbb{Q} \text{ and } (a \preceq_{\mathbb{Q}} b \text{ or } b \preceq_{\mathbb{Q}} a), \quad (2.1.1a)$$

$$\odot(\star_a) \circ_2 \odot(\star_b) \Rightarrow_{\mathbb{Q}} \odot(\star_{a \uparrow_{\mathbb{Q}} b}) \circ_2 \odot(\star_{a \uparrow_{\mathbb{Q}} b}), \quad a, b \in \mathbb{Q} \text{ and } (a <_{\mathbb{Q}} b \text{ or } b <_{\mathbb{Q}} a). \quad (2.1.1b)$$

Let also  $\rightsquigarrow_{\mathbb{Q}}$  be the closure of  $\Rightarrow_{\mathbb{Q}}$ .

2.1.3. Convergent rewrite rule.

LEMMA 2.1.1. *Let  $\mathcal{Q}$  be a poset. Then,  $\Rightarrow_{\mathcal{Q}}$  is an orientation of the space of relations  $\mathcal{R}_{\mathcal{Q}}^*$  of  $\text{As}(\mathcal{Q})$ .*

LEMMA 2.1.2. *Let  $\mathcal{Q}$  be a poset. Then,  $\rightsquigarrow_{\mathcal{Q}}$  is a terminating rewrite rule.*

LEMMA 2.1.3. *Let  $\mathcal{Q}$  be a poset. Then, the set of the normal forms of  $\rightsquigarrow_{\mathcal{Q}}$  is the set of the  $\mathcal{G}_{\mathcal{Q}}^*$ -syntax trees  $t$  such that for any internal node of  $t$  labeled by  $\star_a$  having a left (resp. right) child labeled by  $\star_b$ ,  $a$  and  $b$  are incomparable (resp. are equal or are incomparable) in  $\mathcal{Q}$ .*

Let us denote by  $\mathcal{F}(\mathcal{Q})$  the set of the normal forms of  $\rightsquigarrow_{\mathcal{Q}}$ , described in the statement of Lemma 2.1.3. Moreover, we denote by  $\mathcal{F}(\mathcal{Q})(n)$ ,  $n \geq 1$ , the set  $\mathcal{F}(\mathcal{Q})$  restricted to syntax trees with exactly  $n$  leaves. From their description provided by Lemma 2.1.3, any tree  $t$  of  $\mathcal{F}(\mathcal{Q})$  different from the leaf is of the recursive unique general form

$$t = \begin{array}{c} \star_a \\ \swarrow \quad \searrow \\ s_1 \quad \star_a \\ \quad \swarrow \quad \searrow \\ \quad s_{\ell-1} \quad s_{\ell} \end{array}, \tag{2.1.2}$$

where  $a \in \mathcal{Q}$  and the dashed edge denotes a right comb tree wherein internal nodes are labeled by  $\star_a$ , and for any  $i \in [\ell]$ ,  $s_i$  is a tree of  $\mathcal{F}(\mathcal{Q})$  such that  $s_i$  is the leaf or its root is labeled by a  $\star_b$ ,  $b \in \mathcal{Q}$ , so that  $a$  and  $b$  are incomparable in  $\mathcal{Q}$ .

LEMMA 2.1.4. *Let  $\mathcal{Q}$  be a forest poset. Then,  $\rightsquigarrow_{\mathcal{Q}}$  is a confluent rewrite rule.*

In Lemma 2.1.4, the condition on  $\mathcal{Q}$  to be a forest poset is a necessary condition. Indeed, by setting

$$\mathcal{Q} := \begin{array}{c} \textcircled{1} \quad \textcircled{2} \\ \quad \textcircled{3} \end{array}, \tag{2.1.3}$$

the branching tree

$$\begin{array}{c} \star_1 \\ \swarrow \quad \searrow \\ \star_3 \\ \quad \swarrow \quad \searrow \\ \quad \star_2 \end{array} \tag{2.1.4}$$

of  $\rightsquigarrow_{\mathcal{Q}}$  admits the branching pair consisting in the two syntax trees

$$\begin{array}{c} \star_1 \\ \swarrow \quad \searrow \\ \star_1 \quad \star_2 \\ \quad \swarrow \quad \searrow \\ \quad \star_2 \end{array}, \quad \begin{array}{c} \star_1 \\ \swarrow \quad \searrow \\ \star_1 \quad \star_2 \\ \quad \swarrow \quad \searrow \\ \quad \star_2 \end{array}. \tag{2.1.5}$$

Since these two trees are normal forms of  $\rightsquigarrow_{\mathcal{Q}}$ , this branching pair is not joinable, hence showing that  $\rightsquigarrow_{\mathcal{Q}}$  is not confluent.

2.1.4. *Koszulity.* Lemmas 2.1.1, 2.1.2, 2.1.3, and 2.1.4 imply the following result.

**THEOREM 2.1.5.** *Let  $\mathcal{Q}$  be a forest poset. Then, the operad  $\text{As}(\mathcal{Q})$  is Koszul and the set  $\mathcal{F}(\mathcal{Q})$  forms a Poincaré-Birkhoff-Witt basis of  $\text{As}(\mathcal{Q})$ .*

**2.2. Dimensions and realization.** The Koszulity, and more specifically the existence of a Poincaré-Birkhoff-Witt basis  $\mathcal{F}(\mathcal{Q})$  highlighted by Theorem 2.1.5 for  $\text{As}(\mathcal{Q})$  when  $\mathcal{Q}$  is a forest poset, lead to a combinatorial realization of  $\text{As}(\mathcal{Q})$ . Before describing this realization, we shall provide a functional equation for the Hilbert series of  $\text{As}(\mathcal{Q})$ .

2.2.1. *Dimensions.*

**PROPOSITION 2.2.1.** *Let  $\mathcal{Q}$  be a forest poset. Then, the Hilbert series  $\mathcal{H}_{\mathcal{Q}}(t)$  of  $\text{As}(\mathcal{Q})$  satisfies*

$$\mathcal{H}_{\mathcal{Q}}(t) = t + \sum_{a \in \mathcal{Q}} \mathcal{H}_{\mathcal{Q}}^a(t), \quad (2.2.1)$$

where for all  $a \in \mathcal{Q}$ , the  $\mathcal{H}_{\mathcal{Q}}^a(t)$  satisfy

$$\mathcal{H}_{\mathcal{Q}}^a(t) = \left( t + \bar{\mathcal{H}}_{\mathcal{Q}}^a(t) \right) \left( t + \bar{\mathcal{H}}_{\mathcal{Q}}^a(t) + \mathcal{H}_{\mathcal{Q}}^a(t) \right), \quad (2.2.2)$$

and for all  $a \in \mathcal{Q}$ , the  $\bar{\mathcal{H}}_{\mathcal{Q}}^a(t)$  satisfy

$$\bar{\mathcal{H}}_{\mathcal{Q}}^a(t) = \sum_{\substack{b \in \mathcal{Q} \\ a \not\leq b \\ b \not\leq a}} \mathcal{H}_{\mathcal{Q}}^b(t). \quad (2.2.3)$$

For instance, let us use Proposition 2.2.1 for the operad  $\text{As}(\mathcal{Q})$  when  $\mathcal{Q}$  is the total order on the set  $[\ell]$ ,  $\ell \geq 0$ . This operad is the multiassociative operad, whose definition is recalled in Section 1.1.3. By (2.2.3), we have

$$\bar{\mathcal{H}}_{\mathcal{Q}}^a(t) = 0, \quad a \in [\ell], \quad (2.2.4)$$

and hence, by (2.2.2),

$$\mathcal{H}_{\mathcal{Q}}^a(t) = \frac{t^2}{1-t}, \quad a \in [\ell]. \quad (2.2.5)$$

Then, by (2.2.1), the Hilbert series of  $\text{As}(\mathcal{Q})$  satisfies

$$\mathcal{H}_{\mathcal{Q}}(t) = t + \frac{\ell t^2}{1-t}, \quad \ell \geq 0. \quad (2.2.6)$$

Let us use Proposition 2.2.1 for the operad  $\text{As}(\mathcal{Q})$  when  $\mathcal{Q}$  is the trivial poset on the set  $[\ell]$ ,  $\ell \geq 0$ . This operad is the dual multiassociative operad, whose definition is recalled in Section 1.1.3. By (2.2.3), one has

$$\bar{\mathcal{H}}_{\mathcal{Q}}^a(t) = \sum_{\substack{b \in [\ell] \\ b \neq a}} \mathcal{H}_{\mathcal{Q}}^b(t), \quad a \in [\ell], \quad (2.2.7)$$

implying, by (2.2.1), that

$$\bar{\mathcal{H}}_{\mathcal{Q}}^a(t) = \mathcal{H}_{\mathcal{Q}}(t) - t - \mathcal{H}_{\mathcal{Q}}^a(t), \quad a \in [\ell]. \quad (2.2.8)$$

Now, by (2.2.2), we obtain

$$\mathcal{H}_{\mathcal{Q}}^a(t) = \frac{\mathcal{H}_{\mathcal{Q}}(t)^2}{1 + \mathcal{H}_{\mathcal{Q}}(t)}, \quad a \in [\ell]. \quad (2.2.9)$$

Therefore, by (2.2.1), the Hilbert series of  $\text{As}(\mathcal{Q})$  satisfies the quadratic functional equation

$$t + (t - 1)\mathcal{H}_{\mathcal{Q}}(t) + (\ell - 1)\mathcal{H}_{\mathcal{Q}}(t)^2 = 0, \quad \ell \geq 0, \quad (2.2.10)$$

and can be expressed as

$$\mathcal{H}_{\mathcal{Q}}(t) = \frac{1 - t - \sqrt{1 + (2 - 4\ell)t + t^2}}{2(\ell - 1)}, \quad \ell = 0 \text{ or } \ell \geq 2. \quad (2.2.11)$$

The dimensions of the first homogeneous components of  $\text{As}(\mathcal{Q})$  are

$$1, 2, 6, 22, 90, 394, 1806, 8558, 41586, 206098, \quad \ell = 2, \quad (2.2.12a)$$

$$1, 3, 15, 93, 645, 4791, 37275, 299865, 2474025, 20819307, \quad \ell = 3, \quad (2.2.12b)$$

$$1, 4, 28, 244, 2380, 24868, 272188, 3080596, 35758828, 423373636, \quad \ell = 4, \quad (2.2.12c)$$

$$1, 5, 45, 505, 6345, 85405, 1204245, 17558705, 262577745, 4005148405, \quad \ell = 5. \quad (2.2.12d)$$

These sequences are respectively Sequences **A006318**, **A103210**, **A103211**, and **A133305** of [Slo].

Finally, let us use Proposition 2.2.1 for the operad  $\text{As}(\mathcal{Q})$  when  $\mathcal{Q}$  is the forest poset

$$\mathcal{Q} := \begin{array}{c} \textcircled{1} \quad \textcircled{3} \\ | \quad | \\ \textcircled{2} \quad \textcircled{4} \end{array}. \quad (2.2.13)$$

By (2.2.3), one has

$$\bar{\mathcal{H}}_{\mathcal{Q}}^1(t) = \bar{\mathcal{H}}_{\mathcal{Q}}^2(t) = \mathcal{H}_{\mathcal{Q}}^3(t) + \mathcal{H}_{\mathcal{Q}}^4(t), \quad (2.2.14a)$$

$$\bar{\mathcal{H}}_{\mathcal{Q}}^3(t) = \bar{\mathcal{H}}_{\mathcal{Q}}^4(t) = \mathcal{H}_{\mathcal{Q}}^1(t) + \mathcal{H}_{\mathcal{Q}}^2(t), \quad (2.2.14b)$$

and, by (2.2.2) and straightforward computations, we obtain that

$$\mathcal{H}_{\mathcal{Q}}^1(t) = \mathcal{H}_{\mathcal{Q}}^2(t) = \mathcal{H}_{\mathcal{Q}}^3(t) = \mathcal{H}_{\mathcal{Q}}^4(t), \quad (2.2.15)$$

so that the Hilbert series of  $\text{As}(\mathcal{Q})$  satisfies the quadratic functional equation

$$\frac{1}{2}t + \frac{1}{4}t^2 + \left(t - \frac{1}{2}\right)\mathcal{H}_{\mathcal{Q}}(t) + \frac{3}{4}\mathcal{H}_{\mathcal{Q}}(t)^2 = 0. \quad (2.2.16)$$

This Hilbert series can be expressed as

$$\mathcal{H}_{\mathcal{Q}}(t) = \frac{1 - 2t - \sqrt{1 - 10t + t^2}}{3}, \quad (2.2.17)$$

and the dimensions of the first homogeneous components of  $\text{As}(\mathcal{Q})$  are

$$1, 4, 20, 124, 860, 6388, 49700, 399820, 3298700, 27759076. \quad (2.2.18)$$

Terms of this sequence are the ones of Sequence **A107841** of [Slo] multiplied by 2.



2.2.2. *Realization.* Let us describe a combinatorial realization of  $\text{As}(\mathcal{Q})$  when  $\mathcal{Q}$  is a forest poset in terms of Schröder trees (see Section 2.2.3 of Chapter 1) with a certain labeling and through an algorithm to compute their partial composition.

If  $\mathcal{Q}$  is a poset (not necessarily a forest poset just now), a  *$\mathcal{Q}$ -Schröder tree* is a Schröder tree where internal nodes are labeled on  $\mathcal{Q}$ . For any element  $a$  of  $\mathcal{Q}$  and any  $n \geq 2$ , we denote by  $c_a^n$  the  $\mathcal{Q}$ -Schröder tree consisting in a single internal node labeled by  $a$  attached to  $n$  leaves. We call these trees  *$\mathcal{Q}$ -corollas*. A  *$\mathcal{Q}$ -alternating Schröder tree* is a  $\mathcal{Q}$ -Schröder tree  $t$  such that for any internal node  $y$  of  $t$  having a father  $x$ , the labels of  $x$  and  $y$  are incomparable in  $\mathcal{Q}$ . We denote by  $S(\mathcal{Q})$  the set of all  $\mathcal{Q}$ -alternating Schröder trees and by  $S(\mathcal{Q})(n)$ ,  $n \geq 1$ , the set  $S(\mathcal{Q})$  restricted to trees with exactly  $n$  leaves. Any tree  $t$  of  $S(\mathcal{Q})$  different from the leaf is of the recursive unique general form

$$t = \begin{array}{c} \textcircled{a} \\ \swarrow \quad \searrow \\ s_1 \quad \dots \quad s_\ell \end{array}, \tag{2.2.19}$$

where  $a \in \mathcal{Q}$  and for any  $i \in [\ell]$ ,  $s_i$  is a tree of  $S(\mathcal{Q})$  such that  $s_i$  is a leaf or its root is labeled by a  $b \in \mathcal{Q}$  and  $a$  and  $b$  are incomparable in  $\mathcal{Q}$ .

Relying on the description of the elements of  $\mathcal{F}(\mathcal{Q})$  provided by Lemma 2.1.3 and on their recursive general form provided by (2.1.2), let us consider the map

$$s_{\mathcal{Q}} : \mathcal{F}(\mathcal{Q})(n) \rightarrow S(\mathcal{Q})(n), \quad n \geq 1, \tag{2.2.20}$$

defined recursively by sending the leaf to the leaf and, for any tree  $t$  of  $\mathcal{F}(\mathcal{Q})$  different from the leaf, by

$$s_{\mathcal{Q}}(t) = s_{\mathcal{Q}} \left( \begin{array}{c} \text{---} \\ \text{---} \quad \text{---} \\ \text{---} \quad \text{---} \\ \text{---} \quad \text{---} \\ s_1 \quad \text{---} \quad \text{---} \quad s_{\ell-1} \quad s_\ell \\ \text{---} \quad \text{---} \\ \star_a \quad \quad \quad \star_a \end{array} \right) := \begin{array}{c} \textcircled{a} \\ \swarrow \quad \searrow \\ s_{\mathcal{Q}}(s_1) \quad \dots \quad s_{\mathcal{Q}}(s_\ell) \end{array}, \tag{2.2.21}$$

where  $a \in \mathcal{Q}$  and, in the syntax tree of (2.2.21), the dashed edge denotes a right comb tree wherein internal nodes are labeled by  $\star_a$ , and for any  $i \in [\ell]$ ,  $s_i$  is a tree of  $\mathcal{F}(\mathcal{Q})$  such that  $s_i$  is the leaf or its root is labeled by  $\star_b$ ,  $b \in \mathcal{Q}$ , and  $a$  and  $b$  are incomparable in  $\mathcal{Q}$ . It is immediate that  $s_{\mathcal{Q}}(t)$  is a  $\mathcal{Q}$ -alternating Schröder tree, so that  $s_{\mathcal{Q}}$  is a well-defined map.

LEMMA 2.2.2. *Let  $\mathcal{Q}$  be a poset. Then, for any  $n \geq 1$ , the map  $s_{\mathcal{Q}}$  is a bijection between the set of syntax trees of  $\mathcal{F}(\mathcal{Q})(n)$  with  $n$  leaves and the set  $S(\mathcal{Q})(n)$  of  $\mathcal{Q}$ -alternating Schröder trees with  $n$  leaves.*

In order to define a partial composition for  $\mathcal{Q}$ -alternating Schröder trees, we introduce the following rewrite rule. When  $\mathcal{Q}$  is a forest poset, consider the rewrite rule  $\rightarrow_{\mathcal{Q}}$  on  $\mathcal{Q}$ -Schröder trees (not necessarily  $\mathcal{Q}$ -alternating Schröder trees) satisfying

$$\begin{array}{c} \textcircled{b} \\ \swarrow \quad \searrow \\ \dots \quad \textcircled{a} \quad \dots \\ \swarrow \quad \searrow \\ \square \quad \dots \quad \square \end{array} \rightarrow_{\mathcal{Q}} \begin{array}{c} \textcircled{a \uparrow_{\mathcal{Q}} b} \\ \swarrow \quad \searrow \\ \square \quad \dots \quad \square \end{array}, \quad a, b \in \mathcal{Q} \text{ and } (a \preceq_{\mathcal{Q}} b \text{ or } b \preceq_{\mathcal{Q}} a). \tag{2.2.22}$$

Let also  $\rightsquigarrow_Q$  be the closure of  $\rightarrow_Q$ . Equation (2.2.29) shows examples of steps of rewritings by  $\rightsquigarrow_Q$  for the poset  $Q$  defined in (2.2.26).

LEMMA 2.2.3. *Let  $Q$  be a poset. Then,  $\rightsquigarrow_Q$  is a terminating rewrite rule and the set of its normal forms is the set of all  $Q$ -alternating Schröder trees. Moreover, when  $Q$  is a forest poset,  $\rightsquigarrow_Q$  is confluent.*

In Lemma 2.2.3, the condition on  $Q$  to be a forest poset is a necessary condition for the confluence of  $\rightsquigarrow_Q$ . Indeed, by setting

$$Q := \begin{array}{c} \textcircled{1} \quad \textcircled{2} \\ \diagdown \quad \diagup \\ \textcircled{3} \end{array}, \tag{2.2.23}$$

the branching tree

$$\begin{array}{c} \textcircled{1} \\ \diagdown \quad \diagup \\ \square \quad \textcircled{3} \\ \quad \diagdown \quad \diagup \\ \quad \textcircled{2} \quad \square \\ \quad \diagdown \quad \diagup \\ \quad \square \quad \square \end{array} \tag{2.2.24}$$

of  $\rightsquigarrow_Q$  admits the branching pair consisting in the two trees

$$\begin{array}{c} \textcircled{1} \\ \diagdown \quad \diagup \\ \textcircled{2} \quad \square \\ \diagdown \quad \diagup \\ \square \quad \square \end{array}, \quad \begin{array}{c} \textcircled{1} \\ \diagdown \quad \diagup \\ \square \quad \textcircled{2} \\ \diagdown \quad \diagup \\ \square \quad \square \end{array}. \tag{2.2.25}$$

Since these two trees are normal forms of  $\rightsquigarrow_Q$ , this branching pair is not joinable and hence,  $\rightsquigarrow_Q$  is not confluent.

We define the partial composition  $s \circ_i t$  of two  $Q$ -alternating Schröder trees  $s$  and  $t$  as the  $Q$ -alternating Schröder tree being the normal form by  $\rightsquigarrow_Q$  of the  $Q$ -Schröder tree obtained by grafting the root of  $t$  on the  $i$ th leaf of  $s$ . We denote by  $\text{ASchr}(Q)$  the linear span of the set of the  $Q$ -alternating Schröder trees endowed with the partial composition described above and extended by linearity. Consider for instance the forest poset

$$Q := \begin{array}{c} \textcircled{1} \quad \textcircled{4} \\ \diagdown \quad \diagup \\ \textcircled{2} \quad \textcircled{3} \\ \quad \diagdown \quad \diagup \\ \quad \textcircled{5} \\ \quad \quad \diagdown \quad \diagup \\ \quad \quad \square \quad \textcircled{6} \end{array}. \tag{2.2.26}$$

Then, we have in  $\text{ASchr}(Q)$  the partial composition

$$\begin{array}{c} \textcircled{6} \\ \diagdown \quad \diagup \\ \textcircled{4} \quad \square \end{array} \circ_3 \begin{array}{c} \textcircled{2} \\ \diagdown \quad \diagup \\ \square \quad \textcircled{6} \end{array} = \begin{array}{c} \textcircled{6} \\ \diagdown \quad \diagup \\ \textcircled{4} \quad \textcircled{2} \\ \quad \diagdown \quad \diagup \\ \quad \square \quad \textcircled{6} \end{array}, \tag{2.2.27}$$

and also

$$\begin{array}{c} \textcircled{1} \\ \diagdown \quad \diagup \\ \square \quad \textcircled{4} \end{array} \circ_1 \begin{array}{c} \textcircled{2} \\ \diagdown \quad \diagup \\ \textcircled{3} \quad \textcircled{3} \end{array} = \begin{array}{c} \textcircled{1} \\ \diagdown \quad \diagup \\ \square \quad \square \quad \square \quad \textcircled{4} \end{array}, \tag{2.2.28}$$

since

$$\begin{array}{c} \textcircled{1} \\ \diagdown \quad \diagup \\ \textcircled{2} \quad \textcircled{4} \\ \diagdown \quad \diagup \\ \textcircled{3} \quad \textcircled{3} \quad \square \quad \square \end{array} \rightsquigarrow_Q \begin{array}{c} \textcircled{1} \\ \diagdown \quad \diagup \\ \textcircled{3} \quad \textcircled{3} \quad \textcircled{4} \end{array} \rightsquigarrow_Q \begin{array}{c} \textcircled{1} \\ \diagdown \quad \diagup \\ \textcircled{3} \quad \square \quad \textcircled{4} \end{array} \rightsquigarrow_Q \begin{array}{c} \textcircled{1} \\ \diagdown \quad \diagup \\ \square \quad \square \quad \textcircled{4} \end{array} \tag{2.2.29}$$

is a sequence of rewritings steps by  $\rightsquigarrow_{\mathcal{Q}}$ , where the leftmost tree of (2.2.29) is obtained by grafting the root of the second tree of (2.2.28) onto the first leaf of the first tree of (2.2.28).

**PROPOSITION 2.2.4.** *Let  $\mathcal{Q}$  be a forest poset. Then,  $\text{ASchr}(\mathcal{Q})$  is an operad graded by the number of the leaves of the trees. Moreover, as an operad,  $\text{ASchr}(\mathcal{Q})$  is generated by the set of  $\mathcal{Q}$ -corollas of arity two.*

**THEOREM 2.2.5.** *Let  $\mathcal{Q}$  be a forest poset. Then, the operads  $\text{As}(\mathcal{Q})$  and  $\text{ASchr}(\mathcal{Q})$  are isomorphic.*

**PROOF.** First, by Proposition 2.2.4,  $\text{ASchr}(\mathcal{Q})$  is an operad wherein for any  $n \geq 1$ , its graded component of arity  $n$  has bases indexed by  $\mathcal{Q}$ -alternating Schröder trees with  $n$  leaves. By Lemma 2.2.2, these trees are in bijection with the elements of the Poincaré-Birkhoff-Witt basis  $\mathcal{F}(\mathcal{Q})$  of  $\text{As}(\mathcal{Q})$  provided by Theorem 2.1.5. By [Hof10], this shows that  $\text{ASchr}(\mathcal{Q})$  and  $\text{As}(\mathcal{Q})$  are isomorphic as graded vector spaces.

The generators of  $\text{ASchr}(\mathcal{Q})$ , that are by Proposition 2.2.4  $\mathcal{Q}$ -corollas of arity two, satisfy at least the nontrivial relations

$$c_a^2 \circ_1 c_b^2 - c_{a \uparrow_{\mathcal{Q}} b}^2 \circ_2 c_{a \uparrow_{\mathcal{Q}} b}^2 = 0, \quad a, b \in \mathcal{Q} \text{ and } (a \preceq_{\mathcal{Q}} b \text{ or } b \preceq_{\mathcal{Q}} a), \quad (2.2.30a)$$

$$c_{a \uparrow_{\mathcal{Q}} b}^2 \circ_1 c_{a \uparrow_{\mathcal{Q}} b}^2 - c_a^2 \circ_2 c_b^2 = 0, \quad a, b \in \mathcal{Q} \text{ and } (a \preceq_{\mathcal{Q}} b \text{ or } b \preceq_{\mathcal{Q}} a), \quad (2.2.30b)$$

obtained by a direct computation in  $\text{ASchr}(\mathcal{Q})$ . By using the same reasoning as the one used to establish Proposition 1.2.1, we obtain that there are as many elements of the form (2.2.30a) or (2.2.30b) as generating relations (see (1.1.2a) and (1.1.2b)) for the space of relations  $\mathcal{R}_{\mathcal{Q}}^*$  of  $\text{As}(\mathcal{Q})$ . Therefore, as  $\text{ASchr}(\mathcal{Q})$  and  $\text{As}(\mathcal{Q})$  are isomorphic as graded vector spaces, it cannot be more nontrivial relations in  $\text{ASchr}(\mathcal{Q})$  than Relations (2.2.30a) and (2.2.30b).

Finally, by identifying all symbols  $c_a^2$ ,  $a \in \mathcal{Q}$ , with  $\star_a$ , we observe that  $\text{As}(\mathcal{Q})$  and  $\text{ASchr}(\mathcal{Q})$  admit the same presentation. This implies that  $\text{As}(\mathcal{Q})$  and  $\text{ASchr}(\mathcal{Q})$  are isomorphic operads.  $\square$

As announced, Theorem 2.2.5 provides a combinatorial realization  $\text{ASchr}(\mathcal{Q})$  of  $\text{As}(\mathcal{Q})$  when  $\mathcal{Q}$  is a forest poset.

**2.2.3. Free forest poset associative algebras over one generator.** The realization of  $\text{As}(\mathcal{Q})$ , when  $\mathcal{Q}$  is a forest poset, provided by Theorem 2.2.5 in terms of  $\mathcal{Q}$ -alternating Schröder trees leads to the following description. The free  $\mathcal{Q}$ -associative algebra over one generator, where  $\mathcal{Q}$  is a forest poset, has  $\text{ASchr}(\mathcal{Q})$  as underlying vector space and is endowed with linear operations

$$\star_a : \text{ASchr}(\mathcal{Q}) \otimes \text{ASchr}(\mathcal{Q}) \rightarrow \text{ASchr}(\mathcal{Q}), \quad a \in \mathcal{Q}, \quad (2.2.31)$$

satisfying for all  $\mathcal{Q}$ -alternating Schröder trees  $\mathfrak{s}$  and  $\mathfrak{t}$ ,

$$\mathfrak{s} \star_a \mathfrak{t} = (c_a^2 \circ_2 \mathfrak{t}) \circ_1 \mathfrak{s}. \quad (2.2.32)$$

In an alternative way,  $\mathfrak{s} \star_a \mathfrak{t}$  is the  $\mathcal{Q}$ -alternating Schröder obtained by considering the normal form by  $\rightsquigarrow_{\mathcal{Q}}$  of the tree obtained by grafting  $\mathfrak{s}$  and  $\mathfrak{t}$  respectively as left and right child of a binary corolla labeled by  $a$ .

Let us provide examples of computations in the free  $\mathcal{Q}$ -associative algebra over one generator where  $\mathcal{Q}$  is the forest poset

$$\mathcal{Q} := \begin{array}{c} \textcircled{1} \\ \textcircled{2} \quad \textcircled{3} \\ \quad \quad \textcircled{4} \end{array} \quad \textcircled{5} . \quad (2.2.33)$$

We have

$$\begin{array}{c} \textcircled{2} \\ \square \quad \square \\ \textcircled{4} \end{array} \star_1 \begin{array}{c} \textcircled{3} \\ \textcircled{2} \quad \textcircled{5} \\ \square \quad \square \end{array} = \begin{array}{c} \textcircled{1} \\ \square \quad \square \quad \square \quad \square \\ \textcircled{5} \\ \square \quad \square \end{array} , \quad (2.2.34a)$$

$$\begin{array}{c} \textcircled{2} \\ \square \quad \square \\ \textcircled{4} \end{array} \star_2 \begin{array}{c} \textcircled{3} \\ \textcircled{2} \quad \textcircled{5} \\ \square \quad \square \end{array} = \begin{array}{c} \textcircled{2} \\ \square \quad \square \\ \textcircled{4} \quad \textcircled{3} \\ \square \quad \square \quad \textcircled{2} \quad \textcircled{5} \\ \square \quad \square \quad \square \quad \square \end{array} , \quad (2.2.34b)$$

$$\begin{array}{c} \textcircled{2} \\ \square \quad \square \\ \textcircled{4} \end{array} \star_3 \begin{array}{c} \textcircled{3} \\ \textcircled{2} \quad \textcircled{5} \\ \square \quad \square \end{array} = \begin{array}{c} \textcircled{3} \\ \textcircled{2} \quad \textcircled{2} \quad \textcircled{5} \\ \square \quad \square \quad \square \quad \square \\ \textcircled{4} \\ \square \quad \square \end{array} , \quad (2.2.34c)$$

$$\begin{array}{c} \textcircled{2} \\ \square \quad \square \\ \textcircled{4} \end{array} \star_4 \begin{array}{c} \textcircled{3} \\ \textcircled{2} \quad \textcircled{5} \\ \square \quad \square \end{array} = \begin{array}{c} \textcircled{3} \\ \textcircled{2} \quad \textcircled{2} \quad \textcircled{5} \\ \square \quad \square \quad \square \quad \square \\ \textcircled{4} \\ \square \quad \square \end{array} , \quad (2.2.34d)$$

$$\begin{array}{c} \textcircled{2} \\ \square \quad \square \\ \textcircled{4} \end{array} \star_5 \begin{array}{c} \textcircled{3} \\ \textcircled{2} \quad \textcircled{5} \\ \square \quad \square \end{array} = \begin{array}{c} \textcircled{5} \\ \textcircled{2} \quad \textcircled{3} \quad \textcircled{5} \\ \square \quad \square \quad \square \quad \square \\ \textcircled{4} \\ \square \quad \square \end{array} . \quad (2.2.34e)$$

**2.3. Koszul dual.** We now establish a first presentation for the Koszul dual  $\text{As}(\mathcal{Q})^!$  of  $\text{As}(\mathcal{Q})$  where  $\mathcal{Q}$  is a poset (and not necessarily a forest poset) and provide moreover a second presentation of  $\text{As}(\mathcal{Q})^!$  when  $\mathcal{Q}$  is a forest poset. This second presentation of  $\text{As}(\mathcal{Q})^!$  is simpler than the first one and it shall be considered in the next section.

### 2.3.1. Presentation by generators and relations.

PROPOSITION 2.3.1. *Let  $\mathcal{Q}$  be a poset. Then, the Koszul dual  $\text{As}(\mathcal{Q})^!$  of  $\text{As}(\mathcal{Q})$  admits the presentation  $(\mathfrak{G}_{\mathcal{Q}}^{\bar{\cdot}}, \mathfrak{R}_{\mathcal{Q}}^{\bar{\cdot}})$  where*

$$\mathfrak{G}_{\mathcal{Q}}^{\bar{\cdot}} := \mathfrak{G}_{\mathcal{Q}}^{\bar{\cdot}}(2) := \{\bar{x}_a : a \in \mathcal{Q}\}, \quad (2.3.1)$$

and  $\mathfrak{R}_{\mathcal{Q}}^{\bar{\cdot}}$  is the subspace of  $\text{FO}(\mathfrak{G}_{\mathcal{Q}}^{\bar{\cdot}})$  generated by

$$\begin{aligned} & \odot(\bar{x}_a) \circ_1 \odot(\bar{x}_a) - \odot(\bar{x}_a) \circ_2 \odot(\bar{x}_a) \\ & + \sum_{\substack{b \in \mathcal{Q} \\ a <_{\mathcal{Q}} b}} (\odot(\bar{x}_b) \circ_1 \odot(\bar{x}_a) + \odot(\bar{x}_a) \circ_1 \odot(\bar{x}_b) - \odot(\bar{x}_b) \circ_2 \odot(\bar{x}_a) - \odot(\bar{x}_a) \circ_2 \odot(\bar{x}_b)), \quad a \in \mathcal{Q}, \end{aligned} \quad (2.3.2a)$$

$$\odot(\bar{x}_c) \circ_1 \odot(\bar{x}_d), \quad c, d \in \mathcal{Q} \text{ and } c \not\leq_{\mathcal{Q}} d \text{ and } d \not\leq_{\mathcal{Q}} c, \quad (2.3.2b)$$

$$\odot(\bar{x}_c) \circ_2 \odot(\bar{x}_d), \quad c, d \in Q \text{ and } c \not\prec_Q d \text{ and } d \not\prec_Q c. \quad (2.3.2c)$$

PROPOSITION 2.3.2. *Let  $Q$  be a poset. Then, the dimension of the space  $\mathcal{R}_Q^{\bar{x}}$  of relations of  $\text{As}(Q)^!$  satisfies*

$$\dim \mathcal{R}_Q^{\bar{x}} = 2(\#Q)^2 + 3\#Q - 4 \text{int}(Q). \quad (2.3.3)$$

Observe that, by Propositions 1.2.1 and 2.3.2, we have

$$\begin{aligned} \dim \mathcal{R}_Q^{\bar{x}} + \dim \mathcal{R}_Q^{\bar{x}} &= 4 \text{int}(Q) - 3\#Q + 2(\#Q)^2 + 3\#Q - 4 \text{int}(Q) \\ &= 2(\#Q)^2 \\ &= \dim \mathbf{FO}(\mathcal{G}_Q^{\bar{x}})(3), \end{aligned} \quad (2.3.4)$$

as expected by Koszul duality.

2.3.2. *Alternative presentation.* For any element  $a$  of a poset  $Q$  (not necessarily a forest poset just now), let  $\bar{\Delta}_a$  be the element of  $\text{As}(Q)^!(2)$  defined by

$$\bar{\Delta}_a := \sum_{\substack{b \in Q \\ a \prec_Q b}} \bar{x}_b. \quad (2.3.5)$$

We denote by  $\mathcal{G}_Q^{\bar{\Delta}}$  the set of all  $\bar{\Delta}_a$ ,  $a \in Q$ . By triangularity, the family  $\mathcal{G}_Q^{\bar{\Delta}}$  forms a basis of  $\text{As}(Q)^!(2)$  and hence, generates  $\text{As}(Q)^!$ . Consider for instance the poset

$$Q := \begin{array}{c} \textcircled{1} \quad \textcircled{2} \\ \textcircled{3} \quad \textcircled{4} \\ \textcircled{5} \end{array}. \quad (2.3.6)$$

The elements of  $\mathcal{G}_Q^{\bar{\Delta}}$  then express as

$$\bar{\Delta}_1 = \bar{x}_1 + \bar{x}_3, \quad (2.3.7a)$$

$$\bar{\Delta}_2 = \bar{x}_2 + \bar{x}_3 + \bar{x}_4 + \bar{x}_5, \quad (2.3.7b)$$

$$\bar{\Delta}_3 = \bar{x}_3, \quad (2.3.7c)$$

$$\bar{\Delta}_4 = \bar{x}_4 + \bar{x}_5, \quad (2.3.7d)$$

$$\bar{\Delta}_5 = \bar{x}_5. \quad (2.3.7e)$$

PROPOSITION 2.3.3. *Let  $Q$  be a forest poset. Then, the operad  $\text{As}(Q)^!$  admits the presentation  $(\mathcal{G}_Q^{\bar{\Delta}}, \mathcal{R}_Q^{\bar{\Delta}})$  where  $\mathcal{R}_Q^{\bar{\Delta}}$  is the subspace of  $\mathbf{FO}(\mathcal{G}_Q^{\bar{\Delta}})$  generated by*

$$\odot(\bar{\Delta}_a) \circ_1 \odot(\bar{\Delta}_a) - \odot(\bar{\Delta}_a) \circ_2 \odot(\bar{\Delta}_a), \quad a \in Q, \quad (2.3.8a)$$

$$\odot(\bar{\Delta}_c) \circ_1 \odot(\bar{\Delta}_d), \quad c, d \in Q \text{ and } c \not\prec_Q d \text{ and } d \not\prec_Q c, \quad (2.3.8b)$$

$$\odot(\bar{\Delta}_c) \circ_2 \odot(\bar{\Delta}_d), \quad c, d \in Q \text{ and } c \not\prec_Q d \text{ and } d \not\prec_Q c. \quad (2.3.8c)$$

By considering the presentation of  $\text{As}(\mathcal{Q})^!$  furnished by Proposition 2.3.3 when  $\mathcal{Q}$  is a forest poset, we obtain by Koszul duality a new presentation  $(\mathfrak{G}_{\mathcal{Q}}^{\Delta}, \mathfrak{R}_{\mathcal{Q}}^{\Delta})$  for  $\text{As}(\mathcal{Q})$  where the set of generators  $\mathfrak{G}_{\mathcal{Q}}^{\Delta}$  is defined by

$$\mathfrak{G}_{\mathcal{Q}}^{\Delta} := \mathfrak{G}_{\mathcal{Q}}^{\Delta}(2) := \{\Delta_a : a \in \mathcal{Q}\}, \quad (2.3.9)$$

and the space of relations  $\mathfrak{R}_{\mathcal{Q}}^{\Delta}$  is generated by

$$\odot(\Delta_a) \circ_1 \odot(\Delta_a) - \odot(\Delta_a) \circ_2 \odot(\Delta_a), \quad a \in \mathcal{Q}, \quad (2.3.10a)$$

$$\odot(\Delta_a) \circ_1 \odot(\Delta_b), \quad a, b \in \mathcal{Q} \text{ and } (a <_{\mathcal{Q}} b \text{ or } b <_{\mathcal{Q}} a), \quad (2.3.10b)$$

$$\odot(\Delta_a) \circ_2 \odot(\Delta_b), \quad a, b \in \mathcal{Q} \text{ and } (a <_{\mathcal{Q}} b \text{ or } b <_{\mathcal{Q}} a). \quad (2.3.10c)$$

2.3.3. *Example.* To end this section, let us give a complete example of the spaces of relations  $\mathfrak{R}_{\mathcal{Q}}^*$ ,  $\mathfrak{R}_{\mathcal{Q}}^{\bar{\Delta}}$ , and  $\mathfrak{R}_{\mathcal{Q}}^{\Delta}$  of the operads  $\text{As}(\mathcal{Q})$  and  $\text{As}(\mathcal{Q})^!$  where  $\mathcal{Q}$  is the forest poset

$$\mathcal{Q} := \begin{array}{c} \textcircled{1} \\ \textcircled{2} \quad \textcircled{3} \end{array}. \quad (2.3.11)$$

First, by definition of  $\text{As}$  and by Lemma 1.1.1, the generators of  $\mathfrak{G}_{\mathcal{Q}}^*$  are subjected to the relations

$$\begin{aligned} \star_1 \circ_1 \star_1 &= \star_1 \circ_1 \star_2 = \star_2 \circ_1 \star_1 = \star_1 \circ_1 \star_3 = \star_3 \circ_1 \star_1 \\ &= \star_3 \circ_2 \star_1 = \star_1 \circ_2 \star_3 = \star_2 \circ_2 \star_1 = \star_1 \circ_2 \star_2 = \star_1 \circ_2 \star_1, \end{aligned} \quad (2.3.12a)$$

$$\star_2 \circ_1 \star_2 = \star_2 \circ_2 \star_2, \quad (2.3.12b)$$

$$\star_3 \circ_1 \star_3 = \star_3 \circ_2 \star_3. \quad (2.3.12c)$$

This describes  $\mathfrak{R}_{\mathcal{Q}}^*$ .

By Proposition 2.3.1, the generators of  $\mathfrak{G}_{\mathcal{Q}}^{\bar{\Delta}}$  are subjected to the relations

$$\begin{aligned} \bar{\star}_1 \circ_1 \bar{\star}_1 + \bar{\star}_1 \circ_1 \bar{\star}_2 + \bar{\star}_2 \circ_1 \bar{\star}_1 + \bar{\star}_1 \circ_1 \bar{\star}_3 + \bar{\star}_3 \circ_1 \bar{\star}_1 \\ = \bar{\star}_3 \circ_2 \bar{\star}_1 + \bar{\star}_1 \circ_2 \bar{\star}_3 + \bar{\star}_2 \circ_2 \bar{\star}_1 + \bar{\star}_1 \circ_2 \bar{\star}_2 + \bar{\star}_1 \circ_2 \bar{\star}_1, \end{aligned} \quad (2.3.13a)$$

$$\bar{\star}_2 \circ_1 \bar{\star}_2 = \bar{\star}_2 \circ_2 \bar{\star}_2, \quad (2.3.13b)$$

$$\bar{\star}_3 \circ_1 \bar{\star}_3 = \bar{\star}_3 \circ_2 \bar{\star}_3, \quad (2.3.13c)$$

$$\bar{\star}_2 \circ_1 \bar{\star}_3 = \bar{\star}_3 \circ_1 \bar{\star}_2 = \bar{\star}_3 \circ_2 \bar{\star}_2 = \bar{\star}_2 \circ_2 \bar{\star}_3 = 0. \quad (2.3.13d)$$

This describes  $\mathfrak{R}_{\mathcal{Q}}^{\bar{\Delta}}$ .

By Proposition 2.3.3, the generators of  $\mathfrak{G}_{\mathcal{Q}}^{\Delta}$  are subjected to the relations

$$\bar{\Delta}_1 \circ_1 \bar{\Delta}_1 = \bar{\Delta}_1 \circ_2 \bar{\Delta}_1, \quad (2.3.14a)$$

$$\bar{\Delta}_2 \circ_1 \bar{\Delta}_2 = \bar{\Delta}_2 \circ_2 \bar{\Delta}_2, \quad (2.3.14b)$$

$$\bar{\Delta}_3 \circ_1 \bar{\Delta}_3 = \bar{\Delta}_3 \circ_2 \bar{\Delta}_3, \quad (2.3.14c)$$

$$\bar{\Delta}_2 \circ_1 \bar{\Delta}_3 = \bar{\Delta}_3 \circ_1 \bar{\Delta}_2 = \bar{\Delta}_3 \circ_2 \bar{\Delta}_2 = \bar{\Delta}_2 \circ_2 \bar{\Delta}_3 = 0. \quad (2.3.14d)$$

This describes  $\mathfrak{R}_{\mathcal{Q}}^{\Delta}$ .

Finally, by the observation established at the end of Section 2.3.2, the generators of  $\mathfrak{G}_Q^\Delta$  are subjected to the relations

$$\Delta_1 \circ_1 \Delta_1 = \Delta_1 \circ_2 \Delta_1, \tag{2.3.15a}$$

$$\Delta_2 \circ_1 \Delta_2 = \Delta_2 \circ_2 \Delta_2, \tag{2.3.15b}$$

$$\Delta_3 \circ_1 \Delta_3 = \Delta_3 \circ_2 \Delta_3, \tag{2.3.15c}$$

$$\begin{aligned} \Delta_1 \circ_1 \Delta_2 &= \Delta_2 \circ_1 \Delta_1 = \Delta_1 \circ_1 \Delta_3 = \Delta_3 \circ_1 \Delta_1 \\ &= \Delta_3 \circ_2 \Delta_1 = \Delta_1 \circ_2 \Delta_3 = \Delta_2 \circ_2 \Delta_1 = \Delta_1 \circ_2 \Delta_2 = 0. \end{aligned} \tag{2.3.15d}$$

This describes  $\mathcal{R}_Q^\Delta$ .

### 3. Thin forest posets and Koszul duality

As we have seen in Section 2, certain properties satisfied by the poset  $Q$  imply properties for the operad  $\text{As}(Q)$ . In this section, we show that when  $Q$  is a forest poset with an extra condition, the Koszul dual  $\text{As}(Q)^\dagger$  of  $\text{As}(Q)$  can be constructed via the construction  $\text{As}$ .

**3.1. Thin forest posets.** A subclass of the class of forest posets, whose elements are called thin forest posets, is described here. We also define an involution on these posets that is linked, as we shall see later, to Koszul duality of the concerned operads.

3.1.1. *Description.* A *thin forest poset* is a forest poset avoiding the pattern  (see Section 1.3.2 of Chapter 1 for the definition of pattern avoidance in posets). In other words, a thin forest poset is a poset so that the nonplanar rooted tree  $t$  obtained by adding a (new) root to the Hasse diagram of  $Q$  has the following property. Any node  $x$  of  $t$  has at most one child  $y$  such that the suffix subtree of  $t$  rooted at  $y$  has two nodes or more. For instance, Figure 6.1a shows a thin forest poset, while Figure 6.2 shows a forest poset that does not satisfies the described property.

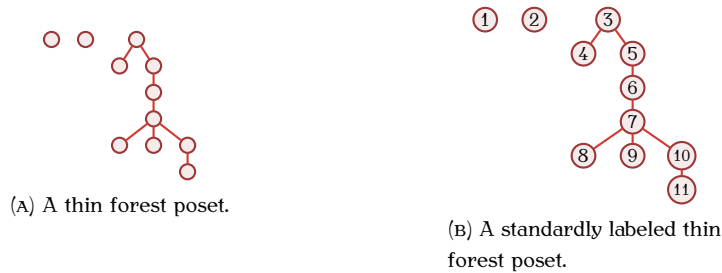

FIGURE 6.1. Hasse diagrams of a thin forest poset and a standardly labeled version.

A *standard labeling* of a thin forest poset  $Q$  consists in labeling the vertices of the Hasse diagram of  $Q$  from 1 to  $\#Q$  in the order they appear in a depth first traversal, by always visiting in a same sibling the node with the biggest subtree as last. For instance, a standard labeling of the poset of Figure 6.1a is the poset shown in Figure 6.1b. In what follows, we shall consider only standardly labeled thin forest posets and we shall identify any element  $x$  of a thin forest posets  $Q$  as the label of  $x$  in a standard labeling of  $Q$ . Moreover, we shall see

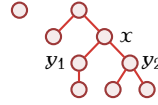

FIGURE 6.2. The Hasse diagram of a forest poset which is not a thin forest poset. Indeed, the node  $x$  has two children  $y_1$  and  $y_2$  such that the suffix subtrees rooted at  $y_1$  and  $y_2$  have both two nodes or more.

thin forest posets as forests of nonplanar rooted trees, obtained by considering the Hasse diagrams of these posets.

Thin forest posets admit the following recursive description. If  $\mathcal{Q}$  is a thin forest poset, then  $\mathcal{Q}$  is the empty forest  $\emptyset$ , or it is the forest

$$\circ \mathcal{Q}' \tag{3.1.1}$$

consisting in the tree of one node  $\circ$  (labeled by 1) and a thin forest poset  $\mathcal{Q}'$ , or it is the forest

$$\begin{array}{c} \circ \\ | \\ \mathcal{Q}' \end{array} \tag{3.1.2}$$

consisting in one root (labeled by 1) attached to the roots of the trees of the thin forest poset  $\mathcal{Q}'$ . Therefore, there are  $2^{n-1}$  thin forest posets of size  $n \geq 1$ .

3.1.2. *Duality.* Given a thin forest poset  $\mathcal{Q}$ , the *dual* of  $\mathcal{Q}$  is the poset  $\mathcal{Q}^\perp$  such that, for all  $a, b \in \mathcal{Q}^\perp$ ,  $a \preceq_{\mathcal{Q}^\perp} b$  if and only if  $a = b$  or  $a$  and  $b$  are incomparable in  $\mathcal{Q}$  and  $a < b$  (for the natural order on the labels  $a$  and  $b$  that are integers). For instance, consider the poset

$$\mathcal{Q} := \begin{array}{c} \textcircled{1} \\ \textcircled{3} \quad \textcircled{2} \\ \textcircled{4} \quad \textcircled{5} \\ \textcircled{6} \end{array} . \tag{3.1.3}$$

Since  $1 \not\preceq_{\mathcal{Q}} 2, 1 \not\preceq_{\mathcal{Q}} 3, 1 \not\preceq_{\mathcal{Q}} 4, 1 \not\preceq_{\mathcal{Q}} 5, 1 \not\preceq_{\mathcal{Q}} 6, 3 \not\preceq_{\mathcal{Q}} 4, 3 \not\preceq_{\mathcal{Q}} 5, 3 \not\preceq_{\mathcal{Q}} 6, 4 \not\preceq_{\mathcal{Q}} 5, 4 \not\preceq_{\mathcal{Q}} 6$ , in the dual  $\mathcal{Q}^\perp$  of  $\mathcal{Q}$  we have  $1 \preceq_{\mathcal{Q}^\perp} 2, 1 \preceq_{\mathcal{Q}^\perp} 3, 1 \preceq_{\mathcal{Q}^\perp} 4, 1 \preceq_{\mathcal{Q}^\perp} 5, 1 \preceq_{\mathcal{Q}^\perp} 6, 3 \preceq_{\mathcal{Q}^\perp} 4, 3 \preceq_{\mathcal{Q}^\perp} 5, 3 \preceq_{\mathcal{Q}^\perp} 6, 4 \preceq_{\mathcal{Q}^\perp} 5, 4 \preceq_{\mathcal{Q}^\perp} 6$  and hence,

$$\mathcal{Q}^\perp = \begin{array}{c} \textcircled{1} \\ \textcircled{2} \quad \textcircled{3} \\ \textcircled{4} \\ \textcircled{5} \quad \textcircled{6} \end{array} . \tag{3.1.4}$$

Observe that this operation  $^\perp$  is an involution on thin forest posets.

We now state two lemmas about thin forest posets and the operation  $^\perp$ .

LEMMA 3.1.1. *Let  $\mathcal{Q}$  be a thin forest poset. The dual  $\mathcal{Q}^\perp$  of  $\mathcal{Q}$  admits the following recursive expression:*

(i) *if  $\mathcal{Q}$  is the empty forest  $\emptyset$ , then*

$$\emptyset^\perp = \emptyset; \tag{3.1.5}$$

(ii) *if  $\mathcal{Q}$  is of the form  $\mathcal{Q} = \circ \mathcal{Q}'$  where  $\mathcal{Q}'$  is a thin forest poset, then*

$$(\circ \mathcal{Q}')^\perp = \begin{array}{c} \circ \\ | \\ \mathcal{Q}'^\perp \end{array}; \tag{3.1.6}$$



(iii) otherwise,  $\mathcal{Q}$  is of the form  $\mathcal{Q} = \begin{array}{c} \circ \\ | \\ \mathcal{Q}' \end{array}$  where  $\mathcal{Q}'$  is a thin forest poset, and then

$$\left( \begin{array}{c} \circ \\ | \\ \mathcal{Q}' \end{array} \right)^\perp = \circ \mathcal{Q}'^\perp. \quad (3.1.7)$$

LEMMA 3.1.2. Let  $\mathcal{Q}$  be a thin forest poset. Then, the number of intervals of  $\mathcal{Q}$  and the number of intervals of its dual are related by

$$\text{int}(\mathcal{Q}) + \text{int}(\mathcal{Q}^\perp) = \frac{(\#\mathcal{Q})^2 + 3\#\mathcal{Q}}{2}. \quad (3.1.8)$$

**3.2. Koszul duality and poset duality.** By defining here an alternative basis for  $\text{As}(\mathcal{Q})$  when  $\mathcal{Q}$  is a thin forest poset, we show that the construction  $\bar{\text{As}}$  is closed under Koszul duality on thin forest posets. More precisely, we show that  $\text{As}(\mathcal{Q})^\dagger$  and  $\text{As}(\mathcal{Q}^\perp)$  are two isomorphic operads.

3.2.1. *Alternative basis.* Let  $\mathcal{Q}$  be a thin forest poset. For any element  $b$  of  $\mathcal{Q}$ , let  $\bar{\square}_b$  be the element of  $\text{As}(\mathcal{Q})^\dagger(2)$  defined by

$$\bar{\square}_b := \sum_{\substack{a \in \mathcal{Q}^\perp \\ a \preceq_{\mathcal{Q}^\perp} b}} \bar{\Delta}_a. \quad (3.2.1)$$

We denote by  $\mathfrak{G}_{\mathcal{Q}}^{\bar{\square}}$  the set of all  $\bar{\square}_b$ ,  $b \in \mathcal{Q}$ . By triangularity, the family  $\mathfrak{G}_{\mathcal{Q}}^{\bar{\square}}$  forms a basis of  $\text{As}(\mathcal{Q})^\dagger(2)$  and hence, generates  $\text{As}(\mathcal{Q})^\dagger$ . Consider for instance the thin forest poset

$$\mathcal{Q} := \begin{array}{c} \textcircled{1} \quad \textcircled{2} \\ \quad \quad \quad \textcircled{3} \\ \quad \quad \quad / \quad \backslash \\ \textcircled{4} \quad \textcircled{5} \\ \quad \quad \quad \backslash \quad / \\ \textcircled{6} \end{array}. \quad (3.2.2)$$

The dual poset of  $\mathcal{Q}$  is

$$\mathcal{Q}^\perp = \begin{array}{c} \textcircled{1} \\ | \\ \textcircled{2} \\ / \quad \backslash \\ \textcircled{3} \quad \textcircled{4} \\ \quad \quad \backslash \quad / \\ \textcircled{5} \quad \textcircled{6} \end{array} \quad (3.2.3)$$

and hence, the elements of  $\mathfrak{G}_{\mathcal{Q}}^{\bar{\square}}$  express as

$$\bar{\square}_1 = \bar{\Delta}_1, \quad (3.2.4a)$$

$$\bar{\square}_2 = \bar{\Delta}_1 + \bar{\Delta}_2, \quad (3.2.4b)$$

$$\bar{\square}_3 = \bar{\Delta}_1 + \bar{\Delta}_2 + \bar{\Delta}_3, \quad (3.2.4c)$$

$$\bar{\square}_4 = \bar{\Delta}_1 + \bar{\Delta}_2 + \bar{\Delta}_4, \quad (3.2.4d)$$

$$\bar{\square}_5 = \bar{\Delta}_1 + \bar{\Delta}_2 + \bar{\Delta}_4 + \bar{\Delta}_5, \quad (3.2.4e)$$

$$\bar{\square}_6 = \bar{\Delta}_1 + \bar{\Delta}_2 + \bar{\Delta}_4 + \bar{\Delta}_6. \quad (3.2.4f)$$

LEMMA 3.2.1. Let  $\mathcal{Q}$  be a thin forest poset. Then, the dimension of the space  $\mathcal{R}_{\mathcal{Q}^\perp}^*$  of relations of  $\text{As}(\mathcal{Q}^\perp)$  and the dimension of the space  $\mathcal{R}_{\mathcal{Q}}^{\bar{\square}}$  of relations of  $\text{As}(\mathcal{Q})^\dagger$  are related by

$$\dim \mathcal{R}_{\mathcal{Q}^\perp}^* = 4 \text{int}(\mathcal{Q}^\perp) - 3\#\mathcal{Q} = \dim \mathcal{R}_{\mathcal{Q}}^{\bar{\square}}. \quad (3.2.5)$$

### 3.2.2. Isomorphism.

**THEOREM 3.2.2.** *Let  $Q$  be a thin forest poset. Then, the map  $\phi : \text{As}(Q^\perp) \rightarrow \text{As}(Q)^\dagger$  defined for any  $a \in Q^\perp$  by  $\phi(\star_a) := \bar{\square}_a$  extends in a unique way to an isomorphism of operads.*

**PROOF.** Let us denote by  $\mathcal{R}_Q^\square$  the space of relations of  $\text{As}(Q)^\dagger$ , expressed on the generating family  $\mathfrak{G}_Q^\square$ . This space is the same as the space  $\mathcal{R}_Q^{\hat{\Delta}}$ , described by Proposition 2.3.3. Let us exhibit a generating family of  $\mathcal{R}_Q^\square$  as a vector space. For this, let  $a$  and  $b$  be two elements of  $Q^\perp$  such that  $a \preceq_{Q^\perp} b$ . We have, by using (3.2.1),

$$\begin{aligned} \bar{\square}_a \circ_1 \bar{\square}_b - \bar{\square}_a \circ_2 \bar{\square}_a &= \sum_{\substack{a', b' \in Q^\perp \\ a' \preceq_{Q^\perp} a \\ b' \preceq_{Q^\perp} b}} \left( \bar{\Delta}_{a'} \circ_1 \bar{\Delta}_{b'} \right) - \sum_{\substack{a', a'' \in Q^\perp \\ a' \preceq_{Q^\perp} a \\ a'' \preceq_{Q^\perp} a}} \left( \bar{\Delta}_{a'} \circ_2 \bar{\Delta}_{a''} \right) \\ &= \sum_{\substack{a' \in Q^\perp \\ a' \preceq_{Q^\perp} a}} \left( \bar{\Delta}_{a'} \circ_1 \bar{\Delta}_{a'} \right) - \sum_{\substack{a' \in Q^\perp \\ a' \preceq_{Q^\perp} a}} \left( \bar{\Delta}_{a'} \circ_2 \bar{\Delta}_{a'} \right) \\ &= 0. \end{aligned} \tag{3.2.6}$$

Indeed the second equality of (3.2.6) comes, by Proposition 2.3.3, from the presence of the elements (2.3.8b) and (2.3.8c) in  $\mathcal{R}_Q^{\hat{\Delta}}$ , together with the fact that for all comparable elements  $a'$  and  $b'$  in  $Q$ , the fact that  $a' \preceq_{Q^\perp} a$ ,  $b' \preceq_{Q^\perp} b$ , and  $a \preceq_{Q^\perp} b$  implies that  $a' = b'$ . Besides, the last equality of (3.2.6) comes, by Proposition 2.3.3, from the presence of the elements (2.3.8a) in  $\mathcal{R}_Q^{\hat{\Delta}}$ . Similar arguments show that

$$\bar{\square}_b \circ_1 \bar{\square}_a - \bar{\square}_a \circ_2 \bar{\square}_a = 0, \tag{3.2.7a}$$

$$\bar{\square}_a \circ_1 \bar{\square}_a - \bar{\square}_b \circ_2 \bar{\square}_a = 0, \tag{3.2.7b}$$

$$\bar{\square}_a \circ_1 \bar{\square}_a - \bar{\square}_a \circ_2 \bar{\square}_b = 0. \tag{3.2.7c}$$

We then have shown that the elements

$$\bar{\square}_a \circ_1 \bar{\square}_b - \bar{\square}_{a \uparrow_{Q^\perp} b} \circ_2 \bar{\square}_{a \uparrow_{Q^\perp} b}, \quad a, b \in Q^\perp \text{ and } (a \preceq_{Q^\perp} b \text{ or } b \preceq_{Q^\perp} a), \tag{3.2.8a}$$

$$\bar{\square}_{a \uparrow_{Q^\perp} b} \circ_1 \bar{\square}_{a \uparrow_{Q^\perp} b} - \bar{\square}_a \circ_2 \bar{\square}_b, \quad a, b \in Q^\perp \text{ and } (a \preceq_{Q^\perp} b \text{ or } b \preceq_{Q^\perp} a). \tag{3.2.8b}$$

are in  $\mathcal{R}_Q^{\hat{\Delta}}$ . It is immediate that the family consisting in the elements (3.2.8a) and (3.2.8b) is free. We denote by  $\mathcal{R}$  the vector space generated by this family. By using the same arguments as the ones used in the proof of Proposition 1.2.1, we obtain that the dimension of  $\mathcal{R}$  is

$$\dim \mathcal{R} = 4 \text{int}(Q^\perp) - 3 \#Q^\perp. \tag{3.2.9}$$

Now, by Lemma 3.2.1, we deduce that  $\dim \mathcal{R} = \dim \mathcal{R}_Q^\star = \dim \mathcal{R}_Q^{\hat{\Delta}}$ , implying that  $\mathcal{R}$  and  $\mathcal{R}_Q^{\hat{\Delta}}$  are equal.

Therefore, the family of the  $\mathfrak{G}_Q^\square$  generating  $\text{As}(Q)^\dagger$  is subjected to the same relations as the family of the  $\mathfrak{G}_Q^\star$  generating  $\text{As}(Q^\perp)$  (compare (3.2.8a) with (1.1.2a) and (3.2.8b) with (1.1.2b)). Whence the statement of the theorem.  $\square$

The isomorphism  $\phi$  between  $\text{As}(\mathcal{Q}^\perp)$  and  $\text{As}(\mathcal{Q})^!$  provided by Theorem 3.2.2 can be expressed from the generating family  $\mathfrak{S}_{\mathcal{Q}^\perp}^*$  of  $\text{As}(\mathcal{Q}^\perp)$  to the generating family  $\mathfrak{S}_{\mathcal{Q}}^*$  of  $\text{As}(\mathcal{Q})^!$ , for any  $b \in \mathcal{Q}^\perp$ , as

$$\phi(\star_b) = \sum_{\substack{a \in \mathcal{Q}^\perp \\ a \preceq_{\mathcal{Q}^\perp} b}} \sum_{\substack{c \in \mathcal{Q} \\ a \preceq_{\mathcal{Q}} c}} \bar{\star}_c. \quad (3.2.10)$$

For instance, by considering the pair of thin forest posets in duality

$$(\mathcal{Q}, \mathcal{Q}^\perp) = \left( \begin{array}{c} \textcircled{1} \textcircled{2} \\ \textcircled{4} \textcircled{5} \\ \textcircled{3} \\ \textcircled{6} \end{array}, \begin{array}{c} \textcircled{1} \\ \textcircled{2} \\ \textcircled{3} \textcircled{4} \\ \textcircled{5} \textcircled{6} \end{array} \right), \quad (3.2.11)$$

the map  $\phi : \text{As}(\mathcal{Q}^\perp) \rightarrow \text{As}(\mathcal{Q})^!$  defined in the statement of Theorem 3.2.2 satisfies

$$\phi(\star_1) = \bar{\star}_1, \quad (3.2.12a)$$

$$\phi(\star_2) = \bar{\star}_1 + \bar{\star}_2, \quad (3.2.12b)$$

$$\phi(\star_3) = \bar{\star}_1 + \bar{\star}_2 + \bar{\star}_3 + \bar{\star}_4 + \bar{\star}_5 + \bar{\star}_6, \quad (3.2.12c)$$

$$\phi(\star_4) = \bar{\star}_1 + \bar{\star}_2 + \bar{\star}_4, \quad (3.2.12d)$$

$$\phi(\star_5) = \bar{\star}_1 + \bar{\star}_2 + \bar{\star}_4 + \bar{\star}_5 + \bar{\star}_6, \quad (3.2.12e)$$

$$\phi(\star_6) = \bar{\star}_1 + \bar{\star}_2 + \bar{\star}_4 + \bar{\star}_6. \quad (3.2.12f)$$

Moreover, by considering the opposite pair of thin posets forests in duality

$$(\mathcal{Q}, \mathcal{Q}^\perp) = \left( \begin{array}{c} \textcircled{1} \\ \textcircled{2} \\ \textcircled{3} \textcircled{4} \\ \textcircled{5} \textcircled{6} \end{array}, \begin{array}{c} \textcircled{1} \textcircled{2} \\ \textcircled{3} \\ \textcircled{4} \textcircled{5} \\ \textcircled{6} \end{array} \right), \quad (3.2.13)$$

the map  $\phi : \text{As}(\mathcal{Q}^\perp) \rightarrow \text{As}(\mathcal{Q})^!$  defined in the statement of Theorem 3.2.2 satisfies

$$\phi(\star_1) = \bar{\star}_1 + \bar{\star}_2 + \bar{\star}_3 + \bar{\star}_4 + \bar{\star}_5 + \bar{\star}_6, \quad (3.2.14a)$$

$$\phi(\star_2) = \bar{\star}_2 + \bar{\star}_3 + \bar{\star}_4 + \bar{\star}_5 + \bar{\star}_6, \quad (3.2.14b)$$

$$\phi(\star_3) = \bar{\star}_3, \quad (3.2.14c)$$

$$\phi(\star_4) = \bar{\star}_3 + \bar{\star}_4 + \bar{\star}_5 + \bar{\star}_6, \quad (3.2.14d)$$

$$\phi(\star_5) = \bar{\star}_3 + \bar{\star}_5, \quad (3.2.14e)$$

$$\phi(\star_6) = \bar{\star}_3 + \bar{\star}_5 + \bar{\star}_6. \quad (3.2.14f)$$

Notice also that since the dual of the total order  $\mathcal{Q}$  on a set of  $\ell \geq 0$  elements is the trivial order  $\mathcal{Q}^\perp$  on the same set, by Theorem 3.2.2,  $\text{As}(\mathcal{Q})$  is the Koszul dual of  $\text{As}(\mathcal{Q}^\perp)$ . This is coherent with the results of Section 5 of Chapter 5 about the multiassociative operad (equal to  $\text{As}(\mathcal{Q})$ ) and the dual multiassociative operad (equal to  $\text{As}(\mathcal{Q}^\perp)$ ).

### Concluding remarks

Through this chapter, we have presented a functorial construction  $As$  from posets to operads establishing a link between the two underlying categories. The operads obtained through this construction generalize the (dual) multiassociative operads. As we have seen, some combinatorial properties of the starting posets  $\mathcal{Q}$  imply properties on the obtained operads  $As(\mathcal{Q})$  as, among others, basicity and Koszulity.

This work raises several questions. We have presented two classes of  $\mathcal{Q}$ -associative algebras: the free  $\mathcal{Q}$ -associative algebras over one generator where  $\mathcal{Q}$  are forest posets and a polynomial algebra involving the antichains of a poset  $\mathcal{Q}$ . The question to characterize free  $\mathcal{Q}$ -associative algebras over one generator with no assumption on  $\mathcal{Q}$  is open. Also, the question to define some other interesting  $\mathcal{Q}$ -associative algebras has not been considered in this work and deserves to be addressed.

Besides, we have shown that when  $\mathcal{Q}$  is a forest poset,  $As(\mathcal{Q})$  is Koszul. The property of being a forest poset for  $\mathcal{Q}$  is only a sufficient condition for the Koszulity of  $As(\mathcal{Q})$  and the question to find a necessary condition is worthwhile. Notice that the strategy to prove the Koszulity of an operad by the partition poset method [MY91, Val07] (see also [LV12]) cannot be applied to our context. Indeed, this strategy applies only to basic operads and we have shown that almost all operads  $As(\mathcal{Q})$  are not basic.



## Operads of decorated cliques

The content of this chapter comes from [Gir17b, Gir17a].

### Introduction

Regular polygons endowed with configurations of diagonals are very classical combinatorial objects. Up to some restrictions or enrichments, sets defined on these polygons can be put in bijection with several combinatorial families. For instance, it is well-known that triangulations [DLRS10], forming a particular subset of the set of all polygons, are in one-to-one correspondence with binary trees, and a lot of structures and operations on binary trees translate nicely on triangulations. Indeed, among others, the rotation operation on binary trees [Knu98] is the covering relation of the Tamari order [Tam62, HT72] (see also Section 1.3.3 of Chapter 1) and this operation translates as a diagonal flip in triangulations. Also, noncrossing configurations [FN99] form another interesting subfamily of such polygons. Natural generalizations of noncrossing configurations consist in allowing, with more or less restrictions, some crossing diagonals. One of these families is formed by the multi-triangulations [CP92], that are polygons wherein the number of mutually crossing diagonal is bounded. Besides, let us emphasize that the class of combinatorial objects in bijection with sets of polygons with configurations of diagonals is large enough in order to contain, among others, dissections of polygons, noncrossing partitions, permutations, and involutions.

The purpose of this work is twofold. First, we are concerned in endowing the linear span of the polygons with configurations of arcs with a structure of an operad. This is justified by the preliminary observation that most of the subfamilies of polygons endowed with configurations of diagonals discussed above are stable for several natural composition operations. Even better, some of these can be described as the closure with respect to these composition operations of small sets of polygons. For this reason, operads are very promising candidates, among the modern algebraic structures, to study such objects under an algebraic and combinatorial flavor. This leads to see these objects under a new light, stressing some of their combinatorial and algebraic properties. Second, we would provide a general construction of operads of polygons rich enough so that it includes some already known operads. As a consequence, we obtain alternative definitions of existing operads and new interpretations of these.

For this aim, we work here with  $\mathcal{M}$ -decorated cliques (or  $\mathcal{M}$ -cliques for short), that are complete graphs whose arcs are labeled on  $\mathcal{M}$ , where  $\mathcal{M}$  is a unitary magma. These objects are natural generalizations of polygons with configurations of arcs since the arcs of any  $\mathcal{M}$ -clique labeled by the unit of  $\mathcal{M}$  are considered as missing. The elements of  $\mathcal{M}$  different

from the unit allow moreover to handle polygons with arcs of different colors. For instance, each usual noncrossing configuration  $c$  can be encoded by an  $\mathbb{N}_2$ -clique  $p$ , where  $\mathbb{N}_2$  is the cyclic additive unitary magma  $\mathbb{Z}/2\mathbb{Z}$ , wherein each arc labeled by  $1 \in \mathbb{N}_2$  in  $p$  denotes the presence of the same arc in  $c$ , and each arc labeled by  $0 \in \mathbb{N}_2$  in  $p$  denotes its absence in  $c$ . Our construction is materialized by a functor  $C$  from the category of unitary magmas to the category of operads. It builds, from any unitary magma  $\mathcal{M}$ , an operad  $C\mathcal{M}$  on  $\mathcal{M}$ -cliques. The partial composition  $p \circ_i q$  of two  $\mathcal{M}$ -cliques  $p$  and  $q$  of  $C\mathcal{M}$  consists in gluing the  $i$ th edge of  $p$  (with respect to a precise indexation) and a special arc of  $q$ , called the base, together to form a new  $\mathcal{M}$ -clique. The magmatic operation of  $\mathcal{M}$  explains how to relabel the two overlapping arcs.

This operad  $C\mathcal{M}$  has a lot of properties, which can be apprehended both under a combinatorial and an algebraic point of view. First, many families of particular polygons with configurations of arcs form quotients or suboperads of  $C\mathcal{M}$ . We can for instance control the degrees of the vertices or the crossings between diagonals to obtain new operads. We can also forbid all diagonals, or some labels for the diagonals or the edges, or all nestings of diagonals, or even all cycles formed by arcs. All these combinatorial particularities and restrictions on  $\mathcal{M}$ -cliques behave well algebraically. Moreover, by using the fact that the direct sum of two ideals of an operad  $\mathcal{O}$  is still an ideal of  $\mathcal{O}$ , these constructions can be mixed to get even more operads. For instance, it is well-known that Motzkin configurations, that are polygons with disjoint noncrossing diagonals, are enumerated by Motzkin numbers [Mot48]. Since a Motzkin configuration can be encoded by an  $\mathcal{M}$ -clique where all vertices are of degrees at most 1 and no diagonal crosses another one, we obtain an operad  $\text{Mot}\mathcal{M}$  on colored Motzkin configurations which is both a quotient of  $\text{Deg}_1\mathcal{M}$ , the quotient of  $C\mathcal{M}$  consisting in all  $\mathcal{M}$ -cliques such that all vertices are of degrees at most 1, and of  $\text{NC}\mathcal{M}$ , the quotient (and suboperad) of  $C\mathcal{M}$  consisting in all noncrossing  $\mathcal{M}$ -cliques. We also get quotients of  $C\mathcal{M}$  involving, among others, Schröder trees, forests of paths, forests of trees, dissections of polygons, Lucas configurations, with colored versions for each of these. This leads to a new hierarchy of operads, wherein links between its components appear as surjective or injective operad morphisms. Table 7.1 lists the main operads constructed in this work and gathers some information about these.

One of the most notable of these substructures is built by considering the  $\mathbb{D}_0$ -cliques that have vertices of degrees at most 1, where  $\mathbb{D}_0$  is the multiplicative unitary magma on  $\{0, 1\}$ . This is in fact the quotient  $\text{Deg}_1\mathbb{D}_0$  of  $C\mathbb{D}_0$  and involves involutions (or equivalently, standard Young tableaux by the Robinson-Schensted correspondence [Sch61, Lot02]). To the best of our knowledge,  $\text{Deg}_1\mathbb{D}_0$  is the first nontrivial operad on these objects. As an important remark at this stage, let us highlight that when  $\mathcal{M}$  is nontrivial,  $C\mathcal{M}$  is not a binary operad. Indeed, all its minimal generating sets are infinite and its generators have arbitrary high arities. Nevertheless, the biggest binary suboperad of  $C\mathcal{M}$  is the operad  $\text{NC}\mathcal{M}$  of noncrossing configurations and this operad is quadratic and Koszul, regardless of  $\mathcal{M}$ . Furthermore, the construction  $C$  maintains some links with the operad  $\text{RatFct}$  of rational functions introduced by Loday [Lod10] (see also Section 4.2.4 of Chapter 2). In fact, provided that  $\mathcal{M}$  satisfies some conditions, each  $\mathcal{M}$ -clique encodes a rational function. This defines an operad morphism from  $C\mathcal{M}$  to  $\text{RatFct}$ . Moreover, the construction  $C$  allows to construct

Operad	Objects	Status with respect to $C\mathcal{M}$	Place
$C\mathcal{M}$	$\mathcal{M}$ -cliques	—	Section 1
$\text{Lab}_{B,E,D}\mathcal{M}$	$\mathcal{M}$ -cliques with restricted labels	Suboperad	Section 2.1.1
$\text{Whi}\mathcal{M}$	White $\mathcal{M}$ -cliques	Suboperad	Section 2.1.2
$\text{Cro}_k\mathcal{M}$	$\mathcal{M}$ -cliques of crossings at most $k$	Suboperad and quotient	Section 2.1.3
$\text{Bub}\mathcal{M}$	$\mathcal{M}$ -bubbles	Quotient	Section 2.1.4
$\text{Deg}_k\mathcal{M}$	$\mathcal{M}$ -cliques of degrees at most $k$	Quotient	Section 2.1.5
$\text{Nes}\mathcal{M}$	Nesting-free $\mathcal{M}$ -cliques	Quotient	Section 2.1.6
$\text{Acy}\mathcal{M}$	Acyclic $\mathcal{M}$ -cliques	Quotient	Section 2.1.7
$\text{NC}\mathcal{M}$	noncrossing $\mathcal{M}$ -cliques	Suboperad and quotient	Section 3

TABLE 7.1. The main operads defined in this work. All these operads depend on a unitary magma  $\mathcal{M}$  which has, in some cases, to satisfy some precise conditions. Some of these operads depend also on a nonnegative integer  $k$  or subsets  $B$ ,  $E$ , and  $D$  of  $\mathcal{M}$ .

already known operads in original ways. For instance, for well-chosen unitary magmas  $\mathcal{M}$ , the operads  $C\mathcal{M}$  contain  $\mathcal{FF}_4$ , a suboperad of the operad of formal fractions  $\mathcal{FF}$  [CHN16], the operad NCT of based noncrossing trees [Cha07, Ler11], and MT and DMT, two operads respectively defined in [LMN13] and in Chapter 12 that involve multi-fildes and double multi-fildes, which are operators coming from formal language theory [CCM11]. Moreover,  $C$  provides a construction of BNC, the operad of bicolored noncrossing configurations (see Chapter 3). For this reason, in particular, all the suboperads of BNC can be obtained from the construction  $C$ . This includes for example the dipterous operad [LR03, Zin12]. The operads  $C\mathcal{M}$  also contains Grav, the gravity operad, a symmetric operad introduced by Getzler [Get94], seen here as a nonsymmetric one [AP15].

This chapter is organized as follows. In Section 1, we introduce  $\mathcal{M}$ -cliques, the construction  $C$ , and study some of its properties. Then, Section 2 is devoted to define several suboperads and quotients of  $C\mathcal{M}$ . This leads to a bunch of new operads on particular  $\mathcal{M}$ -cliques. We focus next, in Section 3, on the study of the suboperad  $\text{NC}\mathcal{M}$  of  $C\mathcal{M}$  on the noncrossing  $\mathcal{M}$ -cliques. Among others, we provide a presentation by generators and relations of  $\text{NC}\mathcal{M}$  and of its Koszul dual. Finally, in Section 4, we use the construction  $C$  to provide alternative definitions of some known operads.

*Note.* This chapter deals only with ns operads. For this reason, “operad” means “ns operad”.



## 1. From unitary magmas to operads

We describe in this section our construction from unitary magmas to operads and study its main algebraic and combinatorial properties.

**1.1. Unitary magmas, decorated cliques, and operads.** We present here our main combinatorial objects, the decorated cliques. The construction  $\mathbb{C}$ , which takes a unitary magma as input and produces an operad, is defined.

**1.1.1. Unitary magmas.** Recall first that a unitary magma is a set endowed with a binary operation  $\star$  admitting a left and right unit  $\mathbb{1}_{\mathcal{M}}$ . For convenience, we denote by  $\bar{\mathcal{M}}$  the set  $\mathcal{M} \setminus \{\mathbb{1}_{\mathcal{M}}\}$ . To explore some examples in this chapter, we shall mostly consider four sorts of unitary magmas: the additive unitary magma on all integers denoted by  $\mathbb{Z}$ , the cyclic additive unitary magma on  $\mathbb{Z}/\ell\mathbb{Z}$  denoted by  $\mathbb{N}_\ell$ , the unitary magma

$$\mathbb{D}_\ell := \{\mathbb{1}, 0, d_1, \dots, d_\ell\} \quad (1.1.1)$$

where  $\mathbb{1}$  is the unit of  $\mathbb{D}_\ell$ ,  $0$  is absorbing, and  $d_i \star d_j = 0$  for all  $i, j \in [\ell]$ , and the unitary magma

$$\mathbb{E}_\ell := \{\mathbb{1}, e_1, \dots, e_\ell\} \quad (1.1.2)$$

where  $\mathbb{1}$  is the unit of  $\mathbb{E}_\ell$  and  $e_i \star e_j = \mathbb{1}$  for all  $i, j \in [\ell]$ . Observe that since

$$e_1 \star (e_1 \star e_2) = e_1 \star \mathbb{1} = e_1 \neq e_2 = \mathbb{1} \star e_2 = (e_1 \star e_1) \star e_2, \quad (1.1.3)$$

all unitary magmas  $\mathbb{E}_\ell$ ,  $\ell \geq 2$ , are not monoids.

**1.1.2. Decorated cliques.** An  $\mathcal{M}$ -decorated clique (or an  $\mathcal{M}$ -clique for short) is an  $\mathcal{M}$ -configuration  $p$  (see Section 3.2 of Chapter 1) such that each arc of  $p$  has a label. When the arc  $(x, y)$  of  $p$  is labeled by an element different from  $\mathbb{1}_{\mathcal{M}}$ , we say that the arc  $(x, y)$  is *solid*. By convention, we require that the  $\mathcal{M}$ -clique  $\circ \text{---} \circ$  of size 1 having its base labeled by  $\mathbb{1}_{\mathcal{M}}$  is the only such object of size 1. The set of all  $\mathcal{M}$ -cliques is denoted by  $\mathcal{C}_{\mathcal{M}}$ .

In our graphical representations, we shall represent any  $\mathcal{M}$ -clique  $p$  by following the drawing conventions of configurations explained in Section 3.2 of Chapter 1 with the difference that non-solid diagonals are not drawn. For instance,



The diagram shows a configuration  $p$  with 7 vertices arranged in a roughly circular pattern. Solid arcs (red) connect vertices (1,2) labeled -1, (1,5) labeled 2, (3,7) labeled -1, and (5,7) labeled 1. Dashed arcs (black) connect vertices (2,3) labeled 0, (2,6) labeled 0, (3,4) labeled 3, (4,5) labeled 2, (4,6) labeled 1, and (6,7) labeled 1. The label  $p :=$  is to the left of the diagram, and the equation number (1.1.4) is to the right.

is a  $\mathbb{Z}$ -clique such that, among others  $p(1, 2) = -1$ ,  $p(1, 5) = 2$ ,  $p(3, 7) = -1$ ,  $p(5, 7) = 1$ ,  $p(2, 3) = 0$  (because  $0$  is the unit of  $\mathbb{Z}$ ), and  $p(2, 6) = 0$  (for the same reason).

Let us now provide some definitions and statistics on  $\mathcal{M}$ -cliques. The *underlying configuration* of  $p$  is the  $\bar{\mathcal{M}}$ -configuration  $\bar{p}$  of the same size as the one of  $p$  and such  $\bar{p}(x, y) := p(x, y)$  for all solid arcs  $(x, y)$  of  $p$ , and all other arcs of  $\bar{p}$  are unlabeled. The *skeleton*, (resp. *degree*, *crossing*) of  $p$  is the skeleton (resp. the degree, the crossing) of  $\bar{p}$ . Moreover,  $p$  is *nesting-free*, (resp. *acyclic*, *white*, an  $\mathcal{M}$ -bubble, an  $\mathcal{M}$ -triangle), if  $\bar{p}$  is nesting-free (resp. acyclic, white, a bubble, a triangle). The set of all  $\mathcal{M}$ -bubbles (resp.  $\mathcal{M}$ -triangles) is denoted by  $\mathcal{B}_{\mathcal{M}}$ .

(resp.  $\mathcal{T}_{\mathcal{M}}$ ). Finally, the **border** of  $p$  is the word  $\text{bor}(p)$  of length  $n$  such that for any  $i \in [n]$ ,  $\text{bor}(p)_i = p_i$ .

1.1.3. *Partial composition of  $\mathcal{M}$ -cliques.* From now on, the **arity** of an  $\mathcal{M}$ -clique  $p$  is its size and is denoted by  $|p|$ . For any unitary magma  $\mathcal{M}$ , we define the vector space

$$C\mathcal{M} := \bigoplus_{n \geq 1} C\mathcal{M}(n), \tag{1.1.5}$$

where  $C\mathcal{M}(n)$  is the linear span of all  $\mathcal{M}$ -cliques of arity  $n$ ,  $n \geq 1$ . The set  $\mathcal{G}_{\mathcal{M}}$  forms hence a basis of  $C\mathcal{M}$  called **fundamental basis**. Observe that the space  $C\mathcal{M}(1)$  has dimension 1 since it is the linear span of the  $\mathcal{M}$ -clique  $\circ - \circ$ . We endow  $C\mathcal{M}$  with partial composition maps

$$\circ_i : C\mathcal{M}(n) \otimes C\mathcal{M}(m) \rightarrow C\mathcal{M}(n + m - 1), \quad n, m \geq 1, i \in [n], \tag{1.1.6}$$

defined linearly, in the fundamental basis, in the following way. Let  $p$  and  $q$  be two  $\mathcal{M}$ -cliques of respective arities  $n$  and  $m$ , and  $i \in [n]$  be an integer. We set  $p \circ_i q$  as the  $\mathcal{M}$ -clique of arity  $n + m - 1$  such that, for any arc  $(x, y)$  where  $1 \leq x < y \leq n + m$ ,

$$(p \circ_i q)(x, y) := \begin{cases} p(x, y) & \text{if } y \leq i, \\ p(x, y - m + 1) & \text{if } x \leq i < i + m \leq y \text{ and } (x, y) \neq (i, i + m), \\ p(x - m + 1, y - m + 1) & \text{if } i + m \leq x, \\ q(x - i + 1, y - i + 1) & \text{if } i \leq x < y \leq i + m \text{ and } (x, y) \neq (i, i + m), \\ p_i \star q_0 & \text{if } (x, y) = (i, i + m), \\ \mathbb{1}_{\mathcal{M}} & \text{otherwise.} \end{cases} \tag{1.1.7}$$

We recall that  $\star$  denotes the operation of  $\mathcal{M}$  and  $\mathbb{1}_{\mathcal{M}}$  its unit. In a geometric way,  $p \circ_i q$  is obtained by gluing the base of  $q$  onto the  $i$ th edge of  $p$ , by relabeling the common arcs between  $p$  and  $q$ , respectively the arcs  $(i, i + 1)$  and  $(1, m + 1)$ , by  $p_i \star q_0$ , and by adding all required non solid diagonals on the graph thus obtained to become a clique (see Figure 7.1). For example, in  $C\mathbb{Z}$ , one has the two partial compositions

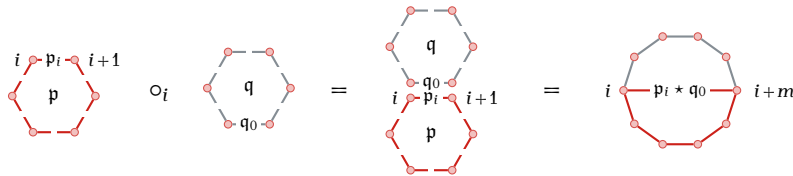

FIGURE 7.1. The partial composition of  $C\mathcal{M}$ , described in geometric terms. Here,  $p$  and  $q$  are two  $\mathcal{M}$ -cliques. The arity of  $q$  is  $m$  and  $i$  is an integer between 1 and  $|p|$ .

$$\tag{1.1.8a}$$

$$(1.1.8b)$$

1.1.4. *Functorial construction from unitary magmas to operads.* If  $\mathcal{M}_1$  and  $\mathcal{M}_2$  are two unitary magmas and  $\theta : \mathcal{M}_1 \rightarrow \mathcal{M}_2$  is a unitary magma morphism, we define

$$C\theta : C\mathcal{M}_1 \rightarrow C\mathcal{M}_2 \tag{1.1.9}$$

as the linear map sending any  $\mathcal{M}_1$ -clique  $p$  of arity  $n$  to the  $\mathcal{M}_2$ -clique  $(C\theta)(p)$  of the same arity such that, for any arc  $(x, y)$  where  $1 \leq x < y \leq n + 1$ ,

$$((C\theta)(p))(x, y) := \theta(p(x, y)). \tag{1.1.10}$$

In a geometric way,  $(C\theta)(p)$  is the  $\mathcal{M}_2$ -clique obtained by relabeling each arc of  $p$  by the image of its label by  $\theta$ .

**THEOREM 1.1.1.** *The construction  $C$  is a functor from the category of unitary magmas to the category of operads. Moreover,  $C$  respects injections and surjections.*

We name the construction  $C$  as the *clique construction* and  $C\mathcal{M}$  as the  *$\mathcal{M}$ -clique operad*. Observe that the fundamental basis of  $C\mathcal{M}$  is a set-operad basis of  $C\mathcal{M}$ . Besides, when  $\mathcal{M}$  is the trivial unitary magma  $\{1_{\mathcal{M}}\}$ ,  $C\mathcal{M}$  is the linear span of all decorated cliques having only non-solid arcs. Thus, each space  $C\mathcal{M}(n)$ ,  $n \geq 1$ , is of dimension 1 and it follows from the definition of the partial composition of  $C\mathcal{M}$  that this operad is isomorphic to the associative operad  $As$ . The next result shows that the clique construction is compatible with the Cartesian product of unitary magmas.

**PROPOSITION 1.1.2.** *Let  $\mathcal{M}_1$  and  $\mathcal{M}_2$  be two unitary magmas. Then, the operads  $(C\mathcal{M}_1) \square (C\mathcal{M}_2)$  and  $C(\mathcal{M}_1 \times \mathcal{M}_2)$  are isomorphic.*

**1.2. General properties.** We investigate here some properties of clique operads, as their dimensions, their minimal generating sets, the fact that they admit a cyclic operad structure, and describe their partial compositions over two alternative bases.

1.2.1. *Dimensions and minimal generating set.*

**PROPOSITION 1.2.1.** *Let  $\mathcal{M}$  be a finite unitary magma. For all  $n \geq 2$ ,*

$$\dim C\mathcal{M}(n) = m \binom{n+1}{2}, \tag{1.2.1}$$

where  $m := \#\mathcal{M}$ .

From Proposition 1.2.1, the first dimensions of  $C\mathcal{M}$  depending on  $m := \#\mathcal{M}$  are

$$1, 1, 1, 1, 1, 1, 1, 1, \quad m = 1, \tag{1.2.2a}$$

$$1, 8, 64, 1024, 32768, 2097152, 268435456, 68719476736, \quad m = 2, \tag{1.2.2b}$$

$$1, 27, 729, 59049, 14348907, 10460353203, 22876792454961, \\ 150094635296999121, \quad m = 3, \tag{1.2.2c}$$

$$1, 64, 4096, 1048576, 1073741824, 4398046511104, 72057594037927936, \\ 4722366482869645213696, \quad m = 4. \quad (1.2.2d)$$

Except for the first terms, the second one forms Sequence **A006125**, the third one forms Sequence **A047656**, and the last one forms Sequence **A053763** of **[Slo]**.

Let  $\mathcal{P}_{\mathcal{M}}$  be the set of all  $\mathcal{M}$ -cliques  $p$  or arity  $n \geq 2$  such that, for any (non-necessarily solid) diagonal  $(x, y)$  of  $p$ , there is at least one solid diagonal  $(x', y')$  of  $p$  such that  $(x, y)$  and  $(x', y')$  are crossing. We call  $\mathcal{P}_{\mathcal{M}}$  the set of all **prime  $\mathcal{M}$ -cliques**. Observe that, according to this description, all  $\mathcal{M}$ -triangles are prime.

**PROPOSITION 1.2.2.** *Let  $\mathcal{M}$  be a unitary magma. The set  $\mathcal{P}_{\mathcal{M}}$  is a minimal generating set of  $C\mathcal{M}$ .*

Computer experiments tell us that, when  $m := \#\mathcal{M} = 2$ , the first numbers of prime  $\mathcal{M}$ -cliques are, size by size,

$$0, 8, 16, 352, 16448, 1380224. \quad (1.2.3)$$

Moreover, remark that each  $n$ th term of this sequence is divisible by  $m^{n+1}$  since the labels of the base and the edges of an  $\mathcal{M}$ -clique  $p$  have no influence on the fact that  $p$  is prime. This gives the sequence

$$0, 1, 1, 11, 257, 10783. \quad (1.2.4)$$

None of these sequences appear in **[Slo]** at this time.

### 1.2.2. Associative elements.

**PROPOSITION 1.2.3.** *Let  $\mathcal{M}$  be a unitary magma and  $f$  be an element of  $C\mathcal{M}(2)$  of the form*

$$f := \sum_{p \in \mathcal{T}_{\mathcal{M}}} \lambda_p p, \quad (1.2.5)$$

where the  $\lambda_p, p \in \mathcal{T}_{\mathcal{M}}$ , are coefficients of  $\mathbb{K}$ . Then,  $f$  is associative if and only if

$$\sum_{\substack{p_1, q_0 \in \mathcal{M} \\ \delta = p_1 * q_0}} \lambda \begin{array}{c} \nearrow \\ p_1 \quad p_2 \\ \searrow \\ p_0 \end{array} \quad \lambda \begin{array}{c} \nearrow \\ q_1 \quad q_2 \\ \searrow \\ q_0 \end{array} = 0, \quad p_0, p_2, q_1, q_2 \in \mathcal{M}, \delta \in \bar{\mathcal{M}}, \quad (1.2.6a)$$

$$\sum_{\substack{p_1, q_0 \in \mathcal{M} \\ p_1 * q_0 = \mathbb{1}_{\mathcal{M}}}} \lambda \begin{array}{c} \nearrow \\ p_1 \quad p_2 \\ \searrow \\ p_0 \end{array} \quad \lambda \begin{array}{c} \nearrow \\ q_1 \quad q_2 \\ \searrow \\ q_0 \end{array} - \lambda \begin{array}{c} \nearrow \\ q_1 \quad p_1 \\ \searrow \\ p_0 \end{array} \quad \lambda \begin{array}{c} \nearrow \\ q_2 \quad p_2 \\ \searrow \\ q_0 \end{array} = 0, \quad p_0, p_2, q_1, q_2 \in \mathcal{M}, \quad (1.2.6b)$$

$$\sum_{\substack{p_2, q_0 \in \mathcal{M} \\ \delta = p_2 * q_0}} \lambda \begin{array}{c} \nearrow \\ p_1 \quad p_2 \\ \searrow \\ p_0 \end{array} \quad \lambda \begin{array}{c} \nearrow \\ q_1 \quad q_2 \\ \searrow \\ q_0 \end{array} = 0, \quad p_0, p_1, q_1, q_2 \in \mathcal{M}, \delta \in \bar{\mathcal{M}}. \quad (1.2.6c)$$

For instance, by Proposition 1.2.3, the binary elements

$$\begin{array}{c} \nearrow \\ 1 \quad 1 \\ \searrow \\ -1 \end{array}, \quad (1.2.7a)$$

$$\begin{array}{c} \nearrow \\ 1 \quad 1 \\ \searrow \\ -1 \end{array} + \begin{array}{c} \nearrow \\ 1 \quad 1 \\ \searrow \\ -1 \end{array} - \begin{array}{c} \nearrow \\ 1 \quad 1 \\ \searrow \\ -1 \end{array} + \begin{array}{c} \nearrow \\ 1 \quad 1 \\ \searrow \\ -1 \end{array} - \begin{array}{c} \nearrow \\ 1 \quad 1 \\ \searrow \\ -1 \end{array} + \begin{array}{c} \nearrow \\ 1 \quad 1 \\ \searrow \\ -1 \end{array} - \begin{array}{c} \nearrow \\ 1 \quad 1 \\ \searrow \\ -1 \end{array} - \begin{array}{c} \nearrow \\ 1 \quad 1 \\ \searrow \\ -1 \end{array} \quad (1.2.7b)$$

of  $C\mathbb{N}_2$  are associative.

1.2.3. *Symmetries.* Let  $\text{ret} : \mathbb{C}\mathcal{M} \rightarrow \mathbb{C}\mathcal{M}$  be the linear map sending any  $\mathcal{M}$ -clique  $p$  of arity  $n$  to the  $\mathcal{M}$ -clique  $\text{ret}(p)$  of the same arity such that, for any arc  $(x, y)$  where  $1 \leq x < y \leq n + 1$ ,

$$(\text{ret}(p))(x, y) := p(n - y + 2, n - x + 2). \quad (1.2.8)$$

In a geometric way,  $\text{ret}(p)$  is the  $\mathcal{M}$ -clique obtained by applying on  $p$  a reflection trough the vertical line passing by its base. For instance, one has in  $\mathbb{C}\mathbb{Z}$ ,

$$\text{ret} \left( \begin{array}{c} \text{Diagram 1} \end{array} \right) = \begin{array}{c} \text{Diagram 2} \end{array}. \quad (1.2.9)$$

PROPOSITION 1.2.4. *Let  $\mathcal{M}$  be a unitary magma. Then, the group of symmetries of  $\mathbb{C}\mathcal{M}$  contains the map  $\text{ret}$  and all the maps  $C\theta$  where  $\theta$  are unitary magma automorphisms of  $\mathcal{M}$ .*

#### 1.2.4. Basic set-operad basis.

PROPOSITION 1.2.5. *Let  $\mathcal{M}$  be a unitary magma. The fundamental basis of  $\mathbb{C}\mathcal{M}$  is a basic set-operad basis if and only if  $\mathcal{M}$  is right cancellable.*

1.2.5. *Cyclic operad structure.* Let  $\rho : \mathbb{C}\mathcal{M} \rightarrow \mathbb{C}\mathcal{M}$  be the linear map sending any  $\mathcal{M}$ -clique  $p$  of arity  $n$  to the  $\mathcal{M}$ -clique  $\rho(p)$  of the same arity such that, for any arc  $(x, y)$  where  $1 \leq x < y \leq n + 1$ ,

$$(\rho(p))(x, y) := \begin{cases} p(x + 1, y + 1) & \text{if } y \leq n, \\ p(1, x + 1) & \text{otherwise } (y = n + 1). \end{cases} \quad (1.2.10)$$

In a geometric way,  $\rho(p)$  is the  $\mathcal{M}$ -clique obtained by applying a rotation of one step of  $p$  in the counterclockwise direction. For instance, one has in  $\mathbb{C}\mathbb{Z}$ ,

$$\rho \left( \begin{array}{c} \text{Diagram 1} \end{array} \right) = \begin{array}{c} \text{Diagram 2} \end{array}. \quad (1.2.11)$$

PROPOSITION 1.2.6. *Let  $\mathcal{M}$  be a unitary magma. The map  $\rho$  is a rotation map of  $\mathbb{C}\mathcal{M}$ , endowing this operad with a cyclic operad structure.*

1.2.6. *Alternative bases.* If  $p$  and  $q$  are two  $\mathcal{M}$ -cliques of the same arity, the *Hamming distance*  $\text{ham}(p, q)$  between  $p$  and  $q$  is the number of arcs  $(x, y)$  such that  $p(x, y) \neq q(x, y)$ . Let  $\leq_{\text{be}}$  be the partial order relation on the set of all  $\mathcal{M}$ -cliques, where, for any  $\mathcal{M}$ -cliques  $p$  and  $q$ , one has  $p \leq_{\text{be}} q$  if  $q$  can be obtained from  $p$  by replacing some labels  $1_{\mathcal{M}}$  of its edges or its base by other labels of  $\mathcal{M}$ . In the same way, let  $\leq_{\text{d}}$  be the partial order on the same set where  $p \leq_{\text{d}} q$  if  $q$  can be obtained from  $p$  by replacing some labels  $1_{\mathcal{M}}$  of its diagonals by other labels of  $\mathcal{M}$ .

For all  $\mathcal{M}$ -cliques  $p$ , let the elements of  $\mathbb{C}\mathcal{M}$  defined by

$$H_p := \sum_{\substack{p' \in \mathcal{G}_{\mathcal{M}} \\ p' \leq_{\text{be}} p}} p', \quad (1.2.12a)$$

and

$$K_p := \sum_{\substack{p' \in \mathcal{G}_{\mathcal{M}} \\ p' \leq_d p}} (-1)^{\text{ham}(p', p)} p'. \quad (1.2.12b)$$

For instance, in  $\mathbb{C}\mathbb{Z}$ ,

$$H = \text{diagram} + \text{diagram} + \text{diagram} + \text{diagram}, \quad (1.2.13a)$$

$$K = \text{diagram} - \text{diagram} - \text{diagram} + \text{diagram}. \quad (1.2.13b)$$

Since by Möbius inversion (see Proposition 1.3.2 of Chapter 2), one has for any  $\mathcal{M}$ -clique  $p$ ,

$$\sum_{\substack{p' \in \mathcal{G}_{\mathcal{M}} \\ p' \leq_{be} p}} (-1)^{\text{ham}(p', p)} H_{p'} = p = \sum_{\substack{p' \in \mathcal{G}_{\mathcal{M}} \\ p' \leq_d p}} K_{p'}, \quad (1.2.14)$$

by triangularity, the family of all the  $H_p$  (resp.  $K_p$ ) forms a basis of  $\mathbb{C}\mathcal{M}$  called the **H-basis** (resp. the **K-basis**).

If  $p$  is an  $\mathcal{M}$ -clique,  $d_0(p)$  (resp.  $d_i(p)$ ) is the  $\mathcal{M}$ -clique obtained by replacing the label of the base (resp.  $i$ th edge) of  $p$  by  $\mathbb{1}_{\mathcal{M}}$ .

PROPOSITION 1.2.7. *Let  $\mathcal{M}$  be a unitary magma. The partial composition of  $\mathbb{C}\mathcal{M}$  can be expressed over the H-basis, for any  $\mathcal{M}$ -cliques  $p$  and  $q$  different from  $\circ - \circ$  and any valid integer  $i$ , as*

$$H_p \circ_i H_q = \begin{cases} H_{p \circ_i q} + H_{d_i(p) \circ_i q} + H_{p \circ_i d_0(q)} + H_{d_i(p) \circ_i d_0(q)} & \text{if } p_i \neq \mathbb{1}_{\mathcal{M}} \text{ and } q_0 \neq \mathbb{1}_{\mathcal{M}}, \\ H_{p \circ_i q} + H_{d_i(p) \circ_i q} & \text{if } p_i \neq \mathbb{1}_{\mathcal{M}}, \\ H_{p \circ_i q} + H_{p \circ_i d_0(q)} & \text{if } q_0 \neq \mathbb{1}_{\mathcal{M}}, \\ H_{p \circ_i q} & \text{otherwise.} \end{cases} \quad (1.2.15)$$

PROPOSITION 1.2.8. *Let  $\mathcal{M}$  be a unitary magma. The partial composition of  $\mathbb{C}\mathcal{M}$  can be expressed over the K-basis, for any  $\mathcal{M}$ -cliques  $p$  and  $q$  different from  $\circ - \circ$  and any valid integer  $i$ , as*

$$K_p \circ_i K_q = \begin{cases} K_{p \circ_i q} & \text{if } p_i \star q_0 = \mathbb{1}_{\mathcal{M}}, \\ K_{p \circ_i q} + K_{d_i(p) \circ_i d_0(q)} & \text{otherwise.} \end{cases} \quad (1.2.16)$$

For instance, in  $\mathbb{C}\mathbb{Z}$ ,

$$H \circ_2 H = \text{diagram} + 2 \text{diagram} + \text{diagram}, \quad (1.2.17a)$$

$$K \begin{array}{c} \circ \\ \swarrow -1 \\ \circ \\ \downarrow 2 \\ \circ \\ \searrow 1 \\ \circ \end{array} \circ_2 K \begin{array}{c} \circ \\ \swarrow -1 \\ \circ \\ \downarrow -1 \\ \circ \\ \searrow 1 \\ \circ \end{array} = K \begin{array}{c} \circ \\ \swarrow -1 \\ \circ \\ \downarrow 2 \\ \circ \\ \searrow 1 \\ \circ \end{array}, \quad (1.2.17b)$$

and in  $\mathbb{D}_1$ ,

$$H \begin{array}{c} \circ \\ \swarrow 0 \\ \circ \\ \downarrow d_1 \\ \circ \\ \searrow 0 \\ \circ \end{array} \circ_2 H \begin{array}{c} \circ \\ \swarrow 0 \\ \circ \\ \downarrow 0 \\ \circ \\ \searrow 0 \\ \circ \end{array} = 3 H \begin{array}{c} \circ \\ \swarrow 0 \\ \circ \\ \downarrow d_1 \\ \circ \\ \searrow 0 \\ \circ \end{array} + H \begin{array}{c} \circ \\ \swarrow 0 \\ \circ \\ \downarrow d_1 \\ \circ \\ \searrow 0 \\ \circ \end{array}, \quad (1.2.18a)$$

$$K \begin{array}{c} \circ \\ \swarrow 0 \\ \circ \\ \downarrow d_1 \\ \circ \\ \searrow 0 \\ \circ \end{array} \circ_2 K \begin{array}{c} \circ \\ \swarrow 0 \\ \circ \\ \downarrow 0 \\ \circ \\ \searrow 0 \\ \circ \end{array} = K \begin{array}{c} \circ \\ \swarrow 0 \\ \circ \\ \downarrow d_1 \\ \circ \\ \searrow 0 \\ \circ \end{array} + K \begin{array}{c} \circ \\ \swarrow 0 \\ \circ \\ \downarrow d_1 \\ \circ \\ \searrow 0 \\ \circ \end{array}. \quad (1.2.18b)$$

**1.2.7. Rational functions.** We develop here a link between  $C\mathcal{M}$  and the operad  $\text{RatFct}$  of rational functions introduced by Loday [Lod10] (see also Section 4.2.4 of Chapter 2).

Let us assume that  $\mathcal{M}$  is a  $\mathbb{Z}$ -graded unitary magma, that is a unitary magma such that there exists a unitary magma morphism  $\theta : \mathcal{M} \rightarrow \mathbb{Z}$ . We say that  $\theta$  is a *rank function* of  $\mathcal{M}$ . In this context, let

$$F_\theta : C\mathcal{M} \rightarrow \text{RatFct} \quad (1.2.19)$$

be the linear map defined, for any  $\mathcal{M}$ -clique  $p$ , by

$$F_\theta(p) := \prod_{(x,y) \in \mathcal{A}_p} (u_x + \dots + u_{y-1})^{\theta(p(x,y))}. \quad (1.2.20)$$

For instance, by considering the unitary magma  $\mathbb{Z}$  together with its identity map  $\text{Id}$  as rank function, one has

$$F_{\text{Id}} \left( \begin{array}{c} \circ \\ \swarrow -2 \\ \circ \\ \downarrow 3 \\ \circ \\ \searrow -1 \\ \circ \\ \swarrow -1 \\ \circ \\ \downarrow 2 \\ \circ \\ \searrow 1 \\ \circ \end{array} \right) = \frac{(u_1 + u_2 + u_3 + u_4)^2 (u_1 + u_2 + u_3 + u_4 + u_5 + u_6) u_4^3}{u_1 (u_3 + u_4 + u_5 + u_6)^2 (u_5 + u_6)}. \quad (1.2.21)$$

**THEOREM 1.2.9.** *Let  $\mathcal{M}$  be a  $\mathbb{Z}$ -graded unitary magma and  $\theta$  be a rank function of  $\mathcal{M}$ . The map  $F_\theta$  is an operad morphism from  $C\mathcal{M}$  to  $\text{RatFct}$ .*

The operad morphism  $F_\theta$  is not injective. Indeed, by considering the magma  $\mathbb{Z}$  together with its identity map  $\text{Id}$  as rank function, one has for instance

$$F_{\text{Id}} \left( \begin{array}{c} \circ \\ \swarrow 1 \\ \circ \\ \downarrow 1 \\ \circ \\ \searrow 1 \\ \circ \end{array} - \begin{array}{c} \circ \\ \swarrow 1 \\ \circ \\ \downarrow 1 \\ \circ \\ \searrow 1 \\ \circ \end{array} - \begin{array}{c} \circ \\ \swarrow 1 \\ \circ \\ \downarrow 1 \\ \circ \\ \searrow 1 \\ \circ \end{array} \right) = (u_1 + u_2) - u_1 - u_2 = 0, \quad (1.2.22a)$$

$$F_{\text{Id}} \left( \begin{array}{c} \circ \\ \swarrow -1 \\ \circ \\ \downarrow -1 \\ \circ \\ \searrow -1 \\ \circ \end{array} - \begin{array}{c} \circ \\ \swarrow -1 \\ \circ \\ \downarrow -1 \\ \circ \\ \searrow -1 \\ \circ \end{array} - \begin{array}{c} \circ \\ \swarrow -1 \\ \circ \\ \downarrow -1 \\ \circ \\ \searrow -1 \\ \circ \end{array} \right) = \frac{1}{u_2 u_3} - \frac{1}{(u_2 + u_3) u_3} - \frac{1}{u_2 (u_2 + u_3)} = 0. \quad (1.2.22b)$$

**PROPOSITION 1.2.10.** *The subspace of  $\text{RatFct}$  of all Laurent polynomials on  $\mathbb{U}$  is the image by  $F_{\text{Id}} : C\mathbb{Z} \rightarrow \text{RatFct}$  of the subspace of  $C\mathbb{Z}$  consisting in the linear span of all  $\mathbb{Z}$ -bubbles.*

On each homogeneous subspace  $C\mathcal{M}(n)$  of the elements of arity  $n \geq 1$  of  $C\mathcal{M}$ , let the product

$$\star : C\mathcal{M}(n) \otimes C\mathcal{M}(n) \rightarrow C\mathcal{M}(n) \tag{1.2.23}$$

defined linearly, for each  $\mathcal{M}$ -cliques  $p$  and  $q$  of  $C\mathcal{M}(n)$ , by

$$(p \star q)(x, y) := p(x, y) \star q(x, y), \tag{1.2.24}$$

where  $(x, y)$  is any arc such that  $1 \leq x < y \leq n + 1$ . For instance, in  $C\mathbb{Z}$ ,

$$\tag{1.2.25}$$

PROPOSITION 1.2.11. *Let  $\mathcal{M}$  be a  $\mathbb{Z}$ -graded unitary magma and  $\theta$  be a rank function of  $\mathcal{M}$ . For any homogeneous elements  $f$  and  $g$  of  $C\mathcal{M}$  of the same arity,*

$$F_\theta(f)F_\theta(g) = F_\theta(f \star g). \tag{1.2.26}$$

PROPOSITION 1.2.12. *Let  $p$  be an  $\mathcal{M}$ -clique of  $C\mathbb{Z}$ . Then,*

$$\frac{1}{F_{\text{Id}}(p)} = F_{\text{Id}}((C\eta)(p)), \tag{1.2.27}$$

where  $\eta : \mathbb{Z} \rightarrow \mathbb{Z}$  is the unitary magma morphism defined by  $\eta(x) := -x$  for all  $x \in \mathbb{Z}$ .

## 2. Quotients and suboperads

We define here quotients and suboperads of  $C\mathcal{M}$ , leading to the construction of some new operads involving various combinatorial objects which are, basically,  $\mathcal{M}$ -cliques with some restrictions.

**2.1. Main substructures.** Most of the natural subfamilies of  $\mathcal{M}$ -cliques that can be described by simple combinatorial properties as  $\mathcal{M}$ -cliques with restrained labels for the bases, edges, and diagonals, white  $\mathcal{M}$ -cliques,  $\mathcal{M}$ -cliques with a fixed maximal value for their crossings,  $\mathcal{M}$ -bubbles,  $\mathcal{M}$ -cliques with a fixed maximal value for their degrees, nesting-free  $\mathcal{M}$ -cliques, and acyclic  $\mathcal{M}$ -cliques inherit the algebraic structure of operad of  $C\mathcal{M}$  and form quotients and suboperads of  $C\mathcal{M}$ . We construct and briefly study here these main substructures of  $C\mathcal{M}$ .

2.1.1. *Restricting the labels.* In what follows, if  $X$  and  $Y$  are two subsets of  $\mathcal{M}$ ,  $X \star Y$  denotes the set  $\{x \star y : x \in X \text{ and } y \in Y\}$ .

Let  $B, E$ , and  $D$  be three subsets of  $\mathcal{M}$  and  $\text{Lab}_{B,E,D}\mathcal{M}$  be the subspace of  $C\mathcal{M}$  generated by all  $\mathcal{M}$ -cliques  $p$  such that the bases of  $p$  are labeled on  $B$ , all edges of  $p$  are labeled on  $E$ , and all diagonals of  $p$  are labeled on  $D$ .

PROPOSITION 2.1.1. *Let  $\mathcal{M}$  be a unitary magma and  $B, E$ , and  $D$  be three subsets of  $\mathcal{M}$ . If  $1_{\mathcal{M}} \in B$ ,  $1_{\mathcal{M}} \in D$ , and  $E \star B \subseteq D$ ,  $\text{Lab}_{B,E,D}\mathcal{M}$  is a suboperad of  $C\mathcal{M}$ .*



PROPOSITION 2.1.2. Let  $\mathcal{M}$  be a unitary magma and  $B, E$ , and  $D$  be three finite subsets of  $\mathcal{M}$ . For all  $n \geq 2$ ,

$$\dim \text{Lab}_{B,E,D}\mathcal{M}(n) = be^n d^{(n+1)(n-2)/2}, \tag{2.1.1}$$

where  $b := \#B$ ,  $e := \#E$ , and  $d := \#D$ .

2.1.2. *White cliques.* Let  $\text{Whi}\mathcal{M}$  be the subspace of  $\text{C}\mathcal{M}$  generated by all white  $\mathcal{M}$ -cliques. Since, by definition of white  $\mathcal{M}$ -cliques,

$$\text{Whi}\mathcal{M} = \text{Lab}_{\{\mathbb{1}_{\mathcal{M}}\},\{\mathbb{1}_{\mathcal{M}}\},\mathcal{M}}\mathcal{M}, \tag{2.1.2}$$

by Proposition 2.1.1,  $\text{Whi}\mathcal{M}$  is a suboperad of  $\text{C}\mathcal{M}$ . It follows from Proposition 2.1.2 that when  $\mathcal{M}$  is finite, the dimensions of  $\text{Whi}\mathcal{M}$  satisfy, for any  $n \geq 2$ ,

$$\dim \text{Whi}\mathcal{M}(n) = m^{(n+1)(n-2)/2}, \tag{2.1.3}$$

where  $m := \#\mathcal{M}$ .

2.1.3. *Restricting the crossings.* Let  $k \geq 0$  be an integer and  $\mathcal{R}_{\text{Cro}_k\mathcal{M}}$  be the subspace of  $\text{C}\mathcal{M}$  generated by all  $\mathcal{M}$ -cliques  $p$  such that  $\text{cros}(p) \geq k + 1$ . As a quotient of graded vector spaces,

$$\text{Cro}_k\mathcal{M} := \text{C}\mathcal{M} / \mathcal{R}_{\text{Cro}_k\mathcal{M}} \tag{2.1.4}$$

is the linear span of all  $\mathcal{M}$ -cliques  $p$  such that  $\text{cros}(p) \leq k$ .

PROPOSITION 2.1.3. Let  $\mathcal{M}$  be a unitary magma and  $k \geq 0$  be an integer. Then, the space  $\text{Cro}_k\mathcal{M}$  is both a quotient and a suboperad of  $\text{C}\mathcal{M}$ .

For instance, in the operad  $\text{Cro}_2\mathbb{Z}$ , we have

$$\tag{2.1.5}$$

When  $0 \leq k' \leq k$  are integers, by Proposition 2.1.3,  $\text{Cro}_k\mathcal{M}$  and  $\text{Cro}_{k'}\mathcal{M}$  are both quotients and suboperads of  $\text{C}\mathcal{M}$ . First, since any  $\mathcal{M}$ -clique of  $\text{Cro}_{k'}\mathcal{M}$  is also an  $\mathcal{M}$ -clique of  $\text{Cro}_k\mathcal{M}$ ,  $\text{Cro}_{k'}\mathcal{M}$  is a suboperad of  $\text{Cro}_k\mathcal{M}$ . Second, since  $\mathcal{R}_{\text{Cro}_k\mathcal{M}}$  is a subspace of  $\mathcal{R}_{\text{Cro}_{k'}\mathcal{M}}$ ,  $\text{Cro}_k\mathcal{M}$  is a quotient of  $\text{Cro}_{k'}\mathcal{M}$ .

Remark that  $\text{Cro}_0\mathcal{M}$  is the linear span of all noncrossing  $\mathcal{M}$ -cliques. We can see these objects as noncrossing configurations [FN99] where the edges and bases are colored by elements of  $\mathcal{M}$  and the diagonals, by elements of  $\bar{\mathcal{M}}$ . The operad  $\text{Cro}_0\mathcal{M}$  has a lot of properties and will be studied in details in Section 3.

2.1.4. *Bubbles.* Let  $\mathcal{R}_{\text{Bub}\mathcal{M}}$  be the subspace of  $\text{C}\mathcal{M}$  generated by all  $\mathcal{M}$ -cliques that are not bubbles. As a quotient of graded vector spaces,

$$\text{Bub}\mathcal{M} := \text{C}\mathcal{M} / \mathcal{R}_{\text{Bub}\mathcal{M}} \tag{2.1.6}$$

is the linear span of all  $\mathcal{M}$ -bubbles.

PROPOSITION 2.1.4. *Let  $\mathcal{M}$  be a unitary magma. Then, the space  $\text{Bub}_{\mathcal{M}}$  is a quotient operad of  $C\mathcal{M}$ .*

For instance, in the operad  $\text{Bub}\mathbb{Z}$ , we have

(2.1.7a)

(2.1.7b)

When  $\mathcal{M}$  is finite, the dimensions of  $\text{Bub}\mathcal{M}$  satisfy, for any  $n \geq 2$ ,

$$\dim \text{Bub}\mathcal{M}(n) = m^{n+1}, \tag{2.1.8}$$

where  $m := \#\mathcal{M}$ .

2.1.5. *Restricting the degrees.* Let  $k \geq 0$  be an integer and  $\mathcal{R}_{\text{Deg}_k\mathcal{M}}$  be the subspace of  $C\mathcal{M}$  generated by all  $\mathcal{M}$ -cliques  $p$  such that  $\text{degr}(p) \geq k + 1$ . As a quotient of graded vector spaces,

$$\text{Deg}_k\mathcal{M} := C\mathcal{M}/\mathcal{R}_{\text{Deg}_k\mathcal{M}} \tag{2.1.9}$$

is the linear span of all  $\mathcal{M}$ -cliques  $p$  such that  $\text{degr}(p) \leq k$ .

PROPOSITION 2.1.5. *Let  $\mathcal{M}$  be a unitary magma without nontrivial unit divisors and  $k \geq 0$  be an integer. Then, the space  $\text{Deg}_k\mathcal{M}$  is a quotient operad of  $C\mathcal{M}$ .*

For instance, in the operad  $\text{Deg}_3\mathbb{D}_2$  (observe that  $\mathbb{D}_2$  is a unitary magma without nontrivial unit divisors), we have

(2.1.10a)

(2.1.10b)

When  $0 \leq k' \leq k$  are integers, by Proposition 2.1.5,  $\text{Deg}_k\mathcal{M}$  and  $\text{Deg}_{k'}\mathcal{M}$  are both quotients operads of  $C\mathcal{M}$ . Moreover, since  $\mathcal{R}_{\text{Deg}_k\mathcal{M}}$  is a subspace of  $\mathcal{R}_{\text{Deg}_{k'}\mathcal{M}}$ ,  $\text{Deg}_{k'}\mathcal{M}$  is a quotient operad of  $\text{Deg}_k\mathcal{M}$ .

Observe that  $\text{Deg}_0\mathcal{M}$  is the linear span of all  $\mathcal{M}$ -cliques without solid arcs. If  $p$  and  $q$  are such  $\mathcal{M}$ -cliques, all partial compositions  $p \circ_i q$  are equal to the unique  $\mathcal{M}$ -clique without solid arcs of arity  $|p| + |q| - 1$ . For this reason,  $\text{Deg}_0\mathcal{M}$  is the associative operad  $\text{As}$ .

Any skeleton of an  $\mathcal{M}$ -clique of arity  $n$  of  $\text{Deg}_1\mathcal{M}$  can be seen as a partition of the set  $[n + 1]$  in singletons or pairs. Therefore,  $\text{Deg}_1\mathcal{M}$  can be seen as an operad on such colored partitions, where each pair of the partitions have one color among the set  $\mathcal{M}$ . In the operad  $\text{Deg}_1\mathbb{D}_0$  (observe that  $\mathbb{D}_0$  is the only unitary magma without nontrivial unit divisors on two elements), one has for instance

(2.1.11a)

(2.1.11b)

By seeing each solid arc  $(x, y)$  of an  $\mathcal{M}$ -clique  $\mathfrak{p}$  of  $\text{Deg}_1\mathbb{D}_0$  of arity  $n$  as the transposition exchanging the letter  $x$  and the letter  $y$ , we can interpret  $\mathfrak{p}$  as an involution of  $\mathfrak{S}_{n+1}$  made of the product of these transpositions. Hence,  $\text{Deg}_1\mathbb{D}_0$  can be seen as an operad on involutions. Under this point of view, the partial compositions (2.1.11a) and (2.1.11b) translate on permutations as

$$42315 \circ_2 3412 = 6452317, \quad (2.1.12a)$$

$$42315 \circ_3 3412 = 0. \quad (2.1.12b)$$

Equivalently, by the Robinson-Schensted correspondence (see for instance [Sch61, Lot02]),  $\text{Deg}_1\mathbb{D}_0$  is an operad of standard Young tableaux. The dimensions of  $\text{Deg}_1\mathbb{D}_0$  operad begin by

$$1, 4, 10, 26, 76, 232, 764, 2620, \quad (2.1.13)$$

and form, except for the first terms, Sequence A000085 of [Slo]. Moreover, when  $\#\mathcal{M} = 3$ , the dimensions of  $\text{Deg}_1\mathcal{M}$  begin by

$$1, 7, 25, 81, 331, 1303, 5937, 26785, \quad (2.1.14)$$

and form, except for the first terms, Sequence A047974 of [Slo].

Besides, any skeleton of an  $\mathcal{M}$ -clique of  $\text{Deg}_2\mathcal{M}$  can be seen as a *thunderstorm graph*, i.e., a graph where connected components are cycles or paths. Therefore,  $\text{Deg}_2\mathcal{M}$  can be seen as an operad on such colored graphs, where the arcs of the graphs have one color among the set  $\bar{\mathcal{M}}$ . When  $\#\mathcal{M} = 2$ , the dimensions of this operad begin by

$$1, 8, 41, 253, 1858, 15796, 152219, 1638323, \quad (2.1.15)$$

and form, except for the first terms, Sequence A136281 of [Slo].

2.1.6. *Nesting-free cliques.* Let  $\mathcal{R}_{\text{Nes}\mathcal{M}}$  be the subspace of  $C\mathcal{M}$  generated by all  $\mathcal{M}$ -cliques that are not nesting-free. As a quotient of graded vector spaces,

$$\text{Nes}\mathcal{M} := C\mathcal{M} / \mathcal{R}_{\text{Nes}\mathcal{M}} \quad (2.1.16)$$

is the linear span of all nesting-free  $\mathcal{M}$ -cliques.

PROPOSITION 2.1.6. *Let  $\mathcal{M}$  be a unitary magma without nontrivial unit divisors. Then, the space  $\text{Nes}\mathcal{M}$  is a quotient operad of  $C\mathcal{M}$ .*

For instance, in the operad  $\text{Nes}\mathbb{D}_2$ ,

$$(2.1.17a)$$

$$(2.1.17b)$$

Remark that in the same way as considering  $\mathcal{M}$ -cliques of crossings no greater than  $k$  leads to quotients  $\text{Cro}_k\mathcal{M}$  of  $C\mathcal{M}$  (see Section 2.1.3), it is possible to define analogous quotients  $\text{Nes}_k\mathcal{M}$  spanned by  $\mathcal{M}$ -cliques having solid arcs that nest at most  $k$  other ones.

PROPOSITION 2.1.7. Let  $\mathcal{M}$  be a finite unitary magma without nontrivial unit divisors. For all  $n \geq 2$ ,

$$\dim \text{Nes}\mathcal{M}(n) = \sum_{0 \leq k \leq n} (m-1)^k \text{nar}(n+2, k), \tag{2.1.18}$$

where  $m := \#\mathcal{M}$ .

In the statement of Proposition 2.1.7,  $\text{nar}(n, k)$  is a Narayana number whose definition is recalled in Section 2.2.3 of Chapter 1.

The skeletons of the  $\mathcal{M}$ -cliques of  $\text{Nes}\mathcal{M}$  of arities greater than 1 are the graphs such that, if  $\{x, y\}$  and  $\{x', y'\}$  are two arcs such that  $x \leq x' < y' \leq y$ , then  $x = x'$  and  $y = y'$ . Therefore,  $\text{Nes}\mathcal{M}$  can be seen as an operad on such colored graphs, where the arcs of the graphs have one color among the set  $\bar{\mathcal{M}}$ .

By Proposition 2.1.7, when  $\#\mathcal{M} = 2$ , the dimensions of  $\text{Nes}\mathcal{M}$  begin by

$$1, 5, 14, 42, 132, 429, 1430, 4862, \tag{2.1.19}$$

and form, except for the first terms, Sequence A000108 of [Slo]. When  $\#\mathcal{M} = 3$ , the dimensions of  $\text{Nes}\mathcal{M}$  begin by

$$1, 11, 45, 197, 903, 4279, 20793, 103049, \tag{2.1.20}$$

and form, except for the first terms, Sequence A001003 of [Slo]. When  $\#\mathcal{M} = 4$ , the dimensions of  $\text{Nes}\mathcal{M}$  begin by

$$1, 19, 100, 562, 3304, 20071, 124996, 793774, \tag{2.1.21}$$

and form, except for the first terms, Sequence A007564 of [Slo].

2.1.7. *Acyclic decorated cliques.* Let  $\mathcal{R}_{\text{Acy}\mathcal{M}}$  be the subspace of  $\text{C}\mathcal{M}$  generated by all  $\mathcal{M}$ -cliques that are not acyclic. As a quotient of graded vector spaces,

$$\text{Acy}\mathcal{M} := \text{C}\mathcal{M} / \mathcal{R}_{\text{Acy}\mathcal{M}} \tag{2.1.22}$$

is the linear span of all acyclic  $\mathcal{M}$ -cliques.

PROPOSITION 2.1.8. Let  $\mathcal{M}$  be a unitary magma without nontrivial unit divisors. Then, the space  $\text{Acy}\mathcal{M}$  is a quotient operad of  $\text{C}\mathcal{M}$ .

For instance, in the operad  $\text{Acy}\mathbb{D}_2$ ,

$$\tag{2.1.23a}$$

$$\tag{2.1.23b}$$

The skeletons of the  $\mathcal{M}$ -cliques of  $\text{Acy}\mathcal{M}$  of arities greater than 1 are acyclic graphs or equivalently, forest of non-rooted trees. Therefore,  $\text{Acy}\mathcal{M}$  can be seen as an operad on colored forests of trees, where the edges of the trees of the forests have one color among the set  $\bar{\mathcal{M}}$ . When  $\#\mathcal{M} = 2$ , the dimensions of  $\text{Acy}\mathcal{M}$  begin by

$$1, 7, 38, 291, 2932, 36961, 561948, 10026505, \tag{2.1.24}$$

and form, except for the first terms, Sequence **A001858** of [**Slo**].

**2.2. Secondary substructures.** Some more substructures of  $C\mathcal{M}$  are constructed and briefly studied here. They are constructed by mixing some of the constructions of the seven main substructures of  $C\mathcal{M}$  defined in Section 2.1 in the following sense.

For any operad  $\mathcal{O}$  and operad ideals  $\mathcal{R}_1$  and  $\mathcal{R}_2$  of  $\mathcal{O}$ , the space  $\mathcal{R}_1 + \mathcal{R}_2$  is still an operad ideal of  $\mathcal{O}$ , and  $\mathcal{O}/_{\mathcal{R}_1 + \mathcal{R}_2}$  is a quotient of both  $\mathcal{O}/_{\mathcal{R}_1}$  and  $\mathcal{O}/_{\mathcal{R}_2}$ . Moreover, if  $\mathcal{O}'$  is a suboperad of  $\mathcal{O}$  and  $\mathcal{R}$  is an operad ideal of  $\mathcal{O}$ , the space  $\mathcal{R} \cap \mathcal{O}'$  is an operad ideal of  $\mathcal{O}'$ , and  $\mathcal{O}'/_{\mathcal{R} \cap \mathcal{O}'}$  is a quotient of  $\mathcal{O}'$  and a suboperad of  $\mathcal{O}/_{\mathcal{R}}$ . For these reasons (straightforwardly provable), we can combine the constructions of the previous section to build a bunch of new suboperads and quotients of  $C\mathcal{M}$ .

2.2.1. *Colored white noncrossing configurations.* When  $\mathcal{M}$  is a unitary magma, let

$$\text{WNC}\mathcal{M} := \text{Whi}\mathcal{M}/_{\mathcal{R}_{\text{Cro}}\mathcal{M} \cap \text{Whi}\mathcal{M}}. \quad (2.2.1)$$

The  $\mathcal{M}$ -cliques of  $\text{WNC}\mathcal{M}$  are white noncrossing  $\mathcal{M}$ -cliques.

PROPOSITION 2.2.1. *Let  $\mathcal{M}$  be a finite unitary magma. For all  $n \geq 2$ ,*

$$\dim \text{WNC}\mathcal{M}(n) = \sum_{0 \leq k \leq n-2} m^k (m-1)^{n-k-2} \text{nar}(n, k), \quad (2.2.2)$$

where  $m := \#\mathcal{M}$ .

When  $\#\mathcal{M} = 2$ , the dimensions of  $\text{WNC}\mathcal{M}$  begin by

$$1, 1, 3, 11, 45, 197, 903, 4279, \quad (2.2.3)$$

and form Sequence **A001003** of [**Slo**]. When  $\#\mathcal{M} = 3$ , the dimensions of  $\text{WNC}\mathcal{M}$  begin by

$$1, 1, 5, 31, 215, 1597, 12425, 99955, \quad (2.2.4)$$

and form Sequence **A269730** of [**Slo**]. Observe that these dimensions are shifted versions the ones of the  $\gamma$ -polytridendriform operads  $\text{TDendr}_\gamma$  (see Section 6.2 of Chapter 5) with  $\gamma := \#\mathcal{M} - 1$ .

2.2.2. *Colored forests of paths.* When  $\mathcal{M}$  is a unitary magma without nontrivial unit divisors, let

$$\text{Pat}\mathcal{M} := C\mathcal{M}/_{\mathcal{R}_{\text{Deg}}\mathcal{M} + \mathcal{R}_{\text{Acy}}\mathcal{M}}. \quad (2.2.5)$$

The skeletons of the  $\mathcal{M}$ -cliques of  $\text{Pat}\mathcal{M}$  are forests of non-rooted trees that are paths. Therefore,  $\text{Pat}\mathcal{M}$  can be seen as an operad on colored such graphs, where the arcs of the graphs have one color among the set  $\mathcal{M}$ .

When  $\#\mathcal{M} = 2$ , the dimensions of  $\text{Pat}\mathcal{M}$  begin by

$$1, 7, 34, 206, 1486, 12412, 117692, 1248004, \quad (2.2.6)$$

an form, except for the first terms, Sequence **A011800** of [**Slo**].

2.2.3. *Colored forests.* When  $\mathcal{M}$  is a unitary magma without nontrivial unit divisors, let

$$\text{For}\mathcal{M} := \mathbb{C}\mathcal{M}/_{\mathcal{R}_{\text{Croq}}\mathcal{M} + \mathcal{R}_{\text{Acy}}\mathcal{M}}. \quad (2.2.7)$$

The skeletons of the  $\mathcal{M}$ -cliques of  $\text{For}\mathcal{M}$  are forests of rooted trees having no arcs  $\{x, y\}$  and  $\{x', y'\}$  satisfying  $x < x' < y < y'$ . Therefore,  $\text{For}\mathcal{M}$  can be seen as an operad on such colored forests, where the edges of the forests have one color among the set  $\bar{\mathcal{M}}$ . When  $\#\mathcal{M} = 2$ , the dimensions of  $\text{For}\mathcal{M}$  begin by

$$1, 7, 33, 81, 1083, 6854, 45111, 305629, \quad (2.2.8)$$

and form, except for the first terms, Sequence **A054727**, of **[Slo]**.

2.2.4. *Colored Motzkin configurations.* When  $\mathcal{M}$  is a unitary magma without nontrivial unit divisors, let

$$\text{Mot}\mathcal{M} := \mathbb{C}\mathcal{M}/_{\mathcal{R}_{\text{Croq}}\mathcal{M} + \mathcal{R}_{\text{Deg1}}\mathcal{M}}. \quad (2.2.9)$$

The skeletons of the  $\mathcal{M}$ -cliques of  $\text{Mot}\mathcal{M}$  are configurations of non-intersecting chords on a circle. Equivalently, these objects are graphs of involutions (see Section 2.1.5) having no arcs  $\{x, y\}$  and  $\{x', y'\}$  satisfying  $x < x' < y < y'$ . These objects are enumerated by Motzkin numbers **[Mot48]**. Therefore,  $\text{Mot}\mathcal{M}$  can be seen as an operad on such colored graphs, where the arcs of the graphs have one color among the set  $\bar{\mathcal{M}}$ . When  $\#\mathcal{M} = 2$ , the dimensions of  $\text{Mot}\mathcal{M}$  begin by

$$1, 4, 9, 21, 51, 127, 323, 835, \quad (2.2.10)$$

and form, except for the first terms, Sequence **A001006**, of **[Slo]**.

2.2.5. *Colored dissections of polygons.* When  $\mathcal{M}$  is a unitary magma without nontrivial unit divisors, let

$$\text{Dis}\mathcal{M} := \text{Whi}\mathcal{M}/_{(\mathcal{R}_{\text{Croq}}\mathcal{M} + \mathcal{R}_{\text{Deg1}}\mathcal{M}) \cap \text{Whi}\mathcal{M}}. \quad (2.2.11)$$

The skeletons of the  $\mathcal{M}$ -cliques of  $\text{Dis}\mathcal{M}$  are *strict dissections of polygons*, that are graphs of Motzkin configurations with no arcs of the form  $\{x, x + 1\}$  or  $\{1, n + 1\}$ , where  $n + 1$  is the number of vertices of the graphs. Therefore,  $\text{Dis}\mathcal{M}$  can be seen as an operad on such colored graphs, where the arcs of the graphs have one color among the set  $\bar{\mathcal{M}}$ . When  $\#\mathcal{M} = 2$ , the dimensions of  $\text{Dis}\mathcal{M}$  begin by

$$1, 1, 3, 6, 13, 29, 65, 148, \quad (2.2.12)$$

and form, except for the first terms, Sequence **A093128** of **[Slo]**.

2.2.6. *Colored Lucas configurations.* When  $\mathcal{M}$  is a unitary magma without nontrivial unit divisors, let

$$\text{Luc}\mathcal{M} := \mathbb{C}\mathcal{M}/_{\mathcal{R}_{\text{Bub}}\mathcal{M} + \mathcal{R}_{\text{Deg1}}\mathcal{M}}. \quad (2.2.13)$$

The skeletons of the  $\mathcal{M}$ -cliques of  $\text{Luc}\mathcal{M}$  are graphs such that all vertices are of degrees at most 1 and all arcs are of the form  $\{x, x + 1\}$  or  $\{1, n + 1\}$ , where  $n + 1$  is the number of vertices of the graphs. Therefore,  $\text{Luc}\mathcal{M}$  can be seen as an operad on such colored graphs, where the arcs of the graphs have one color among the set  $\bar{\mathcal{M}}$ . When  $\#\mathcal{M} = 2$ , the dimensions of  $\text{Luc}\mathcal{M}$  begin by

$$1, 4, 7, 11, 18, 29, 47, 76, \quad (2.2.14)$$

and form, except for the first terms, Sequence A000032 of [Slo].

**2.3. Relations between substructures.** The suboperads and quotients of  $C\mathcal{M}$  constructed in Sections 2.1 and 2.2 are linked by injective or surjective operad morphisms. To establish these, we rely on the following lemma.

LEMMA 2.3.1. *Let  $\mathcal{M}$  be a unitary magma. Then,*

- (i) *the space  $\mathcal{R}_{\text{Acy}\mathcal{M}}$  is a subspace of  $\mathcal{R}_{\text{Deg}_1\mathcal{M}}$ ;*
- (ii) *the spaces  $\mathcal{R}_{\text{Nes}\mathcal{M}}$  and  $\mathcal{R}_{\text{Bub}\mathcal{M}}$  are subspaces of  $\mathcal{R}_{\text{Deg}_0\mathcal{M}}$ ;*
- (iii) *the spaces  $\mathcal{R}_{\text{Cro}_0\mathcal{M}}$  and  $\mathcal{R}_{\text{Deg}_2\mathcal{M}}$  are subspaces of  $\mathcal{R}_{\text{Bub}\mathcal{M}}$ ;*
- (iv) *the spaces  $\mathcal{R}_{\text{Deg}_2\mathcal{M}}$  and  $\mathcal{R}_{\text{Acy}\mathcal{M}}$  are subspaces of  $\mathcal{R}_{\text{Nes}\mathcal{M}}$ .*

2.3.1. *Relations between the main substructures.* Let us list and explain the morphisms between the main substructures of  $C\mathcal{M}$ . First, Lemma 2.3.1 implies that there are surjective operad morphisms from  $\text{Acy}\mathcal{M}$  to  $\text{Deg}_1\mathcal{M}$ , from  $\text{Nes}\mathcal{M}$  to  $\text{Deg}_0\mathcal{M}$ , from  $\text{Bub}\mathcal{M}$  to  $\text{Deg}_0\mathcal{M}$ , from  $\text{Cro}_0\mathcal{M}$  to  $\text{Bub}\mathcal{M}$ , from  $\text{Deg}_2\mathcal{M}$  to  $\text{Bub}\mathcal{M}$ , from  $\text{Deg}_2\mathcal{M}$  to  $\text{Nes}\mathcal{M}$ , and from  $\text{Acy}\mathcal{M}$  to  $\text{Nes}\mathcal{M}$ . Second, when  $B, E,$  and  $D$  are subsets of  $\mathcal{M}$  such that  $1_{\mathcal{M}} \in B, 1_{\mathcal{M}} \in E,$  and  $E \star B \subseteq D,$   $\text{Whi}\mathcal{M}$  is a suboperad of  $\text{Lab}_{B,E,D}\mathcal{M}$ . Finally, there is a surjective operad morphism from  $\text{Whi}\mathcal{M}$  to the associative operad  $\text{As}$  sending any  $\mathcal{M}$ -clique  $p$  of  $\text{Whi}\mathcal{M}$  to the unique basis element of  $\text{As}$  of the same arity as the one of  $p$ . The relations between the main suboperads and quotients of  $C\mathcal{M}$  built here are summarized in the diagram of operad morphisms of Figure 7.2.

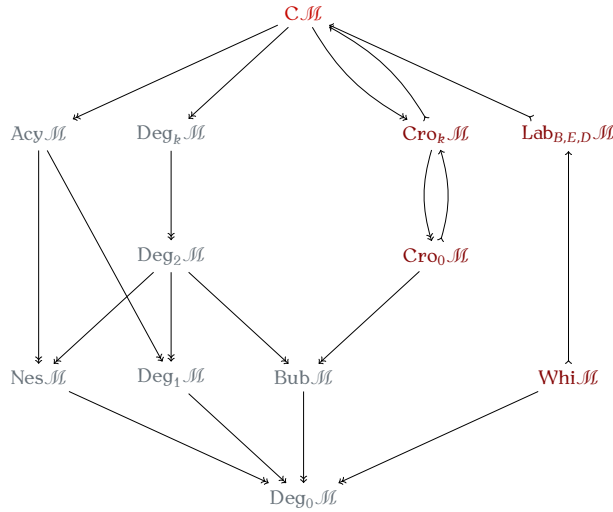

FIGURE 7.2. The diagram of the main suboperads and quotients of  $C\mathcal{M}$ . Arrows  $\mapsto$  (resp.  $\twoheadrightarrow$ ) are injective (resp. surjective) operad morphisms. Here,  $\mathcal{M}$  is a unitary magma without nontrivial unit divisors,  $k$  is a positive integer, and  $B, E,$  and  $D$  are subsets of  $\mathcal{M}$  such that  $1_{\mathcal{M}} \in B, 1_{\mathcal{M}} \in E,$  and  $E \star B \subseteq D.$

2.3.2. *Relations between the secondary and main substructures.* Let us now list and explain the morphisms between the secondary and main substructures of  $C\mathcal{M}$ . First, immediately from their definitions,  $WNC\mathcal{M}$  is a suboperad of  $Cro_0\mathcal{M}$  and a quotient of  $Whi\mathcal{M}$ ,  $Pat\mathcal{M}$  is both a quotient of  $Deg_2\mathcal{M}$  and  $Acy\mathcal{M}$ ,  $For\mathcal{M}$  is both a quotient of  $Cro_0\mathcal{M}$  and  $Acy\mathcal{M}$ ,  $Mot\mathcal{M}$  is both a quotient of  $Cro_0\mathcal{M}$  and  $Deg_1\mathcal{M}$ ,  $Dis\mathcal{M}$  is a suboperad of  $Mot\mathcal{M}$  and a quotient of  $WNC\mathcal{M}$ , and  $Luc\mathcal{M}$  is both a quotient of  $Bub\mathcal{M}$  and  $Deg_1\mathcal{M}$ . Moreover, since by Lemma 2.3.1,  $\mathcal{R}_{Acy\mathcal{M}}$  is a subspace of  $\mathcal{R}_{Deg_1\mathcal{M}}$ ,  $\mathcal{R}_{Deg_2\mathcal{M}}$  and  $\mathcal{R}_{Acy\mathcal{M}}$  are subspaces of  $\mathcal{R}_{Nes\mathcal{M}}$ , and  $\mathcal{R}_{Cro_0\mathcal{M}}$  is a subspace of  $\mathcal{R}_{Bub\mathcal{M}}$ , we respectively have that  $\mathcal{R}_{Deg_2\mathcal{M}} + \mathcal{R}_{Acy\mathcal{M}}$  is a subspace of both  $\mathcal{R}_{Deg_1\mathcal{M}}$  and  $\mathcal{R}_{Nes\mathcal{M}}$ ,  $\mathcal{R}_{Cro_0\mathcal{M}} + \mathcal{R}_{Acy\mathcal{M}}$  is a subspace of  $\mathcal{R}_{Cro_0\mathcal{M}} + \mathcal{R}_{Deg_1\mathcal{M}}$ , and  $\mathcal{R}_{Cro_0\mathcal{M}} + \mathcal{R}_{Deg_1\mathcal{M}}$  is a subspace of  $\mathcal{R}_{Bub\mathcal{M}} + \mathcal{R}_{Deg_1\mathcal{M}}$ . For these reasons, there are surjective operad morphisms from  $Pat\mathcal{M}$  to  $Deg_1\mathcal{M}$ , from  $Pat\mathcal{M}$  to  $Nes\mathcal{M}$ , from  $For\mathcal{M}$  to  $Mot\mathcal{M}$ , and from  $Mot\mathcal{M}$  to  $Luc\mathcal{M}$ . The relations between the secondary suboperads and quotients of  $C\mathcal{M}$  built here are summarized in the diagram of operad morphisms of Figure 7.3.

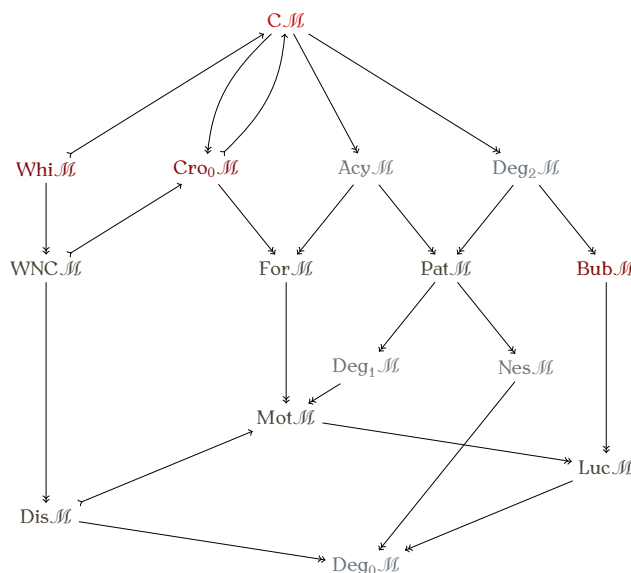

FIGURE 7.3. The diagram of the secondary suboperads and quotients of  $C\mathcal{M}$  together with some of their related main suboperads and quotients of  $C\mathcal{M}$ . Arrows  $\hookrightarrow$  (resp.  $\rightarrow$ ) are injective (resp. surjective) operad morphisms. Here,  $\mathcal{M}$  is a unitary magma without nontrivial unit divisors.

### 3. Operads of noncrossing decorated cliques

We perform here a complete study of the suboperad  $Cro_0\mathcal{M}$  of noncrossing  $\mathcal{M}$ -cliques defined in Section 2.1.3. For simplicity, this operad is denoted in the sequel as  $NC\mathcal{M}$  and named as the *noncrossing  $\mathcal{M}$ -clique operad*. The process giving from any unitary magma  $\mathcal{M}$  the operad  $NC\mathcal{M}$  is called the *noncrossing clique construction*.



**3.1. General properties.** To study  $\text{NC}\mathcal{M}$ , we begin by establishing the fact that  $\text{NC}\mathcal{M}$  inherits some properties of  $\text{C}\mathcal{M}$ . Then, we shall describe a realization of  $\text{NC}\mathcal{M}$  in terms of decorated Schröder trees, compute a minimal generating set of  $\text{NC}\mathcal{M}$ , and compute its dimensions.

First of all, we call *fundamental basis* of  $\text{NC}\mathcal{M}$  the fundamental basis of  $\text{C}\mathcal{M}$  restricted on noncrossing  $\mathcal{M}$ -cliques. By definition of  $\text{NC}\mathcal{M}$  and by Proposition 2.1.3, the partial composition  $p \circ_i q$  of two noncrossing  $\mathcal{M}$ -cliques  $p$  and  $q$  in  $\text{NC}\mathcal{M}$  is equal to the partial composition  $p \circ_i q$  in  $\text{C}\mathcal{M}$ . Therefore, the fundamental basis of  $\text{NC}\mathcal{M}$  is a set-operad basis.

3.1.1. *First properties.*

PROPOSITION 3.1.1. *Let  $\mathcal{M}$  be a unitary magma. Then,*

- (i) *the associative elements of  $\text{NC}\mathcal{M}$  are the ones of  $\text{C}\mathcal{M}$ ;*
- (ii) *the group of symmetries of  $\text{NC}\mathcal{M}$  contains the map  $\text{ret}$  (defined by (1.2.8)) and all the maps  $\text{C}\theta$  where  $\theta$  are unitary magma automorphisms of  $\mathcal{M}$ ;*
- (iii) *the fundamental basis of  $\text{NC}\mathcal{M}$  is a basic set-operad basis if and only if  $\mathcal{M}$  is right cancellable;*
- (iv) *the map  $\rho$  (defined by (1.2.10)) is a rotation map of  $\text{NC}\mathcal{M}$  endowing it with a cyclic operad structure.*

3.1.2. *Treelike expressions on bubbles.* Let  $p$  be a noncrossing  $\mathcal{M}$ -clique of arity  $n \geq 2$ , and  $(x, y)$  be a diagonal or the base of  $p$ . Consider the path  $(x = z_1, z_2, \dots, z_k, z_{k+1} = y)$  in  $p$  such that  $k \geq 2$ , for all  $i \in [k + 1]$ ,  $x \leq z_i \leq y$ , and for all  $i \in [k]$ ,  $z_{i+1}$  is the greatest vertex of  $p$  so that  $(z_i, z_{i+1})$  is a solid diagonal or a (non-necessarily solid) edge of  $p$ . The *area* of  $p$  adjacent to  $(x, y)$  is the  $\mathcal{M}$ -bubble  $q$  of arity  $k$  whose base is labeled by  $p(x, y)$  and  $q_i = p(z_i, z_{i+1})$  for all  $i \in [k]$ . From a geometric point of view,  $q$  is the unique maximal component of  $p$  adjacent to the arc  $(x, y)$ , without solid diagonals, and bounded by solid diagonals or edges of  $p$ . For instance, for the noncrossing  $\mathbb{Z}$ -clique



the path associated with the diagonal  $(4, 9)$  of  $p$  is  $(4, 5, 6, 8, 9)$ . For this reason, the area of  $p$  adjacent to  $(4, 9)$  is the  $\mathbb{Z}$ -bubble



PROPOSITION 3.1.2. *Let  $\mathcal{M}$  be a unitary magma and  $p$  be a noncrossing  $\mathcal{M}$ -clique of arity greater than 1. Then, there is a unique  $\mathcal{M}$ -bubble  $q$  with a maximal arity  $k \geq 2$  such that  $p = q \circ [\tau_1, \dots, \tau_k]$ , where each  $\tau_i$ ,  $i \in [k]$ , is a noncrossing  $\mathcal{M}$ -clique with a base labeled by  $1_{\mathcal{M}}$ .*

Consider the map

$$\text{bt} : \text{NC}\mathcal{M} \rightarrow \mathbf{FO}(\mathcal{B}_{\mathcal{M}}) \tag{3.1.3}$$

defined linearly and recursively by  $\text{bt}(\circlearrowleft) := \perp$  and, for any noncrossing  $\mathcal{M}$ -clique  $p$  of arity greater than 1, by

$$\text{bt}(p) := \odot(q) \circ [\text{bt}(\tau_1), \dots, \text{bt}(\tau_k)], \tag{3.1.4}$$

where  $p = q \circ [\tau_1, \dots, \tau_k]$  is the unique decomposition of  $p$  stated in Proposition 3.1.2. We call  $\text{bt}(p)$  the *bubble tree* of  $p$ . For instance, in  $\text{NC}\mathbb{Z}$ ,

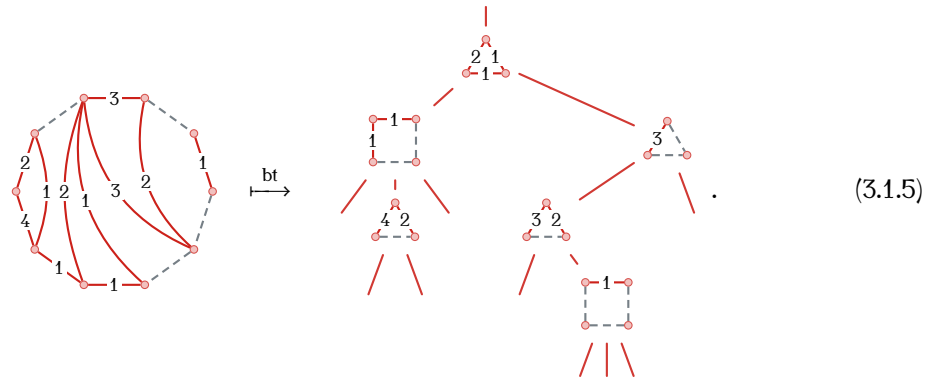

LEMMA 3.1.3. Let  $\mathcal{M}$  be a unitary magma. For any noncrossing  $\mathcal{M}$ -clique  $p$ ,  $\text{bt}(p)$  is a treelike expression on  $\mathcal{B}_{\mathcal{M}}$  of  $p$ .

PROPOSITION 3.1.4. Let  $\mathcal{M}$  be a unitary magma. Then, the map  $\text{bt}$  is injective and the image of  $\text{bt}$  is the linear span of all syntax trees  $t$  on  $\mathcal{B}_{\mathcal{M}}$  such that

- (i) the root of  $t$  is labeled by an  $\mathcal{M}$ -bubble;
- (ii) the internal nodes of  $t$  different from the root are labeled by  $\mathcal{M}$ -bubbles whose bases are labeled by  $\mathbb{1}_{\mathcal{M}}$ ;
- (iii) if  $x$  and  $y$  are two internal nodes of  $t$  such that  $y$  is the  $i$ th child of  $x$ , the  $i$ th edge of the bubble labeling  $x$  is solid.

Observe that  $\text{bt}$  is not an operad morphism. Indeed,

$$\text{bt} \left( \circlearrowleft \circ_1 \circlearrowleft \right) = \text{bubble} \neq \text{bubble} = \text{bt} \left( \circlearrowleft \right) \circ_1 \text{bt} \left( \circlearrowleft \right). \tag{3.1.6}$$

Observe moreover that (3.1.6) holds for all unitary magmas  $\mathcal{M}$  since  $\mathbb{1}_{\mathcal{M}}$  is always idempotent.

3.1.3. *Realization in terms of decorated Schröder trees.* An  $\mathcal{M}$ -Schröder tree  $t$  is a Schröder tree (see Section 2.2.3 of Chapter 1) such that each edge connecting two internal nodes is labeled on  $\bar{\mathcal{M}}$ , each edge connecting an internal node and a leaf is labeled on  $\mathcal{M}$ , and the outgoing edge from the root of  $t$  is labeled on  $\mathcal{M}$  (see (3.1.7) for an example of a  $\mathbb{Z}$ -Schröder tree).

From the description of the image of the map  $\text{bt}$  provided by Proposition 3.1.4, any bubble tree  $t$  of a noncrossing  $\mathcal{M}$ -clique  $p$  of arity  $n$  can be encoded by an  $\mathcal{M}$ -Schröder tree  $s$  with  $n$  leaves. Indeed, this  $\mathcal{M}$ -Schröder tree is obtained by considering each internal node  $x$  of  $t$  and by labeling the edge connecting  $x$  and its  $i$ th child by the label of the  $i$ th edge of the  $\mathcal{M}$ -bubble labeling  $x$ . The outgoing edge from the root of  $s$  is labeled by the label of the base of the  $\mathcal{M}$ -bubble labeling the root of  $t$ . For instance, the bubble tree of (3.1.5) is encoded by the  $\mathbb{Z}$ -Schröder tree

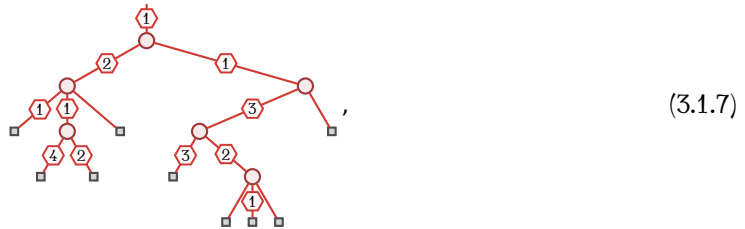

where the labels of the edges are drawn in the hexagons and where unlabeled edges are implicitly labeled by  $1_{\mathcal{M}}$ . We shall use these drawing conventions in the sequel. As a side remark, observe that the  $\mathcal{M}$ -Schröder tree encoding a noncrossing  $\mathcal{M}$ -clique  $p$  and the dual tree of  $p$  (in the usual meaning) have the same underlying unlabeled tree.

This encoding of noncrossing  $\mathcal{M}$ -cliques by bubble trees is reversible and hence, one can interpret  $\text{NC}\mathcal{M}$  as an operad on the linear span of all  $\mathcal{M}$ -Schröder trees. Hence, through this interpretation, if  $s$  and  $t$  are two  $\mathcal{M}$ -Schröder trees and  $i$  is a valid integer, the tree  $s \circ_i t$  is computed by grafting the root of  $t$  to the  $i$ th leaf of  $s$ . Then, by denoting by  $b$  the label of the edge adjacent to the root of  $t$  and by  $a$  the label of the edge adjacent to the  $i$ th leaf of  $s$ , we have two cases to consider, depending on the value of  $c := a \star b$ . If  $c \neq 1_{\mathcal{M}}$ , we label the edge connecting  $s$  and  $t$  by  $c$ . Otherwise, when  $c = 1_{\mathcal{M}}$ , we contract the edge connecting  $s$  and  $t$  by merging the root of  $t$  and the father of the  $i$ th leaf of  $s$  (see Figure 7.4). For instance, in  $\text{NC}\mathbb{N}_3$ , one has the two partial compositions

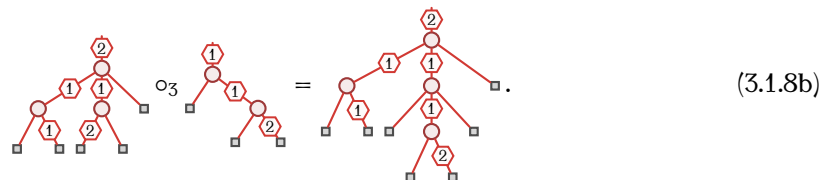
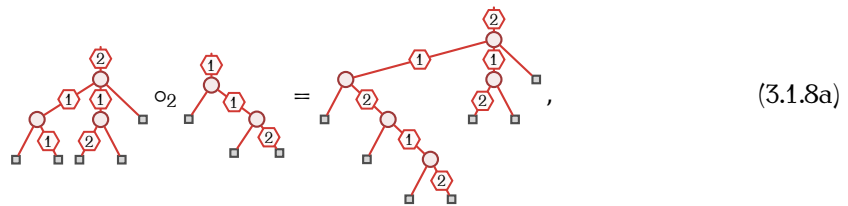

In the sequel, we shall indifferently see  $\text{NC}\mathcal{M}$  as an operad on noncrossing  $\mathcal{M}$ -cliques or on  $\mathcal{M}$ -Schröder trees.

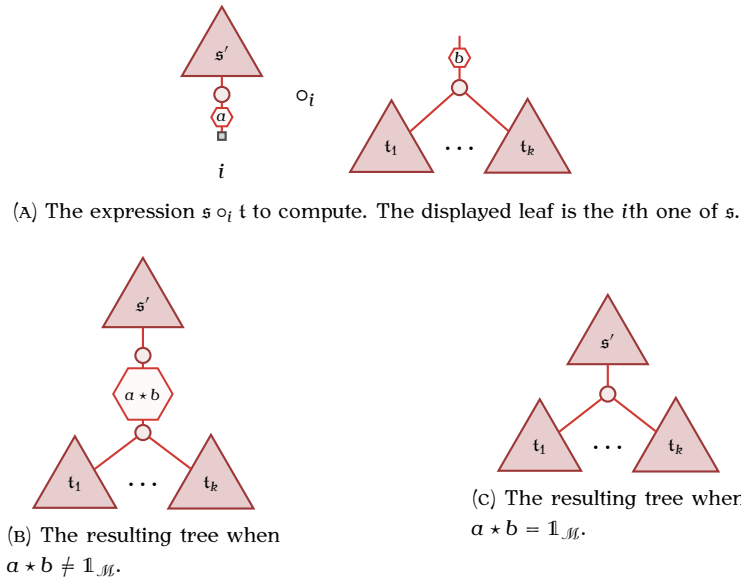

FIGURE 7.4. The partial composition of  $\text{NC}\mathcal{M}$  realized on  $\mathcal{M}$ -Schröder trees. Here, the two cases (b) and (c) for the computation of  $s \circ_i t$  are shown, where  $s$  and  $t$  are two  $\mathcal{M}$ -Schröder trees. In these drawings, the triangles denote subtrees.

3.1.4. Minimal generating set.

PROPOSITION 3.1.5. Let  $\mathcal{M}$  be a unitary magma. The set  $\mathcal{T}_{\mathcal{M}}$  of all  $\mathcal{M}$ -triangles is a minimal generating set of  $\text{NC}\mathcal{M}$ .

Proposition 3.1.5 also says that  $\text{NC}\mathcal{M}$  is the smallest suboperad of  $\text{C}\mathcal{M}$  that contains all  $\mathcal{M}$ -triangles and that  $\text{NC}\mathcal{M}$  is the biggest binary suboperad of  $\text{C}\mathcal{M}$ .

3.1.5. Dimensions. We now use the notion of bubble trees introduced in Section 3.1.2 to compute the dimensions of  $\text{NC}\mathcal{M}$ .

PROPOSITION 3.1.6. Let  $\mathcal{M}$  be a finite unitary magma. The Hilbert series  $\mathcal{H}_{\text{NC}\mathcal{M}}(t)$  of  $\text{NC}\mathcal{M}$  satisfies

$$t + (m^3 - 2m^2 + 2m - 1)t^2 + (2m^2t - 3mt + 2t - 1)\mathcal{H}_{\text{NC}\mathcal{M}}(t) + (m - 1)\mathcal{H}_{\text{NC}\mathcal{M}}(t)^2 = 0, \quad (3.1.9)$$

where  $m := \#\mathcal{M}$ .

We deduce from Proposition 3.1.6 that the Hilbert series of  $\text{NC}\mathcal{M}$  satisfies

$$\mathcal{H}_{\text{NC}\mathcal{M}}(t) = \frac{1 - (2m^2 - 3m + 2)t - \sqrt{1 - 2(2m^2 - m)t + m^2t^2}}{2(m - 1)}, \quad (3.1.10)$$

where  $m := \#\mathcal{M} \neq 1$ .

By using Narayana numbers, whose definition is recalled in Section 2.1.6, one can state the following result.

PROPOSITION 3.1.7. *Let  $\mathcal{M}$  be a finite unitary magma. For all  $n \geq 2$ ,*

$$\dim \text{NC}\mathcal{M}(n) = \sum_{0 \leq k \leq n-2} m^{n+k+1} (m-1)^{n-k-2} \text{nar}(n, k), \quad (3.1.11)$$

where  $m := \#\mathcal{M}$ .

We can use Proposition 3.1.7 to compute the first dimensions of  $\text{NC}\mathcal{M}$ . For instance, depending on  $m := \#\mathcal{M}$ , we have the following sequences of dimensions:

$$1, 1, 1, 1, 1, 1, 1, 1, \quad m = 1, \quad (3.1.12a)$$

$$1, 8, 48, 352, 2880, 25216, 231168, 2190848, \quad m = 2, \quad (3.1.12b)$$

$$1, 27, 405, 7533, 156735, 349263, 81520425, 1967414265, \quad m = 3, \quad (3.1.12c)$$

$$1, 64, 1792, 62464, 2437120, 101859328, 4459528192, 201889939456. \quad m = 4, \quad (3.1.12d)$$

The second one forms, except for the first terms, Sequence A054726 of [Slo]. The last two sequences are not listed in [Slo] at this time.

**3.2. Presentation and Koszulity.** The aim of this section is to establish a presentation by generators and relations of  $\text{NC}\mathcal{M}$ . For this, we will define an adequate rewrite rule on the set of the syntax trees on  $\mathcal{T}_{\mathcal{M}}$  and prove that it admits the required properties.

3.2.1. *Space of relations.* Let  $\mathcal{R}_{\text{NC}\mathcal{M}}$  be the subspace of  $\text{FO}(\mathcal{T}_{\mathcal{M}})(3)$  generated by the elements

$$\odot \left( \begin{array}{c} \text{p}_1 \text{ p}_2 \\ \text{p}_0 \end{array} \right) \circ_1 \odot \left( \begin{array}{c} \text{q}_1 \text{ q}_2 \\ \text{q}_0 \end{array} \right) - \odot \left( \begin{array}{c} \text{r}_1 \text{ p}_2 \\ \text{p}_0 \end{array} \right) \circ_1 \odot \left( \begin{array}{c} \text{q}_1 \text{ q}_2 \\ \text{r}_0 \end{array} \right), \quad \text{if } \text{p}_1 \star \text{q}_0 = \text{r}_1 \star \text{r}_0 \neq \mathbb{1}_{\mathcal{M}}, \quad (3.2.1a)$$

$$\odot \left( \begin{array}{c} \text{p}_1 \text{ p}_2 \\ \text{p}_0 \end{array} \right) \circ_1 \odot \left( \begin{array}{c} \text{q}_1 \text{ q}_2 \\ \text{q}_0 \end{array} \right) - \odot \left( \begin{array}{c} \text{q}_1 \text{ r}_2 \\ \text{p}_0 \end{array} \right) \circ_2 \odot \left( \begin{array}{c} \text{q}_2 \text{ p}_2 \\ \text{r}_0 \end{array} \right), \quad \text{if } \text{p}_1 \star \text{q}_0 = \text{r}_2 \star \text{r}_0 = \mathbb{1}_{\mathcal{M}}, \quad (3.2.1b)$$

$$\odot \left( \begin{array}{c} \text{p}_1 \text{ p}_2 \\ \text{p}_0 \end{array} \right) \circ_2 \odot \left( \begin{array}{c} \text{q}_1 \text{ q}_2 \\ \text{q}_0 \end{array} \right) - \odot \left( \begin{array}{c} \text{p}_1 \text{ r}_2 \\ \text{p}_0 \end{array} \right) \circ_2 \odot \left( \begin{array}{c} \text{q}_1 \text{ q}_2 \\ \text{r}_0 \end{array} \right), \quad \text{if } \text{p}_2 \star \text{q}_0 = \text{r}_2 \star \text{r}_0 \neq \mathbb{1}_{\mathcal{M}}, \quad (3.2.1c)$$

where  $\text{p}$ ,  $\text{q}$ , and  $\text{r}$  are  $\mathcal{M}$ -triangles.

LEMMA 3.2.1. *Let  $\mathcal{M}$  be a unitary magma, and  $\text{s}$  and  $\text{t}$  be two syntax trees of arity 3 on  $\mathcal{T}_{\mathcal{M}}$ . Then,  $\text{s} - \text{t}$  belongs to  $\mathcal{R}_{\text{NC}\mathcal{M}}$  if and only if  $\text{ev}(\text{s}) = \text{ev}(\text{t})$ .*

PROPOSITION 3.2.2. *Let  $\mathcal{M}$  be a finite unitary magma. Then, the dimension of the space  $\mathcal{R}_{\text{NC}\mathcal{M}}$  satisfies*

$$\dim \mathcal{R}_{\text{NC}\mathcal{M}} = 2m^6 - 2m^5 + m^4, \quad (3.2.2)$$

where  $m := \#\mathcal{M}$ .

Observe that, by Proposition 3.2.2, the dimension of  $\mathcal{R}_{\text{NC}\mathcal{M}}$  only depends on the cardinality of  $\mathcal{M}$  and not on its operation  $\star$ .

3.2.2. *Rewrite rule.* Let  $\Rightarrow_{\mathcal{M}}$  be the rewrite rule on the set of the  $\mathcal{T}_{\mathcal{M}}$ -syntax trees on satisfying

$$\odot \left( \begin{array}{c} \text{p}_1 \text{ p}_2 \\ \text{p}_0 \end{array} \right) \circ_1 \odot \left( \begin{array}{c} \text{q}_1 \text{ q}_2 \\ \text{q}_0 \end{array} \right) \Rightarrow_{\mathcal{M}} \odot \left( \begin{array}{c} \delta \text{ p}_2 \\ \text{p}_0 \end{array} \right) \circ_1 \odot \left( \begin{array}{c} \text{q}_1 \text{ q}_2 \\ \text{---} \end{array} \right), \quad \text{if } \text{q}_0 \neq \mathbb{1}_{\mathcal{M}}, \text{ where } \delta := \text{p}_1 \star \text{q}_0, \quad (3.2.3a)$$

$$\odot \left( \begin{array}{c} \text{p}_1 \text{ p}_2 \\ \text{p}_0 \end{array} \right) \circ_1 \odot \left( \begin{array}{c} \text{q}_1 \text{ q}_2 \\ \text{q}_0 \end{array} \right) \Rightarrow_{\mathcal{M}} \odot \left( \begin{array}{c} \text{q}_1 \\ \text{p}_0 \end{array} \right) \circ_2 \odot \left( \begin{array}{c} \text{q}_2 \text{ p}_2 \\ \text{---} \end{array} \right), \quad \text{if } \text{p}_1 \star \text{q}_0 = \mathbb{1}_{\mathcal{M}}, \quad (3.2.3b)$$

$$\odot \left( \begin{array}{c} \text{p}_1 \text{ p}_2 \\ \text{p}_0 \end{array} \right) \circ_2 \odot \left( \begin{array}{c} \text{q}_1 \text{ q}_2 \\ \text{q}_0 \end{array} \right) \Rightarrow_{\mathcal{M}} \odot \left( \begin{array}{c} \text{p}_1 \delta \\ \text{p}_0 \end{array} \right) \circ_2 \odot \left( \begin{array}{c} \text{q}_1 \text{ q}_2 \\ \text{---} \end{array} \right), \quad \text{if } \text{q}_0 \neq \mathbb{1}_{\mathcal{M}}, \text{ where } \delta := \text{p}_2 \star \text{q}_0, \quad (3.2.3c)$$

where  $\text{p}$  and  $\text{q}$  are  $\mathcal{M}$ -triangles. Let also  $\rightsquigarrow_{\mathcal{M}}$  be the closure of  $\Rightarrow_{\mathcal{M}}$ .

PROPOSITION 3.2.3. *Let  $\mathcal{M}$  be a finite unitary magma. Then,  $\rightsquigarrow_{\mathcal{M}}$  is a convergent rewrite rule and an orientation of  $\mathcal{R}_{\text{NC}\mathcal{M}}$ .*

LEMMA 3.2.4. *Let  $\mathcal{M}$  be a unitary magma. The set of the normal forms of  $\rightsquigarrow_{\mathcal{M}}$  is the set of the  $\mathcal{T}_{\mathcal{M}}$ -syntax trees  $\text{t}$  such that, for any internal nodes  $x$  and  $y$  of  $\text{t}$  where  $y$  is a child of  $x$ ,*

- (i) *the base of the  $\mathcal{M}$ -triangle labeling  $y$  is labeled by  $\mathbb{1}_{\mathcal{M}}$ ;*
- (ii) *if  $y$  is a left child of  $x$ , the first edge of the  $\mathcal{M}$ -triangle labeling  $x$  is not labeled by  $\mathbb{1}_{\mathcal{M}}$ .*

Moreover, when  $\mathcal{M}$  is finite, the generating series of the normal forms of  $\rightsquigarrow_{\mathcal{M}}$  is the Hilbert series  $\mathcal{H}_{\text{NC}\mathcal{M}(\text{t})}$  of  $\text{NC}\mathcal{M}$ .

3.2.3. *Presentation and Koszulity.* The results of Sections 3.2.1 and 3.2.2 are finally used here to state a presentation of  $\text{NC}\mathcal{M}$  and the fact that  $\text{NC}\mathcal{M}$  is a Koszul operad.

THEOREM 3.2.5. *Let  $\mathcal{M}$  be a finite unitary magma. Then,  $\text{NC}\mathcal{M}$  admits the presentation  $(\mathcal{T}_{\mathcal{M}}, \mathcal{R}_{\text{NC}\mathcal{M}})$ .*

PROOF. First, Proposition 3.2.3 implies that we can regard the underlying space of the quotient operad

$$\mathcal{O} := \mathbf{FO}(\mathcal{T}_{\mathcal{M}}) / \langle \mathcal{R}_{\text{NC}\mathcal{M}} \rangle \quad (3.2.4)$$

as the linear span of all normal forms of  $\rightsquigarrow_{\mathcal{M}}$ . Moreover, as a consequence of Lemma 3.2.1, the map  $\phi : \mathcal{O} \rightarrow \text{NC}\mathcal{M}$  defined linearly for any normal form  $\text{t}$  of  $\rightsquigarrow_{\mathcal{M}}$  by  $\phi(\text{t}) := \text{ev}(\text{t})$  is an operad morphism. Now, by Proposition 3.1.5,  $\phi$  is surjective. Moreover, by Lemma 3.2.4, we obtain that the dimensions of the spaces  $\mathcal{O}(n)$ ,  $n \geq 1$ , are the ones of  $\text{NC}\mathcal{M}(n)$ . Hence,  $\phi$  is an operad isomorphism and the statement of the theorem follows.  $\square$

By Theorem 3.2.5, the operad  $\text{NC}\mathbb{N}_2$  is generated by

$$\mathcal{T}_{\mathbb{N}_2} = \left\{ \begin{array}{c} \text{---} \\ \text{---} \end{array} \right\}, \quad (3.2.5)$$

and these generators are subjected exactly to the nontrivial relations

$$\begin{array}{c} \text{b}_3 \\ \text{---} \end{array} \circ_1 \begin{array}{c} \text{b}_1 \text{ b}_2 \\ \text{---} \end{array} = \begin{array}{c} \text{---} \text{ b}_3 \\ \text{---} \end{array} \circ_1 \begin{array}{c} \text{b}_1 \text{ b}_2 \\ \text{---} \end{array}, \quad \text{a, b}_1, \text{b}_2, \text{b}_3 \in \mathbb{N}_2, \quad (3.2.6a)$$

$$\begin{array}{c} \text{1} \quad b_3 \\ \diagup \quad \diagdown \\ \text{a} \end{array} \circ_1 \begin{array}{c} b_1 \quad b_2 \\ \diagup \quad \diagdown \\ \text{1} \end{array} = \begin{array}{c} \text{1} \quad b_3 \\ \diagup \quad \diagdown \\ \text{a} \end{array} \circ_1 \begin{array}{c} b_1 \quad b_2 \\ \diagup \quad \diagdown \\ \text{---} \end{array} = \begin{array}{c} b_1 \quad b_2 \\ \diagup \quad \diagdown \\ \text{a} \end{array} \circ_2 \begin{array}{c} b_2 \quad b_3 \\ \diagup \quad \diagdown \\ \text{---} \end{array} = \begin{array}{c} b_1 \quad \text{1} \\ \diagup \quad \diagdown \\ \text{a} \end{array} \circ_2 \begin{array}{c} b_2 \quad b_3 \\ \diagup \quad \diagdown \\ \text{1} \end{array}, \quad a, b_1, b_2, b_3 \in \mathbb{N}_2, \quad (3.2.6b)$$

$$\begin{array}{c} b_1 \quad b_2 \\ \diagup \quad \diagdown \\ \text{a} \end{array} \circ_2 \begin{array}{c} b_2 \quad b_3 \\ \diagup \quad \diagdown \\ \text{1} \end{array} = \begin{array}{c} b_1 \quad \text{1} \\ \diagup \quad \diagdown \\ \text{a} \end{array} \circ_2 \begin{array}{c} b_2 \quad b_3 \\ \diagup \quad \diagdown \\ \text{---} \end{array}, \quad a, b_1, b_2, b_3 \in \mathbb{N}_2. \quad (3.2.6c)$$

THEOREM 3.2.6. For any finite unitary magma  $\mathcal{M}$ ,  $\text{NC}\mathcal{M}$  is Koszul and the set of the normal forms of  $\sim_{\mathcal{M}}$  forms a Poincaré-Birkhoff-Witt basis of  $\text{NC}\mathcal{M}$ .

3.3. Suboperads generated by bubbles. In this section, we consider suboperads of  $\text{NC}\mathcal{M}$  generated by finite sets of  $\mathcal{M}$ -bubbles. We assume here that  $\mathcal{M}$  is endowed with an arbitrary total order so that  $\mathcal{M} = \{x_0, x_1, \dots\}$  with  $x_0 = \mathbb{1}_{\mathcal{M}}$ .

3.3.1. Treelike expressions on bubbles. Let  $B$  and  $E$  be two subsets of  $\mathcal{M}$ . We denote by  $\mathcal{B}_{\mathcal{M}}^{B,E}$  the set of all  $\mathcal{M}$ -bubbles  $p$  such that the bases of  $p$  are labeled on  $B$  and all edges of  $p$  are labeled on  $E$ . Moreover, we say that  $\mathcal{M}$  is  $(E, B)$ -quasi-injective if for all  $x, x' \in E$  and  $y, y' \in B$ ,  $x \star y = x' \star y' \neq \mathbb{1}_{\mathcal{M}}$  implies  $x = x'$  and  $y = y'$ .

LEMMA 3.3.1. Let  $\mathcal{M}$  be a unitary magma, and  $B$  and  $E$  be two subsets of  $\mathcal{M}$ . If  $\mathcal{M}$  is  $(E, B)$ -quasi-injective, then any  $\mathcal{M}$ -clique admits at most one treelike expression on  $\mathcal{B}_{\mathcal{M}}^{B,E}$  of a minimal degree.

3.3.2. Dimensions. Let  $G$  be a set of  $\mathcal{M}$ -bubbles and  $\Xi := \{\xi_{x_0}, \xi_{x_1}, \dots\}$  be a set of noncommutative variables. Given  $x_i \in \mathcal{M}$ , let  $B_{x_i}$  be the series of  $\mathbb{N}\langle\langle \Xi \rangle\rangle$  defined by

$$B_{x_i}(\xi_{x_0}, \xi_{x_1}, \dots) := \sum_{\substack{p \in \mathcal{B}_{\mathcal{M}}^G \\ p \neq \text{---}}} \prod_{i \in [|p|]} \xi_{p_i}, \quad (3.3.1)$$

where  $\mathcal{B}_{\mathcal{M}}^G$  is the set of all  $\mathcal{M}$ -bubbles that can be obtained by partial compositions of elements of  $G$ . Observe from (3.3.1) that a noncommutative monomial  $u \in \Xi^{\geq 2}$  appears in  $B_{x_i}$  with 1 as coefficient if and only if there is in the suboperad of  $\text{NC}\mathcal{M}$  generated by  $G$  an  $\mathcal{M}$ -bubble with a base labeled by  $x_i$  and with  $u$  as border.

Let also for any  $x_i \in \mathcal{M}$ , the series  $F_{x_i}$  of  $\mathbb{N}\langle\langle t \rangle\rangle$  defined by

$$F_{x_i}(t) := B_{x_i}(t + \bar{F}_{x_0}(t), t + \bar{F}_{x_1}(t), \dots), \quad (3.3.2)$$

where for any  $x_i \in \mathcal{M}$ ,

$$\bar{F}_{x_i}(t) := \sum_{\substack{x_j \in \mathcal{M} \\ x_i \star x_j \neq \mathbb{1}_{\mathcal{M}}}} F_{x_j}(t). \quad (3.3.3)$$

PROPOSITION 3.3.2. Let  $\mathcal{M}$  be a unitary magma and  $\mathcal{G}$  be a finite set of  $\mathcal{M}$ -bubbles such that, by denoting by  $B$  (resp.  $E$ ) the set of the labels of the bases (resp. edges) of the elements of  $\mathcal{G}$ ,  $\mathcal{M}$  is  $(E, B)$ -quasi-injective. Then, the Hilbert series  $\mathcal{H}_{(\text{NC}\mathcal{M})^{\mathcal{G}}}(t)$  of the suboperad of  $\text{NC}\mathcal{M}$  generated by  $\mathcal{G}$  satisfies

$$\mathcal{H}_{(\text{NC}\mathcal{M})^{\mathcal{G}}}(t) = t + \sum_{x_i \in \mathcal{M}} F_{x_i}(t). \quad (3.3.4)$$

As a side remark, Proposition 3.3.2 can be proved by using the notion of bubble decompositions of operads developed in Chapter 3. This result provides a practical method to compute the dimensions of some suboperads  $(\text{NC}\mathcal{M})^\mathfrak{G}$  of  $\text{NC}\mathcal{M}$  by describing the series (3.3.1) of the bubbles of  $\mathcal{B}_\mathfrak{M}^\mathfrak{G}$ . This result implies also, when  $\mathfrak{G}$  satisfies the requirement of Proposition 3.3.2, that the Hilbert series of  $(\text{NC}\mathcal{M})^\mathfrak{G}$  is algebraic.

3.3.3. *First example: a cubic suboperad.* Consider the suboperad of  $\text{NCE}_2$  generated by

$$\mathfrak{G} := \left\{ \begin{array}{c} \text{---} \circ_1 \text{---} \\ \text{---} \circ_2 \text{---} \end{array} \right\}. \tag{3.3.5}$$

Computer experiments show that the generators of  $(\text{NCE}_2)^\mathfrak{G}$  are not subjected to any quadratic relation but are subjected to the four cubic nontrivial relations

$$\begin{array}{c} \text{---} \circ_1 \text{---} \\ \text{---} \circ_2 \text{---} \end{array} \circ_2 \left( \begin{array}{c} \text{---} \circ_1 \text{---} \\ \text{---} \circ_2 \text{---} \end{array} \circ_2 \begin{array}{c} \text{---} \circ_1 \text{---} \\ \text{---} \circ_2 \text{---} \end{array} \right) = \begin{array}{c} \text{---} \circ_1 \text{---} \\ \text{---} \circ_2 \text{---} \end{array} \circ_2 \left( \begin{array}{c} \text{---} \circ_2 \text{---} \\ \text{---} \circ_1 \text{---} \end{array} \circ_2 \begin{array}{c} \text{---} \circ_1 \text{---} \\ \text{---} \circ_2 \text{---} \end{array} \right), \tag{3.3.6a}$$

$$\begin{array}{c} \text{---} \circ_1 \text{---} \\ \text{---} \circ_2 \text{---} \end{array} \circ_2 \left( \begin{array}{c} \text{---} \circ_1 \text{---} \\ \text{---} \circ_2 \text{---} \end{array} \circ_2 \begin{array}{c} \text{---} \circ_2 \text{---} \\ \text{---} \circ_1 \text{---} \end{array} \right) = \begin{array}{c} \text{---} \circ_1 \text{---} \\ \text{---} \circ_2 \text{---} \end{array} \circ_2 \left( \begin{array}{c} \text{---} \circ_2 \text{---} \\ \text{---} \circ_2 \text{---} \end{array} \circ_2 \begin{array}{c} \text{---} \circ_1 \text{---} \\ \text{---} \circ_2 \text{---} \end{array} \right), \tag{3.3.6b}$$

$$\begin{array}{c} \text{---} \circ_2 \text{---} \\ \text{---} \circ_1 \text{---} \end{array} \circ_2 \left( \begin{array}{c} \text{---} \circ_1 \text{---} \\ \text{---} \circ_2 \text{---} \end{array} \circ_2 \begin{array}{c} \text{---} \circ_1 \text{---} \\ \text{---} \circ_2 \text{---} \end{array} \right) = \begin{array}{c} \text{---} \circ_2 \text{---} \\ \text{---} \circ_1 \text{---} \end{array} \circ_2 \left( \begin{array}{c} \text{---} \circ_2 \text{---} \\ \text{---} \circ_2 \text{---} \end{array} \circ_2 \begin{array}{c} \text{---} \circ_1 \text{---} \\ \text{---} \circ_1 \text{---} \end{array} \right), \tag{3.3.6c}$$

$$\begin{array}{c} \text{---} \circ_2 \text{---} \\ \text{---} \circ_2 \text{---} \end{array} \circ_2 \left( \begin{array}{c} \text{---} \circ_1 \text{---} \\ \text{---} \circ_2 \text{---} \end{array} \circ_2 \begin{array}{c} \text{---} \circ_2 \text{---} \\ \text{---} \circ_2 \text{---} \end{array} \right) = \begin{array}{c} \text{---} \circ_2 \text{---} \\ \text{---} \circ_2 \text{---} \end{array} \circ_2 \left( \begin{array}{c} \text{---} \circ_2 \text{---} \\ \text{---} \circ_2 \text{---} \end{array} \circ_2 \begin{array}{c} \text{---} \circ_2 \text{---} \\ \text{---} \circ_2 \text{---} \end{array} \right). \tag{3.3.6d}$$

Hence,  $(\text{NCE}_2)^\mathfrak{G}$  is not a quadratic operad. Moreover, it is possible to prove that this operad does not admit any other nontrivial relations between its generators. This can be performed by defining a rewrite rule on the syntax trees on  $\mathfrak{G}$ , consisting in rewriting the left patterns of (3.3.6a), (3.3.6b), (3.3.6c), and (3.3.6d) into their respective right patterns, and by checking that this rewrite rule admits the required properties (like the ones establishing the presentation of  $\text{NC}\mathcal{M}$  by Theorem 3.2.5). The existence of this nonquadratic operad shows that  $\text{NC}\mathcal{M}$  contains nonquadratic suboperads even if it is quadratic.

By describing the bubbles of  $(\text{NCE}_2)^\mathfrak{G}$ , Proposition 3.3.2 leads to the fact that the Hilbert series of  $(\text{NCE}_2)^\mathfrak{G}$  satisfies the algebraic equation

$$t + (t - 1)\mathcal{H}_{(\text{NCE}_2)^\mathfrak{G}}(t) + (2t + 1)\mathcal{H}_{(\text{NCE}_2)^\mathfrak{G}}(t)^2 = 0. \tag{3.3.7}$$

The first dimensions of  $(\text{NCE}_2)^\mathfrak{G}$  are

$$1, 2, 8, 36, 180, 956, 5300, 30316, \tag{3.3.8}$$

and form Sequence A129148 of [Slo].

3.3.4. *Second example: a suboperad of Motzkin paths.* Consider the suboperad of  $\text{NCD}_0$  generated by

$$\mathfrak{G} := \left\{ \begin{array}{c} \text{---} \circ_1 \text{---} \\ \text{---} \circ_2 \text{---} \end{array} \right\}. \tag{3.3.9}$$

Computer experiments show that the generators of  $(\text{NCD}_0)^\mathfrak{G}$  are subjected to four quadratic nontrivial relations

$$\begin{array}{c} \text{---} \circ_1 \text{---} \\ \text{---} \circ_2 \text{---} \end{array} \circ_1 \begin{array}{c} \text{---} \circ_1 \text{---} \\ \text{---} \circ_2 \text{---} \end{array} = \begin{array}{c} \text{---} \circ_1 \text{---} \\ \text{---} \circ_2 \text{---} \end{array} \circ_2 \begin{array}{c} \text{---} \circ_1 \text{---} \\ \text{---} \circ_2 \text{---} \end{array}, \tag{3.3.10a}$$



$$\text{Diagram (3.3.10b)} \tag{3.3.10b}$$

$$\text{Diagram (3.3.10c)} \tag{3.3.10c}$$

$$\text{Diagram (3.3.10d)} \tag{3.3.10d}$$

It is possible to prove that this operad does not admit any other nontrivial relations between its generators. This can be performed by defining a rewrite rule on the syntax trees on  $\mathfrak{C}$ , consisting in rewriting the left patterns of (3.3.10a), (3.3.10b), (3.3.10c), and (3.3.10d) into their respective right patterns, and by checking that this rewrite rule admits the required properties (like the ones establishing the presentation of  $\text{NC}\mathcal{M}$  by Theorem 3.2.5).

By describing the bubbles of  $(\text{NC}\mathbb{D}_0)^\mathfrak{C}$ , Proposition 3.3.2 leads to the fact that the Hilbert series of  $(\text{NC}\mathbb{D}_0)^\mathfrak{C}$  satisfies the algebraic equation

$$t + (t - 1)\mathcal{H}_{(\text{NC}\mathbb{D}_0)^\mathfrak{C}}(t) + t\mathcal{H}_{(\text{NC}\mathbb{D}_0)^\mathfrak{C}}(t)^2 = 0. \tag{3.3.11}$$

The first dimensions of  $(\text{NC}\mathbb{D}_0)^\mathfrak{C}$  are

$$1, 1, 2, 4, 9, 21, 51, 127, \tag{3.3.12}$$

and form Sequence A001006 of [Slo]. The operad  $(\text{NC}\mathbb{D}_0)^\mathfrak{C}$  has the same presentation by generators and relations (and thus, the same Hilbert series) as the operad Motz defined in Section 2.1.5 of Chapter 4, involving Motzkin paths. Hence,  $(\text{NC}\mathbb{D}_0)^\mathfrak{C}$  and Motz are two isomorphic operads. Note in passing that these two operads are not isomorphic to the operad  $\text{Mot}\mathbb{D}_0$  constructed in Section 2.2.4 and involving Motzkin configurations. Indeed, the sequence of the dimensions of this last operad is a shifted version of the one of  $(\text{NC}\mathbb{D}_0)^\mathfrak{C}$  and Motz.

**3.4. Algebras over the noncrossing clique operads.** We begin by briefly describing  $\text{NC}\mathcal{M}$ -algebras in terms of relations between their operations and the free  $\text{NC}\mathcal{M}$ -algebras over one generator. We continue this section by providing two ways to construct (non-necessarily free)  $\text{NC}\mathcal{M}$ -algebras. The first one takes as input an associative algebra endowed with endofunctions satisfying some conditions, and the second one takes as input a monoid.

**3.4.1. Relations.** From the presentation of  $\text{NC}\mathcal{M}$  established by Theorem 3.2.5, an  $\text{NC}\mathcal{M}$ -algebra is a vector space  $\mathcal{A}$  endowed with binary linear operations

$$\hat{\underset{\Delta}{\underset{p_0}{\Delta}}}^{p_1 p_2} : \mathcal{A} \otimes \mathcal{A} \rightarrow \mathcal{A}, \quad p \in \mathcal{T}_{\mathcal{M}}, \tag{3.4.1}$$

satisfying, for all  $a_1, a_2, a_3 \in \mathcal{A}$ , the relations

$$\left( a_1 \hat{\underset{\Delta}{\underset{q_0}{\Delta}}}^{q_1 q_2} a_2 \right) \hat{\underset{\Delta}{\underset{p_0}{\Delta}}}^{p_1 p_2} a_3 = \left( a_1 \hat{\underset{\Delta}{\underset{r_0}{\Delta}}}^{q_1 q_2} a_2 \right) \hat{\underset{\Delta}{\underset{p_0}{\Delta}}}^{r_1 p_2} a_3, \quad \text{if } p_1 \star q_0 = r_1 \star r_0 \neq \mathbb{1}_{\mathcal{M}}, \tag{3.4.2a}$$

$$\left( a_1 \hat{\underset{\Delta}{\underset{q_0}{\Delta}}}^{q_1 q_2} a_2 \right) \hat{\underset{\Delta}{\underset{p_0}{\Delta}}}^{p_1 p_2} a_3 = a_1 \hat{\underset{\Delta}{\underset{p_0}{\Delta}}}^{q_1 r_2} \left( a_2 \hat{\underset{\Delta}{\underset{r_0}{\Delta}}}^{q_2 p_2} a_3 \right), \quad \text{if } p_1 \star q_0 = r_2 \star r_0 = \mathbb{1}_{\mathcal{M}}, \tag{3.4.2b}$$

$$a_1 \hat{\underset{\Delta}{\underset{p_0}{\Delta}}}^{p_1 p_2} \left( a_2 \hat{\underset{\Delta}{\underset{q_0}{\Delta}}}^{q_1 q_2} a_3 \right) = a_1 \hat{\underset{\Delta}{\underset{p_0}{\Delta}}}^{p_1 r_2} \left( a_2 \hat{\underset{\Delta}{\underset{r_0}{\Delta}}}^{q_1 q_2} a_3 \right), \quad \text{if } p_2 \star q_0 = r_2 \star r_0 \neq \mathbb{1}_{\mathcal{M}}, \tag{3.4.2c}$$

where  $p$ ,  $q$ , and  $\tau$  are  $\mathcal{M}$ -triangles. Remark that  $\mathcal{M}$  has to be finite because Theorem 3.2.5 requires this property as premise.

3.4.2. *Free algebras over one generator.* From the realization of  $\text{NC}\mathcal{M}$  coming from its definition as a suboperad of  $\text{C}\mathcal{M}$ , the free  $\text{NC}\mathcal{M}$ -algebra over one generator is the linear span  $\text{NC}\mathcal{M}$  of all noncrossing  $\mathcal{M}$ -cliques endowed with the linear operations

$$\hat{\Delta}_{p_0}^{p_1 p_2} : \text{NC}\mathcal{M}(n) \otimes \text{NC}\mathcal{M}(m) \rightarrow \text{NC}\mathcal{M}(n + m), \quad p \in \mathcal{T}_{\mathcal{M}}, n, m \geq 1, \quad (3.4.3)$$

defined, for any noncrossing  $\mathcal{M}$ -cliques  $q$  and  $\tau$ , by

$$q \hat{\Delta}_{p_0}^{p_1 p_2} \tau := \left( \begin{array}{c} \text{p}_1 \text{ p}_2 \\ \text{p}_0 \end{array} \circ_2 \tau \right) \circ_1 q. \quad (3.4.4)$$

In terms of  $\mathcal{M}$ -Schröder trees (see Section 3.1.3), (3.4.4) is the  $\mathcal{M}$ -Schröder tree obtained by grafting the  $\mathcal{M}$ -Schröder trees of  $q$  and  $\tau$  respectively as left and right children of a binary corolla having its edge adjacent to the root labeled by  $p_0$ , its first edge labeled by  $p_1 \star q_0$ , and second edge labeled by  $p_2 \star \tau_0$ , and by contracting each of these two edges when labeled by  $1_{\mathcal{M}}$ . For instance, in the free  $\text{NCN}_3$ -algebra, we have

$$\text{Diagram (3.4.5a)} \quad (3.4.5a)$$

$$\text{Diagram (3.4.5b)} \quad (3.4.5b)$$

$$\text{Diagram (3.4.5c)} \quad (3.4.5c)$$

$$\text{Diagram (3.4.5d)} \quad (3.4.5d)$$

3.4.3. *From associative algebras.* Let  $\mathcal{A}$  be an associative algebra with associative product denoted by  $\odot$ , and

$$\omega_x : \mathcal{A} \rightarrow \mathcal{A}, \quad x \in \mathcal{M}, \quad (3.4.6)$$

be a family of linear maps, not necessarily associative algebra morphisms, indexed by the elements of  $\mathcal{M}$ . We say that  $\mathcal{A}$  together with this family (3.4.6) of maps is a  *$\mathcal{M}$ -compatible algebra* if

$$\omega_x \circ \omega_y = \omega_{x+y}, \quad (3.4.7)$$

for all  $x, y \in \mathcal{M}$ . Observe that (3.4.7) implies in particular that  $\omega_{1_{\mathcal{M}}} = \text{Id}_{\mathcal{A}}$  where  $\text{Id}_{\mathcal{A}}$  is the identity map on  $\mathcal{A}$ . This notion of  $\mathcal{M}$ -compatible algebras is very similar to the notion of  $\mathcal{M}$ -compatible algebras where  $\mathcal{M}$  is a monoid, developed in Section 1.2 of Chapter 4. Let us now use  $\mathcal{M}$ -compatible associative algebras to construct NC $\mathcal{M}$ -algebras.

**THEOREM 3.4.1.** *Let  $\mathcal{M}$  be a finite unitary magma and  $\mathcal{A}$  be an  $\mathcal{M}$ -compatible associative algebra. The vector space  $\mathcal{A}$  endowed with the binary linear operations*

$$\widehat{\underset{\mathcal{P}_0}{\overset{\mathcal{P}_1 \ \mathcal{P}_2}{\Delta}}} : \mathcal{A} \otimes \mathcal{A} \rightarrow \mathcal{A}, \quad \mathfrak{p} \in \mathcal{T}_{\mathcal{M}}, \quad (3.4.8)$$

defined for each  $\mathcal{M}$ -triangle  $\mathfrak{p}$  and any  $a_1, a_2 \in \mathcal{A}$  by

$$a_1 \widehat{\underset{\mathcal{P}_0}{\overset{\mathcal{P}_1 \ \mathcal{P}_2}{\Delta}}} a_2 := \omega_{\mathcal{P}_0} (\omega_{\mathcal{P}_1} (a_1) \odot \omega_{\mathcal{P}_2} (a_2)), \quad (3.4.9)$$

is an NC $\mathcal{M}$ -algebra.

By Theorem 3.4.1,  $\mathcal{A}$  has the structure of an NC $\mathcal{M}$ -algebra. Hence, there is a left action  $\cdot$  of the operad NC $\mathcal{M}$  on the tensor algebra of  $\mathcal{A}$  of the form

$$\cdot : \text{NC}\mathcal{M}(n) \otimes \mathcal{A}^{\otimes n} \rightarrow \mathcal{A}, \quad n \geq 1, \quad (3.4.10)$$

whose definition comes from the ones of the operations (3.4.8) and Relation (4.1.25) of Chapter 2. We describe here an algorithm to compute the action of any element of NC $\mathcal{M}$  of arity  $n$  on tensors  $a_1 \otimes \cdots \otimes a_n$  of  $\mathcal{A}^{\otimes n}$ . First, if  $\mathfrak{b}$  is an  $\mathcal{M}$ -bubble of arity  $n$ ,

$$\mathfrak{b} \cdot (a_1 \otimes \cdots \otimes a_n) = \omega_{\mathfrak{b}_0} \left( \prod_{i \in [n]} \omega_{\mathfrak{b}_i} (a_i) \right), \quad (3.4.11)$$

where the product of (3.4.11) denotes the iterated version of the associative product  $\odot$  of  $\mathcal{A}$ . When  $\mathfrak{p}$  is a noncrossing  $\mathcal{M}$ -clique of arity  $n$ ,  $\mathfrak{p}$  acts recursively on  $a_1 \otimes \cdots \otimes a_n$  as follows. One has

$$\mathfrak{p} \cdot a_1 = a_1 \quad (3.4.12)$$

when  $\mathfrak{p} = \circ - \circ$ , and

$$\mathfrak{p} \cdot (a_1 \otimes \cdots \otimes a_n) = \mathfrak{b} \cdot \left( (\mathfrak{r}_1 \cdot (a_1 \otimes \cdots \otimes a_{|\mathfrak{r}_1|})) \otimes \cdots \otimes (\mathfrak{r}_k \cdot (a_{|\mathfrak{r}_1|+\cdots+|\mathfrak{r}_{k-1}|+1} \otimes \cdots \otimes a_n)) \right), \quad (3.4.13)$$

where, by setting  $\mathfrak{t}$  as the bubble tree  $\text{bt}(\mathfrak{p})$  of  $\mathfrak{p}$  (see Section 3.1.2),  $\mathfrak{b}$  and  $\mathfrak{r}_1, \dots, \mathfrak{r}_k$  are the unique  $\mathcal{M}$ -bubble and noncrossing  $\mathcal{M}$ -cliques such that  $\mathfrak{t} = \odot(\mathfrak{b}) \circ [\text{bt}(\mathfrak{r}_1), \dots, \text{bt}(\mathfrak{r}_k)]$ .



**Noncommutative polynomials and constant term product:** Consider the unitary magma  $\mathbb{D}_0$ . Let  $A := \{a_1, a_2, \dots\}$  be an infinite alphabet of noncommutative letters. We define on the associative algebra  $\mathbb{K}\langle A \rangle$  of polynomials on  $A$  the linear maps

$$\omega_{\mathbb{1}}, \omega_0 : \mathbb{K}\langle A \rangle \rightarrow \mathbb{K}\langle A \rangle, \quad (3.4.19)$$

as follows. For any  $u \in A^*$ , we set  $\omega_{\mathbb{1}}(u) := u$ , and

$$\omega_0(u) := \begin{cases} 1 & \text{if } u = \epsilon, \\ 0 & \text{otherwise.} \end{cases} \quad (3.4.20)$$

In other terms,  $\omega_0(f)$  is the constant term, denoted by  $f(0)$ , of the polynomial  $f \in \mathbb{K}\langle A \rangle$ . Since  $\omega_{\mathbb{1}}$  is the identity map on  $\mathbb{K}\langle A \rangle$  and, for all  $u \in A^*$ ,

$$(\omega_0 \circ \omega_{\mathbb{1}})(f) = (f(0))(0) = f(0) = \omega_0(f), \quad (3.4.21)$$

we obtain from Theorem 3.4.1 that the operations (3.4.8) endow  $\mathbb{K}\langle A \rangle$  with a  $\text{NC}\mathbb{D}_0$ -algebra structure. For instance, for all polynomials  $f_1$  and  $f_2$  of  $\mathbb{K}\langle A \rangle$ , we have

$$f_1 \underset{\mathbb{1}}{\overset{\mathbb{1}}{\triangle}} f_2 = f_1 f_2, \quad (3.4.22a) \quad f_1 \underset{\mathbb{1}}{\overset{0}{\triangle}} f_2 = f_1(0) f_2, \quad (3.4.22c)$$

$$f_1 \underset{0}{\overset{\mathbb{1}}{\triangle}} f_2 = (f_1 f_2)(0) = f_1(0) f_2(0), \quad (3.4.22b) \quad f_1 \underset{\mathbb{1}}{\overset{0}{\triangle}} f_2 = f_1(f_2(0)). \quad (3.4.22d)$$

From (3.4.22c) and (3.4.22d), when  $f_1(0) = 1 = f_2(0)$ ,

$$f_1 \left( \underset{\mathbb{1}}{\overset{0}{\triangle}} + \underset{\mathbb{1}}{\overset{\mathbb{1}}{\triangle}} \right) f_2 = f_1(0) f_2 + f_1(f_2(0)) = f_1 + f_2. \quad (3.4.23)$$

**3.4.4. From monoids.** If  $\mathcal{M}$  is a monoid, with binary associative operation  $\star$  and unit  $\mathbb{1}_{\mathcal{M}}$ , we denote by  $\mathbb{K}\langle \mathcal{M}^* \rangle$  the space of all noncommutative polynomials on  $\mathcal{M}$ , seen as an alphabet, with coefficients in  $\mathbb{K}$ . This space can be endowed with an  $\text{NC}\mathcal{M}$ -algebra structure as follows.

For any  $x \in \mathcal{M}$  and any word  $w \in \mathcal{M}^*$ , let

$$x * w := (x \star w_1) \dots (x \star w_{|w|}). \quad (3.4.24)$$

This operation  $*$  is linearly extended on the right on  $\mathbb{K}\langle \mathcal{M}^* \rangle$ .

**PROPOSITION 3.4.2.** *Let  $\mathcal{M}$  be a finite monoid. The vector space  $\mathbb{K}\langle \mathcal{M}^* \rangle$  endowed with the binary linear operations*

$$\underset{\mathfrak{p}_0}{\overset{\mathfrak{p}_1 \ \mathfrak{p}_2}{\triangle}} : \mathbb{K}\langle \mathcal{M}^* \rangle \otimes \mathbb{K}\langle \mathcal{M}^* \rangle \rightarrow \mathbb{K}\langle \mathcal{M}^* \rangle, \quad \mathfrak{p} \in \mathcal{T}_{\mathcal{M}}, \quad (3.4.25)$$

defined for each  $\mathcal{M}$ -triangle  $\mathfrak{p}$  and any  $f_1, f_2 \in \mathbb{K}\langle \mathcal{M}^* \rangle$  by

$$f_1 \underset{\mathfrak{p}_0}{\overset{\mathfrak{p}_1 \ \mathfrak{p}_2}{\triangle}} f_2 := \mathfrak{p}_0 * ((\mathfrak{p}_1 * f_1) (\mathfrak{p}_2 * f_2)), \quad (3.4.26)$$

is an  $\text{NC}\mathcal{M}$ -algebra.

Here are few examples of the construction provided by Proposition 3.4.2.

**Words and double shifted concatenation:** Consider the monoid  $\mathbb{N}_\ell$  for an  $\ell \geq 1$ . By Proposition 3.4.2, the operations (3.4.25) endow  $\mathbb{K}\langle \mathbb{N}_\ell^* \rangle$  with a structure of an  $\text{NCN}_\ell$ -algebra. For instance, in  $\mathbb{K}\langle \mathbb{N}_4^* \rangle$ , one has

$$0211 \underset{\triangleleft -1}{\overset{\triangleright 0}{\triangle}} 312 = 3100023. \tag{3.4.27}$$

**Words and erasing concatenation:** Consider the monoid  $\mathbb{D}_\ell$  for an  $\ell \geq 0$ . By Proposition 3.4.2, the operations (3.4.25) endow  $\mathbb{K}\langle \mathbb{D}_\ell^* \rangle$  with a structure of an  $\text{NCD}_\ell$ -algebra. For instance, for all words  $u$  and  $v$  of  $\mathbb{D}_\ell^*$ , we have

$$u \underset{\triangleleft -1}{\overset{\triangleright 1}{\triangle}} v = uv, \tag{3.4.28a}$$

$$u \underset{\triangleleft 0}{\overset{\triangleright 1}{\triangle}} v = 0^{|u|+|v|}, \tag{3.4.28c}$$

$$u \underset{\triangleleft d_i}{\overset{\triangleright 1}{\triangle}} v = (uv)_{d_i}, \tag{3.4.28b}$$

$$u \underset{\triangleleft -1}{\overset{\triangleright d_j}{\triangle}} v = u_{d_i} v_{d_j}, \tag{3.4.28d}$$

where, for any word  $w$  of  $\mathbb{D}_\ell^*$  and any element  $d_j$  of  $\mathbb{D}_\ell$ ,  $j \in [\ell]$ ,  $w_{d_j}$  is the word obtained by replacing each occurrence of  $1$  by  $d_j$  and each occurrence of  $d_i$ ,  $i \in [\ell]$ , by  $0$  in  $w$ .

**3.5. Koszul dual.** Since by Theorem 3.2.5, the operad  $\text{NC}\mathcal{M}$  is binary and quadratic, this operad admits a Koszul dual  $\text{NC}\mathcal{M}^!$ . We end the study of  $\text{NC}\mathcal{M}$  by collecting the main properties of  $\text{NC}\mathcal{M}^!$ .

3.5.1. *Presentation.* Let  $\mathcal{R}_{\text{NC}\mathcal{M}}^!$  be the subspace of  $\text{FO}(\mathcal{T}_{\mathcal{M}})(3)$  generated by the elements

$$\sum_{\substack{p_1, q_0 \in \mathcal{M} \\ p_1 * q_0 = \delta}} \odot \left( \begin{array}{c} \text{triangle with } p_1, p_2 \text{ top, } p_0 \text{ bottom} \end{array} \right) \circ_1 \odot \left( \begin{array}{c} \text{triangle with } q_1, q_2 \text{ top, } q_0 \text{ bottom} \end{array} \right), \quad p_0, p_2, q_1, q_2 \in \mathcal{M}, \delta \in \bar{\mathcal{M}}, \tag{3.5.1a}$$

$$\sum_{\substack{p_1, q_0 \in \mathcal{M} \\ p_1 * q_0 = 1_{\mathcal{M}}}} \odot \left( \begin{array}{c} \text{triangle with } p_1, p_2 \text{ top, } p_0 \text{ bottom} \end{array} \right) \circ_1 \odot \left( \begin{array}{c} \text{triangle with } q_1, q_2 \text{ top, } q_0 \text{ bottom} \end{array} \right) - \odot \left( \begin{array}{c} \text{triangle with } q_1, p_1 \text{ top, } p_0 \text{ bottom} \end{array} \right) \circ_2 \odot \left( \begin{array}{c} \text{triangle with } q_2, p_2 \text{ top, } q_0 \text{ bottom} \end{array} \right), \quad p_0, p_2, q_1, q_2 \in \mathcal{M}, \tag{3.5.1b}$$

$$\sum_{\substack{p_2, q_0 \in \mathcal{M} \\ p_2 * q_0 = \delta}} \odot \left( \begin{array}{c} \text{triangle with } p_1, p_2 \text{ top, } p_0 \text{ bottom} \end{array} \right) \circ_2 \odot \left( \begin{array}{c} \text{triangle with } q_1, q_2 \text{ top, } q_0 \text{ bottom} \end{array} \right), \quad p_0, p_1, q_1, q_2 \in \mathcal{M}, \delta \in \bar{\mathcal{M}}, \tag{3.5.1c}$$

where  $p$  and  $q$  are  $\mathcal{M}$ -triangles.

PROPOSITION 3.5.1. *Let  $\mathcal{M}$  be a finite unitary magma. Then, the Koszul dual  $\text{NC}\mathcal{M}^!$  of  $\text{NC}\mathcal{M}$  admits the presentation  $(\mathcal{T}_{\mathcal{M}}, \mathcal{R}_{\text{NC}\mathcal{M}}^!)$ .*

By Proposition 3.5.1, the operad  $\text{NCN}_2^!$  is generated by

$$\mathcal{T}_{\mathbb{N}_2} = \left\{ \begin{array}{c} \text{triangle with } 1, 1 \text{ top, } 1 \text{ bottom} \\ \text{triangle with } 1, 1 \text{ top, } -1 \text{ bottom} \\ \text{triangle with } 1, -1 \text{ top, } 1 \text{ bottom} \\ \text{triangle with } 1, -1 \text{ top, } -1 \text{ bottom} \\ \text{triangle with } -1, 1 \text{ top, } 1 \text{ bottom} \\ \text{triangle with } -1, 1 \text{ top, } -1 \text{ bottom} \\ \text{triangle with } -1, -1 \text{ top, } 1 \text{ bottom} \\ \text{triangle with } -1, -1 \text{ top, } -1 \text{ bottom} \end{array} \right\}, \tag{3.5.2}$$

and these generators are subjected exactly to the nontrivial relations

$$\begin{array}{c} \text{triangle with } b_3 \text{ top, } a \text{ bottom} \\ \text{triangle with } b_1, b_2 \text{ top, } -1 \text{ bottom} \end{array} \circ_1 + \begin{array}{c} \text{triangle with } 1, b_3 \text{ top, } a \text{ bottom} \\ \text{triangle with } b_1, b_2 \text{ top, } -1 \text{ bottom} \end{array} = 0, \quad a, b_1, b_2, b_3 \in \mathbb{N}_2, \tag{3.5.3a}$$

$$\begin{array}{c} \text{triangle with } 1, b_3 \text{ top, } a \text{ bottom} \\ \text{triangle with } b_1, b_2 \text{ top, } -1 \text{ bottom} \end{array} \circ_1 + \begin{array}{c} \text{triangle with } b_3 \text{ top, } a \text{ bottom} \\ \text{triangle with } b_1, b_2 \text{ top, } -1 \text{ bottom} \end{array} = \begin{array}{c} \text{triangle with } b_1, b_3 \text{ top, } a \text{ bottom} \\ \text{triangle with } b_2, b_3 \text{ top, } -1 \text{ bottom} \end{array} \circ_2 + \begin{array}{c} \text{triangle with } b_1, 1 \text{ top, } a \text{ bottom} \\ \text{triangle with } b_2, b_3 \text{ top, } -1 \text{ bottom} \end{array}, \quad a, b_1, b_2, b_3 \in \mathbb{N}_2, \tag{3.5.3b}$$

$$\begin{array}{c} \text{triangle with } b_1 \text{ top, } a \text{ bottom} \\ \text{triangle with } b_2, b_3 \text{ top, } -1 \text{ bottom} \end{array} \circ_2 + \begin{array}{c} \text{triangle with } b_1, 1 \text{ top, } a \text{ bottom} \\ \text{triangle with } b_2, b_3 \text{ top, } -1 \text{ bottom} \end{array} = 0, \quad a, b_1, b_2, b_3 \in \mathbb{N}_2. \tag{3.5.3c}$$

PROPOSITION 3.5.2. *Let  $\mathcal{M}$  be a finite unitary magma. Then, the dimension of the space  $\mathcal{R}_{\text{NC}\mathcal{M}}^1$  satisfies*

$$\dim \mathcal{R}_{\text{NC}\mathcal{M}}^1 = 2m^5 - m^4, \quad (3.5.4)$$

where  $m := \#\mathcal{M}$ .

Observe that, by Propositions 3.2.2 and 3.5.2, we have

$$\begin{aligned} \dim \mathcal{R}_{\text{NC}\mathcal{M}} + \dim \mathcal{R}_{\text{NC}\mathcal{M}}^1 &= 2m^6 - 2m^5 + m^4 + 2m^5 - m^4 \\ &= 2m^6 \\ &= \dim \mathbf{FO}(\mathcal{T}_{\mathcal{M}})(3), \end{aligned} \quad (3.5.5)$$

as expected by Koszul duality, where  $m := \#\mathcal{M}$ .

### 3.5.2. Dimensions.

PROPOSITION 3.5.3. *Let  $\mathcal{M}$  be a finite unitary magma. The Hilbert series  $\mathcal{H}_{\text{NC}\mathcal{M}^!}(t)$  of  $\text{NC}\mathcal{M}^!$  satisfies*

$$t + (m-1)t^2 + (2m^2t - 3mt + 2t - 1)\mathcal{H}_{\text{NC}\mathcal{M}^!}(t) + (m^3 - 2m^2 + 2m - 1)\mathcal{H}_{\text{NC}\mathcal{M}^!}(t)^2 = 0, \quad (3.5.6)$$

where  $m := \#\mathcal{M}$ .

We deduce from Proposition 3.5.3 that the Hilbert series of  $\text{NC}\mathcal{M}^!$  satisfies

$$\mathcal{H}_{\text{NC}\mathcal{M}^!}(t) = \frac{1 - (2m^2 - 3m + 2)t - \sqrt{1 - 2(2m^3 - 2m^2 + m)t + m^2t^2}}{2(m^3 - 2m^2 + 2m - 1)}, \quad (3.5.7)$$

where  $m := \#\mathcal{M} \neq 1$ .

PROPOSITION 3.5.4. *Let  $\mathcal{M}$  be a finite unitary magma. For all  $n \geq 2$ ,*

$$\dim \text{NC}\mathcal{M}^!(n) = \sum_{0 \leq k \leq n-2} m^{n+1}(m(m-1) + 1)^k (m(m-1))^{n-k-2} \text{nar}(n, k). \quad (3.5.8)$$

We can use Proposition 3.5.4 to compute the first dimensions of  $\text{NC}\mathcal{M}^!$ . For instance, depending on  $m := \#\mathcal{M}$ , we have the following sequences of dimensions:

$$1, 1, 1, 1, 1, 1, 1, 1, \quad m = 1, \quad (3.5.9a)$$

$$1, 8, 80, 992, 13760, 204416, 3180800, 51176960, \quad m = 2, \quad (3.5.9b)$$

$$1, 27, 1053, 51273, 2795715, 163318599, 9994719033, 632496651597, \quad m = 3, \quad (3.5.9c)$$

$$1, 64, 6400, 799744, 111923200, 16782082048, 2636161024000, 428208345579520, \quad m = 4. \quad (3.5.9d)$$

The second one is Sequence A234596 of [Slo]. The last two sequences are not listed in [Slo] at this time. It is worth observing that the dimensions of  $\text{NC}\mathcal{M}^!$  when  $\#\mathcal{M} = 2$  are the ones of the operad BNC of bicolored noncrossing configurations (see Chapter 3).

3.5.3. *Basis.* To describe a basis of  $\text{NC } \mathcal{M}^1$ , let us introduce the following sort of  $\mathcal{M}$ -decorated cliques. A *dual  $\mathcal{M}$ -clique* is an  $\mathcal{M}^2$ -clique such that its base and its edges are labeled by pairs  $(a, a) \in \mathcal{M}^2$ , and all solid diagonals are labeled by pairs  $(a, b) \in \mathcal{M}^2$  with  $a \neq b$ . Observe that a non-solid diagonal of a dual  $\mathcal{M}$ -clique is labeled by  $(1_{\mathcal{M}}, 1_{\mathcal{M}})$ . All definitions about  $\mathcal{M}$ -cliques of Section 1.1 remain valid for dual  $\mathcal{M}$ -cliques. For example,



is a noncrossing dual  $\mathbb{N}_3$ -clique.

PROPOSITION 3.5.5. *Let  $\mathcal{M}$  be a finite unitary magma. The underlying graded vector space of  $\text{NC } \mathcal{M}^1$  is the linear span of all noncrossing dual  $\mathcal{M}$ -cliques.*

Proposition 3.5.5 gives a combinatorial description of the elements of  $\text{NC } \mathcal{M}^1$ . Nevertheless, we do not know for the time being a partial composition on the linear span of these elements providing a realization of  $\text{NC } \mathcal{M}^1$ .

#### 4. Concrete constructions

The clique construction provides alternative definitions of known operads. We explore here the cases of the operad NCT of based noncrossing trees, the operad  $\mathcal{FF}_4$  of formal fractions, the operad BNC of bicolored noncrossing configurations, the operads MT and DMT of multi-tildes and double multi-tildes, and the gravity operad Grav.

4.1. **Rational functions and related operads.** We use here the (noncrossing) clique construction to interpret some few operads related to the operad RatFct of rational functions.

4.1.1. *Dendriform and based noncrossing tree operads.* One can build the operad NCT of based noncrossing trees [Cha07] (see for instance Section 3.2.8 of Chapter 3 where an operad isomorphic to NCT is constructed) in the following way.

PROPOSITION 4.1.1. *The suboperad  $\mathcal{O}_{\text{NCT}}$  of CZ generated by*



is isomorphic to the operad NCT.

By Theorem 1.2.9,  $F_{\text{Id}}$  is an operad morphism from CZ to RatFct. Hence, the restriction of  $F_{\text{Id}}$  on  $\mathcal{O}_{\text{NCT}}$  is also an operad morphism from  $\mathcal{O}_{\text{NCT}}$  to RatFct. Moreover, since

$$F_{\text{Id}} \left( \begin{array}{c} \text{triangle} \\ -1 \\ \text{triangle} \end{array} \right) = \frac{1}{u_1}, \quad (4.1.2a) \quad F_{\text{Id}} \left( \begin{array}{c} \text{triangle} \\ -1 \\ \text{triangle} \end{array} \right) = \frac{1}{u_2}, \quad (4.1.2b)$$

and  $\text{RatFct}^{\{u_1^{-1}, u_2^{-1}\}}$  is isomorphic to the dendriform operad Dendr [Lod01, Lod10] (see Section 4.2.4 of Chapter 2), the map  $F_{\text{Id}}$  is a surjective operad morphism from  $\mathcal{O}_{\text{NCT}}$  to Dendr.



4.1.2. *Operad of formal fractions.* One can build the suboperad  $\mathcal{FF}_4$  of the operad of formal fractions  $\mathcal{FF}$  [CHN16] in the following way.

PROPOSITION 4.1.2. *The suboperad  $\mathcal{O}_{\mathcal{FF}_4}$  of  $C\mathbb{Z}$  generated by*

$$\left\{ \begin{array}{c} \text{⤴} \\ -1 \quad 1 \\ \text{⤵} \\ \text{⤴} \\ 1 \quad -1 \\ \text{⤵} \end{array}, \begin{array}{c} \text{⤴} \\ 1 \quad -1 \\ \text{⤵} \\ \text{⤴} \\ -1 \quad 1 \\ \text{⤵} \end{array}, \begin{array}{c} \text{⤴} \\ 1 \quad 1 \\ \text{⤵} \\ \text{⤴} \\ -1 \quad -1 \\ \text{⤵} \end{array}, \begin{array}{c} \text{⤴} \\ -1 \quad -1 \\ \text{⤵} \\ \text{⤴} \\ 1 \quad 1 \\ \text{⤵} \end{array} \right\} \tag{4.1.3}$$

*is isomorphic to the operad  $\mathcal{FF}_4$ .*

Proposition 4.1.2 shows hence that the operad  $\mathcal{FF}_4$  can be built through the construction C. Observe also that, as a consequence of Proposition 4.1.2, all suboperads of  $\mathcal{FF}_4$  defined in [CHN16] that are generated by a subset of (4.1.3) can be constructed by the clique construction.

4.2. **Operad of bicolored noncrossing configurations.** One can build the operad BNC of bicolored noncrossing configurations (see Chapter 3) in the following way.

Consider the unitary magma  $\mathcal{M}_{\text{BNC}} := \{\mathbb{1}, a, b\}$  wherein operation  $\star$  is defined by the Cayley table

$\star$	$\mathbb{1}$	$a$	$b$
$\mathbb{1}$	$\mathbb{1}$	$a$	$b$
$a$	$a$	$a$	$\mathbb{1}$
$b$	$b$	$\mathbb{1}$	$b$

(4.2.1)

In other words,  $\mathcal{M}_{\text{BNC}}$  is the unitary magma wherein  $a$  and  $b$  are idempotent, and  $a \star b = \mathbb{1} = b \star a$ . Observe that  $\mathcal{M}_{\text{BNC}}$  is a commutative unitary magma, but, since

$$(b \star a) \star a = \mathbb{1} \star a = a \neq b = b \star \mathbb{1} = b \star (a \star a), \tag{4.2.2}$$

the operation  $\star$  is not associative.

Let  $\phi_{\text{BNC}} : \text{BNC} \rightarrow \text{NC}\mathcal{M}_{\text{BNC}}$  be the linear map defined in the following way. For any bicolored noncrossing configuration  $c$ ,  $\phi_{\text{BNC}}(c)$  is the noncrossing  $\mathcal{M}_{\text{BNC}}$ -clique of  $\text{NC}\mathcal{M}_{\text{BNC}}$  obtained by replacing all blue arcs of  $c$  by arcs labeled by  $a$ , all red diagonals of  $c$  by diagonals labeled by  $b$ , all uncolored edges and bases of  $c$  by edges labeled by  $b$ , and all uncolored diagonals of  $c$  by diagonals labeled by  $\mathbb{1}$ . For instance,

$$\phi_{\text{BNC}} \left( \begin{array}{c} \text{⤴} \\ \text{⤵} \\ \text{⤴} \\ \text{⤵} \end{array} \right) = \begin{array}{c} \text{⤴} \\ a \quad b \\ \text{⤵} \\ \text{⤴} \\ a \quad b \\ \text{⤵} \\ \text{⤴} \\ b \quad b \\ \text{⤵} \\ \text{⤴} \\ b \quad a \\ \text{⤵} \end{array}. \tag{4.2.3}$$

PROPOSITION 4.2.1. *The linear span of  $\circ - \circ$  together with all noncrossing  $\mathcal{M}_{\text{BNC}}$ -cliques without edges nor bases labeled by  $\mathbb{1}$  forms a suboperad of  $\text{NC}\mathcal{M}_{\text{BNC}}$  isomorphic to BNC. Moreover,  $\phi_{\text{BNC}}$  is an isomorphism between these two operads.*

Proposition 4.2.1 shows hence that the operad BNC can be built through the noncrossing clique construction. Moreover, observe that in Section 2.2.5 of Chapter 3, an automorphism of BNC called *complementary* is considered. The complementary of a bicolored noncrossing configuration is an involution acting by modifying the colors of some of its arcs. Under our

setting, this automorphism translates simply as the map  $C\theta : \mathcal{O}_{\text{BNC}} \rightarrow \mathcal{O}_{\text{BNC}}$  where  $\mathcal{O}_{\text{BNC}}$  is the operad isomorphic to BNC described in the statement of Proposition 4.2.1 and  $\theta : \mathcal{M}_{\text{BNC}} \rightarrow \mathcal{M}_{\text{BNC}}$  is the unitary magma automorphism of  $\mathcal{M}_{\text{BNC}}$  satisfying  $\theta(\mathbb{1}) = \mathbb{1}$ ,  $\theta(a) = b$ , and  $\theta(b) = a$ .

Besides, it is shown in Chapter 3 that the set of all bicolored noncrossing configurations of arity 2 is a minimal generating set of BNC. Thus, by Proposition 4.2.1, the set

$$\left\{ \begin{array}{c} \text{a} \quad \text{a} \\ \diagup \quad \diagdown \\ \text{a} \quad \text{a} \\ \text{a} \quad \text{a} \end{array}, \begin{array}{c} \text{a} \quad \text{b} \\ \diagup \quad \diagdown \\ \text{a} \quad \text{b} \\ \text{a} \quad \text{b} \end{array}, \begin{array}{c} \text{b} \quad \text{a} \\ \diagup \quad \diagdown \\ \text{a} \quad \text{b} \\ \text{a} \quad \text{b} \end{array}, \begin{array}{c} \text{b} \quad \text{b} \\ \diagup \quad \diagdown \\ \text{a} \quad \text{b} \\ \text{a} \quad \text{b} \end{array}, \begin{array}{c} \text{a} \quad \text{a} \\ \diagdown \quad \diagup \\ \text{a} \quad \text{b} \\ \text{a} \quad \text{b} \end{array}, \begin{array}{c} \text{a} \quad \text{b} \\ \diagdown \quad \diagup \\ \text{a} \quad \text{b} \\ \text{a} \quad \text{b} \end{array}, \begin{array}{c} \text{b} \quad \text{a} \\ \diagdown \quad \diagup \\ \text{a} \quad \text{b} \\ \text{a} \quad \text{b} \end{array}, \begin{array}{c} \text{b} \quad \text{b} \\ \diagdown \quad \diagup \\ \text{a} \quad \text{b} \\ \text{a} \quad \text{b} \end{array} \right\} \quad (4.2.4)$$

is a minimal generating set of the suboperad  $\mathcal{O}_{\text{BNC}}$  of  $\text{NC}\mathcal{M}_{\text{BNC}}$  isomorphic to BNC. As a consequence, all the suboperads of BNC defined in Chapter 3 which are generated by a subset of the set of the generators of BNC can be constructed by the noncrossing clique construction. This includes, among others, the magmatic operad, the free operad on two binary generators, the operad of noncrossing plants NCP [Cha07], the dipterous operad [LR03, Zin12], and the 2-associative operad [LR06, Zin12].

**4.3. Operads from language theory.** We provide constructions of two operads coming from formal language theory by using the clique construction.

4.3.1. *Multi-tildes.* One can build the operad MT of multi-tildes [LMN13] (see also Chapter 12) in the following way.

Let  $\phi_{\text{MT}} : \text{MT} \rightarrow \mathbb{C}\mathbb{D}_0$  be the map linearly defined as follows. For any multi-tilde  $(n, \mathfrak{s})$  different from  $(1, \{(1, 1)\})$ ,  $\phi_{\text{MT}}((n, \mathfrak{s}))$  is the  $\mathbb{D}_0$ -clique of arity  $n$  defined, for any  $1 \leq x < y \leq n + 1$ , by

$$\phi_{\text{MT}}((n, \mathfrak{s}))(x, y) := \begin{cases} 0 & \text{if } (x, y - 1) \in \mathfrak{s}, \\ \mathbb{1} & \text{otherwise.} \end{cases} \quad (4.3.1)$$

For instance,

$$\phi_{\text{MT}}((5, \{(1, 5), (2, 4), (4, 5)\})) = \begin{array}{c} \text{---} \text{---} \text{---} \text{---} \text{---} \\ \diagup \quad \diagdown \quad \diagup \quad \diagdown \\ \text{0} \quad \text{0} \quad \text{0} \quad \text{0} \\ \diagdown \quad \diagup \quad \diagdown \quad \diagup \\ \text{0} \quad \text{0} \quad \text{0} \quad \text{0} \end{array} \quad (4.3.2)$$

**PROPOSITION 4.3.1.** *The operad  $\mathbb{C}\mathbb{D}_0$  is isomorphic to the suboperad of MT consisting in the linear span of all multi-tildes except the nontrivial multi-tilde  $(1, \{(1, 1)\})$  of arity 1. Moreover,  $\phi_{\text{MT}}$  is an isomorphism between these two operads.*

4.3.2. *Double multi-tildes.* One can build the operad DMT of double multi-tildes (see Chapter 12) in the following way.

Consider the operad  $\mathbb{C}\mathbb{D}_0^2$  and let  $\phi_{\text{DMT}} : \text{DMT} \rightarrow \mathbb{C}\mathbb{D}_0^2$  be the map linearly defined as follows. The image by  $\phi_{\text{DMT}}$  of  $(1, \emptyset, \emptyset)$  is the unit of  $\mathbb{C}\mathbb{D}_0^2$  and, for any double multi-tilde  $(n, \mathfrak{s}, \mathfrak{t})$

of arity  $n \geq 2$ ,  $\phi_{\text{DMT}}((n, \mathfrak{s}, \mathfrak{t}))$  is the  $\mathbb{D}_0^2$ -clique of arity  $n$  defined, for any  $1 \leq x < y \leq n + 1$ , by

$$\phi_{\text{DMT}}((n, \mathfrak{s}, \mathfrak{t}))(x, y) := \begin{cases} (0, \mathbb{1}) & \text{if } (x, y - 1) \in \mathfrak{s} \text{ and } (x, y - 1) \notin \mathfrak{t}, \\ (\mathbb{1}, 0) & \text{if } (x, y - 1) \notin \mathfrak{s} \text{ and } (x, y - 1) \in \mathfrak{t}, \\ (0, 0) & \text{if } (x, y - 1) \in \mathfrak{s} \text{ and } (x, y - 1) \in \mathfrak{t}, \\ (\mathbb{1}, \mathbb{1}) & \text{otherwise.} \end{cases} \quad (4.3.3)$$

For instance,

$$\phi_{\text{DMT}}((4, \{(2, 2), (2, 3)\}, \{(1, 3), (1, 4), (2, 3)\})) = \begin{array}{c} \text{---} \circ \text{---} \\ \text{---} \circ \text{---} \\ \text{---} \circ \text{---} \\ \text{---} \circ \text{---} \end{array} \cdot \quad (4.3.4)$$

**PROPOSITION 4.3.2.** *The operad  $\text{CD}_0^2$  is isomorphic to the suboperad of DMT consisting in the linear span of all double multi-tildes except the three nontrivial double multi-tildes of arity 1. Moreover,  $\phi_{\text{DMT}}$  is an isomorphism between these two operads.*

**4.4. Gravity operad.** One can build the nonsymmetric version [AP15] (see Section 4.2.7 of Chapter 2) of the operad Grav of gravity chord diagrams [Get94] in the following way.

Let  $\phi_{\text{Grav}} : \text{Grav} \rightarrow \text{CD}_0$  be the linear map defined in the following way. For any gravity chord diagram  $\mathfrak{c}$ ,  $\phi_{\text{Grav}}(\mathfrak{c})$  is the  $\mathbb{D}_0$ -clique of  $\text{CD}_0$  obtained by replacing all blue arcs of  $\mathfrak{c}$  by arcs labeled by 0 and all unlabeled arcs by arcs labeled by  $\mathbb{1}$ . For instance,

$$\phi_{\text{Grav}} \left( \begin{array}{c} \text{---} \circ \text{---} \\ \text{---} \circ \text{---} \\ \text{---} \circ \text{---} \\ \text{---} \circ \text{---} \end{array} \right) = \begin{array}{c} \text{---} \circ \text{---} \\ \text{---} \circ \text{---} \\ \text{---} \circ \text{---} \\ \text{---} \circ \text{---} \end{array} \cdot \quad (4.4.1)$$

Let us say that an  $\mathcal{M}$ -clique  $\mathfrak{p}$  satisfies the *gravity condition* if  $\mathfrak{p} = \circ \text{---} \circ$ , or  $\mathfrak{p}$  has only solid edges and bases, and for all crossing diagonals  $(x, y)$  and  $(x', y')$  of  $\mathfrak{p}$  such that  $x < x'$ ,  $\mathfrak{p}(x, y) \neq \mathbb{1}_{\mathcal{M}} \neq \mathfrak{p}(x', y')$  implies  $\mathfrak{p}(x', y) = \mathbb{1}_{\mathcal{M}}$ .

**PROPOSITION 4.4.1.** *The linear span of all  $\mathbb{D}_0$ -cliques satisfying the gravity condition forms a suboperad of  $\text{CD}_0$  isomorphic to Grav. Moreover,  $\phi_{\text{Grav}}$  is an isomorphism between these two operads.*

Proposition 4.4.1 shows hence that the operad Grav can be built through the clique construction. Moreover, as explained in [AP15], Grav contains the nonsymmetric version of the Lie operad, the symmetric operad describing the category of Lie algebras. This nonsymmetric version of the Lie operad as been introduced in [ST09]. Since Lie is contained in Grav as the subspace of all gravity chord diagrams having the maximal number of blue diagonals for each arity, Lie can be built through the clique construction as the suboperad of  $\text{CD}_0$  containing all the  $\mathbb{D}_0$ -cliques that are images by  $\phi_{\text{Grav}}$  of such maximal gravity chord diagrams.

Besides, this alternative construction of  $\text{Grav}$  leads to the following generalization for any unitary magma  $\mathcal{M}$  of the gravity operad. Let  $\text{Grav}_{\mathcal{M}}$  be the linear span of all  $\mathcal{M}$ -cliques satisfying the gravity condition. It follows from the definition of the partial composition of  $C\mathcal{M}$  that  $\text{Grav}_{\mathcal{M}}$  is an operad. Moreover, observe that when  $\mathcal{M}$  has nontrivial unit divisors,  $\text{Grav}_{\mathcal{M}}$  is not a free operad.

### Concluding remarks

This chapter presents and studies the clique construction  $C$ , producing operads from unitary magmas. We have seen that  $C$  has many both algebraic and combinatorial properties. Among its most notable ones,  $C\mathcal{M}$  admits several quotients involving combinatorial families of decorated cliques, admits a binary and quadratic suboperad  $\text{NC}\mathcal{M}$  which is a Koszul, and contains a lot of already studied and classic operads. Besides, in the course of this chapter, whose is already long enough, we have put aside a bunch of questions. Let us address these here.

First, we have for the time being no formula to enumerate prime (resp. white prime)  $\mathcal{M}$ -cliques (see (1.2.3) (resp. (1.2.4)) for  $\#\mathcal{M} = 2$ ). Obtaining these forms a first combinatorial question.

When  $\mathcal{M}$  is a  $\mathbb{Z}$ -graded unitary magma, a link between  $C\mathcal{M}$  and the operad of rational functions  $\text{RatFct}$  has been developed in Section 1.2.7 by means of a morphism  $F_{\theta}$  between these two operads. We have observed that  $F_{\theta}$  is not injective (see (1.2.22a) and (1.2.22b)). A description of the kernel of  $F_{\theta}$ , even when  $\mathcal{M}$  is the unitary magma  $\mathbb{Z}$ , seems not easy to obtain. Trying to obtain this description is a second perspective of this work.

Here is a third perspective. In Section 2, we have defined and briefly studied some quotients and suboperads of  $C\mathcal{M}$ . In particular, we have considered the quotient  $\text{Deg}_1\mathcal{M}$  of  $C\mathcal{M}$ , involving  $\mathcal{M}$ -cliques of degrees at most 1. As mentioned,  $\text{Deg}_1\mathbb{D}_0$  is an operad defined on the linear span of involutions (except the nontrivial involution of  $\mathfrak{S}_2$ ). A complete study of this operad seems worth considering, including a description of a minimal generating set, a presentation by generators and relations, a description of its partial composition on the H-basis and on the K-basis, and a realization of this operad in terms of standard Young tableaux.

The last question we develop here concerns the Koszul dual  $\text{NC}\mathcal{M}^!$  of  $\text{NC}\mathcal{M}$ . Section 3.5 contains results about this operad, like a description of its presentation and a formula for its dimensions. We have also established the fact that, as graded vector spaces,  $\text{NC}\mathcal{M}^!$  is isomorphic to the linear span of all noncrossing dual  $\mathcal{M}$ -cliques. To obtain a realization of  $\text{NC}\mathcal{M}^!$ , it is now enough to endow this last space with an adequate partial composition. This is the last perspective we address here.



## **Part 3**

# **Combinatorial Hopf bialgebras**



## Hopf bialgebra of packed square matrices

The content of this chapter comes from [CGM15] and is a joint work with Hayat Cheballah and Rémi Maurice.

### Introduction

The combinatorial collection of the permutations is naturally endowed with two operations. One of them, the shifted shuffle product, takes two permutations as input and put these together by blending their letters. The other one, the deconcatenation coproduct, takes one permutation as input and disassembles it by cutting it into prefixes and suffixes. These two operations satisfy certain compatibility relations, resulting in that the linear span of all permutations forms a Hopf bialgebra [MR95], known as the Malvenuto-Reutenauer Hopf bialgebra or FQSym [DHT02] (see Section 3.2.3 of Chapter 2).

This Hopf bialgebra plays a central role in algebraic combinatorics for at least two reasons. On the one hand, FQSym contains, as Hopf sub-bialgebras, several structures based on well-known combinatorial objects as *e.g.*, standard Young tableaux [DHT02], binary trees [HNT05], and integer compositions [GKL<sup>+</sup>95]. The construction of these substructures revisits many algorithms coming from computer science and combinatorics. Indeed, the insertion of a letter into a Young tableau (following Robinson-Schensted [Sch61, Lot02]) or in a binary search tree [Knu98] are algorithms which prove to be as enlightening as surprising in this algebraic context [DHT02, HNT05]. On the other hand, the polynomial realization of FQSym allows to associate a polynomial with any permutation [DHT02] providing a generalization of symmetric functions, the free quasi-symmetric functions. This generalization offers alternative ways to prove several properties of (quasi)symmetric functions.

It is thus natural to enrich this theory by proposing generalizations of FQSym. In the last years, several generalizations were proposed and each of these depends on the way we regard permutations. By regarding a permutation as a word and allowing repetitions of letters, Hivert introduced in [Hiv99] (see [NT06] for a detailed study) a Hopf bialgebra WQSym on packed words. Additionally, by allowing some jumps for the values of the letters of permutations, Novelli and Thibon defined in [NT07] another Hopf bialgebra PQSym which involves parking functions. These authors also showed in [NT10] that the  $k$ -colored permutations admit a Hopf bialgebra structure  $\text{FQSym}^{(k)}$ . Furthermore, by regarding a permutation  $\sigma$  as a bijection associating the singleton  $\{\sigma(i)\}$  with any singleton  $\{i\}$ , Aguiar and Orellana constructed [AO08] a Hopf bialgebra structure UBP on uniform block permutations, *i.e.*, bijections between set partitions of  $[n]$ , where each part has the same cardinality as its image. Finally, by regarding a permutation through its permutation matrix, Duchamp, Hivert



and Thibon introduced in [DHT02] a Hopf bialgebra MQSym which involves some kind of integer matrices.

In this chapter we propose a new generalization of FQSym by regarding permutations as permutation matrices. For this purpose, we consider the set of 1-packed matrices that are square matrices with entries in the alphabet  $\{0, 1\}$  which have at least one 1 by row and by column. By equipping these matrices with a product and a coproduct, we obtain a bigraded Hopf bialgebra, denoted by  $\text{PM}_1$ . By only considering the grading offered by the size (resp. the number of nonzero entries) of matrices, we obtain a simply graded Hopf bialgebra denoted by  $\text{PMN}_1$  (resp.  $\text{PML}_1$ ). Note that since permutation matrices form a Hopf sub-bialgebra of  $\text{PMN}_1$  (and  $\text{PML}_1$ ) isomorphic to FQSym,  $\text{PMN}_1$  (and  $\text{PML}_1$ ) provides a generalization of FQSym. Now, by allowing the entries different from 0 of a packed matrix to belong to the alphabet  $[k]$  where  $k$  is a positive integer, we obtain the notion of a  $k$ -packed matrix. The definition of  $\text{PM}_1$  (and  $\text{PMN}_1$  and  $\text{PML}_1$ ) obviously extends to these matrices and leads to the Hopf bialgebra  $\text{PM}_k$  (and  $\text{PMN}_k$  and  $\text{PML}_k$ ) involving  $k$ -packed matrices. Besides, since any  $k$ -packed matrix is also a  $k + 1$ -packed matrix,  $(\text{PM}_k)_{k \geq 1}$  is an increasing infinite sequence of Hopf bialgebras for inclusion. Let us now list some remarkable facts about these Hopf bialgebras. First,  $\text{FQSym}^{(k)}$  embeds into  $\text{PMN}_k$  (and  $\text{PML}_k$ ), and the dual  $\text{UBP}^*$  of  $\text{UBP}$  embeds into  $\text{PMN}_1$ . Besides, as associative algebras,  $\text{PML}_1^*$  embeds into MQSym. On the other hand, by considering a bijection between the set of the alternating sign matrices [MRR83] and particular 1-packed matrices, it appears that the linear span of these 1-packed matrices forms a Hopf sub-bialgebra of  $\text{PM}_k$ . This Hopf bialgebra, called ASM, is hence a Hopf bialgebra on alternating sign matrices. Several statistics defined on alternating sign matrices through the six-vertex configurations with domain wall boundary conditions [Kup96] can be interpreted under this algebraic point of view.

Our results are presented as follows. The aims of Section 1 are to introduce  $k$ -packed matrices and the Hopf bialgebra of  $k$ -packed matrices. Section 2 is devoted to the study of the algebraic properties of  $\text{PM}_k$ . In Section 3, we describe morphisms between  $\text{PM}_k$  another Hopf bialgebras. We also provide a general way to construct Hopf sub-bialgebras of  $\text{PM}_k$  analogous to the construction of Hopf sub-bialgebras of FQSym by monoid congruences [Hiv99] (see also [Gir11]). We end this chapter by Section 4 where we study the Hopf sub-bialgebra ASM of  $\text{PMN}_1$ .

## 1. Hopf algebra of packed matrices

We begin this section by defining  $k$ -packed matrices and by enumerating them following their sizes and their number of nonzero entries. Then we introduce the Hopf algebra  $\text{PM}_k$  on the linear span of the  $k$ -packed matrices.

**1.1. Packed matrices.** Let us introduce here the most important combinatorial object of this work.

1.1.1. *First definitions.* Let  $k \geq 1$  be an integer. We denote by  $\mathcal{M}_{k,n,\ell}$  the set of  $n \times n$  matrices with exactly  $\ell$  nonzero entries in the alphabet  $A_k := \{0, 1, \dots, k\}$  and by  $N_r(M)$  (resp.  $N_c(M)$ ) the set of the indices of the zero rows (resp. columns) of  $M \in \mathcal{M}_{k,n,\ell}$ . For example, by considering the matrix

$$M := \begin{bmatrix} 0 & 1 & 0 & 0 & 1 & 0 \\ 0 & 0 & 0 & 1 & 0 & 1 \\ 0 & 1 & 0 & 0 & 0 & 0 \\ 0 & 0 & 0 & 1 & 1 & 0 \\ 0 & 0 & 0 & 0 & 0 & 0 \\ 0 & 0 & 0 & 0 & 0 & 1 \end{bmatrix}, \tag{1.1.1}$$

we have  $N_r(M) = \{5\}$  and  $N_c(M) = \{1, 3\}$ .

A *k-packed matrix*  $M$  of size  $n$  is a matrix of  $\mathcal{M}_{k,n,\ell}$  in which each row and each column contains at least one entry different from 0, that is to say if the subsets  $N_r(M)$  and  $N_c(M)$  are empty.

We shall denote in the sequel by  $\mathcal{P}_{k,n,\ell}$  the set of all  $k$ -packed matrices of size  $n$  with exactly  $\ell$  nonzero entries, by  $\mathcal{P}_{k,n,-}$  the set of all  $k$ -packed matrices of size  $n$ , by  $\mathcal{P}_{k,-,\ell}$  the set of all  $k$ -packed matrices with exactly  $\ell$  nonzero entries, and by  $\mathcal{P}_k$  the set of all  $k$ -packed matrices. The  $k$ -packed matrix of size 0 is denoted by  $\emptyset$ . For instance, the seven 1-packed matrices of size 2 are

$$\begin{bmatrix} 1 & 0 \\ 0 & 1 \end{bmatrix}, \begin{bmatrix} 0 & 1 \\ 1 & 0 \end{bmatrix}, \begin{bmatrix} 1 & 1 \\ 1 & 0 \end{bmatrix}, \begin{bmatrix} 1 & 1 \\ 0 & 1 \end{bmatrix}, \begin{bmatrix} 1 & 0 \\ 1 & 1 \end{bmatrix}, \begin{bmatrix} 0 & 1 \\ 1 & 1 \end{bmatrix}, \begin{bmatrix} 1 & 1 \\ 1 & 1 \end{bmatrix}, \tag{1.1.2}$$

and the ten 1-packed matrices of  $\mathcal{P}_{1,-,3}$  are

$$\begin{bmatrix} 1 & 1 & 1 \\ 1 & 0 & 0 \end{bmatrix}, \begin{bmatrix} 1 & 1 & 1 \\ 0 & 1 & 1 \end{bmatrix}, \begin{bmatrix} 1 & 1 & 0 \\ 1 & 1 & 1 \end{bmatrix}, \begin{bmatrix} 0 & 1 & 1 \\ 1 & 1 & 1 \end{bmatrix}, \begin{bmatrix} 1 & 0 & 0 \\ 0 & 1 & 0 \end{bmatrix}, \begin{bmatrix} 1 & 0 & 0 \\ 0 & 0 & 1 \end{bmatrix}, \begin{bmatrix} 0 & 1 & 0 \\ 1 & 0 & 0 \end{bmatrix}, \begin{bmatrix} 0 & 0 & 1 \\ 1 & 0 & 0 \end{bmatrix}, \begin{bmatrix} 0 & 1 & 0 \\ 0 & 0 & 1 \end{bmatrix}, \begin{bmatrix} 0 & 0 & 1 \\ 0 & 1 & 0 \end{bmatrix}. \tag{1.1.3}$$

1.1.2. *Operations and decompositions.* Let us now define some operations on packed matrices. We shall denote by  $Z_n^m$  the  $n \times m$  null matrix. Given  $M_1$  and  $M_2$  two  $k$ -packed matrices of respective sizes  $n_1$  and  $n_2$ , set

$$M_1 / M_2 := \left[ \begin{array}{c|c} M_1 & Z_{n_1}^{n_2} \\ \hline Z_{n_2}^{n_1} & M_2 \end{array} \right] \quad \text{and} \quad M_1 \setminus M_2 := \left[ \begin{array}{c|c} Z_{n_1}^{n_2} & M_1 \\ \hline M_2 & Z_{n_2}^{n_1} \end{array} \right]. \tag{1.1.4}$$

Note that these two matrices are  $k$ -packed matrices of size  $n_1 + n_2$ . We shall respectively call  $/$  and  $\setminus$  the *over* and *under* operators. These two operators are obviously associative.

Given a matrix  $M$  whose entries are in  $A_k$ , the *compression* of  $M$  is the matrix  $\text{cp}(M)$  obtained by deleting in  $M$  all null rows and columns. Let  $M$  be a  $k$ -packed matrix. The tuple  $(M_1, \dots, M_r)$  is a *column decomposition* of  $M$ , and we write  $M = M_1 \bullet \dots \bullet M_r$ , if for all  $i \in [r]$  the  $\text{cp}(M_i)$  are square matrices (and not necessarily column matrices) and

$$M = \left[ \begin{array}{c|c|c} M_1 & \dots & M_r \end{array} \right]. \tag{1.1.5}$$

Similarly, the tuple  $(M_1, \dots, M_r)$  is a *row decomposition* of  $M$ , and we write  $M = M_1 \circ \dots \circ M_r$ , if for all  $i \in [r]$  the  $\text{cp}(M_i)$  are square matrices (and not necessarily row matrices) and

$$M = \left[ \begin{array}{c} M_1 \\ \dots \\ M_r \end{array} \right]. \tag{1.1.6}$$

For instance, here are a 1-packed matrix of size 5, one of its column decompositions and one of its row decompositions:

$$\begin{bmatrix} 0 & 1 & 1 & 0 & 0 \\ 0 & 0 & 1 & 0 & 0 \\ 0 & 0 & 0 & 1 & 1 \\ 1 & 0 & 0 & 0 & 0 \\ 0 & 0 & 0 & 1 & 1 \end{bmatrix} = \begin{bmatrix} 0 & 1 & 1 \\ 0 & 0 & 1 \\ 0 & 0 & 0 \\ 1 & 0 & 0 \\ 0 & 0 & 0 \end{bmatrix} \bullet \begin{bmatrix} 0 & 0 \\ 0 & 0 \\ 1 & 1 \\ 0 & 0 \\ 1 & 1 \end{bmatrix} = \begin{bmatrix} 0 & 1 & 1 & 0 & 0 \\ 0 & 0 & 1 & 0 & 0 \end{bmatrix} \circ \begin{bmatrix} 0 & 0 & 0 & 1 & 1 \\ 1 & 0 & 0 & 0 & 0 \\ 0 & 0 & 0 & 1 & 1 \end{bmatrix}. \tag{1.1.7}$$

These two decompositions have the following property.

LEMMA 1.1.1. *Let  $M$  be a packed matrix and  $(M_1, M_2)$  be a column (resp. row) decomposition of  $M$ . Then, there is no integer  $i$  such that the  $i$ th rows (resp. columns) of  $M_1$  and  $M_2$  contain both a nonzero entry.*

Lemma 1.1.1 provides a sufficient condition to ensure that a given pair  $(M_1, M_2)$  of matrices cannot be a column (resp. row) decomposition of a matrix  $M$ . Nevertheless, it is not a necessary condition. Indeed, let

$$M := \begin{bmatrix} 1 & 1 & 0 \\ 0 & 0 & 1 \\ 0 & 0 & 1 \end{bmatrix} \quad \text{and} \quad (M_1, M_2) := \left( \begin{bmatrix} 1 & 1 \\ 0 & 0 \end{bmatrix}, \begin{bmatrix} 0 \\ 1 \end{bmatrix} \right). \tag{1.1.8}$$

Then, even if there is no nonzero entry on the same row in  $M_1$  and  $M_2$ ,  $(M_1, M_2)$  is not a column decomposition of  $M$ .

**1.2. Enumeration.** We enumerate here  $k$ -packed matrices by both their size and their number of nonzero entries. We then specialize our enumeration to obtain formulas enumerating these objects by their size and, separately, by their number of nonzero entries.

1.2.1. *General enumeration.* Using the sieve principle, we obtain the following enumerative result.

PROPOSITION 1.2.1. *For any  $k \geq 1$ ,  $n \geq 0$ , and  $\ell \geq 0$ , the number  $\#\mathcal{P}_{k,n,\ell}$  of  $k$ -packed matrices of size  $n$  with exactly  $\ell$  nonzero entries is*

$$\#\mathcal{P}_{k,n,\ell} = \sum_{0 \leq i, j \leq n} (-1)^{i+j} \binom{n}{i} \binom{n}{j} \binom{ij}{\ell} k^\ell. \tag{1.2.1}$$

Table 8.1 shows the first few values of  $\#\mathcal{P}_{k,n,\ell}$ . The enumeration in the case  $k = 1$  is Sequence A055599 of [Slo].

1.2.2. *Enumeration by size.* Notice that for any  $n \geq 0$ , since

$$\mathcal{P}_{k,n,-} = \bigsqcup_{n \leq \ell \leq n^2} \mathcal{P}_{k,n,\ell}, \tag{1.2.2}$$

the set  $\mathcal{P}_{k,n,-}$  is finite. Hence, by using Proposition 1.2.1, we obtain

$$\#\mathcal{P}_{k,n,-} = \sum_{0 \leq i, j \leq n} (-1)^{i+j} \binom{n}{i} \binom{n}{j} (k+1)^{ij}. \tag{1.2.3}$$

Sequences  $(\#\mathcal{P}_{1,n,-})_{n \geq 0}$  and  $(\#\mathcal{P}_{2,n,-})_{n \geq 0}$  respectively start with

$$1, 1, 7, 265, 41503, 24997921, 57366997447, \tag{1.2.4}$$

and

$$1, 2, 56, 16064, 39156608, 813732073472, 147662286695991296. \tag{1.2.5}$$

These are respectively Sequences A048291 and A230879 of [Slo].

(A) Number of 1-packed matrices.

	0	1	2	3	4	5	6	7	8	9
0	1									
1		1								
2			2	4	1					
3				6	45	90	78	36	9	1

(B) Number of 2-packed matrices.

	0	1	2	3	4	5	6	7	8	9
0	1									
1		2								
2			8	32	16					
3				48	720	2880	4992	4608	2304	512

TABLE 8.1. The number of  $k$ -packed matrices of size  $n$  (vertical values) with exactly  $\ell$  nonzero entries (horizontal values).

1.2.3. *Enumeration by number of nonzero entries.* Similarly, since for any  $\ell \geq 0$ ,

$$\mathcal{P}_{k,-,\ell} = \bigsqcup_{\lceil \sqrt{\ell} \rceil \leq n \leq \ell} \mathcal{P}_{k,n,\ell}, \tag{1.2.6}$$

the set  $\mathcal{P}_{k,-,\ell}$  is finite. Hence, by using Proposition 1.2.1, we obtain

$$\#\mathcal{P}_{k,-,\ell} = \sum_{0 \leq i,j \leq n \leq \ell} (-1)^{i+j} \binom{n}{i} \binom{n}{j} \binom{ij}{\ell} k^\ell. \tag{1.2.7}$$

Sequences  $(\#\mathcal{P}_{1,-,\ell})_{\ell \geq 0}$  and  $(\#\mathcal{P}_{2,-,\ell})_{\ell \geq 0}$  respectively start with

$$1, 1, 2, 10, 70, 642, 7246, 97052, 1503700, \tag{1.2.8}$$

and

$$1, 2, 8, 80, 1120, 20544, 463744, 12422656, 384947200. \tag{1.2.9}$$

These are respectively Sequences A104602 and A230880 of [Slo].

**1.3. Hopf bialgebra structure.** We are now in position to define a Hopf bialgebra structure on the linear span of all  $k$ -packed matrices.

1.3.1. *Bigraded space.* Let, for any  $k \geq 1$ ,

$$\text{PM}_k := \bigoplus_{n \geq 0} \bigoplus_{\ell \geq 0} \mathbb{K} \langle \mathcal{P}_{k,n,\ell} \rangle \quad (1.3.1)$$

be the bigraded vector space spanned by the set of all  $k$ -packed matrices. The elements  $F_M$ , where the  $M$  are  $k$ -packed matrices, form a basis of  $\text{PM}_k$ . We shall call this basis the *fundamental basis* of  $\text{PM}_k$ .

1.3.2. *Product and coproduct.* Given  $M_1$  and  $M_2$  two  $k$ -packed matrices of respective sizes  $n_1$  and  $n_2$ , set

$$M_1 \circ n_2 := \begin{bmatrix} M_1 \\ Z_{n_2}^{n_1} \end{bmatrix} \quad \text{and} \quad n_1 \circ M_2 := \begin{bmatrix} Z_{n_1}^{n_2} \\ M_2 \end{bmatrix}. \quad (1.3.2)$$

The *column shifted shuffle*  $M_1 \sqcup M_2$  of  $M_1$  and  $M_2$  is the set of all matrices obtained by shuffling the columns of  $M_1 \circ n_2$  with the columns of  $n_1 \circ M_2$ .

Let us endow  $\text{PM}_k$  with a product  $\cdot$  linearly defined, for any  $k$ -packed matrices  $M_1$  and  $M_2$ , by

$$F_{M_1} \cdot F_{M_2} := \sum_{M \in M_1 \sqcup M_2} F_M. \quad (1.3.3)$$

For instance, in  $\text{PM}_1$  one has

$$F \begin{bmatrix} 0 & 1 \\ 1 & 1 \end{bmatrix} \cdot F \begin{bmatrix} 1 & 0 \\ 0 & 1 \end{bmatrix} = F \begin{bmatrix} 0 & 1 & 0 & 0 \\ 1 & 1 & 0 & 0 \\ 0 & 0 & 1 & 0 \\ 0 & 0 & 0 & 1 \end{bmatrix} + F \begin{bmatrix} 0 & 0 & 1 & 0 \\ 1 & 0 & 1 & 0 \\ 0 & 1 & 0 & 0 \\ 0 & 0 & 0 & 1 \end{bmatrix} + F \begin{bmatrix} 0 & 0 & 0 & 1 \\ 1 & 0 & 0 & 1 \\ 0 & 1 & 0 & 0 \\ 0 & 0 & 0 & 1 \end{bmatrix} + F \begin{bmatrix} 0 & 0 & 1 & 0 \\ 0 & 1 & 1 & 0 \\ 1 & 0 & 0 & 0 \\ 0 & 0 & 0 & 1 \end{bmatrix} + F \begin{bmatrix} 0 & 0 & 0 & 1 \\ 0 & 1 & 0 & 1 \\ 1 & 0 & 0 & 0 \\ 0 & 0 & 1 & 0 \end{bmatrix} + F \begin{bmatrix} 0 & 0 & 0 & 1 \\ 0 & 0 & 1 & 1 \\ 1 & 0 & 0 & 0 \\ 0 & 1 & 0 & 0 \end{bmatrix}. \quad (1.3.4)$$

Moreover, we endow  $\text{PM}_k$  with a coproduct  $\Delta$  linearly defined, for any  $k$ -packed matrix  $M$ , by

$$\Delta(F_M) := \sum_{M=M_1 \bullet M_2} F_{\text{cp}(M_1)} \otimes F_{\text{cp}(M_2)}. \quad (1.3.5)$$

For instance, in  $\text{PM}_1$  one has

$$\Delta F \begin{bmatrix} 1 & 1 & 0 & 0 \\ 0 & 0 & 0 & 1 \\ 1 & 0 & 1 & 0 \\ 0 & 1 & 0 & 0 \end{bmatrix} = F \begin{bmatrix} 1 & 1 & 0 & 0 \\ 0 & 0 & 0 & 1 \\ 1 & 0 & 1 & 0 \\ 0 & 1 & 0 & 0 \end{bmatrix} \otimes F_{\emptyset} + F \begin{bmatrix} 1 & 1 & 0 & 1 \\ 1 & 0 & 1 & 1 \\ 0 & 1 & 0 & 1 \end{bmatrix} \otimes F_{[1]} + F_{\emptyset} \otimes F \begin{bmatrix} 1 & 1 & 0 & 0 \\ 0 & 0 & 0 & 1 \\ 1 & 0 & 1 & 0 \\ 0 & 1 & 0 & 0 \end{bmatrix}. \quad (1.3.6)$$

Note that by definition, the product and the coproduct of  $\text{PM}_k$  are multiplicity free.

**THEOREM 1.3.1.** *The vector space  $\text{PM}_k$  endowed with the product  $\cdot$  and the coproduct  $\Delta$  is a bigraded and connected bialgebra where homogeneous components are finite-dimensional.*

Notice that since any  $k$ -packed matrix is also a  $k+1$ -packed matrix, the vector space  $\text{PM}_k$  is included in  $\text{PM}_{k+1}$ . Hence, and by Theorem 1.3.1,

$$\text{PM}_1 \hookrightarrow \text{PM}_2 \hookrightarrow \dots \quad (1.3.7)$$

is an increasing infinite sequence of bigraded bialgebras for inclusion. The first few dimensions of  $\text{PM}_1$  and  $\text{PM}_2$  are given by Table 8.1.

1.3.3. *Antipode.* Since  $\text{PM}_k$  is, by Theorem 1.3.1, a bigraded and connected bialgebra, it admits an antipode and hence, is a Hopf bialgebra. The antipode  $\nu$  of  $\text{PM}_k$  satisfies, for any  $k$ -packed matrix  $M$ ,

$$\nu(F_M) = \sum_{\substack{\ell \geq 1 \\ M = M_1 \bullet \dots \bullet M_\ell \\ M_i \neq \emptyset, i \in [\ell]}} (-1)^\ell F_{\text{cp}(M_1)} \cdots F_{\text{cp}(M_\ell)}. \quad (1.3.8)$$

For instance, in  $\text{PM}_1$  one has

$$\begin{aligned} \nu \left( F \begin{pmatrix} 0 & 1 & 1 \\ 1 & 0 & 0 \\ 0 & 1 & 0 \end{pmatrix} \right) &= -F \begin{pmatrix} 0 & 1 & 1 \\ 1 & 0 & 0 \\ 0 & 1 & 0 \end{pmatrix} + F_{[1]} \cdot F \begin{pmatrix} 1 & 1 \\ 1 & 0 \end{pmatrix} \\ &= F \begin{pmatrix} 1 & 0 & 0 \\ 0 & 1 & 1 \\ 0 & 1 & 0 \end{pmatrix} + F \begin{pmatrix} 0 & 1 & 0 \\ 1 & 0 & 1 \\ 1 & 0 & 0 \end{pmatrix} + F \begin{pmatrix} 0 & 0 & 1 \\ 1 & 1 & 0 \\ 1 & 0 & 0 \end{pmatrix} - F \begin{pmatrix} 0 & 1 & 1 \\ 1 & 0 & 0 \\ 0 & 1 & 0 \end{pmatrix}. \end{aligned} \quad (1.3.9)$$

Note besides that  $\nu$  is not an involution. Indeed,

$$\nu^2 \left( F \begin{pmatrix} 0 & 1 & 1 \\ 1 & 0 & 0 \\ 0 & 1 & 0 \end{pmatrix} \right) = F \begin{pmatrix} 1 & 1 & 0 \\ 1 & 0 & 0 \\ 0 & 0 & 1 \end{pmatrix} + F \begin{pmatrix} 1 & 0 & 1 \\ 1 & 0 & 0 \\ 0 & 1 & 0 \end{pmatrix} + F \begin{pmatrix} 0 & 1 & 1 \\ 0 & 1 & 0 \\ 1 & 0 & 0 \end{pmatrix} + F \begin{pmatrix} 0 & 1 & 1 \\ 1 & 0 & 0 \\ 0 & 1 & 0 \end{pmatrix} - F \begin{pmatrix} 1 & 0 & 0 \\ 0 & 1 & 1 \\ 0 & 1 & 0 \end{pmatrix} - F \begin{pmatrix} 0 & 1 & 0 \\ 1 & 0 & 1 \\ 1 & 0 & 0 \end{pmatrix} - F \begin{pmatrix} 0 & 0 & 1 \\ 1 & 1 & 0 \\ 1 & 0 & 0 \end{pmatrix}. \quad (1.3.10)$$

1.3.4. *Two alternative gradings.* Let us now set

$$\text{PMN}_k := \bigoplus_{n \geq 0} \mathbb{K} \langle \mathcal{G}_{k,n,-} \rangle \quad \text{and} \quad \text{PML}_k := \bigoplus_{\ell \geq 0} \mathbb{K} \langle \mathcal{G}_{k,-,\ell} \rangle \quad (1.3.11)$$

the vector spaces of  $k$ -packed matrices respectively graded by the size and by the number of nonzero entries of matrices. By Theorem 1.3.1, and since each homogeneous component of these vector spaces is finite-dimensional (see Section 1.2),  $\text{PMN}_k$  and  $\text{PML}_k$  are Hopf bialgebras. Besides,

$$\text{PMN}_1 \hookrightarrow \text{PMN}_2 \hookrightarrow \dots \quad \text{and} \quad \text{PML}_1 \hookrightarrow \text{PML}_2 \hookrightarrow \dots \quad (1.3.12)$$

are increasing infinite sequences of Hopf bialgebras for inclusion. The first few dimensions of  $\text{PMN}_1$  and  $\text{PMN}_2$  are given by (1.2.4) and (1.2.5), and the first few dimensions of  $\text{PML}_1$  and  $\text{PML}_2$  are given by (1.2.8) and (1.2.9). In the sequel, we shall denote by  $\mathcal{H}_{k,n}(t)$  (resp.  $\mathcal{H}_{k,\ell}(t)$ ) the Hilbert series of  $\text{PMN}_k$  (resp.  $\text{PML}_k$ ).

## 2. Algebraic properties

A complete study of the algebraic properties of  $\text{PM}_k$  is performed here. We show that  $\text{PM}_k$  is free as an associative algebra, self-dual, and admit a bidendriform bialgebra structure.

**2.1. Multiplicative bases and freeness.** To show that  $\text{PM}_k$  is free as an associative algebra, we define two multiplicative bases of  $\text{PM}_k$ . The definitions of these bases rely on a poset structure on the set of all  $k$ -packed matrices.

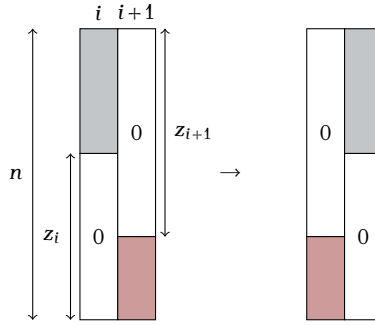

FIGURE 8.1. The condition for swapping the  $i$ th and  $(i + 1)$ st columns of a packed matrix according to the relation  $\rightarrow$ . The darker regions contain any entries and the white ones, only zeros.

2.1.1. *Poset structure.* Let  $\rightarrow$  be the binary relation on  $\mathcal{P}_k$  defined in the following way. If  $M_1$  and  $M_2$  are two  $k$ -packed matrices of size  $n$ , we have  $M_1 \rightarrow M_2$  if there is an index  $i \in [n - 1]$  such that, denoting by  $z_i$  the number of 0 ending the  $i$ th column of  $M_1$ , and by  $z_{i+1}$  the number of 0 starting the  $(i + 1)$ st column of  $M_1$ , one has  $z_i + z_{i+1} \geq n$ , and  $M_2$  is obtained from  $M_1$  by exchanging its  $i$ th and  $(i + 1)$ st columns (see Figure 8.1).

We now endow  $\mathcal{P}_k$  with the partial order relation  $\leq_{\text{PM}}$  defined as the reflexive and transitive closure of  $\rightarrow$ . Figure 8.2 shows an interval of this partial order.

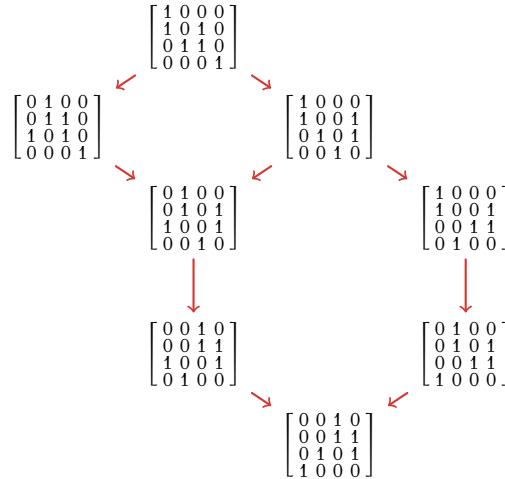

FIGURE 8.2. The Hasse diagram of an interval for the order  $\leq_{\text{PM}}$  of packed matrices.

Notice that by regarding a permutation  $\sigma$  of  $\mathfrak{S}_n$  as its *permutation matrix* (i.e., the 1-packed matrix  $M$  of size  $n$  satisfying  $M_{ij} = 1$  if and only if  $\sigma_j = i$ ), the poset  $(\mathcal{P}_{k,n,-}, \leq_{\text{PM}})$  restricted to permutation matrices is the right weak order on permutations [GR63].

2.1.2. *Multiplicative bases.* By mimicking definitions of the bases of symmetric functions, for any  $k$ -packed matrix  $M$ , the *elementary elements*  $E_M$  and the *homogeneous elements*  $H_M$  are respectively defined by

$$E_M := \sum_{M \leq_{\text{PM}} M'} F_{M'} \quad \text{and} \quad H_M := \sum_{M' \leq_{\text{PM}} M} F_{M'}. \quad (2.1.1)$$

By triangularity, these two families are bases of  $\text{PM}_k$ . For instance, in  $\text{PM}_1$  one has

$$E \begin{bmatrix} 1 & 0 & 0 & 0 \\ 1 & 0 & 0 & 1 \\ 0 & 0 & 1 & 1 \\ 0 & 1 & 0 & 0 \end{bmatrix} = F \begin{bmatrix} 1 & 0 & 0 & 0 \\ 1 & 0 & 0 & 1 \\ 0 & 0 & 1 & 1 \\ 0 & 1 & 0 & 0 \end{bmatrix} + F \begin{bmatrix} 0 & 1 & 0 & 0 \\ 0 & 1 & 0 & 1 \\ 0 & 0 & 1 & 1 \\ 1 & 0 & 0 & 0 \end{bmatrix} + F \begin{bmatrix} 0 & 0 & 1 & 0 \\ 0 & 0 & 1 & 1 \\ 0 & 1 & 0 & 1 \\ 1 & 0 & 0 & 0 \end{bmatrix}, \quad (2.1.2)$$

and

$$H \begin{bmatrix} 0 & 1 & 0 & 0 \\ 0 & 1 & 0 & 1 \\ 1 & 0 & 0 & 1 \\ 0 & 0 & 1 & 0 \end{bmatrix} = F \begin{bmatrix} 0 & 1 & 0 & 0 \\ 0 & 1 & 0 & 1 \\ 1 & 0 & 0 & 1 \\ 0 & 0 & 1 & 0 \end{bmatrix} + F \begin{bmatrix} 0 & 1 & 0 & 0 \\ 0 & 1 & 1 & 0 \\ 1 & 0 & 1 & 0 \\ 0 & 0 & 0 & 1 \end{bmatrix} + F \begin{bmatrix} 1 & 0 & 0 & 0 \\ 1 & 0 & 0 & 1 \\ 0 & 1 & 0 & 1 \\ 0 & 0 & 1 & 0 \end{bmatrix} + F \begin{bmatrix} 1 & 0 & 0 & 0 \\ 1 & 0 & 1 & 0 \\ 0 & 1 & 1 & 0 \\ 0 & 0 & 0 & 1 \end{bmatrix}. \quad (2.1.3)$$

PROPOSITION 2.1.1. *The elements appearing in a product of  $\text{PM}_k$  expressed in the fundamental basis form an interval for the  $\leq_{\text{PM}}$ -partial order. More precisely, for any  $k$ -packed matrices  $M_1$  and  $M_2$ ,*

$$F_{M_1} \cdot F_{M_2} = \sum_{M_1 / M_2 \leq_{\text{PM}} M \leq_{\text{PM}} M_1 \setminus M_2} F_M. \quad (2.1.4)$$

PROPOSITION 2.1.2. *The product of  $\text{PM}_k$  satisfies, for any  $k$ -packed matrices  $M_1$  and  $M_2$ ,*

$$E_{M_1} \cdot E_{M_2} = E_{M_1 / M_2} \quad \text{and} \quad H_{M_1} \cdot H_{M_2} = H_{M_1 \setminus M_2}. \quad (2.1.5)$$

2.1.3. *Freeness.* Given a  $k$ -packed matrix  $M \neq \emptyset$ , we say that  $M$  is *connected* (resp. *anti-connected*) if, for all  $k$ -packed matrices  $M_1$  and  $M_2$ ,  $M = M_1 / M_2$  (resp.  $M = M_1 \setminus M_2$ ) implies  $M_1 = M$  or  $M_2 = M$ .

THEOREM 2.1.3. *The Hopf bialgebra  $\text{PM}_k$  is freely generated as an associative algebra by the elements  $E_M$  (resp.  $H_M$ ) where the  $M$  are connected (resp. anti-connected)  $k$ -packed matrices.*

Theorem 2.1.3 also implies that  $\text{PMN}_k$  and  $\text{PML}_k$  are freely generated by the  $E_M$  (resp.  $H_M$ ) where the  $M$  are connected (resp. anti-connected)  $k$ -packed matrices. Hence, the generating series  $\mathcal{G}_{k,n}(t)$  and  $\mathcal{G}_{k,\ell}(t)$  of algebraic generators of  $\text{PMN}_k$  and  $\text{PML}_k$  satisfy respectively

$$\mathcal{G}_{k,n}(t) = 1 - \frac{1}{\mathcal{H}_{k,n}(t)} \quad \text{and} \quad \mathcal{G}_{k,\ell}(t) = 1 - \frac{1}{\mathcal{H}_{k,\ell}(t)}. \quad (2.1.6)$$

The first few numbers of algebraic generators of  $\text{PMN}_1$  and  $\text{PMN}_2$  are respectively

$$0, 1, 6, 252, 40944, 24912120, 57316485000 \quad (2.1.7)$$

and

$$0, 2, 52, 15848, 39089872, 813573857696, 147659027604370240. \quad (2.1.8)$$

These are respectively Sequences A230881 and A230882 of [Slo]. The first few numbers of algebraic generators of  $\text{PML}_1$  and  $\text{PML}_2$  are respectively

$$0, 1, 1, 7, 51, 497, 5865, 81305, 1293333 \quad (2.1.9)$$



and

$$0, 2, 4, 56, 816, 15904, 375360, 10407040, 331093248. \quad (2.1.10)$$

These are respectively Sequences **A230883** and **A230884** of **[Slo]**.

**2.2. Self-duality.** The product and the coproduct of the dual of  $\text{PM}_k$  are described here. Moreover, the fact that  $\text{PM}_k$  is a self-dual Hopf bialgebra is shown.

**2.2.1. Dual Hopf bialgebra.** Let us denote by  $\text{PM}_k^*$  the bigraded dual vector space of  $\text{PM}_k$ , by  $F_M^*$ , where the  $M$  are  $k$ -packed matrices, the adjoint basis of the fundamental basis of  $\text{PM}_k$ , and by  $\langle -, - \rangle$  the associated duality bracket (see (1.1.17) of Chapter 2).

Let  $M_1$  and  $M_2$  be two  $k$ -packed matrices of respective sizes  $n_1$  and  $n_2$ . By duality, the product in  $\text{PM}_k^*$  satisfies

$$F_{M_1}^* \cdot F_{M_2}^* = \sum_{M \in \mathcal{P}_k} \langle \Delta(F_M), F_{M_1}^* \otimes F_{M_2}^* \rangle F_M^*. \quad (2.2.1)$$

Let us set

$$M_1 \bullet n_2 := \left[ M_1 \mid Z_{n_2}^{n_1} \right] \quad \text{and} \quad n_1 \bullet M_2 := \left[ Z_{n_1}^{n_2} \mid M_2 \right]. \quad (2.2.2)$$

The *row shifted shuffle*  $M_1 * M_2$  of  $M_1$  and  $M_2$  is the set of all matrices obtained by shuffling the rows of  $M_1 \bullet n_2$  with the rows of  $n_1 \bullet M_2$ . By a routine computation, we obtain the following expression for the product of  $\text{PM}_k^*$ :

$$F_{M_1}^* \cdot F_{M_2}^* = \sum_{M \in M_1 * M_2} F_M^*. \quad (2.2.3)$$

For instance, in  $\text{PM}_1^*$  one has

$$F_{\begin{bmatrix} 0 & 1 \\ 1 & 1 \end{bmatrix}}^* \cdot F_{\begin{bmatrix} 1 & 0 \\ 0 & 1 \end{bmatrix}}^* = F_{\begin{bmatrix} 0 & 1 & 0 & 0 \\ 1 & 1 & 0 & 0 \\ 0 & 0 & 1 & 0 \\ 0 & 0 & 0 & 1 \end{bmatrix}}^* + F_{\begin{bmatrix} 0 & 1 & 0 & 0 \\ 0 & 0 & 1 & 0 \\ 1 & 1 & 0 & 0 \\ 0 & 0 & 0 & 1 \end{bmatrix}}^* + F_{\begin{bmatrix} 0 & 0 & 1 & 0 \\ 0 & 1 & 0 & 0 \\ 1 & 1 & 0 & 0 \\ 0 & 0 & 0 & 1 \end{bmatrix}}^* + F_{\begin{bmatrix} 0 & 1 & 0 & 0 \\ 0 & 0 & 1 & 0 \\ 0 & 0 & 0 & 1 \\ 1 & 1 & 0 & 0 \end{bmatrix}}^* + F_{\begin{bmatrix} 0 & 0 & 1 & 0 \\ 0 & 1 & 0 & 0 \\ 0 & 0 & 0 & 1 \\ 0 & 1 & 0 & 0 \end{bmatrix}}^* + F_{\begin{bmatrix} 0 & 0 & 1 & 0 \\ 0 & 0 & 0 & 1 \\ 0 & 1 & 0 & 0 \\ 1 & 1 & 0 & 0 \end{bmatrix}}^*. \quad (2.2.4)$$

Let  $M$  be a  $k$ -packed matrix. By duality, the coproduct in  $\text{PM}_k^*$  satisfies

$$\Delta(F_M^*) = \sum_{M_1, M_2 \in \mathcal{P}_k} \langle F_{M_1} \cdot F_{M_2}, F_M^* \rangle F_{M_1}^* \otimes F_{M_2}^*. \quad (2.2.5)$$

By a routine computation, we obtain the following expression for the coproduct of  $\text{PM}_k^*$ :

$$\Delta(F_M^*) = \sum_{M = M_1 \circ M_2} F_{\text{cp}(M_1)}^* \otimes F_{\text{cp}(M_2)}^*. \quad (2.2.6)$$

For instance, in  $\text{PM}_1^*$  one has

$$\Delta F_{\begin{bmatrix} 0 & 0 & 1 & 0 \\ 0 & 0 & 0 & 1 \\ 1 & 0 & 0 & 0 \\ 1 & 1 & 0 & 0 \end{bmatrix}}^* = F_{\begin{bmatrix} 0 & 0 & 1 & 0 \\ 0 & 0 & 0 & 1 \\ 1 & 0 & 0 & 0 \\ 1 & 1 & 0 & 0 \end{bmatrix}}^* \otimes F_{\emptyset}^* + F_{\begin{bmatrix} 1 & 0 \\ 1 & 1 \end{bmatrix}}^* \otimes F_{\begin{bmatrix} 1 & 0 \\ 0 & 1 \end{bmatrix}}^* + F_{\begin{bmatrix} 0 & 0 & 1 \\ 1 & 0 & 0 \\ 1 & 1 & 0 \end{bmatrix}}^* \otimes F_{[1]}^* + F_{\emptyset}^* \otimes F_{\begin{bmatrix} 0 & 0 & 1 & 0 \\ 0 & 0 & 0 & 1 \\ 1 & 0 & 0 & 0 \\ 1 & 1 & 0 & 0 \end{bmatrix}}^*. \quad (2.2.7)$$

Let us denote by  $M^\top$  the transpose of  $M$ .

**PROPOSITION 2.2.1.** *The map  $\phi : \text{PM}_k \rightarrow \text{PM}_k^*$  linearly defined for any  $k$ -packed matrix  $M$  by*

$$\phi(F_M) := F_{M^\top}^* \quad (2.2.8)$$

*is a Hopf isomorphism.*

Since the transpose of any packed matrix of  $\mathcal{P}_{k,n,\ell}$  also belongs to  $\mathcal{P}_{k,n,\ell}$ , Proposition 2.2.1 also implies that  $\text{PMN}_k$  and  $\text{PML}_k$  are self-dual for the isomorphism  $\phi$ .

2.2.2. *Primitive elements.* For any  $k$ -packed matrix  $M$ , define

$$W^M := F_{M_1}^* \cdots F_{M_r}^* \tag{2.2.9}$$

where the  $M_i$  are connected packed matrices (see Section 2.1.3) and  $M = M_1 / \dots / M_r$ . Then, we have

$$W^M = F_M^* + \sum_{M' \in R} F_{M'}^* \tag{2.2.10}$$

where any matrix  $M'$  of  $R$  satisfies  $M^\top \leq_{\text{PM}} M'^\top$  since the product in  $\text{PM}_k^*$  consists in shifting and shuffling rows of matrices. Thus, by triangularity, the  $W^M$  form a basis of  $\text{PM}_k^*$ . Moreover, for any  $k$ -packed matrices  $M_1$  and  $M_2$ , the product of  $\text{PM}_k^*$  can be expressed as

$$W^{M_1} \cdot W^{M_2} = W^{M_1 / M_2}. \tag{2.2.11}$$

Let us denote by  $V_M$ , where the  $M$  are  $k$ -packed matrices, the adjoint elements of the  $W^M$ .

PROPOSITION 2.2.2. *The elements  $V_M$ , where  $M$  are connected  $k$ -packed matrices, form a basis of the vector space of primitive elements of  $\text{PM}_k$ .*

By Proposition 2.2.2, the  $V_M$ , where  $M$  are connected  $k$ -packed matrices, generate the Lie algebra of primitive elements of  $\text{PM}_k$ . The first few dimensions of the Lie algebras of primitive elements of  $\text{PMN}_1$ ,  $\text{PMN}_2$ ,  $\text{PML}_1$ ,  $\text{PML}_2$  are respectively given by (2.1.7), (2.1.8), (2.1.9), and (2.1.10).

**2.3. Bidendriform bialgebra structure.** We show here that  $\text{PM}_k$  admits a bidendriform bialgebra structure [Foi07] (see also Section 2.3.3 of Chapter 2).

2.3.1. *Dendriform algebra structure.* We denote by  $\text{PM}_k^+$  the subspace of  $\text{PM}_k$  restricted on nonempty matrices. For any nonempty matrix  $M$ , we shall denote by  $\text{last}_c(M)$  its last column. Let us endow  $\text{PM}_k^+$  with two products  $<$  and  $>$  linearly defined, for any nonempty  $k$ -packed matrices  $M_1$  and  $M_2$  of respective sizes  $n_1$  and  $n_2$ , by

$$F_{M_1} < F_{M_2} := \sum_{\substack{M \in M_1 \boxplus M_2 \\ \text{last}_c(M) = \text{last}_c(M_1 \circ n_2)}} F_M \tag{2.3.1}$$

and

$$F_{M_1} > F_{M_2} := \sum_{\substack{M \in M_1 \boxplus M_2 \\ \text{last}_c(M) = \text{last}_c(n_1 \circ M_2)}} F_M. \tag{2.3.2}$$

In other words, the matrices appearing in a  $<$ -product (resp.  $>$ -product) on the fundamental basis involving  $M_1$  and  $M_2$  are the matrices  $M$  obtained by shifting and shuffling the columns of  $M_1$  and  $M_2$  such that the last column of  $M$  comes from  $M_1$  (resp.  $M_2$ ). For example,

$$F \begin{bmatrix} 0 & 1 \\ 1 & 1 \end{bmatrix} < F \begin{bmatrix} 1 & 0 \\ 0 & 1 \end{bmatrix} = F \begin{bmatrix} 0 & 0 & 0 & 1 \\ 1 & 0 & 0 & 1 \\ 0 & 1 & 0 & 0 \\ 0 & 0 & 1 & 0 \end{bmatrix} + F \begin{bmatrix} 0 & 0 & 0 & 1 \\ 0 & 1 & 0 & 1 \\ 1 & 0 & 0 & 0 \\ 0 & 0 & 1 & 0 \end{bmatrix} + F \begin{bmatrix} 0 & 0 & 0 & 1 \\ 0 & 0 & 1 & 1 \\ 1 & 0 & 0 & 0 \\ 0 & 1 & 0 & 0 \end{bmatrix}, \tag{2.3.3a}$$

$$F \begin{bmatrix} 0 & 1 \\ 1 & 1 \end{bmatrix} \succ F \begin{bmatrix} 1 & 0 \\ 0 & 1 \end{bmatrix} = F \begin{bmatrix} 0 & 1 & 0 & 0 \\ 1 & 1 & 0 & 0 \\ 0 & 0 & 1 & 0 \\ 0 & 0 & 0 & 1 \end{bmatrix} + F \begin{bmatrix} 0 & 0 & 1 & 0 \\ 1 & 0 & 1 & 0 \\ 0 & 1 & 0 & 0 \\ 0 & 0 & 0 & 1 \end{bmatrix} + F \begin{bmatrix} 0 & 0 & 1 & 0 \\ 0 & 1 & 1 & 0 \\ 1 & 0 & 0 & 0 \\ 0 & 0 & 0 & 1 \end{bmatrix}. \quad (2.3.3b)$$

Since the last column of any matrix appearing in the shifted shuffle of two matrices comes from exactly of the two operands, for any nonempty packed matrices  $M_1$  and  $M_2$ , one obviously has

$$F_{M_1} \cdot F_{M_2} = F_{M_1} \prec F_{M_2} + F_{M_1} \succ F_{M_2}. \quad (2.3.4)$$

**PROPOSITION 2.3.1.** *The Hopf algebra  $\text{PM}_k$  admits a dendriform algebra structure for the products  $\prec$  and  $\succ$ .*

**2.3.2. Codendriform coalgebra structure.** For any nonempty matrix  $M$ , we shall denote by  $\text{last}_r(M)$  its last row. Let us endow  $\text{PM}_k$  with two coproducts  $\Delta_\prec$  and  $\Delta_\succ$  linearly defined, for any nonempty  $k$ -packed matrix  $M$ , by

$$\Delta_\prec(F_M) := \sum_{\substack{M=L \bullet R \\ \text{last}_r(L \bullet r) = \text{last}_r(M)}} F_{\text{cp}(L)} \otimes F_{\text{cp}(R)} \quad (2.3.5)$$

and

$$\Delta_\succ(F_M) := \sum_{\substack{M=L \bullet R \\ \text{last}_r(\ell \bullet R) = \text{last}_r(M)}} F_{\text{cp}(L)} \otimes F_{\text{cp}(R)}, \quad (2.3.6)$$

where  $r$  (resp.  $\ell$ ) is the number of columns of  $R$  (resp.  $L$ ). In other words, the pairs of matrices appearing in a  $\Delta_\prec$ -coproduct (resp.  $\Delta_\succ$ -coproduct) in the fundamental basis are the pairs  $(L, R)$  of packed matrices such that the last row of  $L$  (resp.  $R$ ) comes from the last row of  $M$ . For example,

$$\Delta_\prec F \begin{bmatrix} 1 & 0 & 0 & 0 & 0 & 0 \\ 0 & 1 & 1 & 0 & 0 & 0 \\ 0 & 0 & 0 & 0 & 0 & 1 \\ 0 & 0 & 0 & 1 & 0 & 0 \\ 0 & 0 & 0 & 1 & 1 & 0 \\ 0 & 0 & 1 & 0 & 0 & 0 \end{bmatrix} = F \begin{bmatrix} 1 & 0 & 0 \\ 0 & 1 & 1 \\ 0 & 0 & 1 \end{bmatrix} \otimes F \begin{bmatrix} 0 & 0 & 1 \\ 1 & 0 & 0 \end{bmatrix} + F \begin{bmatrix} 1 & 0 & 0 & 0 & 0 \\ 0 & 1 & 1 & 0 & 0 \\ 0 & 0 & 0 & 1 & 0 \\ 0 & 0 & 0 & 1 & 1 \\ 0 & 0 & 1 & 0 & 0 \end{bmatrix} \otimes F_{[1]}, \quad (2.3.7a)$$

$$\Delta_\succ F \begin{bmatrix} 1 & 0 & 0 & 0 & 0 & 0 \\ 0 & 1 & 1 & 0 & 0 & 0 \\ 0 & 0 & 0 & 0 & 0 & 1 \\ 0 & 0 & 0 & 1 & 0 & 0 \\ 0 & 0 & 0 & 1 & 1 & 0 \\ 0 & 0 & 1 & 0 & 0 & 0 \end{bmatrix} = F_{[1]} \otimes F \begin{bmatrix} 1 & 1 & 0 & 0 & 0 \\ 0 & 0 & 0 & 0 & 1 \\ 0 & 0 & 1 & 0 & 0 \\ 0 & 0 & 1 & 1 & 0 \\ 0 & 1 & 0 & 0 & 0 \end{bmatrix}. \quad (2.3.7b)$$

Since by Lemma 1.1.1, one cannot vertically split a packed matrix by separating two nonzero entries on a same row, for any nonempty packed matrix  $M$ , one has

$$\Delta(F_M) = 1 \otimes F_M + \Delta_\prec(F_M) + \Delta_\succ(F_M) + F_M \otimes 1. \quad (2.3.8)$$

**PROPOSITION 2.3.2.** *The Hopf algebra  $\text{PM}_k$  admits a codendriform coalgebra structure for the coproducts  $\Delta_\prec$  and  $\Delta_\succ$ .*

**2.3.3. Bidendriform bialgebra structure.**

**THEOREM 2.3.3.** *The Hopf bialgebra  $\text{PM}_k$  admits a bidendriform bialgebra structure for the products  $\prec, \succ$  and the coproducts  $\Delta_\prec, \Delta_\succ$ .*

Theorem 2.3.3 also implies that  $\text{PMN}_k$  and  $\text{PML}_k$  admit a bidendriform bialgebra structure. Following [Foi07], the generating series  $\mathcal{T}_{k,n}(t)$  and  $\mathcal{T}_{k,\ell}(t)$  of totally primitive elements of  $\text{PMN}_k$  and  $\text{PML}_k$  satisfy respectively

$$\mathcal{T}_{k,n}(t) = \frac{\mathcal{F}_{k,n}(t) - 1}{\mathcal{F}_{k,n}(t)^2} \quad \text{and} \quad \mathcal{T}_{k,\ell}(t) = \frac{\mathcal{F}_{k,\ell}(t) - 1}{\mathcal{F}_{k,\ell}(t)^2}. \quad (2.3.9)$$

The first few dimensions of totally primitive elements of  $\text{PMN}_1$  and  $\text{PMN}_2$  are respectively

$$0, 1, 5, 240, 40404, 24827208, 57266105928 \quad (2.3.10)$$

and

$$0, 2, 48, 15640, 39023776, 813415850016, 147655768992433664. \quad (2.3.11)$$

There are respectively Sequences A230885 and A230886 of [Slo]. The first few dimensions of totally primitive elements of  $\text{PML}_1$  and  $\text{PML}_2$  are respectively

$$0, 1, 0, 5, 36, 381, 4720, 67867, 1109434 \quad (2.3.12)$$

and

$$0, 2, 0, 40, 576, 12192, 302080, 8686976, 284015104. \quad (2.3.13)$$

These are respectively Sequences A230887 and A230888 of [Slo].

### 3. Related Hopf bialgebras

In this section, we describe links between  $\text{PM}_k$  and some already known Hopf bialgebras. Next, we provide a method to construct Hopf sub-bialgebras of  $\text{PM}_k$ .

**3.1. Links with known bialgebras.** We consider here the Hopf bialgebras of  $k$ -colored permutations, of uniform block permutations, and of matrix quasi-symmetric functions.

**3.1.1. Hopf bialgebra of colored permutations.** The Hopf bialgebra  $\text{FQSym}^{(k)}$  of  $k$ -colored permutations is introduced in [NT10] (see also Section 3.2.5 of Chapter 2).

**PROPOSITION 3.1.1.** *The map  $\alpha_k : \text{FQSym}^{(k)} \rightarrow \text{PMN}_k$  linearly defined, for any  $k$ -colored permutation  $(\sigma, c)$  by*

$$\alpha_k(F_{(\sigma,c)}) := F_{M^{(\sigma,c)}} \quad (3.1.1)$$

where  $M^{(\sigma,c)}$  is the  $k$ -packed matrix satisfying  $M_{ij}^{(\sigma,c)} = c_j \delta_{i,\sigma_j}$  is an injective Hopf morphism.

In particular, Proposition 3.1.1 shows that  $\text{PMN}_1$  contains  $\text{FQSym}$ . Notice that the map  $\alpha_k$  is still well-defined on the codomain  $\text{PML}_k$  instead of  $\text{PMN}_k$ .

3.1.2. *Hopf bialgebra of uniform block permutations.* The Hopf bialgebra UBP of uniform block permutations is introduced in [AO08] (see also Section 3.2.6 of Chapter 2).

PROPOSITION 3.1.2. *The map  $\beta : \text{UBP}^* \rightarrow \text{PMN}_1$  linearly defined, for any UBP  $\pi$  by*

$$\beta(F_\pi^*) := F_{M^\pi} \quad (3.1.2)$$

where  $M^\pi$  is the 1-packed matrix satisfying

$$M_{ij}^\pi := \begin{cases} 1 & \text{if there is } e \in \pi^d \text{ such that } j \in e \text{ and } i \in \pi(e), \\ 0 & \text{otherwise.} \end{cases} \quad (3.1.3)$$

is an injective Hopf morphism.

For example, if  $\pi$  is the UBP defined by

$$\pi(\{1, 4, 5\}) := \{2, 5, 6\}, \quad \pi(\{2\}) := \{1\}, \quad \text{and} \quad \pi(\{3, 6\}) := \{3, 4\}, \quad (3.1.4)$$

we have

$$\beta(F_\pi^*) = F \begin{bmatrix} 0 & 1 & 0 & 0 & 0 & 0 & 1 \\ 1 & 0 & 0 & 1 & 1 & 0 & 0 \\ 0 & 0 & 1 & 0 & 0 & 1 & 0 \\ 0 & 0 & 1 & 0 & 0 & 1 & 0 \\ 1 & 0 & 0 & 1 & 1 & 0 & 0 \\ 1 & 0 & 0 & 1 & 1 & 0 & 0 \end{bmatrix}. \quad (3.1.5)$$

The existence of this particular morphism  $\beta$  exhibited by Proposition 3.1.2 implies that  $\text{UBP}^*$  is free (as an associative algebra), cofree (as a coassociative coalgebra), self-dual, and admits bidendriform bialgebra structure.

Besides, by using same arguments as those used in Section 2.1, one can build multiplicative bases of  $\text{UBP}^*$  by setting, for any UBP  $\pi$ ,

$$E_{M^\pi}^* := \sum_{M^\pi \leq_{\text{PM}} M^{\pi'}} F_{M^{\pi'}} \quad \text{and} \quad H_{M^\pi}^* := \sum_{M^{\pi'} \leq_{\text{PM}} M^\pi} F_{M^{\pi'}}. \quad (3.1.6)$$

This gives another way to prove the freeness of  $\text{UBP}^*$  by using same arguments as those of Theorem 2.1.3. Hence,  $\text{UBP}^*$  is freely generated by the elements  $E_{M^\pi}^*$  (resp.  $H_{M^\pi}^*$ ) where the  $\pi$  are UBPs such that the  $M^\pi$  are connected (resp. anti-connected) 1-packed matrices. The first few numbers of algebraic generators of  $\text{UBP}^*$  are

$$0, 1, 2, 11, 98, 1202, 19052, 375692, 8981392, 255253291, 8488918198 \quad (3.1.7)$$

and the first few dimensions of totally primitive elements are

$$0, 1, 1, 7, 72, 962, 16135, 330624, 8117752, 235133003, 7929041828. \quad (3.1.8)$$

These are Sequence A230889 and A230890 of [Slo].

Moreover, since for any UBP  $\pi$ , there exists a UBP  $\pi^{-1}$  such that the transpose of  $M^\pi$  is  $M^{\pi^{-1}}$ , by Proposition 2.2.1, the map  $\phi : \text{UBP}^* \rightarrow \text{UBP}$  linearly defined for any UBP  $\pi$  by

$$\phi(F_{M^\pi}^*) := F_{M^{\pi^{-1}}} \quad (3.1.9)$$

is an isomorphism.

3.1.3. *Algebra of matrix quasi-symmetric functions.* The Hopf algebra of matrix quasi-symmetric functions is introduced in [DHT02] (see also [Hiv99] and Section 3.2.3 of Chapter 2).

Let us endow the set of matrices indexing MQSym with a binary relation  $\rightarrow$  defined in the following way. If  $M_1$  and  $M_2$  are two matrices such that  $M_1$  has  $n$  rows and  $m$  columns, we have  $M_1 \rightarrow M_2$  if there is an index  $i \in [n - 1]$  such that, denoting by  $z_i$  the number of 0 which end the  $i$ th row of  $M_1$ , and by  $z_{i+1}$  the number of 0 which start the  $(i + 1)$ st row of  $M_1$ , one has  $z_i + z_{i+1} \geq m$  and  $M_2$  is obtained from  $M_1$  by overlaying its  $i$ th and  $(i + 1)$ st rows (see Figure 8.3).

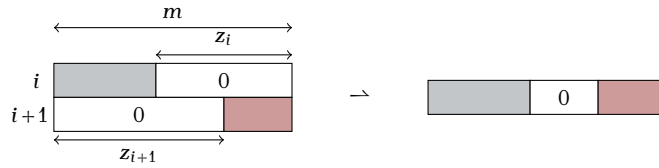

FIGURE 8.3. The condition for overlaying the  $i$ th and  $(i + 1)$ st rows of a (not necessarily square) packed matrix according to the relation  $\rightarrow$ . The darker regions contain any entries and the white ones, only zeros.

We now endow the set of matrices that index MQSym with the partial order relation  $\leq_{\text{MQ}}$  defined as the reflexive and transitive closure of  $\rightarrow$ . Figure 8.4 shows an interval of this partial order.

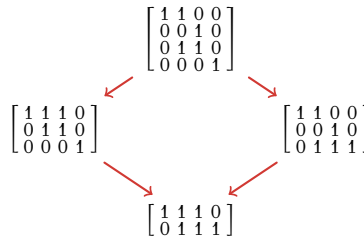

FIGURE 8.4. The Hasse diagram of an interval for the order  $\leq_{\text{MQ}}$  on (not necessarily square) packed matrices.

PROPOSITION 3.1.3. *The map  $\gamma : \text{PML}_1^* \rightarrow \text{MQSym}$  linearly defined, for any 1-packed matrix  $M$  by*

$$\gamma(F_M^*) := \sum_{M \leq_{\text{MQ}} M'} M_{M'}, \tag{3.1.10}$$

*is an injective associative algebra morphism.*

For instance, one has

$$\gamma \left( F^* \begin{pmatrix} 1 & 1 & 0 & 0 \\ 0 & 0 & 1 & 0 \\ 0 & 1 & 1 & 0 \\ 0 & 0 & 0 & 1 \end{pmatrix} \right) = M \begin{pmatrix} 1 & 1 & 0 & 0 \\ 0 & 0 & 1 & 0 \\ 0 & 1 & 1 & 0 \\ 0 & 0 & 0 & 1 \end{pmatrix} + M \begin{pmatrix} 1 & 1 & 1 & 0 \\ 0 & 1 & 1 & 0 \\ 0 & 0 & 0 & 1 \end{pmatrix} + M \begin{pmatrix} 1 & 1 & 0 & 0 \\ 0 & 0 & 1 & 0 \\ 0 & 1 & 1 & 1 \end{pmatrix} + M \begin{pmatrix} 1 & 1 & 1 & 0 \\ 0 & 1 & 1 & 1 \end{pmatrix}. \quad (3.1.11)$$

Notice that  $\gamma$  is not a Hopf morphism since it is not a coassociative coalgebra morphism. Indeed, we have

$$\Delta \left( \gamma \left( F^* \begin{pmatrix} 1 & 1 \\ 1 & 0 \end{pmatrix} \right) \right) = 1 \otimes M \begin{pmatrix} 1 & 1 \\ 1 & 0 \end{pmatrix} + M \begin{pmatrix} 1 & 1 \\ 1 & 0 \end{pmatrix} \otimes 1, \quad (3.1.12)$$

but

$$(\gamma \otimes \gamma) \left( \Delta \left( F^* \begin{pmatrix} 1 & 1 \\ 1 & 0 \end{pmatrix} \right) \right) = 1 \otimes M \begin{pmatrix} 1 & 1 \\ 1 & 0 \end{pmatrix} + M \begin{pmatrix} 1 & 1 \\ 1 & 0 \end{pmatrix} \otimes M \begin{pmatrix} 1 & 1 \\ 1 & 0 \end{pmatrix} + M \begin{pmatrix} 1 & 1 \\ 1 & 0 \end{pmatrix} \otimes 1. \quad (3.1.13)$$

3.1.4. *Diagram of embeddings.* The diagram of Figure 8.5 summarizes the relations between known Hopf algebras related to  $PM_k$  and, more specifically, to its simply graded versions  $PMN_k$  and  $PML_k$ . The Hopf bialgebra ASM is the subject of Section 4.

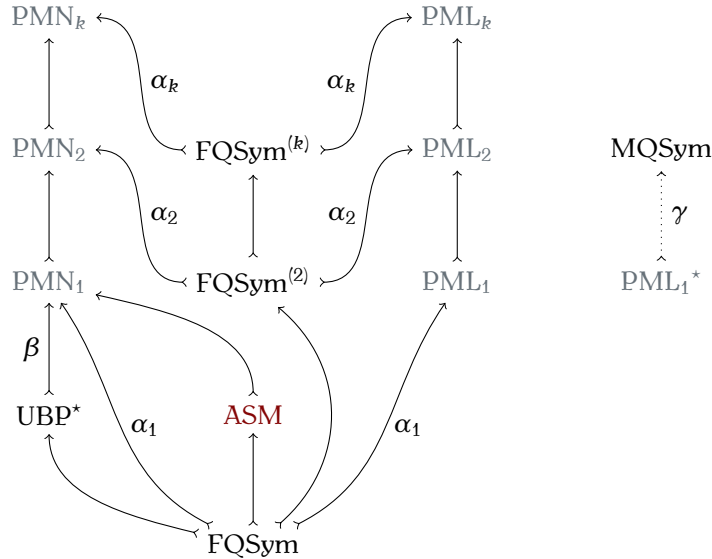

FIGURE 8.5. The diagram of Hopf bialgebras of packed matrices and related structures. Arrows  $\rightarrow$  are injective Hopf bialgebra morphisms. The dotted arrow is an associative algebra morphism.

3.2. **Equivalence relations and Hopf sub-bialgebras.** We provide here a way to construct Hopf sub-bialgebras of  $PM_k$  analogous to the way using congruences to construct Hopf sub-bialgebras of  $FQSym$  (see Section 3.2.4 of Chapter 2).

3.2.1. *The monoid of words of columns.* Let  $C_k^*$  be the free monoid generated by the set  $C_k$  of all  $n \times 1$ -matrices with entries in  $A_k$ , for all  $n \geq 1$ . In other words, the elements of  $C_k^*$  are words whose letters are columns and its product  $\bullet$  is the concatenation of such words. When all the letters of an element  $M \in C_k^*$  have, as columns, a same number of rows,  $M$  is a matrix and we shall denote it as such in the sequel.

The alphabet  $C_k$  is naturally equipped with the total order  $\leq$  where, for any  $c_1, c_2 \in C_k$ ,  $c_1 \leq c_2$  if and only if the bottom to top reading of the column  $c_1$  is lexicographically smaller than the bottom to top reading of  $c_2$ . For instance,

$$\begin{bmatrix} 1 \\ 0 \end{bmatrix} \leq \begin{bmatrix} 0 \\ 1 \end{bmatrix}, \quad \begin{bmatrix} 0 \\ 1 \\ 0 \\ 1 \end{bmatrix} \leq \begin{bmatrix} 0 \\ 0 \\ 1 \\ 1 \end{bmatrix}, \quad \begin{bmatrix} 1 \\ 0 \end{bmatrix} \leq \begin{bmatrix} 0 \\ 1 \\ 1 \end{bmatrix}, \quad \begin{bmatrix} 2 \\ 1 \\ 0 \end{bmatrix} \leq \begin{bmatrix} 1 \\ 2 \\ 0 \end{bmatrix}. \quad (3.2.1)$$

Since  $C_k$  is then totally ordered and  $C_k^*$  is a free monoid, one can consider the previous two congruences on  $C_k^*$  instead on  $A^*$ . For instance, Figure 8.6 represents a  $\leftrightarrow_S$ -equivalence class and a  $\leftrightarrow_P$ -equivalence class of packed matrices.

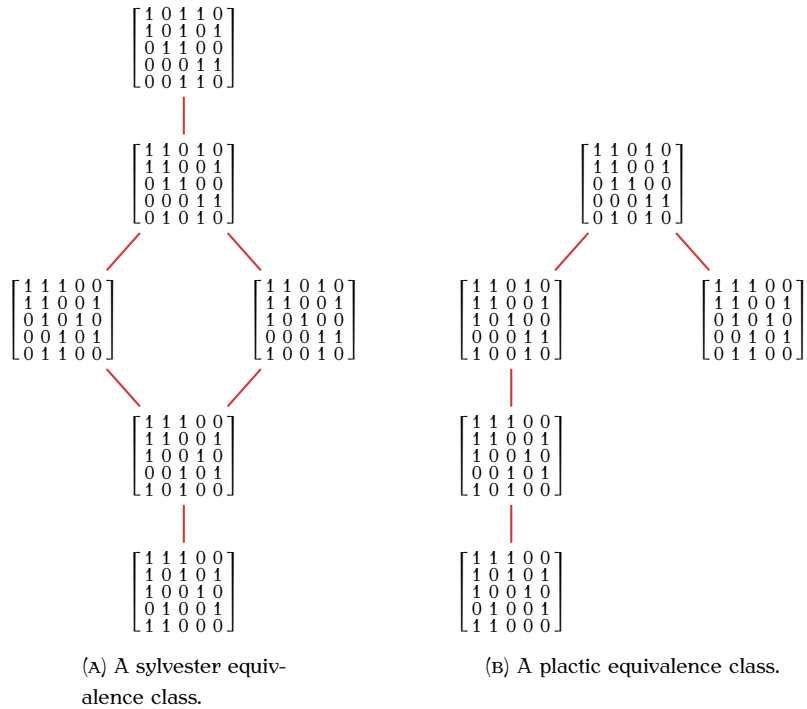

FIGURE 8.6. Two equivalence classes of packed matrices.

The order relation  $\leq$  on  $C_k$  is compatible with the shifted shuffle of packed matrices in the following sense. Let  $M_1$  and  $M_2$  be two nonempty packed matrices and  $M$  be a matrix appearing in  $M_1 \sqcup M_2$ . Then, if  $c_1$  (resp.  $c_2$ ) is a column of  $M$  coming from  $M_1$  (resp.  $M_2$ ), we necessarily have  $c_1 \leq c_2$  and  $c_1 \neq c_2$ . The obvious analogous property holds for words of  $A^*$  and the shifted shuffle of words.



**3.2.2. Properties of equivalence relations.** An equivalence relation  $\leftrightarrow$  on  $C_k^*$  is *compatible with the restriction to alphabet intervals* if for any interval  $I$  of  $C_k$  and for all  $u, v \in C_k^*$ ,  $u \leftrightarrow v$  implies  $u|_I \leftrightarrow v|_I$ , where  $u|_I$  denotes the word obtained by erasing in  $u$  the letters that are not in  $I$ .

Finally, we say that  $\leftrightarrow$  is *compatible with the decompression process* if for all  $u, v \in C_k^*$  such that  $u$  and  $v$  are matrices,  $u \leftrightarrow v$  if and only if  $\text{cp}(u) \leftrightarrow \text{cp}(v)$  and  $u$  and  $v$  have the same commutative image.

**3.2.3. Construction of Hopf sub-bialgebras.** Given an equivalence relation  $\leftrightarrow$  on the words of  $C_k^*$  and a  $\leftrightarrow$ -equivalence class  $[M]_{\leftrightarrow}$  of packed matrices of  $C_k^*$ , we consider the elements

$$P_{[M]_{\leftrightarrow}} := \sum_{M' \in [M]_{\leftrightarrow}} F_{M'} \quad (3.2.2)$$

of  $\text{PM}_k$ .

One has for instance

$$P_{\left[ \begin{bmatrix} 1 & 1 & 0 & 1 & 0 \\ 1 & 1 & 0 & 0 & 1 \\ 0 & 1 & 1 & 0 & 0 \\ 0 & 0 & 0 & 1 & 1 \\ 0 & 1 & 0 & 1 & 0 \end{bmatrix} \right]_{\leftrightarrow}} = F_{\begin{bmatrix} 1 & 1 & 0 & 1 & 0 \\ 1 & 1 & 0 & 0 & 1 \\ 0 & 1 & 1 & 0 & 0 \\ 0 & 0 & 0 & 1 & 1 \\ 0 & 1 & 0 & 1 & 0 \end{bmatrix}} + F_{\begin{bmatrix} 1 & 1 & 0 & 1 & 0 \\ 1 & 1 & 0 & 0 & 1 \\ 1 & 0 & 1 & 0 & 0 \\ 0 & 0 & 0 & 1 & 1 \\ 1 & 0 & 0 & 1 & 0 \end{bmatrix}} + F_{\begin{bmatrix} 1 & 1 & 1 & 0 & 0 \\ 1 & 1 & 0 & 0 & 1 \\ 0 & 1 & 0 & 1 & 0 \\ 0 & 0 & 1 & 0 & 1 \\ 0 & 1 & 1 & 0 & 0 \end{bmatrix}} + F_{\begin{bmatrix} 1 & 1 & 1 & 0 & 0 \\ 1 & 1 & 0 & 0 & 1 \\ 1 & 0 & 0 & 1 & 0 \\ 0 & 0 & 1 & 0 & 1 \\ 1 & 0 & 1 & 0 & 0 \end{bmatrix}} + F_{\begin{bmatrix} 1 & 1 & 1 & 0 & 0 \\ 1 & 0 & 1 & 0 & 1 \\ 1 & 0 & 0 & 1 & 0 \\ 0 & 1 & 0 & 0 & 1 \\ 1 & 1 & 0 & 0 & 0 \end{bmatrix}}. \quad (3.2.3)$$

In particular, if  $\leftrightarrow$  is compatible with the decompression process, any  $\leftrightarrow$ -equivalence class of a packed matrix only contains packed matrices. The family  $P_{[M]_{\leftrightarrow}}$ , where the  $[M]_{\leftrightarrow}$  are  $\leftrightarrow$ -equivalence classes of packed matrices, forms then a basis of a vector subspace of  $\text{PM}_k$  denoted by  $\text{PM}_k^{\leftrightarrow}$ .

**THEOREM 3.2.1.** *Let  $\leftrightarrow$  be an equivalence relation on the words of  $C_k^*$  such that  $\leftrightarrow$*

- (i) *is a monoid congruence on  $C_k^*$ ;*
- (ii) *is compatible with the restriction to alphabet intervals;*
- (iii) *is compatible with the decompression process.*

*Then,  $\text{PM}_k^{\leftrightarrow}$  is a Hopf sub-bialgebra of  $\text{PM}_k$ .*

Let  $\leftrightarrow$  be an equivalence relation on  $C_k^*$  satisfying (i), (ii), and (iii) of Theorem 3.2.1. Note that since  $\leftrightarrow$  is compatible with the decompression process, any matrix contained in a  $\leftrightarrow$ -equivalence class  $[M]_{\leftrightarrow}$  is obtained by switching columns of  $M$ . Then, any  $\leftrightarrow$ -equivalence class  $[M]_{\leftrightarrow}$  of  $k$ -packed matrices only contains matrices whose size and number of nonzero entries are the same as in  $M$ . Hence, Theorem 3.2.1 also implies that the family (3.2.2) forms a basis of Hopf sub-bialgebras of both  $\text{PMN}_k$  and  $\text{PML}_k$ . We respectively denote these by  $\text{PMN}_k^{\leftrightarrow}$  and  $\text{PML}_k^{\leftrightarrow}$ .

**3.2.4. Computer experiments.** By Theorem 3.2.1, the version of sylvester, plactic, Baxter, Bell, hypoplactic, and total equivalence relations (see Section 3.2.4 of Chapter 2) applied to  $C_k^*$  lead to bigraded Hopf sub-bialgebras of  $\text{PM}_k$ . Table 8.2 shows first few dimensions of the Hopf subalgebras of  $\text{PMN}_1$  and  $\text{PML}_1$  obtained from these congruences, computed by computer exploration.

Hopf bialgebra	First dimensions								
$PMN_1^{\leftrightarrow Bx}$	1	1	7	265	38051				
$PMN_1^{\leftrightarrow Bl}$	1	1	7	221	25789				
$PMN_1^{\leftrightarrow S}$	1	1	7	221	24243				
$PMN_1^{\leftrightarrow P}$	1	1	7	177	17339				
$PMN_1^{\leftrightarrow H}$	1	1	7	177	13887				
$PMN_1^{\leftrightarrow T}$	1	1	4	57	2306				
$PML_1^{\leftrightarrow Bx}$	1	1	2	10	68	578	5782	65745	
$PML_1^{\leftrightarrow Bl}$	1	1	2	9	53	390	3389	33881	
$PML_1^{\leftrightarrow S}$	1	1	2	9	52	364	2918	26138	
$PML_1^{\leftrightarrow P}$	1	1	2	8	41	266	1976	16569	
$PML_1^{\leftrightarrow H}$	1	1	2	8	39	220	1396	9716	
$PML_1^{\leftrightarrow T}$	1	1	1	3	11	43	191	939	

TABLE 8.2. First few dimensions of the Hopf sub-bialgebras  $PMN_1^{\leftrightarrow}$  and  $PML_1^{\leftrightarrow}$ , where  $\leftrightarrow$  is successively the Baxter, Bell, Sylvester, plactic, hypoplactic, and total congruence.

### 4. Alternating sign matrices

In this last section of the chapter, we construct and study a Hopf sub-bialgebra of  $PM_1$  whose bases are indexed by ASMs. We provide its main properties and investigate how usual statistics on ASMs behave algebraically inside it.

**4.1. Hopf bialgebra structure.** Let us explain how to encode ASMs by particular 1-packed matrices. As a consequence, we obtain a Hopf bialgebra on ASMs.

4.1.1. *From ASMs to 1-packed matrices.* Let  $\delta$  be an ASM [MRR83] (see also Section 3.4 of Chapter 1). We denote by  $M^\delta$  the matrix satisfying

$$M_{ij}^\delta := \begin{cases} 1 & \text{if } \delta_{ij} \in \{+, -\}, \\ 0 & \text{otherwise.} \end{cases} \tag{4.1.1}$$

For instance,  $\delta$  is the ASM defined by

$$\delta := \begin{bmatrix} 0 & + & 0 & 0 & 0 \\ 0 & 0 & + & 0 & 0 \\ + & - & 0 & 0 & + \\ 0 & + & - & + & 0 \\ 0 & 0 & + & 0 & 0 \end{bmatrix}, \tag{4.1.2}$$

we obtain

$$M^\delta = \begin{bmatrix} 0 & 1 & 0 & 0 & 0 \\ 0 & 0 & 1 & 0 & 0 \\ 1 & 1 & 0 & 0 & 1 \\ 0 & 1 & 1 & 1 & 0 \\ 0 & 0 & 1 & 0 & 0 \end{bmatrix}. \tag{4.1.3}$$

It is immediate that  $M^\delta$  is a 1-packed matrix of the same size as  $\delta$ . Besides, observe that since the + and the - alternate in an ASM, by starting from a 1-packed matrix  $M$ , there is at most one ASM  $\delta$  such that  $M^\delta = M$ .

**4.1.2. Hopf bialgebra structure on ASMs.** Let ASM be the vector space spanned by the set of all ASMs. For any ASM  $\delta$ , let us denote by  $F_\delta$  the element  $F_{M^\delta}$ . Due to the above observation, the family  $F_\delta$ , where  $\delta$  are ASMs, spans ASM. Moreover, since the map  $F_\delta \mapsto F_{M^\delta}$  is an injective morphism from ASM to  $\text{PM}_1$ , this family forms a basis.

The product and the coproduct of  $\text{PM}_1$  induce the product and the coproduct of ASM. For example, we have

$$F \begin{bmatrix} 0 & + & 0 \\ + & - & + \\ 0 & + & 0 \end{bmatrix} \cdot F_{[+]} = F \begin{bmatrix} 0 & + & 0 & 0 \\ + & - & + & 0 \\ 0 & + & 0 & 0 \\ 0 & 0 & 0 & + \end{bmatrix} + F \begin{bmatrix} 0 & + & 0 & 0 \\ + & - & 0 & + \\ 0 & + & 0 & 0 \\ 0 & 0 & + & 0 \end{bmatrix} + F \begin{bmatrix} 0 & 0 & + & 0 \\ + & 0 & - & + \\ 0 & 0 & + & 0 \\ 0 & + & 0 & 0 \end{bmatrix} + F \begin{bmatrix} 0 & 0 & + & 0 \\ 0 & + & - & + \\ 0 & 0 & + & 0 \\ + & 0 & 0 & 0 \end{bmatrix}, \quad (4.1.4)$$

and

$$\Delta F \begin{bmatrix} 0 & + & 0 & 0 \\ 0 & 0 & 0 & + \\ + & - & + & 0 \\ 0 & + & 0 & 0 \end{bmatrix} = F_\emptyset \otimes F \begin{bmatrix} 0 & + & 0 & 0 \\ 0 & 0 & 0 & + \\ + & - & + & 0 \\ 0 & + & 0 & 0 \end{bmatrix} + F \begin{bmatrix} 0 & + & 0 \\ + & - & + \\ 0 & + & 0 \end{bmatrix} \otimes F_{[+]} + F \begin{bmatrix} 0 & + & 0 & 0 \\ 0 & 0 & 0 & + \\ + & - & + & 0 \\ 0 & + & 0 & 0 \end{bmatrix} \otimes F_\emptyset. \quad (4.1.5)$$

**THEOREM 4.1.1.** *The vector space ASM, endowed with the product and coproduct of  $\text{PM}_1$ , forms a free, cofree, and self-dual bigraded Hopf bialgebra which admits a biden-driform bialgebra structure.*

From now on, we shall see ASM as a simply graded Hopf bialgebra so that the degree of any  $F_\delta$ , where  $\delta$  is an ASM, is the size of  $\delta$ . The dimensions of ASM form Sequence **A005130** of **[Slo]** and the first few terms are

$$1, 1, 2, 7, 42, 429, 7436, 218348, 10850216, 911835460, 129534272700. \quad (4.1.6)$$

By using same arguments as those used in Section 2.1, one can build multiplicative bases of ASM by setting, for any ASM  $\delta$ ,

$$E_\delta := \sum_{M^\delta \leq_{\text{PM}} M^{\delta'}} F_{\delta'} \quad \text{and} \quad H_\delta := \sum_{M^{\delta'} \leq_{\text{PM}} M^\delta} F_{\delta'}. \quad (4.1.7)$$

This gives another way to prove the freeness of ASM by using same arguments as those of Theorem 2.1.3. Hence, ASM is freely generated by the elements  $E_\delta$  (resp.  $H_\delta$ ) where the  $\delta$  are ASMs such that the  $M^\delta$  are connected (resp. anti-connected) 1-packed matrices. The first few numbers of algebraic generators of ASM are

$$0, 1, 1, 4, 29, 343, 6536, 202890, 10403135, 889855638, 127697994191 \quad (4.1.8)$$

and the first few dimensions of totally primitive elements are

$$0, 1, 0, 2, 20, 277, 5776, 188900, 9980698, 868571406, 125895356788. \quad (4.1.9)$$

These are respectively Sequences **A231498** and **A231499** of **[Slo]**.

Moreover, since the transpose of an ASM is also an ASM, by Proposition 2.2.1, the map  $\phi : \text{ASM} \rightarrow \text{ASM}^*$  linearly defined for any ASM  $\delta$  by

$$\phi(F_\delta) := F_{\delta^\tau}^* \quad (4.1.10)$$

is an isomorphism.

**4.2. Algebraic interpretation of statistics on ASMs.** We provide algebraic interpretations of very common statistics on ASMs, whose definitions are recalled in Section 3.4 of Chapter 1. These algebraic interpretations rely on the Hopf bialgebra ASM and morphisms from ASM to  $\mathbb{K}(q)$  (see Section 1.2.7 of Chapter 2 for notations about  $q$ -analogs of integers). We also study here algebraic quotients of ASM defined by ideals involving these statistics.

4.2.1. *Maps from ASM to  $q$ -rational functions.* The results presented here are consequences of the following two combinatorial properties, highlighting compatibility between the statistics  $ne, sw, se, nw, oi,$  and  $io$  with the column shifted shuffle product of ASMs.

LEMMA 4.2.1. *Let  $\delta, \delta_1,$  and  $\delta_2$  be three ASMs such that  $M^\delta \in M^{\delta_1} \boxplus M^{\delta_2}$ . Then, for any statistics  $s$  of  $\mathfrak{N}$ ,*

$$s(\delta) = s(\delta_1) + s(\delta_2). \tag{4.2.1}$$

LEMMA 4.2.2. *Let  $\delta, \delta_1,$  and  $\delta_2$  be three ASMs such that  $M^\delta \in M^{\delta_1} \boxplus M^{\delta_2}$ . Let  $m$  be the size of  $\delta_2$  (resp.  $\delta_1$ ) and  $\{k_1 < k_2 < \dots < k_m\}$  be the set of the indices of the columns of  $M^\delta$  coming from  $M^{\delta_2}$  (resp.  $M^{\delta_1}$ ). Then, for any  $s \in \{nw, se\}$  (resp.  $s \in \{sw, ne\}$ ),*

$$s(\delta) = s(\delta_1) + s(\delta_2) + \sum_{1 \leq j \leq m} (k_j - j). \tag{4.2.2}$$

To illustrate Lemmas 4.2.1 and 4.2.2, we show here the product (4.1.4) in ASM, seen on six-vertex configurations, where the vertices represented by squares are of kind  $io$  while those represented by circles are of kind  $nw$ :

$$F \cdot F = F + F + F + F \tag{4.2.3}$$

PROPOSITION 4.2.3. *The maps  $\phi_s : \text{ASM} \rightarrow \mathbb{K}(q)$  and  $\phi'_{s'} : \text{ASM} \rightarrow \mathbb{K}(q)$  linearly defined, for any  $s \in \mathfrak{N}, s' \in \mathfrak{Z}$ , and any ASM  $\delta$  of size  $n$  by*

$$\phi_s(F_\delta) := \frac{q^{s(\delta)}}{n!} \quad \text{and} \quad \phi'_{s'}(F_\delta) := \frac{q^{s'(\delta)}}{(n)_q!} \tag{4.2.4}$$

are associative algebra morphisms.

This previous results remain valid in the dual  $\text{ASM}^*$  of ASM.

PROPOSITION 4.2.4. *The maps  $\psi_s : \text{ASM}^* \rightarrow \mathbb{K}(q)$  and  $\psi'_{s'} : \text{ASM}^* \rightarrow \mathbb{K}(q)$  linearly defined, for any  $s \in \mathfrak{N}, s' \in \mathfrak{Z}$ , and any ASM  $\delta$  of size  $n$  by*

$$\psi_s(F_\delta^*) := \frac{q^{s(\delta)}}{n!} \quad \text{and} \quad \psi'_{s'}(F_\delta^*) := \frac{q^{s'(\delta)}}{(n)_q!} \tag{4.2.5}$$

are associative algebra morphisms.

4.2.2. *Equivalence relations on ASMs and associated subspaces of ASM.* Let  $S \subseteq \mathfrak{S} \cup \mathfrak{N}$  be a set of statistics and  $\sim_S$  be the equivalence relation on the set of ASMs defined, for any ASMs  $\delta_1$  and  $\delta_2$  of the same size, by

$$\delta_1 \sim_S \delta_2 \quad \text{if and only if} \quad s(\delta_1) = s(\delta_2) \quad \text{for all } s \in S. \quad (4.2.6)$$

We denote by  $\mathcal{F}_S$  the associated vector space spanned by

$$\{F_{\delta_1} - F_{\delta_2} : \delta_1 \sim_S \delta_2\}. \quad (4.2.7)$$

4.2.3. *The algebra  $\text{ASM}/I_{\text{io}}$ .* Let us first study the statistics  $\text{io} \in \mathfrak{N}$ .

PROPOSITION 4.2.5. *The quotient  $\text{ASM}/\mathcal{F}_{\text{io}}$  is a commutative associative algebra.*

Note however that  $\text{ASM}/\mathcal{F}_{\text{io}}$  does not inherit the structure of a coalgebra of ASM because even if

$$x := F \begin{bmatrix} 0 & + & 0 & 0 \\ + & - & + & 0 \\ 0 & + & 0 & 0 \\ 0 & 0 & 0 & + \end{bmatrix} - F \begin{bmatrix} 0 & + & 0 & 0 \\ + & - & 0 & + \\ 0 & + & 0 & 0 \\ 0 & 0 & + & 0 \end{bmatrix} \quad (4.2.8)$$

is an element of  $\mathcal{F}_{\text{io}}$ , the element

$$\Delta(x) = 1 \otimes x + F \begin{bmatrix} 0 & + & 0 \\ + & - & + \\ 0 & + & 0 \end{bmatrix} \otimes F_{[+]} + x \otimes 1 \quad (4.2.9)$$

is not in  $\text{ASM} \otimes \mathcal{F}_{\text{io}} + \mathcal{F}_{\text{io}} \otimes \text{ASM}$ . Hence,  $\mathcal{F}_{\text{io}}$  is not a coideal.

PROPOSITION 4.2.6. *For any  $n \geq 0$ , the dimension of the  $n$ th graded component of  $\text{ASM}/\mathcal{F}_{\text{io}}$  satisfies*

$$\dim \text{ASM}/\mathcal{F}_{\text{io}}(n) = \left\lfloor \frac{n^2}{4} \right\rfloor + 1. \quad (4.2.10)$$

The dimensions of  $\text{ASM}/\mathcal{F}_{\text{io}}$  form Sequence A033638 of [Slo] and the first few terms are

$$1, 1, 1, 2, 3, 5, 7, 10, 13, 17, 21. \quad (4.2.11)$$

A basic argument on generating series implies that these dimensions cannot be the ones of a free commutative algebra and hence,  $\text{ASM}/\mathcal{F}_{\text{io}}$  is not free as a commutative associative algebra.

Using the symmetry between the statistics  $\text{io}$  and  $\text{oi}$  provided by Proposition 3.4.1 of Section 3.4 of Chapter 1, we immediately have  $\sim_{\text{oi}} = \sim_{\text{io}}$  and then,  $\text{ASM}/\mathcal{F}_{\text{oi}} = \text{ASM}/\mathcal{F}_{\text{io}}$ .

4.2.4. *The algebra  $\text{ASM}/I_{\text{nw}}$ .* Let us now study the statistics  $\text{nw} \in \mathfrak{S}$ .

PROPOSITION 4.2.7. *The quotient  $\text{ASM}/\mathcal{F}_{\text{nw}}$  is a commutative associative algebra.*

Note however that  $\text{ASM}/\mathcal{F}_{\text{nw}}$  does not inherit the structure of a coalgebra of ASM because even if

$$x := F \begin{bmatrix} 0 & 0 & 0 & + \\ + & 0 & 0 & 0 \\ 0 & 0 & + & 0 \\ 0 & + & 0 & 0 \end{bmatrix} - F \begin{bmatrix} 0 & 0 & + & 0 \\ 0 & + & 0 & 0 \\ + & 0 & - & + \\ 0 & 0 & + & 0 \end{bmatrix} \quad (4.2.12)$$

is an element of  $\mathcal{F}_{\text{nw}}$ , the element

$$\Delta(x) = 1 \otimes x + F_{[+]} \otimes F \begin{bmatrix} 0 & 0 & + \\ 0 & + & 0 \\ + & 0 & 0 \end{bmatrix} + F \begin{bmatrix} + & 0 \\ 0 & + \end{bmatrix} \otimes F \begin{bmatrix} 0 & + \\ + & 0 \end{bmatrix} + F \begin{bmatrix} + & 0 & 0 \\ 0 & 0 & + \\ 0 & 0 & + \end{bmatrix} \otimes F_{[+]} + x \otimes 1 \quad (4.2.13)$$

is not in  $\text{ASM} \otimes \mathcal{G}_{\text{nw}} + \mathcal{G}_{\text{nw}} \otimes \text{ASM}$ . Hence,  $\mathcal{G}_{\text{nw}}$  is not a coideal.

**PROPOSITION 4.2.8.** *For any  $n \geq 0$ , the dimension of the  $n$ th graded component of  $\text{ASM}/\mathcal{G}_{\text{nw}}$  satisfies*

$$\dim \text{ASM}/\mathcal{G}_{\text{nw}}(n) = \binom{n}{2} + 1. \tag{4.2.14}$$

The dimensions of  $\text{ASM}/\mathcal{G}_{\text{nw}}$  form Sequence **A152947** of [**Slo**] and the first few terms are

$$1, 1, 2, 4, 7, 11, 16, 22, 29, 37, 46, 56. \tag{4.2.15}$$

A basic argument on generating series implies that these dimensions cannot be the ones of a free commutative algebra and hence,  $\text{ASM}/\mathcal{G}_{\text{nw}}$  is not free as a commutative associative algebra.

Using the symmetry between the statistics  $\text{nw}$  and  $\text{se}$  provided by Proposition 3.4.1, we immediately have  $\sim_{\text{se}} = \sim_{\text{nw}}$  and then,  $\text{ASM}/\mathcal{G}_{\text{se}} = \text{ASM}/\mathcal{G}_{\text{nw}}$ . Moreover, by using the same arguments as before,  $\text{ASM}/\mathcal{G}_{\text{sw}}$  and  $\text{ASM}/\mathcal{G}_{\text{ne}}$  are the same commutative algebras.

Note that the map  $\theta : \text{ASM}/\mathcal{G}_{\text{nw}} \rightarrow \text{ASM}/\mathcal{G}_{\text{sw}}$  linearly defined for any  $\text{ASM} \delta$  by

$$\theta(\pi_{\text{nw}}(F_\delta)) := \pi_{\text{sw}}(F_{\overleftarrow{\delta}}), \tag{4.2.16}$$

where  $\pi_{\text{nw}}$  (resp.  $\pi_{\text{sw}}$ ) is the canonical projection from  $\text{ASM}$  to  $\text{ASM}/\mathcal{G}_{\text{nw}}$  (resp.  $\text{ASM}/\mathcal{G}_{\text{sw}}$ ) and  $\overleftarrow{\delta}$  is the  $\text{ASM}$  where, for any  $i \in [n]$ , the  $i$ th column of  $\overleftarrow{\delta}$  is the  $(n - i + 1)$ st column of  $\delta$ , is an isomorphism between  $\text{ASM}/\mathcal{G}_{\text{nw}}$  and  $\text{ASM}/\mathcal{G}_{\text{sw}}$ .

4.2.5. *The algebra  $\text{ASM}/\mathcal{I}_{\text{io,nw}}$ .* Let us finally study the set of statistics  $\{\text{io}, \text{nw}\}$ .

**PROPOSITION 4.2.9.** *The quotient  $\text{ASM}/\mathcal{G}_{\text{io,nw}}$  is a commutative associative algebra.*

Note however that  $\text{ASM}/\mathcal{G}_{\text{io,nw}}$  does not inherit the structure of a coalgebra of  $\text{ASM}$  because even if

$$x := F \begin{bmatrix} 0 & + & 0 & 0 \\ + & - & + & 0 \\ 0 & 0 & 0 & + \\ 0 & + & 0 & 0 \end{bmatrix} - F \begin{bmatrix} 0 & + & 0 & 0 \\ 0 & 0 & + & 0 \\ + & - & 0 & + \\ 0 & + & 0 & 0 \end{bmatrix} \tag{4.2.17}$$

is an element of  $\mathcal{G}_{\text{io,nw}}$ , the element

$$\Delta(x) = 1 \otimes x + F \begin{bmatrix} 0 & + & 0 \\ + & - & + \\ 0 & + & 0 \end{bmatrix} \otimes F_{[+]} + x \otimes 1 \tag{4.2.18}$$

is not in  $\text{ASM} \otimes \mathcal{G}_{\text{io,nw}} + \mathcal{G}_{\text{io,nw}} \otimes \text{ASM}$ . Hence,  $\mathcal{G}_{\text{io,nw}}$  is not a coideal.

By computer exploration, the first few dimensions of  $\text{ASM}/\mathcal{G}_{\text{io,nw}}$  are

$$1, 1, 2, 5, 13, 31, 66, 127, 225, \tag{4.2.19}$$

and seems to be Sequence **A116701** of [**Slo**].

A basic argument on generating series implies that these dimensions cannot be the ones of a free commutative associative algebra and hence,  $\text{ASM}/\mathcal{G}_{\text{io,nw}}$  is not free as a commutative algebra.

4.2.6. *Others quotients of ASM.* Using the symmetries provided by Proposition 3.4.1, all the algebras  $ASM/\mathcal{q}_S$ , where  $S$  contains two nonsymmetric statistics, are equal to  $ASM/\mathcal{q}_{io,nw}$ . Moreover, note that by using the same arguments as before, one can prove that for any  $S \in \mathfrak{J} \cup \mathfrak{N}$ ,  $ASM/\mathcal{q}_S$  is a commutative algebra isomorphic to  $ASM/\mathcal{q}_{io}$ ,  $ASM/\mathcal{q}_{nw}$ , or  $ASM/\mathcal{q}_{io,nw}$ .

### Concluding remarks

The work presented in this chapter contributes to enrich the already large collection of combinatorial Hopf bialgebras related to FQSym. Our main contributions are the Hopf bialgebra  $PM_k$  of  $k$ -packed matrices and the Hopf bialgebra ASM of alternating sign matrices.

Naturally, our results raise several questions for further research. First, one can ask for the enumeration of equivalence classes of  $k$ -packed matrices for the equivalence relations considered in Section 3.2.4. Second, we have described an injective associative algebra morphism from  $PML_1^*$  to MQSym (see Proposition 3.1.3). Nevertheless, as observed, this morphism is not a Hopf bialgebra morphism. Then, the question to define a Hopf embedding of  $PML_1^*$  into MQSym is open. Let us address a last research direction. Most Hopf bialgebras related to FQSym have polynomial realizations, that is, a way to encode their elements as polynomials [DHT02], compatible with the product and the alphabet doubling (see for instance [Hiv03]). The question to provide such a polynomial realization of  $PM_k$  seems worth studying.

## From pros to Hopf bialgebras

The content of this chapter comes from [BG16] and is a joint work with Jean-Paul Bultel.

### Introduction

The theory of operads and the one of Hopf bialgebras have several known interactions. One of these is a construction [vdL04] taking an operad  $\mathcal{O}$  as input and producing a Hopf bialgebra  $H(\mathcal{O})$  as output, which is called the natural Hopf bialgebra of  $\mathcal{O}$ . This construction has been studied in some recent works: in [CL07], it is shown that  $H$  can be rephrased in terms of an incidence Hopf bialgebra of a certain family of posets, and in [ML14], a general formula for its antipode is established. Let us also cite [Fra08] in which this construction is considered to study series of trees. The initial motivation of the work contained in this chapter was to generalize this  $H$  construction with the aim of constructing some new and interesting Hopf bialgebras. The direction we have chosen is to start with pros (see [ML65, Lei04, Mar08]), algebraic structures which generalize operads in the sense that pros deal with operators with possibly several outputs (see Section 5.1 of Chapter 2).

Our main contribution consists in the definition of a new construction  $H$  from pros to bialgebras. Roughly speaking, the construction  $H$  can be described as follows. Given a pro  $\mathcal{P}$  satisfying some mild properties, the Hopf bialgebra  $H(\mathcal{P})$  has bases indexed by a particular subset of elements of  $\mathcal{P}$ . The product of  $H(\mathcal{P})$  is the horizontal composition of  $\mathcal{P}$  and the coproduct of  $H(\mathcal{P})$  is defined from the vertical composition of  $\mathcal{P}$ , enabling to separate a basis element into two smaller parts. The properties satisfied by  $\mathcal{P}$  imply, in a nontrivial way, that the product and the coproduct of  $H(\mathcal{P})$  satisfy the required axioms to be a bialgebra. This construction generalizes  $H$  and establishes a new connection between the theory of pros and the theory of Hopf bialgebras.

Let us provide some details about our construction  $H$ . A first version of this construction is presented, associating a Hopf bialgebra  $H(\mathcal{P})$  with a free pro  $\mathcal{P}$ . The fundamental basis of this Hopf bialgebra is a set-basis with respect to the product, and the structure coefficients of the coproduct are nontrivial (i.e., they are possibly different from 0 and 1). As an associative algebra,  $H(\mathcal{P})$  is always free. This construction is extended to a class of non-necessarily free pros. The pros of this class, called stiff pros, can be described by particular quotients of free pros. These pros arise somewhat naturally because, under some mild conditions, two well-known constructions of pros [Mar08] produce stiff pros. The first one,  $R$ , takes as input operads and the second one,  $B$ , takes as input monoids. The construction  $R$  is used to show that the natural Hopf bialgebra of an operad can be reformulated as a particular case of our construction  $H$ . The Hopf bialgebras that one can construct from  $H$  are very similar to



the Connes-Kreimer Hopf bialgebra [CK98] in the sense that their coproduct can be computed by means of admissible cuts in various combinatorial objects. From very simple stiff pros, it is possible to reconstruct the Hopf bialgebra of noncommutative symmetric functions  $\text{Sym}$  [GKL<sup>+</sup>95] and the noncommutative Faà di Bruno Hopf bialgebra  $\text{FdB}$  [BFK06]. Besides, we present a way of using  $H$  to reconstruct some of the Hopf bialgebras  $\text{FdB}_\gamma$ , a  $\gamma$ -deformation of  $\text{FdB}$  introduced by Foissy [Foi08].

This chapter is organized as follows. In Section 1, we recall the natural Hopf bialgebra construction  $H$  of an operad and some background about the noncommutative Faà di Bruno Hopf bialgebra  $\text{FdB}$  and its commutative version  $\text{FdB}$ . We provide in Section 2 the description of our new construction  $H$  and study some of its algebraic and combinatorial properties. We conclude this chapter by giving some examples of applications of  $H$  in Section 3 from very simple pros. We hence obtain several Hopf bialgebras, which, respectively, involve forests of planar rooted trees, some kinds of graphs consisting of nodes with one parent and several children or several parents and one child that we call forests of bitrees, heaps of pieces (see [Vie86] for a general presentation of these combinatorial objects), and a particular class of heaps of pieces that we call heaps of friable pieces. All these Hopf bialgebras depend on a nonnegative integer as parameter  $\gamma$ .

*Note.* This chapter deals only with ns set-operads. For this reason, “operad” means “ns set-operad” in this chapter. Similarly, “pro” means “set-pro”. Moreover, all the free pros appearing here have generators with at least one input and one output.

## 1. Hopf bialgebras and the natural Hopf bialgebra of an operad

We recall in this section a construction associating a combinatorial Hopf bialgebra with an operad. This construction can be used to define the Faà di Bruno Hopf bialgebra.

**1.1. Combinatorial Hopf algebras.** Let us start by recalling some definitions and properties about the Faà di Bruno Hopf bialgebra, the Hopf bialgebra of symmetric functions, and some of its noncommutative analogs. Here, we assume that the ground field  $\mathbb{K}$  on which all the Hopf bialgebras are defined contains  $\mathbb{R}$ .

**1.1.1. Faà di Bruno Hopf bialgebra and its deformations.** Let  $\text{FdB}$  be the free commutative algebra generated by elements  $h_n$ ,  $n \geq 1$ , with  $\deg(h_n) = n$ . The bases of  $\text{FdB}$  are thus indexed by integer partitions, and the unit is denoted by  $h_0$ . Alternatively,  $\text{FdB} := \mathbb{K}\langle \text{Part} \rangle$ , where  $\text{Part}$  is the graded combinatorial collection of integer partitions defined in Section 1.2.4 of Chapter 1. This is the *algebra of symmetric functions* [Mac15]. There are several ways to endow  $\text{FdB}$  with a coproduct to turn it into a Hopf bialgebra. In [Foi08], Foissy obtains, as a byproduct of his investigation of combinatorial Dyson-Schwinger equations in the Connes-Kreimer algebra, a one-parameter family  $\Delta_\gamma$ ,  $\gamma \in \mathbb{R}$ , of coproducts on  $\text{FdB}$ , defined by using alphabet transformations (see [Mac15]), by

$$\Delta_\gamma(h_n) := \sum_{0 \leq k \leq n} h_k \otimes h_{n-k}((k\gamma + 1)X), \quad (1.1.1)$$

where, for any  $\alpha \in \mathbb{R}$  and  $n \in \mathbb{N}$ ,  $h_n(\alpha X)$  is the coefficient of  $t^n$  in the series  $(\sum_{k \geq 0} h_k t^k)^\alpha$ . In particular,

$$\Delta_0(h_n) = \sum_{0 \leq k \leq n} h_k \otimes h_{n-k}. \tag{1.1.2}$$

The algebra  $FdB$  with the coproduct  $\Delta_0$  is the classical *Hopf bialgebra of symmetric functions*  $Sym$  [Mac15]. Moreover, for all  $\gamma \neq 0$ , all  $FdB_\gamma$  are isomorphic to  $FdB_1$ , which is known as the *Faà di Bruno bialgebra* [JR79]. The coproduct  $\Delta_0$  comes from the interpretation of  $FdB$  as the algebra of polynomial functions on the multiplicative group

$$G(t) := \left\{ 1 + \sum_{k \geq 1} a_k t^k : a_k \in \mathbb{R}, k \geq 1 \right\} \tag{1.1.3}$$

of formal power series of constant term 1, and  $\Delta_1$  comes from its interpretation as the algebra of polynomial functions on the group  $tG(t)$  for the series composition of formal diffeomorphisms of the real line.

1.1.2. *Noncommutative analogs.* Formal power series in one variable with coefficients in a noncommutative algebra can be composed (by substitution of the variable). This operation is not associative, so that they do not form a group. For example, when  $a$  and  $b$  belong to a noncommutative algebra, one has

$$(t^2 \circ at) \circ bt = a^2 t^2 \circ bt = a^2 b^2 t^2 \tag{1.1.4}$$

but

$$t^2 \circ (at \circ bt) = t^2 \circ abt = ababt^2. \tag{1.1.5}$$

However, the analogue of the Faà di Bruno Hopf bialgebra still exists in this noncommutative context and is known as the *noncommutative Faà di Bruno Hopf bialgebra*. It is investigated in [BFK06] in view of applications in quantum field theory. In [Foi08], Foissy also obtains an analogue of the family  $FdB_\gamma$  in this context. Indeed, considering noncommutative generators  $S_n$  (with  $\deg(S_n) = n$ ) instead of the  $h_n$ , for all  $n \geq 1$ , leads to a free noncommutative algebra  $FdB$  whose bases are indexed by integer compositions. This is the *algebra of noncommutative symmetric functions* [GKL+95]. The addition of the coproduct  $\Delta_\gamma$  defined by

$$\Delta_\gamma(S_n) := \sum_{0 \leq k \leq n} S_k \otimes S_{n-k}((k\gamma + 1)A), \tag{1.1.6}$$

where, for any  $\alpha \in \mathbb{R}$  and  $n \in \mathbb{N}$ ,  $S_n(\alpha A)$  is the coefficient of  $t^n$  in  $(\sum_{k \geq 0} S_k t^k)^\alpha$ , forms a noncommutative Hopf bialgebra  $FdB_\gamma$ . In particular,

$$\Delta_0(S_n) = \sum_{k=0}^n S_k \otimes S_{n-k}, \tag{1.1.7}$$

where  $S_0$  is the unit. In this way,  $FdB$  with the coproduct  $\Delta_0$  is the *Hopf bialgebra of noncommutative symmetric functions*  $Sym$  [GKL+95, KLT97], and for all  $\gamma \neq 0$ , all the  $FdB_\gamma$  are isomorphic to  $FdB_1$ , which is the *noncommutative Faà di Bruno Hopf bialgebra*.

**1.2. The natural Hopf bialgebra of an operad.** We describe here a construction associating a Hopf bialgebra with an operad (under some conditions). We then apply this construction to obtain  $FdB$  from the associative operad.

**1.2.1. The construction.** A slightly different version of the construction we shall present here is considered in [vdL04, CL07, ML14]. Let  $\mathcal{O}$  be an operad and denote by  $\mathcal{O}^+$  the set  $\mathcal{O} \setminus \{1\}$ . The *natural Hopf bialgebra* of  $\mathcal{O}$  is the free commutative algebra  $H(\mathcal{O})$  spanned by the  $T_x$ , where the  $x$  are elements of  $\mathcal{O}^+$ . The bases of  $H(\mathcal{O})$  are thus indexed by finite multisets of elements of  $\mathcal{O}^+$ . Alternatively,  $H(\mathcal{O}) = \mathbb{K}\langle S(\mathcal{O}^+) \rangle$ , where  $S$  is the multiset operation over graded collections (see Section 1.1.6 of Chapter 1). The unit of  $H(\mathcal{O})$  is denoted by  $T_1$  and the coproduct of  $H(\mathcal{O})$  is the unique associative algebra morphism satisfying, for any element  $x$  of  $\mathcal{O}^+$ ,

$$\Delta(T_x) = \sum_{\substack{y, z_1, \dots, z_\ell \in \mathcal{O} \\ y \circ [z_1, \dots, z_\ell] = x}} T_y \otimes T_{z_1} \dots T_{z_\ell}. \quad (1.2.1)$$

The Hopf bialgebra  $H(\mathcal{O})$  can be graded by  $\deg(T_x) := |x| - 1$ . Note that with this grading, when  $\mathcal{O}(1) = \{1\}$  and when the  $\mathcal{O}(n)$  are finite for all  $n \geq 1$ ,  $H(\mathcal{O})$  becomes a combinatorial Hopf bialgebra.

**1.2.2. The natural Hopf bialgebra of the associative operad.** Let us consider the associative operad  $As$  (see Section 4.2.1 of Chapter 2). The set  $As^+$  consists in the elements  $a_n$  with  $n \geq 2$ . The Hopf bialgebra  $H(As)$  is the linear span of the elements  $T_{\{x_1, \dots, x_\ell\}}$  where  $x_i \in As^+$ ,  $i \in [\ell]$ . Any multiset  $X := \{a_{n_1}, \dots, a_{n_k}\}$  of  $As^+$  can be encoded by a nondecreasing word  $u_1^{\alpha_1} \dots u_r^{\alpha_r}$  where  $\alpha_i$  is the multiplicity of  $a_{i+1}$  in  $X$  for any  $i \in [r]$ . For instance, the basis element  $T_{\{a_2, a_2, a_4, a_6, a_6, a_7\}}$  is encoded by  $T_{655311}$ . Moreover the degrees of such basis elements indexed by words are the sums of their letters. For this reason, the basis elements of  $H(As)$  are indexed by integer partitions. Besides, here is an example of a coproduct in  $H(As)$  using (1.2.1):

$$\begin{aligned} \Delta(T_2) &= T_1 \otimes T_2 + T_1 \otimes (T_1 T_1 + T_1 T_1) + T_2 \otimes T_1 T_1 T_1 \\ &= T_1 \otimes T_2 + 2T_1 \otimes T_1 + T_2 \otimes T_1. \end{aligned} \quad (1.2.2)$$

For instance, the coefficient of  $T_1 \otimes T_1$  in  $\Delta(T_2)$  is 2 because there are two ways to factorize  $a_3$  in  $As$  by using the complete composition map where the first operand is  $a_2$ :  $a_3 = a_2 \circ [a_1, a_2]$  and  $a_3 = a_2 \circ [a_2, a_1]$ . It is known (see for instance [ML14]) that  $H(As)$  is isomorphic to  $FdB_1$ .

## 2. From pros to combinatorial Hopf algebras

We introduce in this section the main construction of this work and review some of its properties. In all this section,  $\mathcal{P}$  is a free pro generated by a bigraded set  $\mathfrak{G}$ . We recall that we work only with generating sets satisfying  $\mathfrak{G}(p, q) = \emptyset$  when  $p = 0$  or  $q = 0$ . Starting with  $\mathcal{P}$ , our construction produces a bialgebra  $H(\mathcal{P})$  whose bases are indexed by the reduced elements of  $\mathcal{P}$ . We shall also extend this construction over a class of non necessarily free pros.

**2.1. The Hopf bialgebra of a free pro.** We shall use from now on the notions about prographs introduced in Section 3.3.3 of Chapter 1 and the notions about free pros contained in Section 5.1.3 of Chapter 2.

The bases of the vector space

$$H(\mathcal{P}) := \mathbb{K} \langle \text{red}(\mathcal{P}) \rangle \tag{2.1.1}$$

are indexed by the reduced elements of  $\mathcal{P}$ . The elements  $S_x, x \in \text{red}(\mathcal{P})$ , form thus a basis of  $H(\mathcal{P})$ , called *fundamental basis*. We endow  $H(\mathcal{P})$  with a product  $\cdot : H(\mathcal{P}) \otimes H(\mathcal{P}) \rightarrow H(\mathcal{P})$  linearly defined, for any reduced elements  $x$  and  $y$  of  $\mathcal{P}$ , by

$$S_x \cdot S_y := S_{x * y}, \tag{2.1.2}$$

and with a coproduct  $\Delta : H(\mathcal{P}) \rightarrow H(\mathcal{P}) \otimes H(\mathcal{P})$  linearly defined, for any reduced elements  $x$  of  $\mathcal{P}$ , by

$$\Delta(S_x) := \sum_{\substack{y, z \in \mathcal{P} \\ y \circ z = x}} S_{\text{red}(y)} \otimes S_{\text{red}(z)}. \tag{2.1.3}$$

Throughout this section, we shall consider some examples involving the free pro generated by  $\mathcal{G} := \mathcal{G}(2, 2) \sqcup \mathcal{G}(3, 1)$  where  $\mathcal{G}(2, 2) := \{a\}$  and  $\mathcal{G}(3, 1) := \{b\}$ , denoted by  $AB$ . For instance, we have in  $H(AB)$

$$S_a \cdot S_b = S_{a * b} \tag{2.1.4}$$

and

$$\Delta S_a = S_{1_0} \otimes S_a + S_a \otimes S_b + S_b \otimes S_a \tag{2.1.5}$$

As a consequence of Lemma 5.1.2 of Chapter 2, the coproduct  $\Delta$  of  $H(\mathcal{P})$  is coassociative. Moreover, this lemma implies that  $\Delta$  is a morphism of associative algebras. Hence, we obtain the following result.

**THEOREM 2.1.1.** *Let  $\mathcal{P}$  be a free pro. Then,  $H(\mathcal{P})$  is a Hopf bialgebra.*

**2.2. Properties of the construction.** Let us now study the general properties of the Hopf bialgebras obtained by the construction  $H$ .

2.2.1. *Algebraic generators and freeness.*

**PROPOSITION 2.2.1.** *Let  $\mathcal{P}$  be a free pro. Then,  $H(\mathcal{P})$  is freely generated as an associative algebra by the set of all  $S_g$ , where the  $g$  are indecomposable and reduced elements of  $\mathcal{P}$ .*

2.2.2. *Gradings.* There are several ways to define gradings for  $H(\mathcal{P})$  to turn it into a combinatorial Hopf bialgebra. For this purpose, we say that a map  $\omega : \text{red}(\mathcal{P}) \rightarrow \mathbb{N}$  is a *grading* of  $\mathcal{P}$  if it satisfies the following four properties:

- (G1) for any reduced elements  $x$  and  $y$  of  $\mathcal{P}$ ,  $\omega(x * y) = \omega(x) + \omega(y)$ ;
- (G2) for any reduced elements  $x$  of  $\mathcal{P}$  satisfying  $x = y \circ z$  where  $y, z \in \mathcal{P}$ ,  $\omega(x) = \omega(\text{red}(y)) + \omega(\text{red}(z))$ ;
- (G3) for any  $n \geq 0$ , the fiber  $\omega^{-1}(n)$  is finite;
- (G4)  $\omega^{-1}(0) = \{1_0\}$ .

A very generic way to endow  $\mathcal{P}$  with a grading consists in providing a map  $\omega : \mathcal{G} \rightarrow \mathbb{N} \setminus \{0\}$  associating a positive integer with any generator of  $\mathcal{P}$ , namely its *weight*; the degree  $\omega(x)$  of any element  $x$  of  $\mathcal{P}$  being the sum of the weights of the occurrences of the generators used to build  $x$ . For instance, the map  $\omega$  defined by  $\omega(a) := 3$  and  $\omega(b) := 2$  is a grading of AB and we have

$$\omega \left( \begin{array}{c} \square \quad \square \\ \diagdown \quad \diagup \\ \text{a} \\ \diagup \quad \diagdown \\ \square \quad \square \\ \diagdown \quad \diagup \\ \text{b} \\ \diagup \quad \diagdown \\ \square \quad \square \end{array} * \begin{array}{c} \square \quad \square \\ \diagdown \quad \diagup \\ \text{a} \\ \diagup \quad \diagdown \\ \square \quad \square \end{array} \right) = 8. \tag{2.2.1}$$

PROPOSITION 2.2.2. *Let  $\mathcal{P}$  be a free pro and  $\omega$  be a grading of  $\mathcal{P}$ . Then, with the grading*

$$H(\mathcal{P}) = \bigoplus_{n \geq 0} \mathbb{K} \langle \{S_x : x \in \text{red}(\mathcal{P}) \text{ and } \omega(x) = n\} \rangle, \tag{2.2.2}$$

$H(\mathcal{P})$  is a combinatorial Hopf bialgebra.

2.2.3. *Antipode.* Since the antipode of a combinatorial Hopf bialgebra can be computed by induction on the degrees, we obtain an expression for the one of  $H(\mathcal{P})$  when  $\mathcal{P}$  admits a grading. This expression is an instance of the Takeuchi formula [Tak71] and is particularly simple since the product of  $H(\mathcal{P})$  is multiplicative.

PROPOSITION 2.2.3. *Let  $\mathcal{P}$  be a free pro admitting a grading. For any reduced element  $x$  of  $\mathcal{P}$  different from  $1_0$ , the antipode  $v$  of  $H(\mathcal{P})$  satisfies*

$$v(S_x) = \sum_{\substack{x_1, \dots, x_\ell \in \mathcal{P}, \ell \geq 1 \\ x_1 \circ \dots \circ x_\ell = x \\ \text{red}(x_i) \neq 1_0, i \in [\ell]}} (-1)^\ell S_{\text{red}(x_1 * \dots * x_\ell)}. \tag{2.2.3}$$

We have for instance in  $H(AB)$ ,

$$\begin{aligned} v S_{\begin{array}{c} \square \quad \square \\ \diagdown \quad \diagup \\ \text{a} \\ \diagup \quad \diagdown \\ \square \quad \square \\ \diagdown \quad \diagup \\ \text{b} \\ \diagup \quad \diagdown \\ \square \quad \square \end{array}} &= -S_{\begin{array}{c} \square \quad \square \\ \diagdown \quad \diagup \\ \text{a} \\ \diagup \quad \diagdown \\ \square \quad \square \\ \diagdown \quad \diagup \\ \text{b} \\ \diagup \quad \diagdown \\ \square \quad \square \end{array}} + S_{\begin{array}{c} \square \quad \square \quad \square \\ \diagdown \quad \diagup \quad \diagdown \\ \text{a} \quad \text{a} \quad \text{b} \\ \diagup \quad \diagdown \quad \diagup \\ \square \quad \square \quad \square \end{array}} \\ &+ S_{\begin{array}{c} \square \quad \square \quad \square \\ \diagdown \quad \diagup \quad \diagdown \\ \text{a} \quad \text{b} \quad \text{a} \\ \diagup \quad \diagdown \quad \diagup \\ \square \quad \square \quad \square \end{array}} - S_{\begin{array}{c} \square \quad \square \quad \square \\ \diagdown \quad \diagup \quad \diagdown \\ \text{a} \quad \text{b} \quad \text{a} \\ \diagup \quad \diagdown \quad \diagup \\ \square \quad \square \quad \square \end{array}}. \end{aligned} \tag{2.2.4}$$

2.2.4. *Duality.* When  $\mathcal{P}$  admits a grading, let us denote by  $H(\mathcal{P})^*$  the graded dual of  $H(\mathcal{P})$ . By definition, the dual basis of the fundamental basis of  $H(\mathcal{P})$  consists in the elements  $S_x^*$ ,  $x \in \text{red}(\mathcal{P})$ .

PROPOSITION 2.2.4. *Let  $\mathcal{P}$  be a free pro admitting a grading. Then, for any reduced elements  $x$  and  $y$  of  $\mathcal{P}$ , the product and the coproduct of  $H(\mathcal{P})^*$  satisfy*

$$S_x^* \cdot S_y^* = \sum_{\substack{x', y' \in \mathcal{P} \\ x' \circ y' \in \text{red}(\mathcal{P}) \\ \text{red}(x')=x, \text{red}(y')=y}} S_{x' \circ y'}^* \tag{2.2.5}$$

and

$$\Delta(S_x^*) = \sum_{\substack{y, z \in \mathcal{P} \\ y * z = x}} S_y^* \otimes S_z^*. \tag{2.2.6}$$

For instance, we have in  $H(AB)$

(2.2.7)

and

(2.2.8)

2.2.5. *Quotient bialgebras.*

PROPOSITION 2.2.5. *Let  $\mathcal{G}$  and  $\mathcal{G}'$  be two bigraded sets such that  $\mathcal{G}' \subseteq \mathcal{G}$ . Then, the map  $\phi : H(\mathbf{FP}(\mathcal{G})) \rightarrow H(\mathbf{FP}(\mathcal{G}'))$  linearly defined, for any reduced element  $x$  of  $\mathbf{FP}(\mathcal{G})$ , by*

$$\phi(S_x) := \begin{cases} S_x & \text{if } x \in \mathbf{FP}(\mathcal{G}'), \\ 0 & \text{otherwise,} \end{cases} \tag{2.2.9}$$

is a surjective bialgebra morphism. Moreover,  $H(\mathbf{FP}(\mathcal{G}'))$  is a quotient bialgebra of  $H(\mathbf{FP}(\mathcal{G}))$ .

**2.3. The Hopf bialgebra of a stiff pro.** We now extend the construction  $H$  to a class a non-necessarily free pros. Still in this section,  $\mathcal{P}$  is a free pro.

Let  $\equiv$  be a congruence of  $\mathcal{P}$ . For any element  $x$  of  $\mathcal{P}$ , we denote by  $[x]_{\equiv}$  (or by  $[x]$  if the context is clear) the  $\equiv$ -equivalence class of  $x$ . We say that  $\equiv$  is a *stiff congruence* if the following three properties are satisfied:

- (C1) for any reduced element  $x$  of  $\mathcal{P}$ , the set  $[x]$  is finite;
- (C2) for any reduced element  $x$  of  $\mathcal{P}$ ,  $[x]$  contains reduced elements only;
- (C3) for any two elements  $x$  and  $x'$  of  $\mathcal{P}$  such that  $x \equiv x'$ , the maximal decompositions of  $x$  and  $x'$  are, respectively of the form  $(x_1, \dots, x_\ell)$  and  $(x'_1, \dots, x'_\ell)$  for some  $\ell \geq 0$ , and for any  $i \in [\ell]$ ,  $x_i \equiv x'_i$ .

We say that a pro is a *stiff pro* if it is the quotient of a free pro by a stiff congruence.

For any  $\equiv$ -equivalence class  $[x]$  of reduced elements of  $\mathcal{P}$ , set

$$T_{[x]} := \sum_{x' \in [x]} S_{x'}. \tag{2.3.1}$$

Notice that thanks to (C1) and (C2),  $T_{[x]}$  is a well-defined element of  $H(\mathcal{P})$ .

For instance, if  $\mathcal{P}$  is the quotient of the free pro generated by  $\mathcal{G} := \mathcal{G}(1, 1) \sqcup \mathcal{G}(2, 2)$  where  $\mathcal{G}(1, 1) := \{a\}$  and  $\mathcal{G}(2, 2) := \{b\}$  by the finest congruence  $\equiv$  satisfying



$$\tag{2.3.2}$$

one has

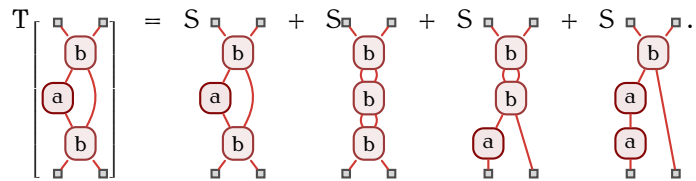

$$\tag{2.3.3}$$

Moreover, we can observe that  $\equiv$  is a stiff congruence.

If  $\equiv$  is a stiff congruence of  $\mathcal{P}$ , (C2) and (C3) imply that all the elements of a same  $\equiv$ -equivalence class  $[x]$  have the same number of factors and are all reduced or all nonreduced. Then, by extension, we shall say that a  $\equiv$ -equivalence class  $[x]$  of  $\mathcal{P}/_{\equiv}$  is *indecomposable* (resp. *reduced*) if all its elements are indecomposable (resp. reduced) in  $\mathcal{P}$ . In the same way, the *wire* of  $\mathcal{P}/_{\equiv}$  is the  $\equiv$ -equivalence class of the wire of  $\mathcal{P}$ .

We shall now study how the product and the coproduct of  $H(\mathcal{P})$  behave on the  $T_{[x]}$ .

2.3.1. *Product.* Let us show that the linear span of the  $T_{[x]}$ , where the  $[x]$  are  $\equiv$ -equivalence classes of reduced elements of  $\mathcal{P}$ , forms an associative subalgebra of  $H(\mathcal{P})$ . The product on the  $T_{[x]}$  is multiplicative and admits the following simple description.

PROPOSITION 2.3.1. *Let  $\mathcal{P}$  be a free pro and  $\equiv$  be a stiff congruence of  $\mathcal{P}$ . Then, for any  $\equiv$ -equivalence classes  $[x]$  and  $[y]$ ,*

$$T_{[x]} \cdot T_{[y]} = T_{[x*y]}, \quad (2.3.4)$$

where  $x$  (resp.  $y$ ) is any element of  $[x]$  (resp.  $[y]$ ).

2.3.2. *Coproduct.* To prove that the linear span of the  $T_{[x]}$ , where the  $[x]$  are  $\equiv$ -equivalence classes of reduced elements of  $\mathcal{P}$ , forms a subcoalgebra of  $H(\mathcal{P})$  and provides the description of the coproduct of a  $T_{[x]}$ , we need the following notation. For any element  $x$  of  $\mathcal{P}$ ,

$$\text{red}([x]) := \{\text{red}(x') : x' \in [x]\}. \quad (2.3.5)$$

LEMMA 2.3.2. *Let  $\mathcal{P}$  be a free pro and  $\equiv$  be a stiff congruence of  $\mathcal{P}$ . For any element  $x$  of  $\mathcal{P}$ ,*

$$\text{red}([x]) = [\text{red}(x)]. \quad (2.3.6)$$

LEMMA 2.3.3. *Let  $\mathcal{P}$  be a free pro,  $\equiv$  be a stiff congruence of  $\mathcal{P}$ , and  $y$  and  $z$  be two elements of  $\mathcal{P}$  such that  $y \equiv z$ . Then,  $\text{red}(y) = \text{red}(z)$  implies  $y = z$ .*

The next result is based upon Lemmas 2.3.2 and 2.3.3.

PROPOSITION 2.3.4. *Let  $\mathcal{P}$  be a free pro and  $\equiv$  be a stiff congruence of  $\mathcal{P}$ . Then, for any  $\equiv$ -equivalence class  $[x]$ ,*

$$\Delta(T_{[x]}) = \sum_{\substack{[y],[z] \in \mathcal{P}/\equiv \\ [y] \circ [z] = [x]}} T_{\text{red}([y])} \otimes T_{\text{red}([z])}. \quad (2.3.7)$$

2.3.3. *Hopf sub-bialgebra.* The description of the product and the coproduct on the  $T_{[x]}$  leads to the following result.

THEOREM 2.3.5. *Let  $\mathcal{P}$  be a free pro and  $\equiv$  be a stiff congruence of  $\mathcal{P}$ . Then, the linear span of the  $T_{[x]}$ , where the  $[x]$  are  $\equiv$ -equivalence classes of reduced elements of  $\mathcal{P}$ , forms a Hopf sub-bialgebra of  $H(\mathcal{P})$ .*

We shall denote, by a slight abuse of notation, by  $H(\mathcal{P}/\equiv)$  the sub-bialgebra of  $H(\mathcal{P})$  spanned by the  $T_{[x]}$ , where the  $[x]$  are  $\equiv$ -equivalence classes of reduced elements of  $\mathcal{P}$ . Notice that the construction  $H$  as it was presented in Section 2.1 is a special case of this latter when  $\equiv$  is the most refined congruence of pros.



Note that this construction of sub-bialgebras of  $H(\mathcal{P})$  by taking an equivalence relation satisfying some precise properties and by considering the elements obtained by summing over its equivalence classes is analog to the construction of certain sub-bialgebras of the Malvenuto-Reutenauer Hopf algebra [MR95]. Indeed, some famous Hopf algebras are obtained in this way (see Sections 3.2.3 and 3.2.4 of Chapter 2).

2.3.4. *The importance of the stiff congruence condition.* Let us now explain why the stiff congruence condition required as a premise of Theorem 2.3.5 is important by providing an example of a non-stiff congruence of pros failing to produce a Hopf bialgebra.

Consider the pro  $\mathcal{P}$  quotient of the free pro generated by  $\mathfrak{G} := \mathfrak{G}(1, 1) \sqcup \mathfrak{G}(2, 2)$  where  $\mathfrak{G}(1, 1) := \{a\}$  and  $\mathfrak{G}(2, 2) := \{b\}$  by the finest congruence  $\equiv$  satisfying

$$\begin{array}{c} \square \\ | \\ \text{a} \\ | \\ \square \end{array} \begin{array}{c} \square \\ | \\ \text{a} \\ | \\ \square \end{array} \equiv \begin{array}{c} \square \quad \square \\ \diagdown \quad \diagup \\ \text{b} \\ \diagup \quad \diagdown \\ \square \quad \square \end{array} \tag{2.3.8}$$

Here,  $\equiv$  is not a stiff congruence since it satisfies (C2) but not (C3).

We have

$$T \left[ \begin{array}{c} \square \\ | \\ \text{a} \\ | \\ \square \end{array} \right] \cdot T \left[ \begin{array}{c} \square \\ | \\ \text{a} \\ | \\ \square \end{array} \right] = S \begin{array}{c} \square \\ | \\ \text{a} \\ | \\ \square \end{array} \cdot S \begin{array}{c} \square \\ | \\ \text{a} \\ | \\ \square \end{array} = S \begin{array}{c} \square \quad \square \\ | \quad | \\ \text{a} \quad \text{a} \\ | \quad | \\ \square \quad \square \end{array} \tag{2.3.9}$$

but this last element cannot be expressed on the  $T_{[x]}$ .

Besides, by a straightforward computation, we have

$$\begin{aligned} \Delta T \left[ \begin{array}{c} \square \\ | \\ \text{a} \\ | \\ \square \end{array} \right] &= \Delta S \begin{array}{c} \square \quad \square \quad \square \\ | \quad | \quad | \\ \text{a} \quad \text{a} \quad \text{a} \\ | \quad | \quad | \\ \square \quad \square \quad \square \end{array} + \Delta S \begin{array}{c} \square \quad \square \\ \diagdown \quad \diagup \\ \text{a} \quad \text{b} \\ \diagup \quad \diagdown \\ \square \quad \square \end{array} + \Delta S \begin{array}{c} \square \quad \square \\ \diagdown \quad \diagup \\ \text{b} \quad \text{a} \\ \diagup \quad \diagdown \\ \square \quad \square \end{array} \\ &= T_{[\mathbb{1}_0]} \otimes T \left[ \begin{array}{c} \square \quad \square \quad \square \\ | \quad | \quad | \\ \text{a} \quad \text{a} \quad \text{a} \\ | \quad | \quad | \\ \square \quad \square \quad \square \end{array} \right] + T \left[ \begin{array}{c} \square \quad \square \quad \square \\ | \quad | \quad | \\ \text{a} \quad \text{a} \quad \text{a} \\ | \quad | \quad | \\ \square \quad \square \quad \square \end{array} \right] \otimes T_{[\mathbb{1}_0]} \\ &\quad + 2T \left[ \begin{array}{c} \square \\ | \\ \text{a} \\ | \\ \square \end{array} \right] \otimes T \left[ \begin{array}{c} \square \quad \square \\ \diagdown \quad \diagup \\ \text{b} \\ \diagup \quad \diagdown \\ \square \quad \square \end{array} \right] + 2T \left[ \begin{array}{c} \square \quad \square \\ \diagdown \quad \diagup \\ \text{b} \\ \diagup \quad \diagdown \\ \square \quad \square \end{array} \right] \otimes T \left[ \begin{array}{c} \square \\ | \\ \text{a} \\ | \\ \square \end{array} \right] \\ &\quad + S \begin{array}{c} \square \\ | \\ \text{a} \\ | \\ \square \end{array} \otimes S \begin{array}{c} \square \quad \square \quad \square \\ | \quad | \quad | \\ \text{a} \quad \text{a} \quad \text{a} \\ | \quad | \quad | \\ \square \quad \square \quad \square \end{array} + S \begin{array}{c} \square \quad \square \\ | \quad | \\ \text{a} \quad \text{a} \\ | \quad | \\ \square \quad \square \end{array} \otimes S \begin{array}{c} \square \\ | \\ \text{a} \\ | \\ \square \end{array}, \tag{2.3.10} \end{aligned}$$

showing that neither the coproduct is well-defined on the  $T_{[x]}$ .

2.3.5. *Properties.* By using similar arguments as those used to establish Proposition 2.2.1 together with the fact that  $\equiv$  satisfies (C3) and the product formula of Proposition 2.3.1, we obtain that  $H(\mathcal{P}/\equiv)$  is freely generated as an algebra by the  $T_{[x]}$  where the  $[x]$  are  $\equiv$ -equivalence classes of indecomposable and reduced elements of  $\mathcal{P}$ . Moreover, when  $\omega$  is a grading of  $\mathcal{P}$  so that all elements of a same  $\equiv$ -equivalence class have the same degree, the bialgebra  $H(\mathcal{P}/\equiv)$  is graded by the grading inherited the one of  $H(\mathcal{P})$  and forms hence a combinatorial Hopf bialgebra.

PROPOSITION 2.3.6. *Let  $\mathcal{P}$  be a free pro and  $\equiv_1$  and  $\equiv_2$  be two stiff congruences of  $\mathcal{P}$  such that  $\equiv_1$  is finer than  $\equiv_2$ . Then,  $H(\mathcal{P}/\equiv_2)$  is a sub-bialgebra of  $H(\mathcal{P}/\equiv_1)$ .*

**2.4. Related constructions.** In this section, we first describe two constructions allowing to build stiff pros. The main interest of these constructions is that the obtained stiff pros can be placed at the input of the construction  $H$ . We next present a way to recover the natural Hopf bialgebra of an operad through the construction  $H$  and the previous constructions of stiff pros.

2.4.1. *From operads to stiff pros.* Any operad  $\mathcal{O}$  gives naturally rise to a pro  $R(\mathcal{O})$  whose elements are sequences of elements of  $\mathcal{O}$  (see [Mar08]).

We recall here this construction. Let us set  $R(\mathcal{O}) := \sqcup_{p \geq 0} \sqcup_{q \geq 0} R(\mathcal{O})(p, q)$  where

$$R(\mathcal{O})(p, q) := \{x_1 \dots x_q : x_i \in \mathcal{O}(p_i) \text{ for all } i \in [q] \text{ and } p_1 + \dots + p_q = p\}. \quad (2.4.1)$$

The horizontal composition of  $R(\mathcal{O})$  is the concatenation of sequences, and the vertical composition of  $R(\mathcal{O})$  comes directly from the composition map of  $\mathcal{O}$ . More precisely, for any  $x_1 \dots x_r \in R(\mathcal{O})(q, r)$  and  $y_{11} \dots y_{1q_1} \dots y_{r1} \dots y_{rq_r} \in R(\mathcal{O})(p, q)$ , we have

$$x_1 \dots x_r \circ y_{11} \dots y_{1q_1} \dots y_{r1} \dots y_{rq_r} := x_1 \circ [y_{11}, \dots, y_{1q_1}] \dots x_r \circ [y_{r1}, \dots, y_{rq_r}], \quad (2.4.2)$$

where for any  $i \in [r]$ ,  $x_i \in \mathcal{O}(q_i)$  and the occurrences of  $\circ$  in the right-member of (2.4.2) refer to the total composition map of  $\mathcal{O}$ .

For instance, if  $\mathcal{O}$  is the magmatic operad  $\text{Mag}$  (see Section 4.2.2 of Chapter 2), since its elements are binary trees, the elements of the pro  $R(\mathcal{O})$  are forests of binary trees. The horizontal composition of  $R(\mathcal{O})$  is the concatenation of forests, and the vertical composition  $f_1 \circ f_2$  in  $R(\mathcal{O})$ , defined only between two forests  $f_1$  and  $f_2$  such that the number of leaves of  $f_1$  is the same as the number of trees in  $f_2$ , consists in the forest obtained by grafting, from left to right, the roots of the trees of  $f_2$  on the leaves of  $f_1$ .

PROPOSITION 2.4.1. *Let  $\mathcal{O}$  be an operad such that the monoid  $(\mathcal{O}(1), \circ_1)$  does not contain any nontrivial subgroup. Then,  $R(\mathcal{O})$  is a stiff pro.*

2.4.2. *From monoids to stiff pros.* Any monoid  $\mathcal{M}$  can be seen as an operad concentrated in arity one. Then, starting from a monoid  $\mathcal{M}$ , one can construct a pro  $B(\mathcal{M})$  by applying the construction  $R$  to  $\mathcal{M}$  seen as an operad.

This construction can be rephrased as follows. We have  $B(\mathcal{M}) = \sqcup_{p \geq 0} \sqcup_{q \geq 0} B(\mathcal{M})(p, q)$  where

$$B(\mathcal{M})(p, q) = \begin{cases} \{x_1 \dots x_p : x_i \in M \text{ for all } i \in [p]\} & \text{if } p = q, \\ \emptyset & \text{otherwise.} \end{cases} \quad (2.4.3)$$

The horizontal composition of  $B(\mathcal{M})$  is the concatenation of sequences and the vertical composition  $\circ : B(\mathcal{M})(p, p) \times B(\mathcal{M})(p, p) \rightarrow B(\mathcal{M})(p, p)$  of  $B(\mathcal{M})$  satisfies, for any  $x_1 \dots x_p \in B(\mathcal{M})(p, p)$  and  $y_1 \dots y_q \in B(\mathcal{M})(q, q)$ ,

$$x_1 \dots x_p \circ y_1 \dots y_p = (x_1 \star y_1) \dots (x_p \star y_p), \quad (2.4.4)$$

where  $\star$  is the product of  $\mathcal{M}$ .

For instance, if  $\mathcal{M}$  is the additive monoid of natural numbers, the pro  $B(\mathcal{M})$  contains all words over  $\mathbb{N}$ . The horizontal composition of  $B(\mathcal{M})$  is the concatenation of words, and the vertical composition of  $B(\mathcal{M})$ , defined only on words with a same length, is the component-wise addition of their letters.

PROPOSITION 2.4.2. *Let  $\mathcal{M}$  be a monoid that does not contain any nontrivial subgroup. Then,  $B(\mathcal{M})$  is a stiff pro.*

2.4.3. *The natural Hopf bialgebra of an operad.* We call *abelianization* of a Hopf bialgebra  $\mathcal{H}$  the Hopf bialgebra quotient of  $\mathcal{H}$  by the Hopf bialgebra ideal spanned by the  $x \cdot y - y \cdot x$  for all  $x, y \in \mathcal{H}$ .

Here is the main link between our construction  $H$  and the construction  $H$ .

PROPOSITION 2.4.3. *Let  $\mathcal{O}$  be an operad such that the monoid  $(\mathcal{O}(1), \circ_1)$  does not contain any nontrivial subgroup. Then, the bialgebra  $H(\mathcal{O})$  is the abelianization of  $H(R(\mathcal{O}))$ .*

### 3. Examples of application of the construction

We conclude this chapter by presenting examples of application of the construction  $H$ . The pros considered in this section fit into the diagram represented by Figure 9.1 and the obtained Hopf bialgebras fit into the diagram represented by Figure 9.2.

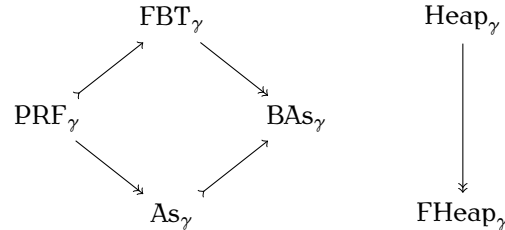

FIGURE 9.1. Diagram of pros where arrows  $\rightarrow$  (resp.  $\twoheadrightarrow$ ) are injective (resp. surjective) pro morphisms. The parameter  $\gamma$  is a positive integer. When  $\gamma = 0$ ,  $PRF_0 = As_0 = Heap_0 = FHeap_0$  and  $FBT_0 = BAs_0$ .

**3.1. Hopf bialgebra of forests.** We present here the construction of two Hopf bialgebras of forests, one depending on a nonnegative integer  $\gamma$ , and with different gradings. The pro we shall define in this section will intervene in the next examples.

3.1.1. *Pro of forests with a fixed arity.* Let  $\gamma$  be a nonnegative integer and  $PRF_\gamma$  be the free pro generated by  $\mathfrak{G} := \mathfrak{G}(\gamma + 1, 1) := \{a\}$ , with the grading  $\omega$  defined by  $\omega(a) := 1$ . Any prograph  $x$  of  $PRF_\gamma$  can be seen as a planar forest of planar rooted trees with only internal nodes of arity  $\gamma + 1$ . Since the reduced elements of  $PRF_\gamma$  have no wire, they are encoded by forests of nonempty trees.

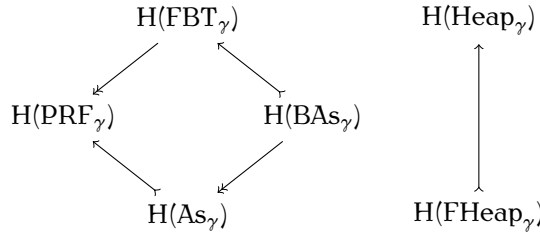

FIGURE 9.2. Diagram of combinatorial Hopf bialgebras where arrows  $\dashrightarrow$  (resp.  $\rightarrow$ ) are injective (resp. surjective) Hopf bialgebras morphisms. The parameter  $\gamma$  is a positive integer. When  $\gamma = 0$ ,  $H(\text{PRF}_0) = H(\text{As}_0) = H(\text{Heap}_0) = H(\text{FHeap}_0)$  and  $H(\text{FBT}_0) = H(\text{BAs}_0)$ .

3.1.2. *Hopf bialgebra.* By Theorem 2.1.1 and Proposition 2.2.2,  $H(\text{PRF}_\gamma)$  is a combinatorial Hopf bialgebra. By Proposition 2.2.1, as an associative algebra,  $H(\text{PRF}_\gamma)$  is freely generated by the  $S_t$ , where the  $t$  are nonempty planar rooted trees with only internal nodes of arity  $\gamma + 1$ . Its bases are indexed by planar forests of such trees where the degree of a basis element  $S_f$  is the number of internal nodes of  $f$ .

Notice that the bases of  $H(\text{PRF}_0)$  are indexed by forests of linear trees and that  $H(\text{PRF}_0)$  and  $\text{Sym}$  are trivially isomorphic as combinatorial Hopf bialgebras.

3.1.3. *Coproduct.* By definition of the construction  $H$ , the coproduct of  $H(\text{PRF}_\gamma)$  is given on a generator  $S_t$  by

$$\Delta(S_t) = \sum_{t' \in \text{Adm}(t)} S_{t'} \otimes S_{t/t'}, \tag{3.1.1}$$

where  $\text{Adm}(t)$  is the set of *admissible cuts* of  $t$ , that is, the empty tree or the subtrees of  $t$  containing the root of  $t$  and where  $t/t'$  denotes the forest consisting in the maximal subtrees of  $t$  whose roots are leaves of  $t'$ , by respecting the order of these leaves in  $t'$  and by removing the empty trees. For instance, we have

$$\Delta S = S_\emptyset \otimes S + S_{\text{left}} \otimes S_{\text{right}} + S_{\text{left}} \otimes S_{\text{right}} + S_{\text{left}} \otimes S_{\text{right}} + S \otimes S_\emptyset. \tag{3.1.2}$$

This coproduct is similar to the one of the noncommutative Connes-Kreimer Hopf bialgebra CK [CK98]. The main difference between  $H(\text{PRF}_\gamma)$  and CK lies in the fact that in a coproduct of CK, the admissible cuts can change the arity of some internal nodes; it is not the case in  $H(\text{PRF}_\gamma)$  because for any  $t' \in \text{Adm}(t)$ , any internal node  $u$  of  $t'$  has the same arity as it has in  $t$ .

3.1.4. *Dimensions.* The series of the algebraic generators of  $H(\text{PRF}_\gamma)$  is

$$\mathcal{G}(t) := \sum_{n \geq 1} \frac{1}{n\gamma + 1} \binom{n(\gamma + 1)}{n} t^n \quad (3.1.3)$$

since its coefficients are the Fuss-Catalan numbers, counting planar rooted trees with  $n$  internal nodes of arity  $\gamma + 1$  (see Section 2.2.2 of Chapter 1). Since  $H(\text{PRF}_\gamma)$  is free as an associative algebra, its Hilbert series is  $\mathcal{H}_{H(\text{PRF}_\gamma)}(t) := \frac{1}{1 - \mathcal{G}(t)}$ .

The first dimensions of  $H(\text{PRF}_1)$  are

$$1, 1, 3, 10, 35, 126, 462, 1716, 6435, 24310, 92378, \quad (3.1.4)$$

and those of  $H(\text{PRF}_2)$  are

$$1, 4, 19, 98, 531, 2974, 17060, 99658, 590563, 3540464, 21430267. \quad (3.1.5)$$

These two sequences are respectively Sequences **A001700** and **A047099** of [Slo].

3.1.5. *Pro of general forests.* We denote by  $\text{PRF}_\infty$  the free pro generated by  $\mathcal{G} := \sqcup_{n \geq 1} \mathcal{G}(n, 1) := \sqcup_{n \geq 1} \{a_n\}$ . Any prograph  $x$  of  $\text{PRF}_\infty$  can be seen as a planar forest of planar rooted trees. Since the reduced elements of  $\text{PRF}_\infty$  have no wire, they are encoded by forests of nonempty trees. Observe that for any nonnegative integer  $\gamma$ ,  $\text{PRF}_\gamma$  is a sub-pro of  $\text{PRF}_\infty$ .

3.1.6. *Hopf bialgebra.* By Theorem 2.1.1,  $H(\text{PRF}_\infty)$  is a Hopf bialgebra. By Proposition 2.2.1, as an associative algebra,  $H(\text{PRF}_\infty)$  is freely generated by the  $S_t$ , where the  $t$  are nonempty planar rooted trees. Its bases are indexed by planar forests of such trees. Besides, by Proposition 2.2.5, since  $\text{PRF}_\gamma$  is generated by a subset of the generators of  $\text{PRF}_\infty$ ,  $H(\text{PRF}_\gamma)$  is a Hopf bialgebra quotient of  $H(\text{PRF}_\infty)$ . Moreover, the coproduct of  $H(\text{PRF}_\infty)$  satisfies (3.1.1).

To turn  $H(\text{PRF}_\infty)$  into a combinatorial Hopf bialgebra, we cannot consider the grading  $\omega$  defined by  $\omega(a_n) := 1$  because there would be infinitely many elements of degree 1. Therefore, we consider on  $H(\text{PRF}_\infty)$  the grading  $\omega$  defined by  $\omega(a_n) := n$ . In this way, the degree of a basis element  $S_f$  is the number of edges of the forest  $f$ . By Proposition 2.2.2,  $H(\text{PRF}_\infty)$  is a combinatorial Hopf bialgebra.

3.1.7. *Dimensions.* The series of the algebraic generators of  $H(\text{PRF}_\infty)$  is

$$\mathcal{G}(t) := \sum_{n \geq 1} \frac{1}{n + 1} \binom{2n}{n} t^n \quad (3.1.6)$$

since its coefficients are the Catalan numbers, counting planar rooted trees with  $n$  edges. As  $H(\text{PRF}_\infty)$  is free as an associative algebra, its Hilbert series is

$$\mathcal{H}_{H(\text{PRF}_\infty)}(t) := \frac{1}{1 - \mathcal{G}(t)} = 1 + \sum_{n \geq 1} \frac{1}{2} \binom{2n}{n} t^n. \quad (3.1.7)$$

The dimensions of  $H(\text{PRF}_\infty)$  are then the same as the dimensions of  $H(\text{PRF}_1)$  (see (3.1.4)).

**3.2. Faà di Bruno Hopf bialgebra and its deformations.** We shall give here a method to construct the Hopf bialgebras  $\text{FdB}_\gamma$  of Foissy [Foi08] from our construction  $H$  in the case where  $\gamma$  is a nonnegative integer.

3.2.1. *Associative pro.* Let  $\gamma$  be a nonnegative integer and  $As_\gamma$  be the quotient of  $PRF_\gamma$  by the finest pro congruence  $\equiv$  satisfying

$$k_1 + k_2 = \gamma = \ell_1 + \ell_2. \quad (3.2.1)$$

We can observe that  $As_\gamma$  is a stiff pro because  $\equiv$  satisfies (C2) and (C3), and that  $As_0 = PRF_0$ . Moreover, observe that, when  $\gamma \geq 1$ , there is in  $As_\gamma$  exactly one indecomposable element of arity  $n\gamma + 1$  for any  $n \geq 0$ . We denote by  $\alpha_n$  this element. We consider on  $As_\gamma$  the grading  $\omega$  inherited the one of  $PRT_\gamma$ . This grading is still well-defined in  $As_\gamma$  since any  $\equiv$ -equivalence class contains prographs of a same degree and satisfies, for all  $n \geq 0$ ,  $\omega(\alpha_n) = n$ . Any element of  $As_\gamma$  is then a word  $\alpha_{k_1} \dots \alpha_{k_\ell}$  and can be encoded by a word of nonnegative integers  $k_1 \dots k_\ell$ . Since the reduced elements of  $As_\gamma$  have no wire, they are encoded by words of positive integers.

3.2.2. *Hopf bialgebra.* By Theorem 2.3.5 and Proposition 2.2.2,  $H(As_\gamma)$  is a combinatorial Hopf bialgebra. As an associative algebra,  $H(As_\gamma)$  is freely generated by the  $T_n$ ,  $n \geq 1$ , and its bases are indexed by words of positive integers where the degree of a basis element  $T_{k_1 \dots k_\ell}$  is  $k_1 + \dots + k_\ell$ .

3.2.3. *Coproduct.* Since any element  $\alpha_n$  of  $As_\gamma$  decomposes into  $\alpha_n = x \circ y$  if and only if  $x = \alpha_k$  and  $y = \alpha_{i_1} \dots \alpha_{i_{k\gamma+1}}$  with  $i_1 + \dots + i_{k\gamma+1} = n - k$ , by Proposition 2.3.4, for any  $n \geq 1$ , the coproduct of  $H(As_\gamma)$  can be expressed as

$$\Delta(T_n) = \sum_{0 \leq k \leq n} T_k \otimes \left( \sum_{i_1 + \dots + i_{k\gamma+1} = n-k} T_{i_1} \dots T_{i_{k\gamma+1}} \right), \quad (3.2.2)$$

where  $T_0$  is identified with the unit  $T_\epsilon$  of  $H(As_\gamma)$ . For instance, in  $H(As_1)$ , we have

$$\begin{aligned} \Delta(T_3) &= T_0 \otimes T_3 + T_1 \otimes (T_0 T_2 + T_1 T_1 + T_2 T_0) \\ &\quad + T_2 \otimes (T_0 T_0 T_1 + T_0 T_1 T_0 + T_1 T_0 T_0) + T_3 \otimes (T_0 T_0 T_0 T_0) \\ &= T_\epsilon \otimes T_3 + 2 T_1 \otimes T_2 + T_1 \otimes T_{11} + 3 T_2 \otimes T_1 + T_3 \otimes T_\epsilon, \end{aligned} \quad (3.2.3)$$

and in  $H(As_2)$ , we have

$$\begin{aligned} \Delta(T_3) &= T_0 \otimes T_3 + T_1 \otimes (T_0 T_0 T_2 + T_0 T_2 T_0 + T_2 T_0 T_0 + T_0 T_1 T_1 + T_1 T_0 T_1 + T_1 T_1 T_0) \\ &\quad + T_2 \otimes (T_0 T_0 T_0 T_0 T_1 + T_0 T_0 T_0 T_1 T_0 + T_0 T_0 T_1 T_0 T_0 + T_0 T_1 T_0 T_0 T_0 + T_1 T_0 T_0 T_0 T_0) \\ &\quad + T_3 \otimes T_0 T_0 T_0 T_0 T_0 T_0 \\ &= T_\epsilon \otimes T_3 + 3 T_1 \otimes T_2 + 3 T_1 \otimes T_{11} + 5 T_2 \otimes T_1 + T_3 \otimes T_\epsilon. \end{aligned} \quad (3.2.4)$$

3.2.4. *Deformation of the noncommutative Faà di Bruno Hopf bialgebra.*

**THEOREM 3.2.1.** *For any nonnegative integer  $\gamma$ , the Hopf bialgebra  $H(As_\gamma)$  is the deformation of the noncommutative Faà di Bruno Hopf bialgebra  $FdB_\gamma$ .*

**3.3. Hopf bialgebra of forests of bitrees.** To define Hopf bialgebras of forests of bitrees, we need the following general construction on pros.

3.3.1. *Symmetrization of pros.* If  $\mathfrak{G}$  is a bigraded collection of the form  $\mathfrak{G} = \sqcup_{p \geq 1} \sqcup_{q \geq 1} \mathfrak{G}(p, q)$ , we denote by  $\mathfrak{G}^*$  the bigraded collection defined by

$$\mathfrak{G}^*(p, q) := \mathfrak{G}(q, p), \quad p, q \geq 1. \quad (3.3.1)$$

From a geometrical point of view, any elementary prograph over  $\mathfrak{G}^*$  is obtained by reversing from bottom to top an elementary prograph over  $\mathfrak{G}$ . We moreover denote by  $\text{rev} : \mathbf{FP}(\mathfrak{G}^*) \rightarrow \mathbf{FP}(\mathfrak{G})$  the bijection sending any prograph  $x$  of  $\mathbf{FP}(\mathfrak{G}^*)$  to the prograph  $\text{rev}(x)$  of  $\mathbf{FP}(\mathfrak{G})$  obtained by reversing  $x$  from bottom to top.

Now, given a pro  $\mathcal{P} := \mathbf{FP}(\mathfrak{G})/\simeq$ , we define the *symmetrization*  $S(\mathcal{P})$  of  $\mathcal{P}$  as the pro

$$S(\mathcal{P}) := \mathbf{FP}(\mathfrak{G} \sqcup \mathfrak{G}^*)/\simeq, \quad (3.3.2)$$

where  $\simeq$  is the finest congruence of  $\mathbf{FP}(\mathfrak{G} \sqcup \mathfrak{G}^*)$  satisfying

$$x \simeq y \quad \text{if } (x, y \in \mathbf{FP}(\mathfrak{G}) \text{ and } x \equiv y) \quad \text{or} \quad (x, y \in \mathbf{FP}(\mathfrak{G}^*) \text{ and } \text{rev}(x) \equiv \text{rev}(y)). \quad (3.3.3)$$

Notice that in this definition, we consider  $\mathbf{FP}(\mathfrak{G})$  and  $\mathbf{FP}(\mathfrak{G}^*)$  as sub-pros of  $\mathbf{FP}(\mathfrak{G} \sqcup \mathfrak{G}^*)$  in an obvious way. Notice also that if  $\mathcal{P}$  is a free pro  $\mathbf{FP}(\mathfrak{G})$ , then the congruence  $\equiv$  is trivial, so that  $\simeq$  is also trivial, and  $S(\mathcal{P}) = \mathbf{FP}(\mathfrak{G} \sqcup \mathfrak{G}^*)$ . Besides, as another immediate property of this construction, remark that when  $\mathcal{P}$  is a stiff pro, the congruence  $\simeq$  satisfies (C2) and (C3), and then,  $S(\mathcal{P})$  is a stiff pro.

We shall present here two Hopf bialgebras coming from the construction  $S$  applied to  $\text{PRF}_\gamma$  and  $\text{As}_\gamma$ .

3.3.2. *Pro of forests of bitrees.* Let  $\gamma$  be a nonnegative integer and  $\text{FBT}_\gamma$  be the free pro generated by  $\mathfrak{G} := \mathfrak{G}(\gamma + 1, 1) \sqcup \mathfrak{G}(1, \gamma + 1)$  where  $\mathfrak{G}(\gamma + 1, 1) := \{a\}$  and  $\mathfrak{G}(1, \gamma + 1) := \{b\}$ , with the grading  $\omega$  defined by  $\omega(a) := \omega(b) := 1$ . One has  $S(\text{PRF}_\gamma) = \text{FBT}_\gamma$ . Any prograph  $x$  of  $\text{FBT}_\gamma$  can be seen as a forest of  *$\gamma$ -bitrees*, that are labeled planar trees where internal nodes labeled by  $a$  have  $\gamma + 1$  children and one parent, and the internal nodes labeled by  $b$  have one child and  $\gamma + 1$  parents. Since the reduced elements of  $\text{FBT}_\gamma$  have no wire, they are encoded by forests of nonempty  $\gamma$ -bitrees.

3.3.3. *Hopf bialgebra.* By Theorem 2.1.1 and Proposition 2.2.2,  $H(\text{FBT}_\gamma)$  is a combinatorial Hopf bialgebra. By Proposition 2.2.1, as an associative algebra,  $H(\text{FBT}_\gamma)$  is freely generated by the  $S_t$ , where the  $t$  are nonempty  $\gamma$ -bitrees. Its bases are indexed by planar forests of such bitrees where the degree of a basis element  $S_f$  is the total number of internal nodes in the bitrees of  $f$ . Moreover, by Proposition 2.2.5, since  $\text{PRF}_\gamma$  is generated by a subset of the generators of  $\text{FBT}_\gamma$ ,  $H(\text{PRF}_\gamma)$  is a quotient bialgebra of  $H(\text{FBT}_\gamma)$ .

3.3.4. *Coproduct.* The coproduct of  $H(\text{FBT}_\gamma)$  can be described, like the one of CK on forests, by means of admissible cuts on forests of  $\gamma$ -bitrees. We have for instance

$$\Delta S = S_\emptyset \otimes S + S \otimes S + S \otimes S + S \otimes S + S \otimes S + S \otimes S + S \otimes S + S \otimes S. \quad (3.3.4)$$

3.3.5. *Dimensions.* We only know the dimensions of  $H(\text{FBT}_\gamma)$  when  $\gamma = 0$ . In this case, 0-bitrees of size  $n$  are linear trees and can hence be seen as words of length  $n$  on the alphabet  $\{a, b\}$ . Therefore, as  $H(\text{FBT}_\gamma)$  is free as an associative algebra, the bases of  $H(\text{FBT}_0)$  are indexed by multiwords on  $\{a, b\}$  and its Hilbert series is

$$\mathcal{H}_{H(\text{FBT}_0)}(t) := 1 + \sum_{n \geq 1} 2^{2n-1} t^n. \quad (3.3.5)$$

3.3.6. *Pro of biassociative operators and its Hopf bialgebra.* Let  $\text{BAS}_\gamma$  be the quotient of  $\text{FBT}_\gamma$  by the finest pro congruence  $\equiv$  satisfying

$$\begin{array}{c} \text{a} \\ \diagup \quad \diagdown \\ \dots \quad \text{a} \quad \dots \\ \diagup \quad \diagdown \\ k_1 \quad \dots \quad k_2 \end{array} \equiv \begin{array}{c} \text{a} \\ \diagup \quad \diagdown \\ \dots \quad \text{a} \quad \dots \\ \diagup \quad \diagdown \\ l_1 \quad \dots \quad l_2 \end{array}, \quad k_1 + k_2 = \gamma = l_1 + l_2, \quad (3.3.6)$$

and

$$\begin{array}{c} k_1 \quad \dots \quad k_2 \\ \diagdown \quad \diagup \\ \dots \quad \text{b} \quad \dots \\ \diagdown \quad \diagup \\ k_1 \quad \dots \quad k_2 \end{array} \equiv \begin{array}{c} l_1 \quad \dots \quad l_2 \\ \diagdown \quad \diagup \\ \dots \quad \text{b} \quad \dots \\ \diagdown \quad \diagup \\ l_1 \quad \dots \quad l_2 \end{array}, \quad k_1 + k_2 = \gamma = l_1 + l_2. \quad (3.3.7)$$

We can observe that  $\text{BAS}_\gamma$  is a stiff pro because  $\equiv$  satisfies (C2) and (C3). Notice that  $S(\text{AS}_\gamma) = \text{BAS}_\gamma$  and  $\text{BAS}_0 = \text{FBT}_0$ . We consider on  $\text{BAS}_\gamma$  the grading  $\omega$  inherited the one of  $\text{FBT}_\gamma$ . This grading is still well-defined in  $\text{BAS}_\gamma$  since any  $\equiv$ -equivalence class contains prographs of a same degree. Notice that  $\text{BAS}_1$  is very similar to the pro governing Hopf bialgebras (see [Mar08]). Indeed, it only lacks in  $\text{BAS}_1$  the usual compatibility relation between its two generators. Notice also that the pro governing bialgebras is not a stiff pro.

By Theorem 2.3.5 and Proposition 2.2.2,  $H(\text{BAS}_\gamma)$  is then a combinatorial Hopf bialgebra. Moreover, we can observe that  $H(\text{AS}_\gamma)$  is a quotient Hopf bialgebra of  $H(\text{BAS}_\gamma)$ .

**3.4. Hopf bialgebra of heaps of pieces.** We present here the construction of a Hopf bialgebra depending on a nonnegative integer  $\gamma$ , whose bases are indexed by heaps of pieces.



3.4.1. *Pro of heaps of pieces.* Let  $\gamma$  be a nonnegative integer and  $\text{Heap}_\gamma$  be the free pro generated by  $\mathfrak{G} := \mathfrak{G}(\gamma + 1, \gamma + 1) := \{a\}$ , with the grading  $\omega$  defined by  $\omega(a) := 1$ . Any prograph  $x$  of  $\text{Heap}_\gamma$  can be seen as a heap of pieces of width  $\gamma + 1$  (see [Vie86] for some theory about these objects). For instance, the prograph

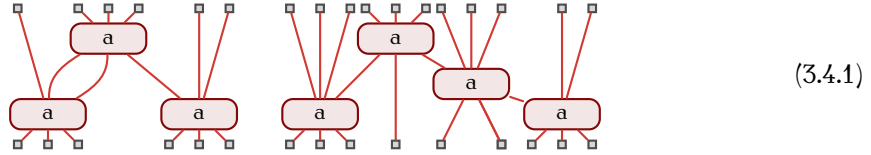

of  $\text{Heap}_2$  is encoded by the heap of pieces of width 3 depicted by



Notice that  $\text{Heap}_0 = \text{PRF}_0$ . Besides, since the reduced elements of  $\text{Heap}_\gamma$  have no wire, they are encoded by horizontally connected heaps of pieces of width  $\gamma + 1$ .

3.4.2. *Hopf bialgebra.* By Theorem 2.1.1 and Proposition 2.2.2,  $H(\text{Heap}_\gamma)$  is a combinatorial Hopf bialgebra. By Proposition 2.2.1, as an associative algebra,  $H(\text{Heap}_\gamma)$  is freely generated by the  $S_\lambda$  where the  $\lambda$  are heaps of pieces that cannot be obtained by juxtaposing two heaps of pieces. Its bases are indexed by horizontally connected heaps of pieces of width  $\gamma + 1$  where the degree of a basis element  $S_\lambda$  is the number of pieces of  $\lambda$ .

3.4.3. *Coproduct.* The coproduct of  $H(\text{Heap}_\gamma)$  can be described, like the one of CK on forests, by means of admissible cuts on heaps of pieces. Indeed, if  $\lambda$  is a horizontally connected heap of pieces, by definition of the construction  $H$ ,

$$\Delta(S_\lambda) = \sum_{\lambda' \in \text{Adm}(\lambda)} S_{\lambda'} \otimes S_{\lambda/\lambda'}, \tag{3.4.3}$$

where  $\text{Adm}(\lambda)$  is the set of *admissible cuts* of  $\lambda$ , that is, the set of heaps of pieces obtained by keeping an upper part of  $\lambda$  and by readjusting it so that it becomes horizontally connected and where  $\lambda/\lambda'$  denotes the heap of pieces obtained by removing from  $\lambda$  the pieces of  $\lambda'$  and by readjusting the remaining pieces so that they form an horizontally connected heap of pieces. For instance, in  $H(\text{Heap}_1)$ , we have

$$\begin{aligned} \Delta S_{\begin{array}{c} \text{---} \\ \text{---} \\ \text{---} \end{array}} &= S_{\emptyset} \otimes S_{\begin{array}{c} \text{---} \\ \text{---} \\ \text{---} \end{array}} + S_{\begin{array}{c} \text{---} \\ \text{---} \end{array}} \otimes S_{\begin{array}{c} \text{---} \\ \text{---} \end{array}} \\ &+ S_{\begin{array}{c} \text{---} \\ \text{---} \end{array}} \otimes S_{\begin{array}{c} \text{---} \\ \text{---} \end{array}} + S_{\begin{array}{c} \text{---} \\ \text{---} \end{array}} \otimes S_{\begin{array}{c} \text{---} \\ \text{---} \end{array}} \\ &+ S_{\begin{array}{c} \text{---} \\ \text{---} \end{array}} \otimes S_{\begin{array}{c} \text{---} \\ \text{---} \end{array}} + S_{\begin{array}{c} \text{---} \\ \text{---} \end{array}} \otimes S_{\emptyset}. \end{aligned} \tag{3.4.4}$$

3.4.4. *Dimensions.*

PROPOSITION 3.4.1. For any nonnegative integer  $\gamma$ , the Hilbert series  $\mathcal{H}_{\text{H}(\text{Heap}_\gamma)}(t)$  of  $\text{H}(\text{Heap}_\gamma)$  satisfies  $\mathcal{H}_{\text{H}(\text{Heap}_\gamma)}(t) = \sum_{n \geq 0} C_{\gamma,n}(t)$ , where

$$C_{\gamma,n}(t) := P_{\gamma,n}(t) - \sum_{k=0}^{n-1} C_{\gamma,k}(t)P_{\gamma,n-k-1}(t), \tag{3.4.5}$$

$$P_{\gamma,n}(t) := \frac{1}{F_{\gamma,n}(t)}, \tag{3.4.6}$$

and

$$F_{\gamma,n}(t) := \begin{cases} 1 & \text{if } n \leq \gamma, \\ F_{\gamma,n-1}(t) - tF_{\gamma,n-\gamma-1}(t) & \text{otherwise.} \end{cases} \tag{3.4.7}$$

By using Proposition 3.4.1, one can compute the first dimensions of  $\text{H}(\text{Heap}_\gamma)$ . The first dimensions of  $\text{H}(\text{Heap}_1)$  are

$$1, 1, 4, 18, 85, 411, 2014, 9950, 49417, 246302, 1230623, \tag{3.4.8}$$

and those of  $\text{H}(\text{Heap}_2)$  are

$$1, 1, 6, 42, 313, 2407, 18848, 149271, 1191092, 9553551, 76910632. \tag{3.4.9}$$

Since by Proposition 2.2.1,  $\text{H}(\text{Heap}_\gamma)$  is free as an associative, the series  $\mathcal{G}_\gamma(t)$  of its algebraic generators satisfies  $\mathcal{G}_\gamma(t) = 1 - \frac{1}{\mathcal{H}_{\text{H}(\text{Heap}_\gamma)}(t)}$ . The first dimensions of the algebraic generators of  $\text{H}(\text{Heap}_1)$  are

$$1, 3, 11, 44, 184, 790, 3450, 15242, 67895, 304267, 1369761, \tag{3.4.10}$$

and those of  $\text{H}(\text{Heap}_2)$  are

$$1, 5, 31, 210, 1488, 10826, 80111, 599671, 4525573, 34357725, 262011295. \tag{3.4.11}$$

These four integer sequences are respectively Sequences **A247637**, **A247638**, **A059715**, and **A247639** of [Slo].

**3.5. Hopf bialgebra of heaps of friable pieces.** By considering special quotient of  $\text{Heap}_\gamma$ , we construct a Hopf bialgebra structure on the  $(\gamma + 1)$ st tensor power of the vector space  $\text{Sym}$ .

3.5.1. *Pro of heaps of friable pieces.* Let  $\gamma$  be a nonnegative integer and  $\text{FHeap}_\gamma$  be the quotient of  $\text{Heap}_\gamma$  by the finest pro congruence  $\equiv$  satisfying

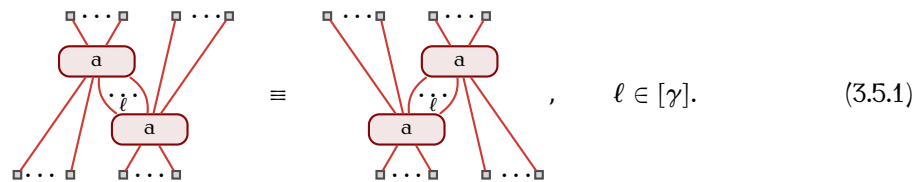

$$\tag{3.5.1}$$



For instance, for  $\gamma = 2$ , the  $\equiv$ -equivalence class of

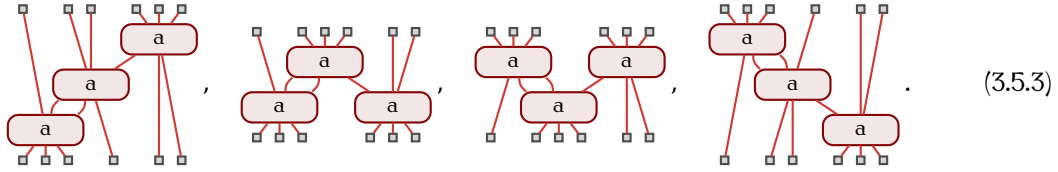

$$\tag{3.5.2}$$

contains exactly the prographs



We can observe that  $\text{FHeap}_\gamma$  is a stiff pro because  $\equiv$  satisfies (C2) and (C3) and  $\text{FHeap}_0 = \text{Heap}_0$ . We call  $\text{FHeap}_\gamma$  the *pro of heaps of friable pieces* of width  $\gamma + 1$ . This terminology is justified by the following observation. Any piece of width  $\gamma + 1$  (depicted by ) consists in  $\gamma + 1$  small pieces, called *bursts*, glued together. This forms a *friable piece* (depicted, for  $\gamma = 2$  for instance, by ). The congruence  $\equiv$  of  $\text{Heap}_\gamma$  can be interpreted by letting all pieces break under gravity, separating the bursts constituting them. For instance, the prographs of (3.5.3), respectively, encoded by the heaps of pieces



all become the heap of friable pieces



obtained by replacing each piece of any heap of pieces of (3.5.4) by friable pieces.

The grading  $\omega$  of  $\text{FHeap}_\gamma$  is the one inherited the one of  $\text{Heap}_\gamma$ . This grading is still well-defined in  $\text{Heap}_\gamma$  since any  $\equiv$ -equivalence class contains prographs of a same degree. Since the reduced elements of  $\text{FHeap}_\gamma$  have no wire, they are encoded by horizontally connected heaps of friable pieces.

Besides,  $\text{FHeap}_\gamma$  admits the following alternative description using the B construction (see Section 2.4.2). Indeed,  $\text{FHeap}_\gamma$  is the sub-pro of  $B(\mathbb{N})$  generated by  $1^{\gamma+1}$ , where  $\mathbb{N}$  denotes here the additive monoid of nonnegative integers and  $1^{\gamma+1}$  denotes the sequence of  $\gamma + 1$  occurrences of  $1 \in \mathbb{N}$ . The correspondence between heaps of friable pieces and words of integers of this second description is clear since any element  $x$  of the sub-pro of  $B(\mathbb{N})$  generated by  $1^{\gamma+1}$  encodes a heap of friable pieces consisting, from left to right, in columns of  $x_i$  bursts for  $i \in [n]$ , where  $n$  is the length of  $x$ . For instance, the word 122211 encodes the heap of friable pieces of (3.5.5).

3.5.2. *Hopf bialgebra.* By Theorem 2.3.5 and Proposition 2.2.2,  $H(\text{FHeap}_\gamma)$  is a combinatorial Hopf sub-bialgebra of  $H(\text{Heap}_\gamma)$ . The bases of  $H(\text{FHeap}_\gamma)$  are indexed by horizontally connected heaps of friable pieces of width  $\gamma + 1$  where the degree of a basis element  $T_\lambda$  is the number of pieces of  $\lambda$ .

3.5.3. *Coproduct.* The coproduct of  $H(\text{FHeap}_\gamma)$  can be described with the aid of the interpretation of  $\text{FHeap}_\gamma$  as a sub-pro of  $B(\mathbb{N})$ . Indeed, if  $\lambda$  is an horizontally connected heap of friable pieces, by Proposition 2.3.4,

$$\Delta(T_\lambda) = \sum_{\substack{\lambda_1, \lambda_2 \in \text{FHeap}_\gamma \\ \lambda = \lambda_1 + \lambda_2}} T_{\lambda_1} \otimes T_{\lambda_2}, \tag{3.5.6}$$

where  $\lambda_1 + \lambda_2$  is the heap of friable pieces obtained by stacking  $\lambda_2$  onto  $\lambda_1$  and where  $\lambda'_1$  (resp.  $\lambda'_2$ ) is the readjustment of  $\lambda_1$  (resp.  $\lambda_2$ ) so that it is horizontally connected. For instance, we have in  $H(\text{FHeap}_1)$

$$T \begin{array}{c} \blacksquare \\ \blacksquare \blacksquare \\ \blacksquare \blacksquare \blacksquare \end{array} = S \begin{array}{c} \blacksquare \blacksquare \\ \blacksquare \blacksquare \blacksquare \end{array} + S \begin{array}{c} \blacksquare \blacksquare \blacksquare \\ \blacksquare \blacksquare \blacksquare \end{array} + S \begin{array}{c} \blacksquare \blacksquare \blacksquare \\ \blacksquare \blacksquare \end{array}, \quad (3.5.7)$$

$$\begin{aligned} \Delta T \begin{array}{c} \blacksquare \\ \blacksquare \blacksquare \\ \blacksquare \blacksquare \blacksquare \end{array} &= T_{\emptyset} \otimes T \begin{array}{c} \blacksquare \\ \blacksquare \blacksquare \\ \blacksquare \blacksquare \blacksquare \end{array} + T \begin{array}{c} \blacksquare \blacksquare \blacksquare \\ \blacksquare \blacksquare \blacksquare \end{array} \otimes T \begin{array}{c} \blacksquare \\ \blacksquare \blacksquare \\ \blacksquare \blacksquare \blacksquare \end{array} + T \begin{array}{c} \blacksquare \blacksquare \blacksquare \\ \blacksquare \blacksquare \blacksquare \end{array} \otimes T \begin{array}{c} \blacksquare \blacksquare \blacksquare \\ \blacksquare \blacksquare \blacksquare \end{array} \\ &+ T \begin{array}{c} \blacksquare \blacksquare \blacksquare \\ \blacksquare \blacksquare \blacksquare \end{array} \otimes T \begin{array}{c} \blacksquare \blacksquare \blacksquare \\ \blacksquare \blacksquare \blacksquare \end{array} + T \begin{array}{c} \blacksquare \blacksquare \blacksquare \\ \blacksquare \blacksquare \blacksquare \end{array} \otimes T \begin{array}{c} \blacksquare \blacksquare \blacksquare \\ \blacksquare \blacksquare \blacksquare \end{array} + T \begin{array}{c} \blacksquare \blacksquare \blacksquare \\ \blacksquare \blacksquare \blacksquare \end{array} \otimes T_{\emptyset}. \end{aligned} \quad (3.5.8)$$

3.5.4. *Dimensions.*

PROPOSITION 3.5.1. *For any nonnegative integers  $\gamma$  and  $n$ , the  $n$ th homogeneous component of  $H(\text{FHeap}_\gamma)$  has dimension  $(\gamma + 2)^{n-1}$ .*

3.5.5. *Miscellaneous properties.* By the dimensions of  $H(\text{FHeap}_\gamma)$  provided by Proposition 3.5.1, as a graded vector space,  $H(\text{FHeap}_\gamma)$  is the  $\gamma + 1$ st tensor power of the underlying vector space of  $\text{Sym}$ . Indeed, the  $n$ th homogeneous components of these two spaces have the same dimension. Besides, notice that since  $\text{FHeap}_\gamma$  is by definition a sub-pro of the pro obtained by applying the construction B to a commutative monoid,  $H(\text{FHeap}_\gamma)$  is cocommutative.

**Concluding remarks**

We have defined a construction H establishing a new link between the theory of pros and the theory of combinatorial Hopf bialgebras, by generalizing a former construction from operads to Hopf bialgebras. By the way, we have exhibited the so-called stiff pros which is the most general class of pros for which our construction works.

By using H, we have introduced some new and recovered some already known combinatorial Hopf bialgebras by starting with very simple pros. Nevertheless, we are very far from having exhausted the possibilities, and it would not be surprising that H could reconstruct some other known Hopf bialgebras, maybe in unexpected bases.

Computing the Hilbert series of a combinatorial Hopf bialgebra is, usually, a routine work. Nevertheless, in the general case, it is very difficult to compute the Hilbert series of  $H(\mathcal{P})$  when  $\mathcal{P}$  is a free pro. Indeed, this computation requires to know, given a free pro  $\mathcal{P}$ , the series

$$\mathcal{H}_{\mathcal{P}}(t) := \sum_{x \in \text{red}(\mathcal{P})} t^{\deg(x)}, \quad (3.5.9)$$

which seems difficult to explicitly describe in general.

As another perspective, it is conceivable to go further in the study of the algebraic structure of the bialgebras obtained by H. The question of the potential autoduality of  $H(\mathcal{P})$  depending on some conditions on the pro  $\mathcal{P}$  is worth studying. A way to solve this problem

is to provide enough conditions on  $\mathcal{P}$  to endow  $H(\mathcal{P})$  with a bidendriform bialgebra structure [Foi07] (see also Section 2.3.3 of Chapter 2). This strategy is based upon the fact that any bidendriform bialgebra is free and self-dual as a bialgebra [Foi07].

## **Part 4**

# **Combinatorics and algorithms**



## Shuffle of permutations

The content of this chapter comes from [GV16] and is a joint work with Stéphane Vialette.

### Introduction

The shuffle product  $\sqcup$  is a well-known operation on words first defined by Eilenberg and Mac Lane [EML53]. Given three words  $u$ ,  $v_1$ , and  $v_2$ ,  $u$  is said to be a shuffle of  $v_1$  and  $v_2$  if it can be formed by interleaving the letters from  $v_1$  and  $v_2$  in a way that maintains the left-to-right ordering of the letters from each word (see also Section 2.3.1 of Chapter 2). Besides purely combinatorial questions, the shuffle product of words naturally leads to the following computational problems:

- (i) Given two words  $v_1$  and  $v_2$ , compute the set of the words appearing in the shuffle of  $v_1$  with  $v_2$ ;
- (ii) Given three words  $u$ ,  $v_1$ , and  $v_2$ , decide if  $u$  appears in the shuffle of  $v_1$  with  $v_2$ ;
- (iii) Given a word  $u$ , decide if there is a word  $v$  such that  $u$  is in the shuffle of  $v$  with itself.

Even if these problems seem similar, they radically differ in terms of time complexity. Let us now review some facts about these. In what follows,  $n$  denotes the size of  $u$  and  $m_i$  denotes the size of each  $v_i$ . A solution to Problem (i) can be computed in  $O\left(\binom{m_1+m_2}{m_1}\right)$  time [Spe86, All00]. Problem (ii) is in **P**; it is indeed a classical textbook exercise to design an efficient dynamic programming algorithm solving it. It can be tested in  $O(n^2/\log(n))$  time [vLN82]. To the best of our knowledge, the first  $O(n^2)$  time algorithm for this problem appeared in [Man83]. This algorithm can easily be extended to check in polynomial-time whether a word is in the shuffle of any fixed number of given words. Let us now finally focus on Problem (iii). It is shown in [RV13, BS14] that it is **NP**-complete to decide if a word  $u$  is a square with respect to the shuffle, that is a word  $u$  with the property that there exists a word  $v$  such that  $u$  appears in the shuffle of  $v$  with itself. Hence, Problem (iii) is **NP**-complete.

This chapter is intended to study a natural generalization of  $\sqcup$ , denoted by  $\bullet$ , as a shuffle of permutations. Roughly speaking, given three permutations  $\pi$ ,  $\sigma_1$ , and  $\sigma_2$ ,  $\pi$  is said to be a shuffle of  $\sigma_1$  and  $\sigma_2$  if  $\pi$  (viewed as a word) appears in the shuffle of two words whose standardized permutations are respectively  $\sigma_1$  and  $\sigma_2$ . This shuffle product was first introduced by Vargas [Var14] under the name of supershuffle. Our intention in this work is to study this shuffle product of permutations  $\bullet$  both from a combinatorial and from a computational point of view by focusing on square permutations, that are permutations  $\pi$  appearing in the shuffle of a permutation  $\sigma$  with itself. Many other shuffle products on permutations appear in the literature. For instance, in [DHT02], the authors define the convolution product and



the shifted shuffle product (see Section 3.2.3 of Chapter 2). It is a simple exercise to prove that, given three permutations  $\pi$ ,  $\sigma_1$ , and  $\sigma_2$ , deciding if  $\pi$  is in the shifted shuffle of  $\sigma_1$  and  $\sigma_2$  is in  $\mathbf{P}$ .

This chapter is organized as follows. In Section 1, we introduce the general notion of square elements in algebras. We take as examples the case of the shifted shuffle product of permutations and the shuffle product of words. We provide a definition of the supershuffle of permutations in Section 2, by introducing it from its dual coproduct  $\Delta$ , called unshuffling coproduct. Some algebraic and combinatorial properties of these product and coproduct are reviewed. Section 3 is devoted to contain an algorithmic study of square permutations with respect to  $\bullet$ . The most important result of this work, concerning the fact that deciding if a permutation is square is  $\mathbf{NP}$ -complete, appears here.

### 1. Square elements, shuffles, and words

Before defining and studying the supershuffle product of permutations, we set here a general algebraic framework about square elements in algebras.

**1.1. Square elements with respect to a product.** The general notion of square elements in polynomial algebras endowed with a binary product is introduced here. This notion relies on the notions of collections (see Section 1 of Chapter 1) and of polynomial algebras (see Section 2 of Chapter 2 for the basic definitions about these structures).

**1.1.1. General definitions.** Let  $C$  be a collection and  $\mathbb{K}\langle C \rangle$  be an algebra (not necessarily an associative algebra) endowed with a binary product  $\star$ . An object  $x$  of  $C$  is a *square* with respect to  $\star$  if there is an object  $y$  of  $C$  such that  $x$  appears in the product  $y \star y$ . In this case, we say that  $y$  is a *square root* of  $x$ . Observe that this notion depends on the basis of  $C$  of  $\mathbb{K}\langle C \rangle$ . Indeed, seen on another basis  $C'$  of  $\mathbb{K}\langle C \rangle$ , square elements can be different.

By duality, by considering the dual  $(\mathbb{K}\langle C \rangle^*, \Delta_\star)$  of  $(\mathbb{K}\langle C \rangle, \star)$ , an element  $x$  of  $C$  is a square and  $y \in C$  is one of its square root if and only if the tensor  $y \otimes y$  appears in  $\Delta_\star(x)$ . Indeed, by definition  $x$  is a square and  $y$  is one of its square root if and only if the structure coefficient  $\xi_\star^{(y \otimes y, x)}$  of  $\star$  is nonzero (see Section 2.1.1 of Chapter 2). Hence, this is equivalent to say that the structure coefficient  $\xi_{\Delta_\star}^{(x, y \otimes y)}$  of  $\Delta_\star$  is nonzero.

In the case where  $(\mathbb{K}\langle C \rangle, \star)$  is graded, there are two algorithmic problems related to these concepts. The first one takes as input an element  $x$  of  $C$  of size  $n$  and consists in deciding whether  $x$  is a square. We call this problem the *square detection problem SDP*. The second one takes as input an element  $x$  of  $C$  of size  $n$  and another element  $y$  of  $C$  and consists in deciding whether  $y$  is a square root of  $x$ . We call this problem the *square root checking problem RCP*. The complexity of these two problems is studied with respect to  $n$ .

**1.1.2. Square permutations in FQSym.** To give an example of this notion of squares, consider the space  $\text{FQSym} = \mathbb{K}\langle \mathfrak{S} \rangle$  of all permutations endowed with the shifted shuffle product (see Section 3.2.3 of Chapter 2). The permutation 316425 is a square since it appears in the shifted shuffle of 312 with itself. The first square permutations are

$$\epsilon, \quad 12, 21, \quad 1234, 1324, 1342, 3124, 3142, 3412, 2143, 2413, 4213, 2431, 4231, 4321, \quad (1.1.1)$$

and the sequence of the number of square permutations begins by

$$1, 0, 2, 0, 12, 0, 120, 0, 1680, 0, 30240, 0, 665280, 0, 17297280, \tag{1.1.2}$$

forming (after removing the 0s) Sequence **A001813** of [Slo].

To test if a permutation  $\sigma$  of an even size  $n$  is a square, one can extract its subword  $u$  consisting in the letters in  $\{1, 2, \dots, \frac{n}{2}\}$ , its subword  $v$  consisting in the letters in  $\{\frac{n}{2} + 1, \frac{n}{2} + 2, \dots, n\}$ , and checking if  $\text{std}(v) = u$ , where  $\text{std}$  is the standardization algorithm (see Section 1.2.5 of Chapter 1). Since all these operations are obviously polynomial in  $n$ , SDP is polynomial.

Besides, to check if a permutation  $v$  is a square root of a permutation  $\sigma$  of an even size  $n$ , one can check if the subword  $u$  of  $\sigma$  consisting in the letters in  $\{1, 2, \dots, \frac{n}{2}\}$  of  $\sigma$  and if the standardized of subword  $v$  consisting in the letters in  $\{\frac{n}{2} + 1, \frac{n}{2} + 2, \dots, n\}$  are both equal to  $v$ . Since these operations are polynomial in  $n$ , RCP is polynomial.

**1.2. Square words for the shuffle product.** We now turn our attention to square words for the shuffle product and the complexity of SDP. These results come from [RV13] and are used as prototype in our upcoming study of square permutations.

1.2.1. *Square words.* Let us consider here the shuffle algebra  $(\mathbb{K}\langle A^* \rangle, \sqcup)$  where  $A$  is a finite alphabet (see Section 2.3.1 of Chapter 2). For instance, if  $A := \{a, b\}$ , the word  $abaaba$  is a square since it appears in the shuffle of  $aba$  with itself. Contrariwise, the word  $abba$  is not a square. Observe that having an even number of occurrences for each letter of  $A$  is a necessary condition to be a square.

1.2.2. *Perfect matchings.* Let us describe a way to decide if a word  $u$  is a square. This comes from [RV13] and use perfect matchings on words. A *perfect matching* on a word  $u \in A^*$  is a graph  $(V, E)$  such that

$$V := \{(u(i), i) : i \in [|u|]\}, \tag{1.2.1}$$

every vertex of  $V$  belongs to exactly one edge of  $E$ , and  $\{(u(i), i), (u(j), j)\} \in E$  implies  $u(i) = u(j)$ . Figure 10.1 shows a perfect matching on a word.

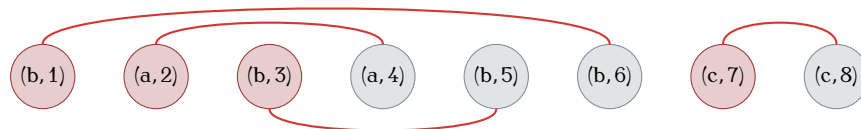

FIGURE 10.1. A perfect matching on the word  $bababbcc$ .

A perfect matching  $(V, E)$  is *containment-free* if there are no edges  $\{(u(i), i), (u(j), j)\}$  and  $\{(u(i'), i'), (u(j'), j')\}$  of  $E$  such that  $i < i' < j' < j$ . Observe that the perfect matching of Figure 10.1 is not containment-free.

The criterion of Rizzi and Viallette [RV13] to recognize square words is the following.

PROPOSITION 1.2.1. A word  $u \in A^*$  is a square if and only if there exists a containment-free perfect matching on  $u$ .

Figure 10.2 shows two examples related to Proposition 1.2.1.

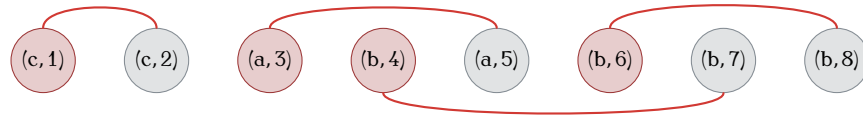

(A) A containment-free perfect matching on the word  $ccababbb$ , showing that it is a square. The associated square root is  $cabb$ .

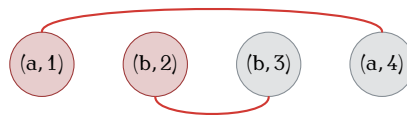

(B) The word  $abba$  is not a square since it admits this only perfect matching which is not containment-free.

FIGURE 10.2. Two perfect matchings on words.

As a consequence of this criterion, given a containment-free perfect matching on  $u$ , a square root of  $u$  is readable by observing the subword  $u(i_1)u(i_2)\dots u(i_n)$  of  $u$  such that the indices  $i_1, i_2, \dots, i_n$  satisfy  $i_1 < i_2 < \dots < i_n$  and, for all  $k \in [n]$ ,  $\{(u(i_k), i_k), (u(j_k), j_k)\}$  is an edge of the perfect matching where  $i_k < j_k$ .

1.2.3. *Recognizing square words.* By using the criterion provided by Proposition 1.2.1, it is possible to perform a polynomial-time reduction from the longest common subsequence problem for binary words (which is NP-complete) to SDP. This leads to the following result [RV13].

THEOREM 1.2.2. In the shuffle algebra  $(\mathbb{K}\langle A^* \rangle, \sqcup)$  where  $A$  is a finite alphabet, SDP is NP-complete.

## 2. Supershuffle of permutations

The purpose of this section is to define a shuffle product  $\bullet$  on permutations, different from the shifted shuffle (see Section 1.1.2). Recall that a first definition of this product was provided by Vargas [Var14]. To present an alternative definition of this product adapted to our study, we shall first define a coproduct denoted by  $\Delta$ , enabling to unshuffle permutations. By duality,  $\Delta$  implies the definition of  $\bullet$ . The reason why we need to pass through the definition of  $\Delta$  to define  $\bullet$  is justified by the fact that a lot of properties of  $\bullet$  depend of properties of  $\Delta$ , and that this strategy allows to write concise and clear proofs of them.

2.1. **Unshuffling coalgebra and square permutations.** After defining the unshuffling coproduct of permutations, we define the supershuffle product. The first properties of this product and of its square elements are reviewed.

2.1.1. *Unshuffling coproduct.* Let us say that two permutations  $\sigma$  and  $\nu$  are *order-isomorphic* if  $\text{std}(\sigma) = \text{std}(\nu)$ . We endow the polynomial space  $\text{FQSym}$  with the linear coproduct  $\Delta$  defined in the following way. For any permutation  $\pi$ , we set

$$\Delta(\pi) = \sum_{P_1 \sqcup P_2 = [[\pi]]} \text{std}(\pi|_{P_1}) \otimes \text{std}(\pi|_{P_2}). \tag{2.1.1}$$

We call  $\Delta$  the *unshuffling coproduct of permutations*. For instance,

$$\Delta(213) = \epsilon \otimes 213 + 2 \cdot 1 \otimes 12 + 1 \otimes 21 + 2 \cdot 12 \otimes 1 + 21 \otimes 1 + 213 \otimes \epsilon, \tag{2.1.2a}$$

$$\Delta(1234) = \epsilon \otimes 1234 + 4 \cdot 1 \otimes 123 + 6 \cdot 12 \otimes 12 + 4 \cdot 123 \otimes 1 + 1234 \otimes \epsilon, \tag{2.1.2b}$$

$$\begin{aligned} \Delta(1432) = \epsilon \otimes 1432 + 3 \cdot 1 \otimes 132 + 1 \otimes 321 + 3 \cdot 12 \otimes 21 \\ + 3 \cdot 21 \otimes 12 + 3 \cdot 132 \otimes 1 + 321 \otimes 1 + 1432 \otimes \epsilon. \end{aligned} \tag{2.1.2c}$$

Observe that the coefficient of the tensor  $1 \otimes 132$  is 3 in (2.1.2c) because there are exactly three ways to extract from the permutation 1432 two disjoint subwords respectively order-isomorphic to the permutations 1 and 132 (that are (4, 132), (3, 142), and (2, 143)).

2.1.2. *Supershuffle product.* Now, by definition of duality, the dual product of  $\Delta$ , denoted by  $\bullet$ , is a linear binary product on  $\text{FQSym}^*$ . Since  $\text{FQSym}$  is a graded combinatorial polynomial space,  $\text{FQSym} \simeq \text{FQSym}^*$ , so that we shall identify these two spaces. We call  $\bullet$  the *supershuffle* of permutations. This product satisfies, for any permutations  $\sigma$  and  $\nu$ ,

$$\sigma \bullet \nu = \sum_{\pi \in \mathfrak{S}} \xi_{\Delta}^{(\pi, \sigma \otimes \nu)} \pi, \tag{2.1.3}$$

where the coefficients  $\xi_{\Delta}^{(\pi, \sigma \otimes \nu)}$  are the structure coefficients of  $\Delta$ . For instance,

$$\begin{aligned} 12 \bullet 21 = 1243 + 1324 + 2 \cdot 1342 + 2 \cdot 1423 + 3 \cdot 1432 + 2134 + 2 \cdot 2314 \\ + 3 \cdot 2341 + 2413 + 2 \cdot 2431 + 2 \cdot 3124 + 3142 + 3 \cdot 3214 + 2 \cdot 3241 \\ + 3421 + 3 \cdot 4123 + 2 \cdot 4132 + 2 \cdot 4213 + 4231 + 4312. \end{aligned} \tag{2.1.4}$$

Observe that the coefficient 3 of the permutation 1432 in (2.1.4) comes from the fact that the coefficient of the tensor  $12 \otimes 21$  is 3 in (2.1.2c).

Intuitively, the supershuffle blends the values and the positions of the letters of the permutations. One can observe that the empty permutation  $\epsilon$  is a unit for  $\bullet$  and that this product is graded by the sizes of the permutations.

2.1.3. *Square permutations.* According to Section 1, a permutation  $\pi$  is a square with respect to  $\bullet$  if there is a permutation  $\sigma$  such that  $\pi$  appears in  $\sigma \bullet \sigma$ . In this case, we say that  $\sigma$  is a *square root* of  $\pi$ . Equivalently,  $\pi$  is a square with  $\sigma$  as a square root if and only if the tensor  $\sigma \otimes \sigma$  appears in  $\Delta(\pi)$ . The first square permutations are

$$\begin{aligned} \epsilon, \quad 12, 21, \quad 1234, 1243, 1324, 1342, 1423, 2134, 2143, 2314, 2413, 2431, \\ 3124, 3142, 3241, 3412, 3421, 4132, 4213, 4231, 4312, 4321. \end{aligned} \tag{2.1.5}$$

In a more combinatorial way, this is equivalent to saying that there are two sets  $P_1$  and  $P_2$  of disjoint indices of letters of  $\pi$  satisfying  $P_1 \sqcup P_2 = [[\pi]]$  such that the subwords  $\pi|_{P_1}$

and  $\pi|_{P_2}$  are order-isomorphic. Computer experiments give us the first numbers of square permutations with respects to their size, which are, from size 0 to 10,

$$1, 0, 2, 0, 20, 0, 504, 0, 21032, 0, 1293418. \quad (2.1.6)$$

This sequence (after removing the 0s) is known as Sequence **A279200** of [Slo]. We do not have any description (by a formula, recurrence, or generating series) of these numbers.

**2.2. Square binary words and permutations.** In this section, we shall establish the fact that the square binary words (*i.e.*, square words on the alphabet  $\{0, 1\}$  with respect to the shuffle product) are in one-to-one correspondence with square permutations avoiding some patterns. This property establishes a link between the shuffle of binary words and the supershuffle of permutations and allows to obtain a new description of square binary words.

**2.2.1. From binary words to permutations.** Let  $u$  be a binary word of length  $n$  with  $k$  occurrences of 0. We denote by  $\text{btp}$  (Binary word To Permutation) the map sending any such word  $u$  to the permutation obtained by replacing from left to right each occurrence of 0 in  $u$  by  $1, 2, \dots, k$ , and from right to left each occurrence of 1 in  $u$  by  $k + 1, k + 2, \dots, n$ . For instance,

$$\text{btp}(101100010) = 918723465. \quad (2.2.1)$$

Observe that for any nonempty permutation  $\pi$  in the image of  $\text{btp}$ , there is exactly one binary word  $u$  such that  $\text{btp}(u0) = \text{btp}(u1) = \pi$ . In support of this observation, when  $\pi$  has an even size, we denote by  $\text{ptb}(\pi)$  (Permutation To Binary word) the word  $ua$  such that  $|ua|_0$  and  $|ua|_1$  are both even, where  $a \in \{0, 1\}$ . For instance,

$$\text{ptb}(615423) = 101100, \quad (2.2.2a)$$

$$\text{ptb}(1423) = 0101. \quad (2.2.2b)$$

**2.2.2. Link between square binary words and square permutations.**

**PROPOSITION 2.2.1.** *For any  $n \geq 0$ , the map  $\text{btp}$  restricted to the set of square binary words of length  $2n$  is a bijection between this last set and the set of square permutations of size  $2n$  avoiding the patterns 213 and 231.*

The number of square binary words is (after removing the 0s) Sequence **A191755** of [Slo] beginning by

$$1, 0, 2, 0, 6, 0, 22, 0, 82, 0, 320, 0, 1268, 0, 5102, 0, 020632. \quad (2.2.3)$$

According to Proposition 2.2.1, this is also the sequence enumerating square permutations avoiding 213 and 231. Notice that it is conjectured in [HRS12] that the number of binary words of length  $2n$  is

$$\binom{2n}{n} \frac{1}{n+1} 2^n - \binom{2n-1}{n+1} 2^{n-1} + O(2^{n-2}). \quad (2.2.4)$$

**2.3. Algebraic properties.** The aim of this section is to establish some of properties of the supershuffle product of permutations  $\bullet$ . It is worth to note that, as we will see, algebraic properties of the unshuffling coproduct  $\Delta$  of permutations defined in Section 2.1.1 lead to combinatorial properties of  $\bullet$ .

### 2.3.1. Associativity and commutativity.

PROPOSITION 2.3.1. *The supershuffle product  $\bullet$  of permutations is associative and commutative, that is  $(\text{FQSym}, \bullet)$  is an associative commutative algebra.*

PROOF. To prove the associativity of  $\bullet$ , we shall prove that its dual coproduct  $\Delta$  is coassociative. This strategy relies on the fact that a product is associative if and only if its dual coproduct is coassociative. For any permutation  $\pi$ , by denoting by  $\text{Id}$  the identity map on  $\text{FQSym}$ , we have

$$\begin{aligned}
 (\Delta \otimes \text{Id})\Delta(\pi) &= (\Delta \otimes \text{Id}) \sum_{P_1 \sqcup P_2 = [|\pi|]} \text{std}(\pi|_{P_1}) \otimes \text{std}(\pi|_{P_2}) \\
 &= \sum_{P_1 \sqcup P_2 = [|\pi|]} \Delta(\text{std}(\pi|_{P_1})) \otimes I(\text{std}(\pi|_{P_2})) \\
 &= \sum_{P_1 \sqcup P_2 = [|\pi|]} \sum_{Q_1 \sqcup Q_2 = [P_1]} \text{std}(\text{std}(\pi|_{P_1})|_{Q_1}) \otimes \text{std}(\text{std}(\pi|_{P_1})|_{Q_2}) \otimes \text{std}(\pi|_{P_2}) \\
 &= \sum_{P_1 \sqcup P_2 \sqcup P_3 = [|\pi|]} \text{std}(\pi|_{P_1}) \otimes \text{std}(\pi|_{P_2}) \otimes \text{std}(\pi|_{P_3}).
 \end{aligned} \tag{2.3.1}$$

An analogous computation shows that  $(\text{Id} \otimes \Delta)\Delta(\pi)$  is equal to the last member of (2.3.1), whence the associativity of  $\bullet$ .

Finally, to prove the commutativity of  $\bullet$ , we shall show that  $\Delta$  is cocommutative, that is for any permutation  $\pi$ , if in the expansion of  $\Delta(\pi)$  there is a tensor  $\sigma \otimes \nu$  with a coefficient  $\lambda$ , there is in the same expansion the tensor  $\nu \otimes \sigma$  with the same coefficient  $\lambda$ . Clearly, a product is commutative if and only if its dual coproduct is cocommutative. Now, from the definition (2.1.1) of  $\Delta$ , one observes that if the pair  $(P_1, P_2)$  of subsets of  $[|\pi|]$  contributes to the coefficient of  $\text{std}(\pi|_{P_1}) \otimes \text{std}(\pi|_{P_2})$ , the pair  $(P_2, P_1)$  contributes to the coefficient of  $\text{std}(\pi|_{P_2}) \otimes \text{std}(\pi|_{P_1})$ . This shows that  $\Delta$  is cocommutative and hence, that  $\bullet$  is commutative.  $\square$

Proposition 2.3.1 implies that  $(\text{FQSym}, \Delta)$  is a coassociative cocommutative coalgebra.

2.3.2. *Endomorphisms.* If  $\pi$  is a permutation of  $\mathfrak{S}(n)$ , we denote by  $\tilde{u}$  the *mirror image* of  $u$ , that is the word  $u_{|u|}u_{|u|-1} \dots u_1$ , by  $\bar{\pi}$  the *complement* of  $\pi$ , that is the permutation satisfying  $\bar{\pi}(i) = n - \pi(i) + 1$  for all  $i \in [n]$ , and by  $\pi^{-1}$  the *inverse* of  $\pi$ .

PROPOSITION 2.3.2. *The three linear maps*

$$\phi_1, \phi_2, \phi_3 : \text{FQSym} \rightarrow \text{FQSym} \tag{2.3.2}$$

*linearly sending a permutation  $\pi$  to, respectively,  $\tilde{\pi}$ ,  $\bar{\pi}$ , and  $\pi^{-1}$  are endomorphisms of the associative algebra  $(\text{FQSym}, \bullet)$ .*

2.3.3. *Operations preserving square permutations.* We now use the algebraic properties of  $\bullet$  exhibited by Proposition 2.3.2 to obtain combinatorial properties of square permutations.

PROPOSITION 2.3.3. *Let  $\pi$  be a square permutation and  $\sigma$  be a square root of  $\pi$ . Then,*

- (i) *the permutation  $\tilde{\pi}$  is a square and  $\tilde{\sigma}$  is one of its square roots;*

- (ii) the permutation  $\bar{\pi}$  is a square and  $\bar{\sigma}$  is one of its square roots;
- (iii) the permutation  $\pi^{-1}$  is a square and  $\sigma^{-1}$  is one of its square roots.

PROOF. All statements (i), (ii), and (iii) are consequences of Proposition 2.3.2. Indeed, since  $\pi$  is a square permutation and  $\sigma$  is a square root of  $\pi$ , by definition,  $\pi$  appears in the product  $\sigma \bullet \sigma$ . Now, by Proposition 2.3.2, for any  $j \in [3]$ , since  $\phi_j$  is an endomorphism of associative algebras of FQSym,  $\phi_j$  commutes with the shuffle product of permutations  $\bullet$ . Hence, in particular, one has

$$\phi_j(\sigma \bullet \sigma) = \phi_j(\sigma) \bullet \phi_j(\sigma). \quad (2.3.3)$$

Then, since  $\pi$  appears in  $\sigma \bullet \sigma$ ,  $\phi_j(\pi)$  appears in  $\phi_j(\sigma \bullet \sigma)$  and appears also in  $\phi_j(\sigma) \bullet \phi_j(\sigma)$ . This shows that  $\phi_j(\sigma)$  is a square root of  $\phi_j(\pi)$  and implies (i), (ii), and (iii).  $\square$

Let us make an observation about Wilf-equivalence classes of permutations restrained on square permutations. Recall that two permutations  $\sigma$  and  $\nu$  of the same size are *Wilf equivalent* if  $\#\mathcal{S}(n)^{\{\sigma\}} = \#\mathcal{S}(n)^{\{\nu\}}$  for all  $n \geq 0$ . The well-known [SS85] fact that there is a single Wilf-equivalence class of permutations of size 3 together with Proposition 2.3.3 imply that 123 and 321 are in the same Wilf-equivalence class of square permutations, and that 132, 213, 231, and 312 are in the same Wilf-equivalence class of square permutations. Computer experiments show us that there are two Wilf-equivalence classes of square permutations of size 3. Indeed, the number of square permutations avoiding 123 begins by

$$1, 0, 2, 0, 12, 0, 118, 0, 1218, 0, 14272, \quad (2.3.4)$$

while the number of square permutations avoiding 132 begins by

$$1, 0, 2, 0, 11, 0, 84, 0, 743, 0, 7108. \quad (2.3.5)$$

Besides, another consequence of Proposition 2.3.3 is that it makes sense to enumerate the sets of square permutations quotiented by the operations of mirror image, complement, and inverse. The sequence enumerating these sets begins by

$$1, 0, 1, 0, 6, 0, 81, 0, 2774, 0, 162945. \quad (2.3.6)$$

These three sequences (2.3.4), (2.3.5), and (2.3.6) are (after removing the 0s) respectively Sequences A279201, A279202, and A279203 of [Slo]. We do not have any description (by a formula, recurrence, or generating series) of these numbers.

### 3. Algorithmic aspects of square permutations

We construct here an analog of the criterion to recognize square words of Rizzi and Valette [RV13] for the case of square permutations. This criterion is a center piece to show that SDP for square permutation is NP-complete.

**3.1. Directed perfect matchings on permutations.** We need a little more complicated combinatorial object than perfect matching here. We work with directed perfect matchings and some notions of pattern avoidance.

3.1.1. *Directed graphs.* A *directed graph* is an ordered pair  $(V, A)$  where  $V$  is a set whose elements are called *vertices* and  $A$  is a set of ordered pairs of vertices, called *arcs* (from a *source* vertex to a *sink* vertex). Notice that the aforementioned definition does not allow a directed graph to have multiple arcs with same source and target nodes. We shall not allow directed loops (that is, arcs that connect vertices with themselves). Two arcs are *independent* if they do not have any common vertex. A directed graph is a *directed matching* if all its arcs are independent. A directed matching is *perfect* if every vertex is either a source or a sink.

3.1.2. *Directed perfect matchings.* A *directed perfect matching* on a permutation  $\pi$  of an even size  $2n$  is a directed perfect matching  $(V, A)$  such that

$$V := \{(\pi(i), i) : i \in [2n]\}. \tag{3.1.1}$$

Figure 10.3 shows a directed perfect matching on a permutation. The *word of sources* (resp. *word of sinks*) of  $(V, A)$  is the subword  $\pi(i_1)\pi(i_2)\dots\pi(i_n)$  of  $\pi$  where the indices  $i_1 < i_2 < \dots < i_n$  are the sources (resp. sinks) of the arcs of  $(V, A)$ .

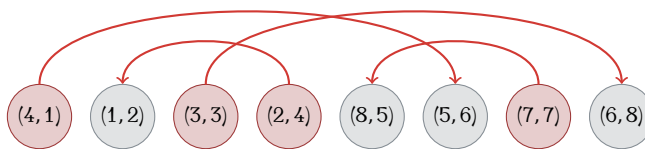



FIGURE 10.3. A directed perfect matching  $\mathcal{M}$  on the permutation 41328576. The word of sources of  $\mathcal{M}$  is 4327 and its word of sinks is 1856.

A *pattern* is a directed perfect matching  $([2k], B)$ . We say that a directed perfect matching  $(V, A)$  on a permutation  $\pi$  admits an *occurrence* of  $([2k], B)$  if

- (i) there is a map  $\phi : [2k] \rightarrow V$  such that, for any  $i, j \in [2k]$ ,  $i < j$  implies that the second coordinate of  $\phi(i)$  is smaller than the second coordinate of  $\phi(j)$ ;
- (ii) for any arc  $(i, j)$  of  $([2k], B)$ ,  $(\phi(i), \phi(j))$  is an arc of  $(V, A)$ .

Observe that this notion of pattern occurrence does not depend on the permutation  $\pi$ . Intuitively,  $(V, A)$  admits an occurrence of  $([2k], B)$  if  $(V, A)$  contains a copy of  $([2k], B)$  as a subgraph by changing some of its labels if necessary and by preserving their order induced by the second coordinates of the labeling pairs. When  $(V, A)$  does not admit any occurrence of  $([2k], B)$ , we say that  $(V, A)$  *avoids*  $([2k], B)$ . In the sequel, we shall draw patterns as unlabeled directed graphs. The vertices of the patterns are implicitly labeled by  $1, 2, \dots, 2k$  from left to right.

For instance, a directed perfect matching  $(V, A)$  on a permutation  $\pi$  admits an occurrence of the pattern  if there are four vertices  $(\pi(i_1), i_1), (\pi(i_2), i_2), (\pi(i_3), i_3), (\pi(i_4), i_4))$  of  $(V, A)$  such that  $i_1 < i_2 < i_3 < i_4$ , and  $(\pi(i_1), i_1), (\pi(i_4), i_4))$  and  $(\pi(i_3), i_3), (\pi(i_2), i_2))$  are arcs of  $(V, A)$ . The directed perfect matching of Figure 10.3 admits hence exactly two occurrences of this pattern: a first one for the arcs  $((4, 1), (5, 6))$  and  $((2, 4), (1, 2))$ , and a second one for the arcs  $((3, 3), (6, 8))$  and  $((7, 7), (8, 5))$ .



**3.2. Hardness of recognizing square permutations.** We are now in position to state our criterion to decide if a permutation is a square.

3.2.1. *Recognizing square permutations.* Let us define two additional properties on directed perfect matchings on permutations. Let  $(V, A)$  be a directed perfect matching on a permutation  $\pi$ . We say that  $(V, A)$  *satisfies PShape* if it avoids all the patterns of the set

$$\left\{ \begin{array}{c} \text{---} \text{---} \text{---} \text{---} \text{---} \text{---} \\ \text{---} \text{---} \text{---} \text{---} \text{---} \text{---} \\ \text{---} \text{---} \text{---} \text{---} \text{---} \text{---} \end{array} \right\}. \quad (3.2.1)$$

Besides, we say that  $(V, A)$  *satisfies PValue* if for any two distinct arcs  $((\pi(i), i), (\pi(j), j))$  and  $((\pi(i'), i'), (\pi(j'), j'))$  of  $(V, A)$ , we have  $\pi(i) < \pi(i')$  if and only if  $\pi(j) < \pi(j')$ .

**PROPOSITION 3.2.1.** *A permutation  $\pi$  is a square if and only if there exists a directed perfect matching on  $\pi$  satisfying PShape and PValue.*

Proposition 3.2.1 is hence the analogous of Proposition 1.2.1 for the supershuffle product and associated square permutations. Moreover, observe that given a square permutation  $\pi$  and a directed perfect matching  $(V, A)$  on  $\pi$  satisfying PShape and PValue, one can recover a square root of  $\pi$  by considering the standardized permutation of the word of sources (or, equivalently, the word of sinks) of  $(V, A)$ .

Figure 10.4 an example related to Proposition 3.2.1.

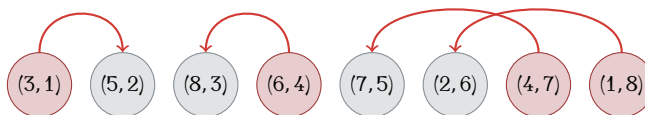

FIGURE 10.4. A directed perfect matching on the permutation  $\pi := 35867241$  satisfying PShape and PValue, showing that it is a square. It follows also that  $\sigma := 2431$  is a square root of  $\pi$  since  $\sigma$  is the standardized of both the word of sources 3641 and the word of sinks 5872 of the directed perfect matching.

3.2.2. *Hardness.* Here is the main algorithmic result of this chapter.

**THEOREM 3.2.2.** *In the supershuffle algebra  $(\text{FQSym}, \bullet)$ , SDP is NP-complete.*

Recall that the *pattern involvement problem* consists, given two permutations  $\pi$  and  $\sigma$ , in deciding if  $\pi$  admits an occurrence of  $\sigma$ . This problem is known to be NP-complete [BBL98]. Theorem 3.2.2 can be shown by performing a polynomial-time reduction from the pattern involvement problem to SDP.

### Concluding remarks

There are a number of further directions of investigation in this general subject. They cover several areas: algorithmic, combinatorics, and algebra. Let us mention several —not necessarily all new— open problems that are, in our opinion, the most interesting.

First ones are enumerative questions. We have computed few first terms of some integer sequences, like (2.1.6) for the number of square permutations, (2.3.6) for the number of square permutations quotiented by their natural symmetries, or (1.1.2) for the number of square permutations avoiding the patterns 213 and 231 (equivalently, by Proposition 2.2.1, this is also the number of square binary words [HRS12]). We can ask about formulas to compute these numbers.

Second ones are algorithmic questions. One can first ask the difficulty of deciding whether a permutation avoiding 213 and 231 is a square (see [HRS12, RV13, BS14] for the point of view of square binary words). Besides, one can ask about the hardness of RCP in the context of the supershuffle. In other terms, the problem consists, given two permutations  $\pi$  and  $\sigma$ , in deciding if  $\sigma$  is a square root of  $\pi$ .

Finally, in a more algebraic flavor, we can ask about the properties of the associative algebra  $(\text{FQSym}, \bullet)$ , continuing the work of Vargas [Var14]. This includes, among others, the description of a generating family, the definitions of multiplicative bases, and determining whether this algebra is free as an associative algebra.



## Bud generating systems

The content of this chapter comes from [Gir16a].

### Introduction

Coming from theoretical computer science and formal language theory, formal grammars [Har78, HMU06] are powerful tools having many applications in several fields of mathematics. A formal grammar is a device which describes—more or less concisely and with more or less restrictions—a set of words, called language. There are several variations in the definitions of formal grammars and some sorts of them are classified by the Chomsky-Schützenberger hierarchy [Cho59, CS63] according to four different categories, taking into account their expressive power. In an increasing order of power, there is the class of Type-3 grammars known as regular grammars, the class of Type-2 grammars known as context-free grammars, the class of Type-1 grammars known as context-sensitive grammars, and the class of Type-0 grammars known as unrestricted grammars. One of the most striking similarities between all these variations of formal grammars is that they work by constructing words by applying rewrite rules [BN98] (see also Section 1.4 of Chapter 1). Indeed, a word of the language described by a formal grammar is obtained by considering a starting word and by iteratively altering some of its factors in accordance with the production rules of the grammar.

Similar mechanisms and ideas are translatable into the world of trees, instead only of those of words. Grammars of trees [CDG<sup>+</sup>07] are hence the natural counterpart of formal grammars to describe sets of trees, and here also, there exist many very different types of grammars. One can cite for instance tree grammars, regular tree grammars [GS84], and synchronous grammars [Gir12e], which are devices providing a way to describe sets of various kinds of treelike structures. Here also, one of the common points between these grammars is that they work by applying rewrite rules on trees. In this framework, trees are constructed by growing from the root to the leaves by replacing some subtrees by other ones. Like free monoids are algebraic structures involving words, free ns operads are algebraic structures involving planar rooted trees. Since monoids are the underlying structures for most of the generating systems on words, it is natural to ask whether ns operads can be thought as underlying structures of generating systems on trees.

The initial spark of this work has been caused by the following simple observation. The partial composition  $x \circ_i y$  of two elements  $x$  and  $y$  of a ns operad  $\mathcal{O}$  can be regarded as the application of a rewrite rule on  $x$  to obtain a new element of  $\mathcal{O}$ —the rewrite rule being encoded essentially by  $y$ . This leads to the idea consisting in considering a ns operad  $\mathcal{O}$  to

define grammars generating some subsets of  $\mathcal{O}$ . In this way, according to the nature of the elements of  $\mathcal{O}$ , this provides a way to define grammars which generate objects different than words (as in the case of formal grammars) and than trees (as in the case of grammars of trees). We rely in this work on ns colored operads (see Section 4.1.10 of Chapter 2). Ns colored operads are the suitable devices to our aim of defining a new kind of grammars since the restrictions provided by the colors allow a precise control on how the rewrite rules can be applied.

Thus, we introduce in this work a new kind of grammars, the bud generating systems. They are defined mainly from a ground ns operad  $\mathcal{O}$ , a set  $\mathcal{C}$  of colors, and a set  $\mathfrak{R}$  of production rules. A bud generating system describes a subset of  $\text{Bud}_{\mathcal{C}}(\mathcal{O})$ —the ns colored operad obtained by augmenting the elements of  $\mathcal{O}$  with input and output colors taken from  $\mathcal{C}$ . The generation of an element works by iteratively altering an element  $x$  of  $\text{Bud}_{\mathcal{C}}(\mathcal{O})$  by composing it, if possible, with an element  $y$  of  $\mathfrak{R}$ . In this context, the colors play the role analogous of the one of nonterminal symbols in the formal grammars and in the grammars of trees. Any bud generating system  $\mathfrak{B}$  specifies two sets of objects: its language  $L(\mathfrak{B})$  and its synchronous language  $L_S(\mathfrak{B})$ . Thereby, bud generating systems can be used to describe sets of combinatorial objects. For instance, they can be used to describe sets of Motkzin paths with some constraints, sets of Schröder trees with some constraints, the set of  $\{2, 3\}$ -perfect trees [MPRS79, CLRS09] and some of its generalizations, and the set of balanced binary trees [AVL62]. One remarkable fact is that bud generating systems can emulate both context-free grammars and regular tree grammars, and allow to see both of these in a unified manner. In the first case, context-free grammars are emulated by bud generating systems with the associative operad  $\text{As}$  as ground ns operad and in the second case, regular tree grammars are emulated by bud generating systems with a free ns operad  $\text{FO}(\mathfrak{G})$  as ground ns operad, where  $\mathfrak{G}$  is a precise set of generators.

A very normal combinatorial question consists, given a bud generating system  $\mathfrak{B}$ , in computing the generating series  $\mathbf{s}_{L(\mathfrak{B})}(t)$  and  $\mathbf{s}_{L_S(\mathfrak{B})}(t)$ , respectively counting the elements of the language and of the synchronous language of  $\mathfrak{B}$  with respect to the arity of the elements. To achieve this objective, we consider a new generalization of formal power series, namely series on ns colored operads. Series on ns operads and operads satisfying some precise properties have been considered [Cha02, Cha08, Cha09] (see also [vdL04, Fra08, LN13]). In this work, we consider series on ns colored operads which are, in some sense, generalizations of these notions of series. Any bud generating system  $\mathfrak{B}$  leads to the definition of three series on ns colored operads: its hook generating series  $\text{hook}(\mathfrak{B})$ , its syntactic generating series  $\text{synt}(\mathfrak{B})$ , and its synchronous generating series  $\text{sync}(\mathfrak{B})$ . The hook generating series allows to define analogues of the hook-length statistics of binary trees [Knu98] for objects belonging to the language of  $\mathfrak{B}$ , possibly different than trees. The syntactic (resp. synchronous) generating series bring functional equations and recurrence formulas to compute the coefficients of  $\mathbf{s}_{L(\mathfrak{B})}(t)$  and  $\mathbf{s}_{L_S(\mathfrak{B})}(t)$ . The definitions of these three series rely on particular operations on series on ns colored operads: a pre-Lie product, an associative product, and their respective Kleene stars.

This chapter is organized as follows. Section 1 begins by introduction the construction  $\text{Bud}_{\mathfrak{C}}$ . Then, we provide elementary definitions about series on ns colored operads, and define a pre-Lie product and an associative product on these series. Next, Section 2 is concerned with the definition of bud generating systems and to study their first properties. This chapter ends with Section 3 wherein we use the definitions and the results of both previous sections to consider bud generating systems as devices to define statistics on combinatorial objects or to enumerate families of combinatorial objects.

*Note.* This chapter deals only with ns set-operads and ns colored set-operads. For these reasons, “operad” means “ns set-operad” and “colored operad” means “ns colored set-operad”.

### 1. Colored operads and formal power series

The purpose of this section is twofold. First, we present a very natural construction  $\text{Bud}_{\mathfrak{C}}$  taking as input a monochrome operad  $\mathcal{O}$  and outputting a colored operad by augmenting the outputs and inputs of the elements of  $\mathcal{O}$  with colors of  $\mathfrak{C}$ . This construction will be used to define bud generating systems in the next section. Second, we consider series on colored operads and define two products on them. These products are considered in the last section of this chapter for enumerative goals.

**1.1. Bud operads.** Let us first present a simple construction producing colored operads from operads.

1.1.1. *Sets of colors.* In all this chapter, we consider that  $\mathfrak{C}$  has cardinal  $k \geq 1$  and that the colors of  $\mathfrak{C}$  are arbitrarily indexed so that  $\mathfrak{C} = \{c_1, \dots, c_k\}$ .

1.1.2. *From monochrome operads to colored operads.* If  $\mathcal{O}$  is a monochrome operad and  $\mathfrak{C}$  is a finite set of colors, we denote by  $\text{Bud}_{\mathfrak{C}}(\mathcal{O})$  the  $\mathfrak{C}$ -colored collection (see Section 1.1.4 of Chapter 1) by

$$\text{Bud}_{\mathfrak{C}}(\mathcal{O})(n) := \mathfrak{C} \times \mathcal{O}(n) \times \mathfrak{C}^n, \quad n \geq 1, \quad (1.1.1)$$

and for all  $(a, x, u) \in \text{Bud}_{\mathfrak{C}}(\mathcal{O})$ ,  $\mathbf{out}((a, x, u)) := a$  and  $\mathbf{in}((a, x, u)) := u$ . We endow  $\text{Bud}_{\mathfrak{C}}(\mathcal{O})$  with the partially defined partial composition  $\circ_i$  satisfying, for all triples  $(a, x, u)$  and  $(b, y, v)$  of  $\text{Bud}_{\mathfrak{C}}(\mathcal{O})$  and  $i \in [|x|]$  such that  $\mathbf{out}((b, y, v)) = \mathbf{in}_i((a, x, u))$ ,

$$(a, x, u) \circ_i (b, y, v) := (a, x \circ_i y, u \leftarrow_i v), \quad (1.1.2)$$

where  $u \leftarrow_i v$  is the word obtained by replacing the  $i$ th letter of  $u$  by  $v$ . Besides, if  $\mathcal{O}_1$  and  $\mathcal{O}_2$  are two operads and  $\phi : \mathcal{O}_1 \rightarrow \mathcal{O}_2$  is an operad morphism, we denote by  $\text{Bud}_{\mathfrak{C}}(\phi)$  the map

$$\text{Bud}_{\mathfrak{C}}(\phi) : \text{Bud}_{\mathfrak{C}}(\mathcal{O}_1) \rightarrow \text{Bud}_{\mathfrak{C}}(\mathcal{O}_2) \quad (1.1.3)$$

defined by

$$\text{Bud}_{\mathfrak{C}}(\phi)((a, x, u)) := (a, \phi(x), u). \quad (1.1.4)$$

**PROPOSITION 1.1.1.** *For any set of colors  $\mathfrak{C}$ , the construction  $(\mathcal{O}, \phi) \mapsto (\text{Bud}_{\mathfrak{C}}(\mathcal{O}), \text{Bud}_{\mathfrak{C}}(\phi))$  is a functor from the category of monochrome operads to the category of  $\mathfrak{C}$ -colored operads.*

Proposition 1.1.1 shows that  $\text{Bud}_{\mathfrak{C}}$  is a functorial construction producing colored operads from monochrome ones. We call  $\text{Bud}_{\mathfrak{C}}(\mathcal{O})$  the  *$\mathfrak{C}$ -bud operad* of  $\mathcal{O}$ .

When  $\mathfrak{C}$  is a singleton,  $\text{Bud}_{\mathfrak{C}}(\mathcal{O})$  is by definition a monochrome operad isomorphic to  $\mathcal{O}$ . For this reason, in this case, we identify  $\text{Bud}_{\mathfrak{C}}(\mathcal{O})$  with  $\mathcal{O}$ .

As a side observation, remark that in general, the bud operad  $\text{Bud}_{\mathfrak{C}}(\mathcal{O})$  of a free operad  $\mathcal{O}$  is not a free  $\mathfrak{C}$ -colored operad. Indeed, consider for instance the bud operad  $\text{Bud}_{\{1,2\}}(\mathcal{O})$ , where  $\mathcal{O} := \mathbf{FO}(C)$  and  $C$  is the monochrome collection defined by  $C := C(1) := \{a\}$ . Then, a minimal generating set of  $\text{Bud}_{\{1,2\}}(\mathcal{O})$  is

$$\left\{ \left( 1, \underset{\cdot}{a}, 1 \right), \left( 1, \underset{\cdot}{a}, 2 \right), \left( 2, \underset{\cdot}{a}, 1 \right), \left( 2, \underset{\cdot}{a}, 2 \right) \right\}. \quad (1.1.5)$$

These elements are subjected to the nontrivial relations

$$\left( d, \underset{\cdot}{a}, 1 \right) \circ_1 \left( 1, \underset{\cdot}{a}, e \right) = \left( d, \underset{\cdot}{a}, e \right) = \left( d, \underset{\cdot}{a}, 2 \right) \circ_1 \left( 2, \underset{\cdot}{a}, e \right), \quad (1.1.6)$$

where  $d, e \in \{1, 2\}$ , implying that  $\text{Bud}_{\{1,2\}}(\mathcal{O})$  is not free.

1.1.3. *Bud operad of the associative operad.* Let us consider the  $\mathfrak{C}$ -bud operads of the associative operad  $\text{As}$  (see Section 4.2.1 of Chapter 2). For any set of colors  $\mathfrak{C}$ , the bud operad  $\text{Bud}_{\mathfrak{C}}(\text{As})$  is the set of all triples

$$(a, a_n, u_1 \dots u_n) \quad (1.1.7)$$

where  $a \in \mathfrak{C}$  and  $u_1, \dots, u_n \in \mathfrak{C}$ . For  $\mathfrak{C} := \{1, 2, 3\}$ , one has for instance the partial composition

$$(2, a_4, \mathbf{3112}) \circ_2 (1, a_3, \mathbf{233}) = (2, a_6, \mathbf{323312}). \quad (1.1.8)$$

The associative operad and its bud operads will play an important role in the sequel. For this reason, to gain readability, we shall simply denote by  $(a, u)$  any element  $(a, a_{|u|}, u)$  of  $\text{Bud}_{\mathfrak{C}}(\text{As})$  without any loss of information.

1.1.4. *Pruning map.* Here and in the sequel, we use the fact that any monochrome operad  $\mathcal{O}$  can be seen as a  $\mathfrak{C}$ -colored operad where all output and input colors of its elements are equal to  $c_1$ , where  $c_1$  is the first color of  $\mathfrak{C}$ . Let

$$\text{pru} : \text{Bud}_{\mathfrak{C}}(\mathcal{O}) \rightarrow \mathcal{O} \quad (1.1.9)$$

be the map defined, for any  $(a, x, u) \in \text{Bud}_{\mathfrak{C}}(\mathcal{O})$ , by

$$\text{pru}((a, x, u)) := x. \quad (1.1.10)$$

We call  $\text{pru}$  the *pruning map* on  $\text{Bud}_{\mathfrak{C}}(\mathcal{O})$ . Observe that  $\text{pru}$  is not a morphism of  $\mathfrak{C}$ -colored operads since it is not a  $\mathfrak{C}$ -colored collection morphism.

**1.2. The space of series on colored operads.** We work here with series on colored operads. We explain how to encode usual noncommutative multivariate series and series on monoids by series on colored operads.

1.2.1. *First definitions.* For any  $\mathfrak{C}$ -colored operad  $\mathcal{G}$ , a  $\mathcal{G}$ -series is a series on  $\mathcal{G}$  seen as a collection (see Section 1.1.7 of Chapter 2). In other terms, a  $\mathcal{G}$ -series is an element of  $\mathbb{K}\langle\langle\mathcal{G}\rangle\rangle$ .

For any combinatorial  $\mathfrak{C}$ -colored collection  $C$ , we denote by  $\mathbf{s}_C$  the generating series of  $C$ , seen as a graded collection.

The  $\mathcal{G}$ -series  $\mathbf{u}$  defined by

$$\mathbf{u} := \sum_{\alpha \in \mathfrak{C}} \mathbf{1}_\alpha \quad (1.2.1)$$

is the *series of colored units* of  $\mathcal{G}$  and will play a special role in the sequel. Since  $\mathfrak{C}$  is finite,  $\mathbf{u}$  is a polynomial.

Observe that  $\mathcal{G}$ -series are defined here on fields  $\mathbb{K}$  instead of on the much more general structures of semirings, as it is the case for series on monoids [Sak09]. We choose to tolerate this loss of generality because this considerably simplifies the theory. Furthermore, we shall use in the sequel  $\mathcal{G}$ -series as devices for combinatorial enumeration, so that it is sufficient to pick  $\mathbb{K}$  as the field  $\mathbb{Q}(q_0, q_1, q_2, \dots)$  of rational functions in an infinite number of commuting parameters with rational coefficients. The parameters  $q_i$ ,  $i \in \mathbb{N}$  intervene in the enumeration of colored subcollections of  $\mathcal{G}$  with respect to several statistics.

1.2.2. *Functorial construction.* If  $\mathcal{G}_1$  and  $\mathcal{G}_2$  are two  $\mathfrak{C}$ -colored operads and  $\phi : \mathcal{G}_1 \rightarrow \mathcal{G}_2$  is a morphism of colored operads,  $\mathbb{K}\langle\langle\phi\rangle\rangle$  is the map

$$\mathbb{K}\langle\langle\phi\rangle\rangle : \mathbb{K}\langle\langle\mathcal{G}_1\rangle\rangle \rightarrow \mathbb{K}\langle\langle\mathcal{G}_2\rangle\rangle \quad (1.2.2)$$

defined, for any  $\mathbf{f} \in \mathbb{K}\langle\langle\mathcal{G}_1\rangle\rangle$  and  $\mathbf{y} \in \mathcal{G}_2$ , by

$$\langle\mathbf{y}, \mathbb{K}\langle\langle\phi\rangle\rangle(\mathbf{f})\rangle := \sum_{\substack{x \in \mathcal{G}_1 \\ \phi(x) = \mathbf{y}}} \langle x, \mathbf{f} \rangle. \quad (1.2.3)$$

Equivalently,  $\mathbb{K}\langle\langle\phi\rangle\rangle$  can be defined, by using the sum notation of series (see Section 1.1.3 of Chapter 2), by

$$\mathbb{K}\langle\langle\phi\rangle\rangle(\mathbf{f}) := \sum_{x \in \mathcal{G}_1} \langle x, \mathbf{f} \rangle \phi(x). \quad (1.2.4)$$

Observe first that  $\mathbb{K}\langle\langle\mathbf{f}\rangle\rangle$  is a linear map. Moreover, notice that (1.2.3) could be undefined for arbitrary colored operads  $\mathcal{G}_1$  and  $\mathcal{G}_2$ , and an arbitrary morphism of colored operads  $\phi$ . However, when all fibers of  $\phi$  are finite, for any  $\mathbf{y} \in \mathcal{G}_2$ , the right member of (1.2.3) is well-defined since the sum has a finite number of terms. Moreover, since any morphism from a combinatorial colored operad has finite fibers, one has the following result.

**PROPOSITION 1.2.1.** *The construction  $(\mathcal{G}, \phi) \mapsto (\mathbb{K}\langle\langle\mathcal{G}\rangle\rangle, \mathbb{K}\langle\langle\phi\rangle\rangle)$  is a functor from the category of combinatorial  $\mathfrak{C}$ -colored operads to the category of  $\mathbb{K}$ -vector spaces.*

1.2.3. *Noncommutative multivariate series.* For any finite alphabet  $A$  of noncommutative letters, recall that  $\mathbb{K}\langle\langle A^* \rangle\rangle$  is the set of noncommutative series on  $A$  [Eil74, SS78, BR10].



Let us explain how to encode any series  $\mathbf{s} \in \mathbb{K}\langle\langle A^* \rangle\rangle$  by a series on a particular colored operad. Let  $\mathcal{C}_A$  be the set of colors  $A \sqcup \{\diamond\}$  where  $\diamond$  is a virtual letter which is not in  $A$ , and  $\mathcal{G}_A$  be the  $\mathcal{C}_A$ -colored subcollection of  $\text{Bud}_{\mathcal{C}_A}(As)$  consisting in arity one in the colored units of  $\text{Bud}_{\mathcal{C}_A}(As)$  and in arity  $n \geq 2$  in the elements of the form

$$(\diamond, a_1 \dots a_{n-1} \diamond), \quad a_1 \dots a_{n-1} \in A^{n-1}. \quad (1.2.5)$$

Since the partial composition of any two elements of the form (1.2.5) is in  $\mathcal{G}_A$ ,  $\mathcal{G}_A$  is a colored suboperad of  $\text{Bud}_{\mathcal{C}_A}(As)$ . Then, any series

$$\mathbf{s} := \sum_{u \in A^*} \langle u, \mathbf{s} \rangle u \quad (1.2.6)$$

of  $\mathbb{K}\langle\langle A^* \rangle\rangle$  is encoded by the series

$$\text{mu}(\mathbf{s}) := \sum_{u \in A^*} \langle u, \mathbf{s} \rangle (\diamond, u \diamond). \quad (1.2.7)$$

of  $\mathbb{K}\langle\langle \mathcal{G}_A \rangle\rangle$ . We shall explain a little further how the usual noncommutative product of series of  $\mathbb{K}\langle\langle A^* \rangle\rangle$  can be translated on  $\text{Bud}_{\mathcal{C}_A}(As)$ -series of the form (1.2.7).

**1.2.4. Series on monoids.** For any monoid  $\mathcal{M}$ , recall that  $\mathbb{K}\langle\langle \mathcal{M} \rangle\rangle$  is the set of noncommutative series on  $\mathcal{M}$  [Sak09]. Noncommutative multivariate series are particular cases of series on monoids since any noncommutative multivariate series of  $\mathbb{K}\langle\langle A^* \rangle\rangle$  can be seen as an  $A^*$ -series, where  $A^*$  is the free monoid on  $A$ .

Let us explain how to encode any series  $\mathbf{s} \in \mathbb{K}\langle\langle \mathcal{M} \rangle\rangle$  by a series on a particular colored operad. Let  $\mathcal{O}_{\mathcal{M}}$  be the monochrome collection concentrated in arity one where  $\mathcal{O}_{\mathcal{M}}(1) := \mathcal{M}$ . We define the map  $\circ_1 : \mathcal{O}_{\mathcal{M}}(1) \times \mathcal{O}_{\mathcal{M}}(1) \rightarrow \mathcal{O}_{\mathcal{M}}(1)$  for all  $x, y \in \mathcal{O}_{\mathcal{M}}$  by  $x \circ_1 y := x \star y$  where  $\star$  is the operation of  $\mathcal{M}$ . Since  $\star$  is associative and admits a unit,  $\circ_1$  satisfy all relations of operads, so that  $\mathcal{O}_{\mathcal{M}}$  is a monochrome operad. Then, any series

$$\mathbf{s} := \sum_{u \in \mathcal{M}} \langle u, \mathbf{s} \rangle u \quad (1.2.8)$$

of  $\mathbb{K}\langle\langle \mathcal{M} \rangle\rangle$  is encoded by the series

$$\text{mo}(\mathbf{s}) := \sum_{u \in \mathcal{O}_{\mathcal{M}}} \langle u, \mathbf{s} \rangle u \quad (1.2.9)$$

of  $\mathbb{K}\langle\langle \mathcal{O}_{\mathcal{M}} \rangle\rangle$ . We shall explain a little further how the usual product of series of  $\mathbb{K}\langle\langle \mathcal{M} \rangle\rangle$ , called Cauchy product in [Sak09], can be translated on series of the form (1.2.9).

Observe that when  $\mathcal{M}$  is a free monoid  $A^*$  where  $A$  is a finite alphabet of noncommutative letters, we then have two ways to encode a series  $\mathbf{s}$  of  $\mathbb{K}\langle\langle A^* \rangle\rangle$ . Indeed,  $\mathbf{s}$  can be encoded as the series  $\text{mu}(\mathbf{s})$  of  $\mathbb{K}\langle\langle \mathcal{G}_A \rangle\rangle$  of the form (1.2.7), or as the series  $\text{mo}(\mathbf{s})$  of  $\mathbb{K}\langle\langle \mathcal{O}_{A^*} \rangle\rangle$  of the form (1.2.9). Remark that the first way to encode  $\mathbf{s}$  is preferable since  $\mathcal{G}_A$  is a combinatorial operad while  $\mathcal{O}_{A^*}$  is not.

1.2.5. *Series of colors.* Let

$$\text{col} : \mathcal{G} \rightarrow \text{Bud}_{\mathcal{C}}(\text{As}) \quad (1.2.10)$$

be the morphism of colored operads defined for any  $x \in \mathcal{G}$  by

$$\text{col}(x) := (\mathbf{out}(x), \mathbf{in}(x)). \quad (1.2.11)$$

By a slight abuse of notation, we denote by

$$\text{col} : \mathbb{K}\langle\langle\mathcal{G}\rangle\rangle \rightarrow \mathbb{K}\langle\langle\text{Bud}_{\mathcal{C}}(\text{As})\rangle\rangle \quad (1.2.12)$$

the map sending any series  $\mathbf{f}$  of  $\mathbb{K}\langle\langle\mathcal{G}\rangle\rangle$  to  $\mathbb{K}\langle\langle\text{col}\rangle\rangle(\mathbf{f})$ , called *series of colors* of  $\mathbf{f}$ . By (1.2.4),

$$\text{col}(\mathbf{f}) = \sum_{x \in \mathcal{G}} \langle x, \mathbf{f} \rangle (\mathbf{out}(x), \mathbf{in}(x)). \quad (1.2.13)$$

Intuitively, the series  $\text{col}(\mathbf{f})$  can be seen as a version of  $\mathbf{f}$  wherein only the colors of the elements of its support are taken into account.

1.2.6. *Series of color types.* The  $\mathcal{C}$ -*type* of a word  $u \in \mathcal{C}^+$  is the word  $\text{type}(u)$  of  $\mathbb{N}^k$  defined by

$$\text{type}(u) := |u|_{c_1} \dots |u|_{c_k}. \quad (1.2.14)$$

By extension, we shall call  $\mathcal{C}$ -*type* any word of  $\mathbb{N}^k$  with at least a nonzero letter and we denote by  $\mathcal{T}_{\mathcal{C}}$  the set of all  $\mathcal{C}$ -types. The *degree*  $\deg(\alpha)$  of  $\alpha \in \mathcal{T}_{\mathcal{C}}$  is the sum of the letters of  $\alpha$ . We denote by  $\mathcal{C}^{\alpha}$  the word

$$\mathcal{C}^{\alpha} := c_1^{\alpha_1} \dots c_k^{\alpha_k}. \quad (1.2.15)$$

Let  $\mathbb{Z}_{\mathcal{C}} := \{z_{c_1}, \dots, z_{c_k}\}$  be an alphabet of commutative letters. For any type  $\alpha$ , we denote by  $\mathbb{Z}_{\mathcal{C}}^{\alpha}$  the monomial

$$\mathbb{Z}_{\mathcal{C}}^{\alpha} := z_{c_1}^{\alpha_1} \dots z_{c_k}^{\alpha_k} \quad (1.2.16)$$

of  $\mathbb{K}\langle\langle\mathbb{Z}_{\mathcal{C}}\rangle\rangle$ . Moreover, for any two types  $\alpha$  and  $\beta$ , the *sum*  $\alpha + \beta$  of  $\alpha$  and  $\beta$  is the type satisfying  $(\alpha + \beta)(i) := \alpha(i) + \beta(i)$  for all  $i \in [k]$ . Observe that with this notation,  $\mathbb{Z}_{\mathcal{C}}^{\alpha} \mathbb{Z}_{\mathcal{C}}^{\beta} = \mathbb{Z}_{\mathcal{C}}^{\alpha + \beta}$ .

Now, set  $\mathbb{X}_{\mathcal{C}}$  and  $\mathbb{Y}_{\mathcal{C}}$  respectively as the two alphabets of commutative letters  $\{x_{c_1}, \dots, x_{c_k}\}$  and  $\{y_{c_1}, \dots, y_{c_k}\}$ . We can see these two alphabets as graded collections where each letter is of size 1. Consider the map

$$\text{colt} : \mathbb{K}\langle\langle\mathcal{G}\rangle\rangle \rightarrow \mathbb{K}\langle\langle\mathbb{S}(\mathbb{X}_{\mathcal{C}} + \mathbb{Y}_{\mathcal{C}})\rangle\rangle, \quad (1.2.17)$$

defined for all  $\alpha, \beta \in \mathcal{T}_{\mathcal{C}}$  by

$$\langle \mathbb{X}_{\mathcal{C}}^{\alpha} \mathbb{Y}_{\mathcal{C}}^{\beta}, \text{colt}(\mathbf{f}) \rangle := \sum_{\substack{(\alpha, u) \in \text{Bud}_{\mathcal{C}}(\text{As}) \\ \text{type}(\alpha) = \alpha \\ \text{type}(u) = \beta}} \langle (\alpha, u), \text{col}(\mathbf{f}) \rangle. \quad (1.2.18)$$

By the definition of the map  $\text{col}$ ,

$$\text{colt}(\mathbf{f}) = \sum_{x \in \mathcal{G}} \langle x, \mathbf{f} \rangle \mathbb{X}_{\mathcal{C}}^{\text{type}(\mathbf{out}(x))} \mathbb{Y}_{\mathcal{C}}^{\text{type}(\mathbf{in}(x))}. \quad (1.2.19)$$

Observe that for all  $\alpha, \beta \in \mathcal{T}_{\mathcal{C}}$  such that  $\deg(\alpha) \neq 1$ , the coefficients of  $\mathbb{X}_{\mathcal{C}}^{\alpha} \mathbb{Y}_{\mathcal{C}}^{\beta}$  in  $\text{colt}(\mathbf{f})$  are zero. In intuitive terms, the series  $\text{colt}(\mathbf{f})$ , called *series of color types* of  $\mathbf{f}$ , can be seen as a version of  $\text{col}(\mathbf{f})$  wherein only the output colors and the types of the input colors of the elements of its support are taken into account, the variables of  $\mathbb{X}_{\mathcal{C}}$  encoding output colors

and the variables of  $\mathbb{Y}_{\mathcal{C}}$  encoding input colors. In the sequel, we are concerned by the computation of the coefficients of  $\text{colt}(\mathbf{f})$  for some  $\mathcal{G}$ -series  $\mathbf{f}$ .

1.2.7. *Pruned series.* Let  $\mathcal{O}$  be a monochrome operad,  $\text{Bud}_{\mathcal{C}}(\mathcal{O})$  be a bud operad, and  $\mathbf{f}$  be a  $\text{Bud}_{\mathcal{C}}(\mathcal{O})$ -series. Since  $\mathcal{C}$  is finite, the series  $\mathbb{K}\langle\langle\text{pru}\rangle\rangle(\mathbf{f})$  is well-defined and, by a slight abuse of notation, we denote by

$$\text{pru} : \mathbb{K}\langle\langle\text{Bud}_{\mathcal{C}}(\mathcal{O})\rangle\rangle \rightarrow \mathbb{K}\langle\langle\mathcal{O}\rangle\rangle \tag{1.2.20}$$

the map sending any series  $\mathbf{f}$  of  $\mathbb{K}\langle\langle\text{Bud}_{\mathcal{C}}(\mathcal{O})\rangle\rangle$  to  $\mathbb{K}\langle\langle\text{pru}\rangle\rangle(\mathbf{f})$ , called *pruned series* of  $\mathbf{f}$ . By (1.2.4),

$$\text{pru}(\mathbf{f}) = \sum_{(a,x,u) \in \text{Bud}_{\mathcal{C}}(\mathcal{O})} \langle(a, x, u), \mathbf{f}\rangle x. \tag{1.2.21}$$

Intuitively, the series  $\text{pru}(\mathbf{f})$  can be seen as a version of  $\mathbf{f}$  wherein the colors of the elements of its support are forgotten. Besides,  $\mathbf{f}$  is said *faithful* if all coefficients of  $\text{pru}(\mathbf{f})$  are equal to 0 or to 1.

1.2.8. *Example: series of trees.* Let  $\mathcal{G}$  be the free  $\mathcal{C}$ -colored operad over  $C$  where  $\mathcal{C} := \{1, 2\}$  and  $C$  is the  $\mathcal{C}$ -colored collection defined by  $C := C(2) \sqcup C(3)$  with  $C(2) := \{a\}$ ,  $C(3) := \{b\}$ ,  $\text{out}(a) := 1$ ,  $\text{out}(b) := 2$ ,  $\text{in}(a) := 21$ , and  $\text{in}(b) := 121$ . Let  $\mathbf{f}_a$  (resp.  $\mathbf{f}_b$ ) be the series of  $\mathbb{K}\langle\langle\mathcal{G}\rangle\rangle$  where for any syntax tree  $t$  of  $\mathcal{G}$ ,  $\langle t, \mathbf{f}_a \rangle$  (resp.  $\langle t, \mathbf{f}_b \rangle$ ) is the number of internal nodes of  $t$  labeled by  $a$  (resp.  $b$ ). The series  $\mathbf{f}_a$  and  $\mathbf{f}_b$  are of the form

$$\begin{aligned} \mathbf{f}_a = & \begin{array}{c} 1 \\ | \\ a \\ / \backslash \\ 2 \quad 1 \end{array} + 2 \begin{array}{c} 1 \\ | \\ a \\ / \backslash \\ 2 \quad a \\ \quad / \backslash \\ \quad 2 \quad 1 \end{array} + 3 \begin{array}{c} 1 \\ | \\ a \\ / \backslash \\ 2 \quad a \\ \quad / \backslash \\ \quad 2 \quad a \\ \quad \quad / \backslash \\ \quad \quad 2 \quad 1 \end{array} + \begin{array}{c} 2 \\ | \\ b \\ / \backslash \\ a \quad 2 \\ \quad / \backslash \\ \quad 2 \quad 1 \end{array} + \begin{array}{c} 2 \\ | \\ b \\ / \backslash \\ 1 \quad 2 \\ \quad / \backslash \\ \quad 2 \quad 1 \end{array} \\ & + \begin{array}{c} 1 \\ | \\ a \\ / \backslash \\ b \quad 1 \\ \quad / \backslash \\ \quad 1 \quad 2 \quad 1 \end{array} + \dots \tag{1.2.22a} \end{aligned}$$

$$\mathbf{f}_b = \begin{array}{c} 2 \\ | \\ b \\ / \backslash \\ 1 \quad 2 \quad 1 \end{array} + \begin{array}{c} 2 \\ | \\ b \\ / \backslash \\ a \quad 2 \\ \quad / \backslash \\ \quad 2 \quad 1 \end{array} + \begin{array}{c} 2 \\ | \\ b \\ / \backslash \\ 1 \quad 2 \\ \quad / \backslash \\ \quad 2 \quad 1 \end{array} + 2 \begin{array}{c} 2 \\ | \\ b \\ / \backslash \\ 1 \quad b \quad 1 \\ \quad / \backslash \\ \quad 1 \quad 2 \quad 1 \end{array} + \dots \tag{1.2.22b}$$

The sum  $\mathbf{f}_a + \mathbf{f}_b$  is the series wherein the coefficient of any syntax tree  $t$  of  $\mathcal{G}$  is its degree. Let also  $\mathbf{f}_{|_1}$  (resp.  $\mathbf{f}_{|_2}$ ) be the series of  $\mathbb{K}\langle\langle\mathcal{G}\rangle\rangle$  where for any syntax tree  $t$  of  $\mathcal{G}$ ,  $\langle t, \mathbf{f}_{|_1} \rangle$  (resp.  $\langle t, \mathbf{f}_{|_2} \rangle$ ) is the number of inputs colors 1 (resp. 2) of  $t$ . The sum  $\mathbf{f}_{|_1} + \mathbf{f}_{|_2}$  is the series wherein the coefficient of any syntax tree  $t$  of  $\mathcal{G}$  is its arity. Moreover, the series  $\mathbf{f}_a + \mathbf{f}_b + \mathbf{f}_{|_1} + \mathbf{f}_{|_2}$  is the series wherein the coefficient of any syntax tree  $t$  of  $\mathcal{G}$  is its total number of nodes.

The series of colors of  $\mathbf{f}_a$  is of the form

$$\text{col}(\mathbf{f}_a) = (1, 21) + 2(1, 221) + 3(1, 2221) + (2, 2121) + (2, 1221) + (1, 1211) + \dots, \quad (1.2.23)$$

and the series of color types of  $\mathbf{f}$  is of the form

$$\text{colt}(\mathbf{f}_a) = x_1 y_1 y_2 + 2x_1 y_1 y_2^2 + x_1 y_1^3 y_2 + 3x_1 y_1 y_2^3 + 2x_2 y_1^2 y_2^2 + \dots. \quad (1.2.24)$$

**1.3. Pre-Lie product on series.** We are now in position to define a binary operation  $\curvearrowright$  on the space of the  $\mathcal{G}$ -series. As we shall see, this operation is partially defined, nonunitary, noncommutative, and nonassociative.

1.3.1. *Pre-Lie product.* Given two  $\mathcal{G}$ -series  $\mathbf{f}, \mathbf{g} \in \mathbb{K}\langle\langle\mathcal{G}\rangle\rangle$ , the *pre-Lie product* of  $\mathbf{f}$  and  $\mathbf{g}$  is the  $\mathcal{G}$ -series  $\mathbf{f} \curvearrowright \mathbf{g}$  defined, for any  $x \in \mathcal{G}$ , by

$$\langle x, \mathbf{f} \curvearrowright \mathbf{g} \rangle := \sum_{\substack{y, z \in \mathcal{G} \\ i \in [|y|] \\ x = y \circ_i z}} \langle y, \mathbf{f} \rangle \langle z, \mathbf{g} \rangle. \quad (1.3.1)$$

Observe that  $\mathbf{f} \curvearrowright \mathbf{g}$  could be undefined for arbitrary  $\mathcal{G}$ -series  $\mathbf{f}$  and  $\mathbf{g}$  on an arbitrary colored operad  $\mathcal{G}$ . Besides, notice from (1.3.1) that  $\curvearrowright$  is bilinear and that  $\mathbf{u}$  (defined in (1.2.1)) is a left unit of  $\curvearrowright$ . However, since

$$\mathbf{f} \curvearrowright \mathbf{u} = \sum_{x \in \mathcal{G}} |x| \langle x, \mathbf{f} \rangle x, \quad (1.3.2)$$

the  $\mathcal{G}$ -series  $\mathbf{u}$  is not a right unit of  $\curvearrowright$ . This product is also nonassociative in the general case since we have, for instance in  $\mathbb{K}\langle\langle\text{As}\rangle\rangle$ ,

$$(\mathbf{a}_2 \curvearrowright \mathbf{a}_2) \curvearrowright \mathbf{a}_2 = 6\mathbf{a}_4 \neq 4\mathbf{a}_4 = \mathbf{a}_2 \curvearrowright (\mathbf{a}_2 \curvearrowright \mathbf{a}_2). \quad (1.3.3)$$

Nevertheless, it satisfies the pre-Lie relation (see (2.3.17) of Section 2.3.4 of Chapter 2).

**PROPOSITION 1.3.1.** *The construction  $(\mathcal{G}, \phi) \mapsto ((\mathbb{K}\langle\langle\mathcal{G}\rangle\rangle, \curvearrowright), \mathbb{K}\langle\langle\phi\rangle\rangle)$  is a functor from the category of combinatorial  $\mathcal{C}$ -colored operads to the category of pre-Lie algebras.*

**PROOF.** Let  $\mathcal{G}$  be a combinatorial  $\mathcal{C}$ -colored operad. First of all, since  $\mathcal{G}$  is combinatorial, the pre-Lie product of any two  $\mathcal{G}$ -series  $\mathbf{f}$  and  $\mathbf{g}$  is well-defined due to the fact that the sum (1.3.1) has a finite number of terms. Let  $\mathbf{f}, \mathbf{g}$ , and  $\mathbf{h}$  be three  $\mathcal{G}$ -series and  $x \in \mathcal{G}$ . We denote by  $\lambda(\mathbf{f}, \mathbf{g}, \mathbf{h})$  the coefficient of  $x$  in  $(\mathbf{f} \curvearrowright \mathbf{g}) \curvearrowright \mathbf{h} - \mathbf{f} \curvearrowright (\mathbf{g} \curvearrowright \mathbf{h})$ . We have

$$\begin{aligned} \lambda(\mathbf{f}, \mathbf{g}, \mathbf{h}) &= \sum_{\substack{y, z, t \in \mathcal{G} \\ i, j \in \mathbb{N} \\ x = (y \circ_i z) \circ_j t}} \langle y, \mathbf{f} \rangle \langle z, \mathbf{g} \rangle \langle t, \mathbf{h} \rangle - \sum_{\substack{y, z, t \in \mathcal{G} \\ i, j \in \mathbb{N} \\ x = y \circ_i (z \circ_j t)}} \langle y, \mathbf{f} \rangle \langle z, \mathbf{g} \rangle \langle t, \mathbf{h} \rangle \\ &= \sum_{\substack{y, z, t \in \mathcal{G} \\ i > j \in \mathbb{N} \\ x = (y \circ_i z) \circ_j t}} \langle y, \mathbf{f} \rangle \langle z, \mathbf{g} \rangle \langle t, \mathbf{h} \rangle \\ &= \sum_{\substack{y, z, t \in \mathcal{G} \\ i > j \in \mathbb{N} \\ x = (y \circ_i t) \circ_j z}} \langle y, \mathbf{f} \rangle \langle z, \mathbf{g} \rangle \langle t, \mathbf{h} \rangle \\ &= \lambda(\mathbf{f}, \mathbf{h}, \mathbf{g}). \end{aligned} \quad (1.3.4)$$

The second and the last equality of (1.3.4) come from Relation (4.1.3a) of Section 4.1.1 of Chapter 2 of operads and the third equality is a consequence of Relation (4.1.3b) of Section 4.1.1 of Chapter 2 of operads. Therefore, since by (1.3.4),  $\lambda(\mathbf{f}, \mathbf{g}, \mathbf{h})$  is symmetric in  $\mathbf{g}$  and  $\mathbf{h}$ , the series  $(\mathbf{f} \frown \mathbf{g}) \frown \mathbf{h} - \mathbf{f} \frown (\mathbf{g} \frown \mathbf{h})$  and  $(\mathbf{f} \frown \mathbf{h}) \frown \mathbf{g} - \mathbf{f} \frown (\mathbf{h} \frown \mathbf{g})$  are equal. This shows that  $\mathbb{K}\langle\langle\mathcal{G}\rangle\rangle$ , endowed with the product  $\frown$ , is a pre-Lie algebra. Finally, by using the fact that by Proposition 1.2.1,  $(\mathcal{G}, \phi) \mapsto (\mathbb{K}\langle\langle\mathcal{G}\rangle\rangle, \mathbb{K}\langle\langle\phi\rangle\rangle)$  is functorial, we obtain that  $\mathbb{K}\langle\langle\phi\rangle\rangle$  is a morphism of pre-Lie algebras. Hence, the statement of the proposition holds.  $\square$

Proposition 1.3.1 shows that  $\frown$  is a pre-Lie product. This product  $\frown$  is a generalization of a pre-Lie product defined in [Cha08], endowing the linear span of the underlying monochrome collection of a monochrome operad with a pre-Lie algebra structure.

1.3.2. *Noncommutative multivariate series and series on monoids.* The pre-Lie product  $\frown$  on  $\mathcal{G}$ -series provides also a generalization of the usual product of noncommutative multivariate series. Indeed, consider the method described in Section 1.2.3 to encode noncommutative multivariate series on an alphabet  $A$  as series on the colored operad  $\text{Bud}_{\mathcal{C}_A}(\text{As})$ . For any  $\mathbf{s}, \mathbf{t} \in \mathbb{K}\langle\langle A^* \rangle\rangle$  and  $u \in A^*$ , we have

$$\begin{aligned} \langle\langle \diamond, u \diamond \rangle\rangle, \text{mu}(\mathbf{s}) \frown \text{mu}(\mathbf{t}) &= \sum_{\substack{v, w \in A^* \\ i \in \mathbb{N} \\ \langle \diamond, u \diamond \rangle = \langle \diamond, v \diamond \rangle \circ_i \langle \diamond, w \diamond \rangle}} \langle\langle \diamond, v \diamond \rangle\rangle, \text{mu}(\mathbf{s}) \langle\langle \diamond, w \diamond \rangle\rangle, \text{mu}(\mathbf{t}) \\ &= \sum_{\substack{v, w \in A^* \\ u = vw}} \langle v, \mathbf{s} \rangle \langle w, \mathbf{t} \rangle \\ &= \langle u, \mathbf{st} \rangle, \end{aligned} \tag{1.3.5}$$

so that  $\text{mu}(\mathbf{st}) = \text{mu}(\mathbf{s}) \frown \text{mu}(\mathbf{t})$ .

Moreover, through the method presented in Section 1.2.4 to encode series on a monoid  $\mathcal{M}$  as series on the colored operad  $\mathbb{K}\langle\langle \mathcal{O}_{\mathcal{M}} \rangle\rangle$ , we have for any  $\mathbf{s}, \mathbf{t} \in \mathbb{K}\langle\langle \mathcal{M} \rangle\rangle$  and  $u \in \mathcal{M}$ ,

$$\begin{aligned} \langle u, \text{mo}(\mathbf{s}) \frown \text{mo}(\mathbf{t}) \rangle &= \sum_{\substack{v, w \in \mathcal{O}_{\mathcal{M}} \\ i \in \mathbb{N} \\ u = v \circ_i w}} \langle v, \text{mo}(\mathbf{s}) \rangle \langle w, \text{mo}(\mathbf{t}) \rangle \\ &= \sum_{\substack{v, w \in \mathcal{M} \\ u = v \star w}} \langle v, \mathbf{s} \rangle \langle w, \mathbf{t} \rangle \\ &= \langle u, \mathbf{st} \rangle, \end{aligned} \tag{1.3.6}$$

where  $\star$  is the operation of  $\mathcal{M}$ , so that  $\text{mo}(\mathbf{st}) = \text{mo}(\mathbf{s}) \frown \text{mo}(\mathbf{t})$ . Hence, the pre-Lie product of series on colored operads is a generalization of the Cauchy product of series on monoids [Sak09].

1.3.3. *Pre-Lie star product.* For any  $\mathcal{G}$ -series  $\mathbf{f} \in \mathbb{K}\langle\langle \mathcal{G} \rangle\rangle$  and any  $\ell \geq 0$ , let  $\mathbf{f}^{\frown \ell}$  be the  $\mathcal{G}$ -series recursively defined by

$$\mathbf{f}^{\frown \ell} := \begin{cases} \mathbf{u} & \text{if } \ell = 0, \\ \mathbf{f}^{\frown \ell-1} \frown \mathbf{f} & \text{otherwise.} \end{cases} \tag{1.3.7}$$

Immediately from this definition and the definition of the pre-Lie product  $\smile$ , the coefficients of  $\mathbf{f}^{\smile \ell}$ ,  $\ell \geq 0$ , satisfies for any  $x \in \mathcal{G}$ ,

$$\langle x, \mathbf{f}^{\smile \ell} \rangle = \begin{cases} \delta_{x, \mathbb{1}_{\text{out}(x)}} & \text{if } \ell = 0, \\ \sum_{\substack{y, z \in \mathcal{G} \\ i \in [|y|] \\ x = y \circ_i z}} \langle y, \mathbf{f}^{\smile \ell - 1} \rangle \langle z, \mathbf{f} \rangle & \text{otherwise.} \end{cases} \quad (1.3.8)$$

LEMMA 1.3.2. *Let  $\mathcal{G}$  be a combinatorial  $\mathcal{C}$ -colored operad and  $\mathbf{f}$  be a series of  $\mathbb{K}\langle\langle\mathcal{G}\rangle\rangle$ . Then, the coefficients of  $\mathbf{f}^{\smile \ell + 1}$ ,  $\ell \geq 0$ , satisfy for any  $x \in \mathcal{G}$ ,*

$$\langle x, \mathbf{f}^{\smile \ell + 1} \rangle = \sum_{\substack{y_1, \dots, y_{\ell+1} \in \mathcal{G} \\ i_1, \dots, i_{\ell} \in \mathbb{N} \\ x = (\dots(y_1 \circ_{i_1} y_2) \circ_{i_2} \dots) \circ_{i_{\ell}} y_{\ell+1}}} \prod_{j \in [\ell+1]} \langle y_j, \mathbf{f} \rangle. \quad (1.3.9)$$

The  $\smile$ -star of  $\mathbf{f}$  is the series

$$\begin{aligned} \mathbf{f}^{\smile*} &:= \sum_{\ell \geq 0} \mathbf{f}^{\smile \ell} \\ &= \mathbf{u} + \mathbf{f} + \mathbf{f}^{\smile 2} + \mathbf{f}^{\smile 3} + \mathbf{f}^{\smile 4} + \dots \\ &= \mathbf{u} + \mathbf{f} + \mathbf{f} \smile \mathbf{f} + (\mathbf{f} \smile \mathbf{f}) \smile \mathbf{f} + ((\mathbf{f} \smile \mathbf{f}) \smile \mathbf{f}) \smile \mathbf{f} + \dots \end{aligned} \quad (1.3.10)$$

Observe that  $\mathbf{f}^{\smile*}$  could be undefined for an arbitrary  $\mathcal{G}$ -series  $\mathbf{f}$ .

In what follows, we shall use the notion of finite factorization introduced in Section 4.1.9 of Chapter 2. More precisely, in this context of colored operads, we say that a subset  $S$  of  $\mathcal{G}(1)$  finitely factorizes  $\mathcal{G}(1)$  if any element of  $\mathcal{G}(1)$  admits finitely many factorizations on  $S$  with respect to the operation  $\circ_1$ .

PROPOSITION 1.3.3. *Let  $\mathcal{G}$  be a  $\mathcal{C}$ -colored operad and  $\mathbf{f}$  be a series of  $\mathbb{K}\langle\langle\mathcal{G}\rangle\rangle$ . Then, if  $\mathcal{G}$  is combinatorial and  $\text{Supp}(\mathbf{f})(1)$  finitely factorizes  $\mathcal{G}(1)$ ,  $\mathbf{f}^{\smile*}$  is a well-defined series. Moreover, in this case, for any  $x \in \mathcal{G}$ , the coefficient of  $x$  in  $\mathbf{f}^{\smile*}$  is*

$$\langle x, \mathbf{f}^{\smile*} \rangle = \delta_{x, \mathbb{1}_{\text{out}(x)}} + \sum_{\substack{y, z \in \mathcal{G} \\ i \in [|y|] \\ x = y \circ_i z}} \langle y, \mathbf{f}^{\smile*} \rangle \langle z, \mathbf{f} \rangle. \quad (1.3.11)$$

Proposition 1.3.3 gives hence a way, given a  $\mathcal{G}$ -series  $\mathbf{f}$  satisfying the constraints stated, to compute recursively the coefficients of its  $\smile$ -star  $\mathbf{f}^{\smile*}$  by using (1.3.11).

PROPOSITION 1.3.4. *Let  $\mathcal{G}$  be a combinatorial  $\mathcal{C}$ -colored operad and  $\mathbf{f}$  be a series of  $\mathbb{K}\langle\langle\mathcal{G}\rangle\rangle$  such that  $\text{Supp}(\mathbf{f})(1)$  finitely factorizes  $\mathcal{G}(1)$ . Then, the equation*

$$\mathbf{x} - \mathbf{x} \smile \mathbf{f} = \mathbf{u} \quad (1.3.12)$$

admits the unique solution  $\mathbf{x} = \mathbf{f}^{\smile*}$ .

**1.4. Composition product on series.** We define here a binary operation  $\odot$  on the space of  $\mathcal{G}$ -series. As we shall see, this operation is partially defined, unitary, noncommutative, and associative.

1.4.1. *Composition product.* Given two  $\mathcal{G}$ -series  $\mathbf{f}, \mathbf{g} \in \mathbb{K}\langle\langle\mathcal{G}\rangle\rangle$ , the *composition product* of  $\mathbf{f}$  and  $\mathbf{g}$  is the  $\mathcal{G}$ -series  $\mathbf{f} \odot \mathbf{g}$  defined, for any  $x \in \mathcal{G}$ , by

$$\langle x, \mathbf{f} \odot \mathbf{g} \rangle := \sum_{\substack{y, z_1, \dots, z_{|y|} \in \mathcal{G} \\ x = y \circ [z_1, \dots, z_{|y|}]}} \langle y, \mathbf{f} \rangle \prod_{i \in [|y|]} \langle z_i, \mathbf{g} \rangle. \quad (1.4.1)$$

Observe that  $\mathbf{f} \odot \mathbf{g}$  could be undefined for arbitrary  $\mathcal{G}$ -series  $\mathbf{f}$  and  $\mathbf{g}$  on an arbitrary colored operad  $\mathcal{G}$ . Besides, notice from (1.4.1) that  $\odot$  is linear on the left and that the series  $\mathbf{u}$  is the left and right unit of  $\odot$ . However, this product is not linear on the right since we have, for instance in  $\mathbb{K}\langle\langle\text{As}\rangle\rangle$ ,

$$\mathbf{a}_2 \odot (\mathbf{a}_2 + \mathbf{a}_3) = \mathbf{a}_4 + 2\mathbf{a}_5 + \mathbf{a}_6 \neq \mathbf{a}_4 + \mathbf{a}_6 = \mathbf{a}_2 \odot \mathbf{a}_2 + \mathbf{a}_2 \odot \mathbf{a}_3. \quad (1.4.2)$$

PROPOSITION 1.4.1. *The construction  $(\mathcal{G}, \phi) \mapsto (\mathbb{K}\langle\langle\mathcal{G}\rangle\rangle, \odot), \mathbb{K}\langle\langle\phi\rangle\rangle$  is a functor from the category of combinatorial  $\mathcal{C}$ -colored operads to the category of monoids.*

Proposition 1.4.1 shows that  $\odot$  is an associative product. This product  $\odot$  is a generalization of the composition product of series on operads of [Cha02, Cha09] (see also [vdL04, Fra08, Cha08, LV12, LN13]).

1.4.2. *Composition star product.* For any  $\mathcal{G}$ -series  $\mathbf{f} \in \mathbb{K}\langle\langle\mathcal{G}\rangle\rangle$  and any  $\ell \geq 0$ , let  $\mathbf{f}^{\odot \ell}$  be the series recursively defined by

$$\mathbf{f}^{\odot \ell} := \prod_{i \in [\ell]} \mathbf{f}, \quad (1.4.3)$$

where the product of (1.4.3) denotes the iterated version of  $\odot$ . Since by Proposition 1.4.1,  $\odot$  is associative, this definition is consistent. Immediately from this definition and the definition of the composition product  $\odot$ , the coefficient of  $\mathbf{f}^{\odot \ell}$ ,  $\ell \geq 0$ , satisfies for any  $x \in \mathcal{G}$ ,

$$\langle x, \mathbf{f}^{\odot \ell} \rangle = \begin{cases} \delta_{x, \mathbb{1}_{\text{out}(x)}} & \text{if } \ell = 0, \\ \sum_{\substack{y, z_1, \dots, z_{|y|} \in \mathcal{G} \\ x = y \circ [z_1, \dots, z_{|y|}]}} \langle y, \mathbf{f}^{\odot \ell-1} \rangle \prod_{i \in [|y|]} \langle z_i, \mathbf{g} \rangle & \text{otherwise.} \end{cases} \quad (1.4.4)$$

LEMMA 1.4.2. *Let  $\mathcal{G}$  be a combinatorial  $\mathcal{C}$ -colored operad and  $\mathbf{f}$  be a series of  $\mathbb{K}\langle\langle\mathcal{G}\rangle\rangle$ . Then, the coefficients of  $\mathbf{f}^{\odot \ell+1}$ ,  $\ell \geq 0$ , satisfy for any  $x \in \mathcal{G}$ ,*

$$\langle x, \mathbf{f}^{\odot \ell+1} \rangle = \sum_{\substack{t \in \text{FCO}_{\text{perf}}(\mathcal{G}) \\ \text{ht}(t) = \ell+1 \\ \text{ev}(t) = x}} \prod_{v \in \mathcal{N}_*(t)} \langle t(v), \mathbf{f} \rangle. \quad (1.4.5)$$

Recall that the notations  $\text{ht}(t)$  and  $\mathcal{N}_*(t)$  appearing in the statement of Lemma 1.4.2 stand respectively for the height of  $t$  and for the set of the internal nodes of  $t$  (see Section 2.1.5 of Chapter 1). Moreover, the notation  $\text{FCO}_{\text{perf}}(\mathcal{G})$  denotes the set of all perfect colored  $\mathcal{G}$ -syntax trees (we recall that a tree  $t$  is perfect if all the maximal paths have the same length).

The  $\odot$ -star of  $\mathbf{f}$  is the series

$$\begin{aligned} \mathbf{f}^{\odot * } &:= \sum_{\ell \geq 0} \mathbf{f}^{\odot \ell} \\ &= \mathbf{u} + \mathbf{f} + \mathbf{f}^{\odot 2} + \mathbf{f}^{\odot 3} + \mathbf{f}^{\odot 4} + \dots \\ &= \mathbf{u} + \mathbf{f} + \mathbf{f} \odot \mathbf{f} + \mathbf{f} \odot \mathbf{f} \odot \mathbf{f} + \mathbf{f} \odot \mathbf{f} \odot \mathbf{f} \odot \mathbf{f} + \dots \end{aligned} \quad (1.4.6)$$

Observe that  $\mathbf{f}^{\odot*}$  could be undefined for an arbitrary  $\mathcal{G}$ -series  $\mathbf{f}$ .

PROPOSITION 1.4.3. *Let  $\mathcal{G}$  be a  $\mathcal{C}$ -colored operad and  $\mathbf{f}$  be a series of  $\mathbb{K}\langle\langle\mathcal{G}\rangle\rangle$ . Then, if  $\mathcal{G}$  is combinatorial and  $\text{Supp}(\mathbf{f})(1)$  finitely factorizes  $\mathcal{G}(1)$ ,  $\mathbf{f}^{\odot*}$  is a well-defined series. Moreover, in this case, for any  $x \in \mathcal{G}$ , the coefficient of  $x$  in  $\mathbf{f}^{\odot*}$  is*

$$\langle x, \mathbf{f}^{\odot*} \rangle = \delta_{x, \mathbb{1}_{\text{out}(x)}} + \sum_{\substack{y, z_1, \dots, z_{|y|} \in \mathcal{G} \\ x = y \circ [z_1, \dots, z_{|y|}]}} \langle y, \mathbf{f}^{\odot*} \rangle \prod_{i \in [|y|]} \langle z_i, \mathbf{f} \rangle. \quad (1.4.7)$$

Proposition 1.4.3 gives hence a way, given a  $\mathcal{G}$ -series  $\mathbf{f}$  satisfying the constraints stated, to compute recursively the coefficients of its  $\odot$ -star  $\mathbf{f}^{\odot*}$  by using (1.4.7).

PROPOSITION 1.4.4. *Let  $\mathcal{G}$  be a combinatorial  $\mathcal{G}$ -colored operad and  $\mathbf{f}$  be a series of  $\mathbb{K}\langle\langle\mathcal{G}\rangle\rangle$  such that  $\text{Supp}(\mathbf{f})(1)$  finitely factorizes  $\mathcal{G}(1)$ . Then, the equation*

$$\mathbf{x} - \mathbf{x} \odot \mathbf{f} = \mathbf{u} \quad (1.4.8)$$

admits the unique solution  $\mathbf{x} = \mathbf{f}^{\odot*}$ .

1.4.3. *Invertible elements.* For any  $\mathcal{G}$ -series  $\mathbf{f} \in \mathbb{K}\langle\langle\mathcal{G}\rangle\rangle$ , the  $\odot$ -inverse of  $\mathbf{f}$  is the series  $\mathbf{f}^{\odot^{-1}}$  whose coefficients are defined for any  $x \in \mathcal{G}$  by

$$\langle x, \mathbf{f}^{\odot^{-1}} \rangle := \frac{\delta_{x, \mathbb{1}_{\text{out}(x)}}}{\langle \mathbb{1}_{\text{out}(x)}, \mathbf{f} \rangle} - \frac{1}{\langle \mathbb{1}_{\text{out}(x)}, \mathbf{f} \rangle} \sum_{\substack{y, z_1, \dots, z_{|y|} \in \mathcal{G} \\ y \neq \mathbb{1}_{\text{out}(x)} \\ x = y \circ [z_1, \dots, z_{|y|}]}} \langle y, \mathbf{f} \rangle \prod_{i \in [|y|]} \langle z_i, \mathbf{f}^{\odot^{-1}} \rangle. \quad (1.4.9)$$

Observe that  $\mathbf{f}^{\odot^{-1}}$  could be undefined for an arbitrary  $\mathcal{G}$ -series  $\mathbf{f}$ .

PROPOSITION 1.4.5. *Let  $\mathcal{G}$  be a combinatorial colored  $\mathcal{C}$ -operad and  $\mathbf{f}$  be a series of  $\mathbb{K}\langle\langle\mathcal{G}\rangle\rangle$  such that  $\text{Supp}(\mathbf{f}) = \{\mathbb{1}_a : a \in \mathcal{C}\} \sqcup S$  where  $S$  is a  $\mathcal{C}$ -colored subcollection of  $\mathcal{G}$  such that  $S(1)$  finitely factorizes  $\mathcal{G}(1)$ . Then,  $\mathbf{f}^{\odot^{-1}}$  is a well-defined series and the coefficients of  $\mathbf{f}^{\odot^{-1}}$  satisfy for any  $x \in \mathcal{G}$ ,*

$$\langle x, \mathbf{f}^{\odot^{-1}} \rangle = \frac{1}{\langle \mathbb{1}_{\text{out}(x)}, \mathbf{f} \rangle} \sum_{\substack{t \in \text{FCO}(S) \\ \text{ev}(t) = x}} (-1)^{\deg(t)} \prod_{v \in \mathcal{N}_*(t)} \frac{\langle t(v), \mathbf{f} \rangle}{\prod_{j \in [|v|]} \langle \mathbb{1}_{\text{in}_j(v)}, \mathbf{f} \rangle}. \quad (1.4.10)$$

PROPOSITION 1.4.6. *Let  $\mathcal{G}$  be a combinatorial colored  $\mathcal{C}$ -operad and  $\mathbf{f}$  be a series of  $\mathbb{K}\langle\langle\mathcal{G}\rangle\rangle$  such that  $\text{Supp}(\mathbf{f}) = \{\mathbb{1}_a : a \in \mathcal{C}\} \sqcup S$  where  $S$  is a  $\mathcal{C}$ -colored subcollection of  $\mathcal{G}$  such that  $S(1)$  finitely factorizes  $\mathcal{G}(1)$ . Then, the equations*

$$\mathbf{f} \odot \mathbf{x} = \mathbf{u} \quad (1.4.11)$$

and

$$\mathbf{x} \odot \mathbf{f} = \mathbf{u} \quad (1.4.12)$$

admit both the unique solution  $\mathbf{x} = \mathbf{f}^{\odot^{-1}}$ .

Proposition 1.4.6 shows that the  $\odot$ -inverse  $\mathbf{f}^{\odot^{-1}}$  of a series  $\mathbf{f}$  satisfying the constraints stated is the inverse of  $\mathbf{f}$  for the composition product. Moreover,  $\mathbf{f}^{\odot^{-1}}$  can be computed recursively by using (1.4.9) or directly by using (1.4.10).



PROPOSITION 1.4.7. *Let  $\mathcal{G}$  be a combinatorial colored  $\mathcal{C}$ -operad. Then, the subset of  $\mathbb{K}\langle\langle\mathcal{G}\rangle\rangle$  consisting in all series  $\mathbf{f}$  such that  $\text{Supp}(\mathbf{f}) = \{\mathbb{1}_a : a \in \mathcal{C}\} \sqcup S$  where  $S$  is a  $\mathcal{C}$ -colored subcollection of  $\mathcal{G}$  such that  $S(1)$  finitely factorizes  $\mathcal{G}(1)$  forms a group for the composition product  $\odot$ .*

The group obtained from  $\mathcal{G}$  of the  $\mathcal{G}$ -series satisfying the conditions of Proposition 1.4.7 is a generalization of the groups constructed from operads of [Cha02, Cha09] (see also [vdL04, Fra08, Cha08, LV12, LN13]).

## 2. Bud generating systems and combinatorial generation

In this section, we introduce bud generating systems. A bud generating system relies on a monochrome operad  $\mathcal{O}$ , a set of colors  $\mathcal{C}$ , and the bud operad  $\text{Bud}_{\mathcal{C}}(\mathcal{O})$ . The principal interest of these objects is that they allow to specify sets of objects of  $\text{Bud}_{\mathcal{C}}(\mathcal{O})$ . We shall also establish some first properties of bud generating systems by showing that they can emulate context-free grammars, regular tree grammars, and synchronous grammars.

**2.1. Bud generating systems.** We introduce here the main definitions and the main tools about bud generating systems.

2.1.1. *Bud generating systems.* A *bud generating system* is a tuple  $\mathcal{B} := (\mathcal{O}, \mathcal{C}, \mathfrak{R}, I, T)$  where  $\mathcal{O}$  is an operad called *ground operad*,  $\mathcal{C}$  is a finite set of colors,  $\mathfrak{R}$  is a finite  $\mathcal{C}$ -colored subcollection of  $\text{Bud}_{\mathcal{C}}(\mathcal{O})$  called *set of rules*,  $I$  is a subset of  $\mathcal{C}$  called *set of initial colors*, and  $T$  is a subset of  $\mathcal{C}$  called *set of terminal colors*.

A *monochrome bud generating system* is a bud generating system whose set  $\mathcal{C}$  of colors contains a single color, and whose sets of initial and terminal colors are equal to  $\mathcal{C}$ . In this case, as explained in Section 1.1.2,  $\text{Bud}_{\mathcal{C}}(\mathcal{O})$  and  $\mathcal{O}$  are identified. These particular generating systems are hence simply denoted by pairs  $(\mathcal{O}, \mathfrak{R})$ .

Let us explain how bud generating systems specify, in two different ways, two  $\mathcal{C}$ -colored subcollections of  $\text{Bud}_{\mathcal{C}}(\mathcal{O})$ . In what follows,  $\mathcal{B} := (\mathcal{O}, \mathcal{C}, \mathfrak{R}, I, T)$  is a bud generating system.

2.1.2. *Generation.* We say that  $x_2 \in \text{Bud}_{\mathcal{C}}(\mathcal{O})$  is *derivable in one step* from  $x_1 \in \text{Bud}_{\mathcal{C}}(\mathcal{O})$  if there is a rule  $r \in \mathfrak{R}$  and an integer  $i$  such that  $x_2 = x_1 \circ_i r$ . We denote this property by  $x_1 \rightarrow x_2$ . When  $x_1, x_2 \in \text{Bud}_{\mathcal{C}}(\mathcal{O})$  are such that  $x_1 = x_2$  or there are  $y_1, \dots, y_{\ell-1} \in \text{Bud}_{\mathcal{C}}(\mathcal{O})$ ,  $\ell \geq 1$ , satisfying

$$x_1 \rightarrow y_1 \rightarrow \dots \rightarrow y_{\ell-1} \rightarrow x_2, \quad (2.1.1)$$

we say that  $x_2$  is *derivable* from  $x_1$ . Moreover,  $\mathcal{B}$  *generates*  $x \in \text{Bud}_{\mathcal{C}}(\mathcal{O})$  if there is a color  $a$  of  $I$  such that  $x$  is derivable from  $\mathbb{1}_a$  and all colors of  $\text{in}(x)$  are in  $T$ . The *language*  $L(\mathcal{B})$  of  $\mathcal{B}$  is the set of all the elements of  $\text{Bud}_{\mathcal{C}}(\mathcal{O})$  generated by  $\mathcal{B}$ . Finally,  $\mathcal{B}$  is *faithful* if the characteristic series of  $L(\mathcal{B})$  is faithful (see Section 1.2.7). Observe that all monochrome bud generating systems are faithful.

The *derivation graph* of  $\mathcal{B}$  is the directed multigraph  $G(\mathcal{B})$  with the set of elements derivable from  $\mathbb{1}_a$ ,  $a \in I$ , as set of vertices. In  $G(\mathcal{B})$ , for any  $x_1, x_2 \in L(\mathcal{B})$  such that  $x_1 \rightarrow x_2$ , there are  $\ell$  edges from  $x_1$  to  $x_2$ , where  $\ell$  is the number of pairs  $(i, r) \in \mathbb{N} \times \mathfrak{R}$  such that  $x_2 = x_1 \circ_i r$ .

2.1.3. *A bud generating system for Motzkin paths.* Let us consider the operad Motz on Motzkin paths introduced in Section 2.1.5 of Chapter 4, seen as a set-operad. Let the bud generating system  $\mathcal{B}_p := (\text{Motz}, \{1, 2\}, \mathfrak{R}, \{1\}, \{1, 2\})$  where

$$\mathfrak{R} := \{(1, \text{○} \text{○} \text{○}, 22), (1, \text{○} \text{○} \text{○}, 111)\}. \tag{2.1.2}$$

Figure 11.1 shows a sequence of derivations in  $\mathcal{B}_p$  and Figure 11.2 shows the derivation graph of  $\mathcal{B}_p$ .

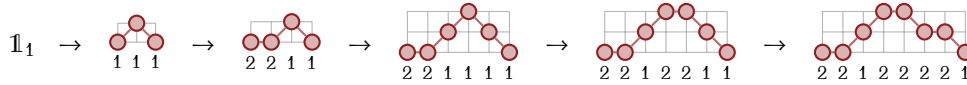

FIGURE 11.1. A sequence of derivations in  $\mathcal{B}_p$ . The input colors of the elements of  $\text{Bud}_{\{1,2\}}(\text{Motz})$  are depicted below the paths. The output color of all these elements is 1.

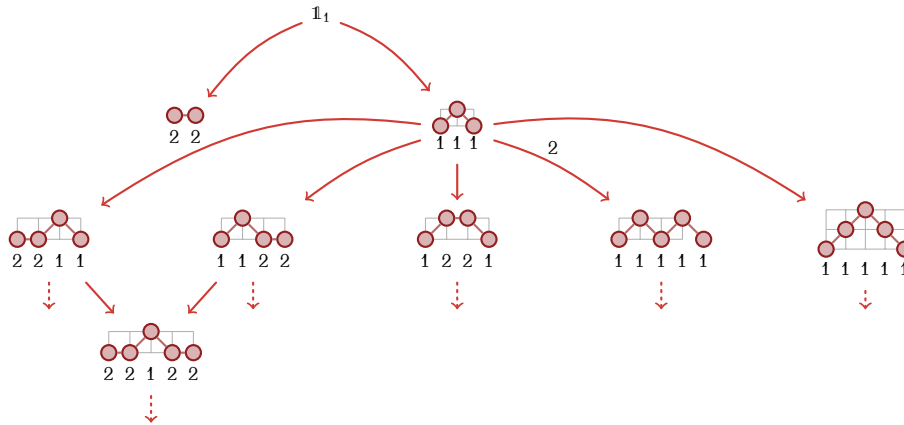

FIGURE 11.2. The derivation graph of  $\mathcal{B}_p$ . The input colors of the elements of  $\text{Bud}_{\{1,2\}}(\text{Motz})$  are depicted below the paths. The output color of all these elements is 1.

Let  $L_{\mathcal{B}_p}$  be the set of Motzkin paths with no consecutive horizontal steps.

PROPOSITION 2.1.1. *The bud generating system  $\mathcal{B}_p$  satisfies the following properties.*

- (i) *It is faithful.*
- (ii) *The restriction of the pruning map  $\text{pru}$  on the domain  $L(\mathcal{B}_p)$  is a bijection between  $L(\mathcal{B}_p)$  and  $L_{\mathcal{B}_p}$ .*
- (iii) *The set of rules  $\mathfrak{R}(1)$  finitely factorizes  $\text{Bud}_{\{1,2\}}(\text{Motz})(1)$ .*

Properties (i) and (ii) of Proposition 2.1.1 together say that the sequence enumerating the elements of  $L(\mathcal{B}_p)$  with respect to their arity is the one enumerating the Motzkin paths with no consecutive horizontal steps. This sequence is Sequence A104545 of [Slo], starting by

$$1, 1, 1, 3, 5, 11, 25, 55, 129, 303, 721, 1743, 4241, 10415, 25761, 64095. \tag{2.1.3}$$

2.1.4. *Synchronous generation.* We say that  $x_2 \in \text{Bud}_{\mathcal{C}}(\mathcal{O})$  is *synchronously derivable in one step* from  $x_1 \in \text{Bud}_{\mathcal{C}}(\mathcal{O})$  if there are rules  $r_1, \dots, r_{|x_1|}$  of  $\mathfrak{R}$  such that  $x_2 = x_1 \circ [r_1, \dots, r_{|x_1|}]$ . We denote this property by  $x_1 \rightsquigarrow x_2$ . When  $x_1, x_2 \in \text{Bud}_{\mathcal{C}}(\mathcal{O})$  are such that  $x_1 = x_2$  or there are  $y_1, \dots, y_{\ell-1} \in \text{Bud}_{\mathcal{C}}(\mathcal{O})$ ,  $\ell \geq 1$ , satisfying

$$x_1 \rightsquigarrow y_1 \rightsquigarrow \dots \rightsquigarrow y_{\ell-1} \rightsquigarrow x_2, \tag{2.1.4}$$

we say that  $x_2$  is *synchronously derivable* from  $x_1$ . Moreover,  $\mathcal{B}$  *synchronously generates*  $x \in \text{Bud}_{\mathcal{C}}(\mathcal{O})$  if there is a color  $a$  of  $I$  such that  $x$  is synchronously derivable from  $\mathbb{1}_a$  and all colors of  $\text{in}(x)$  are in  $T$ . The *synchronous language*  $L_S(\mathcal{B})$  of  $\mathcal{B}$  is the set of all the elements of  $\text{Bud}_{\mathcal{C}}(\mathcal{O})$  synchronously generated by  $\mathcal{B}$ . Finally, we say that  $\mathcal{B}$  is *synchronously faithful* if the characteristic series of  $L_S(\mathcal{B})$  is faithful (see Section 1.2.7). Observe that all monochrome bud generating systems are synchronously faithful.

The *synchronous derivation graph* of  $\mathcal{B}$  is the directed multigraph  $G_S(\mathcal{B})$  with the set of elements synchronously derivable from  $\mathbb{1}_a$ ,  $a \in I$ , as set of vertices. In  $G_S(\mathcal{B})$ , for any  $x_1, x_2 \in L_S(\mathcal{B})$  such that  $x_1 \rightsquigarrow x_2$ , there are  $\ell$  edges from  $x_1$  to  $x_2$ , where  $\ell$  is the number of tuples  $(r_1, \dots, r_{|x_1|}) \in \mathfrak{R}^{|x_1|}$  such that  $x_2 = x_1 \circ [r_1, \dots, r_{|x_1|}]$ .

2.1.5. *A bud generating system for balanced binary trees.* Let us consider the magmatic operad  $\text{Mag}$  (see Section 4.2.2 of Chapter 2). Let the bud generating system  $\mathcal{B}_{\text{bbt}} := (\text{Mag}, \{1, 2\}, \mathfrak{R}, \{1\}, \{1\})$  where

$$\mathfrak{R} := \left\{ \left( 1, \begin{array}{c} \square \\ \square \end{array}, 11 \right), \left( 1, \begin{array}{c} \square \\ \square \end{array}, 12 \right), \left( 1, \begin{array}{c} \square \\ \square \end{array}, 21 \right), \left( 2, \begin{array}{c} \square \\ \square \end{array}, 1 \right) \right\}. \tag{2.1.5}$$

Figure 11.3 shows a sequence of synchronous derivations in  $\mathcal{B}_{\text{bbt}}$ .

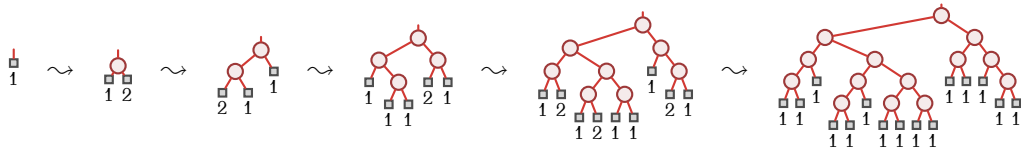

FIGURE 11.3. A sequence of synchronous derivations in  $\mathcal{B}_{\text{bbt}}$ . The input colors of the elements of  $\text{Bud}_{\{1,2\}}(\text{Mag})$  are depicted below the leaves. The output color of all these elements is 1. Since all input colors of the last tree are 1, this tree is in  $L_S(\mathcal{B}_{\text{bbt}})$ .

Recall that if  $t$  is a binary tree, the height of  $t$  is the length of a longest path connecting the root of  $t$  to one of its leaves (see Section 2.1.5 of Chapter 1). A *balanced binary tree* [AVL62] is a binary tree  $t$  wherein, for any internal node  $u$  of  $t$ , the difference between the height of the left subtree and the height of the right subtree of  $u$  is  $-1$ ,  $0$ , or  $1$ .

PROPOSITION 2.1.2. *The bud generating system  $\mathcal{B}_{\text{bbt}}$  satisfies the following properties.*

- (i) *It is synchronously faithful.*
- (ii) *The restriction of the pruning map  $\text{pru}$  on the domain  $L_S(\mathcal{B}_{\text{bbt}})$  is a bijection between  $L_S(\mathcal{B}_{\text{bbt}})$  and the set of balanced binary trees.*
- (iii) *The set of rules  $\mathfrak{R}(1)$  finitely factorizes  $\text{Bud}_{\{1,2\}}(\text{Mag})(1)$ .*

Property (ii) of Proposition 2.1.2 is based upon combinatorial properties of a synchronous grammar  $\mathcal{G}$  of balanced binary trees defined in [Gir12e] and satisfying  $\text{SG}(\mathcal{G}) = \mathcal{B}_{\text{bbt}}$  (see Section 2.3.3 and Proposition 2.3.3). Besides, Properties (i) and (ii) of Proposition 2.1.2 together imply that the sequence enumerating the elements of  $L_S(\mathcal{B}_{\text{bbt}})$  with respect to their arity is the one enumerating the balanced binary trees. This sequence in Sequence A006265 of [Slo], starting by

$$1, 1, 2, 1, 4, 6, 4, 17, 32, 44, 60, 70, 184, 476, 872, 1553, 2720, 4288, 6312, 9004. \quad (2.1.6)$$

**2.2. First properties.** We state now two properties about the languages and the synchronous languages of bud generating systems.

LEMMA 2.2.1. *Let  $\mathcal{B} := (\mathcal{O}, \mathcal{C}, \mathfrak{R}, I, T)$  be a bud generating system. Then, for any  $x \in \text{Bud}_{\mathcal{C}}(\mathcal{O})$ ,  $x$  belongs to  $L(\mathcal{B})$  if and only if  $x$  admits an  $\mathfrak{R}$ -treelike expression with output color in  $I$  and all input colors in  $T$ .*

PROOF. Assume that  $x$  belongs to  $L(\mathcal{B})$ . Then, by definition of the derivation relation  $\rightarrow$ ,  $x$  admits an  $\mathfrak{R}$ -left expression. Lemma 4.1.4 of Chapter 2 implies in particular that  $x$  admits an  $\mathfrak{R}$ -treelike expression  $t$ . Moreover, since  $t$  is a treelike expression for  $x$ ,  $t$  has the same output and input colors as those of  $x$ . Hence, because  $x$  belongs to  $L(\mathcal{B})$ , its output color is in  $I$  and all its input colors are in  $T$ . Thus,  $t$  satisfies the required properties.

Conversely, assume that  $x$  is an element of  $\text{Bud}_{\mathcal{C}}(\mathcal{O})$  admitting an  $\mathfrak{R}$ -treelike expression  $t$  with output color in  $I$  and all input colors in  $T$ . Lemma 4.1.4 of Chapter 2 implies in particular that  $x$  admits an  $\mathfrak{R}$ -left expression. Hence, by definition of the derivation relation  $\rightarrow$ ,  $x$  is derivable from  $\mathbb{1}_{\text{out}(x)}$  and all its input colors are in  $T$ . Therefore,  $x$  belongs to  $L(\mathcal{B})$ .  $\square$

LEMMA 2.2.2. *Let  $\mathcal{B} := (\mathcal{O}, \mathcal{C}, \mathfrak{R}, I, T)$  be a bud generating system. Then, for any  $x \in \text{Bud}_{\mathcal{C}}(\mathcal{O})$ ,  $x$  belongs to  $L_S(\mathcal{B})$  if and only if  $x$  admits an  $\mathfrak{R}$ -treelike expression with output color in  $I$  and all input colors in  $T$  and which is a perfect tree.*

PROPOSITION 2.2.3. *Let  $\mathcal{B} := (\mathcal{O}, \mathcal{C}, \mathfrak{R}, I, T)$  be a bud generating system. Then, the language of  $\mathcal{B}$  satisfies*

$$L(\mathcal{B}) = \{x \in \text{Bud}_{\mathcal{C}}(\mathcal{O})^{\mathfrak{R}} : \text{out}(x) \in I \text{ and } \text{in}(x) \in T^+\}. \quad (2.2.1)$$

PROPOSITION 2.2.4. *Let  $\mathcal{B} := (\mathcal{O}, \mathcal{C}, \mathfrak{R}, I, T)$  be a bud generating system. Then, the synchronous language of  $\mathcal{B}$  is a subset of the language of  $\mathcal{B}$ .*

**2.3. Links with other generating systems.** Context-free grammars, regular tree grammars, and synchronous grammars are already existing generating systems describing sets of words for the first, and sets of trees for the last two. We show here that any of these grammars can be emulated by bud generating systems.

**2.3.1. Context-free grammars.** Recall that a *context-free grammar* [Har78, HMU06] is a tuple  $\mathcal{G} := (V, T, P, s)$  where  $V$  is a finite alphabet of *variables*,  $T$  is a finite alphabet of *terminal symbols*,  $P$  is a finite subset of  $V \times (V \sqcup T)^*$  called *set of productions*, and  $s$  is a variable of  $V$  called *start symbol*. If  $x_1$  and  $x_2$  are two words of  $(V \sqcup T)^*$ ,  $x_2$  is *derivable in one step* from  $x_1$  if  $x_1$  is of the form  $x_1 = uav$  and  $x_2$  is of the form  $x_2 = uwv$  where  $u, v \in (V \sqcup T)^*$  and  $(a, w)$  is a production of  $P$ . This property is denoted by  $x_1 \rightarrow x_2$ , so that  $\rightarrow$  is a binary relation on  $(V \sqcup T)^*$ . The reflexive and transitive closure of  $\rightarrow$  is the *derivation relation*. A word  $x \in T^*$  is *generated* by  $\mathcal{G}$  if  $x$  is derivable from the word  $s$ . The *language* of  $\mathcal{G}$  is the set of all words generated by  $\mathcal{G}$ . We say that  $\mathcal{G}$  is *proper* if, for any  $(a, w) \in P$ ,  $w$  is not the empty word.

If  $\mathcal{G} := (V, T, P, s)$  is a proper context-free grammar, we denote by  $\text{CFG}(\mathcal{G})$  the bud generating system

$$\text{CFG}(\mathcal{G}) := (\text{As}, V \sqcup T, \mathfrak{R}, \{s\}, T) \quad (2.3.1)$$

wherein  $\mathfrak{R}$  is the set of rules

$$\mathfrak{R} := \{(a, u) \in \text{Bud}_{V \sqcup T}(\text{As}) : (a, u) \in P\}. \quad (2.3.2)$$

**PROPOSITION 2.3.1.** *Let  $\mathcal{G}$  be a proper context-free grammar. Then, the restriction of the map  $\mathbf{in}$ , sending any  $(a, u) \in \text{Bud}_{V \sqcup T}(\text{As})$  to  $u$ , on the domain  $L(\text{CFG}(\mathcal{G}))$  is a bijection between  $L(\text{CFG}(\mathcal{G}))$  and the language of  $\mathcal{G}$ .*

**PROOF.** Let us denote by  $V$  the set of variables, by  $T$  the set of terminal symbols, by  $P$  the set of productions, and by  $s$  the start symbol of  $\mathcal{G}$ .

Let  $(a, x) \in \text{Bud}_{V \sqcup T}(\text{As})$ ,  $\ell \geq 1$ , and  $y_1, \dots, y_{\ell-1} \in (V \sqcup T)^*$ . Then, by definition of  $\text{CFG}$ , there are in  $\text{CFG}(\mathcal{G})$  the derivations

$$\mathbb{1}_s \rightarrow (s, y_1) \rightarrow \dots \rightarrow (s, y_{\ell-1}) \rightarrow (a, x) \quad (2.3.3)$$

if and only if  $a = s$  and there are in  $\mathcal{G}$  the derivations

$$s \rightarrow y_1 \rightarrow \dots \rightarrow y_{\ell-1} \rightarrow x. \quad (2.3.4)$$

Then,  $(a, x)$  belongs to  $L(\text{CFG}(\mathcal{G}))$  if and only if  $a = s$  and  $x$  belongs to the language of  $\mathcal{G}$ . The fact that  $\mathbf{in}((s, x)) = x$  completes the proof.  $\square$

**2.3.2. Regular tree grammars.** Let  $V$  be a finite graded collection of *variables* and  $T$  be a finite graded collection of *terminal symbols*. For any  $n \geq 0$  and  $a \in T(n)$  (resp.  $a \in V(n)$ ), the arity  $|a|$  of  $a$  is  $n$ . We moreover impose that all the elements of  $V$  are of arity 0. The tuple  $(V, T)$  is called a *signature*.

A  $(V, T)$ -*tree* is an element of  $\text{Bud}_{V \sqcup T(0)}(\mathbf{FO}(T \setminus T(0)))$ , where  $T \setminus T(0)$  is seen as a monochrome collection. In other words, a  $(V, T)$ -tree is a planar rooted  $t$  tree such that, for any  $n \geq 1$ , any internal node of  $t$  having  $n$  children is labeled by an element of arity  $n$  of  $T$ , and the output and all leaves of  $t$  are labeled on  $V \sqcup T(0)$ .

A *regular tree grammar* [GS84, CDG<sup>+</sup>07] is a tuple  $\mathcal{G} := (V, T, P, s)$  where  $(V, T)$  is a signature,  $P$  is a set of pairs of the form  $(v, \mathfrak{s})$  called *productions* where  $v \in V$  and  $\mathfrak{s}$  is a  $(V, T)$ -tree, and  $s$  is a variable of  $V$  called *start symbol*. If  $t_1$  and  $t_2$  are two  $(V, T)$ -trees,  $t_2$  is *derivable in one step* from  $t_1$  if  $t_1$  has a leaf  $y$  labeled by  $a$  and the tree obtained by replacing  $y$  by the root of  $\mathfrak{s}$  in  $t_1$  is  $t_2$ , provided that  $(a, \mathfrak{s})$  is a production of  $P$ . This property is denoted by  $t_1 \rightarrow t_2$ , so that  $\rightarrow$  is a binary relation on the set of all  $(V, T)$ -trees. The reflexive and transitive closure of  $\rightarrow$  is the derivation relation. A  $(V, T)$ -tree  $t$  is *generated* by  $\mathcal{G}$  if  $t$  is derivable from the tree  $\mathbb{1}_s$  consisting in one leaf labeled by  $s$  and all leaves of  $t$  are labeled on  $T(0)$ . The *language* of  $\mathcal{G}$  is the set of all  $(V, T)$ -trees generated by  $\mathcal{G}$ .

If  $\mathcal{G} := (V, T, P, s)$  is a regular tree grammar, we denote by  $\text{RTG}(\mathcal{G})$  the bud generating system

$$\text{RTG}(\mathcal{G}) := (\mathbf{FO}(T \setminus T(0)), V \sqcup T(0), \mathfrak{R}, \{s\}, T(0)) \tag{2.3.5}$$

wherein  $\mathfrak{R}$  is the set of rules

$$\mathfrak{R} := \{(a, t, u) \in \text{Bud}_{V \sqcup T(0)}(\mathbf{FO}(T \setminus T(0))) : (a, t_{a,u}) \in P\}, \tag{2.3.6}$$

where, for any  $t \in \mathbf{FO}(T \setminus T(0))$ ,  $a \in V \sqcup T(0)$ , and  $u \in (V \sqcup T(0))^{|t|}$ ,  $t_{a,u}$  is the  $(V, T)$ -tree obtained by labeling the output of  $t$  by  $a$  and by labeling from left to right the leaves of  $t$  by the letters of  $u$ .

**PROPOSITION 2.3.2.** *Let  $\mathcal{G}$  be a regular tree grammar. Then, the map  $\phi : L(\text{RTG}(\mathcal{G})) \rightarrow L$  defined by  $\phi((a, t, u)) := t_{a,u}$  is a bijection between the language of  $\text{RTG}(\mathcal{G})$  and the language  $L$  of  $\mathcal{G}$ .*

**2.3.3. Synchronous grammars.** In this section, we shall denote by  $\text{Tree}$  the monochrome operad  $\mathbf{FO}(C)$  where  $C$  is the monochrome collection  $C := \sqcup_{n \geq 1} C(n)$  where  $C(n) := \{a_n\}$ . The elements of this operad are planar rooted trees where internal nodes have an arbitrary arity. Observe that since  $C(1) := \{a_1\}$ ,  $\mathbf{FO}(C)(1)$  is an infinite set, so that  $\mathbf{FO}(C)$  is not combinatorial.

Let  $B$  be a finite alphabet. A *B-bud tree* is an element of  $\text{Bud}_B(\text{Tree})$ . In other words, a  $B$ -bud tree is a planar rooted tree  $t$  such that the output and all leaves of  $t$  are labeled on  $B$ . The leaves of a  $B$ -bud tree are indexed from 1 from left to right.

A *synchronous grammar* [Gir12e] is a tuple  $\mathcal{G} := (B, a, R)$  where  $B$  is a finite alphabet of *bud labels*,  $a$  is an element of  $B$  called *axiom*, and  $R$  is a finite set of pairs of the form  $(b, \mathfrak{s})$  called *substitution rules* where  $b \in B$  and  $\mathfrak{s}$  is a  $B$ -bud tree. If  $t_1$  and  $t_2$  are two  $B$ -bud trees such that  $t_1$  is of arity  $n$ ,  $t_2$  is *derivable in one step* from  $t_1$  if there are substitution rules  $(b_1, \mathfrak{s}_1), \dots, (b_n, \mathfrak{s}_n)$  of  $R$  such that for all  $i \in [n]$ , the  $i$ th leaf of  $t_1$  is labeled by  $b_i$  and  $t_2$  is obtained by replacing the  $i$ th leaf of  $t_1$  by  $\mathfrak{s}_i$  for all  $i \in [n]$ . This property is denoted by  $t_1 \rightsquigarrow t_2$ , so that  $\rightsquigarrow$  is a binary relation on the set of all  $B$ -bud trees. The reflexive and transitive closure of  $\rightsquigarrow$  is the derivation relation. A  $B$ -bud tree  $t$  is *generated* by  $\mathcal{G}$  if  $t$  is derivable from the tree  $\mathbb{1}_a$  consisting is one leaf labeled by  $a$ . The *language* of  $\mathcal{G}$  is the set of all  $B$ -bud trees generated by  $\mathcal{G}$ .

If  $\mathcal{G} := (B, a, R)$  is a synchronous grammar, we denote by  $\text{SG}(\mathcal{G})$  the bud generating system

$$\text{SG}(\mathcal{G}) := (\text{Tree}, B, \mathfrak{R}, \{a\}, B) \quad (2.3.7)$$

wherein  $\mathfrak{R}$  is the set of rules

$$\mathfrak{R} := \{(b, t, u) \in \text{Bud}_B(\text{Tree}) : (b, t_{b,u}) \in R\}, \quad (2.3.8)$$

where, for any  $t \in \text{Bud}_B(\text{Tree})$ ,  $b \in B$ , and  $u \in B^+$ ,  $t_{b,u}$  is the  $B$ -bud tree obtained by labeling the output of  $t$  by  $b$  and by labeling from left to right the leaves of  $t$  by the letters of  $u$ .

**PROPOSITION 2.3.3.** *Let  $\mathcal{G}$  be a synchronous grammar. Then, the map  $\phi : L_S(\text{SG}(\mathcal{G})) \rightarrow L$  defined by  $\phi((b, t, u)) := t_{b,u}$  is a bijection between the synchronous language of  $\text{SG}(\mathcal{G})$  and the language  $L$  of  $\mathcal{G}$ .*

### 3. Series on colored operads and bud generating systems

In this section, we explain how to use bud generating systems as tools to enumerate families of combinatorial objects. For this purpose, we will define and consider three series on colored operads extracted from bud generating systems. Each of these series brings information about the languages or the synchronous languages of bud generating systems. One of a key issues is, given a bud generating system  $\mathcal{B}$ , to count arity by arity the elements of the language or the synchronous language of  $\mathcal{B}$ . In other terms, this amounts to compute the generating series  $\mathbf{s}_{L(\mathcal{B})}$  or  $\mathbf{s}_{L_S(\mathcal{B})}$ . As we shall see, these generating series can be computed from the series of colored operads extracted from  $\mathcal{B}$ .

**3.1. General definitions.** Let us list some notations used in this section. In what follows,  $\mathcal{B} := (\mathcal{O}, \mathcal{C}, \mathfrak{R}, I, T)$  is a bud generating system such that  $\mathcal{O}$  is a combinatorial monochrome operad and, as before,  $\mathcal{C}$  is a set of colors of the form  $\mathcal{C} = \{c_1, \dots, c_k\}$ .

**3.1.1. Characteristic series.** We shall denote by  $\mathbf{r}$  the characteristic series of  $\mathfrak{R}$ , by  $\mathbf{i}$  the series

$$\mathbf{i} := \sum_{a \in I} \mathbb{1}_a, \quad (3.1.1)$$

and by  $\mathbf{t}$  the series

$$\mathbf{t} := \sum_{a \in T} \mathbb{1}_a. \quad (3.1.2)$$

**LEMMA 3.1.1.** *Let  $\mathcal{B} := (\mathcal{O}, \mathcal{C}, \mathfrak{R}, I, T)$  be a bud generating system and  $\mathbf{f}$  be a  $\text{Bud}_{\mathcal{C}}(\mathcal{O})$ -series. Then, for all  $x \in \text{Bud}_{\mathcal{C}}(\mathcal{O})$ ,*

$$\langle x, \mathbf{i} \odot \mathbf{f} \odot \mathbf{t} \rangle = \begin{cases} \langle x, \mathbf{f} \rangle & \text{if } \mathbf{out}(x) \in I \text{ and } \mathbf{in}(x) \in T^+, \\ 0 & \text{otherwise.} \end{cases} \quad (3.1.3)$$

3.1.2. *Polynomials.* For all colors  $a \in \mathcal{C}$  and types  $\alpha \in \mathcal{T}_{\mathcal{C}}$ , let

$$\chi_{a,\alpha} := \# \{r \in \mathfrak{R} : (\mathbf{out}(r), \mathbf{type}(\mathbf{in}(r))) = (a, \alpha)\}. \quad (3.1.4)$$

For any  $a \in \mathcal{C}$ , let  $\mathbf{g}_a(y_{c_1}, \dots, y_{c_k})$  be the series of  $\mathbb{K}\langle\langle S(\mathbb{Y}_{\mathcal{C}})\rangle\rangle$  defined by

$$\mathbf{g}_a(y_{c_1}, \dots, y_{c_k}) := \sum_{\gamma \in \mathcal{T}_{\mathcal{C}}} \chi_{a,\gamma} \mathbb{Y}_{\mathcal{C}}^{\gamma}. \quad (3.1.5)$$

Notice that

$$\mathbf{g}_a(y_{c_1}, \dots, y_{c_k}) = \sum_{\substack{r \in \mathfrak{R} \\ \mathbf{out}(r)=a}} \mathbb{Y}_{\mathcal{C}}^{\mathbf{type}(\mathbf{in}(r))} \quad (3.1.6)$$

and that, since  $\mathfrak{R}$  is finite, this series is a polynomial.

3.1.3. *Maps.* In the sequel, we shall use maps  $\phi : \mathcal{C} \times \mathcal{T}_{\mathcal{C}} \rightarrow \mathbb{N}$  such that  $\phi(a, \gamma) \neq 0$  for a finite number of pairs  $(a, \gamma) \in \mathcal{C} \times \mathcal{T}_{\mathcal{C}}$ , to express in a concise manner some recurrence relations for the coefficients of series on colored operads. We shall consider the two following notations. If  $\phi$  is such a map and  $a \in \mathcal{C}$ , we define  $\phi^{(a)}$  as the natural number

$$\phi^{(a)} := \sum_{\substack{b \in \mathcal{C} \\ \gamma \in \mathcal{T}_{\mathcal{C}}}} \phi(b, \gamma) \chi_a \quad (3.1.7)$$

and  $\phi_a$  as the finite multiset

$$\phi_a := \lfloor \phi(a, \gamma) : \gamma \in \mathcal{T}_{\mathcal{C}} \rfloor. \quad (3.1.8)$$

3.2. **Hook generating series.** We call *hook generating series* of  $\mathcal{B}$  the  $\text{Bud}_{\mathcal{C}}(\mathcal{O})$ -series  $\text{hook}(\mathcal{B})$  defined by

$$\text{hook}(\mathcal{B}) := \mathbf{i} \odot \mathbf{r}^{\frown*} \odot \mathbf{t}. \quad (3.2.1)$$

Observe that (3.2.1) could be undefined for an arbitrary set of rules  $\mathfrak{R}$  of  $\mathcal{B}$ . Nevertheless, when  $\mathbf{r}$  satisfies the conditions of Proposition 1.3.3, that is, when  $\mathcal{O}$  is a combinatorial operad and  $\mathfrak{R}(1)$  finitely factorizes  $\text{Bud}_{\mathcal{C}}(\mathcal{O})(1)$ ,  $\text{hook}(\mathcal{B})$  is well-defined.

3.2.1. *Expression.* The aim of the following is to provide an expression to compute the coefficients of  $\text{hook}(\mathcal{B})$ .

LEMMA 3.2.1. *Let  $\mathcal{B} := (\mathcal{O}, \mathcal{C}, \mathfrak{R}, I, T)$  be a bud generating system such that  $\mathcal{O}$  is a combinatorial operad and  $\mathfrak{R}(1)$  finitely factorizes  $\text{Bud}_{\mathcal{C}}(\mathcal{O})(1)$ . Then, for any  $x \in \text{Bud}_{\mathcal{C}}(\mathcal{O})$ ,*

$$\langle x, \mathbf{r}^{\frown*} \rangle = \delta_{x, \mathbf{1}_{\mathbf{out}(x)}} + \sum_{\substack{y \in \text{Bud}_{\mathcal{C}}(\mathcal{O}) \\ z \in \mathfrak{R} \\ i \in [|y|] \\ x = y \circ_i z}} \langle y, \mathbf{r}^{\frown*} \rangle. \quad (3.2.2)$$

PROPOSITION 3.2.2. *Let  $\mathcal{B} := (\mathcal{O}, \mathcal{C}, \mathfrak{R}, I, T)$  be a bud generating system such that  $\mathcal{O}$  is a combinatorial operad and  $\mathfrak{R}(1)$  finitely factorizes  $\text{Bud}_{\mathcal{C}}(\mathcal{O})(1)$ . Then, for any  $x \in \text{Bud}_{\mathcal{C}}(\mathcal{O})$  such that  $\mathbf{out}(x) \in I$ , the coefficient  $\langle x, \mathbf{r}^{\frown*} \rangle$  is the number of multipaths from  $\mathbf{1}_{\mathbf{out}(x)}$  to  $x$  in the derivation graph of  $\mathcal{B}$ .*



PROOF. First, since  $\mathfrak{R}(1)$  finitely factorizes  $\text{Bud}_{\mathcal{C}}(\mathcal{O})(1)$ , by Proposition 1.3.3,  $\mathbf{r}^{\wedge^*}$  is a well-defined series. If  $x = \mathbb{1}_a$  for a  $a \in I$ , since  $\langle \mathbb{1}_a, \mathbf{r}^{\wedge^*} \rangle = 1$ , the statement of the proposition holds. Let us now assume that  $x$  is different from a colored unit and let us denote by  $\lambda_x$  the number of multipaths from  $\mathbb{1}_{\text{out}(x)}$  to  $x$  in the derivation graph  $G(\mathcal{B})$  of  $\mathcal{B}$ . By definition of  $G(\mathcal{B})$ , by denoting by  $\mu_{y,x}$  the number of edges from  $y \in \text{Bud}_{\mathcal{C}}(\mathcal{O})$  to  $x$  in  $G(\mathcal{B})$ , we have

$$\begin{aligned} \lambda_x &= \sum_{y \in \text{Bud}_{\mathcal{C}}(\mathcal{O})} \mu_{y,x} \lambda_y \\ &= \sum_{y \in \text{Bud}_{\mathcal{C}}(\mathcal{O})} \# \{(i, r) \in \mathbb{N} \times \mathfrak{R} : x = y \circ_i r\} \lambda_y \\ &= \sum_{\substack{y \in \text{Bud}_{\mathcal{C}}(\mathcal{O}) \\ i \in [|y|] \\ r \in \mathfrak{R} \\ x = y \circ_i r}} \lambda_y. \end{aligned} \tag{3.2.3}$$

We observe that Relation (3.2.3) satisfied by the  $\lambda_x$  is the same as Relation (3.2.2) of in the statement of Lemma 3.2.1 satisfied by the  $\langle x, \mathbf{r}^{\wedge^*} \rangle$ . This implies the statement of the proposition.  $\square$

THEOREM 3.2.3. *Let  $\mathcal{B} := (\mathcal{O}, \mathcal{C}, \mathfrak{R}, I, T)$  be a bud generating system such that  $\mathcal{O}$  is a combinatorial operad and  $\mathfrak{R}(1)$  finitely factorizes  $\text{Bud}_{\mathcal{C}}(\mathcal{O})(1)$ . Then, the hook generating series of  $\mathcal{B}$  satisfies*

$$\text{hook}(\mathcal{B}) = \sum_{\substack{t \in \text{FCO}(\mathfrak{R}) \\ \text{out}(t) \in I \\ \text{in}(t) \in T^+}} \frac{\text{deg}(t)!}{\prod_{v \in \mathcal{N}_*(t)} \text{deg}(t_v)} \text{ev}(t). \tag{3.2.4}$$

PROOF. By definition of  $L(\mathcal{B})$  and  $G(\mathcal{B})$ , any  $x \in L(\mathcal{B})$  can be reached from  $\mathbb{1}_{\text{out}(x)}$  by a multipath

$$\mathbb{1}_{\text{out}(x)} \rightarrow y_1 \rightarrow y_2 \rightarrow \dots \rightarrow y_{\ell-1} \rightarrow x \tag{3.2.5}$$

in  $G(\mathcal{B})$ , where  $y_1, \dots, y_{\ell-1}$  are elements of  $\text{Bud}_{\mathcal{C}}(\mathcal{O})$  and  $\mathbb{1}_{\text{out}(x)} \in I$ . Hence, by definition of  $\rightarrow$ ,  $x$  admits an  $\mathfrak{R}$ -left expression

$$x = (\dots ((\mathbb{1}_{\text{out}(x)} \circ_1 r_1) \circ_{i_1} r_2) \circ_{i_2} \dots) \circ_{i_{\ell-1}} r_{\ell} \tag{3.2.6}$$

where for any  $j \in [\ell]$ ,  $r_j \in \mathfrak{R}$ , and for any  $j \in [\ell - 1]$ ,

$$y_j = (\dots ((\mathbb{1}_{\text{out}(x)} \circ_1 r_1) \circ_{i_1} r_2) \circ_{i_2} \dots) \circ_{i_{j-1}} r_j \tag{3.2.7}$$

and  $i_j \in [|y_j|]$ . This shows that the set of all multipaths from  $\mathbb{1}_{\text{out}(x)}$  to  $x$  in  $G(\mathcal{B})$  is in one-to-one correspondence with the set of all  $\mathfrak{R}$ -left expressions for  $x$ . Now, observe that since  $\mathfrak{R}(1)$  finitely factorizes  $\text{Bud}_{\mathcal{C}}(\mathcal{O})(1)$ , by Proposition 1.3.3  $\mathbf{r}^{\wedge^*}$  is a well-defined series. By Proposition 3.2.2, Lemmas 4.1.5 and 4.1.4, and (4.1.33) of Chapter 2, we obtain that

$$\langle x, \mathbf{r}^{\wedge^*} \rangle = \sum_{\substack{t \in \text{FCO}(\mathfrak{R}) \\ \text{ev}(t) = x}} \frac{\text{deg}(t)!}{\prod_{v \in \mathcal{N}_*(t)} \text{deg}(t_v)}. \tag{3.2.8}$$

Finally, by Lemma 3.1.1, for any  $x \in \text{Bud}_{\mathcal{C}}(\mathcal{O})$  such that  $\text{out}(x) \in I$  and  $\text{in}(x) \in T^+$ , we have  $\langle x, \text{hook}(\mathcal{B}) \rangle = \langle x, \mathbf{r}^{\wedge^*} \rangle$ . This shows that the right member of (3.2.4) is equal to  $\text{hook}(\mathcal{B})$ .  $\square$

An alternative way to understand  $\text{hook}(\mathfrak{B})$  hence offered by Theorem 3.2.3 consists in seeing the coefficient  $\langle x, \text{hook}(\mathfrak{B}) \rangle$ ,  $x \in \text{Bud}_{\mathcal{C}}(\mathcal{O})$ , as the number of  $\mathfrak{R}$ -left expressions of  $x$ .

3.2.2. *Support.* The following result establishes a link between the hook generating series of  $\mathfrak{B}$  and its language.

PROPOSITION 3.2.4. *Let  $\mathfrak{B} := (\mathcal{O}, \mathcal{C}, \mathfrak{R}, I, T)$  be a bud generating system such that  $\mathcal{O}$  is a combinatorial operad and  $\mathfrak{R}(1)$  finitely factorizes  $\text{Bud}_{\mathcal{C}}(\mathcal{O})(1)$ . Then, the support of the hook generating series of  $\mathfrak{B}$  is the language of  $\mathfrak{B}$ .*

3.2.3. *Analogs of the hook statistics.* Bud generating systems lead to the definition of analogues of the hook-length statistics [Knu98] for combinatorial objects possibly different than trees in the following way. Let  $\mathcal{O}$  be a monochrome operad,  $\mathfrak{G}$  be a generating set of  $\mathcal{O}$ , and  $\text{HS}_{\mathcal{O}, \mathfrak{G}} := (\mathcal{O}, \mathfrak{G})$  be a monochrome bud generating system depending on  $\mathcal{O}$  and  $\mathfrak{G}$ , called *hook bud generating system*. Since  $\mathfrak{G}$  is a generating set of  $\mathcal{O}$ , by Propositions 2.2.3 and 3.2.4, the support of  $\text{hook}(\text{HS}_{\mathcal{O}, \mathfrak{G}})$  is equal to  $L(\text{HS}_{\mathcal{O}, \mathfrak{G}})$ . We define the *hook-length coefficient* of any element  $x$  of  $\mathcal{O}$  as the coefficient  $\langle x, \text{hook}(\text{HS}_{\mathcal{O}, \mathfrak{G}}) \rangle$ .

Let us consider the hook bud generating system  $\text{HS}_{\text{Mag}, \mathfrak{G}}$  where  $\text{Mag}$  is the magmatic operad (whose definition is recalled in Section 4.2.2 of Chapter 2) and

$$\mathfrak{G} := \left\{ \begin{array}{c} \circ \\ \square \end{array} \right\}. \tag{3.2.9}$$

This bud generating system leads to the definition of a statistics on binary trees, provided by the coefficients of the hook generating series  $\text{hook}(\text{HS}_{\text{Mag}, \mathfrak{G}})$  which begins by

$$\begin{aligned} \text{hook}(\text{HS}_{\text{Mag}, \mathfrak{G}}) = & \begin{array}{c} \circ \\ \square \end{array} + \begin{array}{c} \circ \\ \square \end{array} + \begin{array}{c} \circ \\ \square \end{array} + \begin{array}{c} \circ \\ \square \end{array} + \begin{array}{c} \circ \\ \square \end{array} + \begin{array}{c} \circ \\ \square \end{array} + 2 \begin{array}{c} \circ \\ \square \end{array} + \begin{array}{c} \circ \\ \square \end{array} \\ & + \begin{array}{c} \circ \\ \square \end{array} + \begin{array}{c} \circ \\ \square \end{array} + 3 \begin{array}{c} \circ \\ \square \end{array} + 2 \begin{array}{c} \circ \\ \square \end{array} + 3 \begin{array}{c} \circ \\ \square \end{array} + 3 \begin{array}{c} \circ \\ \square \end{array} \\ & + \begin{array}{c} \circ \\ \square \end{array} + 3 \begin{array}{c} \circ \\ \square \end{array} + \begin{array}{c} \circ \\ \square \end{array} + \begin{array}{c} \circ \\ \square \end{array} + \begin{array}{c} \circ \\ \square \end{array} + 2 \begin{array}{c} \circ \\ \square \end{array} \\ & + \begin{array}{c} \circ \\ \square \end{array} + \begin{array}{c} \circ \\ \square \end{array} + \begin{array}{c} \circ \\ \square \end{array} + \dots \tag{3.2.10} \end{aligned}$$

Theorem 3.2.3 implies that for any binary tree  $t$ , the coefficient  $\langle t, \text{hook}(\text{HS}_{\text{Mag}, \mathfrak{G}}) \rangle$  can be obtained by the usual hook-length formula of binary trees. Alternatively, the coefficient  $\langle t, \text{hook}(\text{HS}_{\text{Mag}, \mathfrak{G}}) \rangle$  is the cardinal of the sylvester class [HNT05] of permutations encoded by  $t$ . This explains the name of hook generating series for  $\text{hook}(\mathfrak{B})$ , when  $\mathfrak{B}$  is a bud generating system.

Consider now a second example of a hook generating system involving the operad  $\text{Motz}$  of Motkzin paths (see Section 2.1.5 of Chapter 4) seen as a set-operad. From its definition,

$$\mathfrak{G} := \left\{ \begin{array}{c} \circ \circ \\ \circ \end{array}, \begin{array}{c} \circ \circ \\ \square \end{array} \right\} \tag{3.2.11}$$

is a generating set of Motz. Hence,  $\text{HS}_{\text{Motz}, \mathfrak{G}}$  is a hook generating system. This leads to the definition of a statistics on Motzkin paths, provided by the coefficients of the hook generating series hook  $(\text{HS}_{\text{Motz}, \mathfrak{G}})$  of  $\text{HS}_{\text{Motz}, \mathfrak{G}}$  which begins by

$$\begin{aligned} \text{hook}(\text{HS}_{\text{Motz}, \mathfrak{G}}) = & \circ + \circ\circ + 2\circ\circ\circ + \begin{array}{c} \circ \\ \diagup \quad \diagdown \\ \circ \end{array} + 6\circ\circ\circ\circ + 2\begin{array}{c} \circ \quad \circ \\ \diagup \quad \diagdown \\ \circ \end{array} + 2\begin{array}{c} \circ \quad \circ \quad \circ \\ \diagup \quad \diagdown \\ \circ \end{array} \\ & + \begin{array}{c} \circ \quad \circ \quad \circ \\ \diagup \quad \diagdown \\ \circ \end{array} + 24\circ\circ\circ\circ\circ + 6\begin{array}{c} \circ \quad \circ \quad \circ \\ \diagup \quad \diagdown \\ \circ \end{array} + 6\begin{array}{c} \circ \quad \circ \quad \circ \quad \circ \\ \diagup \quad \diagdown \\ \circ \end{array} + 3\begin{array}{c} \circ \quad \circ \quad \circ \quad \circ \\ \diagup \quad \diagdown \\ \circ \end{array} + 6\begin{array}{c} \circ \quad \circ \quad \circ \quad \circ \\ \diagup \quad \diagdown \\ \circ \end{array} \\ & + 2\begin{array}{c} \circ \quad \circ \quad \circ \quad \circ \\ \diagup \quad \diagdown \\ \circ \end{array} + 3\begin{array}{c} \circ \quad \circ \quad \circ \quad \circ \\ \diagup \quad \diagdown \\ \circ \end{array} + 2\begin{array}{c} \circ \quad \circ \quad \circ \quad \circ \quad \circ \\ \diagup \quad \diagdown \\ \circ \end{array} + \begin{array}{c} \circ \quad \circ \quad \circ \quad \circ \\ \diagup \quad \diagdown \\ \circ \end{array} + \dots \quad (3.2.12) \end{aligned}$$

**3.3. Syntactic generating series.** We call *syntactic generating series* of  $\mathfrak{B}$  the  $\text{Bud}_{\mathfrak{C}}(\mathcal{O})$ -series  $\text{synt}(\mathfrak{B})$  defined by

$$\text{synt}(\mathfrak{B}) := \mathbf{i} \odot (\mathbf{u} - \mathbf{r})^{\odot -1} \odot \mathbf{t}. \tag{3.3.1}$$

Observe that (3.3.1) could be undefined for an arbitrary set of rules  $\mathfrak{R}$  of  $\mathfrak{B}$ . Nevertheless, when  $\mathbf{u} - \mathbf{r}$  satisfies the conditions of Proposition 1.4.5,  $\text{synt}(\mathfrak{B})$  is well-defined. Remark that this condition is satisfied whenever  $\mathcal{O}$  is combinatorial and  $\mathfrak{R}(1)$  finitely factorizes  $\text{Bud}_{\mathfrak{C}}(\mathcal{O})(1)$ .

3.3.1. *Expression.* The aim of this section is to provide an expression to compute the coefficients of  $\text{synt}(\mathfrak{B})$ .

LEMMA 3.3.1. *Let  $\mathfrak{B} := (\mathcal{O}, \mathfrak{C}, \mathfrak{R}, I, T)$  be a bud generating system such that  $\mathcal{O}$  is a combinatorial operad and  $\mathfrak{R}(1)$  finitely factorizes  $\text{Bud}_{\mathfrak{C}}(\mathcal{O})(1)$ . Then, for any  $x \in \text{Bud}_{\mathfrak{C}}(\mathcal{O})$ ,*

$$\langle x, (\mathbf{u} - \mathbf{r})^{\odot -1} \rangle = \delta_{x, \mathbf{1}_{\text{out}(x)}} + \sum_{\substack{y \in \mathfrak{R} \\ z_1, \dots, z_{|y|} \in \text{Bud}_{\mathfrak{C}}(\mathcal{O}) \\ x = y \circ [z_1, \dots, z_{|y|} ]}} \prod_{i \in [|y|]} \langle z_i, (\mathbf{u} - \mathbf{r})^{\odot -1} \rangle. \tag{3.3.2}$$

THEOREM 3.3.2. *Let  $\mathfrak{B} := (\mathcal{O}, \mathfrak{C}, \mathfrak{R}, I, T)$  be a bud generating system such that  $\mathcal{O}$  is a combinatorial operad and  $\mathfrak{R}(1)$  finitely factorizes  $\text{Bud}_{\mathfrak{C}}(\mathcal{O})(1)$ . Then, the syntactic generating series of  $\mathfrak{B}$  satisfies*

$$\text{synt}(\mathfrak{B}) = \sum_{\substack{t \in \text{FCO}(\mathfrak{R}) \\ \text{out}(t) \in I \\ \text{in}(t) \in T^+}} \text{ev}(t). \tag{3.3.3}$$

Theorem 3.3.2 explains the name of syntactic generating series for  $\text{synt}(\mathfrak{B})$  because this series can be expressed following (3.3.3) as a sum of evaluations of syntax trees. An alternative way to see  $\text{synt}(\mathfrak{B})$  is that for any  $x \in \text{Bud}_{\mathfrak{C}}(\mathcal{O})$ , the coefficient  $\langle x, \text{synt}(\mathfrak{B}) \rangle$  is the number of  $\mathfrak{R}$ -treelike expressions for  $x$ .

3.3.2. *Support and unambiguity.* The following result establishes a link between the syntactic generating series of  $\mathfrak{B}$  and its language.

PROPOSITION 3.3.3. *Let  $\mathfrak{B} := (\mathcal{O}, \mathfrak{C}, \mathfrak{R}, I, T)$  be a bud generating system such that  $\mathcal{O}$  is a combinatorial operad and  $\mathfrak{R}(1)$  finitely factorizes  $\text{Bud}_{\mathfrak{C}}(\mathcal{O})(1)$ . Then, the support of the syntactic generating series of  $\mathfrak{B}$  is the language of  $\mathfrak{B}$ .*

We rely now on syntactic generating series to define a property of bud generating systems. We say that  $\mathcal{B}$  is *unambiguous* if all coefficients of  $\text{synt}(\mathcal{B})$  are equal to 0 or to 1. This property is important from a combinatorial point of view. Indeed, by definition of the series of colors  $\text{col}$  (see Section 1.2.5) and Proposition 3.3.3, when  $\mathcal{B}$  is unambiguous, the coefficient of  $(a, u) \in \text{Bud}_{\mathcal{C}}(\text{As})$  in the series  $\text{col}(\text{synt}(\mathcal{B}))$  is the number of elements  $x$  of  $L(\mathcal{B})$  such that  $(\text{out}(x), \text{in}(x)) = (a, u)$ .

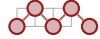
For instance, consider the bud generating system  $\mathcal{B}_p$  introduced in Section 2.1.3. Observe that since the Motzkin path  of  $\text{Motz}(5)$  admits exactly the two  $\mathfrak{R}$ -treelike expressions

 $(3.3.4a)$

 $(3.3.4b)$

by Theorem 3.3.2,  $\langle (1, \text{col}(\mathcal{B}_p), 11111), \text{synt}(\mathcal{B}_p) \rangle = 2$ . Hence  $\mathcal{B}_p$  is not unambiguous.

As a side remark, observe that Theorem 3.3.2 implies in particular that for any bud generating system of the form  $\mathcal{B} := (\mathcal{O}, \mathcal{C}, \mathfrak{R}, \mathcal{C}, \mathcal{C})$ , if  $\text{synt}(\mathcal{B})$  is unambiguous, then the colored suboperad of  $\text{Bud}_{\mathcal{C}}(\mathcal{O})$  generated by  $\mathfrak{R}$  is free. The converse property does not hold.

3.3.3. *Series of color types.* The purpose of this section is to describe the coefficients of  $\text{colt}(\text{synt}(\mathcal{B}))$ , the series of color types of the syntactic series of  $\mathcal{B}$ , in the particular case when  $\mathcal{B}$  is unambiguous. We shall give two descriptions: a first one involving a system of equations of series of  $\mathbb{K} \langle\langle S(\mathbb{Y}_{\mathcal{C}}) \rangle\rangle$ , and a second one involving a recurrence relation on the coefficients of a series of  $\mathbb{K} \langle\langle S(\mathbb{X}_{\mathcal{C}} + \mathbb{Y}_{\mathcal{C}}) \rangle\rangle$ .

LEMMA 3.3.4. *Let  $\mathcal{B} := (\mathcal{O}, \mathcal{C}, \mathfrak{R}, I, T)$  be an unambiguous bud generating system such that  $\mathcal{O}$  is a combinatorial operad and  $\mathfrak{R}(1)$  finitely factorizes  $\text{Bud}_{\mathcal{C}}(\mathcal{O})(1)$ . Then, for all colors  $a \in I$  and all types  $\alpha \in \mathcal{T}_{\mathcal{C}}$  such that  $\mathcal{C}^{\alpha} \in T^+$ , the coefficients  $\langle x_a \mathbb{Y}_{\mathcal{C}}^{\alpha}, \text{colt}(\text{synt}(\mathcal{B})) \rangle$  count the number of elements  $x$  of  $L(\mathcal{B})$  such that  $(\text{out}(x), \text{type}(\text{in}(x))) = (a, \alpha)$ .*

PROPOSITION 3.3.5. *Let  $\mathcal{B} := (\mathcal{O}, \mathcal{C}, \mathfrak{R}, I, T)$  be an unambiguous bud generating system such that  $\mathcal{O}$  is a combinatorial operad and  $\mathfrak{R}(1)$  finitely factorizes  $\text{Bud}_{\mathcal{C}}(\mathcal{O})(1)$ . For all  $a \in \mathcal{C}$ , let  $\mathbf{f}_a(y_{c_1}, \dots, y_{c_k})$  be the series of  $\mathbb{K} \langle\langle S(\mathbb{Y}_{\mathcal{C}}) \rangle\rangle$  satisfying*

$$\mathbf{f}_a(y_{c_1}, \dots, y_{c_k}) = y_a + \mathbf{g}_a(\mathbf{f}_{c_1}(y_{c_1}, \dots, y_{c_k}), \dots, \mathbf{f}_{c_k}(y_{c_1}, \dots, y_{c_k})). \tag{3.3.5}$$

*Then, for any color  $a \in I$  and any type  $\alpha \in \mathcal{T}_{\mathcal{C}}$  such that  $\mathcal{C}^{\alpha} \in T^+$ , the coefficients  $\langle x_a \mathbb{Y}_{\mathcal{C}}^{\alpha}, \text{colt}(\text{synt}(\mathcal{B})) \rangle$  and  $\langle \mathbb{Y}_{\mathcal{C}}^{\alpha}, \mathbf{f}_a \rangle$  are equal.*

THEOREM 3.3.6. *Let  $\mathcal{B} := (\mathcal{O}, \mathcal{C}, \mathfrak{R}, I, T)$  be an unambiguous bud generating system such that  $\mathcal{O}$  is a combinatorial operad and  $\mathfrak{R}(1)$  finitely factorizes  $\text{Bud}_{\mathcal{C}}(\mathcal{O})(1)$ . Let  $\mathbf{f}$  be the series of  $\mathbb{K} \langle\langle S(\mathbb{X}_{\mathcal{C}} + \mathbb{Y}_{\mathcal{C}}) \rangle\rangle$  satisfying, for any  $a \in \mathcal{C}$  and any type  $\alpha \in \mathcal{T}_{\mathcal{C}}$ ,*

$$\langle x_a \mathbb{Y}_{\mathcal{C}}^{\alpha}, \mathbf{f} \rangle = \delta_{a, \text{type}(a)} + \sum_{\substack{\phi: \mathcal{C} \times \mathcal{T}_{\mathcal{C}} \rightarrow \mathbb{N} \\ \alpha = \phi^{(c_1)} \dots \phi^{(c_k)}}} \chi_{a, \sum \phi_{c_1} \dots \sum \phi_{c_k}} \left( \prod_{b \in \mathcal{C}} \phi_b! \right) \left( \prod_{\substack{b \in \mathcal{C} \\ \gamma \in \mathcal{T}_{\mathcal{C}}}} \langle x_b \mathbb{Y}_{\mathcal{C}}^{\gamma}, \mathbf{f} \rangle^{\phi(b, \gamma)} \right). \tag{3.3.6}$$

Then, for any color  $a \in I$  and any type  $\alpha \in \mathcal{T}_{\mathcal{C}}$  such that  $\mathcal{C}^\alpha \in T^+$ , the coefficients  $\langle x_a \mathbb{Y}_{\mathcal{C}}^\alpha, \text{colt}(\text{synt}(\mathcal{B})) \rangle$  and  $\langle x_a \mathbb{Y}_{\mathcal{C}}^\alpha, \mathbf{f} \rangle$  are equal.

**3.3.4. Generating series of languages.** When  $\mathcal{B}$  is a bud generating system satisfying the conditions of Proposition 3.3.5, the generating series of the language of  $\mathcal{B}$  satisfies

$$\mathbf{s}_{L(\mathcal{B})} = \sum_{a \in I} \mathbf{f}_a^T, \quad (3.3.7)$$

where  $\mathbf{f}_a^T$  is the specialization of the series  $\mathbf{f}_a(y_{c_1}, \dots, y_{c_k})$  at  $y_b := t$  for all  $b \in T$  and at  $y_c := 0$  for all  $c \in \mathcal{C} \setminus T$ . Therefore, the resolution of the system of equations given by Proposition 3.3.5 provides a way to compute the coefficients of  $\mathbf{s}_{L(\mathcal{B})}$ .

**THEOREM 3.3.7.** *Let  $\mathcal{B} := (\mathcal{O}, \mathcal{C}, \mathfrak{R}, I, T)$  be an unambiguous bud generating system such that  $\mathcal{O}$  is a combinatorial operad and  $\mathfrak{R}(1)$  finitely factorizes  $\text{Bud}_{\mathcal{C}}(\mathcal{O})(1)$ . Then, the generating series  $\mathbf{s}_{L(\mathcal{B})}$  of the language of  $\mathcal{B}$  is algebraic.*

When  $\mathcal{B}$  is a bud generating system satisfying the conditions of Theorem 3.3.6 (which are the same as the ones required by Proposition 3.3.5), one has for any  $n \geq 1$ ,

$$\langle t^n, \mathbf{s}_{L(\mathcal{B})} \rangle = \sum_{a \in I} \sum_{\substack{\alpha \in \mathcal{T}_{\mathcal{C}} \\ \alpha_i = 0, c_i \in \mathcal{C} \setminus T}} \langle x_a \mathbb{Y}_{\mathcal{C}}^\alpha, \mathbf{f} \rangle. \quad (3.3.8)$$

Therefore, this provides an alternative and recursive way to compute the coefficients of  $\mathbf{s}_{L(\mathcal{B})}$ , different from the one of Proposition 3.3.5.

**3.4. Synchronous generating series.** We call *synchronous generating series* of  $\mathcal{B}$  the  $\text{Bud}_{\mathcal{C}}(\mathcal{O})$ -series  $\text{sync}(\mathcal{B})$  defined by

$$\text{sync}(\mathcal{B}) := \mathbf{i} \odot \mathbf{r}^{\odot*} \odot \mathbf{t}. \quad (3.4.1)$$

Observe that (3.4.1) could be undefined for an arbitrary set of rules  $\mathfrak{R}$  of  $\mathcal{B}$ . Nevertheless, when  $\mathbf{r}$  satisfies the conditions of Proposition 1.4.3, that is, when  $\mathcal{O}$  is a combinatorial operad and  $\mathfrak{R}(1)$  finitely factorizes  $\text{Bud}_{\mathcal{C}}(\mathcal{O})(1)$ ,  $\text{sync}(\mathcal{B})$  is well-defined.

**3.4.1. Expression.** The aim of this section is to provide an expression to compute the coefficients of  $\text{sync}(\mathcal{B})$ .

**LEMMA 3.4.1.** *Let  $\mathcal{B} := (\mathcal{O}, \mathcal{C}, \mathfrak{R}, I, T)$  be a bud generating system such that  $\mathcal{O}$  is a combinatorial operad and  $\mathfrak{R}(1)$  finitely factorizes  $\text{Bud}_{\mathcal{C}}(\mathcal{O})(1)$ . Then, for any  $x \in \text{Bud}_{\mathcal{C}}(\mathcal{O})$ ,*

$$\langle x, \mathbf{r}^{\odot*} \rangle = \delta_{x, \mathbb{1}_{\text{out}(x)}} + \sum_{\substack{y \in \text{Bud}_{\mathcal{C}}(\mathcal{O}) \\ z_1, \dots, z_{|y|} \in \mathfrak{R} \\ x = y \circ [z_1, \dots, z_{|y|}]} \langle y, \mathbf{r}^{\odot*} \rangle. \quad (3.4.2)$$

**THEOREM 3.4.2.** *Let  $\mathcal{B} := (\mathcal{O}, \mathcal{C}, \mathfrak{R}, I, T)$  be a bud generating system such that  $\mathcal{O}$  is a combinatorial operad and  $\mathfrak{R}(1)$  finitely factorizes  $\text{Bud}_{\mathcal{C}}(\mathcal{O})(1)$ . Then, the synchronous generating series of  $\mathcal{B}$  satisfies*

$$\text{sync}(\mathcal{B}) = \sum_{\substack{t \in \text{FCO}_{\text{perf}}(\mathfrak{R}) \\ \text{out}(t) \in I \\ \text{in}(t) \in T^+}} \text{ev}(t). \quad (3.4.3)$$

Theorem 3.4.2 implies that for any  $x \in \text{Bud}_{\mathcal{C}}(\mathcal{O})$ , the coefficient of  $\langle x, \text{sync}(\mathcal{B}) \rangle$  is the number of  $\mathfrak{R}$ -treelike expressions for  $x$  which are perfect trees.

3.4.2. *Support and unambiguity.* The following result establishes a link between the synchronous generating series of  $\mathcal{B}$  and its synchronous language.

PROPOSITION 3.4.3. *Let  $\mathcal{B} := (\mathcal{O}, \mathcal{C}, \mathfrak{R}, I, T)$  be a bud generating system such that  $\mathcal{O}$  is a combinatorial operad and  $\mathfrak{R}(1)$  finitely factorizes  $\text{Bud}_{\mathcal{C}}(\mathcal{O})(1)$ . Then, the support of the synchronous generating series of  $\mathcal{B}$  is the synchronous language of  $\mathcal{B}$ .*

We rely now on synchronous generating series to define a property of bud generating systems. We say that  $\mathcal{B}$  is *synchronously unambiguous* if all coefficients of  $\text{sync}(\mathcal{B})$  are equal to 0 or to 1. This property is important from a combinatorial point of view. Indeed, by definition of the series of colors  $\text{col}$  (see Section 1.2.5) and Proposition 3.4.3, when  $\mathcal{B}$  is synchronously unambiguous, the coefficient of  $(a, u) \in \text{Bud}_{\mathcal{C}}(\text{As})$  in the series  $\text{col}(\text{sync}(\mathcal{B}))$  is the number of elements  $x$  of  $L_S(\mathcal{B})$  such that  $(\text{out}(x), \text{in}(x)) = (a, u)$ .

For instance, the bud generating system  $\mathcal{B}_{\text{bft}}$  introduced in Section 2.1.5 is synchronously unambiguous.

3.4.3. *Series of color types.* The purpose of this section is to describe the coefficients of  $\text{colt}(\text{sync}(\mathcal{B}))$ , the series of color types of the synchronous series of  $\mathcal{B}$ , in the particular case when  $\mathcal{B}$  is unambiguous. We shall give two descriptions: a first one involving a system of functional equations of series of  $\mathbb{K}\langle\langle S(\mathbb{Y}_{\mathcal{C}}) \rangle\rangle$ , and a second one involving a recurrence relation on the coefficients of a series of  $\mathbb{K}\langle\langle S(\mathbb{X}_{\mathcal{C}} + \mathbb{Y}_{\mathcal{C}}) \rangle\rangle$ .

LEMMA 3.4.4. *Let  $\mathcal{B} := (\mathcal{O}, \mathcal{C}, \mathfrak{R}, I, T)$  be a synchronously unambiguous bud generating system such that  $\mathcal{O}$  is a combinatorial operad and  $\mathfrak{R}(1)$  finitely factorizes  $\text{Bud}_{\mathcal{C}}(\mathcal{O})(1)$ . Then, for all colors  $a \in I$  and all types  $\alpha \in \mathcal{T}_{\mathcal{C}}$  such that  $\mathcal{C}^{\alpha} \in T^+$ , the coefficients  $\langle x_a \mathbb{Y}_{\mathcal{C}}^{\alpha}, \text{colt}(\text{sync}(\mathcal{B})) \rangle$  count the number of elements  $x$  of  $L_S(\mathcal{B})$  such that  $(\text{out}(x), \text{type}(\text{in}(x))) = (a, \alpha)$ .*

PROPOSITION 3.4.5. *Let  $\mathcal{B} := (\mathcal{O}, \mathcal{C}, \mathfrak{R}, I, T)$  be a synchronously unambiguous bud generating system such that  $\mathcal{O}$  is a combinatorial operad and  $\mathfrak{R}(1)$  finitely factorizes  $\text{Bud}_{\mathcal{C}}(\mathcal{O})(1)$ . For all  $a \in \mathcal{C}$ , let  $\mathbf{f}_a(y_{c_1}, \dots, y_{c_k})$  be the series of  $\mathbb{K}\langle\langle S(\mathbb{Y}_{\mathcal{C}}) \rangle\rangle$  satisfying*

$$\mathbf{f}_a(y_{c_1}, \dots, y_{c_k}) = y_a + \mathbf{f}_a(\mathbf{g}_{c_1}(y_{c_1}, \dots, y_{c_k}), \dots, \mathbf{g}_{c_k}(y_{c_1}, \dots, y_{c_k})). \tag{3.4.4}$$

*Then, for any color  $a \in I$  and any type  $\alpha \in \mathcal{T}_{\mathcal{C}}$  such that  $\mathcal{C}^{\alpha} \in T^+$ , the coefficients  $\langle x_a \mathbb{Y}_{\mathcal{C}}^{\alpha}, \text{colt}(\text{sync}(\mathcal{B})) \rangle$  and  $\langle \mathbb{Y}_{\mathcal{C}}^{\alpha}, \mathbf{f}_a \rangle$  are equal.*

THEOREM 3.4.6. *Let  $\mathcal{B} := (\mathcal{O}, \mathcal{C}, \mathfrak{R}, I, T)$  be a synchronously unambiguous bud generating system such that  $\mathcal{O}$  is a combinatorial operad and  $\mathfrak{R}(1)$  finitely factorizes  $\text{Bud}_{\mathcal{C}}(\mathcal{O})(1)$ . Let  $\mathbf{f}$  be the series of  $\mathbb{K}\langle\langle S(\mathbb{X}_{\mathcal{C}} + \mathbb{Y}_{\mathcal{C}}) \rangle\rangle$  satisfying, for any  $a \in \mathcal{C}$  and any type  $\alpha \in \mathcal{T}_{\mathcal{C}}$ ,*

$$\langle x_a \mathbb{Y}_{\mathcal{C}}^{\alpha}, \mathbf{f} \rangle = \delta_{\alpha, \text{type}(a)} + \sum_{\substack{\phi: \mathcal{C} \times \mathcal{T}_{\mathcal{C}} \rightarrow \mathbb{N} \\ \alpha = \phi^{(c_1)} \dots \phi^{(c_k)}}} \left( \prod_{b \in \mathcal{C}} \phi_b! \right) \left( \prod_{\substack{b \in \mathcal{C} \\ \gamma \in \mathcal{T}_{\mathcal{C}}} \chi_{b, \gamma}^{\phi(b, \gamma)} \right) \left\langle x_a \prod_{b \in \mathcal{C}} y_b^{\sum \phi_b}, \mathbf{f} \right\rangle. \tag{3.4.5}$$

Then, for any color  $a \in I$  and any type  $\alpha \in \mathcal{T}_{\mathcal{C}}$  such that  $\mathcal{C}^\alpha \in T^+$ , the coefficients  $\langle x_a \mathbb{Y}_{\mathcal{C}}^\alpha, \text{coll}(\text{sync}(\mathcal{B})) \rangle$  and  $\langle x_a \mathbb{Y}_{\mathcal{C}}^\alpha, \mathbf{f} \rangle$  are equal.

**3.4.4. Generating series of synchronous languages.** When  $\mathcal{B}$  is a bud generating system satisfying the conditions of Proposition 3.4.5, the generating series of the synchronous language of  $\mathcal{B}$  satisfies

$$\mathbf{s}_{L_S(\mathcal{B})} = \sum_{a \in I} \mathbf{f}_a^T, \quad (3.4.6)$$

where  $\mathbf{f}_a^T$  is the specialization of the series  $\mathbf{f}_a(y_{c_1}, \dots, y_{c_k})$  at  $y_b := t$  for all  $b \in T$  and at  $y_c := 0$  for all  $c \in \mathcal{C} \setminus T$ . Therefore, the resolution of the system of equations given by Proposition 3.4.5 provides a way to compute the coefficients of  $\mathbf{s}_{L_S(\mathcal{B})}$ . This resolution can be made in most cases by iteration [BLL98, FS09].

Moreover, when  $\mathcal{G}$  is a synchronous grammar [Gir12e] (see also Section 2.3.3 for a description of these grammars) and when  $\text{SG}(\mathcal{G}) = \mathcal{B}$ , the system of functional equations provided by Proposition 3.4.5 and (3.4.6) for  $\mathbf{s}_{L_S(\mathcal{B})}$  is the same as the one which can be extracted from  $\mathcal{G}$ .

When  $\mathcal{B}$  is a bud generating system satisfying the conditions of Theorem 3.4.6 (which are the same as the ones required by Proposition 3.4.5), one has for any  $n \geq 1$ ,

$$\langle t^n, \mathbf{s}_{L_S(\mathcal{B})} \rangle = \sum_{a \in I} \sum_{\substack{\alpha \in \mathcal{T}_{\mathcal{C}} \\ \alpha_i = 0, c_i \in \mathcal{C} \setminus T}} \langle x_a \mathbb{Y}_{\mathcal{C}}^\alpha, \mathbf{f} \rangle. \quad (3.4.7)$$

Therefore, this provides an alternative and recursive way to compute the coefficients of  $\mathbf{s}_{L_S(\mathcal{B})}$ , different from the one of Proposition 3.4.5.

**3.4.5. Example: enumeration of balanced binary trees.** Let us consider the bud generating system  $\mathcal{B}_{\text{bbt}}$  introduced in Section 2.1.5. We have

$$\chi_{a,\alpha} = \begin{cases} 1 & \text{if } (a, \alpha) = (1, 20), \\ 2 & \text{if } (a, \alpha) = (1, 11), \\ 1 & \text{if } (a, \alpha) = (2, 10), \\ 0 & \text{otherwise,} \end{cases} \quad (3.4.8)$$

and

$$\mathbf{g}_1(y_1, y_2) = y_1^2 + 2y_1y_2, \quad (3.4.9a)$$

$$\mathbf{g}_2(y_1, y_2) = y_1. \quad (3.4.9b)$$

Since by Proposition 2.1.2,  $\mathcal{B}_{\text{bbt}}$  satisfies the conditions of Proposition 3.4.5, by this last proposition and (3.4.6), the generating series  $\mathbf{s}_{L_S(\mathcal{B}_{\text{bbt}})}$  of  $L_S(\mathcal{B}_{\text{bbt}})$  satisfies  $\mathbf{s}_{L_S(\mathcal{B}_{\text{bbt}})} = \mathbf{f}_1(t, 0)$  where

$$\mathbf{f}_1(y_1, y_2) = y_1 + \mathbf{f}_1(y_1^2 + 2y_1y_2, y_1). \quad (3.4.10)$$

This functional equation for the generating series of balanced binary trees is the one obtained in [BLL88, BLL98, Knu98, Gir12e] by different methods. As announced in Section 3.4.4, the

coefficients of  $\mathbf{f}_1$  (and hence, those of  $\mathbf{s}_{\mathcal{L}_S(\mathcal{G}_{\text{bbt}})}$ ) can be computed by iteration. This consists in defining, for any  $\ell \geq 0$ , the polynomials  $\mathbf{f}_1^{(\ell)}(y_1, y_2)$  as

$$\mathbf{f}_1^{(\ell)}(y_1, y_2) := \begin{cases} y_1 & \text{if } \ell = 0, \\ y_1 + \mathbf{f}_1^{(\ell-1)}(y_1^2 + 2y_1y_2, y_1) & \text{otherwise.} \end{cases} \quad (3.4.11)$$

Since

$$\mathbf{f}_1(y_1, y_2) = \lim_{\ell \rightarrow \infty} \mathbf{f}_1^{(\ell)}(y_1, y_2), \quad (3.4.12)$$

Equation (3.4.11) provides a way to compute the coefficients of  $\mathbf{f}_1(y_1, y_2)$ . First polynomials  $\mathbf{f}_1^{(\ell)}(y_1, y_2)$  are

$$\mathbf{f}_1^{(0)}(y_1, y_2) = y_1, \quad (3.4.13a)$$

$$\mathbf{f}_1^{(1)}(y_1, y_2) = y_1 + y_1^2 + 2y_1y_2, \quad (3.4.13b)$$

$$\mathbf{f}_1^{(2)}(y_1, y_2) = y_1 + y_1^2 + 2y_1y_2 + 2y_1^3 + 4y_1^2y_2 + y_1^4 + 4y_1^3y_2 + 4y_1^2y_2^2, \quad (3.4.13c)$$

$$\begin{aligned} \mathbf{f}_1^{(3)}(y_1, y_2) &= y_1 + y_1^2 + 2y_1y_2 + 2y_1^3 + 4y_1^2y_2 + y_1^4 + 4y_1^3y_2 + 4y_1^2y_2^2 + 4y_1^5 \\ &\quad + 16y_1^4y_2 + 16y_1^3y_2^2 + 6y_1^6 + 28y_1^5y_2 + 40y_1^4y_2^2 + 16y_1^3y_2^3 + 4y_1^7 + 24y_1^6y_2 \\ &\quad + 48y_1^5y_2^2 + 32y_1^4y_2^3 + y_1^8 + 8y_1^7y_2 + 24y_1^6y_2^2 + 32y_1^5y_2^3 + 16y_1^4y_2^4. \end{aligned} \quad (3.4.13d)$$

Besides, let us recall that  $\mathcal{G}_{\text{bbt}}$  is synchronously unambiguous and satisfies the properties stated by Proposition 2.1.2. Hence,  $\mathcal{G}_{\text{bbt}}$  satisfies the conditions of Theorem 3.4.6. By this last theorem and (3.4.7),  $\mathbf{s}_{\mathcal{L}_S(\mathcal{G}_{\text{bbt}})}$  satisfies, for any  $n \geq 1$ ,

$$\langle t^n, \mathbf{s}_{\mathcal{L}_S(\mathcal{G}_{\text{bbt}})} \rangle = \langle y_1^n y_2^0, \mathbf{f} \rangle, \quad (3.4.14)$$

where  $\mathbf{f}$  is the series satisfying, for any type  $\alpha \in \mathcal{T}_{\{1,2\}}$ , the recursive formula

$$\langle y_1^{\alpha_1} y_2^{\alpha_2}, \mathbf{f} \rangle = \delta_{\alpha, (1,0)} + \sum_{\substack{d_1, d_2, d_3 \in \mathbb{N} \\ \alpha_1 = 2d_1 + d_2 + d_3 \\ \alpha_2 = d_2}} \binom{d_1 + \alpha_2}{d_1} 2^{d_2} \langle y_1^{d_1 + d_2} y_2^{d_3}, \mathbf{f} \rangle. \quad (3.4.15)$$

This recursive formula offers an efficient way to compute the number of balanced binary trees of a given size.

### Concluding remarks

We have presented in this chapter a framework for the generation of combinatorial objects by using colored operads. The described devices for combinatorial generation, called bud generating systems, are generalizations of context-free grammars [Har78, HMU06] generating words, of regular tree grammars [GS84, CDG<sup>+</sup>07] generating planar rooted trees, and of synchronous grammars [Gir12e] generating some treelike structures. We have provided tools to enumerate the objects of the languages of bud generating systems or to define new statistics on these by using formal power series on colored operads and several products on these. There are many ways to extend this work. Here follow some few further research directions.



First, the notion of rationality and recognizability in usual formal power series [Sch61, Sch63, Eil74, BR88], in series on monoids [Sak09], and in series of trees [BR82] are fundamental. For instance, a series  $\mathbf{s} \in \mathbb{K}\langle\langle \mathcal{M} \rangle\rangle$  on a monoid  $\mathcal{M}$  is rational if it belongs to the closure of the set  $\mathbb{K}\langle \mathcal{M} \rangle$  of polynomials on  $\mathcal{M}$  with respect to the addition, the multiplication, and the Kleene star operations. Equivalently,  $\mathbf{s}$  is rational if there exists a  $\mathbb{K}$ -weighted automaton accepting it. The equivalence between these two properties for the rationality property is remarkable. We ask here for the definition of an analogous and consistent notion of rationality for series on a colored operad  $\mathcal{G}$ . By consistent, we mean a property of rationality for  $\mathcal{G}$ -series which can be defined both by a closure property of the set  $\mathbb{K}\langle \mathcal{G} \rangle$  of the polynomials on  $\mathcal{G}$  with respect to some operations, and, at the same time, by an acceptance property involving a notion of a  $\mathbb{K}$ -weighted automaton on  $\mathcal{G}$ . The analogous question about the definition of a notion of recognizable series on colored operads also seems worth studying.

A second research direction fits mostly in the contexts of computer science and compression theory. A straight-line grammar (see for instance [ZL78, SS82, Ryt04]) is a context-free grammar with a singleton as language. There exists also the analogous natural counterpart for regular tree grammars [LM06]. One of the main interests of straight-line grammars is that they offer a way to compress a word (resp. a tree) by encoding it by a context-free grammar (resp. a regular tree grammar). A word  $u$  can potentially be represented by a context-free grammar (as the unique element of its language) with less memory than the direct representation of  $u$ , provided that  $u$  is made of several repeating factors. The analogous definition for bud generating systems could potentially be used to compress a large variety of combinatorial objects. Indeed, given a suitable monochrome operad  $\mathcal{O}$  defined on the objects we want to compress, we can encode an object  $x$  of  $\mathcal{O}$  by a bud generating system  $\mathcal{B}$  with  $\mathcal{O}$  as ground operad and such that the language (or the synchronous language) of  $\mathcal{B}$  is a singleton  $\{y\}$  and  $\text{pru}(y) = x$ . Hence, we can hope to obtain a new and efficient method to compress arbitrary combinatorial objects.

Let us finally describe a third extension of this work. Pros (see Section 5.1 of Chapter 2) are algebraic structures which naturally generalize operads. Indeed, a pro is a set of operators with several inputs and several outputs, unlike in operads where operators have only one output (see for instance [ML65, Mar08]). It seems fruitful to translate the main definitions and constructions of this work (as *e.g.*, bud operads, bud generating systems, series on colored operads, pre-Lie and composition products of series, star operations, *etc.*) with pros instead of operads. We can expect to obtain an even more general class of grammars and obtain a more general framework for combinatorial generation.

## Operads and regular languages

The content of this chapter comes from [GLMN16] and is a joint work with Jean-Gabriel Luque, Ludovic Mignot, and Florent Nicart.

### Introduction

Regular languages form an important class of languages, defined as the ones that can be generated by Type-3 grammars of the Chomsky-Schützenberger hierarchy [Cho59, CS63]. One of the most surprising property of regular languages is that they can be described by nonequivalent different ways, for instance by regular grammars, automata, or regular expressions. These tools are nonequivalent in terms of spatial complexity: a same family of regular languages can be represented for example by automata with a linear number of states but by regular expressions with an exponential number of symbols [EZ76].

Multi-tildes [CCM11] are operators acting on languages and introduced in order to increase the expressiveness of regular expressions (that is, describing regular languages with the smallest possible spatial complexity). These operators allow intuitively to jump forward in a regular expression. Besides, multi-tildes come with a very natural notion of composition, and it appears that this composition endows the graded set of all the multi-tildes with a structure of a ns set-operad [LMN13]. This establishes an unexpected link between the theories of formal languages and of ns operads.

In [LMN13], the ns operads MT of the multi-tildes and Poset of the pseudo-transitive multi-tildes have been defined. The first one is the ns operad aforementioned of multi-tildes and the second one is a quotient operad of MT involving posets. The set of all the languages over a finite alphabet is endowed with the structure of an MT-monoid, and also of a Poset-monoid. The first structure is nonfaithful while the second is faithful (in the sense that two different elements of Poset act differently on languages). The ns operad Poset provides hence a new way to express languages with optimality. Moreover, any finite language can be expressed by the action of an element of Poset on languages that are empty or consisting only in one word of length 1.

The purpose of the present work is to generalize these constructions of ns operads to regular languages (and not only on finite ones). The main idea for this is to extend the notion of multi-tildes to double multi-tildes. These are operators acting on languages and allow intuitively to jump forward or backward in a regular expression. In this generalization also, double multi-tildes are endowed with a natural notion of composition and form a ns set-operad DMT. This operad acts on the set all the languages over a finite alphabet, and provides a way to express any regular language by the action of an element of DMT on

languages that are empty or consisting only in one word of length 1. In this context, we also construct a quotient operad  $\text{Qoset}$  of  $\text{DMT}$  which plays the same role for regular languages as  $\text{Poset}$  plays for finite languages. Indeed, the set of all regular languages forms a faithful  $\text{Qoset}$ -monoid.

All the four ns set-operads considered in this chapter can be constructed in a very similar way. For this reason, we provide an abstraction for their construction through a functorial construction  $\text{PO}$ , producing a ns set-operad from a precomposition. These last structures are kinds of representations of a particular monoid. We provide, by using precompositions and  $\text{PO}$ , alternative constructions for the already known operads  $\text{MT}$  and  $\text{Poset}$ , and interpret our construction of the new operads  $\text{DMT}$  and  $\text{Qoset}$ .

This chapter is organized as follows. Section 1 contains the definition of the category of the precompositions and of the functor  $\text{PO}$ . In Section 2, we provide alternative constructions of  $\text{MT}$  and  $\text{Poset}$ , and define  $\text{DMT}$  and  $\text{Qoset}$ . In Section 3, we study actions of  $\text{DMT}$  and  $\text{Qoset}$  on languages.

*Note.* This chapter deals only with ns set-operads. For this reason, “operad” means “ns set-operad”.

## 1. Breaking operads via precompositions

The objective of this section is to introduce new algebraic objects, the precompositions. These objects are a kind of representation of a certain monoid denoted by  $\mathcal{M}_p$  whose elements can be described in terms of infinite matrices. We present here a functor from the category of precompositions to the category of operads. We shall use this functor in the sequel to reconstruct some already known operads and to construct new ones.

**1.1. Monoids of infinite matrices.** We introduce here an associative algebra  $\tilde{\mathcal{M}}_\infty$  of infinite matrices whose entries are indexed on  $\mathbb{Z}^2$  and a quotient  $\mathcal{M}_\infty$  of  $\tilde{\mathcal{M}}_\infty$  of infinite matrices whose entries are indexed on  $\mathbb{N}^2$ . Moreover, two respective subalgebras  $\tilde{\mathcal{P}}_\infty$  and  $\mathcal{P}_\infty$  of  $\tilde{\mathcal{M}}_\infty$  and  $\mathcal{M}_\infty$  are described. The purpose of this section is to give a realization and a presentation of  $\mathcal{M}_p$ , a monoid defined by seeing  $\mathcal{P}_\infty$  as a monoid.

**1.1.1. A first algebra of infinite matrices.** We consider the vector space  $\tilde{\mathcal{M}}_\infty$  of all infinite matrices  $(A_{ij})_{i,j \in \mathbb{Z}}$  with a finite number of nonzero diagonals whose entries belong to  $\mathbb{K}$ . A typical element  $A$  of  $\tilde{\mathcal{M}}_\infty$  is a finite linear combination of elements

$$D^{(k,\lambda)} := \sum_{i \in \mathbb{Z}} \lambda_i E^{(i+k,i)} \quad (1.1.1)$$

where  $\lambda = (\lambda_i)_{i \in \mathbb{Z}}$  and  $E^{(k,\ell)}$  is the matrix such that

$$E_{i,j}^{(k,\ell)} = \begin{cases} 1 & \text{if } (i,j) = (k,\ell), \\ 0 & \text{otherwise.} \end{cases} \quad (1.1.2)$$

By observing that

$$\begin{aligned} D^{(k,\lambda)} D^{(k',\lambda')} &= \left( \sum_{i \in \mathbb{Z}} \lambda_i E^{(i+k,i)} \right) \left( \sum_{i \in \mathbb{Z}} \lambda'_i E^{(i+k',i)} \right) \\ &= \sum_{i \in \mathbb{Z}} \lambda_{i+k'} \lambda'_i E^{(i+k+k',i)} \\ &= D^{(k+k, \lambda \star_{k'} \lambda')}, \end{aligned} \quad (1.1.3)$$

where  $\lambda \star_{k'} \lambda' := (\lambda_{i+k'} \lambda'_i)_{i \in \mathbb{Z}}$ , we deduce that  $\bar{\mathcal{M}}_\infty$  is stable for the product of infinite matrices. Moreover, the unit of  $\bar{\mathcal{M}}_\infty$  is

$$\mathbb{1} := D^{(0, (\dots, 1, 1, \dots))} = \sum_{i \in \mathbb{Z}} E^{(i,i)}. \quad (1.1.4)$$

This leads to the following result.

**PROPOSITION 1.1.1.** *The space  $\bar{\mathcal{M}}_\infty$  is a unitary associative algebra.*

Notice that when  $\mathbb{K}$  is the field of complex numbers, the algebraic structure of  $\bar{\mathcal{M}}_\infty$  is very rich and has many connections with the study of infinite Lie algebras (see e.g., [Kac90]).

**1.1.2. A first monoid of infinite matrices.** Here, for our purpose, we consider only the structure of monoid of  $\bar{\mathcal{M}}_\infty$ . In particular, we define the submonoid  $\bar{\mathcal{P}}_\infty$  of  $\bar{\mathcal{M}}_\infty$  generated by the matrices

$$M^{(i,n)} := \sum_{j < i} E^{(j,j)} + \sum_{i < j} E^{(j+n-1,j)} \quad (1.1.5)$$

for each  $i \in \mathbb{Z}$  and each  $n \geq 1$ . With these notations we have

$$M^{(i,1)} = \mathbb{1}, \quad (1.1.6)$$

for any  $i \in \mathbb{Z}$ .

**PROPOSITION 1.1.2.** *The monoid  $\bar{\mathcal{P}}_\infty$  is isomorphic to the monoid  $\bar{\mathcal{M}}_p$  generated by the symbols  $\{a_i^n : i \in \mathbb{Z}, n \geq 1\}$  subjected to the relations*

$$a_i^1 = \mathbb{1}, \quad i \in \mathbb{Z}, \quad (1.1.7a)$$

$$a_i^n a_j^m = a_{j+n-1}^m a_i^n, \quad i \leq j, \quad (1.1.7b)$$

$$a_{i+j}^n a_i^m = a_i^{n+m-1}, \quad 0 \leq j < m, \quad (1.1.7c)$$

where  $\mathbb{1}$  is the unit.

**1.1.3. A second algebra of infinite matrices.** Let  $\mathcal{M}_\infty$  be the vector space of all infinite matrices  $(A_{ij})_{i,j \in \mathbb{N}_{\geq 1}}$  with a finite number of nonzero diagonals whose entries belong to  $\mathbb{K}$ . An analogous result as the one stated by Proposition 1.1.1 shows that  $\mathcal{M}_\infty$  is a unitary associative algebra. Moreover, there is a surjective monoid morphism from  $\bar{\mathcal{M}}_\infty$  to  $\mathcal{M}_\infty$  sending any matrix  $(A_{ij})_{i,j \in \mathbb{Z}}$  to  $(A_{ij})_{i,j \in \mathbb{N}_{\geq 1}}$ . Hence,  $\mathcal{M}_\infty$  is a quotient monoid of  $\bar{\mathcal{M}}_\infty$ .

1.1.4. *A second monoid of infinite matrices.* Let us define the submonoid  $\mathcal{P}_\infty$  of  $\mathcal{M}_\infty$  generated by the matrices

$$N^{(i,n)} := \sum_{1 \leq j \leq i} E^{(j,i)} + \sum_{i < j} E^{(j+n-1,j)} \quad (1.1.8)$$

for each  $n, i \geq 1$ .

PROPOSITION 1.1.3. *The monoid  $\mathcal{P}_\infty$  is isomorphic to the monoid  $\mathcal{M}_p$  which is the quotient of the monoid  $\tilde{\mathcal{M}}_p$  satisfying the extra relations*

$$a_i^n = a_0^n, \quad i \leq 0. \quad (1.1.9)$$

**1.2. Precompositions and operads.** Before describing a functor from the category of precompositions to the category of operads, we define this last category. All this relies on the presentation of the monoid  $\mathcal{M}_p$  introduced in Section 1.1.

1.2.1. *Precompositions.* Let  $(S, \star)$  be a commutative monoid endowed with a filtration

$$S = \bigcup_{n \geq 1} S_n \quad (1.2.1)$$

with

$$S_1 \subseteq S_2 \subseteq \cdots \subseteq S_n \subseteq \cdots \quad (1.2.2)$$

and such that each  $S_n$  is a submonoid of  $S$ . We will denote by  $\mathbb{1}_S$  the unit of  $S$ .

A *precomposition* is a monoid morphism

$$\phi : \mathcal{M}_p \rightarrow \text{End}(S), \quad (1.2.3)$$

where  $\text{End}(S)$  denotes the set of all monoid endomorphisms of  $S$ , satisfying

$$\phi(a_i^n) : S_m \rightarrow S_{n+m-1}, \quad m \geq 1, \quad (1.2.4a)$$

$$\phi(a_i^n)|_{S_m} = \text{Id}_{S_m}, \quad i \geq m+1, \quad (1.2.4b)$$

where  $\phi(a_i^n)|_{S_m}$  denotes the restriction of the map  $\phi(a_i^n)$  to the domain  $S_m$ , and  $\text{Id}_{S_m}$  is the identity map on  $S_m$ .

For simplicity, we denote by  $\bar{\phi}_i^n$  the map  $\phi(a_i^n)$ . Observe that the maps  $\bar{\phi}_i^k$  have the following intuitive meaning. If  $s$  is an element of  $S_m$ , one can see  $s$  as an element having any number of inputs non smaller than  $m$ . Under this point of view,  $\bar{\phi}_i^n(s)$  is an element of  $S_{n+m-1}$  obtained by replacing in  $s$  its  $i$ th input by  $n-1$  new ones. Axioms (1.1.7a), (1.1.7b), and (1.1.7c) can be understood in the light of this interpretation.

Now, let  $\phi : \mathcal{M}_p \rightarrow \text{End}(S)$  and  $\phi' : \mathcal{M}_p \rightarrow \text{End}(S')$  be two precompositions. A map  $\alpha : S \rightarrow S'$  is a *precomposition morphism* from  $\phi$  to  $\phi'$  if  $\alpha$  is a monoid morphism and satisfies

$$\alpha : S_n \rightarrow S'_n, \quad n \geq 1, \quad (1.2.5a)$$

$$\bar{\phi}'_i^n(\alpha(s)) = \alpha(\bar{\phi}_i^n(s)), \quad s \in S. \quad (1.2.5b)$$

Let Precomp be the category wherein objects are all precompositions and arrows are precomposition morphisms.

If  $\phi : \mathcal{M}_p \rightarrow \text{End}(\mathcal{S})$  is a precomposition, we define on  $\mathcal{S}$  the binary products  $\circ_i^{(n)}$  by

$$s \circ_i^{(n)} t := \bar{\phi}_i^n(s) \star \bar{\phi}_0^i(t), \quad (1.2.6)$$

where  $\star$  is the binary commutative and associative operation of  $\mathcal{S}$ .

1.2.2. *From precompositions to operads.* Let  $\phi : \mathcal{M}_p \rightarrow \text{End}(\mathcal{S})$  be a precomposition. From the commutative monoid  $\mathcal{S}$ , we define the set

$$\mathbb{S} := \bigsqcup_{n \geq 1} \mathbb{S}_n \quad (1.2.7)$$

where

$$\mathbb{S}_n := \{(n, s) : s \in \mathcal{S}_n\}. \quad (1.2.8)$$

Hence,  $\mathbb{S}$  is the set of all the elements of  $\mathcal{S}$  endowed with an arity. Let the partial compositions maps

$$\circ_i : \mathbb{S}_n \times \mathbb{S}_m \rightarrow \mathbb{S}_{n+m-1} \quad (1.2.9)$$

defined, for any  $(n, s) \in \mathbb{S}_n$  and  $(m, t) \in \mathbb{S}_m$ , by

$$(n, s) \circ_i (m, t) := (n + m - 1, s \circ_i^{(m)} t). \quad (1.2.10)$$

We denote by  $\text{PO}(\phi)$  the set  $\mathbb{S}$  endowed with the maps  $\circ_i$  thus defined.

**THEOREM 1.2.1.** *The construction  $\text{PO}$  is a functor from the category of precompositions to the category of operads.*

1.2.3. *Quotients of precompositions.* Let  $\phi : \mathcal{M}_p \rightarrow \text{End}(\mathcal{S})$  be a precomposition and  $\gamma : \mathcal{S} \rightarrow \mathcal{S}$  be a monoid morphism such that

$$\gamma : \mathcal{S}_n \rightarrow \mathcal{S}_n, \quad n \geq 1, \quad (1.2.11a)$$

$$\gamma \circ \gamma = \gamma, \quad (1.2.11b)$$

$$\bar{\phi}_i^n \circ \gamma = \gamma \circ \bar{\phi}_i^n. \quad (1.2.11c)$$

We call such a morphism  $\gamma$  a *compatible morphism*.

On the operad  $\text{PO}(\phi)$ , we denote, by a slight abuse of notation, by

$$\gamma : \mathbb{S} \rightarrow \mathbb{S} \quad (1.2.12)$$

the map satisfying

$$\gamma((n, s)) = (n, \gamma(s)) \quad (1.2.13)$$

for any  $s \in \mathcal{S}_n$ .

Let  $\equiv_\gamma$  be the equivalence relation on  $\mathcal{S}$  satisfying  $s \equiv_\gamma t$  if  $\gamma(s) = \gamma(t)$  for any  $s, t \in \mathcal{S}$ . Since  $\gamma$  is a monoid morphism,  $\equiv_\gamma$  is a monoid congruence and hence,  $\mathcal{S}/\equiv_\gamma$  is a quotient monoid of  $\mathcal{S}$ .

On the operad  $\text{PO}(\phi)$ , we denote by a slight abuse of notation by  $\equiv_\gamma$  the equivalence relation satisfying  $(n, s) \equiv_\gamma (n, t)$  if  $s \equiv_\gamma t$  for any  $s, t \in \mathcal{S}_n$ .

Moreover, from the precomposition  $\phi$  and the map  $\gamma$ , one defines the precomposition

$$\phi_\gamma : \mathcal{M}_p \rightarrow \text{End}(S/\equiv_\gamma) \tag{1.2.14}$$

defined for any  $\equiv_\gamma$ -equivalence class  $[s]_{\equiv_\gamma}$  by

$$\bar{\phi}_{\gamma_i}^n([s]_{\equiv_\gamma}) := \left[ \bar{\phi}_i^n(s) \right]_{\equiv_\gamma}. \tag{1.2.15}$$

**THEOREM 1.2.2.** *Let  $\phi : \mathcal{M}_p \rightarrow \text{End}(S)$  be a precomposition and  $\gamma$  be a compatible morphism. Then, the operads  $\text{PO}(\phi)/\equiv_\gamma$  and  $\text{PO}(\phi_\gamma)$  are isomorphic.*

### 2. Constructing operads from precompositions

We apply here the construction PO introduced in the previous section to provide alternative constructions of the operads MT and Poset introduced in [LMN13], and to construct two new operads DMT and Qoset. These operads fit into the diagram of Figure 12.1.

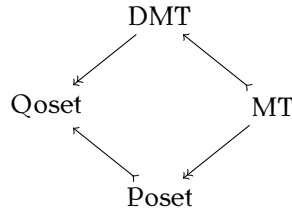

FIGURE 12.1. Diagram of operads where arrows  $\rightarrow$  (resp.  $\twoheadrightarrow$ ) are injective (resp. surjective) operad morphisms.

**2.1. Alternative constructions.** We begin by using the methods exposed in Section 1.2 to construct the operads MT of multi-tildes and Poset of posets.

**2.1.1. Operad of multi-tildes.** Multi-tildes are operators introduced in [CCM11] in the context of formal language theory as a convenient way to express regular languages. Let, for any  $n \geq 1$ ,  $P_n$  be the set

$$P_n := \{(x, y) \in [n]^2 : x \leq y\}. \tag{2.1.1}$$

A *multi-tilde* is a pair  $(n, \mathfrak{s})$  where  $n$  is a positive integer and  $\mathfrak{s}$  is a subset of  $P_n$ . The *arity* of the multi-tilde  $(n, \mathfrak{s})$  is  $n$ . The *binary relation* of  $(n, \mathfrak{s})$  is the binary relation  $\mathcal{R}_{(n, \mathfrak{s})}$  on  $[n + 1]$  satisfying  $x \mathcal{R}_{(n, \mathfrak{s})} y$  if  $x = y$  or  $(x, y - 1) \in \mathfrak{s}$ .

As shown in [LMN13], the graded (by the arity) collection of all multi-tildes admits a very natural structure of an operad. This operad, denoted by MT, is defined as follows. The partial composition  $(n, \mathfrak{s}) \circ_i (m, \mathfrak{t})$ ,  $i \in [n]$ , of two multi-tildes  $(n, \mathfrak{s})$  and  $(m, \mathfrak{t})$  is defined by

$$(n, \mathfrak{s}) \circ_i (m, \mathfrak{t}) := \left( n + m - 1, \{ \text{sh}_i^m(x, y) : (x, y) \in \mathfrak{s} \} \cup \{ \text{sh}_0^i(x, y) : (x, y) \in \mathfrak{t} \} \right), \tag{2.1.2}$$

where

$$\text{sh}_j^p(x, y) := \begin{cases} (x, y) & \text{if } y \leq i - 1, \\ (x, y + p - 1) & \text{if } x \leq i \leq y, \\ (x + p - 1, y + p - 1) & \text{otherwise.} \end{cases} \tag{2.1.3}$$

For instance, one has

$$(5, \{(1, 5), (2, 4), (4, 5)\}) \circ_4 (6, \{(2, 2), (4, 6)\}) = (10, \{(1, 10), (2, 9), (4, 10), (5, 5), (7, 9)\}), \quad (2.1.4a)$$

$$(5, \{(1, 5), (2, 4), (4, 5)\}) \circ_5 (6, \{(2, 2), (4, 6)\}) = (10, \{(1, 10), (2, 4), (4, 10), (6, 6), (8, 10)\}). \quad (2.1.4b)$$

Observe that the multi-tilde  $(1, \emptyset)$  is the unit of MT. Since for any  $n \geq 1$ ,  $\#\text{MT}(n) = \#E(P_n)$  (where  $E(P_n)$  denote the set of all subsets of  $P_n$ ),

$$\#\text{MT}(n) = 2^{\binom{n+1}{2}}. \quad (2.1.5)$$

Hence, the first dimensions of MT are

$$2, 8, 64, 1024, 32768, 2097152, 268435456, 68719476736, \quad (2.1.6)$$

and form Sequence **A006125** of [Slo]. Observe that the dimensions of MT are very similar to the dimensions of the operads obtained by the clique construction applied to a unitary magma having exactly two elements (see Section 1.2.1 of Chapter 7).

Let us provide a construction of MT through the functor PO. Let  $S_n$  be the set of all the subsets of  $P_n$ . By observing that  $S_n \subseteq S_{n+1}$ , let  $S := \cup_{n \geq 1} S_n$ . The pair  $(S, \cup)$  is a commutative monoid whose unit is  $1_S := \emptyset$  and belongs to  $S_1$ . Observe also that  $S$  is, as a monoid, generated by the set  $\{(x, y) : x \leq y\}$ .

Let  $\phi : \mathcal{M}_p \rightarrow \text{End}(S)$  be the precomposition such that each morphism  $\bar{\phi}_i^n$  is defined by its values on the generators of  $S$  by

$$\bar{\phi}_i^n(\{x, y\}) := \begin{cases} \{x, y\} & \text{if } y \leq i - 1, \\ \{x, y + n - 1\} & \text{if } x \leq i \leq y, \\ \{x + n - 1, y + n - 1\} & \text{otherwise.} \end{cases} \quad (2.1.7)$$

One can check that  $\phi$  is a precomposition.

**PROPOSITION 2.1.1.** *The operads MT and PO( $\phi$ ) are isomorphic.*

**2.1.2. Operads of posets.** In [LMN13], an operad Poset defined as the quotient of MT by the operad congruence  $\equiv$  is considered, where for any multi-tildes  $(n, \mathfrak{s})$  and  $(n, \mathfrak{t})$ , one sets  $(n, \mathfrak{s}) \equiv (n, \mathfrak{t})$  if the binary relations  $\mathcal{R}_{(n, \mathfrak{s})}$  and  $\mathcal{R}_{(n, \mathfrak{t})}$  have the same reflexive and transitive closure. Since any  $\equiv$ -equivalence class contains exactly one reflexive, transitive, and anti-symmetric relation, Poset is an operad on the set of all posets. More precisely, the elements of Poset( $n$ ) are posets on  $[n + 1]$  admitting  $(1, 2, \dots, n + 1)$  as a linear extension. For instance, one has

$$(4, \{(1, 3), (2, 2), (3, 4)\}) \equiv (4, \{(1, 3), (2, 2), (2, 5), (3, 4)\}), \quad (2.1.8a)$$

$$(4, \{(1, 1), (2, 3), (4, 4)\}) \equiv (4, \{(1, 1), (1, 3), (1, 4), (2, 3), (2, 4), (4, 4)\}), \quad (2.1.8b)$$

and

$$[(4, \{(1, 3), (2, 2), (3, 4)\})]_{\equiv} \circ_2 [(4, \{(1, 1), (2, 3), (4, 4)\})]_{\equiv} = [(7, \{(1, 6), (2, 3), (3, 4), (5, 5), (6, 7)\})]_{\equiv}. \quad (2.1.9)$$

The first dimensions of Poset are

$$2, 7, 40, 357, 4824, 96428, 2800472, 116473461, \quad (2.1.10)$$

and form Sequence **A006455** of [Slo].



Let us consider the monoid  $\mathcal{S}$  and the precomposition  $\phi$  of Section 2.1.1. Let  $\gamma : \mathcal{S} \rightarrow \mathcal{S}$  be the map sending any set  $\mathfrak{s} \in P_n$  to the set  $\mathfrak{s}' \in P_n$  such that  $\mathcal{R}_{(n,\mathfrak{s}' )}$  is the reflexive and transitive closure of  $\mathcal{R}_{(n,\mathfrak{s})}$ . For instance, the second components of the left members of (2.1.8a) and (2.1.8b) show elements of  $P_4$  and the second components of their respective right members are their reflexive and transitive closures. A multi-tilde  $(n, \mathfrak{s})$  is *pseudo-transitive* if  $\mathfrak{s}$  belongs to the image of  $\gamma$ . One can check that  $\gamma$  is a compatible morphism. Hence, we can consider the operad  $\text{PO}(\phi_\gamma)$  which is, by Theorem 1.2.2, isomorphic to the operad  $\text{MT}/_{\equiv_\gamma}$ .

PROPOSITION 2.1.2. *The operads Poset and  $\text{PO}(\phi_\gamma)$  are isomorphic.*

**2.2. New operads.** We now generalize the concept of multi-tildes to double multi-tildes. In terms of operators on languages (see Section 3), multi-tildes can be seen as operators allowing to jump forward in a regular expression and double multi-tildes as operators allowing to jump both forward or backward in a regular expression. The interest of this extension relies on the fact that, while multi-tildes can emulate the sum and the concatenation, double multi-tildes can emulate in addition to this the Kleene star of regular expressions and their languages. We construct in this section an operad DMT of double multi-tildes and a quotient Qoset of DMT of quasiorders.

2.2.1. *Operad of double multi-tildes.* Let DMT be the *operad of double multi-tildes* defined as

$$\text{DMT} := \text{MT} \sqcap \text{MT}, \quad (2.2.1)$$

where  $\sqcap$  is the Hadamard product of operads. An element of arity  $n$  of DMT is, by definition of  $\sqcap$ , a pair  $((n, \mathfrak{s}), (n, \mathfrak{t}))$  where  $(n, \mathfrak{s})$  and  $(n, \mathfrak{t})$  are multi-tildes. For simplicity, this element is simply denoted by  $(n, \mathfrak{s}, \mathfrak{t})$  and is called a *double multi-tilde*. The *binary relation* of  $(n, \mathfrak{s}, \mathfrak{t})$  is the binary relation  $\mathcal{R}_{(n,\mathfrak{s},\mathfrak{t})}$  on  $[n + 1]$  satisfying  $x \mathcal{R}_{(n,\mathfrak{s},\mathfrak{t})} y$  if  $x = y$  or  $(x, y - 1) \in \mathfrak{s}$  or  $(y - 1, x) \in \mathfrak{t}$ . Since any multi-tilde  $(n, \mathfrak{s})$  can be seen as a double multi-tilde  $(n, \mathfrak{s}, \emptyset)$ , MT is a suboperad of DMT. Observe that the double multi-tilde  $(1, \emptyset, \emptyset)$  is the unit of DMT. Since for any  $n \geq 1$ ,  $\#\text{DMT}(n) = (\#E(P_n))^2$ ,

$$\#\text{DMT}(n) = 4^{\binom{n+1}{2}}. \quad (2.2.2)$$

Hence, the first dimensions of DMT are

$$4, 64, 4096, 1048576, 1073741824, 4398046511104, 72057594037927936, \\ 4722366482869645213696, \quad (2.2.3)$$

and form Sequence A053763 of [Slo]. Observe that the dimensions of DMT are very similar to the dimensions of the operads obtained by the clique construction applied to a unitary magma having exactly four elements (see Section 1.2.1 of Chapter 7).

Let us provide a construction of DMT through the function PO. Let  $\mathcal{D}_n$  be the set of all the pairs  $(\mathfrak{s}, \mathfrak{t})$ , where  $\mathfrak{s}$  and  $\mathfrak{t}$  are subsets of  $P_n$ . By observing that  $\mathcal{D}_n \subseteq \mathcal{D}_{n+1}$ , let  $\mathcal{D} := \cup_{n \geq 1} \mathcal{D}_n$ . We endow  $\mathcal{D}$  with the product  $\cup$  defined by  $(\mathfrak{s}, \mathfrak{t}) \cup (\mathfrak{s}', \mathfrak{t}') := (\mathfrak{s} \cup \mathfrak{s}', \mathfrak{t} \cup \mathfrak{t}')$  for

all  $(s, t), (s', t') \in \mathcal{D}$ . The pair  $(\mathcal{D}, \cup)$  is a commutative monoid whose unit is  $1_{\mathcal{D}} := (\emptyset, \emptyset)$  and belongs to  $\mathcal{D}_1$ . Observe also that  $\mathcal{D}$  is, as a monoid, generated by the set

$$\{(\{(x, y)\}, \emptyset) : x \leq y\} \cup \{(\emptyset, \{(x, y)\}) : x \leq y\}. \quad (2.2.4)$$

Let  $\psi : \mathcal{M}_p \rightarrow \text{End}(\mathcal{D})$  be the precomposition such that each morphism  $\bar{\psi}_i^n$  is defined by its values on the generators of  $\mathcal{D}$  by

$$\bar{\psi}_i^n(\{(x, y)\}, \emptyset) := (\bar{\phi}_i^n(\{(x, y)\}), \emptyset), \quad (2.2.5a)$$

$$\bar{\psi}_i^n(\emptyset, \{(x, y)\}) := (\emptyset, \bar{\phi}_i^n(\{(x, y)\})), \quad (2.2.5b)$$

where the  $\bar{\phi}_i^n$  are the morphisms associated with the precomposition  $\phi$  of Section 2.1.1. One can check that  $\psi$  is a precomposition.

**PROPOSITION 2.2.1.** *The operads DMT and  $\text{PO}(\psi)$  are isomorphic.*

**2.2.2. Operad of quasiorders.** We construct here an operad Qoset which is to DMT what Poset is to MT.

We define the operad Qoset as the quotient of DMT by the operad congruence  $\equiv$  defined as follows. For any double multi-tilde  $(n, s, t)$  and  $(n', s', t')$ , one sets  $(n, s, t) \equiv (n', s', t')$  if the binary relations  $\mathcal{R}_{(n, s, t)}$  and  $\mathcal{R}_{(n', s', t')}$  have the same reflexive and transitive closure. For instance, one has

$$(4, \{(1, 2), (3, 3)\}, \{(1, 3)\}) \equiv (4, \{(1, 2), (1, 3), (3, 3)\}, \{(1, 3)\}). \quad (2.2.6)$$

It is straightforward to check that  $\equiv$  is a congruence of DMT, so that  $\text{Qoset} := \text{DMT}/\equiv$  is an operad. Moreover, since any  $\equiv$ -equivalence class contains exactly one reflexive and transitive relation, Qoset is an operad on the set of all quasiorders on  $[n + 1]$ . The first dimensions of Qoset are

$$4, 29, 355, 6942, 209527, 9535241, 642779354, 63260289423, \quad (2.2.7)$$

and form Sequence **A000798** of **[Slo]**.

Let us consider the monoid  $\mathcal{D}$  and the precomposition  $\psi$  of Section 2.2.1. Let  $\gamma : \mathcal{D} \rightarrow \mathcal{D}$  be the map sending any pair of  $(s, t)$  of  $\mathcal{D}_n^2$  to the pair  $(s', t')$  of  $\mathcal{D}_n^2$  such that  $\mathcal{R}_{(n, s', t')}$  is the reflexive and transitive closure of  $\mathcal{R}_{(n, s, t)}$ . For instance, the pair consisting in the second and third components of the left member of (2.2.6) shows elements of  $P_x^2$  and the second and third components of the right member is its reflexive and transitive closure. A double multi-tilde  $(n, s, t)$  is *pseudo-transitive* if  $(s, t)$  belongs to the image of  $\gamma$ . One can check that  $\gamma$  is a compatible morphism. Hence, we can consider the operad  $\text{PO}(\psi_\gamma)$  which is, by Theorem 1.2.2, isomorphic to the operad  $\text{DMT}/\equiv_\gamma$ .

### 3. Links with language theory

The main motivation for the introduction of the four operads MT, Poset, DMT, and Qoset (the first two in **[LMN13]** and the last two here) relies on the fact that they act on languages. In more precise terms, the set of all languages over a finite alphabet  $A$  is endowed with  $\mathcal{O}$ -monoid structures, where  $\mathcal{O}$  is one of the four aforementioned operads. We describe these structures in this section.

**3.1. Action of multi-tildes and double multi-tildes.** The action of DMT on languages on a finite alphabet can be described in terms of automata. This leads to the construction of a DMT-monoid. All this justifies the role of DMT in formal language theory since this operad provides a concise way to express languages.

**3.1.1. Automata and regular languages.** An *automaton* is a tuple  $(A, Q, \delta, i, t)$  where  $A$  is a *ground alphabet*,  $Q$  is a finite set, called *set of states*,  $\delta : Q \times A \sqcup \{\epsilon\} \rightarrow E(Q)$  is a *transition map*,  $i$  is a state of  $Q$  called *initial state*, and  $t$  is a state of  $Q$  called *terminal state*. We consider here very particular automata (also known as  $\epsilon$ -automata). We use the main definitions of the theory (see for instance [Sak09]), like the notion of language recognized by an automaton, regular languages, regular expressions, etc.

From now on,  $\mathbb{A}$  is the infinite alphabet  $\mathbb{A} := \{a_1, a_2, \dots\}$  and  $A$  is any finite alphabet.

**3.1.2. From double multi-tildes to automata.** Let  $(n, s, t)$  be a double multi-tilde of arity  $n$  of DMT and  $\mathcal{A}_{(n,s,t)}$  be the automaton  $(\mathbb{A}, Q, \delta, q_1, q_{n+1})$  defined by

$$Q := \{q_j : j \in [n+1]\}, \quad (3.1.1)$$

$$\delta(q_j, a_i) := \{q_{j+1}\}, \quad (3.1.2)$$

$$\delta(q_j, \epsilon) := \{q_{k+1} : (j, k) \in s\} \cup \{q_k : (k, j-1) \in s\}. \quad (3.1.3)$$

For instance, by considering the double multi-tilde

$$(n, s, t) := (6, \{(1, 3), (2, 2), (3, 4)\}, \{(2, 2), (2, 3), (4, 5)\}), \quad (3.1.4)$$

the transition map of the automaton  $\mathcal{A}_{(n,s,t)} := (\mathbb{A}, \{q_1, \dots, q_7\}, \delta, q_1, q_7)$  satisfies

$$\begin{aligned} \delta(q_1, a_1) &:= \{q_2\}, & \delta(q_2, a_2) &:= \{q_3\}, & \delta(q_3, a_3) &:= \{q_4\}, \\ \delta(q_4, a_4) &:= \{q_5\}, & \delta(q_5, a_5) &:= \{q_6\}, & \delta(q_6, a_6) &:= \{q_7\}, \end{aligned} \quad (3.1.5)$$

and

$$\begin{aligned} \delta(q_1, \epsilon) &:= \{q_4\}, & \delta(q_2, \epsilon) &:= \{q_3\}, & \delta(q_3, \epsilon) &:= \{q_2, q_5\}, \\ \delta(q_4, \epsilon) &:= \{q_2\}, & \delta(q_5, \epsilon) &:= \emptyset, & \delta(q_6, \epsilon) &:= \{q_4\}. \end{aligned} \quad (3.1.6)$$

This automaton can be depicted as

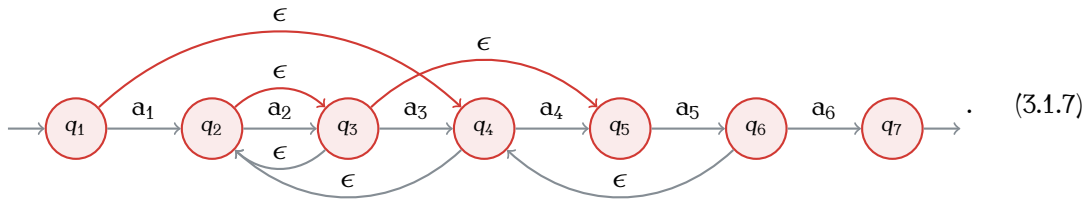



PROPOSITION 3.1.3. Any regular language  $l$  of  $\mathcal{R}_A$  can be expressed as

$$l = (n, \mathfrak{s}, \mathfrak{t}) \cdot (\alpha_1, \dots, \alpha_n), \quad (3.1.14)$$

for some  $n \geq 1$ ,  $(n, \mathfrak{s}, \mathfrak{t}) \in \text{DMT}(n)$ , and  $\alpha_i \in \{\{a\} \in A\} \cup \{\emptyset\}$ .

3.1.5. *Expressions for finite regular languages.* Since MT can be seen as a suboperad of DMT consisting in the double multi-tildes of the form  $(n, \mathfrak{s}, \emptyset)$ , the action  $\cdot$  of DMT on  $\mathcal{L}_A$  described in Section 3.1.3 can be restricted on MT. In this way, we recover a result of [LMN13].

PROPOSITION 3.1.4. Any finite language  $l$  of  $\mathcal{F}_A$  can be expressed as

$$l = (n, \mathfrak{s}, \emptyset) \cdot (\alpha_1, \dots, \alpha_n), \quad (3.1.15)$$

for some  $n \geq 1$ ,  $(n, \mathfrak{s}, \emptyset) \in \text{DMT}(n)$ , and  $\alpha_i \in \{\{a\} \in A\} \cup \{\emptyset\}$ .

**3.2. Action of pseudo-transitive double multi-tildes.** The quotient Qoset of DMT inherits the action of DMT on languages. The main interest to consider the associated Qoset-monoid instead of the DMT-monoid is that this last one is nonfaithful while the first is. Hence, Qoset is an operad providing optimal operators to describe regular languages.

3.2.1. *A nonfaithful action of DMT on languages.* Observe that the description of languages by the action of a double multi-tilde on languages (for instance in the ways provided by Propositions 3.1.3 and 3.1.4) is not optimal since a language  $l$  can be described from different double multi-tildes of the same arity. Indeed,

$$(2, \{(1, 2), (2, 3)\}, \emptyset) \cdot (\{a\}, \{b\}) = (a + \epsilon)(b + \epsilon) = (2, \{(1, 2), (2, 3), (1, 3)\}, \emptyset) \cdot (\{a\}, \{b\}). \quad (3.2.1)$$

In other words, the DMT-monoid consisting in all languages endowed with the action  $\cdot$  is a nonfaithful DMT-monoid.

3.2.2. *A faithful action of Qoset on languages.* Since Qoset is a quotient operad of DMT, the actions  $\cdot$  of DMT on  $\mathcal{L}_A$  defined in Section 3.1.3 are still well-defined on Qoset. More precisely, for any  $\equiv_\gamma$ -equivalence class  $[(n, \mathfrak{s}, \mathfrak{t})]_{\equiv_\gamma}$  of double multi-tildes, where  $\equiv_\gamma$  is the operad congruence introduced in Section 2.2.2, and any languages  $l_1, \dots, l_n$  of  $\mathcal{L}_A$ ,

$$[(n, \mathfrak{s}, \mathfrak{t})]_{\equiv_\gamma} \cdot (l_1, \dots, l_n) := (n, \mathfrak{s}, \mathfrak{t}) \cdot (l_1, \dots, l_n), \quad (3.2.2)$$

where the symbol  $\cdot$  of the right member of (3.2.2) denote the actions of DMT on languages.

Now, contrariwise to the action of DMT on languages, the action of Qoset is optimal in the following sense.

THEOREM 3.2.1. *If  $A$  has at least two letters, the actions  $\cdot$  endow the set  $\mathcal{L}_A$  of all languages on  $A$  with a structure of a faithful Qoset-monoid.*

3.2.3. *Operations of Qoset as operators on languages.* Let us examine all the actions of the elements of Qoset up to arity 2. We denote each element of Qoset by pseudo-transitive double multi-tildes.

In arity 1,

$$(1, \emptyset, \emptyset) \cdot \{a\} = \epsilon, \quad (3.2.3a)$$

$$(1, \{(1, 1)\}, \emptyset) \cdot \{a\} = \epsilon + a, \quad (3.2.3b)$$

$$(1, \emptyset, \{(1, 1)\}) \cdot \{a\} = a^+, \quad (3.2.3c)$$

$$(1, \{(1, 1)\}, \{(1, 1)\}) \cdot \{a\} = a^*. \quad (3.2.3d)$$

In arity 2,

$$(2, \emptyset, \emptyset) \cdot (\{a\}, \{b\}) = ab, \quad (3.2.4)$$

$$(2, \{(1, 1)\}, \emptyset) \cdot (\{a\}, \{b\}) = b + ab, \quad (3.2.5a)$$

$$(2, \{(1, 2)\}, \emptyset) \cdot (\{a\}, \{b\}) = \epsilon + ab, \quad (3.2.5b)$$

$$(2, \{(2, 2)\}, \emptyset) \cdot (\{a\}, \{b\}) = a + ab, \quad (3.2.5c)$$

$$(2, \{(1, 1), (1, 2)\}, \emptyset) \cdot (\{a\}, \{b\}) = \epsilon + b + ab, \quad (3.2.5d)$$

$$(2, \{(1, 2), (2, 2)\}, \emptyset) \cdot (\{a\}, \{b\}) = \epsilon + a + ab, \quad (3.2.5e)$$

$$(2, \{(1, 1), (1, 2), (2, 2)\}, \emptyset) \cdot (\{a\}, \{b\}) = \epsilon + a + b + ab, \quad (3.2.5f)$$

$$(2, \emptyset, \{(1, 1)\}) \cdot (\{a\}, \{b\}) = a^+b, \quad (3.2.5g)$$

$$(2, \emptyset, \{(1, 2)\}) \cdot (\{a\}, \{b\}) = (ab)^+, \quad (3.2.5h)$$

$$(2, \emptyset, \{(2, 2)\}) \cdot (\{a\}, \{b\}) = ab^+, \quad (3.2.5i)$$

$$(2, \emptyset, \{(1, 1), (1, 2)\}) \cdot (\{a\}, \{b\}) = (a^+b)^+, \quad (3.2.5j)$$

$$(2, \emptyset, \{(1, 2), (2, 2)\}) \cdot (\{a\}, \{b\}) = (ab^+)^+, \quad (3.2.5k)$$

$$(2, \emptyset, \{(1, 1), (1, 2), (2, 2)\}) \cdot (\{a\}, \{b\}) = (a^+b^+)^+, \quad (3.2.5l)$$

$$(2, \{(1, 1)\}, \{(1, 1)\}) \cdot (\{a\}, \{b\}) = a^*b \quad (3.2.6a)$$

$$(2, \{(1, 1)\}, \{(2, 2)\}) \cdot (\{a\}, \{b\}) = (\epsilon + a)b^+, \quad (3.2.6b)$$

$$(2, \{(1, 2)\}, \{(1, 2)\}) \cdot (\{a\}, \{b\}) = (ab)^*, \quad (3.2.6c)$$

$$(2, \{(2, 2)\}, \{(1, 1)\}) \cdot (\{a\}, \{b\}) = a^+(\epsilon + b), \quad (3.2.6d)$$

$$(2, \{(2, 2)\}, \{(2, 2)\}) \cdot (\{a\}, \{b\}) = ab^*, \quad (3.2.6e)$$

$$(2, \{(1, 1)\}, \{(1, 2), (2, 2)\}) \cdot (\{a\}, \{b\}) = ((\epsilon + a)b^+)^+, \quad (3.2.7a)$$

$$(2, \{(2, 2)\}, \{(1, 1), (1, 2)\}) \cdot (\{a\}, \{b\}) = (a^+(\epsilon + b))^+, \quad (3.2.7b)$$

$$(2, \{(1, 1)\}, \{(1, 1), (1, 2), (2, 2)\}) \cdot (\{a\}, \{b\}) = (a^*b^+)^+, \quad (3.2.7c)$$

$$(2, \{(2, 2)\}, \{(1, 1), (1, 2), (2, 2)\}) \cdot (\{a\}, \{b\}) = (a^+b^*)^+, \quad (3.2.7d)$$

$$(2, \{(1, 2), (2, 2)\}, \{(1, 1)\}) \cdot (\{a\}, \{b\}) = \epsilon + a^+(\epsilon + b), \quad (3.2.7e)$$

$$(2, \{(1, 1), (1, 2)\}, \{(2, 2)\}) \cdot (\{a\}, \{b\}) = \epsilon + (\epsilon + a)b^+, \quad (3.2.7f)$$

$$(2, \{(1, 1), (1, 2), (2, 2)\}, \{(1, 1)\}) \cdot (\{a\}, \{b\}) = a^*(\epsilon + b), \quad (3.2.7g)$$

$$(2, \{(1, 1), (1, 2), (2, 2)\}, \{(2, 2)\}) \cdot (\{a\}, \{b\}) = (\epsilon + a)b^*, \quad (3.2.7h)$$

$$(2, \{(1, 1), (1, 2)\}, \{(1, 2), (2, 2)\}) \cdot (\{a\}, \{b\}) = ((\epsilon + a)b^+)^*, \quad (3.2.8a)$$

$$(2, \{(1, 1), (1, 2), (2, 2)\}, \{(1, 1), (1, 2), (2, 2)\}) \cdot (\{a\}, \{b\}) = (a + b)^*, \quad (3.2.8b)$$

$$(2, \{(1, 2), (2, 2)\}, \{(1, 1), (1, 2)\}) \cdot (\{a\}, \{b\}) = (a^+(\epsilon + b))^*. \quad (3.2.8c)$$

### Concluding remarks

The work presented in this chapter provides two kinds of results. The first one consists in a general construction of operads through a functor PO, producing an operad from a precomposition. The second one consists in the application of this construction to obtain new operads or alternative descriptions of already existing ones. In this context we have introduced and worked with operads acting on formal languages.

The operad Qoset, quotient of the operad DMT of double multi-tildes, acts faithfully on the set of all regular languages over a finite alphabet. Since Qoset is a combinatorial operad, it offers countable operations for denoting regular languages. The expressions thus obtained to define regular languages lead to the definition of several measures for their complexity. For instance, if  $l$  is a regular language, one can define  $w_1(l)$  (resp.  $w_2(l)$ ) as the minimal arity (resp. number of pairs) of the element of Qoset required to express  $l$  (see Proposition 3.1.3 and Theorem 3.2.1). Intuitively,  $w_1$  and  $w_2$  can be respectively interpreted as functions measuring the width and the height of a language. The first one,  $w_1$ , is indeed the minimal number of occurrences of symbols or  $\emptyset$  in the expression of  $l$ . The measure  $w_2$  expresses the minimal complexity of an operator involved for denoting the languages. These measures deserve to be investigated; in particular a parallel with the size of a minimal automaton (in terms of states or transitions) should be established.

Another perspective is the extension of the conversion methods from automata to expressions by using double multi-tildes. These conversions were studied in [CCM10] and in [CCM12]. By slightly modifying the action of the operads, we aim to extend these algorithms of conversions. Conversely, it seems worth designing algorithms producing automata from expressions (like *e.g.*, position functions [Glu61] or expression derivatives [Brz64, Ant96]).

A last perspective is the following. By the Alexandroff correspondence [Ale37], quasiorders on finite sets are in bijection with finite topologies. The question here consists in investigating if the action of the operad of quasiorders Qoset on languages has a topological interpretation.

## Conclusion

In all this dissertation, our main philosophy is to design operations on combinatorial objects in order to construct algebraic structures on them. By studying algebraically these structures, we hope to grab combinatorial properties on the objects. All this provides a tool to tackle problems coming from enumerative combinatorics or computer science.

We expose in this work numerous constructions inputting simple algebraic structures (like magmas, monoids, or posets) and outputting more complicated ones (like Hopf bialgebras, operads, and pros) and involving combinatorial objects. Therefore, our main contribution is to provide metatools, in the sense that our constructions can be used to endow combinatorial collections with algebraic structures.

Each chapter ends with a section named “Concluding remarks” raising some contextual open questions. For this reason we will not mention these here. Let us instead speak about the general and cross sectional ideas and directions for future research.

### About constructions of operads

A first general direction consists in using the constructions  $T$  (see Chapters 4 and 5),  $As$  (see Chapter 6),  $C$  (see Chapter 7), and  $PO$  (see Chapter 12) to define even more operads. As we have seen, these constructions lead to the definitions of many interesting operads, involving a large range of combinatorial objects and of partial composition operations and algorithms. We think that we are far to have exhausted the subject and that many other operads deserving to be studied can be obtained.

A next logical continuation is to develop more connections between combinatorial algebraic structures and properties of their underlying combinatorial objects. We have pointed out, mostly in Chapter 11, that  $ns$  colored operads lead to a generalization of usual formal power series. By using the operations of operads, we obtain a bunch a natural operations on such generalized series, forming new tools for enumerative prospects. This axis consists in constructing new operads on various kind of objects (like integer partitions, Young tableaux, planar maps, *etc.*) and use these and their formal power series to discover enumerative properties.

### About pros and their combinatorics

In Chapter 9, a link between the theory of pros and the one of Hopf bialgebras has been highlighted through a construction  $H$  associating a Hopf bialgebra with some pros. These last objects are generalizations of operads and their underlying combinatorics is much less



developed and understood than those of operads. For instance, while free operads are very well-known structures, free pros are not well described. Some particular phenomena occur when one considers free pros on generators having null input and/or output arities. The question here is to provide a good combinatorial realization of free pros. The described realization in terms of prographs (see Chapters 1 and 2) allows only generators with at least one input and one output. This research axis contains also questions like a description of the Hilbert series of free pros.

Pros provide also an interesting framework to work with all the symmetric groups at the same time. Indeed, the pro  $\mathbb{K}\langle \text{Per} \rangle$  of all permutations (see Chapter 2) encapsulates the composition operation of all permutations and hence, contains all groups  $\mathfrak{S}_n$ ,  $n \in \mathbb{N}$ . This pro, by computing its presentation by generators and relations, leads to the known presentation of the symmetric groups in terms of elementary transpositions. Here we ask for a general construction associating a pro with any sequence  $W_n$ ,  $n \in \mathbb{N}$ , of Coxeter groups, analog to what is  $\mathbb{K}\langle \text{Per} \rangle$  for  $\mathfrak{S}_n$ ,  $n \in \mathbb{N}$ . This could lead to combinatorial realizations of some Coxeter groups. The same, but more general and hard question, consisting in encapsulating a sequence  $M_n$ ,  $n \in \mathbb{N}$ , of monoids in pros holds also.

Here is a last theme about pros we would like to expose. As said before, (colored) operads are promising devices to generalize usual formal power series. Since pros are in some sense generalizations of operads, series on pros would be an even more powerful generalization of such series. Additionally, they could be very interesting devices for enumeration. Due to the richness of the structure, series on pros come with a lot of different products. At least, a generalization of the pre-Lie and composition product on series on colored ns operads (see Chapter 11) can be considered.

### About biproducts and their algorithmic

As exposed in Chapter 10, combinatorial (bi)algebraic structures are good supports to ask questions of analysis of algorithms. To be more precise, given a combinatorial space  $\mathbb{K}\langle C \rangle$  endowed with a biproduct  $\square$  of arity  $p$ , the question of the complexity of the computation of  $\square(x_1 \otimes \cdots \otimes x_p)$ , where  $x_1, \dots, x_p$  are objects of  $C$  seems in general unexplored and open. The analysis may be performed with respect to the sum of the sizes of  $x_1, \dots, x_p$ . This could lead to a hierarchy of biproducts depending on their complexity. Some biproducts can have different complexity on different bases of  $\mathbb{K}\langle C \rangle$ . This research direction mixes in a balanced way algebraic combinatorics and computer science.

## Bibliography

- [Agu00] M. Aguiar. Pre-Poisson algebras. *Lett. Math. Phys.*, 54(4):263–277, 2000. 80
- [AJ08] N. Alon and Spencer J. *The Probabilistic Method*. Wiley-Blackwell, 3rd edition, 2008. 6
- [AL04] M. Aguiar and J.-L. Loday. Quadri-algebras. *J. Pure Appl. Algebra*, 191(3):205–221, 2004. 80, 153
- [Ale37] P. Alexandroff. Diskrete Räume. *Mat. Sb.*, 2(44)(3):501–519, 1937. 356
- [All00] C. Allauzen. Calcul efficace du shuffle de  $k$  mots. Technical report, Institut Gaspard Monge, Université de Marne la Vallée, 2000. 301
- [Ant96] V. Antimirov. Partial derivatives of regular expressions and finite automaton constructions. *Theor. Comput. Sci.*, 155:291–319, 1996. 356
- [AO08] M. Aguiar and R. C. Orellana. The Hopf algebra of uniform block permutations. *J. Algebr. Comb.*, 28(1):115–138, 2008. 18, 90, 253, 266
- [AP15] J. Alm and D. Petersen. Brown’s dihedral moduli space and freedom of the gravity operad. *To appear in Annales Scientifiques de l’ENS*, 2015. [arXiv:1509.09274v2](https://arxiv.org/abs/1509.09274v2). 18, 104, 213, 248
- [AVL62] G.M. Adelson-Velsky and E. M. Landis. An algorithm for the organization of information. *Soviet Mathematics Doklady*, 3:1259–1263, 1962. 12, 36, 314, 328
- [BBL98] P. Bose, J. F. Buss, and A. Lubiw. Pattern Matching for Permutations. *Inform. Process. Lett.*, 65(5):277–283, 1998. 310
- [BF03] C. Brouder and A. Frabetti. QED Hopf algebras on planar binary trees. *J. Algebra*, no. 1:298–322, 2003. 82
- [BFK06] C. Brouder, A. Frabetti, and C. Krattenthaler. Non-commutative Hopf algebra of formal diffeomorphisms. *Adv. Math.*, 200(2):479–524, 2006. 18, 278, 279
- [BG16] J.-P. Bultel and S. Giraudo. Combinatorial Hopf algebras from PROs. *J. Algebr. Comb.*, 44(2):455–493, 2016. 16, 277
- [Bjö84] A Björner. Orderings of Coxeter groups. In *Combinatorics and algebra*, volume 34 of *Contemp. Math.*, pages 175–195. Amer. Math. Soc., Providence, RI, 1984. 37
- [BLL88] F. Bergeron, G. Labelle, and P. Leroux. Functional Equations for Data Structures. *Lect. Notes Comput. Sc.*, 294:73–80, 1988. 12, 340
- [BLL98] F. Bergeron, G. Labelle, and P. Leroux. *Combinatorial species and tree-like structures*, volume 67 of *Encyclopedia of Mathematics and its Applications*. Cambridge University Press, Cambridge, 1998. 12, 23, 131, 340
- [BLL13] F. Bergeron, G. Labelle, and P. Leroux. *Introduction to the Theory of Species of Structures*. Université du Québec à Montréal, 2013. 23
- [BM03] C. Berger and I. Moerdijk. Axiomatic homotopy theory for operads. *Comment. Math. Helv.*, 78(4):805–831, 2003. 131
- [BMFPR11] M. Bousquet-Mélou, É. Fusy, and L.-F. Préville-Ratelle. The number of intervals in the  $m$ -Tamari lattices. *Electron. J. Comb.*, 18(2), 2011. Paper 31. 36
- [BN98] F. Baader and T. Nipkow. *Term rewriting and all that*. Cambridge University Press, Cambridge, 1998. 9, 37, 38, 125, 313
- [Boz01] S. Bozapalidis. Context-free series on trees. *Inform. Comput.*, 169(2):186–229, 2001. 68
- [BPR12] F. Bergeron and L.-F. Préville-Ratelle. Higher trivariate diagonal harmonics via generalized Tamari posets. *J. Comb.*, 3(3):317–341, 2012. 36
- [BR82] J. Berstel and C. Reutenauer. Recognizable formal power series on trees. *Theor. Comput. Sci.*, 18(2):115–148, 1982. 68, 341

- [BR88] J. Berstel and C. Reutenauer. *Rational series and their languages*, volume 12 of *EATCS Monographs on Theoretical Computer Science*. Springer-Verlag, Berlin, 1988. 341
- [BR10] J. Berstel and C. Reutenauer. *Noncommutative rational series with applications*, volume 137. Cambridge University Press, 2010. 68, 317
- [Brz64] J. A. Brzozowski. Derivatives of regular expressions. *J. ACM*, 11(4):481–494, 1964. 356
- [BS14] S. Buss and M. Soltys. Unshuffling a Square is NP-Hard. *J. Comput. Syst. Sci.*, 80(4):766–776, 2014. 19, 301, 311
- [BV73] J. M. Boardman and R. M. Vogt. Homotopy invariant algebraic structures on topological spaces. *Lect. Notes Math.*, 347, 1973. 10, 11, 90, 98
- [Car07] P. Cartier. A primer of Hopf algebras. In *Frontiers in number theory, physics, and geometry. II*, pages 537–615. Springer, Berlin, 2007. 10, 63
- [Cay57] A. Cayley. On the Theory of the Analytical Forms called Trees. *Phil. Mag.*, 13:172–176, 1857. 23
- [CCM10] P. Caron, J.-M. Champarnaud, and L. Mignot. Acyclic automata and small expressions using multi-tilde-bar operators. *Theor. Comput. Sci.*, 411(38–39):3423–3435, 2010. 356
- [CCM11] P. Caron, J.-C. Champarnaud, and L. Mignot. Multi-Bar and Multi-Tilde Regular Operators. *J. Autom. Lang. Comb.*, 16(1):11–26, 2011. 18, 19, 213, 343, 348
- [CCM12] P. Caron, J.-M. Champarnaud, and L. Mignot. Multi-tilde-bar expressions and their automata. *Acta Inform.*, 49(6):413–436, 2012. 356
- [CDG<sup>+</sup>07] H. Comon, M. Dauchet, R. Gilleron, F. Jacquemard, C. Löding, D. Lugiez, S. Tison, and M. Tommasi. *Tree Automata Techniques and Applications*. <http://www.grappa.univ-lille3.fr/tata>, 2007. 19, 313, 330, 341
- [CG14] F. Chapoton and S. Giraud. Enveloping operads and bicoloured noncrossing configurations. *Exp. Math.*, 23(3):332–349, 2014. 16, 111
- [CGM15] H. Cheballah, S. Giraud, and R. Maurice. Hopf algebra structure on packed square matrices. *J. Comb. Theory A*, 133:139–182, 2015. 16, 253
- [Cha02] F. Chapoton. Un théorème de Cartier-Milnor-Moore-Quillen pour les bigèbres dendriformes et les algèbres braces. *J. Pure Appl. Algebra*, 168(1):1–18, 2002. 11, 68, 82, 314, 324, 326
- [Cha05] F. Chapoton. On some anticyclic operads. *Algebr. Geom. Topol.*, 5:53–69, 2005. 103
- [Cha06] F. Chapoton. Sur le nombre d’intervalles dans les treillis de Tamari. *Sém. Lothar. Combin.*, 55, 2006. 36
- [Cha07] F. Chapoton. The anticyclic operad of moulds. *Int. Math. Res. Notices*, 20:Art. ID rnm078, 36, 2007. 16, 102, 111, 122, 213, 245, 247
- [Cha08] F. Chapoton. Operads and algebraic combinatorics of trees. *Sém. Lothar. Combin.*, 58, 2008. 11, 24, 68, 81, 314, 322, 324, 326
- [Cha09] F. Chapoton. A rooted-trees  $q$ -series lifting a one-parameter family of Lie idempotents. *Algebra & Number Theory*, 3(6):611–636, 2009. 11, 68, 314, 324, 326
- [Cha14] F. Chapoton. Flows on rooted trees and the Menous-Novelli-Thibon idempotents. *Math. Scand.*, 115(1), 2014. 99
- [CHN16] F. Chapoton, F. Hivert, and J.-C. Novelli. A set-operad of formal fractions and dendriform-like sub-operads. *J. Algebra*, 465:322–355, 2016. 18, 213, 246
- [Cho59] N. Chomsky. On certain formal properties of grammars. *Inform. Control*, 2:137–167, 1959. 313, 343
- [CK98] A. Connes and D. Kreimer. Hopf algebras, renormalization and noncommutative geometry. *Commun. Math. Phys.*, 199(1):203–242, 1998. 10, 153, 278, 289
- [CL01] F. Chapoton and M. Livernet. Pre-Lie algebras and the rooted trees operad. *Int. Math. Res. Notices*, 8:395–408, 2001. 2, 9, 63, 82
- [CL07] F. Chapoton and M. Livernet. Relating two Hopf algebras built from an operad. *Int. Math. Res. Notices*, 2007(24):Art. ID rnm131, 27 pp, 2007. 18, 277, 280
- [CLRS09] T.H. Cormen, C. E. Leiserson, R.L. Rivest, and C. Stein. *Introduction to algorithms*. The MIT Press, 3rd edition, 2009. 24, 114, 314
- [Com72] L. Comtet. Sur les coefficients de l’inverse de la série formelle  $\sum n!t^n$ . *C. R. Acad. Sci. Paris, A* 275:569–572, 1972. 5
- [Cox34] H. S. M. Coxeter. Discrete groups generated by reflections. *Ann. Math.*, 35(3):588–621, 1934. 37

- [CP92] V. Capovelas and J. Pach. A Turán-type theorem on chords of a convex polygon. *J. Comb. Theory B*, 56(1):9–15, 1992. [56](#), [211](#)
- [CP17] G. Châtel and V. Pilaud. Cambrian Hopf algebras. *Adv. Math.*, 311:598–633, 2017. [87](#)
- [CS63] N. Chomsky and M. P. Schützenberger. The algebraic theory of context-free languages. In *Computer programming and formal systems*, pages 118–161. North-Holland, Amsterdam, 1963. [313](#), [343](#)
- [CSZ15] C. Ceballos, F. Santos, and G. Ziegler. Many non-equivalent realizations of the associahedron. *Combinatorica*, 35(5):513–551, 2015. [6](#)
- [Cur12] P.-L. Curien. Operads, clones, and distributive laws. In *Operads and universal algebra*, volume 9 of *Nankai Ser. Pure Appl. Math. Theoret. Phys.*, pages 25–49. World Sci. Publ., Hackensack, NJ, 2012. [99](#)
- [DG94] S. Dulucq and O. Guibert. Mots de piles, tableaux standards et permutations de Baxter. *Formal Power Series and Algebraic Combinatorics*, 1994. [88](#)
- [DHNT11] G. Duchamp, F. Hivert, J.-C. Novelli, and J.-Y. Thibon. Noncommutative symmetric functions VII: free quasi-symmetric functions revisited. *Ann. Comb.*, 15(4):655–673, 2011. [63](#)
- [DHT02] G. Duchamp, F. Hivert, and J.-Y. Thibon. Noncommutative Symmetric Functions VI: Free Quasi-Symmetric Functions and Related Algebras. *Int. J. of Algebr. Comput.*, 12:671–717, 2002. [5](#), [8](#), [9](#), [10](#), [18](#), [63](#), [87](#), [90](#), [153](#), [253](#), [254](#), [267](#), [276](#), [301](#)
- [DK10] V. Dotsenko and A. Khoroshkin. Gröbner bases for operads. *Duke Math. J.*, 153(2):363–396, 2010. [11](#), [95](#)
- [DLRS10] J. A. De Loera, J. Rambau, and F. Santos. *Triangulations*, volume 25 of *Algorithms and Computation in Mathematics*. Springer-Verlag, Berlin, 2010. Structures for algorithms and applications. [56](#), [211](#)
- [DM47] A. Dvoretzky and Th. Motzkin. A problem of arrangements. *Duke Math. J.*, 14(2):305–313, 1947. [45](#)
- [EFM09] K. Ebrahimi-Fard and D. Manchon. Dendriform equations. *J. Algebra*, 322(11):4053–4079, 2009. [80](#)
- [EFM14] K. Ebrahimi-Fard and D. Manchon. The Magnus expansion, trees and Knuth’s rotation correspondence. *Found. Comput. Math.*, 14(1):1–25, 2014. [42](#)
- [EFMP08] K. Ebrahimi-Fard, D. Manchon, and F. Patras. New identities in dendriform algebras. *J. Algebra*, 320(2):708–727, 2008. [80](#)
- [Eil74] S. Eilenberg. *Automata, languages, and machines*. Vol. A. Academic Press, New York, 1974. Pure and Applied Mathematics, Vol. 58. [68](#), [317](#), [341](#)
- [EML53] S. Eilenberg and S. Mac Lane. On the groups of  $H(\Pi, n)$ . I. *Ann. Math.*, 58(2):55–106, 1953. [19](#), [301](#)
- [EZ76] A. Ehrenfeucht and H.-P. Zeiger. Complexity Measures for Regular Expressions. *J. Comput. Syst. Sci.*, 12(2):134–146, 1976. [343](#)
- [FFM16] F. Fauvet, L. Foissy, and D. Manchon. Operads of finite posets. [arXiv:1604.08149v2](#), 2016. [17](#), [189](#)
- [FH91] W. Fulton and J. Harris. *Representation Theory: A First Course*. Springer-Verlag, New York, 1991. [6](#)
- [FN99] P. Flajolet and M. Noy. Analytic combinatorics of non-crossing configurations. *Discrete Math.*, 204(1-3):203–229, 1999. [16](#), [56](#), [111](#), [211](#), [222](#)
- [FNT14] L. Foissy, J.-C. Novelli, and J.-Y. Thibon. Polynomial realizations of some combinatorial Hopf algebras. *J. Noncommut. Geom.*, 8(1):141–162, 2014. [10](#)
- [Foi02a] L. Foissy. Les algèbres de Hopf des arbres enracinés décorés. I. *B. Sci. Math.*, 126(3):193–239, 2002. [10](#)
- [Foi02b] L. Foissy. Les algèbres de Hopf des arbres enracinés décorés. II. *B. Sci. Math.*, 126(4):249–288, 2002. [10](#)
- [Foi07] L. Foissy. Bidendriform bialgebras, trees, and free quasi-symmetric functions. *J. Pure Appl. Algebra*, 209(2):439–459, 2007. [80](#), [82](#), [153](#), [263](#), [265](#), [298](#)
- [Foi08] L. Foissy. Faà di Bruno subalgebras of the Hopf algebra of planar trees from combinatorial Dyson-Schwinger equations. *Adv. Math.*, 218(1):136–162, 2008. [18](#), [278](#), [279](#), [290](#)
- [Foi12] L. Foissy. Ordered forests and parking functions. *Int. Math. Res. Notices*, 2012(7):1603–1633, 2012. [82](#)
- [Foi15] L. Foissy. Examples of Com-PreLie Hopf algebras. [arXiv:1501.06375v1](#), 2015. [82](#)
- [Fra08] A. Frabetti. Groups of tree-expanded series. *J. Algebra*, 319(1):377–413, 2008. [11](#), [68](#), [277](#), [314](#), [324](#), [326](#)
- [FS09] P. Flajolet and R. Sedgewick. *Analytic Combinatorics*. Cambridge University Press, 2009. [6](#), [23](#), [24](#), [111](#), [340](#)
- [Ful97] W. Fulton. *Young Tableaux, with Applications to Representation Theory and Geometry*. London Mathematical Society Student Texts. Cambridge University Press, 1997. [88](#)

- [GBV88] D. Gouyou-Beauchamps and X. Viennot. Equivalence of the two-dimensional directed animal problem to a one-dimensional path problem. *Adv. Appl. Math.*, 9(3):334–357, 1988. [148](#)
- [Ger63] M. Gerstenhaber. The cohomology structure of an associative ring. *Ann. Math.*, 78:267–288, 1963. [2](#), [81](#)
- [Get94] E. Getzler. Two-dimensional topological gravity and equivariant cohomology. *Commun. Math. Phys.*, 163(3):473–489, 1994. [18](#), [104](#), [213](#), [248](#)
- [Gir11] S. Giraudo. *Combinatoire algébrique des arbres*. PhD thesis, Université de Marne la Vallée, 2011. [8](#), [87](#), [131](#), [254](#)
- [Gir12a] S. Giraudo. Algebraic and combinatorial structures on pairs of twin binary trees. *J. Algebra*, 360:115–157, 2012. [87](#)
- [Gir12b] S. Giraudo. Algebraic and combinatorial structures on pairs of twin binary trees. *Journal of Algebra*, 360:115–157, 2012. [88](#)
- [Gir12c] S. Giraudo. Constructing combinatorial operads from monoids. *Formal Power Series and Algebraic Combinatorics*, pages 229–240, 2012. [131](#)
- [Gir12d] S. Giraudo. Construction d’opérades ensemblistes à partir de monoïdes. *C. R. Math.*, 350(11–12):549–552, 2012. [131](#)
- [Gir12e] S. Giraudo. Intervals of balanced binary trees in the Tamari lattice. *Theor. Comput. Sci.*, 420:1–27, 2012. [313](#), [329](#), [331](#), [340](#), [341](#)
- [Gir15] S. Giraudo. Combinatorial operads from monoids. *J. Algebr. Comb.*, 41(2):493–538, 2015. [16](#), [131](#)
- [Gir16a] S. Giraudo. Colored operads, series on colored operads, and combinatorial generating systems. [arXiv:1605.04697v1](#), 2016. [16](#), [313](#)
- [Gir16b] S. Giraudo. Operads from posets and Koszul duality. *Eur. J. Combin.*, 56C:1–32, 2016. [16](#), [189](#)
- [Gir16c] S. Giraudo. Pluriassociative algebras I: The pluriassociative operad. *Adv. Appl. Math.*, 77:1–42, 2016. [16](#), [153](#)
- [Gir16d] S. Giraudo. Pluriassociative algebras II: The polydendriform operad and related operads. *Adv. Appl. Math.*, 77:43–85, 2016. [16](#), [153](#)
- [Gir17a] S. Giraudo. Comb-algebraic structures on decorated cliques. *Formal Power Series and Algebraic Combinatorics*, 2017. [16](#), [211](#)
- [Gir17b] S. Giraudo. Operads of decorated cliques. [arXiv:1702.00217v1](#), 2017. [16](#), [211](#)
- [GK94] V. Ginzburg and M. M. Kapranov. Koszul duality for operads. *Duke Math. J.*, 76(1):203–272, 1994. [11](#), [95](#)
- [GK95] E. Getzler and M. M. Kapranov. Cyclic operads and cyclic homology. In *Geometry, topology, & physics*, Conf. Proc. Lecture Notes Geom. Topology, IV, pages 167–201. Int. Press, Cambridge, MA, 1995. [11](#), [100](#)
- [GKL+95] I.M. Gelfand, D. Krob, A. Lascoux, B. Leclerc, V.S. Retakh, and J.-Y. Thibon. Noncommutative symmetric functions I. *Adv. Math.*, 112, 1995. [10](#), [85](#), [153](#), [253](#), [278](#), [279](#)
- [GL01] J. Gordon and M. Liebeck. *Representations and Characters of Groups*. Cambridge University Press, 2nd edition, 2001. [6](#)
- [GLMN16] S. Giraudo, J.-G. Luque, L. Mignot, and F. Nicart. Operads, quasiorders, and regular languages. *Adv. Appl. Math.*, 75:56–93, 2016. [16](#), [343](#)
- [Glu61] V. M. Glushkov. The abstract theory of automata. *Russ. Math. Surv.*, 16:1–53, 1961. [356](#)
- [GR63] G. Th. Guilbaud and P. Rosenstiehl. Analyse algébrique d’un scrutin. *Mathématiques et sciences humaines*, tome 4:9–33, 1963. [8](#), [10](#), [37](#), [260](#)
- [GR16] D. Grinberg and V. Reiner. Hopf Algebras in Combinatorics. [arXiv:1409.8356v4](#), 2016. [10](#), [63](#)
- [GS84] F. Gécseg and M. Steinby. *Tree Automata*. Akadémia Kiadó, 1984. 2nd edition (2015) available at [arXiv:1509.06233 \[cs.FL\]](#). [313](#), [330](#), [341](#)
- [GV16] S. Giraudo and S. Vialette. Unshuffling Permutations. *Latin American Theoretical Informatics Symposium, LNCS*, 9644:509–521, 2016. [16](#), [301](#)
- [Har78] M. A. Harrison. *Introduction to formal language theory*. Addison-Wesley Publishing Co., Reading, Mass., 1978. [19](#), [313](#), [330](#), [341](#)
- [Hiv99] F. Hivert. *Combinatoire des fonctions quasi-symétriques*. PhD thesis, Université de Marne la Vallée, 1999. [8](#), [87](#), [90](#), [253](#), [254](#), [267](#)
- [Hiv03] F. Hivert. *An introduction to Combinatorial Hopf Algebras*. IOS Press, 2003. [87](#), [276](#)

- [HMU06] J. E. Hopcroft, R. Matwani, and J. D. Ullman. *Introduction to Automata Theory, Languages, and Computation*. Pearson, 3rd edition, 2006. 19, 313, 330, 341
- [HN07] F. Hivert and J. Nzeutchap. Dual graded graphs in combinatorial Hopf algebras, 2007. unpublished. 8, 87
- [HNT05] F. Hivert, J.-C. Novelli, and J.-Y. Thibon. The Algebra of Binary Search Trees. *Theor. Comput. Sci.*, 339(1):129–165, 2005. 4, 9, 10, 24, 37, 63, 87, 88, 153, 253, 335
- [Hof10] E. Hoffbeck. A Poincaré-Birkhoff-Witt criterion for Koszul operads. *Manuscripta Math.*, 131(1-2):87–110, 2010. 11, 95, 200
- [HRS12] D. Henshall, N. Rampersad, and J. Shallit. Shuffling and Unshuffling. *Bulletin of the EATCS*, 107:131–142, 2012. 306, 311
- [HT72] S. Huang and D. Tamari. Problems of associativity: A simple proof for the lattice property of systems ordered by a semi-associative law. *J. Comb. Theory. A*, 13:7–13, 1972. 36, 211
- [Joh63] S. Johnson. Generation of permutations by adjacent transposition. *Math. Comput.*, 17:282–285, 1963. 4
- [Joy81] A. Joyal. Une théorie combinatoire des séries formelles. *Adv. Math.*, 42(1):1–82, 1981. 23, 131
- [JR79] S. A. Joni and G.-C. Rota. Coalgebras and bialgebras in combinatorics. *Stud. Appl. Math.*, 61:93–139, 1979. 279
- [Kac90] V. G. Kac. *Infinite-Dimensional Lie Algebras*. Cambridge University Press, 3rd edition, 1990. 345
- [KB70] D. Knuth and P. Bendix. Simple word problems in universal algebras. In *Computational Problems in Abstract Algebra*, pages 263–297. Pergamon, Oxford, 1970. 39, 125
- [KLT97] D. Krob, B. Leclerc, and J.-Y. Thibon. Noncommutative symmetric functions II. Transformations of alphabets. *Int. J. Algebr. Comput.*, 7(2):181–264, 1997. 279
- [Knu97] D. Knuth. *The Art of Computer Programming, volume 1: Fundamental Algorithms*. Addison Wesley Longman, 3rd edition, 1997. 42
- [Knu98] D. Knuth. *The art of computer programming, volume 3: Sorting and searching*. Addison Wesley Longman, 1998. 3, 5, 12, 19, 24, 36, 37, 88, 97, 211, 253, 314, 335, 340
- [Koc09] J. Kock. *Notes on Polynomial Functors*. Unpublished, 2009. <http://mat.uab.es/~kock/cat/notes-on-polynomial-functors.html>. 23
- [KT97] D. Krob and J.-Y. Thibon. Noncommutative symmetric functions IV: Quantum linear groups and Hecke algebras at  $q = 0$ . *Journal Algebr. Comb.*, 6:339–376, 1997. 10, 89
- [KT99] D. Krob and J.-Y. Thibon. Noncommutative symmetric functions V: A degenerate version of  $U_q(\mathfrak{gl}_N)$ . *Int. J. Algebr. Comput.*, 3-4:405–430, 1999. 10, 89
- [Kup96] G. Kuperberg. Another proof of the alternating-sign matrix conjecture. *Int. Math. Res. Notices*, 3:139–150, 1996. 60, 254
- [Lab81] G. Labelle. Une nouvelle démonstration combinatoire des formules d’inversion de Lagrange. *Adv. Math.*, 42(3):217–247, 1981. 24
- [Laf03] Y. Lafont. Towards an algebraic theory of Boolean circuits. *J. Pure Appl. Algebra*, 184(2-3):257–310, 2003. 15, 107
- [Laf11] Y. Lafont. Diagram rewriting and operads. *Sémin. Congr.*, 26:163–179, 2011. 14, 58, 107
- [Las84] A. Lascoux. Fonctions symétriques. *Sém. Lothar. Combin.*, 8:37–58, 1984. 6
- [Lei04] T. Leinster. *Higher operads, higher categories*, volume 298 of *London Mathematical Society Lecture Note Series*. Cambridge University Press, Cambridge, 2004. 14, 63, 105, 277
- [Ler04] P. Leroux. Ennea-algebras. *J. Algebra*, 281(1):287–302, 2004. 80, 153
- [Ler07] P. Leroux. A simple symmetry generating operads related to rooted planar  $m$ -ary trees and polygonal numbers. *J. Integer Seq.*, 10(4):Article 07.4.7, 23, 2007. 80, 153
- [Ler11] P. Leroux. L-algebras, triplicial-algebras, within an equivalence of categories motivated by graphs. *Comm. Algebra*, 39(8):2661–2689, 2011. 122, 213
- [Liv06] M. Livernet. A rigidity theorem for pre-Lie algebras. *J. Pure Appl. Algebra*, 207(1):1–18, 2006. 138
- [LM06] M. Lohrey and S. Maneth. The complexity of tree automata and XPath on grammar-compressed trees. *Theor. Comput. Sci.*, 363(2):196–210, 2006. 342
- [LMN13] J.-G. Luque, L. Mignot, and F. Nicart. Some Combinatorial Operators in Language Theory. *J. Autom. Lang. Comb.*, 18(1):27–52, 2013. 18, 213, 247, 343, 348, 349, 351, 354

- [LN13] J.-L. Loday and N. M. Nikolov. Operadic construction of the renormalization group. In *Lie theory and its applications in physics*, volume 36 of *Springer Proc. Math. Stat.*, pages 191–211. Springer, Tokyo, 2013. [11](#), [68](#), [314](#), [324](#), [326](#)
- [Lod93] J.-L. Loday. Une version non commutative des algèbres de Lie : les algèbres de Leibniz. In *R.C.P. 25, Vol. 44*, volume 41 of *Prépubl. Inst. Rech. Math. Av.*, pages 127–151. Univ. Louis Pasteur, Strasbourg, 1993. [154](#)
- [Lod95] J.-L. Loday. Cup-product for Leibniz cohomology and dual Leibniz algebras. *Math. Scand.*, 77(2), 1995. [9](#), [63](#), [154](#), [185](#)
- [Lod96] J.-L. Loday. La renaissance des opérades. *Séminaire Bourbaki*, 37(792):47–74, 1996. [10](#)
- [Lod01] J.-L. Loday. Dialgebras. In *Dialgebras and related operads*, volume 1763 of *Lecture Notes in Math.*, pages 7–66. Springer, Berlin, 2001. [6](#), [9](#), [13](#), [17](#), [63](#), [79](#), [103](#), [132](#), [150](#), [151](#), [153](#), [154](#), [155](#), [161](#), [162](#), [179](#), [185](#), [186](#), [190](#), [245](#)
- [Lod02] J.-L. Loday. Arithmetree. *J. Algebra*, 258(1):275–309, 2002. Special issue in celebration of Claudio Procesi’s 60th birthday. [80](#)
- [Lod06] J.-L. Loday. Completing the operadic butterfly. *Georgian Math. J.*, 13(4):741–749, 2006. [154](#), [179](#), [186](#)
- [Lod08] J.-L. Loday. Generalized bialgebras and triples of operads. *Astérisque*, 320:x+116, 2008. [6](#), [63](#), [82](#), [102](#), [128](#), [154](#), [181](#)
- [Lod10] J.-L. Loday. On the operad of associative algebras with derivation. *Georgian Math. J.*, 17(2):347–372, 2010. [102](#), [103](#), [186](#), [212](#), [220](#), [245](#)
- [Lot02] M. Lothaire. *Algebraic combinatorics on words*. Encyclopedia of mathematics and its applications. Cambridge university press, New York, 2002. [6](#), [9](#), [10](#), [88](#), [212](#), [224](#), [253](#)
- [LPRR15] D. López, L.-F. Préville-Ratelle, and M. Ronco. Algebraic structures defined on  $m$ -Dyck paths. [arXiv:1508.01252v2](#), 2015. [17](#)
- [LR34] D. E. Littlewood and A. R. Richardson. Group characters and algebra. *Philos. T. Soc. A*, 233:99–141, 1934. [9](#)
- [LR98] J.-L. Loday and M. Ronco. Hopf Algebra of the Planar Binary Trees. *Adv. Math.*, 139:293–309, 1998. [4](#), [10](#), [24](#), [37](#), [63](#), [80](#), [87](#), [153](#)
- [LR02] J.-L. Loday and M. Ronco. Order Structure on the Algebra of Permutations and of Planar Binary Trees. *J. Algebr. Comb.*, 15(3):253–270, 2002. [37](#), [182](#)
- [LR03] J.-L. Loday and M. Ronco. Algèbres de Hopf colibres. *C. R. Math.*, 337(3):153–158, 2003. [18](#), [111](#), [122](#), [129](#), [213](#), [247](#)
- [LR04] J.-L. Loday and M. Ronco. Trialgebras and families of polytopes. In *Homotopy theory: relations with algebraic geometry, group cohomology, and algebraic K-theory*, volume 346 of *Contemp. Math.*, pages 369–398. Amer. Math. Soc., Providence, RI, 2004. [17](#), [80](#), [132](#), [151](#), [153](#), [154](#), [166](#), [183](#)
- [LR06] J.-L. Loday and M. Ronco. On the structure of cofree Hopf algebras. *J. Reine Angew. Math.*, 592:123–155, 2006. [18](#), [111](#), [122](#), [130](#), [177](#), [192](#), [247](#)
- [LR12] S. Law and N. Reading. The Hopf algebra of diagonal rectangulations. *J. Comb. Theory A*, 119(3):788–824, 2012. [87](#), [88](#)
- [LS81] A. Lascoux and M.-P. Schützenberger. Le monoïde plaxique. In *Noncommutative structures in algebra and geometric combinatorics (Naples, 1978)*, volume 109 of *Quad. “Ricerca Sci.”*, pages 129–156. CNR, Rome, 1981. [9](#), [10](#), [88](#)
- [LV12] J.-L. Loday and B. Vallette. *Algebraic Operads*, volume 346 of *Grundlehren der mathematischen Wissenschaften*. Springer, Heidelberg, 2012. [10](#), [11](#), [63](#), [80](#), [95](#), [181](#), [209](#), [324](#), [326](#)
- [Mac15] I. G. Macdonald. *Symmetric Functions and Hall Polynomials*. Oxford Classic Texts in the Physical Sciences. Oxford University Press, second edition, 2015. [7](#), [85](#), [153](#), [278](#), [279](#)
- [Man83] A. Mansfield. On the computational complexity of a merge recognition problem. *Discrete Appl. Math.*, 5:119–122, 1983. [301](#)
- [Man11] D. Manchon. A short survey on pre-Lie algebras. In *Noncommutative geometry and physics: renormalisation, motives, index theory*, ESI Lect. Math. Phys., pages 89–102. Eur. Math. Soc., Zürich, 2011. [2](#), [81](#)

- [Mar08] M. Markl. Operads and PROPs. In *Handbook of Algebra*, volume 5, pages 87–140. Elsevier/North-Holland, Amsterdam, 2008. [9](#), [10](#), [14](#), [18](#), [58](#), [63](#), [105](#), [277](#), [287](#), [293](#), [342](#)
- [May72] J. P. May. *The geometry of iterated loop spaces*. Springer-Verlag, Berlin-New York, 1972. Lectures Notes in Mathematics, Vol. 271. [10](#), [90](#)
- [ML65] S. Mac Lane. Categorical algebra. *Bull. Amer. Math. Soc.*, 71:40–106, 1965. [14](#), [105](#), [277](#), [342](#)
- [ML14] M. Méndez and J. Liendo. An antipode formula for the natural Hopf algebra of a set operad. *Adv. Appl. Math.*, 53:112–140, 2014. [18](#), [277](#), [280](#)
- [MN93] M. Méndez and O. Nava. Colored species,  $c$ -monoids, and plethysm I. *J. Comb. Theory A*, 64(1):102–129, 1993. [131](#)
- [Mot48] Th. Motzkin. Relations between hypersurface cross ratios, and a combinatorial formula for partitions of a polyion, for permanent preponderance, and for non-associative products. *Bull. Amer. Math. Soc.*, 54:352–360, 1948. [212](#), [227](#)
- [MPRS79] R. E. Miller, N. Pippenger, A. L. Rosenberg, and L. Snyder. Optimal 2,3-Trees. *SIAM J. Comput.*, 8:42–59, 1979. [314](#)
- [MR95] C. Malvenuto and C. Reutenauer. Duality between quasi-symmetric functions and the Solomon descent algebra. *J. Algebra*, 177(3):967–982, 1995. [5](#), [10](#), [87](#), [153](#), [253](#), [286](#)
- [MRR83] W.H. Mills, D.P. Robbins, and H. Jr. Rumsey. Alternating sign matrices and descending plane partitions. *J. Comb. Theory A*, 34:340–359, 1983. [18](#), [60](#), [254](#), [271](#)
- [MY91] M. Méndez and J. Yang. Möbius Species. *Adv. Math.*, 85(1):83–128, 1991. [11](#), [17](#), [138](#), [189](#), [209](#)
- [Mé15] M. A. Méndez. *Set operads in combinatorics and computer science*. SpringerBriefs in Mathematics. Springer, Cham, 2015. [10](#), [23](#), [63](#)
- [Nar55] T.V. Narayana. Sur les treillis formés par les partitions d’un entier et leurs applications à la théorie des probabilités. *C. R. Acad. Sci. Paris*, 240:1188–1189, 1955. [46](#)
- [New42] M. H. A. Newman. On theories with a combinatorial definition of “equivalence.”. *Ann. Math.*, 43(2):223–243, 1942. [39](#)
- [Nov14] J.-C. Novelli.  $m$ -dendriform algebras. [arXiv:1406.1616v1](#), 2014. [80](#), [153](#)
- [NT06] J.-C. Novelli and J.-Y. Thibon. Polynomial realizations of some trialgebras. *Formal Power Series and Algebraic Combinatorics*, 2006. [253](#)
- [NT07] J.-C. Novelli and J.-Y. Thibon. Hopf algebras and dendriform structures arising from parking functions. *Fund. Math.*, 193:189–241, 2007. [87](#), [253](#)
- [NT10] J.-C. Novelli and J.-Y. Thibon. Free quasi-symmetric functions and descent algebras for wreath products, and noncommutative multi-symmetric functions. *Discrete Math.*, 310(24):3584–3606, 2010. [89](#), [253](#), [265](#)
- [NT13] J.-C. Novelli and J.-Y. Thibon. Duplicial algebras and Lagrange inversion. [arXiv:1209.5959v2](#), 2013. [42](#)
- [NT14] J.-C. Novelli and J.-Y. Thibon. Hopf Algebras of  $m$ -permutations,  $(m + 1)$ -ary trees, and  $m$ -parking functions. [arXiv:1403.5962v2](#), 2014. [8](#), [87](#)
- [PR85] A. Proskurowski and F. Ruskey. Binary tree gray codes. *J. Algorithms*, 6(2):225–238, 1985. [4](#)
- [PR95] S. Poirier and C. Reutenauer. Algèbres de Hopf de tableaux. *Ann. Sci. Math. Québec*, 19:79–90, 1995. [10](#), [87](#)
- [Rea05] N. Reading. Lattice congruences, fans and Hopf algebras. *J. Comb. Theory A*, 110(2):237–273, 2005. [88](#)
- [Ree58] R. Ree. Lie elements and an algebra associated with shuffles. *Ann. Math.*, 68(2):210–220, 1958. [81](#), [153](#)
- [Reu93] C. Reutenauer. *Free Lie algebras*. Clarendon Press, 1993. [2](#), [63](#)
- [Rey07] M. Rey. Algebraic constructions on set partitions. *Formal Power Series and Algebraic Combinatorics*, 2007. [87](#), [89](#)
- [Rot64] G.-C. Rota. On the foundations of combinatorial theory. I. Theory of Möbius functions. *Z. Wahrscheinlichkeit*, 2:340–368, 1964. [70](#)
- [Rus04] F. Ruskey. *Combinatorial Generation*. Preliminary working draft, 2004. [4](#)
- [RV13] R. Rizzi and S. Vialette. On Recognizing Words That Are Squares for the Shuffle Product. In A.A. Bulatov and A.M. Shur, editors, *8th International Computer Science Symposium in Russia, CSR 2013, Ekaterinburg, Russia*, pages 235–245, 2013. [19](#), [301](#), [303](#), [304](#), [308](#), [311](#)



- [Ryt04] W. Rytter. Grammar compression, Z-encodings, and string algorithms with implicit input. In *Automata, languages and programming*, volume 3142 of *Lect. Notes Comput. Sci.*, pages 15–27. Springer, Berlin, 2004. 342
- [Ré85] J.-L. Rémy. Un procédé itératif de dénombrement d'arbres binaires et son application à leur génération aléatoire. *RAIRO-Theor. Inf. Appl.*, 19(2):179–195, 1985. 6
- [Sak09] J. Sakarovitch. *Elements of Automata Theory*. Cambridge University Press, 2009. 68, 317, 318, 322, 341, 352
- [Sch61] C. Schensted. Longest increasing and decreasing subsequences. *Canadian J. Math.*, 13:179–191, 1961. 9, 88, 212, 224, 253, 341
- [Sch63] M. P. Schützenberger. Certain elementary families of automata. In *Proc. Sympos. Math. Theory of Automata (New York, 1962)*, pages 139–153. Polytechnic Press of Polytechnic Inst. of Brooklyn, Brooklyn, New York, 1963. 341
- [Slo] N. J. A. Sloane. The On-Line Encyclopedia of Integer Sequences. <https://oeis.org/>. 33, 45, 46, 55, 90, 121, 123, 142, 148, 151, 156, 167, 171, 178, 184, 197, 217, 224, 225, 226, 227, 228, 234, 237, 238, 244, 256, 257, 261, 262, 265, 266, 272, 274, 275, 290, 295, 303, 306, 308, 328, 329, 349, 350, 351
- [Soi10] A. Soifer. *Ramsey Theory: Yesterday, Today, and Tomorrow*. Birkhäuser, 2010. 6
- [Spe86] J.-C. Spehner. Le calcul rapide des melanges de deux mots. *Theor. Comput. Sci.*, 47:181–203, 1986. 301
- [SS78] A. Salomaa and M. Soittola. *Automata-theoretic aspects of formal power series*. Springer-Verlag, New York-Heidelberg, 1978. Texts and Monographs in Computer Science. 68, 317
- [SS82] J. A. Storer and T. G. Szymanski. Data compression via textual substitution. *J. Assoc. Comput. Mach.*, 29(4):928–951, 1982. 342
- [SS85] R. Simion and F. W. Schmidt. Restricted permutations. *Eur. J. Combin.*, 6(4):383–406, 1985. 308
- [ST09] P. Salvatore and R. Tauraso. The operad Lie is free. *J. Pure Appl. Algebra*, 213(2):224–230, 2009. 248
- [Sta99] R. P. Stanley. *Enumerative Combinatorics*, volume 2. Cambridge University Press, 1999. 6
- [Sta11] R. P. Stanley. *Enumerative Combinatorics*, volume 1. Cambridge University Press, 2nd edition edition, 2011. 33, 70
- [Ste64] H. Steinhaus. *One hundred problems in elementary mathematics*. Basic Books, Inc., Publishers, New York, 1964. 4
- [Tak71] M. Takeuchi. Free Hopf algebras generated by coalgebras. *J. Math. Soc. Jpn*, 23(4):561–582, 1971. 282
- [Tam62] D. Tamari. The algebra of bracketings and their enumeration. *Nieuw Arch. Wisk.*, 10(3):131–146, 1962. 10, 36, 211
- [Tro62] H. Trotter. Algorithm 115: Perm. *Commun. ACM*, 5(8):434–435, 1962. 4
- [Val07] B. Vallette. Homology of generalized partition posets. *J. Pure Appl. Algebra*, 208(2):699–725, 2007. 11, 17, 99, 189, 209
- [Var14] Y. Vargas. Hopf algebra of permutation pattern functions. *Formal Power Series and Algebraic Combinatorics*, pages 839–850, 2014. 19, 301, 304, 311
- [vdL04] P. van der Laan. *Operads. Hopf algebras and coloured Koszul duality*. PhD thesis, Universiteit Utrecht, 2004. 11, 18, 68, 277, 280, 314, 324, 326
- [Vie86] X. Viennot. Heaps of pieces. I. Basic definitions and combinatorial lemmas. In *Combinatoire énumérative*, volume 1234 of *Lect. Notes Math.*, pages 321–350. Springer, 1986. 18, 278, 294
- [Vin63] È. B. Vinberg. The theory of homogeneous convex cones. *Trudy Moskov. Mat. Obšč.*, 12:303–358, 1963. 2, 81
- [vLN82] J. van Leeuwen and M. Nivat. Efficient Recognition of Rational Relations. *Inform. Process. Lett.*, 14(1):34–38, 1982. 301
- [Yau16] D. Yau. *Colored Operads*. Graduate Studies in Mathematics. American Mathematical Society, 2016. 11, 98
- [YO69] T. Yanagimoto and M. Okamoto. Partial orderings of permutations and monotonicity of a rank correlation statistic. *Ann. I. Stat. Math.*, 21:489–506, 1969. 8, 10, 37
- [Zei96] D. Zeilberger. Proof of the alternating sign matrix conjecture. *Electron. J. Comb.*, 3(2), 1996. Paper 13. 60

- [Zin12] G. W. Zinbiel. Encyclopedia of types of algebras 2010. In *Operads and universal algebra*, volume 9 of *Nankai Ser. Pure Appl. Math. Theoret. Phys.*, pages 217–297. World Sci. Publ., Hackensack, NJ, 2012. [18](#), [101](#), [111](#), [122](#), [128](#), [129](#), [130](#), [186](#), [190](#), [213](#), [247](#)
- [ZL78] J. Ziv and A. Lempel. Compression of individual sequences via variable-rate coding. *IEEE T. Inform. Theory*, 24(5):530–536, 1978. [342](#)





# Operads in algebraic combinatorics

Opérades en combinatoire algébrique

**Samuele Giraudo**

*2010 Mathematics Subject Classification.* 05A15, 05C05, 05E15, 16T05, 18D50, 68Q42.

*Key words and phrases.* Algebraic combinatorics; Computer science; Formal power series; Tree; Rewrite system; Poset; Operad; Colored operad; Hopf bialgebra; Pro.

**ABSTRACT.** This habilitation thesis fits in the fields of algebraic and enumerative combinatorics, with connections with computer science. The main ideas developed in this work consist in endowing combinatorial objects (words, permutations, trees, integer partitions, Young tableaux, *etc.*) with operations in order to construct algebraic structures. This process allows, by studying algebraically the structures thus obtained (changes of bases, generating sets, presentations by generators and relations, morphisms, representations), to collect combinatorial information about the underlying objects. The algebraic structures the most encountered here are magmas, posets, associative algebras, dendriform algebras, Hopf bialgebras, operads, and pros.

This work explores the aforementioned research direction and provides many (functorial or not) constructions having the particularity to build algebraic structures on combinatorial objects. We develop for instance a functor from nonsymmetric colored operads to nonsymmetric operads, from monoids to operads, from unitary magmas to nonsymmetric operads, from finite posets to nonsymmetric operads, from stiff pros to Hopf bialgebras, and from precompositions to nonsymmetric operads. These constructions bring alternative ways to describe already known structures and provide new ones, as for instance, some of the deformations of the noncommutative Faà di Bruno Hopf bialgebra of Foissy and a generalization of the dendriform operad of Loday.

We also use algebraic structures to obtain enumerative results. In particular, nonsymmetric colored operads are promising devices to define formal series generalizing the usual ones. These series come with several products (for instance a pre-Lie product, an associative product, and their Kleene stars) enriching the usual ones on classical power series. This provides a framework and a toolbox to strike combinatorial questions in an original way.

The text is organized as follows. The first two chapters pose the elementary notions of combinatorics and algebraic combinatorics used in the whole work. The last ten chapters contain our original research results fitting the context presented above.