



HAL
open science

Modelling and environmental assessment of source separation scenarios for wastewater at district scale

Mathilde Besson

► **To cite this version:**

Mathilde Besson. Modelling and environmental assessment of source separation scenarios for wastewater at district scale. Chemical and Process Engineering. INSA de Toulouse, 2020. English. NNT : 2020ISAT0039 . tel-03340227

HAL Id: tel-03340227

<https://hal.science/tel-03340227v1>

Submitted on 19 Sep 2024

HAL is a multi-disciplinary open access archive for the deposit and dissemination of scientific research documents, whether they are published or not. The documents may come from teaching and research institutions in France or abroad, or from public or private research centers.

L'archive ouverte pluridisciplinaire **HAL**, est destinée au dépôt et à la diffusion de documents scientifiques de niveau recherche, publiés ou non, émanant des établissements d'enseignement et de recherche français ou étrangers, des laboratoires publics ou privés.



THÈSE

En vue de l'obtention du DOCTORAT DE L'UNIVERSITÉ DE TOULOUSE

Délivré par l'Institut National des Sciences Appliquées de
Toulouse

Présentée et soutenue par
Mathilde BESSON

Le 22 septembre 2020

**Modélisation et évaluation environnementale de scénarios de
séparation à la source des effluents domestiques à l'échelle du quartier**

**Modelling and environmental assessment of source separation scenarios for
wastewater at district scale**

Ecole doctorale : **MEGEP - Mécanique, Energétique, Génie civil, Procédés**

Spécialité : **Génie des Procédés et de l'Environnement**

Unité de recherche :

TBI - Toulouse Biotechnology Institute, Bio & Chemical Engineering

Thèse dirigée par

Mathieu SPERANDIO et Etienne PAUL

Jury

Présidente du Jury : **Mme Ligia Barna-Tiruta**, Examinatrice

Mme Anna Mikola, Rapporteur

M. Eberhard Morgenroth, Rapporteur

Mme Eléonore Loiseau, Examinatrice

M. Fabien Esculier, Examineur

M. Mathieu Spérandio, Directeur de thèse

M. Etienne Paul, Co-directeur de thèse

Abstract

Wastewater management is nowadays pushed towards resource recovery instead of only wastewater treatment. In the meantime, reducing the impact on the environment and especially on the climate change is also required. For this purpose, two approaches are currently considered: improvement of centralised wastewater treatment plant (WWTP) and source separation. In the latter, separating urine or blackwater in the housing allows to keep the high concentration and specific composition of each stream. Resource recovery is therefore easier to implement. However new questions arise, as all the wastewater management is modified. The choice of appropriate technical solutions (transport and treatments) is one of them. Another question is the influence of the urban context in which the systems are installed. A integrated modelling approach is therefore required to evaluate all the possibilities at urban scale. For this purpose, this study models different urban configurations representative of European cities and especially French ones. In these districts, the entire wastewater management has been modelled: separation with toilets, transport, treatments and reuse of products or discharge. Three different scenarios of source separation have been studied and compared to an advanced centralised WWTP with high recovery of nutrients and organic matter. Finally the results from the model have been coupled with a life cycle assessment in order to evaluate the environmental impact of each solution. Results showed that source separation can increase significantly the recovery rate of nitrogen which is difficult to recover in a WWTP. Separating nitrogen allows to reduce the impact on the climate change by decreasing the emission of nitrous oxide and producing nitrogen fertilisers and thus avoiding the production of conventional fertiliser. However the choice of the greywater treatment is critical for the climate change reduction potential, especially due to the related energy consumption. Urbanism has a strong impact on the environmental balance with a low improvement for a low built density due to the large contribution of sewer installation. Moreover, the increase of employee's number compared to inhabitants improves the environmental balance, by modifying the ratio COD/N/P and flowrate of treated flow.

Keywords: Process Modelling, Life cycle assessment, Urban Sanitation, Source Separation, Resources recovery

Résumé

Le système de gestion des eaux usées urbaines actuel doit se transformer pour récupérer les ressources contenues dans les eaux usées, mais aussi diminuer son empreinte environnementale et notamment son impact sur le changement climatique. Pour cela deux optiques complémentaires sont actuellement étudiées : l'amélioration de la station d'épuration centralisée (STEP) et la séparation à la source. Cette dernière permet de conserver des flux concentrés et des compositions très spécifiques, simplifiant ainsi la valorisation de ces flux. Cependant cela a des conséquences sur l'ensemble de la filière avec des nouveaux transports et traitements à mettre en place. Les choix techniques sur ces aspects vont avoir une influence considérable sur l'efficacité des filières, tout comme les types d'urbanisme dans lesquels sont implantés les systèmes de séparation à la source. Une approche de modélisation intégrée s'avère donc indispensable pour accompagner l'évaluation approfondie de ces nouvelles filières au niveau urbain. Pour cela différentes configurations urbaines représentatives des quartiers de villes européennes et françaises ont été considérées. L'ensemble de la filière a été modélisé : la séparation au niveau des toilettes, le transport, les traitements, les rejets et la valorisation des sous-produits. Trois scénarios de séparation à la source ont été comparés à une station d'épuration centralisée qui récupère autant que possible les nutriments et la matière organique. La modélisation des systèmes techniques a été couplée à une analyse de cycle de vie (ACV) afin d'évaluer les impacts environnementaux de chaque solution. Cette étude a montré que la séparation à la source permet d'augmenter significativement les taux de récupération des nutriments et spécifiquement l'azote qui est difficilement capturable dans la station d'épuration. Les effets sur le changement climatique sont diminués par la valorisation de cet azote en engrais et la suppression partielle des émissions de protoxyde d'azote, puissant gaz à effet de serre. Cependant le choix des traitements décentralisés des eaux grises peut nuancer cette conclusion à cause de leur consommation énergétique. De plus, l'urbanisme impacte fortement le bilan environnemental, avec une amélioration des performances limitée pour les faibles densités du fait de la contribution importante des réseaux. L'augmentation de la part des employés vis-à-vis des habitants améliore le bilan environnemental en modifiant les débits et ratios COD/N/P des flux à traiter.

Mots-clés : Modélisation de procédés, Analyse de Cycle de Vie, Assainissement, Séparation à la source, Valorisation des ressources

Acknowledgments

This PhD thesis results from around 4 years of work and will remain a source of strong and happy memories! I would like to express my gratitude to the members of the reviewing committee: Mrs. Anna Mikola, Mr Eberhard Morgenroth, Mr. Fabien Esculier and Mrs Eléonore Loiseau. The time and the attention you have dedicated to read and comment this work and your question during the defense significantly improve the quality of this PhD thesis.

Un grand merci à mes directeurs de thèse Mathieu et Etienne. Durant tout ce travail, vous m'avez toujours fait confiance. Ce fut un grand plaisir de travailler ensemble. Avec des discussions scientifiques toujours aussi passionnantes : état transitoire du système ou son état finalisé ? Merci à vous deux pour votre réactivité et votre rapidité de compréhension qui seront toujours un exemple pour moi. Enfin, je vous remercie tout particulièrement pour m'avoir encouragé à me lancer dans la recherche et à m'aider à continuer ! Merci aussi à Ligia d'avoir toujours su trouver du temps pour suivre mon travail et me donner des conseils très pertinents.

Durant ces quatre années, j'ai croisé la route de nombreuses personnes que je souhaite remercier ! Un grand merci pour les doctorants du bureau international du hall GPE, en plus d'avoir grandement amélioré mon niveau d'anglais, ces bons moments resteront dans ma mémoire ! Un immense merci à Ana, Paul, Allan ! Un grand merci à toutes l'équipe EAD9 pour les moments d'échange, d'histoires et d'une ambiance si particulière ! On se rappellera de la drupe ou bien baie ? des torchons de la cafet, des matchs endiablés de badminton, des sorties canoës, de Garorock et de tous ces moments qui font que cette équipe est bien plus qu'un labo. Merci à Irène pour tous ces moments sur les toilettes et ta bonne humeur communicative, merci Matthieu pour ton humour noir et nos invectives si amicales et bienvenues ! merci à Erika, Léa, Sidonie, Yan... Je ne peux malheureusement pas citer toute l'équipe mais le cœur y est et je vous dis encore une fois un grand merci !

Cette thèse s'est aussi déroulée dans les locaux de Le Sommer Environnement à Bordeaux, un grand merci à toute l'équipe et à leur gentillesse pour m'avoir accueilli pendant plus de 2 ans. Cette cohabitation aura été pour moi l'occasion d'ouvrir mes horizons au monde de la construction. Merci Pauline, Régis, Olivier, Jean-Christophe et Michel pour avoir fait de cet épisode bordelais une parenthèse bienvenue et annonciatrice de la suite de ma vie.

Enfin un immense merci à Kévin qui m'a toujours soutenue même dans les moments les plus durs et même si pour toi aussi ce n'était pas facile ! Merci à toute ma famille qui a regardé ce travail de loin mais qui m'a encouragée et soutenue ! Ca y est, Vincent, tu pourras enfin dire que ta petite sœur est docteure !

Contents

Abstract	I
Résumé	III
Acknowledgments.....	V
Contents.....	VII
List of abbreviations.....	XI
General introduction.....	1
Chapter I. Where are we with source separation systems and with their evaluation?.....	5
I. Introduction	7
II. Definition of source separation sanitation through bibliometric analysis	8
II.1 Methodology	8
II.2 Results	9
II.3 Conclusion on bibliometric analysis	16
III. Pilot project of source separation since 90' years	18
III.1 Historical horizon of pilot projects	18
III.2 Achievements and challenges	23
III.3 Conclusion on real pilot projects and comparison with bibliometric analysis	30
IV. Environmental, economic and societal assessment of source separation systems	32
IV.1 Urine source separation	33
IV.2 Separation of blackwater	35
IV.3 Greywater separation	36
IV.4 Societal analysis.....	37
IV.5 Conclusion	38
V. Scope and structure of the thesis	39
V.1 Challenges	39
V.3 Scope of the thesis.....	40
V.4 Structure of the following manuscript.....	40

Chapter II. Methodology of the decision support tool development	41
I. Introduction	43
I.1 Goals of the tool	43
I.2 Scope and approaches.....	43
II. General methodology.....	44
II.1 Sanitation modelling part	44
II.2 General methodology applied to analyse the scenarios.....	44
III. Description of the studied sanitation systems.....	47
III.1 General description	47
III.2 Reference	48
III.3 Source separation systems	48
IV. Model description.....	50
IV.1 LCA	50
IV.2 District modelling	52
IV.3 Influent production	57
IV.4 Transport.....	59
IV.5 Treatments	65
V. Sensitivity analysis	76
V.1 Random parameter in district generation	77
V.2 Influent generation	80
VI. Conclusions	82
 Chapter III. Integrated environmental assessment of wastewater source separation scenarios for resource recovery	 83
I. Introduction	85
II. Methodology	87
II.1 District scale.....	89
II.2 Simulation of centralised WRRF	92
II.3 Link between LCA	93
II.4 LCA methodology.....	94
II.5 Results analysis	95
III. Results	96
III.1 Mass balance for the district	96
III.2 Energy balance.....	103
III.3 LCA result.....	108
IV. Discussion	116

IV.1 Source separation benefits from an integrated vision.....	116
IV.2 Possible directions for optimisation and future research	117
V. Conclusion	119
Chapter IV. Impact of urbanism and scale-up on source separation systems.	121
I. Introduction	123
II. Methodology	125
II.1 Scenario description	125
II.2 Functional unit.....	126
II.3 Reference flows	126
II.4 General methodology	127
III. Results	128
III.1 Inventory	128
III.2 LCA results	136
IV. Discussion	145
IV.1 Main findings.....	145
IV.2 Uncertainties and sensitivity to energy consumption.	146
IV.3 Perspectives and alternative scenarios	147
V. Conclusions.....	148
Chapter V. Discussion on sensitivity and optimisation.....	149
I. Optimisation for all scenario	151
II. Optimisation of urine scenario	152
III. Optimisation of blackwater management and heat demand	153
III.1 Sensitivity analysis on energy for vacuum sewer consumption	153
III.2 Heat demand optimisation	154
IV. Optimisation of greywater treatment and water reclamation	157
IV.1 MBR energy consumption.....	158
IV.2 Alternative extensive treatment	158
IV.3 About the benefit of substituting potable water production	160
IV.4 Water reuse potential	160
V. Conclusion	162

Chapter VI. Conclusion and perspectives	163
I. Conclusion.....	165
II. Perspectives.....	167
II.1 Improvement of the tool.....	167
II.2 Recommendation and future needs	168
II.3 Integration of the tool in research and society demand.....	169
Scientific production	171
III. Scientific papers published in international and peer reviewed journals	171
III.1 From previous work in the same topic:.....	171
III.2 In preparation	171
IV. Conferences with abstract	172
References	173
List of tables and figures.....	187
Appendices	193

List of abbreviations

AD: Anaerobic digester
AER: Aerated tank
ANAER: Anaerobic tank
ANOX: Anoxic tank
BioP: Biological removal of phosphorus
BNR: biological nutrients removal
BOD5: Biological oxygen demand after 5 days
BW: Scenario with blackwater separation and decentralised treatment, greywater are treated in the centralised wastewater treatment plant.
BW-GW: Scenario with blackwater and greywater separation with decentralised treatment.
CB: Urban configuration of continuous buildings
CC: Urban configuration of city centre
CH₄: Methane
CO₂: Carbone dioxide
CP: Urban configuration of continuous pavilions
DB: Urban configuration of discontinuous buildings
DCO: Chemical oxygen demand
Denit: Denitrification
DP: Urban configuration of discontinuous pavilions
DW: Sludge dewatering
GHG: Greenhouse gas
HT: Urban configuration of high-rise tower.
LCA: Life cycle assessment
MBR: Membrane bioreactor
N: Nitrogen
N₂O: Nitrous oxide
NaOH: caustic soda
Nit: Nitrification
P: Phosphorus
PAER: Post aerobic tank
PANOX: Pots anoxic tank
PE: Population equivalent (60 gBOD₅/day)

List of abbreviations

PPT STR: Struvite precipitation reactor

PRIM: Primary clarifier

PTHK: sludge thickening after anaerobic digestion

SEC: Secondary clarifier

THK: Sludge thickening before anaerobic digestion

TMCS: Transmembrane chemisorption (nitrogen recovery process)

UASB: Upflow anaerobic sludge blanket

WRRF: Wastewater resources recovery facility

WWTP: Wastewater treatment plant

General introduction

Around the globe, more than 80 % of the generated wastewater are discharged without treatment causing environmental damage on freshwater and marine ecosystems but also on human health. Faecal contamination of tap water resources was indeed responsible of 800 000 death in 2012 (WWAP, 2017).

In the meantime, water scarcity increases around the world with, in the 2000s, 58 % of the global population suffering from water scarcity. (Kummu et al., 2016).

Besides population growth, and increase of water withdrawals due to lifestyle, global warming is also responsible of part of this increase. For instance in South West of France, the scenario “Garonne 2050” of (Lhuissier et al., 2016), estimates a temperature increase between 0.5 °C and 3.5 °C leading to a decrease of river flowrate from 20 % to 40 % and even 50 % during summer period for South West of France.

Moreover, water is not the only limited resource that 21st century has to deal with. (Steffen et al., 2015) proposed a new framework for estimating the impact of anthropogenic activities on the environmental state of Earth. They introduced nine planetary boundaries which, if exceeded, can threaten the stability of Holocene state. From the nine thresholds, four have already been exceeded: i) rate of biodiversity loss, ii) human interference with nitrogen cycle iii) land-system change and vi) climate change. Modern agriculture is responsible of disturbance on nitrogen and phosphorus cycles with a significant increase of active nitrogen forms, which have impact on eutrophication and on marine biodiversity. Phosphorus is a mineral component with limited easily accessible resources and therefore recycling should be a significant pathway of management.

Therefore in this context of several crises, it is necessary to apply circular economy principle in order to limit the effect of each issue already mentioned. Wastewater management should be part of this global framework. (WWAP, 2017) stated that wastewater should not only be seen as a “waste” but also as a resource as they are indeed composed of water and nutrients. For instance phosphorus from urine and faeces can support 22 % of global demand of phosphate fertiliser (Mihelcic et al., 2011). Obviously, these efforts need to be conducted jointly with the increase of treatment capacity around the globe to achieve the Goal 6 Clean Water and sanitation of sustainable development goals proposed by United Nations. At horizon 2030, goal 6.3 is to *“improve water quality by reducing pollution, eliminating dumping and minimizing release of hazardous chemicals and materials, halving the proportion of untreated wastewater and substantially increasing recycling and safe reuse globally”* and 6.2 *“achieve access to adequate and equitable sanitation and hygiene for all and end open defecation”*.

Wastewater source separation is one of the investigated ways to achieve these goals. Indeed urine represents around 1 % of the produced volume of wastewater with 70-80 % of nitrogen and around 50 % of phosphorus (Larsen and Gujer, 1996). In the meantime the greywater (wastewater excluding water from toilets) is less contaminated by faecal residues and the handling is safer for water reuse. Source separation seems therefore to be a perfect candidate to wastewater resource recovery by limiting the dilution, mixing and contamination.

Several projects in Europe and around the globe have tested different configurations of source separation since the 1990s. In Europe urine separation and spreading into field was the first one and blackwater separation (wastewater from toilets) was introduced later on. In parallel several pilot projects tested greywater separation and reclamation. A large diversity of treatments has been implemented and even more are developed at laboratory scale.

New projects are limited by this high level of complexity and the number of choices to make without return on experiences. Indeed how to choose between three different separations, several treatments for each stream and even several recovery pathway? Decision support tools are indeed missing when wastewater management is involved and especially for resource oriented sanitation. And complete feasibility cannot be conducted for all the cases. Therefore a modelling tool that can evaluate the different scenarios is now required. It should help to make the right choice between the scenarios for each context. The tool needs to be sufficiently generic to model the entire wastewater management and all the scenarios. Moreover the decision is sensitive to the location where source separation is implemented, especially the urbanism. For instance sparse individual housing induces more pipe length to collect wastewater, and less space is available for decentralised treatment in highly dense neighbourhood. Therefore urban configuration should be considered in the model. Finally, scenarios should be evaluated based with relevant criteria as technical and economical, but also environmental criteria.

This decision support tool can, not only help the emergence of pilot projects, but also help to focus the research needs on relevant processes and bottlenecks, but also on the missing knowledge. Indeed by screening different processes, their environmental burden can be established. Ways of optimisation can be also highlighted. Finally, this methodology can help to focus the research on sensitive parameter and with high uncertainty.

The aim of this work was to create this decision support tool and use it to evaluate different scenarios of source separation. For this purpose, the Chapter I summarizes the literature review performed on source separation pilot projects and their evaluation. This review aims to give the challenges faced by evaluation tools in order to establish the scope of this study.

Chapter II presents the tool development and the methodology to analyse and evaluate source separation scenarios at district scale. Three options of wastewater management have been chosen and are presented with the relevant hypothesis.

Chapter III shows the results from the use of the tool on the different options of wastewater management. This chapter explores the environmental impacts of urine separation and blackwater separation compared to conventional sanitation. Only one urbanism was considered to focus first on the comparison on the performances of the type of source separation (urine or blackwater) and the location of the treatment (centralised or decentralised).

Chapter IV shows the results of the influence of urbanism on environmental assessment of each scenario. The effect of the size of the district is also investigated. Both results allow to conclude on the influence of both density and scale of implementation.

Chapter V is a general discussion on all the results highlighted by this work. This part aims to give a deeper insight on the potential of improvement of each scenario and the sensitive parameters where research should work on.

Conclusions and perspectives are given in Chapter VI.

Chapter I. Where are we with source separation systems and with their evaluation?

I. INTRODUCTION

Source separation is a sanitation system based on the separation of one or several flows. Wastewater is indeed the combination of several streams. The nomenclature of (Tilley et al., 2014) is used in this study (Figure I-1), where blackwater and greywater are distinguished as, respectively, wastewater from toilets and the remaining wastewater coming from washing food, clothes and dishware, as well as from bathing. Blackwater can be again divided into yellow water and brown water which are the combination of excreta, urine and faeces respectively, with flush water and cleansing material (mostly toilet paper in Europe).



Figure I-1: Nomenclature of domestic wastewater streams (adapted from (Tilley et al., 2014))

This sanitation appeared as a way to close the loop of nutrient and facilitate the treatment of wastewater, as urine contains around 70-80 % of nitrogen and around 50 % of phosphorus (Larsen and Gujer, 1996), for only 1 % of the volume. Urine is already a concentrated stream ready for nutrients recovery. Moreover blackwater and especially faeces contains around 50 % of the organic matter, allowing to think to an energetic recovery. Finally greywater have a close composition from wastewater but it is less contaminated by faecal pathogens. Water reuse is therefore simplified and more secure than from wastewater. In this way, separated stream have a specific composition that allows to implement more specific treatment for each stream and relevant compounds.

Even if this sanitation was quite largely performed in the Far-East and especially in China from 1000 years before Christ until the 20th century, the Europe sanitation presents a low circularity of resource from human excretion (Esculier, 2018). This concept have been rediscovered at the end of the 21st century and tested at laboratory scale but also at pilot scale. The knowledge gains by these experiments allowed researcher to make evaluation on both technical, economic and environmental aspects.

This first chapter intends to give an overview of these works performed from the past 30 years. In a first place an overview of the diversity of source separation systems in the world is given and especially in developed countries. Two different perspective is analysed: (1) the academic research have been analysed through a bibliometric analysis; (2) the realisations have been studied with the different pilot projects and their characteristics. In an intermediate section of discussion, the two different points of views are compared.

The third part of this chapter focuses on the evaluation of these systems to identify the lack of research. Finally the last part of this chapter is the definition of the research goals and the scope of this work and the description of the manuscript structure.

II. DEFINITION OF SOURCE SEPARATION SANITATION THROUGH BIBLIOMETRIC ANALYSIS

Bibliometric analysis aims to describe documents, their surroundings and up to the use of these documents (Norton, 2000). Information units are collected as authors, affiliation, publication year, citations or keywords... It allows to describe the mutation in a research field but also the spatial or temporal specifications.

II.1 Methodology

The first step of this kind of analysis is the creation of a corpus of publication representative of the goal of the study. Several databased are available as Web of Science®, Scopus™, SciFinder® and Google Scholar. In this study the Web of Science® have been used. Once the corpus is created, several analysis can be performed, (Eck and Waltman, 2014) highlighted three major analysis: 1) citation relationship, 2) keyword co-occurrence relationship, and 3) co-authorship relationship. The first one can be divided into direct citation relations, co-citation relation and bibliographic coupling relations. Each one are described below:

- Direct citation relationship exists between two publications if one cites the other one.
- Co-citation relationship exists between two publications if a third one cites both of them. The strength of the relationship depends on the number of third publication.
- Bibliographic coupling of two publications exists if they shared the same cited reference. The number of shared references will have an influence on the strength of the link.
- Keyword co-occurrence relationship is based on the number of time each keyword is used.
- Co-authorship relationship is between co-authors.

Each analysis has its strengths and drawbacks, and several need to be conducted to have the entire picture of the research field. For instance co-authorship helps to position the authors, the organisations of research and even the countries one to another. It gives the picture of who is working with who. It can be coupled with a timeline analysis to understand since when each groups is working on the field. Keywords occurrence highlights the subject of research and what are the connection. Finally citation relationship helps to highlight the key publications of the field. It can be the most used publications in the corpus, which favours automatically the older publication (co-citation relation). But it can also be the publication which gathered the most the field (bibliographic coupling relation). In this case the youngest publications are favoured as they can have more overlap. To perform all the analysis and visualise the results

the software VOSviewer developed by (Eck and Waltman, 2014; van Eck and Waltman, 2010) has been used.

However the relevance of these analysis depends on the quality of the corpus. The corpus needs to be the most exhaustive as possible from the studied topic but not containing too much publications related to another field.

In the case of source separation, there is a lack of common and normalised denomination. Several terms are used to describe the same phenomena or event. For example “urine collection” and “urine diversion” and used indifferently in publication, or “greywater” can be spelled in two words or with “graywater”. Moreover different concepts used the same terminology as “grey water footprint” which are related to the water resource and polluted water resources.

To take into account all these denominations, an iterative process has been followed to search if all the relevant documents previously identified with a conventional approach, were collected in the corpus. In order to create a more exhaustive corpus, the research has been modified as presented in Appendix I.1, to take into account homonyms. The research has been focused on several web of sciences categories (WC).

The corpus created with this research is composed of 1,877 publications. After a manual selection to remove non relevant elements, 1,766 documents have been analysed with 1,656 papers, 58 book chapters and 52 conference proceedings.

II.2 Results

The number publications per year (Figure I-2) shows that the first publication was in the 1990s but it is only from the years 2000 that there is a real increase in the number of publications on this topic. Urine and greywater are the two predominant topics with respectively 34 % and 39 % of the total number of publications of the corpus. Blackwater is less studied with only 6 % of the publications and 13 % when considering blackwater associated with greywater or urine.

Japan, Switzerland and Sweden were the first countries to publish in the 1990s however only Switzerland and Sweden was constant contributors along the years. The USA and China started later to investigate the field (in the middle of the 2000 years), but are now leaders in number of publications.

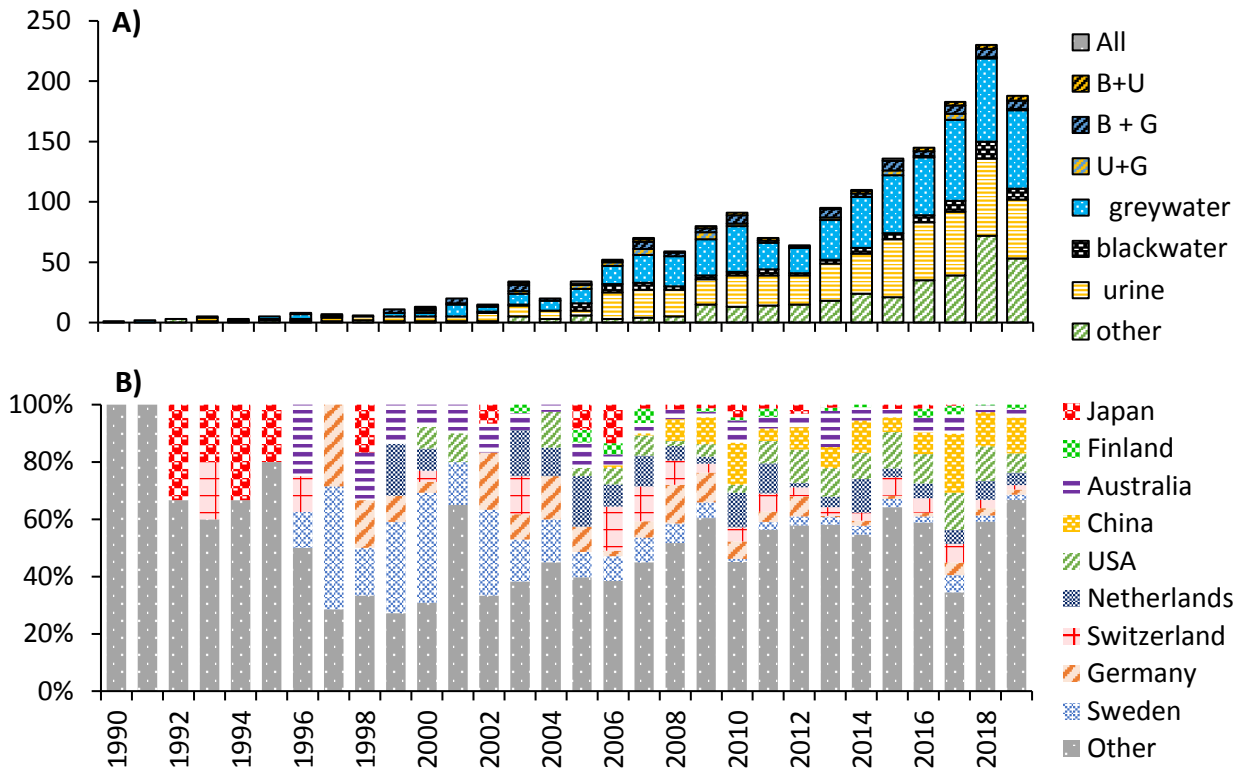

Figure I-2: Publication per year, A) with the subject treated (urine, blackwater and greywater concerns the publication with only one term, U+G: urine and greywater, B+G: blackwater and greywater, B+U: blackwater and urine, All: urine, blackwater and greywater. B) Contribution analysis, if international publication, the publication counts only as the ratio of number of countries.

The analysis of co-occurrence of keywords (Figure I-3) shows 4 clusters. The green and blue clusters are linked to urine and greywater studies respectively. The red clusters deals with the all system analysis and the last cluster (yellow) is linked to blackwater treatments with biogas production. This is in accordance with the analysis of publications per year for which blackwater is the less treated subject.

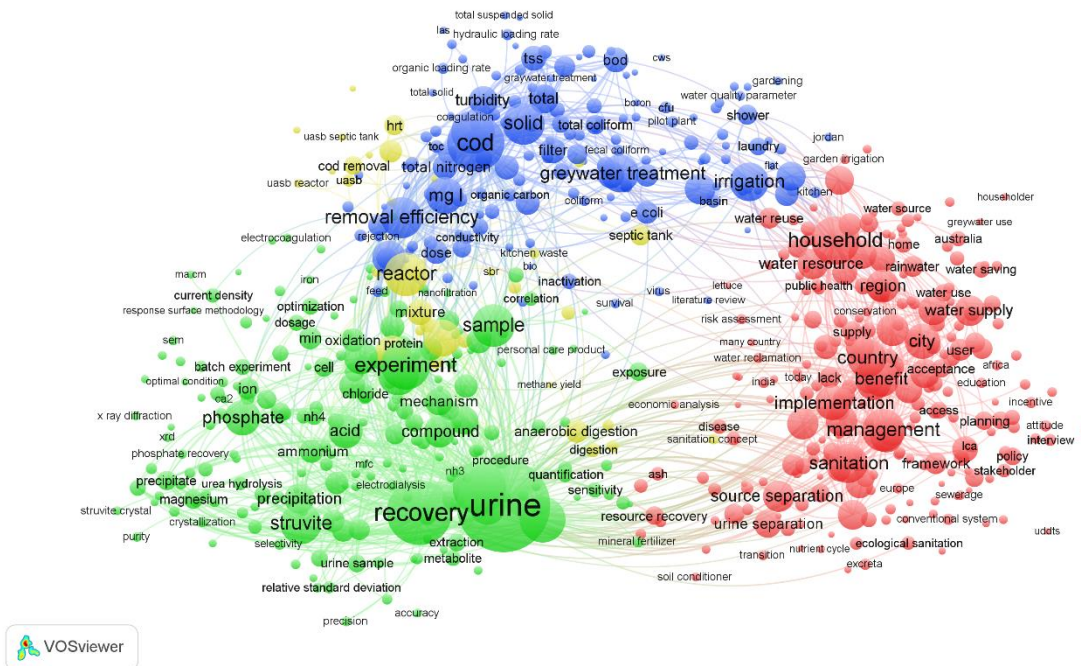

Figure I-3: Co-occurrence map of keywords established by authors and Web of Science®. (Binary counting: the number of occurrence of keyword in the article is not taken into account only the presence or absence)

As these topics of research are not clustered by theme, a specific study has been carried out by dividing the initial corpus into three sub-groups for which, title, keyword or abstract contain urine, blackwater, or greywater (and their homonyms). The three new corpus are described in Table I-1, overlapping is present in these three corpus, and the initial publications were not all retained.

Table I-1: Composition of the three studied corpus

	Blackwater	Urine	Greywater	Total
Total Number	214	622	804	1766
Journal	193	580	743	1656
Books	12	26	28	58
Conference	9	16	33	52

II.2.a Urine corpus

The corpus concerning urine is the second largest one, and the map of co-authorships (Figure I-4) shows a diversity of authors working on the topic. The Eawag institute in Switzerland is the major publisher with 12 % of the documents on urine with K. Udert and T. Larsen as major authors (5 % and 9 % of the publications). As shown by the colorimetric legend, this group works from the early beginning of source separation. In more recent years, they are linked to a group of research in Netherlands (G. Zeeman, CJN Buisman, P. Kuntke). As previously discussed, Germany and Sweden show also pioneer groups. However apparently German groups do not work on the subject anymore on the contrary of Sweden. China is the second country regarding the number of publications, however it seems that several groups of research work with few common publications. UK (with Parker A., and Tyrrel S.), and South Korea are two countries that started to study urine in the recent years. USA and especially the university

of Florida with Boyer, TH researcher, is also a leader on the topic with 2 % of the number of publications (partial counting, number of co-authors is taken into account).

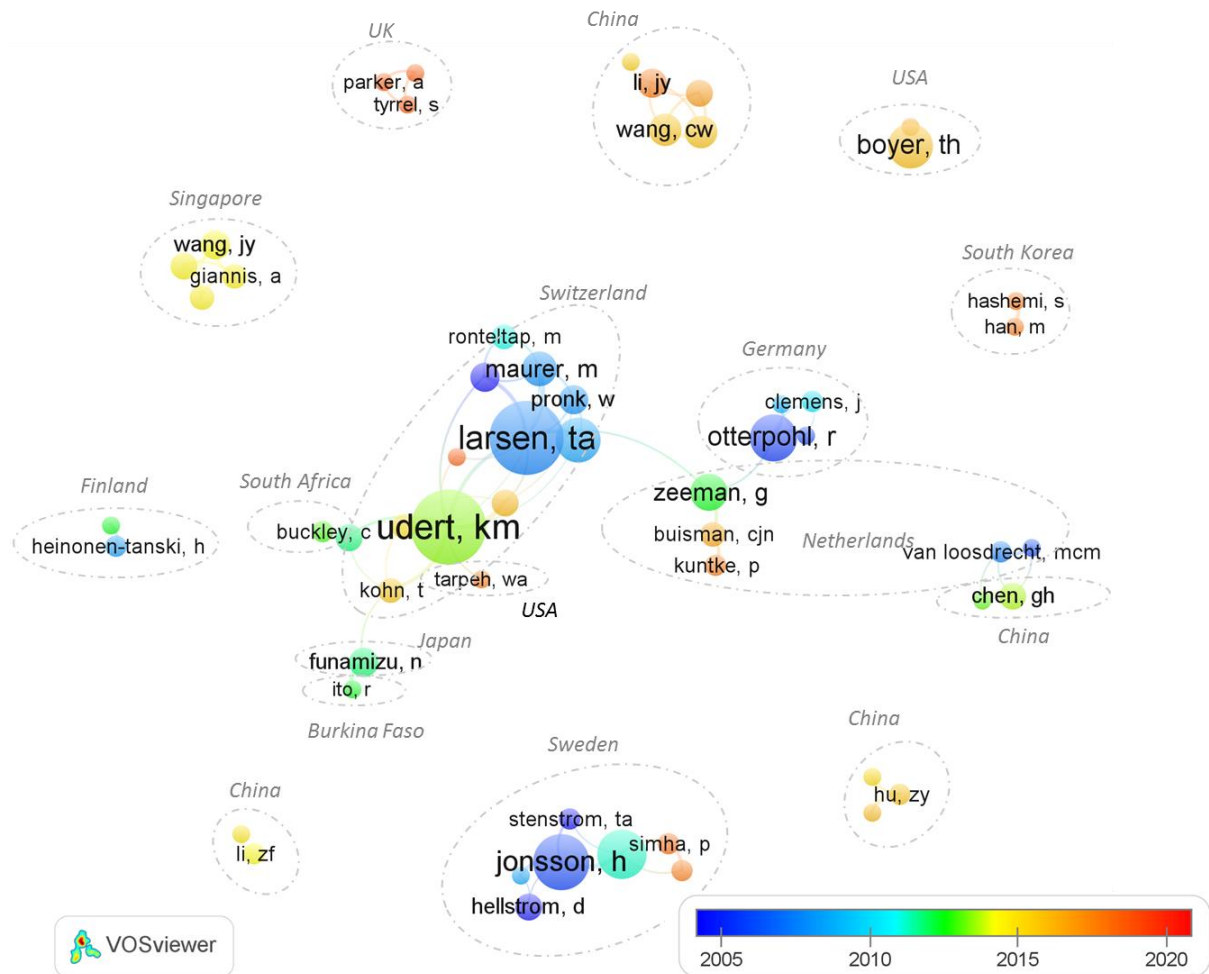

Figure I-4: Map of co-authorship with a minimum of 5 documents per author, with colorimetric scale of average publication year.

The main publications on the field can be distinguished thanks to the number of citations and also the co-citation links. A link exists between two publications if a third one cited both publications. The total link strength is the normalised sum of all the links. Table S 1 summarises the 10th highest rank publications with these two methodologies. The two major topics of research are the treatments to recover nutrients and the composition of urine. Nitrogen treatments and recovery have been compared by the Swiss team (Maurer et al., 2003; K. M. Udert et al., 2003; Udert and Wächter, 2012). Several treatments for nutrients recovery are compared in (Maurer et al., 2006).

The ecotoxicology of wastewater regarding pharmaceuticals is a subject highly cited but not in this corpus (Escher et al., 2011; Lienert et al., 2007b). In the same spirit the highest cited publication (Clarens et al., 2010) is related to algae however there is no link with the corpus, meaning that urine separation is part of the publication but the main aspect is not relevant for urine source separation.

Co-citation analysis tends to show older publications as they need to be cited by a third one later on. Bibliographic coupling analysis allows to highlight publications which shared references. The literature review citing the larger proportion of references in the topic will be highlighted. Table S 2 summarizes the 10th best references linked to this methodology. Without surprise, reviews represent a large part of it as they gathered most of the publication of the corpus. They discussed mostly on the feasibility of recover urine as fertiliser

II.2.b Blackwater corpus

The blackwater corpus shows four groups of researchers working together (Figure I-5). The largest research group linked together Netherlands and Germany thanks to co-writing with Elmitwalli from Egypt. Australia, Sweden and Norway-Slovenia are the three other clusters with few international works. Grietje Zeeman (Wageningen University from Netherlands) presents the highest number of publications and citations, with his involvement in 16 % of the corpus publications. Thanks to the Wageningen University and Wetsus institute, Netherlands holds 20 % of the total publications. Germany represents 13 % of the publications and 8 % for Sweden. One again Germany seems not to work anymore on the subject as the average publication year is around 2006. Norway and Australia are the new comers on the topic.

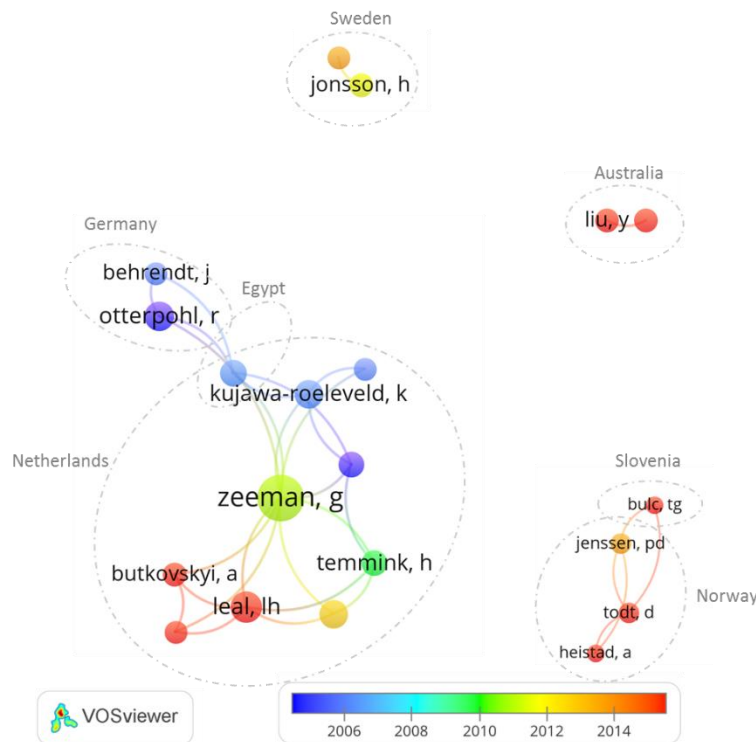

Figure I-5: Map of co-authorship link in the blackwater corpus, countries match the clusters, with colorimetric scale of average publication year. .

Most of the publications are related to treatment with anaerobic digestion and several processes are investigated as upflow anaerobic sludge blanket (UASB) and septic tank, or a hybrid UASB septic tank as the keyword co-occurrence map shows it (Figure I-6). The co-citation analysis on the document shows also that anaerobic digestion is the key development in this topic.

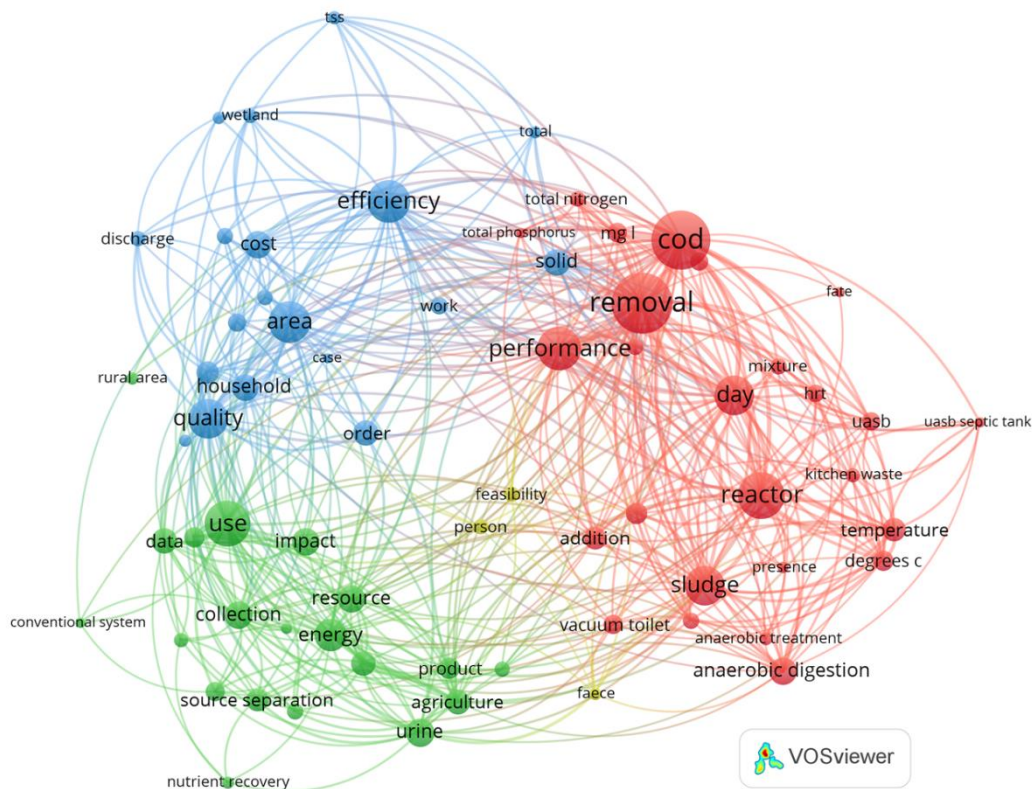

Figure I-6: Keyword co-occurrence map for blackwater corpus

Table S 3 shows a different picture from the field with publication related to the composition of blackwater but also other separated streams. Studies on the evaluation of full scale scenario are also an important part of the key publications from bibliographic coupling analysis (Table S 4 in appendix). Another interesting aspect of this analysis is the relative unknown authors compared to the first co-authorship analysis. The team of Hocaoglu from Turkey did not arise previously (Hocaoglu and Orhon, 2010a, 2010b) who worked on blackwater composition, as well as the Canadian team with Thibodeau (Thibodeau et al., 2014a, 2014b, 2011) who worked on environmental assessment and cost analysis of blackwater separation.

II.2.c Greywater corpus

On the contrary of urine and blackwater corpus, greywater is a topic fragmented in different countries and research teams (Figure I-7). There are links between UK and Greece, between China and Germany and between Japan and Burkina Faso, otherwise most researchers published within their own countries. Moreover, there is not a single researcher leader as for urine and blackwater field. The maximum share of documents per author is indeed 4 % of the corpus for Friedler (Israel), and 2 % for Zeeman (Netherlands), Otterpohl (Germany) and Gross (Israel). However USA and Australia are the main contributors of the topic with 10 % and 8 % of the publications. For both countries, researches have been led in the early 2005 years and continued later on in 2015 by another group of research with few links between them.

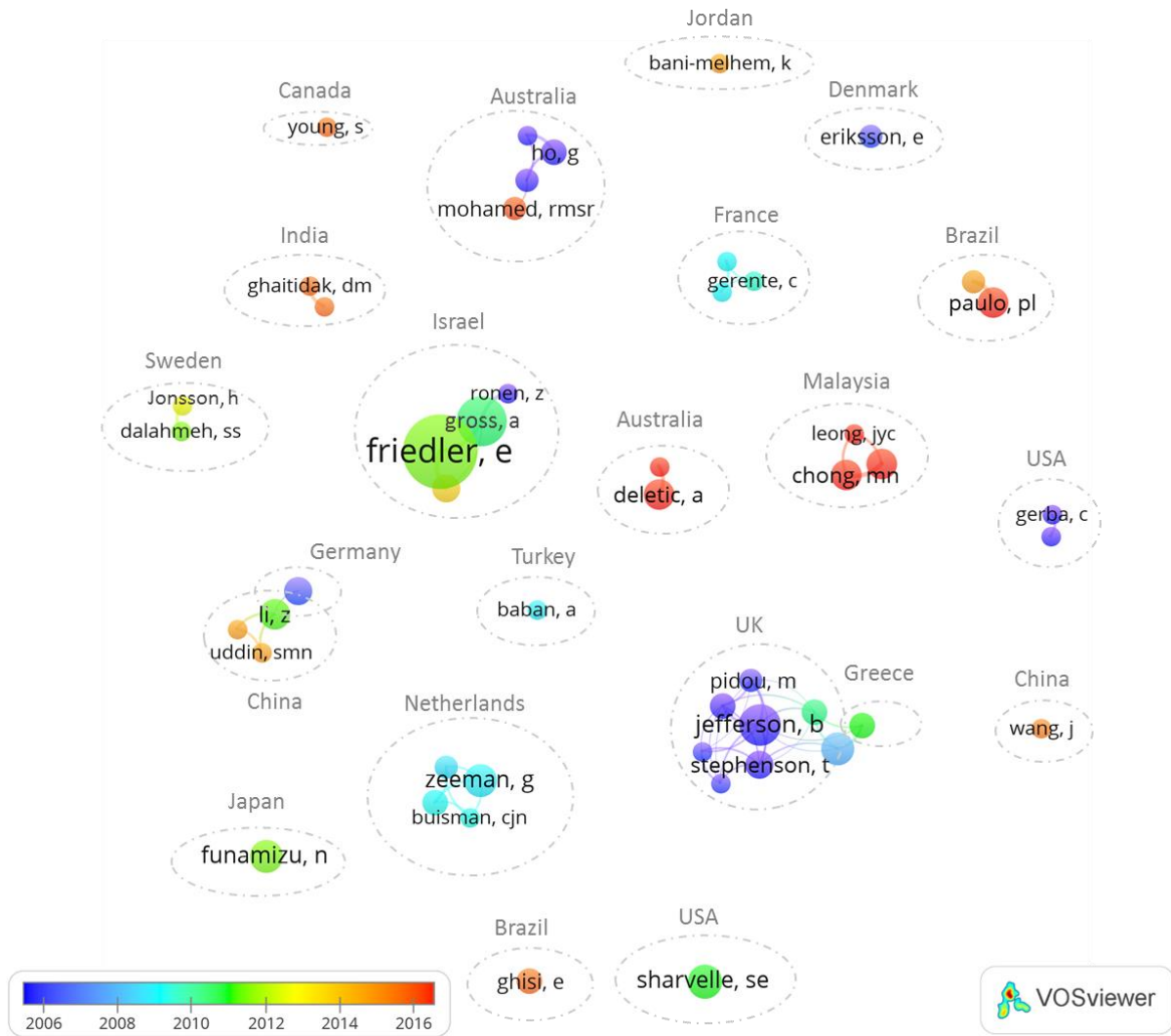

Figure I-7: Map of co-authorship link in the greywater corpus, with the country.

Concerning the topic of research, no separated clusters are observed from the keyword co-occurrence map (Figure I-8). This means that even if the groups of research are fragmented they all work on close topics. Nevertheless the clusters emerging from VOSViewer show the different treated subject, with greywater reuse and management (red), pathogens removal (blue), assessment study (green). Reuse of greywater is one of the most used keyword after greywater, showing the great interest on this topic.

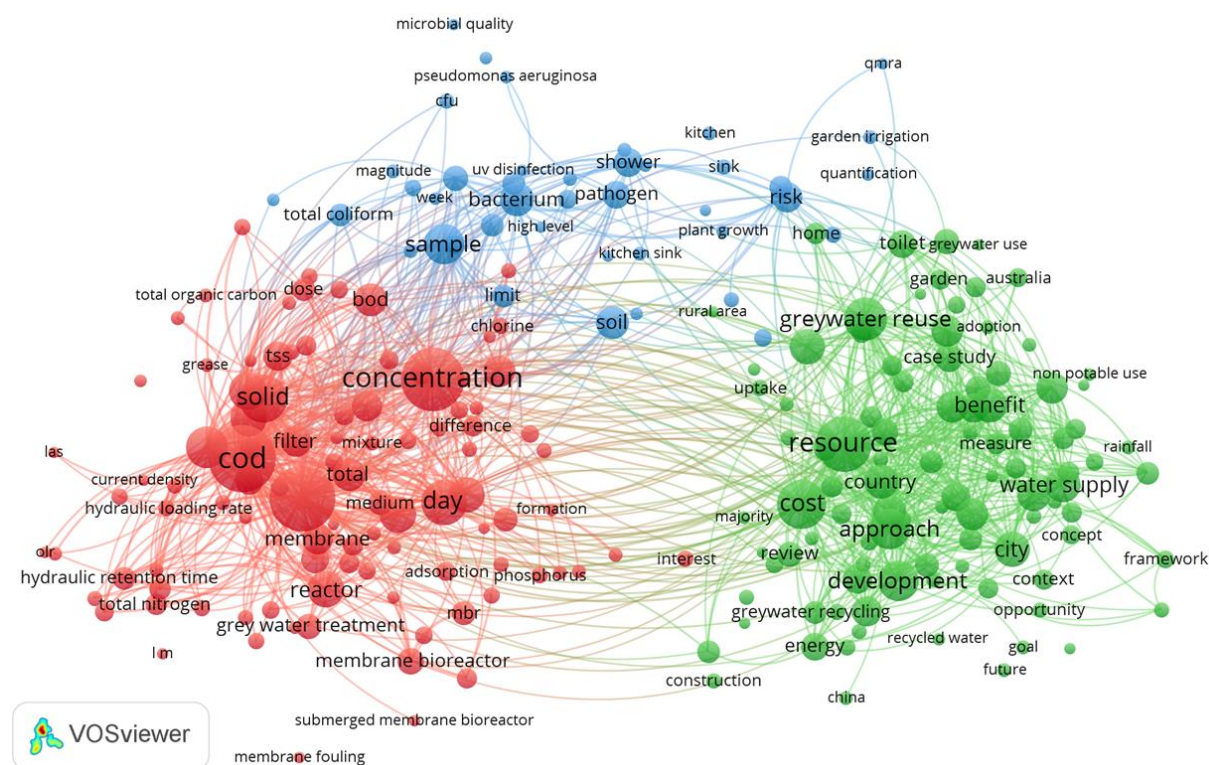

Figure I-8: Keyword co-occurrence map for greywater corpus

The most linked publications with a co-citation methodology (Table S 5) show again, that greywater reuse is the centre of research with their characterisation as well as their treatments to achieve water reclamation (Al-Jayyousi, 2003; Friedler et al., 2005; Li et al., 2009). Moreover, several publications are related to real case study showing the advance on this field close to large implementation (Friedler et al., 2005; Friedler and Hadari, 2006). Bibliographic coupling analysis (Table S 6 in appendix) shows the same trend with reuse and treatment. In both cases, disinfection and pathogen removal is also a topic of research.

II.3 Conclusion on bibliometric analysis

Bibliometric analysis shows the increasing interest for source separation in research world. Greywater is the predominant of research with the emphasis of water reclamation. Moreover this analysis shows the predominance of the research on urine upon blackwater, each topic is being treated by different groups of research. A few researchers are/were active in the different topic, as Zeemann or Otterpohl. If Switzerland and Sweden were the first countries for urine research, they are now joined by teams all around the world but still remains leaders.

Blackwater research is led by Netherlands and few other groups of research are observed from Norway, Sweden and Australia. Germany was the previous leader.

Greywater research is led by Israel, however a large number of research group are noticed (around 15) working in parallel with few collaboration.

Most of the publications are related to treatment of each stream and characterisation of the composition. Anaerobic digestion of blackwater is the most investigated treatment for blackwater. For urine several treatments have been studied especially for nutrients removal or

recovery. Concerning greywater, several publications deal with the implementation at full case, meaning that this approach is closer to commercialisation. Pathogens and micropollutants are naturally also an emerging topic for research.

TAKE HOME MESSAGE

- Urine, blackwater and greywater are three different sectors of research with few connections between them.
 - Greywater management is the largest topic in number of publication with a large dispersion in research groups and countries.
 - Urine is the second topic of research with different treatments for nutrient recovery. Switzerland and Sweden are being the two leader countries.
 - Blackwater is the last research field with leadership in Netherlands and a predominance of anaerobic digestion treatment.
-

III. PILOT PROJECT OF SOURCE SEPARATION SINCE 90' YEARS

III.1 Historical horizon of pilot projects

Projects have been set up and built all around the world to try and implement this source separation solutions. This part focuses on establishing a list of pilot projects with the following criteria:

- In developed countries characterised by a wastewater management already in place and a low demographic growth.
- At the scale of at least a small district are listed
- With a resource recovery
- Where researchers has been involved in the project to follow the scientific results. Some projects was launched by citizens and academic research joined them after the implementation, sometimes there started the project.

It is clear that this pilot projects reporting methodology will let several projects behind. This attempt should not be seen as exhaustive.

Among these experiments, three types can be distinguished: 1) urine source separation, 2) blackwater separation and finally 3) totally separated. A fourth scenario can be also observed, the greywater separation only. However as previously discussed, greywater separation and reuse is closer to real implementation than the other separation and a larger number of pilot projects have been launched. Therefore in this part the focus is given on source separation projects linked to human excreta.

When urine is separated, it is mixed with a variable amount of flush and can then be called yellow water. The grey and brown water are still mixed together. Blackwater separation leads to the separation of greywater. The totally separated systems ends up with three streams, yellow water, brown water and greywater. Other systems can be also found but with a less extend and will be discussed along this chapter.

Figure I-9 shows the history of implementation of source separation systems mostly in Europe. Urine source separation was extensively implemented from 1990 to 2005 at low scale, below 500 inhabitants. Totally separated systems have been tested but to a less extend, with only 5 projects on the 27 reported projects. From 2008, less projects was launched. However, an increase in scale of the following projects can be observed. We can assumed than more time for preparation is necessary. Due to the Great Recession from 2007 - 2012, a number of projects can have been postponed or cancelled.

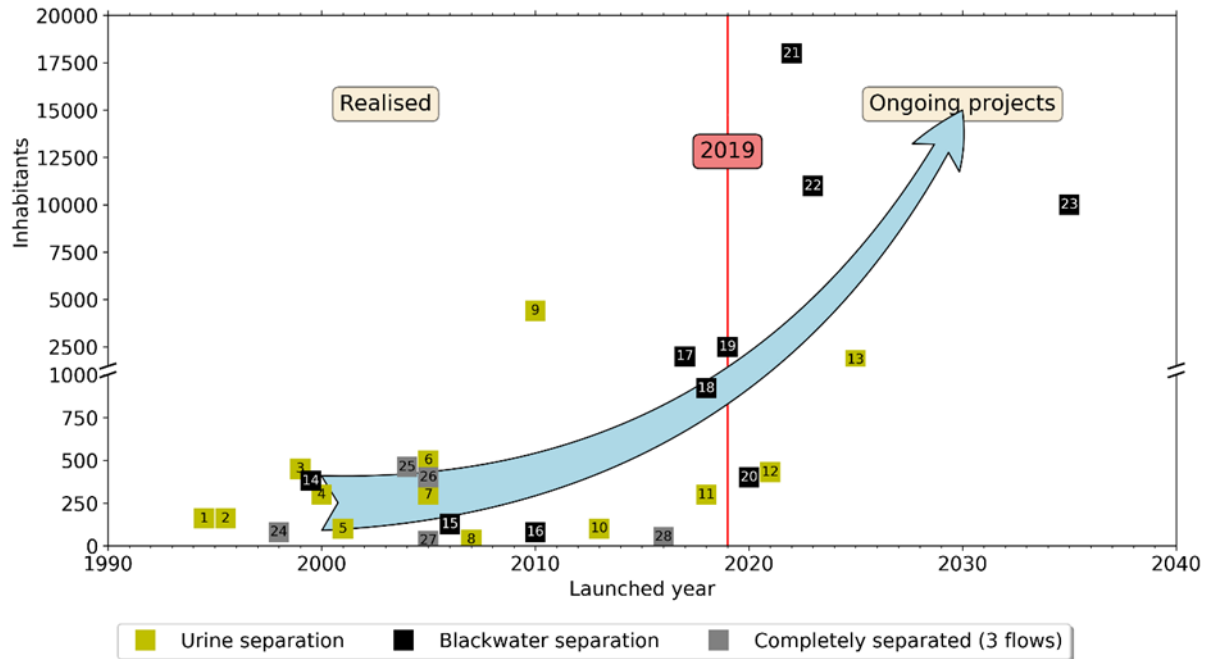

Figure I-9: Evolution of pilot projects regarding their scale and the type of separation (not an exhaustive list)
 1: Understenhöjden (SE), 2: Palsternackan (SE), 3: Ecole Eklandaskolan (SE), 4: Kullön (SE), 5: Universeum Museum (SE), 6: Basel-Landschaft library (SW), 7: Currumbin (AU), 8: Forum Chriesbach (SW), 9: University X Windesheim (NL), 10: ValueFromUrine pilot (NL), 11: Technical building in WWTP, Seine Aval (FR), 12: Aalto University (FI), 13: Saint-Vincent-de-Paul (FR), 14: Flintenbreite (DE), 15: Lemmerweg (NL), 16: Noorderoek stage 1 (NL), 17: Jenfelder Au (DE), 18: Schipperskaai (BE), 19: Buiksloterham (NL), 20: Noorderoek stage 2 (NL), 21: Strandeiland (NL), 22: Stockholm Royal Seaport (SE), 23: H+ (SE), 24: Gebers (SE), 25: Solar City (A), 26: Saniresch (DE), 27: SCST (DE), 28: NEST (SW)

The majority of the planned projects implement blackwater separation and are located in the North European countries (the Netherlands, Sweden...). Several projects of urine separation have been implemented in the 2010's on office and research buildings. Moreover the first French pilot project has been constructed, in the technical building of one of Paris WWTP.

The most representative projects will be detailed in the two following parts by dividing the previous projects and the ones in construction or planned. Moreover Table S 7, Table S 8, Table S 9 in appendix summarised the information collected for each pilot project.

III.1.a Established pilot projects

Sweden was the first country to install urine source separation system. In the middle of 90', around 135,000 diverting toilets were in operation in principal or secondary houses with 15,000 in ceramic (Kvarnström et al., 2006). Most of the time, urine was not recycled (Vinneras and Jönsson, 2013). It was only a way to better handle the composting of faeces without liquid. It has to be noted that most of these projects without urine reuse stopped after few years of operation (Vinneras and Jönsson, 2013).

Several eco-neighbourhoods (Understenhöjden, Palsternackan, Kullön), have been established with urine source separation with a total of 127 apartments and 200 individual houses and reuse of urine. These early projects were characterised by a strong involvement of the inhabitant, as they took in charge all the extra cost and the maintenance and also management of the system (Esculier, 2018).

The Tanum municipality pushed forward its citizens to use ecological sanitation with urine source separation. This led to 440 places equipped with diverting toilets, including three camps, one library and one school (Druitt, 2009). Moreover it is the only city (to our knowledge) that organised the relationship between inhabitants and farmers allowing the urine collection and use from 20 years (Esculier, 2018).

Switzerland is also a precursor of source separation and since the Novaquatis project at Eawag (2000-2006), research has been conducted to improve knowledge on transport, treatment, and social acceptance (Larsen and Lienert, 2007). The library of Liestal, Basel-Landschaft was also equipped with urine source separation with a first on-site treatment with an electro dialysis and ozonation. Unfortunately this pilot plant was stopped after one year of operation because of the under loaded treatment and the extra cost for maintenance (Boller, 2013). The new office building of Eawag (Forum Chriesbach) at Dübendorf was constructed (2006) and the choice has been made to build a “zero energy building” with a new water supply and sanitation (Boller, 2013). Rainwater is used for flush water, diverting toilets are in place and in 2012, a pilot plant was installed in the basement (Keogh, 2018). Urine is still nitrified and distilled with a final step of reaction with activated carbon. This process was developed during the VUNA project in partnership with South-Africa (Etter and Udert, 2015).

Urine source separation systems have been also tested in Germany and Netherlands with less success than in Sweden and Switzerland. In GIZ headquarters (German Corporation for International Cooperation) in Bonn, 50 urine diverting toilets and 23 dry urinals have been installed with on-site sanitation for urine, brownwater and greywater (Winker et al., 2013). However because of precipitation in the toilet element, and difficult cleaning by the flush, they have been removed (Winker, 2013). Moreover the project in the University of Windesheim (Zwolle, Netherlands), with 102 urine diverting toilets installed in 2010, suffered the same fate. One year later, the female toilets have been replaced because of the increase of cleaning intensity due to maluses and faeces on the bowls (Oost, 2011). In 2013 the remaining male toilets have also been removed, the extra cost of maintenance and cleaning was not compensated by the saving from lower water consumption (van de Ven, 2013).

The separate treatment of the three streams (“totally separated”) appeared also in the same period than urine separation. The Gebers project started in 1998, in Sweden, with diverting dry toilets and composting faeces (Kvarnström et al., 2006) is one of the most famous examples. This set of 30 apartments is still in operation (last update 2009). This project involves very strongly the user in their sanitation, since each household is responsible for emptying the bin, at least once a month, and bringing the faeces on the composting area. Moreover another issue has been raised: the difficulty of cleaning the bowl of dry toilet. However, users show pride to not use tap water for flushing human excreta, as well as they appreciated the silence of toilet (no flush noise), and the good design with no smells (Kvarnström et al., 2006).

Projects in Germany, Austria and Switzerland were also launched in the 2000s. These projects at the building level aimed to decentralise all the wastewater treatments. They allowed to test several treatments for each stream. One of the best known is the Sanitation Concepts for

Separate Treatments (SCST) program in Berlin from 2003 to 2006 on 10 apartments and some offices (about 30 people) (Peter-Fröhlich et al., 2007b). The same decentralised sanitation is found in the district of Solar City in Linz, Austria in 2004 (Hochedlinger et al., 2008). This latest project treated conjointly brown waters with greywater with a physical separation of solids. The liquids are then treated in a reed bed filter and the solids are composted. 250 people were equipped with diverting toilets and a school with about 270 children (Hochedlinger et al., 2008). Unfortunately the school toilets had to be replaced by conventional toilets because they were not adapted to the morphology of the children and required too much cleaning and maintenance. No update has been found on the use of diverting toilet in the households nowadays.

The blackwater separation system has been tested mainly in Germany and in the Netherlands. The Flintenbreite district in Germany coupled digestion of blackwater with food remains. Greywater is treated on the neighbourhood by a reed bed filter and infiltration (OtterWasser GmbH, 2009). The blackwater is transported by vacuum networks.

The eco-district Lemmerweg Oost in the city of Sneek in the Netherlands (32 dwellings since 2005) uses the same technology. Water from the toilets (blackwater) is transported under vacuum to a digester (in the neighbourhood) (STOWA, 2014). The heat produced is re-injected into the heat network. Greywater is treated in a micro treatment plant (treatment in high loaded rate) with recovery of the greywater heat.

III.1.b Projects in progress

In recent years the interest in separation seems to be shifting towards the blackwater separation with an increase in the scale (Figure I-9). In addition, France is also starting to set up pilot projects.

Currently, the Water Cycle Hamburg program is renovating the Jenfelder Au district in Hamburg with decentralised sanitation. Blackwater will be treated by anaerobic digestion. Greywater is also treated in a decentralised way in the neighbourhood by a bacterial bed (Augustin et al., 2014). The end of first construction phase was planned for 2016 and 2,000 people will live in this neighbourhood. But in July 2018 only three buildings were constructed with 200 people.

Since 2011, in Sneek (Netherlands) the project continues with the renovation of the Noorderhoek district which equip currently 232 dwellings of a vacuum network for blackwater (Ros, 2017). Grey and blackwater are treated in the same manner as the Lemmerweg Oost project.

Finally, the new offices of the Dutch Ministry of Infrastructure and Environment in The Hague opened in 2016 have installed dry urinals and vacuum toilets. Urine is treated with a bioelectrical fuel cell to recover nitrogen and produce electricity. UASB treats the concentrated blackwater. Finally phosphorus is recovered from both effluent by struvite precipitation (van Merksteijn, 2016).

Sweden, a pioneer in source separation, is setting up a project (H+) in Helsingborg for the renovation of a port with blackwater separation (Skambraks et al., 2017). This district will

eventually include 10,000 inhabitants. The first phase of construction has begun in 2017 for 320 apartments. Blackwater, greywater and food waste will all be collected by vacuum networks and treated in a treatment plant near the district. Food waste from kitchens and blackwater will be digested to produce biogas.

The Schipperskaai district of the port of Ghent in Belgium will also be renovated with the separation of blackwater mixed with food waste and greywater. These two streams will be collected by vacuum networks. Construction has begun in 2017, for the first inhabitants to move in 2018. The project has 435 dwellings (Skambraks et al., 2017). The blackwater and the food remains will be digested and precipitated as struvite. Greywater will be transported by gravity for joint treatment with liquid digestates after heat recovery.

Switzerland and Eawag continued to work on urine separation and treatment with several projects. In 2016, a demonstration building was build (NEST program) for several research purposes including water and energy management, material uses and mutation of building usage (Keogh, 2018). In this building a separated pipe systems was installed for urine, brownwater (faeces), dark greywater (from kitchen) and light greywater (from shower etc) (Etter et al., 2017). The urine is concentrated into a fertiliser with VUNA process.

In France, the SMS project from 2014 to 2018 (Separate micropollutants at the Source) aims to evaluate micropollutant treatment technologies in a sector based on the separation of urine at the source. One of its aims was to develop a urine diverting vacuum toilet that does not exist on the market and to test it. In addition, the SIAAP (Sanitation board of Paris agglomeration) builds a new technical building on the sewage treatment plant Seine Aval with dry urinals and with pipe system available for urine diverting toilets. Moreover, the renovation of headquarters of European spatial Agency in Paris will also be the occasion to install urine source separation system with a decentralised treatment in the building. The end of the construction phase is planned in 2022 and 400 people will be concerned (Lamaze and Lasseur, 2019). Finally the renovation of Saint Vincent de Paul neighbourhood in Paris planned for 2025, will include urine source separation (P&MA, 2019a). The project, with its 1800 inhabitants, is at the beginning stage and the scale of urine separation implementation is still not clear (P&MA, 2019b).

In view of these different pilot projects, some specificities of each sector can be highlighted. First of all, toilets need to be changed: urine diverting toilets or vacuum toilets depending on the separation. In case of segregated blackwater, vacuum toilets reduce the volume of flushing and a concentrated flow is obtained for anaerobic digestion. Thus blackwater with vacuum toilets can achieve 15 gCOD / L (de Graaff et al., 2010) against 2.5 gCOD / L with current dilution.

Secondly a new transport system has to be integrated with different solution regarding the choice of separation mechanism. The transport of urine by truck is more assimilated to waste transport than wastewater. Before transport urine is collected in tanks in the basement of buildings.

In the case of segregated blackwater and the completely segregated wastewater, the water contained in greywater can be recycled in addition to the recovery of nutrients.

III.2 Achievements and challenges

In this part, the pilot projects are summarised based on each steps of the sanitation systems: (1) the mechanisms of separation, (2) transport of each flow, (3) treatments. In each steps the achievements and the remaining challenges are emphasised.

III.2.a Mechanisms of separation

Source separation needs adaptation of toilet in all pilot projects. Urine is separated with urinals or diverting toilets. Dry urinals is preferred to flush urinals in order to keep a high concentrated stream. Blackwater separation used vacuum toilet in order to reduce the dilution and still be able to transport the blackwater

III.2.a.1 Urine diverting toilets

I.III.2.a.1.1 Design

Concerning urine diverting toilet, several prototypes have been constructed, and tested. The good design of urine diverting toilet is a compromise between 1) good flush efficiency to clean the bowl, 2) a high recovery of urine and 3) a small proportion of flush water flowing with urine. However the creation of this toilet is a real challenge.

The first generation of urine diverting toilet were designed for people with strong environmental commitment. The choice was then made to recover urine as much as possible, at low dilution rate. The urine flush was then reduced to its minimal value, and a high barrier separates the bowl into two parts (Figure I-10 A to D).

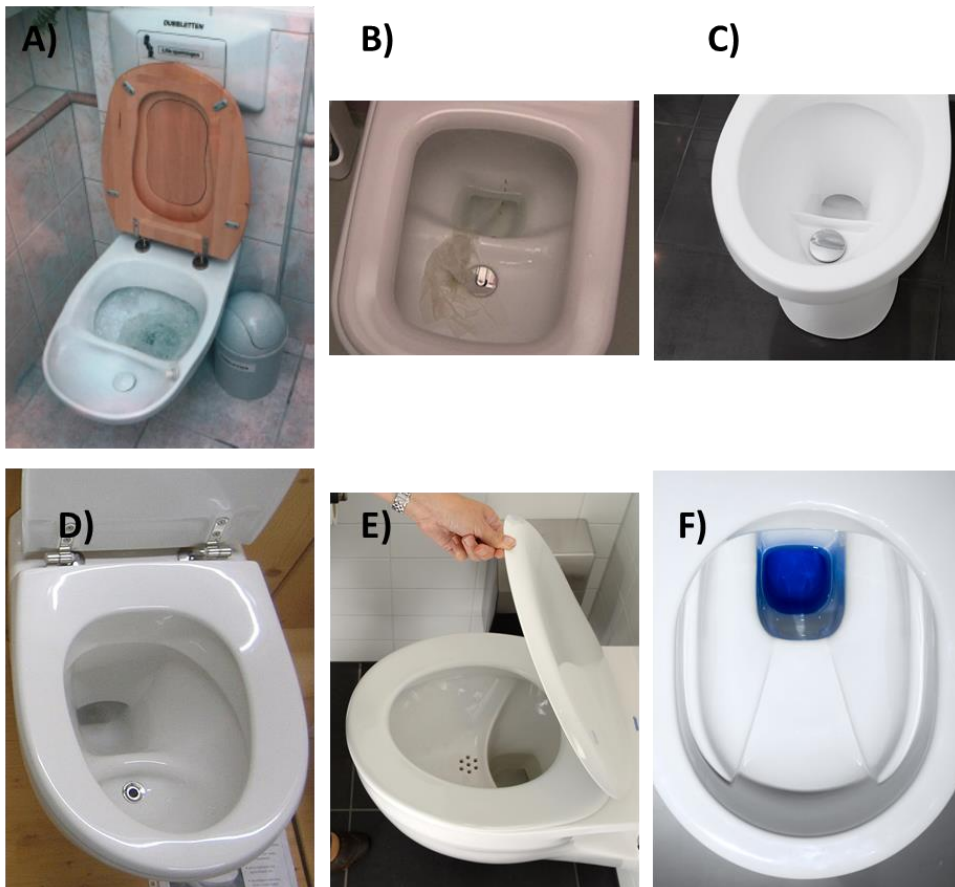

Figure I-10: Different models of urine diverting toilets. A) Dubbletten – BB innovation & Co AB (Johansson, 2000), B) Sealskin toilets (Oost, 2011), Wost Man ecoflush <https://www.wostman.se/en/ecoflush>, D) Gustavsberg Credit: Ulrich 2009, E) Roediger No Mix Credit: Ruedi Keller, F) Save! From Laufen Credit: © Laufen

They encountered, however, several issues: 1) cleaning, 2) blockages. Toilet paper has to be placed in the good compartment in order to be flushed. Moreover if the person is not seated in the right position, or in case of children who seat at the front of the toilet, faeces can be deposit in the urine compartment. Once again, flush will not clean the bowl and the design of the barrier will make the brush cleaning more difficult. As the results the number of flush is high and the benefit of low urine flush is decreased.

Blockages of the toilet and especially the urine part can occur, due to the high salt concentration in urine. Precipitation could be formed in the U-bend of urine or in the small pipe at the output of toilet. Regular cleaning and maintenance with citric acid can limit this inconvenience (Brun, 2019).

The second generation of toilet (Roediger No-Mix Figure I-10 D) tried to limit the cleaning problems by having a small barrier between the two bowls, and the same flush system cleans both bowls. To avoid the dilution of urine, a valve system is introduced. When someone is seated, the valve is open and closed when the pressure is released. However the experience with these toilets shows high discrepancies between projects. In Chriesbach, headquarters of Eawag, the toilets are in place since 2006 and worked well (Keogh, 2018). But in the buildings of GIZ in Eschborn, the toilets have been removed at the end of the project because of too high maintenance cost. Precipitation on the valve and leakage from the urine component (Winker et al., 2013) are the two main issues. The main difference between the two projects is the use of rainwater at Chriesbach for flushing the toilet and tap water for GIZ. As (Kai M. Udert et al., 2003) shows that salts in the flushing water are responsible of a large part of the spontaneous precipitation of urine.

The last generation of urine diverting toilets is very new, with the launch in April 2019 of the Laufen toilet save! This toilet uses the same bowl as conventional toilet to increase the cleaning performance of the bowl. A trap of urine is situated as showed in Figure I-11, it is based only on the surface tension of ceramic which made the liquid flowing into the trap. The urine separation and collection is then totally passive and without being visible from the user. Men still have to sit in order to recover their urine. No published information is yet available on the expected dilution of the collected urine but value of 100 mL/flush has been suggested (Esculier, personal communication) .

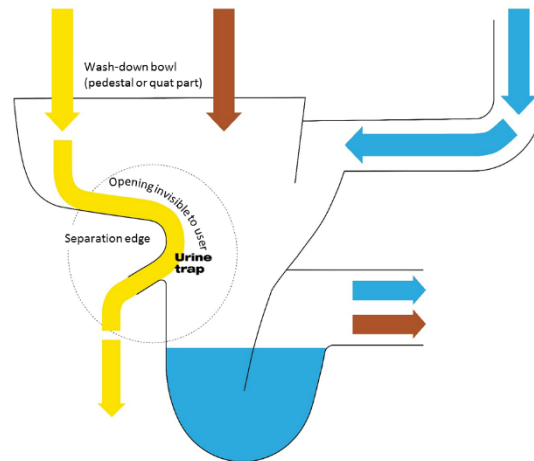

Figure I-11: Urine trap of save! Toilet © Eoos

I.III.2.a.1.2 Urine recovery rate

The first goal of urine diverting toilet is to recover urine, however the recovery rate does not depend only on the design of the toilet but also on the motivation of the users. (Johansson, 2000) argued that the Palsternackan residents who was not involved in the sanitation choice, stopped using the front bowl and especially the men. They need indeed to urinate in seating position in order to collect urine. It has to be identified as a major change in behaviour especially at work place. For instance (Blume and Winker, 2011) shows that only 17 % of respondents from GIZ projects are willing to sit without additional hygiene devices. (Lienert et al., 2006) shows that even if in total 68 % sat on the NoMix toilet, only 42 % of the men. This can lead to a high decrease of recovery rate if no urinals are installed.

However estimating a recovery rate is a challenging task as no direct measurement can be performed. Firstly, using concentration of component in the collected urine is not relevant either as nitrogen and phosphate can be lost by stripping of ammonia or precipitation of struvite. Salt and especially sodium chloride could be a better indicator as less reactive, but it is also less measured. Secondly, we have to consider the time spend in the building. (Jönsson et al., 2005) considered that we spend maximum 10 hours at work and from 14 to 17 hours at home. Finally a child does not produce as much urine as an adult. We need to have a detail description of the inhabitants.

In (Besson, 2015) an attempt was made to calculate the recovery rate and it is summarized in Figure I-12. In Appendix II.2 details of calculation can be found. The projects of Understenshöjden, Pasternackan from data of (Jönsson et al., 1998) and SCST from data of (Peter-Fröhlich et al., 2007a) have been studied, and compared to the value of (Vinnerås, 2002; Vinnerås et al., 2006).

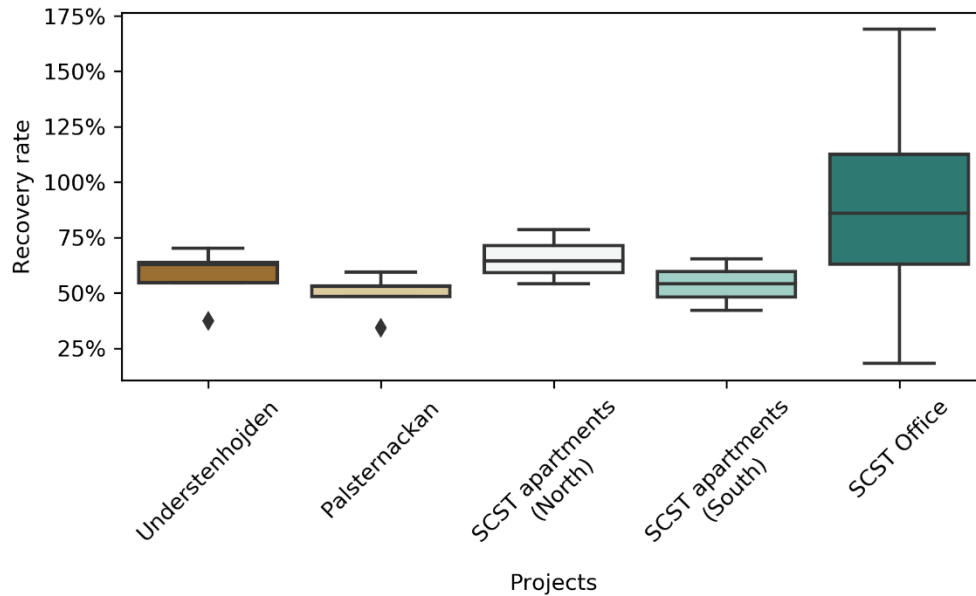

Figure I-12: Calculated urine recovery rate

At home urine recovery rate ranges from 50 % to 70 % in average. With 71 % at maximum recovery rate for SCST North apartments. The boxplot of offices in SCST projects shows very high variation compared to the other projects, with a very high recovery rate calculated based on potassium (162 %) and a very low based on sodium (21 %), which is difficult to explain.

III.2.a.2 Vacuum toilets

Vacuum toilets are used for blackwater collection. Blackwater collected by conventional toilet, are too concentrated in solid, to be transported by gravity sewer. The risk of sedimentation is too high (Larsen and Gujer, 2013). Vacuum sewer and vacuum toilet seems to be the current solution as every blackwater pilot projects used them. The volume of flush is very limited (around 1.2 L/flush) compared to conventional toilet (3/6 L/flush), and water will thus be saved. Moreover high concentration in solid can be achieved, making the treatment easier.

It has to be noticed that the flush volume can still be decreased. (Bisschops et al., 2019) have, indeed, successfully implemented ultra-low dual flush vacuum toilets with only 0.4–0.7 l/flush.

The acceptance by the user is relatively good even if the main concern still remains the noise of the aspiration (Hegger, 2007). The second disadvantages of the vacuum toilet is the difficulty to clean the bowl with the brush, due to the low amount of water kept inside. 55 % of the interviewees mentioned that it is necessary to flush several time the toilet after defecation. Moreover the outlet of the toilet is quite small compared to conventional and the risks of dirtying the wall is high. Even if these disagreements are raised, only four of the eighteen households would change their toilets if the choice was available. The other still wanted vacuum toilet if noise is reduced. The same conclusion can be drawn from the user survey of Waterschoon (Noorderhoek) project (de Graaff and van Hell, 2014). They also revealed that the buildings where the treatment takes place, in the middle of the district, was part of the good opinion of the users, as sanitation is becoming tangible.

In order to limit the flush volume and in the meantime to enjoy the benefits of urine source separation, vacuum separating toilet have been developed with prototypes. The first one was performed by the team of SCST project (Peter-Fröhlich et al., 2007a) from a Roediger No Mix toilet modified to have vacuum collection of faeces. With a volume flush between 1 and 2 L/flush the flush systems was assessed as not performant and the flush noise was too high (Peter-Fröhlich et al., 2007a). As a first prototype, it needs to be improved to be installed elsewhere. No more information can be found about the fate of the prototype in other projects.

The second separating vacuum toilet was developed during the SMS project in France (2015-2018). This time it is a conventional vacuum toilet which has been modified to collect urine. Both urine and faeces are collected by vacuum suction. By decreasing the urine retention time in the pipe, the idea was to limit the risk of precipitation in the toilet and pipes afterward. One prototype has been tested for one year at INSA (France) buildings and shows promising results.

III.2.b Transport of separate streams

When only the urine is separated, grey and brownwater are, in most cases, sent to the centralised wastewater treatment plant and the existing networks are used for the transport. The most common management model for urine is its collection in a storage tank at the building level. These tanks are then, emptied regularly by a truck, which takes them to the centralized treatment plant or near their place of recovery. A second option exists with a building-wide treatment like in the Eawag buildings in Switzerland. Finally, the collection of urine by gravity networks has to be the shortest possible to avoid precipitation and blockages of pipes (Brun, 2019).

In the case of the separation of blackwater the transport is mainly done by a vacuum network. Vacuum toilets are indeed implemented to reduce the flush volume and the dilution. However, the effluent is so concentrated that blackwater cannot be transport by gravity sewer. In addition the vacuum network allows to excavate shallower than the gravity sewer system. Nevertheless, skilled maintenance is required to repair failures due to poor sealing of networks (Islam, 2017). Finally, a long collection distance means high energy consumption to operate these networks, so the treatment is often decentralised at the neighbourhood level as in the project Noorderoek in the Netherlands (de Graaff and van Hell, 2014).

However the optimal scale of decentralisation between the energy consumption related to transportation and treatment effectiveness is unclear and remains to be studied.

III.2.c The different treatments

Given the various challenges that sanitation must address, various pathways and treatments have been tested at the laboratory and pilot scale. Indeed, sanitation must continue to limit the health risk while ensuring protection of the receiving environment by treating carbon, nitrogen and phosphorus pollution. However, in the context of a circular economy, it must also increase the reuse of water, nutrients and organic matter while minimizing material and energy consumption, particularly for the construction and maintenance of infrastructure. Finally, the elimination of micropollutants becomes an emerging issue.

(Harder et al., 2019) performed an exhaustive literature review on human excreta treatments available especially for nutrients recovery. Figure I-13 describes in a non-exhaustive way the different possible treatments (tested at least at the laboratory scale) of all the flows in the case of a separate sanitation at the source.

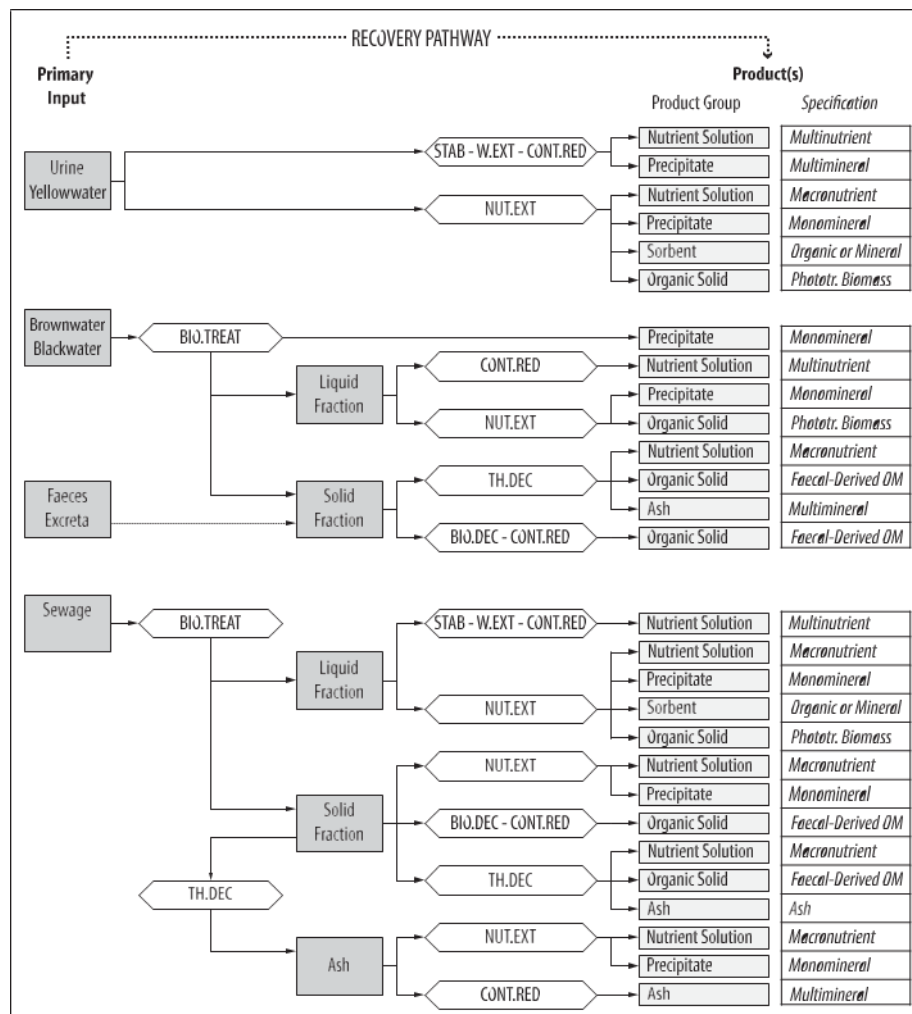

Figure I-13: Simplified representation of recovery pathways targeted towards nutrient recovery from human excreta and streams containing human excreta, from (Harder et al., 2019) Abbreviations: BIO.TREAT: biological treatment; BIO.DEC: biological decomposition; TH.DEC: thermal decomposition; STAB: stabilization; W.EXT: water extraction; CONT.RED: contaminant reduction; NUT.EXT: nutrient extraction

The recovery of organic matter concerns mainly faeces and currently involves either composting or energy recovery in anaerobic digestion. Composting recovers also a part of nitrogen, however most of it is volatilized (Harder et al., 2019).

Concerning the recovery of nutrients, two approaches coexist: either to extract the components of interest (stripping of ammonia, precipitation in the form of struvite); either concentrate the streams (nitrification distillation of the urine, evaporation ...). In the first case, only a part of the nutrients are recovered, mainly nitrogen and phosphorus. Unlike the second approach, which retains almost all components but also potentially harmful components (micropollutants, pathogens) requires additional treatments.

It is noted that there is no treatment that values both nutrients and organic matter, it is therefore necessary to couple several treatments, for example after the anaerobic digestion of blackwater,

the precipitation of phosphorus in the form of struvite can take place on liquid digestates, followed by nitrification and distillation to recover other nutrients or nitrogen stripping (the relevance depends on the level of dilution of the digested effluents).

Other treatments have been tested, such as the cultivation of microalgae (spirulina, etc.), but are still at laboratory scale.

Despite a wide variety of laboratory-scale urine treatment, only a few options are used at the pilot scale. Storage hygiene remains the most common, especially in the first projects in Sweden (Vinneras and Jönsson, 2013). The second method used is nitrification followed by a distillation of urine to stabilize the urine into a liquid fertilizer named AURIN. This pilot was developed by Eawag in Switzerland and is tested in South Africa with the VUNA project and afterward installed in the offices of the Eawag (Boller, 2013; Keogh, 2018). The AURIN product, moreover, obtained approvals for the sale as a fertilizer for flowering plants and more recently for universal uses (2019). Two others pilots with bioelectrochemical processes was installed in Switzerland and Netherlands. The first one was a electro dialysis (Pronk et al., 2007) and the second one was a microbial electrolysis cell coupled with transmembrane chemisorption (TMCS) (Zamora et al., 2017b).

Table I-2 presents the efficiencies of several treatments for recovery of nutrients and organic matter with also their energy consumption. These recovery processes are compared to conventional removal processes: Nitrification and denitrification for nitrogen. It has to be noted that most of the processes consume more energy for the recovery than the one for treatment. TMCS and bioelectrochemical system seems the best technologies for nitrogen recovery. However TMCS needs heat which is not taken into account is this consumption. The nitrification/distillation process is a high electricity consumer even if it concentrates both nitrogen and phosphorus.

For phosphorus removal the analysis is more complex as no electricity is needed but chemical are used. Therefore a more complete study is needed in order to take into account all form of energy.

Table I-2: Comparison of recovery efficiencies for several processes for nutrients and COD recovery with their energy consumption (in negative value) or the production (in positive value).

Recovery target	Treatments	Streams	Outputs	Efficiency			Electricity ¹	Ref ²
				N	P	COD		
P	Precipitation	Urine / blackwater	Precipitate Effluent	16%	86% - 94%	75%	- 14-53 kWh/kgP str	[1], [2], [3], [4]
N	Nitrification / denitrification						- 4 kWh/kgN	[5]
	Stripping	Urine / Digestate of blackwater		95%	0%	0%	- 7 kWh/kgN recovered	[5], [6]
N	TMCS	Urine / Digestate of blackwater	Ammonium sulphate Effluent	80%			- 1.9 kWh//kgNH4- N _{recovered} .	[6], [7]
N, P, K	Nitrification / distillation	Urine	Concentrate	97- 99%	100%	10- 84%	- 76 kWh/kgN recovered	[8], [9]

Recovery target	Treatments	Streams	Outputs	Efficiency			Electricity ¹	Ref ²
				N	P	COD		
COD, N, P, K	Hygienisation	Urine		100%	100%	100%	No energy for treatment	
N, COD	Bioelectrochemical system : microbial fuel cell	Urine	Gas	90%	?		between + 0.97 and - 1.36 kWh/kgN	[10]
			Effluent					
COD	Anaerobic digestion	Blackwater	Biogas			60%	Primary energy production : + 120 MJ/kg CODin	[11]
			Output	100%	100%			
	Composting	Faeces / dewatered blackwater	Compost	50-90%	61-99%	33-70%	/	[12]
			Gas	10-50%	1-39%	30-63%		

¹ Positive value: production, negative value: consumption

² References: [1] (Zamora et al., 2017a) [2] (de Graaff and van Hell, 2014) [3] (Butler, 2018) [4] (Maurer et al., 2006) [5] (Maurer et al., 2003) [6] (Zhang et al., 2020) [7] (Böhler et al., 2016) [8] (Udert and Wächter, 2012) [9] (Udert and Jenni, 2013) [10] (Kuntke et al., 2012) [11] (Tervahauta et al., 2014) [12] (Harder et al., 2019)

III.3 Conclusion on real pilot projects and comparison with bibliometric analysis

Pilot projects seem to follow the same trend as publication with an acceleration of interest in source separation systems. The pilot project size increases extremely in the recent years even if the number of project is less considerable than during the 90's.

On the contrary of what was seen in the bibliographic review, blackwater separation is the most significant separation selected in the future project. It can be assumed that the number of publications related to blackwater separation will increase in the next years.

However urine research does not seem to decrease and some significant events are here to prove it. First of all, the fertiliser produced by Eawag and now VUNA (spin off of Eawag) has the approval for universal use in Switzerland. Secondly a new design of diverting toilet has been launched in March 2019. The Save! Toilet could be the key to unlock the urine source separation at real scale. The previous toilets showed indeed difficulties of use and maintenance, limiting the life time of urine separation project.

Finally French projects are planned in the near future with the technical building of Seine Aval WWTP, but also the European spatial agency and the district of Saint-Vincent-de-Paul in Paris.

TAKE HOME MESSAGE

- Pilot projects have increased the scale of implementation with a decrease of number of projects.
 - Northern European countries gathered the large majority of new projects, Switzerland still works actively. Projects in France are foreseen for the next years.
 - The new urine diverting toilet of Laufen, Save!, can unlock the urine source separation systems, and help to develop new projects
-

IV. ENVIRONMENTAL, ECONOMIC AND SOCIETAL ASSESSMENT OF SOURCE SEPARATION SYSTEMS

Many studies aimed to assess the impacts of source separation from an environmental and economic point of view. The different separation systems were studied with different modes of collection and transport and treatments. 19 publications were analysed to compare Life Cycle Analysis (LCA) and / or economic results and / or material and energy balances. Nine publications focus on the separation of urine, three on blackwater, six on urine and blackwater and finally one on the study of separation into three streams (urine, faeces and greywater). The assessment of only greywater separation was not the focus of this part, however the literature review from Chapter I.II shows 10 publications on this subjects, 5 of them have been investigated. The list of all these publications can be found in Appendix III.

Studying the impact of source separation requires to consider a set of variables in several scientific disciplines. Indeed, source separation has a direct impact on sanitation with the wastewater treatment plant and the sanitation networks. But related systems are also impacted such as the production of fertilizer, electricity production and drinking water. Some studies have an even more comprehensive analysis of organic waste with both wastewater and food residues (Meinzinger et al., 2010a; Thibodeau et al., 2011, 2014a, 2014b). Therefore, considering the whole system in detail requires a thorough knowledge of each subsystem and an increase of computing time.

Moreover, the studies have, most of the time, different scale of implementation. The majority studied source separation at city scale and thus at WWTP scale. However (Lam et al., 2015; Oldenburg et al., 2007) worked at district scale. (Mbaya et al., 2017) assessed the phosphorus recovery at building scale. The scale of toilet is even assessed with (Shi et al., 2018) by studying implementation of public toilets.

Finally, the more the number of hypotheses increases, the more the results can be uncertain. These uncertainties are not identically assessed. Out of 19 publications on life cycle or cost analysis, 10 performed a sensitivity analysis on several parameters. Six of them used Monte Carlo analysis to assess the uncertainty of modelling parameters. Three of them go further with the analysis of Ecoinvent database uncertainty from background processes of LCA.

IV.1 Urine source separation

IV.1.a Environmental assessment

The separation of urine seems beneficial from an environmental point of view thanks to endpoint level (or aggregated) life cycle assessment. (Bisinella de Faria et al., 2015) studied the separation of 50 % of urine from a treatment plant by taking into account the plant, the treatment of urine, the production of fertilizer and electricity. Drinking water, sanitation and food waste were not included in this study. It has been shown that the separation of urine with centralized struvite precipitation at the station does not significantly reduce environmental impacts at the endpoint level (decrease of only 3 %). In order to have a significantly lower environmental impact, a low-cost recovery or disposal of the nitrogen present in the urine (a reduction of at least 30 %) is necessary. Coupled urine separation with a redesigned wastewater treatment plant has significant advantage. (Wilsenach and van Loosdrecht, 2006) has also shown that a new station design with source separation can achieve higher energy production than consumption.

The main impacts of the system are due to climate change, particle formation, and human toxicity. Climate change is related to the station's direct emissions (in water, air), chemicals, electricity consumed and sludge-related emissions.

Studies by (Ishii and Boyer, 2015; Landry and Boyer, 2016) shown that electricity in the treatment plants and nutrient emissions are key factors in reducing impacts. However, gas emissions were not taken into account in WWTP and (Bisinella de Faria et al., 2015) showed that these emissions are responsible for most of the impacts on climate change (around one third).

Several authors pointed out the possibility of reducing drinking water consumption by source separation based on very low flushes: 0.05L / flush (Igos et al., 2017; Ishii and Boyer, 2015; Landry and Boyer, 2016). It should be noted however that this volume of flush is very unlikely for a large deployment, the toilet paper is not trained enough. (Winker et al., 2013) reported that a 3L flush is not necessarily sufficient for a Roediger No-Mix sanitary separator (allowing for near-pure urine), after having tested 50 toilets during a year in GIZ office buildings.

Emissions related to the application of urine or fertilizer from wastewater depend on the application methods. (Tidåker et al., 2007) compares by LCA the fertilization of wheat by application of urine or mineral fertilizer, taking into account the source of urine separation as the production of this fertilizer. This study concludes that with the best application techniques, the use of urine is similar to the use of fertilizer but if the methods of spreading are not optimized, the contribution to climate change may be unfavourable. Moreover, the application of urine leads to an increase in acidification due to higher emissions of NH₃ in the air (losses during storage and spreading) and NO_x (transport of urine and urine collection equipment).

(Kavvada et al., 2017) studied the influence of decentralisation of the urine treatment. In this study, they explored a toilet with ion exchange resin which concentrate urine in cartridge collected regularly. Regeneration of resin facilities are positioned in San Francisco case study. They proved that transport in this dense area was not significant in term of energy balance and greenhouse gases emissions. However the increase of decentralisation, increase significantly the cost of the treatment due to high land price.

Finally, the separation of urine could make it possible to treat micropollutants (pharmaceutical residues) more efficiently because 64 % of the pharmaceutical products ingested are excreted by the urine as a parent metabolite or compound (Lienert et al., 2007a). However, the toxicity of micropollutants is minor compared to the ecotoxicity related to nutrient release in the LCA results (Landry and Boyer, 2016). Thus the urine source separation and its treatment of pharmaceutical products (by ion exchange) is beneficial for the environment (reduction of ecotoxicity and aggregate impacts), mainly due to the effects of higher nutrient removal efficiency. As this study only dealt with the impacts of urine (not taking into account other waters), it is difficult to conclude on the compensation of the energy consumed by the treatment of urine and the consumption avoided in the wastewater treatment plant.

IV.1.b Economical assessment

From an economic point of view, the studies carried out conclude on the same order of magnitude for the total cost. (Oldenburg et al., 2007) reports a decrease of 1 % but transaction costs decrease by 17 %. Although the urine is supposed to be sold to farmers, the benefits from this sale are negligible. (Meinzinger et al., 2010a) observed the same result considering that all infrastructures must be built (only a decrease of 1.5 % of the total cost). In the case of an existing infrastructure, the separation of urine will be more expensive than the reference of about 35 %. Most of the extra cost came from investments in housing (change of toilets, installation of new pipes, etc.).

Early estimates indicate a 4 % increase in urine costs (Landry and Boyer, 2016). (Igos et al., 2017) focused on operational cost and estimate a reduction of operation cost up around 10 % with 50 % of urine separation. A 10 % of separation only reduces the cost by 3 %. However the major driver of this reduction is the water saving, which is related to tap water price. In most countries, this price contains also the wastewater treatment cost and will thus be affected by change in the management. By excluding the water saving, operational cost is still decreased but only up to 1.5 %

As previously discussed, (Kavvada et al., 2017) performed a cost analysis but focus only on urine treatment and did not take into account the benefit at WWTP. However, the cost was driven by the rental cost for the facility. Thanks to fertiliser sale, it was possible to recover 90 % of the urine collection and treatment cost with the centralised facility of resin regeneration.

IV.2 Separation of blackwater

IV.2.a Environmental assessment

With blackwater separation, two scenarios are studied, the composting of blackwater or the anaerobic digestion. Of the 9 studies analysed, 5 linked the treatment of blackwater with organic food waste.

From a nutrient point of view, blackwater recycling can recover much more than urine separation. (Meinzinger et al., 2010a) found a 37 % increase for nitrogen between urine and blackwater, and 120 % for phosphorus. From an energy point of view, the blackwater digestion scenario is less consumer (down 23 %) than the conventional scenario and the separation of urine (Thibodeau et al., 2014b)

This reduction is possible thanks to two main points: a relatively low consumption of the vacuum network ($8.2 \text{ kWh}_{el}/\text{m}^3$) and a decentralised and rustic treatment of greywater (septic tank and reed bed filter). (Remy, 2010) obtains the same conclusion, but the decrease in net energy demand is more obvious (from -41 % to -115 % according to greywater treatments). (Xue et al., 2016) found a decrease of 40 % for total energy consumption. However this value is overestimated as the reference consider landfilling of bio-waste instead of digestion which could generate energy.

However, (Lundin et al., 2000) obtained a contradictory conclusion with a much higher consumption of the vacuum network ($17.8 \text{ kWh}_{el}/\text{m}^3$). Similarly, the blackwater separation scenario (Meinzinger et al., 2010a) consumes more energy than the reference scenario with $15 \text{ kWh}_{el}/\text{m}^3$ for the vacuum network and high-tech treatment of greywater. The value of $8 \text{ kWh}_{el}/\text{m}^3$ (Thibodeau et al., 2014b) is equivalent to the current consumption of the Waterschoon project in the Netherlands ($5.6 \text{ kWh}_{el}/\text{m}^3$ (de Graaff and van Hell, 2014)).

The reuse of greywater does not bring any energy benefit (Remy, 2010) because of the strong energy demand for the membrane bioreactor (MBR). This study concludes that a large volume must be reused ($> 25 \text{ L/pers/day}$) and that the production of drinking water must be complex ($1 \text{ kWh}_{el}/\text{m}^3$ instead of $0.5 \text{ kWh}_{el}/\text{m}^3$). Thus the use of greywater treated only for flushing is unlikely, it must be coupled with at least the washing machine.

According to (Meinzinger et al., 2010a) the scenario for reducing the energy costs of both drinking water and sanitation is the separation of blackwater with centralized greywater treatment. However, this centralised treatment is the same treatment plant as the reference, which is therefore oversized compared to the treatment of greywater alone. (Meinzinger et al., 2010a) further concluded that the recycling of greywater as service water for households and supply of drinking water in the form of a bottle is not energy efficient. In fact, the production of bottled water (with transport) is 500 times more consuming than the production of centralised drinking water ($250 \text{ kWh} / \text{m}^3$ instead of $0.5 \text{ kWh}/\text{m}^3$).

From an environmental point of view, the separation of blackwater shows improvements for most environmental impacts (Remy, 2010) with the exception of acidification which is due to NH_3 emissions to air after the application of fertilizers (organic or mineral). Organic fertilizers emit more than mineral fertilizers.

Several authors studied the impact of source separation in case of on-site sanitation. (Xue et al., 2016) analysed the option of no separation and treatment at a small WWTP or different on-site source separation. The results on eutrophication showed an improvement with source separation, as nutrients are not released anymore in the rivers. (Malila et al., 2019) had similar results with an on-site septic tank as reference scenario. Acidification remains as a critical impacts with the spreading of urine or digestate can lead to more NH_3 emissions.

IV.2.b Economical assessment

From an economic point of view, the two studies carried out (Meinzinger et al., 2010a; Oldenburg et al., 2007) find an total additional cost in the case of blackwater separation (respectively 25 % and 4 %).

For (Meinzinger et al., 2010a) most of the excess cost comes from vacuum transport; the rest of the costs are similar between the two scenarios. A small increase is also visible for the investments related to the toilet in the building. For (Oldenburg et al., 2007) the additional cost also comes from the larger investment but especially from the new installations in the dwellings. (Oldenburg et al., 2007) presented a decrease of 15% of the operational cost. However this decrease is only due to the sale of the heat from biogas which is not consider in the reference scenario.

IV.3 Greywater separation

Several studies focused on greywater treatment and reuse. They found contradictory results on environmental impact.

For instance (Santana et al., 2019) in Spain, proved that greywater recovery and reuse was increasing the carbon footprint, metals depletion, and even the water footprint impacts. This was due to high energy consumption for decentralised treatment (MBR with $28 \text{ kWh/m}^3_{\text{treated}}$) with a Spanish energy mix, where hydroelectric power is a large contributor. Evaporation in reservoir and their exclusive use for power generation, led to a contribution of water footprint around 70 % of the total footprint. It has to be noted that AWARE model is used which relies on country-specific characterization factors, Spain being a scarce water country, the use of water impacts more the assessment.

(Opher and Friedler, 2016) investigated similar scenario in Israel where reused water replaced desalination water. The results were reversed with an improvement in climate change impact and also in water depletion. The electricity mix production in Israel is also responsible of these results as fossil fuel electricity production represents 90 % of the production.

Moreover, on the contrary of urine and blackwater separation assessment, greywater assessment investigates the scale of implementation. (Bonoli et al., 2019; Jeong et al., 2018; Zanni et al., 2019) studied at dwelling scale and district scale for several cities the reclamation of greywater and/or rainwater. They all concluded at a decrease of impact with the increase of scale, due to a decrease in energy consumption for water supply and especially the water for gardening which is correlated to the garden surface (Jeong et al., 2018). MBR energy consumption is also a parameter of concerns as it increases with decreasing the treatment capacity and thus the density according to AQUALOOP membrane bioreactor energy consumption, from (INTEWA

Niederlande, 2013). (Jeong et al., 2018) by using these data found from 11.8 kWh/m³ for a very low dense district (40 inh/ha) to 2.2 kWh/m³ for a very high dense district (622 inh/ha).

IV.4 Societal analysis

The social acceptability of source separation is essential for the proper operation of the separation and its durability over time. As already mentioned in section III.2.a.1, user motivation impacts, directly and strongly, the quantity and quality of urine collected as shown by (Johansson, 2000).

In addition, source separation leads to changes in intimate behaviour. For example, with a separate toilet, men must urinate while sitting, otherwise a large proportion of urine is loosed. Moreover, urination during shower should be avoided in source separated systems in order to increase the recovery rate of nutrients. These changes in habits should not be neglected.

The users feeling about the new toilets (diverting or vacuum) will not be discussed further, as it has already been mentioned in III.2.a.1.

The use of products derived from human excreta as a fertilizer seems to be accepted by users with concerns about micropollutants. Indeed, (Lienert and Larsen, 2010) conducted a study on the acceptability of urine separation compiling 75 publications on 38 pilot sites in 7 countries. It shows that 85 % ± 13 % of the 900 people think that the use of fertilizers from urine is a good or very good idea. The main concern of users comes from pharmaceutical residues (61 % of German respondents). Disease transmissions do not seem to be a major concern (only 5 % of respondents). Finally, from the farmers' point of view, the acceptability of urine-based fertilizers is lower (50 % think it is a good idea and only 34 % would use them). Farmers point out that they do not need a new fertilizer and have doubts about the quality of this fertilizer and the consequences on micropollutants application. Farmers are concerned about possible lawsuits and therefore want the regulation to be clear before involving themselves in the use of such products. Indeed, separation at source must be part of a regulatory framework that has not been created for this remediation.

(Brun, 2018), in France found the same concerns from farmers, with no clear choice for using by-products from human excreta. The question of the form and composition of the by-products was raised, with a preference for solid form and highly concentrated fertiliser, to avoid changing spreading machines. The farmer cooperatives are key actor in the reuse process, as farmers trusted them for the choice of products.

IV.5 Conclusion

The assessments of source separation systems illustrate the diversity and the large number of scenarios that can be studied. The difference in boundaries and scale make it difficult to compare them. Moreover the choice of reference is critical. Most of them used conventional WWTP as if the plant cannot evolve to meet the target of resource oriented sanitation.

Finally infrastructure is difficult to take into account and several studies avoided it.

Nevertheless from all these study the most influencing hypothesis to take into account can be addressed:

- Direct emission from WWTP
- Emissions of NH₃ from spreading
- Vacuum sewer consumption
- Greywater treatment and consumption
- Choice of the scope of study : rural or urban

If source separation of urine seems to be beneficial in all cases, spreading of urine remains the only parameter which can change the results. Blackwater source separation is however less obvious with different conclusion depending on hypothesis.

Finally, the scale of treatment was addressed only once by (Kavvada et al., 2017) but with limited boundaries without taking into account the effect on WWTP.

TAKE HOME MESSAGE

- Several attempts to assess source separation systems
 - Different scales, boundaries and treatments make difficult the comparison between different scenarios
 - Urine seems beneficial compared to reference scenario no matter which one, spreading method of urine seems the key element to change the conclusion
 - Tap water savings is often considered with urine separation even if pilot projects showed that it is not so obvious
 - Blackwater separation has different conclusion depending on the vacuum sewer conclusion and greywater treatments.
-

V. SCOPE AND STRUCTURE OF THE THESIS

This last part intends to establish the scope of the thesis and the scientific questions that remains without answer after literature review.

V.1 Challenges

First of all, we saw that pilot projects have recently increased the scale of implementation and especially for blackwater separation. However even if urine source separation faced several limitations in the real world implementation, a regain of pilot project is foreseen especially in Switzerland and France. Moreover research on urine treatment is still very active. Both scenario needs thus to be studied.

Secondly, the previous assessment of source separation systems shows discrepancies in the boundaries of analysis. This is due to the extended boundaries needed, linked to the change made by source separation. Indeed modifications on wastewater collection and treatment are visible, but also fertiliser production. Water and energy supply can also be modified with reuse of treated waste water and production of energy from anaerobic digestion. An integrated model is therefore needed to take into account all these aspects and modelled their impacts on environment

Thirdly, several studies focused on one aspects and contradictory conclusions have been drawn regarding the context of study (water and electricity mix, stress on water resources etc.). Moreover greywater reuse assessments have shown that scale and human density have a great impact on environmental results. However no similar study, with extended boundaries, has been performed with urine or blackwater separation. In this sense, source separation systems need to be assessed regarding the scale of implementation and the human density.

Moreover, the reference scenario is a key point of the assessment. Most of the studies, used current sanitation solution and compared it with advanced sanitation with source separation at large scale. However, before achieving a separation of even 10 % of urine or blackwater, the centralised treatment plant will also be transformed. Therefore source separation system cannot only be compared to the current applied technology but also to best available technologies of the next decades.

Finally, the number of scenarios that can be imagined is high, due to the number of separation, treatments pathways and scale of decentralisation. Therefore in order to assess different scenario, a focus needs to be made.

V.3 Scope of the thesis

Thanks to the above specifications, the scope of the modelling efforts has been decided:

- An integrated tool has to be developed to model the whole wastewater management with the benefit on fertiliser, energy and water supply.
- The model needs to design the source separation scenarios regarding their implementation (scale and human density)
- Source separation systems need to be compared to advanced solutions available for the centralised sanitation system.
- The model needs to be linked to an environmental assessment and life cycle assessment seems the relevant methodology.
- The model needs to be adaptable to different sanitation systems and can be upgraded with time to investigate different solutions.

To successfully apply this tool within the thesis constraints, a limited number of scenarios needs to be assessed and the scope of analysis has to be restraint. We decided, to only study developed countries application of source sanitation and a specific attention is paid to urban context. Therefore current on-site sanitation are not investigated, as well as dry toilet which is, at the moment, difficult to implement in dense neighbourhood.

The second part of the scope is to focus on nutrients recovery and to add water recovery when it is possible. The water recovery management will be integrated in further studies.

Finally the treatments are chosen from pilot projects, and by keeping in mind that the nutrient recovery is the goal. We assume that a very small proportion of scenario is assessed in this thesis, however the tool will not only be used to investigate which source separation system is performing best in which context, but also to help research to focus on key challenges in processes.

V.4 Structure of the following manuscript

This thesis manuscript is structure in five more chapters after this one. The Chapter II is focusing on the methodology developed in the integrated tool for modelling and assessing source separation systems. The key challenges in each blocks of simulation are therefore highlighted, and the main hypothesis to solve them are described. The model in Appendix IV, Appendix VII and Appendix VIII, aims to give details of calculation and minor hypothesis.

The two following chapters show the results of the use of the integrated tool. The Chapter III, aims to assess, with one particular urban configuration, the environmental impacts of source separation systems. The keys challenge of the chosen processes is, then, highlighted.

The Chapter IV aims to assess the influence of urban configuration and scale of implementation with the same wastewater management systems that the ones assessed in the chapter 3.

Finally the manuscript is ended by perspectives for the following studies (Chapter V) and a conclusion on this work is drawn (Chapter VI).

Chapter II. Methodology of the decision support tool development

I. INTRODUCTION

I.1 Goals of the tool

The developed tool aims to:

- a) Evaluate scenarios of source separation at the district scale. The urbanism where these solutions will be implemented needs to be taken into account.
- b) Be flexible and easily modified to be used for several scenarios and case studies.
- c) Help to design research and development projects: This will support the choice of new pilot projects of source separation system.
- d) Help decision makers: by comparative study between solutions, the tool can guide decision makers to implement best solutions of sanitation in their urbanism operation.

Finally, the advantages and limits of each system would be highlighted.

I.2 Scope and approaches

To achieve the above goals, the tool needs to be generic and systemic, allowing the evaluation of the entire systems to take into account all the impact of source separation system. Moreover it needs to integrate:

- A characterisation of the variety of urban typology representing district in European cities
- The entire sanitation system from collection to valorisation
- The impact on current centralised facilities (WWTP) but also the impact on the future installation
- Evaluation of scenario based on life cycle assessment

The scope of this study focuses on developed countries and especially to the urbanism of European countries. In the entire work, we focus on new district or district upgrading but not on building renewal.

Moreover as a result of the goal and scope, the separation rate at city scale is limited as only one district implements source separation sanitation. In this sense, only transitional regime has been studied. The operation of wastewater management does not need to be changed.

To conclude, the main innovation in the work presented in this chapter, is to aggregate the best available technologies (and their performances) for each step of the system, in a generic and systemic tool.

II. GENERAL METHODOLOGY

II.1 Sanitation modelling part

The general methodology of the developed tool is presented in Figure II-1. The first four blocks correspond to the sanitation system creation in the district with the creation of the district as a first step, followed by the influent characterisation linked to the type of separation. Then, transport and decentralised treatments can be designed. This four steps are modelled in python language. The last step of modelling is the centralised wastewater plant, models through a wide-plant modelling software (SUMO).

The results from every steps of modelling are converted into the life cycle inventory. The life cycle assessment is performed in the Umberto software and finally the results of assessment can be analysed and interpreted. For this last step, all the alternative scenarios need to be compared to the initial time where the initial district was not constructed and to the Reference case.

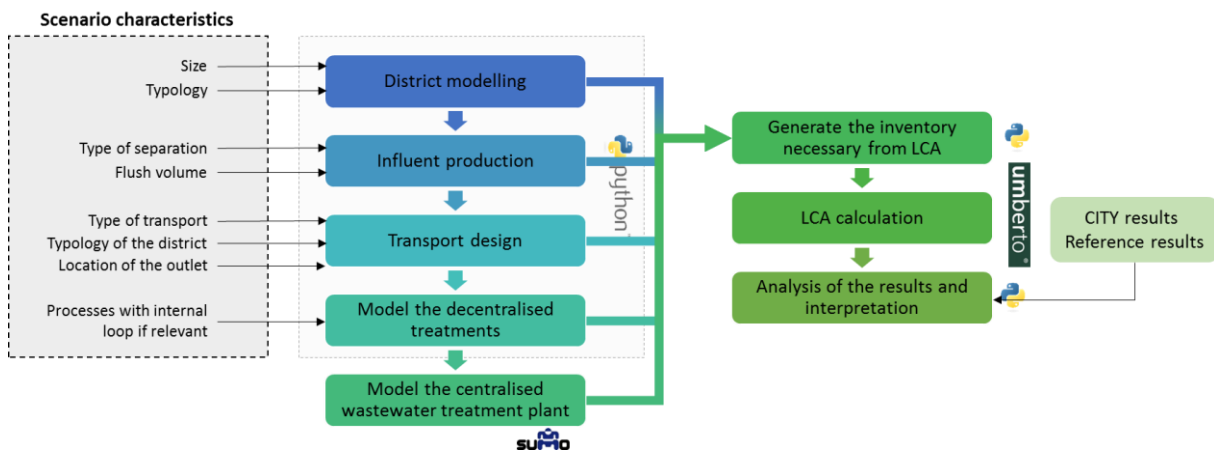

Figure II-1: General methodology of the developed tool for one scenario compared to the reference

II.2 General methodology applied to analyse the scenarios

The goal of this work is to evaluate, at the district scale, several sanitation systems in different typologies and scales of implementation. However, the new district is part of a city, where most of the time, the number of inhabitants is larger than the new district. The impact of the new district needs to be highlighted. For this purpose the centralised WRRF treating the city before the implementation of the new district will be modelled. Then, the results obtained from the city are subtracted to the results of simulation of the whole system including the new district (Equation II-1). In this sense, only the extra “costs” of the district are taking into account.

$$Results_{District} = Results_{District+City} - Results_{City} \quad \text{Equation II-1}$$

Moreover, the results can be normalised by the functional unit of LCA, which is related to the production of wastewater and will be described later on (Chapter II.IV.1.a).

At this stage, each urban configuration for one scale has different production of wastewater and cannot be compared with other typology or scale. To solve this issue, the improvement or the negative effects compared to the reference scenario, for the same typology and scale, are analysed as differences (Equation II-2).

$$Difference, i, j = \frac{(Results_{District,Reference,i,j} - Results_{District,alternative,i,j})}{Results_{District,Reference,i,j}} \quad Equation II-2$$

Where i is the typology and j the scale

This chapter presents in the following paragraphs, first the studied scenarios and secondly the model description. This latter follows the structure of the tool (District generation, influent generation, transport design and treatments with the centralised and decentralised options). It focuses on presenting the state of the art of each block of sanitation system and the main hypothesis used. The details of calculation are presented in the model appendix.

The Figure II-2 summarizes for each block, the main aspects taken into account and main hypothesis as well as the relevant appendix where details can be found.

District modelling	<ul style="list-style-type: none"> • 6 urban configurations representing French districts • District creation is based on statistical data of French cities, it includes the generation of buildings, and their positioning with respect to the built density and contiguity. • Topography is considered flat. • Human density related to floor surface and district surface per urban configuration collected from Toulouse city data 	IV. Creation of the district
Influent production	<ul style="list-style-type: none"> • Urine, faeces and greywater compositions allows to recreate influent for every source separation systems. • Influent production takes into account the ratio of time spent at home and at office. • Number of urination and defecation is location dependent (home or office) 	V. Literature review for influent characteristics VI. Toilet use survey in a building of LISBP, Toulouse France, Mai 2017
Transport design	<ul style="list-style-type: none"> • Gravity sewer has been designed for the collection of wastewater or greywater; and vacuum for blackwater • Design of both sewers, calculates the diameter of pipes, the depth and volume of trenches, the energy consumption for operation. • The life cycle inventory identifies all the materials and energy for construction and for demolition phase. • Collection of urine by a 10 m³ truck has been implemented with the distance intra district and to the treatment facility (10 km). 	VII. 1. Gravity Sewer design VII. 2. Vacuum sewer design VII. 3. Ant algorithm applied to urine collection
Treatments	<ul style="list-style-type: none"> • Modelling of centralised facilities with best available technologies to recover nutrients and as much as possible of organic matter • Nutrients (N & P) recovery is performed in two steps: struvite precipitation and transmembrane chemisorption (TMCS) • Organic matter is recovered through anaerobic production and energy recovery. Conventional CSTR is implemented in centralised facility, and UASB is chosen in decentralised treatment of blackwater as done in some pilot projects. • Only membrane bioreactor is implemented for greywater treatment • Designs of processes are based as much as possible on data from pilot scale studies. • Mass and energy balance are performed for each treatments. 	VIII. 1. Centralised facility a. Matrix from SUMO b. Design of the WRRF VIII. 2. Decentralised a. UASB b. TMCS c. MBR IX. Literature review on electric and heat yield for micro-cogeneration
Inventory of LCA	<ul style="list-style-type: none"> • Goal: compare different sanitation solutions at a district level by taking into account the entire wastewater management system • The boundaries was taken as broad as possible, including process operation and infrastructure (with available data). • Collection and treatment of wastewater as taken into account as well as secondary function such as by-product valorisation, avoided fertilizer production, avoided production of electricity, avoided production of drinking water. • Functional unit is one population equivalent (PE) produced in the district defined as 60 gDBO₅/d. 	VIII. 1. c. Life cycle inventory for WRRF

Figure II-2: Summary of the main aspects taken into account in each block of simulation and the link with the relevant appendix.

III. DESCRIPTION OF THE STUDIED SANITATION SYSTEMS

In this section, the studied sanitation systems are described in order to justify the choice of technology, their detailed description could be find in the next section Chapter II.IV.

III.1 General description

Four different sanitation systems (see Figure III-3) are studied along this work, with an increasing decentralised scale of treatments (the later three are called alternative systems):

- i) the chosen advanced solution for WRRF (*Reference*) where nitrogen and phosphorus recovery take place,
- ii) urine source separation (*Urine*) with a centralised treatment at the WRRF,
- iii) decentralised treatment of blackwater and greywater treated in WRRF (*BW*),
- iv) blackwater / greywater separation and decentralised treatment (*BW-GW*).

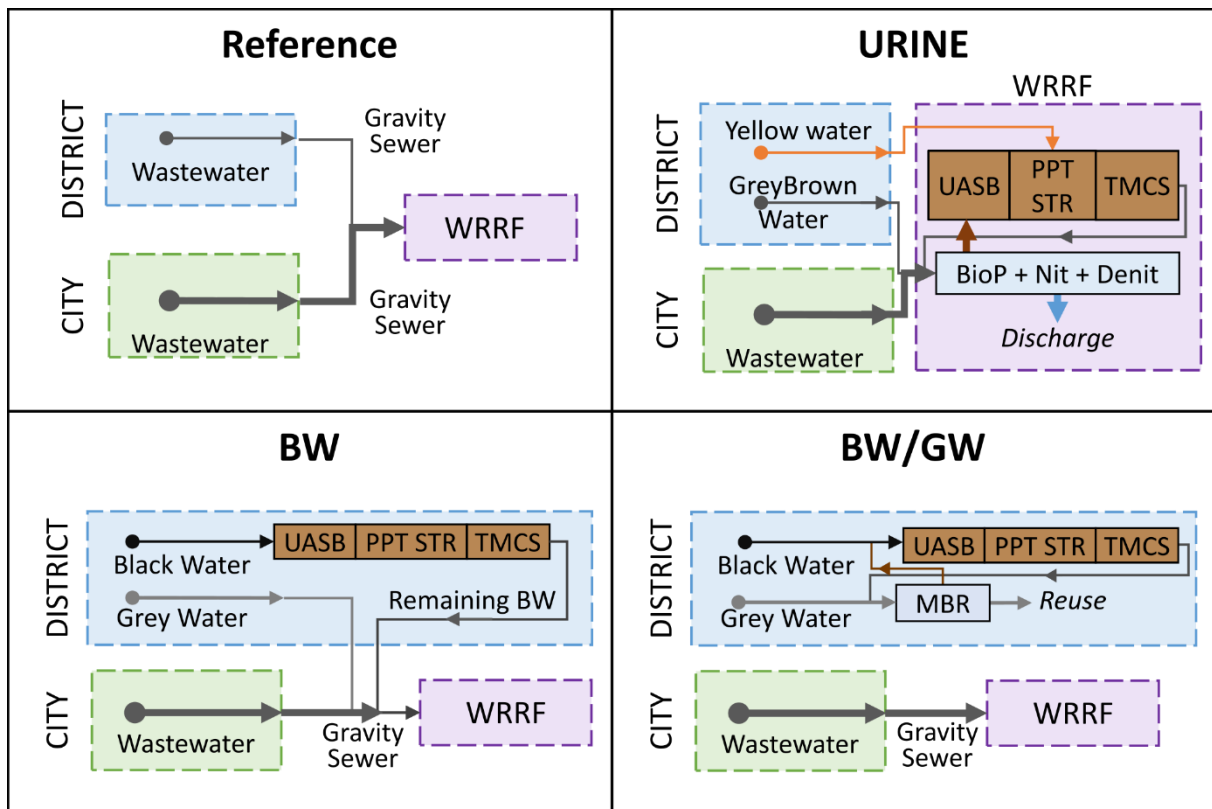

Figure II-3 Presentation of the four scenarios and the WRRF. WRRF: Wastewater recovery facility, AD: Anaerobic digester, PPTSTRU: Struvite precipitation, TMCS: transmembrane chemisorption, UASB: upflow active sludge blanket, MBR: membrane bioreactor, ANAER: anaerobic tank, ANOX: anoxic tank, AER: aerated tank, PANOX: post-anoxic tank, PAER: post aerobic tank, THK: thickening, PTHK: post-thickening, DW: dewatering.

III.2 Reference

In Figure II-3, the scenario A) is the *Reference* where all the wastewater is sent by a gravity sewer to a centralised facility. This treatment plant includes nutrients recovery facilities. This choice is justified because source separation scenarios would integrate nutrients and organic matter recovery. Comparing them to a conventional WWTP will favour these alternative systems.

Literature review (paragraph IV.5.a) shows very little implementation of nitrogen recovery treatments in WRRF, with only two technologies available: (1) ammonia stripping or (2) transmembrane chemisorption (TMCS). The latter is based on the transfer of ammonia through membrane pore, limiting the energy need, and will be assessed in this centralised facilities. This treatment has been chosen due to the lower consumption of energy than stripping as already analysed in Chapter I.III.2.c. Phosphorus is recovered through struvite precipitation as it is already in place in various locations (Le Corre et al., 2009).

III.3 Source separation systems

III.3.a Transport

The three alternative systems are representative of the pilot projects around Europe as described in Chapter I.III, especially concerning the transport systems. The urine is indeed always transported by truck from the production point to the treatment location. Blackwater is also always collected by gravity sewers as it allows to reduce flush water and keep the stream highly concentrated in organic matter.

III.3.b Treatments

The treatment line can differ from one pilot project to another, especially with urine separation, where several treatments have been studied and tested (see Chapter I.). In this study, the choice have been made to use extraction techniques to facilitate the change from waste status to product.

Struvite precipitation is a very convenient technology to extract phosphorus as a precipitate. Moreover it is a well-established technology already tested at pilot scale on urine and blackwater digestate (de Graaff and van Hell, 2014; Winker et al., 2013; Zamora et al., 2017a). As previously discussed, nitrogen recovery is implemented in all the scenarios and will take the form of transmembrane chemo-sorption (TMCS). This step has not been tested at pilot scale for urine treatment, but recently at lab scale (Nagy et al., 2019). However this treatment is, with bioelectrochemical system, the lowest consumer of electricity (see Table I-2 in Chapter I.III.2.c) and therefore will be assessed with environmental criteria. Bioelectrochemical systems have been already assessed with LCA in (Igos et al., 2017).

III.3.b.1 Urine

In this study we only considered the case where urine is sent to treatment in centralised WRRF. The long-term storage as a hygienisation step is not considered because issues limit the direct use. Firstly, the urine nutrients concentration is low compared to fertiliser. (Brun, 2018)

highlighted it as the main obstacle to its appropriation by farmers. Secondly, micropollutants are present in high concentration, and limited knowledge is available on their impact on soil and culture (Winker, 2009).

III.3.b.2 Blackwater

In the case of blackwater separation (BW and BW-GW scenarios) the organic matter is always treated in anaerobic digester. At pilot scale only, upflow anaerobic sludge blanket (UASB) reactors have been implemented due to their compactness and robustness. Phosphorus is sometimes recovered via struvite precipitation reactor. Moreover nitrogen has been only treated through nitrification/denitrification or nitritation/anammox processes (de Graaff and van Hell, 2014).

In our study we add the same TMCS process after the conventional UASB and struvite precipitation. The effluent is always sent to greywater treatment.

III.3.b.3 Greywater

Greywater presents, as urine, a large panel of treatments from the less extensive ones (for example: lagoons) to the more intensives (for example: membrane bioreactor) (Oteng-Peprah et al., 2018; Pidou et al., 2007). In this study, we only focus on the membrane bioreactor as it allows to have a sufficient quality of treated greywater for reuse. As the goal was to try to recover as much as possible resources.

TAKE HOME MESSAGE

- Four scenarios are studied with two different separations (urine and blackwater/greywater) and different scales of decentralised treatment.
 - Nutrients recovery is the main goal achieved by the treatment lines. Organic matter is recovered as much as possible.
 - Water is only recovered in the totally decentralised scenario.
 - The centralised facilities (WWRF) also include a nutrient recovery step and represent in this way the next generation of treatment plants.
-

IV. MODEL DESCRIPTION

The developed simulation tool needs to take into account the entire sanitation system which comprises the production of effluent linked to a specific district, the collection of wastewater (with or without separation), the transport to the treatment plant the treatment itself (centralised and/or decentralised), and then the discharge or valorisation of waste and by-products.

The current section presents the state of the art of each block of the sanitation system and the main hypothesis used to model it.

IV.1 LCA

IV.1.a Goal and scope

The tool developed in this thesis, allows to evaluate the different studied scenarios, by life cycle assessment (LCA). The goal of this study is to compare different sanitation solutions at a district level by taking into account the entire wastewater management system. The comparison aims to identify strategies which will improve the environmental balance compared to the reference treatment system. The boundaries was taken as broad as possible, including process operation and infrastructure (with available data).

The main functional unit used is “management of 1PE (=60 g-BOD₅/d) in the new district by achieving standard effluent discharge concentration for one year”. The limits for effluent discharge at WWRF are fixed at the same value: 10 mg-N/L and 1 mg-P/L.

However other functional unit have been studied (Results of chapter IV in Appendix II.4.) with 1 kg-N/year, 1 kg-P/year and 1 m³/year produced in the district wastewater.

The life cycle inventories is adapted from the model developed by (Bisinella de Faria et al., 2015), though several changes have been made to adapt this model created only for the WWTP to the whole wastewater management as presented in Figure II-4.

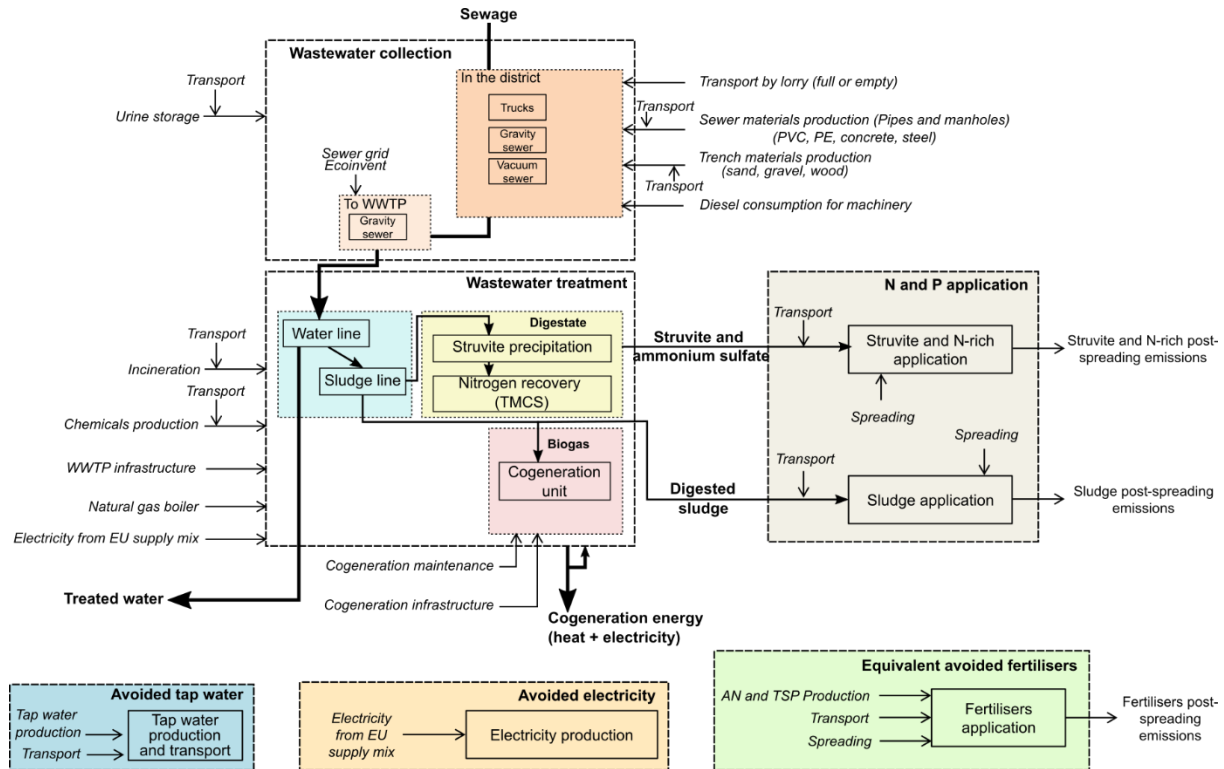

Figure II-4: Extended system boundaries for LCA (adapted from (Bisinella de Faria et al., 2015))

With boundary extension different secondary functions of the system are taken into account, such as, fertilizer production, by-product valorisation, production of an excess of electricity, production of a treated water which can be reuse for non-potable uses.

IV.1.b Inventory

The inventory for LCA is directly linked to the simulation tool and will be developed in the following section. Appendix X.2 summarises also all the hypothesis and Ecoinvent processes uses in the LCA model.

IV.1.c LCIA Methods

The environmental impacts were calculated in Umberto® v5.6 software using the LCA Ecoinvent database v2.2 and ReCiPe 2008 (Goedkoop et al., 2009) with endpoint (H,A) and midpoint (H) as LCIA method. Primary energy demand have been also used with cumulative energy demand methodology (Hischier et al., 2010).

IV.2 District modelling

IV.2.a Objectives

The district modelling aims to create representative district from European cities in order to have a description of the location of the buildings and the number of persons producing wastewater. Moreover, we need also to describe the roads in order to design the transport of wastewater by sewer or truck.

IV.2.b State of the art

Domestic wastewater production depends on the water uses. At the household level, it thus depends on time, lifestyle and number of people per households, age, and social level (Corbella and Pujol, 2009; Henze, 2008). At the district level, it depends mainly on the function of buildings (office or household) and on human density. However, these parameters are linked together and cannot be distinguished from one to another. Thus we need a general urban configuration which represents the most common district of European cities.

(Bonhomme, 2013) thanks to statistical analysis on Paris and Toulouse (French cities) characterized 6 different urban configurations (Figure II-5) with the parameters listed in Table II-1. More recently, the project MaPuCe (Tornay et al., 2017) distinguished 10 houses blocks with an analysis on several French cities. As the work is ongoing and to keep a realistic number of cases, the classification of (Bonhomme, 2013) has been used.

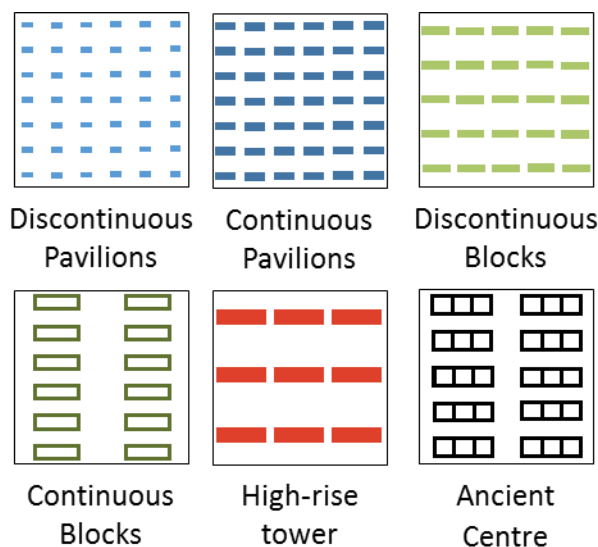

Figure II-5: Simplified morphology for each urban configuration (illustration from (Bonhomme, 2013))

Depending on the type of buildings present in the district, 6 configurations were named:

- *Discontinuous pavilion* is representative of district in suburbs with individual houses, a low built density and a high density of green area (gardens).
- *Continuous pavilion* are very similar to discontinuous pavilion but with a slightly higher built density and height (3 levels instead of 2). The garden are also smaller.

- *Discontinuous block* are a mixed of housing and offices (11.5 %) but a similar built density from continuous pavilion, with a higher buildings (5 levels).
- *Continuous block* has a higher built density and height (6 levels) thanks to more contiguity between buildings. Again the majority are housing but with a small part of offices (11.1 %) especially on the first floor.
- *City centre* are similar to continuous block in term of built density but the morphology of the buildings is characterized by a courtyard in the middle of the block. There is a mix of housing and offices (11.4 %).
- *High-rise tower* is representative of sky-scrappers even so it is not so common in France. It is determined by a high height (around 13 levels) but a quite lower built density than city centre as this district has small footprint and large amount of green area. Large proportion of offices is also observed (66 %).

Industrial buildings is the seventh urban configuration, however they are outside the scope of this study, as only domestic wastewater is analysed.

Table II-1: Parameters used for district generation for each urban configuration from (Bonhomme, 2013))

	Discontinuous Pavilions	Continuous Pavilions	Discontinuous Blocks	Continuous Blocks	Ancient Centre	High-rise tower
Built density ($m^2_{\text{floor}}/m^2_{\text{district}}$)	0.27 ± 0.131	0.7 ± 0.09	0.82 ± 0.36	2.13 ± 0.2	3.16 ± 0.51	2.64 ± 1.94
Land coverage ratio ($m^2_{\text{built}}/m^2_{\text{district}}$)	0.12 ± 0.049	0.22 ± 0.039	0.19 ± 0.08	0.36 ± 0.06	0.48 ± 0.08	0.21 ± 0.11
Average height (m)	6.64	9.94	13.91	18.37	19.92	40.13
Contiguity ($m^2_{\text{shared-wall}}/m^2_{\text{built}}$)	0.03	0.04	0.12	0.29	0.39	0.18
Density of road surface ($m^2_{\text{road}}/m^2_{\text{district}}$)	0.11	0.13	0.18	0.19	0.21	0.22
Road width (m)	3.39	3.49	4.01	4.47	4.89	4.02
Individual / Collective ratio	0	0	0.84	0.97	0.99	0.97

Inhabitant density in the different typologies is a key point in the model as it influences the influent generation and the whole chain afterwards. However, it is varying inside each urban configuration as it is also correlated to the location of the district in the city and attractiveness of the city.

Several authors have investigated the inhabitant density regarding urban configuration and present several definitions of urban configurations with highly varying density as presented in Table II-2. Each configuration has been grouped with the urban configuration from (Bonhomme, 2013) with the closest land coverage ratio and built density.

Table II-2: Comparison of inhabitant density with literature data

Inh/ha	(Belliot, 2006)	(Sabatier, 2010)	(Aucame, 2010)	(Bordes- Pagès, 1995)	IRIS data from Toulouse
Discontinuous Pavilions	57 <i>Discontinuous and grouped individual</i>	14 ± 1 <i>Individual housing</i>	27 <i>Pavilions district</i>		24 ± 5
Continuous Pavilions	111 <i>Continuous individual</i>	19 ± 1 <i>Grouped individual housing</i>	46 <i>Pavilions district</i>	96 <i>Identical individual housing</i>	52 ± 19
Discontinuous Build	233 <i>Discontinuous collective</i>	138 ± 52 <i>Individual housing in rectangle</i>	146 <i>Large urban district</i>	382 <i>Discontinuous collective housing</i>	105 ± 19
Continuous Build	294 <i>Continuous collective</i>	138 ± 45 <i>Low dense collective housing</i>	113 <i>Collective urban district</i>	154 <i>Low height collective building</i>	134 ± 32
High-rise Tower	154 <i>Mixed</i>	230 ± 115 <i>Dense collective housing</i>	320 <i>Dense collective</i>		98 ± 30
City Centre	287 <i>Continuous collective</i>	230 ± 115 <i>Dense collective housing</i>	86 <i>City centre</i>	486 <i>High continuous collective buildings</i>	170 ± 40

Table II-2 presents also the data gathered from two databases:

- The database of housing at sub-municipal level (IRIS) from Toulouse city (INSEE: French national institute of statistics and economic studies)
- The database of BD Topo (IGN 2014)

The two databases have been merged in order to evaluate the population in buildings. Finally, the data was compared to the map of the categorisation of urban district of Toulouse by (Bonhomme, 2013). Human density has been established from a small sample (from 4 to 6) of district for each urban configuration.

IV.2.c Hypothesis in this work for buildings creation

The data from (Bonhomme, 2013) allowed to recreate district by :

- Positioning the road in accordance to the road width and the road density. As a first approach, the road are considered as straight lines with right angles. They are placed with the same spacing between each other.
- Defining the number of buildings in accordance with the land coverage ratio and the surface of one building. The built surface of each building and the shape factor have been also established by (Bonhomme, 2013) for Paris city (Table II-3).
- Positioning the buildings randomly in the district, with two constraints: a fixed distance to the road and obviously no overlap with road or building. The building can be placed with two angles of rotation (horizontal or vertical). The choice of the contiguity of buildings, is verify after each building creation to approach the value of contiguity parameter from Table II-1.

Table II-3: Building/Group parameter for urban configuration (from (Bonhomme, 2013))

Urban configuration	Surface of building or group		Shape factor (length / width)
	Collective	individual	
	m ²	m ²	m/m
Discontinuous Pavilions	174	174	2.01
Continuous Pavilions	262	262	2.88
Discontinuous Blocks	436	174*	3.44
Continuous Blocks	1564	174*	2.6
Ancient Centre	3127	174*	2.63
High-rise tower	1633	174*	3.34

*Own assumptions, equal to the individual building surface of discontinuous pavilions.

A more detailed description of the creation of the district can be find in the Appendix IV.

At the end of this process, a connection point can be created, mimicking the property boundary. In the model, it is the point of the road closest to each building. This point is relevant for collection design, as (i) it is the connection to the sewer and (ii) for truck transport it represents the emptying valve of the storage tank of urine.

To finish with district creation, at this stage of the tool development, the topography is not taken into account. The topography would have a great impact on wastewater collection and especially sewer. However, the number of scenarios would have increased dramatically if different topographies have been explored. For this reason, even if the tool is able to design sewers with different topographies, all the studied districts are considered flat. The analysis of this parameter would be integrated on the case study.

IV.2.d Hypothesis in this work for inhabitant density description

Table II-4 summarizes these values with standard deviation and thanks to a built density (from Table II-1) an inhabitant density expressed per surface of district have been evaluated. Small difference can be observed between the Table II-4 and Table II-2 as the first one is coming from calculation as the last one is directly linked to data from Toulouse.

Table II-4: Inhabitant density along different urban configurations

Urban configuration	Inhabitant density Inh/m ² -housing floor	Inhabitant density Inh /km ²
Discontinuous Pavilions	0.0049 ± 0.0001 (2 %)	1,457 ± 97 (7 %)
Continuous Pavilions	0.0053 ± 0.0009 (17 %)	3,735 ± 435 (12 %)
Discontinuous Blocks	0.0120 ± 0.0021 (18 %)	9,563 ± 914 (10 %)
Continuous Blocks	0.0092 ± 0.0016 (17 %)	19,385 ± 2,722 (14 %)
Ancient Centre	0.0049 ± 0.0013 (27 %)	11,185 ± 2,057 (18 %)
High-rise Tower	0.0043 ± 0.0015 (35 %)	15,829 ± 3,215 (20 %)

As this methodology is based on a small sample, the determination of inhabitant per building takes into account the standard deviation of the density.

In the first step of the methodology, a sample of human density (per housing floor) has been generated (Equation II-3) with the average value and standard deviation of Table II-4. This sample contains the same number of density than number of housing buildings.

$$[Human\ density]_0^{Nb\ buildings} = \left[p(x) = \frac{1}{\sigma\sqrt{2\pi}} e^{-\frac{1}{2}\left(\frac{x-\mu}{\sigma}\right)^2} \right]_0^{Nb\ buildings} \quad Equation\ II-3$$

With:

σ : mean

μ : variance

In a second step, the value of inhabitant per building is calculated through the floor surface of building. As the number of buildings is small, the population of the district does not correspond necessarily to the product of the average value of inhabitant density to the total surface of floor.

TAKE HOME MESSAGE

- 6 urban configurations are selected to represent districts in Europe and especially in France
 - District creation is based on statistical data of French cities, it includes the generation of buildings, and their positioning with respect to the built density and contiguity.
 - Topography is considered flat.
 - Data from Toulouse city have been used to determine the human density related to floor surface and district surface per urban configuration
-

IV.3 Influent production

The influent generation is based on average data obtained from a literature review. As said previously the influent is split up into 3 main categories which represent the domestic wastewater: urine, faeces and greywater. In Appendix III, tables listing the data can be found. Urine composition and flow are already published in (Bisinella de Faria et al., 2019) and count 34 references. Faeces composition and flow are based on 17 references, and greywater on 23 references. The Table II-5 sums up the value considered.

Table II-5: Influent characteristics for domestic wastewater production

	Urine		Faeces		Greywater		Unit
Volume	1.36	± 0.15	0.12	± 0.03	110	± 33	L/pers/j
Concentration							
COD	7.4	± 4.8	423	± 206	0.484	± 0.272	gO ₂ /L
BOD ₅	3.8	± 1.2	103	± 87	0.245	± 0.150	gO ₂ /L
TN	7.8	± 1.7	14	± 4	0.011	± 0.005	gN/L
NH _x	7.3	± 5.4	3.0	± 1.2	0.001	± 0.001	gN-NH _x /L
TP	0.7	± 0.3	5.2	± 1.8	0.005	± 0.004	gP/L
PO ₄	0.6	± 0.5	4.5	± 5.1	0.002	± 0.001	gP-PO ₄ /L
TSS	0.7	± 0.3	376	± 70	0.111	± 0.051	gTSS/L

These wastewater are produced both at home and at office location. A ratio of 2/3 of the time spent at home is considered in agreement with (Jönsson et al., 2005). The number of toilet uses for each purpose (defecation and urination) is derived respectively from works of (Friedler et al., 1996) and (Rauch et al., 2003) and is used for the calculation of the total of flush water. The former researchers measured 1.07 defecation/pers/day (with urination in the meantime) during weekend days at home and 2.39 urination/pers/day. However the latter measured an average of 1.8 L urine/pers/day and 340 mL per urination which means 5.3 urination/pers/day in total with the urine during defecation. This value was already used in several analysis of source separation systems (Bisinella de Faria et al., 2019; STOWA, 2002) and hence it was decided to continue with it.

Thanks to the number of uses and the time spent at home, the production of urine at housing can be calculated. At office, the calculation takes also into account the ratio between faeces and urine releases. Thanks to a survey conducted in the laboratory during more than one month (11 toilets and 1395 answers in total) the ratio between urination and defecation was found around 5.1 at office (see Appendix VI for detail of the survey) which is quite similar to the one that we can calculate at home (4.95). Thanks to this ratio, a number of defecation per person at office can be deduced.

Table II-6 summarizes the values used in the model.

Table II-6: Default value for calculation of number of use of toilet

	Value	Reference
Number of urination per day and per person	5.3±2.9	(Rauch et al., 2003)
Number of defecation per day and person	1.07±1.07	(Friedler et al., 1996)
Ratio at office urination ⁱ /defecation	5.1±0.8	Own assumption

ⁱAll urination is taking into account included the one with defecation.

Greywater production is also spread into housing and offices. However, the ratio is not linked to the time spend at home. We consider 110 L/pers/day of total greywater thanks to the literature review, and 26 L/pers/day at office. This last value comes from the baseline situation of BREEM certification (BREEAM, 2016) for office building (shower are included with wash hand basin taps and kitchen taps).

TAKE HOME MESSAGE

- Urine, faeces and greywater compositions allows to recreate influent for every source separation systems.
 - Influent production takes into account the ratio of time spent at home and at office.
 - Number of urination and defecation is location dependent (home or office)
-

IV.4 Transport

Three types of transport are integrated in the model: gravity and vacuum sewer, and truck collection.

The two types of sewer are characterised by:

- The location of the pipes in the district and by the depth in each point linked to the slope of pipes. The pipes are assumed to follow the path of the road, with the shortest distance between the building collection point and district collection point.
- The district collection point of all the wastewaters can be a central point in the district in case of decentralised treatments or a point at the boundary of the district for centralised treatments.
- The energy used for transportation.

Each transport will be described in the following section with the main hypothesis used.

IV.4.a Gravity sewer

IV.4.a.1 Sewer

Gravity sewer is designed to achieve the transport of the peak flow by choosing the appropriate couple diameter / slope of the pipe. This couple needs to fulfil three self-cleansing conditions to avoid sedimentation in the pipes determined based on velocity in the pipes.

Moreover, when depth is too high, assumed to be 4 meters in our model, a pumping station is placed and designed. It aims to pump the wastewater to a higher level. Pumping station is composed of a retention tank and at least two pumps to have a spare one. Its design is based on the peak flow and the ability to discharge the wastewater quickly enough.

The calculation of this design can be found in Appendix VII.1.

IV.4.a.2 Life cycle inventory

For life cycle assessment, it is necessary to take into account the infrastructure needs in terms of materials and energy. The following elements are taken into account (see also):

- Diesel for installation (excavation and small machinery, data from (Risch et al., 2015))
- PVC pipes with a relationship between the diameter and the quantity of PVC per linear meter according to (Risch et al., 2015).
- Material to fill the trenches (sand and gravel) as shown in Figure II-6

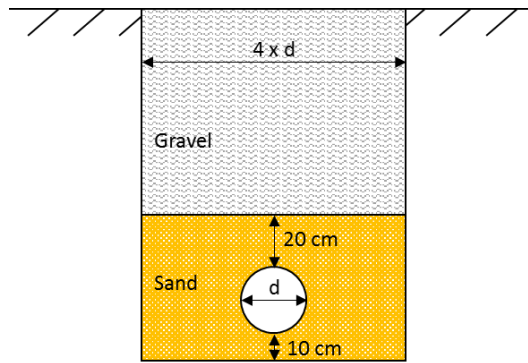

Figure II-6: Trench design

- Material to construct manholes (concrete) according to (Risch et al., 2015). There are placed at every change of direction of the sewer network. In case of a manhole with pump, the pump metal from (Petit-Boix et al., 2014) is used with a lifespan of 10 years.

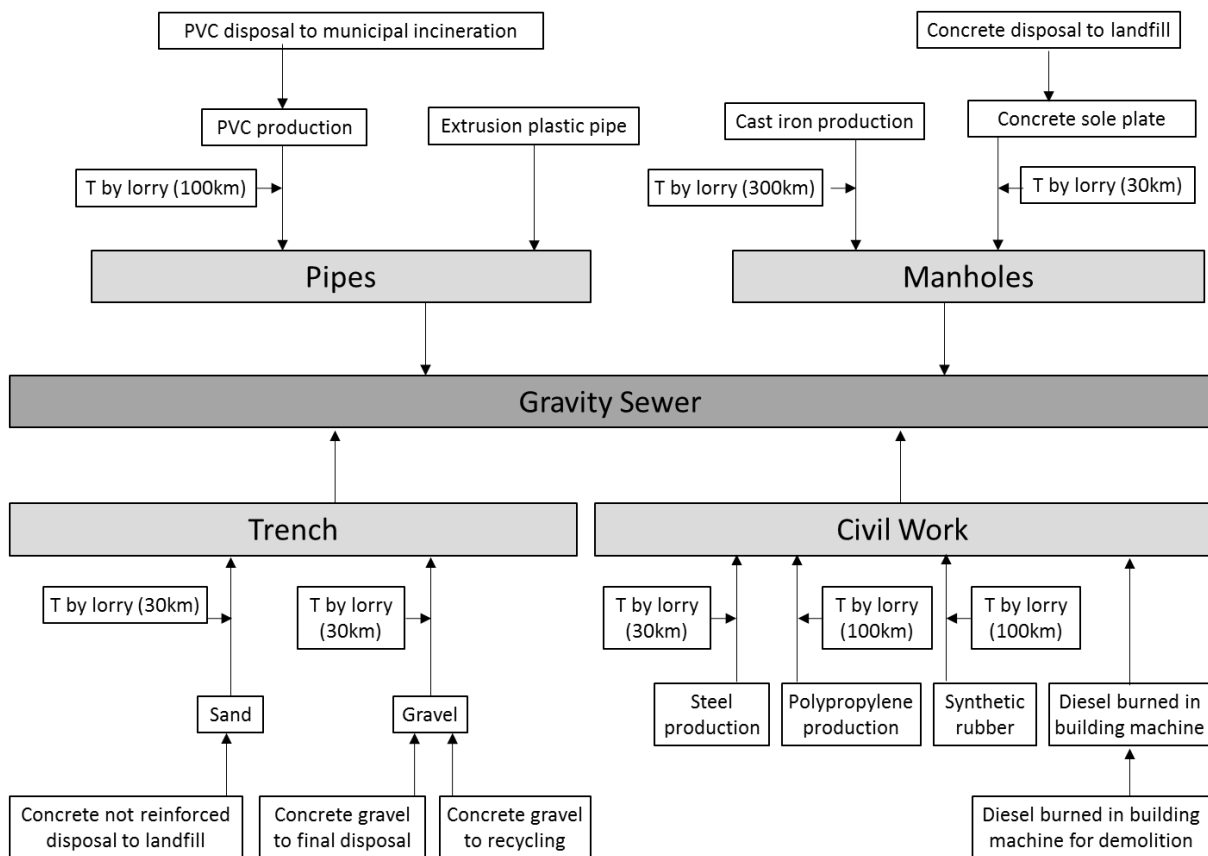

Figure II-7: life cycle inventory of gravity sewer

After the lifespan of the sewer (50 years for gravity sewer), gravel are sent to recycling for 50 % and to final disposal for 50 % (landfilling). The demolition needs diesel and is accounted for 38 MJ according to (Petit-Boix et al., 2014) with a lifespan of 50 years.

IV.4.b Vacuum Sewer

Vacuum sewer works with air transport instead of water transport as in gravity sewer. A depression is kept in the sewer and when wastewater/air enters in it, the mixture will move forwards thanks to the difference in air pressure in front of and behind the wastewater. Vacuum sewer can be applied for the transport of all wastewater and also for separated stream as blackwater which is collected by vacuum toilet.

IV.4.b.1 Operation

A vacuum network is often compared to a water distribution network (Bowne et al., 1991) as it is composed of three main elements: 1) (1) An interface between atmospheric pressure and vacuum pressure; (2) collection mains (pipes); (3) a vacuum pump which can be coupled with a vacuum tank.

Vacuum sewer can transport wastewater or blackwater. When the latter is pumped, the toilet inside the building is the interface between atmospheric pressure and the vacuum in the pipe.

The pipes follows a saw tooth path (Figure II-8) to uphill the liquid transport by vertical lift. At static conditions, the wastewater filled the pipe bore. When a valve is open, a pressure difference is created between the plug making it moved (Islam, 2017). The wastewater will be pushed by air pressure difference through the pipe, lifts are here to recreated time to time, a plug in the sewer and be sure that water is moving with the air. Moreover thanks to the saw tooth path, the pipe will remain at a low depth.

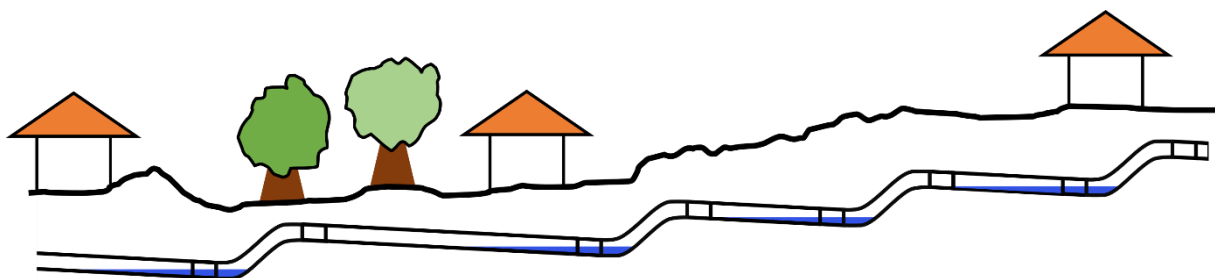

Figure II-8: Saw tooth pattern of vacuum sewer (adapted from (Bowne et al., 1991; Naret, 2007))

Vacuum station is the last element of vacuum sewer. The vacuum pumps installed in it will insure the correct pressure in the entire system. For urban installation, vacuum pump are connected to a vacuum tank and they remove the air to maintain the correct pressure in the sewer. As a large quantity enters into the networks, treatment of vicious air is mandatory.

IV.4.b.2 Advantages and drawbacks

The main advantage of vacuum sewer is the very low excavation need compared to gravity sewer. As water is not used for transport, a very low slope is necessary (minimum 0.2 % m/m, compared to a minimal of 0.5 % for gravity sewer (Islam, 2017)).

The second advantage is linked to air transport instead of water. Sedimentation is indeed not a problem and more solid concentrated flow can be transported. Moreover, the introduction of air into sewer could limit the corrosion of pipe by avoiding anaerobic conditions, even if no literature is available to support or refute this hypothesis.

The third advantage is to be able to avoid obstacles in the path of the sewer by several small lifts (as shown in Figure II-8 at right part to follow the hill). And finally, as the sewer is depressurised, there will be no pollution of wastewater into the soil.

However vacuum sewer has also drawbacks and the more obvious is the need of power to maintain the vacuum. Secondly for resilience in crisis period (flood or natural disaster) an external power of energy is needed. Finally, the last drawback is the need of expertise for the maintenance of the sewer in the buildings and in public mains.

Leakages in the sewer will create high power consumption and will need to be resolved quickly. It has been shown that the main failure of vacuum sewer is vacuum valve failure (more than 80 % of the failure) which fail to close or open (Miszta-Kruk, 2016). On the contrary gravity sewer failure is happening in the pipes by blockages. However, (Miszta-Kruk, 2016) reported that these failures are easy to deal with as the time between failures happened and solving is in more than 60 % of cases below one hour, and around 15 % last more than 2 hours. In the same study, gravity sewer needed more than 2 hours in 40 % of the case and between 1 and 2 hours in 40 % of the failure events.

IV.4.b.3 Design

The design of vacuum sewer follows the rules presented in (Bowne et al., 1991; Islam, 2017; Roediger Vacuum, 2012; SQAЕ, 1994):

- Calculation of the peak flow at building collection point according to (Naret, 2007) see Equation S-3 in appendix.
- Find the location of the vacuum station. As vacuum sewer is only used for decentralised treatment, vacuum station is positioned in the middle of the district. Optimisation is not performed on the station location for decreasing the energy consumption.
- Creation of the path of the pipe with the same algorithm than gravity sewer. Pipes follow road and shortest path algorithm is used to link each building collection point and vacuum station.
- Creation of the four mainlines from vacuum station. For security reason, it is better to have three to four mainlines collecting the wastewater until the vacuum station. In case of issues, only a small part of the sewer has to be cut off.
- Determination of the diameter regarding the peak flow transported according to (SQAЕ, 1994) recommendations.
- Creation of the saw tooth path on the mainlines with the following hypothesis:
 - Minimum slope of 0.002 m/m
 - Minimum distance of 15.2 m between vacuum valve and lift
 - 5 maximal consecutive lifts
 - 6 m minimum between consecutive lifts
 - The exit pipe from vacuum pit is 0.664 m below surface
 - The maximum depth is 1.5m below surface

- Calculate pressure drop with recommendations of (Bowne et al., 1991; Islam, 2017; SQAЕ, 1994) for static pressure drop and of (Jinming and Jingxuan, 2006) for frictional pressure drop.
- Design the vacuum station according to (SQAЕ, 1994) with:
 - Vacuum tank where the wastewater is collected. On the contrary of (SQAЕ, 1994) rules only one tank is considered as (Islam, 2017)
 - Vacuum pumps which ensure vacuum in the network
 - Discharge pumps which evacuates wastewater to treatment.

IV.4.b.4 Life cycle inventory

For life cycle inventory, the same approach as gravity sewer is followed. The pipe are not in PVC but in PE (polyethylene) high density as mentioned by (Islam, 2017). The width and the depth of the trench will be lower than gravity sewer as designed in section Chapter II.IV.4.b.3.

The quantity of PE is deduced from density and ratio between external diameter and thickness (Standard dimension ration SDR).Indeed the plastic industry plays with SDR and type of polyethylene to achieve mechanical resistance. The value of PE100 and SDR 17 (from (Glynwed, n.d.)) has been chosen to fulfil a nominal pressure of 10 bar. This pipe are often used in tap water abduction but also for vacuum sewer (Watercare, 2018).

Moreover, in both scenarios where vacuum sewer is in place, gravity sewer is also designed. For this purpose a same trench is assumed with the design described in Figure II-9.

The lifetime of vacuum is assumed to be 30 years, less than the gravity sewer.

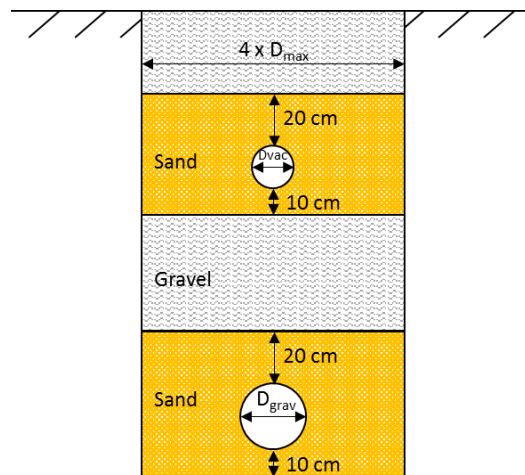

Figure II-9: Vacuum trench design with gravity sewer

IV.4.c Truck transport

Simulating the truck collection of separated urine at building level falls under the well-known capacitated vehicle routing problem. This problem consists on the collection from a central depot to all the “customer” in this case urine storage, by a vehicle with a certain operating

volume. This problem have been extensively studied (Gutin and Punnen, 2006) as it has a large range of application from logistic to public transport (Bell and McMullen, 2004). Moreover, as the number of collection point increases, the number of feasible solutions increases exponentially. Solving a vehicle routing problem is known to NP-hard meaning that there is no polynomial algorithm which will solve every case (Bell and McMullen, 2004).

Heuristic approaches have proved to be adapted to solve this problem and especially the ant algorithm (Bullnheimer et al., 1999; Dorigo and Gambardella, 1997) which mimic the strategy of ant colony for searching food. When ants move they left on the followed path pheromones which will disappeared with time. The ant are attracted to follow path with high density of pheromones. Therefore more pheromones are added and will attract more ants and etc. By this two rules the ant can have individual movement which will be optimised to collect food but also explored the surroundings. Ant colony algorithm follows the exact same rules and are detailed in Appendix VII.3.

The main hypothesis are:

- Urine storage for one week
- a 10 m³ truck for collection
- 10 km between WWRF and the district

TAKE HOME MESSAGE

- Gravity sewer has been designed for the collection of wastewater or greywater; a vacuum has been designed for the collection of blackwater
 - Design of both sewers, calculates the diameter of pipes, the depth and volume of trenches, the energy consumption for operation.
 - The life cycle inventory identifies all the materials and energy for construction and for demolition phase.
 - Collection of urine by truck has been implemented with the distance intra district and between the district and the treatment facility (10 km). A 10 m³ truck is supposed to collect urine.
-

IV.5 Treatments

In this framework of treatment, the simulation tool is developed to give a first estimation and design of the entire process chain of sanitation. This is why the treatment models implemented are quite simple and are more or less based on values of removal efficiency taken from the specialised literature. However, to give particular insight of some processes and some comparisons, a more advanced simulation can be performed. This is the case of the centralized facility, with or without any source separated flow, which has been simulated with SUMO software. It is based on activated sludge model coupled to an anaerobic digestion model and mass balance in process units. The matrix model can be requested in excel file.

IV.5.a Centralised facility simulation

IV.5.a.1 State of the art of water resources recovery facilities (WRRF)

Nowadays wastewater treatment plant (WWTP) is intended to become WRRF (Water Resources Recovery Facility) where not only preservation on environment is performed but also production of resources (Guest et al., 2009) as: water, carbon, phosphorus and nitrogen and heat.

Concerning carbon recovery, the main approach, nowadays is to convert it into energy through anaerobic digestion (Batstone et al., 2015; Khiewwijit et al., 2015). The produced biogas can be used in cogeneration or injected into gas network. Researches are performed to increase the amount of organic matter recovered, with for instance high-rate activated sludge, enhanced primary sedimentation. However, the main challenge is to balance the use of organic matter between the recovery and the denitrification need, and several authors proposed to decoupling the COD and N treatment with two stages of treatment. The use of partial nitrification/ anammox seems to be a promising approach (Besson et al., 2017; Kartal et al., 2010).

Other studies work on the transformation of organic matter into biofuels or biopolymers (Cavaillé et al., 2016; Puyol et al., 2017).

Concerning nutrient recovery, biological processes exist to concentrate phosphorus from wastewater thanks to phosphorus accumulating bacteria. The phosphorus contained in the sludge, is released during anaerobic digestion and is available for extraction process as struvite precipitation with magnesium adjunction.

No concentration processes are yet available for extracting nitrogen from wastewater. Experiments have been conducted for removal of nitrogen with algae (Cai et al., 2013). This technique can indeed uptake nitrogen without needed organic carbon as light and inorganic carbon (CO₂) is the source of energy of the algae. However this process are still challenged by harvesting the algae, low light transmittance in wastewater and downstream process to reuse the nitrogen (Mo and Zhang, 2013).

However sludge contains a small fraction of nitrogen which is also released during anaerobic digestion. (van der Hoek et al., 2018) listed several technologies for nitrogen recovery : stripping, precipitation, absorption on zeolite, hydrophobic and vacuum membranes or

electrochemical systems. These technologies are however not largely applied at industrial scale due to high operational cost respectively for energy and raw material. One pilot of electro dialysis is in operation at Brisbane WWTP in Australia (Ward et al., 2018) and shows an energy consumption equivalent to the nitrification denitrification. As mentioned previously the TMCS is currently adapted to wastewater application for nitrogen recovery (Kunz and Mukhtar, 2016). This technology is currently tested with an industrial pilot in the WWTP of Altenrhein and Yverdon-les-Bains (Böhler et al., 2018). With its low energy consumption it should be an emergent technology for nitrogen recovery.

Water recovery in centralised facilities is increasing in Europe and the world. The main water use is the irrigation of crops or greens areas. However some examples shows the feasibility of reusing wastewater for tap water production as in Singapore and Windhoek (Lafforgue and Lenouvel, 2015). Several technologies exist to recover water, and are implemented as a third stage in the facility after organic matter and nutrient removal. The processes involve several separation techniques such as rotating biological contactor, biological aerated filters, membrane bioreactors, coagulation-flocculation, microfiltration, ultrafiltration, nanofiltration, and reverse osmosis, with or without disinfection techniques as UV disinfection or chlorination (Bixio et al., 2006; Norton-Brandão et al., 2013; Pidou et al., 2007; Raffin et al., 2013). However these technologies are outside the scope of this study.

IV.5.a.2 Design of the WRRF

In this study, the choice have been made to increase the recovery of nutrient and as much as possible of organic matter. Water recovery at centralised facility is not covered yet in this study.

The advanced WRRF is based on biological removal of phosphorus in a “University of Cape Town” (UCT) configuration with additional post denitrification (Figure II-10). Post denitrification are performed with the adjunction of methanol as carbon source. The volume of each tanks can be found in the tables in Appendix VIII.1.a.

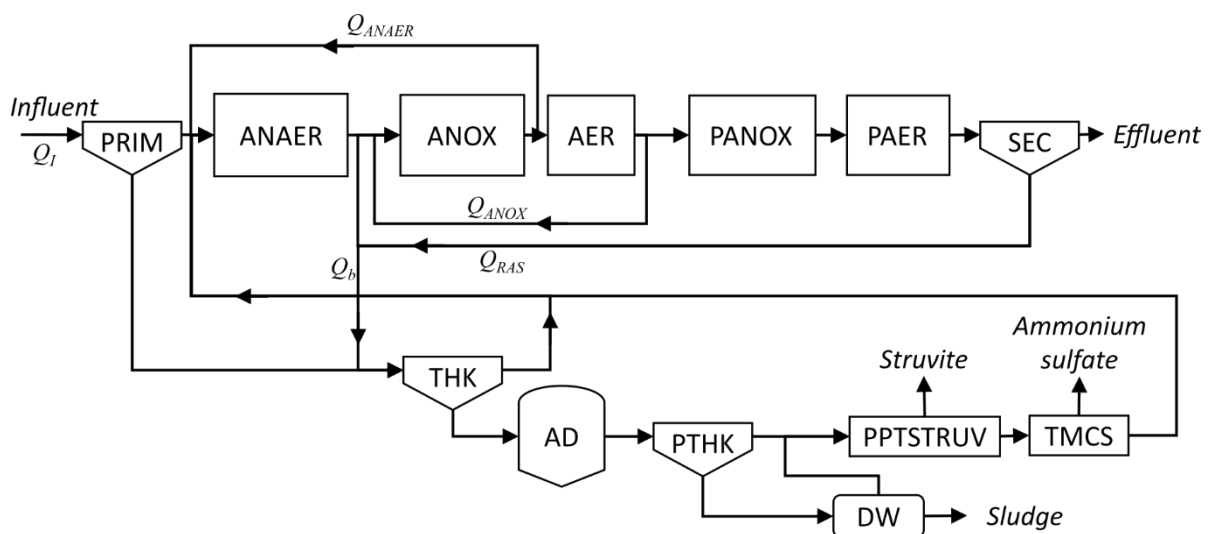

Figure II-10: Process chain of the upgraded WRRF

The anaerobic digestion of the sludge is performed at 35°C and around 25 days of sludge retention time.

Chemical phosphorus removal is also performed with the adjunction of iron chloride into the post anoxic tank.

The recovery of phosphorus is performed by a struvite precipitation of the rejected water of the dewatering of the digested sludge.

Nitrogen will be recovered thanks to a transmembrane chemisorption (TMCS) (see details in the section IV.5.d) also known as ammonia stripping with hydrophobic membrane. This process transfers only gas through the pore of the membrane and especially ammonia. The operational conditions (temperature and pH) need to be chosen in order to favour ammonia against ammonium ion. In this study a pH of 9.6 and 45°C allows to obtain 88.5 % of ammonia. To achieve this pH, caustic soda is injected before the transmembrane chemisorption unit.

Pre-treatment for TMCS is modelled by a retention of 100 % of the solids.

IV.5.a.3 Goals and controls

To achieve the discharge standards (fixed at 10 mg-N/L and 1 mg-P/L), controls in the process are performed via SUMO software. The two recirculations r_{ANOX} and r_{ANAER} are proportional to influent coming in primary decanter. Methanol flow is evaluated to achieve the 10 mg TN/L and iron chloride is added to respect 1 mg TP/L. The caustic soda is used to obtain a pH of 9.6. Finally the magnesium is dosed with a fixed ratio of 1.49 mol Mg / mol TP_{in}.

Several combinations of chemical adjunction can respect these regulatory standards. All the processes are indeed interdependent. Adjunction of iron chloride will block some phosphorus into vivianite crystals in digester, and so less magnesium will be used to precipitate struvite. Carbon used for post denitrification, is also favourable for phosphorus accumulating organisms (PAO) which will enhanced their growth. To have the same operation of the plant, all the scenario simulations start with initialisation value from the modelling of the city without the district.

IV.5.a.4 Life cycle inventory

The life cycle inventory of the centralised treatment plant follows the work of (Bisinella de Faria et al., 2015) and takes into account:

- energy consumption of aeration, pumping, mixing, scrapping, dewatering, heating and the relevant consumption of electricity from grid and heat from natural gas boiler
- the direct emissions into air with N₂O, CO₂, CH₄ gases
- the direct emissions into water with the effluent
- the direct emissions of metals into soil linked to sludge spreading
- the production and transport of chemical
- the transport and handling of grits (incineration)
- infrastructure of WRRF and cogeneration unit

Detail of each hypothesis can be found in Appendix X.2.

Compared to the work of (Bisinella de Faria et al., 2015), in this study TMCS consumption has been added. The pump consumption is taken into account as well as the heat demand to reach 45°C which is supply by cogeneration or by boiler if necessary.

The temperature of influent is assumed to be 30°C as it comes from digester. Applying TMCS to digestate needs pre-treatments to avoid suspended matter which can foul the membrane and lead to process failure. In the pilot plant of Yverdon-les-Bains in Switzerland, the energy consumption was measured at 2.55 kWh/kgNH₄-N_{recovered} without including the consumption during production stops. Pre-treatments (CO₂ stripping and coagulation flocculation) account for respectively 26 % and 18 % of the consumption. Ventilation needs 18 % of the consumption. These consumptions have be added in the model. The reported consumption for circulation of acid in the membrane is only 2 % of the total, however this part is calculated in the model with head loss. In our case, no CO₂ stripping is implemented as magnesium oxide is added before TMCS which elevate pH around. Only soda is added to achieve a PH of 9.6. The energy consumption of TMCS is assumed to be 1.887 kWh/kgNH₄-N_{recovered}.

IV.5.b Upflow Anaerobic sludge blanket (UASB) for blackwater

IV.5.b.1 State of the art

Treating blackwater in digestion have been tested in different processes as continuous stirred reactor (CSTR) (Wendland et al., 2007), septic tank and UASB. However UASB proved to be compact and functional at ambient temperature (25°C) (de Graaff et al., 2010). Upflow anaerobic sludge blanket allows to have in the same reactor, digestion and decantation. It is feasible thanks to an upflow velocity which allows the formation of a sludge blanket in the middle of the reactor with a gradient of particle size. In the upper part of the reactor small particle remains. Normally this reactor works with sludge granules instead of suspended sludge (Chernicharo et al., 2007).

IV.5.b.2 Design

The design of the installation follows the guidelines given by (de Graaff et al., 2010) where the hydraulic retention time (HRT) of the process is estimated with Equation II-4

$$HRT = COD_{in} * \frac{f_{SS}}{X_R} * Rem_{SS} * (1 - H) * SRT \quad \text{Equation II-4}$$

With

COD_{in}: the concentration in the influent (gCOD/L)

f_{SS}: fraction of suspendedsolid in the COD of influent

X_R: sludge concentration in the reactor (gCOD/L)

Rem_{SS}: fraction of suspended organic matter that are removed

H: level of hydrolysis of the removed solid

Design parameters are presented in Table II-7 and are coming from the original design of (de Graaff et al., 2010) and also from data of the pilot plant installed in Sneek (35 m³ design for 530 PE persons and currently treating 79 PE (de Graaff and van Hell, 2014)).

Table II-7: Design parameters for UASB treating blackwater

Parameters	Value	Unit	Reference
T	25	°C	
SRT	75	d	
X_R	34	gCOD/L	(de Graaff et al., 2010)
Rm_{SS}	0.93	-	
H	0.49	-	
Organic Load	1.	gCOD/L/d	
Upflow velocity	2.4	m/d	(de Graaff and van Hell, 2014)
Prod CH₄	0.6	gCOD-CH ₄ /gCODin'	(Tervahauta et al., 2014)
LHV_{methane}	50.	MJ/kg-CH ₄	(20°C; 1 atm).

The concentration in effluent and sludge are calculated from removal efficiency and ratio between total component and species (Table S 25 in appendix) obtained at pilot scale in the Sneek project (de Graaff and van Hell, 2014).

Details of energy balance can be found in appendix VIII.2.a.1, and takes into account:

- The lower heating value of the biogas (LHV_{methane}).
- Heat demand for blackwater pre-heating and fighting the heat loss by reactor walls
 - The digested sludge is used for pre-heating the blackwater entering the reactor (decrease of 5°C of digested sludge). Heat from cogeneration is used to reach the 25°C.
- Micro-cogeneration unit with an electricity and heat yield dependant of the primary energy of the biogas treated.

IV.5.c Struvite precipitation

IV.5.c.1 State of the art

Precipitation of phosphorus into struvite is a process well known and which tends to be further used in WWTP especially in the supernatant of digestate to prevent natural precipitation into pipes and equipment.

Struvite (NH₄MgPO₄·6H₂O) is a salt of ammonium, phosphate and magnesium with an equimolar ratio. Two mains parameters influences the formation of the crystal (Le Corre et al., 2009): pH with an optimal range 8.5 – 9.5, and supersaturation ratio (linked to concentration of species) (Equation II-5). Crystallisation is less sensitive to temperature.

$$\Omega = \frac{a_{Mg^{2+}} \cdot a_{NH_4^+} \cdot a_{PO_4^{3-}}}{K_{SO}} \quad \text{Equation II-5}$$

With:

Ω : supersaturation ratio

a : activity

Struvite precipitation for P-recovery is a challenge because of two issues: (1) a support for nucleation of crystals must be present and (2) good conditions for crystal growth must be achieved in order to be able to separate the crystals from wastewater.

To tackle these problems, two main processes exist to recover struvite: stirred reactor or fluidized bed reactor (FBR) (Peng et al., 2014). There is also selective ion exchange techniques.

Stirred reactor has the advantages to be simple to operate, however with high mixing speed, the crystal growth is low and a large production of fine particles is observed (Le Corre et al., 2009). FBR is the most studied process because it allows different retention time for liquid and solid (Le Corre et al., 2009). By this techniques it is possible to reach 1 mm of particle diameter (Ueno and Fujii, 2001).

However higher energy consumption are observed for fluidized bed reactor as shown in Table II-8, with CSTR consuming around 8 to 14 kWh/kgP_{in} and FBR from 30 to 40 kWh/kgP_{in}. As data from literature are related to different wastewaters to treat, with different concentrations, original energy consumption have been converted in several units. Even if a large discrepancy between values is obtained, FBR seems to consume more energy whatever the basis is (kg of struvite, mass of P in influent, volume treated). It can be explained by the need of recirculation to obtain relevant upflow velocity.

Table II-8: Reported energy consumption for struvite precipitation

	(de Graaff and van Hell, 2014)	(Maurer et al., 2006)	(Butler, 2018)	(Butler, 2018)
Original Data	4 kWh _{elec} /d	50 MJ/m ³	0.48 kWh/m ³	1.76 kWh/m ³
Treated stream	Blackwater	Urine	digestate of red meat processing facility	
Type of reactor	FBR	?	Aerated CSTR Ostara	FBR NuReSys
Comments	457 L/d. 0.95 gP _{STR} /inh/d. 1.25 gP _{influent} /d/inh 79 inh	Urine: 800 - 2000 gP/m ³ 98 % P recovery	Influent: 60 mgP/L and 3000 m ³ /d	Influent: 60 mgP/L and 3000 m ³ /d 200 t _{STR} /year Effluent: 15mgP/L
Consumption				
kWh/m ³	8.8	13.9	0.48	1.76
kWh/kg _{STR}	6.9	1.8		6.6
kWh/P_{in}	40.5	13.9	8	29.3
kWh/kgP_{str}	53.3	14.2		39.1

Struvite crystallisation has been also studied for source separated stream as urine (Barbosa et al., 2016; Etter et al., 2011; Grau et al., 2013; Maurer et al., 2006, 2003; Wilsenach et al., 2007; Zamora et al., 2017a) and blackwater digestate (de Graaff et al., 2011; de Graaff and van Hell, 2014; Gell et al., 2011).

IV.5.c.2 Design

In this model the design of the pilot of decentralised project in Sneek (Netherlands) has been followed according to (de Graaff and van Hell, 2014; Roefs et al., 2017). This pilot is a fluidized bed reactor with design based on an upflow velocity (Equation II-6 and Table II-9 for parameters).

$$Struvite_{r.volume} = UpwardFlow \cdot RT \cdot \frac{Struviteproduction}{Struvite_{r.load}} \quad \text{Equation II-6}$$

Table II-9: Design parameters for struvite fluidized bed reactors (Roefs et al., 2017)

	Unit	Design factors
UpwardFlow	m/h	10
Retention Time (RT)	hours (h)	0.3
Struviteproduction	kg/day	9.2
Struvite reactor load (Struvite_{r.load})	kg/m ² /h	10
Struvite reactor volume (Struvite_{r.volume})	m ³	0.15

A molar ratio of 1.5 Mg/P is necessary to achieve the removal efficiencies described by (de Graaff and van Hell, 2014) and presented in Appendix VIII.2.b, 86 % of the entering phosphate mass flow is recovered.

The ammonium content in the effluent is also modified by precipitation, it is deduced from 1/1 molar ratio between phosphate and ammonium which precipitate.

To calculate the flow of struvite and effluent, a solid content of 0.12 gTSS/gtot are assumed (between 10 and 15 % from (Xiu-Fen et al., 2011)).

IV.5.d Transmembrane Chemisorption (TMCS)

IV.5.d.1 State of the art

The transmembrane chemisorption process is also known as hollow fibre membrane contactors or hydrophobic membrane contactors. The process is based on the transfer of ammonia from the influent to an acid solution through pore of a gas permeable membrane (as shown in Figure II-11). The transferred ammonia will react immediately with the acid with (**Equation II-7**), creating a gradient of concentration supporting the transfer.



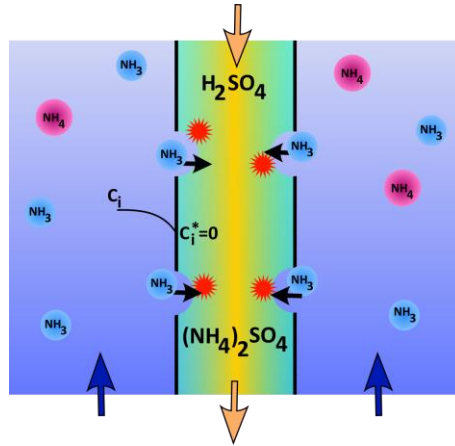

Figure II-11: TMCS principles of operation (adapted from (Darestani et al., 2017))

Few studies have been made on this process and only two semi-industrial pilots exist, one in the WWTP of Altenrhein and Yverdon-les-Bains in Switzerland to treat supernatant of digestates (Böhler et al., 2018).

It is necessary to have condition with a majority of free ammonia against ammonium ion, which depends on the pKa and thus on pH and temperature. The effect of the couple pH/temperature on the ratio of free ammonia is based on the equations (Equation II-8 Equation II-9) proposed by (Montes et al., 2009). For instance, to have more than 80 % of free ammonia it is necessary to work with a pH higher than 9.5 at 40° and higher than 10 at 20°C.

$$f_{NH_3} = \frac{1}{1 + \frac{10^{-pH}}{Ka}} \quad \text{Equation II-8}$$

$$a = 10^{0.05 - \frac{2788}{T}} \quad \text{Equation II-9}$$

Transfer rate coefficient is the most critical parameter for the design of the process, however there is not yet optimized installation. A literature review of the existing experiments shows (Figure II-12) that k_L goes from $1.6 \cdot 10^{-6}$ to $1.7 \cdot 10^{-5}$ m/s depending on temperature, influent concentration and operation conditions.

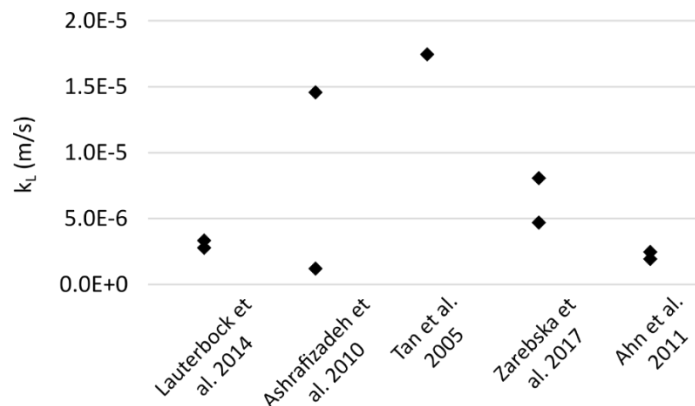

Figure II-12: Transfer rate coefficient of ammonia in TMCS

IV.5.d.2 Design

The most common feature is presented in Figure II-13. In the shell side of the membrane, the influent circulates in one cross with counter flow compared to acid. The acid circulates in the lumen side with a loop in a buffer tank. Concentrated acid is added in the buffer tank to maintain an acid pH at entrance of the membrane. It will be a discontinuous process from acid point of view, with an enrichment in ammonium sulphate. When a specific concentration in nitrogen is reached in the acid, the process stops and the ammonium sulphate solution can be recovered.

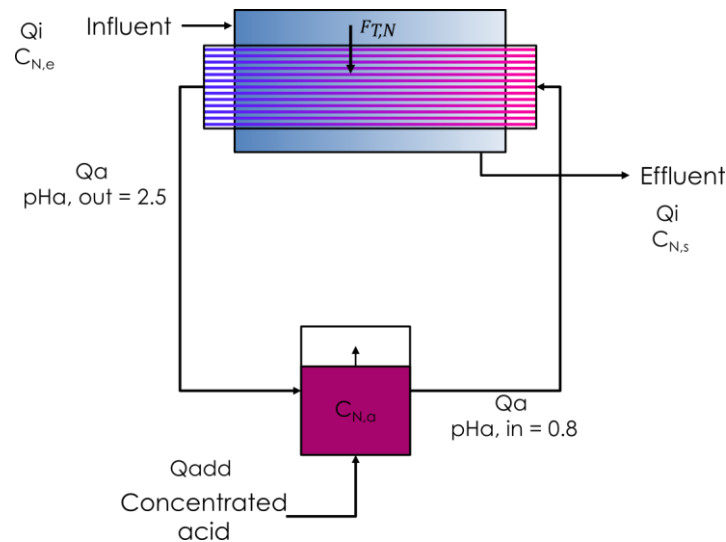

Figure II-13: Process description of TMCS

The main two hypothesis made for the design is the ammonia removal efficiency from effluent side fixed at 90 % and the transfer rate coefficient. This coefficient varies along publication with a factor of ten as previously discussed. As these experiments are mostly lab scale, we can assume that the hydrodynamics can be improved with scale up and the highest value of transfer rate coefficient has been used ($1.7 \cdot 10^{-5}$ m/s).

The design of the unit follows these steps and are detailed in Appendix VIII.2.c:

- From free ammonia mass balance, determination of the surface of membrane
- Calculation of the demand of acid (Q_{add}) based on the consumption of acidity
- Calculation of the flowrate of acid (Q_a) based on the pH entering the membrane (0.8) and the pH at the output (2.5), and the transferred mass of ammonia
- Determination of cycle duration of acid based on the final concentration of the ammonium sulphate and the initial volume of the acid tank.

Energy balance is also performed with electricity need for flow circulation and heat need to reach 45°C in influent.

Electricity demand is based on pressure loss in the membrane calculated from Darcy-Weisbach with a dependence with Reynolds number (see Equation S-30 to Equation S-33 in appendix VIII.2.c.2).

Heat demand is calculated without energy recovery.

IV.5.e Membrane bioreactor (MBR)

IV.5.e.1 State of the art

To treat greywater or wastewater membrane bioreactor (MBR) is an option often proposed in dense area as it is more compact than activated sludge reactor. Activated sludge are forced to work with a suspended solid concentration below 5g/L to maintain good condition for settling. However in MBR, membrane separates the sludge from the effluent and higher concentration is feasible. Too high concentration is not advised to prevent higher energy consumption linked to the decrease in oxygen transfer efficiency.

The main consumption of energy by MBR is for aeration as it allows to give enough oxygen for bacteria but also control the membrane fouling and insure the mixing of the reactor. A range from 0.3 to 8 Nm³/h/m² have been applied in MBR treating greywater at pilot scale (Jefferson et al., 2001; Lesjean and Gnirss, 2006; Merz et al., 2007; Peter-Fröhlich et al., 2007a). The best performances in term of aeration is performed with membrane pore size of 0.04 µm (0.27 Nm³/h/m² (Atanasova et al., 2017)) compared to the membrane with pore size around 0.4 µm.

IV.5.e.2 Design

The detail of the design of the MBR can be found in Appendix VIII.2.d but two different successively cases are implemented for nitrogen removal and three cases for phosphorus removal.

First only nitrification is designed however if the effluent quality is poor (TN > 10mgN/L), denitrification is added. For phosphorus, the first case is only the biological removal of phosphorus without phosphorus accumulating bacteria, if not sufficient, enhanced biological removal is introduced, if there is not enough organic matter to achieve this limit, a polishing chemical removal is designed.

For nitrification only the following procedure has been followed:

- Calculate the current microbial constant at process temperature (°C)
- Calculate yield of heterotrophs and nitrified bacteria the concentration in the effluent knowing the imposed SRT
- Calculate the mass of microorganisms in reactor
- Calculate the volume of reactor knowing the suspended solid concentration
- Calculate operation parameters as sludge production, loading rate, HRT ...
- Calculate membrane surface

For nitrification and denitrification the procedure is:

- Calculate the observed growth rate of nitrifying bacteria knowing the set point of ammonium.
- Calculate the SRT to achieve the observed growth rate
- By iteration calculate until SRT reach the calculated one:
 - Observed yield for heterotrophic and nitrifying bacteria
 - Production of sludge
 - Mass of microorganisms and percentage

- Mass flow of nitrifiable and really nitrified nitrogen
- Mass flow of denitrifiable and actually denitrified nitrogen
- Anoxic volume considering the rate of denitrification and the percentage of denitrifying heterotrophs
- Aerobic volume and total volume
- Recalculation of the SRT and compare to the previous one

The Table S 29 in Appendix VIII.2.dsummarized the parameters used in this design.

In term of energy consumption the value of $1.2 \text{ Nm}^3/\text{h}/\text{m}^2$ has been chosen assuming that industrialisation of process could lead to lowest value of energy consumption mentioned previously.

TAKE HOME MESSAGE

- Modelling of centralised facilities with best available technologies to recover nutrients and as much as possible of organic matter
 - Nutrients (N & P) recovery is performed in two steps: struvite precipitation and transmembrane chemisorption (TMCS)
 - Organic matter is recovered through anaerobic production and energy recovery. Conventional CSTR is implemented in centralised facility, and UASB is chosen in decentralised treatment of blackwater as done in some pilot projects.
 - Only membrane bioreactor is implemented for greywater treatment
 - Designs of processes are based as much as possible on data from pilot scale studies.
 - Mass and energy balance are performed for each treatments.
-

V. SENSITIVITY ANALYSIS

In this last part of this Chapter II, we analyse the influence of two parameters which introduce randomness in the model. Depending on their influence on results, methodology must be adapted. If their influence is great, it should be necessary to analyse sanitation systems with sample of district in the same urban configuration.

The first one is the random generation of the buildings during district creation. The positioning of building follows indeed a controlled random, in respect with several rules (distance to the road and other building, land coverage ratio, contiguity coefficient etc.).

The second parameter is the inhabitant density of the district. A sample of number of inhabitants per building is generated from a normal distribution, in agreement with the average value of inhabitant density and its standard deviation (Table II-4).

The second part of the sensitivity analysis focuses on the influent generation and its impact on the random parameters versus the hypothesis than have been chosen for the generation. This part allows to answer to: what is the default error introduced by these parameters? It will allow to describe qualitatively the results from the next chapters.

Thus we considered two questions:

- Does the random parameters introduce such a variation that it requires modelling with a sample of district?
- To which extend the influent generation is influenced by: the urban configuration or by hypothesis used to build the wastewater composition? What is the standard error introduced by these influent generation parameters?

V.1 Random parameter in district generation

For each urban configuration the model was run for 150 times for one sanitation system. Blackwater are separated from greywater with vacuum toilet (1.25L/flush). Vacuum and gravity sewer transport respectively black and greywater to the central point of the district.

V.1.a Influence on influent generation

V.1.a.1 Building density influence

To analyse the random generation of building, a density graph has been drawn (Figure II-14). The darker the pixel is, the often a building has been position here. The pixel size is one square meter.

It appears that buildings from continuous building and city centre configurations, are positioned every time in the same place. The land coverage ratio by building, roads and courtyard density of these urban configurations implies indeed a total coverage higher than 88 % of the district surface. Thus the total surface is covered by building and randomness is not introduced.

The four other urban configurations present a lower building density with an average value from 8 % to 15 % (without considering the null value). High-rise tower has the higher homogeneity of building density (only 2 % of standard deviation), meaning that few places exist for tower but only a small proportion of the space is covered by buildings.

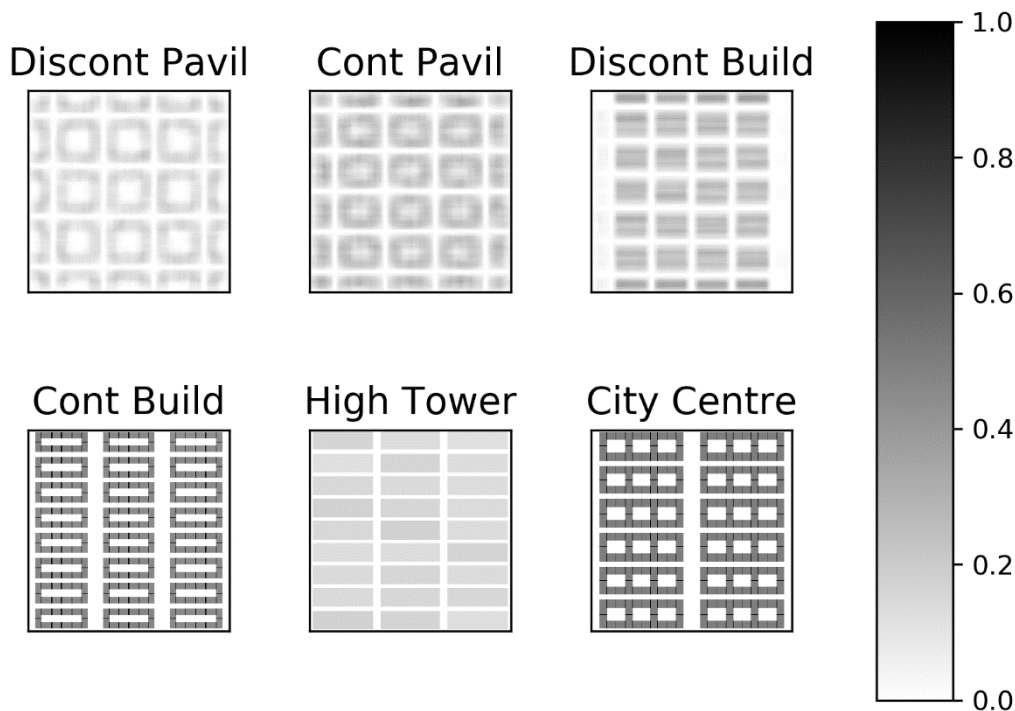

Figure II-14: Building density for each urban configuration

It can be conclude that the random generation of building has a great impact on configurations with low land coverage ratio but no impact on city centre or continuous buildings.

However this variation in position of buildings does not change the total number of building or the total floor surface. That means that the influent generation will not be modified. This parameter has, however, an influence on the wastewater collection.

V.1.a.2 Inhabitant density

The inhabitant density is the second parameter where randomness is introduced. The variability of the inhabitant density is directly correlated to the one state in Table II-4, and has an impact on the influent generation as shown in Figure II-15. Except pavilion configurations each typology shows a linear response to human density. The slope of the line depends of several parameters as the proportion of employees.

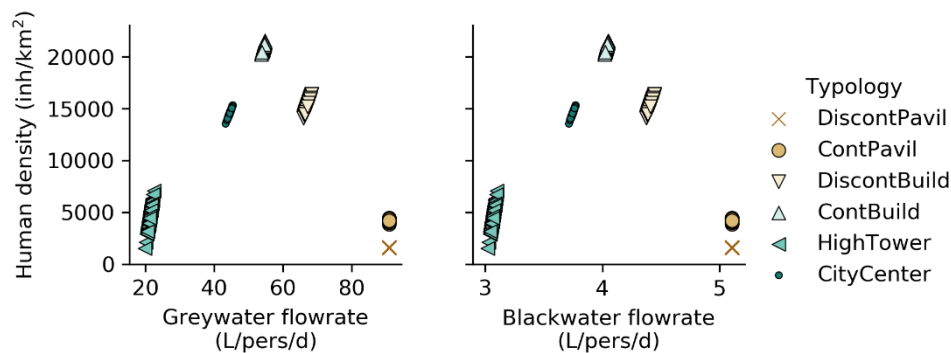

Figure II-15: Human density versus flowrates of greywater and blackwater

However the standard deviation for each urban configuration is low (below 3 %) and is directly linked to the variation in human density. High-rise tower is the only exception with high variability of human density (around 20 %). However, most of the producers of wastewater are employees and the variation of wastewater production remains low (less than 3 %).

It can then be concluded that the human density variability inside a typology has not a great influence on influent generation.

V.1.b Influence on wastewater collection

To evaluate the influence of the random parameter on the collection, the energy consumption for both sewer is analysed.

From Figure II-16, it seems that the main parameters of variation is the influent flowrate and so the human density variation. Length of the sewer shows only a correlation with energy for high-rise tower configuration. This correlation is however not very clear. The case of city centre is also different from the other configurations with two groups of consumptions of gravity sewer, which cannot be explained by a different lengths of sewer.

In each sewer the variation of energy consumption remains below 6 % for all the typologies and sewer, showing the relative small impact of the random parameters. Only the urban configuration high-rise tower and city centre present higher variation on energy consumption up to 15 %.

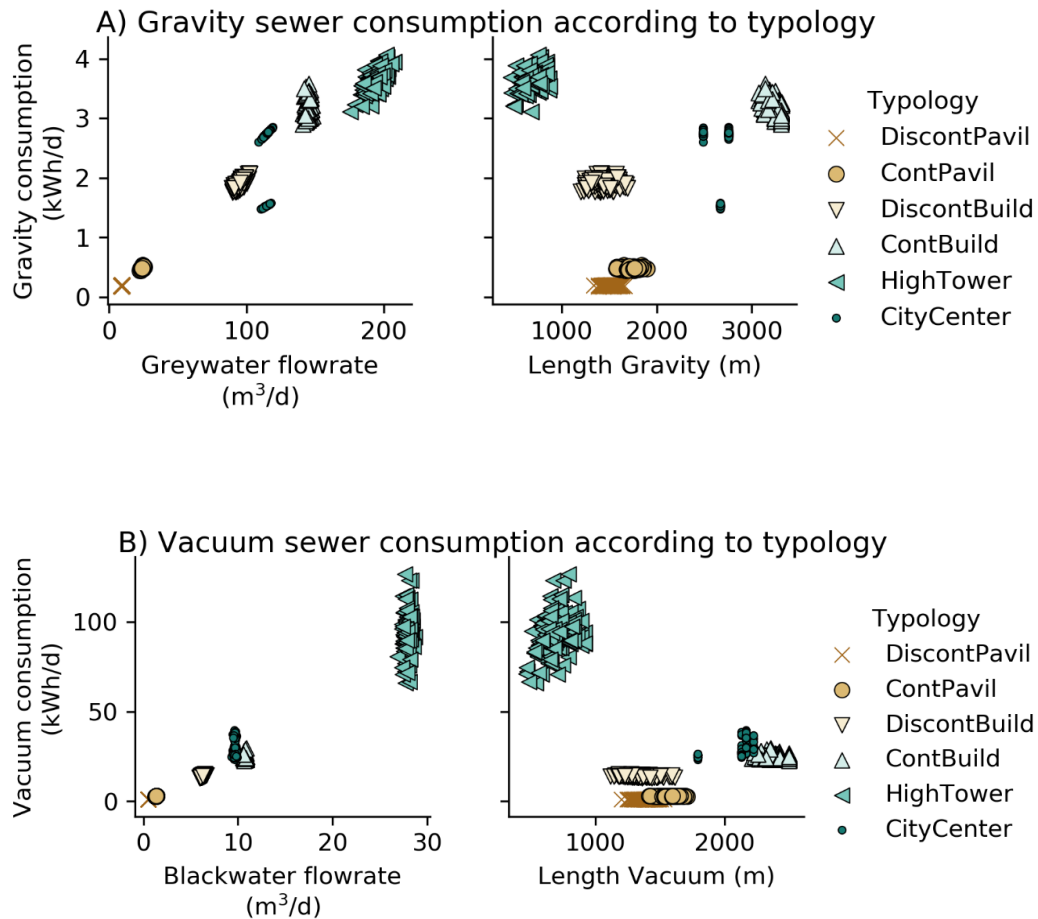

Figure II-16: Energy consumption for both networks: A) Gravity sewer and B) Vacuum sewer, in case of blackwater and greywater separation.

It can be thus concluded that the two random parameters introduce a relatively low impact on the results of the sanitation systems. The systems can then be studied with one district generated per typology. Attention should be drawn for the city centre and high-rise tower where higher variation have been seen.

TAKE HOME MESSAGE

- Even if randomness is introduced with positioning of buildings and human density inside buildings, the variation on influent generation and transport are below 6 %.
 - Only city centre and high-rise tower configurations show higher variation and must be addressed with different districts.
-

V.2 Influent generation

In this part, we want to understand which parameters introduce the most variation of influent generation between urban configuration and influent generation parameters.

A Monte Carlo simulation has been performed with 1200 simulations by considering the four main variables of influent generation. These variables present most of the uncertainty of the generation as very small information are available.

- The ratio of time spend at home $63 \% \pm 12$
- The number of toilet visits for urination at home: 5.3 ± 2.9 visit/pers/day
- The number of toilet visits for defecation at home: 1.07 ± 1.07 visit/pers/day
- The ratio of urination and defecation at work place: 5.1 ± 0.8

For each variables a random sample was generated based on a normal distribution. The calculation consist on the influent modelling for both blackwater at home and office and also for urine considering separated toilet. In case of urine source separated toilet, the flushes were 3L after urination and 6L for defecation, and only 0.25L from the 3L goes to urine compartment. Blackwater are collected with vacuum toilet with 1.2 L/flush. Influent is calculated with the same district generated for each urban configuration.

V.2.a Specific production of wastewater

Thanks to the results from Monte Carlo, a correlation analysis was conducted based on spearman rank correlation coefficient on the production of water per inhabitant or employee. Finally the variance of results was analysed with contribution to variance coefficient (CTV).

From the correlation matrix (Figure II-17) the time spent at home and the number of urine flush are the two most contributing parameters. The number of flush dedicated to defecation does not explained the variation of the results (0.2 % CTV for urine at office), even if the variation of this variable was the highest with a relative standard deviation up to 100 %.

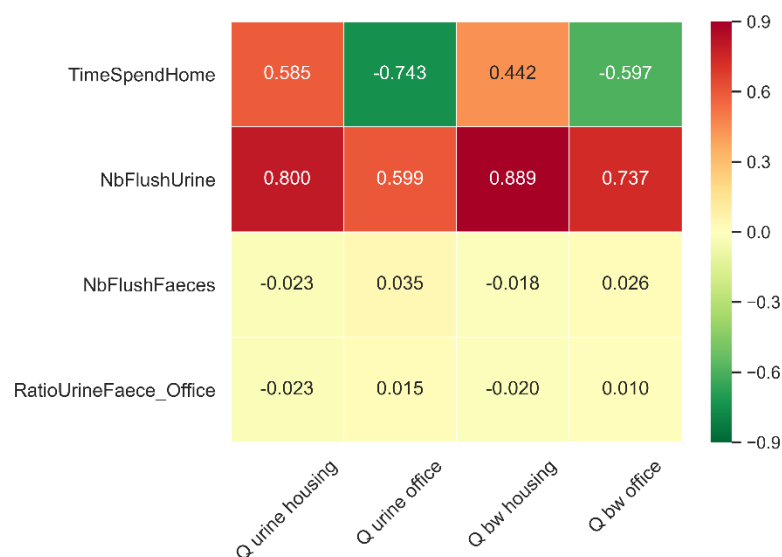

Figure II-17: Correlation Matrix for specific production in housing or office

V.2.b Production of wastewater in each urban configuration

These specific productions of wastewater have an impact on the total production of blackwater and urine (Figure II-18) where overlap is observed between discontinuous and continuous building and city centre, and partly with high-rise tower. However from Student and Welch's t-test, every mean is different from all other configurations.

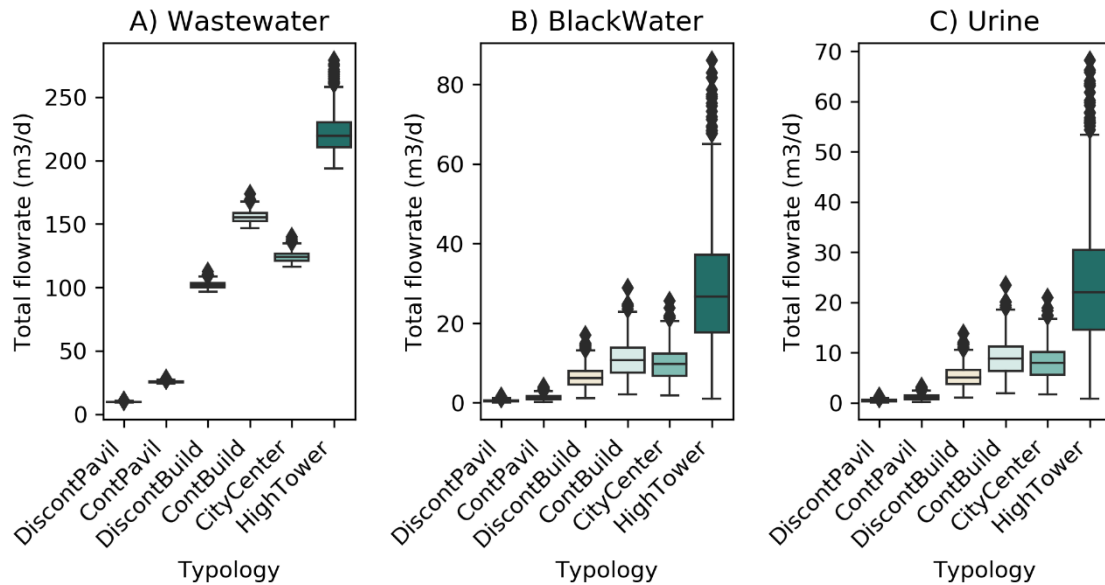

Figure II-18: production of influent (A: all wastewater, B: blackwater from vacuum toilet and C) urine with separated toilet) for each urban configuration.

It can then be concluded, that working with average value is possible and error analysis will not be performed when the analysis with different urban configuration and scale is made.

TAKE HOME MESSAGE

- The influence of main sensitive hypothesis on influent generation has been analysed.
 - The ratio between the times spent at home or spent at office and the number of urine flushes are the two main parameters influencing the wastewater production.
 - Even if these hypothesis have a stronger impact on influent than random generation of building and human density, the production of wastewater is still different from one urban configuration to another (statistical test)
-

VI. CONCLUSIONS

The tool developed in this thesis, is able to evaluate alternative sanitation systems at a district scale. It has been chosen to compare them to a future wastewater treatment plant with nutrient recovery, which is one goal of the current transformation towards the wastewater resource recovery facility.

Data have been gathered from pilot scale studies to design each steps of the sanitation systems including (1) collection by gravity and vacuum sewers and truck collection of urine, (2) treatments of separated streams with organic matter recovery through UASB, phosphorus recovery with struvite precipitation, nitrogen recovery with TMCS, and water recovery with MBR.

Four scenarios are studied in the following chapters, corresponding to the most common scenarios applied in real case studies with the adjunction of nutrient recovery. Two types of separation are implemented: urine source separation from separated toilet, and blackwater and greywater separation with vacuum toilet. Different scales of decentralised treatments are also analysed from totally centralised to totally decentralised treatments.

These four scenarios represent, however, a small proportion of the feasible solutions when we consider alternative sanitations. As shown in Chapter I, the number of systems depends only on the imagination capability of the designer. These four scenarios chosen in this work, represent only an infinitesimal fraction of the possible. With time and patience, thanks to the developed tool, the number of evaluated scenarios will increase. Moreover, the choice of new scenarios to evaluate will result from the assessment of the previous ones. It is thus an ongoing improvement process.

The analysis of parameters integrating randomness shows the small influence of these parameters on influent generation and transport, allowing to work in the following chapters with average districts. Attention should be paid on city centre and high-rise tower where the main variations have been observed. Finally, the hypothesis of influent generation does not interfere within the difference between urban configurations. Only qualitative error analysis will then be performed in the rest of this work.

The next two chapters will use the developed tool to assess the four studied scenarios. Chapter III, focuses on one urban configuration and presents the possible optimisations on processes. Chapter IV focuses on the influence of urban configuration and scale and investigates the processes implementation in term of space requirement.

Chapter III. Integrated environmental assessment of wastewater source separation scenarios for resource recovery

I. INTRODUCTION

Current trends show that wastewater treatment plants (WWTPs) will intend to shift towards WRRF (Water Resources Recovery Facility), with the aim, not only to preserve water bodies but also to produce resources (Guest et al., 2009) such as water, energy, carbon, phosphorus and nitrogen. This new approach is not only beneficial for reducing mineral and fossil resource consumption but also for limiting the impact of wastewater treatment on climate change (Bisinella de Faria et al., 2015). Two approaches are investigated in order to achieve this transformation from conventional water treatment to resource recovery. The first option describes new processes which can be implemented within the WRRF in order to recover specific targeted compounds. The second option refers to the source separation of wastewater, which could be coupled to the first option. The main advantage of this latter, is to keep a highly concentrated influent and a low flowrate, which will optimise the recovery of inherent resources.

Finding highly concentrated wastewater of centralised treatment systems is the main limitation when dealing with the recovery of nutrients. Biological processes are able to concentrate phosphorus from wastewater effluents and this thanks to phosphorus accumulating bacteria, but no similar processes are yet available for extracting the nitrogen from mainstream wastewater. Experiments have been developed to uptake nitrogen and this by using algae without organic carbon inputs (Cai et al., 2013). However, this process are still challenged by (1) harvesting the algae, (2) the low light transmittance in wastewater which impacts algae growth and (3) issues in the downstream process to reuse the nitrogen (Mo and Zhang, 2013). Another prospective for nitrogen recovery is the production of proteins for feed or even food from wastewater (Matassa et al., 2015).

Nitrogen recovery today can only be possible on a concentrated effluent coming out of an anaerobic digestion unit, and outcomes are thus limited to a small fraction of nitrogen. Phosphorus is currently precipitated as struvite with magnesium adjunction, whilst nitrogen recovery can only rely on stripping and absorption on zeolite which is poorly applied due to high operational costs, respectively for energy and raw material. Transmembrane chemisorption for ammonia recovery is currently developed. Indeed, hydrophobic membranes (TMCS) allow ammonia gas to transfer to an acidic solution to form a nitrogen salt. This technology is tested in the WWTP of Altenrhein and Yverdon-les-Bains (Böhler et al., 2018). With its low energy consumption ($2.55 \text{ kWh/kgNH}_4\text{-N}_{\text{recovered}}$ (Böhler et al., 2018) compared to 3.9 kWh/kgN for nitrification/denitrification and 7.2 kWh/kgN for ammonia stripping (Maurer et al., 2003)) TMCS is liable to be one of the best emerging technologies for nitrogen recovery.

In addition to improvements developed within WWTPs, several studies investigated the possibility of a shift in sanitation systems, where wastewater can be separated at the source (within households). Indeed, a large proportion of pollutants (nutrients and organic matter) in wastewater comes from human excreta (Larsen and Gujer, 1996). Although urine alone represents only 1% of the total effluent volume, between 70 % and 80 % of total nitrogen and around 50 % of the phosphorus in wastewater come from this urine. Therefore, source

separation would be efficient to concentrate the targeted nutrients and hence avoid downstream dilution and mixing with other molecules. Two strategies have been tested in northern Europe: projects with a urine source separation approach (Larsen et al., 2013) and another approach involving separation of blackwater at the source, i.e. effluent from domestic toilets (Skambraks et al., 2017). On one hand, blackwater separation is able to recover the organic matter fraction, which represents around 50 % of organic matter coming from the wastewater and this for energy production purposes (biogas from anaerobic digestion) but also nutrient extraction in the following steps. On the other hand, the outcoming greywater can be reused for non-potable use, thereby highlighting the fact that blackwater/greywater separation could be a more promising approach because the entire wastewater can be turned into a resource. In order to optimise blackwater treatment through anaerobic digestion, vacuum collection would need to be implemented. High energy consumption processes force the actual treatment to be decentralised. Therefore, the benefit of recovery is balanced with decentralised management and a disadvantageous scale effect. Finally, urine separation strategy could be coupled with WRRF and should be compared to a blackwater/greywater separation strategy.

Considering the complex interactions and constraints stated above, finding the optimal combination of processes is a challenge, WRRF, for instance, requires carbon inputs for ensuring denitrification and biological removal of phosphorus but also for energy recovery. Increasing energy recovery creates a need for external carbon for denitrification, except if anaerobic deammonification would be developed on the mainstream. From an environmental point of view, the optimal choice is not obvious as several impact categories are involved. Indeed, the recovery of phosphorus decreases the depletion of natural P-resources, whereas nitrogen recovery reduces energy consumption and climate change by substituting the production of synthetic nitrogen fertilizer. Moreover, the recovery of carbon through energy production systems (biogas) can reduce the overall energy consumption of the wastewater treatment. At last greywater reuse for potable use can reduce pressure applied on water bodies and water depletion in general terms. In that sense, each recovery approach needs to be analysed in terms of environmental impacts by developing an integrated environmental assessment.

Several studies have already attempted to evaluate the efficiency and the environmental impact of different resource recovery solutions by modelling and comparing them to conventional sanitation systems (Igos et al., 2017; Remy and Jekel, 2008; Wilsenach and van Loosdrecht, 2006). (Bisinella de Faria et al., 2015), developed a specific influent generator for simulating source separation. A urine separation scenario was compared to a conventional treatment system by presenting different recovery options, such as direct spreading or extraction options. These studies showed the potential benefit of urine separation approaches but without considering other scenarios involving blackwater/greywater separation. Moreover, separation of wastewater at the source has never been compared to advanced WRRF which are able to provide nutrient recovery systems on the long term. And finally, none of these studies take into account the thorough modification it involves on a geographic scale, as well as local specificities related to the district.

To fulfil these gaps, this present study has the aim to analyse the choice of the sanitation systems for a new district. A Life Cycle Assessment (LCA) will be undertaken in order to highlight the limitation of the water resource recovery approach on WWTP and to evaluate to what extent

source separation (blackwater, urine, and greywater management) could help to achieve this goal. This study focuses on the feasibility of applying different sanitation systems on a new district which is built from ground. The goal is to determine if source separation approaches can help to shift conventional WWTPs to wastewater recovery facilities and this by maintaining comparable treatment efficiencies. Moreover, regarding the energy consumption constraints, centralised and decentralised scenarios will also be compared.

II. METHODOLOGY

To perform this study, three different steps are followed for each studied scenario (Figure III-1). Firstly, the district is generated through the developed tool described in Chapter II. Influent characteristics, transport requirements as well as decentralised technologies are evaluated. The second step involves the modelling of the different wastewater recovery facilities treating effluents from the new district and from the existing city. For this purpose, the SUMO commercial software is used with an integrated model based on an activated sludge and anaerobic model coupled to gas exchange. The third step is the LCA, performed with UMBERTO commercial software, on data obtained from the first two steps. A platform has been developed to automate the transfer of information between the different tool and platform based on the previous work of (Bisinella de Faria et al., 2015).

A total of five scenarios have been simulated through this methodology: the first scenario corresponds to the initial state of the city, before building the new district (*City* scenario), the second is the *Reference* scenario which includes the new district equipped with the same wastewater management system than the City. Three alternative scenarios are also simulated: one involving the treatment of urine in the central facility (*Urine* scenario), one involving the separation of black and greywater with blackwater treated in a decentralised system and greywater treated in the WRRF (*BW* scenario), and a last scenario where black and grey water are treated in a decentralised facility (*BW-GW* scenario).

The last step of the methodology is the analysis of results. Since this study focuses on the new district, data coming from the existing city will need to be removed. Therefore, all scenario results are corrected by removing results from the *City* scenario.

The different steps of the modelling strategy provides an analysis with different boundaries. Either results are analysed according to the collection and treatment of the effluents and this in terms of mass and energy balance or the LCA results are analysed with extended boundaries to take into account the benefits provided by fertiliser production, water reused or energy production.

In the following paragraphs, the description of the methodology follows the three steps of a scenario simulation and in the last section the methodology of the results analysis is explain in more details.

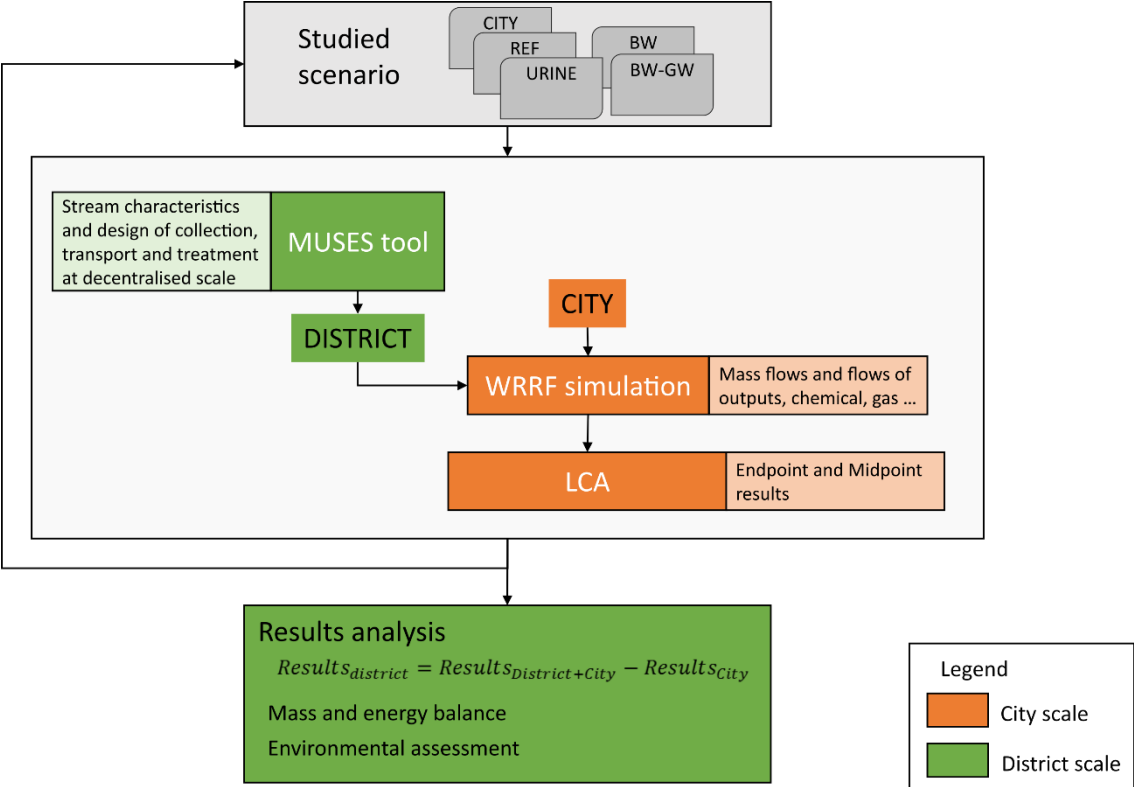

Figure III-1: General methodology followed in the study

II.1 District scale

II.1.a District generation

The study is implemented on a new district built in a city which is already equipped with a WRRF treating 56 003 PE with a flow rate of 12 900m³/d. The urban planning of the district is described as discontinuous blocks according to the work of (Bonhomme et al., 2012) . With a surface of 6.25 ha this type of planning is composed in majority of collective buildings for residence purposes. Besides the 921 inhabitants, 469 external people are employed on site which together represents 697 PE to treat. The planning of the district is presented in Figure III-2.

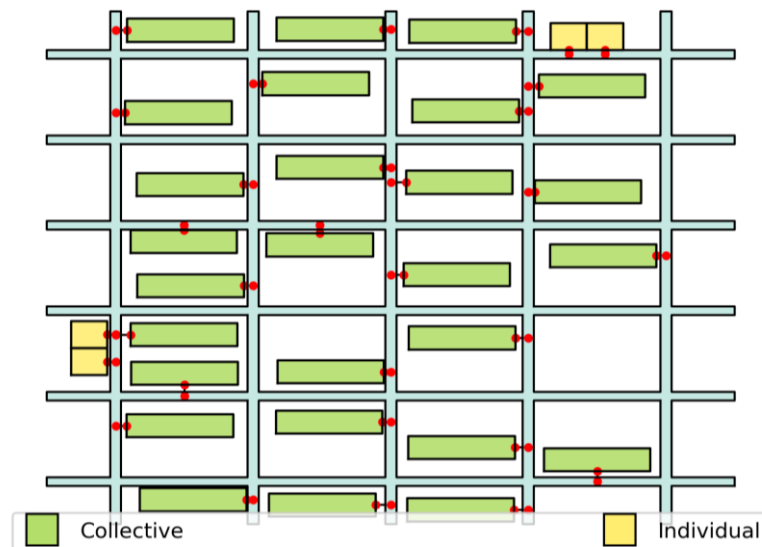

Figure III-2: Map of the modelled district of discontinuous buildings typology

II.1.b Studied scenarios

Four different scenarios are compared (see Figure III-3) with an increasing decentralised scale of treatment:

- i) the chosen advanced solution for WRRF (*Reference*) where nitrogen and phosphorus recovery take place,
- ii) urine source separation (*Urine*),
- iii) decentralised treatment of blackwater and treatment of greywater in WRRF (*BW*),
- iv) black and greywater separation and treatment in a decentralised system (*BW-GW*).

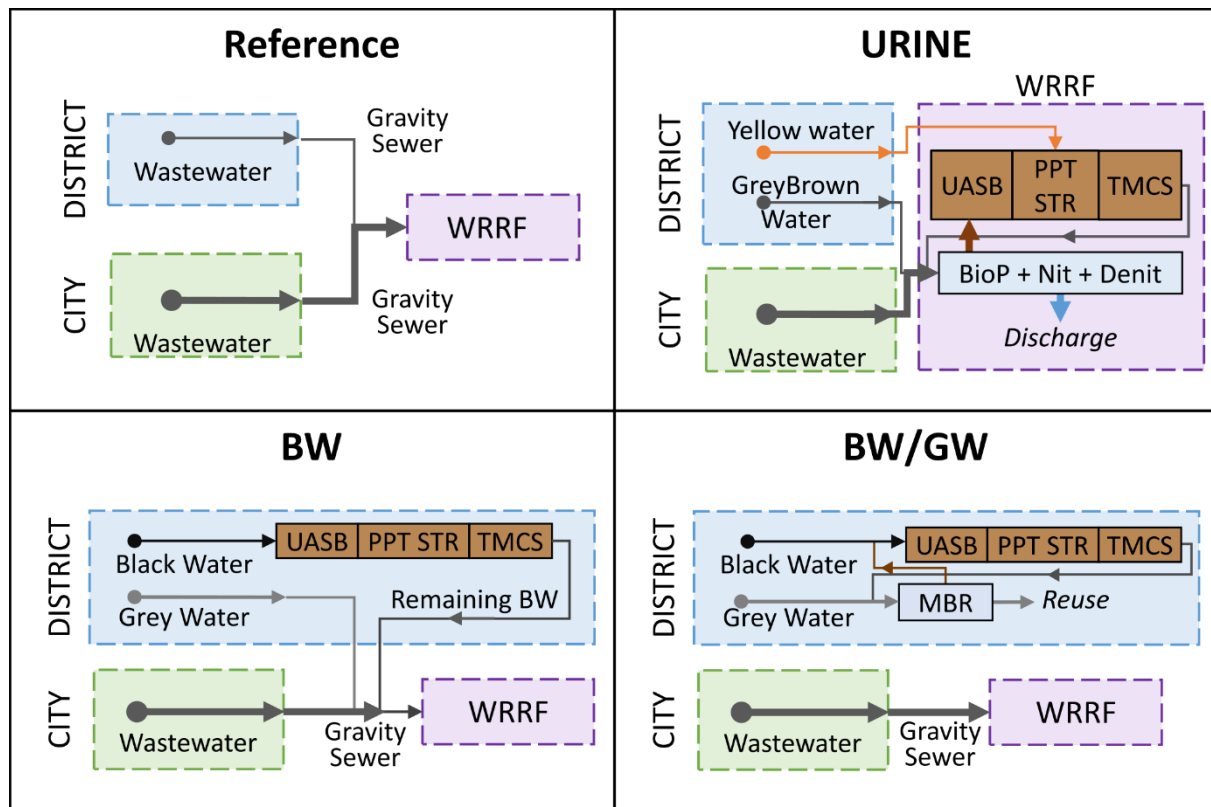

Figure III-3 Presentation of the four scenario and the WRRF. WRRF: Wastewater recovery facility, AD: Anaerobic digester, PPTSTRU: Struvite precipitation, TMCS: transmembrane chemisorption, UASB: upflow active sludge blanket, MBR: membrane bioreactor, ANAER: anaerobic tank, ANOX: anoxic tank, AER: aerated tank, PANOX: post-anoxic tank, PAER: post aerobic tank, THK: thickening, PTHK: post-thickening, DW: dewatering.

These scenarios are representative of several pilot projects already undertaken around Europe as described in Chapter I, however, nitrogen recovery within separated waste effluents is the only treatment which is not implemented in these projects.

In the *Reference* scenario, wastewater is collected with a gravity sewer line. The volume of flushed water is 3 L after urination and 6 L after defecation.

In the *Urine* scenario, urine is collected in tanks and then transported once a week by truck (10m³ trucks, two rounds) to the WRRF. The remaining wastewater is transported as usual through the gravity sewer line. Considering 3 L or 6 L toilet flushes, it is considered that only 0.2 L of every flush goes into the urine compartment and storage, while the remaining volume goes with faeces. Finally only 80 % of urine is still separated which corresponds to the best performances observed in pilot project (data from (Jönsson et al., 1998) and (Peter-Fröhlich et al., 2007a) respectively for Understenshöjden et Palsternackan projects in Sweden and SCST project in Germany). The remaining 20 % is transported with faeces. This urine recovery rate is influenced by the design of the toilet which allows more or less urine retention but also the willingness of the user to facilitate the separation. Indeed, urine separation toilet still requires gents to sit down when urinating.

In both *BW* and *BW-GW* scenarios, blackwater is collected through a vacuum toilet (1.2 L per flush) followed by a vacuum sewer until reaching a vacuum station in the middle of the district where the treatment takes place. The greywater obtained in the *BW* scenario, on the other hand,

is sent to the WRRF through a gravity sewer line. In the *BW-GW* scenario, blackwater and greywater are treated in decentralised systems in the middle of the district.

The influent characteristics used for each scenario are presented in the Table III-1 and are extracted from the literature review described in Chapter II.IV.3 and Appendix X.

Table III-1: Influent characteristics for each scenario

Name	City	District	Urine	Grey brown water	Grey water	Remaining BW	Black water	Unit
Scenario	All	Reference	Urine	Urine	BW and BW-GW	BW	BW-GW	
Flow rate	12900	111.4	1.7	109.7	95.5	5.5	6.1	m ³ /d
TCOD	600.8	864.1	4153.5	814.4	507.0	564.5	7896.9	g COD/m ³
TBOD₅	260.5	374.6	3143.1	332.8	282.6	331.3		g O ₂ /m ³
TN	67.7	88.1	3545.6	35.8	12.1	450.3	1428.5	g N/m ³
SNHx	50.0	66.8	3330.9	17.5	2.4	213.1	1190.8	g N/m ³
TP	11.4	14.2	303.9	9.8	4.9	40.2	183.7	g P/m ³
SPO4	6.0	11.8	289.8	7.6	3.1	18.8	167.8	g P/m ³

II.1.c Decentralised treatments

Only two scenarios have decentralised treatments: *BW* and *BW-GW*. For both, blackwater are digested in an upflow anaerobic sludge blanket (UASB) reactor which allows reaction and decantation to take place in the same unit. Bacteria are aggregated in granules and flocs and are maintained within the reactor by balancing the decantation speed and the upflow velocity of the liquid.

This reactor has been successfully applied by (de Graaff et al., 2010) when treating blackwater at ambient temperature and with a SRT of 75 days. The design parameters of this latter study can be found in Chapter II.IV.5.b, and results show a production of methane between 54 % and 60 % of the blackwater COD, respectively reported by (de Graaff et al., 2010) and (Tervahauta et al., 2014) studies.

After digestion, the effluent is processed for P and N recovery through struvite precipitation and transmembrane chemo-sorption (TMCS). (de Graaff and van Hell, 2014) chose a molar ratio of 1.5 Mg/P to precipitate the P with struvite, leading to the removal of 86 % phosphate and 4 % for other phosphorus compounds. 90 % of ammonia is assumed to be removed in the TMCS module. TMCS operates at 45°C. Therefore a heating system is required to increase the temperature from the operational temperature of UASB (25°C) to 45°C.

Greywater produced in the *BW-GW* scenario, is also treated in a decentralised system, by using a membrane bioreactor (MBR). Aeration is used to prevent membrane clogging which involves a higher energy consumption compared conventional activated sludge treatment systems. However, membrane separation, although being energy intensive, offers, a better quality and stability of outcoming effluents as stated in literature (Winward et al., 2008). Water recovery

hence seems very promising with this technology whether applied on small or large scales. In this present study, the MBR is designed to perform biological removal of phosphorus and denitrification. The effluent of blackwater treatment is indeed sent to the MBR with a mass flow of nitrogen. The sludge obtained through the MBR is also sent to the digester for mineralisation and the outcoming phosphorus can then be captured with struvite precipitation.

II.2 Simulation of centralised WRRF

II.2.a Model

As previously described, the advanced WRRF (Figure III-4) is designed to recover the maximum amount of nutrients as well as much as organic matter as possible. WRRF is based on biological removal of phosphorus coupled to sludge digestion and struvite precipitation of digested sludge. Magnesium is added with a constant ratio between magnesium added and to total phosphorus in entrance.

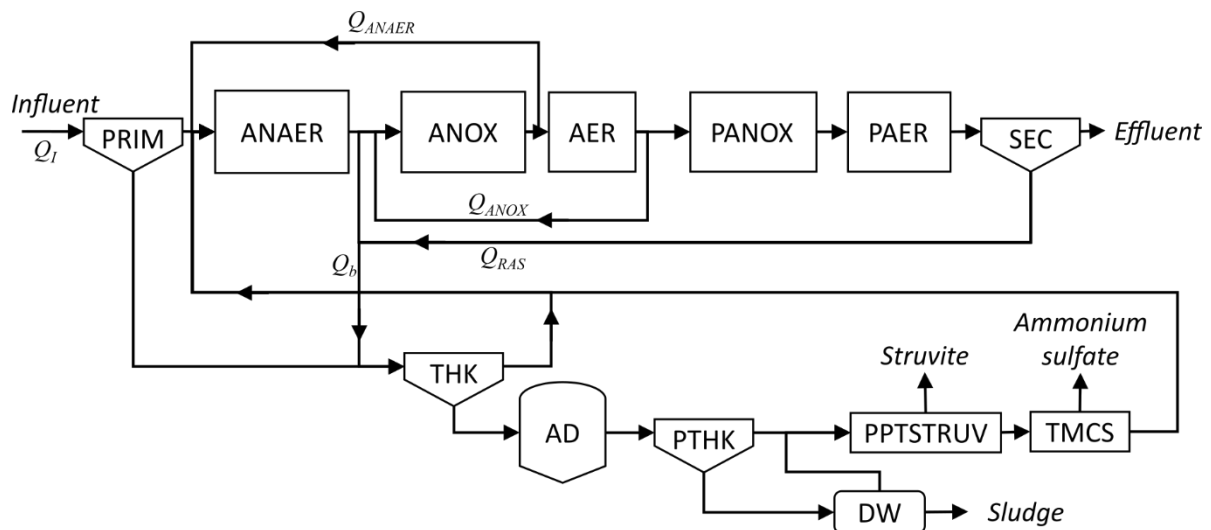

Figure III-4: Description of WRRF operation

Nitrogen will be recovered after precipitation by using the TMCS, also known to strip ammonia through hydrophobic membrane. Considering that only the gas form of ammonia can transfer through the pores, both pH and temperature values have to be controlled. However, optimal values of pH and temperature are still not defined and such topics need to be more intensively investigated. In this study, applying a pH of 9.6 and a temperature of 45 °C allows to obtain 88.5 % of ammonia on the total ammonia, ammonium. To achieve such alkaline pH values, caustic soda is injected upstream from the membrane. Moreover, to prevent fouling of the membrane, solid separation is needed. Pre-treatment is modelled by considering a retention of 100 % of the solids.

In case of urine separation, the collected urine is added to the outcoming effluent of the digester to undergo struvite precipitation and TMCS filtration. On the other hand, greywater produced in the BW scenario as well as the effluent obtained after blackwater treatment are both mixed with the city sewage in the main sewer line, before going through the WRRF.

II.2.b Goals and controls

This study aims to compare the resource recovery potential of different sanitation systems, whilst the first goal of wastewater treatment plants is to remove pollution from environment. To reach this goal, each scenario needs to comply with regulatory standards regarding total nitrogen and phosphorus concentrations, fixed at 10 mgN/L and 1 mgP/L respectively. When effluent is discharged from decentralised treatment systems (BW-GW scenario), the same mass flow of nutrients is considered compared to the reference scenario. Even if regulation standards could allow higher concentrations due to the small load to treat, the purpose of this study is not to increase the release of nutrients. The risk of eutrophication is therefore maintained at the same level. Even if this study focuses on one district, the purpose is not to globally increase the release of nutrients in surface water bodies, but keep an equivalent risk level of eutrophication.

To achieve these standards, controls in the process are performed by using the SUMO software. The two recirculation flowrates, r_{ANOX} and r_{ANAER} , are proportional to the influent flowrate entering the primary decanter. Methanol flow is evaluated to achieve the 10 mg TN/L (total nitrogen) by improving the post-denitrification efficiency. Iron chloride is added to respect 1 mg TP/L (total phosphorus) for the chemical removal of phosphorus. Caustic soda is added to reach the pH of 9.6. Finally, magnesium is added according to a fixed ratio of 1.49 mol Mg / mol TP_{in}.

It has to be noted that several combinations of chemical adjunction can respect these regulatory standards. All the processes are indeed interdependent. Adjunction of iron chloride will block some phosphorus into vivianite crystals in the digester, and therefore less magnesium will be used to precipitate struvite. Carbon, used for post denitrification, is also favourable for phosphorus accumulating organisms (PAO) which will enhance their growth. In order to have equivalent operational standards of the treatment plant, all scenario simulations will begin by initialising the value obtained from modelling outcomes from the city alone, i.e. without the district.

II.3 Link between LCA

An inventory for LCA analysis can be created by using the data obtained from the two previous steps: simulation of collection and transport at district scale and with centralised facilities. This inventory consists in converting the results into relevant units and in calculating missing data. Evaluation of the energy consumption within the WRRF is one of the most important task and follows the work of (Bisinella de Faria et al., 2015) which takes into account, pumping of wastewater and chemicals in the WRRF, mixing the non-aerated tank, energy for aeration, scraping sides of the decanter and energy for dewatering and thickening the sludge. The energy consumption is also related to the heat demand for digestion but also heat production through cogeneration.

In this present study the energy consumption of the TMCS was added in the inventory. Consumption of pumps are taken into account, as well as the heat requirement in order to reach 45°C prior to ammonia stripping, which is supplied by cogeneration or by a boiler if necessary. The outcoming digestate needs to undergo pre-treatments before entering the TMCS in order to avoid suspended matter which can foul the membrane and lead to process failure. In the pilot plant of Yverdon-les-Bains in Switzerland (Böhler et al., 2018), the overall, the energy

consumption was evaluated at $2.55 \text{ kWh/kgNH}_4\text{-N}_{\text{recovered}}$, however this value did not include the consumption during the interruption phases of production (Böhler et al., 2018). Pre-treatments, such as CO_2 stripping and coagulation / flocculation, account for respectively 26 % and 18 % of the consumption. Ventilation requires 18 % of the consumption. These consumption levels have been added in the model. The reported consumption for circulation of acid in the membrane is only 2 % of the total energy demand, however this part is calculated in the model with head loss. In our case, no CO_2 stripping is implemented since magnesium oxide is added before TMCS which increased the pH around 8.6. Only caustic soda is added to reach the targeted pH of 9.6. The energy consumption of TMCS is assumed to be $1.887 \text{ kWh/kgNH}_4\text{-N}_{\text{recovered}}$.

II.4 LCA methodology

The scope of the LCA study covers the collection and treatment of wastewater (foreground processes) but also production and transport of chemicals and electricity (background processes). Avoided processes are also taken into account, such as fertiliser production and tap water production. Indeed, the global water balance is favourable due to less flushed water and the reuse of greywater for non-potable purposes.

The LCA methodology follows the work of (Bisinella de Faria et al., 2015) with the adjunction of effluent collection in background processes. As a reminder Figure III-5 is again described in this section to present the extended system boundaries of the LCA. Regarding sewer infrastructure, the inventory takes into account the diesel used for excavation, pipe production and transport (in PE for vacuum network and PVC in gravity network) and the material to fill trenches (sand, gravel), the infrastructure for inspection is also integrated (manholes and inspection chambers). The bitumen used for building the road is not taken into account as it is allocated to road creation (Petit-Boix et al., 2014). Regarding urine collection, storage tanks are assumed to be placed in the district, one per building. The tanks are assumed to be in polyethylene (PE) with 40 years of lifespan. (Ishii and Boyer, 2015) and represents a mass of HDPE per tank volume of 28.412 kg/m^3 . A 7 day storage is estimated before emptying the tanks. Urine is assumed to be transported by truck (3.5-20t) to the WRRF, located 10 km from the district.

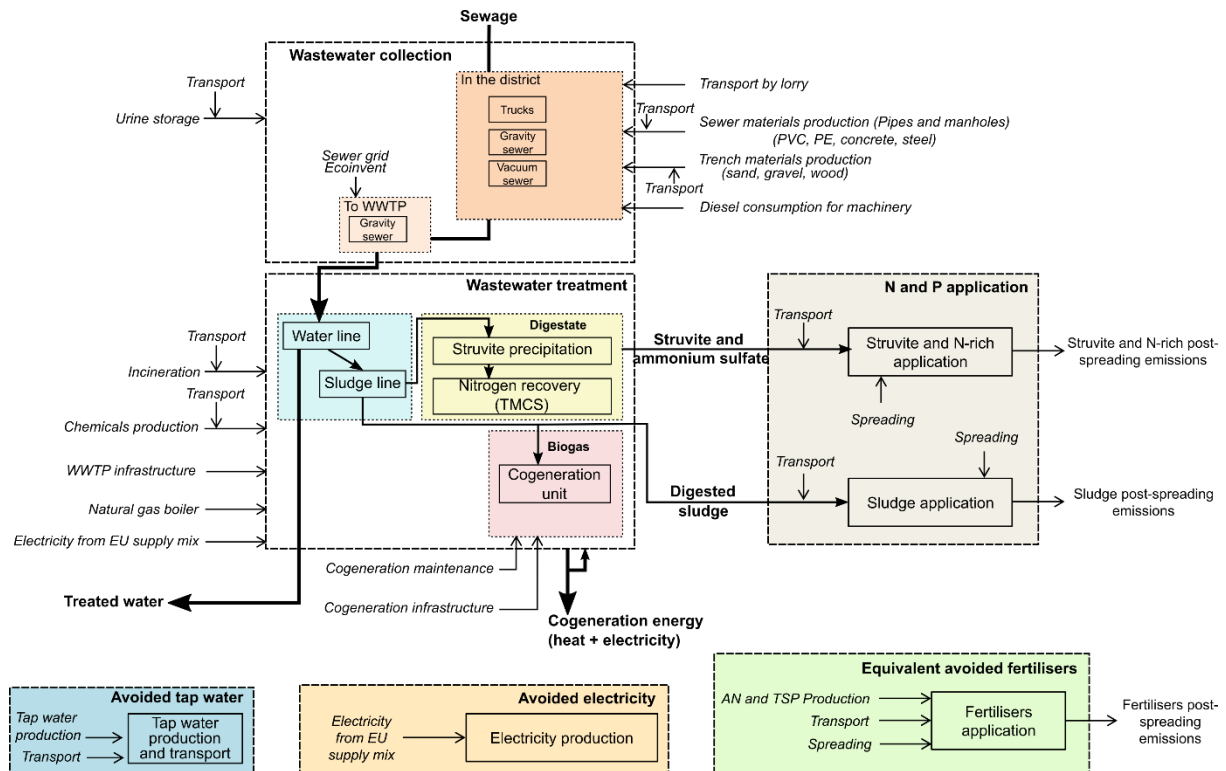

Figure III-5: Extended system boundaries for LCA (adapted from (Bisinella de Faria et al., 2015))

The functional unit is 1PE considering the EU normalized definition: 1 PE = 60 gDBO₅/d. The endpoint and midpoint impact assessment methods from ReCiPe, H have been chosen.

II.5 Results analysis

The results obtained from the transport and treatments are analysed through mass and energy balances at the district scale and city scale. At the district scale, the impact of the city itself before the construction of new district needs to be evaluated and removed.

Energy balances are expressed through power consumption and production rates for the whole system, as well as transport and treatment of wastewater with decentralised and centralised options. The energy balance is also converted to primary energy (equivalent oil) in order to consider the heat demand and production as well as the need of diesel, for transporting the urine by truck, as an example. The following coefficients (Table III-2) are used to convert kWh of final energy into primary energy (oil).

Table III-2: conversion factor in primary energy expressed in tonne of oil equivalent (toe)

Secondary energy	
Electricity	0.2267 toe/MWh
Gas	0.077 toe/MWh
Diesel	0.086 toe/MWh

III. RESULTS

III.1 Mass balance for the district

Mass balances for each compound are expressed in terms of recovery rate in the Table III-3 and Sankey diagrams (Figure III-7, Figure III-8 and Figure III-9) represent the mass flow within the system. The Sankey diagrams aims to describe in more details where recovery takes place in term of location and products.

III.1.a Nutrients

In the Reference system, results show that the WRRF was able to recover 6 % of nitrogen through a fertiliser and 13 % of phosphorus. Nutrient recovery is still limited, even though nitrogen and phosphorus content in sludge is considerable. The sludge still contains 80 % of the phosphorus which can be recovered in ashes if the sludge is incinerated for instance. On the other hand, if sludge is directly spread on the ground, the bioavailability of phosphorus is decreased compared to mineral fertiliser, since part of the phosphorus is bound to ferric ions or with the biomass. Moreover, considering the high level of heavy metals reported in the sludge, using sludge as fertiliser can hence transfer and spread pollution in the environment.

The amount of recovered nitrogen obtained in the *Reference* scenario is compared to literature values in order to be validated. In this study, the amount of nitrogen contained in the digestate is only 14 %. The mass balance obtained in Amsterdam-West WWTP reported by (van der Hoek et al., 2018) reveals a comparable range of values, with 27 % of nitrogen in the digester water effluent, where nitrogen recovery can take place. In this latter WWTP, 20 % of the N entering the system come from external sludge and are directly added in the sewer line, thereby increasing the potential of nitrogen recovery. Moreover (Baker et al., 2001) found a similar range of N in sludge, only 10 % against 14 % in our study.

This present study shows that source separation, as described in the new district, increases the recovery rate of nitrogen up to 48 % in the *Urine* scenario and 54 % for *BW* scenario. The same result is obtained for phosphorus recovery with 58 % for the *Urine* and *BW-GW* scenarios and 73 % for *BW* scenario.

Even if urine represents 76 % of the nitrogen and 42 % of the phosphorus in domestic wastewater, only 80 % of the total amount is collected and sent to recovery. Results show that 60 % of the nitrogen will reach TMCS treatment whilst 88.5 % can be recovered in the blackwater. Therefore, blackwater separation might be more efficient in terms of nitrogen recovery.

Table III-3: Recovery rates for each scenario and each compound at district scale

Recovery rate		Reference	Urine	BW	BW-GW
Nitrogen	Fertiliser	6 %	48 %	54 %	57 %
	Total	21 %	65 %	73 %	69 %
Phosphorus	Fertiliser	13 %	58 %	73 %	68 %
	Total	93 %	93 %	94 %	94 %
COD	Biogas	35 %	32 %	46 %	39 %
	Total	65 %	60 %	74 %	64 %

Fertiliser: struvite and ammonium sulphate

Total: fertiliser + sludge + biogas

Higher phosphorus recovery rate is feasible in source separation scenarios compared to the *Reference* scenario by enhancing biological removal of phosphorus. Indeed, these scenarios showed a slight increase in the ratio of biodegradable COD versus total phosphorus entering the water line. As showed in Figure III-6, less iron chloride per entering phosphorus is necessary. In the *Reference* scenario 47 % of the phosphorus in the final sludge is bound to ferric ions.

Moreover, in both scenarios with blackwater separation, phosphorus recovery with sludge was higher than the other two scenarios since the concentration in the WRRF effluent was fixed at 1 mgP/L. However, by using a vacuum toilet, the flush water consumption was reduced, and mass flow in the effluent would then decrease. Phosphorus in the effluent represents 7.0 % of the entering phosphorus in the *Reference* scenario and only 6.4 % for *BW* and *BW-GW* scenarios.

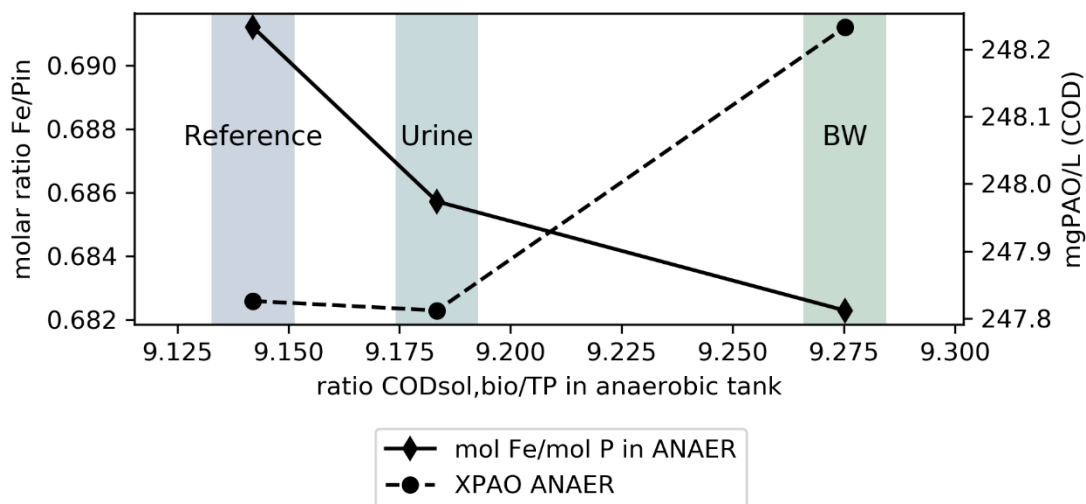

Figure III-6: PAO concentration and iron chloride ratio compared to ratio of soluble biodegradable COD and TP entering anaerobic tank

It has to be highlighted that in the case of *BW* scenario, the production of fertiliser and co-products both appear within centralised and decentralised locations. The first notable effect is the reduction of sludge production within the WRRF. However due to a lower concentration of UASB sludge the total volume of sludge increased by a 3 fold. No process is added for

thickening the sludge in the decentralised location, and may be investigated later on. Indeed, the current management of this sludge is not clearly described in the ongoing pilot projects. Nitrogen is almost entirely recovered in the decentralised location and only 1 % of ammonium sulphate produced from the nitrogen of the new district, is produced at WRRF. For phosphorus, struvite is also mainly recovered in the decentralised location, however sludges from such decentralised treatments and WRRF still contain phosphorus with respectively 15 % and 5 %. In terms of COD recovery, the decentralised location reached 31 % recovery rate, whilst only 15 % was measured in the WRRF.

III.1.b Organic matter

COD recovery is performed through the production of biogas. In the *Reference* scenario, 35 % of the influent COD is converted into biogas. The digestion of blackwater increased the COD recovery up to 46 % in *BW* scenario and up to 39 % for *BW-GW scenario*. On the other hand, urine separation was less efficient than the *Reference* scenario (only 32 % of recovery), which can be explained by the fact that 7 % of COD produced by this district is found in the urine and part of it will be degraded before entering the digester.

However, in order to reach the discharge standard of nitrogen, COD content is increased by adding methanol in the post-denitrification stage. By modifying the COD/TN/TP ratio of the wastewater, source separation reduces the need of methanol. In this perspective, if methanol is considered as the COD inlet, the COD recovery in biogas would be different as presented in Table III-4. It represents the efficiency of COD use in the WRRF.

Table III-4: Comparison of COD recovery rates with and without methanol contribution for each scenario at district scale

	Reference	Urine	BW
COD recovery without methanol	35 %	32 %	46 %
COD recovery with methanol	32 %	34 %	49 %

In this way the *Reference* scenario presents the worst efficiency; with only 32 % of COD converted into biogas (methanol represents 9 % of the COD influent). Since *Urine* and *BW* scenarios need less methanol than the *City* scenario, the COD recovery with methanol contribution is increased compared to the *Reference* scenario.

III.1.c Sensitive parameters

Up to 85 % of the organic matter found in urine is easily biodegradable, with a high content of volatile fatty acid (62 % of the easily biodegradable), thus having a positive impact on biological removal of phosphorus. If all this easily biodegradable organic matter was, in fact, consumed during storage or eliminated during sludge treatment, the adjunction of 33 % of iron chloride would be necessary to treat the phosphorus thereby decreasing the recovery rate of phosphorus to 40% in *Urine* scenario. This beneficial effect has not been reported and much information is needed on the fate of this easily biodegradable substances in storage, struvite precipitation and TMCS to validate this result.

TAKE HOME MESSAGE

- Even with extended recovery processes, the WRRF is not capable of recovering a large part of nutrients into fertiliser (less than 15 %) especially nitrogen
 - Source separation scenarios could increase the recovery of both nitrogen and phosphorus, up to 57 % and 68 % (as fertilisers), respectively
 - Urine and Blackwater recovery show similar P recovery rates, only if biological removal of phosphorus is performed in the centralised treatment plant. In this way, the P in faeces is also recovered in the digestate.
 - Nitrogen and organic compound separation allow an enhanced biological nutrients removal (BNR), achieving high P recovery in BW scenario with the separation of blackwater and greywater.
 - Source separation does not significantly improve the recovery of COD
 - Source separation reduces the need of external methanol additions and hence increases the efficiency of COD use
-

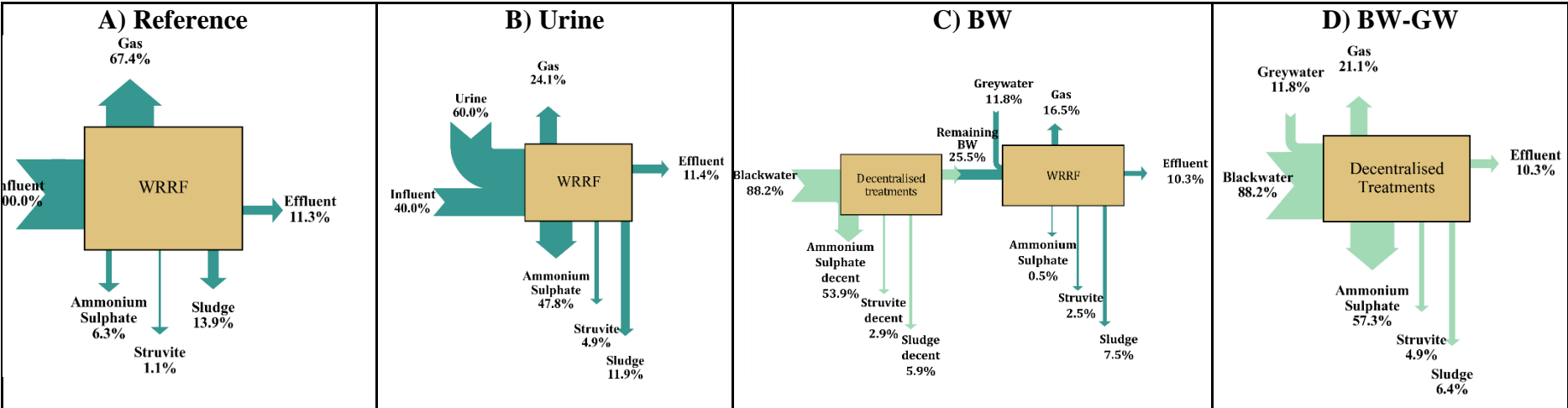

Figure III-7: Mass flow of nitrogen in the treatments system at district scale

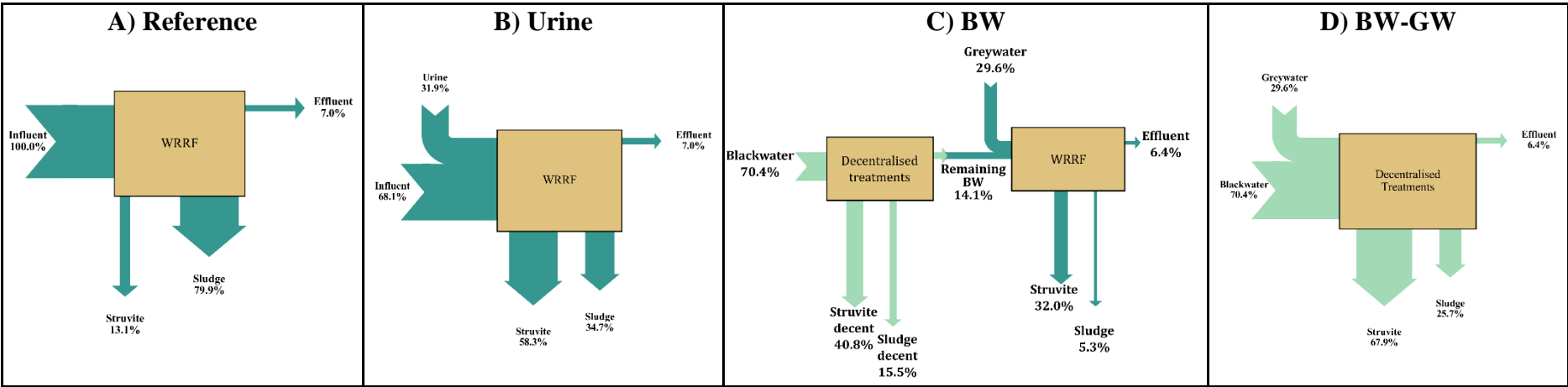

Figure III-8: Mass flow of phosphorus in the treatments system at district scale

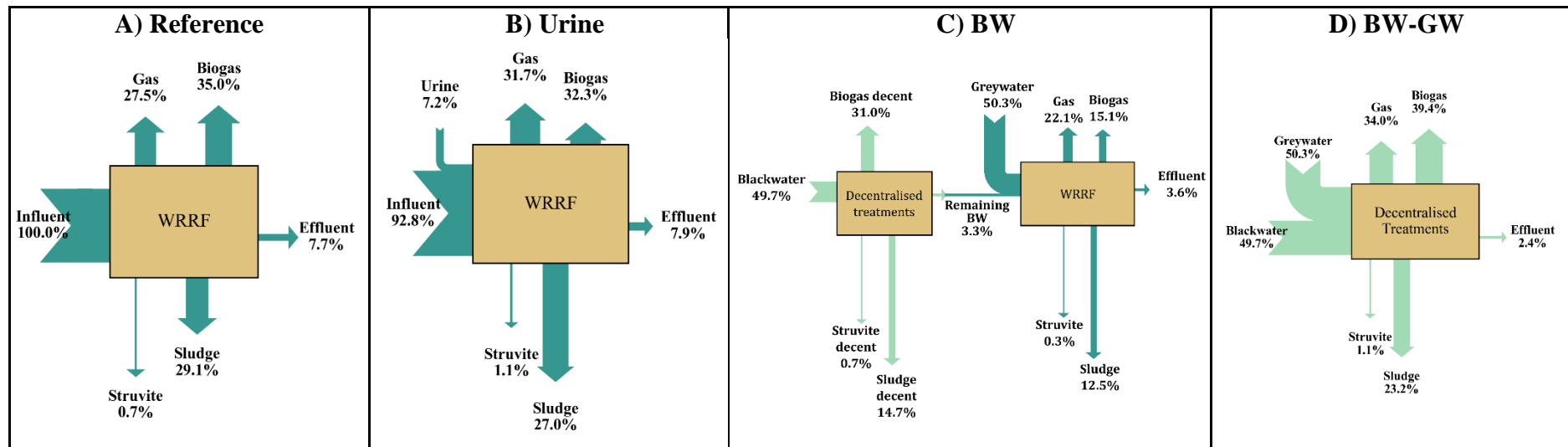

Figure III-9: Mass flow of COD in the treatments system at district scale

III.2 Energy balance

III.2.a Treatment

III.2.a.1 WRRF scale for Reference scenario

If we considered the WRRF at its entire scale, the system consumes 0.33 kWh/m^3 of treated water. By implementing cogeneration with biogas production, electricity and heat are produced. The production of electricity represents only 81 % of the consumption. However, the production of heat by cogeneration is enough to cover twice the actual heat demand.

The advanced treatment plant of this study presents rather low energy consumption values compared to current wastewater treatment plants which show power consumptions ranging from 0.3 to 0.8 kWh/m^3 , without any recovery processes. These recovery processes accounted for 3 % of the total electricity demand in WRRFs and 58 % of the demand in heat.

III.2.a.2 District scale

As stated previously, only the additional costs from the new district is analysed. The electricity balance of the four scenarios are compared in Figure III-10 for the entire sanitation system with transport and treatment. The black bars represent the balance between consumption and production. A negative value shows a higher production than consumption, as for example obtained for the *Reference* scenario.

The overproduction of biogas largely compensated the electricity consumption for treating and transporting the wastewater. In all the scenarios involving WRRF, the electricity return on investment (EROI) is higher than in WRRF scale, because part of the consumption of the WRRF is not associated to the flowrate but rather to the design of the plant, (for example the mixing of non-aerated tanks or scraping). The scale effect is then visible, with a decrease of energy consumption per PE treated when PE increases. On the contrary, there is a linear relationship between the COD entering the WRRF and the recovered energy.

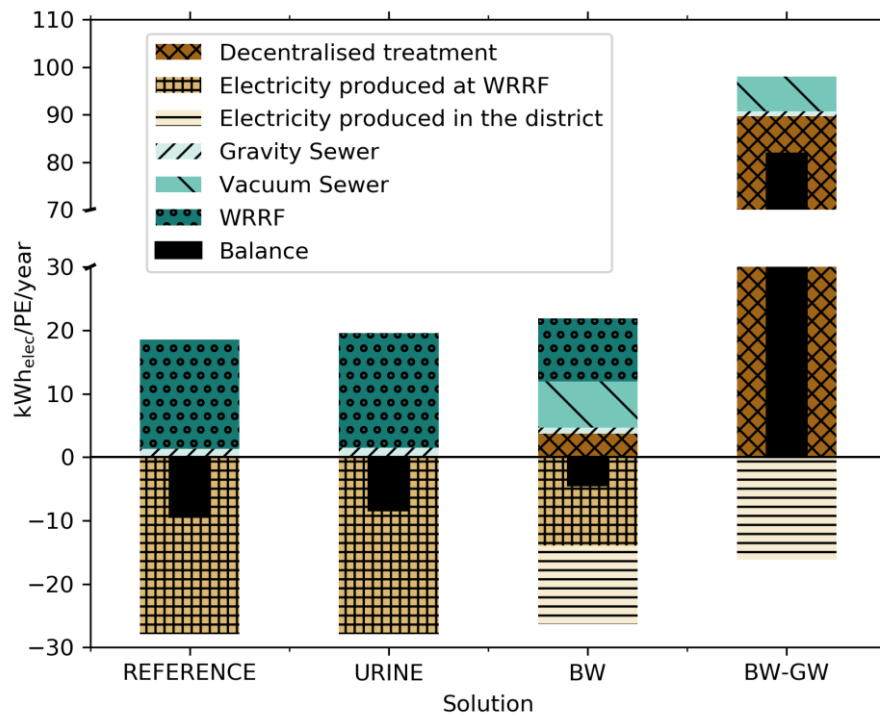

Figure III-10: Electricity balance for each scenario taking into account transport and treatment needs and production

Urine separation increases the electricity consumption in the WRRF due to a higher demand from the TMCS pre-treatment (see also Figure III-11 with a focus on WRRF balance). Indeed, the nitrogen recovered by TMCS increased, but considering the assumed conversion ratio of 1.88 kWh/kg-N_{recovered}, the energy consumption also increased. In the meantime, as previously discussed, the production of electricity from biogas decreased in the *Urine* scenario, and lead to a slightly less beneficial balance.

In the *BW* scenario, blackwater is treated in the district and greywater is sent to WRRF. However, one new energy consumption is added for the transport of blackwater by using a vacuum sewer. Results show, on the other hand, that the consumption in the WRRF is around two-fold less (1.7) compared to the Reference, (9.9 kWh/PE/year versus 17.2 kWh/PE/year). This gain in energy is related to a decrease in the need for aeration since nitrogen is previously removed and treated at the district scale. The total electricity consumption is finally equal to the consumption for the urine separation scenario. As previously discussed, the production of electricity is shared respectively in the WRRF and in the district with the same range of production than in the *Reference* scenario. As a conclusion *BW* scenario presents a negative energy balance but provides less energy compared to the *Reference*.

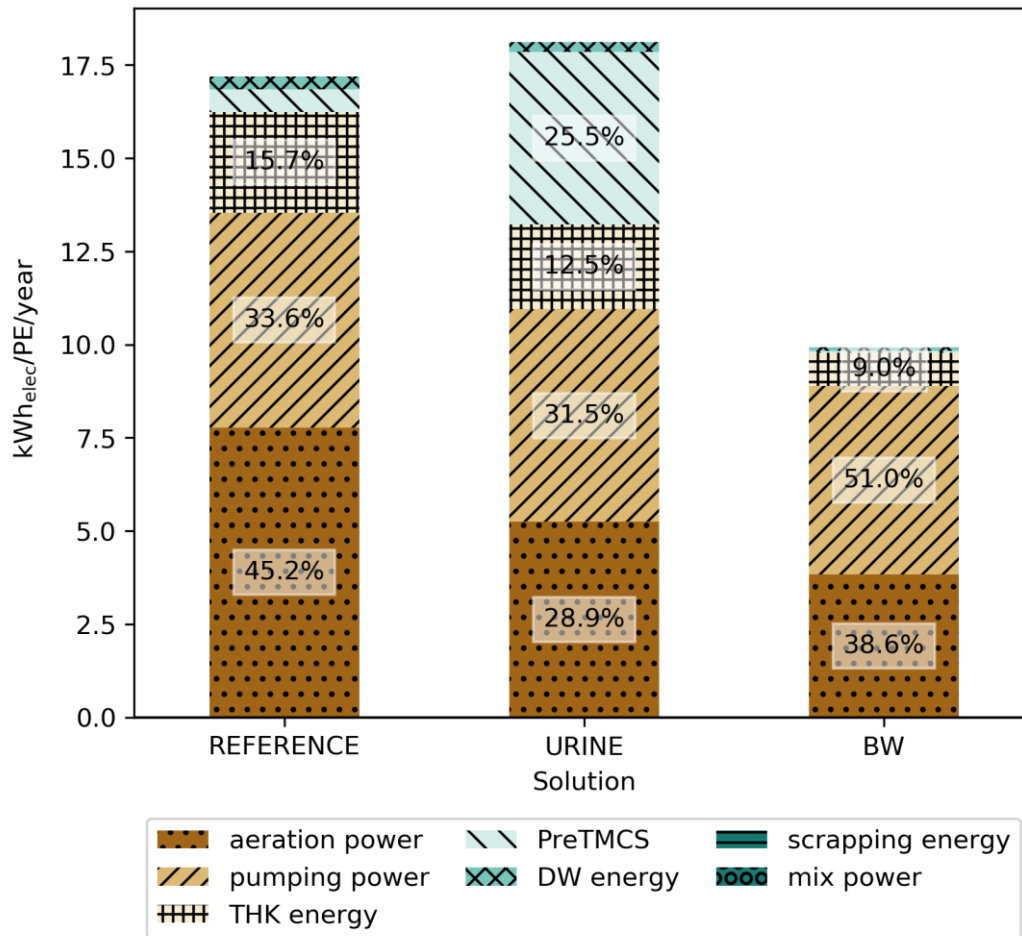

Figure III-11: Electricity consumption at WRRF for each scenario with only the contribution of the district. THK: thickening, PreTMCS: pre-treatments for TMCS, DW: dewatering, mix: mixing

In the decentralised scenario (*BW-GW*), results show that, the greywater treatment consumes much more electricity than all the other scenarios, which leads to a total consumption around 100 kWh_{elec}/PE/year compared to 20 kWh_{elec}/PE/year obtained for all the other scenarios. This is due to the choice of treatment systems for greywater. Indeed, the energy demand of the membrane bioreactor varies between 0.3 and 8 Nm³/h/m² (1.2 Nm³/h/m² was used in this simulation). Even if the best performance is used for airflow consumption, such as 0.27 Nm³/h/m² (Atanasova et al., 2017), this scenario presents a higher electricity consumption (34 kWh/PE/year) and not a beneficial balance. Finally, the production of electricity in *BW-GW* scenario is lower than all the other scenarios, even though the organic matter recovery rate is higher (39 % against 35 %). This is due to the fact that at a small scale, cogeneration production unit brings more heat than electricity.

To conclude this analysis of electricity balance, it has to be noted that the energy demand for transport is not the limiting factor, even with a vacuum sewer. Decentralised treatment and especially greywater treatment need particular attention. The benefit of treating greywater can be observed by water recovery and the associated benefits, such as a low demand in fresh water and a reduced production of potable water. The LCA study will allow to understand if these

benefits compensate the high energy consumption. Urine and BW scenarios still present beneficial electricity balances with higher nutrient recovery rates compared to the *Reference* scenario, as previously discussed.

III.2.b Integrated energy balance

The electricity balance stated above does not take into account all forms of energy, such as heat and fuel. This is why the energy balance is expressed in primary energy (in tons of oil equivalent) by using specific conversion factors described in Table III-2.

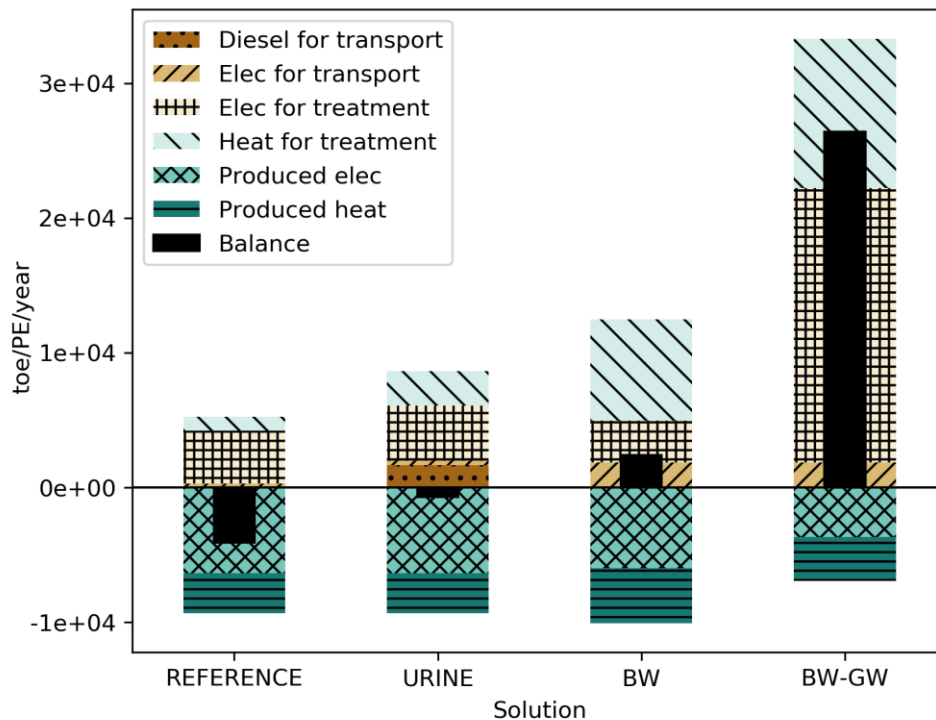

Figure III-12: Energy balance expressed in tonne of oil equivalent (toe). A negative balance is achieved when production is higher than consumption.

Figure III-12 shows the results of the energy balance obtained from each scenario. The more decentralised the treatment is, the worse the balance. This is due to two factors, first the electricity demand increases with the *BW-GW* scenario and secondly, the heat demand is also increased. Heat is necessary to operate the digester and this part is always covered by the heat production by cogeneration. However, heat is also necessary for increasing the temperature of the TMCS influent to 45°C. The required flow of heat is increasing with the *Urine*, *BW* and *BW-GW* scenarios. Moreover, when the treatment is decentralised, the initial temperature is 25°C. It has to be emphasized that each scenario is a comparison with the previous state of the sanitation where WRRF has already a TMCS treating the supernatant of digestate. The heat demand is related to the extra flowrate to treat the new district.

Both alternative transport systems (vacuum sewer and truck transport) are significant and represent respectively 14 % and 19 % of the total energy demand. In the *Urine* scenario, urine is stored in tanks and then transported by truck, once a week (two rounds are necessary) to the

WRRF, located 10 km away. By adding the distances involved in collecting inside the district (visit all buildings), a total of 3,200 km will be driven per year. Results obtained by the LCA will help to decide if the increase of energy consumption with alternative scenarios are worth it, and this by considering the additional benefit of the production of fertilisers.

TAKE HOME MESSAGE

- The *Urine* and *BW* scenarios show the same electricity balance than the Reference. The extra consumption for collecting the effluent with a vacuum pump is compensated by the reduction in aeration in the WRRF
 - Energy consumption for collection becomes significant for the *BW* scenario
 - The production of electricity does not improve with direct *BW* digestion because of the lower electricity efficiency of CHP at a decentralised scale
 - MBR energy consumption is not compensated by the energy production and leads to an unfavourable electricity balance
 - TMCS for N recovery demands a high amount of heat. At centralised WRRF the extra heat for urine treatment is not compensated by the extra production of heat. However, at the WRRF scale there is an excess of heat which is used for TMCS.
 - At a decentralised scale, heat is even less compensated because the required heat flow is larger due to a higher dilution rate of blackwater compared to urine.
-

III.3 LCA result

III.3.a Endpoint impact categories

The first analysis undertaken on endpoint impacts shows (Figure III-13) that scenarios with source separation present a reduction of impacts for each category: ecosystem quality human health and resources. For all scenarios, human health category is the most impacted with on average 53 % overall impacts, followed by resources (around 26 %) and ecosystem quality (around 22 %). Benefits are provided by the diminution of fossil depletion and climate change impact on both human health and ecosystems. Source separation scenarios did not significantly reduce particulate matter formation and toxicity towards humans (micropollutants were not considered). However, thanks to the reduction in the previous cited impacts, particulate matter formation and toxicity towards humans become predominant in the source separation scenarios. These impacts will also be analysed in mid-point impact category.

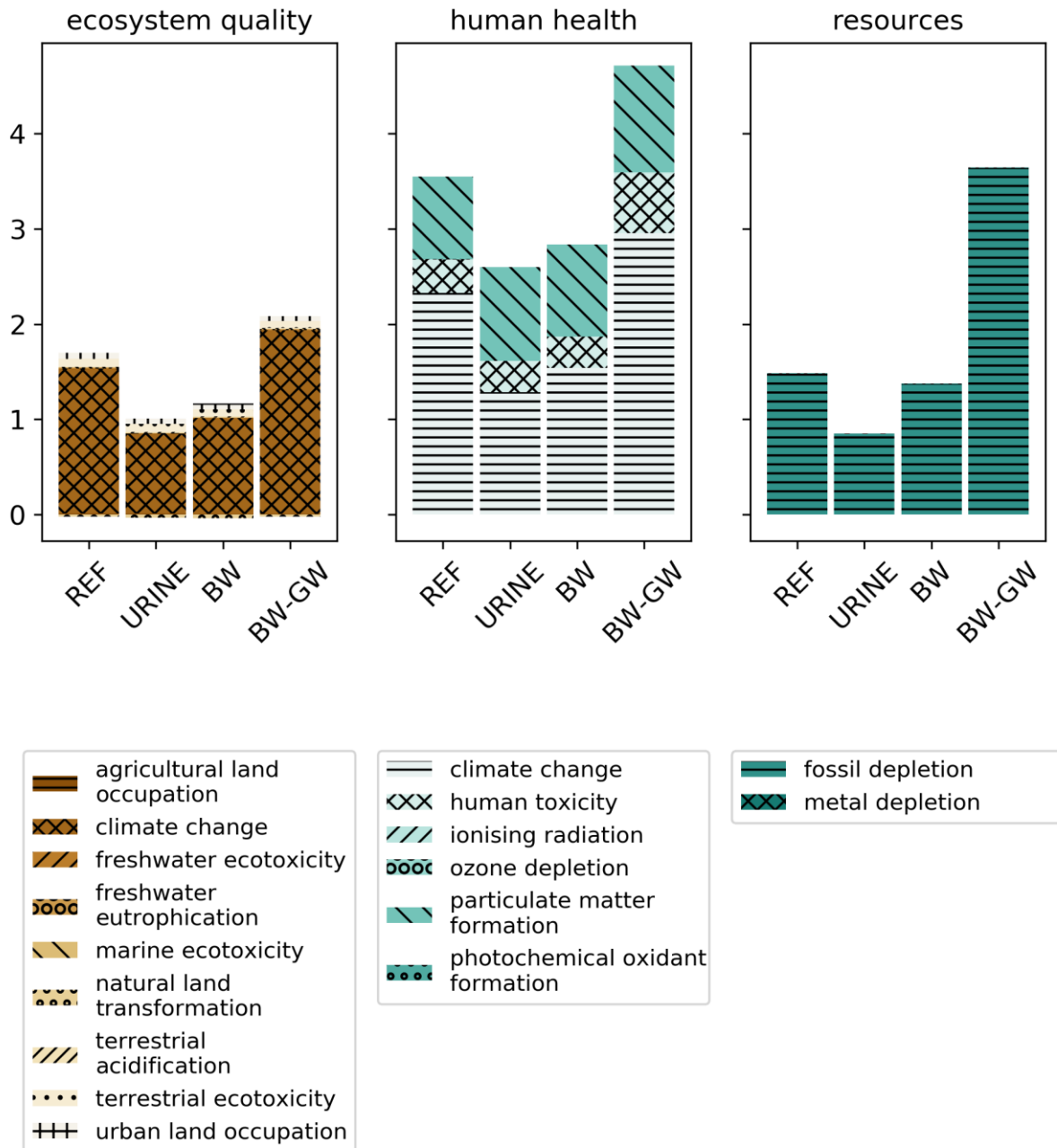

Figure III-13: Endpoint results for ecosystems quality, human health and resources depletion impact categories

III.3.b Midpoint methods

At midpoint level, the results will first be analysed by comparing the total result obtained from each scenario and all the categories. Secondly, the impact categories revealed at endpoint level will be analysed with a contribution analysis. The rest of the detailed graphics can be found in the Appendix I.1.

III.3.b.1 Integrated analysis

All impact results with midpoint methods are summarised in Figure III-14. They are normalised with the value of the *Reference* scenario, meaning that if the value is above 1, the impact is higher than the *Reference*. Results show that none of the four scenarios is better than the

Reference when considering all of the 18 investigated impact categories. However, the *Urine* scenario shows 11 impact categories, among the 18, which are better than the *Reference*; for *BW* scenario 14 impact categories are better; and for *BW-GW* only 5 impact categories are better. Indeed, the *BW-GW* scenario represents the worst situation with 7 impact categories with values reaching 1.5 times higher than the *Reference*. These impact categories are all related to the MBR energy consumption.

All the alternative scenarios increase the photochemical oxidant formation, the terrestrial acidification and the marine eutrophication. The first two represent an insignificant part of the endpoint level (less than 0.25 %). However marine eutrophication is not described at endpoint level. Therefore, no conclusion can be assigned to this increase.

The *Urine* scenario shows an unexpected result with the degradation of water depletion due to the consumption of magnesium which is not compensated by water reuse.

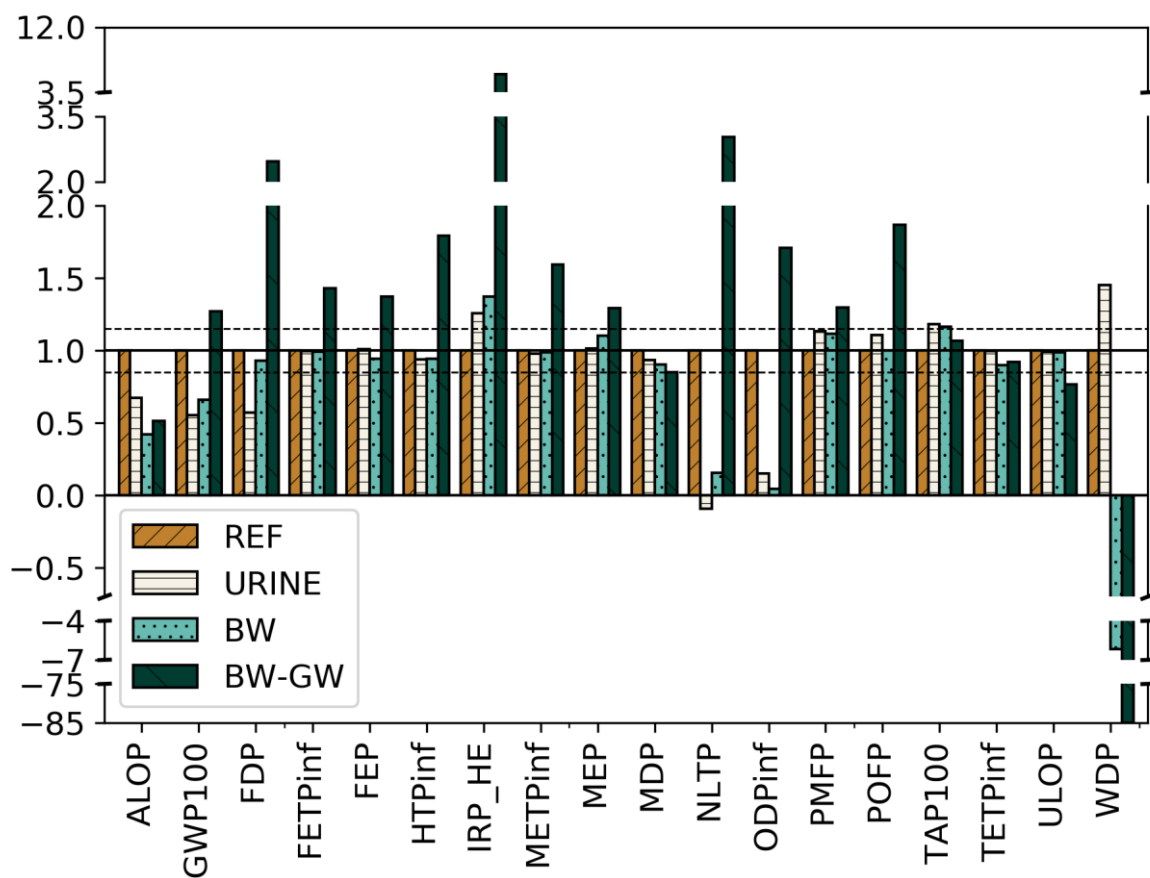

Figure III-14: Normalised comparison of all scenarios to the reference scenario, for each category of impact at midpoint level (ReCiPe H). ALOP: agricultural land occupation, GWP100: climate change, FDP: fossil depletion, FETPinf: freshwater ecotoxicity, FEP: freshwater eutrophication, HTPinf: human toxicity, IRP_HE: ionising radiation, METPinf: marine ecotoxicity, MEP: marine eutrophication, MDP: metal depletion, NLTP: natural land transformation, ODPinf: ozone depletion, PMFP: particulate matter formation, POFP: photochemical oxidant formation, TAP100: terrestrial acidification, TETPinf terrestrial ecotoxicity, ULOP: urban land occupation, WDP: water depletion.

In order to established which scenario is the best from this midpoint level, the first step of the procedure described in (Guérin-Schneider et al., 2018) has been followed. The midpoint categories with less than 1 % of worst total damage between scenarios (endpoint level) was

removed. The last remaining categories are again analysed to see if the same trend is observed in all categories. One again, it is not possible to conclude with a dichotomist answer. The *Urine* and *BW* scenario present the best ratio of improved categories compared to the Reference (67 %). *BW-GW* shows the worst ratio with only 17 % of improved categories.

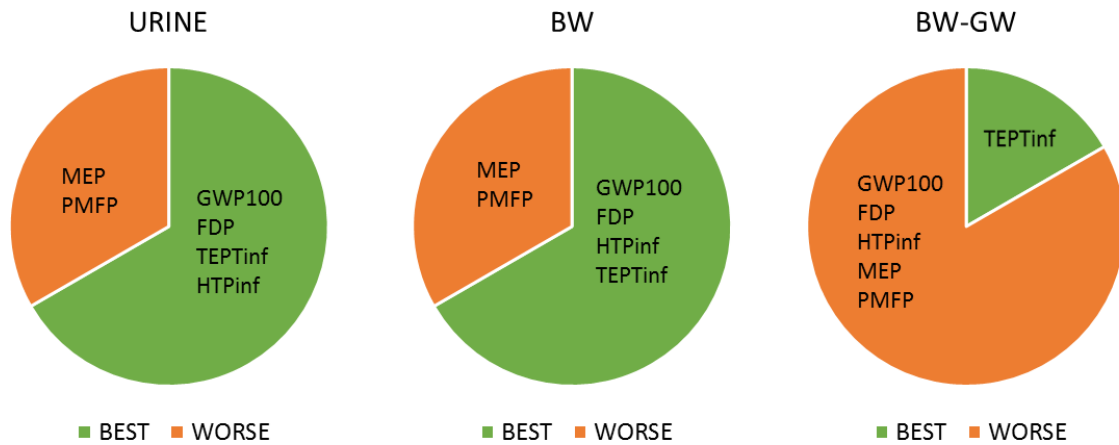

Figure III-15: Ratio of midpoint categories which present better or worse results compare to Reference with the name of the retained categories. GWP100: climate change, FDP: fossil depletion, HTPinf: human toxicity, MEP: marine eutrophication, PMFP: particulate matter formation, TETPinf terrestrial ecotoxicity.

To better understand which the main contributors are, a contribution analysis is performed on the indicators selected by this last analysis.

III.3.b.2 Contribution analysis

All the results presented below are shown with the same graphics. All the positive values represent impacts caused by our system. The negative values of the graph represent impacts which are avoided. These avoided impacts are generated by our scenario outside the boundaries of the studied system, for example avoided conventional fertiliser, tap water production, but also the emissions linked to spreading of conventional fertilisers. The black bars, which represent the balance between impacts and avoided impacts, help to compare different scenarios. The smallest the bar, the better the scenario. Moreover, when we refer to the “impact of the system”, only the positive values are considered.

Figure III-16 shows the impact on climate change for each scenario, it can be concluded that both *Urine* and *BW* scenarios have less impact on climate change compared to the *Reference*, whilst *BW-GW* scenario shows a 27 % impact increase. The main contributions for the *Reference* scenario are the WRRF infrastructure, sewer infrastructure and direct emissions (N₂O, methane, CO₂ into air and water emissions...).

Thanks to the substitution of nitrogen fertilizer, the three other scenarios present an improved avoided climate change impact. This avoided impact of fertiliser production balanced the increase of emissions from the system. Indeed, the *Urine* scenario needs collection transport which contributes to 4 % of the total emissions. More recovered fertiliser is spread into fields which increases greenhouse gas emissions (title co-products valorisation in Figure III-16). While higher recovery is described, a significant decrease of direct emissions is visible (60 %). This is due to less dinitrogen oxide emissions explained by a reduced amount of nitrogen

entering the WRRF. A fixed value of 1.6 % of nitrogen influent from (IPCC, 2019) is used. Both these effects explains a decrease of the total balance of 45 % compared to the *Reference scenario*.

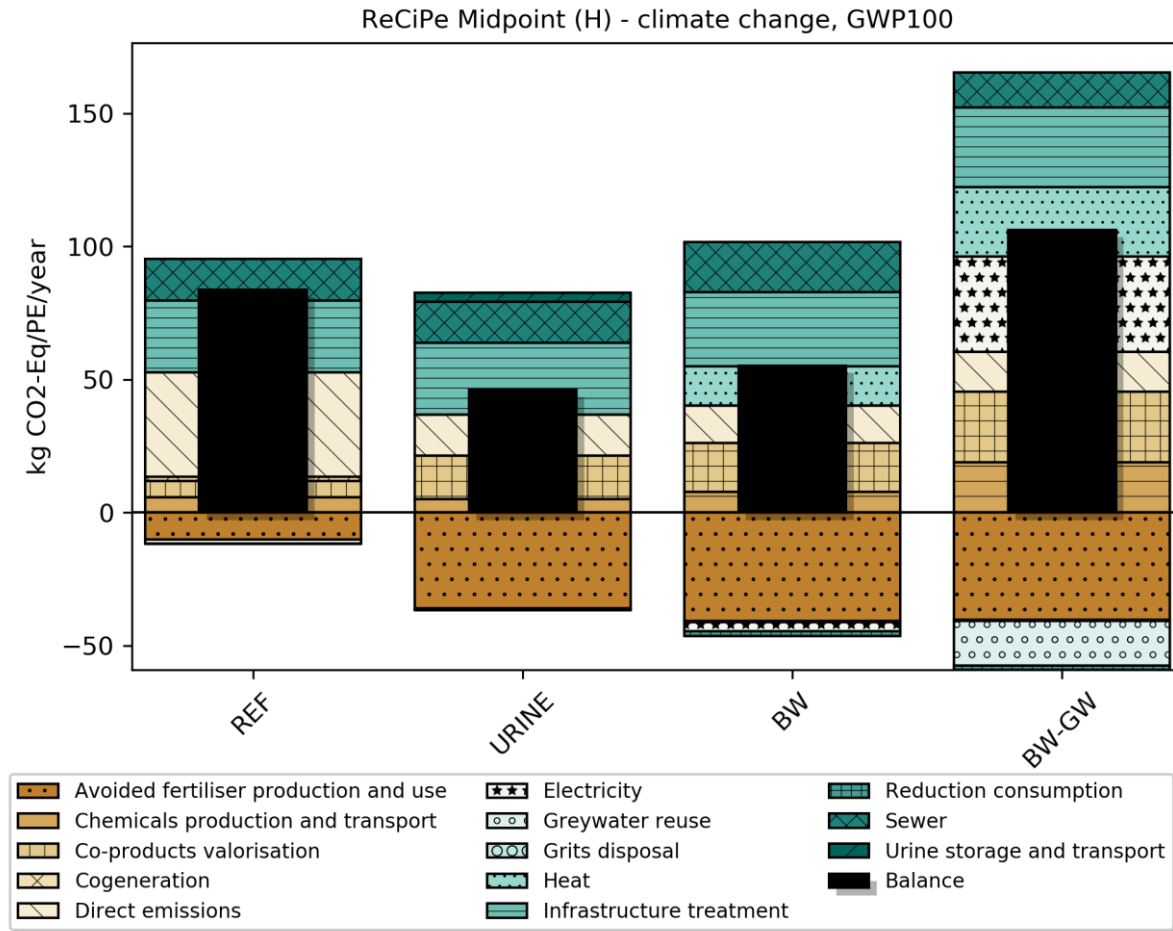

Figure III-16: Comparison of the four scenarios on climate change impact (ReCiPe Midpoint H)

The *BW* scenario requires heat for the nitrogen recovery process which is provided by a boiler operated with natural gas. The emissions related to the heat demand represent 15 % of the total emissions, and are hence not negligible. The optimisation of the TMCS process needs to be performed in order to limit the operating temperature. A similar decrease of direct emissions is visible as described in the *Urine* scenario. A slight increase in nitrogen recovery balances this extra emission of *BW* scenario to finally reach 34 % decrease of the balance compared to the *Reference* scenario.

For decentralised blackwater and greywater treatment systems (*BW-GW* scenario), the total balance increases by 27 % compared to the *Reference*. The emissions related to energy consumption represent 37 % of this impact category, thereby increasing the emissions compared to the *Reference* scenario. Heat demand is once again a major source of impact with 16 % of the emissions. As described in *Urine* and *BW* scenarios, the direct emissions are reduced significantly (62 %) by reducing N₂O emissions. Nevertheless, the overall emissions

are not completely balanced by avoided impacts, such as production of fertiliser and reuse of greywater for non-potable use. To achieve this scenario, all the greywater needs to be reused by replacing tap water, but the flush water volume will only represent 6 % of the available amount of greywater. To reach this water recovery level, new applications need to be found, such as for irrigating green spaces, cleaning roads...

Fossil fuel depletion is the second most predominant impact category. However, fossil depletion and climate change are strongly correlated in this case, as infrastructure and energy have consequences on both impacts. The only difference is the preponderance of chemicals in this impact category. In the *Reference* scenario chemicals represents 26 % of the caused impact, of which 79 % comes from methanol production. The alternative scenarios do not need extra methanol compared to the *City* scenario, before the connection to the new district, which allows a significant decrease of the impact. For instance, in the *Urine* scenario, chemicals represent only 1 % of the impact over the whole system. However, same trends are observed compared to the climate change impact and thus will not be discussed further.

The formation of particulate matter is the third contributor category in the endpoint analysis. This matter is generated through products spread on the field and during infrastructure construction (sewer and WRRF). Particulate matter formation shows the same balance through all scenarios as new emissions are balanced by avoided emissions.

Although freshwater eutrophication does not appear as a significant impact from the endpoint category, it remains one of the main objective of a wastewater treatment plant. Regarding freshwater eutrophication (Figure III-17), direct emissions into the water, with phosphate release in the watersheds stand as the main contributors. Co-product valorisation is also a contributor to freshwater eutrophication, due to the leakage of phosphorus after sludge and struvite spreading. For the Reference scenario, sludge is responsible for the major part of phosphorus leakage. In alternative scenarios, struvite spreading generates most of the phosphorus leakage. Electricity production is the main reason why *BW-GW* scenario presents higher freshwater eutrophication. Production of chemicals and especially sodium hydroxide is also responsible of an increasing part of eutrophication.

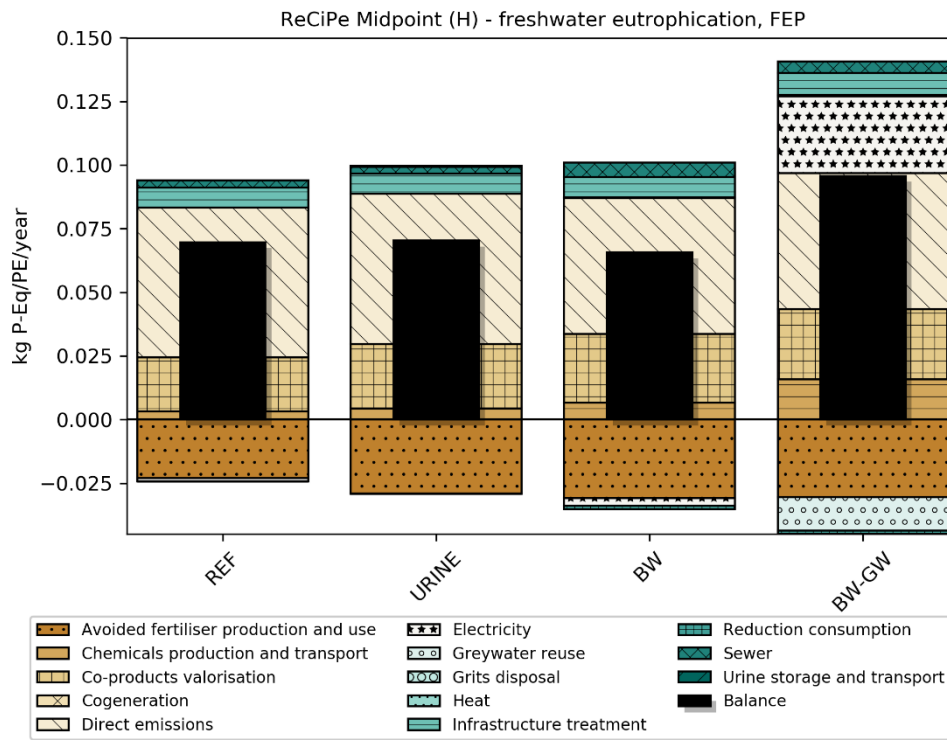

Figure III-17: Comparison of freshwater eutrophication impact for all four scenarios (Reference, Urine, BW and BW-GW)

Discharge of nitrogen is responsible for marine eutrophication, this is why direct emissions are the main contributor (Figure III-18). As freshwater eutrophication, co-product valorisation also contributes, even if to a least extent, to marine eutrophication, with nitrogen leakage during spreading.

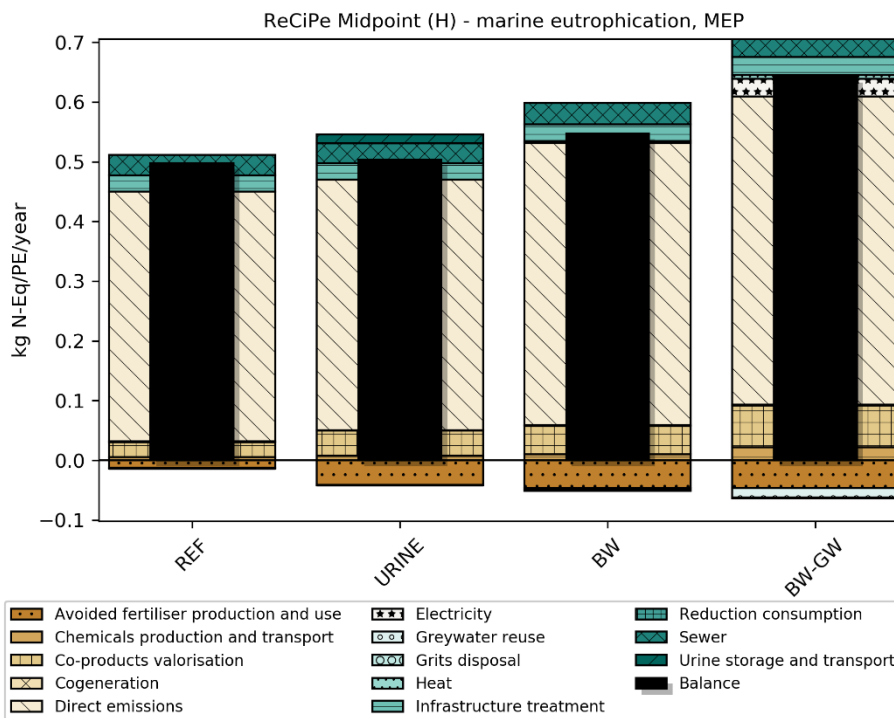

Figure III-18: Comparison of marine eutrophication impact for all four scenarios (Reference, Urine, BW and BW-GW)

TAKE HOME MESSAGE

Endpoint level

- Compared to the Reference scenario the impact of the global wastewater management system is reduced in both the *Urine* and *BW* scenarios but increases for *BW-GW* scenario.
- The main contributors are human health with climate change and particulate matter formation, fossil depletion and climate change on ecosystem quality

Midpoint level

- No clear conclusion can be drawn from the analysis of the 18 impact categories. However, *BW-GW* scenario presents the highest number of categories with the worst results, mainly due to the high energy consumption of the MBR.
 - Reduced N₂O emissions is the main contributor for relieving impacts on climate change. In addition, production of nitrogen fertiliser plays a key role to avoid impacts on climate change.
 - Regarding the *BW-GW* scenario, the high consumption of electricity for operating the MBR and heat requirement for the TMCS are not compensated by the avoided production of tap water, even if the total amount of greywater is reused.
 - The reuse of all the greywater as flush water represents only 6 % of the total greywater produced in the district.
 - Since the same discharge limits are applied in all scenarios, the freshwater eutrophication from the direct emissions is also equivalent. However, electricity and chemicals have an influence on the total eutrophication.
 - Therefore, to maximise the environmental benefit, key aspects should be optimised for implementing treatment chain specific to separated streams: energy consumption and greenhouse gases emissions
-

IV. DISCUSSION

IV.1 Source separation benefits from an integrated vision

This study was able to assess three different wastewater management scenarios with source separation and compared them to an optimal WRRF operating with nutrient and COD recovery. However, besides these recovery processes for Nitrogen and Phosphorus, the WRRF was not able to recover large proportions of available nutrients (less than 15 %) especially regarding nitrogen recovery. Source separation scenarios, on the other hand, was able to increase the recovery of both phosphorus N and P up to 57 % and 73 % (as fertilisers), respectively.

Urine and Blackwater scenarios showed similar P recovery rates, only if the biological removal of phosphorus was performed in the centralised treatment plant. In this way, the P from the faeces was also recovered in the digestate. (Meinzinger et al., 2010a) showed different P recovery rates when chemical removal of phosphorus was implemented in the WRRF. Indeed, phosphorus recovery was found to be 3 times higher for blackwater separation compared to *Urine*. On the other hand, source separation did not significantly improve the recovery of COD in the form of methane, compared to the WRRF.

Regarding energy, the *Urine* and *BW* scenarios showed comparable electricity balances compared to the Reference. The extra consumption due to the collection steps using vacuum pumps was compensated by the reduction in aeration in the WRRF. Moreover the production of electricity did not improve with direct digestion of blackwater (*BW* and *BW-GW* scenarios) because of the lower electricity efficiency of CHP with a decentralised scale. (Thibodeau et al., 2014a) found a similar conclusion for blackwater separation, where: the energy production from blackwater digestion is reduced compared to wastewater digestion, and this because organic matter from greywater is not degraded. For the *BW-GW* scenario, energy consumption by the MBR was not compensated by the energy production which led to an unfavourable electricity balance. (Remy, 2010) found similar conclusions on MBR consumption and energy balances of the *BW-GW* scenario. Finally, the use of TMCS for N recovery consumed large amounts of heat. With a centralised WRRF, the extra heat requirements for urine treatment was not compensated by the extra production of heat. However, at the WRRF scale (considering the new district and the city) there is an excess of heat which is used for operating the TMCS. When considering a decentralised scale, (*BW* and *BW-GW* scenario), the heat was even less compensated because the flow to heat was larger. Indeed, blackwater flow was more diluted than the flow of urine or digestate.

Regarding endpoint damages, the impact of the wastewater management system compared to the *Reference* was reduced for *Urine* and *BW* scenarios but increased for *BW-GW*. The main contributors were human health with climate change and particulate matter formation, fossil depletion and climate change on ecosystem quality.

Regarding midpoint impacts, no clear conclusion can be drawn from the analysis of the 18 impact categories. However, *BW-GW* scenario presented the most categories with worst results, mainly due to the high energy consumption of the MBR. Reduction of climate change impact observed in the *Urine* and *BW* scenarios, was due to the reduction of N₂O emissions and the

avoided production of nitrogen fertiliser. (Thibodeau et al., 2014a) reported different conclusions between *reference* and *BW* scenarios with an increase of 23 %. However, authors did not take into account any direct emission from WWTP, nor any post spreading emissions from mineral fertilisers.

For *BW-GW* scenario, the high consumption of electricity of the MBR and the heat required for operating the TMCS is not compensated by the avoided production of tap water, even if all the greywater is reused. Moreover, flush water represents only 6 % of the total greywater produced in the district. Therefore, new applications need to be found in order to reuse the greywater.

It has to be emphasised that the WRRF used as a reference is not conventional and already provides high environmental performances. However, between conventional WWTP and our advanced WRRF, only 14 % of decrease in climate change impact is observed ($1.05 \text{ kgCO}_2\text{eq/m}^3$ for conventional WWTP of (Bisinella de Faria et al., 2015) with the same N_2O emission factors, and $0.9 \text{ kgCO}_2\text{eq/m}^3$ for our reference). In this perspective, source separation is currently the best option to significantly reduce the impact on climate change. Indeed 54 % of decrease can be achieved between advanced reference and *Urine* scenario at district scale.

Finally, in this study, the European energy mix of 2004 has been used for the LCA analysis. However, before a large implementation of source separation, energy mix would be modified. The contribution to renewable energy is planned to increase, then the disadvantage of power consumption of *BW-GW* scenario will have less impact. Indeed, the European electricity mix of $0.5 \text{ kgCO}_2\text{-eq/kWh}$ is assumed, however, for example, prospective scenarios in Spain can achieve $0.039 \text{ kgCO}_2\text{-eq/kWh}$ in 2050 with 80 % GHG emission reduction compare to 2005 (García-Gusano et al., 2017). Moving towards renewable energy could also decrease the particulate matter formation *BW-GW* scenario as the electricity represents 14 % of the total emissions. Moreover, if the current French mix is used, a very low impact on climate change category will be observed since the emission factor in France is only $0.078 \text{ kgCO}_2\text{-eq/kWh}$ due to the large proportion of nuclear energy. However, the ionising radiation impact will show an increase since the emission factor is 0.53 against $0.37 \text{ kg U235-eq/kWh}$.

IV.2 Possible directions for optimisation and future research

This study showed several directions of future research. Indeed, even if the TMCS process for nitrogen recovery seems relevant to implement, heat consumption should be optimised. Several options are feasible. Firstly, heat recovery from the effluent should be installed in order to pre-heat the inlet. Secondly, greywater heat can also be recovered. Indeed, this can account for a large source of heat but at a low temperature (below 40°C). Moreover, reducing the heat demand by limiting the flowrate can be an option for blackwater treatment. In a final step, after consumption mitigation, other sources of heat can also be investigated to reduce the impact on climate change. For instance, using a boiler with wood pellets has only an emission factor of $0.016 \text{ kgCO}_2\text{-eq/MJ}$ (Ecoinvent database v3.6), against $0.07 \text{ kgCO}_2\text{-eq/MJ}$ for the natural gas boiler (Ecoinvent Database v2.7).

To improve the heat balance, increasing the heat production from cogeneration can be an option. By considering the decentralised treatment, co-digestion of blackwater with kitchen waste can be imagined since it will be studied in future projects deployed in Northern European countries (Skambraks et al., 2017). In WRRF, COD recovery can be improved by producing more primary sludge, for instance, with an enhanced primary sedimentation tank, or high-rate activated sludge. Moreover, a combination of biological removal of phosphorus and anammox bacteria in the mainstream could be an interesting alternative. Anammox bacteria does not need organic matter to degrade nitrogen, therefore, the major part of organic matter can be segregated by high rate activated sludge and then sent for digestion. A first successful trial is reported by (Cao et al., 2017) under warm climate, and shows interesting results. The current bottleneck is to perform PN/A systems in the mainstream under cold climate. However, from an environmental point of view, a mitigation strategy of N₂O emissions needs to be found for mainstream anammox applications as it can completely reverse the advantages in terms of energy consumption (Besson et al., 2017). Greywater treatment at small scale is another research topic to investigate as energy consumption of MBR revealed to be highly impacting on climate change.

V. CONCLUSION

Evaluating alternative wastewater management systems is a challenging task as integrated modelling of the entire system is needed to take into account the collection and treatment, but also the characteristics of the urban district. Moreover, each system can have several advantages and drawbacks on the environment, and integrated assessment, such as Life Cycle Assessment is a useful tool for multi-criteria evaluation.

To tackle this challenge, a tool has been developed to model the collection and decentralised treatment at the district scale. The effect on the centralised treatment plant is taken into account through plant-wide modelling. Results obtained from the simulation are used as inventory for the LCA. This study aimed to compare several options in order to enhance the recovery of resources from wastewater by using a WRRF coupled with, or without, source separation systems.

The main results from this study are:

- *Urine* and *BW* scenarios show similar results in most impact categories, whilst the *BW-GW* scenario only improved water depletion.
- It is shown that nitrogen recovery is the most impacting aspect regarding LCA results. Source separation of urine or blackwater can achieve a much better recovery compared to centralised WRRF. This benefit is related to both chemical fertilizer substitution and reduction of N₂O emissions from biological treatment.
- Climate change is one of the most impacted category produced by WRRF. Both *Urine* and *BW* scenarios reduce this impact by respectively 45 % and 34 %
- TMCS is a big consumer of heat, and more optimisation is needed to reduce this high consumption.
- MBR for greywater treatment is energy intensive. Greywater reuse and avoided potable water production did not compensate the impact on climate change.

This chapter shows the strong benefit of source separation scenario compare to advanced WRRF as reference, at district scale. However, only one type district was studied. In the next chapter, the influence of the urbanism is studied with 6 different type of district. Chapter IV intends to assess if the conclusion drawn in Chapter III are still valid with all the different urbanism.

**Chapter IV. Impact of
urbanism and scale-up on source
separation systems.**

I. INTRODUCTION

In the previous chapter, source separation has been evaluated through an environmental assessment. Urine and blackwater separation presented promising results, especially regarding the reduction of climate change impact especially when treatment systems were centralised. However, the scenario of blackwater and greywater separation, with a totally decentralised treatment, showed a non-beneficial balance compared to the reference scenario.

In this chapter, source separation have been evaluated through environmental assessment with the aims of comparing different urban configurations. The goal is thus to find the best wastewater management scenario for specific urban configuration and propose recommendations for future pilot and demonstration implementation. Moreover, the size of scale-up is also investigated in order to analyse the influence of both population density and size on the feasibility of such a project and on its environmental impact.

Urban population is growing around the globe. In France, for instance, the overall population growth between 2011 and 2016 was approximately + 0.4 % per year, but can reach + 0.8 % in metropole suburbs. New districts are built every year. In France, in 2017, the construction of new single houses represented 1.1 % of the total amount of individual housing, while newly built residential buildings account for 2 %. This high renewal of districts gives good opportunities to implement innovation.

Differences in urban typologies (individual housing or collective buildings) might have effects on the type of sanitation to establish. For example, the population density induced by the type of building, together with the available space for decentralised treatment, can both impact the feasibility of decentralised sanitation systems and the overall mass and energy balances.

To our knowledge, linking urban configuration and sanitation systems through environmental assessments has not yet been performed. (Meinzinger et al., 2010b) made an attempt of an economical assessment of urine source separation. Moreover, (Jeong et al., 2018, 2016) investigated the influence of urbanism on greywater separation and reuse, as well as on rainwater reuse. Both studies concluded that urbanism and the scale of implementation had an effect on the environmental or economical assessment. However, both studies did not take into account the operation of the WWTP with accuracy. Estimation of energy reduction has been based on the treated flowrate, which could lead to overestimation. Moreover the study of (Jeong et al., 2018, 2016) focused more on the building scale which is not the boundary for wastewater treatment, rather than district scale.

This study aims to fulfil these gaps by combining the modelling of wastewater treatment with different urban configurations. Indeed, this chapter has the goal to assess source separation systems associated to an urban configuration in order to highlight guidelines for the implementation of these systems. Limits of each system are then addressed with an urban planning approach in order to highlight the feasibility study of the most promising system(s).

For these purposes, 6 different urban configurations have been simulated with different sanitation systems, and LCA was then performed for each case study. As described in the previous chapter, the centralised wastewater treatment plant is assumed to recover nutrients and

represents the future generation of treatment plants: a Wastewater Resource Recovery Facility (WRRF).

This chapter is divided into three parts with a first section which summarizes the methodology used for the studied scenario and the reference flows obtained for each case study. The second section focuses on results obtained from mass and energy balances as well as results from the LCA regarding each case study. Finally, the last section, will bring perspectives to the performed work and recommend solutions which can solve the arisen issues.

II. METHODOLOGY

II.1 Scenario description

In order to investigate the effect of scale and urban configuration on environmental assessments, several scenarios have been simulated. 18 case studies have been created with 3 different district sizes (6.25 ha, 16 ha and 36 ha) and 6 urban configurations, as described in Chapter II.IV.2.

The same four wastewater management systems as described in Chapter II.III, have been studied (see Figure IV-1 as a reminder), with A) the conventional management (Reference scenario), B) the urine separation and centralised treatment of both streams, C) the separation of blackwater and greywater with decentralised treatment of blackwater, and finally D) the separation of blackwater and greywater with a totally decentralised treatment system. This means that 72 different combinations were analysed.

To facilitate the comprehension through this chapter the following nomenclature has been used:

- Case study: combination of an urban configuration and a size of district
- Sanitation system: refers to the 4 previous solutions of collection and treatment, described in Figure IV-1

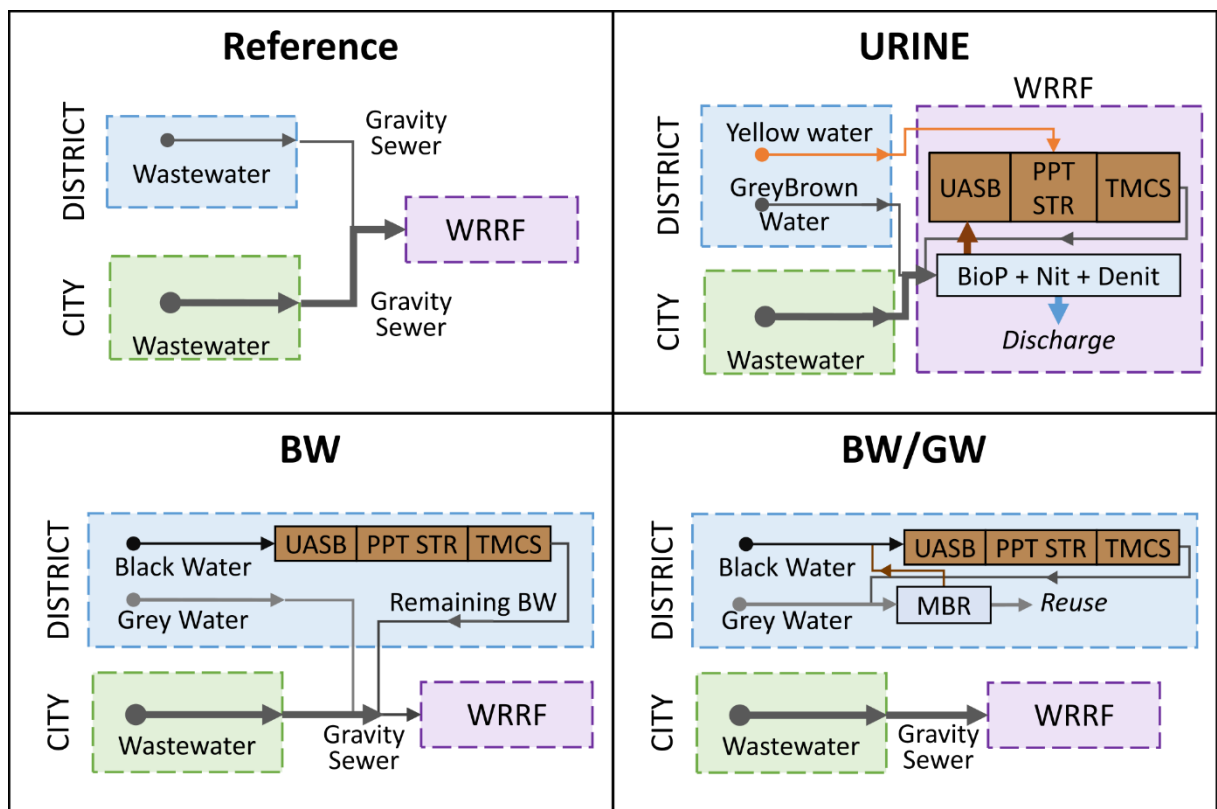

Figure IV-1 Presentation of the four scenarios and the WRRF. WRRF: Wastewater recovery facility, AD: Anaerobic digester, PPTSTRU: Struvite precipitation, TMCS: transmembrane chemisorption, UASB: upflow active sludge blanket, MBR: membrane bioreactor, ANAER: anaerobic tank, ANOX: anoxic tank, AER: aerated tank, PANOX: post-anoxic tank, PAER: post aerobic tank, THK: thickening, PTHK: post-thickening, DW: dewatering.

II.2 Functional unit

Since the surface size and the population density of each urban configuration are both different, it is mandatory to use a functional unit which is representative for all scenarios. For this purpose, the population equivalent (PE), defined as the BOD₅ load, is a good option since it remains identical for all sanitation systems used in each case study. However, the BOD₅ load is not the only parameter characterizing wastewater treatment and valorisation, therefore, other functional units have been studied: 1 kg of nitrogen per day, 1 kg of phosphorus per day and finally 1 m³ of produced wastewater in the district. Results obtained from this comparison are only presented in the Appendix II.4.

II.3 Reference flows

The characteristics of the 72 combinations of case-studies and sanitation systems are presented in Figure IV-2 using the functional units described above and the associated reference flows. Table S 36 in Appendix II.1 gives an overview of the obtained values.

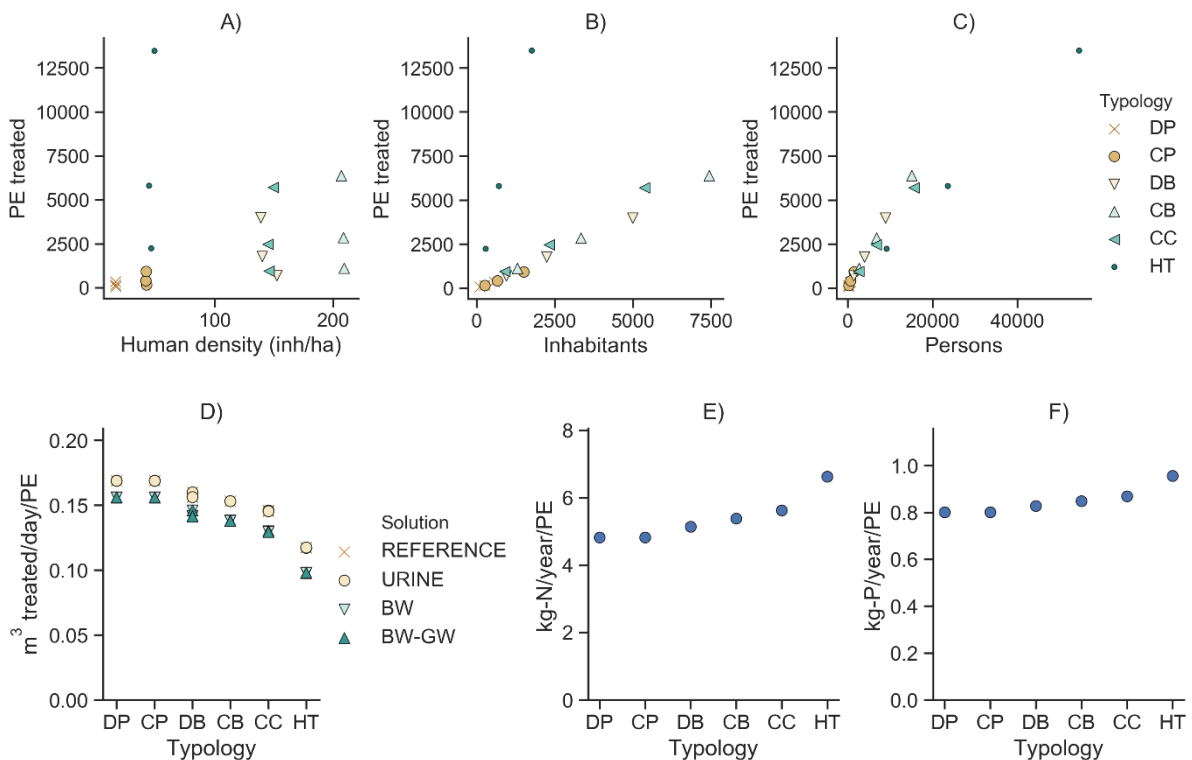

Figure IV-2: Description of the reference flows (A) production of PE regarding the human density; (B) treated PE in regards with the number of inhabitants and person including employees (C); evolution with typology of treated wastewater (D), mass flow of nitrogen (E) and phosphorus (F).

DP: discontinuous pavilions, CP: continuous pavilions, DB: discontinuous buildings, CB: continuous buildings, CC: city centre, HT: high-rise tower

The number of PE treated is correlated with the number of inhabitants (B) and the total number of people present in the district (C, including the number of employees). However, the obtained correlation coefficient depends on the urban configuration and especially on the proportion of employees. With a higher proportion of employees, the increase of the number of inhabitants induces less variation in treated PE (see Figure IV-2 C). This is due to the fact that less greywater, as well as less organic matter, is produced in areas dominated by working offices

compared to households. Therefore, a higher proportion of employees reduces the flowrate of wastewater (see Figure IV-2 D).

Moreover, wastewater production differs between sanitation systems. *Reference* and *Urine* systems have the same production, however with vacuum toilets used in *BW* and *BW-GW* systems, the production is decreased by 8 %.

Finally, it can be observed that the definition of PE based on the load of BOD₅, does not involve a constant load in nitrogen and phosphorus. This is due to different ratios between greywater and human excreta within the urban configurations. The wastewater production value is therefore dependant on the different urban configurations.

It has to be highlighted that increasing loads of N and P per PE involves a more concentrated mixed wastewater in the reference system. However, with a source separation system, the increase of N and P flow does not imply that these compounds are more concentrated in the flow. Indeed, the concentrations for each compound in the greywater are identical, whether coming from office areas or households. Moreover, the concentration in blackwater is estimated from the flush volume. In this sense, as mentioned earlier, a higher proportion of employees decreases the production of greywater. In this case, a lower load of organic matter is produced but with similar loads of nutrients. The ratio between nutrient load and organic load is therefore increased.

II.4 General methodology

As a reminder, the methodology exposed in Chapter II has been applied according to the following steps:

- Modelling of the WWRF without the new district by using SUMO (1 simulation)
- Modelling of each case study at a decentralised scale for each sanitation system (72 simulations)
- Modelling of the WWRF with the new connected district with a determined flow and concentration obtained from the previous step (72 simulations on SUMO)
- Calculation of the LCA inventory for each case study and sanitation system (73 simulations)
- Life cycle assessment for each scenario (73 simulations with ReCiPe methods and cumulative energy demand).
- Calculation of the contribution of the district only, by removing the impact of WWRF without the new district
- Normalisation of results by using functional units.
- For each case study, calculation of improvements in alternative scenarios compared to the reference sanitation system.

III. RESULTS

First results represent an LCA inventory with mass and energy balances for all of the systems. The LCA results are then discussed at midpoint and endpoint level, regarding the improvements compared to the reference sanitation system.

III.1 Inventory

III.1.a Mass balance

Results obtained from the mass balances of nitrogen, COD and phosphorus are presented in Figure IV-3, Figure IV-4 and Figure IV-5 respectively.

As shown in the previous chapter, source separation significantly increases the nutrient recovery rate. The nitrogen recovery rate in ammonium sulphate form was only 6 % for the reference scenario, against 48 % for *Urine* separation, 55 % for *BW*, and 57 % for *BW-GW* scenarios.

The influence of the urban configuration is relatively minor, since only a small increase is observed when increasing the population density in the *BW* scenario. Discontinuous pavilions have only 53 % of nitrogen recovery against 58 % for high-rise tower blocks. This can be explained by the fact that with a decrease in the proportion of greywater due to an increase in proportion of employees, more nitrogen is present in blackwater.

The size of the district does not have an influence on the recovery of nitrogen (data shown in Appendix II.3.e)

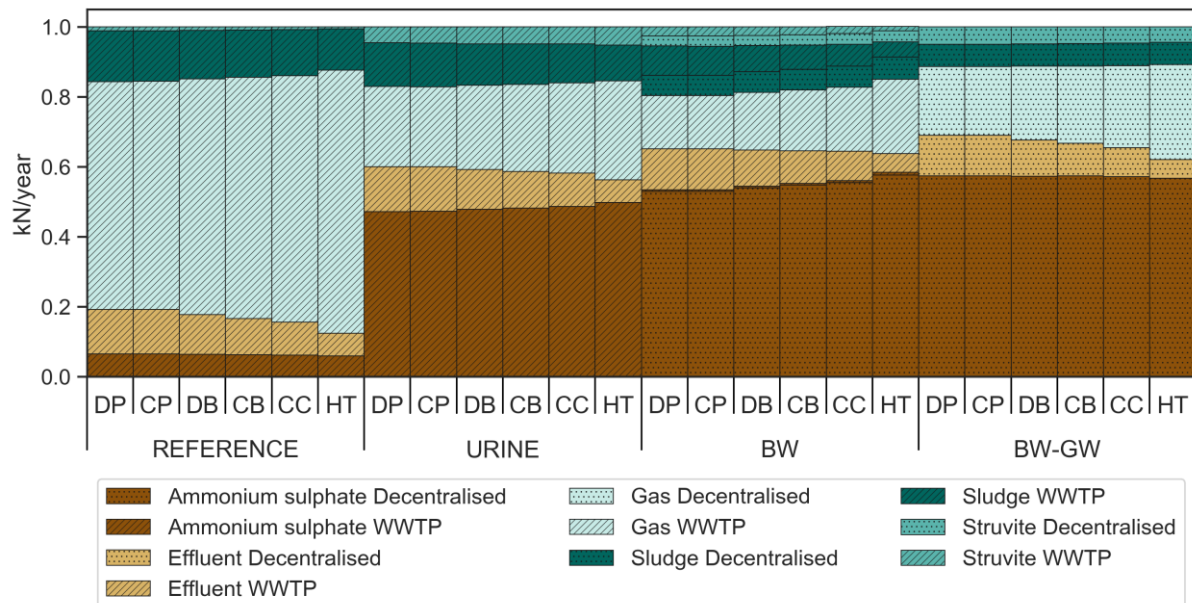

Figure IV-3: Nitrogen mass balance. DP: discontinuous pavilions, CP: continuous pavilions, DB: discontinuous buildings, CB: continuous buildings, CC: city centre, HT: high-rise tower

Regarding phosphorus, the recovery as struvite (Figure IV-4) is improved by applying source separation, but the recovery rates remain comparable between each alternative sanitation system (from 60 % to up to 73 %). However, in this study, urban configurations have a more significant influence especially for urine and BW systems.

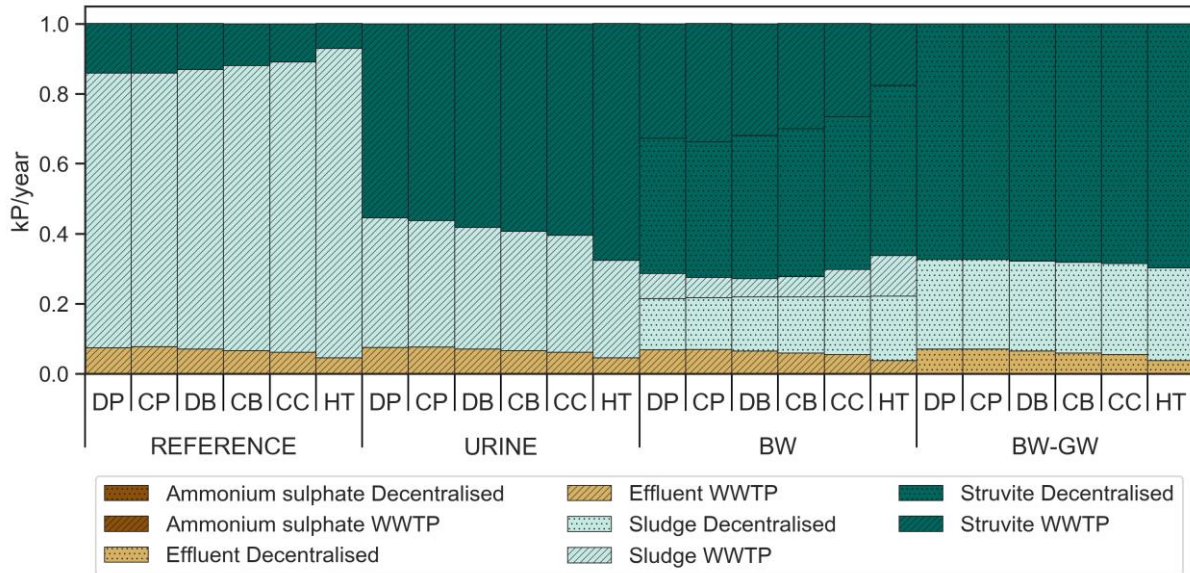

Figure IV-4: Phosphorus mass balance. DP: discontinuous pavilions, CP: continuous pavilions, DB: discontinuous buildings, CB: continuous buildings, CC: city centre, HT: high-rise tower

Moreover, the scale for implementing *BW* systems is also an influencing parameter. For instance, the recovery rate of phosphorus as struvite in the WRRF and for continuous buildings increases from 30 % to 37 % for 6.25 ha and 36 ha size districts respectively and *BW* solution (see figure in Appendix II.2). The recovery of phosphorus within WRRFs depends directly on the entering COD/P ratio (see Figure S 16 in Appendix II.2). Indeed, The PAO organisms growth and P uptake by Phosphate Accumulating Organisms (PAO) are both stimulated under higher COD/P ratios. This is well illustrated in the *BW* system, where a linear correlation is found between the entering COD/P ratio and the P recovery rate. For the *Urine* system, this trend is less straightforward, since the P recovery is first correlated to the P load introduced by the collected urine. The COD/P ratio entering the WRRF influences only the part of P recovery which comes from sludge. This gives an advantage to the densely populated areas presenting more office buildings, and with a higher proportion of blackwater compared to greywater.

The recovery of COD (Figure IV-5) is not influenced by the urban configuration nor by the size of the district, and this for both *Reference* and *Urine* scenarios. On the other hand, urban configuration in the *BW* system does seem to impact COD recovery, and especially the biogas produced in the district. This is directly linked to the proportion of COD brought by blackwater as illustrated in Figure IV-6.

Less COD is recovered in the *BW-GW* system compared to the *BW*, since greywater is treated directly in the MBR without any primary sedimentation, in opposition to the WRRF. In this sense, the COD from greywater is more degraded than recovered in sludge. As an alternative, highly loaded reactors would be able to increase the COD recovery rate, as this was tested in the Waterschoon project (de Graaff and van Hell, 2014).

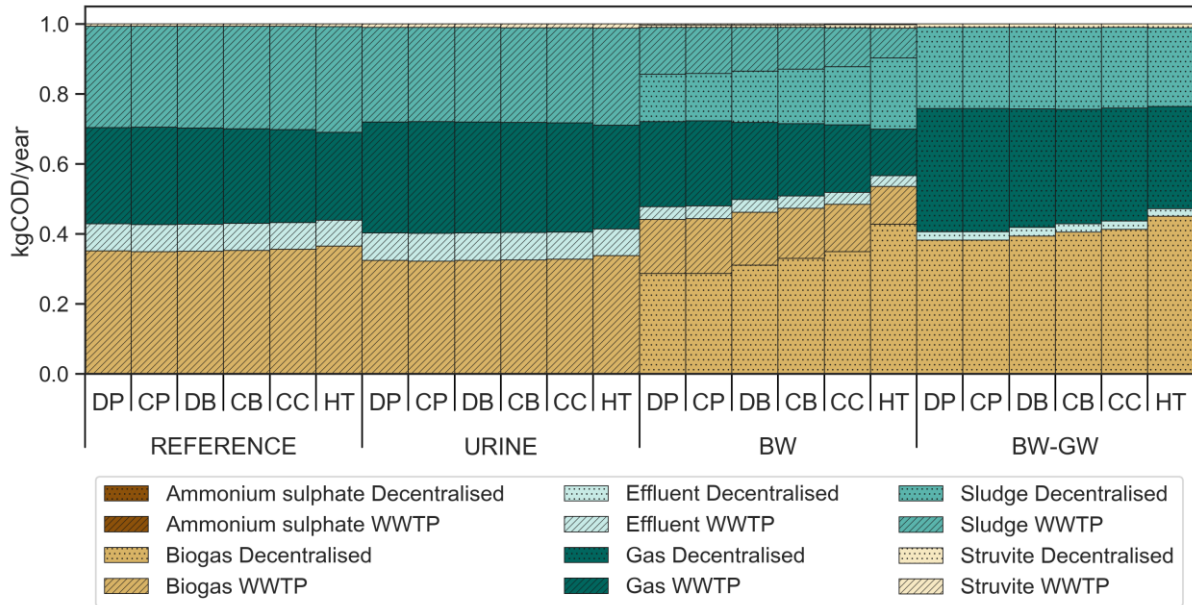

Figure IV-5: COD mass balance DP: discontinuous pavilions, CP: continuous pavilions, DB: discontinuous buildings, CB: continuous buildings, CC: city centre, HT: high-rise tower

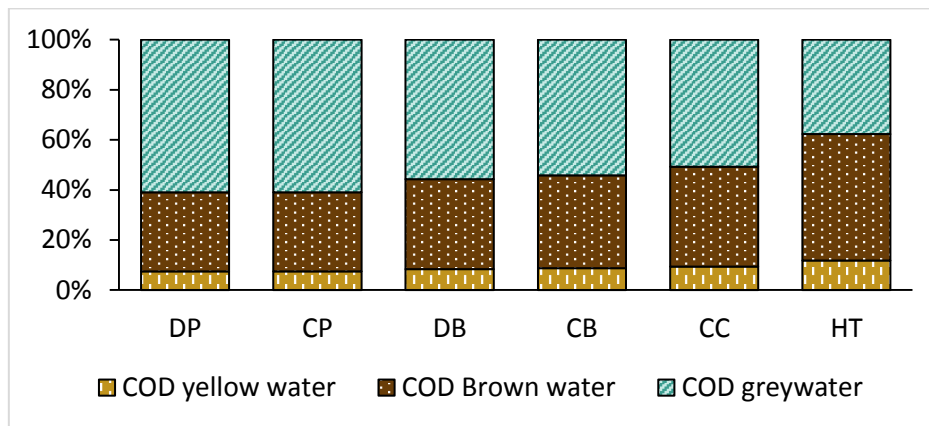

Figure IV-6: COD distribution in the influent of each case study.

TAKE HOME MESSAGE

- Both Nitrogen and phosphorus recovery are improved in source separation scenarios (from 6 % to more than 48 % for nitrogen and from 12 % to more than 60 % for phosphorus)
- Nitrogen recovery was not significantly influenced by urban configuration, density or size of the district, whereas phosphorus recovery is significantly influenced by the typology, due to the variation of COD/P ratios entering the WRRF.
- COD recovery depends on urban configuration due to the variation of blackwater/ greywater ratio due to the change in proportion of employees.

III.1.b Chemicals consumption

The chemical consumption (Figure IV-7) is increased by applying a source separation, and especially with the increasing need of sulfuric acid and caustic soda for recovering nitrogen. The magnesium oxide consumption increases with the phosphorus recovery rate.

However, methanol consumption, which is used within the WRRF for polishing denitrification, reduces dramatically and can be even lower than before establishing the new district. The methanol consumption for the *Reference* system follows the exact same trends compared to the N/PE ratio in the district wastewater (see also Figure IV-2).

Iron chloride consumption, which is used in the WRRF as a polishing treatment for phosphorus removal, also decreases for both *Urine* and *BW* systems. The WRRFs in these systems, require less iron than before installing the new district. This is particularly true for high-rise towers. Indeed, iron consumption is correlated to the phosphorus recovery rate. As mentioned previously, a symbiosis effect is observed between the growth of polyphosphate accumulating bacteria and the increase of COD/P ratios entering the water line.

Finally, no iron chloride nor methanol is necessary at a decentralised scale, as biological removal rates of phosphorus and denitrification are sufficient to reach the discharge limit. However, for high-rise towers, organic matter is lacking in order to ensure biological phosphorus removal in the MBR. Only in this case, an addition of iron is necessary.

Sulfuric acid and caustic soda, which were chemicals scarcely used in the reference system, become preponderant in alternative systems due to the higher nutrient recovery rate.

Regarding the influence of urban configurations, chemical requirements globally increased with urban densities. This is related to the methanol used in the reference scenario, and the use of sulfuric acid in the alternative scenarios. Once again, chemical requirements are directly correlated to the N/PE ratio of produced wastewater in the different urban configurations.

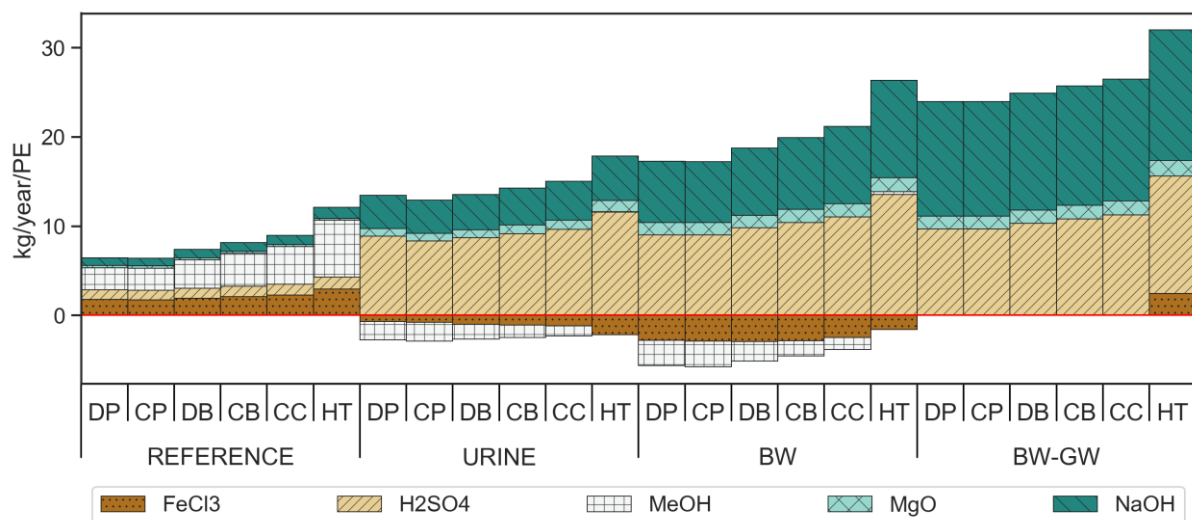

Figure IV-7: Chemicals consumption expressed in kg of molecule DP: discontinuous pavilions, CP: continuous pavilions, DB: discontinuous buildings, CB: continuous buildings, CC: city centre, HT: high-rise tower

TAKE HOME MESSAGE

- Source separation reduces the needs for methanol, but increases the needs for sulfuric acid and caustic soda due to a higher nutrient recovery rate
- Thanks to a higher efficiency of biological removal of phosphorus in the WRRF of all alternative scenarios, less iron chloride is consumed compared to before installing the new district, (minimal reduction of 114 %).
- The needs of methanol and sulfuric acid are directly correlated to the N/PE ratio of each urban configuration.

III.1.c Energy balance

III.1.c.1 Electricity balance

The energy balance presented in Figure IV-8 shows a beneficial value (more production of electricity than consumption) for both the *Reference* and *Urine* sanitation systems, and this independently of the scale and urban configurations. However, as described in Chapter III, the WRRF is not beneficial in terms of electricity consumption. The electricity return on investment (EROI) is approximately 85 % for all the case studies.

In this section, we discussed the extra production of electricity over the extra consumption as well as heat regarding the operation of WRRF, before and after the connection to the new district.

As showed in the Chapter III, *Urine* system produced less electricity than the reference, since the COD contained in urine is not digested.

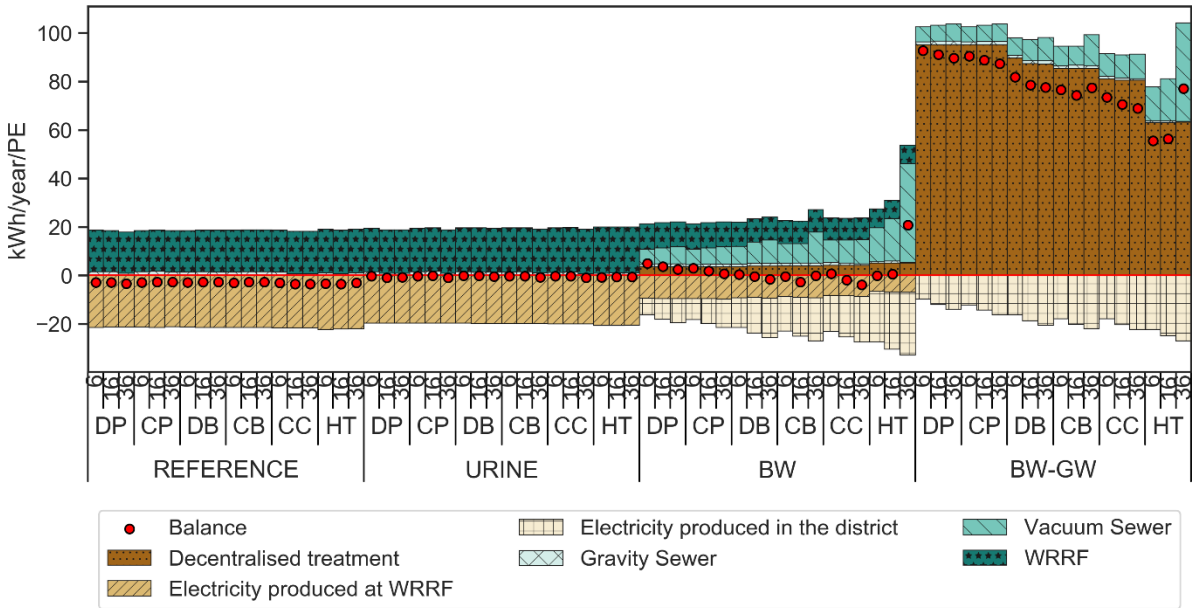

Figure IV-8: Electricity balance at district scale and normalised by the number of PE treated DP: discontinuous pavilions, CP: continuous pavilions, DB: discontinuous buildings, CB: continuous buildings, CC: city centre, HT: high-rise tower

The *BW* system presents a neutral electricity balance, which depends on the urban typology and the district size. Indeed, the denser the district, the better is the balance. However vacuum sewer consumption is also directly correlated to the blackwater flowrate. As the Q/PE ratio increases with the PE density of the urban configuration, the vacuum consumption is higher for a highly dense district (for instance CC) compared to a lower dense district. Moreover, increasing the scale for the densely populated configuration, increases also the consumption of vacuum sewer and the balance can be reversed, which is the case for high-rise towers with a district size of 36 ha. Such results hence show the existence of an optimal urban density (CB 16 ha, CC 36 ha) leading to an optimal energy balance.

The higher consumption of the vacuum sewer is related to the flowrate of water which is transported in each pipe section. The pressure loss is indeed correlated to the flowrate. In high-rise towers, the wastewater flow rate in each building is hence quite high and with few pipes. For example, high-rise towers with a district size of 6 ha, produced 26.9 m³/d against 24.2 m³/d for the city centre scenario covering 16 ha. However, each building in the high-rise tower option rejected 15.3 m³/d blackwater against 1.5 m³/d for the city centre. The pressure loss is ten times higher for this pipe section in the high-rise tower configuration.

For both *BW* and *BW-GW* sanitation systems, the higher the number of PE, the higher is the production of electricity. This is due to a better efficiency of electricity production by cogeneration as described in Chapter II and detailed Appendix IX. The production of heat (Figure IV-9) decreases, whilst the efficiency of the total energy production by cogeneration remains constant.

At last, even though the *BW-GW* sanitation system has a higher energy balance due to the high consumption of the MBR, the system also shows an improvement of its balance with the densification of the district and especially with the reduction of greywater flowrate to treat in the MBR (see also Figure IV-2).

III.1.c.1 Heat balance

The heat balance (Figure IV-9) is not beneficial for all the alternative sanitation systems. However, due to the methodology applied in the WRRF, only the extra production and the extra consumption of heat are presented, and compared to the situation before installing the new district. A positive balance (*Urine* system) means that the extra production of heat (compared to before implementing of the new district) does not cover the extra consumption of heat. If we consider the city scale, the heat balance in the WRRF still remains beneficial. The reference WRRF is indeed producing more energy than necessary for the treatment. Therefore, even if the new district is not self-sufficient, the lacking energy is taken from the extra-energy produced from the rest of the city.

These results indicate that if the scale of urine separation implemented is increased, then a point can be reached where there is not enough energy produced to cover the needs. However, it can be assumed that, in this case, the WRRF should be redesigned for other reasons. Indeed if the

urine separation rate is high, nitrification could be potentially avoided (Wilsenach and van Loosdrecht, 2006).

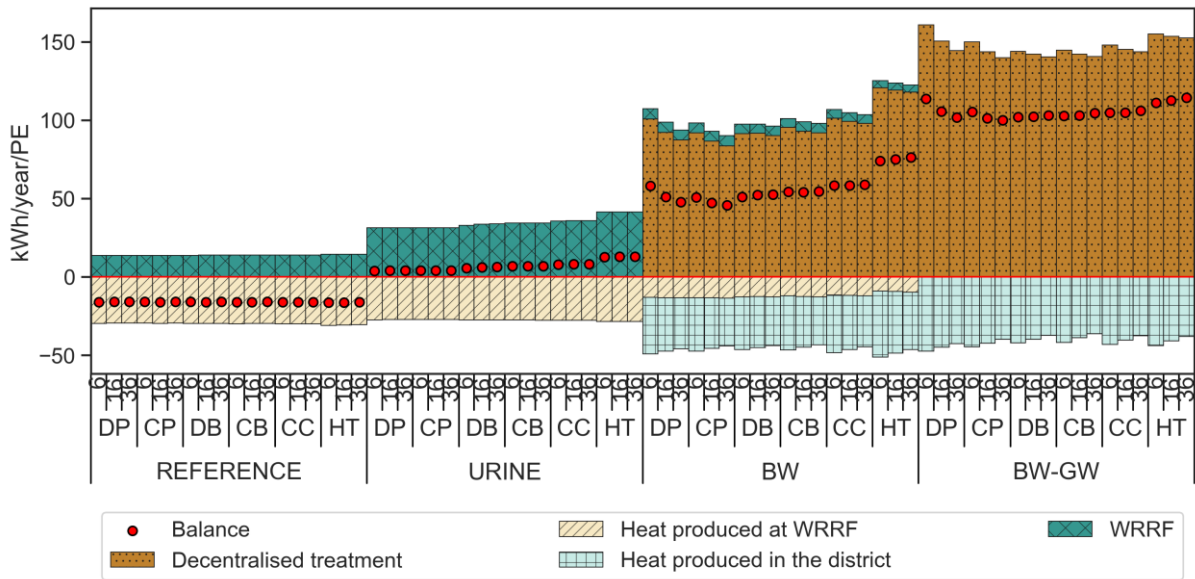

Figure IV-9: Heat balance at district scale and normalised by the number of PE treated. DP: discontinuous pavilions, CP: continuous pavilions, DB: discontinuous buildings, CB: continuous buildings, CC: city centre, HT: high-rise tower

Finally, in both *BW* and *BW-GW* systems, when the scale of the systems are increased, then the consumption of decentralised heat is decreased. This is explained by less heat loss from the UASB due to a larger size. Meanwhile, with a higher population density and larger district size, the decentralised production of heat is decreased which leads to a worst heat balance.

An optimum heat balance can thus be achieved for continuous pavilions with a district size of 36 ha, with 46 kWh/PE/year and 99 kWh/PE/year for *BW* and *BW-GW* respectively.

To summarise the two aspects of the energy balance, the cumulative energy demand is established for the entire life cycle in the following paragraph.

TAKE HOME MESSAGE

- With decentralised cogeneration, *BW* and *BW-GW* systems have an improved electricity balance by increasing the scale.
 - All the alternative sanitation systems, show a worst heat balance, due to a lower heat production (*Urine* system) or higher heat demand (*BW* and *BW-GW*)
 - *BW* and *BW-GW* systems need energy for nitrogen recovery and UASB heating
 - Urban configurations do not influence the energy balance (electricity or heat) for reference and urine systems.
 - For *BW* and *BW-GW* systems the production of electricity increased with highly dense urban configurations, as higher electricity efficiency can be achieved in larger cogeneration units.
 - Vacuum sewer is also influenced by the urban configurations as the Q/PE ratio is varying among them.
 - Heat balance presents an optimal value for *BW* and *BW-GW* systems, as the heat production decreases with larger cogeneration units and the heat loss of UASB decreases also with higher scale.
-

III.2 LCA results

III.2.a Energy use

In addition to the energy balance, the cumulative energy demand is established as a primary energy balance of the life cycle, including both operational aspects and infrastructure. When undertaking the life cycle assessment of each sanitation system, non-renewable energy is the most used type of energy, with around 82 % of the total energy (presented in Appendix II.3.b).

Figure IV-10 presents the contribution analysis of the fossil energy. For the *Reference* sanitation, with a low dense urban configuration (DP, CP), the construction and operation of the sewer systems are the main contributions to primary energy use. It is mainly due to the diesel consumed to construct the pipe trenches. For instance the sewer system of discontinuous pavilions represents approximately 80 % of the total cumulated energy consumption, while this is only 13 % for high-rise tower. Differences are very pronounced between different configurations of pavilions (DP, CP) compared to the other urban configurations, whereas relatively small differences are observed between different densely populated urban configurations (buildings and towers). As all the scenarios use sewer in the district, no major difference can be observed between the different sewer contributions.

The high contribution of sewer for low densely populated areas is explained by the fact that more or less the same size of the sewer is necessary than high densely populated areas but fewer PE is treated.

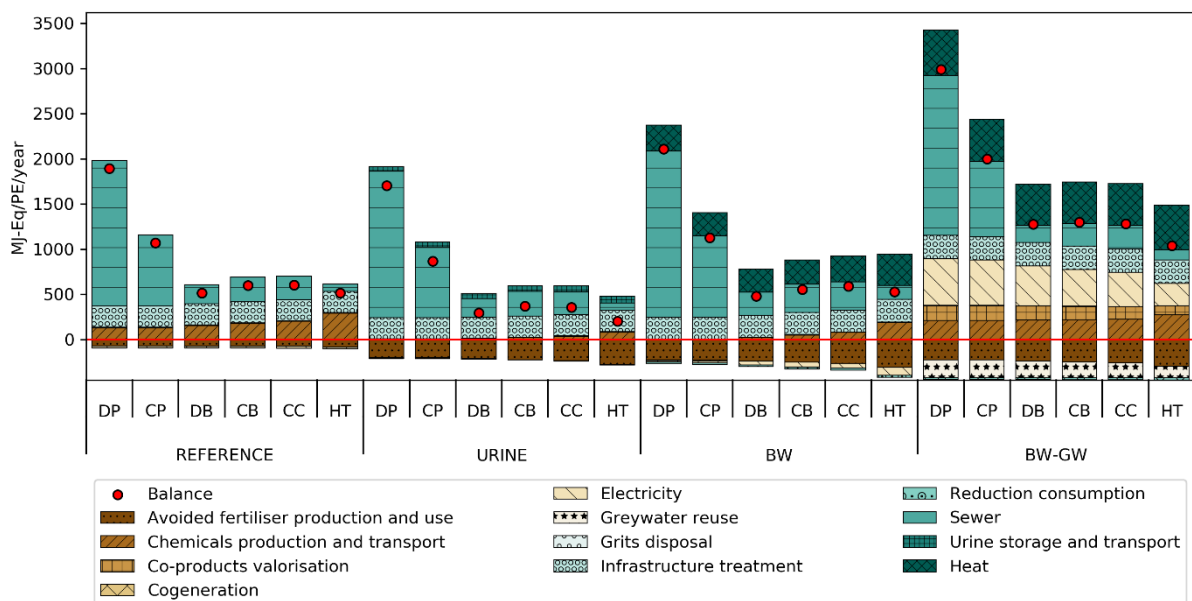

Figure IV-10: Contribution to cumulative energy demand - fossil, non-renewable energy resources

Both Urine and BW systems decrease the energy demand for chemicals. For the *BW* scenario, consumption of energy by vacuum sewer is not negligible, especially for high-rise towers. Moreover, the heat demand for *BW* and *BW-GW* systems has a strong impact on the primary energy demand.

Finally, the *BW-GW* sanitation system presents a higher energy demand for co-product valorisation, which is related to the transport of sludge from the decentralised treatment to

fields. In this study, no thickening was hypothesized for sludge from the UASB, leading to relatively high volumes to be transported. From an environmental point of view, sludge transport is not critical as the other contributions are much higher (represents from 5 % to 9 % of the total emissions). Two different options can be imagined: first, sludge can be transported to WRRF and thickened with the sludge from WRRF. Secondly, sludge can be thickened within the district, but this option would need to add a new dewatering process and the residual water must hence be treated.

III.2.b Endpoint level

Figure IV-11 shows the results obtained from the Life Cycle Assessment at endpoint levels, on the three impact areas: ecosystem quality, human health and resources. Urban configuration has a great impact on the damages caused by all sanitation systems, with low density urbanisms (DP, CP) showing the highest impact.

Four main damages can be identified: i) climate change on both ecosystem quality and ii) human health, iii) particulate matter formation on human health and iv) fossil depletion. By increasing the density of the district, a part of climate change impact is increased in order to lower the fossil depletion.

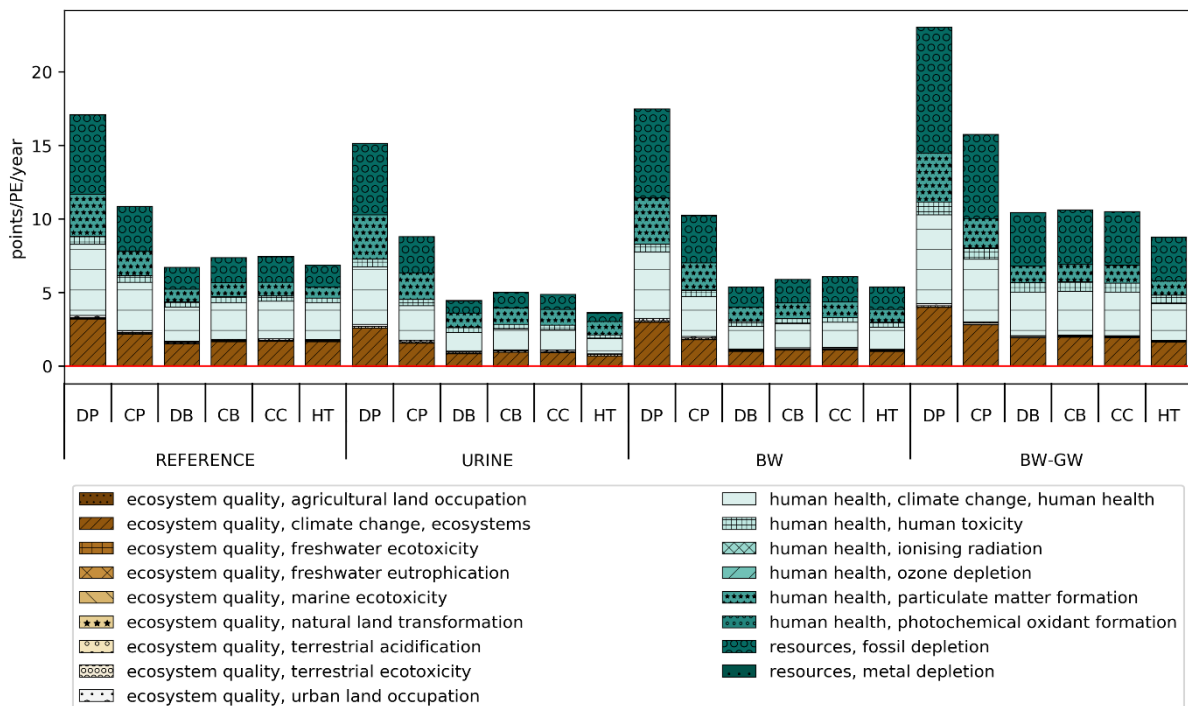

Figure IV-11: Endpoint impact for all the scenarios and representing the different categories of damages. DP: discontinuous pavilions, CP: continuous pavilions, DB: discontinuous buildings, CB: continuous buildings, CC: city centre, HT: high-rise tower

The improvement of alternative sanitation systems, compared to the reference scenario, is illustrated in Figure IV-12. Negative values indicate a reduction of the impact, which means an improvement.

This graph shows that increasing the density of treated PE improves results obtained from alternative systems. *BW-GW* is the only sanitation system where the performances are degraded by 40 %, and this for each urban configuration.

Continuous pavilions (CP) equipped with urine separation systems present a significant improvement (approximately 20 %), which is comparable to discontinuous buildings (CB) in the *BW* system.

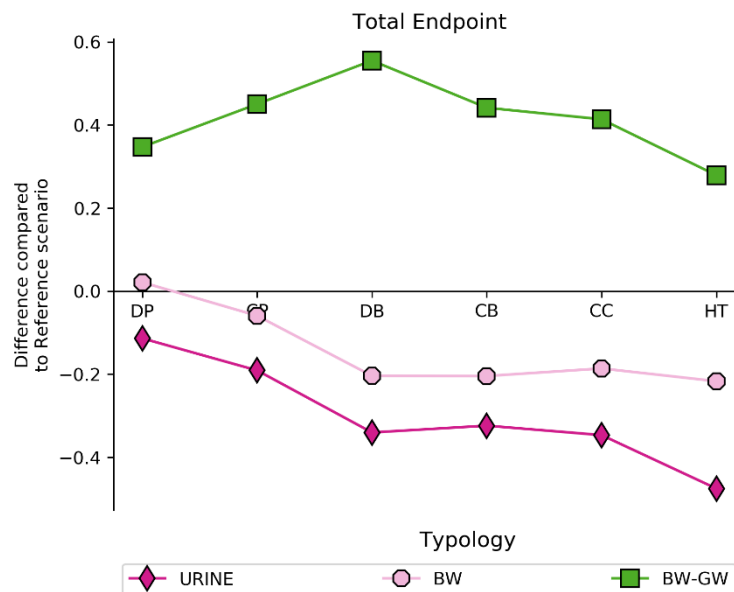

Figure IV-12: Improvements for each alternative sanitation systems at endpoint impact. DP: discontinuous pavilions, CP: continuous pavilions, DB: discontinuous buildings, CB: continuous buildings, CC: city centre, HT: high-rise tower

The scale of implementing the system has little influence on the improvement. The only notable modification is the increase of impacts from the high-tower configuration with a 36 ha district, which is related to an increase on climate change and fossil resource depletion impacts.

TAKE HOME MESSAGE

- At endpoint level, climate change category is the highest contributor to ecosystem quality and human health. The distribution of each category is similar among the different urban configurations.
 - Urine diversion system is the only scenario to present an improvement of endpoint indicator over all the urban configurations. BW system shows an improvement only for continuous building configuration (an optimum for such scenarios).
 - Environmental assessment shows a great influence of urban configuration on the results which is explained by the contribution of sewer and variation of electricity needs for *BW-GW*.
-

III.2.c Climate change (Midpoints impact)

As climate change is one of the major contributors involving damage at endpoint level, the contribution at midpoint level is hence analysed (Figure IV-13). The red points represent the balance between the avoided impact and the produced impact by the system.

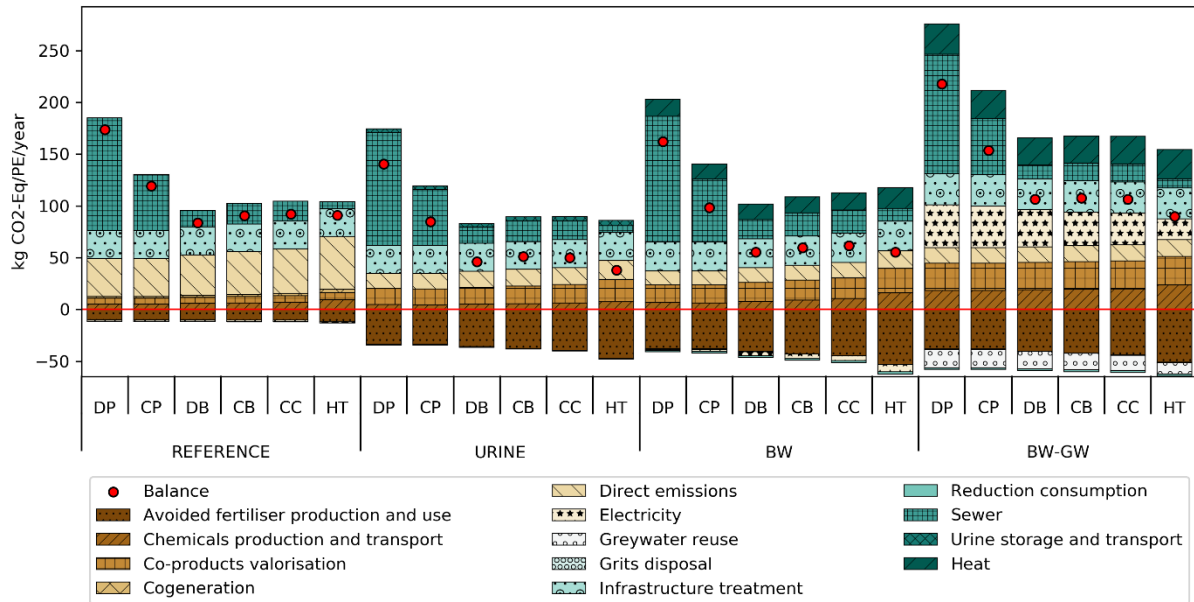

Figure IV-13: Climate change impact for all scenario with IPE as the functional unit. DP: discontinuous pavilions, CP: continuous pavilions, DB: discontinuous buildings, CB: continuous buildings, CC: city centre, HT: high-rise tower

Direct emissions from WRRFs depend on the nitrogen load of the water line. As shown in Figure IV-2, high-rise towers present the highest N/PE ratio and this leads to high direct emissions per treated PE, but also to a higher avoided fertiliser production.

Urine transport is not significant in terms of climate change impact and does not vary between each case study. The impact is associated to the travelled distance by truck and hence relies on the number of trips between the WRRF and the district, as well as the distance between collection sites within the district. For small scale systems, the distance within the district is insignificant compared to the distance to the WRRF. However, when the scale of the system is increased, then this distance becomes more significant, especially for low dense districts. For discontinuous and continuous pavilions, the volume of urine produced per week is below the capacity of the truck and only one trip per week, between the district and the WRRF, is necessary. For instance, with discontinuous pavilions (DP) on a 6 ha district, the, distance travelled within the district represents only 7.7 % of the total distance but increase up to 39.5 % for a 36 ha district.

For both *BW* and *BW-GW* sanitation systems, heat impact does not depend on the scale nor the urban typology. Electricity demand, on the other hand, is dependent on urban configurations. As it has been previously explained with the energy balance, more electricity is produced with a larger scale of cogeneration, which reduces the need for external electricity.

In order to analyse improvements obtained from each case study, applied within the different sanitation systems, the same graph obtained at endpoint level has been drawn to illustrate climate change impact at midpoint level (Figure IV-14). The same conclusion obtained for the

total endpoint can be addressed. High-rise towers in *BW-GW* systems provide the same impact than the reference scenario, and this for the small scale districts (6 and 16 ha, see also Figure S 36 in appendix II.3.e for the influence of scale).

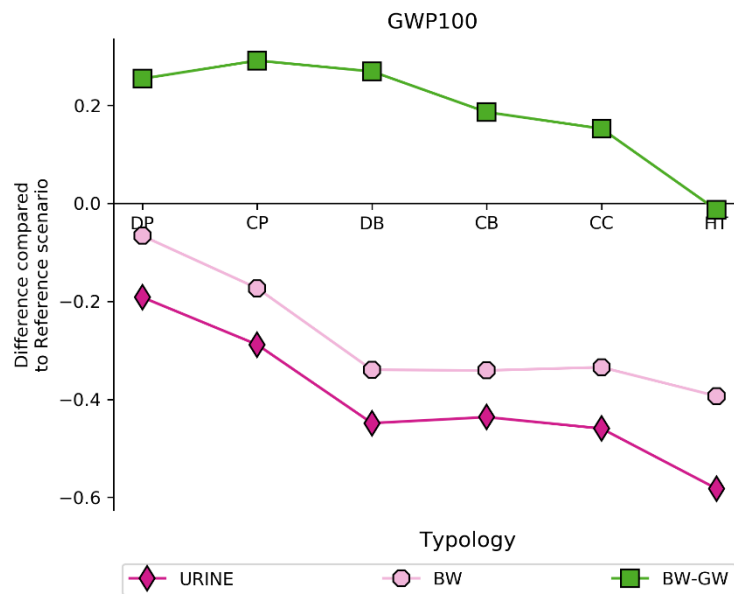

Figure IV-14: Difference in climate change impact for each scenario compare to reference one regarding scale and typology. DP: discontinuous pavilions, CP: continuous pavilions, DB: discontinuous buildings, CB: continuous buildings, CC: city centre, HT: high-rise tower

TAKE HOME MESSAGE

- Urban configuration improves climate change impact of alternative sanitation systems: an increasing benefit is observed with increasing urban density.
 - Regarding climate change, urine separation is the most beneficial scenario, and also the most sensitive to urban densification.
 - *BW-GW* systems with high tower urban configurations can achieve similar climate change impact levels compared to the reference
-

III.2.d Eutrophication

WRRFs are designed to remove nutrients from freshwater, which are liable to impact eutrophication. Although eutrophication did not appear as a significant impact at endpoint level, this impact is here analysed. Figure IV-15, shows the improvement (or degradation) of the eutrophication impact, compared to the reference scenario, by detailing A) the marine eutrophication (kg-N-Eq) and B) the freshwater eutrophication (kg-P-Eq).

For *Urine* systems, no significant differences are observed for both eutrophication impacts, compared to the reference, while the *BW-GW* system experienced an increase on both.

Both eutrophication impacts are related to an increase in the consumption of electricity and chemical requirements (see Figure S 19 and Figure S 20 in Appendix II.3.e for contribution analysis).

Marine eutrophication is more sensitive to urban configurations than freshwater eutrophication, and this because the sewer infrastructure contributes to marine eutrophication.

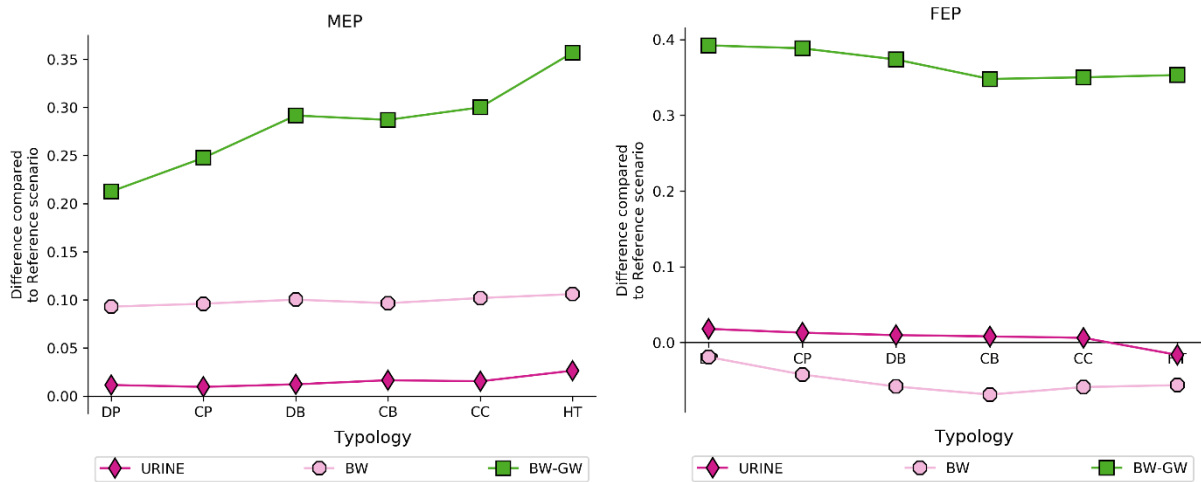

Figure IV-15: Improvement for all the alternative systems compared to the reference for A) Marine eutrophication impact and B) freshwater eutrophication.

DP: discontinuous pavilions, CP: continuous pavilions, DB: discontinuous buildings, CB: continuous buildings, CC: city centre, HT: high-rise tower

TAKE HOME MESSAGE

- Both marine and freshwater eutrophication increased with *BW-GW* scenario due to electricity and chemical requirements.
- Marine eutrophication is more influenced by urban configuration due to a higher contribution of sewer.

III.2.e Overview of all midpoint impacts

For each midpoint impact category, improvements obtained from the different case studies, in comparison to the reference scenario, are presented in the below radar chart (Figure IV-16). The red circles indicate the impact of the reference sanitation system. A higher value indicates that the impact is degraded and a lower value illustrates a benefit. As shown previously, the scale of the district has less influence compared to the urban configuration, this is why the three different scales of each urban configuration are presented in the same colour in these following graphs.

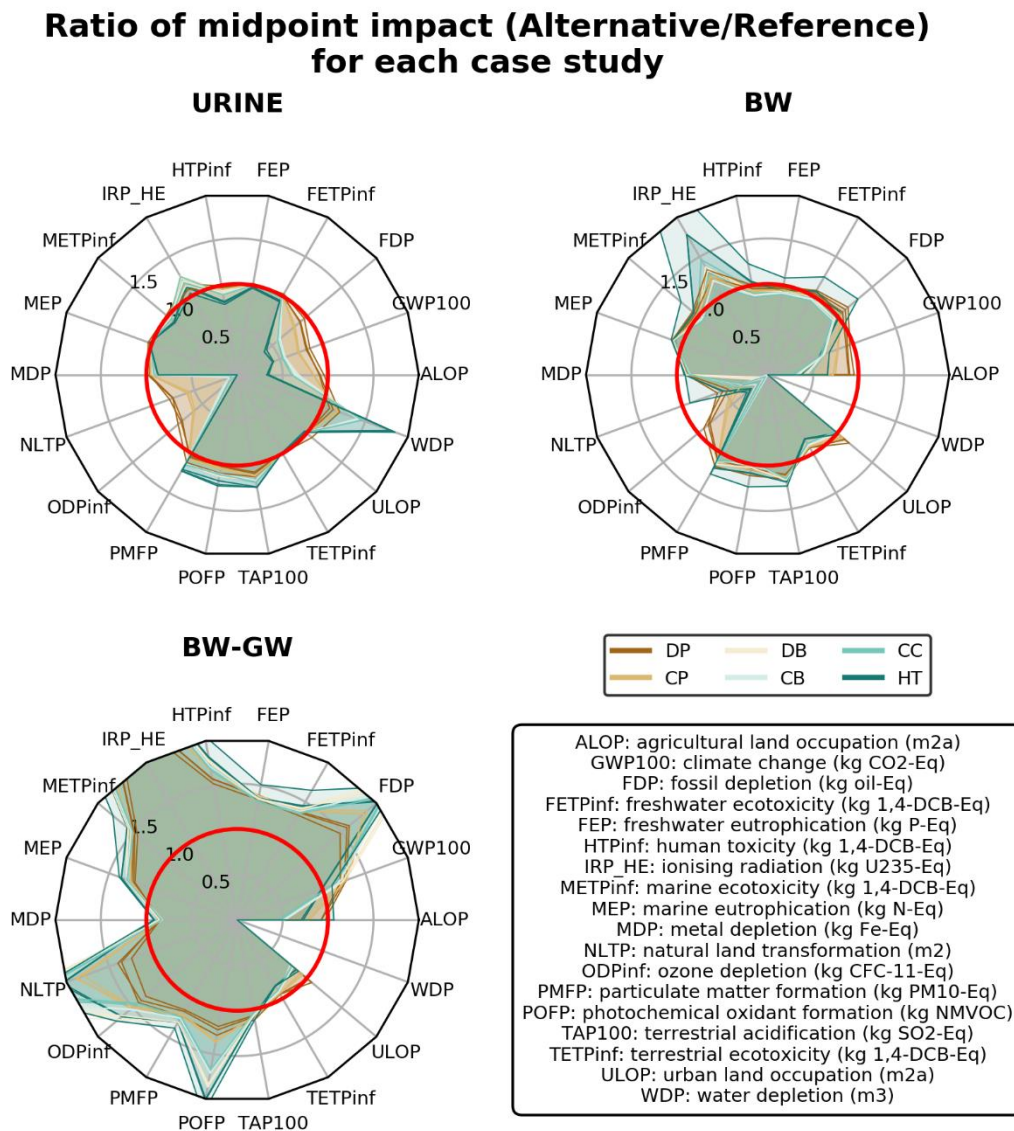

Figure IV-16: Improvement of the different sanitation systems for each category of midpoint impacts. The red circle corresponds to the impact of reference. A higher value means a degradation and a lower means a benefit. DP: discontinuous pavilions, CP: continuous pavilions, DB: discontinuous buildings, CB: continuous buildings, CC: city centre, HT: high-rise tower

These results show that the *Urine* system reduces most of the impact categories, especially climate change, fossil depletion, natural land transformation and ozone depletion. For all the different urban configurations, both ionising radiation (IRP_HE) and water depletion (WDP) increase. The increase in IRP_HE is related to an increasing use of chemicals and especially

sodium hydroxide. Indeed, the production of sodium chloride consumes a large amount of electricity, partly originating from nuclear energy. Water depletion increases with urine source separation, however the absolute value remains very low (less than 4 m³/PE/year) and is directly related to the production of sulfuric acid. Besides reducing the climate change impact, urine source separation also helps reducing impact on natural land transformation (NLPT) by avoiding the production of fertilisers. Nitrogen fertiliser production is known to consume large amounts of natural gas as well as heavy oil. The use of these two primary energy sources for the production of ammonium nitrate explains 75 % of the natural land transformation impact.

BW sanitation systems show a benefit on water depletion and this by reducing water consumption. However, the impact from ionising radiation is again significantly increased with (more than 2 times higher values compared to the reference). The impact on marine eutrophication is also increased and this due the increase of direct emissions of nitrate as explained previously.

BW-GW sanitation systems present higher impacts compared to the *Reference* and this when considering several categories, and mainly for ionising radiation, ozone depletion, photochemical oxidant formation, and fossil fuel formation. This trend is explained by a higher energy demand and therefore production of fossil resources and nuclear power compared to the reference.

Results also show that variations, relative to the reference, obtained in low density configurations (in brown) are smaller than variations obtained in higher density configurations (in blue). Indeed, the highest variations, whether positive or negative, are generally obtained with the highest density configuration (High Towers). This observation is explained by a higher global impact related to low population density configurations; indeed, the contribution from the sewer system in these configurations is strong. Since source separation scenarios do not change the contribution from the sewer system, impact variations from other contributions, expressed in percentages, are hence relatively smaller.

TAKE HOME MESSAGE

- *Urine* systems maintain the majority of impacts in the same order of magnitude than the *reference*. Besides the climate change impact, *urine* system decreases the impact on, fossil depletion, natural land transformation and agricultural land occupation and this due to less fossil energy extraction used for producing fertilisers. Ionising radiation and water depletion are, however, increased due to caustic soda and sulfuric acid production respectively.
 - *BW* and *BW-GW* significantly reduce the water depletion and this if all the greywater is reused. Eutrophication impact is on the other hand increased.
 - *BW-GW*, presents an increase of most of its impacts and this due to a high energy consumption.
 - Regarding the different impacts and the role of urban typology, the differences between source separation systems and the conventional system (reference) are systematically improved for the high density districts.
-

IV. DISCUSSION

IV.1 Main findings

In this chapter, overall results show that urban configurations have a great impact on the environmental assessment of different sanitation options.

The first results emphasize on the strong impact of sewer infrastructure in low densely populated areas (continuous and discontinuous pavilions, CP and DP respectively), where only few people are connected to a large sewer system. (Roux et al., 2011) found similar results when performing an LCA assessment on both gravity sewer and wastewater treatment plants, based on 4 real case studies. Authors reported that the contribution of sewer infrastructure to climate change decreased by 71 % when increasing the population density from low (similar to CP) to high (comparable to CB). In our study, the impact of the sewer system on climate change decreased by 63 %, which is comparable to values obtained above.

Urine source separation systems are well adapted to low densely populated areas, since climate change impact is reduced by at least 20 % compared to the reference system. Due to the high contribution of sewer infrastructure to climate change, this impact cannot be further reduced. Only an on-site treatment for the wastewater exempted from urine, should enable the system to significantly reduce the impact. This means that several units of treatment should be positioned in the district.

For the other urban configurations, the sewer infrastructure is not the main contributor to climate change impact and thus, a significant decrease can be achieved. Indeed, *Urine* and *BW* systems perform well even though reducing climate change impact by 20 % compared to the *reference* system.

The second results underline the influence of PE density on the different urban configurations for *BW* and *BW-GW* systems. High densely populated areas involve larger facilities, especially the cogeneration unit is larger, and hence provide a better energy balance compared to low densely populated areas.

The last results highlight the key role of providing a combination of buildings with different purposes within the same district. Increasing the proportion of employees in the district, decreases the flowrate of greywater produced per PE. Therefore, the load of nitrogen and phosphorus per PE is increased since the organic matter from greywater is produced in lower amounts. In terms of environmental assessment, the increase of PE density increases both direct emissions from the WRRF and avoided fertiliser production. In the *BW-GW* system, since the presence of more employees reduces the total amount of greywater, the flowrate treated in the MBR also reduced, which improves the electricity balance of the system.

Finally, it has to be emphasized that this entire study refers to an optimal WRRF, which is different from the technologies currently applied in treatment plants. Two main differences can be assessed. Firstly, nutrient recovery processes are not conventionally applied. Indeed, phosphorus recovery from struvite is only scarcely installed in treatment plants. Secondly, the

emission factor of N_2O is established by (IPCC, 2019) and refers to 1.6 % of the nitrogen influent load. However N_2O emissions is strongly linked to the treatments implemented in the WWTP and the emissions can vary with seasons. For instance activated sludge in a Modified Ludzack-Ettinger configurations (MLE) has a median N_2O emissions factor equal to 0.857% of the N-load (Vasilaki et al., 2019). In the meantime, between 2.26 % and 4.86 % of removed NH_4 has been reported in intensively operated WTP (Bollon et al., 2016). Therefore, if we refer to this intensive processes N_2O emission factor of 3 % of the total incoming N (i.e. nearly twice the IPCC value), then the *BW-GW* scenario will only present 10 % more impact on climate change compared to the *reference* scenario, and other urban configurations will present equivalent or even better impact values. With HT urban configuration, 20 % of improvement is even reachable.

IV.2 Uncertainties and sensitivity to energy consumption.

Energy consumption has been revealed as a key component in the environmental assessment of sanitation options, and this especially regarding decentralised systems.

First of all, the *BW-GW* system is not beneficial for most of the environmental impacts mostly due to a high energy consumption related to the treatment of greywater by MBR. In this study, energy requirements for the MBR were assumed to be the same for all the investigated district scales. However, (Jeong et al., 2018) studied the consumption of MBRs treating greywater with regards to the treated flowrate at building scale. Based on manufactured MBRs, authors calculated a range of consumption values between 0.41 kWh/m³ and 0.67 kWh/m³, for 0.6 to 1.8 m³/d flowrates respectively. The consumption value used in this present study (1.5 kWh/m³), is much higher than the latter reported value. It appears that more research and development in this area would lead to lowering the energy consumption in order to improve environmental benefit of decentralised treatment systems.

Moreover for *BW* systems, vacuum consumption is not negligible and reached approximately 2 to 4 kWh/m³ (or 5 and 20 kWh/PE/year). This range is lower compared to values reported in the literature, as presented in Chapter I.IV.2.a. Indeed (de Graaff and van Hell, 2014) reported a value of 28.2 kWh/inh/y, while the Waterschoon project measured a consumption value of 5.6 kWh/m³. The latter system worked with only 79 inhabitants but was designed for 232 inhabitants. In Flintenbreite (Germany), in 2008, the system consumed between 13 and 21 kWh/m³, or by taking in consideration the population factor, between 21.9 and 36.5 kWh/inh/d. These values are based on 116 inhabitants, with the construction of 46 terrace houses and 12 flats which are still pending (Albold, n.d.; OtterWasser GmbH, 2009). The consumption per inhabitant is less sensitive to variation since the two projects have very different blackwater production systems (respectively 13.4 and 4.8 L/pers/d). For instance, the Waterschoon project describes the adjunction of kitchen wastes, and this by providing a kitchen grinder within the households.

Several reasons can explain the difference of vacuum sewer consumption revealed between our study and the literature. First of all, the model does not take into account the topography of the project. Indeed, variation of the ground level (slopes, hills...) can increase the number of lift of vacuum sewer collections and hence the energy consumption. Secondly, the model calculates

the theoretical consumption without considering possible pipe leaks which can increase the loss of pressure. Finally, both projects have measured their energy consumptions without referring to the designed capacity, leading to the use of oversized pumps and hence higher consumption.

As mentioned earlier, water reuse is not driven by climate change mitigation but rather by water depletion and water scarcity. In the context where new sources of water are needed, water reuse must be performed with the best available technology and strategies to have the lowest climate change impact. However, the electricity production mix has an impact on this assessment. A mix with more renewable energy could indeed reduce the contribution of electricity consumption on the climate change impact. But other side effects can also be raised. The study of (Santana et al., 2019) is a perfect example, as authors reported that greywater reuse in Spain, in the city of Lloret del Mar, increased impact on water depletion due to water consumption related to additional electricity production needed for treating greywater. Hydroelectricity is a major contributor to an electricity mix and evaporation represent a sink of water resource. In this perspective, an LCA assessment is mandatory to avoid solving local issues which are liable to generate other impacts at a more global scale.

IV.3 Perspectives and alternative scenarios

As a result of this study, several perspectives and scenarios to analyse can be established.

First of all, regarding the influence of urban configuration, other treatment systems of greywater can be investigated. Indeed, in low densely populated areas, where space is available, low energy-intensive technologies can be installed, such as reed bed filters (Peter-Fröhlich et al., 2007a). Moreover, such areas are also well adapted for garden irrigation, thereby increasing the recovery potential of water reclamation.

In high densely populated districts, despite the use of MBRs, rotating disc filters can also be modelled as it has already been tested by (Nolde, 2000). However, the energy consumption still remains high with the optimal value of 2.88 kWh/m³ when operating at a flowrate of 10 m³/d treated greywater (Friedler and Hadari, 2006). Another promising treatment, could be anaerobic-aerobic moving bed reactor to avoid an overconsumption of energy for aeration.

Secondly in this study, urine separation systems have only been investigated with a centralised treatment option equipped with extraction technologies. Several other options can be investigated, such as concentration technics, such as the VUNA process (Etter and Udert, 2015) or again the low tech solution of transport and hygienisation obtained after long term storage, as it has been done in Sweden in the 90s (Johansson, 2000). The expected results can be a decrease in chemical requirements, and a recovery of other compounds used in fertilisers, such as potassium. However, spreading urine in the fields produced more N₂O than mineral fertilisers and the VUNA process consumes more electricity than the present studied process. The entire assessment is thus necessary to conclude on overall benefits.

A third approach that can be studied, is the benefit of treating kitchen wastes with blackwater from densely populated areas and of composting the kitchen wastes in low densely populated areas.

Moreover, to improve the heat balance of each system, heat recovery from greywater treatment can be implemented in densely populated areas. In order to increase the recovery efficiency,

heat transfer must be close to the source and must have sufficient flowrate. Low densely populated areas do not seem adapted for recovering heat at the district scale.

A last perspective regarding the reuse of wastewater is its integration in the water cycle. In this study, we only analysed the case where greywater is reused in a decentralised location. However, treated wastewater in centralised facilities can provide water to be reused for irrigation purposes in nearby green areas (fields, golf, parks etc.). The pending question is hence highlighted “does water reuse provide more benefit in a decentralised location or in centralised facilities?”

V. CONCLUSIONS

Influence of the district typology and surface size on environmental impacts for source separation scenarios were evaluated by an integrated approach. The main results were the following:

- Nitrogen recovery was less sensitive to urban configurations than phosphorus or COD recovery. The biological removal of phosphorus in WRRFs was stimulated by the removal of phosphorus from urine separated from blackwater.
- COD recovery was influenced by the urban configuration by varying the number of employees and inhabitants, and the proportion of COD coming from blackwater.
- Urban configurations do not influence energy balance (electricity or heat) for *reference* and *urine* system.
- For *BW* and *BW-GW* systems the production of electricity increased with high density urban configuration as higher electricity efficiency can be achieved in larger cogeneration.
- Electricity consumption of the vacuum sewer was also increased with the PE density and with the scale of decentralisation.
- The heat balance presented also an optimal condition for *BW* and *BW-GW* systems. The heat loss from UASB is decreased with an increase in the district size, while a decrease in heat production was observed at the expense of the electricity production.
- The PE density influences the contribution of sewer infrastructure (for both vacuum and gravity sewer) on climate change impact, with very high values (up to 75 % between low and high population densities). Since urban configurations have more or less the same sewer systems, the contribution of sewer systems towards climate change will only be impacted by the PE variable. Indeed, the higher the PE, the lower the impact on climate change.
- The *urine* system presented in all the urban configurations provides a significant improvement on climate change impact. For the *BW* system, low densely populated areas (DP and CP) were not significantly different from the *reference*. Finally, the *BW-GW* system degraded the climate change impact for all the urban configurations, except for the high rise tower where the impact, level was similar to the reference scenario.

**Chapter V. Discussion on
sensitivity and optimisation**

In this last chapter a general discussion is conducted regarding the sensitive parameters and the further improvement that can be recommended or expected for each system. First the ways of optimised all the scenario are discussed. Then optimisation of *urine* scenario is analysed. Moreover, the blackwater transport and treatment for *BW* and *BW-GW* scenario are studied. Finally the greywater treatment and water reclamation are optimised for *BW-GW* scenario.

I. OPTIMISATION FOR ALL SCENARIO

Two ways of improvement is available for all the scenarios and also for *reference* scenario.

Firstly, one of the major contributor to climate change impact is the infrastructure of WRRF. In order to decrease infrastructure, more intensive technology could be used. Nowadays granular sludge system is considered as a promising technology with significant reduction of footprint (de Bruin et al., 2004). (Pronk et al., 2015) measured 33 % of decrease in volume for a full scale plant. Despite the gain in term of footprint, this treatment needs to keep the direct emissions as low as possible, and especially the N_2O emission. Recent studies showed that it is not obvious (Gao et al., 2016) reported a emission factor between 1.6 % and 2.76 % of nitrogen influent in N_2O for a simultaneous nitrification and denitrification. (Pronk et al., 2014) reported around 2 - 3 % of nitrogen emitted in N_2O .

The second way of improvement concerns the low density area where the sewer contribution to climate change is high (more than 75 % of the total climate change impact). The only option available is the decentralised small scale wastewater treatment in order to reduce the need of sewer inside the district. However several side-effect arise from this solution, 1) the need of equivalent treatment performances than centralised facility to maintain similar eutrophication impacts and 2) the question of possible increase of energy needs for small installation.

II. OPTIMISATION OF URINE SCENARIO

Urine source separation showed the best results in term of climate change mitigation (Figure V-1) compared to reference scenario (decrease from 20 % to 75 %). However two points can be emphasised.

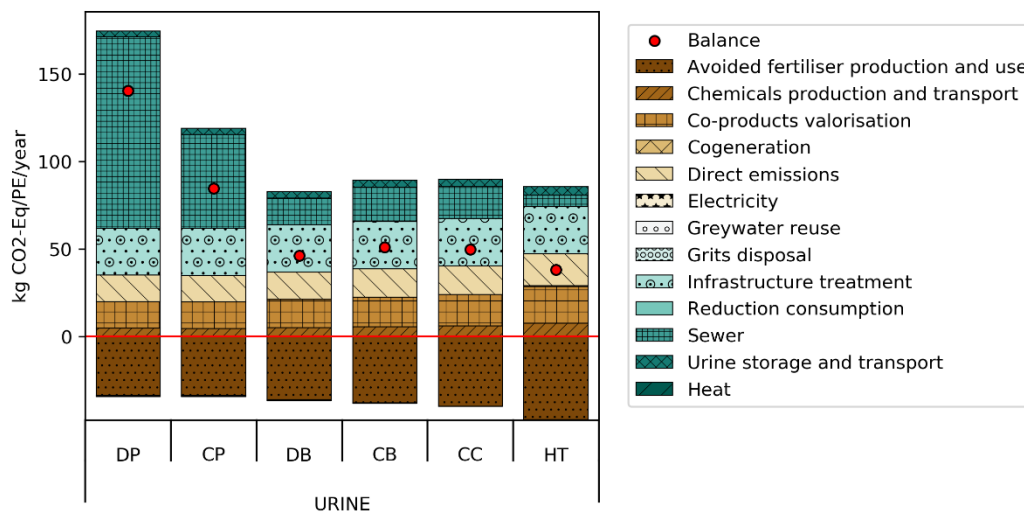

Figure V-1: Climate change impact of Urine scenario for the different urban configurations (extracted from chapter IV)

On one hand, the co-treatment of urine and anaerobic digestion supernatant needs to be demonstrated and optimised. The energy consumption for pre-treatment of TMCS at WRRF is high and compensated the decrease of electricity consumption of aeration (see Chapter III.III.2.a.1 and Figure III-11). Uncertainty on this pre-treatment needs is significant with urine treatment as no experiments have been yet reported. Different options for urine treatment at large scale still need to be developed and demonstrated for collecting representative data on energy, reactants, design and infrastructure.

On the other hand, nitrogen recovery rate is a crucial influencing parameter related to urine separation rate in the diverting toilet. In this study the urine separation rate was assumed to be 80 %, which is already relatively high in comparison with existing experience (50 % to 70 % see Chapter I.III.2.a.1.2). New toilets are now coming to the market with encouraging results but no information is available on the urine separation rate. Based on assumed separation efficiency and the content of nitrogen in urine, only 48 % of the nitrogen can be recovered as fertiliser compared to 55 %-57 % in the case of blackwater separation (see Chapter III). Therefore our technical capability of increasing the separation efficiency will make the urine scenario even more sustainable.

III. OPTIMISATION OF BLACKWATER MANAGEMENT AND HEAT DEMAND

III.1 Sensitivity analysis on energy for vacuum sewer consumption

As discussed in Chapter IV the vacuum consumption calculated by the model is lower than the value from literature and especially from (Albold, n.d.; de Graaff and van Hell, 2014).

In the model the vacuum consumption is directly correlated to the production of blackwater (Figure V-2). After a threshold value around $50 \text{ m}^3/\text{d}$, the linearity between the two variables is not ensured. However the two points which verify this trend are for the same urban configuration: high-rise tower. The particularity of this configuration in regards of vacuum sewer was already discussed. The flowrate transported is indeed very high for a very limited number of pipe, increasing the current flowrate per pipe and thus the friction pressure loss.

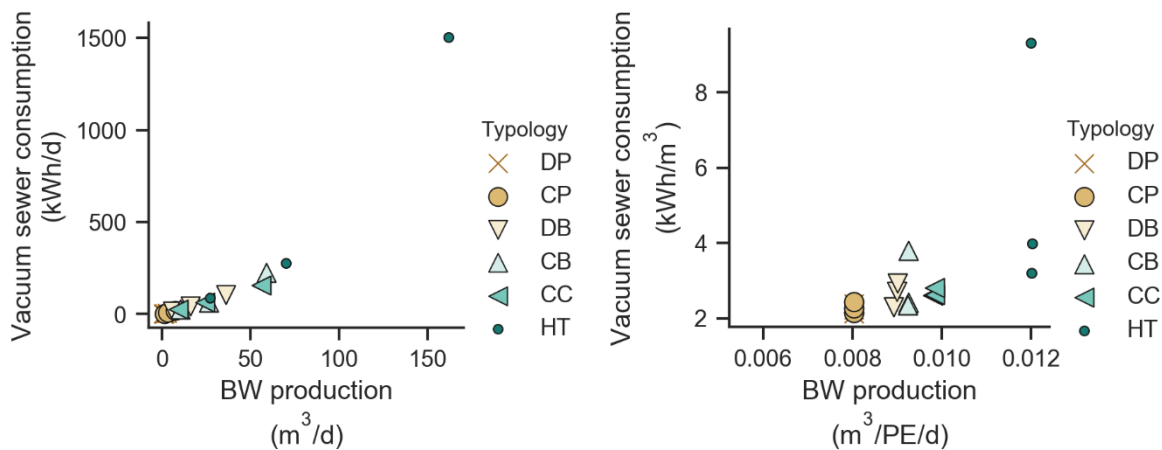

Figure V-2: Vacuum sewer consumption compared to blackwater production DP: discontinuous pavilions, CP: continuous pavilions, DB: discontinuous buildings, CB: continuous buildings, CC: city centre, HT: high-rise tower

As already explained in Chapter IV.IV.2 several reasons can explain the difference between the calculated energy consumption and the one from literature. Topography, pipe leakage and oversized in pilot projects are one of the possible reasons.

Nevertheless, calculations were done with a higher vacuum consumption for *BW* system varying from 5.6 kWh/m^3 to 21 kWh/m^3 (Figure V-3). Results trends are similar to previous simulation obtained with the initial value of the model. However for DP, CP (and at a less extent DB, CB, CC, and HT) urban configurations, the *BW* systems assuming 21 kWh/m^3 for vacuum sewer, leads to an increase of the climate change impact, compared to *Reference* system. From the same figure it comes that the vacuum sewer consumption needs to be kept under 15 kWh/m^3 in order to maintain a positive gain in terms of climate change. CP configuration needs lower value 6 kWh/m^3 and for DP configuration, even with the lowest value, the *BW* systems does not improve the climate change balance compared to the *reference* one.

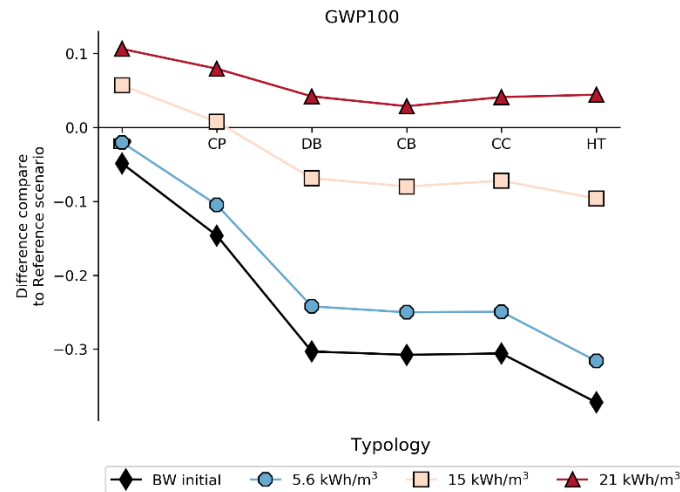

Figure V-3: Climate change impacts for BW scenario and different configurations. Sensitivity analysis on vacuum sewer consumption with the current value of the model and for 5.6 and 21 kWh/m³. DP: discontinuous pavilions, CP: continuous pavilions, DB: discontinuous buildings, CB: continuous buildings, CC: city centre, HT: high-rise tower

This analysis shows also the need of more advanced models for vacuum systems lining the energy consumption with design criteria (length, flowrate, pipe diameter and lift in the tooth saw pattern). These knowledge would help to optimise the design and mitigate the energy needs.

III.2 Heat demand optimisation

Blackwater system is the second best scenario in term of climate change compared to reference (Figure V-4). For high density area (from DB to HT) more than 25 % of improvement is observed compared to reference. For pavilions no significant difference was foreseen compared to reference.

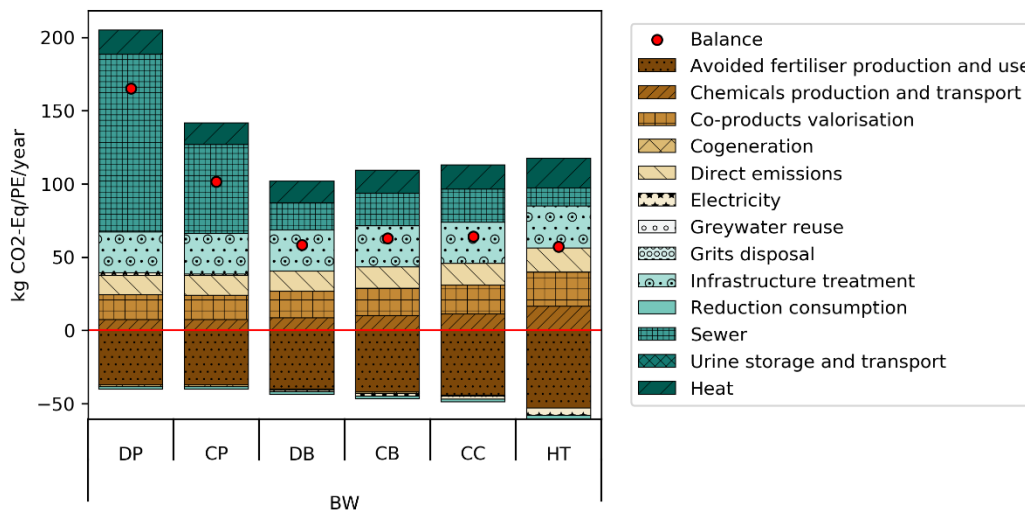

Figure V-4: Climate change impact of BW scenario different urban configurations (extracted from chapter IV)

Heat recovery and energy balance is a crucial point. As already explained in Chapter III and Chapter IV, heat is needed for pre-heating blackwater entering the UASB, keeping the temperature of UASB and the pre-heating digestate entering TMCS. Such needs are not covered by the production of heat from cogeneration.

Several ways of optimisation are feasible and are studied in this paragraph for only one type of urbanism (discontinuous buildings the same as Chapter III) with a summary of the results in Figure V-5-A:

- Heat recovery (HR) from the output of TMCS should be implemented influent pre-heating. But even with 50% of heat recovery, extra source would be needed.
- Reduction of flush of toilet (ULF)
- Increase of the production is possible by installing a boiler instead of the combined heat and power (CHP).
- Increase of the production via the co-digestion of kitchen biowastes
- Combination of above solutions

The last option of optimisation is the change of operating condition of TMCS with lower temperature and higher pH. For each combination of solutions studied in Figure V-5-A, the operating conditions to install in order to reach neutral heat balance is visualised in Figure V-5-B. In order to achieve a neutral heat balance in the *BW-GW* scenario, the temperature of TMCS process has to be maintained at 26 °C (see Figure V-5 B). To obtain the same performance TMCS should be operated at pH 10.2, by adjunction of caustic soda. Then the CO₂ impact of caustic soda will need to be considered.

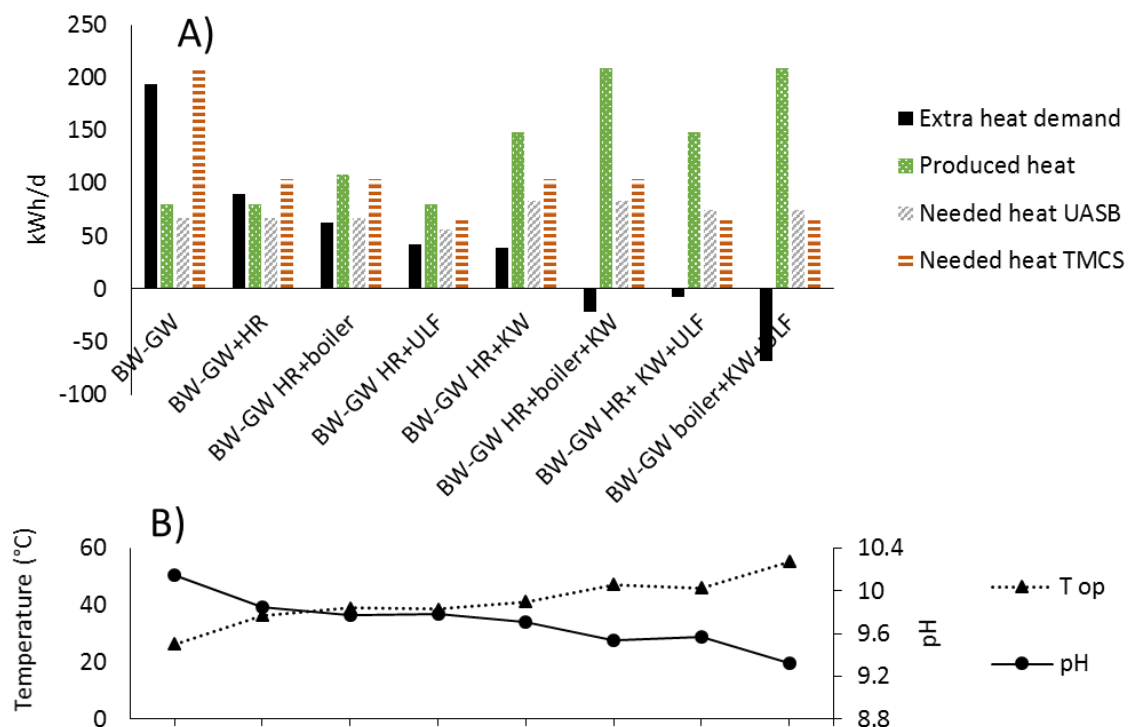

Figure V-5: Sensitivity analysis on heat balance A) with different collection (ULT: Ultra-low flush, KW: kitchen waste mixed with blackwater) or heat production with boiler or CHP as default. B) Corresponding operating conditions of TMCS for neutral heat balance.

The 50 % heat recovery from TMCS effluent to preheat the TMCS influent allows to decrease by 38 % the total heat demand of the scenario. But external heat is still needed.

Reduction of flush water volume is a way to limit both organic and nutrients dilution and improve heat balance. Conventional vacuum toilet was assumed in this study with an average consumption of 1.2 L/flush, however (Bisschops et al., 2019) implemented ultra-low dual flush vacuum toilets with only 0.4–0.7 l/flush. In case of 0.55 L/flush (*BW-GW HR+ULF* scenario in Figure V-5), the TMCS heat demand for N recovery would decrease by 55 %, which corresponds to a 78 % decrease of the external heat demand. However it is not enough to achieve energy sufficiency. Boiler will still have to provide 34 % of the total heat demand against 71 % for the initial scenario.

Regarding the option of co-digestion with kitchen waste (*BW-GW HR+KW*): if the load of (Tervahauta et al., 2013) in kitchen waste is assumed (59 gCOD/pers/d), the production of heat would be 1.8 times higher than without co-digestion. This leads to 80 % decrease of the external heat demand.

Coupling heat recovery with boiler, or ultra-low flush or kitchen waste co-digestion is not enough to remove the need of external need

Considering the last scenario of replacing CHP by conventional boiler: if 82.5 % efficiency is assumed (Hakawati et al., 2017), a neutral heat balance would be achieved by coupling of all possibilities (*BW-GW boiler+KW+ULF scenario*) with normal operating condition for TMCS. Obviously no electricity would be produced in such scenario.

However the last three scenarios allow to produce more energy than consumed. *BW-GW HR+boiler+KW* scenario has a heat recovery on investment of 1.07 and 1.03 and 1.33 respectively for *BW-GW HR+KW+ULF* and *BW-GW HR+boiler+KW+ULF* scenario. In these last scenario, temperature can be increased to 55°C and still has a neutral heat balance.

Moreover if TMCS still need to work at 45°C, it would be beneficial to operate the UASB at a higher temperature than the current 25°C.

Finally in term of climate change impact, even with the *BW-GW-HR* scenario the decrease in climate change impact is of 13 % compared to *BW-GW* scenario. With the same decrease in heat demand, the *BW* scenario will obtain the same climate change impact than *Urine* scenario (3 % of difference between *Urine* and *BW-HR*).

IV. OPTIMISATION OF GREYWATER TREATMENT AND WATER RECLAMATION

The last scenario with totally decentralised treatment of black and grey water (*BW-GW*) showed the worst climate change impact (Figure V-6). This was due mainly to the hypothesis of MBR as a greywater treatment leading to high energy consumption.

Several improvements can be investigated to help this scenario. As *BW* system, the heat balance should be optimised and even more than *BW* system. Indeed as MBR sludge is added in UASB, more flowrate has to be treated in the UASB and the TMCS and thus more heat is needed.

The second improvement is on electricity balance. We saw in Chapter IV, that if the size of cogeneration unit is sufficient the electricity production is higher and the balance better. However even with this best case, only the same climate change impact than the reference is achieved. Then a decrease in consumption is mandatory. Several options of treatments can be investigated as extensive treatment in low dense area (reed-bed filter), or anaerobic –aerobic moving bed reactor for high dense area. This latter can decrease the need of aeration by the anaerobic step and by avoided membrane and the need of aeration for fouling prevention. Only the extensive solution is studied in the next section.

Finally the last improvement, is on chemicals consumption and especially on caustic soda used for TMCS. The assumption has been made to choose a ratio between the flowrate and the need of caustic soda (see Chapter II.IV.5.d.2) and as a higher flowrate of blackwater + MBR sludge is treated more soda is consumed. More experiment should be carried to confirm the consumption, and an optimum should be found between heat and caustic soda consumption.

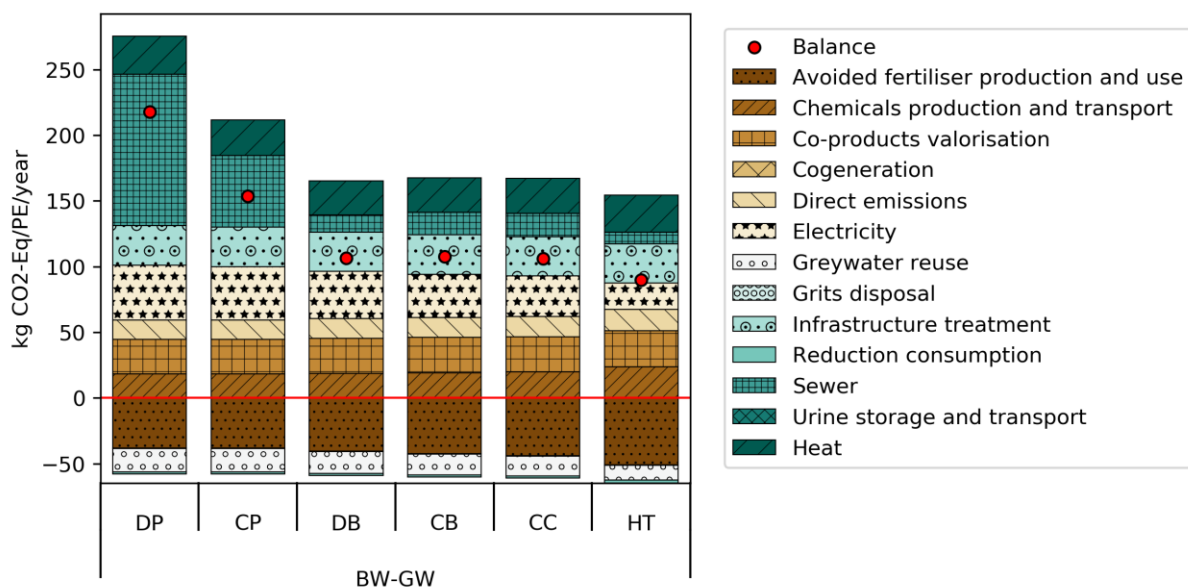

Figure V-6: Climate change impact of *BW-GW* scenario for the different urban configurations (extracted from chapter IV)

IV.1 MBR energy consumption

The *BW-GW* system is not beneficial for most of the environmental impacts, mostly due to high energy consumption for greywater treatment by MBR. In this study, the same consumption for MBR for all the scale was assumed. However (Jeong et al., 2018) presented MBR consumption regarding the treated flowrate. The scale is nevertheless not comparable with this study as the MBR load ranged from 0.3 to 2 m³/d. It is indeed applied for individual treatment or small buildings. Moreover they calculated from manufactured MBR, an energy consumption from 0.41 kWh/m³ to 0.67 kWh/m³.

An attempt is made to calculate the energy consumption needed for all the urban configuration, to reach the same impact on climate change as Reference system. Figure V-7 presents the results regarding typology and size of the district.

The less the district is dense, the more the energy consumption of the MBR should be reduced. Comparison with the value of (Jeong et al., 2018) has been made. By using their highest value of 0.67 kWh/m³, DB, CB and HT configuration indeed performs better than the reference. However in CP and DP, MBR needs to consume less than 0.41 kWh/m³ which seems to be poorly realistic for decentralised systems.

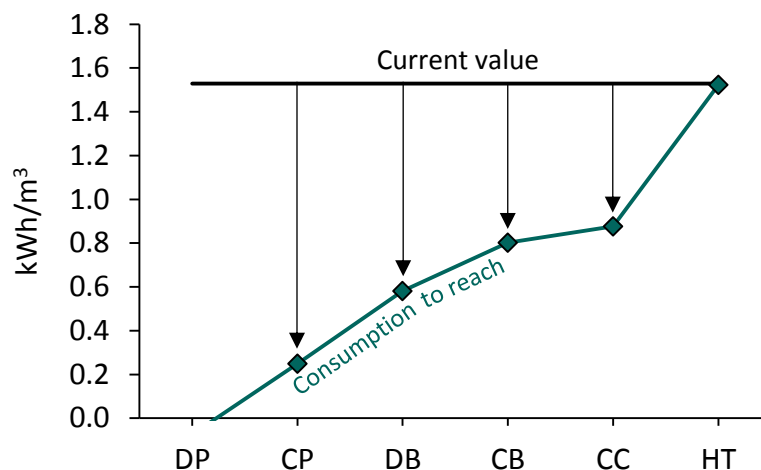

Figure V-7: Decrease in MBR energy consumption to reach in order to obtain the same climate change impact than reference, (for *BW-GW* system at 6.25 ha). DP: discontinuous pavilions, CP: continuous pavilions, DB: discontinuous buildings, CB: continuous buildings, CC: city centre, HT: high-rise tower

Therefore, the implementation at low density of MBR is not achievable and alternative should be found. At higher density the energy consumption should be carefully followed to gain more experiences on real life projects.

IV.2 Alternative extensive treatment

MBR is considered as the best available technique in dense urban area due to its compactness and reject water quality. However more extensive treatment systems can be recommended when it is compatible with urban density.

For instance, constructed wetland are suitable for greywater treatment and have been successfully applied in Flintenbreite project but also Solar City in Austria (Hochedlinger et al., 2008; Oldenburg et al., 2009) and SCST program in Germany.

In this paragraph, an attempt is made to design wetlands regarding to space requirements. For this purpose, available space in each urban configuration is, first, assessed, as illustrated in Figure V-8. Secondly the design of wetlands is performed with specific design criteria (which are still controversial) for greywater treatment: for vertical subsurface wetlands (Oldenburg et al., 2009) reported $1 \text{ m}^2/\text{inh}$ and (Behrendt et al., 2006) advised $1 \text{ m}^2/\text{PE}$. In SCST program, vertical flow wetland was implemented with $2 \text{ m}^2/\text{PE}$ (Peter-Fröhlich et al., 2007a). The design is then performed with a range of design value from 1 to $2 \text{ m}^2/\text{PE}$ of greywater. Finally the two areas are compared and the number of parallel wetlands established, knowing the area available in each district.

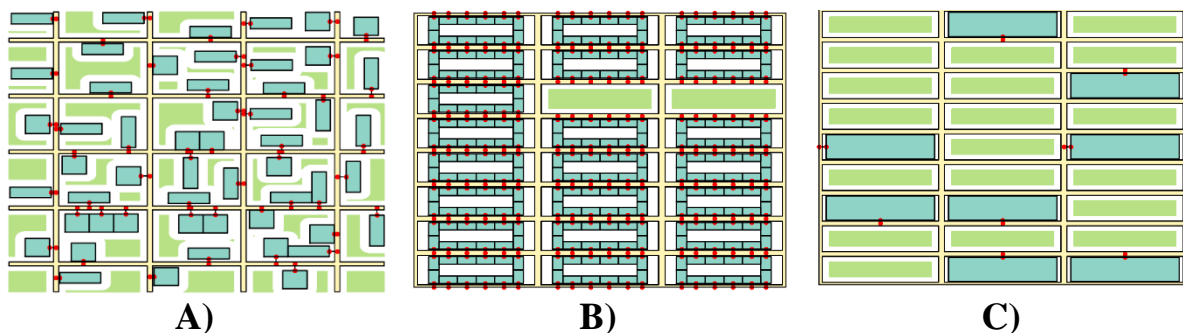

Figure V-8: Available space for reed bed filter (in green) in two case study: A) Continuous pavilions at 6.25 ha, B) Continuous buildings at 6.25 ha and C) High-rise tower at 6.25 ha

Results of this estimation are presented in Figure V-9 A), with the total surface needed to treat all the greywater and in B) with the number of parcel necessary meaning the number of separated wetlands which should be installed. The surface of the reed bed filter represents less than 10 % of available area (Figure V-9 A) for the urban configuration with low land coverage ratio (DP, CP, DB and HT). However for CB and CC the proportion is higher than 20 % and for 6.25 ha and CC there is not enough space. For these last urban configurations a conflict of space could occur with the need of squares and parks.

For other urban configurations, the scale of decentralisation can also be evaluated, in order to limit the number of reed bed filter. In Figure V-9 B), the line at 1 spot, shows that DP has always enough space to implement only one wetlands. For CP the best scale is 30 ha. For DB, CB and HT, a district of 6 ha is the maximum to implement one reed bed filter.

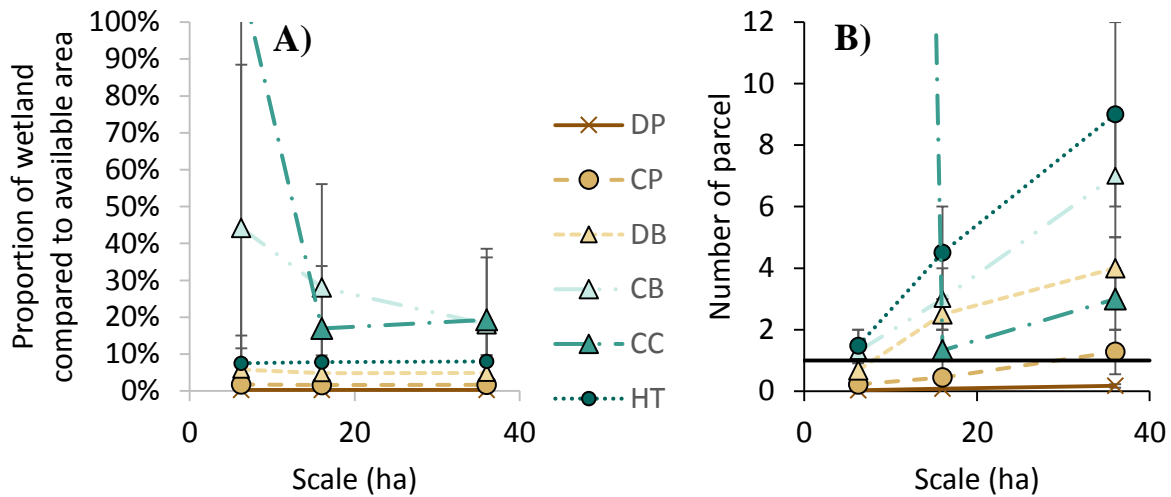

Figure V-9: Description of the reed bed filter design for each case study treating greywater only. A) Surface necessary for the reed bed filter, B) number of plot necessary in each urban configuration to reach this surface (CB and CC are excluded as not relevant). DP: discontinuous pavilions, CP: continuous pavilions, DB: discontinuous buildings, CB: continuous buildings, CC: city centre, HT: high-rise tower

IV.3 About the benefit of substituting potable water production

The reuse of water is more driven by water scarcity and the need of adaptation to global warming than the mitigation of climate change. In this sense, the emission from production of tap water in the future will not necessarily be as low as hypothesised.

In this study the value of $0.32 \text{ kgCO}_2\text{-eq/m}^3$ was used (Ecoinvent database v2.2¹). However in case of desalination the emission factor is $2.9 \text{ kgCO}_2\text{-eq/m}^3$ (Ecoinvent database v3.6²). If the reuse of greywater replaces the need of desalination, reusing only the greywater for flush water will be enough to achieve the same balance as Reference. With 15 % of reuse, the same climate change impacts balance as *Urine* scenario could be reached.

As a comparison (Remy, 2010) found that a “complex” drinking water production with a large reuse of water (more than 50 L/PE) is necessary in order to find a benefit for reusing greywater. However a MBR consumption of 0.6 kWh/m^3 of greywater was assumed in (Remy, 2010) study, which is far below the value chosen in the present study (1.5 kWh/m^3) making difficult the comparison regarding the percentage of reuse necessary to achieve a better scenario. Total reuse seems to be irrelevant in conventional conditions, and it can be stated that the level of substitution for tap water production greatly influences the climate change impact of the system.

IV.4 Water reuse potential

In the *BW-GW* scenario, it was considered that all the greywater was reused for replacing potable water. With such assumption flush water cannot be the only reuse option as it only represents a small proportion of greywater. Gardening is a high consumer of water especially during summer. If we consider the water need of irrigation for Atlanta, USA of $165 \text{ L/m}^2/\text{y}$

¹ tap water, at user, RER

² tap water production, seawater reverse osmosis, ultrafiltration pretreatment, baseline module, single stage

(Jeong et al., 2016), the greywater reuse potential is the following (Figure V-10). The green area for each urban configuration estimated by (Bonhomme, 2013) has been considered (presented in Table V-1).

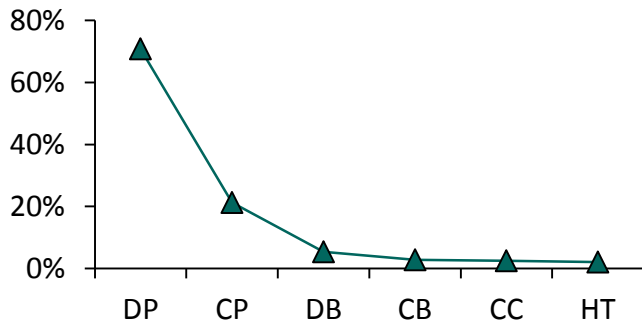

Figure V-10: Recovery rate of greywater as irrigation water at annual basis (for 6 ha district)

Table V-1: Percentage of green area in each urban configurations (Bonhomme, 2013)

	% green area
DP	23 %
CP	18 %
DB	18 %
CB	14 %
CC	10 %
HT	14 %

DP: discontinuous pavilions, CP: continuous pavilions, DB: discontinuous buildings, CB: continuous buildings, CC: city centre, HT: high-rise tower

In this way up to 70 % of the greywater can be reused annually, obviously it is only possible through storage as the irrigation period is mostly needed during warm period (6 months per year). However with continuous pavilions the reuse potential decreases up to 20 %. Irrigation in garden represents less than 5 % for the other urban configurations.

There is, here, a specific correlation between high greywater reuse potential and high sewer contribution to climate change. This means that in the pavilions typologies, reuse of water should be preferred for irrigation through low-technologies and on-site treatment (with low energy consumption). It has to be noted that in these typologies rainwater harvesting is also common and could compete with greywater reuse.

V. CONCLUSION

In this last chapter, sensitive parameters have been investigated in order to establish the representativeness of the result and the results boundaries. It can be concluded that:

- The proposed *urine* separation scenario was highly optimised and relatively small improvements are now expected. However working on the synergy between urine treatment and other concentrated stream, reduction of energy consumption for pre-treatment of TMCS as well as on-site treatment of grey and brown water are certainly some axes for further investigations.
- In the *BW* scenario, the energy consumption for vacuum sewer has a strong influence. The energy needs calculated by the model is lower than most of reported value. With the lowest value of 5.6 kWh/m³ observed in literature the conclusions of our study are unchanged. However, the design and model laws for energy consumption of vacuum sewer needs to be improved in the future. Blackwater separation can be optimised with an improvement of heat consumption. To achieve a neutral balance of heat, several major modification needs to be implemented as ultra-low flush vacuum toilets, boiler instead of CHP and kitchen waste co-digestion. If not all these improvement are made caustic soda consumption has to increase in order to reduce the operating temperature of nitrogen recovery process.
- For greywater management, MBR presents a high energy consumption, and even with the lowest value found in the literature, the *BW-GW* scenario is still not beneficial for climate change for all the urban configuration. However results depends on alternative options for water reclamation: if reused greywater replaced desalted seawater, the last scenario (*BW-GW*) with MBR can have less climate change impact even with a small proportion of water reclamation. MBR technology seems not to be the technology to implement in low dense area because the energy consumption to have an equivalent climate change impact is not achievable. However in these area the need for irrigation in garden is high and a lower quality of reused water can be sufficient. In high density area with limited space other solutions have to be investigated like for instance anaerobic –aerobic moving bed reactor or rotating biodisc.

Chapter VI. Conclusion and perspectives

I. CONCLUSION

Nowadays, wastewater is considered not only as a waste but also as a resource. Its name should therefore be changed in the future! Centralised treatment plants should be progressively upgraded for recovering nutrients, organic matter and water, and being energy self-sufficient. Meanwhile source separation of domestic wastewater has been argued as a promising idea around the world. Different separation and management systems can be conceived, and the environmental burden of each must be addressed. Our conventional way of considering wastewater management and treatment should be renewed. The whole sanitation from the producers to the potent end-users should be considered. It becomes crucial to initiate some structural modifications and demonstrations in future urban area to test these new strategies. The choice between the different technical options is highly complex and this study aimed to develop a methodology for helping stakeholders and decision makers.

Globally, the main achievements through this study are described as follows. First, a tool has been developed in order to simulate the wastewater management at district scale and to take into consideration the impact on the centralised system. Coupling the results of simulation to life cycle assessment has proven to be a successful methodology to assess the different scenarios.

A detailed conclusion on each chapter's achievement is provided hereafter.

In **Chapter I**, a literature review has been performed on source separation system regarding three aspects: 1) a bibliographic analysis to describe the research on this topic, 2) a review on the real life pilot projects has been performed to understand the challenges and limitation in real application, and 3) finally a review on assessment study to understand what is missing in the current state of the art.

It has been shown that source separation topic arose in the 90s. Research focuses a lot of efforts on urine separation and especially treatment of urine. But in the meantime the current and future pilot projects are mainly with blackwater separation in Europe. The urine separation device (urinals or toilets) has been identified as the bottleneck which limits the deployment.

The environmental assessments showed that with the boundaries extended to the whole wastewater management, all the steps were not integrated with the same accuracy. Centralised wastewater treatments were indeed most of the time taken into account only with ratio approach. Direct emission of greenhouse gases was poorly considered. Moreover the current centralised sanitation is used as the reference scenario without taking into account the improvement that can be achieved to recover nutrients. In this sense a favourable reference is chosen in our study, to compare with alternative scenarios. Finally the links between urbanism and comparison of source separation systems was not yet scrutinized, except for greywater reclamation and reuse. In greywater reclamation, urbanism showed a high influence and similar effect could be assumed for the other source separation systems.

In **Chapter II**, the methodology was described. The novelty is the gathering of design of best available technologies in one flexible approach. The tool allows the comparison of all types of source separation system by environmental assessment, coupling a description of the district with the specific sanitation system and the centralised treatment plant. In the district, six urban configurations have been modelled with the spatial location of buildings, roads and associated sewers. Influent generation and decentralised treatment design were also implemented. Regarding the numerous scenarios that can be drawn, three major alternative systems based on the pilot projects (urine, blackwater, blackwater / greywater) were compared to a reference, i.e. an advanced centralised WWRF.

In **Chapter III**, the four scenarios were compared for a given urbanism typology. It was shown that centralised facilities are limited in terms of nutrients recovery. Urine and blackwater separation perform much better for nitrogen recovery, whereas similar phosphorus recovery were obtained in the two systems.

In addition nitrogen recovery was revealed as the best way to reduce global warming potential by a double effect: decrease of the direct N₂O emissions and substitution of nitrogen fertiliser production.

For nitrogen recovery, the transmembrane chemisorption (TMCS) process was assessed for the first time, showing very high performances at centralised location. For decentralised treatment the heat demand seems difficult to fulfil without external source. Natural gas boiler has a significant impact on fossil resources and then on several linked impacts as climate change. More work should be done in order to reduce this heat demand and several leads have been proposed as energy recovery from the effluent, co-digestion with bio-waste or ultra-low flush of vacuum toilets.

The last scenario of totally decentralised sanitation system with high technologies showed more impacts for major criteria (for example climate change) and makes sense only in context where (1) tap water generation is difficult and (2) where high nitrogen and water recovery are both implemented.

In **Chapter IV**, the influence of urbanism and scale have been assessed regarding the efficiency of source separation system. It has been concluded that the main influencing parameters are the ratio between employees and inhabitants and the human density of the district.

For low densely populated areas, the sewer being the major contributor to overall impacts, sewer source separation system cannot decrease more than 20% the impact. On-site sanitation should therefore be investigated to increase the benefit. For higher density, sewer system can still be positively implemented. Phosphorus recovery rate have shown to be influenced by the scale of implementation in centralised treatment. A symbiotic effect is visible between the change of COD/P ratio entering the water line and the phosphorus recovery rate.

The energy balance is also improved with scale-up with better electricity production for cogeneration. The same climate change footprint could be reached for totally decentralised system (BW-GW) and the reference, with high-rise tower configuration. However a total reuse

of water seems unrealistic for such high densely populated urban configuration with limited green surface to irrigate. New use of water should therefore be sought.

Finally it has been concluded that the choice of water reuse implementation is not driven by climate change impact but by water depletion limitation. At least these prospective results show that with some improvements, it could be possible to reuse water without increasing the impact on climate change.

II. PERSPECTIVES

The tool developed in this study is highly flexible to be used as a decision support tool for wastewater management choice but also to make prospective study to analyse the spatial and time trajectory for source separation implementation at large scale.

Three major perspectives are discussed hereafter. First the improvement of the tool are described, in terms of modelling. Secondly the recommendation and the future use are addressed. Finally the integration of the tool in the society and the research team are stated.

II.1 Improvement of the tool

As a first improvement, the tool could be used to perform direct uncertainty analysis considering hypothesis made for influent generation or treatment performances.

In addition a future need is the integration of specific infrastructure in LCA inventory for both centralised and decentralised treatment facilities. Indeed the Ecoinvent database for estimating the need of infrastructure based on the PE treated is old (1995) and made with data collected on Swiss treatment plants. Moreover the decentralised treatment facilities show most of the time higher need in infrastructure than large centralised facilities, which is not observable in this work.

A third point is the improvement of vacuum sewer modelling. As discussed in Chapter V.III.1, the energy consumption modelled seems fairly optimistic. More knowledge should be gained on the link between hydrodynamics and pressure loss in such systems. Specific study on blackwater would help to implement a more realistic model. Moreover the malfunction operations should be also integrated, as the frequency of leaks, blockages etc., and taken into consideration for energy requirements.

Moreover, the operational phase of sewer could be taken into consideration with more accuracy. For instance some direct emissions from sewers can be influenced by wastewater modifications. Each new district has its own gravity sewer but it is also connected to the main sewer pipes for transportation to WWTP with larger diameter. This transport is a variable source of greenhouse gases (GHG) emissions depending on residence time and conditions. Decentralised treatment will reduce the mass flow in existing pipes, reducing GHG emissions from sewer. However in

the current model operational phase of the sewer were not taken into consideration. For instance what is the influence of urine or blackwater separation on hydrogen sulphide emission in the sewer? Less H₂S may be emitted but currently no study exists to confirm this hypothesis.

Another improvement that can be proposed for more flexibility, would be the possibility to choose different decentralisation scales for different streams (greywater, blackwater, urine...).

Dynamic variation could be integrated in the tool as wastewater production is not constant during day, week or even year. (Bisinella de Faria et al., 2015) showed that the simplification from dynamic problem to steady state, induced an error around 20 % on environmental impact. Moreover moving forward to decentralised treatment will increase the daily variation as the residence time in the sewer is reduced. Equalisation tanks are therefore necessary in the process chain and should be taken into account. Finally, production patterns are different from housing and office places. Larger difference can be therefore accounted for, when urban configurations are taking into account.

Finally, real case study is the next step regarding the use of the current tool. In this sense, the aim is to take into account several parameters that cannot be implemented in the theoretical tool for simplification. Topography, tortuosity of road, can be cited in the parameters list. Moreover the real wastewater treatment plant can be used as reference scenario, with still the upgrade that can be achieved in such plants in term of nutrient recovery.

II.2 Recommendation and future needs

Source separation as well as decentralised wastewater management need to receive more attention in the future. With the increasing need for nutrients, energy and water recovery, it is definitively high time to reconsider water management and urban development simultaneously.

Small is beautiful?

The environmental and economic impacts of sewer (especially in low density area) are naturally in favour of more on site sanitation including low tech and extensive systems. These treatments need to be further analysed in details in term of nutrient discharge to take into account the risk of eutrophication. This study focuses more on resources recovery developed at centralised location. It has been stated that source separation shows large gain in term of nutrient recovery but it is now necessary to understand in which current sanitation system the benefit will be better obtained. The assessed WRRF was a high-tech centralised treatment plant in which synergies can be found for nutrient and energy recovery, but other situations should also be analysed. It is expected that source separation will be the good option when existing facilities are not designed for any recovery at all, but this question should endorse spatial and time trajectory in a territorial perspective.

Additionally more research is needed on energy saving in small scale systems. Heat and electrical balance need to be optimised and improved. Several pilot projects installed bio-waste co-digestion with blackwater and heat recovery from greywater. These two extensions should be the next development of the modelling tool but a real effort is also needed to demonstrate the practical acceptance and performance.

More water or less water? That is the question

Secondly, water reclamation will be probably one of the main driver for new wastewater management systems. Water reuse should be investigated both at centralised location or decentralised scale. This study suggests that scenarios should be extended to the case where new water source are needed. As the water sector is a conservative one, more disrupting approach could come from innovative urbanism. In relationship with water reuse, new functions of water should be integrated as urban temperature regulation, heat waves mitigation and climate change adaptation. More research will aim to reinforce the positive role of green and blue area in the city in order to reduce heat island phenomena for instance. Urban farming is also a trend in cities of the future for which more water would be needed.

II.3 Integration of the tool in research and society demand

Even if this tool is quite new, it has already proven to be a perfect tool for aggregating knowledge gained by research and technical data. Indeed the development of the tool was performed within MUSES project financed by local water authority of South west of France (Agence de l'Eau Adour Garonne). It was continued in a larger project called DESIGN financed by the National Agency of Research (ANR) of France. In this last project, not only technical data will be collected but also sociological knowledge. Indeed this project intend to demonstrate the feasibility of the innovative technology for nitrogen recovery (TMCS) on urine treatment and the stakeholder appropriation of urine source separation. Moreover the real case studies will be modelled and evaluate with the environmental consultancy, partner of the project. With an iterative process, knowledge will be shared with actors of wastewater management and urban planning. Indeed besides sociologic study on obstacles and opportunities from the actors, a workshop is organised to make the actors creating their own wastewater management on several territories. The improvement of the tool to be used in this kind of workshop could be an interesting way. It will allows in order to give an evaluation of the solutions proposed by the actors. Environmental results could therefore be an element for decision making process.

This back and forth process was also imagined in a H2020 project that was unfortunately not funded. This project gathered several pilot project cities (planned or in construction) with academic partners and providers of technological solutions. The aim of the project was to gained knowledge on how to help the emergence of new projects and on the stakeholder system. Modelling was in this sense a very helpful tool, to gather information and evaluate the technological solution.

I am now working in an environmental consultancy for building and urban projects and the knowledge gained by the used of the tool, can also answer to a societal and ethic demand. The tool can indeed help to the creation of new pilot projects by supporting the actors in their decision process by adding environmental assessment at each step.

Scientific production

III. SCIENTIFIC PAPERS PUBLISHED IN INTERNATIONAL AND PEER REVIEWED JOURNALS

III.1 From previous work in the same topic:

Bisinella de Faria, A.B., Besson, M., Ahmadi, A., Udert, K.M., Spérandio, M., Forthcoming. A dynamic influent generator to account for alternative wastewater management: the case of urine source separation. *Journal of sustainable water in the built environment*. <https://doi.org/10.1061/JSWBAY.0000904>

Igos, E., Besson, M., Navarrete Gutiérrez, T., Bisinella de Faria, A.B., Benetto, E., Barna, L., Ahmadi, A., Spérandio, M., 2017. Assessment of environmental impacts and operational costs of the implementation of an innovative source-separated urine treatment. *Water Research* 126, 50–59. <https://doi.org/10.1016/j.watres.2017.09.016>

III.2 In preparation

Both chapter III. And Chapter IV are in preparation to submission

IV. CONFERENCES WITH ABSTRACT

- Besson, M., Berger, S., Bessière, Y., Paul, E., 2015. Simulation of scenarii with source separated system integrated in the cities for wastewater added value, in: ResearchGate. Presented at the Eau Mégalopoles et changement global.
- Besson, M., Bisinella de Faria, A.B., Spérandio, M., Paul, E., 2017. Impacts of urban typologies on efficiency of source-separation systems with decentralized treatment, in: Session: Ressource Oriented Sanitation Systems. Presented at the The IWA S2Small2017 Conference on Small Water & Wastewater Systems and Resources Oriented Sanitation, Nantes, France.
- Besson, M., Spérandio, M., Paul, E., Berger, S., 2018. La séparation et la valorisation des eaux usées : modélisation pour différentes typologies de quartiers, in: Eau Et Déchets : Vers Des Services Décarbonnés. Presented at the 97ème Congrès de l'ASTEE, Marseille, France.
- Besson, M., Spérandio, M., Paul, E., Berger, S., 2018. Outil d'aide à la décision pour l'implantation de solution de séparation à la source des eaux usées à l'échelle d'un quartier. Évaluation technico-économique et environnementale de deux scénarios. in: Eaux Résiduaires : Energie et Valorisation de La Matière. Presented at the JIE Journée information Eaux, Poitiers France.
- Besson, M., Tiruta-Barna, L., Paul, E., Spérandio, M., Berger, S., 2019. Integrated environmental assessment of source separation scenarios for water resource recovery, in: Session 14: Holistic Evaluation. Presented at the 10th IWA Symposium on Modelling and integrated assessment, Copenhague, Denmark.
- Besson, M., Tiruta-Barna, L., Paul, E., Sperandio, M., Berger, S., 2019. Analyse environnementale de scenario de séparation à la source pour une valorisation des ressources des eaux usées, in: Thème 3 : La Transition Environnementale, Session Eaux/Reuse. Presented at the SFGP 2019. Le génie des procédés au service des grands enjeux sociétaux et industriels, Nantes, France.

References

- Ahn, Y.T., Hwang, Y.H., Shin, H.S., 2011. Application of PTFE membrane for ammonia removal in a membrane contactor. *Water Sci. Technol. J. Int. Assoc. Water Pollut. Res.* 63, 2944–2948.
- Albold, A., n.d. Flintenbreite.
- Al-Jayyousi, O.R., 2003. Greywater reuse: towards sustainable water management. Desalination, Joint EDS, WSTA and IWA conference on Desalination and the Environment Fresh Water for All UN International Year of Fresh Water 2003 156, 181–192. [https://doi.org/10.1016/S0011-9164\(03\)00340-0](https://doi.org/10.1016/S0011-9164(03)00340-0)
- Ashrafizadeh, S.N., Khorasani, Z., 2010. Ammonia removal from aqueous solutions using hollow-fiber membrane contactors. *Chem. Eng. J.* 162, 242–249. <https://doi.org/10.1016/j.cej.2010.05.036>
- Atanasova, N., Dalmau, M., Comas, J., Poch, M., Rodriguez-Roda, I., Buttiglieri, G., 2017. Optimized MBR for greywater reuse systems in hotel facilities. *J. Environ. Manage.* 193, 503–511. <https://doi.org/10.1016/j.jenvman.2017.02.041>
- Aucame, 2010. Répertoire Formes urbaines résidentielles de Caen-métropole.
- Augustin, K., Skambraks, A.-K., Li, Z., Giese, T., Rakelmann, U., Meinzingler, F., Schonlau, H., Günner, C., 2014. Towards sustainable sanitation – the HAMBURG WATER Cycle in the settlement Jenfelder Au. *Water Sci. Technol. Water Supply* 14, 13–21. <https://doi.org/10.2166/ws.2013.158>
- Baker, L.A., Hope, D., Xu, Y., Edmonds, J., Lauver, L., 2001. Nitrogen Balance for the Central Arizona-Phoenix (CAP) Ecosystem. *Ecosystems* 4, 582–602. <https://doi.org/10.1007/s10021-001-0031-2>
- Barbosa, S.G., Peixoto, L., Meulman, B., Alves, M.M., Pereira, M.A., 2016. A design of experiments to assess phosphorous removal and crystal properties in struvite precipitation of source separated urine using different Mg sources. *Chem. Eng. J.* 298, 146–153. <https://doi.org/10.1016/j.cej.2016.03.148>
- Batstone, D.J., Hülsen, T., Mehta, C.M., Keller, J., 2015. Platforms for energy and nutrient recovery from domestic wastewater: A review. *Chemosphere, Wastewater-Energy Nexus: Towards Sustainable Wastewater Reclamation* 140, 2–11. <https://doi.org/10.1016/j.chemosphere.2014.10.021>
- Behrendt, J., Deegener, S., Meinzingler, F., Gajurel, D.R., Shalabi, M., Wendland, C., Otterpohl, R., 2006. Appropriate de-central wastewater technologies for low income regions, in: Session 4: Separation & Re-Use. Presented at the The 2nd International Dry Toilet Conference, Tampere.
- Bell, J.E., McMullen, P.R., 2004. Ant colony optimization techniques for the vehicle routing problem. *Adv. Eng. Inform.* 18, 41–48. <https://doi.org/10.1016/j.aei.2004.07.001>
- Belliot, M., 2006. Habitat Formes urbaines : Densités comparées et tendances d'évolution en France.

- Besson, M., 2015. Étude des réalisations internationales et simulation d'un scénario de séparation à la source. (Rapport de Master 2). INSA Toulouse, Toulouse, France.
- Besson, M., Tiruta-Barna, L., Spérandio, M., 2017. Environmental Assessment of Anammox Process in Mainstream with WWTP Modeling Coupled to Life Cycle Assessment, in: *Frontiers in Wastewater Treatment and Modelling*. Presented at the Frontiers International Conference on Wastewater Treatment and Modelling, Springer, Cham, pp. 392–397. https://doi.org/10.1007/978-3-319-58421-8_62
- Bisinella de Faria, A.B., Besson, M., Ahmadi, A., Udert, K.M., Spérandio, M., 2019. A dynamic influent generator to account for alternative wastewater management: the case of urine source separation. *J. Sustain. Water Built Environ.* <https://doi.org/10.1061/JSWBAY.0000904>
- Bisinella de Faria, A.B., Spérandio, M., Ahmadi, A., Tiruta-Barna, L., 2015. Evaluation of new alternatives in wastewater treatment plants based on dynamic modelling and life cycle assessment (DM-LCA). *Water Res.* 49, 99–111. <https://doi.org/10.1016/j.watres.2015.06.048>
- Bisschops, I., Kjerstadius, H., Meulman, B., van Eekert, M., 2019. Integrated nutrient recovery from source-separated domestic wastewaters for application as fertilisers. *Curr. Opin. Environ. Sustain.* 40, 7–13. <https://doi.org/10.1016/j.cosust.2019.06.010>
- Bixio, D., Thoeve, C., De Koning, J., Joksimovic, D., Savic, D., Wintgens, T., Melin, T., 2006. Wastewater reuse in Europe. *Desalination, Integrated Concepts in Water Recycling* 187, 89–101. <https://doi.org/10.1016/j.desal.2005.04.070>
- Blume, S., Winker, M., 2011. Three years of operation of the urine diversion system at GTZ headquarters in Germany: user opinions and maintenance challenges. *Water Sci. Technol. J. Int. Assoc. Water Pollut. Res.* 64, 579–586. <https://doi.org/10.2166/wst.2011.530>
- Böhler, M., Fleiner, J., Gruber, W., Seyfried, I., Luning, L., Traksel, D., 2016. POWERSTEP. WP4 : Nitrogen management in side stream. D4.2 Planning and design of a full-scale membrane ammonia stripping (Deliverable No. 4.2). Eawag.
- Böhler, M., Hernandez, A., Gruber, W., Fleiner, J., Seyfried, A., 2018. POWERSTEP. WP4 : Nitrogen management in side stream. D 4.3: Operation and optimization of membrane ammonia stripping (Deliverable No. 4.3). Eawag.
- Boller, M. (Ed.), 2013. Source control and source separation: the Swiss experience, in: *Source Separation and Decentralization for Wastewater Management*. IWA Publ, London.
- Bollon, J., Filali, A., Fayolle, Y., Guerin, S., Rocher, V., Gillot, S., 2016. N₂O emissions from full-scale nitrifying biofilters. *Water Res.* 102, 41–51. <https://doi.org/10.1016/j.watres.2016.05.091>
- Bonhomme, M., 2013. Contribution à la génération de bases de données multi-scalaires et évolutives pour une approche pluridisciplinaire de l'énergétique urbaine (Thèse de doctorat en Génie Civil). Laboratoire de recherche en architecture et Laboratoire matériaux et durabilité des constructions - Université de Toulouse, France.
- Bonhomme, M., Ait Haddou, H., Adolphe, L., 2012. GENIUS: A tool for classifying and modelling evolution of urban typologies. Presented at the 28th Conference, Opportunities, Limits & Needs Towards an environmentally responsible architecture, PLEA2012, Lima, Peru.
- Bonoli, A., Di Fusco, E., Zanni, S., Lauriola, I., Ciriello, V., Di Federico, V., 2019. Green Smart Technology for Water (GST4Water): Life Cycle Analysis of Urban Water Consumption. *Water* 11, 389. <https://doi.org/10.3390/w11020389>
- Bordes-Pagès, E., 1995. Référentiel de densités de de formes urbaines. Contribution pour un référentiel appliqué à l'habitat dans la région Ile-de-France.

- Bowne, W.C., Naret, R.C., Otis, R.J., 1991. Manual - alternative wastewater collection systems (Manual No. EPA/625/1-91/024). U.S. Environmental Protection Agency, Office of research and development, National risk management research laboratory., Cincinnati, Ohio, USA.
- BREEAM, 2016. International Wat 01 Water consumption calculatr.
- Brun, F., 2019. Note pour concevoir et exploiter les réseaux de collecte de l'urine humaine, Programme OCAPI. LEESU.
- Brun, F., 2018. Freins et leviers à l'emploi de fertilisants à base d'urine humaine en agriculture en Île-de-France, Rapport d'étude AGROCAPI.
- Bullnheimer, B., Hartl, R.F., Strauss, C., 1999. Applying the ANT System to the Vehicle Routing Problem, in: Voß, S., Martello, S., Osman, I.H., Roucairol, C. (Eds.), *Meta-Heuristics: Advances and Trends in Local Search Paradigms for Optimization*. Springer US, Boston, MA, pp. 285–296. https://doi.org/10.1007/978-1-4615-5775-3_20
- Butler, B., 2018. Struvite or Traditional Chemical phosphorus Precipitation – What Option Rocks? (Final report). Australien Meat Processor Corporation AMPC.
- Cai, T., Park, S.Y., Li, Y., 2013. Nutrient recovery from wastewater streams by microalgae: Status and prospects. *Renew. Sustain. Energy Rev.* 19, 360–369. <https://doi.org/10.1016/j.rser.2012.11.030>
- Cao, Y., Kwok, B.H., van Loosdrecht, M.C.M., Daigger, G.T., Png, H.Y., Long, W.Y., Chye, C.S., Ghani, Y.A.B.D., 2017. The occurrence of enhanced biological phosphorus removal in a 200,000 m³/day partial nitrification and Anammox activated sludge process at the Changi water reclamation plant, Singapore. *Water Sci. Technol.* 75, 741–751. <https://doi.org/10.2166/wst.2016.565>
- Cavallé, L., Albuquerque, M., Grousseau, E., Lepeuple, A.-S., Uribelarrea, J.-L., Hernandez-Raquet, G., Paul, E., 2016. Understanding of polyhydroxybutyrate production under carbon and phosphorus-limited growth conditions in non-axenic continuous culture. *Bioresour. Technol.* 201, 65–73. <https://doi.org/10.1016/j.biortech.2015.11.003>
- Chernicharo, C.A. de L., Sperling, M. von, Chernicharo, C.A. de L., 2007. *Anaerobic reactors, Biological wastewater treatment series*. IWA Publ, London.
- Clarens, A.F., Resurreccion, E.P., White, M.A., Colosi, L.M., 2010. Environmental Life Cycle Comparison of Algae to Other Bioenergy Feedstocks. *Environ. Sci. Technol.* 44, 1813–1819. <https://doi.org/10.1021/es902838n>
- Corbella, H.M., Pujol, D.S. i, 2009. What lies behind domestic water use?: a review essay on the drivers of domestic water consumption. *Bol. Asoc. Geógrafos Esp.* 297–314.
- Darestani, M., Haigh, V., Couperthwaite, S.J., Millar, G.J., Nghiem, L.D., 2017. Hollow fibre membrane contactors for ammonia recovery: Current status and future developments. *J. Environ. Chem. Eng.* 5, 1349–1359. <https://doi.org/10.1016/j.jece.2017.02.016>
- de Bruin, L.M.M., de Kreuk, M.K., van der Roest, H.F.R., Uijterlinde, C., van Loosdrecht, M.C.M., 2004. Aerobic granular sludge technology: an alternative to activated sludge? *Water Sci. Technol.* 49, 1–7. <https://doi.org/10.2166/wst.2004.0790>
- de Graaff, M.S., Temmink, H., Zeeman, G., Buisman, C.J.N., 2011. Energy and phosphorus recovery from black water. *Water Sci. Technol.* 63, 2759–2765. <https://doi.org/10.2166/wst.2011.558>
- de Graaff, M.S., Temmink, H., Zeeman, G., Buisman, C.J.N., 2010. Anaerobic Treatment of Concentrated Black Water in a UASB Reactor at a Short HRT. *Water* 2, 101–119. <https://doi.org/10.3390/w2010101>
- de Graaff, R., van Hell, A.J., 2014. *Nieuwe Sanitatie Noorderhoek, Sneek deelonderzoeken (New Sanitation Noorderhoek, Sneek sub-studies) (No. 2014–48)*, STOWA. STOWA, Amersfoort - Netherlands.

- Dorigo, M., Gambardella, L.M., 1997. Ant colonies for the travelling salesman problem. *Biosystems* 43, 73–81. [https://doi.org/10.1016/S0303-2647\(97\)01708-5](https://doi.org/10.1016/S0303-2647(97)01708-5)
- Druitt, M., 2009. The Swedish Eco-Sanitation Experience Case studies of successful projects implementing alternative techniques for wastewater treatment in Sweden. Coalition Clean Baltic, Sweden.
- Eck, N.J. van, Waltman, L., 2014. Visualizing Bibliometric Networks, in: *Measuring Scholarly Impact*. Springer, Cham, pp. 285–320. https://doi.org/10.1007/978-3-319-10377-8_13
- Escher, B.I., Baumgartner, R., Koller, M., Treyer, K., Lienert, J., McArdell, C.S., 2011. Environmental toxicology and risk assessment of pharmaceuticals from hospital wastewater. *Water Res.* 45, 75–92. <https://doi.org/10.1016/j.watres.2010.08.019>
- Esculier, F., 2018. The nutrition/excretion system of urban areas: socioecological regimes and transitions. (Theses). Université Paris Est.
- Etter, B., Hubaux, N., Udert, K.M., Morgenroth, E., 2017. Water Hub@ NEST: Practical Implications of Source Separation, in: *IWA S2Small2017 Conference on Small Water & Wastewater Systems and Resources Oriented Sanitation*. pp. 22–26.
- Etter, B., Tilley, E., Khadka, R., Udert, K.M., 2011. Low-cost struvite production using source-separated urine in Nepal. *Water Res.* 45, 852–862. <https://doi.org/10.1016/j.watres.2010.10.007>
- Etter, B., Udert, K.M., 2015. VUNA Final Report. Eawag, Dübendorf, Switzerland.
- Friedler, E., Butler, D., Brown, D.M., 1996. Domestic WC usage patterns. *Build. Environ.* Vol. 31, pp 385-392.
- Friedler, E., Hadari, M., 2006. Economic feasibility of on-site greywater reuse in multi-storey buildings. *Desalination* 190, 221–234. <https://doi.org/10.1016/j.desal.2005.10.007>
- Friedler, E., Kovalio, R., Galil, N.I., 2005. On-site greywater treatment and reuse in multi-storey buildings. *Water Sci. Technol. J. Int. Assoc. Water Pollut. Res.* 51, 187–194.
- Gao, M., Yang, S., Wang, M., Wang, X.-H., 2016. Nitrous oxide emissions from an aerobic granular sludge system treating low-strength ammonium wastewater. *J. Biosci. Bioeng.* 122, 601–605. <https://doi.org/10.1016/j.jbiosc.2016.04.004>
- García-Gusano, D., Garraín, D., Dufour, J., 2017. Prospective life cycle assessment of the Spanish electricity production. *Renew. Sustain. Energy Rev.* 75, 21–34. <https://doi.org/10.1016/j.rser.2016.10.045>
- Gell, K., Ruijter, F.J. de, Kuntke, P., Graaff, M. de, Smit, A.L., 2011. Safety and Effectiveness of Struvite from Black Water and Urine as a Phosphorus Fertilizer. *J. Agric. Sci.* 3, p67. <https://doi.org/10.5539/jas.v3n3p67>
- Glynwed, n.d. Dossier technique Tubes PE100.
- Goedkoop, M.J., Heijungs, R., Huijbregts, M., De Schryver, A., Struijs, J., Van Zelm, R., 2009. ReCiPe 2008, A life cycle impact assessment method which comprises harmonised category indicators at the midpoint and the endpoint level (First edition No. Report I: Characterisation).
- Grau, M.G.P., Rhoton, S.L., Brouckaert, C.J., Buckley, C.A., 2013. Development of a Fully Automated Struvite Reactor to Recover Phosphorus from Source Separated Urine Collected at Urine Diversion Toilets in eThekweni. *Proc. Water Environ. Fed.* 2013, 74–83. <https://doi.org/10.2175/193864713813525806>
- Guérin-Schneider, L., Tsanga-Tabi, M., Roux, P., Catel, L., Biard, Y., 2018. How to better include environmental assessment in public decision-making: Lessons from the use of an LCA-calculator for wastewater systems. *J. Clean. Prod.* 187, 1057–1068. <https://doi.org/10.1016/j.jclepro.2018.03.168>
- Guest, J.S., Skerlos, S.J., Barnard, J.L., Beck, M.B., Daigger, G.T., Hilger, H., Jackson, S.J., Karvazy, K., Kelly, L., Macpherson, L., Mihelcic, J.R., Pramanik, A., Raskin, L., Van Loosdrecht, M.C.M., Yeh, D., Love, N.G., 2009. A New Planning and Design Paradigm

- to Achieve Sustainable Resource Recovery from Wastewater. *Environ. Sci. Technol.* 43, 6126–6130. <https://doi.org/10.1021/es9010515>
- Gutin, G., Punnen, A.P., 2006. *The Traveling Salesman Problem and Its Variations*. Springer Science & Business Media.
- Hakawati, R., Smyth, B.M., McCullough, G., De Rosa, F., Rooney, D., 2017. What is the most energy efficient route for biogas utilization: Heat, electricity or transport? *Appl. Energy* 206, 1076–1087. <https://doi.org/10.1016/j.apenergy.2017.08.068>
- Harder, R., Wielemaker, R., Larsen, T.A., Zeeman, G., Öberg, G., 2019. Recycling nutrients contained in human excreta to agriculture: Pathways, processes, and products. *Crit. Rev. Environ. Sci. Technol.* 49, 695–743. <https://doi.org/10.1080/10643389.2018.1558889>
- Hegger, D., 2007. *Greening sanitary systems: an end-user perspective*. Wageningen University, Wageningen.
- Henze, M. (Ed.), 2008. *Biological wastewater treatment: principles, modelling and design*. IWA Publ, London.
- Hischier, R., Weidema, B., Althaus, H.-J., Bauer, C., Doka, G., Dones, R., Frischknecht, R., Hellweg, S., Humbert, S., Jungbluth, N., Köllner, T., Loerincik, Y., Margni, M., Nemecek, T., 2010. Implementation of life cycle impact assessment methods (No. Ecoinvent report No. 3, v2.2.). Swiss Centre for Life Cycle Inventories, Dübendorf.
- Hocaoglu, S.M., Orhon, D., 2010a. Fate of soluble residual organics in membrane bioreactor. *J. Membr. Sci.* 364, 65–74. <https://doi.org/10.1016/j.memsci.2010.07.050>
- Hocaoglu, S.M., Orhon, D., 2010b. Fate of proteins and carbohydrates in membrane bioreactor operated at high sludge age. *J. Environ. Sci. Health Part A* 45, 1101–1108. <https://doi.org/10.1080/10934529.2010.486342>
- Hochedlinger, M., Steinmüller, H., Oldenburg, M., Schroft, J., Schweighofer, P., Plattner, G., 2008. Experiences from the EcoSan full scale pilot project solarCity Linz. Presented at the 11th International Conference on Urban Drainage, Edinburgh, Scotland, UK.
- Igos, E., Besson, M., Navarrete Gutiérrez, T., Bisinella de Faria, A.B., Benetto, E., Barna, L., Ahmadi, A., Spérandio, M., 2017. Assessment of environmental impacts and operational costs of the implementation of an innovative source-separated urine treatment. *Water Res.* 126, 50–59. <https://doi.org/10.1016/j.watres.2017.09.016>
- INTEWA Nederlande, 2013. AQUALOOP.
- IPCC, 2019. Wastewater treatment and discharge, in: 2019 Refinement to the 2006 IPCC Guidelines for National Greenhouse Gas Inventories. IPCC, Switzerland.
- Ishii, S.K.L., Boyer, T.H., 2015. Life cycle comparison of centralized wastewater treatment and urine source separation with struvite precipitation: Focus on urine nutrient management. *Water Res.* 79, 88–103. <https://doi.org/10.1016/j.watres.2015.04.010>
- Islam, M.S., 2017. Comparative evaluation of vacuum sewer and gravity sewer systems. *Int. J. Syst. Assur. Eng. Manag.* 8, 37–53. <https://doi.org/10.1007/s13198-016-0518-z>
- Jefferson, B., Laine, A.L., Stephenson, T., Judd, S.J., 2001. Advanced biological unit processes for domestic water recycling. *Water Sci. Technol. J. Int. Assoc. Water Pollut. Res.* 43, 211–218.
- Jeong, H., Broesicke, O.A., Drew, B., Crittenden, J.C., 2018. Life cycle assessment of small-scale greywater reclamation systems combined with conventional centralized water systems for the City of Atlanta, Georgia. *J. Clean. Prod.* 174, 333–342. <https://doi.org/10.1016/j.jclepro.2017.10.193>
- Jeong, H., Broesicke, O.A., Drew, B., Li, D., Crittenden, J.C., 2016. Life cycle assessment of low impact development technologies combined with conventional centralized water systems for the City of Atlanta, Georgia. *Front. Environ. Sci. Eng.* 10, 1. <https://doi.org/10.1007/s11783-016-0851-0>

- Jinming, D., Jingxuan, Z., 2006. Studies on frictional pressure drop of gas-non-Newtonian fluid two-phase flow in the vacuum sewers. *Civ. Eng. Environ. Syst.* 23, 1–10. <https://doi.org/10.1080/10286600500431904>
- Johansson, M., 2000. Urine Separation - Closing the Nutrient Cycle (FINAL REPORT ON THE R&D PROJECT). Water Company, Stockholm, Sweden.
- Jönsson, H., Baky, A., Jeppsson, U., Hellström, D., Kärrman, E., 2005. Composition of urine, faeces, greywater and biowaste for utilisation in the URWARE model.
- Jönsson, H., Burström, A., Svensson, J., 1998. Mätning på två urinsorterande avloppssystem (Report No. 228). Uppsala.
- Kartal, B., Kuenen, J.G., van Loosdrecht, M.C.M., 2010. Sewage Treatment with Anammox. *Science* 328, 702–703. <https://doi.org/10.1126/science.1185941>
- Kavvada, O., Tarpeh, W.A., Horvath, A., Nelson, K.L., 2017. Life-Cycle Cost and Environmental Assessment of Decentralized Nitrogen Recovery Using Ion Exchange from Source-Separated Urine through Spatial Modeling. *Environ. Sci. Technol.* 51, 12061–12071. <https://doi.org/10.1021/acs.est.7b02244>
- Keogh, L., 2018. Flows of Science: Source Separation Technology at the Swiss Federal Institute of Aquatic Science and Technology (Eawag). Eawag, Dübendorf, Switzerland.
- Khiewwijit, R., Temmink, H., Rijnaarts, H., Keesman, K.J., 2015. Energy and nutrient recovery for municipal wastewater treatment: How to design a feasible plant layout? *Environ. Model. Softw.* 68, 156–165. <https://doi.org/10.1016/j.envsoft.2015.02.011>
- Kummu, M., Guillaume, J.H.A., de Moel, H., Eisner, S., Flörke, M., Porkka, M., Siebert, S., Veldkamp, T.I.E., Ward, P.J., 2016. The world's road to water scarcity: shortage and stress in the 20th century and pathways towards sustainability. *Sci. Rep.* 6, 38495. <https://doi.org/10.1038/srep38495>
- Kuntke, P., Śmiech, K.M., Bruning, H., Zeeman, G., Saakes, M., Sleutels, T.H.J.A., Hamelers, H.V.M., Buisman, C.J.N., 2012. Ammonium recovery and energy production from urine by a microbial fuel cell. *Water Res.* 46, 2627–2636. <https://doi.org/10.1016/j.watres.2012.02.025>
- Kunz, A., Mukhtar, S., 2016. HYDROPHOBIC MEMBRANE TECHNOLOGY FOR AMMONIA EXTRACTION FROM WASTEWATERS. *Eng. Agric.* 36, 377–386. <https://doi.org/10.1590/1809-4430-Eng.Agric.v36n2p377-386/2016>
- Kvarnström, E., Emilsson, K., Stintzing, A.R., Johansson, M., Jönsson, H., Petersens, E. af, Schönning, C., Christensen, J., Hellström, D., Qvamström, L., Ridderstolpe, P., Drangert, J.-O., 2006. Urine diversion: one step towards sustainable sanitation. Stockholm Environment Institute, Stockholm.
- Lafforgue, M., Lenouvel, V., 2015. Closing the urban water loop: lessons from Singapore and Windhoek. *Environ. Sci. Water Res. Technol.* 1, 622–631. <https://doi.org/10.1039/C5EW00056D>
- Lam, L., Kurisu, K., Hanaki, K., 2015. Comparative environmental impacts of source-separation systems for domestic wastewater management in rural China. *J. Clean. Prod.* 104, 185–198. <https://doi.org/10.1016/j.jclepro.2015.04.126>
- Lamaze, B., Lasseur, C., 2019. Personal Communication.
- Landry, K.A., Boyer, T.H., 2016. Life cycle assessment and costing of urine source separation: Focus on nonsteroidal anti-inflammatory drug removal. *Water Res.* 105, 487–495. <https://doi.org/10.1016/j.watres.2016.09.024>
- Larsen, T.A., Gujer, W. (Eds.), 2013. Implementation of source separation and decentralization in cities, in: *Source Separation and Decentralization for Wastewater Management*. IWA Publ, London.
- Larsen, T.A., Gujer, W., 1996. Separate management of anthropogenic nutrient solutions (human urine). *Water Sci. Technol.* 34, 87–94.

- Larsen, T.A., Lienert, J., 2007. Novaquatis final report. NoMix – A new approach to urban water management. Eawag, 8600 Duebendorf, Switzerland.
- Larsen, T.A., Udert, K.M., Lienert, J. (Eds.), 2013. Source separation and decentralization for wastewater management. IWA Publ, London.
- Lauterböck, B., Ortner, M., Haider, R., Fuchs, W., 2012. Counteracting ammonia inhibition in anaerobic digestion by removal with a hollow fiber membrane contactor. *Water Res.* 46, 4861–4869. <https://doi.org/10.1016/j.watres.2012.05.022>
- Le Corre, K.S., Valsami-Jones, E., Hobbs, P., Parsons, S.A., 2009. Phosphorus Recovery from Wastewater by Struvite Crystallization: A Review. *Crit. Rev. Environ. Sci. Technol.* 39, 433–477. <https://doi.org/10.1080/10643380701640573>
- Lesjean, B., Gnirss, R., 2006. Grey water treatment with a membrane bioreactor operated at low SRT and low HRT. *Desalination* 199, 432–434. <https://doi.org/10.1016/j.desal.2006.03.204>
- Lhuissier, L., Lamblin, V., Sauquet, E., Arama, Y., Goulard, F., Strosser, P., 2016. Retour sur l'étude prospective Garonne 2050. *Houille Blanche* 30–35. <https://doi.org/10.1051/lhb/2016057>
- Li, F., Wichmann, K., Otterpohl, R., 2009. Review of the technological approaches for grey water treatment and reuses. *Sci. Total Environ.* 407, 3439–3449. <https://doi.org/10.1016/j.scitotenv.2009.02.004>
- Lienert, J., Bürki, T., Escher, B.I., 2007a. Reducing micropollutants with source control: substance flow analysis of 212 pharmaceuticals in faeces and urine. *Water Sci. Technol.* 56, 87. <https://doi.org/10.2166/wst.2007.560>
- Lienert, J., Güdel, K., Escher, B.I., 2007b. Screening Method for Ecotoxicological Hazard Assessment of 42 Pharmaceuticals Considering Human Metabolism and Excretory Routes. *Environ. Sci. Technol.* 41, 4471–4478. <https://doi.org/10.1021/es0627693>
- Lienert, J., Larsen, T.A., 2010. High Acceptance of Urine Source Separation in Seven European Countries: A Review. *Environ. Sci. Technol.* 44, 556–566. <https://doi.org/10.1021/es9028765>
- Lienert, J., Thiemann, K., Kaufmann-Hayoz, R., Larsen, T.A., 2006. Young users accept NoMix toilets – a questionnaire survey on urine source separating toilets in a college in Switzerland. *Water Sci. Technol.* 54, 403–412. <https://doi.org/10.2166/wst.2006.920>
- Lundin, M., Bengtsson, M., Molander, S., 2000. Life Cycle Assessment of Wastewater Systems: Influence of System Boundaries and Scale on Calculated Environmental Loads. *Environ. Sci. Technol.* 34, 180–186. <https://doi.org/10.1021/es990003f>
- Malila, R., Lehtoranta, S., Viskari, E.-L., 2019. The role of source separation in nutrient recovery – Comparison of alternative wastewater treatment systems. *J. Clean. Prod.* 219, 350–358. <https://doi.org/10.1016/j.jclepro.2019.02.024>
- Matassa, S., Batstone, D.J., Hülsen, T., Schnoor, J., Verstraete, W., 2015. Can Direct Conversion of Used Nitrogen to New Feed and Protein Help Feed the World? *Environ. Sci. Technol.* 49, 5247–5254. <https://doi.org/10.1021/es505432w>
- Maurer, M., Pronk, W., Larsen, T.A., 2006. Treatment processes for source-separated urine. *Water Res.* 40, 3151–3166. <https://doi.org/10.1016/j.watres.2006.07.012>
- Maurer, M., Schwegler, P., Larsen, T.A., 2003. Nutrients in urine: energetic aspects of removal and recovery. *Water Sci. Technol. J. Int. Assoc. Water Pollut. Res.* 48, 37–46.
- Mbaya, A.M.K., Dai, J., Chen, G.-H., 2017. Potential benefits and environmental life cycle assessment of equipping buildings in dense cities for struvite production from source-separated human urine. *J. Clean. Prod.* 143, 288–302. <https://doi.org/10.1016/j.jclepro.2016.12.111>
- Meinzinger, F., Otterpohl, R., Londong, J., 2010a. Resource efficiency of urban sanitation systems: a comparative assessment using material and energy flow analysis, Hamburger

- Berichte zur Siedlungswasserwirtschaft. Ges. zur Förderung und Entwicklung der Umwelttechnologien an der Techn. Univ. Hamburg-Harburg, Hamburg.
- Meinzinger, F., Ziedorn, V., Peters, I., 2010b. Interactions Between Urban Forms and Source-Separating Sanitation Technologies, in: van Vliet, B., Spaargaren, G., Oosterveer, P. (Eds.), *Social Perspectives on the Sanitation Challenge*. Springer Netherlands, Dordrecht, pp. 125–144. https://doi.org/10.1007/978-90-481-3721-3_8
- Merz, C., Scheumann, R., El Hamouri, B., Kraume, M., 2007. Membrane bioreactor technology for the treatment of greywater from a sports and leisure club. *Desalination* 215, 37–43. <https://doi.org/10.1016/j.desal.2006.10.026>
- Mihelcic, J.R., Fry, L.M., Shaw, R., 2011. Global potential of phosphorus recovery from human urine and feces. *Chemosphere, The Phosphorus Cycle* 84, 832–839. <https://doi.org/10.1016/j.chemosphere.2011.02.046>
- Miszta-Kruk, K., 2016. Reliability and failure rate analysis of pressure, vacuum and gravity sewer systems based on operating data. *Eng. Fail. Anal.* 61, 37–45. <https://doi.org/10.1016/j.engfailanal.2015.07.034>
- Mo, W., Zhang, Q., 2013. Energy–nutrients–water nexus: Integrated resource recovery in municipal wastewater treatment plants. *J. Environ. Manage.* 127, 255–267. <https://doi.org/10.1016/j.jenvman.2013.05.007>
- Montes, F., Rotz, C.A., Chaoui, H., 2009. Process modeling of ammonia volatilization from ammonium solution and manure surfaces: review with recommended models. *Trans. ASABE* 52, 1707–1719.
- Nagy, J., Kaljunen, J., Toth, A.J., 2019. Nitrogen recovery from wastewater and human urine with hydrophobic gas separation membrane: experiments and modelling. *Chem. Pap.* 73, 1903–1915. <https://doi.org/10.1007/s11696-019-00740-x>
- Naret, R., 2007. Vacuum Sewers – Design and Installation Guidelines (No. n° C-8015), PDHengineer Course.
- Nolde, E., 2000. Greywater reuse systems for toilet flushing in multi-storey buildings – over ten years experience in Berlin. *Urban Water* 1, 275–284. [https://doi.org/10.1016/S1462-0758\(00\)00023-6](https://doi.org/10.1016/S1462-0758(00)00023-6)
- Norton, M., 2000. *Introductory Concepts in Information Science*. Information Today, Inc.
- Norton-Brandão, D., Scherrenberg, S.M., van Lier, J.B., 2013. Reclamation of used urban waters for irrigation purposes – A review of treatment technologies. *J. Environ. Manage.* 122, 85–98. <https://doi.org/10.1016/j.jenvman.2013.03.012>
- Oldenburg, M., Peter-Fröhlich, A., Dlabacs, C., Pawlowski, L., Bonhomme, A., 2007. EU demonstration project for separate discharge and treatment of urine, faeces and greywater – Part II: Cost comparison of different sanitation systems. *Water Sci. Technol.* 56, 251. <https://doi.org/10.2166/wst.2007.578>
- Oldenburg, M., Werner, C., Schlick, J., Klingel, F., 2009. Urban urine diversion and greywater treatment system Linz, Austria - Case study of sustainable sanitation projects. Sustainable Sanitation Alliance (SuSanA).
- Oost, R.T.V., 2011. Windesheim vervangt duurzame toiletpotten [WWW Document]. RTV Oost. URL <https://www.rtvooost.nl/pl.aspx?nid=129797> (accessed 9.7.18).
- Opher, T., Friedler, E., 2016. Comparative LCA of decentralized wastewater treatment alternatives for non-potable urban reuse. *J. Environ. Manage.* 182, 464–476. <https://doi.org/10.1016/j.jenvman.2016.07.080>
- Oteng-Peprah, M., Acheampong, M.A., deVries, N.K., 2018. Greywater Characteristics, Treatment Systems, Reuse Strategies and User Perception—a Review. *Water. Air. Soil Pollut.* 229. <https://doi.org/10.1007/s11270-018-3909-8>
- OtterWasser GmbH, 2009. Ecological housing estate, Flintenbreite, Lübeck, Germany (Case study of sustainable sanitation projects), Sustainable Sanitation Alliance (SuSanA).

- Peng, L., Ni, B.-J., Erler, D., Ye, L., Yuan, Z., 2014. The effect of dissolved oxygen on N₂O production by ammonia-oxidizing bacteria in an enriched nitrifying sludge. *Water Res.* 66, 12–21. <https://doi.org/10.1016/j.watres.2014.08.009>
- Peter-Fröhlich, A., Bonhomme, A., Oldenburg, M., 2007a. Sanitation concepts for separate treatment of urine, faeces and greywater (SCST) (Final report: EU-demonstration project No. Contract: LIFE03ENV/D000025). KompetenzZentrum Wasser Berlin gGmbH.
- Peter-Fröhlich, A., Pawlowski, L., Bonhomme, A., Oldenburg, M., 2007b. EU demonstration project for separate discharge and treatment of urine, faeces and greywater – Part I: Results. *Water Sci. Technol.* 56, 239–249. <https://doi.org/10.2166/wst.2007.577>
- Petit-Boix, A., Sanjuan-Delmás, D., Gasol, C.M., Villalba, G., Suárez-Ojeda, M.E., Gabarrell, X., Josa, A., Rieradevall, J., 2014. Environmental Assessment of Sewer Construction in Small to Medium Sized Cities Using Life Cycle Assessment. *Water Resour. Manag.* 28, 979–997. <https://doi.org/10.1007/s11269-014-0528-z>
- Pidou, M., Memon, F.A., Stephenson, T., Jefferson, B., Jeffrey, P., 2007. Greywater recycling: treatment options and applications. *Proc. Inst. Civ. Eng. - Eng. Sustain.* 160, 119–131. <https://doi.org/10.1680/ensu.2007.160.3.119>
- P&MA, 2019a. La collecte des urines : préfiguration du futur quartier | Paris & Métropole Aménagement [WWW Document]. URL <https://www.paris-et-metropole-amenagement.fr/fr/la-collecte-des-urines-prefiguration-du-futur-quartier-319> (accessed 11.25.19).
- P&MA, 2019b. Saint-Vincent-de-Paul. Faire Paris autrement. Direction de la communication de Paris et Métropole Aménagement, Paris.
- Pronk, M., Bassin, J.P., de Kreuk, M.K., Kleerebezem, R., van Loosdrecht, M.C.M., 2014. Evaluating the main and side effects of high salinity on aerobic granular sludge. *Appl. Microbiol. Biotechnol.* 98, 1339–1348. <https://doi.org/10.1007/s00253-013-4912-z>
- Pronk, M., de Kreuk, M.K., de Bruin, B., Kamminga, P., Kleerebezem, R., van Loosdrecht, M.C.M., 2015. Full scale performance of the aerobic granular sludge process for sewage treatment. *Water Res.* 84, 207–217. <https://doi.org/10.1016/j.watres.2015.07.011>
- Pronk, W., Zuleeg, S., Lienert, J., Escher, B., Koller, M., Berner, A., Koch, G., Boller, M., 2007. Pilot experiments with electrodialysis and ozonation for the production of a fertiliser from urine. *Water Sci. Technol.* 56, 219–227. <https://doi.org/10.2166/wst.2007.575>
- Puyol, D., Batstone, D.J., Hülsen, T., Astals, S., Peces, M., Krömer, J.O., 2017. Resource Recovery from Wastewater by Biological Technologies: Opportunities, Challenges, and Prospects. *Front. Microbiol.* 7. <https://doi.org/10.3389/fmicb.2016.02106>
- Raffin, M., Germain, E., Judd, S., 2013. Wastewater polishing using membrane technology: a review of existing installations. *Environ. Technol.* 34, 617–627. <https://doi.org/10.1080/09593330.2012.710385>
- Rauch, W., Brockmann, D., Peters, I., Larsen, T.A., Gujer, W., 2003. Combining urine separation with waste design: an analysis using a stochastic model for urine production. *Water Res.* 37, 681–689. [https://doi.org/10.1016/S0043-1354\(02\)00364-0](https://doi.org/10.1016/S0043-1354(02)00364-0)
- Remy, C., 2010. Life cycle assessment of conventional and source separation systems for urban wastewater management. <https://doi.org/10.14279/depositonce-2370>
- Remy, C., Jekel, M., 2008. Sustainable wastewater management: life cycle assessment of conventional and source-separating urban sanitation systems. *Water Sci. Technol.* 58, 1555. <https://doi.org/10.2166/wst.2008.533>
- Risch, E., Gutierrez, O., Roux, P., Boutin, C., Corominas, L., 2015. Life cycle assessment of urban wastewater systems: Quantifying the relative contribution of sewer systems. *Water Res.* 77, 35–48. <https://doi.org/10.1016/j.watres.2015.03.006>

- Roediger Vacuum, 2012. Vacuum sewer systems. Construction manual. Bilfinger Berger.
- Roefs, I., Meulman, B., Vreeburg, J.H.G., Spiller, M., 2017. Centralised, decentralised or hybrid sanitation systems? Economic evaluation under urban development uncertainty and phased expansion. *Water Res.* 109, 274–286. <https://doi.org/10.1016/j.watres.2016.11.051>
- Ros, E., 2017. The process of urban systems integration (Master thesis). Master Management in the Built Environment at the Faculty of Architecture, Amsterdam, Netherlands.
- Roux, P., Mur, I., Risch, E., Boutin, C., 2011. Urban planning of sewer infrastructure: Impact of population density and land topography on environmental performances of wastewater treatment systems, in: Proceedings of the LCM 2011 International Conference on Life Cycle Management, Berlin, Germany.
- Sabatier, V., 2010. *Forme d’habitat et densités urbaines*.
- Santana, M.V.E., Cornejo, P.K., Rodríguez-Roda, I., Buttiglieri, G., Corominas, L., 2019. Holistic life cycle assessment of water reuse in a tourist-based community. *J. Clean. Prod.* 233, 743–752. <https://doi.org/10.1016/j.jclepro.2019.05.290>
- Shi, Y., Zhou, L., Xu, Y., Zhou, H., Shi, L., 2018. Life cycle cost and environmental assessment for resource-oriented toilet systems. *J. Clean. Prod.* 196, 1188–1197. <https://doi.org/10.1016/j.jclepro.2018.06.129>
- Skambraks, A.-K., Kjerstadius, H., Meier, M., Davidsson, Å., Wuttke, M., Giese, T., 2017. Source separation sewage systems as a trend in urban wastewater management: Drivers for the implementation of pilot areas in Northern Europe. *Sustain. Cities Soc.* 28, 287–296. <https://doi.org/10.1016/j.scs.2016.09.013>
- SQAE, 1994. *Assainissement des eaux usées dans les petites collectivités : techniques particulières de collecte des eaux usées. Volume 3 : Le réseau d’égouts sous vide*. SQAE, Menviq, EAT Environnement.
- Steffen, W., Richardson, K., Rockstrom, J., Cornell, S.E., Fetzer, I., Bennett, E.M., Biggs, R., Carpenter, S.R., de Vries, W., de Wit, C.A., Folke, C., Gerten, D., Heinke, J., Mace, G.M., Persson, L.M., Ramanathan, V., Reyers, B., Sorlin, S., 2015. Planetary boundaries: Guiding human development on a changing planet. *Science* 347, 1259855–1259855. <https://doi.org/10.1126/science.1259855>
- STOWA, 2014. *Nieuwe Sanitatie op Wijkniveau: Ervaringen met de toegepaste technologie op de demo-site Lemmerweg-Oost in Sneek (New Sanitation at District level: Experiences with the applied technology at the demo site Lemmerweg-Oost in Sneek) (No. W02)*. STOWA.
- STOWA, 2002. *Separate urine collection and treatment - Options for sustainable wastewater systems and mineral recovery*. STOWA, Utrecht, Netherlands.
- Tervahauta, T., Bryant, I., Leal, L., Buisman, C., Zeeman, G., 2014. Improved Energy Recovery by Anaerobic Grey Water Sludge Treatment with Black Water. *Water* 6, 2436–2448. <https://doi.org/10.3390/w6082436>
- Tervahauta, T., Hoang, T., Hernández, L., Zeeman, G., Buisman, C., 2013. Prospects of Source-Separation-Based Sanitation Concepts: A Model-Based Study. *Water* 5, 1006–1035. <https://doi.org/10.3390/w5031006>
- Thibodeau, C., Monette, F., Bulle, C., Glaus, M., 2014a. Comparison of black water source-separation and conventional sanitation systems using life cycle assessment. *J. Clean. Prod.* 67, 45–57. <https://doi.org/10.1016/j.jclepro.2013.12.012>
- Thibodeau, C., Monette, F., Glaus, M., 2014b. Comparison of development scenarios of a black water source-separation sanitation system using life cycle assessment and environmental life cycle costing. *Resour. Conserv. Recycl.* 92, 38–54. <https://doi.org/10.1016/j.resconrec.2014.08.004>

- Thibodeau, C., Monette, F., Glaus, M., Laflamme, C.B., 2011. Economic viability and critical influencing factors assessment of black water and grey water source-separation sanitation system. *Water Sci. Technol.* 64, 2417. <https://doi.org/10.2166/wst.2011.796>
- Tidåker, P., Mattsson, B., Jönsson, H., 2007. Environmental impact of wheat production using human urine and mineral fertilisers – a scenario study. *J. Clean. Prod.* 15, 52–62. <https://doi.org/10.1016/j.jclepro.2005.04.019>
- Tilley, E., Ulrich, L., Lüthi, C., Raymond, P., Zurbrügg, C., 2014. *Compendium of Sanitation Systems and Technologies*, 2nd Revised Edition. ed. Swiss Federal Institute of Aquatic Science and Technology (Eawag), Dübendorf.
- Tornay, N., Schoetter, R., Bonhomme, M., Faraut, S., Masson, V., 2017. GENIUS: A methodology to define a detailed description of buildings for urban climate and building energy consumption simulations. *Urban Clim.* 20, 75–93. <https://doi.org/10.1016/j.uclim.2017.03.002>
- Udert, K. M., Fux, C., Münster, M., Larsen, T.A., Siegrist, H., Gujer, W., 2003. Nitrification and autotrophic denitrification of source-separated urine. *Water Sci. Technol. J. Int. Assoc. Water Pollut. Res.* 48, 119–130.
- Udert, K.M., Jenni, S. (Eds.), 2013. *Biological nitrogen conversion processes*, in: *Source Separation and Decentralization for Wastewater Management*. IWA Publ, London.
- Udert, Kai M., Larsen, T.A., Gujer, W., 2003. Estimating the precipitation potential in urine-collecting systems. *Water Res.* 37, 2667–2677. [https://doi.org/10.1016/S0043-1354\(03\)00071-X](https://doi.org/10.1016/S0043-1354(03)00071-X)
- Udert, K.M., Wächter, M., 2012. Complete nutrient recovery from source-separated urine by nitrification and distillation. *Water Res.* 46, 453–464. <https://doi.org/10.1016/j.watres.2011.11.020>
- Ueno, Y., Fujii, M., 2001. Three Years Experience of Operating and Selling Recovered Struvite from Full-Scale Plant. *Environ. Technol.* 22, 1373–1381. <https://doi.org/10.1080/09593332208618196>
- van de Ven, F., 2013. De pot op met scheidings toiletten [WWW Document]. Goeie Zaken. URL <http://www.goeie-zaken.online/artikel/De-pot-op-met-scheidings toiletten> (accessed 11.19.19).
- van der Hoek, J., Duijff, R., Reinstra, O., 2018. Nitrogen Recovery from Wastewater: Possibilities, Competition with Other Resources, and Adaptation Pathways. *Sustainability* 10, 4605. <https://doi.org/10.3390/su10124605>
- van Eck, N.J., Waltman, L., 2010. Software survey: VOSviewer, a computer program for bibliometric mapping. *Scientometrics* 84, 523–538. <https://doi.org/10.1007/s11192-009-0146-3>
- van Merksteijn, C.J.M., 2016. *Smart renovation of Dutch residential housing and residential infrastructure for closed-loop, future proof water & nutrient management* (Master thesis). Wageningen University, Wageningen, Netherlands.
- Vasilaki, V., Massara, T.M., Stanchev, P., Fatone, F., Katsou, E., 2019. A decade of nitrous oxide (N₂O) monitoring in full-scale wastewater treatment processes: A critical review. *Water Res.* 161, 392–412. <https://doi.org/10.1016/j.watres.2019.04.022>
- Vinnerås, B., 2002. *Possibilities for sustainable nutrient recycling by faecal separation combined with urine diversion*, Acta Universitatis Agriculturae Sueciae Agraria. Swedish Univ. of Agricultural Sciences, Uppsala.
- Vinneras, B., Jönsson, H., 2013. The Swedish experience with source separation, in: *Source Separation and Decentralization for Wastewater Management*. IWA Publishing, London, New York.

- Vinnerås, B., Palmquist, H., Balmér, P., Jönsson, H., 2006. The characteristics of household wastewater and biodegradable solid waste—A proposal for new Swedish design values. *Urban Water J.* 3, 3–11. <https://doi.org/10.1080/15730620600578629>
- Ward, A.J., Arola, K., Thompson Brewster, E., Mehta, C.M., Batstone, D.J., 2018. Nutrient recovery from wastewater through pilot scale electro dialysis. *Water Res.* 135, 57–65. <https://doi.org/10.1016/j.watres.2018.02.021>
- Watercare, 2018. Vacuum Wastewater Systems Standard. Watercare, an auckland council organisation, Auckland, New Zealand.
- Wendland, C., Deegener, S., Behrendt, J., Toshev, P., Otterpohl, R., 2007. Anaerobic digestion of blackwater from vacuum toilets and kitchen refuse in a continuous stirred tank reactor (CSTR). *Water Sci. Technol.* 55, 187–194. <https://doi.org/10.2166/wst.2007.144>
- Wilsenach, J.A., Schuurbijs, C.A.H., van Loosdrecht, M.C.M., 2007. Phosphate and potassium recovery from source separated urine through struvite precipitation. *Water Res.* 41, 458–466. <https://doi.org/10.1016/j.watres.2006.10.014>
- Wilsenach, J.A., van Loosdrecht, M.C., 2006. Integration of Processes to Treat Wastewater and Source-Separated Urine. *J. Environ. Eng.* 132, 331–341. [https://doi.org/10.1061/\(ASCE\)0733-9372\(2006\)132:3\(331\)](https://doi.org/10.1061/(ASCE)0733-9372(2006)132:3(331))
- Winker, M., 2013. Susana Forum: Roediger NoMix toilets - good or bad? And SANIRESCH final report (urine diversion project with UD flush toilets and treatment reactors in Eschborn, Germany). available at <https://forum.susana.org/urine-diversion-flush-toilets/3406-roediger-nomix-toilets-good-or-bad-and-saniresch-final-report-urine-diversion-project-with-ud-flush-toilets-and-treatment-reactors-in-eschborn-germany?start=12>.
- Winker, M., 2009. Pharmaceutical Residues in Urine and Potential Risks related to Usage as Fertiliser in Agriculture. Technische Universität Hamburg, Hamburg, Germany.
- Winker, M., Rieck, C., Arnold, U., Spooth, K., Schümann, B., Montag, D., Pinnekamp, J., Romich, M., Schiele, L., Wortmann, C., Röhricht, M., Heynemann, J., Paris, S., Netter, T., Freicht, M., Walberer, J., Schlapp, C., Rüster, C., 2013. Schlussbericht des BMBF-Projekt SanitärRecycling Eschborn (SANIRESCH) (Final report of the BMBF projekt SanitaryRecycling Eschborn (SANIRESCH)). Deutsche Gesellschaft für Internationale Zusammenarbeit (GIZ) GmbH; University of Bonn; RWTH Aachen; THM University of Applied Sciences; HUBER SE; Roediger Vacuum GmbH, Karlsruhe, Germany.
- Winward, G.P., Avery, L.M., Frazer-Williams, R., Pidou, M., Jeffrey, P., Stephenson, T., Jefferson, B., 2008. A study of the microbial quality of grey water and an evaluation of treatment technologies for reuse. *Ecol. Eng.* 32, 187–197. <https://doi.org/10.1016/j.ecoleng.2007.11.001>
- WWAP, 2017. The United Nations World Water Development Report 2017. Wastewater: The Untapped Resource., UNESCO. ed. United Nations World Water Assessment Programme, Paris.
- Xiu-Fen, L., Barnes, D., Jian, C., 2011. Performance of struvite precipitation during pretreatment of raw landfill leachate and its biological validation. *Environ. Chem. Lett.* 9, 71–75. <https://doi.org/10.1007/s10311-009-0248-4>
- Xue, X., Hawkins, T., Schoen, M., Garland, J., Ashbolt, N., 2016. Comparing the Life Cycle Energy Consumption, Global Warming and Eutrophication Potentials of Several Water and Waste Service Options. *Water* 8, 154. <https://doi.org/10.3390/w8040154>
- Zamora, P., Georgieva, T., Salcedo, I., Elzinga, N., Kuntke, P., Buisman, C.J., 2017a. Long-term operation of a pilot-scale reactor for phosphorus recovery as struvite from source-separated urine. *J. Chem. Technol. Biotechnol.* 92, 1035–1045. <https://doi.org/10.1002/jctb.5079>

- Zamora, P., Georgieva, T., Ter Heijne, A., Sleutels, T.H.J.A., Jeremiasse, A.W., Saakes, M., Buisman, C.J.N., Kuntke, P., 2017b. Ammonia recovery from urine in a scaled-up Microbial Electrolysis Cell. *J. Power Sources* 356, 491–499. <https://doi.org/10.1016/j.jpowsour.2017.02.089>
- Zanni, S., Cipolla, S.S., Fusco, E. di, Lenci, A., Altobelli, M., Currado, A., Maglionico, M., Bonoli, A., 2019. Modeling for sustainability: Life cycle assessment application to evaluate environmental performance of water recycling solutions at the dwelling level. *Sustain. Prod. Consum.* 17, 47–61. <https://doi.org/10.1016/j.spc.2018.09.002>
- Zarebska, A., Karring, H., Christensen, M.L., Hjorth, M., Christensen, K.V., Norddahl, B., 2017. Ammonia Recovery from Pig Slurry Using a Membrane Contactor—Influence of Slurry Pretreatment. *Water. Air. Soil Pollut.* 228, 150. <https://doi.org/10.1007/s11270-017-3332-6>
- Zhang, J., Xie, M., Tong, X., Liu, S., Qu, D., Xiao, S., 2020. Recovery of ammonium nitrogen from human urine by an open-loop hollow fiber membrane contactor. *Sep. Purif. Technol.* 239, 116579. <https://doi.org/10.1016/j.seppur.2020.116579>

List of tables and figures.

Table I-1: Composition of the three studied corpus	11
Table I-2: Comparison of recovery efficiencies for several processes for nutrients and COD recovery with their energy consumption (in negative value) or the production (in positive value).....	29
Table II-1: Parameters used for district generation for each urban configuration from (Bonhomme, 2013).....	53
Table II-2: Comparison of inhabitant density with literature data	54
Table II-3: Building/Group parameter for urban configuration (from (Bonhomme, 2013)) ...	55
Table II-4: Inhabitant density along different urban configurations	55
Table II-5: Influent characteristics for domestic wastewater production.....	57
Table II-6: Default value for calculation of number of use of toilet	58
Table II-7: Design parameters for UASB treating blackwater.....	69
Table II-8: Reported energy consumption for struvite precipitation.....	70
Table II-9: Design parameters for struvite fluidized bed reactors (Roefs et al., 2017).....	71
Table III-1: Influent characteristics for each scenario.....	91
Table III-2: conversion factor in primary energy expressed in tonne of oil equivalent (toe) ..	95
Table III-3: Recovery rates for each scenario and each compound at district scale	97
Table III-4: Comparison of COD recovery rates with and without methanol contribution for each scenario at district scale	98
Table V-1: Percentage of green area in each urban configurations (Bonhomme, 2013).....	161
Figure I-1: Nomenclature of domestic wastewater streams (adapted from (Tilley et al., 2014))	7
Figure I-2: Publication per year, A) with the subject treated (urine, blackwater and greywater concerns the publication with only one term, U+G: urine and greywater, B+G: blackwater and greywater, B+U: blackwater and urine, All: urine, blackwater and greywater. B) Contribution analysis, if international publication, the publication counts only as the ratio of number of countries.	10
Figure I-3: Co-occurrence map of keywords established by authors and Web of Science®. (Binary counting: the number of occurrence of keyword in the article is not taken into account only the presence or absence).....	11

Figure I-4: Map of co-authorship with a minimum of 5 documents per author, with colorimetric scale of average publication year.	12
Figure I-5: Map of co-authorship link in the blackwater corpus, countries match the clusters, with colorimetric scale of average publication year.	13
Figure I-6: Keyword co-occurrence map for blackwater corpus	14
Figure I-7: Map of co-authorship link in the greywater corpus, with the country.	15
Figure I-8: Keyword co-occurrence map for greywater corpus	16
Figure I-9: Evolution of pilot projects regarding their scale and the type of separation (not an exhaustive list).....	19
Figure I-10: Different models of urine diverting toilets. A) Dubbletten – BB innovation & Co AB (Johansson, 2000), B) Sealskin toilets (Oost, 2011), Wost Man ecoflush https://www.wostman.se/en/ecoflush , D) Gustavsberg Credit: Ulrich 2009, E) Roediger No Mix Credit: Ruedi Keller, F) Save! From Laufen Credit: © Laufen	24
Figure I-11: Urine trap of save! Toilet © Eoos	25
Figure I-12: Calculated urine recovery rate	26
Figure I-13: Simplified representation of recovery pathways targeted towards nutrient recovery from human excreta and streams containing human excreta, from (Harder et al., 2019) Abbreviations: BIO.TREAT: biological treatment; BIO.DEC: biological decomposition; TH.DEC: thermal decomposition; STAB: stabilization; W.EXT: water extraction; CONT.RED: contaminant reduction; NUT.EXT: nutrient extraction	28
Figure II-1: General methodology of the developed tool for one scenario compared to the reference	44
Figure II-2: Summary of the main aspects taken into account in each block of simulation and the link with the relevant appendix.	46
Figure II-3 Presentation of the four scenarios and the WRRF. WRRF: Wastewater recovery facility, AD: Anaerobic digester, PPTSTRU: Struvite precipitation, TMCS: transmembrane chemisorption, UASB: upflow active sludge blanket, MBR: membrane bioreactor, ANAER: anaerobic tank, ANOX: anoxic tank, AER: aerated tank, PANOX: post-anoxic tank, PAER: post aerobic tank, THK: thickening, PTHK: post-thickening, DW: dewatering.	47
Figure II-4: Extended system boundaries for LCA (adapted from (Bisinella de Faria et al., 2015))	51
Figure II-5: Simplified morphology for each urban configuration (illustration from (Bonhomme, 2013))	52
Figure II-6: Trench design.....	60
Figure II-7: life cycle inventory of gravity sewer	60
Figure II-8: Saw tooth pattern of vacuum sewer (adapted from (Bowne et al., 1991; Naret, 2007))	61
Figure II-9: Vacuum trench design with gravity sewer.....	63
Figure II-10: Process chain of the upgraded WRRF	66
Figure II-11: TMCS principles of operation (adapted from (Darestani et al., 2017)).....	72
Figure II-12: Transfer rate coefficient of ammonia in TMCS (Ahn et al., 2011; Ashrafizadeh and Khorasani, 2010; Lauterböck et al., 2012; Zarebska et al., 2017).....	72
Figure II-13: Process description of TMCS	73
Figure II-14: Building density for each urban configuration	77
Figure II-15: Human density versus flowrates of greywater and blackwater	78
Figure II-16: Energy consumption for both networks: A) Gravity sewer and B) Vacuum sewer, in case of blackwater and greywater separation.....	79

Figure II-17: Correlation Matrix for specific production in housing or office	80
Figure II-18: production of influent (A: all wastewater, B: blackwater from vacuum toilet and C) urine with separated toilet) for each urban configuration.	81
Figure III-1: General methodology followed in the study	88
Figure III-2: Map of the modelled district of discontinuous buildings typology.....	89
Figure III-3 Presentation of the four scenario and the WRRF. WRRF: Wastewater recovery facility, AD: Anaerobic digester, PPTSTRU: Struvite precipitation, TMCS: transmembrane chemisorption, UASB: upflow active sludge blanket, MBR: membrane bioreactor, ANAER: anaerobic tank, ANOX: anoxic tank, AER: aerated tank, PANOX: post-anoxic tank, PAER: post aerobic tank, THK: thickening, PTHK: post-thickening, DW: dewatering.	90
Figure III-4: Description of WRRF operation.....	92
Figure III-5: Extended system boundaries for LCA (adapted from (Bisinella de Faria et al., 2015))	95
Figure III-6: PAO concentration and iron chloride ratio compared to ratio of soluble biodegradable COD and TP entering anaerobic tank.....	97
Figure III-7: Mass flow of nitrogen in the treatments system at district scale.....	100
Figure III-8: Mass flow of phosphorus in the treatments system at district scale.....	100
Figure III-9: Mass flow of COD in the treatments system at district scale.....	101
Figure III-10: Electricity balance for each scenario taking into account transport and treatment needs and production.....	104
Figure III-11: Electricity consumption at WRRF for each scenario with only the contribution of the district. THK: thickening, PreTMCS: pre-treatments for TMCS, DW: dewatering, mix: mixing.....	105
Figure III-12: Energy balance expressed in tonne of oil equivalent (toe). A negative balance is achieved when production is higher than consumption.	106
<i>Figure III-13: Endpoint results for ecosystems quality, human health and resources depletion impact categories</i>	<i>109</i>
<i>Figure III-14: Normalised comparison of all scenarios to the reference scenario, for each category of impact at midpoint level (ReCiPe H). ALOP: agricultural land occupation, GWP100: climate change, FDP: fossil depletion, FETPinf: freshwater ecotoxicity, FEP: freshwater eutrophication, HTPinf: human toxicity, IRP_HE: ionising radiation, METPinf: marine ecotoxicity, MEP: marine eutrophication, MDP: metal depletion, NLTP: natural land transformation, ODPinf: ozone depletion, PMFP: particulate matter formation, POFP: photochemical oxidant formation, TAP100: terrestrial acidification, TETPinf terrestrial ecotoxicity, ULOP: urban land occupation, WDP: water depletion.</i>	<i>110</i>
Figure III-15: Ratio of midpoint categories which present better or worse results compare to Reference with the name of the retained categories.GWP100: climate change, FDP: fossil depletion, HTPinf: human toxicity, MEP: marine eutrophication, PMFP: particulate matter formation, TETPinf terrestrial ecotoxicity.	111
<i>Figure III-16: Comparison of the four scenarios on climate change impact (ReCiPe Midpoint H).....</i>	<i>112</i>
<i>Figure III-17: Comparison of freshwater eutrophication impact for all four scenarios (Reference, Urine, BW and BW-GW).....</i>	<i>114</i>
<i>Figure III-18: Comparison of marine eutrophication impact for all four scenarios (Reference, Urine, BW and BW-GW)</i>	<i>114</i>
Figure IV-1 Presentation of the four scenarios and the WRRF. WRRF: Wastewater recovery facility, AD: Anaerobic digester, PPTSTRU: Struvite precipitation, TMCS: transmembrane	

chemisorption, UASB: upflow active sludge blanket, MBR: membrane bioreactor, ANAER: anaerobic tank, ANOX: anoxic tank, AER: aerated tank, PANOX: post-anoxic tank, PAER: post aerobic tank, THK: thickening, PTHK: post-thickening, DW: dewatering. 125

Figure IV-2: Description of the reference flows (A) production of PE regarding the human density; B) treated PE in regards with the number of inhabitants and person including employees C); evolution with typology of treated wastewater D), mass flow of nitrogen E) and phosphorus F)..... 126

Figure IV-3: Nitrogen mass balance. DP: discontinuous pavilions, CP: continuous pavilions, DB: discontinuous buildings, CB: continuous buildings, CC: city centre, HT: high-rise tower 128

Figure IV-4: Phosphorus mass balance. DP: discontinuous pavilions, CP: continuous pavilions, DB: discontinuous buildings, CB: continuous buildings, CC: city centre, HT: high-rise tower 129

Figure IV-5: COD mass balance DP: discontinuous pavilions, CP: continuous pavilions, DB: discontinuous buildings, CB: continuous buildings, CC: city centre, HT: high-rise tower ... 130

Figure IV-6: COD distribution in the influent of each case study. 130

Figure IV-7: Chemicals consumption expressed in kg of molecule DP: discontinuous pavilions, CP: continuous pavilions, DB: discontinuous buildings, CB: continuous buildings, CC: city centre, HT: high-rise tower 131

Figure IV-8: Electricity balance at district scale and normalised by the number of PE treated DP: discontinuous pavilions, CP: continuous pavilions, DB: discontinuous buildings, CB: continuous buildings, CC: city centre, HT: high-rise tower 132

Figure IV-9: Heat balance at district scale and normalised by the number of PE treated. DP: discontinuous pavilions, CP: continuous pavilions, DB: discontinuous buildings, CB: continuous buildings, CC: city centre, HT: high-rise tower 134

Figure IV-10: Contribution to cumulative energy demand - fossil, non-renewable energy resources..... 136

Figure IV-11: Endpoint impact for all the scenarios and representing the different categories of damages. DP: discontinuous pavilions, CP: continuous pavilions, DB: discontinuous buildings, CB: continuous buildings, CC: city centre, HT: high-rise tower 137

Figure IV-12: Improvements for each alternative sanitation systems at endpoint impact. DP: discontinuous pavilions, CP: continuous pavilions, DB: discontinuous buildings, CB: continuous buildings, CC: city centre, HT: high-rise tower 138

Figure IV-13: Climate change impact for all scenario with 1PE as the functional unit. DP: discontinuous pavilions, CP: continuous pavilions, DB: discontinuous buildings, CB: continuous buildings, CC: city centre, HT: high-rise tower 139

Figure IV-14: Difference in climate change impact for each scenario compare to reference one regarding scale and typology. DP: discontinuous pavilions, CP: continuous pavilions, DB: discontinuous buildings, CB: continuous buildings, CC: city centre, HT: high-rise tower ... 140

Figure IV-15: Improvement for all the alternative systems compared to the reference for A) Marine eutrophication impact and B) freshwater eutrophication..... 141

Figure IV-16: Improvement of the different sanitation systems for each category of midpoint impacts. The red circle corresponds to the impact of reference. A higher value means a degradation and a lower means a benefit. DP: discontinuous pavilions, CP: continuous pavilions, DB: discontinuous buildings, CB: continuous buildings, CC: city centre, HT: high-rise tower 142

Figure V-1: Climate change impact of Urine scenario for the different urban configurations (extracted from chapter IV).....	152
Figure V-2: Vacuum sewer consumption compared to blackwater production DP: discontinuous pavilions, CP: continuous pavilions, DB: discontinuous buildings, CB: continuous buildings, CC: city centre, HT: high-rise tower	153
Figure V-3: Climate change impacts for BW scenario and different configurations. Sensitivity analysis on vacuum sewer consumption with the current value of the model and for 5.6 and 21 kWh/m ³ . DP: discontinuous pavilions, CP: continuous pavilions, DB: discontinuous buildings, CB: continuous buildings, CC: city centre, HT: high-rise tower	154
Figure V-4: Climate change impact of BW scenario different urban configurations (extracted from chapter IV).....	154
Figure V-5: Sensitivity analysis on heat balance A) with different collection (ULT: Ultra-low flush, KW: kitchen waste mixed with blackwater) or heat production with boiler or CHP as default. B) Corresponding operating conditions of TMCS for neutral heat balance.	155
Figure V-6: Climate change impact of BW-GW scenario for the different urban configurations (extracted from chapter IV).....	157
Figure V-7: Decrease in MBR energy consumption to reach in order to obtain the same climate change impact than reference, (for BW-GW system at 6.25 ha). DP: discontinuous pavilions, CP: continuous pavilions, DB: discontinuous buildings, CB: continuous buildings, CC: city centre, HT: high-rise tower	158
Figure V-8: Available space for reed bed filter (in green) in two case study: A) Continuous pavilions at 6.25 ha, B) Continuous buildings at 6.25 ha and C) High-rise tower at 6.25 ha	159
Figure V-9: Description of the reed bed filter design for each case study treating greywater only. A) Surface necessary for the reed bed filter, B) number of plot necessary in each urban configuration to reach this surface (CB and CC are excluded as not relevant). DP: discontinuous pavilions, CP: continuous pavilions, DB: discontinuous buildings, CB: continuous buildings, CC: city centre, HT: high-rise tower	160
Figure V-10: Recovery rate of greywater as irrigation water at annual basis (for 6 ha district)	161

Appendices

Table of Appendices

Appendix I. Description and results of bibliometric analysis	1
I.1 Research performed.....	1
I.2 Results	1
I.3 References	6
Appendix II. Description of pilot projects	10
II.1 Summary of pilot projects.....	10
II.2 Urine recovery rate calculation	15
Appendix III. Literature review on source separation systems assessment	18
Appendix IV. Creation of the district.....	24
Appendix V. Literature review for influent characteristics	26
V.1 Literature review on urine composition and production.....	26
V.2 Literature review on faeces composition and production.....	34
V.3 Literature review on greywater composition and production.....	37
V.4 References.....	40
Appendix VI. Toilet use survey in a building of LISBP, Toulouse France, May 2017	44
Appendix VII. Transport design.....	45
VII.1 Gravity sewer design.....	45
VII.2 Vacuum sewer design	51
VII.3 Ant algorithm applied to urine collection	57
VII.4 References	59
Appendix VIII. Treatments design	60
VIII.1 Centralised facility.....	60
VIII.2 Decentralised treatments.....	63
VIII.3 References.....	73
Appendix IX. Literature review on electric and heat yield for micro cogeneration.....	75
Appendix X. Life cycle inventory.....	78
X.1 Gas emission from fertiliser and by-product application	78
X.2 Inventory of processes	79
X.3 Metal in wastewater	84
Appendix I. Chapter III.....	85

Appendix I. Description and results of bibliometric analysis

I.1 Influent fractionation.....	85
I.2 Midpoint impacts results	89
I.3 References	98
Appendix II. Chapter IV	99
II.1 Functional unit and reference flows.....	99
II.2 Mass and energy balance with scale influence	100
II.3 LCA Results.....	102
II.4 Influence of functional unit.....	125

Appendix I. DESCRIPTION AND RESULTS OF BIBLIOMETRIC ANALYSIS

I.1 Research performed

TS =(

((("source separat*") AND (sanitation OR wastewater OR desar)) OR

("source separat*" AND ("urine" OR faec*)) OR

("source control*" AND (urine or faeces)) OR

(("blackwater" OR "blackwater") AND (sanitation OR wastewater OR desar)) OR

("sustainable sanitation" AND (urine OR faeces)) OR

("urine collect*" AND (sanitation OR wastewater OR desar)) OR

("urine separat*" AND (sanitation OR wastewater OR desar)) OR

("urine separat*" AND (sanitation OR wastewater OR desar)) OR

("urine diversion") OR

("faecal separation") OR

("human urine" AND fertili*) OR

((("remov*" OR "recover*") AND (ammon* OR phosph* OR nitrogen OR nutrient OR N OR

P) AND "human urine") OR

("faecal separation") OR

("nutrient recovery" AND separat*) OR

((("greywater" OR "grey water" OR "graywater" OR "gray water") AND ("domestic" OR

"household*" OR "treatment*"))

)

AND

WC = (ENGINEERING ENVIRONMENTAL OR

ENVIRONMENTAL SCIENCES OR

ENVIRONMENTAL STUDIES OR

GREEN SUSTAINABLE SCIENCE TECHNOLOGY OR

MARINE FRESHWATER BIOLOGY OR

MULTIDISCIPLINARY SCIENCES OR

WATER RESOURCES OR

ENGINEERING CHEMICAL OR

AGRICULTURAL ENGINEERING OR

CHEMISTRY, APPLIED)

I.2 Results

Table S 1: Major publication from Urine corpus regarding the number of citation and the link of co-citation. (The higher it is, the most cited in the corpus is it.)

Document	Title	Times cited	Link strength co-citation
(Maurer et al., 2006)	Treatment processes for source-separated urine	159	136
(Larsen and Gujer, 1996)	Separate management of anthropogenic nutrient solutions (human urine)	184	123
(Udert et al., 2003)	Nitrification and autotrophic denitrification of source-separated urine	67	120

Appendix I. Description and results of bibliometric analysis

(Wilsenach et al., 2007)	Phosphate and potassium recovery from source separated urine through struvite precipitation	135	83
(Etter et al., 2011)	Low-cost struvite production using source-separated urine in Nepal	99	83
(Udert et al., 2006)	Fate of major compounds in source-separated urine	67	73
(Maurer et al., 2003)	Nutrients in urine: energetic aspects of removal and recovery	107	62
(Lind et al., 2001)	Volume reduction and concentration of nutrients in human urine	85	60
(Udert and Wächter, 2012)	Complete nutrient recovery from source-separated urine by nitrification and distillation	64	59
(Larsen et al., 2009)	Source Separation: Will We See a Paradigm Shift in Wastewater Handling?	96	58
(Lienert et al., 2007)	Screening method for ecotoxicological hazard assessment of 42 pharmaceuticals considering human metabolism and excretory routes	122	41
(Lundin et al., 2000)	Life cycle assessment of wastewater systems: Influence of system boundaries and scale on calculated environmental loads	133	11
(Clarens et al., 2010)	Environmental Life Cycle Comparison of Algae to Other Bioenergy Feedstocks	474	0
(Escher et al., 2011)	Environmental toxicology and risk assessment of pharmaceuticals from hospital wastewater	174	0

Table S 2: results of bibliographic coupling analysis on urine corpus

Document	Title	Times cited	Total link strength
(Harder et al., 2019)	Recycling nutrients contained in human excreta to agriculture: Pathways, processes, and products	0	144
(Simha and Ganesapillai, 2017)	Ecological Sanitation and nutrient recovery from human urine: How far have we come? A review	16	115
(Randall and Naidoo, 2018)	Urine: The liquid gold of wastewater	12	76
(Karak and Bhattacharyya, 2011)	Human urine as a source of alternative natural fertilizer in agriculture: A flight of fancy or an achievable reality	76	72
(Kumar and Pal, 2015)	Assessing the feasibility of N and P recovery by struvite precipitation from nutrient-rich wastewater: a review	32	67
(Maurer et al., 2006)	Treatment processes for source-separated urine	238	65
Lamichhane (2012)	An economic appraisal of using source separation of human urine to contain and treat endocrine disruptors in the USA	9	62

(Zhang et al., 2013)	Removal of cytostatic drugs from aquatic environment: a review.	112	61
(Orner and Mihelcic, 2017)	A review of sanitation technologies to achieve multiple sustainable development goals that promote resource recovery	9	59
(Jagtap and Boyer, 2018)	Integrated, multi-process approach to total nutrient recovery from stored urine	2	59
(Ishii and Boyer, 2015)	Life cycle comparison of centralized wastewater treatment and urine source separation with struvite precipitation: Focus on urine nutrient management	41	55
(Zamora et al., 2017)	Long-term operation of a pilot-scale reactor for phosphorus recovery as struvite from source-separated urine	14	55

Table S 3: Results of co-citation analysis for blackwater corpus. (* means that it is not in Web of Science database and no statistics is available for citation)

Document	Title	Times cited	Co-citation link
(Zeeman et al., 2008)	Anaerobic treatment as a core technology for energy, nutrients and water recovery from source-separated domestic waste(water)	84	29
(de Graaff et al., 2010)	Anaerobic Treatment of Concentrated Blackwater in a UASB Reactor at a Short HRT	46	24
(Kujawa-Roeleveld and Zeeman, 2006)	Anaerobic Treatment in Decentralised and Source-Separation-Based Sanitation Concepts	*	21
(Eriksson et al., 2002)	Characteristics of grey wastewater	*	19
(Palmquist and Hanaeus, 2005)	Hazardous substances in separately collected grey- and blackwater from ordinary Swedish households	86	15
(Kujawa-Roeleveld et al., 2005)	Performance of UASB septic tank for treatment of concentrated blackwater within DESAR concept	40	14
(Kujawa-Roeleveld et al., 2006)	Enhanced primary treatment of concentrated blackwater and kitchen residues within DESAR concept using two types of anaerobic digesters	30	14
(Otterpohl et al., 1999)	Source control in urban sanitation and waste management: Ten systems with reuse of resources	93	14
(Wendland et al., 2007)	Anaerobic digestion of blackwater from vacuum toilets and kitchen refuse in a continuous stirred tank reactor (CSTR)	28	14
(Otterpohl et al., 1997)	Sustainable water and waste management in urban areas	106	13
(Zeeman and Lettinga, 1999)	The role of anaerobic digestion of domestic sewage in closing the water and nutrient cycle at community level	137	12

Appendix I. Description and results of bibliometric analysis

(van Voorthuizen et al., 2005)	Nutrient removal by NF and RO membranes in a decentralized sanitation system	60	9
(Jefferson et al., 2001)	Advanced biological unit processes for domestic water recycling	56	0
(Lundin et al., 2000)	Life cycle assessment of wastewater systems: Influence of system boundaries and scale on calculated environmental loads	173	0
(Luostarinen et al., 2006)	Nitrogen removal from on-site treated anaerobic effluents using intermittently aerated moving bed biofilm reactors at low temperatures	72	0
(Verstraete and Vlaeminck, 2011)	ZeroWasteWater: Short-cycling of wastewater resources for sustainable cities of the future	103	0

Table S 4: Results of bibliographic coupling analysis on blackwater corpus

Document	Title	Times cited	Link
(Harder et al., 2019)	Recycling nutrients contained in human excreta to agriculture: Pathways, processes, and products	0	61
(Thibodeau et al., 2014b)	Comparison of development scenarios of a blackwater source-separation sanitation system using life cycle assessment and environmental life cycle costing	15	45.6
(Tervahauta et al., 2013)	Prospects of Source-Separation-Based Sanitation Concepts: A Model-Based Study	21	34
(Thibodeau et al., 2014a)	Comparison of blackwater source-separation and conventional sanitation systems using life cycle assessment	13	32
(Hocaoglu and Orhon, 2010a)	Fate of proteins and carbohydrates in membrane bioreactor operated at high sludge age	10	31
(Hocaoglu and Orhon, 2010b)	Fate of soluble residual organics in membrane bioreactor	31	31
(Murat Hocaoglu et al., 2010)	COD fractionation and biodegradation kinetics of segregated domestic wastewater: black and grey water fractions	29	30
(Butkovskiy et al., 2015)	Fate of pharmaceuticals in full-scale source separated sanitation system	9	30
(Todt et al., 2015)	Load and distribution of organic matter and nutrients in a separated household wastewater stream	14	30
(Kjerstadius et al., 2015)	Potential for nutrient recovery and biogas production from blackwater, food waste and greywater in urban source control systems	13	30

Table S 5: Results of co-citation analysis for greywater corpus. (* means that it is not in Web of Science database and no statistics is available for citation)

Document	Title	Times cited	Co-citation link
(Eriksson et al., 2002)	Characteristics of grey wastewater	*	7
(Li et al., 2009)	Review of the technological approaches for grey water treatment and reuses.	224	13
(Christova-Boal et al., 1996)	An investigation into greywater reuse for urban residential properties	174	7
(Friedler, 2004)	Quality of Individual Domestic Greywater Streams and Its Implication on On-site Treatment and Reuse Possibilities	138	5
(Al-Jayyousi, 2003)	Greywater reuse: towards sustainable water management	156	5
(Jefferson et al., 2004)	Grey water characterisation and its impact on the selection and operation of technologies for urban reuse.	*	8
(Nolde, 2000)	Greywater reuse systems for toilet flushing in multi-storey buildings – over ten years experience in Berlin	*	5
(Friedler et al., 2005)	On-site greywater treatment and reuse in multi-storey buildings	96	6
(Ottoson and Stenström, 2003)	Faecal contamination of greywater and associated microbial risks	168	6
(Friedler and Hadari, 2006)	Economic feasibility of on-site greywater reuse in multi-storey buildings	132	5
(Gross et al., 2007)	Recycled vertical flow constructed wetland (RVFCW) - a novel method of recycling greywater for irrigation in small communities and households	137	64
(Eriksson et al., 2003)	Household chemicals and personal care products as sources for xenobiotic organic compounds in grey wastewater	135	42
(Winward et al., 2008)	Chlorine disinfection of grey water for reuse: Effect of organics and particles	109	42
(Dixon et al., 1999)	Water saving potential of domestic water reuse systems using greywater and rainwater in combination	105	23

Table S 6: Results of bibliographic coupling analysis on greywater corpus

Document	Title	Times cited	Link
(Boyjoo et al., 2013)	A review of greywater characteristics and treatment processes	55	10 9
(Vuppaladadiyam et al., 2019)	A review on greywater reuse: quality, risks, barriers and global scenarios	0	10 9
(Benami et al., 2016)	Potential microbial hazards from graywater reuse and associated matrices: A review	11	10 5

(Leong et al., 2017)	Prospects of hybrid rainwater-greywater decentralised system for water recycling and reuse: A review	21	96
(Wu, 2019)	Membrane-based technology in greywater reclamation: A review	6	93
(Oh et al., 2018)	A review of greywater recycling related issues: Challenges and future prospects, in Malaysia	12	80
(Al-Gheethi et al., 2016)	Reduction of microbial risk associated with greywater by disinfection processes for irrigation	12	76
(Oteng-Peprah et al., 2018)	Greywater Characteristics, Treatment Systems, Reuse Strategies and User Perception-a Review	3	75
(Ceconet et al., 2019)	Membrane bioreactors for sustainable, fit-for-purpose greywater treatment: a critical review	1	72
(Arden and Ma, 2018)	Constructed wetlands for greywater recycle and reuse: A review	10	70

I.3 References

- Al-Gheethi, A.A., Radin Mohamed, R.M.S., Efaq, A.N., Amir Hashim, M.K., 2016. Reduction of microbial risk associated with greywater by disinfection processes for irrigation. *J. Water Health* 14, 379–398. <https://doi.org/10.2166/wh.2015.220>
- Al-Jayyousi, O.R., 2003. Greywater reuse: towards sustainable water management. Desalination, Joint EDS, WSTA and IWA conference on Desalination and the Environment Fresh Water for All UN International Year of Fresh Water 2003 156, 181–192. [https://doi.org/10.1016/S0011-9164\(03\)00340-0](https://doi.org/10.1016/S0011-9164(03)00340-0)
- Arden, S., Ma, X., 2018. Constructed wetlands for greywater recycle and reuse: A review. *Sci. Total Environ.* 630, 587–599. <https://doi.org/10.1016/j.scitotenv.2018.02.218>
- Benami, M., Gillor, O., Gross, A., 2016. Potential microbial hazards from graywater reuse and associated matrices: A review. *Water Res.* 106, 183–195. <https://doi.org/10.1016/j.watres.2016.09.058>
- Boyjoo, Y., Pareek, V.K., Ang, M., 2013. A review of greywater characteristics and treatment processes. *Water Sci. Technol. J. Int. Assoc. Water Pollut. Res.* 67, 1403–1424. <https://doi.org/10.2166/wst.2013.675>
- Butkovskiy, A., Hernandez Leal, L., Rijnaarts, H.H.M., Zeeman, G., 2015. Fate of pharmaceuticals in full-scale source separated sanitation system. *Water Res.* 85, 384–392. <https://doi.org/10.1016/j.watres.2015.08.045>
- Ceconet, D., Callegari, A., Hlavínek, P., Capodaglio, A.G., 2019. Membrane bioreactors for sustainable, fit-for-purpose greywater treatment: a critical review. *Clean Technol. Environ. Policy* 21, 745–762. <https://doi.org/10.1007/s10098-019-01679-z>
- Christova-Boal, D., Eden, R.E., McFarlane, S., 1996. An investigation into greywater reuse for urban residential properties. *Desalination* 106, 391–397. [https://doi.org/10.1016/S0011-9164\(96\)00134-8](https://doi.org/10.1016/S0011-9164(96)00134-8)
- Clarens, A.F., Resurreccion, E.P., White, M.A., Colosi, L.M., 2010. Environmental Life Cycle Comparison of Algae to Other Bioenergy Feedstocks. *Environ. Sci. Technol.* 44, 1813–1819. <https://doi.org/10.1021/es902838n>
- de Graaff, M.S., Temmink, H., Zeeman, G., Buisman, C.J.N., 2010. Anaerobic Treatment of Concentrated Blackwater in a UASB Reactor at a Short HRT. *Water* 2, 101–119. <https://doi.org/10.3390/w2010101>
- Dixon, A., Butler, D., Fewkes, A., 1999. Water saving potential of domestic water reuse systems using greywater and rainwater in combination. *Water Sci. Technol.* 39, 25–32. [https://doi.org/10.1016/S0273-1223\(99\)00083-9](https://doi.org/10.1016/S0273-1223(99)00083-9)
- Eriksson, E., Auffarth, K., Eilersen, A.-M., Henze, M., Ledin, A., 2003. Household chemicals and personal care products as sources for xenobiotic organic compounds in grey wastewater. *Water SA* 29, 135–146. <https://doi.org/10.4314/wsa.v29i2.4848>
- Eriksson, E., Auffarth, K., Henze, M., Ledin, A., 2002. Characteristics of grey wastewater. *Urban Water* 4, 85–104. [https://doi.org/10.1016/S1462-0758\(01\)00064-4](https://doi.org/10.1016/S1462-0758(01)00064-4)
- Escher, B.I., Baumgartner, R., Koller, M., Treyer, K., Lienert, J., McArdell, C.S., 2011. Environmental toxicology and risk assessment of pharmaceuticals from hospital wastewater. *Water Res.* 45, 75–92. <https://doi.org/10.1016/j.watres.2010.08.019>
- Etter, B., Tilley, E., Khadka, R., Udert, K.M., 2011. Low-cost struvite production using source-separated urine in Nepal. *Water Res.* 45, 852–862. <https://doi.org/10.1016/j.watres.2010.10.007>

- Friedler, E., 2004. Quality of Individual Domestic Greywater Streams and its Implication for On-Site Treatment and Reuse Possibilities. *Environ. Technol.* 25, 997–1008. <https://doi.org/10.1080/09593330.2004.9619393>
- Friedler, E., Hadari, M., 2006. Economic feasibility of on-site greywater reuse in multi-storey buildings. *Desalination* 190, 221–234. <https://doi.org/10.1016/j.desal.2005.10.007>
- Friedler, E., Kovalio, R., Galil, N.I., 2005. On-site greywater treatment and reuse in multi-storey buildings. *Water Sci. Technol. J. Int. Assoc. Water Pollut. Res.* 51, 187–194.
- Gross, A., Shmueli, O., Ronen, Z., Raveh, E., 2007. Recycled vertical flow constructed wetland (RVFCW)—a novel method of recycling greywater for irrigation in small communities and households. *Chemosphere* 66, 916–923. <https://doi.org/10.1016/j.chemosphere.2006.06.006>
- Harder, R., Wielemaker, R., Larsen, T.A., Zeeman, G., Öberg, G., 2019. Recycling nutrients contained in human excreta to agriculture: Pathways, processes, and products. *Crit. Rev. Environ. Sci. Technol.* 49, 695–743. <https://doi.org/10.1080/10643389.2018.1558889>
- Hocaoglu, S.M., Orhon, D., 2010a. Fate of proteins and carbohydrates in membrane bioreactor operated at high sludge age. *J. Environ. Sci. Health Part A* 45, 1101–1108. <https://doi.org/10.1080/10934529.2010.486342>
- Hocaoglu, S.M., Orhon, D., 2010b. Fate of soluble residual organics in membrane bioreactor. *J. Membr. Sci.* 364, 65–74. <https://doi.org/10.1016/j.memsci.2010.07.050>
- Ishii, S.K.L., Boyer, T.H., 2015. Life cycle comparison of centralized wastewater treatment and urine source separation with struvite precipitation: Focus on urine nutrient management. *Water Res.* 79, 88–103. <https://doi.org/10.1016/j.watres.2015.04.010>
- Jagtap, N., Boyer, T.H., 2018. Integrated, multi-process approach to total nutrient recovery from stored urine. *Environ. Sci. Water Res. Technol.* 4, 1639–1650. <https://doi.org/10.1039/C8EW00004B>
- Jefferson, B., Laine, A.L., Stephenson, T., Judd, S.J., 2001. Advanced biological unit processes for domestic water recycling. *Water Sci. Technol. J. Int. Assoc. Water Pollut. Res.* 43, 211–218.
- Jefferson, B., Palmer, A., Jeffrey, P., Stuetz, R., Judd, S., 2004. Grey water characterisation and its impact on the selection and operation of technologies for urban reuse. *Water Sci. Technol. J. Int. Assoc. Water Pollut. Res.* 50, 157–164.
- Karak, T., Bhattacharyya, P., 2011. Human urine as a source of alternative natural fertilizer in agriculture: A flight of fancy or an achievable reality. *Resour. Conserv. Recycl.* 55, 400–408. <https://doi.org/10.1016/j.resconrec.2010.12.008>
- Kjerstadius, H., Haghhighatafshar, S., Davidsson, Å., 2015. Potential for nutrient recovery and biogas production from blackwater, food waste and greywater in urban source control systems. *Environ. Technol.* 36, 1707–1720. <https://doi.org/10.1080/09593330.2015.1007089>
- Kujawa-Roeleveld, K., Elmitwalli, T., Zeeman, G., 2006. Enhanced primary treatment of concentrated blackwater and kitchen residues within DESAR concept using two types of anaerobic digesters. *Water Sci. Technol. J. Int. Assoc. Water Pollut. Res.* 53, 159–168. <https://doi.org/10.2166/wst.2006.265>
- Kujawa-Roeleveld, K., Fernandes, T., Wiryawan, Y., Tawfik, A., Visser, M., Zeeman, G., 2005. Performance of UASB septic tank for treatment of concentrated blackwater within DESAR concept. *Water Sci. Technol. J. Int. Assoc. Water Pollut. Res.* 52, 307–313.
- Kujawa-Roeleveld, K., Zeeman, G., 2006. Anaerobic Treatment in Decentralised and Source-Separation-Based Sanitation Concepts. *Rev. Environ. Sci. Biotechnol.* 5, 115–139. <https://doi.org/10.1007/s11157-005-5789-9>
- Kumar, R., Pal, P., 2015. Assessing the feasibility of N and P recovery by struvite precipitation from nutrient-rich wastewater: a review. *Environ. Sci. Pollut. Res. Int.* 22, 17453–17464. <https://doi.org/10.1007/s11356-015-5450-2>
- Larsen, T.A., Alder, A.C., Eggen, R.I.L., Maurer, M., Lienert, J., 2009. Source Separation: Will We See a Paradigm Shift in Wastewater Handling? *Environ. Sci. Technol.* 43, 6121–6125. <https://doi.org/10.1021/es803001r>
- Larsen, T.A., Gujer, W., 1996. Separate management of anthropogenic nutrient solutions (human urine). *Water Sci. Technol.* 34, 87–94.
- Leong, J.Y.C., Oh, K.S., Poh, P.E., Chong, M.N., 2017. Prospects of hybrid rainwater-greywater decentralised system for water recycling and reuse: A review. *J. Clean. Prod.* 142, 3014–3027. <https://doi.org/10.1016/j.jclepro.2016.10.167>
- Li, F., Wichmann, K., Otterpohl, R., 2009. Review of the technological approaches for grey water treatment and reuses. *Sci. Total Environ.* 407, 3439–3449. <https://doi.org/10.1016/j.scitotenv.2009.02.004>
- Lienert, J., Güdel, K., Escher, B.I., 2007. Screening Method for Ecotoxicological Hazard Assessment of 42 Pharmaceuticals Considering Human Metabolism and Excretory Routes. *Environ. Sci. Technol.* 41, 4471–4478. <https://doi.org/10.1021/es0627693>
- Lind, B.-B., Ban, Z., Bydén, S., 2001. Volume reduction and concentration of nutrients in human urine. *Ecol. Eng.* 16, 561–566. [https://doi.org/10.1016/S0925-8574\(00\)00107-5](https://doi.org/10.1016/S0925-8574(00)00107-5)

Appendix I. Description and results of bibliometric analysis

- Lundin, M., Bengtsson, M., Molander, S., 2000. Life Cycle Assessment of Wastewater Systems: Influence of System Boundaries and Scale on Calculated Environmental Loads. *Environ. Sci. Technol.* 34, 180–186. <https://doi.org/10.1021/es990003f>
- Luostarinen, S., Luste, S., Valentín, L., Rintala, J., 2006. Nitrogen removal from on-site treated anaerobic effluents using intermittently aerated moving bed biofilm reactors at low temperatures. *Water Res.* 40, 1607–1615. <https://doi.org/10.1016/j.watres.2006.02.022>
- Maurer, M., Pronk, W., Larsen, T.A., 2006. Treatment processes for source-separated urine. *Water Res.* 40, 3151–3166. <https://doi.org/10.1016/j.watres.2006.07.012>
- Maurer, M., Schwegler, P., Larsen, T.A., 2003. Nutrients in urine: energetic aspects of removal and recovery. *Water Sci. Technol. J. Int. Assoc. Water Pollut. Res.* 48, 37–46.
- Murat Hocaoglu, S., Insel, G., Ubay Cokgor, E., Baban, A., Orhon, D., 2010. COD fractionation and biodegradation kinetics of segregated domestic wastewater: black and grey water fractions. *J. Chem. Technol. Biotechnol.* 85, 1241–1249. <https://doi.org/10.1002/jctb.2423>
- Nolde, E., 2000. Greywater reuse systems for toilet flushing in multi-storey buildings – over ten years experience in Berlin. *Urban Water* 1, 275–284. [https://doi.org/10.1016/S1462-0758\(00\)00023-6](https://doi.org/10.1016/S1462-0758(00)00023-6)
- Oh, K.S., Leong, J.Y.C., Poh, P.E., Chong, M.N., Lau, E.V., 2018. A review of greywater recycling related issues: Challenges and future prospects in Malaysia. *J. Clean. Prod.* 171, 17–29. <https://doi.org/10.1016/j.jclepro.2017.09.267>
- Orner, K.D., Mihelcic, J.R., 2017. A review of sanitation technologies to achieve multiple sustainable development goals that promote resource recovery. *Environ. Sci. Water Res. Technol.* 4, 16–32. <https://doi.org/10.1039/C7EW00195A>
- Oteng-Peprah, M., Acheampong, M.A., deVries, N.K., 2018. Greywater Characteristics, Treatment Systems, Reuse Strategies and User Perception—a Review. *Water. Air. Soil Pollut.* 229. <https://doi.org/10.1007/s11270-018-3909-8>
- Otterpohl, R., Albold, A., Oldenburg, M., 1999. Source control in urban sanitation and waste management: Ten systems with reuse of resources. *Water Sci. Technol.* 39. [https://doi.org/10.1016/S0273-1223\(99\)00097-9](https://doi.org/10.1016/S0273-1223(99)00097-9)
- Otterpohl, R., Grottker, M., Lange, J., 1997. Sustainable water and waste management in urban areas. *Water Sci. Technol., Sustainable Sanitation* 35, 121–133. [https://doi.org/10.1016/S0273-1223\(97\)00190-X](https://doi.org/10.1016/S0273-1223(97)00190-X)
- Ottoson, J., Stenström, T.A., 2003. Faecal contamination of greywater and associated microbial risks. *Water Res.* 37, 645–655. [https://doi.org/10.1016/S0043-1354\(02\)00352-4](https://doi.org/10.1016/S0043-1354(02)00352-4)
- Palmquist, H., Hanaeus, J., 2005. Hazardous substances in separately collected grey- and blackwater from ordinary Swedish households. *Sci. Total Environ.* 348, 151–163. <https://doi.org/10.1016/j.scitotenv.2004.12.052>
- Randall, D.G., Naidoo, V., 2018. Urine: The liquid gold of wastewater. *J. Environ. Chem. Eng.* 6, 2627–2635. <https://doi.org/10.1016/j.jece.2018.04.012>
- Simha, P., Ganesapillai, M., 2017. Ecological Sanitation and nutrient recovery from human urine: How far have we come? A review. *Sustain. Environ. Res.* 27, 107–116. <https://doi.org/10.1016/j.serj.2016.12.001>
- Tervahauta, T., Hoang, T., Hernández, L., Zeeman, G., Buisman, C., 2013. Prospects of Source-Separation-Based Sanitation Concepts: A Model-Based Study. *Water* 5, 1006–1035. <https://doi.org/10.3390/w5031006>
- Thibodeau, C., Monette, F., Bulle, C., Glaus, M., 2014a. Comparison of blackwater source-separation and conventional sanitation systems using life cycle assessment. *J. Clean. Prod.* 67, 45–57. <https://doi.org/10.1016/j.jclepro.2013.12.012>
- Thibodeau, C., Monette, F., Glaus, M., 2014b. Comparison of development scenarios of a blackwater source-separation sanitation system using life cycle assessment and environmental life cycle costing. *Resour. Conserv. Recycl.* 92, 38–54. <https://doi.org/10.1016/j.resconrec.2014.08.004>
- Todt, D., Heistad, A., Jenssen, P.D., 2015. Load and distribution of organic matter and nutrients in a separated household wastewater stream. *Environ. Technol.* 36, 1584–1593. <https://doi.org/10.1080/09593330.2014.997300>
- Udert, K.M., Fux, C., Münster, M., Larsen, T.A., Siegrist, H., Gujer, W., 2003. Nitrification and autotrophic denitrification of source-separated urine. *Water Sci. Technol. J. Int. Assoc. Water Pollut. Res.* 48, 119–130.
- Udert, K.M., Larsen, T.A., Gujer, W., 2006. Fate of major compounds in source-separated urine. *Water Sci. Technol. J. Int. Assoc. Water Pollut. Res.* 54, 413–420.
- Udert, K.M., Wächter, M., 2012. Complete nutrient recovery from source-separated urine by nitrification and distillation. *Water Res.* 46, 453–464. <https://doi.org/10.1016/j.watres.2011.11.020>
- van Voorthuizen, E.M., Zwijnenburg, A., Wessling, M., 2005. Nutrient removal by NF and RO membranes in a decentralized sanitation system. *Water Res.* 39, 3657–3667. <https://doi.org/10.1016/j.watres.2005.06.005>
- Verstraete, W., Vlaeminck, S.E., 2011. ZeroWasteWater: short-cycling of wastewater resources for sustainable cities of the future. *Int. J. Sustain. Dev. World Ecol.* 18, 253–264. <https://doi.org/10.1080/13504509.2011.570804>

Appendix I. Description and results of bibliometric analysis

- Vuppaladadiyam, A.K., Merayo, N., Prinsen, P., Luque, R., Blanco, A., Zhao, M., 2019. A review on greywater reuse: quality, risks, barriers and global scenarios. *Rev. Environ. Sci. Biotechnol.* 18, 77–99. <https://doi.org/10.1007/s11157-018-9487-9>
- Wendland, C., Deegener, S., Behrendt, J., Toshev, P., Otterpohl, R., 2007. Anaerobic digestion of blackwater from vacuum toilets and kitchen refuse in a continuous stirred tank reactor (CSTR). *Water Sci. Technol.* 55, 187–194. <https://doi.org/10.2166/wst.2007.144>
- Wilsenach, J.A., Schuurbiens, C.A.H., van Loosdrecht, M.C.M., 2007. Phosphate and potassium recovery from source separated urine through struvite precipitation. *Water Res.* 41, 458–466. <https://doi.org/10.1016/j.watres.2006.10.014>
- Winward, G.P., Avery, L.M., Stephenson, T., Jefferson, B., 2008. Chlorine disinfection of grey water for reuse: Effect of organics and particles. *Water Res.* 42, 483–491. <https://doi.org/10.1016/j.watres.2007.07.042>
- Wu, B., 2019. Membrane-based technology in greywater reclamation: A review. *Sci. Total Environ.* 656, 184–200. <https://doi.org/10.1016/j.scitotenv.2018.11.347>
- Zamora, P., Georgieva, T., Salcedo, I., Elzinga, N., Kuntke, P., Buisman, C.J., 2017. Long-term operation of a pilot-scale reactor for phosphorus recovery as struvite from source-separated urine. *J. Chem. Technol. Biotechnol.* 92, 1035–1045. <https://doi.org/10.1002/jctb.5079>
- Zeeman, G., Kujawa, K., de Mes, T., Hernandez, L., de Graaff, M., Abu-Ghunmi, L., Mels, A., Meulman, B., Temmink, H., Buisman, C., van Lier, J., Lettinga, G., 2008. Anaerobic treatment as a core technology for energy, nutrients and water recovery from source-separated domestic waste(water). *Water Sci. Technol.* 57, 1207. <https://doi.org/10.2166/wst.2008.101>
- Zeeman, G., Lettinga, G., 1999. The role of anaerobic digestion of domestic sewage in closing the water and nutrient cycle at community level. *Water Sci. Technol.* 39, 187–194. [https://doi.org/10.1016/S0273-1223\(99\)00101-8](https://doi.org/10.1016/S0273-1223(99)00101-8)
- Zhang, J., Chang, V.W.C., Giannis, A., Wang, J.-Y., 2013. Removal of cytostatic drugs from aquatic environment: a review. *Sci. Total Environ.* 445–446, 281–298. <https://doi.org/10.1016/j.scitotenv.2012.12.061>

Appendix II. DESCRIPTION OF PILOT PROJECTS

II.1 Summary of pilot projects

Table S 7: Details of pilot projects for urine source separation system

Ref	Project	Years	Scale (Inh)	Toilets	Transport	Urine treatment	Treatment of the remaining water	Recovery/Removal					
								C	N	P	»	⚡	μ
[1]	Understenhöjden (SE)	1995	160	Diverting	Gravity until storage	6 months storage	Decentralised WWTP	-	●	●	-	-	-
[1], [2]	Palsternackan (SE)	1995	160	Diverting	Gravity until storage	6 months storage	WWTP	-	●	●	-	-	-
[2]	Ecole Eklandaskolan (SE)	1999	450	Diverting	Gravity until storage	6 months storage	Liquid/solid separation Liquid = septic tank for Solid = composting	●	●●	●●	-	-	-
[3]	Küllon (SE)	2000	300	Diverting	Gravity until storage	6 months storage	WWTP	-	●	●	-	-	-
[2]	Universeum Museum (SE)	2001	100	Diverting	Gravity until storage	6 months storage	WWTP	-	●	●	-	-	-
[4]	Library Basel-Landschaft (SW)	2005	500	Diverting: No Mix	Gravity until storage + truck	Electrodialysis + ozonation	WWTP	-	●	●	-	-	●
[5]	Forum Chriesbach	2005	300?	31 No Mix diverting toilets + 7 urinals	Gravity until storage	VUNA process, nitrification + distillation + activated carbon	WWTP	●	●	●	-	●	●
[6]	Technical building at of Seine Aval (FR)	2018	300 employees	Urinals	Gravity until storage	WWTP	WWTP	-	-	-	-	-	-
[7], [8]	University X Windesheim												

[9], [10]	ValueFromUrine (NL)	2012 - 2016	100 L- urine/d	Urinals	Gravity until storage	decentralised treatment: struvite precipitation + BES	WWTP	- ● ● - - -
[11], [12]	Currumbin (AU)	2007	36	Diverting toilets	Gravity until storage + truck	Long term storage	Decentralised WWTP	● ● ● - ● -
[3], [25]	Tanum (SE)	1999.7	400	Separated (dry or not)	Gravity sewer	6 months storage	WWTP (composting of faeces)	● ● ● - - -

Legend : **C** Carbon ; **N** Nitrogen ; **P** Phosphorus ; \heartsuit Heat ; \blacktriangledown Water ; μ : Micropollutants removal
 - Not implemented; ● Implement on urine; ● Implemented for brown water; ● Implemented for greywater

Table S 8: Details of pilot projects for blackwater / greywater source separation system

Ref	Project	Years	Scale (Inh)	Toilets	Transport	Blackwater treatment	Recovery/Removal					
							C	N	P	\heartsuit	\blacktriangledown	μ
[13], [14]	Flintenbreite (NL)	2000	380	Vacuum toilets	Vacuum sewer for greywater and gravity sewer for greywater	Anaerobic digestion + cogeneration	●	-	-	-	-	-
[15]	Lemmerweg (NL)	2006	128	Vacuum toilets	Vacuum sewer for greywater and gravity sewer for greywater	UASB + Anammox	●	-	-	●	-	-
[15]	Noorderoek (NL)	2010	79 - 400 (in 2020)	Vacuum toilets	Vacuum sewer for greywater and gravity sewer for greywater	Anaerobic digestion + cogeneration	●	-	●	●	●	-
[16]	Jenfelder Au (DE)	2017	2000	Vacuum toilets	Vacuum sewer for greywater and gravity sewer for greywater	Anaerobic digestion + cogeneration	●	-	-	-	-	-
[17], [18]	Schipperskaai (BE)	2018	1200	Vacuum toilets	Vacuum sewer for greywater and gravity sewer for greywater	Anaerobic digestion + cogeneration	●	-	●	●	●	-

Appendix II. Description of pilot projects

[19]	H+ (SE)	2035	10000	Vacuum toilets	Vacuum sewer for greywater and gravity sewer for greywater	Anaerobic digestion + cogeneration	● ● ● - - -
------	---------	------	-------	----------------	--	------------------------------------	-------------

Legend : **C** Carbon ; **N** Nitrogen ; **P** Phosphorus ; \heartsuit Heat ; \blacktriangledown Water ; μ : Micropollutants removal
 - Not implemented; \bullet Implement on urine; \bullet Implemented for brown water; \bullet Implemented for greywater

Table S 9 Details of pilot projects for three separation system

Ref	Project	Years	Scale (Inh)	Toilets	Transport	Urine treatment	Faeces treatment	Grey water treatment	Recovery/Removal					
									C	N	P	\heartsuit	\blacktriangledown	μ
[3]	Gebers (SE)	1998	80	Dry separated	Gravity sewer	6 months storage	Composting	WWTP	\bullet	\bullet	\bullet	-	-	-
[20]	Solar City (A)	2004	460	Separated	Gravity sewer	/	Composting	Reed filter bed	\bullet	\bullet	\bullet	-	-	-
[21], [22]	SANIRESC H (DE)	2004.7	400	Separated	Gravity sewer	Storage and struvite precipitation	Membrane bioreactor	Membrane bioreactor	\bullet	\bullet	\bullet	-	-	-
[23], [24]	SCST (DE)	2005.3	30	Separated	Gravity sewer	Several tests	Composting	Reed filter bed	\bullet	\bullet	\bullet	-	-	-
[5]	NEST	2016		50 separated toilets	Gravity sewer	VUNA: nitrification + distillation + activated carbon	Water extraction	MBR activated carbon	+	\bullet	\bullet	-	\bullet	\bullet

Legend : **C** Carbon ; **N** Nitrogen ; **P** Phosphorus ; \heartsuit Heat ; \blacktriangledown Water ; μ : Micropollutants removal
 - Not implemented; \bullet Implement on urine; \bullet Implemented for brown water; \bullet Implemented for greywater

References

- [1] Johansson, M., 2000. Urine Separation - Closing the Nutrient Cycle (FINAL REPORT ON THE R&D PROJECT). Water Company, Stockholm, Sweden.
- [2] Kvarnström, E., Emilsson, K., Stintzing, A.R., Johansson, M., Jönsson, H., Petersens, E. af, Schönning, C., Christensen, J., Hellström, D., Qvamström, L., Ridderstolpe, P., Drangert, J.-O., 2006. Urine diversion: one step towards sustainable sanitation. Stockholm Environment Institute, Stockholm.
- [3] Druitt, M., 2009. The Swedish Eco-Sanitation Experience Case studies of successful projects implementing alternative techniques for wastewater treatment in Sweden. Coalition Clean Baltic, Sweden.
- [4] Larsen, T.A., Lienert, J., 2007. Novaquatis final report. NoMix – A new approach to urban water management. Eawag, 8600 Dübendorf, Switzerland.
- [5] Keogh, L., 2018. Flows of Science: Source Separation Technology at the Swiss Federal Institute of Aquatic Science and Technology (Eawag). Eawag, Dübendorf, Switzerland.
- [6] Esculier, F, personal communication
- [7] Hogeschool Windesheim opent Gebouw X • Weblog Zwolle [WWW Document], 2010. . Weblog Zwolle. URL <https://www.weblogzwolle.nl/nieuws/17467/hogeschool-windesheim-opent-gebouw-x.html> (accessed 9.7.18).
- [8] Gebouw X Hogeschool Windesheim [WWW Document], n.d. URL <https://www.trebbe.nl/projecten/zwolle-gebouw-x/> (accessed 9.7.18).
- [9] Zamora, P., Georgieva, T., Salcedo, I., Elzinga, N., Kuntke, P., Buisman, C.J., 2017. Long-term operation of a pilot-scale reactor for phosphorus recovery as struvite from source-separated urine: Long-term operation of a pilot-scale reactor for phosphorus. *Journal of Chemical Technology & Biotechnology* 92, 1035–1045. <https://doi.org/10.1002/jctb.5079>
- [10] Zamora, P., Georgieva, T., Ter Heijne, A., Sleutels, T.H.J.A., Jeremiasse, A.W., Saakes, M., Buisman, C.J.N., Kuntke, P., 2017. Ammonia recovery from urine in a scaled-up Microbial Electrolysis Cell. *Journal of Power Sources* 356, 491–499. <https://doi.org/10.1016/j.jpowsour.2017.02.089>
- [11] "Hood, B., Gardner, T., Ahmed, W., Beal, C., 2009. An Australian field study of source separated urine. Presented at the OZWater'09 from Challenges to Solutions."
- [12] "Ahmed, W., Hamilton, K.A., Vieritz, A., Powell, D., Goonetilleke, A., Hamilton, M.T., Gardner, T., 2017. Microbial risk from source-separated urine used as liquid fertilizer in sub-tropical Australia. *Microbial Risk Analysis* 5, 53–64. <https://doi.org/10.1016/j.mran.2016.11.005>"
- [13] "Skambraks, A.-K., Kjerstadius, H., Meier, M., Davidsson, Å., Wuttke, M., Giese, T., 2017. Source separation sewage systems as a trend in urban wastewater management: Drivers for the implementation of pilot areas in Northern Europe. *Sustainable Cities and Society* 28, 287–296. <https://doi.org/10.1016/j.scs.2016.09.013>"

Appendix II. Description of pilot projects

- [14] OtterWasser GmbH, 2009. Ecological housing estate, Flintenbreite, Lübeck, Germany (Case study of sustainable sanitation projects), Sustainable Sanitation Alliance (SuSanA).
- [15] de Graaff, R., van Hell, A.J., 2014. Nieuwe Sanitatie Noorderhoek, Sneek deelonderzoeken (New Sanitation Noorderhoek, Sneek sub-studies) (No. 2014–48), STOWA. STOWA, Amersfoort - Netherlands.
- [16] Augustin, K., Skambraks, A.-K., Li, Z., Giese, T., Rakelmann, U., Meinzinger, F., Schonlau, H., Günner, C., 2014. Towards sustainable sanitation – the HAMBURG WATER Cycle in the settlement Jenfelder Au. *Water Science and Technology: Water Supply* 14, 13–21. <https://doi.org/10.2166/ws.2013.158>
- [17] de Smet, Peter. ZAWENT : energie-neutrale wijk te Gent. <https://www.vlario.be/site/files/12-De-Smet-ZAWENT-Energieneutrale-wijk-Gent.pdf>. ZAWENT : energie-neutrale wijk te Gent, Clean energy Invest.
- [18] « Democase Gent ». Nereus Project, <https://www.nereus-project.eu/democases/democase-gent/>. Consulté le 25 novembre 2019.
- [19] "EVAA. Smarta system och listiga lösningar (Smart systems and clever solutions). 16 mai 2013, <https://hplus.helsingborg.se/miljo/>."
- [20] Hochedlinger, M., et al. Experiences from the EcoSan full scale pilot project solarCity Linz. 2008.
- [21] "Blume, S., et M. Winker. « Three Years of Operation of the Urine Diversion System at GTZ Headquarters in Germany: User Opinions and Maintenance Challenges ». *Water Science and Technology: A Journal of the International Association on Water Pollution Research*, vol. 64, n° 3, 2011, p. 579-86. PubMed, doi:10.2166/wst.2011.530."
- [22] Winker, Martina, et al. Schlussbericht des BMBF-Projekt SanitärRecycling Eschborn (SANIRESCH) (Final report of the BMBF projekt SanitaryRecycling Eschborn (SANIRESCH)). Deutsche Gesellschaft für Internationale Zusammenarbeit (GIZ) GmbH; University of Bonn; RWTH Aachen; THM University of Applied Sciences; HUBER SE; Roediger Vacuum GmbH, 31 janvier 2013.
- [23] Peter-Fröhlich, A., et al. Sanitation concepts for separate treatment of urine, faeces and greywater (SCST). Final report: EU-demonstration project, Contract : LIFE03ENV/D000025, KompetenzZentrum Wasser Berlin gGmbH, 2007.
- [24] Peter-Fröhlich, A., et al. « EU Demonstration Project for Separate Discharge and Treatment of Urine, Faeces and Greywater – Part I: Results ». *Water Science and Technology*, vol. 56, no 5, septembre 2007, p. 239-49. DOI.org (Crossref), doi:10.2166/wst.2007.577.
- [25] Esculier, Fabien. The nutrition/excretion system of urban areas: socioecological regimes and transitions. Université Paris Est, mars 2018. HAL Archives Ouvertes, <https://hal.archives-ouvertes.fr/tel-01787854>.

II.2 Urine recovery rate calculation

The urine recovery rate have been calculated in (Besson, 2015) and the calculations are presented here. Data have been retrieved from [1] and [2] (Table S 10: Data from two pilot projects) with the number of people including children, and the time spend at home or at office. Thank to it, it is possible to calculate mass flow regarding the time spend in the building and the extrapolated mass flow for 24h in the building (Table S 11).

Table S 10: Data from two pilot projects

	Understenhöjden [1]	Palsternackan [1]	understenhöjden Palsternackan [1]	+ SCST bureaux [2]	SCST apt North [2]	SCST apt South [2]	SCST apt total [2]
Nb adult	105	105	210	8	12	12	25
nb children	55	21	76				
Time spend in the buildings (h)	13.9	15.9	15	10	17	17	17
Flowrate m3/d	0.1407	0.1365	0.2772	0.007	0.04	0.019	0.059
N (g/L)	3.631	3.3	2.7	3.939	1.45	2	1.627
P (g/L)	0.313	0.308	0.24	0.402	0.15	0.263	0.186
K (g/L)	1	0.888	0.8	2.1	0.3	0.631	0.407
Cl (g/L)	1.768	2.268		0.513	/	/	/
Na (g/L)	1.21	1.307			/	/	/

Table S 11: Mass flow for the time spend in buildings and extrapolate to 24h occupancy

	Understenhöjden [1]	Palsternackan [1]	understenhöjden + Palsternackan [1]	SCST bureaux [2]	SCST North [2]	SCST apt South [2]	SCST apt total [2]
Mass flow on real time							
N (g/day)	511	450	748	28	58	38	96
P (g/day)	44	42	67	3	6	5	11
K (g/day)	141	121	222	15	12	12	24

Appendix II. Description of pilot projects

Cl (g/day)	249	310	0	4			
Na (g/day)	170	178	0	0			
Mass flow extrapolate on one day							
N (g/day)	882.1	679.9	1197.5	66.2	81.9	53.6	135.5
P (g/day)	76.0	63.5	106.4	6.8	8.5	7.1	15.5
K (g/day)	242.9	183.0	354.8	35.3	16.9	16.9	33.9
Cl (g/day)	429.5	467.3	0.0	8.6	0.0	0.0	0.0
Na (g/day)	294.0	269.3	0.0	0.0	0.0	0.0	0.0

From the number of occupants and by taking into account that a children counts as 0.5 adult the mass flow per person can be calculated (Table S 12). Recovery rate calculated based on literature value can then be calculated for each compounds (Table S 13).

Table S 12: Calculated mass flow per person in each projects

Mass flow per person	Literature review*	understenhöjden	Palsternackan	understenhöjden + Palsternackan	SCST bureaux	SCST North	apt	SCST South	apt	SCST total	apt
N (g/day/pers)	10.6	6.7	5.1	5.0	8.3	6.8		4.5		5.4	
P (g/day/pers)	0.9	0.6	0.5	0.4	0.8	0.7		0.6		0.6	
K (g/day/pers)	2.6	1.8	1.4	1.5	4.4	1.4		1.4		1.4	
Cl (g/day/pers)	5.9	3.2	3.5	0.0	1.1	0.0		0.0		0.0	
Na (g/day/pers)	3.7	2.2	2.0	0.0	0.0	0.0		0.0		0.0	

*(see Chapter 2 and Chapter VI.Appendix III)

Table S 13: Calculated recovery rate of urine for each component.

Recovery rate	understenhöjden	Palsternackan	understenhöjden + Palsternackan	SCST bureaux	SCST North	apt	SCST South	apt	SCST total	apt
From N	61%	47%	46%	75%	62%		41%		49%	
From P	57%	48%	45%	84%	71%		59%		62%	

From K	67%	51%	55%	162%	52%	52%	50%
From Cl	62%	68%	0%	21%			
From Na	43%	39%	0%	0%			

Reference

- [1] Jönsson, Håkan, et al. Mätning på två urinsorterande avloppssystem. Report, 228, 1998. pub.epsilon.slu.se, <http://pub.epsilon.slu.se/3827/>.
- [2] Peter-Fröhlich, A., et al. Sanitation concepts for separate treatment of urine, faeces and greywater (SCST). Final report: EU-demonstration project, Contract : LIFE03ENV/D000025, KompetenzZentrum Wasser Berlin gGmbH, 2007.
- Besson, M., 2015. Étude des réalisations internationales et simulation d'un scénario de séparation à la source. (Rapport de Master 2). INSA Toulouse, Toulouse, France.

Appendix III. LITERATURE REVIEW ON SOURCE SEPARATION SYSTEMS ASSESSMENT

Source	Type of study	Goal	Size	Scenario	Optional studies
(Oldenburg et al., 2007)	Cost analysis	Comparison of the cost of 6 sanitation systems	126 ha ; 4891 inh; real estate	Sc1 : REF mixed WW Sc2-3: urine / faeces / greywater Sc4 : urine / faeces + greywater Sc5 : Blackwater / Greywater Sc6 : U / F+G	Sensitivity analysis
(Lundin et al., 2000)	LCA	Future oriented evaluation of projected systems	Sc1: 2700 inhabitants + 1000 people in office. + WW treated 72 000 pe Sc2 : 200 inh (rural area)	Sc1 : Urine // remaining WW Sc2 : Blackwater // greywater	Sensitivity analysis on electricity mix
(Meininger et al., 2010)	Cost, energy and material flow analysis	Comparison of different sanitation systems based on 2 case studies	Case study Hamburg: 1.7 million inh // 960,000 households // 755 km ² , agricultural land : 25% of the surface Case study Arba Minch: 80,000 inh // 16,500 households // 21.9 km ²	Sc REF, 2: WW // organic waste Sc 3: Urine //remaining WW // organic waste Sc 4, 5: BK // GW // OW Sc6: Urine // Faeces // Greywater // OW Sc REF, 2: Faecal sludge // Organic waste Sc3: Urine // Faeces // OW // GW Sc4: BW //OW // GW	Sensitivity analysis
(Tidåker et al., 2007)	LCA	Compared the use of urine in agriculture		Urine separation	Sensitivity analysis
(Bisinella de Faria et al., 2015)	LCA	Comparison at WWTP of conventional treatment and urine source separation	Average flow 20,000 m ³ /d around 78,000PE	REF, 2: no separation Sc 3-6 : Urine // remaining WW	
(Ishii and Boyer, 2015)	LCA	Comparison between urine source separation (with struvite precipitation)	Based on university community around 8800 persons	Sc A : no separation ScB : urine // remaining WW	Uncertainty analysis based on 3000 Monte Carlo

		with centralized WWTP			Sensitivity analysis :
(Lam et al., 2015)	LCA + local environmental impact	Compare source-separation systems with other domestic WW management system.	Village in rural area of north china. 2000 inhabitants. Average family size: 3.27persons/family. 20 ha	Sc1-2-4 : no separation Sc3: Urine /// remaining WW	
(Landry and Boyer, 2016)	LCA + LCC	Comparison of different management system of nonsteroidal anti-inflammatory drugs	Based on the campus of the university of Florida 8,800 around 50,000 persons	Sc A, B : Baseline scenario no separation Sc C-H : urine // remaining WW	Uncertainty analysis based on 3000 Monte Carlo simulation Sensitivity analysis
(Thibodeau et al., 2014b)	LCA	Assess the environmental performances of blackwater and conventional systems over their entire life	50,000 inh 50 years 50 inh/ha	Blackwater // greywater // kitchen refuse	Uncertainty analysis (Monte Carlo: 2000 simulations) sensitivity analysis.
(Thibodeau et al., 2014b)	LCC		50,000 inh 50 years Source separation system : 500 ; 5,000 ; 50,000 inh for GW only 50 inh/ha	Blackwater // greywater // kitchen refuse	Sensitivity analysis on : decrease in flush volume decrease in transport distance increase of resource costs
(Thibodeau et al., 2014a)	LCA LCC	Compare single and combined BWS development scenarios based on	50,000 inh 50 years 50 inh/ha	blackwater / greywater / kitchen refuse OW	

Appendix III. Literature review on source separation systems assessment

		direct recycling of digestate			
(Remy and Jekel, 2008)	LCA	Comparison of integrated concepts of 5000 inh urban wastewater management 40 inh/ha		Ref: Combined WW Sc2-5 : Urine # Faeces # Greywater	/
(Maurer et al., 2003)	Energy balance	Comparison of removal or recovery of urine nutrients		REF: Combined WW	/
	LCA	LCA of entire urine collection system to keep away nitrogen		Sc USS : U //remaining wastewater	/
(Memon et al., 2007)	LCA	Comparison of 4 technologies of greywater treatment for recycling	20 development scale : 0 to 5,000 inhabitants (4 to 1,250 households)	Greywater	
(Malila et al., 2019)	LCA	Compare 2 source separation systems with current sanitation system.	Rural area, on site sanitation for 3 persons with 85% annual use.	1) Urine # faeces # greywater 2) Blackwater # greywater	
(Shi et al., 2018)	LCA	Design toilet systems for different scenarios based on resource-oriented toilet	Publics toilets with 6 female and 2 male toilets and 2 urinals for, serving 780 women and 800 men every day	A1. no separation B1. and B2 and C. urine # feces	sensitivity analysis on source of electricity power and on the flux through FO
(Shi et al., 2018)	LCC	Design toilet systems for different scenarios based on resource-oriented toilet	Publics toilets with 6 female and 2 male toilets and 2 urinals for, serving 780 women and 800 men every day	A1. no separation B1. and B2 and C. urine # feces	
(Xue et al., 2016)	LCA	comparison of 4 alternative decentralised systems with the capability of recovering resources, with the conventional systems	Case study on Cape Cod (Massachussetts) for data collection. Around 2.3 m3/d of tap water consumed and 500L treated /d	1) Reference : no separation (BAU) 2) Urine + faeces // greywater (CT-SS) 3) urine // faeces + greywater (UD-SS) 4) blackwater // greywater (BE-GR) 5) blackwater // greywater // rainwater (BE-GRR)	Monte carlo analysis on 26 paramaters A sensitivity analysis

(Mbaya et al., 2017)	*	determine the additional environmental impacts of the urine separation and P recovery system compare freshwater toilet flushing and seawater toilet flushing	Building level 4 buildings types: existing, and new, and residential and office building. Office buildings have UDT ad waterless urinals	<ol style="list-style-type: none"> 1) struvite precipitation with freshwater for flushing the toilets 2) seawater as flush water 3) Struvite + nitrification reactor (freshwater) 4) same as 3 with seawater 	Sensitivity method Monte carlo analysis on 5000 iterations
LCA	Evaluate the life-cycle energy, GHG emissions and cost of ion exchange for recovery of nitrogen from source-separated urine with geospatial models	Case study of San Fransidco with high population density (6700 inh/km2)	Urine // brown grey water	Monte carlo analysis	
(Igos et al., 2017)	LCA	Assessing the environmental consequences of urine source separation in the Netherlands	50,000 PE SVFU scenario: 10% urine recovery rate = 7.3 m3/d urine treated in 10 units LVFU scenario: 50% urine recovery rate 38 m3/d treated at WWTP	<ol style="list-style-type: none"> 1) Reference : no separation 2) and 3) SVFU and LVFU : urine // grey + brown water 	Monte Carlo on 500 simulation
(Igos et al., 2017)	LCC				

References

- Bisinella de Faria, A.B., Spérandio, M., Ahmadi, A., Tiruta-Barna, L., 2015. Evaluation of new alternatives in wastewater treatment plants based on dynamic modelling and life cycle assessment (DM-LCA). *Water Res.* 84, 99–111. <https://doi.org/10.1016/j.watres.2015.06.048>
- Igos, E., Besson, M., Navarrete Gutiérrez, T., Bisinella de Faria, A.B., Benetto, E., Barna, L., Ahmadi, A., Spérandio, M., 2017. Assessment of environmental impacts and operational costs of the implementation of an innovative source-separated urine treatment. *Water Res.* 126, 50–59. <https://doi.org/10.1016/j.watres.2017.09.016>
- Ishii, S.K.L., Boyer, T.H., 2015. Life cycle comparison of centralized wastewater treatment and urine source separation with struvite precipitation: Focus on urine nutrient management. *Water Res.* 79, 88–103. <https://doi.org/10.1016/j.watres.2015.04.010>
- Kavvada, O., Tarpeh, W.A., Horvath, A., Nelson, K.L., 2017. Life-Cycle Cost and Environmental Assessment of Decentralized Nitrogen Recovery Using Ion Exchange from Source-Separated Urine through Spatial Modeling. *Environ. Sci. Technol.* 51, 12061–12071. <https://doi.org/10.1021/acs.est.7b02244>
- Lam, L., Kurisu, K., Hanaki, K., 2015. Comparative environmental impacts of source-separation systems for domestic wastewater management in rural China. *J. Clean. Prod.* 104, 185–198. <https://doi.org/10.1016/j.jclepro.2015.04.126>
- Landry, K.A., Boyer, T.H., 2016. Life cycle assessment and costing of urine source separation: Focus on nonsteroidal anti-inflammatory drug removal. *Water Res.* 105, 487–495. <https://doi.org/10.1016/j.watres.2016.09.024>
- Lundin, M., Bengtsson, M., Molander, S., 2000. Life Cycle Assessment of Wastewater Systems: Influence of System Boundaries and Scale on Calculated Environmental Loads. *Environ. Sci. Technol.* 34, 180–186. <https://doi.org/10.1021/es990003f>
- Malila, R., Lehtoranta, S., Viskari, E.-L., 2019. The role of source separation in nutrient recovery – Comparison of alternative wastewater treatment systems. *J. Clean. Prod.* 219, 350–358. <https://doi.org/10.1016/j.jclepro.2019.02.024>
- Maurer, M., Schwegler, P., Larsen, T.A., 2003. Nutrients in urine: energetic aspects of removal and recovery. *Water Sci. Technol. J. Int. Assoc. Water Pollut. Res.* 48, 37–46.
- Mbaya, A.M.K., Dai, J., Chen, G.-H., 2017. Potential benefits and environmental life cycle assessment of equipping buildings in dense cities for struvite production from source-separated human urine. *J. Clean. Prod.* 143, 288–302. <https://doi.org/10.1016/j.jclepro.2016.12.111>
- Meinzinger, F., Otterpohl, R., Londong, J., 2010. Resource efficiency of urban sanitation systems: a comparative assessment using material and energy flow analysis, *Hamburger Berichte zur Siedlungswasserwirtschaft. Ges. zur Förderung und Entwicklung der Umwelttechnologien an der Techn. Univ. Hamburg-Harburg, Hamburg.*
- Memon, F.A., Zheng, Z., Butler, D., Shirley-Smith, C., Lui, S., Makropoulos, C., Avery, L., 2007. Life Cycle Impact Assessment of Greywater Recycling Technologies for New Developments. *Environ. Monit. Assess.* 129, 27–35. <https://doi.org/10.1007/s10661-006-9422-3>
- Oldenburg, M., Peter-Fröhlich, A., Dlabacs, C., Pawlowski, L., Bonhomme, A., 2007. EU demonstration project for separate discharge and treatment of urine, faeces and greywater –

- Part II: Cost comparison of different sanitation systems. *Water Sci. Technol.* 56, 251. <https://doi.org/10.2166/wst.2007.578>
- Remy, C., Jekel, M., 2008. Sustainable wastewater management: life cycle assessment of conventional and source-separating urban sanitation systems. *Water Sci. Technol.* 58, 1555. <https://doi.org/10.2166/wst.2008.533>
- Shi, Y., Zhou, L., Xu, Y., Zhou, H., Shi, L., 2018. Life cycle cost and environmental assessment for resource-oriented toilet systems. *J. Clean. Prod.* 196, 1188–1197. <https://doi.org/10.1016/j.jclepro.2018.06.129>
- Thibodeau, C., Monette, F., Bulle, C., Glaus, M., 2014a. Comparison of blackwater source-separation and conventional sanitation systems using life cycle assessment. *J. Clean. Prod.* 67, 45–57. <https://doi.org/10.1016/j.jclepro.2013.12.012>
- Thibodeau, C., Monette, F., Glaus, M., 2014b. Comparison of development scenarios of a blackwater source-separation sanitation system using life cycle assessment and environmental life cycle costing. *Resour. Conserv. Recycl.* 92, 38–54. <https://doi.org/10.1016/j.resconrec.2014.08.004>
- Tidåker, P., Mattsson, B., Jönsson, H., 2007. Environmental impact of wheat production using human urine and mineral fertilisers – a scenario study. *J. Clean. Prod.* 15, 52–62. <https://doi.org/10.1016/j.jclepro.2005.04.019>
- Xue, X., Hawkins, T., Schoen, M., Garland, J., Ashbolt, N., 2016. Comparing the Life Cycle Energy Consumption, Global Warming and Eutrophication Potentials of Several Water and Waste Service Options. *Water* 8, 154. <https://doi.org/10.3390/w8040154>

Appendix IV. CREATION OF THE DISTRICT

Theoretical districts are squared map where the size is set by the length of the square. They are representing by roads and buildings. Each building has a use (offices of housing). As a first step the roads are straight lines with right angle. The buildings are rectangle with a fixed length/width ratio for each urban configuration. Each buildings are placed randomly in the map with constraints: a fixed distance to the road and obviously no overlap with road or building. The building can be placed with two angles of rotation (horizontal or vertical). The random character of building introduces some disparity in the building placement. However with the denser district this cannot be done. The district is covered by buildings and if some buildings are misplaced, all the building can no longer fit in. This is why two methodologies were used (

Figure S 1): one for discontinuous, continuous pavilions, discontinuous blocks and another one for continuous blocks and ancient centre and high-rise tower.

For the low density district, the roads are created before the buildings. The number of road is calculated based on the width of the road and the road density. They are placed with the same spacing between each other. After that the building placement can start. First the number of total buildings is calculated thanks to the land coverage ratio and the surface per building. Secondly, the buildings will be individual or collective regarding the corresponding ratio. Thirdly, the first building will be placed randomly in the map. It has to fulfil the following constraints: i) The distance to the road needs to be less than 5m (default value); ii) No overlap with roads or other districts. Finally, the remaining building will be placed starting with collective buildings. For each new building to be created, the contiguity coefficient will be calculated and if necessary twin buildings will be placed.

The high density district methodology is based on the creation of groups of buildings. The continuous pavilions and ancient centre have indeed a configuration with courtyard. A group of building is defined by the road which surrounding it. As the high build density will let few space available, the road will be created from the characteristic of these groups. First of all, the surface of the group will be defined thanks to the courtyard ratio and the open space ratio. Secondly the number of row and column form by the road grid will be calculated with the size of the district and the shape ratio of the group and the width of the road. In this configuration, a half road is present all around the district. At the end of this step the number of possible position of group is known. It has to be compared to the number of group to be placed. If there is not enough space the group surface are calculated regarding the maximal number of possibilities and by changing the shape ratio. In the next step the group placement will be randomly chosen between the possible choices. Finally the group will be segmented into building with the predetermined form and the contiguity coefficient of the district.

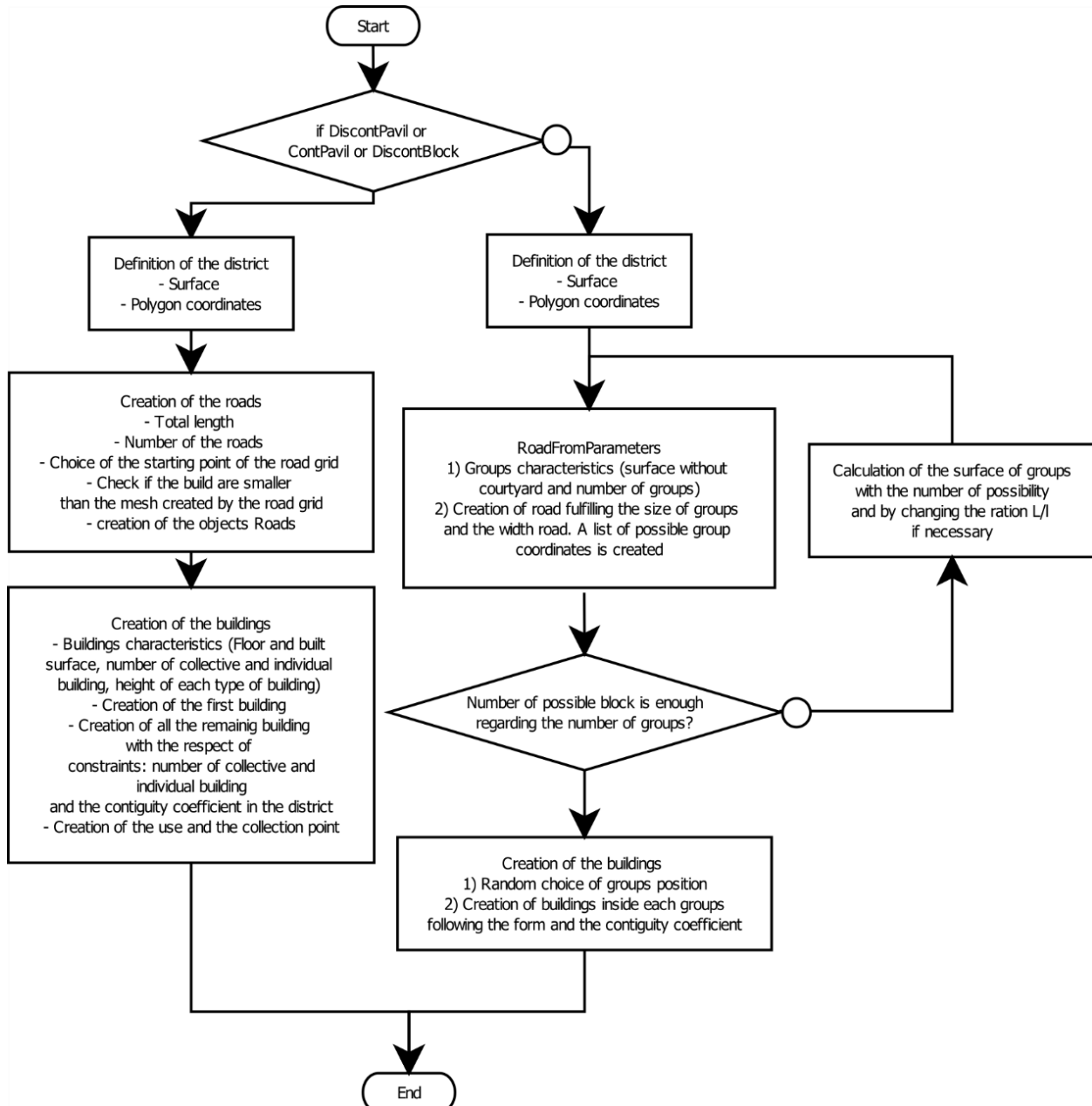

Figure S 1: Methodology of district creation

Appendix V. LITERATURE REVIEW FOR INFLUENT CHARACTERISTICS

V.1 Literature review on urine composition and production

Table S 14 Details of the data used in the bibliographic review of urine composition

Number	Reference	Project Name or comments	Urine state	Comments
1		6 persons age 25-34	Fresh	
2	Udert et al., 2003	6 persons age 25-34, a 2 nd time	Fresh	
3	O'Neal et Boyer, 2013	Synthetic urine	Fresh	
4	Maurer et al., 2006 from Ciba-Geigy, 1977	Medical source	Fresh	
4		Lehnartz, 1943	Fresh	
5		Beck, 1971	Fresh	
6		Strand, 1978	Fresh	
7	Wilsenach	et Ciba Geigy, 1977	Fresh	
8	Loosdrecht, 2001	Berne and Levy, 1998	Fresh	
9		Guyton, 1991	Fresh	
10		Houssay, 1995	Fresh	
11		Wilsenach et Loosdrecht, 2001	Fresh	
12	Triger et al., 2012	Male urine	Fresh	
13	Putnam, 1971	16 samples of mixed urine from 20 to 30 male subjects	Fresh	
14	Etter et al., 2011	14 individuals (8 male, 6 femal between 6 and 64 years old)	Fresh	Urea : 4.450mg/L
15	Kuntkte, 2013	2 sets of samples: employee at Wetsus and hospital patients	Fresh	
16	Fittschen and Hahn, 1998 cited in Remy, 2010	Human urine from 19 to 27 people collected during 24h.	Fresh	
17	Liu et al., 2013	Hydrolysed urine (by adding urease) from 25 healthy adults	Hydrolysed	
18	Udert et al., 2003	sampled in the collection tank of separating toilet	Stored	
19	Almqvist et al., 2007	3 Collections from dry separated toilet from Gebers neighborhood (79 persons) during one week.	Stored	Recalculated from urine mixture (22% of flush water)
20	Vinnerås, B. 1998	8 one-room apartment (Hushagen). Collection of urine during 3 weeks	Stored	1.566 L/pers/d flush water 15.1 h/pers in the apartment. 2.34 L/pers/d urine mixture
21	Jönsson et al., 1998	Palsternackan project, 1653 persons days	Stored	4.13 L urine mixture / d / apartment ; 1.38 L flush/ d / apartment ; 3.1 pers/apartment ==> 0.887 Lurine /pers/d with 14,6 h/ d in the apartment ==> 1.458 Lurine /pers/d (24h)

Appendix V. Literature review for influent characteristics

Number	Reference	Project Name or comments	Urine state	Comments
22	Lindgren, 1999	Nytorrgsgatan (Miljöhuset) project. 30 apartments rented (16 studios, 9 threes, 15 fours). 8 days collection of urine	Stored	Same hypothesis than Jönsson et al., 1998 about amount of flush : 0,34L/pers/ 13h ; 0,51 Lflush/pers/13h ; 16h / d in apartment ; 1,19 Lmixture /pers/16h ==> 1,785 L/pers/d ; ==> 1,275 Lurine/pers/d
23	Maurer et al., 2006 from Kirchmann	SW 5 households. et maximum	Stored	
24	Pettersson, 1994 data	Stensund SW. High school	Stored	
25	Maurer et al., 2006 from Udert et al., 2003 data	sampled in the collection tank of separating toilet	Stored	
26	O'Neal et Boyer, 2013	Synthetic urine	Stored	
27		Synthetic urine	Stored	
28	Triger et al., 2012	Male urine stored between one week to several months from urinals	Stored	
29	Etter et al., 2011	From urine diverting dry toilets in Nepal. (approx 160 persons)	Stored	
30	Palmquist and Jonsson, 2003 cited in Remy, 2010	From Gebers project. 3 samples of one week. Urine with small amount of flush water : 1,76 L/pers/d	Stored	
31	Oldenburg, 2002 cited in Remy, 2010	Lübeck-Flintenbreite project. Diverting toilets	Stored	
32	Jonsson et al., 1997	Understen eco-village, 44 apartments, 160 persons with diverting toilets. consecutive 14-day period	2 Stored	13.9 h/day; 160 inhabitants; 3010 L on 14d with 0.34 L/pers of flush
33	Remy, 2010	Lange et Otterpohl, 2000	Unknown	

T_{COD}: Total COD; **S_F**: Fermentable organic matter; **S_U**: Soluble undegradable organics; **X_{CB}**: Slowly biodegradable substrates; **X_U**: Particulate undegradable organics; **T_N**: Total nitrogen; **S_{NHX}**: Ammonium plus ammonia nitrogen; **S_{NO3}**: nitrate; **S_{NB}**: soluble biodegradable organic; **X_{NB}**: particulate biodegradable organic; **T_P**: Total phosphorus; **S_{PO4}**: orthophosphate; **S_P**: soluble phosphorus; **X_P**: particulate phosphorus; **T_S**: Total sulfur; **S_{SO4}**: sulfate.

Table S 15: Main parameters of urine composition

Number	Volume (no flush water) L/pers/d	Dilution	TSS (gTSS/L)	COD		BOD ₇		N		P		S		pH	
				T _{COD} gCOD/L		gBOD/L		T _N gN/L	S _{NHx}	T _P gP/L	S _{PO4}	X _P T _S gS/L	S _{SO4}		
1				8.2					0.3			0.4		0.3	7.2
2				9.7					0.4			0.6		0.5	6.0
3	1.40											0.6		0.3	
4	1.25							8.8	0.5	0.8-2.0			1.3		6.2
5	1.35									1.0			0.6		6
6	1.20									0.4			0.6		5.5
7	1.20									0.7			0.7		
8	1.25			9.6				9.2		1.1			0.4		6.17
9	1.50								0.7	0.5					6
10	1.50									0.3					
11	1.25									0.5			0.6		
12	1.25			9.6				9.6		0.8			0.8		6
13									0.5		0.5				6.3
14				7.53				6.56	0.16-0.60	0.47-1.07			0.24-2.27		6.63
15				7.66				4.888	0.438			0.388		0.878	5.6
16				9				8.6	0.431	0.7		0.65	0.6	0.39	
17	1.57			8.26				6.88		0.59					6.1
Mean	1.34			8.69				7.79	0.45	0.66		0.52	0.69	0.46	6.14
Standard deviation	0.13			0.90				1.72	0.20	0.35		0.12	0.35	0.25	0.44
Standard deviation %	10%			10%				22%	45%	52%		23%	51%	54%	7%
18															
19				1.7					1.7			0.1		0.1	9.0
20	1.39		0.5	7.4	3.6	7.5	6.1	7.5	6.1	0.5	0.4	0.5	0.5		9.2
21	1.22				5.1	7.1	6.5	7.1	6.5	0.4		0.5	0.5		9.0
22	1.46				2.6	5.0	4.9	5.0	4.9	0.5		0.5	0.5		9.2
23	1.28		0.952			3.9	3.78	3.9	3.78	0.3					8.8
24		0.3				5.4	5.1	5.4	5.1	0.6			0.7		9
25		0.3				7.8	7.5	7.8	7.5	0.6			0.5		8.9
26		0.3		6.4		6.9	6.6	6.9	6.6	0.3			0.3		9
Stored															
27	1.40								10.1			0.4		0.3	9.7
28	1.40								7.0			0.4		0.5	9.3

Appendix V. Literature review for influent characteristics

Number	Volume (no flush water) L/pers/d	Dilution	TSS (gTSS/L)	COD T _{COD} gCOD/L	BOD ₇ gBOD/L	N T _N gN/L	S _{NHx}	P T _P gP/L	S _{PO4}	X _P	S T _S gS/L	S _{SO4}	pH
29							4.4		0.5			0.5	9.0
30									0.195				9.0
31				6.75		6.95		0.45			0.42		
32	1.2			15		8.58		0.92					
33	<i>1.79</i>					<i>4.69</i>	<i>4.61</i>	<i>0.40</i>					
34	1.37						4.25		0.34			0.5	
Mean	1.39	0.31	0.7	7.4	3.8	6.4	5.7	0.5	0.3		0.5	0.3	9.1
Standard deviation	0.19	0.04	0.3	4.8	1.2	1.5	2.1	0.2	0.2		0.1	0.2	0.2
Standard deviation %	13%	13%	41%	65%	33%	24%	37%	37%	47%		24%	52%	3%
Mean	1.36			8.20	3.77	6.97		0.58			0.60	0.41	7.62
Standard deviation	0.15			2.93	1.23	1.72		0.28			0.28	0.20	1.55
All Standard deviation %	11%			36%	33%	25%		48%			46%	49%	20%

Italic values are recalculated with the data present in the publications. See column "comments" of the Table S1.

Appendix V. Literature review for influent characteristics

Table S 16: Calculated ratio of interest for urine

	Number	Ratio T _N / T _P	Ratio COD / T _N	Ratio Na / Cl	Ratio NH ₄ / T _N	Ratio PO ₄ / T _P
	1			0.70		
	2			0.71		
	3					
	4		0.00	0.68	0.05	
	5			0.66		
	6					
	7					
	8	8.21	1.04	1.08		
	9			0.65		
	10			0.62		
	11					
	12	12.00	1.00	0.57		
	13					
	14		1.15			
	15		1.57	0.49	0.09	
	16	12.29	1.05	0.63	0.05	0.93
	17	11.66	1.20			
	Mean	11.04	1.00	0.68	0.06	0.93
	Standard deviation	4.90	0.59	0.36	0.03	0.23
	Standard deviation %	44%	59%	54%	41%	24%
Fresh	18			0.68		
	19			0.60		
	20	15.24	0.98		0.81	0.82
	21	16.43		1.13	0.90	
	22	10.75		0.58	0.99	
	23	12.56			0.96	
	24	8.54		0.39	0.94	
	25	13.05		0.42	0.96	
	26	23.79	0.92	0.60	0.96	
	27			0.54		
	28			0.67		
	29			0.56		
	30			0.49		
	31	15.44	0.97			
32	9.33	1.75				
33	11.60		0.69	0.98		
34						
Stored	Mean	13.67	1.16	0.61	0.94	0.82
	Standard deviation	7.55	0.56	0.32	0.49	0.21
	% Standard deviation	55%	48%	53%	52%	26%
All	Mean	12.92	1.06	0.64	0.70	0.87
	Standard deviation	6.92	0.56	0.34	0.40	0.21
	Standard deviation %	54%	53%	53%	57%	24%

Appendix V. Literature review for influent characteristics

Table S 17: Salts and heavy metals in urine

Number	K	Ca	Mg	Total carbonate	Pb	Cd	Hg	Cu	Cr	Ni	Zn	Cl	Na	Mn	Alkalinity
	gK/L	gCa/L	gMg/L	gC/L	mgPb/L	mgCd/L	mgHg/L	mgCu/L	mgCr/L	mgNi/L	mgZn/L	gCl/L	gNa/L	gMn/L	mM
1	2.17	0.13	0.077									3.8	2.7		
2	2.25	0.17	0.12	< 0.005								5.2	3.7		
3	1.95	0.16	0.096									3.55	1.7		
4	2.20	0.19	0.1	0								3.8	2.6		22
5	2.00	0.37	0.296									6.59	4.37		
6	1.67	0.12	0.12										3.33		
7	2.75	0.25	0.083										4.92		
8	2.16	0.19	0.1									3.8	4.12		
9	2.73	0.24	0.22									4.6	2.99		
10	2.34	0.076	0.18									4.75	2.94		
11	1.60	0.16	0.12										3.2		
12	2.40	0.16	0.16									5.6	3.2		
13	2.05	0.12	0.12									3.86			
14	0.75	- 0.03	- 0.02	- 2.4E-2	-							1.87	- 1.17	-	
	2.61	0.390	0.205	0.14								8.4	4.39		
15	1.87	0.089	0.045									6.62	3.24		
16	1.89	0.106	0.078									3.8	2.41		
17	1.65														
Mean	2.10	0.17	0.13									4.67	3.24		22.00
Standard deviation	0.61	0.08	0.07									1.68	1.16		
Standard deviation %	29%	50%	55%									36%	36%		
18	2.0			1.1								3.8	2.6		
19	0.77	0.028	0.001	1.0								1.4	0.8		
20	1.62	0.0444	0.0306		0.0083	0.0002	0.0003	0.0083	0.0003	0.0071	0.2101		2.1049	0.0017	
21	0.11	0.0068	0.0015		0.005	0.0	0.0	0.1	0.0182	0.0023	0.0	0.1216	0.1	1E-06	
22	1.33	0.0345	0.0103		0.0	0.0	0.0	4.5	0.003	0.033	0.8	3.4007	1.9598	0.0067	
23	0.96		0.0196		0.0294	0.0	0.0005	7.1	0.0098	0.0448					
24	2.62	0.0	0.0049		0.0142	0.0		0.2	0.0039	0.0058	0.5	7.5	2.95	0	
25	3.45	0.0	0.0045									6.7	2.81	0	
26	2.96	0.1	0.0039									5.39	3.22		
27	1.95			3.2								3.6	1.92		

Appendix V. Literature review for influent characteristics

28	1.56			3								3.6	2.39		
29	2.52	0.04	0.004									4.57	2.6		
30	1.87	0.089	0.045									6.62	3.2		
31	1.49				0.0079	0	0	0.033	0	0.0066	0.19				
32	1.83														
33	1.33	0.024	0.015									2.35	1.61	5E-05	
34	1.42														
Mean	1.76	0.05	0.01	2.39	0.02	0.00	0.00	2.00	0.01	0.02	0.35	4.10	2.15	0.00	
Standard deviation	0.87	0.03	0.01	1.24	0.01	0.00	0.00	3.08	0.01	0.02	0.30	2.32	0.94	0.00	
Standard deviation %	49%	66%	110%	52%	82%	141%	72%	154%	119%		86%	57%	44%	191%	
Mean	1.92	0.12	0.08	1.65	0.02	0.00	0.00	2.00	0.01	0.02	0.35	4.37	2.73	0.00	22.00
Standard deviation	0.72	0.09	0.08	1.39	0.01	0.00	0.00	3.08	0.01	0.02	0.30	1.91	1.12	0.00	
All Standard deviation %	37%	73%	96%	84%	82%	141%	72%	154%	119%	107%	86%	44%	41%	191%	

The blue values are under the limit of quantification, meaning that the real value is perhaps inferior to these

V.2 Literature review on faeces composition and production

Table S 18: Main parameters of faeces composition

Number	Reference	Project Name or comments	Volume (no flush water) L/pers/d	TSS	COD	BOD	N		P		S		
				(gTSS/L)	T _{COD} gCOD/L	gBOD/L	T _N gN/L	S _{NHx} gP/L	T _P gS/L	S _{PO4}	X _P	T _S	S _{SO4}
1	Jonsson et al. (2005)	URWARE model	0.11	425.2	567.8	243.7	13.3	2.7	4.4	0.9	3.5	1.5	0.03
2	Andersson & Jenssen (2002)	Gebers project. Urine-diverting system with dry collection of faeces. Around 80 persons.	0.15			17.7	12.8	4.3	4.5			1.4	
3	Kärman et al., (1999)		0.07				21.8		7.3				
4	Vinneras et al (2004); Vinneras (2002)	New design value from two projects measurement: Ekoporten (35 persons) and Gebers (80 persons)	0.15				10.0		3.3				
5	Drangert (1998)	Design value	0.14				10.0		4.0				
6	From Kujawa-Roeleveld (2003)		0.10		810.7				9.9				
7	Lange & Otterpohl (2002)	Collection of literature review	0.10						5.7				
8	Palmquist & Jönsson (2003)	Measurement on Gebers project (80 residents)	0.15			17.8	12.9		4.5			1.4	
9	Ciba-Geigy (1977)	Medical value	0.09		200.8		20.1		6.0				
10	Koppe & Stozek (1999)		0.10		357.7	148.2	18.4						
11	Oldenburg (2002)	Lübeck settlement	0.12		265.8	72.2	16.1		5.6				
12	Remy (2010)	Literature review	0.10		362.5	117.0	15.5		5.2			2.1	
13	Almeida (1999)	Measurement in England (78 residents)	0.08	326.3	398.8			2.1		8.1			
14	Vinneras (2002)		0.12				12.9		4.3				
15	Günther (2000)	From litterature	0.15				10.0		3.3				
16	KujawaRoeleveld & Zeeman (2006)		0.07 - 0.17	250.0	652.9 - 320.6	230 - 226.6	21.4 - 11.8		4.3 - 2.9				

Appendix V. Literature review for influent characteristics

Mean	0.12	375.7	423.4	102.8	14.5	3.0	5.2	4.5	1.6	0.03
Standard deviation	0.03	134	257	73	6.9	1.3	2.5	2.1	0.7	
Standard deviation %	24%	36%	61%	71%	48%	44%	47%	46%	47%	

Value in italic red are calculated thanks to mass density of faeces (1450 g/L) from Niwagaba, et al (2014).

Appendix V. Literature review for influent characteristics

Table S 19: Salts, heavy metal concentration in faeces and main ratio

Number	K	Ca	Mg	Pb	Cd	Hg	Cu	Cr	Ni	Zn	Cl	Na	Ratio T _N / T _P	Ratio COD / T _N
	gK/L	gCa/L	gMg/L	mgPb/L	mgCd/L	mgHg/L	mgCu/L	mgCr/L	mgNi/L	mgZn/L	gCl/L	gNa/L		
1	8.9			0.4	0.1	0.1	9.7	1.2	1.7	94.8			3.0	42.7
2	5.0			0.2	0.1	0.1	11.4	0.9	1.5	304.4			2.8	
3	14.5			0.3	0.1	0.9	16.0	0.3	1.1	159.5			3.0	
4	6.7			0.1	0.1	0.1	7.3	0.1	0.5	71.2			3.0	
5	6.0												2.5	
6														
7	3.4													
8	5.1			0.3	0.1	0.1	11.5	0.9	1.5	305.9			2.9	
9	4.9	9.0	2.7	3.6	1.8		21.9	0.7	2.9	85.9	0.7	1.7		10.0
10					2.9				2.5		0.6			19.5
11	5.6	8.9		0.2	0.1	0.2		0.2	0.6	87.0			2.9	16.5
12	5.7	10.4	2.1	0.2	0.2	0.2	15.5	0.2	2.1	103.6	0.6	1.6	3.0	23.3
13														
14	8.5			0.00	0.00	0.00	0.01	0.00	0.00	0.1			3.0	
15													3.0	
16	11.4 - 5.9	4.4	1.5	0.2	0.1	0.1	9.1	0.2	0.6	89.0			5 - 4	30.5 - 27.3
Mean	6.75	9.42	2.37	0.58	0.54	0.19	11.66	0.48	1.42	134.70	0.62	1.61	3.48	21.40
Standard deviation	4.06	3.81	0.82	0.87	0.80	0.23	7.48	0.39	1.01	103.13	0.25	0.55	2.27	12.54
Standard deviation %	60%	40%	34%	151%	147%	117%	64%	81%	71%	77%	40%	34%	65%	59%

V.3 Literature review on greywater composition and production

Table S 20: Main parameters of grey water composition

Number	Reference	Project Name or comments	Volume	COD		BOD ₇	N	P			S		
			(no flush water) L/pers/d	TSS (mgTSS/L)	T _{COD} mgCOD/L	mgBOD/L	T _N mgN/L	S _{NHx} mgP/L	T _P	S _{PO4}	X _P	T _S	S _{SO4} mgS/L
1	Jönsson et al. (2005)	URWARE Model	130.00	135.4	480.0	260.0	11.8	1.9	5.2	2.2	3.0	3.5	2.62
2	Olsson (1967)	Residential building in Bromsten for one week (25 apartments) ^{a)}	121.50	142.4		241.5	9.1		18.1				
3	Kalgren et al. (1977)	Residential building in Bromsten for two weeks (25 apartments) ^{a)}	133.00			241.5	5.6		2.5				
4	NV (1995)	Measurement in Tuggelite (ecovillage 16 apartments) for 7 days ^{b)}	108.00	84.3	478.7	260.0	10.8	0.6	3.3				
5	Weglin & Vinneras (2000)	Ekoporten residence with 34 residents during three twelve days period. ^{a)}	104.00		64.5	74.0	16.3	< 0.2	4.2			18.9	
6	Palmquist (2001)	Residential area with 169 people with three-hour sample ^{a)}	70.00		557.1	400.0	9.1		7.1			22.9	
7	Andersson & Jenssen (2002)	Gebers project. 79 residents. Three week-long period ^{a)}	100.00	100.0	480.0	217.0	14.0	1.9	6.0	4.8		16.0	
8	Kärroman et al., (1999)	ORWARE model	150.00	95.9	344.7	190.0	6.7	0.5	2.0			27.2	
9	Vinneras et al (2004); Vinneras (2002)	New design value from two projects measurement: Ekoporten (35 persons) and Gebers (79 persons)	100.00		520.5	260.0	13.7		5.2				
10	NV (1995)	Design value	150.00	106.7		190.0	6.7		4.0				
11	Kujawa-Roeleveld & Zeeman (2006)		91.30		569.6	322 - 356.5	11 - 15.3		3.3				
12	Palmquist (2001)		66.40		587.3		9.6		7.5				
13	Vinneras (2002)	From Literature review	109.59				11.5		2.8				
14	Palmquist & Jönsson (2003)	Measurement on Gebers project (80 residents)	110.00		435.9		12.7		5.5			14.5	
15	Koppe & Stozek (1999)		200.00		475.0		6.5		2.5			38.5	
16	Lange & Otterpohl (2000)	Collection of literature review	82.19		425.8		12.2		1.7				
17	Ameilda (1999)	Measurement in England (78 residents)	70.79		886.6								

Appendix V. Literature review for influent characteristics

18	Bahlo (1999)		69.00		478.3		21.7		2.2				
19	Remy (2010)	Literature review	80.00		750.0		16.3		6.3			93.8	
20	Hernandez Leal (2007)	Eco-village Groningen (150 houses) and demonstration project in Sneek (NL) (32 houses)	100.00		425.0	215.0	17.2	7.2	5.7	2.3			
21	Günther (2000)	From literature	150.00				6.7		4.0				
22	Thibodeau (2014)	From Canadian statistical data	132.00		628.0		14.4		3.8				
23	Henze (2008)	From literature	98.63		547.2	414.0	19.4		4.7				
		Mean	109.8	110.8	507.5	246.9	12.0	2.4	4.9	3.1	3.0	29.4	2.6
		Standard deviation	33	50.9	259.8	141.4	5.5	1.6	3.5	1.2	21.3	!	
		Standard deviation %	30%	46%	51%	57%	46%	64%	71%	37%	72%		

^{a)}From Magnusson 2003; ^{b)}From Beck and Speers 2006

Appendix V. Literature review for influent characteristics

Table S 21: Salts, heavy metals and main ratio for grey water

Number	K mgK/L	Ca mgCa/L	Mg mgMg/L	Pb µgPb/L	Cd µgCd/L	Hg µgHg/L	Cu µgCu/L	Cr µgCr/L	Ni µgNi/L	Zn µgZn/L	Cl mgCl/L	Na mgNa/L	Ratio T _N / T _P	Ratio COD / T _N
1	6.1			2	0	0	40	2	4	40			2.3	40.8
2													0.5	
3													2.3	
4													3.3	44.2
5	39.8			13	0	0	111	10	8	126			3.9	3.9
6	7.7			2	0	0	59	4	10	61			1.3	60.9
7	9.5			2	0	0	65	4	7	70			2.3	34.3
8	3.3												3.3	51.7
9	10.0			10	0	0	79	10	12	100			2.6	38.0
10	3.3			< 20	< 4	< 0.4	< 40	< 30	< 20	< 330			1.7	
11	5.5			11	0	0	87	11	14	110			3.3	52.0
12					0		62						1.3	60.9
13	25.0			27	2	0	55	28	18	305			4.2	
14	8.7			2	0	0	59	4	6	56			2.3	34.3
15	9.3										53.0	20.0	2.6	73.1
16	30.4												7.1	35.0
17														
18													10.0	22.0
19	25.0	175.0	37.5	38	3	0	250	38	25	575	87.5	75.0	2.6	46.2
20	11.2	60.8	6.2				0					86.4	3.0	24.7
21													1.7	
22	15.9												3.8	43.6
23	8.3												4.1	28.1
Mean	13.7	117.9	21.8	12.0	0.6	0.1	78.7	12.1	11.5	160.3	70.3	60.5	3.2	40.8
Standard deviation	10.9	38.1	7.9	9.7	0.6	0.1	58.6	9.5	7.0	132.2	20.9	23.4	2.1	23.1
% deviation	80%	32%	36%	81%	102%	87%	74%	79%	61%	82%	30%	39%	67%	57%

V.4 References

- Almeida, M.C., Butler, D., Friedler, E., 1999. At-source domestic wastewater quality. *Urban Water* 1, 49–55. [https://doi.org/10.1016/S1462-0758\(99\)00008-4](https://doi.org/10.1016/S1462-0758(99)00008-4)
- Andersson, Å. & Jenssen A. 2002. Flöden och sammansättning på BDT-vatten, urin, fekalier och fast organiskt avfall i Gebers (Flows and composition of greywater, urine, faeces and solid biodegradable waste in Gebers; In Swedish, English summary). *Institutionsmeddelande 2002:05*, Department of Agricultural Engineering, Swedish University of Agricultural Sciences. Uppsala, Sweden.
- Bahlo, K. (1999): *Bewachsene Bodenfilter zur Grauwasserreinigung (Planted soil filters for greywater treatment)*, pp. 85-95: *Grauwasser-Recycling, Fachvereinigung Betriebs- und Regenwassernutzung e.V.*, Darmstadt, Germany.
- Beck, M.B., Speers, A., 2006. *2nd IWA Leading-Edge on Sustainability in Water-Limited Environments*. IWA Publishing.
- Beck, W.S., (1971) “Human Design”, Harcourt Brace Javanovich Inc
- Berne R.M. and Levy M.N., 1998. *Physiology*. 4th edition, St. Louis Mosby Inc.
- Ciba-Geigy (1977): *Wissenschaftliche Tabellen Geigy, Teilband Körperflüssigkeiten (Scientific tables Geigy, Volume body fluids)*. Ciba-Geigy AG. Basel, Switzerland.
- Drangert, J.-O., 1998. Urine blindness and the use of nutrients from human excreta in urban agriculture. *GeoJournal* 45, 201–208.
- Etter, B., Tilley, E., Khadka, R., Udert, K.M., 2011. Low-cost struvite production using source-separated urine in Nepal. *Water Research* 45, 852–862. doi:10.1016/j.watres.2010.10.007
- Fittschen, I., and Hahn, H. (1998): Characterization of the municipal wastewaterpart human urine and a preliminary comparison with liquid cattle excretion. *Water Science and Technology* 38 (6), 9-16.
- Gernaey, K.V., Flores-Alsina, X., Rosen, C., Benedetti, L., Jeppsson, U., 2011. Dynamic influent pollutant disturbance scenario generation using a phenomenological modelling approach. *Environmental Modelling & Software* 26, 1255–1267. doi:10.1016/j.envsoft.2011.06.001
- Gillot Sylvie
- Gunther, F. (2000) *Wastewater treatment by greywater separation: outline for a biologically based greywater purification plant in Sweden*. *Ecological Engineering* 15, 139–146.
- Guyton A.C., 1991. *Textbook of Medical Physiology*, 8th edition, W.B. Saunders Company.
- Henze, M. (Ed.), 2008. *Biological wastewater treatment: principles, modelling and design*. IWA Publ, London.
- Houssay, B.A., 1955. *Human Physiology*, McGraw Hill Book Company, Inc
- Jönsson, H., Baky, A., Jeppsson, U., Hellström, D., Kärman, E., 2005. Composition of urine, faeces, greywater and biowaste for utilisation in the URWARE model.
- Jönsson, H., Burström, A. & Svensson, J. 1998. Mätning på två urinsorterande avloppssystem (Measurements on two urine separating sewage systems; In Swedish, English summary). Report 228, Department of Agricultural Engineering, Swedish University of Agricultural Sciences. Uppsala, Sweden.

- Jönsson, H., Stenström, T.-A., Svensson, J., Sundin, A., 1997. Source separated urine-nutrient and heavy metal content, water saving and faecal contamination. *Water Science and Technology, Sustainable Sanitation* 35, 145–152. doi:10.1016/S0273-1223(97)00192-3
- Karlgren, L., Ljungström, K., Olsson, E. & Tullander, V. 1977. Hushållsspillvattnet – sammansättning och egenskaper (Household wastewater – composition and characteristics; In Swedish). Statens institut för byggforskning, Meddelande/bulletin M77:16. Stockholm, Sweden.
- Kärman, E., Jönsson, H., Gruvberger, C., Dalemo, M. & Sonesson, U. 1999. Miljösystemanalys av hushållens avlopp och organiska avfall (Environmental systems analysis of wastewater and solid organic household waste). Report 1999•15 VA-FORSK/VAV. Stockholm, Sweden.
- Koppe, P., and Stozek, A. (1999): *Kommunales Abwasser: seine Inhaltsstoffe nach Herkunft, Zusammensetzung und Reaktionen im Reinigungsprozeß einschließlich Klärschlämme* (Municipal sewage: its components and their source, composition, and reactions in the treatment process including sewage sludge). Vulkan-Verlag. Essen, Germany.
- Kujawa-Roeleveld, K., Elmitwalli, T., Gaillard, A., van Leeuwen, M., and Zeeman, G. (2003): Co-digestion of concentrated blackwater and kitchen refuse in an accumulation system within the DESAR (decentralized sanitation and reuse) concept. *Water Science and Technology* 48 (4), 121-128.
- Kuntke, P., 2013. Nutrient and energy recovery from urine. Wageningen University, Wageningen.
- Lange, J., and Otterpohl, R. (2000): *Abwasser - Handbuch zu einer zukunftsfähigen Wasserwirtschaft* (Wastewater - handbook for a sustainable water management). MALLBETON GmbH. Donaueschingen-Pföhren, Germany.
- Lehnartz E., 1943. *Physiological and pathological chemistry. Including Nutrition*. Dieterich Wiesbaden
- Lindgren, M., 1999. Urinsorterande toaletter – rensning av stopp samt uppsamling och attityder (Urine separating toilets – clearing of blockages, collected volume and attitudes: In Swedish, English summary). *Institutionsmeddelande* 99:05, Department of Agricultural Engineering, Swedish University of Agricultural Sciences (SLU). Uppsala, Sweden.
- Liu, B., Giannis, A., Zhang, J., Chang, V.W.-C., Wang, J.-Y., 2013. Characterization of induced struvite formation from source-separated urine using seawater and brine as magnesium sources. *Chemosphere* 93, 2738–2747. doi:10.1016/j.chemosphere.2013.09.025
- Magnusson, J., 2003. Sammansättning på hushållsspillvatten från Hammarby Sjöstad: Hushållens bidrag av miljöfarliga ämnen till avloppsvattnet. Composition on household waste water from Hammarby Sjöstad: (Household contribution of environmentally hazardous substances to wastewater. In Swedish) (Master thesis No. 2003:292 CIV). Lulea Tekniska Universitet.
- Niwagaba, C.B., Mbéguéré, M., Strande, L., 2014. Faecal sludge quantification, characterisation and treatment objectives. *Faecal Sludge Manag Syst Approach Implement Oper* 19.
- NV. 1995. Vad innehåller avlopp från hushåll? (What is the content of household wastewater?; In Swedish). Naturvårdsverket, Rapport 4425. Stockholm, Sweden.

- O'Neal, J.A., Boyer, T.H., 2013. Phosphate recovery using hybrid anion exchange: Applications to source-separated urine and combined wastewater streams. *Water Research* 47, 5003–5017. doi:10.1016/j.watres.2013.05.037
- Oldenburg, M. (2002): Dimensionierungs- und Messwerte für die Siedlung Lübeck-Flintenbreite, persönliche Mitteilung (Design values and measurements for the settlement Lübeck-Flintenbreite, personal communication), Lübeck, Germany.
- Olsson, E. 1967. Hushållsspillvattnet – sammansättning och egenskaper (Household wastewater – composition and characteristics; In Swedish). *Arbetshandling 1:1967 från Byggeforskningen - Installationsgruppen*. P 106 E. Statens Institut för byggnadsforskning. Stockholm, Sweden.
- Palmquist, H., and Jönsson, H. (2003): Urine, faeces, greywater, and biodegradable solid waste as potential fertilisers. 2nd International Symposium on ecological sanitation, Lübeck, Germany. pp. 8.
- Pons, M.-N., Spanjers, H., Baetens, D., Nowak, O., Gillot, S., Nouwen, J., Schuttinga, N., 2004. Wastewater characteristics in Europe - A survey. *European water management online* 4, 10 p.
- Putnam, D.F., 1971. Composition, and chemical, physical, and concentrative properties of human urine (Technical Report No. NASA CR-1802). NASA, WASHINGTON, United States.
- Remy, C., 2010. Life cycle assessment of conventional and source separation systems for urban wastewater management. <https://doi.org/10.14279/depositonce-2370>
- Spérandio, M., Heran, M., Gillot, S., 2007. Modélisation dynamique des procédés biologiques de traitement des eaux. *Techniques de l'ingénieur Gestion de l'eau par les industriels base documentaire : TIB447DUO*.
- Strand, F.L., 1978. *Physiology, A regulatory systems approach*. MacMillan Publishing Co. Inc, New York
- Swedish University of Agricultural Sciences (SLU). Download: <http://epsilon.slu.se>.
- Tchobanoglous, G., Burton, F.L., Stensel, H.D., Metcalf & Eddy, Inc (Eds.), 2003. *Wastewater engineering: treatment and reuse*, 4. ed., internat. ed., [Nachdr.]. ed, McGraw-Hill series in civil and environmental engineering. McGraw-Hill, Boston, Mass.
- Triger, A., Cabassud, C., Pic, J.-S., 2012. Procédé hybride cristallisation et séparation membranaire pour le traitement d'un fluide complexe (urine). Institut National des Sciences Appliquées, Toulouse, France.
- Udert, K.M., Larsen, T.A., Biebow, M., Gujer, W., 2003. Urea hydrolysis and precipitation dynamics in a urine-collecting system. *Water Research* 37, 2571–2582. doi:10.1016/S0043-1354(03)00065-4
- Vinnerås, B. 2002. Possibilities for sustainable nutrient recycling by faecal separation combined with urine diversion. PhD-thesis. *Agraria 353*, Swedish University of Agricultural Sciences (SLU). Download: <http://epsilon.slu.se>.
- Vinnerås, B., 1998. Källsorterad humanurin – skiktning och sedimentering samt uppsamlad mängd och sammansättning. *Institutionsmeddelande* 98:05, Institutionen för lantbruksteknik, SLU. Uppsala.

- Vinnerås, B., Palmquist, H., Balmér, P. & Jönsson, H. 2004. The characteristics of household wastewater and biodegradable solid waste – a proposal for new Swedish design values. Proceedings from IWA: Leading Edge conference Sustainability, November 8-10, Sydney."
- Weglin, J.& Vinnerås, B. 2000. Avloppsvatten och fast organiskt avfall i hyreshuset Ekoporten – sammansättning och flöde. Rapport 242, Institutionen för lantbruksteknik, Sveriges Lantbruksuniversitet. Uppsala.
- Wilsenach, J.A., Loosdrecht, M.C.M. va., 2001. Separate urine collection and treatment - Options for sustainable wastewater systems and mineral recovery (No. 2002–39). STOWA, Utrecht, Netherlands.

Appendix VI. TOILET USE SURVEY IN A BUILDING OF LISBP, TOULOUSE FRANCE, MAY 2017

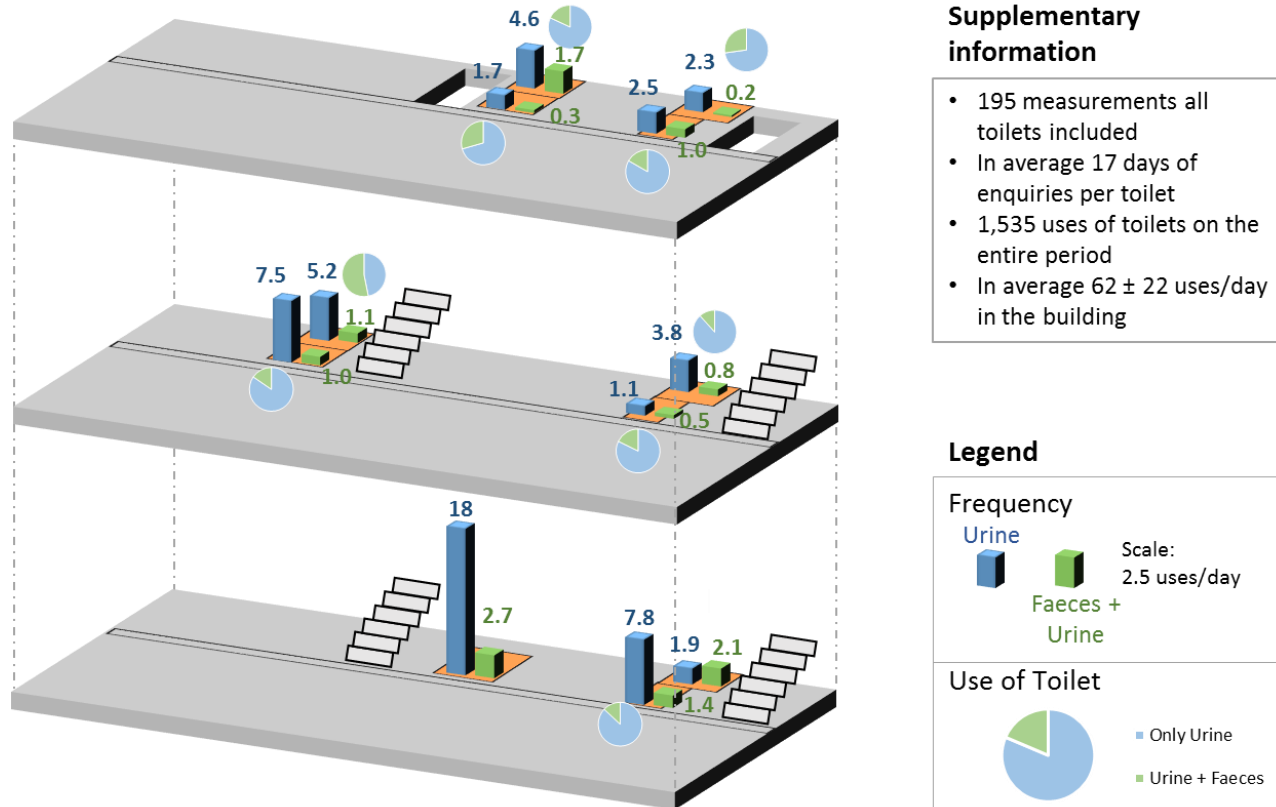

Results from enquiries about toilet use and frequency

Realised from 16/05/2017 to 21/06/2017, in one building with classrooms, laboratory and offices.

Figure S 2: Results from enquiries about toilet use and frequency

Appendix VII. TRANSPORT DESIGN

VII.1 Gravity sewer design

VII.1.a Pipe design

Each node of the gravity sewer graph will be characterised by its coordinates in the district and by several parameters:

- Label: described the type of point can be MidBuild, MidRoad, Road
- pos: coordinates
- BuildInh: number of inhabitant
- Stream: stream object containing flow, mass flow and concentration

The general algorithm used to create gravity transport is presented in Figure S 3. The treatment plant in the district is located at the central place between all the buildings of district with a minimal distance of buildings and a maximal distance from the road and obviously where there is enough place. The creation of the sewer path from building to this plant is based on the shortest path algorithm already implemented in Networkx package. During the creation of the path, flows and concentration are also spread. However this method can produced loop in the sewer meaning that an intermediate node will have more than one outputs (edges). A function to remove these loops are implemented. The next steps is to design the sewer pipe with the diameter and the minimal slope to obtain self-cleansing conditions in the pipe.

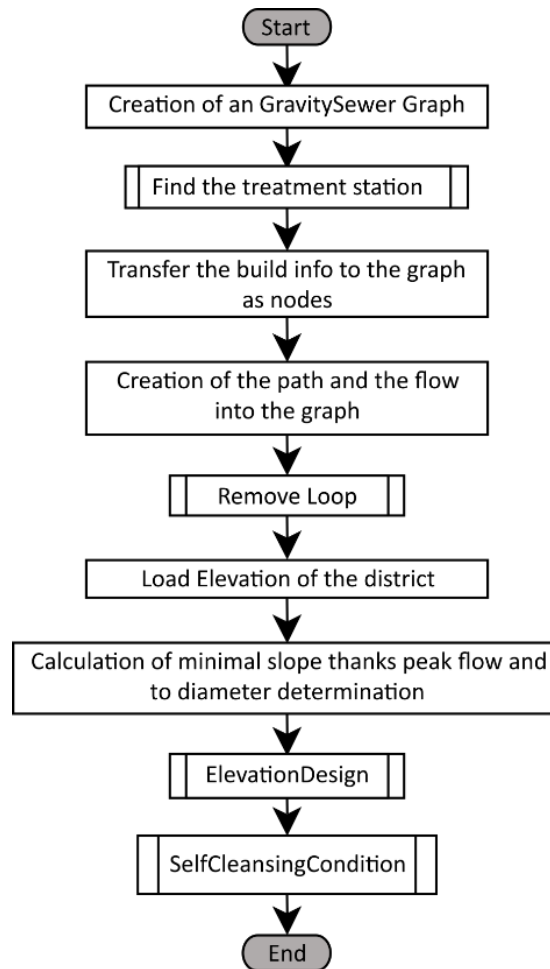

Figure S 3: General algorithm for gravity sewer creation

First of all, the couple pipe diameter / slope needs to be chosen to achieve the transport of the peak flow. Peak flow is calculated based on the average flow and a peak factor determined by Equation S-1.

$$1.5 < PF = 1.5 + \frac{2.5}{\sqrt{Q_m}} < 4 \quad \text{Equation S-1}$$

With:

PF: Peak factor

Q_{av}: Average flow (L/s)

The peak factor will be kept between 1.5 in the last part of the sewer and 4 near the production site.

A first approximation of the diameter and slope is done with the Table S 22 from (Okun et al., 2010).

Table S 22: First estimation of slope and pipe diameter with the peak flow from (Okun et al., 2010)

Slope (m/m)	Pipe Diameter (m)	Peak Flow (L/s)
0.0038	0.20	21.0

0.0030	0.25	31.5
0.0022	0.30	45.6
0.0015	0.38	74.0
0.0012	0.46	105.6
0.0010	0.53	148.0
0.0008	0.61	179.6
0.0007	0.69	227.8
0.0006	0.76	284.7
0.0005	0.91	427.1
0.0004	1.07	569.4
0.0003	1.22	711.8
0.0003	1.37	911.0

The minimal diameter for sewer pipe is 200mm for separated sewer (Berland, 2014a). And the chosen slope/diameter need to fulfil the three self-cleansing conditions (Bourrier, 2008; Monfront, 2009):

- A velocity with half full pipe superior to 0.7 m/s
- A velocity with 2/10 full pipe superior to 0.3 m/s
- Pipe is full at a least 2/10 of the height with the average flow

The ratio of velocity in a partially filled pipe is given by the abacus below (Figure S 4) based on Manning Strickler equation (Equation S-2).

$$V = K \cdot R_H^{2/3} \cdot I^{1/2} \quad \text{Equation S-2}$$

With:

V: Wastewater velocity (m/s)

K: Global coefficient

R_H: Hydraulic radius defined as the ratio between flowing section and wetted perimeter (m)

I: pipe slope (m/m)

The hydraulic radius is defined as the ratio between flowing section and the wetted perimeter of the pipe as illustrated in Figure S 4.

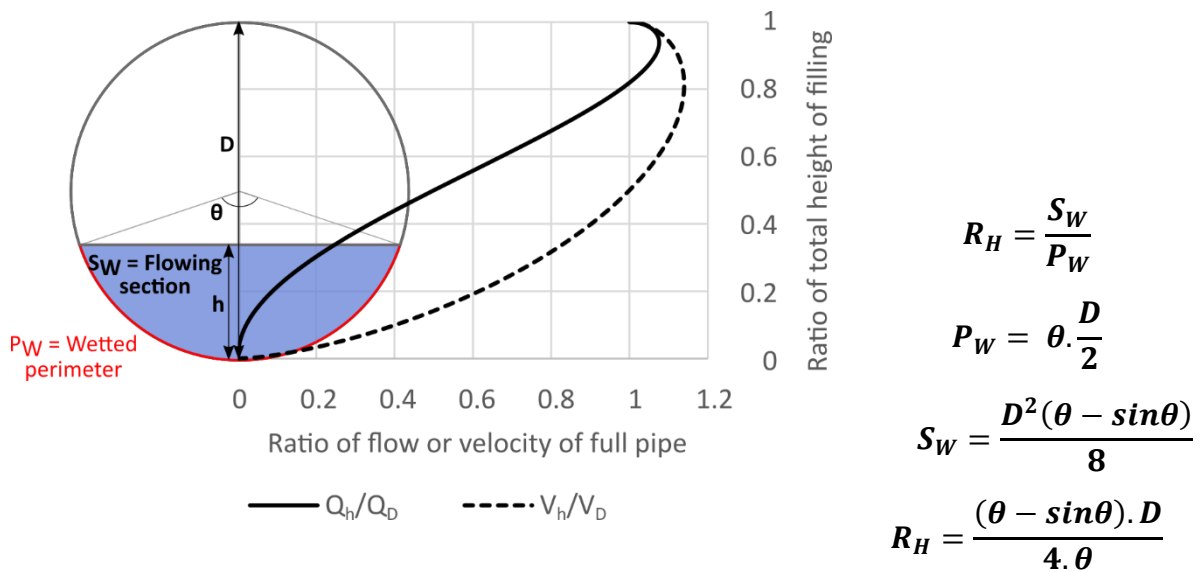

Figure S 4: Abacus representing the ratio of velocity and flow regarding the ratio of fill height in the pipe, with the definition of variable for cylindrical pipe

The calculation of the minimal slope needed for transport will be the first step of the design of sewer. The *ElevationFunction* will use this value to calculate sewer depth according to the pathway conditions. For this purpose, the design of the sewer will start at the source nodes (buildings) and progressively reach the sink node (outlet), however the calculation move to the next node only if all the previous nodes have been positioned as shown in Figure S 5. More advanced information about the algorithm in place can be found in Figure S 7.

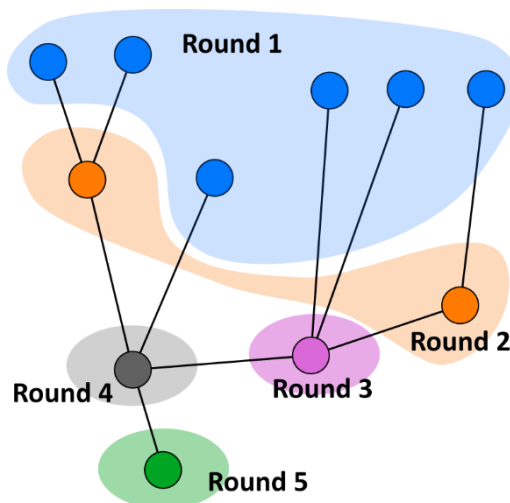

Figure S 5: Principle of ElevationDesign function

At the end the three self-cleansing conditions will be verified and readable in the scenario folder.

VII.1.b Pumping station design

Pumping station is composed of a retention tank and at least two pumps to have a spare one. The design of a lift is based on the peak flow and the ability of discharge the wastewater quickly

enough. (Berland, 2014b) recommends 5 min maximum to discharge 1 m^3 at peak flow. If it is not the case the power flow of the pump will be determinate based on 3 min of 2 m^3 discharge (see Figure S 6 for algorithm details). In both cases the next steps are similar with the pump power calculation and the real volume needed considering two pumps as well as start-up frequency and energy consumption.

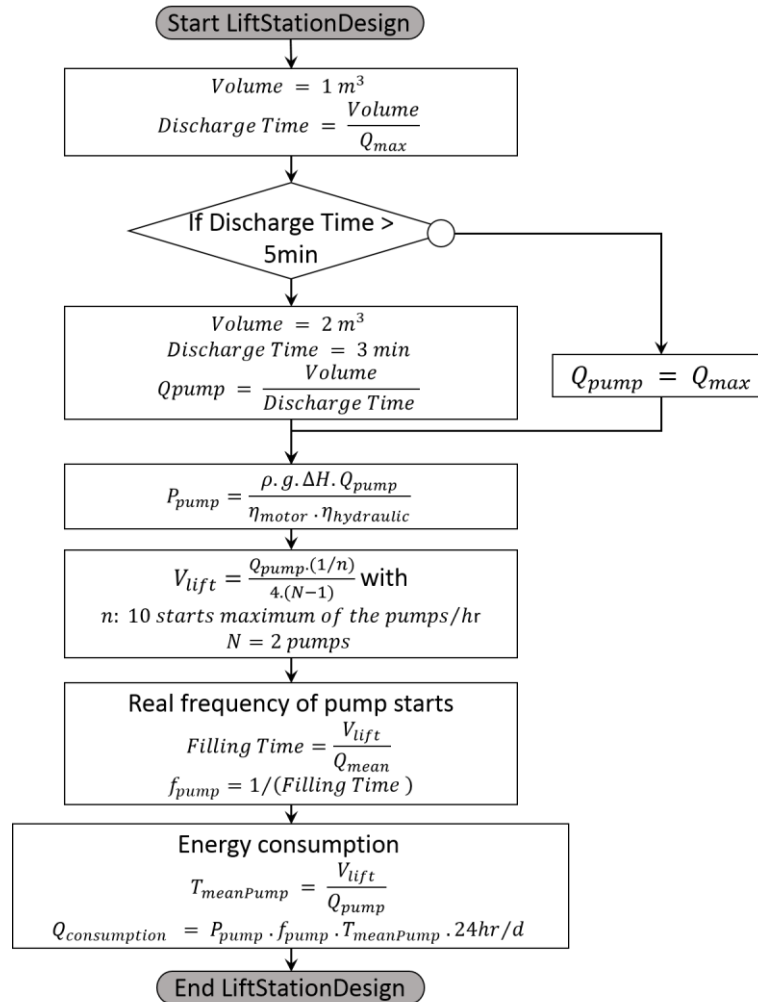

Figure S 6: Algorithm for lift design in gravity sewer

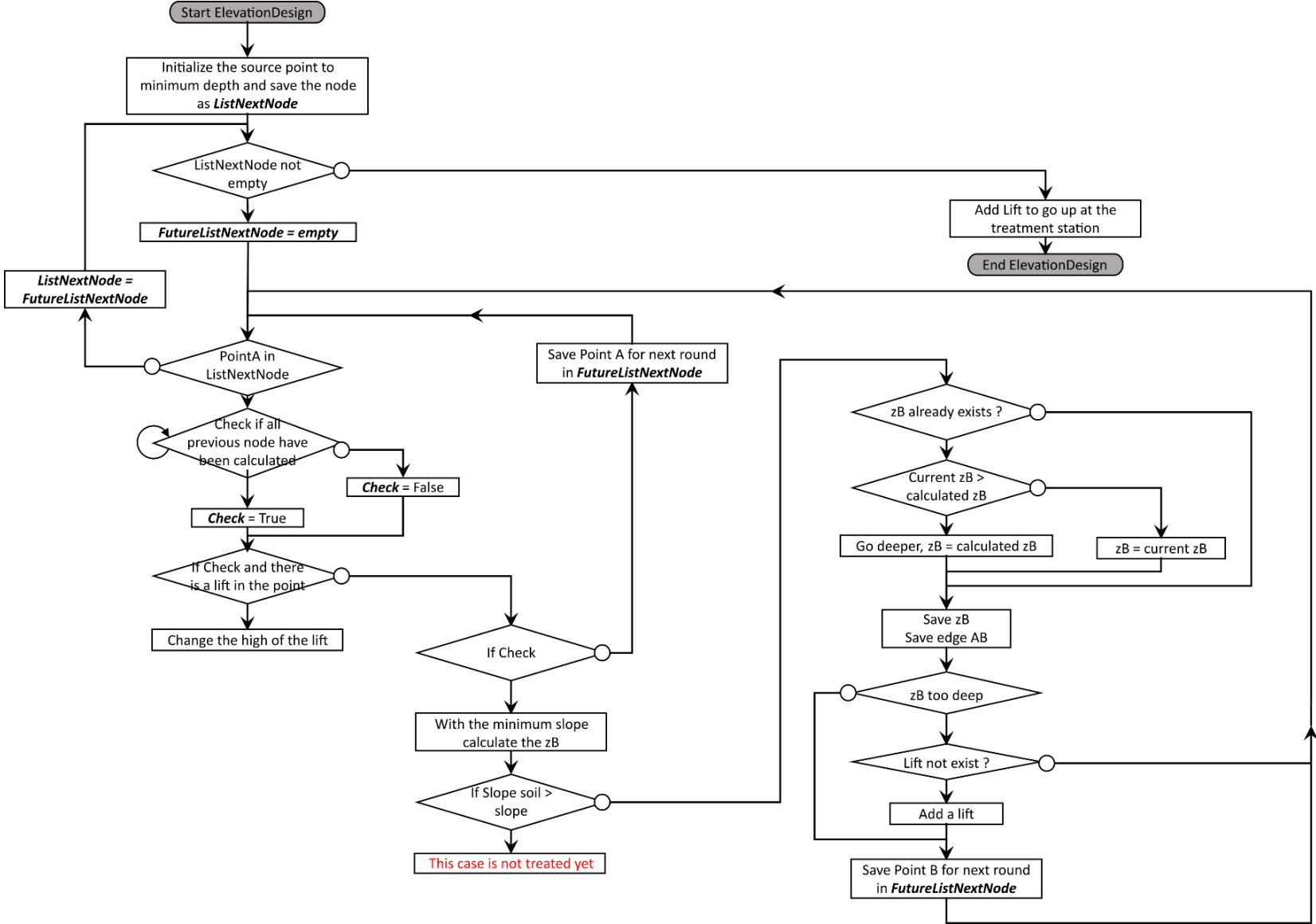

Figure S 7: Algorithm of ElevationDesign function:

VII.2 Vacuum sewer design

VII.2.a General algorithm

The general algorithm of the sewer creation is presented in Figure S 8. It follows the design rules presented in (Bowne et al., 1991; Islam, 2017; Roediger Vacuum, 2012; SQAE, 1994).

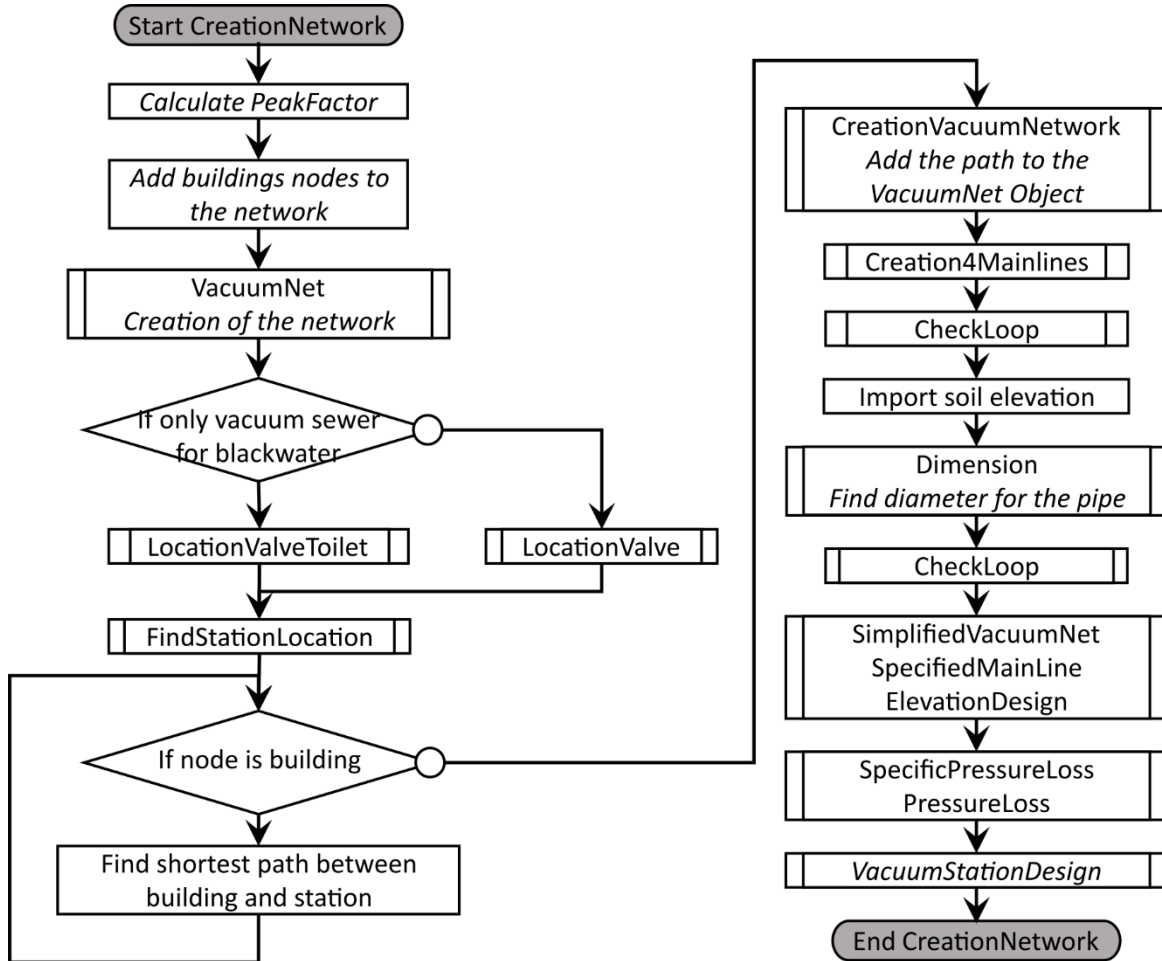

Figure S 8: General algorithm for the creation of vacuum sewer

VII.2.b Peak flow

First peak flows are evaluated at each buildings thanks to a peak factor calculated as described by Equation S-3 according to (Naret, 2007).

$$PF = \frac{18 + \sqrt{\frac{Pop}{1000}}}{4 + \sqrt{\frac{Pop}{1000}}}$$

With:

PF: Peak factor

Pop: population inhabitant of
the district

Equation S-3

The code can be considered both situation if only vacuum toilets are used or if the entire wastewater is collected by vacuum sewer. The only change is the need of vacuum valve in the last scenario. Different prescriptions exist on the position of vacuum valve. If older recommendations allow a single valve for several houses (SQAE, 1994), new publications seem to suggest to avoid this case and install at least one valve per building (Islam, 2017; Naret, 2007). However, the code (function LocationValve) allows to do it with older recommendations by merging buildings which are sufficiently close to each other. The function LocationValveToilet allows to do blackwater collection through vacuum toilets and the newest recommendation of wastewater collection by vacuum sewer.

The algorithm for finding the location of the vacuum station is the same as the one used for gravity sewer (see VII.1.a Pipe design) as well as the algorithm to create a path from vacuum interface to vacuum station. This algorithm does not create four mainlines; however, as previously said, it is better for prevention reasons to separate sewer into three to four mainlines. In this code, four mainlines are generated from the pathway. However, according to the design recommendation, each mainline needs to have a similar pressure height difference. This particular requirement is not yet implemented. Mainlines are created to be shortest to the station.

VII.2.c Pipe diameter

Thanks to the peak flow, the diameter of the pipes will be chosen. Table S 23 summarizes the value recommended by (SQAE, 1994). The European norm NF EN 16932-3 “Drain and sewer systems outside buildings — Pumping systems — Part 3: Vacuum systems” or German norm ATV-DVWK (2004) Worksheet: part 1: vacuum drainage outside of buildings. GFA, Apr 2004 recommend another methodology based on determination of air/water ratio through number of inhabitants. However, this methodology is only applicable for vacuum sewer which collect the entire wastewater.

Table S 23: Pipe diameters and the relation to maximum flow per second

Pipe diameter (mm)	Max flow (L/s)	Lift height (m)
63	Service Line	
75	1.9	0.3
100	2.39	0.3
150	6.60	0.5
200	13.21	0.5
250	23.58	0.7
300	47.16	0.7

The next step of design is the saw tooth pattern. Several recommendation rules the location of these lifts:

- Minimum slope of 0.002 m/m
- Minimum distance of 15.2 m between vacuum valve and lift
- 5 maximal consecutive lifts
- 6 m minimum between consecutive lifts
- The exit pipe from vacuum pit is 0.664 m below surface
- The maximum depth is 1.5m below surface

To achieve this recommendations, the main lines are first recognized as the four longest pathways to vacuum station and pathway follow the saw tooth pattern. Secondly the pattern of branch lines are created.

VII.2.d Static pressure drop

Following step is the calculation of the pressure loss in the system to check if it is below 4 m per main line according to (Bowne et al., 1991; Islam, 2017; SQAЕ, 1994). Pressure loss in the system is the sum of static loss and friction loss. If static loss is easy to calculate and well described, friction loss determination is much more empirical. Static loss is calculated from the difference between lift height and pipe diameter.

VII.2.e Frictional pressure drop

Determination of frictional pressure drop in vacuum sewer is a difficult task due to two-phase flow condition. Wastewater is indeed transport with air and conventional correlation for full pipe is not working anymore. Two methodologies have been accounted for, one which corrects the full pipe correlation (Hazen-William equation) and the second uses the Lockhart and Martinelli correlation usable for two-phase flow. However both solutions have been validated with quite small air/water ratio (from 1 to 5) and none investigated the phenomena with higher ratio 10 or 50 as it can happen with blackwater collection. Indeed the air/water ratio is around 50 in the toilets from EVAC company as around 60 L of air entering the system when flushing 1.2-1.5 L.

(SQAЕ, 1994) proposed a formula for friction loss derived from Hazen-Williams equation which is suitable for water transport. A coefficient is added to take into account the transport of mixture air/wastewater as presented in Equation S-4.

$$f = 2.75 * \frac{10.64}{d^{4.8655}} * \left(\frac{Q}{C}\right)^{1.85} \quad \text{With:}$$

f : friction loss (m/m)

Q : Volumetric flow (m³/d)

d : internal diameter (m) Equation S-4

C : Hazen
– Williams coefficient
(150 for PE and PVC)

However the 2.75 coefficient is an approximation for an air/water ratio of 2/1. The same derivation of Hazens-Williams has been done to take into account different air/water ratio. Hazen-Williams equation (Equation S-5) is applied for full pipe. Secondly a not full pipe is considered (Equation S-6). By dividing both equations, the ratio of friction loss is determined which is the correction factor (Equation S-7). The ratio of velocity can be obtain considering that the same mass flow is transported in the pipe and it is equal to the contrary of wetted area ratio (see Equation S-8). Finally Air/water ratio (Equation S-9) can be linked to the friction loss.

$$V = 0.849 * C * R_H^{0.63} * f^{0.54} \quad \text{With:}$$

f : friction loss (m/m) Equation S-5

V : velocity with full pipe(m/s)

R_H : hydraulic radius

C : Hazen

– Williams coefficient

(150 for PE and PVC)

$$V_h = 0.849 \cdot C \cdot R_h^{0.63} \cdot f_h^{0.54}$$

Underscript h means not full pipe

Equation S-6

$$\frac{f_h}{f} = \left(\frac{V_h}{V}\right)^{1/0.54} \cdot \left(\frac{R_h}{R_H}\right)^{0.63/0.54}$$

Equation S-7

$$\frac{V_h}{V} = \frac{Q}{A_h} \cdot \frac{A}{Q} = \frac{A}{A_h}$$

Equation S-8

$$\frac{\text{air}}{\text{water}} = \frac{A}{A_h} - 1$$

Equation S-9

The second method available to calculate frictional pressure drop (Jinming and Jingxuan, 2006) is based on generalisation of Lockhart and Martinelli formulas for two-phase flow with gas and non-Newtonian fluid (blackwater or sewage). The general idea is to considered first the two phases separately and then applied two-phase frictional correction. (Jinming and Jingxuan, 2006) prove this correlation by experiments with air/water in the range of 1 to 4 and with pipe diameter between 40 to 60 mm.

Both methods have been compared according to air/water ratio knowing that ratio higher than 5 have not been tested and validated by neither or the methods. The first method ends up with an exponential function between the pressure drop and the air/water ratio (Figure S 9-A) and the second one is linear (Figure S 9-B).

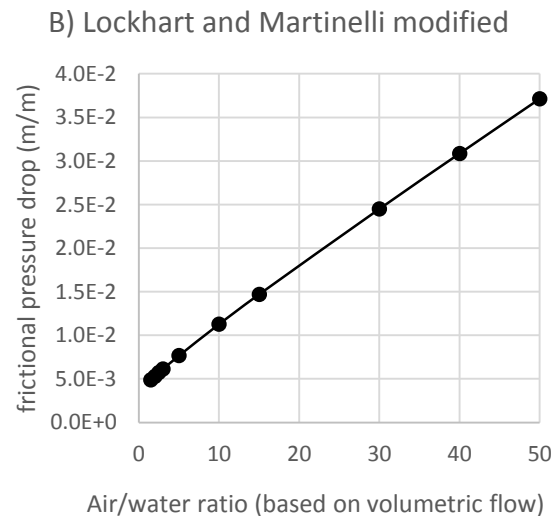
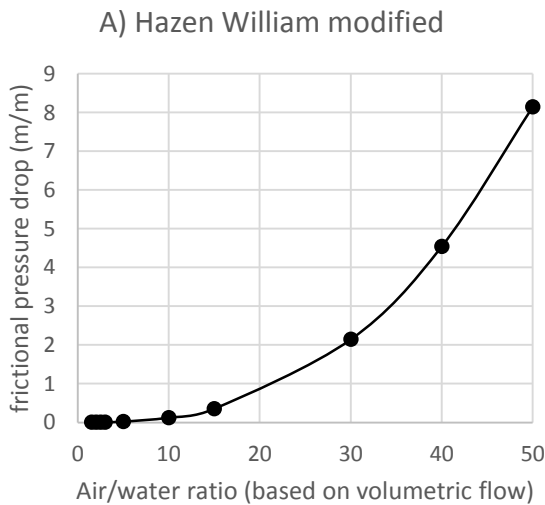

Figure S 9: Calculated frictional pressure drop in vacuum sewer for A) Hazen Williams modified equation and B Lockart and Martinelli modified equation. (Calculation made with 100mm pipe and 2.4 m³/s of liquid at 25°C)

Both methods have the same range of value for air/water ratio around 3 (respectively $5.6 \cdot 10^{-3}$ and $6.1 \cdot 10^{-3}$ mH₂O/m), however it is the only case. Two-phase flow implies in the pipe to have waves of air and liquid. The approach of Hazen-Williams modified equation which supposed a fixed height fill of water in the pipe is not true in this case. Indeed for 40 air/water ratio, the pipe is only filled with 5% of the diameter and the calculated velocity is around 12.5 m/s which is not the case with wave pattern. The Lockhart and Martinelli approach adapted by (Jinming and Jingxuan, 2006) have been then preferred.

VII.2.f Vacuum station

Vacuum station is made of four components: 1) vacuum tank where the wastewater is collected; 2) vacuum pumps which ensure vacuum in the network; 3) discharge pumps which evacuates wastewater to treatment location; 4) air treatment for odours minimization.

The vacuum station design follows the rules presented by (SQAE, 1994). First the discharge pumps are design for cycle time of 15min (time on and off) in the case of minimum flowrate. The discharge flowrate is equal to the peak flow.

Secondly the vacuum tank is designed. The (SQAE, 1994) methodology proposed to have two tanks to have in one the wastewater and in the other one the air at vacuum pressure. However nowadays one tanks is more common especially for blackwater application. The same calculation is still used. The operating volume is indeed calculated based on the volume which is needed to be stored when discharge pumps are off (Equation S-10). As all the wastewater going in during a cycle of discharge pump need to go out, the can be written.

$$V_{op} = (T_{cycle} - T_1) * Q_{min} \quad \text{Equation S-10}$$

With:

V_{op} : operating volume in L

T_{cycle} : duration of discharge pump cycle

T_1 : time when discharge pump is on

Q_{min} : minimum flowrate intering station (L/s)

Q_{dp} : discharge pump flowrate (L/s)

$$V_{op} = T_{cycle} \cdot \frac{Q_{min}}{Q_{dp}} \cdot (Q_{dp} - Q_{min}) \quad \text{Equation S-11}$$

However a security factor must be taken at 3 and the minimum recommended size is 1500 L.

Thirdly the vacuum pumps are designed:

1. A volume of 1500 L of air entering in the station is assumed (20°C and 1 atm)

2. From perfect gas law the volume of air is calculated at the higher pressure in the system and 20°C. This will be the volume of air in the vacuum tank.
3. Time cycle and frequency can then be calculated.
4. If the frequency is higher than 20 times per hour, the allowed volume entering in the station is calculated based on the 20 h⁻¹ frequency of the pump.
5. The vacuum pump capacity is based on a 120s evacuation time and the Equation S-12.

$$t_{evac} = 0.3366 \frac{(f_{air} * V_{pipe} + V_{CollectTank} - V_{op} + V_{VacuumTank})}{Q_{vp}} \quad \text{Equation S-12}$$

With

t_{evac} : evacuation time (s)

f_{air} : fraction of air in the total mixture air/wastewater

V_{pipe} : volume of pipe (L)

$V_{CollectTank}$: volume of collection tank (L)

$V_{VacuumTank}$: volume of vacuum tank (L)

Q_{vp} : capacity of vacuum pump (L/s)

6. Duration of vacuum pump is deduced from this capacity and the volume of air

VII.2.g Energy consumption

Energy consumption is calculated thanks to frictional and static pressure drop and of course the length of the sewer thanks to Equation S-13.

$$E_{vacuum} = \frac{Q_{vp} \cdot \Delta P}{\frac{T_1}{T_{cycle}} * \frac{24h}{d}} \cdot \frac{1}{\eta_{pump}} \quad \text{Equation S-13}$$

With

ΔP : total pressure loss (Pa)

η_{pump} : efficiency of vacuum pump fixed at 65%

The energy consumption for the discharge pump is also taking into account with a pressure loss in the discharge network assumed to be 7.3 mH₂O (SQA, 1994).

VII.3 Ant algorithm applied to urine collection

Ant colony is composed of ant individual which will be moved at each iteration. After each step of the colony the pheromone amount will be calculated and the probability to move for the next iteration can then be calculated. For that 4 equations are necessary. First the probability to follow a path more than another is calculated with Equation S-14.

$$P_{ij} = \frac{(\tau_{ij}^{\alpha} * \eta_{ij}^{\beta})}{\sum_u \tau_{iu}^{\alpha} * \eta_{iu}^{\beta}} \quad \text{Equation S-14}$$

With

P_{ij} : probability to go to j point from i

τ_{ij} : amount of pheromone on the path

η_{ij} : heuristic function which is the inverse of the distance

α : pheromone exponential weight

β : heuristic exponential weight

In this way the probability is higher with high amount of pheromone and low distance. The α coefficient allows to have more weight of pheromones of distance in the probability.

Secondly the choice of the path is based on a random choice of a number between 0 and 1 and the first path with the higher probability than this number is chosen.

Thirdly, after each ants have moved the amount pheromone τ_{ij} will be updated (Equation S-15).

$$\tau_{ij} = \tau_{ij} + \frac{\tau_0}{G} \quad \text{Equation S-15}$$

With

τ_0 : constant

G : total cost of the round of the ant (distance)

And finally the evaporation of the pheromone have to be accounted for (Equation S-16).

$$\tau_{ij} = \tau_{ij} * (1 - \rho) \quad \text{Equation S-16}$$

With

ρ : the evaporation pheromone coefficient

The general algorithm of ant colony optimization for collection problem is presented in Figure S 10.

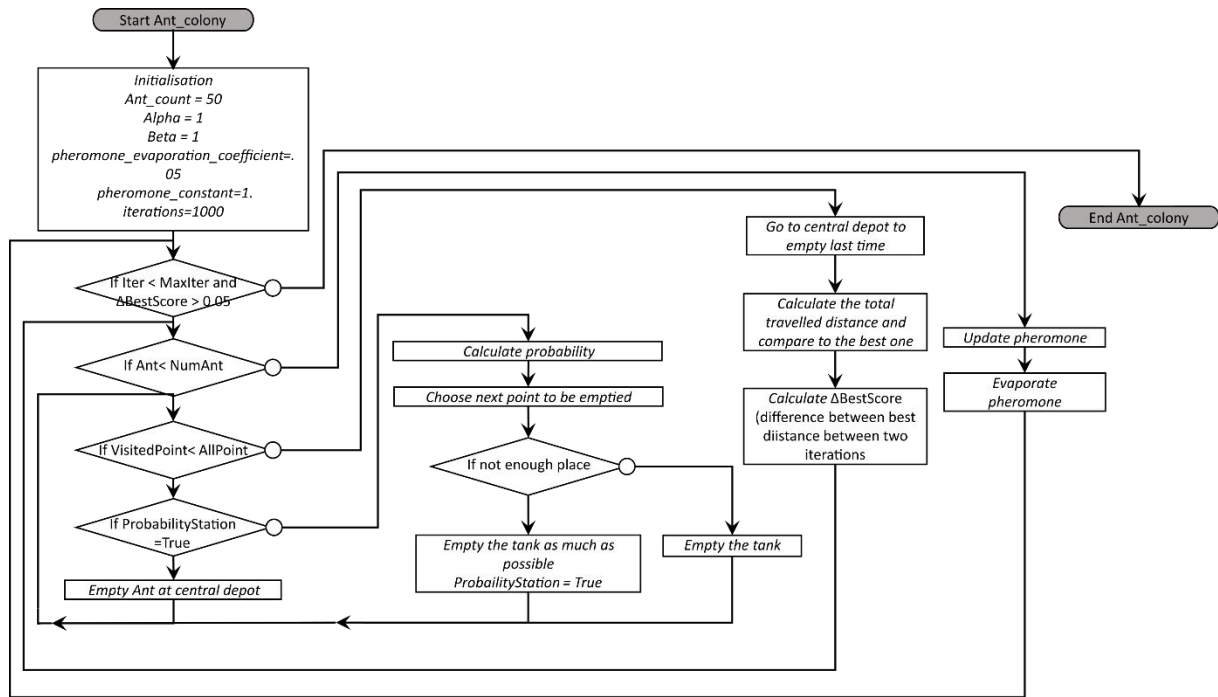

Figure S 10: Ant colony algorithm adapted for collection problem

To use the ant algorithm, only the collection point need to be visited. However the network obtained from district block of modelling has intermediate point as road corner and intersection. This network needs to be simplified. All each collected point will be linked to all the other one by the shortest path.

When the algorithm optimized the travelled way, it will be transform in the real pathway.

VII.4 References

- Berland, J.-M., 2014a. Assainissement des agglomérations. Tech. Ing., Travaux publics et infrastructures.
- Berland, J.-M., 2014b. Traitement des eaux résiduaires des agglomérations - Concepts et relevage. Tech. Ing., Travaux publics et infrastructures.
- Bourrier, R., 2008. Les réseaux d'assainissement - calculs, applications, perspectives (5e éd.). Lavoisier.
- Bowne, W.C., Naret, R.C., Otis, R.J., 1991. Manual - alternative wastewater collection systems (Manual No. EPA/625/1-91/024). U.S. Environmental Protection Agency, Office of research and development, National risk management research laboratory., Cincinnati, Ohio, USA.
- Islam, M.S., 2017. Comparative evaluation of vacuum sewer and gravity sewer systems. *Int. J. Syst. Assur. Eng. Manag.* 8, 37–53. <https://doi.org/10.1007/s13198-016-0518-z>
- Jinming, D., Jingxuan, Z., 2006. Studies on frictional pressure drop of gas-non-Newtonian fluid two-phase flow in the vacuum sewers. *Civ. Eng. Environ. Syst.* 23, 1–10. <https://doi.org/10.1080/10286600500431904>
- Monfront, L., 2009. Dimensionner les canalisations d'assainissement pour assurer leur performance hydraulique. (Sewer design to insure hydraulic performance) (Rapport Etude & Recherche No. 158.E-2), Les Editions du CERIB. CERIB, France.
- Naret, R., 2007. Vacuum Sewers – Design and Installation Guidelines (No. n° C-8015), PDHengineer Course.
- Okun, D.A., Wang, L.K., Shammas, N.K., 2010. Water Supply and Distribution and Wastewater Collection. John Wiley and Sons.
- Roediger Vacuum, 2012. Vacuum sewer systems. Construction manual. Bilfinger Berger.
- SQAE, 1994. Assainissement des eaux usées dans les petites collectivités : techniques particulières de collecte des eaux usées. Volume 3 : Le réseau d'égouts sous vide. SQAE, Menviq, EAT Environnement.

Appendix VIII. TREATMENTS DESIGN

VIII.1 Centralised facility

VIII.1.a Design of the WRRF

Table S 24: Design of the unit process of the WRRF

PRIM			
Symbol	Name	Value	Unit
fXTSS,sludge	Solids percent removal	60	%
XTSS,sludge,target	Sludge solids concentration	5000	g/m ³
ANAER			
Reactor settings			
Symbol	Name	Value	Unit
L.V	Volume	1400	m ³
htank	Tank depth	5	m
Aeration settings			
Symbol	Name	Value	Unit
Qair,N	Air flow	0	Nm ³ gas.d-1
α	Alpha (process water/clean water) factor	0.7	
hsea	Elevation above sea level	200	m
hdiff,floor	Diffuser height from floor	0.2	m
ddiff	Diffuser floor density (diffuser area/tank area)	0.1	m ² /m ²
Adiff	Area per diffuser	0.0373	m ²
ANOX			
Reactor settings			
Symbol	Name	Value	Unit
L.V	Volume	1500	m ³
htank	Tank depth	5	m
Aeration settings			
Symbol	Name	Value	Unit
Qair,N	Air flow	0	Nm ³ gas.d-1
α	Alpha (process water/clean water) factor	0.7	
hsea	Elevation above sea level	200	m
hdiff,floor	Diffuser height from floor	0.2	m
ddiff	Diffuser floor density (diffuser area/tank area)	0.1	m ² /m ²
Adiff	Area per diffuser	0.0373	m ²
AER			
Reactor settings			
Symbol	Name	Value	Unit
L.V	Volume	3500	m ³
htank	Tank depth	5	m
Aeration settings			
Symbol	Name	Value	Unit
SO2	Dissolved oxygen (O ₂) setpoint	2	g O ₂ /m ³

α	Alpha (process water/clean water) factor	0.7	
hsea	Elevation above sea level	200	m
hdiff,floor	Diffuser height from floor	0.2	m
ddiff	Diffuser floor density (diffuser area/tank area)	0.1	m ² /m ²
Adiff	Area per diffuser	0.0373	m ²
Clarifier			
Symbol	Name	Value	Unit
Qsludge,target	Sludge flow	12900	m ³ /d
XTSS,eff,target	Effluent solids	10	g/m ³
AD			
Reactor inputs			
Symbol	Name	Value	Unit
L.V	Liquid volume	1677	m ³
fG.V	Gas/volume fraction	10	%
hliquid	Liquid depth	10	m
T	Water temperature	35	°C
Gas phase settings			
Symbol	Name	Value	Unit
Tgas	Temperature in the gas space	35	°C
pgas	Pressure in the gas space	10000 0	Pa
hsea	Elevation above sea level	200	m
β	Beta correction factor	0.3	
fd,sat,eff	Effective saturation depth fraction	0.1	
Lair	Temperature lapse rate for air pressure calculations	0.0065	K/m
dbubble	Bubble Sauter mean diameter	0.01	m
ϵ_{gas}	Gas hold up (gas phase volume fraction)	0.005	m ³ gas.m ⁻³
ngas,dry,limit	Gas transfer shut down treshold	0.0000 1	
PTHK			
Symbol	Name	Value	Unit
fXTSS,sludge	Solids percent removal	98	%
XTSS,sludge,target	Sludge solids concentration	70000	g/m ³
DW			
Symbol	Name	Value	Unit
fXTSS,sludge	Solids percent removal	99.5	%
XTSS,sludge,target	Dewatered cake solids	28000 0	g/m ³
STR			
Reactor settings			
Symbol	Name	Value	Unit
L.V	Volume	2.7	m ³
htank	Tank depth	5	m
Aeration settings			
Symbol	Name	Value	Unit
SO2	Dissolved oxygen (O ₂) setpoint	0	g O ₂ /m ³

Appendix VIII. Treatments design

α	Alpha (process water/clean water) factor	0.7	
hsea	Elevation above sea level	200	m
hdiff,floor	Diffuser height from floor	0.2	m
ddiff	Diffuser floor density (diffuser area/tank area)	0.1	m ² /m ²
Adiff	Area per diffuser	0.0373	m ²
PANOX			
Reactor settings			
Symbol	Name	Value	Unit
L.V	Volume	1400	m ³
htank	Tank depth	5	m
Aeration settings			
Symbol	Name	Value	Unit
SO2	Dissolved oxygen (O ₂) setpoint	0	g O ₂ /m ³
α	Alpha (process water/clean water) factor	0.7	
hsea	Elevation above sea level	200	m
hdiff,floor	Diffuser height from floor	0.2	m
ddiff	Diffuser floor density (diffuser area/tank area)	0.1	m ² /m ²
Adiff	Area per diffuser	0.0373	m ²
PAER			
Reactor settings			
Symbol	Name	Value	Unit
L.V	Volume	260	m ³
htank	Tank depth	5	m
Aeration settings			
Symbol	Name	Value	Unit
SO2	Dissolved oxygen (O ₂) setpoint	2	g O ₂ /m ³
α	Alpha (process water/clean water) factor	0.7	
hsea	Elevation above sea level	200	m
hdiff,floor	Diffuser height from floor	0.2	m
ddiff	Diffuser floor density (diffuser area/tank area)	0.1	m ² /m ²
Adiff	Area per diffuser	0.0373	m ²
TMCS			
Symbol	Name	Value	Unit
fQ,uflow	Underflow fraction	1	%
f.XB,uflow	Slowly biodegradable substrate mass fraction to underflow	100	%
f.XU,uflow	Particulate unbiodegradable organics mass fraction to underflow	100	%
f.SNHx,uflow	Total ammonia (NH _x) mass fraction to underflow	80	%

VIII.2 Decentralised treatments

VIII.2.a UASB

The concentration in effluent and sludge are calculated from removal efficiency and ratio between total component and species (Table in appendix) obtained at pilot scale in the Sneek project (de Graaff and van Hell, 2014).

Table S 25: Removal efficiency in the effluent of UASB treating backwater from (de Graaff and van Hell, 2014)

Component	Removal efficiency	Ratio
TSS	98%	
COD	92%	
COD_SS	98%	
TN	6.7%	
SNH _x /TN		85.8%
TP	22%	
PO ₄ /TP		88%

For the sludge, the concentration of soluble compounds (SNH_x, PO₄ and soluble COD) are similar to effluent. Total COD is determined by mass balance with COD in methane and in effluent. VSS are calculated thanks to biomass characterisation 1.42 g gCOD/gVSS and TSS from a ratio between VSS/TSS of 68% (de Graaff et al., 2010).

VIII.2.a.1 Energy

In order to realize the energy balance in the UASB, the energy produced from cogeneration needs to be calculated. Moreover, despite the low temperature in the reactor, a minimal temperature has to be maintained. The heat consumption will have to be taken into consideration with heat loss by wall of reactor.

First the primary energy from biogas is calculated from the biogas lower heating value (LHV_{methane}). It is translated into electricity and heat thanks to cogeneration yield. However the yield depends on the size of the installation. A review has been made to extrapolate yield regarding electric power (Figure S 11 and Appendix IX for the table of references). It can be concluded that the total yield is similar for all the electric power, however for small cogeneration unit more heat is produced compared to electricity. For larger unit same yield can be approached.

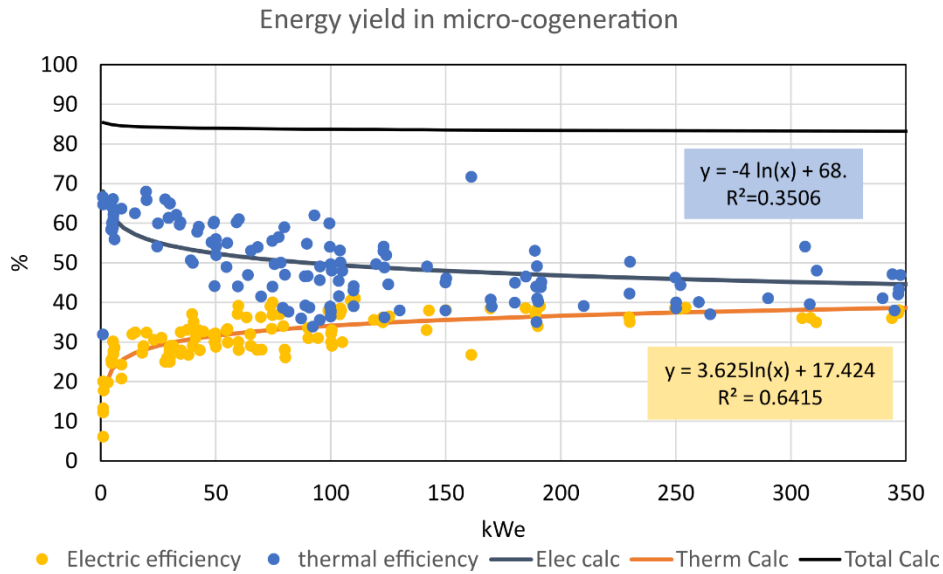

Figure S 11: Energy yield for micro-cogeneration from the literature review presented in Appendix IX

The two equations: Equation S-17 and Equation S-18 have been extrapolated from the literature review and used to estimate each yield and production.

$$\eta_{elec} = 3.625 * \ln(P_{elec}) + 17.4 \quad \text{Equation S-17}$$

$$\eta_{heat} = -4 * \ln(P_{elec}) + 68. \quad \text{Equation S-18}$$

Finally heat consumption is based on the monthly average of blackwater temperature (Figure S 12). It is derived from wastewater temperature at WWTP (from calculator (Gernaey et al., 2011)). Air temperature is also assumed with the calculator (Gernaey et al., 2011); however, no daily variation is taken into account. The exterior air temperature is in this case taken into account. However, the reactor can be inside a building for the smaller size.

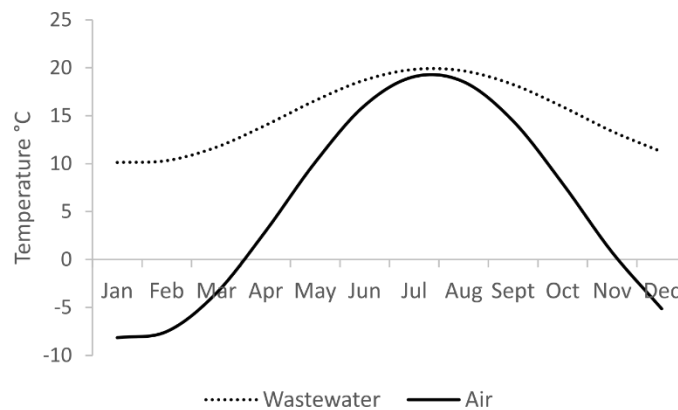

Figure S 12: Monthly average of air and wastewater temperature

The heat consumption for the process is estimated considering the heating of the blackwater up to 25°C by a first heat exchanger (HE I) to use the heat of outgoing effluent and a second heat exchanger (HE II) with the produced heat from cogeneration (Figure S 13). A gradient of 5°C is assumed in the hot stream of HE I. The temperature of the cold stream output can then be deduced (Equation S-19).

$$T_{cs2} = \frac{Q_{hs} * Cp_{hs} * GradT}{Q_{cs} * Cp_{cs}} + T_{cs1} \quad \text{Equation S-19}$$

According to the temperature after HE I, heat from cogeneration is used for pre-heating thanks to Equation S-20.

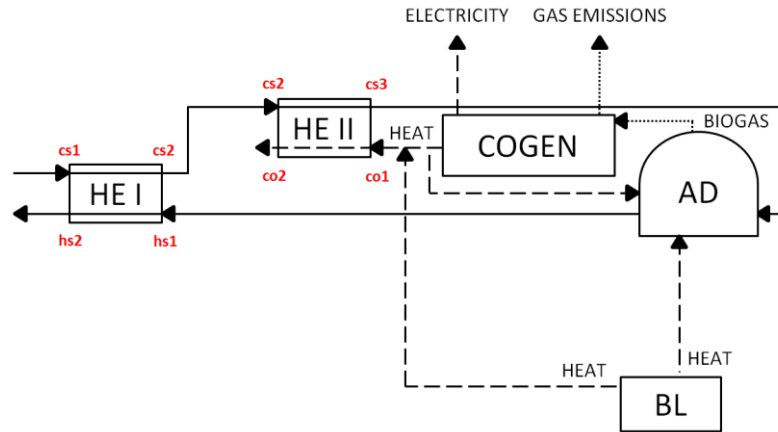

Figure S 13: Configuration of heat recovery from blackwater (Bisinella de Faria et al., 2015)

$$Q_{heat} = Cp_{BW} * Q_{BW} * d_{BW} * (T_{digester} - T_{cs2}) \quad \text{Equation S-20}$$

With:

Q_{heat} : energy to provide (kWh/d)

Cp_{BW} : heat capacity of blackwater (J/K/kg)

Q_{BW} : flowrate of blackwater (m^3/d)

d_{BW} : density of blackwater ($1020 \text{ kg}/m^3$)

$T_{digester}$: temperature inside digester (25°C)

T_{in} : temperature of blackwater coming in ($^\circ\text{C}$)

The heat capacity of blackwater is deduced from the empirical Equation S-21 from (Tchobanoglous et al., 2003) for sludge.

$$Cp_{BW} = (4.214 - 2.286 * 10^{-3} * T_{av} + 4.991 * 10^{-5} * T_{av}^2 + 4.519 * 10^{-7} * T_{av}^3 + 1.857 * 10^{-9} * T_{av}^4) * 1000. \quad \text{Equation S-21}$$

With:

Cp_{BW} : heat capacity of blackwater (J/K/kg)

T_{av} average temperature in $^\circ\text{C}$.

Heat loss by walls and roof is also taken into account with the Equation S-22 and parameters of Table S 26.

$$q_{\text{heat loss}} = U_{\text{wall}} \cdot A_{\text{wall}} \cdot \Delta T_{\text{wall}} + U_{\text{roof}} \cdot A_{\text{roof}} \cdot \Delta T_{\text{roof}} + U_{\text{floor}} \cdot A_{\text{floor}} \cdot \Delta T_{\text{floor}}$$
Equation S-22

With:

U : Heat transfer coefficient $W/(m^2 \cdot ^\circ C)$

A : surface in m^2

ΔT : temperature gradient in $^\circ C$

The delta of temperature for wall is the average between air and digester temperature. For the floor the delta is based on soil temperature which is fixed at $5.5^\circ C$.

Table S 26: Parameters of heat loss in the digester (Tchobanoglous et al., 2003)

Parameters	Value
U_{wall}	0.68 $W/m^2/^\circ C$
U_{roof}	0.91 $W/m^2/^\circ C$
U_{floor}	0.85 $W/m^2/^\circ C$

VIII.2.b Struvite precipitation

A molar ratio of 1.5 Mg/P is necessary to achieve the removal efficiencies described by (de Graaff and van Hell, 2014) and presented in Table S 27.

Table S 27: Removal efficiency for struvite precipitation (de Graaff and van Hell, 2014)

Component	Removal efficiency
TSS	95.5%
COD	74%
COD_SS	95.5%
PO ₄	86%
Other P	4%

VIII.2.c TMCS

The design of TMCS is based on an assumption on the removal efficiency of free ammonia which has been set to 90%. Thanks to a discrete balance in free ammonia (Equation S-23 from influent side the membrane surface can be deduced (Equation S-24).

$$-Q_i \cdot dC_N = k_L (C_N - C_a) dS$$
Equation S-23

$$S = \ln \left(\frac{C_{N,e}}{C_{N,s}} \right) * \frac{Q_i}{k_L}$$
Equation S-24

To be able to transfer with the same rate the transferred ammonia need to react instantly and for that enough acidity need to be present. A decrease of pH will occur from the input of acid to the output which is by assumption from 0.8 to 2.5. An adjunction of concentrated acid will keep the input at the pH. The quantity to add can then be calculated from the ammonia transfer (Equation S-25). Indeed one mole of H^+ is consumed with one mole of ammonia.

$$Q_{add} = \frac{F_{T,N}}{[H_3O^+]_{Concentrated\ acid}} \quad \text{Equation S-25}$$

With Q_{add} in L/d and $F_{H_3O,consummed}$ in mole/d and $[H_3O^+]_{Concentrated\ acid}$ in mole/L.

The flowrate of acid in the loop can be deduced from the pH in and out and the need of acidity (Equation S-26).

$$Q_a = \frac{F_{T,N}}{[H_3O^+]_{a,in} - [H_3O^+]_{a,out}} \quad \text{Equation S-26}$$

The acid circulates in a loop. On the contrary of the influent where only one cross. With time, the concentration in ammonium sulphate increases. When a concentration in nitrogen is achieved the process can stop and the ammonium sulphate can be recovered. The determination of the duration of the acid cycle (t_f) is based on the transfer mass flow (Equation S-27) and the dilution by the concentrated acid (Equation S-28) and the initial volume of the buffer tank (V_0) and can be determined by Equation S-29.

$$F_N = F_{trans} \cdot t_f \quad \text{Equation S-27}$$

$$V_{tot} = V_0 + Q_{add} \cdot t_f \quad \text{Equation S-28}$$

$$t_f = \frac{C_{N,finale} \cdot V_0}{F_N - Q_{add} \cdot C_{N,finale}} \quad \text{Equation S-29}$$

This design does not take into account two phenomena which can occur and can affect the design. Firstly, as ammonia transfer in the influent side, the pH can decrease and this will affect the ratio between free ammonia and ammonium. However the decrease of pH will depend on the composition of the influent and especially its buffer capacity. Finally, gas permeable membrane let get through all gases included water vapour which will dilute the ammonium sulphate solution and increase the time of the acid cycle. However few study mentioned a water transfer and it is hard to estimate.

The last part of design is the module itself. In order to determine the number of fibber a velocity of acid inside the fibber has been chosen, length of the fibber can then be deduced. The same procedure is followed for the shell side. The parameter used are summarized in Equation S-22.

Table S 28: Parameters for design of TMCS

Parameters	Value	Unit	Source
Internal radius of fibber	0.235	mm	
External radius of fibber	0.435	mm	
Velocity in the shell side	$2.55 \cdot 10^{-3}$	m/s	
Velocity in the lumen side	$9.61 \cdot 10^{-4}$	m/s	
pH in, acid	0.8		
pH out, acid	2.5		

Concentration of concentrated acid	36 mol H ⁺ /L	
Transfer rate coefficient k_L	1.75 10 ⁻⁵ m/s	(Tan et al., 2006)
Set point for nitrogen concentration in the product	70 gN/L	
Initial volume of buffer acid tank V₀	20 L	Own assumptions

VIII.2.c.1 Outputs

TMCS is supposed to only remove free ammonia all the other compound are in the same concentration than the input. The current ammonium/ammonia content in the effluent is calculated.

VIII.2.c.2 Energy

Two different consumptions are taken into account, the energy for heating the influent to the proposed temperature of 45°C and the pump consumption for acid loop and effluent.

For pump consumption the pressure loss in the membrane has to be calculated from Darcy-Weisbach equation (Equation S-30):

$$\frac{\Delta P}{L} = f_D \cdot \frac{\rho \cdot V^2}{2 \cdot D_h} \quad \text{Equation S-30}$$

With:

ΔP : pressure drop (Pa)

L : length of the pipe (m)

f_D : Darcy friction factor

ρ : density of the fluid (kg/m³)

V : velocity of the fluid (m/s)

D_h : hydraulic diameter (4. R for cylindrique pipe)

The Darcy friction factor will depend on the flow regime expressed by Reynolds number (Equation S-31)

$$Re = \frac{\rho \cdot V \cdot D}{\mu} \quad \text{Equation S-31}$$

With:

μ : viscosity of the fluid (Pa.s)

If the flow regime is laminar ($Re < 2000$) $f_D = \frac{64}{Re}$, for Reynolds number higher than 4000 (turbulent regime) the calculation depends on the pipe roughness.

Smooth-pipe regime

$$\frac{1}{\sqrt{f_D}} = 1.930 \cdot \log(Re \cdot \sqrt{f_D}) - 0.537 \quad \text{Equation S-32}$$

Rough-pipe regime (Colebrook–White relation)

$$\frac{1}{\sqrt{f_D}} = 2.00 \log \left(\frac{2.51}{Re \cdot \sqrt{f_D}} \left(1 + \frac{R_*}{3.3} \right) \right) \quad \text{Equation S-33}$$

$$R_* = \frac{1}{\sqrt{8}} (Re \sqrt{f_D}) \frac{\varepsilon}{D}$$

With:

R_* : roughness Reynolds number

ε : pipe surface' sroughness height (m)

Considering the pressure drop in the lumen side, the viscosity and density of the acid need to be known and depend on the temperature and concentration of acid. However the acid circulating into pipe has a pH equal to 0.8 which correspond to a concentration of 7.8 gH₂SO₄/L which will be very close to water characteristics. At the end of the cycle, 70 gN/L of ammonium sulphate will be reach which correspond to a density of 1.156 and 29% of ammonium sulphate (Perry et al., 1997). The dynamic viscosity has been estimated thanks to (Hull, 1929). In both cases (start or end of the cycle) the flow is laminar and the Darcy friction factor is around 90 and the pressure drop is around 96 Pa/m.

The same approach have been followed for the influent side with the hydraulic diameter calculated based on the design.

VIII.2.d MBR

MBR is designed in a iterating process. First the MBR is design without denitrification. If the limit of 10 mgN/L is exceed, then denitrification is added. In the same way, the MBR is designed without any biological or chemical removing of phosphorus. If the limit of 1 mgP/L is exceed, biological removal is designed and chemical removal can be added is still the discharge limit is exceeded.

The table summarized the parameters used in this design of MBR.

Table S 29: Parameters used for the design of MBR

Parameter	Value	Unit	Source
X_{tot,R}	5	gTSS/L	(Atanasova et al., 2017)
SRT	22	d	(Lesjean and Gnirss, 2006)
Air Flow rate applied based on the membrane surface	1.2	Nm ³ /h/m ²	(Jefferson et al., 2001; Lesjean and Gnirss, 2006; Merz et al., 2007; Peter-Fröhlich et al., 2007)
Flowrate applied to a surface of membrane	8	L/h/m ²	(Jefferson et al., 2001; Merz et al., 2007)

Heterotroph bacteria

Ks	0.04	g/L
$\mu_{max,20^\circ C}$	6.	d ⁻¹
$Y_{X/S}$	0.44	gX/gS
k_d	0.07	d ⁻¹
Denitrification rate	3.3	mgN-NO ₃ /gVSS/h
Percentage of denitrifying heterotroph	0.8	

Nitrifying bacteria

Ks	0.001	g/L
$\mu_{max,20^\circ C}$	0.6	d ⁻¹
$Y_{X/S}$	0.17	gX/gN
k_d	0.07	d ⁻¹

Ratio in sludge VSS/TSS 0.8

Ratio N in sludge 0.07 gN/gCOD_X

Ratio P in sludge 0.02 gP/gCOD_X

Ratio COD in bacteria 1.42 gCOD_X/gX

Equivalent COD of nitrate 2.86 gCOD/gN-NO₃

VIII.2.d.1 Design of aerated tank alone

X	gMVS/L	$(Y_{X/S})_{obs}$ et $Y_{X/S}$	gCOD/gX	
μ_{obs}, μ_{max}	j ⁻¹	$(Y_{X/N})_{obs}$ et $Y_{X/N}$	gN/gX	$\mathcal{P}_{X,i}$ kg-MVS/j
$NNH_{4,out}$	gN/L	$k_{d,i}$	j ⁻¹	N_{purge} kgN/j
K_N	gN/L	θ_x et θ_H	j	P_{purge} kgP/j
K_S	gCOD/L	V	m ³	DO kgCOD /L
$DCO_{bio,out}$	gCOD /L	Q	m ³ /L	

1. Calculation of the specific growth rate observed based on nitrifying bacteria and sludge retention time

$$\mu_{obs} = \mu_{max,nitrifiante} \frac{NNH_{4,out}}{NNH_{4,out} + K_N} - k_{d,N} \quad (\text{Monod Model})$$

$$\theta_x = \frac{1}{\mu_{obs}} \quad (\text{Par bilan sur le réacteur en cellule})$$

2. Calculation of concentration of biodegradable COD in the effluent

$$DCO_{bio,out} = \frac{K_S \cdot (\mu_{obs} + k_{d,S})}{\mu_{max,OHO} - \mu_{obs} - k_{d,S}} \quad (\text{Monod Model})$$

3. Calculation of observed growth rate

$$(Y_{X/S})_{obs} = \frac{Y_{X/S}}{1 + k_{d,S} \cdot \theta_x} \quad \text{and} \quad (Y_{X/N})_{obs} = \frac{Y_{X/N}}{1 + k_{d,N} \cdot \theta_x}$$

4. Calculation of bacteria mass and inert material in the reactor (I for each population), obtained from reactor mass balance.

The mass of nitrifying bacteria takes into account that the nitrogen is also assimilated for growth of all bacteria. This uptake is calculated based on the production of cells and on 6.3% of nitrogen in bacteria VSS.

$$V \cdot X_h = \theta_x \cdot Q \cdot (Y_{X/h})_{obs} \cdot (S_{i,in} - S_{i,out})$$

$$V \cdot X_n = \theta_x \cdot (Y_{X/n})_{obs} \cdot (Q \cdot (S_{i,in} - S_{i,out}) - N_{purge})$$

$$V \cdot X_u = \theta_x \cdot Q \cdot X_{u,in}$$

5. Calculation of the reactor volume considering the concentration in suspended solid in the reactor.

$$V = \frac{V \cdot X_h + V \cdot X_n + V \cdot X_u}{X_{tot}}$$

6. Calculation of hydraulic retention time, the production of sludge and the flowrate of effluent.

$$\theta_H = \frac{V}{Q}$$

$$Q_p = \frac{\mu_{obs} \cdot X_{tot} \cdot V}{facteur_{concentration} \cdot X_{tot}}$$

$$Q_s = Q - Q_p$$

7. The production of sludge and the demand of oxygen is calculated taken into account that 10% of the VSS of sludge is nitrogen and 2.5 % is phosphorus.

$$\mathcal{P}_{X,i} = \frac{V \cdot X_i}{V \cdot X_h + V \cdot X_n + V \cdot X_u} \cdot Q_p$$

$$N_{purge} = 0,063 \cdot \mathcal{P}_{X,tot}$$

$$P_{purge} = 0,025 \cdot \mathcal{P}_{X,tot}$$

$$DO_h = \left(1 - (Y_{X/S})_{obs} \cdot 1,42\right) \cdot Q \cdot (S_{CODbio,in} - S_{iCODbio,out})$$

$$DO_n = \left(1 - (Y_{X/N})_{obs} \cdot \frac{1,42}{4,57}\right) \cdot (Q \cdot (S_{i,in} - S_{i,out}) - N_{purge}) \cdot 4,57$$

We considered a ratio VSS/TSS of 0.8 and 1.42 gCOD/gVSS in the sludge.

The N_2O is produced with the same rate than in the WRRF: 1.6% of the influent total nitrogen flow. $NN_2O_{sortie} = 1.6\% * S_{N,in} * Q$

VIII.2.d.2 Design with denitrification

1. Hypothesis on the total sludge retention $\theta_{X,global} = 15d$
2. Choice of the value of effluent concentration in ammonium (1mgN/L)
3. Calculation of observed growth rate $\mu_{obs} = \mu_{max,nitrifiante} \frac{NNH_{4,out}}{NNH_{4,out} + K_N} - k_{d,N}$
4. Calculation of COD concentration in the effluent: $COD_{bio,out} = \frac{K_S \cdot (\mu_{obs} + k_{d,S})}{\mu_{max,OHO} - \mu_{obs} - k_{d,S}}$
5. Calculation of global observed yield for heterotrophic bacteria (OHO)

$$(Y_{X/S})_{obs,global} = \frac{Y_{X/S}}{1 + k_{d,S} \cdot \theta_{X,global}}$$

6. Production of bacteria and inert

$$\mathcal{P}_{X,H} = (Y_{X/S})_{obs,global} \cdot Q_{in} \cdot (S_{COD,in} - out)$$

$$\mathcal{P}_{Xu} = \frac{Xu_{in} \cdot Q_{in}}{1,42}$$

$$N_{purge} = 0,01 \cdot (\mathcal{P}_{X,H} + \mathcal{P}_{Xu})$$

7. Calculation of possibly nitrified and nitrified mass flow.

$$Flux \text{ possibly nitrified} = Q_{in,aerated} \cdot (N_{in,aerated} - N_{out,aerated})$$

$$Flux \text{ nitrified} = (1 - Production N_2O) \cdot Flux \text{ possibly nitrified} - N_{purge} \\ = Flux \text{ possibly denitrified}$$

8. Calculation of denitrified mass flow considering that at the output of denitrified tank all the nitrate are degraded in the anoxic tank.

$$Flux \text{ denitrified} = Flux \text{ possibly denitrified}$$

$$-Q_{in} \cdot NNO_{3,out,WWTP}$$

9. Calculation of recirculation (internal and external) from a balance on aerated tank.
Le taux de recyclage interne est calculé grâce à un bilan sur le réacteur aérobie. On obtient ainsi le flux d'azote dans la boucle de recyclage interne :

$$Flux \text{ N in } \beta = Flux \text{ nitrified} - Q_{in,MBR} \cdot NNO_{3,out,MBR} (1 + \alpha)$$

$$\beta = \frac{Flux \text{ N in } \beta}{Q_{in,anoxic} \cdot NNO_{3,out,MBR}}$$

10. Calculation of rate of denitrification from $q_{OHO} = 3,3 \text{ mgN} - \text{NO}_3/\text{gMVS} \cdot \text{h}$ for conventional and considering that 80% heterotrophic bacteria are activated in anoxic tank.

$$r_{OHO} = 0,8 * X_{VSS,tot} * q_{OHO}$$

11. Calculation of total volume of tanks

$$V_{anoxic} = \frac{(\alpha + \beta) \cdot Q_{in,MBR} \cdot NNO_{3,out,MBR}}{r_{OHO}}$$

12. Calculation of COD mass flow necessary for denitrification

$$Flux \text{ COD for denit} = \frac{2,86 * Flux \text{ nitrified}}{1 - (Y_{X/S})_{obs,global} * 1,42}$$

13. Calculation of microorganism mass in the total volume with the different fraction

$$V_{tot} \cdot X_h = \theta_{x,global} \cdot Q \cdot (Y_{X/h})_{obs} \cdot (S_{COD,in} - S_{COD,out})$$

$$V_{tot} \cdot X_n = \theta_{x,global} \cdot (Y_{X/n})_{obs} \cdot (\text{Flux nitrified})$$

$$V_{tot} \cdot X_u = \theta_{x,global} \cdot Q \cdot X_{u,entrée}$$

14. Calculation of aerobic volume from minimal sludge retention time for nitrifying bacteria.

$$V_{aérobie} = (\mathcal{P}_{X,H} + \mathcal{P}_{X_u}) * \frac{\theta_{x,aérobie}}{X_{tot} * 1,42}$$

15. Calculation of wasted flowrate $Q_p = \frac{\mathcal{P}_{X_u}}{\text{facteur concentration} \cdot X_u}$

16. Check the total sludge retention time and iterate from step 1 until no more variation in the $\theta_{x,global}$

$$\theta_{x,global} = \frac{(V_{anoxie} + V_{aérobie})}{Q_p \cdot \text{facteur concentration}}$$

VIII.2.d.3 With biological removal of phosphorus

Biological removal of phosphorus is estimated based on the proportion of phosphorus accumulating bacteria (PAO) among the heterotroph bacteria. This proportion is the ratio of readily biodegradable COD on the total COD.

The P content of the sludge is calculated assuming 0.3 gP/gCODx.

The PAO consumed COD which is no longer available for denitrification, calculated based on the observed yield of growth for heterotroph bacteria.

VIII.2.d.4 With chemical removal of phosphorus

The need of chemical dosing is estimated by the comparison between the content of phosphorus in effluent calculated with the phosphorus sludge content and discharge standard.

If necessary, iron is added with a molar ratio Fe/P (1.5) with the P mass flow to eliminate.

VIII.3 References

- Atanasova, N., Dalmau, M., Comas, J., Poch, M., Rodriguez-Roda, I., Buttiglieri, G., 2017. Optimized MBR for greywater reuse systems in hotel facilities. J. Environ. Manage. 193, 503–511. <https://doi.org/10.1016/j.jenvman.2017.02.041>
- de Graaff, M.S., Temmink, H., Zeeman, G., Buisman, C.J.N., 2010. Anaerobic Treatment of Concentrated Blackwater in a UASB Reactor at a Short HRT. Water 2, 101–119. <https://doi.org/10.3390/w2010101>
- de Graaff, R., van Hell, A.J., 2014. Nieuwe Sanitatie Noorderhoek, Sneek deelonderzoeken (New Sanitation Noorderhoek, Sneek sub-studies) (No. 2014–48), STOWA. STOWA, Amersfoort - Netherlands.

- Gernaey, K.V., Flores-Alsina, X., Rosen, C., Benedetti, L., Jeppsson, U., 2011. Dynamic influent pollutant disturbance scenario generation using a phenomenological modelling approach. *Environ. Model. Softw.* 26, 1255–1267. <https://doi.org/10.1016/j.envsoft.2011.06.001>
- Hull, C., 1929. *International Critical Tables of Numerical Data, Physics, Chemistry and Technology*. National Academies.
- Jefferson, B., Laine, A.L., Stephenson, T., Judd, S.J., 2001. Advanced biological unit processes for domestic water recycling. *Water Sci. Technol. J. Int. Assoc. Water Pollut. Res.* 43, 211–218.
- Lesjean, B., Gnirss, R., 2006. Grey water treatment with a membrane bioreactor operated at low SRT and low HRT. *Desalination* 199, 432–434. <https://doi.org/10.1016/j.desal.2006.03.204>
- Merz, C., Scheumann, R., El Hamouri, B., Kraume, M., 2007. Membrane bioreactor technology for the treatment of greywater from a sports and leisure club. *Desalination* 215, 37–43. <https://doi.org/10.1016/j.desal.2006.10.026>
- Perry, R.H., Green, D.W., Maloney, J.O. (Eds.), 1997. *Perry's chemical engineers' handbook*, 7th ed. ed. McGraw-Hill, New York.
- Peter-Fröhlich, A., Bonhomme, A., Oldenburg, M., 2007. Sanitation concepts for separate treatment of urine, faeces and greywater (SCST) (Final report: EU-demonstration project No. Contract: LIFE03ENV/D000025). KompetenzZentrum Wasser Berlin gGmbH.
- Tan, X., Tan, S.P., Teo, W.K., Li, K., 2006. Polyvinylidene fluoride (PVDF) hollow fibre membranes for ammonia removal from water. *J. Membr. Sci.* 271, 59–68. <https://doi.org/10.1016/j.memsci.2005.06.057>
- Tchobanoglous, G., Burton, F.L., Stensel, H.D., Metcalf & Eddy, Inc (Eds.), 2003. *Wastewater engineering: treatment and reuse*, 4. ed., internat. ed., [Nachdr.]. ed, McGraw-Hill series in civil and environmental engineering. McGraw-Hill, Boston, Mass.

Appendix IX. LITERATURE REVIEW ON ELECTRIC AND HEAT YIELD FOR MICRO COGENERATION

Table S 30.: CI : Compression Ignition ; SI spark ignition

Source	Motor	Ignition	Fuel type	Electric power	Electric yield	Heat yield	Total yield	Data number	Data source
(Bianchi et al., 2012)	Micro Rankine cycle		No	1-100kWelec	5 - 20%	80 - 90%	85 - 95%	12	
	Internal combustion engine		No	1-100kWelec	20-25%	45-75%	80-95%	22	
	Micro gas turbine		No	60-100kWelec	25-30%	40-60%	75-87%	7	
	Stirling engine		No	1kWelec	5-15%	80%	85-95%		
	Stirling engine		No	1< P <10kWelec	15% - 20%	70-80%	90-95%		
	Stirling engine		No	10< P <100kWelec	25-30%	50-70%	80-97%		
(Lantz, 2012)	Internal combustion engine	SI	No	20-50kWelec	25-33%	42-70%			suppliers
	Internal engine	SI	No	50-150kWelec	33-39%	40-60%			
	Internal engine	SI	No	150-400kWelec	33-40%	40-47%			
	Internal engine	CI	No	50-400kWelec	36-44%	44-55%			suppliers
(Thomas, 2008)	Internal combustion engine		Natural gas	5.5kWelec	27.7%	63.6%	91.3%	1	experiments SenerTec Dachs HKA G 5.5
	Stirling engine		natural gas	161 kWelec	26.8%	71.7%	98.5%	1	experiments SOLO Stirling 161 Micro-CHP
	Gas Otto		natural gas	4.7 kWelec	24.70%	64.2%	88.90%	1	Experiment ecopower by PowerPlus Technologies
	Stirling engine		Natural (biogas ok)	9 kWelec ^{gas}	20.80%	63.7%	84.50%	1	Experiment Micro-CHP SM5A by Stirling Denmark
	Micro gas turbine		Biogas	30 kWelec	26%	65%	91%	1	

Appendix IX. Literature review on electric and heat yield for micro cogeneration

(Grammelis , 2011)		Natural gas/propane	30 kWelec	26%	65%	91%	1	Capstone micro-turbine suppliers info	
		Diesel	30 kWelec	25%	65%	90%	1		
		Natural gas (and biogas now)	105 kWelec	30%	48%	78%	1	Turbec	
		Natural gas, propane, butane	28 kWelec	25%	66%	91%	1	Elliot / Bowman	
			60 kWelec	28%	61%	89%	1		
			80 kWelec	28%	47%	75%	1		
		?	55kW - 1MW				84%		DTE Energy Technologies . Kockums AB Sweden
		?	3kWe	>25%		75%			Sigma Elektoteknisk AS Norway
		?	2-9kW			8-24kW	92%-96%		SOLO Kleinmotren GmnH German
		?	1 kWe			7.5-12kW			Whisper Tech Limited, New zealand
	CHP classique ?	Biogas	small scale 10,000t/an	33%	50%	83%		Hypothesis. 3% of electricity is needed for fonctionnement	
(Pöschl et al., 2010)Source		Biogas	large scale 20,000t/an, 1.8 millions m3 biogas/year	40%	48%	88%		Hypothesis 4.5% of electricity is needed for fonctionnement	
	Stirling engine	Biogas	< 400 kWelec	24%	72%	96%		Hypothesis 2% of electricity is needed for fonctionnement	
	Micro gas turbine	Biogas	30-200kWelec	28%	54%	82%		Hypothesis 10% of electricity is needed for fonctionnement	

References

Bianchi, M., De Pascale, A., Spina, P.R., 2012. Guidelines for residential micro-CHP systems design. Appl. Energy 97, 673–685. <https://doi.org/10.1016/j.apenergy.2011.11.023>

- Grammelis, P. (Ed.), 2011. *Solid Biofuels for Energy, Green Energy and Technology*. Springer London, London. <https://doi.org/10.1007/978-1-84996-393-0>
- Jinming, D., Jingxuan, Z., 2006. Studies on frictional pressure drop of gas-non-Newtonian fluid two-phase flow in the vacuum sewers. *Civ. Eng. Environ. Syst.* 23, 1–10. <https://doi.org/10.1080/10286600500431904>
- Lantz, M., 2012. The economic performance of combined heat and power from biogas produced from manure in Sweden – A comparison of different CHP technologies. *Appl. Energy* 98, 502–511. <https://doi.org/10.1016/j.apenergy.2012.04.015>
- Pöschl, M., Ward, S., Owende, P., 2010. Evaluation of energy efficiency of various biogas production and utilization pathways. *Appl. Energy* 87, 3305–3321. <https://doi.org/10.1016/j.apenergy.2010.05.011>
- Thomas, B., 2008. Benchmark testing of Micro-CHP units. *Appl. Therm. Eng.* 28, 2049–2054. <https://doi.org/10.1016/j.applthermaleng.2008.03.010>

Appendix X. LIFE CYCLE INVENTORY

X.1 Gas emission from fertiliser and by-product application

Table S 31 :Post-spreading emissions chosen in(Bisinella de Faria et al., 2015) based on Doka (2009), Bouwman et al. (1997), Bouwman et al. (2002) and Nemecek and Kägi (2007)

N and P sources	N₂O-N of N content)	(% NO_x-N (% of NH₃-N content)	(% PO₄-P to ground PO₄-P to surface water (% of P content)	(% PO₄-P to ground PO₄-P to surface water (% of P content)	
Sludge	1.2	NA	25.6	0.6	2.0
Struvite	0.9	0.6	3.0	1.0	2.7
Ammonium sulfate and mineral fertiliser	1.0	0.7	2.5	1.0	2.7

X.2 Inventory of processes

Table S 32 :List of processes and main hypothesis used for the life cycle inventory

Process	Operational data	Ecoinvent process	Hypothesis	
Wastewater treatment	Infrastructure	WWTP	wastewater treatment plant, class 2 (CH) [unit]	$\frac{PE_{treated}}{30 \text{ years lifetime} * 71133 PE}$
		Decentralised treatment	wastewater treatment plant, class 5 [CH]	$\frac{PE_{treated}}{30 \text{ years lifetime} * 806 PE}$
	Direct emissions	NH ₄	Ammonium, ion, water, river, [kg]	From processes simulation See [1] for the conversion formulas
		NO ₂	Nitrite, water, river, [kg]	
		NO ₃	Nitrate, water, river, [kg]	
		N _{org}	Nitrogen, organic bound, water, river, [kg]	
		PO ₄	Phosphate, water, river, [kg]	
		BDO ₅	BOD5, Biological Oxygen Demand, water, river, [kg]	
		COD	COD, Chemical Oxygen Demand, water, river, [kg]	
		TOC	TOC, Total Organic Carbon, water, river, [kg]	
		DOC	DOC, Dissolved Organic Carbon, water, river, [kg]	
		CO ₃ ²⁻	Carbonate, water, river, [kg]	
		N ₂ O	Dinitrogen monoxide, air, high population density, [kg]	1.6% of total nitrogen entering the water line is emitted as NN ₂ O (IPCC, 2019)
		CH ₄	Methane, biogenic, air, high population density, [kg]	From processes simulation See [1] for the conversion formulas
		CO ₂ biogenic	Carbon dioxide, biogenic, air, high population density, [kg]	
		CO ₂ fossil	Carbon dioxide, fossil, air, high population density, [kg]	
		H ₂	Hydrogen, air, high population density, [kg]	
		Metals	(see table below)	
	Grits collection	Transport	transport, lorry 20-28t, fleet average	10 km [1]
		Disposal	disposal, paper, 11.2% water, to municipal incineration, CH, [kg]	50% in mass [1]
	disposal, plastics, mixture, 15.3% water, to municipal incineration, CH, [kg]		50% in mass (0.03 kg _{grits} /m ³ _{ww})	
Electricity		electricity, production mix RER, RER, [kWh]	From processes simulation	
Heat		heat, natural gas, at boiler modulating >100kW, RER, [MJ]		
Cogeneration unit	Infrastructure	cogen unit 160kWe, common components for heat+electricity, RER, [unit]	5E-9 * MJ biogas	
	Production	lubricating oil, at plant, RER, [kg]	3E-5 * MJ biogas	

Appendix X. Life cycle inventory

	Oil for maintenance	Disposal	disposal, used mineral oil, 10% water, to hazardous waste incineration, CH, [kg]	3E-5 * MJ biogas
	Production		electricity, at cogen with biogas engine, allocation exergy, CH, [kWh] heat, at cogen with biogas engine, allocation exergy, CH, [MJ]	From processes simulation
	Emissions		Dinitrogen monoxide, air, high population density, [kg]	1.5E-5 * MJ biogas
			Methane, biogenic, air, high population density, [kg]	2.3E-5 * MJ biogas
			Carbon dioxide, biogenic, air, high population density, [kg]	0.083502 * %DCO biogenic* MJ biogas
			Carbon dioxide, fossil, air, high population density, [kg]	0.083502 * %DCO fossil* MJ biogas
			Carbon monoxide, biogenic, air, high population density, [kg]	4.8E-5 * %DCO biogenic* MJ biogas
			Carbon monoxide, fossil, air, high population density, [kg]	4.8E-5 * %DCO biogenic* MJ biogas
			NMVOC, non-methane volatile organic compounds, unspecified origin, air, high population density, [kg]	2E-6 * MJ biogas
			Nitrogen oxides, air, high population density, [kg]	1.5E-5 * MJ biogas
		Sulfur dioxide, air, high population density, [kg]	2.1004E-5 * MJ biogas	
		Heat, waste, air, high population density, [MJ]	From process simulation	
Chemicals	Methanol	Production	methanol, at plant, GLO, [kg]	From process simulation
		Transport	transport, freight, rail, RER, [tkm]	600 km
	FeCl ₃	Production	transport, lorry 20-28t, fleet average, CH, [tkm]	50 km
		Transport	iron (III) chloride, 40% in H ₂ O, at plant, CH, [kg]	From process simulation
	MgO	Production	transport, freight, rail, RER, [tkm]	600 km
		Transport	transport, lorry 20-28t, fleet average, CH, [tkm]	50 km
	NaOH	Production	magnesium oxide, at plant, RER, [kg]	From process simulation
		Transport	transport, freight, rail, RER, [tkm]	600 km
	Sulfuric Acid	Production	transport, lorry 20-28t, fleet average, CH, [tkm]	50 km
			sulphuric acid, liquid, at plant"	From process simulation

			Transport	transport, freight, rail, RER, [tkm]	600 km		
				transport, lorry 20-28t, fleet average, CH, [tkm]	50 km		
Struvite utilisation	Transport			transport, lorry 20-28t, fleet average, CH, [tkm]	10 km		
	Spreading			fertilising, by broadcaster, CH, [ha]	0.0002854 * kgTSS _{Struvite}		
	Post emissions	NH ₃			Ammonia, air, high population density, [kg]	NNH ₃ : 3% of TN in struvite	
		N ₂ O			Dinitrogen monoxide, air, high population density, [kg]	NNO ₂ : 0.9% of TN in struvite	
		NO _x			Nitrogen oxides, air, high population density, [kg]	NNO _x : 0.6% of TN in struvite	
		PO ₄				Phosphate, water, river, [kg]	2.679% of TP in struvite
						Phosphate, water, ground-, [kg]	0.9793 of TP in struvite
		Cd			Cadmium, soil, agricultural, [kg]	0.21E-6*TN + 51.32E-6*TP	
		Cu			Copper, soil, agricultural, [kg]	22.25E-6*TN + 118.22E-6*TP	
		Zn			Zinc, soil, agricultural, [kg]	121.43E-6*TN + 751.32E-6*TP	
		Pb			Lead, soil, agricultural, [kg]	5.37E-6*TN + 49.42E-6*TP	
Ni			Nickel, soil, agricultural, [kg]	17.17E-6*TN + 100.46E-6*TP			
Cr			Chromium, soil, agricultural, [kg]	7.81E-6*TN + 589.46E-6*TP			
Sludge utilization	Transport			transport, lorry 20-28t, fleet average, CH, [tkm]	20 km		
	Spreading			slurry spreading, by vacuum tanker, CH, [m3]			
	Post emissions	NH ₃			Ammonia, air, high population density, [kg]	NNH ₃ : 25.8% of TN in sludge	
		N ₂ O			Dinitrogen monoxide, air, high population density, [kg]	NNO ₂ : 1.18% of TN in struvite	
		C			Carbon, soil, agricultural, [kg]	From processes simulation	
		PO ₄				Phosphate, water, river, [kg]	PPO ₄ : 2.005% of TP in sludge
						Phosphate, water, ground-, [kg]	PPO ₄ : 0.57% of TP in sludge
		Mg			Magnesium, soil, agricultural, [kg]	From processes simulation	
Fe				Iron, soil, agricultural, [kg]	From processes simulation		
Other metals					See table below		
Ammonium sulphate utilisation	Transport			transport, lorry 20-28t, fleet average, CH, [tkm]	10 km		
	Spreading			slurry spreading, by vacuum tanker CH [m3]	From processes simulation		
	Post emissions	NH ₃			Ammonia, air, high population density, [kg]	NNH ₃ : 2.5% of TN	
		N ₂ O			Dinitrogen monoxide, air, high population density, [kg]	NNO ₂ : 1 % of TN	
		NO _x			Nitrogen oxides, air, high population density, [kg]	NNO _x : 0.7% of TN	
PO ₄					Phosphate, water, river, [kg]	PPO ₄ : 2.679% of TP	
				Phosphate, water, ground-, [kg]	PPO ₄ : 0.9793% of TP		
Avoided Fertilisers	Production	P-fertilizer		triple superphosphate, as P2O5, at regional storehouse, RER, [kg]	From process simulation		
		N-fertilizer		ammonium nitrate, as N, at regional storehouse, RER, [kg]			
	Transport			transport, freight, rail, RER, [tkm]	100 km		
				transport, lorry 20-28t, fleet average, CH, [tkm]	100 km		

Appendix X. Life cycle inventory

			transport, barge, RER, [tkm]	900 km for N fertiliser and 400 km for P fertiliser	
	Spreading		fertilising, by broadcaster, CH, [ha]	0.005 ha/kg N	
	Post emissions	NH ₃	Ammonia, air, high population density, [kg]	NNH ₃ ; 2% of TN fertiliser	
		N ₂ O	Dinitrogen monoxide, air, high population density, [kg]	NNO ₂ : 0.8% of TN	
		NO _x	Nitrogen oxides, air, high population density, [kg]	NNO _x : 0.6% of TN	
		PO ₄	Phosphate, water, river, [kg]	PPO ₄ : 2.679% of TP fertiliser	
			Phosphate, water, ground-, [kg]	PPO ₄ : 0.9793% of TP fertiliser	
		As	Arsenic, soil, agricultural, [kg]	9.3E-6*TN + 14.5E-6*TP	
		Cd	Cadmium, soil, agricultural, [kg]	6E-6* TN + 39.5E-6* TP	
		Cu	Copper, soil, agricultural, [kg]	26E-6* TN + 90.5E-6* TP	
		Zn	Zinc, soil, agricultural, [kg]	203E-6* TN + 839.2E-6* TP	
		Pb	Lead, soil, agricultural, [kg]	54.9E-6* TN + 67E-6* TP	
		Ni	Nickel, soil, agricultural, [kg]	20.9E-6* TN + 88.3E-6* TP	
		Hg	Mercury, soil, agricultural, [kg]	0.07E-6* TN + 0.3E-6* TP	
		Cr	Chromium, soil, agricultural, [kg]	77.9E-6* TN + 543.2E-6* TP	
Electricity avoided	Electricity		electricity, production mix RER, RER, [kWh]	From process simulation	
Vacuum and gravity sewer	Vacuum Pipes	Production	extrusion, plastic pipes RER, [kg]	955 kg/m3 PE and ratio between diameter and thickness of the pipe $D_e/e = 17$ [3]	
			polyethylene, HDPE, granulate, at plant RER [kg]		
		Transport	transport, lorry 3.5-16t, fleet average [RER]	100 km	
	Gravity Pipes	Disposal	disposal, polyethylene, 0.4% water, to municipal incineration CH [kg]		
			Production	extrusion, plastic pipes RER, [kg]	6 kgPVC/ml for a 200 mm diameter pipe [2]
			polyvinylchloride, at regional storage RER, [kg]		
	Trenches	Sand	transport, lorry 3.5-16t, fleet average [RER]	100 km [2]	
			disposal, polyvinylchloride, 0.2% water, to municipal incineration CH, [kg]		
			silica sand, at plant DE [kg]	See Chapter II.IV.4	
	Manholes	Steel	transport, lorry 3.5-16t, fleet average RER [tkm]	30 km [2]	
disposal, building, concrete, not reinforced, to final disposal CH, [kg]					
Gravel			Gravel, unspecified, at mine CH [kg]	See Chapter II.IV.4	
		transport, lorry 3.5-16t, fleet average RER [tkm]	30 km [2]		
		disposal, building, concrete gravel, to final disposal CH [kg]	50%		
		disposal, building, concrete gravel, to recycling CH [kg]	50%		
		reinforcing steel, at plant, RER [kg]	88 kg / manholes [2]		

		transport, lorry 3.5-16t, fleet average RER [tkm]	300 km [2]
		concrete, sole plate and foundation, at plant CH [kg]	1099 +63.3*(Zpipes – 1.15m) [2]
		transport, lorry 3.5-16t, fleet average RER [tkm]	30 km [2]
		disposal, concrete, 5% water, to inert material landfill CH [kg]	
	Civil Work	steel product manufacturing, average metal working	Calculated for Mecalac, Dump Truck, Mini Excavator, Loader on tyres, Trench compactor and the small equipments
		transport, lorry 3.5-16t, fleet average RER [tkm]	
		polypropylene, granulate, at plant RER [kg]	
		synthetic rubber, at plant RER [kg]	
		diesel, burned in building machine GLO [MJ]	See [2]
	Demolition	diesel, burned in building machine GLO [MJ]	[2]
		sewer grid, class 2 CH [km]	$242 \text{ km} * Q_{WWTP}$
Existing sewer of the city			$14370000 \text{ m}^3/\text{year} * 100 \text{ year lifetime}$
Water avoided		tap water, at user RER [kg]	From process simulation
	Storage	glass fibre, at plant, RER, [kg] (#808)	$\frac{V_{urine} * 1.5 (\text{security coef}) * 2841 \text{ kg fiber}/\text{m}^3_{urine}}{Nb_{collection\text{per year}} * 40 \text{ years (lifetime)}}$
			[4]
Urine collection and transport	Emissions	Ammonia [air/high population density]	NNH ₃ : 0.08% TN urine
	Transport	transport, lorry 20-28t, fleet average, CH, [tkm]	From process simulation 10 km between the district and the WWTP

- [1] Bisinella de Faria, A.B., Spérandio, M., Ahmadi, A., Tiruta-Barna, L., 2015. Evaluation of new alternatives in wastewater treatment plants based on dynamic modelling and life cycle assessment (DM-LCA). Water Research 84, 99–111. <https://doi.org/10.1016/j.watres.2015.06.048>
- [2] Risch, E., Gutierrez, O., Roux, P., Boutin, C., Corominas, L., 2015. Life cycle assessment of urban wastewater systems: Quantifying the relative contribution of sewer systems. Water Research 77, 35–48. <https://doi.org/10.1016/j.watres.2015.03.006>
- [3] Glynwed, n.d. Dossier technique Tube PE100. http://www.aliaxis-ui.fr/Docs/Documents/MASA_PE100_dossier.pdf, accessed February 20, 2020.
- [4] Ishii, S.K.L., Boyer, T.H., 2015. Life cycle comparison of centralized wastewater treatment and urine source separation with struvite precipitation: Focus on urine nutrient management. Water Research 79, 88–103. <https://doi.org/10.1016/j.watres.2015.04.010>

X.3 Metal in wastewater

Table S 33: Initial concentration and transfer coefficients for metals (copied from (Bisinella de Faria et al., 2015))

Concentration in sewage			Transfer Coefficients ¹		Source
Ecoinvent notation	Short name	Concentration (kg.m ⁻³)	To sludge ²	To effluent ³	
Arsenic, ion	As	3E-06	0.22	0.78	Henze and Ledin (2001)
Cadmium, ion	Cd	2E-06	0.50	0.50	
Cobalt	Co	1E-06	0.50	0.50	
Copper, ion	Cu	7E-05	0.75	0.25	
Lead	Pb	6.5E-05	0.90	0.10	
Manganese	Mn	1E-04	0.50	0.50	
Mercury	Hg	2E-06	0.70	0.30	
Nickel, ion	Ni	2.5E-05	0.40	0.60	
Silver, ion	Ag	7E-06	0.75	0.25	
Tin, ion	Sn	3.4E-06	0.59	0.41	
Zinc, ion	Zn	2E-04	0.70	0.30	Henze and Ledin (2001)
Silicon	Si	3.1E-03	0.95	0.05	Doka (2009)
Fluoride	F	3.3E-05	0.00	1.00	Doka (2009)
Potassium, ion	K	4E-04	0.00	1.00	Doka (2009)
Sodium, ion	Na	2.2E-03	0.00	1.00	Doka (2009)
Molybdenum	Mo	9.6E-07	0.50	0.50	Doka (2009)
Chromium VI	Cr	2.5E-05	0.50	0.50	Henze and Ledin (2001)
S particulate	S	2E-03	1.00	0.00	Doka (2009)
Magnesium	Mg	5.7E-03	0.10	0.90	Doka (2009)
Calcium, ion	Ca	5.1E-02	0.10	0.90	Doka (2009)
Aluminum	Al	6.5E-04	0.95	0.05	Henze and Ledin (2001)
Sulfate (dissolved)	SO ₄	4.4E-02	0.00	1.00	Doka (2009)
Iron, ion	Fe	1E-03	0.50	0.50	Henze and Ledin (2001)
Chloride	Cl	3E-02	0.00	1.00	Doka (2009)

¹ Doka (2009)

² Share in particulate matter

³ Dissolved share

Doka, G., 2009. Life cycle inventories of waste treatment services. Ecoinvent report n° 13.
 Henze, M., Ledin, A., 2011. Types, characteristics and quantities of classic, combined domestic wastewaters. In: Decentralised Sanitation and Reuse: Concepts, System and Implementation, Lens, P. G., Zeeman, G., Lettinga, G. (eds), IWA Publishing, London.

Appendix I. CHAPTER III.

I.1 Influent fractionation

This appendix shows the influent fractionation used in SUMO software for each scenario. The procedure and hypothesis are described.

I.1.a City

City influent follows the work of (Bisinella de Faria et al., 2019) and is presented in Table S 35. Modifications had to be done because the proposed more compounds was fractionated than the software. Colloidal nitrogen and phosphorus as well as soluble non-degradable is, in the software, accounted by a fraction of colloidal matter and soluble non degradable organic matter with the coefficient in the Table S 34.

Table S 34: N and P content in organic matter from SUMO software (version 19)

Parameter	Value
N content of biomasses	0.070
N content of endogenous products	0.060
N content of colloidal biodegradable substrate	0.030
N content of colloidal non-degradable organics	0.010
N content of soluble non-degradable organics	0.050
P content of biomasses	0.020
P content of colloidal biodegradable substrate	0.005
P content of colloidal non-degradable organics	0.005
P content of soluble non-degradable organics	0.002

Soluble non-degradable nitrogen was overestimated in SUMO software compared to the work of (Bisinella de Faria et al., 2019). Particulate biodegradable was reduced consistently. The same approach was followed for phosphorus fractionation.

Moreover the other strong cations has to be recalculate as potassium has been added to the model. The default value of 16 gK/m³ has been used. Finally the total inorganic carbon has been converted into gC/m³ from gCO₂/m³.

No adjustment on ions was necessary as the pH was 7.81.

I.1.b District

District influent was defined in MUSES tool regarding the total composite variables (total COD, total nitrogen and total phosphorus) as well as conventional variable as ammonium and phosphate.

Fractionation into state variable follow the same proportion as CITY influent fractionation. However for calcium, magnesium potassium and other anions and cations, ratio with ammonium was used as in the initial work of (Bisinella de Faria et al., 2019).

One more time, no adjustment of ions was performed as pH was equal to 7.15.

I.1.c Urine source separation scenario

I.1.c.1 Urine district

Urine fractionation follows the work of (Bisinella de Faria et al., 2019) with the same adjustment to make than previously. Particulate biodegradable nitrogen and phosphorus was adapted to keep the same total concentration.

One more time, no adjustment of ions was performed as pH was equal to 9.06.

I.1.c.2 Grey and Brownwater

Grey and brownwater was calculated from the difference between CITY influent and URINE influent. However this lead to unrealistic pH (higher than 8.5). Potassium other cation and total inorganic carbon was manually adjusted in SUMO software to have a pH equal to 7.15.

I.1.d Blackwater and Greywater source separation scenario

I.1.d.1 Greywater

Greywater fractionation is uncertain as less data is available. Main categories (Soluble biodegradable and inert, particulate biodegradable and inert) used the work of (Jönsson et al., 2005).

However SUMO model considered also colloidal matter and adjustments had to be done through some hypothesis listed below:

- Particulate inert from (Jönsson et al., 2005) is the sum of colloidal and particulate
- Same percentage of OHO bacteria as in the influent of CITY was considered (1.98% of the total COD).
- Particulate biodegradable with colloids matter was considered as the particulate COD minus the biomass and the inert particulate and colloids.
- The same ratio $\frac{C_u}{C_u+X_u}$ as in CITY is used (20.7%)
- The same ratio $\frac{C_B}{C_B+X_B}$ as in CITY is used (22.4%)
- The same ratio $\frac{S_B}{S_B+S_{VFA}}$ as in CITY is used (65%)
- The ratio between inert and biodegradable matter was used to determine the fractionation into nitrogen and phosphorus.
- Calcium, magnesium and potassium from (Remy, 2010) was used
- Other strong cations (as Na^+), other strong anions (as Cl^-) and total inorganic carbon (CO_2) was manually adjusted to have a pH of 7.3

I.1.d.2 Remaining Water

Remaining water corresponds to the effluent of blackwater treatment as decentralised scale. MUSES tools gives the composition without colloid and none was considered to be present at this stage. Only the proportion of VFA has to be estimate on the total soluble organic compounds and 60% as been chosen as it comes from an anaerobic digestion of blackwater.

Table S 35: Influent fractionation for different stream in each scenario

Name	City	District	Urine	Grey and brown water	Grey water	Remaining Blackwater	Unit
Volatile fatty acids (VFA)	30.0	43.1	2202.3	10.5	70.5	231.2	g COD/ m ³
Readily biodegradable substrate (non-VFA)	56.6	81.4	1328.9	62.5	132.9	154.1	g COD/ m ³
Methanol (MEOL)	0.0	0.0	0.0	0.0	0.0	0.0	g COD/ m ³
Colloidal biodegradable substrate	81.5	117.2	62.0	118.1	46.8	0.0	g COD/ m ³
Slowly biodegradable substrate	282.0	405.6	186.4	408.9	161.8	3.1	g COD/ m ³
Soluble unbiodegradable organics	39.4	56.7	332.3	52.5	13.2	172.5	g COD/ m ³
Colloidal unbiodegradable organics	20.4	29.3	10.4	29.6	14.7	0.0	g COD/ m ³
Particulate unbiodegradable organics	78.2	112.5	31.0	113.7	56.3	2.8	g COD/ m ³
Stored polyhydroxyalkanoates (PHA)	0.0	0.0	0.0	0.0	0.0	0.0	g COD/ m ³
Stored glycogen (GLY)	0.0	0.0	0.0	0.0	0.0	0.0	g COD/ m ³
Endogenous decay products	0.0	0.0	0.0	0.0	0.0	0.0	g COD/ m ³
Anaerobic endogenous decay products	0.0	0.0	0.0	0.0	0.0	0.0	g COD/ m ³
Ordinary heterotrophic organisms (OHO)	11.9	17.1	0.0	17.4	10.0	0.1	g COD/ m ³
Phosphorus accumulating organisms (PAO)	0.1	0.1	0.0	0.1	0.1	0.1	g COD/ m ³
Glycogen accumulating organisms (GAO)	0.1	0.1	0.0	0.1	0.1	0.1	g COD/ m ³
Anoxic methanol utilizers (MEOLO)	0.1	0.1	0.0	0.1	0.1	0.1	g COD/ m ³
Aerobic ammonia oxidizers (AOB)	0.1	0.1	0.0	0.1	0.1	0.1	g COD/ m ³
Nitrite oxidizers (NOB)	0.1	0.1	0.0	0.1	0.1	0.1	g COD/ m ³
Anammox organisms (AMX)	0.1	0.1	0.0	0.1	0.1	0.1	g COD/ m ³
Acidoclastic methanogens (AMETO)	0.1	0.1	0.0	0.1	0.1	0.1	g COD/ m ³
Hydrogenotrophic methanogens (HMETO)	0.1	0.1	0.0	0.1	0.1	0.1	g COD/ m ³
Total ammonia (NH _x)	50.0	66.8	3330.9	17.5	2.4	213.1	g N/ m ³
Nitrite (NO ₂)	0.0	0.0	0.0	0.0	0.0	0.0	g N/ m ³
Nitrate (NO ₃)	0.0	0.0	0.0	0.0	0.0	0.0	g N/ m ³
Dissolved nitrogen (N ₂)	0.0	0.0	0.0	0.0	0.0	0.0	g N/ m ³
Soluble biodegradable organic N (from SB)	2.3	3.0	147.1	0.9	2.9	225.0	g N/ m ³
Particulate biodegradable organic N (from XB)	9.1	9.2	49.0	8.6	2.4	1.8	g N/ m ³
Particulate unbiodegradable organic N	0.8	1.0	0.0	1.1	1.4	1.6	g N/ m ³
Orthophosphate (PO ₄)	6.0	11.8	289.8	7.6	3.1	18.8	g P/ m ³
Stored polyphosphate (PP)	0.0	0.0	0.0	0.0	0.0	0.0	g P/ m ³

Name	City	District	Urine	Grey and brown water	Grey water	Remaining Blackwater	Unit
Soluble biodegradable organic P (from SB)	0.6	0.8	10.3	0.6	0.0	20.7	g P/ m ³
Particulate biodegradable organic P (from XB)	4.0	0.4	2.7	0.4	0.9	0.2	g P/ m ³
Particulate unbiodegradable organic P	0.0	0.0	0.0	0.0	0.4	0.2	g P/ m ³
Dissolved oxygen (O₂)	0.0	0.0	0.0	0.0	0.0	0.0	g O ₂ / m ³
Dissolved methane (CH₄)	0.0	0.0	0.0	0.0	0.0	0.0	g COD/ m ³
Dissolved hydrogen (H₂)	0.0	0.0	0.0	0.0	0.0	0.0	g COD/ m ³
Inorganics in influent and biomass	53.9	77.5	35.7	78.2	30.9	0.6	g TSS/ m ³
Calcium	60.0	80.2	86.5	80.1	117.9	5.0	g Ca/ m ³
Magnesium	11.5	15.4	73.1	14.5	21.8	61.1	g Mg/ m ³
Potassium	16.0	21.4	1920.0	16.0	13.5	60.0	g K/ m ³

I.2 Midpoint impacts results

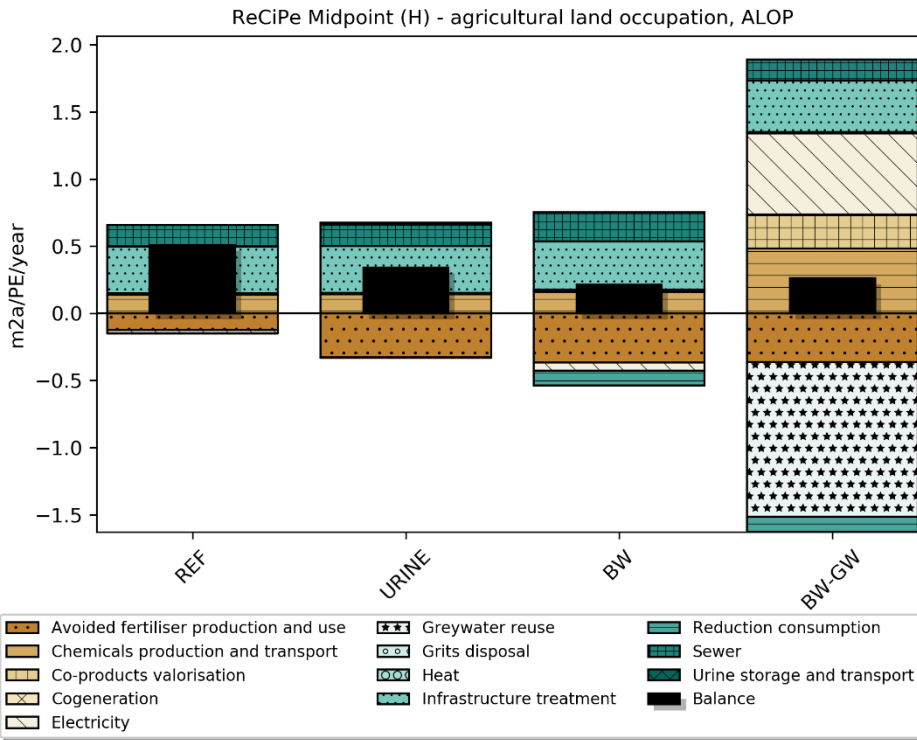
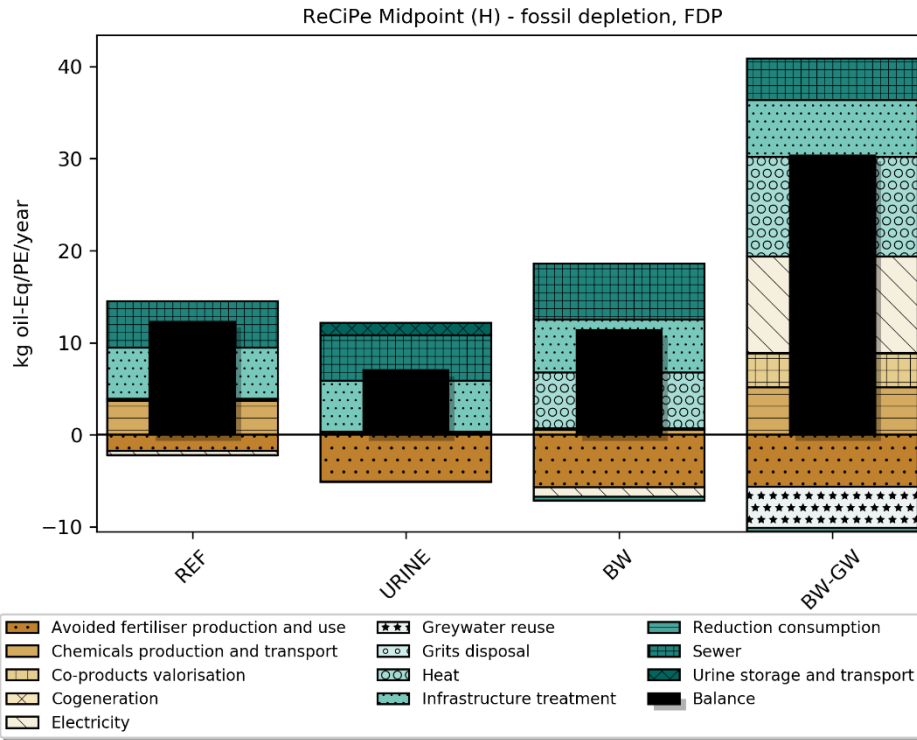

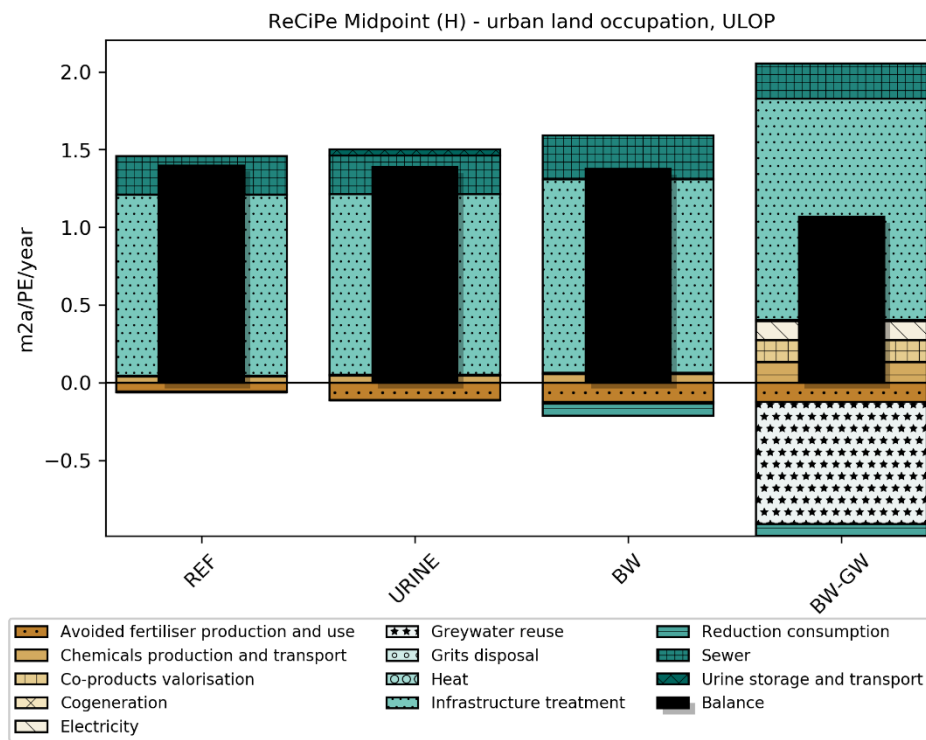
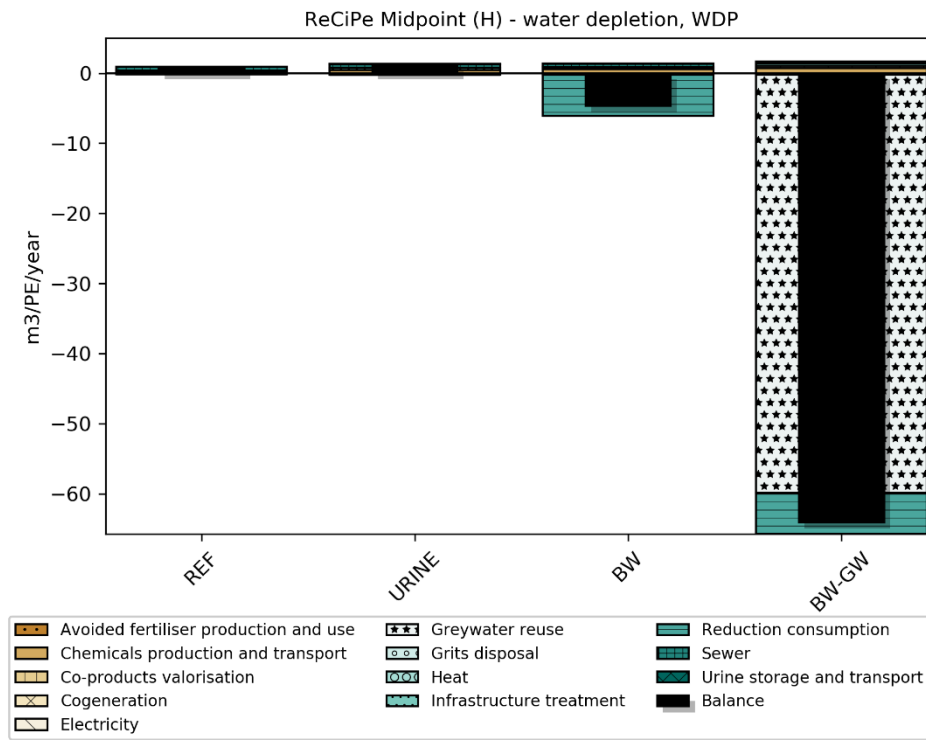

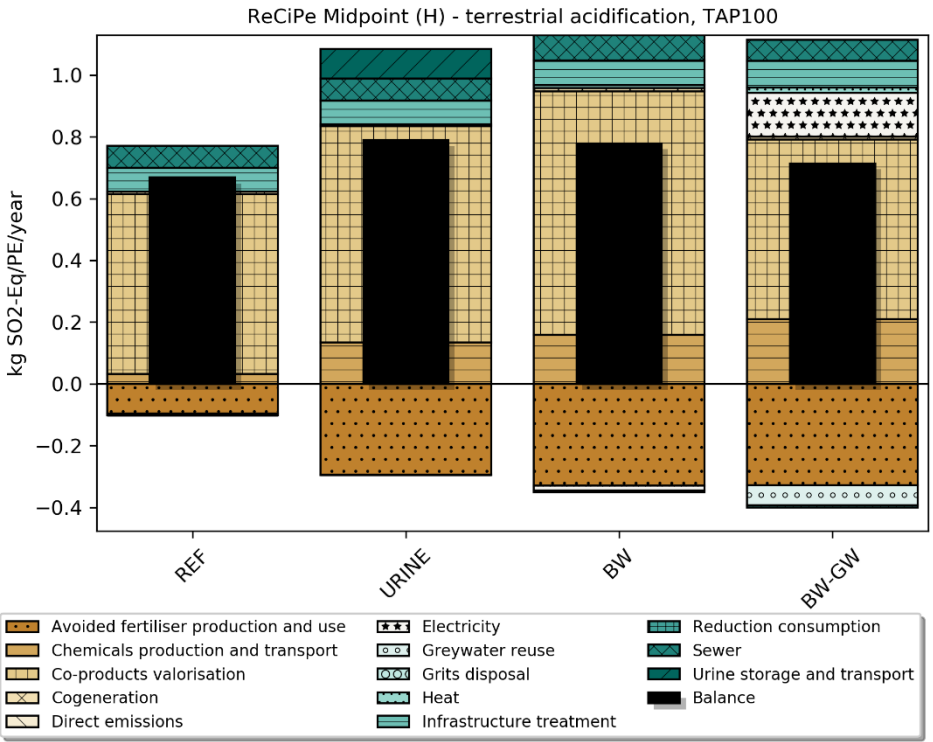
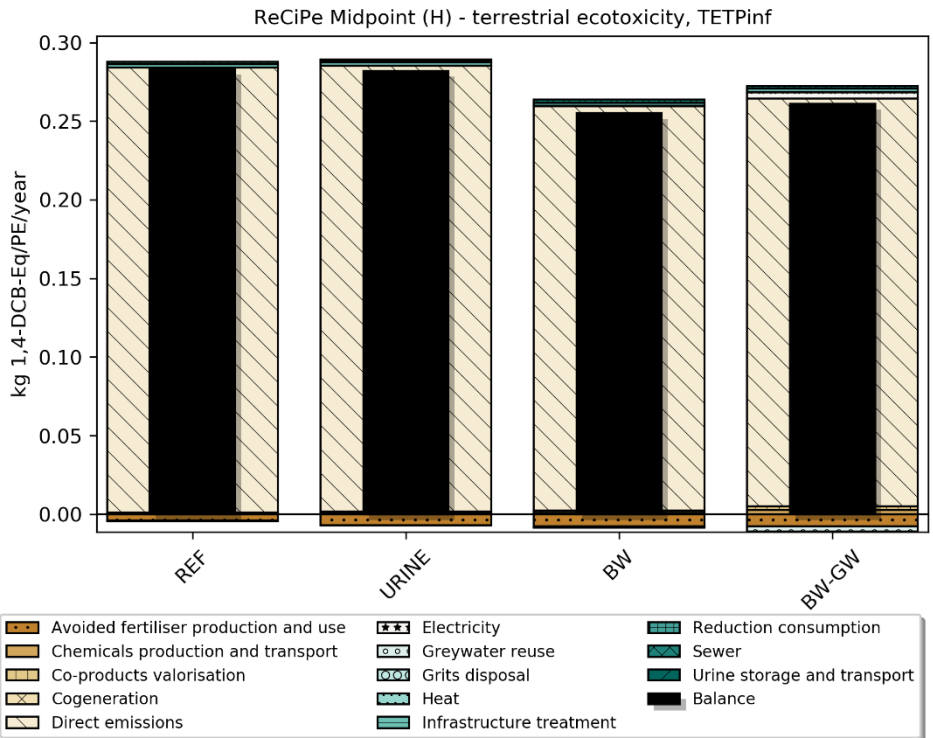

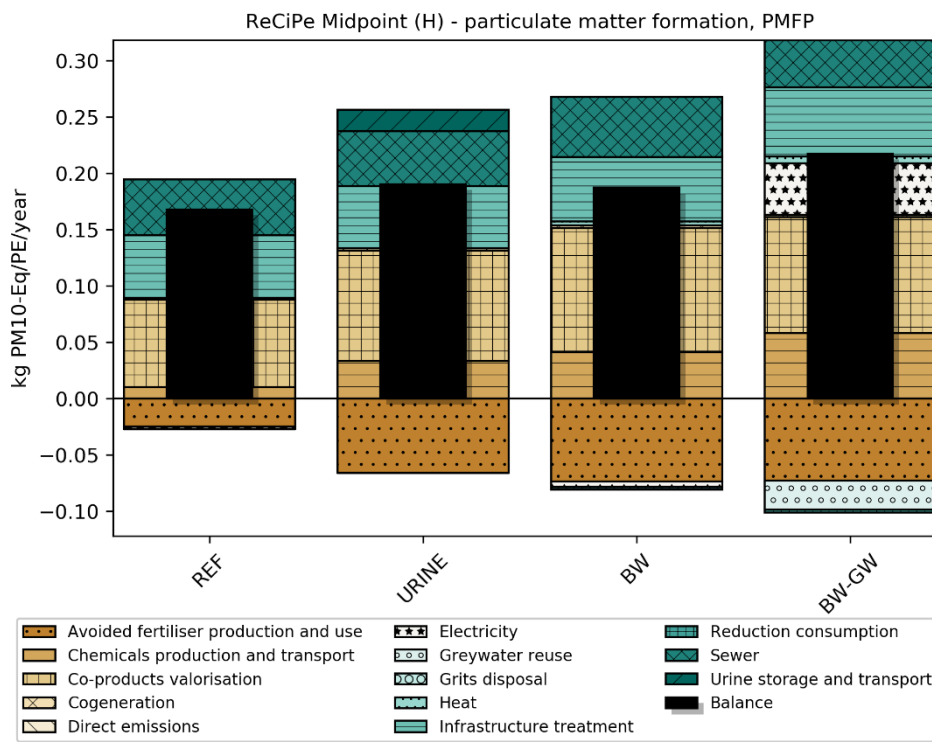
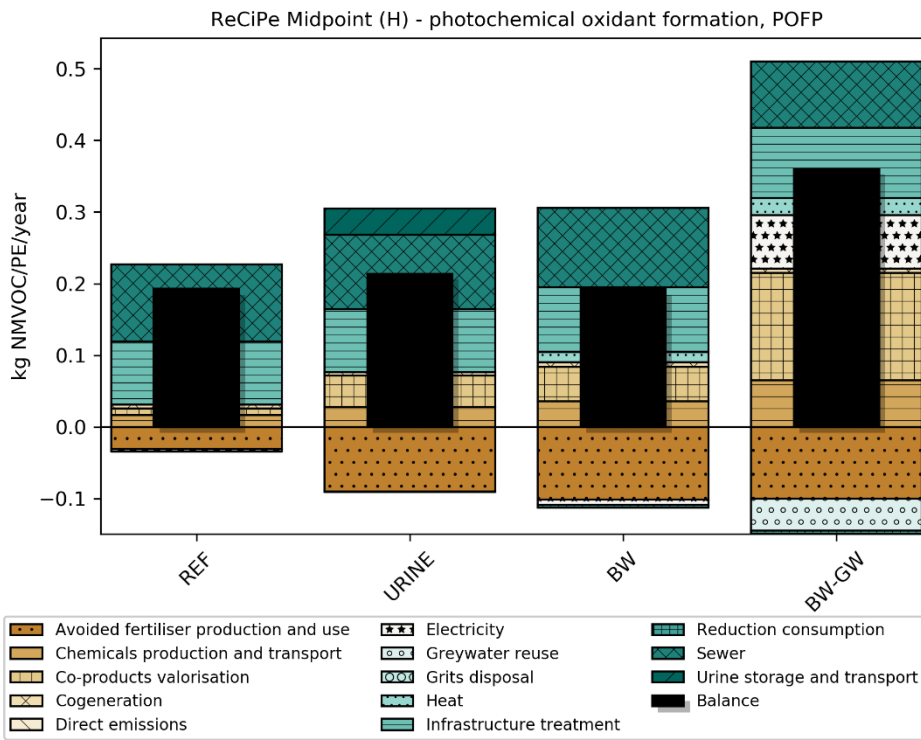

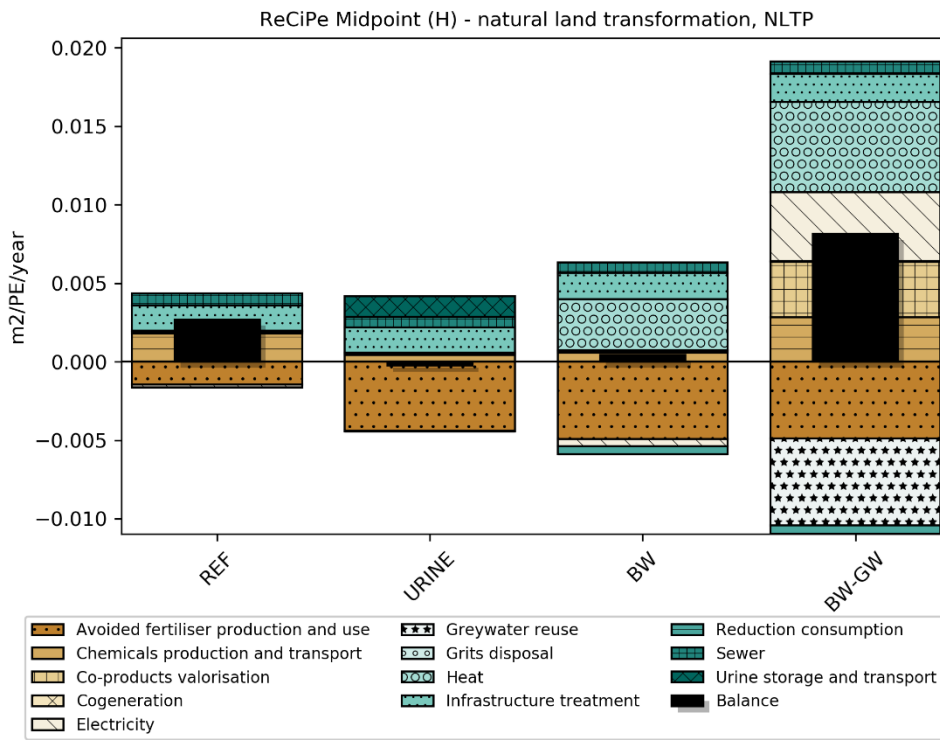
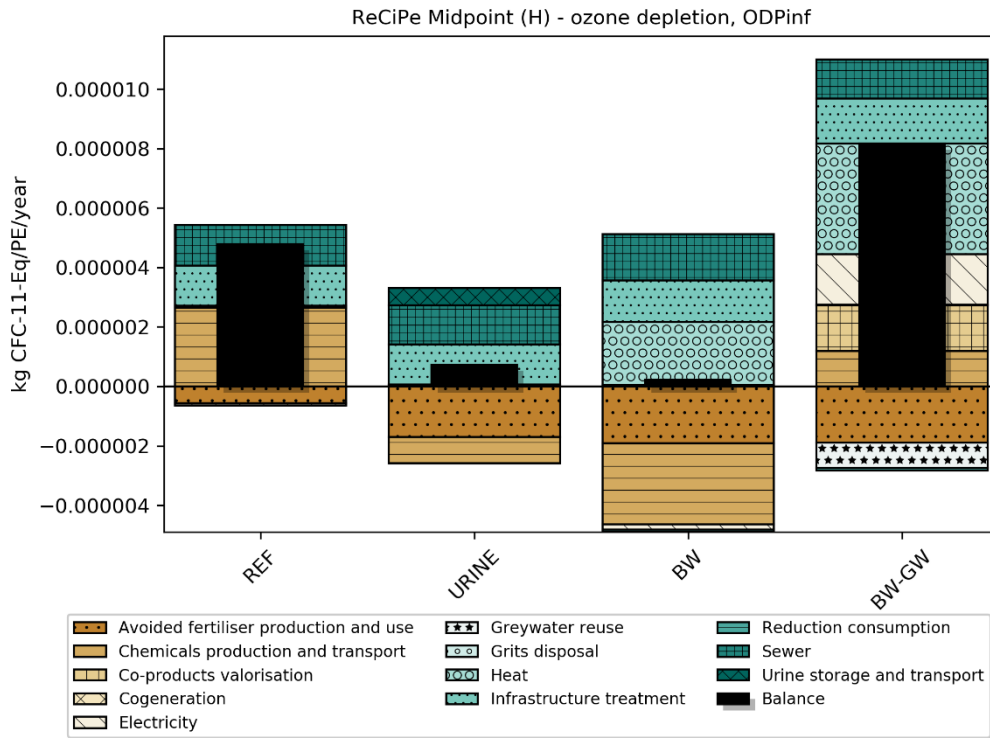

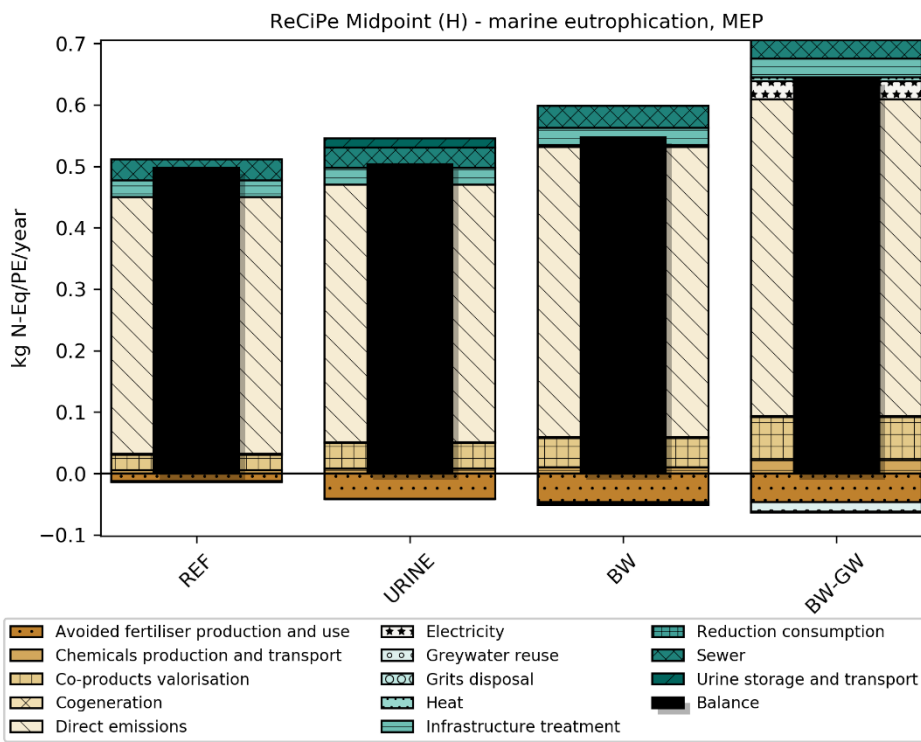
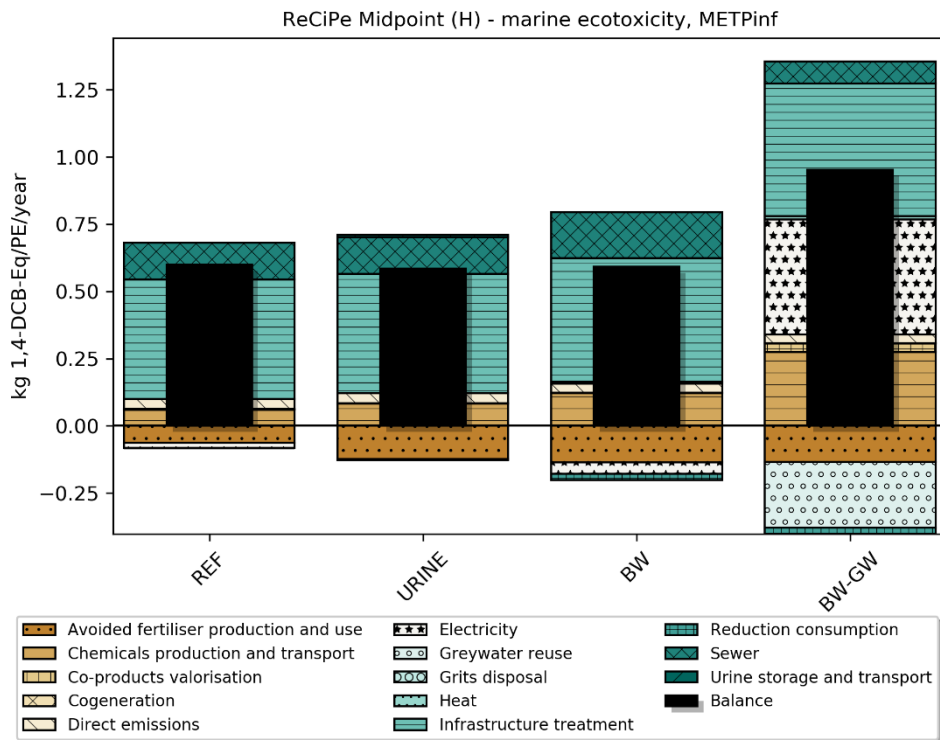

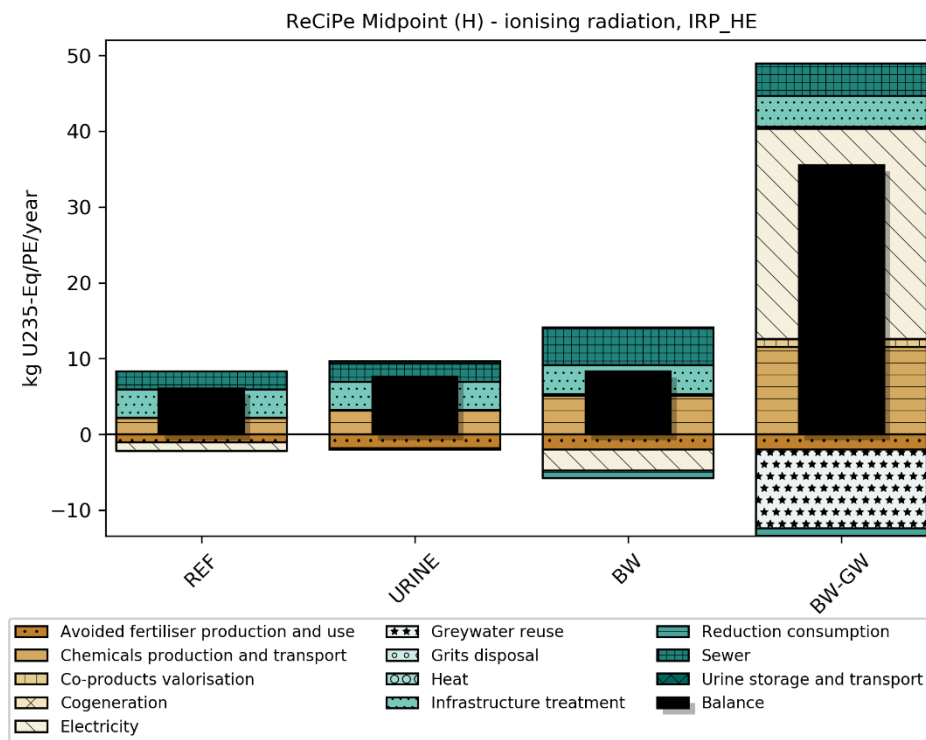
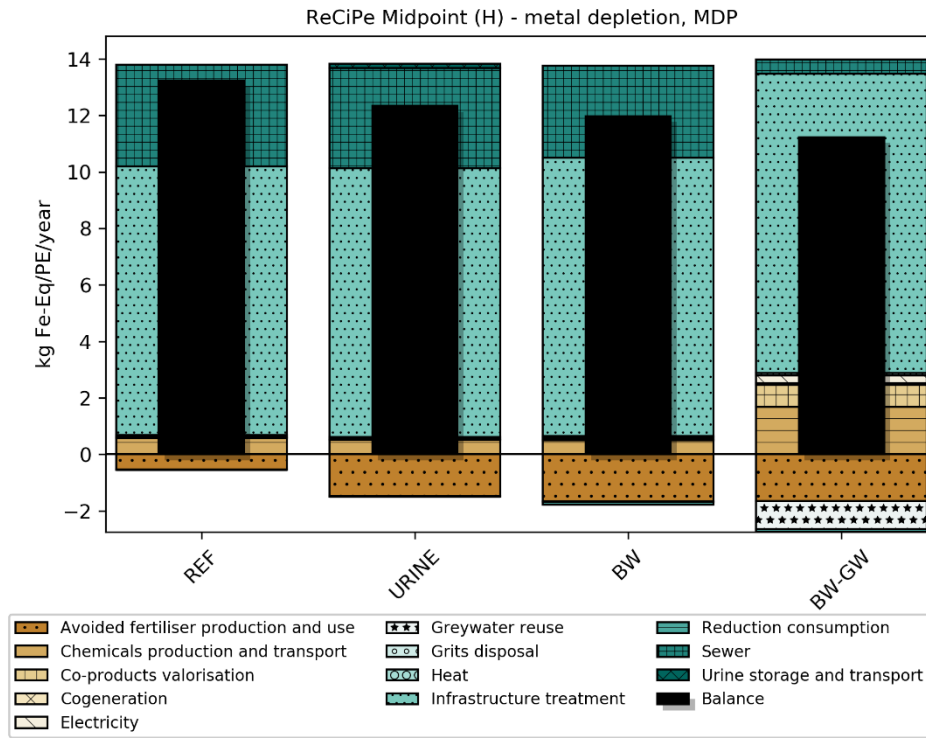

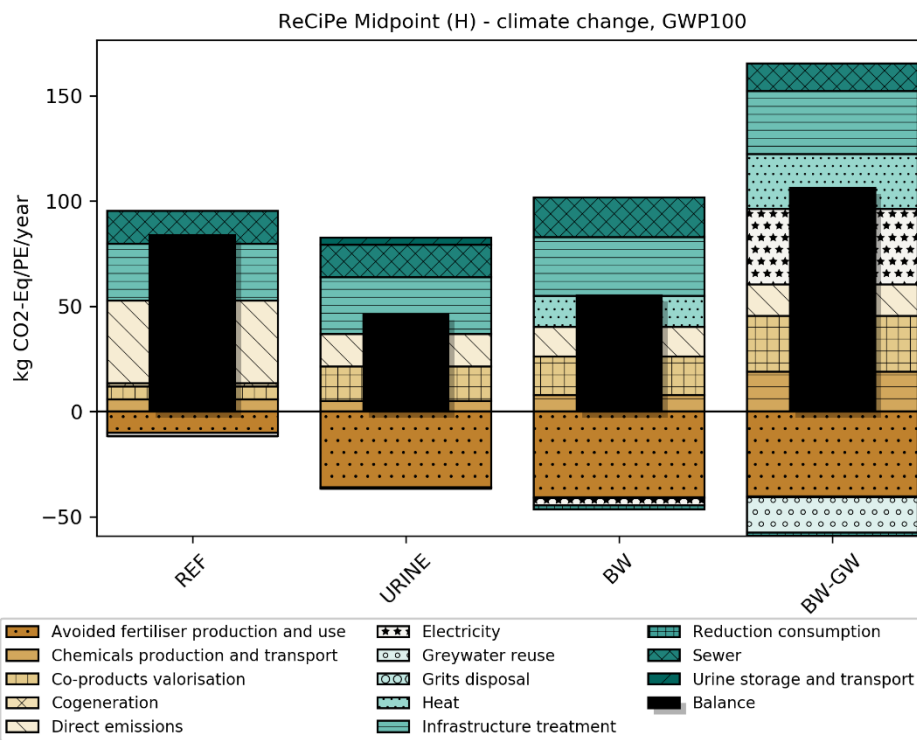
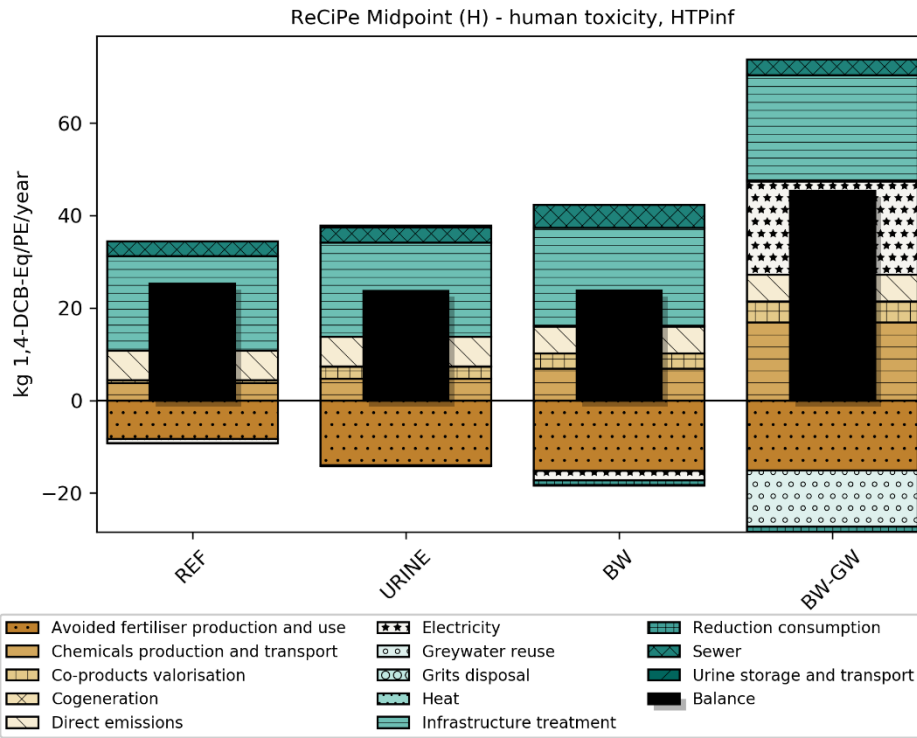

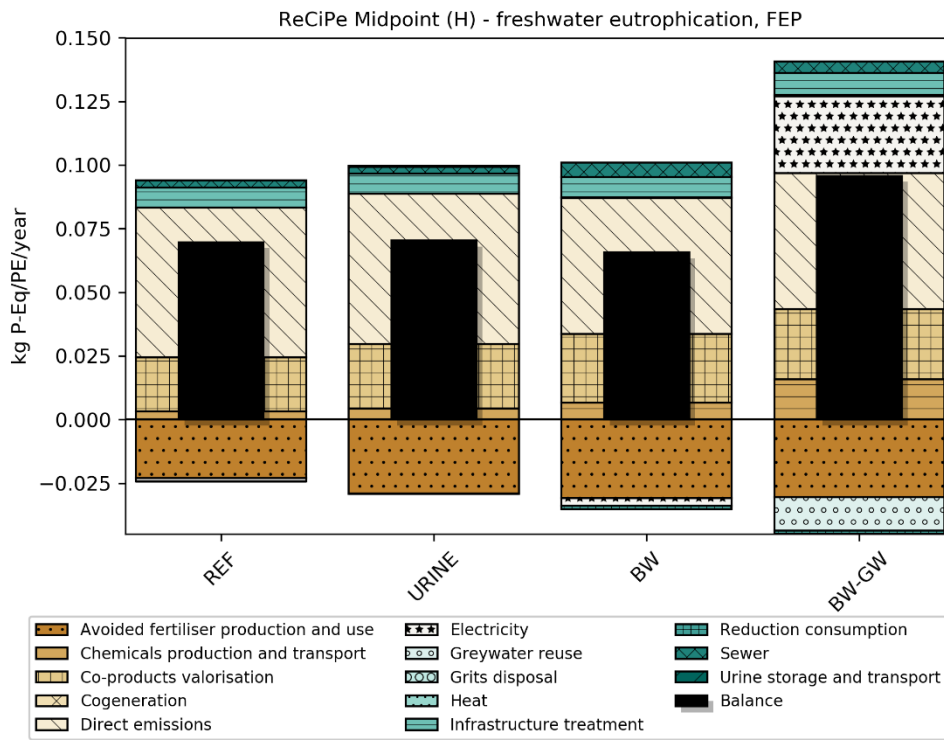
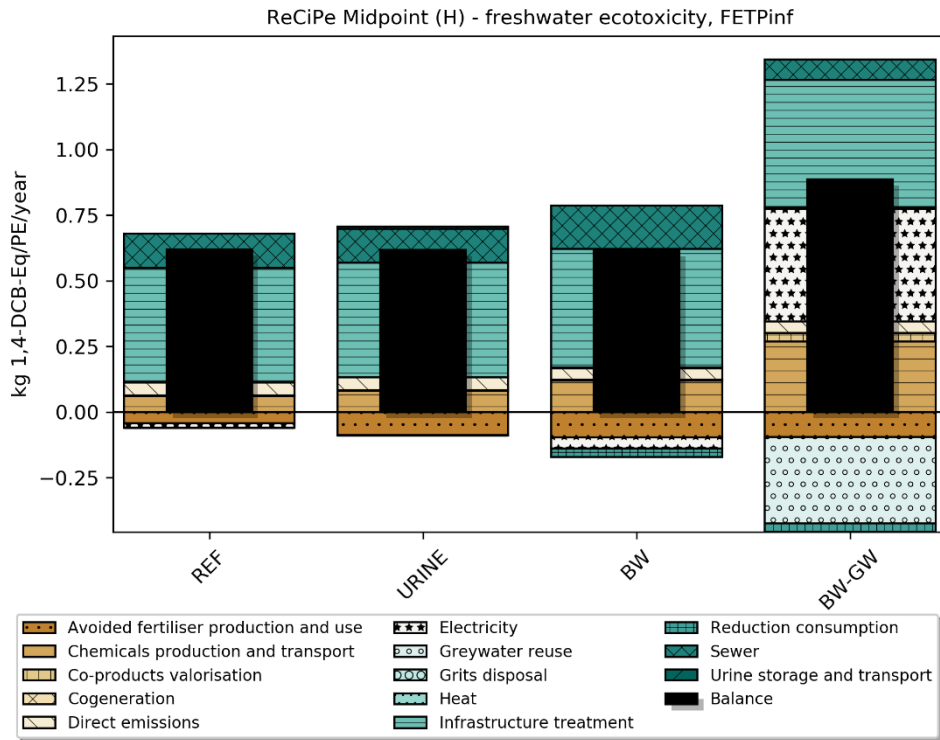

I.3 References

- Bisinella de Faria, A.B., Besson, M., Ahmadi, A., Udert, K.M., Spérandio, M., 2019. A dynamic influent generator to account for alternative wastewater management: the case of urine source separation. *J. Sustain. Water Built Environ.* in Press. <https://doi.org/10.1061/JSWBAY.0000904>
- Jönsson, H., Baky, A., Jeppsson, U., Hellström, D., Kärrman, E., 2005. Composition of urine, faeces, greywater and biowaste for utilisation in the URWARE model.
- Remy, C., 2010. Life cycle assessment of conventional and source separation systems for urban wastewater management. <https://doi.org/10.14279/depositonce-2370>

Appendix II. CHAPTER IV

II.1 Functional unit and reference flows

Table S 36: Mass flow of nitrogen and phosphorus compared to the number of PE treated per case study

Scale (ha)	Typology	PE treated	kg-P/year/PE	kg-N/year/PE
6.25	DP	62.2	0.80	4.83
	CP	162.5	0.80	4.83
	DB	679.8	0.84	5.22
	CB	1122.7	0.85	5.38
	CC	950.6	0.87	5.63
	HT	2244.1	0.96	6.62
16	DP	156.9	0.80	4.83
	CP	407.4	0.80	4.83
	DB	1777.7	0.84	5.26
	CB	2854.7	0.85	5.37
	CC	2461.7	0.87	5.65
	HT	5808.8	0.96	6.63
36	DP	348.9	0.80	4.83
	CP	926.7	0.80	4.83
	DB	3980.3	0.84	5.27
	CB	6377.5	0.85	5.38
	CC	5707.6	0.87	5.65
	HT	13483.5	0.96	6.62

Table S 37: Flowrate of wastewater production (m³/day/PE) for each sanitation systems and each case study

Scale (ha)	Typology	REFERENCE	URINE	BW	BW-GW
6.25	DP	0.169	0.169	0.156	0.156
	CP	0.169	0.169	0.156	0.156
	DB	0.164	0.164	0.149	0.149
	CB	0.153	0.153	0.138	0.138
	CC	0.146	0.146	0.130	0.130
	HT	0.117	0.117	0.098	0.098
16	DP	0.169	0.169	0.156	0.156
	CP	0.169	0.169	0.156	0.156
	DB	0.156	0.156	0.142	0.142
	CB	0.153	0.153	0.138	0.138
	CC	0.145	0.145	0.129	0.129
	HT	0.117	0.117	0.098	0.098
36	DP	0.169	0.169	0.156	0.156
	CP	0.169	0.169	0.156	0.156
	DB	0.156	0.156	0.142	0.142
	CB	0.153	0.153	0.138	0.138

CC	0.145	0.145	0.129	0.129
HT	0.117	0.117	0.098	0.098

Flowrate per PE in the different solutions (WW for Reference, GW and BW for BW and BW-GW and Urine for URINE solution)

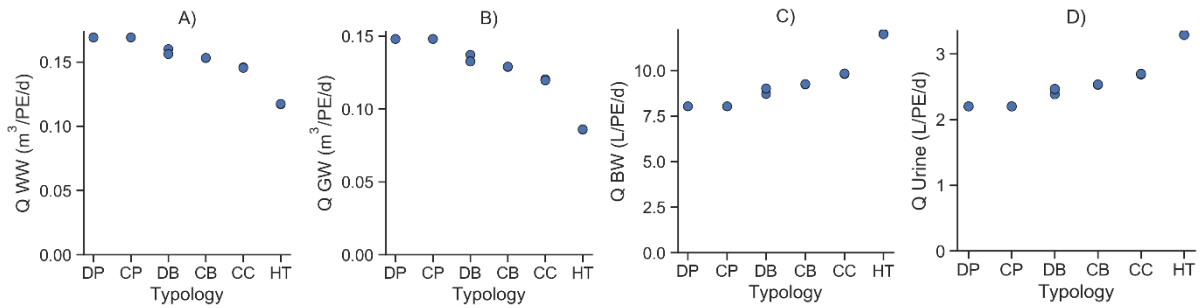

II.2 Mass and energy balance with scale influence

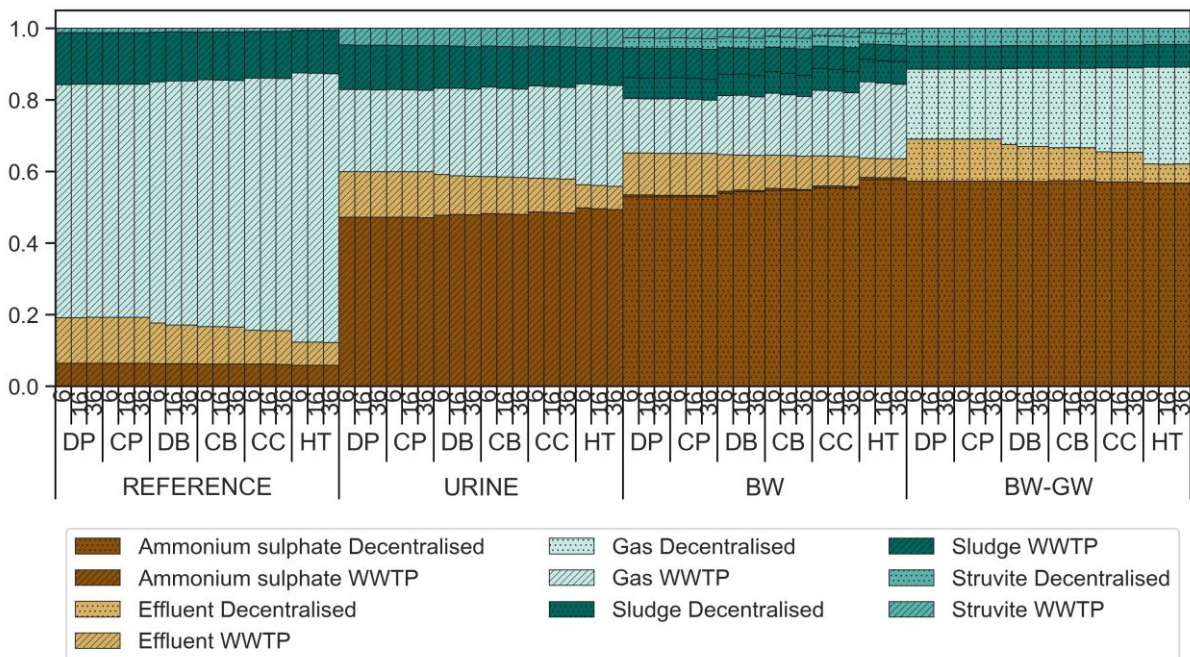

Figure S 14: Nitrogen recovery for the different systems in all urban configuration and scale

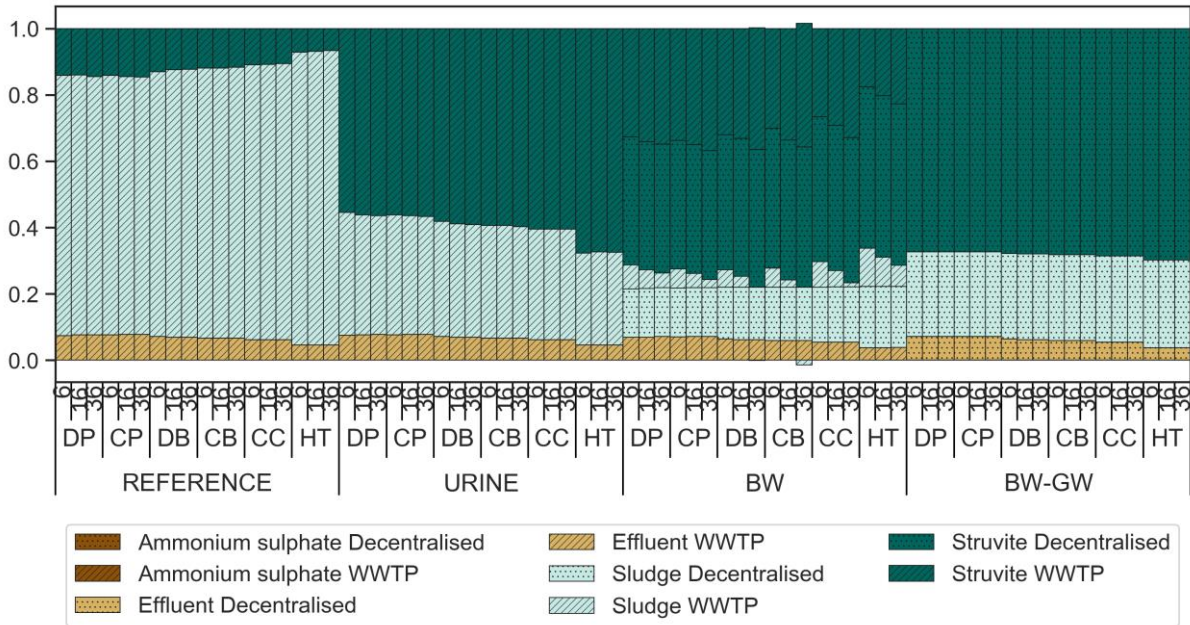

Figure S 15: Phosphorus recovery for the different systems in all urban configuration and scale

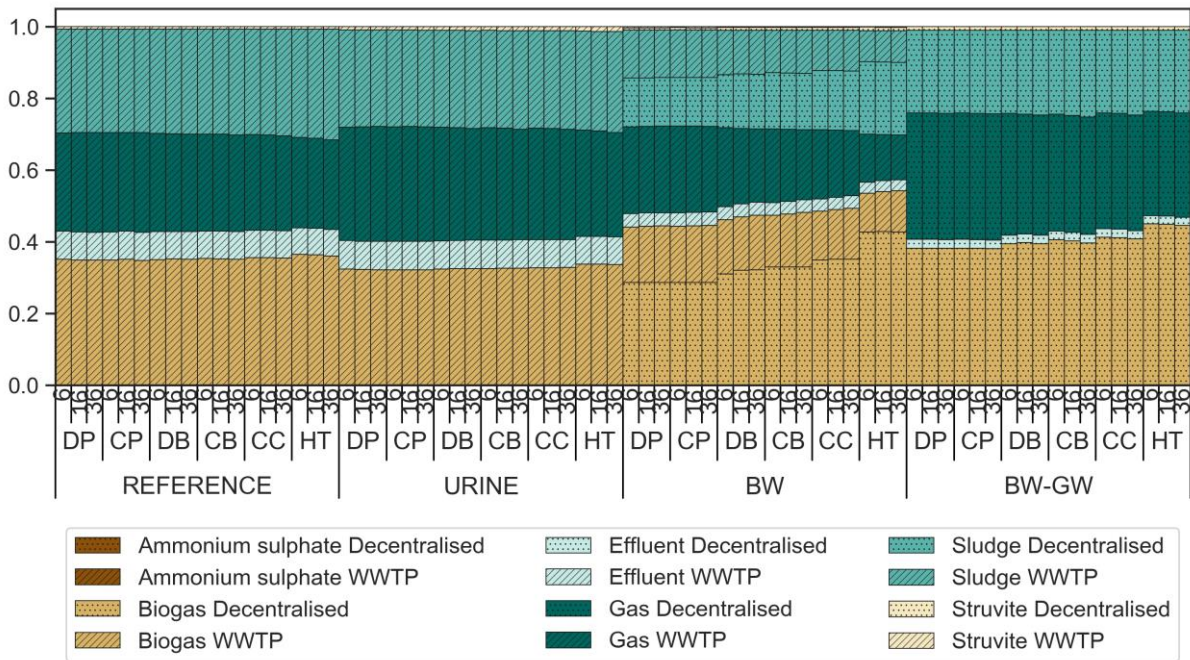

Figure S 16: COD recovery for the different systems in all urban configuration and scale

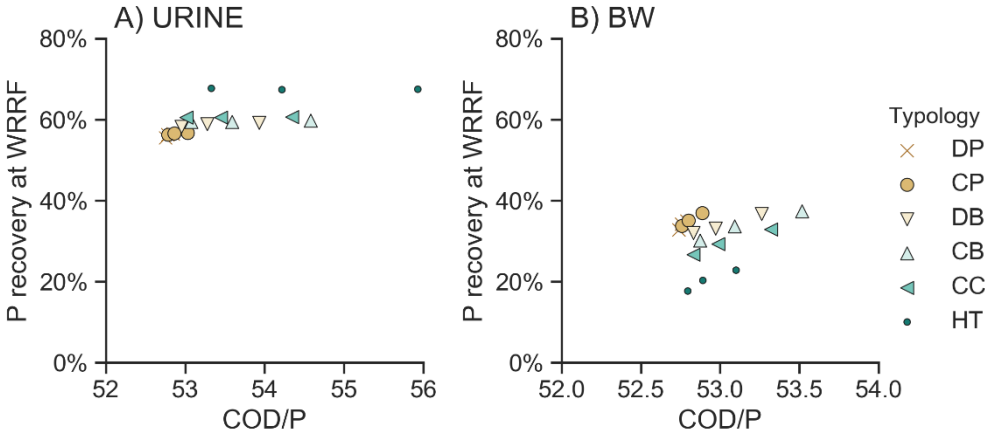

Figure S 17: Influence of ratio COD/P entering the WRRF with the P recovery of the WRRF: 1) for Urine systems and B) for BW solution

II.3 LCA Results

II.3.a Inventory

Table S 38: Inventory for Reference system

	Urban configuration	CITY	DP	CP	DB	CB	CC	HT	DP	CP	DB	CB	CC	HT	DP	CP	DB	CB	CC	HT			
			6.25	6.25	6.25	6.25	6.25	6.25	6.25	16	16	16	16	16	16	16	36	36	36	36	36	36	
			Scale (ha)																				
Total_effluent biogenic DCO	kgCOD/year	891605	892594	894191	902680	909479	906738	927331	894103	898090	919906	937053	930796	984084	897159	906359	954972	993137	982472	1106269			
Total_effluent CO2 total	kgCO2/year	382204	382625	383305	387237	390739	389784	403438	383269	384967	395400	403845	401885	437185	384570	388479	411747	430467	427747	509302			
Total_effluent CO2 input	kgCO2/year	6877	6885	6896	6963	7021	7003	7218	6896	6925	7101	7242	7205	7763	6918	6986	7378	7693	7638	8939			
Total_effluent fossil DCO	kgCOD/year	53924	53982	54076	54747	55474	55428	59279	54070	54304	56209	57839	57848	67763	54249	54788	59046	62640	62977	85644			
Total_effluent Ammonia [air/high population density]	kgNH3/year	1E-31	1E-31	1E-31	1E-31	1E-31	1E-31	1E-31	1E-31	1E-31	1E-31	1E-31	1E-31	1E-31	1E-31	1E-31	1E-31	1E-31	1E-31	1E-31			
Total_effluent Hydrogen [air/high population density]	kgH2/year	1494	1496	1500	1522	1539	1532	1579	1500	1511	1565	1608	1591	1714	1508	1532	1654	1749	1720	2000			
Total_effluent Methane, biogenic [air/high population density]	kgCH4/year	501	502	504	511	518	515	535	503	507	527	543	538	590	506	515	560	597	587	714			
Total_effluent Dinitrogen monoxide [air/high population density]	kgN2O/year	7990	7997	8010	8080	8142	8124	8363	8009	8039	8225	8375	8339	8958	8032	8102	8517	8852	8800	10233			
Total_effluent Nitrogen, organic bound [water/river]	kgN/year	152	152	152	153	154	154	155	152	153	155	157	156	159	153	154	159	163	161	169			
Total_effluent Nitrogen [water/river]	kgN/year	2224	2226	2229	2244	2253	2246	2257	2229	2237	2272	2299	2282	2311	2235	2253	2333	2393	2361	2442			
Total_effluent Ammonium, ion [water/river]	kgNH4/year	4009	4015	4025	4063	4078	4052	3971	4025	4049	4133	4192	4121	3937	4043	4099	4296	4444	4292	3988			
Total_effluent Nitrate [water/river]	kgNO3/year	132075	132158	132290	132965	133470	133225	134461	132283	132614	134304	135596	135026	138113	132538	133297	137011	139806	138814	145497			
Total_effluent Nitrite [water/river]	kgNO2/year	2026	2029	2034	2055	2065	2051	2015	2034	2047	2096	2130	2092	2009	2044	2075	2188	2274	2193	2058			
Total_effluent BOD5, Biological Oxygen Demand [water/river]	kgO2/year	13422	13436	13458	13569	13651	13609	13798	13456	13512	13791	14006	13905	14390	13499	13626	14248	14726	14542	15655			
Total_effluent COD, Chemical Oxygen Demand [water/river]	kgCOD/year	227622	227866	228260	230331	231963	231270	235974	228238	229223	234519	238662	237063	249232	228993	231265	243061	252278	249508	277783			
Total_effluent reference flow	m3/year	52	52	52	52	52	52	52	52	52	52	52	52	52	52	52	52	52	52	52			
Total_effluent Sewage Flow	m3/year	4695600	4699425	4705597	4736153	4758186	4746119	4791495	4705256	4720668	4796840	4854923	4825934	4943343	4717071	4752628	4921972	5051313	4997799	5272142			
Total_effluent Sludge Volum	m3/year	3657	3661	3668	3705	3736	3725	3828	3668	3685	3782	3859	3834	4101	3681	3720	3937	4109	4068	4695			
Total_effluent Effluent Volum	m3/year	4694922	4698745	4704914	4735454	4757472	4745409	4790722	4704573	4719979	4796106	4854152	4825171	4942416	4716383	4751924	4921167	5050423	4996920	5270872			
Total_effluent Phosphate [water/river]	kgPO4/year	14395	14406	14425	14519	14586	14549	14688	14424	14471	14705	14883	14794	15153	14460	14569	15088	15485	15321	16160			
Total_effluent Magnesium [water/river]	kgMg/year	48076	48117	48182	48569	48922	48837	50293	48178	48341	49377	50223	50055	53822	48303	48678	50993	52875	52662	61385			
Total_effluent Calcium, ion [water/river]	kgCa/year	275446	275708	276130	278599	280826	280256	289205	276107	277157	283744	289106	287952	311102	276912	279335	294055	305985	304439	358025			
Total_effluent TOC, Total Organic Carbon [water/river]	kgC/year	121637	121768	121978	123084	123955	123585	126094	121967	122492	125320	127532	126678	133170	122370	123583	129881	134802	133322	148408			
Total_effluent DOC, Dissolved Organic Carbon [water/river]	kgC/year	100626	100737	100917	101871	102634	102325	104625	100907	101356	103806	105731	105025	110977	101251	102286	107746	112031	110825	124655			
Total_effluent Carbonate [water/river]	kgCO3/year	1.76E+08	1.76E+08	1.77E+08	1.78E+08	1.79E+08	1.79E+08	1.83E+08	1.77E+08	1.77E+08	1.81E+08	1.84E+08	1.83E+08	1.93E+08	1.77E+08	1.79E+08	1.87E+08	1.94E+08	1.92E+08	2.14E+08			
Total_effluent N in Biomass	kgN/year	1806	1808	1811	1825	1835	1830	1853	1810	1817	1853	1880	1867	1927	1816	1832	1911	1971	1948	2085			
Total_effluent TSS	kgSS/year	46949	46987	47049	47355	47575	47454	47907	47046	47200	47961	48542	48252	49424	47164	47519	49212	50504	49969	52709			
Total_effluent TN	kgN/year	46949	46987	47049	47354	47575	47454	47907	47046	47200	47961	48542	48252	49424	47164	47519	49212	50504	49969	52709			
Total_effluent TP	kgP/year	4695	4699	4705	4735	4757	4745	4791	4705	4720	4796	4854	4825	4942	4716	4752	4921	5050	4997	5271			
Chloride Coagulant	kgCl/year	106668	106732	106831	107462	108083	107978	110807	106830	107080	108812	110278	110094	117493	107026	107595	111536	114879	114715	132391			
Chloride H2S	kgCl/year	9237	9244	9256	9317	9360	9336	9425	9256	9286	9436	9550	9493	9724	9279	9349	9682	9936	9831	10371			
Sludge Total N	kgN/year	32001	32045	32114	32496	32814	32701	33772	32110	32284	33280	34076	33823	36621	32244	32646	34880	36673	36254	42882			
Sludge Total P	kgP/year	39752	39791	39853	40211	40527	40438	41648	39850	40005	40955	41724	41535	44675	39970	40329	42453	44170	43896	51200			
Sludge Total C	kgC/year	355861	356328	357079	361111	364385	363116	373408	357037	358914	369339	377606	374711	401621	358476	362809	386179	404789	399855	463669			
Total_Sludge Magnesium [soil/agricultural]	kgMg/year	1.65	1.66	1.67	1.72	1.76	1.75	1.90	1.67	1.69	1.83	1.94	1.90	2.34	1.68	1.74	2.05	2.33	2.27	3.52			
Total_Sludge Calcium [soil/agricultural]	kgCa/year	12.34	12.38	12.43	12.75	13.02	12.93	13.91	12.43	12.57	13.40	14.09	13.89	16.63	12.54	12.86	14.79	16.44	16.10	23.52			
Total_Sludge Iron Coagulant	kgFe/year	447.5	448.3	449.5	456.5	462.7	461.0	485.3	449.4	452.5	471.3	486.8	483.0	548.8	451.7	458.8	501.8	538.0	532.2	699.3			
Total_Sludge Iron H2S	kgFe/year	4850	4854	4860	4892	4915	4902	4949	4860	4876	4955	5015	4985	5106	4872	4909	5084	5218	5162	5446			
FeCl3 pure2	kgFeCl3/year	162676	162773	162924	163886	164833	164673	168988	162923	163304	165945	168181	167900	179184	163221	164090	170100	175198	174948	201904			
FeCl3 pure H2S	kgFeCl3/year	14087	14098	14117	14208	14275	14238	14374	14116	14162	14391	14565	14478	14830	14151	14258	14766	15154	14993	15816			
methanol pure	kgMeOH/year	143990	144145	144395	146189	148128	148005	158290	144380	145004	150091	154444	154467	180943	144858	146296	157668	167265	168163	228690			

	Urban configuration	CITY	DP	CP	DB	CB	CC	HT	DP	CP	DB	CB	CC	HT	DP	CP	DB	CB	CC	HT
	Scale (ha)	6.25	6.25	6.25	6.25	6.25	6.25	6.25	16	16	16	16	16	16	36	36	36	36	36	36
Reduction consumption	m3/year	1E-31	1E-31	1E-31	1E-31	1E-31	1E-31	1E-31	1E-31	1E-31	1E-31	1E-31	1E-31	1E-31	1E-31	1E-31	1E-31	1E-31	1E-31	1E-31
Greywater reuse	m3/year	1E-31	1E-31	1E-31	1E-31	1E-31	1E-31	1E-31	1E-31	1E-31	1E-31	1E-31	1E-31	1E-31	1E-31	1E-31	1E-31	1E-31	1E-31	1E-31
elect. byproduct		1E-31	1E-31	1E-31	1E-31	1E-31	1E-31	1E-31	1E-31	1E-31	1E-31	1E-31	1E-31	1E-31	1E-31	1E-31	1E-31	1E-31	1E-31	1E-31
Length gravity	m	1E-31	1544	1877	1528	3474	2752	935	3870	4804	4110	8055	6049	2897	9825	11121	9781	18399	14937	6115
Length vacuum	m	1E-31	1E-31	1E-31	1E-31	1E-31	1E-31	1E-31	1E-31	1E-31	1E-31	1E-31	1E-31	1E-31	1E-31	1E-31	1E-31	1E-31	1E-31	1E-31
Distance travelled (km)	m	1E-31	1E-31	1E-31	1E-31	1E-31	1E-31	1E-31	1E-31	1E-31	1E-31	1E-31	1E-31	1E-31	1E-31	1E-31	1E-31	1E-31	1E-31	1E-31
Sewage flow centralised	m3/year	4695600	4699425	4705597	4736153	4758186	4746119	4791495	4705256	4720668	4796840	4854923	4825934	4943343	4717071	4752628	4921972	5051313	4997799	5272142
Sludge COD centr	kgCOD/year	693497	694403	695859	703689	710055	707600	727696	695777	699418	719667	735726	730135	782636	698569	706972	752348	788469	778964	903255
Sludge COD decentr	kgCOD/year	1E-31	1E-31	1E-31	1E-31	1E-31	1E-31	1E-31	1E-31	1E-31	1E-31	1E-31	1E-31	1E-31	1E-31	1E-31	1E-31	1E-31	1E-31	1E-31
Sludge N centr	kgN/year	32001	32045	32114	32496	32814	32701	33772	32110	32284	33280	34076	33823	36621	32244	32646	34880	36673	36254	42882
Sludge N decentr	kgN/year	1E-31	1E-31	1E-31	1E-31	1E-31	1E-31	1E-31	1E-31	1E-31	1E-31	1E-31	1E-31	1E-31	1E-31	1E-31	1E-31	1E-31	1E-31	1E-31
Sludge P centr	kgP/year	39752	39791	39853	40211	40527	40438	41648	39850	40005	40955	41724	41535	44675	39970	40329	42453	44170	43896	51200
Sludge P decentr	kgP/year	1E-31	1E-31	1E-31	1E-31	1E-31	1E-31	1E-31	1E-31	1E-31	1E-31	1E-31	1E-31	1E-31	1E-31	1E-31	1E-31	1E-31	1E-31	1E-31
struvite N centr	kgN/year	1E-31	1E-31	1E-31	1E-31	1E-31	1E-31	1E-31	1E-31	1E-31	1E-31	1E-31	1E-31	1E-31	1E-31	1E-31	1E-31	1E-31	1E-31	1E-31
struvite P decentr	kgP/year	1E-31	1E-31	1E-31	1E-31	1E-31	1E-31	1E-31	1E-31	1E-31	1E-31	1E-31	1E-31	1E-31	1E-31	1E-31	1E-31	1E-31	1E-31	1E-31
struvite N centr	kgN/year	4345	4349	4354	4384	4405	4393	4430	4354	4370	4443	4498	4469	4563	4366	4402	4563	4683	4629	4839
struvite P centr	kgP/year	9055	9062	9073	9130	9169	9145	9207	9072	9102	9241	9344	9287	9441	9095	9164	9467	9690	9583	9916
struvite COD centr	kgCOD/year	17297	17319	17355	17550	17709	17648	18149	17353	17444	17949	18349	18209	19517	17423	17632	18763	19663	19426	22522
N rich N decentr	kgN/year	1E-31	1E-31	1E-31	1E-31	1E-31	1E-31	1E-31	1E-31	1E-31	1E-31	1E-31	1E-31	1E-31	1E-31	1E-31	1E-31	1E-31	1E-31	1E-31
N rich P decentr	kgP/year	1E-31	1E-31	1E-31	1E-31	1E-31	1E-31	1E-31	1E-31	1E-31	1E-31	1E-31	1E-31	1E-31	1E-31	1E-31	1E-31	1E-31	1E-31	1E-31
N rich COD decentr	kgCOD/year	1E-31	1E-31	1E-31	1E-31	1E-31	1E-31	1E-31	1E-31	1E-31	1E-31	1E-31	1E-31	1E-31	1E-31	1E-31	1E-31	1E-31	1E-31	1E-31
N rich N centr	kgN/year	23218	23237	23268	23443	23593	23545	24084	23266	23344	23802	24168	24066	25453	23326	23505	24524	25332	25177	28351
N rich P centr	kgP/year	1E-31	1E-31	1E-31	1E-31	1E-31	1E-31	1E-31	1E-31	1E-31	1E-31	1E-31	1E-31	1E-31	1E-31	1E-31	1E-31	1E-31	1E-31	1E-31
N rich COD centr	kgCOD/year	225	226	226	228	230	229	235	226	227	233	237	235	249	227	229	242	252	249	281
effluent TN centr	kgN/year	46949	46987	47049	47354	47575	47454	47907	47046	47200	47961	48542	48252	49424	47164	47519	49212	50504	49969	52709
effluent TP centr	kgP/year	4695	4699	4705	4735	4757	4745	4791	4705	4720	4796	4854	4825	4942	4716	4752	4921	5050	4997	5271
effluent COD centr	kgCOD/year	227622	227866	228260	230331	231963	231270	235974	228238	229223	234519	238662	237063	249232	228993	231265	243061	252278	249508	277783
effluent TN decentr	kgN/year	1E-31	1E-31	1E-31	1E-31	1E-31	1E-31	1E-31	1E-31	1E-31	1E-31	1E-31	1E-31	1E-31	1E-31	1E-31	1E-31	1E-31	1E-31	1E-31
effluent TP decentr	kgP/year	1E-31	1E-31	1E-31	1E-31	1E-31	1E-31	1E-31	1E-31	1E-31	1E-31	1E-31	1E-31	1E-31	1E-31	1E-31	1E-31	1E-31	1E-31	1E-31
effluent COD decentr	kgCOD/year	1E-31	1E-31	1E-31	1E-31	1E-31	1E-31	1E-31	1E-31	1E-31	1E-31	1E-31	1E-31	1E-31	1E-31	1E-31	1E-31	1E-31	1E-31	1E-31

Table S 39: Inventory for Urine system

	Urban configuration	CITY	DP	CP	DB	CB	CC	HT	DP	CP	DB	CB	CC	HT	DP	CP	DB	CB	CC	HT
	Scale (ha)	6.25	6.25	6.25	6.25	6.25	6.25	6.25	16	16	16	16	16	16	36	36	36	36	36	36
Total_effluent biogenic DCO	kgCOD/year	891605	892529	894020	901885	908117	905517	924088	893938	897661	917810	933597	927619	975669	896792	905384	950270	985409	975108	1086758
Total_effluent CO2 total	kgCO2/year	382204	382442	382824	384965	386802	386242	392968	382803	383752	389329	393751	392596	409905	383532	385705	397947	407560	405958	445541
Total_effluent CO2 input	kgCO2/year	6877	6882	6890	6935	6972	6960	7089	6890	6910	7026	7118	7090	7424	6905	6952	7209	7411	7368	8139
Total_effluent fossil DCO	kgCOD/year	53924	53875	53797	53484	53341	53531	53946	53801	53608	52934	52516	52985	54178	53653	53217	51848	51033	51948	54831
Total_effluent Ammonia [air/high population density]	kgNH3/year	1E-31	1E-31	1E-31	1E-31	1E-31	1E-31	1E-31	1E-31	1E-31	1E-31	1E-31	1E-31	1E-31	1E-31	1E-31	1E-31	1E-31	1E-31	1E-31
Total_effluent Hydrogen [air/high population density]	kgH2/year	1494	1496	1501	1524	1544	1537	1605	1500	1511	1573	1625	1608	1790	1509	1533	1678	1798	1768	2213
Total_effluent Methane, biogenic [air/high population density]	kgCH4/year	501	502	505	515	524	521	547	504	509	536	555	549	607	508	519	574	613	603	733
Total_effluent Dinitrogen monoxide [air/high population density]	kgN2O/year	7990	7993	7998	8026	8049	8041	8124	7998	8010	8083	8141	8124	8337	8007	8036	8198	8327	8300	8795
Total_effluent Nitrogen, organic bound [water/river]	kgN/year	152	152	153	154	155	154	157	152	153	157	159	158	165	153	154	162	168	166	183
Total_effluent Nitrogen [water/river]	kgN/year	2224	2226	2230	2249	2262	2254	2274	2230	2240	2286	2320	2301	2353	2238	2260	2361	2438	2402	2524
Total_effluent Ammonium, ion [water/river]	kgNH4/year	4009	4003	3994	3951	3924	3932	3842	3994	3973	3897	3875	3870	3766	3978	3938	3890	3969	3900	3954
Total_effluent Nitrate [water/river]	kgNO3/year	132075	132206	132414	133400	134068	133683	134890	132402	132913	135217	136805	135973	138563	132795	133932	138552	141551	140226	145072
Total_effluent Nitrite [water/river]	kgNO2/year	2026	2023	2018	1998	1984	1989	1946	2018	2008	1972	1963	1960	1915	2010	1991	1974	2020	1983	2029

Appendix II. Chapter IV

	Urban configuration	CITY	DP	CP	DB	CB	CC	HT	DP	CP	DB	CB	CC	HT	DP	CP	DB	CB	CC	HT
	Scale (ha)	6.25	6.25	6.25	6.25	6.25	6.25	6.25	16	16	16	16	16	16	36	36	36	36	36	36
Sludge N centr	kgN/year	32001	32039	32099	32427	32699	32600	33519	32095	32246	33103	33790	33564	35983	32211	32559	34494	36056	35672	41467
Sludge N decentr	kgN/year	1E-31	1E-31	1E-31	1E-31	1E-31	1E-31	1E-31	1E-31	1E-31	1E-31	1E-31	1E-31	1E-31	1E-31	1E-31	1E-31	1E-31	1E-31	1E-31
Sludge P centr	kgP/year	39752	39770	39799	39952	40076	40028	40348	39797	39869	40263	40574	40469	41317	39852	40016	40889	41572	41409	43357
Sludge P decentr	kgP/year	1E-31	1E-31	1E-31	1E-31	1E-31	1E-31	1E-31	1E-31	1E-31	1E-31	1E-31	1E-31	1E-31	1E-31	1E-31	1E-31	1E-31	1E-31	1E-31
struvite N decentr	kgN/year	1E-31	1E-31	1E-31	1E-31	1E-31	1E-31	1E-31	1E-31	1E-31	1E-31	1E-31	1E-31	1E-31	1E-31	1E-31	1E-31	1E-31	1E-31	1E-31
struvite P decentr	kgP/year	1E-31	1E-31	1E-31	1E-31	1E-31	1E-31	1E-31	1E-31	1E-31	1E-31	1E-31	1E-31	1E-31	1E-31	1E-31	1E-31	1E-31	1E-31	1E-31
struvite N centr	kgN/year	4345	4359	4382	4520	4644	4609	5133	4381	4440	4816	5128	5050	6419	4426	4565	5427	6133	6015	9207
struvite P centr	kgP/year	9055	9083	9128	9390	9621	9555	10508	9126	9239	9933	10493	10352	12797	9213	9476	11031	12287	12069	17757
struvite COD centr	kgCOD/year	17297	17328	17378	17667	17921	17836	18773	17375	17503	18293	18954	18761	21263	17473	17777	19613	21114	20806	26658
N rich N decentr	kgN/year	1E-31	1E-31	1E-31	1E-31	1E-31	1E-31	1E-31	1E-31	1E-31	1E-31	1E-31	1E-31	1E-31	1E-31	1E-31	1E-31	1E-31	1E-31	1E-31
N rich P decentr	kgP/year	1E-31	1E-31	1E-31	1E-31	1E-31	1E-31	1E-31	1E-31	1E-31	1E-31	1E-31	1E-31	1E-31	1E-31	1E-31	1E-31	1E-31	1E-31	1E-31
N rich COD decentr	kgCOD/year	1E-31	1E-31	1E-31	1E-31	1E-31	1E-31	1E-31	1E-31	1E-31	1E-31	1E-31	1E-31	1E-31	1E-31	1E-31	1E-31	1E-31	1E-31	1E-31
N rich N centr	kgN/year	23218	23359	23588	24924	26127	25818	30607	23575	24145	27701	30588	29965	42316	24012	25324	33249	39647	38817	67282
N rich P centr	kgP/year	1E-31	1E-31	1E-31	1E-31	1E-31	1E-31	1E-31	1E-31	1E-31	1E-31	1E-31	1E-31	1E-31	1E-31	1E-31	1E-31	1E-31	1E-31	1E-31
N rich COD centr	kgCOD/year	225	226	227	231	235	233	248	226	228	240	250	247	287	228	232	260	283	279	372
effluent TN centr	kgN/year	46949	46988	47049	47355	47576	47455	47911	47046	47200	47963	48545	48255	49433	47164	47520	49216	50511	49976	52730
effluent TP centr	kgP/year	4695	4699	4705	4736	4758	4746	4791	4705	4720	4796	4854	4825	4943	4716	4752	4922	5051	4998	5273
effluent COD centr	kgCOD/year	227622	227870	228271	230387	232062	231361	236305	228249	229251	234672	238921	237306	250091	229017	231329	243417	252888	250092	279793
effluent TN decentr	kgN/year	1E-31	1E-31	1E-31	1E-31	1E-31	1E-31	1E-31	1E-31	1E-31	1E-31	1E-31	1E-31	1E-31	1E-31	1E-31	1E-31	1E-31	1E-31	1E-31
effluent TP decentr	kgP/year	1E-31	1E-31	1E-31	1E-31	1E-31	1E-31	1E-31	1E-31	1E-31	1E-31	1E-31	1E-31	1E-31	1E-31	1E-31	1E-31	1E-31	1E-31	1E-31
effluent COD decentr	kgCOD/year	1E-31	1E-31	1E-31	1E-31	1E-31	1E-31	1E-31	1E-31	1E-31	1E-31	1E-31	1E-31	1E-31	1E-31	1E-31	1E-31	1E-31	1E-31	1E-31

Table S 40: Inventory for BW system

	Urban configuration	CITY	DP	CP	DB	CB	CC	HT	DP	CP	DB	CB	CC	HT	DP	CP	DB	CB	CC	HT
	Scale (ha)	6.25	6.25	6.25	6.25	6.25	6.25	6.25	16	16	16	16	16	16	36	36	36	36	36	36
Total_effluent biogenic DCO	kgCOD/year	892166	893073	897494	900602	898784	904409	893023	895288	906232	914516	910110	924663	894759	899984	924300	942751	934514	968603	1086758
Total_effluent CO2 total	kgCO2/year	382366	382622	383900	384870	384491	387392	382595	383217	386248	388369	387678	394447	383078	384417	390360	394441	393549	408106	445541
Total_effluent CO2 input	kgCO2/year	6881	6887	6919	6944	6934	7004	6887	6902	6983	7043	7020	7196	6899	6934	7106	7236	7198	7601	8139
Total_effluent fossil DCO	kgCOD/year	53858	53751	53357	53205	53439	54189	53757	53507	52748	52363	52904	55132	53565	53021	51696	51072	52115	57527	54831
Total_effluent Ammonia [air/high population density]	kgNH3/year	1E-31	1E-31	1E-31	1E-31	1E-31	1E-31	1E-31	1E-31	1E-31	1E-31	1E-31	1E-31	1E-31	1E-31	1E-31	1E-31	1E-31	1E-31	1E-31
Total_effluent Hydrogen [air/high population density]	kgH2/year	1495	1497	1506	1513	1508	1513	1497	1502	1529	1555	1538	1565	1500	1513	1590	1659	1622	1703	2213
Total_effluent Methane, biogenic [air/high population density]	kgCH4/year	502	502	505	507	506	510	502	504	512	518	515	526	503	507	527	542	535	562	733
Total_effluent Dinitrogen monoxide [air/high population density]	kgN2O/year	7993	7997	8023	8045	8038	8113	7997	8009	8076	8130	8114	8308	8006	8033	8184	8303	8277	8728	8795
Total_effluent Nitrogen, organic bound [water/river]	kgN/year	152	153	154	155	155	156	153	153	157	160	159	163	153	155	164	171	168	178	183
Total_effluent Nitrogen [water/river]	kgN/year	2226	2229	2243	2252	2246	2257	2229	2236	2269	2292	2278	2303	2234	2251	2319	2369	2343	2402	2524
Total_effluent Ammonium, ion [water/river]	kgNH4/year	3986	3948	3796	3709	3746	3551	3951	3870	3615	3541	3549	3374	3888	3741	3546	3644	3550	3561	3954
Total_effluent Nitrate [water/river]	kgNO3/year	132295	132646	134223	135239	134688	136564	132625	133449	136839	138905	137896	141381	133262	135001	140989	144489	143047	149463	145072
Total_effluent Nitrite [water/river]	kgNO2/year	2014	1995	1917	1873	1892	1793	1996	1955	1826	1789	1793	1705	1964	1889	1793	1847	1797	1808	2029
Total_effluent BOD5, Biological Oxygen Demand [water/river]	kgO2/year	13436	13459	13575	13658	13610	13769	13458	13516	13812	14046	13922	14358	13503	13640	14327	14874	14633	15697	15945
Total_effluent COD, Chemical Oxygen Demand [water/river]	kgCOD/year	227737	227924	228881	229608	229254	231058	227913	228382	230823	232732	231881	236610	228273	229360	234868	239184	237625	248745	279793
Total_effluent reference flow	m3/year	52	52	52	52	52	52	52	52	52	52	52	52	52	52	52	52	52	52	52
Total_effluent Sewage Flow	m3/year	4699113	4704783	4732377	4751724	4740331	4774828	4704470	4718626	4786884	4838517	4810880	4900139	4715322	4747983	4899641	5014634	4962898	5172047	5256009
Total_effluent Sludge Volum	m3/year	3658	3660	3670	3678	3674	3691	3660	3665	3689	3707	3699	3740	3664	3675	3725	3761	3748	3840	4406
Total_effluent Effluent Volum	m3/year	4698438	4704112	4731732	4751098	4739692	4774216	4703799	4717968	4786297	4837994	4810320	4899676	4714661	4747355	4899202	5014361	4962544	5171958	5273043
Total_effluent Phosphate [water/river]	kgPO4/year	14405	14423	14508	14567	14532	14638	14422	14465	14675	14833	14748	15022	14455	14556	15021	15374	15215	15857	16167
Total_effluent Magnesium [water/river]	kgMg/year	48154	48280	48897	49340	49094	49984	48274	48585	50120	51287	50697	52992	48512	49233	52638	55230	54141	59502	64305
Total_effluent Calcium, ion [water/river]	kgCa/year	275832	276451	279424	281465	280203	283432	276420	277961	285262	290738	287668	295968	277600	281162	297326	309474	303694	323024	357492

	Urban configuration Scale (ha)	CITY 227737	DP 6.25	CP 6.25	DB 6.25	CB 6.25	CC 6.25	HT 6.25	DP 16	CP 16	DB 16	CB 16	CC 16	HT 16	DP 36	CP 36	DB 36	CB 36	CC 36	HT 36
effluent COD centr	kgCOD/year	227737	227924	228881	229608	229254	231058	227913	228382	230823	232732	231881	236610	228273	229360	234868	239184	237625	248745	279793
effluent TN decentr	kgN/year	1E-31	1E-31	1E-31	1E-31	1E-31	1E-31	1E-31	1E-31	1E-31	1E-31	1E-31	1E-31	1E-31	1E-31	1E-31	1E-31	1E-31	1E-31	1E-31
effluent TP decentr	kgP/year	1E-31	1E-31	1E-31	1E-31	1E-31	1E-31	1E-31	1E-31	1E-31	1E-31	1E-31	1E-31	1E-31	1E-31	1E-31	1E-31	1E-31	1E-31	1E-31
effluent COD decentr	kgCOD/year	1E-31	1E-31	1E-31	1E-31	1E-31	1E-31	1E-31	1E-31	1E-31	1E-31	1E-31	1E-31	1E-31	1E-31	1E-31	1E-31	1E-31	1E-31	1E-31

Table S 41: Inventory for BW-GW system

	Urban configuration Scale (ha)	CITY 892418	DP 6.25	CP 6.25	DB 6.25	CB 6.25	CC 6.25	HT 6.25	DP 16	CP 16	DB 16	CB 16	CC 16	HT 16	DP 36	CP 36	DB 36	CB 36	CC 36	HT 36
Total_effluent biogenic DCO	kgCOD/year	892418	893732	900714	906305	904066	920976	893660	896939	914882	928984	923834	967634	896174	903741	943723	975109	966332	1068085	1086758
Total_effluent CO2 total	kgCO2/year	383443	385442	395278	402246	398425	412559	385332	390323	414775	433232	423982	460590	389158	400675	455083	496127	479075	564746	445541
Total_effluent CO2 input	kgCO2/year	7785	9250	16380	21379	18455	27359	9169	12827	30465	43806	36668	59753	11973	20412	59601	89312	75953	130045	8139
Total_effluent fossil DCO	kgCOD/year	53924	53924	53924	53924	53924	53924	53924	53924	53924	53924	53924	53924	53924	53924	53924	53924	53924	53924	54831
Total_effluent Ammonia [air/high population density]	kgNH3/year	1E-30	1E-30	1E-30	1E-30	1E-30	1E-30	1E-30	1E-30	1E-30	1E-30	1E-30	1E-30	1E-30	1E-30	1E-30	1E-30	1E-30	1E-30	1E-31
Total_effluent Hydrogen [air/high population density]	kgH2/year	1494	1494	1494	1494	1494	1494	1494	1494	1494	1494	1494	1494	1494	1494	1494	1494	1494	1495	2213
Total_effluent Methane, biogenic [air/high population density]	kgCH4/year	501	501	501	501	501	501	501	501	501	501	501	501	501	501	501	501	501	501	733
Total_effluent Dinitrogen monoxide [air/high population density]	kgN2O/year	7993	7998	8025	8047	8039	8112	7998	8010	8080	8136	8117	8306	8007	8036	8192	8317	8286	8724	8795
Total_effluent Nitrogen, organic bound [water/river]	kgN/year	152	152	152	152	152	152	152	152	152	152	152	152	152	152	152	152	152	152	183
Total_effluent Nitrogen [water/river]	kgN/year	2224	2224	2224	2224	2224	2224	2224	2224	2224	2224	2224	2224	2224	2224	2224	2224	2224	2224	2524
Total_effluent Ammonium, ion [water/river]	kgNH4/year	4013	4019	4046	4065	4054	4089	4018	4032	4100	4152	4124	4214	4029	4062	4213	4328	4276	4485	3954
Total_effluent Nitrate [water/river]	kgNO3/year	132215	132440	133537	134306	133857	135229	132428	132990	135704	137756	136659	140216	132859	134157	140185	144756	142702	151038	145072
Total_effluent Nitrite [water/river]	kgNO2/year	2026	2026	2026	2026	2026	2026	2026	2026	2026	2026	2026	2026	2026	2026	2026	2026	2026	2026	2029
Total_effluent BOD5, Biological Oxygen Demand [water/river]	kgO2/year	13426	13434	13472	13501	13489	13571	13433	13451	13548	13624	13594	13807	13447	13489	13704	13872	13820	14315	15945
Total_effluent COD, Chemical Oxygen Demand [water/river]	kgCOD/year	227698	227822	228466	228970	228751	230149	227815	228123	229765	231046	230536	234156	228051	228762	232413	235255	234368	242776	279793
Total_effluent reference flow	m3/year	53	53	53	53	53	53	53	53	53	53	53	53	53	53	53	53	53	53	52
Total_effluent Sewage Flow	m3/year	4699128	4704823	4732564	4752048	4740688	4775657	4704508	4718727	4787376	4839329	4811626	4902288	4715408	4748212	4900745	5016449	4964628	5177026	5256009
Total_effluent Sludge Volum	m3/year	3784	3989	4982	5673	5260	6433	3978	4489	6939	8790	7780	10822	4370	5550	10992	15115	13216	20351	4406
Total_effluent Effluent Volum	m3/year	4698426	4704089	4731609	4750914	4739629	4774072	4703769	4717889	4785989	4837502	4809963	4899261	4714599	4747169	4898482	5013204	4961665	5170900	5273043
Total_effluent Phosphate [water/river]	kgPO4/year	14406	14423	14507	14567	14532	14638	14422	14465	14674	14832	14748	15021	14455	14555	15019	15371	15213	15854	16167
Total_effluent Magnesium [water/river]	kgMg/year	48103	48146	48370	48541	48462	48907	48144	48253	48820	49260	49073	50227	48227	48478	49741	50720	50388	53074	64305
Total_effluent Calcium, ion [water/river]	kgCa/year	275446	275446	275446	275446	275446	275446	275446	275446	275446	275446	275446	275446	275446	275446	275446	275446	275446	275446	357492
Total_effluent TOC, Total Organic Carbon [water/river]	kgC/year	121680	121749	122109	122391	122268	123050	121745	121918	122836	123551	123267	125290	121877	122275	124315	125904	125409	130109	149489
Total_effluent DOC, Dissolved Organic Carbon [water/river]	kgC/year	100668	100735	101088	101364	101245	102017	100731	100900	101799	102500	102223	104222	100861	101249	103247	104804	104323	108964	126468
Total_effluent Carbonate [water/river]	kgCO3/year	1.76E+08	1.76E+08	1.76E+08	1.76E+08	1.76E+08	1.76E+08	1.76E+08	1.76E+08	1.76E+08	1.76E+08	1.76E+08	1.76E+08	1.76E+08	1.76E+08	1.76E+08	1.76E+08	1.76E+08	1.76E+08	2.36E+08
Total_effluent N in Biomass	kgN/year	1806	1806	1806	1806	1806	1806	1806	1806	1806	1806	1806	1806	1806	1806	1806	1806	1806	1806	2143
Total_effluent TSS	kgSS/year	46951	46954	46968	46977	46972	46989	46954	46961	46995	47021	47007	47051	46959	46975	47051	47108	47083	47187	52730
Total_effluent TN	kgN/year	46984	47041	47316	47509	47396	47741	47038	47179	47860	48375	48100	48993	47146	47472	48985	50132	49617	51709	52730
Total_effluent TP	kgP/year	4699	4704	4732	4751	4740	4774	4704	4718	4786	4838	4810	4899	4715	4747	4899	5013	4962	5171	5273
Chloride Coagulant	kgCl/year	106668	106668	106668	106668	106668	106668	106668	106668	106668	106668	106668	106668	106668	106668	106668	106668	106668	106668	84091
Chloride H2S	kgCl/year	9237	9237	9237	9237	9237	9237	9237	9237	9237	9237	9237	9237	9237	9237	9237	9237	9237	9237	10339
Sludge Total N	kgN/year	32020	32052	32231	32389	32343	32942	32050	32128	32602	32987	32889	34440	32109	32289	33347	34206	34061	37652	41467
Sludge Total P	kgP/year	39764	39785	39900	39998	39967	40320	39784	39835	40136	40378	40310	41223	39823	39941	40614	41151	41046	43164	43357

	Urban configuration	CITY	DP	CP	DB	CB	CC	HT	DP	CP	DB	CB	CC	HT	DP	CP	DB	CB	CC	HT
	Scale (ha)		6.25	6.25	6.25	6.25	6.25	6.25	16	16	16	16	16	16	36	36	36	36	36	36
Gravity Diesel	m3	36339	42917	31552	79621	64269	17245	96171	111983	92345	193689	138845	52226	225857	259393	223587	407705	316448	120700	155478
Gravity Synthetic rubber	kg	152	180	132	334	270	72	403	470	387	813	583	219	948	1088	938	1711	1328	506	652
Vacuum_sewer_consumption	kWh/year	387	1015	5062	9170	8878	31456	1027	2696	15717	22586	23143	101384	2439	6581	38158	81413	57328	548147	1E-31
Vacuum Sand	kg	334054	416663	380901	507203	401508	276298	858376	105406	133609	1261017	768841	956015	191771	242317	3197974	2372550	1756855	2198424	1E-31
Vacuum Gravel	kg	625753	777804	700674	104966	891354	495140	168898	201221	262858	2774718	1667140	1918272	382126	492827	6471776	4967997	4071416	4705260	1E-31
Vacuum PE	kg	1662	1927	1480	2999	2372	871	4306	4947	4346	7226	5342	2648	10081	11535	10532	15432	12111	5951	1E-31
Vacuum Iron_Manhole	kg	1E-31	1E-31	1E-31	1E-31	1E-31	1E-31	1E-31	1E-31	1E-31	1E-31	1E-31	1E-31	1E-31	1E-31	1E-31	1E-31	1E-31	1E-31	1E-31
Vacuum Concrete_Manhole	kg	1E-31	1E-31	1E-31	1E-31	1E-31	1E-31	1E-31	1E-31	1E-31	1E-31	1E-31	1E-31	1E-31	1E-31	1E-31	1E-31	1E-31	1E-31	1E-31
Vacuum Steel	kg	2489	2913	2234	4538	3593	1309	6500	7486	6577	10940	8085	3979	15265	17467	15947	23373	18341	8931	1E-31
Vacuum Polypropylene	kg	138	162	124	252	200	73	361	416	365	608	449	221	848	970	886	1299	1019	496	1E-31
Vacuum Diesel	m3	32961	38573	29580	60083	47572	17330	86064	99123	87086	144857	107053	52690	202124	231286	211167	309495	242858	118258	1E-31
Vacuum Synthetic rubber	kg	138	162	124	252	200	73	361	416	365	608	449	221	848	970	886	1299	1019	496	1E-31
Total PE	PE	56003	56003	56003	56003	56003	56003	56003	56003	56003	56003	56003	56003	56003	56003	56003	56003	56003	56003	69487
Total PE decentralised	PE	62	162	696	1123	951	2244	157	407	1778	2855	2462	5809	349	927	3980	6377	5708	13483	1E-31
Reduction consumption	m3/year	296115	774004	358939	614181	543136	158374	747617	194087	946364	1559447	1430751	4105491	166234	441534	2122668	3486426	3317168	9511579	1E-31
Greywater reuse	m3/year	350396	915887	366874	559923	447071	791503	884663	229665	910674	1425799	1150408	2043394	196707	522471	2035604	3182824	2667428	4759784	1E-31
elect. byproduct		1E-31	1E-31	1E-31	1E-31	1E-31	1E-31	1E-31	1E-31	1E-31	1E-31	1E-31	1E-31	1E-31	1E-31	1E-31	1E-31	1E-31	1E-31	1E-31
Length gravity	m	1509	1783	1311	3307	2669	716	3994	4651	3836	8045	5767	2169	9381	10774	9287	16934	13144	5013	6458
Length vacuum	m	138	162	124	252	200	73	361	416	365	608	449	221	848	970	886	1299	1019	496	1E-31
Distance travelled (km)	m	1E-31	1E-31	1E-31	1E-31	1E-31	1E-31	1E-31	1E-31	1E-31	1E-31	1E-31	1E-31	1E-31	1E-31	1E-31	1E-31	1E-31	1E-31	34956.1
Sewage flow centralised	m3/year	469560	469560	469560	469560	469560	469560	469560	469560	469560	469560	469560	469560	469560	469560	469560	469560	469560	469560	5256009
Sludge COD centr	kgCOD/year	693497	693497	693497	693497	693497	693497	693497	693497	693497	693497	693497	693497	693497	693497	693497	693497	693497	693497	885074
Sludge COD decentr	kgCOD/year	723	1892	8130	13235	11040	25530	1827	4755	20935	34061	28794	66558	4070	10871	47490	77747	67906	156207	1E-31
Sludge N centr	kgN/year	32001	32001	32001	32001	32001	32001	32001	32001	32001	32001	32001	32001	32001	32001	32001	32001	32001	32001	41467
Sludge N decentr	kgN/year	19.31	50.47	229.52	388.30	342.27	940.87	48.75	126.55	600.71	986.24	888.26	2438.71	108.39	287.90	1345.89	2204.60	2059.46	5650.86	1E-31
Sludge P centr	kgP/year	39752	39752	39752	39752	39752	39752	39752	39752	39752	39752	39752	39752	39752	39752	39752	39752	39752	39752	43357
Sludge P decentr	kgP/year	12.72	33.24	148.18	246.53	215.35	568.14	32.11	83.36	384.82	626.38	558.34	1471.89	71.40	189.65	862.41	1399.89	1294.53	3412.72	1E-31
struvite N decentr	kgN/year	15.03	39.28	175.07	291.27	254.43	671.24	37.94	98.49	454.66	740.05	659.67	1739.00	84.36	224.06	1018.92	1653.93	1529.45	4032.03	1E-31
struvite P decentr	kgP/year	33.53	87.64	390.64	649.92	567.73	1497.75	84.65	219.77	1014.49	1651.30	1471.93	3880.28	188.23	499.95	2273.55	3690.47	3412.71	8996.80	1E-31
struvite N centr	kgN/year	4345	4345	4345	4345	4345	4345	4345	4345	4345	4345	4345	4345	4345	4345	4345	4345	4345	4345	9207
struvite P centr	kgP/year	9055	9055	9055	9055	9055	9055	9055	9055	9055	9055	9055	9055	9055	9055	9055	9055	9055	9055	17757
struvite COD centr	kgCOD/year	17297	17297	17297	17297	17297	17297	17297	17297	17297	17297	17297	17297	17297	17297	17297	17297	17297	17297	26658
N rich N decentr	kgN/year	172	449	2045	3464	3055	8421	434	1126	5355	8798	7929	21826	964	2562	11999	19666	18384	50573	1E-31
N rich P decentr	kgP/year	1E-31	1E-31	1E-31	1E-31	1E-31	1E-31	1E-31	1E-31	1E-31	1E-31	1E-31	1E-31	1E-31	1E-31	1E-31	1E-31	1E-31	1E-31	1E-31
N rich COD decentr	kgCOD/year	1E-31	1E-31	1E-31	1E-31	1E-31	1E-31	1E-31	1E-31	1E-31	1E-31	1E-31	1E-31	1E-31	1E-31	1E-31	1E-31	1E-31	1E-31	1E-31
N rich N centr	kgN/year	23218	23218	23218	23218	23218	23218	23218	23218	23218	23218	23218	23218	23218	23218	23218	23218	23218	23218	67282
N rich P centr	kgP/year	1E-31	1E-31	1E-31	1E-31	1E-31	1E-31	1E-31	1E-31	1E-31	1E-31	1E-31	1E-31	1E-31	1E-31	1E-31	1E-31	1E-31	1E-31	1E-31
N rich COD centr	kgCOD/year	225	225	225	225	225	225	225	225	225	225	225	225	225	225	225	225	225	225	372
effluent TN centr	kgN/year	46949	46949	46949	46949	46949	46949	46949	46949	46949	46949	46949	46949	46949	46949	46949	46949	46949	46949	52730
effluent TP centr	kgP/year	4695	4695	4695	4695	4695	4695	4695	4695	4695	4695	4695	4695	4695	4695	4695	4695	4695	4695	5273
effluent COD centr	kgCOD/year	227622	227622	227622	227622	227622	227622	227622	227622	227622	227622	227622	227622	227622	227622	227622	227622	227622	227622	279793
effluent TN decentr	kgN/year	35	92	367	560	447	792	88	230	911	1426	1150	2043	197	522	2036	3183	2667	4760	1E-31
effluent TP decentr	kgP/year	3.50	9.16	36.69	55.99	44.71	79.15	8.85	22.97	91.07	142.58	115.04	204.34	19.67	52.25	203.56	318.28	266.74	475.98	1E-31
effluent COD decentr	kgCOD/year	77	200	844	1348	1129	2527	193	501	2144	3424	2915	6535	429	1140	4791	7633	6747	15154	1E-31

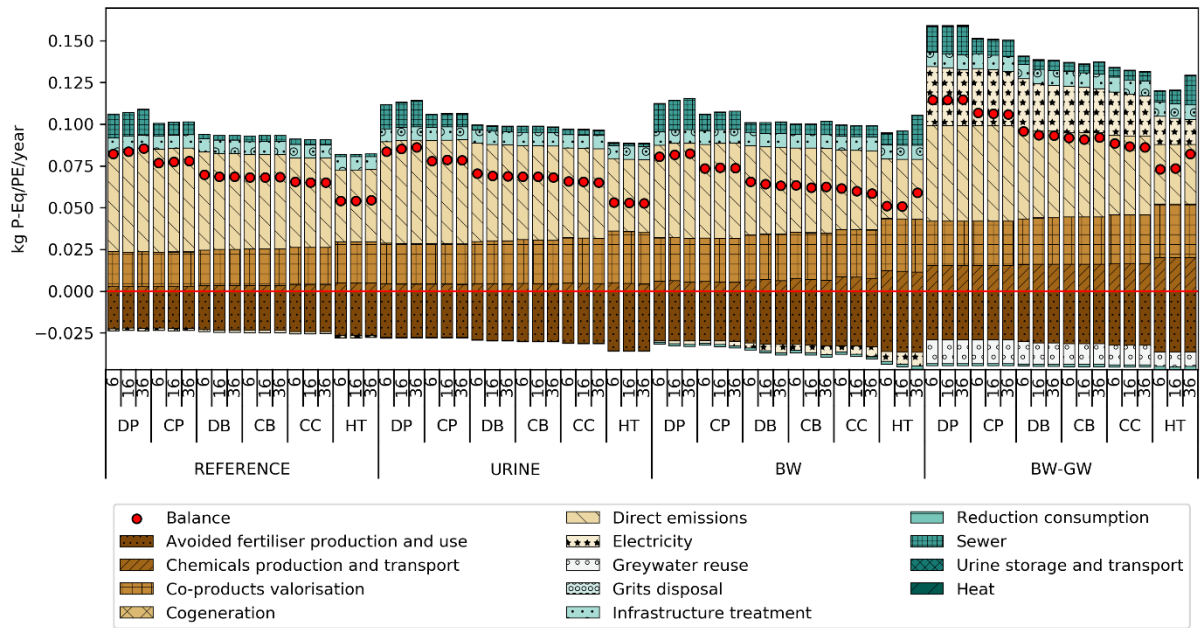

Figure S 20: Contribution analysis on freshwater eutrophication with PE as functional unit

II.3.d Eutrophication impact with wastewater flowrate as functional unit

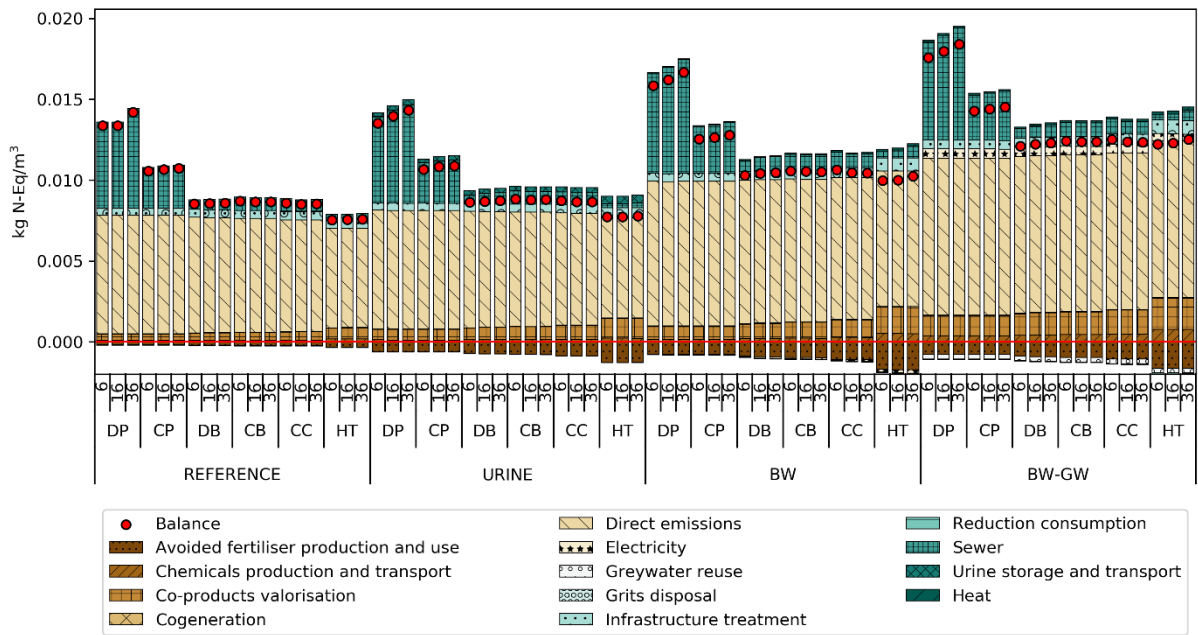

Figure S 21: Contribution analysis on marine eutrophication with wastewater flowrate as functional unit

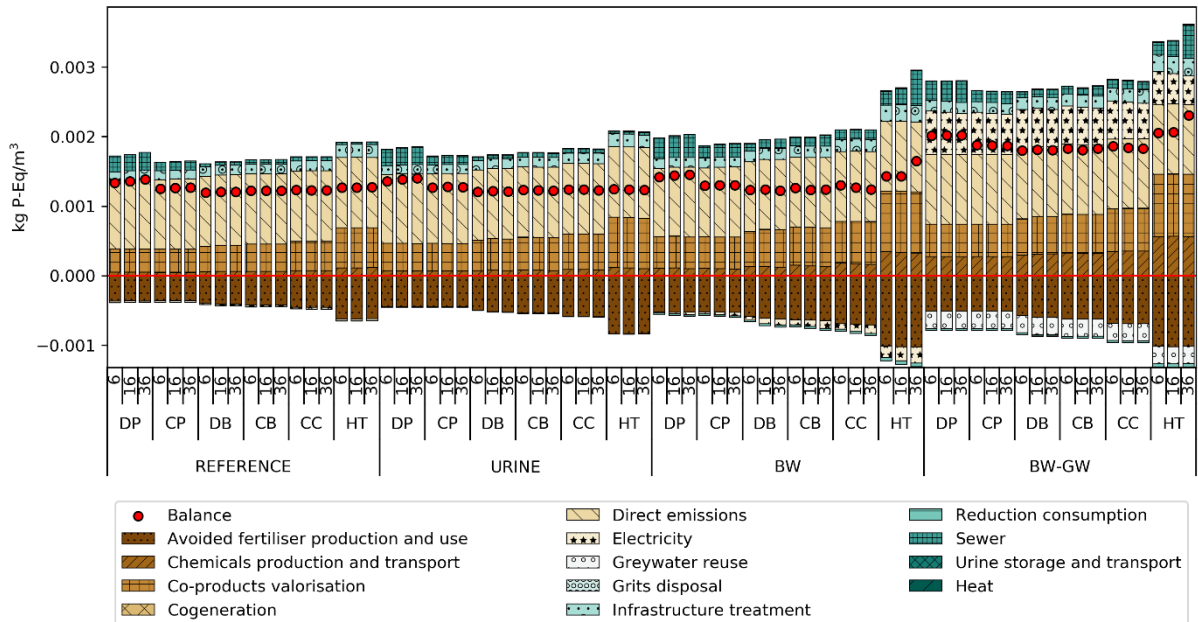

Figure S 22: Contribution analysis on freshwater eutrophication with wastewater flowrate as functional unit

II.3.e Midpoint impact with scale influence

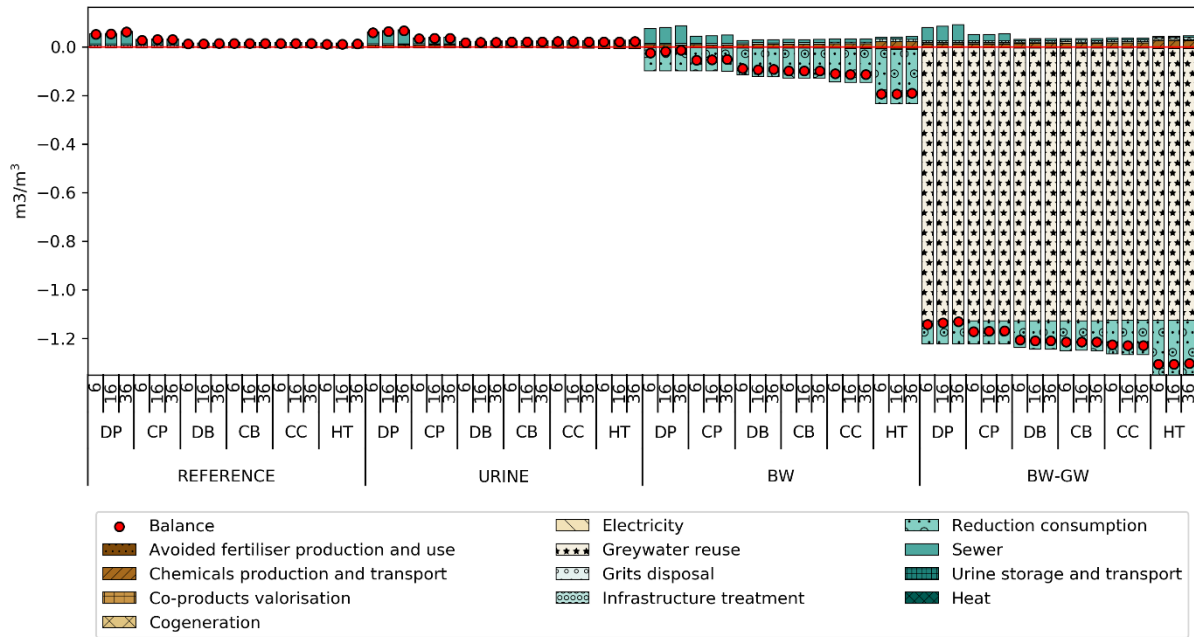

Figure S 23: Contribution analysis on water depletion (PE as functional unit)

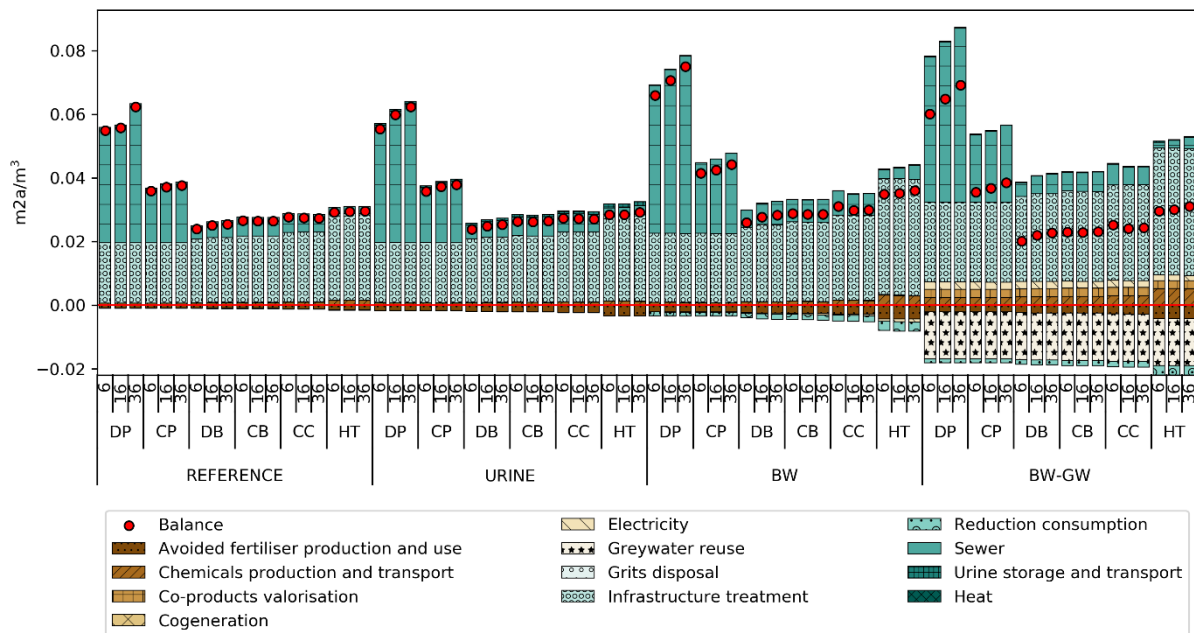

Figure S 24: Contribution analysis on urban land occupation (PE as functional unit)

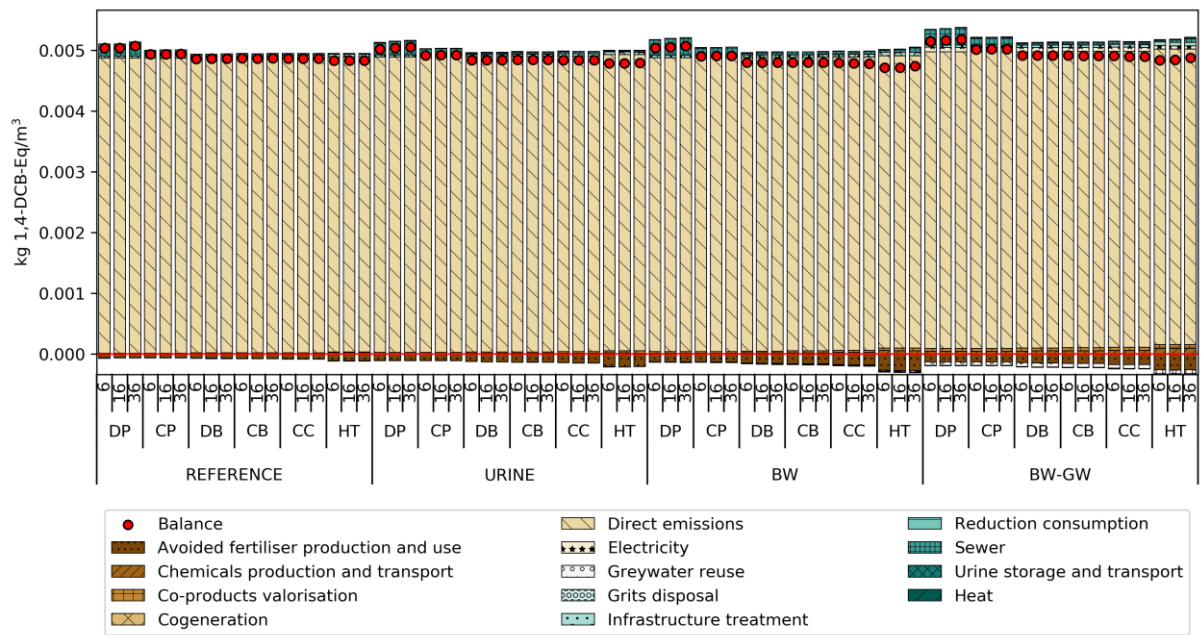

Figure S 25: Contribution analysis on terrestrial ecotoxicity (PE as functional unit)

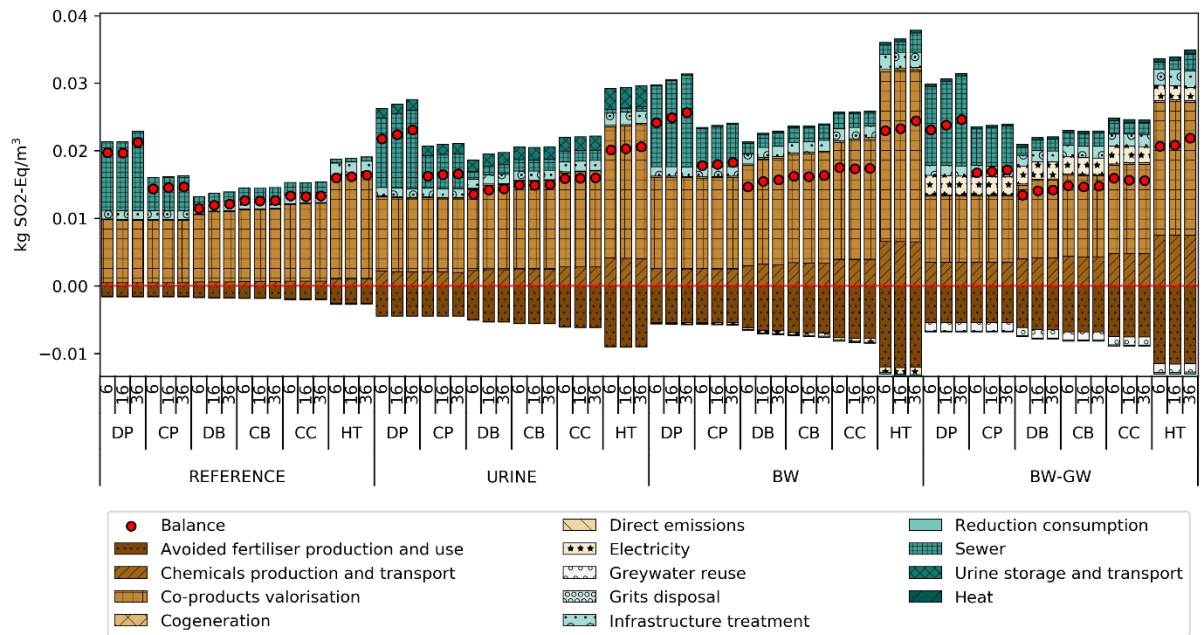

Figure S 26: Contribution analysis on terrestrial acidification (PE as functional unit)

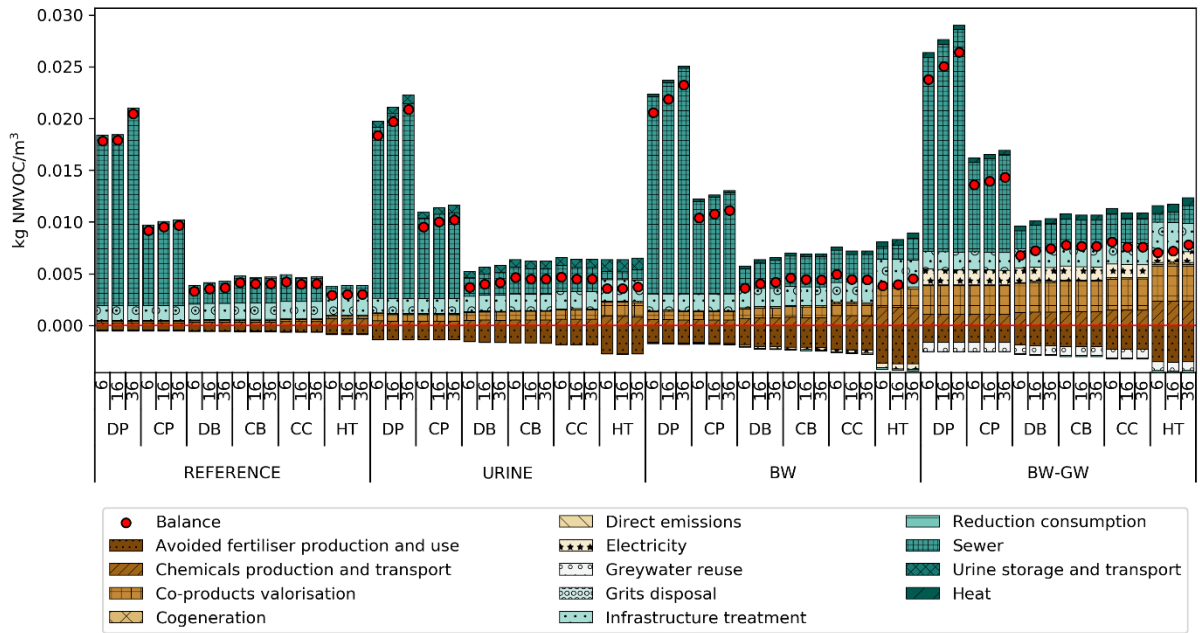

Figure S 27: Contribution analysis on photochemical oxidant formation (PE as functional unit)

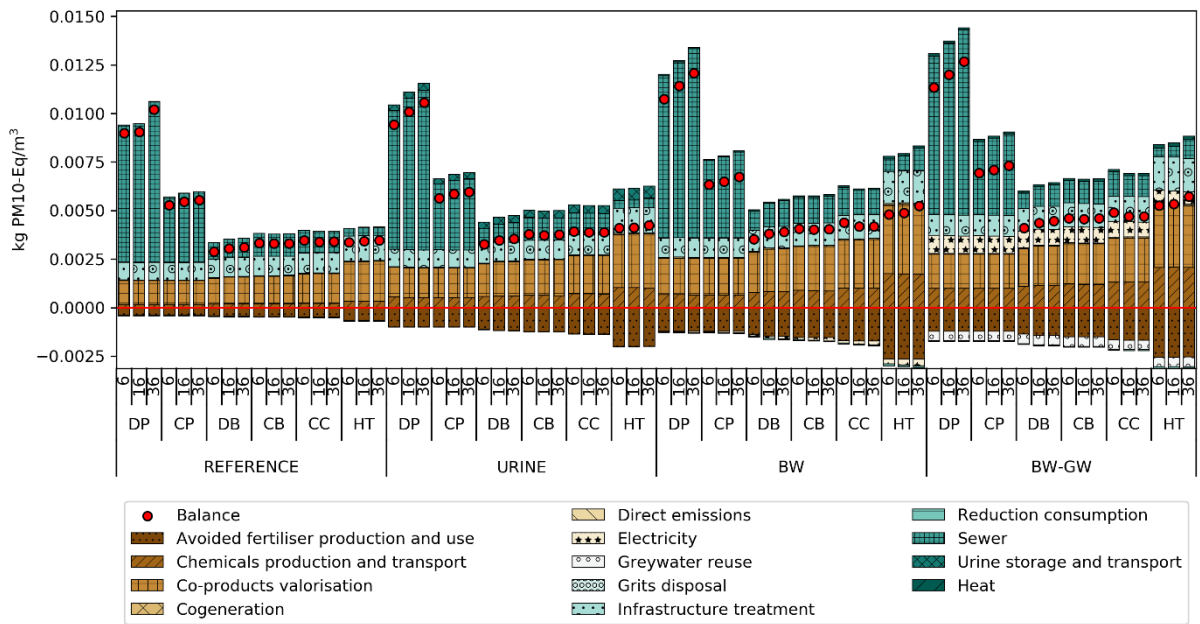

Figure S 28: Contribution analysis on particulate matter formation (PE as functional unit)

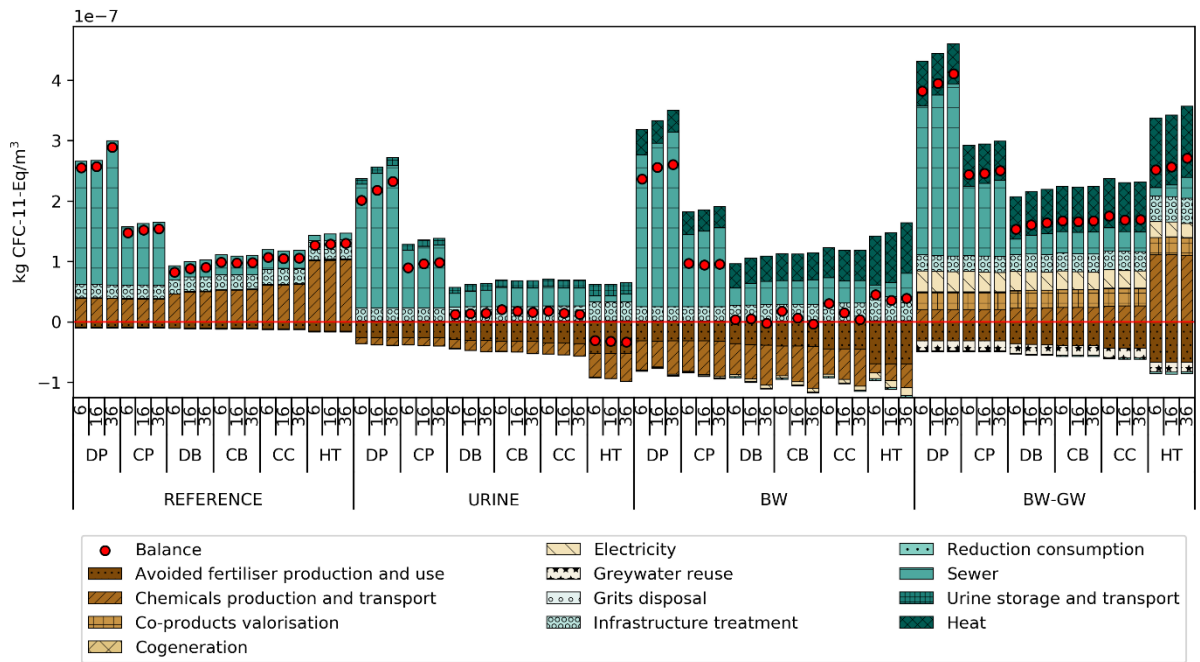

Figure S 29: Contribution analysis on ozone depletion (PE as functional unit)

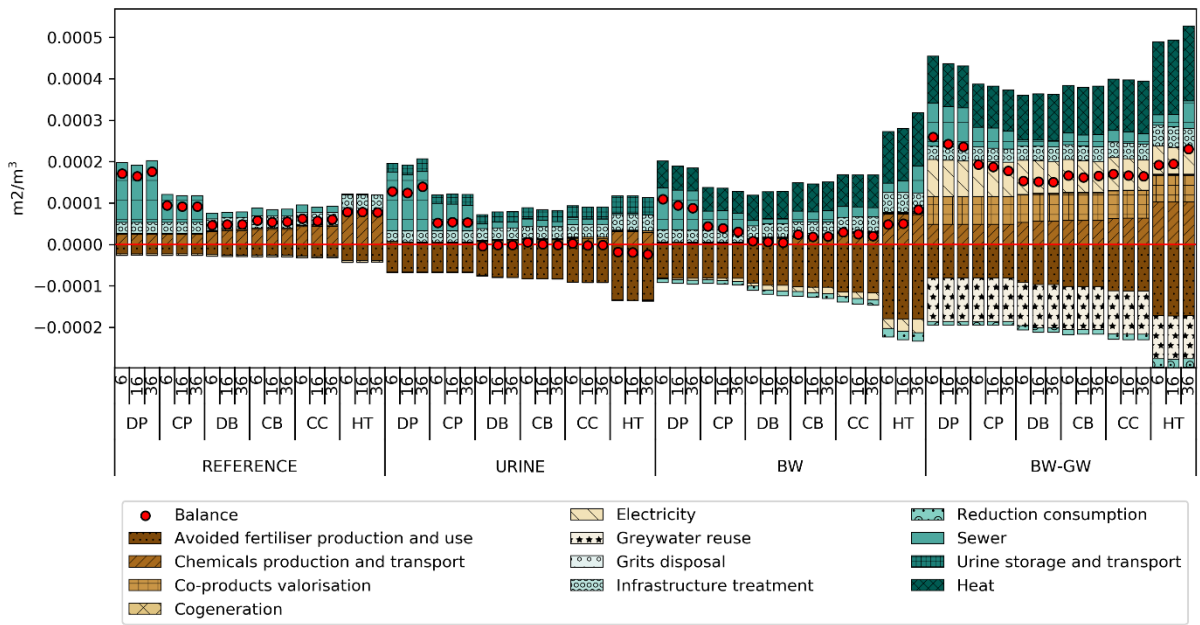

Figure S 30: Contribution analysis on natural land transformation (PE as functional unit)

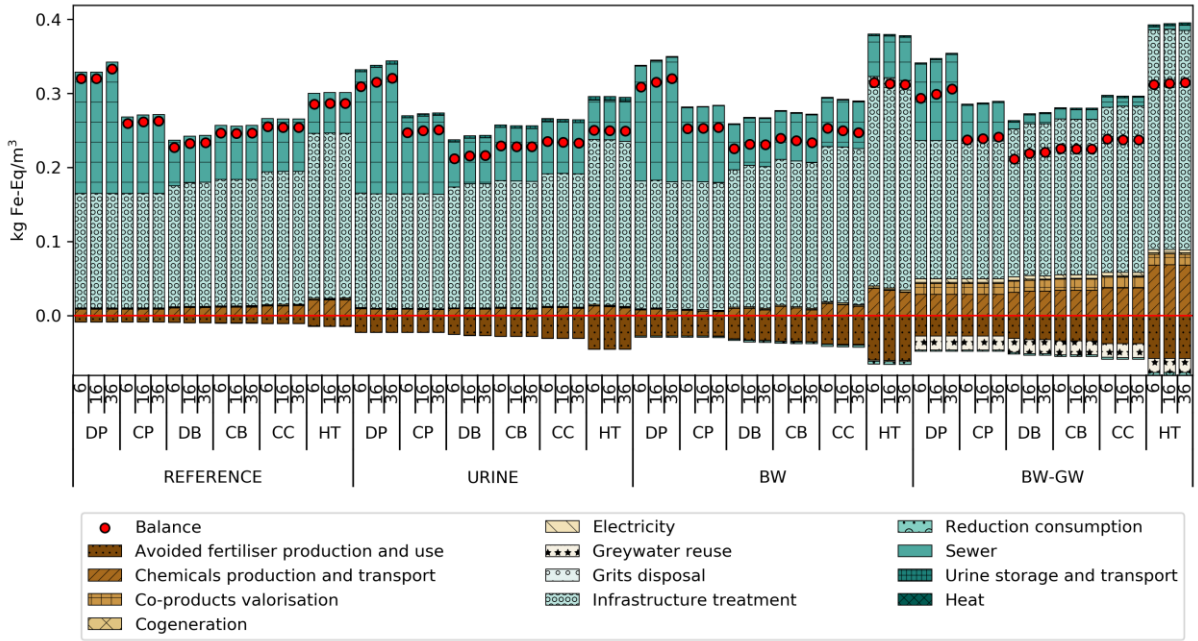

Figure S 31: Contribution analysis on metal depletion (PE as functional unit)

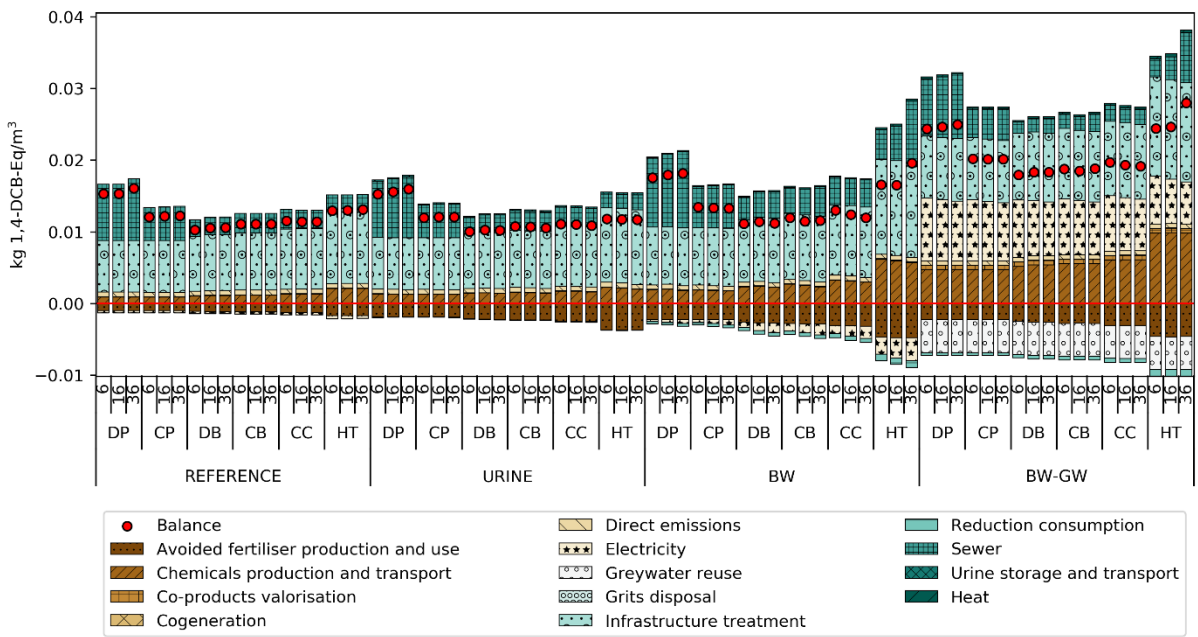

Figure S 32: Contribution analysis on marine ecotoxicity (PE as functional unit)

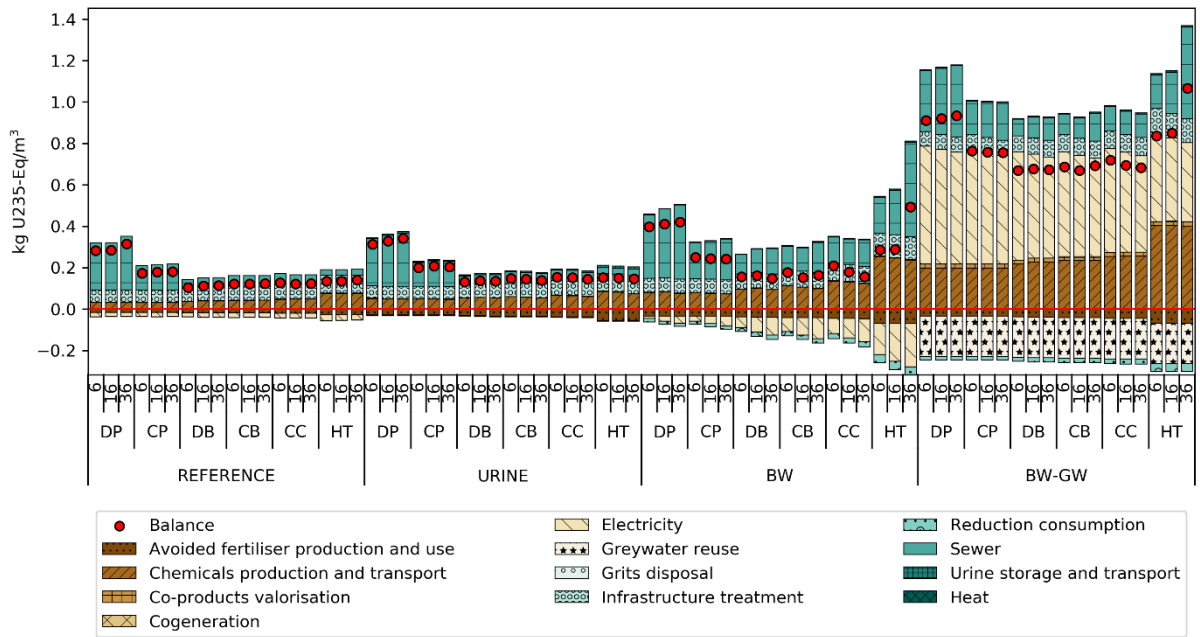

Figure S 33: Contribution analysis on ionising radiation (PE as functional unit)

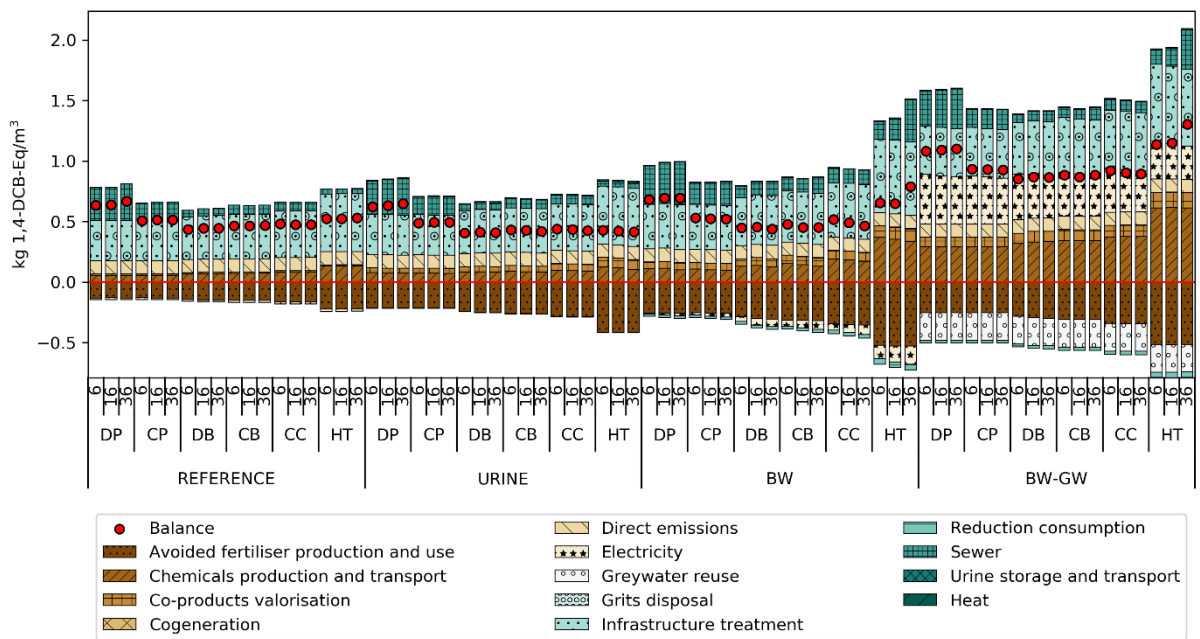

Figure S 34: Contribution analysis on human toxicity (PE as functional unit)

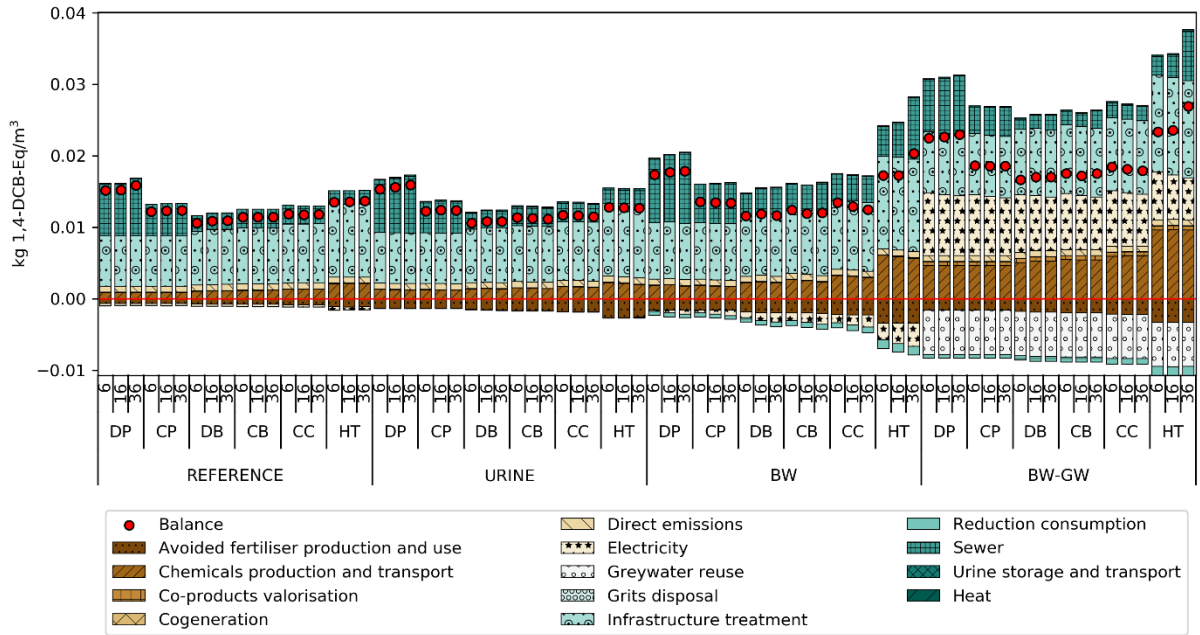

Figure S 35: Contribution analysis on freshwater ecotoxicity (PE as functional unit)

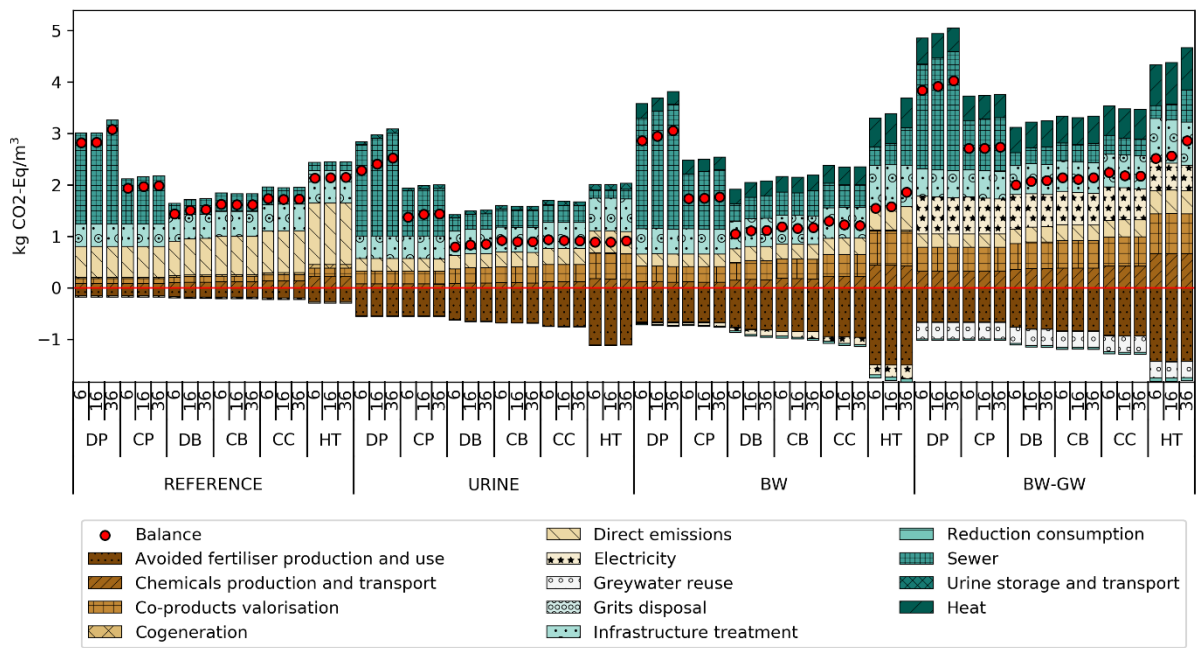

Figure S 36: Contribution analysis on climate change (PE as functional unit)

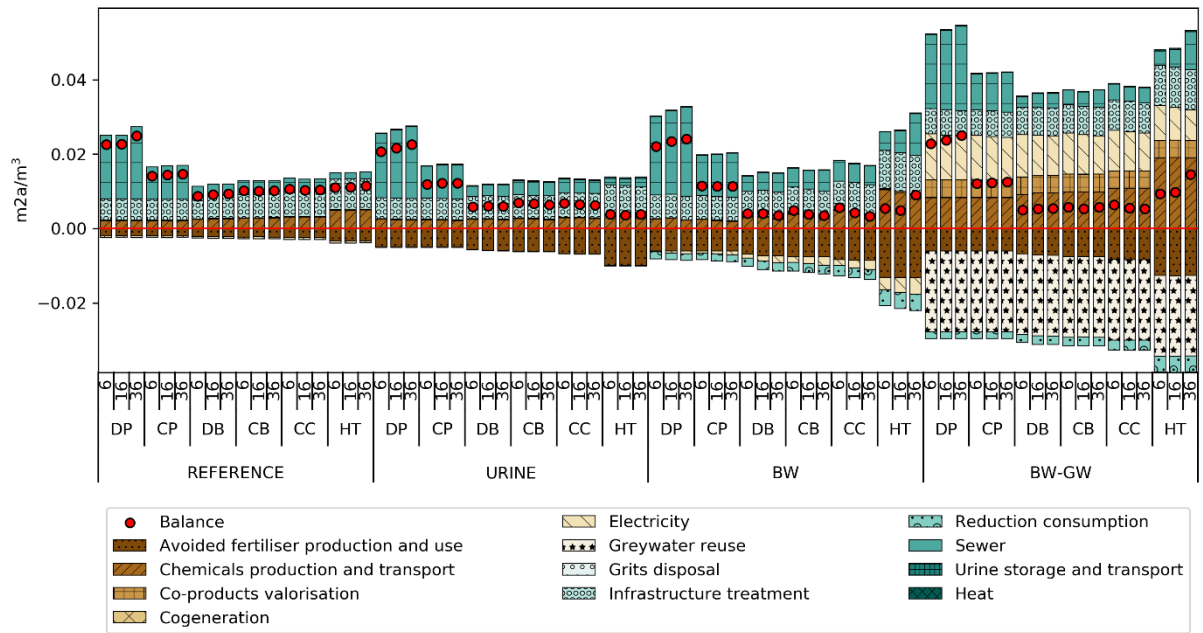

Figure S 37: Contribution analysis on agricultural land occupation (PE as functional unit)

II.4 Influence of functional unit

In this part the influence of the choice of functional unit is analysed. Functional unit allows to normalise results in order to compare different case studies where the size of the district and the wastewater are different. Load in nitrogen and phosphorus as well as the treated wastewater flowrate are investigated and compared to the load in BOD₅ (PE).

II.4.a Nitrogen and phosphorus load

Using nitrogen or phosphorus loads as functional unit do not change significantly the results as the variation of ratio N/PE and P/PE is relatively small (respectively 6 % and 12 % of standard deviation, see also Figure IV-2). The analysis of the results with nitrogen load as functional unit confirms the several hypothesis previously stated. For instance, direct emissions from WWRF is constant through urban configuration, proven in this sense that the variation of direct emission is due to difference in nitrogen load in the influent.

II.4.b Flowrate

BW and BW-GW systems use less water for flushing than the two others and have then, less treated wastewater flowrate. Normalising the LCA results with this parameter has a significant influence for these two systems. For instance, Figure S 38 shows the results of improvement for climate change impact compared to Reference system, with the new functional unit. Both BW and BW-GW lines are translated to higher values, and BW-GW system does not reach a better value than 20 % of degradation.

Thus, the decrease of absolute impacts is lower than the reduction of wastewater flowrate.

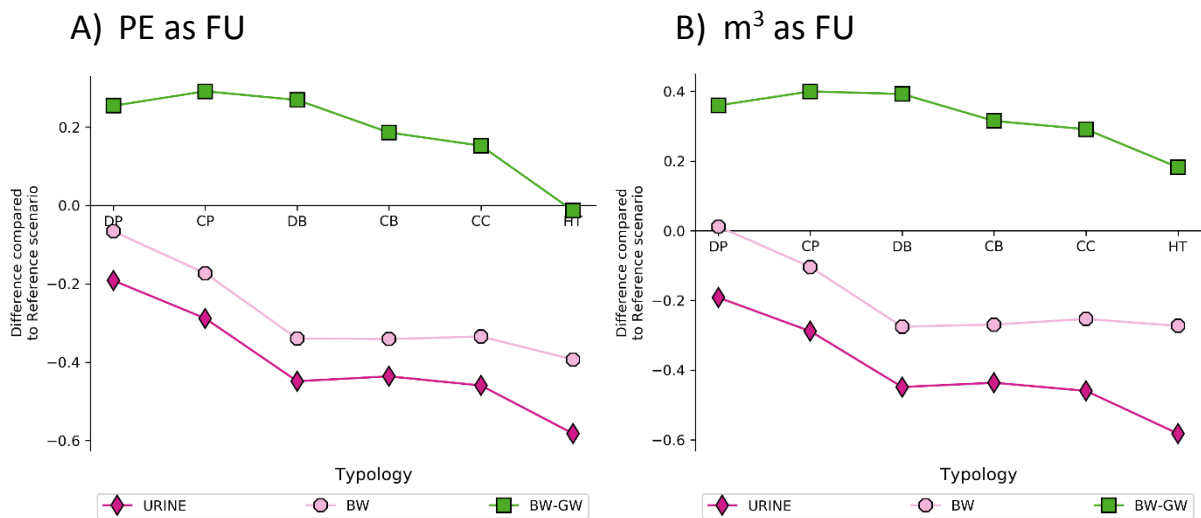

Figure S 38: Comparison of difference in improvement on climate change impact with high-rise tower configuration: A) with PE as functional unit and B) with treated wastewater flowrate as functional unit.

To conclude, load in nitrogen, phosphorus or BOD₅ (PE) can be used without distinction for the assessment of sanitation systems with different urban configurations. However using wastewater flowrate as functional unit will favour scenarios where no reduction is wastewater is performed. This functional unit should therefore be used with caution.

Le système de gestion des eaux usées urbaines actuel doit se transformer pour récupérer les ressources contenues dans les eaux usées, mais aussi diminuer son empreinte environnementale et notamment son impact sur le changement climatique. Pour cela deux optiques complémentaires sont actuellement étudiées : l'amélioration de la station d'épuration centralisée (STEP) et la séparation à la source. Cette dernière permet de conserver des flux concentrés et des compositions très spécifiques, simplifiant ainsi la valorisation de ces flux. Cependant cela a des conséquences sur l'ensemble de la filière avec des nouveaux transports et traitements à mettre en place. Les choix techniques sur ces aspects vont avoir une influence considérable sur l'efficacité des filières, tout comme les types d'urbanisme dans lesquels sont implantés les systèmes de séparation à la source. Une approche de modélisation transdisciplinaire s'avère donc indispensable pour accompagner l'évaluation approfondie de ces nouvelles filières au niveau urbain. Pour cela différentes configurations urbaines représentatives des quartiers de villes européennes et françaises ont été considérées. L'ensemble de la filière a été modélisé : la séparation au niveau des toilettes, le transport, les traitements, les rejets et la valorisation des sous-produits. Trois scénarios de séparation à la source ont été comparés à une station d'épuration centralisée qui récupère autant que possible les nutriments et la matière organique. La modélisation des systèmes techniques a été couplée à une analyse de cycle de vie (ACV) afin d'évaluer les impacts environnementaux de chaque solution. Cette étude a montré que la séparation à la source permet d'augmenter significativement les taux de récupération des nutriments et spécifiquement l'azote qui est difficilement capturable dans la station d'épuration. Les effets sur le changement climatique sont diminués par la valorisation de cet azote en engrais et la suppression partielle des émissions de protoxyde d'azote, puissant gaz à effet de serre. Cependant le choix des traitements décentralisés des eaux grises peut nuancer cette conclusion à cause de leur consommation énergétique. De plus, l'urbanisme impacte fortement le bilan environnemental, avec une amélioration des performances limitée pour les faibles densités du fait de la contribution importante des réseaux. L'augmentation de la part des employés vis-à-vis des habitants améliore le bilan environnemental en modifiant les débits et ratios COD/N/P des flux à traiter.

Wastewater management is nowadays pushed towards resource recovery instead of only wastewater treatment. In the meantime, reducing the environmental impact and especially climate change is also required. For this purpose, two solutions are currently considered: improvement of centralised wastewater treatment plant (WWTP) and source separation. In the latter, separating urine or blackwater in the housing allows to keep the high concentration and specific composition of each stream. Resource recovery is therefore easier to implement. However new questions arise, as all the wastewater management is modified. The choice of appropriate technical solutions (transport and treatments) is one of them. Another question is the influence of the urban context in which the systems are installed. A transdisciplinary approach is therefore required to evaluate all the possibilities at urban scale. For this purpose, this study models different urban configurations representative of European cities and especially French ones. In these districts, the entire wastewater management has been modelled: separation with toilets, transport, treatments and reuse of by-products or discharge. Three different scenarios of source separation have been studied and compared to an advanced centralised WWTP with high recovery of nutrients and organic matter. Finally the results from the model have been coupled with a life cycle assessment in order to evaluate the environmental impact of each solution. Results showed that source separation can increase significantly the recovery rate of nitrogen which is difficult to recover in a WWTP. Separating nitrogen allows to reduce climate change by decreasing the emission of nitrous oxide and avoiding the production of fertiliser. However the choice of the greywater treatment is critical for the climate change reduction potential, especially due to the related energy consumption. Urbanism has a strong impact on the environmental balance with a low improvement for a low built density due to the large contribution of sewer installation. Moreover, the increase of ratio of employees regarding inhabitants improves the environmental balance, by modifying the ratio COD/N/P and flowrate of treated flow.