



HAL
open science

Promoting Pumped Hydroelectric Energy Storage for Sustainable Power Generation in Cameroon: An Assessment of Local Opportunities

Urbain Nzotcha

► **To cite this version:**

Urbain Nzotcha. Promoting Pumped Hydroelectric Energy Storage for Sustainable Power Generation in Cameroon: An Assessment of Local Opportunities. Engineering Sciences [physics]. Université de Yaoundé I, Ecole Nationale Supérieure Polytechnique de Yaoundé, 2020. English. NNT: . tel-03117844

HAL Id: tel-03117844

<https://hal.science/tel-03117844>

Submitted on 21 Jan 2021

HAL is a multi-disciplinary open access archive for the deposit and dissemination of scientific research documents, whether they are published or not. The documents may come from teaching and research institutions in France or abroad, or from public or private research centers.

L'archive ouverte pluridisciplinaire **HAL**, est destinée au dépôt et à la diffusion de documents scientifiques de niveau recherche, publiés ou non, émanant des établissements d'enseignement et de recherche français ou étrangers, des laboratoires publics ou privés.

UNIVERSITE DE YAOUNDE I

Centre de Recherche et de Formation
Doctorale en Sciences, Technologie et
Géosciences

Ecole Nationale Supérieure
Polytechnique de Yaoundé



THE UNIVERSITY OF YAOUNDE I

Post Graduate School of Sciences,
Technology and Geosciences

Yaoundé National Advanced School of
Engineering

**PROMOTING PUMPED HYDROELECTRIC ENERGY STORAGE FOR
SUSTAINABLE POWER GENERATION IN CAMEROON: AN
ASSESSMENT OF LOCAL OPPORTUNITIES**

(PROMOTION DU STOCKAGE D'ENERGIE PAR POMPAGE-TURBINAGE
POUR UNE PRODUCTION DURABLE D'ELECTRICITE AU CAMEROUN :
UNE EVALUATION DES OPPORTUNITES LOCALES)

THESIS

Submitted to

The University of Yaoundé I - National Advanced School of Engineering

By

Urbain NZOTCHA

Engineer, M.Sc.

In fulfilment of the requirements for the degree of

Philosophy Doctor

In

Energy Engineering

Under the supervision of

Prof. Jean NGANHOU and Prof. Joseph KENFACK

Examining Jury

President of the Jury: **Prof. Emer. Médard FOGUE**, University of Dschang

Rapporteurs: **Prof. Emer. Jean NGANHOU**, University of Yaoundé I
Ass. Prof. Joseph KENFACK, University of Yaoundé I

Examiners: **Prof. Godpromesse KENNE**, University of Dschang
Ass. Prof. Lucien MEVA'A, University of Yaoundé I
Ass. Prof. Abraham KANMOGNE, University of Yaoundé I
Ass. Prof. Denis TOKO TCHEUKAM, University of Buea

Publicly defended on August 3th, 2020



Département Coordination et Valorisation de la Recherche

Rapport de soutenance de thèse de Doctorat/PhD de NZOTCHA Urbain

Le lundi 03 août 2020 à 12 heures dans la Salle des Actes de l'Ecole Nationale Supérieure Polytechnique de Yaoundé, Monsieur **NZOTCHA Urbain**, matricule 080V016, étudiant à l'URFD Sciences de l'Ingénieur et Applications (CRFD STG) a soutenu une thèse de Doctorat/PhD sur le thème « PROMOTION DU STOCKAGE D'ENERGIE PAR POMPAGE TURBINAGE POUR UNE PRODUCTION DURABLE D'ELECTRICITE AU CAMEROUN : UNE EVALUATION DES OPPORTUNITES LOCALES » devant le jury composé de :

Président : Monsieur FOGUE Médard ; Professeur Emerite, Université de Dschang
 Rapporteurs : Monsieur NGANHOU Jean ; Professeur Emerite, Université de Yaoundé I
 Monsieur KENFACK Joseph ; Maitres de Conférences, Université de Yaoundé I
 Examineurs : Monsieur KENNE Godpromesse, Professeur, Université de Dschang
 Monsieur MEVA'A Lucien, Maitre de Conférences, Université de Yaoundé I
 Monsieur KANMOGNE, Maitre de Conférences, Université de Yaoundé I
 Monsieur TOKO TCHEUKAM Denis, Maitre de Conférences, Université de Buéa

Le document présenté par Monsieur NZOTCHA Urbain est rédigé en anglais et se lit facilement. Monsieur NZOTCHA a présenté méthodiquement ses travaux de thèse pendant 40 minutes en utilisant aisément les outils didactiques multimédia. A la suite de la présentation, un débat scientifique riche a suivi, débat pendant lequel le candidat a répondu de façon très satisfaisante aux questions des membres du jury. Les résultats présentés par le candidat sont pertinents, d'actualité et pluridisciplinaires pour le secteur des énergies renouvelables en Afrique en général et au Cameroun en particulier. Ils constituent une importante contribution scientifique dans l'analyse multicritère et la prise de décision pour la détermination prospective des sites de pompage-turbinage dans nos pays. La qualité des travaux est validée au niveau international au travers de deux publications dans des revues à comité de lecture et indexées.

Compte tenu de ce qui précède, le jury a décidé à l'unanimité, d'attribuer à monsieur NZOTCHA Urbain, le grade de Docteur/PhD en sciences de l'Ingénieur, option énergétique de l'Université de Yaoundé I, avec la mention très honorable.

Fait à Yaoundé le 03 août 2020

Le Président

FOGUE Médard

Les Rapporteurs

NGANHOU Jean

KENFACK Joseph

Les Examineurs

KENNE Godpromesse

MEVA'A Lucien

KANMOGNE

TOKO TCHEUKAM Denis

Déclaration

Je déclare par la présente que cette soumission est mon propre travail et que, à ma connaissance, elle ne contient aucun travail déjà publié ou écrit par une autre personne ni aucun matériel qui a été accepté pour l'obtention d'un diplôme d'une autre Université ou d'un autre établissement d'enseignement supérieur, sauf lorsque le texte en fait dûment mention.

Urbain NZOTCHA

..... 03/08/2020

La présente certifie que la thèse intitulée « Promotion du stockage d'énergie par pompage-turbinage pour une production durable d'électricité au Cameroun : une évaluation des opportunités locales » soumise par Urbain NZOTCHA exclusivement à l'Ecole Nationale Supérieure Polytechnique de l'Université de Yaoundé I pour l'obtention du diplôme de Doctorat Ph.D constitue un compte rendu fidèle des travaux de recherche qu'il a menés sous notre supervision et direction. Le contenu de la thèse, en tout ou en partie, n'a été soumis à aucun autre institut ou université pour l'obtention d'un autre grade ou diplôme.

Prof. Jean NGANHOU

..... 03/08/2020

Prof. Joseph KENFACK

..... 03/08/2020

Copyright©2020 Urbain Nzotcha. Tous droits réservés. Aucune partie de cette publication ne peut être reproduite, stockée dans un système de recherche documentaire ou transmise sous quelque forme ou par quelque moyen que ce soit, électronique, mécanique, photocopie, enregistrement ou autre sans l'autorisation écrite préalable de l'auteur.

Abstract

This thesis addresses the global question of grid-connected utility-scale energy storage for the integration of energy generated from variable sources, in the context energy transition. Specifically it focus on the case of Cameroon with the objective to formulate an objective point of view about the idea of promoting the pumped hydroelectric energy storage (PHES) alternative for sustainable power generation in Cameroon. To reach this objective, some key aspects supporting the need for bulk energy storage in the power system of Cameroon were analysed, based on a critical analysis of the country's power sector. Afterwards, the technical feasibility of inland small-scale PHES operable with limited environmental impact was analysed, using a spatial analysis model implemented in a geographical information systems (GIS). Finally, the compliance of the local PHES opportunities with sustainability requirements was checked, using a multi-criteria decision-making model for PHES siting. As results from this study, massive grid-connected storage was presented as the missing link in the country's energy commitment. The feasibility of PHES in Cameroon was established as 21 suitable sites were identified totalling an energy storage potential of about 34 GWh, and finally a ranking of these opportunities from a sustainable development perspective was proposed. It was therefore suggested that the Government of Cameroon works with other stakeholders in the power sector to produce a comprehensive energy storage roadmap to valorise the country's graceful energy assets.

Keywords: Pumped hydroelectric energy storage; renewable energy; power system; sustainable development; multi-criteria decision-making; Cameroon.

Résumé

Cette thèse aborde la problématique du stockage massif d'énergie dans les réseaux électriques pour l'intégration de l'énergie produite à partir des sources variables, dans le contexte global de la transition énergétique. Elle se focalise sur le cas du Cameroun avec pour objectif la formulation d'un point de vue objectif sur l'idée de promouvoir l'alternative pompage-turbinage pour une production durable d'électricité dans le pays. Pour atteindre ce but, certains aspects clés susceptibles de soutenir le besoin en stockage massif d'énergie au Cameroun ont été analysés. Par la suite, la faisabilité technique de l'alternative pompage-turbinage a été analysée par le biais d'un modèle d'analyse spatiale appliqué dans l'environnement du système d'information géographique. Enfin, la conformité des opportunités locales avec les exigences de durabilité a aussi été analysée au travers d'un modèle d'aide à la décision multicritères. Il ressort de cette étude que, le stockage massif d'énergie apparaît comme l'élément manquant dans la stratégie de développement du sous-secteur de l'électricité au Cameroun. Par ailleurs, la faisabilité technique de l'alternative pompage-turbinage est établie en territoire camerounais, avec une vingtaine de sites favorables identifiés, totalisant un potentiel d'environ 34 MWh. Enfin, un classement de l'intérêt que peut présenter certains de ces sites au sens du développement durable a été proposé. Il a donc été suggéré que le gouvernement du Cameroun travaille avec d'autres acteurs du secteur de l'électricité pour produire une feuille de route complète de stockage de l'énergie afin de valoriser les précieux atouts énergétiques du pays.

Mots-clés : Pompage-turbinage; énergies renouvelables; système électrique; développement durable; prise de décision multicritères; Cameroun.

Dedication

*Mes parents et mes enfants,
Aux premiers mes hommages et aux seconds mes souhaits !!!*

Préface

A la lumière de la transition vers un système énergétique global plus propre (ou plus précisément de la ruée vers les énergies renouvelables), le stockage d'énergie dans les réseaux électriques interconnectés apparaît telle une problématique particulièrement importante à traiter. Ceci dans le sens où, le stockage à grande échelle est appelé à jouer un rôle majeur dans le paysage énergétique d'aujourd'hui et de demain. Dans ce mémoire est présentée une thèse qui en fait porte sur le stockage hydroélectrique gravitaire encore appelé « pompage-turbinage » dans le contexte du Cameroun, sujet initié suivant la nouvelle orientation de l'enseignement supérieure au Cameroun, qui vise à mettre la recherche au service du développement national. Voici donc le fruit de quatre années pleines (Janvier 2016 - Novembre 2019) de travail passionné en attache avec le Laboratoire de l'Eau, Energie et Environnement (L3E) de l'Ecole Nationale Supérieure Polytechnique de Yaoundé (ENSPY), Université de Yaoundé I. Du fait du caractère pluridisciplinaire de ce sujet, les sinuosités du chemin parcouru vers les objectifs fixés au départ m'ont donné l'occasion d'explorer d'autres domaines avec lesquels je n'étais guère familiarisé au début des travaux. Il s'agit entre autres, de la gestion des systèmes électriques, les systèmes d'information géographiques, la géomatique, l'analyse multicritère, la limnologie, etc. Tout ceci s'est présenté à moi telle une salade de fruits exotiques et je m'en suis régalé avec avidité et satisfaction !!!

Alors, rendu au terme de ces travaux de thèse, je pense d'abord à mes directeurs de thèse, tous deux enseignants à l'ENSPY à qui je dois mon ascension dans le monde des sciences de l'ingénieur. Du fond de mon cœur il me revient que je n'aurais jamais pu bénéficier d'un encadrement académique meilleur que celui qu'ils m'ont sans peine accordé. Alors, dépit de ne pouvoir trouver de mots pour exprimer justement ma gratitude envers ces illustres Professeurs, très humblement je voudrais rendre hommage

- Au Professeur Emérite Jean NGANHOU, qui fut le premier à m'encourager sur le chemin de la recherche, après m'avoir enseigné en cycle Ingénieur. En tant que Directeur de mes travaux de Master Recherche et par la suite Directeur de thèse, le Professeur a fixé des objectifs dont il n'aurait pas été facile d'atteindre sans ses conseils et la rigueur scientifique et humaine qui lui est reconnue. Revivant dans ma mémoire nos premières séances de travail sur l'orientation du travail à faire, ce n'est qu'aujourd'hui que je comprends la portée des recommandations par lui faites ce jour.
- Au Professeur Joseph KENFACK, ce géant sur les épaules de qui j'ai pu atteindre des hauteurs inespérées. D'abord de m'avoir enseigné en formation d'ingénieur, ensuite de m'avoir enseigné et accepter de m'encadrer mes travaux de Master Recherche dès le

premier contact et surtout de m'avoir lancé dans cette belle aventure que fût cette thèse sur la très passionnante thématique du stockage de l'énergie, et de m'avoir guidé minutieusement jusqu'à la soutenance. Pour seulement ce bout de chemin, profiter de son expertise, de ses conseils et encouragements, de son carnet d'adresses, de sa disponibilité à temps et à contretemps pour des longues discussions téléphoniques, etc. a été d'une valeur inestimable pour parvenir à soutenir cette thèse.

J'exprime ma profonde gratitude envers tous ces Professeurs que j'ai côtoyés tout au long du processus d'évaluation de cette thèse. Leurs nombreux conseils et observations, et surtout leurs questions pertinentes ont chaque fois permis d'ouvrir de nouvelles pistes d'amélioration de mes travaux. Il s'agit précisément,

- D'une part, des membres du jury de soutenance que le Professeur Emérite Médard FOGUE m'a fait l'honneur de présider autant que les Professeurs Godpromesse KENNE, Lucien MEVA'A, Denis TCHEUKAM TOKO et Abraham KANMOGNE, qui n'ont ménagé aucun effort pour accepter les rôles d'examineurs.
- D'autre part, des membres du jury d'audition présidé par le Professeur Pierre MEUKAM assisté des Professeurs Paul Salomon NGOHE-EKAM et Bienvenu KENMEGNE.
- Enfin, un remerciement tout particulier au Professeur Denis TCHEUKAM TOKO de l'Université de Buea pour sa grande expérience qu'il a bien voulu m'apporter dans la synthèse des idées et la rédaction de ce mémoire de thèse.

Aussi je tiens à remercier les autres membres du L3E de l'ENSPY, enseignants et thésards dont les nombreuses critiques constructives au cours des séminaires de laboratoire m'ont permis, progressivement de relever mes lacunes et d'améliorer progressivement la qualité de mes travaux.

Des mots spéciaux de remerciement vont à l'endroit de Prof. Meng NI de Hong-Kong Polytechnic University rencontré à Edinbourg en février 2017, qui avait enrichi ma bibliothèque avec de nombreux articles sur le sujet alors que je n'étais encore qu'au début de ces travaux.

J'aimerais aussi saisir cette ultime opportunité pour remercier particulièrement certains camarades « Future Energy Leaders (FEL) » du Conseil Mondial de l'Energie qui n'ont ménagé aucun effort pour apporter leurs contributions à la réalisation de ces travaux, surtout la relecture des articles et des commentaires constructifs. Il s'agit de Dr. James CARTON, Sarine ABADO, Dr. Yousef ALSHAMMARI, et Célien FITOUSSI de la Suisse.

Mes amis, et plus particulièrement à Hermann TEGUEM, Aimé YOUNZO, Pierre Marial CHENDJOU, Colette Isabelle MAGAGOUM qui, de par leurs encouragements et soutiens

multiformes m'ont fait comprendre que l'aboutissement de ce projet de recherche n'importait pas que pour moi seul. Je leur dis chaleureusement merci !

Egalement, j'exprime ma gratitude envers ma famille avec en tête mes précieux parents, pour le soutien reçu d'elle. Je pense précisément aux encouragements de Gilles Patrick TAGOUH, au suivi de mes dossiers du côté de Yaoundé par Estelle MAJO, et à la révision de l'anglais de plusieurs de mes documents Valdès KOUDOUM.

Enfin, à tous ceux qui de près ou de loin, de quelle que façon que ce soit, ont contribué à la réalisation de ce travail et dont les noms n'apparaissent pas ici, recevez par ces mots mes sincères remerciements.

Table of Contents

Abstract	i
Résumé	ii
Dedication	iii
Preface	Erreur ! Signet non défini.
Table of Content	vii
List of Annexes	x
List of Figures	xi
List of Tables	xiv
Nomenclature	xvi
General Introduction	1
Chapter I. Context of the Study: Is Energy Storage the Missing Link in the Cameroon’s Energy Commitment?	5
I.1 The Global Energy Context	5
I.1.1 Energy and Climate Change	5
I.1.2 Dependence on Fossil Fuels and Related Issues	6
I.1.3 Emergence of New Trends in Energy Systems	7
I.1.4 Economic Structure of Power Systems: Electricity Markets	10
I.2 The Specific Context of Cameroon	12
I.2.1 The Power Sector in Cameroon	12
I.2.2 What does the Future Hold for the Power Sector in Cameroon?	20
I.2.3 Critical Need of Bulk Storage-type Projects in the Power System of Cameroon	22
I.3 Background of Energy Storage Systems	23
I.3.1 Main Components of a Storage Device	23
I.3.2 Energy Storage in a Power System	24
I.3.3 Energy Storage Systems (ESSs)	32
I.3.4 Classification of Energy Storage Systems	32
I.4 Why Pumped-Storage Hydropower? A Technological Review	34
I.4.1 Historical development of PHEs	34
I.4.2 Overview on the PHEs Technology	35
I.4.3 Classification of PHEs Plants (PHESP)	38
I.4.4 Literature review on Pumped Hydro Energy Storage	41
I.5 How could PHEs Work in Cameroon?	50
I.5.1 At the Daily Scale	50

I.5.2	At the Seasonal Scale	51
I.6	Potential Benefits Associated with the Integration of PHES in the Power System of Cameroon	52
I.6.1	Economic Benefits	52
I.6.2	Social Benefits.....	54
I.6.3	Environmental Benefits.....	54
I.6.4	Technical Benefits.....	54
I.7	Conclusion.....	55
Chapter II.	An Assessment of Small Pumped Hydroelectric Energy Storage Potential in Cameroon	56
II.1	Introduction	56
II.2	Review of Existing Methods for Assessing PHES Potentials.....	57
II.3	Geographic Information Systems.....	59
II.4	The Adopted Methodology	61
II.4.1	Overview of the Methodology	61
II.4.2	Explanation of Main Steps	62
II.4.3	Assumptions Made.....	72
II.5	Application of the Method to Cameroon.....	72
II.5.1	Accessed Data Sources and Materials.....	72
II.5.2	Delineation of Promising Regions for Reservoirs Detection.....	76
II.5.3	Detection of Reservoirs and Estimation of Sites Potentials.....	81
II.5.4	Determining the Country Global Storage Potential	82
II.5.5	Categorisation of Identified PHES Candidate Sites.....	83
II.6	Geological Considerations of Retained PHES Candidate Sites in Cameroon	89
II.1	Qualitative Analysis of Identified PHES Candidate Sites	90
II.2	Conclusion.....	94
Chapter III .	Multi-Criteria Analysis of Prospective Pumped Hydroelectric Energy Storage Sites in Cameroon	95
III.1	Introduction	95
III.2	Background of Multi-Criteria Analysis and Decision Making	96
III.2.1	MCDM Methods Classification	96
III.2.2	Leading MCDM Methods	97
III.2.3	Applications of MCDM Methods	99
III.3	The PHESP Site Selection MCDM Problem	103
III.3.1	Definition of Decision Factors and Criteria	103

III.3.2	The MCDM Model of the Problem under Consideration	105
III.4	The Proposed Methodology	106
III.4.1	Methodology's Steps.....	106
III.4.2	The Integrated Approach of the Decision-Making Process	108
III.4.3	Addressing the Sustainability.....	117
III.4.4	Sensitivity Analysis.....	118
III.5	Application to the Western Regions of Cameroon.....	118
III.5.1	The Study Area.....	118
III.5.2	Data Collection and Pre-processing	120
III.5.3	Construction of Quantification/Standardisation Models.....	126
III.5.4	Decision-Making Implementation.....	127
III.5.5	The Sensitivity Analysis.....	131
III.6	Conclusion.....	136
General Conclusion and Perspectives		137
General Conclusion.....		137
Limitations and Perspectives.....		138
Some Barriers and Suggestions.....		139
References		141
Annexes		160
Appendices		173
Publications and Other Scientific Activities		173
Curriculum Vitae.....		174

List of Annexes

Annexe 1: State of Cameroon's hydropower infrastructure.....	160
Annexe 2: Identified small-hydropower potential in Cameroon.....	161
Annexe 3: Hydroelectric dam projects to be developed in Cameroon.....	162
Annexe 4: Solar PV power Potential of Cameroon.....	164
Annexe 5: Brief summary of the review of multi-criteria decision-making methods in the domain of pumped hydro-energy storage plant siting.	165
Annexe 6: Main technical socio-environmental characteristics of preselected prospective sites pumped hydro-energy storage in Cameroon.	166
Annexe 7: List of all acceptable connections.	167
Annexe 8: Electricity map of Cameroon.	169
Annexe 9 : Full list of water bodies referred to as lakes in Cameroon.	170
Annexe 10: Hydrologic map showing main rivers in Cameroon.....	171
Annexe 11: Terrain model as used by the method for sites detection.....	172

List of Figures

Fig. 1 : Geographic map of Cameroon [5].....	2
Fig. 2 : General structure of the dissertation.....	4
Fig. 3 : World anthropogenic greenhouse-gas emissions quantified by CO ₂ equivalent and divided by source, including LULUCF for the year 2017.....	6
Fig. 4 : Power distribution system.	9
Fig. 5 : Evolution of developed hydro-capacity in Cameroon.....	15
Fig. 6 : Existing hydro-plants in the Sanaga catchment area.....	16
Fig. 7 : Average daily load profile of the month of March 2018 on the Southern Interconnected Grid.....	18
Fig. 8 : Average yearly load profile on the Southern Interconnected Grid	18
Fig. 9 : Electricity demand projection for Cameroon considering the business as usual Scenario	20
Fig. 10: Schematic structure of an energy storage system	23
Fig. 11 : Schematic diagram of the position of an energy storage device within a power system (a) conventional (b) series connected	24
Fig. 12: Benefits of EES along the electricity value chain	26
Fig. 13: Operating modes or regimes of energy storage.....	29
Fig. 14: Energy balance in the storage system.....	30
Fig. 15: Typical pumped-storage hydropower plant Arrangement.....	36
Fig. 16: Models of open-loop (a) and closed-loop (b) pumped energy storage plants.....	38
Fig. 17: Principle diagram of an Underground PHES plant.	39
Fig. 18: Arrangement of the main components of a ternary unit.....	40
Fig. 19: Conceptual wind power based pumped hydroelectric storage (PHES) system.....	42
Fig. 20: Solar PV-powered PHES system schematic	45
Fig. 21: A hybrid solar-wind system with pumped storage system.....	47
Fig. 22: Load profile of the SIG with the proposed integration of pumped storage.....	51
Fig. 23: Illustration of the complementary seasonal variation of generating capacities and the solar potential in the area of the southern interconnected grid in Cameroon.....	51
Fig. 24: Procedures for assessing the PHES potential.	61
Fig. 25: Conceptual model for delineating promising regions for reservoirs detection.	63
Fig. 26: A high altitude lake used as upper reservoir for PHES.....	65
Fig. 27: An existing hydropower reservoir, which can be used for other purposes including pumped-storage.	65

Fig. 28: Example of dammed stream used as lower reservoir in PHES scheme in northwest Pennsylvania, US.....	66
Fig. 29: Examples of closed terrain depressions used as reservoirs.	67
Fig. 30: Examples of reservoirs dams built in open terrain depressions	67
Fig. 31 : Examples of upper reservoirs with a man-made reservoir wall.	68
Fig. 32: Geometry of a PHES connection.....	70
Fig. 33: Representation of the search area around a waterbody as considered in this study.	72
Fig. 34: SRTM terrain model of Cameroon in mosaicked tiles.....	74
Fig. 35: The two approaches of the lake’s volume theoretical estimation.	75
Fig. 36: Comparison of the two techniques considered in this study for lake volume estimation. ...	76
Fig. 37: ArcGis model for the creation of a territorial mask delimiting the area deemed acceptable for terrain analysis in the country.....	77
Fig. 38: ArcGis model for obtaining in the geographical area of an SRTM DEM tile, the regions favourable for the detection or construction of reservoirs.....	78
Fig. 39: Satellite image of Lagdo Lake visualized through Google Earth Pro.	79
Fig. 40: Lake mapping from a GIS data transfer from Google Earth to ArcGis.	79
Fig. 41 : Definition of the 4km-buffer zone around the water body and extraction of the geographic mask of the area of interest.....	80
Fig. 42: Use of the geographic mask for the extraction of the digital elevation model of the area of interest.	80
Fig. 43: Delimitation of the area of highest altitude (promising area) and transfer to Google Earth for terrain visualization.....	81
Fig. 44: Example of contours map as extracted using the ArcGIS software.	81
Fig. 45: Contribution of sites to the country potential.	83
Fig. 46: Distribution of the river-based (T6-scheme) sites storing capacity.	84
Fig. 47: Distribution of storage capacity of sites based on artificial lakes.	85
Fig. 48: Shares of subgroups of sites following the lake’s position in the PHES scheme.	86
Fig. 49: Proportion of the storage capacity of T2-sites using lakes as lower reservoirs.	87
Fig. 50: Contribution of T2-sites using lakes as Upper Reservoirs.	87
Fig. 51 : Pumped back hydro energy storage configuration.	88
Fig. 52: Sketch of a lake used as a water source for a PHES system.	88
Fig. 53: Contribution of the different schemes to the total potential.	89
Fig. 54: An indication of the Cameroon volcanic line.....	90
Fig. 55: Head and Head-Distance Ratio of connections.....	91

Fig. 56: Classification of the sites following the gross head level.	93
Fig. 57: Distribution of the storage potential based on the nature of the connections.....	94
Fig. 58: General schema of (a): MADM and (b): MODM methods.....	96
Fig. 59: Multiple-criteria decision analysis methods decision tree.	98
Fig. 60: Tree-structure of factors and criteria of the PHESP sites ranking problem.	103
Fig. 61: PHESP site selection decision-making problem model.	106
Fig. 62: Flowchart of the proposed decision model for PHESP site selection.	107
Fig. 63: Fuzzy membership function: (a) increasing and (b) decreasing.....	110
Fig. 64: Schematic of hierarchy in AHP.....	111
Fig. 65: ELECTRE III steps.	115
Fig. 66: MCDM models facing compensability and sustainability	117
Fig. 67: Geographical position of the studied area and preselected PHES sites.	119
Fig. 68: Geology of study area.....	122
Fig. 69: Power lines proximity map.....	122
Fig. 70: Main roads map of the study area.	123
Fig. 71: Earthquake epicentres in the study area.	123
Fig. 72: Urban areas in the study area.	124
Fig. 73: Average wind speed recorded in the study area.	124
Fig. 74: Solar horizontal irradiation in the study area.	125
Fig. 75: The fuzzy MF associated to “Proximity with urban areas” criterion.	126
Fig. 76: Initial ranking of alternatives.	131
Fig. 77: Three ranking perspectives: (a) Economic; (b) Social; (c) Environmental.....	132
Fig. 78: Sensitivity of the initial ranking to +/- 10% variation of thresholds.....	133
Fig. 79: Sensitivity of the economic ranking to +/- 10% variation of thresholds.....	133
Fig. 80: Sensitivity of the social ranking to +/- 10% variation of thresholds.....	134
Fig. 81: Sensitivity of the environmental ranking to +/- 10% variation of thresholds.	134

List of Tables

Table 1 : List of hydro reservoir dams currently in functioning in Cameroon.	17
Table 2 : Grid-connected power plants in Cameroon.....	17
Table 3 : Some major wind/solar renewable energy projects involving grid connection.....	21
Table 4 : Main applications of energy storage systems.....	25
Table 5 : Summary of Transmission and Distribution energy storage benefits.....	27
Table 6 : Classification of ESSs based on discharge times.	33
Table 7 : Classification of energy storage technologies based on power and storage.....	34
Table 8 : Top-12 of PHEs leaders countries.	35
Table 9 : Technical characteristics of PHEs. Information obtained from	37
Table 10: Assumptions made for justifying the investment in a pumped-hydro plant compared with existing thermal plant for peaking generation.	52
Table 11: Possible topologies for assessing large-scale PHEs.....	59
Table 12: Definition of reservoirs reference types considered in the study.	64
Table 13: Topology of sites in accordance with matched reservoirs.....	69
Table 14: Calculation formula of Connection Volume.	71
Table 15: Limitations for different connection parameters.	71
Table 16: Summarising of retained T6-sites.....	84
Table 17: Summarising of candidate sites based on artificial lakes (T5-scheme).....	85
Table 18: Summary of candidate sites based on natural lakes (T2 & T3-schemes).....	86
Table 19: Grouping of connections and sites.....	92
Table 20: Steps in the Proposed Methodology.	108
Table 21: The fundamental Saaty's scale for the comparative judgments	112
Table 22: The average consistencies of random matrices (RI values)	113
Table 23: Formats and sources of some obtained data.	121
Table 24: Parameters values of fuzzy membership functions for quantitative criteria.	126
Table 25: Five point Likert-type scale values for qualitative criteria.....	127
Table 26: Initial AHP-pairwise comparison matrix of the three SD factors.	127
Table 27: AHP-pairwise comparison matrix of economic criteria.	128
Table 28: AHP-pairwise comparison matrix of social criteria.	128
Table 29: AHP-pairwise comparison matrix of environmental criteria.	128
Table 30 : Performance matrix obtained for the case study.	129
Table 31: Preference thresholds for the initial ranking.....	129
Table 32: Credibility Matrix of the ranking.....	130

Table 33: Ranking matrix.	130
Table 34: Weight values assignment for different ranking perspectives.	131
Table 35: Preference thresholds for the initial ranking and the sensitivity analysis.....	132
Table 36: Comparison of the obtained result with those obtained using some existing PHES sites ranking metrics.	135

Nomenclature

General abbreviations

AER :	Agence d'Electrification Rurale	MCA:	Multi-criteria allocation/analysis
AES-		MCDM:	multiple criteria decision-making
SONEL :			
AHP:	analytic hierarchy process	MF:	membership function
ALUCAM:	Aluminium du Cameroun	MINEE:	Ministère de l'Eau et de l'Energie
ARSEL :	Agence de Régulation du Secteur de l'Electricité	MODM:	multi-objective decision making
COP:	Conférence des Parties	MOLA:	Multiple-objective land allocation
CREF:	Cameroon Renewable Energy Fund	MSW:	municipal solid waste
CVL:	Cameroon Volcanic Line	NDC :	Nationally Determined Contribution
DEM:	Digital Elevation Model	NIC:	National Institute of Cartography
DFMF:	Decreasing fuzzy membership function	NIG :	Northern Interconnected Grid
DG :	Distributed Generation	OWA:	Ordered weighted averaging
DM:	decision maker	PDSE:	Energy Sector Development Plan
DPDC:	Dibamba Power Development Company	RHAM:	Rapid Hydropower Assessment Model
EDC:	Electricity Development Corporation	SA:	Simulated annealing
EIG :	Eastern Interconnected Grid	SD:	Sustainable Development
ELECTRE:	ELimination Et Choix Traduisant la REalité	SDG :	Sustainable Development Goal
ENEO:	Energy of Cameroon	SETIS:	Strategic Energy Technologies Information System
ENSP :	Ecole Nationale Supérieure Polytechnique	SIG:	Southern Interconnected Grid
ErDF :	Electricité Réseau Distribution France	SMA:	Spatial Multi-criteria Analysis'
EV :	Electric Vehicles	SNI:	National Investment Corporation
FAW:	Fuzzy additive weighting	SONATREL :	Société Nationale de Transport d'Electricité
FEL:	Future Energy Leader	SRTM:	Shuttle Radar Topography Mission
GA:	Genetic algorithms	TOPSIS:	Technique for Order Preference by Similarity to Ideal Solution
GDP:	Gross Domestic Product	TV :	Television
GEG :	Gaz et Electricité de Grenoble	UNESCO:	United Nations Educational, Scientific and Cultural Organization
GESP :	Growth and Employment Strategic Paper	USA :	United States of America
GIS:	Geographic Information System	USACE:	United States Army Corps of Engineers
HYSACAM:	Hygiène et Salubrité du Cameroun	USGS:	US Geological Survey

IFMF:	Increasing fuzzy membership function	VIKOR:	Vlsekriterijumska Optimizacija I Kompromisno Resenje
KPDC:	Kribi Power Development Company	WDPA:	World Database Protection Areas
L3E :	Laboratoire Eau, Energie et Environnement	WEC :	World Energy Council
MADM:	multi-attribute decision making	WLC:	Weighted linear combination

Particular abbreviations

BAM :	Bamendjin	ENE :	Enep
BAM :	Bambili	MBA :	Mbatu-dam
BAN :	Banefo	MEN :	Mentchum
BEN :	Benakuma	NYI :	Nyi
EC :	Economic	OKU :	Oku
ELU :	Elum	PET :	Petponoun
EN :	Environmental	SO :	Social

Energy, economics, and other units

Ah :	Ampere hour	IPP:	Independent Power Producer
ATES :	Aquiferous Thermal Energy Storage	Km:	kilometre
BES :	Batteries Energy Storage	kV :	Kilo Volt
BOP :	balance of plant	kVA :	Kilo Volt-Ampere
BP :	Bridging Power	kWp :	Kilo Watt-peak
CAES :	Compressed Air Energy Storage	LCE:	levelized cost of energy
CCGT:	Combined Cycle Gas Turbines	LPSP :	loss of power supply probability
CDCS :	charge-discharge control system	m/s :	Metre per second
CES :	Cryogenic Energy Storage	masl :	metre above sea level
CS :	Central Store	Mtoe :	Million tonne of oil equivalent
CSP :	Concentrated Solar	MW :	Mega Watt
DC :	Direct Current	OCGT :	Open Cycle Gas Turbines
EE :	Energy Efficiency	PHES :	Pumped Hydroelectric Energy Storage
EM :	Energy Management	PHESP :	PHES Plant
ESS:	Energy Storage System	PPA:	Power Purchase Agreement
FCS :	Fuel Cells Systems	PQ :	Power Quality
FES :	Flywheel Energy Storage	PTS :	Power Transformation System
GHG :	Greenhouse Gas	PTU:	Programme Thermique d'Urgence
GL:	Giga litre	PV :	Photovoltaic
GW :	Giga Watt	RE :	Renewable Energy
GWh :	Giga Watt-hour	SCES :	Supercapacitor Energy Storage
HESS :	Hydrogen Energy Storage System	T&D :	transmission and distribution
HPES :	Heat-Pump Electrical Storage	TSO :	Transmission System Operator
HTES :	Hot Thermal Energy Storage	TWh:	Tera Watt-hour

HVAC :	heating/ventilation/air conditioning	US\$:	United States of America Dollar
IEA :	International Energy Agency	W/m ² :	Whatt per square metre
IPCC :	Intergovernment Panel on Climate Change	W-PV:	Wind-Solar Photovoltaic

Symbols and description

CI:	Consistency Index	P_{des} :	Desired power flow from the storage device
CO ₂ :	Carbon dioxide	P_s :	Power capacity of the plant
CP _i :	Construction parameters	P_s :	Active power from central store
CR:	Consistency Ratio	PWSRP:	Power system regime parameters
E _C :	Energy charged in the central store	Q_{gen} :	Reactive power generated by the supply side
E _D :	Energy discharged from the central store	Q :	Reactive power consumed by the demand side
E _{gen} :	Energy generated by the power system	Q_s :	Reactive power from central store
E _i :	Energy consumed by the power system	t:	Current time
E _{PTS} :	Energy flow through PTS	t_c :	Charge duration
E _s :	Energy capacity of the Central Store	t_d :	Discharge duration
f _{CDCS} :	Mathematical model of the CDCS	t_s :	Storing duration
f _{CS} :	Energy storage function	VP _i :	Variable parameters
f _{PTS} :	Mathematical model of the PTS	δE_C :	Energy losses during charge
L _i :	Active power consumed by the demand side	δE_D :	Energy losses during discharge
N _{gen} :	Active power generated by the supply side	δE_S :	Energy losses during storing
P _C :	Charge or restoring capacity	η_C :	Charging mode efficiency
P _{CS} :	Power flow from central store	η_D :	Discharging mode efficiency
P _d :	Discharge or generating capacity	η_S :	Storing mode efficiency

General Introduction

“Energy storage is an essential part of any physical process, for without storage all events would occur simultaneously; it is an essential enabling technology in the management of energy.”

Dr. A. Ter-Gazarian, 1994 [1]

This research will contribute in considering this thought of Dr. Ter-Gazarian in the future management of energy in Cameroon. It has been initiated at the Laboratory of Energy, Water and Environment (L3E) of the National Advanced School of Engineering (ENSPY) of the University of Yaoundé I under the instigation of new orientation of the higher education in Cameroon. That orientation is overall to make academy an enabling tool for the country sustainable development. Therefore, the main idea motivating the orientation of this research is to reach new frontiers of the country's explored energy potential as part of the contribution of the academy to the government's ambition to make Cameroon an emerging country by 2035. The government's policy to reach that objective proceeds stepwise. The objective of the first ten-year period (from 2010 to 2020) was published in 2009 as the 'Growth and Employment Strategy Paper (GESP)' [2]. Throughout this document, the government's strategy is to rely on the country's energy assets to cover its internal needs for modern energy services in the short or medium term and, at the sub-regional level, to become an energy exporter to some of its neighbours such as Nigeria, Chad, Equatorial Guinea, etc.

Cameroon (shown in Fig. 1) is a Central African country in the Gulf of Guinea, between the 2nd and 13th northern parallels and between longitudes 9° and 16° east. With a surface area of 475,650 square kilometres, its population is estimated at 23.5 million people (2016), with a growth rate of 2.5% [3]. Cameroon is a globally stable country endowed with huge energy resources-both fossils and renewables-which remain almost untapped. Poor energy access (energy consumption in Cameroon is one of the lowest globally, about 342 kg of oil equivalent per capita) is pointed as a hindrance to the country's economy growth that has been steady (4% on average), somehow below the expectation throughout the last decade. Biomass, which is abundant and to a certain extends renewable and affordable, is still used by the majority of Cameroonian as the main energy source [4] for cooking and heating purposes. Access to electricity in Cameroon is at the lowest (281 kWh per capita per year) compared with other countries of the world. According to the World Energy Outlook (2016), only 54% of the Cameroonian population has access to electricity, with an average of 88% in urban areas versus only 17% in rural areas. However, the government's ambition as detailed throughout the GESp is to ensure sustainable access to energy for all Cameroonians by

2035. The fulfilment of this ambition relies on major infrastructural development, including the power sector [2].



Fig. 1 : Geographic map of Cameroon [5].

Cameroon is blessed with the second largest hydropower potential in central Africa but the exploited share of that potential hardly reaches 5% although the country is facing important challenges in meeting the increasing power demand [6]. All potential hydropower plant sites so far identified across the country are intended for conventional hydro schemes, hydropower dams or run-off-river hydropower plants. Of course it is noteworthy that the current estimation of Cameroon's energy assets still relies on some studies performed before 1980s such as that from C. Steedmann on renewable energy possibilities in Cameroon in 1979 [7]. Obviously, those energy possibilities were shaped at a period far from the current dynamics of modern national energy systems, that the development has been seriously impacted by the issue of climate change. In fact, decarbonising power systems is becoming trendier with at the heart of debates the promotion of renewable energy sources to replace polluting alternatives based on fossil fuels. However, it appears that, high share of intermittent renewable energy sources disrupts the reliability and the proper operation of the electric grid. Research has demonstrated that energy storage systems are suitable for confirming the validity of renewable power sources. Among others energy storage technologies, Pumped Hydroelectric Energy Storage (PHES) is the only mature, proven and most widely used utility-scale electrical energy storage technology with over 300 plants worldwide [8]. It dominates total installed storage capacity integrated into power systems, with 97% of the total of 176 GW installed globally in mid-2017 [9], [10]. In addition, substantial projects have proven the feasibility of PHES for renewable energy power supply [11]. It is demonstrated that PHES can

provide a wide spectrum of services for supporting the operation of the grid. The longevity of PHES installations also aids the long-term planning and development of power systems. The main challenge is the physical requirements of the site, needing both suitable topography and water availability and there can also be social and ecological issues. So far, no massive electricity storage scheme has been experimented with, or even envisaged in the development perspectives of the power sector in Cameroon. This situation creates a lot of uncertainty about the capacity of the power system to accommodate the numerous independent power generation projects, especially since many of these projects are based on variable resources.

The main objective of this thesis is to answer the question of whether the idea of promoting the PHES alternative can be validly defended in the power system of Cameroon. In other words, the aim is to analyse the validity of the question of PHES in the energy debate in Cameroon. The findings should therefore allow the formulation to the attention of decision-makers and policy-makers, an objective opinion which may be favourable or unfavourable to the promotion of pumped-storage hydropower with regard to the specific context of Cameroon. To answer this central research question, the approach adopted consists in analysing in the context of Cameroon, firstly the necessity or need for bulk energy storage in the power system, secondly the possibility or technical feasibility of the technology and thirdly, a deep understanding of the local opportunities. The main objective above is therefore subdivided into three sub-objectives, each corresponding to one of the stages of the approach.

- As first sub-objective which is related to the need for massive energy storage in Cameroon's power system, the work aims at assessing the potential role of storage-type hydropower plants in the country. This means that a conclusion will have to be drawn as to the need for the development of pumped storage, following an analysis of the power system, considering its current situation, its projected development and also feedback from the literature.
- As second sub-objective it will be established, if possible, the technical feasibility in Cameroonian territory of PHES, the implementation of this technology being highly constrained by the existence of favourable sites. It will therefore be a matter of proving the technical feasibility of this energy storage technology through the identification of sites deemed favourable and the assessment of the achievable storage potential, or declaring it unfeasible in case such sites have not been identified.
- As a third sub-objective, the work will aim to deepen the knowledge of the sites that might be identified in the second sub-objective. In concrete terms, the aim will be to position oneself in a sustainable development perspective in order to analyse the relevance of the

sites under consideration on the basis of as many criteria as possible that can differentiate two candidate sites for the construction of a PHES plant.

To reach the objective presented above, the core of this thesis is articulated over the three following chapters, each of them being built to cover a unique challenge defining one the abovementioned sub-objective. This means the dissertation is structured as in Fig. 2.

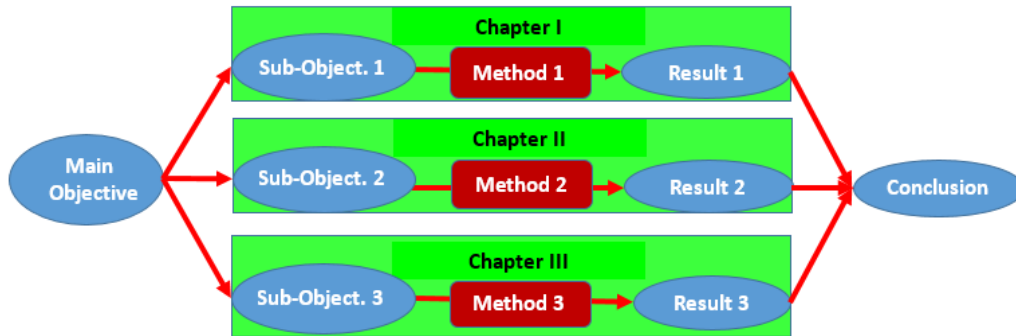

Fig. 2 : General structure of the dissertation.

Then, each chapter could contain an independent and focused introduction or background/literature review, eventually a methodology and a conclusion. This means the three next chapters are of the most relevance to this dissertation. Chapter I places the study in its overall context, with an overview of the status of electricity storage in the breakthrough of renewables in modern power systems. It also addresses the general and theoretical notion of large-scale energy storage with a focus on pumped-hydro storage. Finally, PHES is discussed in terms of the potential benefits that its development could present as a means to overcome some of the challenges that the power system in Cameroon could face through its long term operation. This should lead to a conclusion on the need to consider utility-scale energy storage schemes in the specific context of Cameroon. Chapter II focuses on a geographical search for positions favourable to siting PHES plants and also, proceeds to an estimation of the storage capacities achievable by detected sites. Then a method for detecting suitable sites is proposed and applied to the case of Cameroon for the foremost estimate of a small-scale pumped-hydro storage potential. Chapter III focuses on an in-depth analysis of the PHES opportunities identified in the previous chapter. The aim is to take into account as many criteria and factors as possible that can differentiate such project opportunities, in order to be able to define a ranking metric between them. A multi-criteria decision-making methodology is therefore developed and applied so as to allow the best PHES site selection. To finish, a general conclusion will summarise the partial conclusions generated from separated chapters and in particular, barriers to the promotion of PHES will be targeted from the weakness of policies and the legal framework in Cameroon, and ideas to overcome them will be suggested. Some guidelines for further works and perspectives to this thesis will be highlighted as well.

Chapter I

Context of the Study: Is Energy Storage the Missing Link in the Cameroon's Energy Commitment?

I.1 The Global Energy Context

I.1.1 Energy and Climate Change

According to the Intergovernmental Panel on Climate Change (IPCC), the authoritative scientific voice on climate change, “without active efforts to reduce emissions, the planet is expected to warm by an unprecedented 2.5 to 10°F during the 21st century. This rate of warming is much larger than the observed changes during the 20th century and is very likely to be without precedent during at least the last 10,000 years” [12]. In fact, the quest for energy has created greenhouse gases (GHG) emission problems which have contributed greatly to global warming. Emissions of GHG such as carbon dioxide, methane, and others, have increased dramatically in the last century through fossil fuel burning and land use changes. Human activity has pushed atmospheric concentrations of carbon dioxide, the chief greenhouse gas, to more than 30% above pre-industrial levels, 370 parts per million today compared to about 280 in 1750 [13]. As illustrated in Fig. 3, CO₂ from energy production creates 58.5% of the world's GHG emissions alone and hence the IPCC have concluded since 2005 that “all assessed stabilisation scenarios concur that 60 to 80% of the reductions over the course of the century would come from energy supply and use and industrial processes”.

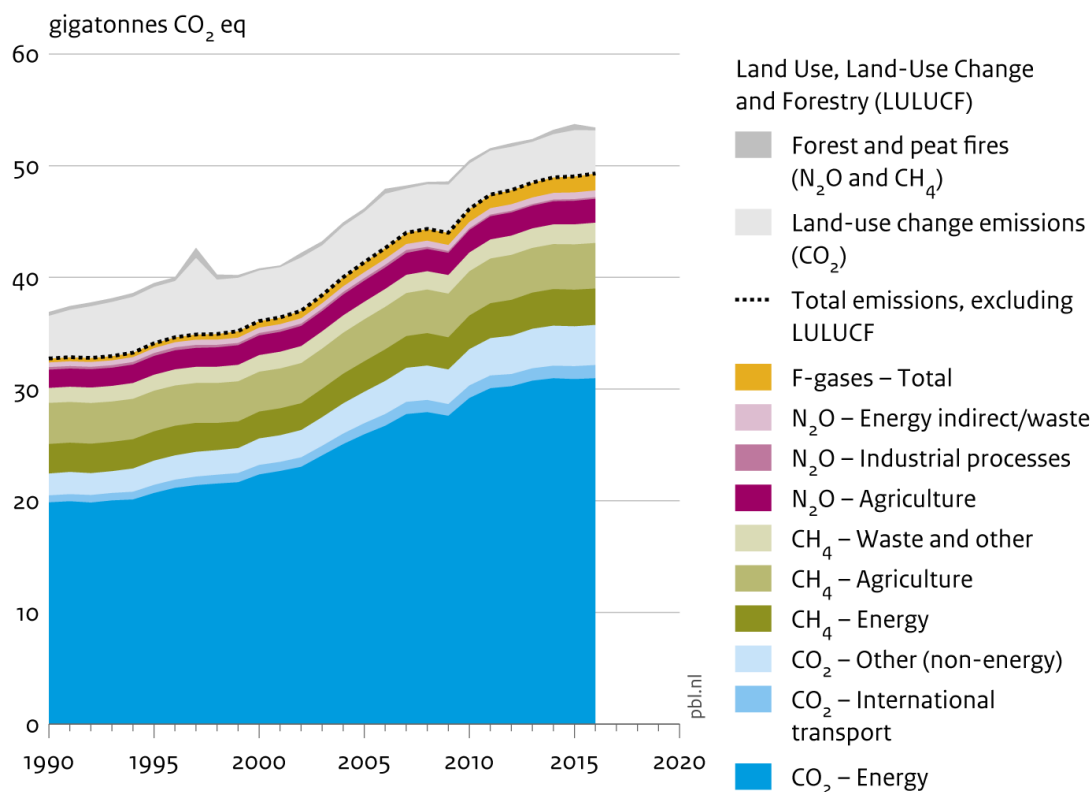

Fig. 3 : World anthropogenic greenhouse-gas emissions quantified by CO₂ equivalent and divided by source, including LULUCF¹ for the year 2017[14].

This means humanity has to keep acting towards decarbonising the energy production systems in order to protect our planet’s climate from irreversible changes which is likely to occur over the next century. Incontestably, energy from fossil fuels has to be replaced by cleaner energies in the way to save the world from climate change catastrophes, by helping to keep the temperature variation on earth surface below 2 degrees by the end of this century.

I.1.2 Dependence on Fossil Fuels and Related Issues

Meanwhile, the current scale of world’s dependence on fossil fuels for power supply remains too important. In fact, taking year 2007 as example, 81.4% of the world’s energy was produced from fossil fuels, which included 20.9% from gas, 26.5% from coal, and 34% from oil, with almost all of the remainder coming from renewables and waste (9.8%), nuclear (5.9%), and hydro (2.2%) [12]. Besides, the world’s global energy demand estimated at 12,029 Mtoe in 2007 is expected by the International Energy Agency (IEA) to grow to 17,014 Mtoe (142%) in 2030, with fossil fuels then accounting for 80.5% of supply. This overdependence on fossil energy resources rises a concern on the availability of such resources in the future because, the assessments of fossil fuels reserves performed by oil companies indicated that there is overall less than 100 years of oil, gas

¹ Land use, Land-use change, and Forestry.

and coal remaining worldwide, which could be cost-effectively exploited based on 2009 consumption levels [15]. It is noteworthy to underline the unequal distribution of existing fossil resources across world's geographies. In fact, if about 90% of global oil reserves are located within 15 countries and 90% of global gas reserves are located within 20 countries [15], the global energy demand is not concentrated in these countries. As result, politically sensitive issues would continue rising if the world maintains the overdependence on fossil fuels which are depleting.

I.1.3 Emergence of New Trends in Energy Systems

I.1.3.1 Penetration of Renewable Energy Sources in Power Systems

According to IEA, renewable energy is energy that is derived from natural processes that are replenished constantly. In its various forms, it derives directly or indirectly from the sun, or from heat generated deep within the earth. Included in the definition is energy generated from solar, wind, biomass, geothermal, hydropower and ocean resources, and biofuels and hydrogen derived from renewable resources. Characteristics of the renewable energy production highly depend on the converted resource properties. In particular, the variability, the limited predictability and the geographical distribution of renewable energy sources are characteristics that distinguish renewable energy production from conventional generation. Renewable energy technologies are environmentally benign and abundant. These benefits make them an attractive electricity generation alternative for mitigating climate change and addressing energy crises [9]. The progressive penetration of renewable energy into modern power systems makes it possible to improve the security of energy supply by reducing countries' energy dependence. In addition, to increase economic efficiency, power systems are nowadays operated within a liberalized electricity sector, under market conditions. Electricity is thus treated as a tradable product, characterized by its quality and reliability [16].

The electricity generation from renewables results from the energy conversion of non-regulated resources, from existing flows of energy from on-going processes. Depending on the type of their resource, renewable energy units can generate electricity constantly or in a variable way, with fluctuations. In particular, wind, photovoltaic and wave power generation are characterized by the natural variability of the energy resource, whereas biomass and hydro power generation (excepting the run-of-the river hydro) can be dispatched based on system requirements [6]. Biomass and hydro power units can thus be considered as conventional units from the power generation management point of view.

Regarding power generation from wind, photovoltaic, and wave, it can be more precisely described as intermittent generation. The term intermittent refers here to the interruption or periodic stopping

of the resource, from the definition in [7]. The intermittency is due to the atmospheric dynamics. The study of the different effects resulting from atmosphere dynamics is a complex subject which refers to meteorology. The intermittency level depends on the renewable energy technology and the natural cycles of the renewable sources [17].

I.1.3.2 Distributed Generation

A key feature of some of renewable energy resources is that they are geographically distributed and presenting a low density on each position site although they are found in huge quantity in nature. This is the case for wind or solar photovoltaic power. In order to capture this energy and convert it to electricity, small-scale converters are spread in many sites and connected into the power system. In the case of the power generation from biomass, the resource cannot be transported long distances without incurring unreasonable cost, because of its low energy density, and, consequently, most biomass units are small-scale units [16]. As a result, most geographically spread renewable energy power units are connected to the distribution network. This introduces the notion of distributed generation (DG) defined by the IEA as a system that consists in generating plants serving a customer on-site or providing support to a distribution network, connected to the grid at distribution-level voltages [18]. It appears from this definition that most renewable energy plants can be referred to as DG units. This is because of their network connection and not the technology they use or the capacity they have [19]. From this definition, the distributed generation units are separated from the units which are connected directly to the transmission network. Different aspects distinguish distribution from transmission networks. First, distribution networks are operated at medium or low voltage, while transmission networks are operated at high voltage. Also, the goal of the two networks is different: the transmission network aims at transporting power generation over long distances, whereas the distribution network aims at delivering the power generation to the consumers.

In line with the orientation given by Sustainable Development Goal n° 7 which advocates universal access to modern energy services, the initial trend was to improve access to electricity through grid extensions. However, economic constraints linked both to the cost of building lines, which were sometimes too long, and to online energy losses, required networks restructuring. From now on, policies are oriented towards energy production as close as possible to the centres of consumption with interconnections, to the extent possible of production centres. This new trend that is referred to as DG creates a new grid structure that the difference with the traditional one is illustrated in Fig. 4.

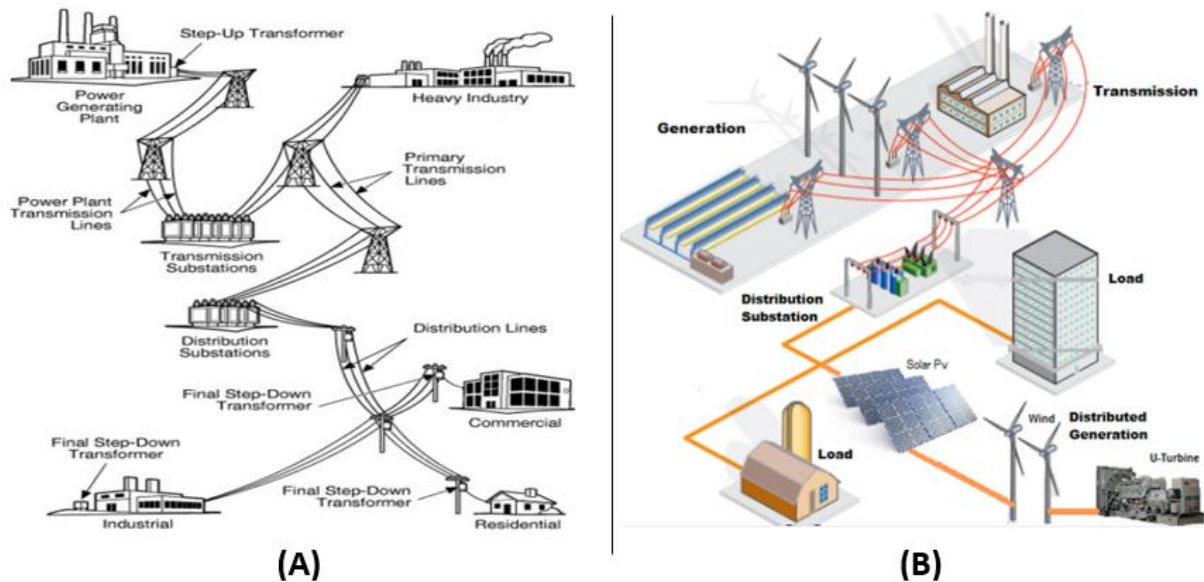

Fig. 4 : Power distribution system: Traditional (A) and with Distributed Generation (B)[20].

DG is expected to become more important in the future generation system [21]. The penetration level of DG units in the distribution system is increasing rapidly due to high rate of global electricity consumption. With the recent trend of technological advancement, DG has contributed with a substantial part of global electricity generation at reduced cost and high efficiency. The application of DG in a modern power system helps consumers to meet their load requirements at a reasonable quality and continuity since DG technologies are more efficient and reliable [22]. DG units may increase the flexibility of the power system while reducing transmission losses; they may also be an alternative to transmission grid reinforcement. More general benefits and issues resulting from DG deployment are explained in [19]. It goes without saying that network-connected energy storage facilities are somehow similar to DG units, as they operate, alternatively as charge or as generator, and potentially at various points of the grid, as we will see later in this chapter.

I.1.3.3 The issue of Sustainability in Modern Power Systems

In general, sustainability refers to an equitable management of limited resources and opportunities in the interconnected context of the economy, the society, and the environment. It aims at the well-being of everyone, now and in the future, admitting that needs in the future can be completely different than what can be imagined at the moment [23]. In the domain of energy, sustainability is commonly defined in terms of efficiency, reliability, and socio-environmental impacts. Then, the sustainability of a power system can be evaluated through its ability to ‘generate enough power for everybody’s needs at an affordable price’ and to ‘help supply the clean, safe and reliable electricity’ [24].

In modern power systems, the ever-increasing penetration of renewable energy, especially from intermittent and fluctuating sources, has given rise to a range of planning and operational problems. The difficulty here is to be able to provide the energy consumer with a reliable service in terms of quality and quantity in an economically acceptable way. At the same time, the energy needs whose growth naturally follows that of the economy have not ceased to force decision-makers to use conventional energy sources with significant impacts on the environment [25]. As viewed in I.1.2, the worldwide accelerated growth of the energy consumption is still highly dependent on finite fossil fuel reserves. Addressing the issue of sustainability in power systems operation involves decarbonising the production of energy, reducing operation costs while reinforcing the grids stability and reliability. In this view, a significant percentage of the global energy demand is expected to be met through widespread supply of renewable electricity in the near future. The challenge to be faced in the short or medium term by system operators worldwide is then that of integrating these energies into the electricity grids [9], which are considered clean but which have the disadvantage of being variable. This is why meeting sustainability requirements is considered as one of the key motivations for finding reliable solutions for integrating energy generated from variable sources. Of course, storage, integrated in many forms at different levels of the power chain is considered as a crucial asset in modern power systems [26].

I.1.4 Economic Structure of Power Systems: Electricity Markets

The modernisation of power systems across the world is leading to the diversification of stakeholders in the sector and is driving the emergence of new markets as a result of the gradual liberalisation of the three main segments of the energy chain, namely production, transmission and distribution. This change of paradigm is leading the introduction of new actors into the energy scene, each holding a responsibility in the operation of the system. Besides, a platform with rules is set up in order to ensure a permanent balance between energy production and consumption as well as a fair tariff plan. A living example is Cameroon, where the flow of modernisation of the power system has led to major reforms with the new 2011 law. The direct effect was, initially, the liberalisation of the production segment with the introduction of several new independent power producers such as KPDC, DPDC, etc. and the establishment of a regulator which is ARSEL, and more recently the coming into play of a transmission system operator, the SONATREL. This example will be better developed later in this chapter.

However, the liberalisation does not occur similarly in all segments of the power system. Nowadays, transmission and distribution networks and also the grid handling in many countries remain managed and regulated by public authorities. In the case of grids covering very large geographical areas, it may happen that the area be divided into sectors in such a way that each

sector is managed by only one operator without competition. For instance in France, the electricity transmission system is managed exclusively by RTE while the distribution network is subdivided into regions with one grid operator (ErDF, GEG, etc.) for each region although about 95% of the distribution network is managed by ErDF [27]. Production and supply of electricity are dissociated from the management of the transmission and distribution infrastructure.

As a whole, following the definition of functions required within the management of the power system, there are three main categories of the electricity markets, including [16]:

- System services markets,
- Transmission markets,
- Energy markets.

System ancillary services are services required to ensure that the system operator meets its responsibilities in relation to the security, secure and reliable operation of the interconnected power system. Such services include mainly Voltage Control, Frequency Regulation, Load Following, Spinning Reserve, Supplemental Reserve (Non-spinning), Backup Supply, Harmonic Compensation, Network Stability, and Peak Shaving [28]–[31]. These services have an economic value and can be remunerated on the basis of market laws or specific contracts. The various system services are generally defined and controlled by the transmission system operator [27].

Transmission markets are markets where the traded commodity is a transmission right. Such a right may be the right to transfer power itself, the right to feed the grid or the right to extract power from it. The importance of the transmission right is mostly observed when congestion occurs in the transmission network. Such markets are already active in the USA for example. However, in most European countries, transmission networks are managed by a Transmission System Operator (TSO), responsible for the secure and efficient operation of the network [16] while in Cameroon a new company (SONATREL) intended to play that was created in 2015 but not yet in full operation. The TSO is also responsible for open access to the grid; it ensures that all grid users (producers, traders, suppliers, customers) can have non-discriminatory access and use the grid to move their power. Moreover, although system services markets and transmission markets are related to the secure operation of the power system for a reliable power supply, energy market is the segment exactly dedicated to the deal of power and so, it is where the competitive trading of electricity occurs in most cases.

I.2 The Specific Context of Cameroon

I.2.1 The Power Sector in Cameroon

I.2.1.1 The Natural Power Potential

Hydropower

Cameroon has a huge hydropower potential, recognized as the second largest in Central Africa (294 TWh), after the Democratic Republic of Congo, with an estimated total theoretical potential of 23 GW and a production potential of 103 TWh/year [3], [6]. Currently, the exploited share of this potential remains below 5%, about 1 MW of installed hydropower capacity in five plants with capacities from 15 to 388 MW. Concerning small-scale hydropower (less than 10 MW installed capacity), Cameroon's potential is estimated at 1.115 TWh, mainly in the eastern and southern regions. Existing plants are operated by private companies: two were operating in 2002, generating 700 MWh per year [32]. Some onsite studies and prototypes of small/micro-hydropower systems for community electricity generation have been performed in Bangang [33] and Kemkem [34], [35], in the western region of the country. About 340 MW is estimated as the total potential of 181 sites deemed suitable for small-hydropower projects across the country, of which 89 are small/mini-hydro sites and 91 are micro-hydro sites. Their locations are visualised on a map of Cameroon in Annexe 2.

Solar

Cameroon being a tropical country is well endowed with solar energy resources, receiving mean annual hours of sunshine per year of over 3000 hours and an average solar radiation intensity of 240W/m² [13]. Some important solar energy resources are available throughout the country (See the solar map of Cameroon in Annexe 1). In the sunnier part of the country, the average solar radiance is estimated at 5.8 kWh/day/m² while it is 4 kWh/day/m² in the rest of the country [32]. So, the solar energy potential is abundant, indicating ideal conditions throughout the country for the exploitation of solar energy through various conversion technologies.

Wind

The wind energy sector in Cameroon is not well developed [36] although there are some favourable sites in the North, the West and in some coastal zones [32], [37]. From the NASA meteorological data, wind speeds in Cameroon are equal to or exceed 3 m/s for over 80% of the time, and the Adamaoua region has annual wind speeds that are equal to or exceed 2 m/s for over 60% of the time, while the rest of the country has wind speeds greater than or equal to 1 m/s for over 50% of the time [13]. The wind power potential for Cameroon is at its peak during months from December to March and can be used to supplement for the shortfalls during the dry season of that period of the year [37].

Biomass

Cameroon has the third largest biomass potential in sub-Saharan Africa. Biomass forms the dominant source of energy accounting for 66.7% of the total national energy consumption, with wood fuel being the dominant biomass form used in Cameroon. Biomass is used in both domestic and commercial sectors for cooking and many other heat applications [13]. Cameroon's potential to produce electricity from biomass residues is estimated at 1,072 GWh, of which 700 GWh could be exported to the grid. Seemingly, local agro-industries have planned several cogeneration projects [38].

Others

Other renewable energy sources exploitable in Cameroon could be about biogas from waste for which two waste-to-biogas plants of 10 MW-360,000 T/year and 60 MW-540,000 T/year are in operation respectively in Yaoundé since June 2011 and Douala since November 2014 by HYSACAM² the company in charge of waste collection while a 2 MW-75,000 T/year is still in project in the West region. Also the geothermal heat can be counted here as some hot water sources are identified in the region of Mount Cameroon in the South-West of the country, even if no detailed study for the assessment of the potential have not yet been done so far [39].

I.2.1.2 Historical Development and the Policy

Power generation from large plants (more than 15 MW) started in Cameroon in 1951 with the Edea run-of-river hydropower plant. Up to 1984, the generating capacity increased with two other hydropower plants (Song-Loulou and Lagdo) and some thermal plants. Since then, development of power infrastructures has been slowdown in 1990s due to the economic crisis, until years 2000s when structuring measures were adopted to address the issue of energy shortage faced by the country. The terrific electricity crisis that occurred in years 2005 was temporally solved with the emergency thermal programme (PTU) that brought 100 MW of power in 2009 [40]. Today, electricity demand in Cameroon remains unsatisfied as Cameroonians are still suffering from recurrent power outages causing significant impact across the whole economy, particularly during hours of peak demand between 6 pm and 11 pm as indicated in Fig. 7. The Ministry of Economy, Planning and Regional Development has estimated that power failure cost close to 5 % of GDP growth per year [41].

Since years 2010s, the development vision of Cameroon's energy sector aims to promote renewable energy and modernise its distribution network in order to respond effectively to

² <https://www.hysacam-proprete.com/article/96> [Accessed: 03/07/2018]

domestic demand and export energy to neighbouring countries. The main objective of this vision is to reach a total installed capacity of 5600 MW in 2020 and 2030, respectively. However, Cameroon's energy sector development policies are organized around its long-term energy sector development plan, its strategic poverty reduction paper [2], its project to extend the electricity network [38], and its vision for emergence by 2035. In this vision, Cameroon has planned to achieve an overall electrification rate of 75%, with 20% in rural areas. In addition, the country committed to reducing its greenhouse gas emissions by 32% by 2035 [42].

I.2.1.3 Institutional and Legal Frameworks

The institutional framework of the energy sector in Cameroon is headed by the Ministry of Water Resources and Energy (MINEE) who elaborates and monitors the implementation of a national energy policy under the control of the Presidency of the Republic. The Electricity Sector Regulation Agency (ARSEL) regulates operators and electricity operations, and participates with the MINEE in defining electricity tariffs. The Electricity Development Corporation (EDC) Develops state owned hydroelectricity projects. The Rural Electrification Agency (AER) promotes rural electrification by elaborating and monitoring State projects while supervising private operators in the rural sector. The new created National Electricity Transmission Company (SONATREL) manages the electricity transmission network for the State. Electricity of Cameroon (ENEO) is the main public-private owned electricity producer. To date, only two Independent Power Producers (IPPs), the Kribi Power Development Company (KPDC, 216 MW gas-fired plant) and the Dibamba Power Development Company (DPDC, 88 MW oil-fired plant) have Power Purchase Agreements (PPAs) with ENEO (and the PPAs will normally be transferred to SONATREL). IPPs are still struggling to get authorization through PPAs to start producing electricity and injecting into the grid, though the monopoly of ENEO for electricity production in Cameroon has already ended. The arrival of SONATREL will certainly facilitate the signature of PPAs with more IPPs, since SONATREL will be more impartial than ENEO, which understandably cannot facilitate access to the grid to other IPPs, considered as competitors [4].

From a legal point of view, the power sector in Cameroon is governed by the legislation N°2011/022 dated December 14, 2011 (the '2011 Law'), which was adopted as result of the reform undertaken by Cameroon seeking to address number of issues and attract foreign investments. The 2011 Law and an implementing decree dated September 24, 2012 enacted the principle of competitive bidding and generalised it to all segments of the electricity market (including IPPs). The 2011 Law clarifies the procurement conditions for production, transmission and distribution projects and only provides for the creation of a transmission system operator as a public company. It defines renewable energy sources in Cameroon as solar, wind, biomass, geothermic, and hydro

below 5 MW [43]. However, despite the importance renewable energies are gaining worldwide, there is no renewable energy law in Cameroon so far. The adoption of a renewable energy law proposed by the MINEE is still awaited [4]. In the meantime, fiscal and customs advantages are granted to importers of solar and wind related equipment from the finance law of 2012.

I.2.1.4 Infrastructure

Generation Equipment

The supply side of the power system in Cameroon includes hydropower plants and thermal plants. The hydropower production being reinforced with some hydro storage dams.

- Hydropower Plants

As a whole, the hydropower installed capacity in Cameroon, from 1953 has evolved as depicted in Fig. 5. The hydropower infrastructure in its current state is presented in Annexe 1.

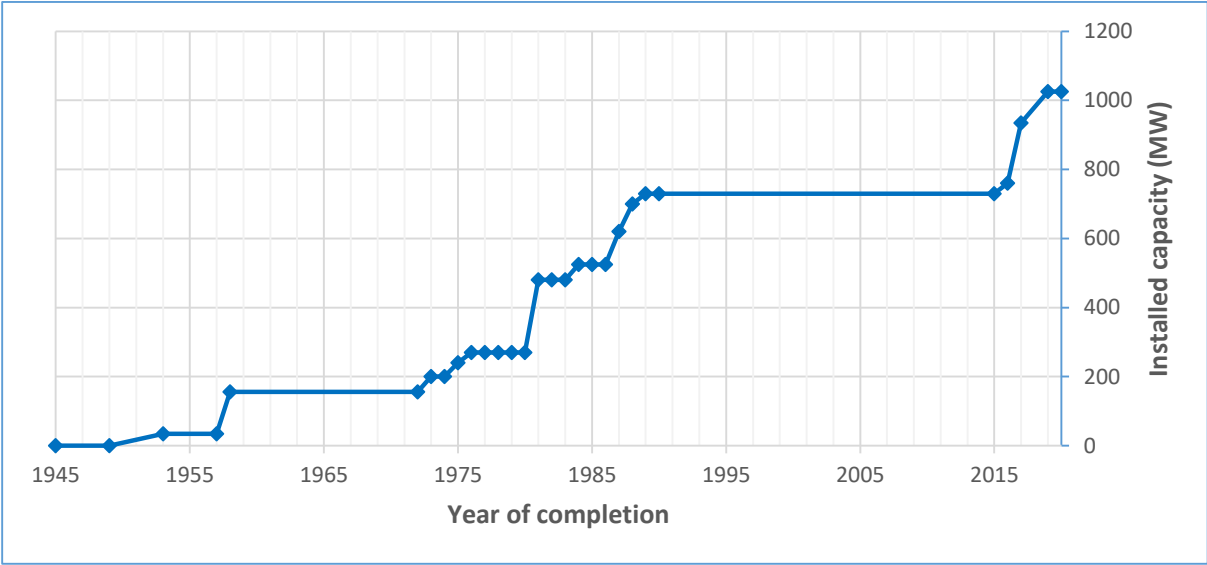

Fig. 5 : Evolution of developed hydro-capacity in Cameroon.

The hydropower plants currently under operation are:

➤ Edea

The first phase of development of the run-of-the-river hydropower plant at Edea occurred between 1949 and 1953, when EDEA I was constructed and equipped with three units of 11.5 MW each. EDEA II (121.8 MW using six units) was built between 1955 and 1958, and EDEA III was built between 1963 and 1975 (107.5 MW using five units). The current total capacity is 264 MW.

➤ Song-Loulou

The Song-Loulou hydropower plant was built in two stages. The first stage was from 1977 to 1981 (four units of 48 MW each), and the second stage was commissioned in 1985, with the installation

of a further four units of 48 MW each. The total installed capacity of the plant is 384 MW. Song-Loulou and Edea are connected to the Southern Interconnected Grid of Cameroon.

➤ Memve’ele

The Memve’ele power plant was constructed on the Ntem River in the southern region of Cameroon. This run-of-the-river hydro powerplant produced its first 80 MW for the Southern Interconnected Grid in April 2019, two years after the planned date. At full production, it is expected to add 211 MW to Cameroon’s power production capacity, and help address the issue of poor electricity supply in the country. A delay in the construction of a 300-km transmission line from Nyabizan (where the dam is located) to Yaoundé has prevented this dam from operating at its full potential.

➤ Mekin

The Mekin hydropower project is located on the Dja River in southern Cameroon. It was intended to be connected to Cameroon’s Eastern Interconnected Grid in 2017, but due to some technical issues, its complete commissioning just occurred. The power station is installed at the base of the dam, with a catchment of 10,800 km² and a normal impounded water level of 613 m. The total installed capacity is 15 MW, with three 5 MW units, and the power generation capacity is expected to be 70 GWh.

➤ Lagdo

The Lagdo hydropower plant was constructed between 1978 and 1983. It consists of four units of 18 MW each (72 MW in total). The Lagdo plant supplies electricity to Cameroon’s northern grid.

- Storage Dams

Electricity production from Edea, Song-Loulou, and the under-construction Nachtigal are sustained by four dams—Bamendjin, Mapé, Mbakaou, and Lom-Pangar—as shown in Fig. 6. These dams regulate the flow of the Sanaga River and mitigate the impact of the dry season.

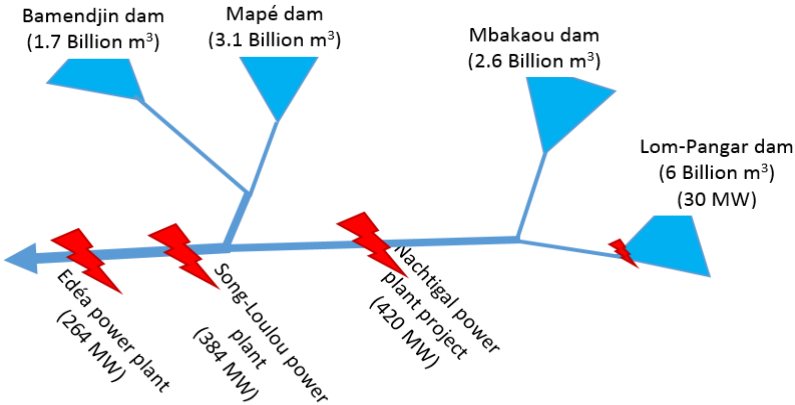

Fig. 6 : Existing hydro-plants in the Sanaga catchment area.

More details concerning the four reservoir dams are provided in Table 1.

Table 1 : List of hydro reservoir dams currently in functioning in Cameroon.

Reservoir's Name	Year of commissioning	Region	Capacity (Billion m ³)	Filled level (Billion m ³)	
				12.17.2008	12.18.2009
Mbakaou	Jully 1969	Adamaoua	2.600	2.600	2.600
Bamendjin	May 1974	West	1.879	1.574	1.822
Mapé	Jully 1987	West	3.300	2.958	2.585
Lom-Pangar	September 2015*	East	6	-	-

**Note: 2015 is the year of partial impoundment of Lom-Pangar dam*

- Thermal Power Plants

There are two categories of thermal power plants in Cameroon, following whether they are connected to an interconnected grid or not. The list of existing fourteen grid-connected thermal power plants is provided in Table 2.

Table 2 : Grid-connected power plants in Cameroon.

Connection Grid	Plant's name	Year of commissioning	Installed capacity (MW)
Southern Interconnected Grid (SIG)	Oyomabang I & II	2000 & 2002	26
	Limbé (Heavy fioul)	2005	85
	Bafoussam	1986	13
	Logbaba I & II	2002 & 2009	14
	Bassa II & III	1980 & 2001	18
	Mbalmayo (PTU)	2012	10
	Bamenda (PTU)	2012	20
	Ebolowa (PTU)	2012	10
	Ahala (PTU)	2012	60
	Dibamba	2009	88
	Kribi (Natural gas)	2013	216
Total thermal capacity of SIG:			560
Northern Interconnected Grid (NIG)	Djamboutou	1971	17
	Kousseri	2013	4.66
Total thermal capacity of NIG:			21.66
Easther Interconnected Grid (EIG)	Bertoua	1972	8.6
Total thermal capacity of EIG:			8.6
Total thermal capacity of Cameroon:			590

Beside these grid-connected thermal power plants, there are about twenty-five isolated small oil-fired power plants for some remote villages and owned by ENEO-Cameroon.

Transmission and Distribution

- The Southern Interconnected Grid (SIG)

The largest power grid in Cameroon is the Southern Interconnected Grid (SIG) that is a 225 kV and 90 kV network connecting the major hydropower stations to the aluminium industry (ALUCAM). It covers main consumption areas in six regions in the southern part of the country. The daily load profile of the SIG and the contribution of each source are shown in Fig. 7 that follows.

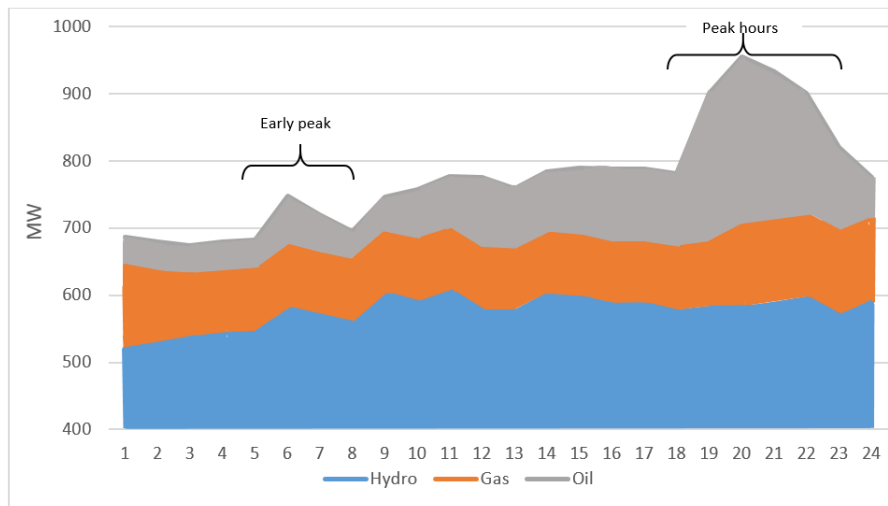

Fig. 7 : Average daily load profile of the month of March 2018 on the Southern Interconnected Grid (Source: ENEO).

Throughout the year, the average load pattern on the SIG shown in Fig. 8 indicates that the grid is powered by hydro, gas and oil at 70%, 22% and 8% respectively for a total of 6 TWh. It is observed a decrease in the generating capacity during the period of February to May, which is the result of the hydro capacity drop that follows the dry season. This results in severe power grid outages being faced by Cameroonians during the dry season, even with the support of thermal plants.

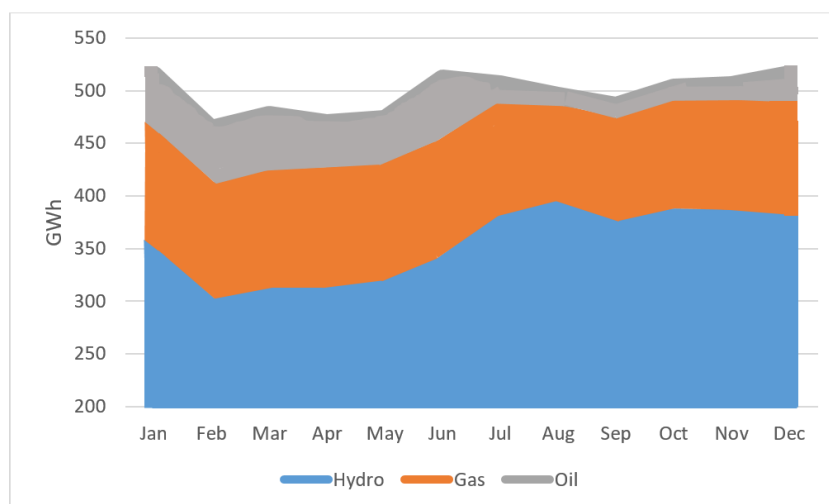

Fig. 8 : Average yearly load profile on the Southern Interconnected Grid (Source: ENEO).

- Other Grids

Other electricity networks in Cameroon include:

- The Northern Interconnected Grid (NIG), which covers the three northern region of the country, dispatching the power mainly generated by the Lagdo power station through a 110 kV and 90 kV transmission structure.
- The Eastern Interconnected Grid (EIG) is a low voltage distribution grid of 30 kV powered by the Bertoua oil power plant.

Future Development

To achieve the 2035 development objectives set by the government, the energy demand generated by strong economic growth must be addressed by the accelerated development of the energy infrastructure, starting with hydropower. This means the country's hydroelectric potential will be better developed in the medium term as Cameroon is already planning the development of numerous hydropower projects, as shown in Annexe 3. Furthermore, the government of Cameroon plans to export electricity to neighbouring countries such as Chad, the Central African Republic, and Nigeria. Some key projects to support this ambition are Chollet (600 MW), Grand Eweng (1,800 MW), Noun-Wouri (1,028 MW) [44]. In addition, other hydroelectric projects are being considered for special uses, such as the new aluminium smelter planned by Rio Tinto Alcan, which will be powered by the 475 MW Ngodi plant.

I.2.1.5 Demand Side

The demand side of the electricity sector in Cameroon is represented by the industry that consumes the majority of distributed electricity (58%), mainly consumed by the aluminium industry. Residential sector accounts for 20% of electricity consumption, public services (healthcare, education, business and administration) for 5%, hospitality sector for 2.5%, agriculture for less than 1%, and other service in the tertiary sector account for the remaining 13.5%. As the economy is growing, the energy demand and consumption is increasing. This growth in demand for electricity is expected to continue rising over the next decade as seen in the 2012–2025 demand forecast (see Fig. 9).

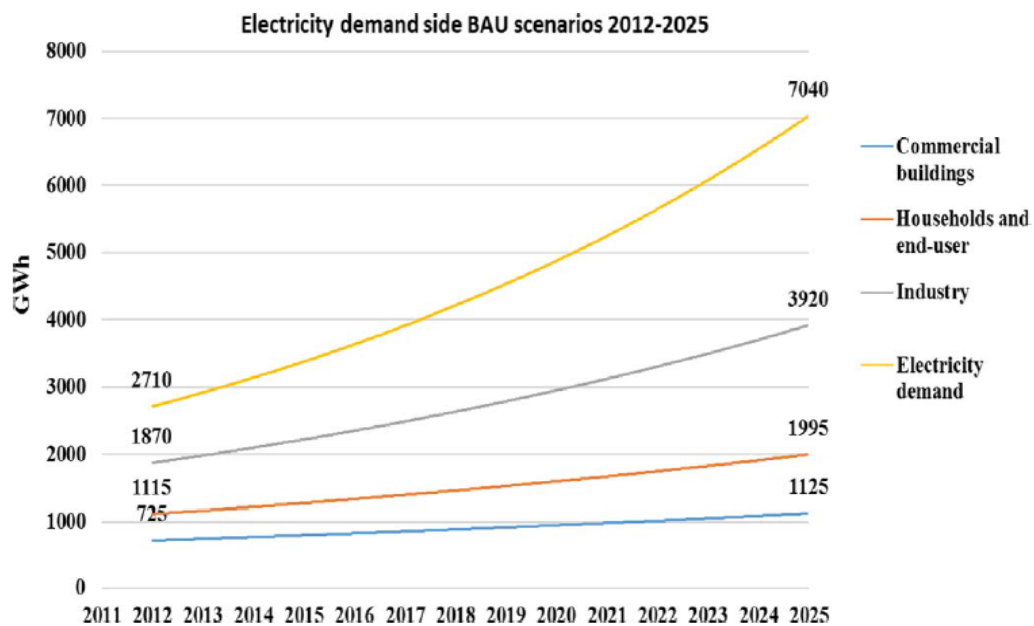

Fig. 9 : Electricity demand projection for Cameroon considering the business as usual Scenario [3].

I.2.2 What does the Future Hold for the Power Sector in Cameroon?

I.2.2.1 Risk of Large-scale Curtailment of Hydroelectricity and Climate Change Vulnerability

The role of hydropower remains crucial in achieving Cameroon's energy objectives, given the country's enormous potential. As a result, many hydroelectric projects are underway for the medium term with a view to exporting energy to some neighbouring countries. However, there is a risk associated with the soaring growth of hydropower capacity, which could be translated mainly in terms of curtailment of huge quantities of electricity generated. An example is from the Yunnan Province in China who has experienced a fast development of hydro in the past several decades as analysed in [45]; Inconsistencies between hydro development and various related resources have progressively led hydropower generation not only to cause large-scale waste of sustainable energy but also to impair the potential higher contribution of hydro for greenhouse gas emissions reduction. Another example is from Zambia where, due to lack of rainfall in the Zambezi River catchment, the drought experienced from October 2017 to January 2018 significantly affected power production at the Kariba dam [46]. Consideration of these two cases among others across the world indicates conventional hydropower does not seem to be as reliable as it used to be. Moreover, the hydro capacity of Cameroon is concentrated (at 75%) in the Sanaga River's basin, which obliges the power system operators to find a satisfactory way to mitigate the hydrological risk, in particular the very low production capacity during the dry season, an issue which would be exacerbated in the event of severe droughts as the climate is changing (climate resilience issue of hydropower systems [47]).

I.2.2.2 High penetration of Fluctuating Renewables

The new electricity law defines tax and customs benefits applicable to goods and services used for the operation of renewable energy, including solar, wind, hydropower below 5 MW and biomass. It guarantees producers of energy from these renewable sources, access to the transmission and distribution networks and moreover, it obliges the TSO or local distributors to purchase the excess renewable energy produced as part of rural electrification, if the producer requests so. It is therefore in this perspective that feasibility studies for many renewable energy projects have already been validated, with a strong focus on solar PV and wind power, for which projects involving grid-connection are detailed in Table 3.

Table 3 : Some major wind/solar renewable energy projects involving grid connection [3], [40].

Project	Capacity (MW)	Location	Partner
Solar PV farm	72 & 500	Mbalmayo & other locations	JCM GREENQUEST SOLAR COOPERATION SARL
Solar PV farm	500	Nothern regions	GSC Eergy (South Africa)
Solar PV farm	50	Far North (Maroua)	JP INTERNATIONAL
Solar PV farm	2.66	Far North	AGREENENERGY Ltd
CSP (Thermal Solar)	100	South-West and North	KUNSONG CONSULTING
Wind farm	40-80	West (Bamboutos)	CGC OVERSEAS
Wind farms	500	Littoral and South	PALUXI ENERGY

I.2.2.3 Shift towards Distributed Generation

The 2011 Law includes new provisions aimed at facilitating electricity production for industrial purposes and obliges any public service operator to connect to the grid all power producers of renewable energy who make the request. Priority is granted to decentralised production of renewable energy and the excess of power produced benefits from the purchase obligation by the TSO. Then, alongside wind and solar projects listed in Table 3, the way is open to renewable distributed generation that some players are identified as it follows.

- In the domain small/micro hydro, some validated projects include Rumbi (2.9 MW), Bare-Bakem (111 kW), Koutaba (158 kW), and Mbakaou-Carrière (5 MW). A total of 243 sites suitable for mini hydro projects totalling 340 MW are identified across the country.
- In the domain of biomass and waste, many cogeneration projects are planned in local agro-industries that the overall capacity is estimated at 1,072 GWh of which 700 GWh could be exported to the grid. Furthermore, a recent study indicated that 34 wood processing

facilities in Cameroon as potential grid-connected electricity prosumers with capacity estimated at 225 GWh per year [48].

I.2.3 Critical Need of Bulk Storage-type Projects in the Power System of Cameroon

With regard to the Cameroon's energy policy, there is keen interest in the development of renewable distributed energy sources to generate power. There are specific renewable energy projects within the country intended to add hundreds MW of wind and solar PV to the power system, in addition to feed-in capacities of agro-food and timber industries estimated at about 1000 GWh/year. Beside, hydro capacity will continue growing as the primary power generation source, intended to feed some major industrial projects and to serve as source of power for export.

The power sector policy is setting number of incentives which include a more enabling business environment, a feed-in tariff system providing a fixed tariff structure, and priority purchase of renewable energy sources by the grid operator. This will undoubtedly result in a high penetration of variable renewable energy into a system that previously did not integrate such energy sources, leading to new challenges in the operation of the entire power system. In the present power market structure in Cameroon, part of electricity is bought from IPPs on the basis of negotiated PPAs, which are long-term contracts of approximately 15-20 years. According to the electricity law, the terms of a PPA are supposed to be negotiated between the IPP and the system operator. Therefore, in the event of a PPA on take-or-pay³ terms, the fact that renewable power producers are guaranteed priority purchase, transmission and distribution could potentially pose a challenge in the power system operations and economics [49]. In fact, such PPAs would expose the Cameroon's power system operator to large financial risks due to possible curtailment of power generated from various sources. Otherwise in the event of a more liberalised electricity market, strong penetration of intermittent renewable energy (namely wind energy and solar PV) may entail more volatility in power prices. Moreover, the soaring growth of installed run-of-river hydropower capacity and large-scale deployment of renewable distributed generation units may cause new issues that facing requires bulk energy storage systems [50], [51]. As such, pumped-hydro storage appears to be an obvious solution in the context of Cameroon where the availability of favourable sites is assumed.

³Take-or-pay terms mean that payment for every kWh of energy delivered is made on the amount of energy available and not on how much is actually used [49].

I.3 Background of Energy Storage Systems

I.3.1 Main Components of a Storage Device

Any energy storage device designed for a power system will fully play its intended role (that is to store energy generated by the system by converting it into a form suitable for storage and return it as much as possible to the system) if it has the three following components: the Central store (CS), the power transformation system (PTS), the charge-discharge control system (CDCS) and eventually the balance of plant (BOP).

- The Central Store (CS) or the storage medium of a storage device is exactly the reservoir that contains the energy potential which can be in the mechanical, chemical or electrical form depending on the technology used.
- The Power Transformation System (PTS) is the component linking the CS and the power system. During the charging mode, it converts electrical power into a storable form (for example from AC current to DC current in the case of a chemical storage system) while ensuring the security of the CS. As well, during the time of reverse, the power system requirement has to be satisfied by the variable characteristic of the PTS.
- The CDCS controls charge and discharge power levels in accordance with the requirements of the power system's regime. It is an essential part of any storage device and usually comprises a number of sensors placed in certain nodes of the power system, in the PTS and in the CS. The information from these sensors has to be collected and used in a computer-based controller which, using relevant software, produces commands for power flow management in the PTS.
- The Balance of Plant (BOP) refers to auxiliary equipment such as those used to house the storage device and also to control the environment of the storage facility. It therefore includes structural and mechanical equipment such as protective enclosure, heating/ventilation/air conditioning (HVAC), the foundation, structure (if needed), etc.

The interconnection of these elements can be schematised as in Fig. 10 below.

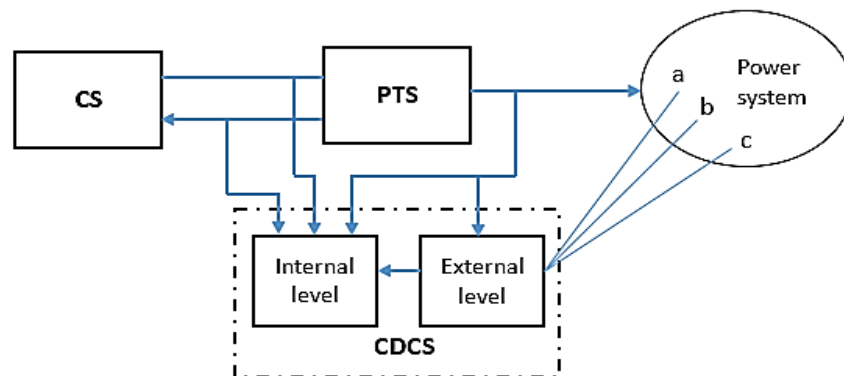

Fig. 10: Schematic structure of an energy storage system [1]; a, b, and c are selected nodes.

I.3.2 Energy Storage in a Power System

Energy storage as addressed in this study refers to the storage of electricity defined as most used energy vector or secondary energy source. From that point of view, energy storage plants are positioned into the power system as special devices which can partly or completely separate the processes of energy generation and consumption. That separation of the supply side and the demand side defines the position of energy storage for which there are two possibilities to connect in the power system, in parallel or in series as shown in Fig. 11 below.

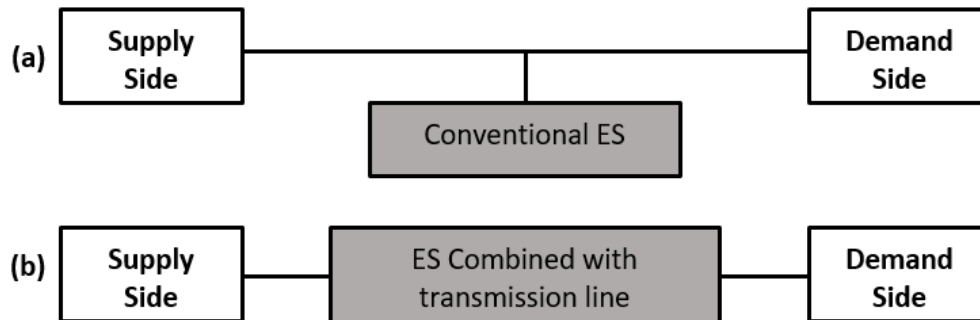

Fig. 11: Schematic diagram of the position of an energy storage device within a power system (a) conventional (b) series connected [1].

When the storage device is parallel-connected (Fig. 11-a), its PTS serves as transmission between its CS and the power system and so, the rated power of the PTS must be the same with that of the system requirement for the energy storage power capacity. When the storage device is series-connected (Fig. 11-b), it is comparable to a transmission line and so, because of that all the power generated passes through the device's PTS, its rated power has to satisfy the system requirements.

I.3.2.1 General Applications of Storage in Power Systems

Akinyele and Rayudu [9] refer to ESSs as “limited energy resources with a narrow band of dispatch and operation” but recognize that they are suitable for various and numerous applications in electrical systems. Table 4 below provides a description of those applications retrieved from [52].

Table 4 : Main applications of energy storage systems.

N°	Application	Description
1	Energy arbitrage or commodity storage:	It involves storing bulk energy generated at off-peaks when the cost is low, and selling it at peak demand periods when the cost is high.
2	Area control:	This is to prevent unplanned transfer of power between one utility and another.
3	Contingency service/Spinning reserve:	Contingency reserve refers to the power capacity capable of providing power to serve customer demand should a power facility fall off-line. Spinning reserves are ready instantaneously, with non-spinning and long-term reserves ready in 10 min or longer.
4	Frequency regulation:	This would enable maintaining a state of frequency equilibrium during regular and irregular grid conditions. Large and rapid changes in the electrical load of a system can damage the generator and customers' electrical equipment.
5	Black-Start:	This refers to units with a capability to start-up on their own in order to energise the transmission system and to assist other facilities to start-up and synchronise to the grid.
6	System stability:	The ability to maintain all system components on a transmission line in synchronous operation with each other to prevent collapse of a system.
7	Voltage regulation:	Stable voltage between each end of all power lines can be maintained through voltage regulation.
8	Asset/investment deferral:	This refers to deferring of the need for additional transmission facilities by supplementing the existing transmission facilities to save capital that otherwise goes underutilised for years.
9	Load levelling:	It is the utilization of the stored energy at peak periods, thereby reducing the requirements of peaking generators.
10	Power quality:	provides electrical service to customers without any secondary oscillations or disruptions to the electricity "waveform" such as swells/sags, spikes, or harmonics.
11	Power Reliability:	Provides bridging power or uninterruptible power supply (UPS) for consumers to 'ride-through' a power disruption. Coupled with energy management storage, this allows remote power operation.
12	Transmission curtailment:	mitigation of power delivery constraint imposed by insufficient transmission capacity.
13	Time-Shifting:	firming and shaping of wind-generated energy by storing it during the off-peak interval (supplemented by power purchased from the grid when wind generation is inadequate) and discharging during the on-peak interval.
14	Forecast Hedge:	mitigation of errors (shortfalls) in wind energy bids into the market prior to required delivery, thus reducing volatility of spot prices and mitigating risk exposure of consumers to this volatility
15	Grid Frequency Support:	Energy storage supports grid frequency during sudden, large decreases in wind generation over a short discharge interval
16	Fluctuation suppression:	Storage systems could minimize the effect of intermittency of renewable energy resources and increase their penetration in power grids, thus, allowing renewable generation to be dispatched.

From the table above, energy storage systems can be integrated to electrical systems, from power generation plants to end-users' appliances, for a great number of applications. These applications can be classified alongside the following segments of electricity value chain, also schematised in Fig. 12 below:

- Power Generation (N°1 – 5),
- Transmission and Distribution (N°6 – 8),
- Energy Services (N°9 – 11),
- Fluctuating Renewable Energy Integration (N°12 – 16).

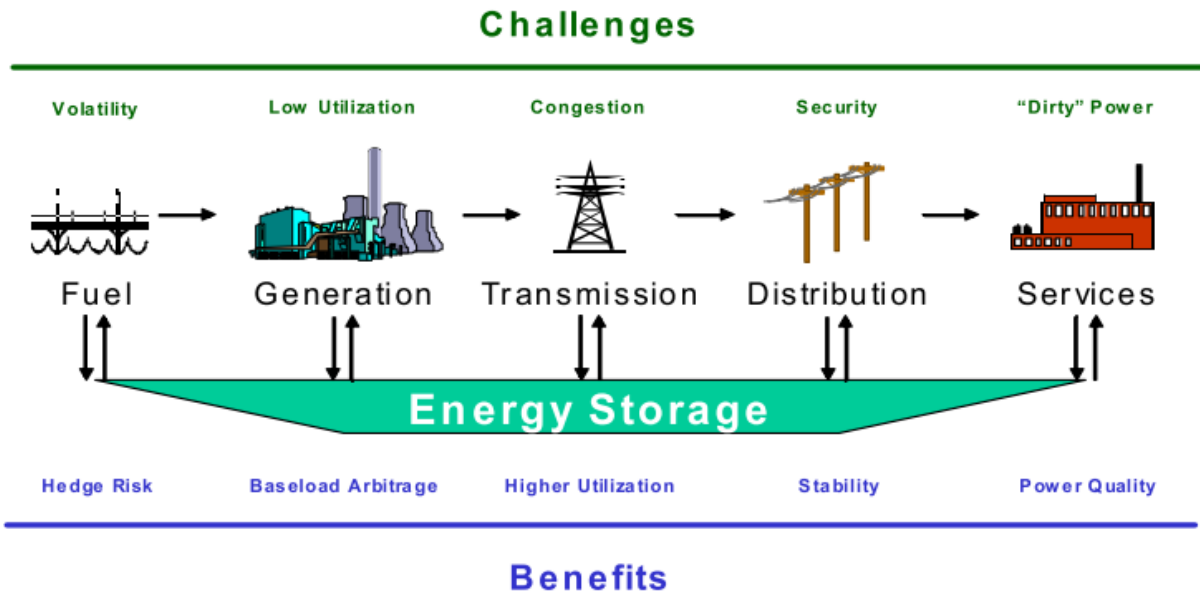

Fig. 12: Benefits of EES along the electricity value chain [53].

I.3.2.2 Storage and Power Transmission

According to E. Alex [54], grid operators around the world continue to recognize the benefits of energy storage technologies, and one of the most intriguing applications is the ability to defer investments in conventional transmission and distribution (T&D) infrastructure. Managing the transmission system in modern power systems is becoming increasingly complex because of changing demand patterns, congestion due to the development of renewable generation in remote areas, and the desire to improve the reliability of electricity supply for customers who have a growing number of alternative options to meet their electricity needs. At the same time, developing T&D systems is becoming more expensive and challenging in much of the world, leading to the demand for ESSs as an alternative to the traditional investments that utilities have relied on for decades. In that context, factors that make energy storage an attractive option for power systems facing the need for transmission upgrades could include faster build times, smaller environmental footprint and also falling costs. Some challenges faced by investment in transmission lines and the corresponding benefits provided by energy storage are summarised in Table 5 below.

Table 5 : Summary of Transmission and Distribution energy storage benefits (Retrieved from [54]).

T&D Challenges	ESS Benefits
Local community opposition	ESSs will have minimal impact on nearby property values, often installed at substation or existing grid facility.
Lengthy (multiyear) planning, permitting, and development process	Storage systems can be designed, built, and made operational in under 6 months.
Uncertain load growth rates and demand patterns	ESSs can be deployed in small modular capacity increments, avoiding oversizing and stranding assets.
Regulation across different jurisdictions	ESSs are deployed only in a single location, avoiding cross-border challenges.
Single use case of expanding grid capacity	When not needed for T&D deferral, ESS can generate revenue and grid operating cost savings by providing frequency regulation, voltage support, spinning reserves, and other services.

In the particular context of high penetration fluctuating energy sources, ESSs are required for T&D curtailment by providing energy in the time frame of 5-12 hours [55]. This is because grid-connected fluctuating power sources have sometimes to be disconnected in order to ensure the stability of the system or to solve congestion issues. At this level, the integration of energy storage devices play an important role as they can store energy for hours and inject it in a controlled manner according to the capacity of transmission lines and stability issues. This therefore allows avoiding the disconnection of fluctuating power sources and consequently, a better use of the installed power generating capacity.

I.3.2.3 Energy Storage for Fluctuating Energy Sources Integration

Most of renewable sources of energy, especially wind, solar PV and tidal are inherently fluctuating and intermittent and so, when connected to the power system, the predictability of their variations for managing the demand and generation balance is always a crucial issue. This issue directly impacts the operating costs of the power system. In fact, conventional fossil fuel thermal power plants commonly used for balancing purposes, operate less efficiently when part-loaded with an efficiency loss of between 10 and 20% or higher, particularly for new gas plant [56]. According to research findings currently available, operating costs of the power system integrating large fluctuating renewable energy would be relatively small if the fluctuations were perfectly predictable with a sufficient flexibility in conventional plant to manage the changes.

For managing the intermittency of some renewables integrated in the power system or more generally to meet the required system flexibility, two types of reserves are used, namely the

spinning reserve and the standing reserve. Spinning reserve is commonly provided by part-loaded synchronised units such as Combined Cycle Gas Turbines (CCGT). For example, a given CCGT plant may be able to ramp output up or down at 10 MW per minute [55], but using such plants has the disadvantage of significant efficiency loss of between 10 and 20% or higher when part-loaded, particularly for new gas plants [56]. Moreover, an important installed capacity of spinning reserve has the effects of reducing the amount of variable generation that can be absorbed, particularly when high fluctuating renewable generation occurs during low power demand periods. Standing reserve is supplied by Open Cycle Gas Turbines (OCGT) and storages facilities, which improve the system performance through reduction of the fuel cost associated with system balancing, even if OCGTs are considered as higher fuel cost plants. In fact, an increase in the efficiency of the system operation and the ability of the system to absorb more variable power generation leads to a decrease in the fuel consumption. This is the reason justifying the reduction of the fuel cost associated with system balancing when standing reserve is considered.

So for balancing purposes within the power system, reserve between synchronised (spinning) and standing plants is a trade-off between the cost of efficiency losses of part-loaded synchronised plant (plant with relatively low marginal cost) and the cost of running standing plant with relatively high marginal cost. The cost of using energy storage facilities for this task is influenced by their efficiency. These arguments are used by Black and Strbac [56] to point bulk energy storage systems such as large-scale pumped-hydro storage an “obvious solution to dealing with the intermittency of renewable sources and the unpredictability of their output”. This because of their ability to store the surplus power during periods when intermittent generation exceeds the demand to cover periods when the load is greater than the generation.

I.3.2.4 Storage as Structural Unit in the Power System

Energy and Power Balance of a Storage Unit

From the connection of the storage device to the power system as presented in I.3.2 , one would like to know the position of such a device vis-à-vis the energy flux: is it a net energy consumer, a net energy producer or just an energy neutral element? That question makes sense owing to that the storage device alternates between energy consumption when charging and energy generation at the discharge regime. Then, the objective here is to analytically describe the roundtrip power and energy balance of such a device.

In fact, from the power system point of view, the central store (CS) is defined by the energy capacity of the “storage reservoir” E_S that the expression depends on the nature of the CS (mechanical, thermal, chemical or electrical).

The power transformation system (PTS) can be defined by its rated charge or restoring capacity P_c , and discharge or generating capacity P_d . Power capacity P_S , equals the maximum of P_c and P_d .

$$P_S = \max(P_c, P_d) \quad \text{Eq. 1}$$

As the storage is an integrated unit of the power system, at any of its operating mode, the power and energy balance has to be verified. This can be written analytically as it follows:

$$N_{gen} - L_l + P_S = 0 \quad \text{Eq. 2}$$

$$Q_{gen} + Q_l + Q_S = 0 \quad \text{Eq. 3}$$

Where

N_{gen} and Q_{gen} are respectively active and reactive power generated by supply side of the power system,

L_l and Q_l are respectively active and reactive power consumed by demand side of the power system,

P_S and Q_S are respectively the active and reactive power from store.

It is assumed that the power generated by or discharged from the store is positive while the power consumed by or charged into the store is negative as indicated in Fig. 13.

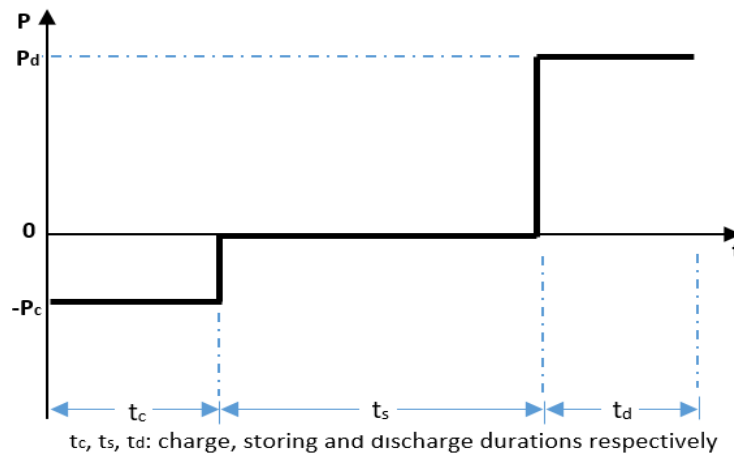

Fig. 13: Operating modes or regimes of energy storage.

In a real case, the storage device is not perfect, the CS that is the repository of energy is subject of losses named δE_S which occur during all operating modes (δE_C , δE_{ST} and δE_D respectively for charge, store and discharge) as shown in Fig. 14. These losses should be taken into account when writing the energy balance equation.

If E_l and E_{gen} are respectively the energy consumed and generated by the power system, the balance equation is written as

$$E_{gen} - \delta E_S - E_l = 0 \quad \text{Eq. 4}$$

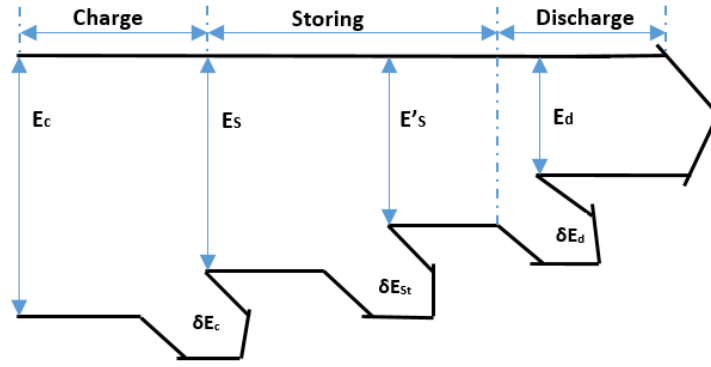

Fig. 14: Energy balance in the storage system.

As explained and shown in Fig. 14, the round trip losses of storage are expressed as it follows:

$$\delta E_S = \delta E_C + \delta E_{ST} + \delta E_d \quad \text{Eq. 5}$$

And also expressed in terms of energy charged and discharged as it follows

$$\delta E_S = E_C - E_d \quad \text{Eq. 6}$$

From that, the charge mode efficiency of storage is defined as

$$\eta_C = \frac{E_S}{E_C} \quad \text{Eq. 7}$$

The store mode efficiency that depends on the duration of this mode is given by

$$\eta_S(t) = \frac{E'_S}{E_S} \quad \text{Eq. 8}$$

The discharge mode efficiency of storage is written as

$$\eta_d = \frac{E'_S}{E_d} \quad \text{Eq. 9}$$

The overall round trip efficiency of storage η_S that is defined as the ratio E_l / E_{gen} or E_d / E_C can also be written as the product

$$\eta_S = \eta_C \cdot \eta_S(t) \cdot \eta_d \quad \text{Eq. 10}$$

Finally, combining Eq. 4 – 10 leads to write the formula of round trip energy loss of the storage as it follows:

$$\delta E_S = E_S \frac{1 - \eta_S}{\eta_C} \quad \text{Eq. 11}$$

Mathematical Model of Energy Storage [1]

The three main components of an energy storage device connected to a power system have been presented in I.3.1 . Writing the mathematical model associated to each of them is required for modelling the operation of the storage device.

The energy E_S stored in the Central Store (CS) at the current time t depends at time on the construction parameters CP_i which are constant for the given energy storage device, variable parameters VP_i which depend on the current regime of the storage and on t .

So, the energy storage function can be written as

$$E_S = f_{CS}(CP_i, VP_i, t) \quad \text{Eq. 12}$$

From the CS equation above, the power flow may be written as

$$P_{CS} = \frac{dE_S}{dt} = \frac{df_{CS}}{dt}(CP_i, VP_i, t) \quad \text{Eq. 13}$$

On the other hand, regulating the power flow from the energy storage in accordance with the reference power system requirements is the main role of the Power Transformation System (PTS) and so, the power flow through it depends on the special regulation parameters (RP_i), the constant parameters of the PTS (CPP_i) and the power system regime parameters ($PWSRP_i$) in the reference node. Therefore the mathematical model of the PTS can be written as it follows:

$$E_{PTS} = f_{PTS}(CPP_i, RP_i, PWSRP_i, VP_i) \quad \text{Eq. 14}$$

The function of the charge-discharge control system (CDCS) is to measure the parameters of the regime in the given node in the storage device and also the power system, calculate the desired power flow P_{des} from the energy storage system and based on this, to calculate the value of the special regulation parameters and send them to the PTS. Finally the mathematical model of the CDCS equations can be written as:

$$P_{des} = f_{CDCS}(PWSRP_i) \quad \text{Eq. 15}$$

$$RP_i = F_{CDCS}(P_{des}, VP_i) \quad \text{Eq. 16}$$

Because of that the energy storage system is not a source of energy, an energy balance equation should be written, taking into account the energy storage efficiency η_S . That energy balance equation is written using the energy charged and discharged from the CS (respectively E_C and E_D) as:

$$E_C - E_D - \frac{(1-\eta_S)}{\eta_S} E_S = 0 \quad \text{Eq. 17}$$

Finally, the full mathematical model of energy storage is given by the following system:

$$\left\{ \begin{array}{l} P_{CS} = \frac{dE_S}{dt} = \frac{df_{CS}}{dt}(CP_i, VP_i, t) \\ E_{PTS} = f_{PTS}(CPP_i, RP_i, PWSRP_i, VP_i) \\ P_{des} = f_{CDCS}(PWSRP_i) \\ RP_i = F_{CDCS}(P_{des}, VP_i) \\ P_{CS} = P_{PTS} = P_{des} \end{array} \right. \quad \text{Eq. 18}$$

When a particular technology of energy storage is selected, the forms of the functions as Eq. 2–5 are written according to the nature of the central store and the power transformation system and the desired number of duties the storage device is intended to perform. Also, the full mathematical model can only be used when a particular type of energy storage is involved and optimisation of its parameters or optimal control is needed. If a system requirement for energy storage is involved,

it is possible to simplify the full model, leaving only *Eq. 15*. Further development of the mathematical model of energy storage is provided in [1].

I.3.3 Energy Storage Systems (ESSs)

There are many technologies currently available for storing energy in power systems. While some technologies are at the commercial stage other are still at the experimentation stage. Each technology has its own particularities in terms of costs, capability and applications. On the basis of the physical principle energy storage technologies can be divided into five main types:

- Mechanical technologies include Pumped Hydroelectric Energy Storage (PHES), Underground-PHES (UPEHES), Compressed Air Energy Storage (CAES), Flywheel Energy Storage (FES);
- Chemical technologies include Batteries Energy Storage (BES), Flow-BES (FBES), Hydrogen Energy Storage System (HESS), Fuel Cells Systems (FCS);
- Electrical technology: Superconducting Magnetic Energy Storage (SMES), Capacitor Storage (CS), Supercapacitor Energy Storage (SCES);
- Thermal: Heat-Pump Electrical Storage (HPES), Hot Thermal Energy Storage (HTES), Cryogenic Energy Storage (CES), Aquiferous Thermal Energy Storage (ATES);
- Electric Vehicles (EVs).

A detailed explanation of any of these energy storage technologies is given in [1], [9], [57], [58]. Overall, there are some common characteristics to energy storage systems as provided below:

- Power Capacity: is the maximum instantaneous output that an energy storage device can provide, usually measured in kilowatts (kW) or megawatts (MW).
- Energy Storage Capacity: is the amount of electrical energy the device can store usually measured in kilowatt-hours (kWh) or megawatt-hours (MWh).
- Efficiency: indicates the quantity of electricity which can be recovered as a percentage of the electricity used to charge the device.
- Response Time: is the length of time it takes the storage device to start releasing power.
- Round-Trip Efficiency: indicates the quantity of electricity which can be recovered as a percentage of the electricity used to charge and discharge the device.

I.3.4 Classification of Energy Storage Systems

I.3.4.1 Classification Based on their Discharge Capacity

Supplying acceptable power (in terms of quality and quantity) to customers is always a challenging task for power systems operators. Apart from the constant voltage level and the frequency which define the power quality from the end-user side, the grid have to be available regardless the day-

time, and the season. To meet the challenge, modern power systems rely on storage at various scale for grid stabilisation. This introduces a classification of ESSs according to their discharge capacities as shown on Table 6 below.

Table 6 : Classification of ESSs based on discharge times.

Function	Time Scales	Key Technologies	Comments
Power Quality (PQ)	From second to minutes	SCES FES SMES	frequency regulation and transient stability by ESSs require technologies with a discharge time up to 10 min and a response time of milliseconds
Bridging Power (BP)	Minutes to an hour	Lead–acid batteries, Lithium-ion batteries, Nickel cadmium batteries, Metal–air batteries	Applications include load following, spinning reserve and forecast uncertainty. Because of less cycling requirement of such applications, batteries are the most commonly used storage technologies for BP [9].
Energy Management (EM)	Hours	CAES PHES Flow-BES TES	EM refers to the possibility to shift energy production over longer timescales. It is allowed by energy storage technologies offering discharge of several hours with a power capacity of up to hundreds of MW.

I.3.4.2 Classification of ESSs Following the Power and Energy Capacities

Connolly [58] provides a classification of these energy storage technologies according to the scale of power and storage capacity everyone can offer. Therefore he classifies technologies into four categories that include devices with large power (>50 MW) and storage (>100 MWh) capacities; devices with medium power (1-50 MW) and storage capacities (5-100 MWh); devices with medium power or storage capacities but not both; and finally, a section on energy storage systems. That classification is shown in Table 7 below.

Table 7 : Classification of energy storage technologies based on power and storage capacities [58].

Scale of power and storage capacities	Technologies
Large power and storage capacities:	-PHES -UPHES -CAES
Medium power and storage capacities:	-BES -FBES
Small power or storage capacities:	-FES -SCES -SMES
Other energy storage systems:	-HESS -TESS -EVs

I.4 Why Pumped-Storage Hydropower? A Technological Review

I.4.1 Historical development of PHES

One of the earliest known applications of PHES technology was in Zurich, Switzerland, in 1882, where a pump and turbine operated with a small reservoir as a hydro-mechanical storage system for nearly a decade [59]. The technology continued its development in Switzerland and Italy in the 1890s and the first large-scale commercial application in the USA in 1929 (Rocky River PHES plant, Hartford) [52]. To date, Europe has the largest installed capacity with over 80% of that commissioned between 1960 and 1990. The majority of the schemes are located in the mountainous regions of Austria, France, Germany, Italy, Spain and Switzerland. Although in many countries development was aligned with significant increases in nuclear capacity, some countries like Austria installed significant PHES capacities despite having no nuclear power at all [60]. At a country level Japan has the largest installed capacity of PHES at about 25 GW [8], which represents over 8.5% of its installed electricity generating capacity. China has the second largest capacity of PHES followed by the USA, however PHES constitutes only 1.8% and 1.9% respectively of their total installed electric generation capacity. The list of the top-12 of countries having largest PHES installed capacities and capacities under construction is provided in Table 8. Percentage of total installed generation corresponding to PHES for the year 2014 is also given.

Table 8 : Top-12 of PHEs leaders countries (An actualisation of [60]).

Country	Installed PHEs capacity (GW)	Under construction (GW)	PHEs power capacity as a % of installed electrical generating capacity
Japan	24.5	3.3	8.5
China	22.6	11.6	1.8
USA	20.5	-	1.9
Italy	7.1	-	5.7
Spain	6.8	-	6.6
Germany	6.3	-	3.5
France	5.8	-	4.4
India	5.0	1.7	2.2
Australia	4.8	0.2	21
Great Britain	2.7	-	3.0
Switzerland	2.5	2.1	12
Portugal	1.1	1.5	6.1

Currently, the fast penetration of fluctuating and intermittent energy is renewing interest in PHEs technology and therefore, is motivating the development of new plants in many countries. Some of the countries who has commissioned their first PHEs plant during the two past decades include Morocco⁴ (0.46 GW), South Africa (total of 3 GW), etc. As far as Sub-Saharan Africa is concerned, the development of PHEs is still there in its early stages. Although there is no explicit mention in the existing literature of a pumped storage power plant in operation in the region, significant progress has already been made in several countries with projects in this direction, including the following Ethiopia, Kenya [49], Zimbabwe, etc.

I.4.2 Overview on the PHEs Technology

The fundamental principle of PHEs technology is the storage of electric energy in the form of hydraulic potential energy by pumping water to a high elevation, where it can be stored indefinitely and then released to pass through hydraulic turbines and generate electrical energy [8]. The charging process converts electrical energy into mechanical energy and eventually into gravitational potential energy by pumping water from a lower reservoir to a higher reservoir. The discharging process is the reverse; it converts gravitational potential energy into mechanical energy and then to electrical energy by allowing water to flow down from the higher reservoir to the lower reservoir, driving a turbine that in turn drives an electrical generator [60]. A typical PHEs plant is composed of two reservoirs of equal volume situated to maximize their height

⁴ The kingdom currently has a hydro power capacity of 1770 MW, 460 MW of which are provided by the pumped-storage hydro power station at Afourer, constructed between 2001 and 2004. The 350 MW Abdelmoumen pumped-storage projects which is currently under development is expected to be commissioned in 2020. From <https://renewablesnow.com/news/onee-starts-work-on-600-mw-hydro-power-projects-this-year-566917/>, Accessed: 06/06/2019.

difference, known as the head. As illustrated in Fig. 15 below, these reservoirs are connected by a system of waterways along which a pumping-generating station is located. Under favorable geological conditions, the station will be located underground otherwise it will be situated on the lower reservoir [61].

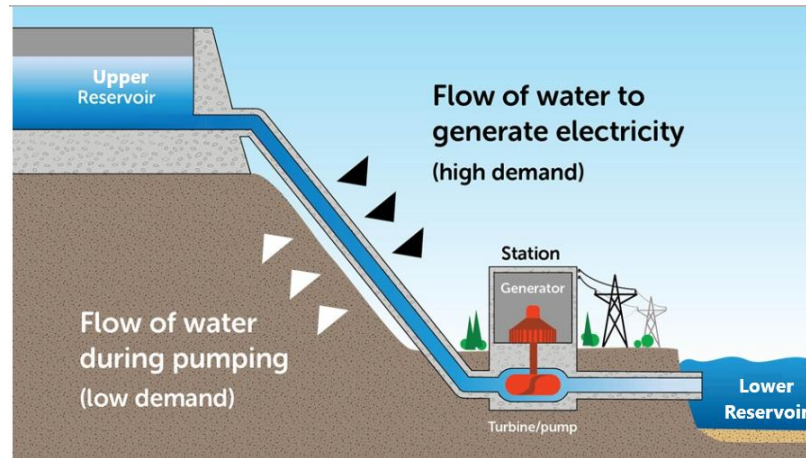

Fig. 15 : Typical pumped-storage hydropower plant Arrangement [62].

Pumping typically takes place mainly during off-peak periods, when electricity demand is low and electricity prices are low. Generation takes place during peak periods, when electricity demand is high [9], as illustrated in I.5.1 (see Fig. 22).

Following is a short description of each of elements common to PHES plants:

- Reservoirs consist in an upper and a lower reservoir: Both are open tanks that feature an inlet/outlet to a pipe, located on the bottom. The elevation difference between two reservoirs is called head.
- Penstocks are large diameter steel pipes connecting the reservoirs to the pump and turbine.
- Pumps are the elements that shaft rotate with the force coming from a motor when the system is storing energy.
- The turbine converts stored energy to mechanical energy and rotates the shaft, which is connected to the generators.
- The generator converts mechanical energy from the turbine output shaft to electrical energy nominally as Alternative Current (AC) for the grid.
- The motor converts electrical energy (AC power from the grid) to mechanical energy in order to drive the pump when the system must store energy.
- The flow control valve modulates the water flow in turbine and pump mode. It serves as an emergency valve during operation. It is completely open during operation.
- The system controller decides the operating mode of the system, based on the power plant output and grid demand.

- Auxiliary equipment such as transformers, AC/DC panels are used for operation and protection of the system.

The electrical energy storage capacity in a PHES plant depends mainly on the volume of the reservoirs and the altitude difference between these two reservoirs. The appropriate relationship is given as *Eq. 19*.

$$E_{PHES} = \eta \cdot m \cdot g \cdot h^* \quad \text{Eq. 19}$$

were

- η is the efficiency of the turbomachinery and Faraday generator combined;
- m is the total mass of water stored in the upper reservoir when it is fully recharged (kg);
- g is the gravitational acceleration (usually taken as 9.81 ms^{-1});
- h^* is the effective head or elevation (m). In practice, h^* obeys to the following relationship:

$$0.75 \cdot h \leq h^* \leq 0.95 \cdot h$$

Where h (m) is the vertical distance (neglecting the variation of water level in the reservoirs since it is small compared to their height difference) between the reservoirs. This is also known as the measured/surveyed head of the PHES.

The maximum power a PHES plant can deliver is expressed as *Eq. 20*.

$$P_{Max} = \eta \cdot Q \cdot \rho \cdot g \cdot h^* \quad \text{Eq. 20}$$

where

- ρ is the density of the stored water ($\sim 1000 \text{ kg/m}^3$) and
- Q is the volume flow rate of the water as it flows through the penstock (m^3/s).

Recent improvements in mechanical engineering and electronics, has led to a decrease of the number of components in a PHES plant with a resulting drop of capital costs. As well, the development in machinery has drastically impacted the way rotary machines are arranged in such plants. Table 9 below gives some of the typical technical characteristics of PHES plants.

Table 9 : Technical characteristics of PHES. Information obtained from [60].

Characteristic	Unit	Value
Power	MW	10–4000
Discharge duration at rated power	hour	1–24+
Round-trip efficiency	%	70–85
Self-discharge	Generally negligible	
Response time	Min	1
Power capital cost	\$/kW	2000–4300
Energy Capital cost	\$/kW	5–100
Lifetime	years	40–60+
Suitable storage duration	Hours - days	1

I.4.3 Classification of PHES Plants (PHESP)

I.4.3.1 Classification Based on the Nature of the Lower Reservoir

On the basis of the nature of reservoirs involved, pumped hydro plants typically come in two types namely open-loop PHES systems and closed-loop PHES systems [63].

Open-loop PHES plants rely entirely on water that has been pumped to an upper reservoir from a lower reservoir, with a continuous hydrologic connection to a natural body of water, as illustrated in Fig. 16-a. The energy capacity of this PHES scheme also known as “pure PHES” is only limited by the size of the upper basin. Most existing PHES are of this type and have the advantage that it uses the existing lake, river or ocean as the lower reservoir. This reduces the cost of construction and the PHES have no significant negative impact on the water body [64].

In a Pump-back or “closed-loop” PHES scheme, there is no water inflow (the reservoirs are not continuously connected to an outside body of water) and so the artificial construction of reservoirs, the lower or the upper one or sometimes both of them is required (see Fig. 16-b). This make PHES scheme suitable for locations with no naturally available lake, river, or ocean to be utilised as the lower reservoir. If this particular scheme has the advantage to have a limited environmental impact, it has the drawback to usually involve huge capital investment and to be often used for small to medium scale PHES [64]. The energy capacity of this PHES is limited by the size of the lower reservoir as well as the upper reservoir and also a make-up water is always required for the replenishment of seepage losses or evaporation.

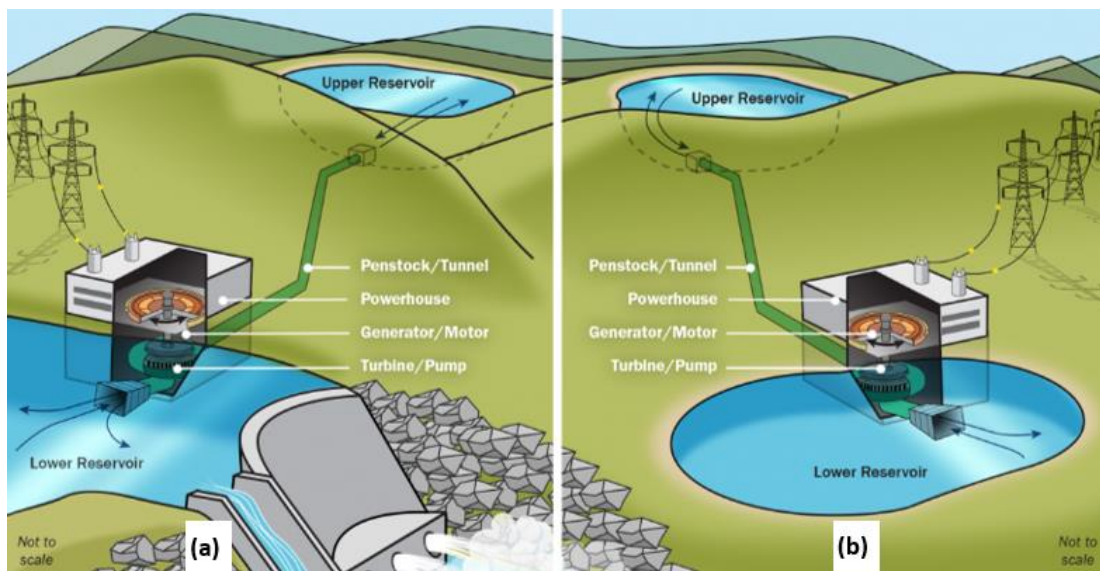

Fig. 16: Models of open-loop (a) and closed-loop (b) pumped energy storage plants [65].

I.4.3.2 Classification Based on the Position of the Reservoirs

Position of the reservoir is defined here relatively to the ground surface. Following that position, there are three types of PHESP: Above-ground, underground plants (UPHES) and Sea-based plants.

Aboveground PHESPs obey to the classical scheme of the PHES technology with both reservoirs well above the ground surface, the lower one being a lake, a river, or even the sea.

UPHES has its upper reservoir located at the ground surface or at shallow depth below the ground, while the lower reservoir is located underground (way below the ground surface as shown in Fig. 17) which can be abandoned deep mines [66] or even an underlying subterranean aquifer water table [67].

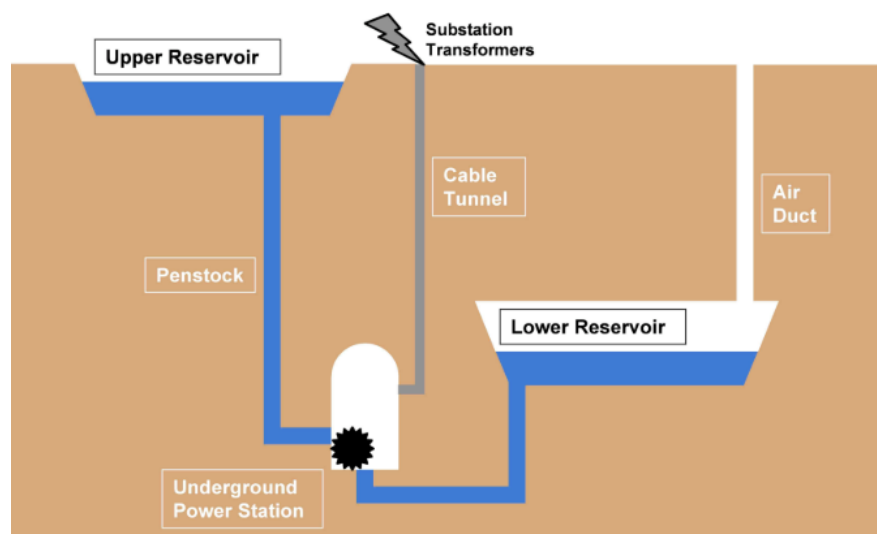

Fig. 17: Principle diagram of an Underground PHES plant [67].

Sea PHESP refers to plants using the sea as lower reservoir coupled with an inland bay used as an upper reservoir. The benefit of using the sea as a natural lower reservoir is the reduction of the construction time and costs [68]. A constraint related to this scheme is that the plant's elements in contact with sea water, such as waterways and turbomachinery should be adapted to salty environment to avoid the rapid deterioration. Currently there is only one project in the world that utilizes the ocean as its lower reservoir. The Okinawa Yanbaru Seawater Pumped Storage Power Station (Japan) was commissioned in 1999. The 30 MW project utilizes an artificial upper reservoir and the Pacific Ocean as its lower reservoir [69]. This project has been successful, but carries added operations and maintenance costs due to a highly corrosive environment for pump-turbines and marine growth on hydraulic structures.

I.4.3.3 Classification Based on the Turbomachinery's Technology

Fixed-speed PHES Plants:

Majority of PHES systems around the world employ fixed-speed pump and turbines. Such systems have evolved over years from separated pumping and generating units towards reversible units running for example the “constant speed Francis runners” [70]. This proven system operates as “a pump in one direction and as a turbine in the other”; however, it cannot provide frequency regulation support to the grid because of its fixed-speed; also, when operating as a turbine, the unit will be unable to run at maximum efficiency at “part load”.

Variable-Speed PHESP

Drawbacks of the fixed-speed technology have been addressed with the development of “Variable” or “Adjustable” Speed units [61], [71]–[74] which currently equip modern PHESPs. Such plants ensure that the power consumed in the pumping mode is varied over a range of outputs, allowing the machine to operate at peak efficiency over a wide range of speeds. In fact, variable-speed operation is one of the most promising improvement in terms of PHES technologies [75] as it allows the PHESP to regulate power both in generating and pumping modes and additionally, it allows enlarging the operating range and increasing the efficiency in generating mode [9]. The widespread application of variable-speed technology in PHES will enable greater renewable power penetration in the future, by providing ancillary service to electrical grids in the presence of a large intermittent renewable power input.

Ternary Units

A ternary pumped storage system consists of a separate turbine and pump on a single shaft with an electric machine that can operate as either a generator or a motor [76], [77] as shown in Fig. 18 below. The turbine can be of either the Francis or Pelton design, depending on the hydraulic characteristics of the site [77].

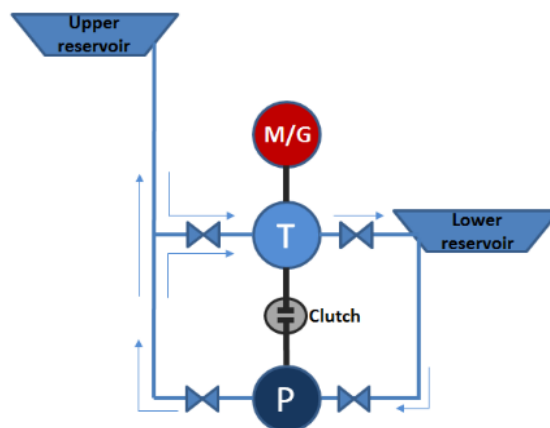

Fig. 18: Arrangement of the main components of a ternary unit [77].

The major difference between a ternary plant and other types of PHESPs is that the ternary plant can simultaneously operate both the pump and turbine referred to as a “hydraulic short circuit”. This ability provides added flexibility in the plant’s operation. The flexibility of the plant is also improved by having the pump and turbine on the same shaft and hence rotating in the same direction, thereby eliminating the need to reverse the rotation to transition from pumping to generating or vice-versa. However, ternary units have the drawback to be technically complex and more expensive than other reversible schemes [78].

I.4.3.4 Classification Based on the Location of the Plant

This classification of PHES plants considers indoor or buildings PHES and outdoor schemes. Almost existing PHESP across the globe are constructed in open spaces and/or below the ground surface (referred to as UPHES explained in I.4.3.2) and therefore considered as outdoor PHES [64]. However, the literature reports some PHES experimental plants sized to fit a building [79]. According to Oliveira and Hendrick [80], the economies of scale that render large PHES installations competitive are not present in such small installations but they point that their costs could be significantly lowered if synergies with existing reservoirs could be found. Such coming PHESP are classified as indoor.

I.4.4 Literature review on Pumped Hydro Energy Storage

I.4.4.1 PHES and Renewable Integration

Wind-PHES Hybrid Systems

The schematic of a power system fed by a wind farm operating in association with a PHES plant is shown in Fig. 19 below.

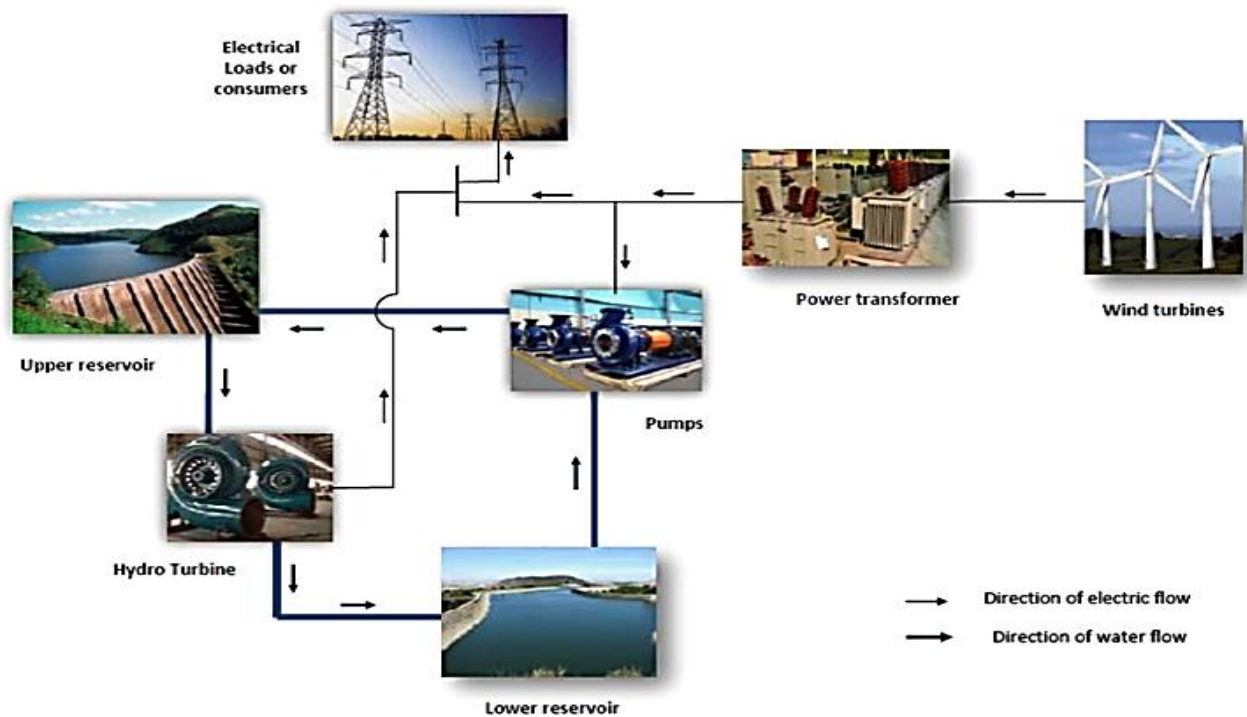

Fig. 19: Conceptual wind power based pumped hydroelectric storage (PHES) system [79].

The way that PHES can assist the integration of fluctuating renewable energy and particularly wind has been investigated by Connolly et al. [81] considering the Irish energy system. They considered three key aspects of PHES including its operation, size and cost to show that PHES can increase the wind penetration feasible on the Irish system and also reduce its operating costs. Anagnostopoulos and Papantonis [82] studied the simulation and size optimisation of a PHES plant for the recovery of wind-farms rejected energy. They present a numerical methodology for optimum sizing of the various components of a reversible hydraulic system designed to recover the electric energy that is rejected from wind farms due to grid limitations. Filipe [83] worked on the optimization strategies for pump-hydro storage and wind farm coordination including wind power uncertainty. He compared two models optimising costs associated to imbalances, spilled wind power, as well as profit from price arbitrage and showed that the stochastic model achieves a marginally higher total profit compared to a deterministic model. J. Levine [84] showed how through the development of PHES coupled with wind, Colorado could manage not only its intermittent power generation but facilitate integration of renewable generation over a much larger geographic region. Dursun and Alboyaci [85] analysed the importance and the necessity of wind-hydro pumped-storage systems for Turkey, emphasizing on the contribution of wind-hydro pumped storage systems in meeting the country's electric energy demand. Canales et al. [86] compared the operation of a wind-hydro hybrid system including a conventional hydropower with a reservoir and including a pumped storage hydropower plant. They concluded that the system with pumped storage plant naturally has the highest initial costs, but the optimal solution of the

hybrid system with pumped storage plant require a smaller flooded area than the system with conventional reservoir, thus representing a lower environmental impact. The stochastic optimisation of the daily operation of wind farm and pumped-hydro storage plant was studied by Ding et al. [87], demonstrating that the coordination of WF and PHESP can greatly alleviate the negative effect of wind power fluctuations on power grid and also increase remarkable profit. A similar work was done by Castronuovo et al. [88], who used an integrated approach to show that the use of a storage device can lead to a significant increase in revenue, up to 11% and as well, Tuohy and O'Malley [89] used a simplified approach to show how with large level of wind power the system is less costly when it operates with PHES. As well, Dragulescu et al. [90] focused on the economics of the wind-PHES association. Rad et al. [91] proposed a new approach to find the optimum capacity of a wind farm to cooperate with a pumped-hydro storage in order to maximize the income and optimize the payback period of their combination. Such combinations have also been studied by Zohbi et al. [92] in Lebanon as an alternative to meet the electricity demand, in Taiwan by Wu et al. [93] as a useful method to compensate the fluctuation of wind power generation by providing frequency support, as a way to provide firm power to the electrical distribution system in Mexico using the "Presidente Benito Juarez" dam and the wind farm located near "La Venta" [94].

The value of storage in providing balancing services for electricity generation systems with high wind penetration was analysed by Black and Strbac [56] from an economic point of view in terms of savings in fuel cost and CO₂ emissions associated with system balancing, compared with other solutions. They found that the efficiency of system operation is increased and the amount of wind power that cannot be absorbed is reduced by the increased reserves needed from standing reserve in the form of pumped hydro storage. The energy storage technology is presented through a case study as the way for smoothing the Norwegian offshore wind energy production in the North Sea. Its contribution to the reduction of the system scheduling costs is assessed by Erez-Diaz and Jimenez [95] who used a hydrothermal weekly unit commitment model to demonstrate that the consideration of constant start-up costs and ramps of the thermal generating units yields unrealistic results, and that the pumped-storage hydropower plant may help reduce the system scheduling costs by 2.5 - 11%. They showed how integrating wind farms and PHES may allow dispensing with the use of some inflexible thermal generating units. Murage and Anderson [49] used an optimal control approach to investigate the benefit of optimally integrating wind power in Kenya with PHES. They found that the use of PHES in conjunction with the wind farm increase the expected daily revenue of the wind farm by over ten thousand dollars. Using the Estonian power system as case study, Raudsaar et al. [96] analysed the increasing wind energy integration impacts

particularly wind energy production forecast errors. They proposed a solution to integrate wind parks with Estonian power grid, which is mainly based on large thermal power plants utilizing fossil fuels, together with a grid-scale energy storage system, particularly pumped-hydro energy storage, in order to balance the forecast errors in wind energy production utilization. Jurasz and Mikulik [97] investigated the benefits of using pumped-hydro storage hydroelectricity as an intermediary between wind turbines and power grid and found that the proposed power unit is capable of ensuring reliable and dispatchable energy generation for next 25 to 48 hours. As well, Investigation on coupling wind and PHEs has been addressed in various circumstances from which some that are remarkable could include the application of power-to-gas [98], the use of electric boilers coupled with PHEs for wind curtailment in China [99] or a wind-PHEs-powered water desalination plant in the island of S. Vicente [100].

Given the abundance of the wind resource in island locations, research effort have focused on pumped-hydro as a key device for building reliable power systems. In particular, Protopapas and Papathanassiou [101] studied the possibility to increase the level of wind power in autonomous island grids where severe limitations are imposed by the constraints introduced by the conventional generating units, pointing PHEs as the most promising alternative to diesel power plants. In the same view, Papaefthymiou et al. [102] proposed an operating strategy applied to three different autonomous island energy systems using a dedicated logistic model, to evaluate the effect of the PHEs on the overall operation and economics of the island systems and to assess the feasibility of PHEs investments. Wealth of results are published on the topic by many authors, including Bakos [103] who investigated the production of low cost electricity in Ikaria and drew useful conclusions regarding the feasibility of these applications in Greek islands and the expected electric energy saving. As well Caralis et al. [104] simulated the combination of PHEs and wind as a means to exploit the abundant wind potential, increase the wind installed capacity and substitute conventional peak supply in the same context. Kaldelis et al. [105] used the Greek island of Lesbos to analyse the use of wind-based PHEs systems in remote island electrical networks energy balance while Papaefthymiou et al. [106] used the Ikaria system to proposed an operating policy for hybrid wind–hydro power stations in island grids. The proposed policy aims at increasing wind penetration levels, while at the same time minimising the impact on the conventional generation system and ensuring the viability of the PHEs investment. The integration of PHEs as support to wind energy penetration in the Aegean Archipelago was addressed by Kaldellis et al. [107], [108] as the supreme method of handling energy shortage and excessive electricity production cost problems for the remote Aegean Sea islands, taking also advantage of the existing high quality local wind potential. In the Aegean Sea island of Lesbos, Kapsalis and Kaldelis [109] examined

the economic viability of a wind-based PHEs system (wind-hydro solution) which provides the local electrical grid with guaranteed energy amounts during the peak-load demand periods. Similar studies have been performed in Karpathos–Kasos by Katsaprakakis [110], in Ireland by Coburn et al. [111], Connolly et al. [12], [81], [112]–[114], in the island of S. Vicente, in Cape Verde by Segurado et al. [100], in Canary Islands by Bueno and Carta [115] and also in Crete Island by Karapidakis [116].

Solar PV-PHEs Hybrid Systems

Less than that with wind, pumped-hydro storage has also been used for the management of the fluctuation and intermittency of solar energy and then the integration of the so produced electricity for grid feeding or other applications. The basic principle is shown in Fig. 20 below.

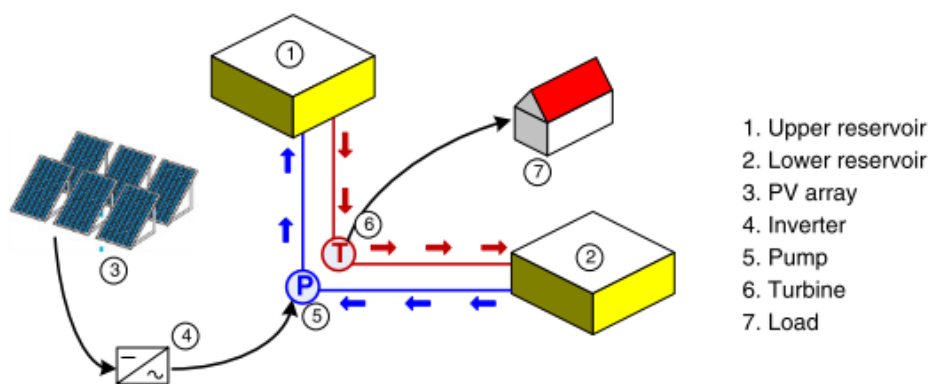

Fig. 20: Solar PV-powered PHEs system schematic [117].

Through the literature, PHEs has been coupled with a park of chemical batteries as reported by Manolakos et al. [118] in the case of a remote village of Donoussa the Aegean Island. That system consisting in a 18 kWp solar farm, a micro PHEs plant composed with a 6 kVA DC pump, a turbine coupled with a generator of 7.5 kVA DC two 150 m³ water reservoirs and a 100 Ah batteries park was proven able to cover energy needs (lighting, TV, refrigerator, etc.) of that village counting 13 houses. A similar system has been proposed by Junhui et al. [119] as solution to the water supply system in remote locations having a good solar potential. The system consists in a PV farm coupled with a chemical batteries park (that levelises the voltage and limits transients) associated a pumping station for the storage of water or the surplus electricity by the solar farm. Biswas and Kumar [120] focused on a similar systems, studying the techno-economic feasibility of a standalone PV/PHEs/Batteries for very low load situation (maximum demand less than 30 kW), demonstrating that utilizing a small battery bank with PHEs greatly reduces the upper reservoir capacity, with least excess energy generation.

More generally, research has been coupling solar PV to hydroelectricity in two different ways following whether the hydro system integrates pumping or not. Solar PV-PHES hybrid systems without pumping have been studied and/or implemented in some circumstances, including rural electrification for remote villages in developing countries by Kenfack et al. [121], water supply [122], the operation of a grid-connected PV-pico hydro system that takes advantage of the seasonal complementarity between solar and hydro by Meshram et al. [123]. Teixeira et al. [124] studied the pre-feasibility of a PV-hydro hybrid system on the Val De Serra that provides water for almost the population of the Santa Maria town in Brazil, proposing a floating PV farm on the water reservoir. Simulating the system, they found that a 227 kW hydropower plant can cost-effectively operate if energy is sold at 0.059 USD/kWh. The sustainability of such hybrid systems was studied by Margeta and Glasnovic through a mathematical model of the optimal sizing of the solar farm, seeing as the key influencer of the technical feasibility [125]. A similar approach was used by Ma et al. [126] for the justification of the techno-economic feasibility of a PHES-based standalone photovoltaic power generation system for remote locations.

Solar PV-hydro hybrid systems under the configuration of pumped storage has comprehensively and variously addressed by many researchers. As the sole storage mean in the system, PHES has been tested in Hong-Kong as reported by Ma et al. [127] who concluded through a hour time scale simulation that the technology is able to provide a full energy autonomy of remote communities. Margeta and Glasnovic who analysed and presented the main features of a new power plant that comprises a modified reversible hydroelectric power plant operating together with the photovoltaic power plant, such power plant using solar energy as the only input for production of solar-hydro energy. They concluded that the hybrid system represents a permanently sustainable energy source that can continuously provide power supply to a consumer, using exclusively natural and renewable energy sources, without causing harmful effects on the environment [128]. Pursuing the analysis, they presented the characteristics of such systems as an alternative to conventional power plants for the sustainable power production [129], [130]. They also analysed the possibility of adding a solar PV generator to an existing hydro dam, taken the case of Zavrleje/Dubrovnik in Croatia to confirm that the association of solar with PHES is realistic and promising [131]. The issue introduced by the high penetration of solar energy is posed by Aihara et al. [132] who evaluated the impact of the large integration of power from solar into the grid. The authors noted a progressive degradation of the system reliability as the solar farm capacity increases while adding a simulated PHES plant highly improves the system output energy quality. Ma et al. [117] proposed a sizing model for the solar photovoltaic system with PHES to optimize the capacity of the PV generator and pumped storage system for power supply in remote areas using a genetic

algorithm. They applied the developed model to a case study on renewable energy power generation system for an island to demonstrate that a technically and economically feasible power supply based on solar PV and PHEs can be easily achieved. El-Jamal et al. [133] studied the feasibility of a PHEs-solar PV hybrid system for meeting peak power demand in Lebanon using the Litany River coupled with an upper artificial reservoir through Francis turbines. Javanbakht et al. [134] studied the transient performance of such systems at small scale. According to the authors, the capability of the PHEs in absorbing excess power from PV and hence alleviating its dynamic oscillations is an added-value for systems with stochastic non-dispatchable generation, and that the system offers many advantages in facilitating higher penetration levels of renewable energy resources such as PV and wind power units in modern distribution systems. Mansour and Djallel [135] studied a case of solar PV-PHEs prototype station implementation designed for the region of Ghardia in Algeria through which they proposed, on the basis of a consumption model of the Wilaya of Ghardia, a PHEs plant as alternative to batteries cell storage which remains out of reach for the majority of citizens.

Wind-PV-PHEs Hybrid Systems

In locations blessed with both solar and wind potentials, precisely islands, pumped hydro storage seems to progressively gain space in Wind-PV hybrid systems as alternative to chemical batteries for a power supply system that is environmental friendly. Such a system is schematised in Fig. 21.

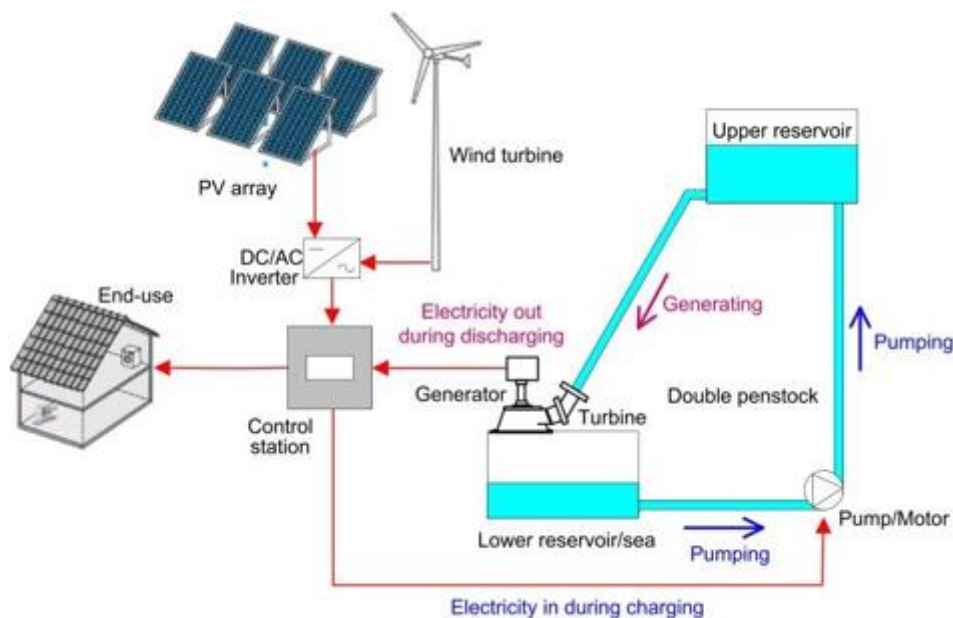

Fig. 21: A hybrid solar-wind system with pumped storage system [136].

Diaf et al. [137] studied the optimal sizing of an autonomous hybrid PV-wind system on the basis of the loss of power supply probability (LPSP) and the levelized cost of energy (LCE) while Solomon et al. [138] used one-year hourly demand data of California's electricity grid together

with the hourly-simulated output of various solar and wind technologies distributed throughout the state to explore various questions regarding very high penetration of intermittent renewable to electricity grid. Both these researches show that wind–solar complementarities carry significant multidimensional benefits to the future grid as compared to a stand-alone wind/solar based grid. Specifically as pointed by Solomon et al. [138], at 20% total energy loss, it was shown that their optimal complementarities lead to very high renewable penetration with smaller storage and backup requirement. So, hybrid systems based on solar PV, wind and PHES known as W-PV-PHES [79] illustrated in Fig. 21 have been studied in various aspects. Li et al. [139] worked on the design of the wind-solar hybrid power supply system for which the batteries park is totally replaced by a PHES plant. They concluded that wind-solar and pumped hydro storage can reliably supply low-cost electricity in the Southern China where wind and solar potentials are appropriate. A similar hybrid system powering a reverse osmosis-water desalination plant in Greek Islands was investigated for the optimal sizing and the operational strategy by Spyrou and Anagnostopoulos [140]. Kusakana [141] presented an energy dispatch model that satisfies the load demand, taking into account the intermittent nature of the solar and wind energy sources and variations in demand, for a hybrid system consisting in a photovoltaic unit, a wind unit, a PHES system and a diesel generator. Applying the proposed model to two test examples, they showed that fuel saving can be achieved compared to the case where the diesel is used alone to supply the same load patterns. Ma et al. [127] studied the technical feasibility of a standalone hybrid solar-wind system with pumped hydro storage for a remote island in Hong-Kong, demonstrating that the PHES based renewable energy system is technically an ideal solution to achieve 100% energy autonomy in remote communities. Always in an island context, Notton et al. [142] studied the operation of a photovoltaic-wind plant with a hydro pumping-storage for electricity peak-shaving and concluded through the simulation of the behaviour of such a system that the covered part of the peak demand can reach 80% in an annual basis. Similarly, Yan et al. [143] modelled and optimized a W-PV-PHES hybrid power system suitable with the special physical geography condition of some islands. Solving the model, they showed an improvement of the system's stability and a reduction of the required investment. Nicolet et al. [76] performed a comparative analysis of the stability of a power supply system composed with solar and wind farms coupled with a PHES plant under two different technologies (especially a Variable speed unit and a Tenary unit) with respect to frequency induced either by wind power fluctuations or PV output power fluctuations and in case of short-circuit. More recently, Yimen et al. [144] analysed the combination of a solar PV/wind/biogas hybrid system with PHES for rural electrification in Sub-Saharan Africa. Considering a case study of Djoundé in northern Cameroon, simulation of an 81.8 kW PV array and a 15 kW biogas generator

resulted in cost of energy (COE) and total net present cost (NPC) of €0.256/kWh and €370,426, respectively.

I.4.4.2 Pumped-Storage Plants as Grid-integrated Units

PHES Plants as Energy Services Providers

Energy arbitrage consists in charging storage at times when energy is plentiful and inexpensive (during off-peak periods) and returning that energy to the power system when it is scarce and expensive (during peak periods). That cycling operation occurs in time frames that can be as long as seasonal to as short as every five minutes, with daily arbitrage being common for PHES. According to Ela et al. [145], a condition for energy arbitrage to be practical, the ratio of the cost of charging the energy to discharging it must be comparable the round-trip efficiency of the storage system, which ranges from 0.7 to 0.8 in modern PHES plants [9]. There must also be a sufficient number of viable arbitrage opportunities to cover the capital and operating cost of the system. In particular, optimal bidding strategies for PHES plant in a pool-based electricity market has been proposed by Kanakasabapathy and Shanti [146].

PHES Plants as Ancillary Services Providers

Ancillary services provided by PHES in power systems typically include frequency control (due to its quick load following operation), load levelling (enabling base-load plants to operate at constant output), reserve operation (to cope with sudden changes in power demand or system failure), and stand-by capacity (to prepare for the unexpected failure of other plants or systems). Regulation services are typically the most valued by market operators, followed by spinning reserves [147].

I.4.4.3 Some Hindrances to the Development of PHES: Site-dependence as the Main Constraint on PHES

The sustainable building of a PHES plant is heavily constrained by the availability of adequate locations. If the hydraulic head is considered as the key parameter indicating the viability of PHES at a given location, in many countries, sites having interesting heads are most often used for other activities banning the construction of power plants, so that the availability of technically and economically feasible sites is becoming scarce. Hence, defining ways and methods for searching new suitable locations for PHES plants has been the subject of many researches, most of which are reviewed in Chapter II.

I.4.4.4 Summary of the Literature Review

Overall, there is a strong interest in the research community on the issue of pumped-hydro storage, with an unprecedented enrichment of the literature since the 2000s. Clearly, this massive energy

storage technology, which is more than a century old, is becoming increasingly important motivated by climate change mitigation policies. Mainly, the development of variable renewable energies in response to an increasingly stringent demand for energy in terms of quality and quantity has motivated advances in equipment technology and also innovations in implementation schemes. However, it should be noted that the development of this storage technology faces significant difficulties that tend to obscure the many advantages associated with its integration into power systems. Noting that the history of pumped-hydro storage has so far been written essentially in countries considered as developed, this thesis tries to shed light on the potential role of this alternative in the context of developing countries, with Cameroon as case study.

I.5 How could PHES Work in Cameroon? The Case of the southern interconnected grid (SIG)

I.5.1 At the Daily Scale

Considering the daily load pattern on the SIG of Cameroon (see Fig. 7), it can be expected from pumped storage facilities to provide the ability to use low-cost power (generated from hydro and other renewable sources) during peak demand period of the day. Specifically, with the number of energy projects in the pipeline and some of which involving large-scales units, the baseload power (including power for pumping water) could be supplied by conventional hydro extended with solar and/or wind, while the intermediate load being covered by more flexible generating units such as gas-fired plants supported by renewable units. Finally peak-power will be supplied by storage units previously charged from baseload generating plants as indicated in Fig. 22. The required capacity of storage will vastly depend on the amount of power needed for meeting the peak demand. Consequently, the baseload is sized assuming that excess energy from conventional hydro or renewable energy plants will be sufficient to pump back water to the upper reservoir. This will then reduce or eliminate the use of costly peaking plants as is the case now.

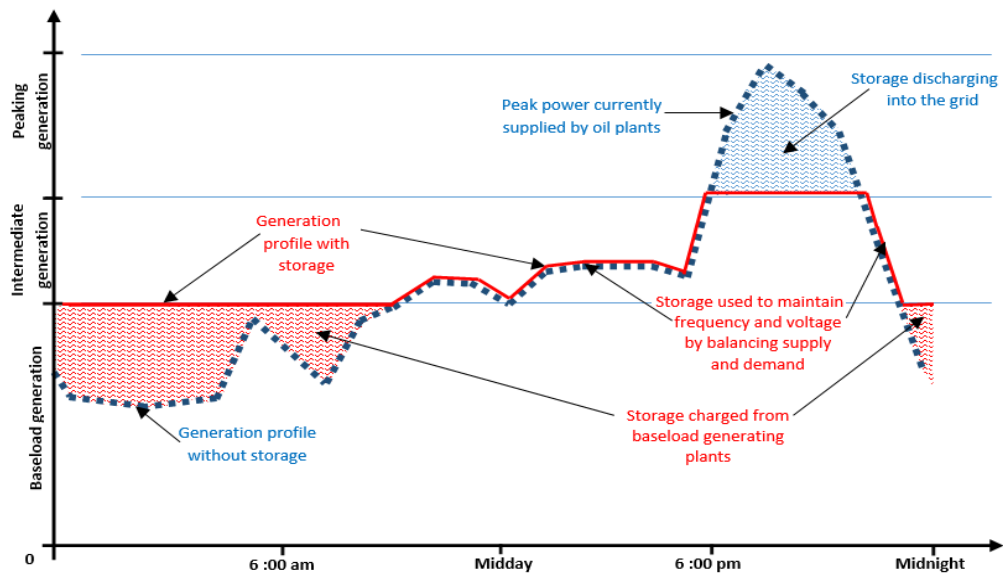

Fig. 22 : Load profile of the SIG with the proposed integration of pumped storage.

I.5.2 At the Seasonal Scale

The annual profile of hydroelectric production in the southern interconnected grid (fed by Edéa and Songloulou hydropower plants, both built on the Sanaga River) indicates a serious decline (by 15%) during the dry season, despite the support of four upstream reservoirs (Bamendjin, Mapé, Mbakaou, and Lom-Pangar) for the regulation of the flow-rate of the Sanaga River. Usually, this drop in hydroelectric generation is offset by a sharp increase in thermal generation, with a severe impact on operating costs and the environment. Fortunately, the dry season coincides with the sunniest months in the area, typically from January to May. During these periods of the year, the overall horizontal irradiation ranges from 5 to 6.5 hours per day, with a clearness index reaching 0.65. This coincidence is illustrated in Fig. 23 below.

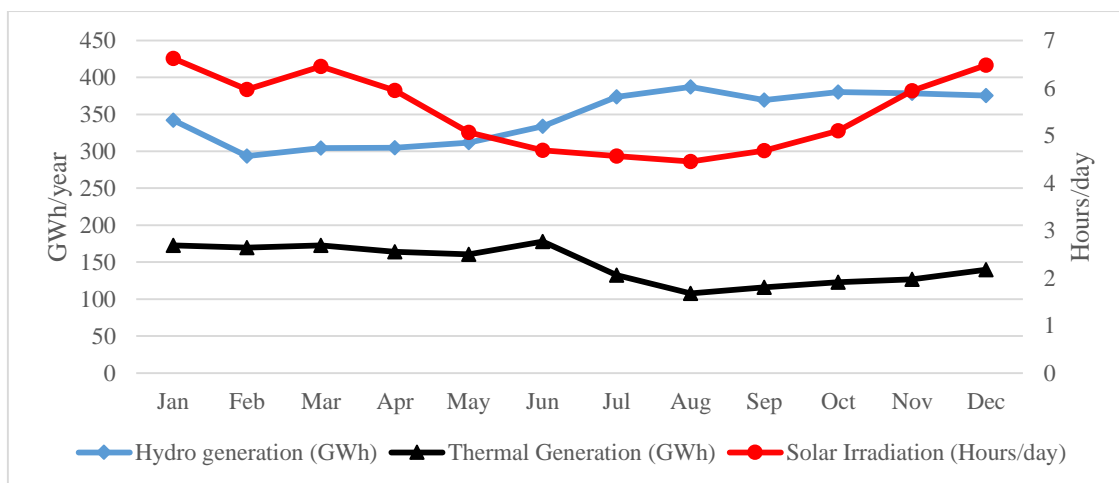

Fig. 23 : Illustration of the complementary seasonal variation of generating capacities (hydro and thermal) and the solar potential in the area of the southern interconnected grid in Cameroon. (The Solar global horizontal radiation data are those obtained at the telecommunication station of Dschang).

This means there is complementarity in time between clean and affordable energy generation capacity and the great solar PV potential. This makes solar PV an alternative to thermal generation and therefore, a great natural advantage for the development of a more reliable power system as targeted by the Cameroon’s energy policy. Of course the hydro capacity of the SIG is going to grow with the completion of ongoing projects including Mekin (15 MW) and Nachtigal (420 MW), but managing the seasonal hydro capacity drop and meeting the peak-power demand in a sustainable manner will remain key issues to address. Therefore, firming power generated from solar PV, and wind or shifting its consumption towards peak-hours will remain a role for a massive energy storage system, especially pumped-storage plants.

I.6 Potential Benefits Associated with the Integration of PHES in the Power System of Cameroon

I.6.1 Economic Benefits

Economic benefits with the integration of pumped-hydro storage in the power system of Cameroon could be appreciated in terms of opportunities for attractive investments, a lowered cost of system operation and deferral of new investments. To better understand how attractive investing in pumped-storage could be considering the power sector of Cameroon, a virtual 300 MW plant is considered and a basic analysis of its viability is performed on the basis of some assumptions made as in Table 10.

Table 10 : Assumptions made for justifying the investment in a pumped-hydro plant compared with existing thermal plant for peaking generation.

N°	Item	Unit	Value	Comment
1	Initial Investment for a 300 MW PHES plant	US\$/kW	1,500	The Energy Storage Association gives a range of costs for Pumped-Hydro of \$500/kW to \$1500/kW. Supposing that figures are correct, the higher end of the range is considered.
2	Round trip efficiency	%	75	The round trip efficiency of pumped-hydro plants typically range from 70% to 85% [9].
3	Daily discharge time	Hours	5	According to Fig. 7, the peak power demand period in Cameroon is from 18:00 to 23:00.
4	Yearly operating days	Days	300	Supposing that the storage plant could be unavailable for some days (82%) during the year.
5	Feed-in price of electricity	\$/kWh	0.15	Currently in Cameroon as reported by ENEO [148], the tariff for Low-Voltage electricity purchased from the grid range from CFA 60 (\$0.10) per kWh at off-peak hours to CFA 85 (\$0.15) per kWh during hours of peak demand.
6	Grid-purchased electricity price	\$/kWh	0.10	

7	Purchasing price of electricity from a solar PV IPP	\$/kWh	0.10	The International Renewable Energy Agency (IRENA) reported that the cheapest onshore wind and solar PV generation costs in 2017 reached respectively \$0.06 and \$0.1 per kWh.
8	Purchasing price of electricity from a solar PV IPP	\$/kWh	0.06	
9	Present cost of thermal peaking power	\$/kWh	0.30	This is the average cost of electricity generated from oil thermal power plants in Cameroon as per ENEO reports [148].

The plant that the discharging time stands for 5 hours per day would require an initial investment of M\$ 450. The income generated by such a facility could be evaluated in term of savings from energy arbitrage, savings from the decommissioning of some aging thermal plants, and finally the remuneration of ancillary services it may provide. Considering only the two first revenue schemes calculated on the basis of assumptions made in Table 10, energy arbitrage revenues are evaluated at M\$ 1.5 per year while savings from peak-power generation are estimated at M\$ 135 per year. Therefore, the initial investment is expected to be paid back within 3.3 years if the plant stores electricity bought from the grid or from a solar PV IPP. That pay-back period falls absolutely under 3 years if the charging energy is purchased from an onshore wind IPP and if a greater feed-in tariff is negotiated near the system operator. This basic analysis does not take into account the potential economic advantage from avoided CO₂ emissions available in the frame of climate incentives, which are intended to improve the attractiveness of such investment schemes.

Furthermore, considering the scenario of a more diversified power system with an increased share of variable grid-connected energy sources, pumped-storage that virtually has zero variable costs would allow multiple extra pumping and power production sessions to come for free. This advantage from large-scale energy storage systems could be beneficial to Cameroon as this shall reduce and stabilise power generation costs in Cameroon. These costs (for which there is an equalised tariff of US\$ 0.30 per kWh applied for on-grid power generation regardless the source [148]) are currently levelised by government subsidies. Therefore, by replacing thermal generation in load following and peak-load management, pumped-storage would contribute to free the power sector from speculations and the volatility imposed by fossil fuels.

Finally, pumped-storage in the power system of Cameroon could defer the need for additional transmission facilities by supplementing the existing ones and thus, allow saving capital that otherwise goes underutilised for years [52]. In fact, there are projects aiming to reinforce and to extend the existing transmission lines in Cameroon. For instance, it is planned that the 90 kV transmission line connecting Bamenda to Douala (about 280 km long) shifts to 225 kV as a way

to address the congestion issue and to improve the power quality in the West and Northwest regions of Cameroon. However, it appears that the western part of the country is blessed with the most relevant pumped-storage sites, which could be easily developed as an economic alternative to the immediate investment on a new transmission line.

I.6.2 Social Benefits

I.6.2.1 The energy security and reliability

Social benefits that can be expected from the integration of storage in the power system of Cameroon could be appreciated in terms of security and reliability of power supply, and lower electricity prices. In fact, the substitution of pumped-storage plants to aging grid-connected oil-fired units whose availability sometimes falls under 50% [40] could effectively solve lot of social issues resulting from frequent grid outages. This substitution may, under certain conditions, help to reduce energy losses along transmission and distribution lines currently estimated at 31% in Cameroon [40]. Moreover, compared to that of thermal plants, lower O&M costs associated with operation of pumped-storage could have a positive impact on electricity prices, which are still very high (from US\$ 0.1 per kWh in households to US\$ 0.16 per kWh for medium-voltage subscribers at peak-hours) to consumers despite government subsidies.

I.6.3 Environmental Benefits

As discussed above, if the shift towards renewable distributed generation scenario were to occur, the integration of storage units would have an environmental benefit in terms of mitigation of carbon emissions. In practice, the surplus electricity generated during off-peak hours by renewable distributed units would be absorbed by storage units for charging. Afterwards, the discharging phase would be scheduled for peak demand hours, typically between 6:00 and 11:00 pm. It is noteworthy that in case of an important integrated capacity of unpredictable plants (such as wind and solar PV farms) a greater standing reserve in the form of pumped-hydro increases the efficiency of system operation and reduces the amount of power that cannot be absorbed [56]. More specifically, the carbon footprint of electricity generated in Cameroon could be minimized if renewable DG units including pumped-hydro plants came in support to large hydropower plants which presently dominate electricity generation in the country.

I.6.4 Technical Benefits

Pumped-storage plants typically have a generation capacity of the order of several hundred megawatts, which provides a considerable volume of flexible capacity to a power system [149]. That flexibility represents a valuable benefit in the operation of the system from a technical point of view. In the specific case of Cameroon that power is supplied from conventional hydro and

thermal plants, the effects that connecting a pumped-hydro plant to the grid could have include – an increased stability of a power system integrating intermittent renewable distributed units as analysed in I.1.3.2 . This benefit would stem the fast response of pumped-hydro plants as they alternate between the charging and the discharging modes to provide voltage stability. –Reduced cycling and ramping of thermal units remaining in the system: with pumped-storage units involved in peak-power supply, this would allow remaining thermal plants to be run in a steadier mode, which improves their efficiency, and reduces ramping stress and cycling. As well, a more stable net-demand allows reducing to the number of start-ups and shut-downs of thermal units, which contributes to diminishing the wear and tear of these assets [149]. Moreover, the flexibility of pumped-hydro plants could be used to modify the power flow in the transmission network, helping to alleviate transmission congestion and improve the transmission assets’ utilisation.

I.7 Conclusion

In this chapter which is ending here, the global energy context has been revisited and an overview of the situation of energy storage in modern electricity systems has been given. However, the chapter was mainly aimed at analysing the need for utility-scale electricity storage in the power system of Cameroon in the medium or the long term. We have come to the conclusion that, pumped-storage hydropower that is itself a new concept for Cameroon’s power system is vital for the effective and sustainable operation of the electricity grid with regard to its future development. In fact, considering existing energy facilities, ongoing projects, policies as well as electricity demand patterns as is the case in this study allowed to forecast some emerging trends pointed as driving forces behind the need for grid-connected bulk energy storage systems. These include the risk of curtailing large amounts of hydropower, climate change vulnerability from heavy reliance on hydropower, high penetration of intermittent renewable energy, and shift towards distributed power generation. As for the implementation of storage in the specific case of Cameroon, the daily and seasonal electricity load profiles on the Southern Interconnected Grid were considered. It results that, the challenge in a near future will be, on one hand, to maintain the grid stability with the integration of energy generated from variable distributed sources and, on the other hand, to sustainably manage the peak demand of electricity. To effectively cope with both issues, pumped-storage schemes will primarily provide the peak power with the excess power generated from conventional hydro and other renewables while helping in load balancing at emergency times. Potential benefits associated with the development of that energy storage technology in the specific context of Cameroon have been analysed as well. It is expected from its implementation to defer some major investments, to support efficient flexibility in the system, to alleviate the dependence on fossil fuels, and finally to reduce and stabilise power generation costs.

Chapter II

An Assessment of Small Pumped Hydroelectric Energy Storage Potential in Cameroon

II.1 Introduction

The previous chapter made it possible, through an analysis of the power system of Cameroon, to better understand the role that large-scale energy storage will have to play in the medium to long term. The high penetration of energy generated from variable sources such as solar PV and wind as well as the shift towards distributed generation, climate change vulnerability from heavy dependence on hydropower were mentioned as key arguments justifying the need to develop storage facilities in the Cameroon. Addressing large-scale grid-connected energy storage systems, state-of-the-art of the implementation of pumped-hydro energy storage (PHES) across the world has been reviewed. It emerged that, although this energy storage technology has many advantages, it is highly restricted by the scarcity of ideal sites, which are heavily influenced by physical constraints such as the terrain morphology and geology, as well as non-physical constraints related to social and environmental considerations [150], [151]. Satisfying these constraints is mandatory to qualify a given geographic location as favourable site for the implementation of the considered energy storage technology.

This Chapter, in accordance with the second sub-objective, focuses on investigations of sites deemed suitable to the implementation of pumped-storage hydropower technology across the territory of Cameroon. This research will have two main steps: first, the development of a method that can be adapted to the context of this study and second, the application of this method to estimate a Cameroon's PHES potential. To achieve this, the literature on existing methods and their applications will be reviewed in order to identify those that would best fit the objective of this study. Subsequently, a detailed description of the adopted methodology will be provided and extended with the formulation of some assumptions. For the application of the method, the different data sources and their required processing will be presented. Finally, an analysis and discussion of the results obtained will follow.

II.2 Review of Existing Methods for Assessing PHES Potentials

PHES is the most mature utility-scale storage option currently available and is more likely to play a crucial role in future energy systems with high shares of variable renewable energy [152]. The scarcity of sites favourable to the development of PHES plants has motivated, over the past decade, the development of methods to identify geographical positions that meet the technical, socio-environmental and even technical requirements of the implementation of this energy storage mean. The authors of these existing methods addressed the issue of PHES plant site location in consideration of various aspects such as the scale of the proposed plants, the extent of the search area and the plant scheme.

Concerning the scale of the envisaged PHES plants, some of the reviewed studies focused on small-PHES. The advantage associated with small-scales PHES being their lower environmental impact, even if they are still suffering from scale effect [153]. For instance, Rogeau et al. [154] estimated the potential of a small-scale PHES in France. Their method detects feasible small-PHES spots considering existing lakes and natural depressions as reservoirs, and estimated a potential of 14-33 GWh depending on the considered natural features. Soha et al. [155] considered artificial landscape features such as artificial reservoirs and open-cast mines, in addition to natural waterbodies, as an opportunity for small- scale PHES deployment in middle mountain areas of Europe. The methodology was applied to an area encompassing 1324 km² in North Hungary, where all the mentioned landscape features are present. The result showed that the sample area has a potential of storing about 1700 MWh of energy theoretically. Connolly et al. [151], [156] proposed a method supported by a computer tool that exploits a Digital Elevation Model (DEM) to identify hill summits suitable for building upper reservoirs and they applied it to the Counties of Limerick and Clare in Ireland to search for suitable locations for the construction of freshwater PHES facilities, which could support the development of renewable electricity generation. The small hydropower potential in Hornad basin in Eastern Slovakia was evaluated by Gergel'ová et al. [157] using a similar work method. Other studies focused on large-scale PHES. The potential of Tibet in terms of Large-PHES (sites with head and reservoirs area greater than 500 m and 60,000 m² respectively) completed by Lu et Wang [158]. Similarly, an evaluation of the potential of the whole Europe considering artificial reservoirs larger than 100,000 m³ and a minimum head of 150 meters has been completed by Gutiérrez and Arántegui [159] on the behalf of European Union Commission.

Through the literature, the extent of search area has varied from a building site as studied by Oliviera and Hendrick [80] to whole region such as Europe [159]. Fitzgerald et al. [150] Proposed a model to calculate the theoretical potential of a large area for the development of PHES schemes

from existing conventional hydropower stations and from non-hydro reservoirs. Their methodology that combines database of existing dams and reservoirs with a Digital Elevation Model to identify suitable reservoirs for transformation has been applied to the Turkey case to produce country level estimates of the theoretical and realisable potential for such transformation. Gimeno-Gutiérrez and Lacal-Aránegui [159] assessed the theoretical PHEs potential of the whole Europe and found that energy storage is significant as it reaches 54 TWh when a maximum distance of 20 km between the existing reservoirs is considered. In Norway, Cortines [160] through its thesis, created a Geographic Information System (GIS) tool that searches for PHEs possible connections between existing reservoirs and dams with the criteria selected by the user. In a larger manner, an approach of the sustainable development of hydropower projects using GIS for morphometric analysis in the lower Satluj river catchment in Himachal Pradesh, India has been proposed by Nishant et al. [161].

Existing PHEs site searching methods have also addressed the diversity of plant types. Some authors such as Fitzgerald et al. [150], Lacal-Aranegui et al. [162] focused on the potential for transforming one existing reservoirs into PHEs plants while [159] considered two existing reservoirs to be connected to create a PHEs plant. Ghorbani et al. [152] considered various site types, including sea and rivers-based reservoirs for the evaluation of the pumped storage potential of Iran. Unlike [152] who did not consider lakes, Rogeau et al. [154] considered existing natural or artificial lakes. Hall and Lee [163] considered a mixture of existing water features used as auxiliary reservoirs in the assessment of new PHEs opportunities in US. Lu et al. [164] considered closed-loop off-stream PHEs schemes on large scale in the development of GIS algorithms to locate respective PHEs sites. Also for the detection of PHEs feasible sites, Ahmadi and Shamsai [165] proposed on a methodology for preliminary site selection for PHEs plant based on geospatial data analysis in a GIS environment. Larentis et al. [166] worked on GIS-based procedures for hydropower potential spotting, using GIS to detect the optimal position to install a dam and build the power house for run-of-river hydropower plant. Kurse et al. [167] completed almost the same work to evaluate the best place in an Indian valley.

Summarising the literature review, the existing methods for searching PHEs sites are as numerous as they are varied in terms of targets. The geographical extent of the application of the methods can vary from one hectare to thousands of square kilometres and the capacity of plants from 1 to thousands of MW. Various PHEs plant schemes are addressed through the literature. These different schemes are summarised by the SETIS experts panel [168] into seven topologies widely used as guidelines by authors for assessing PHEs potentials. These topologies are described in Table 11 below.

Table 11 : Possible topologies for assessing large-scale PHEs [152], [159], [162], [168].

Topology	Potential assessment approach
T1	Linking two existing reservoirs (artificial reservoirs or lakes) with a penstock, and adding a powerhouse to transform them to a PHEs scheme.
T2	Transformation of one existing lake or reservoir to PHEs by detecting a suitable site for a second reservoir. The second reservoir could be on a flat area (by digging or building shallow dams), on a depression or on a valley
T3	A greenfield PHEs based on a suitable topographical context: either valleys, which can be closed with a dam, depressions, hill tops, which could be slashed, etc. This topology is broader i.e. neither based on existing lakes or reservoirs nor assuming a flat area for building the second reservoir.
T4	A greenfield PHEs that uses the sea as the lower reservoir and a new nearby reservoir.
T5	Multi-reservoir systems including both PHEs and conventional hydropower. For example, linking the reservoirs of a conventional hydropower with a lake or an artificial reservoir to add PHEs scheme to the system
T6	The lower reservoir is basically a large river providing sufficient inflow into the PHEs system. An example is the Jochenstein-Riedl PHEs, where the Danube acts as the lower reservoir.
T7	Use of an abandoned mine pit as the basis for the PHEs. The methodology to be used would be similar to the Topology 2 case. An example is the old coal mine of As Pontes, in Spain

The very common feature of all the methods reviewed above is that they are essentially based on Geographic Information System (GIS). Indeed, the acquisition of ground information has been a great challenge in hydropower projects and there is no clear-cut method to evaluate the project-related parameters. So, for any hydro energy project, the adopted method depends at time on many features such as the objective, available tools and the geographical extent of the project. Provided this, GIS appears to be the perfect support as its modern tools allow to easily obtain remotely sensed terrain data with very acceptable accuracy. Its tools have been widely employed to investigate on hydropower opportunities including pumped-hydro energy storage across the World. This overcome the issue posed by conventional work methods that are not cost and time-effective and sometimes unappropriated due the inaccessibility of sites located in rural and mountainous areas.

II.3 Geographic Information Systems

According to M. Goodchild [169] Geographic information systems (GIS) are massive software packages providing a range of functions for creating, acquiring, integrating, transforming, visualizing, analysing, modelling, and archiving information about the surface and near-surface of the earth. They associate locations in space, and often in space–time, with properties such as

temperature, population density, land use, or elevation, and are widely used today in support of research in geography, and in any other disciplines concerned with phenomena on or near the earth's surface [170]. So, GIS not restricted to the conventional view of geography (i.e. that of people and places on the Earth's surface), but GIS is the perfect tool to discover hidden geographies, to explore the hidden facts of World Wide Web, the complex geography of a printed circuit, etc.[171]. Further, with the growing advancement of data processing in computational-GIS and accessibility of satellite imagery information, the development of a number of methodologies for the extraction of terrain characteristics from Digital Elevation Models, as drainage network position, length and slope was made possible [172].

In the domain of renewable energy which most often requires investigating large geographic areas (for instance, the best locations for wind farms in a country, catchment area of a river, slopes and achievable hydraulic head in hydropower projects, etc.) GIS has been a powerful and sophisticated supporting tool for processing spatially localized information [157]. Particularly in the field of hydropower, remote sensing data with GIS based tools is today an incontestable way to go. Punys et al. [173] reviewed and compared software tools for the planning and design of small hydropower plants. According to the authors, the integration of assessment tools into Geographic Information System (GIS) environments has led to a leap forward in the strengthening of the evaluation of the power potential of water streams and consequently, many countries are re-assessing their hydropower capacities based on spatial information of their water stream catchments, and GIS-based tools. In that view, the Rapid Hydropower Assessment Model (RHAM) that identifies hydroelectric power opportunities is based on GIS as it uses Digital Elevation Model (DEM) and regional hydrologic data to calculate the amount of hydroelectric power available on all streams in a study area [174].

However, it should be noted that, error associated with the remote sensing and GIS data acquisition, processing, analysis, conversion and final product presentation can have a significant impact on the confidence of decisions made using data [175]. Accordingly, Goodchild [169] acknowledges that many GIS applications are subject to massive uncertainties, and as a result their outputs are similarly uncertain.

Finally, even if uncertainty might be described as the main limitation of GIS, the application of its based-on tools and remote sensing data on hydropower survey studies have found room in a sector that has been very orthodox in the assessment tools and source of information.

II.4 The Adopted Methodology

II.4.1 Overview of the Methodology

The method used in this study to identify geographical areas favourable to the development of PHES plants is based on the processing of remotely sensed geographical information. Its application therefore requires the systematic use of GIS tools which have been the key support to reach the objectives of similar works. It consists in identifying existing potential reservoirs which can be a waterbody (a lake or a river) or a terrain depression (or sink) in the topography and searching for another compatibly located reservoir nearby in order to pair them as required for a potential PHES site. The overall flowchart of the method is shown in Fig. 24.

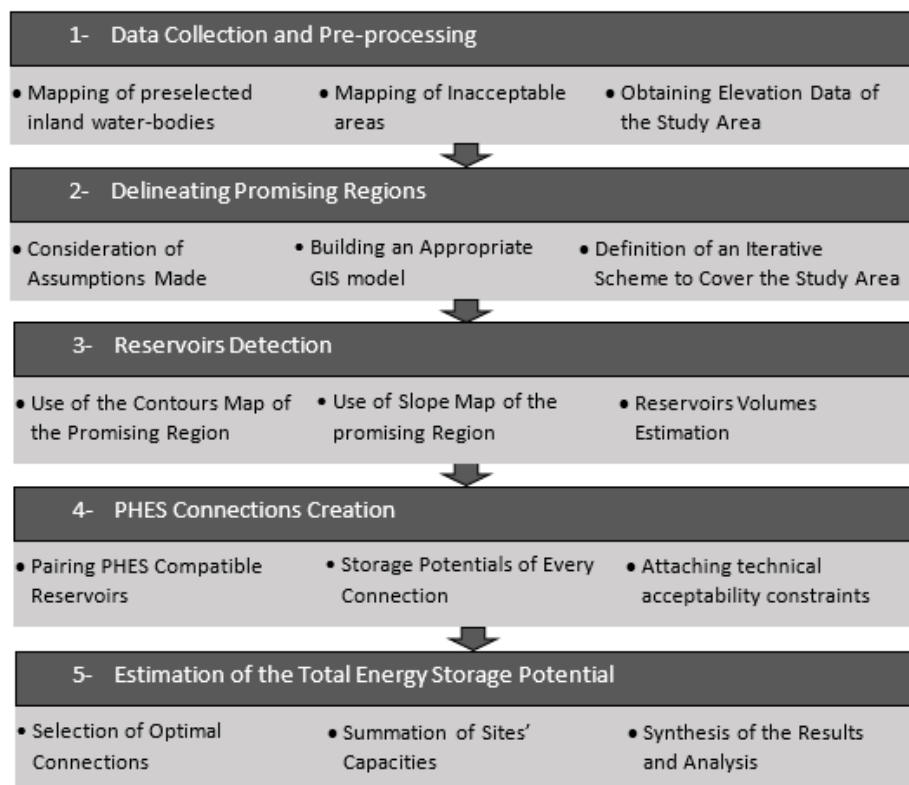

Fig. 24: Procedures for assessing the PHES potential.

It is in fact a GIS-based method resulting from a contextualization of modern geospatial research techniques. Such methods are nowadays widely used in the wider field of renewable energy, most often combined with multi-criteria analysis for the development of decision models at the planning stage of energy projects. In particular, the of similar methods has been at the heart of solving plants siting problems [150], [152], [176]–[184], [154], [155], [157], [158], [160], [161], [166], [172]. Most often, decision criteria are assigned weights so as to mark the difference in importance of one criterion compared to another. But in this study, the search criteria considered at this stage are fundamentals and of the same importance to the development of PHES and then the criteria are assigned equal weights.

II.4.2 Explanation of Main Steps

II.4.2.1 Data Collection and Pre-processing

This first step of the method consists of collecting the required information and, if necessary, formatting it according to the available processing tools. For the study area, three types of geographic data are required:

Waterbodies

The waterbodies considered are those that, regardless of their nature, contain enough water to sustainably serve either as a reservoir or as a water source for a pumped storage system. Thus the targeted inland waterbodies include:

- The main rivers, especially those with a permanent annual regime and, above all, sufficient flow to ensure a daily withdrawal without undergoing a pronounced drying up.
- Natural lakes, only those whose bathymetric information ensures a sufficient water content. A pre-selection may therefore be necessary to select only those which, because of their size, are not likely to undergo level variations from operation of an eventual pumped-storage power plant (charge and discharge on a daily basis).
- Artificial impoundments, including reservoirs for hydropower, dam storage for irrigation, water supply systems, etc. are also considered as candidate waterbodies in this study.

Data on these different resources are likely to be obtained from different sources. It may therefore be necessary to overlay the resulting maps to create a so-called hydrographic data layer.

Mapping of no-go (inacceptable) areas

Flooding initially dry lands as required for reservoir creation is a critical step in a PHES project and may be considered a ‘show stopper’ from social and environmental perspectives [185]. Considering this, the proposed method discards from the investigations the reservoirs or connections intercepting the zones classified as unacceptable. Such zones include all the protected areas regulated by national and international organisations such as the United Nations Educational, Scientific and Cultural Organization (UNESCO) [186]. Briefly, the World Database Protection Areas (WDPA) [187] provides an inventory of the protected areas worldwide regulated by international organisations as well as the different restrictions involved. Moreover, the dense forests and land used for intensive farming, leisure activities, urban extension and other sensitive assets (seaports, airports, stadia, etc.) are also classified as unacceptable. As in the case of waterbodies, these various restrictions must be mapped in a geographic data layer, ready to be processed in any GIS tool.

Obtaining Elevation Data of the Study Area

The geomorphology of the terrain is a crucial factor in the adoption of a site for the construction of a pumped-storage unit. That said, the preliminary search for favourable sites is based on the analysis of the terrain as reported by topography space missions, the most famous of which is the Shuttle Radar Topography Mission (SRTM) held by the National Aeronautics and Space Administration (NASA) through the United States Geological Survey (USGS) [188], available at <https://earthexplorer.usgs.gov/>.

Globally, all generic geographic information for most countries of the world is available on several open access websites. The most popular are, among others:

- <http://www.diva-gis.org/>
- <https://data.humdata.org/>
- https://gadm.org/download_country_V3.html
- <https://mapcruzin.com/>
- <https://www.sogefi-sig.com/ressources/>

II.4.2.2 Delineating Promising Regions

Conducting a geographic search such as the one in this study may sometimes require the processing of large volumes of data depending on the area considered. In such cases, the regions of no interest should be phased out in order to facilitate the processing of the remaining data. Following this principle, one of the key steps in the methodology adopted in this study is the delineation of promising regions, i.e. those with the potential to host an operational water storage reservoir. To this end, the requirements that condition the selection include the altitude of the terrain, the distance to the water source and the land-use. These three factors are taken into account in a spatial analysis model whose conceptual scheme is given in Fig. 25.

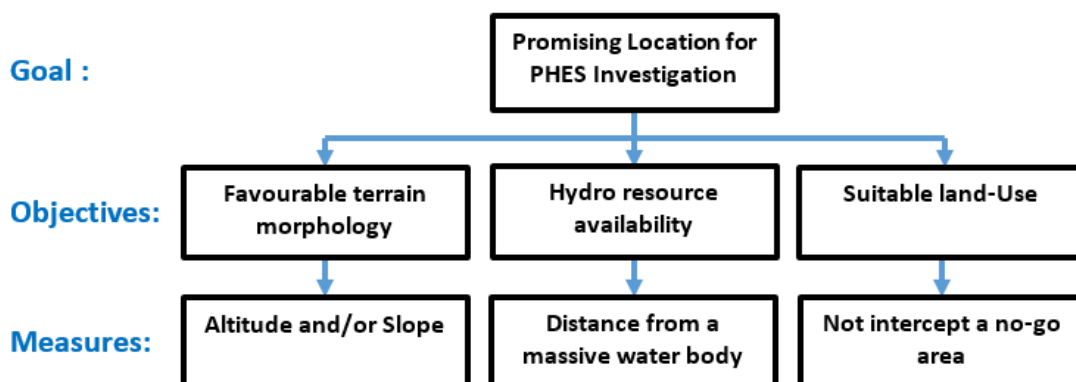

Fig. 25: Conceptual model for delineating promising regions for reservoirs detection.

II.4.2.3 Reservoir Detection

Analysing the Terrain for Reservoirs Detection

Reservoir detection proceeds manually following the delineation of promising areas for PHES site investigation. Indeed, the implementation of the spatial analysis model whose conceptual model was presented above in II.4.2.2 leads, for the identified promising region to the extraction of the slope and the contours maps. These map basically do not exceed a few square kilometres. This makes it easier and to visualise more accurately the areas of interest in order to detect reservoir opportunities, in the case of a manual process. In particular, the contours map allows the detection of potential reservoirs through an automatic or manual process by identifying the closing level lines. Retained location are afterwards confirmed with 3D visualisation through Google Earth application, which also displays the elevation profile of any selected continue line as well as the surface of any selected area on the terrain. The detection of terrain depressions can also be proceeded computationally using tools presented by Planchon and Darboux [189], setting a maximum surface area to ensure that very large valleys are not included in the research. In doing so, in light of the world's experience with PHES reservoirs, several reservoir schemes will be considered as follows.

Definition of Reservoirs' Reference Types

The definition of reservoirs reference types provided here is based on the PHES technology background, considering the most promising reservoirs schemes across the world. Six reference types, R1 to R6 are defined and differentiated by the estimated scope of civil works required to get each of them exploitable in a PHES plant as shown in Table 12 and detailed below.

Table 12 : Definition of reservoirs reference types considered in the study.

Ref. ID	Description
R1	Natural large and permanent lake requiring no additional civil works, considering its current purposes and aquatic live.
R2	Existing artificial reservoir, can be reservoir dam for hydropower, water supply, agriculture or any other purpose, but containing enough water to be used for pumped storage without impacting the current usages.
R3	Dammed stream considering the river flow rate, which limits the transferable volume [153] or an oxbow lake [190] created where possible on a river meander.
R4	Bowl-shaped terrain depression completely closed requiring no dam or particular civil works, assuming good geological conditions.
R5	Open terrain depression or a U-shaped valley requiring a partial dam to be built across the sink or the valley, assuming favourable geological conditions.
R6	A complete ring-like man-made reservoir wall, suitable with hilltops, plateaus extremely large valleys, assuming favourable geological conditions.

- Reference Type R1: Natural Lake

This primary type of PHES reservoirs refers to existing natural lake that will require few or no additional construction works. An example of such a reservoir is shown in Fig. 26 below. The main drawback of this category of reservoirs could be the potential impact that changing lake's shore level from the water transfer can have on aquatic lives and in some cases, the possible conflict with the original purposes of the lake. So, using such water bodies as reservoirs for the pumped hydro technology may require a lot of studies, compromises and authorisations.



Fig. 26: A high altitude lake used as upper reservoir for PHES [191].

- Reference Type R2: Artificial Existing Reservoir

The development of a PHES plant from an existing reservoir is undoubtedly a very relevant scheme because of the many advantages that can be associated with this scheme, especially when it is a hydroelectric reservoir [159], [162]. Indeed, the sites of existing dams already benefit from access to the road network and, in addition, the exceptional advantage offered by the transformation of an existing hydroelectric reservoir into a PHES plant comes from the availability of grid for power exchange [150], [192]. This scheme is attracting more and more interest with the emergence of hybrid power plants with floating solar farms.



Fig. 27: An existing hydropower reservoir, which can be used for other purposes including pumped-storage (in Morocco) [193].

- *Reference Type R3: Dammed stream*

This type of reservoirs is suitable with a river stream, created by constructing a dam across the river-bed while foreseeing as far as it is possible a convoluted way for the migration of aquatic animals (see Fig. 28). This is the primary type of reservoirs for conventional hydro and small hydro power. For PHEs systems uses, the volume of water dammed and transferred should be limited by the flow rate of the river and then this last must be carefully checked when planning to use the river as reservoir [153].



Fig. 28: Example of dammed stream used as lower reservoir in PHEs scheme in northwest Pennsylvania, US⁵.

It can be added into this reference type of reservoirs artificial lakes created by cutting off a river meanders neck. The resulting isolated water body is a crescent-shaped section of the river channel that no longer carries the main discharge of water and is known as an Oxbow lake [190]. The so created water reservoir can be used for many purposes including as a reservoir for PHEs supposing that water will be withdrawn from the river channel for the replenishment of losses in the system. In terms of volume estimation, dammed streams, either as lower or upper reservoirs, are assumed to have an infinite volume. The key parameter which is carefully checked is the yearly minimal flow rate of the river as determined by [assumption 2](#). However, the dimensional specifications of the required weir can be easily estimated from the site's contours map.

- *Reference Type R4: Closed Terrain Depression*

This reference type refers to a natural sink that can contain water with a priori no additional works on its shape (see Fig. 29 below). Therefore, unlike other types of reservoirs to be filled, building a weir as well as excavations are not required and consequently, natural terrain depressions appear to be interesting opportunities for water storage. A particular interest is carried on those found in

⁵ <http://energyhonesty.squarespace.com/blog/tag/hydro> [Accessed: 05/06/2019]

rocky locations as such sites may not require important lining works. Also, there could not be vegetation to be flooded so that a low environmental impact could be expected when using such possibilities.



Fig. 29: Examples of closed terrain depressions used as reservoirs in Scotland [194] (a) and Australia [195] (b).

Estimating the volume of a terrain depression is quite easy when its contours map is available as there are a wide range of engineering tools performing the task (ArcGIS, Sketchup). In particular, in the case of R3-reservoirs, AutoCAD Civil Works seems the most suitable as it allows to outline the required weir before proceeding to the volume calculation.

- *Reference Type R5: Open Terrain Depression*

Assuming favourable geologic conditions are present a dam can be constructed across a valley (with or without a stream or other water feature) or other terrain depression that is not closed. This therefore, enables making a water reservoir with fewer civil works than in the case of a fully man-made one. This type of reservoirs is practically the trendiest in the field of pumped hydro storage. Fig. 30 shows the examples of such type of reservoirs: Fig. 30-a is the upper reservoir of the Cruachan's 440 MW Pumped Storage Hydro Power Station in Scotland while Fig. 30-b is the lower reservoir of the 1,528 MW PHES plant currently running at Manic-5, Québec in Canada.



Fig. 30: Examples of reservoirs dams built in open terrain depressions (a): Cruachan PHES plant, Scotland [196] (b): Manic-5, Québec, Canada [197].

Estimating the volume of this type of reservoir obeys to the same principle as in the case of a R4 type reservoir.

- Reference Type R6: Fully Man-made Reservoir

This type of reservoir is particular in that it is completely man-made and is typically suitable for not advantageous locations such as a very large valley or a hilltop. Building such reservoirs always requires important civil works, so that it may be encouraged in projects where other restricting factors, (the head for instance) are very encouraging. The process of building such ring-like reservoir walls topping mountains when favourable geologic conditions are assumed is described by Connolly et al. [156]. Fig. 31 below shows two examples of such ring-like reservoir walls. Fig. 31-a is the upper reservoir of the 408 MW Taum Sauk PHES plant called “the biggest battery that we have” that was commissioned in 1963 in US [198]. The reservoir built on the top of Proffit Mountain can hold about 5.7 million m³ behind a wall nearly 30 m tall. As well, Fig. 31-b is the 292 MW PHES plant’s upper reservoir built on the flat top of the Turlough Hill in Ireland. That power station is able to ramp up to its full power in just 70 seconds.



Fig. 31: Examples of upper reservoirs with a man-made reservoir wall (a): Taum Sauk PHES [199], USA (b): Turlough Hill PHES [200], Ireland.

It is noteworthy that, beyond the technical advantage this type of reservoirs offers when searching for highest hydraulic heads, another valuable asset is the relatively low environment impact it potentially has. Further, such facilities have the potential to develop other touristic activities, which could be a source for extra incomes that increase the attractiveness of a PHES project.

This type of man-made reservoirs wall has the particularity to be mainly used as upper reservoirs in PHES plants and accordingly, the SETIS PHES expert panel [168] advises that its usable volume be limited by the usable water in the lower reservoir. But in this study, taking into account the fact that the existing reservoir could contain large quantity of water and also our inability to clearly determine the volume of lake’s water currently needed by other purposes, we opt to assume the

height of the wall and to calculate the volume from the estimated surface. From literature in relation to reservoir height, existing man-made ring-like reservoirs have been constructed in excess of 20 m. For example, Coo-Trois-Ponts PHES in Belgium has a reservoir wall that is 47 m high, Revin PHES in France has a reservoir that is 20 m high, Turlough Hill PHES in Ireland has a reservoir that reaches heights up to 30 m [151] and Taum Sauk PHES in US has a reservoir wall that is 30 m high.

Then, a pessimistic height of 25 m has been adopted in this study as reference for the calculation of the volume of ring-like reservoirs wall. So, the following relationship will be used for such reservoirs:

$$Volume = 25 \times Surface \tag{Eq. 21}$$

where is *Surface* the estimated ground surface area of the reservoir.

II.4.2.4 Connections Creation

Matching Reservoirs

Each pair of a lower reservoir and an upper other reservoir, referred to as PHES connection is characterised by the corresponding topology and a certain amount of energy that it can store. From the definition of the reference types of reservoirs, setting connections is constrained by the compatibility between any given pair of reservoirs. Table 13 below is the matrix that analyses the possibility of connection between the six reservoir reference types and, by the same way, establishes the correspondence between pairs of reservoirs and PHES site topologies shown in II.4.3.1 .

Table 13 : Topology of sites in accordance with matched reservoirs.

		Upper Reservoir						
		Hydro reservoirs			Non-hydro reservoirs			
		R1	R2	R3	R4	R5	R6	
Lower Reservoir	Hydro reservoirs	R1	X	X	X	T2	T2	T2
		R2	X	T1	X	T5	T5	T5
		R3	X	X	X	T6	T6	T6
	Non-hydro reservoirs	R4	T2	T5	X	T3	T3	T3
		R5	T2	T5	X	T3	T3	T3
		R6	T2	T5	X	T3	T3	T3

According to the matrix above, pairing some reservoir types is unacceptable. This is related to difficulties that may be of technical nature such as connecting two rivers or using a river as upper

reservoir, or of environmental nature related to the misdeeds of water exchange between two natural lakes. As a reminder, the sea and underground caverns are not taken into account (from [Assumption 1](#)). This is why T4 topologies do not appear in the matrix above.

Calculation of the Capacity of a PHEs Connection

Fig. 32 shows the schematic of a PHEs connection as considered in the method. It is a couple made with two compatible reservoirs, considering that there should be a sufficient head and minimal horizontal distance between them. For simplification, the parameters defining a PHEs connection are limited to the gross head, distance between the reservoirs, volume of the connection, and its energy storage capacity.

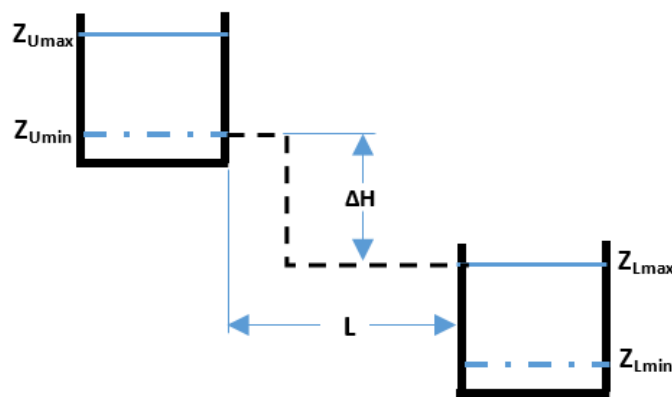

Fig. 32: Geometry of a PHEs connection.

The energy storable, expressed here in Mega-Watt hour (MWh), by a given connection is calculated by the classic relation expressed Eq. 22.

$$E = \frac{\eta \cdot \rho \cdot g \cdot \Delta H \cdot V_{Conn.}}{3.6 \cdot 10^9} \quad Eq. 22$$

where

- η is the efficiency of the plant (the reasonable value of 0.7 is chosen for small/medium-PHEs plants [79]);
- ρ is the water density (kg/m^3);
- g the gravity acceleration (m/s^2);
- ΔH (m) is the gross head of the connection, calculated as

$$\Delta H = Z_{U_{min}} - Z_{L_{max}} \quad Eq. 23$$

With $Z_{U_{min}}$ and $Z_{L_{max}}$ being the minimum and maximum altitude above the sea level of water surface in the upper and lower reservoir respectively.

- $V_{Conn.}$ (m^3) is the volume of the connection or the volume of water available for transfer between reservoirs. It is calculated in accordance with the type of the connection as shown in Table 14.

Table 14 : Calculation formula of Connection Volume.

Connection Topology	Used Formula.	Eq. N°
T1	$V_{Conn.} = 0.9 \cdot Volume_{smaller_reservoir}$	Eq. 24
T2	$V_{Conn.} = \min\{0.7 \cdot Volume_{Lake}; 0.9 \cdot Volume_{Non-hydro_Reservoir}\}$	Eq. 25
T3	$V_{Conn.} = 0.9 \cdot Volume_{smaller_reservoir}$	Eq. 26
T5	$V_{Conn.} = 0.9 \cdot Volume_{Non-hydro_Reservoir}$	Eq. 27
T6	$V_{Conn.} = 0.9 \cdot Volume_{Non-hydro_Reservoir}$	Eq. 28

Attaching technical acceptability constraints

Each parameter defining a connection should not lie beyond a default value that is set for small PHES schemes as summarised in Table 15. So, from a technical point of view, connections with any parameter value exceeding the limit are discarded. The minimum energy threshold has been set as in [154], notably for a 5 MW plant active for 10 hours allowing eliminating small sinks when searching for potential reservoirs. The minimum Head-Distance ratio corresponds to a 10% slope of the penstock [158], [201].

Table 15 : Limitations for different connection parameters.

Criterion	Limit	Default value
Gross Head (m)	Min.	40
Distance between reservoirs (km)	Max.	3.5
Transferable water volume (thousands m ³)	Min.	171
Energy (MWh)	Min.	50
Head:Distance ratio	Min.	0.1

II.4.2.5 Optimisation and Evaluation of the Potential

For sites with more than one acceptable connection, i.e. sites that have several possibilities to install a PHES plant after the application of the acceptability constraints, it is necessary to select the optimal one based on fixed criteria. This is done assuming that except for the case of a very massive water bodies, a reservoir should not be involved in more than one connection. Then, the optimal connection considered by this method is the one maximising the energy as a function of the gross hydraulic head, which should be as high as possible. The potential of the country is finally calculated on the basis of the optimal energy storage capacity of the connection of each PHES candidate site selected by the method.

II.4.3 Assumptions Made

A review of the classification of PHES plants carried out in Chapter I revealed a wide variety of implementation schemes for this energy storage technology. In order to simplify the study, it is therefore necessary to define the scope (geographical and technical) of application of the site research methodology. Thus the following three assumptions are made:

II.4.3.1 Assumption 1: Site Topologies

From the seven PHES plant site topologies detailed in Table 11, this study estimates the technical potential of PHES in Cameroon based on five topologies, T1, T2, T3, T5, and T6. This means that the method considers only pure inland pumped hydro energy storage systems based on lakes, existing reservoirs and rivers. Therefore, underground caverns and the sea as lower reservoirs are not considered.

II.4.3.2 Assumption 2: The Size of Water Bodies

For environmental reasons, the method considers only massive water bodies. Especially, 70% of the volume of a lake should be larger than 1 million m³ and 50% of the lowest flow rate of a river should ensure daily the same minimal volume of water.

II.4.3.3 Assumption 3: The Site' Study Zone

The study zone on a water body site is defined by the 4.5 kilometres-buffer around the lake or alongside the river's shoreline as shown on Fig. 33.

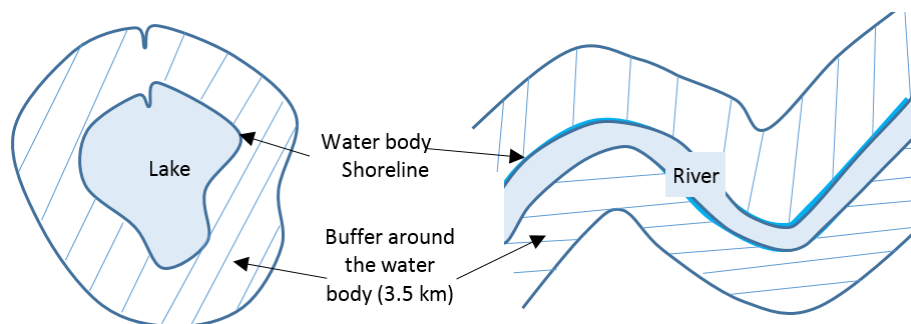

Fig. 33: Representation of the search area around a waterbody as considered in this study.

II.5 Application of the Method to Cameroon

II.5.1 Accessed Data Sources and Materials

For the application of the investigation method presented above, the necessary data were obtained from various sources.

- Most of the geo-referenced data related to geographic information systems were downloaded from the DIVA-GIS website (<http://www.diva-gis.org/>). This site makes the following geographic data freely available to users in "shapefile" format for each country:

- The administrative boundaries at four levels, i.e. for Cameroon for example, territorial limits, the regions, the departments and the communes.
 - A global digital elevation model in raster form,
 - The road and rail routes updated on a yearly basis,
 - Other information such as urban centres, vegetation cover, population densities, etc., are also available.
- Due to the poor quality (lack of clarity and accuracy) of the digital hydrologic map provided by DIVA-GIS, a very good quality map (see Annexe 10) of the main rivers of Cameroon was obtained from the "Institut de Recherche pour le Développement (IRD)".
 - Information on the protected areas of the country, as well as a list of about 51 water bodies referred to as lakes was obtained from the Ministry of Environment Nature Protection and Sustainable Development and from the National Institute of Cartography (NIC), available from <http://www.inc.ayoos.com/>. This list (provided in Annexe 9) includes:
 - Four large artificial impoundments created on the rivers systems for hydropower generation and one reservoir dam serving for water supply (Mbatu-Dam near Bamenda town);
 - 33 volcanic lakes, which are water bodies having history associated with volcanoes. They are calderas (sink on an old volcano that is no longer in activity) and alive craters;
 - 13 other natural lakes that are not related to a volcano. This group can enclose seepage lakes (Natural lakes fed by precipitation, limited runoff and groundwater and without a stream outlet [202]) and drainage lakes (Lakes fed by streams, groundwater, precipitation and runoff and drained by a stream [202]).
 - For a more precise analysis of the terrain, the Shuttle Radar Topography Mission (SRTM) terrain model of Cameroon at 30 meters horizontal resolution has been downloaded from the NASA/USGS site. Indeed, this USGS site provides for most countries a DEM in the form of a tile mosaicked 5 degree x 5 degree tiles, in geographic coordinate system WGS84 datum. These files are available for download in both Arc-Info ASCII format, and as GeoTiff, for easy use in most GIS and Remote Sensing software applications. For Cameroon the territory is entirely covered by 63 SRTM DEM tiles numbered as in Fig. 34.

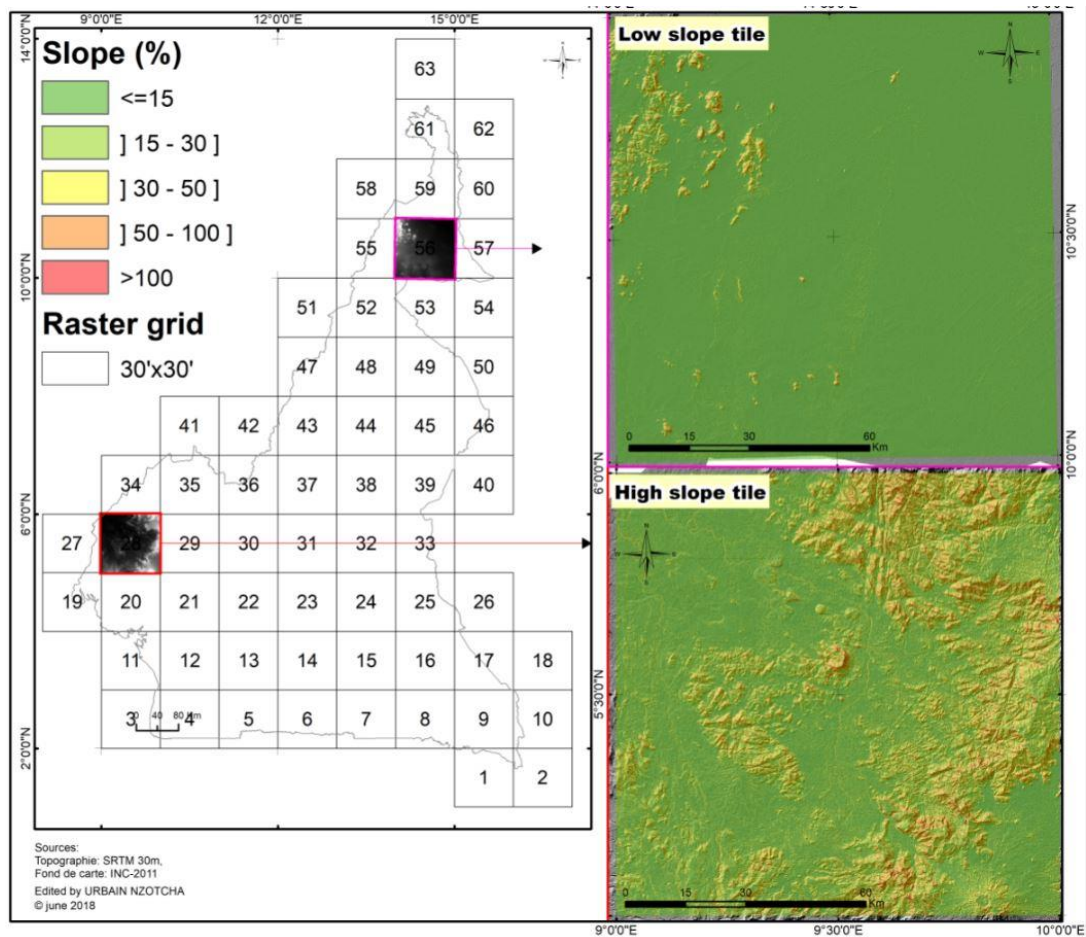

Fig. 34: SRTM terrain model of Cameroon in mosaicked tiles (Slope maps of tiles 28 and 56 are presented).

With all these categories of data available in various formats and media, several data pre-processing operations were necessary, including the geo-referencing of maps available in simple image format (.JPEG, .PNG,...), the assembly of DEM parts to make a global map of the country, the confirmation of the plotting of certain hydrographic features, etc. To do so, two main software packages have proven to be of paramount importance: Google Earth Pro and ArcGis 10.5.

Another important step in the pre-processing of data was the selection of acceptable water bodies, especially, the selection of lakes on the basis of the amount of water each of them may hold. Doing this, required data for artificial water reservoirs are available from various sources and while the maximum depths of 33 volcanic lakes in Cameroon were obtained from [203]. Those lakes were probed in the proceedings of the two fatal disasters which occurred in 1984 (37 deaths) and 1986 (1,700 deaths) due to the carbon dioxide emanation from lakes Monoun and Nyos, respectively [204], [205]. They were used as sample to test the two lake volume estimating models shown as Eq. 21 and Eq. 23 below:

- When the maximum depth of the lake is known, the conical approach evoked by Hollister and Milstead [206] assimilates the lake to a conical solid (see Fig. 35-b) so that its volume can be obtained using *Eq. 29*.

$$Volume_{Lake} = \frac{Surface_{Lake} \times Max_Depth}{3} \quad Eq. 29$$

- Alternatively, the lake is assimilated to a cylinder (see Fig. 35-a) with the high deduced as the mean depth from the maximum depth of the lake using *Eq. 30* proposed by Sobek et al. [207].

$$D_{Mean} = 0.78 + 0.29 \times D_{Max} \quad Eq. 30$$

Then, the lake's volume is simply calculated as the product of its mean depth and its surface area as shown by *Eq. 31*.

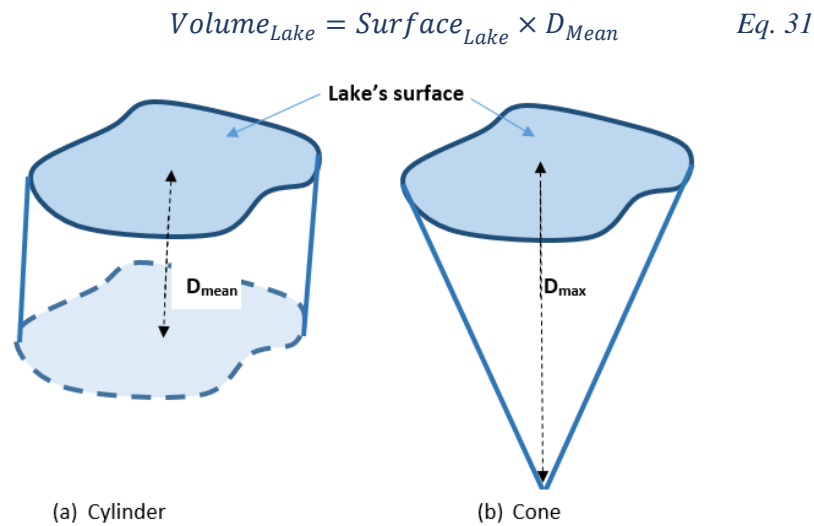

Fig. 35: The two approaches of the lake's volume theoretical estimation.

When no bathymetric information is available, estimating the volume of a lake requires remote sensed data needed as input for the application of models elaborated for the purpose. Such models use the lake's surface area to estimate its volume as done by Liebe et al. [208]. Most recent and accurate models use the surface area in combination with data on terrain surrounding the lake to estimate its volume (Heathcote et al. [209] use the surface area and the elevation change in the 25% lake's surface equivalent-diameter buffer around the lake's shoreline while Sobek et al. [207] use the surface area and the maximum slope in the 50 meters buffer around the lake shoreline) or its maximum depth as done by Hollister et al. [210]. However, the volumes of the 33 Cameroon's volcanic lakes was calculated using both conical and cylindrical approaches and plotted as in Fig. 36 below.

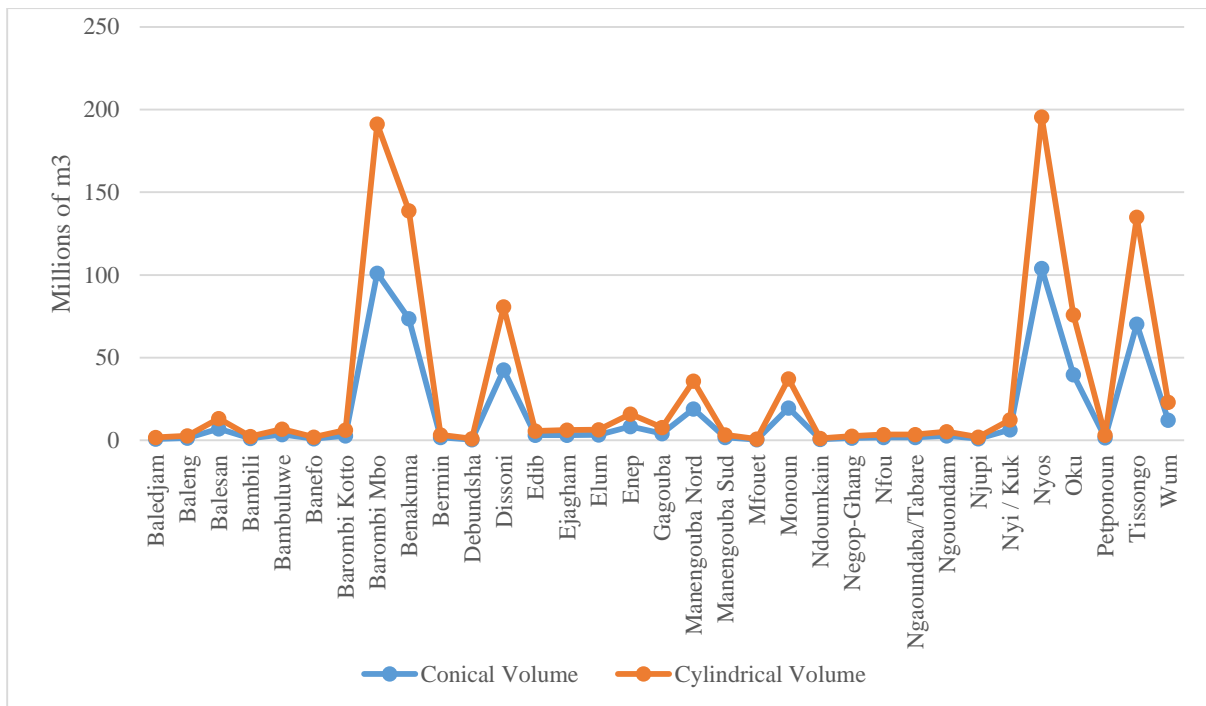

Fig. 36: Comparison of the two techniques considered in this study for lake volume estimation.

From this comparative analysis, it is quite easy to note that both techniques gives almost the same results for relatively small lakes, in particular for those with estimated volume less than 50 Million of m³, and that the cylindrical technique tends to an overestimation. As result, the conical approach (written as Eq. 29) was selected because of that it is more restrictive.

II.5.2 Delineation of Promising Regions for Reservoirs Detection

Following the conceptual model, the objective of “Suitable Land-Use” is reached by excluding from the country’s territory all areas considered as no-go. These include urban areas, protected areas and other sensitive assets, such as airport, pipelines highways, seaports, etc. The use of the MODEL BUILDER module of ArcGis software, shown in Fig. 37 makes it possible to consider these restrictions to produce a map of acceptable zones.

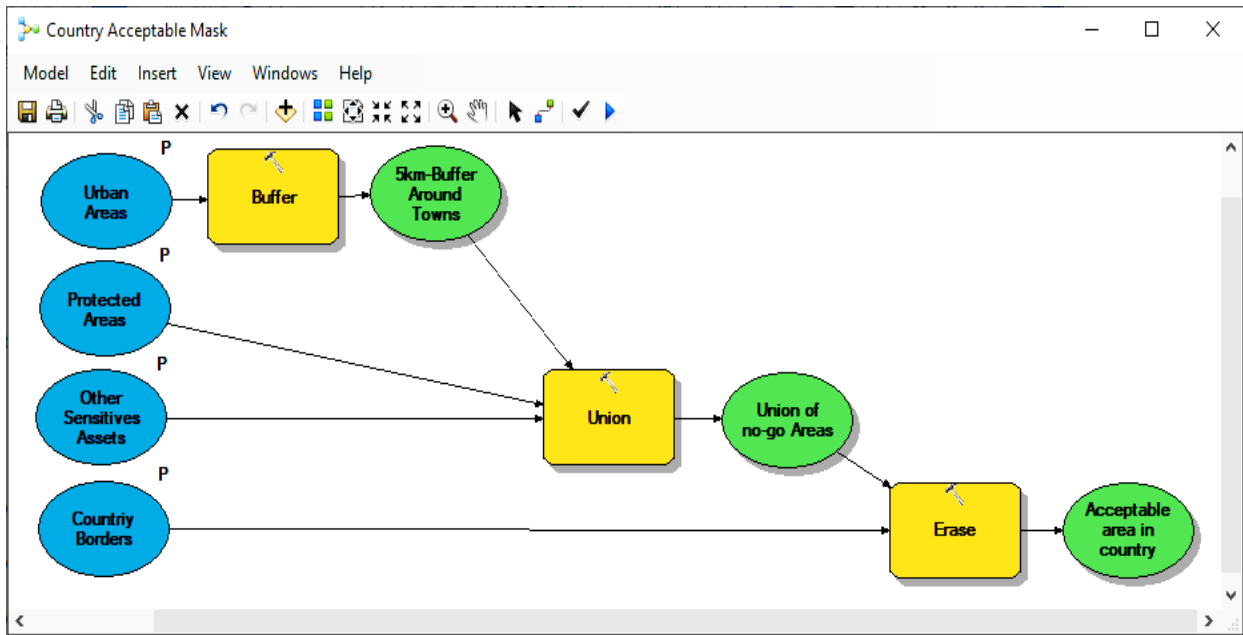

Fig. 37: ArcGis model for the creation of a territorial mask delimiting the area deemed acceptable for terrain analysis in the country (“P” indicates the model parameters. Tools and outputs shadows indicate that the model has been successfully run).

The territorial mask of acceptability thus produced makes it possible, for each SRTM DEM tile element, to construct another extraction mask which this time takes into account the 4 km-buffer zone created around the watercourse intercepting the element. The processing of digital elevation data is particularly demanding in terms of processor performance. So, the advantage of creating this second extraction mask at the scale of a DEM feature is to reduce the processing of altimetry data to only those areas that meet all the acceptability conditions. The ArcGis model presented in Fig. 38 below realises in a macro-step this procedure which takes as parameters a DEM element, the cartography of water bodies and the territorial mask previously built. As output, it gives information on the terrain of the acceptable areas surrounding the water body (ies), in the form of reclassified altitudes and slopes and a contours map.

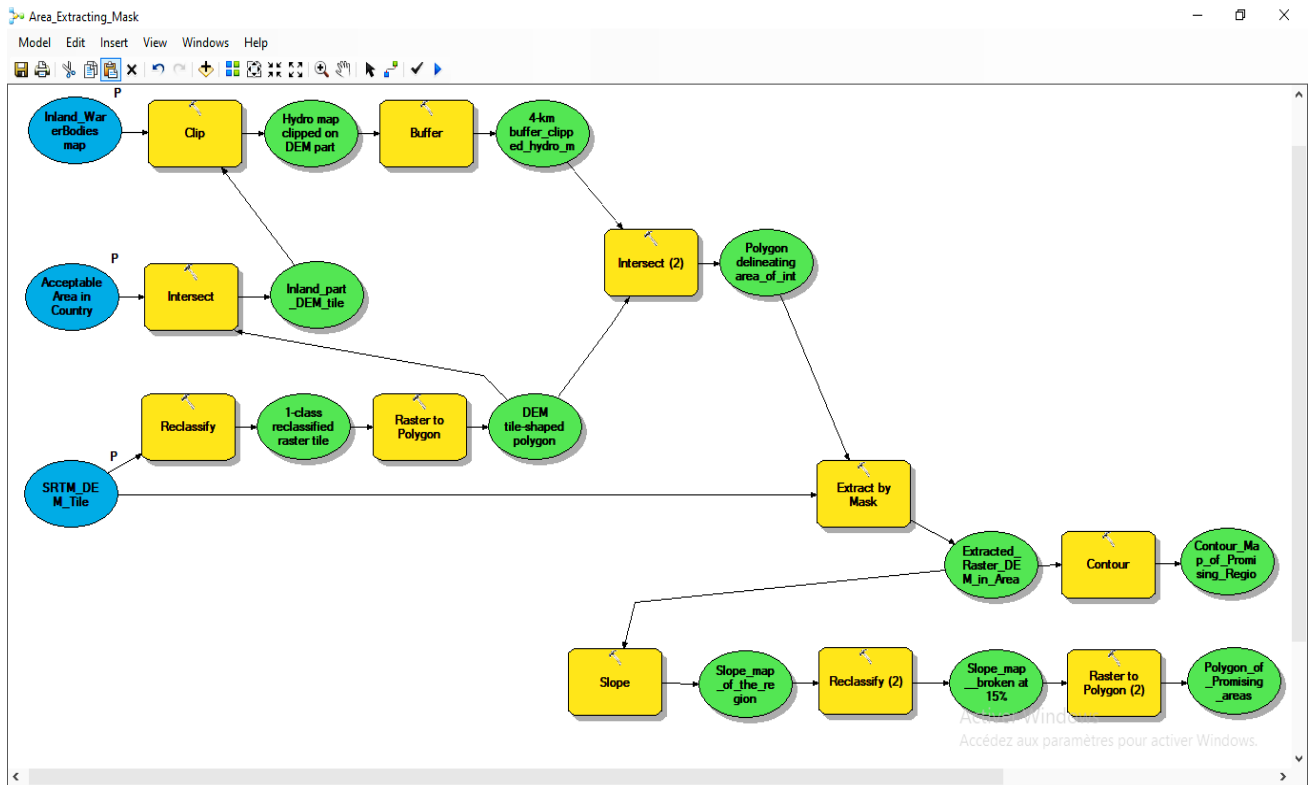

Fig. 38: ArcGis model for obtaining in the geographical area of an SRTM DEM tile, the regions favourable for the detection or construction of reservoirs (“P” indicates the model parameters. Tools and outputs shadows indicate that the model has been successfully run).

The implementation of the conceptual model of investigation necessarily requires the adoption of an iterative scheme, i.e. an element by element processing according to the selected input parameter. Then two possibilities arise:

- Processing by DEM element: This involves conducting successive searches on each SRTM DEM tile intercepting the study area. In the case of Cameroon, the territory is thus covered in 63 iterations, corresponding to the number of raster terrain elements obtained from the NASA/USGS site.
- Treatment by water-body: in this case the search starts from the list of pre-selected water-bodies, each one being the subject of one iteration. In the case of Cameroon about 120 iterations would be necessary, due to about 50 lakes (all types) and about 70 rivers.

By way of illustration, some stages of an iteration of a search for areas favourable to the detection of reservoirs around an artificial lake (in this case that of Lagdo in North Cameroon) are shown below. First of all, the watercourse under consideration is visualised in Google Earth Pro as shown in Fig. 39.



Fig. 39: Satellite image of Lagdo Lake visualized through Google Earth Pro.

The capture of this satellite image followed by its georeferencing in Arcgis 10.5 allows precise mapping of the water-body on the Cameroonian territory, with precision on the surrounding assets as well. Fig. 40 locates Lake Lagdo with by its northern boundary the Lagdo hydroelectric power station and a facility similar to an unloading dock, which are considered sensitive equipment whose surroundings are banned from the search for reservoirs.

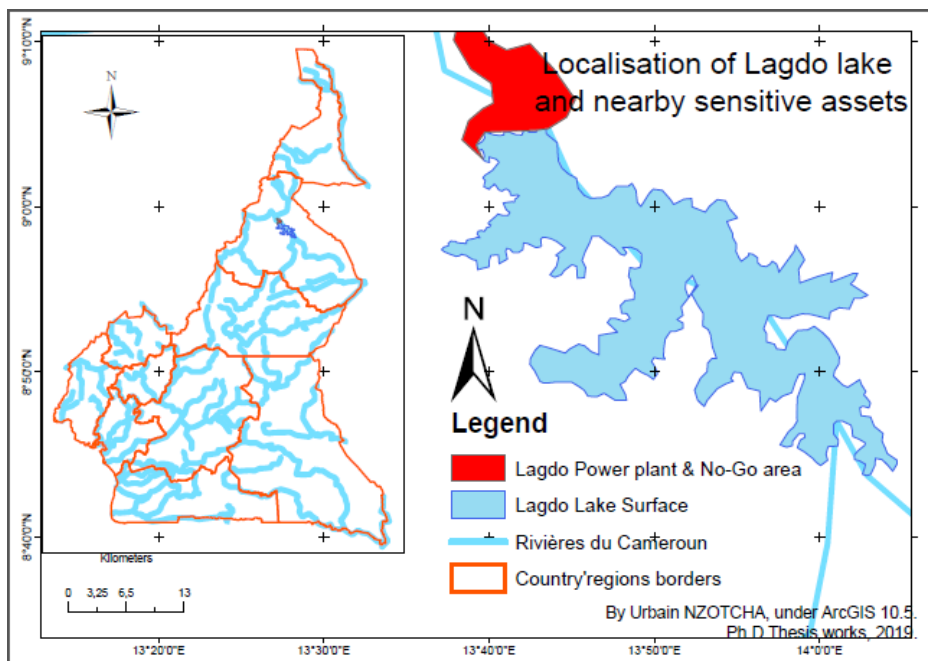

Fig. 40: Lake mapping from a GIS data transfer from Google Earth to ArcGis.

Under Arcgis, the creation of a buffer zone and the erasure from the latter, of the surface of the lake and the surrounding unacceptable areas allows the construction of a geographic mask surrounding the lake. This mask (see Fig. 41) that covers an area of 11 square kilometres will be used for the extraction of terrain data in the area deemed acceptable.

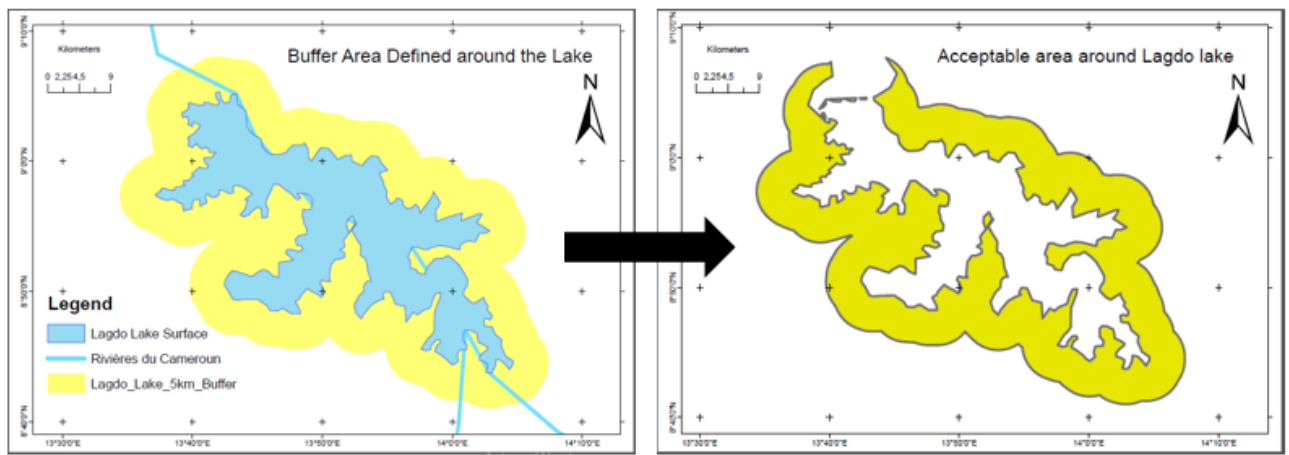

Fig. 41: Definition of the 4km-buffer zone around the water body and extraction of the geographic mask of the area of interest.

The application of the above mask on the digital terrain model previously unified in the concerned geography allows the extraction of the elevation data only for the acceptable area. In this example, the elevations have been reclassified into five classes as shown in Fig. 42. This already makes it possible to identify the areas with higher altitudes, which are those likely to offer possibilities for the results.

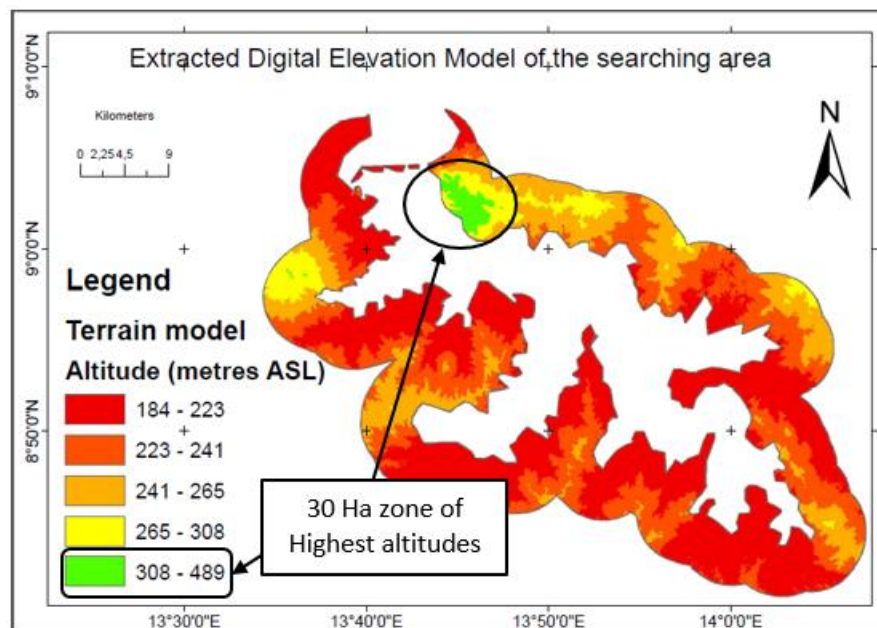

Fig. 42: Use of the geographic mask for the extraction of the digital elevation model of the area of interest.

Thus, of the 11 square kilometres (111,076 Hectares) area previously defined as acceptable, the higher elevation area (between 308 and 489 masl), which represents only 30 hectares, can be considered promising for reservoirs detection. For a better appreciation, the extraction of this higher elevation area as a polygon to Google Earth is possible using a conversion to KML file. This area can then be visualized as shown in Fig. 43.



Fig. 43: Delimitation of the area of highest altitude (promising area) and transfer to Google Earth for terrain visualization.

II.5.3 Detection of Reservoirs and Estimation of Sites Potentials

As explained in II.4.2.3 , once the promising areas have been delineated, the contour lines and/or alternatively the slopes of these areas serve as a support for locating potential reservoirs. In this particular case, level lines were used in a quasi-manual process through which two reservoir opportunities were detected as shown in Fig. 44 below.

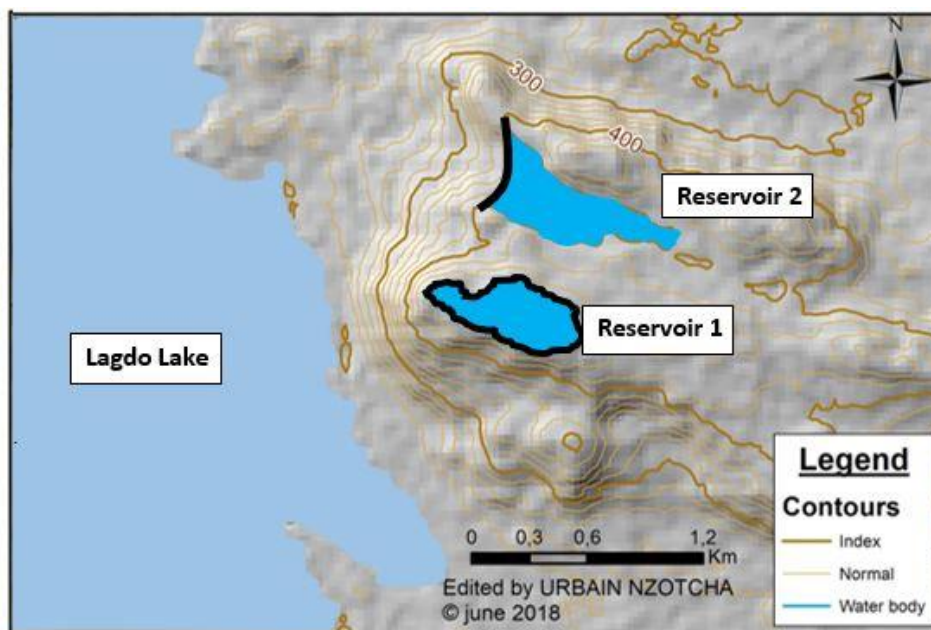

Fig. 44: Example of contours map as extracted using the ArcGIS software.

As shown in the figure above, the location of “Reservoir 1” is determined by the 460 masl contour line, which closes in on itself in the higher elevation area. This thus defines an opportunity for the creation of a R6-type reservoir, namely a ring-like reservoir wall, whose surface area is estimated at 6.8 hectares. Considering the height of the wall as fixed in II.4.2.3 (25 m), this reservoir located at almost 260 meters above the lake surface level would allow water storage capacity of

approximately 1.87 million m³. That is, considering the formula for calculating the energy storage capacity of a given PHES scheme written as equation *Eq. 22*, an estimated energy storage potential of 841 MWh. Nearby, the valley below the hilltop, comparable to an open terrain depression, is conducive to the creation of a R5-type reservoir. This “Reservoir 2” would require the construction of a dam whose crest line can close the 400 masl contour line for a maximum height of 40 metres. The capacity of this reservoir was estimated at 2.5 million m³, and its altitude from the lake surface is evaluated at 160 metres. Thus, the energy storage potential of the PHES scheme connecting Reservoir 2 (the upper reservoir) and Lagdo Lake (the lower reservoir) is evaluated at about 700 MWh.

By scanning the entire Cameroonian territory step by step, a total of 31 acceptable PHES schemes distributed in 21 candidate sites across the country was retained: Mentchum River (3), Bamendjin reservoir (5), Benakuma lake (1), Nyi lake (1) Petponoun Lake (2), Banefo on the Mifi River (2), Lagdo reservoir (2), Noun River (4), Monoun Lake (1), Nyos-Njupi (1), Oku Lake (4), Elum Lake (1), Bambili Lakes (3), Enep Lake (3 with one on the Mentchum River) and M’Batu Dam (1). Their characteristics are shown in Annexe 7.

II.5.4 Determining the Country Global Storage Potential

There were seven sites having more than one acceptable connection and then, the best connection was selected as the one having the highest gross hydraulic head considered as the crucial criterion for selecting the most desirable PHES scheme. Finally, applying the adopted methodology allowed the detection and the evaluation of prospective number of small PHES sites in Cameroon. The full list include: Enep (5,000 MWh), Bamendjin (4,800 MWh), Oku (3,710 MWh), Benakuma (4,861 MWh), Nyi (3,535 MWh), Banefo (750 MWh), Mentchum II (2,554 MWh), Elum (1,314 MWh), Lagdo II (841 MWh), Bambili (378 MWh), Petponoun (463 MWh), Mbatu-dam (64 MWh), Monoun (623 MWh), Mentchum I (2,138 MWh), Noun I (755 MWh), Lagdo I (700 MWh), Noun IV (105 MWh), Nyos (503 MWh), Noun III (114 MWh), Bamendjin II (84 MWh), and Noun II (69 MWh). Exceptionally, two connections were allowed in each of the Bamendjin and Lagdo sites, due to the huge amount of water resource these reservoirs contain.

The twenty-one identified sites combined have a total electrical energy storage capacity roughly estimated at 34 GWh, which can be considered as the potential for small-scale pumped-storage hydropower in Cameroon. The diagram in Fig. 45 below illustrates the individual contribution of each site to this potential.

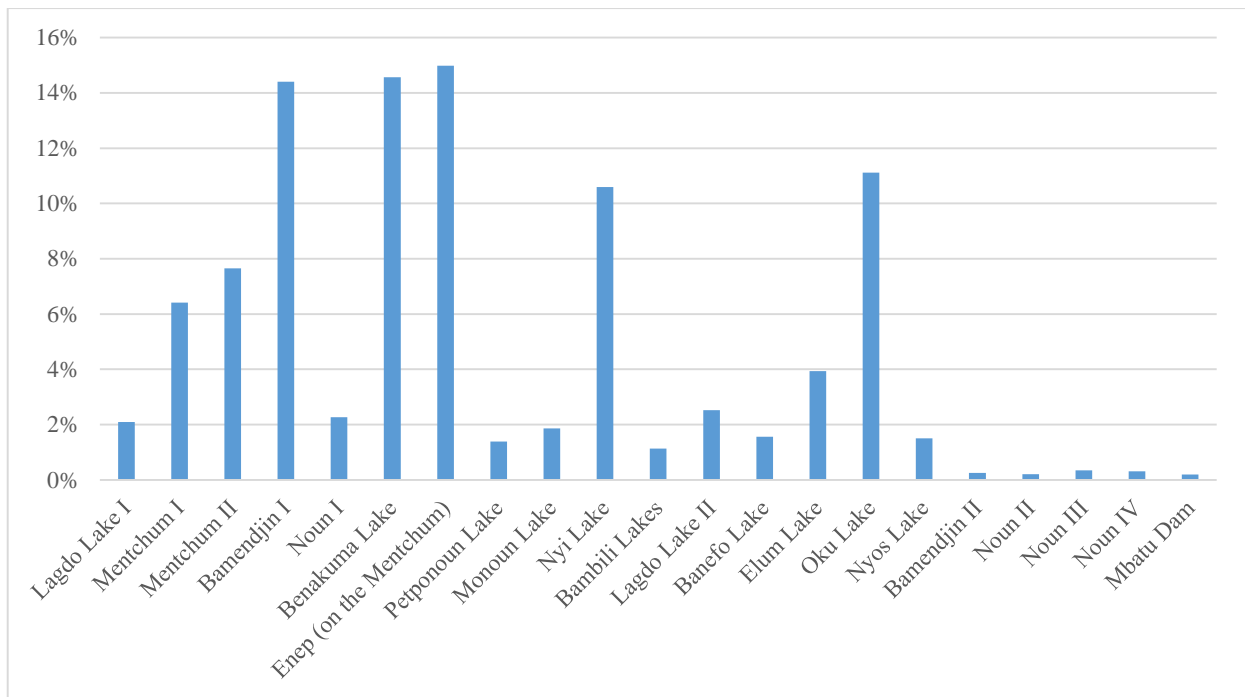

Fig. 45: Contribution of sites to the country potential.

II.5.5 Categorisation of Identified PHES Candidate Sites

II.5.5.1 River-based sites (T6-Connections)

Eight PHES opportunities using dammed streams as lower reservoirs and representing 34% of the country’s estimated potential was detected in Cameroon by applying the adopted method. This potential is carried by the three main rivers which drain with their tributaries almost the Western Highlands of the country. Those rivers include Mentchum (3 sites, 9.7 GWh), Noun (4 sites, 1.04 GWh) and Mifi (1 site, 0.7 GWh). Sites’ details are shown in Table 16.

Table 16 : Summarising of retained T6-sites.

River	Site	Upper Reservoir			Lower Reservoir			Trans. Vol. (Mm ³)	Gross Head (m)	H:L Ratio	Capacity (MWh)
		Type	Localisation (N,E)	Zmin (masl)	Type	Localisation (N,E)	Zmax (masl)				
Mentchum	Mentchum I	R4	(6°19'55, 9°59'32)	650	R3	(6°19'42, 9°59'4)	484	6.6	166	0.22	2,138
	Mentchum II	R4	(6°21'0.46, 9°59'21.39)	800	R3	(6°20'33, 9°58'17)	463	3.9	337	0.17	2,554
	Enep	R5	(6°18'20, 10°2'47)	1,131	R3	(6°17'23, 10°1'47)	571	4.6	560	0.22	4,998
Estimated potential of the Mentchum River											9,690
Noun	Noun I	R5	(5°35'12, 10°32'26)	1,250	R3	(5°34'37, 10°32'31)	1,084	2.3	166	0.28	755
	Noun II	R5	(5°31'12, 10°33'33)	1,095	R3	(5°31'7, 10°33'52)	1,053	0.8	42	0.11	69
	Noun III	R6	(5°30'11, 10°34'23)	1,120	R3	(5°29'54, 10°34'25)	1,024	0.6	96	0.32	114
	Noun IV	R2	(5°39'27, 10°28'35)	1,260	R3	(5°39'44, 10°28'5)	1,127	0.4	133	0.15	105
Estimated potential of the Noun River											1,044
Mifi	Banefo	R5	(5°33'56, 10°26'55)	1,515	R3	(5°35'12, 10°26'20)	1,112	1.0	403	0.16	748
Estimated potential of the Mifi River											748
Total potential of rivers' sites											13,441

The potential of the eight T6-sites detailed above and totalling 13.44 MWh is summarised as shown in Fig. 46.

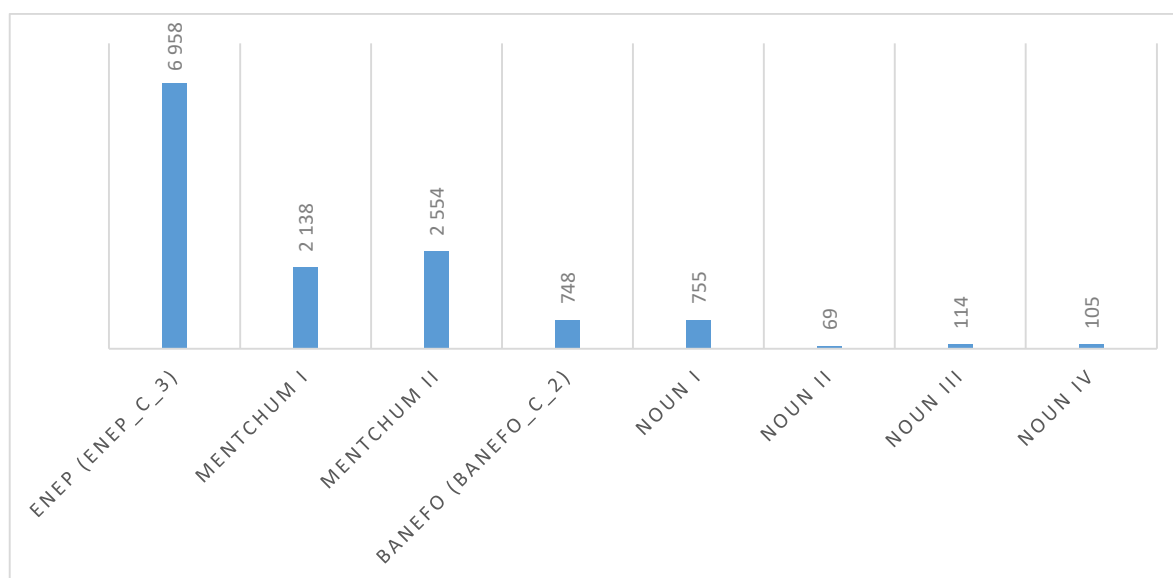

Fig. 46: Distribution of the river-based (T6-scheme) sites storing capacity.

II.5.5.2 Sites Based on Existing Artificial Lakes (T5-connections)

The share of 25% of the country's estimated PHES potential is carried by three artificial impoundments used as lower reservoirs. Those artificial lakes include Bamendjin (333 km² surface area, 1.87 km³ volume and 1,151 masl, commissioned in 1975 [211]), Lagdo (570 km² surface

area, 7.7 km³ volume and 214 masl, commissioned in 1982 [202]) and Mbatu-Dam in the West, North and Northwest regions respectively. Both the first two are currently used for hydropower generation as they contribute to regulate the flow rate of the Sanaga River which feeds two main power plants in the country. Given their important volumes no conflict with the current usage of water could rise as the estimated PHES potentials would use only 0.5%, 0.02% and 5% of water in Bamendjin, Lagdo and Mbatu-Dam respectively. That is the reason why up to two candidate sites have been retained for every of the first two. Their features are summarised in Table 17.

Table 17 : Summarising of candidate sites based on artificial lakes (T5-scheme).

Lake	Site	Upper Reservoir			Lower Reservoir			Trans. Vol. (Mm ³)	Gross Head (m)	H:L Ratio	Capacity (MWh)
		Type	Localisation (N,E)	Zmin (masl)	Type	Localisation (N,E)	Zmax (masl)				
Bamendjin Lake	Bamendjin I	R5	(5°43'46, 10°39'57)	1,700	R2	(5°41'32, 10°32'13)	1,151	4.5	549	0.16	4,804
	Bamendjin II	R5	(5°42'33, 10°29'33)	1,225	R2	(5°41'32, 10°32'13)	1,151	0.6	74	0.10	84
Estimated potential of Bamendjin Lake											4,888
Lagdo Lake	Lagdo I	R5	(9°1'58, 13°44'15)	373	R2	(9°3'21, 13°42'54)	213	2,3	160	0,14	700
	Lagdo II	R6	(9°1'41, 13°44'8)	470	R2	(9°3'21, 13°42'54)	213	1.7	257	0.16	841
Estimated potential of Lagdo Lake											1,541
Mbatu-Dam		R6	(5°55'23, 10°8'44)	1,510	R2	(5°55'12, 10°8'19)	1,326	0.2	184	0.37	64
Total potential of existing artificial lakes' sites											6,493

From this Table, the following graphic (see Fig. 47) can be deduced, indicating the distribution of the potential of t5-scheme.

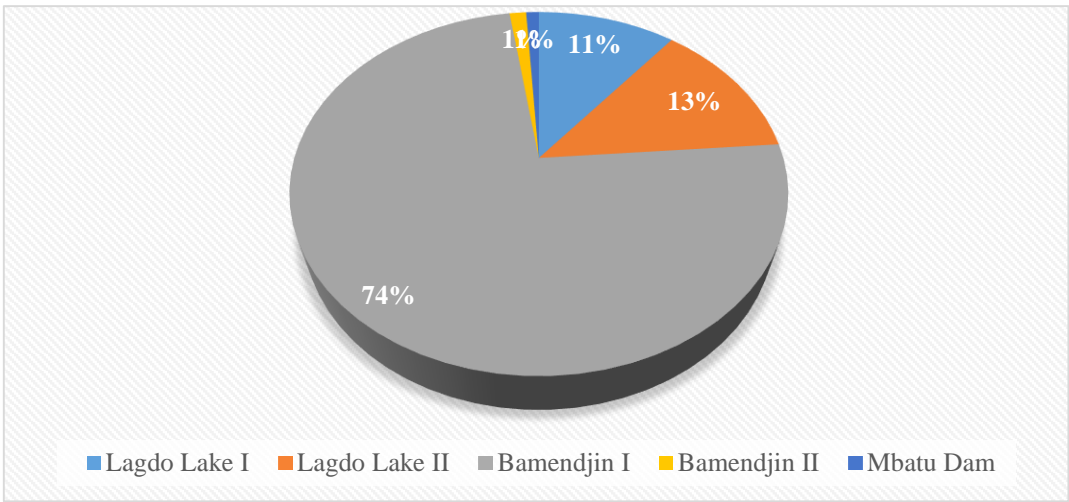

Fig. 47: Distribution of storage capacity of sites based on artificial lakes.

II.5.5.3 Greenfield Sites (T3-Scheme) and Sites Based on Natural Lakes (T2-Scheme)

Eight sites totalling 46% of the global potential use natural lakes either as reservoir (considered as T2-sites) or just as water source through a Greenfield PHES scheme (T3-sites). All of them are detailed in Table 18.

Table 18 : Summary of candidate sites based on natural lakes (T2 & T3-schemes).

Site	Connec tion Type	Upper Reservoir			Lower Reservoir			Trans. Vol. (Mm ³)	Gross Head (m)	H:L Ratio	Capacity (MWh)
		Type	Localisation (N,E)	Zmin (masl)	Type	Localisation (N,E)	Zmax (masl)				
Benakuma Lake	T2	R5	(6°26'20, 9°58'19)	1,130	R2	(6°25'53, 9°56'41)	625	5.0	505	0.20	4,861
Petponoun Lake	T2	R5	(5°39'15, 10°39'14)	1,360	R2	(8°43'43, 14°3'55)	1,150	1.1	210	0.13	463
Monoun Lake	T2	R5	(5°35'21, 10°34'50)	1,268	R2	(5°40'13, 10°32'8)	1,090	1.8	178	0.20	623
Nyi Lake	T2	R1	(5°34'51, 10°35'13)	1,320	R5	(6°24'59, 10°13'40)	815	3.6	505	0.24	3,535
Bambili Lakes	T3	R5	(5°55'31, 10°14'1)	2,485	R4	(5°55'31, 10°14'34)	2,270	0.9	215	0.17	378
Elum Lake	T2	R1	(6°20'20, 10°2'12)	980	R5	(6°20'50, 10°1'27)	670	2.2	310	0.21	1,314
Oku Lake	T3	R5	(6°11'38, 10°30'45)	2,580	R5	(6°12'5, 10°28'16)	2,050	3.6	530	0.14	3,710
Nyos Lake	T2	R1	(6°11'34, 10°26'59)	1,150	R5	(6°26'36, 10°18'43)	1,035	2.3	115	0.18	503
Total potential of natural lakes' sites											15,387

Their total estimated energy storage potential of 15,387 MWh is shared between the three subcategories of sites, based on the role of the involved lake in each scheme as shown in Fig. 48.

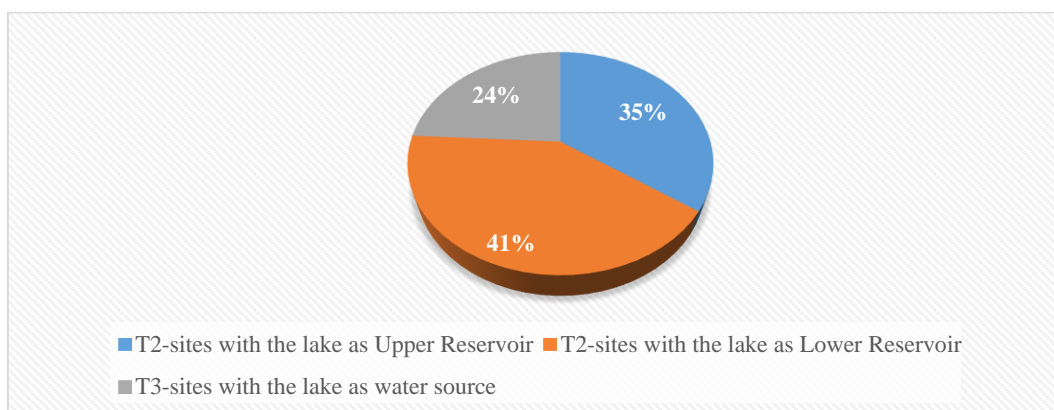

Fig. 48: Shares of subgroups of sites following the lake's position in the PHES scheme.

T2-Sites Using the Lake as Lower Reservoirs

Three T2-sites including Benakuma, Monoun and Petponoun, totalling about 6,000 MWh energy storage capacity use lakes as lower reservoirs. That capacity is dominated by Benakuma lake site (see Fig. 49) which takes advantage of its high head that is of 505 m.

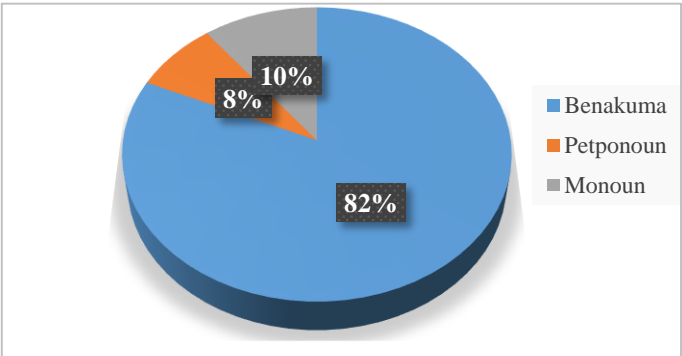

Fig. 49: Proportion of the storage capacity of T2-sites using lakes as lower reservoirs.

This configuration is the simplest and most reputed way to use a lake as reservoir for pumped hydro storage. An advantage offered by this configuration of a PHES plant lies in security from the view point of fail-safe building. In fact, the lake would contain some of the water released in case of a break of the upper reservoir.

T2-Sites Using the Lakes as Upper Reservoirs

Three other sites including Nyi, Elum and Nyos use high altitude lakes (Nyi Lake, Elum Lake, and Nyos having altitude of 1320, 980 and 1150 masl respectively) as natural upper reservoirs and totalling a storage capacity of 5,353 MWh distributed as in Fig. 50.

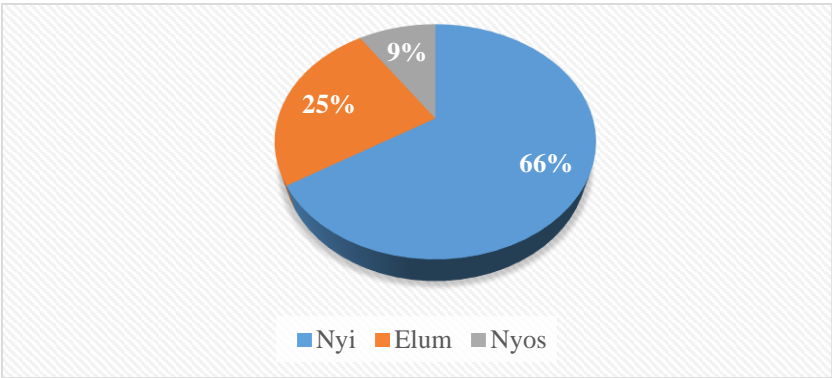

Fig. 50: Contribution of T2-sites using lakes as Upper Reservoirs.

This group of sites introduces a scheme of PHES plants having an existing waterbody as upper reservoir, considered as a pump-back scheme. In such a PHES plant water flows from the lower reservoir into the powerhouse, where reversible pump-turbines (usually, a Francis turbine design) pump it back into the upper reservoir. The scheme of this type of PHES plant is shown in Fig. 51 below.

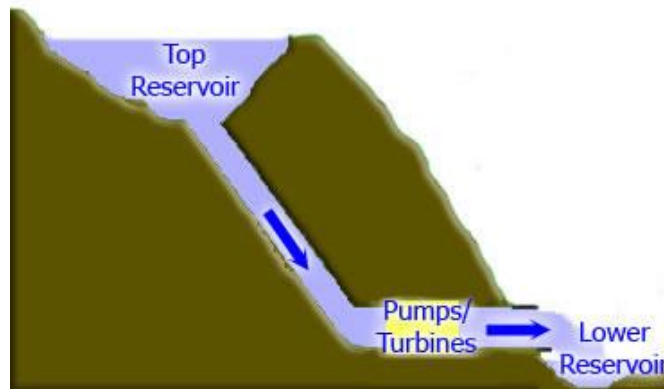

Fig. 51 : Pumped back hydro energy storage configuration [212].

Although more complex in practice (the powerhouse should be connected to the lake serving as upper reservoir via tunnels coming up beneath the lake, known as “lake tapping” systems), this configuration has the advantage to be the basis of high pressure systems, taking the example of Scandinavia where natural lakes are the basis for PHEs plants with heads that reach over 1,000 m [213].

Connections using lake as water source

Unlike the previous cases, two T3-sites (Bambili and Oku) use lakes simply as sources of water. This occurs when the natural terrain morphology offers a lake on a hillside with a sink or plateau at the top as sketched in Fig. 52. This allows the water from the lake to initially fill the lower reservoir created in the valley downstream the lake and ensure the replenishment of water losses. The main advantage of this configuration is the avoidance of the negative impact of the rapid and frequent variation in the shore level of the lake on the aquatic life during the plant operation.

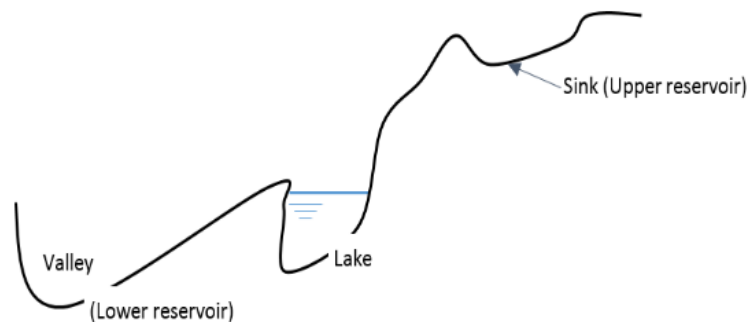

Fig. 52: Sketch of a lake used as a water source for a PHEs system.

II.5.5.4 Summarising the Categorisation of Sites

Finally, the country’s pumped hydro storage investigated in this study estimated at 33,361 MWh shared among the three types of water sources as on Fig. 53.

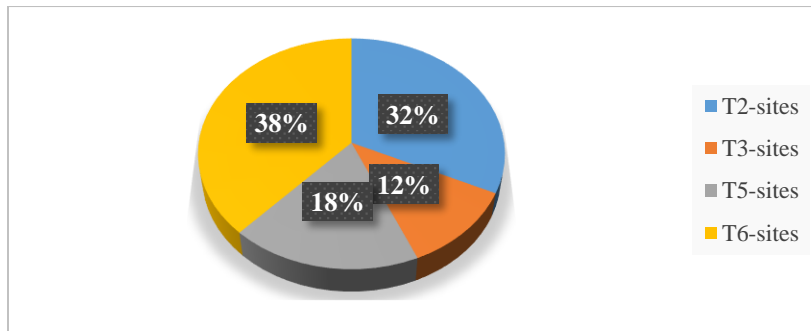

Fig. 53: Contribution of the different schemes to the total potential.

It appears that natural lakes represent the most important reservoirs for storing electricity in Cameroon, offering up to eight sites including Benakuma, Oku and Nyi. These three sites are marginal in terms of hydraulic heads which are larger than 500 metres. However, their capacities are limited by the availability of the water resource. The second important resource for PHES is represented by some rivers, especially Mifi, Noun and Mentchum rivers in the western part of the country with offer respectively 1, 4 and 3 sites, the Mentchum being the most important as the potentials of sites it offers vary from 2.1 GWh to 5 GWh. Artificial lakes of Lagdo and Bamendjin offer each one two sites and the total capacity counted with that of the Mbatu Dam reaches 6.1 GWh. Site's capacities here are relatively small, from 64 to 841MWh apart from the Bamendjin I site that achieves 4.8 GWh with its head that is of 550 metres.

II.6 Geological Considerations of Retained PHES Candidate Sites in Cameroon

Pumped hydro storage systems are highly constrained by geologic and geomorphologic features of sites [58], [71], [111], [214]–[217]. In fact, geological conditions have a significant impact on the selection of sites for the construction of PHES plants. In particular, soil permeability is a parameter of great importance in that it impacts the ability of the reservoir to store water [111]. In some cases, when the soil is considered too permeable, an artificial lining system for reservoirs is necessary. Adding a lining system to a reservoir limits the impact of rapid water level changes (due to frequent filling and emptying) on the stability of reservoir slopes. Also, seepage losses in the reservoir foundations are also a concern, which may require a grout curtain or lining of the reservoir [218]. The lining of reservoirs can be of crucial importance especially in closed-loop T3-sites with limited availability of water resources, especially sites fed by natural lakes without permanent inflows. Further, the construction of hydropower plants and large water tunnels need good geological conditions as poor rock quality requires extensive and expensive safeguards that can make the project unprofitable. Therefore several geological surveys must be performed beforehand to determine the rock quality [160].

For this study, the accessed databases did not provide information on the precise geological characteristics of the identified sites. However, a common feature of most of these sites is their geographical location in the Cameroon Volcanic Line (CVL) delineated in Fig. 54, for which many studies have addressed the overall geology.

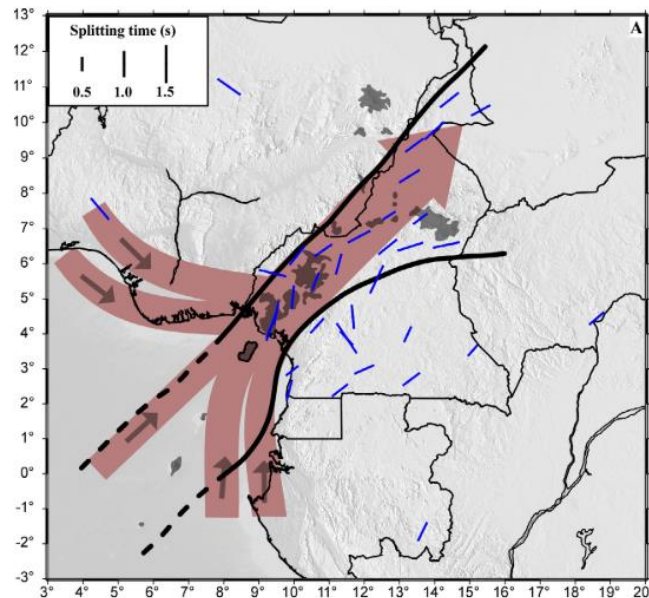

Fig. 54: An indication of the Cameroon volcanic line [219].

As a whole, the CVL's topography consists of both lowlands and mountainous regions and many of the latter occur in the west of the country. The line offers uneven reliefs that have heterogeneous slope morphology, notably plate, wavy, undulating, uneven and steep slopes and its lithology is dominated by a succession of several types of hard rocks such as basalts, basanites, trachytes and ignimbrites [205], [220]. Given their physical properties, such rocks are known as materials suitable for solid constructions [221] and assume a priori favourable geological conditions for establishing PHES reservoirs and powerhouses at limited costs.

II.1 Qualitative Analysis of Identified PHES Candidate Sites

Regarding the fundamental requirements for implementing the PHES technology which include for a given site the topography, availability of water and the geology, it is crucial to carry out a qualitative analysis of the PHES candidate sites identified in this study. Indeed, the energy storage capacity of every identified site has been estimated but, detailed characteristics defining each of them still need to be highlighted. For example, a site A having a hydraulic head of 500 m and a water volume of 100 m³ and a site B having a hydraulic head of 100 m and a volume of 500 m³ will both achieve (using the basic hydro-energy relation provided as Eq. 19) a theoretic storage capacity of $(0.2 \times 10^{-5}) \times 500 \times 100 = 0.1$ MWh. But from a practical point of view, the site A that has the greater head of water is the most interesting as it will require the smaller reservoir, the

hydraulic head being a site-dependent feature. From this example, a project with a higher head would require smaller reservoirs and have smaller electrical-mechanical provide an equivalent amount of energy [218] and consequently the attractiveness and profitability of the investment would be strongly affected by the hydraulic head of the site [222].

It is true that availability of water for storing energy can also be viewed as a site-dependent parameter but the volume of the reservoir to be constructed (in the case it does not exist) is more significant and in almost cases, the size of the reservoir is fixed depending on the energy storage needs. For instance, the United States Army Corps of Engineers (USACE) proposed a simplified equation for determining the storage capacity required in the PHES system following the plant capacity, the storage requirement in hours of equivalent full-load generation and the average gross head [218].

Coming back to our study, if availability of water is assumed for each candidate site (sites with too small capacity have been discarded by attaching technical acceptability constraints defined in II.4.2.4), their quality can be appreciated through the hydraulic heads and eventually the Head-Distance ratio. This last parameter takes into account the distance between the reservoirs. Fig. 55 below is showing both parameters for all connections identified in all sites.

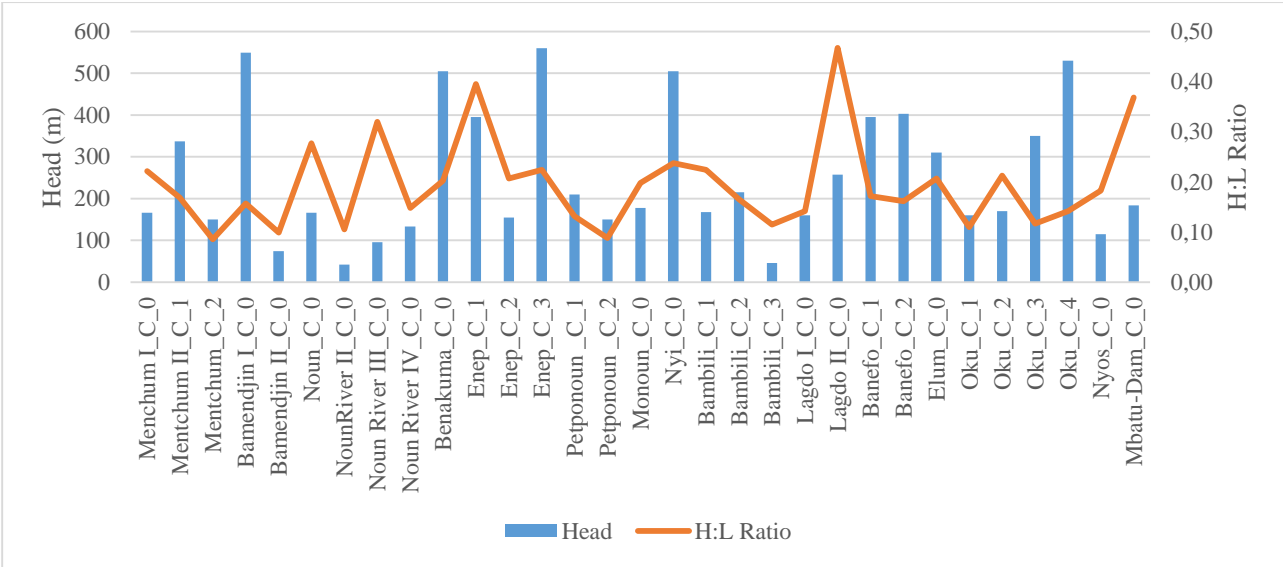

Fig. 55: Head and Head-Distance Ratio of connections.

Provided this, connections and subsequently sites, can be grouped into three ranges of the hydraulic heads:

- “Low Head” containing connections with head of water lower than 300 m;
- “Medium Head” containing connections with hydraulic head comprises between 300 m and 500 m;
- “High Head” containing connections with head of water larger than 500 m.

The grouping of connections and therefore of sites based on their potential energy storage capacity is shown in Table 19 below. It is recalled that, the energy storage capacity of a multiple-connections site is defined as the capacity of the connection having the highest hydraulic head.

Table 19 : Grouping of connections and sites.

Group ID	Connections	Head (m)	Selected Connection		
			Sites	H:L Ratio	Capacity (MWh)
High Head	Enep_C_3	560	Enep	0.22	4 998
	Bamendjin I_C_0	549	Bamendjin	0.16	4 804
	Oku_C_4	530	Oku	0.14	3 710
	Benakuma_C_0	505	Banakuma	0.20	4 861
	Nyi_C_0	505	Nyi	0.24	3 535
Total estimated capacity of High Head sites					21 907
Medium Head	Banefo_C_2	403	Banefo	0.16	748
	Enep_C_1	395	-	-	-
	Banefo_C_1	395	-	-	-
	Oku_C_3	350	-	-	-
	Mentchum II_C_1	337	Mentchum II	0.17	2 554
	Elum_C_0	310	Elum	0.21	1 314
	Lagdo II_C_0	257	Lagdo II	0.47	841
Total estimated capacity of Medium Head sites					5 457
Small Head	Bambili_C_2	215	Bambili	0.17	378
	Petponoun_C_1	210	Petponoun	0.13	463
	Mbatu-Dam_C_0	184	Mbatu Dam	0.37	64
	Monoun_C_0	178	Monoun	0.20	623
	Oku_C_2	170	-	-	-
	Bambili_C_1	168	-	-	-
	Menchum I_C_0	166	Menchum I	0.22	2 138
	Noun_C_0	166	Noun I	0.28	755
	Lagdo I_C_0	160	Lagdo I	0.14	700
	Oku_C_1	160	-	-	-
	Enep_C_2	155	-	-	-
	Mentchum_C_2	150	-	-	-
	Petponoun_C_2	150	-	-	-
	Noun River IV_C_0	133	Noun IV	0.15	105
	Nyos_C_0	115	Nyos	0.18	503
	Noun River III_C_0	96	Noun III	0.32	114
	Bamendjin II_C_0	74	Bamendjin II	0.10	84
	Bambili_C_3	46	-	-	-
	NounRiver II_C_0	42	Noun II	0.11	69
	Total estimated capacity of Low Head sites				
Overall estimated energy storage capacity					33 361

From Table 19, classifying PHES connections based on the hydraulic head provides a clearer view on the relevance (in terms of technical feasibility) of candidate sites identified in this study. The literature reports no clear limit of hydraulic head ensuring the effectiveness of a PHES project. In fact, a SETIS⁶ expert panel reported by Arantegui et al. [168] has suggested a minimum head of between 50 and 200 m for national projects in the European Union. While according to A. Poullikkas [223], as a rule of thumb the head must be in excess of 300 m in order for the PHES plant to become viable economically thought this will depend on various factors. However, a particular example that can be stated here is Baixo Sabor Jusante PHES in Portugal that is currently operating with a head of just 26 m [111], [168]. This study has considered the minimum values of 40 m for the head and 0.1 for the head-distance ratio in order to eliminate too low head connections. The rationale of this is to stay aligned with the logic of minimal environmental impact from that a lower head PHES project will require more volume of water to offer the equivalent storage capacity. As result, all sites retained in this study offer interest as their heads range from 42 m (River Noun II site) to 560 m (Enep site on the Mentchum River), with up to 11 sites having hydraulic heads above 200 m.

Finally, the global estimated storage capacity can be shared among the three classes of quality as shown in Fig. 56 below.

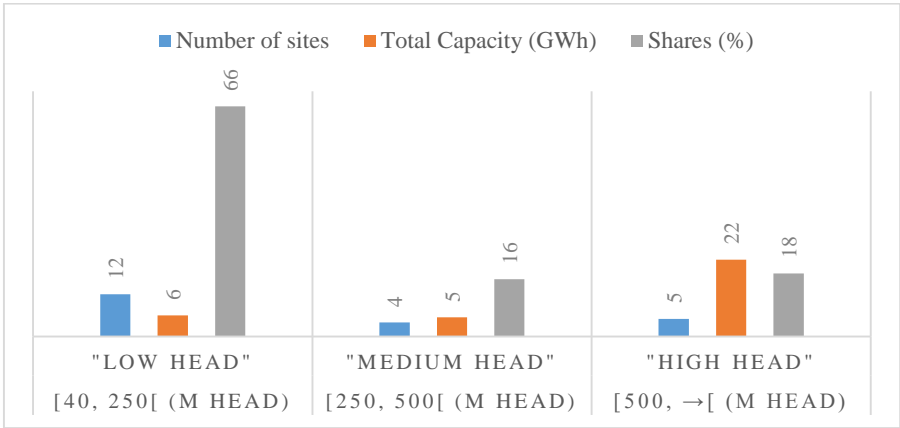

Fig. 56: Classification of the sites following the gross head level.

The method proposed and used in this study is very stringent with the water resource usage, ensuring that no more than 70% of the volume of the lake (as the share of the transferable volume), in any T2 or T3 connection, will be used. In Cameroon, the potential of lake-based sites which is estimated approximately at 22 GWh uses on an average only 28% of the overall volume of the lakes involved. The lakes, particularly artificial ones seem to show the most promising PHES opportunities owing to the large volume of water they contain. In contrast, there are few

⁶ Strategic Energy Technologies Information System [<https://setis.ec.europa.eu/>]

opportunities from rivers (referred to as T5-connections), though the country is endowed with numerous large rivers. This is because the mountains mainly serve as the stream starting points in large-river catchment areas. Overall, the assessed pumped storage potential of Cameroon, considering the nature of the reservoirs involved in the connections, is shared as shown in Fig. 57.

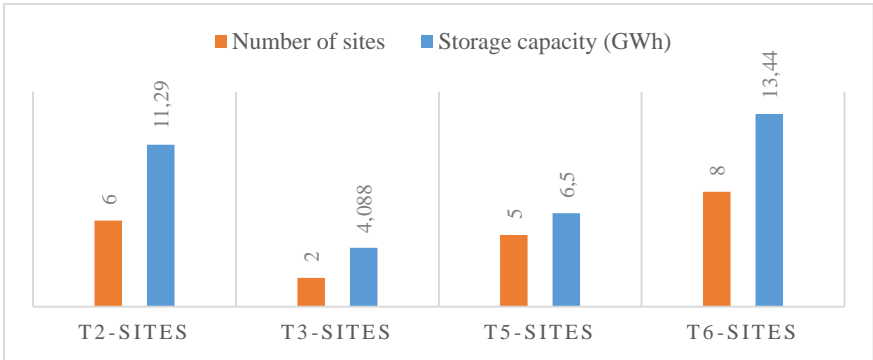

Fig. 57: Distribution of the storage potential based on the nature of the connections.

II.2 Conclusion

The dual objectives of this chapter was to first propose a consistent method to evaluate at country-scale the PHES potential based on the existing inland freshwater bodies and, to use the developed method to establish the technical feasibility of PHES technology in Cameroonian territory. In doing so, the review of similar works has enabled the development of a methodology based on geographical information systems and remote sensing through a spatial analysis model. Applying the methodology to Cameroon allowed the first estimation of the PHES potential of the country as 33.4 GWh distributed in 21 sites detected in the rocky mountain region of the Cameroon Volcanic Line, whose lithology is assumed to have suitable geological conditions for establishing reservoirs. Heads of identified sites vary from 42 to 560 m and capacities from 0.06 to 5 GWh, and the sites are geographically divided between three regions of the country, particularly the north-west (ten sites totalling 72% of the country PHES potential), west (nine sites for 23% of the global potential), and north (two sites for 5% of the potential). Suitable geological conditions were assumed for identified sites as they are located in the volcanic line of Cameroon where hard volcanic rocks are dominant. Therefore, quality of sites in terms PHES feasibility is observable through the hydraulic heads and eventually the Head-Distance ratio, which takes into account the distance between the reservoirs (16 of the 21 sites and representing 85% of the Cameroon’s estimated potential have Head-Distance ratios above 0.15). However, it is noteworthy that sites capacities and thus, the potential estimated here are just indicative and may be subject to extensive discussions. This is due on one hand to the error inherent to remote sensing and handling of data generated by geographic information systems and, on the other hand, the use of a simplified research tool in the field of PHES which is reputed as being influenced by a wide range of factors.

Chapter III

Multi-Criteria Analysis of Prospective Pumped Hydroelectric Energy Storage Sites in Cameroon

III.1 Introduction

The first Chapters established the need for utility-scale storage in relation to the context of the power sector of Cameroon and identified sites favourable to the implementation of pumped-hydro energy storage (PHES) in Cameroon. It is accepted that selecting the best site is a key influencer of the pumped-hydropower plant's ability to sustainably provide the expected benefits throughout its whole lifecycle. However, the problem of selecting the best site for energy projects has always been highly controversial due to its complexity and has therefore been the subject of numerous studies [224]–[228]. The authors of these studies generally approach the problem from the perspective of decision support through multi-criteria analysis [229]. Multi-criteria analysis is generally defined as “a decision-aid and a mathematical tool allowing the comparison of different alternatives or scenarios according to many criteria, often conflicting, in order to guide the decision-maker towards a judicious choice” [230]. That analysis aims at making explicit a coherent group of criteria in order to understand, justify and transform preferences in a decision-making process. Its importance and interest come from that the mono-criteria optimisation does not always reflect the reality and that it may be inappropriate to address certain problems in the way of optimisation. For this reason, taking into account the multifaceted nature of siting energy projects such as pumped-storage hydropower requires a multi-criteria approach in the decision-making process. In this view, this chapter elaborates a multiple criteria decision-making (MCDM) tool designed to rank a set of predetermined PHES plant alternatives based on several factors and criteria defined in the context of sustainable development. This means the adopted decision-making model should simultaneously considers the economic, social, and environmental factors interacting with the PHES planning. The effectiveness and efficiency of the tool will then be tested on the case of Cameroon, precisely by considering the PHES candidate sites identified in the area covered by the Southern Interconnected Grid.

III.2 Background of Multi-Criteria Analysis and Decision Making

III.2.1 MCDM Methods Classification

The first methods in multi-criteria analysis were developed during the 1960s [230] and to date, there is a large number of MCDM methods, which can be broadly divided into two categories, based on their possible solutions: multi-objective decision making (MODM) and multi-attribute decision making (MADM) methods as proposed by several authors [184], [230]–[233]. The general schema of MADM and MODM methods is shown in Fig. 58 and both of them are detailed in the next paragraphs.

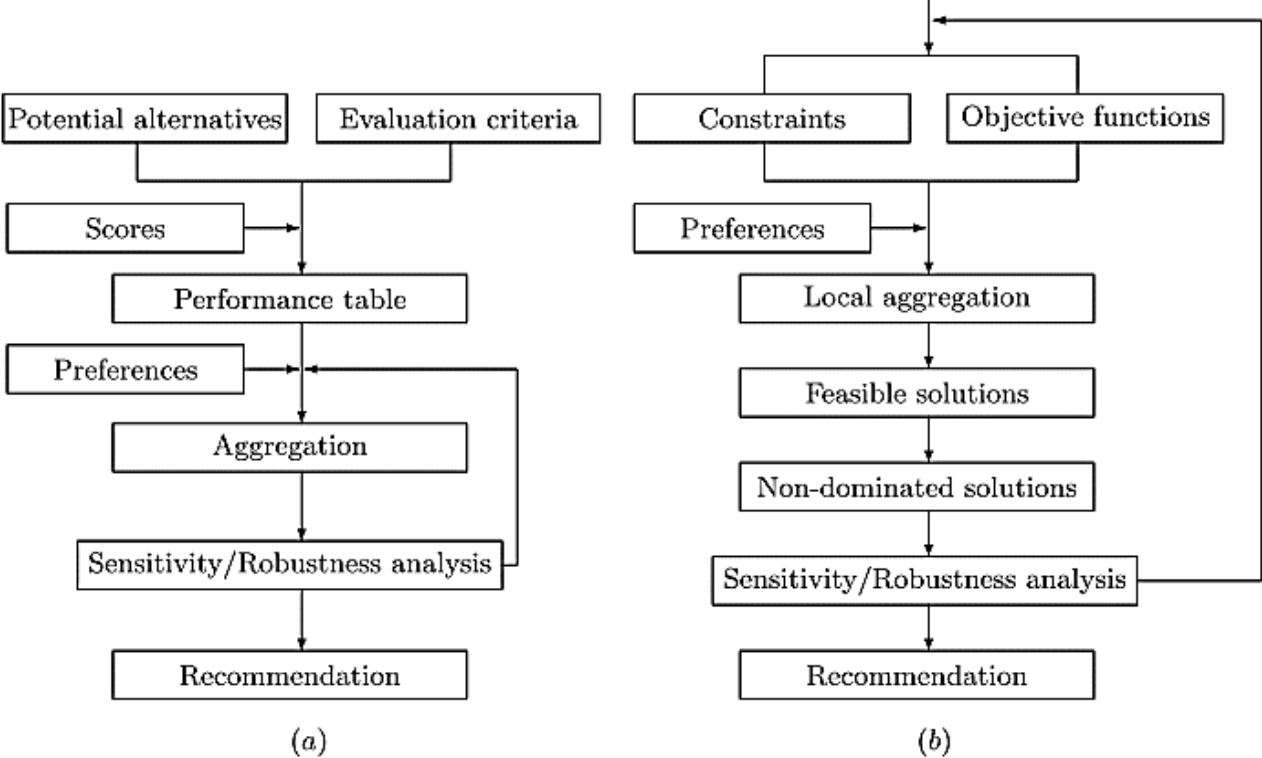

Fig. 58: General schema of (a): MADM and (b): MODM methods [230].

MODM methods are based on the decision maker’s objectives which can be a statement about the desired state of the system [184]. They are used when the decision space is continuous as it is the case with mathematical programming problems for example. For the continuous methods, the decision maker’s preferences generally take the form of weights that are assigned to different objective functions. They may also be represented as target values that should be satisfied with any feasible solution. The decision maker should also indicate, for each objective function, its direction of optimization that is maximization or minimization. No other information than the weights and these directions of optimization are required to define the set of non-dominated solutions. This set contains solutions that are not dominated by any other one [230]. In many practical situations, the decision maker is called upon to relax some of its constraints in order to

guarantee that the set of feasible solutions is not empty or, simply, to test the stability of the results [230].

On the other hand, in the MADM approach, a decision maker (DM) has to choose the best that satisfies the evaluation criteria among a set of predetermined candidate solutions [234]. MADM methods are then about comparing several discrete alternatives with respect to independent criteria [233]. Main inputs of these methods are the relative importance of criteria and the assessment of alternatives with respect to each criterion. MADM methods have the power of identifying the structure of complex decision making problems and elucidating decision makers' preferences [233]. Many of the MADM methods have a common notion of alternatives and attributes. Alternatives represent different choices of action available to the decision-maker, the choice of alternatives usually being assumed to be finite [235]. Different attributes represent different dimensions of looking at the alternatives, and may be in conflict with each other, may not be easily represented on a quantitative scale (and hence may not be directly measurable) and may be stochastic or fuzzy. Further, these attributes may have totally different scales, quantitative or qualitative. Summarising, a MADM problem can be concisely expressed in matrix format as [234]:

$$D = \begin{matrix} & C_1 & C_2 & C_3 & \cdots & C_n \\ \begin{matrix} A_1 \\ A_2 \\ A_3 \\ \vdots \\ A_m \end{matrix} & \begin{bmatrix} x_{11} & x_{12} & x_{13} & \cdots & x_{1n} \\ x_{21} & x_{22} & x_{23} & \cdots & x_{2n} \\ x_{31} & x_{32} & x_{33} & \cdots & x_{3n} \\ \vdots & \vdots & \vdots & \ddots & \vdots \\ x_{m1} & x_{m2} & x_{m3} & \cdots & x_{mn} \end{bmatrix} \end{matrix} \quad \text{Eq. 32}$$

where A_1, A_2, \dots, A_m are possible alternatives among which decision-makers have to choose, C_1, C_2, \dots, C_n are criteria with which alternative performances are measured, x_{ij} is the rating of alternative A_i with respect to criterion C_j .

The output of applying the second category of models is an ordered set of alternatives, allowing the planner to rank and/or to choose the most desired alternative based on the identified criteria.

III.2.2 Leading MCDM Methods

MCDM can be performed using a wide number of methods or combination of methods that the choice of an appropriate one depends mainly on the context of the problem. But based on the nature of the problem (whether there are multiple objectives or not), a clear separation of methods can be defined as in Fig. 59, which provides an approach to simplifying the selection process [178].

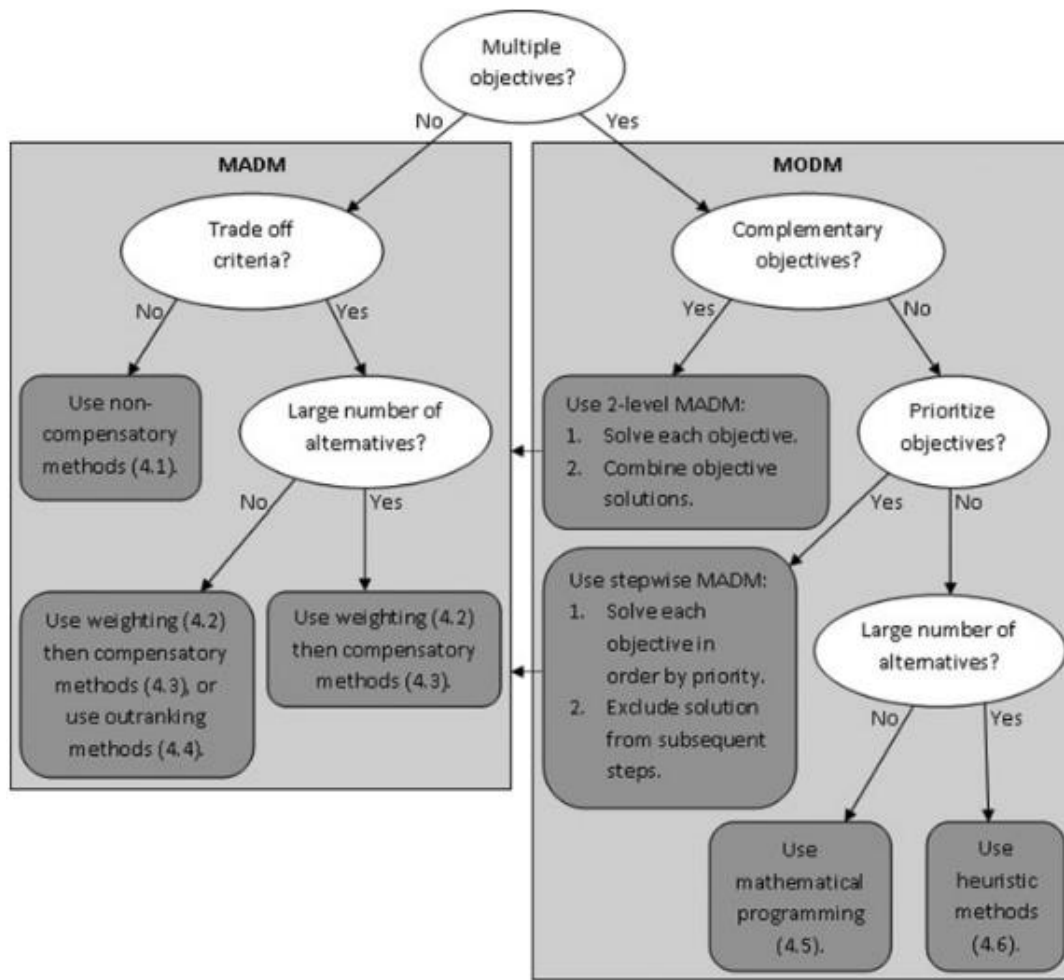

Fig. 59: Multiple-criteria decision analysis methods decision tree [178].

Leading MCDM methods mentioned in Fig. 59 above are summarised hereunder. More details about these methods are available in [178].

- Non-compensatory aggregation methods are used for screening as well as selection. They include conjunctive and disjunctive selection techniques, lexicographic elimination technique, and elimination by aspect and dominance.
- Weighting methods are those used to derive relative criteria weights/importance before applying a compensatory aggregation method. Some examples of this group are scale-rating, analytic hierarchy process (AHP), trade-off analysis...
- The group of compensatory aggregation methods encloses techniques not requiring pairwise comparison of alternatives and can be divided in two sub-categories: -Additive methods that normalise criterion scores to enable comparison of performance on a common scale such as Weighted linear combination (WLC), Fuzzy additive weighting (FAW) and Ordered weighted averaging (OWA). - Non-additive methods that use the original criteria scores such as the Technique for Order Preference by Similarity to Ideal Solution (TOPSIS), Non-dominated set and Reasonable goals method.

- Outranking aggregation methods undertake pairwise comparison of a discrete set of alternatives to rank them based on concordance. The outranking philosophy recognises that decision-makers are subject to ambiguous and evolving value judgements, even during the MCDA process. Well-known methods of this type include PROMETHEE and ELECTRE.
- Mathematical programming methods are those attempting to find the optimal way to satisfy goals by solving systems of equations, such as Linear/integer programming, Goal/compromise programming and Interactive programming.
- Heuristic methods are sometimes used to overcome the issue of computational limitations when there are very large number of alternatives such as in spatially continuous problems modelled using raster layers, where every possible outcome of every raster cell is an alternative. The most reputed of these methods could be the Multiple-objective land allocation (MOLA), the Genetic algorithms (GA) and the Simulated annealing (SA).

Guitouni and Martel [236] acknowledge that despite the development of a large number of refined multi-criterion decision aid methods, no one can be considered as the super method appropriate to all decision making situations. That being said, it appears that the effective method should be problem dependent and so, a deep analysis of the problem being solved must be performed in order to select the most suitable MCDM methodology.

III.2.3 Applications of MCDM Methods

III.2.3.1 Applications in the Field of Energy

The multidimensional nature of energy planning objectives and projects renders the application of conventional financial evaluation tools problematic [237]. This has been strongly growing the interest of energy decision-makers, analysts and scientists to MCDM methods. Many authors focused the use of such methods to handling multidimensional nature of energy projects. For instance, Guitouni and Martel [236] proposed some guidelines for selecting an appropriate MCDM technique, Polatidis et al. [237] and Bagheri et al. [233] did the same, the first authors focusing on renewable energy planning and the second on the electricity planning problems, addressing the sustainability issue. Greene et al. [178] and Chakhar et Mousseau [230] proposed guidelines to couple geographical information systems (GIS) with multi-criteria methods. Macharis et al. [238] worked on the synergies in MCA and propose a technique to strengthen the PROMETHEE method using AHP ideas. Triantaphyllou et al. [239] proposed a sensitivity analysis approach for some deterministic MCDM methods to help addressing the imprecise and changeable nature of such tools.

MCDM methods in combination with GIS have been widely applied for the selection of suitable locations for creating wind energy facilities such as wind observation station as done by Aras et al. [240] in Turkey, or a wind farm as done by Villacreses et al. [231] in Continental Ecuador, Chamanehpour et al. [182] in Iran, H. Hansen [181] in the frame of the “Wind Energy in the Baltic Sea Region” project. Atici et al. [179] addressed the problem of wind farm selection from a different point of view as their work aimed at selecting the best alternative from the thirteen fields in western Turkey. In the same region of Turkey, Aydin et al. [183] proposed a methodology for the selection of sites for wind-solar PV hybrid renewable energy systems.

In solar energy as well, MCDM techniques has been applied in GIS environment by Zoghi et al. [241] for the optimisation of solar site selection in arid and semi-arid region with an application to Isfahan-Iran, Tahri et al. [242] and M. Uyan [176] used a similar approach for the evaluation of solar farms locations respectively in southern Morocco and in Karapinar region in Turkey. Sadeghi and Karimi [180] selected locations for solar and wind turbines in Tehran-Iran. Aragonés-Beltrán et al. [243] proposed a MCDM approach to help the managing board of an important Spanish solar power investment company to decide whether to invest in a particular solar thermal power plant project and, if so, to determine the order of priority of the projects in the company’s portfolio.

Other application of decision-making tools based on multi-criteria analysis could include the identification of suitable locations for pumped hydro energy storage (PHES) investigation as performed by Ahmadi and Shamsai [244] in Iran or the selection of the best PHES plant site from a set of predetermined alternatives as done by Wu et al. [245] in China. Also, a comparison between the five different electricity power production options in Jordan using a MCDM method was performed by Akash et al. [246]. Most recently, Lu et al. [247] focused on the environmental impact assessment as a vital aspect of PHS plant development, proposing a TODIM-based approach for ranking alternative sites. Concerning hydropower projects development in general, Shimray et al. [248] proposed an approach for plants site selection based on genetic algorithm.

III.2.3.2 Application in the Particular Field of PHES

In the field of PHES—despite the enrichment of the existing literature in the recent years—compared to other aspects of the technology, little effort has been made to apply MCDM methods, with limited number of published researches targeting the issue of PHESP site selection. In particular, Ahmadi and Shamsai [165] combined a MODM approach with a geographical information system (GIS) to indicate continuous fuzzy regions as suitable locations for PHES site investigations in the proximity of Zayanderud (Iran) based on PHES fundamental criteria. In the same Country,

Ghorbani et al. [152] recently used a multi-criteria technique in a GIS context to estimate the PHES potential considering four different topologies. Using a similarly approach, Lu et al. [164] developed algorithms to locate prospective off-river pumped-hydro sites across a large land area such as a state or a country, considering dry-gully and turkey's nest reservoir models. The algorithms were applied in the South Australia in order to estimate the PHES potential. However, these works did not aim at selecting the best alternative from a preselected set. Other PHES studies [150], [154], [155], [158], [159], [163], [166], [249] dealing with plants siting focused on highlighting promising regions for reservoirs detection using MODM methods applied in GIS environment. A review of past studies addressing the application of MCDM in the domain of PHES plants siting is briefly summarised in Annexe 5. On the contrary, using another approach of multi-criteria analysis, Kucukali [192] focused on transforming existing hydropower reservoirs for the development of pumped storage, and proposed a simplified methodology to find the most suitable alternative by using a multi-criteria scoring technique. Wu et al. [245] proposed a MADM methodology to select the most ideal PHESP site from numerous alternatives based on fifteen sub-criteria. Based on the Vlsekriterijumska Optimizacija I Kompromisno Resenje (VIKOR) approach, the authors used a combination of data structures to propose the ranking of four possible PHES sites in Zhejiang province of China. Their approach could handle information loss, although it was limited by the complex data structures used which resulted in tedious calculations. Furthermore, the applied method did not fully address the issue of sustainability as it emphasised cost-effectiveness (through financial indicators such as the internal rate of return, payback period, assets-liabilities ratio, and loan repayment period which are induced effects of the PHESP after completion). Meanwhile, the local socio-environmental and economic effects of building and operating a PHESP were not considered.

III.2.3.3 Applications in Other Domains

Apart from the energy sector, MCDM methods have also been applied by researchers and decision-makers in diverse other sectors to solve various decision-making problems. As illustration, one could cite the supplier selection as it is an important issue in supply chain management for which Deng et al. [250] proposed a MCDM method extended by D-numbers. In the domain of transport for the evaluation of policies to reduce climate change impacts as done by Berritella et al. [251]. The evaluation of regional environment sustainability in Turkey proposed by Kara and Köne [252]. Bazzazi et al. [234] elaborated an integrated MCDM method to derive preference order of open pit mining equipment and similarly, a method to evaluate the performance on the basis of customer satisfaction in Turkish banking sector was proposed by Dincer and Hacıoglu [253]. In the domain of regional planning, Prévil et al. [254] attempted to demonstrate how a methodological approach

based on a well-balanced combination of GIS with MCDM help to set apart the preferences of regional players to promote negotiations and simplify the decision-making process.

Some of other fields of application of MCDM techniques could include agriculture, mainly to solve the problem of land suitability [255] and resource management [256], [257], projects management [258], the implementation of sustainable development principles within an organisation [259], decision-making in engineering [260], siting municipal solid waste (MSW) landfills [261] landslide study [262] and the site selection for implementation of managed aquifer recharge [263].

III.2.3.4 Focus on AHP and ELECTRE Methods

In practice, the analytic hierarchy process (AHP) introduced by Saaty in 1977 [235] [264] is one of the best known and most widely used approach based on MCA. Since its invention, AHP has been extensively used by decision-makers and researchers resulting in the publication of many outstanding works [265]. Therefore, it has been successfully applied in various decision-making situations including the selection of the best site for wind power plants [182], the best supplier in supply chain management [250], the contractor prequalification in project management [258], the assessment of the regional environmental sustainability [252], and the evaluation of the transport policies targeting the reduction of the climate change impact [251]. Over the years, several concerns have been raised regarding the inability of AHP to fully reflect the human thinking [232], namely the ability of handling vagueness which is inherent to the expression of human preference when considering scoring alternatives. This has led to the introduction of the principles of fuzzy logic to decision-making and the combination of AHP with fuzzy evaluation in 1985 [232]. Since then, several complex MCDM problems have been solved using the integrated technique including the selection of the suitable bridge construction method [266], the evaluation of the environmental effect of transportation modes and their ranking [232], the site selection of a wind power plant [182], and the performance evaluation of companies in the Turkish banking sector [253]. In some cases—where the established decision criteria included qualitative attribute data—some authors applied a quantification method requiring the definition of a measurement scale from which the most notable is the Likert-type [230], [267]. Similar quantification scales have been used in combination with AHP for selecting sites for solar farms [176] and solar and wind farms [180]. Similar to other methods, AHP is indifferent to irrelevant alternatives (rank reversal) and is considered to be a single synthesising criterion approach [236]. To overcome this issue, several families of MCDM methods have been developed which incorporate some kind of outranking synthesising approach. From these families, the ELECTRE family—which was introduced in 1968 by Benayoun, Roy, and Sussman [268]—is the most well-known [236], [244]. The ELECTRE

family includes six versions from which the ELECTRE III is the most frequently used in the energy sector [233]. ELECTRE III was proved to be more suitable for solving ranking problems [268]. It has been widely used to reflect the sustainability in various decision-making situations including regional planning [254], the optimisation of decentralised energy systems [269], and environmental problems [270], [271].

III.2.3.5 Summarising

Overall, research targeting the development of MCDM methods and their application in various domains of human life has been prolific. However, none of the developed methods can be considered superior in every decision-making situation [236], i.e. the selection of an appropriate method or a combination of methods depends on the context and the problem being solved. In the particular field of PHESP siting, while MODM methods have been used—in association with GIS—intensively, using MADM techniques for precise site qualification have been subject of little research. Nevertheless, the novelty of this study is the integration of the AHP, a fuzzy scoring system, and ELECTRE III to address the issue of sustainability in the ranking of PHESP candidate sites.

III.3 The PHESP Site Selection MCDM Problem

III.3.1 Definition of Decision Factors and Criteria

The first experts meeting reached an agreement on sixteen criteria to be used as the basis of the ranking and divided them into three groups according to the Brundtland’s pillars of sustainable development [23]. These three groups possess a tree-like structure as shown in Fig. 60 and are further elaborated below.

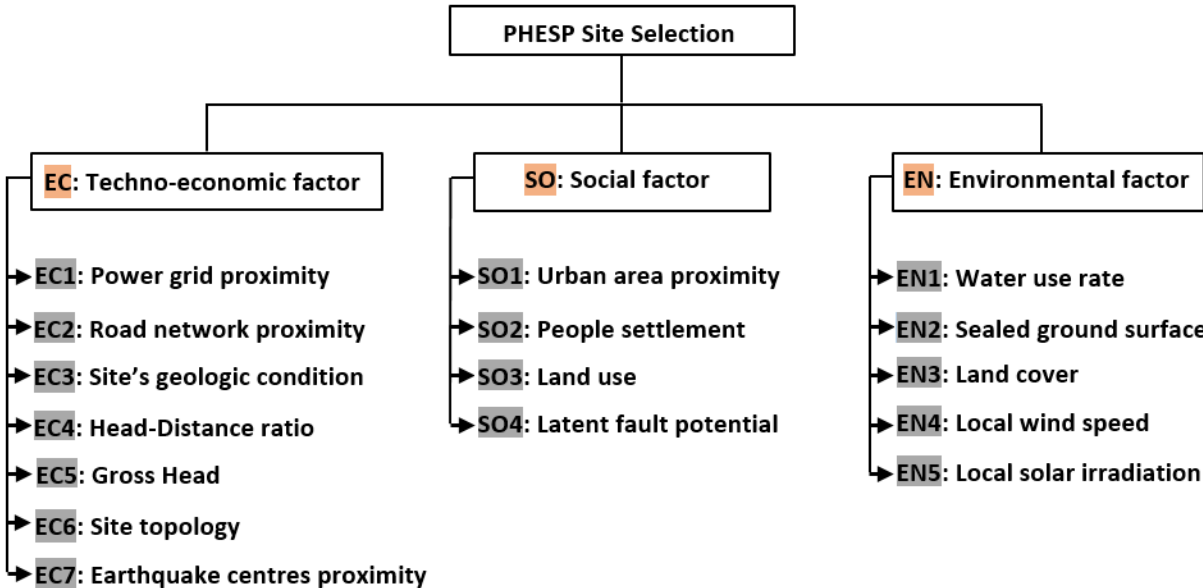

Fig. 60: Tree-structure of factors and criteria of the PHESP sites ranking problem.

III.3.1.1 Economic Factor

Proximity to power lines: building a PHESP near existing power lines reduces the initial investment and decreases losses caused by power exchange (both pumping and generating modes), increasing the overall efficiency with a positive impact on the plant's economics.

Proximity to a road network: like every construction project, developing a PHESP requires site access as well as equipment transport. Therefore, the construction is more cost-effective closer to existing road networks.

The site's geological condition: the cost of civil-works required for siting reservoirs, the powerhouse, and waterways depend on the site's lithology. Furthermore, the roundtrip efficiency of the plant would be negatively affected by the high soil permeability, unless the reservoir lining is foreseen.

The head-distance ratio: refers to the ratio between the gross head and the horizontal distance separating the two reservoirs involved in the PHESP. It characterises the length of the water conveyance and the related costs.

The gross head: the altitude difference between the lowest water level in the upper reservoir and the highest level in the lower one. This is a crucial characteristic of PHES sites as it constraints the site capacity.

Site topology: this refers to the potential complexity of the civil-works (weirs, waterways, tunnels, etc.) required to build a PHES plant. Indeed, the experts of the Join Research Centre (JRC) considered for PHES sites searching seven different topologies according to the nature of the reservoirs involved [168].

Earthquake acceleration: denotes the supplementary cost incurred in civil-works (weirs, waterways, tunnels, etc.) when considering seismic vibrations whose intensity decreases with the distance from the epicentre.

III.3.1.2 Social Factor

Urban area proximity: as a touristic attraction centre, it is advantageous for a PHESP site to be located in the proximity of urban areas. However, given the significant surface area sealed by a PHESP, the plant should not compete with other vital land uses such as urban extension. Therefore, a reasonable distance should be observed.

People settlement: denotes the potential disturbance of permanent or temporal people settlements. The evaluation is based on the number of encampments affected by the PHES project.

Land use: sealing-off a land surface for building a PHESP might conflict with cultural or socioeconomic human activities such as leisure, agriculture, pastures, etc.

Latent fault potential: creating a high altitude artificial reservoir may increase the exposure of neighbouring communities to a new latent fault, envisaging a potential flood in downstream valleys from an eventual failure of the reservoir, similar to that of the 2005 Taum-Sauk storage dam failure [272] in US.

III.3.1.3 Environmental Factor

Water usage rate: using an existing water body as the reservoir—which is a common practice for PHES construction—the implementation of PHES may imply a daily change in the water level (in the case of a lake) or the water flow rate (in the case of a river). Both cases would negatively impact every aquatic ecosystem in the proximity of the site.

Sealed ground surface: denotes the initially dry land surface to be flooded for creating an artificial reservoir which has known environmental effects such as animal migration and changes in the surrounding soil humidity.

Land cover: the environmental influence of land cover is mainly caused by the quantity of vegetation to be flooded for the creation of the reservoir considering the resulting carbon dioxide release.

Local solar irradiation: coupling the storage plant to a nearby solar farm as a standalone unit [126] would help to avoid long transmission lines between the two entities and hence reduce losses.

Local wind speed: similarly to solar power, the selection of a given PHESP site can be motivated by avoiding transmission losses or by generating stable power from a wind farm through a standalone scheme [111], following recent trends.

III.3.2 The MCDM Model of the Problem under Consideration

According to the factors and criteria defined above, the ranking of predetermined PHES options from a SD viewpoint is a multi-attribute decision-making (MADM) problem whose associated model can be written as shown in Fig. 61.

Pumped hydro energy storage plant's site selection										
Factors	Id	EC			SO			EN		
	Weight	w_{EC}			w_{SO}			w_{EN}		
Criteria	Id	EC1	...	EC7	SO1	...	SO4	EN1	...	EN5
	Weight	w_{EC1}	...	w_{EC7}	w_{SO1}	...	w_{SO4}	w_{EN1}	...	w_{EN5}
Alternatives	A_1	x_1^{EC1}	...	x_1^{EC7}	x_1^{SO1}	...	x_1^{SO4}	x_1^{EN1}	...	x_1^{EN5}
	A_2	x_2^{EC1}	...	x_2^{EC7}	x_2^{SO1}	...	x_2^{SO4}	x_2^{EN1}	...	x_2^{EN5}
	\vdots	\vdots	...	\vdots	\vdots	...	\vdots	\vdots	...	\vdots
	A_n	x_n^{EC1}	...	x_n^{EC7}	x_n^{SO1}	...	x_n^{SO4}	x_n^{EN1}	...	x_n^{EN5}

x_j^{*i} is the performance of the alternative A_j on the i^{th} criterion of the factor *.

Fig. 61: PHESP site selection decision-making problem model.

Through the application of the model, x_j^{*i} (* $i = EC1...EC7, SO1...SO4, EN1...EN5; j = 1...n$) are literally, real values to be determined as scores achieved by each pumped-storage alternative site on each weighted decision criterion. The principle of weighting the factors and criteria is such that in each branch of each level of the tree structure presented in Fig. 60, the sum of the weights is equal to the unit. This means that the following four equations are verified:

$$w_{EC} + w_{SO} + w_{EN} = 1 \quad \text{Eq. 33}$$

$$w_{EC1} + \dots + w_{EC7} = 1 \quad \text{Eq. 34}$$

$$w_{SO1} + \dots + w_{SO4} = 1 \quad \text{Eq. 35}$$

$$w_{EN1} + \dots + w_{EN5} = 1 \quad \text{Eq. 36}$$

III.4 The Proposed Methodology

III.4.1 Methodology's Steps

According to the MCDM model describing the PHESP site selection considering sustainable development, the multi-attribute nature of the problem is straightforward. The flowchart (see Fig. 62) of the proposed methodology that is intended to be as realistic as possible and easily applicable is an objective-oriented adjustment of the general scheme of discrete multi-criteria methods proposed in [230], [244]. The three main macro steps of the methodology include the problem statement, the decision-making, and the recommendation. The decision-making procedure is detailed in the following section.

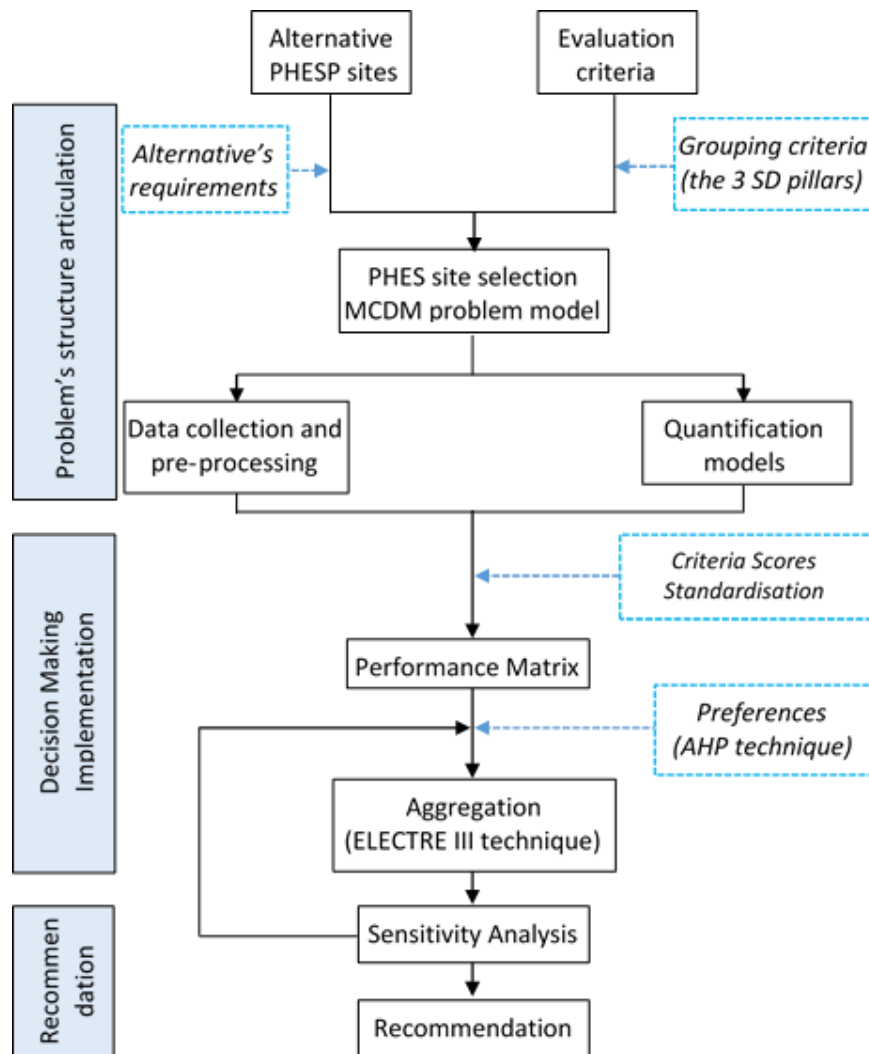

Fig. 62: Flowchart of the proposed decision model for PHESP site selection.

Main steps of the proposed methodology are explained in Table 20 below.

Table 20 : Steps in the Proposed Methodology.

Stage	Steps	Explanations
Problem's structure articulation	Alternatives PHESP sites	Alternative PHESP sites are those identified in a given study area or boundaries and meeting minimal requirements expected by stakeholders
	Evaluation criteria	Identifying aspects which distinguish PHESP candidate sites with respect to the three sustainable development pillars: Economic, Social and Environmental
	PHES MADM problem	Clear statement of the PHESP site selection multi-alternative decision making (MADM) problem, putting together alternative sites and evaluation factors and criteria.
	Data collection	Data of PHES candidate sites are collected from any relevant source based on identified criteria. Especially, GIS-based data are proceeded into usable formats.
	Quantification models	Based on the nature of criteria, quantification models are set up, primarily by application of fuzzy sets theory (fuzzy MFs) and by using the scaling approach (five point Likert-type scale), especially for criteria involving qualitative attribute data.
Decision-making implementation	Performance tables	Alternatives PHES sites are evaluated through the standardisation process (which assigns scores ranging from 0 to 1) using for each criteria the corresponding fuzzy membership or scaling function. The outcome is the performance matrix as in III.3.2 .
	Expressing preferences	Decision-maker's preferences are expressed through the assignment of weights to factors and criteria using the fundamental Saaty's scale for comparative judgment scale (AHP technique).
	Aggregation	From the performance table and weights assigned to criteria, partial rankings are aggregated using the ELECTRE III method for an average ranking.
Recommendation	Sensitivity analysis	Testing the consistency of the decision or its variation in response to any modification in the input data and/or the decision-maker preferences ("What-if analysis").
	Final recommendation	The final recommendation is made as the most stable sites ranking. It is delivered as a classification of PHES sites from best to worst with eventually equal positions.

III.4.2 The Integrated Approach of the Decision-Making Process

The proposed decision-making model aims to extract the benefits from the combination of various established MCDM techniques. At the first stage, elementary performances of the alternatives are standardised using two scoring techniques selected based on each criterion's nature. Secondly, the sixteen decision criteria grouped into the three factors are weighted through the analytic hierarchy process (AHP). Finally, partial evaluations are aggregated with respect to the assigned weights to generate the ranking of the alternatives.

III.4.2.1 The Standardisation Process

The objective of this step is to deal with the heterogeneity of the criteria by standardising every value to a 0–1 scale and to build a real performance matrix as required by the MADM approach shown in Fig. 61. This overcomes the limitation of pairwise-comparison-based methods when the number of items to be analysed becomes large, especially when exceeding nine.

Fuzzy Scoring System

Fuzzy Set Theory was formalised by Professor Lofti Zadeh at the University of California in 1965 [273]. It is a form of many-valued logic in which the truth values of variables may be any real number between 0 and 1. It is employed in MCA to handle the concept of partial truth, where the truth value may range between completely true and completely false, by contrast in Boolean logic where the truth values of variables may only be the integer values 0 or 1 [274]. The application of a membership function (MF) defines the degree of membership of an object z in a fuzzy set A expressed as a membership value between zero (0) and one (1) [275], [276]. This is a basic of the fuzzy sets theory that is a form of many-valued logic in which the truth values of variables may be any real number between 0 and 1.

To efficiently cope with vagueness inherent to the definition of some decision criteria (e.g. expressing the proximity to a given attribute), the proposed model considers such criteria as fuzzy sets whose corresponding membership functions are used throughout the standardisation procedure. Following the advantageous or disadvantageous nature of the attribute being evaluated, the fuzzy MF can be monotonically increasing (IFMF) or decreasing (DFMF) between the two control points ('p-value' and the 'q-value'), as indicated in Fig. 63. Within the DFMF, the lower values of z in a certain subset A give more priority than higher values of z . A feature of the membership function are its two threshold values or control points literally defined as the limit values of the corresponding attribute (notably the corresponding decision criteria). So, for an attribute i characterised by a membership function MF_i , the variable z_i may vary in an interval $[q_i, p_i]$, q_i being the least suitable value of z_i , where the grade of membership is not satisfied and hence has a membership value equal to zero (0), and p_i being the value of z_i where the grade of membership is fully satisfied and hence has a membership value equal to one (1). The mathematical expressions of the two linear MFs used in this study, IFMF and DFMF are given as Eq. 37 and Eq. 38 respectively.

$$IFMF(z_i) = \begin{cases} 0 & \text{if } z_i < p_i \\ \frac{z_i - p_i}{q_i - p_i} & \text{if } p_i \leq z_i \leq q_i \\ 1 & \text{if } z_i > q_i \end{cases} \quad Eq. 37$$

$$DFMF(z_i) = \begin{cases} 1 & \text{if } z_i < p_i \\ \frac{z_i - q_i}{p_i - q_i} & \text{if } p_i \leq z_i \leq q_i \\ 0 & \text{if } z_i > q_i \end{cases} \quad Eq. 38$$

These membership functions are plotted as in Fig. 63 below.

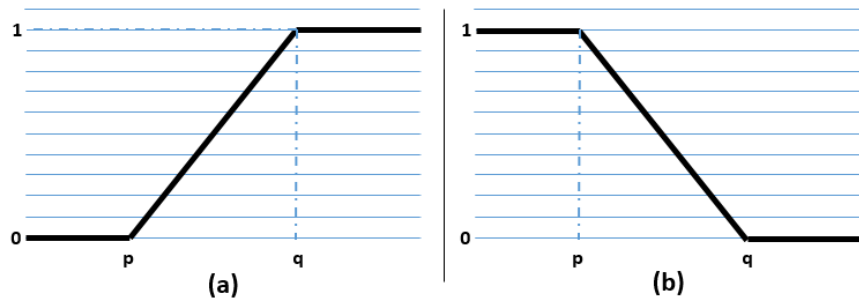

Fig. 63: Fuzzy membership function: (a) increasing and (b) decreasing.

During the second expert meeting, consensus values of the fuzzy MF control points were fixed on the basis of experience of the experts in presence and also the values used by other authors in similar works addressing energy plants siting [183]. These values for each of the identified criteria are shown in Table 24.

Five-point Likert-type Scoring System

For the standardisation of the qualitative criteria, the second expert meeting reached an agreement regarding the formulation of the five-point Likert-type scale (shown in Table 25). The scale is the sum of the responses to several statements. The respondent is asked to evaluate each individually by assigning a quantitative value to each criterion based on arbitrary subjective or objective reasoning [267].

III.4.2.2 Factors and Criteria Weighting: the AHP Method

The AHP technique is supported by seven pillars which are [277] -Ratio scales, proportionality, and normalized ratio scales - Reciprocal paired comparisons - Sensitivity of the principal right eigenvector - Homogeneity and clustering - Synthesis that can be extended to dependence and feedback - Rank preservation and reversal - Group judgments. Over years, AHP has become a popular method used in solving MCDM problems and, among other reasons justifying its popularity, one would cite the fact that it takes into consideration not just tangible but also intangible criteria. For instance in the field of renewable energy, solving the popular MCDM problem of selecting the best location for renewable energy power plant has been intensively addressed [176], [177], [182]–[184], [231], [240], [242], [243], [246] using the AHP technique because the problem involves both many numerical (distances, energy capacities,...) and non-numerical (mainly from people appreciation) criteria. The essence of the AHP process is decomposition of a complex problem into a hierarchy with goal (objective) at the top of the

hierarchy, criteria and sub-criteria at levels and sub-levels of the hierarchy, and decision alternatives at the bottom of the hierarchy as schematised in Fig. 64 below.

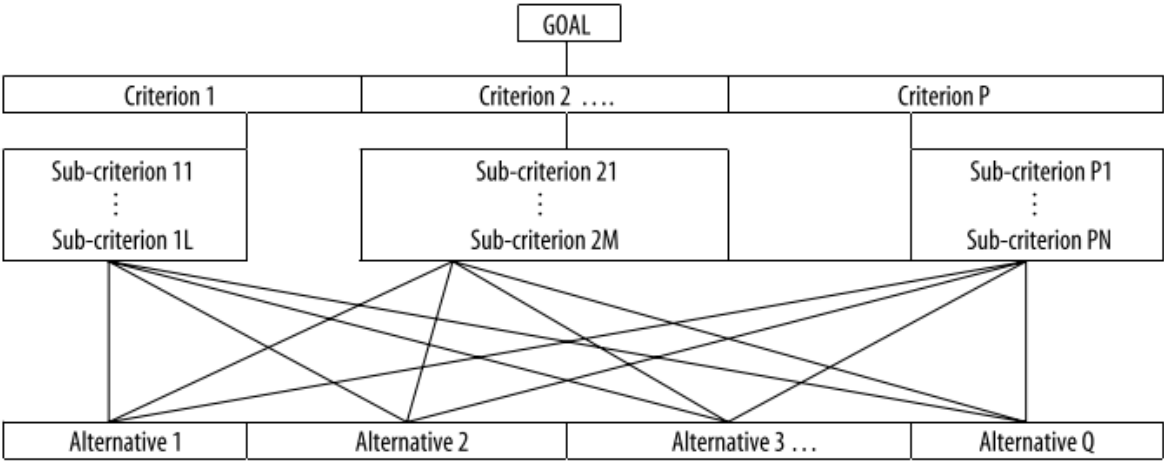

Fig. 64: Schematic of hierarchy in AHP [235].

The AHP decomposes the decision problem into elements, according to their common characteristics, and levels, which correspond to the common characteristic of the elements. The topmost level is the “focus” of the problem or ultimate goal; the intermediate levels correspond to criteria and sub-criteria, while the lowest level contains the “decision alternatives”. If each element of each level depends on all the elements of the upper level, then the hierarchy is complete; otherwise, it is defined incomplete. The elements of each level are compared pairwise with respect to a specific element in the immediate upper level [251]. After decomposing the problem into a hierarchy, elements at a given hierarchy level are compared in pairs to assess their relative preference with respect to each of the elements at the next higher level. The verbal terms of the fundamental Saaty’s scale presented in Table 21 are used to assess the intensity of preference between two elements. Especially, the Saaty’s scale reports the pairwise comparison that allows converting quantifiable and non-quantifiable (qualitative judgments) elements into numerical values, also with intangible attributes. Once the verbal judgments are made, they are translated into numbers by means of the fundamental scale. This procedure is repeated for elements at each level in downward direction.

Table 21 : The fundamental Saaty's scale for the comparative judgments [235], [251].

Numerical values	Verbal terms	Explanation
1	Equally important	Two elements have equal importance regarding the element in higher level
3	Moderately more important	Experience or judgement slightly favours one element
5	Strongly more important	Experience or judgement strongly favours one element
7	Very strongly more important	Dominance of one element proved in practise
9	Extremely more important	The highest order dominance of one element over another
2, 4, 6, 8	Intermediate values	Compromise is needed.
	Explanation	
Reciprocal of above nonzero	If activity i has one of the above nonzero numbers assigned to it when compared with activity j , then j has the reciprocal value when compared with i .	

The AHP is a simple mathematical method based on elementary operations with matrices. Its strong background is, however, in rational treatment of hierarchical relations between different criteria (objectives) and alternatives which all may be understood as decision variables. By creating appropriate hierarchies, and by performing particular step-by-step procedure while creating comparison matrices at different hierarchical levels, AHP computes and aggregates their eigenvectors in straightforward manner until the composite final vector of weight coefficients for alternatives is computed. The entries of final weight coefficients vector reflect the relative importance (value) of each alternative with respect to the goal stated at the top of hierarchy. Decision-makers may use this vector due to his particular needs and interests [235].

To elicit pairwise comparisons performed at given level, a judgmental matrix A , is created in turn by putting the result of pairwise comparison of element i with element j into the position a_{ij} as follows:

$$A = \begin{bmatrix} a_{11} & \cdots & a_{1n} \\ \vdots & \ddots & \vdots \\ a_{n1} & \cdots & a_{nn} \end{bmatrix} \quad \text{Eq. 39}$$

where a_{ij} represents the pairwise comparison rating between the element i and element j of a level with respect to the upper level. The entries a_{ij} are governed by the following rules: $a_{ij} > 0$ (thus A is known as a positive matrix); $a_{ij} \cdot a_{ji} = 1, \forall i, j$ (the reciprocal property) [260]. For example, the entry a_{32} should be set to 5, and a_{23} to as reciprocal value $1/5$ if element 3 is strongly favoured if compared with element 2.

Following Saaty [277], the priorities of the elements can be estimated by finding the principal eigenvector⁷ W of the matrix A , that is:

$$A \cdot W = \lambda_{max} \cdot W \quad \text{Eq. 40}$$

So, the relative ratio scale derived from a pairwise comparison reciprocal matrix of judgments is derived by solving:

$$\begin{cases} \sum_j^n a_{ik} \cdot w_j = \lambda_{max} \cdot w_i \\ \sum_j^n w_j = 1 \end{cases} \quad \text{Eq. 41}$$

When the vector W is normalized, it becomes the vector of priorities of elements of one level with respect to the upper level. λ_{max} is the largest⁸ eigenvalue of the matrix A .

In cases where the pairwise comparison matrix satisfies transitivity for all pairwise comparisons it is said to be consistent and it verifies the following relation:

$$a_{ij} = a_{ik} \cdot a_{kj}, \forall i, j, k. \quad \text{Eq. 42}$$

Saaty (1980) has shown that to maintain reasonable consistency when deriving priorities from paired comparisons, the number of factors being considered must be less or equal to nine. AHP allows inconsistency, but provides a measure of the inconsistency in each set of judgments. The consistency of the judgmental matrix can be determined by a measure called the consistency ratio (CR), defined as:

$$CR = \frac{CI}{RI} \quad \text{Eq. 43}$$

where CI is called the Consistency Index and RI the Random Index.

Furthermore, Saaty [235] provided average consistencies (RI values) of randomly generated matrices as in Table 22 below.

Table 22 : The average consistencies of random matrices (RI values) [235].

Size	1	2	3	4	5	6	7	8	9	10
RI	0.00	0.00	0.52	0.89	1.11	1.25	1.35	1.40	1.45	1.49

The consistency index CI for a matrix of order n is defined [264] as:

$$CI = \frac{\lambda_{max} - n}{n - 1} \quad \text{Eq. 44}$$

⁷ Consider an $n \times n$ square matrix A an n -dimensional vector w . Then, w and λ are an eigenvector and an eigenvalue of A respectively, if and only if $Aw = \lambda w$ [264].

⁸ From the Perron-Frobenius theorem, given a square matrix A , if A is positive, i.e. $a_{ij} > 0 \forall i, j$ $a_{ij} > 0 \forall i, j$, then its maximum eigenvalue is real, $\lambda_{max} \in \mathbb{R}$ [264].

In general, a consistency ratio of 0.1 or less is considered acceptable, this threshold is 0.08 for matrices of size four and 0.05 for matrices of size three. If the value is higher, the judgments may not be reliable and should be elicited again [251]. Saaty (1977) showed in [278] that $\lambda_{\max} = n$ is a necessary and sufficient condition for consistency.

Once the local priorities of elements of different levels are available, in order to obtain final priorities of the alternatives a_i , the priorities are aggregated as follows:

$$S(a_i) = \sum_k w_k \cdot S_k(a_i) \tag{Eq. 45}$$

where w_k is the local priority of the element k and $S_k(a_i)$ is the priority of alternative a_i with respect to element k of the upper level.

Summarising, quantitative criteria used in this study for the ranking of PHESP sites are expressed using the fuzzy set theory, in the form of membership function's value ranging from 0 (for the weakest priority) to 1 (for the strongest priority). That value is calculated through the process of standardisation of criteria and factors (aiming to express human linguistic values of criteria and factors into a standard range of real number values).

III.4.2.3 The ELECTRE III Method

The acronym ELECTRE stands for: ELimination Et Choix Traduisant la REalité (ELimination and Choice Expressing the REality). The ELECTRE family's methods was introduced by Benayoun, Roy and Sussman in 1968 [268]. Since then and particularly over the last three decades, the family has been widely developed and currently includes ELECTRE I, II, III, IV, IS and TRI methods. The common features of these methods is that they are based on the concept of ranking by paired comparisons between alternatives on the appropriate criteria. An alternative is said to dominate the other alternatives if one or more criteria are met (compared with the criterion of other alternatives) and it is equal to the remaining criteria [279]. So, All ELECTRE methods appear to be similar in describing the concepts but differ in type of decision problem being solved.

In particular, ELECTRE III (see the flowchart in Fig. 65) that was designed to improve ELECTRE II, is the most frequently used method in the ELECTRE family and is proved to be more suitable for ranking the problematic [268], as the basic idea of its approach is the ranking of alternatives according to the prioritization level. ELECTRE III evaluates the best choice while taking into account criteria weights and has been proved to be particularly better than other reputed outranking methods such as TOPSIS (technique for order preference by similarity to ideal solution) when the number of alternatives mores [279]. The ELECTRE III weighting step allows considering expert

opinions and enables decision-makers to express eventual judgment differences, leaving the last selection judgment to the decision-maker(s).

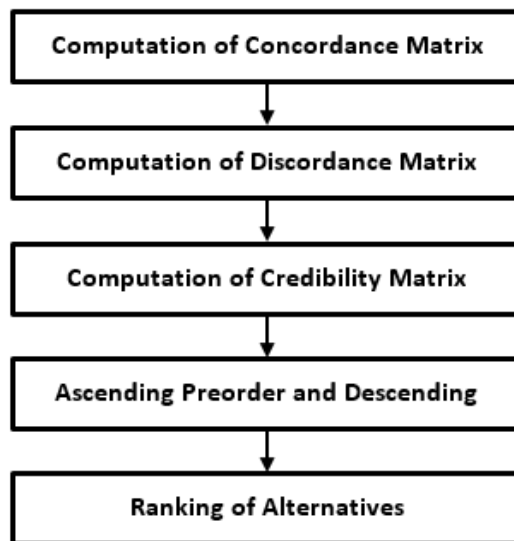

Fig. 65: ELECTRE III steps [268].

The application of the ELECTRE III that steps are shown in Fig. 65 above relies on the construction of an outranking hypothesis between alternatives which are compared by (a, b) pair. Each pair of alternatives is characterised by an outranking relationship $(aRb, \text{ with } R = I, Q, P$ following the difference between performances of alternatives and the values given to different thresholds). The outranking hypothesis is not entirely accepted or rejected but its credibility is evaluated (a value between 0 and 1) through two indices: the concordance index and the discordance index. Two pre-rankings are afterwards built via the two antagonistic distillation processes (ascendant and descendant). The final ranking is obtained at the crossing point of the two processes and the stability of the result is analysed through the sensitivity analysis.

- Pseudo-criteria

Alongside each criteria j in ELECTRE III, three thresholds (indifference, preference and veto represented respectively by q_j, p_j and v_j) allow defining preference areas between two alternatives. The first two thresholds (indifference and preference) create a pseudo-criterion. Considering a and b belonging to the set of alternatives and two thresholds q_j, p_j so that $q_j < p_j$, the following relationship are defined:

- a and b are said to be indifferent when the difference between the performances of the two alternatives is lower than the indifference threshold:

$$(aIb) \Leftrightarrow g_j(a) - g_j(b) \leq q_j(g_j(a)) \quad \text{Eq. 46}$$

- a is said preferred to b when the difference between the performances of the two alternatives is comprise between the indifference and the preference thresholds:

$$(aQb) \Leftrightarrow q_j(g_j(a)) \leq g_j(a) - g_j(b) \leq p_j(g_j(a)) \quad \text{Eq. 47}$$

➤ a is said strictly preferred to b when the difference between the performances of the two alternatives is higher than the preference threshold:

$$(aPb) \Leftrightarrow p_j(g_j(a)) \leq g_j(a) - g_j(b) \quad \text{Eq. 48}$$

- Concordance index

The global concordance index indicates in a first time the importance of the assertion “ aRb ”. Higher the concordance index, more concordant are the two alternatives involved in the assertion. That is expressed in the form:

$$C_{ik} = \frac{\sum_{j=1}^m W_j \cdot c_j(a,b)}{\sum_{j=1}^m W_j} \quad \text{Eq. 49}$$

where W_j is the weight of the criterion j and $c_j(a, b)$ the criterion’s concordance index defined as it follows:

$$\text{For any criteria } j \in J, \begin{cases} c_j(a, b) = 0 & \text{if } p_j < g_j(b) - g_j(a) \\ 0 < c_j(a, b) < 1 & \text{if } q_j < g_j(b) - g_j(a) < p_j \\ c_j(a, b) = 1 & \text{if } g_j(b) - g_j(a) < q_j \end{cases} \quad \text{Eq. 50}$$

- Discordance index:

Unlike the concordance index, two alternatives are more discordant as the discordance index is higher. The discordance index is evaluated from the preference threshold (p_j) and veto threshold (v_j). It is referred to as $D_j(a, b)$ and is expressed as it follows:

$$\text{For any criteria } j \in J, \begin{cases} D_j(a, b) = 1 & \text{if } v_j < g_j(b) - g_j(a) \\ 0 < D_j(a, b) < 1 & \text{if } p_j < g_j(b) - g_j(a) < v_j \\ D_j(a, b) = 0 & \text{if } g_j(b) - g_j(a) < p_j \end{cases} \quad \text{Eq.51}$$

- Degree of credibility:

Considering the values of concordance and discordance indices, the degree of credibility indicates whether or not the outranking hypothesis is plausible. It is referred to as ($\delta_{(a,b)}$) and is expressed as it follows:

$$\delta_{(a,b)} = \begin{cases} C(a, b), & \forall j, D_j(a, b) > C(a, b) \\ C(a, b) \cdot \prod_{i \in J} \frac{1 - D_i(a, b)}{1 - C(a, b)} & \end{cases} \quad \text{Eq. 52}$$

For a given pair of alternatives, the meaning of the above mathematical expression is:

➤ If the concordance index is higher than the discordance index then, the degree of credibility equals the concordance index;

- If the concordance index is strictly higher than the discordance index then, the degree of credibility is equal to the concordance index lowered by discordance indices.

III.4.3 Addressing the Sustainability

Since the green revolution, the attention given to environmental problems has risen which had a significant impact on the planning of energy facilities, including pumped-hydro storage plants. Hence, selecting sites for such facilities should address the notion of enhanced sustainability, i.e. a compromise has to be made between the three key pillars of SD, namely the society, economy, and environment [237]. Several previous studies illustrated that not every MCDM technique has an equal capability of SD planning [233]. Therefore, the proposed methodology is designed to address the issue of sustainability of PHESP site selection by using an approach incorporating partial compensation between decision factors. This introduces the concept of strong sustainability through the aggregation procedure of scored decision criteria as was recommended by Polatidis et al. [237] who proposed the classification of several MCDM techniques focusing on compensability and sustainability, as shown in Fig. 66.

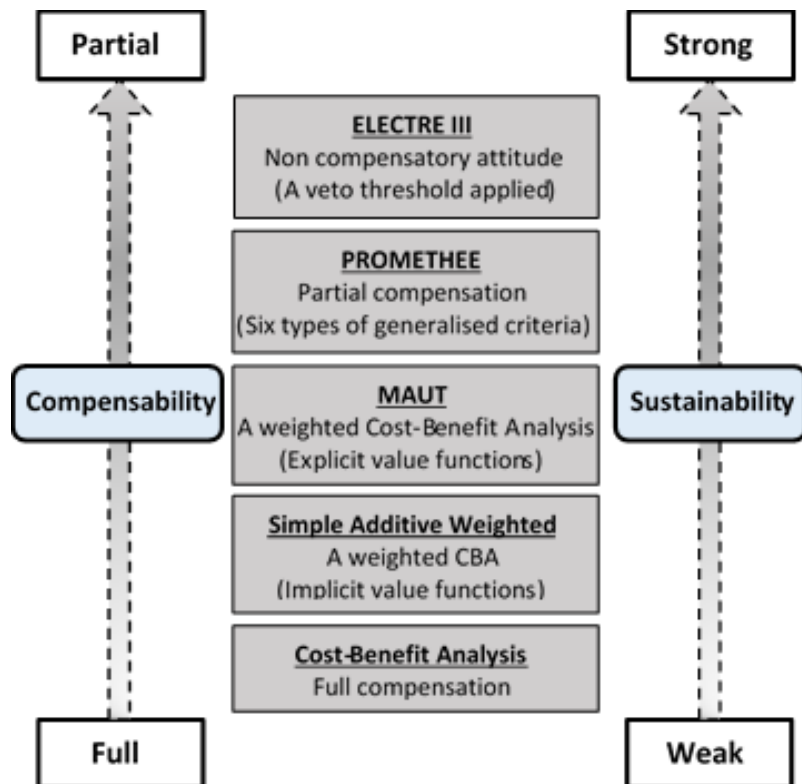

Fig. 66: MCDM models facing compensability and sustainability (arranged from [237]).

Unlike the cost-benefit-analysis-based or utility techniques—which allow a trade-off between decision criteria on a continuous scale—PROMETHEE and ELECTRE III are among the few methods eligible for solving the problems of site selection while considering sustainability. From these two, the ELECTRE III (which is a less compensatory outranking technique) is chosen for the aggregation procedure in our proposed methodology owing to its capability to consider the

sustainability issue by allowing the decision-maker to define thresholds of compensability. This can explain why ELECTRE III has become the most widespread method in the ELECTRE family for energy planning applications [280].

III.4.4 Sensitivity Analysis

Sensitivity analysis that is the base of robustness analysis [230] allows us to understand how robust is our original decision and what are the drivers (i.e., which criteria influenced the original results). It is an important part of the process and, in general, no final decision should be made without performing sensitivity analysis [281]. Particularly in the field of multi-criteria decision making (MCDM) where data are often imprecise and changeable, an important step in many applications of MCDM methods is to perform a sensitivity analysis on the input data [239]. This allows the decision maker to make better decisions as he can determine how critical each criterion is.

In the particular case of ranking PHESP alternative sites on the basis of a heterogeneous set of criteria as is the objective of this work, it is important once the initial ranking is achieved to check how sensitive the actual ranking of alternatives is to change on the current weights of the decision criteria. Having performed the ranking process using an integrated method (for which there is not an existing computer software capable of running all the steps), the sensitivity can be analysed with the more common approach [178] that consists in running multiple iterations using the same method, each time making slight adjustments in the inputs (such as the selection and weighting of criteria) to assess the sensitivity of the resulting outputs.

III.5 Application to the Western Regions of Cameroon

III.5.1 The Study Area

The studied area that consists of the two administrative regions (West and North-West) with a total surface area of about 30,941 km² is situated in the West of Cameroon, at the Nigerian border. The studied area is geographically located between the longitudes 9°37' and 11°19' East and latitudes 4°54' and 7°10' North, as shown in Fig. 67. The area is covered by the main local power grid referred to as 'Southern Interconnected Grid'.

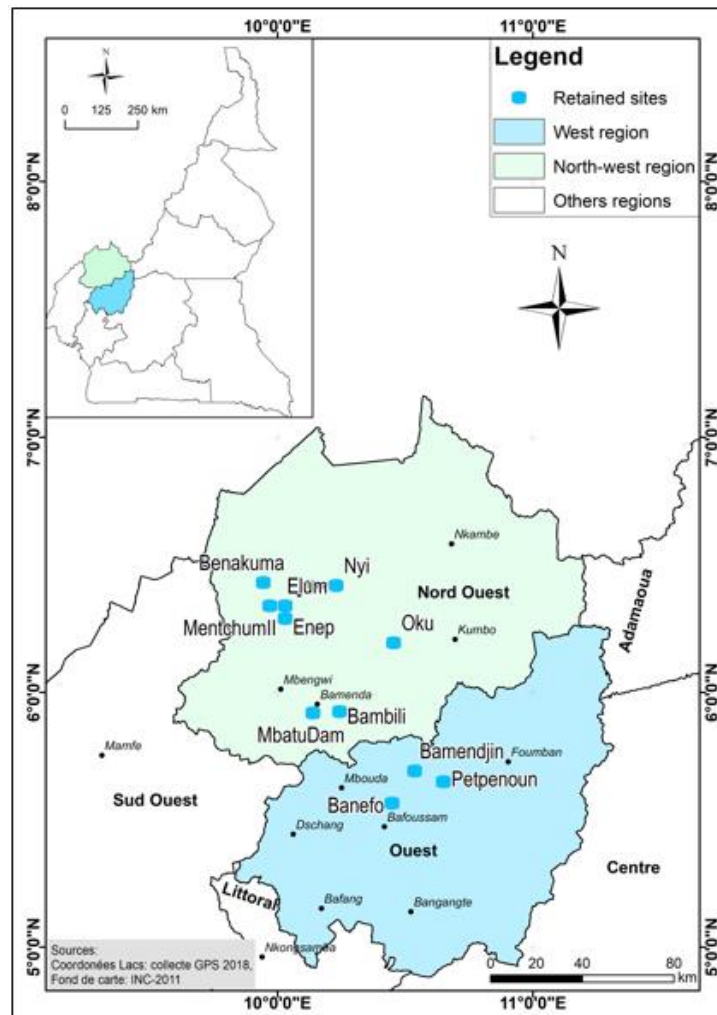

Fig. 67: Geographical position of the studied area and preselected PHEs sites.

Like other countries in the Central African sub-region Cameroon has no history with pumped-hydro energy storage. Recent studies performed on the basis of GIS data, the foremost estimation of the potential of Cameroon in terms of small-scale PHEs. The authors identified in total 21 feasible sites totalling about 33.4 GWh energy capacity across the country. The abovementioned study area was shown to cover up to 95% of the global storage potential through the nineteen sites it contains. From the number of PHEs opportunities previously identified in the considered area, this study has retained eleven, namely the ones with a higher than 180 metres head. These sites are Enep (6°18'20N, 10°2'47E); Bambili (5°55'31N, 10°14'1E); Bamendjin (5°43'46N, 10°39'57E); Banefo (5°33'56N, 10°26'55E); Benakuma (6°26'20N, 9°58'19E); Elum (6°20'50N, 10°1'27E); Mbatu-dam (5°55'23N, 10°8'44E); Mentchum-II (6°21'0.46N, 9°59'21.39E); Nyi (6°24'59N, 10°13'40E); Oku (6°11'38N, 10°30'45E) and Petponoun (5°39'15N, 10°39'14E). The distribution and general location of the eleven sites are shown in Fig. 67 above.

III.5.2 Data Collection and Pre-processing

In order to easily deal with the diversity of PHESP sites characteristic data and information induced by the heterogeneity of the decision criteria, three groups of criteria have been defined based on the nature of related data (crispy and fuzzy-evaluated quantitative criteria and qualitative criteria). As a whole, main sources of data on this case study include the previous research findings, some available databases and above all, Geographic information systems (GIS) that modern powerful tools enables access to local information through remote sensing [169], [175] and the processing of so obtained data in various ways.

III.5.2.1 First Group: Sites Specification Criteria (crispy-evaluated)

This group refers to quantitative criteria that related data are crispy-evaluated and as such, do not require any form of pre-processing. Such data which are included in the findings of Chapter II are about natural media such as surface areas, land cover, people settlement, etc. were remotely collected through GIS tools. They are detailed together with other main characteristics of the selected sites, which include the gross head, the head-distance ratio, the water use rate, the sealed ground surface, and the PHES scheme nature⁹ in Annexe 7.

III.5.2.2 Second Group: Fuzzy Values-Defined Criteria

This is the group of criteria that collection of related data involves official maps, which can be retrieved from various available databases as summarised in Table 23 below. Concerned criteria are quantitative and defined using fuzzy values.

⁹ Exceptionally, this criteria is admitted in the group because of the easiness to classify sites on the evaluation scale, thanks to the clear-cut differences between reservoirs.

Table 23 : Formats and sources of some obtained data.

Criteria		Available data format	Data source
ID	Description		
EC1	Power grid proximity	Power transmission lines map of Cameroon (available in .pdf format)	The Word Bank (2016) and The National Institute of Cartography (NIC), Detailed in Annexe 8
EC2	Road network proximity	Official road map of Cameroon outlining National (N) and Departmental (D) roads	Available for free at www.mapcruzin.com/download-free-arcgis-shapefiles.htm
EC7	Earthquake epicentre proximity	Earthquake epicentres map of Cameroon (available in .jpg format)	Felt earthquakes in Cameroon over the past 160 years (from 1852 until today) [282], [283]
SO1	Proximity with urban areas	Official map of urban areas of Cameroon (available in .shp and .shx formats)	The National Institute of Cartography (NIC)
EN4	Local wind speed	Wind resource map of Cameroon (available in .jpg format)	Arranged from Africa-EU Renewable Energy Corporation Programme –RECP- ¹⁰
EN5	Local solar horizontal irradiation	Solar resource map of Cameroon (available in .png format)	Solargis database [284]

From the table, obtained data in image formats are not exploitable with good accuracy and therefore, need to be pre-processed before being used in the decision-making process. The adequate pre-processing consists in converting such image files into GIS layers. This is done here using the conversion tool available in ArcGIS 10.5 software which generates a “shapefile” (.shp or .shx file commonly used in GIS environments) from image formats (.png or .jpg file). For each concerned criteria, once the corresponding GIS layer is created, obtaining the required measured is straightforward. The synthesis of this process is shown in the following figures.

¹⁰ <https://www.africa-eu-renewables.org/market-information/cameroon/renewable-energy-potential/>
[Accessed: 20:09:2018]

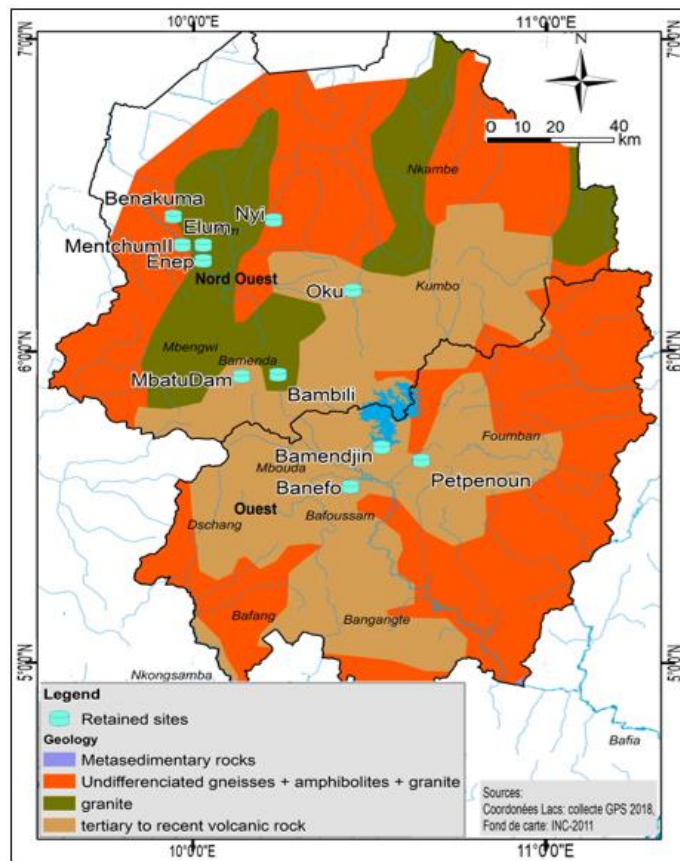

Fig. 68: Geology of study area (Source: an arrangement from [282]).

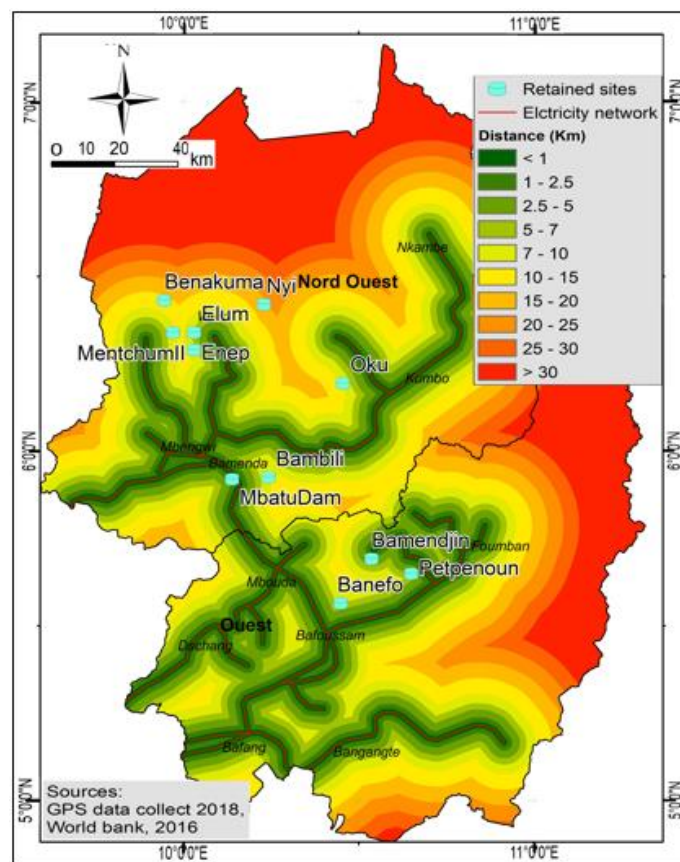

Fig. 69: Power lines proximity map (Source: World Bank 2016).

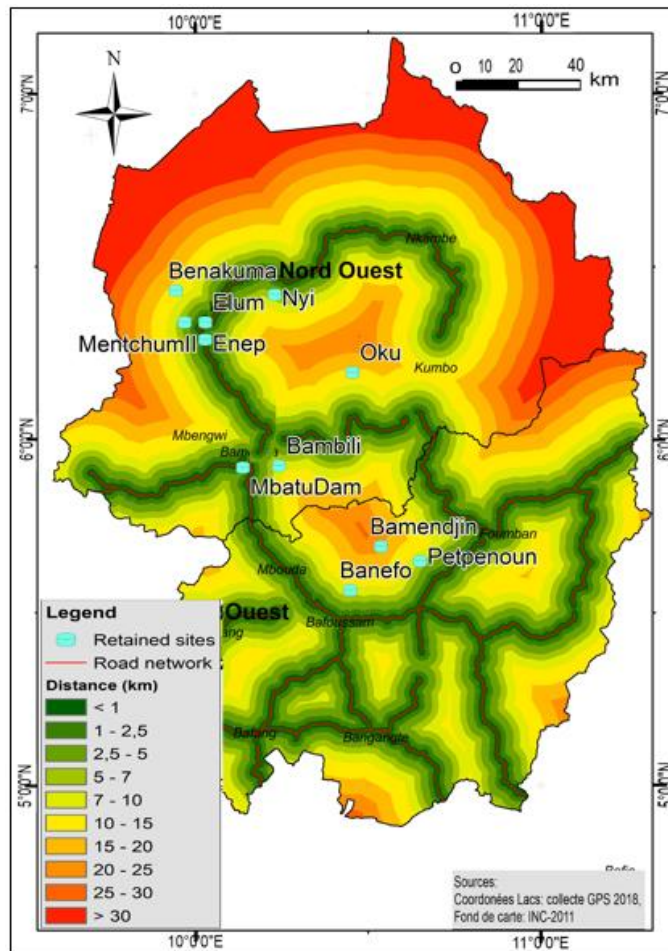

Fig. 70: Main roads map of the study area (National Institute of Cartography, 2011).

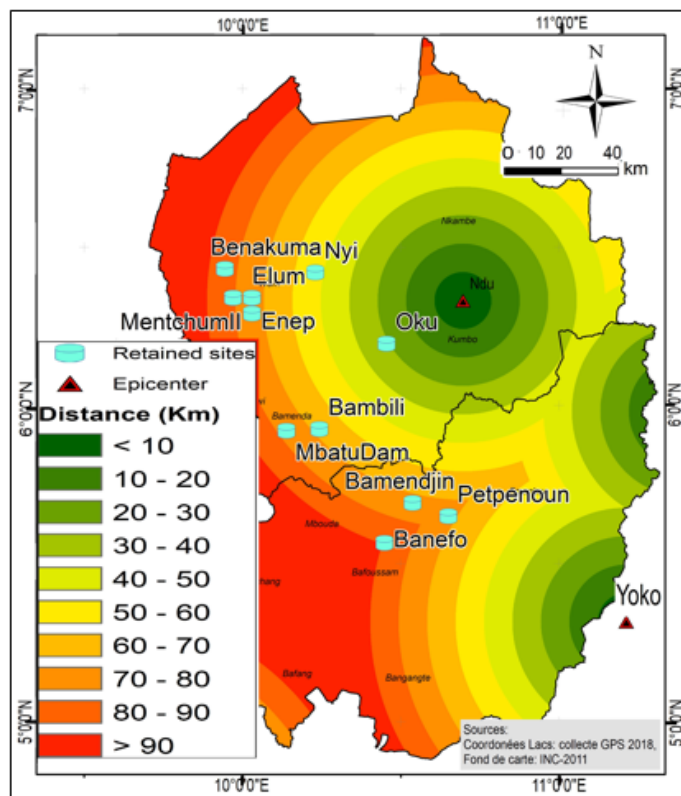

Fig. 71: Earthquake epicentres in the study area (Source: Gaston et al. [283]).

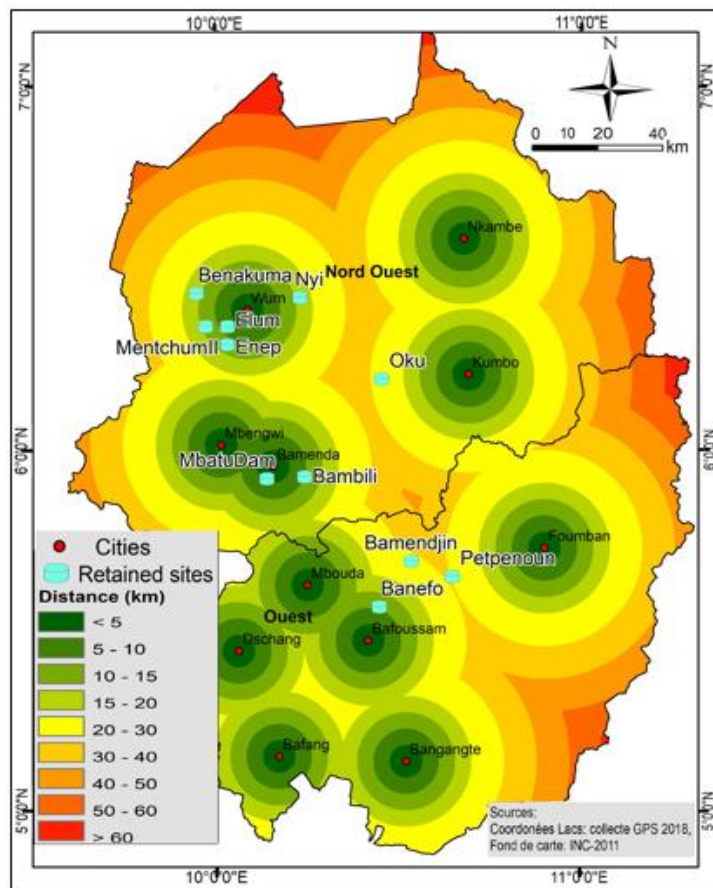

Fig. 72: Urban areas in the study area (Source: National Institute of Cartography, 2011).

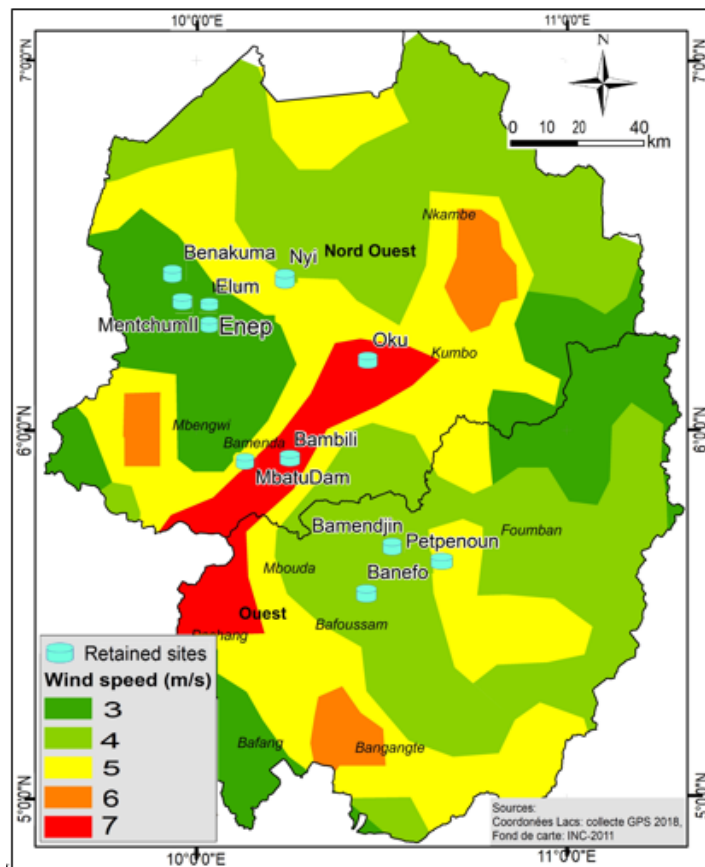

Fig. 73: Average wind speed recorded in the study area.

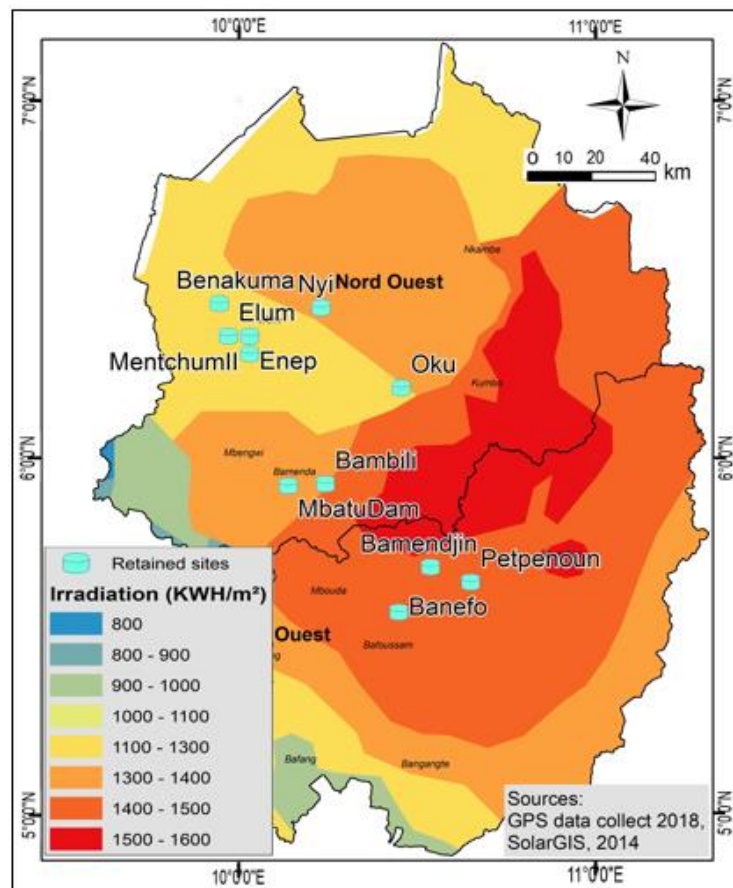

Fig. 74: Solar horizontal irradiation in the study area (Source: Solargis 2018 [284]).

III.5.2.3 Third Group of Data: Synthesised from an Experts Meeting

This last group concerns the remaining four qualitative criteria: site's geologic condition, latent fault potential, land use, and land cover. For the pre-processing of related information, the experts who screened the selection criteria were called in the second meeting that the first task was to characterise individually each PHESP alternative site in terms of land cover, land use and latent fault potential with regard to neighbouring population. It is noteworthy that the key GIS tool used for the purpose was Google Earth 3D visualisation tool as any personal computer used by expert was equipped with. Meanwhile, a fifth expert with background in geology and civil-works was contacted separately, asking for his opinion on the characterisation of the lithology of relevant geologic areas in terms of their impacts on important building designs. Finally, experts reached an agreement on the five point Likert-type scoring system shown in Table 25. Using this for evaluating alternatives resulted in scores provided in Table 30.

III.5.3 Construction of Quantification/Standardisation Models

III.5.3.1 Case of Quantitative Criteria (Fuzzy MFs)

For quantitative criteria which are characterised by the membership functions of associated fuzzy sets, the p-Value and the q-Value (as explained in III.4.2.1) as well as the function type are set as in Table 24 below.

Table 24 : Parameters values of fuzzy membership functions for quantitative criteria.

Criteria	Unit	Fuzzy MF	MF	MF	
Symbol	Definition	Type	p-Value	q-Value	
EC1	Power grid proximity	km	DFMF	1	20
EC2	Road network proximity	km	DFMF	1	20
EC4	Head-Distance ratio	-	IFMF	0.1	0.4
EC5	Gross head	m	IFMF	180	600
EC7	Earthquake centre proximity	km	IFMF	10	90
SO1	Proximity with urban areas	km	IMF	5	10
			DFMF	30	20
SO2	People settlement	-	DFMF	75	25
EN1	Water use rate	%	DFMF	70	0
EN2	Sealed ground surface	10 ³ m ²	DFMF	1,500	200
EN4	Local wind potential	ms ⁻¹	IFMF	5	12
EN5	Local solar potential	kWhm ⁻²	IFMF	700	1,600

Fig. 75 shows the examples of plotting of both decreasing and increasing fuzzy MFs. In particular for the criteria SO1 (Proximity with urban areas), based on the explanation of criteria provided in III.3.1 , a PHESP site should be located at a reasonable distance from towns. Ideally, it should be located between 10 and 20 km as suggested by [184] for wind and solar farms. As consequence, the variation direction of the corresponding MF must change: increasing from 5 km to 10 km and decreasing from 20 km to 30 km as shown in Fig. 75.

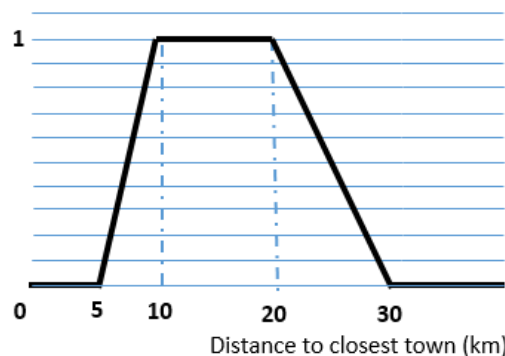

Fig. 75: The fuzzy MF associated to “Proximity with urban areas” criterion.

III.5.3.2 Case of Qualitative Criteria (Likert-Type Scales)

For the five qualitative criteria introduced in 0, the second expert meeting reached agreement of the five point Likert-type scale detailed in Table 25 below.

Table 25 : Five point Likert-type scale values for qualitative criteria.

Criteria	Criteria	Value
Symbol	Definition	Symbol
EC3	Site's geological condition	SO3
	-Severely disfavoured	-Intensive economic activities
	-Disfavoured	-Extensive economic activities
	-Neutral	-Non-regulated leisure
	-Favoured	-Pastures/savannah
	-Highly favoured	-No trace of human activity
SO4	Latent fault potential	EN3
	-Unbearable	-Shrubs/scattered trees
	-Critical	-Shrubs and orchard
	-Moderate	-Grass/sparse shrubs
	-Existing	-Semi-arid land
	-Negligible	-Arid land
EC6	Nature of PHES connection	
	-T1 or T2 with natural TD	-
	-T6 with natural TD, T7	-
	-T2 with reservoir-wall or T5	-
	-T3 or T4 with natural TD	-
	-T3 or T4 with reservoir wall	-
		0.8 - 0.9
		0.6 - 0.7
		0.4 - 0.5
		0.2 - 0.3
		0.1

Note: T1...T7 represent the seven topologies of prospective PHES sites as defined by the SETIS experts panel in [168]. TD: Terrain depression, representing an advantage for the construction of a reservoir.

It is noteworthy that during the scoring process, using an intermediate value in order to materialise a slight advantage of one alternative when compared to another is authorised and encouraged.

III.5.4 Decision-Making Implementation

III.5.4.1 First Step Calculation: Factors and Criteria Weighting (AHP)

Applying the above-presented methodology step-by-step, the second experts meeting focused first on the assignment of criteria weights through the AHP algorithm by the Expert Choice software [285]. At the initial ranking iteration intended to operationalize the sustainability by considering the factors with equal importance, the pairwise comparison matrix of the decision factors was obtained as shown in Table 26 with 0 inconsistency.

Table 26 : Initial AHP-pairwise comparison matrix of the three SD factors.

Factor	Symbol	EC	SO	EN	Weights
Economic	EC	1	1	1	0.333
Social	SO	1	1	1	0.333
Environmental	EN	1	1	1	0.333

In the Level 2 of the tree-structure of the problem, the pairwise comparison of criteria was performed for each factor.

- Using the Expert Choice Software, the result of the pairwise comparison of economic criteria was obtained as in Table 27. The consistency Index of the matrix was calculated as 0.05.

Table 27 : AHP-pairwise comparison matrix of economic criteria.

Economic criteria	Symbol	EC1	EC2	EC3	EC4	EC5	EC6	EC7	Weights
Grid proximity	EC1	1	2.000	3.000	5.000	6.000	4.000	2.000	0.044
Road network proximity	EC2	0.500	1	3.000	5.000	6.000	4.000	2.000	0.036
Site's geologic condition	EC3	0.333	0.333	1	5.000	6.000	3.000	1.000	0.074
Head-Distance ratio	EC4	0.200	0.200	0.200	1	2.000	3.000	4.000	0.325
Hydraulic Head	EC5	0.167	0.167	0.167	0.500	1	4.000	5.000	0.311
Site topology	EC6	0.167	0.250	0.333	0.333	0.250	1	3.000	0.144
Earthquake centre proximity	EC7	0.500	0.500	1.000	0.250	0.200	0.333	1	0.066

- Similarly, Table 28 shows the Saaty's pairwise comparison matrix of social criteria. Calculations indicated a Consistency Index of 0.01.

Table 28 : AHP-pairwise comparison matrix of social criteria.

Social criteria	Symbol	SO1	SO2	SO3	SO4	Weights
Urban area proximity	SO1	1	3.000	14.000	5.000	0.041
Potential people displacement	SO2	0.333	1	7.000	3.000	0.095
Land use	SO3	0.071	0.143	1	3.000	0.634
Risk incurred by population	SO4	0.200	0.333	0.333	1	0.230

- Finally, the pairwise comparison matrix of environmental criteria is shown in Table 29 below with 0.05 Consistency Index.

Table 29 : AHP-pairwise comparison matrix of environmental criteria.

Environmental criteria	Symbol	EN1	EN2	EN3	EN4	EN5	Weights
Hydro resource use	EN1	1	2.000	3.000	3.000	3.000	0.386
Ground surface to be sealed	EN2	0.500	1	1.000	3.000	3.000	0.217
Land cover	EN3	0.333	1.000	1	4.000	4.000	0.236
Local wind potential	EN4	0.333	0.333	0.250	1	1.000	0.081
Local solar potential	EN5	0.333	0.333	0.250	1.000	1	0.081

III.5.4.2 Second Step Calculation: PHESP Sites Scoring (Fuzzy MFs)

Using fuzzy membership functions (for quantitative criteria) and defined scales (for qualitative criteria), the eleven PHESP alternative sites were successively scored on each of the sixteen criteria. Although it is a quite easy task, handling $11 \times 16 = 176$ figures can be tedious if processed manually so using an Excel spreadsheet may be wise. Of course it has been used to generate the below Table 30 standing as the performance matrix (it summarises performances of both criteria and alternatives).

Table 30 Performance matrix obtained for the case study.

Criteria	Weights*	Alternative PHES sites										
		ENE	BAM	OKU	BEN	NYI	BAN	MEN	ELU	BAB	PET	MBA
EC1	0.015	0.737	0.895	0.632	0.211	0.474	0.737	0.579	0.737	0.632	0.789	0.947
EC2	0.012	1.000	0.974	0.526	0.368	0.789	0.737	0.895	1.000	0.789	0.895	1.000
EC3	0.025	0.800	0.700	0.800	0.800	0.700	0.600	0.500	0.700	0.700	0.800	0.900
EC4	0.108	0.413	0.190	0.138	0.340	0.457	0.204	0.228	0.356	0.218	0.104	0.893
EC5	0.104	0.905	0.879	0.833	0.774	0.774	0.531	0.374	0.310	0.083	0.071	0.010
EC6	0.048	0.600	0.800	0.300	0.900	0.800	0.700	0.700	0.900	0.400	0.800	0.500
EC7	0.022	0.875	0.750	0.250	0.875	0.500	0.875	0.875	0.750	0.625	0.750	0.750
SO1	0.014	1.000	1.000	0.300	1.000	1.000	0.800	1.000	0.400	0.200	0.800	0.400
SO2	0.032	1.000	0.750	1.000	1.000	1.000	1.000	1.000	1.000	1.000	1.000	1.000
SO3	0.211	0.700	0.400	0.700	0.900	0.300	0.300	0.700	0.400	0.700	0.900	0.900
SO4	0.077	0.700	0.600	0.300	0.900	0.900	0.800	0.900	0.500	0.700	0.700	0.900
EN1	0.129	1.000	0.997	0.868	0.899	0.191	1.000	1.000	0.067	0.397	0.067	0.931
EN2	0.072	0.940	0.231	0.154	0.800	0.942	1.000	0.931	1.000	0.885	0.737	1.000
EN3	0.079	0.300	0.700	0.500	0.400	0.600	0.700	0.500	0.300	0.600	0.900	0.900
EN4	0.027	0.000	0.286	0.286	0.000	0.000	0.000	0.000	0.000	0.286	0.143	0.286
EN5	0.027	0.611	0.833	0.722	0.611	0.611	0.833	0.611	0.611	0.722	0.833	0.722

ENE=Enep; BAM=Bamendjin; OKU=Oku, BEN=Benakuma; NYI=Nyi; BAN=Banefo; MEN=Mentchum; ELU=Elum; BAB=Bambili; PET=Petponoun; MBA=Mbatu-dam.
 *The weight of a criterion in the final decision is obtained by multiplying its weight in the factor by the factor's weight

III.5.4.3 Third Step Calculation: Aggregation Process (ELECTRE III)

Inputs for applying the ELECTRE III outranking method is the performance matrix obtained above extended with the three preference thresholds (indifference, preference and veto represented respectively by q , p and v). For memory, the three thresholds are set for each criteria in order to define preference areas between two alternatives. So, to aggregate the alternatives' performances on weighted criteria, the expert group reached a consensus on initial preference thresholds required for applying the ELECTRE III technique as in Table 31.

Table 31 : Preference thresholds for the initial ranking.

Thres holds	EC1	EC2	EC3	EC4	EC5	EC6	EC7	SO1	SO2	SO3	SO4	EN1	EN2	EN3	EN4	EN5
q	0.1	0.1	0.1	0.1	0.1	0.1	0.05	0.1	0.3	0.1	0.15	0.2	0.15	0.2	0.1	0.2
p	0.25	0.3	0.2	0.2	0.2	0.25	0.1	0.25	0.4	0.2	0.3	0.4	0.3	0.3	0.25	0.4
v	0.6	0.65	0.4	0.7	0.6	0.50	0.3	0.9	0.8	0.6	0.6	0.8	0.9	0.9	1	1

Using the performance matrix and preference thresholds as inputs to the ELECTRE method, calculations were performed computationally using the J-Electre-v1.0 software¹¹ developed by Pereira et al. [286] to help handling matrices when running the ELECTRE family steps.

¹¹ Available for free at <https://sourceforge.net/projects/j-electre/files/> [Accessed on 18.08.2018].

First, the credibility matrix of the ranking was obtained as in Table 32.

Table 32 : Credibility Matrix of the ranking.

	ENE	BAM	OKU	BEN	NYI	BAN	MEN	ELU	BAB	PET	MBA
ENE	0.00	0.85	0.97	0.72	0.86	0.92	0.97	0.95	0.89	0.67	0.52
BAM	0.45	0.00	0.79	0.32	0.74	0.88	0.54	0.86	0.72	0.64	0.00
OKU	0.00	0.00	0.00	0.00	0.00	0.00	0.00	0.00	0.00	0.00	0.00
BEN	0.82	0.00	0.95	0.00	0.95	0.87	0.97	0.95	0.95	0.48	0.00
NYI	0.00	0.00	0.52	0.00	0.00	0.00	0.00	0.96	0.73	0.00	0.00
BAN	0.53	0.85	0.63	0.00	0.78	0.00	0.78	0.90	0.76	0.00	0.00
MEN	0.59	0.83	0.84	0.62	0.76	0.93	0.00	0.91	0.95	0.66	0.00
ELU	0.00	0.00	0.00	0.00	0.73	0.00	0.00	0.00	0.57	0.49	0.00
BAB	0.00	0.00	0.00	0.00	0.00	0.54	0.22	0.00	0.00	0.62	0.03
PET	0.00	0.00	0.00	0.00	0.00	0.00	0.00	0.73	0.89	0.00	0.00
MBA	0.00	0.00	0.00	0.00	0.00	0.83	0.83	0.85	1.00	0.94	0.00

Following the ELECTRE III outranking principle, the initial average ranking of the alternatives was obtained as in Table 33.

Table 33 : Ranking matrix.

Candidate sites	Ranking Ascendant	Ranking Descendant	Ranking Average
Enep (ENE)	1	1	1
Bamendjin (BAM)	5	5	5
Oku (OKU)	8	9	8.5
Benakuma (BEN)	1	2	1.5
Nyi (NYI)	6	7	6.5
Banefo (BAN)	7	6	6.5
Mentchum (MEN)	4	4	4
Elum (ELU)	10	8	9
Bambili (BAB)	9	9	9
Petponoun (PET)	3	7	5
Mbatu-dam (MBA)	2	3	2.5

From the average ranking shown in Table 33, the outranking of the eleven alternative is schematised as in Fig. 76, with priority level decreasing from top to bottom.

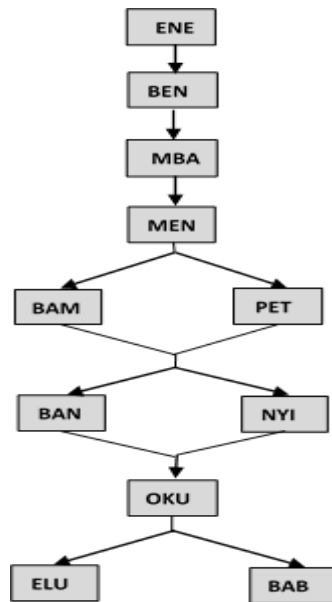

Fig. 76: Initial ranking of alternatives.

III.5.5 The Sensitivity Analysis

Using an integrated methodology that the steps are run separately, once the initial ranking is achieved the robustness can be analysed using the more common approach [178]. That consists in running multiple iterations, each time making slight adjustments in the criteria weights and tracking the change brought into the result. To do that three perspectives were envisaged consisting in assigning successively the highest weight to each of the three decision factors as shown in Table 34.

Table 34 : Weight values assignment for different ranking perspectives.

Factors	Economic (EC)	Social (SO)	Environmental (EN)
Sustainability Perspective	0.33	0.33	0.33
Economic Perspective	0.50	0.25	0.25
Social Perspective	0.25	0.50	0.25
Environmental Perspective	0.25	0.25	0.50

The three iterations led to three various initial rankings from an economic perspective (Fig. 77-a), a social perspective (Fig. 77-b), and an environmental perspective (Fig. 77-c) which are schematically shown in Fig. 77.

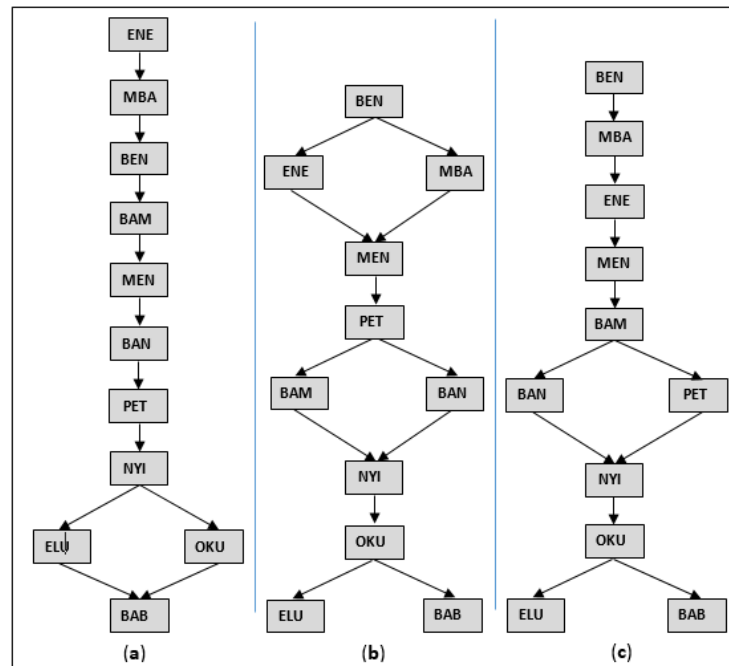

Fig. 77: Three ranking perspectives: (a) Economic; (b) Social; (c) Environmental.

The second step of the sensitivity analysis was the tracking of the influence of a 10 % decrease (referred to as Min. Value) and a 10 % increase (referred to as Max. Value) of the adjustments made to the preference thresholds used for the four iterations so far performed. The influence of these adjustments on the result of each of the above scenarios can be visualised in in Fig. 78 - Fig. 81. For the drawing of these curves, data were obtained from the calculation software, which did not highlight any inconsistency, thus indicating that the model is working as expected.

Table 35 : Preference thresholds for the initial ranking and the sensitivity analysis.

Thresholds		EC1	EC2	EC3	EC4	EC5	EC6	EC7	SO1	SO2	SO3	SO4	EN1	EN2	EN3	EN4	EN5
q	Min.	0.09	0.09	0.09	0.09	0.09	0.09	0.04	0.09	0.27	0.09	0.13	0.18	0.13	0.18	0.09	0.18
	Initial	0.1	0.1	0.1	0.1	0.1	0.1	0.05	0.1	0.3	0.1	0.15	0.2	0.15	0.2	0.1	0.2
	Max.	0.11	0.11	0.11	0.11	0.11	0.11	0.05	0.11	0.33	0.11	0.16	0.22	0.16	0.22	0.11	0.22
P	Min.	0.22	0.27	0.18	0.18	0.18	0.22	0.09	0.22	0.36	0.18	0.27	0.36	0.27	0.27	0.22	0.36
	Initial	0.25	0.3	0.2	0.2	0.2	0.25	0.1	0.25	0.4	0.2	0.3	0.4	0.3	0.3	0.25	0.4
	Max.	0.27	0.33	0.22	0.22	0.22	0.27	0.11	0.27	0.44	0.22	0.33	0.44	0.33	0.33	0.27	0.44
ν	Min.	0.54	0.58	0.36	0.63	0.54	0.45	0.27	0.81	0.72	0.54	0.54	0.72	0.81	0.81	0.9	0.9
	Initial	0.6	0.65	0.4	0.7	0.6	0.50	0.3	0.9	0.8	0.6	0.6	0.8	0.9	0.9	1	1
	Max.	0.66	0.71	0.44	0.77	0.66	0.55	0.33	0.99	0.88	0.66	0.66	0.88	0.99	0.99	1	1

Assuming the same level of priority to the decision factors of the proposed model made it possible to establish a ranking that was supposed to reflect a better consideration of sustainability requirements. Fig. 78 is the illustration of this situation. The ENE site at the top of the initial ranking was caught up by BEN with the 10% increase in preference thresholds, while 10% decrease of the thresholds resulted in slight changes in the middle of the ranking. In this scenario,

ranking first the ENE site can be justified by the natural assets it offers for easy construction of the upper reservoir at more than 500 metres above the Mentchum River.

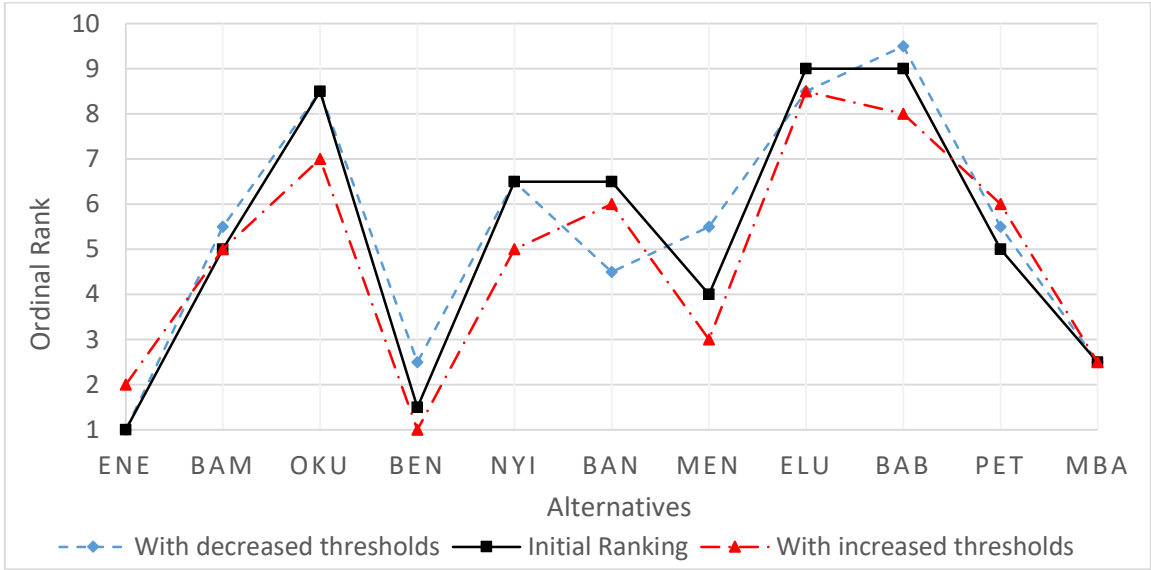

Fig. 78: Sensitivity of the initial ranking to +/- 10% variation of thresholds.

Almost the same ranking was obtained by giving priority to techno-economic factors (see Fig. 79), the main difference appearing on the position of the MBA site which outranked BEN in both the initial and the decreased-thresholds rankings. As the smallest site in terms of head and capacity, MBA has undeniable technical and economic advantages, including access to road and electricity networks, the geology and the relatively small distance between the two reservoirs.

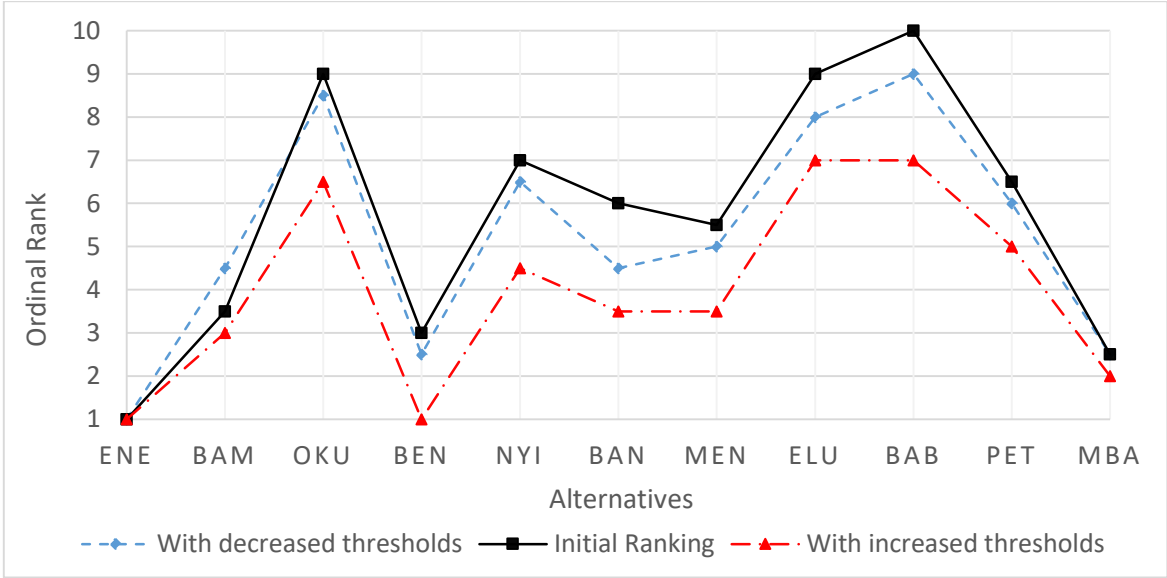

Fig. 79: Sensitivity of the economic ranking to +/- 10% variation of thresholds.

A significant change in the ranking was observed by giving priority to the social factor (see Fig. 80): BEN was ranked first taking into consideration both the initial and the increased-thresholds

rankings, followed by ENE and MBA. This clearly reflects the social advantage of the BEN site due to its remoteness from human activity centres.

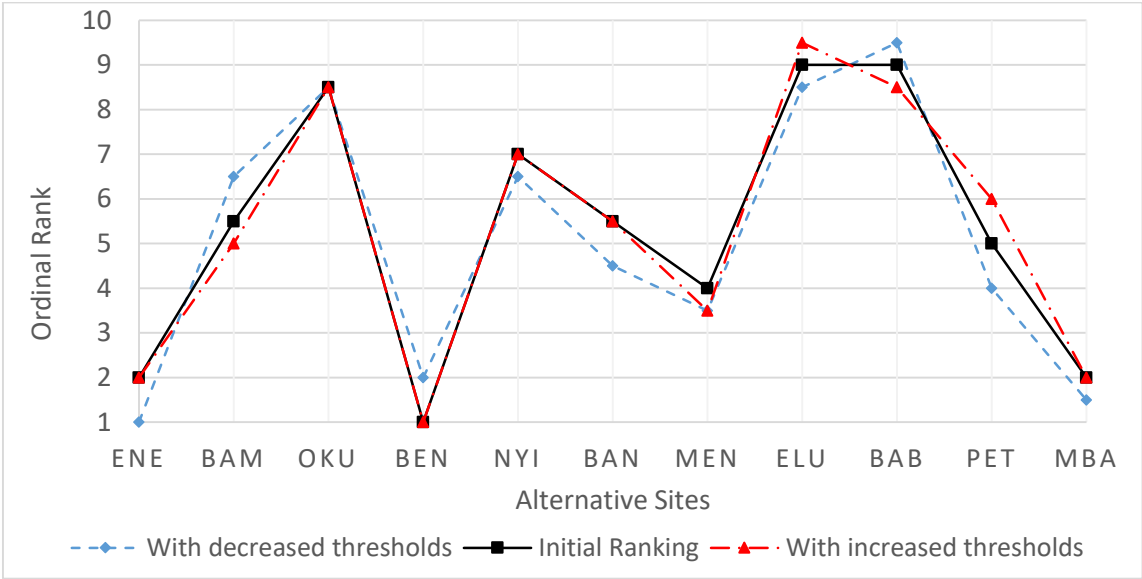

Fig. 80: Sensitivity of the social ranking to +/- 10% variation of thresholds.

This was almost the same when priority was given to the environmental aspect (see Fig. 81). In this last ranking perspective, the ENE site was disadvantaged (relegated to third place behind BEN and MBA) according to the initial and the increased-thresholds rankings, probably because of the large ground surface area to be flooded as required for building the upper reservoir at this site.

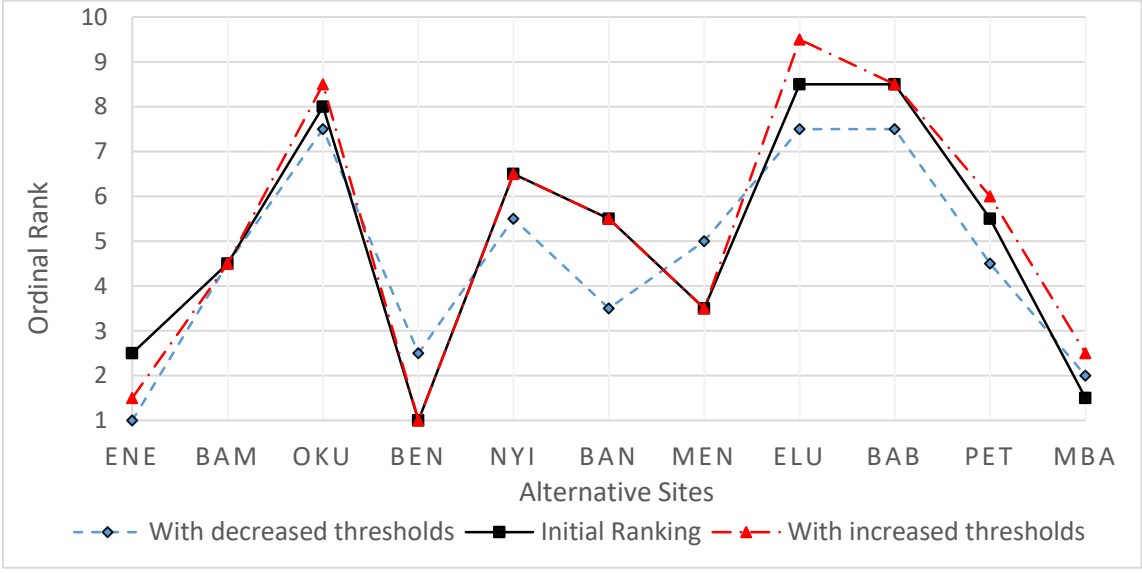

Fig. 81: Sensitivity of the environmental ranking to +/- 10% variation of thresholds.

The application of the proposed decision model to this case study indicates with strong stability that the list of the five best PHES candidate sites identified in Cameroon could include ENE, NBA, BEN, MEN and BAM, ranked in descending order of priority. Indeed, the sensitivity analysis

summarized in Fig. 78 to Fig. 81 shows that this ranking remains slightly affected by slight variations of the criteria weights or preference thresholds.

The result so obtained sufficiently illustrates the relevance of this decision-making model, which emphasises the notion of sustainability. To understand this, it was sufficient to compare the above result with those obtained using some of the ranking metrics proposed in past studies summarised in Annexe 5. Although the orientations of these studies are not identical to the present case, their authors used ranking metrics based on one or few attributes to rank candidate sites in terms of preference in relation to a certain objective. The selected ranking metrics include the maximum energy storage capacity used in [163] and in [150], the maximum head used in [166], the relative closeness of reservoirs used in [152] and [158] translated in terms of head-distance ratio, and the ease of reservoirs construction, referred to in [164] as the water-to-rock ratio. The results obtained using each of these metrics are presented in Table 36 together with the one previously obtained using the selection methodology proposed in this study.

Table 36 : Comparison of the obtained result with those obtained using some existing PHEs sites ranking metrics.

Used Ranking metrics	The five best PHEs alternative sites				
	1	2	3	4	5
The proposed multi-criteria ranking methodology	ENE	MBA	BEN	MEN	BAM
Maximum head	ENE	BAM	OKU	BEN	NYI
Maximum energy storage capacity	ENE	BEN	BAM	OKU	NYI
Head-Distance ratio and length of waterways (reflecting the closeness of reservoirs)	MBA	NYI	ENE	ELU	BEN
Ease of reservoir construction (water-to-rock ratio)	MEN	ENE	BAN	NYI	BEN

ENE=Enep; BAM=Bamendjin; OKU=Oku, BEN=Benakuma; NYI=Nyi; BAN=Banefo; MEN=Mentchum; ELU=Elum; BAB=Bambili; PET=Petponoun; MBA=Mbatu-dam.

The comparison of the result obtained using the model proposed in this study with those obtained using other different ranking metrics highlights significant discrepancies, although it can be noted that ENE, BEN, and MBA are the three most common sites. It results from the definition of the different preference thresholds and especially the veto threshold as is the case with the ELECTRE III outranking method used in this study, that the best alternatives be those that have obtained the most balanced scores possible on all the criteria (of course the reason why ELECTRE III is recommended when the issue of sustainability has to be addressed). This explains why NYI, ELU and OKU, which do not appear in the five best sites selected by the proposed methodology, are

favoured when mono-criteria ranking metrics such as the maximum head or the maximum energy storage capacity are considered. In contrast, MBA which is the site with the lowest head (184 m), considered the least interesting alternative when the abovementioned mono-criteria metrics are used was ranked in the top three best sites according to the present MADM methodology. This would reveal potential major social and environmental benefits associated with the adoption of this site over others. These discrepancies highlighted through this comparative analysis of the results obtained using different ranking models reflect the relevance and effectiveness of the proposed methodology for taking into account sustainability requirements in the PHESP site selection process.

III.6 Conclusion

The objective of this chapter was to propose a decision-making tool for selecting the best alternative from number of PHES plant preselected sites, in the context of sustainable development. A multi-criteria decision-making methodology integrating three different MCDM methods for the three main step of the decision-making process has therefore been developed. The methodology assigns weights to the decision factors and criteria using the pairwise comparison approach of AHP. Meanwhile, the assessed performance of the alternatives based on a set of sixteen heterogeneous criteria is standardised using a scoring system combining fuzzy membership functions and rating scales to deal with the vagueness of human preferences expressed by linguistic variables. Subsequently, ELECTRE III reputed as the least compensatory outranking MCDM method is used for the aggregation of the scored criteria. Compared with existing research, this methodology operationalizes the concept of strong sustainability while dealing with the heterogeneity of the criteria and a larger number of alternatives. Applying the proposed integrated methodology led to the successful and comprehensive ranking of eleven PHESP candidate sites from the twenty-one identified across Cameroon in Chapter II, especially those in Western Cameroon having heads that are higher than 180 metres. Explicitly, it is recommended that from a sustainability viewpoint, the local energy policy-makers consider the PHES opportunities Western Cameroon, as analysed in this study in the following order: (1)-Enep, (2)-Mbatu-dam, (3)-Benakuma, (4)-Bamendjin, (5)-Mentchum, (6)-Banefo, (7)-Petponoun, (8)-Nyi, (9)-Elum or Oku (11)-Bambili.

General Conclusion and Perspectives

General Conclusion

The objective of this work was to pave the way to the promotion of pumped-storage hydropower in the context of Cameroon, considering the potential strategic role this technology could play in the achievement of the country's development objective within the power sector. Reviewing the national energy policy in addition to an overview of the current energy situation of the country allowed to highlight the importance of the research topic, since grid-integrated energy storage has so far not been referenced. In the sense of filling this gap, it was, in simple words, a matter of responding to the question of the importance of the pumped-storage concept in the energy debate in Cameroon. To answer this central question, the approach adopted in this thesis was structured around three segments focusing each on a specific sub-objective of the main objective, each sub-objective being the subject of one chapter. From these three chapters, we have come respectively to the following conclusions: firstly, pumped storage-type hydropower can hold a determinant role in achieving the development objectives of the power sector in Cameroon. Secondly, it is established that this technology is technically feasible with limited environmental impact in Cameroon through the identification of more than twenty acceptable sites and the assessment of an achievable energy storage potential. And finally, it is proposed a ranking of the identified favourable sites in terms of priority in the sense of sustainable development. It was therefore recommended that, from the sustainable development perspective, the ten most relevant PHES plant candidate sites in the western part of Cameroon be considered in decreasing order of priority as follows:

- Enep site, which is based on river Menchum considered as the lower reservoir coupled with an upper reservoir to be dig in the plateau topping the mountain above the Enep Lake;
- Mbatu-dam site was found as an interesting opportunity, taking advantage of the water supply dam as lower reservoir in connection with an artificial reservoir-wall to be built at the top of the nearby mountain;
- Benakuma Lake site, despite being considered distant from the closest urban area was detected as a suitable site, using the natural lake and the mountain top respectively as lower and upper reservoir;
- Bamendjin reservoir which is currently used for the Sanaga river flow rate regulation stabilising the hydropower capacity at Edea and Songloulou plants showed interesting opportunities for PHES development, If the rugged mountainsides surrounding the lake can be exploited for the construction of an upper reservoir;

- Alongside the Mentchum River, there are some bowl-shaped terrain depressions which can be easily used as upper reservoirs paired with a dam built across the River flowing just below;
- Banefo site was detected not far from the Banefo Lake. The site considers damming the Mifi River' streams as lower reservoir in connection with a natural depression topping a mountain nearby;
- Petponoun Lake which is a natural lake currently used mainly for leisure and fisheries was also indicated as a potential PHES plant site, supposing that an upper reservoir can be arranged the rugged mountainsides surrounding the lake.
- Nyi Lake which is a high-altitude lake showed to possibility to be connected to a reservoir created in the valley at the foot of the mountain as PHES plant;
- Elum Lake site was detected as offering a similar opportunity in NYI lake site for high-altitude lakes.
- The opportunity identified around the Oku Lake considers terrain depressions upstream and downstream the lake, to be used as reservoirs. The filling and the replenishment of water losses to be ensured using water from the lake.

In sum, for Cameroon, the need for a grid-connected utility-scale energy storage system has been demonstrated, the technical feasibility of pumped-storage hydropower has been established and an approach to implementing the technology has been analysed. This highlights the importance of the question of bulk energy storage, especially pumped-storage hydropower in the energy debate in Cameroon. It is therefore a matter of calling Cameroonian decision-makers on the strategic role that this new actor could play in the energy scene, specifically the electricity sub-sector. The findings of this study take away from the debate on the question of PHES in Cameroon, technical feasibility and environmental concerns, and leave the discussion essentially on financial uncertainties that are potentially a limiting factor for PHES development.

Limitations and Perspectives

Limitations of this work are twofold. Firstly, conclusions on technical feasibility and the terrain are drawn from data remotely sensed through geographic information systems. The acquisition and processing of such information is inherently error prone. In addition, the synthesis of data obtained from various geo-databases and the difficulty in geo-referencing certain vector data are likely to bias some results. That said, the results presented here are only indicative and only field surveys can allow an accurate assessment of the sites. Secondly, the financial aspect of pumped-storage development has hardly been addressed here. Although the scope of this work does not

explicitly include this aspect, addressing it would certainly have provided another strong argument to present pumped-storage hydropower as the “missing link in the Cameroon’s energy commitment”. Highlighting these limitations opens a window on further works needed to increase knowledge on the topic addressed in this thesis. The first work extending those carried out in this research should necessarily be oriented towards strengthening the arguments justifying quantitatively PHES in the context of Cameroon. This would also serve as a basis for the required economic studies. These quantitative analyses should also include the examination of the implications of adding PHES and how this new actor can be accommodated on a liberalised electricity market in Cameroon. Some guidelines of this can be as follows:

- The assessment of the net storage capacity requirement: This should be the result of a comparative study based on a simulation of the Cameroonian electrical system, with and without storage. Obviously, to take into account future trends, several scenarios reflecting different levels of penetration of existing energy resources (renewables and non-renewables) must be considered, the energy demand pattern being considered as well.
- The economics of the storage: The second step could consist in analysing the economic viability of the business models likely to emerge with regard to the market potential assessed through the assessment of the required storage capacity previously carried out. This will be the place to consider at least two scenarios that deal with two operation models of a storage unit, namely as TSO asset (public-owned) or as an independent unit (private-owned facility).
- The choice of a PHES pilot site: Knowledge of the storage capacity requirement and the economic data of the selected business model will be sufficient to refine the research and selection of favourable sites, to select one to serve as a pilot site. At this stage, the sizing of a prototype and the technical specifications of all the necessary hardware components will necessarily be specified. This may lead to a readjustment of the economic data generated in the previous step, so as to arrive at an optimal scheme from a techno-economic point of view.

Some Barriers and Suggestions

To make all this possible, the legal framework must be favourable to innovative business schemes in the power sector, including decentralised energy production from renewable resources and energy storage. In the case of Cameroon, from the current situation of the power sector as presented in Chapter I, some weaknesses of the institutional and legal frameworks can be identified as barriers to the development of renewable energy and storage. Indeed, policy makers in Cameroon have been for long obsessed by the enormous hydro potential of the country, considering that the

development of large hydropower plants would be enough to solve the energy challenge the country is facing. That said, the first and the main barrier to overcome towards an effective integration of bulk electrical energy storage in Cameroon is cultural. Thus, changing the paradigm will create an enabling environment for innovative frameworks encouraging diversification of the country's energy system with utility-scale storage as support of its flexibility and reliability. Moreover, with regard to the present organisation of the power sector in Cameroon, there are some aspects which could represent significant barriers to the development of renewable distributed generation including the implementation of PHES. Those barriers include:

- The lack of adequate regulation and institutional setting for grid-connected independent power production from renewable sources despite the well-established power sector framework;
- A poor visibility on the issue of feed-in and transport tariffs, which still needs to be clarified, as the 2011 law that provides only general principles was not accompanied by detailed implementation guidelines;
- The non-existence of a local financing mechanism dedicated to investments in energy infrastructure, resulting in heavy dependence on external funds with stringent conditions;
- Lack of technological knowledge from policy makers needs to be addressed through capacity building and capacity enhancement of stakeholders in the country;
- Lack of specific access to key energy infrastructure such as the national electricity grid.

It is therefore suggested that new reforms in the power sector of Cameroon include presenting massive energy storage plants as a new asset class and forming a streamlined licensing process for low-impact bulk energy storage plants. This means that, the power system regulator could allow pumped-storage to qualify as transmission facility for purposes of determining eligibility for government incentives in a near future. An important step will be the clarification of tariffs for energy services (transmission, storage and ancillary services), the empowerment of the regulator and the elaboration an appropriate financing mechanism including subsidies in favour to investment in energy storage. The so-created environment will allow the TSO and IPPs to enter long-term, fixed-price contracts with PHES plants owners. In brief, the government of Cameroon needs to work with other stakeholders in the power sector to produce a comprehensive energy storage roadmap to valorise the country's graceful energy assets.

References

- [1] A. Ter-Gazarian, *Energy Storage for Power Systems*, 1994: Pete., vol. 238. London: Peter Peregrinus Ltd., on behalf of the Institution of Electrical Engineers, London, United Kingdom ©, 1994.
- [2] Republic of Cameroon, “Growth and employment strategy paper,” Yaoundé, Cameroon, 2010.
- [3] E. Muh, S. Amara, and F. Tabet, “Sustainable energy policies in Cameroon: A holistic overview,” *Renew. Sustain. Energy Rev.*, vol. 82, no. November, pp. 3420–3429, Feb. 2018.
- [4] D. Ndongsok and O. Ruppel, “State of Electricity Production and Distribution in Cameroon,” Yaoundé, Cameroon, 2017.
- [5] United Nations, “Les Nations Unies au Cameroun - Profil pays,” 2019. [Online]. Available: <http://cm.one.un.org/content/unct/cameroon/fr/home/about/profil-pays/>. [Accessed: 04-Jun-2020].
- [6] A. Wirba *et al.*, “Renewable energy potentials in Cameroon: Prospects and challenges,” *Renew. Energy*, vol. 76, pp. 560–565, 2015.
- [7] C. Steedman, “Cameroon Renewable Energy: Project Possibilities,” Ann Arbor, Michigan, 1979.
- [8] J. P. Deane, B. O’Gallachóir, and E. J. McKeogh, “Techno-economic review of existing and new pumped hydro energy storage plant,” *Renew. Sustain. Energy Rev.*, vol. 14, no. 4, pp. 1293–1302, 2010.
- [9] D. O. Akinyele and R. K. Rayudu, “Review of energy storage technologies for sustainable power networks,” *Sustain. Energy Technol. Assessments*, vol. 8, pp. 74–91, 2014.
- [10] IRENA, “Electricity storage and renewables: Costs and markets to 2030,” Abu Dhabi, 2017.
- [11] A. Berrada, K. Loudiyi, and I. Zorkani, “System design and economic performance of gravity energy storage,” *J. Clean. Prod.*, vol. 156, no. April, pp. 317–326, 2017.
- [12] D. Connolly, “The Integration of Fluctuating Renewable Energy Using Energy Storage,” University of Limerick, 2010.
- [13] B. N. Tansi, “An Assessment of Cameroon’s renewable energy resource potential and prospects for a sustainable economic development,” Brandenburg University of Technology Cottbus, 2010.
- [14] PBL-NEAA, “Trends in global CO2 and total greenhouse gas emissions: 2017 report | PBL Planbureau voor de Leefomgeving,” Nederlands, 2017.
- [15] BP, “Statistical Review of World Energy | Energy economics | BP,” *Statistical Review of World Energy*, 2017. [Online]. Available: <https://www.bp.com/en/global/corporate/energy-economics/statistical-review-of-world-energy.html>. [Accessed: 14-Nov-2018].
- [16] F. Bourry, “Management of Uncertainties Related to Renewable Generation Participation in Electricity Markets,” MINES ParisTech, 2009.
- [17] IEA, *Variability of Wind Power and Other Renewables: Management Options and*

Strategies. International Energy Agency, 2005.

- [18] IEA, “Distributed Generation in Liberalised Electricity Markets,” Paris, 2002.
- [19] G. Pepermans, J. Driesen, D. Haeseldonckx, and R. Belmans, “Distributed Generation: Definition, Benefits and Issues,” Leuven, 2003–8, 2003.
- [20] S. Ahmad, S. Sardar, A. U. Asar, and B. Noor, “Impact of Distributed Generation on the Reliability of Local Distribution System,” *IJACSA) Int. J. Adv. Comput. Sci. Appl.*, vol. 8, no. 6, pp. 375–382, 2017.
- [21] T. Ackermann, G. Ran Andersson, and L. Söder, “Distributed generation: a definition,” *Electr. Power Syst. Res.*, vol. 57, pp. 195–204, 2001.
- [22] T. Adefarati and R. C. Bansal, “Integration of renewable distributed generators into the distribution system: a review,” *IET Renew. Power Gener.*, vol. 10, no. 7, pp. 873–884, 2016.
- [23] World Commission on Environment, *Our Common Future*. Oxford University Press, 1987.
- [24] K. Alanne and A. Saari, “Distributed energy generation and sustainable development,” *Renew. Sustain. Energy Rev.*, vol. 10, no. 6, pp. 539–558, 2006.
- [25] Nava Raj Karki, Rajesh Karki, Ajit Kumar Verma, and Jaeseok Choi, *Sustainable Power Systems*. Singapore: Springer Singapore, 2017.
- [26] P. Nikolaidis and A. Poullikkas, “A comparative review of electrical energy storage systems for better sustainability,” *J. Power Technol.*, vol. 97, no. 3, pp. 220–245, 2017.
- [27] B. Guinot, “Evaluation multicritère des technologies de stockage couplées aux énergies renouvelables : conception et réalisation de la plateforme de simulation ODYSSEY pour l’optimisation du dimensionnement et de la gestion énergétique,” Université de Grenoble-Alpes, 2013.
- [28] J. Riesz and I. Macgill, “Frequency Control Ancillary Services,” in *Proceedings of the 10th International Workshop on Large-Scale Integration of Wind Power into Power Systems, 2011, Aarhus, Denmark.*, 2011, p. 6.
- [29] Xiaoyan Yu and Leon M. Tolbert, “Ancillary Services Provided from DER with Power Electronics Interface,” 2006.
- [30] EPRI, “Quantifying the Value of Hydropower in the Electric Grid: Plant Cost Elements,” Palo Alto, California, DE-EE0002666, 2013.
- [31] E. Ela, B. Kirby, N. Navid, and J. C. Smith, “Effective Ancillary Services Market Designs on High Wind Power Penetration Systems: Preprint,” in *IEEE Power and Energy Society General Meeting San Diego, California July 22-26, 2012*, 2012, vol. 16560.
- [32] E. Ngnikam and E. Tolale, “Energy Systems : Cameroon,” Paris - France, 2009.
- [33] P. Pawletko, “Community power from hydropower systems: A capacity-building project in Bangang, Cameroon,” *J. Purdue Undergrad. Res.*, vol. 3, pp. 54–71, 2013.
- [34] K. S. Elie Bertrand, O. Hamandjoda, Tekounegning, and J. Nganhou, “Local blacksmithss activity in the west region of Cameroon and their contribution to the development of micro hydroelectric power plants in that region,” *African J. Environ. Sci. Technol.*, vol. 9, no. 5, pp. 428–437, May 2015.

- [35] K. S. Elie Bertrand, O. Hamandjoda, J. Nganhou, and L. Wegang, “Technical and Economic Feasibility Studies of a Micro Hydropower Plant in Cameroon for a Sustainable Development,” *J. Power Energy Eng.*, vol. 05, no. 09, pp. 64–73, 2017.
- [36] M. Kazet, R. Mouangue, A. Kuitche, S. Takam, and J. . Ndjaka, “Modélisation et simulation numérique des données du vent en vue d ’ une prédiction de l ’ énergie électrique d ’ origine éolienne : cas d ’ un site de la ville de Ngaoundéré au C ameroun,” *Rev. des énergies renouvelables*, vol. 16, no. 3, pp. 527–538, 2013.
- [37] D. Afungchui and C. E. Aban, “Analysis of wind regimes for energy estimation in Bamenda , of the North West Region of Cameroon , based on the Weibull distribution,” *Rev. des énergies renouvelables*, vol. 17, pp. 137–147, 2014.
- [38] AEEP, “Cameroon Power Sector Market Brief,” 2013.
- [39] J. Kenfack, M. Fogue, O. Hamandjoda, and T. T. Thomas, “Promoting renewable energy and energy efficiency in Central Africa: Cameroon case study,” in *World Renewable Energy Congress 2011, Sweden 8-13 May 2011*, 2011, pp. 2602–2609.
- [40] Ministry of Water Resources and Energy, “The energy situation of Cameroon,” Yaoundé, Cameroon, 2015.
- [41] RECP, “Cameroon - Energy Sector,” 2016. [Online]. Available: <https://www.africa-eu-renewables.org/market-information/cameroon/energy-sector/>. [Accessed: 31-Jul-2017].
- [42] J. Engo, “Barriers related to the deployment of renewable energies in Cameroon and ways to strengthen policies,” *Resour. Environ. Econ.*, vol. 1, no. 1, pp. 29–38, 2019.
- [43] National Assembly, “Law Governing the Electricity Sector in Cameroon,” *8TH LEGISLATIVE PERIOD LEGISLATIVE YEAR 2011 3rd ORDINARY SESSION*. p. 32, 2011.
- [44] B. Tchatchou, D. J. Sonwa, S. Ifo, and A. M. Tiani, *Deforestation and forest degradation in the Congo Basin: State of knowledge, current causes and perspectives*. Indonésie: Center for International Forestry Research (CIFOR), 2015.
- [45] B. Liu, S. Liao, C. Cheng, F. Chen, and W. Li, “Hydropower curtailment in Yunnan Province, southwestern China: Constraint analysis and suggestions,” *Renew. Energy*, vol. 121, pp. 700–711, Jun. 2018.
- [46] World Bank, “Additional Financing for Zambia Scaling Solar Energy Project (P163958),” 121430-ZM, 2017.
- [47] International Hydropower Association, “Hydropower status report-Sector trends and insights,” London, 2018.
- [48] U. Nzotcha and J. Kenfack, “Contribution of the wood-processing industry for sustainable power generation: Viability of biomass-fuelled cogeneration in Sub-Saharan Africa,” *Biomass and Bioenergy*, vol. 120, pp. 324–331, Jan. 2019.
- [49] M. W. Murage and C. L. Anderson, “Contribution of pumped hydro storage to integration of wind power in Kenya: An optimal control approach,” *Renew. Energy*, vol. 63, no. March 2014, pp. 698–707, 2014.
- [50] B. Zakeri and S. Syri, “Electrical energy storage systems A comparative life cycle cost analysis,” *Renew. Sustain. Energy Rev.*, vol. 42, pp. 569–596, 2015.

- [51] P. Denholm, E. Ela, B. Kirby, and M. Milligan, “The Role of Energy Storage with Renewable Electricity Generation,” Colorado, WER8.5005, 2010.
- [52] H. Chen, T. N. Cong, W. Yang, C. Tan, Y. Li, and Y. Ding, “Progress in electrical energy storage system: A critical review,” *Prog. Nat. Sci.*, vol. 19, no. 3, pp. 291–312, 2009.
- [53] Jason Makansi and Jeff Abboud, “Energy Storage The Missing Link in the Electricity Value Chain An ESC White Paper,” 2002.
- [54] Alex Eller, “Energy storage will disrupt transmission and distribution investments,” © 2018 *Industry Dive.*, 2017. [Online]. Available: <https://www.utilitydive.com/news/energy-storage-will-disrupt-transmission-and-distribution-investments/506945/>. [Accessed: 13-Jun-2018].
- [55] IEA, “Energy Technology Perspectives 2012,” Paris, 2012.
- [56] M. Black and G. Strbac, “Value of storage in providing balancing services for electricity generation systems with high wind penetration,” *J. Power Sources*, vol. 162, no. 2, pp. 949–953, 2006.
- [57] B. Cleary, A. Duffy, A. O. Connor, M. Conlon, and V. Fthenakis, “Assessing the Economic Benefits of Compressed Air Energy Storage for Mitigating Wind Curtailment,” *Sustain. Energy, IEEE Trans.*, vol. PP, no. 99, pp. 0–8, 2015.
- [58] D. Connolly, “A Review of Energy Storage Technologies For the integration of fluctuating renewable energy,” University of Limerick, 2009.
- [59] U.S. Department of Energy, “Pumped Storage and Potential Hydropower from Conduits. (Report to Congress February 2015),” Washington, DC 20585, 2015.
- [60] E. Barbour, Wilson Allan Grant Ian, J. Radcliffe, Y. Ding, and Y. Li, “A review of pumped hydro energy storage development in significant international electricity markets,” *Renew. Sustain. Energy Rev.*, vol. 61, pp. 421–432, 2016.
- [61] S. M. H. Hosseini, M. R. Semsar, and S. E. Afjei, “A Novel Control Method Of Variable Speed Pumped Storage Power Plant,” *IOSR J. Electr. Electron. Eng.*, vol. 6, no. 5, pp. 158–67, 2013.
- [62] ARUP, “Consortium assessing pumped hydro storage plant in South Australia,” *News and Events*, 2020. [Online]. Available: <https://www.arup.com/news-and-events/consortium-assessing-pumped-hydro-storage-plant-in-south-australia>. [Accessed: 21-Jul-2020].
- [63] G. Ardizzon, G. Cavazzini, and G. Pavesi, “A new generation of small hydro and pumped-hydro power plants: Advances and future challenges,” *Renew. Sustain. Energy Rev.*, vol. 31, pp. 746–761, 2014.
- [64] M. K. Egbo, “Utility-scale energy storage systems for electricity : Pumped hydro energy storage (PHES),” Glasgow, Scotland, 2017.
- [65] U.S. Department of Energy, “Pumped-Storage Hydropower,” *WATER POWER TECHNOLOGIES OFFICE*, 2018. [Online]. Available: <https://www.energy.gov/eere/water/pumped-storage-hydropower>. [Accessed: 21-Jul-2020].
- [66] E. Pujades, T. Willems, S. Bodeux, P. Orban, and A. Dassargues, “Underground pumped storage hydroelectricity using abandoned works (deep mines or open pits) and the impact

- on groundwater flow,” *Hydrogeol. J.*, vol. 24, no. 6, pp. 1531–1546, 2016.
- [67] G. D. Martin, “Aquifer Underground Pumped Hydroelectric Energy Storage,” University of Wisconsin-Madison, Colorado, 2001.
- [68] E. Mclean and D. Kearney, “An Evaluation of Seawater Pumped Hydro Storage for Regulating the Export of Renewable Energy to the National Grid,” in *Energy Procedia*, 2014, vol. 46, no. 46, pp. 152–160.
- [69] Energy Storage Association, “Surface Reservoir Pumped Hydroelectric Storage | ESA,” *WHY ENERGY STORAGE | TECHNOLOGIES*, 2017. [Online]. Available: <https://energystorage.org/why-energy-storage/technologies/surface-reservoir-pumped-hydroelectric-storage/>. [Accessed: 21-Jul-2020].
- [70] D. Beevers, L. Branchini, V. Orlandini, A. De Pascale, and H. Perez-Blanco, “Pumped hydro storage plants with improved operational flexibility using constant speed Francis runners,” *Appl. Energy*, vol. 137, pp. 629–637, 2015.
- [71] J. A. Suul, “Variable speed pumped storage hydropower plants for integration of wind power in isolated power systems,” *Renew. Energy*, T J Hammons (Ed.), ISBN 978-953-7619-52-7, *InTech*, pp. 553–580, 2009.
- [72] E. Muljadi, M. Singh, V. Gevorgian, V. Koritarov, M. Mohanpurkar, and R. Hovsopian, “Dynamic Modeling of Adjustable-Speed Pumped Storage Hydropower Plant,” in *IEEE Power and Energy Society General Meeting Denver*, 2015, vol. 17613, no. April.
- [73] Y. Pannatier, “Optimisation des stratégies de réglage d’une installation de pompage-turbinage à vitesse variable,” EPFL, 2010.
- [74] A. Béguin, C. Nicolet, J. Hell, and C. Moreira, “Assessment of power step performances of variable speed pump-turbine unit by means of hydro-electrical system,” *J. Phys. Conf. Ser* 813 (2017)012001, vol. 813, pp. 1–5, 2017.
- [75] N. Destro, M. Korpaas, and J. F. Sauterleute, “Smoothing of Offshore Wind Power Variations with Norwegian Pumped Hydro: Case Study,” *Energy Procedia*, vol. 87, pp. 61–68, 2016.
- [76] C. Nicolet, A. Beguin, B. Kawkabani, Y. Pannatier, A. Schwery, and F. Avellan, “Variable Speed and Ternary Units to Mitigate Wind and Solar Intermittent Production,” *Hydrovision*, pp. 1–21, 2014.
- [77] V. Koritarov *et al.*, “Modeling Ternary Pumped Storage Units,” Washington, 2013.
- [78] S. Gabathuler, D. Pavanello, and C. Münch, “Le pompage-turbinage à petite échelle pour le stockage local d’énergie,” *Bull. ElectroSuisse 2/2015*, vol. 2, pp. 49–54, 2015.
- [79] S. Rehman, L. M. Al-hadhrami, and M. Alam, “Pumped hydro energy storage system: A technological review,” *Renew. Sustain. Energy Rev.*, vol. 44, pp. 586–598, 2015.
- [80] G. de Oliveira e Silva and P. Hendrick, “Pumped hydro energy storage in buildings,” *Appl. Energy*, vol. 179, pp. 1242–1250, 2016.
- [81] D. Connolly, H. Lund, B. V. Mathiesen, E. Pican, and M. Leahy, “The technical and economic implications of integrating fluctuating renewable energy using energy storage,” *Renew. Energy*, vol. 43, pp. 47–60, 2012.

- [82] J. S. Anagnostopoulos and D. E. Papantonis, “Simulation and size optimization of a pumped-storage power plant for the recovery of wind-farms rejected energy,” *Renew. Energy*, vol. 33, no. 7, pp. 1685–1694, Jul. 2008.
- [83] Jorge Miguel Pérola Filipe, “Optimization Strategies for Pump-Hydro Storage and Wind Farm Coordination Including Wind Power Uncertainty,” Faculdade de Engenharia da Universidade do Porto, 2014.
- [84] J. G. Levine, “Pumped Hydroelectric Energy Storage and Spatial Diversity of Wind Resources as Methods of Improving Utilization of Renewable Energy Sources,” Michigan Technological University, 2007.
- [85] B. Dursun and B. Alboyaci, “The contribution of wind-hydro pumped storage systems in meeting Turkey’s electric energy demand,” *Renew. Sustain. Energy Rev.*, vol. 14, no. 7, pp. 1979–1988, 2010.
- [86] F. A. Canales, A. Beluco, C. André, and B. Mendes, “A comparative study of a wind hydro hybrid system with water storage capacity: Conventional reservoir or pumped storage plant?,” *J. Energy Storage*, vol. 4, pp. 96–105, 2015.
- [87] H. Ding, Z. Hu, and Y. Song, “Stochastic optimization of the daily operation of wind farm and pumped-hydro-storage plant,” *Renew. Energy*, vol. 48, no. December 2012, pp. 571–578, 2012.
- [88] E. D. Castronuovo *et al.*, “An integrated approach for optimal coordination of wind power and hydro pumping storage,” *Wind Energy*, vol. 17, no. 6, pp. 829–852, 2014.
- [89] A. Tuohy and M. O’malley, “Impact of pumped storage on power systems with increasing wind penetration,” in *IEEE Power & Energy Society General Meeting, July 26-30, 2009, Calgary, Canada*, 2009, p. 8.
- [90] L. E. Dragulescu, P. C. Benítez, and G. Cornelis Van Kooten, “The Economics of Wind Power with Energy Storage,” *Energy Econ.*, vol. 30, no. 4, pp. 1973–1989, 2008.
- [91] M. Ghaisi Rad, M. Rahmani, P. Gharghabi, A. Zoghi, and S. Hossein H, “Scheduling a Wind Hydro-Pumped-Storage Unit Considering the Economical Optimization,” *Am. J. Electr. Electron. Eng.*, vol. 5, no. 1, pp. 16–22, 2017.
- [92] G. Al Zohbi, P. Hendrick, C. Renie, P. Bouillard, and G. Al Zohbi, “Wind-hydro pumped storage systems to meet lebanese electricity demand,” *Rev. des Energies Renouvelables*, vol. 18, pp. 3–375, 2015.
- [93] Y. Wu, G. W. Chang, B. Hsiao, and L. Chang, “Providing Frequency Support of Hydro-Pumped Storage to Taiwan Power System with Wind Power Integration,” *Smart Grid Renew. Energy*, vol. 7, no. April, pp. 131–141, 2016.
- [94] O. A. Jaramillo, M. A. Borja, and J. M. Huacuz, “Using hydropower to complement wind energy: a hybrid system to provide firm power,” *Renew. Energy*, vol. 29, no. 11, pp. 1887–1909, 2004.
- [95] J. I. P. Erez-Díaz and J. Jimenez, “Contribution of a pumped-storage hydropower plant to reduce the scheduling costs of an isolated power system with high wind power penetration,” *Energy*, vol. 109, pp. 92–104, 2016.
- [96] U. Raudsaar, I. Drovitar, and A. Rosin, “Overview - Pumped-hydro energy storage for balancing wind energy forecast errors,” in *9th International: 2014 Electric Power Quality*

and Supply Reliability Conference, PQ 2014 - Proceedings, 2014, pp. 133–138.

- [97] J. Jurasz and J. Mikulik, “Scheduling Operation of Wind Powered Pumped-Storage Hydroelectricity,” in *International Conference on Industrial Logistics September 28 – October 1, 2016, Zakopane, Poland*, 2016, pp. 74–83.
- [98] H. S. de Boer, L. Grond, H. Moll, and R. Benders, “The application of power-to-gas, pumped hydro storage and compressed air energy storage in an electricity system at different wind power penetration levels,” *Energy*, vol. 72, pp. 360–370, 2014.
- [99] N. Zhang *et al.*, “Reducing curtailment of wind electricity in China by employing electric boilers for heat and pumped hydro for energy storage,” *Appl. Energy*, vol. 184, no. December, pp. 987–994, 2015.
- [100] R. Segurado, J. F. A. Madeira, M. Costa, N. Duić, and M. Graça Carvalho, “Optimization of a wind powered desalination and pumped hydro storage system,” *Appl. Energy*, vol. 177, pp. 487–499, 2016.
- [101] K. Protopapas and S. Papathanassiou, “Application of Pumped Storage to Increase Wind Penetration in Isolated Island Grids,” in *Proceeding of the European Wind Energy Conference 2006. Athens, Greece, 27 February- 2 March, 2006*, pp. 1–8.
- [102] S. Papaefthimiou, E. Karamanou, S. Papathanassiou, and M. Papadopoulos, “Operating policies for wind-pumped storage hybrid power stations in island grids,” *IET Renew. Power Gener.*, vol. 3, no. 3, 2007.
- [103] G. C. Bakos, “Feasibility study of a hybrid wind/hydro power-system for low-cost electricity production,” *Appl. Energy*, vol. 72, no. 3, pp. 599–608, 2002.
- [104] G. Caralis, K. Rados, and A. Zervos, “On the market of wind with hydro-pumped storage systems in autonomous Greek islands,” *Renew. Sustain. Energy Rev.*, vol. 14, no. 8, pp. 2221–2226, 2010.
- [105] J. K. Kaldellis, M. Kapsali, and K. A. Kavadias, “Energy balance analysis of wind-based pumped hydro storage systems in remote island electrical networks,” *Appl. Energy*, vol. 87, no. 8, pp. 2427–2437, 2010.
- [106] Stefanos V. Papaefthymiou, Eleni G. Karamanou, Stavros A. Papathanassiou, and Michael P. Papadopoulos, “A Wind-Hydro-Pumped Storage Station Leading to High RES Penetration in the Autonomous Island System of Ikaria,” *IEEE Trans. Sustain. ENERGY*, vol. 1, no. 3, 2010.
- [107] J. K. Kaldellis, K. A. Kavadias, and E. Christinakis, “Evaluation of the wind–hydro energy solution for remote islands,” *Energy Convers. Manag.*, vol. 42, no. 9, pp. 1105–1120, 2001.
- [108] J. K. Kaldellis, “Parametrical investigation of the wind–hydro electricity production solution for Aegean Archipelago,” *Energy Convers. Manag.*, vol. 43, no. 16, pp. 2097–2113, 2002.
- [109] M. Kapsali and J. K. Kaldellis, “Combining hydro and variable wind power generation by means of pumped-storage under economically viable terms,” *Appl. Energy*, vol. 87, no. 11, pp. 3475–3485, 2010.
- [110] Dimitris Al Katsaprakakis *et al.*, “Introduction of a wind powered pumped storage system in the isolated insular power system of Karpathos – Kasos,” *Appl. Energy*, vol. 97, pp. 38–48, 2012.

- [111] A. Coburn, E. Walsh, P. J. Solan, and K. P. McDonnell, “Combining Wind and Pumped Hydro Energy Storage for Renewable Energy Generation in Ireland,” *J. Wind Energy*, vol. 2014, no. August 2014, 2014.
- [112] D. Connolly and B. V. Mathiesen, “A technical and economic analysis of one potential pathway to a 100% renewable energy system,” *Int. J. Sustain. Energy Plan. Manag.*, vol. 01, pp. 7–28, 2014.
- [113] David Connolly, Henrik Lund, B. V. Mathiesen, and M. Leahy, “The first step towards a 100% renewable energy-system for Ireland,” *Appl. Energy*, vol. 88, no. 2, pp. 502–507, 2011.
- [114] D. Connolly, H. Lund, and Brian Vad Mathiesen, “Smart Energy Europe: The technical and economic impact of one potential 100% renewable energy scenario for the European Union,” *Renew. Sustain. Energy Rev.*, vol. 60, pp. 1634–1653, 2016.
- [115] C. Bueno and J. A. Carta, “Wind powered pumped hydro storage systems , a means of increasing the penetration of renewable energy in the Canary Islands,” *Renew. Sustain. Energy Rev.*, vol. 10, pp. 312–340, 2006.
- [116] E. S. Karapidakis, “Hydro Pump Storage Energy Units in Crete’s Power System,” *Eng. Ind. Ser.*, pp. 105–110, 2015.
- [117] Tao Ma, Hongxing Yang, Lin Lu, and Jinqing Peng, “An Optimization Sizing Model for Solar Photovoltaic Power Generation System with Pumped Storage,” in *The 6th International Conference on Applied Energy – ICAE2014*, 2014, pp. 5–8.
- [118] D. Manolakos, G. Papadakis, D. E. Papantonis, and S. Kyritsis, “A stand-alone photovoltaic power system for remote villages using pumped water energy storage,” *Energy*, vol. 29, no. 1, pp. 57–69, 2004.
- [119] Junhui Zhao, K. Graves, Caisheng Wang, Gene Liao, and Chih-Ping Yeh, “A hybrid electric/hydro storage solution for standalone photovoltaic applications in remote areas,” in *2012 IEEE Power and Energy Society General Meeting*, 2012, pp. 1–6.
- [120] A. Biswas and A. Kumar, *Techno-Economic Optimization of a Stand-alone PV/PHS/Battery Systems for very low load Situation*, vol. 7, no. 2. Gazi Univ., Fac. of Technology, Dep. of Electrical et Electronics Eng, 2017.
- [121] J. Kenfack, F. P. Neirac, T. T. Thomas, D. Mayer, M. Fogue, and A. Lejeune, “Microhydro-PV-hybrid system: Sizing a small hydro-PV-hybrid system for rural electrification in developing countries,” *Renew. Energy*, vol. 34, no. 10, pp. 2259–2263, 2009.
- [122] A. Oi, “Design and Simulation of Photovoltaic Water Pumping System,” California Polytechnic State University, 2005.
- [123] S. Meshram, G. Agnihotri, and S. Gupta, “Modelling of Grid Connected DC Linked PV/Hydro Hybrid System,” *Electr. Electron. Eng. An Int. J.*, vol. 2, no. 3, pp. 13–27, 2013.
- [124] L. E. Teixeira, J. Caux, A. Beluco, I. Bertoldo, J. A. S. Louzada, and R. C. Eifler, “Feasibility Study of a Hydro PV Hybrid System Operating at a Dam for Water Supply in Southern Brazil,” *J. Power Energy Eng.*, no. September, pp. 70–83, 2015.
- [125] J. Margeta and Z. Glasnovic, “Feasibility of the green energy production by hybrid solar+hydro power system in Europe and similar climate areas,” *Renew. Sustain. Energy Rev.*, vol. 14, no. 6, pp. 1580–1590, 2010.

- [126] Tao Ma, Hongxing Yang, Lin Lu, and Jinqing Peng, “Pumped storage-based standalone photovoltaic power generation system: Modeling and techno-economic optimization,” *Appl. Energy*, vol. 137, pp. 649–659, 2015.
- [127] T. Ma, H. Yang, L. Lu, and J. Peng, “Technical feasibility study on a standalone hybrid solar-wind system with pumped hydro storage for a remote island in Hong Kong,” *Renew. Energy*, vol. 69, pp. 7–15, Sep. 2014.
- [128] Z. Glasnovic and J. Margeta, “The features of sustainable Solar Hydroelectric Power Plant,” *Renew. Energy*, vol. 34, no. 7, pp. 1742–1751, 2009.
- [129] J. Margeta and Z. Glasnovic, “Theoretical settings of photovoltaic-hydro energy system for sustainable energy production,” *Sol. Energy*, vol. 86, no. 3, pp. 972–982, 2012.
- [130] J. Margeta and Z. Glasnovic, “Role of water-energy storage in PV-PSH power plant development,” *J. Energy Eng.*, 2011.
- [131] J. Margeta and Z. Glasnovic, “Introduction of PV Energy Into an Existing HEP,” *IEEE Trans. Energy Convers.*, vol. 26, no. 3, pp. 717–727, Sep. 2011.
- [132] R. Aihara, A. Yokoyama, F. Nomiya, and N. Kosugi, “Optimal operation scheduling of pumped storage hydro power plant in power system with a large penetration of photovoltaic generation using genetic algorithm,” in *2011 IEEE Trondheim PowerTech 19-23 June 2011*, 2011, pp. 1–8.
- [133] G. El-Jamal *et al.*, “Technical feasibility study of solar-pumped hydro storage in Lebanon,” in *2014 International Conference on Renewable Energies for Developing Countries, REDEC 2014*, 2014, pp. 23–28.
- [134] P. Javanbakht, S. Mohagheghi, and M. Godoy Simões, “Transient Performance Analysis of a Small-Scale PV-PHS Power Plant Fed by a SVPWM Drive Applied for a Distribution System,” in *Energy Conversion Congress and Exposition (ECCE) IEEE*, 2013, pp. 4532–9.
- [135] Madaci Mansour and Kerdoun Djallel, “Case Study of a Solar Pumped Storage Prototype Station Implementation Designed for the Region of Ghardia,” *Int. J. Renew. ENERGY Res.*, vol. 6, no. 2, pp. 435–446, 2016.
- [136] Tao Ma, Hongxing Yang, Lin Lu, and Jinqing Peng, “Optimal design of an autonomous solar-wind-pumped storage power supply system,” *Appl. Energy*, 2014.
- [137] S. Diaf, D. Diaf, M. Belhamel, M. Haddadi, and A. Louche, “A methodology for optimal sizing of autonomous hybrid PV/wind system,” *Energy Policy*, vol. 35, no. 11, pp. 5708–5718, Nov. 2007.
- [138] A. A. Solomon, D. M. Kammen, and D. Callaway, “Investigating the impact of wind-solar complementarities on energy storage requirement and the corresponding supply reliability criteria,” *Appl. Energy*, vol. 168, pp. 130–145, Apr. 2016.
- [139] Ruisheng Li, Bingxin Wu, Xianwei Li, Fengquan Zhou, and Yanbin Li, “Design of Wind-solar and Pumped-storage Hybrid Power Supply System,” in *2010 3rd IEEE International Conference on Computer Science and Information Technology (ICCSIT)*, 2010, pp. 402–5.
- [140] I. D. Spyrou and J. S. Anagnostopoulos, “Design study of a stand-alone desalination system powered by renewable energy sources and a pumped storage unit,” *Desalination*, vol. 257, no. 1, pp. 137–149, 2010.

- [141] K. Kusakana, “Optimal scheduling for distributed hybrid system with pumped hydro storage,” *Energy Convers. Manag.*, vol. 111, no. January, pp. 253–260, 2016.
- [142] G. Notton, D. Mistrushi, L. Stoyanov, and P. Berberi, “Operation of a photovoltaic-wind plant with a hydro pumping-storage for electricity peak-shaving in an island context,” *Sol. Energy*, vol. 157, no. September, pp. 20–34, 2017.
- [143] R. Yan, Z. Yuan, L. Yanpin, H. Jianjun, and Z. Dun, “Modeling and Optimization of Hybrid Wind/PV pumped-storage Power System,” *Appl. Mech. Mater.*, vol. 48, no. 49, p. 693, 2011.
- [144] N. Yimen, O. Hamandjoda, L. Meva’a, B. Ndzana, and J. Nganhou, “Analyzing of a Photovoltaic/Wind/Biogas/Pumped-Hydro Off-Grid Hybrid System for Rural Electrification in Sub-Saharan Africa—Case study of Djoundé in Northern Cameroon,” *Energies*, vol. 11, no. 10, pp. 26–44, 2018.
- [145] E. Ela, B. Kirby, C. A. Botterud, C. Milostan, I. Krad, and V. Koritarov, “The Role of Pumped Storage Hydro Resources in Electricity Markets and System Operation Preprint,” *PIX*, vol. 16560, 2013.
- [146] P. Kanakasabapathy and K. Shanti Swarup, “Bidding strategy for pumped-storage plant in pool-based electricity market,” *Energy Convers. Manag.*, vol. 51, no. 3, pp. 572–579, 2010.
- [147] R. Walawalkar, J. Apt, and R. Mancini, “Economics of electric energy storage for energy arbitrage and regulation in New York,” *Energy Policy*, vol. 35, no. 4, pp. 2558–2568, 2007.
- [148] World Bank, “Evaluation of Rural Electrification Concessions in sub-Saharan Africa Detailed Case Study: Cameroon,” Washington, D.C, 2015.
- [149] P. J. R. Torrealba, “The Benefits of Pumped Storage Hydro to the UK,” Glasgow, 2016.
- [150] N. Fitzgerald, R. Lacal-Aránegui, E. J. McKeogh, and P. G. Leahy, “A GIS-based model to calculate the potential for transforming conventional hydropower schemes and non-hydro reservoirs to pumped hydropower schemes,” *Energy*, vol. 41, no. 1, pp. 483–490, May 2012.
- [151] D. Connolly and S. MacLaughlin, “Locating Potential Sites for Pumped Hydroelectric Energy Storage,” in *Proceedings of the International Conference on Sustainable Energy Storage*, 2011, pp. 1–13.
- [152] N. Ghorbani, H. Makian, and C. Breyer, “A GIS-based method to identify potential sites for pumped hydro energy storage - Case of Iran,” *Energy*, vol. 169, pp. 854–867, 2019.
- [153] Nicolas Crettenand, “The Facilitation of Mini and Small Hydropower in Switzerland: Shaping the Institutional Framework (with a Particular Focus on Storage and Pumped-Storage Schemes),” EPFL, 2012.
- [154] A. Rogeau, R. Girard, and G. Kariniotakis, “A generic GIS-based method for small Pumped Hydro Energy Storage (PHES) potential evaluation at large scale,” *Appl. Energy*, vol. 197, no. July, pp. 241–253, 2017.
- [155] T. Soha *et al.*, “GIS-based assessment of the opportunities for small-scale pumped hydro energy storage in middle-mountain areas focusing on artificial landscape features,” *Energy*, vol. 141, no. January, pp. 1363–1373, Dec. 2017.
- [156] D. Connolly, S. MacLaughlin, and M. Leahy, “Development of a computer program to locate potential sites for pumped hydroelectric energy storage,” *Energy*, vol. 35, no. 1, pp.

375–381, Jan. 2010.

- [157] M. Gergeľová, Ž. Kuzevičová, and Š. Kuzevič, “A GIS based assessment of hydropower potential in Hornád basin,” *Acta Montan. Slovaca Ročník*, vol. 18, no. 2, pp. 91–100, 2013.
- [158] X. Lu and S. Wang, “A GIS-based assessment of Tibet’s potential for pumped hydropower energy storage,” *Renew. Sustain. Energy Rev.*, vol. 69, pp. 1045–1054, Mar. 2017.
- [159] M. Gimeno-Gutiérrez and R. Lacal-Arántegui, “Assessment of the European potential for pumped hydropower energy storage based on two existing reservoirs,” *Renew. Energy*, vol. 75, pp. 856–868, Mar. 2015.
- [160] C. G. Cortines, “Testing a GIS-based methodology for optimal location of Pumped Storage power plants in Norway,” Norwegian University of Science and Technology, 2013.
- [161] Nishant Vaidya, Jagdish Chandra Kuniyal, and Rohit Chauhan, “Morphometric analysis using Geographic Information System (GIS) for sustainable development of hydropower projects in the lower Satluj river catchment in Himachal Pradesh, India,” *Int. J. GEOMATICS Geosci.*, vol. 3, no. 3, pp. 464–473, 2013.
- [162] R. Lacal-Arántegui, P. G. Leahy, and N. Fitzgerald, “Pumped-hydro energy storage: potential for transformation from single dams,” Luxembourg, 2012.
- [163] Douglas G. Hall and Randy D. Lee, “Assessment of Opportunities for New United States Pumped Storage Hydroelectric Plants Using Existing Water Features as Auxiliary Reservoirs,” Washington, D.C, 2014.
- [164] B. Lu, M. Stocks, A. Blakers, and K. Anderson, “Geographic information system algorithms to locate prospective sites for pumped hydro energy storage,” *Appl. Energy*, vol. 222, pp. 300–312, Jul. 2018.
- [165] H. Ahmadi and A. Shamsai, “Preliminary Site Selection of Pumped Storage,” *AUT J. Model. Simul.*, vol. 11, no. 41, pp. 25–32, 2009.
- [166] D. G. Larentis, W. Collischonn, F. Olivera, and C. E. M. Tucci, “Gis-based procedures for hydropower potential spotting,” *Energy*, vol. 35, no. 10, pp. 4237–4243, 2010.
- [167] B. C. Kusre, D. C. Baruah, P. K. Bordoloi, and S. C. Patra, “Assessment of hydropower potential using GIS and hydrological modeling technique in Kopili River basin in Assam (India),” *Appl. Energy*, vol. 87, no. 1, pp. 298–309, Jan. 2010.
- [168] R. Lacal-Arántegui and E. Tzimas, “SETIS expert workshop on the assessment of the potential of pumped hydropower storage,” Publications Office of the European Union, 2012, Luxembourg, EUR 25367 EN, 2012.
- [169] G. Michael F., “Geographic Information Systems,” in *Approaches to Human Geography*, C&M Digita., S. Aitken and G. Valentine, Eds. London, Thousand Oaks, New Delhi: SAGE Publications, 2006, p. 360.
- [170] D. Liu, “Spatial Analysis of Population Data Based on Geographic Information System,” in *Proceedings of the 21st International Cartographic Conference (ICC) Durban, South Africa, 10 - 16 August 2003*, 2003, pp. 686–692.
- [171] Surekha Dudhani and Ashok Kumar Sinha, “GIS database management for planning of Hydel Power Generation - Geospatial World,” *Geospatial World*, 2009. [Online]. Available: <https://www.geospatialworld.net/article/gis-database-management-for->

planning-of-hydel-power-generation/. [Accessed: 01-Feb-2018].

- [172] Rovick P. Tarife, Anacita P. Tahud, Ellen Jane G. Gulben, Haroun Al Raschid Christopher P., Macalisang, and Ma. Teresa T. Ignacio, "Application of Geographic Information System (GIS) in Hydropower Resource Assessment: A Case Study in Misamis Occidental, Philippines," *Int. J. Environ. Sci. Dev.*, vol. 8, no. 7, pp. 507–511, 2017.
- [173] P. Punys, A. Dumbrasukas, A. Kvaraciejus, and G. Vyciene, "Tools for small hydropower plant resource planning and development: A review of technology and applications," *Energies*, vol. 4, no. 9, pp. 1258–1277, 2011.
- [174] R. Monk, S. Joyce, and M. Homenuke, "Rapid Hydropower Assessment Model Identify Hydroelectric Sites Using Geographic Information Systems."
- [175] Ross S. Lunetta, Russel G. Congalton, Lynn K. Fenstermaker, John R. Jensen, Kenneth C. McGwire, and Larry R. Tinney, "Remote Sensing and Geographic Information System Data Integration: Error Sources and Research Issues," *Photogramm. Eng. Remote Sens.*, vol. 57, no. 6, pp. 677–687, 1991.
- [176] M. Uyan, "GIS-based solar farms site selection using analytic hierarchy process (AHP) in Karapinar region, Konya/Turkey," *Renew. Sustain. Energy Rev.*, vol. 28, pp. 11–17, 2013.
- [177] M. Bobeck, "A GIS-based Multi-Criteria Decision Analysis of Wind Farm Site Suitability in New South Wales, Australia, from a Sustainable Development Perspective," Lund University, 2017.
- [178] R. Greene, R. Devillers, J. E. Luther, and B. G. Eddy, "GIS-Based Multiple-Criteria Decision Analysis," *Geogr. Compass*, vol. 5, no. 6, pp. 412–432, 2011.
- [179] K. B. Atici, A. B. Simsek, A. Ulucan, and M. U. Tosun, "A GIS-based Multiple Criteria Decision Analysis approach for wind power plant site selection," *Util. Policy*, vol. 37, pp. 86–96, 2015.
- [180] M. Sadeghi and M. Karimi, "GIS-Based Solar and Wind Turbine Site Selection Using Multi-Criteria Analysis: Case Study Tehran, Iran," *Int. Arch. Photogramm. Remote Sens. Spat. Inf. Sci.*, vol. XLII-4/W4, pp. 469–476, 2017.
- [181] H. S. Hansen, "GIS-based Multi-Criteria Analysis of Wind Farm Development," in *10th Scandinavian Research Conference on Geographical Information Science*, 2005, pp. 75–87.
- [182] E. Chamanehpour, Ahmadizadeh, and Akbarpour, "Site selection of wind power plant using multi-criteria decision-making methods in GIS: A case study," *Comput. Ecol. Softw.*, vol. 7, no. 2, pp. 49–64, 2017.
- [183] N. Y. Aydin, E. Kentel, and H. Sebnem Duzgun, "GIS-based site selection methodology for hybrid renewable energy systems: A case study from western Turkey," *Energy Convers. Manag.*, vol. 70, pp. 90–106, 2013.
- [184] N. Y. Aydin, "GIS-Based Site Selection Approach for Wind and Solar Energy Systems: A Case Study from Western Turkey," Middle East Technical University, 2009.
- [185] F. S. Barnes and J. G. Levine, *Large Energy Storage Systems Handbook*, Taylor and. New York, United States of America: CRC Press, 2011.
- [186] UNESCO, "UNESCO World Heritage Centre - World Heritage List," 2020. [Online].

- Available: <http://whc.unesco.org/en/list>. [Accessed: 21-Jul-2020].
- [187] Protected Planet, “Discover the world’s protected areas,” 2020. [Online]. Available: <https://www.protectedplanet.net/>. [Accessed: 21-Jul-2020].
- [188] U.S. Geological Survey (USGS), “Shuttle Radar Topography Mission (SRTM) 1 Arc-Second Global | The Long Term Archive,” 2015. [Online]. Available: <https://lta.cr.usgs.gov/SRTM1Arc>. [Accessed: 17-Dec-2017].
- [189] O. Planchon and F. Darboux, “A fast, simple and versatile algorithm to fill the depressions of digital elevation models,” *Catena*, vol. 46, no. 2–3, pp. 159–176, 2002.
- [190] L. Håkanson, “Lakes on Earth, Different Types,” in *Encyclopedia of Lakes and Reservoirs*, L. Bengtsson, R. W. Herschy, and R. W. Fairbridge, Eds. Dordrecht: Springer Netherlands, 2012, pp. 471–472.
- [191] Voith, “Pumped Storage Plants,” *Voith GmbH 2017*, 2017. [Online]. Available: <http://voith.com/corp-en/industry-solutions/hydropower/pumped-storage-plants.html>. [Accessed: 07-Jun-2018].
- [192] S. Kucukali, “Finding the most suitable existing hydropower reservoirs for the development of pumped-storage schemes: An integrated approach,” *Renew. Sustain. Energy Rev.*, vol. 37, pp. 502–508, Sep. 2014.
- [193] “Morocco awards permits for two hydropower plants - CONTRACTS, WATER - Utilities Middle East.” [Online]. Available: <https://www.utilities-me.com/article-5295-morocco-awards-permits-for-two-hydropower-plants>. [Accessed: 21-Jul-2020].
- [194] “Meet Red John - the Highland hydro scheme that could be a gamechanger for renewables | The Scotsman.” [Online]. Available: <https://www.scotsman.com/news/environment/meet-red-john-highland-hydro-scheme-could-be-gamechanger-renewables-279321>. [Accessed: 21-Jul-2020].
- [195] “Industry roundtable: Primed for pumped hydro | EcoGeneration.” [Online]. Available: <https://www.ecogeneration.com.au/industry-roundtable-primed-for-pumped-hydro/>. [Accessed: 21-Jul-2020].
- [196] “New £400m hydro revolution in the Highlands announced | The Scotsman.” [Online]. Available: <https://www.scotsman.com/news/environment/new-aps400m-hydro-revolution-highlands-announced-1481688>. [Accessed: 21-Jul-2020].
- [197] “Hydro News 30 - Hydropower plant Manic 5, Canada.” [Online]. Available: <https://www.andritz.com/hydro-en/hydronews/hy-hydro-news-30/hy-news-30-13-manic-5-canada-hydro>. [Accessed: 21-Jul-2020].
- [198] R. M. Bartos and J. Crutchfield, “North Carolina Department of Natural and Cultural Resources State Historic Preservation Office,” Lincoln and Mecklenburg Counties, FERC #2232, 2016.
- [199] “Taum Sauk Hydroelectric Power Station.” [Online]. Available: https://ipfs.io/ipfs/QmXoyvizjW3WknFiJnKLwHCnL72vedxjQkDDP1mXWo6uco/wiki/Taum_Sauk_Hydroelectric_Power_Station.html. [Accessed: 21-Jul-2020].
- [200] “Generation Asset Map.” [Online]. Available: <https://www.esb.ie/our-businesses/generation-energy-trading-new/generation-asset-map#turlough-hill>. [Accessed: 21-Jul-2020].

- [201] S. A. Berezinskii, A. V. Egorov, V. S. Lashmanova, and I. A. Polinkovskii, “Design of penstocks of pumped-storage stations,” *Hydrotechnical Constr.*, vol. 19, no. 4, pp. 180–187, Apr. 1985.
- [202] Martin van der Knaap, *Status of Fish Stocks and Fisheries of Thirteen Medium-sized African Reservoirs - Google Livres*, CIFA 26. Roma: Food and Agriculture Organization of the United Nations, 1994.
- [203] Alfred Gondo, François F. Ndjock Balock, and Isaac Njilah Konfor, “Rapport Gestion Des Catastrophes Cameroun - Disaster Mitigation Report Cameroon,” Yaoundé (Cameroun), 1997.
- [204] W. C. Evans, G. W. Kling, M. Kusakabe, and Y. Yoshida, “Preliminary Report on the June 2012 Field Expedition to Lakes Nyos and Monoun, Cameroon,” 2012.
- [205] Z. T. Ghislain, N. D. Guimolaire, K. D. Armand, G. D. Merlin, and K. Pierre, “Study of Multi-Origin Hazards and Assessment of Associated Risks in the Lefo Caldera (Bamenda Volcano, Cameroon Line),” *Int. J. Geosci.*, vol. 5, no. 5, pp. 1300–1314, 1984.
- [206] Jeffrey Hollister and W. Bryan Milstead, “Using GIS to estimate lake volume from limited data,” *Lake Reserv. Manag.*, vol. 26, no. 3, pp. 194–199, 2017.
- [207] S. Sobek, J. Nisell, and J. Fölster, “Predicting the volume and depth of lakes from map-derived parameters,” *Inl. Waters*, vol. 1, pp. 177–184, 2011.
- [208] J. Liebe, N. van de Giesen, and M. Andreini, “Estimation of small reservoir storage capacities in a semi-arid environment,” *Phys. Chem. Earth*, vol. 30, no. 6-7 SPEC. ISS., pp. 448–454, 2005.
- [209] A. J. Heathcote, P. A. Giorgio, and Y. T. Prairie, “Predicting bathymetric features of lakes from the topography of their surrounding landscape,” *Can. J. Fish. Aquat. Sci.*, vol. 650, no. 5, pp. 643–650, 2015.
- [210] J. W. Hollister, W. B. Milstead, and M. A. Urrutia, “Predicting maximum lake depth from surrounding topography,” *PLoS One*, vol. 6, no. 9, pp. 1–6, 2011.
- [211] R. A. Mbih, S. K. Ndzeidze, S. L. Driever, and G. Fondze Bamboye, “The Bamendjin Dam and Its Implications in the Upper Noun Valley, Northwest Cameroon,” *J. Sustain. Dev.*, vol. 7, no. 6, pp. 123–132, 2014.
- [212] “Pumped Storage Hydroelectricity (Energy Engineering),” *In Depth Tutorials and Information*, 2019. [Online]. Available: <http://what-when-how.com/energy-engineering/pumped-storage-hydroelectricity-energy-engineering/>. [Accessed: 21-Jul-2020].
- [213] O. Edenhofer, R. Pichs-Madruga, Y. Sokona, and K. Seyboth, “IPCC special report on renewable energy sources and climate change mitigation - Chapter 5: Hydropower,” Cambridge, UK, 2011.
- [214] T. M. I. Mahlia, T. J. Saktisahdan, A. Jannifar, M. H. Hasan, and H. S. C. Matseelar, “A review of available methods and development on energy storage; technology update,” *Renew. Sustain. Energy Rev.*, vol. 33, no. July 2015, pp. 532–545, 2014.
- [215] G. Li and Z. Han, “Principal engineering geological problems in the Shisanling Pumped Storage Power Station, China,” *Eng. Geol.*, vol. 76, no. 1, pp. 165–176, 2004.

- [216] M. Obi, S. M. Jensen, J. B. Ferris, and R. B. Bass, “Calculation of levelized costs of electricity for various electrical energy storage systems,” *Renew. Sustain. Energy Rev.*, vol. 67, no. January, pp. 908–920, 2017.
- [217] V. Koritarov *et al.*, “Modeling and analysis of Value of Pumped Hydro Storage Hydropower in the United States,” *Argonne National Laboratory - Decision and Information Sciences*, p. 372, 2014.
- [218] B. A. Antal, “Pumped Storage Hydropower: A Technical Review,” -Univ.of Colorado Denver, 2014.
- [219] A. A. Elsheikh, S. S. Gao, and K. H. Liu, “Formation of the Cameroon Volcanic Line by lithospheric basal erosion: Insight from mantle seismic anisotropy,” *J. African Earth Sci.*, vol. 100, pp. 96–108, 2014.
- [220] K. Tchamako, T. Fotsing, J. P. Tchouankoue, N. Ngoupayou, N. Ngatcha B, and N. W. Hinman, “Influences of lithology on water quality: a study of the Ngam and Mou watersheds in West Cameroon (Central Africa),” *Procedia Earth Planet. Sci.*, vol. 7, pp. 405–408, 2013.
- [221] University of Auckland, “Geology - rocks and minerals,” 2018. [Online]. Available: https://flexiblelearning.auckland.ac.nz/rocks_minerals/rocks/rhyolite.html. [Accessed: 26-Jan-2018].
- [222] G. Krajačić *et al.*, “Feed-in tariffs for promotion of energy storage technologies,” *Energy Policy*, vol. 39, pp. 1410–1425, 2011.
- [223] A. Poullikkas, “Optimization analysis for pumped energy storage systems in small isolated,” *J. Power Technol.*, vol. 93, no. 2, pp. 78–89, 2013.
- [224] J. Y. Kim, K. S. Kang, K. Y. Oh, J. S. Lee, and M. S. Ryu, “A Study on the Site Selection of Offshore Wind Farm around Korean Peninsula,” in *3rd International Conference on Ocean Energy (Icoe) 2010*, 2010, pp. 4–7.
- [225] A. A. Merrouni and A. Mezrhab, “PV sites suitability analysis in the Eastern region of Morocco,” *Sustain. Energy Technol. Assessments*, vol. 18, pp. 6–15, Dec. 2016.
- [226] Y. Wu, M. Yang, H. Zhang, K. Chen, and Y. Wang, “Optimal site selection of electric vehicle charging stations based on a cloud model and the PROMETHEE method,” *Energies*, vol. 9, no. 3, Mar. 2016.
- [227] H. Woo, M. Acuna, M. Moroni, and M. S. Taskhiri, “Optimizing the Location of Biomass Energy Facilities by Integrating Multi-Criteria Analysis (MCA) and Geographical Information Systems (GIS),” *Forests*, vol. 9, no. 585, pp. 1–15, 2018.
- [228] A. Chaouachi, C. F. Covrig, and M. Ardelean, “Multi-criteria selection of offshore wind farms: Case study for the Baltic States,” *Energy Policy*, vol. 103, pp. 179–192, Apr. 2017.
- [229] E. Vassoney, A. Mammoliti Mochet, and C. Comoglio, “Use of multicriteria analysis (MCA) for sustainable hydropower planning and management,” *Journal of Environmental Management*, vol. 196. Academic Press, pp. 48–55, 01-Jul-2017.
- [230] S. Chakhar and V. Mousseau, “Spatial Multicriteria Decision Making,” *Encyclopedia of geographic information science*. Springer-Verlag, pp. 1–8, 2007.
- [231] G. Villacreses, G. Gaona, J. Martínez-Gómez, and D. J. Jijón, “Wind farms suitability

- location using geographical information system (GIS), based on multi-criteria decision making (MCDM) methods: The case of continental Ecuador,” *Renew. Energy*, vol. 109, pp. 275–286, Aug. 2017.
- [232] U. R. Tuzkaya, “Evaluating the environmental effects of transportation modes using an integrated methodology and an application,” *Int. J. Environ. Sci. Tech*, vol. 6, no. 2, pp. 277–290, 2009.
- [233] N. Bagheri Moghaddam, M. Nasiri, and S. M. Mousavi, “An appropriate multiple criteria decision making method for solving electricity planning problems, addressing sustainability issue,” *Int. J. Environ. Sci. Tech*, vol. 8, no. 3, pp. 605–620, 2011.
- [234] A. A. Bazzazi, M. Osanloo, and B. Karimi, “Deriving preference order of open pit mines equipment through MADM methods: Application of modified VIKOR method,” *Expert Syst. Appl.*, vol. 38, pp. 2550–2556, 2011.
- [235] T. L. Saaty, “Decision making with the analytic hierarchy process,” *Int. J. Serv. Sci.*, vol. 1, no. 1, pp. 83–98, 2008.
- [236] A. Guitouni and J.-M. Martel, “Some Guidelines for Choosing an MCDA Method Appropriate to a Decision Making Context,” Québec (Québec) Canada, 1997–019, 1997.
- [237] H. Polatidis, D. A. Haralambopoulos, G. Munda, and R. Vreeker, “Selecting an appropriate multi-criteria decision analysis technique for renewable energy planning,” *Energy Sources, Part B Econ. Plan. Policy*, vol. 1, no. 2, pp. 181–193, 2006.
- [238] C. Macharis, J. Springael, K. De Brucker, and A. Verbeke, “PROMETHEE and AHP: The design of operational synergies in multicriteria analysis. Strengthening PROMETHEE with ideas of AHP,” *Eur. J. Oper. Res.*, vol. 153, pp. 307–317, 2004.
- [239] E. Triantaphyllou and A. Sánchez, “A Sensitivity Analysis Approach for Some Deterministic Multi-Criteria Decision Making Methods,” *Decis. Sci.*, vol. 28, no. 1, pp. 151–194, 1997.
- [240] H. Aras, Ş. Erdoğan, and E. Koç, “Multi-criteria selection for a wind observation station location using analytic hierarchy process,” *Renew. Energy*, vol. 29, no. 8, pp. 1383–1392, 2004.
- [241] M. Zoghi, A. Houshang Ehsani, M. Sadat, M. javad Amiri, and S. Karimi, “Optimization solar site selection by fuzzy logic model and weighted linear combination method in arid and semi-arid region: A case study Isfahan-IRAN,” *Renew. Sustain. Energy Rev.*, vol. 68, pp. 986–996, Feb. 2017.
- [242] M. Tahri, M. Hakdaoui, and M. Maanan, “The evaluation of solar farm locations applying Geographic Information System and Multi-Criteria Decision-Making methods: Case study in southern Morocco,” *Renew. Sustain. Energy Rev.*, vol. 51, pp. 1354–1362, Nov. 2015.
- [243] P. Aragonés-Beltrán, F. Chaparro-González, J.P. Pastor-Ferrando, and A. Plá-Rubio, “An AHP/ANP-based multi-criteria decision approach for the selection of solar thermal power plant investment projects,” *Energy*, vol. 66, pp. 222–238, 2013.
- [244] S. Chakhar and V. Mousseau, “An algebra for multicriteria spatial modeling,” *Comput. Environ. Urban Syst.*, vol. 31, pp. 572–596, 2007.
- [245] Y. Wu, L. Liu, J. Gao, H. Chu, and C. Xu, “An Extended VIKOR-Based Approach for Pumped Hydro Energy Storage Plant Site Selection with Heterogeneous Information,”

Information, vol. 8, no. 3, pp. 1–19, 2017.

- [246] B. A. Akash, R. Mamlook, and M. S. Mohsen, “Multi-criteria selection of electric power plants using analytical hierarchy process,” *Electr. Power Syst. Res.*, vol. 52, pp. 29–35, 1999.
- [247] Z. Lu, Y. Gao, and W. Zhao, “A TODIM-based approach for environmental impact assessment of pumped hydro energy storage plant,” *J. Clean. Prod.*, p. 119265, Nov. 2019.
- [248] B. A. Shimray, K. M. Singh, T. Khelchandra, and R. K. Mehta, “Ranking of Sites for Installation of Hydropower Plant Using MLP Neural Network Trained with GA: A MADM Approach,” *Comput. Intell. Neurosci.*, vol. 2017, pp. 1–8, 2017.
- [249] J. A. Jiménez Capilla, J. A. Carrión, and E. Alameda-Hernandez, “Optimal site selection for upper reservoirs in pump-back systems, using geographical information systems and multicriteria analysis,” *Renew. Energy*, vol. 86, pp. 429–440, Feb. 2016.
- [250] X. Deng, Y. Hu, Y. Deng, and S. Mahadevan, “Supplier selection using AHP methodology extended by D numbers,” *Expert Syst. Appl.*, vol. 41, no. 1, pp. 156–167, Jan. 2014.
- [251] M. Berrittella, A. Certa, M. Enea, and P. Zito, “An Analytic Hierarchy Process for The Evaluation of Transport Policies to Reduce Climate Change Impacts,” in *CCMP – Climate Change Modelling and Policy*, 2007, p. 25.
- [252] Y. Kara and A. Ç. Köne, “The Analytic Hierarchy Process (AHP) Approach for Assessment of Regional Environmental Sustainability,” in *Evidence for Sustainable Development: 2012 Berlin Conference on the Human Dimensions of Global Environmental Change*, 2012, pp. 5–6.
- [253] H. Dincer and U. Hacıoglu, “Performance evaluation with fuzzy VIKOR and AHP method based on customer satisfaction in Turkish banking sector,” *Perform. Eval.*, vol. 42, no. 7, pp. 1072–1085, 2013.
- [254] C. Prével, M. Thériault, and J. Rouffignat, “Cahiers de géographie du Québec Analyse multicritère et SIG pour faciliter la concertation en aménagement du territoire : vers une amélioration du processus décisionnel?,” *Cah. Geogr. Que.*, vol. 47, no. 130, 2003.
- [255] D. Kurtener, H. Allen Torbert, and E. Krueger, “Evaluation of Agricultural Land Suitability: Application of Fuzzy Indicators,” Springer-Verlag, Berlin Heidelberg, ICCSA 2008, 2008.
- [256] G. A. Mendoza and P. Macoun, “Application de l’analyse multicritère à l’évaluation des critères et indicateurs,” Centre de coopération internationale en recherche agronomique pour le développement (Cirad) Département des forêts, Bogor, Indonésie, 2000.
- [257] G. A. Mendoza and H. Martins, “Multi-criteria decision analysis in natural resource management: A critical review of methods and new modelling paradigms,” *For. Ecol. Manage.*, vol. 230, pp. 1–22, 2006.
- [258] K. M. Al-Subhi Al-Harbi, “Application of the AHP in project management,” *Int. J. Proj. Manag.*, vol. 19, pp. 19–27, 2001.
- [259] M. Merad, N. Dechy, L. Serir, M. Grabisch, and F. Marcel, “Using a multi-criteria decision aid methodology to implement sustainable development principles within an Organization,” *Eur. J. Oper. Res.*, pp. 603–613, 2013.
- [260] E. Triantaphyllou and S. H. Mann, “Using the Analytic Hierarchy Process for Decision

- Making In Engineering Applications: Some Challenges,” *J. Ind. Eng. Appl. Pract.*, vol. 2, no. 1, pp. 35–44, 1995.
- [261] A. Gemitzi, V. A. Tsihrintzis, E. Voudrias, C. Petalas, and G. Stravodimos, “Combining geographic information system, multicriteria evaluation techniques and fuzzy logic in siting MSW landfills,” *Environ. Geol.*, vol. 51, no. 5, pp. 797–811, 2007.
- [262] A. Ramos, L. Cunha, and P. P. Cunha, “Analytic hierarchy process (AHP) applied to the landslides study in a coastal area of the central Portugal: Figueira da Foz – Nazaré,” *Geo. Eco. Trop.*, vol. 38, no. 1, pp. 33–44, 2014.
- [263] M. A. Rahman *et al.*, “A new spatial multi-criteria decision support tool for site selection for implementation of managed aquifer recharge,” *J. Environ. Manage.*, vol. 99, pp. 61–75, May 2012.
- [264] M. Brunelli, “Introduction to the Analytic Hierarchy Process Introduction to the Analytic Hierarchy Process *,” *Springer Briefs Oper. Res.*, no. 1, p. 84, 2015.
- [265] O. S. Vaidya and S. Kumar, “Analytic hierarchy process: An overview of applications,” *Eur. J. Oper. Res.*, vol. 169, pp. 1–29, 2006.
- [266] N.-F. Pan, “Fuzzy AHP approach for selecting the suitable bridge construction method,” *Autom. Constr.*, vol. 17, pp. 958–965, 2008.
- [267] A. Joshi, S. Kale, S. Chandel, and D. K. Pal, “Likert Scale: Explored and Explained,” *Br. J. Appl. Sci. Technol.*, vol. 7, no. 4, pp. 396–403, 2015.
- [268] S. A. Sahaaya Arul Mary and G. Suganya, “Multi-Criteria Decision Making Using ELECTRE,” *Circuits Syst.*, vol. 7, pp. 1008–1020, 2016.
- [269] A. Papadopoulos and A. Karagiannidis, “Application of the multi-criteria analysis method Electre III for the optimisation of decentralised energy systems,” *Omega*, vol. 36, no. 5, pp. 766–776, Oct. 2008.
- [270] J. Hokkanen and P. Salminen, “ELECTRE III and IV Decision Aids in an Environmental Problem,” *J. Multi-Criteria Decis. Anal.*, vol. 6, no. 4, pp. 215–226, Jul. 1997.
- [271] M. Roger S and M. Bruen, “A new system for weighting environmental criteria for use within ELECTRE III,” *Eur. J. Oper. Res.*, vol. 107, no. 3, pp. 552–563, Jun. 1998.
- [272] FERC Taum Sauk Investigation Team, “Report of Findings on the Overtopping and Embankment Breach of the Upper Dam-Taum Sauk Pumped Storage,” Missouri - US, 2277, 2006.
- [273] A. De Luca and S. Termini, “A Definition of a Nonprobabilistic Entropy in the Setting of Fuzzy Sets Theory,” *Inf. Control*, vol. 20, pp. 301–312, 1972.
- [274] V. Novák, I. Perfilieva, and J. Močkoř, *Mathematical principles of fuzzy logic*, Kluwer Aca. Springer; 1999 edition (August 31, 1999), 1999.
- [275] H. R. Pourghasemi, B. Pradhan, and C. Gokceoglu, “Application of fuzzy logic and analytical hierarchy process (AHP) to landslide susceptibility mapping at Haraz watershed, Iran,” *Nat. Hazards*, vol. 63, pp. 965–996, 2012.
- [276] L. A. Zadeh, “Fuzzy sets,” *Inf. Control*, vol. 8, no. 3, pp. 338–353, Jun. 1965.

- [277] T. L. Saaty and L. G. Vargas, "The Seven Pillars of the Analytic Hierarchy Process," in *Models, Methods, Concepts and Applications of the Analytic Hierarchy Process*, vol. 14, T. L. Saaty and V. L. G., Eds. Springer, 2012, p. 346.
- [278] T. L. Saaty, "A scaling method for priorities in hierarchical structures," *J. Math. Psychol.*, vol. 15, no. 3, pp. 234–281, Jun. 1977.
- [279] Ermatita, S. Hartati, R. Wardoyo, and A. Harjoko, "ELECTRE Methods in Solving Group Decision Support System Bioinformatics on Gene Mutation Detection Simulation," *Int. J. Comput. Sci. Inf. Technol.*, vol. 3, no. 1, pp. 40–52, 2011.
- [280] S. D. Pohekar and M. Ramachandran, "Application of multi-criteria decision making to sustainable energy planning-A review," *Renew. Sustain. Energy Rev.*, vol. 8, pp. 365–381, 2004.
- [281] E. Mu and M. Pereyra-Rojas, "Practical Decision Making - Understanding the Analytic Hierarchy Process," *SpringerBriefs Oper. Res.*, vol. 20, no. 12, pp. 7–22, 2017.
- [282] C. K. K. Mosoh Bambi, H. E. E. Frimmel, A. Zeh, and C. E. E. Suh, "Age and origin of Pan-African granites and associated U-Mo mineralization at Ekomédion, southwestern Cameroon," *J. African Earth Sci.*, vol. 88, no. December, pp. 15–37, Dec. 2013.
- [283] B.-W. Gaston, A. F. Tongwa, C. Burnley, and Z. T. Isabella, "Local governance in disaster risk reduction in Cameroon," *Jàmbá J. Disaster Risk Stud.*, vol. 4, no. 1, pp. 1–9, Oct. 2012.
- [284] Solargis, "Solar resource maps and GIS data for 180+ countries | Solargis," © 2017 *The World Bank, Solar resource data*, 2018. [Online]. Available: <https://solargis.com/maps-and-gis-data/download/cameroon>. [Accessed: 19-Oct-2018].
- [285] Expert Choice Inc., "EXPERT CHOICE Tutorial." Expert Choice Inc., pp. 1–11, 2000.
- [286] V. Pereira, H. G. Costa, and L. D. de O. Nepomuceno, "J-Electre-v1.0 User Guide: An ELECTRE I, I_s, I_v, II, III, IV, TRI and TRI ME software." p. 20, 2017.
- [287] Republic of Cameroon, "Raquiring Funding Projects Document (RFPD)," Yaoundé, Cameroon, 2017.

Annexes

Annexe 1. State of Cameroon's hydropower infrastructure.

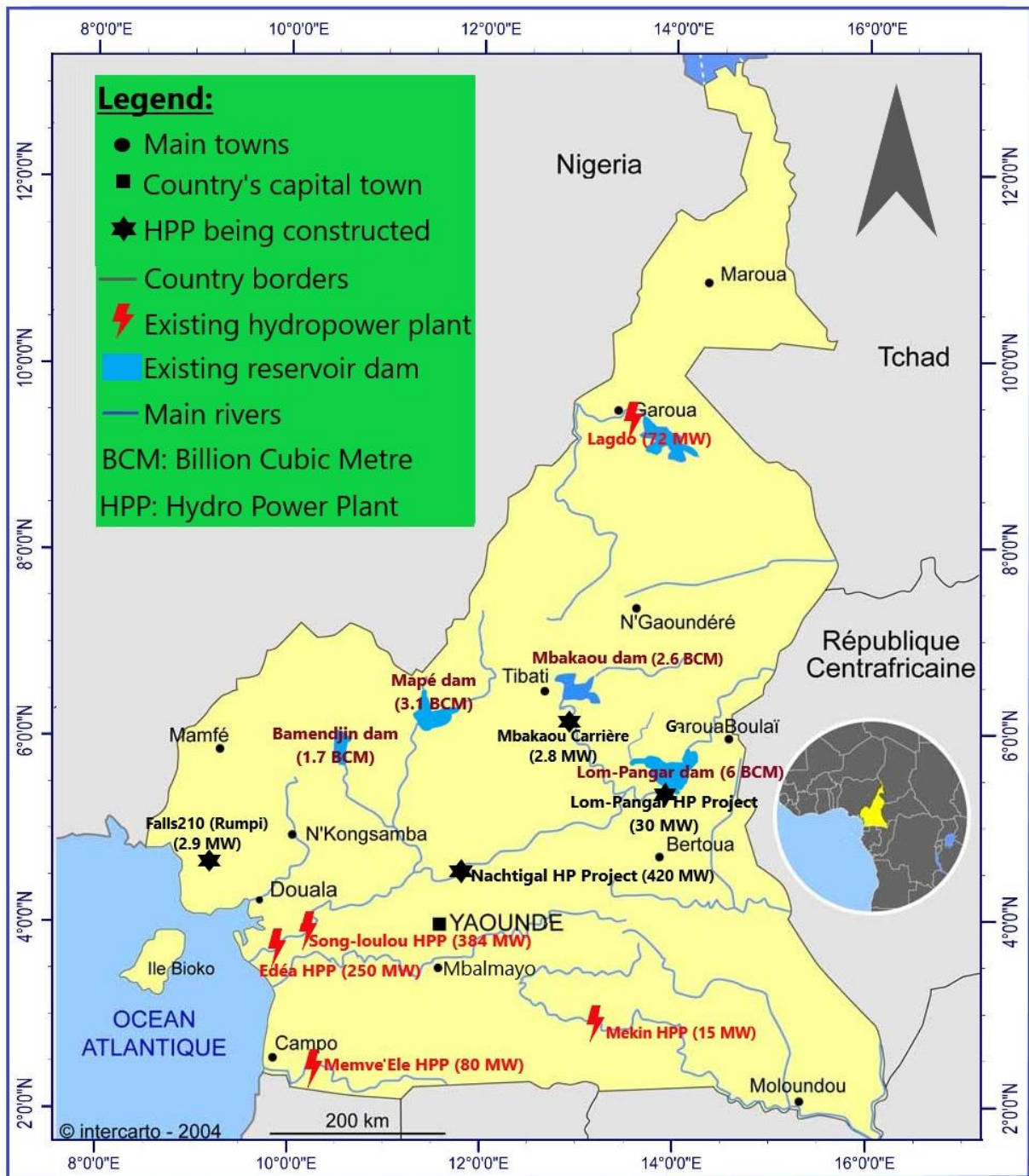

Annexe 2. : Identified small-hydropower potential in Cameroon.

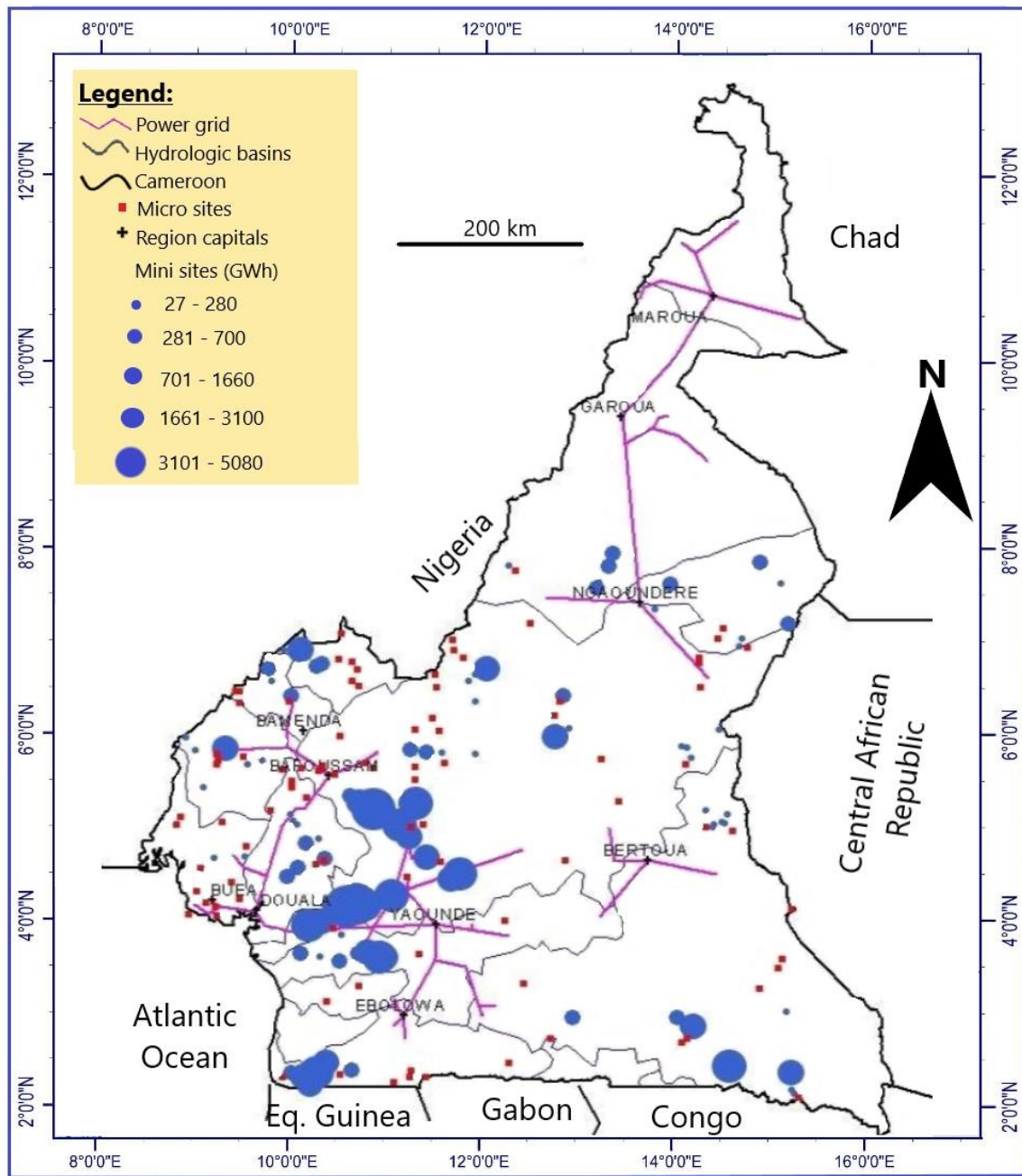

Annexe 3. : Hydroelectric dam projects to be developed in Cameroon (Source: Ministry of Economy, Planning and Regional Development [287]).

Hydropower Project	River, Region	Estimated capacity (MW)	Estimated cost (Billion Cfa F)	Current state of the project	Funding status of the project
Njock	Nyong, Centre	200	180	Draft available	Discussion with Technis (China)
Song Dong	Sanaga, Littoral	280	375	Studies of project details ongoing	Current discussion with Hydrochina International (China)
Noun-Wouri	Noun, West region	1,028	1,030	Contract for feasibility studies signed	In need of funding
Vogzhoum	Vina, North	93	95	Contract award for studies ongoing	In need of funding
Gorges of Ntem	Ntem, South	556	590	Technical studies in progress	In need of funding
Kikot	Sanaga, Littoral	630	640	Preliminary studies received, feasibility studies in progress	Current discussion with Sinohydro (China)
Bayomen	Mbam, Centree	470	410	Studies available need to be updated	In need of funding
Menchum	Menchum, Northwest	75	163	Feasibility studies available	Discussions ongoing with CEW (China)
Makai	Nyong, Centre	350	450	Technical studies ongoing with OZTURK (Turkey)	Current discussion with Platinum Power (Morocco)
Mandourou	Faro, Adamaoua	67	67	Preliminary studies ongoing	Project in need of funding
Mamfe	Manyu, Northwest	123	125	Preliminary studies ongoing	Preliminary studies ongoing
Nyazom	Mbam, Centre	225	475	Technical studies ongoing	Project in need of funding

Song-Mbengue	Sanaga, Littoral	1,080	1,200	Technical studies in progress	In need of funding
Grand Eweng	Sanaga, Littoral	1,800	1,670	Feasibility studies issued	Current discussion with Hydromine (USA)
Katsina-Ala	Katsina, Northwest	485	900	Technical studies in progress	Letter of intent signed with Joule Africa (Great Britain)
Bini à Warak	Bini, Adamaoua	75	85	Preliminary works completed	Financial closure reached with Sinohydro
Ngodi	Sanaga, Littoral	475	-	Environmental and social impact assessment	Partnership contracts signed with Rio Tinto Alcan
Chollet	Dja, South (Cameroon & Congo)	600	-	Technical studies in progress	Financial agreement reached by the two States

Annexe 4. Solar PV power Potential of Cameroon.

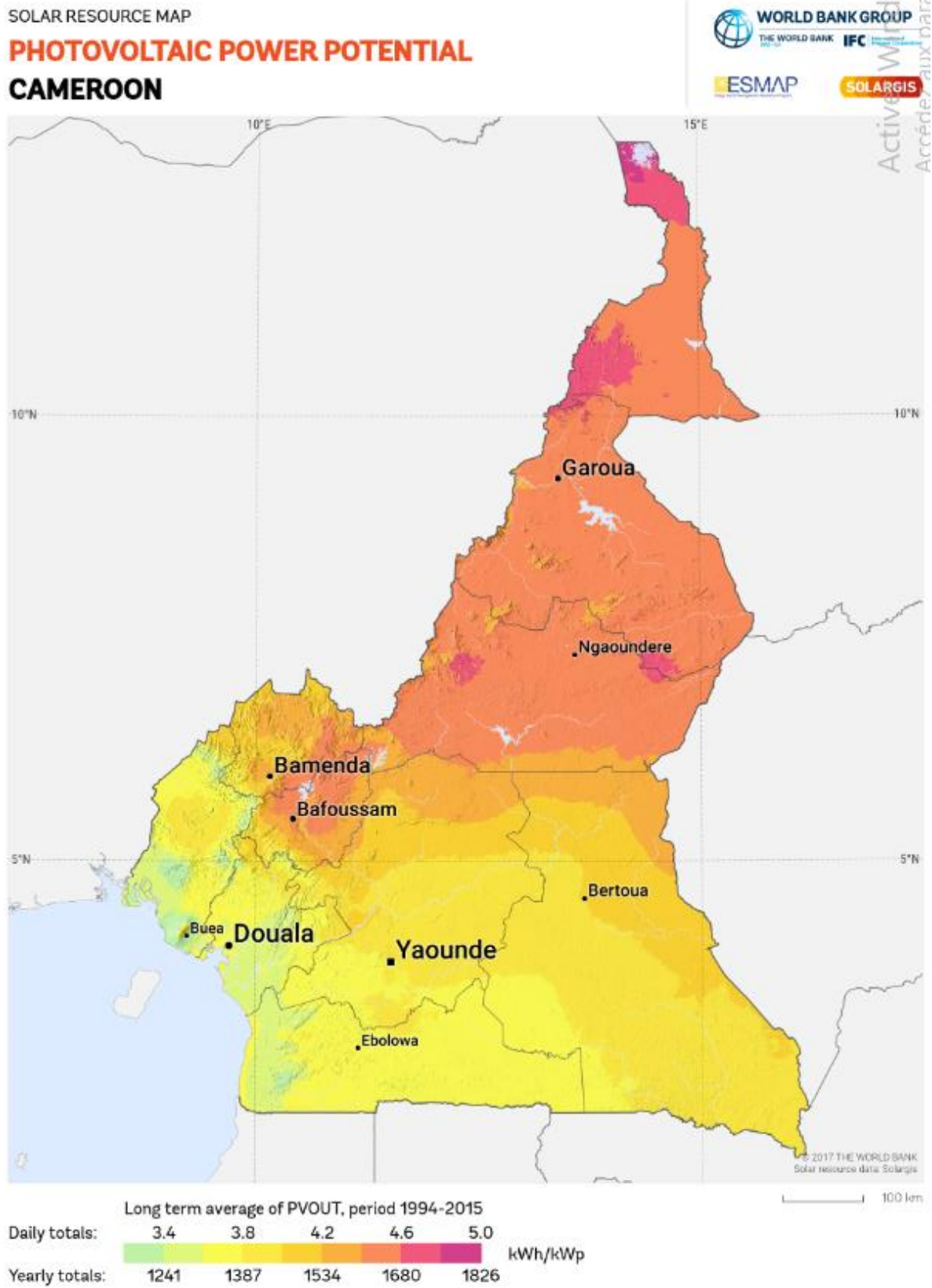

Source : <https://solargis.com/maps-and-gis-data/download/cameroon> [Accessed: 15/06/2019].

Annexe 5. Brief summary of the review of multi-criteria decision-making methods in the domain of pumped hydro-energy storage plant siting.

Study	Year	MCDM Approach	Geography of application	Site type	Input database	Methods used	Ranking metric	Main findings or outputs
Ghorbani et al. [152]	2019	GIS-MODM	Iran	Four different topologies	GIS – terrain models	Spatial analysis and TOPSIS	TOPOGIS RC Index	Technical PHES potential of Iran estimated at 5108 GWh from 250 discovered sites,
Lu et al. [164]	2018	GIS-MODM	South Australia	All PHES site types	GIS data, DEMs	Spatial analysis	N/A	Mathematical model to highlight promising regions for PHES development
Lu and Wang [158]	2017	GIS-MODM	Tibet Province, China	Existing hydropower reservoirs	GIS – terrain models	AHP, Spatial analysis	Max. head	Tibet’s PHES potential under three GIS models
Soha et al. [155]	2017	GIS-MODM	Europe	Abandoned mines used as reservoirs	Terrain models	Spatial analysis	N/A	1590-1700 MWh could be stored in the total of 15 upper reservoirs
Wu et al. [245]	2017	MADM	Zhejiang Province, China	All PHES site types	Existing PHES databases	AHP, VIKOR, TOPSIS	Priority index	Ranking of four candidate PHES plant’s sites
Jimenez et al. [249]	2016	GIS-MODM	Spain	Existing dams	Terrain models	Spatial analysis	Suitability model	Promising areas highlighted from economic and construction criteria
Gimeno-Gutiérrez and Lacal-Aránegui [159]	2015	GIS-MODM	Europe	Two existing reservoirs	GIS - Global DEM	Spatial analysis	N/A	Theoretical European PHES potential, 54 TWh considering up to 20 km between reservoirs
Hall and Lee [163]	2014	GIS	United States of America	Existing hydropower plants and other non-hydro water features	Variety of US terrain models	Spatial analysis	Energy capacity	US PHES potential under various considerations
Kucukali [192]	2014	MADM	Turkey	Existing hydropower reservoirs	Topographic data	Fuzzy scoring system,	Arithmetic mean	Ranking of seven existing hydropower reservoirs
Fitzgerald et al. [150]	2012	GIS-MODM	Turkey	Hydro and non-hydro reservoirs	GIS data, DEMs	Spatial analysis	Max. head	PHES potential of Turkey under various topologies
Larentis et al. [166]	2010	GIS	Taquari-Antas, Brazil	Small-hydro, pumped storage	DEMs-90m	Spatial analysis (ArcGis)	Head and slopes	997 sites, 736 MW
Ahmadi & Shamsai [165]	2009	GIS-MODM	Zayanderud, Iran	Natural and artificial Waterbodies	GIS data	AHP, Spatial analysis	N/A	Suitable areas for building an upper reservoir in the Zayanderud

Legend: DEM: Digital Elevation Model; N/A: Not Applicable

Annexe 6. Main technical socio-environmental characteristics of preselected prospective sites pumped hydro-energy storage in Cameroon.

Site ID	Criterion								
	Gross head	Head-Distance ratio	Site topology	Affected people settlements	Water use rate	Sealed ground surface	Land use	Land cover	Potential risk in case of upper reservoir failure
	m	-	-	-	%	10 ³ m ²	-	-	-
Enep	560	0.22	T6	00	0.0	278	Savannah	Shrubs and orchards	Water released in the river
Bamendjin	549	0.16	T2	30	0.2	1,200	Fishing, no activity nearby	Semi-arid lands	Water released in the lake
Oku	530	0.14	T3	00	10.0	1,300	Pastures	Grass and shrubs	Floods in people settlements
Benakuma	505	0.20	T2	00	7.6	460	No human activity	Dense vegetation	Flow back to the lake
Nyi	505	0.24	T2	00	60.6	275	Extensive agriculture	Semi-arid grasslands and	Flood in semi-arid lands
Banefo	403	0.16	T6	00	0.0	200	Agriculture	Grasslands	Flow back to the river
Mentchum	337	0.17	T6	00	0.0	290	Savannah, pasture	Sparse shrubs and orchards	Water released to the river
Elum	310	0.21	T2	00	70.0	200	Intensive pasture	Sparse shrubs	Flooded vegetation
Bambili	215	0.17	T2	00	45.2	350	Pasture, breeding	Semi-arid and grass	Flow back to the lakes
Petponoun	210	0.13	T2	00	70.0	542	Not regulated activities	Arid lands	Flow back to the lakes
Mbatu-dam	184	0.37	T2	00	5.1	200	No activities	Rocky arid land	Light floods depending on the flow direction

Annexe 7. List of all acceptable connections.

Site	Connection		Upper Reservoir			Lower Reservoir			Gross Head	Trans. Vol (Mm3)	Distance	H:L Ratio	Energy Capacity (MWh)
	ID	Type	Ref. Type	Est. Vol (Mm3)	Zmin	Ref. Type	Est. Vol (Mm3)	Zmax					
Mentchum I	Menchum I_C_0	T6	R4	7.36	650	R3	20	484	166	6.6	750	0.22	2,138
Mentchum II	Mentchum II_C_1	T6	R4	4.33	800	R3	20	463	337	3.9	2000	0.17	2,554
	Mentchum_C_2	T6	R4	4.33	800	R3	7.36	650	150	3.9	1750	0.09	1,137
Bamendjin I	Bamendjin I_C_0	T5	R5	5	1700	R2	1,875	1151	549	4.5	3500	0.16	4,804
Bamendjin II	Bamendjin II_C_0	T5	R5	0.65	1225	R2	1,875	1151	74	0.6	750	0.10	84
Noun I	Noun_C_0	T6	R4	2.6	1250	R3		1084	166	2.3	600	0.28	755
Noun II	NounRiver II_C_0	T6	R4	0.942	1095	R3		1053	42	0.8	400	0.11	69
Noun III	Noun River III_C_0	T6	R5	0.68	1120	R3		1024	96	0.6	300	0.32	114
Noun IV	Noun River IV_C_0	T6	R5	0.45	1260	R3		1127	133	0.4	900	0.15	105
Benakuma Lake	Benakuma_C_0	T2	R1	5.5	1130	R5	65	625	505	5.0	2500	0.20	4,861
Enep (on the Mentchum)	Enep_C_1	T1	R3	5.1	1130	R1	7	735	395	4.6	1000	0.40	3,525
	Enep_C_2	T1	R1	7	726	R3	20	571	155	5.2	750	0.21	1,580
	Enep_C_3	T2	R3	5.1	1131	R1	20	571	560	4.6	2500	0.22	4,998
Petponoun Lake	Petponoun_C_1	T2	R5	26	1360	R1	2	1150	210	1.1	1600	0.13	463
	Petponoun_C_2	T2	R5	3	1300	R1	2	1150	150	1.1	1700	0.09	331
Monoun Lake	Monoun_C_0	T1	R6	2	1268	R1	18	1090	178	1.8	900	0.20	623
Nyi Lake	Nyi_C_0	T2	R1	6	1320	R6	4	815	505	3.6	2130	0.24	3,535
Bambili Lakes	Bambili_C_1	T2	R4	2	2485	R1	1	2317	168	0.9	750	0.22	296

	Bambili_C_2	T3	R4	2	2485	R5	1	2270	215	0.9	1300	0.17	378
	Bambili_C_3	T1	R2	1	2316	R1	1	2270	46	0.9	400	0.12	81
Lagdo Lake I	Lagdo I_C_0	T2	R5	2.5	373	R1	7,700	213	160	2.3	1130	0.14	700
Lagdo Lake II	Lagdo II_C_0	T2	R6	1.87	470	R1	7,700	213	257	1.7	550	0.47	841
Banefo Lake	Banefo_C_1	T1	R3	1.06	1515	R1	1	1120	395	0.7	2300	0.17	520
	Banefo_C_2	T2	R3	1.06	1515	R1	20	1112	403	1.0	2500	0.16	748
Elum Lake	Elum_C_0	T2	R1	3	980	R4	4	670	310	2.2	1500	0.21	1,314
Oku Lake	Oku_C_1	T1	R5	4	2400	R1	36	2240	160	3.6	1460	0.11	1,120
	Oku_C_2	T1	R1	36	2220	R3	4	2050	170	3.6	800	0.21	1,190
	Oku_C_3	T3	R5	4	2400	R4	4	2050	350	3.6	3000	0.12	2,450
	Oku_C_4	T3	R4	6	2580	R4	4	2050	530	3.6	3750	0.14	3,710
Nyos Lake	Nyos_C_0	T2	R1	92	1150	R4	2.5	1035	115	2.3	630	0.18	503
Mbatu Dam	Mbatu-Dam_C_0	T2	R6	0.2	1510	R1	3.5	1326	184	0.18	500	0.37	64

Annexe 8. Electricity map of Cameroon.

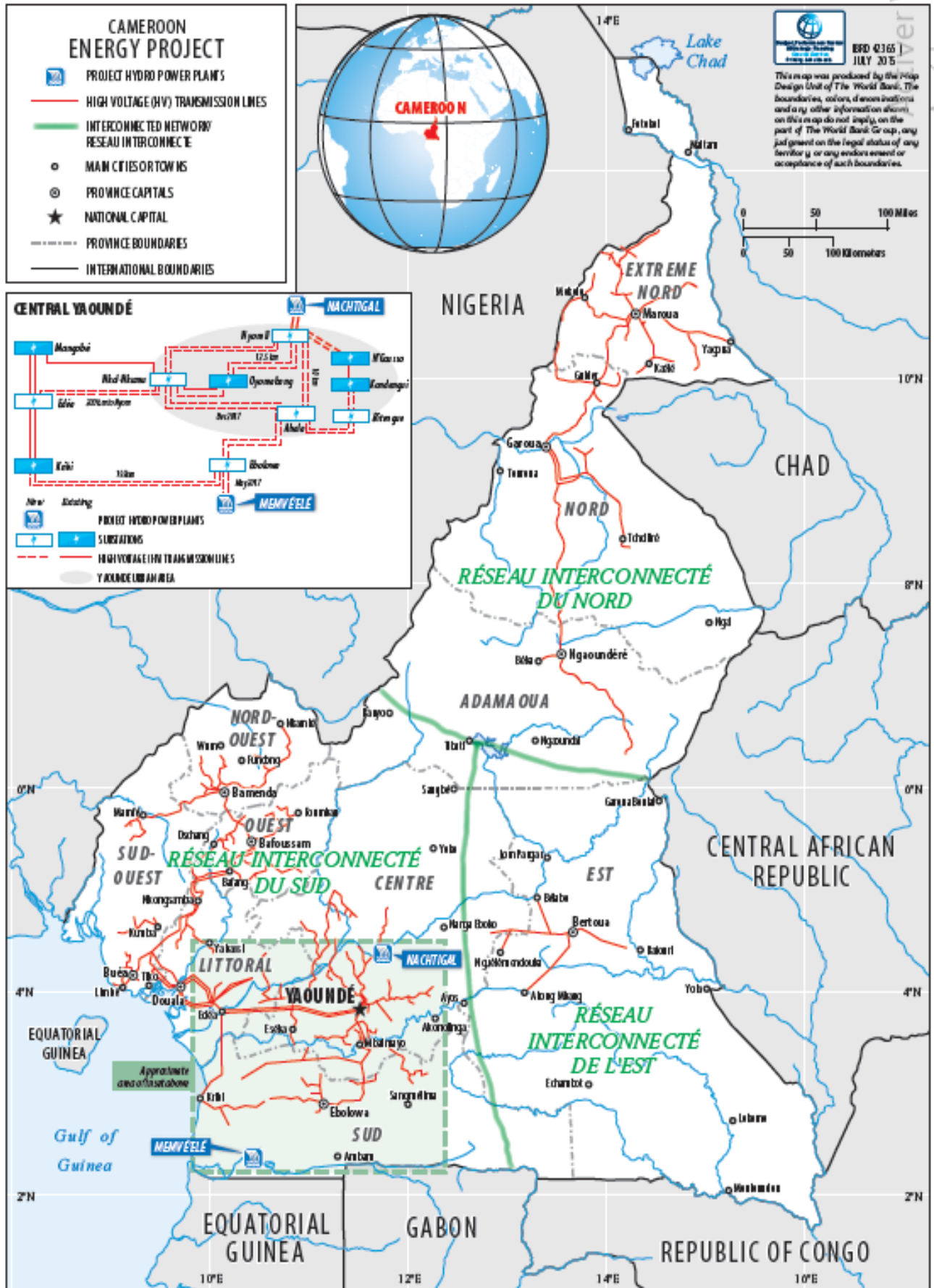

Annexe 9. Full list of water bodies referred to as lakes in Cameroon.

Water body's name*	Coordinates (Lat. & Long.)	Altitude (masl**)	Lake nature	Surface area (Thousands m ²)
Assom	6°37'41N, 12°58'47E	900	Drainage lake	1264
Bafoussam	5°35'12N, 10°26'32E	1115	Seepage lake	50
Baleng	5°33'1N, 10°25'15E	1400	Crater lake	79
Bambili	5°55'31N, 10°14'34E	2317	Crater lake	195
Bamendjin	5°41'32N, 10°32'13E	1151	Reservoir dam for hydropower	170000
Bankim (Mape)	6° 5'47N, 11°21'28E	720	Reservoir dam for hydropower	2600
Barombi Koto	4°28'16N, 9°15'50E	101	Crater lake	1355
Barombi Mbo	4°39'40N, 9°24'8E	315	Crater lake	4287
Benakuma	6°25'53N, 9°56'41E	606	Crater lake	1653
Bermin	5° 9'32N, 9°38'5E	473	Crater lake	332
Dissoni	4°43'45N, 9°16'54E	463	Crater lake	1575
Ejagham	5°45'1N, 8°59'10E	141	Seepage lake	524
Fou	5°32'59N, 10°42'9E	1500	Crater lake	92
Gorom	9°13'24N 13°12'11E	170	Drainage lake	2000
Lagdo	9° 3'21N, 13°42'54E	213	Artificial reservoir	586000
M'Bakaou	6°22'30N, 12°48'53E	846	Artificial reservoir	166000
Mbatu Dam	5°55'12N, 10°8'19E	1326	Reservoir for water supply system	240
Mami water	4°35'21N, 9°36'46E	103	Seepage lake	442
Manengouba	5° 2'13N, 9°49'48E	1916	Crater lake	352
Maga	6°28'17N, 11°31'35E	312	Drainage lake	43
Mayam	6°18'19N, 12° 4'24E	1213	Drainage lake	117
Mbella	3°41'28N, 9°57'23E	900	Drainage lake	6900
Mboli	6°24'32N, 10°12'17E	8	Seepage lake	413
Nyi	5°34'51N, 10°35'13E	1325	Crater lake	614
Monoun	5°40'13N, 10°32'8E	1081	Drainage lake	124
Ndoumkain	7° 7'51N, 13°41'38E	1220	Crater lake	95
Ngaoundaba	6°26'41N, 10°18'49E	1163	Crater lake	170
Njupi	5°32'43N, 10°33'36E	1030	Crater lake	62
Negop-Ghang	5°32'15N, 10°34'46E	1095	Crater lake	60
Mfouet	5°36'43N, 10°33'20E	1080	Crater lake	170
Ngouondam	6°26'16N, 10°17'52E	1095	Crater lake	1582
Nyos	6°11'34N, 10°26'59E	1103	Crater lake	2286
Oku	3°46'33N, 10° 0'49E	2242	Crater lake	9000
Ossa	5°38'5N, 10°38'14E	10	Drainage lake	380
Petpenoun	8°43'43N, 14° 3'55E	1135	Drainage lake	915
Sargari	3°35'4N, 9°53'42E	215	Drainage lake	4393
Tissongo	9°15'23N, 13° 3'17E	20	Drainage lake	4135
Wèlé	3°53'1N, 11°25'26E	174	Drainage lake	971
Yaoundé	6°37'41N, 12°58'47E	722	Seepage lake	1264
Enep	6°17'53N, 10°2'9E	735	Crater lake	320
Elum	6°20'20N, 10°2'12E	1000	Crater lake	285
Edip	4°57'31N, 9°39'7E	985	Crater lake	95
Debundsha	4°6'14N, 8°58'48E	76	Crater lake	96
Wum	6°24'26N, 10°3'18E	1086	Crater lake	295
Bambuluwe	5°51'N, 10°12'E	2089	Crater lake	184
Balesan	7°19'N, 13°44'E	1139	Crater lake	399

* The name provided here may change from one source to another; **Meters Above the Sea Level

Annexe 10. Hydrologic map showing main rivers in Cameroon (Source: <http://sphaera.cartographie.ird.fr>).

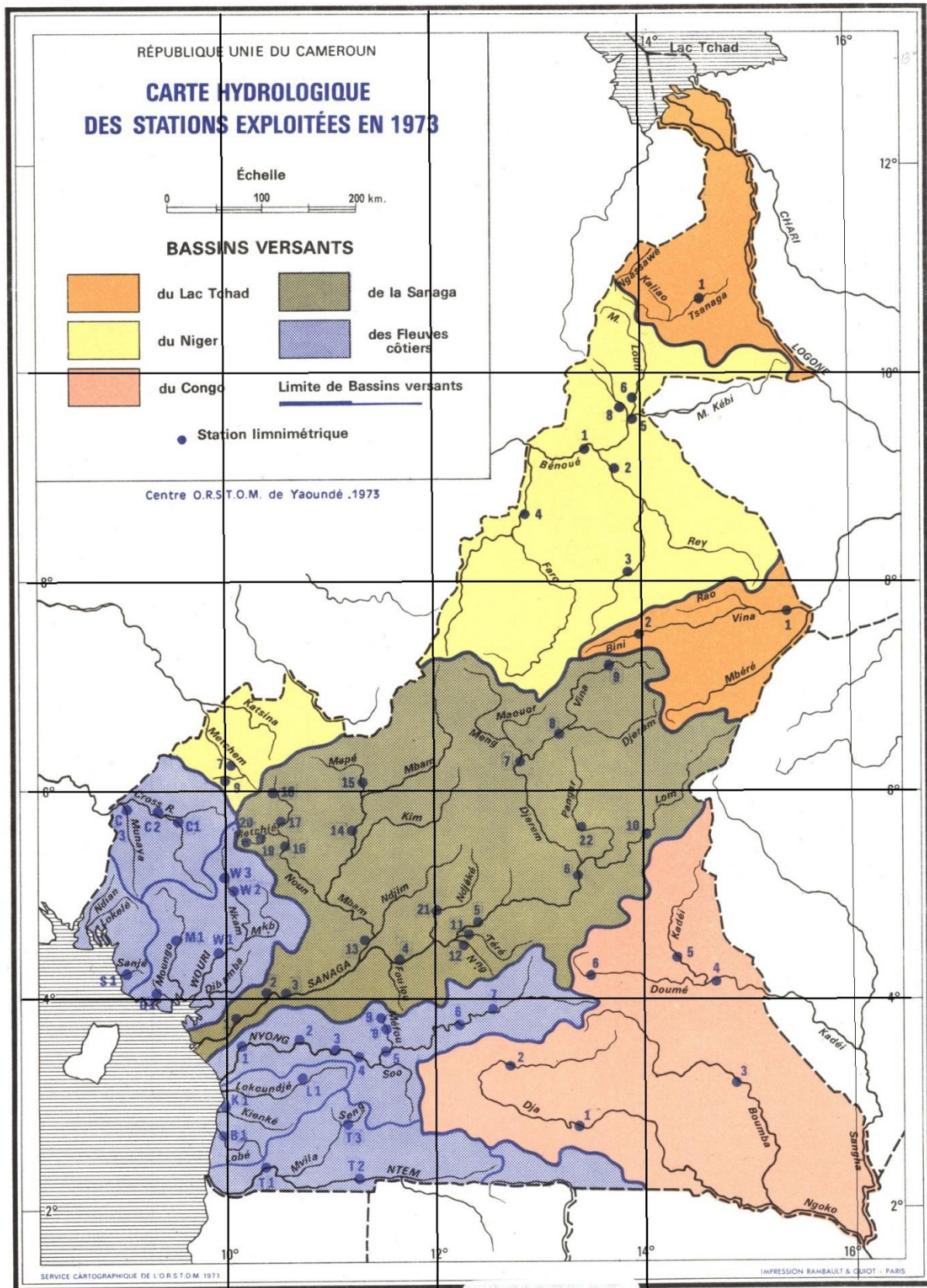

Annexe 11. Terrain model as used by the method for sites detection: Lagdo (a), Benakuma (b), Mentchum River (c), and Bamendjin (d).

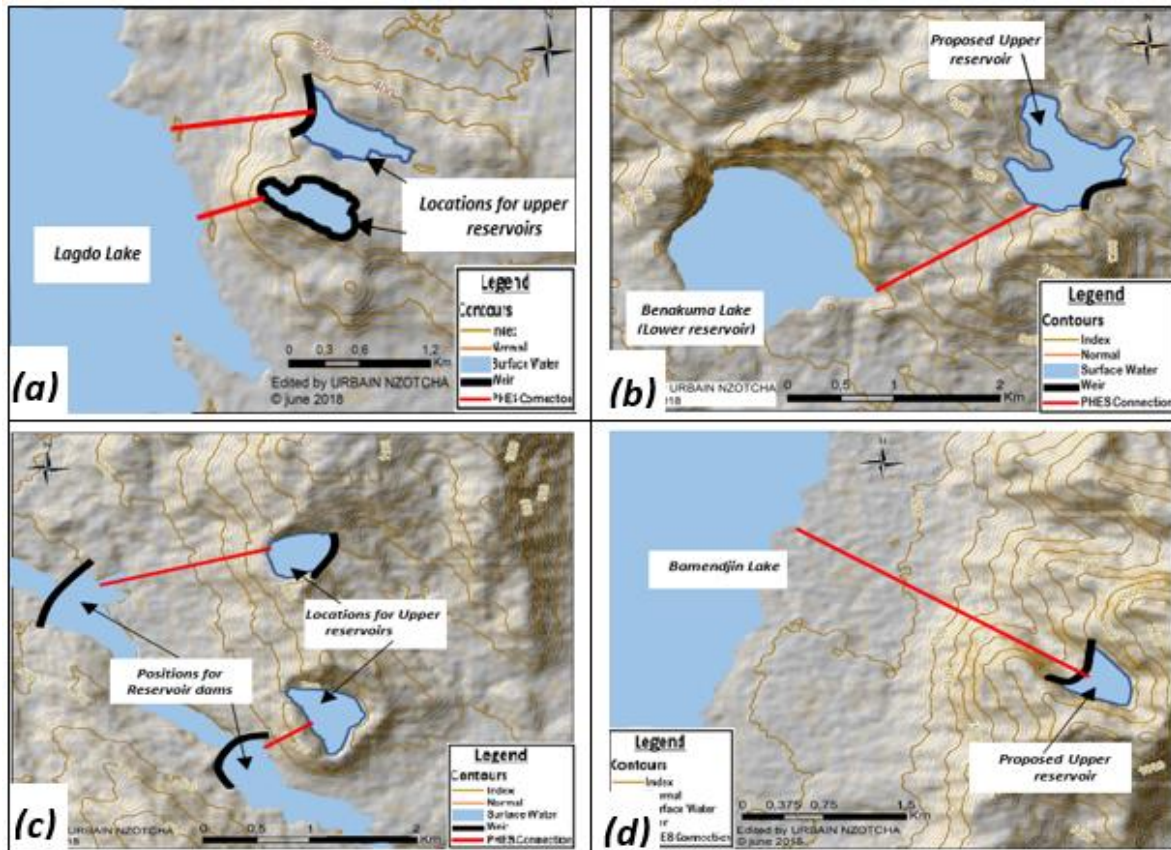

Publications and Other Scientific Activities

Some key research findings (Publications)

- **“Contribution of the wood-processing industry for sustainable power generation: Viability of biomass-fuelled cogeneration in Sub-Saharan Africa”** (Published: Journal of Biomass and Bioenergy 2019; 120:324–331. available at <https://www.sciencedirect.com/science/article/pii/S0961953418303118?dgcid=author>).
- **“Integrated Multi-Criteria Decision Making (MCDM) Methodology for Pumped Hydro Energy Storage Plant (PHESP) Site Selection from a Sustainable Development Perspective with an Application”** (published: Renewable & Sustainable Energy Reviews 2019; 112:930-947, Elsevier. Available at <https://www.sciencedirect.com/science/article/pii/S1364032119304289>);
- **“Overcoming local constraints renewable energy systems for the electrification of remote areas in Africa”** (Accepted for publication in Renewable Energy and Environmental Sustainability, EDP Sciences, Available at <https://doi.org/10.1051/rees/2019007>).
- **“A Simple GIS-Based Approach for the Preliminary Assessment of Small-Scale Pumped Hydro Energy Storage (PHES) Potential with Application to Cameroon”** (Unpublished work);

Speeches Given at Some International Conferences

- **24th World Energy Congress, 08 – 12 September 2019, Abu Dhabi – United Arab Emirates:** Attended many panel discussions as “Future Energy Leader and Sub-Saharan Africa energy issues expert”.
- **Speaker 3rd International Conference on Water Storage and Hydropower Development for Africa (AFRICA 2019), 2 – 4 April 2019, Windhoek – Namibia:** “Promoting Pumped Hydro Storage for Sustainable Intermittent Power Generation in Cameroon” (Session 24).
- **Speaker at the WEC World Energy Week, Future Energy Leaders’ Summit, 08 – 11 October 2018, Milan-Italy:** “Some use cases of innovation increasing energy access for communities in Africa”.
- **Speaker at the WEC World Energy Week, Future Energy Leaders’ Summit, 16 – 19 October 2017, Lisbon-Portugal:** “Bringing the attention to the energy access and fuel poverty issues - promoting and sustaining best practices throughout the world”.
- **Speaker at the International Symposium of Engineering Frontiers for Development 12 – 15 February 2017, Edinburgh-UK, by the UK’s Royal Academy of Engineering,:** “How recycling waste from timber industry for energy production can contribute to Sustainable Development in Sub-Saharan Africa: Case study” (Clean energy Session).
- **Speaker at the 23rd World Energy Council Congress, Future Energy Leaders’ Congress, 09 – 13 October 2016, Istanbul-Turkey:** “Public-Private Partnership (PPP): the ongoing helpful strategy in the Cameroon’s power sector”.

Others

- **Peer reviewer at many Elsevier journals**, including Biomass & Bioenergy (JBB), Journal of Cleaner Production (JCLEPRO);
- **Member of the Research Proposals Reviewing Board near The Research Council (TRC) of Oman** (<https://www.trc.gov.om/trcweb/home>), since November 2019.

Curriculum Vitae

NZOTCHA URBAIN

Engineer, PhD, WEC-FEL Certified

49 Foch Street, Akwa-Douala; P.O. Box: 15196 Douala • Tel: (+237) 674 517 075 • Email: urbainzotcha@yahoo.fr

LinkedIn: <https://www.linkedin.com/in/urbain-nzotcha-73709a5b>

ORCID ID: <https://orcid.org/0000-0002-1749-5471>

Dr. Urbain NZOTCHA is a Cameroonian graduated from the Advanced School of Engineering of the University of Yaoundé I in 2012. He initially works as mechanical engineer in a wood-processing industry before his passion for the energy sector brought him back to the University where as a part-time student, he gained a MSc degree in 2015 and recently (August 2020) a PhD degree in energy engineering. He is co/author of many published research papers addressing issues of sustainable power generation and energy access in developing countries. His strong involvement in the activities of World Energy Council (WEC) he joined in 2016 as Future Energy Leader (FEL), earned him the prestigious WEC-FEL certification in 2019 and today, Urbain is recognized as part of the WEC experts' network. He also has experience with the private sector, working as Consultant and Projects Manager in various domains including industry and rural electrification.

Education

- 2016 - 2020 **Ph.D. in Energy Engineering**
National Advanced School of Engineering, University of Yaoundé I, Cameroon.
- 2014 - 2015 **M.Sc. in Energy Engineering**
National Advanced School of Engineering, University of Yaoundé I, Cameroon.
- 2009 - 2012 **Master's equivalent in Industrial Engineering.**
National Advanced School of Engineering, University of Yaoundé I, Cameroon.
- 2008 - 2009 **Master's equivalent in Mathematics.**
Faculty of Sciences, University of Yaoundé I, Cameroon.
- 2005 - 2008 **Bachelor's equivalent in Mathematics.**
Faculty of Sciences, University of Dschang, Cameroon.

Some key research findings (Scientific papers authorship)

- **“Contribution of the wood-processing industry for sustainable power generation: Viability of biomass-fuelled cogeneration in Sub-Saharan Africa”** (Published: Journal of Biomass and Bioenergy 2019; 120:324–331, Elsevier. Available at <https://doi.org/10.1016/j.biombioe.2018.11.015>);
- **“Integrated Multi-Criteria Decision Making (MCDM) Methodology for Pumped Hydro Energy Storage Plant (PHESP) Site Selection from a Sustainable Development Perspective with an Application”** (published: Renewable & Sustainable Energy Reviews 2019; 112:930-947, Elsevier. Available at <https://doi.org/10.1016/j.rser.2019.06.035>);
- **“Overcoming local constraints when developing renewable energy systems for the electrification of remote areas in Africa”** (Accepted for publication in Renewable Energy and Environmental Sustainability 2020; 5(1):1-10, EDP Sciences, Available at <https://doi.org/10.1051/rees/2019007>);
- **“Assessment of the potential for electricity savings in households in Cameroon: A stochastic frontier approach”** (Accepted Manuscript for publication in Energy, an Elsevier Journal).

- **“Promoting Pumped-hydro Energy Storage for Sustainable Variable Power Generation: Case of Cameroon”** (Under consideration for publication in the Elsevier’s Journal of Renewable Energy, Ref. N° RENE-D-19-02638).

International Conferences

- **24th World Energy Congress, 08 – 12 September 2019, Abu Dhabi – United Arab Emirates:** Attended many panel discussions as “Future Energy Leader and Sub-Saharan Africa energy issues expert”.
- **Speaker 3rd International Conference on Water Storage and Hydropower Development for Africa (AFRICA 2019), 2 – 4 April 2019, Windhoek – Namibia:** *“Promoting Pumped Hydro Storage for Sustainable Intermittent Power Generation in Cameroon”* (Session 24).
- **Speaker at the WEC World Energy Week, Future Energy Leaders’ Summit, 08 – 11 October 2018, Milan-Italy:** *“Some use cases of innovation increasing energy access for communities in Africa”*.
- **Speaker at the WEC World Energy Week, Future Energy Leaders’ Summit, 16 – 19 October 2017, Lisbon-Portugal:** *“Bringing the attention to the energy access and fuel poverty issues - promoting and sustaining best practices throughout the world”*.
- **Speaker at the International Symposium of Engineering Frontiers for Development 12 – 15 February 2017, Edinburgh-UK, by the UK’s Royal Academy of Engineering,:** *“How recycling waste from timber industry for energy production can contribute to Sustainable Development in Sub-Saharan Africa: Case study”* (Clean energy Session).
- **Speaker at the 23rd World Energy Council Congress, Future Energy Leaders’ Congress, 09 – 13 October 2016, Istanbul-Turkey:** *“Public-Private Partnership (PPP): the ongoing helpful strategy in the Cameroon’s power sector”*.

Work Experience

- | | |
|-----------------------|--|
| Nov. 2016 - Present | <p>Project Engineer, Africa Group-co Plc (An investments and real estate services private-owned company in Douala)</p> <ul style="list-style-type: none"> - Management of the company's various engineering projects; - Contribution, in collaboration with partners abroad, to the planning and the pre-engineering studies of industrial projects held by the company. |
| Oct. 2014 – Nov. 2016 | <p>Head of the Solar Energy Department at “Institut de Technologies Appliquées” (A vocational training school in Douala)</p> <ul style="list-style-type: none"> - Management of the training of PV solar technicians; - Coordination of the services offered by the institute. |
| Jan. 2013 – Sep. 2014 | <p>Head of Engineering Department at UNALOR (A wood-processing factory based in Douala)</p> <ul style="list-style-type: none"> - Management of the whole factory’s maintenance, including the spare parts manufacturing and store; - In charge of the engineering office operating as support to the maintenance office; - Managed the “Unalor’s Energy Efficiency” project which aimed at reducing energy costs and optimising the use of wood waste for energy production. |

Others

Certificates and Awards:

- Awarded the Silver Certificate as “Future Energy Leader” (FEL) by the World Energy Council (WEC), March 2019;
- Four year (2005 – 2008) Winner of the “Academic Excellence” awards in the Hauts-Plateaux Division, Cameroon.

Languages:

- French: Native language;
- English: Good command (reading, writing and speaking).

Computer skills:

- High level command with the MS Office package, a wide range of softwares in energy engineering (ENERGYPLAN, LEAP, etc.), industrial engineering (AUTOCAD, SOLID WORKS, SKETCHUP, etc.) projects management (M.S. Projects) and Geographical Information Systems (ARCGIS-ArcMap, Surfer Plot, Google Earth Pro, etc.).

Knowledge communities' membership:

- Reviewer at many Elsevier scientific journals: Biomass & Bioenergy (JBB), Journal of Cleaner Production (JCLEPRO);
- Member of the research proposals reviewing team, Research Department of the Sultan Qaboos University in the Sultanate of Oman, since December 2019;
- Member of the World Energy Council's experts network (Energy Trilemma) and #FEL100 Alumni.

I declare on the honour that all information provided above are exact and verifiable.

Douala, 20th of August 2020



Urbain NZOTCHA