



HAL
open science

A decision support system for long-term supply chain capacity planning: a model-driven engineering approach

Raphaël Oger

► **To cite this version:**

Raphaël Oger. A decision support system for long-term supply chain capacity planning: a model-driven engineering approach. Other [cs.OH]. Ecole des Mines d'Albi-Carmaux, 2019. English. NNT : 2019EMAC0013 . tel-03010406

HAL Id: tel-03010406

<https://hal.science/tel-03010406v1>

Submitted on 1 Jan 2021

HAL is a multi-disciplinary open access archive for the deposit and dissemination of scientific research documents, whether they are published or not. The documents may come from teaching and research institutions in France or abroad, or from public or private research centers.

L'archive ouverte pluridisciplinaire **HAL**, est destinée au dépôt et à la diffusion de documents scientifiques de niveau recherche, publiés ou non, émanant des établissements d'enseignement et de recherche français ou étrangers, des laboratoires publics ou privés.



THÈSE

En vue de l'obtention du

DOCTORAT DE L'UNIVERSITÉ DE TOULOUSE

délivré par

IMT – École Nationale Supérieure des Mines d'Albi-Carmaux

présentée et soutenue par

Raphaël OGER

le 14 novembre 2019

Titre :

A decision support system for long-term supply chain capacity planning:
a model-driven engineering approach

École doctorale et discipline ou spécialité :

EDSYS : Génie Industriel et Informatique

Unité de recherche :

Centre Génie Industriel, IMT Mines Albi

Directeurs de thèse :

Matthieu LAURAS, Professeur, IMT Mines Albi

Benoit MONTREUIL, Professeur, Georgia Institute of Technology

Autres membres du jury :

Maria Jesús SAÉNZ, Professeur, Massachusetts Institute of Technology, Rapporteur

Bruno AGARD, Professeur, École Polytechnique de Montréal, Rapporteur

Yves SALLEZ, Professeur, Université Polytechnique Hauts-de-France, Président

Christophe ROUSSE, Ingénieur, Pierre Fabre Dermo-Cosmétique, Examineur

Frédéric BÉNABEN, Professeur, IMT Mines Albi, Encadrant

ABSTRACT

Long-term Supply Chain Capacity Planning (SCCP) aims to define the plan of all actions to perform that will shape the available and required capacity of supply chains over several years. When performing long-term SCCP, companies are confronted with a multitude of decision options and uncertainty sources as well as a highly dynamic supply chain environment. Each company configures its own Decision Support System (DSS) to perform SCCP, composed of a decision-making process, an information system, and people.

Companies can take advantage of existing decision-making processes and information systems to build their own SCCP DSS. However, the literature review on existing decision-making processes and information systems for SCCP revealed the following three major limitations: first, existing solutions are time-consuming. This constrains companies to consider only a small number of alternative scenarios associated with decision options and uncertainty sources. And it makes it difficult to keep SCCP analysis up to date. Second, existing solutions are designed to perform SCCP analysis on predefined supply chains without considering the whole set of potential alternative configurations. Third, decision-makers are reluctant to accept optimization methods because of the lack of visibility of the analysis leading to the recommended solution.

Therefore, this thesis describes a new SCCP DSS proposal aiming to overcome these limitations. It is composed of an SCCP decision-making process proposal relying on an SCCP information system proposal. The SCCP decision-making process proposal contains two processes: implementation and routine. The SCCP information system proposal contains two software programs: a computational software program and a business intelligence software program.

The SCCP DSS proposal was validated by undertaking two industrial pilot projects with two industrial partners. The following two major benefits have been confirmed: first, SCCP analysis can be performed in encompassing a multitude of decision options and uncertainty sources at a pace allowing updates in accordance with the pace of supply chain changes. Second, it provides decision-makers with the visibility and understanding of the impacts of their respective decisions and uncertainty sources which bolster their confidence in the decisions they can make.

Finally, avenues for future research have been identified, including an opportunity for designing a hyperconnected SCCP DSS that automatically gathers information and triggers decision-making meetings when necessary rather than on a predefined frequency.

Keywords: Supply Chain, Capacity Planning, Decision Support Systems, Information Systems, Decision-Making Processes, Model-Driven Engineering.

RESUME

La planification capacitaire des chaînes logistiques (SCCP) sur un horizon long-terme a pour objectif de définir un plan d'actions contenant l'ensemble des actions qui vont façonner la capacité disponible et requise des chaînes logistiques sur plusieurs années. Lorsque les entreprises réalisent leur SCCP sur un horizon long-terme, elles sont confrontées à une multitude d'options décisionnelles et de sources d'incertitudes, ainsi qu'à un environnement très dynamique. Chaque entreprise met en place son propre système d'aide à la décision (SCCP DSS) pour réaliser sa SCCP. Ce DSS est composé d'un processus de prise de décisions, d'un système d'information, et de personnes.

Les entreprises peuvent utiliser les processus de prise de décisions et systèmes d'information existants pour créer leur propre SCCP DSS. Cependant, la revue de littérature relative aux processus de prise de décisions et systèmes d'information existants pouvant servir à la création d'un SCCP DSS a révélé les trois limitations suivantes : premièrement, les solutions existantes sont très chronophages. Cette limitation contraint les entreprises à ne prendre en compte qu'un nombre limité de scénarios alternatifs associés aux options décisionnelles et aux sources d'incertitudes. De plus, cela rend difficile le maintien à jour des analyses SCCP. Deuxièmement, les solutions existantes sont conçues pour réaliser les analyses SCCP sur des chaînes logistiques prédéfinies et figées, sans considération de l'ensemble des potentielles alternatives structurelles. Troisièmement, les décideurs sont parfois réticents face aux méthodes d'optimisation du fait du manque de visibilité sur le processus d'obtention de la solution recommandée.

Ainsi, cette thèse décrit la proposition d'un nouveau SCCP DSS ayant pour objectif de solutionner ces limitations. Il est composé d'une proposition de processus de prise de décisions SCCP tirant profit d'une proposition de système d'information SCCP. Le processus de prise de décisions SCCP est composé de deux processus : implémentation et routine. Le système d'information SCCP est composé de deux logiciels : un logiciel calculatoire et un logiciel de business intelligence.

La proposition de SCCP DSS a été validée en réalisant deux projets pilotes avec deux partenaires industriels. Deux bénéfices majeurs ont été identifiés : premièrement, cela permet de prendre en compte une multitude d'options décisionnelles et de sources d'incertitudes durant les analyses SCCP à un rythme permettant un maintien à jour de ces analyses. Deuxièmement, cela permet aux décideurs d'avoir de la visibilité sur l'impact que leurs options décisionnelles et sources d'incertitudes auraient sur l'entreprise, ce qui renforce leur confiance vis-à-vis des décisions qu'ils peuvent prendre.

Finalement, des perspectives de recherche ont été identifiées, incluant notamment la conception d'un SCCP DSS hyperconnecté qui collecterait automatiquement les informations et déclencherait des réunions de prises de décisions seulement quand cela est nécessaire plutôt qu'à une fréquence prédéfinie.

Mots clés : Chaînes logistiques, planification capacitaire, systèmes d'aide à la décision, systèmes d'information, processus décisionnels, ingénierie dirigée par les modèles.

RESUME LONG EN FRANÇAIS

Pour fournir leurs produits aux clients, les entreprises organisent l'enchaînement d'un ensemble d'activités (production, transport, etc.) pour transformer les matières premières en produits finis et les livrer. Cet enchaînement d'activités impliquant des flux physiques, financiers, et informationnels est appelé chaîne logistique (APICS 2016). La Figure 1 illustre le concept de chaîne logistique. Elle illustre notamment ses différents types d'acteurs et de flux. Pour que ces chaînes logistiques apportent les résultats souhaités, il faut en organiser la gestion. Le premier ouvrage identifié traitant de la thématique de la gestion de ces chaînes logistiques (« supply chain management » en anglais) est paru en 1982 (Oliver and Webber 1982). Il existe plusieurs points de vue quant à la structuration des activités de gestion des chaînes logistiques. Par exemple, le dictionnaire APICS (2016) définit les 5 processus suivants : conception, planification, exécution, contrôle, et supervision. Un autre point de vue est celui du modèle SCOR (Supply Chain Council 2012) qui définit les 6 processus suivants : approvisionnement, fabrication, livraison, retours (clients et fournisseurs), support, et planification (Figure 2).

Parmi les processus du modèle SCOR, celui de « planification » (qui englobe également celui de « conception » de la définition APICS) a pour objectif d'anticiper les besoins de fonctionnement des autres processus afin de décider de la mise à disposition ou non de ces besoins et d'organiser cette mise à disposition. Cette thèse se focalise sur ce processus de planification (Figure 2). De plus, ce processus est généralement divisé en trois sous-processus : la planification court-terme (ou opérationnelle), la planification moyen-terme (ou tactique), et la planification long-terme (ou stratégique). Cette thèse se focalise sur la planification long-terme (Figure 5). Fournir aux clients une quantité donnée de produits finis nécessite que les chaînes logistiques correspondantes aient la capacité adéquate pour réaliser les activités associées. Un des processus de prise de décisions permettant de définir cette capacité est la « planification capacitaire des chaînes logistiques sur un horizon long-terme ». Ce processus sera appelé par son acronyme anglais dans la suite de ce résumé : SCCP (« Supply Chain Capacity Planning »). Ce processus SCCP a pour objectif de définir les actions que les entreprises vont réaliser pour façonner la capacité disponible et requise des chaînes logistiques sur plusieurs années. Il se focalise notamment sur les actions ayant une longue durée d'implémentation ou des conséquences sur une longue période. Quelques exemples sont donnés en Figure 6. La mise en place d'un processus SCCP dans une entreprise implique la structuration d'un système d'aide à la décision. Ce dernier est défini dans cette thèse comme étant composé de 4 éléments : un processus de prise de décision, un système d'information, un ensemble de personnes, et un objectif (Figure 16).

Cette thèse s'inscrit dans cette thématique des systèmes d'aide à la décision permettant de supporter la prise de décision SCCP. Dans ce cadre, un partenariat académique et industriel, appelé *Chaire Mines Albi Supply Chain Agile avec Pierre Fabre*, a été établi entre deux partenaires industrielles et deux partenaires académiques : premièrement, deux entreprises du groupe Pierre Fabre : Pierre Fabre Dermo-Cosmétique et Pierre Fabre Médicament (Pierre Fabre 2019) ; deuxièmement, le Centre Génie Industriel d'IMT Mines Albi (Centre Génie Industriel 2019), et

le laboratoire Physical Internet Center de l'université Georgia Institute of Technology (Physical Internet Center 2019).

Dans un premier temps, le chapitre d'introduction (page 1) de cette thèse décrit des caractéristiques de l'environnement décisionnel des entreprises ; environnement dans lequel les systèmes d'aide à la décision SCCP sont implémentés et donc auquel ils doivent être adaptés. Des questions industrielles sont déduites du croisement des caractéristiques de l'environnement avec les objectifs du système d'aide à la décision SCCP. Ensuite, le second chapitre (page 27) met en lumière les limites des solutions existantes (processus décisionnels et systèmes d'information) pour leur utilisation dans l'environnement décisionnel des entreprises décrit dans le chapitre d'introduction. En réponse à ces limitations, ce second chapitre introduit un cadre conceptuel pour guider la conception de systèmes d'aide à la décision SCCP adaptés aux caractéristiques de l'environnement décisionnel des entreprises. Après avoir proposé ce cadre conceptuel, les chapitres 3 (page 59) et chapitre 4 (page 103) décrivent respectivement une proposition de système d'information et de processus de prise de décision SCCP. Ces deux propositions ont ensuite été testées au travers de deux projets industriels décrits dans le chapitre 5 (page 137). Finalement, le chapitre 6 (page 185) conclut sur les contributions de cette thèse et ouvre sur des perspectives de recherche. La Figure 14 illustre la structuration des chapitres par rapport aux contributions de ce manuscrit.

Pour ce qui est des caractéristiques de l'environnement décisionnel des entreprises, trois ont été identifiées et considérées pour la construction des questions industrielles de cette thèse (Figure 9) : premièrement, la multitude de sources d'incertitudes ; deuxièmement, la multitude d'options décisionnelles ; troisièmement, la dynamique (c.-à-d. rapidité d'évolution) de l'environnement. L'analyse de la première caractéristique, la multitude de sources d'incertitudes, a aboutie à la première question industrielle (Figure 9) : « Comment considérer la multitude de sources d'incertitudes lors de l'évaluation et la comparaison des alternatives de planification capacitaire des chaînes logistiques, et lors de la sélection de celle à implémenter ? ». L'analyse de la seconde caractéristique, la multitude d'options décisionnelles, a abouti à la seconde question industrielle de cette thèse (Figure 9) : « Comment considérer la multitude d'options décisionnelles lors de l'évaluation et la comparaison des alternatives de planification capacitaire des chaînes logistiques, et lors de la prise de décision de celle à implémenter ? ». L'analyse de la troisième caractéristique, la dynamique de l'environnement, a abouti à la troisième question industrielle de cette thèse (Figure 9) : « Comment rendre le processus SCCP suffisamment simple et rapide pour qu'il puisse devenir une routine permettant aux entreprises de le maintenir leurs décisions à jour au vu de la dynamique de l'environnement de leurs chaînes logistiques ? ».

Pour répondre à ces trois questions industrielles, une revue de littérature des solutions existantes a été effectuée. Elle a été focalisée sur les deux composantes suivantes des systèmes d'aide à la décision : le processus de prise de décision et le système d'information. Pour ce qui est des processus de prise de décisions pouvant répondre aux objectifs SCCP, les quatre suivants ont été identifiés dans la littérature (Figure 17) : Sales and Operations Planning (S&OP), Integrated Business Planning (IBP), Adaptive Sales and Operations Planning (AS&OP), et Collaborative Planning, Forecast, and Replenishment (CPFR). Pour ce qui est des systèmes d'information pouvant répondre aux objectifs SCCP, les trois suivants ont été identifiés dans la littérature (Figure 17) : les progiciels de gestion d'entreprise (Enterprise Resource Planning (ERP) en anglais), les systèmes de planification avancée (Advanced Planning Systems (APS) en anglais),

et les tableurs (ex. Microsoft Excel et Libre Office). Pour ce qui est de l'ensemble de personnes, il est généralement décrit dans les processus de prise de décisions.

Les entreprises peuvent utiliser les processus de prise de décisions et les systèmes d'information existants pour créer leur propre système SCCP. Cependant, les solutions existantes qui ont été identifiées et étudiées durant la revue de littérature ne permettent pas de répondre entièrement aux questions industrielles. Les trois limitations suivantes ont notamment été identifiées : premièrement, les solutions existantes sont très chronophages. Cette limitation contraint les entreprises à ne prendre en compte qu'un nombre limité de scénarios alternatifs associés aux options décisionnelles et aux sources d'incertitudes. De plus, cela rend difficile le maintien à jour des analyses SCCP. Deuxièmement, les solutions existantes sont conçues pour réaliser les analyses SCCP sur des chaînes logistiques prédéfinies et figées, sans considération de l'ensemble des potentielles alternatives structurelles. Troisièmement, les décideurs sont parfois réticents face aux méthodes d'optimisation du fait du manque de visibilité sur le processus d'obtention de la solution recommandée.

Pour surmonter les limitations identifiées, la première question de recherche suivante a été formulée (page 40) : « Quelles seraient les fonctionnalités d'un système d'aide à la décision SCCP permettant de gérer les options décisionnelles, les sources d'incertitudes, ainsi que la dynamique et la visibilité requises par les chaînes logistiques actuelles ? ». De cette première question de recherche a découlé la première contribution de ce manuscrit : un cadre conceptuel SCCP proposant des principes clés pour la conception d'un système d'aide à la décision SCCP répondant à cette première question de recherche. Il est structuré autour de la proposition des étapes du processus de prise de décisions SCCP, incluant les principes clés des interactions avec le système d'information SCCP ainsi que la structuration des rôles des personnes prenant part à ce processus. Les grandes étapes du processus de prise de décisions proposé par le cadre conceptuel SCCP sont inspirées de processus de résolution de problèmes et de prise de décisions décrits dans la littérature (Bell et al. 1977, Sainfort et al. 1990, Klein et al. 1993, Guo 2008). Les trois grandes étapes sont les suivantes : l'identification des alternatives, l'évaluation des alternatives, et enfin la comparaison des alternatives pour supporter la prise de décision. Dans le processus de prise de décisions proposé, ces 3 étapes ont été nommées comme suit : « génération des alternatives de planning SCCP », « évaluation des alternatives de planning SCCP », et « décision de l'alternative de planning SCCP à implémenter » (Figure 22). Chacune de ces étapes est déclinée en 2 ou 3 activités également illustrées par la Figure 22. Ensuite, chacune de ces activités est décrite et les figures Figure 23 à Figure 30 décrivent les 7 activités en synthétisant leurs objectifs, entrées, sorties, et ressources requises. Finalement, la Figure 31 illustre la structuration des catégories d'acteurs du processus ainsi que leurs interactions dans les différentes activités.

Pour terminer sur le second chapitre décrivant la proposition du cadre conceptuel SCCP, la caractéristique majeure du cadre conceptuel SCCP est l'automatisation d'une partie des activités du processus de prise de décision par le système d'information associé.

Après la proposition du cadre conceptuel SCCP vient la proposition concrète d'un système d'aide à la décision SCCP correspondant aux caractéristiques définies par le cadre conceptuel. L'objectif du troisième chapitre (page 59) est d'introduire le système d'information proposé. La proposition de système d'information contient deux logiciels, un logiciel calculatoire SCCP

permettant d'obtenir les résultats des scénarios, et un logiciel d'informatique décisionnelle (c.-à-d. business intelligence) permettant de visualiser ces résultats. Le logiciel calculatoire SCCP est appelé « computational software » dans le manuscrit, et le logiciel d'informatique décisionnelle est appelé « business intelligence software ». Le troisième chapitre se concentre sur la description du logiciel calculatoire SCCP (Figure 32).

Le cadre conceptuel définit que les deux activités suivantes doivent être entièrement automatisées : « générer un modèle d'évaluation compatible avec l'ensemble des scénarios alternatifs » (en anglais : « generate an assessment model compatible with all what-if scenarios. ») et « évaluer les scénarios alternatifs » (en anglais : « assess what-if scenarios. »). Mais, il a été constaté dans la littérature que les modèles existants pour l'évaluation des alternatives de planning SCCP (ex. optimisation, simulation, et heuristiques) requièrent que les utilisateurs fournissent le modèle des chaînes logistiques à évaluer (Ling and Goddard 1988, Van Mieghem 2003, Mula et al. 2006, Wallace and Stahl 2008, Stadtler et al. 2015, Calvete et al. 2016, Martel and Klibi 2016). Une limite qui fait écho à celle identifiée précédemment étant donné que les approches existantes sont trop chronophages pour répondre aux besoins des questions industrielles. Une idée a alors émergé de ces constatations : changer l'approche en passant de la modélisation manuelle des alternatives de chaînes logistiques et du modèle d'évaluation associé, à leur déduction automatisée. Ainsi, la revue de littérature associée au troisième chapitre s'est concentrée sur la recherche de solutions existantes pour déduire automatiquement des alternatives de chaînes logistiques et du modèle d'évaluation associé.

Le résultat de cette revue de littérature est le suivant : toutes les solutions identifiées pour déduire automatiquement de potentielles relations clients-fournisseurs se contentent d'une relation entre deux acteurs, sans proposer de déduction de chaînes logistiques sur plusieurs échelons. Un seul article identifié propose une méthodologie de déduction des chaînes logistiques (Fritz et al. 2018). Mais cette méthodologie est manuelle et décrite comme chronophage. Cela fait écho aux résultats de la première revue de littérature qui concluait notamment que les processus de prise de décisions SCCP existants sont trop chronophages. Certains auteurs tels que Kaipia et al. (2017) indiquent que cette caractéristique des solutions existantes contraint les entreprises à réduire leurs ambitions en termes de qualité de leur processus de prise de décisions. Les auteurs basent notamment leurs conclusions sur l'analyse du processus de planification industrielle et commerciale (« sales and operations planning (S&OP) » en anglais). Ces résultats ont conduit à l'écriture de la seconde question de recherche de ce manuscrit (page 65) : « Comment rendre possible l'objectif d'automatisation introduite par le cadre conceptuel SCCP ? ». Ainsi, le choix a été fait de concentrer les efforts de recherche sur la conception d'un système d'information permettant d'atteindre cet objectif. Un logiciel qui permettrait d'automatiser l'identification et l'évaluation des alternatives de plan SCCP rendues possibles par un ensemble d'acteurs d'un réseau.

Le logiciel calculatoire SCCP mentionné précédemment et décrit dans le troisième chapitre a été conçu pour répondre à la seconde question de recherche. Les principes de fonctionnement du logiciel calculatoire SCCP sont inspirés de l'ingénierie dirigée par les modèles (Bézivin 2005, Czarnecki and Helsen 2006, Object Management Group 2008), incluant les principes de métamodélisation et de transformations de modèles. Le logiciel est composé de trois modules fonctionnant en séquence illustrés par la Figure 34.

Le premier module est le modéleur du réseau d'approvisionnement. Tout d'abord, ce module prend en entrée les données provenant des utilisateurs. Ces données sont relatives aux acteurs du réseau d'approvisionnement, à la demande, ainsi qu'aux options décisionnelles et sources d'incertitudes. Sur la base de ces données, ce module crée un modèle du réseau d'approvisionnement qui pourra ensuite être utilisé par les autres modules. La structure de ce modèle et les données associées sont illustrées par la Figure 35 et les Tableaux Table 2 et Table 3. Il a été conçu pour pouvoir collecter les données de deux manières différentes (Figure 37): premièrement en lisant un fichier XML généré en utilisant le logiciel RIO-Suite (Centre Génie Industriel - IMT Mines Albi 2019), et deuxièmement, en lisant un fichier Excel.

Le second module est le générateur du modèle d'évaluation. Tout d'abord, ce module prend en entrée le modèle du réseau d'approvisionnement créé par le premier module. Sur la base de ce modèle du réseau d'approvisionnement, ce second module génère automatiquement un modèle d'évaluation générique. Les Figures Figure 39 à Figure 42 ainsi que les tableaux Table 7 à Table 10 décrivent et illustrent le fonctionnement et les résultats de ce module. Le terme « modèle d'évaluation » décrit un outil qui peut être utilisé pour évaluer la performance d'un scénario spécifique (ex. : un modèle Excel représentant une planification de chaîne logistique), en lui fournissant en entrée des données qui décrivent les scénarios (ex. en remplissant des cellules Excel avec les valeurs spécifiques au scénario). Le terme « générique » décrit le fait que le modèle d'évaluation est compatible avec tous les scénarios de futurs potentiels pouvant être déduit à partir des informations associées au réseau d'approvisionnement. Autrement dit, le modèle d'évaluation générique n'est pas spécifique à certains scénarios alternatifs, mais peut être utilisé pour évaluer tous les scénarios de futurs potentiels pouvant être déduits à partir des informations associées au réseau d'approvisionnement.

Le troisième module est le générateur et évaluateur de scénarios alternatifs. Tout d'abord, ce module prend en entrée le modèle d'évaluation générique créé par le second module, ainsi que des informations de paramétrage des scénarios de futurs potentiels à considérer fournis par les utilisateurs. Sur la base de ces données, ce module génère la liste des scénarios à évaluer et les évalue. Les Figures Figure 43 à Figure 49 ainsi que les tableaux Table 11 à Table 14 décrivent et illustrent le fonctionnement et les résultats de ce module.

Pour terminer sur le troisième chapitre décrivant la proposition du logiciel calculatoire SCCP (première composante du système d'information SCCP), une des caractéristiques majeures du logiciel calculatoire SCCP proposé est sa capacité à automatiser une partie des activités du processus de prise de décision décrit par le cadre conceptuel SCCP présenté dans le second chapitre.

Après la description de la première composante du système d'information SCCP, l'objectif du quatrième chapitre (page 103) est de finaliser la proposition de système d'aide à la décision SCCP. Ce chapitre décrit la proposition de processus de prise de décisions SCCP ainsi que l'intégration de la seconde composante du système d'information SCCP (le logiciel d'informatique décisionnelle). L'objectif de ce processus de prise de décisions SCCP est de fournir aux entreprises un processus structuré tirant profit du système d'information SCCP pour accompagner la prise de décisions.

Pour concevoir ce processus de prise de décision SCCP, une nouvelle revue de littérature a été réalisée. Le second chapitre a montré que les propositions faites dans la littérature pour ces

processus de prise de décisions intègrent des systèmes d'information considérés comme insuffisants pour répondre aux enjeux de la conception d'un système d'information SCCP. Cependant, tout ou partie des séquences d'activités proposées peuvent s'avérer pertinentes pour la conception d'un processus de prise de décisions en accord avec le cadre conceptuel SCCP. Ainsi, l'objectif de cette revue de littérature était d'identifier, au sein des processus de prise de décisions existants, les éléments qui restent pertinents pour la conception d'un processus SCCP s'appuyant sur le système d'information SCCP proposé. La revue de littérature décrite dans le second chapitre a mis en lumière différents éléments qui ont guidé cette partie du travail. Premièrement, quatre processus potentiellement pertinents pour la construction d'un processus de prise de décisions SCCP : « Sales and Operations Planning » (S&OP) illustré par la Figure 18, « Integrated Business Planning » (IBP) illustré par la Figure 19, « Adaptive Sales and Operations Planning » (AS&OP) illustré par la Figure 20, et « Collaborative Planning, Forecast, and Replenishment » (CPFR) illustré par la Figure 21. Deuxièmement, le fait que le terme IBP est une évolution de S&OP, mais que les descriptions du processus de prise de décisions restent identiques (Palmatier and Crum n.d., Palmatier et al. 2010, Bower 2012). Troisièmement, le fait que la dernière version du processus CPFR (version 2.0) recommande l'utilisation du processus IBP pour la planification correspondant au périmètre considéré dans cette thèse. Ainsi, le focus a été mis sur l'analyse des processus S&OP proposé dans la littérature. Pour faire ces comparaisons, les processus ont été modélisés en utilisant le langage de modélisation BPMN (Object Management Group 2011).

Le résultat de la revue de littérature a montré que, malgré les légères évolutions dans le temps des processus proposés, et malgré les visions légèrement différentes entre auteurs, les principales activités et leur contenu sont restés les mêmes. Notamment une première phase de préparation des informations nécessaires à la prise de décision, puis une seconde phase étant l'instance de prise de décision. De plus, la première phase est généralement découpée en deux étapes, une étape de collection de la vision de chaque département de l'entreprise, puis une seconde étape de consolidation de ces visions en une vision globale et commune pour toute l'entreprise. Considérant le consensus sur les grands principes de certaines étapes du processus, il semble évident qu'elles devraient faire partie du processus de prise de décision SCCP. Cependant, ces processus ne sont pas conçus pour tirer profit de systèmes d'information tels que celui proposé dans le troisième chapitre. Donc, une proposition de processus de prise de décisions SCCP est nécessaire pour finaliser le système d'aide à la décision SCCP. Ce processus doit détailler comment le système d'information SCCP peut être utilisé par les entreprises pour les accompagner dans leur prise de décisions SCCP.

Ces résultats ont conduit à l'écriture de la seconde question de recherche de ce manuscrit (page 110) : « Comment structurer un processus de prise de décisions SCCP en accord avec les principes du cadre conceptuel SCCP en tirant profit du système d'information SCCP proposé ? ». Ainsi, les travaux de recherche qui ont suivi se sont concentrés sur cette question de recherche.

De ces travaux de recherche a résulté la proposition du processus de prise de décisions SCCP décrite dans la seconde section du quatrième chapitre. Le processus de prise de décisions SCCP proposé est composé de deux sous-processus : implémentation et routine. L'objectif du sous-processus d'implémentation est de mettre en place (c.-à-d., configurer) le sous-processus de routine. Et l'objectif du processus de routine est de réaliser cette routine de prise de décisions

SCCP. Le langage de modélisation BPMN (Object Management Group 2011) a été choisi pour formaliser la proposition. La Figure 56 est le plus haut niveau de modélisation proposé décrivant le processus de prise de décisions SCCP avec les deux sous-processus nommés respectivement « Implement the SCCP routine » et « Perform the SCCP routine ».

Le sous-processus de routine est lui-même composé de deux sous-processus : « prepare decision-making meeting » et « perform decision-making meeting » (Figure 72). Premièrement, l'objectif du sous-processus « prepare decision-making meeting » est de collecter, exploiter, et analyser les données SCCP pour préparer des recommandations pour la réunion de prise de décision qui suit. L'objectif est de générer des informations qui seront utiles pour supporter la prise de décision durant la réunion dédiée. Ces informations doivent être aussi complètes et synthétiques que possible pour que les décideurs puissent rapidement comprendre et prendre les décisions. Deuxièmement, l'objectif du sous-processus « perform decisions-making meeting » est de prendre les décisions et de faire des retours d'expérience pour l'amélioration continue du processus dans son ensemble.

Pour ce qui est du sous-processus d'implémentation, il est composé de trois sous-processus : « define decision-making meeting », « define data », et « define stakeholders » (Figure 58). Premièrement, l'objectif du sous-processus « define decision-making meeting » est de définir les entrées et sorties attendues du processus, ainsi que définir la structure de la réunion de prise de décisions. Deuxièmement, l'objectif du sous-processus « define data » est de définir les données qui seront nécessaires durant la préparation de la réunion de prise de décisions. Les informations nécessaires en entrée de la réunion de prise de décisions, définies durant le sous-processus « define decision-making meeting », doivent être prises en compte dans la définition des données nécessaires pour la préparation de la réunion de prise de décisions. Troisièmement, l'objectif du sous-processus « define stakeholders » est de définir les acteurs du processus et leurs rôles. Comme défini par le cadre conceptuel SCCP, chaque personne doit être incluse dans une ou plusieurs des catégories suivantes : « information providers », « SCCP managers » et « decision makers ». Les différents sous-processus sont illustrés au travers d'un diagramme BPMN et les différentes activités de ces sous-processus sont illustrées au travers d'un diagramme IDEF0 (i.e., SADT) (Figures Figure 56 à Figure 79).

Pour terminer sur le quatrième chapitre décrivant la proposition du processus de prise de décisions SCCP, chacune des activités du processus a été conçue pour correspondre au cadre conceptuel SCCP. Le chapitre décrit comment structurer ces activités et comment les entreprises peuvent tirer profit du système d'information SCCP proposé. Dans ce cadre, la seconde composante du système d'information SCCP, le logiciel d'informatique décisionnelle, est introduite au travers de la description de son utilisation dans le processus de prise de décisions SCCP.

Après la description de la proposition de système d'aide à la décision SCCP dans les chapitres II à IV, le cinquième chapitre a pour objectif de valider cette proposition au travers de deux applications industrielles réelles. Comme mentionné précédemment, ce projet de recherche est réalisé en collaboration avec deux entreprises du groupe Pierre Fabre : Pierre Fabre Dermo-Cosmétique et Pierre Fabre Médicament. Une application industrielle a été réalisée avec chaque entreprise. L'objectif de validation peut être découpé en trois composantes : premièrement, la confirmation de l'applicabilité des contributions à deux cas d'application ayant des contextes

industriels différents. Deuxièmement, l'évaluation des bénéfices apportés par les contributions par rapport à la situation existante. Troisièmement, l'identification des limitations et perspectives de recherche associées. Le cinquième chapitre décrit donc les deux cas d'application et résultats associés.

Pour ce qui est de cas d'application avec Pierre Fabre Dermo-Cosmétique (page 139), l'objectif métier était de trouver une solution pour identifier facilement les faiblesses capacitaires au sein de son réseau de fournisseurs de flacons et prioriser celles sur lesquelles focaliser les actions. Durant l'expérimentation, le processus de prise de décisions SCCP proposé a été déroulé, incluant la phase d'implémentation et celle de routine. La phase d'implémentation a permis de définir les informations nécessaires à la prise de décisions, les données à collecter, ainsi que les acteurs du processus. Il a notamment été choisi de travailler avec des données vieilles de deux ans afin de comparer les décisions prises à la fin de la phase de routine avec les décisions qui ont réellement été prises durant les deux années précédant l'expérimentation. Cette comparaison a permis d'identifier les bénéfices, en termes d'amélioration des résultats du processus de prise de décision SCCP, apportés par l'approche proposée dans cette thèse.

Plusieurs bénéfices, notamment permis par le système d'information SCCP, ont pu être observés durant la phase de routine : premièrement, après avoir collecté les informations sur son réseau de fournisseurs de flacons, l'évaluation de la robustesse du réseau face à un grand nombre d'incertitudes a pris très peu de temps par rapport au temps qui aurait dû y être consacré sans le système d'information SCCP. Le système d'information SCCP a également permis d'évaluer automatiquement un grand nombre de scénarios, beaucoup plus de ce que l'entreprise était capable de faire sans ce système d'information SCCP (de quelques dizaines sans à plusieurs milliers avec). Deuxièmement, durant la phase de préparation de la réunion de prise de décisions, l'entreprise a pu décider de changer à la volée les scénarios à évaluer même lorsque ces derniers impliquaient des changements structurels de la chaîne logistique, sans que cela n'impacte de manière conséquente le temps d'évaluation des scénarios. Cela a été rendu possible par le module du système d'information SCCP qui automatise la création d'un modèle d'évaluation générique utilisé pour l'évaluation des scénarios. Troisièmement, la combinaison des données de résultats des scénarios fournis par le logiciel calculatoire SCCP avec les fonctionnalités du logiciel d'informatique décisionnelle a permis de fournir aux décideurs un ensemble de tableaux de bord avec différents niveaux d'agrégation (ex. réseau, fournisseur, type d'équipement, équipement, et produit). Une partie de ces tableaux de bord sont disponibles en figures Figure 87 à Figure 91. Quatrièmement, cela a permis à l'entreprise de rapprocher ses différents départements autour d'une vision commune de la performance capacitaire du réseau de fournisseurs de l'entreprise et de son impact sur les performances de l'entreprise. Cela a été rendu possible par la capacité du logiciel calculatoire SCCP à intégrer dans son modèle des options décisionnelles et sources d'incertitudes relatives à tous les départements de l'entreprise. Car cela a permis à chaque département d'observer et de prendre conscience de l'impact des options décisionnelles et sources d'incertitudes associées à leur propre département.

Finalement, avec les données vieilles de deux ans, cinq points de faiblesses ont été identifiés dans le réseau de fournisseurs de flacons de l'entreprise (Table 34). La comparaison de ces points de faiblesses avec les décisions qui ont réellement été prises durant les deux années qui ont précédé a mis en évidence que seul un de ces points de faiblesse avait été sécurisé. Le système

d'aide à la décision proposé a permis d'identifier quatre faiblesses supplémentaires à investiguer et sécuriser.

Pour ce qui est du cas d'application avec Pierre Fabre Médicament (page 176), on se place dans le contexte de l'équipe responsable d'assurer que l'entreprise aura la capacité de production adéquate pour répondre à la demande dans les années à venir. Pour réaliser cette mission, l'équipe a divisé son portefeuille de produits en familles ayant des caractéristiques similaires. L'équipe a défini une routine pour évaluer la capacité de production associée à une ou deux familles par mois. Chaque famille était donc considérée une fois par an. Ce choix avait été fait, car cela leur prend des jours voire des semaines pour réaliser les analyses correspondantes. De plus, malgré ce choix, l'équipe n'était capable d'évaluer qu'un petit nombre de scénarios alternatifs. Ainsi, l'objectif métier du cas d'application était d'accompagner cette équipe pour diminuer le temps qui lui est nécessaire pour réaliser les analyses capacitaires et de permettre d'aller plus loin dans ces analyses. Durant l'expérimentation, le processus de prise de décisions SCCP proposé a été déroulé, incluant la phase d'implémentation et celle de routine. La phase d'implémentation a permis de définir les informations nécessaires à la prise de décisions, les données à collecter, ainsi que les acteurs du processus. Il a notamment été choisi de se focaliser sur les capacités de production des différentes usines de l'entreprise et sur l'intégralité du portefeuille produit associé.

Plusieurs bénéfices, notamment permis par le système d'information SCCP, ont pu être observés durant la phase de routine : premièrement, le temps nécessaire à la génération et l'évaluation des scénarios capacitaires a été réduit de plusieurs jours à quelques minutes (Figure 94). Cela a été rendu possible par le module du système d'information SCCP qui automatise la création d'un modèle d'évaluation générique utilisé pour l'évaluation des scénarios ainsi qu'au module qui génère et évalue automatiquement les scénarios. Deuxièmement, grâce au gain de temps mentionné précédemment, l'équipe a pu se permettre d'augmenter son temps alloué à l'analyse des résultats à l'aide du logiciel d'informatique décisionnelle. Sans le système d'information SCCP, l'équipe passe la plus grande partie de son temps à l'évaluation des scénarios, alors qu'avec ce système d'information SCCP, l'équipe peut se concentrer sur l'analyse des résultats des scénarios. Cela permet à l'équipe d'améliorer son analyse capacitaire en considérant plus fréquemment l'ensemble des familles de produits, en considérant plus de scénarios alternatifs, et en prenant plus de temps pour la construction et l'analyse d'indicateurs de performance.

Finalement, comme mentionnée par Saenz and Cottrill (2019), la confiance qu'ont les décideurs envers les technologies de l'information est un facteur clé du succès de leur implémentation. Ainsi, l'équipe de l'entreprise a comparé les résultats du processus standard (sans le système d'information SCCP) versus les résultats avec le système d'information SCCP. Pour faire cette comparaison, les tableaux de bord issus du système d'information SCCP ont été utilisés durant une des réunions traditionnelles de revue capacitaire associée à une de ses familles de produits, et ont été comparés avec les informations fournies par les tableaux de bord issus de l'approche traditionnelle de l'entreprise. Cela a permis de démontrer la validité des résultats obtenus via le système d'information SCCP en les comparant aux résultats des scénarios obtenus avec leur approche traditionnelle. Une partie de ces tableaux de bord sont disponibles en Figure 92 et Figure 93.

Pour conclure, un ensemble de limitations et de perspectives de recherche associées ont été identifiées. En ce qui concerne la validation métier du système d'information SCCP qui a été validé sur deux cas d'application industriels, il serait intéressant de le mettre à l'épreuve sur d'avantages de cas d'application industriels de différents secteurs d'activité. De plus, un des cas d'application était focalisé sur l'analyse capacitaire d'un réseau de fournisseurs et l'autre sur la capacité de production interne à l'entreprise. Ces deux cas d'application ont permis de valider de manière indépendante deux types d'analyses capacitaires des chaînes logistiques prises du point de vue d'une entreprise : premièrement, l'approche avec une vision de la capacité interne à l'entreprise, et deuxièmement, l'approche avec une vision de la capacité externe à l'entreprise (en l'occurrence des fournisseurs dans le premier cas d'application). Cependant, aucun des cas d'application ne contenait ces deux visions simultanément. Il serait donc pertinent d'évaluer la proposition du système d'information SCCP sur des cas d'application combinant ces deux visions. Cela permettrait de confirmer la capacité de l'approche proposée de fournir aux entreprises des analyses capacitaires complètes de leurs chaînes logistiques, incluant à la fois les analyses capacitaires amont, aval, et interne, ainsi que leurs dépendances.

En ce qui concerne le système d'information SCCP, quatre perspectives principales ont été identifiées. Premièrement, son extension en ajoutant un module qui permettrait d'automatiser la suggestion de types d'options décisionnelles qui seraient bénéfiques à l'entreprise, pour que cette dernière puisse chercher s'il existe des options décisionnelles de ce type. Cela permettrait de compléter les options décisionnelles identifiées par les équipes de l'entreprise avec de nouvelles suggestions de types d'options décisionnelles qui auraient un impact positif sur la performance de l'entreprise. Deuxièmement, son extension en ajoutant un module qui permettrait d'accompagner les entreprises dans la configuration des scénarios alternatifs à évaluer. Cela pourrait également permettre d'améliorer la culture de l'entreprise en termes de gestion des risques. Troisièmement, son extension avec un module permettant de recommander automatiquement des décisions à prendre. Quatrièmement, l'amélioration du module de génération du modèle d'évaluation générique avec un modèle qui permettrait de relaxer l'hypothèse d'un temps de cycle très inférieur à la granularité temporelle choisie.

En ce qui concerne le processus de prise de décisions SCCP, trois perspectives principales ont été identifiées. Premièrement, l'amélioration des directives pour la mise en place du processus afin de mieux accompagner les entreprises. Deuxièmement, la création d'un modèle de maturité pour évaluer la mise en place du processus. Troisièmement, l'extension du processus qui est centré sur les l'atteinte des objectifs d'une entreprise en un processus collaboratif multi-entreprises permettant de coordonner un réseau de partenaires dans leurs prises de décisions SCCP.

Finalement, une dernière perspective majeure et plus long terme est mise en avant, la conception d'un système d'aide à la décision SCCP hyperconnecté et dirigé par les événements. Un système d'aide à la décision SCCP qui serait entièrement automatisé, depuis la collecte des informations jusqu'aux recommandations de décisions. Et un système d'aide à la décision qui déclencherait des réunions de prises de décisions seulement quand cela est nécessaire plutôt qu'à une fréquence prédéfinie.

ACKNOWLEDGEMENTS

“If I have seen further, it is by standing on the shoulders of giants.”

Isaac Newton

L'histoire conclura que, tout comme le commencement, le dénouement me combla. Mais revenons à l'aube de l'histoire, l'histoire d'une hésitation qui finit en passion.

Tout débuta grâce à l'inspiration de trois chercheurs de renom. Trois passionnés ayant décidé de se lancer dans l'éducation d'un nouvel oisillon. Ce futur nouveau-né que j'ai été avait longuement hésité à s'élancer. Mais il fut admirablement soutenu et conseillé dans cette décision par des amis que je remercie avec passion ! Rapidement convaincu de l'opportunité qui venait de se présenter, il a finalement plongé sans hésiter.

Ce n'est que quelques mois après cette décision que je fus plongé sans attendre dans le Bocal où l'accueil fut jovial. Cette première immersion avec deux compères d'exceptions m'a permis de majestueusement découvrir cet environnement passionnant. Et je leur en suis vraiment reconnaissant pour ce biotope qui fut vraiment au top.

Durant trois années, les trois chercheurs passionnés ont été des encadrants aussi brillants que bienveillants. Leurs complémentarités et leurs capacités à guider les nouveau-nés ne sont plus à prouver. Et je tiens encore à vous remercier chaleureusement pour les opportunités, les idées, le soutien et la liberté que vous m'avez apportés tout au long de ces années !

Ces trois années n'auraient pas été possibles sans le soutien de l'entreprise qui a financé et accompagné ce beau projet, et notamment de toutes les personnes qui la constituent avec talent. Qu'elles aient été de bâbord ou de tribord, ce fut toujours un très grand plaisir de travailler ensemble dans une atmosphère tout aussi conviviale, détendue et amicale, que professionnelle, proactive et efficace. Merci à toutes les équipes de m'avoir accompagné dans ce projet de recherche appliquée ! Et un remerciement tout particulier à celui qui avait expérimenté avant moi l'aventure du doctorat, et qui a su orienter le navire avec passion et clairvoyance. À très bientôt pour de nouveaux projets.

Ces trois années ne pourraient être pleinement décrites sans évoquer quatre périodes outre-Atlantique. Quatre séjours à Atlanta ayant permis de nombreuses découvertes ainsi que de nombreux moments professionnels et personnels inoubliables. Des moments de brainstorming intenses avec de brillants Bordelais, Stéphanois, et Québécois précédemment nommés encadrants. Trois compères avec qui nous avons également eu de belles découvertes sportives et culinaires. Des moments sur les terrains de squash et de badminton avec un plongeur marseillais avec qui nous avons aussi bien été supporter les Braves que se baigner dans le ciel de Géorgie. Des moments sur les terrains de foot et les centaines de kilomètres de pistes cyclables avec un footballeur mexicain. Des moments dans les rues, parcs et musées d'Atlanta avec une passionnée de poney avec qui nous avons éprouvé les trottinettes de la ville ainsi que testé de splendides couvre-chefs d'artistes en plein festival de jazz. Sans oublier les moments avec tous

les autres que je n'ai pas mentionnés ici. Thank you all for all these unforgettable memories! Gracias a todos por estos recuerdos inolvidables! Merci à tous pour tous ces souvenirs inoubliables !

À ce stade de cette tirade, une petite pensée surgit pour Plouf et son junior. Vous vous êtes envolés, mais durant toutes ces années votre aura a perduré, par le doute que nous avons laissé planer sur la vérité de votre destinée.

Ces trois années ont également été parsemées d'aventures de diverses natures. Que ce soit au travers des découvertes scientifiques comme culturelles, d'aventures personnelles comme professionnelles, de nombreux souvenirs se sont accumulés et de nombreuses amitiés se sont forgées. Et pour les raviver, il suffit simplement de lancer quelques mots-clés à tous ces amis que je remercie : 41, le Bocal, Finding Dory, gardien du temple, 1A02, Clapping Routine, Soual, Chartreuse, prendre son après-midi, hydromel, Machu Picchu, physical internet, Milano à pied, bananier, ski, Chien Rouge, kangourous, RIO et ses icônes, j'ai une question pour toi, paella, Patte d'oie, échecs, défibrillateur, Le Terrier, Postcards, skirail, ISCRAM, macro-gammes et macro-nomenclatures, snowballs, trottinette et musées, séminaire d'hiver, 1 mois en Autriche, Frangipane et amusement, poker des cafards, Lisboa et Bilbao, Axolotl, Les Carroz, Les 4 fantastiques, club Sciences & Vie, OVNI, La Tronche, Mustach Club, Surf & Cie, défis pourris, Jougne, SSI, The French connection, club bagarre, stinky tofu and chinese pot, café doctorants, Silver comet, Petra, CGI, fondue bourguillarde, etc. J'ajoute encore un remerciement particulier à mes chaleureux encadrants, pour m'avoir si souvent permis et encouragé à partager les résultats de recherche autant avec la communauté scientifique que la communauté industrielle. Et j'ajoute également un remerciement tout particulier pour le 41 que je tiens à remercier pour toutes ces années d'amitié !

Je me dois aussi de parler de toi, toi qui m'as accompagné dans toutes ces aventures, à la découverte de multiples contrées et de leurs cultures. Peut-être arriverai-je à te combler d'ici à ta retraite, de tous ces tampons folkloriques et parfois féériques, traduisant la beauté de ce monde par sa diversité. De tous les livres, tu resteras mon préféré, car tu me rends ivre par ta capacité à transformer les rêves en réalité !

Je ne pourrais conclure les remerciements sur ces trois années d'aventures sans remercier dans son entièreté une équipe qui n'est pas moins qu'une seconde famille : Merci le CGI !

Finalement, cette idée un peu saugrenue de se lancer dans une thèse inattendue a résulté en une aventure inimaginable devenue une histoire inestimable, qui fit naître des amitiés qui seront à jamais gravées.

Merci à tous !

متشکرم همه از

¡Gracias a todos!

الجميع شكرا

Thank you all!

谢谢大家！

LIST OF ABBREVIATIONS

MOST USED ABBREVIATIONS

APS	Advanced Planning System
AS&OP	Adaptive Sales and Operations Planning
BI	Business Intelligence
BPMN	Business Process Management Notation
CPFR	Collaborative Planning, Forecasting, and Replenishment
DMM	Decision-Making Meeting
DMP	Decision-Making Process
DSS	Decision Support System
ERP	Enterprise Resource Planning
IBP	Integrated Business Planning
IDEF0	Icam DEFinition for Function Modeling
IQ	Industrial Question
IS	Information System
ISO	International Organization for Standardization
JSON	JavaScript Object Notation
KPI	Key Performance Indicator
PFDC	Pierre Fabre Dermo-Cosmétique
PFM	Pierre Fabre Médicament
RQ	Research Question
SCC	Supply Chain Capacity
SCCP	Supply Chain Capacity Planning
SCRM	Supply Chain Risk Management
S&OP	Sales and Operations Planning

OTHER ABBREVIATIONS

APICS	American Production and Inventory Control Society
ASCM	Association for Supply Chain Management
CEO	Chief Executive Officer
CFAR	Collaborative Forecasting and Replenishment
DDI	Demand Driven Institute
DDS&OP	Demand Driven Sales and Operations Planning
IMT	Institut Mines Télécom
MRP II	Manufacturing Resource Planning
NIST	National Institute of Standards and Technology
SCM	Supply Chain Management
SCOPIS	Supply Chain-Oriented Process to Identify Stakeholders
SCOR	Supply Chain Operation Reference
SCP	Supply Chain Planning
UML	Unified Modeling Language
VICS	Voluntary Interindustry Commerce Solutions association
WOS	Web of Science
XML	eXtensible Markup Language

SUMMARY

Abstract	i
Résumé	iii
Résumé long en français	v
Acknowledgements	xv
List of abbreviations	xvii
Summary	xix
Chapter I. Introduction	1
1. Introduction to supply chain capacity planning.....	3
1.1. Supply chain management.....	3
1.2. Supply chain planning	5
1.2.1. Planning	5
1.2.2. Supply chain planning and hierarchical planning	6
1.2.3. Focus on long-term supply chain planning.....	7
1.2.4. Focus on production capacity planning	8
1.3. Supply chain capacity planning.....	9
1.3.1. Definition	9
1.3.2. Focus on assessing and comparing supply chain capacity plan alternatives	10
2. Introduction to the industrial questions	11
2.1.1. Performing SCCP in a supply chain environment with a multitude of uncertainty sources.....	11
2.1.2. Performing SCCP in a supply chain environment with a multitude of decision options	12
2.1.3. Performing SCCP in a dynamic supply chain environment	14
3. Introduction to the research questions and contributions	16
3.1. An SCCP conceptual framework to provide guidance in overcoming the limitations of existing solutions in answering the industrial questions.....	16
3.2. An SCCP information system to make the SCCP conceptual framework possible	17

3.3. An SCCP decision-making process to make the SCCP conceptual framework real by taking advantage of the SCCP information system.....	18
4. Research context and methodology.....	20
4.1. A collaboration between two universities and two industrial partners	20
4.2. Research methodology	21
5. Thesis structure	25
Chapter II. A conceptual framework as a guideline for developing a decision support system for supply chain capacity planning	27
1. Literature review on decision-making processes and information systems for supply chain capacity planning	29
1.1. Overview of existing solutions for building a long-term SCCP decision support system.....	29
1.1.1. Components of a decision support system	29
1.1.2. Overview of existing solutions	30
1.2. Decision-making processes for long-term supply chain capacity planning	32
1.2.1. Sales and Operations Planning	32
1.2.2. Integrated Business Planning.....	33
1.2.3. Adaptive Sales and Operations Planning.....	34
1.2.4. Collaborative Planning, Forecasting, and Replenishment.....	35
1.3. Information systems for long-term supply chain capacity planning	36
1.3.1. Enterprise Resource Planning.....	36
1.3.2. Advanced Planning Systems	37
1.3.3. Spreadsheets	38
1.4. Conclusion and research orientation	39
2. Supply chain capacity planning conceptual framework proposal	41
2.1. Sequence of activities with their objectives and constraints	41
2.1.1. Overview of the sequence of activities.....	41
2.1.2. An approach for deciding which supply chain capacity plan to implement.....	43
2.1.2.1. Compare supply chain capacity plan alternatives.....	43
2.1.2.2. Generate dashboards	45
2.1.3. An approach for assessing supply chain capacity plan alternatives	46
2.1.3.1. Assess what-if scenarios	46

2.1.3.2. Generate an assessment model compatible with all what-if scenarios.....	47
2.1.3.3. Generate what-if scenarios to assess.....	48
2.1.4. An approach for generating supply chain capacity plan alternatives	49
2.1.4.1. Generate relevant supply chain capacity plan alternatives to assess	49
2.1.4.2. Gather supply web and demand plan information including associated decision options and uncertainty sources	50
2.2. Stakeholders	54
2.2.1. Information providers	54
2.2.2. SCCP managers	55
2.2.3. Decision-makers	55
3. Conclusion.....	58
Chapter III. SCCP information system: a proposal for automating the generation and assessment of supply chain capacity plan alternatives.....	59
1. Literature review.....	61
1.1. Literature review objectives	61
1.2. Literature review methodology and results	61
1.3. Conclusion and research orientation.....	64
2. SCCP information system: a computational software proposal	66
2.1. Computational software overview.....	66
2.2. Supply web modeler	67
2.2.1. The supply web metamodel	67
2.2.2. Supply web model creation.....	71
2.2.2.1. Two solutions for providing user inputs: a web-based user interface and company-specific Excel files	71
2.2.2.2. Introduction of the supply web model of the illustrative use case “HelloBread” used to illustrate the contributions	73
2.3. Assessment model generator	78
2.3.1. The potential supply chain map metamodel	78
2.3.2. The metamodel-based algorithm for deducing the potential supply chain map.....	79
2.3.3. The metamodel-based algorithm for deducing key performance indicator formulas	83

2.4. What-if scenario generator and assessor	91
2.4.1. A function for generating the list of what-if scenarios to assess	91
2.4.2. A function for assessing the what-if scenarios	95
2.4.3. A function for structuring the what-if scenario results for the business intelligence software	98
3. Conclusion.....	101
Chapter IV. SCCP decision-making process: a proposal for taking advantage of the SCCP information system proposal.....	103
1. Literature review	105
1.1. Literature review results.....	105
1.1.1. Sales and Operations Planning: Several decision-making process proposals over time	105
1.1.2. Adaptive Sales and Operations Planning.....	108
1.2. Conclusion and research orientation	109
2. SCCP decision-making process proposal.....	111
2.1. Overview	111
2.2. Implement the SCCP routine.....	112
2.2.1. Define decision-making meeting.....	112
2.2.1.1. Define key performance indicators.....	113
2.2.1.2. Define types of decision options.....	117
2.2.1.3. Define types of uncertainty sources.....	118
2.2.1.4. Define decision-making reasoning and associated dashboards ...	119
2.2.2. Define data.....	121
2.2.2.1. Define data scope.....	122
2.2.2.2. Define data granularity	123
2.2.3. Define stakeholders	125
2.2.3.1. Define information providers	126
2.2.3.2. Define decision-makers	128
2.2.3.3. Define SCCP managers	129
2.3. Perform SCCP routine.....	130
2.3.1. Prepare decision-making meeting	130
2.3.2. Perform decision-making meeting.....	134
3. Conclusion.....	136

Chapter V. Two industrial pilot projects: Pierre Fabre Dermo-Cosmétique and Pierre Fabre Médicament	137
1. Pierre Fabre Dermo-Cosmétique pilot project: supporting SCCP decisions associated with the network of suppliers of bottles of the company	139
1.1. Context	139
1.2. Implementation process	140
1.2.1. Define decision-making meeting	141
1.2.1.1. Define types of decision options and types of uncertainty sources	141
1.2.1.2. Define key performance indicators	141
1.2.1.3. Define decision-making reasoning and associated dashboards ...	144
1.2.2. Define data	150
1.2.2.1. Define data scope	150
1.2.2.2. Define data granularity.....	151
1.2.3. Define stakeholders.....	153
1.2.3.1. Define information providers.....	153
1.2.3.2. Define decision-makers	155
1.2.3.3. Define SCCP managers.....	155
1.3. Routine process	155
1.3.1. Decision-making meeting preparation	156
1.3.1.1. Gather data for the computational software	156
1.3.1.2. Run the computational software	157
1.3.1.2.1. Create the supply web model and run the “assessment model generator”	157
1.3.1.2.2. Configure and run the “what-if scenario generator and assessor”	164
1.3.1.3. Analyze what-if scenario assessment results and prepare recommendations for the decision-making meeting	166
1.3.2. Decision-making meeting	173
1.4. Conclusions regarding the PFDC pilot project.....	175
2. Pierre Fabre Médicament pilot project: supporting SCCP decisions associated with the internal production capabilities of the company.....	176
2.1. Context	176
2.2. Implementation process	176

2.2.1. Define decision-making meeting: KPIs, types of decision options and uncertainty sources, and dashboards	176
2.2.2. Define data: scope and granularity	178
2.2.3. Define stakeholders: information providers, decision-makers, and SCCP managers	178
2.3. Routine process	179
2.3.1. Decision-making meeting preparation.....	179
2.3.1.1. Gather data and run the computational software	179
2.3.1.2. Analyze what-if scenario assessment results and prepare recommendations for the decision-making meeting.....	180
2.4. Conclusions regarding the PFM pilot project	183
Chapter VI. Conclusion and avenues for future research.....	185
1. Conclusion.....	186
1.1. Industrial context.....	186
1.2. Literature reviews, research questions, and contributions	186
1.3. Contribution validation	188
2. Avenues for future research	190
2.1. Consolidate the validation of the contributions.....	190
2.2. Enhance the SCCP information system proposal.....	190
2.2.1. Assist companies in identifying the decision options to investigate	190
2.2.2. Assist companies in configuring the list of what-if scenarios to assess ...	190
2.2.3. Automatically provide recommendations.....	191
2.2.4. Overcome the short lead-time assumption	191
2.3. Enhance the SCCP decision-making process proposal	191
2.3.1. Enhance the implementation process guidelines	191
2.3.2. Complement the SCCP DMP with maturity assessment guidelines	192
2.3.3. Extend the SCCP DMP proposal to a multi-company collaborative SCCP DMP.....	192
2.3.4. Connect long-term SCCP to mid- and short-term SCCP	193
2.4. Towards a hyperconnected SCCP DSS.....	193
3. The future is already starting.....	194
References	195
List of figures	207

List of tables	213
Appendices	217
1. Definition of terms used in this thesis	218
2. Description of the supply web modeler algorithm for creating the supply web model from XML files.....	219
3. List of edges that can exist in potential supply chain maps.....	223
4. Diagram of the metamodel-based algorithm for deducing potential supply chain maps	225
5. Pseudocode of the metamodel-based algorithm for deducing the KPI formulas of the potential supply chain map	233
Un système d'aide à la décision pour la planification capacitaire des chaînes logistiques sur un horizon long-terme : une approche d'ingénierie dirigée par les modèles	237
A decision support system for long-term supply chain capacity planning: a model-driven engineering approach.....	238

CHAPTER I. INTRODUCTION

“In the middle of difficulty lies opportunity.”

Albert Einstein

Imagine yourself as the CEO of a company producing bread for bakeries across France. On a Friday afternoon, the director of your supply department comes to you and says: “I am worried about the increasing number of natural disasters occurring in the region. What if next year our suppliers of flour are not able to fulfill our demand?” This reminds you that a few weeks ago two other department directors expressed similar concerns. The first was the director of your quality control department who was worried about two of your yeast subcontractors regarding the variability in the quality of the yeast and the corresponding number of returns. The second was the director of your manufacturing department who heard about the potential signature of a major sales contract and was worried about the impact it would have on the capability of the company to fulfill overall demand. Each time you hear about these types of worries, you redirect the person to the risk analysis performed two years ago when the supply chain was redesigned to ensure its capacity to fulfill demand over the next few years. You know that the supply chain and its environment have evolved in the meantime. Some suppliers and subcontractors have changed, some bread recipes were adapted to new customers’ expectations, and a production line was stopped. But you also remember that it took weeks and a lot of effort to perform the supply chain redesign and the associated risk analysis that led to the final revised supply chain configuration decision. Therefore, you know that you cannot afford to repeat the same decision-making process again as long as there is no major event constraining you to do so. Back home at the end of your day, warm under your blanket and asleep, dreams take you to an unconstrained world that gives you and your company infinite capabilities. In this world, you can instantaneously obtain complete visibility over the capacity of your supply chain to fulfill the demand for all potential futures. The list of potential futures is associated with the list of uncertainties regarding your forecast of the future as well as with the list of decisions you could make. This visibility provides you with all the insights you need for deciding upon the action plan that will guarantee the capacity of your supply chain to fulfill demand at a satisfactory service level for all potential futures.

The ambition of this research project is to move reality closer to the CEO’s dream. The decision-making process consisting in defining the plan of all actions that shape the capacity availability and requirements of supply chains is called Supply Chain Capacity Planning (SCCP) in this thesis. To achieve this ambition, the objective is to make the SCCP decision-making process as fast and easy as possible so that companies can review their Supply Chain Capacity (SCC) plan more frequently taking into account as many potential futures as possible. The thesis mainly focuses on the production capacities of supply chains, and not on transportation or warehousing capacities which should be the focus of subsequent research. A potential future should be understood to be a specific state of the supply chain, including elements such as

organizations, equipment, product flows, and demand. To guarantee that the capacity of their supply chains is sufficient to fulfill forthcoming demand, companies need to assess their current SCC plan choices regarding potential futures because the future that will really occur is not known with certainty. This uncertainty can either be due to the uncertain results of their own actions (e.g., the effective capacity of equipment that has been purchased to make bread is different than forecasted), or due to the uncertain state of external elements (e.g., the demand for bread is higher than forecasted because of an intensive marketing campaign done by another company for a meal requiring bread). The multitude of uncertainty sources associated with supply chains is a reality that cannot be neglected (Hult et al. 2010, Christopher and Holweg 2011, 2017, Simangunsong et al. 2012, Thompson 2017). In addition to challenging the current SCC plan choices, companies usually want to compare it with alternative SCC plans associated with the multitude of decision options they have (e.g., buying a new production line, finding a new supplier or subcontractor, choosing materials when designing a product, or launching a marketing campaign). These alternative SCC plans must also be assessed regarding uncertainties. Therefore, potential futures result from the combination of the potential sets of decision options (i.e., potential SCC plans) aiming to shape the supply chains' state, and the uncertainty sources regarding the effective future state of the supply chains.

The information about the uncertainty sources and the decision options is usually divided among companies' departments. For example, the sales department has information about demand forecasts and associated uncertainties, the marketing department has information about the decision options regarding potential marketing campaigns, the manufacturing department has information about production capacities and associated uncertainties, and the supply department has information about decision options regarding the solicitation of potential suppliers and subcontractors. All this information from different departments is related to the available or required capacities of the supply chains and so can be relevant for performing SCCP. For example, uncertainty sources and decision options of the sales and marketing departments will shape demand and therefore the production requirements; uncertainty sources and decision options of the supply and manufacturing departments will shape the capacity of the supply chains to meet production requirements. Therefore, the ambition of this research project is also to bring all the company's departments together around a common vision. This common vision will provide them with visibility of the consequences of their decision options and uncertainty sources on the company's capacity to fulfill demand and to achieve superior financial performance. This thesis is not about designing an innovative optimization model that will provide a unique solution, but rather about giving decision-makers a vision of potential futures that will give them a full understanding of their decision options regarding the overall impact on the supply chains, notably in the expected turbulent context of the forthcoming decades.

This chapter then proceeds with an overview of the research project and its associated results. The first section positions the research project regarding the supply chain management field. The second section introduces the industrial questions addressed in this thesis. The third section similarly introduces the research questions and contributions addressed in this thesis. The fourth section describes the research context as well as the research methodology used to perform this doctoral research. Finally, the fifth section describes the overall structure of the thesis.

1. Introduction to supply chain capacity planning

1.1. Supply chain management

The term “Supply Chain Management” (SCM) first appeared in the practitioner literature in 1982 (Oliver and Webber 1982). The use of the “supply chain” concept among practitioners began as a consequence of certain changes in the manufacturing environment. These changes included the increase in manufacturing costs, product life cycles becoming shorter, and the globalization of market economies (Beamon 1998, Pinon 2017, Pinon et al. 2018). The APICS¹ Dictionary (APICS 2016) defines a supply chain as “the global network used to deliver products and services from raw materials to end customers through an engineered flow of information, physical distribution, and cash.” Figure 1 illustrates the supply chain concept with a fictitious example. The blue arrows represent the physical flow; in other words, the movement of products (raw material, semi-finished, and finished products) from one supply chain echelon to the following one in the direction of the end customer. The different symbols represent distinct types of actors transforming, storing, or selling products.

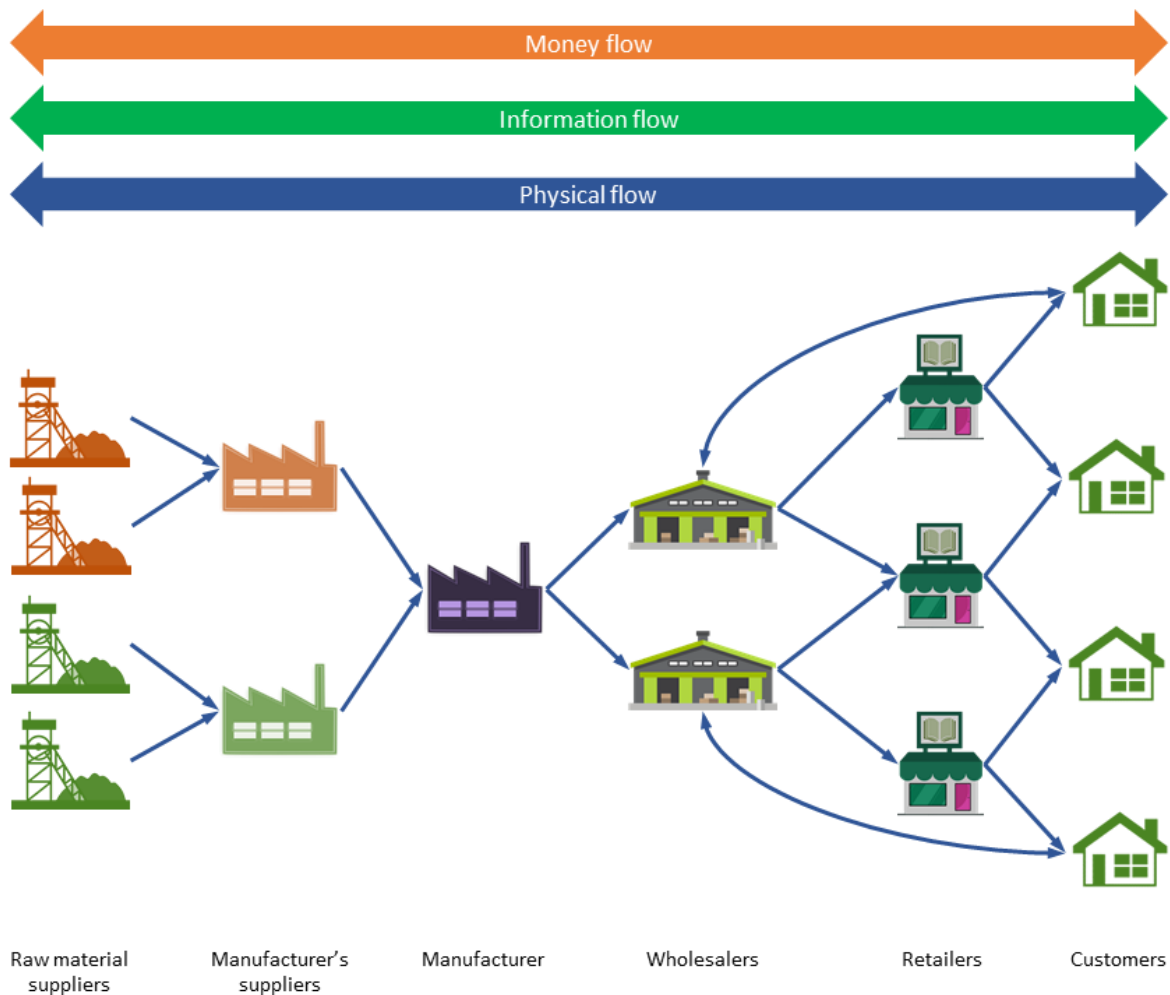

Figure 1: Illustrating the supply chain concept

¹ Since September 2018 the new name of the APICS organization is the Association for Supply Chain Management (ASCM) (APICS News 2019, Association for Supply Chain Management - ASCM 2019).

The SCM concept was increasingly adopted in the 1990s among manufacturers and retailers seeking to improve efficiency throughout the whole value chain and not only inside their company (Tan 2001, Lummus and Vokurka 1999). Supply chains are the heart of the value creation process of industrial companies and are thus the heart of companies' performance. Several authors have demonstrated the relationship between SCM and business performance: Tracey et al. (2005), Kannan and Tan (2005), Li et al. (2006), Gandhi et al. (2017), and Meybodi et al. . According to Tracey et al. (2005), SCM processes create value for customers and affect firms' performance. The paper also indicates that "the quality of a firm's supply chain management processes undoubtedly moderates its ability to please clients." According to Kannan and Tan (2005), "managing the supply chain is a major driver of performance" and "understanding supply chain dynamics has a significant impact on performance."

The APICS Dictionary (APICS 2016) defines SCM as "the design, planning, execution, control, and monitoring of supply chain activities." A different viewpoint is given by the framework to support SCM activities proposed by the Supply Chain Council¹ (2012): the Supply Chain Operation Reference (SCOR) model. As shown in Figure 2, it structures SCM activities according to the six following processes: plan, source, make, deliver, return, and enable. The plan process corresponds to the preparation of the supply chains for the execution of the core activities being source, make, deliver, and return. From the academic viewpoint, the relevance of the SCOR model processes has been validated by several authors such as Huang et al. (2004), Huang et al. (2005), and Akyuz and Erkan (2010). In addition, from the industrial viewpoint, the Supply Chain Council had close to 1000 industrial members in 2012 (Stadtler et al. 2015). This number shows the acceptance of the SCOR model by the industry and thus supports the academic viewpoint.

As mentioned in the introduction of this chapter, the decisions this thesis aims to support are the ones that shape the supply chain's capacity to fulfill demand. They can either be decisions impacting the capacity availability or the capacity requirements. These decisions are spread among the supply chain design and supply chain planning processes from the APICS Dictionary viewpoint (APICS 2016), which can be confusing when trying to design a decision-making process. However, they are all contained in the plan process of the SCOR model viewpoint (Supply Chain Council 2012). This led to the choice of the SCOR model viewpoint to position this thesis in the SCM field. As highlighted in green in Figure 2, this thesis focuses on the plan process of the SCOR model which encompasses planning the source, make, deliver, return, and enable processes of supply chains.

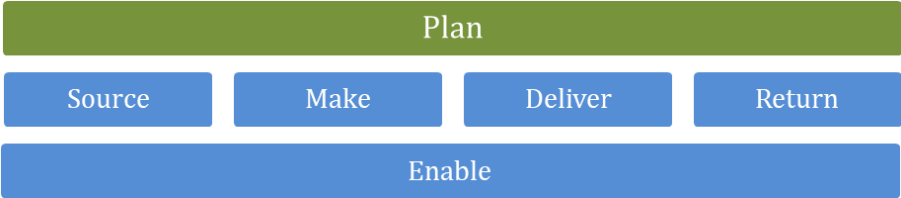

Figure 2: Research positioning versus the SCM processes of the SCOR model

¹ The Supply Chain Council was founded in 1996 as a non-profit organization which expressly created, and still maintain, the SCOR model as a tool for representing, analyzing, and configuring supply chains. In 2014, the Supply Chain Council merged with the APICS, now called ASCM (Association for Supply Chain Management - ASCM 2019).

1.2. Supply chain planning

1.2.1. Planning

The APICS Dictionary (APICS 2016) defines planning as “the process of setting goals for the organization and choosing various ways to use the organization’s resources to achieve the goals.” These goals are related to Key Performance Indicators (KPIs) being used to measure business performance and support decisions (Neely 1999, Amaratunga and Baldry 2002, Bourne 2005, Luras 2013). For each KPI under consideration, the company wants to maximize it, minimize it, or reach a specific value or interval. The achievement measurement of each goal corresponds to the difference between the goal set for the performance indicator and the actual measurement of it. The actual performance of a company depends on the combination of outcomes of all the activities it performs (its inputs and outputs) and the resources available. So, each company must decide which activities to perform to reach the desired performance. However, performing and coordinating activities require resources such as people, equipment, money, products, know-how, authorizations, and especially time¹.

Therefore, a company that wants to achieve its targeted outcomes at a certain point in time must anticipate this targeted outcome according to the time required for performing the activity. This is the first explanation of why anticipation is needed to achieve desired outcomes at a certain point in time. Additional sources of anticipation, such as the four following ones, can exist:

1. The time required for defining the performance goals;
2. The time required for making decisions about the activities to perform and about the resources to acquire to support activities;
3. The time required for acquiring the resources required for performing the activity when the company does not already have them;
4. The latency time between the end of the activity’s realization and its outcomes (e.g., a delay between an advertisement campaign and the time a demand increase is observed).

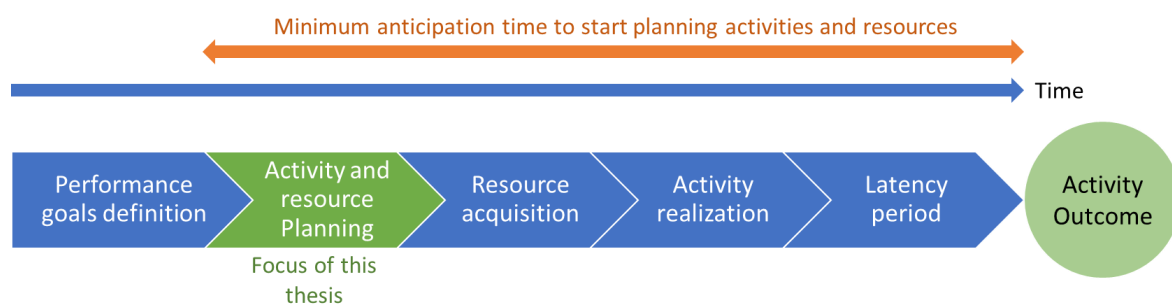

Figure 3: Illustrating reasons why anticipation and planning are required by companies to synchronize performance goals with actual performance at a desired point in time

All these times, illustrated in Figure 3, explain the need for companies to anticipate their activities. This action of deciding ahead of time the activities to perform is called “planning” and in the case of supply chains: “supply chain planning.” It enables companies to synchronize performance goals with the actual performance, the latter being defined by the activities’ outcomes. Finally, planning implies having ahead of time a certain knowledge of the future that

¹ As Albert Einstein said: “The only reason for time is so that everything doesn't happen at once.”

will help make planning decisions (Hopp and Spearman 2011). This knowledge can be information such as future performance goals, time needed to acquire resources, estimated demand, and activity outcomes. Thus, all information about the future used as input for the activity and resource planning task must be forecasted.

1.2.2. Supply chain planning and hierarchical planning

The SCOR model (Supply Chain Council 2012) defines the supply chain planning processes as follows: “the Plan processes describe the activities associated with developing plans to operate the supply chain. The Plan processes include the gathering of requirements, gathering of information on available resources, balancing requirements and resources to determine planned capabilities and gaps in demand or resources and identify actions to correct these gaps.” Stadtler et al. (2015) supplement this definition saying that “planning supports decision-making by identifying alternatives of future activities and selecting some good ones or even the best one.” In other words, supply chain planning is about making decisions that shape the future of supply chains.

To organize the planning tasks among different decision-making levels within a hierarchical organization, Hax and Meal (1973, 1975) introduced hierarchical production planning. Stadtler et al. (2015) generalized it as hierarchical planning to use in the context of supply chains. Stadtler et al. (2015) divided it into the five following components: decomposition and hierarchical structure, aggregation (time, products, and resources), hierarchical coordination, model building, and model solving. The first and third components are illustrated by Figure 4 with the boxes at the same level (Decision unit 1 and Decision unit N) illustrating the decomposition structure (decision units), the levels illustrating the hierarchical structure (e.g., top level), and the arrows illustrating the coordination. The aggregation component reduces the complexity of the model building and model solving components, defining aggregation rules for each decomposition level regarding time, products, and resources. For each decision unit, the model building components aim to represent the decision-making situation with a model that will be used to support decisions. Finally, for each decision unit, the model solving components will make decisions based on information provided by the model.

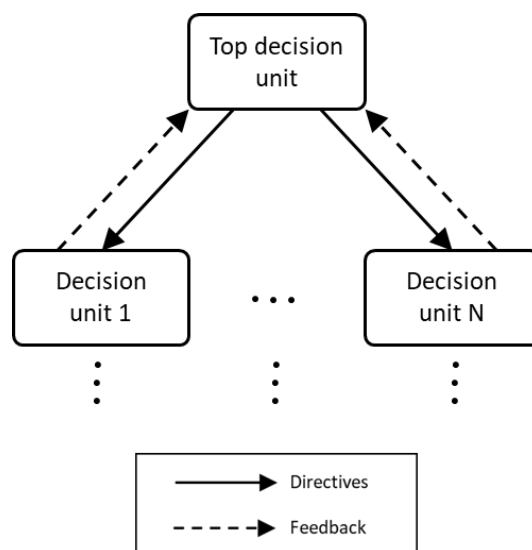

Figure 4: Illustrating the structure of hierarchical planning introduced by Hax and Meal (1973, 1975) to organize planning tasks among different decision-making levels within a hierarchical organization

1.2.3. Focus on long-term supply chain planning

Rohde et al. (2000) and Fleischmann et al. (2002) introduced the Supply Chain Planning Matrix (SCP-Matrix) as a hierarchical planning system for managing supply chain planning decisions (Figure 5). The SCP-Matrix is built around the following two dimensions: the “supply chain process” and the “planning horizon.” The “supply chain process” dimension corresponds to the typical high-level sequence of tasks performed in supply chains: procurement, production, distribution and sales. In companies, this generally corresponds to departments directly managing the physical flow of the supply chain. For the first three tasks, the relationship can easily be made with the source, make, and deliver tasks from the SCOR model. The last one, sales, is not in the scope of the SCOR model (although part of it is addressed in other processes). But, as will be described later, it is still within the scope of this thesis. The “planning horizon” dimension corresponds to the time horizon that will be considered for model building, model solving, and for making decisions. Each planning horizon level will generally have different aggregation rules for time buckets, products, and resources. For each type of decision, the choice of the adequate planning horizon level will depend on several timing parameters such as the minimum anticipation time (defined in the previous subsection) and the time required for taking a backward step in case of undesirable results (i.e., the minimum duration of the impact after the decision is made). Some examples are given in Figure 5, but it is important to keep in mind that this can differ from one company to another. Inspired by Anthony (1965), Fleischmann et al. (2015) built the SCP-Matrix with the following three planning horizons (Figure 5):

1. The long-term planning level is to define long-term orientations that imply decisions having an impact over several years, generally with a strategic horizon of at least two years;
2. The mid-term planning level is to make decisions having an impact over several months, taking long-term planning decisions as inputs, commonly with a tactical horizon from 6 months to 24 months;
3. The short-term planning level is defined as the lowest planning level specifying all activities with detailed instructions for execution and control, usually with an operational horizon from a few days to three months.

In this thesis, the focus is on the “long-term” level of the “planning horizon” dimension.

Fleischmann et al. (2015) indicates that additional dimensions can be considered in the decomposition structure of hierarchical planning systems. Examples are factory sites or product groups. This means that in addition to the temporal hierarchical structure going from short-term (its lowest level according to the SCP-Matrix) to long-term (its highest level according to the SCP-Matrix), there can be a factory site organizational structure such as in the following example: a decision unit for each factory at the lowest level, a decision unit for all factories of each country at a second level, and a decision unit for all countries worldwide.

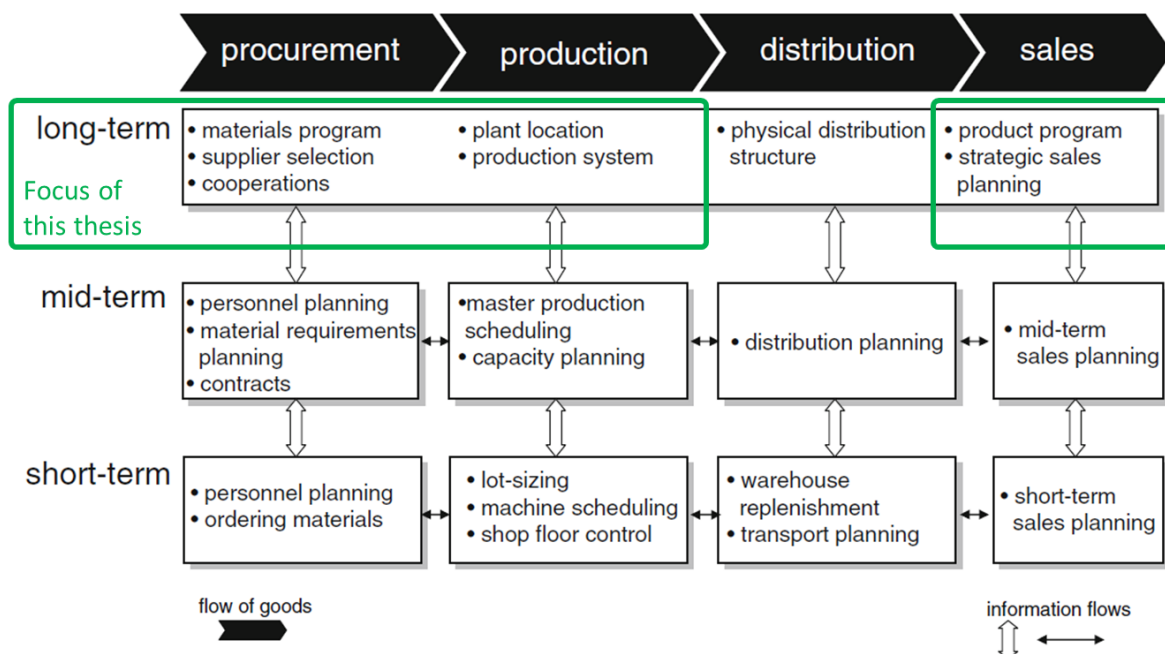

Figure 5: Thesis positioning in regards to the supply chain planning matrix introduced by Rohde et al. (2000) and Fleischmann et al. (2002) as a hierarchical planning system for managing supply chain decisions

1.2.4. Focus on production capacity planning

This research project initially focuses on the production step of the “supply chain process” dimension to support long-term production planning decisions such as those concerning the capacity of the production system (Figure 5). In other words, it focuses on balancing the available production capacity of the companies of the supply chains with the production capacity requirements. However, decisions made for other steps of the “supply chain process” (procurement, distribution, and sales) within a company have an impact on the production capacity requirements of other companies in the downstream or upstream part of the supply chain. For example, the selection decision, relative to the flour suppliers, made by the procurement department of a bakery will impact the upstream part of the supply chain. It will notably impact the production capacity required by the flour producers as well as the production capacity required by the wheat suppliers of the flour producers. Another example is the product development decision, relative to the type of flour chosen to make a certain type of bread, made by the product development department of a bakery, that will also impact the upstream part of the supply chain. Therefore, it was decided to consider procurement and sales because they are required for linking the production requirement of the companies across the supply chains. Distribution (i.e., warehouse and transportation planning) is not considered in this thesis. This focus is illustrated in Figure 5 by positioning it with green-sided rectangles on the SCP-matrix introduced by Rohde et al. (2000) and Fleischmann et al. (2002).

1.3. Supply chain capacity planning

1.3.1. Definition

According to authors such as Eppen et al. (1989) and Hopp and Spearman (2011), capacity planning consists in defining the level of production capacity at considered locations and for several time periods. Capacity planning is performed for different planning horizons: short-term (i.e., operational), mid-term (i.e., tactical), and long-term (i.e., strategic) (Olhager et al. 2001, Karabuk and Wu 2003, Hopp and Spearman 2011, Chen et al. 2013, Martínez-Costa et al. 2014). As mentioned in the previous subsection, the focus of this thesis is on long-term decisions and thus long-term capacity planning, also called “strategic capacity planning” (Geng and Jiang 2009, Hopp and Spearman 2011, Martínez-Costa et al. 2014).

Common capacity planning processes are stated in the definition given by the APICS Dictionary (APICS 2016) as “the process of determining the amount of capacity required for producing in the future. This process may be performed at an aggregate or product-line level (resource requirements planning), at the master-scheduling level (rough-cut capacity planning), and at the material requirements planning level (capacity requirements planning).” This definition is linked to the Manufacturing Resources Planning (MRP II) method which is defined by the APICS Dictionary (APICS 2016) as “a method for the effective planning of all resources of a manufacturing company.” The “resource requirements planning” process, also called “resource planning” by Hopp and Spearman (2011), corresponds to a capacity planning method for the long-term horizon this thesis focuses on. This MRP II method is focused on a single manufacturing company (Hopp and Spearman 2011, APICS 2016). However, when considering a supply chain such as illustrated in Figure 1, the focus is no longer on a single company but on the global network of actors forming the supply chain. Therefore, the term Supply Chain Capacity Planning (SCCP) is used in this thesis to describe a capacity planning process encompassing several supply chain echelons, and is defined as follows: “The process of deciding a plan of actions to perform that will shape the available supply chain capacity as well as the supply chain capacity requirements.” Some examples of types of decisions impacting the available or required supply chain capacity are given in Figure 6. In this thesis, the outcome of the SCCP process is called the Supply Chain Capacity (SCC) plan. The SCC plan corresponds to a set of decision options, among all existing decision options related to the supply chain capacity, that decision-makers have decided to activate and thus to perform the corresponding actions.

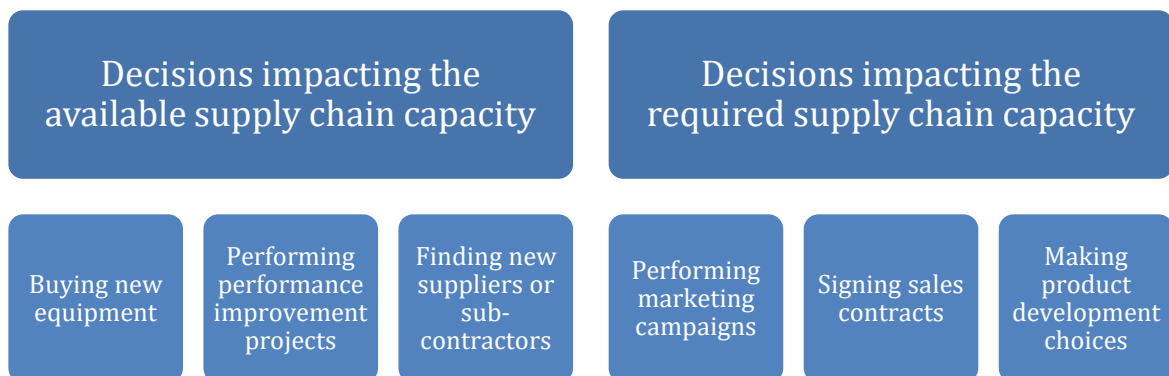

Figure 6: Examples of types of decisions impacting the available or required supply chain capacity

1.3.2. Focus on assessing and comparing supply chain capacity plan alternatives

A process for making decisions (i.e., a decision-making process) usually implies the following steps that can be found in existing approaches within the literature (Bell et al. 1977, Sainfort et al. 1990, Klein et al. 1993, Guo 2008): identify alternatives and associated information, assess alternatives, compare alternatives, and select the alternative to implement. This thesis focuses on the assessment, comparison, and decision steps, and the link with the identification step (Figure 7). Considering long-term SCCP, it means that the focus is on assessing and comparing SCC plan alternatives as well as deciding on the one to implement. The way information about SC plan alternatives can be identified is not within the scope of this thesis, but the way this information can be structured to feed the other steps is.



Figure 7: Positioning of the thesis (in green) regarding common decision-making steps

Finally, Figure 8 synthesizes this section by highlighting the position of the business processes this thesis focuses on (in green) within the fields of business performance, supply chain management, supply chain planning, and finally, supply chain capacity planning.

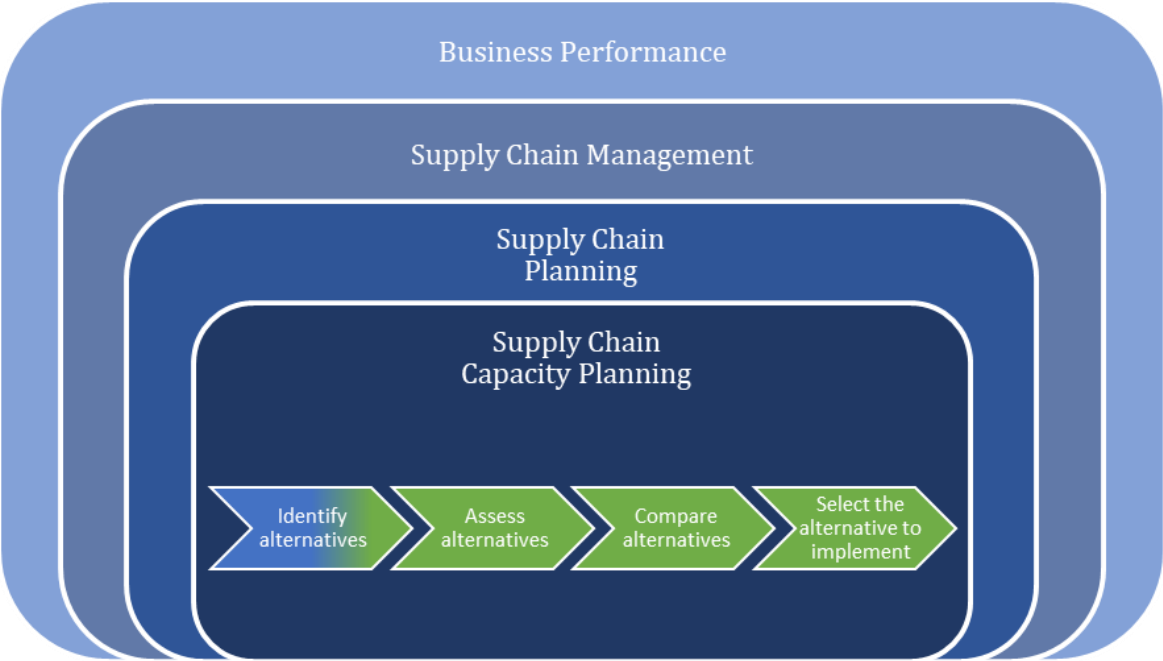

Figure 8: Illustration of the business processes this thesis focuses on (in green) positioned within the fields of business performance, supply chain management, supply chain planning, and finally, supply chain capacity planning

2. Introduction to the industrial questions

2.1.1. Performing SCCP in a supply chain environment with a multitude of uncertainty sources

As mentioned in the previous section, planning requires forecasting and so does SCCP. However, forecasts are by essence uncertain (Hopp and Spearman 2011). The APICS Dictionary (APICS 2016) defines forecasting as “the business function that attempts to predict sales and use of products so they can be purchased or manufactured in appropriate quantities in advance.” The most common forecasting task in industry is sales forecasting. However, it also concerns all other aspects of the planning task such as expected production capacities. When performing planning, all elements considered in assessing a plan come from a forecast and so are subject to uncertainty. Some illustrative examples are given in the insert below.

Illustrative examples

Operational uncertainty: impact of production rates and breakdowns on capacity

Let's consider a production line on one of the echelons of an evaluated supply chain. The capacity provided by the production line is used to perform the SCCP analysis. However, the production rate depends on the team, so this capacity is computed from an average production rate over the year. Therefore, the value of the capacity average should be considered uncertain because of the uncertainty of the production rate and because events such as breakdowns could happen.

Demand uncertainty: impact of sales on aggregated bills of materials

Let's consider a bill of materials of a product family used to perform an SCCP analysis. The bills of materials of product families are usually the results of the aggregation of bills of materials of the products belonging to this product family, using historical data and sometimes sales forecasts. Therefore, the resulting product family bill of materials should be considered uncertain because of the uncertainty of the product mix resulting from the sales forecasts. In addition, products' bills of materials can be approximative, which corresponds to an operational uncertainty which adds to the demand uncertainty.

Supply uncertainty: impact of bankruptcies and natural disasters on supply contracts

Let's consider a manufacturing company with an established supply contract with one of its suppliers for the delivery of a certain amount of raw materials needed for its production activities. The contract should ensure the raw material deliveries. However, events such as supplier bankruptcies or natural disasters could prevent the delivery from occurring. Therefore, the expected outcomes of the supply contract should be considered uncertain.

Management uncertainty: impact of coffee breaks on capacity

Let's consider a production line requiring several employees to perform production tasks. The time the production line runs per day should be constant. However, depending on the team manager, the time spent for coffee breaks can vary. Therefore, the time the production line runs and therefore the associated capacity per day should be considered uncertain.

The ISO 73:2009 standard on risk management vocabulary (International Organization for Standardization 2009) defines uncertainty as “the state, even partial, of deficiency of information related to, understanding or knowledge of, an event, its consequence, or likelihood.” If a company could know with certainty the future of its external environment and the outcomes of each activity it can perform, there would be only one possible outcome for each possible strategic supply chain plan. However, even if it can sometimes be reduced, uncertainty is unavoidable. Ptak and Smith (2011) use the term variability and define four categories of variability sources (which are illustrated in the examples in the insert above): demand, supply, operational, and management. This uncertainty creates the eventuality that a plan based on a deterministic forecast of the future does not lead to the achievement of the expected outcomes (Simangunsong et al. 2012). It has been shown that uncertainty is the norm for organizations and their supply chain environment, which reinforces the idea that it cannot be neglected (Hult et al. 2010, Christopher and Holweg 2011, 2017, Hopp and Spearman 2011, Simangunsong et al. 2012, Sáenz and Revilla 2014, Thompson 2017). In addition, the study undertaken by Boonyathan and Power (2007) shows the negative effect of supply and demand uncertainty on business performance. Hult et al. (2010) and Sáenz and Revilla (2014) give some historical examples of the effect of uncertainty on business performance.

Traditionally, the process of managing the potential negative effects of uncertainty sources on business performance is called Supply Chain Risk Management (SCRM) (Waters 2011, Ho et al. 2015). The ISO standard on risk management guidelines (International Organization for Standardization 2018) defines risk as the “effect of uncertainty on objectives”, with an effect defined as “a deviation from the expected.” The ISO standard on risk management vocabulary (International Organization for Standardization 2009) also defines risk management as the “coordinated activities to direct and control an organization with regard to risk.” According to authors such as Narasimhan and Talluri (2009), Colicchia and Strozzi (2012), and Sáenz and Revilla (2014), managing risks associated with this uncertainty is unavoidable nowadays in managing supply chains and being competitive. Finally, managing risks consists in considering uncertainty sources and decision options that would have a negative effect on the objectives. In the rest of this thesis, risk management will be considered to be part of the SCCP in order to avoid the complexity of having two processes that would be interdependent and therefore would have to be performed together. This multitude of uncertainty sources and the importance of considering them leads to the first industrial question of this thesis:

First Industrial Question (IQ1):

How to consider the multitude of uncertainty sources when assessing and comparing supply chain capacity plans, and deciding on the one to implement?

2.1.2. Performing SCCP in a supply chain environment with a multitude of decision options

The number of SCC plan alternatives corresponds to the number of possible combinations of decision options a company has. However, companies usually have a multitude of decision

options that are related to the available or required supply chain capacity (Hopp and Spearman 2011, Miller 2012, Stadler et al. 2015, Esmailikia et al. 2016). Consequently, the number of potential SCC plan alternatives quickly becomes very high. Different departments across companies (e.g., procurement, manufacturing, sales, marketing, product development, continuous improvement, and finance) have decision options with a direct or indirect impact on the available or required supply chain capacity. Some illustrative examples are given in the insert below. Considering decision options when performing SCCP is important because each

Illustrative examples

Example of a decision option from the manufacturing department

Let's consider a manufacturing department of a company involved in a supply chain. The company has a production line dedicated to one of its major products. One of the department's decision options might be the possibility of setting up an additional production line. The decision option is related to supply chain capacity because a capacity increase is an intrinsic result of having a new production line.

Example of a decision option from the marketing department

Let's consider a marketing department of a company involved in a supply chain. The company has a production line with extra capacity. One of the department's decision options might be the possibility of launching a marketing campaign on a product produced on this production line. The decision option is related to supply chain capacity because of the expected sales increase implying higher production needs and thus an increase in production line utilization.

Example of a decision option from the product development department

Let's consider a product development department of a company involved in a supply chain. The company is developing a new product. One of the department's decision options might be to choose the material the product will be made of. The decision option is related to supply chain capacity for at least two reasons: first, the choice could have an impact on the upstream part of the supply chain because production technologies and suppliers might be different. Second, the choice could have an impact on the downstream part of the supply chain because it might impact demand.

decision option considered is an opportunity to find a better SCC plan than the current one. Therefore, all departments having decision options related to supply chain capacity must be involved in the SCCP decision-making process. This multitude of decision options and the importance of considering them leads to the second industrial question of this thesis:

Second Industrial Question (IQ2):

How to consider the multitude of decision options when assessing and comparing supply chain capacity plans, and deciding on the one to implement?

2.1.3. Performing SCCP in a dynamic supply chain environment

SCCP requires forecasting the future according to what is known about the supply chain environment. But the dynamicity of today's supply chain environment is constantly increasing. The supply chain environment is changing at such a pace that organizations can struggle to keep track of and to respond to changes (Clifford Defee and Fugate 2010, Harrington et al. 2010, Fleischmann and Koberstein 2015, Pinon et al. 2018). Fleischmann and Koberstein (2015) give the example of automotive manufacturers saying the following: "up to the 1990s, an automotive manufacturer, for instance, used to launch a new car model every 2 or 3 years, but nowadays, this happens three to five times every year." Such a shift in new car model launch frequency has an impact on all the actors of the corresponding supply chains who must adapt to these new dynamics. Regarding decisions that were previously considered long-term, Melnyk et al. (2014) considers that the past practice of reviewing supply chain design every 5–10 years is no longer adequate, and claims that dynamic reconfiguration is needed.

In addition, Montreuil (2011, 2012, 2015) showed that supply chains are more and more intensely interconnected on multiple layers, ultimately to anytime and anywhere. The interconnectivity layers notably include digital, physical, operational, business, legal and personal layers. Montreuil (2011, 2012, 2015) calls this new state "hyperconnectivity". Basically, such a state signifies numerous new decision options for supply chain managers, particularly regarding the possibility of supply chains becoming flexible and open instead of rigid and dedicated. This for instance allows a set of supply chain partners beyond the known and active ones to be considered at any time, opening avenues and degrees of freedom when aiming to catch opportunities on the fly as they occur. Christopher and Holweg (2017) highlight the importance of "structural flexibility," defined as "the ability of a firm to reconfigure its supply/demand network in response to changes in the business environment." In other words, it corresponds to the ability to take advantage of supply and demand network reconfiguration options.

Keeping SCCP analysis up to date means keeping up with the dynamicity of the supply chain environment (i.e., the pace of the changes in the supply chain environment). Therefore, the SCCP process must be fast and easy enough to enable companies to keep up with the supply chain environment's dynamicity. This conclusion leads to the third industrial question of this thesis:

Third Industrial Question (IQ3):

How to make the SCCP process fast and easy enough to become a routine allowing companies to keep up with the dynamicity of the supply chain environment?

Finally, Figure 9 synthesizes this section by illustrating the relationship between characteristics of the supply chain environment and the industrial questions (IQ1, IQ2, and IQ3) in the long-term SCCP context this thesis focuses on.

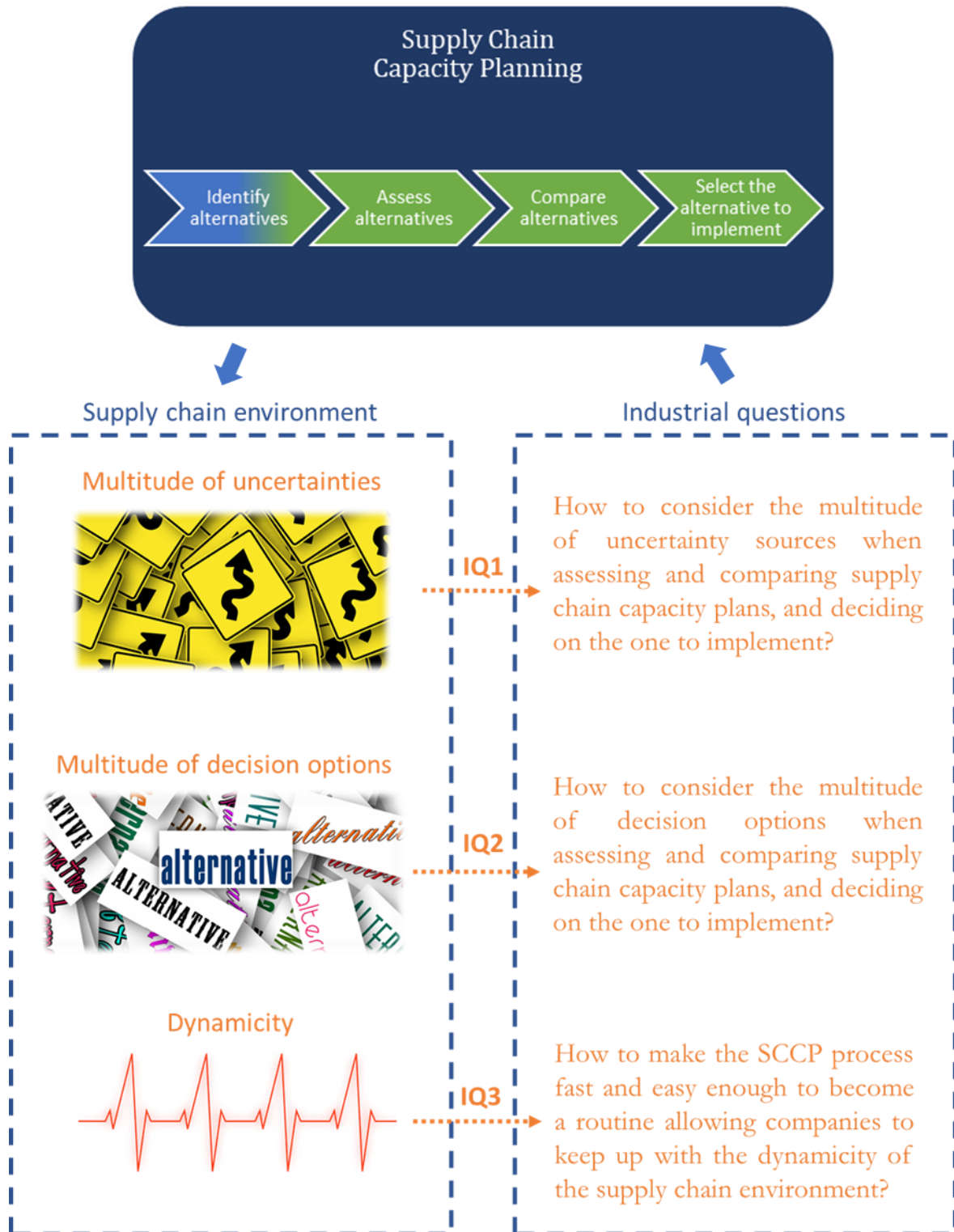

Figure 9: The relation between characteristics of the supply chain environment and the industrial questions (IQ1, IQ2, and IQ3) in the SCCP context this thesis focuses on

3. Introduction to the research questions and contributions

3.1. An SCCP conceptual framework to provide guidance in overcoming the limitations of existing solutions in answering the industrial questions

A literature review of existing solutions for building an SCCP Decision Support System (DSS) has been undertaken (cf. Chapter 2). In this thesis, a DSS is considered to be a system aiming to support decision-making by combining the following four components: a purpose, people, a decision-making process, and an information system (Figure 16). The literature review is structured around two elements: first, Decision-Making Processes (DMPs) aiming to organize the sequence of activities leading to the SCCP decisions. Second, Information Systems (ISs) aiming to support the first element by collecting, processing, storing, and distributing information. Four DMPs and three categories of ISs were identified (Figure 17) in the literature as being relevant for the scope of this thesis (illustrated by Figure 5, Figure 7, and Figure 8). The 4 DMPs are the following (cf. Chapter 2 for more details): Sales and Operations Planning (S&OP), Integrated Business Planning (IBP), Adaptive Sales and Operations Planning (AS&OP), and Collaborative Planning, Forecasting, and Replenishment (CPFR). The 3 categories of ISs are the following (cf. Chapter 2 for more details): Enterprise Resource Planning (ERP), Advanced Planning Systems (APS), and spreadsheets.

The literature review highlighted four major limitations that became the focus of this thesis. The first two are related to the fact that existing solutions are time-consuming (Fleischmann and Koberstein 2015, Kilger 2015, Kaipia et al. 2017, Cristea and Khalif Hassan 2018, Fritz et al. 2018). This time consumption leads to the following observations in practice: first, only a small number of alternative scenarios are considered when performing the SCCP process because each scenario takes time. In other words, a limited number of uncertainty sources and decision options are considered. Second, companies have difficulties keeping their SCCP analysis up to date because it takes time to update the models, especially when there are structural changes and not only quantitative changes. The third limitation is that existing solutions are designed to perform SCCP analysis on predefined supply chains without considering the whole set of potential alternative supply chain structures (Pinon et al. 2018). This is a major limitation in terms of the consideration of the multitude of decision options associated with alternative supply chain structures. The fourth limitation, which especially concerns APS and optimization methods, is the lack of acceptance from decision-makers regarding the solutions provided by these methods (Häberle and Kilger 2015). It is especially because of the lack of visibility regarding the comparison of alternatives leading to the one chosen as the solution. These four limitations led to the first research question (RQ1) of this thesis:

First Research Question (RQ1):

What would be the functional features of an SCCP decision support system able to manage decision options, uncertainty sources, dynamicity, and visibility requirements of current supply chains?

The first contribution (C1) proposed in this thesis is a conceptual framework describing the key principles of an SCCP process that would answer RQ1, without answering how it could be realized in practice. It aims to serve as a guideline for designing an SCCP DSS (i.e., a decision-making process along with an information system and people) that answers RQ1.

First Contribution (C1):

A Supply Chain Capacity Planning
conceptual framework

3.2. An SCCP information system to make the SCCP conceptual framework possible

A specificity of the SCCP conceptual framework (i.e., C1) is that it envisions the automation of several activities of the SCCP DMP. The aim is to make the SCCP DMP fast and easy enough to enable companies to consider the multitude of decision options and uncertainty sources while keeping up with the dynamicity of the supply chain environment. However, the SCCP conceptual framework only describes this goal but does not provide the solution for making it possible. Therefore, a second research question (RQ2) was formulated to overcome this limitation of the SCCP conceptual framework:

Second Research Question (RQ2):

How to make possible the goal of automation introduced in the
SCCP conceptual framework?

The second contribution (C2) proposed in this thesis is an SCCP Information System (IS) that answers RQ2 by automating some of the activities described in the SCCP conceptual framework. It is composed of two software programs: first, a computational software program that collects and processes raw data to generate models and additional information that are required for making decisions. This software was designed and developed specifically for this research project. Second, a business intelligence software program to display the generated information to decision-makers. This software is an existing commercial software program.

Second Contribution (C2):

A Supply Chain Capacity Planning
information system

3.3. An SCCP decision-making process to make the SCCP conceptual framework real by taking advantage of the SCCP information system

A second specificity of the SCCP conceptual framework (C1) is that it is structured as a high-level DMP providing a recommended sequence of activities to perform SCCP that rely on the SCCP IS. However, this high-level DMP is not precise enough to fully take advantage of the SCCP IS proposal (C2). It does not describe precisely how companies could implement and perform an SCCP DMP taking advantage of the SCCP IS proposal (C2). Therefore, a third research question (RQ3) was formulated to overcome this limitation of the SCCP conceptual framework:

Third Research Question (RQ3):

How to organize an SCCP decision-making process complying with the SCCP conceptual framework principles by taking advantage of the SCCP information system proposal?

The third contribution (C3) proposed in this thesis is an SCCP DMP that takes advantage of the SCCP IS to answer RQ3, and more importantly, RQ1 and the industrial questions (IQ1, IQ2, and IQ3).

Third Contribution (C3):

A Supply Chain Capacity Planning
decision-making process

Finally, Figure 10 represents an overview of the results of this thesis by illustrating the contributions and linking them together as one bigger contribution forming an answer to the industrial and research questions. It especially illustrates the following elements: first, the SCCP conceptual framework (C1) providing high-level principles for building an SCCP DSS. Second, the SCCP IS (C2) which includes two software programs: a computational software program and a business intelligence software program. Third, the SCCP DMP (C3) which includes two main structural elements being the process and people. Fourth, the relationship between the SCCP DMP and the SCCP IS.

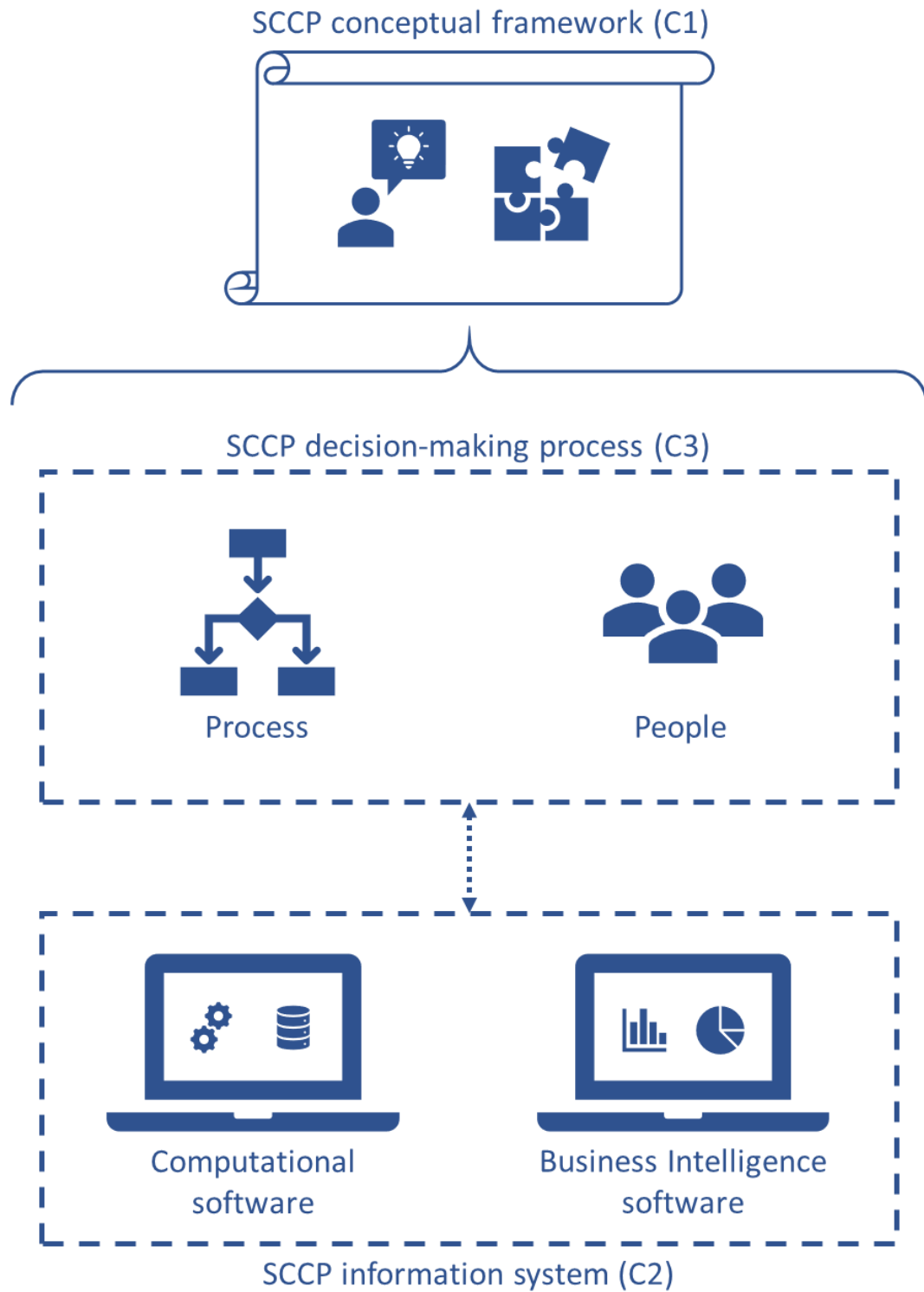

Figure 10: Overview of the contributions (C1, C2, and C3) this thesis proposes for answering the industrial and research questions it is focused on

4. Research context and methodology

The objective of this section is to explain the context in which this research project has been carried out and the methodology undertaken to drive it. The first subsection introduces the collaboration between two universities and two industrial partners that was established to carry out this project. The second subsection describes the methodology followed to undertake the research project.

4.1. A collaboration between two universities and two industrial partners

As mentioned at the beginning of this chapter, the research project started with two industrial partners asking for support to reach the following industrial objective: make mid- and long-term SCCP decisions that enable the company to achieve its performance objectives. The industrial partners are two companies of the Pierre Fabre group. The first one is a pharmaceutical company called “Pierre Fabre Médicament”, and the second one is a dermo-cosmetic company called “Pierre Fabre Dermo-Cosmétique” (Pierre Fabre 2019). There is a twofold interest for having these two partners. First, it helps to cross-validate the results with experiments on two industrial cases. Second, it covers two important areas of the supply chains, because the industrial case of the first company focuses on its internal supply chain capacities, whereas the industrial case of the second company focuses on the supply chain capacities of its network of suppliers. To address this industrial objective, an academic-industrial partnership called *Chaire Mines Albi Supply Chain Agile avec Pierre Fabre* was established between the two industrial partners and the following two academic partners: first, the Industrial Engineering Center of IMT Mines Albi (Centre Génie Industriel 2019), and second, the Physical Internet Center of Georgia Institute of Technology (Physical Internet Center 2019). Two administrative operators are also part of this project for institutional purposes: ARMINES (ARMINES 2019) and the IMT Mines Albi endowment fund (IMT Mines Albi endowment fund 2019). Figure 11 illustrates the research projects with its partners.

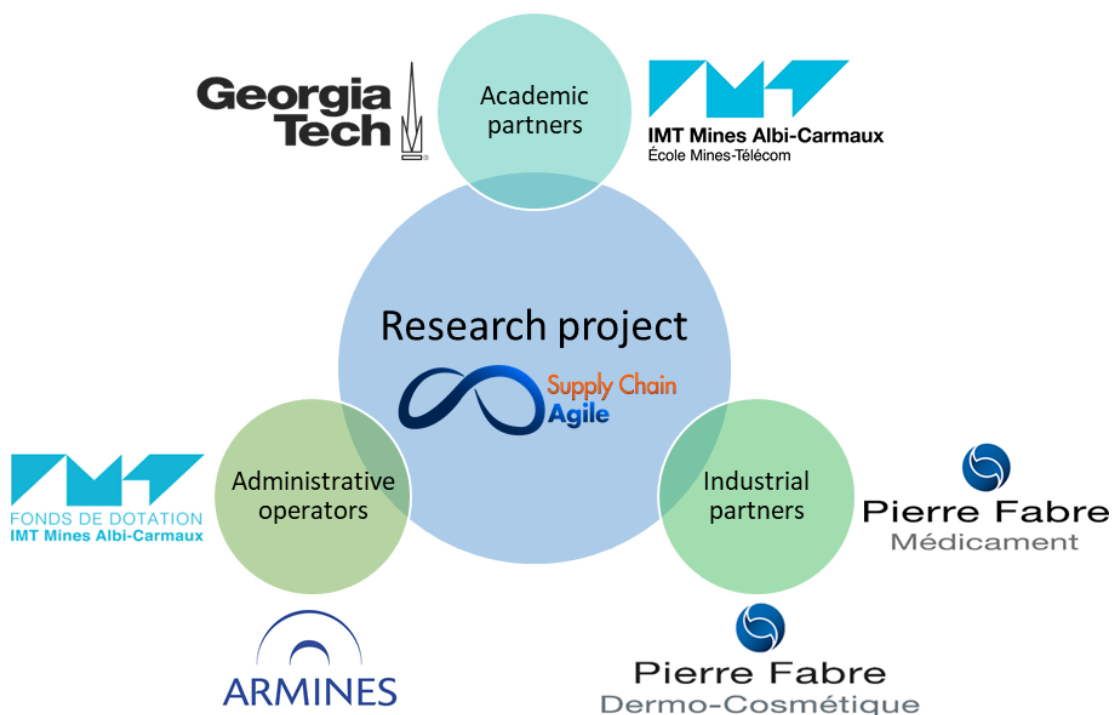

Figure 11: Research project partners

4.2. Research methodology

According to the classification of research design approaches described by Bairagi and Munot (2019), the research introduced in this thesis falls into the “exploratory research” category. This category aims at inventing or discovering new things. It can for example be put in contrast with the “explanatory research” category that aims at explaining an existing phenomenon. In addition, based on the work undertaken by Wieringa (2014) on empirical research methods for technology validation, the validation of the contributions through the two industrial experiments described in this thesis can be classified as part of a “single-case mechanism experiments” method, and more precisely as “testing an artifact prototype on a realistic example in the field.” This method uses the analogic inference principle (i.e., generalization by analogy) to enhance the validation of an artefact in a specific context. In this thesis the artefact is the SSCCP DSS proposal, and the contexts are the characteristics of the experiments described in the previous section such as the type of company and supply chain scope considered. Wieringa (2014) defines the analogic inference principle as “concluding that a target will have the same properties as a source (the experiment) because of some similarity between them.” In other words, validating a proposal on a use case with a certain set of characteristics improves the validation of the generalizability of the proposal to the population of other use cases having similar characteristics. For example, in this thesis the first use case has the characteristics of being undertaken with a cosmetics company and the supply chain scope is its network of suppliers. And the second use case has the characteristics of being undertaken with a pharmaceutical company and the supply chain scope is its internal production capabilities.

Wieringa (2014) proposes to measure the maturity of the validation of a practice (or artefact) by using this analogic inference principle and the inductive generalization principle. He proposes a reference frame with the following two dimensions (Figure 12): the inductive generalization (i.e., sample size, from samples to population) and the analogic generalization (i.e., similarity to population units, from experimental and simple cases to real-world cases). Based on this reference frame, enhancing the validation of a practice, means increasing the position of the set of experiments on both scales. Therefore, regarding the SSCCP DSS proposed in this thesis, the two experiments mainly increase the maturity of its validation on the vertical scale, small sample but realistic cases.

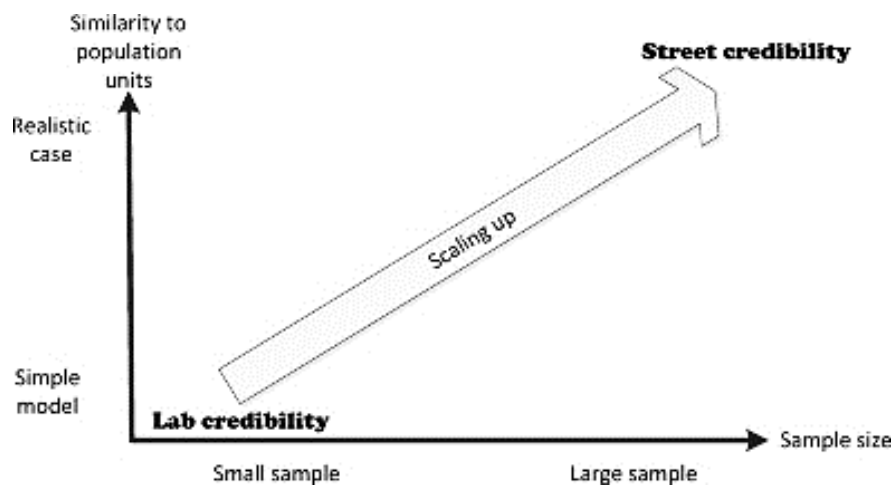

Figure 12: Illustration of the reference frame for scaling up the validation of a practice or system proposed by Wieringa (2014)

The sequence of research activities followed to undertake this research project is illustrated with the diagram in Figure 13. It is inspired from common research methodologies such as those described by Kothari (2004), Kotzab et al. (2005), Wieringa (2014), and Bairagi and Munot (2019).. It is also inspired from the plan-do-check-act (PDCA) methodology (Deming 1986, Moen and Norman 2006). The research activities are represented by rectangles and are positioned according to four dimensions: first, the temporal dimension being represented by a gray spiral (i.e., temporal axis) starting in the middle and moving clockwise. Second, the continuous improvement dimension with four continuous improvement phases represented by each zone delimited by the vertical and horizontal dotted axis. Third, the contribution design dimension with three contribution design phases represented by colored circles or rings. Fourth, the valorization domain dimension with two valorization domains represented by the color of the research activity rectangles. The following three paragraphs provide respectively more details about the last three dimensions.

Regarding the continuous improvement dimensions, the four continuous improvement phases are described thereafter. The first continuous improvement phase is “research question definition and refinement”; positioning the research activities to correspond to interactions with the industrial partners to identify their innovation needs. This corresponds to identifying the challenges partners face regarding the solutions they have in hand and their resulting innovation needs. The solutions they first had in hand corresponded to those they had before the beginning of the research project, and later they corresponded to the solutions provided incrementally during the research project. The second continuous improvement phase is “literature review”, positioning the research activities to correspond to a review of the existing literature. This corresponds to searching for existing solutions that could be used to answer the innovation needs identified during the “research question definition and refinement” phase. The objective is to deduce research orientations corresponding to innovation needs identified during the “research question definition and refinement” phase and for which no solution was found during the “literature review” phase. The third continuous improvement phase is “innovation”, positioning the research activities to correspond to the design of the contributions. This corresponds to designing solutions to the research orientations identified during the previous phase in order to answer the innovation needs identified during the “research question definition and refinement” phase. The fourth continuous improvement phase is “validation”, positioning the research activities corresponding to the industrial validation of the contributions and their scientific valorization through the publication of papers and this thesis. Finally, the continuous improvement process continues with the first continuous improvement phase.

Regarding the contribution design dimension, the three contribution design phases can be described as follows: the first contribution design phase, in blue, is the conceptual framework design phase positioning the research activities related to the design of the first contribution, the SCCP conceptual framework. The second contribution design phase, in cyan, is the information system design phase positioning the research activities related to the design of the second contribution, the SCCP IS. The third contribution design phase, in green, is the decision-making process design phase positioning the research activities related to the design of the third contribution, the SCCP decision-making process.

Regarding the valorization domain dimension, the two valorization domains can be described as follows: the first valorization domain, in orange, is the academic valorization domain which describes research activities in relation to the academic world. The second valorization domain, in purple, is the industrial valorization domain which describes research activities in relation to the industrial world that have been undertaken with the industrial partners.

Finally, the research activities are positioned regarding the four dimensions with the temporal dimension representing the sequence. The first research activity was to perform interviews with our industrial partners to define their needs. Then, their needs were compared with the existing literature to define the research orientations that led to the design of the first contribution (conceptual framework). The first validation of this first contribution was done by conducting interviews with the industrial partners providing their industrial point of view of the contribution. Papers were then written to share these results with the academic community. These first results led to the refinement of the innovation needs done by conducting interviews and brainstorming with the industrial partners. The refined innovation needs were reviewed regarding the existing literature to define the next research orientations that led to the design of the second contribution (the information system). The first validation of this second contribution was done by implementing two industrial use cases in the academic environment and assessing the results with the industrial partners. It was also a second validation of the first contribution. Papers were then written to share these results with the academic community. As with the first results, these second results led to the refinement of the innovation needs done by conducting interviews and brainstorming with the industrial partners. The refined innovation needs were compared with the existing literature to define the next research orientations that led to the design of the third contribution (decision-making process). The validation of this third contribution was done by performing two live experiments with the industrial partners. It was also a third validation of the first contribution and a second validation of the second contribution. Papers were then written to share these results with the academic and industrial communities, and this thesis was written to share the three contributions as one larger contribution. Finally, the next steps expected for this research project can be found in the conclusion and the avenues for future research of this thesis.

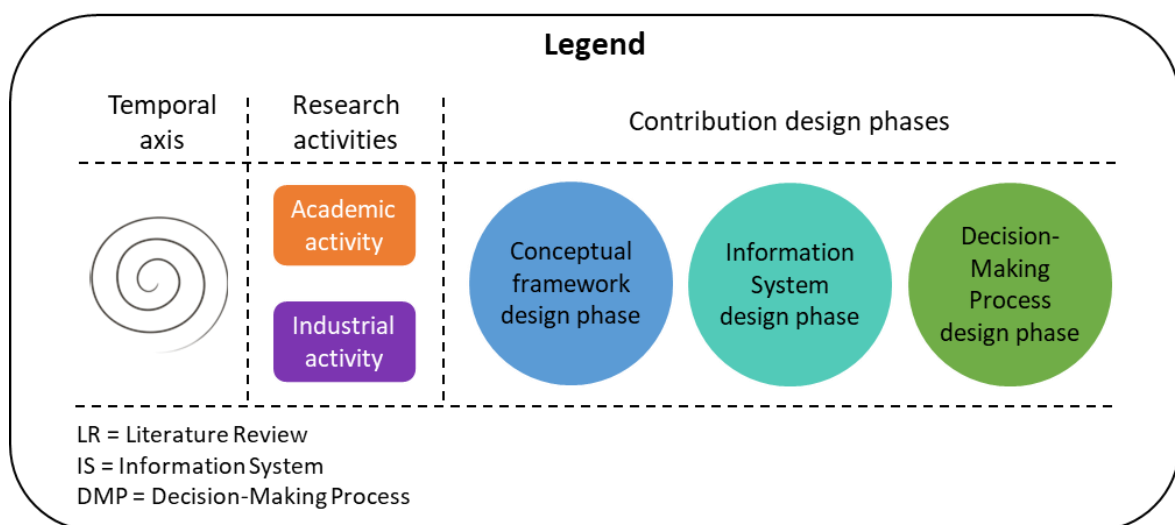
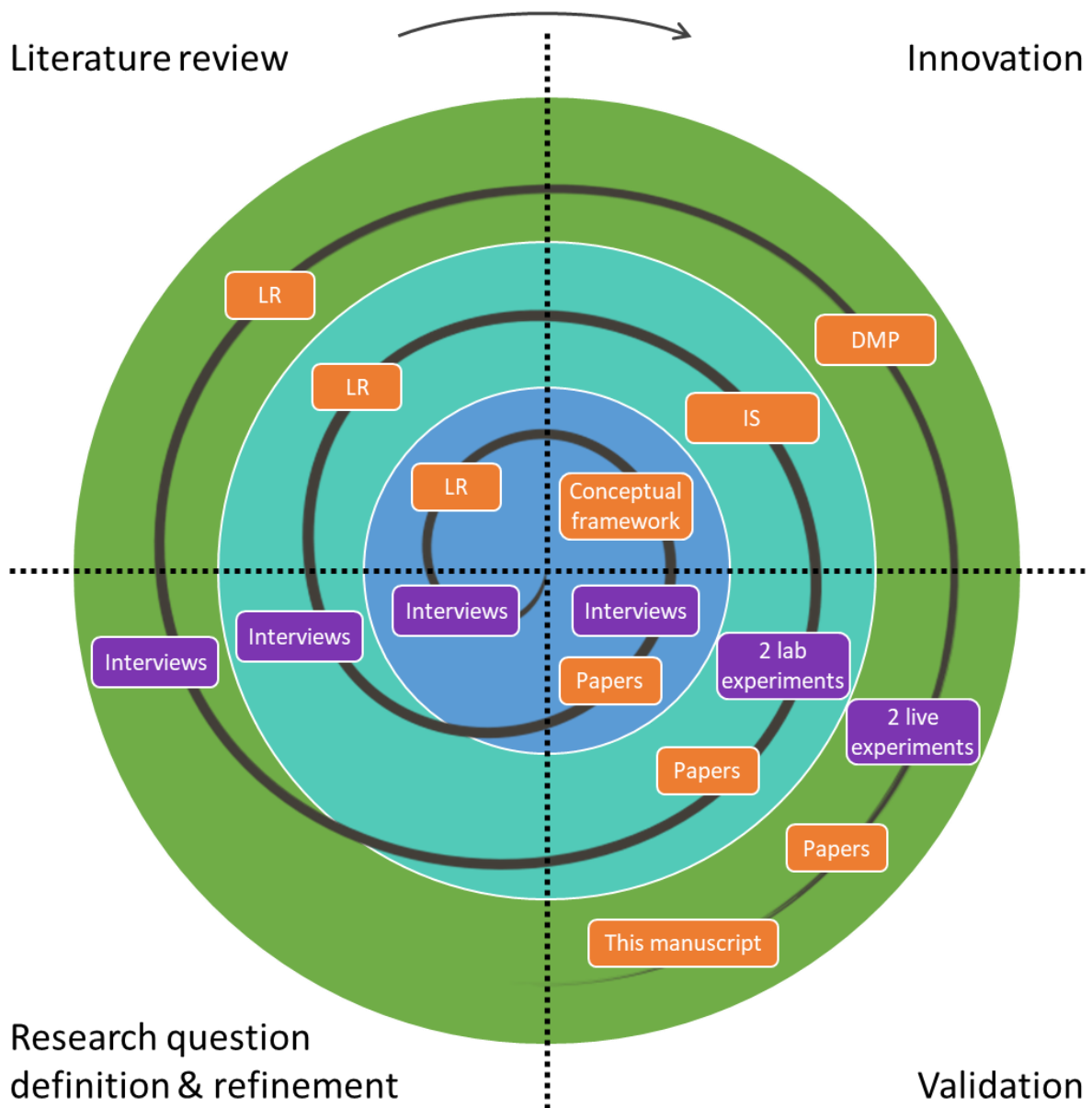

Figure 13: The methodology followed to carry out this thesis

5. Thesis structure

The objective of this section is to describe the structure of this thesis. The thesis starts with a chapter of introduction (this chapter). Then, the following three chapters are organized according to the sequence of the three contributions shown in Figure 10. Afterwards, the fifth chapter describes the industrial validation of the contributions by means of two industrial use cases accomplished respectively with the two industrial partners of this research project. Finally, the sixth chapter concludes the thesis and introduces avenues for future research. Figure 14 graphically positions the chapters (except for the introduction and conclusion) in relation to the overview of the contributions (C1, C2, and C3) this thesis proposes for answering the industrial and research questions it is focused on (Figure 10). Each contribution chapter (II, II, and IV) contains the specific literature review related to its contribution.

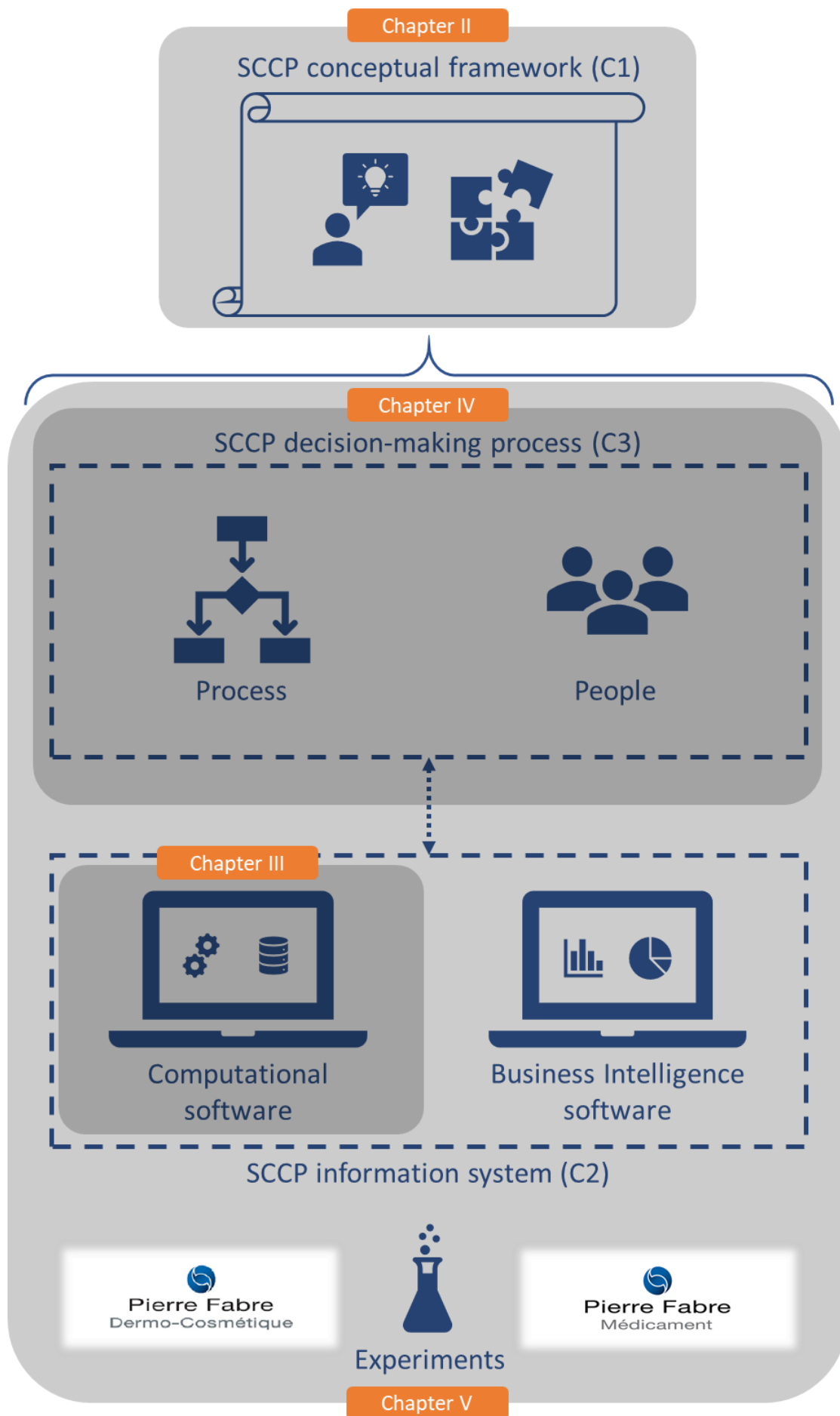

Figure 14: The structure of this thesis in regard to the overview of the contributions (C1, C2, and C3)

CHAPTER II. A CONCEPTUAL FRAMEWORK AS A GUIDELINE FOR DEVELOPING A DECISION SUPPORT SYSTEM FOR SUPPLY CHAIN CAPACITY PLANNING

“Do not follow where the path may lead.
Go instead where there is no path and leave a trail.”

Ralph Waldo Emerson

The objective of this chapter is to introduce the first building block of the Supply Chain Capacity Planning (SCCP) Decision Support System (DSS) proposed in this thesis to answer the industrial and research questions: the SCCP conceptual framework. As mentioned in the first chapter, this SCCP conceptual framework describes the key principles of the approach for guiding the development of an SCCP DSS composed of a Decision-Making Process (DMP) along with an associated Information System (IS) to make SCCP decisions. Figure 15 illustrates the content of this chapter by positioning it on the overview of the contributions of this thesis. The first section of this chapter describes a literature review regarding existing solutions for building an SCCP DSS, explains the orientations of this research project, and introduces the first research question. Then, the second section introduces the SCCP conceptual framework proposal. Finally, the third section concludes the chapter and makes the link with the following two chapters.

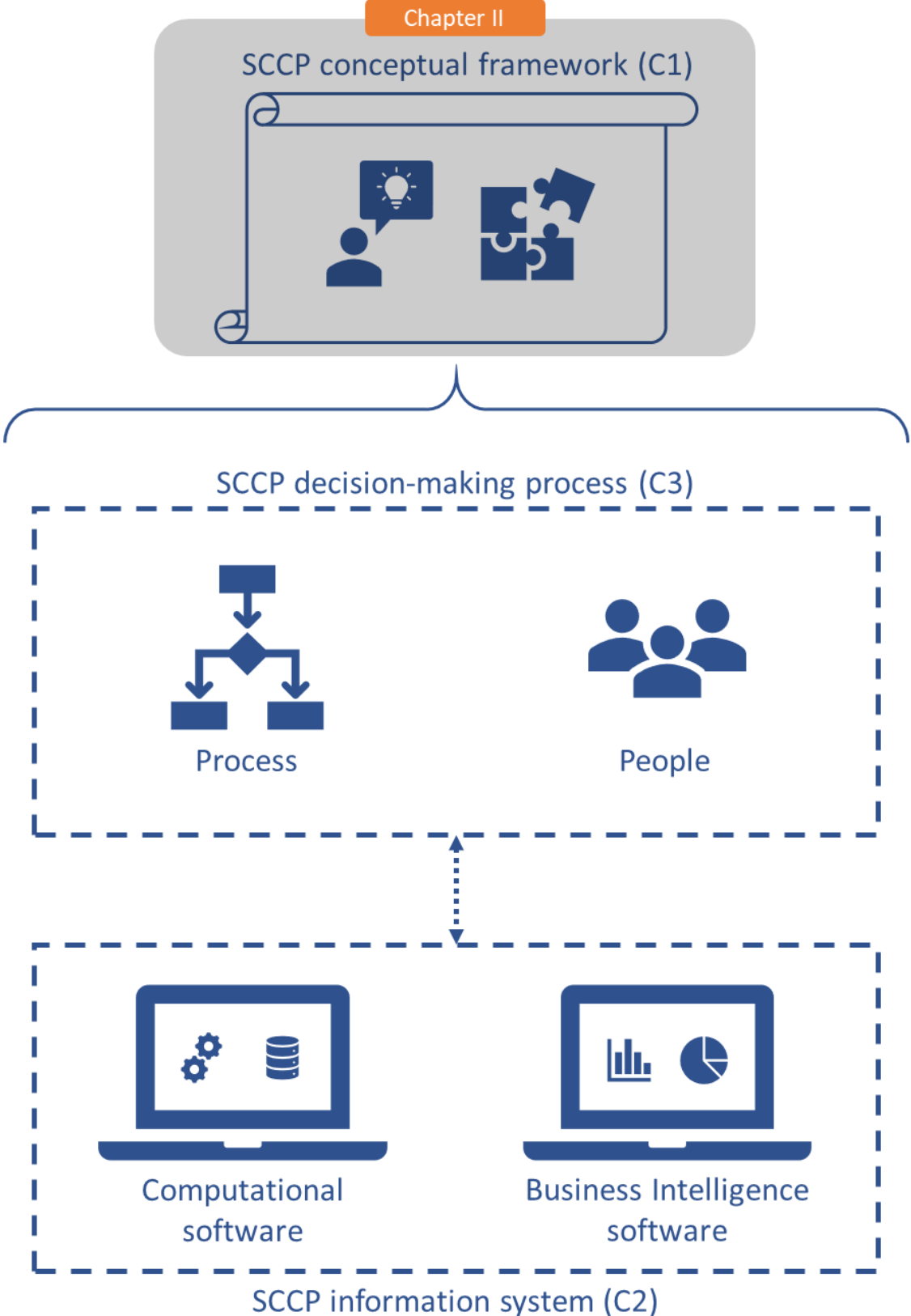

Figure 15: Positioning the content of this second chapter in regard to the overview of the contributions of this thesis (C1, C2, and C3)

1. Literature review on decision-making processes and information systems for supply chain capacity planning

This section synthesizes the results of the literature review undertaken to identify existing solutions for performing SCCP as well as their major limitations regarding the industrial questions and the first research question. The first subsection provides an overview of existing solutions for building an SCCP DSS. It first introduces the DSS vision considered in this thesis, and then synthesizes the existing DMPs and ISs found in the literature. The second subsection describes existing DMPs that can be used to build an SCCP DSS and assesses them regarding the industrial questions and the first research question of this thesis. The third subsection describes existing ISs that can be used to build an SCCP DSS and assesses them regarding the industrial questions and the first research question of this thesis. Finally, the fourth subsection concludes the literature review and describes the orientations of this research project leading to the first contribution described in the following section.

1.1. Overview of existing solutions for building a long-term SCCP decision support system

1.1.1. Components of a decision support system

Authors such as Power (2002) and Averweg (2012) have shown that there are different viewpoints in the literature regarding the definition of a DSS. Some authors limit the definition to a computer system while other authors include the way it can be used by people (i.e., for the DMP). In this thesis, the second mindset was chosen. The objective is to provide companies with not only an IS but a full system for guiding them in making decisions. Therefore, in this thesis, a DSS is considered to be a system aiming to support decision-making by combining the following four components: a purpose, people, a DMP, and an IS (Figure 16).

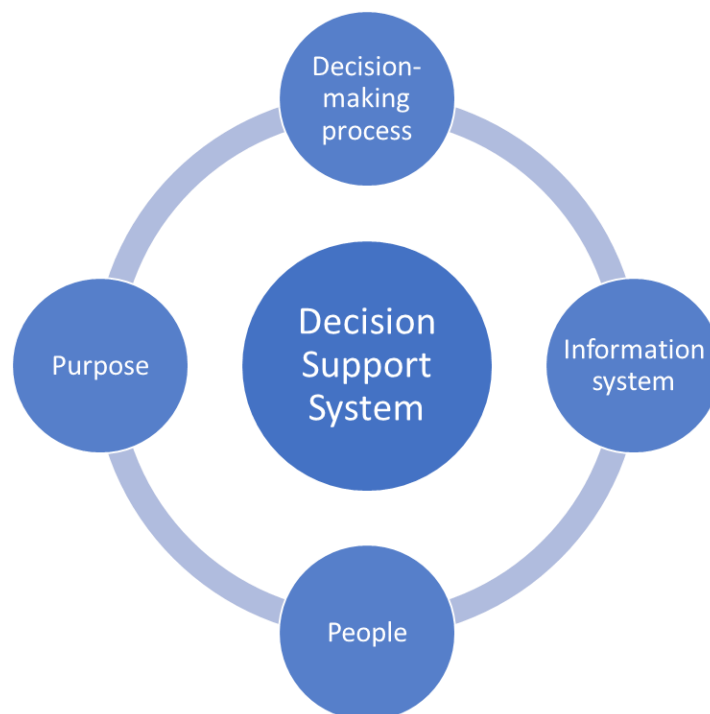

Figure 16: Four components of a decision support system as considered in this thesis

Each of these components interacts in different ways. The DMP is a structured sequence of activities, driven by the purpose, and involving people and interactions with the IS. The IS is a system aiming to deal with information by collecting, processing, storing, and distributing information (Piccoli and Pigni 2008). An IS does not necessarily imply a computer system; however, the distinction is blurred nowadays with the development of information and communication technologies.

1.1.2. Overview of existing solutions

In this thesis, the purpose of the DSS is to make long-term SCCP decisions. Therefore, the literature was investigated to find DMPs and ISs that could be used for this purpose. The next paragraph synthesizes the findings regarding existing DMPs and the following one synthesizes the findings regarding existing ISs.

Regarding the DMPs, five planning processes were found to be potentially relevant by investigating the practices included in the SCOR model (Supply Chain Council 2012): Sales and Operations Planning (S&OP), Integrated Business Planning (IBP), Demand-Driven S&OP (DDS&OP), Supply Network Planning (SNP), and Scenario Planning (SP). Each of these five processes was then further investigated to determine if it was going to be kept for the rest of the literature review. Distribution planning is also part of the practices included in the SCOR model but was not included because distribution is not in the scope of this thesis (Figure 5). The description of S&OP and IBP by several authors show the relevance of these DMPs regarding mid-term SCCP (Palmatier and Crum n.d., Ling and Goddard 1988, Olhager et al. 2001, Lapede 2004, Palmatier et al. 2010, Bower 2012, Olhager 2013). However, Melnyk et al. (2014) showed that performing supply chain design (and thus long-term SCCP) every 5 to 10 years is no longer appropriate and that more dynamic updating is needed. Therefore, S&OP and IBP are considered in the rest of the literature review because these processes, or at least the principles behind them, could also be relevant for building an SCCP DSS. The literature on the DDS&OP process shows that it is part of the broader approach of a Demand Driven Adaptive Enterprise (DDAE) and that the relevant process for long-term decisions is the Adaptive S&OP (AS&OP) process and not the DDS&OP process (Ptak and Ling 2017, Martin et al. 2018, Vidal et al. 2018, p. 20, Demand Driven Institute 2019, Demand Driven Adaptive Enterprise (DDAE) 2019). Therefore, AS&OP is studied in the rest of the literature review and DDS&OP is not. No structured process was found in the academic literature for SNP. The only process found regarding SNP is associated with the utilization of the SAP APO software (SAP Library - Supply Network Planning 2019). However, it is focused on describing the tasks that can be performed by the software and does not provide a DMP showing how to coordinate people and software to make decisions. Therefore, this information found on SNP is considered part of the IS and not the DMP. As defined by the APICS Dictionary (APICS 2016), SP is “a planning process that identifies critical events before they occur and uses this knowledge to determine effective alternatives.” As mentioned in the SCOR model (Supply Chain Council 2012), this is a domain-independent approach that is applied within the S&OP and IBP processes. Therefore, SP is not considered on its own in the rest of the literature review but as part of other processes. An additional DMP relevant for long-term SCCP was found by investigating additional sources in the literature: Collaborative Planning, Forecasting, and

Replenishment (CPFR). The description of CPFR by several authors such as Olhager (2013), and Danese (2006) show the association of a part of this DMP with long-term SCCP. Therefore, CPFR is studied in the rest of the literature review. Finally, the following four DMPs are considered relevant for this thesis and are thus further investigated (Figure 17): S&OP, IBP, AS&OP, and CPFR. Finally, the choice of focusing on these decision-making processes has also been made because the objective was to perform usage oriented research and because even though the literature on long-term capacity planning contains operation research approaches (Geng and Jiang 2009, Martínez-Costa et al. 2014), two observations have been made: first, only few companies seems to use these long-term capacity planning operation research approaches ; second, no structured decision-making processes has been found.

Regarding the ISs, three categories were identified as potentially relevant for building a long-term SCCP DSS and are thus further investigated in the rest of this thesis (Figure 17): Enterprise Resource Planning (ERP), Advanced Planning System (APS), and spreadsheet. They were identified in the supply chain planning literature through papers written by authors such as Rondeau and Litteral (2001), Santa-Eulalia et al. (2011), Olhager (2013), and Stadtler et al. (2015). Some other IS categories that could be used for SCCP are not described in this literature review for one or several of the following reasons: first, because they are related to distribution (i.e., warehousing and transportation, while this thesis focuses on procurement, production, and sales (Figure 5)). Second, because they are associated with the identification of SCC plan alternatives and associated information (e.g., decision options, uncertainty sources, sales forecasts, equipment capacity) while this thesis focuses on the use of this information for assessing, comparing, and deciding (Figure 7). Third, because they are focused on execution and short- or mid-term supply chain management while this thesis focuses on the long-term (Figure 5). Consequently, the following software is not described in this thesis: Distribution Resource Planning (DRP), Transportation Management System (TMS), Warehouse Management System (WMS), Manufacturing Execution System (MES), and sales forecasting software.

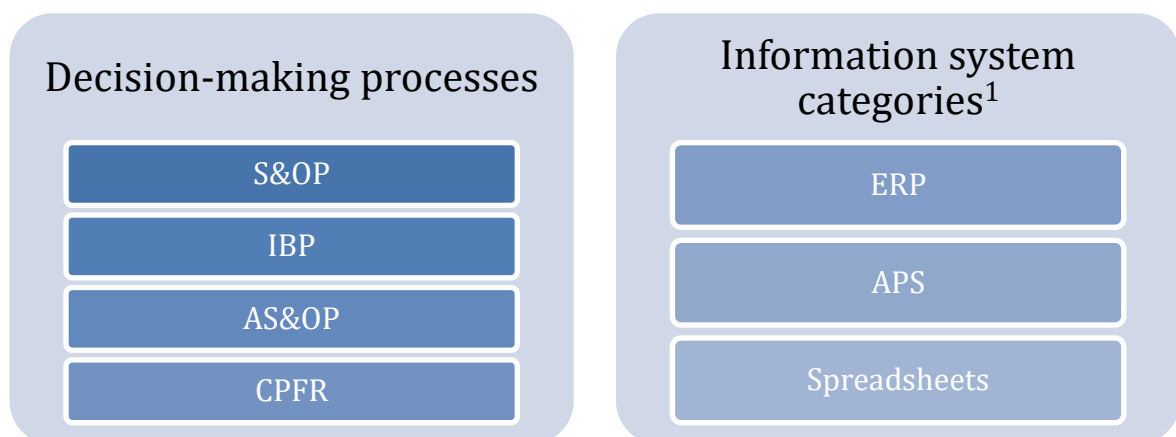

Figure 17: Existing decision-making processes and information system categories¹ found in the literature as being relevant for long-term SCCP and are thus further investigated in the rest of this thesis

¹ The information system categories considered are those aiming to support computations (e.g. supply chain data processing), and not those that could be used to coordinate people during the decision-making process.

1.2. Decision-making processes for long-term supply chain capacity planning

To plan the capacity of their supply chains, companies usually set up DMPs that structure the sequence of the SCCP activities. Generally, some of these activities take advantage of one or several ISs such as those described in the previous subsection. The objective of this subsection is to describe the identified existing DMPs (Figure 17) and assess them regarding the industrial questions of this thesis.

1.2.1. Sales and Operations Planning

The Sales and Operations Planning (S&OP) methodology was created in 1984 by Richard (Dick) Ling (Ptak and Ling 2017). It first appeared in the literature in 1988 with the book “Orchestrating success: Improve control of the business with sales & operations planning” (Ling and Goddard 1988). The S&OP proposal made in 1988 was then updated in 2003 and 2009 (Coldrick et al. 2003, Ling and Coldrick 2009). Figure 18 illustrates the updated S&OP process. There are several definitions for S&OP in the literature, but most authors agree on defining S&OP as a business process that unifies plans from several departments (e.g., sales, marketing, development, manufacturing, sourcing, and financial) into one integrated plan (Olhager et al. 2001, Grimson and Pyke 2007, Thomé et al. 2012). The latter integrated plan aims to achieve a coherent balance among all department plans to benefit the entire company. Most authors consider S&OP a mid-term (also called tactical) planning level with a planning horizon going from 6 to 24 months (Grimson and Pyke 2007, Wang et al. 2012, Albrecht et al. 2015, Meyr et al. 2015).

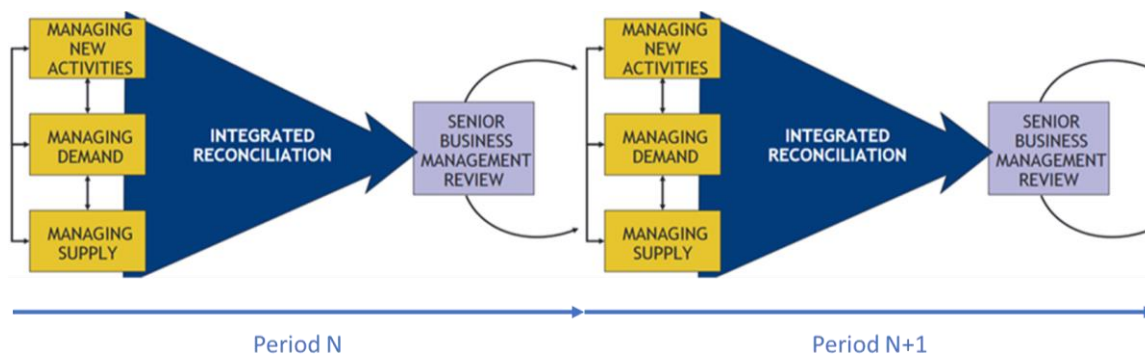

Figure 18: The Sales and Operations Planning (S&OP) process (adapted from Coldrick et al. (2003))

Several authors recommend using spreadsheets to support the S&OP process, and it has been observed that indeed many companies use spreadsheets as the IS to support their S&OP process (Genin et al. 2005, Grimson and Pyke 2007, Wallace and Stahl 2008, Ling and Coldrick 2009, Pinon 2017, Ptak and Ling 2017, Pinon et al. 2018). Some authors also recommend using advanced software when a company reaches a certain maturity level in its S&OP implementation, but without giving any examples (Grimson and Pyke 2007). No other IS solution was found in the S&OP academic literature. To deal with uncertainty sources and decision options, Ling and Coldrick (Ling and Coldrick 2009) recommend running alternative scenarios based on different sets of assumptions. However, their proposal, illustrated with some examples, is manual and seems applicable only to a limited set of alternative scenarios. There are several commercial software programs stating their capability of supporting the S&OP process. However, no detailed information was found about the way they can be integrated into

the DMP, and their mechanisms are not publicly shared. The most detailed review that was found was performed by Gartner (Gartner 2018, 2019a, 2019b) but it does not provide enough information to compare their structure and integration in the process.

Finally, authors seem to agree on the main principles and the sequence of activities constituting the S&OP process. However, the results in terms of consideration of the multitude of decision options and uncertainty sources are limited by the ISs. Therefore, it is lacking a description of an S&OP process that includes an appropriate IS supporting long-term SCCP considering the multitude of decision options and uncertainty sources. This makes it unsatisfying for answering the industrial and research questions this thesis focuses on.

1.2.2. Integrated Business Planning

The Integrated Business Planning (IBP) methodology is very similar to the S&OP methodology (Palmatier and Crum n.d., Palmatier et al. 2010, Wallace and Stahl 2011, Bower 2012, Pinon 2017, Pinon et al. 2018). Several authors consider IBP an advanced version of S&OP (Palmatier and Crum n.d., Palmatier et al. 2010). Other authors consider IBP a mature S&OP implementation (Bower 2012). Palmatier and Crum (n.d.) describe IBP as the following seven-step process: product review, demand review, supply review, financial review, integrated reconciliation, and management business review. Figure 19 illustrates this IBP process.



Figure 19: The Integrated Business Planning (IBP) process (Palmatier and Crum n.d.)

It can be observed with Figure 18 and Figure 19 that S&OP and IBP processes have similarities. However, there is a lack of academic literature on IBP, preventing it from being assessed independently from S&OP (Pinon 2017, Pinon et al. 2018). As a matter of fact, in searching the Web of Science Core Collection, no results regarding this methodology were found searching for “integrated business planning” within the title, and three results mentioning this methodology were found searching for “integrated business planning” within the topic. This reveals the early stage of academic research regarding this methodology that has emerged from the industry. No paper describing ISs to support IBP was found in the academic literature. As for S&OP, there are several commercial software programs stating their capability of supporting the IBP process. However, no detailed information was found about the way they can be

integrated into the DMP, and their mechanisms are not publicly shared. No review focusing on IBP was found. Considering the similarities between IBP and S&OP, the closest was performed by Gartner (Gartner 2018, 2019a, 2019b) on S&OP in which IBP is mentioned in association with several software programs. But not enough information is provided to compare their structure and integration in the process.

Finally, regarding the adequation of the IBP methodology in answering the industrial and research questions, the conclusions are the same as for the S&OP process because of the similarities highlighted by the literature and the lack of academic literature describing it. It is lacking a description of an IBP process that includes an appropriate IS supporting long-term SCCP considering the multitude of decision options and uncertainty sources. This makes the current state of the art on IBP unsatisfying for answering the industrial and research questions this thesis focuses on.

1.2.3. Adaptive Sales and Operations Planning

Adaptive Sales and Operations Planning (AS&OP) is the most recent methodology identified for performing SCCP. It was developed in 2017 by the Demand Driven Institute (DDI) in collaboration with the creator of the original S&OP process, Richard (Dick) Ling (Ptak and Ling 2017, Demand Driven Institute 2019). Adaptive S&OP is defined by Ptak and Ling (2017) as “the integrated business process that provides management the ability to strategically define, direct and manage relevant information in the strategic relevant range and across the enterprise. Market driven innovation is combined with operations strategy, go-to market strategy and financial strategy to create strategic information and requirements for tactical reconciliation and strategic projection to effectively create and drive adaptation.” Ptak and Ling (2017) described AS&OP as a seven-step process: portfolio and new activities, demand, supply, financial, integrated strategic reconciliation, Demand Driven S&OP, and management review. Figure 20 illustrates this AS&OP process. According to Ptak and Ling (2017), one of the main differences between AS&OP and S&OP is the mindset, with AS&OP focusing on flow rather than cost and being demand-driven.

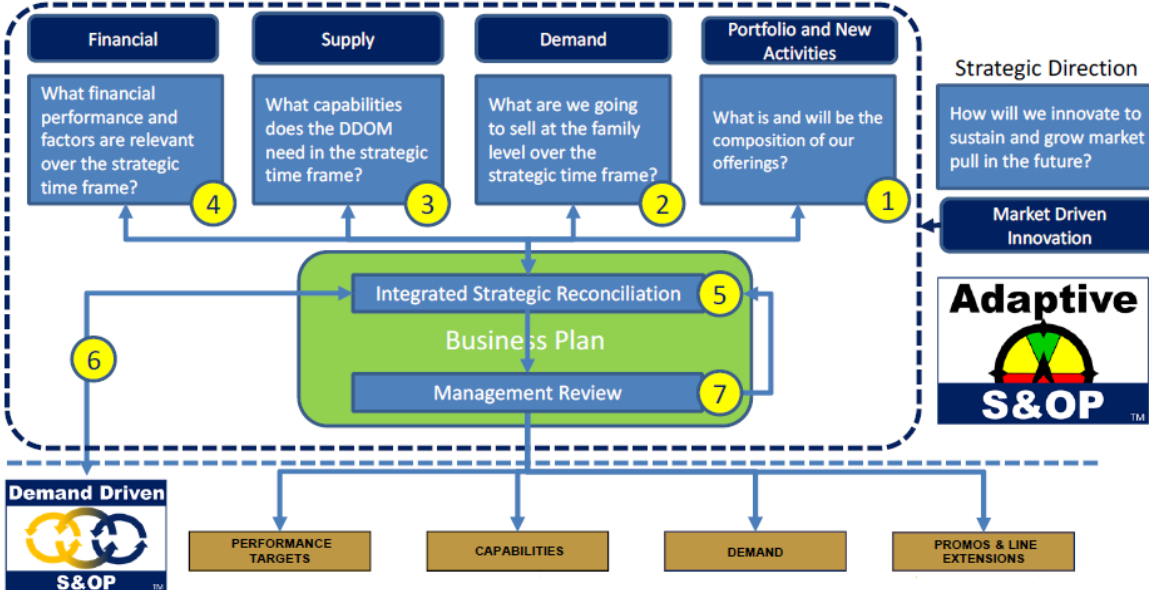

Figure 20: The Adaptive Sales & Operations Planning (AS&OP) process (Ptak and Ling 2017)

It can be observed with Figure 18, Figure 19, and Figure 20 that S&OP, IBP and AS&OP processes have a lot of similarities. However, as with IBP, there is a lack of academic literature on AS&OP preventing it from being assessed independently from S&OP (Pinon 2017, Pinon et al. 2018). Only one paper focusing on AS&OP and written by Vidal et al. (2018) was found on Google Scholar. And only four papers (Martin et al. 2018, Oger et al. 2018b, Pinon et al. 2018, Vidal et al. 2018) were found on Google Scholar mentioning AS&OP. Four requests were used in the Google Scholar search engine: “allintitle: ‘adaptive sales & operations planning’”, “allintitle: ‘adaptive sales and operations planning’”, “ ‘adaptive sales & operations planning’”, and “ ‘adaptive sales and operations planning’”. No result was obtained with the same request used on the Web of Science (WOS) Core Collection search engine. As with IBP, no paper describing ISs to support AS&OP was found in the academic literature. However, unlike S&OP and IBP, no commercial software stating its capability of supporting the AS&OP process was found.

Finally, regarding the adequation of the AS&OP methodology in answering the industrial and research questions, the conclusions are the same as for the S&OP process because of the similarities highlighted by the literature and the lack of academic literature describing it. It is lacking a description of an AS&OP process that includes an appropriate IS supporting long-term SCCP considering the multitude of decision options and uncertainty sources. This makes the current state of the art on AS&OP unsatisfying for answering the industrial and research questions this thesis focuses on.

1.2.4. Collaborative Planning, Forecasting, and Replenishment

Collaborative Planning, Forecasting, and Replenishment (CPFR) corresponds to the evolution of Collaborative Forecasting and Replenishment (CFAR), which was created in the 1990s (Fliedner 2003, Poler et al. 2008). The original name referred to the collaboration between partners regarding forecasting and replenishment tasks. The Voluntary Interindustry Commerce Solutions Association (VICS) (2004) defines CPFR as “a business practice that combines the intelligence of multiple trading partners in the planning and fulfillment of customer demand. CPFR links sales and marketing best practices, such as category management, to supply chain and execution processes to increase availability while reducing inventory, transportation and logistics costs.” It was renamed CPFR to integrate collaborative planning into the methodology (Burnette 2010). The latest version of CPFR integrates it with IBP on the planning aspect (Baumann 2010, Smith et al. 2010, VICS 2010, Hollmann et al. 2015). However, technological solutions found in the literature focus on information sharing between companies and not on information exploitation for IBP (Hollmann et al. 2015). Hollmann et al. (2015) concludes that the lack of information technologies for supporting CPFR is one of the main barriers towards its successful implementation. Another aspect of the results of the literature review undertaken by Hollmann et al. (2015) emphasize the lack of IS solutions: they classified the reviewed papers by type of paper (e.g. “conceptual model”, “survey”, “simulation”, and “industry report”) and there is no category for ISs. In addition, a study on CPFR critical success factors identified some IBP characteristics such as the following as limitations on CPFR implementation: the IBP process was considered too time-consuming by several departments of the studied company (Cristea and Khalif Hassan 2018).

Finally, regarding the adequation of the CPFR methodology in answering the industrial and research questions, a similar conclusion was made for CPFR as for S&OP, IBP and AS&OP: it is lacking a description of a CPFR process that includes an appropriate IS supporting long-term SCCP considering the multitude of decision options and uncertainty sources. This makes the current state of the art on CPFR unsatisfying for answering the industrial and research questions this thesis focuses on.

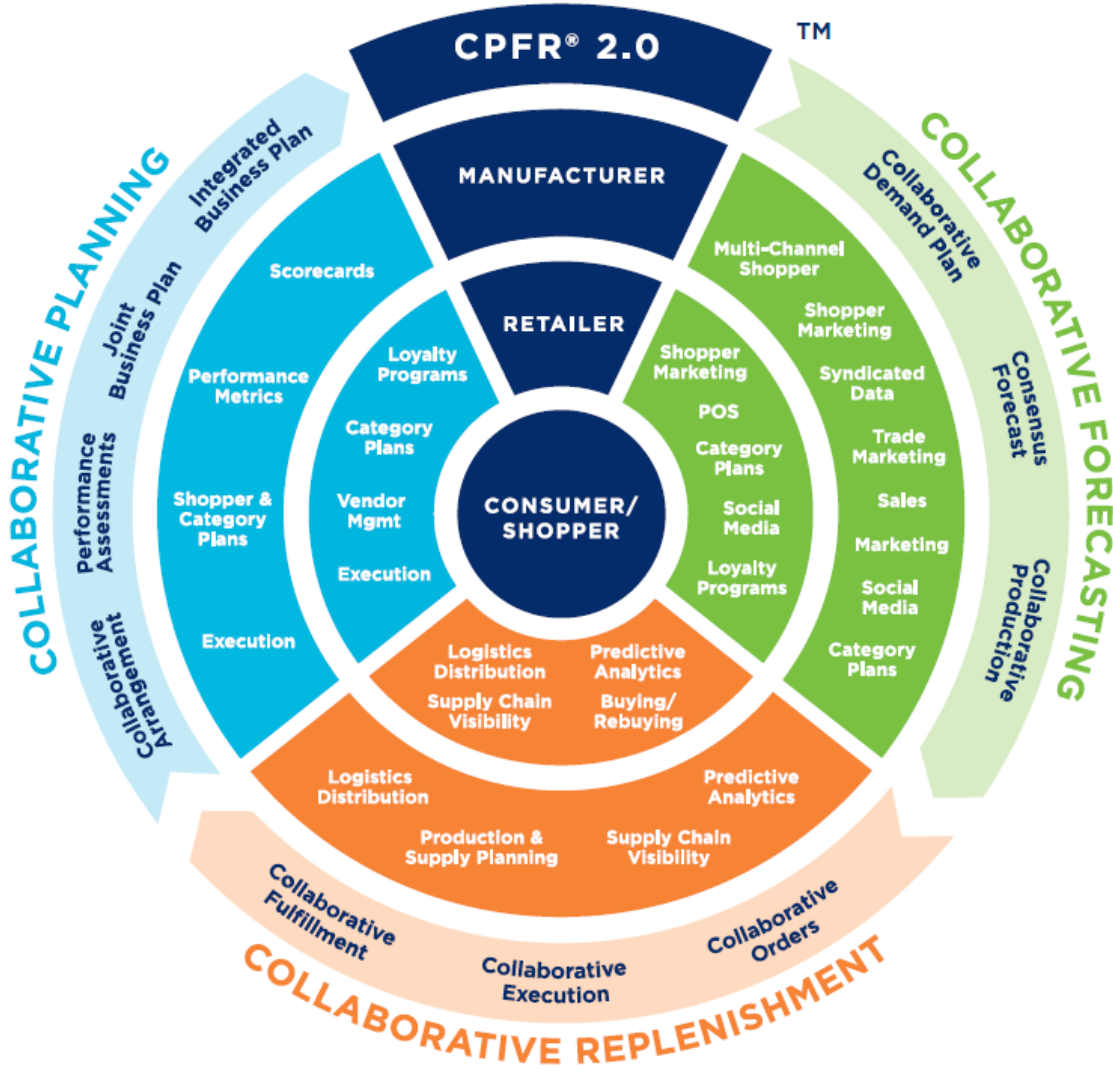

Figure 21: The Collaborative Planning, Forecasting, and Replenishment (CPFR) process (GS1 US 2016)

1.3. Information systems for long-term supply chain capacity planning

To plan the capacity of their supply chains, companies use ISs to assist them during their SCCP DMP. The objective of this subsection is to describe existing ISs identified in the previous subsection (Figure 17) and assess them regarding the industrial questions of this thesis.

1.3.1. Enterprise Resource Planning

Enterprise Resource Planning (ERP) was introduced by the Gartner Group (Wylie 1990) in the 1990s, emerging from the evolution of planning techniques such as Material Requirements Planning (MRP) and Manufacturing Resources Planning (MRP II) (Olhager 2013, Pinon 2017,

Pinon et al. 2018). The APICS Dictionary (APICS 2016) defines Enterprise Resource Planning (ERP) as a “framework for organizing, defining, and standardizing the business processes necessary to effectively plan and control an organization so the organization can use its internal knowledge to seek external advantages. An ERP system provides extensive databanks of information including master file records, repositories of costs and sales, financial details, analysis of product and customer hierarchies, and historic and current transactional data.”

ERP systems are intended to be transactional systems providing data structure and storage capabilities and supporting automated calculations based on the data stored in the system (Kurbel 2013, Stadtler et al. 2015). However, historical ERP systems are not intended to deal with alternative data such as alternative suppliers or lower and upper bounds for capacity constraints (Santa-Eulalia et al. 2011, Stadtler et al. 2015). Therefore, they are not an appropriate solution for evaluating alternative scenarios of decision options such as supplier selection. They are also not an appropriate solution for evaluating risks coming from uncertainties such as demand or capacity variations. In addition, ERP systems are usually designed to focus on a single firm and not entire supply chains (Stadtler et al. 2015). Finally, as mentioned by Santa-Eulalia et al. (2011), “ERP’s planning capabilities, although fundamental to the planning process, are limited when not leveraged by an APS system.” As a result, Advanced Planning Systems (APSs) are the tools investigated in the next sub-subsection.

To conclude, ERP systems alone do not fit the requirements for answering the industrial questions of this thesis. First, their planning capabilities have been designed to deal with static supply chains. Second, they have not been designed for considering a significant number of alternative scenarios. Both these reasons make the consideration of scenarios including the existing and alternative supply chains difficult and time-consuming. Therefore, ERPs are not appropriate for long-term SCCP because it would be too time-consuming to reach a satisfying coverage of the multitude of decision options and uncertainty sources.

1.3.2. Advanced Planning Systems

The Advanced Planning System (APS) is software supporting planning activities for the different areas of supply chain management such as procurement, production, distribution and sales, and for different planning horizons such as long-, medium- and short-term (Stadtler et al. 2015). APSs are normally based on advanced planning and optimization methods aiming to provide businesses with optimal solutions for planning their activities. APSs are intended to supplement existing ERP systems by taking over planning tasks while ERP systems are still required as transactional and execution systems (Stadtler et al. 2015).

Authors such as Stadtler et al. (2015) and Santa-Eulalia et al. (2011) indicate that existing APSs are dedicated to deterministic planning and that the management of uncertainty is a significant limitation of these systems. The review of models for production planning under uncertainty undertaken by Mula et al. (2006) showed that most analytical models address only one type of uncertainty and assume a simple structure of the production process. Stadtler et al. (2015) adds that even with stochastic programming approaches, the risk of high-impact and low-probability catastrophic events such as natural disasters and breakdowns can only be represented with great difficulty. “What-if” scenarios are a growing feature within APSs, with the ability to run

scenarios that change one or more parameters so that the scenarios results can be compared (Musselman et al. 2002, Santa-Eulalia et al. 2011). These features could be useful for overcoming the limitations highlighted by Stadtler et al. (2015) regarding the consideration of scenarios of catastrophic events. However, Santa-Eulalia et al. (2011) says that in practice only a few scenarios can be tested within existing commercial APSs because of the complexity of doing so. Santa-Eulalia et al. (2011) concludes that the existing optimization solutions offered by APS do not allow for robust planning, a conclusion supported by several other authors such as Klibi et al. (2010) and Martel and Klibi (2016).

An industrial experiment within the chemical industry undertaken by Häberle and Kilger (2015) showed additional limitations of the optimization approach offered by APS. It described how decision-makers did not trust the optimization results from the “big model”, saying that no acceptance could be achieved with the results coming out of the “black box” of optimization algorithms. Therefore, they recommended decomposing it into smaller models corresponding to alternative scenarios making it possible for decision-makers to understand the results of the optimizer. This approach is a combination of a “what-if” scenario-based approach and an optimization approach implying the creation of several “what-if” optimization models.

Finally, unlike ERP, APSs have been designed to support planning decisions such as those this thesis focuses on. However, the limitations of existing APSs make it unsatisfactory for answering the industrial questions of this thesis. First, they have a limitation similar to that of ERP systems (even though more appropriate): the number of “what-if” scenarios that can reasonably be considered is limited because it would be too time-consuming to reach a satisfying coverage of the multitude of decision options and uncertainty sources. Second, the acceptance of a unique optimization result that cannot be compared with alternative scenarios can be low and can result in the rejection by decision-makers of decisions that are recommended by the APS.

1.3.3. Spreadsheets

Spreadsheets are used to create personalized decision-making models notably to support supply chain planning decisions. Several authors have shown that spreadsheets are widespread because of their flexibility, and their simplicity of use and understanding (Ozturk et al. 2003, Genin et al. 2005, Grimson and Pyke 2007, Geng and Jiang 2009, Kilger 2015, Pinon 2017, Pinon et al. 2018). Spreadsheets have an advantage compared to ERP and APSs when looking at a long-term horizon: they can contain data that is not available in ERP or APS systems (Stadtler et al. 2015). On a first approach, these characteristics of spreadsheets make them convenient for planners. They can adapt spreadsheet models without much constraint and create new models as needed. When considering SCCP, evaluating alternative scenarios for uncertainty sources such as demand uncertainty scenarios can easily be done by changing values in the corresponding cells. Similarly, alternative scenarios can be evaluated for decision options such as improving the production rate of a production line by changing it in the corresponding cell. However, this advantage of simplicity of spreadsheets for evaluating alternative scenarios is limited to scenarios that do not modify the structure of the supply chains. In most cases, there is a desire for evaluating scenarios that modify the structure of the supply chains, such as including a new supplier or production line. And these alternative scenarios modifying the

structure of the supply chains will require updating the spreadsheet models. But creating new spreadsheet models is a lot more time-consuming than simply evaluating scenarios by changing the value in a cell. Therefore, few scenarios are generally assessed when using spreadsheets. This was confirmed with the industrial partners of this project, for whom it can take days or even weeks to build spreadsheet models to evaluate alternative scenarios. In addition, there are other major drawbacks in using spreadsheets: first, the flexibility can lead to continuous changes in the spreadsheet models' organization that makes it difficult for others (those not building the models) to understand the planning process and results (Kilger 2015). Second, this maintains data locally and does not guarantee data consistency, integrity, or durability, which can lead to inconsistent planning results and a loss of information. Third, the complexity and frequency of SCCP update requests can overload human planners if they use only spreadsheets (Fleischmann and Koberstein 2015).

Finally, the limitations of spreadsheets make them unsatisfactory for answering the industrial questions of this thesis. First, spreadsheets have the same limitations as ERP systems and APSs: the number of alternative scenarios that can reasonably be considered is limited because it would be too time-consuming to reach a satisfying coverage of the multitude of decision options and uncertainty sources. Especially when it comes to considering alternative supply chains and storing data on the scenarios. Second, it is not adapted to managing information over time and across different actors because it is generally stored and updated locally. Therefore, the planning processes based on spreadsheets tend to be long and time-consuming, limiting the quality of the planning results including the consideration of uncertainty and opportunities (Kilger 2015).

1.4. Conclusion and research orientation

The objective of this subsection is to introduce the orientations of this research project by concluding the results of the literature review that were synthesized in the previous subsection and completing them with additional information from the literature.

Considering the information given in the first chapter and the literature review, it seems relevant that a DMP solution provided to answer the research questions cannot be without a computerized IS supporting it. This conclusion is supported by several other authors regarding S&OP and CPFR (Ivert and Jonsson 2010, Tuomikangas and Kaipia 2014, Hollmann et al. 2015, Kristensen and Jonsson 2018). Consequently, the performance outcomes of the DMP are closely related to the use of the capabilities of the IS. However, despite the existence of several types of ISs (e.g., ERP, APSs, and spreadsheets) and mathematical approaches (e.g., optimization, simulation, and heuristics (Van Mieghem 2003, Mula et al. 2006, Calvete et al. 2016, Martel and Klibi 2016)), the only detailed proposals found in the literature regarding DMPs for SCCP taking advantage of an existing IS are with spreadsheets. But, as highlighted in the next paragraph, spreadsheets do not provide the right capabilities for answering the industrial and research questions. Therefore, the first objective of this research project is to propose a DMP for SCCP in which the use of an IS is clearly explained.

In addition, the three types of ISs evaluated have shown several limitations in providing an answer to the industrial and research questions. The major limitation of the three, regarding the industrial and research questions this thesis focuses on, is the time required for considering

different types of uncertainty sources and decision options by evaluating alternative “what-if” scenarios. The main reason behind this limitation is the need to create and use different evaluation models and the time required for doing so. Mula et al. (2006) claim that further research is needed on new approaches to model uncertainty sources that can include each company of the supply chain as well as consider the different types of uncertainty sources (e.g., lead times, quality, failures in production, and bills of materials) in an integrated manner (i.e., without having to create a new evaluation model for each type of uncertainty source and supply chain echelon). This claim for future research is confirmed by other authors (Cecere et al. 2006, Santa-Eulalia et al. 2011, Pinon 2017, Pinon et al. 2018). Therefore, a second objective of this research project, complementary with the first objective mentioned in the previous paragraph, is to propose an IS for SCCP that overcomes the identified limitations of the existing ones.

Therefore, the choice was made to focus the innovation efforts of the research project on designing an SCCP DSS composed of an SCCP DMP supported by an associated SCCP IS. This SCCP DSS should overcome the limitations of existing solutions by achieving these three objectives: first, by considering a multitude of combinations of different types of decision options while including a multitude of different types of uncertainty sources in the assessment. Second, by minimizing the effort and time required by humans to perform the SCCP DMP to make its use realistic and relevant considering the dynamicity of the supply chain environment. Third, by gaining decision-makers’ confidence by increasing their visibility and understanding of potential futures and of the impact of the decisions they can make. Finally, this objective leads to the following research question:

First Research Question (RQ1):

What would be the functional features of an SCCP decision support system able to manage decision options, uncertainty sources, dynamicity, and visibility requirements of current supply chains?

2. Supply chain capacity planning conceptual framework proposal

The objective of this section is now to describe the first building block of the SCCP DSS proposed in this thesis to answer the first research question: the SCCP conceptual framework which is, as mentioned in the introduction, the first contribution of this thesis and corresponds to a conceptual framework describing the key principles of the SCCP DSS. This SCCP conceptual framework is built on the preliminary research work introduced by Oger et al. (2017a, 2017b, 2018b). As mentioned in the conclusion of the literature review, the SCCP DSS this thesis proposes is a DMP supported by an associated IS to perform SCCP. The key principles described by the SCCP conceptual framework include a proposed sequence of activities with their objectives and constraints as well as the involved stakeholders. This SCCP conceptual framework aims to serve as a guideline for designing an SCCP DSS composed of a DMP and an associated IS that is able to answer the industrial questions and first research question. Consequently, it served as a guideline for designing the DMP and IS contributions that are described in the following two chapters. The first subsection describes the proposed high-level sequence of activities of the SCCP DMP supported by an IS. Then, the second subsection describes the stakeholders involved in the DMP.

2.1. Sequence of activities with their objectives and constraints

This subsection introduces the sequence of activities proposed for performing SCCP. The first sub-subsection gives an overview of the sequence of activities. Then, the following three sub-subsections describe each activity with their objectives and constraints. The activities are grouped into three phases corresponding to the three sub-subsections, starting from the last one and finishing with the first one.

2.1.1. Overview of the sequence of activities

The structure of the sequence of activities proposed for performing SCCP is inspired from the structure of existing decision-making and problem-solving approaches described in the literature (Bell et al. 1977, Sainfort et al. 1990, Klein et al. 1993, Guo 2008).

The sequence of activities is divided into three main phases synthesized in Figure 22: first, the generation of Supply Chain Capacity (SCC) plan alternatives. This corresponds to the identification of the set of alternatives from which decision-makers will have to choose the best one. Second, the assessment of the SCC alternatives. This corresponds to the evaluation of the impact that each alternative would have on the supply chains' capacities and associated performance indicators. Third, the decision of the SCC plan alternative to implement. This corresponds to research on the best alternative that should be selected for implementation.

The first phase of the sequence of activities proposed for performing SCCP is composed of two activities. The first activity, "gather supply web and demand plan information including associated decision options and uncertainty sources", aims to gather information about the supply web and the associated demand plan, as well as the decision options and uncertainty sources associated with both the supply web and the demand plan. In this thesis, the terms "supply web", "supply chain", "demand plan", "SCCP decision option", "SCCP uncertainty source" are defined as follows (Table 41):

- A supply web is defined as “a set of identified active and potential supply chain stakeholders from a core business perspective, each with specific abilities, resources and relationships.”
- A supply chain is defined as “a set of sequenced activities and stakeholders from the supply web making it possible to source, make, and deliver a specific product or family of a core business.”
- A demand plan is defined as “a consensus combination of client orders and demand forecasts for the products to be delivered to customers by supply chains enabled by stakeholders of the supply web over the planning horizon.”
- An SCCP decision option is defined as “an ability to make the choice of executing an action implying activation, modification, creation or deletion of elements of the supply web and/or the demand plan.”
- An SCCP uncertainty source is defined as “a potential gap between the forecasted state of the supply web and/or demand plan and the actual future that will happen, resulting from the fact that decision-makers were not able to obtain a forecast with certainty. Uncertainty sources can be separated into two categories: first, uncertainty sources resulting from the imprecision of the forecast of a specific parameter for which the reasons of the variability are unknown. Second, uncertainty sources resulting from the potential occurrence of a specific event that will generate a change in the supply web and/or demand plan.”

The second activity, “generate relevant supply chain capacity plan alternatives to assess”, aims to generate the SCC plan alternatives that are relevant for the company and so should be assessed as part of the alternatives considered when the final decision is made. In this thesis, a supply chain capacity plan is defined as “a combination of SCCP decision options that decision-makers could decide to implement” (Table 41).

The second phase of the sequence of activities proposed for performing SCCP is composed of three activities. The first activity, “generate what-if scenarios to assess”, aims to generate the scenarios of potential futures that should be assessed for supporting SCCP decisions. A what-if scenario corresponds to a specific potential future considering a specific configuration of activated decision options and uncertainty sources happening (Table 41). Therefore, this activity consists in generating the relevant combination of uncertainty sources to assess and combining it with the set of relevant SCC plan alternatives that has already been generated. The second activity, “generate an assessment model compatible with all what-if scenarios”, aims to generate a unique assessment model that will be compatible with all what-if scenarios to assess them. The third activity, “assess what-if scenarios”, aims to assess what-if scenarios generated during the first activity of this second phase, using the assessment model generated during the second activity of this second phase.

The third phase of the sequence of activities proposed for performing SCCP is composed of two activities. The first activity, “generate dashboards”, aims to create and configure dashboards that will support the comparison of SCC plan alternatives based on the outcomes of the assessment of the what-if scenarios performed during the third activity of the second phase. The second activity, “compare supply chain capacity plan alternatives”, aims to decide on the SCC plan to implement by comparing performance indicators of the assessed SCC plan

alternatives, using the dashboards generated during the first activity of this third phase to perform the comparison.

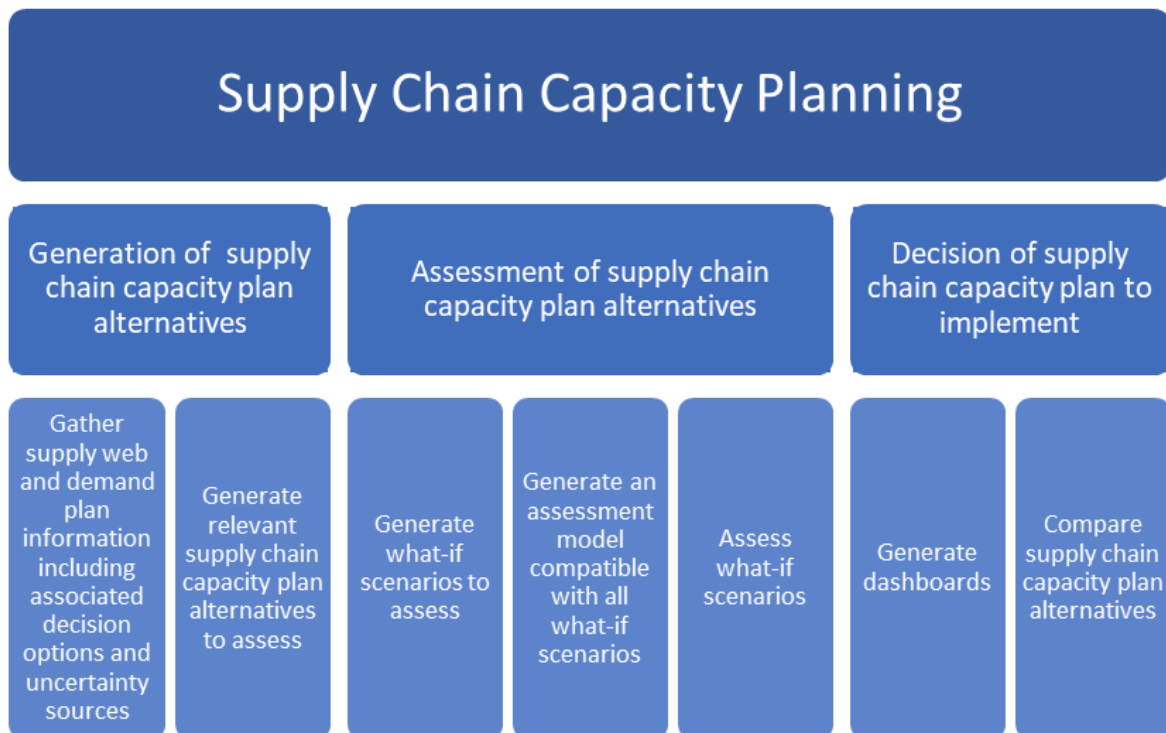

Figure 22: Sequence of activities of the SCCP conceptual framework proposal

The next three sub-subsections respectively describe in more detail the three phases with the corresponding sequence of activities that were introduced in this sub-subsection. They are introduced from right to left to illustrate the reasoning resulting in this conceptual framework. Each activity is illustrated by a figure (Figure 23 to Figure 29) structured according to the IDEF0 standard (Menzel and Mayer 1998): input of the activity on the left, output of the activity on the right, resources required for performing the activity on the bottom, and control rules (i.e., objectives) on the top. Finally, Figure 30 illustrates the entire sequence of activity of the SCCP conceptual framework proposal by linking the IDEF0 diagrams of all activities. This latter figure provides readers with a graphical overview of the relationships among all activities. It is not legible so readers can refer to the specific IDEF0 diagram of each activity for the details (Figure 23 to Figure 29).

2.1.2. An approach for deciding which supply chain capacity plan to implement

2.1.2.1. Compare supply chain capacity plan alternatives

The overall objective of the SCCP DSS is to help decision-makers decide on the SCC plan to implement. In other words, it means helping decision-makers to identify the best SCC plan alternative. As mentioned in the literature review section, a drawback of optimization approaches is the lack of acceptance because the outcome is a unique recommended solution that does not enable decision-makers to compare SCC plan alternatives and thus to easily understand the recommendation. Therefore, the proposed SCCP DSS must provide decision-makers with the ability to compare the SCC plan alternatives.

Comparing the SCC plan alternatives implies having comparison criteria defined here as Key Performance Indicators (KPIs). Therefore, the proposed SCCP DSS must provide decision-makers with the ability to understand and compare the performance of each SCC plan alternative based on KPIs. It is important to keep in mind that the objective is to select the SCC plan alternative that would perform best regarding a multitude of uncertainty sources. So, the performance of each SCC plan alternative should not be based on a unique scenario but on a set of scenarios associated with uncertainty sources. Therefore, the KPIs and their representation must be designed in a way that gives decision-makers an understanding of the impact of uncertainty sources on the SCC plan alternatives' performance.

In addition, different functions (i.e., departments) within a firm can have conflicting objectives. Within some organizations, these functions act as isolated silos, each of them making decisions with only their own performance in mind (Bell et al. 1977, Shapiro 1977, Albrecht et al. 2015). It has been shown that siloed decision-making can have a negative impact on overall business performance, and that functional silos must be broken down to engage in cross-functional cooperation working towards a common goal (Shapiro 1977, Crousillat et al. 1993, Childerhouse and Towill 2000, Grimson and Pyke 2007). Albrecht et al. (2015) says that "it is crucial to create a common view on demand and supply decisions, as well as accountability for the results." With the example of S&OP, Albrecht et al. (2015) indicate that cross-functional cooperation between demand and supply helps to consider sets of decisions that would have not been considered in a siloed organization. Therefore, the proposed SCCP DMP and associated SCCP IS must provide a unified cross-functional vision on which decision-makers can rely.

Finally, the amount of information to manage will generally be very high for two main reasons: the size of the supply web and the multitude of scenarios of potential futures. First, as defined in Table 41, the supply web is the set of identified active and potential supply chain stakeholders from a core business perspective, each with specific abilities, resources and relationships. In a real industrial implementation, the number of active and potential supply chain stakeholders can be very high which implies a significant amount of supply web information. Second, the multitude of decision options which implies a multitude of SCC plan alternatives (i.e., a combination of decision options as defined in Table 41) combined with the multitude of uncertainty sources generates a very high number of scenarios of potential futures. This amount of information would make the analysis of each what-if scenario within a reasonable time frame impossible. Therefore, the proposed SCCP IS must contain a comparison system providing decision-makers with the ability to compare SCC plan alternatives based on aggregated KPIs. The aggregation can be done in different dimensions such as the following: structural (e.g., aggregate KPIs over equipment of a same company or even the entire supply web), temporal (e.g., aggregate KPIs over several time periods), and scenarios (e.g., aggregate KPIs over a certain type of uncertainty scenarios). With this feature, decision-makers must be able to have a high-level look at the situation and zoom in only on the elements of the SCCP analysis they consider as being relevant to investigate. Figure 23 illustrates this activity according to the IDEF0 standard (Menzel and Mayer 1998).

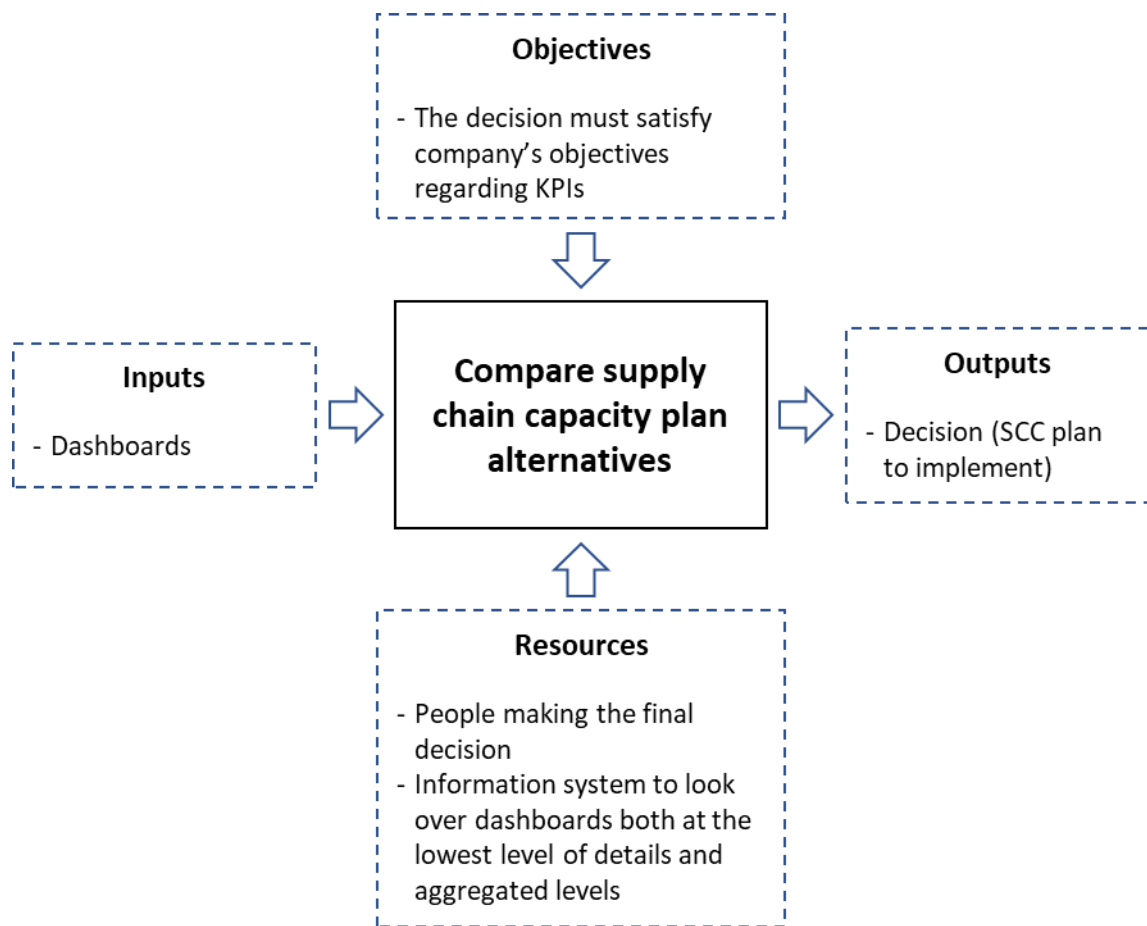

Figure 23: IDEF0 diagram of the seventh activity of the SCCP conceptual framework proposal

2.1.2.2. Generate dashboards

A comparison system is required for comparing SCC plan alternatives. Therefore, a solution must be provided for it. The proposal is to provide decision-makers with interactive dashboards. The interactive dashboards must enable decision-makers to efficiently scan the available information and focus on the most important information that will support their decisions, while fulfilling the requirement mentioned for the previous activity.

Considering that each company can have specific dashboard needs associated with its own KPIs and decision-making behavior, the dashboard configuration feature of the comparison system must be flexible so that it is compatible with all companies without needing specific comparison system adaptation. It must enable each company to design the dashboards that fit its needs best, and to make them evolve over time as needs change. The objective is to give the ability to design personalized dashboards without having to redesign the comparison system. In addition, as mentioned by Ling and Coldrick (Ling and Coldrick 2009), decision-makers must be able to easily understand the assumptions behind the what-if scenarios.

Finally, the generation of the dashboards requires SCC plan alternative assessment results to feed the configured dashboards. Figure 24 illustrates this activity according to the IDEF0 standard (Menzel and Mayer 1998).

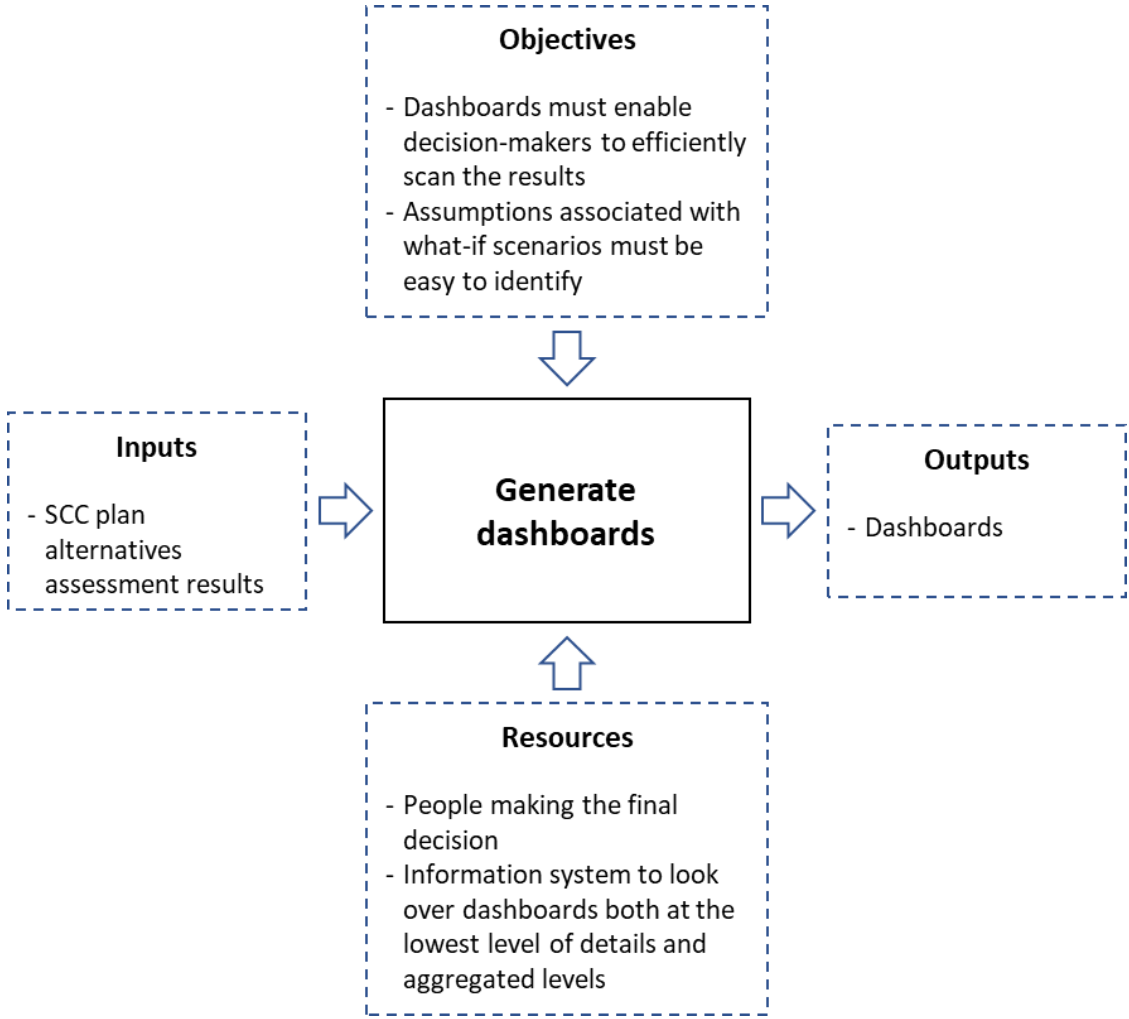

Figure 24: IDEF0 diagram of the sixth activity of the SCCP conceptual framework proposal

2.1.3. An approach for assessing supply chain capacity plan alternatives

2.1.3.1. Assess what-if scenarios

SCC plan alternatives assessment results are required for generating the dashboards. Therefore, a solution must be provided to generate them. The proposal is to feed dashboards with, for each SCC plan alternative, the assessment results of what-if scenarios associated with different combinations of uncertainty sources. The set of all assessed what-if scenarios corresponds to the SCC plan alternatives assessment results needed to feed the dashboards of the comparison system. However, as mentioned in the literature review, a drawback of existing approaches is their limitation in terms of the number and diversity of what-if scenarios that can be analyzed because of the time required for assessing scenarios (Fleischmann and Koberstein 2015, Kilger 2015, Cristea and Khalif Hassan 2018). Therefore, the proposal is to automate the assessment of what-if scenarios, using a set of what-if scenarios to assess and an assessment model compatible with all what-if scenarios. So, the SCCP IS must automate the assessment of the what-if scenarios taking as an input this set of what-if scenarios and the assessment model. Finally, the assessment of the what-if scenarios requires the set of what-if scenarios to assess and an assessment model compatible with all what-if scenarios. Figure 25 illustrates this activity according to the IDEF0 standard (Menzel and Mayer 1998).

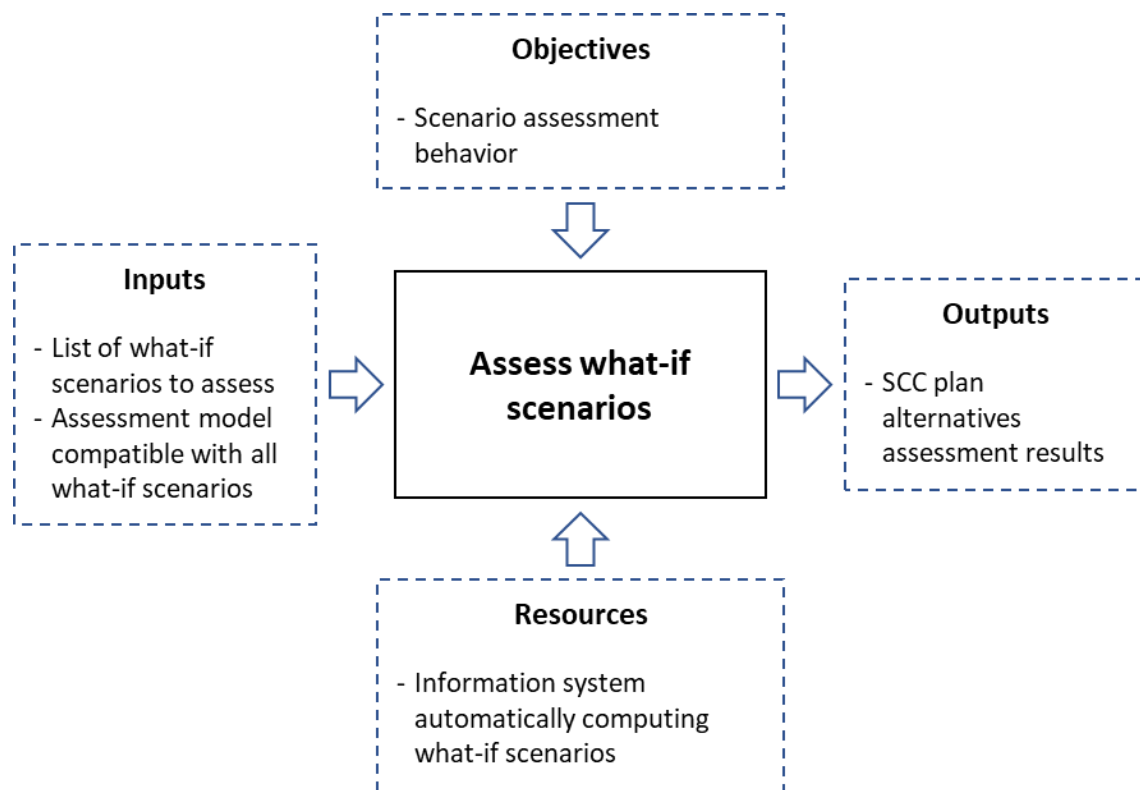

Figure 25: IDEF0 diagram of the fifth activity of the SCCP conceptual framework proposal

2.1.3.2. Generate an assessment model compatible with all what-if scenarios

An assessment model compatible with all what-if scenarios is required for assessing what-if scenarios. Therefore, a solution must be provided to generate it. The proposal is to automatically generate an assessment model that can be used to assess all what-if scenarios. This is an answer to Mula et al. (2006) claiming that further research is needed on new approaches for modeling uncertainty sources that can include each company of the supply chain as well as considering the different types of uncertainty sources in an integrated manner (i.e., without having to create a new evaluation model for each type of uncertainty source and supply chain echelon). This means it should be able to deal with all the changes that decision options and uncertainty sources could imply to the supply web and demand plan, whether those changes are quantitative or qualitative (i.e., structural). This assessment model can therefore be used to automatically assess any set of what-if scenarios. The proposal is that the automated generation of the assessment model relies on information about the supply web and the demand plan, and associated decision options and uncertainty sources. The proposal is also that the solution should be able to include as many supply chain levels as given with the information available. Being able to generate an assessment model supporting the automation of the assessment of any what-if scenario is a key feature in overcoming the limitation of existing approaches that are not able to assess a high number of what-if scenarios.

Finally, the generation of the assessment model requires information about the supply web and the demand plan, and associated decision options and uncertainty sources. Figure 26 illustrates this activity according to the IDEF0 standard (Menzel and Mayer 1998).

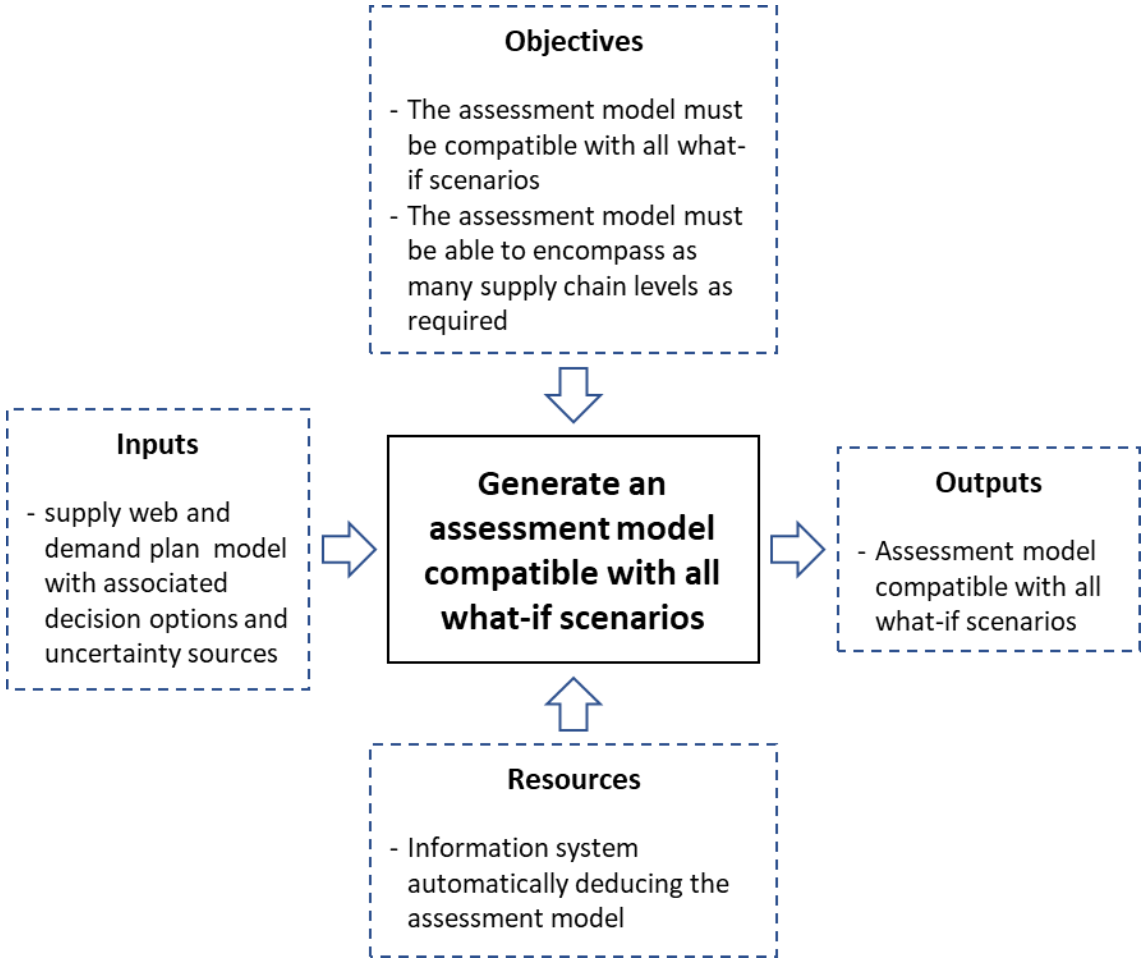

Figure 26: IDEF0 diagram of the fourth activity of the SCCP conceptual framework proposal

2.1.3.3. Generate what-if scenarios to assess

The set of what-if scenarios to assess is required for assessing what-if scenarios. Therefore, a solution must be provided to generate it. The proposal is to automatically generate the set of what-if scenarios to assess. The solution should consider a set of SCC plan alternatives to assess and a set of uncertainty sources combinations to consider. For each SCC plan alternative to assess, a what-if scenario should be generated for each uncertainty combination to consider. Therefore, with N SCC plan alternatives to assess and M uncertainty sources combinations to consider, the number of what-if scenarios generated would be $M * N$.

As for the assessment of what-if scenarios, the proposal is that the SCCP IS automates the generation of the set of uncertainty source combinations to consider. The generation consists in filtering the solution space of all potential combinations, keeping only combinations relevant for the company. Considering that the vision of the relevance can differ between companies and people, the proposal is to give people in charge of the SCCP DMP the ability to configure the filtering behavior of the SCCP IS.

Finally, the generation of what-if scenarios to assess requires the set of SCC plan alternatives to assess and information about the uncertainty sources associated with the supply web and the demand plan. Figure 27 illustrates this activity according to the IDEF0 standard (Menzel and Mayer 1998).

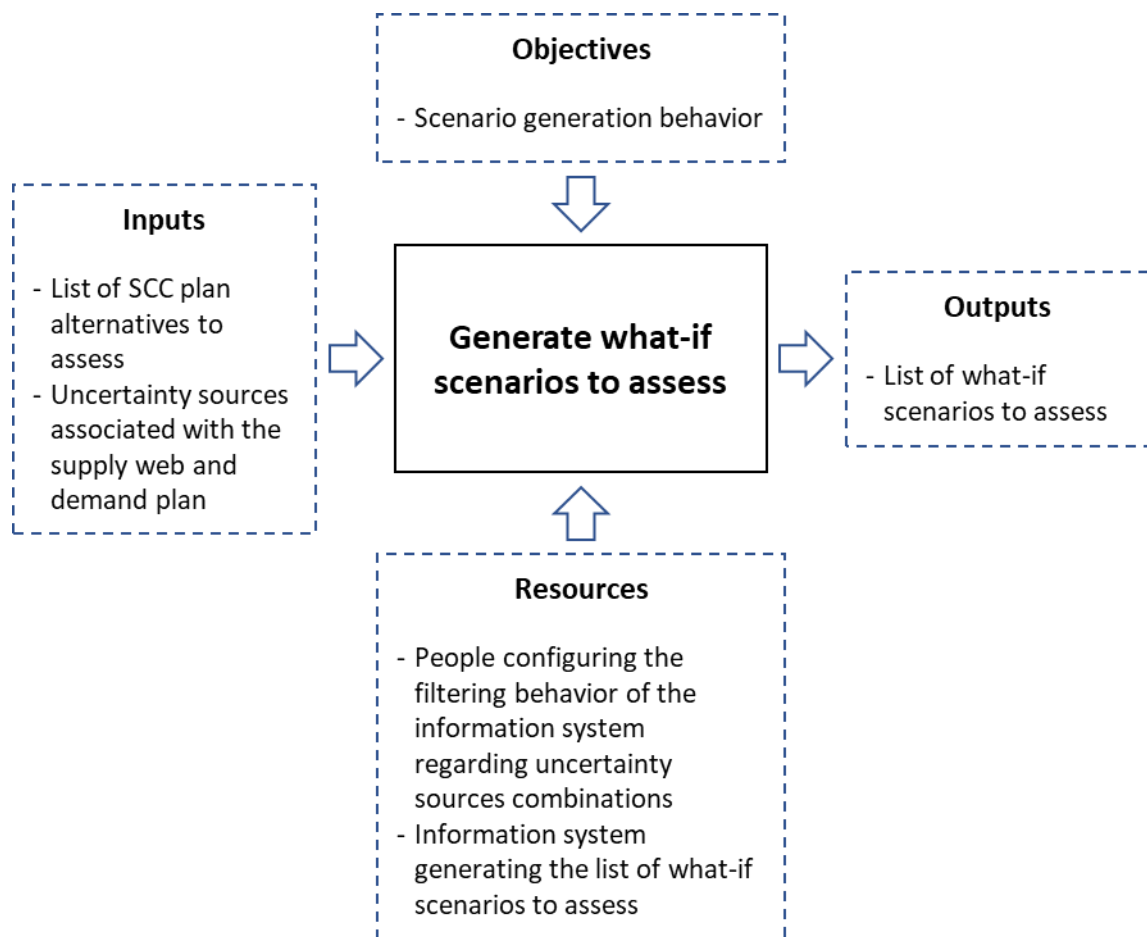

Figure 27: IDEF0 diagram of the third activity of the SCCP conceptual framework proposal

2.1.4. An approach for generating supply chain capacity plan alternatives

2.1.4.1. Generate relevant supply chain capacity plan alternatives to assess

The set of SCC plan alternatives to assess is required for generating the what-if scenarios to assess. Therefore, a solution must be provided to generate it. As for the generation of the set of uncertainty source combinations to consider, the proposal is to automatically generate the set of SCC plan alternatives to assess. So, the SCCP IS must include a solution for it. An SCC plan alternative corresponds to a combination of decision options to activate. The generation consists in filtering the solution space of all potential combinations of decision options keeping only combinations relevant for the company. Considering that the vision of the relevance can differ between companies and people, the proposal is to give people in charge of the SCCP DMP the ability to configure the filtering behavior of the SCCP IS.

Finally, the generation of SCC plan alternatives requires information about the decision options associated with the supply web and the demand plan. Figure 28 illustrates this activity according to the IDEF0 standard (Menzel and Mayer 1998).

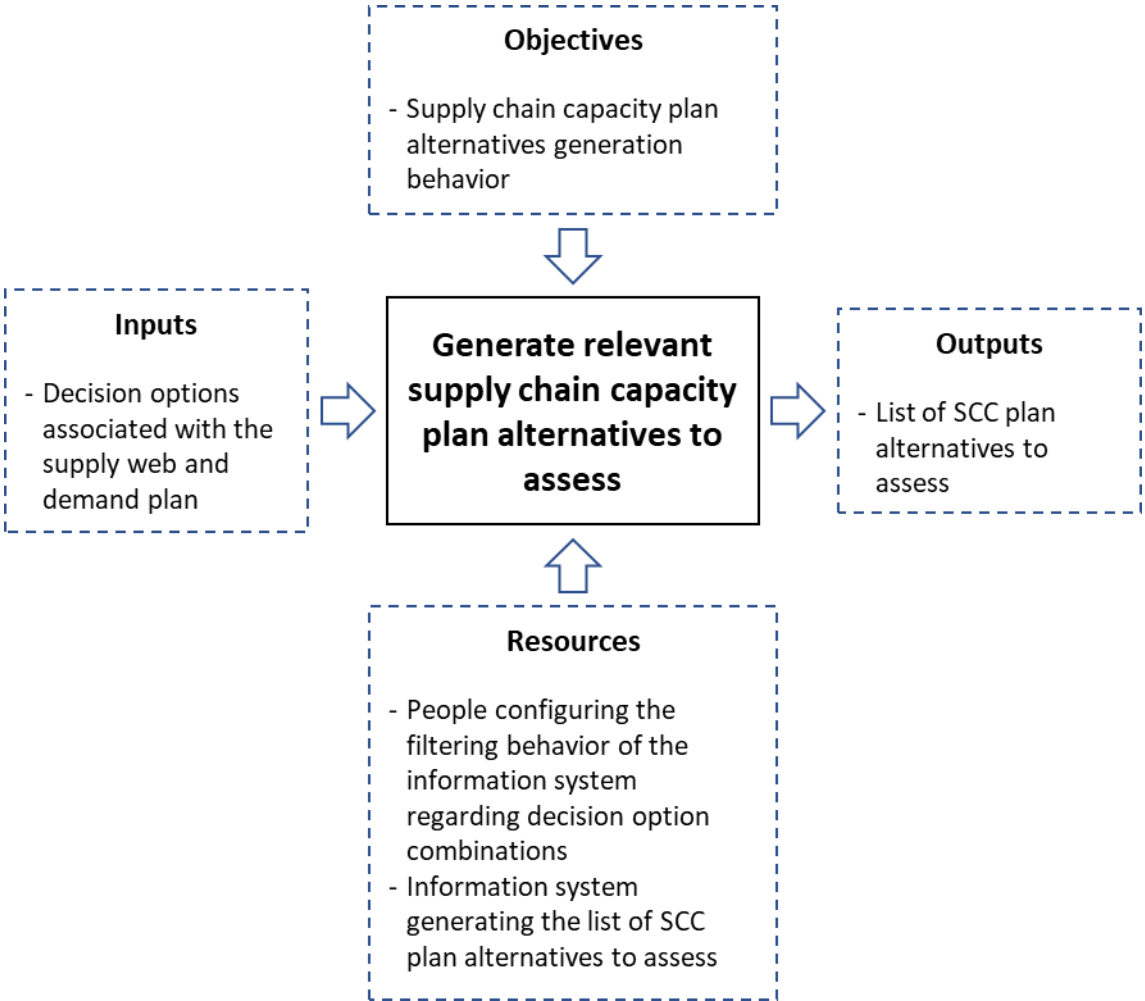

Figure 28: IDEF0 diagram of the second activity of the SCCP conceptual framework proposal

2.1.4.2. Gather supply web and demand plan information including associated decision options and uncertainty sources

The supply web and demand plan with associated decision options and uncertainty sources are required for generating an assessment model compatible with all what-if scenarios; the decision options are required for generating SCC plan alternatives, and the uncertainty sources are required for generating what-if scenarios to assess. Therefore, a solution must be provided to gather supply web and demand plan information including associated decision options and uncertainty sources.

The proposal is to design a solution that can gather all this information into a unique structured model. The objective of this model is to be able to be used by all the other steps of the approach introduced earlier, for which the proposal is to automate it, and to find the information needed for automation. Considering that the focus of the DMP is on planning supply chain capacities, the proposed structured model should contain the information regarding the supply web and demand plan that is needed to build the assessment model that will perform the supply chain capacity analysis.

Regarding decision options and uncertainty sources, the solution should be able to gather anything having an impact on the available supply chain capacity or the supply chain capacity

requirements. Each decision option and uncertainty source within the supply web can be described according to its impact on the available or required supply chain capacity. Among all the decision options and uncertainty sources, some will have no impact, a direct impact, or an indirect impact on the available or required supply chain capacity. Examples of decision options and uncertainty sources are given in the insert below. The solution must be able to gather decision options and uncertainty sources from any stakeholder of the supply web, such as stakeholders from any function (i.e., department) within companies, that have a direct or indirect impact on the available or required supply chain capacity. The notion of being able to consider decision options and uncertainty sources having an indirect impact is a key principle. Because even though the DMP focuses on supply chain capacity planning, there are a lot of

Illustrative examples

Example of a manufacturing decision option:

In the case of a decision option being whether or not to set up a new production line, the decision has a direct impact on the available supply chain capacity because capacity increase is an intrinsic result of having a new production line.

Example of a marketing decision option:

In the case of a decision option being whether or not to launch a marketing campaign, the decision has an indirect impact on the supply chain capacity requirements because of the expected sales increase implying higher production needs.

Example of a manufacturing uncertainty source:

In the case of an uncertainty source being the possibility of having a breakdown of equipment, the event would have a direct impact on the available supply chain capacity because capacity loss is an intrinsic result of having equipment breakdowns.

Example of a sales uncertainty source:

In the case of an uncertainty source being the possibility of having the actual sales being 10 percent higher than forecasted, this situation would have an indirect impact on the supply chain capacity requirements because of the sales increase implying higher production needs.

interdependencies among decisions from different functions inside companies. In addition, as mentioned previously, siloed decision-making can have a negative impact on overall business performance (Shapiro 1977, Crousillat et al. 1993, Childerhouse and Towill 2000, Grimson and Pyke 2007). Therefore, the objective is to avoid functional silos by ensuring cross-functional cooperation working towards a common goal, with each function providing information about relevant uncertainty sources and decision options regarding its own perimeter. Figure 29 illustrates this activity according to the IDEF0 standard (Menzel and Mayer 1998).

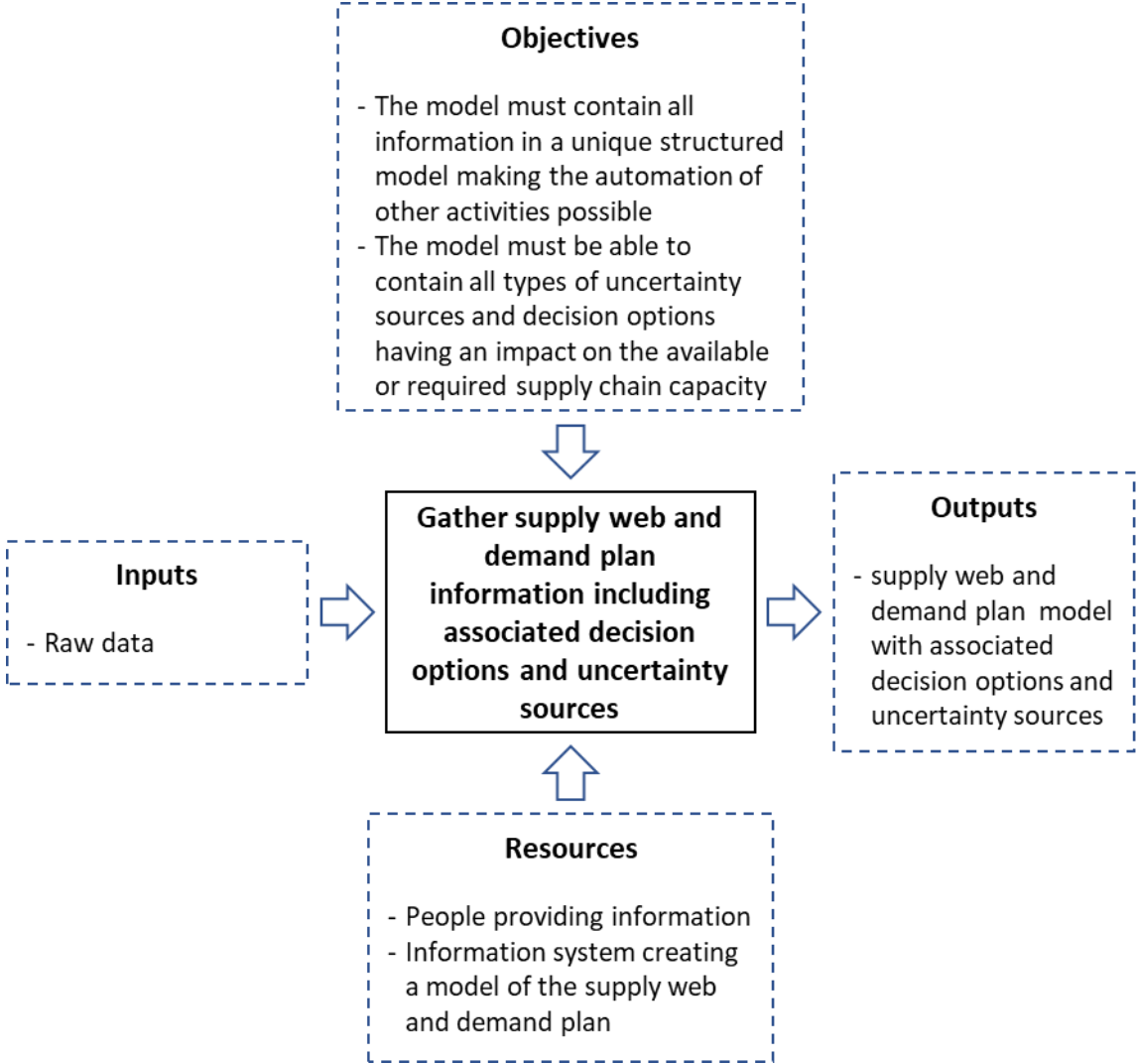

Figure 29: IDEF0 diagram of the first activity of the SCCP conceptual framework proposal

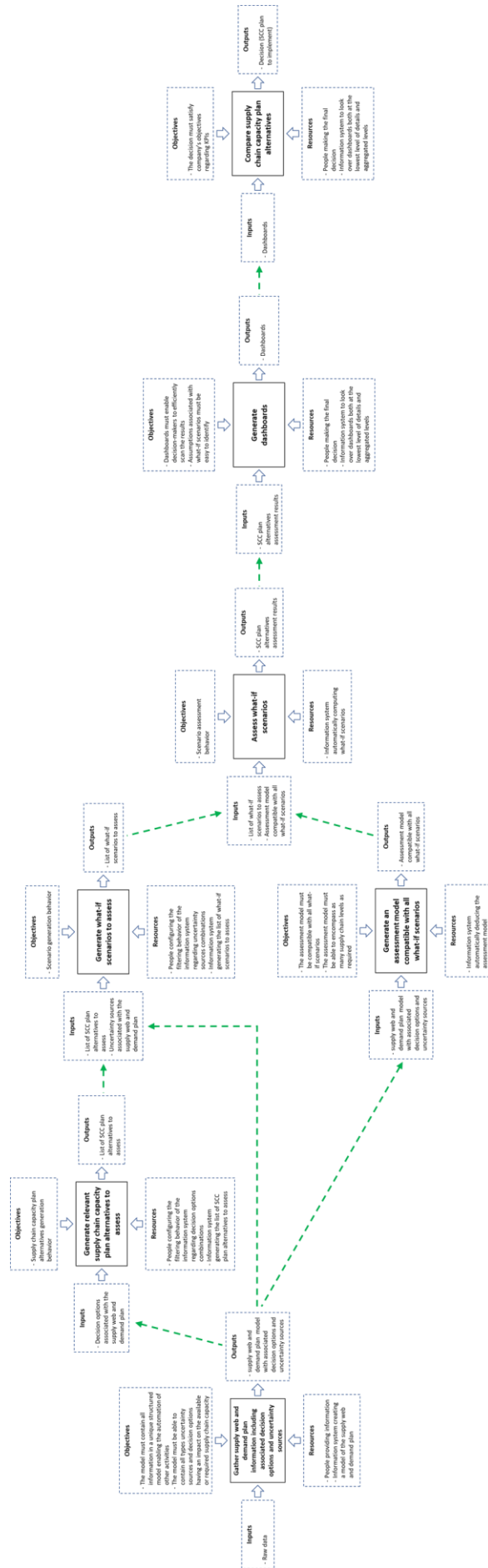

Figure 30: IDEF0 diagram of the entire sequence of activity of the SCCP conceptual framework proposal

2.2. Stakeholders

As mentioned at the beginning of this section, the SCCP conceptual framework proposal includes a sequence of activities with their objectives and constraints as well as the involved stakeholders. The purpose of this subsection is to describe the categories of stakeholders that should be involved in the SCCP DMP. The proposal is to organize stakeholders into three categories: information providers, SCCP managers, and decision-makers. It is possible to have an overlap between categories (i.e., the same person can be part of two or even three categories). Depending on the scope of the decision-making process, these categories could include employees from several companies. For example, information providers could include people from the procurement department of a manufacturing company as well as people from the sales department of a subcontractor of the manufacturing company. The three categories are described in the next three sub-subsections and illustrated in the SCCP conceptual framework overview (Figure 31).

2.2.1. Information providers

The first category of stakeholders is “information providers.” There is information about the supply chain capacity context that is required as input for performing the sequence of activities. As described in the previous subsection, this information corresponds to the supply web and demand plan with associated decision options and uncertainty sources. Therefore, the company should identify the necessary set of stakeholders that will collect this information and should involve these stakeholders in the SCCP DMP as “information providers.” Usually, most of the departments of a company (e.g., supply, procurement, manufacturing, sales, marketing, product development, continuous improvement, finance) have a direct or indirect relationship with the supply web and demand plan and associated decision options and uncertainty sources. Therefore, people from each department should generally be involved in the SCCP DMP as information providers.

Illustrative examples

Example of a procurement department:

In the case of a procurement department of a company, buyers of this department have information about the supply network of the company that will be required for the supply chain capacity analysis. Therefore, one or several buyers should be involved in the SCCP DMP as “information providers” to provide this information.

Example of a sales department:

In the case of a sales department, people in charge of the demand forecasts in this department have information about the demand forecast that will be required for the supply chain capacity analysis. Therefore, one or several of these people should be involved in the SCCP DMP as “information providers” to provide this information.

2.2.2. SCCP managers

The second category of stakeholders is “SCCP managers”. The sequence of activities described in the previous subsection requires configuration decisions for the generation of SCC plan alternatives to assess and the generation of what-if scenarios to assess. In addition, the sequence of activities also requires the configuration of dashboards. Therefore, the role of SCCP managers is to define these three configurations. They must understand the importance and the meaning of the information provided by information providers to make the right configuration decisions.

Illustrative examples

Example for SCC plan alternatives and what-if scenario generation:

To define the people in charge of configuring the SCC plan alternatives and what-if scenario generation, a company could choose people having a good overview of the business operations, with knowledge about each department. An example could be people from the continuous improvement team that realized projects with all departments of the company.

Example for dashboard configuration:

To define the people in charge of configuring the dashboards, a company could choose people having a good vision of business strategies and being an important element in decision-making. An example could be people from the finance department who could consider all other departments’ objectives and constraints while maintaining a financial vision.

An important aspect of the consideration of uncertainty sources is that it helps compensate the poor reliability of certain data by reducing the importance of having very precise information. Taking the example of the production capacity of equipment which is not known with precision but within a range, if the resulting KPIs are acceptable for the entire range, more precise information might not be necessary. However, to know if this uncertainty is critical, information about it must be provided by the information providers. Therefore, SCCP managers are responsible for ensuring the completeness of the information provided by information providers.

Finally, in addition to the previously mentioned elements, SCCP managers are responsible for overseeing the smooth running and maturity of the SCCP DMP, especially by ensuring the involvement and training of all other stakeholders. As mentioned by several authors regarding S&OP, the understanding, acceptance, and trust in the DMP by all stakeholders is crucial for its success (Ling and Goddard 1988, Lapide 2005, Grimson and Pyke 2007).

2.2.3. Decision-makers

Finally, the third category of stakeholders are “decision-makers”. The output of the SCCP DMP is a set of decisions about actions to perform in the future. Each decision is related to a decision option the company has. For each decision option, there are one or several decision-makers from one or several company departments who are empowered to make the decision. As

described in the previous subsection, each decision option can be described according to its impact on the available supply chain capacity and its impact on the supply chain capacity requirements. Among all the decision options, some have no impact, a direct impact, or an indirect impact. For each decision option that has a direct or indirect impact on the available or required supply chain capacity, at least one decision-maker who is empowered to make the decision should be part of the SCCP DMP. It could be the managers of each department of the company involved in the SCCP DMP (e.g., supply, procurement, manufacturing, sales, marketing, product development, continuous improvement, and finance managers) or people having a delegation of power to make the decisions.

Illustrative examples

Example of a plant manager:

In the case of a plant manager empowered to decide whether a new production line can be set up, the decision has a direct impact on the available supply chain capacity. So, the plant manager could be part of the decision-making process.

Example of a marketing director:

In the case of a marketing director empowered to decide whether a marketing campaign can be launched, the decision has an indirect impact on the supply chain capacity requirements because of the expected sales increase. So, the marketing director could be part of the decision-making process.

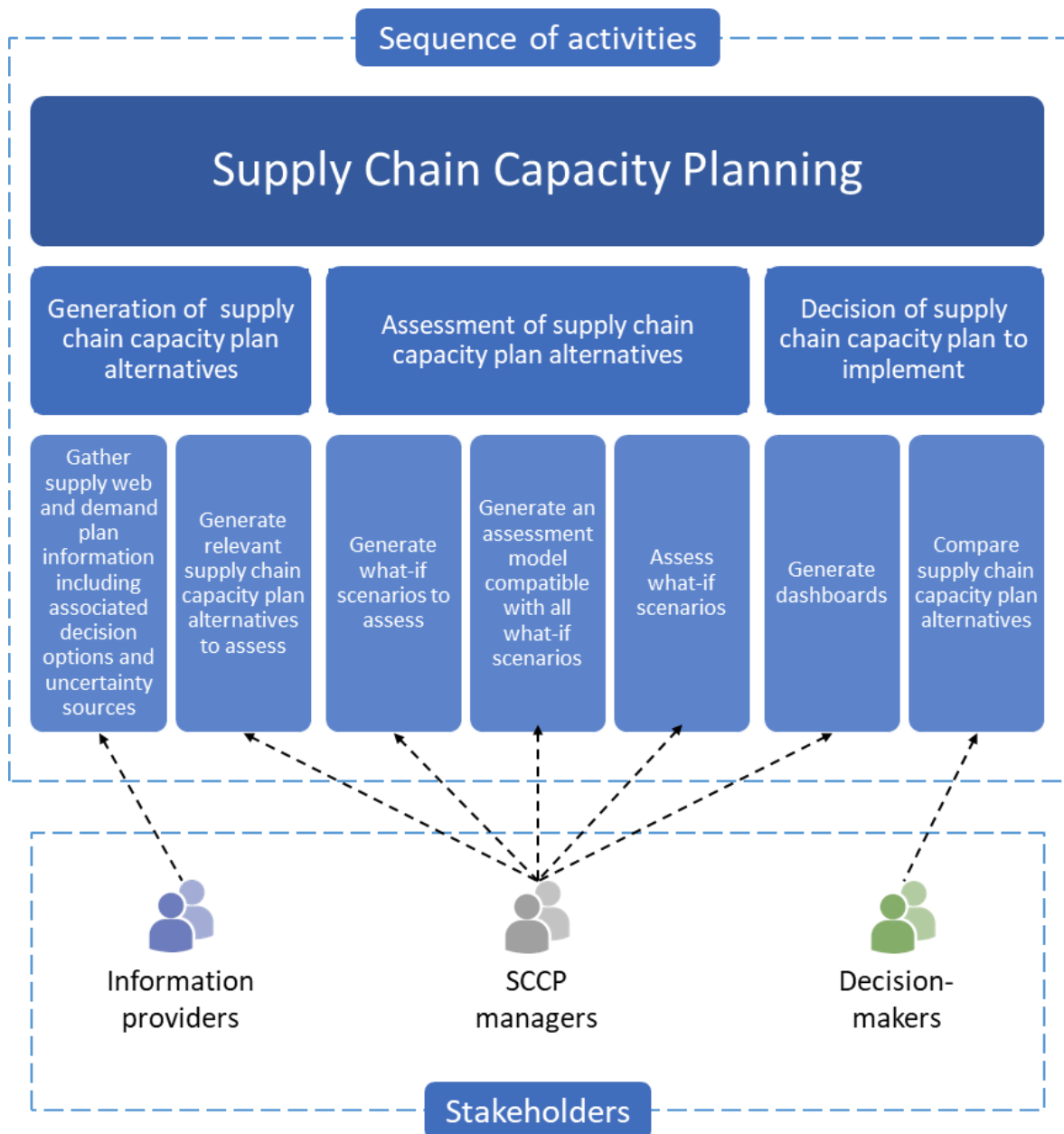

Figure 31: Overview of the SCCP conceptual framework proposal

3. Conclusion

The objective of this chapter was twofold: first, to introduce the orientations of the research project by giving an overview of the existing solutions for answering the industrial and research questions and their limitations. Second, to introduce a new SCCP DSS approach for answering the industrial and research questions by describing its conceptual framework giving the key principles of the SCCP DSS.

Three types of ISs (ERP, APSs, and spreadsheets) and four DMPs (S&OP, AS&OP, IBP, and CPFR) that can be used to perform SCCP were investigated and described along with their limitations in the literature review. The literature review revealed two main limitations: first, existing SCCP DMP literature does not provide detailed frameworks for implementing a full SCCP DSS including the DMP along with the IS. The two most detailed frameworks found for implementing a full DSS are associated with the use of spreadsheets along with the S&OP process by Ling and Goddard (1988) and Wallace and Stahl (2008). But spreadsheets are considered an IS that cannot enable companies to meet the expectations resulting from the industrial and research questions. Second, existing ISs are too time-consuming to realistically answer the industrial and research questions. This literature review resulted in the following research orientation: designing an SCCP DMP supported by an associated IS that provides an answer to the industrial and research questions by achieving the following objectives:

1. Considering a multitude of combinations of different types of decision options while including a multitude of different types of uncertainty sources in the assessment.
2. Minimizing the effort and time required by humans to perform the SCCP DMP to make its use realistic and relevant considering the dynamicity of the supply chain environment.
3. Gaining decision-makers' confidence by increasing their visibility and understanding of potential futures and of the impact of the decisions they can make.

Starting from this research orientation and the industrial and research questions, a new SCCP DSS approach was designed. Its conceptual framework giving the key principles of the SCCP DSS was described in the second section of this chapter. The SCCP conceptual framework is described through two main components: first, a sequence of activities with their objectives and constraints, and second, the categories of stakeholders involved in the sequence of activities. One of the key principles of the sequence of activities is the automation of several tasks by the SCCP IS. Finally, the proposed SCCP conceptual framework aims to be a guide in designing a full SCCP DSS composed of an SCCP DMP along with an SCCP IS that provides an appropriate answer to the industrial questions and the first research question. The validation of such a conceptual proposal is not simple without implementing it, therefore it has been validated as follows: first, according to experts' feedback; and second, by implementing it and validating the benefits of its implementation. An SCCP DSS that follows the SCCP conceptual framework principles is proposed in the next two chapters and validated in the fifth chapter through two real industrial use cases.

CHAPTER III. SCCP INFORMATION SYSTEM: A PROPOSAL FOR AUTOMATING THE GENERATION AND ASSESSMENT OF SUPPLY CHAIN CAPACITY PLAN ALTERNATIVES

“Every once in a while, a new technology, an old problem, and a big idea turn into an innovation.”

Dean Kamen

The objective of this chapter is to introduce a part of the second building block of the Supply Chain Capacity Planning (SCCP) Decision Support System (DSS) proposed in this thesis to answer the industrial and research questions: the computational software of the SCCP information system (IS). As mentioned in the first chapter, this computational software was designed and developed for this research project in accordance with the SCCP conceptual framework principles. This computational software aims to support the first five activities described in the SCCP conceptual framework (Figure 31). It generates the information required for making decisions by collecting and processing raw data. Other activities of the SCCP conceptual framework will be described in the fourth chapter along with the SCCP Decision-Making Process (DMP) proposal. Figure 32 illustrates the content of this chapter by positioning it on the overview of the contributions of this thesis. The first section of this chapter describes a literature review aiming to complete the literature review on information systems for SCCP described in the second chapter. It is focused on searching for existing computerized solutions that could automatically identify supply chain capacity plan alternatives, as well as the assessment model. It concludes with orientations of this research project and introduces the second research question. Then, the second section introduces the computational software proposal in charge of the generation and assessment of supply chain capacity plan alternatives. Finally, the third section concludes the chapter and makes the link with the following one.

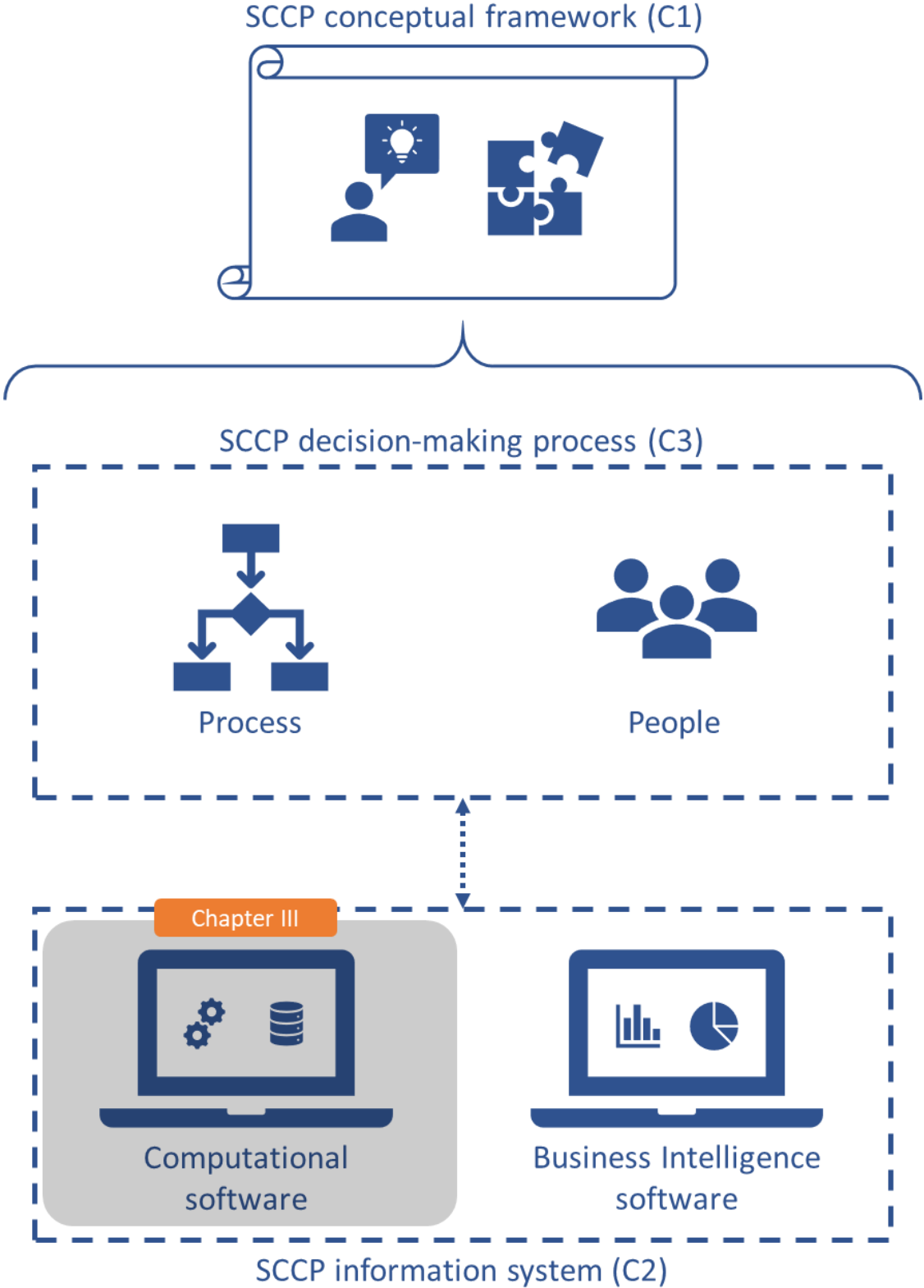

Figure 32: Positioning the content of this third chapter in regard to the overview of the contributions of this thesis (C1, C2, and C3)

1. Literature review

1.1. Literature review objectives

According to the SCCP conceptual framework (Figure 31), the following two activities (fourth and fifth) should be fully automated: “generate an assessment model compatible with all what-if scenarios” and “assess what-if scenarios.” In searching for supply chain capacity plan assessment models, it was observed that existing modeling approaches (e.g., optimization, simulation, and heuristics) require the users to provide a model of the existing or potential supply chains they want to assess (Ling and Goddard 1988, Van Mieghem 2003, Mula et al. 2006, Wallace and Stahl 2008, Stadtler et al. 2015, Calvete et al. 2016, Martel and Klibi 2016). In addition, the literature review of the second chapter revealed that these approaches, when implemented in existing information systems (ERP, APSs, and spreadsheets), are too time-consuming to be satisfying for answering the industrial questions and the first research question of this thesis. An idea emerged from this observation: to change the mindset from modeling the known supply chain capacity plan alternatives and assessment model to automatically deducing it by means of a computerized solution. Therefore, the literature review mindset is about searching for existing computerized solutions that could automatically identify the supply chain capacity plan alternatives as well as the assessment model. Finally, the literature review undertaken is a little bit more general and is focused on searching for existing solutions that could be used to automatically identify potential supply chains and associated stakeholders (encompassing supply chain capacity plan alternatives and assessment model). The investigated literature was a guide for starting the design of the computational software of the SCCP IS described in the next section.

1.2. Literature review methodology and results

This literature review was conducted according to the systematic literature review methodology (Tranfield et al. 2003, Colicchia and Strozzi 2012). The scope of the literature review was defined in terms of searched databases, keywords, combinations of keywords, structures of requests sent to search engines, and the configuration of the search engines. Two databases were used: Web of Science (WOS) and its corresponding WOS Core Collection, and Google Scholar. They have been chosen because of their coverage and their citation analysis features (Li et al. 2010), as well as their ease of use. Selected keywords fall into two groups which then drive the keyword combinations. The first group of keywords includes terms used to describe the type of system studied: *supply chain*, *logistics network*, *supplier*, *subcontractor*. The second group of keywords includes terms used to describe the interaction with the studied system related to the literature review objectives described in the previous subsection: *discovery*, *identification*, *deduction*, *hyperconnection*. The search included all possible combinations of two keywords from distinct groups and their alternative spelling. The terms “capacity plan” and “assessment model” could have been added as a third group of keywords to be even more restrictive regarding the database search but this third group was not added because the set of alternative terms that could be used to describe these concepts was unclear and it was considered too restrictive. For both databases investigated, the requests (Table 1) were focused on paper titles and only English keywords were used, which resulted mainly in papers written in English, and all publication years were considered. For the search request sent to Google Scholar, citations and patents were excluded.

The requests brought up 196 papers from WOS and 805 papers from Google Scholar. The next step was to select the papers that seemed relevant enough, according to the literature review objective, to be investigated by reading the entire paper. This was done in two elimination phases: a first elimination phase based on the titles, and a second elimination phase based on the abstracts. Papers were considered probably relevant when they were understood as probably being about the identification of supply chain stakeholders, of supply chain options, or supply chain solutions. For example, several papers used product identification terminology in the context of product traceability and supply chain visibility, which is not relevant for this study. Overall, 69 papers were tagged as potentially pertinent after the title-based phase and 21 after the abstract-based phase. The final paper selection step was based on a full reading of the potential papers, which resulted in 18 papers chosen to be included in the literature review. The paper selection process of the systematic literature review is illustrated in Figure 33 with the resulting number of papers.

Table 1: Requests send to the Web of Science and Google Scholar search engines

Search engine	Request
Web of Science (WOS)	TITLE: (“supply chain*” OR “logistic* network*” OR “supplier*” OR “subcontractor*”) AND (discover* OR identifi* OR deduc* OR hyperconnect*)
Google Scholar	allintitle: (“supply chain” OR “supply chains” OR “logistics network” OR “logistics networks” OR “logistic network” OR “logistic networks” OR supplier OR suppliers OR subcontractor OR subcontractors) (discovery OR discover OR discovered OR identify OR identifying OR identified OR identification OR deduction OR deduced OR deduce OR hyperconnected OR hyperconnection OR hyperconnectivity)

The first key result of the literature review is that all the reviewed papers covered the identification of supply chain stakeholders and of one type of SCCP decision options: supply options. In this thesis, a supply option is defined as “a specific type of SCCP decision option concerning supply chains. The supply option corresponds to a possible succession of two supply chain activities, implying activation, modification, creation or deletion of relationships between supply web stakeholders” (Table 41). However, only a single paper explicitly treats the identification of supply chain capacity plan alternatives (Fritz et al. 2018). Regarding the supply chain stakeholder identification domain, the team led by Ameri and McArthur produced the most papers (Ameri and McArthur 2010, 2011, 2014, Ameri et al. 2011, McArthur and Ameri 2011a, 2011b). The other papers addressing supply chain stakeholder identification are Aravena-Diaz et al. (2016), Davidrajuh and Deng (2000), Fenves et al. (2009), Fritz et al. (2018), Kang (2011), Kang et al. (2011), Lee et al. (2013, 2015), Lee et al. (2011), Im et al. (2011), Mesmer and Olewnik (2018), and Yamashita et al. (2016).

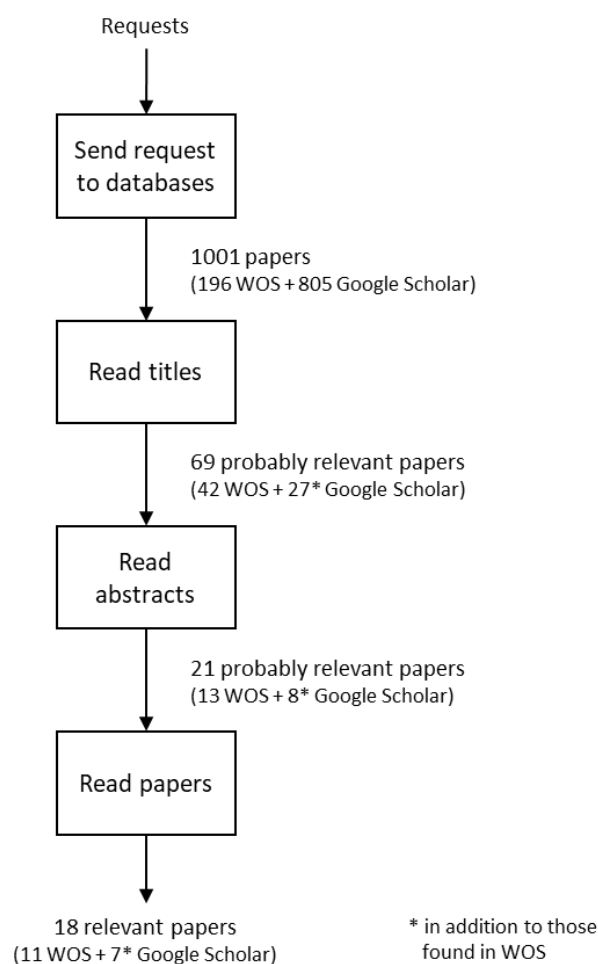

Figure 33: Paper selection process of the systematic literature review with the resulting number of papers

Except for the paper by Fritz et al. (2018), which introduces a human-oriented methodology for supply chain stakeholder identification, all the other 17 papers introduce or discuss computerized methods to partially automate the identification of supply chain stakeholders. Two main types of contributions were identified for automating the identification of supply chain stakeholders. The first corresponds to contributions for gathering information about supply chain stakeholders' capabilities from distributed data sources (e.g., web and peer-to-peer) and consolidating them into a centralized data source. The second corresponds to contributions for matching supply chain stakeholders' capabilities with buyers' requirements from data stored in a centralized data source. For the first type of contribution, the following approaches were found for gathering and consolidating information about supply chain stakeholders' capabilities from distributed data sources: website search (Davidrajuh and Deng 2000), dynamic forms completed by stakeholders (Kang 2011, Kang et al. 2011), and peer-to-peer platform software (Yamashita et al. 2016). For the second type of contribution, the following approaches were found for matching supply chain stakeholders' capabilities with buyers' requirements stored in a centralized data source: semantic reconciliation approaches to find matches (Ameri and McArthur 2010, 2011, 2014, Ameri et al. 2011, Im et al. 2011, Kang 2011, Kang et al. 2011, McArthur and Ameri 2011a, 2011b, Lee et al. 2013, 2015), ontologies to structure information (Ameri and McArthur 2010, 2011, 2014, Ameri et al. 2011, Im et al. 2011, Kang 2011, Kang et al. 2011, McArthur and Ameri 2011a, 2011b, Lee et al. 2013, 2015, Mesmer and Olewnik 2018),

and semantic clustering of supply chain stakeholders' capabilities in a classification tree to classify and retrieve capabilities (Lee et al. 2011). As part of the second type of contributions, the report by Fenves et al. (2009) from the U.S. Department of Commerce and the National Institute of Standards and Technology (NIST) highlights the need for a taxonomy to share a common terminology among supply chain stakeholders to support supply chain stakeholder identification.

In addition to the contributions introduced by the reviewed papers, some mention existing online services provided by businesses to match supply chain stakeholders' capabilities with buyers' requirements from a centralized data source. The following online services, defined by authors as an "e-marketplace" or "e-sourcing portals", were reported: www.alibaba.com, www.ec21.com, www.globalspec.com, www.jobshop.com, www.macraesbluebook.com, www.mfg.com, www.thomasnet.com (Lee et al. 2013, 2015, Mesmer and Olewnik 2018).

Regarding supply chain capacity plan alternative identification, Fritz et al. (2018) introduce a methodology called Supply Chain-Oriented Process to Identify Stakeholders (SCOPIS) to identify supply chain stakeholders and supply chain capacity plan alternatives. It is an approach centered on the production of a product or service. Their proposal provides an organizational human-oriented process to identify supply chain stakeholders and supply chain capacity plan alternatives. However, it is a manual process; no computerized method is mentioned to support it. Fritz et al. (2018) concludes that one of the key limitations of their proposal is the high use of resources and time consumption. This is a limitation for companies who want to perform it frequently to support their decisions.

1.3. Conclusion and research orientation

All the computerized methods identified during the literature review, both from the scientific literature and existing business solutions, are designed to identify supply chain stakeholders and supply chain options for one-to-one relationships between supply chain stakeholders. None of them introduces research on computerized methods for SCC plan identification encompassing several supply chain levels, nor on an associated assessment model. The only paper from the systematic literature review introducing research on supply chain capacity plan identification proposes a human-centered approach described as resource- and time-consuming (Fritz et al., 2018). This echoes the literature review in the second chapter that concluded that existing SCCP decision-making processes are time-consuming. Kaipia et al. (2017) also highlights that planning processes such as Sales and Operations Planning (S&OP) are resource-consuming and that the complexity of the planning situation induces a need for additional planning resources. This leads the authors of the paper to suggest focusing the planning efforts on specific areas such as the critical phases of product launches. This focus might be a good compromise considering the resource consumption of the existing planning processes. But this focus leads to the conclusion that more effective planning processes would be needed to perform the planning process with the same completeness on the entire company planning perimeter. This conclusion is even more relevant when considering the dynamicity of the supply chain environment mentioned in the first chapter. So, the proposal by Fritz et al. (2018) does not meet with the dynamicity requirements of a solution for the dynamic context with a supply web that is potentially large and undergoing constant change.

Finally, no computerized method to automatically identify SCC plan alternatives and associated assessment models was found. According to the results of the first two chapters, this means not being able to fully consider and thus take advantage of the multitude of SCCP decision options associated with the supply web while considering the multitude of uncertainty sources. But the SCCP conceptual framework introduced in Chapter 2 specifies automation requirements for performing the SCCP DMP. This creates a gap between existing solutions available in the literature and the SCCP requirement regarding the computerized method to automatically identify SCC plan alternatives and the associated assessment model. This gap led to the second research question (RQ2) of this thesis:

Second Research Question (RQ2):

How to make possible the goal of automation introduced in the
SCCP conceptual framework?

Therefore, the choice was made to focus the innovation efforts on designing a computerized information system that automates the identification and evaluation of SCC plan alternatives made possible by stakeholders of a supply web: an information system using information about a supply web and demand plan, along with its associated decision options and uncertainty sources. The following section describes a part of the resulting SCCP IS proposal: the computational software proposal.

2. SCCP information system: a computational software proposal

To answer the industrial and research questions, an SCCP IS was designed by following the guidelines provided by the SCCP conceptual framework described in the second chapter of this thesis. The SCCP IS is composed of two software programs: first, computational software and second, business intelligence software. This chapter focuses only on describing the computational software while the business intelligence software is described in the next chapter, along with the SCCP decision-making process proposal. The computational software corresponds to an innovative computerized method for supporting companies in their SCCP decision-making process by providing automation features for identifying and evaluating SCC plan alternatives made possible by a web of supply chain stakeholders. This software is a prototype designed and developed during the research project. The first subsection provides an overview of the computational software by illustrating how it sequentially takes advantage of three software modules. The following three subsections respectively describe the three software modules.

2.1. Computational software overview

The computational software operating principles are inspired from model-driven engineering principles (Bézivin 2005, Czarnecki and Helsen 2006, Object Management Group 2008), including metamodel-based algorithms and model transformations. The computational software is composed of three modules used sequentially (Figure 34). The following paragraphs give an overview of the purpose of each module while the following three subsections provide the details. A first version of the first two modules was introduced by Oger et al. (2018a).

The first module is called the “supply web modeler.” Details about this module are given in the second subsection of this section (subsection 2.2). This first module takes information from the supply web and demand plan, with associated decision options and uncertainty sources (definitions given in Table 41), as inputs to create a model of the supply web that will then be used by the two other modules. It was designed to be able to collect information in two different ways: first, by reading XML files generated by using a graphical user interface, and second, by reading an Excel file.

The second module is called the “assessment model generator.” Details about this module are given in the third subsection of this section (subsection 2.3). This second module takes the supply web model created by the first module as an input to create a generic assessment model. “Assessment model” should be understood to be a model (e.g., an Excel model representing a supply chain) that can be used to assess the supply chain performance of a specific scenario by providing inputs describing this scenario (e.g., by filling Excel cells with values). In addition, “generic” means that it is compatible with all scenarios of potential futures (i.e., what-if scenarios) that can be deduced from the supply web model information. Therefore, this generic assessment model can be used to assess all what-if scenarios that can be deduced from the supply web model information.

The third module is called the “what-if scenario generator and assessor.” Details about this module are given in the fourth subsection of this section (subsection 2.4). This third module takes the assessment model created by the second module as an input as well as the what-if

scenario configuration provided by users. The output of this module is the list of assessed what-if scenarios, along with their assessment results.

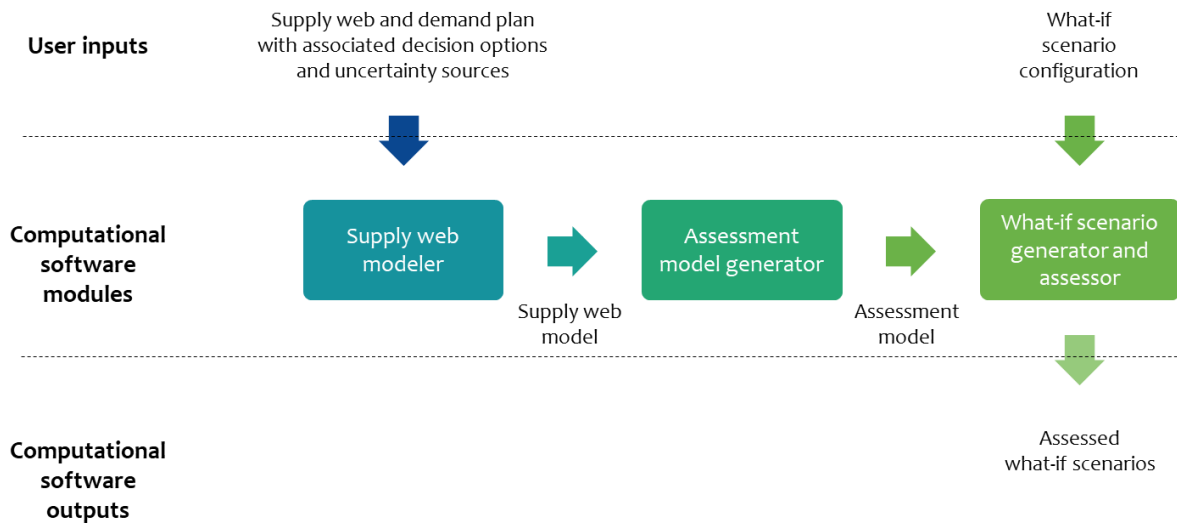

Figure 34: High-level operating diagram of the computational software proposal showing the sequence of the three modules as well as their inputs and outputs

2.2. Supply web modeler

The supply web modeler module is composed of two building blocks: first, a supply web metamodel to structure supply web knowledge, and second, a user interface and specific algorithms that allow users to create the model of the supply web in the computational software according to the metamodel.

2.2.1. The supply web metamodel

The supply web metamodel illustrated in Figure 35 was designed to structure the knowledge of supply webs. The objective of this supply web metamodel is to support the automation of other modules that use this information by relying on the structure of the information guaranteed by the metamodel. The supply web metamodel is represented using the UML Class diagram standard (Object Management Group 2015). It contains nodes that are described in Table 2 and edges that are described in Table 3. Inheritance edges by nature have a very specific meaning, indicating that the source node is a specialized form of the targeted node, therefore Table 3 does not describe these edges because it would correspond to explaining this meaning several times. There are also attributes associated with several concepts and edges to describe quantitative information that is required by the other modules to make possible the performance assessment using KPIs. Finally, symbols are associated with the nodes of the metamodel (Figure 35). These symbols are used in Figure 36 and Figure 38 to illustrate the supply web model.

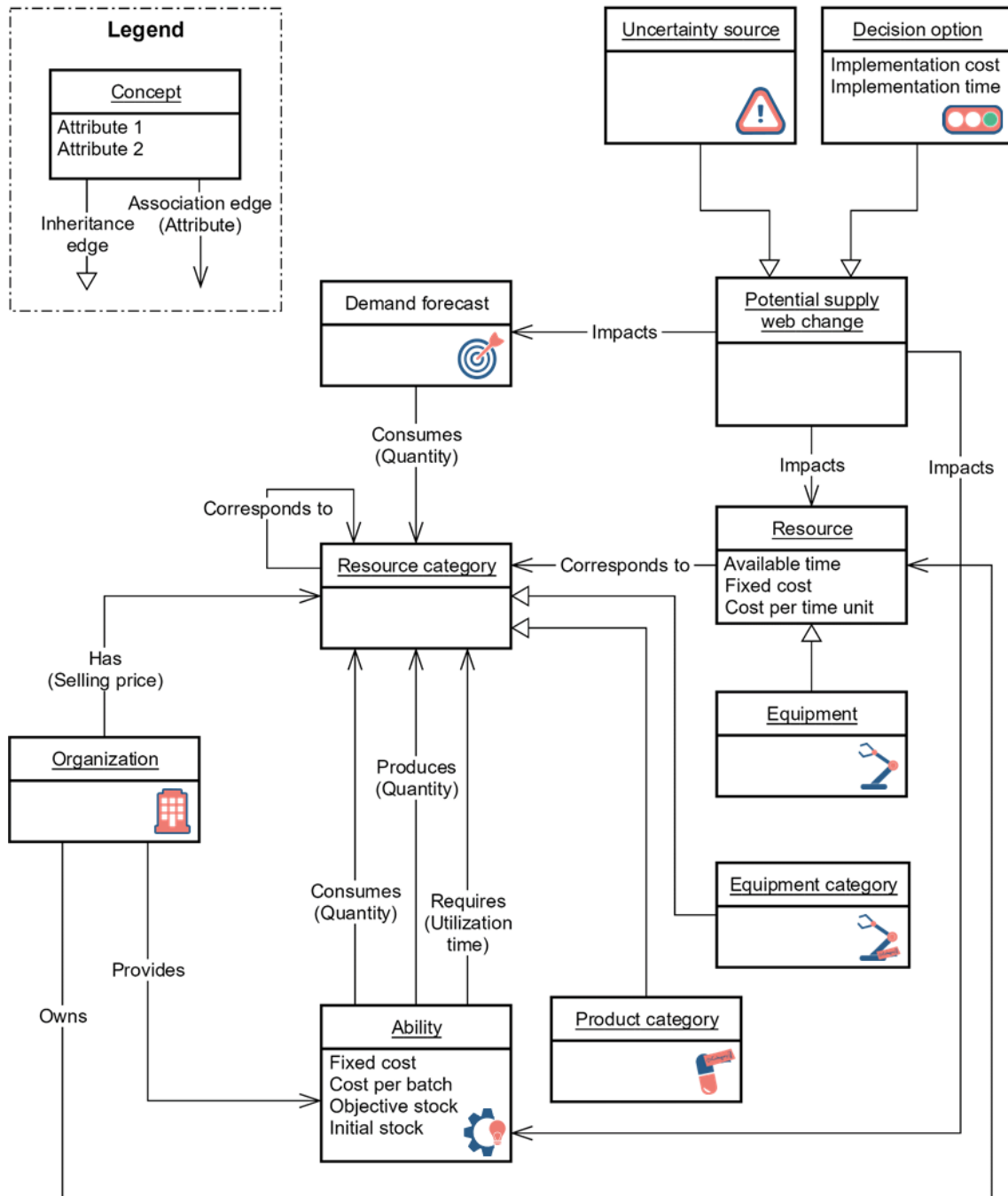

Figure 35: Supply web metamodel designed to make the creation of metamodel-based algorithms possible. It is used as part of two DSS modules: “assessment model generator” and “what-if scenario generator and assessor”

Table 2: Description of the nodes of the supply web metamodel

Node	Description
Organization	Describes a company or business unit that is part of a considered supply web scope.
Ability	Describes an ability (i.e., know-how) that an organization makes available to the supply web and that can therefore be used to fulfill demand.
Resource Category	Describes a group to which resources can be associated when having a certain set of common characteristics. It aims to describe other types of nodes by their relationships to a category of resource rather than a specific resource. It can be specified as being either an equipment category or a product category.
Equipment Category	Describes a specific type of resource category created to simplify users' understanding and usage of the model. It corresponds to a category of non-consumable resources (i.e., equipment).
Product Category	Describes a specific type of resource category created to simplify users' understanding and usage of the model. It corresponds to a category of consumable resources (products).
Resource	Describes a physical resource associated with an organization. It can be specified as equipment or a product (in practice, a product is not part of the metamodel because describing each product unit is not needed in the approach).
Equipment	Describes a specific type of resource category created to simplify users' understanding and usage of the model. It corresponds to a non-consumable resource (i.e., equipment).
Demand forecast	Describes an external demand from the point of view of the organizations that are part of the considered supply web scope.
Potential supply web change	Describes a potential change in the state of the supply web which can either correspond to a chosen change (decision option) or an unwanted change (uncertainty source).
Decision option	Describes a potential supply web change that has the specificity of being chosen (i.e., the result of a decision).
Uncertainty source	Describes a potential supply web change that has the specificity of being uncontrolled (i.e., the result of an uncontrolled element).

Table 3: Description of the “association” edges of the supply web metamodel

Source node	Edge name	Target node	Description
Organization	Provides	Ability	Describes how an organization provides an ability that can be used as part of the supply chains.
Organization	Owns	Resource	Describes how an organization owns a certain resource which can be used as part of the supply chains.
Organization	Has	Resource category	Describes how an organization has the resource category in its product portfolio which is sold at a certain price.
Ability	Consumes	Resource category	Describes how performing a batch using the ability will consume resources of the resource category in a certain quantity.
Ability	Produces	Resource category	Describes how performing a batch using the ability will produce resources of the resource category in a certain quantity.
Ability	Requires	Resource category	Describes how performing a batch using the ability will require resources of the resource category for a certain amount of time.
Resource	Corresponds to	Resource category	Describes how the source resource is part of the resource category.
Demand forecast	Consumes	Resource category	Describes how the demand forecast is associated with the resource category in a certain quantity.
Potential supply web change	Impacts	Demand forecast	Describes how the potential supply chain change impacts the demand forecast and its outgoing edges attributes.
Potential supply web change	Impacts	Resource	Describes how the potential supply chain change impacts the resource and its outgoing edges attributes.
Potential supply web change	Impacts	Ability	Describes how the potential supply chain change impacts the ability and its outgoing edges attributes.
Resource category	Corresponds to	Resource category	Describes how a category of resources can be part of another category of resources.

2.2.2. Supply web model creation

2.2.2.1. Two solutions for providing user inputs: a web-based user interface and company-specific Excel files

Two solutions were designed to create the supply web models from user inputs. For each of these solutions, an algorithm was developed in the supply web modeler. The first solution was designed to allow users to graphically provide supply web information by taking advantage of the web-based user interface of an existing software program. The second solution was specifically designed for the second use case described in the fifth chapter. This second solution was to allow the use of company-specific Excel files as user inputs. It is thus specific to the structure of the Excel files provided by the industrial partner.

Regarding the first solution, the software used to graphically provide supply web information is called [RIO-SUITE](#) (Centre Génie Industriel - IMT Mines Albi 2019). It was developed at the research center Centre Génie Industriel of IMT Mines Albi. This software contains a module called Design Assistant (R-IODA) that takes a metamodel as configuration input and generates a web-based user interface allowing users to graphically create models that follow the metamodel structure. In our case, the metamodel introduced in Figure 35 was used as the configuration input of the R-IODA module to generate a supply web modeling interface. Users can take advantage of this supply web modeling interface to graphically create the supply web model. To help users create the model of the supply web, the R-IODA module projects the supply web metamodel (and thus models) over three projection plans: “organizations & abilities”, “organizations & resources”, and “demand forecasts.” These projection plans lead to three views of the user interface to create and visualize the supply web models. These three views are illustrated in Figure 36. Readers can also refer to the fifth chapter for screenshots of the user interface (Figure 82, Figure 83, and Figure 84). This offers simpler views of the model than if there was only one with all the information provided at once. The R-IODA module also allows the user to export the supply web model as XML files. These XML files can then be provided as inputs to the supply web modeler. In this case, the supply web modeler uses the first algorithm designed to create the supply web model that can be used by the following modules of the computational software. The steps from the user inputs to the [RIO-SUITE](#) modeling interface up to the creation of the supply web model are illustrated in blue on the left side of Figure 37. Regarding the second solution, an algorithm was developed to read Excel files provided by the industrial partner and to create the supply web model that can be used by the following modules. The associated steps are illustrated in green on the right side of Figure 37. These algorithms are described in the appendix (page 219).

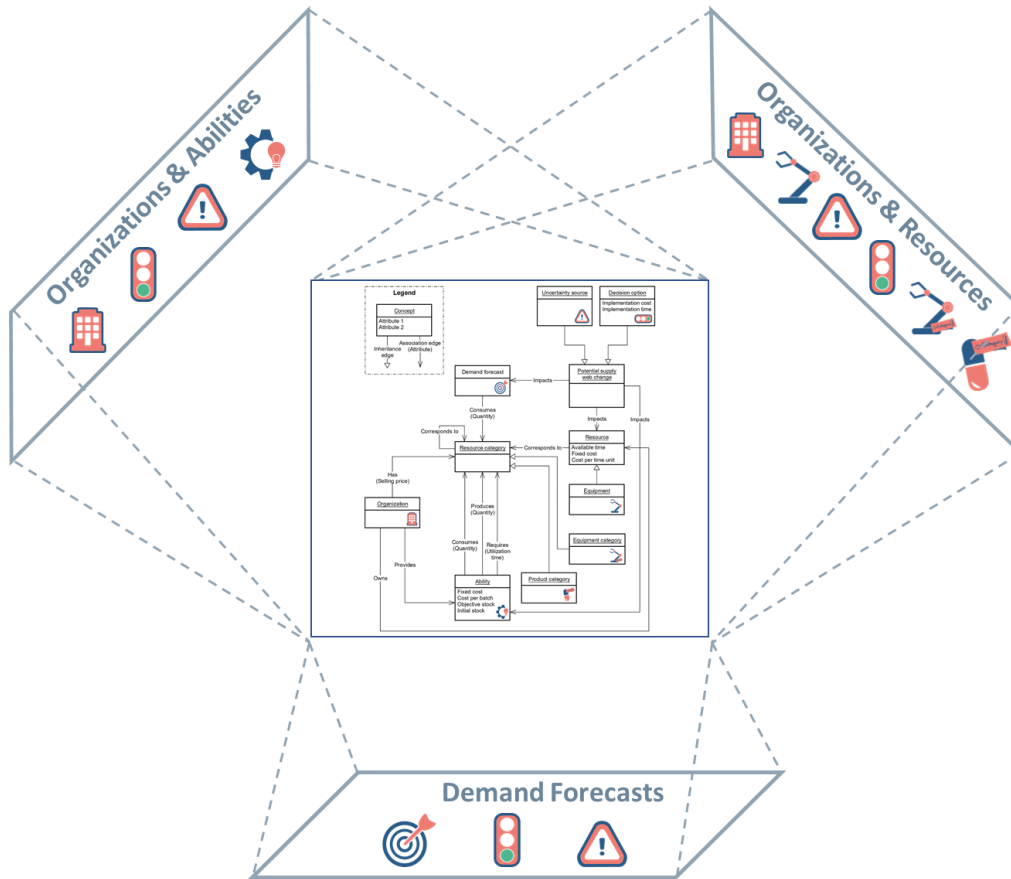

Figure 36: Projection of the supply web model over three projection plans corresponding to three views of the user interface of the [RIO-SUITE](#) software for creating and visualizing the supply web model

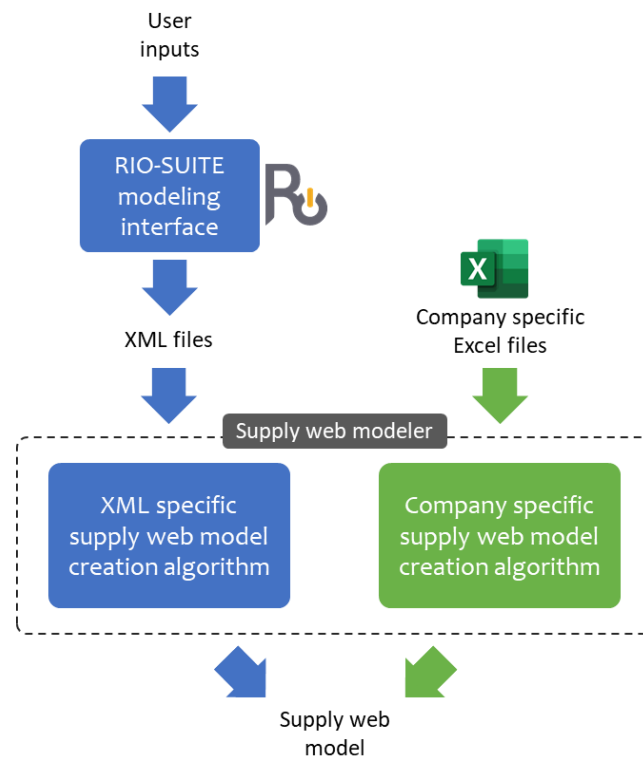

Figure 37: Two solutions for providing the supply web modeler with inputs to create the supply web model

2.2.2.2. Introduction of the supply web model of the illustrative use case “HelloBread” used to illustrate the contributions

A simple fictive use case called “HelloBread” was created to illustrate the contributions. The following paragraphs describe the supply web model of this use case that is then used as a reference throughout this section to illustrate the contributions. The objective of this use case is to make the contributions easy to understand before putting the contribution into practice on a real scale of industrial use cases in the fifth chapter of this thesis. The next paragraph describes the “HelloBread” illustrative use case.

The “HelloBread” use case corresponds to a supply web aiming to meet the demand for two categories of products: bread and yeast. Indeed, the model (Figure 38) contains two demand forecast nodes (“Demand of 6000 units of bread” and “Demand of 1000 kg of yeast”), with each one linked by an edge “consumes” to its corresponding product category (“Bread” and “Yeast”). The supply web model is also composed of 4 organizations (“Bakery 1”, “Bakery 2”, “Yeast producer”, and “Flour producer”). Each organization offers one ability and is linked to its corresponding ability by an edge “owns”, which results in 4 abilities (“Produce bread 1”, “Produce bread 2”, “Produce yeast”, and “Produce flour”). As explained in the previous subsection, the bill of materials and routing of each ability are respectively described by their “produces” and “consumes” edges towards product categories (“Bread”, “Yeast”, and “Flour”) and by their “requires” edges towards equipment categories (“Bread maker”, “Yeast maker”, and “Flour maker”). In addition, each equipment category has equipment corresponding to it which is owned by the organizations. For example, the “Bread maker” equipment category has 3 equipment units corresponding to it (“Bread maker 1”, “Bread maker 2”, and “Bread maker 3”), with the first two owned by the organization “Bakery 1” and the third one owned by the organization “Bakery 2”. Finally, the model contains four supply web changes including two decision options and two uncertainty sources. Regarding the decision options, the first one is called “Add a shift” and aims to increase the available time of the equipment “Bread maker 3”, and the second one is called “Find a new client” and aims to increase the demand forecast of “Demand of 6000 units of bread”. Regarding the uncertainty sources, the first one is called “Demand increase by 10%” and aims to increase the demand forecast “Demand of 1000 kg of yeast”, and a second one is called “Breakdown” and aims to decrease the available time of the equipment “Flour maker 1”. To evaluate this use case over three years (2021 to 2023), its supply web model is duplicated five times to represent the forecasted supply web for each year. To keep it simple, the forecasted supply web structure stays the same for each year (Figure 38) and the only forecasted change is the “Demand of 6000 units of bread” which increases by a thousand units per year from 2022 to 2023. Several types of nodes and edges of a supply web have attributes as described by the supply web metamodel illustrated in Figure 35. This is the case for the nodes and edges of the HelloBread supply web model illustrated in Figure 38, which is an instance of the supply web metamodel. But it would be too complex to graphically illustrate the values of the attributes of all the nodes one by one. Therefore, the following three tables (Table 4, Table 5, and Table 6) provide the values of the attributes of nodes and edges. Readers can refer to them when reading the rest of this thesis when the HelloBread use case is used to illustrate the contributions.

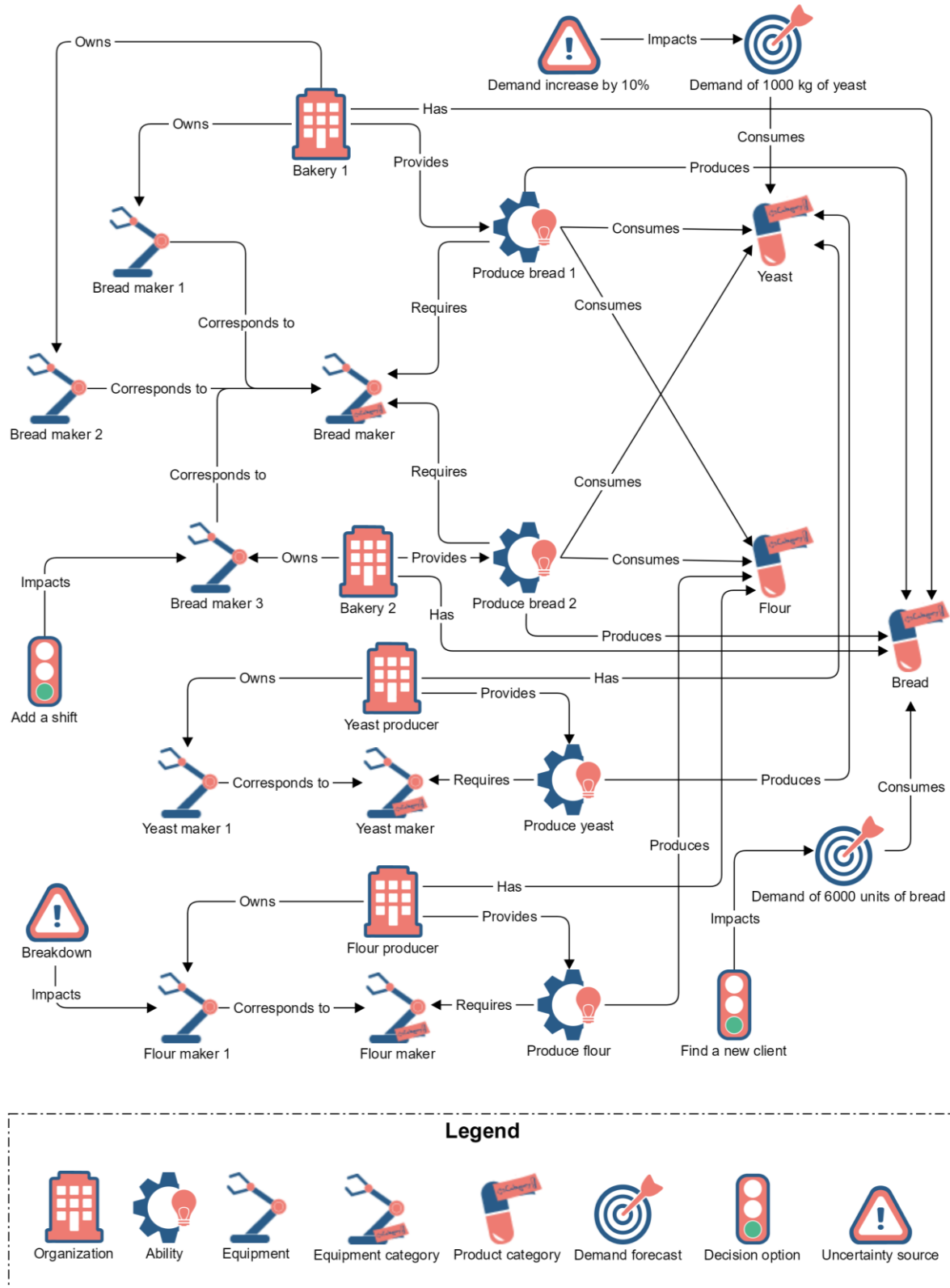

Figure 38: Supply web model of the “HelloBread” use case created to illustrate the contributions

Table 4: Values of the attributes associated with edges of the HelloBread illustrative use case over the three-year horizon

Source node	Target node	Edge	Attribute	Unit	Value for 2021	Value for 2022	Value for 2023
Produce bread 1	Bread	Produces	Quantity	unit	10	10	10
	Yeast	Consumes	Quantity	kg	0.01	0.01	0.01
	Flour	Consumes	Quantity	kg	0.5	0.5	0.5
	Bread maker	Requires	Utilization time	h	0.5	0.5	0.5
Produce bread 2	Bread	Produces	Quantity	unit	10	10	10
	Yeast	Consumes	Quantity	kg	0.01	0.01	0.01
	Flour	Consumes	Quantity	kg	0.6	0.6	0.6
	Bread maker	Requires	Utilization time	h	0.5	0.5	0.5
Produce yeast	Yeast	Produces	Quantity	kg	1	1	1
	Yeast maker	Requires	Utilization time	h	5	5	5
Produce flour	Flour	Produces	Quantity	kg	1	1	1
	Flour maker	Requires	Utilization time	h	0.5	0.5	0.5
Demand of 6000 units of bread	Bread	Consumes	Quantity	unit	6000	7000	8000
Demand of 1000 kg of yeast	Yeast	Consumes	Quantity	kg	1000	1000	1000
Bakery 1	Bread	Has	Selling price	€	1	1.1	1.2
Bakery 2	Bread	Has	Selling price	€	1	1	1
Yeast producer	Yeast	Has	Selling price	€	100	100	100
Flour producer	Flour	Has	Selling price	€	1	1	1

Table 5: Values of the attributes associated with nodes of the HelloBread illustrative use case over the three-year horizon

Node	Attribute	Unit	Value for 2021	Value for 2022	Value for 2023
Produce bread 1	Fixed cost	€	1000	1000	1000
	Cost per batch	€	1	1	1
	Objective stock	unit	0	0	0
	Initial stock	unit	0	0	0
Produce bread 2	Fixed cost	€	500	500	500
	Cost per batch	€	2	2	2
	Objective stock	unit	0	0	0
	Initial stock	unit	0	0	0
Produce yeast	Fixed cost	€	2000	2000	2000
	Cost per batch	€	5	5	5
	Objective stock	kg	100	100	100
	Initial stock	kg	80	/	/
Produce flour	Fixed cost	€	1000	1000	1000
	Cost per batch	€	4	4	4
	Objective stock	kg	1000	1000	1000
	Initial stock	kg	1000	/	/
Bread maker 1	Available time	h	1600	1600	1600
	Fixed cost	€	500	500	500
	Cost per time unit	€	0.2	0.2	0.2
Bread maker 2	Available time	h	1600	1600	1600
	Fixed cost	€	800	800	800
	Cost per time unit	€	0.2	0.2	0.2
Bread maker 3	Available time	h	1500	1500	1500
	Fixed cost	€	500	500	500
	Cost per time unit	€	0.05	0.05	0.05
Yeast maker 1	Available time	h	1700	1700	1700
	Fixed cost	€	1000	1000	1000

SCCP information system: a computational software proposal

	Cost per time unit	€	0.5	0.5	0.5
	Available time	h	2000	2000	2000
Flour maker 1	Fixed cost	€	2000	2000	2000
	Cost per time unit	€	0.5	0.5	0.5
Find a new client	Implementation cost	€	1000	1000	1000
	Implementation time	months	2	2	2
Add a shift	Implementation cost	€	2000	2000	2000
	Implementation time	months	1	1	1

Table 6: Values of the attributes associated with “impact” edges (outgoing from decision options or uncertainty sources) of the HelloBread illustrative use case over the three-year horizon

Source node	Target node	Impacted attribute	Impact operator	Impact value for 2021	Impact value for 2022	Impact value for 2023
Find a new client	Demand of 6000 units of bread	Quantity (on outgoing “consumes” edge)	+	2500	2500	2500
		Available time	+	1600	1600	1600
Add a shift	Bread maker 3	Fixed cost	+	0	0	0
		Cost per time unit	+	0	0	0
		Quantity (on outgoing “consumes” edge)	*	1.1	1.1	1.1
Breakdown	Flour maker 1	Available time	*	0.5	0.5	0.5
		Fixed cost	+	0	0	0
		Cost per time unit	+	0	0	0

2.3. Assessment model generator

The “assessment model generator” module is composed of three building blocks: first, a metamodel to structure the potential supply chain map information. The potential supply chain map is defined as the “graph of interlaced supply options forming a map containing all potential supply chains made possible by the supply web stakeholders for fulfilling the demand plan” (Table 41). Second, a function (i.e., algorithm) that generates the potential supply chain map model according to the metamodel. Third, a function (i.e., algorithm) that deduces generic KPI formulas for several elements of both the potential supply chain map and the supply web models. These three building blocks are respectively described in the following three sub-subsections. Figure 39 illustrates the sequenced use of the two functions of the “assessment model generator” module. There are no user inputs because this module is entirely automated based on the output of the “supply web modeler” module. And there are no computational software outputs because the outputs are directly used by the following module (the “what-if scenario generator and assessor”).

User inputs

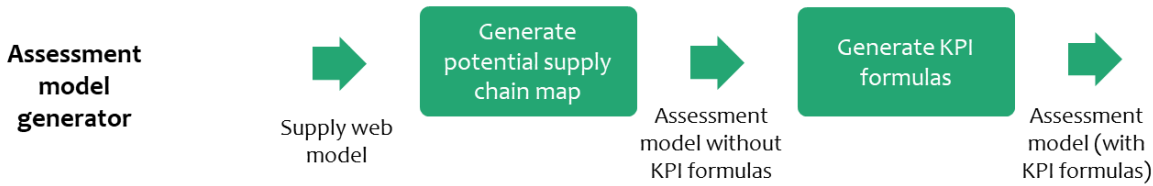

Computational software outputs



Figure 39: Synthesis of the sequence of the two functions of the “assessment model generator” module of the computational software

2.3.1. The potential supply chain map metamodel

The first building block of the assessment model generator is the potential supply chain map metamodel. This metamodel is inspired from process modeling and the research results on the collaborative business processes described by Montarnal et al. (2018). It is a simplified version of the Business Process Model and Notation (BPMN) (Object Management Group 2011, International Organization for Standardization 2013). The choice was made to represent the supply chain options as a process inspired from BPMN for two main reasons: first, it allows for making the analogy between the sequence of activities of a process and the physical flows of a supply chain represented by the edges. Second and most importantly, it makes possible the description of the physical flows with logical links represented by gateways describing when a physical flow is a choice (OR gateways) or a necessity (AND gateways). This metamodel is composed of 7 concepts (i.e., nodes) having specific meanings to describe the potential supply

chain map. The meanings of these nodes are described in Table 7. Additional information is provided in the appendix (page 218) with Table 42 containing the list of edges that can occur in the potential supply chain map and describing their meaning as well as their minimum and maximum occurrences.

Table 7: The potential supply chain map metamodel nodes and their meaning

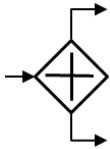
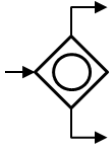
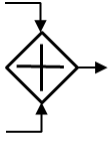
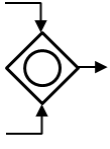
Node	Meaning and associated edges	Legend
Start event	Corresponds to the upstream limit of the potential supply chain map within the scope of the supply web.	
End event	Corresponds to the downstream limit of the potential supply chain map within the scope of the supply web. In other words, it represents the clients of the supply web.	
Activity	Corresponds to an ability of the supply web that can or must (“can” if there is at least one alternative and “must” if there is no alternative) be used as part of the supply chains of the supply web to fulfill demand. There can only be one activity per ability of the supply web.	
AND Opening Gateway	Means that there are at least two branches in the potential supply chain map, so at least one AND Closing Gateway or one OR Closing Gateway. In other words, either two resource categories or more are involved in the product flow or the only one involved has two or more abilities producing it.	
OR Opening Gateway	Means that there are two or more activities in the potential supply chain map that consumes the same resource category as the one produced by the activity preceding the OR Opening Gateway.	
AND Closing Gateway	Corresponds to the aggregation of two or more necessary product flows. This means that the following node, either an activity or the end event, needs two or more different resource categories as inputs to be performed. If it is an activity, it means that the associated ability consumes two or more different resource categories. If it is the end event, it means that considering the set of all objectives of the supply web model, there are two or more different resource categories consumed by these objectives.	
OR Closing Gateway	Means that there are two or more abilities in the supply web that produce the same resource category as the one associated with the outgoing edge of the OR Closing Gateway.	

2.3.2. The metamodel-based algorithm for deducing the potential supply chain map

The second building block of the assessment model generator is an algorithm designed to automatically deduce the potential supply chain map. The algorithm uses the structure of the supply web metamodel to exploit the supply web models and automatically create the potential

supply chain map model according to the potential supply chain map metamodel. It is a model transformation, as defined by Benaben et al. (2017), from the supply web point of view to the potential supply chain map point of view. In other words, it transforms the knowledge of the supply web into knowledge of the potential supply chain map.

The diagrams describing the potential supply chain map deduction algorithm are too long to be placed here in the heart of the thesis. Therefore, they are given in the appendix (page 225). To help readers understand the main principles of the algorithm, Table 8 illustrates it step by step using the “HelloBread” illustrative use case introduced in the previous subsection (Figure 38). It describes with sentences the procedure performed computationally by the algorithm, which leads to the deduction of the potential supply chain map of the “HelloBread” use case. In other words, it illustrates the transformation of the “HelloBread” supply web model (Figure 38) into the “HelloBread” potential supply chain map model (last illustration in Table 8).

Table 8: Illustration of the potential supply chain map model deduction algorithm by describing its steps with sentences for the “HelloBread” illustrative use case

**Potential supply chain map deduction steps for the “HelloBread” use case (Figure 38):
chronological states of the potential supply chain map & explanations**

Create the end event.

Find the resource categories consumed by objectives and store them in a variable called RCCee for this example (in this case the value is [Bread, Yeast]).

As there is more than one element (two) in the variable RCCee, create an AND Closing Gateway and create an edge from this AND Closing Gateway to the end event.

Find the abilities producing the first element of the variable RCCee (bread) and store them in a variable called APbr for this example (in this case the value is [Produce bread 1, Produce bread 2]).

As there are two elements in the variable APbr (more than one), create an OR Closing Gateway and an edge from this OR Closing Gateway to the AND Closing Gateway.

Create an activity associated with the first element of the variable APbr (Produce bread 1) and create an edge from this activity to the OR Closing Gateway.

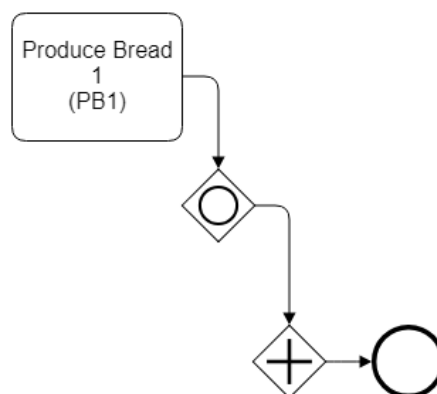

Find the resource categories consumed by the previously created activity (Produce bread 1) and store them in a variable called RCCpb1 for this example (in this case the value is [Flour, Yeast]).

As there are two elements in the variable RCCpb1 (more than one), create an AND Closing Gateway and create an edge from this AND Closing Gateway to the activity.

Find the abilities producing the first element of RCCpb1 (flour) and store them in a variable called APfl for this example (in this case the value is [Produce flour]).

As there is only one element in the variable APfl, create an activity associated with the first element of the variable APfl (Produce flour) and create an edge from this activity to the AND Closing Gateway.

Find the resource categories consumed by the previously created activity (Produce flour) and store them in a variable called RCCpf for this example (in this case the value is []).

As the variable RCCpf is empty and the start event has not already been created, create the start event, and create an edge from this start event to the previously created activity (Produce flour).

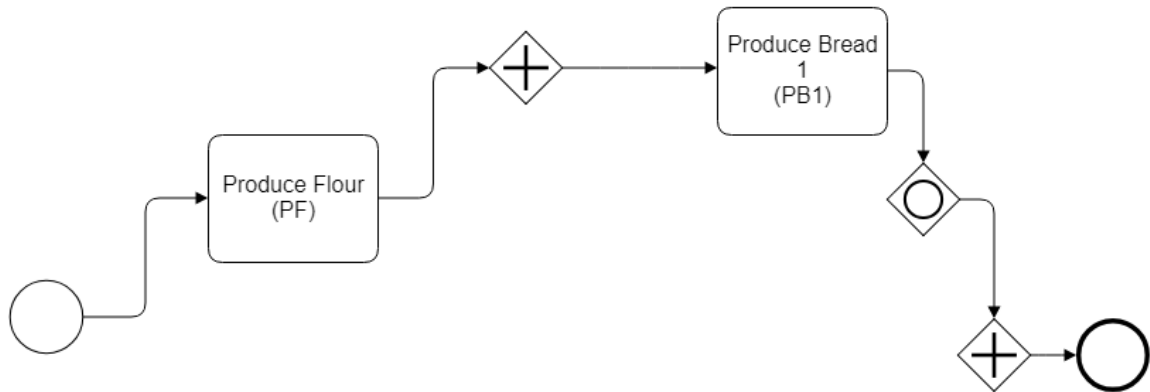

Find the abilities producing the second element of RCCpb1 (yeast) and store them in a variable called APye for this example (in this case the value is [Produce yeast]).

As there is only one element in the variable APye, create an activity associated with the first element of the variable APfl (Produce flour) and create an edge from this activity to the AND Closing Gateway.

Find the resource categories consumed by the previously created activity (Produce yeast) and store them in a variable called RCCpy for this example (in this case the value is []).

As the variable RCCpf is empty, the start event has already been created, and the node following the start event is not an AND Opening Gateway, then: create an AND Opening Gateway, create an edge from this AND Opening Gateway to the previously created activity (Produce yeast), create edges from the AND Opening Gateway to the nodes having an edge arriving from the start event, delete all outgoing edges of the start event, and create an edge from the start event to the AND Opening Gateway.

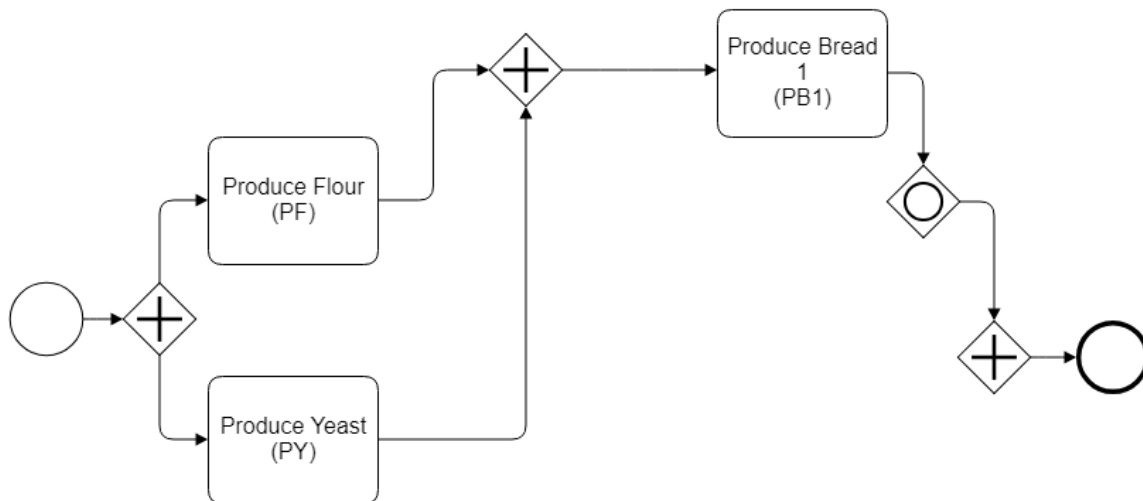

Create an activity associated with the second element of the variable APbr (Produce bread 2) and create an edge from this activity to the OR Closing Gateway.

Find the resource categories consumed by the previously created activity (Produce bread 2) and store them in a variable called RCCpb2 for this example (in this case the value is [Flour, Yeast]).

As there are two elements in the variable RCCpb2 (more than one), create an AND Closing Gateway and create an edge from this AND Closing Gateway to the activity.

Find the abilities producing the first element of the variable RCCpb2 (flour) and store them in a variable called APfl for this example (in this case the value is [Produce flour]).

As there is only one element in the variable APfl, the associated activity has already been created, and the node following this activity is not an OR Opening Gateway, then: create an OR Opening Gateway, create an edge from this OR Opening Gateway to the previously created AND Closing Gateway, create edges from the OR Opening Gateway to the nodes having an edge arriving from the Produce flour activity, delete all outgoing edges of the Produce flour activity, and create an edge from the Produce flour activity to the OR Opening Gateway.

Find the abilities producing the second element of the variable RCCpb2 (yeast) and store them in a variable called APye1 for this example (in this case the value is [Produce yeast]).

As there is only one element in the variable APye1, the associated activity has already been created, and the node following this activity is not an OR Opening Gateway, then: create an OR Opening Gateway, create an edge from this OR Opening Gateway to the previously created AND Closing Gateway, create edges from the OR Opening Gateway to the nodes having an edge arriving from the Produce yeast activity, delete all outgoing edges of the Produce yeast activity, and create an edge from the Produce yeast activity to the OR Opening Gateway.

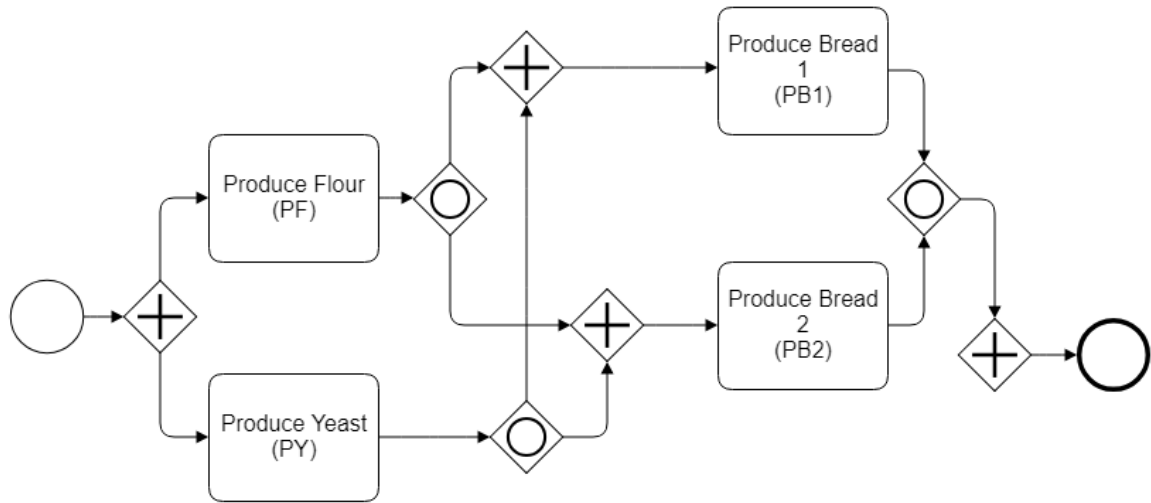

Find the abilities producing the second element of the variable RCCee (yeast) and store them in a variable called APye2 for this example (in this case the value is [Produce yeast]).

As there is only one element in the variable APye2, the associated activity has already been created, and the node following this activity is an OR Opening Gateway, then: create an edge from the OR Opening Gateway following the Produce yeast activity to the AND Closing Gateway preceding the end event.

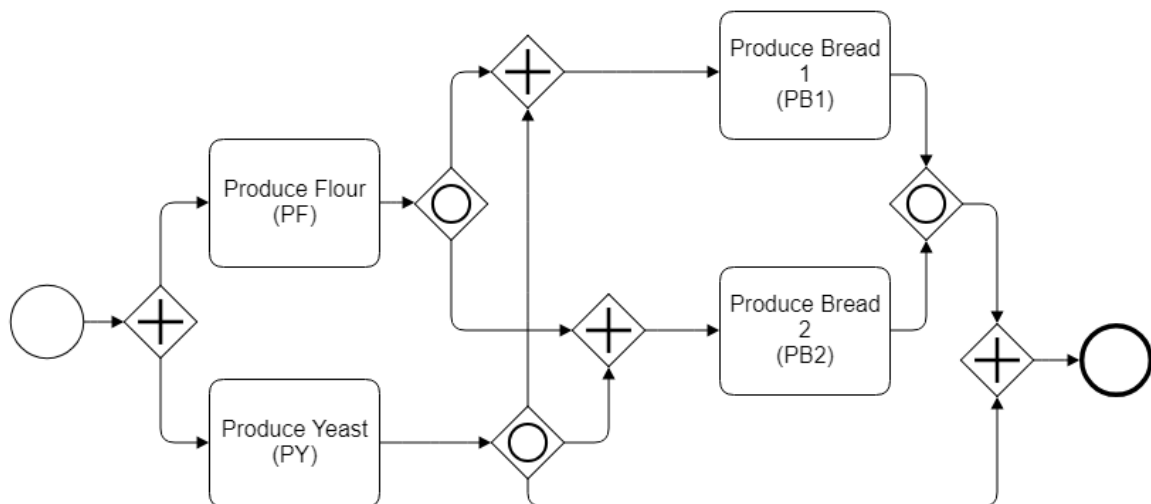

2.3.3. The metamodel-based algorithm for deducing key performance indicator formulas

The third building block of the assessment model generator is an algorithm designed to automatically deduce KPI formulas for several elements of both the supply web and the potential supply chain map models. The algorithm takes both the supply web and the potential supply chain map models as inputs and updates them by adding KPI formulas. The KPI formulas correspond to formulas that contain parameter identifiers rather than their values. The objective of having parameter identifiers rather than values is to have formulas that are compatible with all what-if scenarios, because parameter identifiers can be replaced by their value according to the considered what-if scenario. Table 9 synthesizes the main KPIs for which a formula is deduced. They are organized by associated metamodel and node.

The KPI formulas are deduced for the lowest organizational level of detail of the metamodel so that they can be aggregated to get a higher-level view. For example, aggregating (i.e., summing) the “revenue relying on it” KPI formulas of all resources of an organization gives the formula of the revenue of the corresponding organization. And aggregating (i.e., summing) the “revenue relying on it” KPI formulas among all organizations gives the formula of the revenue of the entire supply web scope considered. The same approach can be made for the “revenue relying on it” of the activities (i.e., abilities) as well as the “Total utilization cost” of the resources and activities.

Table 9: Main key performance indicators for which a generic formula is deduced, organized according to the metamodel and element they are associated with

Metamodel	Node / Edge	Key performance indicator
Potential supply chain map	Activity ¹	Gross requirement
		Net requirement
		Production objective
		Total utilization cost
		Revenue relying on it
Supply web	“Has” from Organization to Resource category ²	Utilization time required
		Available time
		Revenue relying on it
	Resource (Equipment)	Utilization time required
		Total utilization cost
		Revenue relying on it

The pseudocode describing the KPI formula deduction algorithm is too long to be placed here in the heart of the thesis. Therefore, it is given in the appendix (page 233). To help readers understand the main principles of the potential supply chain map deduction algorithm, Figure 40 illustrates the deduction of some KPI formulas by a part of the KPI deduction algorithm which propagates the demand forecasts along the potential supply chain map of the “HelloBread” illustrative use case. The illustrated KPI formulas are the following: demand of resource category (associated with the end event), gross requirement, net requirement, and production objective (associated with the activities). The propagation is performed backwards, starting from the end event and ending at the upstream activities.

¹ The formulas of the “Activity” nodes of the Potential Supply Chain map model can be associated with the corresponding “Ability” nodes of the Supply Web model as there is a one-to-one relationship between “Ability” and “Activity”.

² In practice these formulas are deduced only for resource categories for which an ability of the same organization has an edge “requires” towards the resource category. Generally, these resource categories will be modeled as “equipment categories”.

The KPI formula deduction algorithm first creates a demand of resource category formula for each resource category having at least one associated demand forecast in the supply web model (the first formula described in Table 10). It associates these formulas with the end event as illustrated under the end event in Figure 40: “Bread demand” and “Yeast demand”. These formulas that are associated with the end event are created by aggregating the demand forecasts of the supply web model per resource category (i.e., summing when there are several demand forecasts associated with the same resource category). The two formulas do not contain a sum because the supply chain model of the HelloBread use case (Figure 38) does not contain two demand forecasts associated with the same resource category. There are two demand forecasts for two different resource categories (bread and yeast). Then, the KPI formula deduction algorithm propagates these demand forecast formulas backwards along the potential supply chain map to create the following formulas associated with each activity: gross requirements, net requirements, and production objectives. After deducing these first four types of KPI formulas, the KPI deduction algorithm uses these formulas along with information from the supply web to deduce all the other formulas mentioned in Table 9 for which the mathematical formulation is given in Table 10.

Figure 41 and Figure 42 illustrate the resulting formulas with examples taken from the HelloBread illustrative use case. Figure 41 illustrates the formulas associated with the activity nodes of the potential supply chain map by showing the resulting formulas for the activity “Produce bread 1 (PB1)”. Figure 42 illustrates the formulas associated with the resource nodes of the supply web by showing the resulting formulas for the resource “Bread maker 1”.

Table 10: Generic formulas for the main key performance indicators for which a formula is deduced

Node / Edge	Key performance indicator	Formula
End Event	Demand of resource category X (one KPI for each resource category consumed by a demand forecast)	$\sum_D \left(\begin{array}{c} \text{Quantity associated with} \\ \text{the "consumes" edge} \\ \text{coming out of the} \\ \text{demand forecast D} \end{array} \right)$ (Demand forecasts consuming resource category X)
Activity (i.e., Ability)	Gross requirement	***A formula valid for all activities cannot be specified as it depends on the activity and the structure of the potential supply chain map***
	Net requirement	Gross requirement + Objective stock – Initial stock
	Production objective (batch) ¹	$\left\lceil \frac{\text{Net requirement}}{\text{Quantity associated with the "produces" edge}} \right\rceil$
	Total utilization cost	Production objective * Cost per batch

¹ The symbols “ $\lceil \]$ ” mean rounding up to the nearest integer.

	Revenue relying on it	$\text{Net requirement} * \left(\begin{array}{c} \text{Selling price of the} \\ \text{resource category} \\ \text{it produces} \end{array} \right)$
	Utilization time required	$\sum_A \left(\begin{array}{c} \text{Utilization time of the resource} \\ \text{category required by ability A} \\ * \\ \text{Production objective} \\ \text{of ability A} \end{array} \right)$ <p>(Abilities provided by this organization and requiring this resource category)</p>
“Has” from Organization to Resource category	Available time	$\sum_R \text{(Available time of resource R)}$ <p>(Resources owned by this organization that correspond to this resource category)</p>
	Revenue relying on it	$\sum_A \text{(Revenue relying on ability A)}$ <p>(Abilities provided by this organization and requiring this resource category)</p>
	Utilization time required	$\left(\begin{array}{c} \text{Resource available time} \\ \hline \text{Available time associated with} \\ \text{the edge “has” from organization} \\ \text{owning the resource to the resource} \\ \text{category this resource corresponds to} \end{array} \right) * \text{Utilization time required associated with the edge “has” from organization owning the resource to the resource category this resource corresponds to}$
Resource (Equipment)	Total utilization cost	$\text{Utilization time required} * \text{Cost per time unit}$
	Revenue relying on it	$\left(\begin{array}{c} \text{Resource available time} \\ \hline \text{Available time associated with} \\ \text{the edge “has” from organization} \\ \text{owning the resource to the resource} \\ \text{category this resource corresponds to} \end{array} \right) * \text{Revenue relying on it associated with the edge “has” from organization owning the resource to the resource category this resource corresponds to}$

It is important to note that the validity of the formula propagation algorithm relies on the following assumption: the lead-time between the beginning of the first activities of the potential supply chain map and the last ones is much shorter than the considered period. This is a consequence of the fact that the propagation of the demand forecasts through the supply chain generates production requirements for the same period as the demand forecasts. To give an

example, let's consider the formulas of the HelloBread illustrative use case given in Figure 40. All formulas correspond to the same period, and the value of "Bread demand" at the upstream part of the supply chains has an influence on the resulting value for other formulas in the downstream part of the supply chains. For example, "Bread demand" sequentially impacts the following formulas: "Gross requirement PB1", "Net requirement PB1", "Production objective PB1", "Gross requirement PF", "Net requirement PF", and "Production objective PF". This assumption was made to simplify assessment model deduction and use. It is considered an acceptable assumption because a common time granularity considered when making long-term SCCP decisions is a year, while many industries have supply chain lead times much shorter than a year. This assumption was validated with the considered supply chains of both industrial partners of this research project before being implemented to make sure it was relevant to their industrial context. The use cases performed with the industrial partners are described in the fifth chapter.

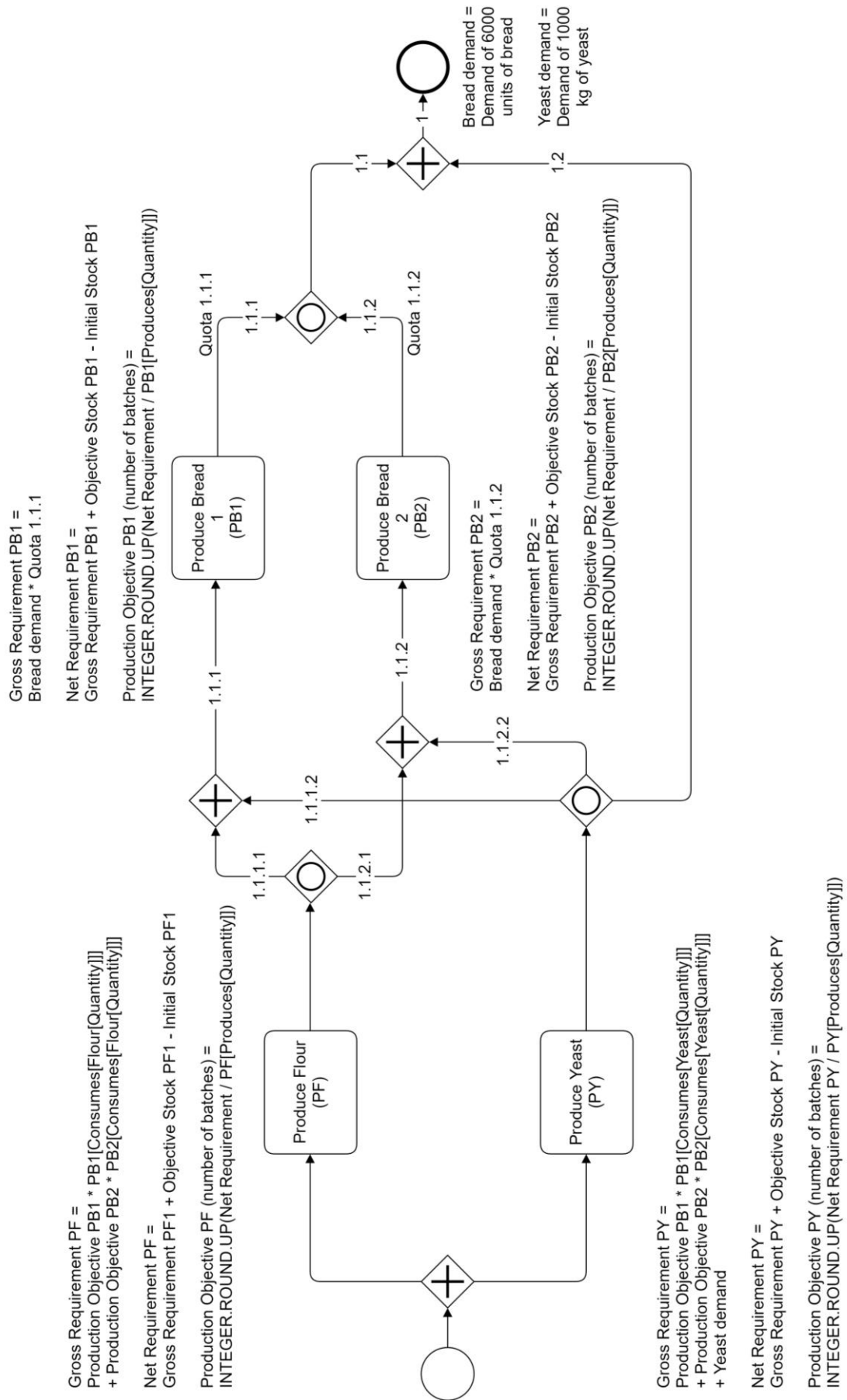

Figure 40: Illustration of the KPI formulas deduced by the algorithm that propagates the demand forecasts along the potential supply chain map of the “HelloBread” illustrative use case

```

{
  "Activities": [
    {
      "name": "Produce bread 1 (PB1)",
      "organization": "Bakery 1",
      "Fixed cost": 1000,
      "Cost per batch": 1,
      "Objective stock": 0,
      "Initial stock": 0,
      "gross requirement":
        DemandOf6000Bread[Consumes[Quantity]] * Quota1.1.1,
      "net requirement":
        (DemandOf6000Bread[Consumes[Quantity]] * Quota1.1.1) +
        PB1[ObjectiveStock] - PB1[InitialStock],
      "production objective (batches)":
        
$$\left[ \frac{(DemandOf6000Bread[Consumes[Quantity]] * Quota1.1.1) + PB1[ObjectiveStock] - PB1[InitialStock]}{PB1[Produces[Quantity]]} \right],$$

      "total utilization cost":
        
$$\left[ \frac{(DemandOf6000Bread[Consumes[Quantity]] * Quota1.1.1) + PB1[ObjectiveStock] - PB1[InitialStock]}{PB1[Produces[Quantity]]} \right] * PB1[CostPerBatch],$$

      "revenue relying on it":
        
$$\left( \frac{(DemandOf6000Bread[Consumes[Quantity]] * Quota1.1.1) + PB1[ObjectiveStock] - PB1[InitialStock]}{PB1[Produces[Quantity]]} \right) * Bakery1[has(Bread)[SellingPrice]],$$

    },
    ...All other activities of the potential supply chain map model...
  ],
}

```

Figure 41: Example of the deduced formulas associated with the HelloBread potential supply chain map model activity nodes. This illustration is done using the JSON format even though in practice these formulas are stored and used in memory as objects of the programming language.

```

{
  "resources": [
    {
      "name": "Bread Maker 1",
      "organization": "Bakery 1",
      "resource category": "Bread Maker",
      "available time": 1600,
      "Fixed cost": 500,
      "Cost per time unit": 0.1,
      "utilization time required":
      (
        (
          (DemandOf6000Bread[Consumes[Quantity]]*Quota1.1.1)+
          PB1[ObjectiveStock]-PB1[InitialStock]
        ) /
        PB1[Produces[Quantity]]
      ) * PB1[Produces[Quantity]] *
      PB1[Requires(BreadMaker)[UtilizationTime]]
      (
        BreadMaker1[AvailableTime]
        BreadMaker1[AvailableTime]+BreadMaker2[AvailableTime]
      ),
      "total utilization cost":
      (
        (
          (DemandOf6000Bread[Consumes[Quantity]]*Quota1.1.1)+
          PB1[ObjectiveStock]-PB1[InitialStock]
        ) /
        PB1[Produces[Quantity]]
      ) * PB1[Produces[Quantity]] *
      PB1[Requires(BreadMaker)[UtilizationTime]]
      (
        BreadMaker1[AvailableTime]
        BreadMaker1[AvailableTime] + BreadMaker2[AvailableTime]
      ) *
      BreadMaker1[CostPerTimeUnit],
      "revenue relying on it":
      (
        (
          (DemandOf6000Bread[Consumes[Quantity]] * Quota1.1.1) +
          PB1[ObjectiveStock]- PB1[InitialStock]
        )
        * Bakery1[has(Bread)[SellingPrice]] *
        (
          BreadMaker1[AvailableTime]
          BreadMaker1[AvailableTime] + BreadMaker2[AvailableTime]
        )
      ),
      ...All other resources of the supply web model...
    ],
  ],
}

```

Figure 42: Example of the deduced formulas associated with the HelloBread supply web model resource nodes. This illustration is done using the JSON format even though in practice these formulas are stored and used in memory as objects of the programming language.

2.4. What-if scenario generator and assessor

The what-if scenario generator and assessor module is composed of three building blocks corresponding to three functions: first, a function that collects the what-if scenario configuration and generates the list of what-if scenarios to assess. Second, a function that assesses all what-if scenarios. Third, a function that structures the results so they can be used by the second software program of the SCCP IS (the business intelligence software). Figure 43 illustrates the sequence of use of these three functions within the “what-if scenario generator and assessor” module. These three functions are respectively described in the following three sub-subsections.

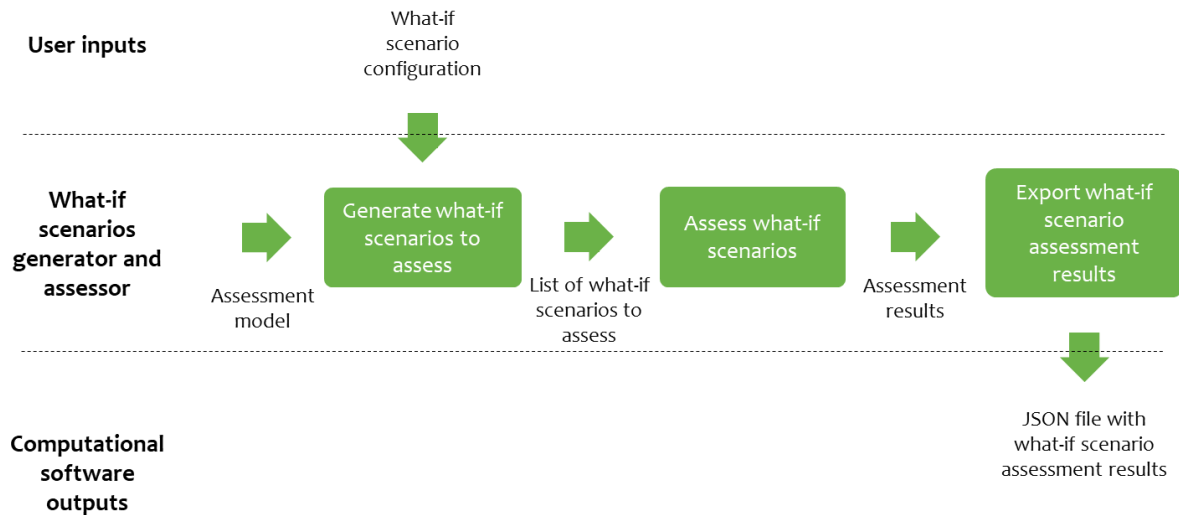

Figure 43: Sequence of the three functions of the “what-if scenario generator and assessor” module of the computational software

2.4.1. A function for generating the list of what-if scenarios to assess

The potential supply chain map created by the assessment model generator contains all possible flows of physical goods. Within this potential supply chain map, there can be OR Closing Gateways representing supply options as defined in Table 41. So, for each OR Closing Gateway, there is a supply option to choose. The organization owning the downstream activity must decide on the distribution of its supplies among the organizations owning the upstream activities. For example, in Figure 40 concerning the HelloBread illustrative use case, the network must decide how to distribute customer demand between “Bakery 1” owning the activity “Produce bread 1” and “Bakery 2” owning the activity “Produce bread 2” (cf. Figure 38 for details regarding the structure of the HelloBread model). In addition, this choice must be made for each period that must be assessed. Therefore, before defining the set of what-if scenarios to assess, the computational software requests users to provide the following information (i.e., what-if scenario configuration):

- time granularity of the provided supply web models,
- time horizon to consider,
- threshold regarding the number of decision options to be considered simultaneously,
- threshold regarding the number of uncertainty sources to be considered simultaneously,
- for each OR Closing Gateway and each period:
 - o the sets of supply options to consider for the what-if scenarios.

The number of potential combinations of decision options (excluding supply options), supply options, uncertainty sources, and periods can quickly be too high to allow for the assessment of all what-if scenarios. Therefore, the what-if scenario space must be filtered according to the relevance of the scenarios for making decisions. Consequently, the configuration of this filtering behavior has been left to users by providing thresholds regarding the number of uncertainty sources they want to be considered simultaneously as well as the number of decision options they want to be considered simultaneously in a what-if scenario. For example, the following what-if scenario configuration is defined for the “HelloBread” illustrative use case introduced with Figure 38 (Table 11 and Table 12):

Table 11: What-if scenario configuration (except for the sets of supply options) for the HelloBread illustrative use case

What-if scenario configuration input	Value
Time granularity	Year
Time horizon	3 years (2021 to 2023)
Threshold regarding the number of decision options to be considered simultaneously	1
Threshold regarding the number of uncertainty sources to be considered simultaneously	2

Table 12: Sets of supply options per period for the HelloBread illustrative use case

Year	Set of supply options ¹	OR Closing Gateway 1.1	
		Quota 1.1.1	Quota 1.1.2
2021	Set of supply options n°1	0.5	0.5
	Set of supply options n°2	1	0
2022	Set of supply options n°1	0.5	0.5
	Set of supply options n°2	1	0
2023	Set of supply options n°1	0.5	0.5
	Set of supply options n°2	1	0

Then, using the what-if scenario configuration provided by users as well as the supply web and potential supply chain map models, the computational software generates the list of what-if scenarios to assess for each period. Figure 44 gives the pseudocode of the function used for

¹ The sets of supply options contain only one supply option, because there is only one OR Closing Gateway in the potential supply chain map of the HelloBread illustrative use case (Figure 40).

each period to generate the list of what-if scenarios. The function contains three main parts described here:

1. First, the function creates the list of possible decision option combinations (excluding supply options) considering the threshold of the number of decision options that can be considered simultaneously in a what-if scenario.
2. Second, it creates the list of possible uncertainty source combinations considering the threshold of the number of uncertainty sources that can be considered simultaneously in a what-if scenario.
3. Third, it creates the list of all what-if scenarios to assess by combining the list of possible decision options combinations, the list of possible uncertainty source combinations, and the sets of supply options.

```

Function GenerateListOfWhatIfScenarios(SupplyWebModel, MaxNumberOfDecisionOptions,
MaxNumberOfUncertaintySources, ListOfSetsOfSupplyOptions):
  ListOfDecisionOptions ← FindDecisionOptionsInSupplyWebModel(SupplyWebModel)
  ListOfCombinationsOfDecisionOptionsToConsider ←
    GenerateCombinations(ListOfDecisionOptions, MaxNumberOfDecisionOptions)
  ListOfUncertaintySources ← FindUncertaintySourcesInSupplyWebModel(SupplyWebModel)
  ListOfCombinationsOfUncertaintySourcesToConsider ←
    GenerateCombinations(ListOfUncertaintySources, MaxNumberOfUncertaintySources)
  ListOfWhatIfScenarios ← []
  For UncertaintySourcesCombination in ListOfCombinationsOfUncertaintySourcesToConsider:
    For DecisionOptionsCombination in ListOfCombinationsOfDecisionOptionsToConsider:
      For SetOfSupplyOptions in ListOfSetsOfSupplyOptions:
        ListOfWhatIfScenarios ← Append([UncertaintySourcesCombination,
          DecisionOptionsCombination, SetOfSupplyOptions])
  Return ListOfWhatIfScenarios
End Function

```

Figure 44: Pseudocode of the function that generates the list of what-if scenarios

Considering the example of the “HelloBread” illustrative use case with the maximum number of decision options to consider simultaneously set at one, the list of decision option combinations contains the following three:

- no decision option considered,
- decision option “Add a shift” considered, and
- decision option “Find a new client” considered.

Similarly, considering the “HelloBread” use case with the maximum number of uncertainty sources to consider simultaneously set at two, the list of uncertainty source combinations contains the following four:

- no uncertainty source considered,
- uncertainty source “Breakdown” considered,
- uncertainty source “Demand increase by 10%” considered, and
- uncertainty sources “Breakdown” and “Demand increase by 10%” considered.

Finally, with the maximum number of decision options to consider simultaneously set at one, the maximum number of uncertainty sources to consider simultaneously set at two, and two sets of supply options per period, the list of what-if scenario to assess will be all possible combinations of one decision option combination, one uncertainty source combination, and one set of supply options. This gives 24 what-if scenarios to assess per period (3 possible decision option combinations, multiplied by 4 possible uncertainty source combinations, and multiplied by 2 sets of supply options). There is an equal number of what-if scenarios per period because the HelloBread use case contains the same decision options, sets of supply options, and uncertainty sources for each period. Table 13 provides the list of 24 what-if scenarios to assess per period for the HelloBread illustrative use case.

Table 13: List of 24 what-if scenarios to assess per period for the HelloBread illustrative use case

What-if scenario number	Decision option combination	Set of supply options	Uncertainty source combination
1	no decision option	Set of supply options n°1	no uncertainty source
2			“Breakdown” considered
3			“Demand increase by 10%”
4			“Breakdown” and “Demand increase by 10%”
5		Set of supply options n°2	no uncertainty source
6			“Breakdown” considered
7			“Demand increase by 10%”
8			“Breakdown” and “Demand increase by 10%”
9	“Add a shift”	Set of supply options n°1	no uncertainty source
10			“Breakdown” considered
11			“Demand increase by 10%”
12			“Breakdown” and “Demand increase by 10%”
13		Set of supply options n°2	no uncertainty source
14			“Breakdown” considered
15			“Demand increase by 10%”
16			“Breakdown” and “Demand increase by 10%”
17	“Find a new client”	Set of supply options n°1	no uncertainty source
18			“Breakdown” considered
19			“Demand increase by 10%”
20			“Breakdown” and “Demand increase by 10%”
21		Set of supply options n°2	no uncertainty source
22			“Breakdown” considered
23			“Demand increase by 10%”
24			“Breakdown” and “Demand increase by 10%”

2.4.2. A function for assessing the what-if scenarios

A function was created to assess all what-if scenarios from the list of what-if scenarios to assess (identified by the previous function) by taking advantage of the assessment model generated by the assessment model generator module. Figure 45 gives the pseudocode of the function for assessing what-if scenarios.

```

Function AssessWhatIfScenarios(AssessmentModel, ListOfWhatIfScenarios):
    ListOfWhatIfScenariosResults ← []
    For WhatIfScenario in ListOfWhatIfScenarios:
        WhatIfScenario_ResultingAssessmentModel ← AssessmentModel
        UncertaintySourcesCombination ←
            GetUncertaintySourcesCombination(WhatIfScenario)
        DecisionOptionsCombination ←
            GetDecisionOptionsCombination(WhatIfScenario)
        SetOfSupplyOptions ←
            GetSetOfSupplyOptions(WhatIfScenario)
        For UncertaintySource in UncertaintySourcesCombination:
            UpdateImpactedAttributesByTheirNewValue(UncertaintySource,
                WhatIfScenario_ResultingAssessmentModel)
        For DecisionOption in DecisionOptionsCombination:
            UpdateImpactedAttributesByTheirNewValue(DecisionOption,
                WhatIfScenario_ResultingAssessmentModel)
        ReplaceAttributeIdentifiersByTheirValueInFormulas(
            WhatIfScenario_ResultingAssessmentModel, SetOfSupplyOptions)
        ComputeFormulas(WhatIfScenario_ResultingAssessmentModel)
        ListOfWhatIfScenariosResults ←
            Append(WhatIfScenario_ResultingAssessmentModel)
    Return ListOfWhatIfScenariosResults
End Function

```

Figure 45: Pseudocode of the function that assesses what-if scenarios

For each what-if scenario, the function takes the KPI formulas of the assessment model (such as those illustrated in Figure 41 and Figure 42) and replaces the parameter identifiers by their values resulting from the combination of decision options (including supply options) and uncertainty sources of this specific what-if scenario. To obtain the value of each parameter, it takes its initial forecasted value and applies the impact of all uncertainty sources and decision options considered in the what-if scenario. Then, it computes the KPI formulas which gives the set of KPI values for each what-if scenario.

Let's now return to the HelloBread illustrative use case of Figure 38. Let's consider, for example, the algorithm being in the "for loop" assessing what-if scenario n°17 (Table 13) for 2023 (i.e., scenario n°65 for the entire set of what-if scenarios) with the decision option "Find a new client" considered (Table 6), the "Set of supply options n°1" considered (cf. Table 12), and no uncertainty source considered. A copy of the assessment model (i.e., potential supply chain map

and supply web models with formulas) is made. There is no uncertainty source considered so there is no modification of the attributes of the nodes of the assessment model because of uncertainty sources. There is one decision option considered: “Find a new client”. This decision option impacts the attribute “Quantity” associated with the “Consumes” edge going from the demand forecast “Demand of 6000 units of bread” to the resource category “Bread”. It adds 2500 units to this attribute, changing it from 6000 to 8500. Then, attribute references from all formulas from the assessment model (such as those illustrated by Figure 41 and Figure 42) are replaced by their values. For the what-if scenario considered, let’s take the example of the formulas associated with the activity “Produce bread 1 (PB1)” given in Figure 41. The assessment model formulas will have the following three states: First, the assessment model contains formulas with attribute identifiers. Second, the attribute identifiers in formulas are replaced by the value of the attributes. Third, the formula is computed. Each of these three states is described in Table 14. Figure 46 shows the what-if scenario assessment results for the activity “Produce bread 1 (PB1)” for this specific what-if scenario. In other words, Figure 46 is the transformation (i.e., assessment) of the part of the assessment model illustrated in Figure 41 for this specific scenario. Table 15 and Figure 47 illustrate this transformation for the equipment “Bread Maker 1” for which the formulas were introduced in Figure 42. Table 15 shows only the last two states (formulas with attribute replaced by their value, and computed formulas) because the formulas are too long to be displayed in the same table (readers can refer to Figure 42 for the formula with attribute identifiers).

Table 14: Example of the three states of the formulas of the assessment model of the HelloBread use case associated with the activity “Produce bread 1 (PB1)” for the what-if scenario for 2023 with the decision option “Find a new client”, the “Set of supply options n°1”, and no risk considered (formulas from Figure 41).

Formula name	Formula with attribute identifiers	Formula with values	Formula computed (result)
Gross requirement	$DemandOf6000Bread[Consumes[Quantity]] * Quota1.1.1$	$8500 * 0.5$	4250
Net requirement	$(DemandOf6000Bread[Consumes[Quantity]] * Quota1.1.1) + PB1[ObjectiveStock] - PB1[InitialStock]$	$(8500 * 0.5) + 0 - 0$	4250
Production objective (batches)	$\left \frac{(DemandOf6000Bread[Consumes[Quantity]] * Quota1.1.1) + PB1[ObjectiveStock] - PB1[InitialStock]}{PB1[Produces[Quantity]]} \right $	$\left \frac{(8500 * 0.5) + 0 - 0}{10} \right $	425
Total utilization cost	$\left \frac{(DemandOf6000Bread[Consumes[Quantity]] * Quota1.1.1) + PB1[ObjectiveStock] - PB1[InitialStock]}{PB1[Produces[Quantity]]} \right * PB1[CostPerBatch]$	$\left \frac{(8500 * 0.5) + 0 - 0}{10} \right * 1$	425
Revenue relying on it	$\left((DemandOf6000Bread[Consumes[Quantity]] * Quota1.1.1) + PB1[ObjectiveStock] - PB1[InitialStock] \right) * Bakery1[has(Bread)[SellingPrice]]$	$\left((8500 * 0.5) + 0 - 0 \right) * 1.2$	510

```

{
  "Activities": [
    {
      "name": "Produce bread 1 (PB1)",
      "organization": "Bakery 1",
      "Fixed cost": 1000,
      "Cost per batch": 1,
      "Objective stock": 0,
      "Initial stock": 0,
      "gross requirement": 4250,
      "net requirement": 4250,
      "production objective (batches)": 425,
      "total utilization cost": 425,
      "revenue relying on it": 5100,
    },
    ...All other activities of the potential supply chain map model...
  ],
}
    
```

Figure 46: What-if scenario assessment results associated with the activity “Produce bread 1 (PB1)” of the HelloBread use case, for the what-if scenario of 2023 with the decision option “Find a new client”, the “Set of supply options n°1”, and no risk considered.

Table 15: Example of the last two states of the formulas of the assessment model of the HelloBread use case associated with the equipment “Bread Maker 1” for the what-if scenario for 2023 with the decision option “Find a new client”, the “Set of supply options n°1”, and no risk considered (first state of the formulas in Figure 42).

Formula name	Formula with values	Formula computed (result)
Utilization time required	$\left(\left[\frac{(8500 * 0.5) + 0 - 0}{10} \right] * 10 * 0.5 \right) * \left(\frac{1600}{1600 + 1600} \right)$	1062.5
Total utilization cost	$\left(\left[\frac{(8500 * 0.5) + 0 - 0}{10} \right] * 10 * 0.5 \right) * \left(\frac{1600}{1600 + 1600} \right) * 0.2$	212.5
Revenue relying on it	$((8500 * 0.5) + 0 - 0) * 1.2 * \left(\frac{1600}{1600 + 1600} \right)$	2550

```
{
  "resources": [
    {
      "name": "Bread Maker 1",
      "organization": "Bakery 1",
      "resource category": "Bread Maker",
      "available time": 1600,
      "Fixed cost": 500,
      "Cost per time unit": 0.1,
      "utilization time required": 1062.5,
      "total utilization cost": 212.5,
      "revenue relying on it": 2550,
    },
    ...All other resources of the supply web model...
  ],
}
```

Figure 47: What-if scenario assessment results associated with the equipment “Bread Maker 1” of the HelloBread use case, for the what-if scenario of 2023 with the decision option “Find a new client”, the “Set of supply options n°1”, and no risk considered.

2.4.3. A function for structuring the what-if scenario results for the business intelligence software

The next chapter will introduce the SCCP Decision Making Process (DMP) that takes advantage of a Business Intelligence (BI) software program chosen by the company. This BI software is the second software program of the SCCP IS and is used to display the what-if scenario assessment results resulting from the computational software. To display the result, it can read data from a certain set of data sources. However, the output of the previous function is the what-if scenario assessment results stored in memory as objects of the programming language, an in-memory storage which is not compatible with the BI software. Therefore, these what-if scenario assessment results must be stored in a format compatible with the BI software. The decision was made to store the what-if scenario assessment results in a file structured according to the JavaScript Object Notation (JSON) standard being compatible with the BI software. This format was chosen because it corresponds to a single file containing all what-if scenario results that can easily be shared and read by different commercial BI software programs. Consequently, a function was designed to create this JSON file that can be read by the BI software. Different existing BI software programs can be chosen, including some of the following: Tableau® (Tableau Software 2019), Power BI (Microsoft 2019), Qlik Sense® (Qlik 2019), and MyReport Essential (Report One 2019).

Figure 48 gives the pseudocode of this function and Figure 49 illustrates the structure of the resulting JSON file. An entire example file is not given because it would be too long to fit in this thesis. Therefore, the partial example given in Figure 49 contains an example of each element structuring the file: one scenario with associated structural information (“scenario number”, “period”, “decision options considered”, “uncertainty sources considered”, “supply options”, “abilities”, and “resources”). Other scenarios are represented with “...All other

assessed what-if scenarios...”. Within “abilities” and “resources”, only one example is given and then others are respectively represented with “...All other abilities of the supply web model...” and “...All other resources of the supply web model...”. The elements given in Figure 49 are associated with the elements of what-if scenario n°17 already used for illustration purposes in the previous sections.

```

Function CreateJSONFile(ListOfWhatIfScenariosResults) :
  ListOfScenarioResultsToWrite ← []
  for WhatIfScenario in ListOfWhatIfScenariosResults:
    ScenarioResultsToWrite ← {}
    AddScenarioNumber(ScenarioResultsToWrite, WhatIfScenario)
    AddYear(ScenarioResultsToWrite, WhatIfScenario)
    AddDecisionOptionsConsidered(ScenarioResultsToWrite, WhatIfScenario)
    AddUncertaintySourcesConsidered(ScenarioResultsToWrite, WhatIfScenario)
    AddSupplyOptionsConsidered(ScenarioResultsToWrite, WhatIfScenario)
    AddAbilities(ScenarioResultsToWrite, WhatIfScenario)
    AddResources(ScenarioResultsToWrite, WhatIfScenario)
    ListOfScenarioResultsToWrite ← Append(ScenarioResultsToWrite)
  CreateJSONFile(ListOfScenarioResultsToWrite)
  Return TRUE
End Function

```

Figure 48: Pseudocode of the function that creates the JSON file containing the what-if scenario assessment results for the business intelligence software

```
{
  "scenario number": 65,
  "period": "2023",
  "decision options considered": "Find a new client",
  "uncertainty sources considered": "",
  "supply options": "Set of supply options n°1",
  "Abilities": [
    {
      "name": "Produce bread 1 (PB1)",
      "organization": "Bakery 1",
      "gross requirement": 4250,
      "net requirement": 4250,
      "production objective (batches)": 425,
      "fixed cost": 1000,
      "total utilization cost": 425,
      "revenue relying on it": 5100,
    },
    ...All other abilities of the supply web model...
  ],
  "resources": [
    {
      "name": "Bread Maker 1",
      "organization": "Bakery 1",
      "resource category": "Bread Maker",
      "available time": 1600,
      "utilization time required": 1062.5,
      "fixed cost": 500,
      "total utilization cost": 212.5,
      "revenue relying on it": 2550,
    },
    ...All other resources of the supply web model...
  ],
}
...All other assessed what-if scenarios...
```

Figure 49: Partial example of the structure of the JSON file created to provide the business intelligence software with the what-if scenario assessment results

3. Conclusion

The objective of this chapter was twofold: first, to introduce the orientations of this research project regarding the design of an SCCP IS, with orientations that were guided by the investigation of the existing literature. Second, to introduce the SCCP IS proposal by describing its first component being the computational software proposal.

The literature review was performed as a systematic literature review based on a set of keywords that was considered relevant for investigating the existing literature on computerized solutions that could exist to automatically identify the SCC plan alternatives, as well as the assessment model. The objective was to have an overview of the existing literature on computerized solutions that could exist to meet the automation objective of the SCCP conceptual framework introduced in the second chapter. This overview resulted in two main observations: first, identified computerized methods are designed to identify supply chain stakeholders and supply chain options for one-to-one relationships on one supply chain echelon. Second, no computerized method for identifying SCC plan alternatives and associated assessment models encompassing several supply chain levels was found. These observations led to the formulation of the second research question (RQ2) of this thesis. Therefore, the choice was made to focus the innovation efforts on designing a computerized information system that automates the identification and evaluation of SCC plan alternatives made possible by stakeholders of a supply web.

Starting from the SCCP conceptual framework proposal as well as the second research question, an SCCP IS was designed. This chapter introduced the first building block of this SCCP IS proposal, being the computational software providing automation features envisioned by the SCCP conceptual framework. This computational software is structured around three modules that were sequentially described in this chapter: the supply web modeler, the assessment model generator, and the what-if scenario generator and assessor. The association of these three modules provides companies with a computerized information system that automates the assessment of a multitude of what-if scenarios among the potential combinations of decision options and uncertainty sources. It gathers information about their supply web and about the what-if scenarios they want to assess; and it uses this information to automate the assessment of the what-if scenarios and the creation of a file containing the results that can then be used by other software. The automation provided by the computational software proposal can help companies consider more what-if scenarios than they would normally when making SCCP decisions, thus enhancing their SCCP decision-making process.

Finally, to complete this computational software proposal, an SCCP decision-making process taking advantage of this computational software proposal, along with a BI software program, is proposed in the next chapter.

CHAPTER IV. SCCP DECISION-MAKING PROCESS: A PROPOSAL FOR TAKING ADVANTAGE OF THE SCCP INFORMATION SYSTEM PROPOSAL

“Technology is best when it brings people together.”

Matt Mullenweg

The objective of this chapter is to introduce the third and last building block of the Supply Chain Capacity Planning (SCCP) approach proposed in this thesis for answering the industrial and research questions: the SCCP Decision-Making Process (DMP). The objective of this SCCP DMP is to provide companies with a structured process for making their SCCP decisions that takes advantage of the SCCP information system (IS) proposal for which the first component (the computational software) was introduced in the previous chapter. Figure 50 illustrates the content of this chapter by positioning it on the overview of the contributions of this thesis. The first section of this chapter describes a literature review on existing DMPs for SCCP which augments the one described in the second chapter on Decision Support Systems (DSS) for SCCP. Then, the second section introduces the SCCP DMP proposal along with the second component of the SCCP IS, the Business Intelligence (BI) software. Finally, the third section concludes the chapter and makes the link with the following one.

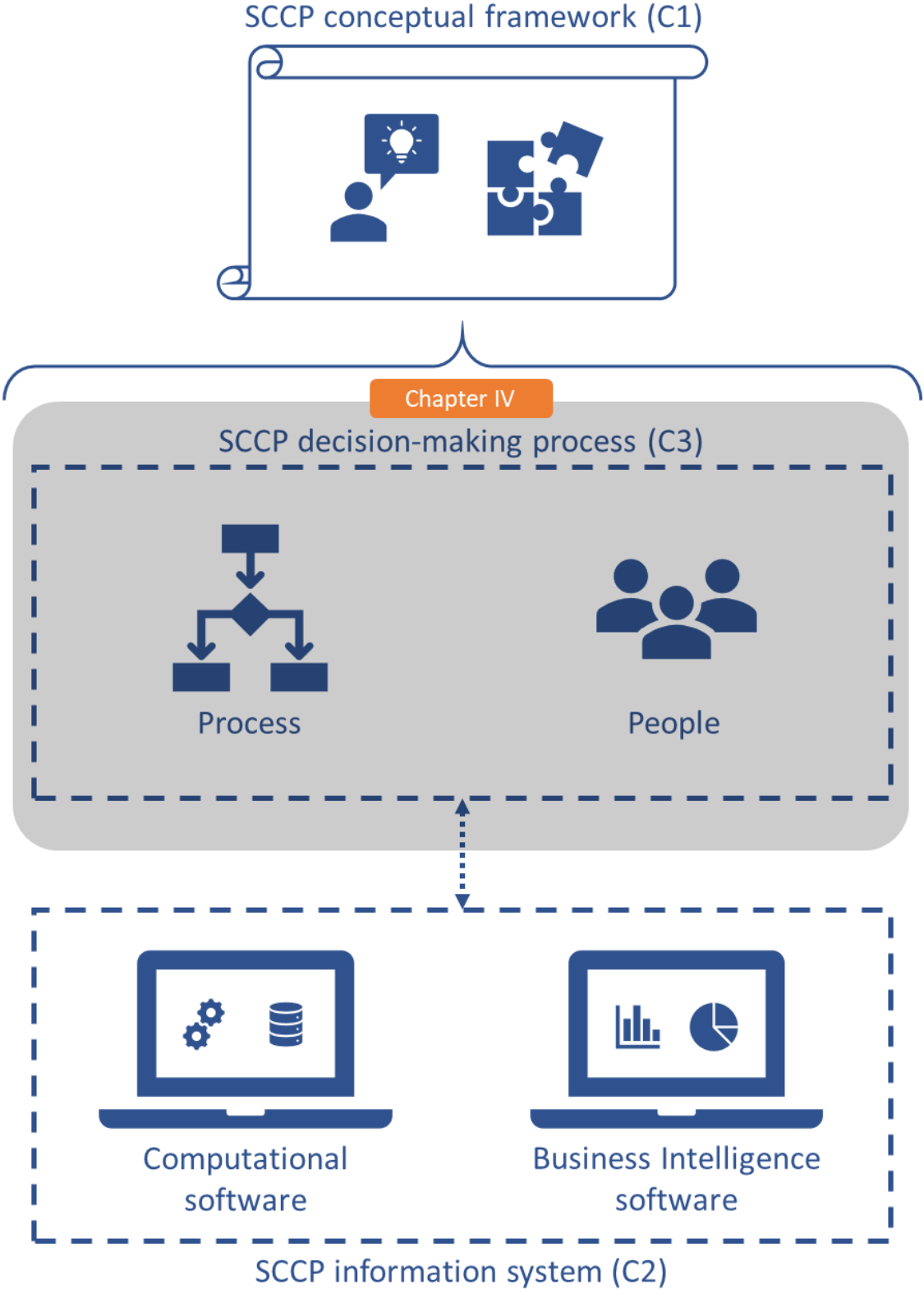

Figure 50: Positioning the content of this fourth chapter in regard to the overview of the contributions of this thesis (C1, C2, and C3)

1. Literature review

This literature review complements the literature review on existing DSSs described in the second chapter. It is important to keep in mind that in this thesis a DSS is defined as the combination of a purpose, people, a DMP, and an information system (Figure 16). The objective was to highlight elements of existing DMPs that are relevant for building the SCCP DMP proposal relying on the SCCP IS proposal. These elements were then considered when designing the SCCP DMP proposal.

The literature review on DSSs described in the second chapter highlighted several elements guiding the literature review of this fourth chapter. First, four DMPs were identified as potentially relevant for building an SCCP DMP: Sales and Operations Planning (S&OP), Integrated Business Planning (IBP), Collaborative Planning, Forecast, and Replenishment (CPFR), and Adaptive Sales and Operations Planning (AS&OP). It was shown in the second chapter that the existing proposals include information systems that were considered insufficient for building an SCCP DSS as defined in Figure 16. However, the proposed sequence of activities could be entirely or partly relevant for an SCCP DMP following the principles suggested by the SCCP conceptual framework proposal. Second, it showed that the term IBP is an evolution of S&OP but corresponds to the same DMPs (Palmatier and Crum n.d., Palmatier et al. 2010, Bower 2012). Third, it showed that the latest version of CPFR (version 2.0) recommends using the IBP process for the planning part corresponding to the scope of this thesis. Taking the last two elements into account, an evaluation of the S&OP DMP was considered sufficient for covering S&OP, IBP, and CPFR. Therefore, S&OP and AS&OP DMPs were investigated in this supplementary literature review on existing DMPs that could be used to build an SCCP DMP satisfying the SCCP conceptual framework principles.

In the investigated literature, no standard process modeling language was used to describe the S&OP and AS&OP process proposals. Therefore, a new formalization of these processes using the Business Process Model and Notation (BPMN) standard (Object Management Group 2011) was created for this thesis. This helps to describe the different DMP proposals in the same way to make comparisons easier, and to identify good practices and potential weaknesses.

1.1. Literature review results

1.1.1. Sales and Operations Planning: Several decision-making process proposals over time

Different S&OP process proposals have been made over time and by different authors. The following paragraphs describe the ones identified in the literature by Pinon et al. (Pinon 2017, Pinon et al. 2018).

The first S&OP process proposal was made by Ling and Goddard in 1988 in the first book introducing the term S&OP: “Orchestrating success: improve control of the business with sales & operations planning” (Ling and Goddard 1988). Ten years after the introduction of this S&OP process, Gianesi (1998) wrote that most of the companies investigated during his research were using this S&OP process framework for implementing S&OP. In recent years, authors such as Calfa et al. (2015) still consider this S&OP process in their research. The process is a linear sequence of the following five activities: gather data, manage demand, manage supply,

pre-S&OP meeting, and S&OP meeting. Figure 51 was created to formalize the S&OP process based on the description made by Ling and Goddard (1988) and using the BPMN standard. This version of S&OP was to guide sales, marketing, and manufacturing to make a monthly agreement on ‘one set of numbers’ for production, sales, and inventory. There was no consideration of new products at that time. There was a “demand planning” meeting where sales would make use of historical trends in demand to forecast the unconstrained volume at the family level to sell for the next 12 to 18 months. Another meeting, called “supply planning”, was carried out by operations to determine how the unconstrained demand would be limited by supply restrictions using resource capacity management and its corresponding production and inventory plans. A “pre-S&OP meeting” would follow so that the functions agreed to prepare for a “S&OP meeting” with senior management. Just after or prior to the S&OP meeting, a reconciliation of the volumes would be made with finance to check against the budget. At the S&OP meeting, a discussion over both supply and demand plans and the reasons for each number in them would take place, any adjustments would be made, and the meeting would end with a collective agreement over the constrained demand forecast. After the meeting, the forecast would be generated at the most detailed level and the agreed-upon plan would be published and distributed to others, so that everybody could adjust their operational plans and evaluate the impact on their function.

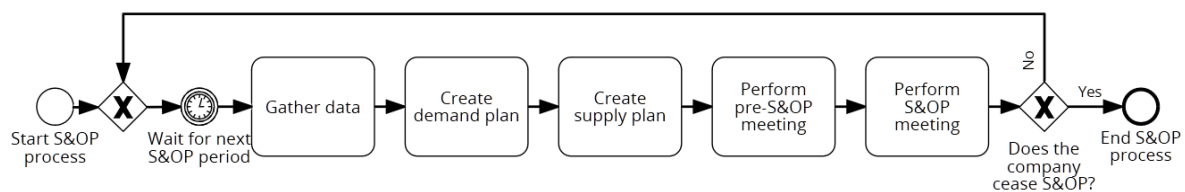

Figure 51: Formalization (using the BPMN standard) of the S&OP process proposal made by Ling and Goddard (1988)

In the 90s, a revised version of the S&OP process was released by Dick Ling and Andy Coldrick (Coldrick et al. 2003, Ling and Coldrick 2009, Ptak and Ling 2017). Several changes were made to the initial version: first, the addition of an activity to manage the portfolio and new activities. Second, the elimination of the “gather data” activity (now implicit in the activities “managing the portfolio and new activities” (or “managing new activities” in Coldrick et al. (2003)), “managing demand”, and “managing supply”). Third, the parallelization of the first three activities and the addition of interactions among them to illustrate that outputs from some are still used as inputs for others. Fourth, the modification of the “pre-S&OP meeting” to “integrated reconciliation”. This modification served mainly to highlight the change from a DMP focusing on volumes and their impact on resources to a DMP focusing on a more global business vision by including finance. Fifth, the modification of the “S&OP meeting” to “senior business management review”, which still has the same objective of making the planning decisions. Figure 52 was created to formalize this revised version of the S&OP process based on the description made by Coldrick et al. (2003) using the BPMN standard.

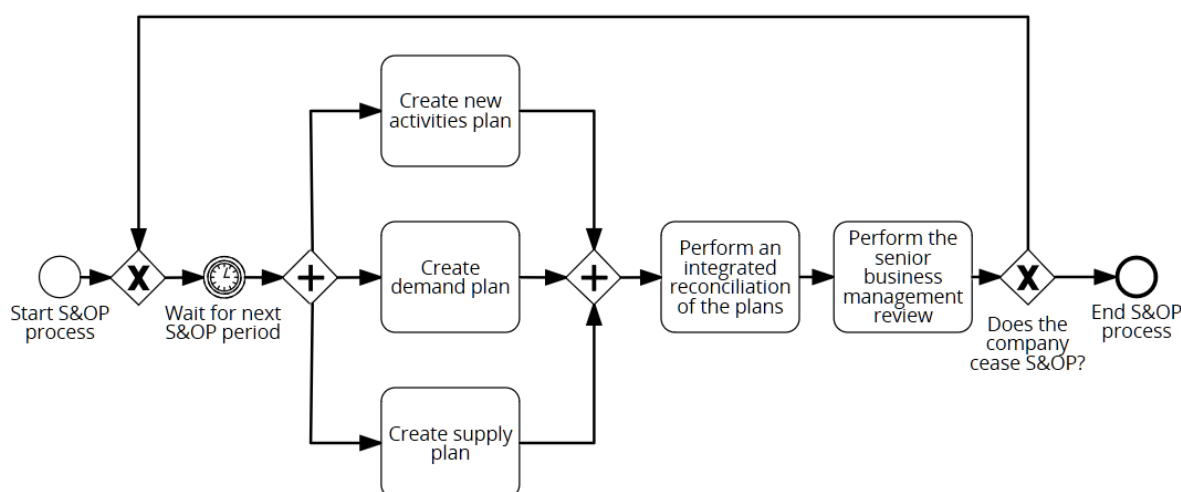

Figure 52: Formalization (using the BPMN standard) of the second version of the S&OP process proposed by Dick Ling and Andy Coldrick in the 90s (Coldrick et al. 2003, Ling and Coldrick 2009, Ptak and Ling 2017)

Grimson and Pyke (2007) undertook a literature review on S&OP and proposed their vision of a “common S&OP process” based on the literature: first, the sales and marketing teams meet to create an unconstrained demand forecast. In the meantime, the operations team gathers supply data about elements such as inventory and capacities. Second, the operations team uses the unconstrained demand forecast to create an initial supply plan. Third, the S&OP team meets to decide on the final operating plan for the next period. The team should be cross-functional and composed of people from sales and marketing, operations, and finance. Fourth, the S&OP teams distribute and implement the chosen operating plan. Fifth, the last activity of the S&OP process is to measure the results and effectiveness of the S&OP process. Grimson and Pyke (2007) did not provide a figure illustrating this S&OP process; therefore Figure 53 was created to formalize this process using the BPMN standard, based on the description made by Grimson and Pyke (2007). They identified that most of the literature (mainly from practitioners) recommend a monthly routine while some authors are starting to recommend a more frequent routine and others an event-driven one.

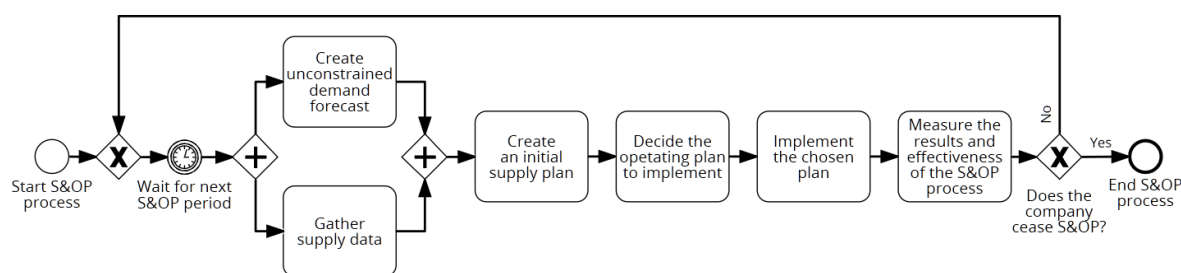

Figure 53: Formalization (using the BPMN standard) of the S&OP process described by Grimson and Pyke (2007) as a common S&OP process resulting from a literature review

Finally, Wallace and Stahl (2008) (also described in Wallace and Stahl (2006)) propose their own description of the S&OP process in the third edition of their book “Sales & Operations Planning: The How-To Handbook”, a book to which Richard (Dick) Ling contributed. It was observed that this book is considered a reference by several of the practitioners met during this research project. For example, it was the reference given in 2019 during a course entitled “World

Class Sales and Operations Planning (S&OP)” given in Atlanta (USA) by the company “LeanCor Training and Education” (LeanCor Training and Education 2019) in partnership with the Georgia Tech Supply Chain and Logistics Institute (n.d.). Thomé et al. (2012) confirm this observation, claiming that this S&OP process is “used at most companies”. On the academic side, researchers such as Thomé et al. (2014) and Wagner et al. (2014) considered this S&OP process in their research. The sequence of activities of the described process is identical to the first process introduced by Ling and Goddard (1988) with slightly reformulated names: data gathering, demand planning, supply planning, pre-meeting, and executive meeting. Figure 54 was created to formalize the S&OP process using the BPMN standard, based on the description made by Wallace and Stahl (2008).

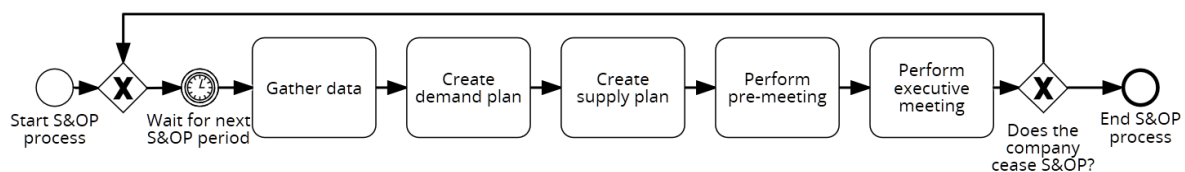

Figure 54: Formalization (using the BPMN standard) of the S&OP process described by Wallace and Stahl (2008)

1.1.2. Adaptive Sales and Operations Planning

AS&OP is probably the most recent methodology for long-term planning in the industry. It was developed in 2017 by the Demand Driven Institute (DDI) in collaboration with the creator of the original S&OP process, Richard (Dick) Ling. The approach was shaped as a strategic complement to the Demand Driven Material Requirements Planning (DDMRP) process, along with Demand Driven S&OP (DDS&OP) for mid-term planning (Ptak and Ling 2017). One of the main differentiation arguments from S&OP is the claim that Adaptive S&OP is focused on flow rather than cost. There is, for example, a contribution margin (cash generation rate) to drive innovation and growth to increase cash generation capability; working capital (inventory, cash and credit) to ensure proper levels to protect and promote flow in both the short and long term; and a customer base (market share, sales, service and quality) to ensure and grow a solid base of business for the company.

The Demand Driven Institute (DDI) provides some details about its AS&OP proposal in two ways: first, standard training sessions called “Adaptive Sales & Operations Planning - Embracing Change and Driving Adaptation.” Part of the team of this research project attended one of these training sessions (Demand Driven Institute 2018). Second, a book called “The Demand Driven Adaptive Enterprise: Surviving, Adapting, and Thriving in a VUCA¹ World” (Ptak and Smith 2018) provides some information about AS&OP. The following paragraphs describe the AS&OP process, synthesizing the information available in the training sessions and book.

The AS&OP process is composed of the following seven activities: portfolio and new activities, demand, supply, financial, integrated strategic reconciliation, Demand Driven S&OP, and management review. Figure 55 illustrates the sequence of activities of the AS&OP process

¹ VUCA: Volatility, Uncertainty, Complexity and Ambiguity

described by the Demand Driven Institute (n.d.) using the BPMN standard. First, “create the portfolio and new activities plan” plans what will be in the composition of the company’s offering. Second, “create demand plan” forecasts what the company is going sell at the family level. Third, “create supply plan” plans what capabilities are needed. Fourth, “create financial plan” plans the relevant financial performance indicators. Fifth, “perform an integrated strategic reconciliation of all the plans” checks the coherence of the plans established during the previous activities (“create the portfolio and new activities plan”, “create demand plan”, “create supply plan”, and “create financial plan”) once they have been compiled in the company business plan, and adapts them when necessary. Sixth, “perform Demand Driven S&OP” is another process that provides information to the AS&OP process, and this activity describes the gathering of the output data of the Demand Driven S&OP process. Seventh, “perform management review” decides on the plans to implement.

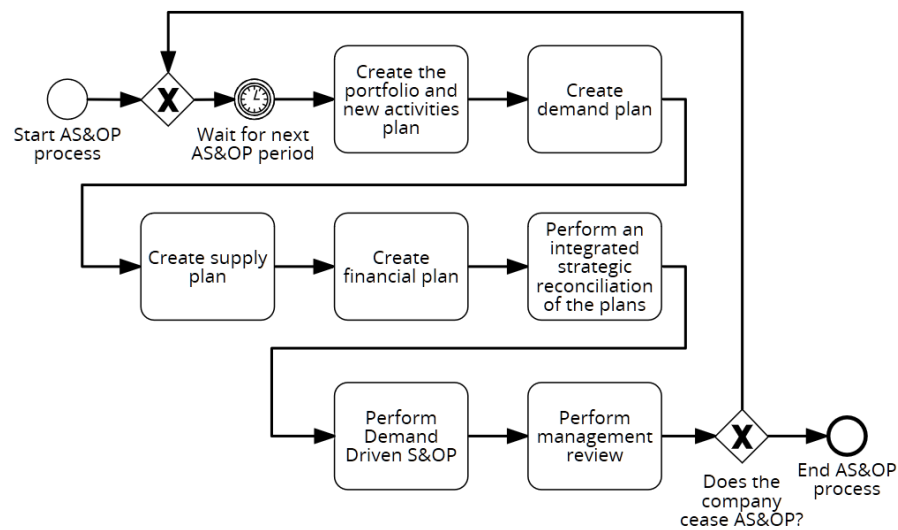

Figure 55: Formalization (using the BPMN standard) of the AS&OP process described by the Demand Driven Institute (n.d.)

1.2. Conclusion and research orientation

The literature review on S&OP and AS&OP DMPs has shown that despite the slight changes of proposals over time and slightly different visions among authors, the main activities of the processes have stayed the same. First, the last step of each DMP is always a meeting of decision-makers to make the final decisions. This meeting will be called Decision-Making Meeting (DMM) in the rest of this thesis. Even for Grimson and Pyke (2007), who include two activities afterwards (the implementation of the plan as well as the measure of the results and effectiveness of the S&OP process), the last decision-making activity is a meeting of decision-makers. Second, all activities before this DMM aim to prepare the later. In each process proposal (except Grimson and Pyke (2007)), the activity before the DMM corresponds to a meeting or a set of meetings aiming to provide a company-wide vision of the potential plans for the future of the company (integrating all department visions) as well as preparing recommendations for the DMM regarding the best ones that could be implemented. Third, the objective of all the activities before this set of meetings is to prepare this set of meetings by providing the vision of each company’s department regarding the potential plans for the future of the company. These visions are divided into at least three categories: the demand-side vision (e.g., sales and marketing

departments), the supply-side vision (e.g., supply, operations, and supply chain departments), and the portfolio and new activities vision (e.g., the product development department). A fourth vision that is implicitly included in the S&OP process (no specific activity) and explicitly included in the AS&OP process (dedicated activity) is the financial vision.

Considering the consensus regarding the main activities of the DMPs, it seems relevant to assume that they should be part of the SCCP DMP proposal. However, the investigated DMP proposals are not designed for taking advantage of the computational software proposal made in the third chapter. So, a specific SCCP DMP proposal is required. This proposal must provide details on how the SCCP IS (computational software and BI software) can be used by companies to help them while performing the SCCP DMP. Therefore, the third research question (RQ3) of this thesis is the following:

Third Research Question (RQ3):

How to organize an SCCP decision-making process complying with the SCCP conceptual framework principles by taking advantage of the SCCP information system proposal?

2. SCCP decision-making process proposal

2.1. Overview

The SCCP DMP proposal is composed of two main processes: implementation and routine. The objective of the implementation process is to set up (i.e., configure) the routine to perform, while the objective of the routine process is to perform this routine. The BPMN standard (Object Management Group 2011) was chosen to formalize the SCCP DMP. Figure 56 formalizes the SCCP DMP with both processes, “implement the SCCP routine” and “perform the SCCP routine.” First, the “implement SCCP routine” process should be performed. Second, the process should be put on hold until the beginning of the next routine period. This represents the periodicity of the routine process. Third, when the routine period starts, the “perform SCCP routine” process should be performed. Then, a first OR Opening Gateway asks the question, “Does the company cease the SCCP DMP?” This defines whether the company has decided to continue or to cease the SCCP DMP. In most cases the answer to the question would be “no” unless the company has decided to completely stop performing the SCCP DMP. Then, a second OR Opening Gateway asks the question, “does feedback require performing a new iteration of the SCCP implementation process?” This defines if the company wants to update its SCCP routine by performing a new iteration of the “implement the SCCP routine” process. This SCCP DMP vision updates the first vision synthesized by Oger et al. (2019).

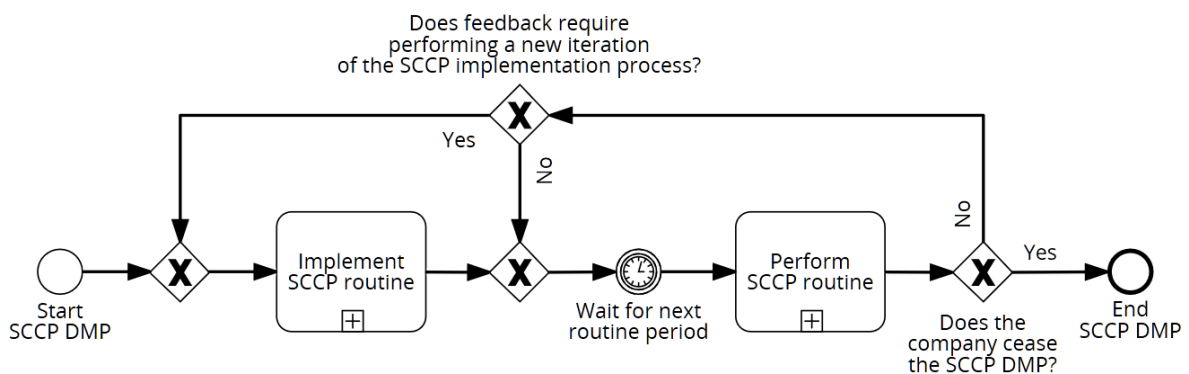

Figure 56: BPMN diagram of the SCCP DMP proposal

The process “perform the SCCP routine” is composed of two subprocesses: Decision-Making Meeting (DMM) preparation and the DMM itself. First, the objective of “prepare decision-making meeting” is to gather, process, and analyze SCCP data to prepare recommendations for decisions for the DMM. The objective is to generate information that will be useful for making decisions during the DMM. This information should be as complete and synthesized as possible so that decision-makers can quickly understand it and make decisions. Second, the “perform decision-making meeting” corresponds to a meeting in which SCCP decisions will be made, and feedback regarding the SCCP DMP for continuous improvement will be provided.

The process “implement the SCCP routine” is composed of three subprocesses: define meeting, define data, and define stakeholders. First, the objective of the “define meeting” subprocess is to define the expected outcomes, inputs, and structure of the DMM. Second, the objective of the “define data” subprocess is to define the input data that will be used during the DMM preparation and how it should be used. The inputs required for the DMM defined during the “define meeting” subprocess should be used to define the required input data during the “define

data” subprocess. Third, the objective of the “define stakeholders” subprocess is to define SCCP DMP stakeholders and their roles. As defined in the SCCP conceptual framework introduced in the second chapter, each SCCP stakeholder should be categorized in one or several of the following three categories: information providers, SCCP managers, and decision-makers (Figure 31). In addition, the definitions of stakeholders’ roles should provide more details regarding their tasks.

Figure 57 illustrates the overview of these two processes and associated subprocesses. Details and illustrative examples are given in the following subsections. Each activity or subprocess of the SCCP DMP proposal is illustrated by a figure structured according to the IDEF0 standard (Menzel and Mayer 1998): input of the activity on the left, output of the activity on the right, resources required for performing the activity on the bottom, and control rules (i.e., objectives) on the top.

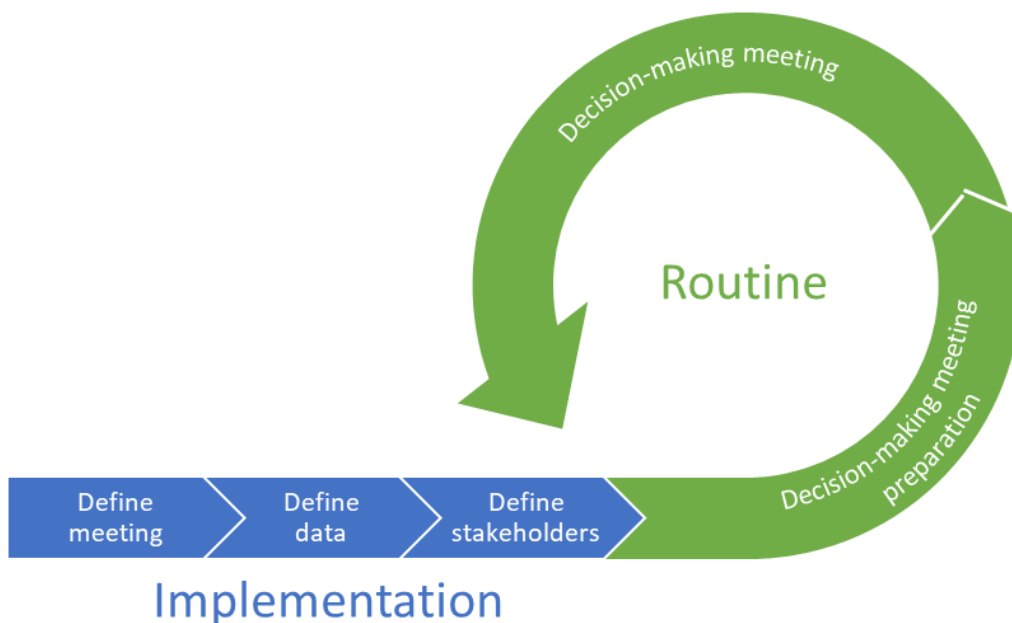

Figure 57: Overview of the SCCP DMP proposal

2.2. Implement the SCCP routine

Figure 58 formalizes the “implement SCCP routine” process using the BPMN standard. It shows the sequence of three subprocesses, respectively described in the following three subsections.

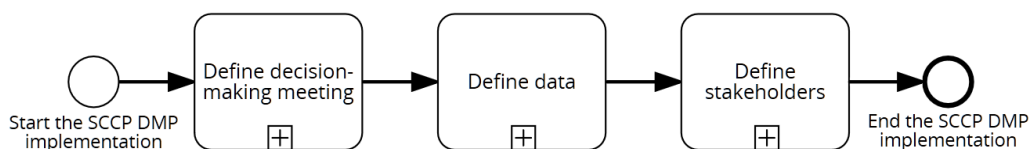

Figure 58: BPMN diagram of the SCCP DMP implementation process proposal

2.2.1. Define decision-making meeting

The objective of the SCCP DMP is to make SCCP decisions. The objective of the first subprocess of the SCCP DMP implementation process is to make sure the decision-making problem, approach, and requirements are clear so that it can properly drive the SCCP DMP

routine process. This first subprocess of the SCCP DMP implementation process is called “define decision-making meeting” and is composed of the following four activities illustrated in Figure 59: “define key performance indicators”, “define types of decision options”, “define types of uncertainty sources”, “define decision-making reasoning and associated dashboards.”

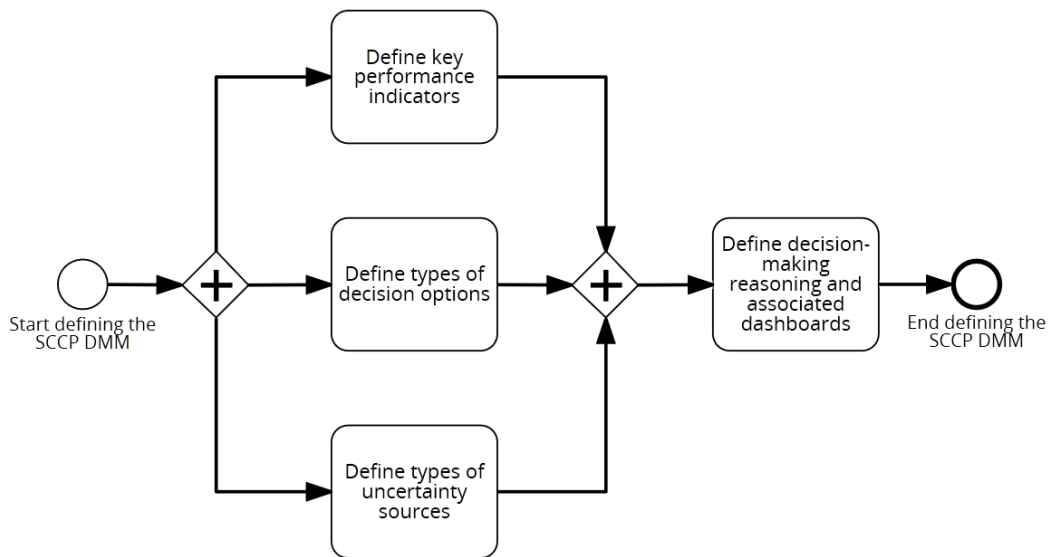

Figure 59: BPMN diagram of the “define decision-making meeting” subprocess of the SCCP DMP implementation process proposal

2.2.1.1. Define key performance indicators

If a company asks the question, “why are we doing this DMP and DMM?”, one of the first answers might be “to guarantee the performance of our business and associated supply chains.” A question the company must answer from this last quote is: “how does the company define its performance?” As defined in the SCCP conceptual framework introduced in the second chapter (page 41), Key Performance Indicators (KPIs) can be used to describe the performance of a company and associated supply chains. In addition, the outcome of the DMP is a Supply Chain Capacity (SCC) plan, chosen among several alternatives, which corresponds to the set of actions the company will perform and that will have an impact on the performance of the business and associated supply chains. This chosen SCC plan impacts performance because the performance results from the actions performed by the company and its environment. Therefore, KPIs can be used to compare SCC plan alternatives and help decide on the one to implement. Consequently, one of the first three activities of the SCCP DMP implementation process proposal is called “define key performance indicators”. The objective of this activity is to define the KPIs that will allow the decision-maker to compare the performance of SCC plan alternatives and decide on the one to implement. For example, KPIs could be associated with revenue, costs, and supply chain capacity requirements versus availability. Figure 61 illustrates this activity according to the IDEF0 standard (Menzel and Mayer 1998) by synthesizing its inputs, objectives, resources, and outputs.

These KPIs should be built by basing them on the performance indicators resulting from the what-if scenario assessment results provided by the computational software which was described in the third chapter (Figure 49). Figure 60 shows the structure of the what-if scenario assessment results generated by the computational software so that readers can refer to it for understanding the notion of performance indicators and aggregation dimensions. Of course, if

performance indicators that could be useful are not among those currently provided by the computational software, then it should be updated to provide them. But this update belongs to the avenues of future research to complement the proposal of this thesis. It is important to remember that the assessment result of each what-if scenario is structured in the same way with the same structure of performance indicators. KPIs can be designed by aggregating performance indicators along different dimensions: network, time, and scenario. A KPI that does not result from aggregation is a KPI whose formula does not contain the same type of performance indicator twice. A counterexample would be a KPI whose formula contains several performance indicators of the same type which can be associated with either several elements of the supply web model, several time periods, or several scenarios. Examples will thus be given when defining aggregation dimensions. The following paragraph describes the three aggregation dimensions and Table 16 synthesizes their definition. KPI aggregation is a component of the proposal; however, this thesis does not propose new aggregation methods. Readers can refer to existing literature on multi-criteria decision analysis and multi-criteria decision-making for more information regarding existing KPI aggregation methodologies (Triantaphyllou 2000, Ho et al. 2010, Ishizaka and Nemery 2013, Velasquez and Hester 2013, Yildiz and Yayla 2015, Marttunen et al. 2017).

Table 16: Three dimensions used to aggregate KPIs to provide an aggregated vision of the what-if scenario assessment results

Dimensions of KPI aggregation	Description
Network	Aggregation over several structural elements of the supply web (e.g., equipment per supplier or income per country)
Time	Aggregation over several time periods
Scenario	Aggregation over several scenarios of potential futures

First, aggregating performance indicators along the “network” dimension corresponds to aggregating the same performance indicators of different elements of the supply web model. An example of this is a KPI aggregating the utilization cost of all resources per company for each scenario. This would correspond to the total utilization cost of resources per company. A value for this KPI would be associated with each scenario and each organization owning a resource. Second, aggregating performance indicators along the “time” dimension corresponds to aggregating performance indicators of several scenarios corresponding to different time periods. An example of this is a KPI aggregating the revenue relying on each resource over several time periods for scenarios having the same qualitative attributes: scenario number, decision options considered, uncertainty sources considered, and supply options. This would correspond each resource to the revenue relying on it for the considered time horizon. A value for this KPI would be associated with each resource and group of scenarios having the same qualitative attributes previously mentioned. Third, aggregating performance indicators along the “scenario” dimension corresponds to aggregating performance indicators of several scenarios having a different combination of the following qualitative attributes: scenario number, decision options considered, uncertainty sources considered, and supply options. A typical example is to aggregate scenarios that have the same attributes “decision options considered” and “supply

options” but different “uncertainty sources considered”. This type of aggregation can be used to create KPIs that can be used for evaluating the impact of uncertainty sources on SCC plan alternatives (i.e., on different combinations of “decision options considered” and “supply options”). Finally, KPIs can also be created without aggregating KPIs on the different dimensions mentioned.

Returning to the HelloBread illustrative example introduced in the third chapter (section 2.2.2.2, page 73), the following KPIs could be considered:

- A “utilization rate” (ratio “available time” versus “utilization time required”) associated with each piece of equipment can be created without aggregation by combining, for each piece of equipment of each scenario, its “available time” with its “utilization time required”. This would result in five KPI instances per what-if scenario, respectively associated with the five pieces of equipment of the supply web.
- A “utilization rate” can be created by aggregation on the network dimension, aggregating equipment per equipment category for each organization. The KPI would be computed by first summing “available time” and “utilization time required” of aggregated equipment, and then dividing the resulting “total utilization time required” by the resulting “total available time”. This would result in the following four KPI instances per what-if scenario: “utilization rate” of bread makers for Bakery 1 (aggregates two pieces of equipment: Bread maker 1 and Bread maker 2), “utilization rate” of bread makers for Bakery 2 (aggregate one piece of equipment: Bread maker 3), “utilization rate” of yeast makers for Yeast producer (aggregate one piece of equipment: Yeast maker 1), and “utilization rate” of flour makers for the Flour producer (aggregate one piece of equipment: Flour maker 1).
- Another “utilization rate” can be created by aggregation on the network dimension, aggregating equipment per equipment category for the entire supply web. As with the previous example, this KPI would be computed by first summing “available time” and “utilization time required” of aggregated equipment, and then dividing the resulting “total utilization time required” by the resulting “total available time”. This would result in the following three KPI instances per what-if scenario: “utilization rate” of bread makers (aggregates three pieces of equipment: Bread maker 1, Bread maker 2, and Bread maker 3), “utilization rate” of yeast makers (aggregate one piece of equipment: Yeast maker 1), and “utilization rate” of flour makers (aggregate one piece of equipment: Flour maker 1).
- A “revenue loss” associated with each ability can be created without aggregation by combining the “revenue relying on it” with the “utilization ratio” of the equipment it requires. Considering that the “available time” of each piece of equipment is evenly shared between abilities, the “revenue loss” would correspond to the “revenue relying on it” divided by the maximum “utilization ratio” among the equipment required. This would result in four KPI instances per what-if scenario, respectively associated with the four abilities of the supply web.
- A “revenue loss” can be created by aggregation on the network dimension, aggregating abilities at the supply web level. The KPI would be computed by summing the “revenue loss” associated with each ability. This would result in one KPI instance per what-if scenario: the “revenue loss” associated with the what-if scenario.

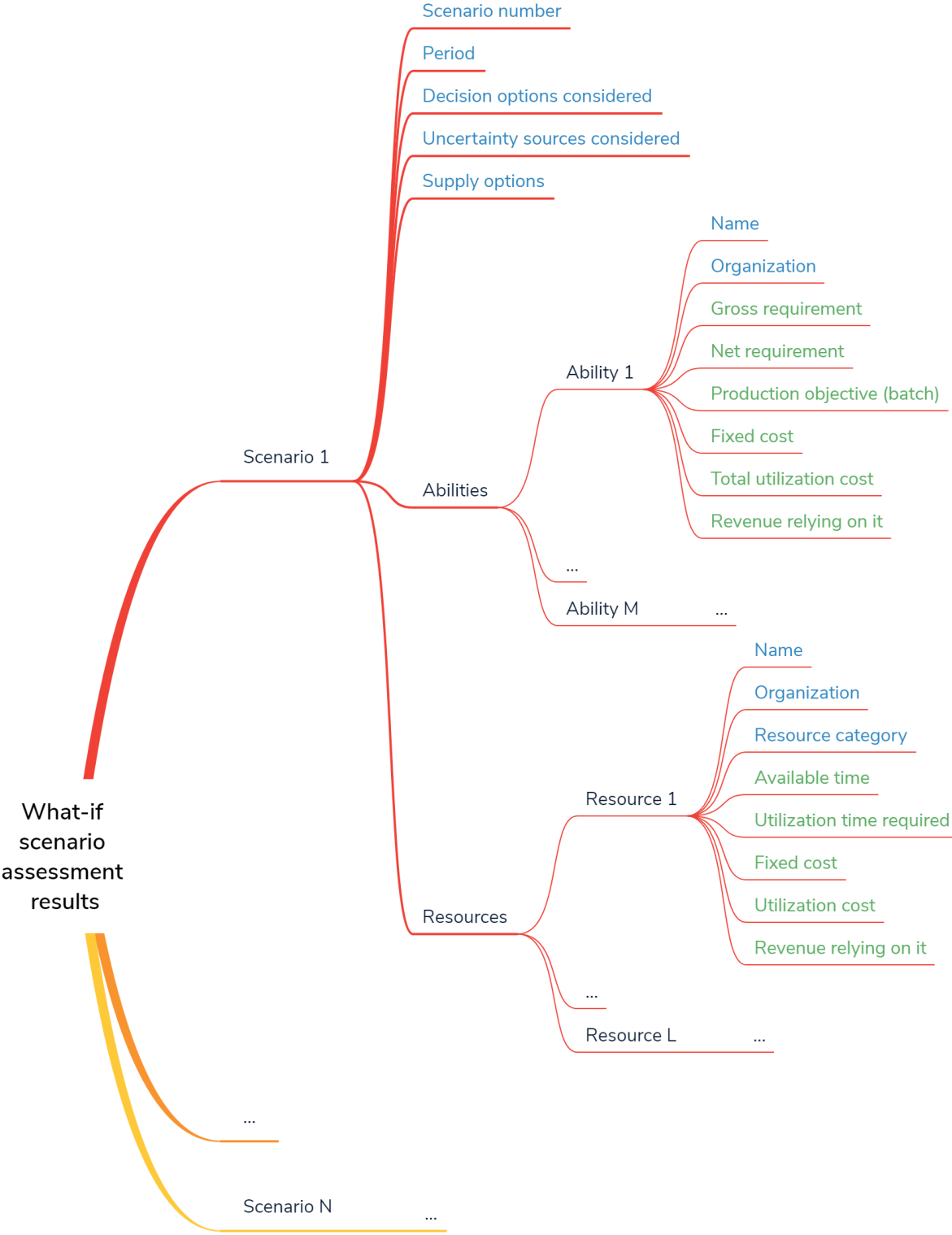

Figure 60: Structure of the what-if scenario assessment results generated by the computational software. Quantitative attributes (i.e., performance indicators) are in green and qualitative attributes in blue.

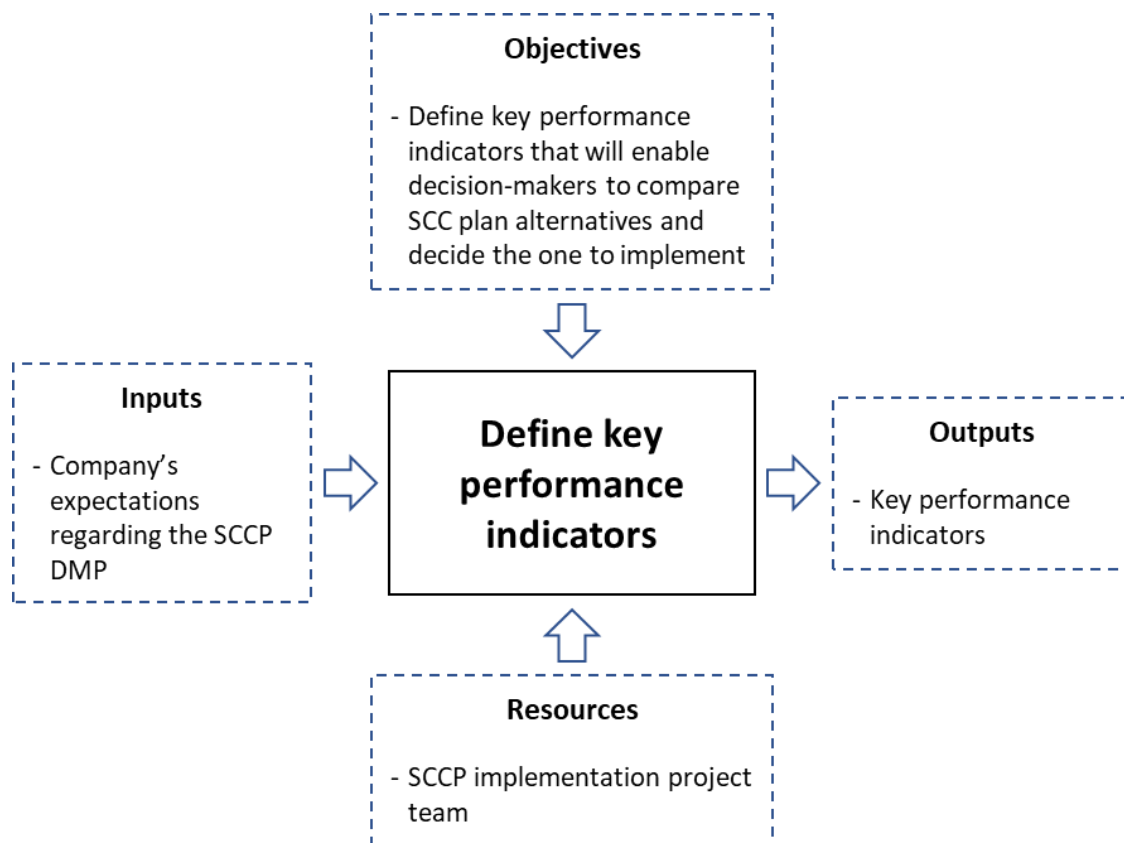

Figure 61: IDEF0 diagram of the “define key performance indicators” activity

2.2.1.2. Define types of decision options

An SCC plan alternative corresponds to a set of actions a company could perform. Each action is associated with a decision. Thus, an SCC plan alternative is associated with a set of decisions that can be made regarding the set of decision options. But one question to answer is: “what types of decision options does the company want to make during the SCCP DMP?” Consequently, one of the first three activities of the SCCP DMP implementation process proposal is called “define types of decision options”. The objective of this activity is to define the types of decision options the company wants to consider during the DMP. This choice will impact the diversity of SCC plan alternatives that will be assessed and that also will be available for comparison. The SCCP conceptual framework introduced in the second chapter suggested the scope of the decision options to consider (section 2.1.4.2 page 50). It suggested including decision options having an impact on the available supply chain capacity or the supply chain capacity requirements. Examples such as the following were given in the second chapter (section 2.1.4.2 page 50): setting up a new production line and launching a marketing campaign. There is an important element to keep in mind: all types of decision options can be considered by the computational software as long as the company is able to indicate their impact on the attributes of the other supply web model elements. In other words, if the company can indicate the impact a decision option would have on the other supply web model elements, then the computational software can consider this impact when computing the what-if scenario KPIs. For example, the computational software cannot deduce what the impact would be of a marketing campaign on the other supply web model elements such as demand. But it allows the company to indicate the impact it would have on the attributes of other supply web model elements so that this can be considered during the assessment of the what-if scenarios. The same principle applies for

any other type of decision options. Finally, the list of types of decision options to consider should be considered a minimal but not limiting checklist, because the company should be able to consider unexpected decision options when performing the DMP without necessarily having to come back to the implementation process. Figure 62 illustrates this activity according to the IDEF0 standard (Menzel and Mayer 1998) by synthesizing its inputs, objectives, resources, and outputs.

Returning to the HelloBread illustrative example introduced in the third chapter (section 2.2.2.2 page 73), there are two decision options: “Find a new client” and “Add a shift”. Therefore, the following two types of decision options can be deduced as types of decision options to consider: finding new clients and adding shifts.

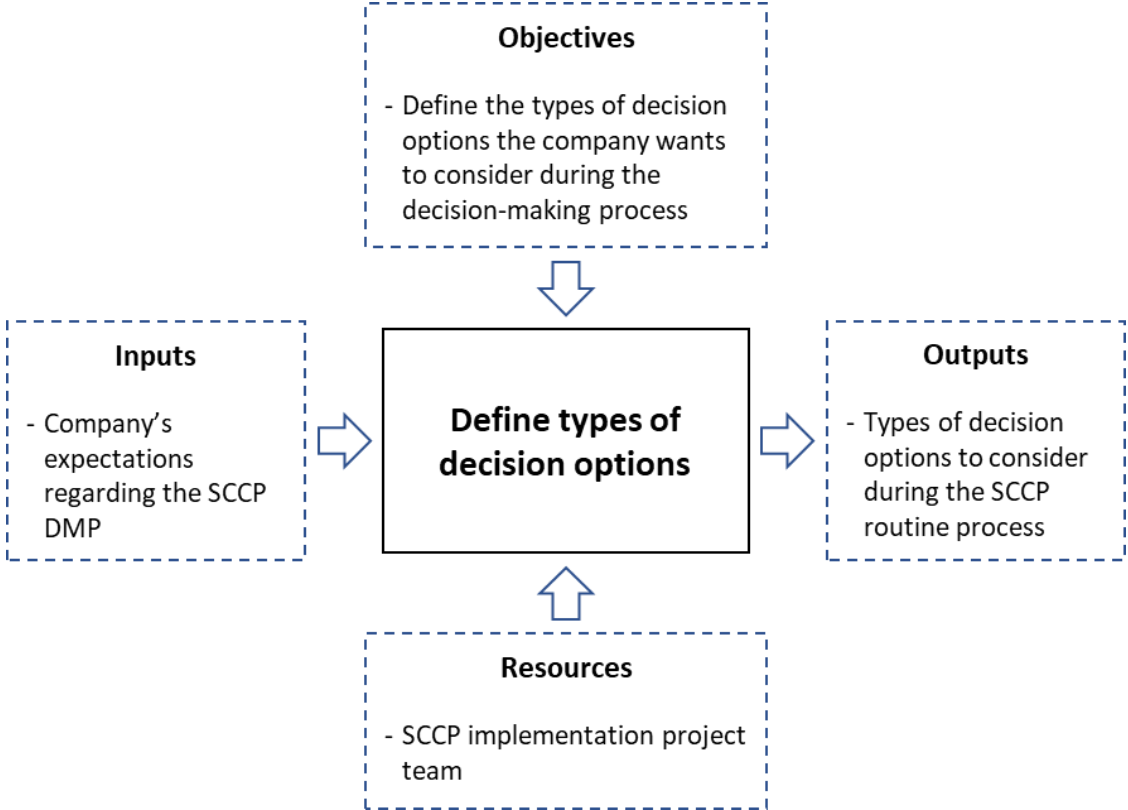

Figure 62: IDEF0 diagram of the “define types of decision options” activity

2.2.1.3. Define types of uncertainty sources

As introduced in the first two chapters, the consideration of uncertainty is very important when making SCCP decisions. Consequently, one of the first three activities of the SCCP DMP implementation process proposal is called “define types of uncertainty sources.” The objective of this activity is to define a list of types of uncertainty sources the company wants to consider during the DMP. As for the decision options, the SCCP conceptual framework introduced in the second chapter suggested the scope of the uncertainty sources to consider (section 2.1.4.2 page 50). It suggested including uncertainty sources having an impact on available supply chain capacity or supply chain capacity requirements. As for decision options, there is an important element to keep in mind: all types of uncertainty sources can be considered by the computational software as long as the company is able to indicate their impact on the attributes of the other supply web model elements. In other words, if the company can indicate the impact an

uncertainty source would have on the other supply web model elements, then the computational software can consider this impact when computing the what-if scenario KPIs. For example, the computational software cannot deduce what the impact would be of a new international trade agreement on the other supply web model elements such as demand and costs. But it allows the company to indicate the impact it would have on the attributes of other supply web model elements so that this can be considered during the assessment of the what-if scenarios. The same principle applies for any other type of uncertainty sources. Finally, the list of types of uncertainty sources to consider should be considered a minimal but not limiting checklist, because the company should be able to consider unexpected uncertainty sources when performing the DMP without necessarily having to come back to the implementation process. Figure 63 illustrates this activity according to the IDEF0 standard (Menzel and Mayer 1998) by synthesizing its inputs, objectives, resources, and outputs.

Returning to the HelloBread illustrative example introduced in the third chapter (section 2.2.2.2 page 73), there are two uncertainty sources: “Demand increase by 10%” and “Breakdown”. Therefore, the following two types of uncertainty sources can be deduced as types of decision options to consider: demand increases and breakdowns.

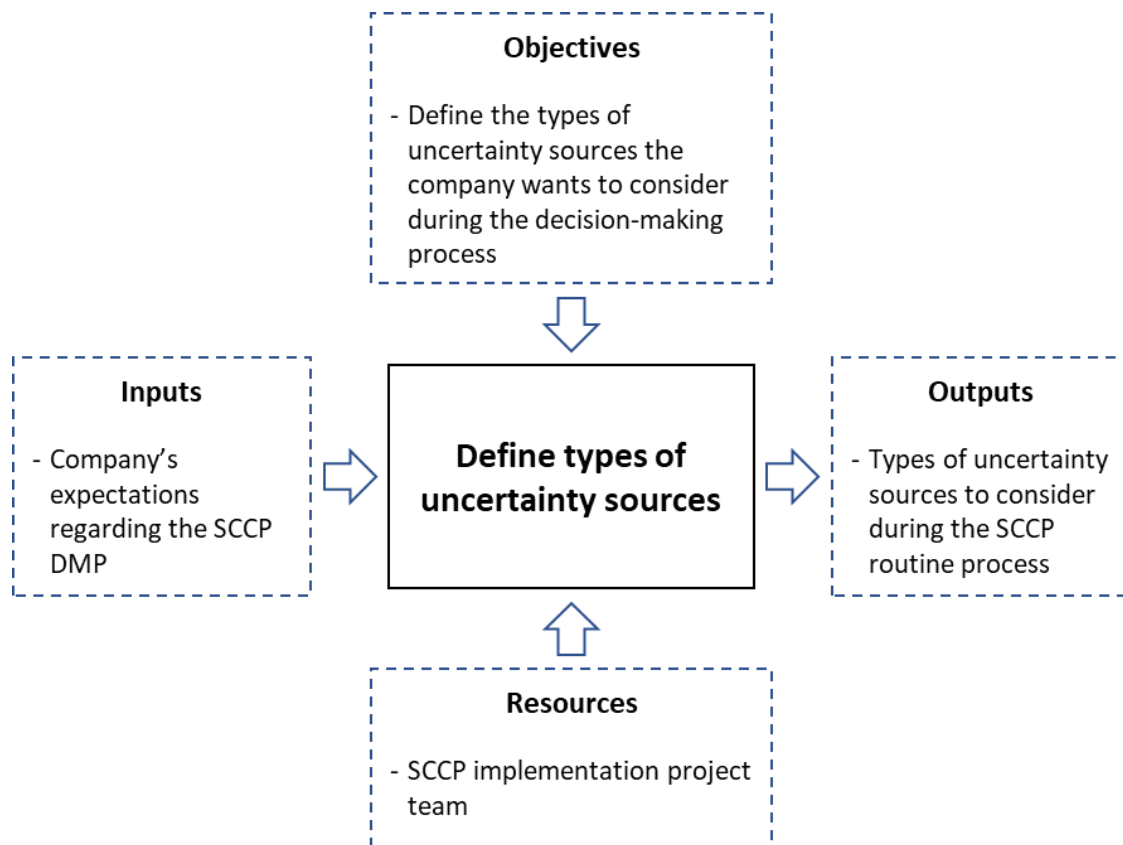

Figure 63: IDEF0 diagram of the “define types of uncertainty sources” activity

2.2.1.4. Define decision-making reasoning and associated dashboards

After defining the KPIs, as well as the types of decision options and uncertainty sources to consider, the company should define a way for decision-makers to consider them (KPIs, decision options, and uncertainty sources) when making SCCP decisions. This is the objective of this fourth activity of the SCCP DMP implementation process called “define decision-making reasoning and associated dashboards”. The proposal is to design the decision-making reasoning

along with a set of interactive dashboards to support decision-makers while performing the DMM. The proposal for creating the interactive dashboards is to take advantage of an existing BI software program supporting the generation of KPIs from the what-if scenario assessment results generated by the computational software and supporting the creation of interactive dashboards to visualize these KPIs. The BI software must be able to read the JSON file created by the computational software. There are many commercial BI software programs that can be used, such as Tableau® (Tableau Software 2019), Power BI (Microsoft 2019), Qlik Sense® (Qlik 2019), and MyReport Essential (Report One 2019). The purpose of the dashboards is to facilitate an effective and efficient DMM. In other words, the purpose is to help decision-makers consider as quickly as possible the multitude of SCC plan alternatives and assess it in regard to the multitude of uncertainty sources, using the KPIs. Dashboards should be designed with this purpose in mind by creating, for example, a succession of dashboards with different levels of detail helping decision-makers have a high-level vision of business performance and then zooming in on specific aspects that require more detail to make decisions. An example is to structure the DMM with the following four phases inspired from MG Taylor Corporation (MG Taylor Corporation 1996): scan, focus, act, and feedback. First, the “scan” phase consists in quickly scanning the dashboards to identify weaknesses in the current SCC plan. The objective is to help decision-makers identify where to focus their attention to make decisions. Second, the “focus” phase consists in identifying and comparing the SCC plan alternatives that could help overcome the identified weaknesses. The objective is to define those that seem to be the best compromises for the company. Third, the “act” phase consists in deciding on the SCC plan alternative to implement. Fourth, the “feedback” phase consists in providing feedback on the current routine process iteration to determine if there is an improvement opportunity justifying the run of a new iteration of the implementation process. If not, only a new iteration of the routine process should be started. Figure 64 illustrates this activity according to the IDEF0 standard (Menzel and Mayer 1998) by synthesizing its inputs, objectives, resources, and outputs.

Returning to the HelloBread illustrative example introduced in the third chapter (section 2.2.2.2, page 73), and considering the KPIs given as examples for the “Define key performance indicators” activity, the following decision-making reasoning, along with the corresponding dashboards, could be designed to support decision-making:

1. Identify weaknesses of the current SCC plan that are associated with equipment utilization ratios:
 - a. Identify equipment categories that have a utilization ratio above 1 at the supply web level (dashboard displaying the utilization ratio per equipment category).
 - b. For each equipment category that has a utilization ratio above 1 at the supply web level:
 - i. Identify equipment categories that have a utilization ratio above 1 at the supplier level (dashboard displaying the utilization ratio per equipment category per supplier).
 - c. For each equipment category that has a utilization ratio above 1 at the supplier level:
 - i. Identify existing equipment of this equipment category with the corresponding supplier and list them as equipment categories requiring

- either an increase in capacity or decrease in utilization time required at the supplier level.
2. Search for SCC plan alternatives overcoming the identified weaknesses:
 - a. Compare the revenue loss associated with each what-if scenario (dashboard displaying the revenue loss per scenario).
 - b. Analyze the what-if scenarios with the lowest revenue loss:
 - i. Identify the weaknesses with the same procedure as for the current SCC plan.
 3. Decide on the SCC plan to implement as well as the new decision options to investigate to try to find better SCC plan alternatives.

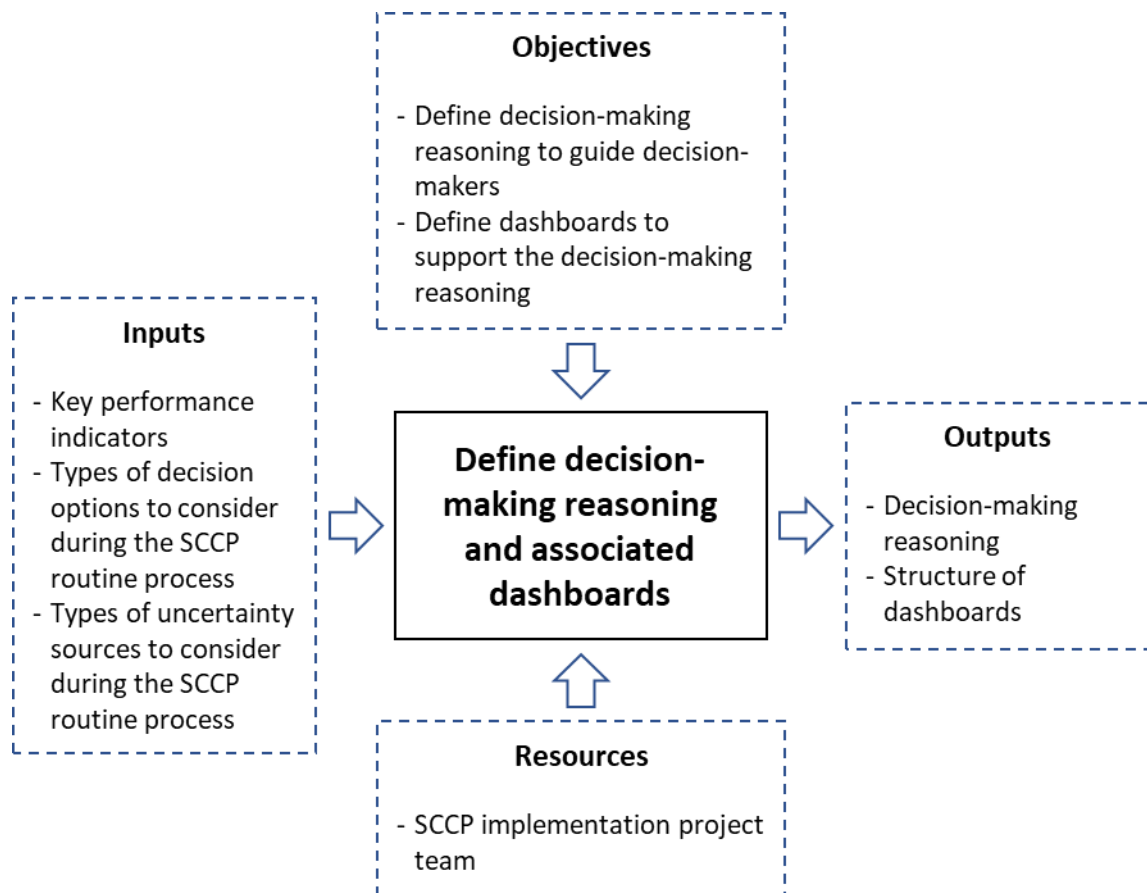

Figure 64: IDEF0 diagram of the “define decision-making reasoning and associated dashboards” activity

2.2.2. Define data

After defining the KPIs that will be used to make decisions, the following question arises: what input data should the generation of these KPIs be based on? The objective of the second subprocess of the SCCP DMP implementation process, called “define data”, is to answer this question. Part of the answer is in the supply web metamodel (Figure 35) introduced in the third chapter defining the structure of the input data required. Input data should correspond to the nodes and edges of this supply web metamodel (Table 2 and Table 3). However, there are different possibilities and thus choices to make for defining these input data. The two main elements to define are the following: the data scope and the data granularity. Therefore, the “define data” subprocess of the SCCP DMP implementation process is composed of the

following two activities formalized in Figure 65: “define data scope” and “define data granularity”.

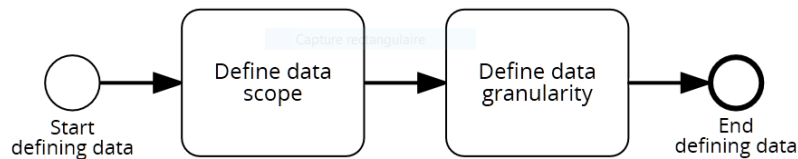

Figure 65: BPMN diagram of the “define data” subprocess of the SCCP DMP implementation process proposal

2.2.2.1. Define data scope

The definition of the data scope corresponds to defining the coverage of the SCCP DMP regarding the following data scope dimensions: the product portfolio, the supply chain, and the decisional and uncertainty dimensions. This is the objective of the activity called “define data scope”. Figure 66 illustrates this activity according to the IDEF0 standard (Menzel and Mayer 1998) by synthesizing its inputs, objectives, resources, and outputs.

First, the product portfolio coverage corresponds to the set of products and associated abilities that a company wants to include in its SCCP DMP. For example, a company could decide to include its entire product portfolio and associated abilities in the SCCP DMP or to select only a specific market segment.

Second, the supply chain coverage corresponds to the set of internal or external organizations (e.g., business units, companies) and associated equipment that a company wants to include in its SCCP DMP. For example, on the supply side, a company could decide whether to include a vision up to its third level suppliers, or only to its first level suppliers. On the client side, a company could decide whether to include a vision up to its third level clients, or only to its first level clients. Regarding the internal vision, the company should decide whether to consider entirely or partially its internal processes and equipment.

Third, the decisional and uncertainty coverage corresponds to the set of the types of decision options and uncertainty sources a company wants to include in its SCCP DMP. This coverage was already defined while performing the following two activities during the previous subprocess: “define types of decision options” and “define types of uncertainty sources”.

If the entire product portfolio or the entire set of equipment is not considered, special attention should be given to the relationship between equipment and product portfolio. There are two reasons for this: first, producing products requires equipment. So, to analyze the ability of an organization to satisfy demand, the required equipment must be part of the scope. Second, equipment can be used to produce different products. So, if a piece of equipment is required by products both in the scope and outside the scope, the available capacity of the equipment as well as the uncertainty sources and decision options impacting it should be taken into account. An example of this is reducing the available capacity attribute by the amount of capacity required by the products outside the scope.

Returning to the HelloBread illustrative example introduced in the third chapter (section 2.2.2.2 page 73), data scope choices can be deduced by looking at the supply web model (Figure 38).

First, the abilities “Produce bread 1” and “Produce bread 2” consume only “Yeast” and “Flour” while the real recipes (i.e. bills of materials) certainly contain additional ingredients such as salt and water. This reveals that there was a decision to focus the product portfolio coverage on yeast and flour. Second, the abilities “Produce yeast” and “Produce flour” do not consume any product category. This reveals that there was a decision to focus the supply chain coverage on the first-tier suppliers of the bakeries (and not on the second-tier suppliers and further). Third, the abilities do not require personnel. This reveals that there was a decision to focus the supply chain coverage on the equipment and not on human resources.

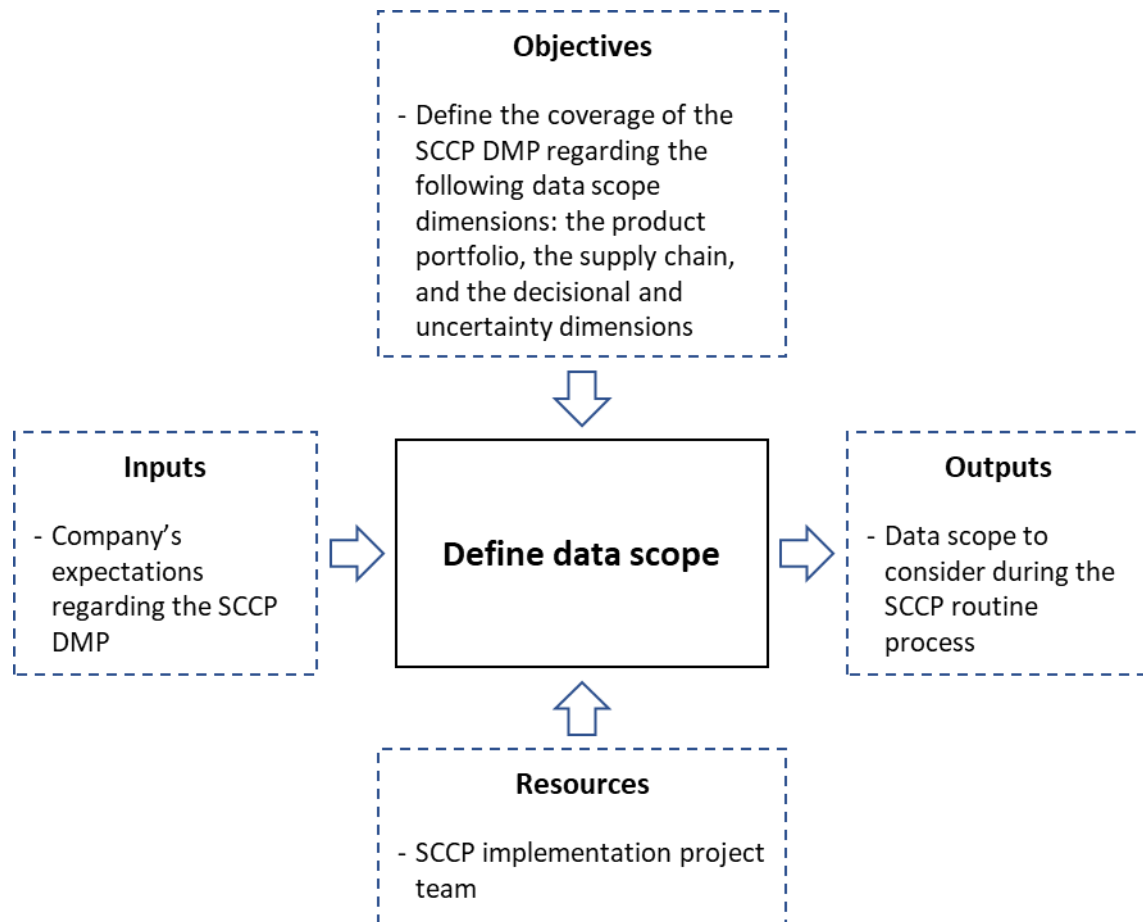

Figure 66: IDEF0 diagram of the “defined data scope” activity

2.2.2.2. Define data granularity

For each data scope dimension previously defined (the product portfolio, the supply chain, and the decisional and uncertainty dimensions), the data granularity (i.e., level of detail) to consider should be defined because when performing long-term planning, it is not always necessary to consider information at the lowest level of detail. This is the objective of the activity called “define data granularity”. Figure 67 illustrates this activity according to the IDEF0 standard (Menzel and Mayer 1998) by synthesizing its inputs, objectives, resources, and outputs. The main objective of using a low level of detail (i.e., a high-level view) is to simplify the model creation, calculations, and the analysis of the results. But a low level of detail reduces the flexibility and precision of the analysis. For example, if a company considers ten products as one product family, then it simplifies the analysis, but this prevents the company from considering these products separately in the analysis. Authors such as Agard (2004) and Wallace

and Stahl (2008) provide some insight for defining product families. Therefore, the objective is to find a tradeoff between simplicity on one side and flexibility and precision on the other side. The principle of the computational software introduced in the third chapter is to automate the calculations, and the principle of the dashboards with the BI software is to be able to easily analyze KPIs at different levels of detail. This reduces the importance of having a low level of detail and so could help companies to consider a higher level of detail than they are used to. But there are still disadvantages to consider with a high level of detail: first, the higher the level of detail, the longer the time for gathering data will be, especially for the uncertainty sources and decision options. Second, even if computations are automated, the higher the level of detail, the longer the computational time will be.

For the supply chain dimension, defining data granularity corresponds to defining the level of detail for resources, resource categories, and organizations. For resources, it corresponds to deciding to consider, for example, a level of detail such as machines, production lines, or production units. The same approach applies to resource categories. For organizations, it corresponds to deciding, for example, a level of detail such as companies, business units, or even groups of companies.

For the product portfolio dimension, defining data granularity corresponds to defining the level of detail for the product (i.e., product families). The highest level of detail would be to consider product references and the lowest would be to consider only one product family for the entire product portfolio. Wallace and Stahl (2008) suggest finding the lowest level of detail that make sense for both the sales and marketing departments' vision and the operations and supply departments' vision. From the sales and marketing departments' vision, making sense especially corresponds to the level of detail used to create demand forecasts and the associated uncertainty sources and decision options. From the operations and supply departments' vision, making sense especially corresponds to the lowest level of detail that has product families with similar characteristics (routing and bills of materials) and associated uncertainty sources and decision options. Defining a product family implies defining associated abilities with their macro-routing (i.e., the edge "requires" between the "ability" node and the "resource category" node in the supply web metamodel) in accordance with the equipment categories, and macro-bills of materials (i.e., edges "consumes" and "produces" between the "ability" node and the "resource category" node in the supply web metamodel) in accordance with the other product families (product categories).

For the decisional and uncertainty dimension, the data granularity does not need to be defined during the implementation process because the level of detail of the decisional and uncertainty dimension is impacted by but does not impact the level of detail choices regarding the product portfolio and supply chain dimensions. In other words, changing the level of detail of the product portfolio or supply chain dimensions would imply modification to the definition of the uncertainty sources and decision options. For example, if a product family was divided into two product families, a decision option of launching a marketing campaign associated with the initial product family should be adapted to describe its impact on the two new product families. But changing the level of detail of the product portfolio or supply chain dimensions would not imply modifications to the definition of the organization, resource categories, resources, abilities, or demand forecasts. Returning to the example of the marketing campaign associated with a

product family, if the marketing campaign changes to add another product family in its scope, no modification is needed on the product families.

Returning to the HelloBread illustrative example introduced in the third chapter (section 2.2.2.2, page 73), data granularity choices can be deduced by looking at the supply web model (Figure 38). First, each piece of equipment corresponds to actual equipment and not an aggregation of several pieces of equipment, and organizations correspond to the companies and not a group of companies. This reveals that for the supply chain dimension there was a decision to consider the level of detail of machines and companies. Second, the abilities “Produce bread 1” and “Produce bread 2” produce the product category “Bread” and not a specific type of bread. This reveals that for the product portfolio dimension there was a decision to create a product family encompassing all types of bread.

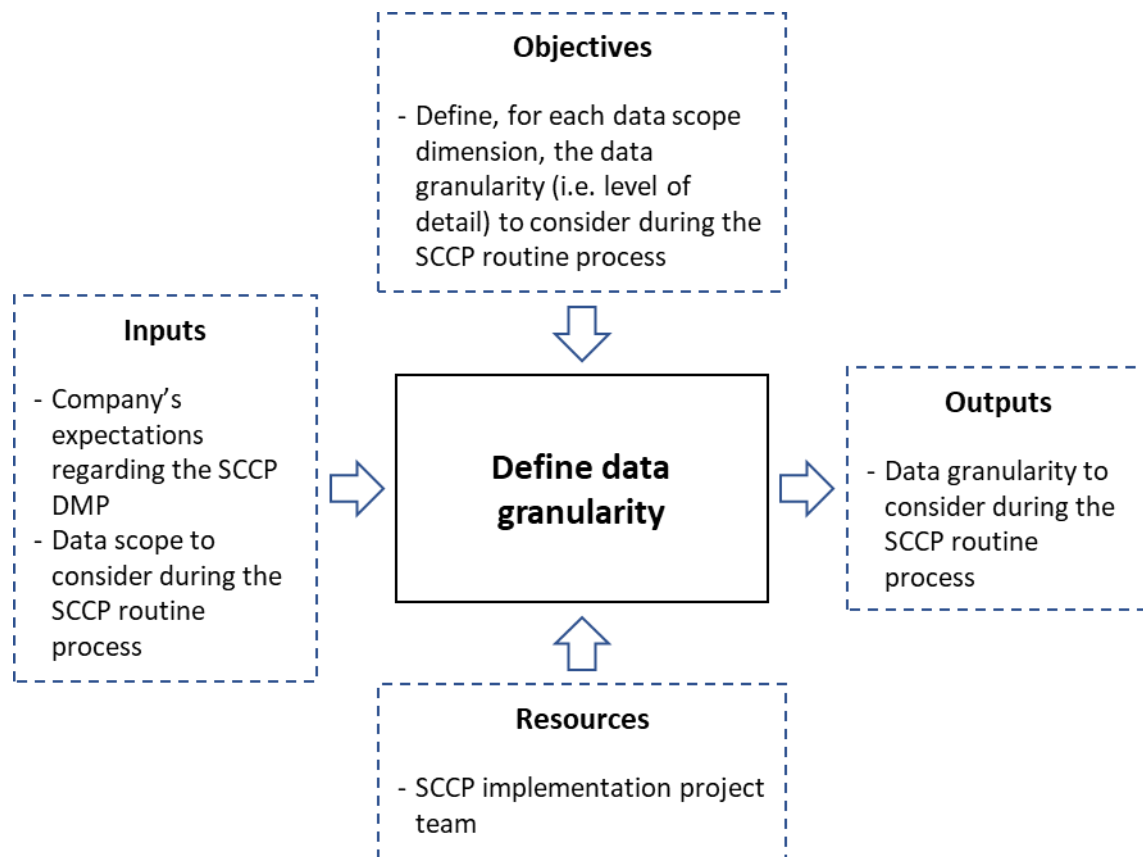

Figure 67: IDEF0 diagram of the “define data granularity” activity

2.2.3. Define stakeholders

Throughout the previous activities of the implementation process, several questions should arise. After defining the types of decision options to include in the SCCP DMP, the following question arises: who makes the decisions? After defining the data required for performing the SCCP DMP, the following question arises: who provides the data? And the following question should arise when implementing the SCCP DMP: who ensures the smooth running of the SCCP DMP routine process? All these questions are associated with the stakeholders of the SCCP DMP. The objective of the third subprocess of the SCCP DMP implementation process called “define stakeholders” is to answer these questions. The SCCP conceptual framework introduced in the second chapter defined these three categories of stakeholders involved in the SCCP DMP: information providers, SCCP managers, and decision-makers (Figure 31).

Therefore, during this subprocess, as described by the SCCP conceptual framework, the company should define the people who will be in each of these three categories of stakeholders. Figure 68 formalizes the “define stakeholders” subprocess of the SCCP DMP implementation process including the following three activities to define the three categories of stakeholders: “define information providers”, “define decision-makers”, and “define SCCP managers”.

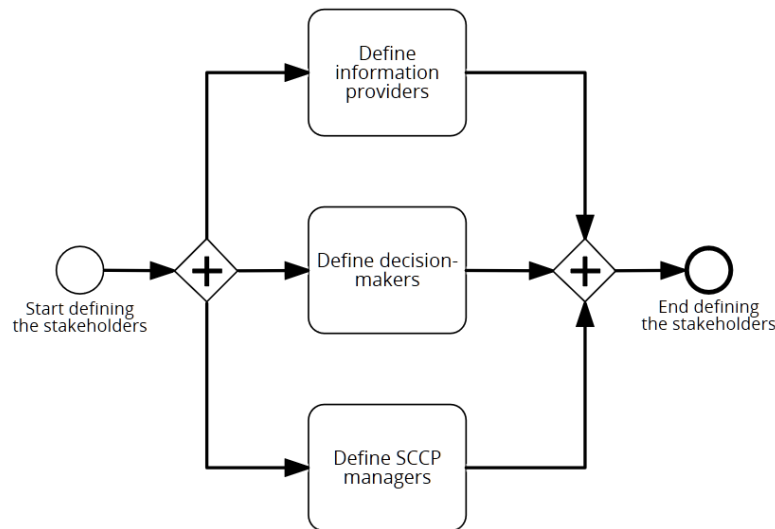

Figure 68: BPMN diagram of the “define stakeholders” subprocess of the SCCP DMP implementation process proposal

2.2.3.1. Define information providers

As described in the SCCP conceptual framework, information providers are the stakeholders who should provide information about the supply web and demand plan along with associated uncertainty sources and decision options. In other words, they are the stakeholders who provide information feeding the creation of the supply web model and what-if scenario configuration as described in the second and third chapters (Figure 31 and Figure 34). The required information providers depend on the SCCP DMP configuration decisions made during the previous activities of the implementation process. This is particularly related to the decisions made during the “define data scope” activity of the “define data” subprocess. The objective of the “define information providers” activity is to define the list of people who will provide the information required for creating the supply web model and what-if scenario configurations. Figure 69 illustrates this activity according to the IDEF0 standard (Menzel and Mayer 1998) by synthesizing its inputs, objectives, resources, and outputs.

First, decisions regarding the supply chain coverage will have an impact on the departments and people involved in gathering information. For example, if suppliers (first-tier or upstream) are included in the scope, then the departments responsible for supplier relationships (e.g., supply and buying departments) should probably be involved as the stakeholders providing information about suppliers’ capabilities. If the internal processes are included in the scope, then the departments responsible for internal operations (e.g., operations and manufacturing departments) should probably be involved as the stakeholders providing information about internal operations. Whether it is the first-tier customers, or those further downstream, or none of them that are included in the scope, the department responsible for demand forecasts (e.g.,

sales and demand departments) should be included in the scope. In practice, a department with information about internal operations (e.g., operations and manufacturing departments) should always be involved in making the link between demand and either supply, internal operations, or both. Even if internal operations are not included in the scope, the bills of materials of products are required for making the link between the demand quantities and the supply quantities.

Second, decisions regarding the product portfolio coverage will have an impact on the department and people involved in gathering information. For example, if a product family is not included in the scope, then the demand forecasts associated with this product family are not needed. And if the department responsible for demand forecasting is divided into teams, one for each product family, then the team responsible for the product family that is not included in the scope does not need to be defined as an information provider. Similarly, on the supply side, if the department responsible for supplier selection is divided into teams, one for each family of supplied products, and if one of these families of the supplied product was dedicated to the product family that is not included in the scope, then the team responsible for this dedicated family of supplied products does not need to be defined as an information provider.

Third, decisions regarding the decisional and uncertainty coverage will have an impact on departments and people involved in gathering information. This is especially linked to the decisions made during the “define types of decision options” and “define types of uncertainty sources” of the “define decision-making meeting” subprocess. For example, if a company wants to consider the decision options associated with marketing campaigns it could perform, the department having the associated information (e.g., the marketing department) should be involved and part of the information providers. The same principle applies for all decision options such as product development choices and human resources, and for all uncertainty sources such as supply uncertainty (e.g., due to natural disasters), productivity uncertainty (e.g., strikes), and demand uncertainty (e.g., new trade regulations).

Returning to the HelloBread illustrative example introduced in the third chapter (section 2.2.2.2, page 73), information providers should be defined so that each element and the associated attributes of the supply web model (Figure 38) are associated with a person providing the information. For example, if we consider that “Bakery 1” and “Bakery 2” are two bakeries of the same company, this could be the following:

- Personnel from the operations department could provide information about the “consumes”, “produces” and “requires” edges of the “Bakery 1” and “Bakery 2” abilities, as well as decision options associated with adding shifts;
- Personnel from the finance department could provide information about the financial attributes associated with abilities and equipment;
- Personnel from the sales department could provide information about the demand forecasts, the decision options associated with finding new clients, and uncertainty sources associated with demand increases;
- Personnel from the maintenance department could provide information about the uncertainty sources associated with breakdowns for “Bakery 1” and “Bakery 2” (there is no uncertainty source of this type associated with the bakeries in the proposed

- HelloBread supply web model but there could be, and information providers must be defined because this type of uncertainty source was defined as part of the data scope);
- Personnel from the supply department could provide information about the abilities and uncertainty sources associated with the “Yeast producer” and “Flour producer”.

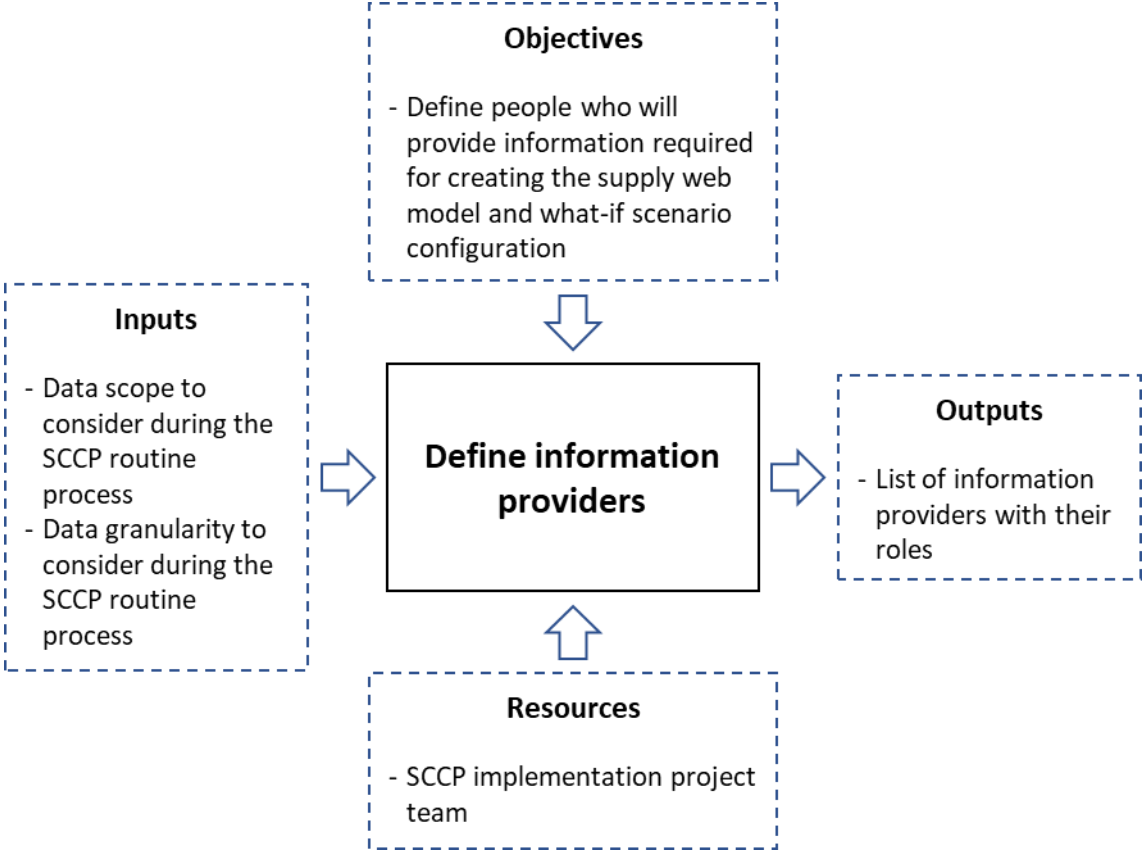

Figure 69: IDEF0 diagram of the “define information providers” activity

2.2.3.2. Define decision-makers

As described in the SCCP conceptual framework, decision-makers are the stakeholders who are empowered to make one or several SCCP decisions associated with the types of decision options defined during the “define types of decision options” of the “define decision-making meeting” subprocess. The objective of the “define information providers” activity is to define people who will make decisions regarding the SCC plan alternative to implement. Each decision option included in the SCCP DMP should be associated with one or several decision-makers empowered to make the decision of whether to activate the decision option. Therefore, for each type of decision option identified during the “define types of decision options” activity of the “define decision-making meeting” subprocess, one or several decision-makers should be designated as those empowered to make decisions about whether to activate the associated decision options. Figure 70 illustrates this activity according to the IDEF0 standard (Menzel and Mayer 1998) by synthesizing its inputs, objectives, resources, and outputs.

Returning to the HelloBread illustrative example introduced in the third chapter (section 2.2.2.2, page 73), decision-makers of the SCCP DMP could be selected based on the departments of the information providers previously defined. For each department associated with the defined information providers (operations, sales, finance, maintenance, and supply departments), one

or several decision-makers of the department could be selected as SCCP decision-makers. In this way, each department is represented during the decision-making meeting.

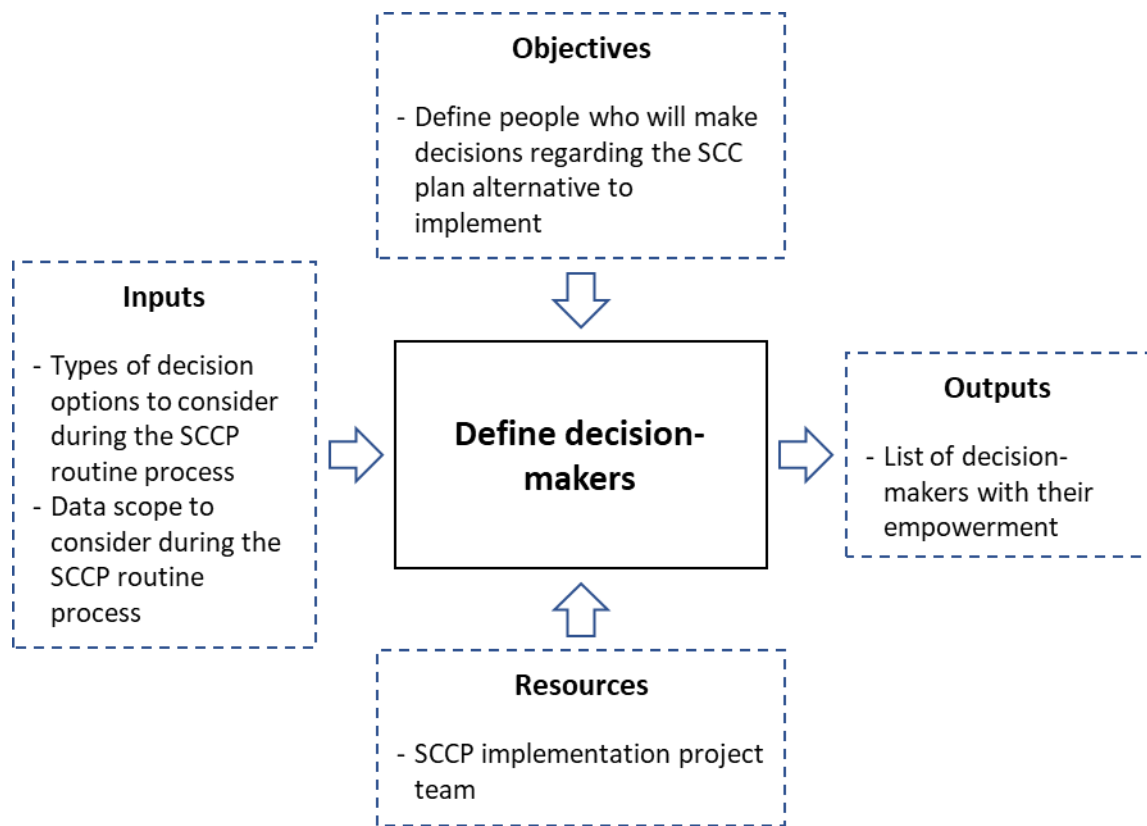

Figure 70: IDEF0 diagram of the “define decision-makers” activity

2.2.3.3. Define SCCP managers

As described in the SCCP conceptual framework, SCCP managers are the stakeholders who are responsible for overseeing the SCCP DMP, for ensuring its smooth running and its growth to maturity. The objective of the “define SCCP managers” activity is to define these SCCP managers. Their mission also includes two other aspects: first, ensuring the completeness and quality of the information provided by information providers; and second, configuring the behavior of the computational software regarding the sets of what-if scenarios (combinations of SCC plan alternatives and uncertainty sources) that will be assessed. There are several skills that are important for SCCP managers to have, such as the following: first, a good understanding of the job, the objectives, and the constraints of all the different departments involved in the SCCP DMP. Second, good interpersonal and change management skills. Third, a good understanding of the company’s strategy. These skills will be useful for SCCP manager tasks such as the following: first, guide information providers toward the completeness and quality of the information they provide. Second, to manage discussions among departments having different visions and sometimes conflicting objectives. Third, to direct the decisions of all decision-makers towards a common vision for the success of the overall company. Figure 71 illustrates this activity according to the IDEF0 standard (Menzel and Mayer 1998) by synthesizing its inputs, objectives, resources, and outputs.

Returning to the HelloBread illustrative example introduced in the third chapter (section 2.2.2.2, page 73), SCCP managers of the SCCP DMP could be selected based on the departments

involved considering information providers and decision-makers. This could be, for example, a person from the finance department having a vision of the financial objectives, and a person from the operations department having broader knowledge about supply chain management.

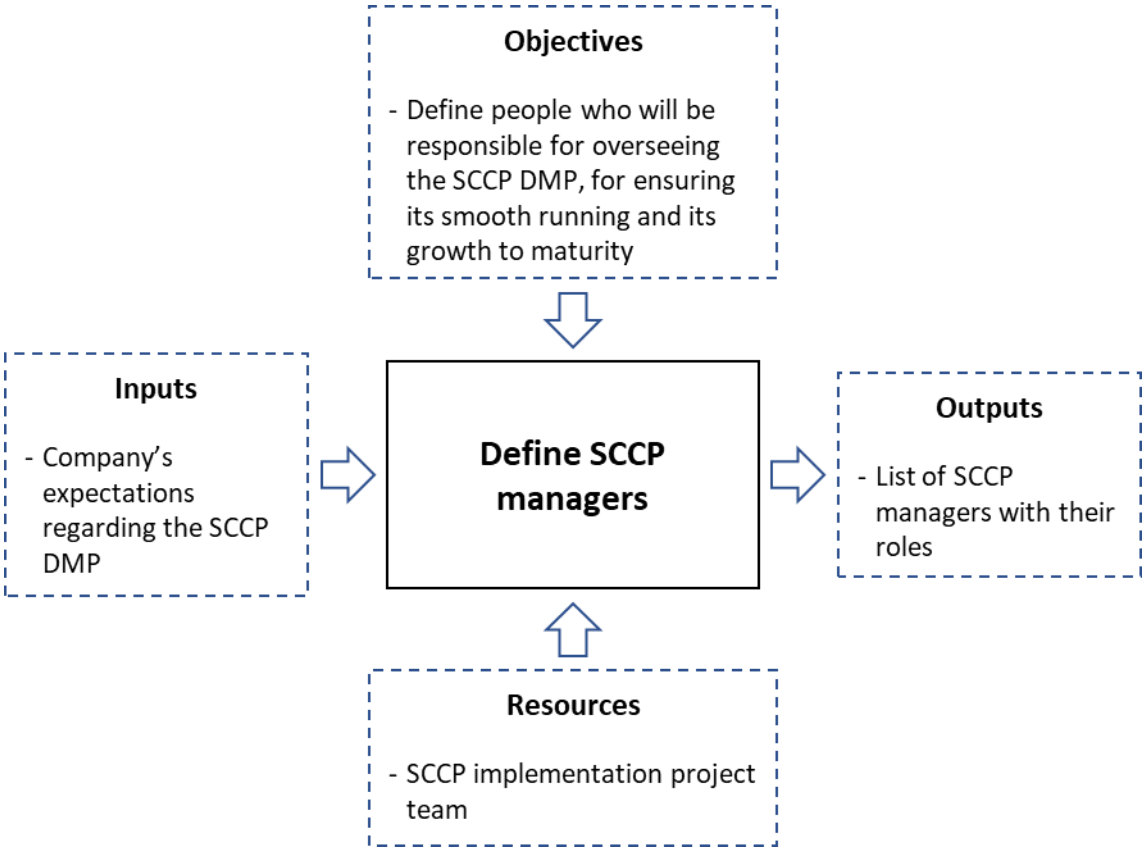

Figure 71: IDEF0 diagram of the “define SCCP managers” activity

2.3. Perform SCCP routine

The “perform SCCP routine” process was designed to structure the routine part of the SCCP DMP and guide the stakeholders involved. It is composed of two subprocesses: first, “prepare decision-making meeting”, and second, “perform decision-making meeting”. The following two sub-subsections respectively describe these two subprocesses. Figure 72 formalizes the SCCP DMP implementation process by providing its BPMN diagram.

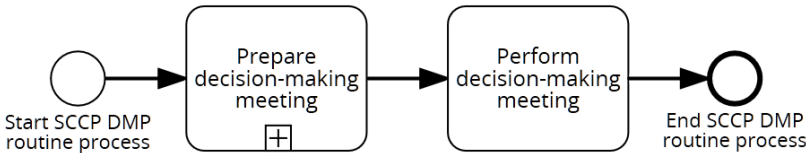

Figure 72: BPMN diagram of the SCCP DMP routine process proposal

2.3.1. Prepare decision-making meeting

The objective of the “prepare decision-making meeting” subprocess is to facilitate an effective and efficient DMM. The DMM preparation consists of the following three activities: “gather and prepare data for the computational software”, “run the computational software”, and “analyze what-if scenario assessment results and prepare recommendations for the decision-making meeting.” These three activities are respectively detailed in the following three

paragraphs. Figure 73 formalizes the “prepare decision-making meeting” subprocess of the SCCP DMP routine process by providing its BPMN diagram.

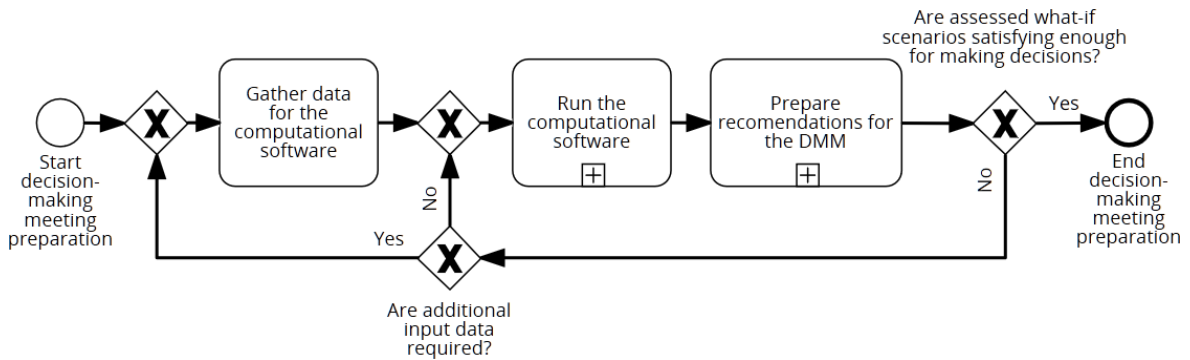

Figure 73: BPMN diagram of the “prepare decision-making meeting” subprocess of the SCCP DMP routine process proposal

The objective of the first activity, called “gather data for the computational software”, is to gather data that will be provided to the computational software. During this activity, all the information providers defined during the implementation process should gather the data they are responsible for and prepare this data to feed the computational software. Data gathering responsibilities were defined by the combination of the “define data” and “define stakeholders” subprocesses of the SCCP DMP implementation process. Figure 74 illustrates this activity according to the IDEF0 standard (Menzel and Mayer 1998) by synthesizing its inputs, objectives, resources, and outputs.

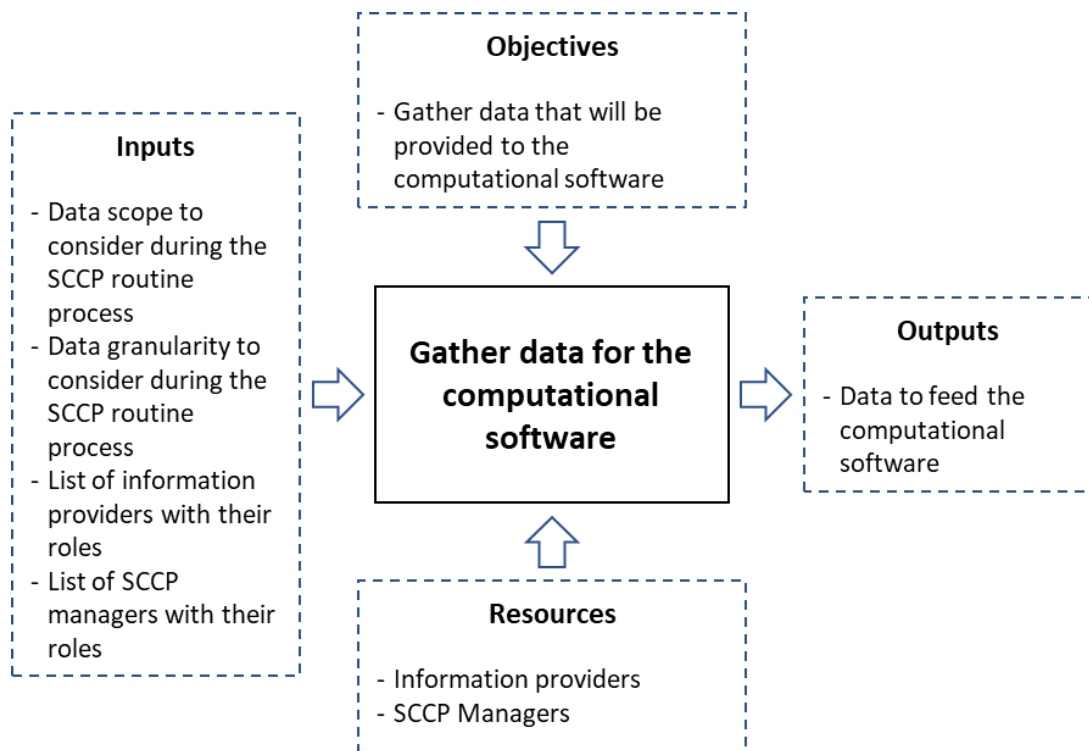

Figure 74: IDEF0 diagram of the “gather data for the computational software” activity

The second activity is a subprocess called “run the computational software”. The objective of this subprocess is to generate data that can be used to make SCCP decisions by running the computational software with the data gathered during the previous activity. It is composed of

the following four activities: the goal of the first activity, “create the supply web model”, is to feed the computational software with the gathered data. This corresponds to creating the supply web model as defined in the third chapter by using the “supply web modeler” module of the computational software (section 2.2 page 67). The goal of the second activity, “run the assessment model generator module”, is to run the “assessment model generator” module as defined in the third chapter (section 2.3 page 78), which generates the assessment model that will be used to assess what-if scenarios. The goal of the third activity, “configure the what-if scenario generator and assessor”, is to configure the “what-if scenario generator and assessor” module as defined in the third chapter (section 2.4 page 91). This corresponds to providing the following information: first, the time granularity of the supply web model and also the time horizon to consider for the what-if scenarios. Second, the sets of supply options to consider for the what-if scenarios. Third, thresholds regarding the number of uncertainty sources and decision options to consider simultaneously in a what-if scenario. The goal of the fourth activity “run the what-if scenario generator and assessor” is to run the “what-if scenario generator and assessor” module which generates the what-if scenarios to assess, assesses them, and creates a file with the what-if scenario assessment results. Figure 75 illustrates this subprocess by synthesizing its inputs, objectives, resources, and outputs, while Figure 76 formalizes it by providing its BPMN diagram. Only one IDEF0 diagram was created to describe this subprocess rather than each of its activities to avoid detail not considered necessary for understanding the proposal.

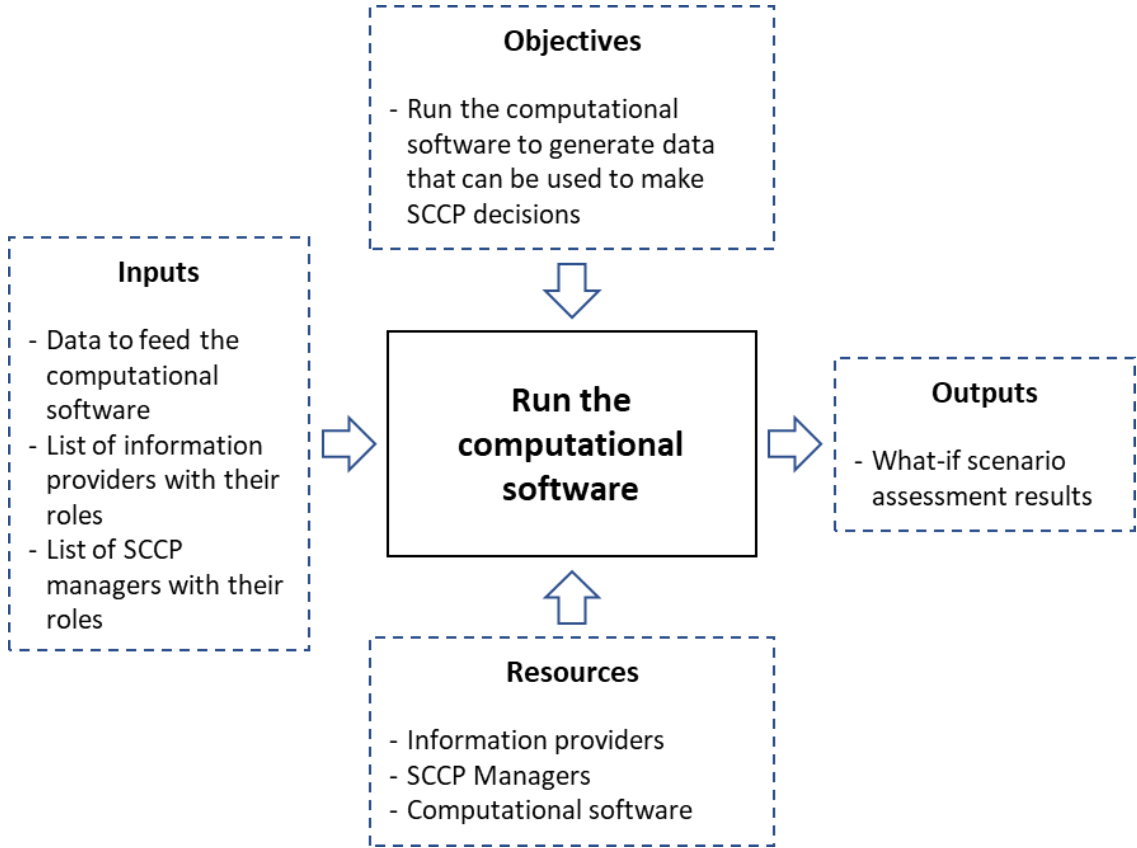

Figure 75: IDEF0 diagram of the “run the computational software” subprocess

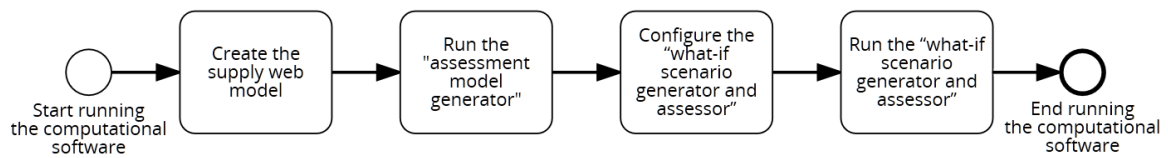

Figure 76: BPMN diagram of the “run the computational software” subprocess of the “prepare decision-making meeting” subprocess of the SCCP DMP routine process proposal

The third activity is a subprocess called “prepare recommendations for the decision-making meeting”. The objective of this subprocess is to ensure a smooth, effective, and efficient DMM by preparing the recommendations of decisions to make. It is composed of the following four activities: the objective of the first activity, called “identify current SCC plan weaknesses”, is to identify weaknesses of the current SCC plan. The objective of the second activity, called “identify better SCC plan alternatives”, is to identify SCC plan alternatives (i.e., decision option combinations) that would perform better than the current SCC plan. These first two activities should be done by analyzing the what-if scenario assessment results. These what-if scenario assessment results can be analyzed by using the dashboards created during the “define decision-making reasoning and associated dashboards” activity of the “define decision-making meeting” subprocess of the SCCP DMP implementation process. The objective of the third activity, called “define the recommendations to make during the decision-making meeting”, is to define the set of recommendations that will be made during the decision-making meeting to guide decision-makers towards the final decisions. Then, an OR Opening Gateway asks the question, “is the dashboard configuration from the implementation process satisfying?” If the answer is yes, the “prepare recommendations for the decision-making meeting” process ends. If the answer is no, there is a fourth activity to perform: “configure and organize the dashboards.” The objective of this activity is to configure and organize dashboards so that decision-makers can effectively and efficiently support decision-making during the DMM. In other words, it serves to make sure decision-makers can effectively and efficiently understand recommendations and make decisions during the DMM. Figure 78 illustrates this subprocess by synthesizing its inputs, objectives, resources, and outputs, while Figure 77 formalizes it by providing its BPMN diagram. Only one IDEF0 diagram was created to describe this subprocess rather than each of its activities, to avoid details not considered necessary for understanding the proposal.

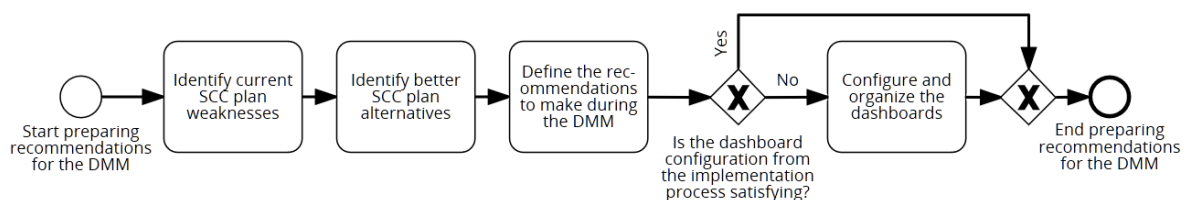

Figure 77: BPMN diagram of the “prepare recommendations for the decision-making meeting” subprocess of the “prepare decision-making meeting” subprocess of the SCCP DMP routine process proposal

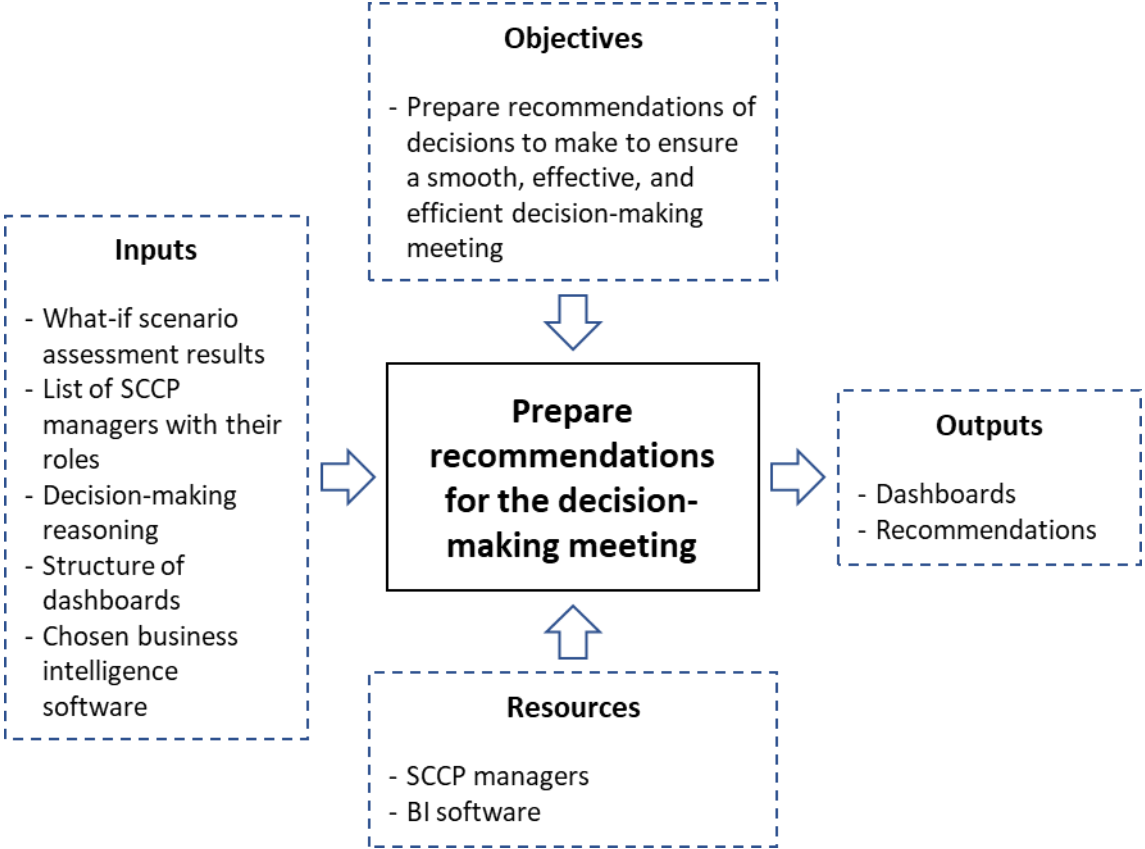

Figure 78: IDEF0 diagram of the “prepare recommendations for the decision-making meeting” subprocess

Finally, an OR Opening Gateway asks the question, “are assessed what-if scenarios satisfying enough for making decisions?” If the answer is yes, the “prepare decision-making meeting” process ends. If the answer is no (i.e., there are what-if scenarios that could be useful for making decisions, but they were not assessed), then a second OR Opening Gateway represents the need to ask a second question, “are additional input data required?” If the answer is no, then the process should continue going back to the subprocess called “run the computational software.” If the answer is yes, then the process should continue going back to the “gather data for the computational software” activity to gather the additional input data required.

2.3.2. Perform decision-making meeting

The “perform decision-making meeting” activity corresponds to the DMM itself and is the last activity of the SCCP DMP routine process. The objective of this activity is to decide on the SCC plan to implement. All decision-makers from the different departments should agree on the SCC plan alternative they consider the best for the company as a whole. The dashboards created with the BI software should be used to support decision-making along with the recommendations prepared during the previous activity. Dashboards should help gathering all decision-makers around a common vision of the company’s performance. Each decision-maker should be able to understand the impacts of their decision options on the entire company’s performance, and on other departments as well as on their own department. The agenda of the DMM should follow the decision-making reasoning defined during the “define decision-making reasoning and associated dashboards” activity of the “define decision-making meeting”

subprocess of the SCCP DMP implementation process. The proposal made when introducing the “define decision-making reasoning and associated dashboards” activity is to structure the DMM with the following four phases inspired from the MG Taylor Corporation (MG Taylor Corporation 1996): scan, focus, act, and feedback. First, the objective of “scan” is to identify weaknesses within the current SCC plan. Second, “focus” is to identify and compare the SCC plan alternatives that could help overcome the identified weaknesses. Third, “act” is to decide on the SCC plan alternative to implement. Fourth, “feedback” is to provide feedback on the current routine process iteration to determine whether there is an improvement opportunity justifying the run of a new iteration of the implementation process. Finally, the outputs of this activity are the following two: first, the decision regarding the SCC plan alternative to implement, which corresponds to the list of decision options that decision-makers decide to activate. Second, a list of feedback for improving the next iterations of the SCCP DMP and determining whether a new iteration of the SCCP DMP implementation process is necessary. Figure 79 illustrates this activity according to the IDEF0 standard (Menzel and Mayer 1998) by synthesizing its inputs, objectives, resources, and outputs.

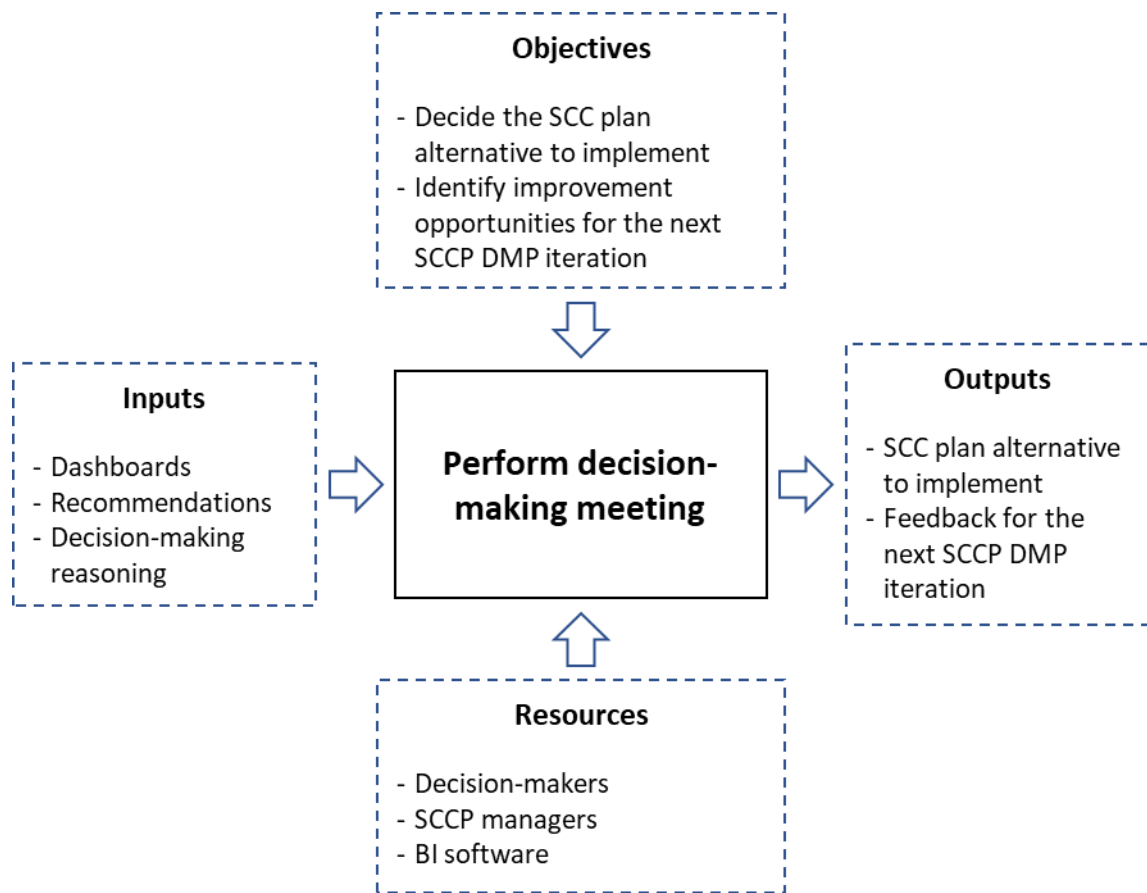

Figure 79: IDEF0 diagram of the “perform decision-making meeting” activity

3. Conclusion

The objective of this chapter was twofold: first, to describe the major results of the literature review undertaken to find ideas and good practices for designing an SCCP DMP. Second, to introduce the third and last building block of the SCCP DSS proposed in this thesis: the SCCP DMP proposal.

The literature review described in the first section concluded that existing DMP proposals have a similar structure composed of two phases: a first phase to prepare information needed to make decisions, and a second phase being a meeting aiming to make the decisions. Additionally, the first phase is generally structured in two subphases: a first subphase providing the vision of each department regarding the potential futures of the company, and a second subphase integrating these visions into a unique coherent vision for the whole company. However, the DMP is not designed for taking advantage of the SCCP IS proposal (computational software proposal and BI software) to support SCCP decisions. Therefore, the third and last research question (RQ3) of this thesis was introduced: “How to organize an SCCP decision-making process complying with the SCCP conceptual framework principles by taking advantage of the SCCP information system proposal?”

The second section introduced the SCCP DMP proposal that was designed based on the results of the literature review as well as the first two contributions introduced in the second and third chapters (respectively the SCCP conceptual framework and the computational software). The SCCP DMP proposal contains two processes: the “implementation process” and the “routine process”. The objective of the implementation process is to configure the routine to perform, while the objective of the routine process is to perform this routine. The routine process was structured in a similar way to the existing DMPs investigated during the literature review. It contains two subprocesses: the first one to prepare the meeting for making decisions, and the second one being this decision-making meeting. Each of these subprocesses was adapted to follow the SCCP conceptual framework principles as well as to describe how the company can take advantage of the computational software proposal. The second component of the SCCP IS, the BI software, was introduced, along with the routine process. This completes the introduction of the SCCP IS started during the third chapter with the computational software.

Finally, two experiments on industrial use cases were undertaken to assess the SCCP DSS proposal. These experiments are described in the next chapter.

CHAPTER V. TWO INDUSTRIAL PILOT PROJECTS: PIERRE FABRE Dermo-COSMÉTIQUE AND PIERRE FABRE MÉDICAMENT

“It doesn't matter how beautiful your theory is, it doesn't matter how smart you are.
If it doesn't agree with experiment, it's wrong.”

Richard P. Feynman

As mentioned in the introduction, this thesis is part of an academic-industrial partnership called *Chaire Mines Albi Supply Chain Agile avec Pierre Fabre* supported by the Pierre Fabre group. The research project involves its two main companies: Pierre Fabre Dermo-Cosmétique and Pierre Fabre Médicament. The research work was undertaken in close collaboration with Pierre Fabre as illustrated in Figure 13. After identifying the needs and designing the contributions, it was time to assess the latter on two industrial pilot projects. To assess these contributions, introduced in the last three chapters, experiments (i.e., the pilot projects) were undertaken at each of the Pierre Fabre branches. These pilot projects had three objectives: first, to confirm the applicability of the contributions with two pilot projects having different contexts. An important element of these two different contexts is that they complement one another towards the validation of the genericity of the approach and so its applicability to all use cases that can have different supply chain scopes. One is focused on the internal supply chain of the first considered company, and on decisions related to internal capacity availability and requirements. And the other is focused on the external supply chain of the second considered company, and on decisions related to external capacity availability such as supplier selection. Second, to evaluate the benefits of the contributions. Third, to identify the limitations and avenues for future research. The objective of this chapter is to describe these pilot projects and the associated results¹. Figure 80 illustrates the content of this chapter by positioning it on the overview of the contributions of this thesis. The first section describes the pilot project undertaken at Pierre Fabre Dermo-Cosmétique. The second section describes the pilot project undertaken at Pierre Fabre Médicament.

¹ Some changes were made from the final results for confidentiality reasons: numbers were changed (while keeping them valid for the analysis described) and names were anonymized.

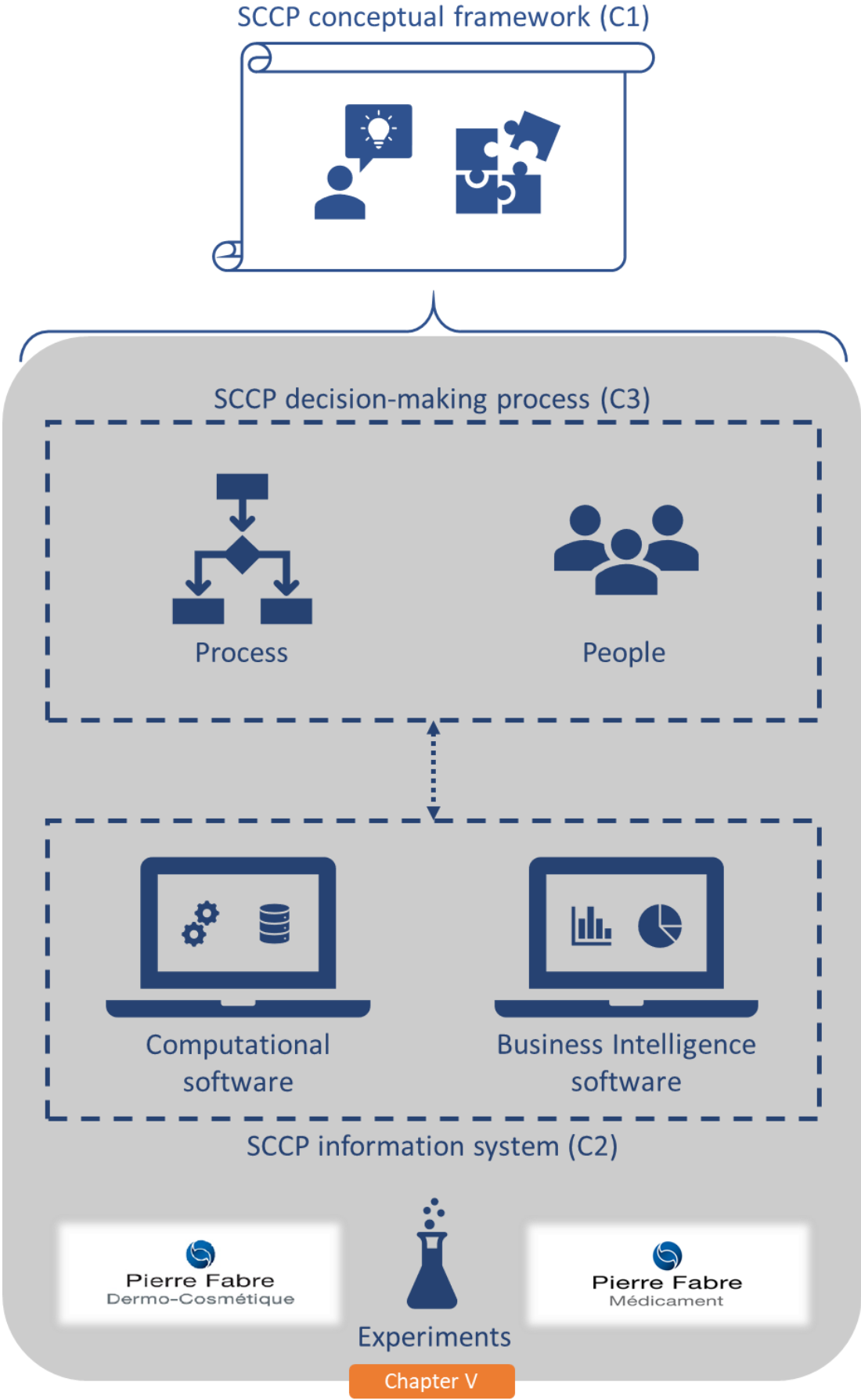

Figure 80: Positioning the content of this fifth chapter in regard to the overview of the contributions of this thesis (C1, C2, and C3)

1. Pierre Fabre Dermo-Cosmétique pilot project: supporting SCCP decisions associated with the network of suppliers of bottles of the company

1.1. Context

Part of the product portfolio of Pierre Fabre Dermo-Cosmétique (PFDC) is liquid packaged in bottles. This segment of the product portfolio is called the bottle family in this thesis. All the products within this bottle family are those which require bottles in order to be produced (i.e., a bottle is part of their bill of materials). Some products are packaged in the same types of bottles while others have specific bottles. The company has decided to buy bottles rather than producing them internally. Therefore, it has a set of suppliers supplying the different types of bottles required for producing each product of the bottle family.

A few years ago, one of the suppliers decided to cease its activity and announced its decision only a few weeks beforehand. This event had a very negative impact on PFDC, for whom it took a few years to recover. Therefore, to evaluate the benefits the contributions of this thesis could bring, PFDC decided to focus its first pilot project on the interface between the company and its suppliers of bottles. Their objective was to be able to identify and grade weaknesses regarding their network of suppliers of bottles. In particular, it was to identify and grade weaknesses in the network of suppliers of bottles regarding the ability to fulfill PFDC's demand. Therefore, the contribution would need to support company decisions regarding the configuration of the network of suppliers of bottles as well as other decisions having an impact on the solicitation of this network (i.e., an impact on PFDC's demand for bottles). Once weaknesses were identified and graded, the company would be able to decide which parts of the network to safeguard to ensure the desired performance.

To produce bottles, suppliers have two types of machines corresponding to two technologies for producing bottles (injection blow molding and extrusion blow molding). In addition to these machines, suppliers have molds for each type of bottle produced. These molds can be mounted on one of the types of machines that produce the corresponding type of bottle. In terms of capacity, this pilot project focuses on these machines and molds. Figure 81 illustrates the relations among the following concepts in the PFDC pilot project: equipment category (i.e., type of molds (or machines)), equipment category per organization (i.e., type of molds (or machines) per supplier), and equipment (i.e., machines or molds). It also illustrates the relation between the following concepts in the PFDC pilot project: product category (i.e., type of bottle) and equipment category required for production (a type of machine and a type of mold).

This pilot project was overseen by a team of four people. Two were from the PFDC company: one person from the performance improvement project team and one of the people in charge of the Sales and Operations Planning (S&OP) process. Two people were from the research center on industrial engineering of IMT Mines Albi: Raphaël Oger (author of this thesis) and Matthieu Lauras (PhD advisor to Raphaël Oger and the chair of the academic-industrial partnership with the Pierre Fabre group).

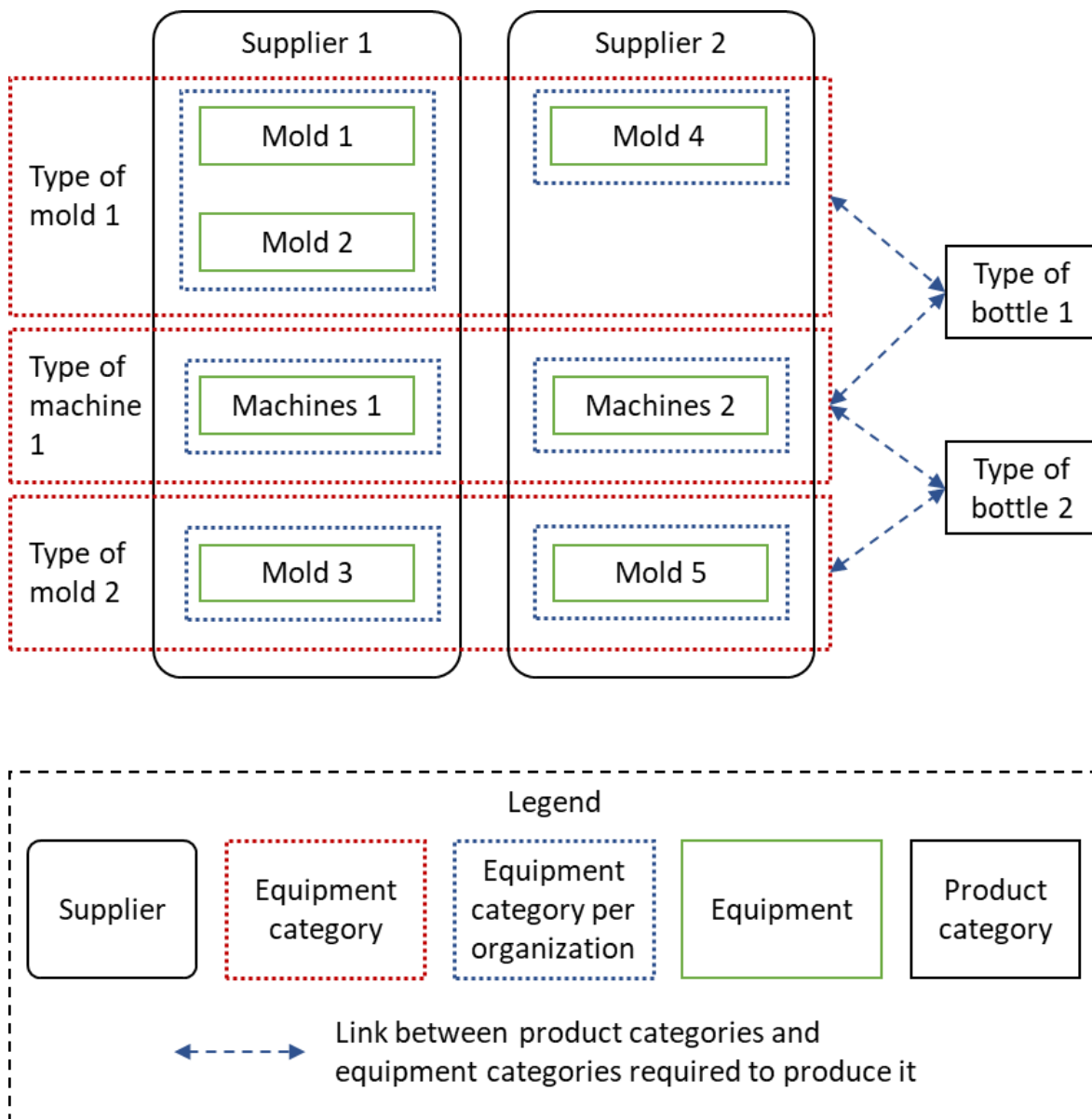

Figure 81: Illustration of the relationships among the different types of elements constituting the supply web of the PFDC pilot project.

1.2. Implementation process

The implementation process of the Supply Chain Capacity Planning (SCCP) Decision-Making Process (DMP) was performed according to the description given in the fourth chapter. The results of the three subprocesses are respectively described in the next three sub-subsections: “define decision-making meeting”, “define data”, and “define stakeholders”. The outcome of the implementation process activities described in these sections is the result of two iterations of the implementation process. A first iteration of the entire SCCP DMP was performed. During this first iteration, the Decision-Making Meeting (DMM) of the SCCP DMP routine process provided feedback that triggered a second iteration of the SCCP DMP implementation process. The feedback was thus considered during this second iteration of the SCCP DMP implementation process to improve the SCCP DMP routine process configuration.

1.2.1. Define decision-making meeting

1.2.1.1. Define types of decision options and types of uncertainty sources

After defining the focus of the pilot project, the first activity undertaken was the “define types of decision options” of the “define decision-making meeting” subprocess. The objective was to define the types of decision options to be considered in the SCCP DMP routine process. The conclusion of the working session was that the priority of PFDC regarding this pilot project was on identifying weaknesses in its supplier network of bottles regarding the ability to supply bottles. For this first pilot project, PFDC wanted to use the contribution to identify the weaknesses, and therefore asked its teams to investigate decision options that could overcome these weaknesses. A small set of types of decision options that would allow decision-makers to easily define several decision options was chosen, in order to assess the contribution before going further regarding the decision options in this pilot project. The following two types of decision options were thus chosen for the first iteration of the SCCP DMP routine: supplier selection and product packaging development choices.

The second activity undertaken was the “define types of uncertainty sources” of the “define decision-making meeting” subprocess. The objective was to define types of uncertainty sources to be considered in the SCCP DMP routine process. The conclusion of the working session was that the priority of PFDC regarding this pilot project was on assessing the network of suppliers of bottles regarding two types of uncertainty sources: demand forecast uncertainties and potential mold breakdown.

1.2.1.2. Define key performance indicators

After defining the types of decision options and uncertainty sources to include in the SCCP DMP routine process, the third activity undertaken was the “define key performance indicators” of the “define decision-making meeting” subprocess. The objective was to define the Key Performance Indicators (KPIs) that would be relevant while identifying weaknesses in the network of suppliers of bottles and making decisions. For this pilot project, three categories of KPIs were defined to support decisions: resource utilization, financial dependency and criticality. Table 17 synthesizes these three categories of KPIs with their respective objectives. First, the objective of the “resource utilization” category was to assess the ability of the company’s supply network to produce enough bottles to supply PFDC in the right quantities. KPIs in this category should be linked to the available time and utilization time required of the resources (i.e., equipment). Second, the objective of the “financial dependencies” category was to describe the financial dependencies of the company towards different elements of the supply web. KPIs in this category should be linked with performance indicators related to costs and revenues. Third, the objective of the “criticality” category was to evaluate the financial risks associated with disruptions that might occur within the network of suppliers of bottles. KPIs in this category should be linked to performance indicators related to costs and revenues, as well as to available time and utilization time required of the resources (i.e., equipment).

Table 17: Categories of KPIs with their respective objectives

KPI category	Objective
Resource utilization	To assess the ability of PFDC's network of suppliers of bottles to supply bottles in the right quantities.
Financial dependencies	To describe the financial dependencies of the company towards different elements of the supply web.
Criticality	To evaluate financial risks associated with disruptions that might occur within the network of suppliers of bottles.

Within each of these categories, a set of KPIs was defined to describe the performance associated with a what-if scenario. First, a set of KPIs was defined to describe the utilization of resources. A KPI “saturation per piece of equipment” (i.e. “load/capacity ratio per equipment”) was defined and associated with each piece of equipment. This KPI uses the performance indicators “available time” and “utilization time required” by dividing the latter by the former. Then, two other KPIs were created by aggregation of the “saturation per piece of equipment”: “saturation per equipment category per supplier” and “saturation per equipment category (for the whole network)”. Formulas for the three KPIs are given below in Table 18.

Table 18: KPIs defined to describe the utilization of resources

KPI name	Unit	KPI formula
Saturation per piece of equipment	\emptyset^*	$\frac{\text{“utilization time required”}}{\text{“available time”}}$
Saturation per equipment category per supplier	\emptyset^*	$\frac{\sum_E \text{“utilization time required”}}{\sum_E \text{“available time”}}$ E = set of equipment of the considered equipment category and considered supplier
Saturation per equipment category (for the whole network)	\emptyset^*	$\frac{\sum_E \text{“utilization time required”}}{\sum_E \text{“available time”}}$ E = set of equipment of the considered equipment category

*No unit

Second, a set of KPIs was defined to describe the financial dependencies of the company towards different elements of the supply web. These KPIs correspond to different levels of aggregation of the performance indicator “revenue relying on it” associated with each ability and piece of equipment. The levels of aggregation of the performance indicator on equipment are the following: per supplier, per equipment category, per country, and the first two combined. Formulas for the four KPIs are given below in Table 19.

Table 19: KPIs defined to describe the financial dependencies of the company towards different elements of the supply web

KPI name	Unit	KPI formula
Revenue relying on all equipment of an equipment category of a supplier	€	\sum_E "revenue relying on it" E = set of equipment of the considered equipment category and considered supplier
Revenue relying on all equipment of a supplier	€	\sum_E "revenue relying on it" E = set of abilities of the considered supplier
Revenue relying on all equipment of an equipment category	€	\sum_E "revenue relying on it" E = set of equipment of the considered equipment category
Revenue relying on all equipment of suppliers of a country	€	\sum_E "revenue relying on it" E = set of abilities provided by organizations located in the considered country

Third, a set of KPIs was defined to describe the financial risks associated with disruptions that might occur within the network of suppliers of bottles. These KPIs, described in Table 20, were defined especially to describe the revenue loss that would be caused by the breakage of a piece of equipment, and they rely on the financial dependency KPIs defined in Table 19. The first KPI, called “breakdown criticality per piece of equipment”, was defined at the equipment aggregation level. Its goal is to describe the revenue loss that would be caused by the breakage of this specific piece of equipment. The second one, called “breakdown criticality per equipment category per supplier”, was defined at the equipment category per supplier aggregation level. Its goal is to describe the revenue loss that would be caused by the breakage of one of the pieces of equipment in the considered equipment category and considered supplier. The third one, called “breakdown criticality per equipment category”, was defined at the equipment category aggregation level. Its goal is to describe the revenue loss that could be caused by the breakage of one of the pieces of equipment of the considered equipment category within the whole network of suppliers of bottles. These KPIs require some information that is not part of the what-if scenario results (“time to call on backups” and “time to set up new equipment”). So, in addition to the what-if scenario results, this information should be provided to the Business Intelligence (BI) software when building dashboards. Adding this information to the supply web model and what-if scenario results could be an interesting avenue for future research.

Table 20: KPIs defined to describe the financial risks associated with disruptions that might occur within the network of suppliers of bottles

KPI name	Unit	KPI formula
<p>Breakdown criticality per piece of equipment</p> <p>(i.e., revenue loss in the case of the breakdown of the considered equipment. Considering a contingency plan of setting up new equipment and using potential backups in the meantime.)</p>	€	<p>"revenue relying on it" * "estimation of time loss"</p> <p>with</p> <p>"estimation of time loss" = "time to call on backups" + ("time to set up new equipment" – "time to call on backups") * "saturation per equipment category"</p>
<p>Breakdown criticality per equipment category per supplier</p> <p>(i.e., revenue loss in case of breakdown of equipment in the considered equipment category and supplier. Considering a contingency plan of setting up new equipment and using potential backups in the meantime.)</p>	€	$\frac{\sum_E \text{"breakdown criticality per equipment"}}{\sqrt{\text{"Number of pieces of equipment considered in E"}}$ <p>E = set of equipment of the considered equipment category and considered supplier</p>
<p>Breakdown criticality per equipment category</p> <p>(i.e., revenue loss in case of breakdown of equipment in the considered equipment category. Considering a contingency plan of setting up new equipment and using potential backups in the meantime.)</p>	€	$\frac{\sum_E \text{"breakdown criticality per equipment"}}{\sqrt{\text{"Number of pieces of equipment considered in E"}}$ <p>E = set of equipment of the considered equipment category</p>

1.2.1.3. Define decision-making reasoning and associated dashboards

After defining the types of decision options, uncertainty sources, and KPIs to include in the SCCP DMP routine process, the fourth activity undertaken was the “define decision-making reasoning and associated dashboards” of the “define decision-making meeting” subprocess. The objective was to define the decision-making reasoning to reach decisions as well as to define the associated dashboards for supporting decision-makers while following this decision-making reasoning during the DMM. The BI software called Tableau® (Tableau Software 2019) was chosen to create and display the dashboards. The primary focus of this pilot project was to assess the performance of the current SCC plan, to identify weaknesses, and to decide which weaknesses the company would like to overcome. Therefore, the dashboards were organized with this mindset. Three sets of dashboards were defined to guide decision-makers in their decision-making reasoning. Table 21 gives an overview of these three sets of dashboards and associated dashboards by providing their objectives, aggregation levels, and expected outcomes.

Table 21: Dashboards defined to guide decision-makers during the decision-making meeting

Objective of the set of dashboards	Objective of the dashboard	Expected outcomes
Vision of the change of the saturation of equipment categories over the time horizon	Vision at the network level	Identify equipment categories (machines or molds) requiring actions to decrease their saturation (e.g., additional capacity of machines, demand decrease by canceling a marketing campaign).
	Vision per supplier	Identify equipment categories per supplier (machines or molds) requiring actions to decrease their saturation (e.g., additional capacity of machines, demand decrease by changing PFDC's supply quotas).
Vision of the impacts of demand forecast uncertainty on the saturation of equipment categories	Vision at the network level	Identify if there are additional equipment categories that might require actions to change their saturation to protect them from demand forecast uncertainty sources.
	Vision per supplier	Identify if there are additional equipment categories per supplier that might require actions to change their saturation to protect them from demand forecast uncertainty sources.
Vision of the financial impact of a potential mold breakdown	Vision at the network level per equipment category	Understand the equipment categories that are the most sensitive (in terms of financial loss for PFDC) to the breakdown of one piece of its equipment. Prioritize equipment categories to focus actions on protecting the network of suppliers from this type of uncertainty sources.

The first set of two dashboards was defined to help decision-makers in identifying equipment categories which will need either an increase in available capacity or a decrease in required capacity to be able to meet the demand from PFDC, and thus to help PFDC serve its own customers. This means that the identified equipment categories require actions that decrease their saturation. These two dashboards are focused on deterministic what-if scenarios (i.e., without uncertainty sources). The goal of the first dashboard is to identify equipment categories that do not have enough capacity despite combining all of the equipment of the network of suppliers. This helps to identify equipment categories that require actions that would decrease their saturation (increase capacity or decrease demand) at the network level. Actions having an impact at the network level are required because actions balancing demand among suppliers would not be sufficient, as the network does not have enough capacity to meet demand. The identified equipment categories should be added to a “list of equipment categories requiring actions at the network level.” A screenshot of the dashboard filled with data resulting from the routine process is given in Figure 87. The goal of the second dashboard is to identify suppliers that do not have enough capacity of certain equipment categories. This helps to identify these equipment categories at the supplier level that require actions that would decrease the saturation

of these equipment categories (increase capacity or decrease demand). If the equipment category was identified in the previous dashboard, it means that actions balancing demand between suppliers would not be sufficient. In this case, no additional action is required. If the equipment category was not identified in the previous dashboard, it means actions balancing demand between suppliers would be sufficient. The identified equipment categories per supplier should be added to a “list of equipment categories per supplier requiring actions at the supplier level.” A screenshot of the dashboard filled with data resulting from the routine process is given in Figure 88. These two lists allow PFDC to list the weaknesses in its network of suppliers of bottles regarding the capacity of these suppliers to produce bottles in the right quantities considering the deterministic future (i.e., without uncertainty sources). The meaning of “actions at the network level” and “actions at the supplier level” are defined in Table 22. Table 23 describes these first two dashboards by giving a description of the dashboard, guidance for the dashboard analysis, and the expected outcome of the dashboard analysis.

Table 22: Meaning of the terms “actions at the network level” and “actions at the supplier level”

Actions associated with a certain aggregation level	Meaning
Actions at the network level	Actions having an impact on the KPIs when looking at the network aggregation level (e.g., overall capacity or utilization requirement associated with an equipment category). This means that changing the supply strategy to change a part of the supply from one supplier to another cannot be sufficient because it would not have an impact at the network aggregation level.
Actions at the supplier level	Actions having an impact on the KPIs when looking at the supplier aggregation level (e.g., capacity or utilization requirement associated with an equipment category at a supplier). This means that changing the supply strategy to change a part of the supply from one supplier to another can be sufficient. Actions at the network level are included in the actions at the supplier level because at least one supplier will be impacted by an action at the network level.

Table 23: Dashboards used to define the list of equipment categories requiring actions if PFDC wants to fully meet the demand of its customers in the next 5 years (at the network and at the supplier levels)

Dashboard description	Guidance for the dashboard analysis	Expected outcome of the dashboard analysis
Saturation of the network per equipment category over the 5-year horizon	<p><u>Reasoning:</u></p> <p>For each equipment category having a saturation above 1:</p> <p>Actions at the network level must be undertaken before the year saturation goes over 1. Therefore, add this</p>	<p>List of equipment categories requiring actions at the network level.</p> <p>Each equipment category of the list should be associated with the year actions need to</p>

(Figure 87)	information to the list of equipment categories requiring actions at the network level.	be done beforehand as well as the amount of missing capacity.
<u>Comment:</u>		
As the dashboard shows the saturation at network aggregation level, simply changing supply strategies cannot be sufficient. Actions must either increase the overall capacity of the network, decrease the utilization requirement of the considered equipment category, or both.		
Saturation of the suppliers per equipment category over the 5-year horizon	<u>Reasoning:</u> For each equipment category per supplier having a saturation above 1: If (the equipment category is not in the “list of equipment categories requiring actions at the network level”) OR (it has the year saturation goes over 1 sooner than at the network level), then: Additional actions must be undertaken at the supplier level before the year saturation goes over 1. Therefore, add this information to the list of equipment categories per supplier requiring actions at the supplier level.	List of equipment categories per supplier requiring actions at the supplier level. Each equipment category per supplier of the list should be associated with the year actions need to be done beforehand as well as the amount of missing capacity.
	<u>Comment:</u> As these equipment categories were not in the “list of equipment categories requiring actions at the network level”, it means changing supply strategies can be sufficient. But this doesn’t mean it should be the only type of considered action. Therefore, actions can either increase the capacity of the supplier and thus of the network, or decrease the utilization requirement of the considered equipment category for the considered supplier (by changing supply strategies or by decreasing the utilization requirement for the entire network), or both.	

The second set of dashboards has a similar objective to the first one. The difference is that rather than focusing on the deterministic scenarios, it considers scenarios associated with demand forecast uncertainties. This is designed to help decision-makers in identifying equipment categories which would need either an increase in capacity or a decrease in utilization requirements if PFDC wants to protect them from demand forecast uncertainties. In other

words, this means identifying equipment categories that would require a decrease in saturation if PFDC wants to guarantee the ability of its supply network to meet its demand in case of the occurrence of scenarios associated with demand forecast uncertainties. The goal of the first dashboard is to complete the “list of equipment categories requiring actions at the network level” with equipment categories requiring actions if PFDC wants to guarantee the ability of its network of suppliers of bottles to meet demand in case of the occurrence of one of the what-if scenarios associated with demand uncertainties. A screenshot of the dashboard filled with data resulting from the routine process is given in Figure 89. The goal of the second dashboard is to complete the “list of equipment categories requiring actions at the supplier level” with equipment categories per supplier requiring actions if PFDC wants to guarantee the ability of its network of suppliers of bottles to meet demand in case of the occurrence of one of the what-if scenarios associated with demand uncertainties. A screenshot of the dashboard filled with data resulting from the routine process is given in Figure 90. Table 24 describes these second two dashboards by giving a description of the dashboard, guidance for the dashboard analysis, and the expected outcome of the dashboard analysis. If the reader would like more information about what the lists can look like, the “list of equipment categories requiring actions at the network level” and “list of equipment categories requiring actions at the supplier level” obtained during the routine process are given in Table 33. They were combined as one table organized by priority rather than aggregation level.

Table 24: Dashboards used to complete the lists of equipment categories requiring actions if PFDC wants to fully meet the demand of its customers (both at the network and at the supplier level) in case of demand variations associated with the demand forecast uncertainties

Dashboard description	Guidance for the dashboard analysis	Expected outcome of the dashboard analysis
Interval of saturation per equipment category at the network level for scenarios of demand forecasts uncertainty (Figure 89)	<p><u>Reasoning:</u></p> <p>For each equipment category having the maximum of the saturation interval above 1:</p> <p>If (the equipment category is not in the “list of equipment categories requiring actions at the network level”) OR (it has the year saturation goes over 1 sooner than in the list), then:</p> <p>Actions could be undertaken to prevent the lack of capacity of this equipment category in case of demand variation from the forecast. Therefore, add this information to the list of equipment categories requiring actions at the network level.</p>	Updated “list of equipment categories requiring actions at the network level” with equipment categories requiring actions if PFDC wants to guarantee the ability of its network of suppliers of bottles to meet demand in case of the occurrence of one of the what-if scenarios associated with demand uncertainties.

Comment:

As the dashboard is for a specific year, years should be analyzed in chronological order to identify the year saturation intervals go over 1.

Reasoning:

For each equipment category per supplier having the maximum of the saturation interval above 1:

If (the equipment category is not already in the “list of equipment categories requiring actions at the supplier level”) OR (in the “list of equipment categories requiring actions at the network level”) OR (it has the year saturation goes over 1 sooner than in the lists), then:

Actions could be undertaken to prevent the lack of capacity of these equipment categories in case of demand variation from the forecast. Therefore, add this information to the list of equipment categories per supplier requiring actions at supplier level.

Updated “list of equipment categories per supplier requiring actions at supplier level” with equipment categories requiring actions if PFDC wants to guarantee the ability of its network of suppliers of bottles to meet demand in case of the occurrence of one of the what-if scenarios associated with demand uncertainties.

Interval of saturation per equipment category at the supplier level for scenarios of demand forecasts uncertainty (Figure 90)

Comment:

As the dashboard is per year, years should be analyzed in chronological order to identify the year saturation intervals go over 1.

Finally, the third set of dashboards was defined to help decision-makers identify equipment categories which would need actions to reduce financial loss in case of breakage of one of the pieces of equipment of this category. This set of dashboards is composed of one dashboard combining two interactive diagrams. The goal of the first diagram is to rank equipment categories (at the network level) by the financial loss that would result from the breakage of one of the pieces of equipment of this category. The goal of the second diagram is to get additional information (when selecting a certain equipment category) to understand the ranking of this equipment category. A screenshot of the dashboard filled with data resulting from the routine process is given in Figure 91. Table 25 describes this fifth dashboard by giving a description of the dashboard, guidance for the dashboard analysis, and the expected outcome of the dashboard analysis.

Table 25: Dashboard used to help decision-makers identify equipment categories which would need actions to reduce financial loss in case of breakage of one of the pieces of equipment of this category

Dashboard description	Guidance for the dashboard analysis	Expected outcome of the dashboard analysis
<p>Ranking of equipment categories according to financial loss in case of breakage of a piece of equipment of the category</p> <p>(Figure 91)</p>	<p><u>Reasoning:</u></p> <p>For each equipment category with high criticality:</p> <p>Identify the reasons for it (no backup, high saturation, or both) and identify types of actions that would help protect it from potential breakage of a mold. Add this information to the list of equipment categories requiring actions in terms of protecting it from the potential breakage of a mold.</p> <p><u>Comments:</u></p> <p>The equipment categories located in the top right part of the diagram are the most critical (the ones that would generate the greatest financial loss in case of breakage of a mold of the corresponding equipment category).</p>	<p>List of equipment categories requiring actions in terms of protecting them from potential breakage of a mold, ranked by a priority defined by decision-makers.</p> <p>Types of actions to investigate, associated with each equipment category of the list, for protecting it from potential breakage of a mold.</p>

1.2.2. Define data

1.2.2.1. Define data scope

After defining the DMM, the “define data” subprocess was undertaken, starting with its first activity: “define data scope”. The objective was to define the scope of the data to gather regarding the following two dimensions: product portfolio and supply chain. The context section introducing the pilot project has already given information that partly defines the scope of the data to consider regarding the product portfolio and supply chain dimensions. For the product portfolio dimension, it indicates the focus on the bottle family containing all the products having a bottle in their bill of materials. In particular, it was decided to consider only those bottles associated with a level of demand above a certain threshold called “bottle consideration threshold” (which represented 99% of the volumes at the time of the pilot project). This last choice was made because it was considered that the effort to gather information about the remaining 1% was not necessary for this pilot project. For the supply chain dimension, it indicates the focus on suppliers of one specific component of the bill of materials of the product of the bottle family: the bottle. The focus is on the first-tier suppliers of considered bottles and there is no consideration of PFDC internal capacity in this pilot

project. Regarding the considered resources, the focus is on the following equipment owned by suppliers: molds and machines on which molds are mounted. All machines are considered. However, regarding the molds, it was decided to consider only the molds used to produce bottles with a demand above a certain threshold called “mold consideration threshold” (higher than the “bottle consideration threshold” previously mentioned, and which represented 75% of the volumes at the time of the pilot project). This last choice was made because it was considered that the effort to gather information about the molds associated with the remaining 25% of the bottles was not necessary for this pilot project. Table 26 synthesizes the scope defined for each node of the supply web metamodel.

1.2.2.2. Define data granularity

After defining the scope of the data to gather to feed the computational software, the second activity of the “define data” subprocess was undertaken: “define data granularity”. The objective was to define the data granularity to consider regarding the elements within the defined scope for the product portfolio and supply chain dimensions.

Regarding the product portfolio dimension, it was decided to consider each bottle with a demand above the “mold consideration threshold” as one “product category” in the supply web model. For all the other bottles that were part of the scope but with a lower demand than the “mold consideration threshold”, it was decided to aggregate them into two “product categories” in the supply web model. There were two technologies for machines and molds for producing the bottles and each bottle was associated with a certain technology. So, all the bottles of each technology with a demand lower than the “mold consideration threshold” were aggregated as one “product category” in the supply web model. This means that the “demand forecasts” were also aggregated accordingly in the supply web model.

Regarding the resources within the supply chain dimension, it was decided to consider all molds at the highest level of detail, being the mold itself, so each mold was considered to be one piece of “equipment” in the supply web model. For the machines, there were two technologies used for producing the bottles, and it was decided to aggregate machines per technology. So, for each supplier, all machines of a certain technology had to be considered to be one piece of “equipment” in the supply web model. For each type of mold associated with a considered bottle, an “equipment category” had to be created in the supply web model. Similarly, for each technology of a machine, an “equipment category” had to be created in the supply web model. Regarding the organizations within the supply chain dimension, it was decided to consider each supplier to be an “organization” in the supply web model. Table 26 synthesizes the granularity defined for each node of the supply web metamodel.

Table 26: Synthesis of the scope and granularity defined for each node of the supply web metamodel

Supply web node	Scope	Granularity
Product category	Types of bottles for which PFDC has a demand above “bottle consideration threshold”.	Each type of bottle (specific shape and material) is considered to be a product category. A type of bottle corresponds to bottles before any specialization associated with text and images added on the bottle.
Organization	Suppliers’ bottles associated with the types of bottles being part of the scope*.	Each supplier is considered to be an organization. There is no visibility inside potential business units of suppliers, and no merging of suppliers into groups.
Equipment	Machines that suppliers use to produce the bottles being part of the scope* Molds that suppliers use to produce the bottles for which PFDC has a demand above the “mold consideration threshold”.	Machines are grouped per type of machine (type of technology used to produce the bottles) and per supplier. Each of these groups is considered to be a piece of equipment. Each mold is considered to be a piece of equipment.
Equipment category	Types of machines that suppliers use to produce the bottles being part of the scope* Types of molds that suppliers use to produce the bottles for which PFDC has a demand above the “mold consideration threshold”.	Each type of machine is considered to be an equipment category. Each type of mold is considered to be an equipment category.
Ability	Abilities suppliers provide to produce the types of bottles being part of the scope*.	Each ability a supplier provides to produce a type of bottle is considered to be an ability.
Demand forecast	Demand forecasts associated with the types of bottles being part of the scope*.	Each type of bottle has an associated demand forecast.
Decision option	Decision options associated with product packaging development choices for the types of bottles being part of the scope*.	Same as the product categories.
Uncertainty source	Uncertainty sources associated with demand forecast uncertainty regarding the types of bottles being part of the scope*.	Each type of bottle has associated demand forecast uncertainty sources.

* Types of bottles being part of the scope are the ones for which PFDC has a demand above the “bottle consideration threshold”

1.2.3. Define stakeholders

After defining the data to gather to feed the computational software, the “define stakeholders” subprocess was undertaken, starting with the following three activities: “define information providers”, “define decision-makers”, and “define SCCP managers”.

1.2.3.1. Define information providers

The objective of the “define information providers” activity was to define the people who will provide the required information. For this pilot project, the following four teams were involved in providing information: purchasing, finance, product packaging development, and performance improvement. Table 27 shows the information providers defined for the first input data required by the computational software. This is the data called “supply web and demand plan with associated decision options and uncertainty sources” required for the supply web model creation (Figure 34).

Table 28 shows the information providers defined for the second input data required by the computational software. This is the data called “what-if scenario configuration” required for generating and assessing what-if scenarios (Figure 34).

Table 27: Information providers defined for the first input data required by the computational software (data required to create the supply web model)

Information to provide	Corresponding node/edge in the supply web metamodel	Attributes	Team(s) in charge of providing the information
Suppliers of bottles	Organization	Name	Purchasing
	Ability	Name	Purchasing
Abilities of the suppliers of bottles	Edges “consumes” from Ability to Resource category	Quantity	Purchasing
	Edges “produces” from Ability to Resource category	Quantity	Purchasing
	Edges “requires” from Ability to Resource category	Utilization time	Purchasing
	Edge “provides” from Organization to Ability	/	Purchasing
Equipment used by the suppliers of bottles to produce bottles (molds and machines)	Equipment	Name Available time	Purchasing
	Equipment category	Name	Purchasing

	Edge “corresponds to” from Resource to Resource Category	/	Purchasing
Types of bottles	Product category	Name	Purchasing
Demand forecasts for considered products from the bottle family	Demand forecast	Name	Purchasing
	Edge “consumes” from Demand forecast to Resource category	Quantity	Purchasing
Price PFDC sells the products of the bottle family (revenue associated with each unit)	Edge “has” from Organization to Resource category	Selling price	Finance
Decision options associated with product packaging development choices	Decision option	Name	Product packaging development
	Edge “impacts” from Decision option to demand forecast	Impacts	Product packaging development
Uncertainty sources associated with demand forecast uncertainties	Uncertainty source	Name	Performance improvement
	Edge “impacts” from Uncertainty source to demand forecast	Impacts	Performance improvement
Uncertainty sources associated with potential mold breakdown	Uncertainty source	Name	Purchasing
	Edge “impacts” from Uncertainty source to Equipment	Impacts	Purchasing

Table 28: Information providers defined for the second input data required by the computational software (what-if scenario configuration data required for generating and assessing what-if scenarios)

Information to provide	Team(s) in charge of providing the information
Time granularity	SCCP managers
Time horizon	SCCP managers
Threshold regarding the number of decision options to be considered simultaneously	SCCP managers
Threshold regarding the number of uncertainty sources to be considered simultaneously	SCCP managers
Sets of supply options	Purchasing

1.2.3.2. Define decision-makers

The objective of the “define decision-makers” activity was to define the people who will be part of the team attending the DMM and making the final decisions. Table 29 shows the chosen stakeholders with the department they belong to.

Table 29: Stakeholders and associated departments chosen to be part of the team of decision-makers attending the decision-making meeting and making the final decisions for the PFDC’s pilot project

Department	Stakeholders
Purchasing	- Department director - Buyer
Operations	- Department director - Supply chain director - S&OP manager
Finance	- Financial controller
Product packaging development	- Department director
Performance improvement	- Department director - Project manager
Quality insurance	- Department director - Packaging quality manager

1.2.3.3. Define SCCP managers

The objective of the “define SCCP managers” activity was to define the people who will be overseeing the SCCP DMP to ensure its smooth operation and its growth towards maturity. One person was chosen for this pilot project. This person is one of the people currently in charge of the S&OP process and is part of the operations department. This person was chosen for three main reasons: having a global vision of the company, good problem-solving skills, and good communication skills.

1.3. Routine process

After performing the implementation process, the routine process of the SCCP DMP was performed according to the description given in the fourth chapter. The results of the “prepare decision-making meeting” subprocess and the “decision-making meeting” activity are respectively described in the following two sub-subsections. The “prepare decision-making meeting” subprocess was performed with data from 2016 and a visibility over five years (from 2017 to 2021), but the “decision-making meeting” activity was performed at the end of 2018. Thus, the “decision-making meeting” activity resulted in a set of decisions that could have been made in 2016 if PFDC had been using the SCCP DSS proposal described in this thesis. The objective was to assess the benefits of the SCCP DSS proposal by comparing this set of decisions with the one that had actually been made between 2016 and 2018.

1.3.1. Decision-making meeting preparation

1.3.1.1. Gather data for the computational software

The first activity performed during the routine process was the “gather data for the computational software”, being the first activity of the “prepare decision-making meeting” subprocess. The objective was to gather all data required for creating the supply web model. Table 30 synthesizes the resulting data gathered to create the supply web model of the PDFC pilot project. It gives the following information for each node of the supply web metamodel introduced in the third chapter (Figure 35): the number of instances of the nodes, and some additional information about the nodes to describe what they correspond to for the company.

Table 30: Synthesis of the instances of nodes within the supply web model of the PDFC pilot project

Supply web metamodel node	Number of instances of the node	Additional information about the nodes
Product category	28	Including 26 product categories corresponding to the types of bottles for which PFDC has a demand above the “mold consideration threshold”. Including 2 product categories representing the types of bottles for which PFDC has a demand between the “bottle consideration threshold” and the “mold consideration threshold”, which are divided into two types associated with the two types of technologies used to produce bottles.
Organization	6	Including 6 organizations corresponding to the suppliers associated with the 28 product categories.
Equipment category	28	Including 26 equipment categories corresponding to the types of molds associated with the 26 types of bottles for which PFDC has a demand above the “mold consideration threshold”. Including 2 equipment categories corresponding to the types of machines associated with the two types of technologies used to produce bottles.
Equipment	53	Including 43 pieces of equipment corresponding to molds associated with the 26 types of bottles for which PFDC has a demand above the “mold consideration threshold”. Including 10 pieces of equipment corresponding to machines associated with the two types of technologies used to produce bottles.
Ability	50	Including 50 abilities corresponding to the abilities of the suppliers associated with the 28 product categories.
Demand forecast	28	Including 28 demand forecasts corresponding to the demand forecasts associated with the 28 product categories (one per product category).

Decision option	1	Corresponds to an alternative of product packaging development; a product of the bottle family could change the type of bottle in its bill of materials from one of the types of bottles for which PFDC has a demand above the “mold consideration threshold” to another one.
Uncertainty source	56	56 demand forecast uncertainty sources associated with the 28 demand forecasts (one +25% and one -25%).

1.3.1.2. Run the computational software

1.3.1.2.1. Create the supply web model and run the “assessment model generator”

After gathering the data required by the computational software, it was time to use the computational software. As described in the third chapter, the computational software can take two types of files as inputs to create the supply web model (Figure 37): first, XML files that can be created by modeling the supply web with the [RIO-SUITE](#) software (Centre Génie Industriel - IMT Mines Albi 2019) and exporting this model as the XML files; second, a specific format of Excel files. The first option was chosen for this pilot project, so the [RIO-SUITE](#) software was used to model the supply web, then the model was exported as XML files readable by the computational software. Therefore, a supply web model containing all instances of nodes mentioned in Table 30 was created using the [RIO-SUITE](#) software.

As described in the third chapter, the model of the supply web is projected on three projection plans corresponding to the three user interfaces of the [RIO-SUITE](#) software (Figure 36). Figure 82, Figure 83, and Figure 84 show screenshots of the resulting three user interfaces showing the supply web model of this pilot project according to the corresponding three projection plans described in the third chapter. Figure 82 shows the following two screenshots of the [RIO-SUITE](#) user interface containing the PFDC supply web model associated with the “organization and abilities” projection plan. At the bottom, there is a view of the entire projected model. At the top, there is a view of a part of the projected model which has been enlarged to help users read it. Figure 83 shows the following two screenshots of the [RIO-SUITE](#) user interface containing the PFDC supply web model associated with the “organization and resources” projection plan. At the bottom, there is a view of the entire projected model. At the top, there is a view of a part of the projected model which was enlarged to help users read it. Figure 84 shows the following two screenshots of the [RIO-SUITE](#) user interface containing the PFDC supply web model associated with the “demand forecasts” projection plan. At the bottom, there is a view of the entire projected model. At the top, there is a view of a part of the projected model which was enlarged to help users read it. After modeling the supply web on the [RIO-SUITE](#) user interface, it was exported as XML files to feed the computational software. The supply web model was created over five years with the same nodes but an increase in the quantity associated with the demand forecasts.

Finally, the “supply web modeler” of the computational software was run, using the previously generated XML files of the PFDC supply web model as inputs. After the “supply web modeler” ended the creation of the supply web model in memory, it automatically ran the “assessment model generator”. The latter created the assessment model. Figure 85 and Figure 86 illustrate

the potential supply chain map of this assessment model. It is divided into two figures because it would not be legible on only one page. Then, the “assessment model generator” automatically started to run the “what-if scenario generator and assessor” which is described in the following paragraphs.

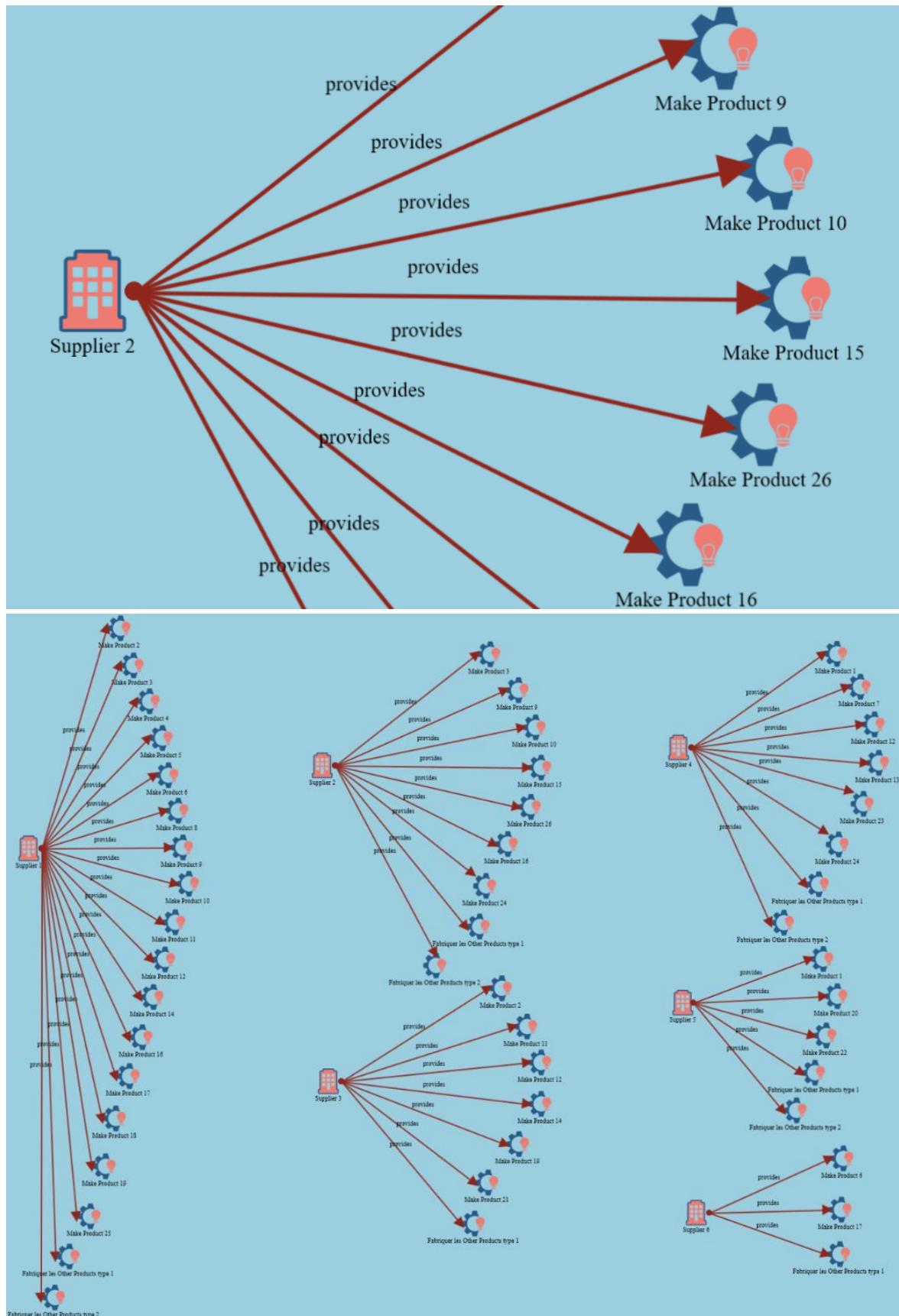

Figure 82: Two screenshots of the [RIO-SUTTE](#) user interface containing the PFDC supply web model associated with the “organization and abilities” projection plan. At the bottom, a view of the entire projected model. At the top, a view of part of the projected model which has been enlarged to help users read it.

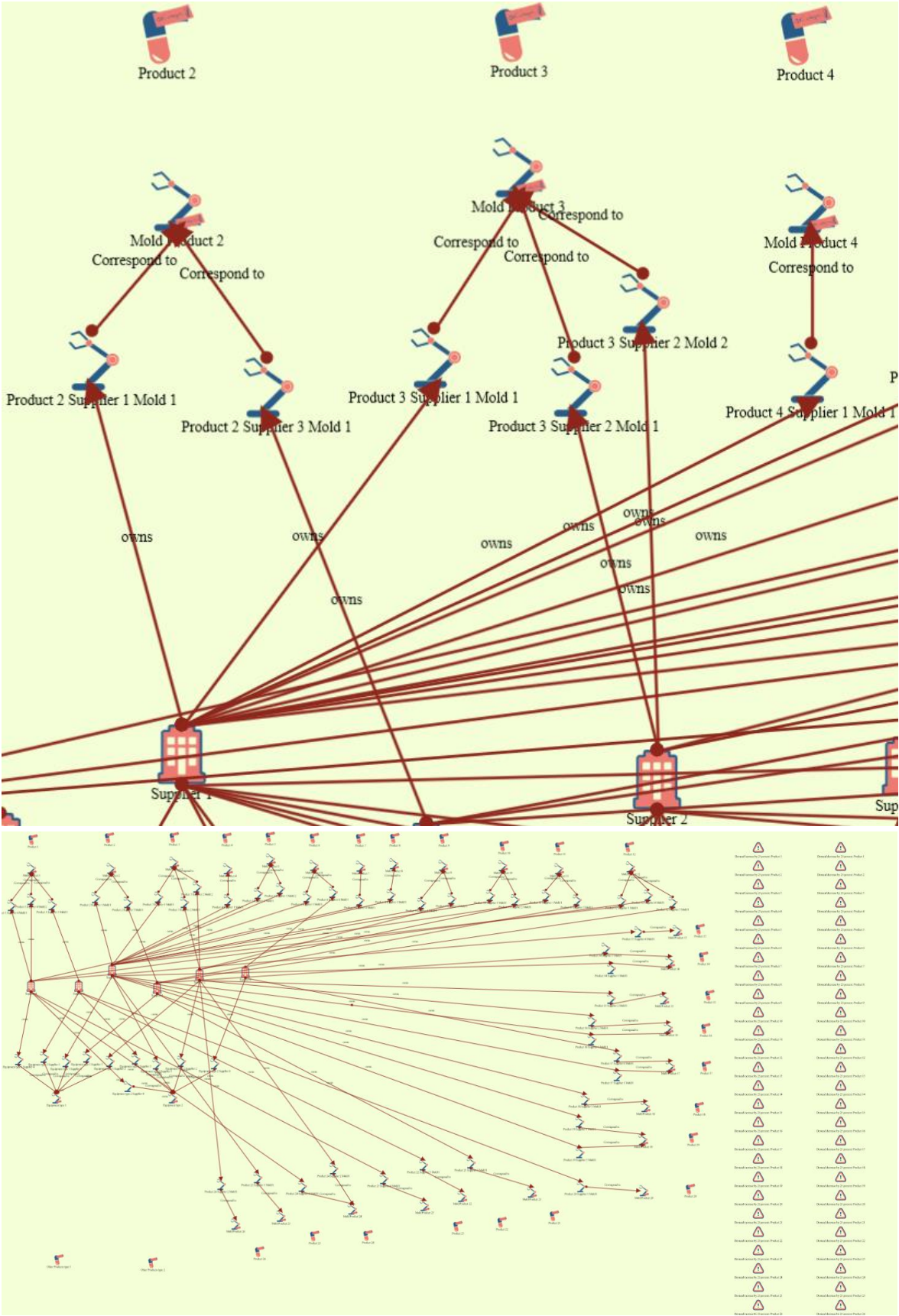

Figure 83: Two screenshots of the [RIO-SUITE](#) user interface containing the PFDC supply web model associated with the “organization and resources” projection plan. At the bottom, a view of the entire projected model. At the top, a view of a part of the projected model which has been enlarged to help users read it.

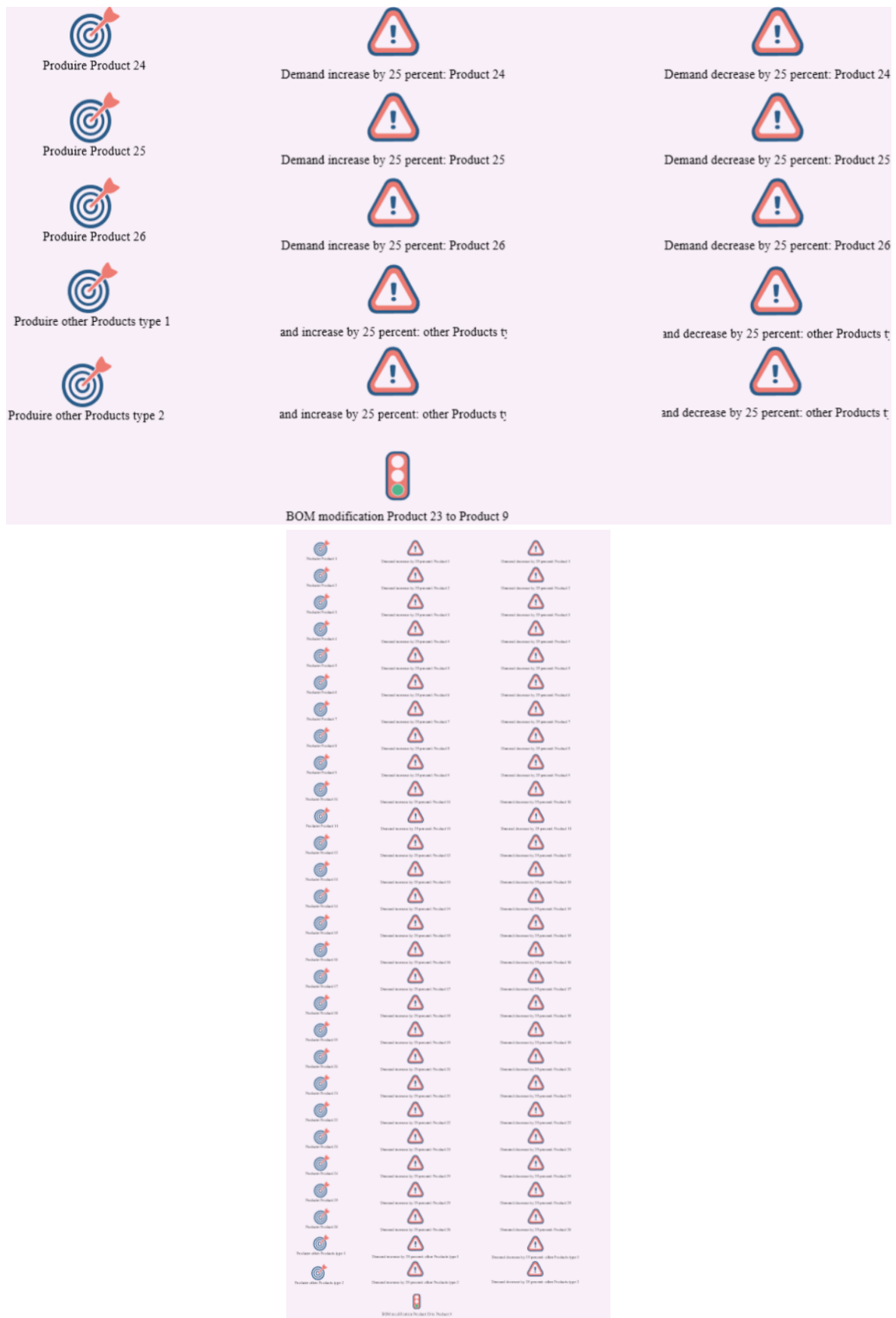

Figure 84: Two screenshots of the [RIO-SUITE](#) user interface containing the PFDC supply web model associated with the “demand forecasts” projection plan. At the bottom, a view of the entire projected model. At the top, a view of part of the projected model which has been enlarged to help users read it.

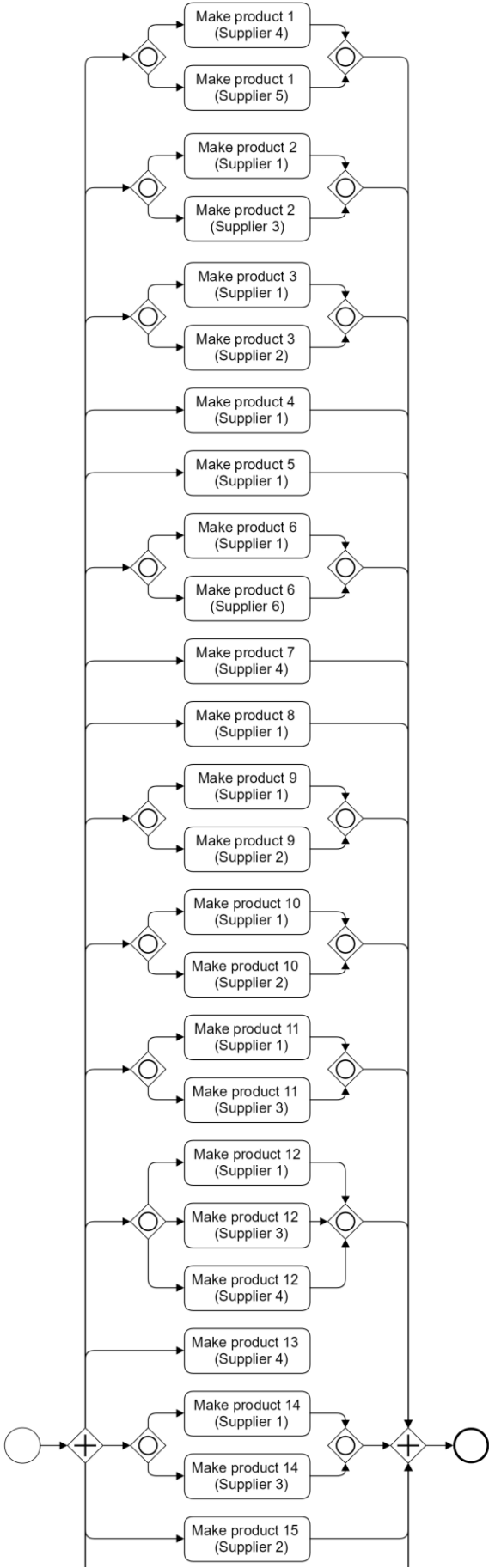

Figure 85: Illustration of the potential supply chain map created by the assessment model generator (1/2)

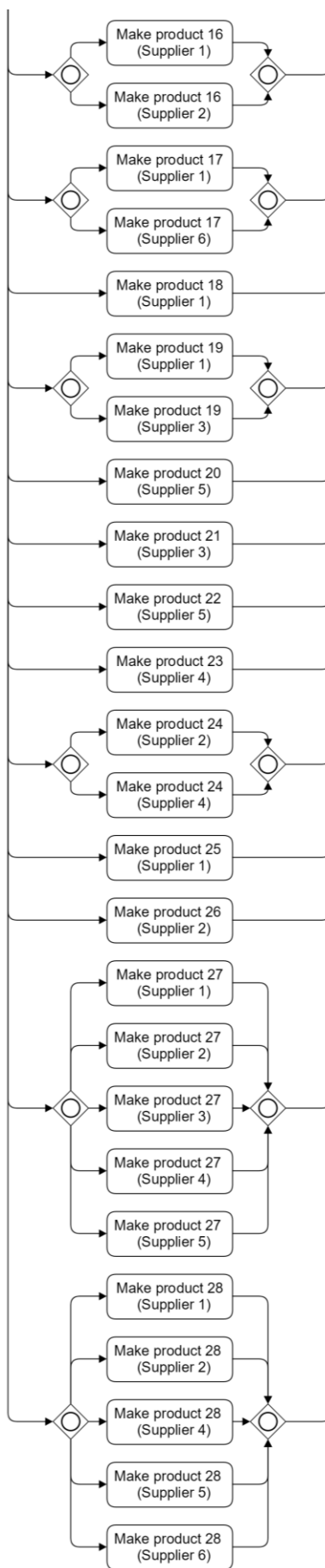

Figure 86: Illustration of the potential supply chain map created by the assessment model generator (2/2)

1.3.1.2.2. *Configure and run the “what-if scenario generator and assessor”*

The run of the “what-if scenario generator and assessor” requested additional user inputs (the what-if scenario configuration) as described in the third chapter (Figure 43). Table 31 shows the what-if scenario configuration (except for the sets of supply options) chosen for the PFDC pilot project. In accordance with the supply web model created, the chosen time granularity was a year with a time horizon of five years (from 2017 to 2021). The “threshold regarding the number of decision options to be considered simultaneously” and the “threshold regarding the number of uncertainty sources to be considered simultaneously” were set to one. Then, two sets of supply options were defined for each year. Sets were kept identical from one year to another. Table 32 illustrates the structure of these two sets of supply options. Readers can refer to the potential supply chain map given in Figure 85 and Figure 86 to understand the supply options by comparing the product associated with several suppliers and the OR Closing Gateway of the potential supply chain map. The given values do not represent reality for confidentiality reasons.

Table 31: What-if scenario configuration (except for the sets of supply options) chosen for the PFDC pilot project

What-if scenario configuration input	Value
Time granularity	Year
Time horizon	5 years (2017 to 2021)
Threshold regarding the number of decision options to be considered simultaneously	1
Threshold regarding the number of uncertainty sources to be considered simultaneously	1

Table 32: Structure of the two sets of supply options defined for the PFDC pilot project (given values do not represent reality for confidentiality reasons)

Year		2017/2018/2019/2020/2021		
Set of supply options		Set of supply options n°1	Set of supply options n°2	
Quota per product and supplier	Product 1	Supplier 4	0.5	1
		Supplier 5	0.5	0
	Product 2	Supplier 1	0.5	1
		Supplier 3	0.5	0
	Product 3	Supplier 1	0.5	1
		Supplier 2	0.5	0
	Product 4	Supplier 1	1	1
	Product 5	Supplier 1	1	1
	Product 6	Supplier 1	0.5	1
		Supplier 6	0.5	0
	Product 7	Supplier 4	1	1
	Product 8	Supplier 1	1	1
	Product 9	Supplier 1	0.5	1

Pierre Fabre Dermo-Cosmétique pilot project: supporting SCCP decisions associated with the network of suppliers of bottles of the company

	Supplier 2	0.5	0
Product 10	Supplier 1	0.5	1
	Supplier 2	0.5	0
Product 11	Supplier 1	0.5	1
	Supplier 3	0.5	0
Product 12	Supplier 1	0.4	1
	Supplier 3	0.4	0
	Supplier 4	0.2	0
Product 13	Supplier 4	1	1
Product 14	Supplier 1	0.5	1
	Supplier 3	0.5	0
Product 15	Supplier 2	1	1
Product 16	Supplier 1	0.5	1
	Supplier 2	0.5	0
Product 17	Supplier 1	0.5	1
	Supplier 6	0.5	0
Product 18	Supplier 1	1	1
Product 19	Supplier 1	0.5	1
	Supplier 3	0.5	0
Product 20	Supplier 5	1	1
Product 21	Supplier 3	1	1
Product 22	Supplier 5	1	1
Product 23	Supplier 4	1	1
Product 24	Supplier 2	0.5	1
	Supplier 4	0.5	0
Product 25	Supplier 1	1	1
Product 26	Supplier 2	1	1
Product 27	Supplier 1	0.2	0.5
	Supplier 2	0.2	0.5
	Supplier 3	0.2	0
	Supplier 4	0.2	0
	Supplier 5	0.2	0
Product 28	Supplier 1	0.2	0.5
	Supplier 2	0.2	0.5
	Supplier 4	0.2	0
	Supplier 5	0.2	0
	Supplier 6	0.2	0

Finally, the “what-if scenario generator and assessor” module was run with the what-if scenario configuration described in Table 31 and Table 32. It took less than 0.5 seconds for the software to provide the results on a laptop with a seventh-generation Intel Core i7 and 16 GB of RAM. The results were 1140 scenarios generated and assessed. These scenarios corresponded to the combination of 57 combinations of uncertainty sources, 2 combinations of decision options, 2 sets of supply options, and a time horizon of 5 years ($57 * 2 * 2 * 5 = 1140$). This resulted in the creation of the JSON file containing the what-if scenario assessment results that could be read by the BI software.

1.3.1.3. Analyze what-if scenario assessment results and prepare recommendations for the decision-making meeting

The BI software was used to display the dashboards defined during the implementation process and prepare recommendations for the decision-making meeting. Figure 87, Figure 88, Figure 89, Figure 90, and Figure 91 are screenshots of the resulting dashboards.

Figure 87 shows the changes of the saturation of equipment categories over the five years at the network level. The screenshot shows the what-if scenarios from 2017 to 2021 without uncertainty sources considered, without decision options considered, and with the set of supply options n°1. The dashboard helps to identify the following information which is added to the “list of equipment categories requiring actions” given in Table 33:

- The saturation of the type of mold “Mold product 8” would exceed 1 in 2019 if there was no action taken to prevent it.

Figure 88 shows the changes of the saturation of equipment categories over the five years at the supplier level. The screenshot shows the what-if scenarios from 2017 to 2021 without uncertainty sources considered, without decision options considered, and with the set of supply options n°1. No type of mold for which the saturation would exceed one is identified, in addition to the one already identified at the network level in Figure 87. The dashboard shows that only Supplier 1 will lack capacity associated with this type of mold.

Figure 89 shows the interval of saturation of equipment categories at the network level, considering the deterministic what-if scenario as well as what-if scenarios associated with the demand forecast uncertainty sources. The screenshot shows all the what-if scenarios for 2021 associated with the demand forecast uncertainty sources (and the scenario without), without decision option activated, and with the set of supply options n°1. The dashboard helps to identify the following information which is added to the “list of equipment categories requiring actions” given in Table 33:

- The type of mold “Mold product 2” would have its saturation exceeding 1 in 2020 if the scenario of +25% of the demand forecast for Product 2 turned out to be the reality.
- The type of mold “Mold product 5” would have its saturation exceeding 1 in 2019 if the scenario of +25% of the demand forecast for Product 5 turned out to be the reality.
- The type of mold “Mold product 8” would have its saturation exceeding 1 in 2017 if the scenario of +25% of the demand forecast for Product 8 turned out to be the reality.

Figure 90 shows the interval of saturation of equipment categories at the supplier level, considering the deterministic what-if scenario as well as what-if scenarios associated with the demand forecast uncertainty sources. The screenshot shows all the what-if scenarios for 2021 associated with the demand forecast uncertainty sources (and the scenario without), without the decision option activated, and with the set of supply options n°1. Additional points can be observed on the intervals of “equipment type 1” and “equipment type 2” because they correspond to the two types of technologies of the machines. And unlike molds which are dedicated to a type of bottle (i.e., product category), machines are used in the production of several product categories. Thus, from all the demand forecast uncertainty sources, there are only two (plus and minus 25%) which impact a type of mold, while all demand forecast

uncertainty sources impact either one or the other type of machines. The dashboard helps to identify the following information which is added to the “list of equipment categories requiring actions” given in Table 33:

- The type of machine “Equipment type 2” of Supplier 1 would have its saturation exceeding 1 in 2021 if the scenario of +25% of the demand forecast for Product 5 turned out to be the reality.
- The type of mold “Mold product 10” of Supplier 1 would have its saturation exceeding 1 in 2020 if the scenario of +25% of the demand forecast for Product 10 turned out to be the reality.

Figure 91 shows the breakdown criticality KPI of equipment categories for all types of molds at the network level (i.e., indicator of the revenue loss in case of breakdown of a piece of equipment in the considered equipment category). The screenshot shows the configuration of the network of suppliers without the decision option considered, with the set of supply options n°1, and for the year 2021. The dashboard helps to define the following three priority equipment categories to focus actions on for protecting the network of suppliers against potential mold breakdowns (three equipment categories at the top right part of the diagram on the left):

1. The type of mold “Mold product 22”.
2. The type of mold “Mold product 2”.
3. The type of mold “Mold product 7”.

Considering the identified weaknesses synthesized in Table 33, the first four dashboards were used to investigate SCC plan alternatives by displaying the resulting performance of considering the decision option and the set of supply options n°2. But this would not have been enough to overcome the weaknesses. Therefore, additional what-if scenarios corresponding to additional decision options and sets of supply options would be necessary. For example, new sets of supply options could be investigated to overcome weaknesses identified at the supplier level. However, for weaknesses identified at the network level, new sets of supply options would not be enough so new decision options would be required. The assessment of additional what-if scenarios would have required the process to return to the data gathering activity to gather additional decision options and sets of supply options. However, as this routine process was performed with data from 2016, it was decided not to return to the gathering part but to continue with the DMM which would be focused on the risk analysis leading to the identification of weaknesses and associated priorities in terms of types of actions to investigate. Therefore, the objective was to assess the benefits of the SCCP DSS proposal by comparing the weaknesses and associated set of actions to investigate with the actions that had actually been taken between 2016 and 2018.

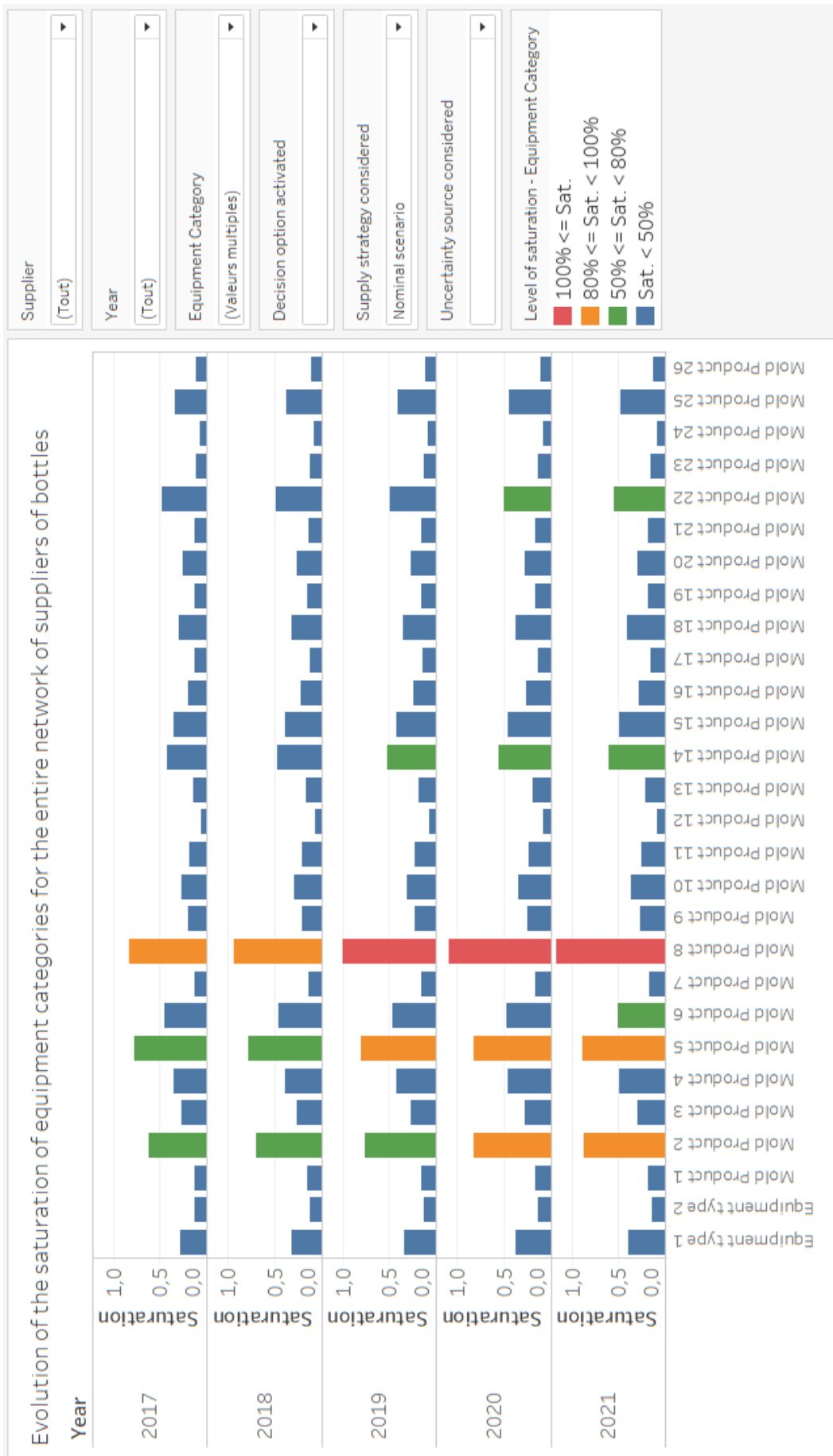

Figure 87: Changes in the saturation of equipment categories over the five years at the network level

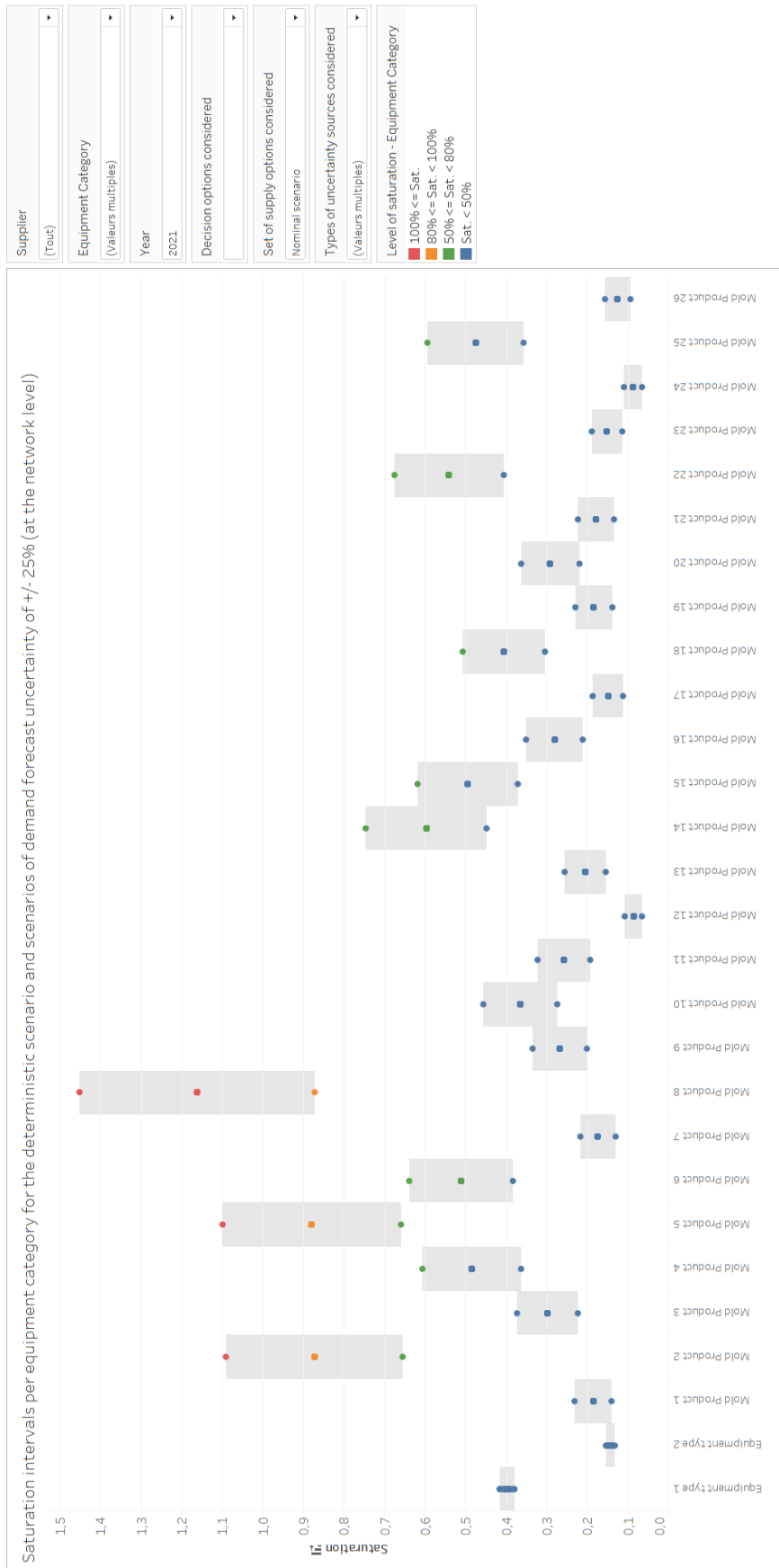

Figure 89: Interval of the saturation of equipment categories at the network level, considering the deterministic what-if scenario as well as what-if scenarios associated with the demand forecast uncertainty sources

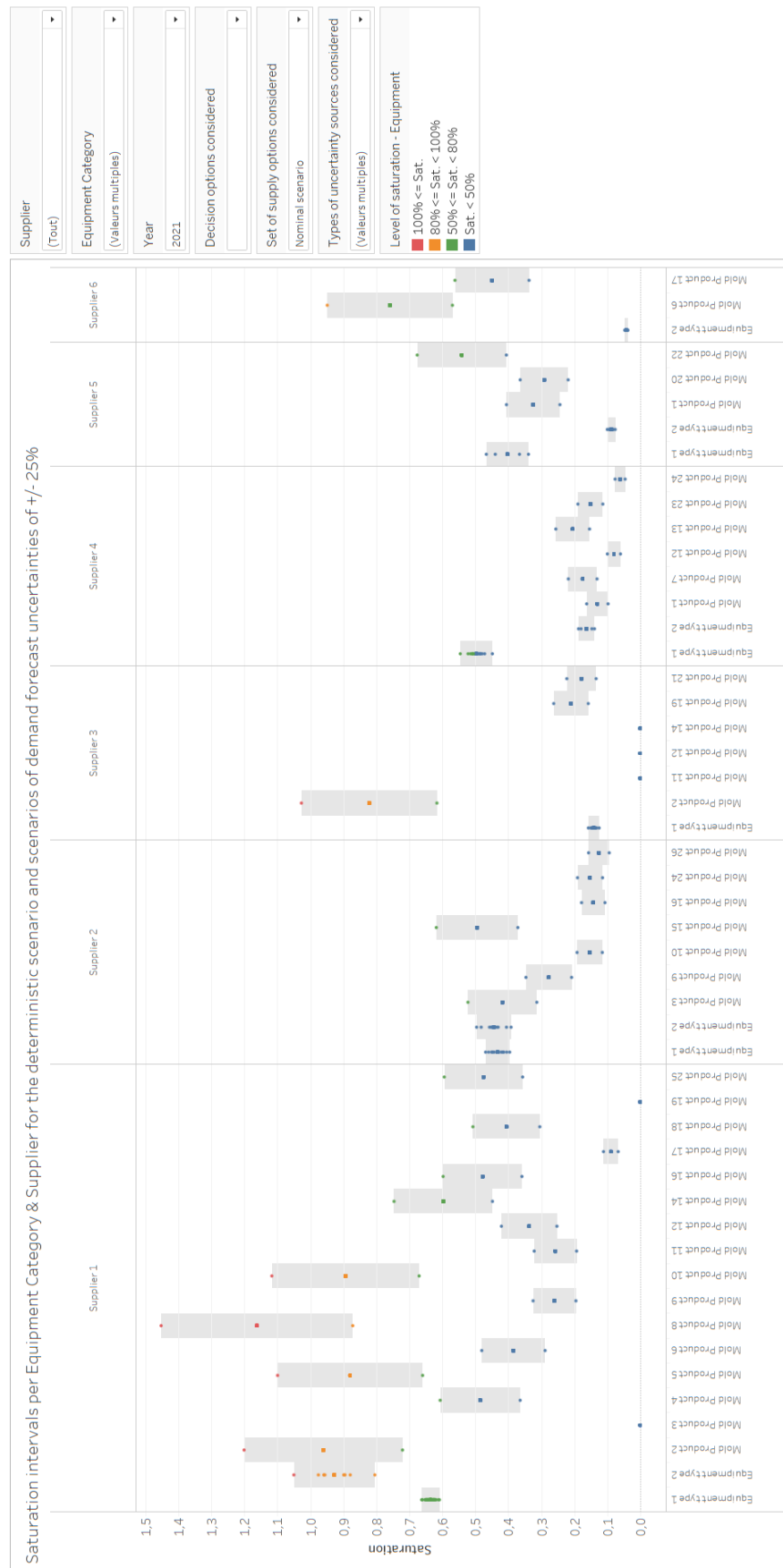

Figure 90: Interval of the saturation of equipment categories at the supplier level, considering the deterministic what-if scenario as well as what-if scenarios associated with the demand forecast uncertainty sources

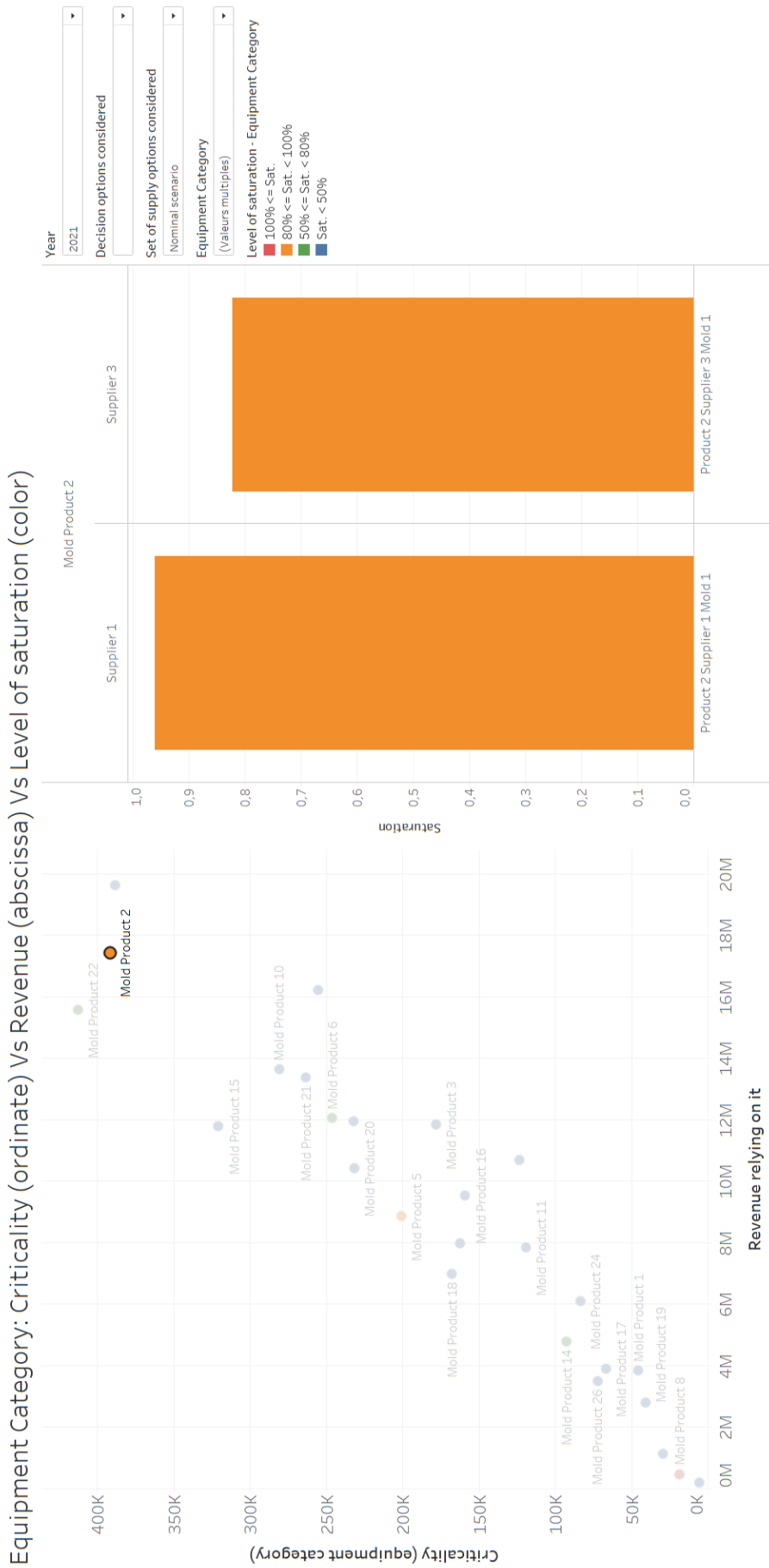

Figure 91: Breakdown criticality KPI of equipment categories for all types of molds at the network level

Table 33: List of equipment categories requiring actions identified from the deterministic and demand uncertainty what-if scenarios at the network and supplier levels

What-if scenarios considered	Aggregation		Equipment category	Year saturation goes over 1	Lack of capacity for the year saturation exceeds 1 (unit)	Missing capacity for the last year of the horizon (2021) (unit)
	Level	Entity				
Deterministic	Network	/	Mold product 8	2019	5k	519k
			Mold product 2	2020	133k	778k
	Network	/	Mold product 5	2019	17k	457k
			Mold product 8	2017	117k	1 451k
	Supplier	Supplier 1	Equipment type 2	2021	411k	411k
		Supplier 1	Mold product 10	2020	108k	313k

1.3.2. Decision-making meeting

After ending the preparation of the DMM, the DMM was undertaken at the end of 2018. The stakeholders defined in Table 29 participated in this DMM. During the DMM, the list of equipment categories requiring actions identified in Table 33 were compared with actions that had already been made between 2016 and 2018. In addition, the stakeholders identified additional actions that could have been performed to overcome the weaknesses if they had performed this SCCP DMP in 2016. Table 34 synthesizes the following information for each equipment category requiring actions identified in Table 33: first, actions that were already undertaken between 2016 and 2018 to overcome the corresponding weaknesses; second, additional actions that could have been performed to overcome the corresponding weaknesses as well as the expected outcomes of these actions. Finally, even though data were from 2016, some of the additional actions identified remained useful because they were associated with the years 2019, 2020 and 2021.

Table 34: Equipment category requiring actions identified in Table 17, actions that had already been taken, and additional actions that could have been performed to overcome the weakness

Equipment category requiring actions identified in Table 33	Actions already undertaken between 2016 and 2018 to overcome the weakness	Additional actions that could have been performed to overcome the weakness	
		Actions	Expected outcomes
Mold product 8		Investigate potential capacity investments.	Increase the capacity at the network level and reduce the breakdown criticality KPI.
		Investigate potential new suppliers.	Increase the capacity at the network level and reduce the breakdown criticality KPI.
Mold product 2		Investigate potential capacity investments.	Increase the capacity at the network level and reduce the breakdown criticality KPI.
		Investigate potential new suppliers.	Increase the capacity at the network level and reduce the breakdown criticality KPI.
Mold product 5		Investigate potential capacity investments.	Increase the capacity at the network level and reduce the breakdown criticality KPI.
		Investigate potential new suppliers.	Increase the capacity at the network level and reduce the breakdown criticality KPI.
Equipment type 2 at Supplier 1	Purchase of new machines of the category “equipment type 2” by Supplier 1	Investigate alternative sets of supply options.	Decrease the demand at “Supplier 1” for types of bottles requiring “equipment type 2” to be produced by increasing it for other suppliers.
		Investigate alternative technology choices for product packaging development.	Decrease the demand at network level for types of bottles requiring equipment type 2 to be produced by increasing the demand for types of bottles requiring equipment type 1.
Mold product 10 at Supplier 1		Investigate alternative sets of supply options.	Decrease the demand for “Product 10” at “Supplier 1” by increasing it for other suppliers.
		Investigate potential capacity investments.	Increase the capacity at Supplier 1 and reduce the breakdown criticality KPI at the network level.

1.4. Conclusions regarding the PFDC pilot project

Before starting the research project and associated pilot project, PFDC teams were wondering how to prepare for potential disruptions having an impact on the available or required capacity of its network of suppliers. No solution was available for easily identifying weaknesses and deciding on those to focus actions on. Therefore, the business objective of this pilot project was to find a solution for easily identifying weaknesses and prioritizing those to focus actions on. The creation of the SCCP DSS proposal described in the second, third, and fourth chapter had the objective of answering this business objective.

Taking advantage of this SCCP DSS proposal during this pilot project provided several benefits: first, it allowed the company to quickly assess its network of suppliers regarding the high number of uncertainty sources. It allowed PFDC to consider more what-if scenarios than they would have been able to without the contributions, increasing the number from tens to thousands. Second, an important benefit observed was that the automation of the creation of the assessment model allowed the company to add new structural elements (e.g., new suppliers, equipment, and products) at any time without worrying about the time it would take to update the assessment model. Third, it allowed PFDC's decision-makers to have dashboards supporting top-down decision-making reasoning (network, supplier, type of equipment, type of equipment at suppliers, and equipment). Fourth, it allowed PFDC to bring different departments closer to each other by unifying them around a common vision of the business. This was made possible by consolidating their respective information and interdependencies into a common model of the supply web and what-if scenario assessment results, and by displaying it.

Finally, performing the pilot project on two-year-old data resulted in the identification of several decisions that could have been made if the decision-making process had been in operation two years ago.

2. Pierre Fabre Médicament pilot project: supporting SCCP decisions associated with the internal production capabilities of the company

2.1. Context

Pierre Fabre Médicament (PFM) specializes in producing medicines. A capacity management team is responsible for ensuring that the company has the right level of capacity for meeting demand in the following years. To do this, the team has divided the product portfolio into families of products having similar production characteristics (routing). The team had defined a routine of assessing the production capacity for one or two families per month. Thus, each year, each family was assessed once. This routine was established because it was taking days or even weeks to perform the analysis for one family. In addition, the team was able to consider only a small set of what-if scenarios and associated KPIs. Therefore, to evaluate the benefits the contributions could bring, PFM decided to focus their first pilot project on supporting the capacity management team in performing the internal production capacity analysis. Unlike the PFDC pilot project, which focused on uncertainty sources associated with the external part of their supply chains (its network of suppliers of bottles), the PFM pilot project focused on decision options associated with their internal production capabilities. To avoid repetition, this section on the PFM pilot project will not provide as much detail as in the first section for the PFDC pilot project.

This pilot project was overseen by four people. The two people from the PFM company were the director of the global supply department as well as the director of the demand department. The two people from the research center on industrial engineering of IMT Mines Albi were Raphaël Oger (author of this thesis) and Matthieu Lauras (PhD advisor to Raphaël Oger and the chair of the academic-industrial partnership with the Pierre Fabre group).

2.2. Implementation process

2.2.1. Define decision-making meeting: KPIs, types of decision options and uncertainty sources, and dashboards

The focus was on being able to assess decision options associated with all the production lines of the company and with the entire portfolio of products, regarding their impact on the saturation of the production lines. Table 35 shows the two KPIs, one type of decision options, and one type of uncertainty sources that were defined to do this.

Table 36 describes the two main dashboards that were defined for the PFM pilot project by giving the following information: dashboard objectives, aggregation levels, KPIs, and expected outcomes. Readers can refer to Figure 92 and Figure 93, which are screenshots of the resulting dashboards.

Table 35: KPIs, types of decision options, and types of uncertainty sources that were defined for the PFM pilot project

Type of element to define	Element chosen for the PFM pilot project
Key Performance Indicators	<ol style="list-style-type: none"> Utilization time required per production line (i.e., equipment) per product brand (i.e., product category). Saturation per production line (i.e., equipment).
Type of decision options	<ol style="list-style-type: none"> Setting the number of working shifts.
Type of uncertainty sources	<ol style="list-style-type: none"> Demand forecast uncertainty associated with the effective demand for one of the product brands for which a new sales contract in a new country was signed.

Table 36: Dashboards that were defined for the PFM pilot project

Dashboard objective	Aggregation level	KPIs	Expected outcomes
Visualize the saturation of equipment & Understand which product brands are responsible for it	Equipment	<ol style="list-style-type: none"> Saturation per piece of equipment Load per piece of equipment per product brand 	<ol style="list-style-type: none"> Identify equipment that would need the activation of decision options to either increase its available capacity or decrease the capacity requirements. Identify potential opportunities for decreasing the capacity requirements by identifying product brands responsible for it.
Compare the saturation of equipment for what-if scenarios two by two	Equipment	<ol style="list-style-type: none"> Saturation per piece of equipment 	<ol style="list-style-type: none"> Identify decision options that would help to obtain a satisfying level of saturation.

2.2.2. Define data: scope and granularity

Concerning the data to provide as input of the computational software, Table 37 describes the choices made in terms of scope and granularity of these data.

Table 37: Choices made in terms of scope and granularity of the data to provide as input of the computational software for the PFM pilot project

Characteristic	Dimension	Choice for the PFM pilot project
Scope	Product portfolio	Entire PFM product portfolio except products associated with one market segment
	Supply chain	All PFM equipment with the exception of one production unit
Granularity	Product portfolio	Aggregation of product references per product brand, per factory, per production unit, per production line (e.g., a product category in the supply web model will correspond to a set of product references (semi-finished or finished) that are produced on a certain production line of a certain factory and that are associated with a certain product brand)
	Supply chain	Level of detail of the production lines (i.e., production lines will be the equipment in the supply web model)

2.2.3. Define stakeholders: information providers, decision-makers, and SCCP managers

Concerning the stakeholders to involve in the SCCP DMP, information providers were defined to provide the required information. The decision-makers defined for this first pilot project were the two people from the PFM company in charge of overseeing this pilot project: the director of the global supply department as well as the director of the demand department. The SCCP manager defined for this first pilot project was the author of this thesis: Raphaël Oger. Table 38 synthesizes the defined stakeholders.

Table 38: SCCP DMP stakeholders defined for the PFM pilot project

Stakeholder category	Stakeholders
Information providers	Demand management team providing demand forecasts.
	Capacity management team providing the following information about production lines: name, the factory each line belongs to, available capacity, and production rate per product category (considering the granularity defined in Table 37).
Decision-makers	The two people from the PFM company in charge of overseeing this pilot project: the director of the global supply department as well as the director of the demand department.
SCCP managers	The author of this thesis: Raphaël Oger.

2.3. Routine process

2.3.1. Decision-making meeting preparation

2.3.1.1. Gather data and run the computational software

To prepare the Decision-Making Meeting (DMM), data was gathered by performing the following steps:

1. The demand management team provided demand forecasts over 4 years (from 2019 to 2022) at the lowest level of detail (product reference) to the capacity management team.
2. The capacity management team used this demand forecast to run their SAP planning module that generated the deterministic planning over the 4-year horizon.
3. The capacity management team extracted the following information from SAP (as Excel files): the previously created deterministic plan the equipment with associated available time, and production rates associated with the product categories as defined in Table 37 (aggregation of product references per product brand, per factory, per production unit, and per production line).
4. The Excel files were used as input to run the computational software as illustrated in Figure 37. Table 39 synthesizes the composition of the resulting supply web model. In addition, the what-if scenario configuration described in Table 40 was provided. No set of supply options was provided because the assessment model did not require supply decisions (i.e., the potential supply chain map does not contain an OR Closing Gateway).

Table 39: Synthesis of the instances of nodes within the supply web model of the PFM pilot project

Supply web metamodel node	Number of instances of the node	Additional information about the nodes
Product category	392	Corresponds to 392 sets of product references (semi-finished or finished) that are produced on a certain production line of a certain factory and that are associated with a certain product brand. The sets of product references are associated with 103 product brands, 4 factories, and 134 production lines.
Organization	4	Corresponds to 4 factories.
Equipment category	134	Corresponds to 134 types of production lines associated with the 134 production lines.
Equipment	134	Corresponds to 134 production lines.
Ability	392	Corresponds to 392 production abilities associated with the 392 product categories.
Demand forecast	392	Corresponds to 392 demand forecasts associated with the 392 product categories.

Decision option	3	Corresponds to three different production shift configurations (3 shifts from Monday to Friday, 3 shifts from Monday to Saturday, 3 shifts from Monday to Sunday). Remark: the nominal scenario was set to 2 shifts from Monday to Friday.
Uncertainty source	2	Corresponds to two alternatives for the demand forecasts associated with one of the product brands for which a new sales contract in a new country was signed (+10% and +20% from the nominal demand forecast).

Table 40: What-if scenario configuration (except for the sets of supply options) chosen for the PFM pilot project

What-if scenario configuration input	Value
Time granularity	Year
Time horizon	4 years (2019 to 2022)
Threshold regarding the number of decision options to be considered simultaneously	1
Threshold regarding the number of uncertainty sources to be considered simultaneously	1

2.3.1.2. Analyze what-if scenario assessment results and prepare recommendations for the decision-making meeting

As for the PFDC pilot project, the BI software called Tableau® (Tableau Software 2019) was used to create and display the dashboards defined during the implementation process and to prepare recommendations for the DMM. Figure 92 and Figure 93 are screenshots of the resulting dashboards. Figure 92 corresponds to the screenshot of the dashboard designed to help visualize the saturation of equipment (i.e., production lines) and to understand which product brands were responsible for it. Figure 93 corresponds to the screenshot of the dashboard designed to help compare the saturation of equipment (i.e., production lines) for what-if scenarios two by two. For this pilot project, rather than preparing the recommendation for a new SCCP DMM, these dashboards were developed to support the DMM of the existing capacity planning process, along with the traditional decision-support material. These dashboards were used for the capacity review of one product family. The observations are given in the conclusion.

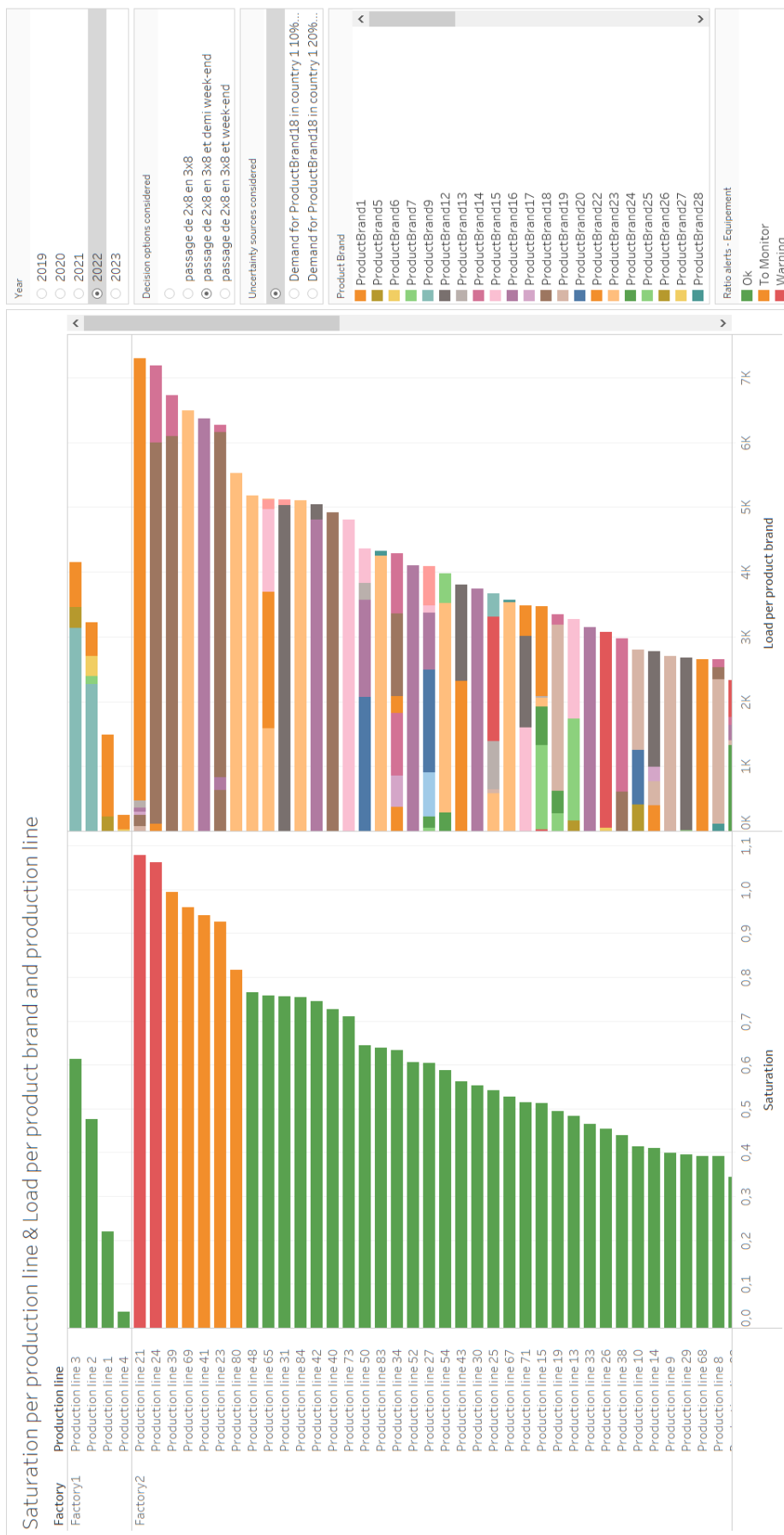

Figure 92: Screenshot of the dashboard designed to help visualize the saturation of equipment (i.e., production lines) and understand which product brands are responsible for this saturation.

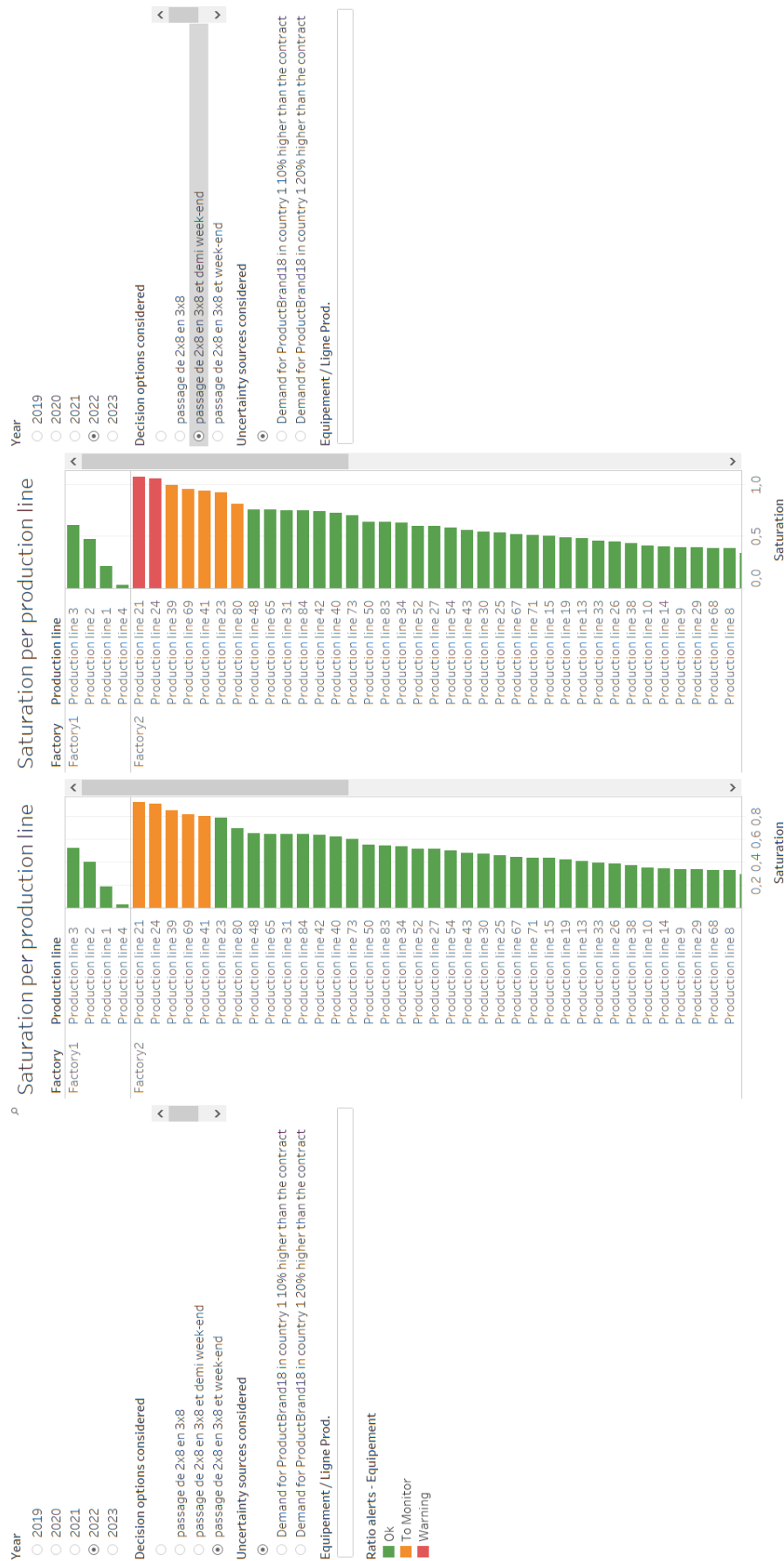

Figure 93: Screenshot of the dashboard designed to help compare the saturation of equipment (i.e., production lines) for what-if scenarios two by two.

2.4. Conclusions regarding the PFM pilot project

Before starting the research project and associated pilot project, PFM teams were dealing with a serious issue regarding their capacity planning process: it took the team too much time to perform the analysis to assess all the necessary what-if scenarios. Tasks such as the following were very time consuming: gathering information, creating the assessment models and assessing them, and preparing the what-if scenario assessment results. Therefore, the business objective of this pilot project was to find a solution for quickly assessing the what-if scenarios allowing the company to assess the decision options associated with the capacity of PFM's internal production capabilities. The creation of the SCCP DSS proposal described in the second, third, and fourth chapters had the objective of responding to this business challenge.

Taking advantage of this SCCP DSS proposal during this pilot project demonstrated several benefits for PFM: first, the time taken by the last two tasks mentioned (“create the what-if scenario assessment models and assess them” and “prepare the what-if scenario assessment results”) was drastically reduced, from days to minutes. Figure 94 illustrates the benefits of the contributions of this thesis brought in terms of time saving associated with PFM's capacity planning process when performing the analysis to assess what-if scenarios. The proportions in the figure should only be considered to qualitatively understand where the time savings are and should not be considered as quantitatively representing the time savings. Second, this time saving allowed people to focus more on analyzing the what-if scenario assessment results. Without the contribution, people spent most of their time on assessing what-if scenarios, while with the contribution they could now focus more on analyzing the what-if scenario assessment results. Consequently, this helped the company to qualitatively improve its SCCP analysis by considering additional what-if scenarios and KPIs.

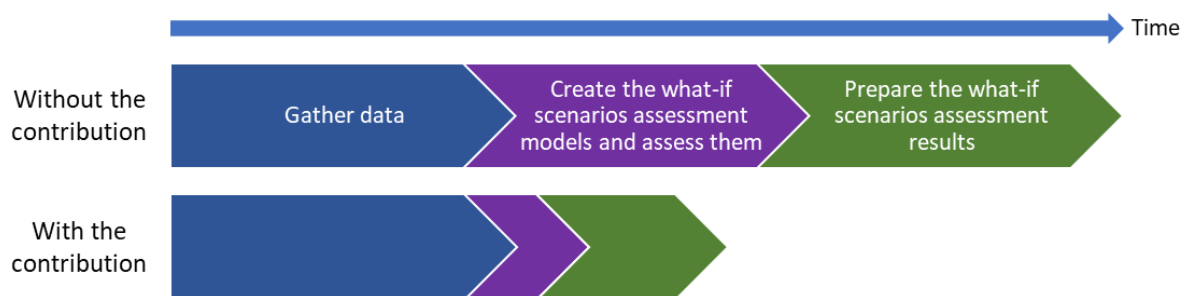

Figure 94: Illustration of the benefits of the contributions of this thesis in terms of time saving associated with PFM's capacity planning process when performing the analysis to assess what-if scenarios (proportions of this figure should be considered qualitatively and not quantitatively).

Finally, as mentioned by Saenz and Cottrill (2019), building trust in information technologies is a critical success factor of their implementation. Therefore, the dashboards resulting from the SCCP DSS were used in parallel to PFM's traditional approach during the capacity review of a product family. This demonstrated the validity of the results obtained from the SCCP DSS by comparing them with several what-if scenarios assessed with their traditional approach. The SCCP DSS even helps to provide further information because people can spend more time for a deeper analysis of the results.

CHAPTER VI. CONCLUSION AND AVENUES FOR FUTURE RESEARCH

“The future depends on what you do today.”

Mahatma Gandhi

This chapter concludes this thesis and suggests avenues for future research.

1. Conclusion

1.1. Industrial context

The Decision Support System (DSS) to define the plan of all the actions that shape the capacity availability and requirements of supply chains is called the Supply Chain Capacity Planning (SCCP) DSS in this thesis. In this thesis a DSS was defined as the combination of the following elements: a purpose, a Decision-Making Process (DMP), an Information System (IS), and people. This SCCP DSS is composed of an SCCP DMP and an SCCP IS. The industrial objective of this thesis was to make the SCCP DMP as fast and as easy as possible so that companies could assess their Supply Chain Capacity (SCC) plan more frequently regarding as many potential futures as possible. It is especially focused on long-term decisions.

This objective, combined with characteristics of the supply chain environment, led to several conclusions regarding expectations associated with the SCCP DSS. First, the supply chains are associated with a multitude of decision options as well as a multitude of uncertainty sources. This implies a multitude of potential futures that should be considered when making long-term SCCP decisions. This conclusion led to the first two industrial questions of this thesis:

1. “How to consider the multitude of uncertainty sources when assessing and comparing supply chain capacity plans, and deciding on the one to implement?” (IQ1).
2. “How to consider the multitude of decision options when assessing and comparing supply chain capacity plans, and deciding on the one to implement?” (IQ2).

Second, supply chains and their environments are very dynamic, which implies a need for frequent updates of the analysis to verify the validity of the decisions made. This conclusion led to the third industrial question of this thesis:

3. “How to make the SCCP process fast and easy enough to become a routine allowing companies to keep up with the dynamicity of the supply chain environment?” (IQ3).

1.2. Literature reviews, research questions, and contributions

To answer these industrial questions, a literature review on existing DSSs to perform SCCP was undertaken. The following DMPs were investigated: Sales and Operations Planning (S&OP), Integrated Business Planning (IBP), Adaptive Sales and Operations Planning (AS&OP), and Collaborative Planning, Forecast and Replenishment (CPFR). And the following ISs were investigated: Enterprise Resource Planning (ERP), Advanced Planning Systems (APS), and spreadsheets.

Three major limitations emerged from the literature review on existing DSSs for SCCP. The first two limitations are associated with the observation that existing DSSs are very time-consuming: first, only a small number of what-if scenarios can be considered, which is far from the expectation of being able to consider the multitude of potential futures. Second, companies face difficulties keeping analyses up to date with the state of the supply chains and their environments. The third limitation is the lack of understanding and confidence decision-makers have regarding optimization methods providing a unique solution out of a black box.

The first research question was formulated based on the industrial questions and the limitations of existing DSSs for SCCP identified during the literature review:

1. “What would be the functional features of an SCCP decision support system able to manage decision options, uncertainty sources, dynamicity, and visibility requirements of current supply chains?” (RQ1).

The SCCP conceptual framework described in the second chapter was proposed to structure the key principles of an SCCP DSS that would answer RQ1. It corresponds to the first contribution of this thesis (C1) and aims to serve as a guideline for designing an SCCP DSS that answers RQ1. However, it does not answer how such a DSS could be implemented in practice. Therefore, the following two additional research questions were formulated based on the key principle of C1, which is to automate part of the decision-making process to make it easier and faster:

2. “How to make possible the goal of automation introduced in the SCCP conceptual framework?” (RQ2).
3. “How to organize an SCCP decision-making process complying with the SCCP conceptual framework principles by taking advantage of the SCCP information system proposal?” (RQ3).

Regarding RQ2, the computational software described in the third chapter was proposed to answer it. It corresponds to the second contribution of this thesis (C2) and it is the first component of the SCCP IS proposal. Regarding RQ3, the SCCP DMP described in the third chapter was proposed to answer it. It corresponds to the third contribution of this thesis (C3). Finally, the following characteristics of the SCCP DSS proposal explain how it answers the IQs and RQs:

- The SCCP DSS proposal provides a partially automated approach, based on model-driven engineering principles, which is faster than those identified in the literature. This first characteristic corresponds to the answer the SCCP DSS proposal provides for IQ3, the dynamicity aspect of RQ1, and RQ2.
- The SCCP DSS proposal provides an approach that is compatible with all uncertainty sources and decision options (i.e., all what-if scenarios). This second characteristic, associated with the first one, corresponds to the answer the SCCP DSS proposal provides for IQ1, IQ2, and the decision option and uncertainty source aspects of RQ1.
- The SCCP DSS proposal provides companies with a structured SCCP DMP composed of two subprocesses (Figure 57): first, an implementation process to guide companies when setting up the SCCP DMP. Second, a routine process to guide companies performing the SCCP DMP routine. This third characteristic corresponds to the answer the SCCP DSS proposal provides for RQ3.
- The SCCP DSS proposal provides decision-makers with an approach for guiding them when making decisions by using BI software which provides the visibility needed to understand the what-if scenario results resulting from the computational software. This fourth characteristic corresponds to the answer the SCCP DSS proposal provides for the visibility aspect of RQ1.

1.3. Contribution validation

This thesis is part of an academic-industrial partnership called *Chaire Mines Albi Supply Chain Agile avec Pierre Fabre* supported by the Pierre Fabre group. This partnership involves the two main companies of the Pierre Fabre group: Pierre Fabre Dermo-Cosmétique (PFDC) and Pierre Fabre Médicament (PFM). Two industrial experiments (i.e., pilot projects) were respectively undertaken with them to validate the contributions.

The PFDC pilot project was designed to validate the applicability of the contributions to the external part of the supply chains of the company performing the SCCP DSS proposal. It was focused on one product family: the bottle family containing all products having a bottle in their bill of materials. PFDC's objective was to assess the capacity of its network of suppliers of bottles to supply the right quantity of bottles, thus allowing PFDC to produce the products of the bottle family for the next 5 years. Regarding potential futures to consider, the focus was on uncertainty sources more than on decision options. The goal was to assess the current Supply Chain Capacity (SCC) plan regarding the uncertainties to identify weaknesses in the network of suppliers and prioritize decision options to investigate. The PFDC pilot project resulted in the following conclusions:

- It allowed PFDC to consider more what-if scenarios that they would have been able to without the contributions, increasing the number from tens to thousands.
- It allowed PFDC to add a new structural element into the scope of the analysis (e.g., new suppliers, equipment, and products) at any time without worrying about the time it would take to update the assessment model.
- It allowed PFDC's decision-makers to have dashboards supporting top-down decision-making reasoning (network, supplier, type of equipment, type of equipment at suppliers, equipment).
- It allowed PFDC to bring different departments closer to each other by unifying them around a common vision and an understanding of the potential futures of the company. This was made possible by the consolidation of their respective information and interdependencies into a common model of the supply web and what-if scenario assessment results, and by displaying these what-if scenario assessment results.

The PFM pilot project was designed to validate the applicability of the contributions to the internal part of the supply chains of companies that would be interested in taking advantage of the SCCP DSS proposal. It included almost the entire portfolio of products and almost the entire set of production lines. PFM's objective was to assess the capacity of its internal production capabilities for the next 4 years. Regarding potential futures to consider, the focus was on assessing different SCC plan alternatives regarding shift configuration, and on assessing uncertainty sources regarding a new sales contract. The PFM pilot project resulted in the following conclusions:

- First, it allowed PFM to save significant amounts of time regarding the assessment of what-if scenarios by decreasing the time needed from days to minutes.
- Second, it allowed people to focus more on analyzing the what-if scenario assessment results. Without the contribution, people spent most of their time assessing what-if

scenarios, while with the contribution, they were able to focus more on analyzing the what-if scenario assessment results.

Finally, these two pilot projects demonstrated that the contributions effectively answered the industrial and research questions as mentioned in the previous subsection. First, they made it possible to perform SCCP analysis encompassing a multitude of decision options and uncertainty sources at a pace allowing updates to remain in step with the pace of supply chain changes. Second, they provided decision-makers with the visibility and understanding of the impacts of their respective decisions and uncertainty sources which bolstered their confidence in the decisions they were able to make. In addition, the validity of SCCP analysis was confirmed for both the internal and external parts of the supply chains of the company performing the SCCP analysis.

2. Avenues for future research

Even though the contribution of this thesis was confirmed as being beneficial for companies in performing long-term SCCP, there are several limitations and associated avenues for future research. The following subsections describe the major avenues for future research.

2.1. Consolidate the validation of the contributions

The contributions were designed to be usable for any type of supply web and associated supply chains. Up until now they have been successfully applied to two industrial use cases from pharmaceutical and dermo-cosmetic companies as well as one fictive use case. It would be interesting to assess the contributions with additional use cases from different business sectors. In addition, the dermo-cosmetic company use case was focused on its network of first-tier suppliers, while the pharmaceutical company use case was focused on its internal production capabilities. These use cases helped to validate the validity of the contributions for both internal and external visions of the supply chain capabilities. However, no industrial use cases containing both internal and external visions of the supply chain capabilities were undertaken. Therefore, it would be relevant to assess the contributions on this type of use case to consolidate the validation of the contributions.

2.2. Enhance the SCCP information system proposal

2.2.1. Assist companies in identifying the decision options to investigate

The SCCP IS proposed in this thesis used decision options provided by the users to deduce the potential supply chain map and generate the list of what-if scenarios to assess. This means that companies must identify beforehand all their existing decision options (and possibly other potential ones that could be investigated) so that they can be considered. However, it takes time for companies to investigate decision options they could take advantage of; and thus, they might decide to focus only on the most obvious ones. Therefore, it would be beneficial for companies if the SCCP IS was able to suggest types of decision options to investigate based on the performance improvements they would bring if they actually existed. This would be helpful for companies in deciding on where to focus their decision option investigation efforts. This could be done by designing an algorithm that automatically investigated the performance improvements that would bring different types of decision options that were not already part of the supply web model.

2.2.2. Assist companies in configuring the list of what-if scenarios to assess

The SCCP IS proposed in this thesis used basic filtering rules based on two parameters provided by users: “threshold regarding the number of decision options to be considered simultaneously” and “threshold regarding the number of uncertainty sources to be considered simultaneously”. Depending on the values chosen for these parameters and the size of the use case, the number of resulting what-if scenarios could be very high (from tens to billions). However, it would take too long for the SCCP IS to compute billions of what-if scenarios, so users must adapt the parameters considering this limitation. In addition, this filtering behavior does not guarantee the assessment of the most relevant what-if scenarios, as it is entirely configured by user inputs. Therefore, it would be interesting to improve this filtering behavior to guarantee the assessment

of the most relevant what-if scenarios. Two ideas for solutions that might make it possible to reach this objective have emerged: first, by designing an algorithm that dynamically updates the list of what-if scenarios to assess while assessing what-if scenarios. Second, by designing an algorithm that mathematically identifies the relevant what-if scenarios by analyzing the formulas of the assessment model and the impacts the decision options and uncertainty sources have on these formulas.

2.2.3. Automatically provide recommendations

The SCCP IS proposed in this thesis provides performance results for each assessed what-if scenario. However, it does not provide recommendations that would guide decision-makers towards the best supply chain capacity plan alternatives they could choose to implement. The design of this feature was left to people by using the Business Intelligence (BI) software. To go further in supporting companies making SCCP decisions, it would be relevant to complement the SCCP IS with recommendation features. A solution could be to include optimization features in the assessment model. This would help companies take advantage of the visibility improvement provided by the current proposal and take advantage of the optimization principles to provide a set of recommendations that could be compared to each other.

2.2.4. Overcome the short lead-time assumption

The “assessment model generator” module of the SCCP IS proposed in this thesis is based on the assumption that the lead-time between the beginning of the first activities of the potential supply chain map and end of the last ones is much shorter than the considered period (section 2.3.3 page 83). This was considered to be an acceptable assumption because of the combination of the following two observations: first, a common time granularity considered when making long-term SCCP decisions is a year, and second, many industries have supply chain lead times much shorter than a year. However, this assumption is not valid for some companies. In addition, despite the long-term vision, companies might want to have a more detailed vision than a yearly time granularity (e.g., quarterly or monthly). Therefore, it would be relevant to find a solution for overcoming this assumption so that companies with longer lead-times can also take advantage of the SCCP DSS proposal. In this case, KPIs associated with stocks should systematically be added to the proposal because the impacts of stock on the SCCP decisions would not be negligible. This would require updating the KPI formula deduction algorithm proposed in this thesis.

2.3. Enhance the SCCP decision-making process proposal

2.3.1. Enhance the implementation process guidelines

The SCCP DMP proposed in this thesis provides several guidelines for implementing the SCCP routine. However, a set of complementary guidelines that could increase the chance of successful implementations of the SCCP DMP was identified: first, by providing recommendations for the choice of the right SCCP DMP stakeholders. This could consist in identifying factors that ensure DMP success associated with each role, such as skills and mindsets. Second, by providing recommendations for choosing pilot projects for the SCCP DMP implementation. This could consist in identifying characteristics of product families and

production units, as well as other elements defining the scope of the SCCP DMP, that would have the highest probability of leading to successful pilot projects. Third, by providing one or more generic decision-making meeting structures that companies could use as sources of inspiration. This could consist in providing generic decision-making reasoning with the associated types of dashboards.

2.3.2. Complement the SCCP DMP with maturity assessment guidelines

The SCCP DMP proposed in this thesis provides guidelines for performing the SCCP routine. The proposed SCCP routine process contains a feedback loop so that the company can choose whether it wants to perform a new iteration of the implementation process (to improve the SCCP routine). However, the SCCP DMP proposal does not provide guidelines for assessing the SCCP routine performance. This type of guideline could help companies to choose whether to perform a new iteration of the implementation process. Therefore, it would be relevant to design an SCCP routine maturity assessment model guiding companies in the evaluation of the performance of their SCCP routine.

2.3.3. Extend the SCCP DMP proposal to a multi-company collaborative SCCP DMP

Even though the SCCP DMP proposal is based on gathering information from several organizations constituting a supply web, it does not contain any guidelines for making collaborative decisions involving several companies. Extending the SCCP DMP proposal to a multi-company collaborative SCCP DMP could be an interesting avenue for future research to ensure that decisions are beneficial to the supply chain as a whole rather than focusing on the performance of only some echelons of the supply chain. Even if the SCCP DMP takes all the echelons of a supply chain into account, if each company has its own SCCP DMP involving only the company making its own decisions, decisions would probably focus only on the performance of this particular company. This situation might end up being less beneficial because decision options from one company would be uncertainty sources for other companies. However, with a multi-company SCCP DMP, decision options of a company would remain decision options for all companies, and thus the number of uncertainty sources due to a lack of visibility over the decision options of other companies would be reduced.

To design a multi-company collaborative SCCP DMP, some parts of the SCCP DMP proposal would probably need to be rethought while others might not need many adaptations. Regarding the implementation process, major adaptations would probably be required in the “define decision-making meeting” and “define stakeholders” subprocesses, while the “define data” subprocess would probably remain very similar. Regarding the routine process, activities associated with the use of the computational software would probably remain very similar while other activities associated with the data preparation, and especially the decision-making meeting, would probably need major adaptations because of the multi-company collaboration requirements. In addition, the three types of stakeholders (information providers, SCCP managers, and decision-makers) included in the SCCP DMP proposal could be updated to include additional ones. The objective would be to make sure that the role of each stakeholder of the decision-making process can be described with its own specificities and interactions.

2.3.4. Connect long-term SCCP to mid- and short-term SCCP

The SCCP DSS introduced in this thesis is focused on long-term SCCP, and so is the associated SCCP DMP. It does not provide guidelines to connect this long-term SCCP DMP with the planning processes dedicated to other planning horizons (e.g. short-term and mid-term). However, these interactions between planning processes are necessary because they should feed each other in terms of information. For example, information such as the following should be shared: decisions that have been made by one and have an impact on another one. Therefore, a framework encompassing the different planning horizons (e.g. short-term, mid-term, and long-term) and associated processes should be designed to guide companies towards an integrated set of planning processes. This framework should enable companies to organize their planning processes by clearly defining the types of decisions to make, assessment models, as well as the information inputs and stakeholders associated with each planning process.

2.4. Towards a hyperconnected SCCP DSS

Finally, the combination of the automation features proposed in this thesis with the increasing hyperconnectivity of our world opens promising opportunities. In a hyperconnected environment such as the one described by Montreuil et al. (Montreuil 2011, 2015, Montreuil et al. 2013), supply web information could be gathered automatically and thus all SCCP analysis could be automatically updated as dynamically as the changes to the supply web. A hyperconnected SCCP IS combining automation and hyperconnection principles could be designed. The design of such an SCCP IS would make it possible to design an event-driven SCCP DMP that triggers decision-making meetings only when necessary rather than on a predefined frequency. This would result in a hyperconnected SCCP DSS being the combination of an event-driven SCCP DMP and a hyperconnected SCCP IS.

The design of such a hyperconnected SCCP DSS could be made by combining the following research topics: first, research on the automation of the identification of supply chain stakeholder that was mentioned in the literature review of the third chapter of this thesis; and second, the contributions of this thesis.

Going further, we could even think about public regulations requiring supply chain stakeholders to register with a digitalized service that would automatically evaluate supply chain solutions according to sustainability performance indicators and to create a sustainability cartography of the industry and associated supply chains. Keeping the sustainability focus but going back to the business point of view, it could be interesting to evaluate to what extent this contribution could be applied to supporting the approach introduced by Villena and Gioia (2018) aiming to help businesses managing the sustainability of their supply networks.

3. The future is already starting

A new partnership has already been established between the Industrial Engineering Center of IMT Mines Albi (Centre Génie Industriel 2019), a supply chain consulting company and a BI software editor to create the industrial future of this research project. The first task will be to perform the industrial transfer of the whole SCCP DSS proposed in this thesis and then to perform industrial implementations. Let's shape the future of SCCP!

REFERENCES

- Agard, B., 2004. Modélisation des familles de produits : État de l'art. *Mechanics & Industry*, 5 (3), p.275–288. <https://doi.org/10.1051/meca:2004030>.
- Akyuz, G.A. and Erkan, T.E., 2010. Supply chain performance measurement: a literature review. *International Journal of Production Research*, 48 (17), p.5137–5155. <https://doi.org/10.1080/00207540903089536>.
- Albrecht, M., Rohde, J., and Wagner, M., 2015. Master planning. In: *Supply Chain Management and Advanced Planning: Concepts, Models, Software, and Case Studies*. Berlin: Springer, p.155–175.
- Amaratunga, D. and Baldry, D., 2002. Moving from performance measurement to performance management. *Facilities*, 20 (5/6), p.217–223.
- Ameri, F. and McArthur, C., 2010. An Ontological Approach to Manufacturing Supplier Discovery in Virtual Markets. In: *ASME Proceedings - 30th Computers and Information in Engineering Conference, Parts A and B*. Presented at the ASME 2010 International Design Engineering Technical Conferences and Computers and Information in Engineering Conference, Montreal, Quebec, Canada: American Society of Mechanical Engineers, p.435–447. <https://doi.org/10.1115/DETC2010-28179>.
- Ameri, F. and McArthur, C., 2011. An Experimental Evaluation of a Rule-Based Approach to Manufacturing Supplier Discovery in Distributed Environments. In: *ASME Proceedings | 31st Computers and Information in Engineering Conference, Part A and B*. Presented at the ASME 2011 International Design Engineering Technical Conferences and Computers and Information in Engineering Conference, Washington, DC, USA: American Society of Mechanical Engineers, p.1121–1133. <https://doi.org/10.1115/DETC2011-47768>.
- Ameri, F. and McArthur, C., 2014. Semantic rule modelling for intelligent supplier discovery. *International Journal of Computer Integrated Manufacturing*, 27 (6), p.570–590. <https://doi.org/10.1080/0951192X.2013.834467>.
- Ameri, F., McArthur, C., Asiabanpour, B., and Hayasi, M., 2011. A web-based framework for semantic supplier discovery for discrete part manufacturing. In: *Proceedings of NAMRI/SME*. Presented at the North American Manufacturing Research Conference (NAMRC).
- Anthony, R.N., 1965. *Planning and Control Systems: A Framework for Analysis*. First Edition edition. Boston: Division of Research, Harvard Business School.
- APICS, 2016. *APICS Dictionary, 15th Edition*. American Production and Inventory Control Society (APICS).
- APICS News [online], 2019. Available from: <http://www.apics.org/about/overview/apics-news-detail/2018/09/30/announcing-the-association-for-supply-chain-management> [Accessed 24 May 2019].
- Aravena-Diaz, V., Gacitua, R., Astudillo, H., and Labra-Gayo, J., 2016. Identifying potential suppliers for competitive bidding using Latent Semantic Analysis. In: *Proceedings of the 2016 XLII Latin American Computing Conference (clei)*. Presented at the 2016 XLII Latin American Computing Conference (CLEI), Valparaíso, Chile: IEEE, p.1–12. <https://doi.org/10.1109/CLEI.2016.7833360>.
- ARMINES [online], 2019. Available from: <https://www.armines.net> [Accessed 17 Apr 2019].
- Association for Supply Chain Management - ASCM [online], 2019. Available from: <https://www.ascm.org/> [Accessed 24 May 2019].

- Averweg, U.R.F., 2012. *Decision-making support systems: Theory & practice*. bookboon. com.
- Bairagi, V. and Munot, M.V., 2019. *Research Methodology: A Practical and Scientific Approach*. 1st ed. Chapman and Hall/CRC.
- Baumann, F., 2010. The shelf-connected supply chain: strategically linking CPFR with S&OP at the executive level. *The Journal of Business Forecasting*, 29 (4), p.21.
- Beamon, B.M., 1998. Supply chain design and analysis: *International Journal of Production Economics*, 55 (3), p.281–294. [https://doi.org/10.1016/S0925-5273\(98\)00079-6](https://doi.org/10.1016/S0925-5273(98)00079-6).
- Bell, D.E., Keeney, R.L., and Raiffa, H., 1977. *Conflicting objectives in decisions*. John Wiley & Sons.
- Benaben, F., Truptil, S., Mu, W., Pingaud, H., Touzi, J., Rajsiri, V., and Lorre, J.-P., 2017. Model-driven engineering of mediation information system for enterprise interoperability. *International Journal of Computer Integrated Manufacturing*, p.1–22. <https://doi.org/10.1080/0951192X.2017.1379093>.
- Bézivin, J., 2005. On the unification power of models. *Software and Systems Modeling*, 4 (2), p.171–188. <http://dx.doi.org/10.1007/s10270-005-0079-0>.
- Boonyathan, P. and Power, D., 2007. The impact of supply chain uncertainty on business performance and the role of supplier and customer relationships: Comparison between product and service organizations. In: *DSI Mini Conference on Services Management, Pittsburgh, USA*. p.391–402.
- Bourne, M., 2005. Researching performance measurement system implementation: the dynamics of success and failure. *Production Planning & Control*, 16 (2), p.101–113.
- Bower, P., 2012. Integrated Business Planning: Is It a Hoax or Here to Stay? *The Journal of Business Forecasting*, 31 (1), p.11–17.
- Burnette, R., 2010. CPFR: fact, fiction, or fantasy? *Journal of Business Forecasting*, 29 (4).
- Calfa, B.A., Agarwal, A., Bury, S.J., Wassick, J.M., and Grossmann, I.E., 2015. Data-Driven Simulation and Optimization Approaches To Incorporate Production Variability in Sales and Operations Planning. *Industrial & Engineering Chemistry Research*, 54 (29), p.7261–7272. <https://doi.org/10.1021/acs.iecr.5b01273>.
- Calvete, H.I., Galé, C., and Polo, L., 2016. Integrated Supply Chain Planning: A Review. In: *Modeling and Simulation in Engineering, Economics and Management*. Springer, p.92–103.
- Cecere, L., Hillman, M., and Masson, C., 2006. *The handbook of sales and operations planning technologies*. AMR research report, AMR.
- Centre Génie Industriel - IMT Mines Albi, 2019. R-IOSUITE [online]. Available from: <https://r-iosuite.com/> [Accessed 7 May 2019].
- Centre Génie Industriel [online], 2019. Available from: <https://gind.mines-albi.fr/> [Accessed 17 Apr 2019].
- Chen, Y.-Y., Chen, T.-L., and Liou, C.-D., 2013. Medium-term multi-plant capacity planning problems considering auxiliary tools for the semiconductor foundry. *International Journal of Advanced Manufacturing Technology*, 64 (9–12), p.1213–1230. <https://doi.org/10.1007/s00170-012-4080-9>.
- Childerhouse, P. and Towill, D., 2000. Engineering supply chains to match customer requirements. *Logistics information management*, 13 (6), p.337–346.
- Christopher, M. and Holweg, M., 2011. “Supply Chain 2.0”: managing supply chains in the era of turbulence. *International Journal of Physical Distribution & Logistics Management*, 41 (1), p.63–82. <https://doi.org/10.1108/09600031111101439>.

- Christopher, M. and Holweg, M., 2017. Supply chain 2.0 revisited: a framework for managing volatility-induced risk in the supply chain. *International Journal of Physical Distribution & Logistics Management*, 47 (1), p.2–17. <https://doi.org/10.1108/IJPDLM-09-2016-0245>.
- Clifford Defee, C. and Fugate, B.S., 2010. Changing perspective of capabilities in the dynamic supply chain era. *The International Journal of Logistics Management*, 21 (2), p.180–206. <https://doi.org/10.1108/09574091011071915>.
- Coldrick, A., Ling, D., and Turner, C., 2003. Evolution of Sales & Operations Planning-From Production Planning to Integrated Decision Making. *Strata Bridge*.
- Colicchia, C. and Strozzi, F., 2012. Supply chain risk management: a new methodology for a systematic literature review. *Supply Chain Management: An International Journal*, 17 (4), p.403–418. <https://doi.org/10.1108/13598541211246558>.
- Cristea, E. and Khalif Hassan, G., 2018. Critical success factors of potential CPFR implementations: Two manufacturing case studies in Sweden based on a pre-CPFR stage from the perspective of a buyer--seller relationship. Master Thesis. Jönköping University, Jönköping.
- Crousillat, E.O., Dorfner, P., Alvarado, P., and Merrill, H.M., 1993. Conflicting objectives and risk in power system planning. *IEEE Transactions on Power Systems*, 8 (3), p.887–893. <https://doi.org/10.1109/59.260914>.
- Czarnecki, K. and Helsen, S., 2006. Feature-based survey of model transformation approaches. *IBM Systems Journal*, 45 (3), p.621- 630,632-645.
- Danese, P., 2006. Collaboration forms, information and communication technologies, and coordination mechanisms in CPFR. *International Journal of Production Research*, 44 (16), p.3207–3226. <https://doi.org/10.1080/00207540600557991>.
- Davidrajuh, R. and Deng, Z.Q., 2000. Identifying potential supplier for formation of virtual manufacturing systems. In: *Proceedings of 16th IFIP World Computer Congress*.
- Demand Driven Adaptive Enterprise (DDAE) [online], 2019. *ddmain*. Available from: <https://www.demanddriveninstitute.com/demand-driven-adaptive-enterprise-m> [Accessed 29 Apr 2019].
- Demand Driven Institute, 2018. *Adaptive Sales & Operations Planning - Embracing Change and Driving Adaptation*.
- Demand Driven Institute, 2019. Adaptive S&OP [online]. Available from: <https://www.demanddriveninstitute.com/adaptive-s-op> [Accessed 29 Apr 2019].
- Deming, W.E., 1986. Out of the crisis. *Cambridge - MIT Center for Advanced Engineering Study*.
- Eppen, G., Martin, R., and Schrage, L., 1989. A Scenario Approach to Capacity Planning. *Operations Research*, 37 (4), p.517–527. <https://doi.org/10.1287/opre.37.4.517>.
- Esmailikia, M., Fahimnia, B., Sarkis, J., Govindan, K., Kumar, A., and Mo, J., 2016. A tactical supply chain planning model with multiple flexibility options: an empirical evaluation. *Annals of Operations Research*, 244 (2), p.429–454. <https://doi.org/10.1007/s10479-013-1513-2>.
- Fenves, S.J., Mani, M., Subrahmanian, E., and Jones, A.T., 2009. An enabler for supplier discovery in virtual supply chains: a shared terminology. *NIST Inter-agency/Internal Report (NISTIR)*, p.7647.
- Fleischmann, B. and Koberstein, A., 2015. Strategic network design. In: *Supply Chain Management and Advanced Planning: Concepts, Models, Software, and Case Studies*. Berlin: Springer, p.107–123.

- Fleischmann, B., Meyr, H., and Wagner, M., 2002. Advanced planning. *In: Supply chain management and advanced planning*. Berlin: Springer, p.71–95.
- Fleischmann, B., Meyr, H., and Wagner, M., 2015. Advanced planning. *In: Supply Chain Management and Advanced Planning: Concepts, Models, Software, and Case Studies*. Berlin: Springer, p.71–95.
- Fliedner, G., 2003. CPFR: an emerging supply chain tool. *Industrial Management & data systems*, 103 (1), p.14–21.
- Fritz, M.M.C., Rauter, R., Baumgartner, R.J., and Dentchev, N., 2018. A supply chain perspective of stakeholder identification as a tool for responsible policy and decision-making. *Environmental Science & Policy*, 81, p.63–76. <https://doi.org/10.1016/j.envsci.2017.12.011>.
- Gandhi, A.V., Shaikh, A., and Sheorey, P.A., 2017. Impact of supply chain management practices on firm performance: Empirical evidence from a developing country. *International Journal of Retail & Distribution Management*, 45 (4), p.366–384. <https://doi.org/10.1108/IJRDM-06-2015-0076>.
- Gartner, 2018. Magic Quadrant for Supply Chain Planning System of Record [online]. Available from: <https://www.gartner.com/en/documents/3887865> [Accessed 8 Jan 2019].
- Gartner, 2019a. Sales and Operations Planning (S&OP) Software Reviews [online]. *Gartner*. Available from: <https://gartner.com/market/sales-and-operations-planning-systems-of-differentiation> [Accessed 2 Jun 2019].
- Gartner, 2019b. Magic Quadrant for Sales and Operations Planning Systems of Differentiation [online]. Available from: <https://www.gartner.com/en/documents/3913323-magic-quadrant-for-sales-and-operations-planning-systems> [Accessed 2 Jun 2019].
- Geng, N. and Jiang, Z., 2009. A review on strategic capacity planning for the semiconductor manufacturing industry. *International Journal of Production Research*, 47 (13), p.3639–3655. <https://doi.org/10.1080/00207540701871051>.
- Genin, P., Lamouri, S., and Thomas, A., 2005. SALES AND OPERATIONS PLANNING OPTIMISATION Contribution and limits of linear programming. *In: A. Dolgui and J. Soldek, eds. Supply Chain Optimisation: Product/Process Design, Facility Location and Flow Control*. New York: Springer, p.191–204.
- Georgia Tech Supply Chain and Logistics Institute, 2019. Georgia Tech Supply Chain and Logistics Institute [online]. Available from: <https://www.scl.gatech.edu/> [Accessed 2 Jul 2019].
- Gianesi, I.G.N., 1998. Implementing manufacturing strategy through strategic production planning. *International Journal of Operations & Production Management*, 18 (3), p.286–299. <https://doi.org/10.1108/01443579810196499>.
- Grimson, J.A. and Pyke, D.F., 2007. Sales and operations planning: an exploratory study and framework. *The International Journal of Logistics Management*, 18 (3), p.322–346. <https://doi.org/10.1108/09574090710835093>.
- GS1 US, 2016. CPFR 2.0 [online]. *GS1 US*. Available from: https://www.gs1us.org/DesktopModules/Bring2mind/DMX/Download.aspx?Command=Core_Download&EntryId=377 [Accessed 30 Apr 2019].
- Guo, K.L., 2008. DECIDE: a decision-making model for more effective decision making by health care managers. *The health care manager*, 27 (2), p.118–127.
- Häberle, J. and Kilger, C., 2015. Strategic Network Design in the Chemical Industry. *In: Supply Chain Management and Advanced Planning*. Springer, p.363–376.

- Hakimi, D., Montreuil, B., and Labarthe, O., 2009. Supply Web: Concept and Technology. *In: Proceedings of 7th Annual International Symposium on Supply Chain Management, Toronto, Canada*. Presented at the 7th Annual International Symposium on Supply Chain Management, Toronto, Canada.
- Harrington, L.H., Boyson, S., and Corsi, T., 2010. *X-SCM: The New Science of X-treme Supply Chain Management*. Routledge.
- Hax, A.C. and Meal, H.C., 1973. Hierarchical integration of production planning and scheduling.
- Hax, A.C. and Meal, H.C., 1975. *Hierarchical integration of production planning and scheduling*. Amsterdam: North-Holland/TIMS Studies in the Management Sciences.
- Ho, W., Xu, X., and Dey, P.K., 2010. Multi-criteria decision making approaches for supplier evaluation and selection: A literature review. *European Journal of Operational Research*, 202 (1), p.16–24. <https://doi.org/10.1016/j.ejor.2009.05.009>.
- Ho, W., Zheng, T., Yildiz, H., and Talluri, S., 2015. Supply chain risk management: a literature review. *International Journal of Production Research*, 53 (16), p.5031–5069. <https://doi.org/10.1080/00207543.2015.1030467>.
- Hollmann, R.L., Scavarda, L.F., and Thomé, A.M.T., 2015. Collaborative planning, forecasting and replenishment: a literature review. *International Journal of Productivity and Performance Management*, 64 (7), p.971–993.
- Hopp, W.J. and Spearman, M.L., 2011. *Factory Physics: Third Edition*. Waveland Press.
- Huang, S.H., Sheoran, S.K., and Keskar, H., 2005. Computer-assisted supply chain configuration based on supply chain operations reference (SCOR) model. *Computers & Industrial Engineering*, 48 (2), p.377–394. <https://doi.org/10.1016/j.cie.2005.01.001>.
- Huang, S.H., Sheoran, S.K., and Wang, G., 2004. A review and analysis of supply chain operations reference (SCOR) model. *Supply Chain Management: An International Journal*, 9 (1), p.23–29.
- Hult, G.T.M., Craighead, C.W., and Ketchen Jr., D.J., 2010. Risk Uncertainty and Supply Chain Decisions: A Real Options Perspective: Risk Uncertainty and Supply Chain Decisions. *Decision Sciences*, 41 (3), p.435–458. <https://doi.org/10.1111/j.1540-5915.2010.00276.x>.
- Im, K., Lee, J., Kim, B., Peng, Y., and Cho, H., 2011. Conceptual framework of supplier discovery via ontology-driven semantic reasoning. *In: Proceedings of the 41st International Conference on Computers and Industrial Engineering, Los Angeles, California, USA, October*. p.23–25.
- IMT Mines Albi endowment fund [online], 2019. Available from: <https://www.imt-mines-albi.fr/en/endowment-fund-0> [Accessed 17 Apr 2019].
- International Organization for Standardization, 1985. *ISO 5807:1985(en) Information processing -- Documentation symbols and conventions for data, program and system flowcharts, program network charts and system resources charts*.
- International Organization for Standardization, 2009. *ISO Guide 73:2009 Risk management -- Vocabulary*.
- International Organization for Standardization, 2013. *ISO/IEC 19510:2013 Information technology -- Object Management Group Business Process Model and Notation*.
- International Organization for Standardization, 2018. *ISO 31000:2018 Risk management -- Guidelines*.
- Ishizaka, A. and Nemery, P., 2013. *Multi-criteria decision analysis: methods and software*. John Wiley & Sons.

- Ivert, L.K. and Jonsson, P., 2010. The potential benefits of advanced planning and scheduling systems in sales and operations planning. *Industrial Management & Data Systems*, 110 (5–6), p.659–681. <https://doi.org/10.1108/02635571011014713>.
- Kaipia, R., Holmstrom, J., Smaros, J., and Rajala, R., 2017. Information sharing for sales and operations planning: Contextualized solutions and mechanisms. *Journal of Operations Management*, 52, p.15–29. <https://doi.org/10.1016/j.jom.2017.04.001>.
- Kang, Y., 2011. *Extensible dynamic form for supplier discovery*. Citeseer.
- Kang, Y., Kim, J., and Peng, Y., 2011. Extensible Dynamic Form approach for supplier discovery. In: *2011 IEEE International Conference on Information Reuse & Integration*. Presented at the International Conference on Information Reuse & Integration (IRI), Las Vegas, NV, USA: IEEE, p.83–87. <https://doi.org/10.1109/IRI.2011.6009525>.
- Kannan, V.R. and Tan, K.C., 2005. Just in time, total quality management, and supply chain management: understanding their linkages and impact on business performance. *Omega*, 33 (2), p.153–162.
- Karabuk, S. and Wu, S.D., 2003. Coordinating Strategic Capacity Planning in the Semiconductor Industry. *Operations Research*, 51 (6), p.839–849. <https://doi.org/10.1287/opre.51.6.839.24917>.
- Kilger, C., 2015. The definition of a supply chain project. In: *Supply Chain Management and Advanced Planning: Concepts, Models, Software, and Case Studies*. Berlin: Springer, p.281–300.
- Klein, G.A., Orasanu, J., Calderwood, R., and Zsombok, C.E., 1993. *Decision making in action: Models and methods*. Westport, CT, US: Ablex Publishing.
- Klibi, W., Martel, A., and Guitouni, A., 2010. The design of robust value-creating supply chain networks: A critical review. *European Journal of Operational Research*, 203 (2), p.283–293. <https://doi.org/10.1016/j.ejor.2009.06.011>.
- Kothari, C.R., 2004. *Research methodology: Methods and techniques*. New Age International.
- Kotzab, H., Seuring, S., Müller, M., and Reiner, G., 2005. *Research Methodologies in Supply Chain Management*. Springer Science & Business Media.
- Kristensen, J. and Jonsson, P., 2018. Context-based sales and operations planning (S&OP) research: A literature review and future agenda. *International Journal of Physical Distribution & Logistics Management*.
- Kurbel, K.E., 2013. *Enterprise Resource Planning and Supply Chain Management*. Berlin, Heidelberg: Springer Berlin Heidelberg. <https://doi.org/10.1007/978-3-642-31573-2>.
- Lapide, L., 2004. Sales and operations planning part I: the process. *The Journal of business forecasting*, 23 (3).
- Lapide, L., 2005. Sales and operations planning Part III: a diagnostic model. *The Journal of Business Forecasting*, 24 (1), p.13.
- Lauras, M., 2013. Systèmes d'aide à la décision pour des organisations collaboratives efficaces et agiles: application à la gestion de chaînes logistiques et à la gestion de crises. Habilitation à Diriger des Recherches. Institut National Polytechnique de Toulouse, Albi.
- LeanCor Training and Education, 2019. Public Classroom Training and Workshops [online]. *LeanCor Academy*. Available from: <https://store.leancor.com/collections/public-classroom-training-workshops> [Accessed 23 Jun 2019].
- Lee, C., Lee, Y.H., Peng, Y., and Cho, H., 2011. A Supplier Discovery Framework for Effective and Efficient Configuration. *International Journal of Industrial Engineering: Theory Applications and Practice*, 18 (3), p.109–119. <https://doi.org/doi:10.1115/DETC2010-28179>.

- Lee, J., Jung, K., Kim, B.H., and Cho, H., 2013. Semantic Web-Based Supplier Discovery Framework. *In: V. Prabhu, M. Taisch, and D. Kiritsis, eds. Advances in Production Management Systems. Sustainable Production and Service Supply Chains.* Presented at the IFIP International Conference on Advances in Production Management Systems, Berlin: Springer Berlin Heidelberg, p.477–484. https://doi.org/10.1007/978-3-642-41266-0_57.
- Lee, J., Jung, K., Kim, B.H., Peng, Y., and Cho, H., 2015. Semantic web-based supplier discovery system for building a long-term supply chain. *International Journal of Computer Integrated Manufacturing*, 28 (2), p.155–169. <https://doi.org/10.1080/0951192X.2013.874594>.
- Li, J., Burnham, J.F., Lemley, T., and Britton, R.M., 2010. Citation Analysis: Comparison of Web of Science®, Scopus™, SciFinder®, and Google Scholar. *Journal of Electronic Resources in Medical Libraries*, 7 (3), p.196–217. <https://doi.org/10.1080/15424065.2010.505518>.
- Li, S.H., Ragu-Nathan, B., Ragu-Nathan, T.S., and Rao, S.S., 2006. The impact of supply chain management practices on competitive advantage and organizational performance. *Omega-International Journal of Management Science*, 34 (2), p.107–124. <https://doi.org/10.1016/j.omega.2004.08.002>.
- Ling, D. and Coldrick, A., 2009. Breakthrough Sales & Operations Planning: How we developed the process.
- Ling, R.C. and Goddard, W.E., 1988. *Orchestrating success: improve control of the business with sales & operations planning.* Oliver Wight Ltd. Publications.
- Lummus, R.R. and Vokurka, R.J., 1999. Defining supply chain management: a historical perspective and practical guidelines. *Industrial Management & Data Systems*, 99 (1), p.11–17. <https://doi.org/10.1108/02635579910243851>.
- Martel, A. and Klibi, W., 2016. *Designing value-creating supply chain networks.* Springer.
- Martin, G., Baptiste, P., Lamothe, J., Miclo, R., and Lauras, M., 2018. Vers une cartographie de processus explicite pour le modèle Demand Driven Adaptive Enterprise. *In: Papier présenté à la 12ème Conférence internationale de Modélisation, Optimisation et SIMulation (MOSIM). Toulouse, France, Juin.*
- Martínez-Costa, C., Mas-Machuca, M., Benedito, E., and Corominas, A., 2014. A review of mathematical programming models for strategic capacity planning in manufacturing. *International Journal of Production Economics*, 153, p.66–85. <https://doi.org/10.1016/j.ijpe.2014.03.011>.
- Marttunen, M., Lienert, J., and Belton, V., 2017. Structuring problems for Multi-Criteria Decision Analysis in practice: A literature review of method combinations. *European Journal of Operational Research*, 263 (1), p.1–17. <https://doi.org/10.1016/j.ejor.2017.04.041>.
- McArthur, C. and Ameri, F., 2011a. Knowledge Representation for Supplier Discovery in Distributed Design and Manufacturing. *In: S.J. Culley, B.J. Hicks, T.C. McAloone, T.J. Howard, and W. Chen, eds. Proceedings of the 18th International Conference on Engineering Design (iced 11): Impacting Society Through Engineering Design, Vol 6: Design Information and Knowledge.* Glasgow: Design Soc, p.121–130.
- McArthur, C. and Ameri, F., 2011b. Knowledge representation for supplier discovery in distributed manufacturing. *In: International Conference on Engineering Design, ICED11.* p.1–11.
- Melnyk, S.A., Narasimhan, R., and DeCampos, H.A., 2014. Supply chain design: issues, challenges, frameworks and solutions. *International Journal of Production Research*, 52 (7), p.1887–1896. <https://doi.org/10.1080/00207543.2013.787175>.

- Menzel, C. and Mayer, R.J., 1998. The IDEF Family of Languages. *In: P. Bernus, K. Mertins, and G. Schmidt, eds. Handbook on Architectures of Information Systems*. Berlin, Heidelberg: Springer Berlin Heidelberg, p.209–241. https://doi.org/10.1007/978-3-662-03526-9_10.
- Mesmer, L. and Olewnik, A., 2018. Enabling supplier discovery through a part-focused manufacturing process ontology. *International Journal of Computer Integrated Manufacturing*, 31 (1), p.87–100. <https://doi.org/10.1080/0951192X.2017.1357837>.
- Meyr, H., Wagner, M., and Rohde, J., 2015. Structure of advanced planning systems. *In: Supply Chain Management and Advanced Planning: Concepts, Models, Software, and Case Studies*. Berlin: Springer, p.99–106.
- MG Taylor Corporation, 1996. Scan Focus Act [online]. Available from: <http://legacy.mgtaylor.com/mgtaylor/glasbead/SFA.htm> [Accessed 26 Feb 2019].
- Microsoft, 2019. Power BI [online]. Available from: <https://powerbi.microsoft.com> [Accessed 6 Aug 2019].
- Miller, T.C., 2012. *Hierarchical Operations and Supply Chain Planning*. Springer Science & Business Media.
- Moen, R. and Norman, C., 2006. *Evolution of the PDCA cycle*. Citeseer.
- Montarnal, A., Mu, W., Benaben, F., Lamothe, J., Lauras, M., and Salatge, N., 2018. Automated deduction of cross-organizational collaborative business processes. *Information Sciences*, 453, p.30–49. <https://doi.org/10.1016/j.ins.2018.03.041>.
- Montreuil, B., 2011. Toward a Physical Internet: meeting the global logistics sustainability grand challenge. *Logistics Research*, 3 (2–3), p.71–87.
- Montreuil, B., 2012. *Physical Internet Manifesto*. No. Version 1.11.1.
- Montreuil, B., 2015. The Physical Internet: A Conceptual Journey, Keynote Presentation. *2nd International Physical Internet Conference (IPIC), Paris, France*.
- Montreuil, B., Meller, R.D., and Ballot, E., 2013. Physical Internet Foundations. *In: Service Orientation in Holonic and Multi Agent Manufacturing and Robotics*. Springer, Berlin, Heidelberg, p.151–166. https://doi.org/10.1007/978-3-642-35852-4_10.
- Mula, J., Poler, R., García-Sabater, J.P., and Lario, F.C., 2006. Models for production planning under uncertainty: A review. *International journal of production economics*, 103 (1), p.271–285.
- Musselman, K., O'Reilly, J., and Duket, S., 2002. The role of simulation in advanced planning and scheduling. *In: Simulation Conference, 2002. Proceedings of the Winter*. IEEE, p.1825–1830.
- Narasimhan, R. and Talluri, S., 2009. Perspectives on risk management in supply chains. *Journal of Operations Management, Special Issue: Perspectives on Risk Management in Supply Chains*, 27 (2), p.114–118. <https://doi.org/10.1016/j.jom.2009.02.001>.
- Neely, A., 1999. The performance measurement revolution: why now and what next? *International journal of operations & production management*, 19 (2), p.205–228.
- Object Management Group, (OMG), 2008. Meta object facility (MOF) Version 2.0 Query/View/Transformation Specification [online]. Available from: <https://www.omg.org/spec/QVT/1.0/About-QVT/> [Accessed 6 Oct 2018].
- Object Management Group, (OMG), 2011. BPMN 2.0 [online]. Available from: <http://www.omg.org/spec/BPMN/2.0/> [Accessed 21 Apr 2017].
- Object Management Group, (OMG), 2015. UML 2.5 [online]. Available from: <http://www.omg.org/spec/UML/2.5/> [Accessed 14 Apr 2017].

- Oger, R., Benaben, F., Lauras, M., and Montreuil, B., 2018a. Towards Decision Support Automation for Supply Chain Risk Management among Logistics Network Stakeholders. *In: IFAC-PapersOnLine*. Presented at the 16th IFAC Symposium on Information Control Problems in Manufacturing (INCOM 2018), Bergamo, Italy, p.1505–1510. <https://doi.org/10.1016/j.ifacol.2018.08.287>.
- Oger, R., Lauras, M., Benaben, F., and Montreuil, B., 2019. Strategic Supply Chain Planning and Risk Management: Experiment of a Decision Support System Gathering Business Departments Around a Common Vision. Presented at the 8th International Conference on Industrial Engineering and Systems Management (IESM 2019), Shanghai, China, p.306–311. <https://doi.org/10.1109/IESM45758.2019.8948116>.
- Oger, R., Lauras, M., Montreuil, B., and Benaben, F., 2017a. Enabling Supply Chain Agility and Resilience Improvement: Toward a Methodology and Platform. Presented at the IFAC 2017 World Congress, Toulouse, France, p.9560–9564. <https://hal-mines-albi.archives-ouvertes.fr/hal-01712425>.
- Oger, R., Lauras, M., Montreuil, B., Benaben, F., and Salatge, N., 2017b. Towards Hyperconnected Resource Requirements Planning. Presented at the 4th International Physical Internet Conference (IPIC 2017), Graz, Austria, p.115–125. <https://hal-mines-albi.archives-ouvertes.fr/hal-01582357>.
- Oger, R., Montreuil, B., Lauras, M., and Benaben, F., 2018b. Towards Hyperconnected Supply Chain Capability Planning: Conceptual Framework Proposal. Presented at the 5th International Physical Internet Conference (IPIC 2018), Groningen, The Netherlands, p.72–82. <https://hal.archives-ouvertes.fr/hal-01875900>.
- Olhager, J., 2013. Evolution of operations planning and control: from production to supply chains. *International Journal of Production Research*, 51 (23–24), p.6836–6843. <https://doi.org/10.1080/00207543.2012.761363>.
- Olhager, J., Rudberg, M., and Wikner, J., 2001. Long-term capacity management: Linking the perspectives from manufacturing strategy and sales and operations planning. *International Journal of Production Economics, Strategic Planning for Production Systems*, 69 (2), p.215–225. [https://doi.org/10.1016/S0925-5273\(99\)00098-5](https://doi.org/10.1016/S0925-5273(99)00098-5).
- Oliver, R.K. and Webber, M.D., 1982. Supply-chain management: logistics catches up with strategy. *Outlook*, 5 (1), p.42–47.
- Ozturk, O., Coburn, M.B., and Kitterman, S., 2003. Factory capacity and throughput planning: conceptualization, design and implementation of a static capacity model. *In: Winter Simulation Conference*. <https://doi.org/10.1145/1030818.1031002>.
- Palmatier, G. and Crum, C., n.d. How to Leverage Longer Planning Horizons in Integrated Business Planning (Advanced S&OP). *Oliver Wight International*.
- Palmatier, G.E., Crum, C., and Wight, O., 2010. A Transition from Sales and Operations Planning to Integrated Business Planning. *Oliver Wight whitepaper series—Informative guide on industry best practices, Oliver Wight Americas*.
- Physical Internet Center [online], 2019. Available from: <https://www.picenter.gatech.edu/> [Accessed 17 Apr 2019].
- Piccoli, G. and Pigni, F., 2008. *Information Systems for Managers*. John Wiley & Sons.
- Pierre Fabre [online], 2019. Available from: <https://www.pierre-fabre.com> [Accessed 17 Apr 2019].
- Pinon, D., 2017. Are Existing Strategic Supply Chain Planning Methodologies Sufficient to Prepare Supply Chains to Perform in Today's Challenging Market Conditions? Master Thesis. IMT Mines Albi & Toulouse Business School, Albi, France.

- Pinon, D., Oger, R., and Lauras, M., 2018. Supply Chain Evolution and Supply Chain Capability Planning Methodologies: A Review and Gap Identification. Presented at the 7th International Conference on Information Systems, Logistics and Supply Chain (ILS 2018), Lyon, France. <https://hal-mines-albi.archives-ouvertes.fr/hal-01886020>.
- Poler, R., Hernandez, J.E., Mula, J., and Lario, F.C., 2008. Collaborative forecasting in networked manufacturing enterprises. *Journal of Manufacturing Technology Management*, 19 (4), p.514–528.
- Power, D., 2002. *Decision support systems: concepts and resources for managers*. Greenwood Publishing Group.
- Ptak, C. and Ling, D., 2017. Adaptive Sales & Operations Planning - Embracing Change and Driving Adaptation. Presented at the Adaptive S&OP workshop, Albi, France: IMT Mines Albi & Agilea.
- Ptak, C. and Smith, C., 2018. *The Demand Driven Adaptive Enterprise: Surviving, Adapting, and Thriving in a VUCA World*. First edition. Norwalk, CT: Industrial Press, Inc.
- Ptak, C.A. and Smith, C., 2011. *Orlicky's Material Requirements Planning, Third Edition*. 3 edition. New York: McGraw-Hill Education.
- Qlik, 2019. Qlik Sense [online]. Available from: <https://www.qlik.com/us/products/qlik-sense> [Accessed 6 Aug 2019].
- Report One, 2019. MyReport Essential [online]. *MyReport*. Available from: <http://www.myreport.fr/> [Accessed 6 Aug 2019].
- Rohde, J., Meyr, H., and Wagner, M., 2000. Die supply chain planning matrix. *In: PPS Management* 5(1). p.10–15.
- Rondeau, P. and Litteral, L.A., 2001. The evolution of manufacturing planning and control systems: From reorder point to enterprise resource planning. *Production and Inventory Management Journal*, 42 (2).
- Saenz, M.J. and Cottrill, K., 2019. Navigating the road to digital supply chain transformation. *Supply Chain Management Review*.
- Sáenz, M.J. and Revilla, E., 2014. Creating more resilient supply chains. *MIT Sloan management review*, 55 (4), p.22–24.
- Sainfort, F.C., Gustafson, D.H., Bosworth, K., and Hawkins, R.P., 1990. Decision support systems effectiveness: Conceptual framework and empirical evaluation. *Organizational Behavior and Human Decision Processes*, 45 (2), p.232–252. [https://doi.org/10.1016/0749-5978\(90\)90013-Y](https://doi.org/10.1016/0749-5978(90)90013-Y).
- Santa-Eulalia, L.A. de, D'Amours, S., Frayret, J.-M., Menegusso, C.C., and Azevedo, R.C., 2011. Advanced Supply Chain Planning Systems (APS) Today and Tomorrow. *Supply Chain Management - Pathways for Research and Practice*. <https://doi.org/10.5772/19098>.
- SAP Library - Supply Network Planning [online], 2019. Available from: https://help.sap.com/doc/saphelp_scm50/5.0/en-US/72/aafbc364f811d3b6380000e82de178/frameset.htm [Accessed 31 May 2019].
- Shapiro, B.P., 1977. Can Marketing and Manufacturing Coexist? *Harvard Business Review*, (September 1977).
- Simangunsong, E., Hendry, L.C., and Stevenson, M., 2012. Supply-chain uncertainty: a review and theoretical foundation for future research. *International Journal of Production Research*, 50 (16), p.4493–4523. <https://doi.org/10.1080/00207543.2011.613864>.
- Smith, L., Andraski, J.C., and Fawcett, S.E., 2010. Integrated business planning: a roadmap to linking S&OP and CPFR. *The Journal of Business Forecasting*, 29 (4), p.4.

- Stadtler, H., Kilger, C., and Meyr, H., eds., 2015. *Supply Chain Management and Advanced Planning: Concepts, Models, Software, and Case Studies*. 5th ed. Berlin Heidelberg: Springer-Verlag.
- Supply Chain Council, 2012. *Supply Chain Operations Reference (SCOR) Model*. 11.0. USA: Supply Chain Council.
- Tableau Software, 2019. Tableau: Business Intelligence and Analytics Software [online]. Available from: <https://www.tableau.com/> [Accessed 24 Feb 2019].
- Tan, K.C., 2001. A framework of supply chain management literature. *European Journal of Purchasing & Supply Management*, 7 (1), p.39–48. [https://doi.org/10.1016/S0969-7012\(00\)00020-4](https://doi.org/10.1016/S0969-7012(00)00020-4).
- Thomé, A.M.T., Scavarda, L.F., Fernandez, N.S., and Scavarda, A.J., 2012. Sales and operations planning: A research synthesis. *International Journal of Production Economics*, 138 (1), p.1–13. <https://doi.org/10.1016/j.ijpe.2011.11.027>.
- Thomé, A.M.T., Sousa, R.S., and Scavarda do Carmo, L.F.R.R., 2014. The impact of sales and operations planning practices on manufacturing operational performance. *International Journal of Production Research*, 52 (7), p.2108–2121.
- Thompson, J.D., 2017. *Organizations in Action: Social Science Bases of Administrative Theory*. Routledge. <https://doi.org/10.4324/9781315125930>.
- Tracey, M., Lim, J.-S., and Vonderembse, M.A., 2005. The impact of supply-chain management capabilities on business performance. *Supply Chain Management: An International Journal*, 10 (3), p.179–191.
- Tranfield, D., Denyer, D., and Smart, P., 2003. Towards a Methodology for Developing Evidence-Informed Management Knowledge by Means of Systematic Review. *British Journal of Management*, 14 (3), p.207–222. <https://doi.org/10.1111/1467-8551.00375>.
- Triantaphyllou, E., 2000. *Multi-criteria Decision Making Methods: A Comparative Study*. Springer US.
- Tuomikangas, N. and Kaipia, K., 2014. A coordination framework for sales and operations planning (S&OP): Synthesis from the literature. *International Journal of Production Economics*, 154, p.243–262. <https://doi.org/10.1016/j.ijpe.2014.04.026>.
- Van Mieghem, J.A., 2003. Commissioned paper: Capacity management, investment, and hedging: Review and recent developments. *Manufacturing & Service Operations Management*, 5 (4), p.269–302.
- Velasquez, M. and Hester, P.T., 2013. An analysis of multi-criteria decision making methods. *International Journal of Operations Research*, 10 (2), p.56–66.
- VICS, V.I.C.S., 2010. *Linking CPFR and S&OP: A Roadmap to Integrated Business Planning. VICS Voluntary Interindustry Commerce Solutions*. Lawrenceville, New Jersey.
- Vidal, J.-B., Lauras, M., Lamothe, J., and Miclo, R., 2018. Adaptive sales & operations planning: Innovative concept for manufacturing collaborative decisions? In: *Working Conference on Virtual Enterprises*. Springer, p.362–374.
- Villena, V.H. and Gioia, D.A., 2018. On the riskiness of lower-tier suppliers: Managing sustainability in supply networks. *Journal of Operations Management*. <https://doi.org/10.1016/j.jom.2018.09.004>.
- Voluntary Interindustry Commerce Solutions Association (VICS), 2004. Collaborative Planning, Forecasting and Replenishment (CPFR®) [online]. Available from: https://www.gs1us.org/DesktopModules/Bring2mind/DMX/Download.aspx?Command=Core_Download&EntryId=492&language=en-US&PortalId=0&TabId=134 [Accessed 29 Nov 2017].

References

- Wagner, S.M., Ullrich, K.K., and Transchel, S., 2014. The game plan for aligning the organization. *Business Horizons*, 57 (2), p.189–201.
- Wallace, T.F. and Stahl, R., 2006. *Sales & Operations Planning: The Executive's Guide*. TF Wallace & Company.
- Wallace, T.F. and Stahl, R.A., 2008. *Sales and Operations Planning The How-To Handbook*. 3rd ed. T. F. Wallace & Company.
- Wallace, T.F. and Stahl, R.A., 2011. *Sales & Operations Planning: Beyond the Basics*. Steelwedge Software.
- Wang, J.-Z., Hsieh, S.-T., and Hsu, P.-Y., 2012. Advanced sales and operations planning framework in a company supply chain. *International Journal of Computer Integrated Manufacturing*, 25 (3), p.248–262.
- Waters, D., 2011. *Supply Chain Risk Management: Vulnerability and Resilience in Logistics*. Kogan Page Publishers.
- Wieringa, R., 2014. Empirical research methods for technology validation: Scaling up to practice. *Journal of Systems and Software*, 95, p.19–31. <https://doi.org/10.1016/j.jss.2013.11.1097>.
- Wylie, L., 1990. A Vision of the Next-Generation MRP II. Scenario S-300–339.
- Yamashita, A., Kutsuzawa, R., Takemura, N., Matsumoto, J., and Yamanaka, N., 2016. Design of multi-dimensional search queries for efficient discovery of suppliers in the smart grid. *In: 2016 IEEE International Conference on Smart Grid Communications (SmartGridComm)*. Presented at the 2016 IEEE International Conference on Smart Grid Communications (SmartGridComm), Sydney, Australia: IEEE, p.63–67. <https://doi.org/10.1109/SmartGridComm.2016.7778739>.
- Yildiz, A. and Yayla, A.Y., 2015. Multi-Criteria Decision-Making Methods for Supplier Selection: A Literature Review. *South African Journal of Industrial Engineering*, 26 (2), p.158–177. <https://doi.org/10.7166/26-2-1010>.

LIST OF FIGURES

Figure 1: Illustrating the supply chain concept.....	3
Figure 2: Research positioning versus the SCM processes of the SCOR model.....	4
Figure 3: Illustrating reasons why anticipation and planning are required by companies to synchronize performance goals with actual performance at a desired point in time.....	5
Figure 4: Illustrating the structure of hierarchical planning introduced by Hax and Meal (1973, 1975) to organize planning tasks among different decision-making levels within a hierarchical organization.....	6
Figure 5: Thesis positioning in regards to the supply chain planning matrix introduced by Rohde et al. (2000) and Fleischmann et al. (2002) as a hierarchical planning system for managing supply chain decisions.....	8
Figure 6: Examples of types of decisions impacting the available or required supply chain capacity.....	9
Figure 7: Positioning of the thesis (in green) regarding common decision-making steps.....	10
Figure 8: Illustration of the business processes this thesis focuses on (in green) positioned within the fields of business performance, supply chain management, supply chain planning, and finally, supply chain capacity planning.....	10
Figure 9: The relation between characteristics of the supply chain environment and the industrial questions (IQ1, IQ2, and IQ3) in the SCCP context this thesis focuses on.....	15
Figure 10: Overview of the contributions (C1, C2, and C3) this thesis proposes for answering the industrial and research questions it is focused on.....	19
Figure 11: Research project partners.....	20
Figure 12: Illustration of the reference frame for scaling up the validation of a practice or system proposed by Wieringa (2014).....	21
Figure 13: The methodology followed to carry out this thesis.....	24
Figure 14: The structure of this thesis in regard to the overview of the contributions (C1, C2, and C3).....	26
Figure 15: Positioning the content of this second chapter in regard to the overview of the contributions of this thesis (C1, C2, and C3).....	28
Figure 16: Four components of a decision support system as considered in this thesis.....	29
Figure 17: Existing decision-making processes and information system categories found in the literature as being relevant for long-term SCCP and are thus further investigated in the rest of this thesis.....	31
Figure 18: The Sales and Operations Planning (S&OP) process (adapted from Coldrick et al. (2003)).....	32

Figure 19: The Integrated Business Planning (IBP) process (Palmatier and Crum n.d.).....	33
Figure 20: The Adaptive Sales & Operations Planning (AS&OP) process (Ptak and Ling 2017)	34
Figure 21: The Collaborative Planning, Forecasting, and Replenishment (CPFR) process (GS1 US 2016)	36
Figure 22: Sequence of activities of the SCCP conceptual framework proposal.....	43
Figure 23: IDEF0 diagram of the seventh activity of the SCCP conceptual framework proposal	45
Figure 24: IDEF0 diagram of the sixth activity of the SCCP conceptual framework proposal	46
Figure 25: IDEF0 diagram of the fifth activity of the SCCP conceptual framework proposal	47
Figure 26: IDEF0 diagram of the fourth activity of the SCCP conceptual framework proposal	48
Figure 27: IDEF0 diagram of the third activity of the SCCP conceptual framework proposal	49
Figure 28: IDEF0 diagram of the second activity of the SCCP conceptual framework proposal	50
Figure 29: IDEF0 diagram of the first activity of the SCCP conceptual framework proposal	52
Figure 30: IDEF0 diagram of the entire sequence of activity of the SCCP conceptual framework proposal.....	53
Figure 31: Overview of the SCCP conceptual framework proposal	57
Figure 32: Positioning the content of this third chapter in regard to the overview of the contributions of this thesis (C1, C2, and C3).....	60
Figure 33: Paper selection process of the systematic literature review with the resulting number of papers	63
Figure 34: High-level operating diagram of the computational software proposal showing the sequence of the three modules as well as their inputs and outputs.....	67
Figure 35: Supply web metamodel designed to make the creation of metamodel-based algorithms possible. It is used as part of two DSS modules: “assessment model generator” and “what-if scenario generator and assessor”	68
Figure 36: Projection of the supply web model over three projection plans corresponding to three views of the user interface of the RIO-SUITE software for creating and visualizing the supply web model.....	72
Figure 37: Two solutions for providing the supply web modeler with inputs to create the supply web model.....	72
Figure 38: Supply web model of the “HelloBread” use case created to illustrate the contributions	74
Figure 39: Synthesis of the sequence of the two functions of the “assessment model generator” module of the computational software.....	78

Figure 40: Illustration of the KPI formulas deduced by the algorithm that propagates the demand forecasts along the potential supply chain map of the “HelloBread” illustrative use case.....	88
Figure 41: Example of the deduced formulas associated with the HelloBread potential supply chain map model activity nodes. This illustration is done using the JSON format even though in practice these formulas are stored and used in memory as objects of the programming language.....	89
Figure 42: Example of the deduced formulas associated with the HelloBread supply web model resource nodes. This illustration is done using the JSON format even though in practice these formulas are stored and used in memory as objects of the programming language.	90
Figure 43: Sequence of the three functions of the “what-if scenario generator and assessor” module of the computational software.....	91
Figure 44: Pseudocode of the function that generates the list of what-if scenarios	93
Figure 45: Pseudocode of the function that assesses what-if scenarios.....	95
Figure 46: What-if scenario assessment results associated with the activity “Produce bread 1 (PB1)” of the HelloBread use case, for the what-if scenario of 2023 with the decision option “Find a new client”, the “Set of supply options n°1”, and no risk considered.	97
Figure 47: What-if scenario assessment results associated with the equipment “Bread Maker 1” of the HelloBread use case, for the what-if scenario of 2023 with the decision option “Find a new client”, the “Set of supply options n°1”, and no risk considered.....	98
Figure 48: Pseudocode of the function that creates the JSON file containing the what-if scenario assessment results for the business intelligence software	99
Figure 49: Partial example of the structure of the JSON file created to provide the business intelligence software with the what-if scenario assessment results.....	100
Figure 50: Positioning the content of this fourth chapter in regard to the overview of the contributions of this thesis (C1, C2, and C3)	104
Figure 51: Formalization (using the BPMN standard) of the S&OP process proposal made by Ling and Goddard (1988)	106
Figure 52: Formalization (using the BPMN standard) of the second version of the S&OP process proposed by Dick Ling and Andy Coldrick in the 90s (Coldrick et al. 2003, Ling and Coldrick 2009, Ptak and Ling 2017)	107
Figure 53: Formalization (using the BPMN standard) of the S&OP process described by Grimson and Pyke (2007) as a common S&OP process resulting from a literature review	107
Figure 54: Formalization (using the BPMN standard) of the S&OP process described by Wallace and Stahl (2008).....	108
Figure 55: Formalization (using the BPMN standard) of the AS&OP process described by the Demand Driven Institute (n.d.)	109

Figure 56: BPMN diagram of the SCCP DMP proposal	111
Figure 57: Overview of the SCCP DMP proposal.....	112
Figure 58: BPMN diagram of the SCCP DMP implementation process proposal.....	112
Figure 59: BPMN diagram of the “define decision-making meeting” subprocess of the SCCP DMP implementation process proposal.....	113
Figure 60: Structure of the what-if scenario assessment results generated by the computational software. Quantitative attributes (i.e., performance indicators) are in green and qualitative attributes in blue.	116
Figure 61: IDEF0 diagram of the “define key performance indicators” activity.....	117
Figure 62: IDEF0 diagram of the “define types of decision options” activity	118
Figure 63: IDEF0 diagram of the “define types of uncertainty sources” activity	119
Figure 64: IDEF0 diagram of the “define decision-making reasoning and associated dashboards” activity.....	121
Figure 65: BPMN diagram of the “define data” subprocess of the SCCP DMP implementation process proposal.....	122
Figure 66: IDEF0 diagram of the “defined data scope” activity.....	123
Figure 67: IDEF0 diagram of the “define data granularity” activity	125
Figure 68: BPMN diagram of the “define stakeholders” subprocess of the SCCP DMP implementation process proposal.....	126
Figure 69: IDEF0 diagram of the “define information providers” activity.....	128
Figure 70: IDEF0 diagram of the “define decision-makers” activity.....	129
Figure 71: IDEF0 diagram of the “define SCCP managers” activity	130
Figure 72: BPMN diagram of the SCCP DMP routine process proposal.....	130
Figure 73: BPMN diagram of the “prepare decision-making meeting” subprocess of the SCCP DMP routine process proposal.....	131
Figure 74: IDEF0 diagram of the “gather data for the computational software” activity	131
Figure 75: IDEF0 diagram of the “run the computational software” subprocess.....	132
Figure 76: BPMN diagram of the “run the computational software” subprocess of the “prepare decision-making meeting” subprocess of the SCCP DMP routine process proposal....	133
Figure 77: BPMN diagram of the “prepare recommendations for the decision-making meeting” subprocess of the “prepare decision-making meeting” subprocess of the SCCP DMP routine process proposal.....	133
Figure 78: IDEF0 diagram of the “prepare recommendations for the decision-making meeting” subprocess	134
Figure 79: IDEF0 diagram of the “perform decision-making meeting” activity.....	135

Figure 80: Positioning the content of this fifth chapter in regard to the overview of the contributions of this thesis (C1, C2, and C3)	138
Figure 81: Illustration of the relationships among the different types of elements constituting the supply web of the PFDC pilot project.....	140
Figure 82: Two screenshots of the RIO-SUITE user interface containing the PFDC supply web model associated with the “organization and abilities” projection plan. At the bottom, a view of the entire projected model. At the top, a view of part of the projected model which has been enlarged to help users read it.	159
Figure 83: Two screenshots of the RIO-SUITE user interface containing the PFDC supply web model associated with the “organization and resources” projection plan. At the bottom, a view of the entire projected model. At the top, a view of a part of the projected model which has been enlarged to help users read it.	160
Figure 84: Two screenshots of the RIO-SUITE user interface containing the PFDC supply web model associated with the “demand forecasts” projection plan. At the bottom, a view of the entire projected model. At the top, a view of part of the projected model which has been enlarged to help users read it.	161
Figure 85: Illustration of the potential supply chain map created by the assessment model generator (1/2)	162
Figure 86: Illustration of the potential supply chain map created by the assessment model generator (2/2)	163
Figure 87: Changes in the saturation of equipment categories over the five years at the network level.....	168
Figure 88: Changes in the saturation of equipment categories over the five years at the supplier level.....	169
Figure 89: Interval of the saturation of equipment categories at the network level, considering the deterministic what-if scenario as well as what-if scenarios associated with the demand forecast uncertainty sources	170
Figure 90: Interval of the saturation of equipment categories at the supplier level, considering the deterministic what-if scenario as well as what-if scenarios associated with the demand forecast uncertainty sources	171
Figure 91: Breakdown criticality KPI of equipment categories for all types of molds at the network level.....	172
Figure 92: Screenshot of the dashboard designed to help visualize the saturation of equipment (i.e., production lines) and understand which product brands are responsible for this saturation.....	181
Figure 93: Screenshot of the dashboard designed to help compare the saturation of equipment (i.e., production lines) for what-if scenarios two by two.....	182
Figure 94: Illustration of the benefits of the contributions of this thesis in terms of time saving associated with PFM’s capacity planning process when performing the analysis to assess	

what-if scenarios (proportions of this figure should be considered qualitatively and not quantitatively).....	183
Figure 95: Illustrative extract of the XML file created by the RIO-SUITE software corresponding to the “organization & abilities” view as defined in Figure 36 and Figure 37	219
Figure 96: Illustrative extract of the XML file created by the RIO-SUITE software corresponding to the “organization & resources” view as defined in Figure 36 and Figure 37	220
Figure 97: Illustrative extract of the XML file created by the RIO-SUITE software corresponding to the “demand forecasts” view as defined in Figure 36 and Figure 37.	221
Figure 98: Pseudocode of the algorithm of the supply web modeler (of the SCCP computational software) designed to create the supply web model by using the XML files created with the RIO-SUITE software	222
Figure 99: Supplementary legend of the ISO 5807 standard to distinguish the function, detailed or not, in this thesis.....	225

LIST OF TABLES

Table 1: Requests send to the Web of Science and Google Scholar search engines	62
Table 2: Description of the nodes of the supply web metamodel.....	69
Table 3: Description of the “association” edges of the supply web metamodel.....	70
Table 4: Values of the attributes associated with edges of the HelloBread illustrative use case over the three-year horizon	75
Table 5: Values of the attributes associated with nodes of the HelloBread illustrative use case over the three-year horizon	76
Table 6: Values of the attributes associated with “impact” edges (outgoing from decision options or uncertainty sources) of the HelloBread illustrative use case over the three-year horizon	77
Table 7: The potential supply chain map metamodel nodes and their meaning	79
Table 8: Illustration of the potential supply chain map model deduction algorithm by describing its steps with sentences for the “HelloBread” illustrative use case	80
Table 9: Main key performance indicators for which a generic formula is deduced, organized according to the metamodel and element they are associated with.....	84
Table 10: Generic formulas for the main key performance indicators for which a formula is deduced	85
Table 11: What-if scenario configuration (except for the sets of supply options) for the HelloBread illustrative use case.....	92
Table 12: Sets of supply options per period for the HelloBread illustrative use case.....	92
Table 13: List of 24 what-if scenarios to assess per period for the HelloBread illustrative use case.....	94
Table 14: Example of the three states of the formulas of the assessment model of the HelloBread use case associated with the activity “Produce bread 1 (PB1)” for the what-if scenario for 2023 with the decision option “Find a new client”, the “Set of supply options n°1”, and no risk considered (formulas from Figure 41).....	96
Table 15: Example of the last two states of the formulas of the assessment model of the HelloBread use case associated with the equipment “Bread Maker 1” for the what-if scenario for 2023 with the decision option “Find a new client”, the “Set of supply options n°1”, and no risk considered (first state of the formulas in Figure 42).	97
Table 16: Three dimensions used to aggregate KPIs to provide an aggregated vision of the what-if scenario assessment results	114
Table 17: Categories of KPIs with their respective objectives.....	142
Table 18: KPIs defined to describe the utilization of resources	142

Table 19: KPIs defined to describe the financial dependencies of the company towards different elements of the supply web	143
Table 20: KPIs defined to describe the financial risks associated with disruptions that might occur within the network of suppliers of bottles	144
Table 21: Dashboards defined to guide decision-makers during the decision-making meeting	145
Table 22: Meaning of the terms “actions at the network level” and “actions at the supplier level”	146
Table 23: Dashboards used to define the list of equipment categories requiring actions if PFDC wants to fully meet the demand of its customers in the next 5 years (at the network and at the supplier levels).....	146
Table 24: Dashboards used to complete the lists of equipment categories requiring actions if PFDC wants to fully meet the demand of its customers (both at the network and at the supplier level) in case of demand variations associated with the demand forecast uncertainties	148
Table 25: Dashboard used to help decision-makers identify equipment categories which would need actions to reduce financial loss in case of breakage of one of the pieces of equipment of this category	150
Table 26: Synthesis of the scope and granularity defined for each node of the supply web metamodel.....	152
Table 27: Information providers defined for the first input data required by the computational software (data required to create the supply web model).....	153
Table 28: Information providers defined for the second input data required by the computational software (what-if scenario configuration data required for generating and assessing what-if scenarios).....	154
Table 29: Stakeholders and associated departments chosen to be part of the team of decision-makers attending the decision-making meeting and making the final decisions for the PFDC’s pilot project.....	155
Table 30: Synthesis of the instances of nodes within the supply web model of the PFDC pilot project	156
Table 31: What-if scenario configuration (except for the sets of supply options) chosen for the PFDC pilot project	164
Table 32: Structure of the two sets of supply options defined for the PFDC pilot project (given values do not represent reality for confidentiality reasons).....	164
Table 33: List of equipment categories requiring actions identified from the deterministic and demand uncertainty what-if scenarios at the network and supplier levels.....	173
Table 34: Equipment category requiring actions identified in Table 17, actions that had already been taken, and additional actions that could have been performed to overcome the weakness	174

Table 35: KPIs, types of decision options, and types of uncertainty sources that were defined for the PFM pilot project.....	177
Table 36: Dashboards that were defined for the PFM pilot project.....	177
Table 37: Choices made in terms of scope and granularity of the data to provide as input of the computational software for the PFM pilot project.....	178
Table 38: SCCP DMP stakeholders defined for the PFM pilot project.....	178
Table 39: Synthesis of the instances of nodes within the supply web model of the PFM pilot project.....	179
Table 40: What-if scenario configuration (except for the sets of supply options) chosen for the PFM pilot project.....	180
Table 41: Synthesis of the definitions for important terms that are used throughout this paper and that could be understood in different ways if not clearly defined.....	218
Table 42: List of edges that can occur in the potential supply chain map, their meaning, and their minimum and maximum occurrences.....	223

APPENDICES

1. Definition of terms used in this thesis

Several terms used throughout this thesis could be interpreted in different ways because there are several definitions in the literature. Therefore, Table 41 synthesizes the definition used for each of these terms so that readers can refer to this table when reading this thesis.

Table 41: Synthesis of the definitions for important terms that are used throughout this paper and that could be understood in different ways if not clearly defined

Term	Definition used in this paper
Supply web	A set of identified active and potential supply chain stakeholders from a core business perspective, each with specific abilities, resources and relationships (definition inspired from (Hakimi et al. 2009)).
Supply chain	A set of sequenced activities and stakeholders from the supply web making it possible to source, make, and deliver a specific product or family of a core business.
Demand plan	A consensus combination of client orders and demand forecasts for the products to be delivered to customers by a supply chain of the core business over the planning horizon.
SCCP decision option	An ability to make the choice of executing an action implying activation, modification, creation or deletion of elements of the supply web and/or the demand plan.
SCCP uncertainty source	A potential gap between the forecasted state of the supply web and/or demand plan and the actual future that will happen, resulting from the fact that decision-makers were not able to obtain a forecast with certainty. Uncertainty sources can be separated into two categories: first, uncertainty sources resulting from the imprecision of the forecast of a specific parameter for which the reasons of the variability are unknown. Second, uncertainty sources resulting from the potential occurrence of a specific event that will generate a change in the supply web and/or demand plan.
Supply option	A specific type of SCCP decision option concerning supply chains. The supply option corresponds to a possible succession of two supply chain activities, implying activation, modification, creation or deletion of relationships between supply web stakeholders.
Potential supply chain map	The graph of interlaced supply options forming a map containing all potential supply chains made possible by the supply web stakeholders for fulfilling the demand plan.
Supply chain capacity plan	A combination of SCCP decision options that decision-makers could decide to implement.
What-if scenario	A specific potential future state of the supply web and demand plan considering a specific supply chain capacity plan and a set of uncertainty sources happening.

2. Description of the supply web modeler algorithm for creating the supply web model from XML files

Figure 37 describes the steps for creating the supply web model by using the [RIO-SUITE](#) software. The objective of the following figures is to describe the algorithm of the supply web modeler (of the SCCP computational software) designed to create the supply web model by using the XML files created with the [RIO-SUITE](#) software.

The following three figures are illustrative extracts of the XML files. These illustrative extracts were lightened by keeping only the information used by the algorithm and one node per type of node (e.g., only one among all abilities is illustrated). First, Figure 95 illustrates the XML file corresponding to the “organization & abilities” view as defined in Figure 36. Second, Figure 96 illustrates the XML file corresponding to the “organization & resources” view as defined in Figure 36. Third, Figure 97 illustrates the XML file corresponding to the “demand forecasts” view as defined in Figure 36. Then, Figure 98 describes the algorithm by providing the corresponding pseudocode.

```
<?xml version="1.0" encoding="UTF-8"?>
<model>
  <name>Abilities view</name>
  <node>
    <id>node_identifier_7</id>
    <role>organization</role>
    <property name="name" value="Bakery 1"/>
  </node>
  <node>
    <id>node_identifier_8</id>
    <role>ability</role>
    <property name="name" value="Produce Bread 1"/>
    <property name="consumes" value="[{'id':'node_identifier_30', 'name':'Flour',
'quantity':'0.5', 'unit':'Kg'}, {'id':'node_identifier_31', 'name':'Yeast',
'quantity':'0.01', 'unit':'Kg'}]"/>
    <property name="produces" value="[{'id':'node_identifier_3', 'name':'Bread',
'quantity':'10', 'unit':'Units'}]"/>
    <property name="requires" value="[{'id':'node_identifier_4', 'name':'Bread Maker 1',
'utilization time required':'10', 'unit':'hours'}]"/>
    <property name="fixed cost" value="[{'unit':'Euros', 'value':'1000'}]"/>
    <property name="cost per batch" value="[{'unit':'Euros', 'value':'1'}]"/>
    <property name="initial stock" value="[{'unit':'Units', 'value':'0'}]"/>
    <property name="objective stock" value="[{'unit':'Units', 'value':'0'}]"/>
  </node>
  <edge>
    <id>edge_identifier_5</id>
    <role>provides</role>
    <source>node_identifier_7</source>
    <target>node_identifier_8</target>
  </edge>
  [...Other abilities and edges...]
</model>
```

Figure 95: Illustrative extract of the XML file created by the [RIO-SUITE](#) software corresponding to the “organization & abilities” view as defined in Figure 36 and Figure 37

```

<?xml version="1.0" encoding="UTF-8"?>
<model>
  <name>Resources view</name>
  <node>
    <id>node_identifier_1</id>
    <role>organization</role>
    <property name="name" value="Bakery 1"/>
  </node>
  <node>
    <id>node_identifier_2</id>
    <role>equipment_category</role>
    <property name="name" value="Bread maker"/>
  </node>
  <node>
    <id>node_identifier_3</id>
    <role>product_category</role>
    <property name="name" value="Bread"/>
  </node>
  <node>
    <id>node_identifier_4</id>
    <role>equipment</role>
    <property name="name" value="Bread Maker 1"/>
    <property name="available time" value="[{'unit':'hours', 'value':'1600'}]"/>
    <property name="cost per time unit" value="[{'unit':'Euros', 'value':'0.2'}]"/>
    <property name="fixed cost" value="[{'unit':'Euros', 'value':'500'}]"/>
  </node>
  <node>
    <id>node_identifier_5</id>
    <role>uncertainty source</role>
    <property name="name" value="Breakdown"/>
    <property name="Impacts on resources" value="[{'resource name':Flour Maker 1', 'resource id':'node_identifier_20', 'impacts':[{'name':'available time', 'operator':'*', 'value':0.5, 'unit':'hours'}, {'name':'fixed cost', 'operator':'+', 'value':0, 'unit':'Euros'}, {'name':'cost per time unit', 'operator':'+', 'value':0, 'unit':'Euros'}]]]"/>
  </node>
  <node>
    <id>node_identifier_6</id>
    <role>decision option</role>
    <property name="name" value="Add a shift"/>
    <property name="Impacts on resources" value="[{'resource name':Bread Maker 3', 'resource id':'node_identifier_25', 'impacts':[{'name':'available time', 'operator':'+', 'value':1600, 'unit':'hours'}, {'name':'fixed cost', 'operator':'+', 'value':0, 'unit':'Euros'}, {'name':'cost per time unit', 'operator':'+', 'value':0, 'unit':'Euros'}]]]"/>
  </node>
  <edge>
    <id>edge_identifier_1</id>
    <role>correspond_to</role>
    <source>node_identifier_4</source>
    <target>node_identifier_2</target>
  </edge>
  <edge>
    <id>edge_identifier_2</id>
    <role>provides</role>
    <source>node_identifier_1</source>
    <target>node_identifier_4</target>
  </edge>
  <edge>
    <id>edge_identifier_3</id>
    <role>impacts</role>
    <source>node_identifier_5</source>
    <target>node_identifier_4</target>
  </edge>
  <edge>
    <id>edge_identifier_4</id>
    <role>impacts</role>
    <source>node_identifier_6</source>
    <target>node_identifier_4</target>
  </edge>
  [...Other equipment categories, equipment, product categories, uncertainty sources, decision options, and edges...]
</model>

```

Figure 96: Illustrative extract of the XML file created by the [RIO-SUITE](#) software corresponding to the “organization & resources” view as defined in Figure 36 and Figure 37

```

<?xml version="1.0" encoding="UTF-8"?>
<model>
  <name>Demand forecasts view</name>
  <node>
    <id>node_identifier_9</id>
    <role>demand forecast</role>
    <property name="name" value="Demand of 6000 units of bread"/>
    <property name="consumes" value="{ 'id':'node_identifier_3', 'name':'Bread', 'quantity':'6000', 'unit':'Units' }"/>
  </node>
  <node>
    <id>node_identifier_10</id>
    <role>uncertainty source</role>
    <property name="Impacts on tasks" value=""/>
    <property name="name" value="Demand increase by 10%"/>
    <property name="Impacts on objectives" value="{ 'objective name':'Demand of 6000 units of bread', 'objective id':'node_identifier_9', 'impacts':[ { 'name':'consumes::Bread::quantity', 'operator':'*', 'value':'1.1', 'unit':'Units' } ] }"/>
  </node>
  <node>
    <id>node_identifier_11</id>
    <role>decision option</role>
    <property name="name" value="Find a new client"/>
    <property name="Impacts on objectives" value="{ 'objective name':'Demand of 6000 units of bread', 'objective id':'node_identifier_9', 'impacts':[ { 'name':'consumes::Bread::quantity', 'operator':'+', 'value':'2500', 'unit':'Units' } ] }"/>
  </node>
  <edge>
    <id>edge_31bf9b40-2b27-5cd5-8941-a41376d4c3a2</id>
    <role>impacts</role>
    <source>node_identifier_10</source>
    <target>node_identifier_9</target>
  </edge>
  <edge>
    <id>edge_842a31a3-fe5a-1a32-c576-30d93a535eb9</id>
    <role>impacts</role>
    <source>node_identifier_11</source>
    <target>node_identifier_9</target>
  </edge>
  [...Other demand forecasts, uncertainty sources, decision options, and edges...]
</model>

```

Figure 97: Illustrative extract of the XML file created by the [RIO-SUITE](#) software corresponding to the “demand forecasts” view as defined in Figure 36 and Figure 37

```
Function CreateSupplyWebModelFromXMLFiles (XMLFilesFolderPath):  
    SupplyWebModel ← CreateEmptySupplyWebModel ()  
    For ResourceCategory in FindAllResourceCategories (XMLFilesFolderPath):  
        CreateResourceCategoryInSupplyWebModel (SupplyWebModel, ResourceCategory)  
    For Objective in FindAllObjectives (XMLFilesFolderPath):  
        CreateObjectiveInSupplyWebModel (SupplyWebModel, Objective)  
    For Organization in FindAllOrganizations (XMLFilesFolderPath):  
        CreateOrganizationInSupplyWebModel (SupplyWebModel, Organization)  
    For Ability in FindAllAbilities (XMLFilesFolderPath):  
        CreateAbilityInSupplyWebModel (SupplyWebModel, Ability)  
    For Resource in FindAllResources (XMLFilesFolderPath):  
        CreateResourceInSupplyWebModel (SupplyWebModel, Resource)  
    For UncertaintySource in FindAllUncertaintySources (XMLFilesFolderPath):  
        CreateUncertaintySourceInSupplyWebModel (SupplyWebModel, UncertaintySource)  
    For DecisionOption in FindAllDecisionOptions (XMLFilesFolderPath):  
        CreateDecisionOptionInSupplyWebModel (SupplyWebModel, DecisionOption)  
End Function
```

Figure 98: Pseudocode of the algorithm of the supply web modeler (of the SCCP computational software) designed to create the supply web model by using the XML files created with the [RIO-SUITE](#) software

3. List of edges that can exist in potential supply chain maps

The following table contains the list of edges that can occur in the potential supply chain map and describes their meaning as well as their minimum and maximum occurrences.

Table 42: List of edges that can occur in the potential supply chain map, their meaning, and their minimum and maximum occurrences

Source node	Target node	Meaning	Occurrences	
			Min	Max
Start Event	Activity	There is only one resource category consumed by the supply web model demand forecasts, there is only one ability producing this resource category (the target activity is the instance of this ability), and this ability does not consume any resource category.	0	1
	AND Opening Gateway	Either there is at least one resource category involved in the supply chain physical flow having several abilities able to produce it, and/or there are two or more different resource categories consumed by the supply web model demand forecasts.	0	1
Activity	Activity	The target activity consumes only one resource category and the resource category produced by the source activity is consumed only by one node (activity or end event) of the potential supply chain map (the target activity).	0	∞
	AND Closing Gateway	The node (activity or end event) following the target AND Closing Gateway consumes two or more resource categories, and the resource category produced by the source activity is consumed only by one node (activity or end event) of the potential supply chain map (the node following the target AND Closing Gateway).	0	∞
	OR Opening Gateway	The resource category produced by the source activity is consumed by two or more nodes (activities or end event) of the potential supply chain map.	0	∞
	OR Closing Gateway	The resource category produced by the source activity is also produced by at least one other activity of the potential supply chain map, and the resource category produced by the source activity is consumed only by one node (activity or end event) of the potential supply chain map (the first activity or end event following the target OR Closing Gateway).	0	∞
	End Event	There is only one resource category consumed by the supply web model demand forecasts, and there is only one ability producing this resource category (the source activity is the instance of this ability).	0	1
AND Opening Gateway	Activity	There are at least two activities in the potential supply chain map model.	0	∞
OR Opening Gateway	Activity	The target activity consumes only one resource category (the one produced by the activity preceding the source OR Opening Gateway), the activity preceding the source OR Opening Gateway is the only ability producing this resource category, and this resource category is consumed by two or more nodes (activities or end event) of the potential supply chain map.	0	∞
	OR Closing Gateway	The resource category produced by the source activity is also produced by at least one other activity of the potential supply chain map, and this resource category is consumed by two or more nodes (activities or end event) of the potential supply chain map.	0	∞

Appendices

AND Closing Gateway	The activity preceding the source OR Opening Gateway is the only ability producing the resource category it produces, and the node (activity or end event) following the target AND Closing Gateway consumes two or more resource categories.	0	∞
AND Closing Gateway	Activity The target activity consumes two or more resource categories.	0	∞
End Event	The target end event consumes two or more resource categories (i.e. there are two or more different resource categories consumed by the demand forecasts of the supply web model).	0	1
OR Closing Gateway	Activity The target activity consumes only one resource category, and this resource category is produced by two or more activities of the potential supply chain map model.	0	∞
AND Closing Gateway	The activity following the target AND Closing Gateway consumes two or more resource categories, and the resource category produced by the activities preceding the source OR Closing Gateway is produced by two or more activities of the potential supply chain map model.	0	∞
End Event	The target end event consumes only one resource category (i.e. there is only one resource category consumed by the demand forecasts of the supply web model), and this resource category is produced by two or more activities of the potential supply chain map model.	0	1

4. Diagram of the metamodel-based algorithm for deducing potential supply chain maps

The set of following diagrams describes the metamodel-based algorithm designed to deduce potential supply chain maps from supply web models. It is structured according to the ISO 5807 standard (International Organization for Standardization 1985). Some functions are specific to the chosen language, would have been too long to describe in detail, and are basic enough to be re-developed without the details provided. Therefore, these functions are not detailed. A supplementary legend to the ISO 5807 standard was created to distinguish the functions that are detailed and those that are not. This legend is shown in Figure 99.

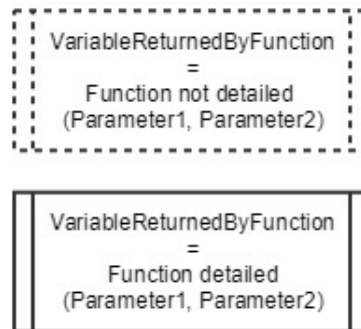
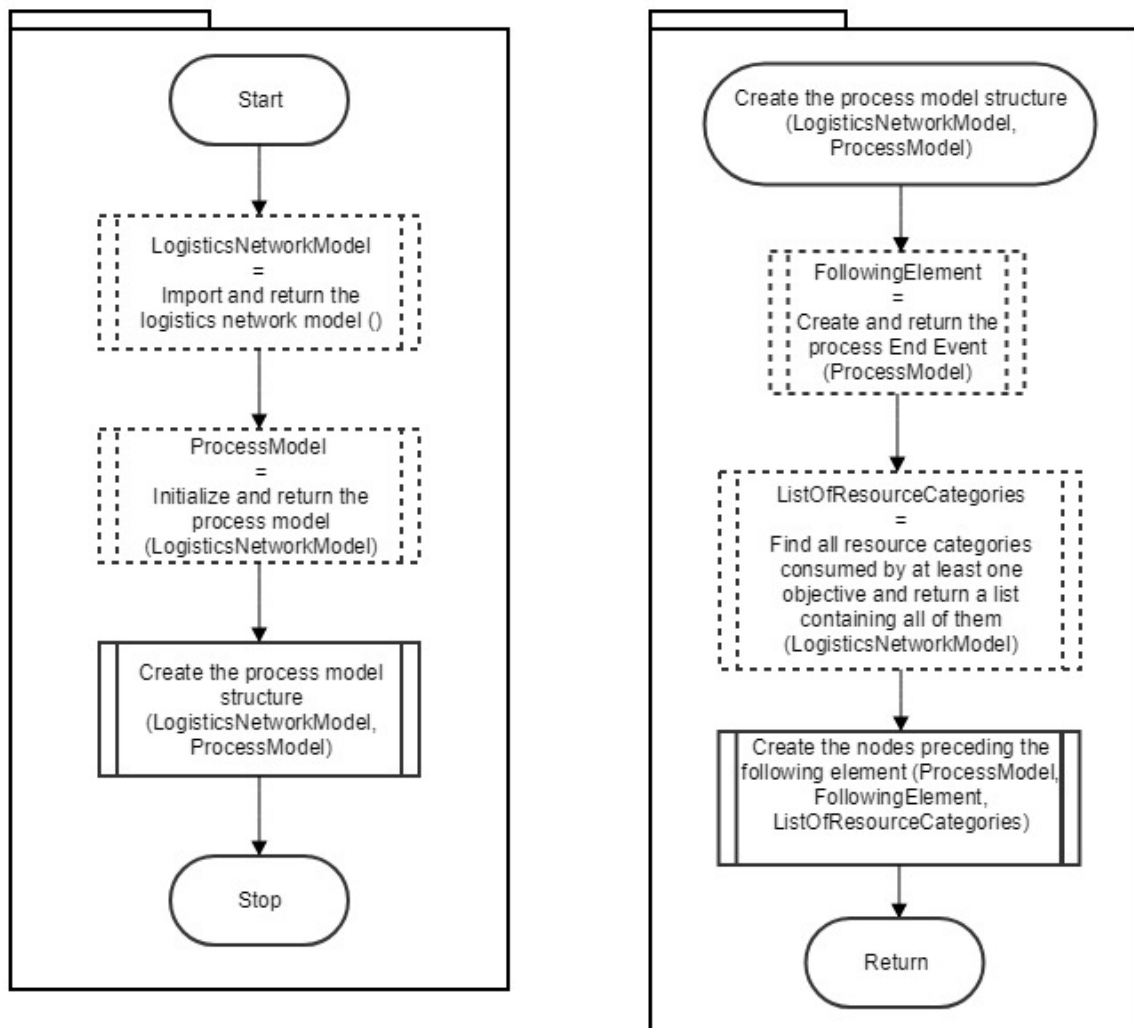
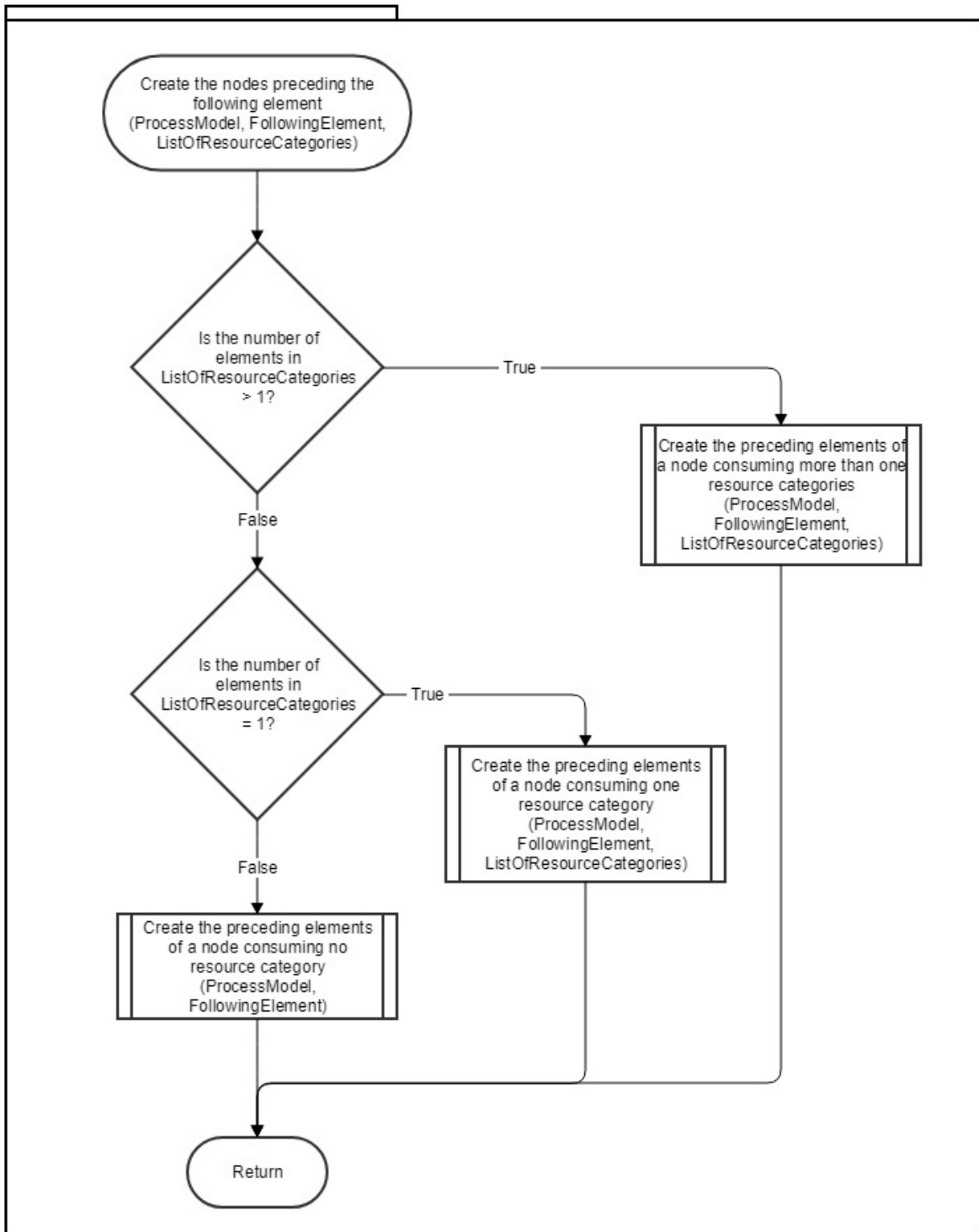
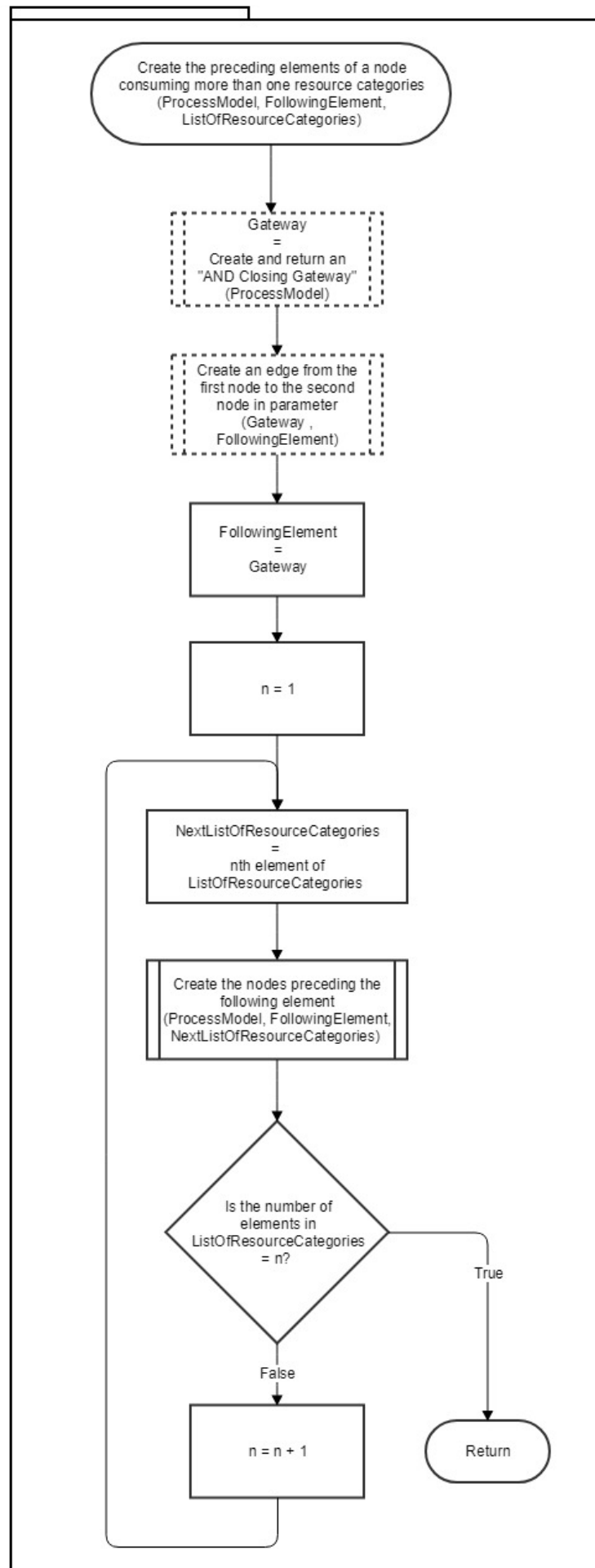
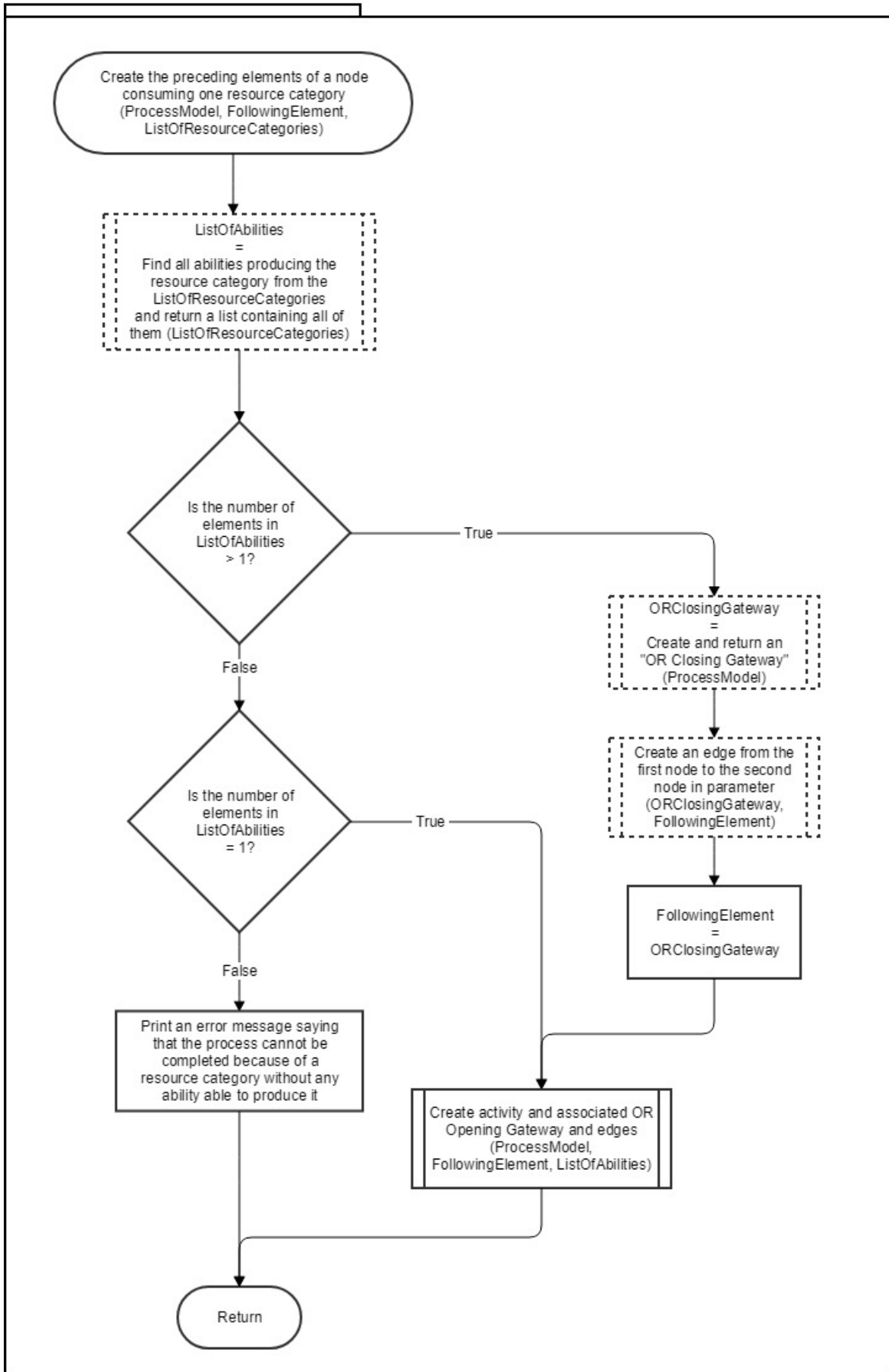

Figure 99: Supplementary legend of the ISO 5807 standard to distinguish the function, detailed or not, in this thesis









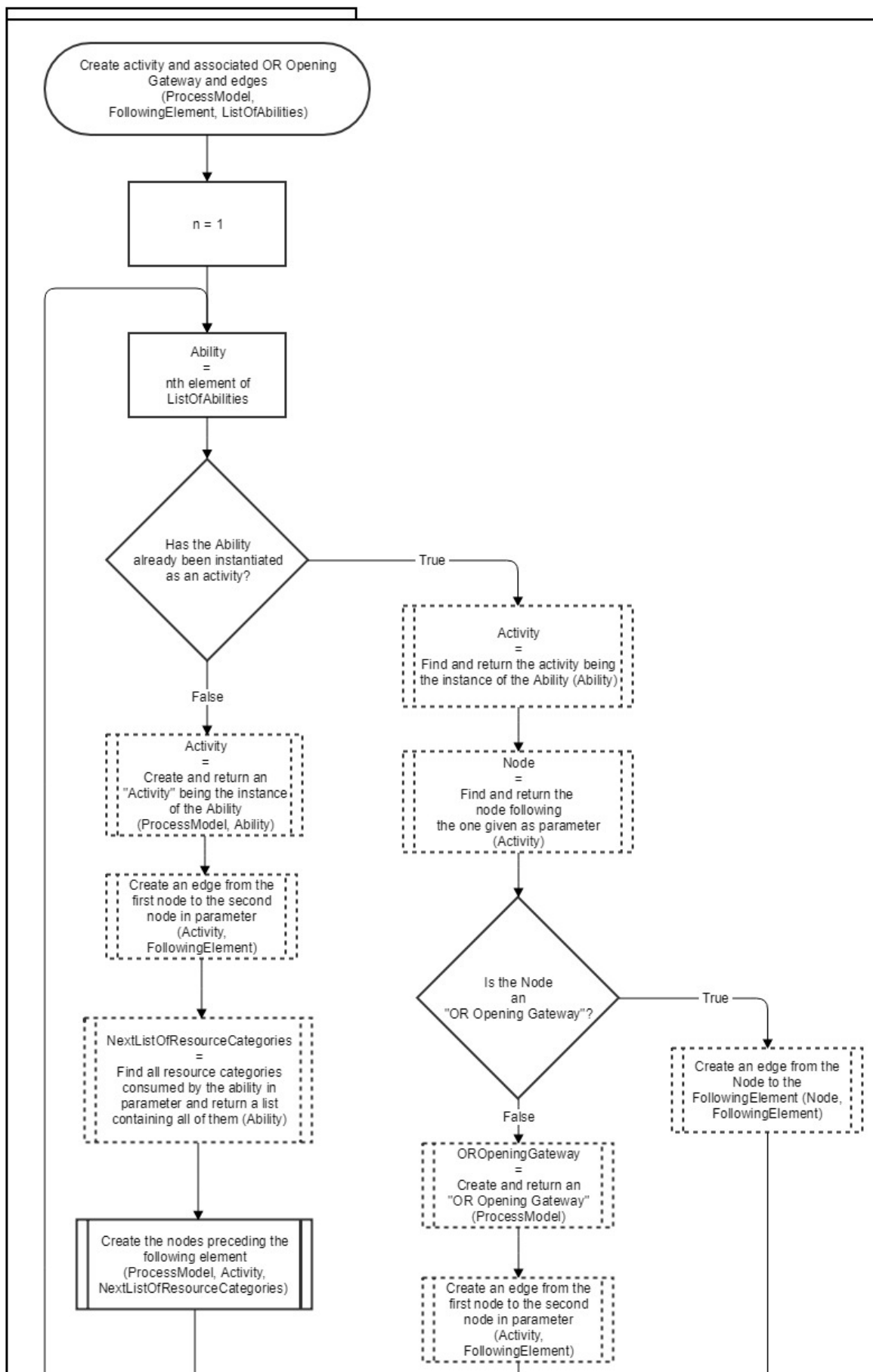

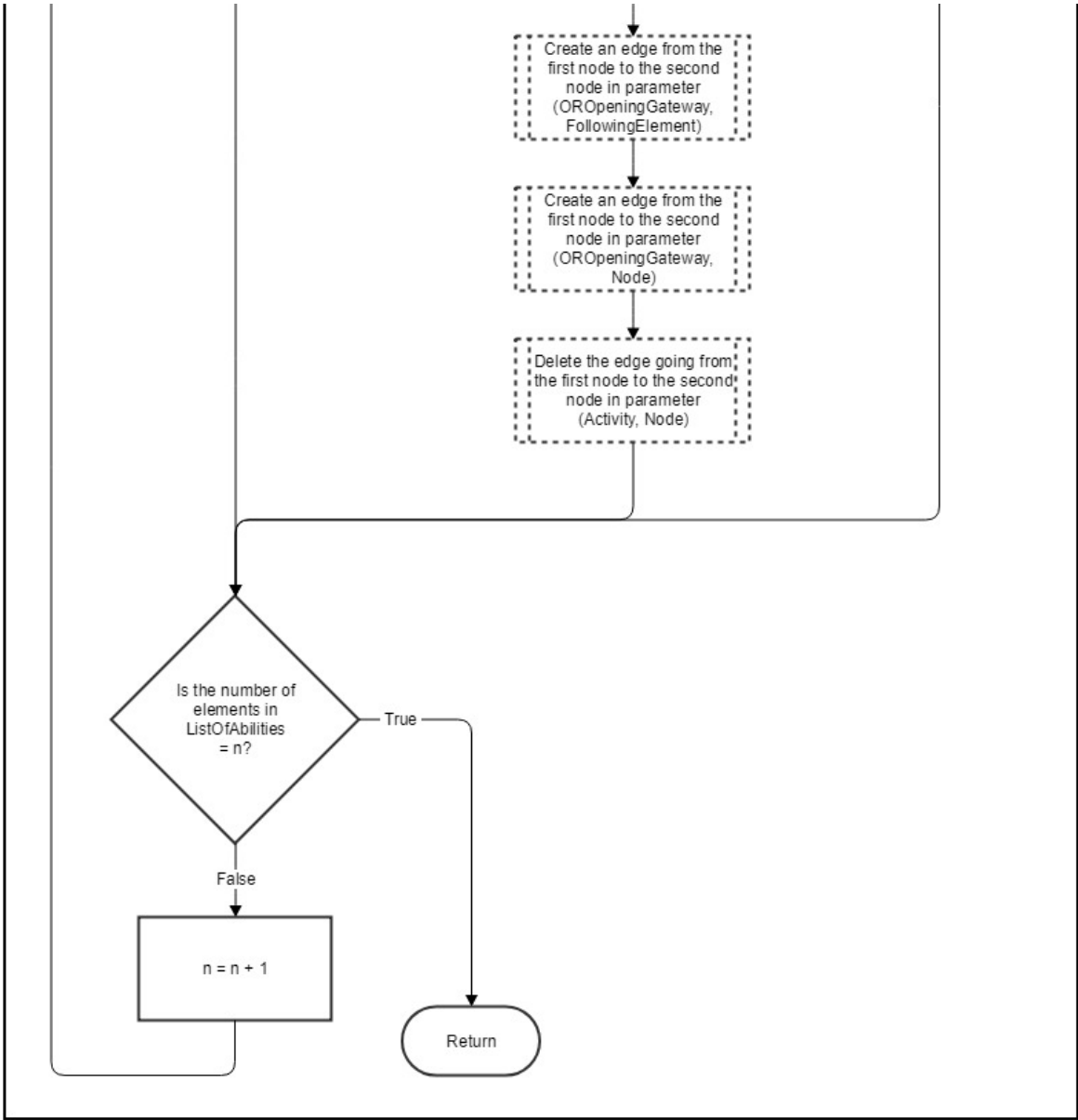

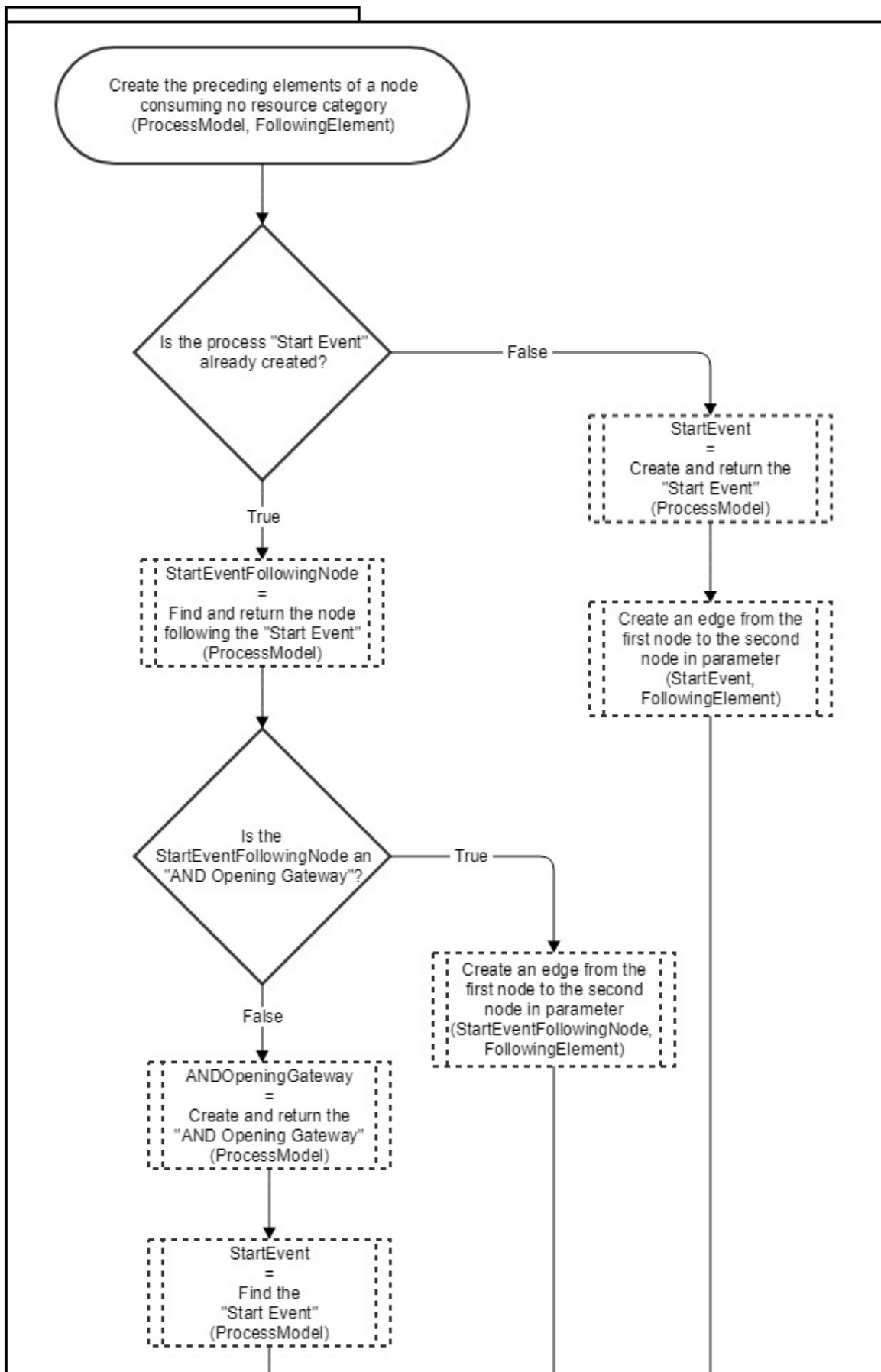

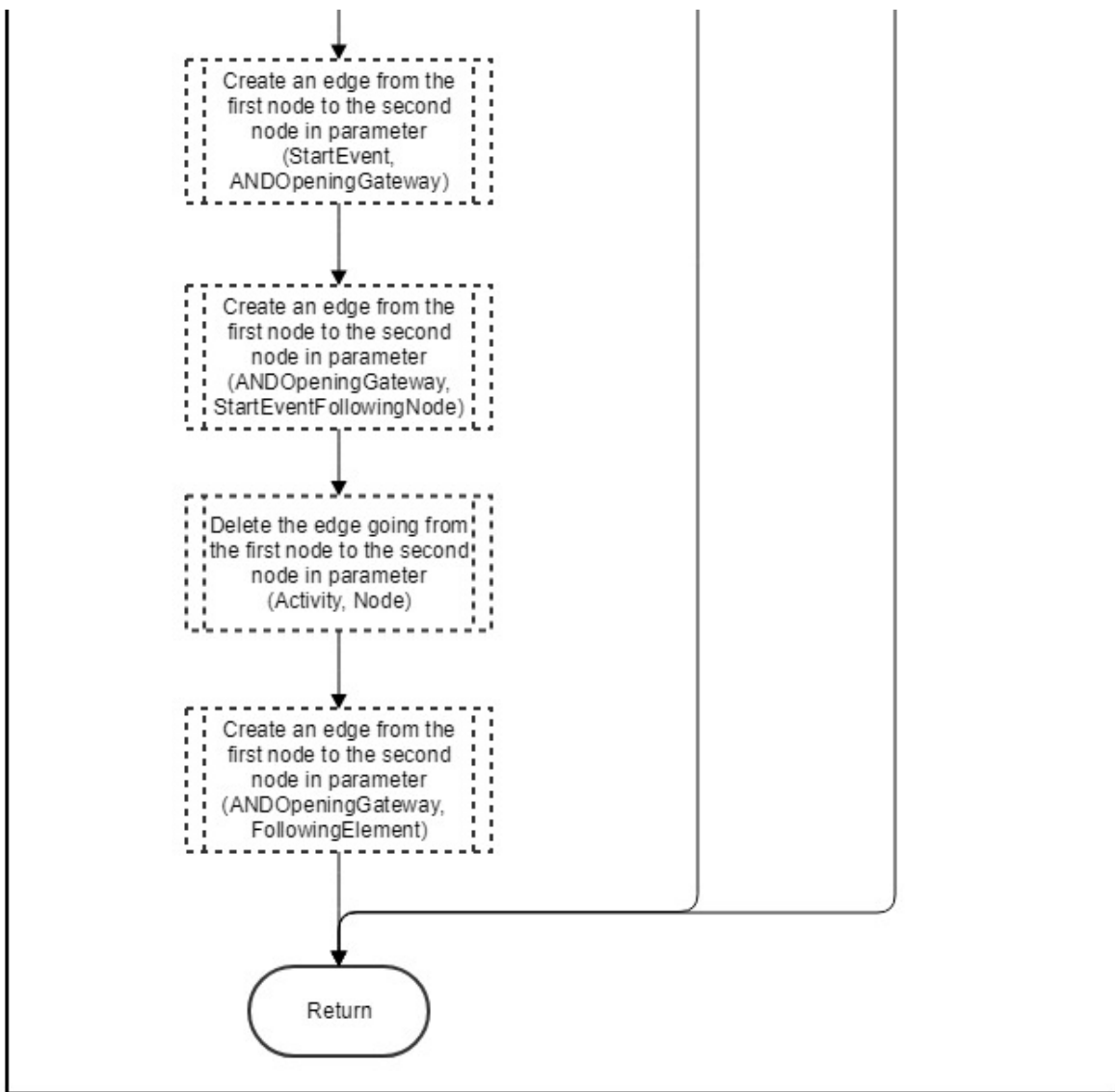

5. Pseudocode of the metamodel-based algorithm for deducing the KPI formulas of the potential supply chain map

The following figures correspond to the pseudocode of the metamodel-based algorithm designed to deduce the KPI formulas of the potential supply chain map. The pseudocode is displayed over several pages to make it legible for readers.

```

Function CreatePotentialSupplyChainMapFormulas (SupplyWeb,
    PotentialSupplyChainMap,
    FollowingNode = Null):
    If FollowingNode == Null Then:
        FollowingNode ← PotentialSupplyChainMap.EndEvent
    For DemandForecast in SupplyWeb.ListOfDemandForecasts:
        For ConsumesEdge in DemandForecast.ListOfOutgoingConsumesEdges:
            GrossRequirementOnConsumedResourceCategoryAlreadyExist ← False
            For GrossRequirement in FollowingNode.ListOfGrossRequirements:
                If ConsumesEdge.ResourceCategory == GrossRequirement.ResourceCategory Then:
                    | FollowingNode.UpdateGrossRequirementFormula(GrossRequirement, ConsumesEdge)
                    | GrossRequirementOnConsumedResourceCategoryAlreadyExist ← True
            If GrossRequirementOnConsumedResourceCategoryAlreadyExist == False Then:
                | FollowingNode.AppendNewGrossRequirement(ConsumesEdge)
            CreatePotentialSupplyChainMapFormulas(SupplyWeb, PotentialSupplyChainMap, FollowingNode)
    Else:
        If Length(FollowingNode.ListOfIncomingEdges) >= 2 Then:
            If FollowingNode.type == "ORClosingGateway" Then:
                For IncomingEdge in FollowingNode.ListOfIncomingEdges:
                    | SourceNode ← IncomingEdge.SourceNode
                    | If SourceNode.type == "Activity" Then:
                        | SourceNode.CreateActivityFormulas()
                        | CreatePotentialSupplyChainMapFormulas(SupplyWeb,
                            | PotentialSupplyChainMap,
                            | SourceNode)
                    | Elif SourceNode.type == "OROpeningGateway" Then:
                        | If SourceNode.NumberOfOutgoingEdgeAlreadyConsideredInFormula == 0 Then:
                            | | SourceNode.CreateOROpeningGatewayGrossRequirementFormula(FollowingNode)

```

```

Else:
  | SourceNode.UpdateOpeningGatewayGrossRequirementFormula (FollowingNode)
  | SourceNode.NumberOfOutgoingEdgeAlreadyConsideredInFormula += 1
If SourceNode.NumberOfOutgoingEdgeAlreadyConsideredInFormula ==
  Length (SourceNode.ListOfOutgoingEdges) Then:
  | CreatePotentialSupplyChainMapFormulas (SupplyWeb,
  | PotentialSupplyChainMap,
  | SourceNode)
Elif Length (FollowingNode.ListOfIncomingEdges) == 1 Then:
  | SourceNode ← FollowingNode.ListOfIncomingEdges[0].SourceNode
If SourceNode.type == "ANDClosingGateway" Then:
  | For IncomingEdge in SourceNode.ListOfIncomingEdges:
  | SourceNodeOfANDClosingGateway ← IncomingEdge.SourceNode
If SourceNodeOfANDClosingGateway.type == "ORClosingGateway" Then:
  | If FollowingNode.type == "EndEvent" Then:
  | | For GrossRequirement in FollowingNode.ListOfGrossRequirements:
  | | | If SourceNodeOfANDClosingGateway.AssociatedResourceCategory ==
  | | | GrossRequirement.AssociatedResourceCategory Then:
  | | | SourceNodeOfANDClosingGateway.UpdateGrossRequirement (GrossRequirement)
  | | | CreatePotentialSupplyChainMapFormulas (SupplyWeb,
  | | | PotentialSupplyChainMap,
  | | | SourceNodeOfANDClosingGateway)
If FollowingNode.type == "Activity" Then:
  | | For ConsumesEdge in FollowingNode.CorrespondingAbility.ListOfConsumesEdge:
  | | | If SourceNodeOfANDClosingGateway.AssociatedResourceCategory ==
  | | | ConsumesEdge.AssociatedResourceCategory Then:
  | | | SourceNodeOfANDClosingGateway.UpdateGrossRequirement (ConsumesEdge)
  | | | CreatePotentialSupplyChainMapFormulas (SupplyWeb,
  | | | PotentialSupplyChainMap,
  | | | SourceNodeOfANDClosingGateway)
Elif SourceNodeOfANDClosingGateway.type == "Activity" Then:

```

```

If FollowingNode.type == "EndEvent" Then:
    For GrossRequirement in FollowingNode.ListOfGrossRequirements:
        If SourceNodeOfANDCclosingGateway.ProducedResourceCategory ==
            GrossRequirement.AssociatedResourceCategory Then:
            SourceNodeOfANDCclosingGateway.CreateActivityFormulas (GrossRequirement)
            CreatePotentialSupplyChainMapFormulas (SupplyWeb,
                PotentialSupplyChainMap,
                SourceNodeOfANDCclosingGateway)
    If FollowingNode.type == "Activity" Then:
        For ConsumesEdge in FollowingNode.CorrespondingAbility.ListOfConsumesEdge:
            If SourceNodeOfANDCclosingGateway.ProducedResourceCategory ==
                ConsumesEdge.AssociatedResourceCategory Then:
                SourceNodeOfANDCclosingGateway.CreateActivityFormulas (ConsumesEdge)
                CreatePotentialSupplyChainMapFormulas (SupplyWeb,
                    PotentialSupplyChainMap,
                    SourceNodeOfANDCclosingGateway)
Elif SourceNodeOfANDCclosingGateway.type == "OROpeningGateway" Then:
If FollowingNode.type == "EndEvent" Then:
    For GrossRequirement in FollowingNode.ListOfGrossRequirements:
        If SourceNodeOfANDCclosingGateway.AssociatedResourceCategory ==
            GrossRequirement.AssociatedResourceCategory Then:
            If SourceNodeOfANDCclosingGateway.NumberOfOutgoingEdgeAlreadyConsideredInFormula == 0 Then:
                SourceNodeOfANDCclosingGateway.CreateOpeningGatewayGrossRequirementFormula (FollowingNode)
            Else:
                SourceNodeOfANDCclosingGateway.UpdateOpeningGatewayGrossRequirementFormula (FollowingNode)
            SourceNodeOfANDCclosingGateway.NumberOfOutgoingEdgeAlreadyConsideredInFormula += 1
        If SourceNodeOfANDCclosingGateway.NumberOfOutgoingEdgeAlreadyConsideredInFormula ==
            Length (SourceNodeOfANDCclosingGateway.ListOfOutgoingEdges) Then:
            CreatePotentialSupplyChainMapFormulas (SupplyWeb,
                PotentialSupplyChainMap,
                SourceNodeOfANDCclosingGateway)
If FollowingNode.type == "Activity" Then:

```

```

For ConsumesEdge in FollowingNode.CorrespondingAbility.ListOfConsumesEdge :
  If SourceNodeOfANDCclosingGateway.AssociatedResourceCategory ==
    ConsumesEdge.AssociatedResourceCategory Then :
    If SourceNodeOfANDCclosingGateway.NumberOfOutgoingEdgeAlreadyConsideredInFormula == 0 Then :
      SourceNodeOfANDCclosingGateway.CreateOROpeningGatewayGrossRequirementFormula (FollowingNode)
    Else :
      SourceNodeOfANDCclosingGateway.UpdateOROpeningGatewayGrossRequirementFormula (FollowingNode)
    SourceNodeOfANDCclosingGateway.NumberOfOutgoingEdgeAlreadyConsideredInFormula += 1
  If SourceNodeOfANDCclosingGateway.NumberOfOutgoingEdgeAlreadyConsideredInFormula ==
    Length (SourceNodeOfANDCclosingGateway.ListOfOutgoingEdges) Then :
    CreatePotentialSupplyChainMapFormulas (SupplyWeb,
      PotentialSupplyChainMap,
      SourceNodeOfANDCclosingGateway)

Elif SourceNode.type == "Activity" Then :
  SourceNode.CreateActivityFormulas (FollowingNode)
  CreatePotentialSupplyChainMapFormulas (SupplyWeb,
    PotentialSupplyChainMap,
    SourceNode)

Elif SourceNode.type == "OROpeningGateway" Then :
  If SourceNode.NumberOfOutgoingEdgeAlreadyConsideredInFormula == 0 Then :
    SourceNode.CreateOROpeningGatewayGrossRequirementFormula (FollowingNode)
  Else :
    SourceNode.UpdateOROpeningGatewayGrossRequirementFormula (FollowingNode)
  SourceNode.NumberOfOutgoingEdgeAlreadyConsideredInFormula += 1
  If SourceNode.NumberOfOutgoingEdgeAlreadyConsideredInFormula ==
    Length (SourceNode.ListOfOutgoingEdges) Then :
    CreatePotentialSupplyChainMapFormulas (SupplyWeb,
      PotentialSupplyChainMap,
      SourceNode)

End Function

```

UN SYSTEME D'AIDE A LA DECISION POUR LA PLANIFICATION CAPACITAIRE DES CHAINES LOGISTIQUES SUR UN HORIZON LONG-TERME : UNE APPROCHE D'INGENIERIE DIRIGEE PAR LES MODELES

Résumé :

La planification capacitaire des chaînes logistiques (SCCP) sur un horizon long-terme a pour objectif de définir un plan d'actions contenant l'ensemble des actions qui vont façonner la capacité disponible et requise des chaînes logistiques sur plusieurs années. Lorsque les entreprises réalisent leur SCCP sur un horizon long-terme, elles sont confrontées à une multitude d'options décisionnelles et de sources d'incertitudes, ainsi qu'à un environnement très dynamique. Chaque entreprise met en place son propre système d'aide à la décision (SCCP DSS) pour réaliser sa SCCP. Ce DSS est composé d'un processus de prise de décisions, d'un système d'information, et de personnes.

Les entreprises peuvent utiliser les processus de prise de décisions et systèmes d'information existants pour créer leur propre SCCP DSS. Cependant, la revue de littérature relative aux processus de prise de décisions et systèmes d'information existants pouvant servir à la création d'un SCCP DSS a révélé les trois limitations suivantes : premièrement, les solutions existantes sont très chronophages. Cette limitation contraint les entreprises à ne prendre en compte qu'un nombre limité de scénarios alternatifs associés aux options décisionnelles et aux sources d'incertitudes. De plus, cela rend difficile le maintien à jour des analyses SCCP. Deuxièmement, les solutions existantes sont conçues pour réaliser les analyses SCCP sur des chaînes logistiques prédéfinies et figées, sans considération de l'ensemble des potentielles alternatives structurelles. Troisièmement, les décideurs sont parfois réticents face aux méthodes d'optimisation du fait du manque de visibilité sur le processus d'obtention de la solution recommandée.

Ainsi, cette thèse décrit la proposition d'un nouveau SCCP DSS ayant pour objectif de solutionner ces limitations. Il est composé d'une proposition de processus de prise de décisions SCCP tirant profit d'une proposition de système d'information SCCP. Le processus de prise de décisions SCCP est composé de deux processus : implémentation et routine. Le système d'information SCCP est composé de deux logiciels : un logiciel calculatoire et un logiciel de business intelligence.

La proposition de SCCP DSS a été validée en réalisant deux projets pilotes avec deux partenaires industriels. Deux bénéfices majeurs ont été identifiés : premièrement, cela permet de prendre en compte une multitude d'options décisionnelles et de sources d'incertitudes durant les analyses SCCP à un rythme permettant un maintien à jour de ces analyses. Deuxièmement, cela permet aux décideurs d'avoir de la visibilité sur l'impact que leurs options décisionnelles et sources d'incertitudes auraient sur l'entreprise, ce qui renforce leur confiance vis-à-vis des décisions qu'ils peuvent prendre.

Finalement, des perspectives de recherche ont été identifiées, incluant notamment la conception d'un SCCP DSS hyperconnecté qui collecterait automatiquement les informations et déclencherait des réunions de prises de décisions seulement quand cela est nécessaire plutôt qu'à une fréquence prédéfinie.

Mots clés : Chaînes logistiques, planification capacitaire, systèmes d'aide à la décision, systèmes d'information, processus décisionnels, ingénierie dirigée par les modèles.

A DECISION SUPPORT SYSTEM FOR LONG-TERM SUPPLY CHAIN CAPACITY PLANNING: A MODEL-DRIVEN ENGINEERING APPROACH

Abstract:

Long-term Supply Chain Capacity Planning (SCCP) aims to define the plan of all actions to perform that will shape the available and required capacity of supply chains over several years. When performing long-term SCCP, companies are confronted with a multitude of decision options and uncertainty sources as well as a highly dynamic supply chain environment. Each company configures its own Decision Support System (DSS) to perform SCCP, composed of a decision-making process, an information system, and people.

Companies can take advantage of existing decision-making processes and information systems to build their own SCCP DSS. However, the literature review on existing decision-making processes and information systems for SCCP revealed the following three major limitations: first, existing solutions are time-consuming. This constrains companies to consider only a small number of alternative scenarios associated with decision options and uncertainty sources. And it makes it difficult to keep SCCP analysis up to date. Second, existing solutions are designed to perform SCCP analysis on predefined supply chains without considering the whole set of potential alternative configurations. Third, decision-makers are reluctant to accept optimization methods because of the lack of visibility of the analysis leading to the recommended solution.

Therefore, this thesis describes a new SCCP DSS proposal aiming to overcome these limitations. It is composed of an SCCP decision-making process proposal relying on an SCCP information system proposal. The SCCP decision-making process proposal contains two processes: implementation and routine. The SCCP information system proposal contains two software programs: a computational software program and a business intelligence software program.

The SCCP DSS proposal was validated by undertaking two industrial pilot projects with two industrial partners. The following two major benefits have been confirmed: first, SCCP analysis can be performed in encompassing a multitude of decision options and uncertainty sources at a pace allowing updates in accordance with the pace of supply chain changes. Second, it provides decision-makers with the visibility and understanding of the impacts of their respective decisions and uncertainty sources which bolster their confidence in the decisions they can make.

Finally, avenues for future research have been identified, including an opportunity for designing a hyperconnected SCCP DSS that automatically gathers information and triggers decision-making meetings when necessary rather than on a predefined frequency.

Keywords: Supply Chain, Capacity Planning, Decision Support Systems, Information Systems, Decision-Making Processes, Model-Driven Engineering.